

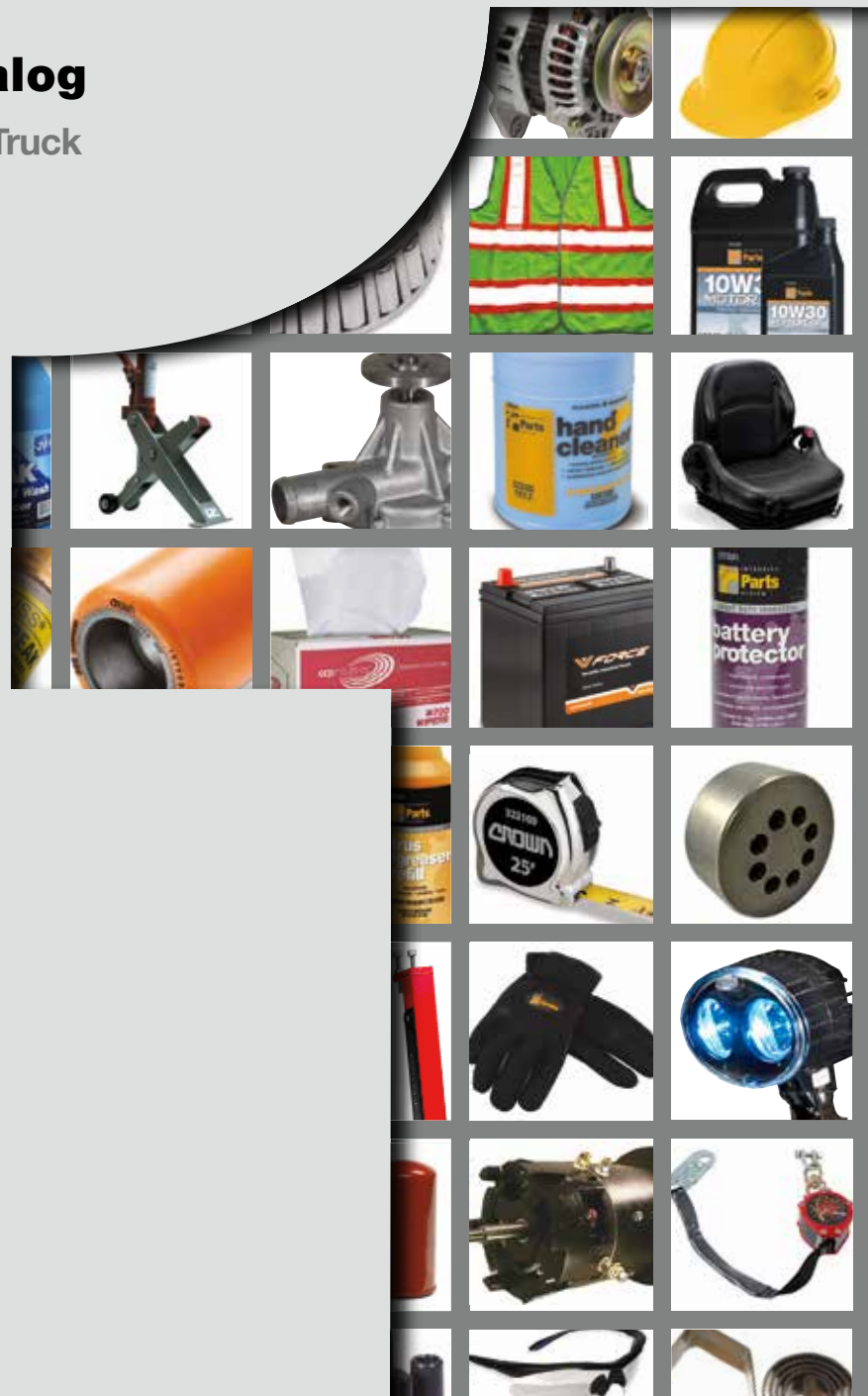

**one**<sup>®</sup>  
**source**  
LIFT TRUCK PARTS

## Spring 2014 Catalog

Your One Source for Lift Truck  
Parts and Accessories



# ONE SOURCE LIFT TRUCK PARTS PROGRAM KEEPS YOUR MIXED FLEET MOVING

**Have a mixed fleet of material handling equipment? Count on Crown to keep your fleet moving.**

Our award-winning Demonstrated Performance<sup>®</sup> Service Training provides technicians with hands-on lift truck repair experience instead of traditional classroom lectures. The result? Better-trained technicians who fix it right the first time while lowering your operation cost.

Add Crown's One Source program and you'll also receive quality replacement parts for over 50 brands of material handling equipment. Crown uses the same expertise when selecting and offering other lift truck replacement parts as we do with our own Crown Integrity Parts<sup>™</sup>. Call your local branch or dealer for details.

**one**<sup>®</sup>  
**source**  
LIFT TRUCK PARTS



# Crown One Source Contents

Section 1	Service Supplies
Section 2	Safety Equipment
Section 3	Electric Truck Components
Section 4	Internal Combustion (IC) Truck Components
Section 5	Work Assist®
Section 6	PTH 50, Chain, Forks and Attachment Parts
Section 7	Battery and Charger
Section 8	Tools
Section 9	Hydraulic Components
Section 10	Wheels and Tires
Section 11	Crown Operator and Service Training
Section 12	Index

▶ Featured Crown promotional items, available through the Crown Store, listed on reverse side.



THE CROWN STORE

Available through the Crown Store:  
Crown Branded Promotional Items

To Order: Visit us online at [crownstore.crown.com](http://crownstore.crown.com)  
or call 1-800-298-4708.



### Integrity Parts and Service Mugs

NEW!

- S-MG-1652-IP (Integrity Parts® logo)
- S-MG-1623-IS (Integrity Service® logo)
- Sleek design with an innovative 360° spill-proof lid
- Can drink from any direction
- Double-wall plastic tumbler with plastic liner
- BPA free
- 15 oz.



### Flexfit Caps

#### - Integrity Parts and Service

- C-CP-6577-IP (Integrity Parts® logo)
- C-CP-6577-IS (Integrity Service® logo)

- Integrity Parts or Service logo on front
- Crown Lift Trucks logo on back
- Six Panel, low profile, poly pique mesh cap with contrasting sandwich visor
- 3.5 inch crown, 6 sewn eyelets with medium buckram back, 4 rows of stitching on a Permacurv® visor, matching under-visor, taped seams
- 92% polyester, 8% spandex
- Stretches to fit a wide variety of head sizes comfortably (6 7/8"-7 1/2")



### USB Memory Stick

Part Number - S-CP-15

- USB 2.0 flash memory
- 512MB capacity
- Removable cap
- Activity light LED lets you know it's working
- Key hole
- Split ring



### Mugger Coaster

Part Number - S-CO-200

- Hand-washable
- Neoprene material
- Soaks up drips and condensation



### Tape Measure

Part Number - S-TL-200

- 25 ft x 1 inch blade
- Metric/inch scale only
- Genuine rubber grip



### Key Ring

Part Number - S-KF-2112-15

- Flexible vinyl
- Split metal ring



### Garry 2AA Tuff Lite

Part Number - S-FL-1225

- Rubber; 6.5" H x 1.77" dia.
- Super durable, water resistant, shockproof; able to float
- Krypton bulb and patented multifaceted reflector
- Stainless steel push-button power switch
- Thickly-grooved handle for superior grip
- 2 AA batteries included



### Scale Models

- S-TK-5350 (Service Van)
- S-TK-6050 (Crown Semi Truck)
- S-TK-77000 (ESR) NEW!
- S-TK-77010 (RM)
- S-TK-77700 (PE 4000)
- S-TK-77400 (SP 3000)
- S-TK-77900 (RC 5500)
- S-TK-77800 (C5)

S-TK-77010

- Durable model replicas
- Rigid polyurethane plastic



### Mini Mag-Lite - Flashlight

Part Number - S-FL-25000

- High-intensity light beam from flood to spot with a twist of the wrist
- Converts quickly to a freestanding candle mode
- Rugged, machined aluminum construction with knurled design
- Anodized inside and out for improved corrosion resistance
- Water and shock resistant
- 5.75 inches in length
- AA batteries included
- Compact carrying case

### Integrity Parts Pen

Part Number - S-PN-IP

- Metal ballpoint pen
- Twist action
- Rubber ring grip



### Integrity Parts & Service Counter Mat

Part Number - S-MT-IPIS

- Heavy duty, vynex krystex
- 17" x 26"
- 1/8" thickness



## Section 1

# Service Supplies

### Contents

Oils	1.02
Fluids	1.03
Grease	1.04
Cleaners	1.06
Aerosol Lubricants	1.09
Bulk Service Supplies	1.10
Wiper Blades/Cable Ties	1.11
Paint	1.12
Gloves	1.12
Industrial Wiping Products	1.14
Tape/Packaging	1.17
Chemicals	1.18
Filter Cross Reference	1.21

### Aerosols, Oils, and Service Supplies Brochure

For a condensed list of the Aerosols, Oils, and Service Supplies listed here please reference the Crown Integrity Parts Brochure available through your local Crown Lift Truck dealer. (PF14683)



#### New Items:

- AW46 Hydraulic Oil - p. 1.02
- Windshield Washer Fluid, 55 gal. - p. 1.04
- DAYLube Food Grade Grease - p. 1.05
- Komatsu Aerosol Paint - p. 1.12
- Gloves - p. 1.12-1.13
- Tape Dispenser - p. 1.17
- Utility Knife & Blades - p. 1.17

Note: 1910.178(q)(5) (1998) of the Occupational Safety and Health Act (OSHA) requires that "All parts of any such industrial truck requiring replacement shall be replaced only by parts equivalent as to safety with those used in the original design."





**5W30 Motor Oil**

**Part Number Sales Unit**

363502-001	Quart
363502-012	12 Quart/Case
363502-055	55 Gallon/Drum

Superior high quality, multi-viscosity and fuel-efficient motor oil which exceeds manufacturers' warranty requirements. Meets API highest automotive standards for high temperature protection (API SM, SL, SJ, SH, SG).



**5W20 Motor Oil**

**Part Number Sales Unit**

363526-001	Quart
363526-012	12 Quart/Case

Heavy duty motor oil. Used on Hamech V34 lift trucks with a 2.4 Hyundai LP engine. Excellent low-temperature pumpability for protection during cold starts. Formulated to protect emissions control system catalysts. Keep engine clean by minimizing deposit formation. Improved gas mileage. Reduce oil consumption by reducing volatility and oil evaporation. API SN/RC; SM/SL. API SJ & SH, ILSAC GF-5, Ford (WSS-M2C945A & WSS-M2C946A), Chrysler (MS-6395).



**10W30 Motor Oil**

**Part Number Sales Unit**

363500-001	Quart
363500-012	12 Quart/Case
363500-101	Gallon
363500-106	6 Gallon/Case
363500-055	55 Gallon/Drum

Heavy-duty motor oil provides the highest API performance level available for gasoline engines. Exceeds U.S. car and truck warranty requirements. Thermal stability to combat sludge build-up. Anti-rust and anti-foam additives.



**Universal 10W30 Motor Oil**

**Part Number Sales Unit**

363510-001	Quart
363510-012	12 Quart/Case
363510-101	Gallon
363510-106	6 Gallon/Case

Universal 10W30 motor oil exceeds the demands of API service classification CI-4/CH-4/CG-4/CF-4/CF/CE/SL. It is a commercial multigrade oil for all-season use by fleets with diesel power or mix of gasoline and diesel power engines. This oil is designed to perform with currently marketed low and high sulfur diesel fuels. It provides exceptional low temperature flow properties to help cold start, enhanced oxidation stability, excellent TBN retention, superior viscosity retention, deposit control, superior engine protection and durability and outstanding soot handling ability.



**15W40 Motor Oil**

**Part Number Sales Unit**

363523-001	Quart
363523-012	12 Quart/Case
363523-101	Gallon
363523-106	6 Gallon/Case
363523-055	55 Gallon/Drum

High quality motor oil that is an ideal year-round oil for use in diesel and gasoline powered engines. Provides complete engine protection. Allows easy cold starting and guards against sludge, soot formation, rust and corrosion. Performs with low sulfur diesel fuels. Meets or exceeds API Service Classification (CJ-4/CI-4 Plus/CI-4/CH-4/CG-4 Allison C4 Caterpillar ECF-3/1 Cummins CES 20081 Detroit Diesel 93K218/50/60 series Mack EO-O Premium Plus Mercedes-Benz p228.3 Navistar TSI-97-12-03 Volvo VDS 4/3/2 ACEA E7-04 Renault VI RDL-3 MBE 4000/900 MTU Type I and II engine tests).



**Hydraulic Oil DTE 24**

**Part Number Sales Unit**

063001-021	1 Gallon
------------	----------

Mobil DTE 20 Series oils are supreme performance anti-wear hydraulic oils designed to satisfy a wide range of hydraulic equipment requirements.



**Food Grade AW32 Hydraulic Oil**

**Part Number Sales Unit**

363516-005	5 Gallon
363516-055	55 Gallon/Drum

Premium quality, ashless, food-grade lubricant specially developed for the lubrication of machinery in food processing and beverage plants. Registered by NSF International as an H1 lubricant for use where incidental food contact may occur, also as an H2 lubricant for use in applications where there is no chance for incidental food contact. It also meets former 1998 USDA H1 & H2 guidelines, and is certified Kosher and Pareve. **Meets FDA 21 CFR 178.3570 for incidental food contact.** Used in hydraulic systems, rotary air compressors and circulating systems. Meets performance requirements of Parker Hannifin HPD and Vickers (Eaton). Excellent wear protection for critical system components. Good oxidation resistance to minimize sludge and varnish formation. Protects against rust & corrosion. Good water-separating properties to minimize the formation of emulsions.



**AW46 Hydraulic Oil**

**Part Number Sales Unit**

353527-005	5 Gallon
353527-055	55 Gallon/Drum



Quality anti-wear AW46 hydraulic oil designed to meet the requirements of fluid power systems. Formulated with a proven anti-wear additive that is effective in reducing pump wear. Excellent water separation, rust and corrosion prevention, oxidation stability and anti-foam properties. Meets or exceeds: Cincinnati Milacron P-68, P-69, P-70, Denison HF-1, HF-2, HF-0, Vickers 35VQ25M-2950-S, I-286-S, GM LH-04-1, LH-06-1, LH-15-1, DIN 51524, Part II, Toshiba Machinery.

**Note:** All products rated by the API will continually be upgraded to meet or exceed the newest standards. All products are blended using some of the highest quality base oils and additives available.

# Oils

## 80W90 Gear Oil



Part Number	Sales Unit
363506-001	Quart
363506-012	12 Quart/Case
363506-005	5 Gallon
363506-055	55 Gallon/Drum

High Performance, multi-purpose gear lubricant. Protects in the extreme pressure gear conditions encountered in heavy-duty equipment, trucks, farm tractors, passenger cars, earthmoving, and construction equipment. This gear oil is recommended where a multi-purpose gear oil or one suitable for API Services, MT-1, GL-5, Mack GO-H, GO-J are required.

## 75W-90 Synthetic Gear Oil



Part Number	Sales Unit
363514-001	Quart
363514-012	12 Quart/Case
063002-044	5 Gallon
063002-047	55 Gallon

Recommended for TSP 6000 and RC 5500 & SC5200 drive unit, standard or freezer trucks. Used in heavy-duty transmissions, axles and drives requiring API GL-5 and MT-1 performance. Off-highway industries including construction, mining, quarrying and agriculture. Used on-highway light and heavy-duty trucks, busses and vans.

## Synthetic Compressor Oil



Part Number	Sales Unit
363524-001	Quart
363524-012	12 Quart/Case

Quality compressor oil has four times the life of mineral-grade compressor oils. Synthetic, all-temperature blend that is designed to increase efficiency, reduce wear and prevent carbon buildup. For use with single and two stage reciprocating air compressors.

## Oil Test Kit



Part Number 363515 — Tests hydraulic and motor oil. Mail oil samples in for content test results. Comes with container for oil, mailing container and labels.

Part Number 363515-PPR — Same as 363515 plus Particle Count.

### Test Kit Accessories

#### Suction Pump

Part Number - 363515-001



#### Tubing, 100 Feet

Part Number - 363515-002

# Fluids

Continued ▶

## Hydraulic Fluid Anti-Wear



Part Number	Sales Unit
363504-101	Gallon
363504-106	6 Gallon/Case
363504-005	5 Gallon Pail
363504-055	55 Gallon/Drum

Excellent benefits are achieved when using our high quality Anti-Wear Hydraulic Fluid. Reduced filter blockage and sludge formation. Extended fluid and pump life. Improved durability of non-ferrous parts. Compatible with existing fluids. Reduces downtime and maintenance cost.

## Automatic Transmission Fluid



Part Number	Sales Unit
363503-001	Quart
363503-012	12 Quart/Case
363503-055	55 Gallon/Drum

Premium transmission fluid provides transmission protection, smooth shifting and long service life. Meets the requirements of most US and import specifications. Recommended for service in cars & light truck automatic transmissions where Dexron® III or Mercon® fluid is specified. Meets Allison C-4, ZF TEML 14 Heavy Duty.

## Hydraulic Fluid Low Temp



Part Number	Sales Unit
363505-101	1 Gallon
363505-106	6 Gallon/Case
363505-005	5 Gallon Pail
363505-055	55 Gallon/Drum

Low temp hydraulic fluid meets the most severe requirements of hydraulic pump and equipment manufacturers. This high quality formulation has a long history of excellent performance and provides long, trouble-free service over a wide range of operating conditions. Operates in a wide range of temperatures and is designed for freezer applications.

## Universal Hydraulic and Transmission Fluid



Part Number	Sales Unit
363513-001	Quart
363513-012	12 Quart/Case
063001-025	55 Gallon/Drum

All season hydraulic and transmission fluid designed to meet the special lube requirements of most industrial trucks and implements. This fluid provides EP protection, oxidation and corrosion resistance, and moisture dispersion capability. Meets or exceeds the following fluid requirements. AGCO-ALLIS, ALLIS CHALMERS, DEUTZ-ALLIS Power Fluid 821 XL, 272843, 257541, 246634/ Allison C-3, C-4. International B-6 (Hy-Tran), B-5, Steiger SEMS 17001/ Caterpillar T0-2/ Denison HF-0, HF-1, HF-2/ John Deere J20D (Hy-Gard), J20C (Hy-Gard), J20A/B, J14B (303 Fluid)/ Kubota UDT Fluid.

## Fluids

Image Not Available

### Shell Donax TC Transmission Fluid

Part Number	Sales Unit
363522-005	5 Gallon Pail
363522-055	55 Gallon Drum

Premium transmission fluid provides excellent compatibility with transmission components and premium frictional characteristics to maximize equipment performance. Exceeds the requirements of Caterpillar TO-2 and TO-4 for powerlift transmissions and are Allison C-3/C-4 approved. SAE viscosity grade 10W. Used in new Komatsu IC forklifts.



### Dot 3 Brake Fluid

Part Number	Sales Unit
363507-001	Net wt 12 oz
363507-012	Case (12) - 12 oz

National Brake Fluid meets SAE J1703 and FMVSS-116 specs.



### Dot 5 Brake Fluid

Part Number	Sales Unit
063004-002	Net wt 12 oz
063004-003	Gallon

Premium brake fluid that meets all required specs for use in Crown lift trucks.



### Blue DEF Diesel Exhaust Fluid

Part Number	Sales Unit
363525-002	2.5 Gallon
363525-055	55 Gallon Drum

Mixture of high purity synthetic urea and deionized water. Contains no chemical additives or other compounds that could cause SCR system failure. Meets the quality standards established by the ISO-22241-1 for Diesel Exhaust Fluid. Certified by the American Petroleum Institute. For Diesel SCR engines.



### Dex-Cool Antifreeze/Coolant - Concentrated

Part Number	Sales Unit
363511-101	Gallon
363511-106	6 Gallon/Case

DEX-COOL approved. Protection up to five years/150,000 miles. Patented formula contains no silicates, phosphates, borates, nitrates or amines. Excellent rust and corrosion protection. Helps prevent boil-overs and freeze-ups. Protects all cooling system metal including aluminum. Organic Acid Technology (OAT) minimizes corrosion inhibitor depletion.



### Antifreeze - Concentrated

Part Number	Sales Unit
363509-101	Gallon
363509-106	6 Gallon/Case
363509-055	55 Gallon Drum

### Antifreeze - 50/50

363509-101-50	Gallon
363509-106-50	6 Gallon/Case

Universal formula for both automotive and heavy-duty diesel engines (ASTM D3306 and ASTM D4985).



### Windshield Washer Fluid

Part Number	Sales Unit
300100-101	1 Gallon
300100-106	6 Gallon/Case
300100-055	55 Gallon Drum

Windshield Washer Fluid is a conventional blue all-season windshield cleaner that is safe to use in any vehicle. Formula strengths -20°F.

**Note:** Windshield wiper blades available.



## Grease

Continued ▶



### Multi-Purpose Grease

Part Number	Sales Unit
063002-034	Net wt 14 oz Tube
063002-045	Case (40) - 14 oz Tubes
063002-032	35.2 lbs
363003	121.2 lb Keg
363003-055	396.8 lb drum

Multi-purpose, high performance, high temperature, lithium grease that provides exceptional resistance to water wash out and prevents wear. Recommended for heavy-duty service in all lubricating points. NLGI 2. Used in the following applications: wheel axles, fork slides, steering gears, reach assembly. Temperature maximum: 284°F.



### JT6 Multi-Purpose Grease

Part Number	Sales Unit
363005-001	14 oz Cartridge
363005-010	Case (10) - 14 oz Cartridges

Multi-Purpose Grease is extremely water resistant and water insoluble. Light-colored, low staining, and has a very low oil separation rate. Provides excellent anti-seize protection under high loads. Stays in place better than most other greases. It is fully rust and oxidation inhibited. A medium temperature range multi-purpose grease for extreme pressure loads, slow to medium speed bearings, greased chassis points, fifth wheels, and water pumps. Temperature Range: 0 to 250°F.



# Grease

## DAYLube™ Food Grade NanoCeramic Lubricating Grease



**Part Number Sales Unit**

363008-001	16oz Tube
------------	-----------



High Performance lubricating grease, NLGI No. 2, used where incidental contact with food is a possibility (NSF-H1). Excels in applications where resistance to water washout and broad operating temperatures are absolutely necessary. Operating range of -40° F to + 800°. The formulation of this product provides unsurpassed resistance to extreme pressures and corrosion, including salt spray. It contains no heavy metals or other environmentally undesirable additives.

## Premium Multi-Purpose Lubricating Grease



**Part Number Sales Unit**

063002-025	Net wt 14.5 oz Tube
------------	---------------------

063002-026	35 lbs (5 gallons)
------------	--------------------

Mobilux EP 2 is a high performance, general-purpose industrial-type grease. This lithium hydroxystearate based grease is formulated to provide extra protection against wear, rusting and water washout. The recommended operating temperature range is from -20°C to 130°C, but it may be used at higher temperatures if the lubrication frequency is increased.

## Food Grade Multi-Purpose Grease



**Part Number Sales Unit**

363002-001	Net wt 14 oz Tube
------------	-------------------

363002-030	Case (30) - 14 oz Tubes
------------	-------------------------

363002-005	37.5 lbs (5 gallons)
------------	----------------------

Advanced food grade grease specially formulated for the toughest food processing applications. Provides outstanding protection against wear and water washout, over a wide range of operating temperatures. **Meets the highest food industry safety standards.** Temperature range: -40°F to 392°F.

## JT6 Lo-Temp Grease



**Part Number Sales Unit**

363006-001	14 oz Cartridge
------------	-----------------

363006-010	Case (10) - 14 oz Cartridges
------------	------------------------------

Lo-Temp Grease is Superior Multi-Purpose, EP Lubricant with outstanding low temperature properties. Excellent water resistant, anti-wear and rust corrosion protection. JT-6 Low-Temp Extreme is especially recommended for extremely low to medium temperatures where friction and good flow at low temperatures are required. Temperature Range: -65° to 250°F.

## Low Temperature Multi-Purpose Grease



**Part Number Sales Unit**

063002-017	Net wt 14 oz Tube
------------	-------------------

063002-046	Case (40) - 14 oz Tubes
------------	-------------------------

063002-005	5 Gallon Pail
------------	---------------

High performance grease for low temperature applications. Provides a high resistance to water wash and prevents wear in the coldest environments. Temperature range: -60°F to 250°F.

## JT6 High-Temp Grease



**Part Number Sales Unit**

363004-001	14 oz Cartridge
------------	-----------------

363004-010	Case (10) - 14 oz Cartridges
------------	------------------------------

363004-002	121 lb keg
------------	------------

High temperature lithium grease. Provides excellent protection to disc brake wheel bearings, hinge pins and conveyor bearings. Approved for use in Rockwell and Spicer universal joints. Red in color. NLGI certified. Temperature range: -10° to 325°.

## Spline Grease



**Part Number Sales Unit**

063002-039	1 lb Jar
------------	----------

127801S	1 oz Jar
---------	----------

Synthetic spline grease with PTFE & MoS2. Used specifically for Crown lift pump motor spline connection.

## Molykote BR2-Plus Multi-Purpose Extreme Pressure Grease



**Part Number Sales Unit**

063002-024	Net wt 14.1 oz Tube
------------	---------------------

063002-022	35 lb Pail
------------	------------

Extreme pressure bearing grease. Used for ball bearings, roller bearings, sleeve bearings, swivel joints, metal-to-metal, spindles, splines & shafts. Recommended using in mast channels.

## Molykote 44M Grease



**Part Number Sales Unit**

063002-043	Net wt 5.3 oz Tube
------------	--------------------

High temperature bearing grease with medium consistency. Contains silicone, resistant to oxidation, moisture and corrosive atmospheres, -40° F to 400° F.

## Mobile Grease XHP005



**Part Number Sales Unit**

063002-060	16 oz. can
------------	------------

High-temperature grease for centralized grease application systems, gear lubrication, and where extreme-cold-temperature pumpability is important. NLGI grade 00. Used on steering gearbox on TSP6000/6500/7000.

## Cleaners - Kit and Accessories

### Aerosol Products Kit

Part Number - 363121

Kit includes heavy-duty storage bucket with lid seat kit contents listed right. MSDS sheets included in kit.



### ▼ Contents

Part Number (Can)	Product	Quantity
363120	5 Gallon Storage Bucket with Lid Seat	1
363119-001	Low V.O.C. Brake and Parts Cleaner	1
363115-001	Premium Chain & Cable Lube	1
363106-001	Electrical Grade High Purity Contact Cleaner	1
363104-001	Penetrating Lubricant	1
363108-001	Premium Formula Multi-Purpose Grease	1
363110-001	White Lithium Grease	1
363109-001	Choke & Carburetor Cleaner	1
363105-001	Degreaser & Cleaner	1
363114-001	All Purpose Cleaner	1
363101-001	Glass Cleaner	1
363111-001	Waterless Hand Cleaner	1



**Note:** PF14423 6-Pack Carrier. Holds up to 6 aerosols or soaps. Aerosols not included.



### 5 Gallon Storage Bucket with Lid Seat

Part Number - 363120

## Cleaners - Hand Cleaners and Accessories



### Waterless Hand Cleaner

Part Number	Sales Unit
363111-001	Net wt 15 oz Tube
363111-012	Case (12) - 15 oz Tubes
363117-001	Gallon Jug
363117-004	Case (4) - 1 Gallon Jugs

Excellent for service technicians on the road, this waterless hand cleaner removes oil, grease, paint, and soil without the need to rinse with water. Keeps your hands from feeling raw or dry from over scrubbing.



### Pumiced and Smooth Hand Cleaner

Part Number	Sales Unit
363118-001	Net wt 16 oz Bottle
363118-012	Case (12) - 16 oz Bottles
363112-001	Gallon Jug
363112-004	Case (4) - 1 Gallon Jugs

Pumice fortified hand cleaner that removes encrusted grime, soil, heavy grease, and embedded paints and stains. This one gallon jug can be dispensed with a hand pump or wall mounted shop dispenser.



### Soap Hand Pump

Gallon Jug - 363123

Durable hand pump designed to remove the maximum amount of soap from each container, with its extra long tube.



### Wall Mounted Deluxe Soap Dispenser

Part Number - 363122

Heavy-duty stainless steel construction, with a pump that will not drip.

## Cleaners - Surface Cleaners



### Citra-Sol Degreaser

**Part Number Sales Unit**

363146-001	Net wt 19 oz Can
363146-012	Case (12) - 19 oz Cans

Formulated with orange citrus solvents, this product removes grease, especially animal fats, oil, dirt, and scuff marks from floors. Can be used on porcelain and tile surfaces. Effective on sticky or tar based surfaces. Leaves no residue, and is safe on painted surfaces.



### All Purpose Cleaner

**Part Number Sales Unit**

363114-001	Net wt 19 oz Can
363114-012	Case (12) - 19 oz Cans

Safe to use on almost any surface, this foaming cleaner contains a unique blend of detergent systems that cut through dirt, grime, and grease. Dries streak-free leaving surfaces crystal clear.



### Glass Cleaner

**Part Number Sales Unit**

363101-001	Net wt 19 oz Can
363101-012	Case (12) - 19 oz Cans

Easy to use, fast-acting product that uses a clinging foam to break-up soils and hold them even on vertical surfaces. With an exclusive formulation using denatured alcohol and no ammonia, this product cleans thoroughly, dries quickly, requires no rinsing and leaves no streaks.



### Degreaser and Cleaner

**Part Number Sales Unit**

363105-001	Net wt 19 oz Can
363105-012	Case (12) - 19 oz Cans

Heavy-duty formula uses a high foaming spray for cleaning and clinging to vertical and horizontal surfaces. With a blend of ammonia and butyl, this fast-acting cleaner attacks and loosens dirt, greases, oils and much more from hard surfaces. May remove certain paints - test in small area.

## Cleaners - Specialty Cleaners

Continued ▶



### Low V.O.C. Brake and Parts Cleaner

**Part Number Sales Unit**

363119-001	Net wt 14 oz Can
363119-012	Case (12) - 14 oz Cans

High performance non-chlorinated brake cleaner with no carbon tetrachloride or silicones. Accomplishes 3 times the work of an economy low V.O.C. brake cleaner. No more one can per brake job usage. Designed with a powerful blasting spray for fast acting, quick drying, and residue free results. Extension tube included.



### Non-Flammable Brake Cleaner

**Part Number Sales Unit**

363116-001	Net wt 19 oz Can
363116-012	Case (12) - 19 oz Cans

High performance non-flammable brake cleaner. Designed with a powerful blasting spray for fast acting, quick drying, and residue-free results. Extension tube included. **Not for use in California and New Jersey.**



### 45% V.O.C. Brake & Parts Cleaner

**Part Number Sales Unit**

363154-001	Net wt 14 oz Can
363154-012	Case (12) - 14 oz Cans

High performance non-chlorinated brake cleaner. Designed with a powerful blasting spray for fast acting, quick drying, and residue free results. More powerful than our Low V.O.C. Quickly removes brake fluid, grease, oil and other contaminants from brake linings & pads. Extension tube included. **Can not use in California.**



### Choke and Carburetor Cleaner

**Part Number Sales Unit**

363109-001	Net wt 14 oz Can
363109-012	Case (12) - 14 oz Cans

Instantly cleans carburetor throat, the automatic choke butterfly valve, the PCV valve and the linkage. This excellent cleaner is computer/oxygen sensor safe, leaves no sticky film, removes gum and varnish and helps increase gas mileage. Extension tube included.



### High V.O.C. Brake & Parts Cleaner

**Part Number Sales Unit**

363147-001	Net wt 12.5 oz Can
363147-012	Case (12) - 12.5 oz Cans

Helps improve brake performance by instantly removing grease, oil, brake fluid, dirt and other residues from brake linings and drums. Application can be made without disassembling brake unit. Reduces disc brake squeal, and leaves no surface film. **NOTE: Can not use in the following states: California, Connecticut, Delaware, District of Columbia, Illinois, Indiana, Maine, Maryland, Massachusetts, Michigan, New Hampshire, New Jersey, New York, Ohio, Pennsylvania, Rhode Island, Vermont and Virginia; also Canada.**



### Final Step

**Part Number Sales Unit**

363129-001	Net wt 11 oz Can
363129-012	Case (12) - 11 oz Cans

Great silicone release agent. Works on plastic, rubber, vinyl and metal. **Will not collect dirt.** No need to wipe off; spray on and leave it.

## Cleaners - Specialty Cleaners



### Battery Cleaner

Part Number	Sales Unit
-------------	------------

363124-001	Net wt 18 oz Can
------------	------------------

363124-012	Case (12) - 18 oz Cans
------------	------------------------

Heavy duty industrial battery cleaner is engineered for fast, effective, economical maintenance of storage battery terminals, hold downs, cables and battery boxes. It detects leaks by changing from yellow to reddish purple when it comes in contact with acid. It neutralizes the acid.



### Battery Protector

Part Number	Sales Unit
-------------	------------

363125-001	Net wt 15 oz Can
------------	------------------

363125-012	Case (12) - 15 oz Cans
------------	------------------------

Heavy-duty industrial, non-methylene chloride, battery protector extends battery life and prevents corrosion. It provides an air-tight, waterproof seal, and resists oil, gasoline, dirt, grease and heat. Assures maximum electrical connectivity.



### Black Battery Reconditioner

Part Number	Sales Unit
-------------	------------

363133-001	Net wt 12 oz Can
------------	------------------

363133-006	Case (6) - 12 oz Cans
------------	-----------------------

Restores battery to original look. Formulated to adhere to battery plastics and metal. Ideal for automotive, truck and industrial batteries. When dry, paint finish resembles gloss of original molded plastic. Industrial grade, high solids for single coat coverage, outstanding hardness and durability, resists abrasion and heat. Fast drying. Other uses include battery hold-downs, trays and cases.



### Contact Cleaner

Part Number	Sales Unit
-------------	------------

363128-001	Net wt 11 oz Can
------------	------------------

363128-012	Case (12) - 11 oz Cans
------------	------------------------

Excellent precision cleaning solvent that cleans and protects sensitive electronic components and contacts. Instantly penetrates hard-to-reach areas to safely dissolve dirt, dust, grease, flux and other contaminants on contact. Dries fast with zero residue. Regular use helps prevent contact failure and malfunction. Harmless to most plastics and paper tapes. 22,600 volts/mil dielectric strength. EPA snap approved.



### Non-Flammable Electrical Grade High Purity Contact Cleaner

Part Number	Sales Unit
-------------	------------

363106-001	Net wt 10 oz Can
------------	------------------

363106-012	Case (12) - 10 oz Cans
------------	------------------------

Electrical grade high purity contact cleaner is safe to use on almost any electrical product: Circuit Boards, Wire Terminals, Relays, Switches, Contacts, Circuit Breakers, Tuners, Pen-tioner, Control Panels, Motors, and other electrical equip-ment. There are cheaper contact cleaners on the market, but they run a much greater risk of damaging the plastics, paints, and rubbers that surround most electrical compo-nents. This product can be used with the confidence that it will not damage the components you are trying to clean.



### DeoxIT Contact Cleaner

Part Number	Sales Unit
-------------	------------

363136	Net wt 5 oz Can
--------	-----------------

DeoxIT Contact Cleaner/Rejuvenator is a fast-acting deoxidizing solution that cleans, lubricates, protects and improves conductivity on metal connectors, contacts and surfaces. It is ideal for stationary and moving contacts and connectors. Stabilizes connections between similar and dissimilar metals.



### DeoxIT Shield

Part Number	Sales Unit
-------------	------------

363137	Net wt 5 oz Can
--------	-----------------

DeoxIT Shield seals, lubricates and protects new/clean metal surfaces from oxidation and contamination. Note: For harsh environments (water, salt, pollution) use DeoxIT Shield after DeoxIT Contact Cleaner/Rejuvenator for longer lasting protection.



### DeoxIT Gold

Part Number	Sales Unit
-------------	------------

363155	Net wt 5 oz Can
--------	-----------------

DeoxIT Gold is a unique contact cleaner, conditioner, enhancer, lubricant and protectant for PLATED metal surfaces. Improves conductivity, maintains optimum signal quality, reduces fretting & dendrite corrosion, and stabilizes connections between similar and dissimilar metals. It also reduces wear and abrasion, arcing, RFI and intermittent connections and improves connector performance/reli-ability. Ideal for gold plated surfaces. On oxidized surfaces, pre-treat with DeoxIT contact cleaner.



### Multi-Surface Cleaner Wipes

Part Number	Sales Unit
-------------	------------

363130-001	70 wipes per Tub
------------	------------------

363130-006	Case 6 Tubs
------------	-------------

Heavy-duty waterless cleaner wipes cut through tar, grease, wax, ink, paint, lubricants and adhesives. These non-scratching, citrus-scented towels are industrial strength but gentle on hands and skin. They don't leave an annoying residue.



## Aerosol Lubricants

**Chain and Cable Lube**

Part Number	Sales Unit
363107-001	Net wt 15 oz Can
363107-012	Case (12) - 15 oz Cans

Premium-quality chain lube fortified with molybdenum disulfide and graphite, reducing friction and wear for longer chain life. This lubricating film will not wipe away under extreme pressure and high speeds. Especially recommended for exposed chains where contamination is a problem. Extension tube included.

**Premium Chain and Cable Lube**

Part Number	Sales Unit
363115-001	Net wt 12 oz Can
363115-012	Case (12) - 12 oz Cans

Superior, non-gumming premium oil that penetrates and lubricates all types of chains and cables. Prevents wear and rust. Loosens rusty nuts. Goes on clean; not running or dripping. Extension tube included.

**Dock and Door Lube**

Part Number	Sales Unit
363145-001	Net wt 12 oz Can
363145-012	Case (12) - 12 oz Cans

Superior lubricant that prevents friction and wear. This long-lasting, odorless, non-drip spray is safe on most plastics. Use on garage or overhead doors, hinges and pins, cables, springs, door tracks and chains, bearings and bushings, dock parts, hold-downs, rollers and toe guards. It's great in a variety of applications where a high quality lubricant is needed.

**Penetrating Lubricant**

Part Number	Sales Unit
363104-001	Net wt 20 oz Can
363104-012	Case (12) - 20 oz Cans

Heavy-duty penetrant that cleans, loosens and protects faster than traditional products. The high concentration of AOLX in this product displaces water and reaches deep down to loosen nuts and bolts where corrosion and rust have collected. Inhibits rust and stops corrosion on battery terminals. Extension tube included.

**Channel Slide Lubricant**

Part Number	Sales Unit
363143-001	Net wt 10.5 oz Can
363143-012	Case (12) - 10.5 oz Cans

High performance petroleum based lubricant, fortified with finely diffused moly sulfide to protect against wear and corrosion. Designed for use in industrial, heavy equipment, shop applications, automotive, marine, and farm. Use on inner slides and mast slides, torsion bars, fifth wheels, rails and rollers.

**Premium Formula Multi-Purpose Grease**

Part Number	Sales Unit
363108-001	Net wt 13 oz Can
363108-012	Case (12) - 13 oz Cans

Premium Formula Multi-Purpose Grease is a unique formulation of superior quality industrial lubricants in a convenient aerosol form. This product offers tremendous coating ability that withstands seizing, pounding out, wash-out and excessive wear. Timken rated (load bearing) to 65 lb and heat stable to 500 plus degrees.

**White Lithium Grease**

Part Number	Sales Unit
363110-001	Net wt 14 oz Can
363110-012	Case (12) - 14 oz Cans

Highly concentrated, heavy-duty spray grease lubricant that leaves a long-lasting film and has excellent resistance to heat. Great for anything that squeaks, sticks or rusts. Extension tube included.

**Moly PTFE 45 Plus Lubricant**

Part Number	Sales Unit
363153-001	Net wt 15 oz Can
363153-012	Case (12) - 15 oz Cans

This lubricant is formulated with PTFE and fortified with Moly to provide long lasting lubrication and protection from friction, wear and corrosion. The light viscosity of this product allows for deep penetration into hard to reach parts. Safe for use on most surfaces.

**Food Grade Machinery Lubricant**

Part Number	Sales Unit
363127-001	Net wt 12 oz Can
363127-012	Case (12) - 12 oz Cans

Non-toxic, anti-wear fortified oil for use on bottling, dairy and food processing machinery. For chain, cables, conveyors, slides, o-rings, valves, pistons, seals and general lubrication. Certified OU Kosher Pareve. Manufactured with ingredients that comply with FDA regulation 21 CFR 178.3570 and 178.3530 for lubricants with incidental food contact.

**Food Grade Silicone Spray**

Part Number	Sales Unit
363126-001	Net wt 11 oz Can
363126-012	Case (12) - 11 oz Cans

Can be used on food packaging and processing equipment as a protective anti-rust film, as a release agent on gaskets or seals of tank closures and as a lubricant for machine parts and equipment. This product can be used in contact with fresh, frozen, cooked or baked food products when used in accordance to prescribed regulations. **Manufactured with ingredients that comply with FDA regulation 21 CFR 178.3570 for lubricants with incidental food contact.**



**Citrus Degreaser Spray**

Part Number	Sales Unit
363156-001*	Net wt 32 oz Bottle
363156-012*	Case (12) - 32 oz Bottles
363139	32 oz Bottle Hand Pump
363157-101	1 Gallon Refill
363157-106	Case (6) - 1 Gallon Refills
363158-101	1 Gallon (Concentrated)
363158-106	Case (6) - 1 Gallon (Concentrated)

Instantly cleans grease, oils, and fats without the use of harsh acids, alkalines or petroleum solvents. For use on all washable surfaces. 100% biodegradable. Environmentally friendly with reusable containers and no ozone hazardous chemicals. More economical than aerosol cleaners especially when using the refills. Available in quart spray bottles and 1 gallon refills.

\*Note: Includes Pump Spray Nozzle



**Industrial Battery Cleaner/Neutralizing Wash Cleaner**



Part Number	Sales Unit
300422-001	Quart
300422	5 Gallon
300422-035	35 Gallon

- Dissolves corrosion, eliminates acid shorts
- Stops damaging corrosion
- Allows for reuse of wash water
- Safe to use on all industrial and starter batteries
- Neutralizing Wash Cleaner with color change, turns purple when acid is present and back to yellow when safe

Wash Cleaner color indicates when acid is neutralized.



**Note:** Protective acid resistant goggles and gloves are recommended.

**55 Gallon Poly Drum (Empty)**

Part Number - 363141

Mix Ratio: 3 Gallons Citrus Degreaser Concentrate (P.N. 363158-106) per 52 Gallons Water  
Contents Label included



**55 Gallon Drum Plastic Pump**  
Part Number - 363142



**Wash Water Neutralizer**

Part Number	Sales Unit
300415-001	1 Gallon
300415-004	Case (4) Gallon
300415-005	5 Gallon
300415-035	35 Gallon

Used to adjust pH in wash water and clean acid contaminated floors and equipment such as battery racks and delivery vehicles.

- Concentrated sulfuric acid neutralizer
- Non-corrosive and non-hazardous
- Allows for reuse of wash water
- Can also be used to remove acid from concrete floors
- Use on Reusable Battery Acid Floor and Counter Mat P.N. 300403-050 (see Section 7, Battery and Charger)

**Non-Flammable Brake Cleaner Bulk**

Part Number Sales Unit

363150-005	6 Gallon
363150-055	55 Gallon Drum

Formulated to effectively and quickly flush dust, grease, dirt, and oil from brake shoes, retaining springs, and backing plates. **NOTE: Not for use in California and New Jersey.**



**Stainless Steel & Plastic Pumps**

Part Number	Sales Unit
363151-001	55 Gallon Stainless Steel Drum
363151-002	5 Gallon Stainless Steel Bucket
363142	55 Gallon Drum Plastic Pump (see photo above)



**Acid Spill Absorber and Neutralizer**

Part Number	Sales Unit
300421	5 Gallon
300421-030	30 Gallon

- Specifically formulated to absorb and neutralize battery acid, with color change to show when acid is neutralized and safe for disposal
- Ideal for use in acid drip pans
- Safe and non-hazardous
- Sweeps up clean and dry, is not dusty like kitty litter/clay
- Durable easy to store container with resealable lid
- Instructions and MSDS included  
See OSHA 1926.441 & 1910.173

## Bulk Service Supplies



### Floor and Vehicle Wash - Concentrated

Part Number	Sales Unit
363132	6 Gallon
363132-055	55 Gallon

Premium liquid floor cleaner and vehicle wash. It is formulated to remove grease and oils, dirt, road film and bug residue in one application without brushing. Safe on all paint at the suggested dilution, is free rinsing and leaves a shine. This wash is made from 100% biodegradable detergents and contains no caustics, phosphates, acids or solvents. Was designed for use with sweeper/scrubber floor cleaning units as well as pressure washing applications. This very concentrated product can be diluted 40:1 for light cleaning and 10:1 for heavy cleaning on vehicles. Works well in sweeper/scrubber floor cleaning units at 25:1 dilution. Use with a bucket and brush at 20:1 dilution ratio.



### Non-Butyl Cleaner/Degreaser

Part Number	Sales Unit
063009-005	1 Gallon

General purpose cleaner for food processing plants, kitchens, factories, schools and office buildings. Its degreasing and deodorizing properties make it suitable for mopping, spraying or wiping. Use it to clean walls, floors, fixtures, equipment and utensils. Its low-sudsing formula contains rust inhibitors, rinses quickly and is fortified with builders for fast soil penetration and emulsification.

## SPRAY TOOLS

Sure Shot sprayers are an inexpensive way to apply bulk chemicals like cleaners, degreasers, penetrating oils, solvents and lubricants. They use readily available compressed air, instead of propellants, and because they are reusable you don't have to worry about disposal of empty cans. Not recommended for acids or paint.



### Sure Shot Sprayer - 32 oz.

- Part Number - 363148
- Enameled steel
- Brass nozzles
- Can be used with oil and solvent-based materials
- Do not use water or water-based materials in steel sprayers
- 200 PSI maximum
- Includes (1) standard nozzle, 363148-003

#### Nozzle Options:

Part Number	Description
363148-002	Pin Stream
363148-003	Cone Pattern Standard
363148-004	Fan Shape Flat



363148-002



363148-003



363148-004



### Sure Shot Sprayer Kit - 16 oz.

- Part Number - 363148-001
- Electroless Nickel Plated Aluminum, w/ Plastic Cap, superior chemical resistance compared to base aluminum
- Slim design fits in hand easily
- 200 PSI Maximum
- Includes extra valve, seal, and nozzle assortment, including: 2 fine, 2 regular, 2 medium, 2 coarse and 1 pin stream nozzle

#### Nozzle Options:

Part Number	Description
363148-005	Pin Stream
363148-006	Medium Spray
363148-007	Fine Spray
363148-008	Regular Spray (Standard)
363148-009	Coarse Spray

## Wiper Blades



### Chevrolet Full Size Service Van 22" Wiper Blades

Part Number	Description
300099-001	Standard
300099-002	Premium
300099-003	Winter Premium

**Note:** Windshield washer fluid part number is 300100-101.

### Ford Full Size Service Van 20" Wiper Blades

Part Number	Description
300099-020	Premium
300099-020-01	Winter Premium

(One blade per package)

**Note:** Windshield washer fluid part number is 300100-101.



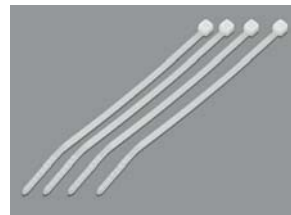











## Cable Ties



Part Number	Length (in)	Width (in)	Maximum Wire Bundle	Color	Qty Per Box
365003-002	4.00	0.09	0.63	Natural	1000
365003-003	7.44	0.19	1.75	Natural	1000
365003-004	5.60	0.14	1.38	Black	1000
365003-005	11.40	0.14	3.00	Black	1000





# Paint

## Aerosol Paint Cans - Net wt 12 oz.

Color	Individual	Case (12 Cans)
Crown 88 Dark Gray	063011-007	063011-017
Crown 94 Medium Gray	063011-008	063011-018
Crown 94 Beige	063011-009	063011-019
Crown Bright Beige	063011-033	063011-034
Crown Alpine White	063011-025	
Crown Light Graphite	063011-027	
Crown Crystal Silver	063011-029	
Crown Control Orange	063011-031	
Crown 88 Blue	063011-010	
Crown Motor Silver	063011-035	
Crown 90 Orange	063011-002	
Crown 90 Yellow	063011-021	
Hamech 8782539 Yellow	 363018-002	
Hamech 8772306 Black	 363018-003	
Hyster HY1345809 Nugget Yellow	 363018-004	
Kalmar/Tusk 8776201 Red	 363018-001	
Komatsu 3EE-97-21110L Blue	 363018-012	
Komatsu 3ZB-97-21110L Gray	 363018-013	
Komatsu 3EB-99-A6110 Natural Yellow	 363018-019	
Komatsu 3EB-99-A6120 Black	 363018-003	
Komatsu 3EB-99-A6130 Summer Green	 363018-018	
Komatsu 3EB-99-31120 2K Blue	 363018-014	
Komatsu 3EB-99-31110 2K Yellow	 363018-015	
Komatsu 3EB-99-31130 2K Teal Green	 363018-016	
Raymond 1053174-001 High Gloss Red	 363018-010	
Raymond 990-181 93 Red/Orange	 363018-011	
Toyota 90900-U9024-71 New Orange	 363018-007	
Toyota 90900-U9022-71 Black	 363018-008	
Toyota 90900-U9023-71 Gray	 363018-009	
Yale 310120350 Bright Gold	 363018-005	
Yale 310120348 Bright Parchment	 363018-006	

NEW!  
NEW!

## \*Quart, Gallon and 5 Gallon Paint Cans

Color	Quart	Gallon	5 Gallons
Crown 88 Dark Gray	063016-007	063000-104	063000-040
Crown 94 Medium Gray	063016-008	063000-106	063000-034
Crown 94 Beige	063016-009	063000-108	
Crown Bright Beige	063016-029	063000-105	063000-069
Hamech 8782541 Yellow		363017-002	
Hamech 8772305 Black		363017-003	
Kalmar/Tusk 8776201 Red		363017-001	
Komatsu 3EB-99-A6220 Black		363017-003	

\*Note: Spray equipment required.



# Gloves

Continued ▶



## Nitrile, Latex & Vinyl Gloves

Part Number	Description	Size
300075-006	Nitrile, 5 mil, Powder Free, Black	Small
300075-001	Nitrile, 5 mil, Powder Free, Black	Medium
300075-002	Nitrile, 5 mil, Powder Free, Black	Large
300075-003	Nitrile, 5 mil, Powder Free, Black	X-Large
300075-004	Nitrile, 5 mil, Powder Free, Black	XX-Large
300076-006	Nitrile, 5 mil, Powdered, Blue	Small
300076-001	Nitrile, 5 mil, Powdered, Blue	Medium
300076-002	Nitrile, 5 mil, Powdered, Blue	Large
300076-003	Nitrile, 5 mil, Powdered, Blue	X-Large
300073-001	Latex, 5 mil, Powder Free	Medium
300073-002	Latex, 5 mil, Powder Free	Large
300073-003	Latex, 5 mil, Powder Free	X-Large
300074-001	Latex, 5 mil, Powdered	Medium
300074-002	Latex, 5 mil, Powdered	Large
300074-003	Latex, 5 mil, Powdered	X-Large
300077-001	Vinyl, Powdered	Medium
300077-002	Vinyl, Powdered	Large
300077-003	Vinyl, Powdered	X-Large

Note: 100 per package

NEW!

## Latex Gloves\*

Part Number	Sales Unit	Size
365248-006-01	1 box of 100	Small
365248-006-10	10 boxes of 100	Small
365248-001-01	1 box of 100	Medium
365248-001-10	10 boxes of 100	Medium
365248-002-01	1 box of 100	Large
365248-002-10	10 boxes of 100	Large
365248-003-01	1 box of 100	X-Large
365248-003-10	10 boxes of 100	X-Large

Heavy duty, industrial grade. 8 mil. Non-sterile. Powder free.



## Nitrile Gloves\*

Part Number	Sales Unit	Size
365235-001-01	1 box of 50	Medium
365235-001-10	10 boxes of 50	Medium
365235-002-01	1 box of 50	Large
365235-002-10	10 boxes of 50	Large
365235-003-01	1 box of 50	X-Large
365235-003-10	10 boxes of 50	X-Large



Resistant to many chemicals and blood-borne pathogens. Provides more protection than standard nitrile gloves. Industrial grade, latex-free. 8 mil. Single use. Meets FFDC requirements for food contact. 12" length, textured grip.

\*Available only to customers in USA



# Gloves

Continued ▶

## Nitrile Gloves\*

Part Number	Sales Unit	Size
365241-003-01	1 pair	Large
365241-003-12	12 pairs	Large
365241-004-01	1 pair	X-Large
365241-004-12	12 pairs	X-Large

15 mil green nitrile. Nitrile flock, lined. 13" length.



## Polyurethane-Coated, Abrasion/Cut Resistant Knit Gloves\*

Part Number	Sales Unit	Size
365229-006-12	12 pairs	Small
365229-001-12	12 pairs	Medium
365229-002-12	12 pairs	Large
365229-003-12	12 pairs	X-Large
365229-004-12	12 pairs	XX-Large

Shell is made with HPPE fiber - high performance polyethylene fiber which is 10 times stronger than steel and 40% stronger than blended fabrics.

Palm coated with gray polyurethane. Cut/abrasion resistant.



## Nitrile Coated Flex Gloves\*

Part Number	Sales Unit	Size
365236-001-01	1 pair	Medium
365236-001-12	12 pairs	Medium
365236-002-01	1 pair	Large
365236-002-12	12 pairs	Large
365236-003-01	1 pair	X-Large
365236-003-12	12 pairs	X-Large

High-dexterity foam nitrile coated. Gray nylon knit shell. Excellent grip.



## Neoprene Over Latex Gloves\*

Part Number	Sales Unit	Size
365239-002-01	1 pair	Large
365239-002-12	12 pairs	Large
365239-003-01	1 pair	X-Large
365239-003-12	12 pairs	X-Large

Heavyweight neoprene over latex, flock lined - 28 mil. Chemical/oil resistant. Outstanding dexterity. Impermeable to gases, vapor and moisture.



## Cotton Poly Coated Flex Gloves\*

Part Number	Sales Unit	Size
365237-001-01	1 pair	Medium
365237-001-12	12 pairs	Medium
365237-002-01	1 pair	Large
365237-002-12	12 pairs	Large
365237-003-01	1 pair	X-Large
365237-003-12	12 pairs	X-Large

Excellent abrasion resistance with a high level of dexterity. Heavy latex with textured palm and fingers. String knit, palm dipped in latex, knit wrist.



## Leather Palm Gloves\*

Part Number	Sales Unit	Size
365238-001	1 pair	One Size
365238-012	12 pairs	One Size

Made from select shoulder leather. Leather palms, fingers and knuckle strap. 2 1/2" rubberized safety cuff. Safety Orange back and cuff.



## Polyurethane-Coated, Nylon Knit Gloves\*

Part Number	Sales Unit	Size
365228-006-12	12 pairs	Small
365228-001-12	12 pairs	Medium
365228-002-12	12 pairs	Large
365228-003-12	12 pairs	X-Large
365228-004-12	12 pairs	XX-Large

Polyurethane palm coating is tough and durable. Gray nylon knit shell. Durable, but still allows for excellent tactile feel.



## Drivers Gloves\*

Part Number	Sales Unit	Size
365242-002-01	1 pair	Medium
365242-002-12	12 pairs	Medium
365242-003-01	1 pair	Large
365242-003-12	12 pairs	Large
365242-004-01	1 pair	X-Large
365242-004-12	12 pairs	X-Large

Select pigskin drivers gloves. Shirred back. Keystone thumb. Unlined.



## Cotton Jersey Gloves\*

Part Number	Sales Unit	Size
365240-001	1 pair	One Size
365240-012	12 pairs	One Size
365240-072	72 pairs	One Size

General duty. Can be used alone or as glove liners. Brown cotton jersey. Knit cuff.



## Mechanics Insulated Gloves\*

Part Number	Sales Unit	Size
365471-001	1 pair	Medium
365471-002	1 pair	Large
365471-003	1 pair	X-Large

High dexterity mechanics gloves. Full fingertip and knuckle protection. Insulated with 3M thinsulate. Adjustable velcro closure & padded palm.



\*Available only to customers in USA

## Gloves

### Mechanics Gloves



Part Number	Description	Size
300094-001	Integrity Service Black	Medium
300094-002	Integrity Service Black	Large
300094-003	Integrity Service Black	X-Large

Lightweight, yet durable for the toughest tasks. Synthetic leather palm extends life of the glove while the spandex back provides breathability. Reinforced fingertips for maximum durability. Easy slip-on, open cuff design. Sold by the pair.

### Crown Mechanics Fingerless Gloves

Part Number	Sales Unit	Size
152892-011	1 pair	Large
152892-012	1 pair	X-Large

Cow grain leather palm extends life of the glove while the spandex back provides breathability. Fingerless, double stitched for maximum durability. Velcro wrist closure.



## Industrial Wiping Products

Continued ▶

### Pop-Up Wipers\*



Part Number	Sales Unit
365201-700-10	10 boxes/case

Durable, made with Hydrospun Technology. Excellent tear strength. Solvent resistant. Superior wipe-dry. Ideal for manufacturing, maintenance, transportation & hi-tech areas. Compare to KC Wypall® X70. White, 9" x 16". 100 sheets in a box.



Part Number	Sales Unit
365201-600-10	10 boxes/case

Durable, low lint, made with Hydrospun Technology. Excellent shop towel replacement. Ideal for light manufacturing, general maintenance & transportation. Resistant to most solvents. Compare to Wypall® KC X60. White, 9" x 16.5". 125 sheets in a box.



Part Number	Sales Unit
365201-050-09	9 boxes/case

Excellent general purpose wiper. Durable and strong. Packaging allows for wipers to be contained and portable. Can be assigned to worker to help control over usage. Compare to KC Wypall® X50. Blue. 16.5" x 9.5". 100 sheets in a box.



Part Number	Sales Unit
365212-50-08	8 boxes/case

Excellent general purpose wiper. Durable and strong. Packaging allows for wipers to be contained and portable. Can be assigned to worker to help control over usage. Compare to KC Wypall® X50. White, 12.75" x 9.5". 275 sheets in a box.



Part Number	Sales Unit
365201-030-09	9 boxes/case

Lightweight general purpose wiper. Soft enough to use as a personal wiper. Easily absorbs liquids, lubricants and oils. Compare to KC Wypall® L30. White. 9.8" x 16.4". 120 sheets in a box.



Part Number	Sales Unit
365201-010-18	18 boxes/case

High quality, for everyday tasks. Compare to KC Wypall® L10. White, 2-ply. 9" x 10.25". 110 sheets in a box.

### Jumbo Roll / Small Roll Wipers\*



Part Number	Sales Unit
365202-800-03	3 rolls/case

Heavy-duty absorbency and maintains strength in solvents & other liquids. Made with Hydrospun Technology. Durable wiper for extended cleaning performance. Reusable, long-lasting performance. High capacity Jumbo Roll helps control waste. Compare to KC Wypall® X-80 Jumbo Roll. Red, perforated. 12.5" x 12". 500 sheets on a roll.



Part Number	Sales Unit
365202-700-03	3 rolls/case

Heavy-duty absorbency and maintains strength in solvents & other liquids. Made with Hydrospun Technology. Durable wiper for extended cleaning performance. Reusable, long-lasting performance. High capacity Jumbo Roll helps control waste. Compare to KC Wypall® X-70 Jumbo Roll. White, perforated. 12.6" x 13.1". 870 sheets on a roll.



Part Number	Sales Unit
365202-600-03	3 rolls/case

Made with Hydrospun Technology. Medium-duty absorbency and strength in solvents and other liquids. Durable wiper for extended cleaning performance. Reusable, long-lasting performance. High capacity Jumbo Roll helps control waste. Compare to Wypall® X-60 Jumbo Roll. White, perforated. 12.5" x 13". 1100 sheets on a roll.

\*Available only to customers in USA

# Industrial Wiping Products

Continued ▶



Part Number	Sales Unit
365202-040-03	3 rolls/case

Excellent general purpose wiper. Durable and strong. High capacity Jumbo Roll helps control waste. Compare to Wypall® L-40 Jumbo Roll. White, perforated. 11.8" x 13.4". 750 sheets on a roll.



Part Number	Description
365203-001	Dispenser, wall mount

Holds 1 Jumbo Roll. Mount on wall in work station. Blue. Metal.



Part Number	Description
365203-002	Dispenser, floor

Holds 1 Jumbo Roll. Mobile floor mount for use in work station. Blue. Metal.



Part Number	Sales Unit
365204-040-30	30 rolls/case

Excellent general purpose wiper. Durable and strong. Small roll can be used in standard household paper towel dispenser. Perforated sheets. Blue. 11" x 9.4". 60 sheets on a roll.



Part Number	Sales Unit
365210-040-30	30 rolls/case

Excellent general purpose wiper. Durable and strong. Small roll can be used in standard household paper towel dispenser. Perforated sheets. White. 11" x 9.4". 56 sheets on a roll.



Part Number	Sales Unit
365205-010-30	30 rolls/case

General purpose, kitchen paper towel. Fits all standard roll towel dispensers. Lightweight. Rolls are not individually wrapped. Premium quality for softness and absorption. White. Bulk packed. 11" x 11". 90 sheets on a roll.

## Centerfeed Towels\*



Part Number	Sales Unit
365206-002	2 rolls/case

Excellent general purpose wiper. Durable and strong. Centerfeed rolls. Fits standard center pull dispensers. White. 8.4" x 14". 200 sheets on a roll.



Part Number	Sales Unit
365207-040-08	8 rolls/case

Excellent general purpose wiper. Durable and strong. Centerfeed rolls. Fits standard center pull dispensers. Blue, perforated. 9" x 15". 275 feet on a roll.



Part Number	Sales Unit
365208-006	6 rolls/case

100% cellulose. Excellent mechanics wipe. Centerfeed towel dispensing. Two-ply. A low lint light duty wiper. White, perforated. 9" x 13". 554 sheets on a roll.



Part Number	Description
365209	Centerfeed dispenser

Strong, durable ABS plastic construction. Centerfeed nozzle can be adjusted to thickness of towel. All centerfeed towels listed above fit in this dispenser. Color is smoke grey.

## Flat Bulk Materials & Quarter Fold\*



Part Number	Sales Unit
365211-040-18	18 packages/case

Leading all-purpose wiper. Highly absorbent. Soft, cloth-like feel. Compare to KC Wypall® L40. White. ¼ fold. 12.5" x 13". 56 sheets in package.



Part Number	Sales Unit
365213	Approximately 1700/case

Leading grease and oil wiper. Excellent for any type of automotive clean-up. Soft and thick. Highly absorbent with grease and oil. White. Flat packed. 15" x 13".



Part Number	Sales Unit
365215	Approximately 1650/case

Smooth. Hydroknit irregulars. 25 lb. bulk. White or colors. 10" or 12" x 15".

## Woven Wiping Materials\*



Part Number	Sales Unit
365220-012	12/case

Cleans without harmful chemicals. Use wet or dry. Non-Abrasive. Non-Linting. Machine Washable. Blue. 16" x 16".



Part Number	Sales Unit
365221-500	500/case

100% cotton shop towel. High absorption capability. Used for many grease and oil applications. A popular towel among mechanics. Red. 18" x 18".



Part Number	Sales Unit
365222-025	25 lbs./case

Mostly cotton hand towel. Will vary in size and color within each case. High absorbent and becomes even more absorbent after laundering. 14" x 24".

\*Available only to customers in USA

## Industrial Wiping Products



Part Number	Sales Unit
365223-050	50 lbs./case

Mostly cotton T-shirt towel. Excellent for cleaning, polishing and staining. Light to medium weight material. Soft and low linting. Towels compressed into heavy gauge polybags for shipping and storage. Unwashed material. Gray 12" x 18" to 24" x 24".



Part Number	Sales Unit
365224-050	50 lbs./case

Mostly cotton recycled knit T-shirt. Washed. Resists bleeding. Packaged in Spaceworks bag to reduce shipping costs. Inexpensive alternative to rental rags. Some may have screen printing. Shades of gray.



Part Number	Sales Unit
365341-125-16	16 packs/case

Premium Multi-Fold towel. White. 9½" x 9½". 150/pack.



Part Number	Sales Unit
365342-250-16	16 packs/case

Multi-Fold towels are soft, strong and absorbent. Made from 100% recycled fiber - EcoLogo Certified. White. 9½" x 9½". 250/pack.

### Hand Towels\*



Part Number	Sales Unit
365340-150-16	16 packs/case

C-Fold towels are soft, strong and absorbent. Made from 100% recycled fiber - EcoLogo Certified. White. 12¾" x 10½". 150/pack.

### Drape Material/Fender Covers\*



Part Number	Sales Unit
365226-072	72 sheets/case

Treated material to repel liquids. Economy drape material. Can be used as an outdoor cover, fender cover or floor/carpet protection. Blue/green material. 6' x 41".

\*Available only to customers in USA

**Crown offers an extensive line of competitive parts.**

**See Section 4 for IC parts, like starters, radiators, pumps & spark plugs.**

**See Section 3 for electric truck parts, like motors, cards & handles.**

## Tape/Packaging

### Double Coated Tape

Part Number	Description
061000-002	5 mil, 1" x 36 yds - 3M #410M

Utilizes a natural rubber adhesive system that offers good to excellent adhesion to many types of surfaces. Good holding power to a wide variety of materials. Low temp -40, high temp 200. Used on C5, SC45 & FC45 seats.

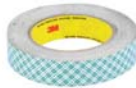

### Industrial Strapping Tape

Part Number	Description
061000-003	½" x 180' - 3M #898

Reinforces corrugated and fiberboard boxes. Tackles heavy duty sealing and bundling. Recommended for "L" clip closures and "C" clip reinforcements. Excellent abrasion, moisture and scuff resistance. Clear polypropylene backing reinforced with glass yarn filaments. Synthetic rubber adhesive.



### 3.5 Mil Transparent Polyester Film

Part Number	Description
061000-004	¾" x 72 yds - 3M #57
061000-005	1" x 72 yds - 3M #57

Rubber adhesive, supplied on 3" core. Is suited for use as a coil cover, layer insulation and capacitor wrap where higher electrical strength is desirable. Color is yellow. Temperature class 266°F/ 130°C. Used on coil in contactor.



### Acetate Black Cloth Tape

Part Number	Description
061000-006	7 mil, ¾" x 72'

This tape offers excellent conformability in coil wrapping applications up to 105°C, 221°F. Acetate cloth tape offers excellent absorption of resins and varnishes. Printable. Used on coil in contactor.



### Black Fusion Tape

Part Number	Description
061000-015	1" x .020" x 30' - Amp 605980-2

Fusion Tape is very easy to use and is ideal for wrapping electrical cable splices and terminations. It provides neat, trim, long-lasting insulation on a wide range of sizes, shapes, and materials. Applications are mostly electrical but Fusion Tape can be used in a wide variety of areas. This durable, black elastic tape has excellent electrical properties, water resistance, ozone resistance, and corrosion resistance at temperatures ranging from (-40°C) to 212°F, (100°C) continuous, and to 266°F (130°C) for short periods of time.



### Electrical Tape

Part Number	Description
380030-053	7 mil, ¾" x 60'

Suitable for use at not more than 600 V and not more than 176°F (80°C). UL rated.



### Blue Painters Tape\*

Part Number	Description	Sales Unit
365408-024	5.6 mil, 1.5" x 60 yds	6 rolls/case

Low adhesion painters tape, acrylic-based adhesive. Not for body shop use. Removes cleanly from cured painted walls, trim, woodwork, glass and metal for up to 14 days without damage to the substrate even when exposed to direct or indirect sunlight.



### Tape Dispenser\*

Part Number	Description
365414	Tape dispenser

Holds 48mm x 110 yds (2" x 110 yds) roll. Adjustable tension brake.



### Carton Sealing Tape\*

Part Number	Description	Sales Unit
365410-024	1.9 mil, 3" x 110 yds	24 rolls/case
365411-036	1.9 mil, 2" x 110 yds	36 rolls/case

Sticks instantly to most surfaces. Conformable with smooth, easy release. Clear polypropylene with acrylic adhesive. Hot melt.



### Masking Tape\*

Part Number	Description	Sales Unit
365406-024	5.1 mil, 2" x 60 yds	24 rolls/case
365407-016	5.1 mil, 3" x 60 yds	16 rolls/case

Industrial grade, general purpose masking tape for everyday needs. Used for masking, packaging, bundling and labeling. Off white.



### Duct Tape\*

Part Number	Description	Sales Unit
365409-006	9 mil, 2" x 60 yds	6 rolls/case

Has a strong poly-coated cloth backing. Excellent product to use to fix, repair, patch and seal. Sticks instantly in high and low temperatures. Silver. Individually wrapped.



### Shrink Wrap, Small Rolls\*

Part Number	Description	Sales Unit
365405-018	90 gauge, 3" x 1000'	18 rolls/case

Polyethylene-cast stretch film. Exceptional load holding force. Superior cling and tear resistance in a wide variety of applications. **Faster and more economical to use than tape or strapping.** Includes handle.



### Shrink Wrap\*

Part Number	Description	Sales Unit
365405-004	80 gauge, 18" x 1500'	4 rolls/case

Polyethylene-cast stretch film. Exceptional load holding force. Superior cling and tear resistance in a wide variety of applications. **Faster and more economical to use than tape or strapping.**



### Utility Knife and Blades\*

Part Number	Description	Sales Unit
365412-006	Utility Knife	6 knives
365413-100	Replacement Blades	100 blades

Retractable utility knife. Bi-metal blade stays sharper, lasts 3 times longer than other blades. Built in wire cutter.



\*Available only to customers in USA

## Chemicals - Adhesives

**Devcon Zip-Grip #4044 - Instant Adhesive**

Part Number	Sales Unit
061001-004	Net wt 1/2 oz or 14 gram Bottle

Suitable for bonding plastics, rubber, metals and dissimilar substrates. Adhesive fixes in seconds and provides a durable bond. Resistant to aging and weathering. Low viscosity for close fitting parts. Use on grommets and pedal pads.

**Super Bonder 498 Thermal Cycling Resistant - Instant Adhesive**

Part Number	Sales Unit
061001-022	Net wt 1 oz Bottle

A medium viscosity, high temperature product for all metals, and most plastics and rubbers. Resists temperatures to 223 F continuous or up to 250 F intermittent. Used on thermal sensor on lift and drive motors.

**3M Scotch Grip 1099 - Plastic Adhesive**

Part Number	Sales Unit
061001-018	Net wt 5 oz Tube

Excellent for bonding most vinyl extrusions and sheeting. Also bonds many fabrics and foams. Note: it may stain light colored, flexible vinyls; check before using. It is not recommended for bonding polyethylene or polypropylene. Meets MIL-A-13883B, Type I and MMM-A-189C, Class 2. Used on felt seals like on caster brake assembly on reach trucks.

**3M Super Weatherstrip and Gasket Adhesive**

Part Number	Sales Unit
061001-023	Net wt 2 oz Tube

Yellow in color - A strong, flexible, rubbery adhesive that can withstand vibration and extreme temperature variations. It can be used to bond automotive weatherstripping and is a great adhesive for holding paper, cork, or rubber gaskets in place during installation. Used to glue wear strip on quick adjust casters.

**3M 1300 Rubber and Gasket Adhesive**

Part Number	Sales Unit
061001-015	Net wt 5 oz Tube

Yellow, versatile, heat resistant and adheres to metal and wood. A yellow, premium quality, versatile, brushable, heat resistant adhesive that develops strength rapidly. Has excellent adhesion to metal, bake enamel, wood, most plastics, and neoprene, reclaim, SBR, and butyl rubber. NOT for EPDM rubber. Used on felt seals, poly pads, and grommets.

**3M Fastbond 30NF Adhesive**

Part Number	Sales Unit
061001-021	Quart

Water-dispersed high-strength contact adhesive. Has high coverage, a long bonding range, and good heat resistance. Can be used to bond foamed plastics, plastic laminate, wood, plywood and wood veneer, and canvas to themselves and each other, as well as for post-forming operations. Non-flammable in the wet state. Neutral color. Used on foot pedals along with 061001-004. Also used on plastic grommets, seal strip extrusion like in the steering on SC and screws.

**Hernon Instant Bond 113 - General Purpose**

Part Number	Sales Unit
061001-007	Net wt 1 oz Bottle

This thin liquid is suitable for close tolerance bonding of a wide variety of materials. Used on self tapping screws.

**Turbo Fuse Instant Bonding Super Glue**

Part Number	Sales Unit
061001-024	Net wt 16 oz Bottle

Used on floor mats. Comes with nozzle.

**Jowat Laminating Adhesive**

Part Number	Sales Unit
363600	9 lb jug

Laminating Adhesive - PVA Water based primer suitable for solid woods & high pressure laminates. Plastic film lamination / Primer for HPL. Used on rubber mats and grommets.

**TRA-BOND 2143D**

Part Number	Sales Unit
061001-020	6 cc

A medium viscosity adhesive recommended for industrial bonding and sealing applications where toughness, impact resistance, and superior mechanical properties are required. This two-part adhesive is easily mixed and cured at room temperature, and develops strong bonds to most clean, dry material surfaces including most metals, rigid plastics, glass, ceramics, leather, rubber, wood and concrete. Fully cured TRA-BOND 2143D bonds offer good low-temperature electrical, mechanical, and impact resistant properties, superior thermal shock resistance, low permeability to gases and vapors, good dimensional stability, and resistance to water, weather, oxygen and ozone, most petroleum products, mild acids and alkalis, and many other chemicals. Used on buttons and inserts like in the control handle.

## Chemicals - Lubricants



### O-ring and Valve Lubricant / Sealant

Part Number Sales Unit

063002-020 | Net wt 5.3 oz Tube

Used as a lubricant for rubber and plastic o-rings, water softener and faucet valves, valve stems for potable water, aircraft vacuum systems, electronic and ignition systems. Used as a sealant in applications such as vacuum and pressure systems, equipment subject to washing and harsh environments, electrical service entrances and underground connections, and transformer gaskets and equipment enclosures. Used on Wave traction pod on torsion springs, FC4 compression spring on park brake switch, spacer in Wave clip pad.



### Nygel Contact Lubricant

Part Number Sales Unit

127189-001 | 55 cc

Recommended lubricate for pins and sockets of GE EV100/200 and GenII products.



### G-n Metal Assembly Spray

Part Number Sales Unit

063002-021 | Net wt 11 oz Can

Contains MoS<sub>2</sub>. Reduces galling and seizing. Use for cutting and shearing, drills and taps, metal fabricating, metal forming, press fitting, and running-in. Used on threaded shaft in servo control valve and spacer in height sensor.



### Loctite Silver Grade Anti-Seize 76732

Part Number Sales Unit

065005-003 | Net wt 8 oz Bottle

Heavy-duty, temperature resistant, petroleum-based lubricant compound fortified with graphite and metallic flake. Inert, will not evaporate or harden in extreme cold or heat. For use in assemblies up to 1600°F (871°C). Tested to MIL-PRF-907E. Used on ball bearings in bottom drive unit, hub in drive unit, on wheel nuts, and floorboard spacers.

## Chemicals - Silicone



### Silicone Dielectric

Part Number Sales Unit

063002-018 | Net wt 5.3 oz Tube

Insulator and bushing flashover protection. Good resistance against oxidation, moisture, and salt spray.



### Electrical Insulating Compound

Part Number Sales Unit

063002-019 | Net wt 5.3 oz Tube

Contains silicone. Provides moisture barrier. -70° F to 400° F. Applications: Electrical assemblies and terminals, cable connectors, battery terminals, and rubber and plastic o-rings.

## Chemicals - Retaining Compounds

### Loctite Retaining Compounds

Part Number	Sales Unit	Description
061004-027	0.5 ml	Loctite 680 - Slip Fit
061004-021	250 ml	Loctite 680 - Slip Fit
061004-022	50 ml	Loctite 680 - Slip Fit
061004-025	0.5 ml	Loctite 609 - Press Fit
061004-009	10 ml	Loctite 609 - Press Fit



## Chemicals - Heat Sink Compounds



### Silicone Heat Sink Compound

Part Number Sales Unit

063002-029 | Net wt 5.0 oz Tube

Thermal coupling of electrical/electronic devices to heat sinks. High thermal conductivity, low bleed, stable at high temperatures. White grease-like silicone heavily filled with heat-conductive metal oxides. Used on Access II & III traction control modules.



### Heat Sink Compound

Part Number

093983

Extra high-efficiency heat transfer compound. Used on heat sink assemblies, SCR panels, contactor panels and freezer heaters and limit switch assembly.

## Chemicals - Sealants

Continued ▶



### Primer

Part Number Sales Unit

061004-002 | Net wt 4.5 oz Can

Loctite 7471 Locquic Primer T - Increases cure speed of Loctite anaerobic products. Especially recommended for applications with passive metals or inert surfaces and with large bond gaps. Use of activator is particularly recommended for cure conditions below 15° C.



### Primer

Part Number Sales Unit

061004-016 | Net wt 4.5 oz Can

Loctite 7649 Primer N - a solvent-based primer that features very long on-part life. Use to speed the cure of all Loctite Anaerobic Products and ensure proper cure on inactive metals. Ideal for cure conditions below room temperature.

## Chemicals - Sealants

### Loctite Thread Locker

Part Number	Sales Unit	Description
061004-019	0.5 ml	Loctite 271 high strength
061004-010	10 ml	Loctite 271 high strength
061004-026	0.5 ml	Loctite 242 medium strength
061004-012	10 ml	Loctite 242 medium strength
061004-020	10 ml	Loctite 222 low strength
061004-018	250 ml	Nuts'n bolts 420 low strength
061004-028	20 g	Loctite 425 instant adhesive - assure surface curing



### Loctite Thread Sealant

Part Number	Sales Unit	Description
061004-011	50 ml	Loctite 569 - high strength hydraulic sealant
061004-023	50 ml	Loctite 565 - PST pipe sealant
061004-029	250 ml	Loctite 565 - PST pipe sealant
061004-014	10 ml	Nuts'n bolts 431- fast cure, penetrating, preassembled parts



### Liquid Gasket

Part Number Sales Unit

061004-030	50 ml
061004-015	300 ml

Loctite 518 gasket eliminator - preferred sealant for aluminum flanges.



### Loctite Flange Sealant

Part Number Sales Unit

805044	50 ml
--------	-------

Fast curing, provides resistance to low pressures immediately after assembly of flanges.



### Gasket Maker

Part Number Sales Unit

363007-001	7 oz.
------------	-------

Permatex 85224 Powerbead The Right Stuff Instant Rubber Gasket Maker. The Right Stuff is blowout resistant and outperforms pre-cut gaskets. Protects against leaks caused by vibration and thermal expansion. Temp Range -75°F to 450°F continuous, 500°F intermittent and is Sensor-Safe.



### Release Compound

Part Number Sales Unit

063002-033	Net wt 5.3 oz Tube
------------	--------------------

Non-Curing release agent. Applications: mold release agent, mold break-in, release agent for adhesives, release agent for plastic extruders, lubricant for plastics and elastomers.



## Chemicals - Sealant RTV

### Dow Corning 732 Multi-Purpose Sealant

Part Number Sales Unit Color

065031-001	Net wt 10.3 oz Cartridge	Clear
065031-002	Net wt 3 oz tube	Clear
065031-003	Net wt 3 oz tube	Black

Used for general sealing and bonding. One part nonslumping RTV paste. Tough, rubbery solid. Used on gaskets and terminal blocks



### Dow Corning RTV Sealant 734 Flowable Sealant

Part Number Sales Unit

065031-005	Net wt 3 oz Tube
------------	------------------

100% silicone rubber. Self-leveling consistency. Forks flexible, long lasting seal. Extreme temperature performance. Applications: Making formed in place gaskets, filling minute cracks and crevices, sealing electrical equipment, sealing threads, coating fabrics and encapsulating small components. Used on heaters in freezer applications.



### Dow Corning 748 Non-Corrosive Sealant

Part Number Sales Unit Color

065031-004	Net wt 10.3 oz Cartridge	White
065031-007	Net wt 3.3 oz Tube	White

100% silicone rubber, safe for food contact, non-corrosive, -67° F to 350° F. Applications: Sealing corrosion-sensitive electrical & electronic equipment (electrical connections, wire entries, power and control cable connections, etc.), bonding and sealing food processing equipment. Formed-in-place gaskets for sensitive substrates. Used on modules and distribution panels.



## Chemicals - Gasket Sealer

### Form-A-Gasket Sealant Liquid

Part Number Sales Unit

065005-001	Net wt 16 oz Can
------------	------------------

Resists hot and cold water, antifreeze, glycerine, fuel oil, kerosene, butane, and other fluids. Pressure resistant and leakproof to high octane gasoline, grease and lubricating oils. Applied as liquid changes to paste in a few seconds.



### Loctite Hi-Tack Gasket Sealant 30525

Part Number Sales Unit

065005-002	Net wt 16 oz Can
------------	------------------

Red-colored, liquid sealant that holds gaskets in place during assembly. Seals and bonds rubber, cork, paper, felt, metal and asbestos gaskets. Sets quickly to a very tacky film.



### Permatex High Tack Spray-A-Gasket Sealant

Part Number Sales Unit

065005-004	Net wt 12 oz Can
------------	------------------

Fast-drying all-purpose sealant dries to a highly tacky, non-brittle film. A reliable general adhesive. Remains effective under temperatures of -65°F to 500°F (-54°C to 260°C). Resists gasoline, oil, antifreeze, axle lube, kerosene, propane and butane. Suggested Applications: Valve covers, fuel pumps, carburetors, manifold gaskets; seals all felt, cork, metal, paper, rubber and asbestos gaskets.





# Filter Cross Reference



Oil & Transmission Filters  
364100-xxx



Fuel Filters  
364300-xxx



Hydraulic Filters  
364500-xxx



Fuel/Water Separators  
364600-xxx



Air Filters  
364200-xxx

OE Number	Crown Part Number
<b>AC Delco (AB)</b>	
550C	364200-024
A1033C	364200-027
A5004	364200-027
A529C	364200-036
PF1051	364100-008
PF1056	364100-051
PF1091	364500-009
PF1097	364500-014
PF1127	364100-046
PF1180	364100-057
PF1212	364100-017
PF1218	364100-048
PF1222	364100-008
PF1230	364100-008
PF1233	364100-041
PF1237	364100-065
PF1238	364100-044
PF1250	364100-049
PF13	364100-020
PF17	364100-052
PF20	364100-057
PF2057	364100-067
PF2072	364500-011
PF2112	364100-065
PF2123	364100-044
PF2132	364100-050
PF2135	364100-065
PF2140	364100-050
PF2191	364100-050
PF2203	364100-051
PF2210	364100-050
PF28	364100-052
PF41	364100-044
PF46	364100-019
PF48	364100-031
PF881	364500-009
PF9	364100-047
PF926	364500-005
PF952	364100-050
PF960	364100-045
T1068	364300-017
WF114	364900-001
X116	364100-017
X119	364100-046
X120	364100-008
X124	364100-017
X13	364100-050
X15	364100-044
X18	364100-044
X1K	364100-020
X20	364100-044
X46	364100-008
X7	364100-050
X72	364100-075
X9	364100-044
XD701	364300-013

OE Number	Crown Part Number
<b>Allis Chalmers/Tusk (AC)</b>	
0232578	364100-005
0237000	364100-005
0255191	364100-026
0681546	364900-001
0697635	364900-001
1004421	364200-018
10044213	364200-018
1004652	364200-018
10046522	364200-018
10050698	364300-003
10050789	364300-003
1014120	364100-038
1014121	364100-026
1122177	364100-026
1140887	364200-018
20974077	364200-007
240760	364200-007
243163	364200-003
246364	364200-007
246366	364200-007
247060	364200-007
2470607	364200-007
251397	364300-003
2513976	364300-003
252050	364300-003
3100276	364100-035
4059263	364100-016
4059343	364100-016
4060050	364300-003
40600504	364300-003
4135600-0	364100-050
43905934	364100-016
4490296	364300-003
4511629	364100-005
4512207	364100-016
4530702	364100-007
4789026	364200-003
4855745	364100-034
4900600	364100-016
4905902	364100-035
4906397	364100-035
4907794	364200-002
4907795	364200-003
4910328	364100-038
4910775	364100-005
4910810	364100-005
4915223	364100-036
4915238	364200-007
4915347	077145
4940471	364400-004
4941243	364500-003
4941711	364500-004
4942265	364100-001
4942493	364100-001
4942494	364100-005
4942587	364200-003

OE Number	Crown Part Number
4942657	364100-036
4945308	364400-004
4947751	364100-034
4948738	364100-050
4948955	364100-001
4949078	364200-002
4966684	364100-020
4968759	364100-037
4996245	364200-003
4997958	364100-036
4999447	364100-035
62703506	364100-026
639050	364200-003
70239518	364200-002
70240760	364200-007
70243163	364200-003
70246364	364200-007
70246366	364200-007
70247060	364200-007
70639050	364200-003
72470607	364200-007
73100276	364100-035
74059263	364100-016
74059343	364100-016
74512207	364100-016
74530702	364100-007
74789026	364200-003
74855745	364100-034
74900600	364100-016
74905902	364100-035
74906397	364100-035
74907794	364200-002
74907795	364200-003
74915043	364300-003
74915238	364200-007
74915347	077145
74920158	364100-004
74941575	364200-002
74942265	364100-001
74942493	364100-001
74942587	364200-003
74943271	364200-002
74947751	364100-034
74947978	364100-007
74948955	364100-001
74949078	364200-002
74996245	364200-003
74996253	364200-002
74999447	364100-035
8760118	364100-041
8761948	364100-014
8763270	364100-037
8765210	364100-030
8765656	380102-335
8767408	364200-014
8774110	380101-879
8775054	364100-015

OE Number	Crown Part Number
8775086	364200-026
8775575	364100-015
DE65245	364100-016
DHD222	364100-034
DPF20	364100-037
DPF2072	364500-011
DPF56	364100-038
DPF855	364100-035
DPF881	364500-009
DPF939	364100-026
<b>Baker (BK)</b>	
0009830608	364100-034
0009830608V	364100-034
0009830621	364100-068
0009831615	364300-001
0009831617	364300-001
0009831625	364300-001
0009831625V	364300-001
0009831631	364200-018
0009831647	364300-001
0009831647V	364300-001
0009839012	364200-027
0009839012V	364200-027
068127177B	364300-001
101052	077145
101053	364100-007
101254	364100-016
1035337001	364300-003
1036728001	364100-038
104170	364200-003
118740	364100-022
126695	364100-007
135396	364100-022
151418	364300-001
3562229031	364100-077
400204	364100-005
737J1	364200-009
737R1	364100-016
737W1	364100-016
9033AY1	364200-002
9033BM1	364200-003
9830606	364100-020
9830608	364100-034
9830621	364100-068
9831625	364300-001
9831631	364200-018
9839012	364200-027
A0102	364100-020
G151310232900	364300-009
L0009830600N	364100-026
L0009830607	364100-045
L0009830621	364100-068
L0009831615	364300-001
L0009831617	364300-001
L0009831647	364300-001
L0160000002	364100-032
L0312225208N	364100-026

Note: More crosses available; contact your dealer.

Baker Continued ▶

# Filter Cross Reference

Baker Continued

OE Number	Crown Part Number
L1160024	364100-032
L1174418	364100-032
L68115561BN	364100-026
L68115561N	364100-026
L7995000510	364100-032
LAE725006049	364100-044
LF9454982	364500-009
LFM8000435	364100-016
LFM8102165	364100-044
LH17W04	364100-032
LPC202	364100-032
LW94018	364100-032
XVW074115562	364100-068
<b>Baldwin (BW)</b>	
B113	364100-001
B114	364100-045
B114B	364100-045
B120	364100-037
B125	364100-028
B132	364100-050
B1400	364100-065
B1402	364100-015
B1405	364100-076
B141	364100-047
B141B	364100-047
B1428	364100-048
B1428B	364100-048
B143	364100-009
B1431	364100-067
B1431B	364100-067
B159	364100-017
B159B	364100-017
B160	364100-031
B161	364100-008
B161-S	364100-008
B161SB	364100-008
B163	364100-020
B173-S	364100-004
B178	364100-022
B2	364100-005
B227	364100-046
B227B	364100-046
B228	364100-044
B228B	364100-044
B233	364100-050
B243	364100-039
B247	364100-010
B252	364100-034
B253	364100-034
B27	364100-012
B31	364100-019
B329	364100-049
B33	364100-041
B34	364100-023
B35-S	364100-003
B37	364100-011
B421	364100-002
B421B	364100-002
B43	364100-024
B43-S	364100-024
B50	364100-016
B7042	364100-013
B7049	364100-014
B7125	364100-028
B7144	364100-033
B7144B	364100-033

OE Number	Crown Part Number
B7181	364100-025
B7240	364100-066
B7240B	364100-066
B7243	364100-071
B7290	364100-075
B7306	364100-027
B7333	364100-069
B7446	364100-043
B75	364100-051
BD7154	364100-077
BD7154B	364100-077
BF1110	364300-015
BF1110B	364300-015
BF1210	364500-001
BF1257	364300-005
BF1257B	364300-005
BF1258	364300-004
BF1258B	364300-004
BF1261	364300-013
BF1261B	364300-013
BF1280	364300-017
BF1280B	364300-017
BF5800	364300-002
BF587	364300-001
BF7633	364300-007
BF7534	364600-003
BF7673	364300-008
BF7673B	364300-008
BF7673D	364300-008
BF7675	364500-001
BF7675B	364500-001
BF7675D	364600-002
BF7683	364300-010
BF7683B	364300-010
BF7760	364300-018
BF7760B	364300-018
BF7766	364300-019
BF7766B	364300-019
BF7863	364300-011
BF7932	364300-016
BF7957	364300-014
BF825	364300-003
BF9894	364300-020
BPH13A	364100-012
BPH8A	364100-005
BT215	364100-038
BT216	364100-026
BT217	364100-064
BT217B	364100-064
BT223	364100-030
BT259	364100-052
BT259B	364100-052
BT260-10	364100-036
BT282-10	364100-035
BT287-10	364100-029
BT310	364100-006
BT344-S	364100-021
BT351	364500-009
BT351B	364500-009
BT364	364100-007
BT389-10	364500-014
BT389-10B	364500-014
BT427	364100-032
BT7237	364100-078
BT7237-MPG	364100-078
BT8301B	364100-057

OE Number	Crown Part Number
BT839-10	077145
BT8409	364400-001
BT8428-MPF	364100-040
BT8439-MPG	364400-003
BT8449-10	364100-035
BT8449-10B	364100-035
BT8472	364500-008
BT8472B	364500-008
BT8493	364400-002
BT8840-MPG	364100-018
BT9422	364500-013
BW5086	364900-002
BW5086B	364900-002
P7308	364100-068
PA1667-FN	364200-003
PA1681-FN	364200-018
PA1690-FN	364200-002
PA1822-FN	364200-036
PA1822-FNB	364200-036
PA1865-FN	364200-007
PA2221	364200-004
PA2360-FN	364200-024
PA2450	364600-001
PA2575	364200-006
PA2576	364200-016
PA2725	364200-022
PA2778-FN	364200-001
PA2949-FN	364200-025
PA3608-FN	364200-020
PA3612	364200-027
PA3651-FN	364200-028
PA3792	364200-037
PA3792B	364200-037
PA3805-FN	364200-005
PA3833	364200-011
PA3989-FN	364200-041
PA3989-FNB	364200-041
PA640	364200-009
PF717	364300-009
PF717B	364300-009
PT381	364500-011
PT510	364500-001
PT83	364500-005
PT83B	364500-005
PT9167	364500-007
PT9448	380030-114
RS3528	364200-013
RS3529	364200-017
RS3542	364200-039
RS3543	380030-009
RS3544	364200-026
RS3544B	364200-026
RS3545	364200-031
RS3549	364200-010
RS3703	364200-015
RS3703B	364200-015
RS3704	364200-021
RS3704B	364200-021
RS3705	364200-042
RS3716	364200-014
RS3747	364200-023
RS3920	364200-040
RS3920B	364200-040
RS3940	364200-008
RS3940B	364200-008
RS4131	364200-019

OE Number	Crown Part Number
RS4578	380030-123
<b>Bosch (BQ)</b>	
1-457-429-619	364100-068
1-457-429-838	364200-027
1-457-434-103	364300-013
1-457-434-116	364300-013
1-457-434-118	364300-013
1-986-452-003	364100-020
1-986-452-006	364100-008
3312	364100-008
451-001-001	364100-050
451-001-002	364100-050
451-001-002-850	364100-050
451-001-053	364100-050
451-001-053-850	364100-050
451-001-150	364100-050
451-102-001	364100-044
451-102-002	364100-020
451-102-056	364100-044
451-102-901	364100-044
451-103-003	364100-020
451-103-011	364100-050
451-103-011-310	364100-020
451-103-012	364100-020
451-103-014	364100-020
451-103-018	364100-050
451-103-018-850	364100-050
451-103-019	364100-044
451-103-021	364100-044
451-103-022	364100-050
451-103-025	364100-020
451-103-026	364100-044
451-103-027	364100-075
451-103-029	364100-050
451-103-034	364100-075
451-103-035	364100-075
451-103-036	364100-075
451-103-040	364100-050
451-103-041	364100-050
451-103-041-850	364100-050
451-103-043	364100-044
451-103-044	364100-050
451-103-048	364100-075
451-103-049	364100-044
451-103-050	364100-044
451-103-073	364100-075
451-103-080	364100-075
451-103-084	364100-044
451-103-096	364100-044
451-103-127	364100-044
451-103-133	364100-050
451-103-136	364100-050
451-103-141	364100-050
451-103-142	364100-020
451-103-166	364100-050
451-103-167	364100-050
451-103-171	364100-020
451-103-901	364100-044
451-103-902	364100-020
451-103-903	364100-050
451-104-005-850	364100-052
451-104-065	364100-045
451-163-019	364100-075
451-203-003	364100-050
451-203-009	364100-026
451-203-009-850	364100-026

Note: More crosses available; contact your dealer.

Bosch Continued ▶

# Filter Cross Reference

Bosch Continued

OE Number	Crown Part Number
451-203-010	364100-064
451-203-012	364100-045
451-203-061	364100-045
451-203-088	364100-045
451-203-154	364100-020
451-203-194	364100-026
72101	364100-020
72103	364100-020
72177	364100-017
8244H	364100-008
9-450-732-002	364100-020
9-450-732-005	364100-020
9-450-732-006	364100-050
9-450-732-010	364100-044
9-457-280-14050	364100-052
9-457-281-270	364100-050
9-457-282-170	364100-020
9-457-282-190	364100-075
9-457-282-440	364100-008
986-452-003	364100-050
986-452-006	364100-008
986-452-007	364100-046
986-452-008	364100-047
986-452-019	364100-075
986-452-028	364100-041
986-452-903	364100-020
986-452-917	364100-041
986-452-928	364100-041
O004	364100-041
O133	364100-044
O213	364100-044
O219	364100-050
O222	364100-050
O231	364100-050
O314	364100-020
O317	364100-041
O626	364100-045
OF124	364100-045
OF152	364100-045
OF160	364100-045
OF162	364100-050
P1150	364100-050
P2003	364100-050
P2006	364100-008
P2007	364100-046
P2008	364100-047
P2028	364100-041
P2056	364100-044
P3010	364100-064
P3012	364100-045
P3029	364100-050
P3050	364100-044
P3084	364100-044
P3136	364100-050
P3141	364100-050
P3142	364100-020
P3154	364100-020
P3166	364100-050
P3167	364100-050
P3171	364100-020
P3194	364100-026
P4065	364100-045
S9838	364200-027
<b>Caterpillar/Towmotor (CT)</b>	
0068147	364100-016
0068940	364200-003

OE Number	Crown Part Number
0313658	364100-005
0314361	364100-005
0329060	364100-026
0342449	364100-029
0349804	364500-011
0363992	364500-009
0663384	364200-018
0665459	364200-018
0665934	077145
0668373	364200-018
0684163	364200-018
0689401	364200-003
0694229	364100-005
0902900	364100-018
0938717	364200-018
0971215	364100-034
0971426	364200-007
0971427	364100-004
0971434	364100-006
0971451	364100-007
0971489	364100-038
0972415	364100-035
0972629	364100-034
0972961	364200-001
0973352	380103-911
0973412	364200-001
0973440	364100-006
0973608	364100-006
0973976	364100-003
0973999	364200-004
1014755	364100-002
1015177	364400-007
1015412	364200-028
1015623	364500-003
1032901	364300-015
1033496	364200-018
1033660	364500-010
1036887	074105
1037452	364400-007
1037819	364100-002
1038604	364100-004
1039208	364100-007
1039649	364200-011
1039880	364100-015
1041296	364600-003
1041340	364100-015
1041426	364100-002
1041427	364100-015
1049852	077145
1049853	077145
1085330	364200-011
1090360	380102-358
1106326	364200-026
1146853	364100-033
1146934	364100-006
1157207	364400-007
1177394	077145
1194740	364500-012
1213661	364200-021
1232367	364200-039
1402334	364200-015
14049960	364200-027
14483050	364500-010
1467172	364200-021
1467472	364200-021
1767710	364100-075

OE Number	Crown Part Number
1N4402	364100-013
1N4402H	364100-013
1R0714	364100-051
1R0734	364100-007
1R734	364100-007
216434	364200-024
226-6567	364900-001
231-0167	364200-039
231-0168	380030-009
213007	364100-015
215044	364200-003
215120	077145
215488	364100-036
215999	364200-027
216318	364100-035
216434	364200-024
218660	364100-011
2W4246	380100-087
302877	364100-038
3063056800	364200-002
30A4000100	364100-015
30A4000101	364100-015
30A4000102	364100-015
30A4000103	364100-015
30A4000105	364100-006
313658	364100-005
314361	364100-005
329060	364100-026
32A3005300	380100-088
32B4000100	364100-033
32B4010100	364100-033
32C4000100	364100-006
342449	364100-029
3446200300	364300-015
3446211040	364600-003
3446221040	364600-003
349804	364500-011
349970	364100-029
361745	364300-003
363992	364500-009
364464	364100-005
371682	364100-038
386926	364100-021
3C2877	364100-038
3G6337	364500-012
3G6925	364500-012
3G6928	364100-021
3I0396	364200-018
3I0601	364500-005
3I0806	364200-018
3I0932	364200-018
3I1178	364300-017
3I1080	364300-001
3I1089	364100-052
3I1114	364100-003
3I1136	364100-050
3I1214	364100-020
3I1261	364100-050
3I1290	364900-001
3I1296	364100-026
3I1337	364100-051
3I1438	364500-005
3I1479	364100-065
3I1490	364100-020
3I1597	364500-009
3I1603	364100-006

OE Number	Crown Part Number
3I1627	364100-050
3I1663	364500-014
3I2109	364100-049
3I2132	364300-017
3I2147	364200-021
4T6788	364100-029
4T7948	364500-012
50020152	364500-009
50021437	364200-039
50021439	380030-009
50237043	364200-040
51209	364500-012
566B1405	364100-076
566B7290	364100-075
566BD7154	364100-077
566BD7176	364100-074
566BF1280	364300-017
566BF7760	364300-018
566BF7766	364300-019
566BT344S	364500-012
566BT38910	364500-014
566BT7237MPG	364100-078
566BT8417	364500-012
566BT8454	364500-013
566BW5073	364900-001
566BW5086	364900-002
566RS3705	364200-042
5882210072	364400-007
5C1791	364100-005
6-E-924	364500-012
6-I-1451	364200-017
6-N-1009	077145
64-9229E	364100-026
6437591800	364100-004
6562505300	364100-006
665459	364200-018
665934	077145
676987	364300-003
68147	364100-016
68148	364100-016
687744	364200-018
68940	364200-003
689401	364200-003
694229	364100-005
6A5162	364200-027
6A5162V	364200-027
6E0924	364500-012
6E0925	364500-012
6E924	364500-012
6G924	364500-012
6I1450	364200-013
6I1451	364200-017
6N1009	077145
7N9027	364200-016
7N9028	364200-006
7W2326	380103-911
7W2327	364100-005
7W2328	364100-038
7W2692	364200-006
7W6221	364100-026
817003	364100-075
8J1600	364100-029
8N5504	364200-006
8N5504E	364200-006
8N5540	364200-006
8N9586	077145

Note: More crosses available; contact your dealer.

Caterpillar/Towmotor Continued ▶

## Filter Cross Reference

Caterpillar/Towmotor Continued

OE Number	Crown Part Number
902900	364100-018
9042000460	364100-003
9042501750	364100-002
9042508220	364300-006
9042508330	380101-879
9122000500	364100-004
9122010500	364100-004
9122407100	364400-007
9122407101	364400-007
9126100040	364200-028
9126100041	364200-028
9126100700	364200-002
9126106700	364200-028
9127503300	364500-003
9127503301	364500-003
9127513000	364500-003
9127513300	364500-003
9127513301	364500-003
9127605100	364100-004
9136100900	364200-011
9136100901	364200-011
9136103300	364200-011
9136110900	364200-011
9136113300	364200-011
9137503800	380030-114
9186101600	364200-041
9186105600	364200-018
9187501400	364500-010
9187505900	364500-010
9187511400	364500-010
9196507800	380101-880
91A6500611	364300-006
91B6100112	364200-021
91B6100912	364200-014
91E6100112	364200-010
91E6100600	380100-103
91H2001870	364100-014
91K6101700	380030-009
91K6102300	380030-009
93A2405500	380102-334
971215	364100-034
971216	364200-009
971217	364200-002
971251	364100-001
971289	364100-020
971309	364100-020
971357	364300-003
971426	364200-007
971427	364100-004
971434	364100-006
971441	364100-012
971451	364100-007
971489	364100-038
971630	364100-020
972225	380102-328
972415	364100-035
972422	364100-020
972545	364100-020
972597	364100-005
972629	364100-034
972703	364100-001
972961	364200-001
973356	364100-022
973412	364200-001
973440	364100-006
973608	364100-006

OE Number	Crown Part Number
973976	364100-003
973999	364200-004
9G6926	364500-012
9I2646	364100-006
9L9054	364100-007
9L9200	364100-007
9N3717	364900-001
9N5570	364100-007
9N5680	364100-007
9T5664	364100-029
9Y0858	364100-051
9Y4450	364100-052
9Y4455	364100-003
9Y4479	364100-026
9Y4480	364100-038
9Y4487	364100-020
9Y4492	364100-044
9Y4494	364100-006
9Y4506	364100-050
9Y4507	364100-006
9Y4523	364500-005
9Y4532	364900-001
9Y6841	364200-018
9Y858	364100-051
A000000063	364200-010
A000000313	364100-016
A000002445	364500-002
A000002806	364200-008
A000003164	364100-015
A000003273	364200-011
A000003458	364200-021
A000005479	364100-011
A000009231	364500-010
A000010905	364200-026
A000013911	364300-002
A000015985	364300-009
A000016007	364300-017
A000027284	364100-078
A000031589	364500-012
A218649	364100-012
A218869	364200-029
A218870	364200-030
D180237	364200-006
D490060	364200-029
D490416	364200-030
D501564	364500-002
E38874	364100-020
FW17	364900-001
FW9AFP	364900-001
GE924	364500-012
LE3ADG6926	364500-012
LM40DQ9804	364500-011
LM4ODQ9804	364500-011
MCF00321	364100-021
MD001445	364100-004
MD001450	364100-004
MD005445	364100-004
MD005450	364100-004
MD007095	364100-004
MD007360	364100-004
MD013661	364100-013
MD01445	364100-004
MD017410	364100-004
MD030795	364100-004
MD031805	364100-004
MD041462	364100-004

OE Number	Crown Part Number
MD071462	364100-006
MD071462/A	364100-004
MD084693	364100-015
MD108063	364400-002
MD135707	364100-015
MD135737	364100-015
MD136466	364100-002
MD136780	364100-015
MD136790	364100-002
MD162326	364100-006
MD322508	364100-015
MD325714	364100-015
MD332687	364100-002
MD352626	364100-002
MD360935	364100-015
ME013661	364100-013
MM200570	364200-007
MM220900	364600-003
MM310860	364100-004
MM315200	364100-004
MM404981	364200-007
MM433093	364300-009
MO031805	364100-015
NA087002	074105
<b>Champ/Luberfiner (CH)</b>	
HP1	364100-034
L296F	364300-003
LAF1275	364200-002
LAF1732	364200-027
LAF1820	364200-006
LAF222	364200-003
LAF2745A	364200-007
LAF4246	364200-022
LAF4544	364200-026
LAF5042	364200-020
LAF8157	364200-025
LAF8630	364200-001
LFF3417	364300-017
LFF3504	364300-001
LFH4268	364500-009
LFP2215	364100-020
LS165	364100-075
LS99	364100-075
PH16	364100-001
PH227K	364100-020
PH228	364100-002
PH2808	364100-037
PH2830	364100-030
PH2835	364100-011
PH2841	364100-038
PH8862	364100-075
<b>Chrysler (CY)</b>	
3549957	364100-050
3685741	364100-050
3838011	364100-047
4026486	364100-047
4186165	364100-047
4417559	364100-050
4417560	364100-050
44199700	364100-050
5281090	364100-023
75221481	364100-050
83501080	364100-050
L1008	364100-050
L19	364100-050
L19V	364100-050

OE Number	Crown Part Number
L19X	364100-050
L31750	364100-052
L319	364100-020
L530	364100-020
MD017440	364100-046
MD136790	364100-046
T0730077	364100-047
T1365661	364100-020
X3549957	364100-050
<b>Clark (CL)</b>	
1232560	364300-009
1238466	364500-013
1375550	364400-002
1618480	380102-357
161WA258	364200-018
161WA357	364200-018
1624567	364200-018
1670331	364200-007
1765756	380105-919
1800976	364100-016
1801141	364100-034
1803991	364200-003
1803993	364200-002
1803995	364200-001
1804012	364200-016
1804038	077145
1804039	364100-029
1804041	364100-035
1804042	364100-013
1804045	364100-006
1804048	364100-016
1804053	364100-034
1804054	364100-020
1804059	364100-050
1804065	364100-009
1804067	364100-006
1804073	364100-020
1804075	364100-021
1804081	364100-037
1804082	364100-013
1804083	364100-017
1804084	364100-001
1804085	364100-008
1804087	364100-003
1804088	364100-006
1804090	364100-044
1804107	077145
1804109	364200-020
1804110	364200-003
1804122	364300-015
1804129	364500-011
1804130	364500-009
1804133	364200-013
1804134	364200-017
1804139	364100-006
1804160	364400-004
1804169	364200-011
1804170	364100-014
1804185	364100-012
1804193	380102-343
1804194	364100-041
1804199	364100-035
1804200	364600-003
1804201	364200-002
1804223	364200-027
1804225	364200-003

Note: More crosses available; contact your dealer.

Clark Continued ▶

# Filter Cross Reference

Clark Continued

OE Number	Crown Part Number
1804420	364100-032
1805375	364200-021
1810143	380102-356
1810437	380102-357
1810620	380102-357
1810884	364100-026
1810918	380102-328
1810935	364100-038
1815007	364200-003
1815143	364100-076
1902215	364200-018
1917097	364100-018
1992366	364300-017
218869	364200-029
218870	364200-030
220070365	364500-011
2353816	364200-002
2373789	364200-004
2393449	364200-024
2399992	364200-004
247050	380030-046
26561118	364300-001
2786616	364100-018
2791707	364200-010
2817055	364100-012
2P0661	364100-016
3000063	364500-012
3000084	364500-011
3006350	364500-012
3040205	364500-011
3042173	364200-010
3042258	364500-012
3043684	364600-003
3140102	364500-012
3143748	364500-012
3291008	364300-003
3338969	364300-003
3339643	364100-026
3340165	364100-037
3493878	364200-002
3575976	364900-001
3580376	364200-007
3653017	364500-009
3734465	364100-038
3734468	364100-038
3736405	364100-044
3736833	364100-020
3777841	364100-026
3779228	364300-003
3779685	364100-007
3918206	364100-001
3974113	364100-006
3974113-B	364100-046
3974896B	364100-050
3981922	364300-003
411975	364100-032
4127481	364100-032
4203691	364100-018
4307873	364600-003
4317841	364500-009
4318784	364500-009
4335192	364100-015
4352191	364100-022
4367855	364100-008
448055	364400-007
448215	364500-010

OE Number	Crown Part Number
6511766	364100-026
6515541	077145
6516722	077145
6552449	364100-029
6591038	364100-029
6598361	364200-003
6599543	364100-018
6632745	364100-004
6644015	364100-047
6644210	364100-047
6647773	364300-005
6653968	364300-009
6661248	364100-018
6666333	364200-010
6666334	364200-015
6666376	380030-009
6667352	364300-005
6669547	364200-021
6676705	364200-015
668788	364200-009
7000484	364200-028
7004639	364900-001
7021037	364100-075
7024278	364900-001
733289	380102-356
739411010	364600-003
783407	364200-009
800038169	364900-001
8021179	364200-029
8021590	380030-009
8027765	364100-002
8048681	364100-078
870299	364500-009
871975	380105-920
883687	380102-356
886525	364200-003
889098	364200-002
892842	364100-036
897064	364200-007
900010	364900-001
904318	364300-009
907211	364300-003
907823	364100-005
909213	364100-004
910207	364100-020
910535	364100-026
910758	364100-052
910780	364100-073
910814	380105-923
913556	364300-017
918250	364100-015
918648	364100-002
919996	380102-355
920519	380103-915
920665	364600-003
922138	364100-003
923801	364200-010
925682	364500-003
925952	364100-002
926293	364100-015
928543	364100-003
928825	364300-017
930770	364100-015
931800	364100-006
932675	364100-002
948418	364900-001

OE Number	Crown Part Number
949418	364900-001
949844	364300-003
960044	364900-001
960698	380103-911
960978	364900-001
961673	364900-001
978418	364900-001
990936	364100-016
990937	364100-005
992221	364100-034
994579	077145
997239	364200-003
997393	364100-029
AF4066	364200-027
FAC1000350	364500-003
FS1280	364300-017
HCF11054	364200-018
HCF11590	364200-018
HCF14205	364200-018
HCF15919	364200-018
HF6107	364100-034
HF6149	364500-011
HF6160	364100-035
HF6177	364500-009
HF6351	364100-034
HF7933	364100-035
LF3310	364100-044
LF3328	364100-051
LF3536	364100-008
LF3537	364100-008
LF3593	364100-051
LF3653	364100-032
LF4014	364100-044
LF4056	364100-032
LF701	364100-026
MD135753	364100-015
<b>Daewoo (DW)</b>	
0750-131-061	364500-013
130-3539	364900-001
141106	364200-017
141107	364200-013
213624	364200-015
3446221040	364600-003
4720292	364200-013
P551329	364300-017
P552126	364900-002
P552200	364300-019
P552203	364300-018
P559000	364100-077
65055105009	364100-025
65055105015	364100-025
65055105021	364100-025
65125017028B	364600-003
65125035011	364300-004
65125035016	364300-004
65125155006	364300-015
65125155008	364600-003
65215017028B	364600-003
7W2327	364100-005
9912-15115	364900-001
A138746	364500-013
A213624	364200-015
A213625	364200-010
A213938	364200-015
A213939	364200-010
A218226	364100-065

OE Number	Crown Part Number
A218649	364100-012
A218869	364200-029
A218870	364200-030
A223181	380102-006
A232028	364100-003
A251025	364100-026
A273017	364400-004
A273757	364100-025
A273813	364600-003
A293020	364600-003
D140182	364100-021
D141100	364100-013
D141106	364200-017
D141107	364200-013
D141121	364200-017
D144020	380102-358
D160552A	364100-026
D161308	364300-001
D164821	364500-011
D180237	364200-006
D180238	364200-016
D470244	364200-015
D470245	364200-010
D490060	364200-029
D490416	364200-030
D501564	364500-002
D501696	364500-001
K1019575	364400-001
P550520	364100-078
<b>Donaldson (DN)</b>	
21915-99003	364900-001
21915-990032	364900-001
A052526	364200-002
A065007	364200-003
AO80031	364200-018
CFP554073	364900-001
DU770CT	364200-018
DU770T	364200-018
ELF7680	364100-007
ELF7900	364100-077
FFP170915	364300-002
FFP550439	364300-017
FHG080147	364200-036
FHG080193	364200-018
FHG080286	364200-018
FHG080297	364200-018
FHG080318	364200-018
FHG080491	364200-036
FL915-99003	364900-001
FPG057511	364200-021
FPG057512	364200-021
FPG057513	364200-021
FPG057514	364200-021
FPG065011	364200-015
FPG065411	364200-015
FPG065424	364200-015
FPG065432	364200-015
FPG065433	364200-015
FPG065459	364200-015
FPG065530	364200-015
FPG070006	364200-039
FPG070009	364200-039
FPG070017	364200-039
FPG070018	364200-039
FPG070019	364200-039
FPG070020	364200-039

Note: More crosses available; contact your dealer.

Donaldson Continued ▶

## Filter Cross Reference

Donaldson Continued

OE Number	Crown Part Number
FPG070059	364200-039
FPG070060	364200-039
FW9B	364900-001
FWA060062	364200-018
FWA080022	364200-018
FWA080027	364200-018
FWA080031	364200-018
FWA080046	364200-018
FWF080061	364200-018
FWG080013	364200-018
FWG080023	364200-018
FWG080026	364200-018
FWG080028	364200-018
FWG080038	364200-018
FWG080044	364200-036
FWG080045	364200-018
FWG080057	364200-018
FWG080070	364200-018
FWG080073	364200-018
FWG080074	364200-018
FWG080085	364200-018
FWG080089	364200-018
FWG080097	364200-018
FWG080117	364200-018
FWG080119	364200-018
FWG080124	364200-018
FWG080141	364200-018
FWG080146	364200-018
FWG080196	364200-018
FWG080380	364200-018
G057511	364200-021
G057512	364200-021
G057513	364200-021
G057514	364200-021
G065424	364200-015
G065432	364200-015
G065433	364200-015
G070006	364200-039
G070009	364200-039
G070017	364200-039
G070018	364200-039
G070019	364200-039
G070020	364200-039
G070059	364200-039
G070060	364200-039
G070125	364200-039
KAX000512	364200-018
KAX002049	364200-018
KAX002420	364200-018
KAX002662	364200-018
LFP170007	364100-051
LFP170008	364100-005
LFP170025	364100-012
LFP170050	364100-016
LFP550020	364100-052
LFP550047	364100-024
LFP550051	364100-003
LFP550173	364100-004
LFP550227	364100-001
LFP552518	364100-050
LFP554403	364100-026
LFP556007	364100-051
P101146	364200-018
P101271	364200-018
P105368	364200-036
P107435	364200-018

OE Number	Crown Part Number
P107668	364200-036
P107868	364200-036
P108160	364200-018
P112329	364200-018
P115155	364200-018
P118652	364200-036
P124154	364200-018
P124173	364200-036
P124178	364200-018
P126040	364200-018
P132976	364200-018
P133653	364200-018
P134468	364200-006
P151145	364200-036
P154632	364200-036
P162017	364500-005
P163067	364100-035
P164375	364100-018
P164376	364100-018
P165243	364100-035
P168011	364100-024
P168090	364100-026
P168365	364100-051
P171534	364500-007
P171606	364500-008
P172527	364100-023
P172539	364100-022
P172540	364100-022
P172553	364100-024
P172654	364300-017
P172900	364500-014
P172931	364900-001
P172932	364900-001
P172933	364900-001
P181054	364200-018
P181060	364200-024
P181062	364200-024
P183215	364200-018
P184196	364200-018
P502007	364100-015
P502015	364100-041
P502019	364100-041
P502022	364100-044
P502049	364100-046
P502051	364100-008
P502062	364100-065
P502067	364100-065
P502069	364100-014
P502071	364100-046
P502080	364100-033
P502143	364300-015
P502161	364300-009
P526873	364200-009
P532410	364200-010
P533109	364200-013
P533110	364200-017
P534885	364200-023
P535337	364200-005
P537377	364200-004
P539507	364200-015
P542711	380030-009
P544098	364200-019
P546641	364200-011
P550020	364100-052
P550047	364100-024
P550072	364100-023

OE Number	Crown Part Number
P550083	364100-065
P550084	364500-001
P550095	364100-020
P550148	364500-009
P550162	364100-046
P550208	364100-050
P550210	364100-037
P550222	364100-034
P550243	364100-051
P550335	364100-030
P550351	364300-008
P550390	364600-003
P550422	364100-033
P550438	364300-017
P550439	364300-017
P550486	364500-012
P550520	364100-078
P550690	364300-005
P550726	364100-046
P550882	364100-020
P550963	364100-023
P550964	364100-048
P550965	364100-049
P551001	364300-004
P551176	364300-017
P551215	364500-011
P551241	364500-014
P551251	364100-050
P551307	364100-019
P551313	364300-007
P551324	364100-021
P551327	364100-034
P551329	364300-017
P551352	364100-028
P551740	364300-007
P552060	364900-001
P552073	364900-001
P552126	364900-002
P552200	364300-019
P552203	364300-018
P552224	364100-074
P552518	364100-050
P552849	364100-008
P554073	364900-001
P554403	364100-026
P554408	364100-038
P554685	364900-001
P554770	364100-039
P555461	364500-005
P555961	364500-005
P556005	364100-036
P556007	364100-051
P556245	364300-003
P557780	364100-045
P558616	364100-032
P559000	364100-077
P600501	364200-019
P606948	364200-025
P606953	364200-037
P610903	364200-008
P610905	364200-008
P770123	364200-018
P770372	364200-018
P770589	364200-026
P771538	364200-018
P771543	364200-018

OE Number	Crown Part Number
P772579	364200-039
P775300	380030-009
P775749	364200-001
P776730	364200-020
P777654	364200-008
P778404	364200-027
P779146	364100-052
P779150	364100-050
P779152	364100-026
P779164	364100-008
P779180	364100-024
P779184	364100-022
P779191	364100-019
P779193	364100-047
P779197	364100-020
P779208	364100-051
P779215	364100-044
P779217	364100-023
P779219	364100-044
P779523	364500-014
P779600	364500-014
P779612	364500-011
P779671	364100-037
P779961	364100-009
P812537	364200-021
P812543	364200-021
P812588	364200-014
P821575	364200-021
P822769	364200-015
P827653	364200-039
P827654	364200-008
P827655	364200-008
P828889	364200-026
P829332	380030-009
P829333	364200-031
P829964	364200-008
P831424	364200-014
PA640	364200-009
SBG1000343	364200-018
SMP771538	364200-018
SMP771543	364200-018
WA923	364900-001
WA923-5	364900-001
WA956	364900-001
WA9561	364900-001
<b>Doosan (DOS)</b>	
141106	364200-017
65.12503-5016	364300-004
65.12515-5008	364600-003
A213625	364200-010
A213938	364200-015
D141106	364200-017
D141121	364200-017
D501564	364500-002
K1019575	364400-001
<b>Fleetguard (FG)</b>	
0009863	364900-001
3300391S	364300-002
70501	364900-001
AA2922	364200-036
AF1606K	364200-024
AF1658	364200-007
AF1759	364700-001
AF1891	364200-016
AF2081	364900-001
AF25042K	364200-020

Note: More crosses available; contact your dealer.

Fleetguard Continued ▶

## Filter Cross Reference

Fleetguard Continued

OE Number	Crown Part Number
AF25070K	364200-003
AF25279	364200-013
AF25280	364200-017
AF25287K	364200-041
AF25291	364200-039
AF25292	364200-026
AF25308	364200-010
AF25337	364200-008
AF25337M	364200-008
AF25352	364200-026
AF25442	364200-028
AF25477	364200-011
AF25484	380030-009
AF25485	364200-031
AF25497	364200-015
AF25519	364200-015
AF25526	364200-039
AF25551	364200-021
AF25554	364200-023
AF25555	364200-039
AF25556	380030-009
AF25565	364200-040
AF25575	364200-021
AF25578M	364200-037
AF25588	364200-039
AF25648	364200-008
AF25854	364200-019
AF26193	364200-014
AF284	364200-009
AF2974	364200-024
AF3286	364700-001
AF3497	364200-016
AF4059K	364200-036
AF4066	364200-027
AF409K	364200-018
AF435K	364200-002
AF4536	364200-022
AF4573K	364200-025
AF4923K	364200-001
AF4924	364200-004
AF4941K	364200-018
AF70	364200-009
AF7996	364200-019
AG25576	364200-042
AH19065	364200-036
AH19066	364200-036
AH19083	364200-021
AH19084	364200-021
AH19085	364200-021
AH19086	364200-021
AH19091	364200-039
AH19092	364200-039
AH19093	364200-039
AH19094	364200-039
FF167	364300-003
FF2200	364300-019
FF2203	364300-018
FF4062	364300-001
FF5038	364300-017
FF5056	364300-017
FF5103	364300-009
FF5160	364600-003
FF5245	364300-007
FF5300	364300-015
FF5320	364300-007
FL2271979	364200-026

OE Number	Crown Part Number
FL26510342	364200-026
FL2976002	364200-026
FL2981113	364200-026
FL46562	364200-026
FL6005011111	364200-026
FL69800017	364200-026
FL7619404	364200-026
FL84036676	364200-026
FL873021003	364200-026
FL92793025	364200-026
FL9783	364200-026
FL993216	364200-026
FLAEM2668	364200-026
FLAF25292	364200-026
FLAF25352	364200-026
FLAF9969	364200-026
FLC17337	364200-026
FLCA5741	364200-026
FLDOP828889	364200-026
FLP770589	364200-026
FLP772580	364200-026
FLP774602	364200-026
FLP828889	364200-026
FLRS3544	364200-026
FLSA16580	364200-026
FLWGA1080	364200-026
FLX2950576	364200-026
FS1001	364300-004
FS1235	364300-005
FS1280	364300-017
FS19516	364300-008
FS19534	364300-005
FS19573	364500-001
HF28783	364400-001
HF28853	364500-012
HF28946	364500-010
HF35005	364100-065
HF35102	364500-008
HF35140	364500-013
HF35255	364500-001
HF6005	364100-036
HF6067	364100-029
HF6133	364100-029
HF6137	364500-014
HF6149	364500-011
HF6164	364100-057
HF6177	364500-009
HF6202	364500-005
HF6206	364100-007
HF6252	364500-010
HF6337	364100-021
HF6505	364100-040
HF6517	364100-018
HF6552	364100-018
HF6710	364100-029
HF6711	364500-014
HF6749	364500-014
HF7534	364500-014
HF7904	364500-007
HF7926	364100-021
HF7947	364500-009
HF929	364100-006
LF115	364100-005
LF117	364100-016
LF155	364100-044
LF16011	364400-001

OE Number	Crown Part Number
LF16015	364100-078
LF16176	364100-068
LF16224	364100-071
LF3306	364100-005
LF3309	364100-023
LF3310	364100-044
LF3311	364100-020
LF3314	364100-045
LF3328	364100-051
LF3335	364100-030
LF3336	364100-004
LF3338	364100-044
LF3339	364100-039
LF3341	364100-050
LF3345	364100-032
LF3361	364100-010
LF3377	364100-020
LF3378	364100-020
LF3400	364100-020
LF3434	364100-001
LF3435	364100-037
LF3451	364100-045
LF3462	364100-046
LF3466	364100-034
LF3486	364100-003
LF3501	364100-050
LF3547	364100-051
LF3568	364100-022
LF3587	364100-051
LF3588	364100-051
LF3599	364100-009
LF3600	364100-013
LF3604	364100-023
LF3614	364100-041
LF3615	364100-041
LF3624	364100-047
LF3679	364100-048
LF3681	364100-049
LF3690	364100-017
LF3692	364100-065
LF3703	364100-028
LF3713	364100-025
LF3714	364100-047
LF3758	364100-050
LF3766	364100-044
LF3776	364100-008
LF3812	364100-008
LF3855	364400-001
LF385F	364100-001
LF3886	364100-078
LF3933	364100-037
LF3948	364100-011
LF4014	364100-044
LF4015	364100-020
LF402	364100-046
LF4095	364500-009
LF417	364100-014
LF42502	364100-019
LF488	364100-033
LF542	364100-002
LF583	364100-012
LF607	364100-016
LF678	364100-052
LF67822	364100-052
LF689	364100-050
LF700	364100-038

OE Number	Crown Part Number
LF701	364100-026
LF701ER	364100-026
LF711	364100-024
LF716	364100-008
LF769	364500-005
LF780	364100-024
LF785	364100-022
LF796	364100-019
LF798	364100-047
LF9001	364100-077
LF9011	364100-077
LF9018	364100-077
LF9024	364100-074
LFH4955	364100-029
PF2160	364500-012
WF1012	364900-001
WF2012	364900-001
WF2053A	364900-001
WF2061	364900-001
WF2073	364900-001
WF2125	364900-002
WF2126	364900-002
<b>Ford (FD)</b>	
11425472	364100-020
11464467	364100-050
11464498	364100-050
11525472	364100-050
130366060	364300-009
1457512	364100-044
1482151	364100-050
1498017	364100-050
1498022	364100-044
1508831	364100-050
1515160	364100-050
1520660	364100-050
1536304	364100-044
1553370	364100-044
1555451	364100-050
1559937	364100-044
1651563	364900-001
1696300351	364900-001
178562	364100-020
1S7Z-6731-DA	364400-001
26550001	364900-001
3315115	364900-001
3963907	364100-026
40491	364900-001
457412	364500-009
5000185	364100-050
5000480	364100-044
5000513	364100-026
5001156	364100-050
5001248	364100-050
5002230	364100-050
5002530	364100-044
5003329	364100-044
5003331	364100-044
5003455	364100-046
5003456	364100-008
5003914	364100-044
5003929	364100-044
5003930	364100-044
5003967	364100-044
5003968	364100-044
5004264	364200-027
5004388	364100-008

Note: More crosses available; contact your dealer.

Ford Continued ▶

## Filter Cross Reference

Ford Continued

OE Number	Crown Part Number
5004926	364100-044
5004930	364100-050
5005079	364100-008
5005080	364100-008
5005572	364100-044
5006227	364100-047
5007222	364100-050
5008589	364100-050
5008677	364100-050
5008720	364100-044
5008721	364100-044
5008722	364100-044
5009088	364100-044
5009421	364100-050
5010292	364100-017
5012037	364100-050
5012555	364100-044
5012580	364100-045
5013149	364100-050
5013319	364100-044
5018034	364300-013
5022798	364100-008
5023923	364300-013
542957	364100-020
5582	364250-001
6041176	364100-044
6063340	364100-050
6066094	364100-044
6066095	364100-044
6066096	364100-044
70HM-6714-AA	364100-050
741M-6714-BA	364100-044
741M-6714-CA	364100-044
74HM-6714-BA	364100-026
78HM-6714-AA	364100-050
78TM-6714-BA	364100-050
81SM-6714-A3A	364100-044
81SM-6714-A4A	364100-044
83970552	364300-009
83971969	364900-001
83987767	364900-001
949418	364900-001
9613322	364100-052
9613324	364100-026
9613327	364100-045
9912-15115	364900-001
991215115	364900-001
9N-6123	364900-001
A690X-6A692-RA	364100-044
A700X-6714-AA	364100-044
A700X-6714-JA	364100-044
A720X-6714-FA	364100-044
A730X-6714-AA	364100-044
A730X-6714-BA	364100-026
A740X-6714-CA	364100-050
A760X-6714-KA	364100-044
A770X-6714-ABA	364100-044
A770X-6714-ACA	364100-044
A770X-6714-BA	364100-044
A770X-6714-DA	364100-044
A770X-6714-GA	364100-008
A770X-6714-NA	364100-044
A770X-6714-SA	364100-044
A770X-6714-TA	364100-044
A780X-6714-AA	364100-008
A780X-6714-EA	364100-044

OE Number	Crown Part Number
A780X-6714-MA	364100-008
A780X-6714-NA	364100-008
A780X-9601-CA	364200-027
A790X-6714-BA	364100-044
A790X-6714-CA	364100-044
A800X-6714-AA	364100-047
A810X-6714-JA	364100-044
A810X-6714-KA	364100-044
A810X-6714-LA	364100-044
AFL5033	364100-047
AFL56	364100-008
C5ZZ-6731-A	364100-050
C6JZ-6714-A	364100-020
C6JZ-6714-B	364100-020
CCOZ-6714-AG	364100-020
D1RY-6731-A	364100-020
D27Z-6731-A	364100-008
D27Z-6731-ADP	364100-008
D4ZZ-6731-B	364100-050
D87Z-6731-A	364100-008
D8PJ-6714-AA	364100-020
D8PZ-6731-A	364100-020
E73Z-6731-B	364100-047
E7GZ-6731-A	364100-046
E7HZ8A424A	364900-001
E7NN-6714-DA	364100-050
E8BZ-6731-A	364100-046
E8HZ-4A420-A	364100-050
E8NN-6714-CA	364100-020
E92Z-6731-A	364100-008
E92Z-9731-A	364100-008
E9GZ-6731-A	364100-065
E9NN-6714-AA	364100-020
F1AE-6714-BC	364100-049
F1AZ-6731-A	364100-049
F1AZ-6731-BD	364100-049
F3HZ-8A424-D	364900-001
F3HZ-9162-A	364300-017
FL322	364100-038
FL813	364100-047
SBA130366050	364300-009
SBA130366060	364300-009
SBA140517020	364400-001
V104040	364900-001
V34778	364100-026
V88833	364300-017
<b>Fram (FR)</b>	
B328	364500-012
BPH43	364100-050
BT8417	364500-012
BT8417B	364500-012
C1191A	364300-003
C1723	364500-005
C1723A	364500-005
C7330	364100-065
C7361	364500-001
C7578	364500-001
CA4300	364200-027
CA5745	364200-039
CA7111SY	364200-027
CA7242	364200-027
CA8737	364200-026
CA9268	364200-019
CA9269	364200-019
CA9550	364200-021
CAK565	364200-036

OE Number	Crown Part Number
CAK8390	364200-018
CH2870A	364100-022
CH2872	364100-009
CH6482	364500-011
CH8530	364100-068
DG16	364100-020
DG2	364100-049
DG2849A	364100-008
DG2870A	364100-022
DG3387A	364100-024
DG3682	364100-001
DG3950	364100-004
DG3980	364100-003
DG43	364100-050
DG4967	364100-041
DG6607	364100-065
DG7317	364100-065
GH110	364100-023
HP-1	364100-034
K1532	364200-024
LFP815F	364300-002
LFP815FN	364300-002
P2805	364100-016
P2814	364100-050
P29195	364200-018
P3415	364100-035
P3761	364100-057
P3961	364500-014
P4157	364300-001
P4520	364300-013
P4886	364600-003
P5068	364100-007
P5157	364300-015
P5158	364500-009
P6808	364500-009
P6881	364100-018
P7040	364500-014
P7510	364300-013
P7542	364500-014
P7559	364500-009
P8267	364500-009
P8317	364500-012
P8334	364300-007
P8707	364500-012
P9280	364100-057
P961PL	364100-050
P9644	364300-019
PA2844	364100-050
PER3911	364900-001
PF9715	364100-065
PH16	364100-020
PH16FP	364100-020
PH2	364100-049
PH20	364100-052
PH208	364100-052
PH20A	364100-052
PH228	364100-020
PH28001	364100-023
PH28032	364100-026
PH28041	364100-026
PH2806A	364100-023
PH2807	364100-050
PH2815	364100-045
PH2816	364100-023
PH2816S	364100-022
PH2820A	364100-020

OE Number	Crown Part Number
PH2821C	364100-026
PH28231	364100-023
PH2832	364100-020
PH2835	364100-030
PH2840	364100-041
PH2844	364100-044
PH2849A	364100-006
PH2855	364100-020
PH2855A	364100-020
PH2857A	364100-023
PH2861A	364100-030
PH2861B	364100-050
PH2862C	364100-024
PH2863	364100-023
PH28631	364100-023
PH2868	364100-023
PH2870	364100-022
PH2870A	364100-022
PH2870B	364100-022
PH2871	364100-008
PH2879	364100-050
PH2885A	364100-038
PH2895	364100-075
PH2899	364100-050
PH28A	364100-039
PH2951	364100-017
PH2953A	364100-033
PH2954	364100-022
PH2957	364100-075
PH2964	364100-044
PH2966	364100-057
PH2978	364100-075
PH2990	364100-023
PH2993	364100-023
PH2FP	364100-049
PH3353	364100-019
PH3354	364100-024
PH3387	364100-024
PH3387A	364100-024
PH3387AFP	364100-024
PH3432	364100-019
PH35	364100-050
PH3503	364100-021
PH3506	364100-019
PH3508	364100-045
PH3516	364100-008
PH3545	364100-051
PH3567	364100-029
PH3569	364100-045
PH3593A	364100-058
PH3614	364100-030
PH3651A	364100-037
PH3664	364100-047
PH3807	364100-008
PH3807A	364100-008
PH3816	364100-044
PH3900	364100-032
PH3917	364100-008
PH3946	364100-047
PH43	364100-050
PH4386	364100-011
PH43FP	364100-050
PH4469	364100-051
PH4478	364100-023
PH4482	364100-047
PH46A	364100-075

Note: More crosses available; contact your dealer.

Fram Continued ▶



# Filter Cross Reference

Fram Continued

OE Number	Crown Part Number
PH4703A	364100-075
PH4722	364100-024
PH4722A	364100-024
PH4743	364100-026
PH48	364100-050
PH4824	364100-020
PH4826	364100-013
PH4883	364100-022
PH4913	364100-008
PH4967	364100-041
PH4998	364100-065
PH5	364100-048
PH5195	364100-008
PH5491	364100-023
PH5FP	364100-048
PH6010A	364100-046
PH6017	364100-065
PH6017A	364100-065
PH6607	364100-065
PH6682	364100-022
PH6811	364100-046
PH7226	364100-023
PH7328	364100-020
PH7575	364100-030
PH8	364100-034
PH8026	364100-033
PH8476	364100-028
PH8691	364100-077
PH922A1	364100-020
PH9566	364400-001
PH961	364100-057
PH965	364100-020
PH966B	364100-044
PH966B11	364100-044
PH9715	364100-065
PH977A	364100-052
PR3392	364900-001
PR3910	364900-001
PR8693	364900-002
PS7407	364300-008
PS8047	364300-004
TG4967	364100-041
TG6607	364100-065
TG7317	364100-065
XG2	364100-049
XG43	364100-050
XG5	364100-048
<b>General Motors (GM)</b>	
12339037	364100-008
12339909	364100-008
12339995	364100-041
1513904	364200-019
15153904	364200-019
15511626	364100-051
21000872	364100-019
25010251	364100-075
25010277	364100-047
25010766	364100-024
25010964	364500-005
25010965	364500-005
25011130	364100-026
25011131	364100-026
25011162	364100-052
25011292	364100-050
25011293	364100-050
25011354	364100-008

OE Number	Crown Part Number
25011574	364100-008
25011902	364100-051
25012001	364300-017
25012355	364500-011
25012428	364500-009
25012488	364500-014
25012895	364900-001
25013977	364100-048
25014422	364100-065
25014520	364100-049
25014818	364100-044
25026209	364100-047
25096246	364200-027
25160561	364100-048
25161877	364100-046
25161878	364100-008
25161879	364100-008
25161880	364100-041
25171946	364100-065
25313741	364100-051
3448991	364100-045
3448992	364100-045
4984919	364100-045
5577618	364100-020
5579164	364100-020
64363832	364100-052
6437419	364100-020
6437968	364100-052
6438162	364100-050
6439142	364100-050
6439143	364100-050
6439354	364100-047
6439355	364100-008
6439517	364100-008
6439518	364100-008
6488346	364200-036
650352	364100-044
650362	364100-045
650364	364100-044
650365	364100-044
650373	364100-044
650400	364100-044
6696776	364100-044
7884256	364100-044
7965049	364100-044
7965051	364100-044
7973235	364100-044
7973429	364100-044
7984229	364100-026
7984366	364100-050
7984655	364100-045
81093682	364200-036
813566	364300-013
88971573	364100-041
893156634	364100-008
90027778	364100-044
90166585	364300-013
9059521	364200-036
9059571	364200-036
91176162	364100-017
93156186	364100-044
93156299	364100-075
93156363	364100-045
93156665	364100-046
93156666	364100-008
93156670	364100-017

OE Number	Crown Part Number
93156769	364100-047
93891769	364300-013
94037791	364100-051
9414941	364100-046
94149418	364100-046
94201942	364100-047
94412815	364100-008
94456741	364100-046
94459700	364100-008
94847351	364100-041
94851874	364100-041
94853643	364100-041
94858995	364100-041
96058042	364100-017
97182282	364100-045
9974200	364200-027
9975227	364100-045
9975267	364100-075
P2275	364500-012
V1119324	364100-050
<b>Hyster (HY)</b>	
0127644	364100-012
01328692	380105-918
0156391	364200-018
0169741	364100-005
0180595	364100-007
0230413	364300-001
0231488	364100-005
0258237	364100-037
0259964	364100-005
0295599	364100-005
0305080	364200-003
0309112A	364100-020
0324692	364100-008
0327645	364300-003
0333642	364100-006
0369398	074105
0379411	364200-003
0803864	364300-003
0841244	364500-009
127644	364100-012
1304950	380101-996
1306331	364300-001
1307931	364200-018
1320000	364100-003
1320000-M	364100-003
1324476	364600-003
1327905	380103-911
1328691	364100-034
1328692	380105-918
1324476	364600-003
1330033	364600-003
1330342	380102-336
1334350	364600-003
1337159	380102-336
134887	364200-018
1350036	364100-043
1360190	364200-007
1360557	380102-336
1361808	364100-006
1368753	380103-919
1368758	364600-003
1368795	364600-003
1368864	364100-020
1369809	364200-002
1369907	364100-006

OE Number	Crown Part Number
1375550	364400-002
1377080	364200-010
1377093	380100-094
1377788	380103-914
1452112	380100-103
1462439	380030-123
1512430	364300-017
1515822	364100-077
1544792	380101-881
154818	364200-018
1559418	380030-064
156391	364200-018
1568700	364100-077
156931	364200-018
1584120	380030-068
169741	364100-005
170681	364200-018
176683	364100-032
179955	364200-018
180282	364100-016
180283	364100-020
1804017	364500-012
180595	364100-007
194740	364500-012
195852	364100-026
201571	364300-001
2021461	364100-020
2021933	364500-003
2021935	380102-349
2028654	364200-010
2033611	364200-002
2033682	364100-012
2034117	364200-021
2037740	380102-329
2038072	364100-003
2039646	364500-010
2039649	380102-350
2040364	364200-003
2040365	364200-026
2048047	364200-042
2070611	380102-337
2077983	380103-918
2305543	364100-035
2314368	364200-003
231488	364100-005
236093	380105-920
251755-12	364100-064
258237	364100-037
259025	364100-038
259264	364100-026
259964	364100-005
290732	364200-024
295599	364100-005
297865	364100-034
3000042	364500-009
3000043	364100-016
3000046	364100-005
3000047	364100-034
3000058	364100-050
3000059	364100-005
3000063	364500-012
3000065	364100-006
3000066	364100-007
3000068	364100-035
3000071	380100-092
3000084	364500-011

Note: More crosses available; contact your dealer.

Hyster Continued ▶

## Filter Cross Reference

Hyster Continued

OE Number	Crown Part Number
3000107	364200-006
3000111	364200-009
3000227	364100-035
3000231	364100-038
3000235	380102-356
3000238	380102-328
3000240	077145
3000243	364100-004
3000244	364100-036
3000249	364100-038
3000329	364200-003
3000331	364200-018
3000336	380100-089
3000339	364200-007
3000340	364200-003
3000346	380105-920
3000526	364200-003
3000538	077145
3000539	364100-001
3000856	364100-007
3000870	364100-064
3002377	077145
3002381	364200-002
3003599	364100-013
3005980	077145
3006174	364100-018
3006350	364500-012
3006884	074105
3006890	364200-004
3016477	364100-034
3020819	364200-028
3020900	364200-001
3020904	364600-003
3020906	364300-015
3020911	364200-002
3035679	364100-002
3035750	364200-003
3035751	364200-002
3035752	364100-016
3040015	364300-003
3040036	364100-005
3040047	364100-038
3040066	364200-002
3040204	364500-009
3040205	364500-011
3040874	364200-027
3040875	364300-003
3040987	364300-003
3041065	364200-016
3041500	364200-033
3041630	364100-030
3041828	364200-006
3041879	364300-003
3041904	364100-032
3042045	364100-032
3042059	364100-001
3042258	364500-012
3044227	364200-001
3044229	364200-003
3044230	364100-009
3043552	364200-003
3045509	364600-003
3049210	364300-015
305080	364200-003
3051156	364300-003
3051790	364200-002

OE Number	Crown Part Number
3051791	364100-016
3051792	364100-020
3051794	077145
3051898	364100-005
3052457	364100-038
3052867	364200-003
3052982	364200-002
3053707	364200-018
3065108	364500-003
3066680	364500-009
3070501	364900-001
3070503	364300-017
309112	364100-020
3101099	364100-044
3115428	364500-010
3120941	364400-007
3121285	364100-014
3122704	364100-033
3123959	364100-035
3124027	364100-015
3125150	364100-057
3125993	364100-036
3130925	364400-004
3131805	364300-017
3133746	364300-015
3134130	364100-026
3135948	364100-038
3135954	364200-010
313796	380102-336
3140102	364500-012
3140677	364400-001
3142484	364300-017
3142965	364200-002
3143748	364500-012
3172629	364500-003
324347	380105-923
324376	364200-002
324692	364100-008
326483	364200-002
327645	364300-003
333642	364100-006
336567	364200-024
342347	364300-015
369398	074105
375588	364100-003
379411	364200-003
42863BS	364100-026
5021	364100-026
80009809	364300-002
80009842	364100-017
80009848	364100-021
80009850	364100-007
80009855	077145
80009856	077145
80009887	364100-037
800019174	074105
800020939	364200-016
800023214	364100-037
800029694	074105
800030999	364200-015
800036083	364200-001
800036992	364100-007
800042000	074105
800050880	364100-011
800050990	364200-008
800057090	364100-007

OE Number	Crown Part Number
800057698	074105
800060556	364200-014
800062048	364100-017
800064076	364100-035
800064083	364100-035
800064140	364200-007
800068066	364200-004
800069148	364100-018
800070916	364100-015
800071711	364100-034
800076192	076755
800077915	364200-013
800077916	364200-017
800078728	364200-006
800086149	364200-011
800087373	364100-014
800087376	364100-003
800087400	364200-001
800119842	364100-015
800121569	364200-015
800121583	364200-020
800121854	364100-017
800121895	364100-017
800122432	364100-017
800123835	364100-001
800124003	364600-003
800126800	364300-009
800126810	364200-008
800132708	364100-078
800132711	364500-013
803864	364300-003
841244	364500-009
8500023	364400-002
865571	364300-001
865761	364200-002
S007624611	364200-039
<b>Jungheinrich (JU)</b>	
14043500	364300-003
140435002	364300-003
1404996	364200-027
14049960	364200-027
1410487	364200-018
14104870	364200-018
141048706	364200-018
1411463	364100-036
1432639	364600-003
14326390	364100-036
14341450	364300-003
1434228	364100-036
14342280	364100-036
1436599	364100-006
14365990	364100-006
143659900	364100-006
143659905	364100-006
1437927	364500-003
14379270	364500-003
1448305	364500-010
14483050	364500-010
14521664	364100-003
14712700	364200-027
14712720	364600-003
14719480	364600-003
440052940	364200-027
50020152	364500-009
50021437	364200-039
50021439	380030-009

OE Number	Crown Part Number
50033032	364200-026
50050362	364200-026
50158345	364200-027
50235644	364200-039
50236415	380030-009
50237043	364200-040
<b>Kalmar LMV (KM)</b>	
1005365	364200-018
114080	364500-009
119210	364500-012
1316602	364100-026
137769	364100-006
4048789	380105-920
4048796	380105-920
4531050	380102-003
4910983	380100-092
4941456	380105-922
4942265	364100-001
4942657	364100-036
4947979	380105-923
4948580	380101-997
4949208	380100-106
4949706	380100-088
4953804	380103-911
4997568	380100-089
800033699	364300-017
800045125	364100-077
807201965	364900-002
8761948	364100-014
8762282	380103-918
8764816	380030-009
8764821	380030-123
8767408	364200-014
8775054	364100-015
8775086	364200-026
904352	364500-009
920040001	364500-009
920090001	364500-009
9211040001	364100-026
92247104500	364500-009
9231080699	364500-009
9231200407	364500-009
9234360720	364200-039
9234360721	380030-009
9238290616	364100-018
923976.4754	364500-013
HGC257002	364500-009
PEC114916	364100-026
PEC257003	364100-026
PFC257004	364100-038
SHP904352	364500-009
<b>Komatsu (KO)</b>	
1-13240-122-0	364100-051
1-13240-160-1	364100-051
1-13240-168-1	364100-051
1085330	364200-011
11421-50280	364200-018
1196-60-35150	364100-046
129150-35151	364100-002
15000-2300	364100-017
15028-65011	364100-005
15028-H8903	364100-001
15208-01B01	364100-014
15208-01B02	364100-014
15208-01B02L	364100-014
15208-01B0B	364100-014

Note: More crosses available; contact your dealer.

Komatsu Continued ▶

## Filter Cross Reference

Komatsu Continued

OE Number	Crown Part Number
15208-01BOBL	364100-014
15208-13203	364100-001
15208-13210	364100-001
15208-13211	364100-001
15208-13212	364100-001
15208-55Y00	364100-001
15208-65011	364100-005
15208-78203	364100-001
15208-H1010	364100-001
15208-H8903	364100-001
15208-H8904	364100-001
15208-H8911	364100-001
15208-H8916	364100-001
15208-H8920	364100-001
15208-W1103	364100-037
15208-W1106	364100-037
15208-W1120	364100-005
15208-W1120L	364100-005
15208-W1193	364100-005
16098-FU460	380101-879
16546-FJ170	364200-014
16919-W1602	364300-006
1894-91-1440	364100-065
1984-91-1440	364100-065
20501K1470	364100-026
2276	364200-002
29901-55850	364200-007
3-EA-01-16120	364600-003
30-118	364200-010
30-122	364200-007
304-913-1021	364200-002
305-913-1021	364200-002
307-15-12720	380105-922
30C-13-11520	364100-016
31-101	364100-030
31-103	364100-075
31-105	364100-006
32670-12620-7	364400-001
32670-12620-71	364100-017
34-702	364100-017
34-900	364400-004
34A-02-34130	364200-007
34B-02-31930	364200-002
34B-66-15180	364500-004
34C-02-45140	364200-003
34C-02-45150	364200-003
37Z-01-11630	380100-088
37Z-02-38770	364200-042
37Z-02-0F201	364100-001
37Z-02-0F201L	364100-001
37Z-02-0F301	364100-020
37Z-02-38730	364200-021
37Z-02-AF234	380100-086
37Z-02-AF331	380100-084
37Z-02-AF931	364200-002
37Z-02-AF931L	364200-002
37Z-02-AF932	364200-007
37Z-02-AF935	364200-002
37Z-02-OF105	380103-914
37Z-02-OF201	364100-001
37Z-02-OF201L	364100-001
37Z-02-OF201LA	364100-001
37Z-02-OF301	364100-020
37Z-02-OF302	364100-011
37Z-AF-34790	380100-103
38510100021	364500-001
38510100022	364500-001

OE Number	Crown Part Number
3EA-01-16120	364200-007
3EA-01-16120A	364200-007
3EA-01-A5390	364200-021
3EA-15-11600	364400-004
3EA-15-11610	364400-004
3EB-01-A5340	364200-002
3EB-02-25550	380100-106
3EB-02-34750	364200-010
3EB-02-34790	380100-103
3EB-02-38730	364200-021
3EB-15-31550	364100-008
3EB-66-11710	364500-003
3EB-66-11711	364500-003
3EB-66-11711L	364500-003
3EB-66-A2320	364500-002
3EB-76-11711	364500-003
3EC-01-11730	364200-003
3EC-01-11730L	364200-003
3EC-01-11738	364200-003
3EC-01-52590	380030-009
3EC-01-90020A	380030-009
3EC-02-19630	364200-003
3EC-02-A5230	364200-026
3EC-04-31610	380102-343
3EC-66-17720	380102-335
3ED-66-11330	364100-036
3ED-66-11330L	364100-036
3ED-66-11331	364100-036
3ED-66-11331L	364100-036
42416-11140	364500-001
42Y15-H0592	364500-001
600-181-7260	364200-003
600-181-7280	364200-003
600-181-7300	364200-003
600-181-7600	364200-003
600-211-2110	364400-001
600-211-1340	364100-077
600-211-5520	364100-007
600-211-6140	364600-003
600-211-6140L	364100-007
600-211-6141	364100-007
600-211-6240	364100-007
600-211-6241	364100-007
600-211-6242	364100-007
600-311-6220	380105-923
600-311-8140	364300-009
600-311-9651	380101-998
60031-18140	364300-009
6180-51-5130	364100-026
6610515050	364100-016
6610515300	364100-016
6732716120	364300-017
6754-71-6140	364300-014
6754-79-6130	364300-014
6754-79-6140	364300-014
6810-51-5130	364100-026
8764816	380030-009
8FG-123-8029A	364100-008
9-14219-135-1	364200-018
91220-10500	364100-004
AS15000-2300	364400-001
AS15000-2300A	364100-017
AS15000-2300L	364400-001
BG8129832	364200-039
BG8876279	364200-039
BG8925297	380030-009
BL8619705	364300-003

OE Number	Crown Part Number
BL8690958	364100-020
CU3903410	364300-017
CUFS1280	364300-017
DUP122510	364200-002
F3123567	364300-003
HE0256269-00	364100-020
HE40-0000407	364100-050
HE40-0000415	364100-050
L920090001	364500-009
L9234360720	364200-039
L9234360721	380030-009
OKR62189	364100-030
PK140516190	364100-020
TJ-15601-9600	364100-041
TJ-90915-10002	364100-075
TJ1560-96001	364100-020
TJ156017600871	364100-011
TJ1560196001	364100-020
TJ1560196001	364100-020
TJ90915-03001	364100-041
TJ90915-03004	364100-041
TK4781-14-302	364100-006
YM12910055650	364300-009
YM12911055650	364300-009
YM12915035152	364100-006
YM12915035151	364100-002
YM12990155850	364600-003
YT901301815	364100-011
Z148943692993	364600-003
Z149091403004	364100-011
Z149091503004	364100-011
Z76-02-38730	364200-021
Z76-66-11711	364500-003
Z760234750	364200-039
Z760234790	380030-009
Z760238730	364200-021
Z7602AF932	364200-007
Z7602BX006	364200-010
Z7602BX106	364200-015
Z761531550	364100-006
Z766611711	364500-003
<b>Kubota (KB)</b>	
1521332430	364100-022
1521511221	364200-007
1522111223	364200-007
1522111224	364200-007
1522211220	364200-007
1522211221	364200-007
1522211222	364200-007
1522211223	364200-007
1522211224	364200-007
1522211225	364200-007
1522711221	364200-007
1522787481	364200-007
1523111221	364200-007
15241-39092	364100-046
1524111017	364200-007
1527211222	364200-007
1531911221	364200-007
1532111011	364200-007
1532111221	364200-007
1532811221	364200-007
1534111221	364200-007
15400-67900-3	364100-046
15400-67901-3	364100-046
1545143560	364300-003
1550111080	364200-007

OE Number	Crown Part Number
1550111220	364200-007
1556211080	364200-007
1584132430	364100-008
1585211220	364200-007
1585399170	364100-065
1585399179	364100-065
15906-32090	364100-044
1609749441	364200-018
1627132090	364100-008
1921511220	364200-007
1923787481	364200-007
30401-37580	364100-046
38087-21000	364100-046
401-42270	364200-038
445143560	364300-003
6609158220	364200-007
66201-36161	364100-017
6780058300	364200-007
6816143610	364200-007
6870162190	364500-003
6870162192	364500-003
70000-14640	364100-052
70000-14647	364100-045
70000-14653	364100-026
70000-32050	364100-046
7000014671	364100-003
76650-25430	364100-046
R140142270	364200-010
RD40142270	364200-038
TA04093230	364200-021
Z140F-10044	364100-026
<b>Linde (LI)</b>	
0001160024	364100-032
0009830600N	364100-026
0009830607	364100-045
0009830621	364100-068
0009839012	364200-027
0009839012V	364200-027
009839012	364200-027
0160000002	364100-032
0312225208N	364100-026
1160024	364100-032
1174418	364100-032
2654403	364100-026
312225208	364100-026
3562229031	364100-077
56115561G	364100-001
68115561	364100-045
68115561B	364100-005
68115561BN	364100-026
68115561N	364100-026
7995000510	364100-032
9839012	364200-027
AE725006049	364100-044
F9454982	364500-009
FM8102165	364100-044
H17W04	364100-005
H17W05	364100-005
PC202	364100-032
T001005003	364500-009
W94018	364100-032
XVW074115562	364100-068
<b>Mann Filters (MV)</b>	
45.3029292.1	364200-040
4530092911	364200-040
4530092941	364200-040
C1176-3	364200-027

Note: More crosses available; contact your dealer.

Mann Filters Continued ▶

Service Supplies 1.31

# Filter Cross Reference

Mann Filters Continued

OE Number	Crown Part Number
C14200-1	364200-039
C14202-1	364200-039
C15300	364200-040
C16190FR	364200-041
CF850	380030-009
CF97	364200-015
HU726-2X	364100-068
W1374-2	364500-009
W7121	364100-050
W12901	364500-014
W71210	364100-050
W81181	364100-075
W914-2	364100-075
W91415	364100-075
W9149X	364100-020
W916-1	364100-075
W920-12	364100-075
W920-21	364100-020
W920-23	364100-020
W920-26	364100-020
W920-70	364100-020
W920-80	364100-050
W920700	364100-020
W92099	364100-050
W930-8	364100-050
W9309	364100-020
W935-99	364100-050
WD930/26	364500-012
WF914-2	364100-020
WF9140	364100-020
WF916	364100-050
WF916-1	364100-020
WF9160	364100-020
WF91610	364100-020
WK832	364300-013
WP12120	364100-077
<b>Mitsubishi (MB)</b>	
0349804	364500-011
0363992	364500-009
0971289	364100-020
0971630	364100-023
1015177	364400-007
1015623	364500-003
1032901	364300-015
1033660	364500-010
1037452	364400-007
1157207	364400-007
1194740	364500-012
123-2367	364200-039
129675	364600-003
14049960	364200-027
14483050	364500-010
1767710	364100-051
1R0714	364200-027
220900	364100-075
215999	364600-003
218005	364300-015
2W4246	380030-045
30462-72000	364300-003
30630-56800	364200-002
30A04-00100	364100-004
30A40-00100	364100-002
30A40-00101	364100-002
30A40-00102	364100-002
30A40-00105	364100-006
32143-00200	364200-007

OE Number	Crown Part Number
32414-300	364100-046
32540-11600D	364100-051
32A40-00100	380103-915
32B40-00100	364100-033
32B40-10100	364100-033
32C40-00100	364100-006
34462-00300	380102-003
34462-01040	380103-916
34462-01041	364600-003
34462-11040	364600-003
34462-21040	364600-003
34467-21040	364600-003
34740-00200	364600-003
349804	364500-011
3A440-00100	364100-015
363992	364500-009
38610107	364200-007
3G6337	364500-012
3G6925	364500-012
3G6928	364500-012
311178	364300-017
311663	364500-014
312132	364300-017
40633-96	364100-047
4T7948	364500-012
50020152	364500-009
50021437	364200-039
50021439	380030-009
50237043	364200-040
51209	364500-012
566B1405	364100-074
566B7290	364100-076
566BD7154	364100-077
566BD7176	364500-012
566BF1280	364300-017
566BF7760	364300-018
566BF7766	364300-019
566BT344S	364100-075
566BT7237MPG	364100-078
566BT38910	364500-014
566BT8417	364500-012
566BT8454	364500-013
566BW5086	364900-002
566RS3705	364200-042
5882210072	364400-007
6562505300	364100-006
6A5162	364200-027
6E0924	364500-012
6E0925	364500-012
6E924	364500-012
6G924	364500-012
817003	364100-075
89424-35020	364100-004
90425-01750	364100-075
90425-08220	364300-006
91220-10500	364100-004
91224-07100	364400-007
91224-07101	364400-007
91261-00040	364200-028
91261-00041	364200-028
91261-00700	364200-002
91261-06200	380100-090
91261-06700	364200-028
91261-08200	380100-091
91264-06100	380102-005
91265-09700	364300-006

OE Number	Crown Part Number
91275-03300	364500-003
91275-03301	364500-003
91275-13000	364500-003
91275-13300	364500-003
91275-13301	364500-003
91275-15500	380102-352
91375-03800	380030-114
91375-23600	380102-354
91461-01500	364200-003
91861-01600	364200-041
91875-01400	364500-010
91875-05900	364500-010
91875-11400	364500-010
91A65-00611	364300-006
91B61-00112	364200-021
91B61-00912	364200-014
91K61-01700	380030-009
91K61-02300	380030-009
925952	364100-015
94611-11500	364200-003
971211	380102-356
971212	380102-357
971289	364100-020
971308	380100-092
971630	364100-023
9G6926	364500-012
A0000-00313	364100-016
A0000-02806	364200-008
A0000-03458	364200-021
A0000-16007	364300-017
A0000-16133	380030-009
A0000-16205	380030-009
A0000-27284	364100-078
A0000-31589	364500-012
A218869	364200-029
A218870	364200-030
AW343979	364100-067
D001445	364100-004
D001450	364100-004
DO1450	364100-047
GE924	364500-012
K4662010	364100-004
K4732350	380030-009
K486201	364100-004
K4862010	364100-004
K4862011	364100-004
K9665400	364100-004
LE3ADG6926	364500-012
LM40DQ9804	364500-011
LM4AHN9027	364200-016
LM4AHW2327	364100-005
LM4AJN5504	364200-006
LM4ODQ9804	364500-011
M12004311	364200-010
MD-031805	364100-004
MD014450	364100-047
MD129809	364100-030
MD136466	364100-002
MD136790	364100-002
MD321589	364100-067
MD332687	364100-002
MD352626	364100-002
MD352627	364100-067
MD356000	364100-046
MD365876	364100-002
MD409365	364100-046

OE Number	Crown Part Number
ME034878	364100-051
MM433093	364300-009
MO-031805	364100-015
TC01124	364100-004
XD00145	364100-006
<b>Moffett (ZM)</b>	
15521-43160	364300-009
504.055.0005	364100-070
RD401-42270	364200-038
<b>Napa (NP)</b>	
1037	364100-024
1040	364100-024
1040MP	364100-024
1041	364100-019
1042	364100-019
1060	364100-048
1064	364100-002
1068	364100-020
1069	364100-012
1083	364100-006
1084	364100-020
1085	364100-023
1085MP	364100-023
1191	364100-045
1240	364100-036
1243	364100-052
12435	364100-052
1243MP	364100-052
1288	364100-044
1307	364100-020
1311	364100-020
1316	364100-020
1334	364100-046
1334MP	364100-046
1335	364400-002
1344	364100-008
1347	364100-008
1348	364100-030
1348MP	364100-017
1358	364100-065
1372	364100-049
1372MP	364100-049
1395	364100-041
1422	364100-035
1460	364100-038
1521	364100-020
1545	364100-034
1568	364100-008
1602	364100-032
1622	364100-034
1626	364100-047
1650	364100-035
1663	364100-036
1723	364500-011
1746	364100-029
1759	364100-029
1775	364100-005
1785	364100-030
1798	364100-051
1806	364100-026
1806MP	364100-026
1858	364500-009
202150	364100-050
21060	364100-048
21068	364100-050
21307	364100-020

Note: More crosses available; contact your dealer.

Napa Continued ▶

# Filter Cross Reference

Napa Continued

OE Number	Crown Part Number
21334	364100-046
21334MP	364100-046
21347	364100-008
21348	364100-017
21348MP	364100-017
21356	364100-015
21365	364100-065
21372	364100-049
21372MP	364100-049
21380	364100-047
21452	364100-045
21521	364100-057
21626	364100-047
2276	364200-002
2518	364200-024
2654033	364100-026
26573	364200-019
2868	364200-036
3192	364300-005
3356	364300-007
3357	364300-017
3357MP	364300-017
3394	364300-015
3507	364300-009
3528	364300-007
3531	364300-008
3548	364500-001
3691	364300-018
3711	364300-019
4112	364900-002
6313	364200-027
6438	364200-021
6439	364200-014
6483	364200-037
6490	364200-015
6562	364200-026
6573	364200-019
6652	364200-039
6671	364200-039
6672	380030-009
6836	364200-040
7025	364500-012
7037	364100-078
7092	364100-071
7102	364100-057
7116	364500-012
7181	364400-001
7210	364100-068
7220	364400-003
7411	364100-033
7723	364500-013
7746	364100-077
7746XD	364100-077
M46360	364200-002
NA-1394	364100-014
<b>Nissan (NI)</b>	
11720-06000	364100-032
15201-Z9010	364100-051
15208-01B01	364100-014
15208-01B02	364100-014
15208-01B10	364100-014
15208-01B15	364100-014
15208-01BOB	364100-001
15208-08901	364100-075
15208-13201	364100-001
15208-13213	364100-001

OE Number	Crown Part Number
15208-29D00	364100-057
15208-31401	364100-015
15208-31U00	364100-015
15208-31U01	364100-015
15208-43G00	364100-005
15208-43G0A	364100-054
15208-65014	364100-005
15208-65F00	364100-065
15208-65F01	364100-065
15208-80W00	364100-057
15208-9C600	364100-020
15208-FM000	380103-915
15208-H1000	364100-001
15208-H1011	364100-001
15208-H1111	364100-057
15208-H8911B	364100-001
15208-H8923	364100-001
15208-H8994PC	364100-001
15208-W1101	364100-057
15208-W1103PC	364100-037
15208-W1120PC	364100-005
15208-W1123	364100-005
15208-W8916	364100-057
15208-Y9701	364100-026
15209-10H00	364100-001
15209-10H00B	364100-001
15209-J5602	364100-032
16098-GS07A	380101-880
16403-J5500	380105-923
16404-78225	380101-997
16404-K4046	380101-997
16404-L1100	380101-997
16405-FM000	380101-998
16405-T9005	364600-003
16444-29000	364300-001
16546-00H03	364200-002
16546-00H03B	364200-002
16546-00H10	364200-001
16546-00H10-B	364200-001
16546-00H10B	364200-001
16546-05H10	364200-001
16546-0K000	364200-001
16546-1G000	364200-002
16546-40K00	364200-033
16546-49216	380100-086
16546-51H10	364200-033
16546-51H10D	364200-033
16546-K4046	380100-080
16546-L3000	380100-081
16546-L3200	380100-082
16546-L8010	364200-018
16546-L9010	364200-018
165461G000	364200-002
16919-N7000	364300-006
16919-N7001	364300-006
16919-W1601	364300-006
16919-W1602	364300-006
17741-30510	364200-026
1806	364100-026
20801-01361	364100-014
31725-L1000	380105-923
31728-11H01	380102-334
31728-40K00	380102-334
31728-FJ100	364400-007
32132-48270	380105-922
41524-1060	364100-046

OE Number	Crown Part Number
43820003	364100-015
53651-72061	364200-014
53651-72161	364200-014
58395-91H01	364100-007
58396-47601	364100-007
58396-47601-B	364100-007
58396-91H10	364100-007
6011-10240	364100-015
6041-10220	364500-003
69220-6K200	364500-003
69220-FK100	380030-114
69270-FK100	380102-354
69270-L1100	380102-348
91224-07101	364400-007
A5208-W1103	364100-020
A5208-W1106	364100-020
A6405-FM000	364600-003
CK1804057	364100-006
CK918648	364100-002
F57851	364100-033
NF32B40-00100	364600-003
NF34462-00300	364300-015
NF90425-08220	364300-006
NF91224-07101	364400-007
NF91861-05600	364200-018
NF91875-05900	364500-010
NF91875-11400	364500-010
NFMD352626	364100-002
PA1690-FN	364200-002
<b>Purolator (PU)</b>	
30137	364100-026
6665973	364100-016
6665976	364100-012
6665979	364100-044
6675008	364100-037
6675912	364200-003
6694095	364300-002
A22011	364200-007
A23496	364200-006
A27758	364200-027
A35167	364200-022
A35300	364200-001
A42019	364200-002
A52040	364200-018
A55400	364200-019
A62044	364200-036
A62974	364200-024
A65351	364200-031
A75173	364200-004
AF2011K	364200-007
AF2093	364100-022
AF4425	364200-027
EP221	364300-001
EP221N	364300-001
F50086	364300-001
F50149	364300-003
F50221	364300-001
F54423	364300-017
F54557	364300-009
F55110	364300-008
F55325	364300-005
F57174	364300-003
F57248	364300-001
F57507	364300-003
F57629	364300-003
F57805	364300-001

OE Number	Crown Part Number
F57851	364300-001
F58247	364600-003
F59221	364300-001
F60043	364300-017
F60152	364300-001
F60217	364300-001
F60222	364300-001
F64863	364300-017
F67803	364600-003
F78367	364300-001
FC0258	364400-002
FC101	364100-020
FC114	364100-075
FC1141	364100-020
FC140	364100-075
FC141	364100-075
FC142	364100-006
FC603	364400-002
FC81	364400-002
FCA3398	364100-009
FCG152	364300-001
FCO0291	364100-006
FCO101	364400-002
FCO160	364100-004
FCO167	364100-006
FCO17	364100-020
FCO18	364100-020
FCO201	364100-044
FCO213	364100-022
FCO2166	364100-001
FCO2167	364100-037
FCO252	364100-022
FCO257	364100-045
FCO28	364100-044
FCO321	364100-008
FCO64	364100-009
FCO73	364100-008
FPT750	364100-016
FPT750B	364100-016
FPT750H	364100-016
H20294	364500-012
H30135	364100-035
H32210	364100-036
H35235	364100-018
H40029	364100-029
H40175	364500-009
H55151	364500-001
HOT81	364100-050
L10017	364100-020
L10018	364100-020
L10101	364100-050
L10111	364100-024
L10112	364100-024
L10193	364100-004
L14006	364100-019
L14459	364100-002
L14476	364100-041
L14477	364100-011
L14610	364100-015
L14620	364100-015
L14622	364100-015
L14670	364100-023
L17603	364400-002
L20064	364100-009
L20081	364100-050
L20173	364100-003

Note: More crosses available; contact your dealer.

Purolator Continued ▶

## Filter Cross Reference

Purulator - Continued

OE Number	Crown Part Number
L20252	364100-022
L20287	364100-013
L22167	364100-037
L24007	364100-019
L24011	364100-003
L24458	364100-008
L24466	364100-022
L25100	364500-012
L27159	364100-004
L27190	364100-022
L30015	364100-052
L30054	364100-007
L30068	364100-051
L30138	364100-038
L30257	364100-045
L34480	364100-013
L34631	364100-048
L35197	364100-028
L37735	364100-068
L39001	364100-034
L45308	364100-068
L60750	364100-016
L60751	364100-016
L65329	364100-077
LI3550	364100-020
LI3968	364100-023
LI4117	364100-020
LI4218	364100-023
LX272	364200-027
MF36300A	364100-020
MF36304B	364100-020
MF45800A	364100-020
MF53400A	364100-023
MF6103	364100-030
MF6200A	364100-044
MF63000	364100-044
MF63000A	364100-075
MF63005A	364100-022
MFF629A	364300-003
ML16810	364100-046
ML16817	364100-065
ML16819	364100-065
OC47	364100-022
OC49	364100-022
PC20	364100-044
PC201	364100-044
PC200F	364100-075
PC21	364100-044
PC2130F	364100-022
PC218	364100-020
PC22	364100-020
PC222	364100-007
PC23	364100-020
PC237	364100-026
PC238	364100-038
PC252	364100-022
PC253	364100-022
PC258	364100-023
PC265	364100-020
PC27	364100-075
PC32	364100-020
PC32/1	364100-044
PC38	364100-020
PER43	364300-017
PER4423F	364300-017
PER-73	364100-006

OE Number	Crown Part Number
PER-81	364100-020
PER101	364100-050
PER111	364100-024
PER112	364100-024
PER124	364100-019
PER151F	364300-001
PER152F	364300-001
PER159	364100-004
PER163	364100-044
PER168	364100-020
PER17	364100-075
PER170	364100-023
PER175H	364500-009
PER175HMIC10	364500-009
PER179	364100-044
PER17K	364100-044
PER17M	364100-020
PER18	364100-020
PER188	364100-022
PER190	364100-022
PER194	364100-004
PER211	364100-044
PER2167	364100-037
PER217F	364300-001
PER241	364100-017
PER244	364100-024
PER247F	364300-001
PER249F	364300-001
PER252	364100-022
PER257	364100-045
PER268	364100-017
PER270	364100-004
PER275	364100-023
PER276	364100-020
PER277	364100-044
PER28	364100-075
PER287	364100-013
PER289	364100-004
PER291	364100-006
PER294	364500-012
PER307	364100-024
PER309	364100-057
PER321	364100-008
PER323F	364300-013
PER349	364100-047
PER362	364100-022
PER367F	364300-001
PER393	364100-004
PER4000	364100-037
PER4007	364100-019
PER4011	364100-003
PER40M	364100-037
PER4458	364100-008
PER4459	364100-046
PER4466	364100-022
PER4476	364100-041
PER4477	364100-011
PER4619	364100-004
PER4622	364100-065
PER4631	364100-048
PER4651	364100-049
PER4670	364100-023
PER58	364100-050
PER73	364100-008
PER74	364100-008
PER81	364100-050

OE Number	Crown Part Number
PER86	364300-001
PF3146	364300-003
PF3174	364300-009
PF4557	364600-003
PIL25	364100-023
PIL29	364100-023
PIL32	364100-023
PL10017	364100-020
PL10111	364100-024
PL14006	364100-019
PL14476	364100-041
PL14612	364100-065
PL14619	364100-047
PL14622	364100-065
PL20064	364100-039
PL20081	364100-050
PL20252	364100-022
PL22167	364100-057
PL24458	364100-008
PL24651	364100-049
PL34631	364100-048
PL4670	364100-023
PM206A	364200-027
PM1758	364500-011
PM6056	364100-075
PMP322	364100-020
SK211102	364100-026
T134	364100-023
T750	364100-016
TB0816	364100-050
TBO111	364100-024
TBO17	364100-020
TBO241	364100-020
TBO81	364100-050
<b>Raymond (RA)</b>	
520-509-01	077145
520-512	364100-036
520-528	077145
520-610	077145
520-610-01	077145
850-508	074105
850-516	074105
850-521	074105
850-522	074105
850-523	074105
DS223161	074105
DS232176	077145
<b>TCM (TC)</b>	
112T2-52501	364400-001
11421-50320	364200-018
115G3-82241	364400-001
115G3-82241R	364400-001
12163-82301A	364100-006
12163-82302	380105-917
1K011-43060	364200-010
20103361	364600-003
20801-01041	364100-001
20801-01191	380103-914
20801-01281	364100-015
20801-01361	364100-014
20801-01431	364100-002
20801-02021	380105-923
20801-02061	380101-997
20801-02141	380100-082
20801-03021	364600-003
20801-03041	380100-086

OE Number	Crown Part Number
20801-03061	364200-018
20801-03131	364200-002
20801-03131R	364200-002
20801-03132	364200-002
20801-03221	364200-003
20801-03271	364200-001
20801-03281	380100-080
20801-03291	380100-081
20801-03311	364200-002
20801-03351	364200-021
20801-03351A	364200-021
20801-03351R	364200-021
20801-03361	364200-010
20801-03361A	364200-010
20801-03511	364200-026
210F7-52022	380102-330
212T1-05851	364100-011
212T1-05851R	364100-011
213T1-02011	364200-021
214A1-02601	364200-003
214A7-52081	380102-331
216G7-52051	380102-340
230C1-02061	364200-026
23441-00422	364200-002
23657-62061	380102-332
25597-60301A	380102-332
25601-08011	364200-021
256C1-08011	364200-021
256C1-08011UL	364200-021
256G1-08011	364200-010
25967-82001	380102-333
26402-37011	364200-026
271A7-52301	380102-331
513A0-52391	364300-006
513AO-52391	364300-006
89433-17480	364100-006
89436-91993	364600-003
89436-92990	364600-003
89436-92992	364600-003
89436-92993	364600-003
902950106	364600-003
AE-602950106	364100-008
DET000124	364200-018
E602950106	364100-006
FA3651-72061	364200-021
N-15208-01B01	364100-014
N-15208-13210	364100-001
N-15208-13211	364100-001
N-15208-13212	364100-001
N-15208-65011	364100-005
N-15208-65014	364100-005
N-15208-H1000	364100-001
N-15208-H1010	364100-001
N-15208-H1011	364100-001
N-15208-H8911	364100-001
N-15208-H8916	364100-001
N-15208-W1103	364100-037
N-15208-W1123	364100-005
N-16546-00H10	364200-001
N-16546-51H10	364200-033
N-16919-W1602	364300-006
P-10-4972	364200-018
P-10-5629	364200-002
P-12-2514	364200-002
P181054	364200-018
T-4781-14-302	364100-015

Note: More crosses available; contact your dealer.

TCM Continued ▶

# Filter Cross Reference

TCM Continued

OE Number	Crown Part Number
T-F2SM-13-Z40	364200-002
Z-9-14215-135-1	364200-018
Z8943212191	364100-033
Z8944160690	364100-033
Z9142-15135	364200-018
<b>Tennant (TN)</b>	
35254	364200-002
369746	364200-014
48127	364200-002
515601	364200-002
515601-1	364200-002
51561	364200-002
51561-1	364200-002
54141	364200-002
54141-1	364200-002
541414	364200-002
54141M	364200-002
55849	364100-008
58120	364200-002
<b>Toyota (TY)</b>	
00591-00111-81	364100-035
00591-01197-81	364200-024
00591-01965-81	364200-004
00591-02197-81	364200-024
00591-02570-81	364100-018
00591-02700-81	364100-038
00591-03681-81	364100-026
00591-03688-81	364100-052
00591-03784-81	364300-017
00591-03871-81	364100-002
00591-03998-81	364100-034
00591-05332-81	364500-012
00591-05337-81	364200-013
00591-05338-81	364200-017
00591-05449-81	364200-016
00591-05672-81	364100-006
00591-06175-81	364100-038
00591-06188-81	364100-020
00591-06344-81	364200-003
00591-06347-81	364100-020
00591-06549-81	364200-028
00591-06550-81	364200-011
00591-07056-81	364200-003
00591-07057-81	364200-002
00591-10935-81	364100-017
00591-11044-81	364100-006
00591-14062-81	364400-004
00591-14063-81	364100-036
00591-14066-81	364500-011
00591-14090-81	364600-003
00591-14820-81	364100-035
00591-19020-81	364100-005
00591-20166-81	364300-015
00591-20222-81	364500-009
00591-20312-81	364200-003
00591-20758-81	364500-004
00591-22139-81	364100-037
00591-22155-81	364200-023
00591-22159-81	364200-020
00591-22303-81	364100-041
00591-22391-81	364100-035
00591-27216-81	364200-029
00591-27326-81	364500-003
00591-27449-81	364100-016
00591-30483-81	364100-015
00591-30899-81	364200-033

OE Number	Crown Part Number
00591-31053-81	364200-011
00591-31302-81	364100-002
00591-32747-81	364200-009
00591-32750-81	364200-002
00591-32752-81	364200-003
00591-32762-81	364100-006
00591-32763-81	364100-004
00591-32769-81	364100-037
00591-32771-81	364100-007
00591-32772-81	364200-004
00591-32776-81	364200-027
00591-32785-81	364100-035
00591-32786-81	364100-034
00591-32791-81	364200-006
00591-32795-81	364100-007
00591-32796-81	364100-006
00591-32798-81	364100-002
00591-32799-81	364100-006
00591-32800-81	364100-012
00591-32801-81	364100-035
00591-32807-81	364200-001
00591-32808-81	364600-003
00591-32810-81	364200-016
00591-32817-81	364100-003
00591-32821-81	364100-013
00591-32826-81	364200-024
00591-32827-81	364200-003
00591-32828-81	364100-006
00591-34081-81	364100-044
00591-34082-81	364100-038
00591-34092-81	364100-022
00591-34113-81	364100-020
00591-34115-81	364100-026
00591-34131-81	074105
00591-34137-81	364500-009
00591-34138-81	364100-018
00591-34140-81	364100-001
00591-34145-81	364500-011
00591-34150-81	364500-012
00591-34151-81	364200-007
00591-34156-81	364200-024
00591-34161-81	364500-012
00591-34162-81	364200-013
00591-34165-81	364100-017
00591-34167-81	364200-028
00591-34170-81	364100-020
00591-34176-81	364100-036
00591-34177-81	364100-014
00591-34180-81	364200-017
00591-34181-81	364200-010
00591-34190-81	364400-002
00591-34191-81	364500-003
00591-34192-81	364100-015
00591-42846-81	364100-009
00591-42847-81	364200-023
00591-45311-81	364200-020
00591-45315-81	364200-021
00591-45329-81	364400-007
00591-50320-81	364200-033
00591-50593-81	364200-003
00591-50594-81	364200-001
00591-50598-81	364200-002
00591-50599-81	364200-009
00591-50602-81	364200-007
00591-50610-81	364100-016
00591-50614-81	364100-007

OE Number	Crown Part Number
00591-50615-81	364100-001
00591-50617-81	364100-006
00591-50619-81	364100-035
00591-50623-81	364100-038
00591-53022-81	364100-013
00591-53048-81	364500-009
00591-53072-81	364500-012
00591-53079-81	364200-016
00591-53084-81	364100-018
00591-53316-81	364100-034
00591-53318-81	364100-009
00591-54428-81	364200-028
00591-54432-81	364100-035
00591-54435-81	364200-011
00591-54436-81	364100-015
00591-54440-81	364100-017
00591-54443-81	364100-012
00591-54444-81	364100-012
00591-54446-81	364100-006
00591-54457-81	364100-006
00591-54458-81	364100-002
00591-54459-81	364100-020
00591-54465-81	364500-011
00591-54469-81	364500-012
00591-54473-81	077145
00591-54474-81	364100-020
00591-54475-81	364100-036
00591-54479-81	364500-003
00591-54481-81	364300-015
00591-54483-81	364200-010
00591-54489-81	364200-011
00591-54490-81	364100-014
00591-54491-81	364200-017
00591-54494-81	364400-002
00591-54495-81	364100-015
00591-59425-81	364100-003
00591-59433-81	364100-034
00591-61126-81	364100-035
00591-61171-81	364200-004
00591-62086-81	364600-003
00591-62751-81	364100-029
00591-63185-81	364200-027
00591-63204-81	364100-001
00591-63387-81	364200-003
00591-63602-81	364100-036
00591-63696-81	364100-006
00591-64106-81	364100-026
00591-64503-81	364100-002
00591-71906-81	364100-048
00591-72357-81	364600-003
00591-72359-81	364100-051
00591-72368-81	364100-017
00591-72372-81	077145
00591-72387-81	364200-015
00591-74725-81	074105
00591-76662-81	364400-002
00591-76870-81	364500-010
04234-76001-71	380101-997
04234-76002-71	380101-997
04234-76003-71	380101-997
08922-02001	364100-011
08922-02002	364100-011
08922-02002-71	364100-011
08922-02004	364100-030
08922-02011	364100-041
10115-88420-71	364300-009

OE Number	Crown Part Number
11501-01211	364100-004
11501-01211-71	364100-004
11501-01390	364100-011
11501-01390-71	364100-011
11501-01660	364100-011
11501-01660-71	364100-011
11501-01670	364100-041
11531-00042	364100-020
11531-00042-71	364100-037
15600-01020	364100-011
15600-01020-71	364100-011
15600-16010	364100-011
15600-16010-71	364100-011
15600-20550	364100-050
15600-20550-71	364100-050
15600-25010	364100-050
15600-39015	364100-009
15600-44010	364100-030
15600-47011	364100-050
15600-49045	364100-050
15600-49046	364100-050
15600-61030	364100-005
15600-76003-71	364100-005
15600-76007-71	364100-050
15600-76009-71	364100-026
15600-76017-71	364100-050
15600-76018-71	364100-050
15600-41010	364100-005
15601-13000-71	364100-037
15601-20550-71	364100-030
15601-20560-71	364100-005
15601-22010	364100-009
15601-33010	364100-009
15601-33020	364100-009
15601-33021	364100-009
15601-41010	364100-017
15601-41830	364100-002
15601-42160-71	364100-006
15601-42830	364100-004
15601-42830-71	364100-004
15601-42840	364100-002
15601-44010	364100-030
15601-44010-83	364100-017
15601-44011	364100-030
15601-44011-83	364100-017
15601-68101-71	364100-026
15601-76001-71	364100-009
15601-76002-71	364100-017
15601-76003-71	364100-017
15601-76005	364100-011
15601-76006	364100-011
15601-76006-71	380105-923
15601-76007	364100-011
15601-76007-71	364100-011
15601-76008	364100-011
15601-76008-71	364100-011
15601-76009	364100-001
15601-76009-71	364100-075
15601-78001-71	364100-075
15601-87305	364100-013
15601-87305-71	364100-013
15601-87310	364100-008
15601-96001	364100-050
15601-96101	364100-020
15601-U2120-71	364100-012
15601-U2120-F	364100-012

Note: More crosses available; contact your dealer.

Toyota Continued ▶

## Filter Cross Reference

Toyota Continued

OE Number	Crown Part Number
15611-31720	364100-003
15611-31720-71	364100-003
17702-23470-71	364200-008
17702-30750	364200-018
17702-30750-71	364200-018
17702-42500-71	364200-010
17703-23470-71	364200-008
17704-30710-71	364200-018
17712-96395-71	364200-002
17731-41830	364200-007
17731-41830-71	364200-007
17741-13600	364200-008
17741-13600-71	364200-008
17741-23600	364200-008
17741-23600-71	364200-008
17741-30510-71	364200-026
17741-98333-71	364200-008
17741-F9860	364200-008
17741-F9860-71	364200-008
17741-U1100-71	364200-008
17741-U2100	364200-010
17741-U2100-71	364200-010
17741-U3330-71	364200-026
17742-32850	364200-008
17742-32850-71	364200-008
17743-23600	364200-008
17743-23600-71	364200-008
17743-98333-71	364200-008
17743-F9860	364200-008
17743-F9860-71	364200-008
17743-U1100	364200-008
17743-U1100-71	364200-008
17744-U2100-71	380100-103
17744-U2230-71	380100-104
17744-U3330-71	380100-105
17752-20540	364200-003
17752-20540-71	364200-003
17791-11120-71	364200-002
17791-22000-71	380100-106
17792-22000-71	364200-003
17801-15010	364100-009
17801-15010-71	364100-009
17801-20540-71	380100-083
17801-22000-71	380100-084
17801-23000-71	364200-003
17801-23001	364200-003
17801-23001-71	364200-003
17801-30240-71	380100-085
17801-76003-71	380100-084
17801-7600371	380100-084
1780115010	364100-009
17802-23000-71	364200-003
17802-23001-71	364200-003
17802-U2020-71	364200-003
17803-U2050-71	364200-003
17803-U2051-71	364200-003
17806-23800	364200-020
17806-23800	364200-020
17806-23800-71	364200-020
23300-78150-71	380101-999
23301-30205-71	380100-085
23302-31960-71	380105-923
23303-30370-71	364200-003
23303-76002-71	380102-001
23303-76003-71	380105-923
23323-42830-71	364300-009

OE Number	Crown Part Number
23854-23470-71	380102-002
25310-34950-71	380101-997
32150-40840-71	364100-017
32623-12620-71	364100-044
32623-20570-71	364100-017
32670-12620	364400-001
32670-12620-71	364100-017
32760-12620-71	364400-001
32901-31630-71	380102-343
40150-30370-71	364100-017
53-0042	380101-876
53-0043	380101-877
53-0045	380101-878
5911093581	364100-017
5913089981	364200-033
5913416581	364100-017
5914532981	364400-007
5915032081	364200-033
5915444081	364100-017
5917236881	364100-017
5917687081	364500-010
67501-11120-71	380102-339
67501-12900-71	380102-338
67501-23001-71	380102-339
67501-23320-71	380102-340
67501-32880-71	380102-341
67502-13300-71	380102-342
67502-20540-71	380102-343
67502-23000-71	380102-344
67502-23320-71	380102-345
67502-26600-71	380102-346
67502-32881-71	380106-486
67502-U2230-71	380102-346
67503-U2170-71	380102-347
67503-U217071	380102-347
67532-42800	364100-018
67532-42800-71	364100-018
78520-30200	364100-034
80915-76010	364100-001
80915-76010-71	364100-001
80915-76012	364100-011
80915-76012-71	364100-011
80915-76024-71	364100-030
89220-2005	364100-041
90080-91034	364100-041
90080-91058	364100-041
90915-03001	364100-041
90915-03002	364100-030
90915-03004	364100-041
90915-03005	364100-001
90915-10001	364100-030
90915-10002	364100-011
90915-10004	364100-011
90915-20001	364100-017
90915-20002	364100-001
90915-20003	364100-030
90915-20004	364100-001
90915-TA001	364100-041
90915-YZZA1	364100-011
90915-YZZA2	364100-041
90915-YZZB9	364100-017
90915-YZZD1	364100-017
90915-YZZD9	364100-041
90915-YZZF1	364100-011
90915-YZZF2	364100-041
C0120-00013	364100-041

OE Number	Crown Part Number
VM52739001	364100-026
WIX / Air Refiner (WX)	
13	364100-019
15	364100-020
22	364100-024
24	364100-019
24112	364900-002
25442	364200-028
26	364100-022
3119	364100-023
318P	364100-023
319P	364100-023
321P	364100-009
322P	364100-023
330P	364100-023
33118	364300-002
33128	364300-003
33166	364600-003
33192	364300-005
33356	364300-007
33357	364300-017
33357MP	364300-017
33373	364300-001
33394	364300-015
333P	364100-023
33407	364300-004
33507	364300-009
33528	364300-007
33531	364300-008
33548	364500-001
335P	364100-044
33691	364300-018
33711	364300-019
342P	364100-023
345P	364100-023
347P	364100-008
350P	364100-023
42126	364200-018
42180	364200-025
42222	364200-003
42276	364200-002
42338	364200-018
42370	364200-009
42518	364200-024
42598	364700-001
42645	364200-007
42806	364200-008
42868	364200-036
46142	364200-004
46232	364200-006
46233	364200-016
46262	364200-001
46309	364200-022
46313	364200-027
46434	364200-013
46438	364200-021
46438FR	364200-014
46439	364200-014
46480	364200-020
46483	364200-037
46489	364200-010
46490	364200-015
46513	364200-011
46562	364200-026
46567	364200-024
46569	364200-031

OE Number	Crown Part Number
46573	364200-019
46614	364100-043
46652	364200-039
46671	364200-039
46672	380030-009
46836	364200-040
49020	364200-036
51036	364100-003
51037	364100-024
51040	364100-024
51040MP	364100-024
51041	364100-019
51042	364100-019
51050	364100-016
51060	364100-048
51064	364100-046
51068	364100-050
51068MP	364100-050
51069	364100-012
51083	364100-006
51084	364100-020
51085	364100-023
51085MP	364100-023
51088	364100-022
51182	364100-013
51191	364100-045
51194	364500-005
51243	364100-052
51243MP	364100-052
51261	364100-007
51288	364100-044
51307	364100-020
51311	364100-020
51312	364100-020
51316	364100-020
51319	364100-020
51334	364100-002
51334MP	364100-046
51338	364100-008
51339	364100-022
51342	364100-008
51344	364100-075
51345	364100-001
51348	364100-030
51348MP	364100-017
51356	364100-015
51362	364100-020
51372	364100-049
51372MP	364100-049
51376	364100-051
51380	364100-008
51381	364100-004
51391	364100-017
51393	364100-022
51394	364100-041
51395	364100-041
51396	364100-011
51412	364500-001
51422	364100-035
51452MP	364100-045
51455	364100-018
51460	364100-038
51515	364100-005
51516	364100-039
51521	364100-037
51545	364100-034

Note: More crosses available; contact your dealer.

WIX/Air Refiner Continued ▶



# Filter Cross Reference

WX/Air Refiner Continued

OE Number	Crown Part Number
51568	364100-008
51602	364100-032
51607	364100-025
51622	364100-034
51626	364100-047
51650	364100-035
51663	364100-036
51723	364500-011
51725	364100-033
51746	364100-029
51759	364100-029
51798	364100-051
51806	364100-026
51806MP	364100-026
51858	364500-009
533711	364300-019
542338	364200-018
546313	364200-027
546438	364200-021
546439	364200-014
546483	364200-037
546490	364200-015
546652	364200-039
546671	364200-039
546672	380030-009
551338	364100-008
551362	364100-020
551394	364100-041
551626	364100-047
557025	364500-012
557085	364100-044
557210	364100-068
57025	364500-012
57037	364100-078
57060	364100-031
57085	364100-044
57092	364100-071
57094	364100-014
57102	364100-057
57116	364500-012
57181	364400-001
57210	364100-068
57243	364100-028
57451	364500-010
57723	364500-013
57746	364100-077
57746XD	364100-077
59116	364100-065
59181	364300-015
A112	364200-027
CA415	364100-023
CW243MP	364100-052
CW452MP	364100-045
CW84MP	364100-020
DT1246	364200-018
PC307P	364100-020
PC311P	364100-020
PC312P	364100-020
PC316	364100-020
PC319P	364100-023
<b>Yale (YT)</b>	
005910368181	364100-026
014049960	364200-027
044052940	364200-027
066457800	364200-002
066457900	364200-003

OE Number	Crown Part Number
119005-35100	364100-008
119660-35150	364100-046
124085-35111	364100-008
129087-12510	364200-021
140499600	364200-027
150011600	364100-020
150012700	364200-002
150012800	364200-003
150017200	364100-020
150017600	364100-006
150022200	380100-079
150023100	364200-002
150127002	364300-001
190886001	364500-003
220000637	364500-009
220001862	364100-018
220002418	364100-007
220002486	074105
220002487	364200-004
220003608	364200-041
220004261	364100-001
220004522	364200-016
220005321	364100-001
220006498	364100-037
220007093	364100-001
220007910	364100-034
220010432	364200-027
220016046	364100-002
220016442	364100-022
220017036	364200-010
220018074	364100-014
220018365	364200-020
220018642	364200-023
220019061	364100-008
220020159	364200-041
220020426	074105
220020474	074105
220020845	364100-057
220021000	364100-057
220021422	364100-004
220021672	364100-006
220021873	364100-012
220021874	364100-034
220021883	364200-033
220022271	077145
220023301	364200-041
220023405	364300-017
220023427	364100-002
220023954	364200-011
220024174	364100-014
220024667	364100-009
220025201	364100-037
220025232	364200-003
220026447	364300-015
220027050	364100-018
220028173	364200-014
220028667	364200-002
220031787	364100-017
220036196	364200-008
220036199	364100-017
220036241	364600-003
220036509	364100-011
220037602	364200-010
220040677	364100-017
220042484	364300-017
220042965	364200-002

OE Number	Crown Part Number
220043605	364100-012
220043748	364500-012
220044119	364100-002
220044765	364200-015
220052149	364100-006
220052452	364100-005
220054022	364200-001
220054026	364600-003
220054027	364300-015
220054030	364200-002
220054033	364200-003
220070304	364500-011
220070365	364600-003
220070367	364200-006
220070371	077145
220070380	364100-044
220070490	364500-012
220070555	364100-030
220070633	364200-001
220071699	364200-007
220072541	364100-003
220074151	364500-009
220075007	364300-003
220075012	364100-016
220075013	364100-020
220075018	364100-026
220075022	364100-038
220075033	364200-003
220075043	364200-002
220075112	364100-020
220075116	364100-007
220079879	364200-017
220088276	364100-044
220102404	364200-010
249999000	364200-002
249999001	364100-006
249999002	364100-016
249999003	364200-003
249999004	364100-001
249999005	364100-004
249999006	364100-013
249999007	364100-050
249999008	364100-026
249999019	364100-026
249999021	364100-007
249999022	364100-026
249999023	077145
249999024	364500-012
249999025	364200-001
249999026	364100-009
249999027	364100-038
249999028	364100-015
249999030	364100-006
249999031	364200-041
249999032	364200-010
249999033	364200-013
249999034	364200-009
249999035	364200-006
249999037	364300-015
249999038	364100-002
249999039	364200-011
249999040	364100-037
3122275	364200-023
330035194	364200-027
330035556	364100-032
440052940	364200-027

OE Number	Crown Part Number
440054069	364100-026
440054600	364100-038
44052940	364200-027
461015223	364100-032
502903501	077145
504025100	364200-018
504240863	364200-003
504297790	364100-012
504449744	074105
505676800	364200-018
505960559	364100-006
505966578	364100-020
505973580	380102-336
506973401	364200-018
507640800	364200-018
513498801	364100-034
515133806	364100-038
515133851	364300-003
515133856	364100-038
5151413	364100-005
515141300	364100-005
515033801	364100-035
5158648	364200-003
515864800	364200-003
515865800	364200-002
515935800	364100-016
516042852	364300-003
517584860	364100-038
518801624	380105-925
5194548	364100-020
519454800	364100-050
520045030	364200-015
524136754	380103-911
524228505	380103-918
580000543	380100-103
580002784	364200-018
580004421	364300-001
580007144	364100-034
580008852	364100-005
580010991	380030-123
580012151	380102-329
580043255	380101-881
580048839	380030-064
580052153	380102-337
580056944	380030-068
66457800	364200-002
751287402	364100-035
800058909	083318
800071711	364100-034
900001224	380101-996
900006282	364100-003
900011232	380102-004
900291828	364100-006
900506400	364100-034
900506401	364100-034
900533802	364100-008
900538802	364100-008
900546802	364200-003
900770802	364100-032
900907800	364100-008
900907804	364600-003
900907810	364600-003
900907811	364600-003
901030815	364600-003
901091803	364200-003
901095857	380103-919

Yale Continued ▶

## Filter Cross Reference

Yale Continued

OE Number	Crown Part Number
901277817	364200-002
901281813	364100-006
901301815	364100-006
901397803	364200-003
901515400	364200-002
901517400	364100-006
901544400	364500-003

OE Number	Crown Part Number
901870801	364200-003
901992850	364200-002
902166802	364200-014
902225300	364200-002
902255802	364200-010
902426801	364200-026
902489801	364200-042

OE Number	Crown Part Number
904788100	364100-020
905332600	364100-036
905332601	364100-036
907160600	364100-036
907160601	364100-036
907172400	364100-020
910361400	364100-020

OE Number	Crown Part Number
910544400	364500-003
910545401	380102-349
910545403	380102-350
917380400	364500-010
927788400	364100-020

## Section 2

# Safety Equipment

### Contents

Seat Belts	2.02
Safety Belts and Accessories	2.02
Harnesses	2.03
Lanyards	2.05
Maintenance Safety Items	2.06
Eye/Hearing/Breathing Protection	2.07
First Aid Kits	2.09
Disposable Safety Apparel	2.09
Hard Hats	2.10
Safety Related Accessories	2.10
Spill Clean Up Products	2.11
Mirrors	2.12

#### New Items:

Glasses/Goggles - p. 2.07  
 Ear Muffs - p. 2.08  
 Breathing Protection - p. 2.08  
 Face Protection - p. 2.09  
 Fire Extinguisher - p. 2.10  
 Barricade/Caution Tape - p. 2.10  
 Safety/Traffic Cones - p. 2.10  
 Mirror - p. 2.12

Note: 1910.178(q)(5) (1998) of the Occupational Safety and Health Act (OSHA) requires that "All parts of any such industrial truck requiring replacement shall be replaced only by parts equivalent as to safety with those used in the original design."



# Seat Belts

## Seat Belts

Part Number Orange	Part Number Black	Part Number w/ Interlock Switch	Type	Retractor Style	Belt Width	Belt Length	Dim. A	Dim. B	Includes U-shaped Bracket
122003-002	122003		Retractable, Anti-cinch	"Y"	2"	50"	4"	11.50"	X
122016-002	122016		Retractable, Anti-cinch	"Y"	2"	50"	4"	9.60"	
132257-002	132257		Retractable, Anti-cinch	"Z"	2"	54"	10.50"	8.50"	X
132252-002	132252	132252-003	Retractable, Anti-cinch	"Z"	2"	54"	10.50"	8.50"	
139951-002	139951	139951-003	Retractable, Anti-cinch	"X"	2"	51"	5.50"	10.5"	
300000	NA		Retractable	"Y"	2"	50"	4"	11.50"	X

**Note:** Mounting hardware included. Seat belts meet requirements of SAE J386 and FMVSS 302.

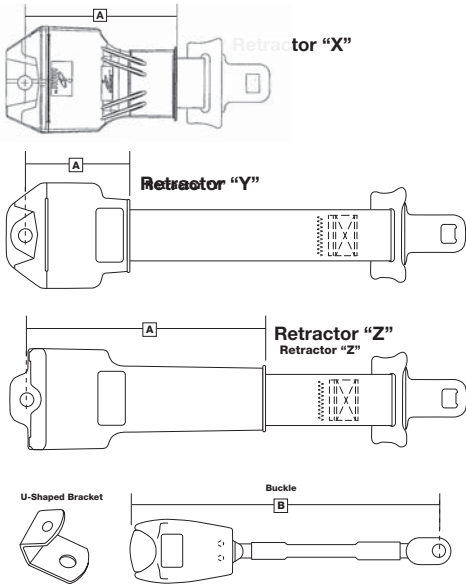

# Fall Protection - Safety Belts and Accessories



### Belts\*

Part Number	Size
300003-005	XXX-Small, 20" - 26"
300003-007	XX-Small, 24" - 32"
300003-001	Small, 31" - 39"
300003-002	Medium, 35" - 43"
300003-003	Large, 38" - 47"
300003-004	X-Large, 42" - 50"
300003-006	XX-Large, 46" - 54"



### Belts\*

Part Number	Size
077456-006	XX-Small, 24-32
077456-005	X-Small, 28-36
077456-002	Small, 31" - 39"
077456-001	Medium, 35" - 43"
077456-003	Large, 38" - 47"
077456-004	XL, 42" - 50"



### Carabiners Turn Open Lock

Part Number	Gate
300064	3/4"
300006	1"

**\*Notes:** May not meet OSHA requirements for certain states, example California. See below chart for new ANSI standards B56.1 (4.17). New Standards effective Feb. 23, 2013.

Use safety belts with self-retracting lanyards only.

### Did you know?

New standards effective Feb. 23, 2013.

## Personal Fall Protection System Configurations (lbs.)

Fall Protection / Prevention Device	Operator Weight (lbs.)			
	<220	220-310 <sup>1</sup>	311-400 <sup>1</sup>	>400 <sup>1</sup>
Body Belt	X			
Full Body Harness	X	X	X	X
Energy Absorber - max total length (6ft.)		X	X	
Self Retracting Lanyard	X	X	X	X <sup>2</sup>
Maximum Arresting Force Permitted (lbs)	900	1800	1800	1800

1) Truck Capacity shall be reduced by the operator(s) weight in excess of 220 lbs.

2) Self Retracting Lanyard - shall be rated for the operator's weight. Contact Truck Manufacturer.



### Full Body Harness with Mating Buckle

Part Number	Size
300001-004	X-Small
300001-001	Small/Medium
300001-002	Large/X-Large
300001-003	XX-Large

- Lightweight nylon webbing
- Permits unrestricted movement
- Lightweight and durable
- Forged-steel sliding back D-ring
- Mating buckles on legs and shoulder straps



### Full Body Harness with D-ring web extension

Part Number	Size
300030-001	Small/Medium
300030-002	Universal

- Stretchable webbing design
- Unique D-ring web extension
- Lanyard ring
- For warehouse pickers



### Full Body Harness with Tongue Buckle

Part Number	Size
300002-001	Small/Medium
300002-002	Large/X-Large
300002-003	XX-Large
300002-004	XXX-Large

- Conventional nylon webbing
- Friction buckles on chest and shoulder straps
- Tongue buckle leg straps
- Forged steel sliding back D-ring
- Permits unrestricted movement



### Full Body Harness with Tongue Buckle

Part Number	Size
128775	Large/X-Large

- Friction buckle shoulder strap adjustment
- Tongue buckle leg strap adjustment
- Forged steel sliding back D-ring
- Mating chest strap buckle
- Sub pelvic strap
- Pull-free lanyard ring
- Non-stretch webbing

Part Number	Capacity (lbs.)	Sliding Back D-Ring	Side D-Rings	Shoulder Strap Buckles*	Leg Strap Buckles*	Chest Strap Buckle*	Sub-Pelvic Strap	Pull-Free Lanyard Rings	Stretchable Webbing	Manufacturer	Shoulder & Leg Padding Removable
300001-XXX	400	Yes	No	M	M	M	Yes	Yes	No	Titan	No
300002-XXX	400	Yes	No	M	T	M	Yes	Yes	No	Titan	No
128775-XXX	400	Yes	No	F	T	M	Yes	Yes	No	Miller	No
300030-XXX	400	Yes	No	F	M	M	Yes	Yes	Yes	Miller	No

\*Key: F-Friction; M-Mating; T-Tongue

### Harness Size Reference Chart

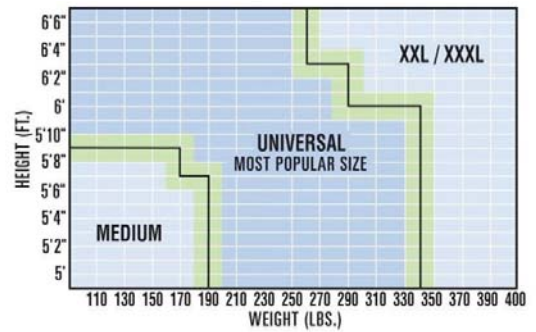

1. Sliding Back D-Ring; 2. Side D-Ring; 3. Mating Buckle; 4. Friction Buckle; 5. Tongue Buckle

# Fall Protection - Harnesses



## AirCore Full Body Harness with Aluminum Hardware

- Corrosion resistant aluminum hardware
- Breathable, open-core padding technology
- Stretchable webbing provides flexibility and comfort
- Cam buckles on the shoulder straps for easy adjustments
- Universal (Large/X-Large)

Part Number	Side D-Rings	Chest Strap Buckle	Leg Strap Buckles	Lumbar Pad	Removeable Belt
300031-050	No	Quick-Connect	Tongue	No	No
300031-051	No	Quick-Connect	Quick-Connect	No	No
300031-052	Yes	Quick-Connect	Tongue	No	No
300031-053	Yes	Quick-Connect	Quick-Connect	No	No
300031-054	Yes	Quick-Connect	Tongue	Yes	Yes
300031-055	Yes	Quick-Connect	Quick-Connect	Yes	Yes



## AirCore Full Body Harness with Steel Hardware

- Breathable, open-core padding technology
- Stretchable webbing provides flexibility and comfort
- Cam buckles on the shoulder straps for easy adjustments
- Universal (Large/X-Large)

Part Number	Side D-Rings	Chest Strap Buckle	Leg Strap Buckles	Lumbar Pad	Removeable Belt
300031-010	No	Quick-Connect	Quick-Connect	No	No
300031-011	No	Quick-Connect	Tongue	No	No
300031-012	Yes	Quick-Connect	Quick-Connect	No	No
300031-013	Yes	Quick-Connect	Tongue	No	No
300031-014	Yes	Quick-Connect	Quick-Connect	Yes	Yes
300031-015	Yes	Quick-Connect	Tongue	Yes	Yes
300031-016	No	Mating Buckle	Tongue	No	No
300031-017	Yes	Mating Buckle	Tongue	Yes	Yes

### Harness Size Reference Chart

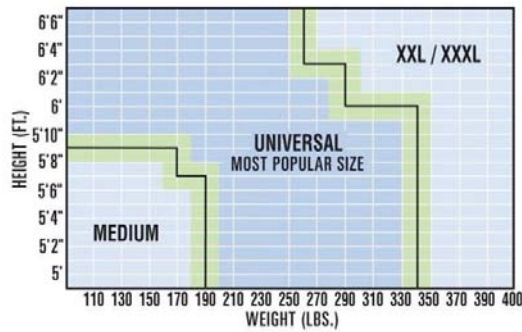

## Fall Protection - Lanyards



### Universal Cab Mount 8 ft. Fall Limiter Assembly

Part Number	Length (ft)	Weight Capacity (lb)
300052	8	310

#### Cab Mount

- Adjustable side brackets promotes a custom fit from 3.75" to 9.125"
- Quick and easy installation
- Non-protruding mount provides greater head room

#### Fall Limiter

- Capacity 310 lbs, can add 300020-001 shock absorbing pack for capacity of 400 lbs
- Quick-activating, high-strength stainless steel braking system

### Fall Limiter (Only)

Part Number	Description	Size (ft)
300052-001	For use with Cab Mount	8



### Lanyard Energy-Absorbing

Part Number	Length (ft)	Weight Capacity (lb)
129935-001	6	310

Orange - locking snap hooks on each end.  
Add P.N. 300020-001 energy absorbing pack for capacity of 400 lbs.



### Lanyard Self-Retracting

Part Number	Length (ft)	Weight Capacity (lb)	Color
153557	8	310	Red
353558	8	400	Red

Small, lightweight design. Quick-activating, high-strength stainless steel breaking system - arrest free falls. Visual load indicator - indicates the unit must be removed from service.



### Energy-Absorbing Pack

Part Number	Description
300020-001	Add to P.N. 153557, 129935-001 for a weight limit capacity of 400 lbs.

See  
Section  
10.

**100**  
SERIES  
Light Duty

**200**  
SERIES  
Midrange

**300**  
SERIES  
High Capacity

**400**  
SERIES  
Heavy Duty

**1 Lower Maintenance Labor Cost**

**2 Minimize Operator Downtime**

**3 Reduce Parts Inventory**



# Maintenance Safety Items



### Self-Retracting Lifeline\*

Part Number	Length (ft)	Weight Capacity (lb)
300067	11	310
300058	20	310
300068	50	310
300069	66	310
300070	85	310

- Industry's lightest and most compact SRL.
- Unique speed-sensing brake reduces clearance requirements and limits fall arrest forces to 900 lbs or less.

\*Note: Not for operator use on lift truck.



### 3' Tie-off Adaptor\*

Part Number	Length (ft)	Weight Capacity (lb)
300059	3	310

- 1 1/4" polyester strength member, 5000 lb minimum tensile strength.
- 3" wide polyester wear pad for added abrasion resistance.

\*Note: Not for operator use on lift truck.



### Tag Line\*

Part Number	Length (ft)
300060	25

3/8" polypropylene rope with o-ring at end used to tie to end of self retracting lifelines to bring end down to the user.

\*Note: Not for operator use on lift truck.



### Storage Bag\*

Part Number	Size (in)
300066	22W x 10H x 9.5D

Used to store and carry harnesses, lanyards, tag lines, etc.



### Carabiners Turn Open Lock

Part Number	Gate
300064	3/4"



### Lanyard Positioning\*

Part Number	Length (ft)	Weight Capacity (lb)
300063	6	310

1" wide web built in wear indicator informs user when to replace self-locking snap hooks at both ends.



### ExoFit XP Harness with back and side D-rings

- Soft lightweight polyester webbing is strong without feeling stiff
- Soft edging prevents rubbing and chafing
- Unique spring loaded "stand-up" dorsal D-ring ensures fast, easy and safe connections and safe D-rings for work positioning
- Coated hardware for corrosion resistance
- Washable with removable padding

Part Number	Size	Capacity (lbs.)	Sliding Back D-Ring	Side D-Rings	Shoulder Strap Buckles*	Leg Strap Buckles*	Chest Strap Buckle*	Sub-Pelvic Strap	Stretchable Webbing	Shoulder & Leg Padding Removable
300082	S	420	Yes	Yes	M	M	M	Yes	No	Yes
300056	M	420	Yes	Yes	M	M	M	Yes	No	Yes
300057	L	420	Yes	Yes	M	M	M	Yes	No	Yes
300071	XL	420	Yes	Yes	M	M	M	Yes	No	Yes
300072	XXL	420	Yes	Yes	M	M	M	Yes	No	Yes

\*Key: M-Mating

### ▲ ExoFit XP Harness Accessories

#### Storage Pouch

Part Number	Description
300061	Belt loops for easy attachment to your belt and harness snap closure to secure items. Size: 7.5" x 7.5" x 3".



#### Cell Phone Pouch

Part Number	Description
300062	Attaches to harness



### Ratchet Strap\*

Part Number	Length (ft)
300065	6

- 1" wide strap
- Work load limit 500 lbs.
- Breaking strength 1,500 lbs.

\*Not for operator use on lift trucks.



## Eye Protection\*



### Safety Glasses

Part Number	Sales Unit
365250-001	Single
365250-012	Case of 12

Economical protection. Full coverage. Frost color frame, clear lens. Wraparound style, lightweight. Conforms with ANSI Z87.1.



### Safety Glasses

Part Number	Sales Unit
365251-001	Single
365251-012	Case of 12

Soft padding on temple arm tip and padded nose bridge. Black frame, clear lens. Adjustable temple arm. Wrap-around style, durable frame. Conforms with ANSI Z87.1.



### Safety Glasses

Part Number	Sales Unit
365252-001	Single
365252-012	Case of 12

Wraparound Hi-Vis Green design for maximum field of vision. Padded nose bridge. Adjustable temple arm. Hi-Vis Green retainer cord. Conforms with ANSI Z87.1.



### Safety Glasses

Part Number	Sales Unit
365254-001	Single
365254-012	Case of 12

Basic eyewear protection for visitors. Economical. Clear frame, clear lens, fits over glasses. ANSI approved Z87.1.



### Goggles

Part Number	Sales Unit
365253-001	Single
365253-012	Case of 12

For complete eye protection where splash or heavy particles are in the air. Full face flange allows for comfort while the polycarbonate lens give full protection. With Anti-Fog lenses and indirect ventilation. Meets ANSI Z87 safety standard.

ANTI-FOG



### +1.5 Reading Lens

Part Number	Sales Unit
365256	Single

100% Polycarbonate scratch resistant lenses. Nose buds secure the glass & prevent slipping, adjustable temple arm. Provides 99% protection from harmful UL UV-A & UV-B rays. Exceeds ANSI Z87.1 high impact requirements & CE EN166 certified.

NEW!



### I-Force Goggles

Part Number	Sales Unit
365257	Single

Sporty, lightweight design. Quick release interchangeable temples & elastic strap. Anti-fog, clear lens. Exceeds ANSI/ISEA Z87.1 standards.

NEW!



### Pre-Moistened Towelettes

Part Number	Sales Unit
365255	10 boxes/case

5" x 8", 100 to a box. NOT for use on coated lenses. For glasses and computer screens. Individual packages for convenience and portability.

## Eye Wash Products\*



### 16 Gallon Eye Wash Station

Part Number	Sales Unit
365466	1 kit

15 minute flow, required by ANSI Z358.1-2009. Includes steel wall bracket, 2 oz. sterile water solution, and test log and drainage hose. Drain and refill every 4 months with 2 oz. solution, part number 365467-002-04.



### Eye Wash Station

Part Number	Sales Unit
365468	1 kit

Two bottle wall-mounted eye wash station. Includes two 16 oz bottles of sterile eye wash. Easily mounts to any wall.

Image Not Available

### Sterile Solution for 16 Gallon Eye Wash Station

Part Number	Sales Unit
365467-002-04	Four 2 oz. bottles

Add one bottle in 16 gallon tank, part number 365466.



### Replacement Bottle of Eye Wash

Part Number	Sales Unit
365469-001	One 16 oz. bottle

Sterile eye wash. Can be used alone or with 365468 eyewash station.

\*Available only to customers in USA

## Hearing Protection\*



### Ear Plugs

Part Number	Sales Unit
365280-200	200 pairs/box

NRR 33. Officially licensed ear plugs of NASCAR®. Tapered for easy insertion in any ear canal. Different colors in every package. Individually wrapped. 1 pair per bag.



### Ear Plugs

Part Number	Sales Unit
365281-100	100 pairs/box

NRR 33. Officially licensed ear plugs of NASCAR®. Tapered for easy insertion in any ear canal. Different colors in every package. Individually wrapped. 1 pair per bag. With cord.



### Ear Muffs

Part Number	Sales Unit
365282	Single

Low profile design. Soft foam ear cups. Adjustable to fit all sizes. Fold-away padded headband. Meets ANSI S3.19 requirements, CE EN 352-2-2002 certification, NRR 31.

**NEW!**

## Breathing Protection\*



### Respirator Mask

Part Number	Sales Unit
365270-020-02	2 boxes/case

Protects against ultra-fine particles. Inner soft foam nose cushion. Metal-free. Yellow color-coded double straps. NIOSH approved, N95. 20/box.



### Respirator Mask w/Exhale Valve

Part Number	Sales Unit
365271-010-02	2 boxes/case

Protects against ultra-fine particles. Inner soft foam nose cushion. Metal-free. Blue color-coded double straps. With exhale valve. NIOSH approved, N95. 10/box.



### Moldex® 2300 N95 Particulate Respirator

Part Number	Sales Unit
365277-010-01	10/box

Dura-Mesh shell for durability. Protects against fine, dry particles. Softspun inner liner for comfort; molded nose bridge. Blue/white. Size: medium/large. NIOSH approved. With exhale valve.

**NEW!**



### Nuisance Mask

Part Number	Sales Unit
365272-050-04	4 boxes/case

For dirt, dust and nuisance cleaning. Single strap and metal nose piece. Not NIOSH approved. 50/box.



### Moldex 9000 Reusable Full-Face Respirator

Part Number	Sales Unit
365274	Single

Provides lung and face protection. Lightweight. Strap buckles are securely molded to face piece for rugged use. Coated lens for scratch resistance. Size: Large. NIOSH approved.

**NEW!**



### Protective Sheets for Face Shield

Part Number	Sales Unit
365274-001	15 sheets/box

For use on full-face respirator (P.N. 365274) to protect face piece.

**NEW!**



### Moldex N95 Particulate Pre-Filter

Part Number	Sales Unit
365275	5 pair/pack

Use with vapor cartridge or stand alone. NIOSH certified.

**NEW!**



### Organic Vapor Cartridges

Part Number	Sales Unit
365276	1 pair/pack

Protection against organic vapors. Use with half-mask respirator (P.N. 365273) or full-face respirator (P.N. 365274).

**NEW!**



### Moldex 7000 Reusable Half-Mask Respirator

Part Number	Sales Unit
365273	Single

Totally adjustable. Lightweight. Fits under welding helmets & with safety glasses. NIOSH approved. Size: Large. Includes 2 organic vapor cartridges (P.N. 365276).

**NEW!**

\*Available only to customers in USA

## Face Protection\*



**Face Mask**

Part Number	Sales Unit
365258	Single

Full face protection, fits over prescription glasses. Removable shield. Exceeds ANSI Z87.1 high-impact requirements. CE EN166 certified. Exceeds CAN/CSA Z94.3-07 standards.





**Universal Hard Hat Adapter**

Part Number	Sales Unit
365262	Single

For use with face shields.





**Tear-Off Goggle Protectors**

Part Number	Sales Unit
365259	6/pack

Disposable.







**Polyethylene Face Shield**

Part Number	Sales Unit
365263	Single

8" x 15" x .040" thick. Meets ANSI Z87.1 requirements; CSA Z94.1-05.







**Headgear for Face Shield**

Part Number	Sales Unit
365261	Single

Constructed from durable nylon. Universal pegs will accommodate a wide variety of face shields. Ratchet style adjustment for easy fit. Pivoting action allows user to lift face shield while wearing.





**Polycarbonate Face Shield**

Part Number	Sales Unit
365264	Single

8" x 15" x .040" thick. Meets ANSI Z87.1 requirements; CSA Z94.1-05.



## First Aid Kits\*

**First Aid Kits**

Part Number	Group of
365290-010	10
365290-025	25
365290-050	50

Should be in clear view of workers in case of accidents. For groups of 10, 25 or 50. Kit includes: bandages, gauze, adhesive tape, antiseptic, cold pack, scissors, soothing sting, swabs, burn cream packets and cut cleaner.



## Disposable Safety Apparel\*



**Protection Coveralls - Zipper Front**

12 per case

Part Number	Size
365300-001-12	Medium
365300-002-12	Large
365300-003-12	X-Large
365300-004-12	2XL
365300-005-12	3XL

Provides protection against dry particulates and light liquid splash. Breathable, elastic wrists and ankles, zipper flap. Seamless front. Durable and abrasion resistant. Meets ANSI/ISES 101-1996 sizing standard.



**Apron**

1 Apron

Part Number	Description
365260-001	Double coated nitrile. Nylon stitched edges. Neoprene for use with batteries. USDA accepted for food and meat handling.





**Safety Vests**

2 per pack

Part Number	Size
365311-001-02	Medium
365311-002-02	Large
365311-003-02	X-Large
365311-004-02	2XL
365311-005-02	3XL
365311-006-02	4XL
365310-001-02	Medium
365310-002-02	Large
365310-003-02	X-Large
365310-004-02	2XL
365310-005-02	3XL
365310-006-02	4XL

**Part Number 365311 is Solid.**  
**Part Number 365310 is Mesh.**  
 3 pockets, velcro closure. Meets Class 2 classification. Meets ANSI 107-2004 standard. Allows greater visibility with fluorescent lime green color, orange stripe and reflective tape.





**Shoe Covers**

Part Number	Description
365301-300	Non-skid bottom. Polyoriolyene. Elastic around ankles. Large/X-Large. 300 pairs.

\*Available only to customers in USA

## Hard Hats\*

### Hard Hats

Part Number	Color
365470-001	Blue
365470-002	High Vis Green
365470-003	Red
365470-004	White
365470-005	Yellow
365470-006	Orange



- High density polyethylene construction
- 4 point ratchet suspension
- Meets ANSI Z89.1-2009 standard, type 1, class C, G & E



**Note:** Universal face shield adapter for hard hats (P.N. 365262) is listed on page 2.09.

## Safety Related Accessories



### Lockout Tag Out Kit (single connector only)

**Part Number**  
300037 (includes 10 lockout tags)

Fits - SB and SBX connectors  
Fits - 50, 175 and 350 AMP connectors

Individual Items  
300037-002 (box only)  
300037-003 (lock only)

Accessories:  
Tag Refill Kit (Qty. 25 pc)  
P.N. 300037-025



### Fire Extinguisher

#### Part Number

079528 (includes bracket)  
2.5 lb. multi-purpose ABC  
dry chemical with aluminum valve

Accessories:  
Mounting Bracket  
(P.N. 379528)

**Note:** See Work Assist  
section for other kits.



### Fire Extinguisher

#### Part Number

127237 (includes two straps)  
2.5 lb. multi-purpose ABC  
dry chemical with aluminum valve

**Note:** See Work Assist  
section for other kits.



### Lock Out Box (dual connectors)

#### Part Number

300420

Fits - SB, SBX, and DIN connectors  
Fits - 50, 175 and 350 AMP connectors

Note: Lock Not Included

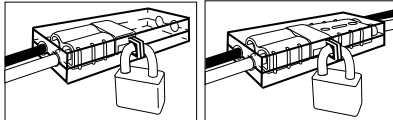

Lock Out

Lock Together

### Barricade/Caution Tape\*

#### Part Number Sales Unit

365265 Single

Weather resistant. Compliant under OSHA  
standards, 1910-144(A) physical standards.  
3' x 1000', 3.0 mil.



### Safety/Traffic Cones\*

#### Part Number Height

365266-001 18"

365266-002 28"

Tough all-weather orange cones. 100%  
PVC. Meets federal MUTCD & NCHRP-350  
specifications.

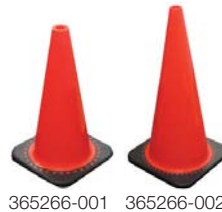

365266-001

365266-002



### Safety/Traffic Cones\*

#### Part Number Color

365266-003 Orange

365266-004 Lime

Tough all-weather cones. 100% PVC. Meets  
federal MUTCD & NCHRP-350 specifications.  
28" high with 4" & 6" reflective collars.



365266-003

365266-004



\*Available only to customers in USA

# Battery Spill Kit

## Part Number - 300035

Note: Instructional label inside lid.

### ▲ Individual Items

Part Number	Description	Quantity
300042	Faceshield	1
300041	Headgear	1
300049	32 oz Acid neutralizer (per bottle)	2 bottles
300043	Acid spill sorbent cleanup pads	10
300047	Yellow heavy-duty chemical disposal bag	1
300048	Mini broom	1
300051	16 oz eye wash flush	1 bottle
300044	Green acid resistant glove	1 pair
300045	Acid-resistant sleeve	1 pair
300050	Acid-resistant rubber overboot	1 pair
300046	Acid-resistant apron	1

Note: Individual part numbers sold by piece or pair.



**Be prepared for a variety of accidental spills**

# Spill Absorbent Products

Continued ▶



## Acid Spill Absorber and Neutralizer

Part Number	Sales Unit	Absorbs
300421	25 lbs.	6 gallons of electrolyte
300421-030	160 lbs.	40 gallons of electrolyte

- Specifically formulated to absorb and neutralize battery acid, with color change to show when acid is neutralized and safe for disposal
- Ideal for use in acid drip pans
- Safe and non-hazardous
- Sweeps up clean and dry, is not dusty like kitty litter/clay
- Durable easy to store container with resealable lid
- Instructions and MSDS included  
See OSHA 1926.441 & 1910.173

**Cold Form:** Uses pre-formed cotton fibers. These cotton fibers, once processed, provide a high degree of strength, durability & absorbency. Requires less energy to produce, earth-friendly/green, made from renewable & recycled resources. Poly backed pads prevent leaks from penetrating to surface below.



### Pads & Rolls\*

Part Number	Sales Unit
365321-100	Gray, 15" x 18", 100/case
365322-001	Gray, 28" x 150', 1 roll/case, perforated every 18"

Earth friendly/green. Large liquid holding capacity. Quick absorbency. Long product life. Great for fast clean-up. Absorbs oil, coolants, solvents and water.



**Meltblown Technology:** Polypropylene — the industry standard. American made polypropylene is the most popular sorbent in the market.



### Pads & Rolls\*

Part Number	Sales Unit
365323-100	Gray, 15" x 18", 100/case
365324-001	Gray, dimpled, 30" x 150', 1 roll/case, perforated every 18"

Quick absorbency. Large liquid holding capacity. Long product life. Great for fast clean-up. Absorbs oil, coolants, solvents and water.



## QuiKleen Absorbent Powder

Part Number	Sales Unit
363200	20 lb Bag
363201	Case (4) Easy Pour Jugs
363205	5 Gallon Pail

QuiKleen Absorbent Powder is an instant response to your most frequent liquid spill needs. It is an environmentally safe product that is landfill acceptable and EPA certified. Absorbs gas, oil, coolants, water, eggs, syrups, paint, blood, vomit, and many solvents. (DO NOT USE IN CLEAN UP OF HYDRO-FLUORIC ACID).



## Matting\*

Part Number	Sales Unit
365319-001	18" x 150' roll; 2 rolls/case
365320-001	36" x 150' roll; 1 roll/case

Use as a maintenance rug. Keep liquid from damaging floors. Absorbs non-aggressive liquids. Non-perforated.



## Pads\*

Part Number	Sales Unit
365328-100	Gray, 15" x 18", 100/case

Fastest absorbing. Superior liquid holding capacity. Longest product life. Absorbs oil, coolants, solvents and water.

\*Available only to customers in USA

# Spill Absorbent Products



### Drum Top Covers\*

**Part Number**   **Sales Unit**

365325-025   |   Gray, 25/case

Absorb excess liquids on top of 55 gallon drum.



### Response Kits\*

**Part Number**   **Sales Unit**

365327-001   |   1 kit

Packed in a zippered, clear vinyl bag. Labeled with an easy to read yellow safety tag. Oil specific. Includes 20 pads, 2 socks, 2 clean-up bags.



### Socks\*

**Part Number**   **Sales Unit**

365326-040   |   Gray, 42" x 3", 40/case

Flexible to fit around machinery and excellent for containing spills. Absorbs oil, coolants, solvents and water.

\*Available only to customers in USA

# Mirrors

Part Number	Dimensions W x L (in)	Description
111481	4.44 x 5.75	Bolts on with 1/4"-20 UNC nut
094723	5.65 x 8.65	Bolts on with 1/4"-20 UNC nut
137670	7.32 x 12.52	Mounts onto .55" - .79" (14-20 mm) diameter rod
105035	6.00 x 23.00	Flat mirror, no mounting
105036	6.00 x 23.00	Includes mirror (P.N. 105035) and machined cover mount mirror.
148613	4.50 x 8.00	Plastic mirror, bolts on with 3/8" UNC nut
151007	6.37 diameter	Round acrylic lens

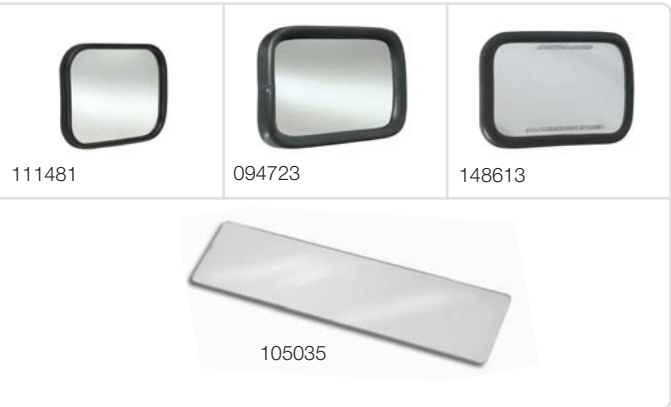

Part Number - 380030-006

### Mirror

4" x 7.875"

▼ OEM Reference  
TY 58710-20540-71



Part Number - 380030-007

### Mirror

3.875" x 6.25"

▼ OEM Reference  
HM 7395  
NI 96303-11H00



Part Number - 380030-044

### Mirror

4.625" x 8"

▼ OEM Reference  
HM 7390  
KM 4966092  
KO 3EB-55-13571  
NI 96303-6G000  
TY 58720-23320-71  
TY 58720-26600-71



300130-001

### Anti-Blind Spot Dome Mirrors

These plastic mirrors give a complete 180° view, allowing the operator to give a quick safety check before traveling in reverse. Installs on any lift truck in seconds with either two-sided tape or a magnet.



300130-002

Part Number - 300130-001

3M two-sided tape;  
8.5" x 6.25" x 3"

Part Number - 300130-002

Magnet; 8.25" x 7.5" x 3"

## Section 3

# Electric Truck Components

## Contents

Replacement Bulbs	3.02
Lights	3.02
Horns	3.06
Back-Up Alarms	3.07
GE Plug Kits	3.07
Deutsch Connectors	3.08
Switches	3.09
Wire and Cable	3.14
Fuses	3.15
Contactors/Contactor Tips	3.18
Cards	3.20
Battery Capacity Indicators & Hour Meters	3.22
DC/DC Converters	3.23
Yale, Hyster, Raymond Parts Breakdown	3.24 & 3.36
Lift Structure	3.27
Drive Unit, Brake, and Steering	3.38
Motor and Hydraulic	3.41
Cylinders/Seal Kits	3.52
Miscellaneous	3.53
Electric Truck Components Cross Reference by Manufacturer	3.55

### New Items:

Replacement Bulb - p. 3.02  
 Strobe Lamp - p. 3.03  
 12V Horn - p. 3.06  
 Ignition Switch - p. 3.13  
 Contactors & Tips - p. 3.19  
 Battery Capacity Indicator - p. 3.22  
 Bushing - p. 3.35  
 Motors - p. 3.42-3.44  
 Motor Brushes - p. 3.47-3.48

Note: 1910.178(q)(5) (1998) of the Occupational Safety and Health Act (OSHA) requires that "All parts of any such industrial truck requiring replacement shall be replaced only by parts equivalent as to safety with those used in the original design."



## Replacement Bulbs



Part Number	Voltage	Vendor Number	Series	
<b>Dual Element</b>				
122232	12	1142		
112480	12	1157	FC	
078533-001	24	1638	Stockpickers, FC/FP, PE 4000	
117993	36	SP1	FC/FP, FC 4000, SC 4000	
101957	36	SP5	Turrets, RC, SC	
117994	48	SP2	FC, FC 4000	
<b>Single Element</b>				
110578	12	93	Stockpickers	
116364	12	1141	RR/RD 3000, RR/RD 5000	
110581	12	1156	Stockpickers, FC/FP, TSev100	
H49784-573	12	1156, LED	Stockpickers, FC/FP, TSev100	
101365	24	1683	TSev100	
083307	24	3011	SP36, SP42, SP48, TS	
118321	36	SP7	FC/FP	
105491	48	SP6	TSP	
118322	48	SP8	FC/FP, RC 3000	
<b>Small with Short Base</b>				
086042-001	14	386	RR, RD, RS, RR and RD Heated Cab, TS	
087227	24	1819	PC, PE, PR, PW, RC, RR/RD/RS, RC, SC, SP36, SP42, SP48, W(HD), WB, WR	
<b>Sealed Beam (102 mm/4 in) Diameter</b>				
340002-001	12	4411		
346957	12-48		LED sealed beam is a direct replacement for part numbers 340002-001, 087195-001, 102195 and 105619.	
087195-001	24	4589	Reach Trucks, Stockpickers	
102195	36	4350	Reach Trucks, Turrets, FC 4000, RC, RC 3000, SC, SC 4000	
105619	48	4340	TSP	
<b>Small with Long Base</b>				
105816	36	1822	TSP, TSev100, SP 3000	
<b>Long with Dual Contacts</b>				
111382	12	211-2	FC	
<b>Strobe Halogen</b>				
340009	12-80	5001	RR 5000	
<b>Bulb with Plug, Halogen</b>				
125672	12	862	FC/FP, FC 4000, PE 4000	
<b>Flashtube - Strobe</b>				
111782		400-537	TSP 6000	
<b>Bulb with Wire</b>				
		<b>Specs</b>	<b>Wattage</b>	
112481	12	H-3	FC	55
796059-005	24	H-3	ESR 4500	70
340080	36	H-3		35
340075	48	H-3		55



## LED Strobe Lights



### Flat Mount Base

Part Number	Color	Assembly Height (in)	Mounting Hole to Mounting Hole (in)	Voltage
138445-001	Amber	5.25	3.40	12-48
138445-002	Red	5.25	3.40	12-48
138445-003	Blue	5.25	3.40	12-48

Note: 5-year warranty.



### Conduit Mount Base

Part Number	Color	Assembly Height (in)	Diameter (in)	Voltage
138445-004	Amber	5.25	2.81	12-48
138445-005	Red	5.25	2.81	12-48
138445-006	Blue	5.25	2.81	12-48

Note: 5-year warranty.



### ◀ 138445-XXX Accessories

#### Replacement Lens

Part Number	Color
340024-001	Amber
340024-002	Red
340024-003	Blue



#### Accessory Guard

Part Number
118898





## Strobe Lights



### Flat Mount Base

Part Number	Color	Assembly Height (in)	Mounting Hole to Mounting Hole (in)	Voltage
127651-001	Amber	5.25	3.40	12-80
127651-002	Red	5.25	3.40	12-80
127651-003	Blue	5.25	3.40	12-80

Note: 1-year warranty.

### Kits (Flat Mount Base Only)

Part Number	Color	Voltage	Series
127509-001	Amber	12-80	SC 4000 Series, FC 4000 Series
127509-002	Red	12-80	SC 4000 Series, FC 4000 Series
127509-003	Blue	12-80	SC 4000 Series, FC 4000 Series

Note: Kits include weldment cover and lens blackout.



### Conduit Mount Base

Part Number	Color	Assembly Height (in)	Diameter (in)	Voltage
112951-001	Amber	5.19	2.88	12-80
112951-002	Red	5.19	2.88	12-80
112951-003	Blue	5.19	2.88	12-80

Note: 1-year warranty.



### Flat Mount Base - Low Profile

Part Number	Color	Assembly Height (in)	Mounting Hole to Mounting Hole (in)	Voltage
133186-001	Amber	4.48	4.382	12-80
133186-003	Blue	4.48	4.382	12-80
133186-004	Red	4.48	4.382	12-80

Note: 1-year warranty.



### Strobe Lamp

Part Number	Color	Height (in)	Width (in)	Diameter (in.)	Voltage
380030-108	Amber	2.75	2.25	5.5	12-80

Note: 1-year warranty.

Replacement Flash Tube: P.N. 380101-907

### 127651-XXX / 112951-XXX Accessories

#### Replacement Lens

Part Number	Color
113611	Amber
113612	Blue
113613	Red



#### Replacement Bulb

Part Number
340009



#### Accessory Guard

Part Number
118898



### 133186-XXX Accessories

#### Replacement Lens

Part Number	Color
137195-001	Red
137195-002	Amber
137195-003	Blue
137195-004	Green

#### Replacement Bulb

Part Number
111782

### ▼ OEM Reference

CL	2366970
HM	72268A
HY	800049142
TY	00591-08516-81



## Tail Lights



117998



380030-039



380030-076



340014-xxx

Part Number	Series	Voltage	Replacement Bulb	Warranty
117998	FC/FP	48	117994	1-year
117998	FC/FP	36	117993	1-year
380030-039	KM 8761802	12		1-year
380030-076	KO 37B-1EB-3010	12		1-year
380030-076	KO 3EB-55-A6660	12		1-year

### LED Light

340014-001		12		5-year
340014-002		24-36		5-year
340014-003		48		5-year
380030-077	KO 3EB-55-A7720	12		1-year

\*LED not replaceable.



380030-077

### ◀ Bulb Light Accessories

#### Replacement Lens

Part Number	Color	Used On
120717	Small Red	117998
120718	Red Center	117998
120719	Small Clear	117998
380030-043	One Piece	380030-039



380030-043

### ◀ 340014-XXX Wiring Instructions

Wire Color	Function
White	Backup
White/Red	Tail
Red	Brake
Yellow	Turn
Black	Ground

## Flashing Lights



Part Number	Description	Voltage	Series	Replacement Bulb
101458	2 wire filter	24	Stockpickers, PE 4000	078533-001
101755	2 wire filter	36	TS, TSP-72V	101957
102984	3 wire filter	36	RC, SC, TSev100, TSP-72V	101957

**Note:** 1-year warranty.

### ▲ Kits

Part Number	Voltage	Series
101475-001	24	SP42
101475-002	24	SP36, SP48
101746	24	SP36, SP42, SP48, TSev100
102986	36	RC, SC

**Note:** 1-year warranty.



### ▲ Accessories

#### Replacement Dome

Part Number	Color
085031	Amber
083308	Red



#### Accessory Guard

Part Number
085322



### ◀ 133186-002 Accessories

#### Replacement Lens

Part Number	Color
137195-001	Red
137195-002	Amber
137195-003	Blue
137195-004	Green

#### Replacement Bulb

Part Number
110581



### Low Profile - Two Wire Filter

Part Number	Color	Assembly Height (in)	Width (in)	Voltage	Series
133186-002	Amber	4.48	4.38	12-48	TSP 6000/7000 Series

**Note:** 1-year warranty.

### Low Profile - LED Flashing Light



Part Number	Color	Assembly Height (in)	Width (in)	Voltage	Series
133186-005	Amber	4.50	4.38	12-110	TSP 6000/7000 Series
133186-006	Blue	4.50	4.38	12-110	TSP 6000/7000 Series
133186-007	Green	4.50	4.38	12-110	TSP 6000/7000 Series
133186-008	Red	4.50	4.38	12-110	TSP 6000/7000 Series

**Note:** 5-year warranty.



## Dome Lights



Part Number	Voltage	Series	Replacement Bulb
109810	12	SP 3000, FC, TS, SP	110581

**Note:** 1-year warranty.

### ▲ Kits

Part Number	Description	Voltage	Series
117835-001	Assembly, 27" Batt. Comp.	12	FC
117835-002	Assembly, 33" Batt. Comp.	12	FC
117835-003	Assembly, 36" Batt. Comp.	12	FC

**Note:** 1-year warranty.



Part Number	Voltage	Series	Replacement Bulb
105043	48	TSP	105491
107392	36	TSP	101957

### ▲ Accessories

#### Replacement Lens

Part Number
104305

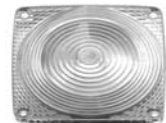

Part Number	V/C.P.	Series	Replacement Bulb
109811	12/15	SP 3000	110578
116319	12/21	RR 3000	116364

V/C.P. = Voltage/Candle Power

**Note:** 1-year warranty.

**Work Lights**

Part Number	Description	Voltage	Series	Replacement Bulb	Lens
145981	Front Work	12	C5	125672	Plastic
107712	Front Work	12	FC/FP	112481	Plastic
125674	Front Work	12	FC/FP	125672	Plastic
118129 (Bulb not included)	Front Work		FC/FP, RC 3000	110581 (12 volt) 118321 (36 volt) 118322 (48 volt)	Plastic
128653	Front/Rear Work	12	FC 4000, PE 4000	125672	Plastic
107713	Rear Work	12	FC/FP	112481	Plastic

**Note:** 1-year warranty.



◀ **125674 Accessories**



**LED Work Lights**

Part Number	Description	Voltage	Lens
340023-001	Bottom/Horizontal Mount	12-48	Plastic
340023-003	Bottom/Horizontal Mount with switch	12-48	Plastic
340023-004	Bottom/Horizontal Mount with switch and sensor	12-48	Plastic
340023-002	Side/Vertical Mount	12-48	Plastic
340023-005	Side/Vertical Mount with switch	12-48	Plastic
340023-006	Side/Vertical Mount with switch and sensor	12-48	Plastic



**Note:** 5-year warranty. **With Switch:** on/off function only. **With Switch and Sensor:** on/off function plus sensor will automatically dim the lamp to 25 percent of full power when in a bright environment. In dark environment will operate at full power. **Replacement Part:** Wire assembly for all LED work lights is 340053. **Additional Note:** FC 4000 Series trucks require Mounting Bracket P.N. 145887.

**LED Work Light**

Part Number	Description	Voltage	Lens
152949-001	Bottom/Vertical Mount - No harness, has deutsch connector. Flood lens. 5-year warranty.	12-48	Plastic



**LED Work Light with Turn Signal**

Part Number	Description	Voltage	Lens
144053-002	Bottom/Vertical Mount - White LEDs for visibility & amber for turn signal functionality. Flood lens. 5-year warranty.	12-48	Plastic



**Front Lamp**

Part Number - 380030-005

▼ OEM Reference

AC 4949757	HAM 37B-1EA-2010	HAM 37B-1EH-2010A	KM 4949757
HAM 4949757	HAM 37B-1EH-2010	HAM 37B-1EH-2010L	KO 37B-1EH-2010

**Note:** 1-year warranty.



## Work/Spot Lights

### Spot Lights

Part Number	Description	Voltage	Series	Replacement Bulb	Lens	Mounting Hardware Included
104296-001	Front/Rear	48	TSP	105619	Glass	x
104296-002	Front/Rear	36	RC, RC 3000, SC, SC 4000, Reach, TSev100, TSP	102195	Glass	x
104296-003	Front/Rear	24	Reach, SP	087195-001	Glass	x
104296-004	Spotlight	36	RC, RC3, SC, SC4, Reach, TSev100, TSP	102195	Glass	
104296-005	Spotlight	24	Reach, SP	087195-001	Glass	



**Note:** 1-year warranty.

### LED Spot Lights

146958S	LED Spot light	12-48		346957	Plastic	
145982-001	LED Spot light	12-48		346957	Plastic	x



- Polycarbonate lens, can be used in food applications
- Last for life of the truck
- Lower cost of ownership than sealed beams
- Energy savings

- Bright light, more visibility
- One light, multiple voltages

**Note:** 5-year warranty

### Blue LED Spot Light

- **P.N. 340081**
- 12-48V; plastic; mounting hardware included
- Blue light provides warning for pedestrians
- UV-resistant polycarbonate lens, can be used in food applications
- Rugged solid state LEDs can withstand shock & vibration
- LED long life
- Die-cast aluminum housing provides maximum protection
- Spot beam pattern
- Universal mount
- 3 x 5 oval
- Does not include wiring; connector needed is 320060 & (2) contacts part number 320061

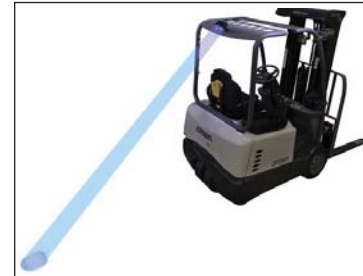

**Note:** 5-year warranty

## Horns



### Electronic Horn with Straight Bracket

Part Number	Voltage	Life Cycles
332199	12, 24	1,000,000
332198	24, 36, 48	500,000



### Mechanical Horns

Part Number	Voltage	Life Cycles
078708-011	12	60,000
078708-002	24	60,000
078708-008	72	60,000



### Electronic Horn with "L" Bracket

Part Number	Voltage	Life Cycles
147631-001	24, 36, 48	500,000



Part Number - 380030-113  
**Horn (12 Volt)**

- ▼ OEM Reference
- HAM 3EB-55-23511
- HM 12-720



### Electronic Horn with "L" Bracket

Part Number	Voltage
143503*	12

\***Note:** Kit includes: horn, L-bracket, harness and kit instructions.



### Suppressor

Part Number	Description
077732	For use with mechanical horns, 078708.
129579	Suppressor only needed in certain applications with new horn style, 147631-001 and 332198.

## Back-Up Alarms



### White Sound Back-Up Alarm

Part Number	Voltage	Decibel Level	Type
300116	12-24	77-97	Smart
300122	12-24	82	Standard
300117	36-80	77-97	Smart
300115	36-80	82	Standard

- Multi frequency broadband sound
- Shh-shh-shh sound compared to the beep-beep-beep of tonal alarms
- Tough, durable and guaranteed waterproof
- Lifetime warranty

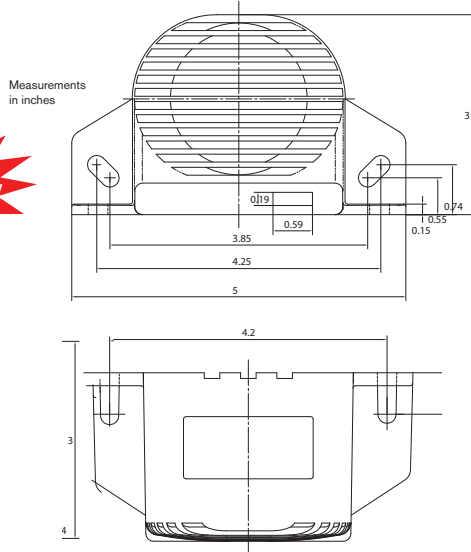

Part Number	Voltage	Decibel Level	Type
115565	12-48	97	Standard
129615	12-48	77-97	Smart
139068-001	12-24	82-102	Smart

▲ **Accessories:** Filter Block (P.N. 112533) for use with back-up alarms.



Filter Block Wiring Diagram

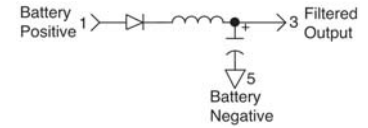

## Grounding Straps

Part Number	Length (in.)
102126-001	18.00
102126-002	10.50
102126-003	8.50
102126-004	5.75

Resistivity 100 OHM-CM



## GE Plug Kits

### Plug Kit (A) P.N. 108934



### Plug Kit (Y) P.N. 112528



### Plug Kit (B) P.N. 108935

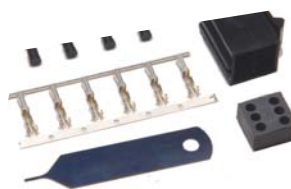

### Plug Kit (Z) P.N. 108936



### ▲ Plug Kit Reference - Control Card

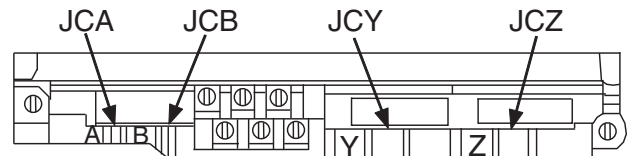

# Deutsch Connectors

## Deutsch Connector Kits



Part Number	Number of Circuits
130197-002	2
130197-003	3
130197-004	4
130197-006	6
130197-008	8
130197-012	12

**Note:** Kits include receptacle, plug, contacts, seals, inserts, and instructions on how to use extraction tool and crimping tool.

### ▲ Replacement Contacts

Part Number	Description	Quantity
130197-015	Pin, Nickel	25
130197-016	Socket, Nickel	25
130197-017	Pin, Gold	25
130197-018	Socket, Gold	25

**Note:** Used only on 130197-XXX.

## Deutsch DTM Connector Kits



Part Number	Number of Circuits
131237-002	2
131237-003	3
131237-004	4
131237-006	6
131237-008	8
131237-012	12

**Note:** Kits include receptacle, plug, contacts, seals, inserts, and instructions on how to use extraction tool and crimping tool.

### ▲ Replacement Contacts

Part Number	Description	Quantity
131237-015	Pin, Nickel	25
131237-016	Socket, Nickel	25
131237-017	Pin, Gold	25
131237-018	Socket, Gold	25

**Note:** Used only on 131237-XXX.



### Extraction Tool

**Part Number - 062706**

Used to remove Deutsch pin and socket contacts from DT and DTM connectors.



### Crimping Tool

**Part Number - 062737-002**

For stripping insulation and crimping new terminals on light gauge electrical wire for insertion into Deutsch DT and DTM connectors.

**If forks are worn beyond 10%, they need to be replaced.**

**Do you know how to check your forks to see if they need to be replaced?**

**Crown offers a fork wear caliper to check thickness and bore size. See Page 6.06.**

## Switches - Rocker and Toggle



**Part Number - 117268**  
Turtle / rabbit symbols  
Single pole / single throw

▼ OEM

SW-2139	TY00591-45237-81	YT220015942
LP393-2604		



**Part Number - 077633**  
Single pole / single throw  
6A @ 125vdc  
3A @ 250vdc

▼ OEM

CL7004240	TO2I5054	YT220014497
HY800076231	TY00591-41984-81	YT800076231
SW-430	TY00591-60665-81	



**Part Number - 062595-001**  
On-off-on  
SPDT

▼ OEM

HY800018665	TY00591-73979-81	YT800018665
LP393-9904	YT220041952	



**Part Number - 062595-003**  
On (momentary)-off-on (momentary)  
SPDT

▼ OEM

SW-1794	LP393-9906	YT220042501
HY800018687	TY00591-73985-81	YT800018687



**Part Number - 062595-002**  
On-none-off  
SPST

▼ OEM

SW-1793	LP393-9905	YT220042503
HY800018666	TY00591-73980-81	YT800018666



**Part Number - 062595-004**  
On (momentary)-none-on  
DPDT

▼ OEM

SW-1795	TY00591-73981-81	SW-1832
HY800018667	YT800018667	LP393-7922
LP393-9907		

## Switches - Snap Action Continued ▶



**Part Number - 109759**  
600vac  
12A

▼ OEM

SW-1377	TY00591-32296-81	YT220015021
CL7004135	TY00591-60557-81	YT800058911
HY800058911	TY00591-70676-81	



**Part Number - 118901**  
SPNO  
Polarity sensitive  
10A @ 125 & 250vac  
6A @ 30vdc

▼ OEM

SW-1283	LP393-8125	TY00591-57447-81
CL444113	TO2I5930	YT220003207
HY3012366	TY00591-05049-81	YT220003207
HY800076716	TY00591-32276-81	YT800076716



**Part Number - 109758**  
600vac  
12A

▼ OEM

SW-1348	TY00591-32290-81	TY00591-60556-81
HY3013965	TY00591-52550-81	YT220003692
TY00591-05093-81		



**Part Number - 089362**  
Operating Force 6.5 oz min.  
15A @ 125 and 250vac  
0.6A @ 125vdc  
0.3A @ 250vdc

▼ OEM

CL444113	LP393-8125	TY00591-57447-81
HY3012366	TO2I5930	YT220003207
HY800076716	TY00591-05049-81	YT220030452
SW-1283	TY00591-32276-81	YT800076716



**Part Number - 073363**

Operating Force 7-13 oz  
Single Throw  
Single Pole  
Normally Open

▼ OEM

CL7004066	TY00591-32235-81	TY00591-60634-81
SW-1207		



**Part Number - 082813**

Operating force 45 oz. max.  
Double Pole, Double Throw  
Normally Closed

▼ OEM

CL7004134	TY00591-41846-81	YT220014503
HY800058813	TY00591-60694-81	YT800058813
SW-1376	TY00591-70619-81	



**Part Number - 082605**

15A @ 30vdc

▼ OEM

BALF021874	SW-2154	YT220016301
HY800076416	LP393-2533	YT800076416



**Part Number - 088294**

Operating Force 7.8 max.

▼ OEM

CL7004239	SW-429	TY00591-60723-81
HY800076690	TY00591-32345-81	YT800076690



**Part Number - 062714**

15A  
SPDT  
Operating Force 90 grams max.

▼ OEM

SW-1831	LP393-7921
---------	------------



**Part Number - 077656**

15A, 250vac  
SPDT  
Operating Force 14-20 oz.

▼ OEM

BA130091	SW-32	YT6202871
BA985383	SW-33	YT220023939
BA985838	SW-342	YT220037742
BA986600	SW-344	YT220043325
BA997030	LP393-2160	YT220051993
BA177MJH1	LP393-2172	YT500205100
BABZ2RQ13A2	RA1-150-324	YT600287100
BABZ2RQ1A2	RA590-023	YT620287100
BAPAL32	RA590-058	YT620287101
BAPAL-32A	RADS226498	YT2200519-93
CL991179	TO0972328	YT5002051-00
HY1371673	TO1009550	YT6202871-00
HY2307677	TY00591-32333-81	YT6202871-01
HY3007411	TY00591-51917-81	YT62028710A
HY3008403	TY4516581100-71	



**Part Number - 147014**

General Purpose  
Single Throw  
Single Pole  
Normally Open  
2A 48VDC

▼ OEM

CL7004060	SW-1199	TY00591-60635-81
HY3012350	TO216161	YT220014587
HY800019130	TY00591-32227-81	YT800019130



**Part Number - 073375**

15A @ 125vac & 250vac  
SPDT  
Operating Force 20 oz max

▼ OEM

CL443898	SW-1227	TY00591-57409-81
CL946483	LP393-2500	YT220003926
CL7004078	TO216162	YT800076075
HY3015165	TY00591-04651-81	
HY800076075	TY00591-32247-81	



**Part Number - 101589**

Operating Force 15 oz max  
15A @ 125vac and 250vac

▼ OEM

CL7004122	TO216135	TY00591-60538-81
HY800075101	TY00591-04181-81	YT220016504
SW-1359	TY00591-32291-81	YT800075101



**Part Number - 113352**

15A @ 1/2 HP 125/250vac  
SPDT

▼ OEM

SW-1897	113352	LP393-2798
---------	--------	------------



**Part Number - 079133**

15A, 125-250vac  
¾ HP @ 125vac  
1½ HP @ 250vac  
Operating Force 15 oz max.

▼ OEM

CL7004092	LP393-8216	TY00591-60672-81
HY800076274	TO216134	YT220015887
SW-1275	TY00591-32271-81	YT800076274





**Part Number - 062683**

Operating force 75 grams max  
Release force 10 grams min  
SPDT with gold contacts

▼ OEM

HY800018685	LP393-2325	YT800018685
SW-1643	TY00591-73984-81	



**Part Number - 086221**

▼ OEM

CL7004131	LP393-7910	TY00591-70648-81
HY800058861	TY00591-41845-81	YT220014951
SW-1373	TY00591-60714-81	YT800058861



**Part Number - 072007**

25A - 125-250vac  
1 HP @ 125vac  
2 HP @ 250vac  
Operating Force 30 oz max.

▼ OEM

CL7004058	TY00591-41779-81	YT220021468
SW-1197	TY00591-60632-81	



**Part Number - 078879**

25A 125 - 250vac  
1 HP @ 125vac  
2 HP @ 250vac  
Operating Force 30 oz max.

▼ OEM

CL7004059	TO215965	YT220002205
HY3017812	TY00591-32226-81	
SW-1198	TY00591-60668-81	



**Part Number - 077133-001**

Blue  
10A @ 28vdc

▼ OEM

CL7004054	TO216159	YT220013133
HY3013964	TY00591-04742-81	YT800076207
HY800076207	TY00591-32220-81	
SW-1191	TY00591-52537-81	



**Part Number - 077133-002**

Black  
SPDT  
10A @ 28vdc

▼ OEM

CL7004055	TO216155	TY00591-60663-81
HY800076208	TY00591-04743-81	YT220003691
SW-1192	TY00591-32221-81	



**Part Number - 075198**

Single pole - double throw  
Operating force 8 oz  
Release force 4 oz

▼ OEM

AC4932316	PM201199	YT220024965
AC74932316	PMQU-161A8598G1	YT220051040
BA992567	RA1150-034	YT500742800
BRA27350-6	RA1150-322	YT721260301
CL996101	RA921-000/224	YT721260303
HY1194848	RADS226131	YT800076158
HY3008482	TO0972065	YT800076269
HY3012351	TO1009548	YT0136151CB
HY800076158	TY00591-04789-81	YT0523328-00
HY800076269	TY00591-32318-81	YT136151-CB
HYA-3720	TY00591-51929-81	YT5007428-00
SW-151CB	TY00591-51930-81	YT549-GS-92-A
KO7870-30-7120	YT015804300	YT549-GS-92-B
KO7870-30-7210	YT015804400	YT6136151CB
KO78703-07210	YT015804500	YT7212603-01
LP393-4219	YT052332800	YT7212603-03
LP393-4230	YT220023578	



**Part Number - 062766**

10 A @ 115/230 ½ HP  
2 circuit, 1 Normally Open, 1 Normally Closed  
Double Break

▼ OEM

AC4932316	PMQU-161A8598G1	YT052332800
AC74932316	RA1150-034	YT220023578
BA992567	RA1-150-322	YT220024965
BR27350-006	RA921-000-224	YT220051040
BRA27350-6	RADS226131	YT500742800
CL996101	TO0972065	YT721260301
HY1194848	TO972065	YT721260303
HY3008482	TO1009548	YT800076158
HY3012351	TY00591-04789-81	YT800076269
HY800076158	TY00591-32318-81	YT0136151CB
HY800076269	TY00591-51929-81	YT0523328-00
HYA-3720	TY00591-51930-81	YT5007428-00
SW-151CB	YT158044	YT549-GS-92-A
KO7870-30-7120	YT158045	YT549-GS-92-B
KO78703-07210	YT523328	YT6136151CB
LP393-4219	YT5007428	YT7212603-01
LP393-4230	YT015804300	YT7212603-03
PM201199	YT015804400	
	YT015804500	



**Part Number - 077481**

▼ OEM

CL778570	HYA121224	TY00591-04755-81
HY121224	SW-1029	TY00591-41762-81
HY1198464	LP393-8115	TY00591-57445-81
HY3007247	LP393-9153	



**Part Number - 123437**

Operating force 8.5 ox max,  
Release force 1.5 oz min

▼ OEM

INSW-1595	LP393-2532	YT800108047
HY800108047	YT220035914	

## Switches - Snap Action



**Part Number** - 062715

Operating force 175 grams  
Release force 19 grams

▼ **OEM**

SW-1789	LP393-1939	TOSE000006
SW-1830	LP393-7920	



**Part Number** - 380050-044

**Micro Switch**

▼ **OEM**

CL8027922	TY00591-62171-81	YT5800047-04
TY00590-00953-71	TY00591-74612-81	YT5800047-05
TY00591-06518-81	YT5042272-84	YT580004704
TY00591-32219-81	YT504227284	YT580004705
TY00591-41785-81	YT5170858-04	
TY00591-51923-81	YT517085804	



**Part Number** - 087373

Operating force 6.5 oz max  
Release force 1.5 oz min. 10A @ 30vdc

▼ **OEM**

AC4778736	CL906619	TOMCF00313
AC4795031	DW908450	TY00591-32194-81
AC4798071	HY2304182	TY00591-32359-81
AC74778736	HY2311178	TY00591-51916-81
AC74795031	HY3016151	TY00591-51928-81
AC74798071	HY519515302	TY00591-60541-81
BA106944	SW-1039	YT5148261
BA106994	SW-151FA	YT5152921
BA709677	SW-1859	YT220002082
BA985402	SW-983	YT220015035
BA992717	KO34B-55-23610	YT220015420
BA177MBH1	KO34B-55-23610	YT220023943
BABXRW22A2	KO34B-57-23610	YT220051964
BABZ2RM22A2	KO3BA-57-23610	YT514826100
BABZ2RW22A2	LP393-2142	YT515292100
BACB6	LP393-4172	YT01361510F
BACB61	PM49965-00	YT01361510N
BACB6-1	PMA49965	YT0136151FA
BACB6DASH1	TO0015949	YT2200519-64
BK3736759	TO0060302	YT5148261-00
BR28841-330	TO0300905	YT5152921-00
BR29000465-000	TO0319033	YT519515302
BRT29-465	TO0336130	YT61361510F
BRT-29-465	TO0659968	YT61361510N
CL1310067	TO0908450	YT6136151FA
CL2795597	TO0972189	YT6136151-0F
CL7004041	TO9I2463	YT61361510N
CL7004253	TOMCF00311	YT6136151FA



**Part Number** - 079267

Operating Force 6 oz max  
25A @ 125/250vac  
1 HP @ 125vac  
2 HP @ 250vac

▼ **OEM**

HY800076277	TY00591-41801-81	YT220015460
SW-1274	TY00591-60673-81	YT800076277
TY00591-04793-81		



**Part Number** - 370249

**Switch**

▼ **OEM**

CL1304793	HY2303007	YT519515301
CL2394430	HY3020121	YT5195153-01
CL2803519	HY3049726	
CL3788232	HY3057595	



**Part Number** - 370145

**Switch**

▼ **OEM**

HY1486370  
YT580019693

## Switches - Key

Continued▶



**Part Number** - 078513

Includes: two keys

▼ **OEM**

CL7004107	LP309-1678	TY00591-32282-81
HY3013966	TO2I6142	TY00591-56095-81
HY800019359		



**Part Number** - 370054

Includes: two keys

▼ **OEM**

AC4734244	HY 1197136	RA154-005-697
BJ 20725	HY 1197960	RA590-004
BK 152202	HY 1197961	RA590-006
CL 1681146	HY 2033697	RA812-001-255
CL 2345332	HY 2303433	RA921-000-887
CL 2809875	HY 2305167	RADS223177
CL 301728	HY 254007	RADS224389
CL 352148	HY 3005833	RADS226396
CL 3700309	HY 3052440	SC41-25093
CL 3853257	HY 3066611	TA 71120
CL 611885	HY A-3716	TA 71-120-00
CL 613472	HY A-3716-1	TY 00590-00613-71
CL 624112	HY A-3716-2	TY 00591-01780-81
CL 624597	HY A-49164-A	TY 00591-32356-81
CL 678376	HY A-49164A	TY 00591-41881-81
CL 7004163	MB 1009544	TY 00591-41950-81
CL 896614	MB 1055276	TY 00591-51256-81
CT 972202	MB 1086860	TY 00591-51257-81
CT 1009544	MB972202	YT 16051600
CT 1055276	MBNA013888	YT 47001100
CT 972202	MBNA013889	YT 50649900
CTNA013888	MBNA013890	YT 80142300
CTNA013889	PB 304387K	YT 500863100
CTNA013890	PB 3304387K	YT 500863101
HY 254007	RA 114-010-175	YT 500863102
HY 1197132	RA 1-150-065	YT 500863104
HY 1197133	RA 1-150-368	YT 500863105
HY 1197134	RA 1-150-378	YT 500863110
HY 1197135	RA 1-150-392	YT 645082800

## Switches - Key



Part Number - 380050-040  
Includes: two keys

### ▼ OEM Reference

CL7004147	JU14483690	YT504240854
CT216444	TY00591-06240-81	YT580007799
HY379902	TY00591-32300-81	YT580021375
HY379902	TY00591-51265-81	YT580022227
HY1492154	YT220003423	
HY2035830	YT504240838	



Part Number - 108066  
Includes: two keys

### ▼ OEM

AC3EB-55-A3621	HY0202017	MB97004-06500
AC4722682	HY0260873	MB971156
AC4848481	HY0272041	MB972252
AC4848483	HY0392891	MB972256
AC4910557	HY131116	MB972293
AC4913250	HY1328442	MB9X2143
AC4966572	HY181332	MESM7-85
AD56478640	HY186305	MJV4866/3
AF00304	HY202017	NI125-0017
BR125-0017	HY260873	TN47485
CL1659819	HY265211	TY00591-00142-81
CL1723186	HY272041	TY00591-03098-81
CL1756213	HY2798391	TY00591-06155-81
CL2339413	HY3001108	TY00591-32298-81
CL2342572	HY3001109	TY00591-32357-81
CL2342572R	HY3001875	TY00591-32361-81
CL2342572-R	HY3020087	TY00591-41956-81
CL2356172	HY3044816	TY00591-51251-81
CL2394129	HY3053416	TY00591-51255-81
CL3480033	HY3057812	TY00591-51259-81
CL668782	HY3122805	TY00591-51266-81
CL7004210	HY3124064	TY00591-60555-81
CT0366463	HY3135532	TY220000801
CT0971156	HY392891	TY220000860
CT0972252	HY55959	TY220002990
CT0972256	HY80000360	TY220003465
CT0972293	HY800013610	TY220012746
CT332270	HY800083450	TY220019875
CT354343	JU14491250	TY220027238
CT366463	KO31-242	TY220037812
CT376938	KO3EB-55-16190	WM10A18229
CT9700406500	KO3EB-55-A3621	WM203011631
CT97004-06500	KO3EB-55-A3630	YT220000801
CT971156	KO4722682	YT220000860
CT972252	KO4783418	YT220002990
CT972256	KO4832941	YT220003465
CT972293	KO4834418	YT220012746
CT9X2143	KO4845729	YT220019875
DR1116553	KO4848481	YT220027238
DR116508	KO4848483	YT220037812
DRD-1460	KO4910557	YT277236300
DW366463	KO4913250	YT330027845
ET35035	LIK31-242	YT330028829
ET35041	LIK3EB-55-A3621	YT330028830
ET35388	MB0366463	YT330033742
ET35625	MB0971156	YT330050314
ET35705	MB0972252	YT330050421
ET35746	MB0972256	YT330050546
ET35750	MB0972293	YT330051166
HK4966572	MB332270	YT330053819
HY0055959	MB354343	YT330058266
HY0131116	MB366463	YT504227254
HY0181332	MB376938	
HY0186305	MB9700406500	



Part Number - 380050-022

### Ignition Switch

### ▼ OEM

NI 25150-02H01



Part Number - 146286  
Includes: two keys

### ▼ OEM

AC14835-22	HY3005111	MBA221
AC20151-00	HY3007557	MBB2007
AC4003998	HY3056776	PM20151-00
BK130659	HY3144134	PMP-20151
BK992516	HY800057763	RA20151-00
BR28842-300	HY800076063	SC31-40156
BT14835-22	HY800132257	SC33-12112
BT20151-00	HY800133230	SC33-12113
CL908586	KO14835-22	SC33-12130
CL919487	KO20151-00	TC20151
CT0053635	KO8730954	TCP-20151
CT0338753	L130659	TY00591-04645-81
CT0A221	L1992516	TY00591-07636-81
CT0B2007	LIA1132	TY00591-51261-81
CT338753	MB0053635	TY220001540
CT53635	MB0338753	TY220020175
CTA221	MB0A221	TY220044134
CTB2007	MB0B2007	YT220001540
ET35046	MB338753	YT220020175
HY1049164	MB53635	YT220044134

Part Number - 062623



### Keyless Switch

Four Switch Positions

1. Accessories Only
2. Off Position
3. Accessories and Ignition
4. Ignition and Start (Spring Return)

### ▼ OEM

HY800085364	LP309-2271	YT220025682
SW-1598	TY00591-14061-81	YT800085364
KO31-608		

## Lift Truck Power Switch Keys

Part Number	Type	Truck Series
107151-001	Molded	Walkies, Pallet, Tuggers, PR, Wave
089216-001	Not Molded	
107151-002	Molded	Reach, Turret, Stockpickers, Counterbalance, PR
107543-001	Not Molded	



Part Number - 370087

### Key - 1 Piece

### ▼ OEM

CL7004106	HY3131733	YT220041746
CL905512-R	TY00591-16442-81	YT500863106
HY2309436	TY00591-41818-81	
HY262798	YT220014812	



Part Number - 370235

### Key - 2 Sided

### ▼ OEM

TY57591-23330-71

# Wire and Cable

## Power Cable

Gauge	Color	UL Rated	Bulk Part Number	10 ft box 305 cm	50 ft reel, 1,524 cm	100 ft reel, 3,048 cm	250 ft reel, 7,620 cm	500 ft reel, 15,240 cm
6	black	UL	084568-010					
4	black	UL	084569-105	384569-010	384569-050	384569-105	384569-250	
4	red	UL	384575-001		384575-050	384575-100		
2	black	UL	084570-100		344570-050	344570-100		344570-500
2	red	UL	384576-001		384576-050	384576-100		
1	black	UL	084571-100		344571-050	344571-100		
1	red	UL	384571-001		384571-050-02	384571-100-02		
1/0	black	UL	084572-021		384572-050	384572-100		
1/0	red	UL	384574-001		384574-050	384574-100		
2/0	black	UL	084573-013			384573-100	384573-250	
2/0	red	UL					384573-250-OR	
2/0	red	not UL	384573-013R			384573-013		
2/0	orange	not UL	384573-014R			384573-014		
4/0	black	UL	384577-100-01			384577-100		
4/0	red	not UL	384578-100-01			384578-100		

## Control Cable

Wires/ AWG	Bulk Part Number	25 ft, 762 cm	50 ft reel, 1,524 cm	100 ft reel, 3,048 cm	200 ft reel, 6,096 cm	250 ft reel, 7,620 cm	500 ft reel, 15,240 cm	750 ft reel, 22,860 cm	1000 ft reel, 30,480 cm
18-12	119203-014					119203-015	119203-016		
18-9	119203-011			389203-011-01					
18-8	119203-001		389203-001-50	389203-001-01	389203-001-02	119203-002	119203-003		
18-6	389204-001-06			389204-100-06		389204-250-06	389204-500-06		
18-5	119203-004		389203-004-50	389203-004-01		119203-005	119203-006		
18-4	087374-001	387374-025		387374-100				387374-750	
18-3	119203-007			389203-007-01		119203-008	119203-009		
18-2	079495-001		389495-050	389495-100		389495-250			389495-001

## Aircraft Cable, Nylon Coated Galvanized

Bulk Part Number	50 ft reel, 1,524 cm	100 ft reel, 3,048 cm	250 ft reel, 7,620 cm
074755-086	384755-050	384755-100	074755-083

## Freezer Control Cable

Wires/ AWG	Bulk Part Number	250 ft reel, 7,620 cm	500 ft reel, 15,240 cm
8-16	151261-001	151261-002	151261-003
5-16	351261-001	351261-250	
3-16	151261-004	151261-005	151261-006

## Aircraft Cable, Galvanized Steel

Bulk Part Number	50 ft reel, 1,524 cm	100 ft reel, 3,048 cm	250 ft reel, 7,620 cm	500 ft reel, 15,240 cm
083189-137	383189-050	383189-100	083189-128	083189-129

## Control Wire - Extra Flex

#22 AWG = 7/24/44 strands  
 #18 AWG = 7/59/44 strands  
 -50 C° to +105° C  
 UL1095 listed



Gauge	Color	Bulk Part Number	100 ft reel, 3,048 cm	500 ft reel, 15,240 cm
22	black	126517-001	126517-002	
22	brown	126517-004	126517-005	
22	red	126517-007	126517-008	
22	orange	126517-010	126517-011	
22	yellow	126517-013	126517-014	
22	green	126517-016	126517-017	
22	blue	126517-019	126517-020	
22	violet	126517-022	126517-023	
22	gray	126517-025	126517-026	
22	white	126517-028	126517-029	
18	black	132187-001	132187-002	132187-003
18	brown	132187-004	132187-005	132187-006
18	red	132187-007	132187-008	132187-009
18	orange	132187-010	132187-011	132187-012
18	yellow	132187-013	132187-014	132187-015
18	green	132187-016	132187-017	132187-018
18	blue	132187-019	132187-020	132187-021
18	violet	132187-022	132187-023	132187-024
18	gray	132187-025	132187-026	132187-027
18	white	132187-028	132187-029	132187-030
18	red/white	132187-031	132187-032	132187-033
18	green/white	132187-034	132187-035	132187-036

## Control Wire

#18 AWG, 41 strands  
 0.03 min thermoplastic insulation  
 -40 C° to +105° C  
 UL1015 listed



Gauge	Color	Bulk Part Number	100 ft reel, 3,048 cm
18	black	086563-001	086563-002
18	brown	086564-001	086564-002
18	red	086565-001	086565-002
18	orange	086566-001	086566-002
18	yellow	086567-001	086567-002
18	green	086568-001	086568-002
18	blue	086569-001	086569-002
18	violet	086570-001	086570-002
18	gray	086571-001	086571-002
18	white	086572-001	086572-002
18	red stripe/white	086573-001	086573-002
18	green stripe/white	086574-001	086574-002

**Small DIM**



Part Number	Max Voltage	Amps	Ferraz/ Gould	Littelfuse	Bussman
340032-002	250Vac	2	GDC2	312-2	AGC2
340032-R06	250Vac	6	GDC-R-6	312-6	AGC-R-6
090132	250Vac	10	GDC10	312-10	AGC10
340032-015	32Vac	15	GGC15	312-15	AGC15
340032-020	32Vac	20	GGC20	312-20	AGC20
340032-030	32Vac	30	GGC30	312-30	AGC30

**Small DIM**



Part Number	Max Voltage	Amps	Ferraz/ Gould	Littelfuse	Bussman
340044-002	250Vac	2	GSC2	239002	GMD-2-R

**Small DIM**



Part Number	Max Voltage	Amps	Ferraz/ Gould	Littelfuse	Bussman
340039-025	250Vac	1/4	GDL1-1/4	313250	MDL-1/4
100645		1	GDL7	313001	MDL-1
340039-002	250Vac	2	GDL2	313002	MDL-2
340039-015	32Vac	15	GDL15	313015	MDL-15
100988	32Vac	20	GDL20	313020	MDL-20

**Small DIM**



Part Number	Max Voltage	Amps	Ferraz/ Gould	Littelfuse	Bussman
340049-001	250Vac	1	GGM1	235001	GMA-1-R
094744	250Vac	3	GGM3	235003	GMA-3-R

**Medium Time-Delay**



Part Number	Max Voltage	Amps	Ferraz/ Gould	Littelfuse	Bussman
340045-001	250Vac	1	GSC1	235-1	GMC-1-R
340045-005	125Vac	5	GSC5	235-5	GMC-5-R

**MIN TD**



Part Number	Max Voltage	Amps	Ferraz/ Gould	Littelfuse	Bussman
127038-001	250Vac (or Less)	1/4	GDG1/4	218.250	GDC250mA
340034-001	250Vac (or Less)	1	GDG1	218 001	GDC1
340034-016	250Vac (or Less)	1.6	GDG1-6/10	218 01.6	GDC1.6
340034-003	250Vac (or Less)	3.15	GDG3-15/100	218 3.15	
340034-005	250Vac (or Less)	5	GDG5	218 005	GDC5

**Semiconductor**



Part Number	Max Voltage	Amps	Ferraz/ Gould	Littelfuse	Bussman
340033-012	250Vac/125Vdc	12	250VFA6X32	322-12	GBB12R

**Auto**



Part Number	Max Voltage	Amps	Ferraz/ Gould	Littelfuse	Bussman
071902-001	32Vac	7	307007	SFE9	SFE9
071902-002	32Vac	14	307014	SFE14	SFE14

**Fast Acting**



Part Number	Max Amp	Max Voltage	Type	Littelfuse	Bussman	A in	B in
084190	1/4	250	AGX	361.250	AGX1/4	1.0	0.25

**Medium-Acting Radial Leaded Ceramic**



Part Number	Amp	Max Voltage	A mm	B mm	Littelfuse
052071-001	0.63	80	20	5	2010630
052071-002	2	100	20	5	234002
052071-003	10	100	20	5	234010

**Fast Acting**



Part Number	Max Voltage	Amp	Ferraz/ Gould	Littelfuse	Bussman	A in	B in
094362-005	250Vac/125Vdc	3/8	GAB3/8	314.375	ABC3/8	1.25	0.25
094362-004	250Vac/125Vdc	3/4	GAB3/4	314.75	ABC3/4	1.25	0.25
094362-003	250Vac/125Vdc	2	GAB2	314002	ABC2	1.25	0.25
094362-008	250Vac/125Vdc	3	GAB3	314.003	ABC3	1.25	0.25
094362-001	250Vac/125Vdc	4	GAB4	314004	ABC4	1.25	0.25
094362-006	250Vac/125Vdc	5	GAB5	314005	ABC5	1.25	0.25
094362-012	250Vac/125Vdc	6	GAB6	314006	ABC6	1.25	0.25
094362-013	250Vac/125Vdc	8	GAB8	314008	ABC8	1.25	0.25
094362-010	250Vac/125Vdc	10	GAB10	314010	ABC10	1.25	0.25
094362-002	250Vac/125Vdc	15	GAB15	314015	ABC15	1.25	0.25
094362-007	125Vac/125Vdc	30	GAB30	314030	ABC30	1.25	0.25
094362-009			Shorting Bar		NCC	1.25	0.25

**Fast Acting**



Part Number	Max Voltage	Amp	Ferraz/ Gould	Littelfuse	Bussman	A in	B in
094362-011	250Vac (or Less)	1	GSA1	326001	MDA1	1.25	0.25
094362-017	250Vac (or Less)	15	GSA15	326015	MDA15	1.25	0.25
094362-020	250Vac (or Less)	20	GSA20	326020	MDA20	1.25	0.25
340052-025	250Vac (or Less)	25	GSA25	326025	MDA25-R	1.25	0.25

**Fast Acting General Purpose**



Part Number	Max Voltage	Amps	Ferraz/ Gould	Littelfuse	Bussman
340038-005	600	5	SBS005	KLQ005	KTQ5

**One Time General Purpose Fuse**



Part Number	Max Voltage	Amps	Ferraz/ Gould	Littelfuse	Bussman
090125	250Vac	30	OT-30	NLN-30	NON-30
340050-060	250 Vac	60	OT-60	NLN-60	NON-60

**Low Voltage, Time Delay, Supplementary**



Part Number	Max Voltage	Amps	Ferraz/ Gould	Littelfuse	Bussman
066052-002	250VAC or less	2.5	FNM-2.5	FLM-2.5	FLM02.5T
340042-004	250Vac or less	4	FNM-4	FLM-4	FNM-4
340042-005	250Vac or less	5	FNM-5	FLM-5	FNM-5
340042-006	250Vac or less	6	FNM-6	FLM-6	FNM-6
340042-012	125Vac or less	12	FNM-12	FLM-12	FNM-12

**Low Voltage, Time-Delay, Branch Circuit, Rejection Type**



Part Number	Max Voltage	Amps	Ferraz/ Gould	Littelfuse	Bussman
340041-025	600Vac or less	0.25	FNQ-R-.25	FLQ-R-.25	FNQ-R-.25
340041-050	600Vac or less	0.5	FNQ-R-.5	FLQ-R-.5	FNQ-R-.5
340041-001	600Vac or less	1	FNQ-R-1	FLQ-R-1	FNQ-R-1
340041-035	600Vac or less	3.5	FNQ-R-3.5	FLQ-R-3.5	FNQ-R-3.5

**Low Voltage, Fast Acting, Branch Circuit, Rejection Type**



Part Number	Max Voltage	Amps	Ferraz/ Gould	Littelfuse	Bussman
340037-005	600Vac or less	1	ATMR1	KLK-R-1	KTK-R-1
340037-001	600Vac or less	1.5	ATMR1.5	KLK-R-1.5	KTK-R-1.5
340037-004	600Vac or less	4	ATMR4	KLK-R-4	KTK-R-4

**Low-Peak CC TD**



Part Number	Max Voltage	Amps	Ferraz/ Gould	Littelfuse	Bussman
340030-003	150Vdc-300Vdc-600Vac	3	ATDR3	KLMR3	LP-CC-3
340030-004	150Vdc-300Vdc-600Vac	4	ATDR4	KLMR4	LP-CC-4
340030-005	150Vdc-300Vdc-600Vac	5	ATDR5	KLMR5	LP-CC-5
340030-006	150Vdc-300Vdc-600Vac	6	ATDR6	KLMR6	LP-CC-6
340030-008	150Vdc-300Vdc-600Vac	8	ATDR8	KLMR8	LP-CC-8
340030-010	150Vdc-300Vdc-600Vac	10	ATDR10	KLMR10	LP-CC-10
340030-015	150Vdc-300Vdc-600Vac	15	ATDR15	KLMR15	LP-CC-15
340030-020	150Vdc-300Vdc-600Vac	20	ATDR20	KLMR20	LP-CC-20
340030-030	150Vdc-300Vdc-600Vac	30	ATDR30	KLMR30	LP-CC-30

**RK5 TD**



Part Number	Max Voltage	Amps	Ferraz/ Gould	Littelfuse	Bussman
340018-005	600	5	TRS5R	FLSR-R5	FRS-R5
340018-006	600	6	TRS6R	FLSR-R6	FRS-R6
340018-007	600	7	TRS7R	FLSR-R7	FRS-R7
340018-008	600	8	TRS8R	FLSR-R8	FRS-R8
340018-009	600	9	TRS9R	FLSR-R9	FRS-R9
340018-010	600	10	TRS10R	FLSR-R10	FRS-R10
340018-012	600	12	TRS12R	FLSR-R12	FRS-R12
340018-015	600	15	TRS15R	FLSR-R15	FRS-R15
340018-017	600	17.5	TRS17-1/2R	FLSR-R17-1/2	FRS-R17-1/2
340018-020	600	20	TRS20R	FLSR-R20	FRS-R20
340018-025	600	25	TRS25R	FLSR-R25	FRS-R25
340018-030	600	30	TRS30R	FLSR-R30	FRS-R30
340018-035	600	35	TRS35R	FLSR-R35	FRS-R35
340018-040	600	40	TRS40R	FLSR-R40	FRS-R40
340018-045	600	45	TRS45R	FLSR-R45	FRS-R45
340018-050	600	50	TRS50R	FLSR-R50	FRS-R50
340018-060	600	60	TRS60R	FLSR-R60	FRS-R60

**Class H**



Part Number	Max Voltage	Amps	Ferraz/ Gould	Littelfuse	Bussman
340015-010	600	10	OTS10	NLS10	NOS10
340015-015	600	15	OTS15	NLS15	NOS15
340015-020	600	20	OTS20	NLS20	NOS20
340015-025	600	25	OTS25	NLS25	NOS25
340015-030	600	30	OTS30	NLS30	NOS30
340015-035	600	35	OTS35	NLS35	NOS35
340015-040	600	40	OTS40	NLS40	NOS40
340015-045	600	45	OTS45	NLS45	NOS45
340015-050	600	50	OTS50	NLS50	NOS50

**Low Peak, Dual Element, Time Delay**



Part Number	Max Voltage	Amps	Ferraz/ Gould	Littelfuse	Bussman
340031-028	600Vac/300Vdc	2 <sup>2</sup> / <sub>10</sub>	AJT2 <sup>2</sup> / <sub>10</sub>	JTD2 <sup>2</sup> / <sub>10</sub>	LPJ-2 <sup>2</sup> / <sub>10</sub> S
340031-045	600Vac/300Vdc	4.5	AJT4.5	JTD4.5	LPJ-4.5SP
340031-010	600Vac/300Vdc	10	AJT10	JTD10	LPJ-10SP
340031-012	600Vac/300Vdc	12	AJT12	JTD12	LPJ-12SP
340031-015	600Vac/300Vdc	15	AJT15	JTD15	LPJ-15SP
340031-020	600Vac/300Vdc	20	AJT20	JTD20	LPJ-20SP
340031-025	600Vac/300Vdc	25	AJT25	JTD25	LPJ-25SP
340031-030	600Vac/300Vdc	30	AJT30	JTD30	LPJ-30SP
340031-035	600Vac/300Vdc	35	AJT35	JTD35	LPJ-35SP
340031-040	600Vac/300Vdc	40	AJT40	JTD40	LPJ-40SP
340031-044	600Vac/300Vdc	45	AJT45	JTD45	LPJ-45SP
340031-050	600Vac/300Vdc	50	AJT50	JTD50	LPJ-50SP
340031-060	600Vac/300Vdc	60	AJT60	JTD60	LPJ-60SP
340031-070*	600Vac/300Vdc	70	AJT70	JTD70	LPJ-70SP
340031-080*	600Vac/300Vdc	80	AJT80	JTD80	LPJ-80SP
340031-090*	600Vac/300Vdc	90	AJT90	JTD90	LPJ-90SP
340031-100*	600Vac/300Vdc	100	AJT100	JTD100	LPJ-100SP
340031-125*	600Vac/300Vdc	125	AJT125	JTD125	LPJ-125SP
340031-150*	600Vac/300Vdc	150	AJT150	JTD150	LPJ-150SP
340031-175*	600Vac/300Vdc	175	AJT175	JTD175	LPJ-175SP
340031-225*	600Vac/300Vdc	225	AJT225	JTD225	LPJ-225SP
340031-400*	600Vac/300Vdc	400	AJT400	JTD400	LPJ-400SP

\*- with terminals

**Stud MTD**



Part Number	Max Voltage	Amps	Ferraz/ Gould	Littelfuse	Bussman
132083-001	125	50	CNN50	CNN50	ANN50
340016-060	125	60	CNN60	CNN60	ANN60
340016-100	125	100	CNN100	CNN100	ANN100
132083-008	125	125	CNN125	CNN125	ANN125
132083-007	125	150	CNN150	CNN150	ANN150
340016-175	125	175	CNN175	CNN175	ANN175
132083-009	125	200	CNN200	CNN200	ANN200
340016-225	125	225	CNN225	CNN225	ANN225
340016-250	125	250	CNN250	CNN250	ANN250
132083-005	125	300	CNN300	CNN300	ANN300
340016-325	125	325	CNN325	CNN325	ANN325
340016-350	125	350	CNN350	CNN350	ANN350
132083-002	125	400	CNN400	CNN400	ANN400
132083-003	125	500	CNN500	CNN500	ANN500
132083-006	125	700	CNN700	CNN700	ANN700
132083-004	125	800	CNN800	CNN800	ANN800
340047-040	80	40	CNL40	CNL40	ANL40
340047-080	80	80	CNL80	CNL80	ANL80
340047-200	80	200	CNL200	CNL200	ANL200
340047-250	80	250	CNL250	CNL250	ANL250
340047-350	80	350	CNL350	CNL350	ANL350
340047-500	80	500	CNL500	CNL500	ANL500
340047-600	80	600	CNL600	CNL600	ANL600
340047-675	80	675	CNL675	CNL675	ANL675

**V-Fuse, Enclosed**

Part Number	Max Voltage	Amps
814995-002	24	50



**Specialty Fuse - Use in EE & ES applications**



Part Number	Max Voltage	Amps	Ferraz/ Gould	Littelfuse	Bussman
143962-001	48	500		0581500.T	
143962-002	48	800		0581800.T	
143962-003	48	50		0581050.T	
143962-004	48	125		581125	

# Fuses

## Fuse Strip w/Housing for Battery Powered Vehicles - Fast Acting



Part Number	Max Voltage	Amps	Ferraz/ Gould	Littelfuse	A mm	B mm
802816-006	80	50		157.5917.5501	60	9
806720-002	80	50		157.5701.5501	60	11
806720-003	80	80		157.5701.5801	60	11
802816-003	80	100		157.5701.6101	60	11
802816-007	80	100		157.5917.6101	60	9
802816-001	80	125		157.5701.6121	60	11
802816-005	80	125		157.5917.6121	60	9
802816-009	80	150		157.5917.6151	60	9
802816-002	80	160		157.5701.6161	60	11
802816-004	80	200		157.5701.6201	60	11
790586	80	250			60	11
802816-011	80	355		157.5917.6351	60	9
802816-012	80	400	Z228849	157.5701.6401	60	11
806720-001	80	425		157.5701.642	60	11

## T-Tron Fast Acting



Part Number	Max Voltage	Amps	Ferraz/ Gould	Littelfuse	Bussman
340046-001	300Vac or less	70	A3T70	JLLN70	JJN70
340046-080	300VAC or less	80	A3T80	JLLN80	JJN80
340046-002	300Vac or less	100	A3T100	JLLN100	JJN100
340046-003	300Vac or less	150	A3T150	JLLN150	JJN150
340046-300	300VAC or less	300	A3T300	JLLN300	JJN300
340046-004	300Vac or less	350	A3T350	JLLN350	JJN350
340046-400	300VAC or less	400	A3T400	JLLN400	JJN400
340046-005	300Vac or less	450	A3T450	JLLN450	JJN450
340046-006	300Vac or less	600	A3T600	JLLN600	JJN600

## High Speed Fuse



Part Number	Max Voltage	Amps	Ferraz/ Gould	Littelfuse	Bussman
340017-080	150	80	A15QS-80-4	L15S80	FWA-80B
340017-100	150	100	A15QS-100-4	L15S100	FWA-100B
340017-150	150	150	A15QS-150-4	L15S150	FWA-150B
340017-200	150	200	A15QS-200-4	L15S200	FWA-200B
340017-250	150	250	A15QS-250-4	L15S250	FWA-250B
091344	150	300	A15QS-300-4	L15S300	FWA-300B
340017-350	150	350	A15QS-350-4	L15S350	FWA-350B
340017-400	150	400	A15QS-400-4	L15S400	FWA-400B
340017-500	150	500	A15QS-500-4	L15S500	FWA-500A

## Fast Acting Automotive Blade



Part Number	Max Voltage	Amps	Ferraz/ Gould	Littelfuse	Bussman	Type
805751-002	32	2	AF2	164.6185.4202	ATC2	Grey
805751-006	32	4	AF4	166.7000.440	ATC4	Pink
340077-005	32	5	AF5		ATC5	Tan
805751-001	32	10	AF10	164.6185.5102	ATC10	Red
062765-001	32	15	AF15	164.6185.5152	ATC15	Blue
045979	32	80		299080		Clear
806703-002	80	5		166.7000.450		Light brown
806703-004	80	10		166.7000-450		Light red
806703-001	80	15		166.7000.515		Light blue
806703-005	80	20		166.7000-520		Light yellow
806703-003	80	30		166.7000-530		Light green

## Time Delay Fuse



Part Number	Max Voltage	Amps	Ferraz/ Gould	Littelfuse	Bussman
076924-017	125	15		CCK15	ACK15
076924-018	125	20		CCK20	ACK20
076924-012	125	30		CCK30	ACK30
076924-011	125	40		CCK40	ACK40
076924-001	125	60		CCK60	ACK60
076924-003	125	100			ALS100
076924-004	125	120			ACK120A
076924-005	125	140			ACK140
076924-014	125	160			ACK160
076924-006	125	175			ACK175
076924-016	125	175			ALS175B
076924-002	125	200			ALS200B
076924-007	125	200			ACK200
076924-015	125	225			ALS225B
076924-009	125	250			ALS250B
076924-020	125	250			ACK250
076924-010	125	300			ALS300B
076924-013	125	300			ACK300
076924-021	125	300	ALS300		
076924-022	125	300	ACK300		
076924-008	125	400			ALS400B
340051-500	125	500	ALS500		

## In-Line Non-Rejecting



Part Number	Max Voltage	Amps	Ferraz/ Gould	Littelfuse	Bussman
340035-003	300Vac (or Less)	3	SLR3	LGR3	GLR-3
340035-010	300Vac (or Less)	10	SLR10	LGR10	GLR-10

## Super-Lag Renewable

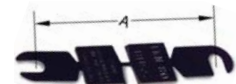

Part Number	Max Voltage	Amps	Ferraz/ Gould	Littelfuse	Bussman	A in
081614	80	250	RL80	LKN80	LKN80	2.56
076789	125	250	RL125	LKN125	LKN125	2.625
074282	200	250	RL200	LKN200	LKN200	2.625
071597	250	250	RL250	LKN250	LKN250	2.625

## Automotive ATM Mini Blade



Part Number	Max Voltage	Amps	Littelfuse	Type
062897-001	42	5	997005	Tan
062897-002	42	7.5	99707.5	Brown
062897-003	42	10	997010	Red
062897-004	42	15	997015	Blue
062897-005	42	20	997020	Yellow
062897-006	42	2	997002	Gray

## J-Case, Slo-Blo Automotive Cartridge



Part Number	Max Voltage	Amps	Type	Littelfuse
062902-003	32	40	Green	995-40



Style A



Style B



Style C



Style D



Style E

**OEM Key**

AC = Allis Chalmers  
BR = Barrett

CL = Clark  
HY = Hyster  
JG = Jungheinrich

KO = Komatsu  
LP = LPM  
MT = Mitsubishi

NI = Nissan  
PM = Prime Mover  
RA = Raymond

TO = Caterpillar/Towmotor  
TY = Toyota  
YT = Yale

Part Number	Style	Voltage	Amps	OEM		
116794-002	A	24	150	HY800075381 LP375-1943	LP375-7809	TY00591-44166-81
116794-005	A	24	150	HY800075380 LP375-1948	LP375-6125	TY00591-44171-81
110613-001	B	24	150	LP375-1945	LP375-3047	TY00591-44168-81
110613-002	B	24				
110613-003	B	24	150	HY800064625 LP375-1946	LP375-3048 TY00591-44169-81	TY00591-72323-81 YT520293803
110613-005	B	36/48	150	HY800075255 LP375-1947	LP375-3049	TY00591-44170-81
110613-007	B	36				
117853-001	B	24	250	HY800000537	LP375-1073	
120975	B	24	100	LP375-1951 LP375-3056	TY00591-44150-81	YT220043708
104483	C	24	150	AC4967344 AC4967616 AC4967618 AC78730634 BR39187-001 CL4308934 CL7001657 CL912089 CL912363 CL913903 HY0388227 HY2014096 HY0388227 HY800082018 HY800082021	JG14480230 JG14520932 KO200098 KO24205-01 27692-00 KO3BA-47-A4170 KO3WB-47-A1530 LP375-7100-GE MT9712402600 MT97C5701100 PM7692-00 PM200098 PM27692 RA1-105-204 TO9712402600	TO97C5701100 TY00591-04280-81 TY00591-23819-81 TY00591-30734-81 TY00591-51694-81 TY00591-30736-81 YT501227249 YT504227249 YT505075506 YT220023787 YT220073460 YT800082018 YT800082021
111634	C	24	100	CL914626 HY800082008 LP375-7117-GE NICK914626	PM201348 PMQU-IC2800M254C4B TY00591-23809-81	TY0059-136799-81 TY0059-151676-81 TY00591-63750-81
370233	C	24	300	YT505075522		
370234	C	36/48	150	HY1301515		
093575	D	24		CL7001616 LP375-6121 LP375-6121-GE	PM201354 PMQU-IC0M611AA13A TO2I6138	TY00591-30691-81 TY00591-51691-81 YT220003286
093576	D	24		CL7001619 LP375-6006	TY00591-30695-81	YT220003287
093574	D	24		LP375-6129 PM201356	PMQU-IC0M611AC13A TY00591-30692-81	YT220003285
112329	D			CL7001619 LP375-6006	TY00591-30695-81	YT220003287
112329-002	D					
116962	D			HY800075391	LP375-7833	
112328	D			HY800076791	LP375-6008	
112327	D			HY800020423	LP375-6007	
104140	E	24	150	BR28841-654 BR39186-001 CL912091 KO3WB-47-A1540 KOGA150AH124XN LP375-7101-GE	PM200100 PM26673-02 PM27693-02 TO97124-02800 TY00591-30732-81	TY00591-51695-81 YT220015003 YT220023784 YT5042242-80 YT5050755-07
106109-001	E	36	150	AC8730877 CL912094 HY3055351 HY388016 LP375-7118-GE	NICK912094 PM202169 PM27693-04 YT220023785 TY00591-23814-81	TY00591-36801-81 TY00591-57039-81 TY00591-60549-81
106109-003	E	36-48	150	CL915631 HY1300938 HY800082014 LP375-7113-GE	MT97122-06600 TO9712206600 TY00591-23815-81	TY00591-30733-81 TY00591-57037-81 YT220026251



# Contactors



Style F



Style G



Style H



Style I



Style J

**OEM Key**

AC = Allis Chalmers  
BR = Barrett

CL = Clark  
HY = Hyster  
JG = Jungheinrich

KO = Komatsu  
LP = LPM  
MT = Mitsubishi

NI = Nissan  
PM = Prime Mover  
RA = Raymond

TO = Caterpillar/Towmotor  
TY = Toyota  
YT = Yale

Part Number	Style	Voltage	Amps	OEM		
118396	F	24	150	HY800075421 LP375-1949	LP375-3018	TY00591-44144-81
370153	G	36		CL444238 CT0083636 CT0399717	MB0083636 PL66-061 PLHB409KC360EA	PLJAF-4004D TY00591-20262-81 YT220013711
380030-002	H	24		HMCTR-24-280		
380030-085	I	36		TY 24420-13300-71		
380030-086	J	24		HY2305835 HY2307724	YT505175502	YT505175504



## Contactor Tip and Tip Kits



Part Number - 370183

**Contactor Tip**

▼ OEM Reference

CL 7000194	NI 29348-L4005GN	TY 00591-31635-81
CT 218004	NI 29366-40H10	TY 00591-32654-81
DS P115-0011	TB 10-1131	TY 00591-51875-81
HY 3000709	TC AB-MSD4-1520	UC 8015
HY 3000709T	TC ABMSD-41520	YT 220070387
KO FBMSD-41520	TC ABMSD-41521	
NI 29348-L4005	TY 00591-07282-81	



Part Number - 370071

**Contactor Tip Kit**

▼ OEM Reference

DS P111-0030	PL JEA-3003S	TY 00591-07577-81
DS P111-0104	PL K2096-10	TY 00591-53115-81
HY 1316399	RA 1-105-055-02	TY 00591-57340-81
PL 67-042	RA 154-008-741-216	
PL JCA-3003S	TB 10-1K38	



Part Number - 370070

**Contactor Tip Kit**

▼ OEM Reference

AC 4912002	HY 3006743	TB 10-1K23
CL 996819	NK 118311	TB 10-1K27
CL 7003151	PL 67-029	TY 00591-09003-81
CL 7003190	PL JBC-3001S	TY 00591-31595-81
CT 217526	RA 1-105-023-04	TY 00591-31603-81
DS P111-0032	SC 29-10413	TY 00591-31636-81
DS P111-0044	SC 33-14640	TY 00591-51868-81
HY 3000614	SC 39-90057	TY 00591-63174-81



Part Number - 370072

**Contactor Tip Kit**

▼ OEM Reference

CT 1051087	TY 00591-39838-81	YT 220017209
DS P103-0050	TY 00591-57328-81	YT 220034535
TY 00591-21059-81	HY 3039475	



Part Number - 380030-084

**Contactor Tip Kit**

▼ OEM Reference

HY 2305749  
YT 150091008



Part Number - 370072-001

**Contactor Tip Kit - 450 amp**

▼ OEM Reference

RA 1-105-129-111  
RA 154-008-740-416  
RA DS223295  
RA DS232734



Part Number - 3C0001-R

**Curtis PMC Control**

- ▼ OEM Reference
- FL 1204-021
- HY 3181079
- TA 62-204-00
- YT 1501056-67

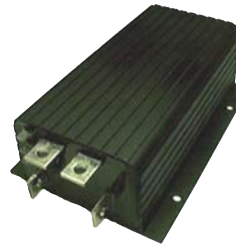

Part Number - 3C0009-R

**Curtis PMC Control**

- ▼ OEM Reference
- RA 1-187-085
- FL 1214-8703
- HY 3175374
- YT 1500226-84
- YT 2201753-74



Part Number - 3C0003-R

**Curtis PMC Control**

- ▼ OEM Reference
- FL 1205X-4417
- HY 3033962
- HY 1500220-25
- YT 150022025
- YT 5183616-10
- YT 2200152-58



Part Number - 3C0010-R

**Curtis PMC Control**

- ▼ OEM Reference
- RA 1017149
- FL 1214-8708



Part Number - 3C0005-R

**Curtis PMC Control**

- ▼ OEM Reference
- FL 1214-8709
- HY 3183796
- RA 1017150
- YT 1501207-73



Part Number - 3C0017-R

**Curtis PMC Control**

- ▼ OEM Reference
- EZ 2097-G1
- FL 1204-027
- HY 3142096
- YT 220042096



Part Number - 3C0006-R

**Curtis PMC Control**

- ▼ OEM Reference
- CU 4110440
- FL 1207A-4119
- HY 3182195
- YT 1501071-79



Part Number - 3C0018-R

**Curtis PMC Control**

- ▼ OEM Reference
- BR 27732-068
- FL 1205-111
- HY 3026561
- YT 220012004



Part Number - 3C0007-R

**Curtis PMC Control**

- ▼ OEM Reference
- FL 1243C-4278
- HY 1674663
- RA 312668-001
- RA 939-353-059
- YT 524370-09



Part Number - 3C0002-R

**Curtis SX Control**

- ▼ OEM Reference
- FL 1244-4467
- HY 3183244
- RA 1-187-094/005
- TY 00590-45652-71
- YT 1501149-96



Part Number - 3C0008-R

**Curtis PMC Control**

- ▼ OEM Reference
- TA CTL-2000
- FL 1204-001
- EZ 27094G01
- CU 831722
- HY 3026554
- YT 1500225-74
- YT 2200119-97



Part Number - 3C0004-R

**Curtis SX Control**

- ▼ OEM Reference
- FL 1244-4424
- HY 3174204
- RA 1-187-094/003
- YT 1500226-98
- YT 2201742-04

## Cards



Part Number - 3C0022-R

### Regen SX Control

▼ OEM Reference

CL 7006590  
 GE IC3645SR3R4U4N2  
 GE IC3645SR4U404N2  
 HY 3172279  
 YT 150022014  
 YT 580011153



Part Number - 3C0014-R

### Easi Reach Coil Driver-R

▼ OEM Reference

FL 828-004-206/003  
 HY 3178790  
 RA 828-004-206/003  
 RA 828-004-207/001  
 YT 150050141



Part Number - 3C0012-R

### EV100 ZX Traction Card-R

▼ OEM Reference

FL IC3645LXCD12H  
 GE IC3645LXCD1ZH  
 HY 1397304  
 HY 1459419  
 HY 3039525  
 HY 3126503  
 YT 150021994  
 YT 220021426  
 YT 580006862



Part Number - 3C0015-R

### 1204X-4215 Curtis PMC Control-R

▼ OEM Reference

RA 1-187-070  
 FL 1204X-4215



Part Number - 3C0013-R

### Easi Reach Power Card-R

▼ OEM Reference

FL 154-012-429/103  
 HY 3178786  
 RA 154-012-429/102  
 RA 154-012-429/103  
 RA 154-012-429/104  
 RA 154-012-430/004  
 RA 154-012-430/006  
 RA 154-012-430/007  
 YT 150050137



Part Number - 3C0016-R

### 24V MPB SX Zapi Control-R

▼ OEM Reference

FL 66-FC2086A  
 HY 2045951  
 YT 585098300

Check out Crown's huge selection of aerosols and oils. See Section 1.



Part Number	Voltage	Body Diameter	Overall		Display
			Length	Lens	
130997	12-24	66.7mm (2.63")	52mm (2.05")	Glass	Hour Meter
824819	24-48	69mm (2.73")	52mm (2.05")		99999.9 LCD BDI - LED



Combines in one instrument a completely solid state battery discharge indicator, an LCD hour meter and lift lockout, housed in a 52 mm case. Indicates state of charge in 10 bar LED display. Void of moving parts, this instrument is exceptionally reliable even in severe operating environments. Suitable for all electric vehicles. Mounting hardware included.



Part No.	Voltage	Lens	Display
153830	24-48	Polycarbonate	LED

Overall Length	Body Diameter
54mm (2.13")	58.5mm (2.30")

Discharge meter, use in conjunction with 134527, 134528 and 134529 battery interrupts. Hardware to mount included.



Part Number	Voltage	Lens	Display
115083	12-24	Lexan	LED
106288	24-36		
126238-002*	24-36		

Overall Length	Body Diameter
64mm (2.53")	52mm (2.05")

Dual voltage, easy to install "fuel" gage. Reliable, accurate and easy to read display of battery state-of-charge. For lead acid battery-powered vehicles that require a display function only. Mounting hardware included.

\*Note: Maintenance free batteries.



Part Number	Voltage	Lens	Display
370092	24-36		BDI, Hour Meter

▼ OEM Reference

Part	Code	Part	Code
BT	301445-000	HY	864794
CL	448375	KO	301445-00
CL	7000601	KO	301445-000
CL	913739	MB	1009518
CL	917966	MB	1100728
CL	919749	PM	23268-01
CT	NA017474	PM	301445-000
CT	1009518	RA	DS226823
CT	1100728	RA	DS226824
HY	0864794	RA	850-139-183-004
HY	1361313	RA	870-231-002
HY	2046257	RA	870-231-003
HY	3057690	RA	870-248
HY	3137245	RA	870-256
		RA	939-122
		TY	00590-00528-71
		TY	00590-00609-71
		TY	00590-00610-71
		TY	00590-03794-81
		TY	00590-09015-81
		TY	00590-42119-71
		TY	00591-03794-81
		TY	00591-09015-81
		YT	220029245
		YT	220037690
		YT	524148929
		YT	752060402
		YT	752626302

Part Number	Voltage	Type	Lens	Display
130600-001	12	Standard	Glass	Hour Meter 8 alpha-numeric, LCD, BDI-LED
130600-002	12	Freezer		

Overall Length	Body Diameter
64mm (2.53")	52mm (2.05")

Displays various system parameters, such as battery state-of-charge, operation hours or maintenance status from a motor controller or other serial communication source. Ideal for pallet trucks, walkies, stackers and order pickers as well as other equipment with a need to display data using a dedicated unidirectional asynchronous serial signal. Mounting hardware included.



Part Number	Voltage	Lens	Display
370005	12-24		BDI, Hour Meter

▼ OEM Reference

HY	2046546
YT	580026708

Part Number	Voltage	Lens	Display
129042	36-48	Lexan	BDI, Hour Meter, LCD

Overall Length	Body Diameter
91.69 mm (3.61")	62.23mm (2.45")

Displays various system parameters, such as battery state of charge, operation hours, event code, and 10K light. Used on FC4. Battery charge light, when on, shows the percent of charge left in the battery. It will flash to warn you of a low battery charge. When key is turned off, the display will show total hours of truck operation. Used on trucks with two controllers.



Part Number	Voltage	Vendor Number
134527	24	Curtis 933
134528	36	Curtis 933
134529	24-36-48	Curtis 933

Controller with lift lockout and adjustable reset and discharge settings. It features a rugged aluminum controller for reliable operation, even in the most severe conditions. It prolongs battery life and protects vehicle components from the effects of deep discharge in material handling and other battery powered vehicles. Use in conjunction with part number 153830.

Part Number	Voltage	Lens	Display
124819	36	Lexan	BDI, Hour Meter, LCD

Overall Length	Body Diameter
91.69 mm (3.61")	62.23mm (2.45")

Displays various system parameters, such as battery state of charge, operation hours, event code, and 10K light. Used on FC4 & SC4. Battery charge light, when on, shows the percent of charge left in the battery. It will flash to warn you of a low battery charge. When key is turned off, the display will show total hours of truck operation.



Note: All round gauges utilize an industry standard mounting hole.

## Battery Capacity Indicators & Hour Meters



Part Number	Voltage	Display
113773-001	12-48	9999.9
Overall Length	Body Diameter	
38mm (1.48")	52mm (2.05")	

Highly reliable solid state hour meter that offers an unprecedented combination of patented technology, performance, reliability and value. It has a provision for continuous display. Has LCD display. DC only. Mounting hardware included. Signal input positive.



Part Number	Voltage	Display
113773-004	12-48	9999.9
Overall Length	Body Diameter	
34mm (1.318")	31mm x 54mm (1.224" x 2.098")	

Highly reliable solid state hour meter that offers an unprecedented combination of patented technology, performance, reliability and value. It has a provision for continuous display. Has LCD display. DC only. Utilizes flat quick-connect terminal tabs with hole.



Part Number	Voltage	Display
113773-006	12-48	9999.9
Overall Length	Body Diameter	
54mm (2.12")	52mm (2.05")	

Highly reliable solid state hour meter that offers an unprecedented combination of patented technology, performance, reliability and value. It has a provision for continuous display. Has LCD display. DC only. Includes hardware to mount. Signal input negative.



Part Number	Voltage	Display
107666	36-80	9999.9
Overall Length	Body Diameter	
59mm (2.34")	32mm x 54mm (1.25" x 2.125")	

Rugged and reliable mechanical hour meter. Two wire hookup included. DC only.

## DC/DC Converters



### Part Number - 110979

- Operates 12V
- UL recognized
- Input voltage range: 18v minimum, 55v maximum
- Output current: 5 amp
- Not suitable for solid state electronics



### Part Number - 128652

- Operates 12V
- UL recognized
- Input voltage range: 36v minimum, 48v maximum
- Output current: 21-23 amps
- Input over and under voltage protection
- Input polarity protection
- Input spike protection
- Output short circuit protection
- Thermal protection
- Suitable for all electronics

### Replacement Parts:

Input fuse: 094362-002  
Output fuse: 062765-001

Frame and Undercarriage

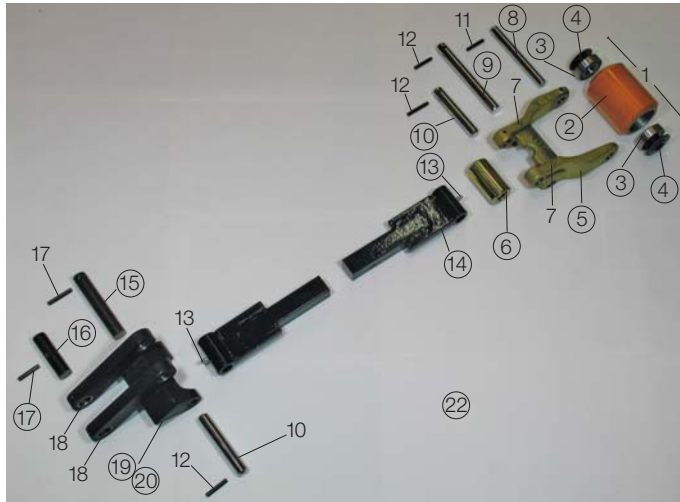

○ Current parts available from Crown

**2 - Load Wheel**

P.N. 310245-xxx

- ▼ OEM Reference
- HY 2046054
- YT 524148750

**3 - Wheel Bearing**

P.N. 370059

- ▼ OEM Reference
- HY 2046055
- YT 524148751

**4 - Bushing/String Guard**

P.N. 370142

- ▼ OEM Reference
- HY 2046056
- YT 524148752

**5 - Riser**

P.N. 370010

- ▼ OEM Reference
- HY 2046053
- YT 524148749

**6 - Exit Roller**

P.N. 370017

- ▼ OEM Reference
- HY 2307475
- TY 00591-11035-81
- TY 00591-30854-81
- TY 00591-54001-81

**8 - Load Wheel Axle**

P.N. 370009

- ▼ OEM Reference
- HY 2046057
- YT 524148753

**9 - Pivot Pin**

P.N. 370002

- ▼ OEM Reference
- HY 2046263
- YT 585096306

**10 - Pivot Pin**

P.N. 370001

- ▼ OEM Reference
- HY 2046263
- YT 585096307

**13 - Grease Fitting**

P.N. 370120

- ▼ OEM Reference
- HY 2042833

**14 - Push Rod**

P.N. 370016

- ▼ OEM Reference
- HY 2046286
- YT 585094505

**15 - Pivot Pin**

P.N. 370045

- ▼ OEM Reference
- HY 2046260
- YT 585096303

**16 - Push Rod Pin**

P.N. 370044

- ▼ OEM Reference
- HY 2046259
- YT 585096302

**17 - Pin Coiled**

P.N. 370262

- ▼ OEM Reference
- HY 2050088
- YT 585096801

**19 - Lower Rear Link RH**

P.N. 370036

- ▼ OEM Reference
- HY 2050086
- YT 524144864

**20 - Lower Rear Link LH**

P.N. 370037

- ▼ OEM Reference
- HY 2050085
- YT 524144865

**22 - Load Wheel & Riser Assembly**

P.N. 370013

- ▼ OEM Reference
- HY 2043251
- YT 524143966

## Frame and Undercarriage

### 1 - Poly Load Wheel

P.N. 310185-302

▼ OEM Reference  
HY 3005911

### 5 - Load Wheel Axle w/Lube Fitting

P.N. 370046

▼ OEM Reference  
HY 3005736

### 6 - Lube Fitting

P.N. 100779

▼ OEM Reference  
HY 13957

### 7 - Roll Pin

P.N. 060000-068

▼ OEM Reference  
HY 2307242

### 8 - Pivot Pin

P.N. 370027

▼ OEM Reference  
HY 2309397

### 9 - Roll Pin

P.N. 060000-024

▼ OEM Reference  
HY 2307086

### 15 - Lube Fitting

P.N. 100779

▼ OEM Reference  
HY 16041

### 22 - Retaining Ring

P.N. 060009-005

▼ OEM Reference  
HY 58903

### 27 - Roll Pin

P.N. 060000-104

▼ OEM Reference  
HY 19913

### 10 - Riser Assembly w/Lube Fitting

P.N. 370050

▼ OEM Reference  
HY 2302730

### 16 - Push Rod, 48" Forks

P.N. 370022

▼ OEM Reference  
HY 2308822

### 23 - Hex Washer

P.N. 060021-009

▼ OEM Reference  
HY 15055

### 28 - Pin

P.N. 370023

▼ OEM Reference  
HY 2311661

### 12 - Steel Roller Assembly w/Bearing

P.N. 370017

▼ OEM Reference  
HY 2307475

### 19 - Pin, Push Rod

P.N. 370049

▼ OEM Reference  
HY 3008398

### 24 - Lockwasher

P.N. 090875

▼ OEM Reference  
HY 15155

### 32 - Bellcrank Pin, 27" Wide Forks

P.N. 370032

▼ OEM Reference  
HY 2309006

### 13 - Link Pin

P.N. 370018

▼ OEM Reference  
HY 3006808

### 20 - Pin

P.N. 370021

▼ OEM Reference  
HY 2304484

### 25 - Pin

P.N. 370047

▼ OEM Reference  
HY 2305824

### 34 - Nut

P.N. 060021-009

▼ OEM Reference  
HY 15001

### 14 - Roll Pin

P.N. 060000-024

▼ OEM Reference  
HY 2307086

### 21 - Link

P.N. 370020

▼ OEM Reference  
HY 2307680

### 26 - Hex Bolt

P.N. 060016-004

▼ OEM Reference  
HY 18497

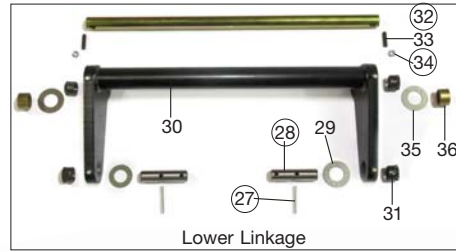

○ Current parts available from Crown

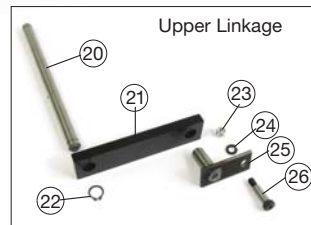
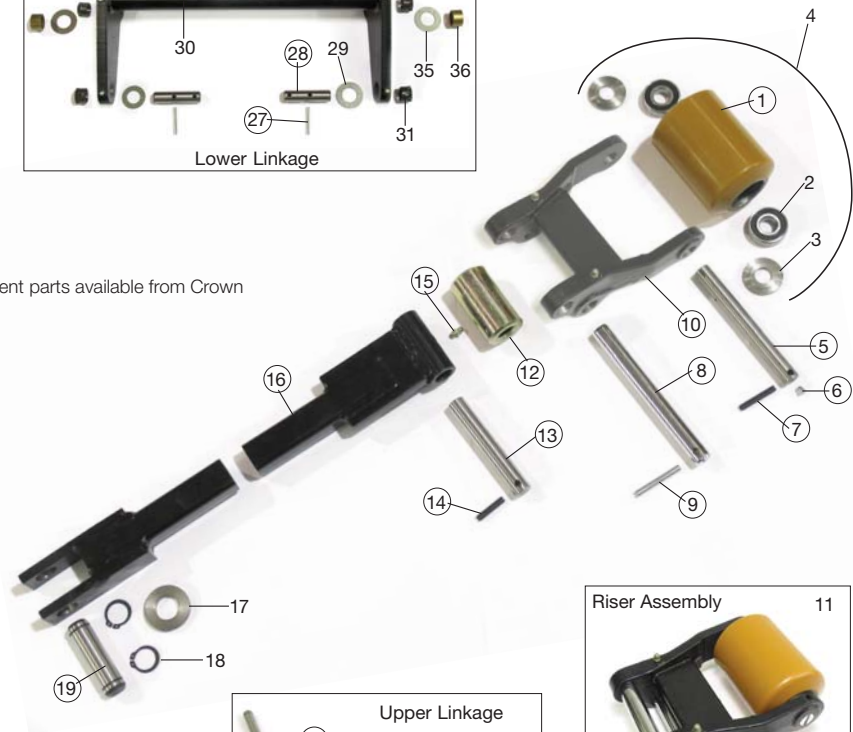

## Frame and Undercarriage

### 1 - Fork Riser 6000 lbs.

P.N. 370177

▼ OEM Reference  
RA 1025351-002

### Fork Riser 8000 lbs.

P.N. 370178

▼ OEM Reference  
RA 1025353-002

### 2 - Bushing, 8000 lbs.

P.N. 065117-001

▼ OEM Reference  
RA 1025349-007

### 3 - Grease Fitting

P.N. 100779

▼ OEM Reference  
RA 840-033

### 4 - Spiral Pin

P.N. 060000-081

▼ OEM Reference  
RA 810-747

### 5 - Bearing Non-Shielded

P.N. 042022

▼ OEM Reference  
RA 441-015

### 6 - Bearing Shielded

P.N. 065081-021

▼ OEM Reference  
RA 441-127

### 11 - Load Wheel

P.N. 310178-XXX

▼ OEM Reference  
RA 632-069

### 12 - Load Wheel Axle, Single

P.N. 370122

▼ OEM Reference  
RA 850-135-634

### 13 - Load Wheel, Tandem

P.N. 310180-XXX

▼ OEM Reference  
RA 632-071

### 16 - Load Wheel, Tandem Split

P.N. 310125-XXX

▼ OEM Reference  
RA 632-076

### 31 - Grease Fitting

P.N. 370159

▼ OEM Reference  
RA 840-018

### 35 - Retaining Ring

P.N. 060009-037

▼ OEM Reference  
RA 810-131

### 36 - Spiral Pin

P.N. 370066

▼ OEM Reference  
RA 810-762

### 39 - Spacer, Tube 6000 lbs.

P.N. 370180

▼ OEM Reference  
RA 1045247-001

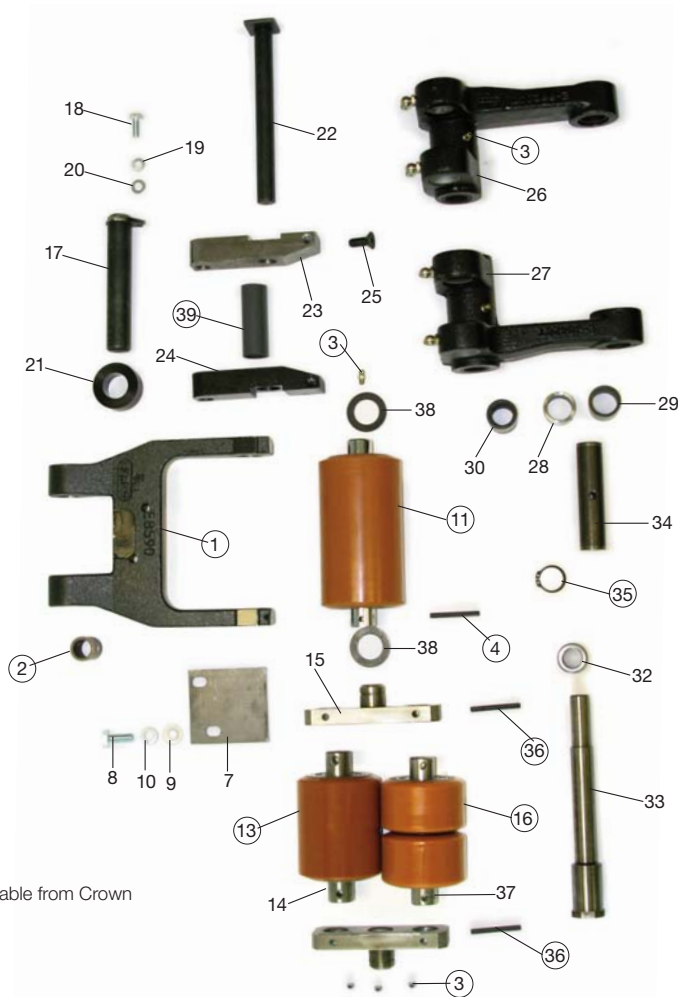

○ Current parts available from Crown



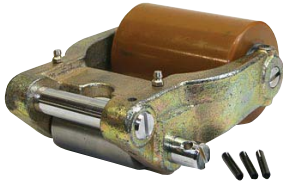

Part Number - 370013

**Riser Wheel Axle Assembly**

▼ OEM Reference  
HY 2043251  
YT 524143966

Part Number - 370016

**Push Rod 48 in. Forks**

▼ OEM Reference  
HY 2046286  
YT 585094505



Part Number - 370050

**Riser Assembly**

▼ OEM Reference

BK 992626	HY 3011678	YT 64856600
BK 992627	TY 00591-30852-81	YT 65054700
HY 2302730	TY 00591-52307-81	YT 643182400

Part Number - 370022

**Push Rod 48 in. Forks**

▼ OEM Reference

BK 992640	TY 00591-30860-81	YT 502447503
CL 7001866	YT 501771303	YT 502448503
HY 2308822		



Part Number - 370010

**Riser**

▼ OEM Reference  
HY 2046053  
YT 524148749



Part Number - 370036

**Lower Link (Right)**

▼ OEM Reference  
HY 2050086  
YT 524144864



Part Number - 370176

**Wheel Fork/Riser**

▼ OEM Reference  
PM 312638-000  
RA 939-352-256  
TY 00590-43543-71

Part Number - 370037

**Lower Link (Left)**

▼ OEM Reference  
HY 2050085  
YT 524144865



Part Number - 370074

**Axle**

▼ OEM Reference  
HY 2045925  
YT 524148464



Part Number - 370177

**Fork Riser**

▼ OEM Reference  
RA 1025351-002  
TY 00590-46291-71



Part Number - 370044

**Pivot Pin Axle**

▼ OEM Reference  
HY 2046259  
YT 585096302



Part Number - 370178

**Fork Riser**

▼ OEM Reference  
RA 1025353-002  
TY 00590-46288-71



Part Number - 370045

**Pivot Pin Axle**

▼ OEM Reference  
HY 2046260    YT 585096303  
HY 2046262    YT 585096305



Part Number - 370078

**Link Assembly**

▼ OEM Reference

HY 2039904	YT 524141180
HY 2058037	YT 524177337



Part Number - 370174

**Pivot Axle**

▼ OEM Reference  
YT 524301377



Part Number - 370260

**Fork Riser**

▼ OEM Reference

LP 763-1206  
RA 1025355



Part Number - 370075

**Load Wheel Axle**

▼ OEM Reference

CL 7002781	HY 2061914	YT 524187950
HY 2039868	YT 524141151	YT 524230699
HY 2039869	YT 524141153	



Part Number - 370067  
**Load Wheel Axle**

▼ OEM Reference

CL 7002631	TY 00591-58564-81	YT 505617500
TY 00591-38443-81	TY 00591-76605-81	



Part Number - 370009  
**Load Wheel Axle**

▼ OEM Reference

HY 2046057	YT 524148753
------------	--------------



Part Number - 370046  
**Load Wheel Axle**

▼ OEM Reference

BK 992629	HY 3005736	YT 220037538
CL 7001749	TY 00591-30754-81	YT 640374100
CT 218051	TY 00591-52316-81	YT 641433100
HY 2304088	TY 00591-76717-81	



Part Number - 370095  
**Axle Load Wheel**

▼ OEM Reference

BK LN153450	BK 153450
-------------	-----------



Part Number - 370119  
**Triple Load Wheel Axle**

▼ OEM Reference

RA 850-135-634-3
------------------



Part Number - 370122  
**Axle**

▼ OEM Reference

CL 7002767	RA 850-135-305	TY 00591-38729-81
CT 1009733	RA 850-135-634	TY 00591-58588-81
HY 3121689	RA DS226867	YT 220018798
MB 1009733	TY 00590-00020-71	



Part Number - 370123  
**Axle**

▼ OEM Reference

CL 7001987	CT NA-013763	TY 00591-30961-81
CT 1055818	MB NA-013763	YT 220003938
CT 1055827	RA 623-010-110-002	
CT NA012942B	RA 623-010-181-002	



Part Number - 370130  
**Load Roller Axle**

▼ OEM Reference

BG 906-0013	PM 47133	RA 111257
BT 47133	PM 111257	TY 00591-43227-81
BT 111257	RA 47133	TY 00591-43588-81



Part Number - 370138  
**Axle**

▼ OEM Reference

BR 40001-FS002
----------------



Part Number - 370140  
**Axle**

▼ OEM Reference

CL 7001873	RA 812-000-106	TY 00591-30868-81
CT A000003155	RA 812-001-261	TY 00591-63154-81
HY 3005844	TY 00591-07615-81	YT 220001768



Part Number - 370155  
**Axle**

▼ OEM Reference

BK 986042	CL 7001803	TY 00591-30794-81
BK PAL18	CT 218049	TY 00591-36969-81
BK 138043	HY 3005747	TY 00591-52025-81
BK 984297	HY 3143583	TY 00591-70791-81
BK 986036	SC 21-41323	YT 220016551
BK 986042	SC 21-41520	YT 220043583
CL 7001797	SC 41-27543	YT 505340501
CL 7001802	TY 00591-30790-81	YT 505340502



Part Number - 370167  
**Axle Entry Roller**

▼ OEM Reference

HY 2039255	YT 524140913
------------	--------------



Part Number - 370187  
**Axle**

▼ OEM Reference

CL 7001794	MB A3448	YT 501193100
CT A3448	TY 00591-36965-81	YT 524163144
HY 2309107	TY 00591-60840-81	
HY 3005832	YT 220035767	



Part Number - 370189  
**Roller Axle**

▼ OEM Reference

BK L1700000	JU 3310058	MB 71305310
CT 27811190	JU 3312263	MT 3310058
CT 33122630	JU 33122630	MT 38686
CT 71305310	JU 7130531	RA 38686
HP MU38686	JU 71305310	TY 00591-43128-81
JU 2781065	MB 27811190	TY 00591-55629-81
JU 27810650	MB 33122630	



Part Number - 370119  
**Triple Axle**

▼ OEM Reference

RA 850-135-634-3	RA 850-135-634-3HL
------------------	--------------------



Part Number - 370192  
**Wheel Axle Assembly**  
▼ OEM Reference  
RA 623-010-297



Part Number - 370270  
**Caster Axle**  
▼ OEM Reference  
RA 828-006-728



Part Number - 370193  
**Axle**  
▼ OEM Reference  
HY 1450616    HY 2013153    YT 580000461  
HY 1450617    TY 00591-74534-81    YT 580000462  
HY 1493867    YT 519433626    YT 580024028



Part Number - 370232  
**Shaft/Axle**  
▼ OEM Reference  
CT 33138380  
JU 33138380  
MB W2050-10198  
MB 33138380



Part Number - 370222  
**Axle**  
▼ OEM Reference  
CT 51065679  
JU 51065679  
MB 51065679  
MB W205013572  
MB W2050-13572



Part Number - 370076  
**Axle Sleeve**  
▼ OEM Reference  
HY 2304696  
YT 505034200



Part Number - 370224  
**Axle/Shaft**  
▼ OEM Reference  
JU 33138390



Part Number - 370190  
**Shaft**  
▼ OEM Reference  
CL 7002450    TY 00591-72261-81    YT 504599200  
HY 2302981    YT 220049717  
TY 00591-38020-81    YT 500640818



Part Number - 370226  
**Axle**  
▼ OEM Reference  
JU 33138370



Part Number - 370265  
**Shaft Pivot**  
▼ OEM Reference  
YT 507247500



Part Number - 370229  
**Load Wheel Axle**  
▼ OEM Reference  
CT 51012680    JU 51059718    MB 51059718  
CT 51059718    MB W2050-13546  
JU 51012680    MB 51012680

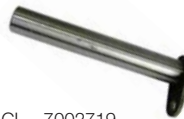

Part Number - 370088  
**Pin**  
▼ OEM Reference  
CL 7002719    TY 00591-76606-81    YT 507244500  
TY 00591-31352-81    YT 505654500    YT 220037532  
TY 00591-58507-81    YT 505654600



Part Number - 370268  
**Load Wheel Axle**  
▼ OEM Reference  
RA 1014758-001



Part Number - 370021  
**Pin**  
▼ OEM Reference  
HY 2304484  
YT 502303101



Part Number - 370269  
**Load Wheel Axle**  
▼ OEM Reference  
RA 1014758-002



Part Number - 370023  
**Pin**  
▼ OEM Reference  
HY 2033718  
HY 2311661  
TY 00591-76553-81  
YT 503688200



Part Number - 370047

**Pin**

▼ OEM Reference  
 HY 2305824  
 TY 00591-76719-81  
 YT 640697303



Part Number - 370134

**Threaded Pin**

▼ OEM Reference  
 BT 301779-000  
 KO 301779-000  
 PM 301779-000  
 RA 301779-000



Part Number - 370112

**Pin**

▼ OEM Reference  
 LI 149463



Part Number - 370184

**Pin**

▼ OEM Reference

BR PM301996002	HY 3137894	KO 8730181
BR PM301996-002	HY 3137894SYS	KO OP03000786
CL 921509	KO 301996-002	PM 301996-002



Part Number - 370117

**Pin**

▼ OEM Reference  
 LI 149444



Part Number - 370118

**Pin**

▼ OEM Reference  
 LI 149448



Part Number - 370186

**Pin**

▼ OEM Reference  
 PM 301996-000



Part Number - 370113

**Pin**

▼ OEM Reference  
 LI 149447  
 SL 149447



Part Number - 370188

**Pin**

▼ OEM Reference

CL 7002788	TY 00591-38810-81	YT 506634500
HY 2033820	TY 00591-58525-81	YT 507327500
HY 2305449	TY 00591-76629-81	
HY 3057533	TY 220037533	



Part Number - 370135

**Pin**

▼ OEM Reference  
 BT 47930  
 BT 600114  
 BT 650595  
 JU 47930  
 KO 47930  
 LR 20274P  
 PM 47930  
 RA 47930



Part Number - 370018

**Link Pin**

▼ OEM Reference

BK 992658	HY 3005847	TY 00591-57741-81
CL 7001855	HY 3006808	TY 00591-76456-81
HY 2307202	TY 00591-37127-81	YT 64857200



Part Number - 370131

**Pin**

▼ OEM Reference  
 BT 47931  
 JU 47931  
 KO 47931  
 LR 20275  
 PM 47931  
 RA 47931  
 TY 00591-43274-81



Part Number - 370027

**Pivot Pin**

▼ OEM Reference

BK 992657	HY 2309397	TY 00591-58555-81
CL 7001856	TY 00591-30853-81	TY 00591-76570-81
CL 7002612	TY 00591-38395-81	YT 64857300
HY 2303559	TY 00591-54000-81	YT 504734200



Part Number - 370165

**Pin**

▼ OEM Reference  
 HY 2039118  
 YT 524140838



Part Number - 370001

**Pivot Pin**

▼ OEM Reference  
 YT 585096307  
 HY 2046264



Part Number - 370002

**Pivot Pin**

▼ OEM Reference  
HY 2046263  
YT 585096306



Part Number - 370125

**Pivot Pin**

▼ OEM Reference  
HY 3139433  
RA 114-008-685  
YT 220031433



Part Number - 370261

**Pivot Pin**

▼ OEM Reference  
HY 2039120  
YT 524140840



Part Number - 370124

**Pin Weldment**

▼ OEM Reference  
CT 1037037  
HY 3134462  
RA 114-007-795  
RA DS236851  
YT 220027831



Part Number - 370049

**Push Rod Pin**

▼ OEM Reference

BK 992655	HY 3008398	TY 00591-76721-81
CL 7001861	TY 00591-37129-81	YT 641786100
HY 2306563	TY 00591-58542-81	YT 641786101



Part Number - 370107

**Pin - Lower Link Pivot**

▼ OEM Reference  
HY 2039119  
YT 524140839



Part Number - 370032

**Bellcrank Pin**

▼ OEM Reference  
HY 2309006  
TY 00591-74640-81  
YT 518360601



Part Number - 370066

**Pin Coil**

▼ OEM Reference  
RA DS227111  
RA 810-762  
TY 00590-00633-71



Part Number - 370262

**Pin Coiled**

▼ OEM Reference  
HY 2050087  
HY 2050088  
YT 585096801  
YT 585096802



Part Number - 050000-095

**Roll Pin**

▼ OEM Reference

AC 8730573	HY 3143377	PM 301964-032
BK LM200142000	JU 50021409	RA 301964-032
BK L1036914001	JU 50180203	SL 501898
BK L9380620220	JU 71805830	SL 5442415
BK 9380620220	KM 101359	SL 8005505
BR PM301964-032	KO 301964-032	TY 33664-13500-71
BT 301964-032	LI M200142000	WG 5505
CL 01JM04032	LI 1036914001	YT 200078120
CL 3JM4032	LI 9380620220	YT 220043377
CL 730668	MT 0200078120	YT 272204800
CL 924657	MT 0200142000	YT 449034012
HY 2035130	MT 04207867977	YT 954508909
HY 2791837	NY 30304032	



Part Number - 370219

**Roll Pin**

▼ OEM Reference  
JU 25700520



Part Number - 370223

**Roll Pin**

▼ OEM Reference

CT 25700810	KO 04025-00532	MB 948810532
CT 948810532	MB 09488-10532	MB W2050-11894
JU 25700810	MB 25700810	YT 449034019



Part Number - 370168

**Pin-Coiled Roll**

▼ OEM Reference  
CL 2039122  
HY 2039122  
YT 524140842



Part Number - 370090

**Tandem Pivot**

▼ OEM Reference  
CT 1202315  
RA DS225210  
RA 850-137-664  
TY 00590-00682-71



Part Number - 370094

**End Cap**

▼ OEM Reference

BK A5A	BK 985194	TY 00591-70790-81
BK PAL18A	CL 7001798	YT 220017020
BK PAL18AK	SC 21-41501	
BK 153451	TY 00591-30791-81	



Part Number - 370251

**Bushing**

▼ OEM Reference  
JU 51173971



Part Number - 370169

**Bushing**

▼ OEM Reference  
HY 2039224  
YT 524140878



Part Number - 370254

**Bushing**

▼ OEM Reference

CL 7003600	MB 1063128	TY 00591-40800-81
CT 1063128	RA DS232947	YT 220002046
HY 3015671	RA 623-005-041	



Part Number - 370114

**Bushing**

▼ OEM Reference  
BK 153083  
LI 153083

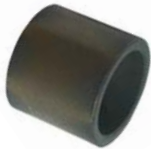

Part Number - 370115

**Bushing**

▼ OEM Reference  
BK 153082  
LI 153082



Part Number - 370089

**Bushing**

▼ OEM Reference

HY 2033629	YT 504248505
HY 2034088	YT 507248505
HY 2038070	YT 585086303
TY 00591-74609-81	



Part Number - 370142

**Bushing/String Guard**

▼ OEM Reference  
YT 524148752  
HY 2046056



Part Number - 370132

**Bushing**

▼ OEM Reference

BT 176827	PM 176827
HY 2027716	RA 176827
LR 20306	YT 912630302



Part Number - 370126

**Entry Roller**

▼ OEM Reference

BT 47150	MG 545
JU 47150	PM 47150
KO 47150	RA 47150
LR 10281	TY 00591-43241-81



Part Number - 370166

**Bushing**

▼ OEM Reference  
HY HY2039226  
YT YT524140880



Part Number - 370017

**Exit Roller**

▼ OEM Reference

BK 992656	HY 3006938	TY 00591-54001-81
HY 2307475	TY 00591-11035-81	YT 64857600
HY 3003759	TY 00591-30854-81	YT 751791300



Part Number - 370225

**Bushing**

▼ OEM Reference  
JU 26904730

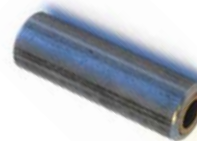

Part Number - 370173

**Roller Assembly**

▼ OEM Reference  
HY 2039905  
YT 524141181

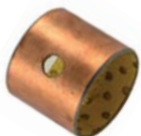

Part Number - 370250

**Bushing**

▼ OEM Reference  
JU 51173883



Part Number - 370127

**Load Wheel Assembly - Nylon**

▼ OEM Reference

BG 906-0023-N-A	BT 56771	RA 126729
BT 126729	LR 20210N	RA 167600
BT 167600	PM 126729	
BT 167609-SUPER	PM 167600	



Part Number - 370230

**Load Wheel Assembly**

▼ OEM Reference

CT 51064639
JU 51064639
MB 51064639



Part Number - 370231

**Load Wheel Assembly**

▼ OEM Reference

CT 50136157	JU 50136157	MB 50136157
CT 50179921	JU 7180668	MB 50179921
CT 71305290	JU 71305290	MB 71305290
CT W2050-11106	JU 71806680	MB W2050-11106



Part Number - 370198

**Load Wheel Assembly**

▼ OEM Reference

CT 50265511
MB 50265511
MT 090153008
NI MT090153008



Part Number - 370156

**Shim - 1/32"**

▼ OEM Reference

BK 985849	BK PAL46132	YT 220015767
BK 986200	BK PAL46A	YT 220019486
BK PAL46	CL 7001746	



Part Number - 370020

**Link**

▼ OEM Reference

CL 7002613	HY 2307680	TY 00591-58622-81
HY 2033719	TY 00591-38396-81	YT 500989200



Part Number - 370091

**Threaded Rod**

▼ OEM Reference

CL 2039315
HY 2039315
YT S00736690075
YT 524141079



Part Number - 370109

**Shaft - Truck Link Weldment**

▼ OEM Reference

RA 850-138-231
----------------



Part Number - 370159

**Grease Fitting**

▼ OEM Reference

RA 840-018
------------



Part Number - 370120

**Grease Fitting Threaded**

▼ OEM Reference

HY 2042833
RA 20026



Part Number - 370121

**Grease Fitting Flush**

▼ OEM Reference

BK 001640	HY 3014862	RA 310549-000
BR 9872-008	HY 3055565	RA 841-111
BR A9872-8	HY 3064274	RA DS227104
BR CK624280	HY 3143332	TY 00590-00423-71
BT 310546-000	LI 001640	TY 00591-00599-81
BT 310549-000	MB 1009498	TY 00591-36910-81
CA 624280	MB 217554	TY 00591-54032-81
CL 624280	MB GS00-01766	TY 00591-54033-81
CL 1313115	NI CK1313115	YT 220003882
CT 1009498	NI CK624280	YT 220016081
CT 217554	PM 310546-000	YT 220043332
CT GS00-01766	PM 310549-000	YT 220072237
HY 2302457	RA 310546-000	YT 507167800
HY 3012701		



Part Number - 370227

**Grease Fitting**

▼ OEM Reference

JU 50007986
-------------



Part Number - 370228

**Grease Fitting**

▼ OEM Reference

JU 50013308
-------------



Part Number - 370129

**Control**

▼ OEM Reference

CT A000010382	NI CK924663	RA 301718-000
KO 301718-000	PM 301718-000	YT 220043370

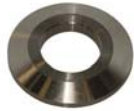

Part Number - 370096

**Bearing Seal**

▼ OEM Reference

BK LN152669	CT A0000-14665	LI LI152669
BK 152669	CT A000014665	LI 152669



Part Number - 370144

**Seal**

▼ OEM Reference

CL 7003816	RA 530-615	WM 20-P-68
CT GS0000888	TY 00591-41247-81	WM 21-H-3325
CT 1062983	TY 00591-54596-81	WM 30-P-575
HY 3013840	WM 20-H-1160	WM 403692-D
MB GS0000888	WM 20-P-358	YT 220003634
RA DS225024	WM 20-P-4191	YT 220016555



Part Number - 370157

**Seal**

▼ OEM Reference

BK 001383	HY 3050644	TY 00591-32048-81
BK 12AL213	HY 3131031	TY 00591-58736-81
CL 7003779	KO 37B-7AV-1211	YT 220006678
CT 215622	LI 001383	YT 220022631
HY 0046671	TY 00591-00174-81	



Part Number - 370158

**Seal**

▼ OEM Reference

BK 001384	HY 3004303	TY 00591-32050-81
BK 12AL2141	HY 3131032	TY 00591-54582-81
CL 443535	LI 001384	YT 220022632
CL 7003780	SC 41-24724	YT 220052887
CT 215623	TY 00591-00175-81	



Part Number - 370205

**Oil Seal**

▼ OEM Reference

CL 562783	CT 973721	RA 530-641
CL 952179	KO 4995652	YT 091654100
CT 0973721	RA 530-517	YT 220004243
CT 1036493	RA 530-617	YT 220050212



Part Number - 370179

**Oil Seal**

▼ OEM Reference

CL 102361	HY 3006347	SL S20098
CL 1124E2	HY 3125222	TY 00590-00415-71
CL 117604	MB A0000-00050	TY 00591-07603-81
CT A0000-00050	MB A000000050	TY 00591-32057-81
CT 1009119	MB 1009119	TY 00591-50668-81
CT 3J4776	MB 217577	YT 220001910
HY 0018773	RA DS224928	YT 220002307
HY 0029058	RA DS226562	YT 220017349
HY 18773	RA 530-638	YT 220020222
HY 29058	RA 530-688	

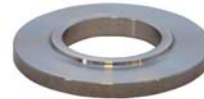

Part Number - 370139

**Shield Bearing**

▼ OEM Reference

CL 7002777	HY 3142320	TY 00591-76552-81
CT A000032617	TY 00591-38769-81	YT 503480200
HY 2042262	TY 00591-58661-81	



Part Number - 370207

**Seal Kit**

▼ OEM Reference

CL 7003597	RA 530-712-01	RA DS228499
CT 1008994	RA 530-725-01	TY 00591-31900-81
CT 1056005	RA 531-103	TY 00591-70194-81
HY 3006383	RA 531-209	YT 220001916
MB 1008994	RA 623-005-122	



Part Number - 370209

**Seal Kit**

▼ OEM Reference

CT 50033984
JU 50033984
MB 50033984
RA 530-749-001



Part Number - 370255

**Seal Kit**

▼ OEM Reference

HY 3035475
RA 540-047-06
TY 00591-76033-81
YT 220016053



Part Number - 370175

**Flanged Bearing**

▼ OEM Reference

HY 2100235
YT 524302804





Part Number - 370164

### Spring

▼ OEM Reference  
HY 1531075  
YT 580038175



Part Number - 370170

### Screw

▼ OEM Reference

HY 2791024	HY 296203	YT 277274300
HY 2798772	YT 273075800	YT 580013990



Part Number - 370172

### Washer

▼ OEM Reference

BR 9878-024	HY 2035534	YT 062960000
BR 9878024	LP 1069-1210	



Part Number - 370263

### Washer

▼ OEM Reference

HY 2307951  
YT 065055200



Part Number - 370162

### Spacer

▼ OEM Reference

CL 7001735	TY 00591-30752-81	YT 121357100
HY 2037487	TY 00591-60741-81	YT 220035779
HY 3007123	TY 00591-76463-81	



Part Number - 370266

### Spacer

▼ OEM Reference

RA 1031101



Part Number - 370180

### Tube Spacer

▼ OEM Reference  
RA 1045247-001



Part Number - 370210

### Swivel Assembly

▼ OEM Reference

CL 7001918	RA 870-410-17	RA 870-410-26
HY 3018295	RA 870-410-20	RA 870-410-27
PM 200903	RA 870-410-22	TY 00591-30924-81
PM QJ-112207	RA 870-410-23	TY 00591-63170-81
PM QJB-002881	RA 870-410-24	YT 220002254
RA 787-047-100	RA 870-410-25	



Part Number - 370194

### Plate Carrier

▼ OEM Reference

CL 7002175	RA 623-010-154	TY 00591-70849-81
CT 1055823	RA 828-008-204	YT 220017203
CT NAO12934C	RA DS237267	
HY 3039852	TY 00591-31076-81	



Part Number - 370267

### Plate Carrier

▼ OEM Reference

RA 623-010-109

Image Not Available

Part Number - 065007-102

### Bushing



▼ OEM Reference

AC 1902-55019	HY 2792008	MB 27807160
AC 3BA-25-25270	HY 2792092	MB 50012676
AC 4930406	HY 2793267	MB 50019663
AE 109983	HY 3025470	MB 560502020
BK 0009230231	HY 3123928	MB 77800733
BK L0009230231	HY 800012333	MB W205010319
BK L0199990340	HY 800075575	MT 23163
BR AT109983	HY 800086751	MT 77800733
CL 2754471	JU 26915362	NI AL109983
CL 70014440	JU 27807160	TY 00591-02391-81
CT 27807160	JU 50012676	TY 00591-36099-81
CT 50012676	JU 50019663	TY 00591-60582-81
CT 50019663	KO 3BA-25-25270	TY 00591-75329-81
CT 560502020	KO 4930406	YN SA430134
CT 77800733	KO 4967811	YT 220005064
CT W205010319	LI 0009230231	YT 220035999
DW A376514	LI L0009230231	YT 272019100
HP MU23163	LI L0199990340	YT 273130200



**Battery Discharge Indicator**

P.N. 370005

- ▼ OEM Reference
- HY 2046546
- YT 580026708

**Pump Motor**

P.N. 370041

- ▼ OEM Reference
- HY 1466025
- YT 580012669

**Solenoid**

P.N. 084343

- ▼ OEM Reference
- HY 1198392

**Ignition Switch**

P.N. 370054

- ▼ OEM Reference
- HY 3005833
- YT 500863104

**Caster Assembly**

P.N. 310261-306-YT

- ▼ OEM Reference
- HY 2044852
- YT 580023164

**Controller**

P.N. 3C0016-R

- ▼ OEM Reference
- HY 2045951-R
- YT 585098300-R

**Key - 1 Piece**

P.N. 370087

- ▼ OEM Reference
- HY 262798
- YT 500863106

**Caster Wheel**

P.N. 310282

- ▼ OEM Reference
- HY 2046537
- YT 524149213

**Fuse 150 amp**

P.N. 802816-009

- ▼ OEM Reference
- HY 354589
- YT 504450730

**Hub**

P.N. 370061

- ▼ OEM Reference
- HY 2049428
- YT 501087300

**Handle Assembly - Control Arm**

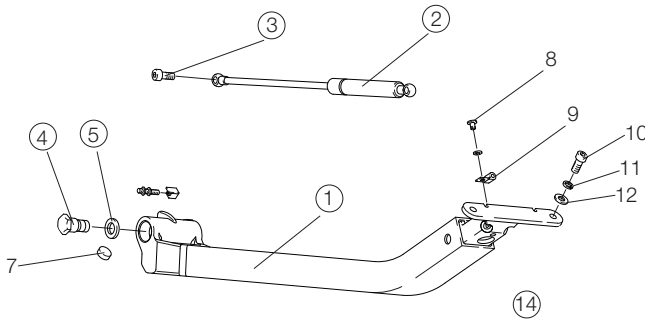

**1 - Steer Arm Assembly**

P.N. 370011

- ▼ OEM Reference
- HY 2050082
- YT 524143951

○ Current parts available from Crown

**2 - Gas Spring**

P.N. 370008

- ▼ OEM Reference
- HY 2050083
- YT 524149338

**3 - Pin**

P.N. 370060

- ▼ OEM Reference
- HY 302375
- YT 580031999

**4 - Steer Arm Pin**

P.N. 370006

- ▼ OEM Reference
- HY 2059695
- YT 272027800

**5 - Washer**

P.N. 370012

- ▼ OEM Reference
- HY 2791931
- YT 272006400

**14 - Handle Wiring Harness**

P.N. 370015

- ▼ OEM Reference
- HY 2066432
- YT 580046976

**Control Handle Assembly**

**1 & 2 - Control Handle Upper/Lower Set**

P.N. 370259

**1 - Control Handle Upper**

P.N. 370033

- ▼ OEM Reference
- HY 2045501
- YT 524139006

**2 - Control Handle Lower**

P.N. 370040

- ▼ OEM Reference
- HY 1467778
- YT 580011989

○ Current parts available from Crown

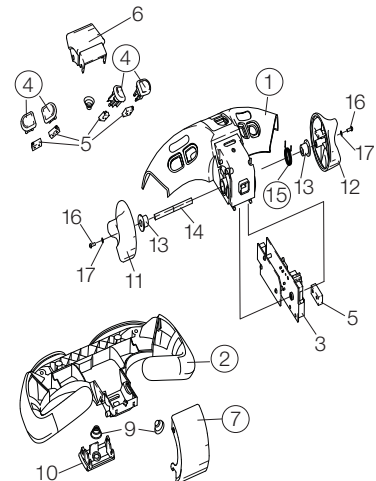

**4 - Switch Assembly**

P.N. 370058

- ▼ OEM Reference
- HY 1466877
- YT 524148521

**7 - Switch Cover**

P.N. 370163

- ▼ OEM Reference
- HY 1467779
- YT 580011991

**15 - Spring**

P.N. 370077

- ▼ OEM Reference
- HY 1466607
- YT 580012970

## Yale MPB 040E and Hyster W40

### Drive Unit and Brake Assembly

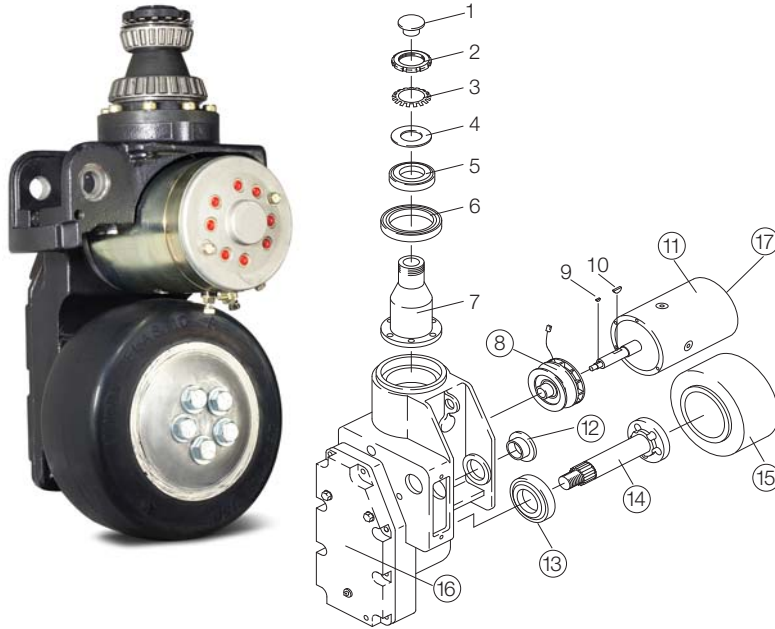

○ Current parts available from Crown

#### 8 - Brake Assembly

P.N. 370038

▼ OEM Reference  
HY 2046003  
YT 524148583

#### 11 - Drive Motor

P.N. 370043

▼ OEM Reference  
HY 2049316  
YT 580031000

#### 12 - Bushing

P.N. 370019

▼ OEM Reference  
HY 2791987  
YT 580031000

#### 13 - Bearing Cup

P.N. 065105

▼ OEM Reference  
HY 163971  
YT 055076400

#### 14 - Drive Axle

P.N. 370031

▼ OEM Reference  
HY 2304321  
YT 506566500

#### 15 - Poly Tire

P.N. 077848-xxx-xx

▼ OEM Reference  
HY 2045112  
YT 524142925

#### 15 - Rubber Tire

P.N. 076751-xxx

▼ OEM Reference  
HY 2045107  
YT 524142926

#### 16 - Motor Cover RH

P.N. 370034

▼ OEM Reference  
HY 1495763  
YT 524144502

#### 16 - Motor Cover LH

P.N. 370035

▼ OEM Reference  
HY 1495764  
YT 524144503

#### 17 - Drive Motor Brush Set & Springs

P.N. 370042

▼ OEM Reference  
HY 1506791  
YT 580029149

## Hyster W40 XL / W40 XT

### Drive Unit and Brake Assembly

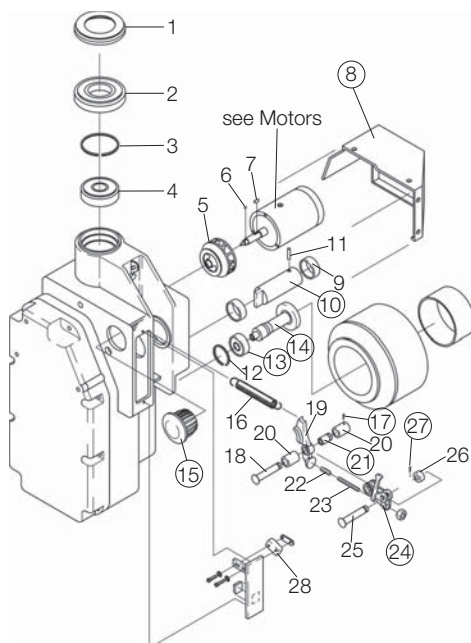

○ Current parts available from Crown

#### 8 - Drive Motor Cover

P.N. 370024

▼ OEM Reference  
HY 2041689

#### 10 - Shaft

P.N. 370030

▼ OEM Reference  
HY 2305815

#### 13 - Bearing Cup

P.N. 065105

▼ OEM Reference  
HY 163971

#### 13 - Bearing Cone

P.N. 065106

▼ OEM Reference  
HY 174230

#### 14 - Drive Axle

P.N. 370031

▼ OEM Reference  
HY 2304321

#### 15 - Plug

P.N. 370055

▼ OEM Reference  
HY 2307952

#### 17 - Cotter Pin

P.N. 060038-013

▼ OEM Reference  
HY 2302589

#### 21 - Bushing

P.N. 370052

▼ OEM Reference  
HY 2302396

#### 24 - Brake Cam Lever

P.N. 370196

▼ OEM Reference  
HY 2304545

#### 27 - Cotter Pin

P.N. 060038-002

▼ OEM Reference  
HY 15200

Part Number - 370011

**Steer Arm**

▼ OEM Reference  
HY 2050082  
YT 524143951



Part Number - 370028

**Handle Arm**

▼ OEM Reference  
HY 2306615      YT 504981702  
HY 2311282      YT 518218600  
YT 504027700



Part Number - 370025

**Steer Arm Weldment**

▼ OEM Reference  
HY 2308794  
YT 503771700



Part Number - 370033

**Control Handle Upper**

▼ OEM Reference  
HY 2045501  
YT 524139006



Part Number - 370040

**Control Handle Lower**

▼ OEM Reference  
YT 580011989  
HY 1467778



Part Number - 370259

**Control Handle Upper/Lower Set**

Includes part numbers 370033 & 370040



Part Number - 370264

**Handle Assembly**

▼ OEM Reference  
YT 550013954



Part Number - 370007

**Handle Switch**

▼ OEM Reference  
HY 2049350  
YT 524153715



Part Number - 370015

**Handle Wiring Harness**

▼ OEM Reference  
HY 2066432  
YT 580046976



Part Number - 370039

**Handle Wiring Harness Assembly**

▼ OEM Reference  
HY 2035394  
YT 580002386



Part Number - 370058

**Switch Assembly**

▼ OEM Reference  
HY 1466877  
YT 524148521



Part Number - 370163

**Cover Switch**

▼ OEM Reference  
HY 1467779  
YT 580011991



Part Number - 370006

**Handle Pin**

▼ OEM Reference

HY 2059695      HY 2793129      YT 524179191  
HY 2062561      YT 272027800  
HY 2792053      YT 272311800



Part Number - 370012

**Handle Pin Washer**

▼ OEM Reference  
HY 2791931  
YT 272006400



Part Number - 370053

**Pivot Pin**

▼ OEM Reference  
HY 2302412  
YT 723683100



Part Number - 370220

**Drive Tire**

▼ OEM Reference  
JU 50460101



Part Number - 370031

**Drive Axle**

▼ OEM Reference

HY 2303658      HY 2311203      YT 640846831  
HY 2304321      YT 501785300      YT 640846878  
HY 2304729      YT 506566500





Part Number - 370024  
**Drive Motor Cover**

▼ OEM Reference  
HY 2041689  
HY 2306863  
YT 503753700  
YT 580017142



Part Number - 370003  
**Gas Spring**

▼ OEM Reference  
HY 2040528      YT 524141471      YT 580046627  
HY 2047141      YT 524149833      YT 580046811  
HY 2066311      YT 524182270



Part Number - 370030  
**Shaft**

▼ OEM Reference  
HY 2305815  
YT 505984500



Part Number - 370191  
**Spring Handle Return**

▼ OEM Reference  
KO 301765-000  
KO 8730367  
KO OP03001388  
PM 301765-000  
TY 00591-75880-81  
YT 220043000  
YT 220043373



Part Number - 370019  
**Bushing**

▼ OEM Reference

BK L0039169600      HY 2799263      YT 272015100  
CL 925414      LI L10039169600      YT 277323300  
HY 2791987



Part Number - 370065  
**Washer - Flat**

▼ OEM Reference

CT 1009446      RA DS226870      TY 00590-00015-71  
MB 1009446      RA 771-156



Part Number - 370052  
**Bushing**

▼ OEM Reference  
HY 2302396  
TY 00591-76732-81  
YT 723673100



Part Number - 370068  
**Belt Timing Kit**

▼ OEM Reference  
CT 1051301  
RA 828-900-067



Part Number - 370055  
**Plug**

▼ OEM Reference  
HY 2307952  
YT 501864902



Part Number - 370077  
**Spring**

▼ OEM Reference  
HY 1466607  
YT 580012970



Part Number - 370060  
**Pin**

▼ OEM Reference  
HY 302375  
YT 580031999



Part Number - 370038  
**Brake Assembly**

▼ OEM Reference  
HY 2046003  
YT 524148583



Part Number - 370008  
**Gas Spring**

▼ OEM Reference  
HY 2050083      YT 524149338      YT 580083554  
HY 2066312      YT 580046812



Part Number - 370148  
**Brake - Electromagnetic**

▼ OEM Reference  
HY 2055944  
YT 524169212



Part Number - 370196  
**Brake Cam Lever**

▼ OEM Reference  
HY 2304545  
YT 505354500

## Drive Unit, Brake, and Steering



Part Number - 370102

### Disc - Brake

▼ OEM Reference  
RA 870-920-119



Part Number - 370103

### Disc - Brake

▼ OEM Reference  
RA 870-923-111



Part Number - 370098

### Disc - Brake

▼ OEM Reference

CT	NA014187	MB	NA014187	RA	870-901-115
CT	1050475	RA	870-834-121	TY	00591-76120-81



Part Number - 370097

### Plate - Friction

▼ OEM Reference  
CT 1050473  
RA 870-834-119



Part Number - 370099

### Rotor - Brake

▼ OEM Reference  
RA 870-920-120

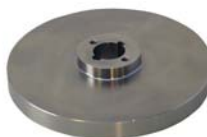

Part Number - 370100

### Rotor - Brake

▼ OEM Reference  
CT NA052004  
MB NA052004  
RA 870-856-111



Part Number - 370200

### Rotor - Brake

▼ OEM Reference  
CT 1050474  
GM 0681-17JX  
HY 3142755  
MB 1050474  
RA 870-834-120  
YT 220042755



Part Number - 370201

### Cylinder Inner

▼ OEM Reference

DS	P264-0012	RA	821-900-039-002
RA	820-001-711	RA	870-616
RA	820-002-013	RA	870-747
RA	820-002-173	RA	870-747-100
RA	820-900-019	RA	870-747-200
RA	821-900-039-001	TY	00591-57992-81



Part Number - 3J97220-05200-R  
**Pump R-Motor 36/48V**  
 ▼ OEM Reference  
 CT 97220-05200



Part Number - 3J570-269-500-R  
**Pump R-Motor 36V**  
 ▼ OEM Reference  
 RA 570-269-500



Part Number - 370041  
**Pump AM Motor 24V**  
 ▼ OEM Reference  
 HY 1466025  
 YT 580012669



Part Number - 3J570-287-500-R  
**Pump R-Motor 36V**  
 ▼ OEM Reference  
 RA 570-287-500



Part Number - 3J5045752-33-R  
**Pump R-Motor 36V**  
 ▼ OEM Reference  
 HY 2305653  
 YT 5045752-33



Part Number - 3J570-236-500-R  
**Pump R-Motor 36V**  
 ▼ OEM Reference  
 RA 570-236-500



Part Number - 3J14510U116071-R  
**Pump R-Motor**  
 ▼ OEM Reference  
 TY 14510-U1160-71



Part Number - 3J570-367-500-R  
**Pump R-Motor 36V**  
 ▼ OEM Reference  
 RA 570-367-500



Part Number - 3J326940-R  
**Pump R-Motor 12V**  
 ▼ OEM Reference  
 HY 326940



Part Number - 3J570-358-451-R  
**Pump R-Motor 36V**  
 ▼ OEM Reference  
 OH D-481581X7147A  
 RA 570-358-450  
 RA 570-358-451



Part Number - 3J005904128971-R  
**Pump R-Motor 24V**  
 ▼ OEM Reference  
 TY 00590-41289-71



Part Number - 3J570-317-500-R  
**Pump R-Motor 24V**  
 ▼ OEM Reference  
 RA 570-317-500



Part Number - 3J143201224171-R  
**Pump R-Motor**  
 ▼ OEM Reference  
 TY 14320-12241-71



Part Number - 3J570-379-451-R  
**Auxiliary Pump R-Motor 36V**  
 ▼ OEM Reference  
 RA 570-379-451



Part Number - 3J570-273-500-R  
**Pump R-Motor 36/48V**  
 ▼ OEM Reference  
 RA 570-273-500



Part Number - 3J570-299-500-R  
**Pump R-Motor 24/36V**  
 ▼ OEM Reference  
 RA 570-299  
 RA 579-299  
 RA 570-299-500



Part Number - 3J570-412-R  
**Pump R-Motor 24V**  
▼ OEM Reference  
RA 570-412



Part Number - 3J570-348-500-R  
**Drive R-Motor 36V EASI**  
▼ OEM Reference  
RA 570-348-500



Part Number - 3JMHP4005-R  
**Pump R-Motor 24V**  
▼ OEM Reference  
PL MHP4005  
RA 570-429-100



Part Number - 3J570-869-500-R  
**Drive R-Motor 24V**  
▼ OEM Reference  
RA 570-869-500



Part Number - 3J143201224071-R  
**Pump R-Motor 36V**  
▼ OEM Reference  
TY 14320-12240-71



Part Number - 3J570-325-500-R  
**Drive R-Motor 24V**  
▼ OEM Reference  
RA 570-325-500  
RA 570-867-500  
TY 00590-40563-71



Part Number - 3J570-867-500-R  
**Drive R-Motor 24V**  
▼ OEM Reference  
RA 570-867-500



Part Number - 3J570-392-500-R  
**Drive R-Motor 36V**  
▼ OEM Reference  
RA 570-392-500



Part Number - 3J570-388-500-R  
**Drive R-Motor 36V**  
▼ OEM Reference  
RA 570-388-500



Part Number - 3J570-368-500-R  
**Drive/Traction R-Motor 36V Pacer**  
▼ OEM Reference  
RA 570-368-500



Part Number - 3J570-863-500-R  
**Drive R-Motor 36V**  
▼ OEM Reference  
RA 570-863-500



Part Number - 3J570-400-500-R  
**Drive/Traction R-Motor 36V**  
▼ OEM Reference  
RA 570-400-500



Part Number - 3J570-869-701-R  
**Drive R-Motor 24V**  
▼ OEM Reference  
RA 570-869-701



Part Number - 3J579-355-R  
**Drive R-Motor 24/36V**  
▼ OEM Reference  
RA 579-355  
RA 570-355-500



Part Number - 3J570-350-500-R  
**Drive R-Motor 24V**  
▼ OEM Reference  
AD AN6-4003  
RA 579-350  
RA NN6-4003  
RA 570-350-500



Part Number - 3J570-415-201-R  
**Drive R-Motor 24V**  
▼ OEM Reference  
RA 570-415-201







Part Number - 3J570-298-500-R

**Drive R-Motor 24/36V**

▼ OEM Reference  
CT 1008792  
MB 1008792  
RA 570-298-500



Part Number - 3J70-054-41-R

**Drive R-Motor**

▼ OEM Reference  
TA 70-054-41



Part Number - 3J579-350-R

**Drive R-Motor 24V**

▼ OEM Reference  
AD AN6-4003  
RA 579-350  
RA AN6-4003



Part Number - 3J2798905-R

**Drive R-Motor**

▼ OEM Reference  
CL 2798905



Part Number - 3J570-251-200-R

**Drive R-Motor 36V**

▼ OEM Reference  
RA 570-251/200



Part Number - 3J2819155-R

**Drive R-Motor 36V**

▼ OEM Reference  
CL 2819155



Part Number - 370043

**Drive Motor 24V AM**

▼ OEM Reference  
HY 2049316  
YT 580031000



Part Number - 3J2798867-R

**Drive R-Motor 24V**

▼ OEM Reference  
AD K89-4002  
CL 2798867  
CL 2780604



Part Number - 3J325744-R

**Drive R-Motor 36/48V**

▼ OEM Reference  
HY 325744  
HY 1461192



Part Number - 3J70-054-00 (New)

Part Number - 3J70-054-00-R (Rebuilt)

**Drive R-Motor 24/36/48V**

▼ OEM Reference  
GE 5BC49JB305  
GE 5BC49JB305B  
GE 5BC49JB399C  
TA 70-054-00  
TA 70-054-03



Part Number - 3J5800166-68-R

**Drive R-Motor 24V**

▼ OEM Reference  
HY 2040658  
HY 2310528  
HY 2310528-G  
YT 730004021  
YT 730004021-G  
YT 730024021-AM



Part Number - 3J570-363-451-R

**Steer R-Motor Reach 36V**

▼ OEM Reference  
RA 570-363-451



Part Number - 3J7300310-00-R

**Drive R-Motor**

▼ OEM Reference  
YT 7300310-00



Part Number - 3J504575231-R

**Power Steering R-Motor 24V**

▼ OEM Reference  
HY 8620016  
YT 504575231



Part Number - 3J7300120-20-R

**Drive Motor 24V**

▼ OEM Reference  
YT 730012020



Part Number - 3J580035626-R

**Steer R-Motor 36/48V**

▼ OEM Reference  
HY 8517245  
YT 580035626



Part Number - 370035

**Motor Cover (Right)**

▼ OEM Reference  
HY 1495764  
HY 1537410  
YT 524144503  
YT 524184972



Part Number - 3J1457327 (New)  
Part Number - 3J1457327-R (Rebuilt)

**Steer R-Motor 36V**

▼ OEM Reference  
HY 1457327



Part Number - 370034

**Motor Cover (Left)**

▼ OEM Reference  
HY 1495763  
HY 1537409  
YT 524144502  
YT 524184971



Part Number - 3J29210-41H11 (New)  
Part Number - 3J29210-41H11-R (Rebuilt)

**Steer R-Motor 36V**

▼ OEM Reference  
NI 29210-41H11



Part Number - 370133

**Brush Kit (Set of 4)**

0.486 D x 1.258 W x 1.150 L  
▼ OEM Reference  
RA 570-869-735  
RA 570-869-735-KIT



Part Number - 3J5170726-02-R

**Steer R-Motor 24V**

▼ OEM Reference  
YT 517072602



Part Number - 370136

**Brush Kit (Set of 4)**

0.500 D x 1.250 W x 1.285 L  
▼ OEM Reference  
YT 582004077



Part Number - 3J97121-31900-R

**Steer R-Motor 48V**

▼ OEM Reference  
CT 97121-31900  
CT 97121-31901



Part Number - 072059

**Brush**

▼ OEM Reference  
CT 216035  
TY 00591-04641-81  
TY 00591-33330-81  
TY 00591-60633-81  
YT 220015891



Part Number - 3J2781993-R

**Steer R-Motor 36V**

▼ OEM Reference  
CL 2781993  
CL 2388112  
CL 2809539



Part Number - 073854

**Brush**

0.375 D X 0.750 W x 0.786 L  
▼ OEM Reference  
TY 00591-04670-81  
TY 00591-33331-81  
TY 00591-60651-81  
YT 220016331



Part Number - 021157-001

**Brush**

0.62 D x 1.24 W x 1.34 L

▼ OEM Reference

BT 306270-000	KO 302362-000	TY 00591-03840-81
CL 915595	PM 300417-000	TY 00591-33295-81
CL 915933	PM 300430-000	TY 00591-56358-81
CL 915934	PM 301504-000	YT 220014573
HY 3033063	PM 302362-000	YT 220021829
HY 3134050	PM 306270-000	YT 220027150
KO 300430-000	RA 939-194	YT 220044744



Part Number - 370143

**Brush Kit (4 of 021157-001)**

0.62 D x 1.24 W x 1.34 L

▼ OEM Reference

CT 1008664	MB 1075049	RA DS225074
CT 1008668	MB 1142628	RA DS225081
CT 1009186	MB NA057020	RA DS228921
CT 1036510	RA 570-236-514	YT 00590-04567-71
CT 1075049	RA 570-277-515	TY 00590-04575-71
CT 1142628	RA 570-295-514	TY 00591-21088-81
CT NA057020	RA 570-322-122	TY 00591-42660-81
HY 3034522	RA 570-449-513	TY 00591-42677-81
HY 3126436	RA 570-604-512	YT 220016152
MB 1008664	RA DS223442	YT 220021620
MB 1009186	RA DS224933	



Part Number - 118942

**Brush Set (8 of 021157-001)**

0.62 D x 1.24 W x 1.34 L

▼ OEM Reference

HY 3121150	TY 00590-42110	TY 00591-23043-81
RA 570-260-511	TY 00591-42661-81	YT 220017761
TY 00590-41853		



Part Number - 074604

**Brush**

0.500 D X 0.625 W x 1.750 L

▼ OEM Reference

BR 16954-007	HY 800076129	TY 00591-51482-81
BR 28802-014	TY 00591-04685-81	YT 220015861
BR A16954-7	TY 00591-04685-81	YT 220016545
CT 215023	TY 00591-32390-81	YT 220054093



Part Number - 074614

**Brush Set**

▼ OEM Reference

AC 4906521	PL 17-63	YT 5066058
AC 74906521	PL MBD-1418-S	YT 129159026
BJ 003704	PM 200185	YT 220008074
BK 116088	PM EMBD-1418-S	YT 220023298
BK 15MP9A	RA 570-416-06	YT 500838400
CL 883802	SC 33-11408	YT 506605800
CT 973039	SC 41-25683	YT 1169404DX
HY 3001328	TY 00591-30135-81	YT 1291590-26
HY 3002686	TY 00591-51472-81	
HY 3007446	YT 5008384	
HY 3018819		



Part Number - 084304

**Brush Set**

▼ OEM Reference

AC 4907386	HY 3001857	SC 33-11417
AC 4912263	HY 800071662	TY 00591-03981-81
BK 004327	PL 17-149	TY 00591-30634-81
CL 991251	PL 17-159	TY 00591-51471-81
HY 241365	PL 17-183	YT 220051431
HY 365180	PL MHR-2012-AS	YT 507413800
HY 3001236	PL MHR-2012-BS	YT 509016814
HY 3001334	PL MHR-2012-S	YT 509016816
HY 3001855	SC 33-11412	



Part Number - 084312

**Brush Set (Set of 4)**

▼ OEM Reference

AC 4905965	CT 215165	PM EMDL-2012AS
AC 4905973	HY 0079645	PM EMDL-2012FS
BK 004356	HY 1198287	RA 570-410-02
BK 004357	HY 1199049	SC 33-11404
BK 004363	HY 3000022	SC 33-11407
BK 988673	HY 3001909	SC 41-25633
BK 988679	HY 3007721	TY 00591-32386-81
BK 993965	HY 3050891	TY 00591-51437-81
BR 15953-048	HY A113315	YT 057457400
BR 16954-004	PL 17-111	YT 061499400
BR 28802-022	PL 17-21	YT 121456630
BR 28802-024	PL MDL-2012-AS	YT 220007563
BR A16954-4	PL MDL-2012FS	YT 220050575
CL 886268	PM 200212	YT 506210800
CL 898765	PM 200215	YT 1214566AD
CT 0066168		



Part Number - 084547

**Brush**

0.370 D x 0.812 W x 1.157 L

▼ OEM Reference

AC 4911481	HY 3052675	TY 00591-32455-81
BK 123603	HY 3144749	TY 00591-51463-81
CL 906300	HY 800063773	TY 00591-72254-81
CL 909819	ME B250407-4	YT 220003593
CT 0973796	ME BMP31-214	YT 220025259
HY 0286081	OH B-250407-4	YT 220044749
HY 3013765	PM 300665-002	YT 220075025



Part Number - 116510

**Brush Set (4 of 084547)**

0.370 D x 0.812 W x 1.157 L

▼ OEM Reference

CT 973391	TY 00591-32460-81	YT 220016055
OH B-250411-01K	TY 00591-60991-81	YT 518264825



Part Number - 087233  
**Brush Set (Set of 8)**

▼ OEM Reference

BJ 003772	HY A-120311	TY 00591-04137-81
CL 893724	PL 17-216	TY 00591-14088-81
CL 999426	PL 17-227	TY 00591-31765-81
HY 1198441	PL 17-87	TY 00591-33335-81
HY 3006288	PL MCP-2012-KS	TY 00591-56357-81
HY 3007481	PL MFH-1012S	TY 00591-56436-81
HY 3013766	PL MTD-1012-S	YT 220002716
HY 800072005	RA 570-433-02	YT 220003595
HY 800108167	RA 570-433-214	



Part Number - 094843  
**Brush Set (Set of 4)**

▼ OEM Reference

AC 4914589	HY 3006290	PM 200248
AC 4916087	PL 17-188	PM EMGQ-2012-BS
BR 28829-059	PL 17-193	RA 570-205-04
CL 906578	PL 17-235	RA 570-436-04
CL 998234	PL MGQ-2012-AS	TY 00591-32476-81
CL 1819404	PL MGQ-2012-BS	YT 5090168-19
CT 973515	PL MGQ-2012-S	
CT 973516	PM 200021	



Part Number - 087522  
**Brush Set**  
0.27 D x 0.76 W x 0.87 L

▼ OEM Reference

CL 68587	PL 17-203	TY 00591-51456-81
CL 999158	PL 17-223	TY 00591-64378-81
CT 215781	PL MAD-1512-AS	YT 220023631
HY 0328114	PL MBD-1512-S	YT 220051433
HY 328114	PM 200188	YT 509016821
HY 0328914	PM EMBD-1512-S	YT 518264883
HY 3002679	TY 00591-32452-81	YT 5090168-21
HY 3053018	TY 00591-42281-81	



Part Number - 100530  
**Brush**

▼ OEM Reference  
TY 00591-33333-81



Part Number - 100730  
**Brush Set (Set of 4)**

▼ OEM Reference

CT 928965	RA 570-215-219	TY 00591-32471-81
CT 973756	RA 570-240-115	TY 00591-42278-81
CT 1036558	RA 570-241-114	TY 00591-52520-81
HY 360809	TY 00591-04168-81	



Part Number - 090276  
**Brush Set (Set of 4)**  
0.500 D x 1.265 W x 1.376 L

▼ OEM Reference

CL 892234	HY 228615	PM EMEA-1012BS
CL 905878	HY 288201	RA 570-437-02
CL 988646	PL MEA-1012AS	RA 570-437-211
CL 998642	PM EEME-1012CS	TY 00591-42276-81
CL 998646		



Part Number - 103842  
**Brush**

▼ OEM Reference

BR 16954-008	BR A16954-9	TY 00591-51464-81
BR 16954-009	CT 973863	TY 00591-56396-81
BR 16954-014	HY 3012562	YT 220003254
BR 28802-015	TY 00591-30254-81	YT 220016358
BR A16954-8	TY 00591-33355-81	YT 220023635



Part Number - 087393  
**Brush Set (Set of 8)**  
0.550 D x 1.000 W x 1.385 L

▼ OEM Reference

PL MTE-1012S
YT 220041853



Part Number - 104868  
**Brush**  
0.500 D x 0.625 W x 1.445 L

▼ OEM Reference

BK 129964	HY 3007484	TY 00591-52523-81
BR 16954-015	HY 3012560	YT 220007694
BR 16954-015S	HY 3031310	YT 220007703
BT 300300-000	HY 3057512	YT 220013162
CL 1893222	HY 3131910	YT 220023510
CT 216357	HY 3144747	YT 220037512
DS P221-1043	PM 300300000	YT 220044747
GE 625A649AK5	TC FA72E1-05672	YT 220075082
HY 1309377	TY 00591-04239-81	YT 504230259
HY 1309385	TY 00591-32456-81	YT 504237261
HY 1346277	TY 00591-33332-81	YT 518805656
HY 1376980	TY 00591-43681-81	YT 580028320
HY 3007439	TY 00591-51466-81	



Part Number - 370275

**Brush Set (Set of 4)**

▼ OEM Reference  
TY 14543-U1090-71



Part Number - 370273

**Brush Set (4 pairs)**

▼ OEM Reference  
DX 1402083



Part Number - 104888

**Brush Set (Set of 8)**

0.548 D x 0.997 W x 1.500 L

▼ OEM Reference

CT 1049941	TY 00591-04241-81	TY 00591-52524-81
CT 1049942	TY 00591-32457-81	YT 220010146
RA 570-236-114	TY 00591-42283-81	YT 220015020



Part Number - 111768

**Brush**

0.625 D x 1.125 W x 1.750 L

▼ OEM Reference

CT 973810	HY 1386170	TY 00591-06234-81
CT 9722002800	KO 3BB-17-A3340	TY 00591-32462-81
GE 36A291746AC002	MB 9722002800	TY 00591-60320-81
GE 36A291746ACP02	MB SE000168	TY 14147-U2090-71
GM 0105-5919	NI 29142-8G201	YT 220070227
HY 364674	TC FA72G1-05142	YT 520045399



Part Number - 107304

**Brush Set**

▼ OEM Reference  
HY 800075206  
TY 00591-20030-81  
TY 00591-33326-81  
TY 00591-60552-81



Part Number - 113328

**Brush Set (Set of 4)**

0.62 D x 1.25 W x 1.34 L

▼ OEM Reference

HY 800075249	RA DS227871	YT 220015628
RA 570-240-229	TY 00591-04291-81	YT 220023517
RA 570-252-517	TY 00591-33327-81	
RA 570-447-513	TY 00591-52528-81	



Part Number - 107312

**Brush Set**

▼ OEM Reference  
BR 27327-215  
BR 27327-216  
TY 00591-52527-81  
YT 220015280



Part Number - 113498

**Brush**

▼ OEM Reference  
HY 3121436  
YT 220018132



Part Number - 109953

**Brush**

0.500 D x 1.250 W x 1.625 L

▼ OEM Reference

HY 1335385	TY 00591-63177-81	YT 580011010
HY 1462472	YT 220013161	
TY 00591-33292-81	YT 220026265	



Part Number - 370276

**Brush Set (Set of 4)**

▼ OEM Reference  
TY 14544-U1090-71



Part Number - 110200

**Brush**

0.500 D x 1.125 W x 1.450 L

▼ OEM Reference

BG 030-807	HY 3054719	TY 00591-60319-81
HY 362118	KO 3BA-18-25490	TY 14344-U1090-71
HY 389722	TY 00591-04288-81	YT 220044108
HY 2013288	TY 00591-32469-81	



Part Number - 113652

**Brush Set (Set of 4)**

0.628 D x 1.240 W x 1.300 L

▼ OEM Reference  
TY 00591-42668-81  
YT 220015245



Part Number - 116363

**Brush Set (4 of 110200)**

0.500 D x 1.125 W x 1.450 L

▼ OEM Reference

TY 00591-33334-81  
TY 00591-56409-81  
YT 220018823



Part Number - 114502

**Brush Set (Set of 4)**

0.490 D x 1.240 W x 1.340 L

▼ OEM Reference  
HY 3033370  
YT 220015301



Part Number - 114541  
**Brush Set (Set of 8)**

▼ OEM Reference  
HY 3144797  
TY 00591-42661-81  
YT 220044797

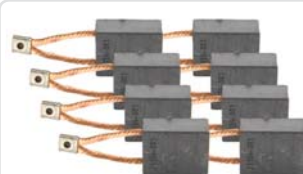

Part Number - 116961  
**Brush Set (Set of 8)**

0.628 D x 1.247 W x 1.500 L  
▼ OEM Reference  
YT 220043258



Part Number - 370271  
**Brush Set (Set of 8)**

▼ OEM Reference  
TY 14351-21440-71



Part Number - 118913  
**Brush Set (Set of 4)**

▼ OEM Reference

CT 1092493	MB 1202335	RA 570-360-511
CT 1203335	MB 1203335	RA DS232755
CT NA012195	MB NA012195	TY 00590-04748-71
CT NA013903	MB NA013903	TY 00591-42678-81
CT NA-013903	RA 570-268-515	YT 220018826
HY 3122590	RA 570-316-516	YT 220029109
HY 3137109	RA 570-334-512	



Part Number - 370272  
**Brush Set (Set of 4)**

▼ OEM Reference  
TY 00590-41782-71



Part Number - 125020

**Brush Set**

▼ OEM Reference  
HY 3135864  
YT 220036158



Part Number - 370274  
**Brush Set (Set of 4)**

▼ OEM Reference  
CT 97020-10170  
MB 97020-10170



Part Number - 126697  
**Brush Set (Set of 4)**

▼ OEM Reference

BJ 905044	RA DS226175	YT 220016235
CT 1009182	TY 00591-32446-81	YT 220017669
HY 1334247	TY 00591-56363-81	
RA 560-204-334	YT 220013562	



Part Number - 114671  
**Brush Set (Set of 4)**

▼ OEM Reference  
RA 570-235-513  
RA 570-317-515  
RA 570-383-512  
YT 220018821



Part Number - 370149  
**Brush w/BWI (Set of 2)**

▼ OEM Reference  
HY 1507462  
YT 580029663



Part Number - 111136  
**Brush Set (Set of 4)**

▼ OEM Reference  
RA 570-427-516  
TY 00591-42667-81  
YT 220029734



Part Number - 370150

**Brush**

▼ OEM Reference

CL 2307487	HY 2307487	YT 520344803
CT A0000-13061	MB A0000-13061	YT 582004027



Part Number - 087713  
**Brush Set (Set of 8)**

▼ OEM Reference  
PL 17-218  
PL MEA-1012BS  
TY 00591-30635-81  
TY 00591-60718-81



Part Number - 370151  
**Brush Kit (Set of 4)**

▼ OEM Reference

CT 07125-06700	MB 07125-06700	YT 580007602
CT 97125-06700	MB 97125-06700	
HY 1459684	TY 14543-U1160-71	



Part Number - 370152

**Brush (Set of 2)**

▼ OEM Reference

CT 1058341	HY 3057511	YT 220037511
CT 9712006300	HY 3144107	YT 220044107
GE 36A291850AHP02	HY 3144124	YT 220044124
GE 36A291850AHP03	MB 1058341	YT 220075064
GM 0105-6637	MB 97120-06300	YT 504229255
HY 366090	NI 29142-8G000	YT 504229274
HY 1312816	TY 00591-06236-81	YT 519466014
HY 3056409	TY 00591-56410-81	



Part Number - 370242

**Brush Set (1 Pair)**

▼ OEM Reference  
HY 1389604  
YT 723791145



Part Number - 370243

**Brush (1 Pair)**

▼ OEM Reference  
HY 374531  
YT 518804691  
TY 14341-U2090-71



Part Number - 100358

**Brush & Lug Assembly**

▼ OEM Reference  
TY 00591-42669-81



Part Number - 021158-001

**Brush**

0.49 D X 0.97 W x 1.30 L

▼ OEM Reference  
YT 220026664



Part Number - 370244

**Brush**

▼ OEM Reference  
TY 14181-11480-71  
TY 14112-12240-71



Part Number - 370237

**Brush Set (1 Piece)**

▼ OEM Reference  
LI 0009718156



Part Number - 370245

**Brush**

▼ OEM Reference  
LI 0009718189

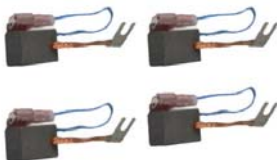

Part Number - 370238

**Brush Kit (Set of 4)**

▼ OEM Reference  
HY 1459693  
YT 580007606

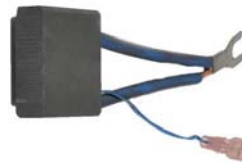

Part Number - 370246

**Brush Pump Motor**

▼ OEM Reference  
TY 14352-21440-71  
TY 14111-F1090-71



Part Number - 370239

**Brush Kit (Set of 4)**

▼ OEM Reference  
HY 1461570  
YT 580010369



Part Number - 370247

**Brush Set (Set of 4)**

0.880 D x 0.880 W x 0.880 L

▼ OEM Reference  
RA 1016523-215



Part Number - 370240

**Brush**

▼ OEM Reference  
HY 1502113  
YT 580027030



Part Number - 370248

**Brush Set (1 Pair)**

0.280 D x 0.880 W x 0.880 L

▼ OEM Reference  
RA 570-237-218



Part Number - 370241

**Brush Set (Set of 2)**

▼ OEM Reference  
HY 2034133  
YT 582004043



Part Number - 370042

**Drive Motor Brush Set with Springs (Set of 4)**

0.350 D x 0.5000 W x 0.950 L

▼ OEM Reference  
HY 1506791  
YT 580029149



Part Number - 370154

**Brush & Spring**

▼ OEM Reference

CL 912404	TY 00591-56450-81	YT 521558001
HY 3039096	YT 220017107	YT 521558002
PM 202028	YT 519578814	
TY 00591-33323-81	YT 519578824	



Part Number - 119538

**Brush Mechanism**

▼ OEM Reference

BR 22393-009	HY 3012563	TY 00591-30160-81
BR A22393-9	ME 161L216AC001	TY 00591-51372-81
CL 7000910	ME 161L216AA1	YT 220003255



Part Number - 125789

**Brush & Spring Set**

▼ OEM Reference

BK 152156	CL 929325	TY 00590-40635-71
BR 27327-287	HY 1463273	YT 519616815
BR 27327-293	RA 560-213-07	
BR 69580-FS000	RA 850-139-013	



Part Number - 082661

**Brush Holder**

▼ OEM Reference

AC 74912772	HY 0275047	RA 570-413-06
BK 115114	HY 0317714	RA 570-415-18
CL 905799	HY 1199508	SC 33-11361
CL 906182	HY 3052917	SC 33-11368
CL 991548	PL 90-2710	TY 00591-35188-81
CL 994644	PL MEE-1164	YT 220051425
CL 999470	PM 200148	YT 509015804
CT 216387	PM E-90-2495	YT 511274800
	PM E-90-2596	
	PM E-90-2710	



Part Number - 090286

**Brush Set & Terminal Stud Pkg.**

▼ OEM Reference

CL 444116	RA 441-116	TY 00591-32461-81
CL 444335	RA 570-211-118	TY 00591-60728-81
HY 1306014	TY 00591-20137-81	YT 220015328



Part Number - 084548

**Ring Brush Assembly**

▼ OEM Reference

AC 4911482	HY 3019763	YT 504223284
CL 906294	TY 00591-30163-81	YT 518264803
HY 0286080	YT 220002204	YT 518264826
HY 3017806	YT 220079575	YT 518264835



Part Number - 106772

**Brush Rigging Assembly**

▼ OEM Reference

BK 129962	HY 3009521	TY 00591-30170-81
CL 7000921	RA 570-115-111	YT 220003089



Part Number - 074606

**Brush Spring**

▼ OEM Reference

BR 22393-016	HY 800076131	YT 054038000
CL 7003934	TY 00591-32135-81	YT 220017582
HY 3012785	TY 00591-56262-81	



Part Number - 020018

**Brush Box Assembly**

▼ OEM Reference

BK 709652	HY 360810	TY 00591-42335-81
CL 910218	PL 36-1175	TY 00591-64431-81
CL 913225	PM 200065	YT 220029198
CL 7004338	RA 570-215-216	YT 220054705
CT 1036517	TY 00591-17521-81	



Part Number - 074617

**Brush Spring Set (Set of 8)**

▼ OEM Reference

AC 4906528	PL 50-267	TY 00591-51361-81
BJ 900199	PL 50-326	TY 00591-64385-81
BK 116093	PL MEA-18S	YT 023403300
BK 15MP21	PM 200190	YT 023403700
BR 27327-120	PM EMBD-19-S	YT 220018307
CL 893695	RA 570-403-04	YT 220019566
CT 2P8868	RA 570-416-11	YT 220027589
HY 129700	SC 33-11453	YT 220050286
HY 1198707	TY 00591-32146-81	YT 506600800
HY 3053654	TY 00591-42289-81	



Part Number - 100729

**Brush Plate**

▼ OEM Reference

RA 570-240-116
----------------





Part Number - 107090

**Brush Spring Set (Set of 4)**

▼ OEM Reference

CL 7004330	PL 50-525	TY 00591-64383-81
CT 1036520	RA 570-240-119	YT 220007922
CT 1050062	RA 570-249-213	YT 220034592
DW A200836	TY 00591-42287-81	



Part Number - 087884

**Brush Spring**

▼ OEM Reference

BK 129963	RA 570-115-115	TA 85-412-00
CL 7003964	RA 570-445-214	TY 00591-32166-81



Part Number - 076481

**Brush Spring Set (Set of 4)**

▼ OEM Reference

AC 1009710	CL 6517648	TY 00591-51366-81
AC 4906486	CT 311022	YT 015948600
AC 71009710	CT 1009189	YT 023403100
AC 74906486	HY 0055613	YT 023403400
BK 993459	HY 0238760	YT 052041100
BK 12MP32	HY 1198105	YT 056210400
BK 94MBY1	HY A-98629	YT 058786800
BK EP311	PL 50-263	YT 066158200
BK EP311A	PL MZ-19-S	YT 129159024
BK EP477	PM 200305	YT 220051365
BR 27327-038	PM EMZ-19S	YT 505104800
BR 27327-199	RA 560-010-12	YT 506273800
BR 27793-011	RA 570-417-08	YT 1169404DH
CL 68866	SC 33-11452	YT 6066614AC
CL 893682	TY 00591-41490-81	



Part Number - 125918

**Brush Spring**

▼ OEM Reference

CL 915596	HY 800071351	TY 00591-42623-81
HY 3145024	PM 300418-000	YT 220028029
HY 800017481	TY 00591-03828-81	YT 220045024



Part Number - 078496

**Brush Spring Set (Set of 4)**

▼ OEM Reference

AC 4905999	HY 3001792	RA 570-414-08
BJ 003711	HY A-134258	RA 570-415-10
BJ 900136	HY A-144545	SC 33-11456
BK 108782	ME MGP18SS	TC 2002410
BK 993956	ME SMP12-470	TC EMGP18SS0
BR 28829-058	ME SMP12-472	TY 00591-41515-81
CL 908767	PL 50-368	TY 00591-51363-81
CL 980767	PL MGP-18-SS	YT 220023441
CT 0973393	PM 200241	YT 220051423
HY 1144545	PM 30556-00	YT 509014801
HY 1198953	PM EMGP-18-SS	
HY 1199363	RA 570-236-113	



Part Number - 078468

**Brush Spring Set (Set of 8)**

▼ OEM Reference

AC 4907766	HY 3018031	TY 00591-32145-81
BK 993946	ME MGP-18S	TY 00591-42286-81
BK 18AL4	ME SMP12-471	TY 00591-51364-81
CL 894024	PL 50-375	WM 20-7302001
CL 894302	PL MGP-18-S	YT 5076238
CL 897024	PM 200240	YT 220023328
CT 0907239	PM EMGP-18-S	YT 296065403
CT 0917194	PM EMGP-18S	YT 507623800
HY 1198228	SC 33-11454	



Part Number - 370056

**Fitting**

▼ OEM Reference

HY 2309185	YT 504114800
------------	--------------



Part Number - 087398

**Brush Spring**

▼ OEM Reference

AC 4911483	HY 0286082	PM 300665-001
AC 4968002	HY 3002482	TY 00591-03656-81
BK 112546	HY 3003312	TY 00591-32165-81
CL 906301	HY 3052676	TY 00591-51371-81
CL 909820	KO 3BB-19-24560	YT 220051868
CL 915801	ME B240501	YT 504228298
CT 0973392	OH B240501	YT 518264804



Part Number - 370208

**Reservoir**

▼ OEM Reference

CL 3798160	HY 3038235	RA 870-903
CL 8027617	JU 27602230	TY 00591-35395-81
CL 6035-10870	JU 27623760	TY 00591-58049-81
CT 27602230	MB 0802082	YT 220012366
CT 27623760	MB 802082	YT 220017463
CT 398724	MB 27602230	YT 252370600
CT 802082	MB 27623760	YT 580006015
HY 1300155	MB W505010139	YT 580021039
HY 1489805	MB W5050-10139	
HY 2305052	NI 6035-10870	



Part Number - 370197

**Solenoid**

▼ OEM Reference

TY 00590-43462-71
-------------------

## Cylinders/Seal Kits



Part Number - 370202  
**Ram Assembly Cylinder**  
 ▼ OEM Reference  
 RA 540-091-300



Part Number - 370204  
**Master Cylinder**  
 ▼ OEM Reference  
 RA 870-896-002  
 RA 870-896-004



Part Number - 370203  
**Master Cylinder**  
 ▼ OEM Reference  
 MB A000030255  
 MB A0000-30255  
 RA 870-630-100



Part Number - 370199  
**Master Cylinder**  
 ▼ OEM Reference

BR B-19121-4	HY 3038442	RA 824-900-003-002
BR B19121-4	HY 3121012	RA 824-900-003-003
BR D-19121-14	RA 1009641	RA 870-614-100
BR 19121-004	RA 1011257-100	RA 870-614
CL 7001018	RA 820-001-687	TY 00591-21103-81
CT NA019019	RA 820-001-688	TY 00591-30176-81
CT 1036894	RA 821-900-040-001	TY 00591-30243-81
DS P261-0013	RA 821-900-040-002	TY 00591-52201-81
GM 0246-M9XA	RA 821-900-040-1	TY 00591-53118-81
HY 3007219	RA 821-900-040	YT 220007708
HY 3007688	RA 824-900-003-001	YT 220018189



Part Number - 370029  
**Seal Kit Lift Cylinder**

▼ OEM Reference

HY 2307177	TY 00591-42560-81
HY 3054871	TY 00591-60896-81



**Reduce Product  
Damage by Adding  
a Forklift Guidance  
System.**

**See Page 5.11**



**New Work Assist  
Options Available.**  
**See Page 5.07**



**New Items Added to  
Safety Section, Like  
Cones, Caution Tape  
& Masks.**

**See Section 2**



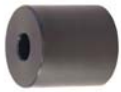

Part Number - 370106

**Roller**

▼ OEM Reference

CT 1051077	RA 123-001-382	TY 00591-70714-81
HY 3034352	RA 828-005-498	YT 220015913
RA DS223092	RA 828-006-726	



Part Number - 370195

**Button Reverse**

▼ OEM Reference

TY 00590-47054-71



Part Number - 104164-007

**Solenoid Coil**

▼ OEM Reference

YL 580038835



Part Number - 370073

**Horn Contact**

▼ OEM Reference

TY 57413-22500-71  
TY 57413-22500



Part Number - 370079

**Horn Contact**

▼ OEM Reference

TY 57415-23600-71  
YT 220034250



Part Number - 370062

**Horn Contact - Ring**

▼ OEM Reference

TY 45123-23600-71



Part Number - 370083

**Horn Contact - Ring**

▼ OEM Reference

HY 3141503  
TY 45112-22000-71  
TY 45112-22001-71  
TY 45112-22002-71  
YT 220041503



Part Number - 370084

**Horn Contact - Ring**

▼ OEM Reference

HY 3122944  
TY 45111-23000-71  
YT 220018881



Part Number - 370063

**Horn Contact - Spring**

▼ OEM Reference

TY 45124-23600-71



Part Number - 370064

**Horn Contact - Spring**

▼ OEM Reference

TY 57414-22500-71



Part Number - 370082

**Horn Spring**

▼ OEM Reference

TY 45115-22500-71  
YT 220018884



Part Number - 370085

**Horn Spring**

▼ OEM Reference

TY 57414-23600-71



Part Number - 370086

**Horn Spring**

▼ OEM Reference

HY 3046967  
TY 45112-20540-71  
YT 220010769



Part Number - 370081

**Horn Plate**

▼ OEM Reference

CT A000014902  
TY 00591-71832-81  
TY 45113-22500-71  
YT 220019121



Part Number - 370080

**Horn Plate**

▼ OEM Reference

HY 3003064  
TY 45116-20540-71  
TY 45116-20540  
YT 220076629



Part Number - 370221

**Bolt**

▼ OEM Reference

CT 51023801	JU 51058719	MB W2050-13429
CT 51058719	MB 51023801	MB W2050-13534
JU 51023801	MB 51058719	

# Miscellaneous

Electric Truck  
Components



Part Number - 370051

### Battery Cover Knob

▼ OEM Reference  
HY 2033545  
YT 721528104



Part Number - 370057

### Wire Harness

▼ OEM Reference  
YT 524149943  
HY 2047806



Part Number - 370206

### Packing Back-up Plug

▼ OEM Reference

CL 7003604	MB 1063129	TY 00591-40804-81
CT 1063129	RA 623-005-050	YT 220003944
HY 3015316	RA DS232945	



Part Number - 370026

### Wiring Harness Assembly

▼ OEM Reference  
HY 2307607  
YT 503918700



Part Number - 370146

### AC Cord & Plug

▼ OEM Reference  
YT 644087802



Part Number - 370069

### Transistor

▼ OEM Reference

NI 29327-15K00	RA 1-125-014	RA DS223474
NI 29327-15K01	RA 828-900-101	TY 90891-03006-71



Part Number - 370147

### Wire Harness

▼ OEM Reference  
HY 2063768  
YT 524141442  
YT 580043706



Part Number - 380006-012-01

### Hydraulic Pump (Lift)

▼ OEM Reference  
RA 1032206

# Electric Truck Components Cross Reference by Manufacturer

OE Number	Crown Part Number	Description
<b>Advance (AD)</b>		
AN6-4003	3J579-350-R	24V Drive R-Motor
K89-4002	3J2798867-R	24V Drive R-Motor
<b>Allis Chalmers/ Tusk (AC)</b>		
4253918	370182	Bearing
8731797	370185	Bearing
1009710	076481	Brush Spring Set
4253406	370059	Load Wheel Bearing
4253915	370059	Load Wheel Bearing
4734244	370054	Ignition Switch
4905965	084312	Brush Set
4905973	084312	Brush Set
4905999	078496	Brush Spring Set
4906486	076481	Brush Spring Set
4906521	074614	Brush Set
4906528	074617	Brush Spring Set
4907386	084304	Brush Set
4907766	078468	Brush Spring Set
4911481	084547	Brush
4911482	084548	Ring Brush Asm
4911483	087398	Brush Spring
4912002	370070	Contact Tip Kit
4912263	084304	Brush Set
4914589	094843	Brush Set
4916087	094843	Brush Set
4916929	094290	Brush Set
4917126	370059	Load Wheel Bearing
4932176	370059	Load Wheel Bearing
4968002	087398	Brush Spring
71009710	076481	Brush Spring Set
74906486	076481	Brush Spring Set
74906521	074614	Brush Set
74912772	082661	Brush Holder
8500041	370059	Load Wheel Bearing
8730185	370059	Load Wheel Bearing
8730573	050000-095	Roll Pin
<b>Baker (BK)</b>		
000786	370182	Bearing
108782	078496	Brush Spring Set
112546	087398	Brush Spring
115114	082661	Brush Holder
116088	074614	Brush Set
116093	074617	Brush Spring Set
1209	370059	Load Wheel Bearing
123603	084547	Brush
129962	106772	Brush Rigging Asm
129963	087884	Brush Spring
129964	104868	Brush
12AL213	370157	Seal
12AL2141	370158	Seal
12MP32	076481	Brush Spring Set
131135Q	094290	Brush Set
131141Q	094290	Brush Set
138043	370155	Axle
1383	370157	Seal
1384	370158	Seal
152156	125789	Brush & Spring Set
152202	370054	Ignition Switch
152669	370096	Bearing Seal
152680	370093	Bearing
153082	370115	Bushing
153083	370114	Bushing
153450	370095	Axle Load Wheel
153451	370094	End Cap
15MP21	074617	Brush Spring Set
15MP9A	074614	Brush Set
1640	370121	Grease Fitting Flush
1640	370121	Grease Fitting Flush

OE Number	Crown Part Number	Description
18AL4	078468	Brush Spring Set
3736759	087373	Switch
4327	084304	Brush Set
4356	084312	Brush Set
4357	084312	Brush Set
4363	084312	Brush Set
709652	020018	Brush Box Asm
786	370182	Bearing
8505	370059	Load Wheel Bearing
8605	370182	Bearing
9380620220	050000-095	Roll Pin
94MBY1	076481	Brush Spring Set
984297	370155	Axle
985191	370059	Load Wheel Bearing
985194	370094	End Cap
985849	370156	Shim 1/32
986036	370155	Axle
986042	370155	Axle
986042	370155	Axle
986200	370156	Shim 1/32
988673	084312	Brush Set
988679	084312	Brush Set
992626	370050	Riser Assembly
992627	370050	Riser Assembly
992629	370046	Load Wheel Axle
992640	370022	Push Rod, 48
992655	370049	Push Rod Pin
992656	370017	Exit Roller
992657	370027	Pivot Pin
992658	370018	Link Pin
993459	076481	Brush Spring Set
993946	078468	Brush Spring Set
993956	078496	Brush Spring Set
993965	084312	Brush Set
A5A	370094	End Cap
EP311	076481	Brush Spring Set
EP311A	076481	Brush Spring Set
EP477	076481	Brush Spring Set
HP28A	370059	Load Wheel Bearing
L0039169600	370019	Bushing
L1036914001	050000-095	Roll Pin
L1700000	370189	Roller Axle
L9380620220	050000-095	Roll Pin
LM200142000	050000-095	Roll Pin
LN152669	370096	Bearing Seal
LN153450	370095	Axle Load Wheel
PAL14	370059	Load Wheel Bearing
PAL18	370155	Axle
PAL18A	370094	End Cap
PAL18AK	370094	End Cap
PAL46	370156	Shim 1/32
PAL46132	370156	Shim 1/32
PAL46A	370156	Shim 1/32
<b>Barrett (BR)</b>		
15953-048	084312	Brush Set
16954-004	084312	Brush Set
16954-007	074604	Brush
16954-008	103842	Brush
16954-009	103842	Brush
16954-014	103842	Brush
16954-015	104868	Brush
16954-015S	104868	Brush
19121-004	370199	Master Cylinder
22393-009	119538	Brush Mechanism
22393-016	074606	Brush Spring
27327-038	076481	Brush Spring Set
27327-120	074617	Brush Spring Set
27327-194	094290	Brush Set

Note: More crosses available; contact your dealer.

Barrett Continued ▶

# Electric Truck Components Cross Reference by Manufacturer

Barrett Continued

Electric Truck Components

OE Number	Crown Part Number	Description
27327-199	076481	Brush Spring Set
27327-201	094290	Brush Set
27327-215	107312	Brush Set
27327-216	107312	Brush Set
27327-287	125789	Brush & Spring Set
27327-293	125789	Brush & Spring Set
27793-008	094290	Brush Set
27793-011	076481	Brush Spring Set
27793-020	094290	Brush Set
28700-267	370059	Load Wheel Bearing
28802-014	074604	Brush
28802-015	103842	Brush
28802-019	094290	Brush Set
28802-020	094290	Brush Set
28802-022	084312	Brush Set
28802-024	084312	Brush Set
28829-058	078496	Brush Spring Set
28829-059	094843	Brush Set
40001-FS002	370138	Axle
69580-FS000	125789	Brush & Spring Set
9872-008	370121	Grease Fitting Flush
9878-024	370172	Washer
9878024	370172	Washer
A16954-4	084312	Brush Set
A16954-7	074604	Brush
A16954-8	103842	Brush
A16954-9	103842	Brush
A22393-9	119538	Brush Mechanism
A27327-194	094290	Brush Set
A27327-201	094290	Brush Set
A27793-20	094290	Brush Set
A27793-8	094290	Brush Set
A9872-8	370121	Grease Fitting Flush
B-19121-4	370199	Master Cylinder
B19121-4	370199	Master Cylinder
CK1302085	370182	Bearing
CK440433	370185	Bearing
CK624280	370121	Grease Fitting Flush
D-19121-14	370199	Master Cylinder
PM26260-00	370182	Bearing
PM301964-032	050000-095	Roll Pin
PM301996-002	370184	Pin
PM301996002	370184	Pin
PM49748-00	370059	Load Wheel Bearing
PM49910-01	370059	Load Wheel Bearing
27732-068	3C0018-R	24/ 36V Curtis PMC Control-R
<b>Big Joe (BJ)</b>		
20725	370054	Ignition Switch
3704	074614	Brush Set
3711	078496	Brush Spring Set
3772	087233	Brush Set
900136	078496	Brush Spring Set
900199	074617	Brush Spring Set
905044	126697	Brush Set
<b>Blue Giant (BG)</b>		
030-807	110200	Brush
6305-RS	370185	Bearing
8505N	370059	Load Wheel Bearing
8605	370182	Bearing
906-0013	370130	Load Roller Axle
906-0023-N-A	370127	Load Wheel Asm - Nylon
FM8505N	370059	Load Wheel Bearing
ND8505	370059	Load Wheel Bearing
ND8605	370182	Bearing
<b>BT (BT)</b>		
111257	370130	Load Roller Axle
126729	370127	Load Wheel Asm - Nylon
167600	370127	Load Wheel Asm - Nylon

OE Number	Crown Part Number	Description
167609-SUPER	370127	Load Wheel Asm - Nylon
176827	370132	Bushing
26260-00	370182	Bearing
300300-000	104868	Brush
301445-000	370092	BDI/HR Meter 24-36
301779-000	370134	Threaded Pin
301779-000	370134	Threaded Pin
301964-032	050000-095	Roll Pin
306270-000	021157-001	Brush
310546-000	370121	Grease Fitting Flush
310549-000	370121	Grease Fitting Flush
47133	370130	Load Roller Axle
47150	370126	Entry Roller
47930	370135	Pin
47931	370131	Pin
49748-00	370059	Load Wheel Bearing
56771	370127	Load Wheel Asm - Nylon
600114	370135	Pin
650595	370135	Pin
<b>Cascade (CA)</b>		
624280	370121	Grease Fitting Flush
<b>Caterpillar/ Towmotor (CT)</b>		
07125-06700	370151	Brush Kit (Set of 4)
0972141	370181	Bearing Assembly
0972188	370182	Bearing
0973721	370205	Oil Seal
1008664	370143	Brush Kit (Set of 4)
1008668	370143	Brush Kit (Set of 4)
1008792	3J570-298-500-R	Drive R-Motor 24-36V
1008994	370207	Seal Kit
1009119	370179	Oil Seal
1009182	126697	Brush Set
1009186	370143	Brush Kit (Set of 4)
1009189	076481	Brush Spring Set
1009446	370065	Washer - Flat
1009498	370121	Grease Fitting Flush
1009518	370092	BDI/HR Meter 24-36
1009544	370054	Ignition Switch
1009733	370122	Axle
1036493	370205	Oil Seal
1036510	370143	Brush Kit (Set of 4)
1036517	020018	Brush Box Asm
1036520	107090	Brush Spring Set
1036558	100730	Brush Set
1036894	370199	Master Cylinder
1037037	370124	Pin Weldment
1049941	104888	Brush Set
1049942	104888	Brush Set
1050062	107090	Brush Spring Set
1050473	370097	Plate - Friction
1050474	370200	Brake Rotor
1050475	370098	Disc - Brake
1051077	370106	Roller
1051087	370072	Contacting Tip Kit
1051301	370068	Belt Timing Kit
1055276	370054	Ignition Switch
1055818	370123	Axle
1055823	370194	Plate Carrier
1055827	370123	Axle
1056005	370207	Seal Kit
1058341	370152	Brush (Set of 2)
1062983	370144	Seal
1063128	370254	Bushing
1063129	370206	Packing Back-up Plug
1075049	370143	Brush Kit (Set of 4)
1092493	118913	Brush Set
1100728	370092	BDI/HR Meter 24-36
1142628	370143	Brush Kit (Set of 4)

Note: More crosses available; contact your dealer.

Caterpillar/Towmotor Continued ▶

# Electric Truck Components Cross Reference by Manufacturer

Caterpillar/Towmotor Continued

OE Number	Crown Part Number	Description
1202315	370090	Tandem Pivot
1202337	370059	Load Wheel Bearing
1203335	118913	Brush Set
12448	370059	Load Wheel Bearing
215622	370157	Seal
215623	370158	Seal
25700810	370223	Roll Pin
27602230	370208	Reservoir
27623760	370208	Reservoir
27811190	370189	Roller Axle
2H3814	370059	Load Wheel Bearing
2I5023	074604	Brush
2I5165	084312	Brush Set
2I5781	087522	Brush Set
2I6035	072059	Brush
2I6357	104868	Brush
2I6387	082661	Brush Holder
2I7526	370070	Contact Tip Kit
2I7554	370121	Grease Fitting Flush
2I8004	370183	Contact Tip
2I8049	370155	Axle
2I8051	370046	Load Wheel Axle
2P8868	074617	Brush Spring Set
311022	076481	Brush Spring Set
33122630	370189	Roller Axle
33138380	370232	Axle/Shaft
398724	370208	Reservoir
399717	370153	Contactactor
3J4776	370179	Oil Seal
50033984	370209	Seal Kit
50136157	370231	Load Wheel Assembly
50179921	370231	Load Wheel Assembly
50265511	370198	Load Wheel Assembly
51012680	370229	Load Wheel Axle
51023801	370221	Bolt
51058719	370221	Bolt
51059718	370229	Load Wheel Axle
51064639	370230	Load Wheel Assembly
51065679	370222	Axle
600462	370059	Load Wheel Bearing
66168	084312	Brush Set
71305290	370231	Load Wheel Assembly
71305310	370189	Roller Axle
802082	370208	Reservoir
83636	370153	Contactactor
907239	078468	Brush Spring Set
917194	078468	Brush Spring Set
928965	100730	Brush Set
948810532	370223	Roll Pin
9712006300	370152	Brush (Set of 2)
97020-10170	370274	Brush Set of 4 Pieces
97121-31900	3J97121-31900-R	48V Power Steering R-Motor
97121-31901	3J97121-31900-R	48V Power Steering R-Motor
97125-06700	370151	Brush Kit (Set of 4)
972141	370181	Bearing Assembly
972188	370182	Bearing
97220-05200	3J97220-05200-R	36/48V Pump R-Motor
9722002800	111768	Brush
972202	370054	Ignition Switch
972202	370054	Ignition Switch
973039	074614	Brush Set
973391	116510	Brush Set
973392	087398	Brush Spring
973393	078496	Brush Spring Set
973515	094843	Brush Set
973516	094843	Brush Set
973721	370205	Oil Seal
973756	100730	Brush Set

OE Number	Crown Part Number	Description
973796	084547	Brush
973810	111768	Brush
973863	103842	Brush
97520-00800	370185	Bearing
9752000800	370185	Bearing
A0000-00050	370179	Oil Seal
A0000-12075	370182	Bearing
A0000-13061	370150	Brush
A0000-14665	370096	Bearing Seal
A000003155	370140	Axle
A000010382	370129	Control
A000012075	370182	Bearing
A000014902	370081	Plate - Horn
A000032617	370139	Shield- Bearing
A3448	370187	Axle
GS00-01766	370121	Grease Fitting Flush
GS0000888	370144	Seal
GS0001766	370121	Grease Fitting Flush
NA-013903	118913	Brush Set
NA012195	118913	Brush Set
NA012934C	370194	Plate Carrier
NA012942B	370123	Axle
NA013763	370123	Axle
NA013888	370054	Ignition Switch
NA013889	370054	Ignition Switch
NA013890	370054	Ignition Switch
NA013903	118913	Brush Set
NA014187	370098	Disc - Brake
NA017474	370092	BDI/HR Meter 24-36
NA019019	370199	Master Cylinder
NA052004	370100	Rotor - Brake
NA057020	370143	Brush Kit (Set of 4)
RL197468	370185	Bearing
W2050-11106	370231	Load Wheel Assembly
<b>Clark (CL)</b>		
01JM04032	050000-095	Roll Pin
102361	370179	Oil Seal
112400	370179	Oil Seal
117604	370179	Oil Seal
124629	370059	Load Wheel Bearing
1302085	370182	Bearing
1304793	370249	Switch
1310067	087373	Switch
1313115	370121	Grease Fitting Flush
1681146	370054	Ignition Switch
1819404	094843	Brush Set
1820816	370059	Load Wheel Bearing
1893222	104868	Brush
2039122	370168	Pin- Coiled Roll
2039315	370091	Threaded Rod
205-F	370059	Load Wheel Bearing
205-KD	370059	Load Wheel Bearing
205-SF	370059	Load Wheel Bearing
2307487	370150	Brush
232539	370181	Bearing Assembly
2345332	370054	Ignition Switch
2388112	3J2781993-R	Steer R-Motor 36V
2394430	370249	Switch
2780604	3J2798867-R	24V Drive R-Motor
2781993	3J2781993-R	Steer R-Motor 36V
2795597	087373	Switch
2798867	3J2798867-R	24V Drive R-Motor
2798905	3J2798905-R	Drive R-Motor 36V
2803519	370249	Switch
2809539	3J2781993-R	Steer R-Motor 36V
2809875	370054	Ignition Switch
2819155	3J2819155-R	36V Drive Motor
301728	370054	Ignition Switch

Note: More crosses available; contact your dealer.

Clark Continued ▶

# Electric Truck Components Cross Reference by Manufacturer

Clark Continued

Electric Truck Components

OE Number	Crown Part Number	Description
352148	370054	Ignition Switch
3700309	370054	Ignition Switch
3788232	370249	Switch
3798160	370208	Reservoir
3853257	370054	Ignition Switch
3JM4032	050000-095	Roll Pin
440433	370185	Bearing
443535	370158	Seal
444116	090286	Brush Set & Terminal Stud Pkg
444238	370153	Contact
444335	090286	Brush Set & Terminal Stud Pkg
445721	094290	Brush Set
448375	370092	BDI/HR Meter 24-36
562783	370205	Oil Seal
6035-10870	370208	Reservoir
611885	370054	Ignition Switch
613472	370054	Ignition Switch
624112	370054	Ignition Switch
624280	370121	Grease Fitting Flush
624597	370054	Ignition Switch
6517648	076481	Brush Spring Set
678376	370054	Ignition Switch
68587	087522	Brush Set
68866	076481	Brush Spring Set
7000194	370183	Contact Tip
7000601	370092	BDI/HR Meter 24-36
7000910	119538	Brush Mechanism
7000921	106772	Brush Rigging Asm
7001018	370199	Master Cylinder
7001300	370182	Bearing
7001337	370059	Load Wheel Bearing
7001376	370093	Bearing
7001735	370162	Spacer
7001746	370156	Shim 1/32
7001749	370046	Load Wheel Axle
7001794	370187	Axle
7001797	370155	Axle
7001798	370094	End Cap
7001802	370155	Axle
7001803	370155	Axle
7001855	370018	Link Pin
7001856	370027	Pivot Pin
7001861	370049	Push Rod Pin
7001866	370022	Push Rod, 48
7001873	370140	Axle
7001918	370210	Swivel Assembly
7001987	370123	Axle
7002175	370194	Plate Carrier
7002450	370190	Shaft
7002612	370027	Pivot Pin
7002613	370020	Link
7002631	370067	Load Wheel Axle
7002719	370088	Pin
7002767	370122	Axle
7002777	370139	Shield- Bearing
7002781	370075	Load Wheel Axle
7002788	370188	Pin
7003151	370070	Contact Tip Kit
7003190	370070	Contact Tip Kit
7003597	370207	Seal Kit
7003600	370254	Bushing
7003604	370206	Packing Back-up Plug
7003779	370157	Seal
7003780	370158	Seal
7003816	370144	Seal
7003934	074606	Brush Spring
7003964	087884	Brush Spring

OE Number	Crown Part Number	Description
7004106	370087	Key - 1
7004163	370054	Ignition Switch
7004330	107090	Brush Spring Set
7004338	020018	Brush Box Asm
7006590	3C0022-R	Regen SX Control-R 48V/400amps
730668	050000-095	Roll Pin
8027617	370208	Reservoir
850907	370182	Bearing
855135	370182	Bearing
883802	074614	Brush Set
886268	084312	Brush Set
892234	090276	Brush Set
893682	076481	Brush Spring Set
893695	074617	Brush Spring Set
893724	087233	Brush Set
894024	078468	Brush Spring Set
894302	078468	Brush Spring Set
896614	370054	Ignition Switch
897024	078468	Brush Spring Set
898765	084312	Brush Set
905512-R	370087	Key - 1
905799	082661	Brush Holder
905878	090276	Brush Set
906182	082661	Brush Holder
906294	084548	Ring Brush Asm
906300	084547	Brush
906301	087398	Brush Spring
906578	094843	Brush Set
908605	370182	Bearing
908767	078496	Brush Spring Set
909819	084547	Brush
909820	087398	Brush Spring
910218	020018	Brush Box Asm
912404	370154	Brush & Spring
912866	370059	Load Wheel Bearing
913225	020018	Brush Box Asm
913739	370092	BDI/HR Meter 24-36
915595	021157-001	Brush
915596	125918	Brush Spring
915801	087398	Brush Spring
915933	021157-001	Brush
915934	021157-001	Brush
917966	370092	BDI/HR Meter 24-36
919749	370092	BDI/HR Meter 24-36
921509	370184	Pin
924657	050000-095	Roll Pin
925414	370019	Bushing
929325	125789	Brush & Spring Set
952179	370205	Oil Seal
956336	370059	Load Wheel Bearing
980767	078496	Brush Spring Set
988646	090276	Brush Set
991251	084304	Brush Set
991548	082661	Brush Holder
992317	094290	Brush Set
994644	082661	Brush Holder
996819	370070	Contact Tip Kit
998234	094843	Brush Set
998642	090276	Brush Set
998646	090276	Brush Set
999158	087522	Brush Set
999426	087233	Brush Set
999470	082661	Brush Holder
<b>Cushman (CU)</b>		
4110440	3C0006-R	Curtis PMC Control
831722	3C0008-R	Curtis PMC Control

Note: More crosses available; contact your dealer.



# Electric Truck Components Cross Reference by Manufacturer

OE Number	Crown Part Number	Description
<b>Daewoo (DW)</b>		
A200836	107090	Brush Spring Set
<b>Dockstocker (DS)</b>		
P103-0050	370072	Contact Tip Kit
P111-0030	370071	Contact Kit
P111-0032	370070	Contact Tip Kit
P111-0044	370070	Contact Tip Kit
P111-0104	370071	Contact Kit
P115-0011	370183	Contact Tip
P221-1043	104868	Brush
P261-0013	370199	Master Cylinder
P264-0012	370201	Cylinder Inner
<b>Drexel (DX)</b>		
1402083	370273	Brush Set of 4 Pair - 8pcs
<b>EZ-GO (EZ)</b>		
2097-G1	3C0017-R	24/ 36V Curtis PMC Control-R
27094G01	3C0008-R	Curtis PMC Control
<b>Flight Systems (FL)</b>		
1204-001	3C0008-R	Curtis PMC Control
1204-021	3C0001-R	Curtis PMC Control
1204-027	3C0017-R	24/ 36V Curtis PMC Control-R
1204x-4215	3C0015-R	1204X-4215 Curtis PMC Control-R
1205-111	3C0018-R	24/ 36V Curtis PMC Control-R
1205x-4417	3C0003-R	Curtis PMC Control
1207A-4119	3C0006-R	Curtis PMC Control
1214-8703	3C0009-R	Curtis PMC Control
1214-8708	3C0010-R	Curtis PMC Control
1214-8709	3C0005-R	Curtis PMC Control
1243C-4278	3C0007-R	Curtis PMC Control
1244-4424	3C0004-R	Curtis SX Control
1244-4467	3C0002-R	Curtis SX Control
154-012-429/103	3C0013-R	Easi Reach Power Card-R
66-FC2086A	3C0016-R	24V MPB SX Zapi Control-R
828-004-206/003	3C0014-R	Easi Reach Coil Driver-R
IC3645LXCD12H	3C0012-R	EV100 ZX Traction Card-R
<b>General Electric (GE)</b>		
36A291746AC002	111768	Brush
36A291746ACP02	111768	Brush
36A291850AHP02	370152	Brush (Set of 2)
36A291850AHP03	370152	Brush (Set of 2)
5BC49JB305	3J70-054-00	Drive R-Motor 24-36-48V
5BC49JB305B	3J70-054-00	Drive R-Motor 24-36-48V
5BC49JB399C	3J70-054-00	Drive R-Motor 24-36-48V
625A649AK5	104868	Brush
IC3645LXCD1ZH	3C0012-R	EV100 ZX Traction Card-R
IC3645SR-3R4U4N2	3C0022-R	Regen SX Control-R 48V/400amps
IC3645S-R4U404N2	3C0022-R	Regen SX Control-R 48V/400amps
<b>General Motors (GM)</b>		
0105-5919	111768	Brush
0105-6637	370152	Brush (Set of 2)
0105-69WF	021157-001	Brush
0246-M9XA	370199	Master Cylinder
0681-17JX	370200	Brake Rotor
<b>Hand Pallet (HP)</b>		
MU38686	370189	Roller Axle
<b>Hyster (HY)</b>		
0048605	370182	Bearing
0200577	370182	Bearing
1144545	078496	Brush Spring Set
1150050	370182	Bearing
1197132	370054	Ignition Switch
1197133	370054	Ignition Switch
1197134	370054	Ignition Switch
1197135	370054	Ignition Switch
1197136	370054	Ignition Switch

OE Number	Crown Part Number	Description
1197960	370054	Ignition Switch
1197961	370054	Ignition Switch
1198105	076481	Brush Spring Set
1198228	078468	Brush Spring Set
1198287	084312	Brush Set
1198441	087233	Brush Set
1198707	074617	Brush Spring Set
1198953	078496	Brush Spring Set
1199049	084312	Brush Set
1199363	078496	Brush Spring Set
1199508	082661	Brush Holder
124627	370059	Load Wheel Bearing
124629	370059	Load Wheel Bearing
129700	074617	Brush Spring Set
1300155	370208	Reservoir
1301515	370234	Contact Kit 150amp 36/48V
1306014	090286	Brush Set & Terminal Stud Pkg
1309377	104868	Brush
1309385	104868	Brush
1312816	370152	Brush (Set of 2)
1316399	370071	Contact Kit
1334247	126697	Brush Set
1335385	109953	Brush
1346277	104868	Brush
1361313	370092	BDI/HR Meter 24-36
1376980	104868	Brush
1386170	111768	Brush
1389604	370242	Brush Set
1397304	3C0012-R	EV100 ZX Traction Card-R
1450616	370193	Axle
1450617	370193	Axle
1457327	3J1457327	Steer R-Motor 36V
1459419	3C0012-R	EV100 ZX Traction Card-R
1459684	370151	Brush Kit (Set of 4)
1459693	370238	Brush Kit 4pcs
1461192	3J325744-R	36/48V Drive R-Motor
1461570	370239	Brush Kit 4pcs
1462472	109953	Brush
1463273	125789	Brush & Spring Set
1466025	370041	24V Pump Am Motor
1466607	370077	Spring
1466877	370058	Switch Assembly
1467778	370040	Control Handle Low
1467779	370163	Cover Switch
1486370	370145	Switch
1489805	370208	Reservoir
1493867	370193	Axle
1495763	370034	Motor Cover LH
1495764	370035	Motor Cover RH
1500220-25	3C0003-R	Curtis PMC Control
1502113	370240	Brush
1506791	370042	Drive Motor Brushset w Springs
1507462	370149	Brush w BWI (Set of 2)
1531075	370164	Spring
1537409	370034	Motor Cover LH
1537410	370035	Motor Cover RH
1607815	370252	Charger On Board
1674663	3C0007-R	Curtis PMC Control
18773	370179	Oil Seal
18773	370179	Oil Seal
200577	370182	Bearing
2013153	370193	Axle
2013288	110200	Brush
2027716	370132	Bushing
2033545	370051	Battery Cover Knob
2033629	370089	Bushing
2033697	370054	Ignition Switch
2033718	370023	Pin

Note: More crosses available; contact your dealer.

Hyster Continued ▶

# Electric Truck Components Cross Reference by Manufacturer

Hyster Continued

Electric Truck Components

OE Number	Crown Part Number	Description
2033719	370020	Link
2033820	370188	Pin
2034088	370089	Bushing
2034133	370241	Brush Set 2pcs
2035130	050000-095	Roll Pin
2035394	370039	Handle Wiring Harness Asm
2035534	370172	Washer
2037487	370162	Spacer
2038070	370089	Bushing
2039118	370165	Pin
2039119	370107	Pin - Lower Link Pivot
2039120	370261	Pin Pivot
2039122	370168	Pin- Coiled Roll
2039224	370169	Bushing
2039226	370166	Bushing
2039255	370167	Axle Entry Roller
2039315	370091	Threaded Rod
2039868	370075	Load Wheel Axle
2039869	370075	Load Wheel Axle
2039904	370078	Link Assembly
2039905	370173	Roller Assembly
2040528	370003	Gas Spring
2040658	3J5800166-68-R	24V Drive R-Motor
2041689	370024	Drive Motor Cover
2042262	370139	Shield- Bearing
2043251	370013	Riser Wheel Axle Asm
2045501	370033	Control Handle Upp
2045925	370074	Axle
2045951	3C0016-R	24V MPB SX Zapi Control-R
2046003	370038	Brake Assembly
2046053	370010	Riser
2046055	370059	Load Wheel Bearing
2046056	370142	Bushing/ String Guard
2046057	370009	Load Wheel Axle
2046257	370092	BDI/HR Meter 24-36
2046259	370044	Pivot Pin Axle
2046260	370045	Pivot Pin Axle
2046262	370045	Pivot Pin Axle
2046263	370001	Pivot Pin
2046264	370002	Pivot Pin
2046286	370016	Push Rod, 48
2046546	370005	BDI
2047141	370003	Gas Spring
2047806	370057	Wire Harness
2048079	370252	Charger On Board
2049316	370043	Drive Motor 24V Am
2049350	370007	Handle Switch
2050082	370011	Steer Arm
2050083	370008	Gas Spring
2050085	370037	Lower Link LH
2050086	370036	Lower Link RH
2050087	370262	Pin Coiled
2050088	370262	Pin Coiled
2054228	370252	Charger On Board
2055944	370148	Brake - Electromagnic
2058037	370078	Link Assembly
2059695	370006	Handle Pin
2061914	370075	Load Wheel Axle
2062561	370006	Handle Pin
2063768	370147	Wire Harness
2066311	370003	Gas Spring
2066312	370008	Gas Spring
2066432	370015	Handle Wiring Harness
2073416	370252	Charger On Board
2075424	370059	Load Wheel Bearing
2100235	370175	Flanged Bearing
2102631	370252	Charger On Board
228615	090276	Brush Set

OE Number	Crown Part Number	Description
2302396	370052	Bushing
2302412	370053	Pivot Pin
2302457	370121	Grease Fitting Flush
2302730	370050	Riser Assembly
2302981	370190	Shaft
2303007	370249	Switch
2303433	370054	Ignition Switch
2303559	370027	Pivot Pin
2303658	370031	Drive Axle
2304088	370046	Load Wheel Axle
2304182	087373	Switch
2304321	370031	Drive Axle
2304484	370021	Pin
2304545	370196	Brake Cam Lever
2304696	370076	Axle Sleeve
2304729	370031	Drive Axle
2305052	370208	Reservoir
2305167	370054	Ignition Switch
2305449	370188	Pin
2305653	3J5045752-33-R	36V Pump R-Motor
2305815	370030	Shaft
2305824	370047	Pin
2306563	370049	Push Rod Pin
2306615	370028	Handle Arm
2306863	370024	Drive Motor Cover
2307177	370029	Seal Kit Lift Cylinder
2307202	370018	Link Pin
2307475	370017	Exit Roller
2307487	370150	Brush
2307607	370026	Wiring Harness Asm
2307680	370020	Link
2307951	370263	Washer
2307952	370055	Plug
2308794	370025	Steer Arm Weldment
2308822	370022	Push Rod, 48
2309006	370032	Bellcrank Pin
2309107	370187	Axle
2309185	370056	Fitting
2309397	370027	Pivot Pin
2309436	370087	Key - 1
2310528	3J5800166-68-R	24V Drive R-Motor
2310528-G	3J5800166-68-R	24V Drive R-Motor
2311203	370031	Drive Axle
2311282	370028	Handle Arm
2311661	370023	Pin
234730	370059	Load Wheel Bearing
238760	076481	Brush Spring Set
241365	084304	Brush Set
254007	370054	Ignition Switch
254007	370054	Ignition Switch
262798	370087	Key - 1
275047	082661	Brush Holder
2791024	370170	Screw
2791837	050000-095	Roll Pin
2791931	370012	Handle Pin Washer
2791987	370019	Bushing
2792053	370006	Handle Pin
2793129	370006	Handle Pin
2798772	370170	Screw
2799263	370019	Bushing
286080	084548	Ring Brush Asm
286081	084547	Brush
286082	087398	Brush Spring
288201	090276	Brush Set
29058	370179	Oil Seal
29058	370179	Oil Seal
296203	370170	Screw
3000022	084312	Brush Set

Note: More crosses available; contact your dealer.

Hyster Continued ▶

# Electric Truck Components Cross Reference by Manufacturer

Hyster Continued

OE Number	Crown Part Number	Description
3000614	370070	Contact Tip Kit
3000709	370183	Contact Tip
3000709T	370183	Contact Tip
3001236	084304	Brush Set
3001328	074614	Brush Set
3001334	084304	Brush Set
3001792	078496	Brush Spring Set
3001855	084304	Brush Set
3001857	084304	Brush Set
3001909	084312	Brush Set
3002482	087398	Brush Spring
3002679	087522	Brush Set
3002686	074614	Brush Set
3003064	370080	Plate
3003312	087398	Brush Spring
3003759	370017	Exit Roller
3004303	370158	Seal
3005736	370046	Load Wheel Axle
3005747	370155	Axle
3005832	370187	Axle
3005833	370054	Ignition Switch
3005844	370140	Axle
3005847	370018	Link Pin
3006288	087233	Brush Set
3006290	094843	Brush Set
3006347	370179	Oil Seal
3006383	370207	Seal Kit
3006743	370070	Contact Tip Kit
3006808	370018	Link Pin
3006938	370017	Exit Roller
3007123	370162	Spacer
3007219	370199	Master Cylinder
3007439	104868	Brush
3007446	074614	Brush Set
3007481	087233	Brush Set
3007484	104868	Brush
3007688	370199	Master Cylinder
3007721	084312	Brush Set
3007791	094290	Brush Set
3008398	370049	Push Rod Pin
3009521	106772	Brush Rigging Asm
3010476	094290	Brush Set
3011678	370050	Riser Assembly
3012559	093585	Brush Set
3012560	104868	Brush
3012562	103842	Brush
3012563	119538	Brush Mechanism
3012701	370121	Grease Fitting Flush
3012785	074606	Brush Spring
3013765	084547	Brush
3013766	087233	Brush Set
3013840	370144	Seal
3014862	370121	Grease Fitting Flush
3015316	370206	Packing Back-up Plug
3015671	370254	Bushing
3017806	084548	Ring Brush Asm
3018031	078468	Brush Spring Set
3018295	370210	Swivel Assembly
3018819	074614	Brush Set
3019499	370181	Bearing Assembly
3019763	084548	Ring Brush Asm
3020121	370249	Switch
302375	370060	Pin
3026554	3C0008-R	Curtis PMC Control
3026561	3C0018-R	24/ 36V Curtis PMC Control-R
3031310	104868	Brush
3033063	021157-001	Brush
3033370	114502	Brush Set

OE Number	Crown Part Number	Description
3033962	3C0003-R	Curtis PMC Control
3034352	370106	Roller
3034522	370143	Brush
3035475	370255	Seal Kit
3038235	370208	Reservoir
3038442	370199	Master Cylinder
3039096	370154	Brush & Spring
3039475	370072	Contact Tip Kit
3039525	3C0012-R	EV100 ZX Traction Card-R
3039852	370194	Plate Carrier
3046967	370086	Spring - Horn
3049726	370249	Switch
3050644	370157	Seal
3050891	084312	Brush Set
3051169	370059	Load Wheel Bearing
3052440	370054	Ignition Switch
3052675	084547	Brush
3052676	087398	Brush Spring
3052917	082661	Brush Holder
3053018	087522	Brush Set
3053603	370182	Bearing
3053654	074617	Brush Spring Set
3054719	110200	Brush
3054871	370029	Seal Kit Lift Cylinder
3055565	370121	Grease Fitting Flush
3056409	370152	Brush (Set of 2)
3057511	370152	Brush (Set of 2)
3057512	104868	Brush
3057533	370188	Pin
3057595	370249	Switch
3057690	370092	BDI/HR Meter 24-36
3064274	370121	Grease Fitting Flush
3066611	370054	Ignition Switch
3121012	370199	Master Cylinder
3121150	118942	Brush Set (Set of 8)
3121436	113498	Brush Set
3121689	370122	Axle
3122590	118913	Brush Set
3122944	370084	Ring - Horn Contact
3125222	370179	Oil Seal
3126436	370143	Brush Kit (Set of 4)
3126503	3C0012-R	EV100 ZX Traction Card-R
3131031	370157	Seal
3131032	370158	Seal
3131122	370182	Bearing
3131733	370087	Key - 1
3131910	104868	Brush
3134050	021157-001	Brush
3134462	370124	Pin Weldment
3135864	125020	Brush Set
3137109	118913	Brush Set
3137245	370092	BDI/HR Meter 24-36
3137894	370184	Pin
3137894SYS	370184	Pin
3139433	370125	Pivot Pin
3141503	370083	Ring - Horn Contact
3142096	3C0017-R	24/ 36V Curtis PMC Control-R
3142319	370093	Bearing
3142320	370139	Shield- Bearing
3142755	370200	Brake Rotor
3143332	370121	Grease Fitting Flush
3143377	050000-095	Roll Pin
3143583	370155	Axle
3144107	370152	Brush (Set of 2)
3144124	370152	Brush (Set of 2)
3144747	104868	Brush
3144749	084547	Brush
3144797	114541	Brush Set

Electric Truck Components

Note: More crosses available; contact your dealer.

Hyster Continued ▶

# Electric Truck Components Cross Reference by Manufacturer

HyStar Continued

Electric Truck Components

OE Number	Crown Part Number	Description
3145024	125918	Brush Spring
3172279	3C0022-R	Regen SX Control-R 48V/400amps
3174204	3C0004-R	Curtis SX Control
3175374	3C0009-R	Curtis PMC Control
317714	082661	Brush Holder
3178786	3C0013-R	Easi Reach Power Card-R
3178790	3C0014-R	Easi Reach Coil Driver-R
3181079	3C0001-R	Curtis PMC Control
3182195	3C0006-R	Curtis PMC Control
3183244	3C0002-R	Curtis SX Control
3183796	3C0005-R	Curtis PMC Control
325744	3J325744-R	36/48V Drive R-Motor
326940	3J326940-R	12V Pump Motor
328114	087522	Brush Set
328114	087522	Brush Set
328914	087522	Brush Set
360804	093585	Brush Set
360809	100730	Brush Set
360810	020018	Brush Box Asm
362118	110200	Brush
364674	111768	Brush
365180	084304	Brush Set
366090	370152	Brush (Set of 2)
374531	370243	Brush 1 pair
389722	110200	Brush
43205T	370059	Load Wheel Bearing
4603626	370252	Charger On Board
46671	370157	Seal
48605	370182	Bearing
55613	076481	Brush Spring Set
79645	084312	Brush Set
800017481	125918	Brush Spring
800063773	084547	Brush
800071351	125918	Brush Spring
800071662	084304	Brush Set
800072005	087233	Brush Set
800075206	107304	Brush Set
800075249	113328	Brush Set
800076129	074604	Brush
800076131	074606	Brush Spring
800076793	093585	Brush Set
800108167	087233	Brush Set
8512512	370252	Charger On Board
8517245	3J580035626-R	36/48V Power Steering R-Motor
8620016	3J504575231-R	24V Power Steering R-Motor
864794	370092	BDI/HR Meter 24-36
A-120311	087233	Brush Set
A-134258	078496	Brush Spring Set
A-144545	078496	Brush Spring Set
A-3716	370054	Ignition Switch
A-3716-1	370054	Ignition Switch
A-3716-2	370054	Ignition Switch
A-49164A	370054	Ignition Switch
A-98629	076481	Brush Spring Set
A113315	084312	Brush Set
<b>INA (IA)</b>		
6305RS	370185	Bearing
<b>Jungheinrich (JU)</b>		
14093400	370059	Load Wheel Bearing
25700520	370219	Roll Pin
25700810	370223	Roll Pin
26904730	370225	Bushing
27602230	370208	Reservoir
27623760	370208	Reservoir
2781065	370189	Roller Axle

OE Number	Crown Part Number	Description
27810650	370189	Roller Axle
3310058	370189	Roller Axle
3312263	370189	Roller Axle
33122630	370189	Roller Axle
33138370	370226	Axle
33138380	370232	Axle/Shaft
33138390	370224	Axle/Shaft
47150	370126	Entry Roller
47930	370135	Pin
47931	370131	Pin
50007986	370227	Grease Fitting
50013308	370228	Grease Fitting
50021409	050000-095	Roll Pin
50033984	370209	Seal Kit
50136157	370231	Load Wheel Assembly
50180203	050000-095	Roll Pin
50460101	370220	Drive Tire
51012680	370229	Load Wheel Axle
51023801	370221	Bolt
51058719	370221	Bolt
51059718	370229	Load Wheel Axle
51064639	370230	Load Wheel Assembly
51065679	370222	Axle
51173883	370250	Bushing
51173971	370251	Bushing
71305290	370231	Load Wheel Assembly
7130531	370189	Roller Axle
71305310	370189	Roller Axle
71805830	050000-095	Roll Pin
7180668	370231	Load Wheel Assembly
71806680	370231	Load Wheel Assembly
<b>Kalmar (KM)</b>		
101359	050000-095	Roll Pin
4943232	380030-043	Lens
8761802	380030-039	Rear Lamp
<b>Komatsu (KO)</b>		
04025-00532	370223	Roll Pin
300430-000	021157-001	Brush
301445-000	370092	BDI/HR Meter 24-36
301765-000	370191	Spring Handle Return
301779-000	370134	Threaded Pin
301964-032	050000-095	Roll Pin
301996-002	370184	Pin
302362-000	021157-001	Brush
37B-1EB-3010	380030-039	Rear Lamp
37B-7AV-1211	370157	Seal
3BA-18-25490	110200	Brush
3BB-17-A3340	111768	Brush
3BB-19-24560	087398	Brush Spring
3EB-55-12321	380030-043	Lens
47150	370126	Entry Roller
47930	370135	Pin
47931	370131	Pin
49748-00	370059	Load Wheel Bearing
49910-01	370059	Load Wheel Bearing
49910-1	370059	Load Wheel Bearing
4995652	370205	Oil Seal
8730181	370184	Pin
8730367	370191	Spring Handle Return
8731797	370185	Bearing
8732910	370182	Bearing
FBMSD-41520	370183	Contact Tip
OP03000786	370184	Pin
OP03001388	370191	Spring Handle Return
301718-000	370129	Control
<b>Koyo (KY)</b>		
6305RS	370185	Bearing

Note: More crosses available; contact your dealer.

## Electric Truck Components Cross Reference by Manufacturer

OE Number	Crown Part Number	Description
<b>Lift Rite (LR)</b>		
10281	370126	Entry Roller
20210N	370127	Load Wheel Asm - Nylon
20274P	370135	Pin
20275	370131	Pin
20306	370132	Bushing
<b>Linde (LI)</b>		
000786	370182	Bearing
0009718156	370237	Brush Set Asm - 1pc
0009718189	370245	Brush
0039169600	370019	Bushing
1036914001	050000-095	Roll Pin
1209	370059	Load Wheel Bearing
1383	370157	Seal
1384	370158	Seal
149444	370117	Pin
149447	370113	Pin
149448	370118	Pin
149463	370112	Pin
152669	370096	Bearing Seal
152680	370093	Bearing
153082	370115	Bushing
153083	370114	Bushing
1640	370121	Grease Fitting Flush
786	370182	Bearing
8505	370059	Load Wheel Bearing
8605	370182	Bearing
9380620220	050000-095	Roll Pin
985191	370059	Load Wheel Bearing
HP28A	370059	Load Wheel Bearing
M200142000	050000-095	Roll Pin
PAL14	370059	Load Wheel Bearing
<b>LPM (LP)</b>		
763-1206	370260	Fork Riser
<b>Magnum (MG)</b>		
545	370126	Entry Roller
<b>Mercury-Pettibone (ME)</b>		
161L216AA1	119538	Brush Mechanism
161L216AC001	119538	Brush Mechanism
8239-00084	370059	Load Wheel Bearing
B240501	087398	Brush Spring
B250407-4	084547	Brush
BM4	370059	Load Wheel Bearing
BM4-7	370059	Load Wheel Bearing
BMP31-214	084547	Brush
MGP-18S	078468	Brush Spring Set
MGP18SS	078496	Brush Spring Set
SMP12-470	078496	Brush Spring Set
SMP12-471	078468	Brush Spring Set
SMP12-472	078496	Brush Spring Set
<b>Minuteman Sweeper (MH)</b>		
55-371	370059	Load Wheel Bearing
<b>Mitsubishi (MB)</b>		
0405-62055	370059	Load Wheel Bearing
07125-06700	370151	Brush Kit (Set of 4)
0802082	370208	Reservoir
09488-10532	370223	Roll Pin
1008664	370143	Brush Kit (Set of 4)
1008792	3J570-298-500-R	Drive R-Motor 24-36V
1008994	370207	Seal Kit
1009119	370179	Oil Seal
1009186	370143	Brush Kit (Set of 4)
1009446	370065	Washer - Flat
1009498	370121	Grease Fitting Flush
1009518	370092	BDI/HR Meter 24-36
1009544	370054	Ignition Switch
1009733	370122	Axle
1050474	370200	Brake Rotor

OE Number	Crown Part Number	Description
1055276	370054	Ignition Switch
1058341	370152	Brush (Set of 2)
1063128	370254	Bushing
1063129	370206	Packing Back-up Plug
1075049	370143	Brush Kit (Set of 4)
1086860	370054	Ignition Switch
1100728	370092	BDI/HR Meter 24-36
1142628	370143	Brush Kit (Set of 4)
1202335	118913	Brush Set
1202337	370059	Load Wheel Bearing
1203335	118913	Brush Set
25700810	370223	Roll Pin
27602230	370208	Reservoir
27623760	370208	Reservoir
27811190	370189	Roller Axle
2H3814	370059	Load Wheel Bearing
2I7554	370121	Grease Fitting Flush
2I7577	370179	Oil Seal
33122630	370189	Roller Axle
33138380	370232	Axle/Shaft
40562055	370059	Load Wheel Bearing
50033984	370209	Seal Kit
50136157	370231	Load Wheel Assembly
50179921	370231	Load Wheel Assembly
50265511	370198	Load Wheel Assembly
51012680	370229	Load Wheel Axle
51023801	370221	Bolt
51058719	370221	Bolt
51059718	370229	Load Wheel Axle
51064639	370230	Load Wheel Assembly
51065679	370222	Axle
71305290	370231	Load Wheel Assembly
71305310	370189	Roller Axle
802082	370208	Reservoir
83636	370153	Contactora
948810532	370223	Roll Pin
97020-10170	370274	Brush Set of 4 Pieces
97120-06300	370152	Brush (Set of 2)
97125-06700	370151	Brush Kit (Set of 4)
9722002800	111768	Brush
972202	370054	Ignition Switch
97520-00800	370185	Bearing
A0000-00050	370179	Oil Seal
A0000-13061	370150	Brush
A0000-30255	370203	Master Cylinder
A3448	370187	Axle
GS0000888	370144	Seal
GS0001766	370121	Grease Fitting Flush
NA-013763	370123	Axle
NA012195	118913	Brush Set
NA013888	370054	Ignition Switch
NA013889	370054	Ignition Switch
NA013890	370054	Ignition Switch
NA013903	118913	Brush Set
NA014187	370098	Disc - Brake
NA052004	370100	Rotor - Brake
NA057020	370143	Brush Kit (Set of 4)
RL197468	370185	Bearing
SE000168	111768	Brush
W2050-10198	370232	Axle/Shaft
W2050-11106	370231	Load Wheel Assembly
W2050-11894	370223	Roll Pin
W2050-13429	370221	Bolt
W2050-13534	370221	Bolt
W2050-13546	370229	Load Wheel Axle
W2050-13572	370222	Axle
W205013572	370222	Axle
W5050-10139	370208	Reservoir

Note: More crosses available; contact your dealer.

Mitsubishi Continued ▶

# Electric Truck Components Cross Reference by Manufacturer

OE Number	Crown Part Number	Description
W505010139	370208	Reservoir
<b>Multiton (MT)</b>		
0640301	370185	Bearing
090153008	370198	Load Wheel Assembly
200078120	050000-095	Roll Pin
200142000	050000-095	Roll Pin
26403010	370185	Bearing
3310058	370189	Roller Axle
38686	370189	Roller Axle
4207867977	050000-095	Roll Pin
<b>Nissan (NJ)</b>		
13054-90000	370059	Load Wheel Bearing
29142-8G000	370152	Brush (Set of 2)
29142-8G201	111768	Brush
29210-41H11	3J29210-41H11	Steer R-Motor 36V
29327-15K00	370069	Transistor
29327-15K01	370069	Transistor
29348-L4005	370183	Contact Tip
29348-L4005GN	370183	Contact Tip
29366-40H10	370183	Contact Tip
6035-10870	370208	Reservoir
CK1302085	370182	Bearing
CK1313115	370121	Grease Fitting Flush
CK440433	370185	Bearing
CK624280	370121	Grease Fitting Flush
CK924663	370129	Control
MT090153008	370198	Load Wheel Assembly
<b>NSK (NK)</b>		
118311	370070	Contact Tip Kit
<b>NYK (NY)</b>		
30304032	050000-095	Roll Pin
<b>Ohio Motor (OH)</b>		
B-250407-4	084547	Brush
B-250411-01K	116510	Brush Set
B240501	087398	Brush Spring
D-481581X7147A	3J570-358-451-R	36V Pump R-Motor
<b>Power Boss (PB)</b>		
304387K	370054	Ignition Switch
3304387K	370054	Ignition Switch
<b>Prestolite (PL)</b>		
17-111	084312	Brush Set
17-122	094290	Brush Set
17-149	084304	Brush Set
17-159	084304	Brush Set
17-183	084304	Brush Set
17-188	094843	Brush Set
17-193	094843	Brush Set
17-203	087522	Brush Set
17-21	084312	Brush Set
17-216	087233	Brush Set
17-218	087713	Brush Set
17-223	087522	Brush Set
17-227	087233	Brush Set
17-235	094843	Brush Set
17-63	074614	Brush Set
17-87	087233	Brush Set
17-88	094290	Brush Set
36-1175	020018	Brush Box Asm
50-263	076481	Brush Spring Set
50-267	074617	Brush Spring Set
50-326	074617	Brush Spring Set
50-368	078496	Brush Spring Set
50-375	078468	Brush Spring Set
50-525	107090	Brush Spring Set
66-061	370153	Contact Kit
67-029	370070	Contact Tip Kit
67-042	370071	Contact Kit
90-2710	082661	Brush Holder

OE Number	Crown Part Number	Description
HB409KC360EA	370153	Contact Kit
JAF-4004D	370153	Contact Kit
JBC-3001S	370070	Contact Tip Kit
JCA-3003S	370071	Contact Kit
JEA-3003S	370071	Contact Kit
K2096-10	370071	Contact Kit
MAD-1512-AS	087522	Brush Set
MBD-1418-S	074614	Brush Set
MBD-1512-S	087522	Brush Set
MCP-2012-KS	087233	Brush Set
MDL-1118-A	094290	Brush Set
MDL-1118-AS	094290	Brush Set
MDL-1118-B	094290	Brush Set
MDL-1118-BS	094290	Brush Set
MDL-2012-AS	084312	Brush Set
MDL-2012FS	084312	Brush Set
MEA-1012AS	090276	Brush Set
MEA-1012BS	087713	Brush Set
MEA-18S	074617	Brush Spring Set
MEE-1164	082661	Brush Holder
MFH-1012S	087233	Brush Set
MGP-18-S	078468	Brush Spring Set
MGP-18-SS	078496	Brush Spring Set
MGQ-2012-AS	094843	Brush Set
MGQ-2012-BS	094843	Brush Set
MGQ-2012-S	094843	Brush Set
MHP4005	3JMHP4005-R	24V Pump Motor
MHR-2012-AS	084304	Brush Set
MHR-2012-BS	084304	Brush Set
MHR-2012-S	084304	Brush Set
MTD-1012-S	087233	Brush Set
MTE-1012S	087393	Brush Set
MZ-19-S	076481	Brush Spring Set
<b>Prime Mover (PM)</b>		
111257	370130	Load Roller Axle
126729	370127	Load Wheel Asm - Nylon
167600	370127	Load Wheel Asm - Nylon
200021	094843	Brush Set
200065	020018	Brush Box Asm
200148	082661	Brush Holder
200185	074614	Brush Set
200188	087522	Brush Set
200190	074617	Brush Spring Set
200209	094290	Brush Set
200210	094290	Brush Set
200212	084312	Brush Set
200215	084312	Brush Set
200240	078468	Brush Spring Set
200241	078496	Brush Spring Set
200248	094843	Brush Set
200305	076481	Brush Spring Set
200903	370210	Swivel Assembly
202028	370154	Brush & Spring
23268-01	370092	BDI/HR Meter 24-36
26260-00	370182	Bearing
300300000	104868	Brush
300417-000	021157-001	Brush
300418-000	125918	Brush Spring
300430-000	021157-001	Brush
300665-001	087398	Brush Spring
300665-002	084547	Brush
301445-000	370092	BDI/HR Meter 24-36
301504-000	021157-001	Brush
301718-000	370129	Control
301765-000	370191	Spring Handle Return
301779-000	370134	Threaded Pin
301964-032	050000-095	Roll Pin
301996-000	370186	Pin

Note: More crosses available; contact your dealer.

Prime Mover Continued ▶

# Electric Truck Components Cross Reference by Manufacturer

Prime Mover Continued

OE Number	Crown Part Number	Description
301996-002	370184	Pin
302362-000	021157-001	Brush
30556-00	078496	Brush Spring Set
306270-000	021157-001	Brush
310546-000	370121	Grease Fitting Flush
310549-000	370121	Grease Fitting Flush
312638-000	370176	Wheel Fork/ Riser
47133	370130	Load Roller Axle
47150	370126	Entry Roller
47930	370135	Pin
47931	370131	Pin
49748-00	370059	Load Wheel Bearing
49910-01	370059	Load Wheel Bearing
49910-1	370059	Load Wheel Bearing
A-26260	370182	Bearing
A-49748	370059	Load Wheel Bearing
A-49910-1	370059	Load Wheel Bearing
E-90-2495	082661	Brush Holder
E-90-2596	082661	Brush Holder
E-90-2710	082661	Brush Holder
EEME-1012CS	090276	Brush Set
EMBD-1418-S	074614	Brush Set
EMBD-1512-S	087522	Brush Set
EMBD-19-S	074617	Brush Spring Set
EMDL-1118-AS	094290	Brush Set
EMDL-1118-BS	094290	Brush Set
EMDL-2012AS	084312	Brush Set
EMDL-2012FS	084312	Brush Set
EMEA-1012BS	090276	Brush Set
EMGP-18-S	078468	Brush Spring Set
EMGP-18-SS	078496	Brush Spring Set
EMGQ-2012-BS	094843	Brush Set
EMZ-19S	076481	Brush Spring Set
QJ-112207	370210	Swivel Assembly
QJB-002881	370210	Swivel Assembly
176827	370132	Bushing
<b>Raymond (RA)</b>		
1-105-023-04	370070	Contact Tip Kit
1-105-055-02	370071	Contact Kit
1-105-129-111	370072-001	Contact Kit
1-125-014	370069	Transistor
1-150-065	370054	Ignition Switch
1-150-368	370054	Ignition Switch
1-150-378	370054	Ignition Switch
1-150-392	370054	Ignition Switch
1-187-070	3C0015-R	1204X-4215 Curtis PMC Control-R
1-187-085	3C0009-R	Curtis PMC Control
1-187-094/003	3C0004-R	Curtis SX Control
1-187-094/005	3C0002-R	Curtis SX Control
1009641	370199	Master Cylinder
1011257-100	370199	Master Cylinder
1014758-001	370268	Load Wheel Axle
1014758-002	370269	Load Wheel Axle
1016523-215	370247	Brush Set 4pcs
1017149	3C0010-R	Curtis PMC Control
1017150	3C0005-R	Curtis PMC Control
1025351-002	370177	Fork Riser
1025353-002	370178	Fork Riser
1025355	370260	Fork Riser
1031101	370266	Spacer
1032206	380006-012-01	Hydraulic Pump (Lift)
1045247-001	370180	Tube Spacer
111257	370130	Load Roller Axle
114-007-795	370124	Pin Weldment
114-008-685	370125	Pivot Pin
114-010-175	370054	Ignition Switch
123-001-382	370106	Roller

OE Number	Crown Part Number	Description
126729	370127	Load Wheel Asm - Nylon
154-005-697	370054	Ignition Switch
154-008-740-416	370072-001	Contact Kit
154-008-741-216	370071	Contact Kit
154-012-429/102	3C0013-R	Easi Reach Power Card-R
154-012-429/103	3C0013-R	Easi Reach Power Card-R
154-012-429/104	3C0013-R	Easi Reach Power Card-R
154-012-430/004	3C0013-R	Easi Reach Power Card-R
154-012-430/006	3C0013-R	Easi Reach Power Card-R
154-012-430/007	3C0013-R	Easi Reach Power Card-R
167600	370127	Load Wheel Asm - Nylon
176827	370132	Bushing
26260-00	370182	Bearing
301718-000	370129	Control
301779-000	370134	Threaded Pin
301964-032	050000-095	Roll Pin
310546-000	370121	Grease Fitting Flush
310549-000	370121	Grease Fitting Flush
312668-001	3C0007-R	Curtis PMC Control
38686	370189	Roller Axle
441-116	090286	Brush Set & Terminal Stud Pkg
443-022	370093	Bearing
449-032	370236	Bearing
47133	370130	Load Roller Axle
47150	370126	Entry Roller
47930	370135	Pin
47931	370131	Pin
49748-00	370059	Load Wheel Bearing
49910-01	370059	Load Wheel Bearing
530-517	370205	Oil Seal
530-615	370144	Seal
530-617	370205	Oil Seal
530-638	370179	Oil Seal
530-641	370205	Oil Seal
530-688	370179	Oil Seal
530-712-01	370207	Seal Kit
530-725-01	370207	Seal Kit
530-749-001	370209	Seal Kit
531-103	370207	Seal Kit
531-209	370207	Seal Kit
540047006	370255	Seal Kit
540-047-06	370255	Seal Kit
540-091-300	370202	Ram Assembly Cylinder
560-010-12	076481	Brush Spring Set
560-204-334	126697	Brush Set
560-213-07	125789	Brush & Spring Set
570-115-111	106772	Brush Rigging Asm
570-115-115	087884	Brush Spring
570-205-04	094843	Brush Set
570-211-118	090286	Brush Set & Terminal Stud Pkg
570-215-216	020018	Brush Box Asm
570-215-219	100730	Brush Set
570-235-513	114671	Brush Set
570-236-113	078496	Brush Spring Set
570-236-114	104888	Brush Set
570-236-500	3J570-236-500-R	36V Pump R-Motor
570-236-514	370143	Brush Kit (Set of 4)
570-237-218	370248	Brush Set 2 pcs
570-240-115	100730	Brush Set
570-240-116	100729	Brush Plate
570-240-119	107090	Brush Spring Set
570-240-229	113328	Brush Set
570-241-114	100730	Brush Set
570-249-213	107090	Brush Spring Set
570-251/200	3J570-251-200-R	36V Drive Motor
570-252-517	113328	Brush Set
570-260-511	118942	Brush Set
570-268-515	118913	Brush Set

Electric Truck Components

Note: More crosses available; contact your dealer.

Raymond Continued ▶

# Electric Truck Components Cross Reference by Manufacturer

Raymond Continued

Electric Truck Components

OE Number	Crown Part Number	Description
570-269-500	3J570-269-500-R	36V R-Motor
570-273-500	3J570-273-500-R	36/48V Pump R-Motor
570-277-515	370143	Brush Kit (Set of 4)
570-287-500	3J570-287-500-R	36V R-Motor
570-295-514	370143	Brush Kit (Set of 4)
570-298-500	3J570-298-500-R	Drive R-Motor 24-36V
570-299	3J570-299-500-R	24/36V Pump R-Motor
570-299-500	3J570-299-500-R	24/36V Pump R-Motor
570-316-516	118913	Brush Set
570-317-500	3J570-317-500-R	24V Pump R-Motor
570-317-515	114671	Brush Set
570-322-122	370143	Brush Kit (Set of 4)
570-325-500	3J570-325-500-R	24V Drive R-Motor
570-334-512	118913	Brush Set
570-348-500	3J570-348-500-R	36V Drive R-Motor Easi
570-350-500	3J570-350-500-R	24V Drive R-Motor
570-352	3J570-348-500-R	36V Drive R-Motor Easi
570-355-500	3J579-355-R	24/36V Drive R-Motor
570-358-450	3J570-358-451-R	36V Pump R-Motor
570-358-451	3J570-358-451-R	36V Pump R-Motor
570-360-511	118913	Brush Set
570-363-451	3J570-363-451-R	36V Steer R-Motor Reach
570-367-500	3J570-367-500-R	36V Pump R-Motor
570-368-500	3J570-368-500-R	36V Drive R-Motor Pacer
570-379-451	3J570-379-451-R	36V Auxiliary Pump R-Motor
570-383-512	114671	Brush Set
570-388-500	3J570-388-500-R	36V Drive R-Motor
570-392-500	3J570-392-500-R	36V Drive R-Motor
570-400-500	3J570-400-500-R	Drive/ Traction R-Motor
570-403-04	074617	Brush Spring Set
570-410-02	084312	Brush Set
570-412	3J570-412-R	24V Pump Motor
570-413-06	082661	Brush Holder
570-414-08	078496	Brush Spring Set
570-415-10	078496	Brush Spring Set
570-415-18	082661	Brush Holder
570-415-201	3J570-415-201-R	Drive R-Motor 24V
570-416-06	074614	Brush Set
570-416-11	074617	Brush Spring Set
570-417-08	076481	Brush Spring Set
570-427-516	111136	Brush Set
570-429-02	094290	Brush Set
570-429-100	3JMHP4005-R	24V Pump Motor
570-433-02	087233	Brush Set
570-433-214	087233	Brush Set
570-436-04	094843	Brush Set
570-437-02	090276	Brush Set
570-437-211	090276	Brush Set
570-445-214	087884	Brush Spring
570-447-513	113328	Brush Set
570-449-513	370143	Brush Kit (Set of 4)
570-604-512	370143	Brush Kit (Set of 4)
570-863-500	3J570-863-500-R	36V Drive R-Motor
570-867-500	3J570-325-500-R	24V Drive R-Motor
570-867-500	3J570-867-500-R	24V Drive R-Motor
570-869-500	3J570-869-500-R	Drive R-Motor 112
570-869-701	3J570-869-701-R	24V Drive R-Motor
570-869-735	370133	Brush Kit (Set of 4)
570-869-735-KIT	370133	Brush Kit (Set of 4)
579-299	3J579-299-R	24/36V Pump R-Motor
579-350	3J570-350-500-R	24V Drive R-Motor
579-355	3J579-355-R	24/36V Drive R-Motor
590-004	370054	Ignition Switch
590-006	370054	Ignition Switch
623-005-041	370254	Bushing
623-005-050	370206	Packing Back-up Plug
623-005-122	370207	Seal Kit
623-010-109	370267	Plate Carrier

OE Number	Crown Part Number	Description
623-010-110-002	370123	Axle
623-010-154	370194	Plate Carrier
623-010-181-002	370123	Axle
623-010-297	370192	Wheel Axle Assembly
771-156	370065	Washer - Flat
787-047-100	370210	Swivel Assembly
810-131	060009-037	Ring Retaining
810-762	370066	Pin - Coil
812-000-106	370140	Axle
812-001-255	370054	Ignition Switch
812-001-261	370140	Axle
820-001-687	370199	Master Cylinder
820-001-688	370199	Master Cylinder
820-001-711	370201	Cylinder Inner
820-002-013	370201	Cylinder Inner
820-002-173	370201	Cylinder Inner
820-900-019	370201	Cylinder Inner
821-900-039-001	370201	Cylinder Inner
821-900-039-002	370201	Cylinder Inner
821-900-040	370199	Master Cylinder
821-900-040-001	370199	Master Cylinder
821-900-040-002	370199	Master Cylinder
821-900-040-1	370199	Master Cylinder
824-900-003-001	370199	Master Cylinder
824-900-003-002	370199	Master Cylinder
824-900-003-003	370199	Master Cylinder
828-004-206/003	3C0014-R	Easi Reach Coil Driver-R
828-004-207/001	3C0014-R	Easi Reach Coil Driver-R
828-005-498	370106	Roller
828-006-726	370106	Roller
828-006-728	370270	Caster Axle
828-008-204	370194	Plate Carrier
828-900-067	370068	Belt Timing Kit
828-900-101	370069	Transistor
840-018	370159	Grease Fitting
841-111	370121	Grease Fitting Flush
850-135-305	370122	Axle
850-135-634	370122	Axle
850-135-634-3	370119	Triple Load Wheel Axle
850-135-634-3HL	370119	Triple Load Wheel Axle
850-137-664	370090	Tandem Pivot
850-138-231	370109	Shaft - Truck Link Weldment
850-139-013	125789	Brush & Spring Set
850-139-183-004	370092	BDI/HR Meter 24-36
870-231-002	370092	BDI/HR Meter 24-36
870-231-003	370092	BDI/HR Meter 24-36
870-248	370092	BDI/HR Meter 24-36
870-256	370092	BDI/HR Meter 24-36
870-410-17	370210	Swivel Assembly
870-410-20	370210	Swivel Assembly
870-410-22	370210	Swivel Assembly
870-410-23	370210	Swivel Assembly
870-410-24	370210	Swivel Assembly
870-410-25	370210	Swivel Assembly
870-410-26	370210	Swivel Assembly
870-410-27	370210	Swivel Assembly
870-614	370199	Master Cylinder
870-614-100	370199	Master Cylinder
870-616	370201	Cylinder Inner
870-630-100	370203	Master Cylinder
870-747	370201	Cylinder Inner
870-747-100	370201	Cylinder Inner
870-747-200	370201	Cylinder Inner
870-834-119	370097	Plate - Friction
870-834-120	370200	Brake Rotor
870-834-121	370098	Disc - Brake
870-856-111	370100	Rotor - Brake
870-896-002	370204	Master Cylinder

Note: More crosses available; contact your dealer.

Raymond Continued ▶



# Electric Truck Components Cross Reference by Manufacturer

Raymond Continued

OE Number	Crown Part Number	Description
870-896-004	370204	Master Cylinder
870-901-115	370098	Disc - Brake
870-903	370208	Reservoir
870-920-119	370102	Disc - Brake
870-920-120	370099	Rotor - Brake
870-923-111	370103	Disc - Brake
921-000-850	370059	Load Wheel Bearing
921-000-887	370054	Ignition Switch
939-122	370092	BDI/HR Meter 24-36
939-194	021157-001	Brush
939-352-211	370059	Load Wheel Bearing
939-352-256	370176	Wheel Fork/ Riser
939-353-059	3C0007-R	Curtis PMC Control
939-353-264	370137	Bearing
AN6-4003	3J570-350-500-R	24V Drive R-Motor
DS223092	370106	Roller
DS223177	370054	Ignition Switch
DS223295	370072-001	Contact Tip Kit
DS223442	370143	Brush Kit (Set of 4)
DS223474	370069	Transistor
DS224389	370054	Ignition Switch
DS224928	370179	Oil Seal
DS224933	370143	Brush Kit (Set of 4)
DS225024	370144	Seal
DS225074	370143	Brush Kit (Set of 4)
DS225081	370143	Brush Kit (Set of 4)
DS225210	370090	Tandem Pivot
DS226025	370059	Load Wheel Bearing
DS226175	126697	Brush Set
DS226396	370054	Ignition Switch
DS226562	370179	Oil Seal
DS226823	370092	BDI/HR Meter 24-36
DS226824	370092	BDI/HR Meter 24-36
DS226867	370122	Axle
DS226870	370065	Washer - Flat
DS227104	370121	Grease Fitting Flush
DS227111	370066	Pin - Coil
DS227871	113328	Brush Set
DS228499	370207	Seal Kit
DS228921	370143	Brush Kit (Set of 4)
DS232734	370072-001	Contact Tip Kit
DS232755	118913	Brush Set
DS232945	370206	Packing Back-up Plug
DS232947	370254	Bushing
DS236851	370124	Pin Weldment
DS237267	370194	Plate Carrier
<b>Schreck (SC)</b>		
21-41323	370155	Axle
21-41501	370094	End Cap
21-41520	370155	Axle
29-10413	370070	Contact Tip Kit
31-43405	370059	Load Wheel Bearing
31-43465	370059	Load Wheel Bearing
33-11361	082661	Brush Holder
33-11368	082661	Brush Holder
33-11404	084312	Brush Set
33-11407	084312	Brush Set
33-11408	074614	Brush Set
33-11412	084304	Brush Set
33-11415	094290	Brush Set
33-11417	084304	Brush Set
33-11452	076481	Brush Spring Set
33-11453	074617	Brush Spring Set
33-11454	078468	Brush Spring Set
33-11456	078496	Brush Spring Set
33-14640	370070	Contact Tip Kit
39-90057	370070	Contact Tip Kit
41-23313	370059	Load Wheel Bearing

OE Number	Crown Part Number	Description
41-23314	370182	Bearing
41-24724	370158	Seal
41-25093	370054	Ignition Switch
41-25633	084312	Brush Set
41-25683	074614	Brush Set
41-27543	370155	Axle
<b>SKF (SF)</b>		
6305RS	370185	Bearing
KL44610	370181	Bearing Assembly
<b>Still (SL)</b>		
149447	370113	Pin
501898	050000-095	Roll Pin
5442415	050000-095	Roll Pin
8005505	050000-095	Roll Pin
S20098	370179	Oil Seal
<b>Taylor Dunn (TA)</b>		
62-204-00	3C0001-R	Curtis PMC Control
70-054-00	3J70-054-00	Drive R-Motor 24-36-48V
70-054-03	3J70-054-00	Drive R-Motor 24-36-48V
70-054-41	3J70-054-41-R	TA Drive R-Motor
71-120-00	370054	Ignition Switch
71120	370054	Ignition Switch
85-412-00	087884	Brush Spring
CTL-2000	3C0008-R	Curtis PMC Control
<b>TCM (TC)</b>		
2002410	078496	Brush Spring Set
49748-00	370059	Load Wheel Bearing
A-49748	370059	Load Wheel Bearing
AB-MSD4-1520	370183	Contact Tip
ABMSD-41520	370183	Contact Tip
ABMSD-41521	370183	Contact Tip
EMDL-1118	094290	Brush Set
EMGP18SS0	078496	Brush Spring Set
FA72E1-05672	104868	Brush
FA72G1-05142	111768	Brush
<b>Timken(TM)</b>		
6305RS1	370185	Bearing
<b>Tipcon (TB)</b>		
10-1131	370183	Contact Tip
10-1K23	370070	Contact Tip Kit
10-1K27	370070	Contact Tip Kit
10-1K38	370071	Contact Tip Kit
<b>Toyota (TY)</b>		
00590-00012-71	370059	Load Wheel Bearing
00590-00015-71	370065	Washer - Flat
00590-00020-71	370122	Axle
00590-00415-71	370179	Oil Seal
00590-00423-71	370121	Grease Fitting Flush
00590-00528-71	370092	BDI/HR Meter 24-36
00590-00609-71	370092	BDI/HR Meter 24-36
00590-00610-71	370092	BDI/HR Meter 24-36
00590-00613-71	370054	Ignition Switch
00590-00633-71	370066	Pin - Coil
00590-00682-71	370090	Tandem Pivot
00590-03794-81	370092	BDI/HR Meter 24-36
00590-04566-71	370059	Load Wheel Bearing
00590-04567-71	370143	Brush Kit (Set of 4)
00590-04575-71	370143	Brush Kit (Set of 4)
00590-04744-71	370059	Load Wheel Bearing
00590-04748-71	118913	Brush Set
00590-04774-71	370059	Load Wheel Bearing
00590-04902-71	370059	Load Wheel Bearing
00590-05128-71	370185	Bearing
00590-09015-81	370092	BDI/HR Meter 24-36
00590-40563-71	3J570-325-500-R	24V Drive R-Motor
00590-40635-71	125789	Brush & Spring Set
00590-41289-71	3J005904128971-R	24V Pump R-Motor
00590-41782-71	370272	Brush Set of 4 Pieces

Electric Truck Components

Note: More crosses available; contact your dealer.

Toyota Continued ▶

# Electric Truck Components Cross Reference by Manufacturer

Toyota Continued

Electric Truck Components

OE Number	Crown Part Number	Description
00590-41853	118942	Brush Set
00590-42110	118942	Brush Set
00590-42119-71	370092	BDI/HR Meter 24-36
00590-43462-71	370197	Solenoid
00590-43543-71	370176	Wheel Fork/ Riser
00590-45652-71	3C0002-R	Curtis SX Control
00590-46288-71	370178	Fork Riser
00590-46291-71	370177	Fork Riser
00590-47054-71	370195	Button Reverse
00591-00174-81	370157	Seal
00591-00175-81	370158	Seal
00591-00530-81	370182	Bearing
00591-00599-81	370121	Grease Fitting Flush
00591-01780-81	370054	Ignition Switch
00591-02814-81	370185	Bearing
00591-03656-81	087398	Brush Spring
00591-03794-81	370092	BDI/HR Meter 24-36
00591-03828-81	125918	Brush Spring
00591-03840-81	021157-001	Brush
00591-03981-81	084304	Brush Set
00591-04137-81	087233	Brush Set
00591-04168-81	100730	Brush Set
00591-04239-81	104868	Brush
00591-04241-81	104888	Brush Set
00591-04288-81	110200	Brush
00591-04291-81	113328	Brush Set
00591-04641-81	072059	Brush
00591-04670-81	073854	Brush
00591-04685-81	074604	Brush
00591-05090-81	093585	Brush Set
00591-06234-81	111768	Brush
00591-06236-81	370152	Brush (Set of 2)
00591-06448-81	370059	Load Wheel Bearing
00591-07282-81	370183	Contact Tip
00591-07577-81	370071	Contact Kit
00591-07603-81	370179	Oil Seal
00591-07615-81	370140	Axle
00591-09003-81	370070	Contact Tip Kit
00591-09015-81	370092	BDI/HR Meter 24-36
00591-11035-81	370017	Exit Roller
00591-14088-81	087233	Brush Set
00591-16442-81	370087	Key - 1
00591-17521-81	020018	Brush Box Asm
00591-20030-81	107304	Brush Set
00591-20137-81	090286	Brush Set & Terminal Stud Pkg
00591-20262-81	370153	Contact Kit
00591-21059-81	370072	Contact Kit
00591-21088-81	370143	Brush Kit (Set of 4)
00591-21103-81	370199	Master Cylinder
00591-23043-81	118942	Brush Set (Set of 8)
00591-30135-81	074614	Brush Set
00591-30160-81	119538	Brush Mechanism
00591-30163-81	084548	Ring Brush Asm
00591-30170-81	106772	Brush Rigging Asm
00591-30176-81	370199	Master Cylinder
00591-30243-81	370199	Master Cylinder
00591-30254-81	103842	Brush
00591-30255-81	370059	Load Wheel Bearing
00591-30269-81	370182	Bearing
00591-30342-81	370181	Bearing Assembly
00591-30634-81	084304	Brush Set
00591-30635-81	087713	Brush Set
00591-30752-81	370162	Spacer
00591-30754-81	370046	Load Wheel Axle
00591-30790-81	370155	Axle
00591-30791-81	370094	End Cap
00591-30794-81	370155	Axle
00591-30852-81	370050	Riser Assembly

OE Number	Crown Part Number	Description
00591-30853-81	370027	Pivot Pin
00591-30854-81	370017	Exit Roller
00591-30860-81	370022	Push Rod, 48
00591-30868-81	370140	Axle
00591-30924-81	370210	Swivel Assembly
00591-30961-81	370123	Axle
00591-31076-81	370194	Plate Carrier
00591-31352-81	370088	Pin
00591-31595-81	370070	Contact Tip Kit
00591-31603-81	370070	Contact Tip Kit
00591-31635-81	370183	Contact Tip
00591-31636-81	370070	Contact Tip Kit
00591-31765-81	087233	Brush Set
00591-31900-81	370207	Seal Kit
00591-32048-81	370157	Seal
00591-32050-81	370158	Seal
00591-32057-81	370179	Oil Seal
00591-32135-81	074606	Brush Spring
00591-32145-81	078468	Brush Spring Set
00591-32146-81	074617	Brush Spring Set
00591-32165-81	087398	Brush Spring
00591-32166-81	087884	Brush Spring
00591-32356-81	370054	Ignition Switch
00591-32386-81	084312	Brush Set
00591-32390-81	074604	Brush
00591-32446-81	126697	Brush Set
00591-32452-81	087522	Brush Set
00591-32455-81	084547	Brush
00591-32456-81	104868	Brush
00591-32457-81	104888	Brush Set
00591-32460-81	116510	Brush Set
00591-32461-81	090286	Brush Set & Terminal Stud Pkg
00591-32462-81	111768	Brush
00591-32469-81	110200	Brush
00591-32471-81	100730	Brush Set
00591-32476-81	094843	Brush Set
00591-32654-81	370183	Contact Tip
00591-33292-81	109953	Brush
00591-33295-81	021157-001	Brush
00591-33323-81	370154	Brush & Spring
00591-33326-81	107304	Brush Set
00591-33327-81	113328	Brush Set
00591-33328-81	093585	Brush Set
00591-33330-81	072059	Brush
00591-33331-81	073854	Brush
00591-33332-81	104868	Brush
00591-33333-81	100530	Brush
00591-33334-81	116363	Brush Set
00591-33335-81	087233	Brush Set
00591-33355-81	103842	Brush
00591-35188-81	082661	Brush Holder
00591-35395-81	370208	Reservoir
00591-35798-81	370182	Bearing
00591-35879-81	370059	Load Wheel Bearing
00591-35977-81	370093	Bearing
00591-36653-81	094290	Brush Set
00591-36910-81	370121	Grease Fitting Flush
00591-36965-81	370187	Axle
00591-36969-81	370155	Axle
00591-37127-81	370018	Link Pin
00591-37129-81	370049	Push Rod Pin
00591-38020-81	370190	Shaft
00591-38396-81	370020	Link
00591-38443-81	370067	Load Wheel Axle
00591-38729-81	370122	Axle
00591-38769-81	370139	Shield- Bearing
00591-38810-81	370188	Pin
00591-39838-81	370072	Contact Kit

Note: More crosses available; contact your dealer.

Toyota Continued ▶

# Electric Truck Components Cross Reference by Manufacturer

Toyota Continued

OE Number	Crown Part Number	Description
00591-40800-81	370254	Bushing
00591-40804-81	370206	Packing Back-up Plug
00591-41247-81	370144	Seal
00591-41490-81	076481	Brush Spring Set
00591-41515-81	078496	Brush Spring Set
00591-41818-81	370087	Key - 1
00591-41881-81	370054	Ignition Switch
00591-41950-81	370054	Ignition Switch
00591-42276-81	090276	Brush Set
00591-42278-81	100730	Brush Set
00591-42281-81	087522	Brush Set
00591-42283-81	104888	Brush Set
00591-42286-81	078468	Brush Spring Set
00591-42287-81	107090	Brush Spring Set
00591-42289-81	074617	Brush Spring Set
00591-42335-81	020018	Brush Box Asm
00591-42560-81	370029	Seal Kit Lift Cylinder
00591-42623-81	125918	Brush Spring
00591-42660-81	370143	Brush Kit (Set of 4)
00591-42661-81	118942	Brush Set
00591-42667-81	111136	Brush Set
00591-42668-81	113652	Brush Set
00591-42669-81	100358	Brush & Lug Asm
00591-42677-81	370143	Brush Kit (Set of 4)
00591-42678-81	118913	Brush Set
00591-43128-81	370189	Roller Axle
00591-43227-81	370130	Load Roller Axle
00591-43241-81	370126	Entry Roller
00591-43274-81	370131	Pin
00591-43588-81	370130	Load Roller Axle
00591-43681-81	104868	Brush
00591-50042-81	370181	Bearing Assembly
00591-50668-81	370179	Oil Seal
00591-50818-81	370059	Load Wheel Bearing
00591-50821-81	370182	Bearing
00591-51256-81	370054	Ignition Switch
00591-51257-81	370054	Ignition Switch
00591-51361-81	074617	Brush Spring Set
00591-51363-81	078496	Brush Spring Set
00591-51364-81	078468	Brush Spring Set
00591-51366-81	076481	Brush Spring Set
00591-51371-81	087398	Brush Spring
00591-51372-81	119538	Brush Mechanism
00591-51437-81	084312	Brush Set
00591-51441-81	094290	Brush Set
00591-51456-81	087522	Brush Set
00591-51463-81	084547	Brush
00591-51464-81	103842	Brush
00591-51466-81	104868	Brush
00591-51471-81	084304	Brush Set
00591-51472-81	074614	Brush Set
00591-51482-81	074604	Brush
00591-51868-81	370070	Contact Tip Kit
00591-51875-81	370183	Contact Tip
00591-52025-81	370155	Axle
00591-52201-81	370199	Master Cylinder
00591-52307-81	370050	Riser Assembly
00591-52316-81	370046	Load Wheel Axle
00591-52520-81	100730	Brush Set
00591-52523-81	104868	Brush
00591-52524-81	104888	Brush Set
00591-52527-81	107312	Brush Set
00591-52528-81	113328	Brush Set
00591-53115-81	370071	Contact Kit
00591-53118-81	370199	Master Cylinder
00591-54000-81	370027	Pivot Pin
00591-54001-81	370017	Exit Roller
00591-54032-81	370121	Grease Fitting Flush

OE Number	Crown Part Number	Description
00591-54033-81	370121	Grease Fitting Flush
00591-54582-81	370158	Seal
00591-54596-81	370144	Seal
00591-54965-81	370182	Bearing
00591-55037-81	370093	Bearing
00591-55629-81	370189	Roller Axle
00591-56262-81	074606	Brush Spring
00591-56357-81	087233	Brush Set
00591-56358-81	021157-001	Brush
00591-56363-81	126697	Brush Set
00591-56396-81	103842	Brush
00591-56409-81	116363	Brush Set
00591-56410-81	370152	Brush (Set of 2)
00591-56436-81	087233	Brush Set
00591-56450-81	370154	Brush & Spring
00591-57328-81	370072	Contact Tip Kit
00591-57340-81	370071	Contact Kit
00591-57741-81	370018	Link Pin
00591-57992-81	370201	Cylinder Inner
00591-58049-81	370208	Reservoir
00591-58507-81	370088	Pin
00591-58525-81	370188	Pin
00591-58542-81	370049	Push Rod Pin
00591-58555-81	370027	Pivot Pin
00591-58564-81	370067	Load Wheel Axle
00591-58588-81	370122	Axle
00591-58622-81	370020	Link
00591-58661-81	370139	Shield- Bearing
00591-58736-81	370157	Seal
00591-60319-81	110200	Brush
00591-60320-81	111768	Brush
00591-60552-81	107304	Brush Set
00591-60633-81	072059	Brush
00591-60651-81	073854	Brush
00591-60718-81	087713	Brush Set
00591-60728-81	090286	Brush Set & Terminal Stud Pkg
00591-60732-81	093585	Brush Set
00591-60741-81	370162	Spacer
00591-60840-81	370187	Axle
00591-60896-81	370029	Seal Kit Lift Cylinder
00591-60991-81	116510	Brush Set
00591-63154-81	370140	Axle
00591-63170-81	370210	Swivel Assembly
00591-63174-81	370070	Contact Tip Kit
00591-63177-81	109953	Brush
00591-64378-81	087522	Brush Set
00591-64383-81	107090	Brush Spring Set
00591-64385-81	074617	Brush Spring Set
00591-64431-81	020018	Brush Box Asm
00591-70194-81	370207	Seal Kit
00591-70714-81	370106	Roller
00591-70790-81	370094	End Cap
00591-70791-81	370155	Axle
00591-70849-81	370194	Plate Carrier
00591-71832-81	370081	Plate - Horn
00591-72254-81	084547	Brush
00591-72261-81	370190	Shaft
00591-74534-81	370193	Axle
00591-74609-81	370089	Bushing
00591-74640-81	370032	Bellcrank Pin
00591-75880-81	370191	Spring Handle Return
00591-76033-81	370255	Seal Kit
00591-76120-81	370098	Disc - Brake
00591-76455-81	370181	Bearing Assembly
00591-76456-81	370018	Link Pin
00591-76463-81	370162	Spacer
00591-76537-81	370093	Bearing
00591-76552-81	370139	Shield- Bearing

Note: More crosses available; contact your dealer.

Toyota Continued ▶

# Electric Truck Components Cross Reference by Manufacturer

Toyota Continued

Electric Truck Components

OE Number	Crown Part Number	Description
00591-76553-81	370023	Pin
00591-76570-81	370027	Pivot Pin
00591-76597-81	370029	Seal Kit Lift Cylinder
00591-76605-81	370067	Load Wheel Axle
00591-76606-81	370088	Pin
00591-76629-81	370188	Pin
00591-76717-81	370046	Load Wheel Axle
00591-76719-81	370047	Pin
00591-76721-81	370049	Push Rod Pin
00591-76732-81	370052	Bushing
14111-F1090-71	370246	Brush Pump Motor
14112-12240-71	370244	Brush
14147-U2090-71	111768	Brush
14181-11480-71	370244	Brush
14320-12240-71	3J143201224071-R	Pump R Motor 36V
14320-12240-71	3J143201224071-R	36V Pump Motor
14320-12241-71	3J143201224171-R	Pump R-Motor
14341-U2090-71	370243	Brush 1 pair
14344-U1090-71	110200	Brush
14351-21440-71	370271	Brush Set of 8 Pieces
14352-21440-71	370246	Brush Pump Motor
14510-U1160-71	3J14510U116071-R	Pump R-Motor
14543-U1090-71	370275	Brush Set of 4 Pieces
14543-U1160-71	370151	Brush Kit (Set of 4)
14544-U1090-71	370276	Brush Set of 4 Pieces
33664-13500-71	050000-095	Roll Pin
41144-10330-71	370059	Load Wheel Bearing
45111-23000-71	370084	Ring - Horn Contact
45112-20540-71	370086	Spring - Horn
45112-22000-71	370083	Ring - Horn Contact
45112-22001-71	370083	Ring - Horn Contact
45112-22002-71	370083	Ring - Horn Contact
45113-22500-71	370081	Plate - Horn
45115-22500-71	370082	Spring - Horn
45116-20540	370080	Plate
45116-20540-71	370080	Plate
45123-23600-71	370062	Horn Contact- Ring
45124-23600-71	370063	Horn Contact- Spring
57413-22500	370073	Horn Contact
57413-22500-71	370073	Horn Contact
57414-22500-71	370064	Horn Contact- Spring
57414-23600-71	370085	Spring - Horn
57415-23600-71	370079	Horn Contact
57591-23330-71	370235	Key 2 sided
90891-03006-71	370069	Transistor
<b>United Contacts (UC)</b>		
8015	370183	Contact Tip
<b>Wagner (WG)</b>		
5505	050000-095	Roll Pin
<b>White Mobilift (WM)</b>		
20-7302001	078468	Brush Spring Set
20-H-1160	370144	Seal
20-P-358	370144	Seal
20-P-4191	370144	Seal
20-P-68	370144	Seal
21-H-3325	370144	Seal
30-P-575	370144	Seal
403692-D	370144	Seal
F-650	370059	Load Wheel Bearing
<b>Yale (YT)</b>		
064856300	370181	Bearing Assembly
065055200	370263	Washer
090196300B	370059	Load Wheel Bearing
09019630B	370059	Load Wheel Bearing
091654100	370205	Oil Seal
1169404DH	076481	Brush Spring Set
1169404DX	074614	Brush Set
121357100	370162	Spacer

OE Number	Crown Part Number	Description
121456630	084312	Brush Set
1214566AD	084312	Brush Set
1291590-26	074614	Brush Set
129159024	076481	Brush Spring Set
129159026	074614	Brush Set
150021994	3C0012-R	EV100 ZX Traction Card-R
150022014	3C0022-R	Regen SX Control-R 48V/400amps
150022025	3C0003-R	Curtis PMC Control
1500225-74	3C0008-R	Curtis PMC Control
1500226-84	3C0009-R	Curtis PMC Control
1500226-98	3C0004-R	Curtis SX Control
150050137	3C0013-R	Easi Reach Power Card-R
150050141	3C0014-R	Easi Reach Coil Driver-R
1501056-67	3C0001-R	Curtis PMC Control
1501071-79	3C0006-R	Curtis PMC Control
1501149-96	3C0002-R	Curtis SX Control
1501207-73	3C0005-R	Curtis PMC Control
15948600	076481	Brush Spring Set
16051600	370054	Ignition Switch
200078120	050000-095	Roll Pin
220001768	370140	Axle
220001910	370179	Oil Seal
220001916	370207	Seal Kit
220002046	370254	Bushing
220002204	084548	Ring Brush Asm
220002254	370210	Swivel Assembly
220002307	370179	Oil Seal
220002716	087233	Brush Set
220003089	106772	Brush Rigging Asm
220003254	103842	Brush
220003255	119538	Brush Mechanism
220003527	370182	Bearing
220003593	084547	Brush
220003595	087233	Brush Set
220003634	370144	Seal
220003882	370121	Grease Fitting Flush
220003938	370123	Axle
220003944	370206	Packing Back-up Plug
220004243	370205	Oil Seal
220006678	370157	Seal
220007563	084312	Brush Set
220007694	104868	Brush
220007703	104868	Brush
220007708	370199	Master Cylinder
220007922	107090	Brush Spring Set
220008074	074614	Brush Set
220010146	104888	Brush Set
220010653	370185	Bearing
220010769	370086	Spring - Horn
2200119-97	3C0008-R	Curtis PMC Control
220012004	3C0018-R	24/ 36V Curtis PMC Control-R
220012366	370208	Reservoir
220013076	094290	Brush Set
220013161	109953	Brush
220013162	104868	Brush
220013562	126697	Brush Set
220013711	370153	Contacto
220014573	021157-001	Brush
220014812	370087	Key - 1
220015020	104888	Brush Set
2200152-58	3C0003-R	Curtis PMC Control
220015245	113652	Brush Set
220015280	107312	Brush Set
220015301	114502	Brush Set
220015328	090286	Brush Set & Terminal Stud Pkg
220015628	113328	Brush Set
220015767	370156	Shim 1/32

Note: More crosses available; contact your dealer.

Yale Continued ▶

# Electric Truck Components Cross Reference by Manufacturer

Yale Continued

OE Number	Crown Part Number	Description
220015861	074604	Brush
220015891	072059	Brush
220015913	370106	Roller
220016053	370255	Seal Kit
220016055	116510	Brush Set
220016081	370121	Grease Fitting Flush
220016152	370143	Brush Kit (Set of 4)
220016235	126697	Brush Set
220016331	073854	Brush
220016358	103842	Brush
220016545	074604	Brush
220016551	370155	Axle
220016555	370144	Seal
220017020	370094	End Cap
220017107	370154	Brush & Spring
220017203	370194	Plate Carrier
220017209	370072	Contacting Tip Kit
220017349	370179	Oil Seal
220017463	370208	Reservoir
220017582	074606	Brush Spring
220017669	126697	Brush Set
220017761	118942	Brush Set
220018132	113498	Brush Set
220018189	370199	Master Cylinder
220018307	074617	Brush Spring Set
220018798	370122	Axle
220018821	114671	Brush Set
220018823	116363	Brush Set
220018826	118913	Brush Set
220018881	370084	Ring - Horn Contact
220018884	370082	Spring - Horn
220019121	370081	Plate - Horn
220019486	370156	Shim 1/32
220019566	074617	Brush Spring Set
220020222	370179	Oil Seal
220021426	3C0012-R	EV100 ZX Traction Card-R
220021829	021157-001	Brush
220022631	370157	Seal
220022632	370158	Seal
220022722	370182	Bearing
220023298	074614	Brush Set
220023328	078468	Brush Spring Set
220023441	078496	Brush Spring Set
220023510	104868	Brush
220023517	113328	Brush Set
220023631	087522	Brush Set
220023635	103842	Brush
220025259	084547	Brush
220026265	109953	Brush
220026664	021158-001	Brush
220027150	021157-001	Brush
220027589	074617	Brush Spring Set
220027831	370124	Pin Weldment
220028029	125918	Brush Spring
220029109	118913	Brush Set
220029198	020018	Brush Box Asm
220029245	370092	BDI/HR Meter 24-36
220029734	111136	Brush Set
220031433	370125	Pivot Pin
220034250	370079	Horn Contact
220034535	370072	Contacting Tip Kit
220034592	107090	Brush Spring Set
220035767	370187	Axle
220035779	370162	Spacer
220036158	125020	Brush Set
220037511	370152	Brush (Set of 2)
220037512	104868	Brush

OE Number	Crown Part Number	Description
220037532	370088	Pin
220037533	370188	Pin
220037538	370046	Load Wheel Axle
220037690	370092	BDI/HR Meter 24-36
220041503	370083	Ring - Horn Contact
220041746	370087	Key - 1
220041853	087393	Brush Set
220042096	3C0017-R	24/ 36V Curtis PMC Control-R
220042319	370093	Bearing
220042755	370200	Brake Rotor
220043000	370191	Spring Handle Return
220043258	116961	Brush Set
220043332	370121	Grease Fitting Flush
220043370	370129	Control
220043373	370191	Spring Handle Return
220043377	050000-095	Roll Pin
220043583	370155	Axle
220044107	370152	Brush (Set of 2)
220044108	110200	Brush
220044124	370152	Brush (Set of 2)
220044744	021157-001	Brush
220044747	104868	Brush
220044749	084547	Brush
220044797	114541	Brush Set
220045024	125918	Brush Spring
220049717	370190	Shaft
220050212	370205	Oil Seal
220050286	074617	Brush Spring Set
220050575	084312	Brush Set
220050957	370059	Load Wheel Bearing
220051365	076481	Brush Spring Set
220051423	078496	Brush Spring Set
220051425	082661	Brush Holder
220051431	084304	Brush Set
220051433	087522	Brush Set
220051868	087398	Brush Spring
220052887	370158	Seal
220054093	074604	Brush
220054705	020018	Brush Box Asm
220070227	111768	Brush
220070387	370183	Contacting Tip
220072237	370121	Grease Fitting Flush
220075025	084547	Brush
220075064	370152	Brush (Set of 2)
220075082	104868	Brush
220076629	370080	Plate
220079575	084548	Ring Brush Asm
2201742-04	3C0004-R	Curtis SX Control
2201753-74	3C0009-R	Curtis PMC Control
22063800	370059	Load Wheel Bearing
23403100	076481	Brush Spring Set
23403300	074617	Brush Spring Set
23403400	076481	Brush Spring Set
23403700	074617	Brush Spring Set
252370600	370208	Reservoir
272006400	370012	Handle Pin Washer
272015100	370019	Bushing
272027800	370006	Handle Pin
272204800	050000-095	Roll Pin
272311800	370006	Handle Pin
273075800	370170	Screw
277274300	370170	Screw
277323300	370019	Bushing
296065403	078468	Brush Spring Set
449034012	050000-095	Roll Pin
449034019	370223	Roll Pin
47001100	370054	Ignition Switch

Electric Truck Components

Note: More crosses available; contact your dealer.

Yale Continued ▶

# Electric Truck Components Cross Reference by Manufacturer

Yale Continued

Electric Truck Components

OE Number	Crown Part Number	Description
500120803	370059	Load Wheel Bearing
500120903	370059	Load Wheel Bearing
500640818	370190	Shaft
500838400	074614	Brush Set
500863100	370054	Ignition Switch
500863101	370054	Ignition Switch
500863102	370054	Ignition Switch
500863104	370054	Ignition Switch
500863105	370054	Ignition Switch
500863106	370087	Key - 1
500863110	370054	Ignition Switch
500989200	370020	Link
501193100	370187	Axle
501771303	370022	Push Rod, 48
501785300	370031	Drive Axle
501864902	370055	Plug
502303101	370021	Pin
502447503	370022	Push Rod, 48
502448503	370022	Push Rod, 48
502669901	370093	Bearing
503480200	370139	Shield- Bearing
503688200	370023	Pin
503753700	370024	Drive Motor Cover
503771700	370025	Steer Arm Weldment
503918700	370026	Wiring Harness Asm
504027700	370028	Handle Arm
5040D3046	370059	Load Wheel Bearing
5040D3096	370059	Load Wheel Bearing
5040G3066	370059	Load Wheel Bearing
504114800	370056	Fitting
504223284	084548	Ring Brush Asm
504228298	087398	Brush Spring
504229255	370152	Brush (Set of 2)
504229274	370152	Brush (Set of 2)
504230259	104868	Brush
504237261	104868	Brush
504248505	370089	Bushing
5045752-33	3J5045752-33-R	36V Pump R-Motor
504575231	3J504575231-R	24V Power Steering R-Motor
504599200	370190	Shaft
504734200	370027	Pivot Pin
504981702	370028	Handle Arm
505034200	370076	Axle Sleeve
505075522	370233	Contacto 300amp 24v
505104800	076481	Brush Spring Set
505163001	370029	Seal Kit Lift Cylinder
505340501	370155	Axle
505340502	370155	Axle
505354500	370196	Brake Cam Lever
505617500	370067	Load Wheel Axle
505654500	370088	Pin
505654600	370088	Pin
505984500	370030	Shaft
506210800	084312	Brush Set
506273800	076481	Brush Spring Set
50649900	370054	Ignition Switch
506566500	370031	Drive Axle
506600800	074617	Brush Spring Set
506605800	074614	Brush Set
506634500	370188	Pin
507167800	370121	Grease Fitting Flush
507244500	370088	Pin
507247500	370265	Shaft Pivot
507248505	370089	Bushing
507327500	370188	Pin
507413800	084304	Brush Set
507623800	078468	Brush Spring Set
509014801	078496	Brush Spring Set

OE Number	Crown Part Number	Description
509015804	082661	Brush Holder
5090168-19	094843	Brush Set
5090168-21	087522	Brush Set
509016814	084304	Brush Set
509016816	084304	Brush Set
509016821	087522	Brush Set
509016822	094290	Brush Set
509016823	094290	Brush Set
511274800	082661	Brush Holder
517072602	3J5170726-02-R	24V Steer R-Motor
518218600	370028	Handle Arm
518264803	084548	Ring Brush Asm
518264804	087398	Brush Spring
518264825	116510	Brush Set
518264826	084548	Ring Brush Asm
518264835	084548	Ring Brush Asm
518264883	087522	Brush Set
518360601	370032	Bellcrank Pin
5183616-10	3C0003-R	Curtis PMC Control
518804691	370243	Brush 1 pair
518805656	104868	Brush
519433626	370193	Axle
519466014	370152	Brush (Set of 2)
5195153-01	370249	Switch
5195153-02	087373	Switch
519515301	370249	Switch
519515302	087373	Switch
519578814	370154	Brush & Spring
519578824	370154	Brush & Spring
519616815	125789	Brush & Spring Set
520045399	111768	Brush
520344803	370150	Brush
52041100	076481	Brush Spring Set
520426873	370182	Bearing
521558001	370154	Brush & Spring
521558002	370154	Brush & Spring
524139006	370033	Control Handle Upp
524140838	370165	Pin
524140839	370107	Pin - Lower Link Pivot
524140840	370261	Pin Pivot
524140842	370168	Pin- Coiled Roll
524140878	370169	Bushing
524140880	370166	Bushing
524140913	370167	Axle Entry Roller
524141079	370091	Threaded Rod
524141151	370075	Load Wheel Axle
524141153	370075	Load Wheel Axle
524141180	370078	Link Assembly
524141181	370173	Roller Assembly
524141442	370147	Wire Harness
524141471	370003	Gas Spring
524143951	370011	Steer Arm
524143966	370013	Riser Wheel Axle Asm
524144502	370034	Motor Cover LH
524144503	370035	Motor Cover RH
524144864	370036	Lower Link RH
524144865	370037	Lower Link LH
524148464	370074	Axle
524148521	370058	Switch Assembly
524148583	370038	Brake Assembly
524148749	370010	Riser
524148751	370059	Load Wheel Bearing
524148752	370142	Bushing/ String Guard
524148753	370009	Load Wheel Axle
524148929	370092	BDI/HR Meter 24-36
524149338	370008	Gas Spring
524149833	370003	Gas Spring
524149943	370057	Wire Harness

Note: More crosses available; contact your dealer.

Yale Continued ▶

# Electric Truck Components Cross Reference by Manufacturer

Yale Continued

OE Number	Crown Part Number	Description
524153715	370007	Handle Switch
524163144	370187	Axle
524169212	370148	Brake - Electromagnetic
524177337	370078	Link Assembly
524179191	370006	Handle Pin
524182270	370003	Gas Spring
524184971	370034	Motor Cover LH
524184972	370035	Motor Cover RH
524187950	370075	Load Wheel Axle
524230699	370075	Load Wheel Axle
524245865	370252	Charger On Board
524301377	370174	Pivot Axle
524302804	370175	Flanged Bearing
524370-09	3C0007-R	Curtis PMC Control
54038000	074606	Brush Spring
550013954	370264	Handle Assembly
56210400	076481	Brush Spring Set
57457400	084312	Brush Set
580000461	370193	Axle
580000462	370193	Axle
580002386	370039	Handle Wiring Harness Asm
580006015	370208	Reservoir
580006862	3C0012-R	EV100 ZX Traction Card-R
580007602	370151	Brush Kit (Set of 4)
580007606	370238	Brush Kit 4pcs
580010369	370239	Brush Kit 4pcs
580011010	109953	Brush
580011153	3C0022-R	Regen SX Control-R 48V/400amps
580011989	370040	Control Handle Low
580011991	370163	Cover Switch
580012669	370041	24V Pump Am Motor
580012970	370077	Spring
580013990	370170	Screw
5800166-68	3J5800166-68-R	24V Drive R-Motor
580017142	370024	Drive Motor Cover
580019693	370145	Switch
580021039	370208	Reservoir
580024028	370193	Axle
580026708	370005	BDI
580027030	370240	Brush
580028320	104868	Brush
580029149	370042	Drive Motor Brushset w Springs
580029663	370149	Brush w BWI (Set of 2)
580029671	370252	Charger On Board
580031000	370043	Drive Motor 24V Am
580031999	370060	Pin
580034920	370252	Charger On Board
580035626	3J580035626-R	36/48V Power Steering R-Motor
580038175	370164	Spring
580038835	104164-007	Solenoid Coil
580043706	370147	Wire Harness
580046627	370003	Gas Spring
580046811	370003	Gas Spring

OE Number	Crown Part Number	Description
580046812	370008	Gas Spring
580046976	370015	Handle Wiring Harness
580055473	370252	Charger On Board
580083554	370008	Gas Spring
580087314	370252	Charger On Board
582003887	370252	Charger On Board
582004027	370150	Brush
582004043	370241	Brush Set 2pcs
582004077	370136	Brush Kit (Set of 4)
585086303	370089	Bushing
585094505	370016	Push Rod, 48
585096302	370044	Pivot Pin Axle
585096303	370045	Pivot Pin Axle
585096305	370045	Pivot Pin Axle
585096306	370002	Pivot Pin
585096307	370001	Pivot Pin
585096801	370262	Pin Coiled
585096802	370262	Pin Coiled
585098300	3C0016-R	24V MPB SX Zapi Control-R
58786800	076481	Brush Spring Set
6066614AC	076481	Brush Spring Set
61499400	084312	Brush Set
62960000	370172	Washer
640374100	370046	Load Wheel Axle
640697303	370047	Pin
640846831	370031	Drive Axle
640846878	370031	Drive Axle
641433100	370046	Load Wheel Axle
641786100	370049	Push Rod Pin
641786101	370049	Push Rod Pin
643182400	370050	Riser Assembly
644087802	370146	AC Cord & Plug
645082800	370054	Ignition Switch
64856600	370050	Riser Assembly
64857200	370018	Link Pin
64857300	370027	Pivot Pin
64857600	370017	Exit Roller
65054700	370050	Riser Assembly
66158200	076481	Brush Spring Set
721528104	370051	Battery Cover Knob
723673100	370052	Bushing
723683100	370053	Pivot Pin
723791145	370242	Brush Set
730004021	3J5800166-68-R	24V Drive R-Motor
730004021-G	3J5800166-68-R	24V Drive R-Motor
730024021-AM	3J5800166-68-R	24V Drive R-Motor
730012020	3J7300120-20-R	24V Drive Motor
7300310-00	3J7300310-00-R	Drive R-Motor
751791300	370017	Exit Roller
752060402	370092	BDI/HR Meter 24-36
752626302	370092	BDI/HR Meter 24-36
80142300	370054	Ignition Switch
912630302	370132	Bushing
954508909	050000-095	Roll Pin
S00736690075	370091	Threaded Rod

Note: More crosses available; contact your dealer.

Electric Truck  
Components

# INTRODUCING THE CROWN TOOL PROGRAM

The Crown tool program offers high quality tools selected specifically for technicians to handle most lift truck repairs. Each item offered in the Crown tool kit is individually labeled with the Crown logo and Crown part number. **All tool kits come with a Lifetime Warranty.**

The program offers an all-inclusive, 212-piece Mechanics Tool Kit which contains all the items listed below. Items can be purchased individually or all together in the Mechanics Tool Kit.

## Tool Kits:

- Mechanics Tool Kit
- Combination Wrench Set – SAE
- Combination Wrench Set - Metric
- Angle Wrench Set
- 1/4" Drive Socket Set
- 3/8" Drive Socket Set
- 1/2" Drive Socket Set
- Screwdriver Set
- Pliers Set
- Hex Wrench Set - L TYPE, SAE Ball
- Hex Wrench Set - L TYPE, Metric Ball
- Pry Bar Set
- Roll Pin Punch Set
- Punch and Chisel Set

## Individual Tools:

- Ball Peen Hammer
- Tape Measure
- Locking Pliers 7"
- Locking Pliers 10"
- Adjustable Wrench - 6"
- Adjustable Wrench - 10"
- Wire Stripper
- Pick Set
- Screw Starter - Phillips
- Screw Starter - Flathead
- Inspection Mirror
- Pick-up Tool Magnetic
- Slide Rail Socket Holders
- Tote Tool Bag



**Contact your local Crown Dealer  
for more information on the  
Crown Tool Program.**

**See pages 8.02 and 8.03 of the One Source  
catalog for individual part numbers.**



## Section 4

# Internal Combustion (IC) Truck Components

### Contents

Seats	4.02
Seat Belts	4.06
LPG Tanks/Parts	4.07
Starters/Replacement Parts	4.10
Alternators	4.12
Pumps	4.13
Radiators and Accessories	4.14
Brake Cylinders	4.15
Miscellaneous Brake Parts	4.16
Pipes	4.18
Distributors/Caps, Rotors, Spark Plug Wires	4.19
Coils	4.22
Spark Plugs	4.23
Fan Blades	4.25
Belts	4.25
Seals	4.27
Cylinder Parts	4.29
Miscellaneous	4.31
(IC) Truck Components Cross Reference by Manufacturer	4.37

### New Items:

Starter - p. 4.11  
Radiator & Hose - p. 4.14-4.15  
Brake Parts - p. 4.17-4.18  
Ignition Wire Set - p. 4.20, p.4.22  
Distributor Caps - p. 4.22  
Spark Plug - p. 4.24  
Belts - p. 4.26  
Seals - p. 4.28-4.29  
Cylinder Seal Kits - p. 4.29-4.30  
Wheel Cylinder - p. 4.30  
Hardware - p. 4.31-4.34  
Oil Pressure Switch - p. 4.34  
Valve Assembly - p. 4.35  
Miscellaneous Parts - p. 4.35-4.36  
Thermostat/O-Ring - p. 4.35  
Master Cylinders - p. 4.35  
Solenoid - p. 4.36  
Gas Spring - p. 4.36

Note: "1910.178(q)(5) All parts of any such industrial truck requiring replacement shall be replaced only by parts equivalent as to safety with those used in the original design."

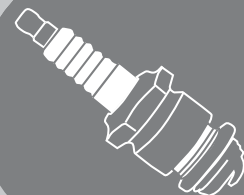



Part Number - 380070-001

**Lumbar Seat  
Forward Tilt & Fold Back**

Part Number - 380070-001-E

**Seat with Electric Switch**

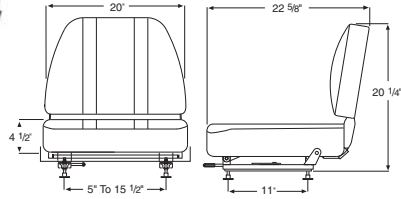

- Seat belt brackets
- Heavy duty 7/8" tubular frame with Flex-O-Lator & coil spring support
- 6" fore & aft adjusters 11" O/C front to rear mount
- 5" to 15 1/2" lateral adjustment
- 1.4 lb. density foam pack with 55 lb. compression foam cushion
- 40 oz. fire retardant vinyl

▼ OEM Reference

AF 00440	IN STWM599	TC 24846-80302
CT 973522	LP 753-7035	TC 27416-80201
ET 32002	LP WM-599	TC 27416-80202
ET 32106	NI 87000-60K05	TY 00591-07835-81
HM MODEL100	NI 87000-L2000	TY 00591-07876-81
HM MODEL100-ELE	NI 87000-L2100	TY 00591-30008-81
HY 3022576	NI FLPRTSS000	TY 00591-58448-81
HY 3029291	SY 800116885	YT 150016902
HY 3030127	SY 1862	YT 150016903
HY 3031084	TC 22196-82001	YT 150039503
IN 85-347	TC 23656-80102	YT 150039766
IN ST973522	TC 24846-80301	



Part Number - 380070-015

**Injection Molded Seat  
Straight Back**

Part Number - 380070-015-E

**Seat with Electric Switch**

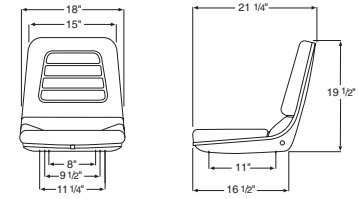

- Molded 1-PC seat assembly
- Heavy 14 gauge steel frame with black powder coat finish
- 6" fore & aft adjusters 11" O/C mounting
- 8"-9 1/2"-11 1/4"-18" lateral adjustment
- Hip restraints mounting
- Contoured molded foam for optimum body support
- 67 mil. heavy duty black molded cover

▼ OEM Reference

AF 00439	HY 138081	LP 753-7022
CL 377901	HY 192268	ST WM1183
ET 32005	HY 364911	SY 1732
ET 32005-WS	HY 377904	SY 1769
GM 0706-1943	HY 377967	TY 00591-32859-81
HM MODEL1500	HY 806441	TY 00591-58466-81
HM MODEL1500-ELE	HY 3032277	YT 220013187
HY 127504	HY 3054800	YT 504232248
HY 130798	HY 3058160	YT 504236274
HY 130799	IN 85-137	
HY 130800	IN STWM1183	



Part Number - 380070-013

**Full Body Seat  
Forward Tilt and Fold Back**

Part Number - 380070-013-E

**Seat with Electric Switch**

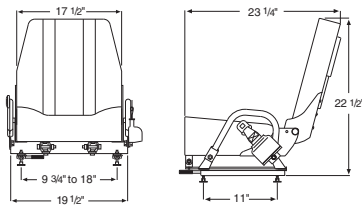

- With Retractable Seat Belt
- Heavy duty steel frame with black enamel finish
- 6" fore & aft adjusters 11" O/C front to rear mount
- 9 3/4" to 18" lateral adjustment
- Contoured back and seat cushions
- 32 oz. fire retardant vinyl
- Multi position folding back rest
- Hip restraints

▼ OEM Reference

HM MODEL1300	SY 800116971	TY 00591-21199-81
HM MODEL1300-ELE	SY 1627	WS WM1208
SY 800048446	TC WM1208	



Part Number - 380070-022

**Bucket Seat  
Fold Back**

Part Number - 380070-022-E

**Seat with Electric Switch**

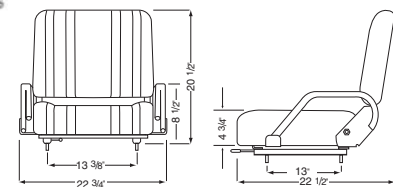

- Safety hip restraints
- Heavy steel frame with black powder coat finish
- 6" fore & aft adjusters 11" O/C mounting
- 11" & 13 3/8" lateral adjustment
- Contoured molded foam for optimum body support
- No-Sag spring construction
- 50 oz. heavy duty black vinyl

▼ OEM Reference

AC 3EB-50-A5890	KO 4901422	NI 87000-43K20
BK KM3EB-50-A5890	KO 4949484	NI 87000-60K01
CT A000026796	KO 4968103	NI 87600-91H55
ET 32107	KO 4969403	ST WM745
HM MODEL2200	KO 3306-6134E	SY 1866
HM MODEL2200-ELE	KO 3BB-50-A3120	SY 34430
HY 3125880	KO 3EB-50-A5860	TY 00591-07878-81
HY 3135726	KO 3EB-50-A5890	YT 150039574
IN 85-349	KO 3EB-50-A4910	YT 220027604
IN STWM-745	LP 753-7041	
KM 3EB-50-A5890	MB A000026796	



Part Number - 380070-016

**Suspension Seat (Vinyl)  
Straight Back**

Cloth seat see P.N. 380070-030

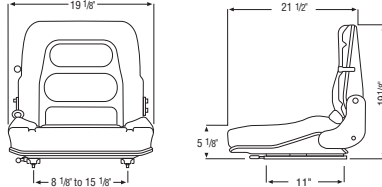

- Fore and aft adjustment 150mm in increments of 15mm
- Suspension stroke 40mm
- Weight adjustment 110-265 lbs. infinitely
- Angle adjustment of backrest infinitely 15°
- Specifically designed for a forklift which requires a low S.I.P.
- The fully integrated suspension within the backrest pan reduces harmful shocks for fatigue-free and safe operation
- The upholstery is of the vacuum formed and poured in-place type and can be easily exchanged for serviceability

▼ OEM Reference

BK 3244331000	JU 0760966	SL 524145
BK 3244331001	JU 0762781	ST 127266
BK 3244331002	JU 0763489	ST ST116073
BK 3244331005	JU 0763590	ST ST127266
BK 3244331010	JU 0763598	ST STSGRS12B1
BK 3244331011	JU 2760966	SY 800048466
BK 3244331032	JU 2763590	SY 800048479
BT 680396	JU 6132896	SY 800048480
CL 1400305	JU 14057390	SY 800048486
CL 2389314	JU 14388510	SY 800116985
CL 2793120	JU 27609660	SY 800124739
CL 3737932	JU 27627810	SY 1535
CL 3772793	JU 27632940	SY 1660
CL 3777118	JU 27634890	SY 1670
CL 3796400	JU 27635900	SY 1675
CL 3796460	JU 27635980	SY 1960
CL 4308663	JU 27636190	SY 1990
CL 4310868	JU 27636200	SY 35425
CL 4358426	JU 27637070	TA 90-160-70
CL 5456200	JU 50010821	TN 1056543
CL 6632388	JU 61260430	TY 00591-02129-81
ET 32001	JU 61263920	TY 00591-32845-81
GG 1129306	JU 61328960	TY 00591-34208-81
HM MODEL1600	JU 70051620	TY 00591-58460-81
HY 116073	LP 753-3003	TY 00591-58462-81
HY 226198	LP 753-7003	TY 53710-20720-71
HY 309702	MN 208521	TY 53730-20720-71
HY 322757	MN 409115	YT 150019501
HY 326480	MT 4207919651	YT 220071655
HY 335599	MT 4209717924	YT 220073083
HY 374171	NI 0255-49NNN	YT 220079977
HY 377906	NI 87000-03K00	YT 504226267
HY 823886	SL 300558	YT 504235296
HY 1345826	SL 521452	YT 505959514
HY 3069750	SL 522414	YT 751647603



Part Number - 380070-030

**Suspension Seat (Cloth)  
Straight Back**

Vinyl seat see P.N. 380070-016

▼ OEM Reference

BK 3244331015	HY 3070641	SY SY1995
CL 1802151	IN 85-125	TN 34251
CL 1802446	LI 3244331015	TN 53845
CL 2775193	LP 753-3004	TY 00591-01114-81
CL 3736995	LP 753-7005	TY 00591-32847-81
CT A000028641	MB A000028641	TY 00591-34209-81
ET 32068	MH 3300489	TY 00591-58461-81
ET 32088	MN 454238	TY 00591-58463-81
ET 32145	SY SY1665	YT 150019503
HM MODEL3000	SY SY1965	YT 220072123



Part Number - 380070-023

**Contoured Pan Seat  
Fold Back**

Part Number - 380070-023-E  
**Seat with Electric Switch**

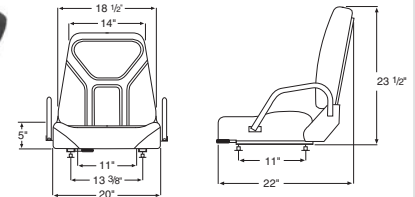

- Seat belt
- Adjustable back/hip restraint
- 6" fore & aft adjusters 11" O/C mounting
- 11" & 13 3/8" lateral mounting
- 14 gauge steel tubing
- 20" wide bottom seat cushion
- 18 1/2" tapered back cushion
- No-Sag spring construction
- 50 oz. heavy duty black vinyl
- Contoured molded foam for optimum body support
- Folding back rest with operator pouch

▼ OEM Reference

AC 8005-2116E	KO 3EA-50-A1150	KO H08005-2116
AC H08005-2116E	KO 3EB-50-16110	KO H03110-19
AF 00438	KO 3EB-50-A5160A	KO H08002-2113
BK KMHO8003-2113	KO 3EB-50-A5180	KO H08003-2113
BK KMHO8005-2116E	KO 3EB-50-A5181	KO H08005-2116
HM MODEL2300	KO 3EB-50-A5181B	LI KM3EB-50-A5180
HM MODEL2300-ELE	KO 3EB-50-A5930	LI KM3EB-50-A5930
KO 3303-8116E	KO H03110-17	SY 1790
KO 3EA-50-A1120	KO H03110-19	TC WM1077

(IC) Truck  
 Components



Part Number - 380070-026

**Contoured Back Seat  
Fold Back**

Part Number - 380070-026-E  
**Seat with Electric Switch**

- Seat belt
- 14 gauge stamped steel
- 2 piece molded cushion
- 67 mil. heavy duty vinyl
- Multi adjustment 11", 13" & 13 3/4"

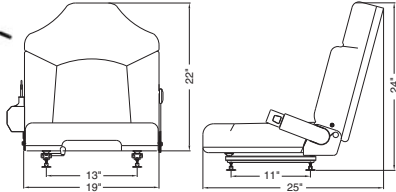

▼ OEM Reference

BK 147394	CL 926069	HM MODEL2600-ELE
BR 908830	CL 926072	LI 147394
BR 926069	CL 1636257	NI CK908830
BR CK2813105	CL 2389326	NI CK926069
CK 908830	CL 2389703	SY 800048420
CK 926069	CL 2795958	SY 1584
CL 908830	CL 2803280	YT 220170056
CL 908831	CL 2817183	
CL 915588	HM MODEL2600	



Part Number - 380070-032

**Molded Seat  
Fold Back**

Part Number - 380070-032-E  
**Seat with Electric Switch**

- Retractable seat belt
- 14 gauge steel pan
- 2 piece molded cushion
- 67 mil. heavy duty vinyl
- Shoulder restraint
- Multi adjustment 11" & 13"

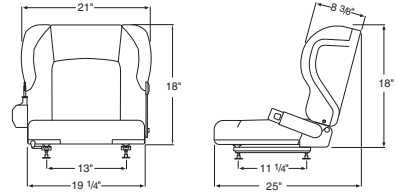

▼ OEM Reference

CL 448492	TY 53706-U2001-71	TY 53760-23000-71
CL 448494	TY 53706-U2100-71	TY 53760-23001-71
HM Model3200	TY 53730-U2100-71	TY 53760-23610-71
SY 1698	TY 53740-22750-71	TY 53760-U2100-71
TY 53706-U2000-71	TY 53740-23000-71	

▼ OEM Reference for Seat with Electric Switch Part No. 380070-032-E

HM MODEL3200-ELE	TY 53710-U1160-71	TY 53740-13300-71
SY 1695	TY 53720-U1090-71	
TY 53710-U1090-71	TY 53740-11590-71	



Part Number - 380070-029

**Contoured Seat  
No Tilt or Fold Back**

- 67 mil. heavy duty vinyl
- Self-draining seat
- Seat belt mounting
- Contemporary styling
- Contoured for operator comfort
- 14 gauge stamped steel shell with black powder coat finish

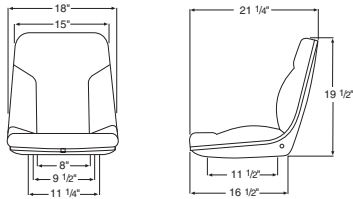

▼ OEM Reference

CT A000028830	SY 800048444	TC WM1268-1
HM MODEL2900	SY 1625	YT 504268740



Part Number - 380070-033

**Suspension Molded Seat  
Fold Back**

Part Number - 380070-033-E  
**Seat with Electric Switch**

- Retractable seat belt
- 14 gauge steel pan
- 2 piece molded cushion
- 67 mil. heavy duty vinyl
- Shoulder restraint
- Multi adjustment 11" & 13"

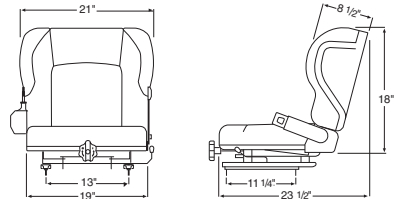

▼ OEM Reference

HM MODEL3300	TY 53780-U2101-71	WS WM1579
SY 1633		

▼ OEM Reference for Seat with Electric Switch Part No. 380070-033-E

HM MODEL3300-ELE	TY 53960-88300-71	
------------------	-------------------	--

# Seats



Part Number - 380070-034

### Molded Seat Fold Back

Part Number - 380070-034-E

### Seat with Electric Switch

- Seat belt
- 14 gauge steel pan
- 2 piece molded cushion
- 67 mil. heavy duty vinyl
- Multi adjustment 11", 13" & 13 3/8"

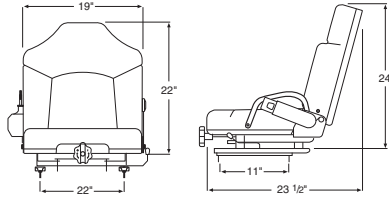

#### ▼ OEM Reference

CL 2817623	HM MODEL3400	LP 753-9031
CL 926070	IN 85-430	SY 1575
HY 3170058	KO 3EB-50-A5320	

#### ▼ OEM Reference for Seat with Electric Switch Part No. 380070-034-E

HM MODEL3400-E	KO 3EB-50-A5322
----------------	-----------------



Part Number - 380070-035

### Molded Seat Fold Back

Part Number - 380070-035-E

### Seat with Electric Switch

- Adjustable back angle 90° - 120°
- Adjustable lumbar with hip restraint
- 14 1/4" x 11" adjustor spacing
- Metal pan seat and back
- Vinyl pouch on back

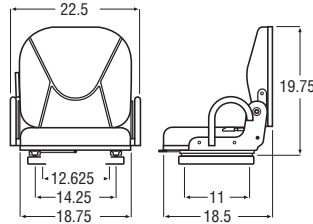

#### ▼ OEM Reference

CT 93014-00010	HM MODEL3500-ELE	SY 1424
HM MODEL3500	MB 93014-00010	



Part Number - 380070-012

### Pan Seat Straight Back

Part Number - 380070-012-E

### Seat with Electric Switch

- Swing up molded armrest
- 14 gauge steel black powder coat finish pan frame
- 6" fore & aft adjusters 11" O/C front to rear mount
- 4" to 11 1/4" lateral adjustment
- 1.4 lb density foam pack with 55 lb. compression foam cushion
- 50 oz. fire retardant black madrid expanded vinyl

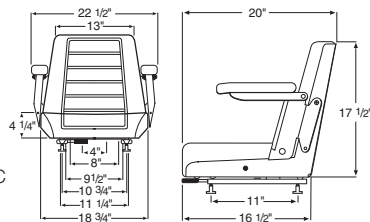

#### ▼ OEM Reference

HM MODEL1200	SY 1848	TY 00591-07862-81
HM MODEL1200-ELE	TC WM684	WS WM684
SY 800116870		



Part Number - 380070-037-E

### Molded Seat with Electric Switch

- Retractable safety belt
- Fore and aft slide rail with adjustment of 150mm
- Document bag
- Electric switch
- Universal mounting pan covering:
  - Toyota: 330 x 285mm
  - TCM: 230 x 285mm
  - Mitsubishi: 320 x 275mm
  - Komatsu: 340 x 255mm
  - Nissan: 280 x 280mm



#### ▼ OEM Reference

CT 91A14-01010	CT 91A14-21030	NI 87000-6G400
CT 91A14-01030	HM Model3700	NI 87000-FB400
CT 91A14-11010	LP 753-2049	NI 87000-FW50B
CT 91A14-21010	NI 87000-6G210	YT 800037371



Part Number - 380070-009

### Pan Seat Straight Back

Part Number - 380070-009-E

### Seat with Electric Switch

- 16 gauge steel black powder coat finish pan frame
- 6" fore & aft adjusters 11" O/C front to rear mount
- 4" to 11 1/2" lateral adjustment
- 1.4 lb density foam pack with 55 lb. compression foam cushion
- 40 oz. fire retardant black madrid expanded vinyl

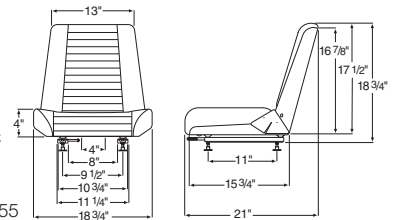

#### ▼ OEM Reference

AF 00459	LP 753-3001	TY 00591-07880-81
BK 104056	LP WM127	TY 00591-30004-81
BR 87000-UMP00	MB ST973139	TY 00591-32844-81
CT 0973139	ME S4304-79-11	TY 00591-34205-81
HM MODEL900	ME S4304-79-2	TY 00591-58444-81
HM MODEL900-ELE	ME S4304-79-9	YT 150016901
HY 109983	NI 87000-UMP00	YT 150039250
HY 3021855	NI FLPRTPSP0006	YT 150039755
HY 3026746	NP 8231310	YT 514092400
HY 3031979	NP BK8231310	YT 518324400
HY 109983A	TC WM-127	YT 519678401
HY 112155A	TC WM682	
LI 104056	TY 00591-07818-81	
LP 753-2003	TY 00591-07859-81	

(IC) Truck  
 Components

# Seat Belts

## Lap Belts

Part Number	Description
380080-048	48" Black
380080-060	60" Black
380080-072	72" Orange
380080-074	74" Black
380080-110	110" Black



380080-048



380080-060, 380080-074,  
380080-110



380080-072

## Retractable Seat Belts

Part Number	Description
380081-060	60" Black
380081-060-O	60" Orange
380081-072	72" Black



380081-060, 380081-072



380081-060-O

## Retractable Electric Seat Belts - Open

Part Number	Description
380082-060-E	60" Black
380082-060-OE	60" Orange
380082-072-E	72" Black



380082-060-E



380082-060-OE



380082-072-E

## Retractable Electric Seat Belts - Closed

Part Number	Description
380084-060-OE	60" Orange
380084-060-E	60" Black



380084-060-OE



380084-060-E

## Retractable Anti-Cinch Seat Belts

Part Number	Description
380083-060	60" Black
380083-060-O	60" Orange



380083-060



380083-060-O

## Retractable Anti-Cinch Electric Seat Belts

Part Number	Description
380085-060-E	Open 60" Black
380086-060-E	Closed 60" Black



380085-060-E



380086-060-E

### Notes:

Seat belts meet requirements of SAE J386 and FMVSS 302.

An open circuit, when wired, does not require the latch (male side) be inserted into the buckle in order to start the forklift. If wired to a buzzer or to an alarm, they will sound until the latch (male side) is inserted into the buckle or if wired to a dash lamp, the lamp will stay illuminated until the latch (male side) is inserted into the buckle. A closed circuit, when wired, requires that the latch (male side) be inserted into the buckle to complete the circuit in order to be able to start the forklift.

## LPG Tanks



### Steel Tanks

Part Number	Weight kg/lb	LPG Capacity l/gal	Cylinder Volume l/gal	Cylinder Diameter mm/in	Cylinder Height mm/in
340012-005	9.0/20.0	17.8/4.7	21.6/5.71	310/12.2	486/19.2
340012-008	15.2/33.5	29.9/7.9	36.3/9.59	310/12.2	692/27.3
340012-010	19.7/43.5	37.48/9.9	47/12.42	310/12.2	845/33.3

**Tanks include:** Quick fill valve, sight gauge, quick coupler, safety relief and fixed liquid level splitter.

**Notes:** Dimensions and capacities are approximate and may vary slightly. Can be filled or mounted vertically or horizontally. Three-year warranty.



### Aluminum Tanks

Part Number	Weight kg/lb	LPG Capacity l/gal	Cylinder Volume l/gal	Cylinder Diameter mm/in	Cylinder Height mm/in
340013-005	9.0/20.0	17.8/4.7	21.6/5.71	312/12.3	486/19.2
340013-008	15.2/33.5	29.9/7.9	36.3/9.59	312/12.3	692/27.3
340013-010	19.7/43.5	37.48/9.9	47/12.42	312/12.3	845/33.3

**Tanks include:** Quick fill valve, sight gauge, quick coupler, safety relief and fixed liquid level splitter.

**Notes:** Dimensions and capacities are approximate and may vary slightly. Can be filled or mounted vertically or horizontally. Three-year warranty.

### Tank Replacement Parts

Part Number	Description
340065-001	Sight Gauge with Dial Chamber
340065-002	Dial Chamber for 340065-001
340065-003	Male Quick Coupler
340065-004	Liquid Service Valve - turns gas off to truck
340065-005	1-3/4" Acme Fill Valve

### LPG Safety Valve

Part Number	Description
340400	LPG Safety Valve - 90°
340401	LPG Safety Valve - 45°



- Installs in just minutes
- Fits most all lift trucks
- Increases LPG cylinder exchange safety
- Increases speed of LPG cylinder changes
- Handle design covers the coupler, preventing the operator from disconnecting the hose while the valve is in the open position



## LPG Parts

Continued ▶



Part Number - 380001-001-01

### Converter VFF-30-2-IMP (OEM part)

**Replacement part:**  
Repair Kit - P.N. 380001-004-01

#### ▼ OEM Reference

AC 4870598	HY 258321	TC 53320-50401
AC 74870598	HY 287647	TY 00591-08206-81
AC 8641341	HY 3052453	TY 00591-31700-81
BK 105627	IMP VFF30-2	TY 00591-44714-81
CL 3675433	KO 34B-04-46310	TY 00591-51137-81
CL 6015-10340	MB 7N314	TY 23640-U2000-71
CL 923048	MB 91865-03100	YT 505966558
CT 7N314	MB C0053321	YT 904990600
CT 91865-03100	ME CHI70269-001	
CT 9326500070	NI 16245-VFF30	
HY 0258321	NI 16400-90H71	
HY 0287647	NI NF91865-13100	



Part Number - 380001-002-01

### Converter JB-2 (OEM part)

**Replacement part:**  
Repair Kit - P.N. 380001-005-01

#### ▼ OEM Reference

AC 74830760	CT 93265-30800	IMP 1040397
AC 74884393	CT 93465-10010	IMP 1085401
AC AC4830760	HY 195193	IMP 1085402
CL 932437	HY 196193	IMP JB
CL 2360140	HY 213549	IMP JB-2
CT 93165-03100	HY 3004951	KO JB
CT 93165-13100	HY 3052059	NI NI16010-JBREG
CT 93265-10060	IMP 1015871	TC 53320-50501
CT 93265-10080	IMP 1015887	TY 23530-2280071
CT 93265-20800	IMP 1015971	YT 5170798-00



Part Number - 380001-003-01

**Converter Cobra (OEM part)**

Replacement part:  
Repair Kit - P.N. 380001-006-01

▼ OEM Reference

CL 923049	HY 1458025	YT 520002399
CL 932435	HY 2023640	YT 520037830
CT 91465-0020	HY 2026468	YT 580002388
CT 93165-23100	IMP COBRA	YT 580002399
DOS A218012	NI 6016-10330	
DW A218012	YT 505959551	



Part Number - 380001-008-01

**Regulator LPG (OEM part)**

▼ OEM Reference

TY 23530-U1100-71
TY 23530-U1101-71
TY 23530-U1102-71
TY 23530-U1103-71
TY 23530-U1104-71



Part Number - 380001-004-01

**Repair Kit VFF30-2 (380001-001-01) (OEM part)**

▼ OEM Reference  
KO RK-VFF30-2



Part Number - 380001-007-01

**Repair Kit CA100/CA125 (OEM part)**

▼ OEM Reference

AC 4906962	JU 141150106	TY 00591-05456-81
BK 3155729000	JU 14348300	TY 00591-14729-81
CL 4339780	JU 14348310	TY 00591-31729-81
CL 448383	JU 14348320	TY 00591-31741-81
CL 998838	LI 9810306	TY 00591-51156-81
CT 91865-06400	LI D3155729000	YT 220079907
DW 7W5191	MB 7W5191	YT 505963504
DW D700725	MB A0000-00355	YT 505963589
HY 204782	MB LM4AHN9223	YT 516987805
HY 1358246	NI CK998838	YT 520045894
HY 1358247	PG AV1-14-1	YT 900971806
HY 3052003	PG AV1-14-4	YT 900971809
HY 3069660	PG N00-7426A	YT 900971837
IMP AV1-14-4	TC 52050-59871	YT 902249814
JU 14115000	TC DET000997	
JU 14115010	TY 00591-04117-81	



Part Number - 380001-005-01

**Repair Kit JB2 (380001-002-01) (OEM part)**

▼ OEM Reference

BK 105593I	MB MIC-0053100I	TY 00591-64562-81
HY 3004958I	MB MIC-0053110I	TY 04255-U20117I
IMP RKJ	MB MDI-700210I	YT 517080800I
MB 93165-03110I	TY 00591-14708-81	YT 900969823I
MB MDI-700210I	TY 00591-44723-81	



Part Number - 380001-013-01

**Vaporizer K21-K25 (OEM part)**

▼ OEM Reference

HAM 8777431	HAM 16310-GS40A	NI 16310-GS40A
HAM 8779362	HAM 16310-GU20A	NI 16310-GU20A



Part Number - 380001-006-01

**Repair Kit Cobra (380001-003-01) (OEM part)**

▼ OEM Reference

CL 920165	HY 2026721	TY 00591-14711-81
CL 923292	IMP RK-COBRA	YT 518807650
CL 932698	IMP RK-K	YT 580007732
CT 93165-13110	IMP RK-K-2	YT 902057822
DW A213955	IMP N00-6314A	YT 902057825
HY 1375031	JU 14518910	YT 902057827
HY 1459717	MB 93165-13110	YT 924088300
HY 2023646	NI NF93165-13110	
HY 2023647	TY 00591-14608-81	
HY 2026467		



Part Number - 380001-012-01

**Vaporizer Assembly K21-K25 (OEM part)**

▼ OEM Reference  
KO 16310-FT860



Part Number - 380001-015-01

**Vaporizer Nikki (OEM part)**

▼ OEM Reference

AC AC8772296	NI 16310-GS00A	NI 16310-GY36B
CT 91A65-01601	NI 16310-GS00C	NI 16310-GZ560
CT 91A65-21600	NI 16310-GY361	TC 547C0-52001



# LPG Parts



Part Number - 380030-069

**Repair Kit  
K21-K25 (OEM part)**

For 380001-012 & 38000105-01 vaporizers

▼ OEM Reference

CT 90425-08490	KO 16328-GY010	NI 16328-GY010
CT 91965-07500	NI 16328-GS00A	



Part Number - 380001-011-02

**O Ring Outer Flat  
7141M3**

▼ OEM Reference

AG 7141M3	PG 7141M3	TY 00591-31740-81
IN LPG-1066	RE 7141M-3R	TY 00591-51127-81
IN LPG-1073	TY 00591-31734-81	YT 064926500



Part Number - 380001-016

**Repair Kit**

For vaporizers 380001-012-01 & 380001-015-01

▼ OEM Reference

NI 16310-RPKIT



Part Number - 380001-010-01

**Connector LPG Male  
(OEM part)**

▼ OEM Reference

KO 7141M	CT 9316503500	PG 7141M
AC 4737405	CT 9316503500	PG C-971-4
BK 9Y11864	CT MIC0053089	PG REGO7141M
CL 6016-10470	GA 557-03	RE 7141M
CL 715977	HY 0124010	TC 7141M
CL 926118	HY 3051152	TY 00591-07633-81
CT 0049099	MB 9136103501	TY 00591-31696-81
CT 1085332	MB 9136113500	TY 00591-51085-81
CT 1085392	MB 9300201300	WM 35A9481
CT 49099	MB 9316503500	WM 35P517
CT 9136103500	MB MIC0053089	YT 054966400
CT 9136103501	NI 78001-7141M	YT 136350101
CT 9136113500	NI 7B001-7141N	YT 220050483
CT 9300201300	NI CK715977	YT 520035885



Part Number - 380001-014-02

**Torque Converter  
(Brand New)**

▼ OEM Reference

KO 30B-13-11110



Part Number - 064423

**Connector LPG Female  
(OEM part)**

▼ OEM Reference

KO 7141-F	HM 7141F	PG REGO7141F
AC 4738548	HY 0097999	RE 7141F
BK 101411	HY 97999	TY 00591-07632-81
BK 9Y11863	JL 2180387	TY 00591-11157-81
CL 655335	KO 7141F	TY 00591-31692-81
CL 715976	LP 225-6267	TY 00591-51083-81
CL 866176	MB 1015874	TY 23560-U2100-71
CL 926119	MB 93165-03600	TY 23560-U2101-71
CT 0045019	MB 93165-03800	WM 35A9482
CT 1015874	MB LM40AQ5019	WM 35P519
CT 45019	MB LM40AQ5019	YT 054966300
CT 9316503600	MB MDI700050	YT 136350102
CT 93165-03800	MB MIC0053011	YT 220014644
CT LM40AQ5019	MR E7141F	YT 220050482
CT MIC-0053011	NI 78001-7141F	YT 251102100
DW 045019	NI NF93165-03600	YT 505966505
DW D700178	PG 7141F	YT 912514300
GA 557-04	PG C-971-3	



Part Number - 137811

**Clamp Toggle LP Tank**

▼ OEM Reference

KO TB260



Part Number - 136232

**Clamp Toggle LP Tank**

12.16" diameter  
2" width



Part Number - 380005-001-01

**Starter H20-H20II-H25  
(OEM part)**

Teeth (9)

▼ OEM Reference

AC 4948522	KO 23300-K9160	NI 91H20-03330
AC 4967525	NI 23300-K9160	TC 23300-K9160



Part Number - 380005-006-01

**Starter H20  
(OEM part)**

Teeth (8)

▼ OEM Reference

AC 4942421	NI 23300-00H10	NI 23300-L2912
KO 23300-00H10	NI 23300-00H11	TC 23300-00H10
KO 23300-00H11	NI 23300-L2910	
MB M3T21882D	NI 23300-L2911	



Part Number - 380005-002-01

**Starter 4P-4Y-5R-5P  
(OEM part)**

Teeth (9)

▼ OEM Reference

TC 212T1-07201  
TY 28100-20553-71  
TY 28100-20553  
TY 28300-22003  
TY 90928-29006-71



Part Number - 380005-008-02

**Starter K21-K25**

Teeth (9)

▼ OEM Reference

KO 23300-GS20A	MB 91H2003330	SY SN0143
CT 91H2003330	NI 23300-FU410	TC N-23300-FU410
KO 23300-FU410		



Part Number - 380005-003-01

**Starter VA-F2-FE  
(OEM part)**

Teeth (8)

▼ OEM Reference

HY 2314322  
YT 918139600



Part Number - 380005-009-02

**Starter GM 2.4L**

Teeth (9)

▼ OEM Reference

HY 1548620	HY 80-1406	HY 9000890
HY 300-1555	HY 800136352	YT 5800448-85



Part Number - 380005-004-01

**Starter 4G63-4G64  
(OEM part)**

Teeth (10)

▼ OEM Reference

AC 4920209	CT MD320618	MB MD171228
CL 911410	DW A218315	MB MD320618
CL 918306	KM 4920209	MD 320618
CL 920971	MB M002T-58681	NI MD171228
CT M002T-58681	MB M2T58581	NI MD320618
CT MD171228		



Part Number - 380005-011-02

**Starter F2 & FE**

Teeth (8)

▼ OEM Reference

HY 1534424-NEW  
HY 2314322-NEW  
TC TFFSC18400-NEW  
YT 580040914-NEW  
YT 918139600-NEW



Part Number - 380005-005-02

**Starter GM 3.0L**

Teeth (11)

▼ OEM Reference

CL 2817056	DR 9000822	JU 50018782
CL 925874	DR 9000850	JU 50137926
CL 930707	HY 1374621	SB 8156144
CL 933605	HY 1391321	YT 220044332
CT A0000-05846	HY 1457047	YT 580000049
DR 10455012	HY 1486530	YT 580002210
DR 9000820	HY 1650426	YT 580019725



Part Number - 380005-012-02

**Starter Yanmar 2.6L Diesel**

Teeth (9)

▼ OEM Reference

HY 1599845-NEW  
KM 8762412-NEW  
KO YM129900-77010N  
YT 580062748-NEW

## Starters



Part Number - 380005-013-02

**Starter TB45**  
Teeth (9)

▼ OEM Reference  
CT 90425-02580-N  
KM 4968855-NEW  
NI 23300-52H00-N



Part Number - 380005-014-02

**Starter C240 XM Diesel**  
Teeth (9)

▼ OEM Reference  
HY 1519632-NEW  
HY 1519632



## Starter Replacement Parts



Part Number - 380005-050

**Starter Drive**

▼ OEM Reference  
HY 2314328  
TC TB63018X45  
YT 9023618-06



Part Number - 380005-051

**Starter Solenoid**

▼ OEM Reference

HM 520	HY 2314342	YT 901286817
HM 555	TC T-4894-24-760	YT 901991817
HY 1368862	TC TFESE18X10	YT 902361820
HY 1574092	YT 580053798	



**Eye Wash Stations**  
Now Available.  
See Page 2.07



**Triple Load Wheel,**  
Your Flat Spotting  
Solution.  
See Page 10.07



**Anti-Blind Spot**  
Mirrors Now  
Available.  
See Page 2.12



# Alternators



Part Number - 380011-001-01

**Alternator K21-K25  
(OEM part)**

▼ OEM Reference

AC 8762055	CT 91H20-03270	NI 23100-FU410
AC 8772271A	MB 91H20-03270	TC N-23100-FU410



Part Number - 380011-002-01

**Alternator 4Y - GN81-41  
(OEM part)**

▼ OEM Reference

KO TJ27060-78003-71	TC 212T1-06941	TY 27060-78003-71
KO TJ270607800371	TY 00591-10795-81	YT 220042179
ND 100211-4540	TY 00591-50056-81	



Part Number - 380011-003-02

**Alternator 4Y**

▼ OEM Reference

TY 27060-78153-71  
TY 27060-78156-71  
TY 27060-78158-71



Part Number - 380011-005-01

**Alternator D5-F2-FE  
(OEM part)**

▼ OEM Reference

HY 1361853	YT 505960560	YT 580026829
HY 1450928	YT 5800009-90	YT 901948801
JU 14485060		



Part Number - 380011-006-02

**Alternator 4G52-4G54**

▼ OEM Reference

AC 4789142	CL 907739	JU 14705000
CL 2363677	CL 908106	PL 110-460
CL 2383064	CL 908221	PL 8AR2200L
CL 2399509	CT 2I3346	SG 2383064
CL 2399511	HY 3029189	TY 00591-21035-81
CL 2807382	HY 3046654	TY 00591-27362-81
CL 6513962	HY 385656	TY 00591-33616-81
CL 6599739	JU 1470500	YT 220005010
CL 905949		



Part Number - 380011-004-02

**Alternator H20-P40-TB42**

▼ OEM Reference

AC 4949046	HY 3020078	NI 23100-M0401
BO 986032431	KO 23100-B9810	NI 23100-M0402
BO 986033481	MB A1T20271	NI 23100-M0410
CL 7000289	MB A1T21171	NI 23100-U0111
CT A0000-02071	MB A1T22581	NI 23100A4602
FL 2475677210	MB A1T24371	NI 23100A4800
HA LT125-04	MB AG2025A	NI 23100A4810
HA LT125-06B	MB AG2030A	NI 23100A5500
HA LT130-41K	MB AG2035A	NI 23100A5501
HA LT130-65	MB AG2035A2	NI 23100A5502
HA LT130-72	MB AG2035N1	NI 23100B8001
HA LT130-72B	MB AH2035N1	NI 23100B8002
HA LT130-75	MZ GE01-18-300	NI 23100E5200
HA LT135-13	NI 23100-06000	NI 23100H0100
HA LT135-13B	NI 23100-A4602	NI 23100H0110
HA LT135-17B	NI 23100-A4800	NI 23100H0300
HA LT135-19B	NI 23100-A4810	NI 23100H0310
HA LT135-19C	NI 23100-A5500	NI 23100M0400
HA LT135-19E	NI 23100-A5501	NI 23100M0401
HA LT135-20	NI 23100-A5502	NI 23100M0402
HA LT135-24	NI 23100-B8001	NI 23100M0410
HA LT135-35	NI 23100-B8002	NI 23100M0410
HA LT135-35B	NI 23100-B9802	NI 23100U0111
HA LT135-35C	NI 23100-B9810	TC 53032-72601
HA LT135-54	NI 23100-B9810-B	TC N-23100-B9810
HA LT135-68	NI 23100-E5200	TC N-23300-B9810
HA LT135-69	NI 23100-H0100	TY 00591-33739-81
HA LT150-25	NI 23100-H0110	TY 00591-55972-81
HA LT150-25B	NI 23100-H0300	YT 150014500
HC LT135-68	NI 23100-H0310	YT 150022504
HY 1310962	NI 23100-M0400	YT 901285801



Part Number - 380011-007-02

**Alternator H20**

▼ OEM Reference

AC 4942402	NI 23100-H7703	NI 23100-U0114
AC 4947935	NI 23100-M0413	NI 23100-U4601
CT 971562	NI 23100-M0414	TC 23100-M0413
KO 23100-C6000	NI 23100-M6601	TC 23100-U0103
KO 23100-M0413	NI 23100-U0100	TC N-23100-C6000
KO 23100-M0414	NI 23100-U0102	TC N-23100-M0413
KO 23100-U0105	NI 23100-U0103	TC N-23100-M0414
NI 23100-A4600	NI 23100-U0104	TC N-23100-U0100
NI 23100-A4601	NI 23100-U0105	TC N-23100-U0102
NI 23100-A4611	NI 23100-U0110	TC N-23100-U0103
NI 23100-C6000	NI 23100-U0112	TY 00591-08089-81
NI 23100-H6215	NI 23100-U0113	



Part Number - 380006-001-02  
**Water Pump H20 New Style**

▼ OEM Reference

AC 4942349	KO 21010-L1125	NI 21010-L1128
AC 4969885	KO 21010-L1126	TC N-21010-L1100
CL 7000507	KO 21010-L1128	TC N-21010-L1125
CT 0971264	KO 64-101	TC N-21010-L1126
CT 971264	NI 21010-L1100	TY 00591-07978-81
HY 3041677	NI 21010-L1101	TY 00591-32887-81
HY 3045360	NI 21010-L1125	TY 00591-50484-81
KO 21010-L1100	NI 21010-L1126	YT 220007606
KO 21010-L1101		



Part Number - 380006-005-02  
**Water Pump 4G63-4G64**

▼ OEM Reference

CT 1041579	CT MD970338	MB MD970338
DW A218276	CT MD972457	MB MD972457



Part Number - 380006-006-02  
**Water Pump GM 3.0L**

▼ OEM Reference

CL 924942
DW A218653
HY 388365
TY 16100-U2120-71



Part Number - 380006-002-02  
**Water Pump K21-K25**

Includes 8 fins; the impeller is flush with the housing

▼ OEM Reference

AC 8761949	NI 21010-50K01	NI 21010-P7526
CT 91H20-02580	NI 21010-50K02	YT 220024192
DW D490720	NI 21010-FU425	



Part Number - 380006-007-02  
**Water Pump 4Y 5-6 Series**

▼ OEM Reference

CL 446097	TY 00591-32889-81	TY 16120-96151-71
HY 3046758	TY 00591-53193-81	YT 220010746
TY 00591-10723-81	TY 16120-78151-71	



Part Number - 380006-003-02  
**Water Pump HER2.7-1404**

▼ OEM Reference

AC 4948821	DW 2W8554	KO HE40-2035079
CT 1W0404	DW 4W1583	MB 9Y5969
CT 1W404	DW 9Y5969	MB D700615
CT 4W1583	DW D700615	MB MCF00036
CT 9Y5969	HY 402035079	NI D700615
CT D700615	KO HE40-2035063	TY 00591-05705-81
CT MCF00036	KO HE40-2035078	YT 220007160



Part Number - 380006-009-02  
**Water Pump VA**

▼ OEM Reference

CT 219273	HY 326774	YT 220007409
HY 1339931	HY 326779	YT 220070181
HY 1376005	TY 00591-34296-81	
HY 3002535	TY 00591-54109-81	



Part Number - 380006-004-02  
**Water Pump FE**

▼ OEM Reference

CL 7000511	JU 14520447	YT 220079608
HY 1361811	MZ FE7915010C	YT 5059605-79
HY 2022312	TY 00591-22426-81	YT 901302802
JU 14365400	TY 00591-32891-81	
JU 14365450	TY 00591-61180-81	



Part Number - 380006-010-02  
**Water Pump 4Y 7 Series**

▼ OEM Reference

TC 212T1-09451
TY 16110-78156-71



Part Number - 380006-011-02  
**Water Pump H20II-H25**

Includes 6 fins; the impeller is raised out from the housing

▼ OEM Reference

CT A0000-00429	KO 21010-50K29	TC N-21010-50K28
KO 21010-50K26	KO 21010-FF225	TY 00591-21011-81
KO 21010-50K28	KO 64-102	TY 00591-34284-81
	TC N-21010-50K26	TY 00591-54104-81

**Note:** All water pumps include gasket

## Pumps



Part Number - 380006-013-01  
**Transmission Charging Pump**

▼ OEM Reference  
 KO 30B-13-11200

## Radiators and Accessories

Continued ▶



Part Number - 380009-001-02  
**Radiator**

▼ OEM Reference  
 AC 8761212  
 KO 3EB-04-A5111



Part Number - 380009-007-02  
**Radiator K21-K25**

▼ OEM Reference  
 KO 3EB-04-A6110



Part Number - 380009-002-02  
**Radiator**

▼ OEM Reference  
 TY 16410-F1100-71  
 TY 16410-U2200-71  
 TY 16410-U2201-71



Part Number - 380009-008-02  
**Radiator**

▼ OEM Reference  
 KO 3EA-04-51110  
 HAM 3EA-04-51110



Part Number - 380009-003-02  
**Radiator**

▼ OEM Reference  
 NI 21460-90H15  
 NI 21460-90H15-D



Part Number - 380009-009-01  
**Radiator**

▼ OEM Reference  
 TY 16420-U1280-71



Part Number - 380009-004-02  
**Radiator**

▼ OEM Reference  
 NI 21460-6G000  
 NI 21460-6G100  
 NI 21460-6G101  
 NI 21460-G6000



Part Number - 380009-100  
**Lower Hose**

▼ OEM Reference  
 HY 2064054  
 YT 5800442-23



Part Number - 380009-107  
**Lower Hose**

▼ OEM Reference

KO 3EB-04-23220  
 KO 3EB-04-A5121

KO 3EB-04-A5122  
 KM 8761217  
 KM 4949229



Part Number - 380009-005-02  
**Radiator**

▼ OEM Reference  
 CT A0000-12933  
 TY 16410-23010-71  
 TY 16410-23070-71  
 TY 16410-U2000-71



Part Number - 380009-101  
**Upper Hose**

▼ OEM Reference  
 HY 2064053  
 YT 5800442-22



Part Number - 380009-006-02  
**Radiator**

▼ OEM Reference  
 NI 21460-24H10  
 NI 21460-90H10



Part Number - 380009-108  
**Upper Hose**

▼ OEM Reference

TY 16511-12810-71  
 TY 16511-16640-71

KO 3EB-04-A5131  
 KO 3EB-04-A5132  
 KM 8761218

## Radiators and Accessories



Part Number - 380009-109

### Hose

▼ OEM Reference

CT 91H20-02770	KA 8761960	NI 14080-50K00
DA D490732	MI 91H20-02770	



Part Number - 380009-110

### Hose

▼ OEM Reference

KO 8777797	KO 3EB-04-A7520
KO 8779168	KO 3EB-04-A7521



Part Number - 380009-102

### Radiator Cap

▼ OEM Reference

HY 1352140  
YT 5059725-63



Part Number - 380009-104

### Radiator Cap

▼ OEM Reference

AC 4949074	HAM 3EB-04-21130	NI 21430-91H00
AC 8761209	HAM CPC89C0025010	NI 21430-FK300
CL 925303	HAM CPC89C0175010	TC 222A2-10211
CL 926014	HY 2022397	TY 16401-23000-71
CT 42713-30600	KM 4949074	TY 16401-U2000-71
HAM 4949074	KM 8761209	YT 901900802
HAM 4949228	KO CPC89C0025010	YT 901913802
HAM 8761209	KO CPC89C0175010	
HAM 8782583	NI 21430-01F02	



Part Number - 380009-105

### Thermostat/Gasket

▼ OEM Reference

AC 8761954	HY 301793	KO 6140-11-6310
AC 8772261	KM 8761954	NI 21200-58G04
CT 32A46-02100	KO 01NI21200-VJ200	NI 21200-96015
CT 91H20-02680	KO 21200-0C811	NI 21200-96061
HAM 8761954	KO 21200-50K00	NI 21200-0C811
HAM 8772261	KO 21200-53J00	NI 21200-VJ200
HAM 21200-0C811	KO 21200-VJ200	NI 21200-VJ200D
HAM 21200-50K00	KO 21200-VJ200K0	NI 21200-VJ200N
HAM 21200-53J00	KO 600-421-6110	NI 21200-VJ200S
HAM 21200-VJ200	KO 600-421-6210	TUSK 8761954



Part Number - 380009-106

### Thermostat/Gasket

▼ OEM Reference

CL 907438	HY 1495428	TY 80916-76065-71
CL 911166	HY 151570	TY 80916-76085-71
CL 913788	HY 231522	TY 90916-03037
CL 920235	HY 324370	TY 90916-03954-71
CL 925020	KM 4920199	YT 524253576
CT 91920-05100	KM 4942370	YT 580000179
DW A218287	NI 21200-G3100	YT 580000381
HY 1361820	TY 16302-U2120-71	YT 580024168
HY 1450643	TY 80916-76032-71	YT 9012828-47
HY 1450696	TY 80916-76033-71	



Part Number - 380009-103

### Thermostat

Includes O-Ring

▼ OEM Reference

HY 1584121  
YT 5800569-45

(IC) Truck  
Components

## Brake Cylinders



Part Number - 380021-001-02

### Brake Cylinder

▼ OEM Reference

AC 8761597  
AC 8766117  
KO 3EB-36-31280  
KO 3EB-36-31281  
KO MY022-8098-00  
TY 00591-27394-81



Part Number - 380021-003-02

### Brake Cylinder

▼ OEM Reference

CL 7001081	JU 14495460	TY 00591-58023-81
HY 1347048	MA M45110	YT 220037522
HY 3057522	TY 00591-35435-81	YT 505963537



Part Number - 380021-004-02

### Brake Cylinder

▼ OEM Reference

CL 7001049	MB 1015776	RA 750
CT 1015776	MB 91484-17100	RA 990-253
CT 1015777	MB 91484-27100	TY 00591-35379-81
CT 91484-17100	MB 91484-27101	TY 00591-58010-81
CT 91484-27100	MB 91484-37100	TY 47530-42100-71
CT 91484-27101	RA 1-164-912	
CT 91484-37100	RA 1-164-915	



Part Number - 380021-002-02

### Brake Cylinder

▼ OEM Reference

CT 91346-40300  
CT 93146-02500  
CT 93146-12500  
MB 93146-02500  
MB 93146-12500



Part Number - 380020-008-02-R

**Shoe - Right Hand (2)**

▼ OEM Reference  
 HY 1565314  
 KO 3EB-K3-0204C  
 YT 5800513-33  
 YT 524248309



Part Number - 380020-008-02-L

**Shoe - Left Hand (2)**

▼ OEM Reference  
 HY 1565313  
 KO 3EB-K3-0203C  
 YT 5800513-32  
 YT 524248308



Part Number - 380020-001-02

**Brake Shoe Kit (4)**

▼ OEM Reference  
 AC 8762610  
 KO 3EB-30-A31180  
 NI 44999-22H00



Part Number - 380020-002-02

**Brake Shoe (2)**

A pin is included in this kit to make it adaptable for RH or LH use. Kit includes 2 shoes to do one side of the truck. Need to order 2 kits if doing both sides.

▼ OEM Reference

TC 20803-71151	KO 3EA-30-1144C	TY 47510-U113071
TC 20803-71161	KO 3EA-30-1145C	TY 47520-U113071



Part Number - 380020-003-02

**Brake Shoe (2)**

▼ OEM Reference  
 HY 1334620  
 YT 1500132-07  
 YT 5059595-61  
 HY 1363007



Part Number - 380020-004-02

**Brake Shoe (1)**

▼ OEM Reference

AC 8761527	KO 3EB-30-31150	TY 47503-3386071
AC 8761528	KO 3EB-30-31160	TY 47504-3386071
AC 8761529	KO 3EB-30-31170	TY 47505-3386071
CT 91446-17100	NI 44060-22H60	TY 47512-3306071
CT 91546-12500	NI 44070-22H60	TY 47513-3306071
CT 91546-12600	NI 44070-22H70	TY 47514-3306071



Part Number - 380020-007-02

**Brake Shoe Kit (4)**

▼ OEM Reference

AC 4940527	KO 3EA-30-31160	NI 44070-11H16
AC 4940532	KO 3EA-30-31170	NI 44070-FJ500
AC 4940535	MB 91246-16800	NI 44070-FJ510
CT 91B46-10313	MB 91246-16900	TY 47403-12810-71
CT 91B46-10314	MB 91246-17100	TY 47403-13300-71
CT 91B46-10412	NI 44060-00H60	TY 47403-16600-71
DW A273363	NI 44060-11H03	TY 47404-12810-71
DW A273364	NI 44060-11H06	TY 47404-13300-71
DW A273365	NI 44060-FJ500	TY 47404-16600-71
KO 32532-21500	NI 44060-L0105	TY 47405-12810-71
KO 32532-21600	NI 44070-00H60	TY 47405-13000-71
KO 3EA-30-11410	NI 44070-00H70	TY 47405-13300-71
KO 3EA-30-11420	NI 44070-0K301	TY 47405-1660071
KO 3EA-30-11430	NI 44070-0K311	TY 47505-1300071
KO 3EA-30-31150	NI 44070-11H06	TY 47506-1300071



Part Number - 380020-006-02

**Brake Shoe (2)**

▼ OEM Reference

HY 1334640	YT 5059635-91	TC CK21122083000
HY 1358223	YT 5800326-88	KO 3EB-30-2300K
HY 1515374	YT 9182593-00	KO 3EB-30-23450
TC 22433-79901	YT 9301324-00	



Part Number - 380020-010-02

**Brake Shoe (2)**

▼ OEM Reference

CL 932683	KO 3EB-30-3158C	TY 47510-U2130-71
CL 932684	KO 3EB-30-3159C	TY 47520-U2130-71



Part Number - 380020-011-02

**Brake Shoe (2)**

▼ OEM Reference

HY 1463226	KM 8761128	KO 3EC-30-11840
HY 1463229	KO 3EC-30-11601	YT 580011203
HY 2047122	KO 3EC-30-1162LH	YT 580011206
HY 2047123	KO 3EC-30-1172RH	YT 902392851
KM 8761124	KO 3EC-30-11830	YT 902392861





Part Number - 380020-012-02  
**Brake Shoe (2)**

▼ OEM Reference  
HY 2026303  
HY 2026787  
YT 927113300  
YT 929151300



Part Number - 380030-057  
**Spring**

▼ OEM Reference  
CT 91246-03400 NI 44070-L0100 TY 47635-10110-71  
KM 4941373 NI 44090-L1400 TY 47675-11630-71  
KO 300-32-31760 TC C521100304010 TY 47675-U1130-71



Part Number - 380020-013-02  
**Brake Shoe (2)**

▼ OEM Reference  
HY 1591664  
YT 580059824



Part Number - 380030-059  
**Spring**

▼ OEM Reference  
CL 932574 MB 91446-03900 TY 47438-U2130-71  
KM 4942605 NI 44090-22H00  
KO 3EC-30-11340 TY 47438-32060-71



Part Number - 380020-014-02  
**Brake Shoe (2)**

▼ OEM Reference  
HY 1591665  
YT 580059825



Part Number - 380030-025  
**Spring**

▼ OEM Reference  
CL 932575 KO 8763193 NI 44147-22H00  
HY 2037340 KO 8765283 TY 47472-21801-71  
KM 4920659 KO 3EB-30-31320 TY 47472-U2130-71  
KM 8763193 KO 3EC-30-11360 YT 900955827  
KO 4942607 KO 3EC-30-31320  
KO 8761532 MB 91846-12500



Part Number - 380020-015-02  
**Brake Shoe (1)**

▼ OEM Reference

KM 4940946 KO 3EB-30-23440 TY 47403-32062-71  
KM 4940947 KO 3EB-30-24430 TY 47404-32062-71  
KO 3EB-30-23430 KO 3EB-30-24440



Part Number - 380030-100  
**Spring Kit (2)**

▼ OEM Reference  
HY 1334638  
HY 1565316  
YT 580051335  
YT 913589300



Part Number - 380030-031  
**Spring**

▼ OEM Reference

CT 91246-04500 NI 44147-00H00 TY 47472-11631-71  
KM 4940538 NI 44147-11H04 TY 47472-U1130-71



Part Number - 380023-002  
**Plate, Disk Brakes**

▼ OEM Reference  
DW D700251



Part Number - 380030-024  
**Spring**

▼ OEM Reference

AC 4942534 KO 4942534 NI 44090-22H10  
CL 932573 KO 4942606 TY 47434-32500-71  
CT 91846-14100 KO 4968244 TY 47438-33060-71  
KM 4942534 KO 34B-30-14351 TY 47438-U3130-71  
KO 4941616 KO 3EC-30-11350



Part Number - 380023-003  
**Friction Plate, Disk Brakes**

▼ OEM Reference  
DW D141112



## Miscellaneous Brake Parts



Part Number - 380020-005-02

### Brake Pad (1)

▼ OEM Reference  
 TY 47117-1224071  
 AC 4943897  
 CT 97046-21800  
 TC C51M001507405  
 KO 3BA-30-31731



Part Number - 380023-004

### Sheave, Brake



▼ OEM Reference  
 HY 1334644      KO 3EC-30-11180      YT 919139450  
 KO 4944644      MB 91446-03800  
 KO 3BB-30-12180      NI 44025-22H00



Part Number - 380023-001-02

### Brake Pedal Cover

▼ OEM Reference

AC 8761606	KO 3EB-36-31130	TY 31319-22000-71
CL 446183	TY 00591-10808-81	TY 31319-23000-71
CL 7000977	TY 00591-35270-81	YT 220004289
CT 0971315	TY 00591-53231-81	
HY 3045352	TY 31319-20540-71	



Part Number - 380030-075

### Emergency Brake Handle

▼ OEM Reference  
 KO 3EB-39-41112



Part Number - 380023-005

### Accelerator Pedal



▼ OEM Reference  
 HY 1383672  
 YT 915356400

## Pipes



Part Number - 380007-001-02

### Exhaust Pipe

▼ OEM Reference  
 AC 4949214  
 KO 3EB-03-22110  
 TY 00591-06324-81



Part Number - 380007-002-02

### Exhaust Pipe

▼ OEM Reference  
 KO 3EB-03-35311

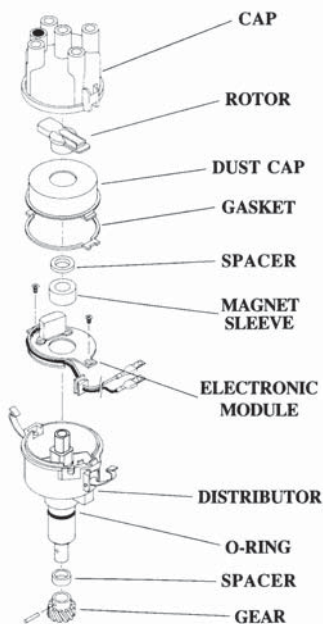

Part Number - 380012-002-02

**Distributor - H20II**

▼ OEM Reference

AC 8762077	NI 22100-50K15
AC 8762122	NI 22100-55K10
DW D490742	TC N-22100-50K10
KO 20-203	TY 00591-27353-81
KO 22100-50K10	TY 00591-42798-81
KO 22100-50K15	
KO 22100-55K10	
NI 22100-50K10	



Part Number - 380012-001-02

**Distributor Cap - H20II**

▼ OEM Reference

AC 8762078	NI 22162-55K10
DW D490743	TC 22162-55K10
KO 22162-55K10	TC 22162-55K11
KO 25-011	TY 00591-23165-81



Part Number - 380015-001-02

**Rotor - H20II, 4G63, 4G64**

▼ OEM Reference

AC 8762079	DW A218357	MB MM611850
BR CK923627	DW D490744	MB T880T-18972
CL 4335223	HN MD618262	NI 22157-55K10
CL 923627	HY 3142510	NI 22157-55K15
CT 91H20-04710	KO 22157-55K10	NI CK923627
CT 9I4658	KO 26-011	RN J5-5610
CT MD611817	MB 91H20-04710	RN J5-5611
CT MD618262	MB 9I4658	TC N-22157-55K10
CT MM611850	MB MD611817	TY 00591-23164-81
CT T880T-18972	MB MD618262	YT 220025671



Part Number - 380012-003-02

**Distributor - 4Y**

▼ OEM Reference

CT A0000-14798	TY 19030-78151-71
ND 290000621	TY 19030-78154-71
TC 212T1-06101	TY 19030-96150
TY 19030-78150-71	



Part Number - 380012-004-02

**Distributor Cap - 4Y**

▼ OEM Reference

CL 7000255	TY 00591-53200-81
CT 2I5154	TY 19101-71010-71
HY 3048471	TY 19101-76007-71
TC 212T1-06111	TY 19101-76013-71
TY 00591-10752-81	YT 220004547
TY 00591-32688-81	



Part Number - 380015-002-02

**Rotor - 4Y**

▼ OEM Reference

CL 446130	TY 00591-10757-81	TY 19102-73020
CT 2I5133	TY 00591-63393-81	TY 19102-73021
HY 3046813	TY 19102-16020	TY 19102-73180
HY 3133089	TY 19102-16040	TY 19102-76007-71
HY 3143266	TY 19102-33010-71	TY 19102-76009-71
RN J5-5613	TY 19102-63010-71	TY 19102-76013-71
TC 212T1-06121		



Part Number - 380014-006-02

**Ignition Wire Set - H20II**

▼ OEM Reference

DW D490816	NI 22450-50K25	TC 20801-0K042
KO 22450-50K25	NI 22450-50K50	TC N-22450-50K50
KO 22450-50K50	NI 22450-50KA0	TY 00591-33605-81
KO 22450-50KA0	TC 20801-0K041	TY 00591-56038-81



Part Number - 380012-013-02

**Distributor Cap - Hercules**

Style - DC-27

▼ OEM Reference

CL 443487	KM 4911926
DW D700696	MB 7N7542



Part Number - 380014-001-02

**Ignition Wire Set - 4Y**

▼ OEM Reference

TC 20801-0K052	TY 80919-76106-71
TC 212T1-08551	TY 90919-22132
TY 80919-76102-71	



Part Number - 380012-005-02

**Distributor - H20**

▼ OEM Reference

AC 4942371	NI 22100-71317
CL 445285	NI 22100-74011
CL 7000308	NI 22100-K7201
CT 0971564	TC N-22100-49207
HY 3123249	TC N-22100-71306
KO 20-200	TC N-22100-71317
KO 22100-K7201	TC N-22100-K7201
NI 22100-49206	TY 00591-07207-81
NI 22100-49207	TY 00591-32718-81
NI 22100-49210	TY 00591-51220-81
NI 22100-71305	YT 220024204
NI 22100-71306	YT 220025194
NI 22100-71315	



Part Number - 380015-008-02

**Rotor - H20, J15**

▼ OEM Reference

AC 4942380
KO 22157-05M02
KO 37Z-02-HR901



Part Number - 380012-011-02

**Distributor Cap - 4G32-52-54, H20, A15**

▼ OEM Reference

AC 4920234	KO 22162-R9006	SG MD611686
AC 4921224	KO 22162-R9007	TC N-22162-25G10
AC 4949023	MB 1017046	TC N-22162-25G11
CL 3779914	MB MD602756	TC N-22162-R9006
CL 7000312	MB MD602949	TC N-22162-R9007
CL 909351	MB MD607597	TY 00591-03628-81
CL 916005	MB MD611686	TY 00591-31074-81
CT 0971276	MB T232T-46772	TY 00591-32686-81
CT 0971771	NI 22162-11E07	TY 00591-33765-81
CT 1017046	NI 22162-17M01	TY 00591-33766-81
CT 971276	NI 22162-17M03	TY 00591-51412-81
CT 971771	NI 22162-25G10	TY 00591-51418-81
CT MD602756	NI 22162-25G11	TY 00591-51420-81
CT MD602949	NI 22162-A3514	TY 00591-56301-81
CT MD607597	NI 22162-R9006	YT 220000727
CT MD611686	NI 22162-R9007	YT 220012921
CT T232T-46772	NI 2216217M01	YT 220016273
HY 3000542	NI 2216217M03	YT 220054038
HY 3020828	NI CK3779914	YT 220054193
HY 3021276	NI MD611686	YT 901284807
HY 3043274	SG 3779914	YT 901304806
KO 22162-25G11	SG MD611685	



Part Number - 380015-007-02

**Rotor - 4G32-52-54, J15, H20, A15, 4G33**

▼ OEM Reference

AC 4920235	CT MD602758	MB MD602758
BR CK909353	CT MD611850	MB MD611850
BR CK916006	KO 22157-R9007	NI 22157-R9007
CL 909353	MB 1017001	NI CK909353
CL 916006	MB 1041551	NI CK916006



Part Number - 380014-008-02

**Ignition Wire Set - H20**

▼ OEM Reference

AC 4942394	NI 22450-49251	TY 00591-00152-81
CL 1810436	NI 22450-L0150B	TY 00591-01133-81
HY 0214998	NI 22450-L1051	TY 00591-06286-81
HY 3052065	NI 22450-L1125	TY 00591-32723-81
KO HE-2500753	TC 22450-L1051	TY 00591-56004-81
KO HE-2500754		



Part Number - 380012-012-02

**Distributor Cap - H20**

▼ OEM Reference

AC 4969894	KO 22162-78A10	NI 22162-78A00
CL 445294	KO 25-003	NI 22162-78A10
CL 7000253	MB T46371	TC N-22162-G5710
CL 872631	MB 216276	TC N-22162-G5711
CT 46371	NI 22162-G5710	TC N-22162-23G15
CT 216276	NI 22162-G5711	TC N-22162-78A10
HY 3046816	NI 22162-17M02	TY 00591-07216-81
HY 3132609	NI 22162-17M04	TY 00591-32687-81
KO 22162-G5710	NI 22162-23G15	TY 00591-51417-81
KO 22162-G5711	NI 22162-40F00	YT 220012748
KO 22162-23G15	NI 22162-40F10	YT 220024209
	NI 22162-75A10	YT 220070292
	NI 22162-78AX0	



Part Number - 380051-001

**Ignition Wire Set - 4G52 & 4G54**

▼ OEM Reference

CL 909376
CL 1811616
CL 1811917
CL 3779999
KM 4920321





Part Number - 380012-009-02

**Distributor - 4G63-4G64**

▼ OEM Reference

CL 918313	MB MD169418
CT 1041457	MB T3T65675
CT MD169418	NI MD169418
MB 1041457	TY 00591-42783-81



Part Number - 380012-007-02

**Distributor Cap - 4G63-4G64**

▼ OEM Reference

CL 4335221	MB MD618364
CL 923626	MB T232T-48372
CT MD618364	NI CK923626
CT T232T-48372	NI MD618364
DW A218353	NP EP-335
HN MD618364	SG MD618364
HY 1554033	TY 00591-75236-81
HY 3127916	YT 220022013
HY 3143902	YT 220043902
	YT 580047018



Part Number - 380015-001-02

**Rotor - H20II, 4G63-4G64**

▼ OEM Reference

AC 8762079	DW A218357	MB MM611850
BR CK923627	DW D490744	MB T880T-18972
CL 4335223	HN MD618262	NI 22157-55K10
CL 923627	HY 3142510	NI 22157-55K15
CT 91H20-04710	KO 22157-55K10	NI CK923627
CT 9I4658	KO 26-011	RN J5-5610
CT MD611817	MB 91H20-04710	RN J5-5611
CT MD618262	MB 9I4658	TC N-22157-55K10
CT MM611850	MB MD611817	TY 00591-23164-81
CT T880T-18972	MB MD618262	YT 220025671



Part Number - 380014-002-02

**Ignition Wire Set - 4G63-4G64**

▼ OEM Reference

CL 920989	CT MD972033	DW A218378
CL 920990	CT MD972748	MB 1085017



Part Number - 380015-005-02

**Rotor - FE-FE2**

▼ OEM Reference

HY 1554034
YT 580047019



Part Number - 380012-006-02

**Distributor Cap - F2-FE**

▼ OEM Reference

HY 1326394	TY 00591-33666-81
HY 1339151	TY 00591-56299-81
HY 1370740	TY 00591-56303-81
HY 3054982	YT 150022511
JU 14415530	YT 220020015
JU 14491840	YT 505960556
JU 14501360	YT 505960583
MB T45327	YT 901357802
TC T-FEEN-18-V00	YT 901580802
TY 00591-06004-81	YT 901580812
TY 00591-31680-81	



Part Number - 380015-004-02

**Rotor - F2-FE**

▼ OEM Reference

CL 444460	NP EP-780	TY 00591-33710-81
CL 446399	RN J5-5614	TY 00591-56318-81
CT 218115	RN J5-5615	TY 00591-56319-81
HY 1326395	TC T-F829-18-V05	TY 00591-56321-81
HY 1362035	TC T-FE2S-18-V05	YT 150022510
HY 1367561	TY 00591-06005-81	YT 220070293
HY 2022460	TY 00591-11046-81	YT 505960565
HY 2023725	TY 00591-31681-81	YT 901356803
MZ F829-18-V05	TY 00591-31813-81	YT 901356814
MZ FE25-18-V05	TY 00591-33617-81	YT 901357803
NP EP-339	TY 00591-33686-81	YT 901953805



Part Number - 380014-005-02

**Ignition Wire Set - F2-FE**

▼ OEM Reference

CL 7000201	TY 00591-11105-81	YM YA901303803
CL 7000218	TY 00591-33553-81	YT 220100562
HY 1362113	TY 00591-33593-81	YT 505976593
HY 1369893	TY 00591-56029-81	YT 901283805
JU 14364620	TY 00591-61181-81	YT 901303803
JU 14495050	TY 00591-76611-81	



Part Number - 380012-014-02

**Distributor - H25**

▼ OEM Reference

AC 78762077	KO 22100-60K11	NI 22100-60K11
AC 22100-60K15	KO 22100-60K15	NI 22100-60K15
AC 22100-60K15A	KO 22100-60K15A	TC N-22100-60K10
KO 22100-60K10	NI 22100-60K10	TC N-22100-60K15



Part Number - 380012-008-02

**Distributor Cap - D5**

▼ OEM Reference

HY 1371206	TY 00591-11106-81
HY 3020958	YT 901356802
NP FA-164	

## Distributors/Caps, Rotors, Spark Plug Wires



Part Number - 380012-015-02

### Distributor Cap - GM 4.3L

▼ OEM Reference

CT 93720-09911  
HY 1566458  
TY 19101-U3330-71  
YT 580051808

**NEW!**



Part Number - 380012-016-02

### Distributor Cap - Nissan TB45

▼ OEM Reference

AC 8775050  
KO 8775050  
KO 22162-VB011  
NI 22162-VB011

**NEW!**



Part Number - 380015-009-02

### Rotor - GM 6 cyl, GM 4 cyl, GM 3.0L, GM 4.3L

▼ OEM Reference

CL 1342529	HY 1334403	TY 00591-56322-81
CL 2575926	HY 1342529	TY 19102-31720-71
CL 922220	HY 1374329	TY 19102-U3160-71
CL 922221	MB 90420-01480	YT 580000384
CT 90420-01480	NI NF90420-01480	YT 900005266
DW A232133	TY 00591-33685-81	



Part Number - 380015-006-02

### Rotor - TB42 6 cyl., 6G72

▼ OEM Reference

AC 4968831	HY 3122011	RN J5-5612
CL 2572769	KO 22157-52H20	TC N-22157-52H20
CL 444901	MB 1038060	TY 00591-20723-81
CT 1038060	MB MM502535	YT 220018323
CT MM502535	MB T880X17571	
CT T880X17571	NI 22157-52H20	



Part Number - 380014-007-02

### Ignition Wire Set - GM 3.0L

▼ OEM Reference

DOS A218755	HY 1329534	TY 19335-U2120-71
DW A218755	HY 1337666	



Part Number - 380015-010-02

### Rotor

▼ OEM Reference

CL 7000271	KM 4911933	MB 2W2257
DW D700682	KO HE40-2504609	



Part Number - 380014-009-02

### Ignition Wire Set

▼ OEM Reference

DW A413624

**NEW!**

## Coils



Part Number - 380016-001-02

### Coil

▼ OEM Reference

CL 925969	CT MD326638	MB MD326638
CL 4335230	DW A218371	TY 00591-27426-81
CT MD358504	MB MD358504	
CT 1832A002	MB 1832A002	



Part Number - 380016-002-02

### Ignition Coil

▼ OEM Reference

CT 91H20-02930	HAM 22448-AR215	NI 22448-AR215
HAM 8772266	NI 22433-AR215	

**FIVE RING DESIGN** - The five rib design prevents flashover and reduces voltage loss. It offers 20% more insulation than conventional plugs. This improved performance is especially significant in plugs with a large gap operating under high voltage.

**INSULATOR** - The insulators are made of a highly purified alumina powder, which gives strength and thermal conductivity at high temperatures, as well as greater physical strength.

**SPECIAL COPPER-GLASS SEAL** - A special mixture of copper and glass powder bonds the center electrode and insulator together for a gas-tight seal. Proper heat is maintained and hot combustion gases are excluded.

**U-GROOVED GROUND ELECTRODE** - This U-Groove allows the spark to fill the gap formed by the U. The ball of fire develops, a larger and hotter flash front, so that the combustion is more complete.

**COPPER CORED CENTER ELECTRODE** - A special center electrode incorporates copper into the core of the nickel chrome binary alloy. This gives superior thermal conductivity, and increases the operating range.

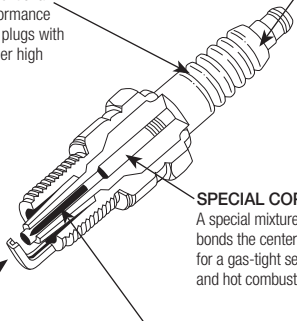

**Part Number - 380013-001-02**

**Spark Plug - W20ES-U**

▼ OEM Reference

AC 4905798	PL 43N	PL B6ES-11
KO 22401-58001	PL 43XL	PL C43N
KO 22401-M7714	PL 44N	PL C44N
KO 22401-M7716	PL 44XL	PL N288
KO 37Z-02-SP04A	PL AG3	PL N5C
KO 37Z-02-SP05A	PL AG30C	PL S43XL
NI N-22401-M7716	PL AG3CX	PL S44XL
PL 394	PL AG3X	PL W16ES-U
PL 4056	PL B6ES	

**Part Number - 380013-002-02**

**Spark Plug - Q14R-U11**

▼ OEM Reference

CT 91H20-02860	PL BCP4ES11	PL DCP4ES11
KO 22401-FU412	PL BCP4EY11	PL DCP4EY11
PL BCP4ES	PL DCP4E7	PL FR9DCX
PL BCP4ES11	PL DCP4ES	

**Part Number - 380013-004-02**

**Spark Plug - W14EXR-U**

▼ OEM Reference

AC 4516333	CT 1017268	NI 22401-V1414
AC 4516353	HY 3002290	TC N-22401-L1600
AC 4933394	HY 3002347	TY 00591-02042-81
CL 2385639	KO 22401-V1414	TY 00591-33646-81
CL 4338827	MB 1017268	YT 150112466
CL 913639	MB MB1017268	
CN SP200S00009RNYC	NI 22401-L1600	

**Part Number - 380013-005-02**

**Spark Plug - W9EXR-U**

▼ OEM Reference

HY 1361837	PL BPR2ES	YT 5059605-35
PL BPR2E	TY 90919-01954-71	

**Part Number - 380013-010-02**

**Spark Plug - W16EXR-U**

▼ OEM Reference

ND W16EXR-U

**Part Number - 380013-006-02**

**Spark Plug - W16EX-U**

▼ OEM Reference

AC 4920323	MB MS851101	PL C44NS
CL 909378	PL 4253	PL MS851243
CT 2W9486	PL 44NS	PL N11YC
CT MS851101	PL B2401-89904	PL N12YC
MB 1038083	PL BP5EA-L	PL W16EX-U
MB MS851022	PL BP5EY	TY 90919-01954

**Part Number - 380013-007-02**

**Spark Plug - W9EP**

▼ OEM Reference

AC 8762050	PL 14G82	TY 80919-76009-71
BH W10DC	SL 144483	TY 80919-76011-71
CL 444771	TC 20801-0A041	TY 80999-76018-71
CT 0971353	TC N-22401-W8914	TY 90098-09125
HY 0326827	TC W9EP	TY 90098-20395
HY 3002288	TY 00591-06208-81	TY 90919-01021
HY 326827	TY 00591-06209-81	TY 90919-01055-71
KO 22401-W8914	TY 00591-32695-81	TY 90919-01950-71
KO 37Z-02-SP02E	TY 00591-33649-81	TY 90999-09001-71
KO TJ-90098-09125	TY 00591-50973-81	TY 90999-09002-71
KO TJ-90919-01055	TY 00591-50976-81	YT 150038500
KO TJ-90919-01950-71	TY 80098-76006-71	YT 220001599
ND W9EP	TY 80919-76004-71	YT 900537827
NI 22401-W8914	TY 80919-76005-71	
PL 14G22	TY 80919-76008-71	

**Part Number - 380013-008-02**

**Spark Plug - T16PR-U**

▼ OEM Reference

BH HR8BC	HY 0388361	TY 00591-32692-81
BH HR8BP	HY 1332675	TY 00591-42808-81
BH HR9BC	HY 1332676	TY 00591-50978-81
CL 446323	HY 1451269	TY 90098-16785
CL 925049	HY 1467579	YT 150112453
CT 216460	ND T16PRU	YT 516484800
DR R-45-TS	TN 07764	YT 580005036
DW A218756	TN 39046	YT 580008972
DW A219024	TY 00591-06165-81	YT 580013445
DX 1411740	TY 00591-10918-81	

**Part Number - 380013-009-02**

**Spark Plug - W16EPR-U**

▼ OEM Reference

CT 1038083	PL CR43CXLS	PL RN12YCC
DW A218377	PL CR44NS	PL RN14YC
PL 1Y00-18-110	PL ON11Y	
PL 3322	PL ON12Y	
PL BPR5E	PL R44LT	
PL CR425XLS	PL RN11YCC	

**Part Number - 380013-013-02**

**Spark Plug - Q20PR-U**

▼ OEM Reference

DW A223103  
NG BCPR6E

# Spark Plugs

(IC) Truck  
Components

Part Number - 380013-014-02

**Spark Plug - PT16EPR-L13**

▼ OEM Reference

BO HR9DPX	MB 90420-01620	TY 19111-90098-71
BO HR9DPY	ND PT16EPR-L13	TY 19111-U3161-71
CL 923702	NI NF90420-01620	TY 90098-66113-71
CT 90420-01620	TY 19111-31720-71	TY 90420-01190-71
HY 1389133	TY 19111-31721-71	YT 900015293

Part Number - 380013-012-02

**Spark Plug - L14-U**

▼ OEM Reference

AC 232560	CT 0041663	PL 18-9
AC 4513315	CT 0631202	TY 00591-07885-81
AC 4613261	CT 0676637	TY 00591-07896-81
AC 4660976	CT 0972385	TY 00591-32691-81
AC 4810105	CT 0973283	TY 00591-50970-81
AC 4905800	CT 2A3643	TY 00591-50971-81
AC 4908597	CT 353706	TY 00591-53307-81
AC 4910105	CT 8N2630	TY 90098-64015
AC 4916015	DR C-86	WK 110532
BK 101359	DR C-87	WK 209316
BK 101527	HY 0028758	WM 10-R-385
BK 115923	HY 0079161	WM 10R1191
BK 116251	HY 0123872	WM 20-7000680
BK 716D1	HY 0138366	WM 20-7000681
BK 716J1	HY 0197885	WM 20-7000949
CL 3739054	HY 1312459	WM 20-7100035
CL 742159	HY 1332693	YT 016254800
CL 784250	HY 3001582	YT 016255000
CL 890215	HY 3001585	YT 016255100
CL 890217	HY 3001586	YT 031314500
CL 890221	HY 3001590	YT 063194200
CL 890222	HY 3002287	YT 150015100
CL 890227	HY 3002348	YT 150112405
CL 890245	HY 3002349	YT 150112406
CL 890246	HY 3002575	YT 150112407
CL 890247	HY 3002577	YT 150112408
CL 890255	HY 3040014	YT 150112409
CL 890256	HY 3050408	YT 150112410
CL 890264	HY 3051151	YT 150112411
CL 890271	HY 3051322	YT 150112413
CL 890272	MB 2A3643	YT 150112420
CL 890273	MB 8N2630	YT 150112427
CL 890274	ME 41073	YT 220007428
CL 890276	ME 41273	YT 220010987
CL 907621	ME 41663	YT 220011080
CL 913628	ND L14-U	YT 220011107
CL 913633	NI CK913628	YT 220011205
CL 913638	NP UD-16	YT 220052206
CL 913831	PL 18-10	YT 509295802
CL 940328	PL 18-4	YT 510764800
CN YD6	PL 18-8	YT 517451800
CT 0007954		

Part Number - 380013-016-02

**Spark Plug - T14PR-U**

▼ OEM Reference

BH H9BC	JU 14148410	TY 00591-50979-81
BO 242219516	ND T14PR-U	TY 19111-U2120-71
CL 922786	PL 14RF42	TY 90098-14785
DR R-45-RB	PL 14RF52	YT 220013371
HY 0281844	PL 14RF62	YT 580000628
HY 1330468	SB 8155723	

Part Number - 380013-017-02

**Spark Plug - W16S-U**

▼ OEM Reference

AC 4907334	CT MD997476	ND W16S-U
AC 4948894	CT 851101	PL 14-4
AC 9001652	CT 997476	PL 14-5
BK 716G1	DW 8N2236	PL 14R8
CL 446583	DW D141267	TY 00591-05493-81
CL 890210	DW D700699	TY 00591-10919-81
CL 890219	HY 0360046	TY 00591-20174-81
CL 890220	HY 1312454	TY 00591-33687-81
CL 890225	HY 3001588	TY 00591-55310-81
CL 890236	HY 3002289	TY 80098-76004-71
CL 890252	HY 360046	TY 80098-76005-71
CL 890253	KO HE0052048-00	YT 150112473
CL 890265	KO HE0110256-00	YT 150112490
CL 890267	KO HE0110526-00	YT 150112494
CT 0099476	KO HE40-2502314	
CT 141267	KO HE52892	
CT 8N2236	MB 8N2236	
CT 99476	MB MD997476	
CT MD851101	MB 997476	

Part Number - 380013-018-01

**Spark Plug - T20EPR-U**

▼ OEM Reference

AB CR42CLTS	CZ RS10LC	MO AGSF22C
AB R42CLTS	CZ RS281YC	MO AGSF24C
AB R42LTS	CZ RS9YCC	MO AGSF32C
AB R42LTSM	CZ RS9YCX	MO AGSF33C
AB R43LTS	HY 1570595	MO AGSF34C
AB R43LTSE	MO AWRP32	MO AGSF34EE
AC DCR42CLTS	MO AWSF22C	MO AGSF34EEM
AC DR42CLTS	MO AWSF22E	MO AGSF34FP
AC DR42LTS	MO AWSF32C	NG BPR6EFS
AO 103	MO AWSFA32C	NG BUR6EFSZ
AO 104	MO AGFS22FE13J	NG TR5
AO 483	MO AGRF2	NG TR5-1
AO 764	MO AGRF22C	NG TR6
AO 864	MO AGRF22C1	ND T20EPR-U
AO 985	MO AGRF22PP	ND T20EPRU
AO 5144	MO AGRF32	YT 580052996
AO 5164	MO AGRF32C1	
CT A0000-14416	MO AGRP44	

Part Number - 380105-057

**Spark Plug - W14EX-U**

▼ OEM Reference

AC 45NS	ND W14EXU	TY 00591-03633-81
CL 1332679	ND W14EX-U	TY 00591-32673-81
CL 909377	NG BP4E	TY 00591-50969-81
CL 912703	NG BP4ES	TY 90919-01056
CT 9122000400	NG BP4EY	YT 150112478
CT 91220-00400	NG BP5EA	YT 220034475
HY 3057352	PL 14G52	

Part Number - 380105-051

**Spark Plug - W14LM-U**

▼ OEM Reference

AC DLM46	ND W14LM-U
AC DLM49	NG B4LM



## Fan Blades



Part Number - 380008-001-02

### Fan Blade - K21-K25

▼ OEM Reference  
 AC 8779236  
 KO 21060-FU40A  
 NI 21060-GY360  
 TC N21060FU40A



Part Number - 380008-004-02

### Fan Blade - H20

▼ OEM Reference

AC 4942359	KO 21060-49003	TC N-21060-48210
CL 445268	KO FN-200	TY 00591-07192-81
CL 7001677	NI 21060-48210	TY 00591-36864-81
HY 3124790	NI 21060-49001	
KO 21060-48210	NI 21060-49003	



Part Number - 380008-002-02

### Fan Blade - 4Y 6-7 Series

▼ OEM Reference

AC 8762498	KO YM129900-44700	TY 16361-23860-71
KO YM129900-4470	TC 212T1-05981	YT 220034759



Part Number - 380008-005-02

### Fan Blade - 4G63-4G64 K-Series

▼ OEM Reference

CT 91202-07400	MB 91202-07400	TY 00591-27429-81
CT 91202-17400	MB 91202-17400	



Part Number - 380008-003-02

### Fan Blade - H20 II

▼ OEM Reference

AC 4901388	KO FN-201	TC N-21060-50K00
DW D491452	NI 21010-50K00	TY 00591-36868-81
KO 21060-50K00	NI 21060-50K00	TY 00591-54141-81
KO 21060-87V00	NI 21060-87V00	

## Belts

Continued ▶



Part Number - 380010-004-02

### Belt-Fan

▼ OEM Reference

CL 2814061	HY 3061904	TY 00591-33845-81
CL 3790816	HY 3099227	TY 00591-33876-81
CT 1017158	MB 1017158	TY 00591-33878-81
CT MM115231	MB MM115231	TY 00591-51007-81
HY 1526078	NI 11720-J0300	TY 00591-53127-81
HY 188643	TC 20801-04331	TY 00591-55347-81
HY 2339656	TY 00591-06095-81	YT 580035882

Part Number - 380010-001-02

### Belt-Fan

▼ OEM Reference

AC 8761967	KM 8761967	NI 11720-87V10
CL 2781527	KO 11720-52H01-F1	NI 11720-K4080
CT A000013592	KO 11720-87V10	TC N-11720-K4080
DW D490878	KO 11720-K4080	TY 00591-75559-81
KM 4968642	KO 11720-K4080A	

Part Number - 380010-005-02

### Belt-Fan

▼ OEM Reference

CT 91921-06300	MB 91921-06300	NI 11720-FM010
CT 91H20-02560	MB 91H20-02560	NI 02117-21521
KO 02117-21521	MB 91H2002560	

Part Number - 380010-003-02

### Belt-Fan

▼ OEM Reference

CL 352780	KO 02117-23523	TY 90916-02975-71
CL 3490402	LP 156-1648	TY 00591-51028-81
CT 91H20-03350	LP 156-17484	TY 90916-02975-71
CT 9L2248	LP 156-9001	YT 295675600
HY 809400	NI 02117-20021	YT 900534806
HY 3057598	NI 02117-20021	YT 220011118
HY 3064467	TC 20801-04081	YT 220052043
HY 104728	TY 16372-13010-71	YT 295675700
HY 2039256	TY 89322-76009-71	

Part Number - 380010-011-02

### Belt-Fan

▼ OEM Reference

DW A213971
LP 156-20442

# Belts

Part Number - 380010-002-02

**Belt-Fan**

▼ OEM Reference

AC 4942145	HY 191845	NI 02117-01011
AC 4966574	HY 370411	NI 02117-03011
BK 101286	HY 374011	NI 11720-B1100
BK 9491000624	HY 3000555	NI 11720-B1101
CL 2361378	HY 3051878	NI 11720-L1101
CT 99841	KA 4942145	NI 11720-Y4400
CT 099841	KA 4966574	TC 20801-04261
CT 62923	KO 11720-B1101L	TC 11720-B1101
CT 99481	KO 11720-B1101	TC N-11720-B1101
CT 308302	KO 11720-L1102	TC N-11720-Y4400
CT 347191	LP 156-1001	TY 00591-06238-81
CT 347192	LP 156-13395	TY 00591-07109-81
CT 347196	LP 156-13415	TY 00591-33834-81
CT 0308302	MB 2N159	TY 00591-33846-81
CT 0347191	NI 02117-01011-F1	TY 00591-51009-81
CT 0347192	NI 02117-02011-F1	TY 00591-51010-81
CT 0347196	NI 11720-B1101F1	TY 00591-51014-81
CT 062923	NI 11720-B1101-F1	TY 00591-55397-81
CT 099481	NI 11720-Y4400	
CT 2N0159	NI 20801-04261	

Part Number - 380010-012-02

**Belt-Fan**

▼ OEM Reference

BK LFM8105471	KO 11720-K7201	TY 00591-33863-81
CL 913259	NI 11720-69200	TY 00591-33868-81
CL 3773658	NI 11720-K7201	TY 00591-51008-81
CL 7000351	NI 11720-N9515	TY 00591-55374-81
HY 172895	NI 21067-38800	YT 220002518
HY 233965	NI 21067-K7201	YT 220052061
HY 807004	TY 00591-02732-81	
HY 3051858	TY 00591-07107-81	

Part Number - 380010-010-02

**Belt-Fan**

▼ OEM Reference

AC 4860509	HY 123577	TY 99322-01170-71
BK 9265026	HY 0123577	TY 00591-10965-81
CL 448458	JU 14087210	TY 00591-51011-81
CL 774608	KO 4860509	TY 90916-02952-71
CT 971472	LP 156-1182	WM 10A16423
HY 860712	LP 156-13465	YT 220024785
HY 86071	LP 156-16460	YT 220001588
HY 0086071	PM BM-15-1	YT 449089003
HY 111107	TY 90916-02952-71	
HY 0111107	TY 99322-01170	

Part Number - 380010-006-02

**Belt-Fan**

▼ OEM Reference

CL 7000350	LP 156-17415	TY 00591-33843-81
CL 7000353	MB 1039078	TY 00591-33850-81
CT 1039078	MB 91401-09700	TY 00591-33855-81
CT 216256	MB 91401-09800	TY 00591-33880-81
CT 91401-09800	TY 00591-33869-81	TY 00591-42813-81
HY 3000569	TY 00591-55348-81	TY 00591-51025-81
LP 156-1183	TY 16374-32870-71	TY 00591-75169-81
LP 156-16424	TY 00591-10954-81	
LP 156-16631	TY 00591-10963-81	

Part Number - 380010-009-02

**Belt-Fan**

▼ OEM Reference

CL 659050	KO 11720-F2700	TY 00591-33877-81
CL 920231	MB 1041623	TY 00591-33879-81
CL 930768	MB MM407440	TY 00591-55359-81
CT 1041623	NI 01978-11004	TY 00591-55375-81
CT 1041823	NI 11720-F2700	TY 00591-74115-81
CT 2W2530	NI 21140-90301	TY 00591-74817-81
CT MM407440	NI CK930768	YT 580035883
DW A273823	TC 20801-04101	YT 220042751
HY 1526079	TC N-02117-00511	

Part Number - 380010-008-02

**Belt-Timing**



▼ OEM Reference

CL 7000659	JU 14364210	TY 00591-34661-81
CT A000000345	JU 14704390	TY 00591-53504-81
HY 1361733	LP 100-FE10	TY 00591-54549-81
HY 3057775	LP 124-1294	YT 220034390
HY 3061901	LP 138-1004	YT 220100725
HY 3115283	MZ FE09-12-205	YT 901294816
JU 147043904	TY 00591-22425-81	YT 901294829

Part Number - 380030-101

**Belt-Timing**



▼ OEM Reference

CL 7000647	JU 144118105	TY 00591-54055-81
CT 14411810	LP 100-F227	YT 504258756
HY 2028852	LP 124-4003	YT 901577816
JU 1441181	MB 14411810	
JU 14411810	TY 00591-34628-81	

Part Number - 380030-096



**Belt-Fan**

▼ OEM Reference

CL 799544	DW D141101	KM 4965293
CT 5M8137	HY 353393	KO 6204-81-3270

Part Number - 380030-104

**Belt-Timing**



▼ OEM Reference

CL 918706



Part Number - 380050-001

**Oil Seal**

▼ OEM Reference  
HY 1523530



Part Number - 380050-002

**Oil Seal**

▼ OEM Reference

CL 7003887	JU 14374480	TY 00591-76873-81
HY 2027701	TY 00591-33124-81	YT 220020044
HY 2027817	TY 00591-54664-81	YT 911086300
JU 1437448	TY 00591-71480-81	YT 920803300



Part Number - 380050-046

**Oil Seal**

▼ OEM Reference

HAM 4940277	HAM 8772429	KO 07012-00080
HAM 4940278	HAM 07012-00080	TC 24843-02051
HAM 4942457	KM 4942457	



Part Number - 380050-047

**Oil Seal**

▼ OEM Reference

HAM 8779491	KM 4948613
HAM 3EA-22-11210	KO 3EA-22-11210



Part Number - 380050-007

**Oil Seal**

▼ OEM Reference

CL 7003807	JU 14458080	YT 220029615
CT 215416	JU 14473480	YT 220075001
HY 44542	SL S200851	YT 504224218
HY 44542	TY 00591-32069-81	
HY 3137615	TY 00591-60402-81	



Part Number - 380050-048

**Oil Seal**

▼ OEM Reference

AC 4940905	HAM 3EB-21-15130	KM 4940905
HAM 4940905	HAM 3EB-21-15130A	KO 3EB-21-15130
HAM 8777919	HAM 3EB-21-15130L	



Part Number - 380050-011

**Oil Seal**

▼ OEM Reference

CT 973851	HY 266733	TY 00591-52483-81
CT 973851	HY 3057503	YT 220037503
HY 153718	TY 00591-20561-81	YT 220075023
HY 153718	TY 00591-32092-81	YT 504224242



Part Number - 380030-042

**Oil Seal**

▼ OEM Reference

TY 42125-22000-71	TY 42125-U2100-71
-------------------	-------------------



Part Number - 380030-035

**Oil Seal**

▼ OEM Reference

KM 4944592	KO 3EC-21-15140
------------	-----------------



Part Number - 380060-001

**Oil Seal**

▼ OEM Reference

CT 91B33-01100	NI 43090-00H00
----------------	----------------



Part Number - 380050-045

**Oil Seal**

▼ OEM Reference

AC 8776236	HAM 3EB-21-15140	KM 8776236
HAM 8776236	KM 4940906	KO 3EB-21-15140



Part Number - 380060-002

**Oil Seal**

▼ OEM Reference

HY 1354997	YT 505965509
------------	--------------



Part Number - 380060-003

**Oil Seal**

▼ OEM Reference

HY 325568	YT 504224208
-----------	--------------



Part Number - 380060-004

**Oil Seal**

▼ OEM Reference

CT 6V8407	DW D700581
-----------	------------



Part Number - 380060-005  
**Oil Seal**

▼ OEM Reference  
TY 42415-10480-71



Part Number - 380060-007  
**Oil Seal**

▼ OEM Reference  
CT 91E43-02300  
NI 40227-FK000



Part Number - 380060-006  
**Oil Seal**

▼ OEM Reference  
KM 4949337 KO 3EB-22-21160



Part Number - 380060-008  
**Oil Seal**

▼ OEM Reference  
KM 8765021  
KO 8765021  
KO 3EC-21-36250



Part Number - 380050-049  
**Oil Seal**

▼ OEM Reference  
AC 8761245 HAM 3EB-21-32180 KO 3EB-21-32180  
HAM 8761245 KM 8761245



Part Number - 380060-009  
**Oil Seal**

▼ OEM Reference  
TY 42415-11630-71



Part Number - 380050-027  
**Oil Seal**

▼ OEM Reference  
NI 43090-22H00



Part Number - 380060-010  
**Oil Seal**

▼ OEM Reference  
TY 42125-23320-71



Part Number - 380050-033  
**Seal Oil Drive Axle**

▼ OEM Reference  
BK 219990 LI 219990 TY 00591-41351-81  
BK 241238 LI 241238 TY 00591-54654-81  
CL 7003866 NI 43533-L1100 YT 220054163  
HY 3042586 TY 00591-07374-81



Part Number - 380060-011  
**Oil Seal, Steer Axle**

▼ OEM Reference  
MB 91A43-02300  
NI 48522-FJ101



Part Number - 380050-030  
**Oil Seal**

▼ OEM Reference  
HY 3025861 TY 00591-07432-81 TY 00591-54658-81  
NI 48522-00H00 TY 00591-41385-81 YT 22024966



Part Number - 380060-012  
**Oil Seal**

▼ OEM Reference  
CL 2786180



Part Number - 380050-031  
**Oil Seal**

▼ OEM Reference  
CT 91E43-01800  
MB 91E43-01800  
NI 48525-FK000



Part Number - 380060-013  
**Oil Seal**

▼ OEM Reference  
HY 2021557  
KM 4940496  
KO 3EA-21-14140  
YT 921949300



Part Number - 380060-014  
**Oil Seal**

▼ OEM Reference  
HY 300801  
YT 505959512



## Seals



Part Number - 380060-015

### Oil Seal

▼ OEM Reference  
CT 9X7695  
DW D700306

**NEW!**



Part Number - 380060-017

### Oil Seal

▼ OEM Reference  
NI 43252-J2000

**NEW!**



Part Number - 380060-016

### Oil Seal

▼ OEM Reference  
MB 93433-12400

**NEW!**



Part Number - 380060-018

### Oil Seal

▼ OEM Reference  
CL 245020

**NEW!**

(IC) Truck  
Components

## Cylinder Parts

Continued ▶



Part Number - 380050-037

### Packing Cylinder Kit

▼ OEM Reference

CL 446444	JU 14462360	YT 220021100
CT 973546	TY 00591-22382-81	YT 516149005
HY 2302265	TY 00591-32404-81	
HY 3054917	TY 00591-60962-81	



Part Number - 380050-050

### Tilt Cylinder O/H Kit

▼ OEM Reference  
KO 3EB-64-05190  
KM 4948516



Part Number - 380055-056

### Seal Kit - Tilt Cylinder

▼ OEM Reference  
HY 1493306

**NEW!**



Part Number - 380050-038

### Lift Cylinder O/H Kit

▼ OEM Reference  
TY 00591-76586-81  
YT 505136031  
YT 522375008



Part Number - 380030-038

### Power Steering O/H Kit

▼ OEM Reference  
KO ON43001-06565



Part Number - 380055-054

### Lift Cylinder O/H Kit

▼ OEM Reference  
CA 561307  
TY 04654-U2010-71



Part Number - 380055-055

### Power Steering O/H Kit

▼ OEM Reference  
KM 4949737  
KO 3EB-64-A2000



Part Number - 380050-039

### Lift Cylinder O/H Kit

▼ OEM Reference  
CL 7004445 TY 00591-45306-81  
HY 2307874 YT 220037756  
HY 3057756 YT 505136027



Part Number - 380055-057

### Seal Kit - Hydraulic Cylinder

▼ OEM Reference  
HY 2028626

**NEW!**



Part Number - 380050-041

### Tilt Cylinder O/H Kit

▼ OEM Reference  
HY 2302714 TY 00591-60963-81  
HY 3054918 TY 00591-76642-81  
JU 1444116 YT 220021877  
JU 14441160 YT 506149006  
TY 00591-32407-81 YT 516149006

# Cylinder Parts



Part Number - 380055-058

**Lift Cylinder O/H Kit**

▼ OEM Reference  
CA 560349



Part Number - 380050-052

**Wheel Cylinder**

▼ OEM Reference

CT	91E46-00112	HY	1565290	YT	580051320
HAM	8776249	KO	3EB-30-41440		
HAM	3EB-30-41440	NI	44100-FK000		



Part Number - 380055-059

**Lift Cylinder O/H Kit**

▼ OEM Reference  
CA 562591



Part Number - 380050-053

**Wheel Cylinder**

▼ OEM Reference

AC	AC8761142	HAM	34A-30-11401	NI	44100-FJ500
CT	91246-01800	HAM	3EA-30-25111	NI	44100-L1400
CT	91B46-00312	HAM	3EA-30-25121	TC	C521102952000
DW	A251738	KM	4941515	TY	47410-10480-71
HAM	4941515	KO	325-32-21400	TY	47410-11630-71
HAM	8761142	KO	3EA-30-25111	TY	47410-12000-71
HAM	8762946	NI	44100-00H00	TY	47430-11630-71
HAM	34A-30-11400	NI	44100-11H01		



Part Number - 380055-061

**Lift Cylinder O/H Kit**

▼ OEM Reference  
TY 04652-U2020-71



Part Number - 380055-060

**Wheel Cylinder**

▼ OEM Reference

CT	93446-01300	KM	8765304	TY	47410-32060-71
KM	4940951	KO	3EC-30-12120		
KM	4944669	KO	3EC-30-39110		



Part Number - 380050-051

**Wheel Cylinder**

▼ OEM Reference

CL	932561	KM	4940945	TY	47410-21580-71
CT	215467	KM	4949375	TY	47410-21800-71
CT	91446-00900	KO	34B-30-14311	TY	47410-22500-71
CT	91846-00800	KO	34B-30-15311	TY	47410-32500-71
HY	1334648	KO	3EB-30-11310	TY	47410-U2130-71
HY	2027398	NI	44100-22H00	YT	505963500
KM	4920078	TC	C521124652001	YT	900488803



Part Number - 380030-001

**Accelerator Unit**

▼ OEM Reference

AC 8772287	HAM 18919-AM810	NI 18919-AM810
CT 91A51-08400	KM 8772287	
HAM 8772287	KO 18919-AM810	



Part Number - 380030-110

**Bolt, Tie Rod**

▼ OEM Reference  
KM 4949361  
KO 3EB-24-21581



Part Number - 380030-003

**Adjuster Cable**

▼ OEM Reference

AC 8761533	KM 8761533	NI 44215-22H00
HAM 4923069	KO 3BB-30-12190	TY 47470-33060-71
HAM 8761533	MB 91546-02300	TY 47470-U2130-71
HAM 3BB-30-12190		



Part Number - 380030-014

**Bolt, Tie Rod**

▼ OEM Reference  
KM 8761511  
KO 3EB-24-35130



Part Number - 380030-015

**Bolt, Tie Rod**

▼ OEM Reference  
KM 8761509  
KO 3EB-24-35140



Part Number - 380030-004

**Adjuster Cable**

▼ OEM Reference

AC 4940537	KM 4940537	NI 44215-00H00
HAM 4940537	KO 3EA-30-11330	TY 47501-11630-71
HAM 3EA-30-11330	MB 91246-04400	TY 47504-U1130-71



Part Number - 380030-105

**Bolt, Tie Rod**

▼ OEM Reference  
KM 8764087  
KO 8764087  
KO 3EC-24-31690  
KO 3ED-24-41270



Part Number - 380030-011

**Bolt**

▼ OEM Reference

AC 4941509	HAM 34A-24-11220	KO 34A-24-11220
HAM 4941509	KM 4941509	



Part Number - 380030-066

**Pin, Tie Rod**

▼ OEM Reference  
TY 43731-23442-71



Part Number - 380030-012

**Bolt**

▼ OEM Reference

AC 4941592	HAM 34B-24-11221	KO 34B-24-11221
CL 444932	KM 4941592	NI 40222-FJ100
HAM 4941592		



Part Number - 380030-050

**Bolt**

▼ OEM Reference  
HY 2027593  
HY 2037408  
YT 9037583-00



Part Number - 380030-013

**Bolt**

▼ OEM Reference

AC 4949338	HAM 3EB-22-21170	KO 3EB-22-21170
HAM 4949338	KM 4949338	



Part Number - 380030-051

**Bolt**

▼ OEM Reference  
HY 1502276  
HY 2027595  
YT 580061342  
YT 9037753-00



Part Number - 380030-109

**Bolt**

▼ OEM Reference  
HY 118714  
YT 504226246



Part Number - 380030-089

**Bolt, Tie Rod**

▼ OEM Reference  
KM 4949344  
KO 3EB-24-A2570





Part Number - 380030-055  
**Bolt**  
 ▼ OEM Reference  
 KM 4949328  
 KO 3EB-21-25170



Part Number - 380030-037  
**Steer Link Pin**  
 ▼ OEM Reference  
 CT 908169  
 DW D700583



Part Number - 380050-029  
**Bolt**  
 ▼ OEM Reference  
 CL 445458  
 NI 43225-L1300  
 TC 43225-L1300  
 TY 80114-76006-71

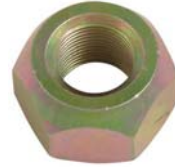

Part Number - 380030-016  
**Nut**  
 ▼ OEM Reference  
 AC 4941586 HAM 34B-21-14151 KO 34B-21-14151  
 HAM 4941586 KM 4941586



Part Number - 380030-052  
**Tie Rod Pin**  
 ▼ OEM Reference  
 HY 2021793 SY HY2021793 YT YT911982300  
 HY HY2021793 YT 9119823-00

HY 2021793 SY HY2021793 YT YT911982300  
 HY HY2021793 YT 9119823-00



Part Number - 380030-017  
**Nut**  
 ▼ OEM Reference  
 CT F2335-16000 KO 01593-31613 NI 08911-0461A  
 KM 8761510 NI 08911-04610 TY 90171-16001-71



Part Number - 380030-093  
**Tie Rod Pin**  
 ▼ OEM Reference  
 TY 43731-13311-71  
 TY 43731-13360-71



Part Number - 380030-065  
**Nut**  
 ▼ OEM Reference  
 KM 4940132  
 KO 01582-11815

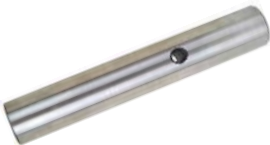

Part Number - 380030-115  
**King Pin**  
 ▼ OEM Reference  
 CT 6R6961  
 DW D700576



Part Number - 380030-018  
**Nut**  
 ▼ OEM Reference  
 AC 4941345 HY 2021593 TC 23654-34051  
 CT 64343-19900 KM 4941345 TY 80942-76005-71  
 HAM 4941345 KO 300-22-31241 TY 90179-14001-71  
 HAM 300-22-31240 NI 40224-0T005 YT 900126308  
 HAM 300-22-31241 NI 40224-FJ100

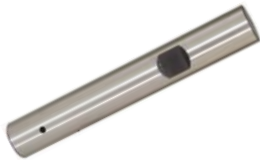

Part Number - 380030-103  
**King Pin**  
 ▼ OEM Reference  
 TY 43232-9NML8-71  
 TY 43232-U2170-71  
 TY 43232-U3270-71  
 TY 43232-U3271-71



Part Number - 380030-019  
**Nut**  
 ▼ OEM Reference  
 AC 4944661 HY 1374550 TY 90179-12003-71  
 CT 05634-01200 HY 2021595 TY 94186-11200-71  
 CT 91446-04300 KM 4944661 YT 580003984  
 HAM 4944661 KO 3EC-30-11490 YT 901202809  
 HAM 3EC-30-11490 TC 271F6-42531 YT 9124713-03  
 HY 1312624 TC 44217-22H00  
 HY 1360799 TY 84186-76001-71



Part Number - 380030-088  
**King Pin Repair Kit**  
 ▼ OEM Reference  
 TY 04432-10100-71  
 TY 04432-10120-71  
 TY 04432-20061-71  
 TY 04432-20080-71  
 TY 04432-U1030-71  
 TY 04432-U2020-71  
 TY 04432-U2021-71







Part Number - 380030-080

**Nut**

▼ OEM Reference  
TY 90179-14002-71



Part Number - 380030-026

**Steer Axle Bushing**

▼ OEM Reference

HAM 4941532    HAM 34A-42-11411A    KO 34A-42-11411  
HAM 4941533    HAM 34A-42-11411L  
HAM 34A-42-11411    KM 4941533



Part Number - 380030-102

**Nut**

▼ OEM Reference

KO 4944952    KO 310-30-26310    KO 3EC-21-36811  
KO 8771656    KO 3EC-21-36810



Part Number - 380030-049

**Steer Axle Bushing**

▼ OEM Reference

HY 2021794  
YT 911983300



Part Number - 380030-116

**Nut, Castle**

▼ OEM Reference

KM 4940141    KO 8764088    KO 01593-11813  
KO 4940141    KO 8771486    KO 01593-31813  
KO 4972207



Part Number - 380030-087

**Collar**

▼ OEM Reference  
TY 43735-13310-71



Part Number - 380030-020

**Plate**

▼ OEM Reference

HAM 4940458    HAM 3EA-15-11180A    KM 4940458  
HAM 3EA-15-11180    HAM 3EA-15-11180L    KO 3EA-15-11180



Part Number - 380030-097

**Collar**

▼ OEM Reference  
TY 43735-23440-71



Part Number - 380030-030

**Washer**

▼ OEM Reference  
TY 43755-23440-71



Part Number - 380030-092

**Grease Fitting**

▼ OEM Reference  
TY 86456-76002-71



Part Number - 380030-021

**Shim**

▼ OEM Reference

KM 4941505    KO 34A-24-11150  
KM 4941506    KO 34A-24-11160



Part Number - 380030-023

**Spring**

▼ OEM Reference

AC 4941622    HAM 3EC-30-15750    MB 91246-03600  
CL 932582    HY 350379    NI 44024-L0700  
HAM 4941622    KM 4906137    NI 44026-L0100  
HAM 4969577    KM 4920622    NI 44083-00H00  
HAM 8761530    KM 4941622    TY 47636-10110-71  
HAM 34B-30-14420    KO 34B-30-14420    TY 47636-U1100-71



Part Number - 380030-022

**Shim**

▼ OEM Reference

AC 4941755    HAM 360-27-11220    KO 360-27-13280  
HAM 4941755    KM 4941755    TY 90564-28002-71  
HAM 4968320    KO 360-27-11220



Part Number - 380030-058

**Spring**



▼ OEM Reference

CL 932576	KO 34B-30-14320	TC C521123254540
CT 91446-02500	KO 3EC-30-11330	TY 47435-32060-71
KM 4941613	NI 44039-22H00	TY 47435-U2130-71

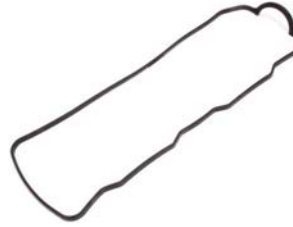

Part Number - 380030-029

**Valve Cover Gasket**

▼ OEM Reference

CL 930135
DW A218023
MB MD130494



Part Number - 380030-119

**Spring**



▼ OEM Reference

AC AC4940530	KO 3EA-30-11150	TY 47512-U1130-71
CT 97546-01700	NI 44214-00H10	
KM 4940530	TY 47512-22500-71	



Part Number - 380030-062

**Valve Cover Gasket**

▼ OEM Reference

HY 1360886
YT 901290811



Part Number - 380030-081

**Spring**



▼ OEM Reference

KO 3BB-30-12260
-----------------

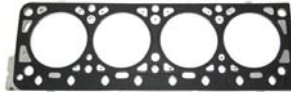

Part Number - 380030-033

**Head Gasket**

▼ OEM Reference

CT 91H20-00370
NI 11044-FU460



Part Number - 380030-027

**Valve Cover Gasket**

▼ OEM Reference

CL 925017	TY 11214-U2120-71
DW A218625	YT 580000617
HY 388323	

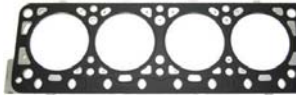

Part Number - 380030-067

**Head Gasket**

▼ OEM Reference

CT 91H20-00360
NI 11044-FU400



Part Number - 380030-061

**Valve Cover Gasket**

▼ OEM Reference

CL 925017	TY 11214-U2120-71
DW A218625	YT 580000617
HY 388323	



Part Number - 380030-034

**Manifold Gasket**

▼ OEM Reference

CT 91H20-01740
MB 14035-FY500



Part Number - 380050-008

**O-Ring**

▼ OEM Reference

CL 39678	HY 39678	YT 5042252-36
CT 05500-31070	MB 05500-31070	
HY 39677	YT 504225236	



Part Number - 380030-028

**Valve Cover Gasket**

▼ OEM Reference

CT 91H20-06510	HAM13270-FY500
HAM8772239	HAM13270-FY50A
HAM8777419	NI 13270-FY50A



Part Number - 380030-117

**Oil Pressure Switch**

▼ OEM Reference

KM 4942519
KO YM114250-39450
NI 25240-89902
NI 25240-89910





Part Number - 380050-032

**Oil Pressure Switch**

▼ OEM Reference

CL 888765	HY 1360086	NI 25240-FJ10A
CL 920227	HY 2026608	NI 25240-FM00A
CL 920441	KM 4920089	TC 25240-FJ10A
CT 31A90-00300	KM 4968878	TC T-B366-18-501
CT 90425-00390	KO 25240-FJ10A	TY 83530-76005-71
CT MC840219	MB 31A90-00300	TY 83530-78202-71
CT MD138993	MB 90425-00390	TY 83530-U2120-71
DOS A218441	MB MC840219	YT 901860807
HAM25240-FJ10A	MB MD138993	



Part Number - 380030-060

**Diaphragm Kit (Nikki)**

▼ OEM Reference

CT 91H20-14470
KO 17960-VR500
NI 17960-VR500



Part Number - 380030-122

**Valve Assembly**

▼ OEM Reference

CT 91H20-04460
HM 17962-FU460
KO 8774026
KO 17962-FU460
NI 17962-FU460



Part Number - 380030-063

**Master Cylinder**

▼ OEM Reference

KO 3EB-36-51180
-----------------



Part Number - 380030-120

**Thermostat/O-Ring**

▼ OEM Reference

TC 212T1-08481
TY 90916-03950-71



Part Number - 380030-090

**Master Cylinder**

▼ OEM Reference

AT 47530-U2100-71
TY 47530-13201-71
TY 47530-13400-71
TY 47530-U2100-71
TY 47530-U2100-71A



Part Number - 380030-091

**Master Cylinder**

▼ OEM Reference

NI 46010-04H00
NI 46010-11H01



Part Number - 380030-070

**Steering Link**

▼ OEM Reference

TY 43751-23440-71
-------------------



Part Number - 380030-071

**Steering Link**

▼ OEM Reference

TY 43752-23442-71
-------------------



Part Number - 380030-121

**Tie Rod End**

▼ OEM Reference

HY 185870
YT 504224200
YT 504224219



Part Number - 380030-036

**PCV Valve**

▼ OEM Reference

CT 91H20-00480	NI 11810-75T00	TY 12204-76014-71
HY 1360893	TC 212T1-09141	YT 9012908-19



Part Number - 380030-040

**Crankshaft Sensor**

▼ OEM Reference

CT 91H20-01160
NI 23731-6J906



Part Number - 380030-078

**Tie Rod End**

▼ OEM Reference

NI 48520-10H04
----------------



Part Number - 380030-041

**O2 Sensor**

▼ OEM Reference

CT 91A62-03500
NI 22690-FU460

# Miscellaneous



Part Number - 380030-054

**Hub Cap**

▼ OEM Reference  
KM 8772430  
KO 3EB-24-11160



Part Number - 380030-112

**Gas Spring**

▼ OEM Reference  
CT 91312-02900  
MB 93113-09600  
NI 65320-FB401



Part Number - 380030-056

**Hood Hinge**

▼ OEM Reference  
KO 3EB-50-31271



Part Number - 380030-113

**Horn (12 Volt)**

▼ OEM Reference  
HAM 3EB-55-23511  
HM 12-720



Part Number - 380030-082

**Solenoid**

▼ OEM Reference  
TA 72-501-43



Part Number - 380030-032

**Horn Kit Cup**

▼ OEM Reference  
TY 45122-23600-71



Part Number - 380030-083

**Hose - sheave**

▼ OEM Reference  
HY 1494017



Part Number - 380030-106

**Horn Button**

▼ OEM Reference  
TY 45121-U2100-71



Part Number - 380030-118

**Plug**

▼ OEM Reference  
HY 109169 KO 07046-13520 YT 012156900  
HY 1194451 NI 00933-33500  
KM 4940295 TY 80330-76010-71



Part Number - 380030-094

**Plate, Steer Axle**

▼ OEM Reference  
TY 43237-13310-71



Part Number - 380030-072

**Clutch Cover**

▼ OEM Reference  
KO 3EB-10-11510  
KO 3EA-10-14130  
KO 3EB-10-21610  
CT 91221-05010



Part Number - 380030-107

**Ignition Module**

▼ OEM Reference  
HY 1326536  
KM 4968820  
NI 22020-G5111  
YT 901953809



Part Number - 380030-111

**Diaphragm Kit (Nikki)**

▼ OEM Reference  
CT 91H20-04380  
HM 17053-FU460  
KO 17053-FU460  
NI 17053-FU460



Part Number - 380030-073

**Injector**

▼ OEM Reference

AC 16600-GS17B	KO A6600-FU471	MB 91H20-16690
CT 90425-08560	KO A6600-FU571	MB 91H20-16690
CT 90425-18040	KO 16600-GS17B	MB 16600-GS07B
CT 91H20-06690	KO 8779367	NI A6600-FU471
CT 91H20-15230	KO 16600-GS07A	NI A6600-FU571
CT 91H20-16690	KO 16600-GS07B	NI 16600-GS17B
HAM A6600-FU471	MB 90425-08560	TC A6600-FU471
HAM A6600-FU571	MB 90425-18040	TC A6600-FU571
HM 16600-GS07C	MB 91H20-15230	

(IC) Truck Components

## (IC) Truck Components Cross Reference by Manufacturer

OE Number	Crown Part No.	Description
<b>Allis Chalmers/Tusk (AC)</b>		
16600-GS17B	380030-073	Injector
22100-60K15	380012-014-02	Distributor
22100-60K15A	380012-014-02	Distributor
232560	380013-012-02	Spark Plug L14-U
4513315	380013-012-02	Spark Plug L14-U
4516333	380013-004-02	Spark Plug W14EXR-U
4516353	380013-004-02	Spark Plug W14EXR-U
45NS	380105-057	Spark Plug W14EX-U
4613261	380013-012-02	Spark Plug L14-U
4660976	380013-012-02	Spark Plug L14-U
4737405	380001-010-01	Connector LPG Male 7141M
4738548	064423	Female LP Tank Fitting
4789142	380011-006-02	Alternator 4G52-4G54
4810105	380013-012-02	Spark Plug L14-U
4830760	380001-002-01	Converter JB2
4860509	380010-010-02	Belt - Fan
4870598	380001-001-01	Lockoff VFF-30-2-IMP
4901388	380008-003-02	Fan Blade H20 II
4905798	380013-001-02	Spark Plug W20ES-U
4905800	380013-012-02	Spark Plug L14-U
4907334	380013-017-02	Spark Plug W16S-U
4908597	380013-012-02	Spark Plug L14-U
4910105	380013-012-02	Spark Plug L14-U
4916015	380013-012-02	Spark Plug L14-U
4920209	380005-004-01	Starter 4G63-4G64
4920234	380012-011-02	Distributor Cap DC-20 4G32-52-54
4920235	380015-007-02	Rotor RT-10 4G32-52-54
4920323	380013-006-02	Spark Plug W16EX-U
4921224	380012-011-02	Distributor Cap DC-20 4G32-52-54
4933394	380013-004-02	Spark Plug W14EXR-U
4940236	380050-004	Inner Bearing
4940527	380020-007-02	Brake Shoe Kit (4)
4940532	380020-007-02	Brake Shoe Kit (4)
4940535	380020-007-02	Brake Shoe Kit (4)
4940537	380030-004	Adjuster Cable
4940905	380050-048	Oil Seal
4941345	380030-018	Nut
4941509	380030-011	Bolt
4941586	380030-016	Nut
4941592	380030-012	Bolt
4941622	380030-023	Spring
4941755	380030-022	Shim
4942145	380010-002-02	Belt - Fan
4942349	380006-001-02	Pump Water H20 New Style
4942359	380008-004-02	Fan Blade H20
4942371	380012-005-02	Distributor C H20
4942380	380015-008-02	Rotor H20
4942394	380014-008-02	Plug Wire Set H20
4942402	380011-007-02	Alternator H20
4942421	380005-006-01	Starter H20
4942534	380030-024	Spring
4943832	380050-036	Bearing Assm
4943897	380020-005-02	Brake Pad (1)
4944661	380030-019	Nut
4945286	380050-003	Outer Bearing
4947935	380011-007-02	Alternator H20
4948504	380050-036	Bearing Assm
4948522	380005-001-01	Starter H20-H20II-H25
4948821	380006-003-02	Pump Water HER2.7-1404
4948894	380013-017-02	Spark Plug W16S-U
4949023	380012-011-02	Distributor Cap DC-20 4G32-52-54
4949046	380011-004-02	Alternator H20-P40-TB42
4949074	380009-104	Radiator Cap
4949214	380007-001-02	Exhaust Pipe KO3EB-03-22110
4949338	380030-013	Bolt
4949757	380030-005	Front Lamp

OE Number	Crown Part No.	Description
4966574	380010-002-02	Belt - Fan
4966957	380070-023	Pan Seat
4966982	380070-023	Pan Seat
4967525	380005-001-01	Starter H20-H20II-H25
4968831	380015-006-02	Rotor RT-13 TB42 6Cyl
4969885	380006-001-02	Pump Water H20 New Style
4969894	380012-012-02	Distributor Cap H20II
74830760	380001-002-01	Converter JB2
74870598	380001-001-01	Lockoff VFF-30-2-IMP
74884393	380001-002-01	Converter JB2
78762077	380012-014-02	Distributor
8005-2116E	380070-023	Pan Seat
8641341	380001-001-01	Lockoff VFF-30-2-IMP
8761142	380050-053	Wheel Cylinder
8761209	380009-104	Radiator Cap
8761212	380009-001-02	Radiator
8761245	380050-049	Oil Seal
8761527	380020-004-02	Brake Shoe (1)
8761528	380020-004-02	Brake Shoe (1)
8761529	380020-004-02	Brake Shoe (1)
8761533	380030-003	Adjuster Cable
8761597	380021-001-02	Brake Cylinder
8761606	380023-001-02	Brake Pedal Cover
8761949	380006-002-02	Pump Water K21-K25
8761954	380009-105	Thermostat/ Gasket
8761967	380010-001-02	Belt - Fan
8762050	380013-007-02	Spark Plug W9EP
8762055	380011-001-01	Alternator K21-K25
8762077	380012-002-02	Distributor G H20II
8762078	380012-001-02	Distributor Cap DC-10 H20II
8762079	380015-001-02	Rotor RT-11 H20II
8762122	380012-002-02	Distributor G H20II
8762498	380008-002-02	Fan Blade 4Y 6-7 Series
8762610	380020-001-02	Brake Shoe Kit (4)
8766117	380021-001-02	Brake Cylinder
8766473	380070-023	Pan Seat
8772261	380009-105	Thermostat/ Gasket
8772271A	380011-001-01	Alternator K21-K25
8772287	380030-001	Accelerator Unit
8775050	380012-016-02	Distributor Cap
8776236	380050-045	Oil Seal
8779236	380008-001-02	Fan Blade K21-K25
9001652	380013-017-02	Spark Plug W16S-U
927269	380050-006	Bearing Cone
927272	380050-005	Bearing Cup
AC4940530	380030-119	Spring
AC8772296	380001-015-01	Vaporizer (Nikki)
DCR42CLTS	380013-018-01	Spark Plug T20EPR-U
DLM46	380105-051	Spark Plug W14LM-U
DLM49	380105-051	Spark Plug W14LM-U
DR42CLTS	380013-018-01	Spark Plug T20EPR-U
DR42LTS	380013-018-01	Spark Plug T20EPR-U
<b>Baker (BK)</b>		
101286	380010-002-02	Belt - Fan
101359	380013-012-02	Spark Plug L14-U
101411	064423	Female LP Tank Fitting
101527	380013-012-02	Spark Plug L14-U
104056	380070-009	Pan Seat
105593I	380001-005-01	Repair Kit JB2
105627	380001-001-01	Lockoff VFF-30-2-IMP
115923	380013-012-02	Spark Plug L14-U
116251	380013-012-02	Spark Plug L14-U
147394	380070-026	Contoured Back Seat
219990	380050-033	Seal Oil Drive Axle
241238	380050-033	Seal Oil Drive Axle
3244331000	380070-016	Suspension Seat - Vinyl
3244331001	380070-016	Suspension Seat - Vinyl

Baker Continued ▶

# (IC) Truck Components Cross Reference by Manufacturer

Baker Continued

OE Number	Crown Part No.	Description
3244331002	380070-016	Suspension Seat - Vinyl
3244331005	380070-016	Suspension Seat - Vinyl
3244331010	380070-016	Suspension Seat - Vinyl
3244331011	380070-016	Suspension Seat - Vinyl
3244331015	380070-030	Suspension Seat - Cloth
3244331032	380070-016	Suspension Seat - Vinyl
6022	380050-006	Bearing Cone
6024	380050-005	Bearing Cup
683819	380050-018	Thrust Roller
716D1	380013-012-02	Spark Plug L14-U
716G1	380013-017-02	Spark Plug W16S-U
716J1	380013-012-02	Spark Plug L14-U
9247374	380050-036	Bearing Assm
9265026	380010-010-02	Belt - Fan
9491000624	380010-002-02	Belt - Fan
9Y11863	064423	Female LP Tank Fitting
9Y11864	380001-010-01	Connector LPG Male 7141M
KMCC662145	380050-017	Roller
L0009246860	380050-036	Bearing Assm
L0009247374	380050-036	Bearing Assm
L9509000865	380050-036	Bearing Assm
LD0009246860	380050-036	Bearing Assm
LFM53100008	380050-004	Inner Bearing
LFM8105471	380010-012-02	Belt - Fan
<b>Barrett (BR)</b>		
27494-000	380050-035	Bearing Mast
87000-BT000	380170-003	Bucket Seat
87000-SB000	380170-002	Bucket Straight Back Seat
87000-SB000-E	380170-002-E	Bucket Seat w Electric Switch
87000-SFB00	380170-004	Bucket Seat
87000-UMPP00	380070-009	Pan Seat
908830	380070-026	Contoured Back Seat
926069	380070-026	Contoured Back Seat
B27494	380050-035	Bearing Mast
CK1318727	380050-005	Bearing Cup
CK1318728	380050-006	Bearing Cone
CK1817083	380050-036	Bearing Assm
CK909353	380015-007-02	Rotor RT-10 4G32-52-54
CK916006	380015-007-02	Rotor RT-10 4G32-52-54
CK923627	380015-001-02	Rotor RT-11 H20II
<b>Blue Giant (BG)</b>		
104910PK	380050-005	Bearing Cup
104948PK	380050-006	Bearing Cone
209MZZ1	380050-035	Bearing Mast
30214JR	380050-004	Inner Bearing
83B089B	380050-019	Roller-Lift
AK30214JR	380050-004	Inner Bearing
AK83B089B	380050-019	Roller-Lift
FMMG209DD	380050-035	Bearing Mast
HVX559	380050-035	Bearing Mast
JLM104910	380050-005	Bearing Cup
JLM104948	380050-006	Bearing Cone
MG209DD	380050-035	Bearing Mast
MG5208VFFQ	380050-016	Roller
MR209MZZ1	380050-035	Bearing Mast
NT104910PK	380050-005	Bearing Cup
NT104948PK	380050-006	Bearing Cone
NTSX09A63	380050-035	Bearing Mast
SX09A63	380050-035	Bearing Mast
X559	380050-035	Bearing Mast
<b>Boman (BO)</b>		
242219516	380013-016-02	Spark Plug T14PR-U
986032431	380011-004-02	Alternator H20-P40-TB42
986033481	380011-004-02	Alternator H20-P40-TB42
HR9DPX	380013-014-02	Spark Plug PT16EPR-L13
HR9DPY	380013-014-02	Spark Plug PT16EPR-L13

IC) Truck Components

OE Number	Crown Part No.	Description
<b>Brad Harris (BH)</b>		
H9BC	380013-016-02	Spark Plug T14PR-U
HR8BC	380013-008-02	Spark Plug T16PR-U
HR8BP	380013-008-02	Spark Plug T16PR-U
HR9BC	380013-008-02	Spark Plug T16PR-U
W10DC	380013-007-02	Spark Plug W9EP
<b>BT (BT)</b>		
680396	380070-016	Suspension Seat - Vinyl
<b>Cascade (CA)</b>		
231359	380050-066	Mast Bearing
231426	380050-069	Mast Bearing
560349	380055-058	Lift Cylinder O/H Kit
561307	380055-054	Lift Cylinder O/H Kit
562591	380055-059	Lift Cylinder O/H Kit
661549	380050-063	Mast Bearing
662145	380050-017	Roller
662145A	380050-017	Roller
664206	380050-063	Mast Bearing
683819	380050-018	Thrust Roller
797469	380050-017	Roller
C662145	380050-017	Roller
C797469	380050-017	Roller
CC662145	380050-017	Roller
CC683819	380050-018	Thrust Roller
CC683919	380050-018	Thrust Roller
<b>Caterpillar/Towmotor (CT)</b>		
05500-31070	380050-008	O-Ring
05634-01200	380030-019	Nut
0973519-E	380170-002-E	Bucket Seat w Electric Switch
1009115	380050-036	Bearing Assm
1015148	380170-031	Molded Pan Seat
1015776	380021-004-02	Brake Cylinder
1015777	380021-004-02	Brake Cylinder
1015874	064423	Female LP Tank Fitting
1017046	380012-011-02	Distributor Cap DC-20 4G32-52-54
1017158	380010-004-02	Belt - Fan
1017268	380013-004-02	Spark Plug W14EXR-U
1029645	380170-027	Molded Seat
1032322	380050-004	Inner Bearing
1033164	380170-027	Molded Seat
1037451	380170-027	Molded Seat
1038060	380015-006-02	Rotor RT-13 TB42 6Cyl
1038083	380013-009-02	Spark Plug W16EPR-U
1038589	380170-027	Molded Seat
1039078	380010-006-02	Belt - Fan
1041457	380012-009-02	Distributor B 4G63-4G64
1041551	380015-007-02	Rotor RT-10 4G32-52-54
1041579	380006-005-02	Pump Water 4G63-4G64
1041623	380010-009-02	Belt - Fan
1041823	380010-009-02	Belt - Fan
1049976	380170-027	Molded Seat
1058285	380170-027	Molded Seat
1075032	380050-006	Bearing Cone
1075034	380050-005	Bearing Cup
1075199	380170-020	Pan Seat
1085332	380001-010-01	Connector LPG Male 7141M
1085392	380001-010-01	Connector LPG Male 7141M
1097358	380170-027	Molded Seat
1129507	380170-020	Pan Seat
141267	380013-017-02	Spark Plug W16S-U
14411810	380030-101	Timing Belt
1832A002	380016-001-02	Coil A218371 MD358504 925969
1W0404	380006-003-02	Pump Water HER2.7-1404
1W404	380006-003-02	Pump Water HER2.7-1404
2A3643	380013-012-02	Spark Plug L14-U
2I3346	380011-006-02	Alternator 4G52-4G54

Caterpillar/Towmotor Continued ▶

## (IC) Truck Components Cross Reference by Manufacturer

Caterpillar/Towmotor Continued

OE Number	Crown Part No.	Description
2I5133	380015-002-02	Rotor RT-07 4Y
2I5154	380012-004-02	Distributor Cap DC-6 4Y
2I5416	380050-007	Oil Seal
2I5467	380050-051	Wheel Cylinder
2I5812	380050-034	Bearing Mast
2I6256	380010-006-02	Belt - Fan
2I6276	380012-012-02	Distributor Cap H20II
2I6444	380050-040	Ignition Switch
2I6460	380013-008-02	Spark Plug T16PR-U
2I8115	380015-004-02	Rotor RT-03 F2-FE
2I9273	380006-009-02	Pump Water VA
2N0159	380010-002-02	Belt - Fan
2W2530	380010-009-02	Belt - Fan
2W4246	380030-045	Air Filter
2W9486	380013-006-02	Spark Plug W16EX-U
308302	380010-002-02	Belt - Fan
31A90-00300	380050-032	Oil Pressure Switch
32A46-02100	380009-105	Thermostat/ Gasket
347191	380010-002-02	Belt - Fan
347192	380010-002-02	Belt - Fan
347196	380010-002-02	Belt - Fan
353706	380013-012-02	Spark Plug L14-U
41663	380013-012-02	Spark Plug L14-U
42713-30600	380009-104	Radiator Cap
45019	064423	Female LP Tank Fitting
46371	380012-012-02	Distributor Cap H20II
49099	380001-010-01	Connector LPG Male 7141M
4W1583	380006-003-02	Pump Water HER2.7-1404
5M8137	380030-096	Fan Belt
62923	380010-002-02	Belt - Fan
631202	380013-012-02	Spark Plug L14-U
64313-10075	380170-031	Molded Pan Seat
64314-10073	380170-031	Molded Pan Seat
64314-10075	380170-031	Molded Pan Seat
64314-10600	380170-031	Molded Pan Seat
64314-10601	380170-031	Molded Pan Seat
64314-10602	380170-031	Molded Pan Seat
64343-19900	380030-018	Nut
676637	380013-012-02	Spark Plug L14-U
683819	380050-018	Thrust Roller
6R6961	380030-115	King Pin
6R7181	380170-027	Molded Seat
6R7182	380170-027	Molded Seat
6V8407	380060-004	Oil Seal
7954	380013-012-02	Spark Plug L14-U
7N314	380001-001-01	Lockoff VFF-30-2-IMP
801985	380050-036	Bearing Assm
8N2236	380013-017-02	Spark Plug W16S-U
8N2630	380013-012-02	Spark Plug L14-U
90420-01480	380015-009-02	Rotor RT-01 GM 6Cyl
90420-01620	380013-014-02	Spark Plug PT16EPR-L13
90425-00390	380050-032	Oil Pressure Switch
90425-02580-N	380005-013-02	Starter (Brand New)
90425-08490	380030-069	Repair Kit (Nikki)
90425-08560	380030-073	Injector
90425-18040	380030-073	Injector
90440-00700	380050-061	Bearing Assm
90440-00900	380050-055	Bearing Assm
90440-01700	380050-065	Bearing Assembly
908169	380030-037	Pin, Steer Link
91202-07400	380008-005-02	Fan Blade 4G63-4G64 K Series
91202-17400	380008-005-02	Fan Blade 4G63-4G64 K Series
91214-00300	380170-031	Molded Pan Seat
91214-01080	380170-019	Fold Back Lumbar Seat

OE Number	Crown Part No.	Description
91214-01100	380170-031	Molded Pan Seat
91214-01300	380170-031	Molded Pan Seat
91214-11100	380170-031	Molded Pan Seat
91214-21300	380170-031	Molded Pan Seat
91214-33900	380170-031	Molded Pan Seat
91214-36300	380170-027	Molded Seat
91214-41100	380170-027	Molded Seat
91214-41300	380170-027	Molded Seat
91214-43900	380170-027	Molded Seat
91214-46300	380170-031	Molded Pan Seat
91214-51100	380170-031	Molded Pan Seat
91214-53900	380170-027	Molded Seat
9121401080	380170-019	Fold Back Lumbar Seat
9121411300	380170-027	Molded Seat
9121421100	380170-027	Molded Seat
9121431100	380170-027	Molded Seat
9121431300	380170-027	Molded Seat
91220-00400	380105-057	Spark Plug W14EX-U
91221-05010	380030-072	Clutch Cover
91246-01800	380050-053	Wheel Cylinder
91246-03400	380030-057	Spring
91246-04500	380030-031	Spring
91312-02900	380030-112	Gas Spring
91314-08500	380170-020	Pan Seat
9131408500	380170-020	Pan Seat
91346-40300	380021-002-02	Brake Cylinder
9136103500	380001-010-01	Connector LPG Male 7141M
9136103501	380001-010-01	Connector LPG Male 7141M
9136113500	380001-010-01	Connector LPG Male 7141M
91401-09800	380010-006-02	Belt - Fan
91444-09600	380050-062	Bearing, Spherical
91446-00900	380050-051	Wheel Cylinder
91446-02500	380030-058	Spring
91446-04300	380030-019	Nut
91446-17100	380020-004-02	Brake Shoe (1)
91465-0020	380001-003-01	Converter Cobra
91484-17100	380021-004-02	Brake Cylinder
91484-27100	380021-004-02	Brake Cylinder
91484-27101	380021-004-02	Brake Cylinder
91484-37100	380021-004-02	Brake Cylinder
91546-12500	380020-004-02	Brake Shoe (1)
91546-12600	380020-004-02	Brake Shoe (1)
91846-00800	380050-051	Wheel Cylinder
91846-14100	380030-024	Spring
91865-03100	380001-001-01	Lockoff VFF-30-2-IMP
91920-05100	380009-106	Thermostat/ Gasket
91921-06300	380010-005-02	Belt - Fan
91965-07500	380030-069	Repair Kit (Nikki)
91A14-01010	380070-037-E	Molded Seat w Electric Switch
91A14-01030	380070-037-E	Molded Seat w Electric Switch
91A14-11010	380070-037-E	Molded Seat w Electric Switch
91A14-21010	380070-037-E	Molded Seat w Electric Switch
91A14-21030	380070-037-E	Molded Seat w Electric Switch
91A51-08400	380030-001	Accelerator Unit
91A62-03500	380030-041	Sensor, O2
91A65-01601	380001-015-01	Vaporizer (Nikki)
91A65-21600	380001-015-01	Vaporizer (Nikki)
91B33-01100	380060-001	Oil Seal
91B43-05624	380050-062	Bearing, Spherical
91B46-00312	380050-053	Wheel Cylinder
91B46-10313	380020-007-02	Brake Shoe Kit (4)
91B46-10314	380020-007-02	Brake Shoe Kit (4)
91B46-10412	380020-007-02	Brake Shoe Kit (4)
91E43-01800	380050-031	Oil Seal

Caterpillar/Towmotor Continued

Caterpillar/Towmotor Continued ▶

## (IC) Truck Components Cross Reference by Manufacturer

Caterpillar/Towmotor Continued

(IC) Truck Components

OE Number	Crown Part No.	Description
91E43-02300	380060-007	Oil Seal
91E43-05722	380050-025	Bearing Spherical
91E46-00112	380050-052	Wheel Cylinder
91H20-00360	380030-067	Head Gasket
91H20-00370	380030-033	Head Gasket
91H20-00480	380030-036	PCV Valve
91H20-01160	380030-040	Sensor, Crankshaft
91H20-01740	380030-034	Manifold Gasket
91H20-02560	380010-005-02	Belt - Fan
91H20-02580	380006-002-02	Pump Water K21-K25
91H20-02680	380009-105	Thermostat/ Gasket
91H20-02770	380009-109	Hose
91H20-02860	380013-002-02	Spark Plug Q14R-U11
91H20-02930	380016-002-02	Ignition Coil
91H20-03270	380011-001-01	Alternator K21-K25
91H20-03330	380005-008-02	Starter K21-K25
91H20-03350	380010-003-02	Belt - Fan
91H20-04380	380030-111	Diaphragm Kit (NIKKI)
91H20-04460	380030-122	Valve Assy (NIKKI)
91H20-04710	380015-001-02	Rotor RT-11 H20II
91H20-06510	380030-028	Valve Cover Gasket
91H20-06690	380030-095	Injector
91H20-14470	380030-060	Diaphragm Kit (Nikki)
91H20-15230	380030-073	Injector
91H20-16690	380030-073	Injector
91H2003270	380011-001-01	Alternator K21-K25
93014-00010	380070-035	Molded Seat
9301400010	380070-035	Molded Seat
93146-02500	380021-002-02	Brake Cylinder
93146-12500	380021-002-02	Brake Cylinder
93165-03100	380001-002-01	Converter JB2
93165-03800	064423	Female LP Tank Fitting
93165-13100	380001-002-01	Converter JB2
93165-13110	380001-006-01	Repair Kit Cobra
93165-23100	380001-003-01	Converter Cobra
9316503500	380001-010-01	Connector LPG Male 7141M
9316503600	064423	Female LP Tank Fitting
93265-10060	380001-002-01	Converter JB2
93265-10080	380001-002-01	Converter JB2
93265-20800	380001-002-01	Converter JB2
93265-30800	380001-002-01	Converter JB2
9326500070	380001-001-01	Lockoff VFF-30-2-IMP
93446-01300	380055-060	Wheel Cylinder
93465-10010	380001-002-01	Converter JB2
93720-09911	380012-015-02	Distributor Cap
953582	380050-006	Bearing Cone
97046-21800	380020-005-02	Brake Pad (1)
97114-00100	380170-031	Molded Pan Seat
97114-10100	380170-031	Molded Pan Seat
97114-20100	380170-031	Molded Pan Seat
97114-30100	380170-031	Molded Pan Seat
97114-40100	380170-031	Molded Pan Seat
971264	380006-001-02	Pump Water H20 New Style
971276	380012-011-02	Distributor Cap DC-20 4G32-52-54
971315	380023-001-02	Brake Pedal Cover
971353	380013-007-02	Spark Plug W9EP
971472	380010-010-02	Belt - Fan
971562	380011-007-02	Alternator H20
971564	380012-005-02	Distributor C H20
971771	380012-011-02	Distributor Cap DC-20 4G32-52-54
972385	380013-012-02	Spark Plug L14-U
972433	380050-035	Bearing Mast
973138	380170-003	Bucket Seat
973139	380070-009	Pan Seat
973283	380013-012-02	Spark Plug L14-U

OE Number	Crown Part No.	Description
973519	380170-002	Bucket Straight Back Seat
973519-E	380170-002-E	Bucket Seat w Electric Switch
973520	380170-004	Bucket Seat
973522	380070-001	Lumbar Seat
973546	380050-037	Packing Cylinder Kit
973851	380050-011	Oil Seal
973960	380050-035	Bearing Mast
97546-01700	380030-119	Spring
99476	380013-017-02	Spark Plug W16S-U
99481	380010-002-02	Belt - Fan
99841	380010-002-02	Belt - Fan
914658	380015-001-02	Rotor RT-11 H20II
9L2248	380010-003-02	Belt - Fan
9S3581	380050-005	Bearing Cup
9S3582	380050-006	Bearing Cone
9X7695	380060-015	Oil Seal
9Y5969	380006-003-02	Pump Water HER2.7-1404
A0000-00429	380006-011-02	Pump Water H20II-H25
A0000-02071	380011-004-02	Alternator H20-P40-TB42
A0000-05846	380005-005-02	Starter GM 3.0L
A0000-07882	380050-005	Bearing Cup
A0000-07892	380050-006	Bearing Cone
A0000-10379	380050-017	Roller
A0000-12933	380009-005-02	Radiator
A0000-13592	380010-001-02	Belt - Fan
A0000-14416	380013-018-01	Spark Plug T20EPR-U
A0000-14798	380012-003-02	Distributor I 4Y
A0000-16203	380170-025	Wing Seat
A0000-20015	380170-028-E	Seat w Electric Switch
A0000-25819	380170-002	Bucket Straight Back Seat
A0000-25820	380170-004	Bucket Seat
A0000-26570	380050-006	Bearing Cone
A0000-26796	380070-022	Bucket Seat
A0000-28641	380070-030	Suspension Seat - Cloth
A0000-28785	380170-025	Wing Seat
A0000-28790	380170-025	Wing Seat
A0000-28830	380070-029	Contoured Seat
A0000-30247	380170-028	Seat
A000000345	380010-008-02	Belt - Timing
D700615	380006-003-02	Pump Water HER2.7-1404
F2335-16000	380030-017	Nut
F8140-30214	380050-004	Inner Bearing
F8143-32212	380050-003	Outer Bearing
LM40AQ5019	064423	Female LP Tank Fitting
M002T-58681	380005-004-01	Starter 4G63-4G64
MC840219	380050-032	Oil Pressure Switch
MCF00036	380006-003-02	Pump Water HER2.7-1404
MD138993	380050-032	Oil Pressure Switch
MD169418	380012-009-02	Distributor B 4G63-4G64
MD171228	380005-004-01	Starter 4G63-4G64
MD320618	380005-004-01	Starter 4G63-4G64
MD326638	380016-001-02	Coil A218371 MD358504 925969
MD358504	380016-001-02	Coil A218371 MD358504 925969
MD602756	380012-011-02	Distributor Cap DC-20 4G32-52-54
MD602758	380015-007-02	Rotor RT-10 4G32-52-54
MD602949	380012-011-02	Distributor Cap DC-20 4G32-52-54
MD607597	380012-011-02	Distributor Cap DC-20 4G32-52-54
MD611686	380012-011-02	Distributor Cap DC-20 4G32-52-54
MD611817	380015-001-02	Rotor RT-11 H20II
MD611850	380015-007-02	Rotor RT-10 4G32-52-54
MD618262	380015-001-02	Rotor RT-11 H20II
MD618364	380012-007-02	Distributor Cap DC-19 4G63-4G64
MD851101	380013-017-02	Spark Plug W16S-U
MD970338	380006-005-02	Pump Water 4G63-4G64
MD972033	380014-002-02	Plug Wire Set 4G63-4G64

Caterpillar/Towmotor Continued ▶



# (IC) Truck Components Cross Reference by Manufacturer

Caterpillar/Towmotor Continued

OE Number	Crown Part No.	Description
MD972457	380006-005-02	Pump Water 4G63-4G64
MD972748	380014-002-02	Plug Wire Set 4G63-4G64
MD997476	380013-017-02	Spark Plug W16S-U
MIC-0053011	064423	Female LP Tank Fitting
MIC0053089	380001-010-01	Connector LPG Male 7141M
MM115231	380010-004-02	Belt - Fan
MM407440	380010-009-02	Belt - Fan
MM502535	380015-006-02	Rotor RT-13 TB42 6Cyl
MM611850	380015-001-02	Rotor RT-11 H20II
MS851101	380013-006-02	Spark Plug W16EX-U
NA040025	380050-036	Bearing Assm
T232T-46772	380012-011-02	Distributor Cap DC-20 4G32-52-54
T232T-48372	380012-007-02	Distributor Cap DC-19 4G63-4G64
T880T-18972	380015-001-02	Rotor RT-11 H20II
T880X17571	380015-006-02	Rotor RT-13 TB42 6Cyl
<b>Century (CE)</b>		
662145	380050-017	Roller
CC662145	380050-017	Roller
<b>Clark (CL)</b>		
1310275	380050-058	Bearing, Spherical
1318727	380050-005	Bearing Cup
1318728	380050-006	Bearing Cone
1332679	380105-057	Spark Plug W14EX-U
1333648	380050-016	Roller
1342529	380015-009-02	Rotor RT-01 GM 6Cyl
1400305	380070-016	Suspension Seat - Vinyl
1636257	380070-026	Contoured Back Seat
1802035	380170-020	Pan Seat
1802151	380070-030	Suspension Seat - Cloth
1802446	380070-030	Suspension Seat - Cloth
1810436	380014-008-02	Plug Wire Set H20
1811616	380051-001	Ignition Wire Set
1811917	380051-001	Ignition Wire Set
1817083	380050-036	Bearing Assm
2360140	380001-002-01	Converter JB2
2361378	380010-002-02	Belt - Fan
2363677	380011-006-02	Alternator 4G52-4G54
2366970	380030-108	Strobe Lamp (Amber)
2383064	380011-006-02	Alternator 4G52-4G54
2385639	380013-004-02	Spark Plug W14EXR-U
2389314	380070-016	Suspension Seat - Vinyl
2389326	380070-026	Contoured Back Seat
2389703	380070-026	Contoured Back Seat
2399509	380011-006-02	Alternator 4G52-4G54
2399511	380011-006-02	Alternator 4G52-4G54
245020	380060-018	Oil Seal
247050	380030-046	Transmission Filter
2572769	380015-006-02	Rotor RT-13 TB42 6Cyl
2575926	380015-009-02	Rotor RT-01 GM 6Cyl
2775193	380070-030	Suspension Seat - Cloth
2781527	380010-001-02	Belt - Fan
2786180	380060-012	Oil Seal
2793120	380070-016	Suspension Seat - Vinyl
2794459	380050-025	Bearing Spherical
2795958	380070-026	Contoured Back Seat
2803280	380070-026	Contoured Back Seat
2807382	380011-006-02	Alternator 4G52-4G54
2814061	380010-004-02	Belt - Fan
2817056	380005-005-02	Starter GM 3.0L
2817183	380070-026	Contoured Back Seat
2817623	380070-034	Suspension Molded Seat
3490402	380010-003-02	Belt - Fan
352780	380010-003-02	Belt - Fan
3675433	380001-001-01	Lockoff VFF-30-2-IMP
3736995	380070-030	Suspension Seat - Cloth
3737932	380070-016	Suspension Seat - Vinyl

OE Number	Crown Part No.	Description
3739054	380013-012-02	Spark Plug L14-U
3772793	380070-016	Suspension Seat - Vinyl
3773658	380010-012-02	Belt - Fan
3777091	380050-062	Bearing, Spherical
3777118	380070-016	Suspension Seat - Vinyl
377901	380070-015	Molded Seat
3779914	380012-011-02	Distributor Cap DC-20 4G32-52-54
3779999	380051-001	Ignition Wire Set
3790816	380010-004-02	Belt - Fan
3796400	380070-016	Suspension Seat - Vinyl
3796460	380070-016	Suspension Seat - Vinyl
3799599	380050-025	Bearing Spherical
3799728	380050-006	Bearing Cone
3799729	380050-005	Bearing Cup
39678	380050-008	O-Ring
4151715	380050-003	Outer Bearing
4308663	380070-016	Suspension Seat - Vinyl
4310868	380070-016	Suspension Seat - Vinyl
4335221	380012-007-02	Distributor Cap DC-19 4G63-4G64
4335223	380015-001-02	Rotor RT-11 H20II
4335230	380016-001-02	Coil A218371 MD358504 925969
4338827	380013-004-02	Spark Plug W14EXR-U
4358426	380070-016	Suspension Seat - Vinyl
443487	380012-013-02	Distributor Cap
444460	380015-004-02	Rotor RT-03 F2-FE
444771	380013-007-02	Spark Plug W9EP
444881	380050-004	Inner Bearing
444901	380015-006-02	Rotor RT-13 TB42 6Cyl
444932	380030-012	Bolt
445268	380008-004-02	Fan Blade H20
445285	380012-005-02	Distributor C H20
445294	380012-012-02	Distributor Cap H20II
445458	380050-029	Bolt
446097	380006-007-02	Pump Water 4Y 5-6 Series
446130	380015-002-02	Rotor RT-07 4Y
446183	380023-001-02	Brake Pedal Cover
446323	380013-008-02	Spark Plug T16PR-U
446399	380015-004-02	Rotor RT-03 F2-FE
446444	380050-037	Packing Cylinder Kit
446583	380013-017-02	Spark Plug W16S-U
448114	380170-020	Pan Seat
448324	380170-027	Molded Seat
448458	380010-010-02	Belt - Fan
448491	380170-028	Seat
448492	380070-032	Molded Seat
448494	380070-032	Molded Seat
5456200	380070-016	Suspension Seat - Vinyl
6015-10340	380001-001-01	Lockoff VFF-30-2-IMP
6016-10470	380001-010-01	Connector LPG Male 7141M
6513962	380011-006-02	Alternator 4G52-4G54
655335	064423	Female LP Tank Fitting
659050	380010-009-02	Belt - Fan
6599739	380011-006-02	Alternator 4G52-4G54
662145	380050-017	Roller
6632388	380070-016	Suspension Seat - Vinyl
683819	380050-018	Thrust Roller
7000201	380014-005-02	Plug Wire Set F2-FE
7000218	380014-005-02	Plug Wire Set FE
7000253	380012-012-02	Distributor Cap H20II
7000255	380012-004-02	Distributor Cap DC-6 4Y
7000271	380015-010-02	Rotor
7000289	380011-004-02	Alternator H20-P40-TB42
7000308	380012-005-02	Distributor C H20
7000312	380012-011-02	Distributor Cap DC-20 4G32-52-54
7000350	380010-006-02	Belt - Fan
7000351	380010-012-02	Belt - Fan

(IC) Truck Components

Clark Continued ▶

## (IC) Truck Components Cross Reference by Manufacturer

Clark Continued

OE Number	Crown Part No.	Description
7000353	380010-006-02	Belt - Fan
7000507	380006-001-02	Pump Water H20 New Style
7000511	380006-004-02	Pump Water FE
7000647	380030-101	Timing Belt
7000659	380010-008-02	Belt - Timing
7000977	380023-001-02	Brake Pedal Cover
7001049	380021-004-02	Brake Cylinder
7001081	380021-003-02	Brake Cylinder
7001125	380050-019	Roller-Lift
7001266	380050-004	Inner Bearing
7001320	380050-034	Bearing Mast
7001677	380008-004-02	Fan Blade H20
7003807	380050-007	Oil Seal
7003866	380050-033	Seal Oil Drive Axle
7003887	380050-002	Oil Seal
7004147	380050-040	Ignition Switch
7004445	380050-039	Lift Cylinder O/H Kit
715976	064423	Female LP Tank Fitting
715977	380001-010-01	Connector LPG Male 7141M
742159	380013-012-02	Spark Plug L14-U
774608	380010-010-02	Belt - Fan
784250	380013-012-02	Spark Plug L14-U
799544	380030-096	Fan Belt
8027922	380050-044	Micro Switch
866176	064423	Female LP Tank Fitting
872631	380012-012-02	Distributor Cap H20II
888765	380050-032	Oil Pressure Switch
890210	380013-017-02	Spark Plug W16S-U
890215	380013-012-02	Spark Plug L14-U
890217	380013-012-02	Spark Plug L14-U
890219	380013-017-02	Spark Plug W16S-U
890220	380013-017-02	Spark Plug W16S-U
890221	380013-012-02	Spark Plug L14-U
890222	380013-012-02	Spark Plug L14-U
890225	380013-017-02	Spark Plug W16S-U
890227	380013-012-02	Spark Plug L14-U
890236	380013-017-02	Spark Plug W16S-U
890245	380013-012-02	Spark Plug L14-U
890246	380013-012-02	Spark Plug L14-U
890247	380013-012-02	Spark Plug L14-U
890252	380013-017-02	Spark Plug W16S-U
890253	380013-017-02	Spark Plug W16S-U
890255	380013-012-02	Spark Plug L14-U
890256	380013-012-02	Spark Plug L14-U
890264	380013-012-02	Spark Plug L14-U
890265	380013-017-02	Spark Plug W16S-U
890267	380013-017-02	Spark Plug W16S-U
890271	380013-012-02	Spark Plug L14-U
890272	380013-012-02	Spark Plug L14-U
890273	380013-012-02	Spark Plug L14-U
890274	380013-012-02	Spark Plug L14-U
890276	380013-012-02	Spark Plug L14-U
905949	380011-006-02	Alternator 4G52-4G54
907438	380009-106	Thermostat/ Gasket
907621	380013-012-02	Spark Plug L14-U
907739	380011-006-02	Alternator 4G52-4G54
908106	380011-006-02	Alternator 4G52-4G54
908221	380011-006-02	Alternator 4G52-4G54
908830	380070-026	Contoured Back Seat
908831	380070-026	Contoured Back Seat
909351	380012-011-02	Distributor Cap DC-20 4G32-52-54
909353	380015-007-02	Rotor RT-10 4G32-52-54
909376	380051-001	Ignition Wire Set
909377	380105-057	Spark Plug W14EX-U
909378	380013-006-02	Spark Plug W16EX-U
911166	380009-106	Thermostat/ Gasket

OE Number	Crown Part No.	Description
911410	380005-004-01	Starter 4G63-4G64
912703	380105-057	Spark Plug W14EX-U
913259	380010-012-02	Belt - Fan
913628	380013-012-02	Spark Plug L14-U
913633	380013-012-02	Spark Plug L14-U
913638	380013-012-02	Spark Plug L14-U
913639	380013-004-02	Spark Plug W14EXR-U
913788	380009-106	Thermostat/ Gasket
913831	380013-012-02	Spark Plug L14-U
915588	380070-026	Contoured Back Seat
916005	380012-011-02	Distributor Cap DC-20 4G32-52-54
916006	380015-007-02	Rotor RT-10 4G32-52-54
918306	380005-004-01	Starter 4G63-4G64
918313	380012-009-02	Distributor B 4G63-4G64
918706	380030-104	Timing Belt
920165	380001-006-01	Repair Kit Cobra
920227	380050-032	Oil Pressure Switch
920231	380010-009-02	Belt - Fan
920235	380009-106	Thermostat/ Gasket
920441	380050-032	Oil Pressure Switch
920971	380005-004-01	Starter 4G63-4G64
920989	380014-002-02	Plug Wire Set 4G63-4G64
920990	380014-002-02	Plug Wire Set 4G63-4G64
922220	380015-009-02	Rotor RT-01 GM 6Cyl
922221	380015-009-02	Rotor RT-01 GM 6Cyl
922786	380013-016-02	Spark Plug T14PR-U
923048	380001-001-01	Lockoff VFF-30-2-IMP
923049	380001-003-01	Converter Cobra
923292	380001-006-01	Repair Kit Cobra
923626	380012-007-02	Distributor Cap DC-19 4G63-4G64
923627	380015-001-02	Rotor RT-11 H20II
923702	380013-014-02	Spark Plug PT16EPR-L13
924942	380006-006-02	Pump Water GM 3.0L
925017	380030-061	Valve Cover Gasket
925020	380009-106	Thermostat/ Gasket
925049	380013-008-02	Spark Plug T16PR-U
925303	380009-104	Radiator Cap
925874	380005-005-02	Starter GM 3.0L
925969	380016-001-02	Coil A218371 MD358504 925969
926014	380009-104	Radiator Cap
926069	380070-026	Contoured Back Seat
926070	380070-034	Suspension Molded Seat
926072	380070-026	Contoured Back Seat
926118	380001-010-01	Connector LPG Male 7141M
926119	064423	Female LP Tank Fitting
930135	380030-029	Valve Cover Gasket
930707	380005-005-02	Starter GM 3.0L
930768	380010-009-02	Belt - Fan
932435	380001-003-01	Converter Cobra
932437	380001-002-01	Converter JB2
932561	380050-051	Wheel Cylinder
932573	380030-024	Spring
932574	380030-059	Spring
932575	380030-025	Spring
932576	380030-058	Spring
932582	380030-023	Spring
932683	380020-010-02	Brake Shoe Set (2 Shoes)
932684	380020-010-02	Brake Shoe Set (2 Shoes)
932698	380001-006-01	Repair Kit Cobra
933605	380005-005-02	Starter GM 3.0L
940328	380013-012-02	Spark Plug L14-U
<b>Clarke Sweepers (CK)</b>		
908830	380070-026	Contoured Back Seat
926069	380070-026	Contoured Back Seat

## (IC) Truck Components Cross Reference by Manufacturer

OE Number	Crown Part No.	Description
<b>Continental (CN)</b>		
SP-200S00009RNYC	380013-004-02	Spark Plug W14EXR-U
YD6	380013-012-02	Spark Plug L14-U
<b>Daewoo (DW)</b>		
2W8554	380006-003-02	Pump Water HER2.7-1404
45019	064423	Female LP Tank Fitting
4W1583	380006-003-02	Pump Water HER2.7-1404
8N2236	380013-017-02	Spark Plug W16S-U
9Y5969	380006-003-02	Pump Water HER2.7-1404
A123042	380050-003	Outer Bearing
A123043	380050-003	Outer Bearing
A213066	380050-036	Bearing Assm
A213955	380001-006-01	Repair Kit Cobra
A213971	380010-011-02	Belt - Fan
A218012	380001-003-01	Converter Cobra
A218023	380030-029	Valve Cover Gasket
A218276	380006-005-02	Pump Water 4G63-4G64
A218287	380009-106	Thermostat/ Gasket
A218315	380005-004-01	Starter 4G63-4G64
A218353	380012-007-02	Distributor Cap DC-19 4G63-4G64
A218357	380015-001-02	Rotor RT-11 H20II
A218371	380016-001-02	Coil A218371 MD358504 925969
A218377	380013-009-02	Spark Plug W16EPR-U
A218378	380014-002-02	Plug Wire Set 4G63-4G64
A218625	380030-061	Valve Cover Gasket
A218653	380006-006-02	Pump Water GM 3.0L
A218755	380014-007-02	Plug Wire- Set GM 3.0L
A218756	380013-008-02	Spark Plug T16PR-U
A219024	380013-008-02	Spark Plug T16PR-U
A223103	380013-013-02	Spark Plug Q20-PR-U
A232133	380015-009-02	Rotor RT-01 GM 6Cyl
A233320	380050-005	Bearing Cup
A251738	380050-053	Wheel Cylinder
A273363	380020-007-02	Brake Shoe Kit (4)
A273364	380020-007-02	Brake Shoe Kit (4)
A273365	380020-007-02	Brake Shoe Kit (4)
A273823	380010-009-02	Belt - Fan
A293947	380050-004	Inner Bearing
A413624	380014-009-02	Ignition Wire Set
D131093	380050-062	Bearing, Spherical
D141101	380030-096	Fan Belt
D141112	380023-003	Friction Plate, Disc Brakes
D141267	380013-017-02	Spark Plug W16S-U
D490720	380006-002-02	Pump Water K21-K25
D490732	380009-109	Hose
D490742	380012-002-02	Distributor G H20II
D490743	380012-001-02	Distributor Cap DC-10 H20II
D490744	380015-001-02	Rotor RT-11 H20II
D490816	380014-006-02	Plug Wire Set H20II
D490878	380010-001-02	Belt - Fan
D491287	380030-027	Valve Cover Gasket
D491452	380008-003-02	Fan Blade H20 II
D700178	064423	Female LP Tank Fitting
D700251	380023-002	Plate, Disc Brakes
D700306	380060-015	Oil Seal
D700576	380030-115	King Pin
D700579	380050-061	Bearing Ass'y
D700581	380060-004	Oil Seal
D700583	380030-037	Pin, Steer Link
D700615	380006-003-02	Pump Water HER2.7-1404
D700682	380015-010-02	Rotor
D700696	380012-013-02	Distributor Cap
D700699	380013-017-02	Spark Plug W16S-U
<b>Delco-Remy (DR)</b>		
10455012	380005-005-02	Starter GM 3.0L

OE Number	Crown Part No.	Description
9000820	380005-005-02	Starter GM 3.0L
9000822	380005-005-02	Starter GM 3.0L
9000850	380005-005-02	Starter GM 3.0L
C-86	380013-012-02	Spark Plug L14-U
C-87	380013-012-02	Spark Plug L14-U
R-45-RB	380013-016-02	Spark Plug T14PR-U
R-45-TS	380013-008-02	Spark Plug T16PR-U
<b>Doosan (DOS)</b>		
A218012	380001-003-01	Converter Cobra
A218441	380050-032	Oil Pressure Switch
A218755	380014-007-02	Plug Wire Set GM 3.0L
<b>Drexel (DX)</b>		
1411740	380013-008-02	Spark Plug T16PR-U
<b>General Motors (GM)</b>		
0706-1943	380070-015	Molded Seat
<b>Grammer (GG)</b>		
1129306	380070-016	Suspension Seat - Vinyl
<b>Halla (HA)</b>		
LT125-04	380011-004-02	Alternator H20-P40-TB42
LT125-06B	380011-004-02	Alternator H20-P40-TB42
LT130-41K	380011-004-02	Alternator H20-P40-TB42
LT130-65	380011-004-02	Alternator H20-P40-TB42
LT130-72	380011-004-02	Alternator H20-P40-TB42
LT130-72B	380011-004-02	Alternator H20-P40-TB42
LT130-75	380011-004-02	Alternator H20-P40-TB42
LT135-13	380011-004-02	Alternator H20-P40-TB42
LT135-13B	380011-004-02	Alternator H20-P40-TB42
LT135-17B	380011-004-02	Alternator H20-P40-TB42
LT135-19B	380011-004-02	Alternator H20-P40-TB42
LT135-19C	380011-004-02	Alternator H20-P40-TB42
LT135-19E	380011-004-02	Alternator H20-P40-TB42
LT135-20	380011-004-02	Alternator H20-P40-TB42
LT135-24	380011-004-02	Alternator H20-P40-TB42
LT135-35	380011-004-02	Alternator H20-P40-TB42
LT135-35B	380011-004-02	Alternator H20-P40-TB42
LT135-35C	380011-004-02	Alternator H20-P40-TB42
LT135-54	380011-004-02	Alternator H20-P40-TB42
LT135-68	380011-004-02	Alternator H20-P40-TB42
LT135-69	380011-004-02	Alternator H20-P40-TB42
LT150-25	380011-004-02	Alternator H20-P40-TB42
LT150-25B	380011-004-02	Alternator H20-P40-TB42
<b>Hamech (HAM)</b>		
07012-00080	380050-046	Oil Seal
13270-FY500	380030-028	Valve Cover Gasket
13270-FY50A	380030-028	Valve Cover Gasket
16310-GS40A	380001-013-01	Vaporizer
16310-GU20A	380001-013-01	Vaporizer
18919-AM810	380030-001	Accelerator Unit
21200-0C811	380009-105	Thermostat/ Gasket
21200-50K00	380009-105	Thermostat/ Gasket
21200-53J00	380009-105	Thermostat/ Gasket
21200-VJ200	380009-105	Thermostat/ Gasket
22448-AR215	380016-002-02	Ignition Coil
25240-FJ10A	380050-032	Oil Pressure Switch
300-22-31240	380030-018	Nut
300-22-31241	380030-018	Nut
30B-13-11110	380001-014-02	Torque Convertor (Brand New)
34A-24-11220	380030-011	Bolt
34A-30-11400	380050-053	Wheel Cylinder
34A-30-11401	380050-053	Wheel Cylinder
34A-42-11411	380030-026	Steer Axle Bushing
34A-42-11411A	380030-026	Steer Axle Bushing
34A-42-11411L	380030-026	Steer Axle Bushing
34B-21-14151	380030-016	Nut
34B-24-11221	380030-012	Bolt
34B-30-14351	380030-024	Spring

Hamech Continued ▶

## (IC) Truck Components Cross Reference by Manufacturer

Hamech Continued

OE Number	Crown Part No.	Description
34B-30-14420	380030-023	Spring
360-27-11220	380030-022	Shim
37B-1EA-2010	380030-005	Front Lamp
37B-1EH-2010	380030-005	Front Lamp
37B-1EH-2010A	380030-005	Front Lamp
37B-1EH-2010L	380030-005	Front Lamp
3BB-30-12190	380030-003	Adjuster Cable
3EA-04-51110	380009-008-02	Radiator
3EA-15-11180	380030-020	Plate
3EA-15-11180A	380030-020	Plate
3EA-15-11180L	380030-020	Plate
3EA-22-11161	380050-054	Bearing Assm
3EA-22-11161A	380050-054	Bearing Assm
3EA-22-11161L	380050-054	Bearing Assm
3EA-22-11210	380050-047	Oil Seal
3EA-30-11330	380030-004	Adjuster Cable
3EA-30-25111	380050-053	Wheel Cylinder
3EA-30-25121	380050-053	Wheel Cylinder
3EB-04-21130	380009-104	Radiator Cap
3EB-21-15130	380050-048	Oil Seal
3EB-21-15130A	380050-048	Oil Seal
3EB-21-15130L	380050-048	Oil Seal
3EB-21-15140	380050-045	Oil Seal
3EB-21-32180	380050-049	Oil Seal
3EB-22-21160	380060-006	Oil Seal
3EB-22-21170	380030-013	Bolt
3EB-24-32260	380050-057	Bearing Assm
3EB-30-31320	380030-025	Spring
3EB-30-41440	380050-052	Wheel Cylinder
3EC-30-11350	380030-024	Spring
3EC-30-11360	380030-025	Spring
3EC-30-11490	380030-019	Nut
3EC-30-15750	380030-023	Spring
3EC-30-31320	380030-025	Spring
4923069	380030-003	Adjuster Cable
4940277	380050-046	Oil Seal
4940278	380050-046	Oil Seal
4940458	380030-020	Plate
4940503	380050-054	Bearing Assm
4940537	380030-004	Adjuster Cable
4940905	380050-048	Oil Seal
4941345	380030-018	Nut
4941509	380030-011	Bolt
4941515	380050-053	Wheel Cylinder
4941532	380030-026	Steer Axle Bushing
4941533	380030-026	Steer Axle Bushing
4941586	380030-016	Nut
4941592	380030-012	Bolt
4941616	380030-024	Spring
4941622	380030-023	Spring
4941755	380030-022	Shim
4942457	380050-046	Oil Seal
4942534	380030-024	Spring
4942606	380030-024	Spring
4942607	380030-025	Spring
4944661	380030-019	Nut
4949074	380009-104	Radiator Cap
4949228	380009-104	Radiator Cap
4949338	380030-013	Bolt
4949757	380030-005	Front Lamp
4968244	380030-024	Spring
4968320	380030-022	Shim
4968837	380013-004-02	Spark Plug W14EXR-U
4969577	380030-023	Spring
8761142	380050-053	Wheel Cylinder
8761209	380009-104	Radiator Cap

(IC) Truck Components

OE Number	Crown Part No.	Description
8761245	380050-049	Oil Seal
8761530	380030-023	Spring
8761532	380030-025	Spring
8761533	380030-003	Adjuster Cable
8761954	380009-105	Thermostat/ Gasket
8762946	380050-053	Wheel Cylinder
8763193	380030-025	Spring
8765283	380030-025	Spring
8772239	380030-028	Valve Cover Gasket
8772261	380009-105	Thermostat/ Gasket
8772265	380013-002-02	Spark Plug Q14R-U11
8772266	380016-002-02	Ignition Coil
8772287	380030-001	Accelerator Unit
8772429	380050-046	Oil Seal
8776236	380050-045	Oil Seal
8776249	380050-052	Wheel Cylinder
8777419	380030-028	Valve Cover Gasket
8777431	380001-013-01	Vaporizer
8777919	380050-048	Oil Seal
8777963	380050-057	Bearing Assm
8779362	380001-013-01	Vaporizer
8779491	380050-047	Oil Seal
8782583	380009-104	Radiator Cap
A6600-FU471	380030-073	Injector
A6600-FU571	380030-073	Injector
CPC89C0025010	380009-104	Radiator Cap
CPC89C0175010	380009-104	Radiator Cap
<b>Helmar (HM)</b>		
12-720	380030-113	Horn (12 Volt)
16600-GS07C	380030-095	Injector
17053-FU460	380030-111	Diaphragm Kit (NIKKI)
17962-FU460	380030-122	Valve Assy (NIKKI)
3600	380170-036-E	Suspension Seat w Ele Switch
520	380050-051	Starter Solenoid
555	380050-051	Starter Solenoid
72268A	380030-108	Strobe Lamp (Amber)
7390	380030-044	Mirror
7395	380030-007	Mirror
CTR-24-280	380030-002	Contactora (24 Volt)
MODEL100	380070-001	Lumbar Seat
MODEL1000	380170-010	Lumbar Support Seat
MODEL1100	380170-011	Seat
MODEL1200	380070-012	Pan Seat w Armrest
MODEL1300	380070-013	Full Body Seat
MODEL1400	380170-014	Pan Seat
MODEL1500	380070-015	Molded Seat
MODEL1600	380070-016	Suspension Seat - Vinyl
MODEL1700	380170-017	Suspension Seat
MODEL1700-ELE	380170-017-E	Suspension Seat w Ele Switch
MODEL1800	380170-018	Bucket Seat
MODEL1900	380170-019	Fold Back Lumbar Seat
MODEL200	380170-002	Bucket Straight Back Seat
MODEL200-E	380170-002-E	Bucket Seat w Electric Switch
MODEL2000	380170-020	Pan Seat
MODEL2100	380170-021	Pan Seat w Arm Rest
MODEL2200	380070-022	Bucket Seat
MODEL2300	380070-023	Pan Seat
MODEL2300-ELE	380070-023-E	Pan Seat W Electric Switch
MODEL2400	380170-024	Low Profile Seat
MODEL2400-ELE	380170-024-E	Low Profile Seat w Ele Switch
MODEL2400-HRB	380170-024-H	Low Profile Seat w Hip Restraint
MODEL2500	380170-025	Wing Seat
MODEL2600	380070-026	Contoured Back Seat
MODEL2700	380170-027	Molded Seat
MODEL2800	380170-028	Seat
MODEL2800-ELE	380170-028-E	Seat w Electric Switch

Helmar Continued ▶

# (IC) Truck Components Cross Reference by Manufacturer

Helmar Continued

OE Number	Crown Part No.	Description
MODEL2900	380070-029	Contoured Seat
MODEL300	380170-003	Bucket Seat
MODEL3000	380070-030	Suspension Seat - Cloth
MODEL3100	380170-031	Molded Pan Seat
MODEL3200	380070-032	Molded Seat
MODEL3200-ELE	380070-032-E	Molded Seat w Electric Switch
MODEL3300	380070-033	Suspension Molded Seat
MODEL3300-ELE	380070-033-E	Suspension Seat W Elec Switch
MODEL3400	380070-034	Suspension Molded Seat
MODEL3500	380070-035	Molded Seat
MODEL3600	380170-036-E	Suspension Seat w Ele Switch
MODEL3700	380070-037-E	Molded Seat w Electric Switch
MODEL3800	380170-038-E	Molded Seat w Electric Switch
MODEL3900	380170-039	Wing Seat
MODEL400	380170-004	Bucket Seat
MODEL500	380170-005	Bucket Seat
MODEL600	380170-006	Standard Seat
MODEL700	380170-007	Standard Seat
MODEL800	380170-008	Contoured Seat
MODEL900	380070-009	Pan Seat
Hyster (HY)		
0109983A	380170-009	Contoured Seat
0112155A	380170-009	Contoured Seat
104728	380010-003-02	Belt - Fan
109169	380030-118	Plug
109983	380070-009	Pan Seat
109983A	380070-009	Pan Seat
111107	380010-010-02	Belt - Fan
112155A	380070-009	Pan Seat
116073	380070-016	Suspension Seat - Vinyl
118714	380030-109	Bolt
1194451	380030-118	Plug
123577	380010-010-02	Belt - Fan
123872	380013-012-02	Spark Plug L14-U
124010	380001-010-01	Connector LPG Male 7141M
127504	380070-015	Molded Seat
1300919	380050-025	Bearing Spherical
1304950	380030-047	Fuel Filter
130798	380070-015	Molded Seat
130799	380070-015	Molded Seat
130800	380070-015	Molded Seat
1310962	380011-004-02	Alternator H20-P40-TB42
1312454	380013-017-02	Spark Plug W16S-U
1312459	380013-012-02	Spark Plug L14-U
1312624	380030-019	Nut
1326394	380012-006-02	Distributor Cap DC-11 F2-FE
1326395	380015-004-02	Rotor RT-03 F2-FE
1326536	380030-107	Ignition Module
1329534	380014-007-02	Plug Wire Set GM 3.0L
1330468	380013-016-02	Spark Plug T14PR-U
1332675	380013-008-02	Spark Plug T16PR-U
1332676	380013-008-02	Spark Plug T16PR-U
1332693	380013-012-02	Spark Plug L14-U
1333399	380050-067	Mast Bearing
1333648	380050-016	Roller
1334403	380015-009-02	Rotor RT-01 GM 6Cyl
1334620	380020-003-02	Brake Shoe Kit (2)
1334638	380030-100	Spring Kit
1334640	380020-006-02	Brake Shoe Set (2)
1334644	380023-004	Sheave, Brake
1334648	380050-051	Wheel Cylinder
1337666	380014-007-02	Plug Wire Set GM 3.0L
1339151	380012-006-02	Distributor Cap DC-11 F2-FE
1339931	380006-009-02	Pump Water VA
1342529	380015-009-02	Rotor RT-01 GM 6Cyl

OE Number	Crown Part No.	Description
1345826	380070-016	Suspension Seat - Vinyl
1347048	380021-003-02	Brake Cylinder
1352140	380009-102	Radiator Cap
1353192	380050-067	Mast Bearing
1354997	380060-002	Oil Seal
1358223	380020-006-02	Brake Shoe Set (2)
1360086	380050-032	Oil Pressure Switch
1360799	380030-019	Nut
1360886	380030-062	Valve Cover Gasket
1360893	380030-036	PCV Valve
1361733	380010-008-02	Belt - Timing
1361811	380006-004-02	Pump Water FE
1361820	380009-106	Thermostat/ Gasket
1361837	380013-005-02	Spark Plug W9EXR-U
1361853	380011-005-01	Alternator D5-F2-FE
1362035	380015-004-02	Rotor RT-03 F2-FE
1362113	380014-005-02	Plug Wire Set FE
1363007	380020-003-02	Brake Shoe Kit (2)
1367561	380015-004-02	Rotor RT-03 F2-FE
1368862	380050-051	Starter Solenoid
1369893	380014-005-02	Plug Wire Set F2-FE
1370740	380012-006-02	Distributor Cap DC-11 F2-FE
1371206	380012-008-02	Distributor DC-5 D5
1374329	380015-009-02	Rotor RT-01 GM 6Cyl
1374550	380030-019	Nut
1374621	380005-005-02	Starter GM 3.0L
1375031	380001-006-01	Repair Kit Cobra
1375492	380050-004	Inner Bearing
1376005	380006-009-02	Pump Water VA
138081	380070-015	Molded Seat
138366	380013-012-02	Spark Plug L14-U
1383672	380023-005	Accelerator Pedal
1389133	380013-014-02	Spark Plug PT16EPR-L13
1391321	380005-005-02	Starter GM 3.0L
1450643	380009-106	Thermostat/ Gasket
1450696	380009-106	Thermostat/ Gasket
1450928	380011-005-01	Alternator D5-F2-FE
1451269	380013-008-02	Spark Plug T16PR-U
1457047	380005-005-02	Starter GM 3.0L
1458025	380001-003-01	Converter Cobra
1459717	380001-006-01	Repair Kit Cobra
1461670	380050-006	Bearing Cone
1461673	380050-006	Bearing Cone
1462439	380030-123	Air Filter (Fire Ret.)
1463226	380020-011-02	Brake Shoe Set (2 Shoes)
1463229	380020-011-02	Brake Shoe Set (2 Shoes)
1467579	380013-008-02	Spark Plug T16PR-U
1486530	380005-005-02	Starter GM 3.0L
1492154	380050-040	Ignition Switch
1493306	380055-056	Seal Kit - Tilt Cylinder
1494017	380030-083	Hose - Sheave
1495428	380009-106	Thermostat/ Gasket
1502276	380030-051	Bolt
1515374	380020-006-02	Brake Shoe Set (2)
151570	380009-106	Thermostat/ Gasket
1519632	380005-014-02	Starter (Brand New)
1519632-NEW	380005-014-02	Starter (Brand New)
1523530	380050-001	Oil Seal
1526078	380010-004-02	Belt - Fan
1526079	380010-009-02	Belt - Fan
1534424-NEW	380005-011-02	Starter (Brand New)
153718	380050-011	Oil Seal
1548620	380005-009-02	Starter
1554033	380012-007-02	Distributor Cap DC-23 FE-F2
1554034	380015-005-02	Rotor RT-17 FE-FE2

Components  
(IC) Truck

Hyster Continued ▶

## (IC) Truck Components Cross Reference by Manufacturer

Hyster Continued

OE Number	Crown Part No.	Description
1559418	380030-064	Air Filter (Fire Ret.)
1565290	380050-052	Wheel Cylinder
1565313	380020-008-02-L	Shoe, Left Hand
1565314	380020-008-02-R	Shoe, Right Hand
1565316	380030-100	Spring Kit
1566458	380012-015-02	Distributor Cap
1570595	380013-018-01	Spark Plug T20EPR-U
1574092	380050-051	Starter Solenoid
1584120	380030-068	Oil Filter
1584121	380009-103	Thermostat
1591664	380020-013-02	Brake Shoe Set (2)
1591665	380020-014-02	Brake Shoe Set (2)
1599845-NEW	380005-012-02	Starter (Brand New)
1650426	380005-005-02	Starter GM 3.0L
172895	380010-012-02	Belt - Fan
183614	380050-005	Bearing Cup
183615	380050-006	Bearing Cone
185870	380030-121	Tie Rod End
188643	380010-004-02	Belt - Fan
191845	380010-002-02	Belt - Fan
192268	380070-015	Molded Seat
192814	380050-058	Bearing, Spherical
195193	380001-002-01	Converter JB2
197885	380013-012-02	Spark Plug L14-U
2021557	380060-013	Oil Seal
2021593	380030-018	Nut
2021595	380030-019	Nut
2021793	380030-052	Pin, Tie Rod
2021794	380030-049	Bushing, Steer Axle
2022312	380006-004-02	Pump Water FE
2022397	380009-104	Radiator Cap
2022460	380015-004-02	Rotor RT-03 F2-FE
2023640	380001-003-01	Converter Cobra
2023646	380001-006-01	Repair Kit Cobra
2023647	380001-006-01	Repair Kit Cobra
2023725	380015-004-02	Rotor RT-03 F2-FE
2026303	380020-012-02	Brake Shoe Set (2 Shoes)
2026467	380001-006-01	Repair Kit Cobra
2026468	380001-003-01	Converter Cobra
2026608	380050-032	Oil Pressure Switch
2026721	380001-006-01	Repair Kit Cobra
2026787	380020-012-02	Brake Shoe Set (2 Shoes)
2027398	380050-051	Wheel Cylinder
2027593	380030-050	Bolt
2027595	380030-051	Bolt
2027662	380050-004	Inner Bearing
2027663	380050-003	Outer Bearing
2027664	380050-064	Needle Bearing
2027665	380050-057	Bearing Assm
2027701	380050-002	Oil Seal
2027817	380050-002	Oil Seal
2028626	380055-057	Seal Kit - Hydraulic Cylinder
2028655	380050-055	Bearing Assm
2028852	380030-101	Timing Belt
2035830	380050-040	Ignition Switch
2037340	380030-025	Spring
2037408	380030-050	Bolt
2039210	380050-003	Outer Bearing
2039256	380010-003-02	Belt - Fan
2039336	380050-034	Bearing Mast
2039337	380050-034	Bearing Mast
2047122	380020-011-02	Brake Shoe Set (2 Shoes)
2047123	380020-011-02	Brake Shoe Set (2 Shoes)
2064053	380009-101	Upper Hose
2064054	380009-100	Lower Hose
213549	380001-002-01	Converter JB2

OE Number	Crown Part No.	Description
214998	380014-008-02	Plug Wire Set H20
226198	380070-016	Suspension Seat - Vinyl
2302265	380050-037	Packing Cylinder Kit
2302714	380050-041	Packing Cylinder Kit
2303610	380050-034	Bearing Mast
2303874	380050-035	Bearing Mast
2305749	380030-084	Tip Kit - Contact
2305835	380030-086	Contacto 24V
2307724	380030-086	Contacto 24V
2307874	380050-039	Lift Cylinder O/H Kit
2309514	380050-035	Bearing Mast
2314322	380005-003-01	Starter VA-F2-FE
2314322-NEW	380005-011-02	Starter (Brand New)
2314328	380050-050	Starter Drive
2314342	380050-051	Starter Solenoid
231522	380009-106	Thermostat/ Gasket
233965	380010-012-02	Belt - Fan
2339656	380010-004-02	Belt - Fan
258321	380001-001-01	Lockoff VFF-30-2-IMP
266733	380050-011	Oil Seal
2797577	380050-036	Bearing Assm
281844	380013-016-02	Spark Plug T14PR-U
28758	380013-012-02	Spark Plug L14-U
287647	380001-001-01	Lockoff VFF-30-2-IMP
300-1555	380005-009-02	Starter
3000542	380012-011-02	Distributor Cap DC-20 4G32-52-54
3000555	380010-002-02	Belt - Fan
3000569	380010-006-02	Belt - Fan
3001582	380013-012-02	Spark Plug L14-U
3001585	380013-012-02	Spark Plug L14-U
3001586	380013-012-02	Spark Plug L14-U
3001588	380013-017-02	Spark Plug W16S-U
3001590	380013-012-02	Spark Plug L14-U
3002287	380013-012-02	Spark Plug L14-U
3002288	380013-007-02	Spark Plug W9EP
3002289	380013-017-02	Spark Plug W16S-U
3002290	380013-004-02	Spark Plug W14EXR-U
3002347	380013-004-02	Spark Plug W14EXR-U
3002348	380013-012-02	Spark Plug L14-U
3002349	380013-012-02	Spark Plug L14-U
3002535	380006-009-02	Pump Water VA
3002575	380013-012-02	Spark Plug L14-U
3002577	380013-012-02	Spark Plug L14-U
3003695	380050-035	Bearing Mast
3004951	380001-002-01	Converter JB2
3004958	380001-005-01	Repair Kit JB2
3004979	380050-004	Inner Bearing
3004980	380050-003	Outer Bearing
300801	380060-014	Oil Seal
301793	380009-105	Thermostat/ Gasket
3020078	380011-004-02	Alternator H20-P40-TB42
3020828	380012-011-02	Distributor Cap DC-20 4G32-52-54
3020958	380012-008-02	Distributor DC-5 D5
3021276	380012-011-02	Distributor Cap DC-20 4G32-52-54
3021364	380050-035	Bearing Mast
3021855	380070-009	Pan Seat
3022576	380070-001	Lumbar Seat
3025206	380050-062	Bearing, Spherical
3025861	380050-030	Oil Seal
3026737	380170-025	Wing Seat
3026746	380070-009	Pan Seat
3027413	380050-004	Inner Bearing
3029189	380011-006-02	Alternator 4G52-4G54
3029291	380070-001	Lumbar Seat
3029906	380170-003	Bucket Seat
3030127	380070-001	Lumbar Seat

Hyster Continued ▶

# (IC) Truck Components Cross Reference by Manufacturer

Hyster Continued

OE Number	Crown Part No.	Description
3031084	380070-001	Lumbar Seat
3031979	380070-009	Pan Seat
3031982	380170-003	Bucket Seat
3031991	380170-004	Bucket Seat
3032015	380170-024-E	Low Profile Seat w Ele Switch
3032029	380170-024-E	Low Profile Seat w Ele Switch
3032277	380070-015	Molded Seat
3035129	380050-035	Bearing Mast
3040014	380013-012-02	Spark Plug L14-U
3040033	380050-005	Bearing Cup
3040949	380050-005	Bearing Cup
3041677	380006-001-02	Pump Water H20 New Style
3042586	380050-033	Seal Oil Drive Axle
3043274	380012-011-02	Distributor Cap DC-20 4G32-52-54
3044732	380050-036	Bearing Assm
3045352	380023-001-02	Brake Pedal Cover
3045360	380006-001-02	Pump Water H20 New Style
3046220	380050-036	Bearing Assm
3046489	380050-020	Roller-Lift 94mm Dia
3046654	380011-006-02	Alternator 4G52-4G54
3046758	380006-007-02	Pump Water 4Y 5-6 Series
3046813	380015-002-02	Rotor RT-07 4Y
3046816	380012-012-02	Distributor Cap H20II
3046919	380050-019	Roller-Lift
3048471	380012-004-02	Distributor Cap DC-6 4Y
3050408	380013-012-02	Spark Plug L14-U
3051151	380013-012-02	Spark Plug L14-U
3051152	380001-010-01	Connector LPG Male 7141M
3051322	380013-012-02	Spark Plug L14-U
3051807	380050-005	Bearing Cup
3051808	380050-006	Bearing Cone
3051858	380010-012-02	Belt - Fan
3051878	380010-002-02	Belt - Fan
3052059	380001-002-01	Converter JB2
3052065	380014-008-02	Plug Wire Set H20
3052453	380001-001-01	Lockoff VFF-30-2-IMP
3053301	380050-036	Bearing Assm
3054631	380050-034	Bearing Mast
3054800	380070-015	Molded Seat
3054910	380050-035	Bearing Mast
3054917	380050-037	Packing Cylinder Kit
3054918	380050-041	Packing Cylinder Kit
3054982	380012-006-02	Distributor Cap DC-11 F2-FE
3055603	380050-004	Inner Bearing
3056632	380050-003	Outer Bearing
3056654	380050-035	Bearing Mast
3057352	380105-057	Spark Plug W14EX-U
3057503	380050-011	Oil Seal
3057522	380021-003-02	Brake Cylinder
3057598	380010-003-02	Belt - Fan
3057756	380050-039	Lift Cylinder O/H Kit
3057775	380010-008-02	Belt - Timing
3058160	380070-015	Molded Seat
3061901	380010-008-02	Belt - Timing
3061904	380010-004-02	Belt - Fan
3064467	380010-003-02	Belt - Fan
3069750	380070-016	Suspension Seat - Vinyl
3070641	380070-030	Suspension Seat - Cloth
309702	380070-016	Suspension Seat - Vinyl
3099227	380010-004-02	Belt - Fan
3115283	380010-008-02	Belt - Timing
3122011	380015-006-02	Rotor RT-13 TB42 6Cyl
3123249	380012-005-02	Distributor C H20
3124790	380008-004-02	Fan Blade H20
3125880	380070-022	Bucket Seat
3127916	380012-007-02	Distributor Cap DC-23 FE-F2

OE Number	Crown Part No.	Description
3130754	380050-004	Inner Bearing
3132196	380050-004	Inner Bearing
3132609	380012-012-02	Distributor Cap H20II
3133089	380015-002-02	Rotor RT-07 4Y
3135726	380070-022	Bucket Seat
3137615	380050-007	Oil Seal
3142510	380015-001-02	Rotor RT-11 H20II
3143266	380015-002-02	Rotor RT-07 4Y
3143902	380012-007-02	Distributor Cap DC-23 FE-F2
3170058	380070-034	Suspension Molded Seat
322757	380070-016	Suspension Seat - Vinyl
324370	380009-106	Thermostat/ Gasket
325568	380060-003	Oil Seal
326480	380070-016	Suspension Seat - Vinyl
326774	380006-009-02	Pump Water VA
326779	380006-009-02	Pump Water VA
326827	380013-007-02	Spark Plug W9EP
335599	380070-016	Suspension Seat - Vinyl
350379	380030-023	Spring
352407	380050-061	Bearing Ass'y
353393	380030-096	Fan Belt
360046	380013-017-02	Spark Plug W16S-U
364911	380070-015	Molded Seat
368427	380050-036	Bearing Assm
370411	380010-002-02	Belt - Fan
374011	380010-002-02	Belt - Fan
374171	380070-016	Suspension Seat - Vinyl
377904	380070-015	Molded Seat
377906	380070-016	Suspension Seat - Vinyl
377967	380070-015	Molded Seat
379902	380050-040	Ignition Switch
385656	380011-006-02	Alternator 4G52-4G54
388323	380030-061	Valve Cover Gasket
388361	380013-008-02	Spark Plug T16PR-U
388365	380006-006-02	Pump Water GM 3.0L
39677	380050-008	O-Ring
39678	380050-008	O-Ring
402035079	380006-003-02	Pump Water HER2.7-1404
44542	380050-007	Oil Seal
683819	380050-018	Thrust Roller
79161	380013-012-02	Spark Plug L14-U
80-1406	380005-009-02	Starter
800049142	380030-108	Strobe Lamp (Amber)
800136352	380005-009-02	Starter
806441	380070-015	Molded Seat
807004	380010-012-02	Belt - Fan
809400	380010-003-02	Belt - Fan
823886	380070-016	Suspension Seat - Vinyl
86071	380010-010-02	Belt - Fan
860712	380010-010-02	Belt - Fan
887001	380050-025	Bearing Spherical
9000890	380005-009-02	Starter
97999	064423	Female LP Tank Fitting
<b>Impco (IMP)</b>		
1015871	380001-002-01	Converter JB2
1015887	380001-002-01	Converter JB2
1015971	380001-002-01	Converter JB2
1040397	380001-002-01	Converter JB2
1085401	380001-002-01	Converter JB2
1085402	380001-002-01	Converter JB2
COBRA	380001-003-01	Converter Cobra
JB	380001-002-01	Converter JB2
JB-2	380001-002-01	Converter JB2
N00-6314A	380001-006-01	Repair Kit Cobra
RK-COBRA	380001-006-01	Repair Kit Cobra
RK-K	380001-006-01	Repair Kit Cobra

Components  
(IC) Truck

Impco Continued ▶

## (IC) Truck Components Cross Reference by Manufacturer

Impco Continued

OE Number	Crown Part No.	Description
RK-K-2	380001-006-01	Repair Kit Cobra
RKJ-2	380001-005-01	Repair Kit JB2
VFF30-2	380001-001-01	Lockoff VFF-30-2-IMP
<b>JLG (JL)</b>		
2180387	064423	Female LP Tank Fitting
<b>Jungheinrich (JU)</b>		
14057390	380070-016	Suspension Seat - Vinyl
14087210	380010-010-02	Belt - Fan
1409636	380050-035	Bearing Mast
14096360	380050-035	Bearing Mast
14148410	380013-016-02	Spark Plug T14PR-U
14364210	380010-008-02	Belt - Timing
14364620	380014-005-02	Plug Wire Set F2-FE
14365400	380006-004-02	Pump Water FE
14365450	380006-004-02	Pump Water FE
1436990	380050-035	Bearing Mast
14369900	380050-035	Bearing Mast
143699003	380050-035	Bearing Mast
1437448	380050-002	Oil Seal
14374480	380050-002	Oil Seal
1438437	380050-034	Bearing Mast
14384370	380050-034	Bearing Mast
14384440	380050-034	Bearing Mast
14388510	380070-016	Suspension Seat - Vinyl
1441181	380030-101	Timing Belt
14411810	380030-101	Timing Belt
144118105	380030-101	Timing Belt
14415530	380012-006-02	Distributor Cap DC-11 F2-FE
1444116	380050-041	Packing Cylinder Kit
14441160	380050-041	Packing Cylinder Kit
14458080	380050-007	Oil Seal
14462360	380050-037	Packing Cylinder Kit
14473480	380050-007	Oil Seal
14483690	380050-040	Ignition Switch
14485060	380011-005-01	Alternator D5-F2-FE
14491840	380012-006-02	Distributor Cap DC-11 F2-FE
14495050	380014-005-02	Plug Wire Set FE
14495460	380021-003-02	Brake Cylinder
14501360	380012-006-02	Distributor Cap DC-11 F2-FE
14518910	380001-006-01	Repair Kit Cobra
14520447	380006-004-02	Pump Water FE
14704390	380010-008-02	Belt - Timing
147043904	380010-008-02	Belt - Timing
1470500	380011-006-02	Alternator 4G52-4G54
14705000	380011-006-02	Alternator 4G52-4G54
2760966	380070-016	Suspension Seat - Vinyl
27609660	380070-016	Suspension Seat - Vinyl
27627810	380070-016	Suspension Seat - Vinyl
27632940	380070-016	Suspension Seat - Vinyl
27634890	380070-016	Suspension Seat - Vinyl
2763590	380070-016	Suspension Seat - Vinyl
27635900	380070-016	Suspension Seat - Vinyl
27635980	380070-016	Suspension Seat - Vinyl
27636190	380070-016	Suspension Seat - Vinyl
27636200	380070-016	Suspension Seat - Vinyl
27637070	380070-016	Suspension Seat - Vinyl
50010821	380070-016	Suspension Seat - Vinyl
50018782	380005-005-02	Starter GM 3.0L
50137926	380005-005-02	Starter GM 3.0L
61260430	380070-016	Suspension Seat - Vinyl
61263920	380070-016	Suspension Seat - Vinyl
6132896	380070-016	Suspension Seat - Vinyl
61328960	380070-016	Suspension Seat - Vinyl
70051620	380070-016	Suspension Seat - Vinyl
760966	380070-016	Suspension Seat - Vinyl
762781	380070-016	Suspension Seat - Vinyl

OE Number	Crown Part No.	Description
763489	380070-016	Suspension Seat - Vinyl
763590	380070-016	Suspension Seat - Vinyl
763598	380070-016	Suspension Seat - Vinyl
<b>Kalmar (KM)</b>		
4906137	380030-023	Spring
4911926	380012-013-02	Distributor Cap
4911933	380015-010-02	Rotor
4920078	380050-051	Wheel Cylinder
4920089	380050-032	Oil Pressure Switch
4920199	380009-106	Thermostat/ Gasket
4920209	380005-004-01	Starter 4G63-4G64
4920321	380051-001	Ignition Wire Set
4920622	380030-023	Spring
4920659	380030-025	Spring
4940132	380030-065	Nut
4940141	380030-116	Nut, Castle
4940233	380050-065	Bearing Assembly
4940235	380050-055	Bearing Assm
4940295	380030-118	Plug
4940458	380030-020	Plate
4940496	380060-013	Oil Seal
4940503	380050-054	Bearing Assm
4940530	380030-119	Spring
4940537	380030-004	Adjuster Cable
4940538	380030-031	Spring
4940905	380050-048	Oil Seal
4940906	380050-045	Oil Seal
4940945	380050-051	Wheel Cylinder
4940946	380020-015-02	Brake Shoe
4940947	380020-015-02	Brake Shoe
4940951	380055-060	Wheel Cylinder
4941345	380030-018	Nut
4941351	380030-048	Thrust Bearing
4941373	380030-057	Spring
4941505	380030-021	Shim
4941506	380030-021	Shim
4941509	380030-011	Bolt
4941515	380050-053	Wheel Cylinder
4941533	380030-026	Steer Axle Bushing
4941586	380030-016	Nut
4941592	380030-012	Bolt
4941613	380030-058	Spring
4941622	380030-023	Spring
4941754	380050-064	Needle Bearing
4941755	380030-022	Shim
4941757	380050-059	Thrust Bearing
4942145	380010-002-02	Belt - Fan
4942234	380030-027	Valve Cover Gasket
4942370	380009-106	Thermostat/ Gasket
4942457	380050-046	Oil Seal
4942519	380030-117	Oil Pressure Switch
4942534	380030-024	Spring
4942605	380030-059	Spring
4943232	380030-043	Lens
4944592	380030-035	Oil Seal
4944661	380030-019	Nut
4944669	380055-060	Wheel Cylinder
4948516	380050-050	Tilt Cylinder O/H Kit
4948613	380050-047	Oil Seal
4949074	380009-104	Radiator Cap
4949229	380009-107	Radiator Hose (Lower)
4949328	380030-055	Bolt
4949337	380060-006	Oil Seal
4949338	380030-013	Bolt
4949344	380030-089	Bolt, Tie Rod
4949345	380050-058	Bearing, Spherical

Kalmar Continued ▶



# (IC) Truck Components Cross Reference by Manufacturer

Kalmat Continued

OE Number	Crown Part No.	Description
4949361	380030-110	Bolt, Tie Rod
4949375	380050-051	Wheel Cylinder
4949737	380055-055	Power Steering O/H Kit
4949757	380030-005	Front Lamp
4965293	380030-096	Fan Belt
4966092	380030-044	Mirror
4966574	380010-002-02	Belt - Fan
4968642	380010-001-02	Belt - Fan
4968820	380030-107	Ignition Module
4968855-NEW	380005-013-02	Starter (Brand New)
4968878	380050-032	Oil Pressure Switch
8761124	380020-011-02	Brake Shoe Set (2 Shoes)
8761128	380020-011-02	Brake Shoe Set (2 Shoes)
8761209	380009-104	Radiator Cap
8761217	380009-107	Radiator Hose (Lower)
8761218	380009-108	Radiator Hose (Upper)
8761245	380050-049	Oil Seal
8761509	380030-015	Bolt, Tie Rod
8761510	380030-017	Nut
8761511	380030-014	Bolt, Tie Rod
8761533	380030-003	Adjuster Cable
8761802	380030-039	Rear Lamp
8761954	380009-105	Thermostat/ Gasket
8761960	380009-109	Hose
8761967	380010-001-02	Belt - Fan
8762412-NEW	380005-012-02	Starter (Brand New)
8763193	380030-025	Spring
8764087	380030-105	Bolt, Tie Rod
8764821	380030-123	Air Filter (Fire Ret.)
8765021	380060-008	Oil Seal
8765304	380055-060	Wheel Cylinder
8772287	380030-001	Accelerator Unit
8772430	380030-054	Hub Cap
8776236	380050-045	Oil Seal
<b>Komatsu (KO)</b>		
01582-11815	380030-065	Nut
01593-11813	380030-116	Nut, Castle
01593-31613	380030-017	Nut
01593-31813	380030-116	Nut, Castle
01N121200-VJ200	380009-105	Thermostat/ Gasket
02117-21521	380010-005-02	Belt - Fan
02117-23523	380010-003-02	Belt - Fan
06000-30207	380050-056	Bearing Assm
06000-30209	380050-065	Bearing Assembly
06000-30214	380050-004	Inner Bearing
06000-30214L	380050-004	Inner Bearing
06000-32011	380050-036	Bearing Assm
06000-32021	380050-036	Bearing Assm
06000-32200	380050-055	Bearing Assm
06000-32206	380050-061	Bearing Ass'y
06000-32209	380050-055	Bearing Assm
06002-30214	380050-004	Inner Bearing
06002-30214L	380050-004	Inner Bearing
07012-00080	380050-046	Oil Seal
07046-13520	380030-118	Plug
11720-52H01-F1	380010-001-02	Belt - Fan
11720-87V10	380010-001-02	Belt - Fan
11720-B1101	380010-002-02	Belt - Fan
11720-B1101L	380010-002-02	Belt - Fan
11720-F2700	380010-009-02	Belt - Fan
11720-K4080	380010-001-02	Belt - Fan
11720-K4080A	380010-001-02	Belt - Fan
11720-K7201	380010-012-02	Belt - Fan
11720-L1102	380010-002-02	Belt - Fan
1310-FT860	380001-012-01	Vaporizer Assembly
16328-GY010	380030-069	Repair Kit (Nikki)

OE Number	Crown Part No.	Description
16600-GS07A	380030-095	Injector
16600-GS07B	380030-095	Injector
16600-GS17B	380030-073	Injector
17053-FU460	380030-111	Diaphragm Kit (Nikki)
17960-VR500	380030-060	Diaphragm Kit (Nikki)
17962-FU460	380030-122	Valve Assy (NIKKI)
18919-AM810	380030-001	Accelerator Unit
20-200	380012-005-02	Distributor C H20
20-203	380012-002-02	Distributor G H20II
21010-50K26	380006-011-02	Pump Water H20II-H25
21010-50K28	380006-011-02	Pump Water H20II-H25
21010-50K29	380006-011-02	Pump Water H20II-H25
21010-FF225	380006-011-02	Pump Water H20II-H25
21010-L1100	380006-001-02	Pump Water H20 New Style
21010-L1101	380006-001-02	Pump Water H20 New Style
21010-L1125	380006-001-02	Pump Water H20 New Style
21010-L1126	380006-001-02	Pump Water H20 New Style
21010-L1128	380006-001-02	Pump Water H20 New Style
21060-48210	380008-004-02	Fan Blade H20
21060-49003	380008-004-02	Fan Blade H20
21060-50K00	380008-003-02	Fan Blade H20 II
21060-87V00	380008-003-02	Fan Blade H20 II
21060-FU40A	380008-001-02	Fan Blade K21-K25
21200-0C811	380009-105	Thermostat/ Gasket
21200-50K00	380009-105	Thermostat/ Gasket
21200-53J00	380009-105	Thermostat/ Gasket
21200-VJ200	380009-105	Thermostat/ Gasket
21200-VJ200K0	380009-105	Thermostat/ Gasket
22100-50K10	380012-002-02	Distributor G H20II
22100-50K15	380012-002-02	Distributor G H20II
22100-55K10	380012-002-02	Distributor G H20II
22100-60K10	380012-014-02	Distributor
22100-60K11	380012-014-02	Distributor
22100-60K15	380012-014-02	Distributor
22100-60K15A	380012-014-02	Distributor
22100-K7201	380012-005-02	Distributor C H20
22157-05M02	380015-008-02	Rotor H20
22157-52H20	380015-006-02	Rotor RT-13 TB42 6Cyl
22157-55K10	380015-001-02	Rotor RT-11 H20II
22157-R9007	380015-007-02	Rotor RT-10 4G32-52-54
22162-23G15	380012-012-02	Distributor Cap H20II
22162-25G11	380012-011-02	Distributor Cap DC-20 4G32-52-54
22162-55K10	380012-001-02	Distributor Cap DC-10 H20II
22162-78A10	380012-012-02	Distributor Cap H20II
22162-G5710	380012-012-02	Distributor Cap H20II
22162-G5711	380012-012-02	Distributor Cap H20II
22162-R9006	380012-011-02	Distributor Cap DC-20 4G32-52-54
22162-R9007	380012-011-02	Distributor Cap DC-20 4G32-52-54
22162-VB011	380012-016-02	Distributor Cap
22401-58001	380013-001-02	Spark Plug W20ES-U
22401-FU412	380013-002-02	Spark Plug Q14R-U11
22401-L1600	380013-007-02	Spark Plug W9EP
22401-M7714	380013-001-02	Spark Plug W20ES-U
22401-M7716	380013-001-02	Spark Plug W20ES-U
22401-V1414	380013-004-02	Spark Plug W14EXR-U
22401-W8914	380013-007-02	Spark Plug W9EP
22450-50K25	380014-006-02	Plug Wire Set H20II
22450-50K50	380014-006-02	Plug Wire Set H20II
22450-50KA0	380014-006-02	Plug Wire Set H20II
23100-B9810	380011-004-02	Alternator H20-P40-TB42
23100-C6000	380011-007-02	Alternator H20
23100-FU410	380011-001-01	Alternator K21-K25
23100-M0413	380011-007-02	Alternator H20
23100-M0414	380011-007-02	Alternator H20
23100-U0105	380011-007-02	Alternator H20
23300-00H10	380005-006-01	Starter H20

Kalmat  
Components

Komatsu Continued ▶

## (IC) Truck Components Cross Reference by Manufacturer

Komatsu Continued

OE Number	Crown Part No.	Description
23300-00H11	380005-006-01	Starter H20
23300-FU410	380005-008-02	Starter K21-K25
23300-GS20A	380005-008-02	Starter K21-K25
23300-K9160	380005-001-01	Starter H20-H20II-H25
25-003	380012-012-02	Distributor Cap H20II
25-011	380012-001-02	Distributor Cap DC-10 H20II
25240-FJ10A	380050-032	Oil Pressure Switch
26-011	380015-001-02	Rotor RT-11 H20II
300-22-31241	380030-018	Nut
300-27-11170	380030-048	Thrust Bearing
300-32-31760	380030-057	Spring
30B-13-11110	380001-014-02	Torque Convertor (Brand New)
30B-13-11200	380006-013-01	Transmission Charging Pump
310-30-26310	380030-102	Nut
325-32-21400	380050-053	Wheel Cylinder
32532-21500	380020-007-02	Brake Shoe Kit (4)
32532-21600	380020-007-02	Brake Shoe Kit (4)
3303-8116E	380070-023	Pan Seat
3306-6134E	380070-022	Bucket Seat
34A-21-13210	380050-003	Outer Bearing
34A-24-11150	380030-021	Shim
34A-24-11160	380030-021	Shim
34A-24-11220	380030-011	Bolt
34A-42-11411	380030-026	Steer Axle Bushing
34B-04-46310	380001-001-01	Lockoff VFF-30-2-IMP
34B-21-14151	380030-016	Nut
34B-24-11221	380030-012	Bolt
34B-30-14311	380050-051	Wheel Cylinder
34B-30-14320	380030-058	Spring
34B-30-14351	380030-024	Spring
34B-30-14420	380030-023	Spring
34B-30-15311	380050-051	Wheel Cylinder
360-27-11171	380050-064	Needle Bearing
360-27-11220	380030-022	Shim
360-27-13260	380050-059	Thrust Bearing
360-27-13280	380030-022	Shim
37B-1EB-3010	380030-039	Rear Lamp
37B-1EH-2010	380030-005	Front Lamp
37Z-02-HR901	380015-008-02	Rotor H20
37Z-02-SP02E	380013-007-02	Spark Plug W9EP
37Z-02-SP04A	380013-001-02	Spark Plug W20ES-U
37Z-02-SP05A	380013-001-02	Spark Plug W20ES-U
3BA-25-25190	380050-068	Needle Bearing
3BA-30-31731	380020-005-02	Brake Pad (1)
3BB-30-12180	380023-004	Sheave, Brake
3BB-30-12190	380030-003	Adjuster Cable
3BB-30-12260	380030-081	Spring
3BB-50-A3120	380070-022	Bucket Seat
3BD-22-11280	380050-003	Outer Bearing
3EA-04-51110	380009-008-02	Radiator
3EA-10-14130	380030-072	Clutch Cover
3EA-15-11180	380030-020	Plate
3EA-21-14140	380060-013	Oil Seal
3EA-22-11161	380050-054	Bearing Assm
3EA-22-11210	380050-047	Oil Seal
3EA-30-11150	380030-119	Spring
3EA-30-11330	380030-004	Adjuster Cable
3EA-30-11340	380030-031	Spring
3EA-30-11410	380020-007-02	Brake Shoe Kit (4)
3EA-30-11420	380020-007-02	Brake Shoe Kit (4)
3EA-30-11430	380020-007-02	Brake Shoe Kit (4)
3EA-30-1144C	380020-002-02	Brake Shoe Kit (2)
3EA-30-1145C	380020-002-02	Brake Shoe Kit (2)
3EA-30-25111	380050-053	Wheel Cylinder
3EA-30-31150	380020-007-02	Brake Shoe Kit (4)

OE Number	Crown Part No.	Description
3EA-30-31160	380020-007-02	Brake Shoe Kit (4)
3EA-30-31170	380020-007-02	Brake Shoe Kit (4)
3EA-50-A1120	380070-023	Pan Seat
3EA-50-A1150	380070-023	Pan Seat
3EB-03-22110	380007-001-02	Exhaust Pipe KO3EB-03-22110
3EB-03-35311	380007-002-02	Exhaust Pipe
3EB-04-23220	380009-107	Radiator Hose (Lower)
3EB-04-A5111	380009-001-02	Radiator
3EB-04-A5121	380009-107	Radiator Hose (Lower)
3EB-04-A5122	380009-107	Radiator Hose (Lower)
3EB-04-A5131	380009-108	Radiator Hose (Upper)
3EB-04-A5132	380009-108	Radiator Hose (Upper)
3EB-04-A6110	380009-007-02	Radiator K21-K25
3EB-04-A7520	380009-110	Radiator Hose
3EB-04-A7521	380009-110	Radiator Hose
3EB-10-11510	380030-072	Clutch Cover
3EB-10-21610	380030-072	Clutch Cover
3EB-21-15130	380050-048	Oil Seal
3EB-21-15140	380050-045	Oil Seal
3EB-21-25170	380030-055	Bolt
3EB-21-32180	380050-049	Oil Seal
3EB-22-21160	380060-006	Oil Seal
3EB-22-21170	380030-013	Bolt
3EB-24-11160	380030-054	Hub Cap
3EB-24-21581	380030-110	Bolt, Tie Rod
3EB-24-32260	380050-057	Bearing Assm
3EB-24-35130	380030-014	Bolt, Tie Rod
3EB-24-35140	380030-015	Bolt, Tie Rod
3EB-24-A2570	380030-089	Bolt, Tie Rod
3EB-24-A2580	380050-058	Bearing, Spherical
3EB-30-11310	380050-051	Wheel Cylinder
3EB-30-2300K	380020-006-02	Brake Shoe Set (2)
3EB-30-23430	380020-015-02	Brake Shoe
3EB-30-23440	380020-015-02	Brake Shoe
3EB-30-23450	380020-006-02	Brake Shoe Set (2)
3EB-30-24430	380020-015-02	Brake Shoe
3EB-30-24440	380020-015-02	Brake Shoe
3EB-30-31150	380020-004-02	Brake Shoe (1)
3EB-30-31160	380020-004-02	Brake Shoe (1)
3EB-30-31170	380020-004-02	Brake Shoe (1)
3EB-30-31320	380030-025	Spring
3EB-30-3158C	380020-010-02	Brake Shoe Set (2 Shoes)
3EB-30-3159C	380020-010-02	Brake Shoe Set (2 Shoes)
3EB-30-41440	380050-052	Wheel Cylinder
3EB-30-A31180	380020-001-02	Brake Shoe Kit (4)
3EB-36-31130	380023-001-02	Brake Pedal Cover
3EB-36-31280	380021-001-02	Brake Cylinder
3EB-36-31281	380021-001-02	Brake Cylinder
3EB-36-51180	380030-063	Master Cylinder
3EB-39-41112	380030-075	Emergency Brake Handle
3EB-50-16110	380070-023	Pan Seat
3EB-50-31271	380030-056	Hood Hinge
3EB-50-A4910	380070-022	Bucket Seat
3EB-50-A5160	380070-023	Pan Seat
3EB-50-A5160A	380070-023	Pan Seat
3EB-50-A5160B	380070-023	Pan Seat
3EB-50-A5180	380070-023	Pan Seat
3EB-50-A5181	380070-023	Pan Seat
3EB-50-A5181B	380070-023	Pan Seat
3EB-50-A5320	380070-034	Suspension Molded Seat
3EB-50-A5322	380070-034-E	Suspension Seat W Ele Switch
3EB-50-A5860	380070-022	Bucket Seat
3EB-50-A5890	380070-022	Bucket Seat
3EB-50-A5930	380070-023	Pan Seat
3EB-55-12321	380030-043	Lens

Komatsu Continued ▶

# (IC) Truck Components Cross Reference by Manufacturer

Komatsu Continued

OE Number	Crown Part No.	Description
3EB-55-13571	380030-044	Mirror
3EB-55-23511	380030-113	Horn (12 Volt)
3EB-55-A6660	380030-076	Rear Lamp 12 Volt
3EB-55-A7720	380030-077	Rear Lamp 12 Volt
3EB-64-05190	380050-050	Tilt Cylinder O/H Kit
3EB-64-A2000	380055-055	Power Steering O/H Kit
3EB-79-A5210	380050-066	Mast Bearing
3EB-79-A5220	380050-069	Mast Bearing
3EB-K3-0203C	380020-008-02-L	Shoe, Left Hand
3EB-K3-0204C	380020-008-02-R	Shoe, Right Hand
3EC-21-15140	380030-035	Oil Seal
3EC-21-36250	380060-008	Oil Seal
3EC-21-36810	380030-102	Nut
3EC-21-36811	380030-102	Nut
3EC-24-31690	380030-105	Bolt, Tie Rod
3EC-30-11180	380023-004	Sheave, Brake
3EC-30-11330	380030-058	Spring
3EC-30-11340	380030-059	Spring
3EC-30-11490	380030-019	Nut
3EC-30-11601	380020-011-02	Brake Shoe Set (2 Shoes)
3EC-30-1162LH	380020-011-02	Brake Shoe Set (2 Shoes)
3EC-30-1172RH	380020-011-02	Brake Shoe Set (2 Shoes)
3EC-30-11830	380020-011-02	Brake Shoe Set (2 Shoes)
3EC-30-11840	380020-011-02	Brake Shoe Set (2 Shoes)
3EC-30-12120	380055-060	Wheel Cylinder
3EC-30-39110	380055-060	Wheel Cylinder
3ED-22-11280	380050-003	Outer Bearing
3ED-24-41270	380030-105	Bolt, Tie Rod
4860509	380010-010-02	Belt - Fan
4901422	380070-022	Bucket Seat
4940141	380030-116	Nut, Castle
4944644	380023-004	Sheave, Brake
4944952	380030-102	Nut
4949484	380070-022	Bucket Seat
4968103	380070-022	Bucket Seat
4969403	380070-022	Bucket Seat
4972207	380030-116	Nut, Castle
600-421-6110	380009-105	Thermostat/ Gasket
600-421-6210	380009-105	Thermostat/ Gasket
6140-11-6310	380009-105	Thermostat/ Gasket
6204-81-3270	380030-096	Fan Belt
64-101	380006-001-02	Pump Water H20 New Style
64-102	380006-011-02	Pump Water H20II-H25
662142	380050-017	Roller
683819	380050-018	Thrust Roller
683919	380050-018	Thrust Roller
7141-F	064423	Female LP Tank Fitting
7141F	064423	Female LP Tank Fitting
7141M	380001-010-01	Connector LPG Male 7141M
8005-2116E	380070-023	Pan Seat
8764087	380030-105	Bolt, Tie Rod
8764088	380030-116	Nut, Castle
8765021	380060-008	Oil Seal
8765304	380055-060	Wheel Cylinder
8768952	380050-069	Mast Bearing
8771486	380030-116	Nut, Castle
8771656	380030-102	Nut
8774026	380030-122	Valve Assy (NIKKI)
8775050	380012-016-02	Distributor Cap
8777797	380009-110	Radiator Hose
8779168	380009-110	Radiator Hose
8779367	380030-095	Injector
A6600-FU471	380030-073	Injector
A6600-FU571	380030-073	Injector
CC662145	380050-017	Roller
CC662145A	380050-017	Roller

OE Number	Crown Part No.	Description
CC683819	380050-018	Thrust Roller
CC683919	380050-018	Thrust Roller
CPC89C0025010	380009-104	Radiator Cap
CPC89C0175010	380009-104	Radiator Cap
FN-200	380008-004-02	Fan Blade H20
FN-201	380008-003-02	Fan Blade H20 II
HE-2500753	380014-008-02	Plug Wire Set H20
HE-2500754	380014-008-02	Plug Wire Set H20
HE0052048-00	380013-017-02	Spark Plug W16S-U
HE0110256-00	380013-017-02	Spark Plug W16S-U
HE0110526-00	380013-017-02	Spark Plug W16S-U
HE40-2035063	380006-003-02	Pump Water HER2.7-1404
HE40-2035078	380006-003-02	Pump Water HER2.7-1404
HE40-2035079	380006-003-02	Pump Water HER2.7-1404
HE40-2502314	380013-017-02	Spark Plug W16S-U
HE40-2504609	380015-010-02	Rotor
HE52892	380013-017-02	Spark Plug W16S-U
JB	380001-002-01	Converter JB2
MY022-8098-00	380021-001-02	Brake Cylinder
ON43001-06565	380030-038	Power Steering O/H Kit
RK-VFF30-2	380001-004-01	Repair Kit VFF30-2
TB260	137811	Clamp Toggle
TJ-90098-09125	380013-007-02	Spark Plug W9EP
TJ-90919-01055	380013-007-02	Spark Plug W9EP
TJ-90919-01950-71	380013-007-02	Spark Plug W9EP
TJ27060-78003-71	380011-002-01	Alternator 4Y - GN81-41
YM114250-39450	380030-117	Oil Pressure Switch
YM129900-4470	380008-002-02	Fan Blade 4Y 6-7 Series
YM129900-44700	380008-002-02	Fan Blade 4Y 6-7 Series
YM129900-77010N	380005-012-02	Starter (Brand New)
<b>Linde (LI)</b>		
104056	380070-009	Pan Seat
147394	380070-026	Contoured Back Seat
219990	380050-033	Seal Oil Drive Axle
241238	380050-033	Seal Oil Drive Axle
3244331015	380070-030	Suspension Seat - Cloth
6022	380050-006	Bearing Cone
6024	380050-005	Bearing Cup
9246860	380050-036	Bearing Assm
9247374	380050-036	Bearing Assm
9509000865	380050-036	Bearing Assm
D0009246860	380050-036	Bearing Assm
FM53100008	380050-004	Inner Bearing
<b>LPM (LP)</b>		
100-F227	380030-101	Timing Belt
100-FE10	380010-008-02	Belt - Timing
124-1294	380010-008-02	Belt - Timing
124-4003	380030-101	Timing Belt
138-1004	380010-008-02	Belt - Timing
156-1001	380010-002-02	Belt - Fan
156-1182	380010-010-02	Belt - Fan
156-1183	380010-006-02	Belt - Fan
156-13395	380010-002-02	Belt - Fan
156-13415	380010-002-02	Belt - Fan
156-13465	380010-010-02	Belt - Fan
156-16424	380010-006-02	Belt - Fan
156-16460	380010-010-02	Belt - Fan
156-1648	380010-003-02	Belt - Fan
156-16631	380010-006-02	Belt - Fan
156-17415	380010-006-02	Belt - Fan
156-17484	380010-003-02	Belt - Fan
156-20442	380010-011-02	Belt - Fan
156-9001	380010-003-02	Belt - Fan
753-2003	380070-009	Pan Seat
753-3001	380070-009	Pan Seat
WM-127	380070-009	Pan Seat

Components  
(IC) Truck

## (IC) Truck Components Cross Reference by Manufacturer

OE Number	Crown Part No.	Description
<b>Mazda (MZ)</b>		
F829-18-V05	380015-004-02	Rotor RT-03 F2-FE
FE09-12-205	380010-008-02	Belt - Timing
FE25-18-V05	380015-004-02	Rotor RT-03 F2-FE
FE7915010C	380006-004-02	Pump Water FE
GE01-18-300	380011-004-02	Alternator H20-P40-TB42
<b>Mercury-Pettibone (ME)</b>		
41073	380013-012-02	Spark Plug L14-U
41273	380013-012-02	Spark Plug L14-U
41663	380013-012-02	Spark Plug L14-U
CH170269-001	380001-001-01	Lockoff VFF-30-2-IMP
S4304-79-11	380070-009	Pan Seat
S4304-79-2	380070-009	Pan Seat
S4304-79-9	380070-009	Pan Seat
<b>Mitsubishi (MB)</b>		
0415-30214	380050-004	Inner Bearing
05500-31070	380050-008	O-Ring
0973519-E	380170-002-E	Bucket Seat w Electric Switch
1009115	380050-036	Bearing Assm
1015776	380021-004-02	Brake Cylinder
1015874	064423	Female LP Tank Fitting
1017001	380015-007-02	Rotor RT-10 4G32-52-54
1017046	380012-011-02	Distributor Cap DC-20 4G32-52-54
1017158	380010-004-02	Belt - Fan
1017268	380013-004-02	Spark Plug W14EXR-U
1029645	380170-027	Molded Seat
1033164	380170-027	Molded Seat
1037451	380170-027	Molded Seat
1038060	380015-006-02	Rotor RT-13 TB42 6Cyl
1038083	380013-006-02	Spark Plug W16EX-U
1038589	380170-027	Molded Seat
1039078	380010-006-02	Belt - Fan
1041457	380012-009-02	Distributor B 4G63-4G64
1041551	380015-007-02	Rotor RT-10 4G32-52-54
1041623	380010-009-02	Belt - Fan
1049976	380170-027	Molded Seat
1058285	380170-027	Molded Seat
1075032	380050-006	Bearing Cone
1075034	380050-005	Bearing Cup
1075199	380170-020	Pan Seat
1085017	380014-002-02	Plug Wire Set 4G63-4G64
1097358	380170-027	Molded Seat
14035-FY500	380030-034	Manifold Gasket
14411810	380030-101	Timing Belt
16600-GS07B	380030-095	Injector
1832A002	380016-001-02	Coil A218371 MD358504 925969
2A3643	380013-012-02	Spark Plug L14-U
215812	380050-034	Bearing Mast
216276	380012-012-02	Distributor Cap H20II
2N159	380010-012-02	Belt - Fan
2W2257	380015-010-02	Rotor
2W4246	380030-045	Air Filter
31A90-00300	380050-032	Oil Pressure Switch
41530214	380050-004	Inner Bearing
683819	380050-018	Thrust Roller
6R7181	380170-027	Molded Seat
6R7182	380170-027	Molded Seat
7N314	380001-001-01	Lockoff VFF-30-2-IMP
7N7542	380012-013-02	Distributor Cap
801985	380050-036	Bearing Assm
8N2236	380013-017-02	Spark Plug W16S-U
8N2630	380013-012-02	Spark Plug L14-U
90420-01480	380015-009-02	Rotor RT-01 GM 6Cyl
90420-01620	380013-014-02	Spark Plug PT16EPR-L13
90425-00390	380050-032	Oil Pressure Switch
90425-08560	380030-073	Injector

OE Number	Crown Part No.	Description
90425-18040	380030-073	Injector
91202-07400	380008-005-02	Fan Blade 4G63-4G64 K Series
91202-17400	380008-005-02	Fan Blade 4G63-4G64 K Series
91214-01080	380170-019	Fold Back Lumbar Seat
91214-11300	380170-027	Molded Seat
91214-21100	380170-027	Molded Seat
91214-31100	380170-027	Molded Seat
91214-31300	380170-027	Molded Seat
91214-46300	380170-031	Molded Seat
91214-53900	380170-027	Molded Seat
9121401080	380170-019	Fold Back Lumbar Seat
9121436300	380170-027	Molded Seat
9121441100	380170-027	Molded Seat
9121441300	380170-027	Molded Seat
9121443900	380170-027	Molded Seat
91246-03600	380030-023	Spring
91246-04400	380030-004	Adjuster Cable
91246-16800	380020-007-02	Brake Shoe Kit (4)
91246-16900	380020-007-02	Brake Shoe Kit (4)
91246-17100	380020-007-02	Brake Shoe Kit (4)
91314-08500	380170-020	Pan Seat
9131408500	380170-020	Pan Seat
9136103501	380001-010-01	Connector LPG Male 7141M
9136113500	380001-010-01	Connector LPG Male 7141M
91375-03800	380030-114	Hydraulic Filter
91401-09700	380010-006-02	Belt - Fan
91401-09800	380010-006-02	Belt - Fan
91443-15600	380050-059	Thrust Bearing
91446-03800	380023-004	Sheave, Brake
91446-03900	380030-059	Spring
91484-17100	380021-004-02	Brake Cylinder
91484-27100	380021-004-02	Brake Cylinder
91484-27101	380021-004-02	Brake Cylinder
91484-37100	380021-004-02	Brake Cylinder
91546-02300	380030-003	Adjuster Cable
91846-12500	380030-025	Spring
91865-03100	380001-001-01	Lockoff VFF-30-2-IMP
91921-06300	380010-005-02	Belt - Fan
91A43-02300	380060-011	Oil Seal, Steer Axle
91E43-01800	380050-031	Oil Seal
91E43-05722	380050-025	Bearing Spherical
91H20-02560	380010-005-02	Belt - Fan
91H20-02770	380009-109	Hose
91H20-03270	380011-001-01	Alternator K21-K25
91H20-03330	380005-008-02	Starter K21-K25
91H20-04710	380015-001-02	Rotor RT-11 H20II
91H20-15230	380030-073	Injector
91H20-16690	380030-073	Injector
91H20-16690	380030-073	Injector
9300201300	380001-010-01	Connector LPG Male 7141M
93014-00010	380070-035	Molded Seat
93113-09600	380030-112	Gas Spring
93146-02500	380021-002-02	Brake Cylinder
93146-12500	380021-002-02	Brake Cylinder
93165-03110I	380001-005-01	Repair Kit JB2
93165-03600	064423	Female LP Tank Fitting
93165-03800	064423	Female LP Tank Fitting
9316503500	380001-010-01	Connector LPG Male 7141M
93433-12400	380060-016	Oil Seal
97114-30100	380170-031	Molded Seat
97114-40100	380170-031	Molded Seat
972433	380050-035	Bearing Mast
973139	380070-009	Pan Seat
973519	380170-002	Bucket Straight Back Seat
973519-E	380170-002-E	Bucket Seat w Electric Switch

Mitsubishi Continued ▶

# (IC) Truck Components Cross Reference by Manufacturer

Mitsubishi Continued

OE Number	Crown Part No.	Description
973520	380170-004	Bucket Seat
9I4658	380015-001-02	Rotor RT-11 H20II
9S3581	380050-005	Bearing Cup
9S3582	380050-006	Bearing Cone
9Y5969	380006-003-02	Pump Water HER2.7-1404
A0000-10379	380050-017	Roller
A0000-16203	380170-025	Wing Seat
A0000-20015	380170-028-E	Seat w Electric Switch
A0000-25819	380170-002	Bucket Straight Back Seat
A0000-25820	380170-004	Bucket Seat
A0000-26570	380050-006	Bearing Cone
A0000-26796	380070-022	Bucket Seat
A0000-28641	380070-030	Suspension Seat - Cloth
A0000-28785	380170-025	Wing Seat
A0000-28790	380170-025	Wing Seat
A1T20271	380011-004-02	Alternator H20-P40-TB42
A1T21171	380011-004-02	Alternator H20-P40-TB42
A1T22581	380011-004-02	Alternator H20-P40-TB42
A1T24371	380011-004-02	Alternator H20-P40-TB42
AG2025A	380011-004-02	Alternator H20-P40-TB42
AG2030A	380011-004-02	Alternator H20-P40-TB42
AG2035A	380011-004-02	Alternator H20-P40-TB42
AG2035A2	380011-004-02	Alternator H20-P40-TB42
AG2035N1	380011-004-02	Alternator H20-P40-TB42
AH2035N1	380011-004-02	Alternator H20-P40-TB42
C0053321	380001-001-01	Lockoff VFF-30-2-IMP
D700615	380006-003-02	Pump Water HER2.7-1404
F8140-30214	380050-004	Inner Bearing
F8143-32212	380050-003	Outer Bearing
K0000-10379	380050-017	Roller
K000010379	380050-017	Roller
LM40AQ5019	064423	Female LP Tank Fitting
M002T-58681	380005-004-01	Starter 4G63-4G64
M2T58581	380005-004-01	Starter 4G63-4G64
M3T21882D	380005-006-01	Starter H20
MC840219	380050-032	Oil Pressure Switch
MCF00036	380006-003-02	Pump Water HER2.7-1404
MD130494	380030-029	Valve Cover Gasket
MD138993	380050-032	Oil Pressure Switch
MD169418	380012-009-02	Distributor B 4G63-4G64
MD171228	380005-004-01	Starter 4G63-4G64
MD320618	380005-004-01	Starter 4G63-4G64
MD326638	380016-001-02	Coil A218371 MD358504 925969
MD358504	380016-001-02	Coil A218371 MD358504 925969
MD602756	380012-011-02	Distributor Cap DC-20 4G32-52-54
MD602758	380015-007-02	Rotor RT-10 4G32-52-54
MD602949	380012-011-02	Distributor Cap DC-20 4G32-52-54
MD607597	380012-011-02	Distributor Cap DC-20 4G32-52-54
MD611686	380012-011-02	Distributor Cap DC-20 4G32-52-54
MD611817	380015-001-02	Rotor RT-11 H20II
MD611850	380015-007-02	Rotor RT-10 4G32-52-54
MD618262	380015-001-02	Rotor RT-11 H20II
MD618364	380012-007-02	Distributor Cap DC-19 4G63-4G64
MD970338	380006-005-02	Pump Water 4G63-4G64
MD972457	380006-005-02	Pump Water 4G63-4G64
MD997476	380013-017-02	Spark Plug W16S-U
MDI-700210I	380001-005-01	Repair Kit JB2
MDI700050	064423	Female LP Tank Fitting
MIC-0053100I	380001-005-01	Repair Kit JB2
MIC-0053110I	380001-005-01	Repair Kit JB2
MIC0053011	064423	Female LP Tank Fitting
MIC0053089	380001-010-01	Connector LPG Male 7141M
MM115231	380010-004-02	Belt - Fan
MM407440	380010-009-02	Belt - Fan
MM502535	380015-006-02	Rotor RT-13 TB42 6Cyl
MM611850	380015-001-02	Rotor RT-11 H20II

OE Number	Crown Part No.	Description
MS851022	380013-006-02	Spark Plug W16EX-U
MS851101	380013-006-02	Spark Plug W16EX-U
NA040025	380050-036	Bearing Assm
ST973139	380070-009	Pan Seat
T232T-46772	380012-011-02	Distributor Cap DC-20 4G32-52-54
T232T-48372	380012-007-02	Distributor Cap DC-19 4G63-4G64
T3T65675	380012-009-02	Distributor B 4G63-4G64
T45327	380012-006-02	Distributor Cap DC-11 F2-FE
T46371	380012-012-02	Distributor Cap H20II
T880T-18972	380015-001-02	Rotor RT-11 H20II
T880X17571	380015-006-02	Rotor RT-13 TB42 6Cyl
<b>Mortec (MD)</b>		
320618	380005-004-01	Starter 4G63-4G64
<b>Multiton (MT)</b>		
26500550	380050-036	Bearing Assm
410031122	380050-036	Bearing Assm
4207748133	380050-036	Bearing Assm
4207919651	380070-016	Suspension Seat - Vinyl
4208848227	380050-036	Bearing Assm
4209717924	380070-016	Suspension Seat - Vinyl
650055	380050-036	Bearing Assm
<b>Napa (NP)</b>		
8231310	380070-009	Pan Seat
BK8231310	380070-009	Pan Seat
EP-335	380012-007-02	Distributor Cap DC-19 4G63-4G64
EP-339	380015-004-02	Rotor RT-03 F2-FE
EP-780	380015-004-02	Rotor RT-03 F2-FE
FA-164	380012-008-02	Distributor DC-5 D5
UD-16	380013-012-02	Spark Plug L14-U
<b>NGK (NG)</b>		
B4LM	380105-051	Spark Plug W14LM-U
BCPR6E	380013-013-02	Spark Plug Q20-PR-U
BP4E	380105-057	Spark Plug W14EX-U
BP4ES	380105-057	Spark Plug W14EX-U
BP4EY	380105-057	Spark Plug W14EX-U
BP5EA	380105-057	Spark Plug W14EX-U
BPR6EF	380013-018-01	Spark Plug T20EPR-U
BPR6EFS	380013-018-01	Spark Plug T20EPR-U
BUR6EFSZ	380013-018-01	Spark Plug T20EPR-U
TR5	380013-018-01	Spark Plug T20EPR-U
TR5-1	380013-018-01	Spark Plug T20EPR-U
TR6	380013-018-01	Spark Plug T20EPR-U
TR6GP	380013-018-01	Spark Plug T20EPR-U
<b>Nippondenso (ND)</b>		
100211-4540	380011-002-01	Alternator 4Y - GN81-41
290000621	380012-003-02	Distributor I 4Y
L14-U	380013-012-02	Spark Plug L14-U
PT16EPR-L13	380013-014-02	Spark Plug PT16EPR-L13
T14PR-U	380013-016-02	Spark Plug T14PR-U
T16PRU	380013-008-02	Spark Plug T16PR-U
T20EPRU	380013-018-01	Spark Plug T20EPR-U
W14EX-U	380105-057	Spark Plug W14EX-U
W14LM-U	380105-051	Spark Plug W14LM-U
W16EXR-U	380013-010-02	Spark Plug W16EXR-U
W16S-U	380013-017-02	Spark Plug W16S-U
W9EP	380013-007-02	Spark Plug W9EP
<b>Nissan (NI)</b>		
00933-33500	380030-118	Plug
01978-11004	380010-009-02	Belt - Fan
02117-01011	380010-002-02	Belt - Fan
02117-01011-F1	380010-002-02	Belt - Fan
02117-02011-F1	380010-002-02	Belt - Fan
02117-03011	380010-002-02	Belt - Fan
02117-20021	380010-003-02	Belt - Fan
02117-21521	380010-005-02	Belt - Fan
0255-49NNN	380070-016	Suspension Seat - Vinyl

Components  
(IC) Truck

Nissan Continued ▶

## (IC) Truck Components Cross Reference by Manufacturer

Nissan Continued

OE Number	Crown Part No.	Description
08322-1201P	380050-003	Outer Bearing
08911-04610	380030-017	Nut
08911-0461A	380030-017	Nut
11044-FU400	380030-067	Head Gasket
11044-FU460	380030-033	Head Gasket
11720-69200	380010-012-02	Belt - Fan
11720-87V10	380010-001-02	Belt - Fan
11720-B1100	380010-002-02	Belt - Fan
11720-B1101	380010-002-02	Belt - Fan
11720-B1101-F1	380010-002-02	Belt - Fan
11720-F2700	380010-009-02	Belt - Fan
11720-FM010	380010-005-02	Belt - Fan
11720-J0300	380010-004-02	Belt - Fan
11720-K4080	380010-001-02	Belt - Fan
11720-K7201	380010-012-02	Belt - Fan
11720-L1101	380010-002-02	Belt - Fan
11720-N9515	380010-012-02	Belt - Fan
11720-Y4400	380010-002-02	Belt - Fan
11810-75T00	380030-036	PCV Valve
13270-E3400	380030-027	Valve Cover Gasket
13270-FY50A	380030-028	Valve Cover Gasket
14080-50K00	380009-109	Hose
16010-JBREG	380001-002-01	Converter JB2
16245-VFF30	380001-001-01	Lockoff VFF-30-2-IMP
16310-GS00A	380001-015-01	Vaporizer (Nikki)
16310-GS00C	380001-015-01	Vaporizer (Nikki)
16310-GS40A	380001-013-01	Vaporizer
16310-GU20A	380001-013-01	Vaporizer
16310-GY361	380001-015-01	Vaporizer (Nikki)
16310-GY36B	380001-015-01	Vaporizer (Nikki)
16310-GZ560	380001-015-01	Vaporizer (Nikki)
16310-RPKIT	380001-016	Repair Kit (Vaporizer)
16328-GS00A	380030-069	Repair Kit (Nikki)
16328-GY010	380030-069	Repair Kit (Nikki)
16400-90H71	380001-001-01	Lockoff VFF-30-2-IMP
16600-GS17B	380030-073	Injector
17053-FU460	380030-111	Diaphragm Kit (NIKKI)
17960-VR500	380030-060	Diaphragm Kit (Nikki)
17962-FU460	380030-122	Valve Assy (NIKKI)
18919-AM810	380030-001	Accelerator Unit
20801-04261	380010-002-02	Belt - Fan
21010-50K00	380008-003-02	Fan Blade H20 II
21010-50K01	380006-002-02	Pump Water H20II-H25
21010-50K02	380006-002-02	Pump Water H20II-H25
21010-FU425	380006-002-02	Pump Water K21-K25
21010-L1100	380006-001-02	Pump Water H20 New Style
21010-L1101	380006-001-02	Pump Water H20 New Style
21010-L1125	380006-001-02	Pump Water H20 New Style
21010-L1126	380006-001-02	Pump Water H20 New Style
21010-L1128	380006-001-02	Pump Water H20 New Style
21010-P7526	380006-002-02	Pump Water H20II-H25
21060-48210	380008-004-02	Fan Blade H20
21060-49001	380008-004-02	Fan Blade H20
21060-49003	380008-004-02	Fan Blade H20
21060-50K00	380008-003-02	Fan Blade H20 II
21060-87V00	380008-003-02	Fan Blade H20 II
21060-GY360	380008-001-02	Fan Blade K21-K25
21067-38800	380010-012-02	Belt - Fan
21067-K7201	380010-012-02	Belt - Fan
21140-90301	380010-009-02	Belt - Fan
21200-58G04	380009-105	Thermostat/ Gasket
21200-96015	380009-105	Thermostat/ Gasket
21200-96061	380009-105	Thermostat/ Gasket
21200-G3100	380009-106	Thermostat/ Gasket
21200-OC811	380009-105	Thermostat/ Gasket
21200-VJ200	380009-105	Thermostat/ Gasket

OE Number	Crown Part No.	Description
21200-VJ200D	380009-105	Thermostat/ Gasket
21200-VJ200N	380009-105	Thermostat/ Gasket
21200-VJ200S	380009-105	Thermostat/ Gasket
21430-01F02	380009-104	Radiator Cap
21430-91H00	380009-104	Radiator Cap
21430-FK300	380009-104	Radiator Cap
21460-24H10	380009-006-02	Radiator
21460-6G000	380009-004-02	Radiator
21460-6G100	380009-004-02	Radiator
21460-6G101	380009-004-02	Radiator
21460-90H10	380009-006-02	Radiator
21460-90H15	380009-003-02	Radiator
21460-90H15-D	380009-003-02	Radiator
21460-G6000	380009-004-02	Radiator
22020-G5111	380030-107	Ignition Module
22100-49206	380012-005-02	Distributor C H20
22100-49207	380012-005-02	Distributor C H20
22100-49210	380012-005-02	Distributor C H20
22100-50K10	380012-002-02	Distributor G H20II
22100-50K15	380012-002-02	Distributor G H20II
22100-55K10	380012-002-02	Distributor G H20II
22100-60K10	380012-014-02	Distributor
22100-60K11	380012-014-02	Distributor
22100-60K15	380012-014-02	Distributor
22100-71305	380012-005-02	Distributor C H20
22100-71306	380012-005-02	Distributor C H20
22100-71315	380012-005-02	Distributor C H20
22100-71317	380012-005-02	Distributor C H20
22100-74011	380012-005-02	Distributor C H20
22100-K7201	380012-005-02	Distributor C H20
22157-05M02	380015-008-02	Rotor H20
22157-52H20	380015-006-02	Rotor RT-13 TB42 6Cyl
22157-55K10	380015-001-02	Rotor RT-11 H20II
22157-55K15	380015-001-02	Rotor RT-11 H20II
22157-R9007	380015-007-02	Rotor RT-10 4G32-52-54
22162-11E07	380012-011-02	Distributor Cap DC-20 4G32-52-54
22162-17M01	380012-011-02	Distributor Cap DC-20 4G32-52-54
22162-17M02	380012-012-02	Distributor Cap H20II
22162-17M03	380012-011-02	Distributor Cap DC-20 4G32-52-54
22162-17M04	380012-012-02	Distributor Cap H20II
22162-23G15	380012-012-02	Distributor Cap H20II
22162-25G10	380012-011-02	Distributor Cap DC-20 4G32-52-54
22162-25G11	380012-011-02	Distributor Cap DC-20 4G32-52-54
22162-40F00	380012-012-02	Distributor Cap H20II
22162-40F10	380012-012-02	Distributor Cap H20II
22162-55K10	380012-001-02	Distributor Cap DC-10 H20II
22162-75A10	380012-012-02	Distributor Cap H20II
22162-78A00	380012-012-02	Distributor Cap H20II
22162-78A10	380012-012-02	Distributor Cap H20II
22162-78AX0	380012-012-02	Distributor Cap H20II
22162-A3514	380012-011-02	Distributor Cap DC-20 4G32-52-54
22162-G5710	380012-012-02	Distributor Cap H20II
22162-G5711	380012-012-02	Distributor Cap H20II
22162-R9006	380012-011-02	Distributor Cap DC-20 4G32-52-54
22162-R9007	380012-011-02	Distributor Cap DC-20 4G32-52-54
22162-VB011	380012-016-02	Distributor Cap
22401-M7716	380013-009-02	Spark Plug W16EPR-U
22401-V1414	380013-004-02	Spark Plug W14EXR-U
22401-W8914	380013-007-02	Spark Plug W9EP
22433-AR215	380016-002-02	Ignition Coil
22448-AR215	380016-002-02	Ignition Coil
22450-49251	380014-008-02	Plug Wire Set H20
22450-50K25	380014-006-02	Plug Wire Set H20II
22450-50K50	380014-006-02	Plug Wire Set H20II
22450-50KA0	380014-006-02	Plug Wire Set H20II
22450-L0150	380014-008-02	Plug Wire Set H20

Nissan Continued ▶

# (IC) Truck Components Cross Reference by Manufacturer

Nissan Continued

OE Number	Crown Part No.	Description
22450-L1051	380014-008-02	Plug Wire Set H20
22450-L1125	380014-008-02	Plug Wire Set H20
22690-FU460	380030-041	Sensor, O2
23100-06000	380011-004-02	Alternator H20-P40-TB42
23100-A4600	380011-007-02	Alternator H20
23100-A4601	380011-007-02	Alternator H20
23100-A4602	380011-004-02	Alternator H20-P40-TB42
23100-A4611	380011-007-02	Alternator H20
23100-A4800	380011-004-02	Alternator H20-P40-TB42
23100-A4810	380011-004-02	Alternator H20-P40-TB42
23100-A5500	380011-004-02	Alternator H20-P40-TB42
23100-A5501	380011-004-02	Alternator H20-P40-TB42
23100-A5502	380011-004-02	Alternator H20-P40-TB42
23100-B8001	380011-004-02	Alternator H20-P40-TB42
23100-B8002	380011-004-02	Alternator H20-P40-TB42
23100-B9802	380011-004-02	Alternator H20-P40-TB42
23100-B9810	380011-004-02	Alternator H20-P40-TB42
23100-B9810-B	380011-004-02	Alternator H20-P40-TB42
23100-C6000	380011-007-02	Alternator H20
23100-E5200	380011-004-02	Alternator H20-P40-TB42
23100-FU410	380011-001-01	Alternator K21-K25
23100-H0100	380011-004-02	Alternator H20-P40-TB42
23100-H0110	380011-004-02	Alternator H20-P40-TB42
23100-H0300	380011-004-02	Alternator H20-P40-TB42
23100-H0310	380011-004-02	Alternator H20-P40-TB42
23100-H6215	380011-007-02	Alternator H20
23100-H7703	380011-007-02	Alternator H20
23100-M0400	380011-004-02	Alternator H20-P40-TB42
23100-M0401	380011-004-02	Alternator H20-P40-TB42
23100-M0402	380011-004-02	Alternator H20-P40-TB42
23100-M0410	380011-004-02	Alternator H20-P40-TB42
23100-M0413	380011-007-02	Alternator H20
23100-M0414	380011-007-02	Alternator H20
23100-M6601	380011-007-02	Alternator H20
23100-U0100	380011-007-02	Alternator H20
23100-U0101	380011-004-02	Alternator H20-P40-TB42
23100-U0102	380011-007-02	Alternator H20
23100-U0103	380011-007-02	Alternator H20
23100-U0104	380011-007-02	Alternator H20
23100-U0105	380011-007-02	Alternator H20
23100-U0110	380011-007-02	Alternator H20
23100-U0111	380011-004-02	Alternator H20-P40-TB42
23100-U0112	380011-007-02	Alternator H20
23100-U0113	380011-007-02	Alternator H20
23100-U0114	380011-007-02	Alternator H20
23100-U4601	380011-007-02	Alternator H20
23300-00H10	380005-006-01	Starter H20
23300-00H11	380005-006-01	Starter H20
23300-52H00-N	380005-013-02	Starter (Brand New)
23300-FU410	380005-008-02	Starter K21-K25
23300-K9160	380005-001-01	Starter H20-H20II-H25
23300-L2910	380005-006-01	Starter H20
23300-L2911	380005-006-01	Starter H20
23300-L2912	380005-006-01	Starter H20
23731-6J906	380030-040	Sensor, Crankshaft
25150-02H01	380050-022	Ignition Switch
25240-89902	380030-117	Oil Pressure Switch
25240-89910	380030-117	Oil Pressure Switch
25240-FJ10A	380050-032	Oil Pressure Switch
25240-FM00A	380050-032	Oil Pressure Switch
38140-30K00	380050-057	Bearing Assm
38440-61500	380050-003	Outer Bearing
38440-86160	380050-004	Inner Bearing
40210-61501	380050-055	Bearing Assm
40210-C6000	380050-065	Bearing Assembly
40210-FJ100	380050-061	Bearing Ass'y

OE Number	Crown Part No.	Description
40211-48201	380050-057	Bearing Assm
40211-49000	380050-003	Outer Bearing
40211-49001	380050-003	Outer Bearing
40215-10360	380050-036	Bearing Assm
40222-FJ100	380030-012	Bolt
40224-0T005	380030-018	Nut
40224-FJ100	380030-018	Nut
40227-FK000	380060-007	Oil Seal
43090-00H00	380060-001	Oil Seal
43090-22H00	380050-027	Seal - Dust (Oil Seal)
43210-76000	380050-054	Bearing Assm
43215-76000	380050-036	Bearing Assm
43215-T8000	380050-036	Bearing Assm
43225-L1300	380050-029	Bolt
43252-J2000	380060-017	Oil Seal
43533-L1100	380050-033	Seal Oil Drive Axle
44024-L0700	380030-023	Spring
44025-22H00	380023-004	Sheave, Brake
44026-L0100	380030-023	Spring
44039-22H00	380030-058	Spring
44060-00H60	380020-007-02	Brake Shoe Kit (4)
44060-11H03	380020-007-02	Brake Shoe Kit (4)
44060-11H06	380020-007-02	Brake Shoe Kit (4)
44060-22H60	380020-004-02	Brake Shoe (1)
44060-FJ500	380020-007-02	Brake Shoe Kit (4)
44060-L0105	380020-007-02	Brake Shoe Kit (4)
44070-00H60	380020-007-02	Brake Shoe Kit (4)
44070-00H70	380020-007-02	Brake Shoe Kit (4)
44070-0K301	380020-007-02	Brake Shoe Kit (4)
44070-0K311	380020-007-02	Brake Shoe Kit (4)
44070-11H06	380020-007-02	Brake Shoe Kit (4)
44070-11H16	380020-007-02	Brake Shoe Kit (4)
44070-22H60	380020-004-02	Brake Shoe (1)
44070-22H70	380020-004-02	Brake Shoe (1)
44070-FJ500	380020-007-02	Brake Shoe Kit (4)
44070-FJ510	380020-007-02	Brake Shoe Kit (4)
44070-L0100	380030-057	Spring
44083-00H00	380030-023	Spring
44090-22H00	380030-059	Spring
44090-22H10	380030-024	Spring
44090-L1400	380030-057	Spring
44100-00H00	380050-053	Wheel Cylinder
44100-11H01	380050-053	Wheel Cylinder
44100-22H00	380050-051	Wheel Cylinder
44100-FJ500	380050-053	Wheel Cylinder
44100-FK000	380050-052	Wheel Cylinder
44100-L1400	380050-053	Wheel Cylinder
44147-00H00	380030-031	Spring
44147-11H04	380030-031	Spring
44147-22H00	380030-025	Spring
44214-00H10	380030-119	Spring
44215-00H00	380030-004	Adjuster Cable
44215-22H00	380030-003	Adjuster Cable
44999-22H00	380020-001-02	Brake Shoe Kit (4)
46010-04H00	380030-091	Master Cylinder
46010-11H01	380030-091	Master Cylinder
48520-10H04	380030-078	Tie Rod End
48522-00H00	380050-030	Oil Seal
48522-FJ101	380060-011	Oil Seal, Steer Axle
48525-FK000	380050-031	Oil Seal
48544-51K02	380050-062	Bearing, Spherical
48544-6K000	380050-025	Bearing Spherical
59117-01H00	380050-020	Roller-Lift 94mm Dia
59117-01H03	380050-020	Roller-Lift 94mm Dia
59117-20H00	380050-019	Roller-Lift
59117-20H03	380050-019	Roller-Lift

Nissan  
Truck  
Components

Nissan Continued ▶

## (IC) Truck Components Cross Reference by Manufacturer

Nissan Continued

OE Number	Crown Part No.	Description
6016-10330	380001-003-01	Converter Cobra
65320-FB401	380030-112	Gas Spring
662145	380050-017	Roller
683819	380050-018	Thrust Roller
69220-FK100	380030-114	Hydraulic Filter
78001-7141F	064423	Female LP Tank Fitting
78001-7141M	380001-010-01	Connector LPG Male 7141M
7B001-7141N	380001-010-01	Connector LPG Male 7141M
87000-03K00	380070-016	Suspension Seat - Vinyl
87000-11H00	380070-023	Pan Seat
87000-11H01	380070-023	Pan Seat
87000-43K20	380070-022	Bucket Seat
87000-60K01	380070-022	Bucket Seat
87000-60K05	380070-001	Lumbar Seat
87000-6G010	380070-023	Pan Seat
87000-6G210	380070-037-E	Molded Seat w Electric Switch
87000-6G400	380070-037-E	Molded Seat w Electric Switch
87000-6G410	380070-023	Pan Seat
87000-90H00	380070-023	Pan Seat
87000-91H00	380070-023	Pan Seat
87000-FB400	380070-037-E	Molded Seat w Electric Switch
87000-FW50B	380070-037-E	Molded Seat w Electric Switch
87000-L1105	380070-023	Pan Seat
87000-L2000	380070-001	Lumbar Seat
87000-L2100	380070-001	Lumbar Seat
87000-SS999	380170-010	Lumbar Support Seat
87000-UMP00	380070-009	Pan Seat
87600-91H55	380070-022	Bucket Seat
91H20-03330	380005-001-01	Starter H20-H20II-H25
96303-11H00	380030-007	Mirror
96303-6G000	380030-044	Mirror
A6600-FU471	380030-073	Injector
A6600-FU571	380030-073	Injector
CK1318727	380050-005	Bearing Cup
CK1318728	380050-006	Bearing Cone
CK1817083	380050-036	Bearing Assm
CK3779914	380012-011-02	Distributor Cap DC-20 4G32-52-54
CK715977	380001-010-01	Connector LPG Male 7141M
CK909353	380015-007-02	Rotor RT-10 4G32-52-54
CK913628	380013-012-02	Spark Plug L14-U
CK916006	380015-007-02	Rotor RT-10 4G32-52-54
CK923626	380012-007-02	Distributor Cap DC-19 4G63-4G64
CK923627	380015-001-02	Rotor RT-11 H20II
CK930768	380010-009-02	Belt - Fan
D700615	380006-003-02	Pump Water HER2.7-1404
FLPRTSP0006	380070-009	Pan Seat
FLPRTSS000	380070-001	Lumbar Seat
MD169418	380012-009-02	Distributor B 4G63-4G64
MD171228	380005-004-01	Starter 4G63-4G64
MD320618	380005-004-01	Starter 4G63-4G64
MD611686	380012-011-02	Distributor Cap DC-20 4G32-52-54
MD611850	380015-007-02	Rotor RT-10 4G32-52-54
MD618364	380012-007-02	Distributor Cap DC-19 4G63-4G64
N-22401-L1600	380013-004-02	Spark Plug W14EXR-U
NF90420-01480	380015-009-02	Rotor RT-01 GM 6Cyl
NF90420-01620	380013-014-02	Spark Plug PT16EPR-L13
NF91865-13100	380001-001-01	Lockoff VFF-30-2-IMP
NF93165-03600	064423	Female LP Tank Fitting
NF93165-13110	380001-006-01	Repair Kit Cobra
NFF8140-30214	380050-004	Inner Bearing
<b>NYK (NY)</b>		
30214	380050-004	Inner Bearing
41530214	380050-004	Inner Bearing
434035070	380050-004	Inner Bearing
F814030214	380050-004	Inner Bearing
<b>Peugeot (PG)</b>		
7141F	064423	Female LP Tank Fitting

OE Number	Crown Part No.	Description
7141M	380001-010-01	Connector LPG Male 7141M
7141M3	380001-011-02	O-Ring Outer Flat 7141M3
C-971-3	064423	Female LP Tank Fitting
C-971-4	380001-010-01	Connector LPG Male 7141M
GO7141M	380001-010-01	Connector LPG Male 7141M
REGO7141F	064423	Female LP Tank Fitting
<b>Power Boss (PB)</b>		
300489	380070-030	Suspension Seat - Cloth
<b>Prestolite (PL)</b>		
110-460	380011-006-02	Alternator 4G52-4G54
14-4	380013-017-02	Spark Plug W16S-U
14-5	380013-017-02	Spark Plug W16S-U
14G22	380013-007-02	Spark Plug W9EP
14G52	380105-057	Spark Plug W14EX-U
14G82	380013-007-02	Spark Plug W9EP
14R8	380013-017-02	Spark Plug W16S-U
14RF42	380013-016-02	Spark Plug T14PR-U
14RF52	380013-016-02	Spark Plug T14PR-U
14RF62	380013-016-02	Spark Plug T14PR-U
18-10	380013-012-02	Spark Plug L14-U
18-4	380013-012-02	Spark Plug L14-U
18-8	380013-012-02	Spark Plug L14-U
18-9	380013-012-02	Spark Plug L14-U
8AR2200L	380011-006-02	Alternator 4G52-4G54
<b>Prime Mover (PM)</b>		
BM-15-1	380010-010-02	Belt - Fan
<b>Raymond (RA)</b>		
1-164-912	380021-004-02	Brake Cylinder
1-164-915	380021-004-02	Brake Cylinder
1032206	380006-012-01	Hydraulic Pump (Lift)
447-098	380050-006	Bearing Cone
447-105	380050-036	Bearing Assm
447-562	380050-005	Bearing Cup
460-690	380050-058	Bearing, Spherical
750	380021-004-02	Brake Cylinder
921-000-195	380050-036	Bearing Assm
990-253	380021-004-02	Brake Cylinder
DS223655	380050-006	Bearing Cone
DS223657	380050-005	Bearing Cup
<b>Rego (RE)</b>		
7141F	064423	Female LP Tank Fitting
7141M	380001-010-01	Connector LPG Male 7141M
7141M-3R	380001-011-02	O-Ring Outer Flat 7141M3
<b>Samsung (SG)</b>		
1318727	380050-005	Bearing Cup
1318728	380050-006	Bearing Cone
2383064	380011-006-02	Alternator 4G52-4G54
3779914	380012-011-02	Distributor Cap DC-20 4G32-52-54
MD611685	380012-011-02	Distributor Cap DC-20 4G32-52-54
MD611686	380012-011-02	Distributor Cap DC-20 4G32-52-54
MD618364	380012-007-02	Distributor Cap DC-19 4G63-4G64
<b>Still (SL)</b>		
141231	380050-017	Roller
144483	380013-007-02	Spark Plug W9EP
145542	380050-036	Bearing Assm
300558	380070-016	Suspension Seat - Vinyl
309925	380070-030	Suspension Seat - Cloth
521452	380070-016	Suspension Seat - Vinyl
522335	380070-030	Suspension Seat - Cloth
522414	380070-016	Suspension Seat - Vinyl
524145	380070-016	Suspension Seat - Vinyl
524335	380070-030	Suspension Seat - Cloth
5411744	380050-004	Inner Bearing
S200851	380050-007	Oil Seal
<b>Taylor Dunn (TA)</b>		
72-501-43	380030-082	Solenoid
90-160-70	380070-016	Suspension Seat - Vinyl

Nissan Continued



## (IC) Truck Components Cross Reference by Manufacturer

OE Number	Crown Part No.	Description
<b>TCM (TC)</b>		
03071-30209	380050-065	Bearing Assembly
03071-30214	380050-004	Inner Bearing
1017	380170-017	Suspension Seat
11720-B1101	380010-002-02	Belt - Fan
19502-52301	380050-055	Bearing Assm
20801-04081	380010-003-02	Belt - Fan
20801-04101	380010-009-02	Belt - Fan
20801-04261	380010-002-02	Belt - Fan
20801-04331	380010-004-02	Belt - Fan
20801-0A041	380013-007-02	Spark Plug W9EP
20801-0K041	380014-006-02	Plug Wire Set H20II
20801-0K042	380014-006-02	Plug Wire Set H20II
20801-0K052	380014-001-02	Plug Wire Set 4Y
20803-71151	380020-002-02	Brake Shoe Kit (2)
20803-71161	380020-002-02	Brake Shoe Kit (2)
212T1-05981	380008-002-02	Fan Blade 4Y 6-7 Series
212T1-06101	380012-003-02	Distributor I 4Y
212T1-06111	380012-004-02	Distributor Cap DC-6 4Y
212T1-06121	380015-002-02	Rotor RT-07 4Y
212T1-06941	380011-002-01	Alternator 4Y - GN81-41
212T1-07201	380005-002-01	Starter 4P-4Y-5R-5P
212T1-08481	380030-120	Thermostat /O-Ring
212T1-08551	380014-001-02	Plug Wire Set 4Y
212T1-09141	380030-036	PCV Valve
212T1-09451	380006-010-02	Pump Water 4Y 7 Series
215E4-52231	380050-025	Bearing Spherical
22162-55K10	380012-001-02	Distributor Cap DC-10 H20II
22162-55K11	380012-001-02	Distributor Cap DC-10 H20II
22196-82001	380070-001	Lumbar Seat
222A2-10211	380009-104	Radiator Cap
22433-79901	380020-006-02	Brake Shoe Set (2)
22450-L1051	380014-008-02	Plug Wire Set H20
23100-M0413	380011-007-02	Alternator H20
23100-U0103	380011-007-02	Alternator H20
23300-00H10	380005-006-01	Starter H20
23300-K9160	380005-001-01	Starter H20-H20II-H25
23453-02071A	380050-054	Bearing Assm
23654-34051	380030-018	Nut
23656-80102	380070-001	Lumbar Seat
24843-02051	380050-046	Oil Seal
24846-80301	380070-001	Lumbar Seat
24846-80302	380070-001	Lumbar Seat
25240-FJ10A	380050-032	Oil Pressure Switch
271F6-42531	380030-019	Nut
27416-80201	380070-001	Lumbar Seat
27416-80202	380070-001	Lumbar Seat
43225-L1300	380050-029	Bolt
44217-22H00	380030-019	Nut
53032-72601	380011-004-02	Alternator H20-P40-TB42
53320-50401	380001-001-01	Lockoff VFF-30-2-IMP
53320-50501	380001-002-01	Converter JB2
547C0-52001	380001-015-01	Vaporizer (Nikki)
7141M	380001-010-01	Connector LPG Male 7141M
A6600-FU471	380030-073	Injector
A6600-FU571	380030-073	Injector
C51M001507405	380020-005-02	Brake Pad (1)
C521100304010	380030-057	Spring
C521102952000	380050-053	Wheel Cylinder
C521123254540	380030-058	Spring
C521124652001	380050-051	Wheel Cylinder
CK21122083000	380020-006-02	Brake Shoe Set (2)
FA4846-80403	380170-039	Wing Seat
N-02117-00511	380010-009-02	Belt - Fan
N-11720-B1101	380010-002-02	Belt - Fan
N-11720-K4080	380010-001-02	Belt - Fan

OE Number	Crown Part No.	Description
N-11720-Y4400	380010-002-02	Belt - Fan
N-21010-50K26	380006-011-02	Pump Water H20II-H25
N-21010-50K28	380006-011-02	Pump Water H20II-H25
N-21010-L1100	380006-001-02	Pump Water H20 New Style
N-21010-L1125	380006-001-02	Pump Water H20 New Style
N-21010-L1126	380006-001-02	Pump Water H20 New Style
N-21060-48210	380008-004-02	Fan Blade H20
N-21060-50K00	380008-003-02	Fan Blade H20 II
N-22100-49207	380012-005-02	Distributor C H20
N-22100-50K10	380012-002-02	Distributor G H20II
N-22100-60K10	380012-014-02	Distributor
N-22100-60K15	380012-014-02	Distributor
N-22100-71306	380012-005-02	Distributor C H20
N-22100-71317	380012-005-02	Distributor C H20
N-22100-K7201	380012-005-02	Distributor C H20
N-22157-52H20	380015-006-02	Rotor RT-13 TB42 6Cyl
N-22157-55K10	380015-001-02	Rotor RT-11 H20II
N-22162-23G15	380012-012-02	Distributor Cap H20II
N-22162-25G10	380012-011-02	Distributor Cap DC-20 4G32-52-54
N-22162-25G11	380012-011-02	Distributor Cap DC-20 4G32-52-54
N-22162-78A10	380012-012-02	Distributor Cap H20II
N-22162-G5710	380012-012-02	Distributor Cap H20II
N-22162-G5711	380012-012-02	Distributor Cap H20II
N-22162-R9006	380012-011-02	Distributor Cap DC-20 4G32-52-54
N-22162-R9007	380012-011-02	Distributor Cap DC-20 4G32-52-54
N-22401-L1600	380013-004-02	Spark Plug W14EXR-U
N-22401-W8914	380013-007-02	Spark Plug W9EP
N-22450-50K50	380014-006-02	Plug Wire Set H20II
N-23100-B9810	380011-004-02	Alternator H20-P40-TB42
N-23100-C6000	380011-007-02	Alternator H20
N-23100-FU410	380011-001-01	Alternator K21-K25
N-23100-M0413	380011-007-02	Alternator H20
N-23100-M0414	380011-007-02	Alternator H20
N-23100-U0100	380011-007-02	Alternator H20
N-23100-U0102	380011-007-02	Alternator H20
N-23100-U0103	380011-007-02	Alternator H20
N-23300-B9810	380011-004-02	Alternator H20-P40-TB42
N-23300-FU410	380005-008-02	Starter K21-K25
N21060FU40A	380008-001-02	Fan Blade K21-K25
T-4894-24-760	380050-051	Starter Solenoid
T-B366-18-501	380050-032	Oil Pressure Switch
T-F829-18-V05	380015-004-02	Rotor RT-03 F2-FE
T-FE2S-18-V05	380015-004-02	Rotor RT-03 F2-FE
T-FEEN-18-V00	380012-006-02	Distributor Cap DC-11 F2-FE
TB63018X45	380050-050	Starter Drive
TFESE18X10	380050-051	Starter Solenoid
TFFSC18400-NEW	380005-011-02	Starter (Brand New)
W9EP	380013-007-02	Spark Plug W9EP
WM1015	380170-018	Bucket Seat
WM1017	380170-017	Suspension Seat
WM1077	380070-023	Pan Seat
WM1177	380170-011	Seat
WM1208	380070-013	Full Body Seat
WM127	380070-009	Pan Seat
WM455	380170-024-H	Low Profile Seat w Hip Restraint
WM682	380070-009	Pan Seat
WM684	380070-012	Pan Seat w Armrest
WM697	380170-005	Bucket Seat
WM700	380170-007	Standard Seat
<b>Tennant (TN)</b>		
1056543	380070-016	Suspension Seat - Vinyl
34251	380070-030	Suspension Seat - Cloth
39046	380013-008-02	Spark Plug T16PR-U
53845	380070-030	Suspension Seat - Cloth
7764	380013-008-02	Spark Plug T16PR-U

## (IC) Truck Components Cross Reference by Manufacturer

OE Number	Crown Part No.	Description
<b>Timken (TM)</b>		
JLM104910	380050-005	Bearing Cup
JLM104948	380050-006	Bearing Cone
<b>Toyota (TY)</b>		
00590-00414-71	380050-036	Bearing Assm
00590-00909-71	380050-006	Bearing Cone
00590-00911	380050-005	Bearing Cup
00590-00911-71	380050-005	Bearing Cup
00590-00953-71	380050-044	Micro Switch
00591-00152-81	380014-008-02	Plug Wire Set H20
00591-00643-81	380050-005	Bearing Cup
00591-00644-81	380050-006	Bearing Cone
00591-01114-81	380070-030	Suspension Seat - Cloth
00591-01133-81	380014-008-02	Plug Wire Set H20
00591-02042-81	380013-004-02	Spark Plug W14EXR-U
00591-02129-81	380070-016	Suspension Seat - Vinyl
00591-02732-81	380010-012-02	Belt - Fan
00591-03628-81	380012-011-02	Distributor Cap DC-20 4G32-52-54
00591-03633-81	380105-057	Spark Plug W14EX-U
00591-05493-81	380013-017-02	Spark Plug W16S-U
00591-05705-81	380006-003-02	Pump Water HER2.7-1404
00591-06004-81	380012-006-02	Distributor Cap DC-11 F2-FE
00591-06005-81	380015-004-02	Rotor RT-03 F2-FE
00591-06008-81	380050-016	Roller
00591-06095-81	380010-004-02	Belt - Fan
00591-06165-81	380013-008-02	Spark Plug T16PR-U
00591-06208-81	380013-007-02	Spark Plug W9EP
00591-06209-81	380013-007-02	Spark Plug W9EP
00591-06238-81	380010-002-02	Belt - Fan
00591-06240-81	380050-040	Ignition Switch
00591-06279-81	380050-004	Inner Bearing
00591-06286-81	380014-008-02	Plug Wire Set H20
00591-06324-81	380007-001-02	Exhaust Pipe KO3EB-03-22110
00591-06467-81	380050-035	Bearing Mast
00591-06518-81	380050-044	Micro Switch
00591-07107-81	380010-012-02	Belt - Fan
00591-07109-81	380010-002-02	Belt - Fan
00591-07192-81	380008-004-02	Fan Blade H20
00591-07207-81	380012-005-02	Distributor C H20
00591-07216-81	380012-012-02	Distributor Cap H20II
00591-07374-81	380050-033	Seal Oil Drive Axle
00591-07432-81	380050-030	Oil Seal
00591-07485-81	380050-020	Roller-Lift 94mm Dia
00591-07487-81	380050-019	Roller-Lift
00591-07632-81	064423	Female LP Tank Fitting
00591-07633-81	380001-010-01	Connector LPG Male 7141M
00591-07818-81	380070-009	Pan Seat
00591-07824-81	380170-006	Standard Seat
00591-07826-81	380170-008	Contoured Seat
00591-07829-81	380170-002	Bucket Straight Back Seat
00591-07829-81-E	380170-002-E	Bucket Seat w Electric Switch
00591-07830-81	380170-004	Bucket Seat
00591-07831-81	380170-003	Bucket Seat
00591-07835-81	380070-001	Lumbar Seat
00591-07836-81	380170-011	Seat
00591-07859-81	380070-009	Pan Seat
00591-07862-81	380070-012	Pan Seat w Armrest
00591-07867-81	380170-005	Bucket Seat
00591-07870-81	380170-007	Standard Seat
00591-07876-81	380070-001	Lumbar Seat
00591-07877-81	380170-025	Wing Seat
00591-07878-81	380070-022	Bucket Seat
00591-07879-81	380170-020	Pan Seat
00591-07880-81	380070-009	Pan Seat
00591-07885-81	380013-012-02	Spark Plug L14-U
00591-07896-81	380013-012-02	Spark Plug L14-U

OE Number	Crown Part No.	Description
00591-07978-81	380006-001-02	Pump Water H20 New Style
00591-08089-81	380011-007-02	Alternator H20
00591-08206-81	380001-001-01	Lockoff VFF-30-2-IMP
00591-08516-81	380030-108	Strobe Lamp (Amber)
00591-10723-81	380006-007-02	Pump Water 4Y 5-6 Series
00591-10752-81	380012-004-02	Distributor Cap DC-6 4Y
00591-10757-81	380015-002-02	Rotor RT-07 4Y
00591-10795-81	380011-002-01	Alternator 4Y - GN81-41
00591-10808-81	380023-001-02	Brake Pedal Cover
00591-10918-81	380013-008-02	Spark Plug T16PR-U
00591-10919-81	380013-017-02	Spark Plug W16S-U
00591-10954-81	380010-006-02	Belt - Fan
00591-10963-81	380010-006-02	Belt - Fan
00591-10965-81	380010-010-02	Belt - Fan
00591-11046-81	380015-004-02	Rotor RT-03 F2-FE
00591-11105-81	380014-005-02	Plug Wire Set F2-FE
00591-11106-81	380012-008-02	Distributor DC-5 D5
00591-11157-81	064423	Female LP Tank Fitting
00591-14608-81	380001-006-01	Repair Kit Cobra
00591-14708-81	380001-005-01	Repair Kit JB2
00591-14711-81	380001-006-01	Repair Kit Cobra
00591-20174-81	380013-017-02	Spark Plug W16S-U
00591-20561-81	380050-011	Oil Seal
00591-20723-81	380015-006-02	Rotor RT-13 TB42 6Cyl
00591-21011-81	380006-011-02	Pump Water H20II-H25
00591-21035-81	380011-006-02	Alternator 4G52-4G54
00591-21199-81	380070-013	Full Body Seat
00591-22382-81	380050-037	Packing Cylinder Kit
00591-22425-81	380010-008-02	Belt - Timing
00591-22426-81	380006-004-02	Pump Water FE
00591-23164-81	380015-001-02	Rotor RT-11 H20II
00591-23165-81	380012-001-02	Distributor Cap DC-10 H20II
00591-27353-81	380012-002-02	Distributor G H20II
00591-27362-81	380011-006-02	Alternator 4G52-4G54
00591-27394-81	380021-001-02	Brake Cylinder
00591-27426-81	380016-001-02	Coil A218371 MD358504 925969
00591-27429-81	380008-005-02	Fan Blade 4G63-4G64 K Series
00591-30003-81	380170-003	Bucket Seat
00591-30004-81	380070-009	Pan Seat
00591-30006-81	380170-002	Bucket Straight Back Seat
00591-30006-81-E	380170-002-E	Bucket Seat w Electric Switch
00591-30007-81	380170-004	Bucket Seat
00591-30008-81	380070-001	Lumbar Seat
00591-30316-81	380050-006	Bearing Cone
00591-30336-81	380050-035	Bearing Mast
00591-30424-81	380050-034	Bearing Mast
00591-31074-81	380012-011-02	Distributor Cap DC-20 4G32-52-54
00591-31680-81	380012-006-02	Distributor Cap DC-11 F2-FE
00591-31681-81	380015-004-02	Rotor RT-03 F2-FE
00591-31692-81	064423	Female LP Tank Fitting
00591-31696-81	380001-010-01	Connector LPG Male 7141M
00591-31700-81	380001-001-01	Lockoff VFF-30-2-IMP
00591-31734-81	380001-011-02	O-Ring Outer Flat 7141M3
00591-31740-81	380001-011-02	O-Ring Outer Flat 7141M3
00591-31813-81	380015-004-02	Rotor RT-03 F2-FE
00591-32069-81	380050-007	Oil Seal
00591-32092-81	380050-011	Oil Seal
00591-32219-81	380050-044	Micro Switch
00591-32300-81	380050-040	Ignition Switch
00591-32404-81	380050-037	Packing Cylinder Kit
00591-32407-81	380050-041	Packing Cylinder Kit
00591-32673-81	380105-057	Spark Plug W14EX-U
00591-32686-81	380012-011-02	Distributor Cap DC-20 4G32-52-54
00591-32687-81	380012-012-02	Distributor Cap H20II
00591-32688-81	380012-004-02	Distributor Cap DC-6 4Y
00591-32691-81	380013-012-02	Spark Plug L14-U

Toyota Continued ▶

# (IC) Truck Components Cross Reference by Manufacturer

Toyota Continued

OE Number	Crown Part No.	Description
00591-32692-81	380013-008-02	Spark Plug T16PR-U
00591-32695-81	380013-007-02	Spark Plug W9EP
00591-32718-81	380012-005-02	Distributor C H20
00591-32723-81	380014-008-02	Plug Wire Set H20
00591-32834-81	380170-020	Pan Seat
00591-32844-81	380070-009	Pan Seat
00591-32845-81	380070-016	Suspension Seat - Vinyl
00591-32847-81	380070-030	Suspension Seat - Cloth
00591-32859-81	380070-015	Molded Seat
00591-32887-81	380006-001-02	Pump Water H20 New Style
00591-32889-81	380006-007-02	Pump Water 4Y 5-6 Series
00591-32891-81	380006-004-02	Pump Water FE
00591-33124-81	380050-002	Oil Seal
00591-33553-81	380014-005-02	Plug Wire Set F2-FE
00591-33593-81	380014-005-02	Plug Wire Set FE
00591-33605-81	380014-006-02	Plug Wire Set H20II
00591-33616-81	380011-006-02	Alternator 4G52-4G54
00591-33617-81	380015-004-02	Rotor RT-03 F2-FE
00591-33646-81	380013-004-02	Spark Plug W14EXR-U
00591-33649-81	380013-007-02	Spark Plug W9EP
00591-33666-81	380012-006-02	Distributor Cap DC-11 F2-FE
00591-33685-81	380015-009-02	Rotor RT-01 GM 6Cyl
00591-33686-81	380015-004-02	Rotor RT-03 F2-FE
00591-33687-81	380013-017-02	Spark Plug W16S-U
00591-33710-81	380015-004-02	Rotor RT-03 F2-FE
00591-33739-81	380011-004-02	Alternator H20-P40-TB42
00591-33765-81	380012-011-02	Distributor Cap DC-20 4G32-52-54
00591-33766-81	380012-011-02	Distributor Cap DC-20 4G32-52-54
00591-33834-81	380010-002-02	Belt - Fan
00591-33843-81	380010-006-02	Belt - Fan
00591-33845-81	380010-004-02	Belt - Fan
00591-33846-81	380010-002-02	Belt - Fan
00591-33850-81	380010-006-02	Belt - Fan
00591-33855-81	380010-006-02	Belt - Fan
00591-33863-81	380010-012-02	Belt - Fan
00591-33868-81	380010-012-02	Belt - Fan
00591-33869-81	380010-006-02	Belt - Fan
00591-33876-81	380010-004-02	Belt - Fan
00591-33877-81	380010-009-02	Belt - Fan
00591-33878-81	380010-004-02	Belt - Fan
00591-33879-81	380010-009-02	Belt - Fan
00591-33880-81	380010-006-02	Belt - Fan
00591-34205-81	380070-009	Pan Seat
00591-34208-81	380070-016	Suspension Seat - Vinyl
00591-34209-81	380070-030	Suspension Seat - Cloth
00591-34284-81	380006-011-02	Pump Water H20II-H25
00591-34296-81	380006-009-02	Pump Water VA
00591-34628-81	380030-101	Timing Belt
00591-34661-81	380010-008-02	Belt - Timing
00591-35270-81	380023-001-02	Brake Pedal Cover
00591-35379-81	380021-004-02	Brake Cylinder
00591-35435-81	380021-003-02	Brake Cylinder
00591-35528-81	380050-005	Bearing Cup
00591-35745-81	380050-004	Inner Bearing
00591-36864-81	380008-004-02	Fan Blade H20
00591-36868-81	380008-003-02	Fan Blade H20 II
00591-41351-81	380050-033	Seal Oil Drive Axle
00591-41385-81	380050-030	Oil Seal
00591-41785-81	380050-044	Micro Switch
00591-42783-81	380012-009-02	Distributor B 4G63-4G64
00591-42798-81	380012-002-02	Distributor G H20II
00591-42808-81	380013-008-02	Spark Plug T16PR-U
00591-42813-81	380010-006-02	Belt - Fan
00591-44714-81	380001-001-01	Lockoff VFF-30-2-IMP
00591-44723-81	380001-005-01	Repair Kit JB2
00591-45306-81	380050-039	Lift Cylinder O/H Kit

OE Number	Crown Part No.	Description
00591-50056-81	380011-002-01	Alternator 4Y - GN81-41
00591-50484-81	380006-001-02	Pump Water H20 New Style
00591-50757-81	380050-006	Bearing Cone
00591-50877-81	380050-035	Bearing Mast
00591-50969-81	380105-057	Spark Plug W14EX-U
00591-50970-81	380013-012-02	Spark Plug L14-U
00591-50971-81	380013-012-02	Spark Plug L14-U
00591-50973-81	380013-007-02	Spark Plug W9EP
00591-50976-81	380013-007-02	Spark Plug W9EP
00591-50978-81	380013-008-02	Spark Plug T16PR-U
00591-50979-81	380013-016-02	Spark Plug T14PR-U
00591-51007-81	380010-004-02	Belt - Fan
00591-51008-81	380010-012-02	Belt - Fan
00591-51009-81	380010-002-02	Belt - Fan
00591-51010-81	380010-002-02	Belt - Fan
00591-51011-81	380010-010-02	Belt - Fan
00591-51014-81	380010-002-02	Belt - Fan
00591-51025-81	380010-006-02	Belt - Fan
00591-51028-81	380010-003-02	Belt - Fan
00591-51083-81	064423	Female LP Tank Fitting
00591-51085-81	380001-010-01	Connector LPG Male 7141M
00591-51127-81	380001-011-02	O-Ring Outer Flat 7141M3
00591-51137-81	380001-001-01	Lockoff VFF-30-2-IMP
00591-51220-81	380012-005-02	Distributor C H20
00591-51265-81	380050-040	Ignition Switch
00591-51412-81	380012-011-02	Distributor Cap DC-20 4G32-52-54
00591-51417-81	380012-012-02	Distributor Cap H20II
00591-51418-81	380012-011-02	Distributor Cap DC-20 4G32-52-54
00591-51420-81	380012-011-02	Distributor Cap DC-20 4G32-52-54
00591-51923-81	380050-044	Micro Switch
00591-52483-81	380050-011	Oil Seal
00591-52666-81	380050-034	Bearing Mast
00591-53127-81	380010-004-02	Belt - Fan
00591-53193-81	380006-007-02	Pump Water 4Y 5-6 Series
00591-53200-81	380012-004-02	Distributor Cap DC-6 4Y
00591-53231-81	380023-001-02	Brake Pedal Cover
00591-53307-81	380013-012-02	Spark Plug L14-U
00591-53504-81	380010-008-02	Belt - Timing
00591-54055-81	380030-101	Timing Belt
00591-54104-81	380006-011-02	Pump Water H20II-H25
00591-54109-81	380006-009-02	Pump Water VA
00591-54141-81	380008-003-02	Fan Blade H20 II
00591-54549-81	380010-008-02	Belt - Timing
00591-54654-81	380050-033	Seal Oil Drive Axle
00591-54658-81	380050-030	Oil Seal
00591-54664-81	380050-002	Oil Seal
00591-54879-81	380050-005	Bearing Cup
00591-55310-81	380013-017-02	Spark Plug W16S-U
00591-55347-81	380010-004-02	Belt - Fan
00591-55348-81	380010-006-02	Belt - Fan
00591-55359-81	380010-009-02	Belt - Fan
00591-55374-81	380010-012-02	Belt - Fan
00591-55375-81	380010-009-02	Belt - Fan
00591-55397-81	380010-002-02	Belt - Fan
00591-55972-81	380011-004-02	Alternator H20-P40-TB42
00591-56004-81	380014-008-02	Plug Wire Set H20
00591-56029-81	380014-005-02	Plug Wire Set FE
00591-56038-81	380014-006-02	Plug Wire Set H20II
00591-56299-81	380012-006-02	Distributor Cap DC-11 F2-FE
00591-56301-81	380012-011-02	Distributor Cap DC-20 4G32-52-54
00591-56303-81	380012-006-02	Distributor Cap DC-11 F2-FE
00591-56318-81	380015-004-02	Rotor RT-03 F2-FE
00591-56319-81	380015-004-02	Rotor RT-03 F2-FE
00591-56321-81	380015-004-02	Rotor RT-03 F2-FE
00591-56322-81	380015-009-02	Rotor RT-01 GM 6Cyl
00591-58010-81	380021-004-02	Brake Cylinder

Toyota Components

Toyota Continued ▶

## (IC) Truck Components Cross Reference by Manufacturer

Toyota Continued

OE Number	Crown Part No.	Description
00591-58023-81	380021-003-02	Brake Cylinder
00591-58443-81	380170-003	Bucket Seat
00591-58444-81	380070-009	Pan Seat
00591-58446-81	380170-002	Bucket Straight Back Seat
00591-58446-81-E	380170-002-E	Bucket Seat w Electric Switch
00591-58447-81	380170-004	Bucket Seat
00591-58448-81	380070-001	Lumbar Seat
00591-58460-81	380070-016	Suspension Seat - Vinyl
00591-58461-81	380070-030	Suspension Seat - Cloth
00591-58462-81	380070-016	Suspension Seat - Vinyl
00591-58463-81	380070-030	Suspension Seat - Cloth
00591-58466-81	380070-015	Molded Seat
00591-60402-81	380050-007	Oil Seal
00591-60962-81	380050-037	Packing Cylinder Kit
00591-60963-81	380050-041	Packing Cylinder Kit
00591-61180-81	380006-004-02	Pump Water FE
00591-61181-81	380014-005-02	Plug Wire Set F2-FE
00591-61205-81	380050-004	Inner Bearing
00591-62171-81	380050-044	Micro Switch
00591-63393-81	380015-002-02	Rotor RT-07 4Y
00591-64562-81	380001-005-01	Repair Kit JB2
00591-71480-81	380050-002	Oil Seal
00591-74115-81	380010-009-02	Belt - Fan
00591-74612-81	380050-044	Micro Switch
00591-74817-81	380010-009-02	Belt - Fan
00591-75169-81	380010-006-02	Belt - Fan
00591-75236-81	380012-007-02	Distributor Cap DC-19 4G63-4G64
00591-75559-81	380010-001-02	Belt - Fan
00591-76004-81	380050-036	Bearing Assm
00591-76586-81	380050-038	Lift Cylinder O/H Kit
00591-76611-81	380014-005-02	Plug Wire Set FE
00591-76642-81	380050-041	Packing Cylinder Kit
00591-76827-81	380050-034	Bearing Mast
00591-76873-81	380050-002	Oil Seal
04255-U2011-71	380001-005-01	Repair Kit JB2
04421-27010	380050-036	Bearing Assm
04421-27050	380050-036	Bearing Assm
04421-30010	380050-036	Bearing Assm
04421-30011	380050-036	Bearing Assm
04421-30012	380050-036	Bearing Assm
04432-10100-71	380030-088	King Pin Repair Kit
04432-10120-71	380030-088	King Pin Repair Kit
04432-20061-71	380030-088	King Pin Repair Kit
04432-20080-71	380030-088	King Pin Repair Kit
04432-U1030-71	380030-088	King Pin Repair Kit
04432-U2020-71	380030-088	King Pin Repair Kit
04432-U2021-71	380030-088	King Pin Repair Kit
04652-U2020-71	380055-061	King Pin Repair Kit
04654-U2010-71	380055-054	Lift Cylinder O/H Kit
11214-U2120-71	380030-061	Valve Cover Gasket
12204-76014-71	380030-036	PCV Valve
16100-U2120-71	380006-006-02	Pump Water GM 3.0L
16110-78156-71	380006-010-02	Pump Water 4Y 7 Series
16120-78151-71	380006-007-02	Pump Water 4Y 5-6 Series
16120-96151-71	380006-007-02	Pump Water 4Y 5-6 Series
16302-U2120-71	380009-106	Thermostat/ Gasket
16361-23860-71	380008-002-02	Fan Blade 4Y 6-7 Series
16372-13010-71	380010-003-02	Belt - Fan
16374-32870-71	380010-006-02	Belt - Fan
16401-23000-71	380009-104	Radiator Cap
16401-U2000-71	380009-104	Radiator Cap
16410-23010-71	380009-005-02	Radiator
16410-23070-71	380009-005-02	Radiator
16410-F1100-71	380009-002-02	Radiator
16410-U1130-71	380104-439	Radiator
16410-U2000-71	380009-005-02	Radiator

OE Number	Crown Part No.	Description
16410-U2200-71	380009-002-02	Radiator
16410-U2201-71	380009-002-02	Radiator
16420-U1280-71	380009-009-01	Radiator
16511-12810-71	380009-108	Radiator Hose (Upper)
16511-16640-71	380009-108	Radiator Hose (Upper)
19030-78150-71	380012-003-02	Distributor I 4Y
19030-78151-71	380012-003-02	Distributor I 4Y
19030-78154-71	380012-003-02	Distributor I 4Y
19030-96150	380012-003-02	Distributor I 4Y
19101-71010-71	380012-004-02	Distributor Cap DC-6 4Y
19101-76007-71	380012-004-02	Distributor Cap DC-6 4Y
19101-76013-71	380012-004-02	Distributor Cap DC-6 4Y
19101-U3330-71	380012-015-02	Distributor Cap
19102-16020	380015-002-02	Rotor RT-07 4Y
19102-16040	380015-002-02	Rotor RT-07 4Y
19102-31720-71	380015-009-02	Rotor RT-01 GM 6Cyl
19102-33010-71	380015-002-02	Rotor RT-07 4Y
19102-63010-71	380015-002-02	Rotor RT-07 4Y
19102-73020	380015-002-02	Rotor RT-07 4Y
19102-73021	380015-002-02	Rotor RT-07 4Y
19102-73180	380015-002-02	Rotor RT-07 4Y
19102-76007-71	380015-002-02	Rotor RT-07 4Y
19102-76009-71	380015-002-02	Rotor RT-07 4Y
19102-76013-71	380015-002-02	Rotor RT-07 4Y
19102-U3160-71	380015-009-02	Rotor RT-01 GM 6Cyl
19111-31720-71	380013-014-02	Spark Plug PT16EPR-L13
19111-31721-71	380013-014-02	Spark Plug PT16EPR-L13
19111-90098-71	380013-014-02	Spark Plug PT16EPR-L13
19111-U2120-71	380013-016-02	Spark Plug T14PR-U
19111-U3161-71	380013-014-02	Spark Plug PT16EPR-L13
19335-U2120-71	380014-007-02	Plug Wire Set GM 3.0L
23530-22800-71	380001-002-01	Converter JB2
23530-U1100-71	380001-008-01	Regulator LPG
23530-U1101-71	380001-008-01	Regulator LPG
23530-U1102-71	380001-008-01	Regulator LPG
23530-U1103-71	380001-008-01	Regulator LPG
23530-U1104-71	380001-008-01	Regulator LPG
23560-U2100-71	064423	Female LP Tank Fitting
23560-U2101-71	064423	Female LP Tank Fitting
23640-U2000-71	380001-001-01	Lockoff VFF-30-2-IMP
24420-13300-71	380030-085	Contacto 36V
27060-78003-71	380011-002-01	Alternator 4Y - GN81-41
27060-78153-71	380011-003-02	Alternator 4Y
27060-78156-71	380011-003-02	Alternator 4Y
27060-78158-71	380011-003-02	Alternator 4Y
28100-20553	380005-002-01	Starter 4P-4Y-5R-5P
28100-20553-71	380005-002-01	Starter 4P-4Y-5R-5P
28300-22003	380005-002-01	Starter 4P-4Y-5R-5P
31319-20540-71	380023-001-02	Brake Pedal Cover
31319-22000-71	380023-001-02	Brake Pedal Cover
31319-23000-71	380023-001-02	Brake Pedal Cover
42125-22000-71	380030-042	Oil Seal
42125-23320-71	380060-010	Oil Seal
42125-U2100-71	380030-042	Oil Seal
42415-10480-71	380060-005	Oil Seal
42415-11630-71	380060-009	Oil Seal
43221-U1170-71	380050-065	Bearing Assembly
43222-U2170-71	380050-055	Bearing Assm
43228-U2170-71	380050-060	Needle Bearing
43229-23320-71	380050-059	Thrust Bearing
43232-9NML8-71	380030-103	King Pin
43232-U2170-71	380030-103	King Pin
43232-U3270-71	380030-103	King Pin
43232-U3271-71	380030-103	King Pin
43237-13310-71	380030-094	Plate, Steer Axle
43731-13311-71	380030-093	Pin, Tie Rod

Toyota Continued ▶

# (IC) Truck Components Cross Reference by Manufacturer

Toyota Continued

OE Number	Crown Part No.	Description
43731-13360-71	380030-093	Pin, Tie Rod
43731-23442-71	380030-066	Pin, Tie Rod
43735-13310-71	380030-087	Collar
43735-23440-71	380030-097	Collar
43735-U2100-71	380050-062	Bearing, Spherical
43751-23440-71	380030-070	Steering Link
43752-23442-71	380030-071	Steering Link
43755-23440-71	380030-030	Washer
43815-31620-71	380050-003	Outer Bearing
45121-U2100-71	380030-106	Horn Button
45122-23600-71	380030-032	Cup, Horn Kit
47117-12240-71	380020-005-02	Brake Pad (1)
47403-12810-71	380020-007-02	Brake Shoe Kit (4)
47403-13300-71	380020-007-02	Brake Shoe Kit (4)
47403-16600-71	380020-007-02	Brake Shoe Kit (4)
47403-32062-71	380020-015-02	Brake Shoe
47404-12810-71	380020-007-02	Brake Shoe Kit (4)
47404-13300-71	380020-007-02	Brake Shoe Kit (4)
47404-16600-71	380020-007-02	Brake Shoe Kit (4)
47404-32062-71	380020-015-02	Brake Shoe
47405-12810-71	380020-007-02	Brake Shoe Kit (4)
47405-13000-71	380020-007-02	Brake Shoe Kit (4)
47405-13300-71	380020-007-02	Brake Shoe Kit (4)
47405-16600-71	380020-007-02	Brake Shoe Kit (4)
47410-10480-71	380050-053	Wheel Cylinder
47410-11630-71	380050-053	Wheel Cylinder
47410-12000-71	380050-053	Wheel Cylinder
47410-21580-71	380050-051	Wheel Cylinder
47410-21800-71	380050-051	Wheel Cylinder
47410-22500-71	380050-051	Wheel Cylinder
47410-32060-71	380055-060	Wheel Cylinder
47410-32500-71	380050-051	Wheel Cylinder
47410-U2130-71	380050-051	Wheel Cylinder
47430-11630-71	380050-053	Wheel Cylinder
47434-32500-71	380030-024	Spring
47435-32060-71	380030-058	Spring
47435-U2130-71	380030-058	Spring
47438-32060-71	380030-059	Spring
47438-33060-71	380030-024	Spring
47438-U2130-71	380030-059	Spring
47438-U3130-71	380030-024	Spring
47470-33060-71	380030-003	Adjuster Cable
47470-U2130-71	380030-003	Adjuster Cable
47472-11631-71	380030-031	Spring
47472-21801-71	380030-025	Spring
47472-U1130-71	380030-031	Spring
47472-U2130-71	380030-025	Spring
47501-11630-71	380030-004	Adjuster Cable
47503-33860-71	380020-004-02	Brake Shoe (1)
47504-33860-71	380020-004-02	Brake Shoe (1)
47504-U1130-71	380030-004	Adjuster Cable
47505-13000-71	380020-007-02	Brake Shoe Kit (4)
47505-33860-71	380020-004-02	Brake Shoe (1)
47506-13000-71	380020-007-02	Brake Shoe Kit (4)
47510-U1130-71	380020-002-02	Brake Shoe Kit (2)
47510-U2130-71	380020-010-02	Brake Shoe Set (2 Shoes)
47512-22500-71	380030-119	Spring
47512-33060-71	380020-004-02	Brake Shoe (1)
47512-U1130-71	380030-119	Spring
47513-33060-71	380020-004-02	Brake Shoe (1)
47514-33060-71	380020-004-02	Brake Shoe (1)
47520-U1130-71	380020-002-02	Brake Shoe Kit (2)
47520-U2130-71	380020-010-02	Brake Shoe Set (2 Shoes)
47530-13201-71	380030-090	Master Cylinder
47530-13400-71	380030-090	Master Cylinder

OE Number	Crown Part No.	Description
47530-42100-71	380021-004-02	Brake Cylinder
47530-U2100-71	380030-090	Master Cylinder
47530-U2100-71A	380030-090	Master Cylinder
47635-10110-71	380030-057	Spring
47636-10110-71	380030-023	Spring
47636-U1100-71	380030-023	Spring
47675-11630-71	380030-057	Spring
47675-U1130-71	380030-057	Spring
53706-U2000-71	380070-032	Molded Seat
53706-U2001-71	380070-032	Molded Seat
53706-U2100-71	380070-032	Molded Seat
53710-20720-71	380070-016	Suspension Seat - Vinyl
53710-23320-71	380170-036-E	Suspension Seat w Ele Switch
53710-23620-71	380170-036-E	Suspension Seat w Ele Switch
53710-26601-71	380170-036-E	Suspension Seat w Ele Switch
53710-88300-71	380170-036-E	Suspension Seat w Ele Switch
53710-88301-71	380170-036-E	Suspension Seat w Ele Switch
53710-D2132-71	380170-036-E	Suspension Seat w Ele Switch
53710-F2131-71	380170-036-E	Suspension Seat w Ele Switch
53710-U1090-71	380070-032-E	Molded Seat w Electric Switch
53710-U1160-71	380070-032-E	Molded Seat w Electric Switch
53720-U1090-71	380070-032-E	Molded Seat w Electric Switch
53730-20720-71	380070-016	Suspension Seat - Vinyl
53730-23000-71	380170-010	Lumbar Support Seat
53730-26701-71	380170-036-E	Suspension Seat w Ele Switch
53730-U2100-71	380070-032	Molded Seat
53740-11590-71	380070-032-E	Molded Seat w Electric Switch
53740-13300-71	380070-032-E	Molded Seat w Electric Switch
53740-22750-71	380070-032	Molded Seat
53740-23000-71	380070-032	Molded Seat
53760-13300-71	380170-028-E	Seat w Electric Switch
53760-22750-71	380170-028	Seat
53760-2275071	380170-028	Seat
53760-23000-71	380070-032	Molded Seat
53760-23001-71	380070-032	Molded Seat
53760-23610-71	380070-032	Molded Seat
53760-U2001-71	380170-025	Wing Seat
53760-U2100-71	380070-032	Molded Seat
53780-U2101-71	380070-033	Suspension Molded Seat
53850-98333-71	380170-038-E	Molded Seat w Electric Switch
53850-98334-71	380170-036-E	Suspension Seat w Ele Switch
53960-88300-71	380070-033-E	Suspension Seat W Elec Switch
58710-20540-71	380030-006	Mirror
58720-23320-71	380030-044	Mirror
58720-26600-71	380030-044	Mirror
5910111481	380070-030	Suspension Seat - Cloth
5910781881	380170-009	Contoured Seat
5910782481	380170-006	Standard Seat
5910783681	380170-011	Seat
5910785981	380170-009	Contoured Seat
5910786281	380070-012	Pan Seat w Armrest
5910787781	380170-025	Wing Seat
5910787981	380170-020	Pan Seat
5910788081	380170-009	Contoured Seat
5913000481	380170-009	Contoured Seat
5913283481	380170-020	Pan Seat
5913284481	380170-009	Contoured Seat
5913284781	380070-030	Suspension Seat - Cloth
5913420581	380170-009	Contoured Seat
5913420981	380070-030	Suspension Seat - Cloth
5915844481	380170-009	Contoured Seat
5915846181	380070-030	Suspension Seat - Cloth
5915846381	380070-030	Suspension Seat - Cloth
80098-76004-71	380013-017-02	Spark Plug W16S-U
80098-76005-71	380013-017-02	Spark Plug W16S-U

Toyota Components

Toyota Continued ▶

## (IC) Truck Components Cross Reference by Manufacturer

Toyota Continued

OE Number	Crown Part No.	Description
80098-76006-71	380013-007-02	Spark Plug W9EP
80114-76006-71	380050-029	Bolt
80330-76010-71	380030-118	Plug
80367-76009-71	380050-059	Thrust Bearing
80916-76032-71	380009-106	Thermostat/ Gasket
80916-76033-71	380009-106	Thermostat/ Gasket
80916-76065-71	380009-106	Thermostat/ Gasket
80916-76085-71	380009-106	Thermostat/ Gasket
80919-76004-71	380013-007-02	Spark Plug W9EP
80919-76005-71	380013-007-02	Spark Plug W9EP
80919-76008-71	380013-007-02	Spark Plug W9EP
80919-76009-71	380013-007-02	Spark Plug W9EP
80919-76011-71	380013-007-02	Spark Plug W9EP
80919-76102-71	380014-001-02	Plug Wire Set 4Y
80919-76106-71	380014-001-02	Plug Wire Set 4Y
80942-76005-71	380030-018	Nut
80999-76018-71	380013-007-02	Spark Plug W9EP
83530-76005-71	380050-032	Oil Pressure Switch
83530-78202-71	380050-032	Oil Pressure Switch
83530-U2120-71	380050-032	Oil Pressure Switch
84186-76001-71	380030-019	Nut
86456-76002-71	380030-092	Grease Fitting
87600-76010-71	380050-061	Bearing Ass'y
89322-76009-71	380010-003-02	Belt - Fan
90098-09125	380013-007-02	Spark Plug W9EP
90098-14785	380013-016-02	Spark Plug T14PR-U
90098-16785	380013-008-02	Spark Plug T16PR-U
90098-20395	380013-007-02	Spark Plug W9EP
90098-64015	380013-012-02	Spark Plug L14-U
90098-66113-71	380013-014-02	Spark Plug PT16EPR-L13
90171-16001-71	380030-017	Nut
90179-12003-71	380030-019	Nut
90179-14001-71	380030-018	Nut
90179-14002-71	380030-080	Nut
90366-45104-71	380050-065	Bearing Assembly
90369-35003	380050-036	Bearing Assm
90420-01190-71	380013-014-02	Spark Plug PT16EPR-L13
90564-28002-71	380030-022	Shim
90916-02952-71	380010-010-02	Belt - Fan
90916-02975-71	380010-003-02	Belt - Fan
90916-03037	380009-106	Thermostat/ Gasket
90916-03950-71	380030-120	Thermostat/O-Ring
90916-03954-71	380009-106	Thermostat/ Gasket
90919-01021	380013-007-02	Spark Plug W9EP
90919-01055-71	380013-007-02	Spark Plug W9EP
90919-01056	380105-057	Spark Plug W14EX-U
90919-01950-71	380013-007-02	Spark Plug W9EP
90919-01954-71	380013-005-02	Spark Plug W9EXR-U
90919-22132	380014-001-02	Plug Wire Set 4Y
90928-29006-71	380005-002-01	Starter 4P-4Y-5R-5P
90999-09001-71	380013-007-02	Spark Plug W9EP
90999-09002-71	380013-007-02	Spark Plug W9EP
94186-11200-71	380030-019	Nut
97600-32011-71	380050-036	Bearing Assm
97600-32206-71	380050-061	Bearing Ass'y
97600-32210-71	380050-057	Bearing Assm
99322-01170-71	380010-010-02	Belt - Fan
<b>Tusk (TUSK)</b>		
4930390	380050-055	Bearing Assm
4940235	380050-055	Bearing Assm
8761954	380009-105	Thermostat/ Gasket
8767444	380050-055	Bearing Assm
<b>Waukesha (WK)</b>		
110532	380013-012-02	Spark Plug L14-U
209316	380013-012-02	Spark Plug L14-U

OE Number	Crown Part No.	Description
<b>White Mobilift (WM)</b>		
10-R-385	380013-012-02	Spark Plug L14-U
10A16423	380010-010-02	Belt - Fan
10R1191	380013-012-02	Spark Plug L14-U
20-7000680	380013-012-02	Spark Plug L14-U
20-7000681	380013-012-02	Spark Plug L14-U
20-7000949	380013-012-02	Spark Plug L14-U
20-7100035	380013-012-02	Spark Plug L14-U
35A9481	380001-010-01	Connector LPG Male 7141M
35A9482	064423	Female LP Tank Fitting
35P517	380001-010-01	Connector LPG Male 7141M
35P519	064423	Female LP Tank Fitting
<b>Wise (WS)</b>		
WM1015	380170-018	Bucket Seat
WM1107	380170-021	Pan Seat w Arm Rest
WM1177	380170-011	Seat
WM1208	380070-013	Full Body Seat
WM1579	380070-033	Suspension Molded Seat
WM455	380170-024-H	Low Profile Seat w Hip Restraint
WM684	380070-012	Pan Seat w Armrest
WM684SM	380070-012	Pan Seat w Armrest
WM697SM	380170-005	Bucket Seat
WM700	380170-007	Standard Seat
<b>Yale (YT)</b>		
12156900	380030-118	Plug
132614401	380050-006	Bearing Cone
132614402	380050-005	Bearing Cup
136350101	380001-010-01	Connector LPG Male 7141M
136350102	064423	Female LP Tank Fitting
1500132-07	380020-003-02	Brake Shoe Kit (2)
150014500	380011-004-02	Alternator H20-P40-TB42
150015100	380013-012-02	Spark Plug L14-U
150016901	380070-009	Pan Seat
150016902	380070-001	Lumbar Seat
150016903	380070-001	Lumbar Seat
150016913	380170-025	Wing Seat
150019501	380070-016	Suspension Seat - Vinyl
150019503	380070-030	Suspension Seat - Cloth
150022504	380011-004-02	Alternator H20-P40-TB42
150022510	380015-004-02	Rotor RT-03 F2-FE
150022511	380012-006-02	Distributor Cap DC-11 F2-FE
150031100	380050-035	Bearing Mast
150038500	380013-007-02	Spark Plug W9EP
150039250	380070-009	Pan Seat
150039503	380070-001	Lumbar Seat
150039574	380070-022	Bucket Seat
150039698	380170-007	Standard Seat
150039755	380070-009	Pan Seat
150039766	380070-001	Lumbar Seat
150039769	380170-002	Bucket Straight Back Seat
150091008	380030-084	Tip Kit - Contact
150112405	380013-012-02	Spark Plug L14-U
150112406	380013-012-02	Spark Plug L14-U
150112407	380013-012-02	Spark Plug L14-U
150112408	380013-012-02	Spark Plug L14-U
150112409	380013-012-02	Spark Plug L14-U
150112410	380013-012-02	Spark Plug L14-U
150112411	380013-012-02	Spark Plug L14-U
150112413	380013-012-02	Spark Plug L14-U
150112420	380013-012-02	Spark Plug L14-U
150112427	380013-012-02	Spark Plug L14-U
150112453	380013-008-02	Spark Plug T16PR-U
150112466	380013-004-02	Spark Plug W14EXR-U
150112473	380013-017-02	Spark Plug W16S-U
150112478	380105-057	Spark Plug W14EX-U

Yale Continued ▶

# (IC) Truck Components Cross Reference by Manufacturer

Yale Continued

OE Number	Crown Part No.	Description
150112490	380013-017-02	Spark Plug W16S-U
16254800	380013-012-02	Spark Plug L14-U
16255000	380013-012-02	Spark Plug L14-U
16255100	380013-012-02	Spark Plug L14-U
220000727	380012-011-02	Distributor Cap DC-20 4G32-52-54
220001588	380010-010-02	Belt - Fan
220001599	380013-007-02	Spark Plug W9EP
220002518	380010-012-02	Belt - Fan
220003423	380050-040	Ignition Switch
220004289	380023-001-02	Brake Pedal Cover
220004547	380012-004-02	Distributor Cap DC-6 4Y
220005010	380011-006-02	Alternator 4G52-4G54
220007160	380006-003-02	Pump Water HER2.7-1404
220007409	380006-009-02	Pump Water VA
220007428	380013-012-02	Spark Plug L14-U
220007606	380006-001-02	Pump Water H20 New Style
220010746	380006-007-02	Pump Water 4Y 5-6 Series
220010987	380013-012-02	Spark Plug L14-U
220011080	380013-012-02	Spark Plug L14-U
220011107	380013-012-02	Spark Plug L14-U
220011118	380010-003-02	Belt - Fan
220011205	380013-012-02	Spark Plug L14-U
220011358	380050-036	Bearing Assm
220012748	380012-012-02	Distributor Cap H20II
220012921	380012-011-02	Distributor Cap DC-20 4G32-52-54
220013187	380070-015	Molded Seat
220013371	380013-016-02	Spark Plug T14PR-U
220014644	064423	Female LP Tank Fitting
220015777	380050-004	Inner Bearing
220016206	380050-035	Bearing Mast
220016273	380012-011-02	Distributor Cap DC-20 4G32-52-54
220018323	380015-006-02	Rotor RT-13 TB42 6Cyl
220019999	380050-003	Outer Bearing
220020015	380012-006-02	Distributor Cap DC-11 F2-FE
220020044	380050-002	Oil Seal
220021100	380050-037	Packing Cylinder Kit
220021877	380050-041	Packing Cylinder Kit
220022013	380012-007-02	Distributor Cap DC-19 4G63-4G64
220023796	380050-004	Inner Bearing
220024192	380006-002-02	Pump Water K21-K25
220024204	380012-005-02	Distributor C H20
220024209	380012-012-02	Distributor Cap H20II
220024381	380170-020	Pan Seat
220024785	380010-010-02	Belt - Fan
220025194	380012-005-02	Distributor C H20
220025671	380015-001-02	Rotor RT-11 H20II
220027604	380070-022	Bucket Seat
220027712	380050-004	Inner Bearing
220029615	380050-007	Oil Seal
220034034	380050-034	Bearing Mast
220034390	380010-008-02	Belt - Timing
220034475	380105-057	Spark Plug W14EX-U
220034759	380008-002-02	Fan Blade 4Y 6-7 Series
220035000	380170-020	Pan Seat
220035307	380170-020	Pan Seat
220035887	380050-035	Bearing Mast
220036635	380050-003	Outer Bearing
220037503	380050-011	Oil Seal
220037522	380021-003-02	Brake Cylinder
220037756	380050-039	Lift Cylinder O/H Kit
220042179	380011-002-01	Alternator 4Y - GN81-41
220042751	380010-009-02	Belt - Fan
220043902	380012-007-02	Distributor Cap DC-19 4G63-4G64
220044332	380005-005-02	Starter GM 3.0L
220050482	064423	Female LP Tank Fitting
220050483	380001-010-01	Connector LPG Male 7141M

OE Number	Crown Part No.	Description
220051134	380050-006	Bearing Cone
220051135	380050-005	Bearing Cup
220052043	380010-003-02	Belt - Fan
220052061	380010-012-02	Belt - Fan
220052160	380050-004	Inner Bearing
220052206	380013-012-02	Spark Plug L14-U
220054038	380012-011-02	Distributor Cap DC-20 4G32-52-54
220054163	380050-033	Seal Oil Drive Axle
220054193	380012-011-02	Distributor Cap DC-20 4G32-52-54
220070181	380006-009-02	Pump Water VA
220070292	380012-012-02	Distributor Cap H20II
220070293	380015-004-02	Rotor RT-03 F2-FE
220070685	380050-020	Roller-Lift 94mm Dia
220070718	380050-019	Roller-Lift
220071655	380070-016	Suspension Seat - Vinyl
220072123	380070-030	Suspension Seat - Cloth
220072690	380050-016	Roller
220073083	380070-016	Suspension Seat - Vinyl
220075001	380050-007	Oil Seal
220075023	380050-011	Oil Seal
220075153	380050-036	Bearing Assm
220079608	380006-004-02	Pump Water FE
220079977	380070-016	Suspension Seat - Vinyl
220100562	380014-005-02	Plug Wire Set F2-FE
220100725	380010-008-02	Belt - Timing
220170056	380070-026	Contoured Back Seat
22024966	380050-030	Oil Seal
251102100	064423	Female LP Tank Fitting
253851100	380050-035	Bearing Mast
258086900	380050-004	Inner Bearing
277154700	380050-036	Bearing Assm
295675600	380010-003-02	Belt - Fan
295675700	380010-003-02	Belt - Fan
31314500	380013-012-02	Spark Plug L14-U
440065120	380050-036	Bearing Assm
449058030	380050-004	Inner Bearing
449058034	380050-003	Outer Bearing
449089003	380010-010-02	Belt - Fan
502029902	380050-006	Bearing Cone
502029903	380050-005	Bearing Cup
502029910	380050-036	Bearing Assm
502276300	380050-035	Bearing Mast
502276301	380050-035	Bearing Mast
502276302	380050-035	Bearing Mast
502276303	380050-035	Bearing Mast
502277301	380050-035	Bearing Mast
502277302	380050-035	Bearing Mast
5023767-00	380170-024	Low Profile Seat
502376700	380170-024	Low Profile Seat
502536904	380050-058	Bearing, Spherical
503295702	380170-024-E	Low Profile Seat w Ele Switch
503536215	380050-006	Bearing Cone
503536216	380050-005	Bearing Cup
503536245	380050-004	Inner Bearing
503536246	380050-003	Outer Bearing
503536248	380050-035	Bearing Mast
5038987-00	380170-024	Low Profile Seat
503898700	380170-024	Low Profile Seat
504117200	380050-035	Bearing Mast
504224200	380030-121	Tie Rod End
504224208	380060-003	Oil Seal
504224218	380050-007	Oil Seal
504224219	380030-121	Tie Rod End
504224242	380050-011	Oil Seal
5042252-36	380050-008	O-Ring
504225236	380050-008	O-Ring

Yale  
Truck  
Components

Yale Continued ▶

## (IC) Truck Components Cross Reference by Manufacturer

Yale Continued

OE Number	Crown Part No.	Description
504226246	380030-109	Bolt
504226267	380070-016	Suspension Seat - Vinyl
5042272-84	380050-044	Micro Switch
504227284	380050-044	Micro Switch
504232239	380170-020	Pan Seat
504232248	380070-015	Molded Seat
504235296	380070-016	Suspension Seat - Vinyl
504236274	380070-015	Molded Seat
504240838	380050-040	Ignition Switch
504240854	380050-040	Ignition Switch
504258756	380030-101	Timing Belt
5042687-40	380070-029	Contoured Seat
504268740	380070-029	Contoured Seat
505136027	380050-039	Lift Cylinder O/H Kit
505136031	380050-038	Lift Cylinder O/H Kit
505175502	380030-086	Contacto 24V
505175504	380030-086	Contacto 24V
5059595-61	380020-003-02	Brake Shoe Kit (2)
505959512	380060-014	Oil Seal
505959514	380070-016	Suspension Seat - Vinyl
505959551	380001-003-01	Converter Cobra
5059605-35	380013-005-02	Spark Plug W9EXR-U
5059605-79	380006-004-02	Pump Water FE
505960556	380012-006-02	Distributor Cap DC-11 F2-FE
505960560	380011-005-01	Alternator D5-F2-FE
505960565	380015-004-02	Rotor RT-03 F2-FE
505960583	380012-006-02	Distributor Cap DC-11 F2-FE
5059635-91	380020-006-02	Brake Shoe Set (2)
505963500	380050-051	Wheel Cylinder
505963537	380021-003-02	Brake Cylinder
505965509	380060-002	Oil Seal
505966505	064423	Female LP Tank Fitting
505966558	380001-001-01	Lockoff VFF-30-2-IMP
5059725-63	380009-102	Radiator Cap
505976593	380014-005-02	Plug Wire Set FE
506149006	380050-041	Packing Cylinder Kit
507033500	380050-035	Bearing Mast
508801800	380050-035	Bearing Mast
509295802	380013-012-02	Spark Plug L14-U
510764800	380013-012-02	Spark Plug L14-U
513375800	380050-035	Bearing Mast
514092400	380070-009	Pan Seat
516149005	380050-037	Packing Cylinder Kit
516149006	380050-041	Packing Cylinder Kit
516484800	380013-008-02	Spark Plug T16PR-U
5170798-00	380001-002-01	Converter JB2
517080800	380001-005-01	Repair Kit JB2
5170858-04	380050-044	Micro Switch
517085804	380050-044	Micro Switch
517396600	380170-024-E	Low Profile Seat w Ele Switch
517451800	380013-012-02	Spark Plug L14-U
518324400	380070-009	Pan Seat
5184346-00	380170-024-H	Low Profile Seat w Hip Restraint
518434600	380170-024-H	Low Profile Seat w Hip Restraint
518807650	380001-006-01	Repair Kit Cobra
519244814	380050-036	Bearing Assm
519678401	380070-009	Pan Seat
520002399	380001-003-01	Converter Cobra
520035885	380001-010-01	Connector LPG Male 7141M
520037830	380001-003-01	Converter Cobra
520045369	380050-016	Roller
522375008	380050-038	Lift Cylinder O/H Kit
5241448-96	380170-017-E	Suspension Seat w Ele Switch
524144896	380170-017-E	Suspension Seat w Ele Switch
524248308	380020-008-02-L	Shoe, Left Hand
524248309	380020-008-02-R	Shoe, Right Hand

OE Number	Crown Part No.	Description
524253576	380009-106	Thermostat/ Gasket
54966300	064423	Female LP Tank Fitting
54966400	380001-010-01	Connector LPG Male 7141M
580000049	380005-005-02	Starter GM 3.0L
580000179	380009-106	Thermostat/ Gasket
580000381	380009-106	Thermostat/ Gasket
580000384	380015-009-02	Rotor RT-01 GM 6Cyl
580000617	380030-061	Valve Cover Gasket
580000628	380013-016-02	Spark Plug T14PR-U
5800009-90	380011-005-01	Alternator D5-F2-FE
580002210	380005-005-02	Starter GM 3.0L
580002388	380001-003-01	Converter Cobra
580002399	380001-003-01	Converter Cobra
580003984	380030-019	Nut
5800047-04	380050-044	Micro Switch
5800047-05	380050-044	Micro Switch
580004704	380050-044	Micro Switch
580004705	380050-044	Micro Switch
580005036	380013-008-02	Spark Plug T16PR-U
580007732	380001-006-01	Repair Kit Cobra
580007799	380050-040	Ignition Switch
580008972	380013-008-02	Spark Plug T16PR-U
580010475	380050-006	Bearing Cone
580010479	380050-006	Bearing Cone
580010991	380030-123	Air Filter (Fire Ret.)
580011203	380020-011-02	Brake Shoe Set (2 Shoes)
580011206	380020-011-02	Brake Shoe Set (2 Shoes)
580013445	380013-008-02	Spark Plug T16PR-U
580019725	380005-005-02	Starter GM 3.0L
580021375	380050-040	Ignition Switch
580022227	380050-040	Ignition Switch
580024168	380009-106	Thermostat/ Gasket
580026829	380011-005-01	Alternator D5-F2-FE
5800326-88	380020-006-02	Brake Shoe Set (2)
580035882	380010-004-02	Belt - Fan
580035883	380010-009-02	Belt - Fan
580036620	380050-036	Bearing Assm
580040914-NEW	380005-011-02	Starter (Brand New)
5800442-22	380009-101	Upper Hose
5800442-23	380009-100	Lower Hose
5800448-85	380005-009-02	Starter
580047018	380012-007-02	Distributor Cap DC-23 FE-F2
580047019	380015-005-02	Rotor RT-17 FE-FE2
580048839	380030-064	Air Filter (Fire Ret.)
5800513-32	380020-008-02-L	Shoe, Left Hand
5800513-33	380020-008-02-R	Shoe, Right Hand
580051320	380050-052	Wheel Cylinder
580051335	380030-100	Spring Kit
580051808	380012-015-02	Distributor Cap
580052996	380013-018-01	Spark Plug T20EPR-U
580053798	380050-051	Starter Solenoid
5800569-45	380009-103	Thermostat
580056944	380030-068	Oil Filter
580057480	380170-020	Pan Seat
580059824	380020-013-02	Brake Shoe Set (2)
580059825	380020-014-02	Brake Shoe Set (2)
580061342	380030-051	Bolt
580062748-NEW	380005-012-02	Starter (Brand New)
63194200	380013-012-02	Spark Plug L14-U
64926500	380001-011-02	O-Ring Outer Flat 7141M3
751647603	380070-016	Suspension Seat - Vinyl
800037371	380070-037-E	Molded Seat w Electric Switch
900001224	380030-047	Fuel Filter
900005266	380015-009-02	Rotor RT-01 GM 6Cyl
900015293	380013-014-02	Spark Plug PT16EPR-L13
900126308	380030-018	Nut

Yale Continued ▶



## (IC) Truck Components Cross Reference by Manufacturer

Yale Continued

OE Number	Crown Part No.	Description
900488803	380050-051	Wheel Cylinder
900534806	380010-003-02	Belt - Fan
900537827	380013-007-02	Spark Plug W9EP
900955827	380030-025	Spring
9009698231	380001-005-01	Repair Kit JB2
901202809	380030-019	Nut
9012828-47	380009-106	Thermostat/ Gasket
901283805	380014-005-02	Plug Wire Set F2-FE
901284807	380012-011-02	Distributor Cap DC-20 4G32-52-54
901285801	380011-004-02	Alternator H20-P40-TB42
901286817	380050-051	Starter Solenoid
9012908-19	380030-036	PCV Valve
901290811	380030-062	Valve Cover Gasket
901294816	380010-008-02	Belt - Timing
901294829	380010-008-02	Belt - Timing
901302802	380006-004-02	Pump Water FE
901303803	380014-005-02	Plug Wire Set F2-FE
901303803	380014-005-02	Plug Wire Set F2-FE
901304806	380012-011-02	Distributor Cap DC-20 4G32-52-54
901356802	380012-008-02	Distributor DC-5 D5
901356803	380015-004-02	Rotor RT-03 F2-FE
901356814	380015-004-02	Rotor RT-03 F2-FE
901357802	380012-006-02	Distributor Cap DC-11 F2-FE
901357803	380015-004-02	Rotor RT-03 F2-FE
901577816	380030-101	Timing Belt
901580802	380012-006-02	Distributor Cap DC-11 F2-FE
901580812	380012-006-02	Distributor Cap DC-11 F2-FE
901860807	380050-032	Oil Pressure Switch
901900802	380009-104	Radiator Cap
901913802	380009-104	Radiator Cap
901948801	380011-005-01	Alternator D5-F2-FE
901953805	380015-004-02	Rotor RT-03 F2-FE
901953809	380030-107	Ignition Module
901991817	380050-051	Starter Solenoid
902057822	380001-006-01	Repair Kit Cobra
902057825	380001-006-01	Repair Kit Cobra
902057827	380001-006-01	Repair Kit Cobra
9023618-06	380050-050	Starter Drive
902361820	380050-051	Starter Solenoid

OE Number	Crown Part No.	Description
902392851	380020-011-02	Brake Shoe Set (2 Shoes)
902392861	380020-011-02	Brake Shoe Set (2 Shoes)
9037583-00	380030-050	Bolt
9037753-00	380030-051	Bolt
904515101	380050-035	Bearing Mast
904515102	380050-035	Bearing Mast
904990600	380001-001-01	Lockoff VFF-30-2-IMP
905148300	380050-003	Outer Bearing
906197100	380050-003	Outer Bearing
907595300	380050-034	Bearing Mast
907595301	380050-034	Bearing Mast
909932403	380050-004	Inner Bearing
909932404	380050-003	Outer Bearing
909932407	380050-055	Bearing Assm
909932408	380050-064	Needle Bearing
909932417	380050-057	Bearing Assm
911086300	380050-002	Oil Seal
9119823-00	380030-052	Pin, Tie Rod
911982300	380030-052	Pin, Tie Rod
911983300	380030-049	Bushing, Steer Axle
9124713-03	380030-019	Nut
912514300	064423	Female LP Tank Fitting
913589300	380030-100	Spring Kit
913987301	380050-034	Bearing Mast
913987302	380050-034	Bearing Mast
915356400	380023-005	Accelerator Pedal
918139600	380005-003-01	Starter VA-F2-FE
918139600-NEW	380005-011-02	Starter (Brand New)
9182593-00	380020-006-02	Brake Shoe Set (2)
919139450	380023-004	Sheave, Brake
920803300	380050-002	Oil Seal
921949300	380060-013	Oil Seal
924088300	380001-006-01	Repair Kit Cobra
927113300	380020-012-02	Brake Shoe Set (2 Shoes)
929151300	380020-012-02	Brake Shoe Set (2 Shoes)
9301324-00	380020-006-02	Brake Shoe Set (2)
950517913	380050-004	Inner Bearing
99719800	380170-002	Bucket Straight Back Seat

(IC) Truck Components



Versatile Industrial Charging Systems

# V-110 Plug In 24v Charger

Easy and Affordable Battery Charging

## Features:

- 40 amps DC output
- 24v batteries with amp hour range of 300-550
- Maintenance mode keeps batteries charged while in storage
- Self-detecting input automatically senses and adjusts to single phase
- AC voltage ranges 100v-240v
- Includes SB175 gray connector and 10' DC cable

The V-110 Charger utilizes High Frequency Charger Technology with an IEI profile for flooded batteries and an IE profile for sealed, lead acid batteries.

As single shift application charger, the V-110 Charger is commonly used to charge Walkie Pallet Trucks containing industrial battery sizes 12-85-5 and 12-85-7.



Contact Your Local  
Crown Dealer Today

See page 7.04 of the One Source catalog for more details.

## Section 5

# Work Assist®

### Contents

Work Assist® Accessories Application Chart	5.02
Work Assist® Accessories	5.03
RAM Mounts	5.07
Forklift Laser Guidance System	5.11
Forklift Covers & Enclosures	5.12

#### New Items:

Tube Kit - p. 5.03  
Work Assist® Interface with RAM Mounting System - p. 5.03  
Terminal Mounting Plate - p. 5.03  
Storage Module - p. 5.05  
Mirror Kit - p. 5.05  
RAM Mounts, including Crown Work Assist® Ball Mount - p. 5.07-5.10

Note: 1910.178(q)(5) (1998) of the Occupational Safety and Health Act (OSHA) requires that "All parts of any such industrial truck requiring replacement shall be replaced only by parts equivalent as to safety with those used in the original design."



**Work Assist® Accessories Application Chart**

Work Assist Accessories	C-5	FC4000/4500	PC4500	PE4000/4500	PR4500	PW3500	RC5500	RR/RD5000/5200/5700, RM/RMD6000	SC4000/4500/5200	SH5500/SHR5500	SP3000/3200/3400/ 3500/4000	SR	ST3000	SX3000	TR4500	TSP6000/6500/7000	WAVE	WP3000
Accessory Clamp & Mounting Plate (RF)				•	•													
Adjustable Mounting Arm System												•				•		
Clamp, Accessory	•	•	•	•	•		•	•	•		•	•	•	•	•	•		
Clip Pad	•		•				•	•		•			•	•	•			•
Clip Pad & Hook	•	•		•	•		•	•	•	•	•	•	•	•		•		
Clip Pad, Desktop							•											
Cup Holder	•	•	•						•			•			•			
Fan	•	•		•	•				•	•			•	•		•		
Fire Extinguisher	•	•					•		•									
Hook	•						•	•		•		•	•	•				
Hook, Utility																	•	
Light Console Area								•										
Light, Dome							•											
Light, Flashing				•	•													
Light, Strobe				•	•													
Light, Work				•	•								•	•		•		
Mirror, Rear View	•	•							•									
Pocket	•	•		•	•		•	•	•	•	•	•	•	•			•	•
Shrink Wrap Holder	•	•	•						•							•		•
Shrink Wrap Tray				•	•													
Storage Module - Battery Cover Mount			•	•	•	•												
Storage Module - Magnetic Mount			•													•		
Storage Net Behind Seat	•																	
Storage Tray, Upper or Lower	•	•	•						•									
Terminal Mounting Plate (RF)	•	•		•	•		•	•	•		•	•				•		
Tube				•	•		•	•			•		•	•				
Tube, Extended			•	•	•													

Work Assist®



**Tubes**



Part No.	Description	Model	Part No.	Description	Model
130879	Accessory Rail Kit LH or RH	SP 3000 Series	131416	Work Assist Tube Kit	RR/RD 5000/S Series
131380	Standard Work Assist Tube Kit	PE 4000 Series	131960-001	TT Mast	ST/SX 3000
131381	Works Assist Tube Extension Kit	PE 4000 Series	131960-002	TL Mast	ST/SX 3000
143680	Standard Work Assist Tube Kit; Note: Electrical kit is P.N. 143681	PR 4500	141296-001	84.5" Work Assist Tube Kit	RC 5500
131414	Right Tube Assembly Kit	RR/RD 5000/S Series	141296-002	88" Work Assist Tube Kit	RC 5500
			823238	Work Assist Tube Kit	SR5200 

Note: Plug for tubes is P.N. 124530

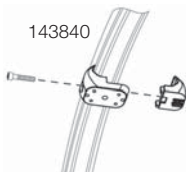

**Clamp**

**Part Number**

130145	
143840-001	Used on C5 Pneumatic, 45° angle
143840-002	Used on C5 Pneumatic, in line w/truck mtg



130145

**Work Assist® Interface with RAM Mounting System**



The new Crown Ball Mount design (P.N. 351094-XXX) allows you to add the RAM mounting system to the Crown Work Assist® clamps and accessories. The addition of the RAM mounting system allows you to position your accessories for the best access and prevent damage due to shock and vibration. See RAM mount pages 5.07-5.10.

**Terminal Mounting Plates**

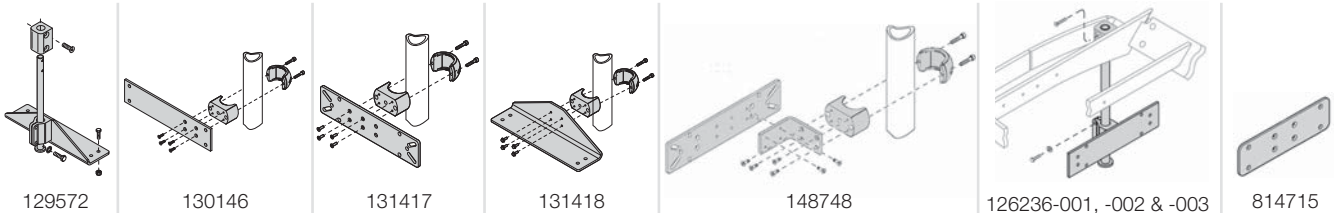

Part No.	Description	Model	Part No.	Description	Model
126236-001	Mounting Bracket LXE	RR/RD 5000/S Series	131417	Universal Mounting Plate	RR/RD 5000/S Series, RC 3000, RC 5500
126236-002	Mounting Bracket Norand	RR/RD 5000/S Series	131418	Mounting Bracket	FC 4000 Series, SC 4000 Series, PE 4000 Series, RR/RD 5000/S Series, RM/RMD 6000/S, SP 3000/4000 Series, C5, RC 5500
126236-003	Mounting Bracket Telxon	RR/RD 5000/S Series	148748	Universal Terminal Mounting Kit	C5, FC 4000 Series, SC 4000 Series, RC 3000/RC 5500, RM/RMD 6000/S, SP 3000 Series, PE 4000 Series, RR/RD 5000/S Series
129572	Adjustable Bar & Mounting Bracket	RR/RD 5000/S Series, RC 3000	814715	Bracket Data Log	ESR 4500/5000 
130146	Mounting Plate	FC 4000 Series, SC 4000 Series, SP 3000/4000 Series, C5, RR/RD 5000 Series, PE 4000 Series			

Note: Optional recommended ball mount size: 2.25" - P.N. 351094-003



**Clip Pad**

**Part Number**

131415	Includes clamp
141462	Used on SH/SHR 5500
151743	Used on WP 3000

Note: Optional recommended ball mount size: 2.25" - P.N. 351094-003

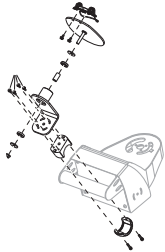

**Clip Pad, Clamp-On**

**Part Number**

146238

Used on PC 4500, E-Steer.

Note: Optional recommended ball mount size: 2.25" - P.N. 351094-003



**Clip Pad and Hook**

**Part Number**

130144	Includes clamp
141460	No clamp; includes plate to use on SH/SHR 5500

Note: Optional recommended ball mount size: 2.25" - P.N. 351094-003



**Hook**

**Part Number**

131419	For use with RF, includes clamp
141463	Does not include clamp, includes plate used on SH/SHR 5500

Note: Optional recommended ball mount size: 1.5" - P.N. 351094-002

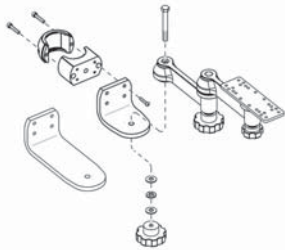

**Adjustable Arm System Kit**

**Part Number**

136994

Note: Used on TSP 6000/7000 & SR



**Pocket**

**Part Number**

130868	Gray; includes clamp
125997-001	Gray; used on Wave; 1 pocket kit
125997-002	Gray; used on Wave; 2 pocket kit
141461	Gray; used on SH/RHR 5500 kit
151744	Orange; used on WP 3000
125502	Gray pocket only
141751	Orange pocket only

Note: Optional recommended ball mount size: 1" - P.N. 351094-001

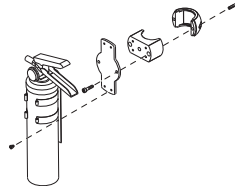

**Fire Extinguisher Kit**

**Part Number**

141187

Includes fire extinguisher. Used on SC 4000/5000 Series, FC 4000 Series, C5 & RC 5500

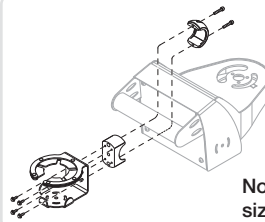

**Cup Holder, Clamp-On**

**Part Number**

145078

Used on PC 4500, E-Steer, FC 4000 Series, SC 4000 & 5000 Series, C5

Note: Optional recommended ball mount size: 1.5" - P.N. 351094-002

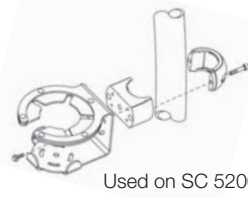

**Cup Holder**

**Part Number**

144444	Cup holder
128362	Clamp
127697	Clamp
060062-060	Screw (2)
060061-022	Screw (4)

Used on SC 5200

Note: Optional recommended ball mount size: 1.5" - P.N. 351094-002



**Shrink Wrap Holder Kit - Mounts on Pole**

**Part Number**

145080

Used on PC 4500

Note: Optional recommended ball mount size: 2.25" - P.N. 351094-003



**Fan Kits**

Part Number	Type	Model
131388	24-volt	PE 4000
140125	24-volt	PE 4500
132781-002	24-volt	ST/SX 3000 (Mounted on work platform)
141459	24-volt	SH/SHR5500
127503-001	36-volt	FC 4000 Series, SC 4000 Series
140083	36-volt	RC 5500
127592-001	36-volt, w/Drive Thru Overhead Guard	FC 4000, SC 4000 Series
127592-002	48-volt, w/Drive Thru Overhead Guard	FC 4000 Series
127503-002	48-volt	FC 4000 Series

Note: Optional recommended ball mount size: 1.5" - P.N. 351094-002

**Fan Only**

Part Number	Type	Model
127259-010	12V with switch	C5
127259-007	24V with switch	PE 4000 Series, ST/SX 3000, RR 5200
125755	24V with switch	RC 3000
127259-004	24V without switch	PE 4000 Series
127259-002	36V with switch	SC 4000 Series, FC 4000 Series, RR 5200
127259-005	36V without switch	FC 4000 Series, SC 4000 Series, RC 5500
127259-003	48V with switch	FC 4000, TSP 6000
127259-006	48V without switch	FC 4000 Series, TSP 6000



**Dome Light**

**Part Number**

123683

Used on RM/RMD 6000/S, RC 5500. Will also need to order plate 139555, 2 of 060030-010, 2 of 060059-034, 2 of 060061-038, 2 of 060062-027 and clamp 130145.

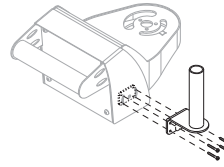

**Shrink Wrap Holder, Bolt-On**

**Part Number**

145081

Used on PC 4500, E-Steer

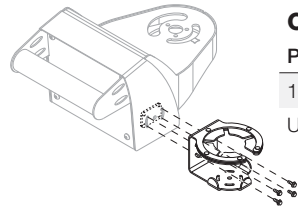

**Cup Holder, Bolt-On**

**Part Number**

145079

Used on PC 4500, E-Steer.

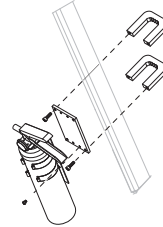

**Fire Extinguisher Kit - Drive Thru Rack**

**Part Number**

127591

Includes fire extinguisher. Used on FC 4000 Series & SC 4000/5000 Series

**Note:** U-clamps only, 127419

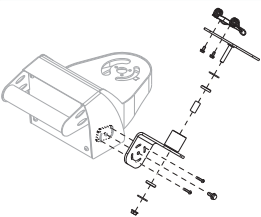

**Clip Pad, Bolt-On**

**Part Number**

146237

Used on PC 4500, E-Steer.



**Clip Pad, Desktop**

**Part Number**

816658	Housing
814594	Spring
060062-003	Screw (qty. 2)

Used on RC 5500

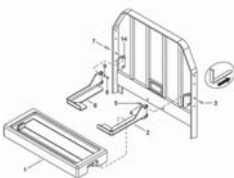

**Storage Module - Battery Cover Mount**

**Part Number**

137513	Mounts to bolt-on load backrest
137514	Mounts to hinged load backrest



**Shrink Wrap Tray**

**Part Number**

131379

Used on PE 4000 Series, PW 3500

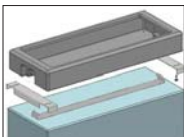

**Storage Module - Battery Cover Mount**



**Part Number**

117420	Used on trucks with no load backrest; includes one long bracket
141042	Used on trucks with no load backrest; includes two side brackets



**Utility Hook**

**Part Number**

131036

**Note:** Includes two hooks and warning labels.



**Storage Tray Upper & Lower Kits**

**Part Number**

141228S	Upper Storage Tray
141229S	Lower Storage Tray



**Bracket Assembly for Mirror, Rear View**

**Part Number**

134212

**Note:** Used on TSP 6000/7000, SP 4000

Order Separately  
 - Clamp 130145  
 - Screw 060061-022 (Qty.4)  
 - Mirror 137670



**Storage Module, Magnetic Mount**

**Part Number**

144441S

Includes tray, magnet and hardware. Can put two together and put on pallet truck battery cover. Used on PC 4500, TR 4500.



**Mirror Kit**

**Part Number**

130673

**Note:** Includes left- & right-hand brackets, 2 mirrors, and hardware to mount. Mounts on overhead guard. Used on C5, FC 4000/4500 & SC 4000/45000/5200.



Work Assist®

## Work Assist® Accessories

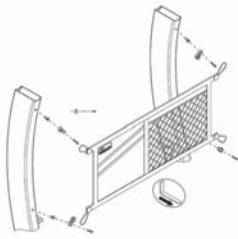

### Storage Net Behind Seat

#### Part Number

147005S

Also order:

- 4 inserts 060103-006
- 4 screws 060062-041
- 4 wall hooks 147008



### Strobe Light Kit

#### Part Number Color

131377-001	Amber
131377-002	Red
131377-003	Blue



### Flashing Light Kit

#### Part Number

131378



131376 (PE 4000)

### Front Worklight Kits

Part Number	Description	Model
128921	Drive Thru Overhead Guard	FC 4000 Series
129589	Standard Overhead Guard Mounted	FC 4000 Series
127528-001	Drive Thru Overhead Guard	SC 4000
127532-001	Standard Overhead Guard Mounted	SC 4000 Series
*131376	Mounted on Work Assist Pole	PE 4000 Series
140126	Mounted on Work Assist Pole	PR 4500 & PE 4500
133896-002	Mounted on Work Assist Pole	ST/SX 3000

\*Does not include mounting brackets



### Snap-On Platform

#### Part Number W x L (in)

131069-001	25 x 36.50
131069-002	25 x 42.50
131069-003	25 x 48.50

Used on ST/SX 3000



### Programmable Security Lock

#### Part Number

130863-002

This keypad offers an enhanced level of security to deter unauthorized or untrained personnel from operating the vehicle. A four digit Personal Identification Number can be assigned for up to 200 operators that use the vehicle. Supervisor can "lockout" vehicle through keypad and can program keypad to turn vehicle "OFF" automatically if vehicle is idle for prolonged periods. Power input is 15 amps externally fused, 48 volts maximum. Power output is 10 amps maximum. Operating temperature range is -40 to +85 degrees Celsius.



### Work Platform

#### Part Number

133892

Accessories:

Work Platform Tray  
(P.N. 133894)

Used on ST/SX 3000



### Remote

Part Number	Mast Type	Application
132782-002	ST/SX 3000, TL	Ground
132782-003	ST/SX 3000, TT	Ground
133895-002	ST 3000, TL Mast	Platform
133895-003	ST 3000, Sideshift, TL Mast	Platform
133895-004	SX 3000, TL Mast	Platform
133895-005	ST 3000, TT Mast	Platform
133895-006	ST 3000, Sideshift, TT Mast	Platform
133895-007	SX 3000, TT Mast	Platform



### Tool Retractor

#### Part Number

300114

Capacity 1.76-4.4 lbs. (0.8-2.0kg)  
Extended rope length - 5.5 ft.



## RAM Mounts

**NEW!**

Protect your electronic devices by using the RAM Mounting System. RAM mounts utilize a patented rubber ball and socket design which isolates and dampens shock and vibration up to 50G of shock, allowing you to mount just about anything, anywhere on your forklift. Adjustable positioning features can not be matched by another mounting method. Mounting bases quickly attach and fit every OEM lift cage or overhead guard made. All backed by a lifetime manufacturer's warranty. Made in USA.

### How to Order:



\*Base may be required; see holder requirements.

## Bases & Attachments

**NEW!**

Continued ▶

Work Assist®



### Crown Work Assist® Ball Base

Rubber ball connected to oval base with mounting holes aligned to work with Crown Work Assist® Accessories. See pages 5.03 & 5.04.

Part No.	Description
351094-001	1" ball with 2.52" x 1.85" oval base
351094-002	1.5" ball with 2.52" x 1.85" oval base
351094-003	2.25" ball with 2.52" x 1.85" oval base



### Square Base with Rubber Ball

Rubber ball, connected to a 4.75" square plate with 4x100mm holes and 4x75mm holes in each corner.

Part No.	Description
351095-012	1.5" ball
351095-013	2.25" ball
351095-014	2.25" ball (reinforced steel)



### Round Base with Rubber Ball

Consists of a rubber ball connected to a flat round base. This mount has pre-drilled holes, including the universal AMPS hole pattern.

Part No.	Description
351095-006	1" ball with 2 <sup>7</sup> / <sub>16</sub> " diameter base
351095-007	1.5" ball with 2 <sup>1</sup> / <sub>2</sub> " diameter base
351095-008	2.25" ball with 3 <sup>1</sup> / <sub>16</sub> " diameter base
351095-009	2.25" ball with 3 <sup>1</sup> / <sub>16</sub> " diameter base, reinforced steel



### Square Base with Rubber Ball

Rubber ball, connected to a 3.625" square plate with a 75x75mm VESA hole pattern. The rubber ball is positioned 0.88" from the center of one edge.

Part No.	Description
351095-015	1.5" ball
351095-016	2.25" ball



### 3.25" Diameter Suction Cup

Suction cup designed to have an extra hold on any smooth, non-porous surface. For best results mount the suction cup on glass or non-porous plastic surface.

Part No.	Description
351095-010	1" ball



### Rectangular Base with Rubber Ball

Rubber ball connected at right angles to a flat 6.25"x2" rectangular plate. The plate contains different combinations of pre-drilled holes which will match up to many electronic devices and mounts, including Marine GPS, CB Radios, Ham Radios, Gimbal Brackets and more.

Part No.	Description
351095-017	1.5" ball



### 2.5" Diameter Round Base

Has pre-drilled holes, including the AMP's hole pattern. The magnetic base contains 3 rare earth magnets that hold firm to ferrous metals. The adapter designed to conceal the magnets is made of a durable plastic composite to prevent scratching the mounting surface.

Part No.	Description
351095-011	1" ball



### Diamond Base with Rubber Ball

Consists of a 1" diameter rubber ball connected at right angles to a 2.43" x 1.31" diamond base. The base has 2 holes 1.912" from center to center, matches the industry standard AMP's hole pattern and will connect to a large variety of RAM mount and third party cradles.

Part No.	Description
351095-018	1" ball

## Bases & Attachments

**NEW!**



### Rubber Ball with Clamp Base - 4"

Fits on square rails up to 4" wide and 2 1/8" deep. Can fit much smaller rails if needed by angling.

Part No.	Description
351095-001	1" ball
351095-002	1.5" ball
351095-003	2.25" ball



### Rubber Ball with Clamp Base - 2.5"

Fits on square rails up to 2.5" wide.

Part No.	Description
351095-004	1.5" ball
351095-005	2.25" ball



#### How to measure your lift truck rail diameter:

Measure the horizontal length of the variable side of your rail to determine which RAM Mount Base you will need.

Work Assist®



### Roof Rack

Lift Truck Back-Up Mounting Plate is the ideal way to get a ball attached to most any lift cage or overhead guard. Utilizing two identical plates of stamped steel with numerous common hole patterns and slots makes attachment a breeze. Two popular ball sizes: 1.5" & 2.25" diameter may be attached to this plate system. Up to 2 square bases may be attached to the same plate for multiple applications. Installation is as easy as attaching the base with ball to one of the plates and then sandwiching the guard or cage between the two mounting plates using the hardware provided.

Requires a square base: 1.5" ball (P.N. 351095-012) or 2.25" ball (P.N. 351095-013 or P.N. 351095-014).

Part No.
351095-019



### V Base Ball and Straps

Fits circular and square rails from 1" to a max of 2.1" diameter. To mount, place the saddle shaped plate on the rail then wrap the metal clamp strap around the rail and plate. Tighten the screw knob on the metal strap with a screw driver until the strap has a firm hold on the rail.

Part No.	Description
351095-021	1" ball
351095-022	1.5" ball



### Clamp for Rail Mounting

The clamp base will fit rails in diameter from 0.625" to a maximum of 1.25". The ball is at a right angle to the plane of the mount: when connected to a rail, the ball sits parallel to the rail.

Part No.	Description
351095-023	1" ball

## Mount Assembly

**NEW!**



### Universal Mount with 2 Round Bases

Consists of a double socket arm (P.N. 351095-027) and two 2 1/16" diameter round bases (P.N. 351095-006) that contain the universal AMP's hole pattern. Has adjustment points at both ends of the double socket arm; this allows for almost infinite adjustment and perfect viewing angles. The hole pattern found on the round base adapter will connect to many RAM cradles, including all iPad cradles. Overall height 5".

Part No.
144357

## Arms

**NEW!**



### Double Ball Socket Arm, Short

The short double socket arm, has a socket at both ends that fits ball bases. RAM socket technology allows for almost infinite adjustment and perfect viewing angles.



Part No.	Works With	Overall Length
351095-027	1" ball	2.38"
351095-028	1.5" ball	3.5"
351095-029	2.25" ball	5.0625"

### Double Ball Socket Arm, Long

Has a socket at both ends that fits ball bases. A single spring inside the arm opens the end sockets, allowing you to pivot the ball and socket connection. This socket technology allows for almost infinite adjustment and perfect viewing angles.



Part No.	Works With	Overall Length
351095-030	1" ball	6"
351095-031	1.5" ball	9.125"
351095-032	2.25" ball	12.875"

### Double Ball Socket Arm, Standard

Has socket at both ends that fits ball bases. A single spring inside the arm opens the end sockets, allowing you to pivot the ball and socket connection. Allows for almost infinite adjustment and perfect viewing angles.



Part No.	Works With	Overall Length
351095-024	1" ball	3.69"
351095-025	1.5" ball	5.625"
351095-026	2.25" ball	8.375"

### Adjustable Socket with Octagon Socket

Consists of double 1" diameter open ball sockets with a 360° rotation point at the center & a connecting swivel joint that rotates forward and back 180°. The rubber ball and socket at either end, and a central pivot point provides unsurpassed adjustability. The RAM ball sockets maximize ball coverage for optimal fit.



Part No.	Works With	Overall Length
351095-033	1" ball	6.25"

Work Assist®

## Holders

**NEW!**

Continued ▶



### X-Grip® Universal Holder

Has a clean and clever four leg design that sports great holding power without hiding your phone behind foam pads and plastic. Dimensions: width - 1.875" - 3.25", depth 0.875".

No ball base required.

Part No.	Description
351095-034	1" ball

### Universal Holder for Scanner Guns and Handheld Computers

Fits the following dimensions.



	Depth of 1.125" or less	Depth of 1.125" & 2.25"	Depth of 2.25" & 4.25"
min. length	4.375"	3.500"	2.000"
max. length	10.750"	10.000"	8.500"
width limit	no	no	2.625"

Part No.  
351095-038

Requires ball base 351095-007.



### X-Grip® Universal for 5" Phablets

Has a clean and clever four leg design that sports great holding power without hiding your phone or phablet behind foam pads and plastic. Compatible and interchangeable with a wide range of mounts. Dimensions: width 1.75"-4.5".

No ball base required.

Part No.	Description
351095-035	1" ball

### Universal Finger-Grip™ Phone/Radio Holder

This holder is designed to hold a large amount of cell phones & electronic devices. The holder comes with (3 sets) of four flexible rubber coated fingers placed along sides to grip your device. The fingers open by squeezing the ends to open the small finger arms. The bottom of the holder includes a back plate that adds support to the device being held by the mount. The spine plate contains the universal AMPs and 1.5" x 2" hole patterns. Min/Max with top & bottom plates: Height 5.25" to 6". Plates can be removed for larger devices.



Requires ball base 351095-006.

Part No.  
351095-036



### Power-Grip™ Universal Scanner Gun Cradle

Compatible with a wide range of ruggedized 2D barcode scanners.

Requires ball base 391095-007.

Part No.  
351095-037



**Tab-Tite™ Kit for Large Tablets**

Fits most 10" tablets. Includes 2 sets of interchangeable cups to give the user a custom fit. Spring loaded. Cradle dimensions:

Height	Max. Width	Max. Edge Depth
8.50" - 10.75"	7.75"	0.56"
8.75" - 10.75"	8.25"	1.10"

Requires ball base 351095-007.

**Part No.**  
351095-042



**Tab-Lock™ Kit for Large Tablets**

Same as 351095-042 except locks for theft deterrent. Cradle dimensions:

Height	Max. Width	Max. Edge Depth
8.00" - 10.25"	6.80"	0.50"
8.25" - 10.25"	7.75"	0.56"

Requires ball base 351095-007.

**Part No.**  
351095-043



**Tab-Tite™ Kit for Small Tablets**

Fits most 7-8" tablets. Includes 3 sets of interchangeable cups to give the user a custom fit. Spring loaded retention to hold device securely on the forklift. It is compatible with the following tablets with or without skins, sleeves or cases: Archos 7, Asus EEE Pad Memo, Asus Tough-ETBW11AA, Barnes & Nobel NOOKcolor, BlackBerry Playbook, Dell Streak 7, HTC Flyer, Google Nexus 7, Samsung Galaxy. Cradle is compatible with any tablet that will fit the dimensions listed below. It is important to verify the dimensions of your tablet with a case/sleeve/skin when determining the overall size. Cradle dimensions:

Height	Max. Width	Max. Edge Depth
6.80" - 9.000"	5.31"	0.125" - 0.56"
7.00" - 9.100"	4.70"	0.125" - 0.44"
7.30" - 9.620"	5.31"	1.06"

Requires ball base 351095-007.

**Part No.**  
351095-040

Features:

1. Support cups contain open slots to fit tablets of various sizes
2. Back plate can support various size support cups
3. Spring loaded tension provides secure support for your tablet
4. Spring loaded cradle allows for quick release of your tablet
5. Full access to all ports



**Tab-Lock™ Kit for Small Tablets**

Same as 351095-040 except locks for theft deterrent. Cradle dimensions:

Height	Max. Width	Max. Edge Depth
6.55" - 9.80"	5.31"	0.125" - 0.56"
6.75" - 9.90"	4.70"	0.125" - 0.44"
7.05" - 10.42"	5.31"	1.06"

Requires ball base 351095-007.

**Part No.**  
351095-041



**Universal Laptop Mount Tough Tray II™**

Spring loaded holder for large tablets, with or without a case. Accommodates netbooks as well. Dimensions:

Tray Depth	Tray Thickness	Tray Width (Expansion)	Side Clamp Arm Height
6.0"	1.0"	8.56" - 11.12"	2.75" max

Requires ball base 351095-007.

**Part No.**  
351095-044



**RAM-X-Grip® III Universal Clamping Cradle for 10" Tablets**

Spring loaded holder for large tablets, with or without a case. Accommodates netbooks as well. Dimensions:

Tray Depth	Tray Thickness	Tray Width (Expansion)	Side Clamp Arm Height
6.0"	1.0"	8.56" - 11.12"	2.75" max

Requires ball base 351095-007.

**Part No.**  
351095-045



**Universal X-Grip® II Tablet Holder with 1.5" Ball for Small Tablets**

Four leg design has great holding power and does not hide your tablet behind foam pads or plastic. Spring loaded holder and 1.5" rubber ball connect to the back of the base. Includes extra easy access grip knobs located on the back of the holder for quick release of your tablet. This holder expands and contracts for perfect fit of most 7" tablets.

Min. Width	Max. Width	Depth
2.25"	5.75"	0.875"

Note: Devices 2.25" in width must be a minimum of 7" in height to fit.

No ball base required.

**Part No.**  
351095-046



**Universal Holder for Scanner Guns and Handheld Computers**

Specially designed cradle that will hold most types of gun scanner handles. On the side of the cradle is a spring loaded lever that will securely hold the gun scanner in the cradle. Designed for pistol grip scanners.

Requires ball base 3951095-007.

**Part No.**  
351095-039



**Locking Knob**

Includes a brass thread for 1" or 1.5" socket arms, thus allowing you to disengage the screwing of the knob. Once you have set your mount in the location you need, you can lock it in place and feel safe that your mounted device will stay right where you left it.

Part No.	Thread Size	Works With
351095-047	¼" - 20 thread	1" ball arm
351095-048	⅝" - 18 thread	1.5" ball arm

The Forklift Laser Guidance System provides operators a continuous visual reference of fork position which aids in increasing safety, accuracy, and productivity, while reducing product damage.

The laser projects a line or dot onto the pallet or product indicating the level of the forks which allows operator heightened visibility and more accurate fork placement.

**Laser Models:**

- Basic Standard - Basic standard
- Cold Storage - Designed for low-temperature and high-moisture environments
- Height Control - Designed only to operate at 7' and above

**Laser Types:**

- Line - Best for low-light areas such as warehouses
- Dot - Best for cold storage and outdoor usage

**Features:**

- Contains two rechargeable nickel metal hydride batteries
- Charger included
- Shuts off after 4 mins without movement, saving battery life
- Automated vibration controlled start
- Heavy duty
- Self contained
- Quick battery change

**Mounting:**

- Single laser, dual laser, and hard wired series units mount directly to the forklift carriage in less than five minutes. Fork mount laser units attach to the fork directly.



## Forklift Laser Guidance Systems

Laser Series	Power Source	Laser Type	Part Number	Description	Water Resistant Seal	Cold Storage	Height Control	Fork Mount
Single	Battery	Dot	351093-001-D	Basic Std				
Single	Battery	Dot	351093-002-D	Cold Storage - Water Resistant	•	•		
Single	Battery	Dot	351093-003-D	Height Control			•	
Single	Battery	Dot	351093-007-D	Basic Std - Fork Mount				•
Single	Battery	Dot	351093-008-D	Cold Storage - Water Resistant - Fork Mount	•	•		•
Single	Battery	Dot	351093-009-D	Height Control - Fork Mount			•	•
Single	Battery	Dot	351093-019-D	Height Control - Cold Storage - Water Resistant	•	•	•	
Single	Battery	Line	351093-001	Basic Std				
Single	Battery	Line	351093-002	Water Resistant	•			
Single	Battery	Line	351093-003	Height Control			•	
Single	Battery	Line	351093-007	Basic Std - Fork Mount				•
Single	Battery	Line	351093-008	Water Resistant - Fork Mount	•			•
Single	Battery	Line	351093-009	Height Control - Fork Mount			•	•
Single	Battery	Line	351093-019	Height Control - Water Resistant	•		•	
Single	Hard Wired	Dot	351093-012-D	Basic Std				
Single	Hard Wired	Dot	351093-013-D	Cold Storage - Water Resistant	•	•		
Single	Hard Wired	Dot	351093-014-D	Height Control			•	
Single	Hard Wired	Dot	351093-015-D	Height Control - Cold Storage - Water Resistant	•	•	•	
Single	Hard Wired	Line	351093-012	Basic Std				
Single	Hard Wired	Line	351093-013	Water Resistant	•			
Single	Hard Wired	Line	351093-014	Height Control			•	
Single	Hard Wired	Line	351093-015	Height Control - Water Resistant	•		•	
Dual	Battery	Line & Dot	351093-004	Basic Std				
Dual	Battery	Dot & Dot	351093-005	Cold Storage - Water Resistant	•	•		
Dual	Battery	Line & Dot	351093-006	Height Control	•		•	
Dual	Battery	Dot & Dot	351093-020	Height Control - Cold Storage - Water Resistant	•	•	•	
Dual	Hard Wired	Line & Dot	351093-016	Hard Wired - Basic Std				
Dual	Hard Wired	Dot & Dot	351093-017	Hard Wired - Cold Storage - Water Resistant	•			
Dual	Hard Wired	Line & Dot	351093-018	Hard Wired - Height Control			•	

## Forklift Laser Guidance System

### Single Laser Series

Part Number	Description	Laser Type
351093-001	Basic Std	Line
351093-001-D	Basic Std	Dot
351093-002	Water Resistant	Line
351093-002-D	Cold Storage - Water Resistant	Dot
351093-003	Height Control	Line
351093-003-D	Height Control	Dot
351093-019	Height Control - Water Resistant	Line
351093-019-D	Height Control - Cold Storage - Water Resistant	Dot



### Fork Mount Laser Series

Part Number	Description	Laser Type
351093-007	Basic Std	Line
351093-007-D	Basic Std	Dot
351093-008	Water Resistant	Line
351093-008-D	Cold Storage - Water Resistant	Dot
351093-009	Height Control	Line
351093-009-D	Height Control	Dot



Fork mount lasers are designed for the non-standard fork carriages. Lasers are mounted directly to the fork of the lift truck.

### Dual Laser Series

Part Number	Description	Laser Type
351093-004	Basic Std	Dot & Line
351093-005	Cold Storage - Water Resistant	Dot & Dot
351093-006	Height Control	Dot & Line
351093-020	Height Control - Cold Storage - Water Resistant	Dot & Dot
351093-016	Hard Wired - Basic Std	Dot & Line
351093-017	Hard Wired - Cold Storage - Water Resistant	Dot & Dot
351093-018	Hard Wired - Height Control	Dot & Line



The dual laser feature is designed for repetitive moving of product. This feature incorporates two distinct lasers to aid the operator. The first laser directs the forks into the pallet and the second laser guides the pallet onto the rack.

### Hard Wired Laser Series

Part Number	Description	Laser Type
351093-012	Basic Std	Line
351093-012-D	Basic Std	Dot
351093-013	Water Resistant	Line
351093-013-D	Cold Storage - Water Resistant	Dot
351093-014	Height Control	Line
351093-014-D	Height Control	Dot
351093-015	Height Control - Water Resistant	Line
351093-015-D	Height Control - Cold Storage - Water Resistant	Dot



Oil and water resistant wires are hard wired directly into truck battery with voltage systems between 12-55 DC. Matching pigtails are provided for power connection. (Wiring for most not included.) Experienced personnel are recommended for self-installation.

### Accessories

Part Number	Description
351093-010	Rechargeable NIMH Batteries
351093-011	Solid-State Charger
351093-022	Face Plate Assembly

## Forklift Covers & Enclosures



### Forklift Enclosures - Atrium

Part Number	Description	Size
300125-001	Standard - Super Clear Vinyl	Fits up to 6,000 lbs
300125-002	Large - Super Clear Vinyl	Fits 6,000-12,000 lbs

Great for the yard and warehouse. Keeps the rain or dust away from the operator. Zippered doors can be shut or unzipped and folded back into place while working. Universal for most lifts. UV yellow inhibitor. Freeze point flexibility. Marine grade stitching. Attaches in seconds. Super clear material.



### Forklift Cap Covers

Part Number	Description	Size
300125-003	Super Clear Tinted Vinyl	52.5" L x 46" W
300125-004	Super Clear Vinyl	40" L x 45.5" W

Attaches with built-in bungee cords; just wrap around roof poles and attach back to itself. Attaches in seconds. Fits all lifts. Super clear material. Absorbs impacts. Protection from sun (tinted version only). Protection from rain and falling debris. Great for all warehouses and yards.



### Forklift Storage Cover

Part Number	Description	Size
300125-005	Forklift Storage Cover	Fits up to 8,000 lbs 100"L x 45"W x 80"H

This is manufactured from the most durable fabrics and is great for the yard or warehouse, keeping your lift's resale value high. Slips on in seconds. Get a better resale value. Easy access zipper. Strong, durable non-rip fabric. Anti-loft/anti-moisture vents. Sizing straps for secure fit. Strong elastic bottom hem.

## Section 6

# PTH 50, Chain, Forks and Attachment Parts

### Contents

Crown PTH 50 Series Pallet Truck	6.02
Leaf Chain	6.03
Roller Chain	6.04
Fork Pin Kits	6.04
Forks	6.05
Cascade Cross Reference	6.07

Note: 1910.178(q)(5) (1998) of the Occupational Safety and Health Act (OSHA) requires that "All parts of any such industrial truck requiring replacement shall be replaced only by parts equivalent as to safety with those used in the original design."

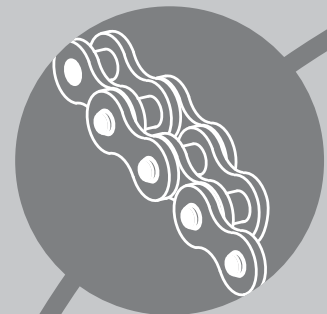

# Crown PTH 50 Series Pallet Truck

## Features

- Crown Built Durability
- 5000 lb Capacity
- 2.9" Lowered Height - Pallet entry is a non-issue even on non-standard pallets
- Articulated Steer Wheels ensure continual contact with the floor
- Low Rolling Resistance provides longer wear on wheels and bearings
- Dual Entry/Exit System ensures the PTH will virtually glide in and out of any pallet
- Box Section Style Push Rods are stronger than the competitions
- C-Channel Formed Steel Forks designed for maximum strength
- Ergonomic Handle and only a few strokes results in 5" of lift
- Less service, more use - uses sealed bearings and bushings, only one grease zerk

Order Online:  
**crown.com**



## Specifications

Base Part Number	Width (in)	Dim A Fork Length (in)	Standard w/Poly Tire	Skid Adapter w/Poly Tire	48" Load Backrest w/Poly Tire	60" Load Backrest w/Poly Tire	Standard w/Nylon Tire	Dim B Load Wheel Lowered (in)	Dim C Load Wheel Raised (in)	Weight (lb)
PTH50-016-36	15.8	36	-1	-2			-5	29.5	23.5	132
PTH50-018-42	17.7	42	-1	-2			-5	35.5	29.5	141
PTH50-018-48	17.7	48	-1	-2			-5	41.5	35.5	148
PTH50-020-36	20.5	36	-1	-2			-5	29.5	23.5	137
PTH50-020-42	20.5	42	-1	-2			-5	35.5	29.5	143
PTH50-020-48	20.5	48	-1	-2			-5	41.5	35.5	150
PTH50-027-32	27	32	-1	-2	-3	-4	-5	25.5	19.5	139
PTH50-027-36	27	36	-1	-2	-3	-4	-5	29.5	23.5	143
PTH50-027-42	27	42	-1	-2	-3	-4	-5	35.5	29.5	150
PTH50-027-48	27	48	-1	-2	-3	-4	-5	41.5	35.5	159
PTH50-027-54	27	54	-1	-2	-3	-4	-5	47.5	41.5	174
PTH50-027-60	27	60	-1	-2	-3	-4	-5	53.5	47.5	187
PTH50-027-72	27	72	-1	-2	-3	-4	-5	65.5	59.5	209

Add dash number to base number for complete part number, example PTH50-016-36-1 is a standard truck.

**Note:** Skid Adapters increase lowered height to 5.5" and raised height increases to 10.5". Available on all trucks except PTH50-027-72.

**Note:** Load Backrests are constructed of 5/16" steel and are available in 48" and 60" sizes. Only available on PTH's with a 27" width.

## Replacement Parts

Item Description	Part Number
Load Wheel	044507
Load Wheel Bearing	065081-020
Load Wheel Assembly	044506-101
Steer Wheel - Poly, Dark Gray	818270
Steer Wheel Bearings, Sealed	065081-018
Hydraulic Unit	816814-001
Seal Kit for Hydraulic Unit	819934
Handle Assembly	044521-012
Piston Retainer Tool - used on Hydraulic Unit to keep spring down	816908

## Dimensions

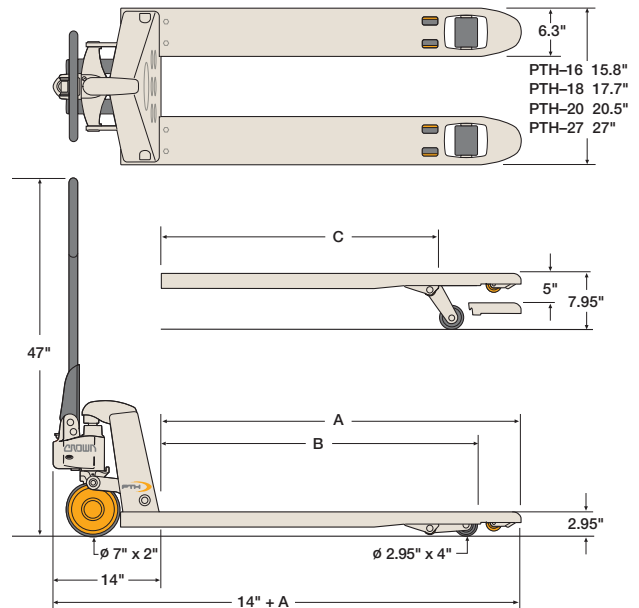



# Leaf Chain

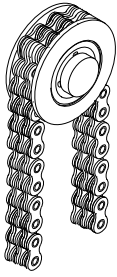

## Specifications

Base Number	Type	Lacing	ANSI Number	Pitch in / mm	Ultimate Strength Minimum lb / kg
120191	B	2 x 2	BL422	0.500 / 13	5,000 / 2,267
090738	B	2 x 3	BL523	0.625 / 16	9,000 / 4,082
083633	B	3 x 4	BL534	0.625 / 16	11,000 / 4,989
342908	B	4 X 4	BL544	0.625 / 16	15,000 / 6,803
342909	B	4 X 6	BL546	0.625 / 16	15,000 / 6,803
073991	B	3 x 4	BL634	0.750 / 19	20,400 / 9,253
342907 (was 042907)	B	4 x 4	BL644	0.750 / 19	26,000 / 11,793
103267	B	2 x 2	BL822	1.000 / 25	20,500 / 9,298
340834	B	3 X 4	BL834	1.000 / 25	28,500 / 12,928
089260	B	4 x 4	BL844	1.000 / 25	40,000 / 18,144

## Order Lengths by Part Number

Base Number	10 ft box 305 cm	15 ft box 457 cm	20 ft box 610 cm	25 ft box 762 cm	28 ft box 853 cm
083633	083633-010	083633-011	083633-012	083633-013	
342908	342908-010	342908-015	342908-020		
342909	342909-010	342909-015			
073991	073991-122	073991-123	073991-124	073991-024	073991-073
342907 (was 042907)		342907-015			
103267	103267-020	103267-021	103267-022		
089260	089260-080	089260-081	089260-082	089260-083	
Base Number	30 ft box 914 cm	37 ft box 1,128 cm	50 ft box 1,524 cm	100 ft reel 3,048 cm	400 ft reel 12,192 cm
083633			083633-014	083633-015	
342908				342908-100	
342909				342909-100	
073991		073991-076		073991-100	073991-400
342907 (was 042907)	342907-030			342907-100	
103267			103267-024	103267-025	
340834				340834-100	
089260				089260-085	

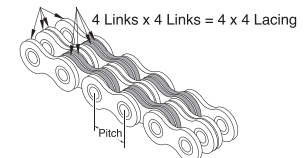
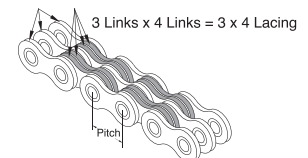
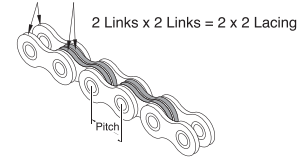

### ► Bulk Order Numbers - 090738-030 and 120191-002

Zinc-plated chain 073991-135 & 089260-137 for corrosive environments

## Chains Cut to Lengths Available\*

Part Number	Plate Lacing	ANSI Number	Pitch (Inches)	Tensile Strength (lbs.)	Connecting Link
380103-534	4x4	AL644	0.75	18,000	
380103-535	6x6	AL866	1.00	48,100	380101-244
380103-532	6x6	AL1066	1.25	69,200	380101-243
380103-533	6x6	AL1266	1.50	96,300	
380103-553	2x3	BL423	0.50	6,100	
380103-554	4x6	BL446	0.50	12,200	
380103-559	6x6	BL566	0.63	21,000	380101-255
380103-560	2x2	BL622	0.75	12,000	
380103-561	2x3	BL623	0.75	13,600	380101-256
380103-564	4x6	BL646	0.75	27,200	380101-259
380103-565	6x6	BL666	0.75	35,000	380101-260
380103-567	2x3	BL823	1.00	23,000	380101-261
380103-570	4x6	BL846	1.00	46,100	380101-264
380103-571	6x6	BL866	1.00	53,100	380101-244
380103-537	2x3	BL1023	1.25	32,100	
380103-538	3x4	BL1034	1.25	50,200	380101-245
380103-539	4x4	BL1044	1.25	59,000	
380103-540	4x6	BL1046	1.25	64,200	380101-246
380103-541	6x6	BL1066	1.25	82,200	380101-247
380103-542	3x4	BL1234	1.50	66,700	
380103-544	4x6	BL1246	1.50	82,300	
380103-546	3x4	BL1434	1.75	76,900	
380103-547	4x6	BL1446	1.75	104,300	

\*Available only to customers in USA

PTH 50, Chain, Forks and Attachment Parts

## Roller Chain

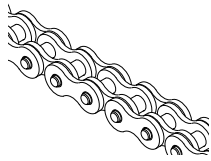

### 077159 Pre-packaged Service Chain Lengths (ANSI Chain Number 40, Pitch 0.5 in/13 mm)

Part Number	Length			Packaging	Links	Connecting Links Included
	in	ft	cm			
367159-004	47.5	3.96	120.65	Bag	95	x
367159-005	59.5	4.96	151.13	Bag	119	x
367159-010	120	10	304.8	Box	240	x
367159-100	1200	100	3050	Reel	2400	

### 078833 Pre-packaged Service Chain Lengths (ANSI Chain Number 50, Pitch 0.6 in/16 mm)

078833S002	36.87	3.08	93.66	Bag	59	x
------------	-------	------	-------	-----	----	---

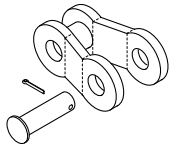

#### Offset Link

Part Number	ANSI Chain Number	Pitch in / mm
076902-002	40	0.5 / 13
076902-004	50	0.6 / 16

#### Chain Wear Scale

Part Number - 106440

Used to check leaf and roller chain wear used for lift and steering functions.

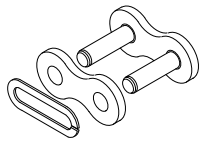

#### Connecting Link

Part Number	ANSI Chain Number	Pitch in / mm
076902-001	40	0.5 / 13
076902-003	50	0.6 / 16
076902-005	80	1.0 / 25

#### Did you know?

Highly-stressed precision chains require periodic maintenance to deliver maximum service life. After every 250 hours of truck operation, lift chains should be inspected and lubricated. Inspect chains every 50 hours if in corrosive environment. When chains have elongated 3%, they should be replaced.

## Fork Pin Kits



#### 390004-001 Class II

OEM / Number	OEM / Number
CA 7000034	TY A000009261
CA CCK2PKR-M	YL 04640-U2010-71
CA K2PKR-M	YL 55829000
CL 932775	YL 0558290-00
HY 1477241	YL 504236267
HY 1500773	YL 522520001
HY 1523735	YL 580016784
RA 811-885	YL 580026744
TY A000002859	YL 580035002

#### 390004-002 Class III

OEM / Number	OEM / Number
CA 7000035	HY 369796
CA CC-K3PKR	KN K3PKR-M
CA CC-K3PKRM	KO K3PKR-M
CA CCK480	KO K3PKR
CA FPK-4736	KO 8772139
CA K3PKR	KO 8777178
CA K3PKR-M	MB A000002860
CA K480	MB A000009262
CA K485	NI CK908250
CT A0000-09262	TY A000002860
CT A000002860	TY A000009262
CT A000009262	YL 504236277
CL 908250	YL 519479802
CL 919405	YL 522520002
CL 932776	YL 580016734
HY 0369796	YL 580016740
HY 1500774	YL 580035017
HY 1523739	



#### 103442 Class II

OEM / Number
AC 4933021
BK 101A
CL 999783
HY 3010780
HY 3027923
HY 3131893
RA 811-815-001
SC 31-90210
YL 220015615
YL 220023493
YL 519476805

#### 111582 Class III

OEM / Number

**Fork Dimensions**

Note: Dimensional diagram applies to all ITA Class II and III forks.

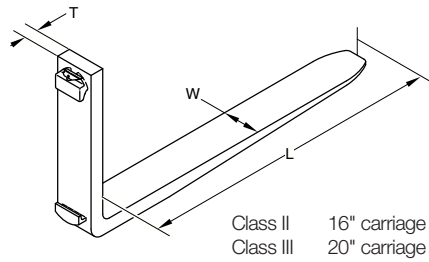

**Partial Taper**

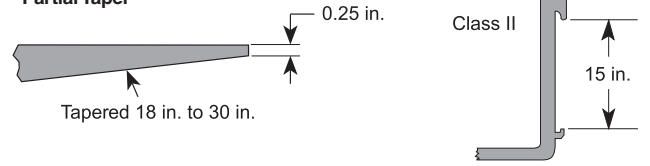

**Full Taper**

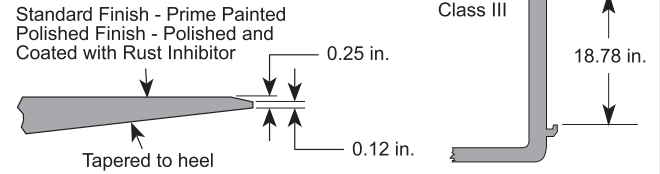

**Did you know?**

Orange fork tip indicators enhance visibility and productivity, while reducing damage potential. Only Crown's are recessed during the forging process which ensures Crown's will last much longer than the painted forks. These forks are fully compliant with ISO and ASME standards.

**Fork Tip Indicator Labels**

P.N. 396538



**Fork Tip Indicator Labels**

P.N. 396539



See Work Assist section for Fork Laser Guides



**ITA Class II Forks (Standard Finish, Partial Taper)**

Dimensions T x W x L - in	Dimensions T x W x L - mm	Capacity lb / kg	Part Number
1.5 x 4 x 30	40 x 100 x 760	3000 / 1361	075324-001
1.5 x 4 x 36	40 x 100 x 915	3000 / 1361	075324-002
1.5 x 4 x 39	40 x 100 x 990	3000 / 1361	075324-006
1.5 x 4 x 42	40 x 100 x 1065	3000 / 1361	075324-003
1.5 x 4 x 42	40 x 100 x 1065	3000 / 1361	152758*
1.5 x 4 x 45	40 x 100 x 1145	3000 / 1361	075324-005
1.5 x 4 x 48	40 x 100 x 1220	3000 / 1361	075324-004
1.5 x 4 x 54	40 x 100 x 1370	3000 / 1361	075324-007
1.5 x 4 x 60	40 x 100 x 1525	3000 / 1361	075324-008
1.5 x 4 x 72	40 x 100 x 1829	3000 / 1361	075324-009

**ITA Class II Forks (Polished Finish, Full Taper)**

Dimensions T x W x L - in	Dimensions T x W x L - mm	Capacity lb / kg	Part Number
1.75 x 4 x 30	45 x 100 x 760	5000 / 2268	088228-001
1.75 x 4 x 31.50	45 x 100 x 800	5000 / 2268	088228-009
1.75 x 4 x 36	45 x 100 x 915	5000 / 2268	088228-002
1.75 x 4 x 39	45 x 100 x 990	5000 / 2268	088228-006
1.75 x 4 x 40	45 x 100 x 1015	5000 / 2268	088228-011
1.75 x 4 x 42	45 x 100 x 1065	5000 / 2268	088228-003
1.75 x 4 x 43.31	45 x 100 x 1100	5000 / 2268	088228-010
1.75 x 4 x 45	45 x 100 x 1145	5000 / 2268	088228-005
1.75 x 4 x 48	45 x 100 x 1220	5000 / 2268	088228-004
1.75 x 4 x 54	45 x 100 x 1370	5000 / 2268	088228-007
1.75 x 4 x 60	45 x 100 x 1525	5000 / 2268	088228-008
1.75 x 5 x 31.50	45 x 130 x 800	5500 / 2495	106212-009
1.75 x 5 x 36	45 x 130 x 915	5500 / 2495	106212-002
1.75 x 5 x 39	45 x 130 x 990	5500 / 2495	106212-007
1.75 x 5 x 40	45 x 130 x 1015	5500 / 2495	106212-011
1.75 x 5 x 42	45 x 130 x 1065	5500 / 2495	106212-003
1.75 x 5 x 43.31	45 x 130 x 1100	5500 / 2495	106212-010
1.75 x 5 x 45	45 x 130 x 1145	5500 / 2495	106212-008
1.75 x 5 x 48	45 x 130 x 1220	5500 / 2495	106212-004
1.75 x 5 x 54	45 x 130 x 1370	5500 / 2495	106212-005
1.75 x 5 x 60	45 x 130 x 1525	5500 / 2495	106212-006

1.75 x 4 x 30	45 x 100 x 760	5000 / 2268	094182-001
1.75 x 4 x 31.50	45 x 100 x 800	5000 / 2268	094182-009
1.75 x 4 x 36	45 x 100 x 915	5000 / 2268	094182-002
1.75 x 4 x 39	45 x 100 x 990	5000 / 2268	094182-006
1.75 x 4 x 42	45 x 100 x 1065	5000 / 2268	094182-003
1.75 x 4 x 42	45 x 100 x 1065	5000 / 2268	152759*
1.75 x 4 x 43.31	45 x 130 x 1100	5000 / 2268	094182010
1.75 x 4 x 45	45 x 100 x 1145	5000 / 2268	094182-005
1.75 x 4 x 48	45 x 100 x 1220	5000 / 2268	094182-004
1.75 x 4 x 48	45 x 100 x 1370	5000 / 2268	152762*
1.75 x 4 x 54	45 x 100 x 1370	5000 / 2268	094182-007
1.75 x 4 x 60	45 x 100 x 1525	5000 / 2268	094182-008
1.75 x 4 x 72	45 x 100 x 1829	5000 / 2268	094182-012

1.75 x 5 x 30	45 x 130 x 760	5500 / 2495	106211-001
1.75 x 5 x 31.50	45 x 130 x 800	5500 / 2495	106211-009
1.75 x 5 x 36	45 x 130 x 915	5500 / 2495	106211-002
1.75 x 5 x 39	45 x 100 x 990	5500 / 2495	106211-007
1.75 x 5 x 42	45 x 130 x 1065	5500 / 2495	106211-003
1.75 x 5 x 43.31	45 x 130 x 1100	5500 / 2495	106211-010
1.75 x 5 x 45	45 x 130 x 1145	5500 / 2495	106211-008
1.75 x 5 x 48	45 x 130 x 1220	5500 / 2495	106211-004
1.75 x 5 x 54	45 x 130 x 1370	5500 / 2495	106211-005
1.75 x 5 x 60	45 x 130 x 1525	5500 / 2495	106211-006
1.75 x 5 x 72	45 x 130 x 1829	5500 / 2495	106211-012

\* One Source fork options less Fork Tip Indicators

## ITA Class III Forks (Polished Finish, Full Taper)

Dimensions T x W x L - in	Dimensions T x W x L - mm	Capacity lb / kg	Part Number
1.75 x 5 x 31.50	45 x 130 x 800	6000 / 2722	106214-009
1.75 x 5 x 36	45 x 130 x 915	6000 / 2722	106214-002
1.75 x 5 x 39	45 x 130 x 990	6000 / 2722	106214-007
1.75 x 5 x 40	45 x 130 x 1015	6000 / 2722	106214-011
1.75 x 5 x 42	45 x 130 x 1065	6000 / 2722	106214-003
1.75 x 5 x 43.31	45 x 130 x 1100	6000 / 2722	106214-010
1.75 x 5 x 45	45 x 130 x 1145	6000 / 2722	106214-008
1.75 x 5 x 48	45 x 130 x 1220	6000 / 2722	106214-004
1.75 x 5 x 54	45 x 130 x 1370	6000 / 2722	106214-005
1.75 x 5 x 60	45 x 130 x 1525	6000 / 2722	106214-006
1.75 x 5 x 36	45 x 122 x 915	6500 / 2948	147262-002*
1.75 x 5 x 42	45 x 122 x 1065	6500 / 2948	147262-003*
1.75 x 5 x 48	45 x 122 x 1220	6500 / 2948	147262-004*
1.75 x 5 x 60	45 x 122 x 1525	6500 / 2948	147262-006*

## ITA Class III Forks (Standard Finish, Partial Taper)

Dimensions T x W x L - in	Dimensions T x W x L - mm	Capacity lb / kg	Part Number
1.75 x 5 x 31.5	45 x 130 x 800	6000 / 2722	106213-009
1.75 x 5 x 36	45 x 130 x 915	6000 / 2722	106213-002
1.75 x 5 x 39	45 x 130 x 990	6000 / 2722	106213-007
1.75 x 5 x 40	45 x 130 x 1015	6000 / 2722	106213-011
1.75 x 5 x 42	45 x 130 x 1065	6000 / 2722	106213-003
1.75 x 5 x 43.31	45 x 130 x 1100	6000 / 2722	106213-010
1.75 x 5 x 45	45 x 130 x 1145	6000 / 2722	106213-008
1.75 x 5 x 48	45 x 130 x 1220	6000 / 2722	106213-004
1.75 x 5 x 54	45 x 130 x 1370	6000 / 2722	106213-005
1.75 x 5 x 60	45 x 130 x 1525	6000 / 2722	106213-006
1.75 x 5 x 72	45 x 130 x 1830	6000 / 2722	106213-012
1.75 x 5 x 36	45 x 122 x 915	6500 / 2948	147261-002*
1.75 x 5 x 42	45 x 122 x 1065	6500 / 2948	147261-003*
1.75 x 5 x 48	45 x 122 x 1220	6500 / 2948	147261-004*
1.75 x 5 x 60	45 x 122 x 1525	6500 / 2948	147261-006*

\* Do Not Have Fork Tip Indicators

## Fork Dimensions

Note: Dimensional diagram applies to all Stockpicker forks.

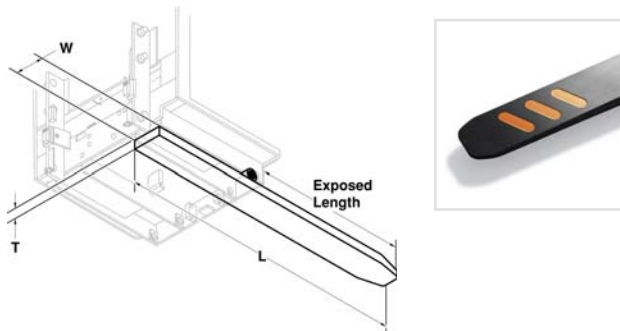

## TS Forks

Dimensions T x W x L - in	Dimensions T x W x L - mm	Part Number
2 x 4 x 30	50 x 100 x 760	089883-001
2 x 4 x 36	50 x 100 x 915	089883-002
2 x 4 x 37.40	50 x 100 x 950	089883-015
2 x 4 x 42	50 x 100 x 1065	089883-005
2 x 4 x 45.28	50 x 100 x 1150	089883-016
2 x 4 x 48	50 x 100 x 1220	089883-008

Note: Order in pairs. Does not include mounting hardware.

## TSP/TSP 6000, 6500, 7000 Forks

Dimensions T x W x L - in	Dimensions T x W x L - mm	Part Number
1.75 x 4 x 30	44 x 102 x 760	108617-014
1.75 x 4 x 36	44 x 102 x 915	108617-004
1.75 x 4 x 37.40	44 x 102 x 950	108617-015
1.75 x 4 x 42	44 x 102 x 1065	108617-005
1.75 x 4 x 45.28	44 x 102 x 1150	108617-016
1.75 x 4 x 48	44 x 102 x 1220	108617-006

## Stockpickers Manufactured (1986 to Present)

Dimensions T x W x L - in	Dimensions T x W x L - mm	Exposed Length in / mm	Part Number
2 x 4 x 60.5	50 x 100 x 1540	30 / 760	102476-001
2 x 4 x 66.5	50 x 100 x 1690	36 / 915	102476-002
2 x 4 x 69.5	50 x 100 x 1765	39 / 990	102476-010
2 x 4 x 72.5	50 x 100 x 1840	42 / 1070	102476-003
2 x 4 x 75.5	50 x 100 x 1920	45 / 1145	102476-009
2 x 4 x 78.5	50 x 100 x 1995	48 / 1220	102476-004
2 x 4 x 84.5	50 x 100 x 2145	54 / 1370	102476-005
2 x 4 x 90.5	50 x 100 x 2300	60 / 1525	102476-006
2 x 4 x 102.5	50 x 100 x 2605	72 / 1830	102476-007
2 x 4 x 114.5	50 x 100 x 2910	84 / 2135	102476-008

## Stockpicker Tubular Forks (Use with Platform Load Decks)

Dimensions T x W x L - in	Dimensions T x W x L - mm	Exposed Length in / mm	Part Number
3 x 6 x 114	76 x 152 x 2900	84 / 2135	141114-001

Note: Order in pairs. Does not include mounting hardware.

## Did you know?

OSHA states that forks worn beyond 10% of their original thickness should not be returned to service.



## Fork Wear Calipers

Part Number - 107330

Used to gauge minimum fork thickness and maximum bore size.



360036-029



360036-055

360036-086



Cascade Part No.	Crown Part No.	Description
2375	360036-364	Fitting
2451	360036-528	Fitting
2453	360036-339	Fitting
2492	360036-702	Fitting
2617	360037-302	Nut
2669	360036-961	Fitting
2680	360036-359	Fitting
2705	360036-581	O-Ring
2710	360036-724	O-Ring
2718	360037-307	O-Ring
2785	112016	O-Ring
2803	360037-306	O-Ring
2840	360036-500	O-Ring
2841	360037-019	O-Ring
2843	360037-018	O-Ring
3128	360036-405	Retaining Ring
3140	360036-743	Retaining Ring
3154	360036-396	Retaining Ring
3557	360036-920	Capscrew Hex Head
4305	360036-046	Capscrew
4466	360036-113	Capscrew
4468	360037-166	Capscrew
4472	360037-167	Capscrew
4504	360037-168	Capscrew
4506	360036-369	Capscrew
4671	360036-387	Capscrew
4672	360036-051	Capscrew
4673	360036-174	Capscrew
4674	360036-007	Capscrew
4751	360036-561	Capscrew
4772	360036-389	Capscrew
4780	360036-061	Capscrew
4880	360036-671	Capscrew
5718	360036-411	Nut
5721	360037-303	Nut
5930	360036-109	Nut
6095	360036-955	Esna Nut
6205	360036-602	Washer
6229	360036-045	Washer
6234	094027	Washer
6372	360037-121	Washer
6444	360036-060	Washer
6447	360036-770	Washer
6455	360036-078	Washer
6510	360036-227	Pin
6513	360037-034	Pin
6517	360036-631	Pin
6525	360036-414	Pin
6609	360036-504	Plug
6688	360037-202	Elbow
7189	360036-397	Retaining Ring
7190	360036-452	Retaining Ring
7202	094016	Snap Ring
7217	360036-742	Retaining Ring
7401	360037-208	Fitting
7403	116877	Grease Fitting
7861	360037-064	Roll Pin
7891	360037-061	Roll Pin
7912	360036-507	Roll Pin

Cascade Part No.	Crown Part No.	Description
7917	360037-062	Roll Pin
7962	360037-063	Roll Pin
8007	360036-065	Rivet
8603	360036-672	Capscrew
15241	360036-499	Nut
15797	360036-070	Pad
15807	360037-037	Plate
15809	360036-075	Pin
200006	360037-016	Nut
200007	360037-014	Nut
200016	360036-623	Hose
200173	360036-017	Capscrew
200255	360037-173	Coil
200504	360036-052	Capscrew
200590	360036-009	Bushing
200647	360036-034	Tube
200648	360036-123	Tube
200649	360036-072	Tube
200816	360037-356	Ring Gear Assm Kit
200877	360036-066	Drive Pin
200882	360036-470	Capscrew
201260	360037-332	Platen Spacer Kit
201467	360037-250	Hose
201816	360036-439	Washer Disk
202346	360036-704	Flat Washer
202348	360036-771	Washer
203112	360036-041	Fork Pin Kit
203405	360036-026	Capscrew
203406	360036-219	Capscrew
204134	360037-049	Relief Cartridge
204137	360036-463	Bronze Bearing
204182	126901	Lower Hook Service Kit
204186	360036-707	Hook
204186	116875	Hook Lower
204187	360036-899	Bearing Segment
204187	116873	Bearing Upper
204188	123322	Bearing Lower
204200	360036-698	Cylinder
204201	360037-131	Anchor
204211	360037-240	Hook
204212	360036-894	Bearing
204532	360036-119	Shim
204533	360036-094	Pin
204534	360037-025	Pin
204535	360036-055	Bearing
204604	360036-243	Arm
204625	360037-228	Frame
204634	360036-800	Faceplate
204639	360036-801	Faceplate-48H P/P
204660	360037-294	Motor
204690	360036-248	Arm
204691	360036-244	Arm
204692	360036-264	Arm
204693	360036-229	Arm
204694	360036-167	Arm
204695	360036-021	Pin
204696	360036-160	Pin
204938	360036-053	Setscrew
204968	360037-045	Platen Spacer Kit

Cascade Part No.	Crown Part No.	Description
204977	360037-432	Wire Assembly
204982	360037-175	Coil
205019	360036-242	Frame
205065	360036-149	Pin
205066	360037-074	Shaft
205070	360036-030	Roller Bushed
205075	360036-268	Service Kit
205076	360037-071	Service Kit
205369	360036-738	Restrictor Group
205824	360037-107	Tube
205840	116871-001	Cylinder
205841	360036-251	Cylinder
205842	360036-262	Cylinder
205845	360037-193	Cylinder
205857	360037-039	Plate
205957	360036-042	Hose
205958	360036-056	Hose
206174	360036-419	Capscrew
206383	360036-443	Hose Retrofit
206394	360037-006	Motor Kit
206396	360036-232	Gripper Jaw
206403	360036-531	Gripper Bar
206405	360036-826	Service Kit
206418	360036-988	Hydraulic Motor
206419	360036-640	Shaft Seal Kit
206589	360036-344	Retainer
206591	360037-344	Retainer
206914	360036-274	Lug
206915	360036-127	Bearing
206916	360036-573	Grommet
206917	360037-153	Bearing
206918	360037-428	Valve-Body
206919	360036-768	Valve
206921	360037-214	Flow Control Group
206923	360036-338	Eyebolt
206924	360036-193	Capscrew
206925	360036-379	Pin
206926	360036-356	Clevis Pin
206931	360037-106	Tube
206932	360036-545	Tube
206933	360036-645	Tube
206934	360037-103	Tube
206935	360037-102	Tube
206936	360036-869	Tube
206937	360037-105	Tube
206964	360036-456	Bearing
206969	360036-294	Shim
206991	360036-872	Valve
206997	360036-614	Coil
207042	360037-397	Tube
207043	360036-643	Tube
207184	360036-773	Anchor Bracket
207185	360037-135	Anchor Bracket
207208	360036-964	Fork Carrier
207209	123322	Bearing Lower
207210	360036-838	Pin
207300	360036-725	O-Ring
207304	360036-960	Fitting
207309	360037-400	Tube

Cascade Part No.	Crown Part No.	Description
207310	360037-405	Tube
207314	360036-609	Bracket
207317	360036-791	Cylinder
207425	360036-297	Hose
207552	360036-206	Block Adjustment
207563	360036-819	Hose
207564	360036-979	Hose
207565	360036-818	Hose
207568	360036-816	Hose
207569	360037-253	Hose
207578	360036-140	Hose
208350	360036-549	Bearing
208352	360036-815	Hook Group
208355	360036-741	Retainer
208378	126121	Cap End
208387	360036-896	Bearing
208781	360036-228	Spring
208857	390002-006	Upper Bearing
208858	390002-007	Lower Bearing
208859	360036-054	Pin
208860	360036-084	Wear Tile
208861	360036-510	Shim
208863	360036-432	Shim
208871	360036-928	Contact Pad
208872	360036-236	Contact Pad
208874	360036-785	Contact Pad
208888	360036-289	Half Oval
208900	360036-862	Stabilizer
208904	360036-863	Stabilizer
209016	360036-670	Capscrew
209020	360036-142	Capscrew
209021	360036-769	Washer
209083	360036-460	Bearing Upper
209084	360036-459	Bearing Lower
209119	360036-202	Bearing
209120	360036-194	Bearing Upper
209303	360036-343	Bearing
209305	360036-574	Grommet
209306	360036-521	Block-Adjustment
209308	360036-837	Pin
209310	360036-876	Valve Assembly
209311	360037-424	Valve Body
209384	360037-226	Frame
209394	360037-134	Anchor Bracket
209431	360037-092	Spring Keeper
209433	360037-031	Pin
209487	360036-700	Cylinder
209488	360037-189	Cylinder
209493	360036-945	Cylinder
209494	360036-946	Cylinder
209514	360037-251	Hose
209521	360036-535	Hose
209522	360037-252	Hose
209542	360036-624	Key
209560	360036-147	Wear Gauge ITA II
209561	360036-374	Wear Gauge ITA III
209654	360036-300	Bearing
209667	360036-765	Tube
209668	360037-104	Tube
209669	360036-622	Hose
209737	360037-122	Washer
209738	360036-517	Washer
209740	360037-120	Washer
209771	360036-509	Seal Kit
209850	360037-055	Retainer Half Ring
209909	360036-496	Link Casting

Cascade Part No.	Crown Part No.	Description
209916	360037-002	Link
209921	360037-065	Rubber Pad
209937	360036-860	Spacer
209941	360036-511	Shim
209986	360037-056	Retaining Ring
210080	360036-895	Bearing
210090	360036-101	Seal Kit
210097	360037-182	Cylinder
210117	360036-245	Cylinder
210118	360037-233	Frame
210133	360036-751	Seal Service Kit
210139	360037-269	Hydraulic Motor
210140	360036-120	Bearing Retainer
210154	360036-028	Spring
210161	360036-014	Pin
210179	360036-047	Filler Block
210180	360036-050	Filler Block
210182	360036-958	Filler Block Upper
210183	360036-527	Filler Block Lower
210288	360036-306	Seals
210403	360036-762	Stabilizer LH
210404	360037-387	Stabilizer LH
210406	360036-864	Stabilizer RH
210407	360037-388	Stabilizer RH
210436	360036-492	Hose
210437	360036-981	Hose
210438	360036-980	Hose
210449	360036-313	Hose
210452	360037-072	Service Kit
210489	360036-345	Bar
210490	360036-360	Retainer Ring
210491	360036-311	Hook Casting
210587	360037-084	Spacer
210591	360036-491	Hook
210592	360036-814	Hook
211128	360036-096	Capscrew
211129	360036-353	Bolt
211162	360036-708	Hook Group
211173	360036-547	Lower Hook Grp
211174	360036-161	QD Hook
211175	360037-246	Hook
211179	360036-186	Washer
211180	360036-049	Capscrew
211272	360037-363	Roller Assembly
211277	360037-362	Roller Assembly
211371	360036-606	Anchor Bracket
211379	360036-451	Retainer
211380	360036-431	Retainer
211456	360037-292	Manifold
211689	360036-169	Capscrew
211728	360036-812	Gas Spring
211729	360037-090	Spring
211748	360037-070	Service Kit
211757	360036-302	Tube
211758	360036-080	Tube
211807	360036-803	Fitting
211997	360037-342	Retainer
211998	360037-343	Retainer
212382	360037-199	Dowel Pin
212385	360037-059	Rod End
212559	360036-150	Shim
212569	360036-974	Hook Group
212585	360036-187	Bearing Retainer
212586	360036-218	Bearing Retainer
212632	360036-675	Capscrew
212683	360037-234	Gas Cylinder

Cascade Part No.	Crown Part No.	Description
212687	360036-091	Fork Stop
212709	360036-655	Block
212723	360037-222	Fork Stop
212724	360037-221	Fork Stop
212863	360036-842	Pressure Relief Kit
212867	360037-375	Service Kit
212887	360037-114	Valve Body
212988	360036-197	Paint
212999	360036-312	Center Key
213011	360036-164	Ball Joint
213023	360036-613	Capscrew
213364	360036-577	Key
213652	360037-379	Split Pad
213653	360037-380	Split Pad
213735	360036-116	Bearing Spacer
213736	360037-161	Bracket
213737	360036-904	Bracket
213751	360037-392	T-Bar
213783	360037-165	Cap
213856	360037-096	Tie Rod Service Kit
213899	360036-315	Bearing
213913	360036-216	Shim
214053	360036-032	O-Ring
214301	360036-571	Cylinder
214405	360036-782	Cartridge, X-Over Relief
214414	360036-093	Capscrew
214487	360036-183	Capscrew
214620	360036-526	Cylinder
214622	360036-135	Cylinder
214649	360036-594	Seal
214991	360036-913	Capscrew
215420	360036-386	Decal, Pressure Warning
215756	360037-326	Piston
215876	360037-418	Valve
216691	360036-636	Seal Kit
216838	360036-875	Valve Assembly
217932	360037-178	Converter Kit
217948	360036-998	Lens
217950	360037-284	Lens
217952	360037-285	Lens
218206	360037-242	Hook
218207	360036-813	Hook
218208	360037-085	Spacer
218895	360036-213	Gas Cylinder
218921	360037-338	Rail
219040	360037-216	Flow Divider/Combiner
219316	360037-079	Shim Kit
219400	126844	Fork Stop Kit
219700	360036-966	Gas Cylinder Conv Kit
219703	360036-811	Gas Cylinder
219868	126903	Rod Seal Service Kit
219979	360036-184	Cylinder Gas
220008	360037-051	Retainer
220009	360036-846	Retainer
220135	360037-241	Hook
220138	360037-238	Hook
220139	360037-239	Hook
220143	360037-095	T-Bar
220169	360036-246	Contact Pad
220173	360036-934	Contact Pad
220689	360037-021	Pallet Protector
220760	360037-129	Actuator-Rotary Helical

Cascade Part No.	Crown Part No.	Description
220804	360037-371	Seal Kit
220959	360037-143	Arm LH
220986	360037-245	Hook
220996	360037-011	Mounting Plate
220997	360037-298	Mounting Plate
221088	360036-774	Arm
221280	360036-224	Frame
221304	360036-467	Capscrew
221402	360036-883	Arm
221417	360036-220	Frame
221510	360036-024	Contact Pad
221733	126845	Flow Restrictor, 1.5 mm
221906	146788	Decal Warning
221980	360036-464	Bumper
222369	360036-143	Contact Pad
222700	360037-176	Contact Pad
222703	360036-062	Contact Pad
222707	360036-929	Contact Pad
222719	360036-933	Contact Pad
223679	360037-327	Plate
223680	360036-753	Sheave
223681	360037-152	Bearing
224409	360036-892	Bearing
224459	360036-727	Pigtail Assembly
225345	360036-148	Bearing Retainer
225346	360036-033	Capscrew
225394	360036-965	Fork Control Group
226842	360036-285	Bronze Lower Bearing
227854	360037-235	Guide
227962	360036-371	Eye Pin
228165	390002-002	Lower Bronze Hook
228166	360036-077	Hook
228395	360036-146	Shim
228818	069865	Label Service SS
229350	360037-116	Video Push Pull
229351	360036-878	Video Carton Clamp
230791	360036-334	Retainer
326317	360036-582	Pad
328591	360036-930	Contact Pad
333044	360037-177	Contact Pad
334028	360036-690	Contact Pad
335727	360036-754	Shell
343359	360037-403	Tube
343684	360036-240	Valve Assembly
343685	360037-336	Plugged Assembly
355200	360037-035	Pin, .5 Dia X 10.5 lg
358455	360036-877	Valve Cartridge
360772	360036-748	Rubber Pad
360869	360036-554	Bushing
364238	360036-775	Arm
364239	360037-141	Arm In Sec LH 50" w/ Gr. Fitting
364240	360037-142	Arm Inn Sec RH 50" w/Gr. Fitting
368073	360037-201	Drive Assembly
370156	360037-024	Pin
373321	360036-696	Cylinder
379439	360036-258	Wear Strip
381839	360037-186	Cylinder
389397	360037-331	Platen LH
392589	360036-478	Contact Pad
393961	360037-288	LH Fork Wldmnt,2X6X72,100C
395315	360036-808	Frame
395316	360037-229	Frame
413799	360036-442	Cylinder Retainer

Cascade Part No.	Crown Part No.	Description
416991	360037-359	Rod
503727	360037-028	Pin
550218	360036-006	Locknut
553857	094004	Nut
553861	094020	Seal Kit
553866	360036-827	Seal Kit
554598	360037-066	Seal
554989	360037-372	Seal Kit
555153	360036-695	Cylinder
555156	360036-790	Cylinder
555207	360037-050	Retainer
555227	360036-290	Cylinder Seal Loader Kit
555439	360037-117	Washer
555440	360037-350	Retaining Ring
557212	360036-272	Check Valve
557360	360037-183	Cylinder
557425	360037-271	Kit
558400	360037-324	Piston
558626	360036-744	Rod
559696	360037-052	Retainer
559697	360036-117	Bushing
559698	360036-454	Spacer
559865	360037-305	O-Ring
559866	360037-144	Backup Ring
559972	088465	Seal Kit
559974	360036-715	Seal Kit
560729	360036-106	Service Kit
561256	360037-430	Wiper
561430	360037-374	Service Kit
562055	360036-735	Piston & Rod
562131	116860	Wiper Seal
562338	360036-099	Service Kit
562339	360036-163	Cylinder Seal Loader Kit
562792	360036-590	Retainer
562837	360037-366	Seal
562847	360037-091	Spring
562942	116862	Retaining Ring
562951	116861	Snap Ring
563059	360036-687	Connecting Link
563462	360037-304	Nut
563487	116872	Seal kit
563785	360037-429	Washer
563906	360036-845	Retainer
564160	360037-325	Piston
564185	360036-798	Cylinder Rod
564193	360036-304	Rod End
564195	360037-357	Rod
564409	360036-453	Service Kit
564452	360036-593	Rod End
564453	360036-495	Service Kit
580029	360036-948	Cylinder
580137	360037-184	Cylinder
582635	360036-260	Cylinder
582636	360036-481	Cylinder
583942	360036-699	Cylinder
583943	360036-255	Cylinder
583944	360036-796	Cylinder
583951	360036-254	Cylinder
583952	360036-795	Cylinder
583970	360036-701	Cylinder
583971	120042	Cylinder 36"
583972	360037-188	Cylinder
584001	360036-944	Cylinder
584003	360037-191	Cylinder

Cascade Part No.	Crown Part No.	Description
599474	360037-005	Lubricant
600312	360036-522	Bushing
600313	360036-336	Bushing
600316	360037-314	Pin
600318	360036-131	Pin
600319	360036-335	Spring
601377	360036-529	Fitting
601676	360036-212	Fitting
601975	360036-656	Bushing
601976	360036-657	Bushing
602025	360036-158	Wear Plate
602579	360037-333	Plug
602580	360036-103	Plug
603722	360036-977	Hose
604510	360036-393	Plug
604511	360036-121	Fitting
605235	360036-217	Adapter
605743	360036-488	Fitting Adapter
607059	360036-407	Capscrew
607084	360036-665	Capscrew
607085	360036-469	Capscrew
607102	360036-382	Capscrew
607103	360036-203	Capscrew
607105	360036-112	Capscrew
609234	360037-335	Plug
609453	360037-334	Plug
611288	360036-189	Fitting
614089	360036-859	Solenoid Valve 12V
614092	360036-641	Solenoid Valve 36V
614093	360037-081	Solenoid Valve 48V
615122	360036-455	Backup Ring
615128	112017	Backup Ring
615154	360037-145	Backup Ring
615492	360037-297	Mounting Group
617641	360036-703	Fitting
617915	094009	Fitting
617917	360037-207	Fitting
617918	360036-340	Fitting
619235	360036-284	Fitting
621248	360036-129	Bushing
622674	360036-886	Arm Base
622675	360037-140	Arm Base
622907	360036-057	Pin
622908	360036-063	Spring
624394	360036-992	Keeper
625497	360037-147	Bar
626468	360037-431	Wiper
627459	360037-296	Mounting Group
629996	360036-271	Pad
630148	360037-022	Pin
631881	360036-107	Shim
633523	360036-401	Capscrew
636853	360036-390	Rod Wiper
638243	360036-384	Nylon Ring
638601	360036-523	Capscrew
639121	360036-211	Capscrew
639277	360036-192	Bushing
640013	360036-681	Capscrew
640699	360036-560	Capscrew
641956	360037-273	Seal Kit
643352	360037-017	O-Ring
643368	360036-836	O-Ring
643423	360036-445	O-Ring
643538	360036-917	Capscrew
643539	360036-391	Capscrew
644010	360036-843	Relief Fitting

PTH 50, Chain, Forks and Attachment Parts

Cascade Part No.	Crown Part No.	Description
645982	106470	Plug Spring Retaining Nut
645986	360036-580	Nut
645988	081716	Flange
646062	360037-209	Fitting Group #6
646067	081717	Flange
646068	360037-211	Flange
646075	081719	Hose Guide
646246	081731	Mounting Block
646249	081721	Spring Asm
646250	081718	Spring Asm
646305	360037-275	Seal Kit
646318	360037-205	Fitting
646339	081725	Service Kit
646340	360036-829	Seal Kit
646607	081722	Divider
647626	360036-508	Seal Kit
649055	081730	Felt Seal
649106	106473	Screw
650587	360036-778	Bolt
650844	360036-729	Pin
650845	360037-089	Spring
650846	360037-318	Pin
651090	360037-080	Shoulder Bolt
651113	360036-199	Plug
651876	360036-995	Shaft Service Kit
655949	360036-629	O-Ring
656038	360036-159	Decal
656223	360037-277	Service Kit, Cartridge Seals
657682	360036-880	Anchor
658378	360036-848	Retainer
658749	360036-828	Seal Kit
658947	360037-427	Valve Kit
659058	360036-223	Cartridge Valve
659828	360036-493	Junction Block
659889	360036-683	Capscrew
659917	360037-349	Retainer Spring
660024	360037-274	Seal Kit
660051	360037-076	Sheave Assembly
660176	360037-317	Pin
660200	360036-191	Shim
660203	360036-978	Hose
660412	129429	4-Position Pressure Relief
660414	360036-341	Connector
660418	088464	Rod
660628	360036-734	Pin
660633	360036-685	Chain Anchor
660954	360036-714	Cylinder Service Kit
660955	360037-369	Seal Kit
661031	360037-010	Mounting Group
661212	360036-221	Spring
661347	360036-996	Service Kit
661549	360036-746	Roller
661675	360036-732	Pin
661742	360036-919	Capscrew
661816	360036-684	Cartridge Valve
662145	360036-283	Roller Assembly
662187	360036-487	Fitting
662377	360036-314	Junction Group
662383	360036-909	Cable Assm, Electric 196" lg
662448	360036-350	Seal
662449	360037-367	Seal
663011	360036-441	Cable Assm-Electric, 276" lg

Cascade Part No.	Crown Part No.	Description
663091	360037-068	Seal Kit
663694	360036-632	Plug
663728	360036-853	Piston Seal
664206	360036-279	Roller
664885	360037-088	Spring
664886	360037-384	Spring Assembly
665046	360036-565	Coil 36V
665047	360037-174	Coil
665327	360036-381	Capscrew
665595	360036-027	Decal
665641	360036-578	Nut
665681	360036-781	Cable Hose Assembly
665682	360036-911	Cable Hose Assm 284" lg
665683	360036-534	Hose
665707	360036-723	Nut
665712	360036-502	Pin
665801	360037-027	Pin
666183	360036-628	O-Ring
666984	360036-175	Fitting
667222	360037-206	Fitting
667225	116876	Washer
667350	360037-276	Cylinder Seal Kit
667358	360036-506	Roll Pin
667369	360036-373	Capscrew
667370	360036-533	Hook
667371	360036-972	Hook
667471	360036-861	Spool
667475	360037-420	Valve Assembly
667487	360036-362	Spring
667488	360036-761	Spring
667490	360036-805	Fitting Special
667491	360036-599	Sleeve
667492	360036-588	Poppet
667494	360036-486	Fitting
667510	360037-282	Service Kit
667513	360036-310	Service Kit
667516	360036-357	Seal Kit
667624	360036-039	Retainer
667625	360036-058	Nut
667626	360036-155	Washer
667659	360037-230	Frame
667661	360036-317	Bearing
667662	360036-308	Bearing
667663	390002-009	Bearing
667667	360036-591	Retainer
667668	360036-721	Nut
667675	360037-340	Retainer
667676	360036-342	Washer
667678	360037-109	Tube
667699	360036-706	Hex Extension Tool
667705	360036-870	Tube
667706	360037-411	Tube
667723	360036-542	Service Kit
667765	360036-669	Capscrew
667843	360036-010	Pop Rivet
667904	360037-231	Frame
667906	360036-137	Bearing
667907	360036-136	Bearing
667909	360036-370	Capscrew
667910	360036-092	Washer
667911	360036-525	Cylinder
667914	360037-358	Rod
667917	360037-341	Retainer
667995	360036-086	Seal Kit
668020	360037-237	Hex Extension

Cascade Part No.	Crown Part No.	Description
668021	360036-069	Service Kit
668031	360036-409	Nut
668861	360037-113	Valve Assembly
668865	360037-422	Valve Assembly
668898	360037-119	Washer
668914	360037-426	Valve Group
668925	360036-428	Nut Kit
668926	360036-118	Cylinder Nut Kit
669152	360036-799	Decal
669305	360036-472	Capscrew
669344	360037-279	Stop Block Kit
669597	130765	Seal Kit
669651	360036-555	Cable Kit
669654	360036-780	Cable Harness
669694	360036-166	Shim
669704	360036-583	Pad
669708	360036-942	Contact Surface
669710	360036-786	Contact Pad
669711	360036-931	Contact Pad
669712	360036-170	Contact Pad
669762	360036-201	Valve Assembly
669766	360036-887	Backrest
669894	360036-085	Retaining Ring
669935	360036-927	Cont Pit 48X29.75-1428
669939	360036-566	Contact Pad
669957	360037-130	Adaptor
670386	360037-383	Spring
670393	360036-888	Bar
670468	360036-999	Lever
670515	360037-365	Seal
670523	360037-243	Hook
670524	360037-244	Hook
670526	360037-038	Plate
670539	360037-046	Plunger
670540	360036-967	Gland
670556	360037-323	Pinion
670563	360037-293	Manifold Plate
670575	360036-530	Gasket
670579	360036-893	Bearing
670582	360037-270	Key
670891	360037-036	Piston
670931	360037-067	Seal Felt
671047	360036-639	Seal Loader, Piston
671048	360036-444	Seal Loader Kit
671051	360036-638	Seal Loader, Retainer
671165	094001	Bearing Segment
671212	360037-337	Pressure Gauge Grp
671423	112004	Service Kit
671476	360036-806	Flow Meter Kit
671477	360037-217	Flow Meter Kit
671512	360037-404	Tube
671545	360036-273	Bumper
671549	360036-809	Frame
671566	360037-108	Tube
671569	360037-407	Tube
671570	360036-241	Cylinder
671571	360036-200	Cylinder Rod
671573	360036-182	Cylinder
671574	360036-596	Shell Assembly
671588	360036-650	Arm
671590	360036-649	Arm
671591	360037-137	Arm
671618	360036-941	Contact Pad Group
671626	360036-692	Contact Plate
671757	360036-394	Shim



Cascade Part No.	Crown Part No.	Description
671758	360036-398	Shim
671851	360036-457	Bearing
671852	360036-458	Bearing
672018	112006	Segment Bearing
672022	360037-158	Bearing Service Kit
672040	360037-127	Actuator
672041	360037-128	Actuator
672043	360036-461	Bell Crank Assembly
672045	360036-415	Washer
672047	360036-130	Spring
672050	360037-179	Cover
672181	360036-730	Pin
672223	360036-731	Pin
672285	360036-589	QD Kit
672326	360036-494	Locking Pin Service Kit
672331	360036-779	Bumper
672482	360036-851	Ring Gear Kit
672540	360036-757	Sleeve
672543	360037-376	Shaft
672547	360037-268	Hub
672563	360036-337	Thinline Hose Reel Service Kit
672567	360037-212	Flange
672568	360037-210	Flange
672569	360037-213	Flange
672570	360036-984	Hose Reel Assembly
672572	360036-820	Hose Reel Assembly
672573	360037-255	Hose Reel Assembly
672574	113253	Hose Reel
672575	360036-822	Hose Reel Assembly
672576	360036-821	Hose Reel Assembly
672577	360036-985	Hose Reel Assembly
672609	360036-651	Bearing
672610	360036-652	Bearing
672712	360036-018	Pad - Gripper
672726	094021	Pin Cotter
672904	360037-281	Seal Loader Kit
672909	360036-997	Seal Loader Kit
672926	360037-311	Pin
672932	360036-691	Contact Pad
672991	360036-710	Hose
672994	360036-709	Hose
673061	360036-907	Bushing
673062	360037-057	Retaining Ring
673063	360036-918	Capscrew
673064	360037-381	Spool
673089	360036-544	Spool Assembly
673098	360036-435	Spring
673385	360036-068	Pin
673393	360037-267	Hose, 5500606040404 Twin-154"
673394	360037-254	Hose - Twin
673395	360036-281	Hose - Twin
673428	360036-922	Clamp
673459	360036-064	Drive Pin
673496	360036-536	Hose Terminal Connector
673497	360036-986	Hose Terminal Down Kit #8
673561	360037-262	Hose Reel, #4-11 LH (672571)
673563	360037-259	Hose Reel #6-13 LH, Basic 672573
673564	113353	Hose Reel Kit #6 RH
673565	113354	Hose Reel Kit #6 LH

Cascade Part No.	Crown Part No.	Description
673566	360036-823	Hose Reel Group #8 16" RH
673592	360037-257	Hose Reel Hyd Supply Grp #4 11
673594	360036-987	Hyd Supply Grp, (Basic 672572)
673596	360037-256	Hose Reel Hsg #6-16 RH
673598	360037-258	Hose Reel Hyd Supply Grp #8 RH
673872	360037-094	Switch Assembly
674051	360037-395	Tube
674141	360036-267	Wear Tile Kit
674168	360036-619	Frame
674191	360036-179	Pin Kit
674252	360036-663	Capscrew
674256	360037-033	Pin
674261	360036-914	Capscrew
674265	360036-372	Pin
674288	121365	Hose Terminal Up Connection
674298	360036-512	Shim
674313	360037-249	Hose
674319	360037-412	Tube
674356	360036-516	Tube End
674378	360036-275	Pin
674424	360037-309	O-Ring Extractor Kit
674449	360037-266	Hose Terminal-Down Kit
674700	360036-625	Link Casting
674701	360036-215	Pin
674702	360036-788	Contact Pad
674705	360037-138	Arm
674769	360036-882	Arm
674806	360037-280	Service Kit
674827	360036-327	Retainer
674837	360036-383	Shim
674840	360036-325	Bushing
674843	360036-465	Bushing
674928	360036-844	Repair Kit
674993	360036-585	Pin
675055	360036-196	Hose
675287	360037-433	ZZ Kit 6 4 Port
675326	360036-122	D-Series Carton Clamp Arm Bar Bearing Shim Kit
675514	360036-029	Hook
675515	360036-040	Guide
675548	112000	Sideshift Cylinder
675550	112014	Washer
675610	106472	Snap Ring
675614	360036-110	Wear Tile
675620	360036-011	Washer
675621	360036-866	Tip
675624	360036-865	Tip
675626	360036-309	Bushing Driver
675637	360036-551	Bearing Service Kit
675662	360036-320	Bearing
675852	111999	Bracket Anchor
675854	112005	Bearing Set Lower
675854	94024	Bearing Holder
675942	360037-295	Mounting Group
675957	360036-970	Hook
675958	360036-968	Guide
675968	360036-067	Hook
675969	360036-288	Hook
676006	360037-151	Base Plate

Cascade Part No.	Crown Part No.	Description
676037	360037-082	Spacer
676069	360036-352	Shim
676070	360036-347	Shim
676092	360037-172	Check Valve
676110	360037-054	Retainer
676280	360036-190	Hook
676281	360036-579	Nut
676328	360036-238	Contact Pad
676329	360037-385	Stabilizer
676331	360037-386	Stabilizer
676650	360036-653	Bearing
676704	360037-148	Bar
676841	360036-537	Contact Pad Mtg Hole Sleeve Kit
676868	360036-936	Contact Pad
676873	360036-567	Contact Pad
677093	360036-858	Shim
677094	360036-433	Shim
677112	360036-071	Switch Assembly
677124	360036-873	Valve
677125	360036-647	Valve
677160	112003	Hook Lower
677205	360036-100	Pin
677206	360037-313	Pin
677267	360037-075	Sheave
677280	094026	Hook Lower
677828	360036-210	Capscrew
677833	106471	Seal Kit
677836	360037-126	6-N-1 Hose Reel (669660) RH
677837	360037-125	6-N-1 Cable Hose Reel 14.5" LH
677844	360036-879	6-N-1 Hose Cable Reel 16.5" RH
678019	360037-015	Nut
678027	360036-817	Hose
678034	112008	Hook Lower
678036	360036-694	Cylinder Nut Kit
678270	360036-277	Valve
678525	112001	Pin Clevis
678528	360036-540	Pin
678588	360036-908	Bushing Driver
678598	360037-378	Spanner Wrench
678661	360036-686	Chain Anchor
678665	360036-176	Wear Tile
678666	360036-177	Wear Tile
678667	360036-503	Pin
678832	360036-004	Pin
678833	360036-250	Hook Group
678934	360036-287	Hook Group
678935	360037-248	Hook Group
678942	360036-097	Capscrew
678986	360036-777	Bearing
678988	360036-505	Ring
678990	360036-375	Nut
678991	360036-403	Lockwasher
678992	360036-626	Lockwasher
678996	360036-558	Capscrew
679059	360037-198	Decal
679060	360037-203	Electric Cable Reel RH 11.5
679150	360036-079	Decal
679532	360037-261	Hose Reel, RH Single Line H2R
679534	105500	Reel Hose
679535	105501	Reel Hose
679542	106655	Hose Reel Right

PTH 50, Chain, Forks and Attachment Parts

Cascade Part No.	Crown Part No.	Description
679543	106654	Hose Reel Left
679808	360037-077	Shim
679812	360036-584	Pin
679827	360036-556	Capscrew
679846	360036-514	Spool Assembly
679992	360037-370	Seal Kit
679994	119732	Junction Block-Right
679995	119731	Junction Block-Left
679997	360036-634	RH Junction Block #8
679998	360036-830	LH Junction Block #8
680023	360037-247	Hook Group
680031	360036-939	Contact Pad
680032	360036-446	Pin
680033	360037-001	Link
680062	360036-854	Service Kit
680086	360037-149	Bar
680115	360036-712	Hose
680217	360036-832	Lockwasher
680218	360036-563	Capscrew
680253	360036-019	Lockwasher
680441	360037-290	Long Arm
680461	360036-975	Hose
680470	360037-136	Arm
680488	360036-792	Cylinder
680623	360037-012	Mounting Plate
680624	360037-013	Mounting Plate
680630	360037-009	Mounting Group
680632	360037-008	Mounting Group
680640	360037-315	Pin
680688	360037-007	Mounting Group
681047	360036-912	Capscrew
681473	360036-173	Spring Washer
681585	360036-366	Seal Kit
681595	360037-272	Side Thrust Roller Service Kit
681778	360036-586	Pin Kit
681780	360036-234	Pin Kit
681786	360036-171	Pin Kit
681787	360036-448	Pin Kit
682067	360037-087	Spacer Center
682068	360036-758	Spacer
682170	360036-637	Seal Kit
682543	360036-884	Arm
682550	360036-519	Anchor Bracket
682554	360036-605	Anchor Bracket
682557	360037-132	Anchor Bracket
682814	360036-156	Bearing
682819	360036-728	Pin
682820	360037-312	Pin
682821	360036-322	Pin
682822	360036-282	Pin
682823	360036-198	Pin
682824	360036-323	Pin
682825	360036-326	Pin
682826	360036-226	Pin
682827	360037-023	Pin
682844	360036-195	Cylinder
682850	360036-332	Stop
682851	360036-303	Hook
682991	360036-601	Tube
682992	360036-318	Tube
682994	360037-401	Tube
683142	360036-468	Capscrew
683149	360036-354	Bushing
683150	360036-346	Bushing
683151	360036-207	Bushing

Cascade Part No.	Crown Part No.	Description
683152	360036-349	Bushing
683153	360036-016	Bearing
683154	360036-022	Bushing
683155	360036-105	Bushing
683157	360036-154	Shim
683158	360036-377	Shim
683159	360036-172	Shim
683160	360036-153	Shim
683161	360036-020	Shim
683162	360036-013	Shim
683163	360036-115	Shim
683164	360036-087	Shim
683165	360036-333	Spacer
683170	360036-015	Nut
683173	360036-108	Hose
683178	360036-295	Hook Group
683179	360036-249	Hook Group
683182	360036-012	Capscrew
683186	360036-319	Tube
683187	360036-515	Tube
683188	360036-269	Pivot Hook
683189	360036-036	Pin
683199	360037-330	Platen Group
683200	360036-261	Platen
683201	360036-252	Platen
683203	360036-839	Platen
683204	360036-840	Platen
683218	360037-083	Spacer
683225	360037-396	Tube
683226	360037-398	Tube
683234	360037-181	Cylinder
684586	360036-048	Spring Washer
684625	360037-283	Seal Kit
684649	360036-403	Capscrew
684659	360036-090	Capscrew
684827	H01000-359	Service Kit
684873	360036-483	Decal
684956	360036-772	Wire Tie
685127	360037-086	Spacer
685533	360036-276	Hook
685534	360036-557	Capscrew
685607	360036-971	Hook
685661	360036-204	Capscrew
685663	360037-058	Rod
685664	360037-346	Retainer
685677	360036-181	Capscrew
685743	360037-329	Platen
685744	360037-328	Platen
685752	360037-042	Platen
685753	360036-736	Platen
685767	360037-040	Platen
685768	360037-041	Platen
685831	360036-104	Hose
685978	360036-074	Hose
686081	360037-159	Block Nut
686214	360037-030	Pin
686215	360036-784	Clevis Pin
686217	360036-789	Cotter Pin
686240	360037-133	Anchor Bracket
686243	360037-185	Cylinder
686414	360036-559	Capscrew
686415	360036-392	Capscrew
686465	360036-412	Gasket
686503	360037-417	Valve
686509	360037-110	Tube
686510	360036-871	Tube

Cascade Part No.	Crown Part No.	Description
686513	360036-764	Tube
686514	360036-644	Tube
686515	360037-408	Tube
686516	360037-410	Tube
686573	360036-025	Bearing
687301	360037-204	End Block
688379	360036-180	Shim
688386	360036-233	Hook
688698	360036-982	Hose
688935	360036-983	Hose
689151	360036-666	Capscrew
689279	360036-575	Hook
689280	360036-621	Hook
689900	360036-430	Plug
689937	360037-308	O-Ring
741126	360037-171	Check Valve
751511	360036-351	Capscrew
751525	360036-380	Capscrew
752903	360036-133	Capscrew
753159	360036-476	Capscrew
762900	360036-413	Capscrew
763021	360036-673	Capscrew
763024	360036-915	Capscrew
763025	360036-185	Hex Nut
763166	360036-916	Capscrew
763169	360036-524	Capscrew
765329	360036-098	Capscrew
766154	360036-474	Capscrew
766646	360036-008	Capscrew
766929	360036-399	Capscrew
767439	360036-035	Capscrew
767614	360036-422	Capscrew
767615	360036-404	Bolt
767961	360036-023	Capscrew
768208	360036-421	Capscrew
768303	360036-388	Capscrew
768414	360036-611	Capscrew
768520	360036-420	Capscrew
768529	360036-677	Capscrew
768554	360036-145	Capscrew
768556	360036-674	Capscrew
768558	360036-680	Capscrew
768577	360036-368	Capscrew
768684	360036-682	Capscrew
768685	360036-348	Capscrew
768697	360036-473	Capscrew
768704	360036-043	Capscrew
768705	360036-059	Capscrew
768706	360036-001	Capscrew
768710	360036-083	Capscrew
768712	360036-667	Capscrew
768714	360036-037	Capscrew
768759	360037-073	Setscrew
768785	360036-562	Capscrew
768795	360036-475	Capscrew
768802	360036-676	Capscrew
768827	360036-141	Capscrew
768837	360036-168	Capscrew
768838	360036-612	Capscrew
768953	360036-395	Pin
769009	360036-235	Roll Pin
769014	360037-361	Roll Pin
769016	360036-410	Roll Pin
769573	360036-376	Capscrew
769574	360036-363	Capscrew
769577	360036-361	Capscrew

Cascade Part No.	Crown Part No.	Description
769578	360036-138	Capscrew
773842	360036-002	Nut
775552	360037-180	Cover Machined
779009	360036-209	Capscrew
779010	360036-076	Capscrew
781422	360036-543	Setscrew
781534	360036-722	Nut
783608	360036-678	Capscrew
783609	360036-749	Seal
783800	360037-301	Nut
787372	360036-044	Capscrew
787375	360036-005	Capscrew
787383	360036-518	Washer
787398	360036-081	Washer
795492	360037-200	Drive Assembly
797610	360036-760	Spacer Upper
797611	360037-377	Spacer Lower
804065	360036-298	Bearing Segment Upper
825751	360037-112	Valve
827203	360036-906	Bushing
836707	360037-123	Wear Strip
836995	360036-259	Platen Tip Kit
838612	360037-355	RH Fork 1.5 X 5 X 48
838613	360037-287	LH Fork 1.5 X 5 X 48
844527	360037-236	Handle Kit
849642	360036-750	Seal Kit
1134076	360037-310	Pin
1134452	360037-197	Cylinder Bushings
1134457	360036-747	Rubber Pad
1188538	360037-048	Radio Transmitter
3008466	360036-482	Cylinder Assembly
3008467	360036-480	Cylinder
3008477	360036-151	Hose
3008478	360036-713	Hose Assembly
3008505	360036-857	Shim
3008506	360036-856	Shim
3008508	360036-576	Hook-Outsides Order w/ 3008504
3008509	360036-597	Shim
3008510	360036-598	Shim
3008564	360037-390	Stop
3008566	360036-868	Tube
3008567	360036-867	Tube
3008584	360036-423	Contact Pad
3008657	360036-485	Feeder Tube
3008658	360036-763	Tube
3010449	360036-745	Rod End
3010450	360036-635	Rod End
3010451	360037-319	Pin
3011636	360036-697	Cylinder
3011638	360037-360	Rod, S-10494.1 S-10496.1
3012691	360036-720	Nut
3013267	360037-169	Carriage
3014870	360037-364	Seal
3016157	360037-215	Flow Divider Valve Assembly
3016175	360036-479	Contact Pad
6000359	360036-924	Coil 48V
6001138	360036-926	Conduit With Adaptor
6001555	360036-111	Washer
6001637	360036-642	Switch
6002106	360036-301	Coil
6002109	360036-165	Hose Assembly
6002135	360036-265	Valve

Cascade Part No.	Crown Part No.	Description
6002138	360036-031	Hose
6002139	360036-038	Hose
6002142	360036-426	Faceplate
6002330	360036-532	Hook
6002591	360036-949	Cylinder
6003377	360036-932	Contact Pad
6003464	360037-029	Pin
6003660	360037-026	Pin
6003718	360036-152	Retaining Ring
6003951	360036-937	Contact Pad
6004656	360036-538	LH Platen
6004657	360036-592	RH Platen
6004779	360036-427	Hook
6006759	360036-553	Bushing
6007221	360036-570	Cylinder
6008358	360037-164	Bumper Assembly
6009164	360037-373	Seal Kit
6009379	360036-513	Spacer
6009928	360037-391	Switch
6012866	360036-539	Mounting Group
6013405	360036-646	Tube
6013406	360037-101	Tube
6013409	360036-957	Feeder Tube
6013417	360037-402	Tube
6014089	360036-088	Pin
6014935	360036-162	Rubber Wear Strip
6017490	360037-348	Retainer Assembly
6017682	360037-124	Wear Strip
6018494	360036-237	Frame
6019053	360036-804	Fitting
6019954	360036-299	Spacer - QFM Platens
6020048	360037-196	Cylinder
6020412	360036-447	Pin
6020429	360036-003	Eye Pin
6020443	360036-157	Cylinder Assembly
6020444	360036-132	Cylinder Assembly
6020451	360036-477	Collar
6020458	360036-256	Cylinder
6020459	360036-253	Cylinder
6020462	360036-126	Collar
6020463	360036-400	Retaining Ring
6020486	360036-902	Bearing Service Kit
6020486	131989	Upper Bearing Composite
6020745	360036-688	Contact Pad
6021069	360036-615	Converter
6022761	360037-099	Tube
6022767	360036-802	Feeder Tube
6023093	360037-111	Tube - Sht SV/LF TM
6024293	360037-425	Valve Flow Divider
6024522	360037-352	Revolving Connection
6024818	360037-339	Restrictor Washer
6025134	360036-231	Check Valve
6025243	360037-320	Pin Kit
6025244	360037-321	Pin Kit
6025580	360037-353	Revolving Connection
6025682	360036-950	Cylinder
6025683	127572	Sideshift Cylinder
6025684	126841-001	Cylinder Asm 34.5", 38"
6025685	360036-270	Cylinder
6025686	126841-002	Cylinder Asm 44"
6025687	360037-195	Cylinder
6025987	360037-351	Rev Conn Seal Kit
6026274	360037-192	Cylinder
6026296	360037-069	Seal Kit

Cascade Part No.	Crown Part No.	Description
6026956	360036-733	Pin
6028757	360036-280	Filler Block Order As A Set
6029740	360036-278	Filler Block Order As A Set
6030548	360036-990	Inst Hose Assembly
6030557	360036-824	Inst Hose Assembly
6030606	360036-139	Hose
6032091	360037-187	Cylinder
6033386	360036-603	Wear Strip
6033485	390001-001	Upper Bronze Slide
6033486	360036-230	Bearing Service Kit
6033487	131990	Lower Bearing Composite
6033643	360036-976	Hose
6034401	360037-044	Platen
6034405	360037-043	Platen
6034408	360036-737	Platen
6034873	360036-450	Push/Pull Driver Training
6035056	360036-810	Function Labels
6035990	360037-421	Valve Assembly
6038603	360036-940	Contact Pad
6038929	360036-292	Valve Cartridge
6039179	360037-060	Rod Seal - 15mm Rod
6040801	360036-471	Capscrew
6042658	360036-633	Restrictor Fitting
6042689	360036-618	Fitting Adapter
6042830	360036-705	Half Ring
6043332	360036-489	Fitting Adapter
6043535	360036-321	Driver Training & Features DVD
6044120	360036-793	Cylinder
6044555	360036-787	Contact Pad
6044561	360036-424	Contact Pad
6045015	360036-847	Retainer
6045496	360037-415	Tube
6047151	360036-679	Capscrew
6047530	360036-767	Tube
6047717	360036-689	Contact Pad
6048960	360037-170	Cartridge w/ Relief
6048983	360036-434	Shim Kit
6050000	360037-227	Frame
6050227	360037-347	Retainer
6050414	360037-345	Retainer
6051249	390002-004	Upper Slide
6051665	360036-291	Service Kit
6052038	360036-239	Contact Pad
6052709	360036-969	Head
6052742	360037-416	Valve
6053498	360037-100	Tube
6053896	360036-766	Tube
6054844	360037-413	Tube
6054916	360037-220	Fork Positioner
6054925	360036-546	Tube
6054991	360037-389	Stabilizer RH
6055020	360036-726	Pad
6055245	360036-144	Contact Pad
6055389	360036-616	Cylinder Service Kit
6055842	360037-163	Bumper
6056137	360037-414	Tube
6056142	360037-409	Tube
6056535	360036-835	Mounting Plate RH
6056651	360036-572	Frame
6057018	360036-935	Contact Pad
6057162	390002-005	Lower Slide

PTH 50, Chain, Forks and Attachment Parts

# Cascade Cross Reference

PTH 50, Chain,  
Forks and  
Attachment Parts

Cascade Part No.	Crown Part No.	Description
6057546	360036-214	Pin
6057565	360036-114	Contact Pad
6059195	360037-162	Bumper
6059589	360036-719	Nameplate Service Kit
6060988	360036-938	Contact Pad
6061486	126841-004	Cylinder Asm
6061953	360036-617	Filter
6061983	360036-874	Valve Assembly
6063316	360036-783	Check Valve Assm
6064659	360036-841	Power Converter
6066555	360036-385	Nut
6066556	360036-358	Bushing
6066570	360036-759	Spacer
6066574	360036-305	Lower Hook
6066832	360036-324	Seal
6066892	360036-925	Collar - Split
6067507	360036-956	Fastener Kit
6068008	360036-752	Service Kit
6068131	360037-232	Frame
6068835	360037-223	Fork Weld-SHTSV/1pc
6068961	360037-354	RF Transmission Kit
6070661	360036-330	Ring
6070833	360036-205	Lower Bearing
6071303	360036-296	Wire Harness
6072245	360036-552	Bulkhead Fitting
6072531	360036-564	Class II QD
6075736	360036-889	Battery
6076039	360036-490	Fork
6076514	360036-604	Adapter Fitting
6076828	360036-794	Cylinder
6077615	360036-693	Cover Plate
6081143	360037-286	LH Fork
6081563	360036-881	Anchor Bracket Assm
6081564	360036-991	J-Plate
6082095	360036-963	Fork Carrier
6085314	360037-020	Pad
6085925	360036-648	Valve Assembly
6086018	360036-910	Cable Assembly
6086319	360036-833	Lower Hook
6088014	360036-134	Shim Kit
6088642	360036-436	Touch Up Paint
6090443	360036-222	Cable Assembly
6090450	360036-659	Cable Assembly
6090454	360036-658	Cable Assembly
6091922	360036-257	Rubber Wear Strip
6092256	360036-776	Arm-Insec Sym-Freepin-Grz
6092964	360036-569	Contact Pad Assm
6095754	360037-299	Nameplate
6099460	360036-568	Contact Pad
6103571	360036-954	Cylinder Support
6105189	360037-190	Cylinder
6106138	360036-943	Conversion Kit
6106298	360037-291	Lower Hook Group
6108541	360037-118	Washer
6108953	360036-716	Lower Bearing
6109210	360036-831	LH Wear Shoe
6109212	360036-850	RH Wear Shoe
6109571	360037-115	Valve Cartridge
6109657	360036-951	Cylinder Assembly
6110402	360036-897	Bearing Plate
6110442	360036-630	Pin
6111893	360036-124	Spring
6113448	360037-224	Fork Wld/Mch Outer LH

Cascade Part No.	Crown Part No.	Description
6113734	360036-263	Gas Spring Kit
6114027	360037-219	Fork Group
6115159	360037-423	Valve Assembly
6116181	360036-331	Control Valve Knob/Lever
6116811	360037-393	T-Bar Short
6117789	360037-368	Seal Kit
6117790	360037-154	Bearing Kit
6118832	360037-139	Arm Bar
6118833	360036-885	Arm Bar
6118836	360036-520	Arm Bar
6118837	360036-247	Arm Bar
6122007	360036-089	Bearing Retainer
6122773	360036-989	IFC Assembly
6125098	360036-438	Washer
6125817	360036-718	Mounting Hook
6125818	360036-627	Mounting Hook
6125824	360037-093	Strap
6126868	360036-595	Setscrew
6126983	360037-004	Lower Inner Fork Hook RH
6127049	360036-102	Bearing Segment
6128567	360036-834	Mounting Group Cl II
6128877	360036-717	Mounting Group
6128972	360036-607	Anchor Bracket Assm
6129471	360036-740	Retainer
6129916	360036-600	Spring
6130007	360036-953	Cylinder Bracket
6130008	360036-952	Cylinder Bracket
6130364	360036-923	Class II To III Kit
6130740	360036-608	Bracket
6131022	360036-316	Bearing Upper Right
6131023	360036-328	Bearing Upper Left
6131029	360036-993	Key
6131086	360036-962	Fork
6131935	360037-003	Lower Inner Fork Hook
6133449	360037-382	Spring
6138135	360036-307	Bearing
6138136	360037-150	Bar
6138137	360036-947	Cylinder
6138142	360036-266	Spring
6145433	360037-218	Fork
6146611	360036-797	Gas Cylinder
6147759	360036-225	Gas Spring Kit
6151478	360036-849	RH Hook
6154686	360037-289	LH Inner Fork Carrier
6154687	360036-550	Bearing
6154691	360036-128	Brake Assembly
6157178	360036-462	Brake & Bearing Kit
6157183	360036-417	Brake Kit
6157340	360036-548	Bar
6159215	360036-402	Locknut
6405045	360036-668	Capscrew
6804773	360037-394	Tube
6812659	360036-610	Cable Assembly
6817149	390002-008	Upper / Lower Bearing Kit
7000031	360036-587	Pin Kit
7000032	360036-449	Pin Kit
7000033	360036-429	Pin Kit
7000034	390004-001	Knob Lock Pin Assemb Class 2
7000035	390004-002	Knob Lock Pin Assemb Class 3
7004851	107330	Calipers Fork Wear
8508373	360036-329	Lower Hook

Cascade Part No.	Crown Part No.	Description
8508374	360036-365	Bearing
8508375	360036-437	Upper Bearing
8508376	360036-367	Bearing
8508377	360036-498	Lower Bearing
10273-0243	360036-903	Bracket
10638-720	360037-047	Push Rod
218324A	360037-053	Retainer
28182-0354	360037-160	Bracket
4175-150	360037-316	Pin
4318-1040	360036-654	Bearing Segment
4501-0222	360036-082	Bearing
4730-1040	360036-073	Bearing Segment
4730-1050	360036-095	Bearing Segment
4786-0413	360037-155	Bearing Segment
4786-0468	360036-286	Bearing Segment
4786-0488	360036-440	Bearing Segment
4787-0413	360037-156	Bearing Segment
4787-0468	360036-293	Bearing Segment
4787-0488	360036-416	Bearing Segment
55F-SSS-A058	136579-003	Sideshifter 1111 Class II
55F-SSS-A059	136579-001	Sideshifter 871 Class II
55F-SSS-A060	136579-002	Sideshifter 959 Class II
55F-SSS-A062	127757-001	Sideshifter Class II 34.5"
55F-SSS-A063	127757-002	Sideshifter Class III 38"
55F-SSS-A064	127757-003	Sideshifter Class III 44"
55F-SSS-A172	129709-001	Sideshifter 34.5" Class II
55F-SSS-A173	129709-002	Sideshifter 38" Class II
55F-SSS-A180	127757-004	Sideshifter Class III 31.9"
65F-SSS-B059	136579-004	Sideshifter 959 Class III
65F-SSS-B063	129709-004	Sideshifter 38" Class III
7403X	116877	Zerk
TR20MK45	360036-755	Shock
TR20MK88	360036-756	Shock

## Section 7

# Battery and Charger

### Contents

V-Force® Industrial Battery Chargers	7.02
Battery Chargers	7.04
V-Force® Battery Display Rack	7.04
V-Force® Deep Cycle Batteries	7.05
V-Force® Starter Batteries	7.06
V-Force® Retail Mobility Cart Batteries	7.06
Battery Cross Reference	7.07
Rescue Jump Packs	7.09
Battery Acid Indicators	7.10
Battery Accessories	7.10
Battery Repair Parts	7.11
Leadhead Shrouds	7.11
V-Force® Intercell Connectors/Shrouds	7.11
Leadheads	7.12
Safety Boots/Protective Caps	7.13
Battery Connectors	7.14
Power Cable	7.17
Expandable Sleeving/Heat Shrink/Lugs	7.17
Battery Watering Application Chart	7.18
Battery Watering Injector System	7.18
Battery Watering Float System	7.21
Watering Guns	7.24
Battery Tools	7.25
Battery Service Supplies	7.27

#### New Items:

Portable Charger - p. 7.04  
Deep Cycle Battery - p. 7.05  
Battery Connectors - p. 7.14-7.15  
Hydro Cart Injector Replacement Part - p. 7.19  
Battery Watering - Float System Replacement Parts - p. 7.22-7.24

Note: 1910.178(q)(5) (1998) of the Occupational Safety and Health Act (OSHA) requires that "All parts of any such industrial truck requiring replacement shall be replaced only by parts equivalent as to safety with those used in the original design."

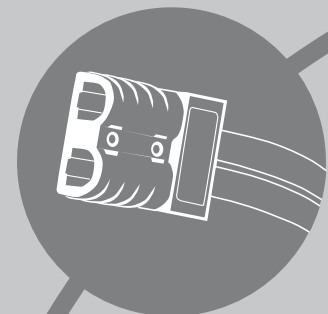

**VFORCE**  
Versatile Industrial Charging Systems



**V SCR SERIES**

**Default Configuration**

All Chargers will ship with the following configuration:

- Input Voltage: 480 Volts
- Battery Type: Flooded
- Connector: Listed in chart
- Lead Length: 9 Feet
- AMP HR Setting: Maximum

**Specs**

- Utilizes silicon controlled rectifier (SCR) technology
- 100% rated multi-shift charger  
(Charges batteries in eight hours or less)
- Adjustable input voltages 480/240/208 Volts AC
- Adjustable flooded or sealed batteries
- 60 Hertz
- UL & CSA approved

**Features**

- Extends battery life by reducing heat during charge cycle. (IEI charge profile)
- Ensures batteries are fully charged through dV/dt charge termination
- Automatic start and stop. (5 second start delay)
- Charge cycle is constantly monitored and stopped when any critical voltage or current threshold is exceeded
- AMP HR rating adjustable down to 65% of chargers rated capacity
- In unplanned or emergency situations, allows for charging of batteries up to double the amp-hour rating of the charger with extended charge time
- Rugged design (no moving parts)
- Better warranty than the competition, 10 year warranty on transformers and power semi-conductors, and 5 years on all other parts (excluding fuses)
- Opportunity Charge profile capable
- Conventional & Opportunity Charge profile capable

Crown Part Number	V-SCR Model Numbers (Cells-Phase-Amp per hour)	Connector
<b>24 Volt</b>		
390475-124-01	SMC12-1-475	Gray 175
390600-124-01	SMC12-1-600	Gray 175
390475-324-01	SMC12-3-475	Gray 175
390600-324-01	SMC12-3-600	Gray 175
390750-124-01	SMC12-1-750	Red 350
390865-124-01	SMC12-1-865	Red 350
390750-324-01	SMC12-3-750	Red 350
390865-324-01	SMC12-3-865	Red 350
390965-324-01	SMC12-3-965	Red 350
391050-324-01	SMC12-3-1050	Red 350
<b>36 Volt</b>		
390600-136-01	SMC18-1-600	Gray 350
390750-136-01	SMC18-1-750	Gray 350
390750-336-01	SMC18-3-750	Gray 350
390865-336-01	SMC18-3-865	Gray 350
390965-336-01	SMC18-3-965	Gray 350
391050-336-01	SMC18-3-1050	Gray 350
391200-336-01	SMC18-3-1200	Gray 350
<b>48 Volt</b>		
390750-348-01	SMC24-3-750	Blue 350
390865-348-01	SMC24-3-865	Blue 350
390965-348-01	SMC24-3-965	Blue 350
391050-348-01	SMC24-3-1050	Blue 350

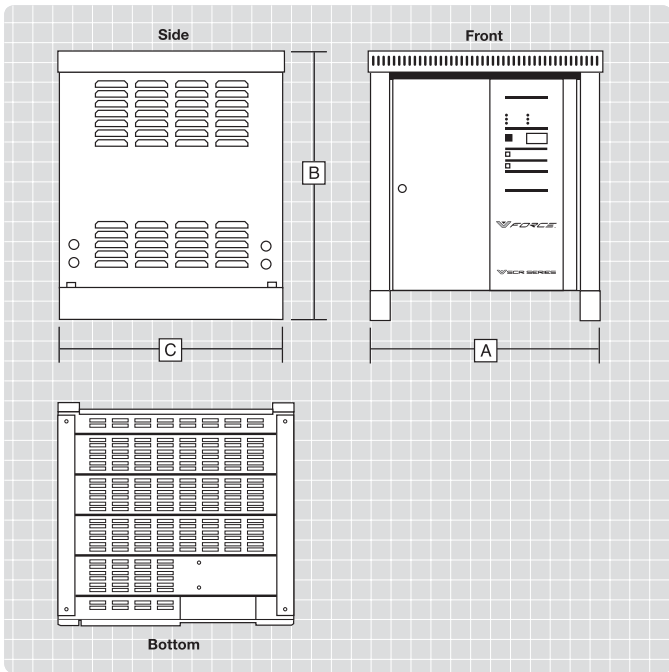

**Dimensions**

Cabinet Model	Dim. A	Dim. B	Dim. C
B	22.70"	26.65"	22.25"

**Note:** For additional information on the industrial chargers listed here, please reference the VForce SCR Charger brochure available through your local Crown Lift Truck dealer. (PF14703)

## V-HFM SERIES

### High-Frequency Modular Chargers



FS3

Model	FS3 Single Phase or Three Phase MP130	FS3 Three Phase MP330	FS5 Three Phase MP330	FS9 Three Phase MP330
Mains Voltage	208-240V AC	380-480V AC	380-480V AC	380-480V AC
Efficiency	Up to 93%	Up to 93%	Up to 93%	Up to 93%
Normal Charging Voltage	24V, 36V, 48V	24V, 36V, 48V	24V, 36V, 48V	24V, 36V, 48V
Charging Current	Up to 180A	Up to 180A	Up to 300A	Up to 540A
Battery Capacity 8 hr (.16c)	Up to 1175Ahr	Up to 1175Ahr	Up to 1500Ahr	Up to 3375Ahr
Opportunity Charging (.25c)	Up to 750Ahr	Up to 750Ahr	Up to 1200Ahr	Up to 2160Ahr
Fast Charging (.4c)	Up to 450Ahr	Up to 450Ahr	Up to 750Ahr	Up to 1350Ahr
Dimensions (WxDxH in.)	7.75x15.25x15.25	7.75x15.25x15.25	13.40x26.0x17.32	13.40x26.0x17.32
Weight (lbs.)	46 (3x modules)	46 (3x modules)	95 (5x modules)	123 (9x modules)
Marks of Conformity	CE and RoHS Compliant - UL Listed			
Warranty	1 + 4 (1 year full parts and labor, 4 years parts)			



FS5 - FS9

Note: For additional information on the V-HFM series charger, please reference the brochure (PF18640) available through your local Crown dealer.

## Modular Design



### Specs

- Reliable & Redundant — if a module does fail, the charger will continue to charge at a reduced rate
- Flexible configurations — multi-voltage and multi-amp hour
- Capable of Conventional, Opportunity & Fast Charge
- Compact & lightweight — occupies approx. 67% less space than typical charger (FS3 cabinet only)
- More efficiency helps to lower energy costs. Gain up to 15% power savings when compared to traditional Ferro & SCR chargers
- Charge 100% in 8 hours or less
- Maximize battery life with IEI (constant current - constant voltage — contact current) charge profile and Auto/Manual Equalization
- Intelligent control allows for configurable options such as variations to the charge profile
- Accurately monitor performance and battery condition with optional BMID Module
- Downloadable charge logs, up to 2400

Note: P.N. 300118 for USB cable

### Safety Features

- Reverse polarity protection prevents charging of an incorrect battery configuration
- Extensive alarm monitoring of the charger and battery, allowing you to have a safe charge every time
- Protective timers monitor each stage in the charging cycle
- The control card will stop the charge if any critical voltage or current threshold is exceeded

## Options and Accessories

### BMID - Battery Monitoring Identification Device

Part Number - 396525



The BMID Module is designed to mount on top of the battery. When the battery is plugged into the HF Series Charger it talks to the charger and sends the information on the charge profile to be used for that particular battery. During the charge process it constantly reports on cell voltage and temperature to optimize the charger settings.

The BMID Module also stores charge history information to allow analysis of operating conditions and lifetime performance.

Note: BMID compatible only with Crown V-Force HFM Charger

### Universal Mounting Bracket For FS3

Part Number - 396521

A universal mounting bracket allows the charger to be wall mounted from either the rear, side, or floor.

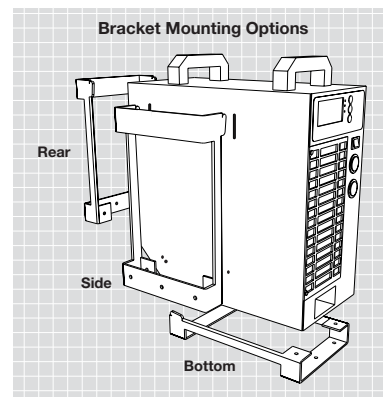

### Rear Mounting Bracket for FS5 and FS9

Part Number - 396547-001



# Battery Chargers



## V-110 Plug In 24V Charger

Part Number - 390040-124

Model - HBS1200-24 Charger



### Features

- Single Shift Application Charger
- UL & CSA approved
- 40 amp DC output
- Utilizes High Frequency charger technology
- Charges Flooded or Sealed 24Volt Batteries (300A-hr to 550A-hr) in 16 hours or less
- Self detecting input automatically senses and adjusts to single phase AC voltages (100, 110, 115, 120, 220, 230, or 240 Volts) and frequencies (50 or 60Hz). (8ft AC Cable)
- Minimum standard 15A circuit breaker at 120 VAC required
- Maintenance mode to keep batteries charged while in storage
- IEL charge profile for flooded batteries and IE type for sealed lead acid batteries
- Manual start and stop
- Completely sealed case (7" width x 11.26" length x 8.27" height)
- 1-year parts warranty
- SB175 gray connector (10' DC cable)
- Works on WP Industrial Batteries, battery sizes 12-85-5 & 12-85-7
- New wall mount bracket available - **part number 390040-BRKT**



390040-BRKT

## Portable or On-Board - 24 or 36 Volt Charger



391210

391215



392412,  
392425,  
393625

392425-OB,  
393625-OB

### Features

- Use with Lead Acid (Wet/AGM) batteries
- Designed for tough duty applications
- UL approved
- Exclusive temperature compensation
- Reverse polarity spark free operation
- Fan cooled
- Portable and On Board Options
- Fully automatic with float maintenance
- 18 months parts warranty
- Made in USA

Part Number	Output Voltage	Output Amps	Input Voltage	Cycle	Dimensions H x W x L (in)	Connector Attached	Weight	Brand	Description
391210	12	10	120V	50-60 hz	4.75 x 8.00 x 6.38	SB50	5.5 lbs.	Sportsman Series	Portable
391215	12	15	120V	50-60 hz	5.00 x 8.25 x 6.38	Ring Terminals	7 lbs.	Professional Series	Portable
392412	24	12	120V	50-60 hz	9.75 x 8.38 x 8.25	SB50	19 lbs.	Eagle Performance Series	Portable
392425	24	25	120V	50-60 hz	9.75 x 8.38 x 8.25	SB50	19 lbs.	Eagle Performance Series	Portable
393625	36	25	120V	50-60 hz	9.75 x 8.38 x 8.25	SB50	19 lbs.	Eagle Performance Series	Portable
392425-OB	24	25	120V	50-60 hz	9.00 x 8.50 x 5.75	Ring Terminals	22 lbs.	Eagle Performance Series	On-Board
393625-OB	36	25	120V	50-60 hz	9.00 x 8.50 x 5.75	Ring Terminals	28 lbs.	Eagle Performance Series	On-Board



Part Number - 370252

### Charger On Board

▼ OEM Reference

HY 1607815	HY 4603626	YT 580055473
HY 2048079	HY 8512512	YT 580087314
HY 2054228	YT 524245865	YT 582003887
HY 2073416	YT 580029671	
HY 2102631	YT 580034920	

### Battery Display Rack

Part Number	Holds Number of Batteries
345000	6
345001	9





# Deep Cycle Batteries

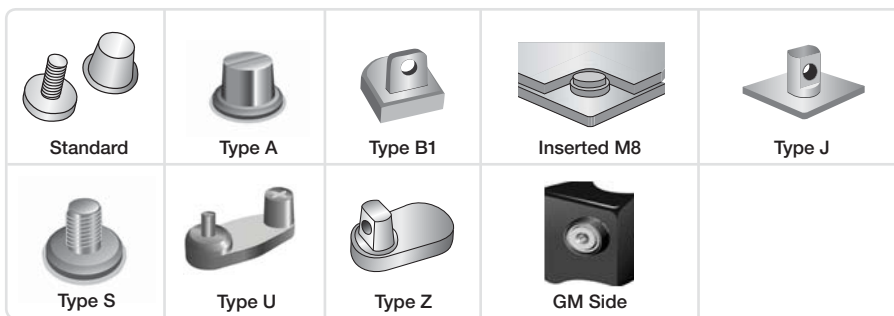

Battery and Charger

Part Number	BCI Group	RC Min	20Hr Rate (AH)	Crown Applications	Terminal Style	Weight (lb)	LxWxH (in)	Liquid Level Indicator
<b>Flooded 6 Volt</b>								
345006-095	1	130 @ 25 A	640		Type A	31	9.08x6.91x8.75	No
071419-001	1	180 @ 75 A	100	M, B, ST3000	Type A	32	9.00x6.78x8.88	No
345006-180	GC2	90 @ 75 A	180		Type S	55	10.25x7.13x10.75	No
072798-001	GC2	100 @ 75 A	190	M	Type A	59	10.25x7.12x10.62	No
072798-002 (Dry)	GC10P	100 @ 75 A	190	M	Type A	59	10.25x7.12x10.62	No
345006-200-01	GC2	105 @ 75 A	200		Standard	60	10.25x7.13x10.75	No
371419-002	1	130 @ 75 A	100		Type A	34	9.03x6.86x8.69	No
345225	GC2	115 @ 75 A	225	GPW, WAVE	Standard	63	10.25x7.13x10.75	No
092222-002 (Dry)	GC2	115 @ 75 A	225		Standard	63	10.75x7.13x10.75	No
345006-235	GC2	125 @ 75 A	235		Standard	68	10.25x7.13x10.75	No
345006-240	Euro GC	125 @ 75 A	240		Type A	64	9.63x7.50x10.75	No
120194-001	GC2H	145 @ 75 A	245	WAVE	Type S	73	10.25x7.13x11.5	No
345006-250	901	140 @ 75 A	250		Standard	72	11.75x7.19x11.25	No
345006-275	901	155 @ 75 A	275		Standard	76	11.75x7.19x11.25	No
345006-305	902	175 @ 75 A	305		Standard	92	12.19x7.19x14.13	Yes
345006-325	902	196 @ 75 A	325		Standard	100	12.19x7.19x14.13	Yes
345006-350	903	210 @ 75 A	350		Standard	112	12.38x7.19x16.13	Yes
345006-395	903	225 @ 75 A	395		Standard	120	12.38x7.19x16.13	Yes
<b>Flooded 8 Volt</b>								
345008-165	GC8	75 @ 75 A	165		Type S	64	10.31x7.13x10.75	No
<b>Flooded 12 Volt</b>								
345012-085	24	140 @ 25 A	95		Standard	50	10.88x6.75x9.38	No
345012-115	27	170 @ 25 A	115		Standard	58	12.63x6.75x9.38	Yes
345012-140	31	200 @ 25 A	130		Standard	66	13.00x6.75x9.38	Yes
345012-155	920	68 @ 75 A	155		Type A & S	87	13.63x6.75x12.25	No
345012-185	921	85 @ 75 A	185		Type S & Z	108	15.50x7.00x14.50	Yes
345012-210	921	110 @ 75 A	210		Standard	131	15.50x7.00x14.50	Yes
<b>Sealed 6 Volt</b>								
345006-200 (Gel)	GC2	105 @ 75 A	200		Standard	67	10.24x7.13x10.61	No
153930	27	195 @ 25 A	220	WAVE	Inserted M6	64.9	12.09x6.61x8.39	No
152920	27	226 @ 25 A	220	WP2000, WP2300, ST3000, SX3000	Inserted M6	90	12.13x6.69x10.83	No
345006-220	27	195 @ 25 A	220		Inserted M6	75	12.05x6.85x8.80	No
<b>Sealed 12 Volt</b>								
345012-018-0S	12V - 18 Ah	10 @ 25 A	18		Type B1	11.61	7.13x3.03x6.57	No
345012-026-0S	12V - 26 Ah	14 @ 25 A	26		Type B1	17.14	6.50x6.93x5.00	No
345012-055-0S	22NF	60 @ 75 A	55		Type Z	37	9.00x5.43x8.19	No
345012-055-0G (Gel)	22NF	65 @ 75 A	55		Type Z	42	9.00x5.43x8.31	No
345012-075	24	145 @ 25 A	75		Type Z	49	10.2x6.61x8.31	No
345012-075-01	24	140 @ 25 A	75		Type Z	49	10.25x6.61x9.06	No
345012-100 (Gel)	27	180 @ 75 A	98		Standard	68	12.00x6.57x8.20	No
345012-100-0S	27	175 @ 25 A	100		Type Z	60	12.09x6.65x8.31	No
345012-100-SS	27	175 @ 25 A	100		Type S	60	12.09x6.65x8.31	No
345012-100-0U	27	175 @ 25A	100		Standard	60	12.09x6.65x8.31	No
811377	27	95 @ 25A	110	ST3000	Inserted M6	70.4	12.05x6.85x8.80	No
345012-031-0G (Gel)	31	200 @ 25 A	110		Standard	68	12.96x6.81x8.23	No
345012-031-SS	31	175 @ 25 A	120		Standard	57	13.00x6.75x9.38	No
345012-035-0S	U1	N/A	35		Type Z	22.33	7.68x5.12x6.10	No
345012-135-0S	920		135		Standard	92.5	13.39x6.81x11.14	No

# Starter Batteries



Battery and Charger

Part Number	BCI Group	RC-Reserve Capacity @ 25 Amps	CCA	Terminal Style	Weight (lb)	LxWxH (in)
<b>Flooded 6 Volt</b>						
345004-950	4H-950	300	950	Type A	49	12.63x7.00x9.50
<b>Flooded 12 Volt</b>						
345004-100	4D-1000	300	1000	Type A	100	20.63x8.63x10.00
345004-130	4D-1300	375	1300	Type A	52	20.63x8.63x10.00
345022	22NF	65	400	Type A	27	9.50x5.56x9.00
345024	24	85	550	Type A	39	10.25x6.75x9.00
345024-675	24	90	675	Type A	39	10.25x6.75x9.00
345024-675-01	24F*	105	675	Type A	42	10.25x6.75x9.00
345025-500	25	100	500	Type A	35	9.63x7.00x8.88
345026-500	26/26R	65	500	Type A	29	8.25x6.81x8.25
345027-800	27	125	800	Type A	51	12.00x6.63x9.00
345029-340	29NF	90	340	Type A	39	13.00x5.50x8.88
345031-625	31	135	625	Type S	53	12.94x6.75x9.44
345031-730	31	190	730	3/8 x 16 Post	62.5	13.00x6.75x9.50
345031-775	31	170	775	Type A	58	12.94x6.75x9.44
345031-775-01	31	170	775	Type A	58	12.94x6.75x9.44
345031-1000	31	185	1000	Type S	61	12.94x6.75x9.44
345031-1000-A	31	185	1000	Type A	61	12.94x6.75x9.44
345034-675	34	105	675	Type A	42	10.25x6.81x8.19
345034-675-01	34R*	105	675	Type A	42	10.25x6.81x8.19
345034-800	34/78	90	690	Type A / GM Side	39	10.25x6.88x8.19
345035-540	35	90	540	Type A	37	9.13x6.75x8.63
135898	45	75	500	Type A	29	9.25x5.50x8.88
347047-600	47	95	600	Type A	34	9.63x7.00x6.94
345051-450	51	85	450	Type A	28	9.38x5.00x8.75
345051-450-0R	51R*	80	450	Type A	28	9.38x5.00x8.75
345055-525	55	85	525	Type A	29	8.56x6.06x8.38
345058-600	58	80	600	Type A	32	9.31x7.25x7.00
345058-600-0R	58R*	80	600	Type A	32	9.31x7.25x7.00
345065-650	65	100	650	Type A	42	12.06x7.44x7.56
345075-690	75	90	690	GM Side	37	9.13x7.06x7.38
345078-800	78	105	800	GM Side	42	10.25x7.06x7.38
345003-400-EE	3EE-400	100	400	Type A	44	19.25x4.34x8.75
345008-147-50	8D	430	1475	Type A	132	20.63x10.94x10.00
<b>Sealed 12 Volt</b>						
136392 (Gel)	51	66	450	Type A	28	9.25x5.12x8.94

\*Signifies reverse post. **Note:** See terminal types listed on page 7.05.

## Retail Mobility Carts - Battery Replacement Guide

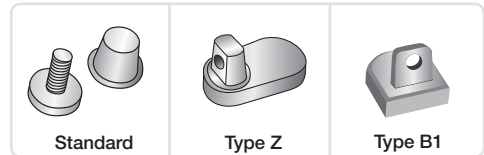

Make/Model	Quantity	Crown Part No.	Voltage	BCI Group	RC Min.	20Hr Rate (AH)	Terminal Style	Weight (lbs.)	LxWxH (in.)								
Amigo - Smart Shopper	2	345012-035-0S	12V Sealed	U1	N/A	35	Type Z	23.33	7.68x5.12x6.10								
Amigo - Value Shopper	2																
Amigo - Value Shopper XL	2																
Invacare - Lynx 3 Wheel	1 or 2																
Invacare - Lynx 4 Wheel	1 or 2																
Invacare - Lynx L-3X	1 or 2																
Invacare - Leo 3 Wheel	2																
Invacare - Leo 4 Wheel	2																
MartCart - 3563	1 or 2																
MartCart - 3500	1 or 2																
MartCart - 3524	1 or 2																
Shoprider Scooters - Sunrunner	2																
Dane Technologies - SmartKART	2																
Amigo - Value Shopper 34	2									345012-018-0S	12V Sealed	12V-18 Ah	10 @ 25A	18	Type B1	11.61	7.13x3.03x6.57
Pride Mobility - Go-Go Elite Plus	2																
Dane Technologies - QuickKART	3	345012-085	12V Flooded	24	160 @ 25A	85	Standard	50	11.13x6.75x9.38								



**Starter Battery Supplier Cross Reference**

BCI Group Size No.	Crown Equipment	Crown Battery Mfg Co.	Interstate Battery	East Penn Mfg Co	Exide Tech	NAPA Batteries
<b>North American BCI Group Sizes - 12 Volt Automotive</b>						
24	345024-675	24-675		624MF	24-72	7524
	345024	24-550	I-24	524MF	24-60	6024
24F	345024-675-01	24F-675	I-24F	624FMF	24F-72	6024F
25	345025-500	25-500	MT-25	525MF	25-72	5025
26/26R	345026-500	26/26R-500	MT-26/26R	526 / 526R	26/26R-60	6026 / 6026R
27	345027-800	27-800	MTP-27	727MF	27-60	8427 / 7527
34	345034-675	34-675	MT-34	634MF	34-72	8434
34R	345034-675-01	34R-675	MT-34R	634RMF	34R-72	
35	345035-540	35-540	MT-35	535MF	35-72	5035
55	345055-525	55-525	MT-56	555MF	56-535	8456 / 7556
58	345058-600	58-600	MT-58	658MF	58-540	8458 / 6058
58R	345058-600-0R	58R-600	MT-58R	658RMF	58R-580	7558R
65	345065-650	65-650	MT-65	565MF	65-650	7565
75	345075-690	75-675	MTP-75	675MF	75-630	8475
78	345078-800	78-800	MTP-78	778MF	78-770	8478
<b>North American BCI Group Sizes - 12 Volt Automotive Dual Terminal</b>						
34/78	345034-800	34/78-800	I-78DT	678DT	78DT-650	8434/78
<b>North American BCI Group Sizes - 6, 8 &amp; 12 Volt Commercial Starting</b>						
31	345031-1000-A	31A-1000	31-MHD P	1131XMF	XHP-31E	7235 / 7237
	345031-1000	31S-1000	31-MHD S	1131XMF(S)	XHP-31D	7234 / 7236
	345031-775	31A-775	31-LHD P	1131PMF	31E-925	7239
	345031-625	31S-625	V-31S-7	931PMF(S)	31D-700	7231
	345031-730	31A-SD775		7T31		
	345031-775	31S-SD775		7T31(S)		
8D	345008-147-50	8D-1475	8D-MHD	908D	8D-1300	7271 / 8276
1	345006-095	1-640	1-VHD	901MF	1-625	7244
3EE	345003-400-EE	3EE-400	3EE-VHD	403E	3EE-370	7250
22NF	345022	22NF-400	SP-22NF	322NF	22NF-390	5022NF
29NF	345029-340	29NF-400	29NF-VHD	429NF	29NF-390	7280

Battery and Charger



**Starter Battery Supplier Cross Reference**

BCI Group Size No.	Crown Equipment	Crown Battery Mfg Co.	Interstate Battery	East Penn Mfg Co	Exide Tech	NAPA Batteries
<b>European / Asian BCI Group Sizes - 12 Volt Automotive</b>						
45	135898	45-500	I-45	545MF	45-495	7545 / 5045
51	345051-450	51-500	MT-51	551MF	51-450	5051
51R	345051-450-0R	51R-500	MT-51R	551RMF	51R-450	5051R

# Starter & Deep Cycle Battery Supplier Cross Reference



## Deep Cycle Battery Supplier Cross Reference

BCI Group Size No.	Crown Equipment	Crown Battery Mfg Co.	Interstate Battery	East Penn Mfg Co	Exide Tech	NAPA Batteries
North American BCI Group Sizes - 6, 8 & 12 Volt Deep Cycle						
GC2	345006-180	CR-180	U1800		Trojan Pacer	US-1800
	345006-200-01	CR-200	U2000	GC-10	T-605	US-2000
	345225	CR-225	U2200	GC-15	T-105	US-2200
	345006-235	CR-235	V1255	GC-25	T-125	US-125
Euro GC	345006-240	CR-240			TE-35	
GC2H	120194-001	CR-245		GC-45	T-145	US-145
901	345006-250	CR-250	U2500	8C11	J250P	US-250
	345006-275	CR-275		9C11	J250HC	US-250HC
902	345006-305	CR-305	U3050		J305P	US-305
	345006-325	CR-325		8C6V	J305HC	US-305HC
903	345006-350	CR-350	UL16		L16P	L16
	345006-395	CR-395		8L16	L16HC	L16H
GC8	345008-165	CR-165	U8VGC	GC8V	T-875	8VGC
24	345012-085	24DC95	SRM-24		24TMX	
27	345006-220	6CE220	SLA0157		M86CHP06V27	
	345012-115	27DC115	SRM-27		27TMX	27TMX
31	345012-140	31DC140	SRM-29	DC31DT	31XHS	31TMX
47	347047-600	47-600				
920	345012-155	CR-155		8KFS	5SH	EV-145
921	345012-185	CR-185	U1850	8C12	J185G	US-185E
	345012-210	CR-210		9C12	J185HC	US-185H

Battery and Charger



## VRLA Battery Competitor Cross Reference

BCI Group Size No.	Crown Equipment	Crown Battery Mfg Co.	Discover Batteries	East Penn Mfg Co	Interstate Batteries
6 Volt VRLA Batteries					
GC2	345006-200	6CEG200		8GGC2	
6V-27	149455	6CE220	DBEV627A		
12 Volt VRLA Batteries					
12V - 18 Ah	345012-018-0S	12CE18			SLA1116
12V - 26 Ah	345012-026-0S	12CE26			SLA1146
U1L	345012-035-0S	12CE35	EVU1A-A	8AU1	SLA1155
22NF	345012-055-0S	12CE55	EV22A-A	8A22NF	
24	345012-075	12CE75	EV24A-A	8A24	
27	345012-100-0S	12CE100(J)	EV27A-A	8A27	
	345012-100-SS	12CE100(M)	EV27A-A	8A27	
	345012-100-0U	12CE100(U)	EV27A-A	8A27	
	345012-100	12CEG100		8G27	
31	345012-031-0G	12CEG31		8G31	

## Rescue Jump Packs

Crown Part Number	Description	Peak Amps	Volt	Cable Length	Gauge	DC Power Source	Air Compressor/ Air Gauge	LED Battery Status Gauge	Built-In Work Light & Flasher	Illuminated LED Clamps	Other Specs
300455-091	Rescue Jump Pack Model iStart					●					Personal jump pack, light weight, powerful, jumper cables, 12V DC plug, built-in flashlight and charger.
300455-090	Rescue Jump Pack Model 900	1000	12	27"	6	●					Premium 18 amp hour AGM battery, LED battery charging status, built-in charger.
300455-095	Rescue Jump Pack Model 950	1000	12	55"	6	●	●	●	●	●	18 amp hour AGM battery, Multiple air tips, polarity alarm, built-in charger, LED battery charging status.
300455-106	Rescue Jump Pack Model 1060	2000	12	55"	6	●	●	●	●	●	20 amp hour AGM battery, polarity alarm, 300W 120V inverter with 2 outlets and USB connection, built-in charger
300455-122	Rescue Jump Pack Model 1220	1500	12		2	●		●	●		Truck, aircraft and ground support starter, SB style connectors, Cessna style plug-ins (90" reach), 12V polarized style plug-ins (90" reach), parrot clamps (62" reach), safeguard audible signal, 2 heavy duty 20 amp hour batteries
300455-180	Rescue Jump Pack Model 1800	4000	12	62"	2	●		●	●		2 heavy duty 20 amp hour AGM batteries, safeguard audible signal and light, polarity alarm, internal battery gauge
300455-240	Rescue Jump Pack Model 2400	900	24	62"	2	●		●	●		2 heavy duty 20 amp hour batteries, safeguard audible signal and light, red handle indicates 24 volts
300455-242	Rescue Jump Pack Model 2420	900	24		2	●		●	●		Truck, aircraft and ground support starter, SB style connectors, Cessna style plug-ins (90" reach), 12V polarized style plug-ins (90" reach), parrot clamps (62" reach), safeguard audible signal, 2 heavy duty 20 amp hour batteries.
300455-300	Rescue Jump Pack Model 3000		12	55"	4	●		●	●	●	You choose and add your own battery deep cycle or starter (accepts most U1 sealed batteries), safeguard audible signal & light, add your own battery, polarity alarm, internal battery gauge, built-in charger.
300455-092	Rescue Jump Pack Cart										Sturdy and lightweight, easy to assemble, fits all Rescue models except 900 & iStart, large 4" rubber wheels, jump packs snaps into place.



300455-090



300455-095



300455-300

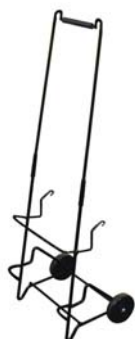

300455-092



300455-122

## Battery Acid Indicators



**Blinky**  
Part Number  
340011-003

UL classified, probe-mounted LED that is permanently mounted into one cell of a battery. Flashing green LED means electrolyte level is okay. No light means it is time to water the cells.



**Smart Blinky Remote**  
Part Number  
340011-004

Smart-Sensing Technology monitors the electrolyte level over a period of time before it decides to change indication. This ensures a truer and more reliable signal than older technologies, which have no intelligence and can flicker. 2.35" probe length. Ideal for batteries that do not leave the truck or for batteries that are charged on multi-level racks where the indicator LED can be edge mounted for high visibility. The indicator LED is housed in a separate body from the probe, which allows the LED to be remotely mounted from the probe. UL classified.



**Smart Blinky**  
Part Number  
340011-005

One piece design is ideal for batteries where the top of the battery can be seen and where Red/Green indication is needed. The Smart Blinky utilizes a one piece design where the indicator LED is located above the probe. The compact design is small enough to fit on even the smallest industrial battery cell. Blinking green LED means the electrolyte level is good. Blinking red LED means water is needed. Installation is easier because the power wires are different lengths. Brighter Indicator LED. Improved probe design. Probe is easier to trim. Patented Smart Sensing Technology. UL classified.



**Battery Acid Level Indicator**  
Part Number Description

340011-001	Battery Acid Level Indicator, Cell Cap Style
------------	--

**Note:** Signals low battery acid level at a glance.

- If LED is flashing, acid level is okay.
- If LED is off, add distilled water before operating battery to achieve long life and capacity.

## Battery Accessories



**Battery Side-Lift Carrier**  
Part Number Description

300040-002	Best quality for all battery types and sizes. Adjustable notches securely lock in place. Features bicycle grip handle and sidewall pads.
------------	--

### Battery Strap

Part Number	Description	Style
300040	Used to lift & move battery P.N. 149455 & 811377	A
300040-001	Used to lift & move battery P.N. 345012-075	A
300040-003	For post terminal use only. Double grip jaws automatically lock. Non-conductive plastic strap is acid resistant.	B
300040-004	For post terminal use only. Double grip jaws automatically lock. Non-conductive plastic strap is acid resistant.	C

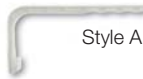

### Battery Caps



Part Number	Type	Color	Height (in)
300053-001	Screw	Yellow	
300053-003	Screw	Red	
300053-004	Screw	White	
300053-002	Flip top w/blue lid	Yellow	1.25
300053-005	Flip top w/black lid	Yellow	1.00

**Note:** Fits all batteries except Douglas.



**L-Bracket**  
Part Number Description

300460	L-Bracket; includes hardware. Used to mount pogo stick to racking.
--------	--

### Insulator Terminal Protectors



Part Number	Color	Fits Gauges	Post Height (in)	Type
125958-001	Red	6 & 8	0.94	A
125958-002	Black	6 & 8	0.94	A
125588-001	Black	1/0 & 2/0	1.02	B
125588-002	Black	4 & 6	0.85	C
125588-003	Black	4 & 6	0.95	D
125588-004	Black	10	0.75	E
125588-005	Black	3/0 & 4/0	0.95	B
125588-006	Black	4/0	1.60	B
125588-007	Black	2 & 4	0.90	F

Protects against electrical system shorts. Reduces the risk of battery explosion caused by sparks. High temperature PVC construction. Color coded for easy polarity identification.

### Battery Pogo Stick



Part Number	Description
300038	Used to keep battery connectors and cables off the floor at charging stations, preventing damage and wear. 39" in length, 1" in diameter. g damage and wear. 39" in length, 1" diameter. Supports up to 10 ft of 3/0 cable.

▲ **Replacement** Rubber Grommet P.N. 300038-001



# Battery Repair Parts

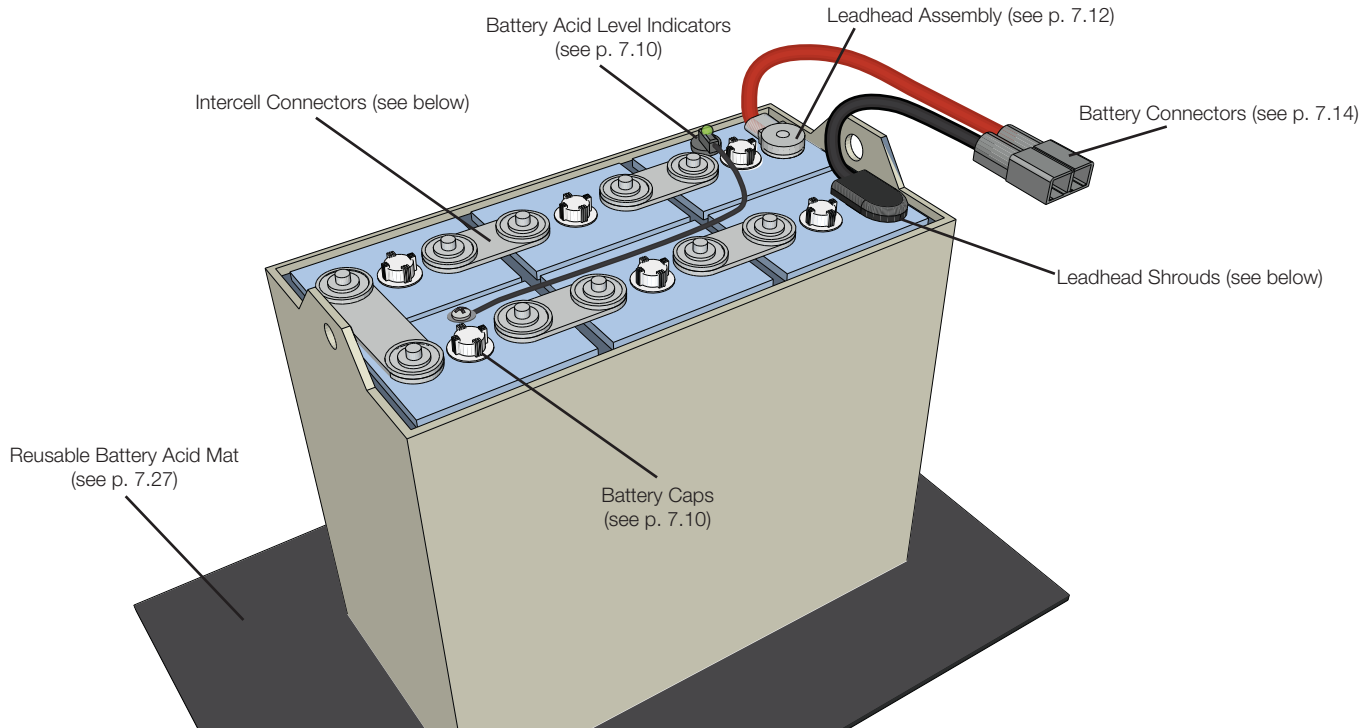

## Leadhead Shrouds

Part Number	Description
<b>Straight</b>	
300430-001	Black
300431-001	Red
<b>Offset, One Hole</b>	
300426-001	Black/Right
300427-001	Red/Right
300428-001	Black/Left
300429-001	Red/Left
<b>Offset Two Hole - 3.00" Center to Center</b>	
300432-001	Black/Right
300433-001	Red/Right
300434-001	Black/Left
300435-001	Red/Left
<b>Offset Two Hole - 3.75" Center to Center</b>	
300436-001	Black/Right
300437-001	Red/Right
300438-001	Black/Left
300439-001	Red/Left
<b>Universal</b>	
300451	Black

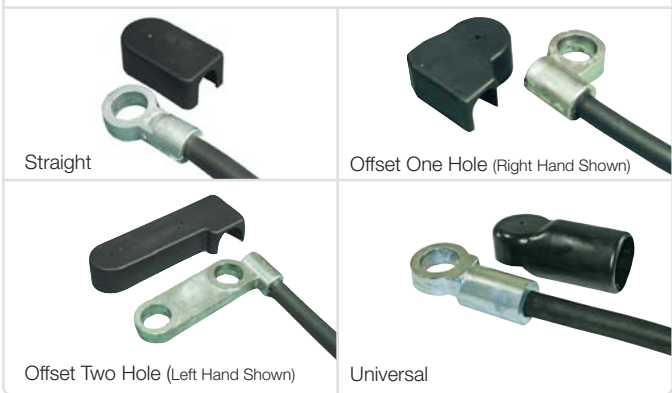

## Fast Charge Leadhead Shrouds



**Fast-Charge Leadhead Shrouds**

Part Number	Description
300464-00R	Red
300464-00B	Black

- Fits 2/0, 3/0 & 4/0

## Intercell Connectors/Shrouds

**V-Force® Intercell Battery Connectors, 5 per pkg.**

Part Number	Single Piece	Description
300402-001-05	300402-001	3" - 2 hole connector
300402-007-05	300402-007	3½" - 2 hole connector
300402-003-05	300402-003	3¾" - 2 hole connector
300402-002-05	300402-002	5" - 2 hole connector
300402-004-05	300402-004	5" - 2 hole connector
300402-005-05	300402-005	5¾" - 2 hole connector
300402-006-05	300402-006	6" - 2 hole connector

- Safe-burning, High-conductivity Lead
- 3% Antimonial Lead, Free of Voids And Porosity, Greater Electrical Conductivity

Note: length is measured center to center



**V-Force® Intercell Shrouds**

Part Number	Size (Center to Center)
300424-001	3" - 3½"
300425-001	3½"
300425-005	3¾"
300425-004	5"
300425-007*	5¼"
300425-006*	6"
300425-002	10½" - 10¾"
300425-003	12½" - 12¾"

\*Are not V-Force branded



Battery and Charger

**Standard Cable Assemblies**

Note: For Enersys Batteries, use Universal Leadhead Assemblies.

Part Number	Description	Style	
<b>Straight</b>			
300400-008	#2 red cable	A	
300400-007	#2 black cable		
300400-001	#1 red cable		
300400-002	#1 black cable		
300400-009	1/0 red cable		
300400-010	1/0 black cable		
300400-022	2/0 red cable		
300400-021	2/0 black cable		
300400-027	3/0 red cable		
300400-028	3/0 black cable		
300400-031	4/0 red cable		
300400-032	4/0 black cable		
<b>Offset, 90 degree</b>			
300400-003	#2 red cable		B
300400-004	#2 black cable		
300400-033	#1 red cable		
300400-034	#1 black cable		
300400-011	1/0 red cable		
300400-012	1/0 black cable		
300400-019	2/0 red cable		
300400-020	2/0 black cable		
300400-030	3/0 red cable		
300400-029	3/0 black cable		
300400-038	4/0 red cable	C	
300400-037	4/0 black cable		
<b>Offset, 90 degree, Two Hole Posts, 3.00" Post Hole Centers</b>			
300400-013	1/0 red cable		C
300400-014	1/0 black cable		
300400-015	2/0 red cable		
300400-016	2/0 black cable		
300400-023	3/0 red cable		
300400-024	3/0 black cable		
300400-058	4/0 red cable		
300400-057	4/0 black cable		
<b>Offset, 90 degree, Two Hole Posts, 3.75" Post Hole Centers</b>			
300400-040	1/0 red cable	C	
300400-039	1/0 black cable		
300400-018	2/0 red cable		
300400-017	2/0 black cable		
300400-025	3/0 red cable		
300400-026	3/0 black cable		
300400-035	4/0 red cable		
300400-036	4/0 black cable		
<b>Offset, 90 degree, Three Hole Posts, 3" Post Hole Centers</b>			
300400-044	1/0 red cable	D	
300400-043	1/0 black cable		
300400-046	2/0 red cable		
300400-045	2/0 black cable		
300400-050	3/0 red cable		
300400-049	3/0 black cable		
300400-054	4/0 red cable		
300400-053	4/0 black cable		
<b>Offset, 90 degree, Three Hole Posts, 3.75" Post Hole Centers</b>			
300400-042	1/0 red cable	D	
300400-041	1/0 black cable		
300400-048	2/0 red cable		
300400-047	2/0 black cable		
300400-052	3/0 red cable		
300400-051	3/0 black cable		
300400-056	4/0 red cable		
300400-055	4/0 black cable		

**Universal Burn-on 5 ft. Leadhead Cable Assemblies**

Note: Designed to be burned onto intercell connectors; use Universal Leadheads on Enersys Batteries.

Part Number	Description	Style
<b>Straight</b>		
300466-001	1/0 red cable	A
300466-002	1/0 black cable	
300466-003	2/0 red cable	
300466-004	2/0 black cable	
300466-005	3/0 red cable	
300466-006	3/0 black cable	
300466-007	4/0 red cable	
300466-008	4/0 black cable	

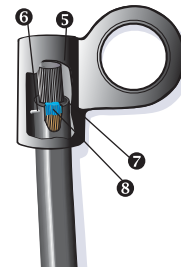
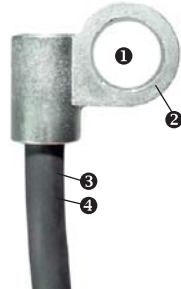

- ❶ Post Hole 15/16"
- ❷ 5% Antimonial Lead for Durability
- ❸ EPDM Insulation  
Rated 600 Volt  
Temperature Range: -40 +105°C  
(-40 +221°F), Flame Resistant, Abrasion,  
Tear and Cut Resistant, Impervious to  
Battery Acid, Oil, Grease
- ❹ Quickflex Cable, Soft Bare #30 Copper  
Wire, Class K, Rope Stranded for  
Maximum Flexibility, Conforms to  
ICEA/NEMA Welding Cable Requirements,  
Meets or Exceeds ASTM-B-172
- ❺ Copper Wire Hot Tinned for Maximum Bond  
to Lead
- ❻ Anti-pullback Lock Pin
- ❼ Cable Deeply Embedded in Lead,  
Preventing Insulation Pull-back
- ❽ Internal Silicone Seal™ Silicone Seal Under  
Insulation Prevents Corrosion, Sealing Out  
Acid and Water

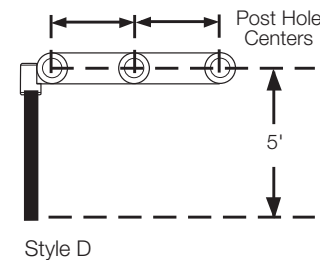
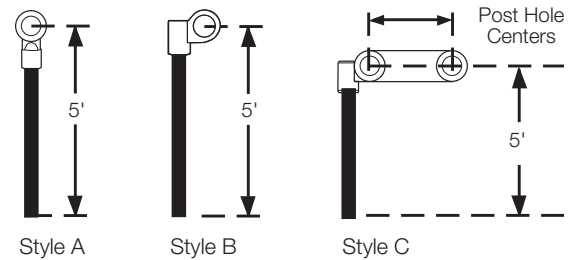



## Leadheads

### Fast Charge Leadheads

Part Number	Description	Style
<b>Offset 90 degree</b>		
300461-013	2/0 red cable	A
300461-014	2/0 black cable	
300461-015	3/0 red cable	
300461-016	3/0 black cable	
300461-017	4/0 red cable	
300461-018	4/0 black cable	
<b>Offset, 90 degree, Two Hole Posts, 3" Post Hole Centers</b>		
300461-001	2/0 red cable	B
300461-002	2/0 black cable	
300461-005	3/0 red cable	
300461-006	3/0 black cable	
300461-009	4/0 red cable	
300461-010	4/0 black cable	
<b>Offset, 90 degree, Two Hole Posts, 3.75" Post Hole Centers</b>		
300461-003	2/0 red cable	B
300461-004	2/0 black cable	
300461-007	3/0 red cable	
300461-008	3/0 black cable	
300461-011	4/0 red cable	
300461-012	4/0 black cable	

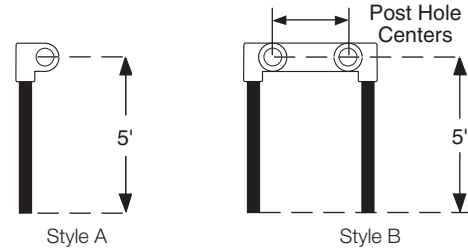
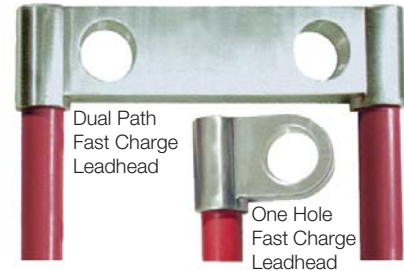

### Bolt-on 5 ft. Cable Assemblies

Part Number	Description
300401-001	#2 red - single cable
300401-002	#2 black - single cable
300401-011	#1 red - single cable
300401-012	#1 black single cable
300401-003	1/0 red - single cable
300401-004	1/0 black - single cable
300401-005	2/0 red - single cable
300401-006	2/0 black - single cable
300401-007	3/0 red - single cable
300401-008	3/0 black - single cable
300401-009	4/0 red - single cable
300401-010	4/0 black- single cable

**Note:** Cone & Fastener not included in assembly. Must be ordered separately.



Cable Assembly



Standard Cone



Fastener



### Standard Cones, 5 per package (Fits all gauge sizes)

Part Number	Single Piece	Description
300416-001-05	300416-001-01	1 hole
300416-002-05	300416-002-01	2 hole - 3"
300416-003-05	300416-003-01	2 hole - 3 3/4"
300416-004-05	300416-004-01	3 hole - 3 3/4"

### Fastener

Part Number	Description
300419	Includes 10 of each: bolt, flat washer and lockwasher

## Safety Boots/Protective Caps



Part Number	Amp	SB/SBX
300463-050	50	SB
300463-175	175	SB
300463-350	350	SB

- Keep terminals clean



SB



SBX

Part Number	Amp	SB/SBX
300413-050	50	SB
300413-175	175	SB
300413-350	350	SB
300462-175	175	SBX
300462-350	350	SBX

- Strain relief for cables
- Seals contacts and cable from corrosion, acid, chemicals, salt, water, and dirt
- Adjustable cable ports cut to fit cable gauge
- Does not interfere with mounting brackets, handles & protective caps
- Made of black vinyl rubber
- Operator safety
- Reduces chances of a short circuit
- Isolates negative from positive
- Ergonomic grip



**50 SB Ampere**

Part Number	Color	Cable Size
-------------	-------	------------

**Connector Housing**

078723-005	Gray	NA
340054-001	Red	NA

**Housing & Contact Kits**

340054-003	Red	10-12
077917-005	Gray	10-12
340054-002	Red	6

**Contacts**

078724-003	NA	10-12
078724-005	NA	6

▼ **Accessories**

Part Number	Description
-------------	-------------

**Battery Connecting Handle**

120573	Red - Includes hardware
--------	-------------------------

**Cable Clamp**

340056-001	Cannot be used in combination with handle
------------	---



120573



340056-001



**175 SB Ampere**

Part Number	Color	Cable Size
-------------	-------	------------

**Connector Housing**

078723-002	Gray	NA
078723-004	Yellow	NA
078723-007	Red	NA
078723-008	Blue	NA
078723-010	Orange	NA

**Housing & Contact Kits**

077917-002	Gray	1/0
077917-004	Yellow	1/0

**Contacts**

300452-001	NA	2
078724-002	NA	1/0

▼ **Accessories**

Part Number	Description
-------------	-------------

**Battery Connecting Handle**

340029-002	Plastic, gray - includes hardware
340029-003	Plastic, red - includes hardware
340029-005	Steel, red - includes hardware

**Cable Clamp**

340056-002	Includes hardware, use without handle
340056-003	Includes hardware, used with "A Frame" handle only

**Drive Block**

077034	For use with Quick Disconnect
--------	-------------------------------



340029-005



340029-002



340056-003



077034



**350 SB Ampere**

Part Number	Color	Cable Size
-------------	-------	------------

**Connector Housing**

078723-001	Gray	NA
078723-003	Red	NA
078723-006	Blue	NA
078723-009	Yellow	NA
078723-011	Green	NA
078723-012	Black	NA
378723-015	Orange	NA

**Housing & Contact Kits**

077917-001	Gray	2/0
077917-003	Red	2/0
380000	Blue	2/0

**Contacts**

078724-006	NA	1/0
078724-001	NA	2/0
078724-004	NA	3/0
078724-007	NA	4/0

▼ **Accessories**

Part Number	Description
-------------	-------------

**Battery Connecting Handle**

340029	Plastic, gray - includes hardware
340029-004	Plastic, red - includes hardware
340029-005	Steel, red - includes hardware

**Cable Clamp**

340056-004	Includes hardware; can be used with or without handle
------------	---



340029-004



340029-005



340056-004



**160 SBE Ampere**

Part Number	Color	Cable Size
-------------	-------	------------

**Connector Housing**

108801-005	Red	NA
108801-007	Black	NA

**Housing & Contact Kits**

108800-005	Red	1
------------	-----	---

**Contacts**

340085	NA	1
108802-002	NA	1/0

**Auxiliary Contact Kit**

340084	SBE & SBX
--------	-----------

▼ **Accessories**

Part Number	Description
-------------	-------------

**Battery Connecting Handle**

340029-002	Plastic, gray - includes hardware
340029-003	Plastic, red - includes hardware

**Cable Clamp**

340056-005	Includes hardware, use with or without handle
------------	---



340029-002



340056-005



## 320 SBE Ampere

Part Number	Color	Cable Size
-------------	-------	------------

### Connector Housing

108801-001	Gray	NA
108801-003	Red	NA
108801-006	Blue	NA
108801-008	Yellow	NA
108801-010	Black	NA

### Housing & Contact Kits

108800-007	Gray	1/0
108800-001	Gray	2/0
108800-008	Blue	2/0
108800-009	Gray	2/0
108800-006	Red	3/0

### Contacts

108802-001	NA	2/0
108802-003	NA	3/0
108802-004	NA	4/0

### Auxiliary Contact Kit

340084	SBE & SBX
--------	-----------

### ▼ Accessories

Part Number	Description
-------------	-------------

108437	Drive Block used on P.N. 108800-006 & 108800-009.
060015-025	Screw
060005-006	Lockwasher
060021-006	Nut
108852-002	Contact Bushing used to go from 2/0 to 1/0

### Battery Connecting Handle

340029	Plastic gray - includes hardware
340029-004	Plastic, red - includes hardware

### Cable Clamp

340056-006	Includes hardware, use with or without handle
------------	---



340029-004



340056-006



## Contact Bushing

Part Number	Description
-------------	-------------

108852-001	1/0 to 1
108852-002	2/0 to 1/0

■ Used on SB, SBE or SBX Contacts



## Manual Release Handle - SBE 320/SBX 350

Part Number - H47593-533

Charger/Truck Half  
(includes hardware)

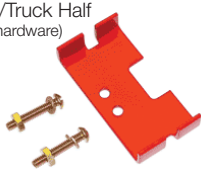

Part Number - 340060-001

Battery Half  
(includes hardware)



## Manual Release Handle - SBX 175

Part Number - 340060-005

Charger/Truck Half  
(includes hardware)



Part Number - 340060-004

Battery Half  
(includes hardware)



## SB Extraction Tool

Part Number	Amps
-------------	------

340089-001	SBE160 / SBX175
340089-002	SBE320 / SBX350



## 175 SBX Ampere

Part Number	Color	Cable Size
-------------	-------	------------

### Connector Housing

340028-001	Gray	1/0
340028-002	Blue	1/0
340028-003	Orange	1/0
340028-004	Yellow	1/0
340028-005	Red	1/0
340028-006	Green	1/0

### Contacts

108802-002	1/0
------------	-----

### Auxiliary Contact Kit

340084	SBE & SBX
--------	-----------

### ▼ Accessories

Part Number	Description
-------------	-------------

340029-002	Plastic gray - includes hardware
------------	----------------------------------

### Cable Clamp

340056-005	Includes hardware, without handle
------------	-----------------------------------



340029-002

340056-005

## 350 SBX Ampere

Part Number	Color	Cable Size
-------------	-------	------------

### Connector Housing

118802-001	Gray	2/0
118802-002	Blue	2/0
118802-003	Red	2/0
118802-004	Green	2/0
118802-005	Black	2/0
118802-006	Yellow	2/0
340055-001	Blue	4/0
340055-002	Yellow	4/0
340055-003	Gray	4/0
340055-004	Red	4/0
340055-005	Gray	3/0
340055-006	Blue	3/0
340055-007	Red	3/0
340055-008	Yellow	3/0

### Connector Housing

340090-001	Gray
340090-002	Red

### Contacts

108802-001	2/0
108802-003	3/0
108802-004	4/0

### Auxiliary Contact Kit

340084	SBE & SBX
--------	-----------

### ▼ Accessories

Part Number	Description
-------------	-------------

340029	Plastic, gray - includes hardware
--------	-----------------------------------

### Cable Clamp

340056-006	Includes hardware, use with or without handle
------------	---



340029

340056-006

### Complete Kit - P.N. 139685

Includes: 2 each of H47593-533 and 340060-001 manual release handles, 1 each of 118802-001 & 118802-003 connectors with 2/0 terminals.

**A320**

**Crown Part Number Description**

**A320 Complete Kits - handle, auxiliary tips, clamp and carrier**

340320-115	A320 Conn- Male Pin, 1/0
340320-215	A320 Conn- Male Pin, 2/0
340320-315	A320 Conn- Male Pin, 3/0
340320-415	A320 Conn- Male Pin, 4/0
340320-105	A320 Conn- Female Skt, 1/0 - without handle
340320-205	A320 Conn- Female Skt, 2/0
340320-305	A320 Conn- Female Skt, 3/0
340320-405	A320 Conn- Female Skt, 4/0

**A320 Kits - Do not include contact tips, auxiliary tips or handle**

340320-211	A320 Kit- Male Pin Hsg, Clamps, Carrier
340320-201	A320 Kit- Female Skt Hsg, Clamps, Carrier

**A320 Connectors with Contacts**

340320-112	A320 Conn- Male Pin, 1/0
340320-212	A320 Conn- Male Pin, 2/0
340320-312	A320 Conn- Male Pin, 3/0
340320-412	A320 Conn- Male Pin, 4/0
340320-102	A320 Conn- Female Skt, 1/0
340320-202	A320 Conn- Female Skt, 2/0
340320-302	A320 Conn- Female Skt, 3/0
340320-402	A320 Conn- Female Skt, 4/0

**A320 Auxiliary Tips**

340320-012	A160/320 Aux Pin Contact, Lower #10 6mm AWG
340320-013	A160/320 Aux Pin Contact, Upper #12 4mm AWG
340320-002	A320 Aux Pin Contact, Lower 14/18 AWG
340320-003	A320 Aux Skt Contact, Lower, 14/18 AWG
340320-004	A320 Aux Pin Contact, Upper 14/18 AWG
340320-005	A320 Aux Skt Contact, Upper, 14/18 AWG

**A320 Contact Tips**

340320-006	A320 Contact, Male Pin, 2/0
340320-007	A320 Contact, Male Pin, 3/0
340320-008	A320 Contact, Male Pin, 4/0
340320-009	A320 Contact, Female Skt, 2/0
340320-010	A320 Contact, Female Skt, 3/0
340320-011	A320 Contact, Female Skt, 4/0

**A160**

**Crown Part Number Description**

**A160 Complete Kits - handle, auxiliary tips, clamp and carrier**

341227-115	A160 Conn- Male Pin, 1/0
341227-125	A160 Conn- Female Skt, 1/0

**A160 Kits - Do not include contact tips, auxiliary tips or handle**

341227-112	A160 Conn- Male Pin, 1/0
341227-122	A160 Conn- Female Skt, 1/0

**A160 Auxiliary Tips**

340320-012	A160/320 Aux Pin Contact, Lower #10 6mm AWG
340320-013	A160/320 Aux Pin Contact, Upper #12 4mm AWG

**A160 Contact Tips**

341227-003	A160 Contact, Male Pin 1/0
341227-002	A160 Contact, Female Pin 1/0

340320-405 / 341227-125



340320-201 / 341227-122



340320-212 / 341227-112



340320-402 / 341227-122



340320-002



340320-003



340320-004



340320-005



340320-006 / 341227-003



340320-009 / 341227-002



340320-001

340327



340328



**A320/A160 Tools and Accessories**

**Crown Part Number Description**

340320-001	A160 & A320 Handle
340329	Hand Crimp Tool - crimps auxiliary DIN contacts

**A320 (only) Tools and Accessories**

**Crown Part Number Description**

340060-002	A320 Manual Release Brkt. Battery half
340060-003	A320 Manual Release Lever, Charger/Truck Half
340321	Crimp Tool-A320 Aux Contacts
340322	Crimp Tool-Manual/Hydraulic; bench mounted; has built-in die selector, no need for external dies
340323	Crimp Tool-Battery Powered; hand held hydraulic tool that uses dies 340325 & 340326
340324	Crimp Tool-Hand held hydraulic tool that uses dies 340325 & 340326
340331	Die Set - 6-12 guage - use with 340321
340325	Die Set-2/0 - use with 340323 & 340324
340326	Die Set-3/0-4/0 - use with 340323 & 340324
340327	Latch Plate w/hardware
340328	A-Frame Handle for Latch, w/hardware

## Battery Connectors - 1 Pole



### 120 Ampere

Part Number	Color	Cable Size
<b>Connector Housing</b>		
081591	Blue	NA
<b>Contacts</b>		
081823	NA	2/0



### 180 Ampere

Part Number	Color	Cable Size
<b>Connector Housing</b>		
084528	Blue	NA
<b>Kit Housing/Contacts</b>		
084529	Blue	1/0
<b>Contacts</b>		
078724-002	NA	1/0

## Power Cable

### Power Cable

Gauge	Color	UL Rated	Bulk Part Number	10 ft box 305 cm	50 ft reel, 1,524 cm	100 ft reel, 3,048 cm	250 ft reel, 7,620 cm	500 ft reel, 15,240 cm
6	black	UL	084568-010					
4	black	UL	084569-105	384569-010	384569-050	384569-105	384569-250	
4	red	UL	384575-001		384575-050	384575-100		
2	black	UL	084570-100		344570-050	344570-100		344570-500
2	red	UL	384576-001		384576-050	384576-100		
1	black	UL	084571-100		344571-050	344571-100		
1	red	UL	384571-001		384571-050-02	384571-100-02		
1/0	black	UL	084572-021		384572-050	384572-100		
1/0	red	UL	384574-001		384574-050	384574-100		
2/0	black	UL	084573-013			384573-100	384573-250	
2/0	red	not UL	384573-013R			384573-013		
2/0	orange	not UL	384573-014R			384573-014		
4/0	black	UL	384577-100-01			384577-100		
4/0	red	not UL	384578-100-01			384578-100		

### Cable Ties

Part Number	Length (in)	Width (in)	Max. Wire Bundle	Color	Qty Per Box
365003-002	4.00	0.09	0.63	Natural	1000
365003-003	7.44	0.19	1.75	Natural	1000
365003-004	5.60	0.14	1.38	Black	1000
365003-005	11.40	0.14	3.00	Black	1000



### Expandable Sleeving - Black

Part Number	Size	Expansion Range (Min. - Max.)
300467-100	3/4" - 100 ft. roll	5/8" - 1"
300456-100	1 1/4" - 100 ft. roll	1" - 1 1/2"

- Fray resistant, cuts with scissors
- High abrasion resistance
- Increased braid density for better coverage
- Will fit both negative & positive cables from 1 gauge to 4/0 gauge



### Expandable Sleeving - Red

Part Number	Size	Expansion Range (Min. - Max.)
300468-075	3/4" - 75 ft. roll	3/4" - 1 1/4"
300468-250	3/4" - 250 ft. roll	3/4" - 1 1/4"
300469-050	1 1/4" - 50 ft. roll	3/4" - 1 3/4"
300469-250	1 1/4" - 250 ft. roll	3/4" - 1 3/4"

- Cut and abrasion resistant
- Resists gasoline, engine chemicals and cleaning solvents
- Economical and easy to install
- FMVSS 302 Approval
- Not anti-fray



### Cable End - Copper Tin Plated

AWG Wire Size	Stud Size	Description	Part Number
4	0.344	straight	384000-003
6	0.344	straight	384000-004
1/0	0.344	straight	384000-001
2/0	0.344	straight	384000-002
4	0.344	90° angle	384001-003
6	0.344	90° angle	384001-004
1/0	0.344	90° angle	384001-001
2/0	0.344	90° angle	384001-002

384000-XXX



384001-XXX

LEAD FREE

### Automotive Battery Connectors, 10 per package

Part Number	Single Piece	Description	Specifications
300457-010	300457-001	Heavy Duty Universal Top Post Lead Terminal	Clamps designed for truck, bus, construction, agriculture & industrial applications. Accepts 1 thru 4/0 gauge cable.
300458-010	300458-001	Automotive Universal Top Post Lead Terminal	Automotive and light truck applications. Accepts 6 thru 2/0 gauge cable sizes.

300457-010



300458-010



### Heat Shrink Tubing

Part Number	Color	Expanded		Gauge Size	Length (in)
		Shrunk Dia. (in)	Expanded Dia. (in)		
300414-001	Black	0.75	0.25	4 thru 2/0	6
300414-002	Red	0.75	0.25	4 thru 2/0	6
300414-003	Black	1.125	0.375	1/0 thru 250 MCM	6
300414-004	Red	1.125	0.375	1/0 thru 250 MCM	6

- Double wall with extra meltable sealant
- Premium quality for heavy duty applications or for use in abusive environments requiring protection from abrasion
- Inner surface lined with adhesive sealant which melts when heated; permanently seals connection as tube cools & shrinks
- Conforms to DOD Mil-DTL-23053/15A Class 1 & 2 specifications



## Battery Watering Application Chart

Use the following table to help determine the best system for the application at hand. Not all applications are alike; be sure to put the appropriate product into the correct application to ensure years of cost effective & reliable operation.

Product	Water Injector System	Float System	Watering Gun
Facility Size	25 or more batteries	5-25 batteries	1-5 batteries
Application	Heavy Duty Abusive Conditions Rapid Charge Battery Changers	Medium Duty Low Water Pressure Medium Facility	Light Duty Small Facility Infrequent Use Golf Course
Time to Install	3 Minutes	12 Minutes	Not Applicable
Time to Fill an 18-Cell Battery	15 Seconds	2-10 Minutes	20 Minutes
Payback/ROI	\$\$\$	\$\$	\$

## Injector System

Continued ▶

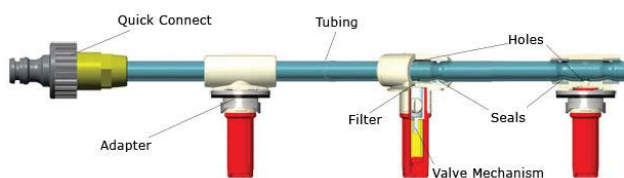

### Injector Kits

Part Number	Vendor Number	Description
300301-012	INJ-S12	24V Injector Kit Standard
300301-018	INJ-S18	36V Injector Kit Standard
300301-024	INJ-S24	48V Injector Kit Standard

Note: Prestrung options available upon request.

**ATTENTION:** Water Injectors require a minimum of 25 psi of flowing water at a rate of 8 gallons per minute. If the flow is inadequate, the Injectors will not shut off. If a factory authorized water supply is not being used water pressure from the wall must be confirmed with a 300310-027 Water Flow Pressure Measurement Tool.



### Features

- **Very Fast Operation:** An average industrial truck battery can be filled, with precise level control, in less than 15 seconds. The savings in labor costs alone often pays for the system within its first year of operation.
- **Quality of Watering:** It extends the life of each expensive battery it is installed on due to improved quality of watering. The battery is properly watered every time.
- **Safety and Environmental Cleanliness:** There is no need to peer into cells to inspect levels as with manual filling, and Water Injectors™ automatically fill each cell to the correct level, so no over filling and no electrolyte overflow during charge.
- **Compact:** A very low profile allows them to fit on almost any battery. Injectors can snap in and out to allow inspection of electrolyte levels and specific gravities.
- **Rugged:** Tough enough to survive impacts, abuse and extremes of battery temperatures. There are no exposed parts to break off even when an Injector is removed from a cell. True level sensing mechanism. Needs no submergence to sense level as a float does. Can work right down to the top of the separators. Will not fail if it touches cell components.
- **No-Freeze Tubing:** The surplus water drains from the tubing into cells after filling is complete. This allows the system to be used in cold stores and other freezing environments.
- **2-Stage Filtration:** In addition to the filter screen in the water tubing, each Injector has its own individual filter.
- **5-Year Warranty:** Warrantable against defects in materials and workmanship.





**Bladder Tank 10 Gallon**

**Part Number Vendor Number**

300306 | INJ-T10M

- 10 gallon steel tank
- Requires no power

**Tank capacities based on input pressure**

**Input Pressure Tank Capacity**

80 PSI	10 Gallon
70 PSI	9.5 Gallon
60 PSI	8 Gallon
50 PSI	6 Gallon

**Note:** Water pressure below 50 PSI will require a booster pump.

**Replacement parts:**

- Instant Valve Pro - P.N. 300310-033 (INJ-607)
- Female Quick Disconnect - P.N. 300227-029 (INJ-527)
- Replacement Hose - P.N. 300306-001 (ACC-065)



**Hydro Cart Injector**

**Part Number Vendor Number**

300302 | INJ-HCT

- Sturdy 20 gallon polypropylene tank
- 30 ft of total reach, 15-ft power cord plus 15 ft of 5/8" high-output industrial hose
- Handles like a hand truck
- On/off switch and power indicator located on front of unit
- Plug into 110 VAC outlet
- Flow indicator tells when the injectors have shut off

**Replacement parts:**

- Pump - P.N. 300311 (INJ-540)
- Inline Regulator Assm - P.N. 300310-038 (INJ-645)
- Instant Valve Pro - P.N. 300310-033 (INJ-607)
- Black Handle Assm., includes wheels, bearings & axle - P.N. 300312 (Q-0239)
- Parts Kit, includes hoses & fittings to connect to the submersible pump for charger mounted water supplies - P.N. 300310-037 (INJ-657)
- Gray Switch - P.N. 300302-001 (INJ-672)



**Mini Hydro Cart Injector**

**Part Number Vendor Number**

300303 | INJ-MINI

- 8 gallon polypropylene tank
- 23 ft of total reach
- Easy to transport to remote locations
- Plug into 110 VAC outlet

**Replacement parts:**

- Wheels, Axle & Cap - P.N. 300313 (Q-0185)
- Pump - P.N. 300311 (INJ-540)
- Instant Valve Pro - P.N. 300310-033 (INJ-607)



**Booster Pump**

**Part Number Vendor Number**

300304 | INJ-BP

- Use with 300306 and 300307 bladder tanks
- Delivers 1.5 Gallons per minute
- Automatically turns off when output pressure reaches 80 psi
- Wall mountable and requires 110v A/C outlet
- 15 ft input hose

Used when the in-plant water pressure is not high enough to completely fill a bladder tank. It cannot be used to fill the injector system directly since it does not have a high enough flow rate.

**Replacement part:**

- Quick Connect Set, includes male quick connect x female hose thread, female quick connect x female hose thread, & check valve - P.N. 300227-023 (PS-122)



**Direct Fill Hose Injector**

**Part Number Vendor Number Length**

300305 | INJ-DF | 20 ft.

**Note:** The Direct Fill Hose Injector requires a minimum of 25 psi of flowing water at a rate of 8 gallons per minute. If the flow is inadequate, the Injectors will not shut off. If a factory authorized water supply is not being used, water pressure from the wall must be confirmed with a 300310-027 Water Flow Pressure Measurement Tool.

**Replacement part:**

- Instant Valve Pro - P.N. 300310-033 (INJ-607)

**Injector Watering System**

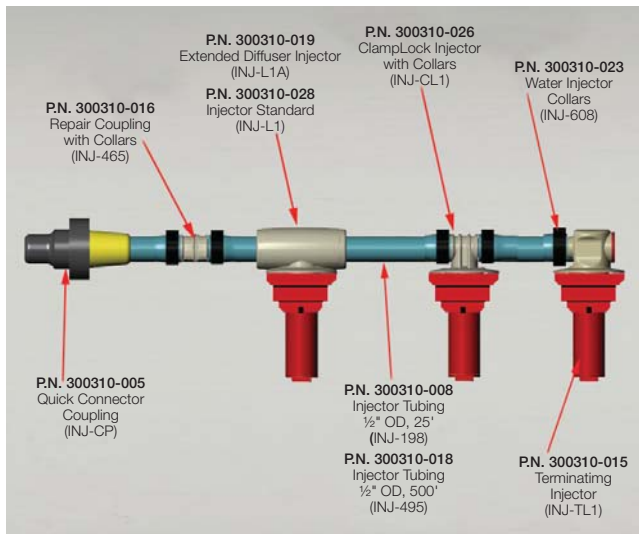

▲ **Note:** The use of deionized water is recommended for all tanks.

# Injector System



## Injector System Supplies

Part Number	Vendor Number	Description
300227-029	INJ-527	Female Quick Disconnect
300310-005	INJ-CP	Coupling Quick Connect
300310-008	INJ-198	Injector Tubing 25 feet, 1/2" OD
300310-010	INJ-212	Terminating Injector Clamp (1)
300310-012	INJ-250	Vent Adapter Quarter Turn
300310-013	INJ-253	Vent Adapter DIN
300310-015	INJ-TL1	Terminating Injector
300310-016	INJ-465	Repair Coupling
300310-017	INJ-472	Check Valve (2)
300310-018	INJ-495	Tubing Type 2, 500 feet, 1/2" OD
300310-019	INJ-L1A	Extended Diffuser Injector
300310-020	INJ-534	Injector Input, Dual Barb with extended downtube
300310-023	INJ-608	Water Injector Collars (3)
300310-025	INJ-615	Wye Fitting with Ratchet Clamps (10 Pack) (4)
300310-026	INJ-CL1	ClampLock Injector (single) with collars

Part Number	Vendor Number	Description
300310-028	INJ-L1	Injector Standard
300310-033	INJ-607	Instant Valve Pro, replaces INJ120 (On/Off Valve) & INJ121 (Nozzle), INJ491 (Quick Connect, Female, Male Thread) (5)
300310-034	ACC-038	Check Valve/Quick Disconnect Coupling Male (6)
300310-037	INJ-657	Replacement Parts Kit - hoses and fittings to connect the hydrotronic to submersible pump (7)
300310-038	INJ-645	Inline Regulator Assembly 

Tools		
Part Number	Vendor Number	Description
300310-009	INJ-202	Installation Tape 36 yards
300310-014	INJ-311	Punch Tool Tubing
300310-022	INJ-601	Water Injector Collar Installation Tool
300310-027	INJ-FC	Water Flow Pressure Measurement Tool

### Key:

- (1) Used on Terminating End of Injector Kit; also used with Wye Fitting to lock the Hose
- (2) Quick disconnect on End of Injector System that will plug into water supply
- (3) Includes Male Quick Connect x Female Hose Thread, Female Quick Connect x Female Hose Thread, and Check Valve
- (4) Connects the Fill Hose to the Injector System
- (5) Replaces On/Off Valve - INJ-120, Nozzle - INJ-121, and Instant Valve Assembly - INJ-491
- (6) Replacement part for 300307 (Bladder Tank Max - INJ-T20M)
- (7) Includes Hoses and Fittings to connect to the Submersible Pump for Charger-Mounted Water Supplies



### Features:

- The Float based, single-point watering system precisely fills all battery cells to the same level simultaneously. It makes battery watering safe, easy and affordable.
- Push-fit tubing ports - a unique design feature - makes tubing installation fast, easy and secure. Secure tubing by simply pushing tubing into ports.
- Operating pressure range is from 3 to 45 psi.
- The system tubing is kink and crush-resistant. With a small bend radius, it fits the smallest cells easily, including 5- and 7-plate batteries.
- No need for multiple float sizes. This unique system design incorporates a one-size-fits-all philosophy.
- Designed to sit lower than the intercell connectors when installed on a battery. This means reduced damage from the battery's cables as they move across the top of the battery.

### Float Kits

Part Number	Vendor Number	Description
300220-012	FLT-K12	24v Standard Float Kit
300220-018	FLT-K18	36v Standard Float Kit
300220-024	FLT-K24	48v Standard Float Kit
300221-012	FLT-DK12	24v Douglas Float Kit *
300221-018	FLT-DK18	36v Douglas Float Kit *
300221-024	FLT-DK24	48v Douglas Float Kit *

\*Note: Includes float assembly adaptor part number 300227-016 for each battery cell. Adaptor only required for Douglas batteries.



300220-012



300220-018



300220-024

**Note:** Crown does not recommend the installation of the float watering system into Exide Technologies/GNB Batteries. Crown cannot guarantee that the float valves will fit into all cells of the Exide Technologies/GNB battery. Because of this we recommend the use of the Water Injector System or Water Injector Spider System for Exide Technologies/GNB batteries, which fit all Exide Technologies/GNB cells. Customers that want to install the float watering system onto Exide Technologies/GNB batteries do so of their own accord and assume responsibility if it does not fit.



### 5 Gallon Gravity Flow Tank-Hose

Part Number Vendor Number

300223 | FLT-GT

- Sturdy 5-gallon polypropylene tank
- Easy to fill
- Flow indicator
- 25 ft. hose attaches with a rugged connector
- Note: Unit needs to be mounted at least 5 feet above the top of the battery.

#### Replacement parts:

- Injector Tubing - P.N. 300310-008 (INJ-198)
- Direct Link Front End Only - P.N. 300227-026 (FLT-070)
- Flow Indicator Spinner - P.N. 300227-021 (FLT-032)
- Female Float Valve Coupling - Use with Flow Rite - P.N. 300227-011 (FLT-035)
- Female Float Valve Coupling - Use with BFS Blue - P.N. 300227-030 (FLT-035E)
- Female Float Valve Coupling - Use with BFS Black - P.N. 300227-012 (FLT-035A)
- Shelf - 300223-002 (FLT-018)

### 300225-001



**Highly Visible Fill Level Indicator**  
Viewable from top and side

**Push-fit Tubing Ports**

- Secure tubing by simply pushing tubing into ports
- No barbed fittings to break

**Snap-Fit Base**  
No separate adapter required

**Rotatable Base**  
Once installed

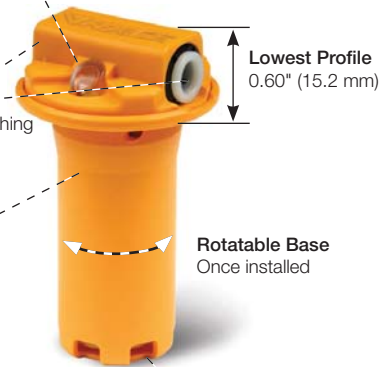

**One Size Fits All Design**

- Fills all cells to appropriate level
- Multiple float sizes not needed

**Built in Float Guard**

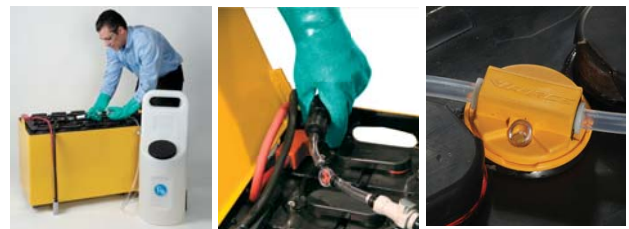

### Shelf For Float System Gravity Tank

Part Number Vendor Number

300223-002 | FLT-018

- Wall-mountable shelf to hold 5-gallon gravity tank shown above



### Direct Fill Link

Part Number Vendor Number

300222 | FLT-DL

- Designed to attach to in-house plumbing. Water pressure may not exceed 80 PSI. Do not fill from a faucet.

#### Replacement parts:

- Hose 6.1m (20 ft) - P.N. 300222-020 (FLT-039)
- Direct Link Front End Only - P.N. 300227-026 (FLT-070)
- Flow Indicator Spinner - P.N. 300227-021 (FLT-032)
- Female Float Valve Coupling - Use with Flow Rite - P.N. 300227-011 (FLT-035)
- Female Float Valve Coupling - Use with BFS Blue - P.N. 300227-030 (FLT-035E)
- Female Float Valve Coupling - Use with BFS Black - P.N. 300227-012 (FLT-035A)
- Pressure Regulator 35 PSI - P.N. 300227-020 (GUN-AT)





**12v 10 Gallon Watering Cart**

Part Number	Vendor Number
300224-010	CRT-12V

- Easy to transport to remote locations
- Easy to fill; large opening
- Charge the battery operated unit from any 120 VAC outlet with the provided charger
- Sturdy 10-gallon polypropylene tank
- On/off switch on rear of unit
- Easy to use; instructions printed on the unit

**Replacement parts:**

- Battery - P.N. 300224-010-01 (CRT-095)
- Charger - P.N. 300228 (CRT-035)
- Pump - P.N. 300224-011 (CRT-040)
- Female Float Valve Coupling - Use with BFS Blue - P.N. 300227-030 (FLT-035E)
- Female Float Valve Coupling - Use with BFS Black - P.N. 300227-012 (FLT035A)
- Direct Link Front End Only - P.N. 300227-026 (FLT-070)
- Flow Indicator Spinner - P.N. 300227-021 (FLT-032)
- Female Float Valve Coupling - Use with Flow Rite - P.N. 300227-011 (FLT-035)
- Repair Kit, includes black panel, on/off switch, charger jack, screws, does not include wiring - P.N. 300233 (ACC-066)



**Water Deionizer**

Part Number	Vendor Number
300226	WD-300

- Comes with everything you need to make pure water from the tap
- Operates at full-line pressure to dispense pure water directly from the deionizer
- Quick cartridge replacement requires no tools
- 20-ft output hose allows maximum watering flexibility and convenience
- Optional Watering Gun lets you fill a battery directly from the deionizer

**Replacement parts:**

- Deionizer Filter - P.N. 300226-001 (PS-600)
- Deionizer Hose Output, 20 ft - P.N. 300231 (PS-150)
- D/C Purity Light with Tee - P.N. 300226-002 (PS-191)
- Deionizer Input Hose - P.N. 300226-003 (PS-140)
- Quick Connect Set, includes male quick connect x female hose thread, female quick connect x female hose thread and check valve - P.N. 300227-023 (PS-122)
- Adapter to convert from float system to injector system - P.N. 300229 (FLT-015)



Battery and Charger



**110v A/C 20 Gallon Watering Cart**

Part Number	Vendor Number
300225-020	FLT-12AC20

- Includes a 300229 converter to use on float system.
- Sturdy 20-gallon polypropylene tank
- Plugs into any 110 VAC outlet
- Handles like a hand truck
- On/off switch and power indicator located on front of unit
- 30 ft of total reach — 15 ft. power cord plus 15 ft of 5/8" high-output industrial hose
- Flow indicator tells when the injectors have shut off

**Replacement parts:**

- Pump - P.N. 300311 (INJ-540)
- Inline Regulator Assm - P.N. 300310-038 (INJ-645)
- Instant Valve Pro - P.N. 300310-033 (INJ-607)
- Black Handle Assm., includes wheels, bearings & axle - P.N. 300312 (Q-0239)
- Parts Kit, includes hoses & fittings to connect to the submersible pump for charger mounted water supplies - P.N. 300310-037 (INJ-657)



**Watering System**

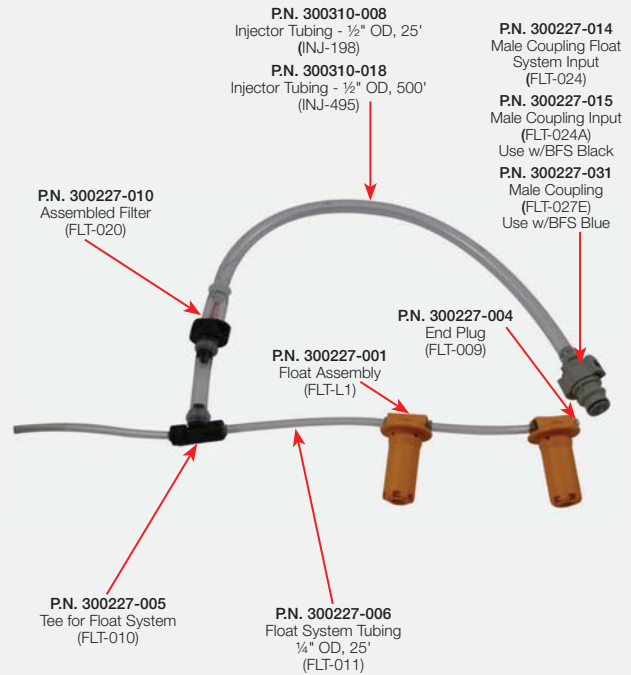

# Float System

## Float System Supplies

Part No.	Vendor No.	Description
300224-011	CRT-040	Pump
300225-001	FLT-1L	Float Assembly - Orange, V-Force
300227-001	FLT-L1	Float Assembly - Black
300227-002	FLT-004	Float Input Assembly with Filter (1)
300227-003	FLT-004A	Float Input Assembly with Filter - BFS (2)
300227-004	FLT-009	End Plug, Float Systems
300227-005	FLT-010	Tee for Float System
300227-006	FLT-011	1/4" Tubing, 25 ft, Float System
300227-017	198-IN	1/2" Tubing, 12 ft
300227-007	FLT-012	Tubing Cutter, Float System
300227-010	FLT-020	Assembled Filter
300227-011	FLT-035	Float Valve, Coupling, Female - use w/Flow Rite (3)
300227-012*	FLT-035A	Float Valve, Coupling, Female - BFS - Black (4)
300227-014	FLT-024	Male Coupling, Float System Input
300227-015*	FLT-024A	Input Coupling Male - BFS Converter - Black (4)
300227-016	FLT-030	Douglas Float Assembly Adaptor
300227-021	FLT-032	Flow Indicator Spinner
300227-026	FLT-070	Direct Link Front End Only
300227-030	FLT-035E	Female Coupling - BFS Converter - Blue Connector (5)

Part No.	Vendor No.	Description
300227-031	FLT-027E	Male Coupling - BFS system - Blue Connector (5)
300227-037	09MBLU1	BWT 1/4" Male Coupler
300227-038	09FWM1	Spinner/Flow Indicator
300227-039	BA-032	Back Flow Preventor
300227-040	BA-031	Hose Bibb Pressure Reducer
300228	CRT-035	Charger
300233	ACC-066	Repair Kit for 300224-010. Black back panel includes on/off switch, charger jack, and 6 mounting screws. Does not include wiring. (6)
300310-008	INJ-198	Injector Tubing 25 feet, 1/2" OD
300310-018	INJ-495	Tubing Type 2, 500 feet, 1/2" OD
300310-038	INJ-038	Inline Regulator Assembly

\*Note: Order this coupling if you already have BFS fill guns or links.

## Water Deionizer Replacement Parts

300226-001	PS-600	Deionizer Filter (7); rated for 600 gallons
300226-002	PS-191	D/C Purity Light with Tee
300226-003	PS-140	Deionizer Input Hose
300227-023	PS-122	Quick Connect Set for Water Deionizer
300231	PS-150	Deionizer Output Hose, 20 ft

### Key:

- (1) Includes 300227-005 (Tee for Float System - FLT-010), 300227-010 (Assembled Filter - FLT-020), 300310-008 (Injector Tubing 7.62 m [25 ft], 12.7 mm [0.5 in] OD - INJ-198), and 300227-014 (Male Coupling Float System Input - FLT-024)
- (2) Includes 300227-005 (Tee for Float System - FLT-010), 300227-010 (Assembled Filter - FLT-020), 300310-008 (Injector Tubing 7.62 m [25 ft], 12.7 mm [0.5 in] OD - INJ-198), and 300227-015 (Male Coupling Input - FLT-024A)
- (3) Use with Flow Rite
- (4) Use with BFS - Black CPC Connector; order this if you already have BFS Fill Guns or Links
- (5) Use with BFS - Blue CPC Connector
- (6) Includes Black Panel, On/Off Switch, Charger Jack, and six Mounting Screws; does not include wiring
- (7) Cartridge is 0.61 m (2 ft) long and rated for 2271.25 L (600 gal) of pure water; actual output may vary with tap water quality



300224-011



300225-001



300226-001



300226-003



300227-001



300227-002



300227-003 (BFS)



300227-004



300227-005



300227-006



300227-007



300227-010



300227-011



300227-012



300227-014



300227-015



300227-016



300227-021



300227-023



300227-026



300227-030



300227-031



300227-037



300227-039



300227-040



300228



300231



300233

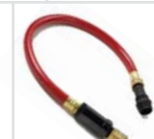

300310-038

# Watering Guns

## Battery Watering Gun

Part No.	Vendor No.	Description
300234	GUN-X	Works in 5/8" and 7/8" nozzle applications. Replaces GUN-B, GUN-FB, GUN-C, GUN-FC, GUN-G, GUN-FG, GUN-K, GUN-FK, GUN-R, GUN-R24.
300234-001	GUN-HC	Replacement Handle for 300234

**Note:** Replacement nozzle not available; order gun.

## GUN-B Replacement Part

Part No.	Vendor No.	Description
300227-020	GUN-AT	Pressure Regulator



**Superior Strength**

- Built from rugged, engineered ABS plastic
- Weak points eliminated; pressure regulator incorporated into nozzle

**Ergonomically Designed**

- Easy-squeeze, rugged handle
- 45° bend nozzle
- Less bending over to fill battery

**Integrated Flow Indicator**

- Shows you when filling has stopped

**Secure Level Control**

- Will not move over time
- Adjustable or removable
- Pre-set for optimum level for most motive power batteries
- Beveled to conform to vent well at many angles

**Flow Diffuser**

- Converts the rapid flow to a gentle spray
- Protects nozzle from damage

**Faster Fill**

- 1.7 GPM
- Spend less time watering

Battery and Charger

## Flow Rite - Float Kits and Replacement Parts

Part No.	Vendor No.	Description
300220-005*	BA-MS-320-20	Water Supply for 6V Float Kit
300220-006**	BG-U24V-4G	6V Universal Float Kit
300220-001	BG-U24V-1G	6V Float Kit w/2.7" Spacing
300220-002	BG-U24V-2G	6V Float Kit w/3.3" Spacing
300220-003	BA-Y7A-10	Valve/Float Replacement
300220-004	BD-TI4	Tubing Replacment; 3 ft Piece
300220-007	BA-FLW-20	Flow Indicator Replacement
300220-008	BA0QDV-805	Quick Coupler Replacement
300220-009	BA-QDV-505	Male Coupler 1/4"
300220-010	BA-QDV-231	Female Coupler
300220-011	BA-FLW-80	Female Coupler & Flow Indicator
300220-013	BA-FLW-60	Flow Indicator

300220-005

300220-006

300220-003

300220-001 & 002

300220-004

300220-007

300220-008

300220-009

300220-010

300220-011

300220-013

\*One water supply required per location.

\*\*Complete kit for 6V WP battery pack. Kit includes floats for set of 4, 6V batteries. Features:

- Automatic shut-off valves interconnected with tubing
- Quick coupling
- Flow indicator
- Extend battery life and performance
- Time-saving convenience

**NEW!**

**NEW!**



**Post Drill Bit, 2 Flute**

Part Number - 300404

Designed for Leadheads, FastCharge Leadheads and Intercells.

- Extra tall flutes allow drilling depth of up to one inch
- 1 inch O.D. leaves a .70 inch post
- Tool length 5 inches
- Center pin to guide drill straight
- Can be resharpened
- Use centerless drill for deep bore
- Use Penetrating Lubricant: P.N. 363104-001

- ① Three flats on shank prevent spinning in chuck
- ② Extra tall flutes improve drilling depth in thick leadheads; Wide flutes prevent chip pile-up
- ③ Electroplating improves corrosion resistance



**Hydrometer - Glass**

Part Number - 300406

- Professional quality for highest accuracy
- Precision graduated specific gravity float
- Overall Length 13.5 inches, glass barrel 8 inches long



**Hydrometer - Plastic**

Part Number - 300407

- Professional quality for highest accuracy
- Precision graduated specific gravity float

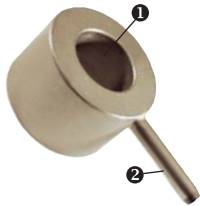

**Post Builder Mold**

Part Number - 300405

- Create a post on batteries or intercells
- Post mold is tall enough that when leadhead is attached, the post will burn down and fill leadhead cavity, creating tight seal
- Enables you to add a leadhead where needed

- ① Tapered mold for ease of release
- ② Handle to break mold free from new post



**Lead Sticks**

Part Number - 300417-005 (5 - 1 lb sticks)

- Made of 5 percent antimonial lead
- Clean melting alloy, free of foreign material, voids and porosity
- Sticks are 12 inches long (30.5 cm) and weigh 1lb (.45 kg)



**QuickStrip Pro - Cable Strippers**

Part Number - 300412

- Strips insulation from cable 10 - 250 mcm
- Includes spare blade

Replacement Blade: P.N. 300412-001



**QuickStrip - Cable Strippers**

Part Number - 300411

- Strips insulation from cable 10 - 4/0 gauge
- Includes spare blade

Replacement Blade: P.N. 300418



**Carbon Arc Burner**

Part Number - 300440

- No Flame
- Use voltage from battery to melt lead to repair battery

▼ **Accessories**

**Copper Coated Electrodes**

Part Number - 300441-050

- For use with Carbon Arc Burner
- 50 in a box

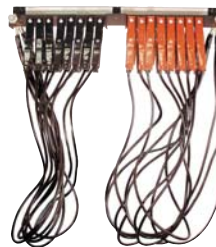

**Multi-Charging Bus Bar**

Part Number - 300453

- Charge up to 8 batteries at one time
- Affordable - low cost alternative to multiple charger's Flexible - can be mounted on wall, work bench or charger housing

**Includes:** Mounting hardware, side terminal-to-top post conversion connectors (4 pairs)

**Note:** Used to charge SLI and SLA batteries

**SLI** = (Starting, Lighting and Ignition) most common lead acid battery, typical starting battery in any car, truck.

**SLA** = (Sealed Lead Acid) sealed battery, you cannot add water to it, most commonly used in standby systems.



**Butane Torch**

Part Number - 300408

Butane Torch used for heat shrink applications along with soldering of some smaller connectors. Not used to repair batteries.



**Brute Hammer Crimper**

Part Number - 300465

- Use with hammer, vise or press
- Crimps 8 thru 4/0 gauge connectors
- Spring loaded pin locks in "up" position for loading connector and cable. When released, pin holds connector securely during crimping.

# Battery Tools



### Clamp

Part Number - 320056

- Use two of these clips to lift out battery cells
- See DP module for instructions.

### Oxygen & Acetylene Torch Welding & Regulator

Part Number - 300442

#### Includes:

- Tote
- 150 Series Cutting Attachment
- 150 Series Oxygen / Acetylene Regulators
- #2 Welding Nozzle Welds to
- #0 Cutting Tip Cuts to 1/2"
- 3/16" X 12.5' Dualine Hose
- Goggles/Shade #5 and Strik
- 10 cu ft "MC" Acetylene Cyl and 20 cu ft "R" Oxygen Cylinder (Empty)



#### ▼ Replacement Parts

Part Number	Description	Quantity
300443	Welding Nozzle, 0-W-1	1
300444	Cutting Tip, 0-3-101	1
300445	Cutting Attachment	1
300446	Welding Handle	1
300447	Regulator Oxygen	1
300448	Regulator Acetylene	1
300449	3/16" x 12-1/2" Hose Twin	1
300450	2001 Spark Lighter Single	Box (10)



### Quick Cutter 2 - Heavy-Duty Cutter

Part Number - 300409

- Hand held
- Cuts cable up to 6/0 gauge
- 22 inch handle for easier cutting
- Blades made of 1075 carbon steel, hardened for long life, can be resharpened
- Made in North America
- 2-year warranty



### Hex Crimp 26 inch

Part Number - 300410

- Crimps 8 thru 4/0 gauge cable
- Crimps all major brands of connectors
- Hand held
- 26 inch handles
- Made in North America
- 2-year warranty



### Hex Crimp Repair Kit

Part Number - 300410-001

- Includes 2 dies, 2 springs, 2 pins and 2 washers



### Carrying Case for Crimp Tools

Part Number - 300454



# Battery Service Supplies



## Wash Water Neutralizer

Part Number	Sales Unit
300415-001	Gallon
300415-004	Case (4) Gallon
300415-005	5 Gallon
300415-035	35 Gallon

Used to adjust pH in wash water and clean acid contaminated floors and equipment such as battery racks and delivery vehicles.

- Concentrated sulfuric acid neutralizer
- Non-corrosive and non-hazardous
- Allows for reuse of wash water
- Can also be used to remove acid from concrete floors
- Use on Reusable Battery Acid Floor and Counter Mat P.N. 300403-050

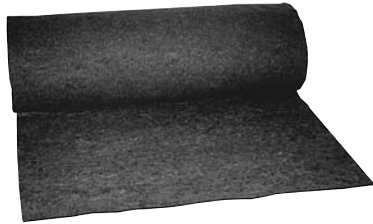

\*Wash Water

## Reusable Battery Acid Floor and Counter Mat

Part Number	Size (ft)
300403-002	3 x 2 piece
300403-050	3 x 50 roll (can be cut easily)

- Absorbs 6 oz. of acid per square foot
- Cut to size for battery compartments, storage racks or drip pans
- Mat absorbs acid but won't leak through tough polypropylene backing
- Electrically isolates battery, preventing parasitic discharge
- Use on floor or under the battery
- Use mat over and over again

**\*Note:** Use Wash Water Neutralizer P.N. 300415-001 on mat and sweep it up with shop vac.



## Battery Cleaner

Part Number	Sales Unit
363124-001	Net wt 18 oz Can
363124-012	Case (12) - 18 oz Cans

Heavy-duty industrial battery cleaner is engineered for fast, effective, economical maintenance of storage battery terminals, hold-downs, cables and battery boxes. It detects leaks by changing from yellow to reddish purple when it comes in contact with acid.



## Battery Protector

Part Number	Sales Unit
363125-001	Net wt 15 oz Can
363125-012	Case (12) - 15 oz Cans

Heavy-duty industrial, non-methylene chloride, battery protector extends battery life and prevents corrosion. It provides an air-tight, waterproof seal, and resists oil, gasoline, dirt, grease and heat. Assures maximum electrical connectivity.



## Black Battery Reconditioner

Part Number	Sales Unit
363133-001	Net wt 12 oz Can
363133-006	Case (6) - 12 oz Cans

Restores battery to original look. Formulated to adhere to battery plastics and metal. Ideal for automotive, truck and industrial batteries. When dry, paint finish resembles gloss of original molded plastic. Industrial grade, high solids for single coat coverage, outstanding hardness and durability, resists abrasion and heat. Fast drying. Other uses include battery hold-downs, trays and cases.



## Industrial Battery Cleaner/Neutralizing Wash Cleaner

Part Number	Sales Unit
300422-001	Quart
300422	5 Gallon
300422-035	35 Gallon

- Dissolves corrosion, eliminates acid shorts
- Stops damaging corrosion
- Allows for reuse of wash water
- Safe to use on all industrial and starter batteries
- Neutralizing Wash Cleaner with color change, turns purple when acid is present and back to yellow when safe

Wash Cleaner color indicates when acid is neutralized.

Acid Present	Neutralizing	Safe
--------------	--------------	------

**Note:** Protective acid resistant goggles and gloves are recommended.



# REDUCE DAMAGE AND INCREASE PRODUCTIVITY

A line laser, shown, is best for low-light areas such as warehouses while dot lasers are best for cold storage and outdoor usage.

**A forklift laser guidance system provides** operators a continuous visual reference of fork position which aids in increasing safety, accuracy, and productivity while reducing product damage. The laser projects a line or dot onto the pallet or product indicating the level of the forks which allows operator heightened visibility and more accurate fork placement. Single laser, dual laser, and hard-wired series units mount directly to the forklift carriage in less than five minutes.

**Contact Your Local  
Crown Dealer Today**



See page 5.11 of the One Source catalog for more details.



# Section 8

# Tools

## Contents

Crown Branded Tool Program	8.02
Mechanical Tools	8.04
Hydraulic Tools	8.08
Drive Tools	8.12
Diagnostic Tools	8.13
Electrical Tools	8.15
Brake Tools	8.18
Steering Tools	8.19

Battery Tools  
(See Section 7 - Battery and Charger)

### New Items:

Fork Lift Jack Replacement Parts - p. 8.04  
Wheel Chocks & Blocking Tools - p. 8.05  
Accumulator Charging Tool Replacement Part - p. 8.11

Note: 1910.178(q)(5) (1998) of the Occupational Safety and Health Act (OSHA) requires that "All parts of any such industrial truck requiring replacement shall be replaced only by parts equivalent as to safety with those used in the original design."

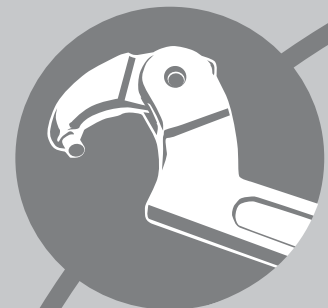

The Crown tool program offers high quality tools selected specifically for technicians to handle most lift truck repairs. Each item offered in the Crown tool kit is individually labeled with the Crown logo and Crown part number.



**Mechanics Tool Kit**

Part Number - 322999

212 pieces; includes all parts on this page and next page.



**Screwdriver Set (11 pieces)**

Part Number - 322150

Includes: Flat Head - 0.018" x 3", 3/16" x 3", 1/4" x 4", 5/16" x 6", 1/8" x 6". Phillips - #0 x 3", #0 x 6", #1 x 3", #2 x 4", #3 x 6". Gasket Scraper 5".

Note: Lifetime warranty.



**3/8" Drive Socket Set (72 pieces)**

Part Number - 322040

Includes: Ratchet, Universal Joint, Drive Extensions 3" and 5", Adaptor 3/8" Female to 1/4" Male, Adaptor 3/8" Female to 1/2" Male, Adaptor 1/2" Female to 3/8" Male, Drive Spinner Handle, 12 Point Shallow Sockets 5/16" thru 7/8", 12 Point Deep Sockets 5/16" thru 3/4", 12 Point Shallow Sockets 6mm thru 19mm, 12 Point Deep Sockets 6mm thru 19mm, Hex Head Drivers 1/8" thru 3/8", Torx Drivers T10 thru T55, Spark Plug Sockets 5/8" & 13/16".

Note: Lifetime warranty.



**Pliers Set (4 pieces)**

Part Number - 322140

Includes: Needle Nose Pliers, Gripping Pliers, Side Cutter, Arc Joint Pliers.

Note: Lifetime warranty.



**Combination Wrench Set - SAE (13 pieces)**

Part Number - 322170

Includes: 1/4", 5/16", 3/8", 7/16", 1/2", 9/16", 5/8", 11/16", 3/4", 13/16", 7/8", 15/16", 1". 15° offset box end knuckle clearance. Made of heat-treated alloy steel for strength exceeding ANSI specifications.

Note: Lifetime warranty.



**Hex Wrench Set - L Type, SAE Ball (13 pieces)**

Part Number - 322113

Includes: 0.050" thru 3/8".

Note: Lifetime warranty.



**Combination Wrench Set - Metric (10 pieces)**

Part Number - 322190

Includes: 10mm thru 19mm. 15° offset box end knuckle clearance. Made of heat-treated alloy steel for strength exceeding ANSI specifications.

Note: Lifetime warranty.



**Hex Wrench Set - L Type, Metric Ball (9 pieces)**

Part Number - 322114

Includes: 1.5mm thru 10mm. Ball end allows better angle of entry for hard to reach areas. Chrome vanadium steel with black oxide finish.

Note: Lifetime warranty.



**Angle Wrench Set (6 pieces)**

Part Number - 322162

Includes: 5/8", 11/16", 3/4", 7/8", 15/16", 1".

Note: Lifetime warranty.



**Pry Bar Set (2 pieces)**

Part Number - 322115

Includes: 6" and 18". Heat treated alloy steel. Bi-mold rubberized comfort grip.

Note: Lifetime warranty.



**1/2" Drive Socket Set (16 pieces)**

Part Number - 322120

Includes: Ratchet, Drive Extension 5", 12 Point Sockets 7/16" thru 1-1/4".

Note: Lifetime warranty.



**1/4" Drive Socket Set (39 pieces)**

Part Number - 322000

Includes: Ratchet, Universal Joint, Drive Extensions 1-1/2" and 6", Adaptor 1/4" Female to 3/8" Male, Drive Spinner Handle, 12 Point Shallow Sockets 5/32" thru 9/16", 12 point Deep Sockets 5/32" thru 9/16", 12 Point Shallow Sockets 4mm thru 14mm.

Note: Lifetime warranty.



**Roll Pin Punch Set (8 pieces)**

Part Number - 322210

Includes: 1/16" thru 5/16".

Note: Lifetime warranty.

## Crown Branded Tool Program



### Punch and Chisel Set (8 pieces)

Part Number - 322220

Includes: 1/8" Pin Punch, 3/16" Pin Punch, 1/4" Pin Punch, Taper Punch, 3/8" Center Punch, 5/16" Cold Chisel, 1/2" Cold Chisel, 3/4" Cold Chisel.

**Note:** Lifetime warranty.



### Pick Set (4 pieces)

Part Number - 322145

Includes: 45°, Straight, 90°, Awl.

**Note:** Lifetime warranty.



### Ball Peen Hammer

Part Number - 322139

**Note:** Lifetime warranty.



### Screwdriver - Phillips

Part Number - 322219

**Note:** 90-day warranty.



### Tape Measure

Part Number - 322169

**Note:** 1-year warranty.



### Screwdriver - Flathead

Part Number - 322221

**Note:** 90-day warranty.



### Locking Pliers - 7"

Part Number - 322119

**Note:** Lifetime warranty.



### Inspection Mirror

Part Number - 322222

Stainless steel shaft pick up tool. Shaft telescopes from 6½" to 33".

**Note:** 90-day warranty.



### Locking Pliers - 10"

Part Number - 322118

**Note:** Lifetime warranty.



### Pick-Up Tool - Magnetic

Part Number - 322223

Stainless steel shaft pick up tool. Shaft telescopes from 6½" to 33". 5lb magnetic power for easy picking of heavy parts.

**Note:** 90-day warranty.



### Adjustable Wrench - 6"

Part Number - 322137

**Note:** Lifetime warranty.



### Slide Rail Socket Holders

Part Number - 322225

**Note:** 90-day warranty.



### Adjustable Wrench - 10"

Part Number - 322138

**Note:** Lifetime warranty.



### Tote Tool Bag

Part Number - 322224

**Note:** 1-year warranty.



### Wire Stripper

Part Number - 322209

**Note:** Lifetime warranty.

**Hydraulic Fork Lift Jack with Two Stands**

Part Number - 300080

8800 lb capacity. One year warranty.  
Spring loaded lowering knob for safety.

**Seal Kit**

Part Number - 300080-001

Includes 2 each index # 8, 12, 17 & 41 and  
1 each # 24, 31, 32, 33, 35, 37 & 42

**(Jack - Only)**

Part Number - 300083

**Fork Lift Stands (two)**

Part Number - 300081

7 ton capacity per set of two.

Replacement - P.N. 300081-001, pin with lanyard chain



**Hydraulic Fork Lift (Jack only)**

Part Number - 300084

14,000 lb capacity

**Note:** 1-year warranty

**Seal Kit:** P.N. 300080-001



**Hydraulic Fork Lift Jack Replacement Parts**

Part Number	Description	Chart	
		Ref. No.	Note
300080-101	Grip	1	Used on 300083 & 300084
300080-102	Handle	2	Used on 300083
300080-003	Ring	3	Used on 300083
300080-004	Pin	4	Used on 300083
300080-005	Handle base	5	Used on 300083
300080-009	Retaining ring	9	Used on 300083 & 300084
300080-010	Pin	10	Used on 300083
300084-010	Pin	10	Used on 300084
300080-015	Pin	15	Used on 300083
300080-018	Port Ring	18	Used on 300083 & 300084
300080-023	Ball	23	Used on 300083 & 300084
300080-024	O-Ring	24	Used on 300083 & 300084
300080-025	Release rod	25	Used on 300083 & 300084
300080-026	Release knob	26	Used on 300083 & 300084
300080-027	Pin	27	Used on 300083 & 300084
300080-028	Link	28	Used on 300083
300080-029	Pin	29	Used on 300083 & 300084
300080-030	Plunger	30	Used on 300083 & 300084
300080-032	Back-up ring	32	Used on 300083 & 300084
300080-033	O-ring	33	Used on 300083 & 300084
300080-034	Pump	34	Used on 300083 & 300084
300080-047	Piston rod pad	47	Used on 300083 & 300084
300080-048	Pin	48	Used on 300083 & 300084
300080-049	Saddle	49	Used on 300083 & 300084
300080-055	Snap ring	55	Used on 300083 & 300084
300080-056	Washer	56	Used on 300083 & 300084
300080-057	Wheel	57	Used on 300083 & 300084
300080-060	Lockwasher	60	Used on 300083 & 300084
300080-063	Screw	63	Used on 300083 & 300084
300080-064	Trunion	64	Used on 300083 & 300084
300080-066	Snap ring	66	Used on 300083
300080-067	Screw	67	Used on 300083 & 300084
300080-071	Scraper seal	71	Used on 300083 & 300084
300080-072	U-cup	72	Used on 300083 & 300084
300084-074	Spring	74	Used on 300083 & 300084
300080-076	Pin	76	Used on 300083
300080-077	Pin	77	Used on 300083
300080-100	Capacity Label	—	Used on 300083
300081	two fork lift stands, 7 ton capacity per set of 2		



**Replacement Part Reference for Part Numbers 300083 & 300084**

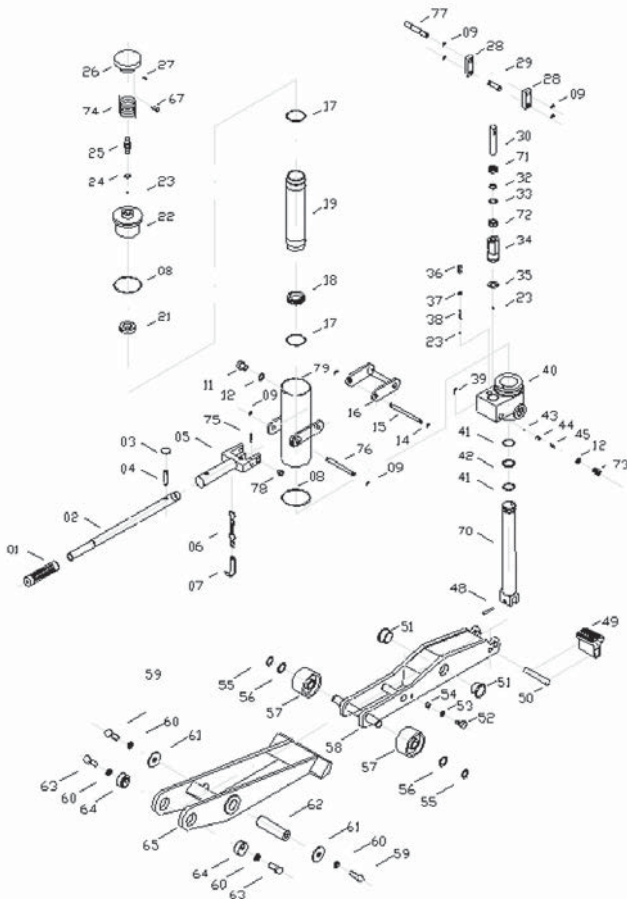

**Hydraulic Jack Seal Kit**

Part Number - 341225-001

Seal kit for Hydraulic Jack P.N. 341225.

**NOT for use with Hydraulic Fork Lift Jack P.N. 300080 and P.N. 300084 listed above.**



**Wheel Chock - Small**

Part Number - 061140  
2.5" x 2.5" x 3"



**Standard Wheel Chock - Large**

Part Number - 061145  
5.8" x 3.6" x 12"



**Blocking Outrigger - Load Wheel Changes**

Part Number - 061141  
2.5" x 3.5" x 12"



**Blocking Truck Frame/Steer Axle**

Part Number - 061144  
6" x 7" x 12"



**Block Pantograph Assemblies**

Part Number - 061142-001  
RD. 3.5" x 3.5" x 9"



Part Number - 061142-002  
RR. 3.5" x 3.5" x 13"



**Blocking Mast Assemblies**

Part Number - 061143-001  
Short. 4" x 4" x 22"



Part Number - 061143-002  
Long. 4" x 4" x 48"



**Axle Remover**

Part Number - 090705  
For single or dual load wheel axle removal on PE, PC, PR, PW trucks. One piece tool.



**Roll Pin Insertion and Extraction Tool**

Part Number - 110567  
Removal and installation of load wheel axle roll pin. Used on Stockpickers and RR/RD 3000 and 5000 Series.

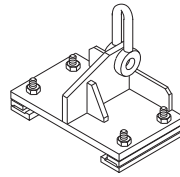

**Auxiliary Mast Lifting Tool**

Part Number - 110571  
Facilitates handling auxiliary mast. Used on TS. Refer to platform maintenance of service manual, (section 9.0). One piece tool.



**Gage Shim Assembly**

Part Number - 125535  
Gage used to shim Wave masts. Used with Part Numbers 125539 and 133403. See maintenance section for where used.

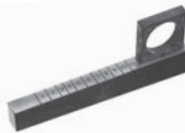

**Gage Shim Assembly**

Part Number - 125539  
Gage used to shim Wave masts. Used with Part Numbers 125535 and 133403. See maintenance section for where used.



**Gage Shim Assembly**

Part Number - 133403  
Gage used to shim Wave masts. Used with Part Numbers 125535 and 125539. See maintenance section for where used.



**Spanner Tool**

Part Number - 100455  
For removal, installation and torquing the axle locknuts. Used on RC, SC, Reach, TSP, TS and SP 3000 Series.



**Tool Assembly**

Part Number - 132501  
Used for installation of load wheels on stockpickers, WR and reach trucks with an axle diameter of 1.375. This tool aligns the shims and wheels to make it easier to get the axles in.



**Tool Assembly**

Part Number - 132502  
Used for installation of load wheels on stockpickers, WR and reach trucks with an axle diameter of .975. This tool aligns the shims and wheels to make it easier to get the axles in.



**Quick Change Load Wheel Installation Tool**

Part Number - 150192 (for 2.88" load wheel)  
Part Number - 150193 (for 4.12" load wheel)  
Used to install quick change load wheels on Reach trucks.



**Tire Adapter**

Part Number - 134169  
Used to press on drive tire on RR/RD 5000 Series trucks. See PIB 05-08-02.



**Mast Tool**

Part Number - 810705  
ESR4000 Mast Tool used to calculate the required roller diameter.



**3rd Stage Mast Locking Bar Tool**

Part Number - 150796  
Used to move mast stops on RM/RMD series mono masts.



**Shield / Screen Installation Tool - Tapered Tip**

Part Number - 340020-001  
Used to install shields on RR/RD 5000 series, Stockpicker and Turret trucks.



**Shield / Screen Installation Tool - Complete Kit**

Part Number - 340020-002  
Used to install shields on RR/RD 5000 series, Stockpicker and Turret trucks.



**Nut Adjusting Tool**

Part Number - 104958  
For removal, installation and torquing of locknuts on the center pivot assembly of reach assemblies. Used on Reach trucks.



**Compression Gauge and Hose Assembly**

Part Number - 145739  
High Quality Snap on Engine Compression Gauge for measuring cylinder compression on internal combustion engines.

**Accessory Items:** Compression Test Assembly (P.N. 145006)  
Adapter to be used with the 145739 Engine Compression Gauge. This is required for measuring cylinder compression on RST-50 and RP-50 Internal Combustion forklifts.

**Replacement part:** Schrader valve/check valve - P.N. 145740



**Swaging Tool**

Part Number - 107416  
Crimping stop ferrule on wire rope. Used on Turret and SP 3400 height sensors.



**Hand Swage**

Part Number - 090526  
Properly crimp compression fittings when repairing or replacing cable. Usage: SP Steering cable, Pallet clamp cable and TS, TSP hose take-up cable. Crimps both shielded and unshielded aircraft control cable. One piece tool, manufacturer's instructions included.



**Chain Wear Scale**

Part Number - 106440  
Used to check leaf and roller chain wear used for lift and steering functions.



**Air Solvent Gun**

Part Number - 065174-001  
Use with any solvent.



**Handle and Gate Spanner Tool**

Part Number - 104712  
For installation and removal of torsion springs on control handles and platform gates. Used on Pallet trucks, heavy-duty Walkies, Stockpickers, and Tow Tractors. Replacement pins: 061011-013



**Spanner Wrench**

Part Number - 104836  
For removal, installation and adjustment of Pallet Truck lift cylinder. Used on PW, PE, PC and PR.



**Molding Insertion Tool**

Part Number - 103792  
To ease installation of the two piece safety glass rubber molding. Used on Stockpickers after 10/86 and Turrets. TSB 227



**Digital Calipers**

Part Number - 320040-001

- Capacity 0-6"
- Rugged stainless steel body and jaws
- 4-Way measurement, inside, outside, depth and step
- LCD display
- Powered by one silver oxide battery 1.55V, type SR44
- Suitable for machinists and toolmakers

## Mechanical Tools



### Fork Wear Calipers

Part Number - 107330

Used to gauge minimum fork thickness and maximum bore size.



### Bushing Installation Tool

Part Number - 144931

Used to install drive axle bushings (145321) on RST-50 and C-5 models.



### Timkin Socket Tools

Part Number - 100253-XXX

For removal, installation and torquing of locknuts. Adapts to 1/2" drive socket.

#### Individual Items:

100253-001 - Fits locknut 060043-004

100253-002 - Fits locknut 060043-002

100253-003 - Fits locknut 060043-003

100253-004 - Fits locknut 060043-001

100253-005 - Fits locknut 060043-005

100253-006 - Fits locknut 060043-006

100253-007 - Fits locknut 060043-010

100253-008 - Fits locknut 060043-008

100253-009 - Fits locknut 135496



### Axle Hub Alignment Tool

Part Number - 143129

Used to install drive axle hub on RST-50 and C-5 models. Helps align hub and protects hub seal when installing drive hubs. Use with 143130 axle hub alignment tool.



### Axle Hub Bearing Driver Tool

Part Number - 143130

Used to install drive axle hub on RST-50 and C-5 models. Use with 143129 axle hub alignment tool.



### Axle Bearing Tool

Part Number - 145012

Used to assist in removing drive axle hubs. Fits into end of axle on RST-50 and C-5 models to give puller tool a platform to press against.



### Wrench Fan Bearing Bushing

Part Number - 141921

Use to tighten or loosen engine fan on RST-50 & C-5 models without ODC.



**Mobil Crimp 4-20 Digital Dial Control**

Part Number	Vendor Number
320040-420	7480-0051

Thermoplastic or Rubber Hose. This lightweight, versatile crimper is powerful enough to crimp up to 1-1/4" 4 spiral-wire hose. Weighing approximately 57 pounds, this new field crimper combines the latest crimping technology with old-fashioned toughness and durability. Unit supplied with digital calipers, instructional CD, and manuals.

**Note:** See below for Die Selection Chart

Replacement knob: P.N. 320040-420-07



320040-420-01



320040-420-02



320040-420-03



320040-420-05



320040-420-06

**Mobil Crimp 4-20 Power Sources**

Power Sources	Description	(PSI) Rating	Weight (lb)	Vendor Number	Part Number
Hand Pump	No power source needed. Economical, convenient and portable for use anywhere. Make factory-quality assemblies in the field to minimize downtime.	10,000	25.6	7481-0006	320040-420-01
Shop Air Pump	Works off standard shop air (90 psi). Economical, convenient and versatile for use wherever 90 psi compressed air is available.	10,000	10	7481-0002	320040-420-02
12 Volt DC Pump 1/4 HP	Mobile operation, runs on standard 12 volt car/truck battery or a 12 Volt portable battery pack. Ideal for tough jobs in the field.	10,000	20.5	7481-0037	320040-420-03
115 Volt AC Pump 1/2 HP	Medium speed. Economical. Recommended for a stationary or mobile application.	10,000	32	7481-0034	320040-420-05
115 Volt AC Pump 1-1/2 HP	High speed. Recommended for stationary applications only.	10,000	108	7481-0035	320040-420-06

**▲ Mobile Crimp 4-20 Die Selection Chart**

Part Number	Die Set	M3K, M2T, G1 (C1T) & G2(C2AT) Gates	
		Rubber Hose Size	3160, 3360, 30CT Synflex Hose Size
320040-422	MC22	3/8"	1/2"
320040-431	MC31	1/4"	5/16" and 3/8"
320040-423	MC33	1/2"	5/8"
320040-424	MC34	5/8"	
320040-435	MC35	3/4"	
320040-437	MC37	1"	
320040-425	MC45		1/4" and 3/16"

**Note:** Check crimp diameter and length after each use.

**▼ PC707 Die Selection Chart**

Part Number	Die Set	M3K, M2T, G1(C1T) & G2(C2AT) Gates	
		Rubber Hose Size	3160, 3360, 30CT Synflex Hose Size
320040-731	731	1/4"	5/16" and 3/8"
320040-732	732	3/8"	1/2"
320040-733	733	1/2"	5/8"
320040-734	734	5/8"	
320040-735	735	3/4"	
320040-737	737	1"	
320040-745	745		1/4" and 3/16"

**Note:** Check crimp diameter and length after each use.



**Power Crimp PC707 Crimper Only**

Part Number	Vendor Number
320040-707-01	7480-0043

Thermoplastic or Rubber Hose. PC707 is the most precise, yet simplest crimper made. It has electronic digital readout to indicate gauge settings. Just push a button and it makes factory-quality hose assemblies in a few seconds. Wired for 115 volts. Includes die backup ring and a notched cone. Weighs 188 lbs. Unit supplied with digital calipers, instructional CD, and manuals.

**Note:** See above right for Die Selection Chart



**Power Crimp PC707 Power Source**

Part Number	Vendor Number
320040-707-02	7481-0023

Pressure Rating	Weight (lb)
4,900 psi	70

The flow of two fixed displacement pumps are combined to deliver a high volume of oil at low pressure for fast transversion.





**Thermoplastic Hose Power Swaging Tool**

Part Number	Vendor Number
108160	4530-009S0



**Hose Cutter**

Part Number	Vendor Number
108159	4523-04006

**Replacement Blade**

Part Number	Vendor Number
320032	4523-04003

**Note:** For use with P.N. 108159 and 320014



**Thermoplastic Hose Hand Swaging Tool**

Part Number	Vendor Number
108161	4530-01002



**Hose Cutter**

Part Number	Vendor Number
320014	4523-04002

**Replacement Blade**

Part Number	Vendor Number
320032	4523-04003

**Note:** For use with P.N. 320014 and 108159



**Pusher**

Part Number	Vendor Number	Part Number	Vendor Number
320017	4599-FP002	108150	4599-MP008
108137	4599-FP005	108151	4599-MP009
108138	4599-FP006	108152	4599-MP011
108139	4599-FP008	320018	4599-MP037
320025	4599-FP010	320026	4599-MP045
108141	4599-FP012	320019	4599-MP046
108142	4599-FP013	320020	4599-SP031
108143	4599-FP015	108153	4599-TP204
320031	4599-FP040	108154	4599-TP205
108146	4599-MP002	108155	4599-TP206
108147	4599-MP004	108157	4599-TP308
108148	4599-MP005	108158	4599-TP310
108149	4599-MP007	320034	4599-TP312

**Note:** Used with Hand and Power Swaging Tool, 108160 and 108161.

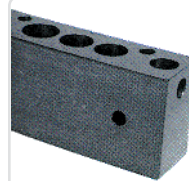

**Insertion Depth Marker**

Part Number	Vendor Number
320033	45J0-04603



**Pusher and Coupling Carrying Case**

Part Number	Vendor Number
320021	45J0-0433

**Note:** Only trays included.



**Swager and Die Carrying Case**

Part Number	Vendor Number
108163	45J0-04300

**Note:** Tools & Dies not included.

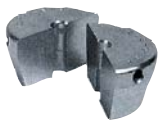

**Die**

Part Number	Vendor Number	Part Number	Vendor Number
108130	4540-303	320049	4540-A0800
108131	4540-304	108135	4540-H06
108132	4540-305	108136	4540-H08
108133	4540-306	320015	4540-J06N0
108134	4540-308	320016	4540-35340

**Note:** Used with Hand and Power Swaging Tool, 108160 and 108161.



**Die and Pusher Rack**

Part Number	Vendor Number
108162	45J0-03401



**Cylinder Groove Filler Strip**  
Part Number - 090779

To aid in removal of pistons by minimizing packing damage during removal. Used on all trucks with piston type (double acting) cylinders utilizing a wire retainer to secure the end cap such as tilt, reach and sideshift cylinders. See TSB 163. One piece (16" long).



**Seal and Piston Tool Kit**  
Part Number - 127576

Used on SC4000 & SC5000 Series steer cylinder. See maintenance section, M6.0. Kit instructions PF16486

**Individual Items:**  
Seal Loading Tool (P.N. 127521),  
Piston Loading Tool (P.N. 127522)



**Poly Pack Seal Tools**  
Part Number - 091240-001 thru 091240-020

Aids in installing seals in poly pak or rod packing cylinders. One tool per dash number, i.e., 091240-004 represents one specific size tool. See TSB 155 and TSB 193.



**Cylinder Seal Tool Kit for Stockpickers**  
Part Number - 150081

includes 150063 cap socket, 150066 polypack driver, 149323 cap socket, 150067 polypack driver, 091240-005 poly pak sleeve and 091240-009 poly pack sleeve.



**Cylinder Cap Tool**  
Part Number - 106438

For removal and installation of cylinder caps used on turret trucks.



**Test Plug Assembly (7/8"-14)**  
Part Number - 092177

Used to isolate faulty hydraulic component valves. All Crown lift trucks using 7/8"-14 thread hydraulic external component valves, except relief valves. One piece plug with sealing rings.



**Spanner Wrench**  
Part Number - 104836

For removal, installation and adjustment of Pallet Truck lift cylinder. Used on PW, PE, PC and PR.



**Test Plug Assembly (3/4"-16)**  
Part Number - 093391

Used to isolate faulty hydraulic component valves. Utilizing 3/4"-16 thread hydraulic external component valves, except relief valves. One piece plug with sealing rings.



**Socket Weldment**  
Part Number - 143065

Cylinder cap tool for removal and installation of cylinder cap (133084) used on TSP 6000.



**Funnel with 100 Mesh Filter**  
Part Number - 126098

Anti-Splash Funnel with Filter Anti-Splash Ring eliminates spilling of liquid caused by swirling. Greater capacity designed for farm and industry. Comes with one 100 mesh filter. Handy hang-up tab on rim. 9" in diameter.



**Cap Socket**  
Part Number - 117318

For removing cap on main lift cylinder on TSTN, TSPTN.



**Oil Test Kit**  
Part Number 363515 — Tests hydraulic and motor oil. Mail oil samples in for content test results. Comes with container for oil, mailing container and labels.

Part Number 363515-PPR — Same as 363515 plus Particle Count.

▼ **Test Kit Accessories**  
**Suction Pump**  
Part Number - 363515-001





**Tubing, 100 Feet**  
Part Number - 363515-002



**Cylinder Packing Tool**

Part Number	Used on Cylinder Cap
804714-001	804751
804714-002	804750
804714-003	804749
804714-005	810639



**Cylinder Cap Tool**

Part Number	Used on Ram
804726-001	804718
804726-002	804719
804726-003	804720/804722
804726-004	804721
804726-005	804723
804726-006	804727

## Hydraulic Tools



### Accumulator Charging Tool

Part Number - 103623-004

For charging and testing bladder and diaphragm type nitrogen charged accumulators. Accumulators used on Turrets and Stockpickers. Includes: gauge, valve, hose, adapter for nitrogen tank, carrying case and manufacturer's instructions.

#### Individual Items:

- Upper Seal (P.N. 300092)
- Lower Seal (P.N. 300093)
- Hose with Fittings - (P.N. 121422)
- Manual Bleed Valve - (P.N. 300133)



### Hydraulic Pressure Gauge

Part Number - 104812

Used to check hydraulic systems pressure on truck. Used on all Crown lift trucks except tow tractors. Includes: gauge, hose (36") and fitting (1/2" N.P.T.) for TS/TSP model trucks.

All other models of trucks require fitting and connector listed below, not included with gauge.  
Female fitting (P.N. 123321)  
Connector (P.N. 064005-003)



### Pressure Gauge

Part Number - 300098

- New 4000 PSI single gauge
- 0 to 4000 PSI
- Quick Disconnect (P.N. 123321)
- Used on RST50 & C5



### Coupler

Part Number - 123321

- Used on 300098 and 104812
- Works with nipple part numbers 123887 & 127214



123887



127214



### 1/2" Thin Wall Socket

Part Number - 104884

For removal and installation of relief valve seat on J.S. Barnes pump and motor assemblies. Used on PW, PE, PC, GPW, SP 3000 Series.



### 1/4"-12 Point Socket

Part Number - 104885

For disassembly and reassembly of J.S. Barnes pumps and Charlyn torque generators.



### Hose Pulling Tool

Part Number - 106465-001 and 106465-002

To couple replacement hose to existing hose for ease of replacement.  
Kit instructions - PF8075.

3/4"-16 fitting use P.N. 106465-001  
9/16"-18 fitting use P.N. 106465-002



### Spanner Tool

Part Number - 108641

Adjust hose take-up used on TS and TSP.



### Lifting Bracket

Part Number - 151332

Used on RM6000 to lift out secondary lift cylinder ram out of the cylinder without removing the secondary cylinder assembly.



### Velocity Fuse Tool

Part Number - 126400

For removal of velocity fuse in left hand cylinder. Used on RR/RD5000/5200/5700 standard & S class trucks.



### Piston Retainer Tool

Part Number - 816908

Used on PTH 50 Hydraulic Unit (P.N. 816814-001) to keep spring down.



### Hydraulic Lifter Bleed Down Tool

Part Number - 141920

Used to disperse oil from the lifters on C-5 when replacing the cylinder head.

A 144998 flywheel timing lock pin is also recommended.



## Drive Tools



### Stud Alignment Tool

Part Number - 125097

Used on RR and RR 3000 Series trucks, SP 3000 Series and TSP. Used to install Drive Unit Steer Bearing and Stud Kit (P.N. 125096). Kit Instructions - PF6947 and PF6948

#### Individual Items:

Alignment Tool (P.N. 125093),  
Drill Bushing (P.N. 125098),  
Reamer (P.N. 125101)



### Drive Unit Mount Gauge

Part Number - 126383

Used to shim drive unit on RR 5000.  
Kit Instructions - PF6998



### Gauge Pivot Stud

Part Number - 128463

Used to shim drive units on RR/RD 3000 and 5000 Series, SP 3000 Series, TS and TSP. See kit instructions PF16487 & PF16762.



### Special Roll Tap

Part Number - 126105

Used to tap dowel pins on RR 5000 Series drive unit. See TSB 378.



### Drive Wheel Hub Puller

Part Number - 141356

Used to remove locking nut to replace drive axle seal. Used on RC 5500 & SC 5200. See kit instructions PF16825.



### Spanner Tool

Part Number - 145194

Used to remove the threaded adjuster plate from the back side of the RC 5500 & SC 5200 drive unit. It is required for drive unit disassembly.



### Drive Wheel Hub Puller

Part Number - 340079

Used to remove locking nut to replace drive axle seal. Improved, deluxe model. Makes it easier to remove hub and takes a lot less time than using 141356. Used on RC 5500 & SC 5200.



### Drive Unit Mount Tool

Part Number - 145509

Used to mount the RC 5500 & SC 5200 drive unit in a vice to hold it in position while working on it.



### Driver Nut Assembly

Part Number - 141357

Used with gear puller to remove wheel hub. Used on RC 5500 & SC 5200. See kit instructions PF16825.



### Steer Bearing Cup Removal Kit

Part Number - 133884

Used to remove drive unit mounting stud on RR/RD 5000 Series trucks. Kit instructions - PF16746

Individual Items: Push-Off Bolt (P.N. 060133)



### Brush Retaining Tool

Part Number - 803547-001

Used with Drive Motor (P.N. 803703).



### Seal Installation Tool

Part Number - 091009

Aids in installing 2nd reduction gears inner (and outer) oil seal on pre-3000 SP, Pallet, Tow Tractors and Heavy-Duty Walkies. TSB 152, Kit Instructions PF6445 included with part. Includes: threaded sleeve, threaded body, 2 piece handle, 3 locking bolts, depth gauge.

Accessory Items: Gauge (P.N. 091263)



### Retaining Ring Pliers

Part Number - 092668

For removal and installation of large retaining rings. Used on pre-3000 series Stockpickers, Pallet trucks, Tow tractors and heavy-duty Walkies. Tip replacement set (P.N. 106141)

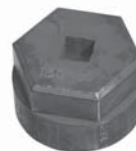

### Bearing Cup Tool

Part Number - 130675

Used to rebuild drive unit on FC 4000.



### Pilot Rods

Part Number - 141316

Used to align RC5500 traction motor. Need quantity of 4.



### Drive Coupler

Part Number - 131348

For drive motor pinion locknut installation of FC 4000.



**Meter Kit** (P.N. 100696)

**Multimeter Fluke Series 179**

Part Number - 121357

Precise readings of A.C. or D.C. voltage, resistance, low current and frequency. Required for wire guidance systems. Used also for electrical troubleshooting. Includes: 179 Series multimeter, yellow holster, test leads, batteries and instruction manual.

**Kits:** Meter Kit - (P.N.100696), includes Fluke Meter, Carrying Case, Test Leads, and Thermocouple Probe.



**Multimeter Fluke Series 87 Series III True RMS**

Part Number - 121359

Precise readings of A.C. or D.C. voltage, resistance, low current and frequency. Required for wire guidance systems. Used also for electrical troubleshooting. Includes: 87 Series multimeter, yellow holster, test leads, batteries and instruction manual. Includes: Thermocouple Probe.

**Accessory Items:** Holster (P.N. 121360), Test Lead Assembly (P.N. 321359)



**Multimeter (VOM)**

Part Number - 089226

For accurate measurement of A.C. and D.C. voltage, resistance and current. Includes: Simpson Model 260-6XLMP Analog Meter, carrying case, batteries, probes and instructions.

**Individual Items:** Meter only (P.N. 089738), Meter Case (P.N. 089739)



**Current Clamp**

Part Number - 109039

For accurate measurement of AC or DC up to 1000A current draw on battery without inline shunt connection. Includes instructions.



**Field Strength Meter**

Part Number - 112953

To check field strength of guide wire. Label on meter with instructions. See TSB 317.

**Multimeter Accessory Items**

Used with Part Numbers - 121357 and 121359

**Thermocouple Probe**

(Part Number 300091)

One piece construction with banana jack. Measurement range: -40 to 500°F (-40 to 260°C) Type K



**Shrouded Test Kit**

(Part Number 121421)

For use with multimeters that accept shrouded standard diameter, 0.16" (4mm), banana plugs. Manufacturer instructions included. Includes: 2 - #18 AWG (0.75mm2) test leads 48" (1.2m) long, one red, one black. Two insulated alligator clips with banana jacks, 5/16" (7.9 mm) jaw opening. Two spade lugs. One safety-grip spring loaded hook style test clip. One test lead pouch.



**Lead Set (Clip-on)**

(Part Number 101490)

For use with digital (VOM) multimeter on printed circuit boards and close areas where standard tips may short out components. Required on wire guidance P.C. boards such as sensor amplifier boards. Includes: 2 leads with jacks and spring loaded probes (1) red and (1) black.



**Probe Set**

(Part Number 102973)



**Tool Carry Case**

(Part Number 128321)



**Sevcon Calibrator**

Part Number - 111930-00S

Dial-in calibration settings, check and monitor inputs from switches and accelerator potentiometer, read battery voltage, motor voltage, motor current and temperature of controller Mosfet. Used on PE, PC, PR, PE/PC/ PR 3000, TWR, TR, TWR/TR 3000, W, WB, WR. Includes interconnecting cord and calibrator.

**Accessory Item:** White Connector (P.N. 803450-019)



**Extender (Board) Card**

Part Number - 090116

Extension between the logic board receptacle and logic board to permit access for making voltage checks. Used on pre 3000 Series Reach trucks.

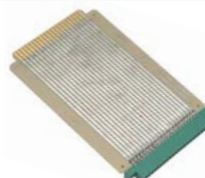

**Wave Repair Kit (without Handset)**

Part Number - 127674-001

**Wave Repair Kit (with Handset)**

Part Number - 127674-002

Kit Contents Listed (Right)



Part Number	Description	Qty.	Part Number	Description	Qty.
120195	Potentiometer	1	062595-003	Raise/Lower Switch	1
146286	Key Switch w/keys	1	062595-005	Drive/Tow Switch	1
107151-001	Keys	1	120127	AC Inlet	1
120200-001	Raise Switch	1	125253	Pin Link	2
120200-002	Lower Switch	1	125254	Link	4
128364-001	Presence Switch	1	060009-092	Retaining Ring	8
128364-002	High Speed Switch	1	060009-003	Retaining Ring	4
120283-001	Top Shim .015	4	062536-001	Terminal	24
120283-002	Top Shim .025	4	062536-002	Terminal	24
120283-003	Top Shim .035	4	062594-002	Connector Red	2
120284-001	Bottom Shim .015	4	062594-003	Connector Black	2
120284-002	Bottom Shim .025	4	062535-005	Connector	2
120284-003	Bottom Shim .035	4	069188	Decal	1
120198-001	ED Switch	2	118993	Extraction Tool	1
062692	Switch	4	117615	Extraction Tool	1
142809	Display	1	116858	Terminal	12
123928	ED Contact Kit	1	127671	Carry Case	1
094362-002	15 Amp Fuse	2	127672	Parts Case	1
076924-011	40 Amp Fuse	2	127673	Info Pack	1
084343	Lift Solenoid	2	130475	Handset	1
113772	Fuse Holder	2		(Kit 127674-002 only)	



**GE Handset**

Part Number - 112209

Dial in calibration settings, retrieve service code numbers. Used on FC/FP, FC 4000, RR/RD/RS, RR/RD/RS 3000, SP 3000, SP 3200, RC 3000, SC 4000. EV100LX and GE SX. Includes: Soft side carrying case, interconnecting cord, handset and manufacturer's instructions.

**Accessory Items:**

Replacement Cord (P.N. 113972)  
Replacement Cord for SC 4000 (P.N. 127085)  
Handset and Both cords (P.N. 127458)



**Service Terminal Kit**

Part Number - 118207

Enables monitoring service condition (malfunction) history. Allows performing calibration procedures without opening electronic boxes. TS, TSP, SP 3000, SP 3200, SP 3400 (not SP 3500). Includes: terminal keyboard with two line liquid crystal displays, detachable cables and connectors, foam filled shock resistance carrying case with instruction and operating guide, "How to Use Your Crown Service Terminal" Kit instructions: PF6703.

**Accessory Items:** TS/TSP Cable Assembly (P.N. 102226), SP 3000 Series Cable Assembly (P.N. 118845-00S), Case (P.N. 118954), Service Terminal (P.N. 101528-001), Service Terminal Manual (PF10462)



**Curtis Calibrator Handset**

Part Number - 154158

Used to input calibration settings, monitor inputs and outputs, diagnostic and troubleshooting aid. Used on GPW, Wave, PE 4000, WE/WS 2000/2300, WP 3000, TR 3600, PC 3600 and GPC 2000 Series. See maintenance manual (M4.2) for instructions. Includes two cords: 130480 / Molex style and 130481 / phone style (RJ11).



**Controller Handset**

Part Number - 793548

Handset for Zapi controller. Used on WP 2000 series and ST/SX series. Includes black housing and mounting hardware, white connector and terminals.

**Accessory Item:** White Connector (P.N. 803450-019)



**Curtis Handset Cord - Molex**

Part Number - 125736

Handset cord for 117617 Curtis calibrator (1207).



**▲ Connector Rebuild Kit**

Part Number - 320055

For controller handset 793548. Includes black housing and mounting hardware, white connector and terminals.



**Unimeter Programmer**

Part Number - 300034

Program settings on unimeter.



**BMID Battery Monitoring Identification Device**

Part Number - 396525

BMID compatible only with Crown V-Force HFM charger. For more details, see page 7.03.

## Diagnostic Tools



### Cell Trac Power Kit

Part Number - 390220-PK

The Power Kit is designed to diagnose and isolate battery problems. The kit is used to perform a power study and analysis. The kit includes software, USB communicator, power jack and battery cable.



### Cell Trac device with Power Jack

Part Number - 390220-PJ

Standard unit with power jack and adapter.



### Cell Trac USB Communicator

Part Number - 390220-USB

## Electrical Tools

Continued ▶

### AMP



### AMP Crimper

Part Number	Used on Connector Series	Used on Crown Contacts
062726-001	Mate-N-Lock	062036-XXX
062726-002	Mini Mate-N-Lock	062536-XXX
062726-003	Amplimite (dsub)	062526-XXX
062726-004	Multilock 040	062663-XXX
062726-005	Multilock 070	062663-001
062726-006	Ampseal	062721-001



### Extraction Tool

Part Number	Used on Crown Contacts
146583-001	062882-001
146583-002	062882-002

Removal of contacts. Amp and Tyco style.



### Crimping Tool

Part Number - 090118

For stripping insulation and crimping new terminals on light gauge electrical wire for insertion into Mate-N-Lock connectors (Amp style). Works on 062037 connectors and 062036 contacts. See TSB 173. One piece tool.



### Crimping Tool

Part Number	Used on Crown Contacts
110965	062090-XXX

Serial link cable terminal crimping also used on TS, TSP trucks for the terminals in the screw on connectors on the electronics boxes. Instructions not available (Amp style).



### Extraction Tool

Part Number - 090117

Removal of the Mate-N-Lock pin and socket contacts from various Amp connector blocks. See TSB 173 and TSB 175. Includes one piece tool with manufacturer's instructions.



### Extraction Tool

Part Number - 100380

For removal of the Mate-N-Lock pin and socket contacts from various Amp connector blocks. One piece, spring loaded tool with manufacturer's instructions.



### Extraction Tool

Part Number - 100381

For removal of Amp leaf contacts from sensor amplifier P.C. board receptacle. For trucks with wire guidance systems. Contact removal on receptacles. One piece, spring loaded tool with manufacturer's instructions.

**AMP**

**Extraction/Insertion Tool**

Part Number	Used on Crown Contacts
100521	062090-XXX

For extracting and inserting Amp male and female contacts on screw on connectors. Used in the electronics boxes on the 40TS/30TSP trucks. Two piece mated plastic tool (blue end - insertion, white end - extraction).



**Extraction Tool**

Part Number - 093493

Removal of lead assemblies from printed circuit board connector receptacles. Used on RR, RS, RD and TS trucks, RR, RS and RD circuit selector box, lamp and P.C. Board (Amp style). Used on contacts 062036-XXX. See TSB 175.



**Extraction Tool**

Part Number - 126884

For extracting and inserting Amp male and female contacts on screw in connectors.



**Insertion Tool**

Part Number - 126885

25 Replacement tips for extraction tool (P.N. 126884)



**Extraction Tool**

Part Number - 100522

Removal of contacts from connectors on traction SCR control, EV100 controls (Amp style).



**Extraction Tool**

Part Number - 118993

For removing sockets from connector. Used with 062536 terminals. Amp style, miniature rectangular Mate-N-Lock connectors.



**Insertion Tool**

Part Number - 100382

For insertion of unstripped electrical leads into MTA 100 connectors to form a reliable connection. One piece tool.



**Insertion Tool**

Part Number - 100524

For insertion of unstripped electrical leads into MTA 156 connectors to form a reliable connection. Used on TS/TSP. One piece tool.



**Cannon**

**Extraction Tool**

Part Number - 100379

For removal of pins from the sensor assembly connector. Used on trucks with Portec wire guidance (Cannon style).



**Crimping Tool**

Part Number Used on Crown Contacts

118504	062589
	062588

Crimp terminals 062589 and 062590, Cannon style.



**Extraction Tool**

Part Number Used on Crown Contacts

118505	062589
	062588

For removing pins on P.N. 062587 and P.N. 062588. Cannon style connectors.



**Deutsch**

**Extraction Tool**

Part Number Used on Crown Contacts

062706	062704-XXX
	062797-XXX

Used to remove Deutsch pin and socket contacts from DT and DTM connectors.



**Crimping Tool**

Part Number Used on Crown Contacts

062737-002	062704-XXX
	062797-XXX

For stripping insulation and crimping new terminals on light gauge electrical wire for insertion into Deutsch DT and DTM connectors.



**Molex**

**Extraction Tool**

Part Number Used on Crown Contacts

117615	116858
	129761-XXX
	803450-XXX

For removing pins from mini fit connectors. Used on GPW with Curtis 1207 transistor controller and WP 2000 wiring harness handle.



**Crimping Tool**

Part Number Used on Crown Contacts

117636	116858
	129761-XXX
	803450-XXX

For crimping mini fit terminals to wires. Used on GPW with Curtis 1207 transistor controller. Manufacturer's instructions included.





# Electrical Tools

## Weidmuller



### Crimping Tool

Part Number	Used on Crown Contacts
803452-003	803452-005 803452-006 803452-008

For stripping insulation and crimping Weidmuller terminals.



### Extraction Tool

Part Number	Used on Crown Contacts
803452-004	803452-005 803452-006 803452-008

Used to remove Weidmuller pin and socket contacts from connectors.

## Packard

Image Not Available

### Crimping Tool

Part Number	Used on Crown Contacts
320051	062729-XXX

For crimping Packard pin and sleeve terminals. Crimps terminals and seals in a single cycle.

Image Not Available

### Extraction Tool

Part Number	Used on Crown Contacts
320053	062729-XXX

For removing pins from Packard connectors.

Image Not Available

### Crimping Tool

Part Number	Used on Crown Contacts
320052	062896-XXX

For crimping Packard Metri-pack 150 & 280 sealed 20-14 guage terminals. Core & insulation wings are crimped in a separate motion.

Image Not Available

### Extraction Tool

Part Number	Used on Crown Contacts
320054	062896-XXX

For removing terminals in Packard Metri-pack 150 & 280 connectors.



### SB Extraction Tool

Part Number	Amps
340089-001	175
340089-002	350



### Static Field Service Kit

Part Number - 101491  
Used to prevent damage to static sensitive components while handling or working with them. Includes: work mat, 15 foot ground cord, adjustable wrist strap, coiled ground cord and manufacturer's instructions.

**Accessory Items:** Coiled Cord Wrist Strap (P.N. 121425)



### Commutator Dressing Stone

Part Number - 114888  
Removing film and dirt buildup on motor commutator. Used on motors with limited room in endhead at commutator. 6 pieces in box.



### Commutator Brush Stone Set

Part Number - 101582

For dressing commutators. Used on all Crown brush style motors, lift, steer and accessory. Includes: holder with 2 stones.

**Individual Items:** Holder (P.N. 101580), Green Finish Stones/Qty. 6 (P.N. 101581), Yellow Medium Stones/Qty. 6 (P.N. 301581)



### Trimpot Adjustable Tool

Part Number - 107369

Use to adjust trimpots. (variable resistors) Use on traction and pump controls with trimpot tune-up adjustments.



### PC Down Load Cable

Part Number - 126456

Serial cable for software download on RR 5000 Series trucks & SP 3400.

See kit instructions PF16547.



### USB Cable

Part Number - 300118

Used to download software for High Frequency Chargers.



### Isolator Connector

Part Number - 062785-001

Used on RR 5000 Series when downloading software.



### USB to Serial RS232 Adapter Cable

Part Number - 320058

Used for software downloading on RR5000-RR5200 and SP3400 Traction Modules.



### Software Download Kit

Part Number - 062915-00S

Used with six pin can interface connections to download software to truck. See kit instructions PF16877.

Used on PE 4500, PR 4500, SC 4500, SC 5200, SC 5300, RC 5500, TSP 6000, FC 4500 and SP 3500.



### Charger Cable 10'

Part Number - 127490

For use on Wave.



### 4024 Electronic Data Link Kit

Part Number - 145005

Used for downloading RST-50 & C-5 software into truck.

## Brake Tools



### Brake Adjusting Tool

Part Number - 104604

For removal, installation and adjusting the electric brake on SP36, SP42 and SP48 Stockpickers. One piece tool adapts to 1/2 inch drive.



### Brake Release Tool

Part Number - 127373

Release drive brake. Use on RR 5000 Series trucks, RM/RMD6000/S. See TSB 412. Use with Harness Adapter (P.N. 129694).



### RC Brake Special Nut

Part Number - 114050

For assembly and disassembly of brake actuation spring. Use on RC with disc brakes.



### Brake Adapter Harness

Part Number - 129694

Use with Brake Release Tool (P.N. 127373) on RR 5000 Series trucks. See TSB 412.



### RC Brake Adjustment Threaded Tube

Part Number - 114051

For assembly and disassembly of brake actuation spring. Use on RC with disc brakes.



### Brake Release Tool

Part Number - 139956-001 / 139956-002

Release drive brake. Use on SC 4500 and RC 5500 series trucks. See kit instructions PF16819.

139956-001 - 24 volt

139956-002 - 36/48 volt



### Riveter Press

Part Number - 114518

Used to replace brake pads on SP 3000 Series and SC & SC 4000 trucks. Used with Brake Pad Rivet Tool (P.N. 112397).



### Piston Removal Tool

Part Number - 126431

Used on FC/FP with power disc brakes and FC 4000 Series. Removes piston from service brake.



### Riveter Base

Part Number - 119343

Used with 114518 on SP 3000 Series. See maintenance section, (M5.0) for instructions.



### Brake Pedal Adjustment Kit

Part Number - 129765

Used to adjust brake linkage on RC 3000. Kit instructions PF16550



### Brake Pad Rivet Tool

Part Number - 112397

Used to replace brake pads on SP 3000 Series and SC & SC 4000 trucks. Used with Riveter Press (P.N. 114518).



### Retainer Ring Assembly Tool

Part Number - 132417

Used to disassemble caster and brake assembly on RR 5000S class Series only. Kit instructions: PF16763



### Brake Shoe Setting Gauge

Part Number - 120988

For setting brake shoes prior to installing brake drum. Used on FC/FP. Instructions see Service and Maintenance Manual, (section M5.0).



### Telescoping Gauge

Part Number - 300089

Used to check power brake wear on RST-50 & C-5 models with power brake option.

## Steering Tools



### Hand Swage

Part Number - 090526

Properly crimp compression fitting when repairing or replacing cable. Usage: SP Steering cable, Pallet clamp cable and TS, TSP hose take-up cable. Crimps both shielded and unshielded aircraft control cable. One piece tool, manufacturer's instructions included.



### Ball Joint Separator

Part Number - 122532

Used to separate steering ball joint connections. Used on FC/FP and FC 4000.



### Seal and Piston Tool Kit

Part Number - 127576

Used on SC 4000 & SC5000 series steer cylinders. See maintenance section, M6.0, Kit instructions PF16486

#### Individual Items:

Seal Loading Tool (P.N. 127521),  
Piston Loading Tool (P.N. 127522)



### Steering Wheel Removal Tool

Part Number - 129257

To remove steering wheel on SC 4000/4500/5200 trucks manufactured from September 9, 1999 to present. Kit instructions - PF16549.



### Steer Axle Spanner Socket

Part Number - 146107

Used to remove locknut 060043-009. Used on SC 4000/4500/5200, RC 5500 and TSP 6000 steering assemblies.



Versatile Industrial Charging Systems

# Battery Monitoring Identification Device

Protects Batteries, Ensures Optimum Charging

## Benefits and Advantages:

- Automatically configures charger for the correct voltage/Ah output.
- Allows any battery to be plugged into any charger.
- Built-in electrolyte monitor eliminates the need for a blinky device.
- On-demand EQ charge ensures the battery is equalized as required.
- Allows you to track individual battery history through charge logs to easily identify battery issues and charging habits.
- Compensates output to battery temperature so the battery is never overheated increasing battery life.
- Fits all V-HFM Series chargers, new or existing.

To fully optimize the capabilities of your V-HFM Series Chargers, we recommend mounting a Battery Monitoring Identification Device (BMID) to all of your industrial batteries.



See page 7.03 of the One Source catalog for more details.

**Intelligent Control = Longer Battery Life**

## Section 9

# Hydraulic Components

### Contents

Thermoplastic Hose	9.02
Steel Wire Braid Hose	9.02
Thermoplastic Hose Couplings	9.03
Thermoplastic Hose Couplings Cross Reference	9.05
Rubber Hose	9.05
Rubber Hose Couplings	9.06

### New Items:

Plugs - p. 9.04

$\frac{3}{4}$ " Rubber Hose - p. 9.05

**Note: See Section 8, Tools, for a list of hydraulic tools, including power crimps, dies, pushers, hose cutters, and swager tools.**

Note: 1910.178(q)(5) (1998) of the Occupational Safety and Health Act (OSHA) requires that "All parts of any such industrial truck requiring replacement shall be replaced only by parts equivalent as to safety with those used in the original design."



## Thermoplastic Hose

### Medium Pressure (2000 - 3000 psi/138 - 207 bar)

I.D.	Vendor Number	Maximum Working Pressure	Bulk Part Numbers	250 ft roll
3/16	3160-03	3000	064101-062	064101-067
1/4	3160-04	3000	064101-063	064101-068
5/16	3160-05	2500	064101-064	064101-069
3/8	3160-06	2250	064101-065	064101-070
1/2	3160-08	2000	064101-066	064101-071

### Constant Pressure (3000 psi/207 bar)

I.D.	Vendor Number	Maximum Working Pressure	Bulk Part Numbers	250 ft roll
5/8	3360-10	3000		320024

### High Pressure (2000-5000 psi/138-354 bar)

I.D.	Vendor Number	Maximum Working Pressure	Bulk Part Numbers	250 ft roll
3/8	3R80-06	4000		320046

### Constant Pressure (3000 psi/276 bar)

I.D.	Vendor Number	Maximum Working Pressure	Bulk Part Numbers	250 ft roll
1/4	30CT-04	3000	320045-005-01	320045-005
5/16	30CT-05	3000	320045-004-01	320045-004
3/8	30CT-06	3000	320045-001-01	320045-001
1/2	30CT-08	3000	320045-003-01	320045-003
5/8	30CT-10	3000	320045-002-01	320045-002

## Thermoplastic Hose Cross Reference

Part Number (250 ft Roll)	Pressure Type	Furon*	Dayco Parker	Aeroquip	Eastman
064101-067	Medium	3160-03	55LT-3	FC372-03	NA
064101-068	Medium	3160-04	55LT-4	FC372-04	C204
064101-069	Medium	3160-05	55LT-5	FC372-05	C205
064101-070	Medium	3160-06	55LT-6	FC372-06	C206
064101-071	Medium	3160-08	55LT-8	NA	NA
064101-067	Medium	3160-03	540N-3	NA	NA
064101-068	Medium	3160-04	540N-4	NA	NA
064101-069	Medium	3160-05	540N-5	NA	NA
064101-070	Medium	3160-06	540N-6	NA	NA
064101-071	Medium	3160-08	540N-8	NA	NA
064101-067	Medium	3160-03	550H-3	NA	NA
064101-068	Medium	3160-04	550H-4	NA	NA
064101-069	Medium	3160-05	550H-5	NA	NA
064101-070	Medium	3160-06	550H-6	NA	NA
320024	**	3360-10	53LT-10	NA	NA
320046	High	3R80-06	520N-6	NA	NA
320045-001	Constant	30CT-06	55LT-06	30CT-06	NA
320045-002	Constant	30CT-10	55LT-10	30CT-10	NA
320045-003	Constant	30CT-08	55LT-08	30CT-08	NA
320024	**	3360-10	53DM-10	NA	NA

\*Note: Although all Furon hoses meet or exceed the pressure ratings of the competitors equivalent hose, not all are made from the same materials or construction nor were designed for the exact same applications.

\*\*Note: 3,000 psi constant

## Steel Wire Braid Hose\*

### Medium Pressure\*\* (2250 - 3500 psi/155 - 241 bar)

I.D.	Vendor Number	Maximum Working Pressure	Bulk Part Numbers	250 ft roll
3/8	3580-06	3250	320039-006-01	320039-006
1/2	3580-08	3000		320039-008

\*Note: Do not use 3580 hose in over sheave (pulley) applications.

\*\*Note: Steel wire reinforced medium pressure hose (meets or exceeds 100R1 & 100R7 performance specs).

### Steel Wire Braid Hose Cross Reference

Part Number (250 ft Roll)	Pressure Type**	Furon*	Dayco Parker
320039-006 ***	Medium	3580-06	560-6
320039-008	Medium	3580-08	560-8

\*Note: Although all Furon hoses meet or exceed the pressure ratings of the competitors equivalent hose, not all are made from the same materials or construction nor were designed for the exact same applications.

Do not use 3580 hose in over sheave (pulley) applications.

\*\*Note: Steel wire reinforced medium pressure hose (meets or exceeds 100R1 & 100R7 performance specs).

\*\*\*Note: Dayco Parker 560-6 has 4,000 PSI, 16,000 burst pressure and Furon 3580-06 has 3,200 PSI, 13,000 burst pressure.

**Note:** See Section 8, Tools, for a list of hydraulic tools, including power crimps, dies, pushers, hose cutters, and swager tools.



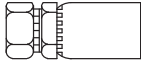

**30° Inverted Flare NPSM**

Hose I.D.	Dash Size	Thread	Current Vendor Number	Former Vendor Number	Part Number	Fitting Hose Depth
1/4	-4	1/4-18	90304-042400	3903-04244	320006	1-5/16

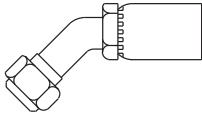

**45° Bent Tube Female Swivel JIC 37 degree**

Hose I.D.	Dash Size	Thread	Current Vendor Number	Former Vendor Number	Part Number	Fitting Hose Depth
5/16	-6	9/16-18	90305-065540	3903-05606	064227-001	1-5/8
3/8	-6	9/16-18	90306-065540	3903-06606	320027-002	1-11/16
3/8	-8	3/4-16	90308-085540	3903-06608	320027	1-7/8
1/2	-10	7/8-14	90308-105540	3903-08610	320027-003	1-5/16

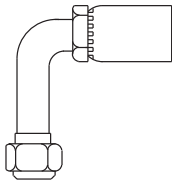

**90° Long Bent Tube Female Swivel, JIC 37 degree**

Hose I.D.	Dash Size	Thread	Current Vendor Number	Former Vendor Number	Part Number	Fitting Hose Depth
1/4	-4	7/16-20	90304-0455L0	3903-04844	320002	1-1/4
5/16	-6	9/16-18	90305-0655L0	3903-05846	064226-001	1-5/16
3/8	-6	9/16-18	90306-0655L0	3903-06846	064226-007	1-3/8
3/8	-8	3/4-16	90306-0855L0	3903-06848	064226-002	1-1/2
1/2	-8	3/4-16	90308-0855L0	3903-08848	320002-001	1-7/16
1/2	-10	7/8-14	90308-1055L0	3903-08850	320002-002	1-9/16

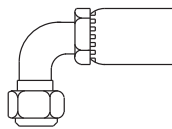

**90° Short Bent Tube Female Swivel, JIC 37 degree**

Hose I.D.	Dash Size	Thread	Current Vendor Number	Former Vendor Number	Part Number	Fitting Hose Depth
1/4	-4	7/16-20	90304-0455S0	3903-04644	064226-003	1-1/4
1/4	-6	7/16-18	90304-0655S0	3903-04646	320001	1-3/8
5/16	-6	9/16-18	90305-0655S0	3903-05646	064226-005	1-5/16
3/8	-6	9/16-18	90306-0655S0	3903-06646	064226-008	1-3/8
3/8	-8	3/4-16	90306-0855S0	3903-06648	064226-006	1-1/2
1/2	-10	7/8-14	90308-1055S0	3903-08650	320001-002	1-9/16
1/2	-8	3/4-16	90308-0855S0	3903-08648	320001-001	1-7/16

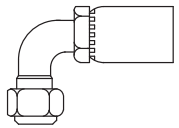

**90° Elbow Female Swivel, O-Ring Face Seal**

Hose I.D.	Dash Size	Thread	Current Vendor Number	Former Vendor Number	Part Number	Fitting Hose Depth
3/8	-6	11/16-16	90306-0640S0	3903-06476	320009	1-7/16
1/2	-8	13/16-16	90H08-0840S0	3903-08478	320009-001	1-1/2

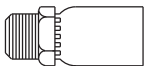

**Male Rigid**

Hose ID	Pipe Size	Current Vendor Number	Former Vendor Number	Part Number	Fitting Hose Depth
1/4	1/4	90304-041000	3903-04104	320004	1-3/16
1/4	3/8	90304-061000	3903-04106	320005	1-5/16
5/16	1/4	90305-041000	3903-05104	064116-001	1-3/16
5/16	3/8	90305-061000	3903-05106	064116-003	1-1/4

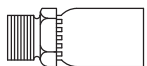

**Male O-Ring Straight Thread**

Hose I.D.	Dash Size	Thread	Current Vendor Number	Former Vendor Number	Part Number	Fitting Hose Depth
3/16	-4	7/16-20	90303-04D000	3903-03D04	064224-002	1-1/16
1/4	-5	1/2-20	90304-05D000	3903-04D05	320007	1-1/32
3/8	-6	9/16-18	90306-06D000	3903-06D06	320007-001	1-5/32

\*Note: See Section 8, Tools, for pusher and die Crown part numbers.

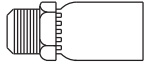

### JIC 37° Male Rigid

Hose I.D.	Dash Size	Thread	Current Vendor Number	Former Vendor Number	Part Number	Fitting Hose Depth
3/16	-4	7/16-20	90303-045000	3903-03504	064113-005	1-1/4
1/4	-4	7/16-20	90304-045000	3903-04504	064113-001	1-1/4
1/4	-6	9/16-18	90304-065000	3903-04506	320044	1-3/16
5/16	-6	9/16-18	90305-065000	3903-05506	064113-010	1-5/16
3/8	-6	9/16-18	90306-065000	3903-06506	064113-009	1-5/16
3/8	-8	3/4-16	90306-085000	3903-06508	064113-002	1-7/16
1/2	-10	7/8-14	90308-105000	3903-08510	320044-002	1-9/16
1/2	-8	3/4-16	90308-085000	3903-08508	320044-001	1-3/8

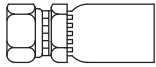

### SAE 45° Female Swivel

Hose I.D.	Dash Size	Thread	Current Vendor Number	Former Vendor Number	Part Number	Fitting Hose Depth
3/16	-4	7/16-20	90304-045400	3903-03544	064112-011	1-3/8
1/4	-5	1/2-20	90304-055400	3903-04545	064225-002	1-7/16
5/16	-5	1/2-20	90305-055400	3903-05545	320047	1-3/8
3/8	-8	3/4-16	90306-085400	3903-06548	064112-004	1-9/16
1/2	-8	3/4-16	90308-085400	3903-08548	064112-014	1-5/8
1/2	-10	7/8-14	90308-105400	3903-08550	320013-002	1-5/8

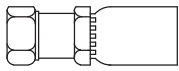

### Straight with Female Swivel O-Ring Face Seal

Hose I.D.	Dash Size	Thread	Current Vendor Number	Former Vendor Number	Part Number	Fitting Hose Depth
1/4	-4	9/16-18	90304-044000	3903-04404	320000	1.520
5/16	-5	11/16-16	90305-064000	3903-05406	320003	1.545
3/8	-6	11/16-16	90306-064000	3903-06406	064277-016	1.440
3/8	-6	13/16-16	90306-084000	3903-06408	064277-017	1.788
1/2	-8	13/16-16	90308-084000	3903-08408	320003-001	1.565
5/8	-10	1-14	90H10-104000	390H-10410	064277-010	2.060
5/8	-10	1-14	90N10-10420T	390N-10410-001	064277-018	1.625
5/8	-10	1.188-12	90N10-124200	390N-10412	320003-002	1.560

Note: 390H fittings use on 3360-10 hose, 390N fittings use on 30CT-10 hose.

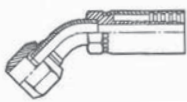

### Female Swivel O-Ring Face Seal 45 degree Bend

Hose I.D.	Dash Size	Thread	Current Vendor Number	Former Vendor Number	Part Number	Fitting Hose Depth
1/4	-4	9/16-18	90304-044040	3903-04444	320057	1.500

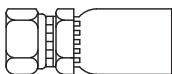

### JIC 37° Female Swivel

Hose I.D.	Dash Size	Thread	Current Vendor Number	Former Vendor Number	Part Number	Fitting Hose Depth
3/16	-4	7/16-20	90303-045400	3903-03544	064112-011	1-3/8
1/4	-4	7/16-20	90304-045400	3903-04544	064112-001	1-7/16
1/4	-5	1/2-20	90304-055400	3903-04545	064225-002	1-7/16
5/16	-5	1/2-20	90305-055400	3903-05545	320047	1-3/8
1/4	-6	9/16-18	90304-065500	3903-04546	064112-003	1-7/16
5/16	-6	9/16-18	90305-065500	3903-05546	064112-002	1-7/16
3/8	-6	9/16-18	90306-065500	3903-06546	064112-005	1-9/16
3/8	-8	3/4-16	90306-085400	3903-06548	064112-004	1-9/16
1/2	-8	3/4-16	90308-085400	3903-08548	064112-014	1-5/8
1/2	-10	7/8-14	90308-105400	3903-08550	320013-002	1-5/8
5/8	-12	1-1/16-12	90H10-125500	390H-10552	320013	1-7/8

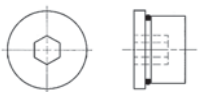

### Plug with O-Ring

Part Number	Thread	Depth	SAE	Tube Size OD
064091-001	3/4 - 16	0.438	8	0.50
064091-002	9/16 - 18	0.391	6	0.38
064091-004	5/16 - 24	0.297	2	0.12
064091-005	1-1/16 - 12	0.594	12	0.75
064091-006	7/16 - 20	0.360	4	0.25
064091-007	7/8 - 14	0.500	10	0.62
064091-008	1-5/16 - 12	0.594	16	1.00
064091-009	1-5/8 - 12	0.594	12	0.75
064091-010	3/8 - 24	0.297	3	0.19
064091-011	1-7/8 - 12	0.594	24	1.50

**NEW!**

Note: See Section 8, Tools, for pusher and die Crown part numbers.



## Thermoplastic Hose Couplings

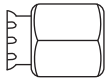

### Cap

Part Number	Thread	Depth
064128-001	3/4-16	0.75
064128-002	11/16-18	0.62
064128-003	7/16-20	0.59
064128-004	1 1/16-12	1.02
064128-005	7/8-14	0.97



### Cap O-Ring Face Seal

Part Number	Thread	Depth
064311-004	9/16-18	0.58
064311-006	11/16-16	0.67
064311-008	13/16-16	0.83
064311-010	1-14	0.93
064311-012	1 13/16-12	1.02

## Thermoplastic Hose Couplings Cross Reference

Furon	Crown Number	Parker
<b>30° Inverted Flare NPSM</b>		
3903-04244	320006	1MU55-4-4
<b>45° Bent Tube Female Swivel, JIC 37°</b>		
3903-05606	064227-001	13755-6-5
3903-06608	320027	13755-8-6
<b>90° Long Bent Tube Female Swivel, JIC 37°</b>		
3903-04844	320002	14155-4-4
3903-05846	064226-001	14155-6-5
3903-06846	064226-007	14155-6-6
3903-06848	064226-002	14155-8-6
3903-08848	320002-001	14155-8-8
3903-08850	320002-002	14155-10-8
<b>90° Short Bent Tube Female Swivel, JIC 37°</b>		
3903-04644	064226-003	1L955-4-4
3903-04645	064226-004	13955-5-4
3903-04646	320001	13955-6-4
3903-05646	064226-005	1L955-6-5
3903-06646	064226-008	1L955-6-6
3903-06648	064226-006	1L955-8-6
3903-08648	320001-001	1L955-8-8
3903-08650	320001-002	NA
<b>90° Elbow Female Swivel, O-Ring Face Seal</b>		
3903-06476	320009	1J955-6-6
<b>JIC 37° Female Swivel</b>		
3903-03544	064112-011	10655-4-3
3903-04544	064112-001	10655-4-4
3903-04546	064112-003	10655-6-4
3903-05546	064112-002	10655-6-5
3903-06546	064112-005	10655-6-6
3903-06548	064112-004	10655-8-6
3903-08548	064112-014	10655-8-8
3903-08550	320013-002	10655-8-10

Furon	Crown Number	Parker
<b>Male Rigid</b>		
3903-05104	064116-001	10155-4-5
3903-06106	064116-002	10155-6-6
3903-05106	064116-003	10155-6-5
3903-04104	320004	10155-4-4
3903-04106	320005	10155-6-4
<b>JIC 37° Male Rigid</b>		
3903-04504	064113-001	10355-4-4
3903-04506	320044	10355-6-4
3903-03504	064113-005	10355-4-3
3903-05506	064113-010	10355-6-5
3903-06506	064113-009	10355-6-6
3903-06508	064113-002	10355-8-6
3903-08508	320044-001	10355-8-8
3903-08510	320044-002	10355-8-10
<b>Male O-Ring Straight Thread</b>		
3903-03D04	064224-002	10555-4-3
3903-04D05	320007	10555-4-4
3903-06D06	320007-001	10555-6-6
<b>SAE 45° Female Swivel</b>		
3903-03544	064225-001	10655-4-3
3903-04545	064225-002	10655-5-4
<b>Straight w/Female Swivel, O-Ring Face Seal</b>		
3903-04404	320000	1JS55-4-4
3903-05406	320003	1JS55-6-5
3903-06406	064277-016	1JS55-6-6
3903-06408	064277-017	1JC55-8-6
3903-08408	320003-001	1SS55-8-8
390H-10410	064277-010	1JS58-10-10
390N-10410-001	064277-018	10158-10-10

## Rubber Hose



I.D. (in)	Working Pressure (psi)	Minimum Bend Radius (in)	SAE Spec.	Vendor Number	Bulk Part Number	10 ft	250 ft
<b>Wire Braid High Tensile Steel</b>							
1/4	5000		100R16	4M2T-MTF	320041-009-01		320041-009
1/4	3275	4.0	100R1	4G1	320041-010-01		320041-010
3/8	3000	2.5	100R17	6M3K	320041-002-01		320041-002
3/8	4800	5.0	100R2	6G2	320041-006-01		320041-006
3/8	3000		100R17	6M3K-XTF	320041-007-01		320041-007
3/8	3500		100R16	6M2T	320041-008-01		320041-008
1/2	3000	3.5	100R17	8M3K	320041-003-01		320041-003
1/2	3500	3.5	100R16	8M2T	320041-005-01		320041-005
5/8	3000	4.0	100R17	10M3K	320041-004-01		320041-004
3/4	3000	4.8	100R17	12M3K	320041-011-01		320041-011
<b>Fiber Braid</b>							
1/2	300	5.0		8LOLA	064100-001	324100-001-10	
5/8	300	6.0		10LOLA	064100-105		
3/4	750	6.0	100R3	12G3H	064100-018	324100-018-10	
3/4	300	7.0		12LOLA	064100-037	324100-037-10	
1	565	8.0	100R3	16G3H	064100-027	324100-027-10	



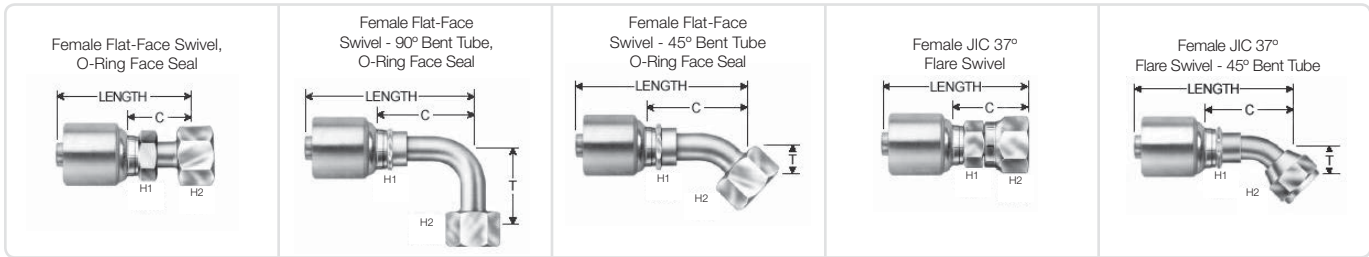

Hose I.D. mm (in.)	Vendor Number	Part Number	Thread Size	H1 (in)	H2 (in)	"T" Drop mm (in)	Length mm (in)	"C" Cut-Off mm (in)
<b>Female Flat-Face Swivel, O-Ring Face Seal</b>								
6.4 (1/4)	4G-4FFORX	320042-001	9/16-18	9/16	11/16	NA	54.5 (2.15)	28.5 (1.12)
6.4 (1/4)	4G-6FFORX	320042-002	11/16-16	5/8	13/16	NA	57 (2.24)	31 (1.22)
9.5 (3/8)	6G-4FFORX	320042-085	9/16-18	21/32	11/16	NA	57 (2.24)	29.1 (1.15)
9.5 (3/8)	6G-6FFORX	320042-003	11/16-16	5/8	13/16	NA	59 (2.32)	31 (1.22)
9.5 (3/8)	6G-8FFORX	320037	13/16-16	3/4	15/16	NA	64 (2.52)	36.1 (1.42)
9.5 (3/8)	6GE-8FFORX	320042-066	13/16 - 16	3/4	15/16	NA	64.0 (2.52)	36.1 (1.42)
12.7 (1/2)	8G-8FFORX	320042-004	13/16-16	13/16	15/16	NA	73.5 (2.89)	36 (1.42)
12.7 (1/2)	8G-10FFORX	320042-051	1-14	15/16	1-1/8	NA	81.0 (3.19)	43.5 (1.71)
12.7 (1/2)	8G-12FFORX	320042-087	1 3/16-12	15/16	1 3/8	NA	84.3 (3.32)	46.8 (1.84)
15.8 (5/8)	10G-10FFORX	320042-005	1-14	1	1-1/8	NA	81.5 (3.21)	44.0 (1.73)
19.0 (3/4)	12G-12FFORX	320042-088	1 3/16-12	1 1/16	1 3/8	NA	96.0 (3.78)	45.0 (1.77)
<b>Female Flat-Face Swivel 90° Bent Tube, O-Ring Face Seal</b>								
6.4 (1/4)	4G-4FFORX90S	320042-013	9/16-18	1/2	11/16	20.8 (0.82)	60.4 (2.38)	34.4 (1.35)
6.4 (1/4)	4G-4FFORX90M	320042-014	9/16-18	1/2	11/16	32.0 (1.26)	55.2 (2.17)	29.2 (1.15)
6.4 (1/4)	4G-4FFORX90L	320042-015	9/16-18	1/2	11/16	45.7 (1.80)	55.2 (2.17)	29.2 (1.15)
9.5 (3/8)	6G-6FFORX90S	320042-016	11/16-16	5/8	13/16	22.9 (0.90)	64.7 (2.55)	36.7 (1.44)
9.5 (3/8)	6G6FFORX90M	320042-077	11/16 -16	5/8	13/16	38.4 (1.51)	64.7 (2.55)	36.8 (1.45)
9.5 (3/8)	6G-6FFORX90L	320042-048	11/16-16	5/8	13/16	54.1 (2.13)	62.9 (2.48)	35.0 (1.38)
9.5 (3/8)	6G-8FFORX90S	320042-017	13/16-16	5/8	15/16	29.2 (1.15)	73.0 (2.87)	45.0 (1.77)
12.7 (1/2)	8G-8FFORX90S	320042-018	13/16-16	13/16	15/16	29.2 (1.15)	83.9 (3.30)	46.5 (1.83)
12.7 (1/2)	8G-8FFORX90M	320042-047	13/16-16	13/16	15/16	41.2 (1.62)	83.9 (3.30)	46.5 (1.83)
12.7 (1/2)	8G-8FFORX90L	320042-046	13/16-16	13/16	15/16	63.8 (2.51)	83.9 (3.30)	46.5 (1.83)
12.7 (1/2)	8G-8FFORX90-083	320042-052	13/16-16	13/16	15/16	83.0 (3.26)	83.9 (3.30)	46.5 (1.83)
12.7 (1/2)	8G-10FFORX90S	320042-019	1-14	13/16	1-1/8	32.3 (1.27)	84.0 (3.30)	46.5 (1.83)
15.8 (5/8)	10G-10FFORX90S	320042-020	1-14	15/16	1-1/8	32.3 (1.27)	83.4 (3.28)	45.9 (1.81)
15.8 (5/8)	10G-10FFORX90M	320042-075	1-14	15/16	1-1/8	47.0 (1.85)	77.6 (3.06)	40.2 (1.58)
15.8 (5/8)	10G-10FFORX90L	320042-053	1-14	15/16	1-1/8	70.1 (2.76)	77.5 (3.05)	40.0 (1.57)
19.0 (3/4)	12-G12FFORX90M	320042-089	1 3/16-12	11/16	1 5/8	57.9(2.28)	106.8(4.20)	55.8 (2.20)
<b>Female Flat-Face Swivel - 45° Bent Tube, O-Ring Face Seal</b>								
6.4 (1/4)	4G-4FFORX45	320042-008	9/16-18	9/16	11/16	10.4 (0.41)	65 (2.56)	39 (1.54)
6.4 (1/4)	4G-6FFORX45	320042-009	11/16-16	5/8	13/16	10.9 (0.43)	68.5 (2.70)	42.5 (1.67)
9.5 (3/8)	6G-6FFORX45	320042-010	11/16-16	5/8	13/16	10.9 (0.43)	69.8 (2.75)	41.9 (1.65)
9.5 (3/8)	6G4FFORX45S	320042-083	9/16-18	5/8	11/16	10.0(0.39)	66.1 (2.60)	38.1 (1.50)
12.7 (1/2)	8G-8FFORX45	320042-011	13/16-16	13/16	15/16	15 (0.59)	89 (3.5)	52.5 (2.07)
12.7 (1/2)	8G-10DD0EZ45	320042-084	1-14	13/16	1 1/8	16.5 (0.65)	89.5 (3.52)	52.1 (2.05)
15.8 (5/8)	10G-10FFORX45	320042-012	1-14	1	1-1/8	16.5 (0.65)	89 (3.5)	51.4 (2.02)
<b>Female JIC 37° Flare Swivel English Hex</b>								
6.4 (1/4)	4GE-4FJX	320042-059	7/16 - 20	1/2	9/16	NA	53.4 (2.10)	27.4 (1.08)
6.4 (1/4)	4GE-6FJX	320042-060	9/16 - 18	9/16	3/4	NA	56.3 (2.22)	30.2 (1.19)
9.5 (3/8)	6GE-6FJX	320042-061	9/16-18	5/8	3/4	NA	58.8 (2.31)	30.2 (1.19)
9.5 (3/8)	6GE-8FJX	320042-062	3/4-16	11/16	7/8	NA	63.1 (2.48)	35.1 (1.38)
<b>Female JIC 37° Flare Swivel - 45° Bent Tube</b>								
6.4 (1/4)	4GE-4FJX45	320042-063	7/16 - 20	1/2	9/16	11.9 (.47)	58.0 (2.28)	32.0 (1.26)
6.4 (1/4)	4G-5FJX45S	320042-054	1/2-20	1/2	5/8	14.2 (0.56)	65.0 (2.56)	39.0 (1.54)
9.5 (3/8)	6G-6FJX45	320042-023	9/16-18	5/8	11/16	14.2 (0.56)	73.9 (2.91)	46.0 (1.81)
9.5 (3/8)	6G-8FJX45	320042-050	3/4-16	5/8	7/8	17.5 (0.69)	73.1 (2.88)	45.2 (1.78)
12.7 (1/2)	8G-8FJX45	320042-044	3/4-16	13/16	7/8	17.5 (.69)	84.1 (3.31)	46.6 (1.83)

Hydraulic Components

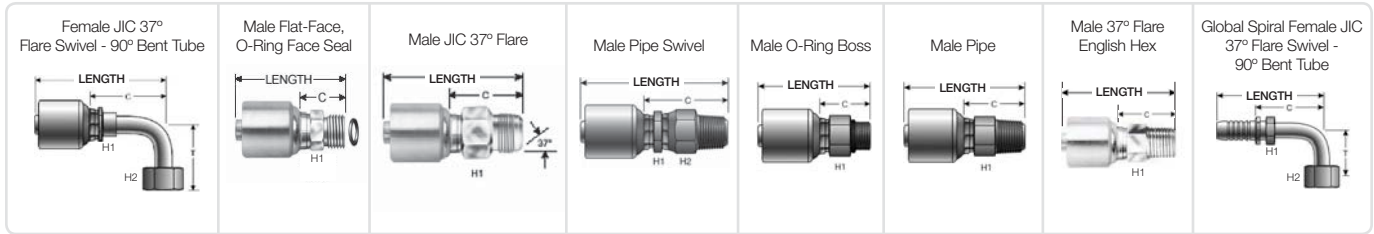

Hose I.D. mm (in.)	Vendor Number	Part Number	Thread Size	H1 (in)	H2 (in)	"T" Drop mm (in)	Length mm (in)	"C" Cut-Off mm (in)
<b>Female JIC 37° Flare Swivel</b>								
6.4 (1/4)	4G-4FJX	320042-021	7/16-20	1/2	9/16	NA	53.4 (2.10)	27.4 (1.08)
6.4 (1/4)	4G-6FJX	320042-037	9/16-18	9/16	3/4	NA	56.3 (2.22)	30.2 (1.19)
9.5 (3/8)	6G-6FJX	320042-022	9/16-18	5/8	3/4	NA	58.8 (2.31)	30.2 (1.19)
9.5 (3/8)	6G-8FJX	320042-031	3/4-16	11/16	7/8	NA	63.1 (2.48)	35.1 (1.38)
12.7 (1/2)	8G-8FJX	320042-045	3/4-16	13/16	7/8	NA	71.6 (2.82)	34.1 (1.34)
12.7 (1/2)	8G-12FJX	320042-073	1 1/16 - 12	1	1-1/4	NA	80.1 (3.15)	42.6 (1.68)
15.8 (5/8)	10G-8FJX	320042-071	3/4-16	15/16	7/8	NA	73.6 (2.90)	36.1 (1.42)
15.8 (5/8)	10G-10FJX	320042-042	7/8-14	15/16	1-1/16	NA	77.1 (3.04)	39.7 (1.56)
<b>Female JIC 37° Flare Swivel - 90° Bent Tube</b>								
6.4 (1/4)	4G-4JX90M	320042-072	7/16 - 20	1/2	9/16	22.4 (0.88)	52.25 (2.06)	26.2 (1.03)
6.4 (1/4)	4G-5FJX90L	320042-039	1/2 - 20	1/2	5/8	45.7 (1.80)	55.2 (2.17)	29.2 (1.15)
9.5 (3/8)	6G-6FJX90S	320042-024	9/16 - 18	5/8	11/16	21.6 (0.85)	60 (2.36)	31.0 (1.22)
9.5 (3/8)	6GE-6FJX90S	320042-064	9/16 - 18	5/8	11/16	85.0 (21.6)	60.0 (2.36)	31.0 (1.22)
9.5 (3/8)	6G-6FJX90M	320042-025	9/16 - 18	5/8	11/16	28.7 (1.13)	60.0 (2.36)	31.0 (1.22)
9.5 (3/8)	6G-6FJX90L	320042-040	9/16 - 18	5/8	11/16	55.4 (2.18)	66.0 (2.60)	38.1 (1.50)
9.5 (3/8)	6G-8FJX90S	320042-038	3/4 - 16	5/8	15/16	27.7 (1.09)	69.7 (2.74 )	41.8 (1.65)
9.5 (3/8)	6GE-8FJX90S	320042-065	3/4 - 16	5/8	7/8	27.7 (1.09)	69.7 (2.74 )	41.8 (1.65)
12.7 (1/2)	8G-8FJX90S	320042-074	3/4 - 16	13/16	7/8	29.0 (1.14)	80.3 (3.16)	42.8 (1.69)
12.7 (1/2)	8G-8FJX90M	320042-043	3/4 - 16	13/16	7/8	41.0 (1.38)	74.3 (2.93)	36.8 (1.45)
12.7 (1/2)	8G-8FJX90L	320042-078	3/4 - 16	13/16	7/8	64.0 (2.52)	74.0 (2.91)	36.6 (1.44)
12.7 (1/2)	8G-10FJX90M	320042-049	7/8 - 14	13/16	1	44.5 (1.75)	81.3 (3.20)	43.9 (1.73)
15.8 (5/8)	10G-10FJX90S	320042-041	7/8 - 14	15/16	1	31.2 (1.23)	85.5 (3.37)	48.0 (1.89)
<b>Male Flat-Face, O-Ring Face Seal</b>								
9.5 (3/8)	6G-6MFFOR	320042-006	11/16 - 16	3/4	NA	NA	56.0 (2.20)	28.1 (1.11)
9.5 (3/8)	6G-8MFFOR	320042-007	13/16 - 16	7/8	NA	NA	59.0 (2.32)	31.1 (1.22)
15.8(5/8)	10G-12MFFOR	320042-069	1 3/16 - 12	1-1/4	NA	NA	72.0 (2.83)	34.5 (1.36)
19.0 (3/4)	12G-12MFFOR	320042-090	1 3/16-12	1 1/4	NA	NA	90.0 (3.54)	39.0 (1.54)
<b>Male JIC 37° Flare</b>								
9.5 (3/8)	6G-6MJ	320042-032	9/16-18	5/8	NA	NA	57.5 (2.26)	29.6 (1.17)
9.5 (3/8)	6G-8MJ	320042-033	3/4-16	3/4	NA	NA	61.0 (2.40)	33.1 (1.30)
<b>Male Pipe Swivel</b>								
9.5 (3/8)	6G-4MPX	320042-055	1/4 - 18	5/8	NA	NA	72.8 (2.87)	44.9 (1.77)
9.5 (3/8)	6G-6MPX	320042-056	3/8 - 18	5/8	NA	NA	71.5 (2.81)	43.6 (1.72)
9.5 (3/8)	6G-8MPX	320042-057	1/2 - 14	3/4	NA	NA	77.5 (3.05)	49.5 (1.95)
<b>Male O-Ring Boss</b>								
6.4 (1/4)	4G-4MB	320042-082	7/16 - 20	9/16	NA	NA	50.5 (1.99)	24.5 (0.96)
<b>Male Pipe</b>								
6.4 (1/4)	4G-4MP	320042-036	1/4 - 18	9/16	NA	NA	55.0 (2.17)	29.0 (1.14)
9.5 (3/8)	6G-4MP	320042-076	1/4 - 16	5/8	NA	NA	59.0 (2.32)	31.1 (1.22)
<b>Male 37° Flare English Hex</b>								
9.5 (3/8)	6GE-8MJ	320042-058	3/4-16	3/4	NA	NA	61.0 (2.40)	33.1 (1.30)
<b>Global Spiral Female JIC 37° Flare Swivel 90° Bent Tube</b>								
12.7 (1/2)	8GS-8FJX90S	320042-081	3/4 - 16	7/8	7/8	29.0 (1.14)	86.0 (3.39)	48.6 (1.91)
12.7 (1/2)	8GS-8FJX90M	320042-080	3/4 - 16	7/8	7/8	41.0 (1.61)	92.0 (3.62)	54.6 (2.15)

# Rubber Hose Couplings

Global Spiral Ferrule for 4-Spiral Hose

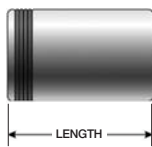

Male O-Ring Face Plug

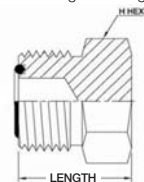

Male 37° Plug

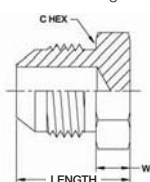

## Komatsu Metric Fittings

Female Swivel

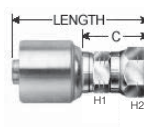

Female Swivel - 90° Bent Tube

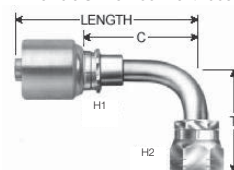

Hose I.D. mm (in.)	Vendor Number	Part Number	Inside Diameter	Length mm (in)	Outside Diameter	
<b>Global Spiral Ferrule for 4-Spiral Hose</b>						
12.7 (1/2)	8GS1F-4	320042-079	12.7 (1.5)	36.6 (1.44)	34.4 (1.35)	
	Vendor Number	Part Number	Thread Size	Length mm (in)	H Hex	
<b>Male O-Ring Face Plug</b>						
3/8	FS2408-6	320043-001	11/16-16	19.05 (.75)	3/4	
Tube O.D.	Vendor Number	Part Number	Thread Size	Length mm (in)	C Hex	Width mm (in)
<b>Male 37° Plug</b>						
3/8	2408-6	320043-002	9/16-18	21.41 (.843)	5/8	6.35 (0.25)

## Komatsu Metric Fittings

Hose I.D. mm (in.)	Vendor Number	Part Number	Thread Size	H1 mm (in)	H2 mm (in)	"T" Drop mm (in)	Length mm (in)	"C" Cut-Off mm (in)
<b>Female Swivel</b>								
6.4 (1/4)	4G-4FKX	320042-026	M14 x 1.5	14.3	19.0	NA	56.3 (2.22)	30.2 (1.19)
9.5 (3/8)	6G-6FKX	320042-027	M18 x 1.5	17.5	22.2	NA	62.8 (2.47)	34.9 (1.37)
12.7 (1/2)	8G-8FKX	320042-028	M22 x 1.5	20.7	27.0	NA	74.5 (2.93)	37.0 (1.46)
<b>Female Swivel - 90° Bent Tube</b>								
6.4 (1/4)	4G-4FKX90	320042-029	M14 x 1.5	(1/2)	(3/4)	38 (1.5)	69.0 (2.72)	43.0 (1.69)
12.7 (1/2)	8G-8FKX90	320042-030	M22 x 1.5	(13/16)	(11/16)	35 (1.38)	88.0 (3.46)	50.5 (1.99)

## Section 10

# Wheels and Tires

### Contents

Wheel Selection Guide	10.02
Wheel Application Guide	10.03
Polyurethane Wheels by Size	10.04
Non-Polyurethane Wheels by Size	10.06
Triple Load Wheels	10.07
Quick Change Load Wheel	10.07
Pallet Truck - One Source Casters	10.08
Raymond Pallet Truck Caster Wheel	10.09
Bearings	10.10
Tire Application Guide	10.13
Polyurethane Tires by Size	10.14
Hole Tires	10.15
Sweeper Scrubber Rubber Tires	10.15
Hubs	10.16
Resilient/Pneumatic Tires	10.17
Tubes/Flaps/Rims	10.19
Rubber Tires by Size	10.20
Wheel & Tire Cross References by Manufacturer	10.24

#### New Items:

Polyurethane Wheels - p. 10.05-10.06  
Bearings - p. 10.11-10.12  
Hubs - p. 10.16  
Resilient/Pneumatic Tires - p. 10.17-10.18  
Rubber Tire - p. 10.20

Note: 1910.178(q)(5) (1998) of the Occupational Safety and Health Act (OSHA) requires that "All parts of any such industrial truck requiring replacement shall be replaced only by parts equivalent as to safety with those used in the original design."



# What's on your truck?



### Crown Brand

All genuine Crown wheels have an identifier code stamped into the hub and Crown Integrity Parts System™ or Crown One Source Lift Truck Parts® with compound number printed on the wheel.



### Wheel Selection Guide Color Reference

If you see one of these wheel colors...	If you see one of these wheel colors...	If you see one of these wheel colors...	If you see one of these wheel colors...
			
...then your equivalent compound is in this series.	...then your equivalent compound is in this series.	...then your equivalent compound is in this series.	...then your equivalent compound is in this series.
<b>100</b> SERIES	<b>200</b> SERIES	<b>300</b> SERIES	<b>400</b> SERIES

Note: For additional information contact your local Crown Lift Truck dealer.

# Wheel Application Guide



## Application Types

Wheel Series	Compound Number	Shore A Hardness	Long Runs/ Heavy Loads	Dock Boards/ Expansion Joints (Chunking)	Metal Chips/ Floor Debris (Flat Spotting)	Wet Conditions	Freezer
<b>100</b> SERIES Light Duty	These economical 100 Series Light Duty wheel compounds are best suited for light loads and intermittent use.						
	101	95A		○	○	○	○
	102	95A		○	○	○	○
<b>200</b> SERIES Midrange	The Mid-Range wheels are designed for light to medium loads and short to medium runs.						
	201*	83A		●	●	●	●
	204	85A		●	●	●	●
<b>300</b> SERIES High Capacity	For the typical demands of most applications, High Capacity wheels feature compounds designed for high capacities and long runs.						
	301	95A	●	●	●	●	●
	302*	95A	●	●	●	●	●
	305	95A	●	●	●	○	●
<b>400</b> SERIES Heavy Duty	Heavy Duty wheels are designed for maximum capacities and extreme runs.						
	401	93A	●	●	●		
	402	99A	●				

\*Typically shipped with all new Crown lift trucks depending on model.

○ = Good    ● = Better    ● = Best

### Shore A Hardness

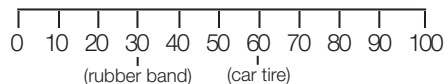

Softer compounds are typically more cut and tear resistant and provide a smoother ride. Harder compounds typically provide improved travel speeds, due to less rolling resistance, and generate less heat.

### Wheel Dimensions

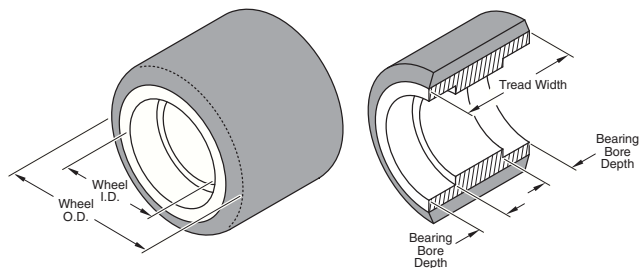







## Polyurethane Wheels by Size

## Non-Polyurethane Wheels by Size

\* Indicates Assemblies; ‡ Add -88 after compound number for assembly; Δ add-66 after compound number for sealed assembly

7.00 O.D. Continued

O.D.	Tread Width	I.D.	Bearing Bore Depth	Bearing Ball or Cup	Cone	Crown Part Number
7.00	2.00	1.850	0.55	NA	NA	818275-001*
7.00	2.00	1.850	0.55	NA	NA	818275-002*
7.00	2.00	1.850	0.55	NA	NA	818275-101*
7.00	2.00	1.850	0.55	NA	NA	818275-102*
7.00	2.00	1.850	0.55	NA	NA	818275-201*
7.00	2.00	1.850	0.55	NA	NA	818275-202*
7.00	2.00	1.850	0.55	065081-020	NA	818270
7.00	2.00	1.850	0.55	065081-020	NA	818271
7.00	2.50	2.326	Non-Typical	065105	065106	310155
7.00	2.50	2.328	Non-Typical	065105	065106	310107
7.00	2.75	1.980	NA	065134	065135	310227
7.00	2.86	2.047	Non-Typical	065081-021	NA	310087
7.00	4.00	2.440	0.63	NA	NA	310292*
7.00	4.00	2.440	0.84	312000-003	312000-011	310192
7.00	5.00	2.562	NA	NA	NA	093442
<b>7.87 O.D.</b>						
7.87	2.00	1.85	NA	NA	NA	041269
<b>7.88 O.D.</b>						
7.88	2.48	2.047	Non-Typical	065081-021	NA	310091
<b>8.00 O.D.</b>						
8.00	2.00	1.750	NA	NA	NA	310089
8.00	2.00	1.980	0.81	065134	065135	310148
8.00	2.00	1.998	thru	NA	NA	310097
8.00	2.00	2.047	0.60	065081-021	NA	310090
8.00	2.00	2.047	0.67	065081-021	NA	310092
8.00	2.00		NA	NA	NA	082274-001*
8.00	2.00	2.044	NA	065081-021	NA	083834-001
8.00	2.00	2.438		065081-025	NA	083834-002
8.00	2.06	1.188	thru	NA	NA	073900
8.00	2.25	2.439	0.68	NA	NA	100688
8.00	2.50	2.047	Non-Typical	065081-022/ 311000-006	NA	310283
8.00	2.50	7.600	2.64	NA	NA	310130
8.00	3.75	3.150	0.83	065081-008	NA	080915‡
8.00	4.00	2.440	0.66	065081-025	NA	310179‡
8.00	4.00	2.835	0.91	065081-067	NA	127723‡
<b>8.50 O.D.</b>						
8.50	2.66	2.754	Non-Typical	NA	NA	310131
8.50	2.69	2.754	2.5	NA	NA	310129
8.50	2.69	2.760	Non-Typical	065081-031	NA	132359
<b>9.00 O.D.</b>						
9.00	5.00	3.543	0.79	NA	NA	310117
<b>10.00 O.D.</b>						
10.00	3.00	2.325	NA	NA	NA	311520
10.00	3.00	2.325	NA	NA	NA	311521*
10.00	3.00	2.325	NA	NA	NA	081520*
<b>11.22 O.D.</b>						
11.22	3.94					810574-001
<b>13.00 O.D.</b>						
13.00	3.94	2.950	1.38	NA	NA	807544
13.00	3.94	2.950	NA	NA	NA	810583
13.00	3.94	2.950	NA	NA	NA	810601*
<b>14.25 O.D.</b>						
14.25	8.00	9.980	NA	NA	NA	133753
14.25	8.00	9.980	NA	NA	NA	*132458

O.D.	Tread Width	I.D.	Bearing Bore Depth	Bearing Ball	Type	Crown Part Number
<b>2.88 O.D.</b>						
2.88	2.06	1.189	thru	NA	Steel	072426*
2.88	2.06		NA	NA	Steel	104633
<b>2.90 O.D.</b>						
2.90	3.88	1.850	0.55	065081-019	Nylon	044508
2.90	3.88	1.850	0.55	NA	Nylon	044506-002*
<b>2.91 O.D.</b>						
2.91	3.84	1.850	0.56	065081-019	Steel	120738
2.91	3.84	1.850	0.56	NA	Steel	120740*
<b>3.25 O.D.</b>						
3.25	3.25	2.047	0.59	065081-021	Steel	082742
3.25	3.25	2.047	0.59	065081-021	Nylon	082740
3.25	3.88	1.849	0.63	NA	Nylon	082283-002*
3.25	3.88	1.849	0.63	NA	Steel	082283-003*
3.25	3.88	1.849	0.63	065081-020	Nylon	082285
3.25	3.88	1.849	0.63	065081-020	Steel	082286
3.25	4.50	2.440	0.66	065081-025	Nylon	083968
3.25	4.50	2.440	0.66	065081-025	Steel	083969
3.25	5.00	2.047	0.63	065081-021	Nylon	082741
3.25	5.00	2.047	0.63	065081-021	Steel	082743
<b>4.00 O.D.</b>						
4.00	2.06	1.189	thru	NA	Steel	071426
4.00	2.06	1.189	thru	NA	Phenolic	071893
4.00	2.06	1.189	thru	NA	Phenolic	073895
4.00	2.88	1.850	0.575	NA	NA	310128
<b>5.00 O.D.</b>						
5.00	1.62	0.750	thru	NA	Steel	071916*
5.00	2.00	1.188	thru	NA	Phenolic	073324*
5.00	2.12	0.750	thru	NA	Phenolic	071891
5.00	2.12	0.750	thru	NA	Steel	073602*
<b>7.00 O.D.</b>						
7.00	2.00	1.850	0.55	065081-020	Nylon	044497
7.00	2.00	1.850	0.55	065081-020	Rubber	044498
7.00	5.00	3.150	thru	NA	Rubber	077533*
7.00	5.00		NA	NA	Moldon	083167

Wheels and Tires

**NEW!**

**Note:** You need to add the compound part number to the base number listed above. See compounds listed on page 10.03 for the dash number. Complete part number format is XXXXX-XXX.

## Triple Load Wheels



316802



370119

Independent wheel rotation to reduce coning and increase load wheel life

### Crown Three Wheel Kit

Part Number	Description	Note
310125-101	Wheel 3.25X2X2.047X0.59	Wheel Only
310125-201	Wheel 3.25X2X2.047X0.59	Wheel Only
310125-205	Wheel 3.25x2x2.047x0.59	Wheel Only
310125-301	Wheel 3.25X2X2.047X0.59	Wheel Only
310125-302	Wheel 3.25X2X2.047X0.59	Wheel Only
310125-305	Wheel 3.25X2X2.047X0.59	Wheel Only
310125-306	Wheel 3.25x2x2.047x0.59	Wheel Only
310125-401	Wheel 3.25X2X2.047X0.59	Wheel Only
310125-101-88	Wheel Asm 3.25x2x2.047x0.59	Wheel and Bearings - greasable
310125-201-88	Wheel Asm 3.25x2x2.047x0.59	Wheel and Bearings - greasable
310125-301-88	Wheel Asm 3.25x2x2.047x0.59	Wheel and Bearings - greasable
310125-302-88	Wheel Asm 3.25x2x2.047x0.59	Wheel and Bearings - greasable
310125-305-88	Wheel Asm 3.25x2x2.047x0.59	Wheel and Bearings - greasable
310125-306-88	Wheel Asm 3.25x2x2.047x0.59	Wheel and Bearings - greasable
310125-401-88	Wheel Asm 3.25x2x2.047x0.59	Wheel and Bearings - greasable
316802	Triple Load Wheel Axle	Axle with 3 holes

### Raymond 939-WHL Three Wheel Kit

Part Number	Description	Note
310250-101	Wheel 3.25x1.88x2.047x0.595	Wheel Only
310250-102	Wheel 3.25x1.88x2.047x0.595	Wheel Only
310250-204	Wheel 3.25x1.88x2.047x0.595	Wheel Only
310250-205	Wheel 3.25x1.88x2.047x0.595	Wheel Only
310250-301	Wheel 3.25x1.88x2.047x0.595	Wheel Only
310250-302	Wheel 3.25x1.88x2.047x0.595	Wheel Only
310250-305	Wheel 3.25x1.88x2.047x0.595	Wheel Only
310250-306	Wheel 3.25x1.88x2.047x0.595	Wheel Only
310250-306-KITGL	Wheel 3.25x1.88x2.047x0.595 GL	3 wheels, all bearings - greaseless
310250-306-KIT	Wheel 3.25x1.88x2.047x0.595	3 wheels, all bearings - greasable
310250-301-INNER	Wheel 3.25x1.88x2.047x0.595 I	1 inner wheel with bearings - greaseless
310250-301-OUTER	Wheel 3.25x1.88x2.047x0.595 O	1 outer wheel with bearings - greaseless
310250-301-KIT	Wheel Kit 3.25x1.88x2.047x0.595	3 wheels and all bearings - greaseless
370119	Triple Load Wheel Axle	Axle with 3 holes

## Quick Change Load Wheel

### Reach Truck Quick Change Load Wheel Kits

Replace a set of load wheels in 2-3 minutes anywhere in your facility.

- Increase truck uptime
- Reduce maintenance labor expense
- No jack required



### Quick Change Outrigger Kit

Part Number	Size	Note	Bearing
151701-301	5x2.88	(115032-301-66 load wheel assemblies included)	065081-005
151702-302	5x4.12	(115033-302-66 load wheel assemblies included)	065081-005
151703-301	6x2.88	(125069-301-66 load wheel assemblies included)	065081-085
151704-302	6x4.12	(125070-302-66 load wheel assemblies included)	065081-085

Your truck must already have standard bolt on outriggers to install this kit.



### Quick Change Load Wheel Spare Kit Assembly (less outriggers)

Part Number	Size	Note	Bearing
151705-301	5x2.88	(115032-301-66 load wheel assemblies included)	065081-005
151706-302	5x4.12	(115033-302-66 load wheel assemblies included)	065081-005
151707-301	6x2.88	(125069-301-66 load wheel assemblies included)	065081-085
151708-302	6x4.12	(125070-302-66 load wheel assemblies included)	065081-085

Your truck must have quick change outriggers installed to use this kit.



### Quick Change Load Wheel Installation Tool

Part Number	Size
150192	2.88"
150193	4.12"

**Notes:** Each kit is for a complete truck assembly (both sides). Order Wheel Part numbers that end in -66 for the wheel assemblies with sealed bearings. See "Polyurethane Wheels by Size" for other load wheel compound options.

**One Source Assembly Casters**

Part Number	Vendor Number	Wheel Number	Asm. Caster Height	Turning Radius	Centered or Offset Swivel	Load Wheel Size	Base Plate Size	Slots of Holes	Bolt Pattern
310273-102	STR2001	310276-xxx	7.5	4.1875	Centered	4x2.5	4x4.75	Slots	3.004x992 and 2.287x3.275
310273-204	STR2001	310276-xxx	7.5	4.1875	Centered	4x2.5	4x4.75	Slots	3.004x992 and 2.287x3.275
310273-306	STR2001FS*	310276-xxx	7.5	4.1875	Centered	4x2.5	4x4.75	Slots	3.004x992 and 2.287x3.275
310273-102-CR	STR2001CR2	310276-xxx	7.5	4.1875	Centered	4x2.5	5x5	2-sets of Holes	2.625x3.625 and 4.125x4.125
310273-204-CR	STR2001CR2	310276-xxx	7.5	4.1875	Centered	4x2.5	5x5	2-sets of Holes	2.625x3.625 and 4.125x4.125
310273-306-CR	STR2001CR2 FS*	310276-xxx	7.5	4.1875	Centered	4x2.5	5x5	2-sets of Holes	2.625x3.625 and 4.125x4.125
310273-306-BL	STR2001BL FS*	310276-xxx	7.5	3.875	Centered	4x2.5	4x4.75	Holes	2.756x3.386
310273-306-CT	STR2001TY FS*	310276-xxx	7.5	4.1875	Centered	4x2.5	4x5.75	Holes	3x5
310273-306-HY	STR2001HY FS*	310276-xxx	7.5	4.1875	Centered	4x2.5	4x4.50	Threaded Holes	2.795x3.295
310273-102-RA	STR2001RA	310276-xxx	7.625	4.1875	Offset	4x2.5	5x6	Slots	3x5 and 2.625x4.5
310273-204-RA	STR2001RA	310276-xxx	7.625	4.1875	Offset	4x2.5	5x6	Slots	3x5 and 2.625x4.5
310273-306-RA	STR2001RA FS*	310276-xxx	7.625	4.1875	Offset	4x2.5	5x6	Slots	3x5 and 2.625x4.5
310274-102	STR3001	310276-xxx	9.125	4.1875	Centered	4x2.5	5x7	Slots	3.328x5.269 and 2.731x4.672
310274-204	STR3001	310276-xxx	9.125	4.1875	Centered	4x2.5	5x7	Slots	3.328x5.269 and 2.731x4.672
310274-306	STR3001 FS*	310276-xxx	9.125	4.1875	Centered	4x2.5	5x7	Slots	3.328x5.269 and 2.731x4.672
310275-102	STR4001	310276-xxx	8.375	4.1875	Centered	4x2.5	5x5.375	Holes	4x4
310275-204	STR4001	310276-xxx	8.375	4.1875	Centered	4x2.5	5x5.375	Holes	4x4
310275-306	STR4001 FS*	310276-xxx	8.375	4.1875	Centered	4x2.5	5x5.375	Holes	4x4
310260-204-BR	STR9041	310281-xxx	8	5.125	Offset	6x3.25	6.25x4.5	Holes	5.25x3.375
310260-306-BR	STR9041FS*	310281-xxx	8	5.125	Offset	6x3.25	6.25x4.5	Holes	5.25x3.375
310261-306-YT	STR1500FS*	310282-xxx	5.5	3.125	Offset	3.25x1.57	3.15x4.587	Threaded Holes	3 Hole
310262-306-RA	STR3201FS*	310276-xxx	7.5	4.1875	Centered	4x2.5	5x7	Slots	3.328x5.269 and 2.731x4.672
310263-306-JU	STR09029	310126-xxx	7	3.875	Centered	5x2.5	5.5x4.25	Holes	4.125x3.125
310279-306-BR	STR6110FS*	310126-xxx	9.875	4.25	Centered	5x2.5	6.25x4.5	Slots	5.25x3.375 and 4.938x2.438

\*All -306 Assemblies come with the Food Service option which includes a greaseable pivot and wheel axles.

**Note:** See cross references on next page.

**Features**

- 3 simple designs fit most manufactures pallet trucks.
- Poly-block creates a dampening effect to eliminate rocking and provide greater stability.
- Adjustable height eliminates the need for spacer plates and shims.

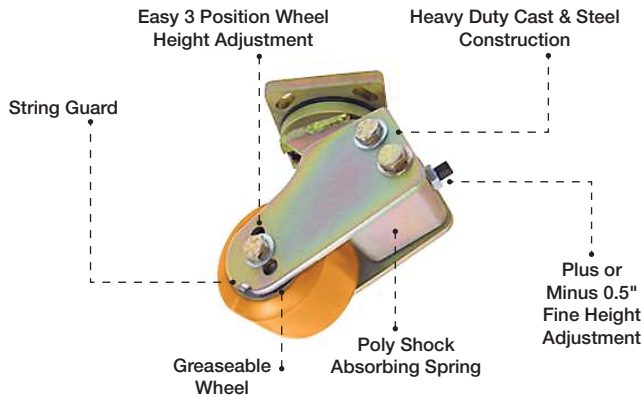

**Replacement Parts**

Part Number	Description	Bearing
310276-102	Wheel	065081-021
310276-204	Wheel	065081-021
310276-306	Wheel	065081-021
310281-204	Wheel	311000-021
310281-306	Wheel	311000-021
310282-306	Wheel	065081-021
310126-306	Wheel	065081-020
310277-102*	Wheel Assembly	NA
310277-204*	Wheel Assembly	NA
310277-306*	Wheel Assembly	NA
*Includes Wheel 310276-xxx, Bearings, String Guards, Spacers and Bushing		
310278*	Axle Kit	NA
310278-001*	Axle Kit Food Service	NA
*Includes Wheel Axle Bolt, Washers, Nuts, and Height Adjustment Screw		

## Pallet Truck - One Source Casters Manufacturer Cross Reference

Crown Number	OE Number	OEM Name
310273-XXX	00590-00027-71	TOYOTA
310274-XXX	00590-01556-71	TOYOTA
310274-XXX	00590-01662-71	TOYOTA
310274-XXX	00590-39633-71	TOYOTA
310273-XXX	0951-C01	RVI
310273-XXX	1009237	CATERPILLAR
310273-XXX	1009299	CATERPILLAR
310273-XXX-RA	1082408	RAYMOND
310273-XXX	1202032	CATERPILLAR
310273-XXX	127520	BAKER
310273-XXX	138071	BAKER
310273-XXX	138073	BAKER
310273-XXX	138075	BAKER
310273-XXX	139312	BAKER
310273-XXX	139312	PRIME MOVER
310273-XXX	150120033	YALE
310273-XXX	152865	BAKER
310273-XXX	153858	BAKER
310273-306-BL	154148	LINDE/BAKER
310275-XXX	1779711	CLARK
310273-XXX	2007884	HYSTER
310261-306-YT	2044852	HYSTER
310273-306-HY	2079240	HYSTER
310273-306-CT	217384	CATERPILLAR
310274-XXX	2308415	HYSTER
310275-XXX	2314632	CLARK
310275-XXX	2314636	CLARK
310273-XXX	27332	PRIME MOVER
310275-XXX	2743452	CLARK
310273-XXX	27675	PRIME MOVER
310275-XXX	2779621	CLARK
310279-306-BR	27835-003	BARRETT
310273-XXX	27849	PRIME MOVER
310275-XXX	2786022	CLARK
310273-XXX	323772	HYSTER
310273-XXX	3246410	HYSTER
310273-306-HY	346201	HYSTER
310273-XXX	346202	HYSTER
310273-XXX	351314	HYSTER

Crown Number	OE Number	OEM Name
310279-306-BR	37194-003S	BARRETT
310279-306-BR	37194-006	BARRETT
310273-XXX	42660-81100-71	TOYOTA
310274-XXX	43380-FS000	BARRETT
310274-XXX	43380-FS001	BARRETT
310274-XXX	43380-FS002	BARRETT
310260-XXX-BR	43380-FS400	BARRETT
310274-XXX	4972078	ALLIS CHALMERS/TUSK
310263-306-JU	50440054	JUNGHEINRICH
310274-XXX	516012603	YALE
310274-XXX	518782600	YALE
310274-XXX	520583002	YALE
310274-XXX	524153612	YALE
310273-306-HY	524244220	YALE
310273-306-HY	524267533	YALE
310261-306-YT	580023164	YALE
310273-XXX-RA	59048553	RAYMOND
310262-306-RA	671-012	RAYMOND
310273-XXX	671-017	RAYMOND
310273-XXX	671-023	RAYMOND
310273-XXX	671-024	RAYMOND
310273-XXX	671-025	RAYMOND
310273-XXX	671-026	RAYMOND
310273-XXX-RA	671-042	RAYMOND
310274-XXX	720465006	YALE
310274-XXX	74970278	ALLIS CHALMERS/TUSK
310273-XXX	826120	HYSTER
310273-XXX	826275	HYSTER
310273-XXX	993465	BAKER
310273-XXX	993994	BAKER
310273-XXX	LC2000	LARCASTER
310273-XXX-CR	LC2400	LARCASTER
310273-XXX	LC2500	LARCASTER
310274-XXX	LC3001	LARCASTER
310274-XXX	LC3501	LARCASTER
310275-XXX	LC4001	LARCASTER
310275-XXX	LC4501	LARCASTER
310273-306-CT	NA014895	CATERPILLAR
310273-XXX	NA067022	MITSUBISHI

## Raymond Pallet Truck Caster Wheel

### Raymond Pallet Casters

Part Number	Description
137564-001	Raymond Caster Kit, includes two assemblies
137564-003	Raymond Caster Kit - Freezer, includes two assemblies

**Note:** Fits older version

### Replacement Parts

Part Number	Description
137534	Plate Adapter
060017-109	Screw .375
060017-007	Screw .375
060005-009	Lockwasher
133109-001-OS	Caster Asm Kit, one side
133109-004-OS	Caster Asm Kit, one side (Freezer)

### Caster Cross Reference

Base Number	Raymond Part Number
137564	671-012
	671-017
	671-023(100)
	671-024(100)
	671-025(100)
	671-026(100)



### Features

- Crown's rugged all steel design, weighs 3.78 lbs. more than Raymond caster
- Eccentric axle easily adjusts to four different heights
- Spacers & Shims are eliminated saving labor hours
- Good lateral stability, especially when making turns
- Reduced drive/load/caster wheel wear
- Optimum handling

## Ball Bearings

\*Note: ♦ clearance greater than standard, ▲ shoulder bearing, ★ high temp, ● alternative durability, ■ lip seals



O.D.	I.D.	Width	Manuf. No.	No Seal/ Shield	1 Seal	2 Seals	1 Rubber Seal	2 Rubber Seals	1 Shield	2 Shields	1 Seal, 1 Shield
0.500	0.250	0.219	FRW188					065120			
0.625	0.250	0.191	R4					065081-050			
0.875	0.375	0.240	400-6	065081-040							
1.102	0.472	0.310	6001	065081-074							
1.125	0.500	0.307	R8					065081-001			
1.181	0.393	0.349	6200	065081-012, 065081-075		065081-069				065081-013	
1.255	0.472	0.389	6201					065081-011■, 065081-015		065081-014	
1.375	0.500	0.433	1621	065081-039			370137♦	065081-037			
1.375	0.625	0.339	R10					065081-061			
1.375	0.625	0.433	99502H			065081-038					
1.378	0.590	0.428	6202	065081-060, 065081-073				065081-044, 311000-022			
1.574	0.669	0.467	6203	065081-082				311000-004, 065081-017★■		065081-016, 809754	
1.625	0.750	0.438	R12					311000-010			
1.650	0.790	0.470	6004					055002-021			
1.653	0.984	0.349	6905			065081-064					
1.750	0.750	0.495	1635							065081-036	
1.844	0.750	0.562	ASF-169-3A			074722					
1.850	0.669	0.546	6303	065081-072						065081-002	
1.850	0.787	0.546	6204	065081-080		065081-018		065081-066, 311000-005	065081-020, 365081-020●	065081-019, 805494	
1.850	0.984	0.467	6005			065081-063					
2.047	0.787	0.586	6304	065081-003			065081-004, 065081-065				
2.047	0.984	0.586	6205	065081-071, 365081-071●, 065081-083, 042022			370059	065081-051♦, 311000-006, 065081-023	065081-021, 365081-021●, 065081-070▲, 365081-070▲●	065081-022, 365081-022●	
2.047	0.984	0.625	87505								311000-011
2.047	0.984	0.813	5205					370093	311000-001	311000-016	
2.050	0.790	0.590	6304							311000-012	
2.165	1.181	0.507	6006	065081-032				055002-027, 311000-003, 065081-031■, 365081-031●	065081-062, 365081-062●		
2.165	1.181	0.901	30BG05S5G	065089-004							
2.440	0.984	0.664	6305				370185	065081-005, 065081-056♦	065081-057, 365081-057●, 365081-057-01▲	311000-013	
2.440	0.984	0.995	5305			065089-003					
2.440	1.181	0.625	6206	065081-024				055002-017, 065081-010■, 365081-010●, 065081-054♦	065081-025, 365081-025●	065081-041	
2.440	1.378	0.546	6007			065081-033		065081-052♦, 055002-014			
2.441	0.984	0.669	6305					311000-007			370182▲
2.441	0.984	0.827	8605								
2.441	1.181	0.630	BL-206	042023							
2.441	1.181	0.938	5206	065025-001				065025-002			
2.834	1.378	0.669	6207					065081-027	311000-019		
2.834	1.181	0.743	6306			065081-058♦	055002-018	065081-006, 365081-006●	065081-067, 365081-067●	311000-014	
2.834	1.378	1.053	5207					065089-005			
2.952	1.771	0.625	6009					065081-079♦			
3.149	1.378	0.822	6307	065081-081, 065081-009				065081-085♦, 065081-007	065081-008, 365081-008●	311000-009	
3.149	1.968	0.625	6010	065081-078							
3.149	2.165	0.506	6911			065081-076					
3.240	1.380	1.220	MG307			380050-020					
3.346	1.771	0.743	6209	065081-029				065081-045	065081-028, 365081-028●		

**Ball Bearings (continued)**

**NEW!**

**NEW!**

O.D.	I.D.	Width	Manuf. No.	No Seal/ Shield	1 Seal	2 Seals	1 Rubber Seal	2 Rubber Seals	1 Shield	2 Shields	1 Seal, 1 Shield
3.543	1.574	0.901	6308			065081-042					
3.543	1.574	0.901	MRC 308	065081-048							
3.543	1.968	0.783	6210			065081-059					
3.630	1.378	1.230	MG207FFUE			380050-067					
3.740	1.574	1.125	MG208-FFH			380050-063					
3.740	2.362	0.704	6012			065081-034					
3.940	2.560	0.430	16013	807701							
3.940	2.560	0.710	6013					055002-019			
3.970	1.575	1.000	MG208-FFA			370236					
3.975	1.772	1.125	MG209			380050-035					
3.990	1.574	1.125	MG208-FFK			380050-017					
4.082	1.575	1.760	MG5208			380050-016					
4.200	1.570	1.040	MG208-FF8			380050-069					
4.220	1.570	1.030	MG208-FF7			380050-066					
4.330	2.362	0.861	6212	065081-030		065081-055					
4.486	1.570	1.250	MG308			380050-019					
4.990	2.360	1.220	1276			380050-034					
5.905	3.936	0.937	6020					065081-043			
6.500	5.000	0.750	FPXF500	042021							

**Ball Bearings with Snap Ring**



O.D.	I.D.	Width	Manuf. No.	No Seal/ Shield	1 Seal	2 Seals	1 Rubber Seal	2 Rubber Seals	1 Shield	2 Shields	1 Seal, 1 Shield
1.850	0.787	0.546	6204					065010-001			
2.047	0.787	0.585	6304					065010-006			
2.047	0.984	0.585	6205					065010-005			
2.165	1.181	0.507	6006					065010-007			
2.440	1.378	0.546	6007					065010-004			
2.834	1.378	1.053	5207	065010-008							

**Thrust Bearings**



O.D.	I.D.	Width	Manuf. No.	Crown Part No.
2.000	1.110	0.630	28TAG12	380050-059
2.760	1.760	0.550	51110	055018-001
2.938	2.010	0.625	T199	065043
3.940	2.950	0.750	51115	055018-002
4.720	3.540	0.590	07352	380050-048
7.000	5.813	0.688	T581	065086

**Needle Bearings**



**NEW!**

O.D.	I.D.	Width	Manuf. No.	Crown Part No.
1.000	0.750	0.875	BA121614	065082
1.140	1.180	0.870	HMK2230	380050-068
1.380	1.100	0.980	HK283525	380050-064
1.500	1.187	0.625	YB-1910	072092
1.540	1.100	1.180		380050-060
1.654	1.378	0.630	TLA3516UU	065013-007
2.500	2.120	1.000	BA3416Z-OH	065013-004

**Thrust Roller Bearing**



O.D.	I.D.	Width	Manuf. No.	Crown Part No.
2.240	0.500	1.060	MG205	380050-018

**Roller Bearings**



O.D.	I.D.	Width	Manuf. No.	Crown Part No.
2.063	1.500	1.250	BR-243320	073449
2.250	1.688	1.000	BR273616	073442
2.830	1.730	0.120	NU207E	065193

**Spherical Bearings**



**NEW!**

O.D.	I.D.	Width	Manuf. No.	Crown Part No.
1.180	0.670	0.550	GE17ES-2RS	380050-062
1.380	0.790	0.630	GE20ES-2RS	380050-025
1.438	0.875	0.765		380050-058

# Bearings

## Cone Bearings



O.D.	I.D.	Width	Manuf. No.	Crown Part No.	Use With
N/A	0.747	0.727	LM11900LA	312000-005	
N/A	0.750	0.439	A6075	065045	065044 cup
N/A	0.750	0.655	LM11949	065137	065136 cup
N/A	0.750	0.755	09067 20024	312000-006	
N/A	0.780	1.630	LM501349	065148	065147 cup
N/A	0.875	0.561	07087	071544	071545 cup
N/A	0.980	0.870	X33205	134610	134609 cup
N/A	1.000	0.561	7100	071543	071545 cup
N/A	1.000	0.622	07000LA	312000-010	
N/A	1.000	0.813	15100	312000-011	312000-003 cup
N/A	1.000	1.000	L44643	312000-008	065134 cup
N/A	1.063	0.580	L44649	065135	065134 cup
N/A	1.188	0.847	M86610	065110	065109 cup
N/A	1.250	0.655	LM67048	065106	065105 cup
N/A	1.250	0.715	15123	312000-015	312000-003
N/A	1.250	1.000	2580	135282	135281 cup
N/A	1.375	0.720	LM48548	065131	065118 cup
N/A	1.375	1.052	14136A	312000-013	312000-014 cup
N/A	1.380	0.988	25877	312000-012	312000-004 cup
N/A	1.406	1.003	HM88648	065052	065051 cup
N/A	1.438	1.138	HM89249	065097	065096 cup
N/A	1.625	1.003	26882	065099	065098 cup
N/A	1.781	0.781	LM603049	065133	065132 cup
N/A	1.797	1.003	25590	042020	042019 cup
N/A	1.969	0.847	JLM104948	380050-006	
N/A	2.000	0.880	LM104949	065108	065107 cup
N/A	2.125	1.455	539	065128	065127 cup
N/A	2.165	0.906	JLM506849	065019	065018 cup
N/A	2.165	1.142	JM207049	065024	065023 cup
N/A	2.625	1.196	39590	065101	065100 cup
N/A	2.880	1.190	33287	065146	065145 cup
N/A	2.950	0.980	JLM714149 N-000	045319*	045318 cup
N/A	2.952	0.984	JLM714149	077015	077014 cup
N/A	3.150	1.140	X32016X	135495	135500 cup
N/A	3.250	1.313	47686	065161	065162 cup
N/A	3.346	1.142	JM716648	065157	065158 cup
N/A	3.750	1.141	42375	065126	065125 cup

## Cup Bearings



O.D.	I.D.	Width	Manuf. No.	Crown Part No.	Use With
1.576	N/A	0.375	A6157	065044	065045 cone
1.781	N/A	0.610	LM11910	065136	065137 cone
1.938	N/A	0.562	09195	312000-001	
1.969	N/A	0.531	07196	071545	071544 or 071543 cone
1.979	N/A	0.560	L44610	065134	065135 cone
2.050	N/A	0.710	Y33205	134609	134610 cone
2.328	N/A	0.625	LM67010	065105	065106 cone, spacer is 103936
2.441	N/A	0.715	15245	312000-003	312000-015 cone
2.532	N/A	0.658	M86649	065109	065110 cone
2.563	N/A	0.550	LM48510	065118	065131 cone
2.717	N/A	0.625	14274	312000-014	312000-013 cone
2.750	N/A	0.750	2523	135281	135282 cone
2.844	N/A	0.771	HM88610	065051	065052 cone
2.875	N/A	0.748	25821	312000-004	312000-012 cone
2.890	N/A	0.580	LM501310	065147	065148 cone
3.063	N/A	0.594	LM603011	065132	065133 cone
3.126	N/A	0.752	26822	065098	065099 cone
3.126	N/A	1.160	HM89210	065096	065097 cone
3.228	N/A	0.847	JLM104910	380050-005	
3.250	N/A	0.650	LM104911	065107	065108 cone
3.266	N/A	0.752	25520	042019	042020 cone
3.543	N/A	0.728	JLM506810	065018	065019 cone
3.740	N/A	0.925	JM207010	065023	065024 cone
4.250	N/A	1.125	532X	065127	065128 cone
4.439	N/A	0.940	39520	065100	065101 cone
4.528	N/A	0.748	JLM714110	077014	077015 cone
4.530	N/A	0.750	JLM714110 N-000	045318*	045319 cone
4.630	N/A	0.150	33462	065145	065146 cone
4.920	N/C	0.870	Y32016X	135500	135495 cone
5.110	N/A	0.945	JH716610	065158	065157 cone
5.250	N/A	1.031	47620	065162	065161 cone
5.844	N/A	0.844	42584	065125	065126 cone

## Cup & Cone Bearings



O.D.	I.D.	Width	Manuf. No.	Crown Part No.
1.438	1.250		302087	794109-007
1.625	0.563		30302	794109-002
1.938	1.063		L446410	794109-001
2.656	1.500	1.578	LM29748	075717
2.718	1.250	0.781	14124	065069
2.813	1.500		30207J	794109-006
2.835	1.380	0.720	30207	380050-056
3.000	1.980	0.969	L44610/L44649	370181
3.347	0.748	0.974	32209	380050-055
3.350	1.770	0.820	30209	380050-065
3.350	1.770	0.820	30209	380050-065
3.540	2.170	0.910	32011xj	794109-004
3.540	2.170	0.910	32011	380050-036
3.543	0.748	0.974	32210	380050-057
3.740	2.360	1.220		380050-054
3.940	2.560	0.910	32013XU	794109-003
4.331	0.945	0.906	32212	380050-003
4.921	0.827	1.034	30214	380050-004





# Tire Application Guide



## Application Types

Tire Series	Compound Number	Non-Marking Compound Number	Shore A Hardness	Composition	Wet/Freezer	Dock Boards Rough Floors Floor Debris	Heavy Loads Long Runs	Floor Debris
					Resistant to Poor Traction	Resistant to Chunking	Resistant to Extreme Heat	Resistant to Flat Spotting
<b>100 Series</b> Light Duty	These economical 100 Series Light Duty tires are best suited for light loads and intermittent use.							
	141	151	91	Polyether				
	142	152	93	Polyether				
<b>200 Series</b> Midrange	The 200 Series Midrange tires are designed for light to medium loads and short to medium runs.							
	241	251	87	Polyether	•	•		
	242	252	85	Polyester	•	•		
	243*	253	83	Polyester	•	•		•
	244	254	83	Polyester	•	•		•
<b>300 Series</b> High Capacity	For the typical demands of most applications, 300 Series High Capacity tires are designed for high capacities and long runs.							
	341	351	95	Polyester	•	•	•	•
	342*	352	90	Polyester	•	•	•	•
	343	353	85	Polyether	•	•	•	
	344	354	95	Polyester	•	•	•	•
	345	355	90	Polyester	•	•	•	•
	346	356	95	Polyester	•	•	•	•
	347	357	90	Polyether	•	•	•	•
	348	358	95	Polyether	•	•	•	•
<b>400 Series</b> Heavy Duty	The 400 Series Heavy Duty tires are designed for maximum capacities and extreme runs.							
	441	451	99	Polyether	When your application consists of heavy loads, long runs and extreme heat beyond the capabilities of the 300 Series High Capacity tires, the premium 400 Series Heavy Duty compounds are designed for maximum performance.			
	442		93	Vulkollan™				

\*Note: Typically shipped with all new Crown lift trucks depending on model.

## Treads



**Contour/Smooth -01**  
All purpose.



**Center Groove -02**  
Dissipates heat and provides better traction. Heavy loads, long runs, extreme heat.



**22° Router Sipe -03**  
Increased traction. Designed for wet/freezer application.



**22° Thin Sipe -04**  
Increased traction. Designed for wet/freezer application.



**Diamond Sipe -05**  
Increased traction. Designed for wet/freezer application.

# Polyurethane Tires by Size

O.D.	Width	I.D.	Crown Part Number	Notes
<b>6.00 O.D.</b>				
6.00	3.00	4.000	310198	
<b>8.00 O.D.</b>				
8.00	4.00	6.250	310002	
8.00	4.00	6.500	310199	
8.00	4.50	6.500	310246	1" Insert for Brake
8.00	4.50	4.500	310003	
<b>8.50 O.D.</b>				
8.50	4.00	4.000	077984	
<b>9.00 O.D.</b>				
9.00	2.75	1.770	310296	
9.00	3.50	6.500	310005	
9.00	5.00	5.000	077848	
9.00	5.00	5.000	310208	Step
9.00	5.00	5.000	317848	
9.00	5.00	5.750	126266	
9.00	7.00	6.250	310293	
<b>10.00 O.D.</b>				
10.00	3.00	7.500	310007	
10.00	3.50	8.000	310008	
10.00	4.00	6.500	075715	
10.00	4.00	6.500	310049	
10.00	4.50	7.000	310237	
10.00	4.50	8.000	310009	
10.00	4.75	6.500	310011	Contour Profile
10.00	4.75	6.500	310200	10° Angle
10.00	5.00	6.500	107933	Contour - 18° Angle
10.00	5.00	6.500	310294	Contour - 18° Angle
10.00	5.00	6.500	310012	Smooth 15° Angle
10.00	5.00	6.500	310202	Beveled Edge
10.00	6.00	6.250	310013	
10.00	6.00	6.500	310014	
10.00	7.00	6.250	310015	
10.00	7.00	8.000	310016	
<b>10.50 O.D.</b>				
10.50	3.50	8.000	310017	
10.50	4.00	8.000	105088	
10.50	4.50	8.000	105089	
10.50	5.00	5.000	310019	
10.50	5.00	6.500	310020	
10.50	6.00	5.000	310021	
10.50	6.00	6.500	310022	
10.50	6.50	8.000	310023	
10.50	7.00	6.500	310024	
<b>12.00 O.D.</b>				
12.00	4.00	8.000	310030	
12.00	4.50	8.000	310025	
12.00	5.00	8.000	310027	
12.00	5.00	9.000	310026	Contour Profile
12.00	5.00	9.000	310029	Smooth
12.00	5.50	8.000	310028	
<b>13.00 O.D.</b>				
13.00	4.50	8.000	079494	
13.00	4.50	8.000	310031	Angled to a 2" footprint
13.00	4.50	8.000	310204	
13.00	4.50	10.000	310032	
13.00	5.50	8.000	079266	
13.00	5.50	8.000	319266	
13.00	5.50	9.500	121501	
13.00	5.50	9.500	310214	
13.00	6.00	10.500	310034	

O.D.	Width	I.D.	Crown Part Number	Notes
<b>13.50 O.D.</b>				
13.50	4.50	8.000	310035	
13.50	5.00	8.000	310038	
13.50	5.50	8.000	077050	Contour Profile
13.50	5.50	8.000	310039	Smooth
13.50	5.50	10.000	310053	
13.50	5.50	10.500	310284	
13.50	6.00	8.000	100368	
13.50	6.00	10.000	114493	
13.50	6.00	10.500	310037	
13.50	6.50	8.000	310040	
13.50	7.00	8.000	100700	
13.50	7.00	10.000	114494	
<b>14.00 O.D.</b>				
14.00	4.50	8.000	310042	
14.00	5.00	10.000	310045	
14.00	5.00	11.250	310044	
14.00	6.00	11.250	310046	
14.00	8.00	10.250	310271	
14.00	8.00	11.250	310047	
<b>14.75 O.D.</b>				
14.75	6.50	10.750	310272	
<b>15.00 O.D.</b>				
15.00	5.00	11.250	310048	
15.00	6.00	11.250	310052	
15.00	6.00	11.750	310054	
15.00	6.50	10.750	310463	
15.00	7.00	11.250	310055	
15.00	8.00	11.200	090270	
15.00	8.00	11.250	310056	
<b>15.25 O.D.</b>				
15.25	7.00	11.250	133904	
<b>15.50 O.D.</b>				
15.50	5.00	10.000	310057	
15.50	6.00	10.000	310058	
<b>16.00 O.D.</b>				
16.00	4.00	12.125	310059	
16.00	5.00	10.500	310060	
16.00	6.00	10.500	310061	
16.00	7.00	10.500	139567	
16.00	7.00	10.500	310567	
16.00	7.00	12.000	310063	
<b>16.25 O.D.</b>				
16.25	5.00	11.250	310064	
16.25	6.00	11.250	310065	
16.25	7.00	11.250	310066	
16.25	10.00	11.250	310228	
<b>18.00 O.D.</b>				
18.00	5.00	12.125	310067	
18.00	6.00	12.125	310068	
18.00	7.00	12.125	310069	
18.00	7.00	15.000	310070	
18.00	8.00	12.125	310071	
18.00	9.00	12.125	310072	
<b>21.00 O.D.</b>				
21.00	7.00	15.000	310073	
21.00	8.00	15.000	310121	
<b>22.00 O.D.</b>				
22.00	5.00	16.000	310074	
22.00	8.00	16.000	310075	
22.00	9.00	16.000	310207	
22.00	10.00	16.000	310076	

**Note:** You need to add the compound and tread part number to the base number listed above. See compounds and treads listed on page 10.13 for the dash number. Complete part number format is XXXXXX-XXX-XX. Contact your local Crown dealer for pricing and availability of each compound and tread.

## Hole Tires

### Polyurethane Hole Pattern Tires

- Great on damp floors
- Resistance to chunking and tearing
- Cold storage applications
- Produce areas

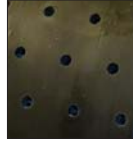

OD	Width	ID	Crown Part Number
9.00	5.00	5.00	317848-341-06
9.00	5.00	5.75	316266-341-06
10.00	4.00	6.50	310049-243-06
10.00	4.75	6.50	310011-341-06
10.00	5.00	6.50	310294-341-06
10.00	7.00	6.25	310015-341-06
12.00	4.50	8.00	310025-341-06
12.00	5.50	8.00	310028-341-06
13.00	4.50	8.00	310204-243-06
13.00	4.50	8.00	310204-341-06
13.00	4.50	8.00	310204-352-06
13.00	5.50	8.00	319266-243-06
13.00	5.50	8.00	319266-253-06
13.00	5.50	8.00	319266-341-06
13.00	5.50	9.50	310214-243-06
13.00	5.50	9.50	310214-342-06
13.00	5.50	9.50	310214-352-06
13.50	4.50	8.00	310035-243-06

OD	Width	ID	Crown Part Number
13.50	4.50	8.00	310035-341-06
13.50	5.50	8.00	310039-243-06
13.50	5.50	8.00	310039-341-06
13.50	5.50	8.00	310039-342-06
13.50	6.00	8.00	310368-341-06
13.50	6.00	10.00	314493-341-06
13.50	6.00	10.50	310037-243-06
13.50	6.00	10.50	310037-341-06
13.50	6.00	10.50	310037-342-06
13.50	7.00	10.00	314494-341-06
15.00	5.00	11.25	310048-243-06
15.00	5.00	11.25	310048-341-06
16.00	6.00	10.50	310061-243-06
16.00	7.00	10.50	310567-341-06
16.25	6.00	11.25	310065-341-06
16.25	7.00	11.25	310066-341-06
18.00	7.00	12.13	310069-243-06
18.00	7.00	12.13	310069-341-06

## Sweeper Scrubber Rubber Tires

405



406



O.D.	Width	I.D.	Profile	Manufacturer	Compound	Crown Part Number
10.00	5.00	6.50	Diamond Sipe	Superior	P7	350007-406-05
10.00	5.00	6.50	Smooth	Superior	P7	350007-406-41
12.00	4.50	8.00	Diamond Sipe	Superior	P7	350032-406-05
12.00	4.50	8.00	Smooth	Superior	P7	350032-406-41
13.50	5.50	8.00	Diamond Sipe	Superior	P7	350055-406-05
13.50	5.50	8.00	Smooth	Superior	P7	350055-406-41
16.00	3.50	12.125	Diamond Sipe	Superior	P7	350066-406-05
16.00	5.00	12.125	Diamond Sipe	Superior	P7	350056-406-05
16.00	5.00	12.125	Smooth	Superior	P7	350056-406-41
16.00	6.00	10.50	Lugged	Monarch	Monogrip	350054-405-42
16.00	6.00	10.50	Diamond Sipe	Superior	P7	350054-406-05
16.00	6.00	10.50	Smooth	Superior	P7	350054-406-41
16.00	6.00	11.25	Diamond Sipe	Superior	P7	350018-406-05
16.00	6.00	11.25	Smooth	Superior	P7	350018-406-41
16.25	6.00	11.25	Diamond Sipe	Superior	P7	350018-406-05
16.25	6.00	11.25	Smooth	Superior	P7	350018-406-41
18.00	6.00	12.125	Diamond Sipe	Superior	P7	350022-406-05
18.00	6.00	12.125	Smooth	Superior	P7	350022-406-41
18.00	6.00	12.125	Lugged	Monarch	Monogrip	350022-405-42

**WARNING: Sweeper scrubber tires are only to be used on scrubber trucks as misapplication on a lift truck will affect stability and reduce the load capacity of forklift trucks by 30% or more.**

# Hubs

## One Source Hubs



370061 358002 358003 358004 358005 358006 358007 358008 358009 358010

Part No.	Dimensions	OE	Truck Model	Cross References	Bolts
370061	5 x 2.5	Yale Hyster	MPB040 B60Z	501087300 2308186	
358002	6.5 x 3.317	Raymond	Gofer, 109 Walkies, NPV 60	850-135-500	6 Bolt Hub
358003	6.5 x 3.3	Raymond	109, 111, 112, 113, 114 Pallet Jacks, 111, 112, 113, 114 Walkies	850-138-111	5 Bolt Hub
358004	6.25 x 7	Raymond	630, 640, 650 Counterbalance Trucks	123-000-586	Steer Hub
358005	10.5 x 4.44	Raymond	PDPM-0085, PDPM-0186 Easi Reach, Easi Order Picker	828-003-073	7 Bolt Concave Hub
358006	8.99 x 4.98	Raymond	Easi Order Picker	114-008-501	5 Bolt Raised Lip Dr. Hub
358007		Komatsu	FD20,23,25,28,30-12 FG20/C/H/HT/T, 23/T, 25/C/H/HT/T, 28/T, 30/C/H/HT/T - 12,14	3EB-21-32171	
358008		Caterpillar/ Mitsubishi	FD20/25/28/30/33/35, FG20/25/28/30/33/35, P4000, P5000, P5500, P6000, P6500, P7000	91E43-10800	
358009		Toyota	02-5FD,FDU/20/23/25/28/30, 02-5FG28/30, 40-4FG20/25, 40-5FG20/23/25, 42-2FG,4FG/20/25, 42-5FG,FGU/20/23/25, 5FD,FG/20/23/25/28/30, 8FDU,FGU20/25/30/32	43811-20540-71	
358010		Komatsu	FB20/25/30/30 SH-4, FD20/23/25/25S,28,30-11,12, FG20/C/H/HT/S/T,23/T,25/C/H/HT/S/T,28/T,30/C/H/HT/S/T -11,12,14	3EB-24-21210	
358011	10.75x6	Raymond	Swing Reach	838-010-001	9 Bolt Hub
358012	11.25x7	Raymond	Pacer	223-001-152/002	8 Bolt Hub
358013	11.25x6	Raymond	Pacer	223-001-153/002	8 Bolt Hub



## Crown Hubs

Hub Part Number	Tire	Steer/ Drive	Truck
121502	121501	Drive	RR/RD 5700/5200/5000
115025	079266	Drive	RR 3000
087391	079266	Drive	SP 3000/3200/3500/3400 3 wheel/ 3400 4 wheel
113361	079494	Drive	PC 4500/ PE 4000/ PR 4500
113362	074458	Drive	PC 4500/ PE 4000/ PR 4500
127250	127251	Drive	WP 3000
140692	135906	Drive	RC 5500
134825	107933	Steer	RC 5500
114981	114493	Drive	RC 3000
126267	126266	Steer	RC 3000
076752	076751	Steer	RC 3000
116561	077848	Steer	RC 3000
124300	137033	Drive	SC 4000/ SC 4500
124798	137216	Drive	SC 4000/ SC 4500
146015	137031	Steer	SC 4000/ SC 4500/ SC 5200
147717	137033	Drive	SC 5200
121973	136019	Drive	FC 4000/ FC 4500
128375	136019/ 137210	Drive	FC 4000/ FC 4500/ C5 Cushion
117444	135906/ 136162	Steer	FC 4000/ FC 4500/ C5 Cushion
138111	141058	Steer	C5 Cushion
140796	136019/ 137210	Drive	C5 Cushion



Wheels and Tires

Tread Reference Only



341



342



021, 121, 381 & 391



382 & 392



480 & 490



181, 191, 281, 291,  
486, 487 & 497

Crown Part Number	Size	Tire O.D.	Tire Width	Rim Width	Ply	Profile	Notes	Manufacturer
<b>Solid Resilient</b>								
141509-021-01	15 x 4.5-8	14.92	4.41	3.00		Lugged	Solid Resilient	Solideal
141509-021-02	15 x 4.5-8	14.92	4.41	3.00		Lugged - NM Grey	Solid Resilient	Solideal
355158-480-42	15 x 4.5-8	14.80	4.50	3.00		Lugged	Solid Resilient	Solideal
355158-487-42	15 x 4.5-8	14.80	4.50	3.00		Lugged	Solid Resilient	Solideal
355158-497-42	15 x 4.5-8	14.80	4.50	3.00		Lugged - NM Grey	Solid Resilient	Solideal
103163-002	18.00 x 7-8	18.00	6.20	4.33		Lugged	Solid Resilient	Monarch
141511-021-01	18.00 x 7-8	17.87	5.79	4.33		Lugged	Solid Resilient	Solideal
141511-021-02	18.00 x 7-8	17.87	5.79	4.33		Lugged - NM Grey	Solid Resilient	Solideal
152568-181-42	18.00 x 7-8	17.80	6.00	4.33		Lugged	Solid Resilient	Solideal
152568-191-42	18.00 x 7-8	17.80	6.00	4.33		Lugged - NM Grey	Solid Resilient	Solideal
355708-392-42	18.00 x 7-8	18.00	6.20	4.33		Lugged - NM Cream	Solid Resilient	Monarch
355708-480-42	18.00 x 7-8	17.90	6.20	4.33		Lugged	Solid Resilient	Solideal
355708-487-42	18.00 x 7-8	17.80	6.00	4.33		Lugged	Solid Resilient	Solideal
355708-497-42	18.00 x 7-8	17.80	6.00	4.33		Lugged - NM Grey	Solid Resilient	Solideal
355610-382-42	21 x 8-9	20.40	7.30	6.00		Lugged	Solid Resilient	Monarch
355239-487-42	23 x 9-10	23.00	8.00	6.50		Lugged	Solid Resilient	Solideal
103164-002	23 x 10-12	22.80	9.00	8.00		Lugged	Solid Resilient	Monarch
355023-392-42	23 x 10-12	23.10	9.40	8.00		Lugged - NM Cream	Solid Resilient	Monarch
355250-480-42	250 x 15	28.20	8.90	7.00		Lugged	Solid Resilient	Solideal
141511-121-01	200/50-10	17.99	7.32	6.50		Lugged	Solid Resilient	Solideal
141511-121-02	200/50-10	17.99	7.32	6.50		Lugged - NM Grey	Solid Resilient	Solideal
152571-281-42	200/50-10	18.10	7.50	6.50		Lugged	Solid Resilient	Solideal
152571-291-42	200/50-10	18.10	7.50	6.50		Lugged - NM Grey	Solid Resilient	Solideal
355200-382-42	200/50-10	18.00	7.70	6.50		Lugged	Solid Resilient	Monarch
355200-392-42	200/50-10	18.00	7.70	6.50		Lugged - NM Grey	Solid Resilient	Monarch
355200-481-42	200/50-10	18.10	7.50	6.50		Lugged	Solid Resilient	Solideal
355200-487-42	200/50-10	18.10	7.50	6.50		Lugged	Solid Resilient	Solideal
355200-497-42	200/50-10	18.10	7.50	6.50		Lugged - NM Grey	Solid Resilient	Solideal
355401-382-42	4.00 x 8	16.10	4.70	2.50		Lugged- Rib	Solid Resilient	Monarch
355400-381-42	4.00 x 8	16.00	4.80	3.75		Lugged- Rib	Solid Resilient	Solideal
355500-382-42	5.00 x 8	18.10	4.80	3.00		Lugged	Solid Resilient	Monarch
355500-392-42	5.00 x 8	18.10	4.80	3.00		Lugged - NM Cream	Solid Resilient	Monarch
355500-393-42	5.00 x 8	17.90	4.40	3.00		Lugged	Solid Resilient	Solideal
355500-486-42	5.00 x 8	17.70	4.80	3.00		Lugged	Solid Resilient	Solideal
355508-381-42	5.00 x 8	17.80	5.30	3.75		Lugged- Rib	Solid Resilient	Solideal
355508-382-42	5.00 x 8	18.00	6.00	3.75		Lugged	Solid Resilient	Monarch
136238-381-42	6.00 x 9	21.00	6.50	4.00		Lugged	Solid Resilient	Solideal
136238-391-42	6.00 x 9	20.55	5.67	4.00		Lugged - NM Grey	Solid Resilient	Solideal
359609-200-42	6.00 x 9	20.60	5.60	4.00		Lugged	Solid Resilient	Solideal
355609-382-42	6.00 x 9	20.70	5.50	4.00		Lugged	Solid Resilient	Monarch
355609-392-42	6.00 x 9	20.70	5.50	4.00		Lugged - NM Cream	Solid Resilient	Monarch
355609-480-42	6.00 x 9	20.60	5.40	4.00		Lugged	Solid Resilient	Solideal
355609-485-42	6.00 x 9	20.60	5.40	4.00		Lugged	Solid Resilient	Solideal
355609-490-42	6.00 x 9	20.60	5.40	4.00		Lugged - NM Grey	Solid Resilient	Solideal
355609-486-42	6.00 x 9	20.60	5.40	4.00		Lugged	Solid Resilient	Solideal
355609-487-42	6.00 x 9	20.60	5.40	4.00		Lugged	Solid Resilient	Solideal
142925-381-42	6.50 x 10	22.52	6.18	5.00		Lugged	Solid Resilient	Solideal
142925-391-42	6.50 x 10	22.52	6.18	5.00		Lugged - NM Grey	Solid Resilient	Solideal
355650-381-41	6.50 x 10	22.30	6.20	5.00		Smooth	Solid Resilient	Solideal
355650-392-41	6.50 x 10	22.70	6.30	5.00		Smooth - NM Cream	Solid Resilient	Monarch
355650-392-42	6.50 x 10	22.70	6.30	5.00		Lugged - NM Cream	Solid Resilient	Monarch
355650-480-42	6.50 x 10	22.30	6.40	5.00		Lugged	Solid Resilient	Solideal
355650-490-42	6.50 x 10	22.30	6.40	5.00		Lugged - NM Grey	Solid Resilient	Solideal

New part

# Resilient/Pneumatic Tires

Crown Part Number	Size	Tire O.D.	Tire Width	Rim Width	Ply	Profile	Notes	Manufacturer
<b>Solid Resilient (continued)</b>								
355650-486-42	6.50 x 10	22.30	6.40	5.00		Lugged	Solid Resilient	Solideal
136236-381-42	7.00 x 12	25.71	6.65	5.00		Lugged	Solid Resilient	Solideal
136236-391-42	7.00 x 12	25.71	6.65	5.00		Lugged - NM Grey	Solid Resilient	Solideal
355712-382-42	7.00 x 12	25.60	6.80	5.00		Lugged	Solid Resilient	Monarch
355712-392-42	7.00 x 12	25.60	6.80	5.00		Lugged - NM Cream	Solid Resilient	Monarch
355712-480-42	7.00 x 12	25.70	6.80	5.00		Lugged	Solid Resilient	Solideal
355712-485-42	7.00 x 12	25.70	6.80	5.00		Lugged	Solid Resilient	Solideal
355712-490-42	7.00 x 12	25.70	6.80	5.00		Lugged - NM Grey	Solid Resilient	Solideal
355712-486-42	7.00 x 12	25.60	6.60	5.00		Lugged	Solid Resilient	Solideal
355712-487-42	7.00 x 12	25.60	6.60	5.00		Lugged	Solid Resilient	Solideal
355715-382-42	7.00 x 15	28.70	7.10	5.50		Lugged	Solid Resilient	Monarch
355715-385-42	7.00 x 15	28.50	7.10	6.00		Lugged	Solid Resilient	Solideal
355715-480-42	7.00 x 15	28.70	7.00	5.50		Lugged	Solid Resilient	Solideal
142923-381-42	8.15 x 15 or 28 x 9-15	26.97	8.19	7.00		Lugged	Solid Resilient	Solideal
142923-391-42	8.15 x 15 or 28 x 9-15	26.97	8.19	7.00		Lugged - NM Grey	Solid Resilient	Solideal
355815-382-42	8.15 x 15 or 28 x 9-15	27.30	8.80	7.00		Lugged	Solid Resilient	Monarch
355815-392-42	8.15 x 15 or 28 x 9-15	27.30	8.80	7.00		Lugged - NM Cream	Solid Resilient	Monarch
355815-480-42	8.15 x 15 or 28 x 9-15	27.00	8.60	7.00		Lugged	Solid Resilient	Solideal
355815-490-42	8.15 x 15 or 28 x 9-15	27.00	8.60	7.00		Lugged - NM Grey	Solid Resilient	Solideal
355815-486-42	8.15 x 15 or 28 x 9-15	27.00	8.60	7.00		Lugged	Solid Resilient	Solideal
355825-382-42	8.25 x 15	31.80	8.20	5.50		Lugged	Solid Resilient	Monarch
355826-382-42	8.25 x 15	31.80	8.20	6.50		Lugged	Solid Resilient	Monarch
355826-480-42	8.25 x 15	32.00	8.30	6.50		Lugged	Solid Resilient	Solideal
355826-481-42	8.25 x 15	32.00	8.30	6.50		Lugged	Solid Resilient	Solideal
355300-385-42	3.00 x 15	32.00	10.10	8.00		Lugged	Solid Resilient	Monarch
148737-381-42	27 x 10-12	27.09	9.61	8.00		Lugged	Solid Resilient	Solideal
355027-487-42	27 x 10-12	26.60	9.60	8.00		Lugged	Solid Resilient	Solideal
148740-381-42	28 x 12.5-15	27.48	11.42	9.75		Lugged	Solid Resilient	Solideal
152565-181-42	140/55-9	14.80	5.10	4.00		Lugged	Solid Resilient	Solideal
152565-191-42	140/55-9	14.80	5.10	4.00		Lugged - NM Grey	Solid Resilient	Solideal
355140-487-42	140/55-9	14.80	5.10	4.00		Lugged	Solid Resilient	Solideal
355140-497-42	140/55-9	14.80	5.10	4.00		Lugged - NM Grey	Solid Resilient	Solideal
<b>Air Pneumatic</b>								
355250-341-42	250 x 15	28.80	9.20	7.50	16	Lugged	Air Pneumatic	Solideal
350500-342-42	5.00 x 8	18.70	5.70	3.00	10	Lugged	Air Pneumatic	Monarch
355508-341-42	5.00 x 8	18.40	5.20	3.00	8	Lugged	Air Pneumatic	Solideal
355609-341-42	6.00 x 9	20.80	5.90	4.00	10	Lugged	Air Pneumatic	Solideal
355609-342-42	6.00 x 9	21.70	6.50	4.00	12	Lugged	Air Pneumatic	Monarch
355650-341-42	6.50 x 10	23.10	6.70	5.00	10	Lugged	Air Pneumatic	Solideal
355712-341-42	7.00 x 12	26.60	7.60	5.00	12	Lugged	Air Pneumatic	Solideal
355712-342-42	7.00 x 12	27.10	7.80	5.00	14	Lugged	Air Pneumatic	Monarch
355712-441-42	7.00 x 12	26.70	7.20	5.00	14	Lugged	Air Pneumatic	Solideal
355715-342-42	7.00 x 15	30.10	8.10	5.50	14	Lugged	Air Pneumatic	Monarch
355715-441-42	7.00 x 15	30.00	8.00	5.50	14	Lugged	Air Pneumatic	Solideal
355716-341-42	7.50 x 16	32.00	8.00	5.50	12	Lugged	Air Pneumatic	Solideal
355825-441-42	8.25 x 15	33.20	9.10	6.50	14	Lugged	Air Pneumatic	Solideal
355825-442-42	8.25 x 15	32.80	10.00	6.50	14	Lugged	Air Pneumatic	Monarch
355825-443-42	8.25 x 15	33.10	9.70	6.50	14	Lugged	Air Pneumatic	Solideal
355815-341-42	8.15 x 15 or 28 x 9-15	28.10	8.80	7.00	14	Lugged	Air Pneumatic	Solideal
355032-443-42	32 x 12.1-15	31.70	12.40	9.75	24	Lugged	Air Pneumatic	Solideal
359031-345-42	31x15.5-15	31.70	15.00	13.00	8	Lugged	Air Pneumatic	Solideal
359031-345-52	31x15.5-15	31.70	15.00	13.00	8	Lugged	Air Pneumatic	Solideal
359315-346-42	31.5x13-16.5	31.50	13.90	9.75	10	Lugged	Air Pneumatic	Solideal
359315-346-52	31.5x13-16.5	31.50	13.90	9.75	10	Lugged	Air Pneumatic	Solideal
☀ New part								

**Please note:** All Monarch Air Pneumatics include Tire, Flaps, and Tubes;  
All Solideal Air Pneumatics include Tire and Flap - tube to be ordered separately

## Tubes

Crown Part	Size
315000-250	250 x 15
315000-408	4.00 x 8
315000-508	5.00 x 8

Crown Part	Size
136247	6.00 x 9
315000-650	6.50 x 10
136243	7.00 x 12

Crown Part	Size
315000-715	7.00 x 15
315000-815	8.15 x 15

## Flaps

Crown Part	Size
136249	600 x 12
136244	700 x 12

Crown Part	Size
141518-001	400/500/570x8

Crown Part	Size
141518-002	16 x 6-8

## Rims

Crown Part	Size
136246	4.00E-9
152564*	4.00E-9
152567*	4.33R-8
152570*	6.50F-10

Crown Part	Size
113041	4.33R-8
143317	5.00F-10
136242	5.00S-12
142934	7.10-15

Crown Part	Size
113042	8.00G-12
148738	8.00G-12
148741	9.75-15

\*Quick Tire Only



**Competitive Seats  
Available.  
See Page 4.02**



**Hard Hats, Safety  
Vests and Glasses  
Available.  
See Section 2**



**V-Force Batteries  
Available.  
See Page 7.05**











# Rubber Tires by Size

Note: Profile and manufacturer key on page 10.20.

21.00 O.D. Continued

O.D.	Width	I.D.	Profile	Compound	Crown Part Number	Manuf.
21.00	7.00	15.000	SM - Flat	Rubber NM Cream	129219-003	MO
21.00	7.00	15.000	SM - Flat	Rubber	129219-004	MO
21.00	7.00	15.000	SM	Rubber	136019-301-41	SL
21.00	7.00	15.000	Lugged	Rubber	136019-301-42	SL
21.00	7.00	15.000	SM	Rubber NM Grey	136019-311-41	SL
21.00	7.00	15.000	Lugged	Rubber NM Grey	136019-311-42	SL
21.00	7.00	15.000	SM	Rubber	350047-201-41	RR
21.00	7.00	15.000	Lugged	Rubber	350047-201-42	RR
21.00	7.00	15.000	SM	Rubber NM Dk Grey	350047-211-41	RR
21.00	7.00	15.000	Lugged	Rubber NM Dk Grey	350047-211-42	RR
21.00	7.00	15.000	DS	Rubber	350047-302-05	MO
21.00	7.00	15.000	Lugged	Rubber	350047-408-42	SL
21.00	7.00	15.000	SM	FG IM	350047-421-41	RR
21.00	7.00	15.000	Lugged	FG IM	350047-421-42	RR
21.00	7.00	15.000	SM	FG IM NM Black	350047-431-41	RR
21.00	7.00	15.000	Lugged	FG IM NM Black	350047-431-42	RR
21.00	7.00	15.000	Lugged	FG IM NM White	350047-438-43	ML
21.00	8.00	15.000	Lugged	Rubber	103152-001	MO
21.00	8.00	15.000	Lugged	Rubber NM Cream	103152-002	MO
21.00	8.00	15.000	SM	Rubber NM Cream	103152-003	MO
21.00	8.00	15.000	SM	Rubber	103152-004	MO
21.00	8.00	15.000	Lugged	Rubber	129220-001	MO
21.00	8.00	15.000	Lugged	Rubber NM Cream	129220-002	MO
21.00	8.00	15.000	SM - Flat	Rubber NM Cream	129220-003	MO
21.00	8.00	15.000	SM - Flat	Rubber	129220-004	MO
21.00	8.00	15.000	SM	Rubber	137210-301-41	SL
21.00	8.00	15.000	Lugged	Rubber	137210-301-42	SL
21.00	8.00	15.000	SM	Rubber NM Grey	137210-311-41	SL
21.00	8.00	15.000	Lugged	Rubber NM Grey	137210-311-42	SL
21.00	8.00	15.000	SM	Rubber	350048-201-41	RR
21.00	8.00	15.000	Lugged	Rubber	350048-201-42	RR
21.00	8.00	15.000	SM	Rubber NM Dk Grey	350048-211-41	RR
21.00	8.00	15.000	Lugged	Rubber NM Dk Grey	350048-211-42	RR
21.00	8.00	15.000	Lugged	Rubber	350048-408-42	SL
21.00	8.00	15.000	Lugged	Rubber NM Grey	350048-418-42	SL
21.00	8.00	15.000	SM	FG IM	350048-421-41	RR
21.00	8.00	15.000	Lugged	FG IM	350048-421-42	RR
21.00	9.00	15.000	Lugged	Rubber	103153-001	MO
21.00	9.00	15.000	Lugged	Rubber NM Cream	103153-002	MO
21.00	9.00	15.000	SM	Rubber NM Cream	103153-003	MO
21.00	9.00	15.000	SM	Rubber	103153-004	MO
21.00	9.00	15.000	Lugged	Rubber	129221-001	MO
21.00	9.00	15.000	Lugged	Rubber NM Cream	129221-002	MO
21.00	9.00	15.000	SM - Flat	Rubber NM Cream	129221-003	MO
21.00	9.00	15.000	SM - Flat	Rubber	129221-004	MO

O.D.	Width	I.D.	Profile	Compound	Crown Part Number	Manuf.
21.00	9.00	15.000	SM	Rubber	137211-301-41	SL
21.00	9.00	15.000	Lugged	Rubber	137211-301-42	SL
21.00	9.00	15.000	SM	Rubber NM Grey	137211-311-41	SL
21.00	9.00	15.000	Lugged	Rubber NM Grey	137211-311-42	SL
<b>22.00 O.D.</b>						
22.00	6.00	16.000	SM	Rubber	350065-306-41	SL
22.00	8.00	16.000	SM	Rubber	350039-302-41	MO
22.00	8.00	16.000	Lugged	Rubber	350039-302-42	MO
22.00	8.00	16.000	SM	Rubber NM Cream	350039-312-41	MO
22.00	8.00	16.000	Lugged	Rubber NM Cream	350039-312-42	MO
22.00	8.00	16.000	SM	Rubber NM Grey	350039-318-41	SL
22.00	8.00	16.000	Lugged	Rubber	350039-408-42	SL
22.00	8.00	16.000	SM	FG IM	350039-421-41	RR
22.00	8.00	16.000	Lugged	FG IM	350039-421-42	RR
22.00	9.00	16.000	SM	Rubber	350029-201-41	RR
22.00	9.00	16.000	Lugged	Rubber	350029-201-42	RR
22.00	9.00	16.000	SM	Rubber NM Dk Grey	350029-211-41	RR
22.00	9.00	16.000	Lugged	Rubber NM Dk Grey	350029-211-42	RR
22.00	9.00	16.000	SM	Rubber	350029-302-41	MO
22.00	9.00	16.000	Lugged	Rubber	350029-302-42	MO
22.00	9.00	16.000	SM	Rubber	350029-306-41	SL
22.00	9.00	16.000	SM	Rubber NM Grey	350029-316-41	SL
22.00	9.00	16.000	Lugged	Rubber	350029-307-42	MO
22.00	9.00	16.000	SM	Rubber NM Cream	350029-312-41	MO
22.00	9.00	16.000	Lugged	Rubber NM Cream	350029-312-42	MO
22.00	9.00	16.000	Lugged	Rubber NM Cream	350029-317-42	MO
22.00	9.00	16.000	Lugged	Rubber	350029-408-42	SL
22.00	9.00	16.000	Lugged	Rubber NM Grey	350029-418-42	SL
22.00	9.00	16.000	SM	FG IM	350029-421-41	RR
22.00	9.00	16.000	Lugged	FG IM	350029-421-42	RR
22.00	10.00	16.000	SM	Rubber	350035-302-41	MO
22.00	10.00	16.000	SM	Rubber	350035-306-41	SL
22.00	10.00	16.000	SM	Rubber NM Cream	350035-312-41	MO
22.00	12.00	16.000	SM	Rubber	350037-302-41	MO
22.00	12.00	16.000	Lugged	Rubber	350037-302-42	MO
22.00	12.00	16.000	SM	Rubber NM Cream	350037-312-41	MO
22.00	12.00	16.000	Lugged	Rubber NM Cream	350037-312-42	MO
<b>28.00 O.D.</b>						
28.00	12.00	22.000	SM	Rubber	350030-302-41	MO
28.00	12.00	22.000	Lugged	Rubber	350030-302-42	MO
28.00	12.00	22.000	SM	Rubber	350030-306-41	SL
28.00	12.00	22.000	SM	Rubber NM Cream	350030-312-41	MO
28.00	12.00	22.000	Lugged	Rubber NM Cream	350030-312-42	MO
28.00	12.00	22.000	SM	Rubber NM Grey	350030-316-41	SL
28.00	12.00	22.000	SM	Rubber	350030-402-41	MO

# Wheel & Tire Cross References by Manufacturer

OE Number	Crown Number	Description
<b>Allis Chalmers (AC)</b>		
105	310077	Wheel 3.25x5.88x2.047x0.599
202	310078	Wheel 3.25x2.88x2.047x0.59
204	310080	Wheel 3x2x2.047x0.625
301	073961	Wheel 4.00x2.88x2.047x0.59
302	310164	Wheel 5x2.88x2.047x0.59
304	310154	Wheel 6x3.94x2.872x1.224
306	310160	Wheel 5x3.63x2.44x0.668
353	071894	Wheel 4 Poly
653	310244	Wheel 3.25x4.5x2.047x.594
981	310102	Wheel 5x3.62x2.834x0.76
983	310077	Wheel 3.25x5.88x2.047x0.599
986	310154	Wheel 6x3.94x2.872x1.224
987	310078	Wheel 3.25x2.88x2.047x0.59
989	077086	Wheel 3.25x5.00x2.047x0.59
9812	310077	Wheel 3.25x5.88x2.047x0.599
9824	310080	Wheel 3x2x2.047x0.625
9827	310164	Wheel 5x2.88x2.047x0.59
9828	310101	Wheel 3.38x2.63x1.979x1.242
9851	310244	Wheel 3.25x4.5x2.047x.594
9862	310160	Wheel 5x3.63x2.44x0.668
9870	310164	Wheel 5x2.88x2.047x0.59
605035	310077	Wheel 3.25x5.88x2.047x0.599
4814152	073961	Wheel 4.00x2.88x2.047x0.59
4814484	310101	Wheel 3.38x2.63x1.979x1.242
4816552	073961	Wheel 4.00x2.88x2.047x0.59
4826270	310164	Wheel 5x2.88x2.047x0.59
4826279	310164	Wheel 5x2.88x2.047x0.59
4854131	081645	Wheel Poly
4854131	081645	Wheel Poly
4865875	310132	Wheel 6x3x2.047x0.595
4876612	310077	Wheel 3.25x5.88x2.047x0.599
4878390	310082	Wheel 6x2.4x1.979x0.8800
4879331	310087	Wheel 7x2.86x2.047xNon Typical
4900617	310102	Wheel 5x3.62x2.834x0.76
4910260	073961	Wheel 4.00x2.88x2.047x0.59
4930044	310087	Wheel 7x2.86x2.047xNon Typical
4930101	310164	Wheel 5x2.88x2.047x0.59
4930836	310102	Wheel 5x3.62x2.834x0.76
4932096	310077	Wheel 3.25x5.88x2.047x0.599
4932226	310077	Wheel 3.25x5.88x2.047x0.599
4934289	083179	Wheel 4.00x2.50x2.047x0.59
4972095	083179	Wheel 4.00x2.50x2.047x0.59
8611635	310078	Wheel 3.25x2.88x2.047x0.59
8611657	310077	Wheel 3.25x5.88x2.047x0.599
8612234	310077	Wheel 3.25x5.88x2.047x0.599
8623144	310155	Wheel 7x2.5x2.326xNon Typical
8623929	310101	Wheel 3.38x2.63x1.979x1.242
8730186	077086	Wheel 3.25x5.00x2.047x0.59
8730186	077086	Wheel 3.25x5.00x2.047x0.59
8730459	310085	Wheel 3.25x6x2.047x0.585
8730461	310147	Wheel 3.25x6x2.047x1.187
8731313	310155	Wheel 7x2.5x2.326xNon Typical
8731340	310102	Wheel 5x3.62x2.834x0.76
8732658	310154	Wheel 6x3.94x2.872x1.224
8733670	310227	Wheel 7x2.75x1.98
8733671	310227	Wheel 7x2.75x1.98
8733981	310227	Wheel 7x2.75x1.98
49306145	310160	Wheel 5x3.63x2.44x0.668
74814152	073961	Wheel 4.00x2.88x2.047x0.59
74814484	310077	Wheel 3.25x5.88x2.047x0.599
74816552	073961	Wheel 4.00x2.88x2.047x0.59
74826270	310087	Wheel 7x2.86x2.047xNon Typical
74826279	310090	Wheel 8x2x2.047x0.595
74850520	310132	Wheel 6x3x2.047x0.595
74854131	310078	Wheel 3.25x2.88x2.047x0.59
74865815	310154	Wheel 6x3.94x2.872x1.224
74865875	310154	Wheel 6x3.94x2.872x1.224
74876612	310077	Wheel 3.25x5.88x2.047x0.599

OE Number	Crown Number	Description
74878390	073961	Wheel 4.00x2.88x2.047x0.59
74879331	310090	Wheel 8x2x2.047x0.595
74900617	310102	Wheel 5x3.62x2.834x0.76
74930614	310087	Wheel 7x2.86x2.047xNon Typical
74930744	310164	Wheel 5x2.88x2.047x0.59
74931496	310080	Wheel 3x2x2.047x0.625
74932910	310235	Wheel 4x2.88x2.44x0.672
74934289	083179	Wheel 4.00x2.50x2.047x0.59
74972095	083179	Wheel 4.00x2.50x2.047x0.59
78612234	310077	Wheel 3.25x5.88x2.047x0.599
78623929	310101	Wheel 3.38x2.63x1.979x1.242
78730461	310077	Wheel 3.25x5.88x2.047x0.599
78731313	310164	Wheel 5x2.88x2.047x0.59
78731340	310102	Wheel 5x3.62x2.834x0.76
78731798	310087	Wheel 7x2.86x2.047xNon Typical
78734185	310244	Wheel 3.25x4.5x2.047x.594
749306145	071894	Wheel 4 Poly
S653	310244	Wheel 3.25x4.5x2.047x.594
S654	073961	Wheel 4.00x2.88x2.047x0.59
S976	310164	Wheel 5x2.88x2.047x0.59
S977	310160	Wheel 5x3.63x2.44x0.668
S979	310102	Wheel 5x3.62x2.834x0.76
S981	310102	Wheel 5x3.62x2.834x0.76
S983	310077	Wheel 3.25x5.88x2.047x0.599
S986	310155	Wheel 7x2.5x2.326xNon Typical
S987	310078	Wheel 3.25x2.88x2.047x0.59
S988	310087	Wheel 7x2.86x2.047xNon Typical
S991	310080	Wheel 3x2x2.047x0.625
S992	310080	Wheel 3x2x2.047x0.625
S994	310101	Wheel 3.38x2.63x1.979x1.242
S995	071894	Wheel 4 Poly
<b>Atlas (AT)</b>		
9433	310189	Wheel 3 x 3.5 x 1.85 x 0.56
<b>Baker (BK)</b>		
529	310144	Wheel 3.25x6x2.047x0.812
114421	310142	Wheel 4x2.88x2.44x0.75
115311	310133	Wheel 5x2.88x2.44x0.775
138074	310094	Wheel 4x2x1.575x0.575
138938	310133	Wheel 5x2.88x2.44x0.775
139064	310146	Wheel 3.25x6.38x2.047x0.812
139840	310146	Wheel 3.25x6.38x2.047x0.812
146158	310146	Wheel 3.25x6.38x2.047x0.812
704152	310140	Wheel 3.25x3.88x2.047x.812
704522	310141	Wheel 3.25x3x2.047x0.812
705720	310094	Wheel 4x2x1.575x0.575
707100	310142	Wheel 4x2.88x2.44x0.75
708076	310146	Wheel 3.25x6.38x2.047x0.812
708077	310142	Wheel 4x2.88x2.44x0.75
708078	310133	Wheel 5x2.88x2.44x0.775
708372	310140	Wheel 3.25x3.88x2.047x.812
984075	310141	Wheel 3.25x3x2.047x0.812
984840	310146	Wheel 3.25x6.38x2.047x0.812
984841	310149	Wheel 3.25x3x2.047x0.656
984842	310190	Wheel 3.25x6.38x2.047x1.187
985604	310141	Wheel 3.25x3x2.047x0.812
992628	310185	Wheel 3.25x4.5x1.575x0.56
993470	073961	Wheel 4.00x2.88x2.047x0.59
993472	073961	Wheel 4.00x2.88x2.047x0.59
994070	310179	Wheel 8x4x2.44x0.656
1064596	807557	Drive Tire Assy ESR4500
0009902353	807557	Drive Tire Assy ESR4500
9902353	807557	Drive Tire Assy ESR4500
314X6	310144	Wheel 3.25x6x2.047x0.812
314X6	310144	Wheel 3.25x6x2.047x0.812
8X4	310179	Wheel 8x4x2.44x0.656
AW-3-4	310179	Wheel 8x4x2.44x0.656
AW-4-1	310179	Wheel 8x4x2.44x0.656
BHP-014	310189	Wheel 3 x 3.5 x 1.85 x 0.56
BKAW-3-4	310179	Wheel 8x4x2.44x0.656

Baker Continued ▶

Note: You need to add the compound part number to the wheel base number listed above. See compounds listed on page 10.03 for the dash number. Complete part number format is XXXXX-XXX.

# Wheel & Tire Cross References by Manufacturer

Baker Continued

OE Number	Crown Number	Description
BKAW-4-1	310179	Wheel 8x4x2.44x0.656
BKW3-4G	073961	Wheel 4.00x2.88x2.047x0.59
L0009902353	807557	Drive Tire Assy ESR4500
M0106SPEC	310147	Wheel 3.25x6x2.047x1.187
P30W	310185	Wheel 3.25x4.5x1.575x0.56
PAL-13	310145	Wheel 3.25x6.25x2.047x0.812
PAL-13-C	310141	Wheel 3.25x3x2.047x0.812
PAL-13-D	310141	Wheel 3.25x3x2.047x0.812
PAL-13GH	310140	Wheel 3.25x3.88x2.047x.812
PAL-13-GLD	310141	Wheel 3.25x3x2.047x0.812
PAL-13K	310140	Wheel 3.25x3.88x2.047x.812
PAL-13KG	310140	Wheel 3.25x3.88x2.047x.812
PAL-13M	310144	Wheel 3.25x6x2.047x0.812
PAL-43-A	310141	Wheel 3.25x3x2.047x0.812
W34	073961	Wheel 4.00x2.88x2.047x0.59
W3-4	073961	Wheel 4.00x2.88x2.047x0.59
W34A	073961	Wheel 4.00x2.88x2.047x0.59
W3-4A	073961	Wheel 4.00x2.88x2.047x0.59
W3-4G	073961	Wheel 4.00x2.88x2.047x0.59
<b>Barrett (BR)</b>		
106	310144	Wheel 3.25x6x2.047x0.812
110	310084	Wheel 3.25x6x1.98x0.912
115	310210	Wheel 3.25 x 5.5 x 1.98 x .69
201	310193	Wheel 4x2.75x1.78x0.72
203	310181	Wheel 4x2.88x2.44x0.832
205	310195	Wheel 5x3x1.78x0.812
228	310194	Wheel 3.25x2.88x1.98xNon Typical
234	310193	Wheel 4x2.75x1.78x0.72
238	310192	Wheel 7x4x2.44x0.838
239	310191	Wheel 6x3x2.44x0.838
246	310210	Wheel 3.25 x 5.5 x 1.98 x .69
248	310084	Wheel 3.25x6x1.98x0.912
254	310195	Wheel 5x3x1.78x0.812
255	310195	Wheel 5x3x1.78x0.812
257	310183	Wheel 4x2.75x2.44x0.843
262	310171	Wheel 6x3x1.781x0.81
268	310196	Wheel 6x3x1.938x0.969
305	310191	Wheel 6x3x2.44x0.838
308	310133	Wheel 5x2.88x2.44x0.775
308	310143	Wheel 5x2.88x2.44x0.75
315	310192	Wheel 7x4x2.44x0.838
336	310171	Wheel 6x3x1.781x0.81
9806	310149	Wheel 3.25x3x2.047x0.656
9811	077086	Wheel 3.25x5.00x2.047x0.59
9842	310181	Wheel 4x2.88x2.44x0.832
9844	310235	Wheel 4x2.88x2.44x0.672
9852	310133	Wheel 5x2.88x2.44x0.775
9852	310143	Wheel 5x2.88x2.44x0.75
9870	310155	Wheel 7x2.5x2.326xNon Typical
116810	310071-243-01	Tire Poly 18x8x12.125
116813	310064-243-01	Tire Poly 16.25x5x11.25
116814	310068-243-01	Tire Poly 18x6x12.125
116815	310060-243-01	Tire Poly 16X5X10.5
127220	310061-243-01	Tire Poly 16x6x10.5
127222	310073-243-01	Tire Poly 21x7x15
137868	310003-243-01	Tire Poly 8X4.5X4.5
139191	310202-243-01	Tire Poly 10X5X6.5 w/Bevel
704662	310003-243-01	Tire Poly 8X4.5X4.5
705357	310003-243-01	Tire Poly 8X4.5X4.5
708394	310024-341-01	Tire Poly 10.5X7X6.5
708396	310022-243-01	Tire Poly 10.5x6x6.5
708397	075715-243-01	Tire Poly 10 X 4 X 6.5
710330	310019-243-01	Tire Poly 10.5x5x5
991012	107933-243-01	Tire Poly 10X5X6.5 Contour
10761-058	310192	Wheel 7x4x2.44x0.838
10761-29	310171	Wheel 6x3x1.781x0.81
27462-008	310195	Wheel 5x3x1.78x0.812
27462-025	310171	Wheel 6x3x1.781x0.81
27845-11	310196	Wheel 6x3x1.938x0.969

OE Number	Crown Number	Description
27845-21	310195	Wheel 5x3x1.78x0.812
27845-40	310195	Wheel 5x3x1.78x0.812
28-12	310191	Wheel 6x3x2.44x0.838
28-152	310191	Wheel 6x3x2.44x0.838
28-156	310192	Wheel 7x4x2.44x0.838
28700-064	077086	Wheel 3.25x5.00x2.047x0.59
28841-088	310181	Wheel 4x2.88x2.44x0.832
28842-676	107933-243-01	Tire Poly 10X5X6.5 Contour
28842-942	310155	Wheel 7x2.5x2.326xNon Typical
304A	310196	Wheel 6x3x1.938x0.969
39102-005	310171	Wheel 6x3x1.781x0.81
39102-007	310171	Wheel 6x3x1.781x0.81
40310-FS000	310178	Wheel 3.25x5.91x2.047x1.18
40310-FS001	310147	Wheel 3.25x6x2.047x1.187
40310-FS001	310242	Wheel 3.25x5.98x2.047x1.368
40350-FS002	310242	Wheel 3.25x5.98x2.047x1.368
43382-FS000	310126	Wheel 5x2.5x1.85x0.675
9988-005	310193	Wheel 4x2.75x1.78x0.72
9988-038	310144	Wheel 3.25x6x2.047x0.812
9988-04	310084	Wheel 3.25x6x1.98x0.912
9988-048	310084	Wheel 3.25x6x1.98x0.912
9988-055	310144	Wheel 3.25x6x2.047x0.812
9988-057	310210	Wheel 3.25 x 5.5 x 1.98 x .69
9988-063	310194	Wheel 3.25x2.88x1.98xNon Typical
9988-064	310235	Wheel 4x2.88x2.44x0.672
9988-065	310144	Wheel 3.25x6x2.047x0.812
9988-066	310084	Wheel 3.25x6x1.98x0.912
9988-068	310133	Wheel 5x2.88x2.44x0.775
9988-068	310143	Wheel 5x2.88x2.44x0.75
9988-57	310210	Wheel 3.25 x 5.5 x 1.98 x .69
9988-60	310183	Wheel 4x2.75x2.44x0.843
9988-63	310149	Wheel 3.25x3x2.047x0.656
A10761-002	310191	Wheel 6x3x2.44x0.838
A10761-006	310192	Wheel 7x4x2.44x0.838
A-10761-006	310192	Wheel 7x4x2.44x0.838
A10761-2	310191	Wheel 6x3x2.44x0.838
A-10761-2	310191	Wheel 6x3x2.44x0.838
A10761-49	310171	Wheel 6x3x1.781x0.81
A-10761-49	310171	Wheel 6x3x1.781x0.81
A10761-6	310192	Wheel 7x4x2.44x0.838
A-10761-6	310192	Wheel 7x4x2.44x0.838
A11151-2	310196	Wheel 6x3x1.938x0.969
A13076-008	107933-243-01	Tire Poly 10X5X6.5 Contour
A27462-008	310195	Wheel 5x3x1.78x0.812
A-27462-008	310195	Wheel 5x3x1.78x0.812
A27845-2	310196	Wheel 6x3x1.938x0.969
A27845-40	310229	Wheel 5x3x3.25x1.78
A30629-001	310202-243-01	Tire Poly 10X5X6.5 w/Bevel
A9988-005	310193	Wheel 4x2.75x1.78x0.72
A-9988-005	310193	Wheel 4x2.75x1.78x0.72
A-9988-048	310084	Wheel 3.25x6x1.98x0.912
A9988-057	310210	Wheel 3.25 x 5.5 x 1.98 x .69
A9988-30	310195	Wheel 5x3x1.78x0.812
A-9988-30	310229	Wheel 5x3x3.25x1.78
A9988-38	310144	Wheel 3.25x6x2.047x0.812
A-9988-38	310144	Wheel 3.25x6x2.047x0.812
A9988-48	310084	Wheel 3.25x6x1.98x0.912
A9988-5	310193	Wheel 4x2.75x1.78x0.72
A9988-54	310194	Wheel 3.25x2.88x1.98xNon Typical
A-9988-54	310194	Wheel 3.25x2.88x1.98xNon Typical
A-9988-57	310210	Wheel 3.25 x 5.5 x 1.98 x .69
AT-10761-29	310171	Wheel 6x3x1.781x0.81
AT-11151-2	310196	Wheel 6x3x1.938x0.969
AT-28-10	310196	Wheel 6x3x1.938x0.969
AT-28-12	310191	Wheel 6x3x2.44x0.838
AT-28-140	310196	Wheel 6x3x1.938x0.969
AT-28-152	310191	Wheel 6x3x2.44x0.838
B9988-54	310194	Wheel 3.25x2.88x1.98xNon Typical
PM40265-00	107933-243-01	Tire Poly 10X5X6.5 Contour

Wheels  
and  
Tires

Barrett Continued ►

**Note:** You need to add the compound part number to the wheel base number listed above. See compounds listed on page 10.03 for the dash number. Complete part number format is XXXXX-XXX.

# Wheel & Tire Cross References by Manufacturer

Barrett Continued

OE Number	Crown Number	Description
S227	310149	Wheel 3.25x3x2.047x0.656
S228	310194	Wheel 3.25x2.88x1.98xNon Typical
S230	310144	Wheel 3.25x6x2.047x0.812
S234	310193	Wheel 4x2.75x1.78x0.72
S238	310192	Wheel 7x4x2.44x0.838
S239	310191	Wheel 6x3x2.44x0.838
S241	310196	Wheel 6x3x1.938x0.969
S246	310210	Wheel 3.25 x 5.5 x 1.98 x .69
S248	310084	Wheel 3.25x6x1.98x0.912
S250	310210	Wheel 3.25 x 5.5 x 1.98 x .69
S254	310195	Wheel 5x3x1.78x0.812
S255	310183	Wheel 4x2.75x2.44x0.843
S256	310084	Wheel 3.25x6x1.98x0.912
S258	310195	Wheel 5x3x1.78x0.812
S262	310171	Wheel 6x3x1.78x0.81
S263	310133	Wheel 5x2.88x2.44x0.775
S263	310143	Wheel 5x2.88x2.44x0.75
S268	310196	Wheel 6x3x1.938x0.969
S275	310195	Wheel 5x3x1.78x0.812
S282	310155	Wheel 7x2.5x2.326xNon Typical
S284	310192	Wheel 7x4x2.44x0.838
S294	310181	Wheel 4x2.88x2.44x0.832
S295	310133	Wheel 5x2.88x2.44x0.775
S295	310143	Wheel 5x2.88x2.44x0.75
S304A	310196	Wheel 6x3x1.938x0.969
T0018-512PV	310067-243-01	Tire Poly 18x5x12.125
T0021-715SPU	310073-243-01	Tire Poly 21x7x15
T0186-12PUS	310068-243-01	Tire Poly 18x6x12.125
T0228-16TPU	310075-243-01	Tire Poly 22x8x16
T8-192	310191	Wheel 6x3x2.44x0.838
T-8-192	310191	Wheel 6x3x2.44x0.838
T8-197	310192	Wheel 7x4x2.44x0.838
T-8-28	310196	Wheel 6x3x1.938x0.969
<b>Big Joe (BJ)</b>		
106	310184	Wheel 3.38x2.75x2.047x0.605
107	310244	Wheel 3.25x4.5x2.047x.594
108	077084	Wheel 3.25x3.25x2.047x0.59
119	310101	Wheel 3.38x2.63x1.979x1.242
202	310098	Wheel 4x2.75x1.938xThru
312	310132	Wheel 6x3x2.047x0.595
338	310101	Wheel 3.38x2.63x1.979x1.242
467	310132	Wheel 6x3x2.047x0.595
2335	310244	Wheel 3.25x4.5x2.047x.594
2352	310098	Wheel 4x2.75x1.938xThru
2353	310099	Wheel 4x2.75x2.047x0.59
2360	310184	Wheel 3.38x2.75x2.047x0.605
9133	077084	Wheel 3.25x3.25x2.047x0.59
9145	081645	Wheel Poly
78217	310184	Wheel 3.38x2.75x2.047x0.605
78228	310184	Wheel 3.38x2.75x2.047x0.605
78242	310080	Wheel 3x2x2.047x0.625
78255	077084	Wheel 3.25x3.25x2.047x0.59
78257	310244	Wheel 3.25x4.5x2.047x.594
78262	100462	Wheel 3.25x6.50x2.047x1.44
78262	310000	Wheel 3.25x6.5 Single Bearing
78264	310101	Wheel 3.38x2.63x1.979x1.242
78288	310184	Wheel 3.38x2.75x2.047x0.605
78414	310099	Wheel 4x2.75x2.047x0.59
78433	310099	Wheel 4x2.75x2.047x0.59
79114	310020-243-01	Tire Poly 10.5x5x6.5
79161	075715-243-01	Tire Poly 10 X 4 X 6.5
79162	075715-243-01	Tire Poly 10 X 4 X 6.5
79163	310020-243-01	Tire Poly 10.5x5x6.5
79266	079266-243-01	Tire Poly 13x5.5x8
79494	079494-243-04	Tire Poly 13x4.5x8
501324	310132	Wheel 6x3x2.047x0.595
501433	077084	Wheel 3.25x3.25x2.047x0.59
501692	310244	Wheel 3.25x4.5x2.047x.594
504146	310101	Wheel 3.38x2.63x1.979x1.242

OE Number	Crown Number	Description
800032	081645	Wheel Poly
800059	310132	Wheel 6x3x2.047x0.595
908000	310020-243-01	Tire Poly 10.5x5x6.5
911144	310020-243-01	Tire Poly 10.5x5x6.5
941182	310208-243-01	Tire Poly 9x5x5 Smooth Step
S2352	310098	Wheel 4x2.75x1.938xThru
S2353	310099	Wheel 4x2.75x2.047x0.59
S2356	077084	Wheel 3.25x3.25x2.047x0.59
S2358	310132	Wheel 6x3x2.047x0.595
S2361	081645	Wheel Poly
S2364	100462	Wheel 3.25x6.50x2.047x1.44
S2364	310000	Wheel 3.25x6.5 Single Bearing
S2365	310244	Wheel 3.25x4.5x2.047x.594
S2373	310184	Wheel 3.38x2.75x2.047x0.605
S2376	310101	Wheel 3.38x2.63x1.979x1.242
S338	310101	Wheel 3.38x2.63x1.979x1.242
<b>Blue Giant (BG)</b>		
007-106-1	310083	Wheel 3x3.75x1.625x0.435
007-125-1	310090	Wheel 8x2x2.047x0.595
020-031	310090	Wheel 8x2x2.047x0.595
020-056-99	310083	Wheel 3x3.75x1.625x0.435
101	310083	Wheel 3x3.75x1.625x0.435
102-U	310090	Wheel 8x2x2.047x0.595
103	310085	Wheel 3.25x6x2.047x0.585
103-291	310083	Wheel 3x3.75x1.625x0.435
103-297	310083	Wheel 3x3.75x1.625x0.435
107193	310097	Wheel 8x2x1.998xThru
108-943	310085	Wheel 3.25x6x2.047x0.585
108-973-99	310085	Wheel 3.25x6x2.047x0.585
110-930	310083	Wheel 3x3.75x1.625x0.435
114-514	310083	Wheel 3x3.75x1.625x0.435
200-061	310083	Wheel 3x3.75x1.625x0.435
300-000	310083	Wheel 3x3.75x1.625x0.435
300-028	310083	Wheel 3x3.75x1.625x0.435
301	310090	Wheel 8x2x2.047x0.595
930	310083	Wheel 3x3.75x1.625x0.435
931	310090	Wheel 8x2x2.047x0.595
9810	310085	Wheel 3.25x6x2.047x0.585
BLR3-2120	310083	Wheel 3x3.75x1.625x0.435
LR-783	310090	Wheel 8x2x2.047x0.595
S925	310090	Wheel 8x2x2.047x0.595
S930	310083	Wheel 3x3.75x1.625x0.435
S931	310090	Wheel 8x2x2.047x0.595
S935	310085	Wheel 3.25x6x2.047x0.585
108-943	310085	Wheel 3.25x6x2.047x0.585
108-973-99	310085	Wheel 3.25x6x2.047x0.585
<b>BT (BT)</b>		
23041-00	077086	Wheel 3.25x5.00x2.047x0.59
40265-00	107933-243-01	Tire Poly 10X5X6.5 Contour
<b>Caterpillar/Towmotor (CT)</b>		
101	310162	Wheel 3.38x2.25x1.85x0.551
115	310178	Wheel 3.25x5.91x2.047x1.18
202	310164	Wheel 5x2.88x2.047x0.59
206	310160	Wheel 5x3.63x2.44x0.668
314	310161	Wheel 6x2.5x2.327x1.967
325	310172	Wheel 6x3.63x2.44x0.668
327	310179	Wheel 8x4x2.44x0.656
629	310125	Wheel 3.25x2x2.047x0.59
630	310162	Wheel 3.38x2.25x1.85x0.551
632	310176	Wheel 4x2x2.44xNon Typical
636	310078	Wheel 3.25x2.88x2.047x0.59
641	073961	Wheel 4.00x2.88x2.047x0.59
644	310221	Wheel 4x1.92x1.781x.84
645	310158	Wheel 4x3.62x2.047x0.59
653	310164	Wheel 5x2.88x2.047x0.59
654	310160	Wheel 5x3.63x2.44x0.668
663	310161	Wheel 6x2.5x2.327x1.967
673	310172	Wheel 6x3.63x2.44x0.668
684	310179	Wheel 8x4x2.44x0.656

**Note:** You need to add the compound part number to the wheel base number listed above. See compounds listed on page 10.03 for the dash number. Complete part number format is XXXXXX-XXX.

Caterpillar/Towmotor Continued ▶

# Wheel & Tire Cross References by Manufacturer

Caterpillar/Towmotor Continued

OE Number	Crown Number	Description
699	310177	Wheel 6x3x2.047x0.67
700	310178	Wheel 3.25x5.91x2.047x1.18
7711	310180	Wheel 3.25x4.19x2.047x1.18
9143	083179	Wheel 4.00x2.50x2.047x0.59
9811	077086	Wheel 3.25x5.00x2.047x0.59
12710	073961	Wheel 4.00x2.88x2.047x0.59
12711	310158	Wheel 4x3.62x2.047x0.59
12713	310164	Wheel 5x2.88x2.047x0.59
12714	310160	Wheel 5x3.63x2.44x0.668
12726	310179	Wheel 8x4x2.44x0.656
12754	310172	Wheel 6x3.63x2.44x0.668
17102	310221	Wheel 4x1.92x1.781x.84
63009	310172	Wheel 6x3.63x2.44x0.668
67018	083179	Wheel 4.00x2.50x2.047x0.59
120737	120737	Wheel Steer
289069	310178	Wheel 3.25x5.91x2.047x1.18
971756	073961	Wheel 4.00x2.88x2.047x0.59
971757	310160	Wheel 5x3.63x2.44x0.668
971758	310161	Wheel 6x2.5x2.327x1.967
971761	083179	Wheel 4.00x2.50x2.047x0.59
971761	083179	Wheel 4.00x2.50x2.047x0.59
971763	082021	Wheel 6.00x2.75x3.149x0.83
971764	083587	Wheel 5.00x4.12x3.149x0.98
971768	083586	Wheel 5.00x2.88x3.149x0.98
971875	077086	Wheel 3.25x5.00x2.047x0.59
971880	077086	Wheel 3.25x5.00x2.047x0.59
971943	073961	Wheel 4.00x2.88x2.047x0.59
971994	082443	Wheel
971995	072718	Wheel Assm Poly
971997	075999	Wheel
971999	083879	Roller Load
972001	071665	Wheel Polyurethane
972005	083879	Roller Load
972007	100462	Wheel 3.25x6.50x2.047x1.44
972008	077086	Wheel 3.25x5.00x2.047x0.59
972010	083585	Wheel 4.00x2.88x2.047x0.75
972012	081645	Wheel Poly
972015	073961	Wheel 4.00x2.88x2.047x0.59
972016	081645	Wheel Poly
972019	071892	Wheel 5 dia
972020	073602	Wheel 5 Steel Assm
972021	083586	Wheel 5.00x2.88x3.149x0.98
972025	082020	Wheel 6.00x4.25x3.149x0.83
972027	080915	Wheel 8.00x3.75x3.15x0.83
972061	083879	Roller Load
973588	100462	Wheel 3.25x6.50x2.047x1.44
1009233	310177	Wheel 6x3x2.047x0.67
1009234	310178	Wheel 3.25x5.91x2.047x1.18
1009298	310221	Wheel 4x1.92x1.781x.84
1009309	310221	Wheel 4x1.92x1.781x.84
1029601	310177	Wheel 6x3x2.047x0.67
1029602	310178	Wheel 3.25x5.91x2.047x1.18
1029606	310177	Wheel 6x3x2.047x0.67
1029607	310178	Wheel 3.25x5.91x2.047x1.18
1029608	310177	Wheel 6x3x2.047x0.67
1036603	310172	Wheel 6x3.63x2.44x0.668
1049809	073961	Wheel 4.00x2.88x2.047x0.59
1049911	310158	Wheel 4x3.62x2.047x0.59
1050132	310164	Wheel 5x2.88x2.047x0.59
1050137	310160	Wheel 5x3.63x2.44x0.668
1050142	310179	Wheel 8x4x2.44x0.656
1050234	310179	Wheel 8x4x2.44x0.656
1050236	310179	Wheel 8x4x2.44x0.656
1050237	310160	Wheel 5x3.63x2.44x0.668
1050280	310018-243-01	Tire Poly 10.5X4.5X8
1051264	310179	Wheel 8x4x2.44x0.656
1055548	310160	Wheel 5x3.63x2.44x0.668
1055550	310158	Wheel 4x3.62x2.047x0.59
1055551	073961	Wheel 4.00x2.88x2.047x0.59

OE Number	Crown Number	Description
1055553	310164	Wheel 5x2.88x2.047x0.59
1055574	310018-243-01	Tire Poly 10.5X4.5X8
1075061	077086	Wheel 3.25x5.00x2.047x0.59
1075062	077086	Wheel 3.25x5.00x2.047x0.59
1075063	077086	Wheel 3.25x5.00x2.047x0.59
1075064	077086	Wheel 3.25x5.00x2.047x0.59
1086863	310180	Wheel 3.25x4.19x2.047x1.18
1086864	310180	Wheel 3.25x4.19x2.047x1.18
1086865	310180	Wheel 3.25x4.19x2.047x1.18
1086866	310180	Wheel 3.25x4.19x2.047x1.18
1092509	310176	Wheel 4x2x2.44xNon Typical
1149188	310162	Wheel 3.38x2.25x1.85x0.551
1154009	310125	Wheel 3.25x2x2.047x0.59
1154011	310125	Wheel 3.25x2x2.047x0.59
1154013	310125	Wheel 3.25x2x2.047x0.59
1179201	310078	Wheel 3.25x2.88x2.047x0.59
1179210	073961	Wheel 4.00x2.88x2.047x0.59
1179213	310164	Wheel 5x2.88x2.047x0.59
1201281	310078	Wheel 3.25x2.88x2.047x0.59
1201281	310078	Wheel 3.25x2.88x2.047x0.59
1201764	310125	Wheel 3.25x2x2.047x0.59
1201766	073961	Wheel 4.00x2.88x2.047x0.59
1201767	310158	Wheel 4x3.62x2.047x0.59
1201768	310158	Wheel 4x3.62x2.047x0.59
1201769	310164	Wheel 5x2.88x2.047x0.59
1201770	310160	Wheel 5x3.63x2.44x0.668
1201771	310160	Wheel 5x3.63x2.44x0.668
1201774	310078	Wheel 3.25x2.88x2.047x0.59
1201776	310179	Wheel 8x4x2.44x0.656
1201777	310179	Wheel 8x4x2.44x0.656
1201778	310172	Wheel 6x3.63x2.44x0.668
1201779	310172	Wheel 6x3.63x2.44x0.668
1201785	310018-243-01	Tire Poly 10.5X4.5X8
1202029	310078	Wheel 3.25x2.88x2.047x0.59
10289069	310178	Wheel 3.25x5.91x2.047x1.18
50136157	370231	Load Wheel Assembly
50179921	370231	Load Wheel Assembly
71305290	370231	Load Wheel Assembly
00590-00027	310178	Wheel 3.25x5.91x2.047x1.18
00590-41747	310225	Wheel 6x3x1.9687
116P	310078	Wheel 3.25x2.88x2.047x0.59
212824	077086	Wheel 3.25x5.00x2.047x0.59
215852	310131	Wheel 8.5x2.66x2.754xNon Typical
215854	310131	Wheel 8.5x2.66x2.754xNon Typical
215938	041269	Wheel Poly
310225-035	310225	Wheel 6x3x1.9687
325-P	310174	Wheel 3.25x4x1.85x0.551
590-00013-71	310180	Wheel 3.25x4.19x2.047x1.18
590-00506-71	310078	Wheel 3.25x2.88x2.047x0.59
632-041	310168	Wheel 5x1.12x2.047xNon Typical
CTNA067018	083179	Wheel 4.00x2.50x2.047x0.59
CTS654X	310160	Wheel 5x3.63x2.44x0.668
S132	310180	Wheel 3.25x4.19x2.047x1.18
S2400	310178	Wheel 3.25x5.91x2.047x1.18
S2401	310162	Wheel 3.38x2.25x1.85x0.551
S2402	310164	Wheel 5x2.88x2.047x0.59
S2403	310160	Wheel 5x3.63x2.44x0.668
S2404	310161	Wheel 6x2.5x2.327x1.967
S626	310078	Wheel 3.25x2.88x2.047x0.59
S627	310125	Wheel 3.25x2x2.047x0.59
S629	310178	Wheel 3.25x5.91x2.047x1.18
S632	310176	Wheel 4x2x2.44xNon Typical
S636	077086	Wheel 3.25x5.00x2.047x0.59
S640	310221	Wheel 4x1.92x1.781x.84
S645	310158	Wheel 4x3.62x2.047x0.59
S653	310164	Wheel 5x2.88x2.047x0.59
S654	310160	Wheel 5x3.63x2.44x0.668
S654X	310160	Wheel 5x3.63x2.44x0.668
S673	310172	Wheel 6x3.63x2.44x0.668

Wheels  
and  
Tires

**Note:** You need to add the compound part number to the wheel base number listed above. See compounds listed on page 10.03 for the dash number. Complete part number format is XXXXX-XXX.

Caterpillar/Towmotor Continued ▶

# Wheel & Tire Cross References by Manufacturer

Caterpillar/Tomtronic Continued

OE Number	Crown Number	Description
S674	310172	Wheel 6x3.63x2.44x0.668
S675	310177	Wheel 6x3x2.047x0.67
S684	310179	Wheel 8x4x2.44x0.656
S700	310178	Wheel 3.25x5.91x2.047x1.18
S9811	077086	Wheel 3.25x5.00x2.047x0.59
S9812	077086	Wheel 3.25x5.00x2.047x0.59
S9813	077086	Wheel 3.25x5.00x2.047x0.59
S9814	077086	Wheel 3.25x5.00x2.047x0.59
S984	310078	Wheel 3.25x2.88x2.047x0.59
W2050-11106	370231	Load Wheel Assembly
W205012975	100462	Wheel 3.25x6.50x2.047x1.44
<b>Clark (CL)</b>		
105	077086	Wheel 3.25x5.00x2.047x0.59
109	310100	Wheel 3.38x2.63x1.967x0.935
119	310101	Wheel 3.38x2.63x1.979x1.242
123	310110	Wheel 3.38x2.63x2.047x0.67
125	310110	Wheel 3.38x2.63x2.047x0.67
130	310112	Wheel 3.38x2.63x2.047x1.137
136	310118	Wheel 4x2.5x2.63x2.046x1.1373
201	071894	Wheel 4 Poly
202	310103	Wheel 4.00x2.63x2.44x0.77
203	310105	Wheel 4x2.5x1.938x0.96
204	310114	Wheel 4x2.5x2.047x0.76
211	310186	Wheel 4x2.37x1.938x0.96
300	310113	Wheel 3.35x5.74x2.047x1.452
301	310118	Wheel 3.25x2.63x2.046x1.1373
303	310112	Wheel 3.38x2.63x2.047x1.137
304	310114	Wheel 4x2.5x2.047x0.76
306	310154	Wheel 6x3.94x2.872x1.224
308	310109	Wheel 6x4x2.834x1.17
309	310112	Wheel 3.38x2.63x2.047x1.137
321	310104	Wheel 5x2.62x2.834x0.77
325	310107	Wheel 7x2.5x2.328xNon Typical
326	310106	Wheel 4x3.62x2.44x0.77
332	310116	Wheel 5x3.75x2.834x0.74
335	310100	Wheel 3.38x2.63x1.967x0.935
338	310101	Wheel 3.38x2.63x1.979x1.242
339	310110	Wheel 3.38x2.63x2.047x0.67
341	310103	Wheel 4.00x2.63x2.44x0.77
342	310105	Wheel 4x2.5x1.938x0.96
343	310106	Wheel 4x3.62x2.44x0.77
351	310104	Wheel 5x2.62x2.834x0.77
353	310102	Wheel 5x3.62x2.834x0.76
354	310116	Wheel 5x3.75x2.834x0.74
362	310109	Wheel 6x4x2.834x1.17
372	310107	Wheel 7x2.5x2.328xNon Typical
395	310117	Wheel9x5x3.542x0.787 Black
502	310108	Wheel 4x1.88x2.44x0.76
653	310164	Wheel 5x2.88x2.047x0.59
824	310186	Wheel 4x2.37x1.938x0.96
9102	071894	Wheel 4 Poly
9111	082021	Wheel 6.00x2.75x3.149x0.83
9119	310131	Wheel 8.5x2.66x2.754xNon Typical
9136	100462	Wheel 3.25x6.50x2.047x1.44
9139	083970	Wheel 3.25x4.50x2.44x0.66
9151	083587	Wheel 5.00x4.12x3.149x0.98
9152	083586	Wheel 5.00x2.88x3.149x0.98
9330	310188	Wheel 3.25x3.75x1.75xThru
9811	077086	Wheel 3.25x5.00x2.047x0.59
9842	310181	Wheel 4x2.88x2.44x0.832
9862	310154	Wheel 6x3.94x2.872x1.224
182145	077086	Wheel 3.25x5.00x2.047x0.59
301473	310109	Wheel 6x4x2.834x1.17
310806	310109	Wheel 6x4x2.834x1.17
311679	310109	Wheel 6x4x2.834x1.17
314713	310100	Wheel 3.38x2.63x1.967x0.935
315538	310100	Wheel 3.38x2.63x1.967x0.935
315540	310100	Wheel 3.38x2.63x1.967x0.935
326915	310100	Wheel 3.38x2.63x1.967x0.935

OE Number	Crown Number	Description
326917	310100	Wheel 3.38x2.63x1.967x0.935
327229	310109	Wheel 6x4x2.834x1.17
399153	310103	Wheel 4.00x2.63x2.44x0.77
885906	310061-243-01	Tire Poly 16x6x10.5
886191	310071-243-01	Tire Poly 18x8x12.125
886192	310067-243-01	Tire Poly 18x5x12.125
886310	107933-243-01	Tire Poly 10X5X6.5 Contour
886342	310100	Wheel 3.38x2.63x1.967x0.935
887050	077086	Wheel 3.25x5.00x2.047x0.59
898577	310105	Wheel 4x2.5x1.938x0.96
908684	310154	Wheel 6x3.94x2.872x1.224
910970	310186	Wheel 4x2.37x1.938x0.96
915157	083179	Wheel 4.00x2.50x2.047x0.59
996691	310107	Wheel 7x2.5x2.328xNon Typical
1612413	310104	Wheel 5x2.62x2.834x0.77
1747963	310108	Wheel 4x1.88x2.44x0.76
1780716	310101	Wheel 3.38x2.63x1.979x1.242
1784625	310222	Wheel 6x3.88x2.834x.735
1800127	310109	Wheel 6x4x2.834x1.17
1800338	310103	Wheel 4.00x2.63x2.44x0.77
1800344	073961	Wheel 4.00x2.88x2.047x0.59
1800435	310104	Wheel 5x2.62x2.834x0.77
1802523	310106	Wheel 4x3.62x2.44x0.77
1802848	310039-142-01	Tire Poly 13.5x5.5x8
1803654	083587	Wheel 5.00x4.12x3.149x0.98
1803655	083586	Wheel 5.00x2.88x3.149x0.98
1803656	082021	Wheel 6.00x2.75x3.149x0.83
1803657	132359	Wheel Caster
1803657	310131	Wheel 8.5x2.66x2.754xNon Typical
1803659	100462	Wheel 3.25x6.50x2.047x1.44
1803792	310164	Wheel 5x2.88x2.047x0.59
1803794	083970	Wheel 3.25x4.50x2.44x0.66
1803829	100462	Wheel 3.25x6.50x2.047x1.44
1819046	310181	Wheel 4x2.88x2.44x0.832
1820704	310003-243-01	Tire Poly 8X4.5X4.5
1821946	077086	Wheel 3.25x5.00x2.047x0.59
2309088	310116	Wheel 5x3.75x2.834x0.74
2309954	107933-243-01	Tire Poly 10X5X6.5 Contour
2324039	105089-060-01	Tire Poly 10.5 X 4.5 X 8
2324040	310017-243-01	Tire Poly 10.5X3.5X8
2324041	105089-060-01	Tire Poly 10.5 X 4.5 X 8
2324106	310102	Wheel 5x3.62x2.834x0.76
2326083	310072-341-01	Tire Poly 18x9x12.125
2326659	310068-243-01	Tire Poly 18x6x12.125
2334092	079266-243-01	Tire Poly 13x5.5x8
2338041	310060-243-01	Tire Poly 16X5X10.5
2381813	310101	Wheel 3.38x2.63x1.979x1.242
2389996	310110	Wheel 3.38x2.63x2.047x0.67
2742092	310110	Wheel 3.38x2.63x2.047x0.67
2742092	310111	Wheel 3.35x2.63x2.047x0.76
2750167	310144	Wheel 3.25x6x2.047x0.812
2751505	310106	Wheel 4x3.62x2.44x0.77
2758129	107933-243-01	Tire Poly 10X5X6.5 Contour
2760613	310101	Wheel 3.38x2.63x1.979x1.242
2775267	310117	Wheel9x5x3.542x0.787 Black
2777378	310114	Wheel 4x2.5x2.047x0.76
2777940	310112	Wheel 3.38x2.63x2.047x1.137
2778678	310113	Wheel 3.35x5.74x2.047x1.452
2778705	107933-243-01	Tire Poly 10X5X6.5 Contour
2779408	310112	Wheel 3.38x2.63x2.047x1.137
2780830	310113	Wheel 3.35x5.74x2.047x1.452
2788079	310116	Wheel 5x3.75x2.834x0.74
2788081	310115	Wheel 5x3x2.834x0.74
2792213	310117	Wheel9x5x3.542x0.787 Black
2793182	310117	Wheel9x5x3.542x0.787 Black
2793509	310039-142-01	Tire Poly 13.5x5.5x8
2794001	310208-243-01	Tire Poly 9x5x5 Smooth Step
2794307	079266-243-01	Tire Poly 13x5.5x8
2795684	310116	Wheel 5x3.75x2.834x0.74

Clark Continued ▶

**Note:** You need to add the compound part number to the wheel base number listed above. See compounds listed on page 10.03 for the dash number. Complete part number format is XXXXXX-XXX.



# Wheel & Tire Cross References by Manufacturer

Clark Continued

OE Number	Crown Number	Description
2795685	310115	Wheel 5x3x2.834x0.74
2800769	310138	Wheel 3.25x4.71x2.047x0.825
2800770	310118	Wheel 3.25x2.63x2.046x1.1373
7002324	082742	Wheel Steel
7003071	082274	Wheel Assm
7003097	044495	Wheel Assm Poly
7003580	082443	Wheel
7003582	081645	Wheel Poly
106A	310144	Wheel 3.25x6x2.047x0.812
B26460	310154	Wheel 6x3.94x2.872x1.224
L000318	310118	Wheel 3.25x2.63x2.046x1.1373
L000319	310112	Wheel 3.38x2.63x2.047x1.137
L000322	310112	Wheel 3.38x2.63x2.047x1.137
L000328	310112	Wheel 3.38x2.63x2.047x1.137
L000333	310110	Wheel 3.38x2.63x2.047x0.67
L000335	310100	Wheel 3.38x2.63x1.967x0.935
L000338	310101	Wheel 3.38x2.63x1.979x1.242
L000339	310111	Wheel 3.35x2.63x2.047x0.76
L000341	310103	Wheel 4.00x2.63x2.44x0.77
L000342	310105	Wheel 4x2.5x1.938x0.96
L000343	310106	Wheel 4x3.62x2.44x0.77
L000344	310181	Wheel 4x2.88x2.44x0.832
L000345	077086	Wheel 3.25x5.00x2.047x0.59
L000346	310114	Wheel 4x2.5x2.047x0.76
L000351	310104	Wheel 5x2.62x2.834x0.77
L000353	310102	Wheel 5x3.62x2.834x0.76
L000359	310113	Wheel 3.35x5.74x2.047x1.452
L000362	310109	Wheel 6x4x2.834x1.17
L000366	310154	Wheel 6x3.94x2.872x1.224
L000372	310107	Wheel 7x2.5x2.328xNon Typical
L000376	310115	Wheel 5x3x2.834x0.74
L000377	310116	Wheel 5x3.75x2.834x0.74
L000393	310117	Wheel9x5x3.542x0.787 Black
L000399	310112	Wheel 3.38x2.63x2.047x1.137
L000529	310144	Wheel 3.25x6x2.047x0.812
L000581	310179	Wheel 8x4x2.44x0.656
L000641	073961	Wheel 4.00x2.88x2.047x0.59
L000684	310179	Wheel 8x4x2.44x0.656
L000850	310093	Wheel 3.25x6.5x1.98x1.177
L002361	081645	Wheel Poly
L009101	072718	Wheel Assm Poly
L009103	073602	Wheel 5 Steel Assm
L009105	071892	Wheel 5 dia
L009107	071665	Wheel Polyurethane
L009110	075999	Wheel
L009111	082021	Wheel 6.00x2.75x3.149x0.83
L009112	082443	Wheel
L009113	083834	Wheel
L009116	080915	Wheel 8.00x3.75x3.15x0.83
L009117	082020	Wheel 6.00x4.25x3.149x0.83
L009119	310131	Wheel 8.5x2.66x2.754xNon Typical
L009130	311520	Wheel 10x3 Caster
L009132	083879	Roller Load
L009135	077086	Wheel 3.25x5.00x2.047x0.59
L009136	100462	Wheel 3.25x6.50x2.047x1.44
L009138	083879	Roller Load
L009138S	083879	Roller Load
L009140	071665	Wheel Polyurethane
L009142	081645	Wheel Poly
L009143	083179	Wheel 4.00x2.50x2.047x0.59
L009145	081645	Wheel Poly
L009146	083585	Wheel 4.00x2.88x2.047x0.75
L009149	088628	Wheel 4.00x4.12x2.047x0.75
L009150	115032	Wheel 5.00x2.88x2.44x0.83
L009151	083587	Wheel 5.00x4.12x3.149x0.98
L009152	083586	Wheel 5.00x2.88x3.149x0.98
L009153	115033	Wheel 5.00x4.12x2.44x0.83
L009154	310131	Wheel 8.5x2.66x2.754xNon Typical
L009157	115033	Wheel 5.00x4.12x2.44x0.83
L009532	083879	Roller Load

OE Number	Crown Number	Description
L010210	044507	Roller Poly
L300628	310251	Wheel 3.25x5.937x2.047x0.591
L300982	081645	Wheel Poly
L309105	071892	Wheel 5 dia
L309107	071665	Wheel Polyurethane
L309111	082021	Wheel 6.00x2.75x3.149x0.83
L309116	080915	Wheel 8.00x3.75x3.15x0.83
L309117	082020	Wheel 6.00x4.25x3.149x0.83
L309130	311520	Wheel 10x3 Caster
L309140	071665	Wheel Polyurethane
L309146	083585	Wheel 4.00x2.88x2.047x0.75
L309149	088628	Wheel 4.00x4.12x2.047x0.75
L309153	115033	Wheel 5.00x4.12x2.44x0.83
L309154	310131	Wheel 8.5x2.66x2.754xNon Typical
L309157	115033	Wheel 5.00x4.12x2.44x0.83
L502361	081645	Wheel Poly
L509101	072718	Wheel Assm Poly
L509109	083586	Wheel 5.00x2.88x3.149x0.98
L509110	075999	Wheel
L509142	081645	Wheel Poly
L509146	083585	Wheel 4.00x2.88x2.047x0.75
L509149	088628	Wheel 4.00x4.12x2.047x0.75
L509150	115032	Wheel 5.00x2.88x2.44x0.83
L509152	083586	Wheel 5.00x2.88x3.149x0.98
L509817	083179	Wheel 4.00x2.50x2.047x0.59
L510210	044507	Roller Poly
R0101	310188	Wheel 3.25x3.75x1.75xThru
S303	310112	Wheel 3.38x2.63x2.047x1.137
S312	310188	Wheel 3.25x3.75x1.75xThru
S317	310186	Wheel 4x2.37x1.938x0.96
S318	310118	Wheel 3.25x2.63x2.046x1.1373
S319	310118	Wheel 3.25x2.63x2.046x1.1373
S322	310112	Wheel 3.38x2.63x2.047x1.137
S328	310112	Wheel 3.38x2.63x2.047x1.137
S333	310110	Wheel 3.38x2.63x2.047x0.67
S335	310100	Wheel 3.38x2.63x1.967x0.935
S338	310101	Wheel 3.38x2.63x1.979x1.242
S339	310110	Wheel 3.38x2.63x2.047x0.67
S339	310111	Wheel 3.35x2.63x2.047x0.76
S341	310103	Wheel 4.00x2.63x2.44x0.77
S342	310105	Wheel 4x2.5x1.938x0.96
S343	310106	Wheel 4x3.62x2.44x0.77
S344	310181	Wheel 4x2.88x2.44x0.832
S345	077086	Wheel 3.25x5.00x2.047x0.59
S346	310114	Wheel 4x2.5x2.047x0.76
S351	310104	Wheel 5x2.62x2.834x0.77
S353	310102	Wheel 5x3.62x2.834x0.76
S354	310116	Wheel 5x3.75x2.834x0.74
S359	310113	Wheel 3.35x5.74x2.047x1.452
S362	310109	Wheel 6x4x2.834x1.17
S366	310154	Wheel 6x3.94x2.872x1.224
S372	310107	Wheel 7x2.5x2.328xNon Typical
S376	310115	Wheel 5x3x2.834x0.74
S377	310116	Wheel 5x3.75x2.834x0.74
S393	310117	Wheel9x5x3.542x0.787 Black
S395	310117	Wheel9x5x3.542x0.787 Black
S399	310112	Wheel 3.38x2.63x2.047x1.137
S502	310108	Wheel 4x1.88x2.44x0.76
S529	310144	Wheel 3.25x6x2.047x0.812
S9811	077086	Wheel 3.25x5.00x2.047x0.59
S9842	310181	Wheel 4x2.88x2.44x0.832
S9862	310154	Wheel 6x3.94x2.872x1.224
SP0766-508	310199-243-01	Tire Poly 8X4X6.5
<b>Hyster (HY)</b>		
105	077086	Wheel 3.25x5.00x2.047x0.59
108	310174	Wheel 3.25x4x1.85x0.551
124	310135	Wheel 3.25x3.25x2.047x0.825
132	310137	Wheel 3.25x4.28x2.047x0.825
133	310136	Wheel 3.25x4.71x2.047x0.825
134	310138	Wheel 3.25x5.75x2.047x0.825

Wheels and Tires

**Note:** You need to add the compound part number to the wheel base number listed above. See compounds listed on page 10.03 for the dash number. Complete part number format is XXXXX-XXX.

Hyster Continued ▶

# Wheel & Tire Cross References by Manufacturer

Hyster Continued

OE Number	Crown Number	Description
143	310183	Wheel 4x2.75x2.44x0.843
153	312360	Wheel 5x3.88x2.05x0.60
202	310164	Wheel 5x2.88x2.047x0.59
203	073961	Wheel 4.00x2.88x2.047x0.59
312	310132	Wheel 6x3x2.047x0.595
354	310116	Wheel 5x3.75x2.834x0.74
371	310134	Wheel 6x3x2.44x0.775
377	310133	Wheel 5x2.88x2.44x0.775
383	310139	Wheel 5x2.5x1.939x0.95
386	310091	Wheel 7.88x2.48x2.047xNon Typical
420	310125	Wheel 3.25x2x2.047x0.59
423	310174	Wheel 3.25x4x1.85x0.551
425	310137	Wheel 3.25x4.28x2.047x0.825
429	310138	Wheel 3.25x5.75x2.047x0.825
435	310145	Wheel 3.25x6.25x2.047x0.812
441	310136	Wheel 3.25x4.71x2.047x0.825
442	310135	Wheel 3.25x3.25x2.047x0.825
445	310135	Wheel 3.25x3.25x2.047x0.825
452	310094	Wheel 4x2x1.575x0.575
455	310139	Wheel 5x2.5x1.939x0.95
459	310134	Wheel 6x3x2.44x0.775
467	310132	Wheel 6x3x2.047x0.595
553	310133	Wheel 5x2.88x2.44x0.775
606	310091	Wheel 7.88x2.48x2.047xNon Typical
641	073961	Wheel 4.00x2.88x2.047x0.59
647	310094	Wheel 4x2x1.575x0.575
653	310164	Wheel 5x2.88x2.047x0.59
806	310245	Wheel 3.25x4.5x2.047x.710
815	310093	Wheel 3.25x6.5x1.98x1.177
828	083179	Wheel 4.00x2.50x2.047x0.59
9133	077084	Wheel 3.25x3.25x2.047x0.59
9143	083179	Wheel 4.00x2.50x2.047x0.59
9811	077086	Wheel 3.25x5.00x2.047x0.59
103219	073961	Wheel 4.00x2.88x2.047x0.59
206435	073961	Wheel 4.00x2.88x2.047x0.59
207444	310135	Wheel 3.25x3.25x2.047x0.825
211349	077086	Wheel 3.25x5.00x2.047x0.59
213841	310143	Wheel 5x2.88x2.44x0.75
223853	310174	Wheel 3.25x4x1.85x0.551
230711	310164	Wheel 5x2.88x2.047x0.59
239145	310135	Wheel 3.25x3.25x2.047x0.825
267314	077086	Wheel 3.25x5.00x2.047x0.59
267317	310135	Wheel 3.25x3.25x2.047x0.825
267318	077086	Wheel 3.25x5.00x2.047x0.59
281070	310094	Wheel 4x2x1.575x0.575
326410	310094	Wheel 4x2x1.575x0.575
338604	077050-343-01	Tire Poly 13.5X5.5X8 Contour
340480	310139	Wheel 5x2.5x1.939x0.95
350534	310138	Wheel 3.25x5.75x2.047x0.825
350561	310135	Wheel 3.25x3.25x2.047x0.825
350562	310137	Wheel 3.25x4.28x2.047x0.825
350563	310136	Wheel 3.25x4.71x2.047x0.825
350564	310138	Wheel 3.25x5.75x2.047x0.825
354575	310135	Wheel 3.25x3.25x2.047x0.825
354576	310137	Wheel 3.25x4.28x2.047x0.825
354577	310136	Wheel 3.25x4.71x2.047x0.825
354578	310138	Wheel 3.25x5.75x2.047x0.825
358719	077050-343-01	Tire Poly 13.5X5.5X8 Contour
358720	077050-343-01	Tire Poly 13.5X5.5X8 Contour
365649	310095	Wheel 5x2.88x2.047x0.625
389630	310091	Wheel 7.88x2.48x2.047xNon Typical
813378	310048-243-01	Tire Poly 15x5x11.25
813421	310048-243-01	Tire Poly 15x5x11.25
885900	310061-243-01	Tire Poly 16x6x10.5
1032195	073961	Wheel 4.00x2.88x2.047x0.59
1048320	310134	Wheel 6x3x2.44x0.775
1098878	310013-243-01	Tire Poly 10x6x6.25
1151016	310132	Wheel 6x3x2.047x0.595
1152781	310125	Wheel 3.25x2x2.047x0.59

OE Number	Crown Number	Description
1195247	310132	Wheel 6x3x2.047x0.595
1195954	077086	Wheel 3.25x5.00x2.047x0.59
1195955	077086	Wheel 3.25x5.00x2.047x0.59
1196008	073961	Wheel 4.00x2.88x2.047x0.59
1196100	310174	Wheel 3.25x4x1.85x0.551
1196530	073961	Wheel 4.00x2.88x2.047x0.59
1196604	310164	Wheel 5x2.88x2.047x0.59
1196605	077086	Wheel 3.25x5.00x2.047x0.59
1196637	310095	Wheel 5x2.88x2.047x0.625
1196869	310145	Wheel 3.25x6.25x2.047x0.812
1196908	310125	Wheel 3.25x2x2.047x0.59
1197013	310143	Wheel 5x2.88x2.44x0.75
1300306	310091	Wheel 7.88x2.48x2.047xNon Typical
1457073	083179	Wheel 4.00x2.50x2.047x0.59
1492447	310134	Wheel 6x3x2.44x0.775
1548228	310239	Wheel 6x3.89x3.149x.828
2013297	310094	Wheel 4x2x1.575x0.575
2033219	310131	Wheel 8.5x2.66x2.754xNon Typical
2039298	310240	Wheel 3.25x6.50x2.047x1.00
2039299	100462	Wheel 3.25x6.50x2.047x1.44
2039299	310041	Wheel 3.25x6.5x2.047x1.681
2039300	310241	Wheel 3.25x3.125x2.047x.975
2045917	083179	Wheel 4.00x2.50x2.047x0.59
2046054	310245	Wheel 3.25x4.5x2.047x.710
2066073	310259	Wheel 5x4x2.44x0.63
2091428	083179	Wheel 4.00x2.50x2.047x0.59
2302342	310183	Wheel 4x2.75x2.44x0.843
2302392	310185	Wheel 3.25x4.5x1.575x0.56
2305605	310164	Wheel 5x2.88x2.047x0.59
2306047	312360	Wheel 5x3.88x2.05x0.60
2307117	312360	Wheel 5x3.88x2.05x0.60
2307857	073961	Wheel 4.00x2.88x2.047x0.59
2308415	310094	Wheel 4x2x1.575x0.575
2309701	310095	Wheel 5x2.88x2.047x0.625
2309954	107933-243-01	Tire Poly 10X5X6.5 Contour
3005911	310185	Wheel 3.25x4.5x1.575x0.56
3005984	310164	Wheel 5x2.88x2.047x0.59
3005987	073961	Wheel 4.00x2.88x2.047x0.59
3012693	083586	Wheel 5.00x2.88x3.149x0.98
3012706	082742	Wheel Steel
3012707	077086	Wheel 3.25x5.00x2.047x0.59
3012710	100462	Wheel 3.25x6.50x2.047x1.44
3012931	310125	Wheel 3.25x2x2.047x0.59
3012933	310174	Wheel 3.25x4x1.85x0.551
3012947	310164	Wheel 5x2.88x2.047x0.59
3012949	310134	Wheel 6x3x2.44x0.775
3012966	310144	Wheel 3.25x6x2.047x0.812
3013015	075999	Wheel
3013115	075999	Wheel
3013116	082021	Wheel 6.00x2.75x3.149x0.83
3013117	082443	Wheel
3013122	082020	Wheel 6.00x4.25x3.149x0.83
3013133	081645	Wheel Poly
3013134	083585	Wheel 4.00x2.88x2.047x0.75
3013137	083587	Wheel 5.00x4.12x3.149x0.98
3013173	073961	Wheel 4.00x2.88x2.047x0.59
3017646	310131	Wheel 8.5x2.66x2.754xNon Typical
3020006	071894	Wheel 4 Poly
3021893	310071-243-01	Tire Poly 18x8x12.125
3021924	310012-243-01	Tire Poly 10x5x6.5
3021936	310061-243-01	Tire Poly 16x6x10.5
3021949	077848-243-01	Tire Poly 9 X 5 X 5
3022125	077848-243-01	Tire Poly 9 X 5 X 5
3022375	310060-243-01	Tire Poly 16X5X10.5
3022382	310014-341-01	Tire Poly 10x6x6.5
3022517	310075-243-01	Tire Poly 22x8x16
3022554	107933-243-01	Tire Poly 10X5X6.5 Contour
3022555	310022-243-01	Tire Poly 10.5x6x6.5
3022556	310025-243-01	Tire Poly 12x4.5x8

**Note:** You need to add the compound part number to the wheel base number listed above. See compounds listed on page 10.03 for the dash number. Complete part number format is XXXXX-XXX.

Hyster Continued ▶

# Wheel & Tire Cross References by Manufacturer

Hyster Continued

OE Number	Crown Number	Description
3022557	310042-243-01	Tire Poly 14X4.5X8
3022558	310068-243-01	Tire Poly 18x6x12.125
3022571	075715-243-01	Tire Poly 10 X 4 X 6.5
3022601	310061-243-01	Tire Poly 16x6x10.5
3022612	310072-341-01	Tire Poly 18x9x12.125
3022782	077984-243-01	Tire Poly 8.5 X 4 X 4
3022806	310014-341-01	Tire Poly 10x6x6.5
3022937	310076-243-02	Tire Poly 22x10x16
3023045	310060-243-01	Tire Poly 16X5X10.5
3025553	310067-243-01	Tire Poly 18x5x12.125
3025565	310207-243-02	Tire Poly 22x9x16
3026131	310024-341-01	Tire Poly 10.5X7X6.5
3026509	077050-343-01	Tire Poly 13.5X5.5X8 Contour
3027350	310048-243-01	Tire Poly 15x5x11.25
3027736	310024-341-01	Tire Poly 10.5X7X6.5
3027773	310125	Wheel 3.25x2x2.047x0.59
3028194	077848-243-01	Tire Poly 9 X 5 X 5
3028200	075715-243-01	Tire Poly 10 X 4 X 6.5
3028227	310207-243-02	Tire Poly 22x9x16
3028670	077848-243-01	Tire Poly 9 X 5 X 5
3029013	077848-243-01	Tire Poly 9 X 5 X 5
3029017	075715-243-01	Tire Poly 10 X 4 X 6.5
3030218	077984-243-01	Tire Poly 8.5 X 4 X 4
3030223	075715-243-01	Tire Poly 10 X 4 X 6.5
3030828	075715-243-01	Tire Poly 10 X 4 X 6.5
3031330	310131	Wheel 8.5x2.66x2.754xNon Typical
3032897	310178	Wheel 3.25x5.91x2.047x1.18
3051525	310093	Wheel 3.25x6.5x1.98x1.177
3056709	310091	Wheel 7.88x2.48x2.047xNon Typical
3056852	310164	Wheel 5x2.88x2.047x0.59
3068626	077086	Wheel 3.25x5.00x2.047x0.59
3102707	077086	Wheel 3.25x5.00x2.047x0.59
3120636	107933-243-01	Tire Poly 10X5X6.5 Contour
3120637	077848-243-01	Tire Poly 9 X 5 X 5
3120638	310025-243-01	Tire Poly 12x4.5x8
3121144	082021	Load Wheel Assm 6.00 x 2.75
3126223	081520	Wheel Caster Assm 10 x 3
3133013	115033	Wheel 5.00x4.12x2.44x0.83
3133017	310181	Wheel 4x2.88x2.44x0.832
504575264	310283	Wheel 7.88x2.48x2.047xNon Typical
754507300	310091	Wheel 7.88x2.48x2.047xNon Typical
800017067	123603	Load Wheel Assm 3.25 x 4.50
800017230	125070	Wheel 6.00x4.12x3.149x0.98
800017585	127723	Wheel Caster 8x4x2.83
800020380	077084	Load Wheel Assm 3.25 x 3.25
800020380	092537	Wheel Assm 3.25x3.25x2.047x0.59
800026169	310131	Wheel 8.5x2.66x2.754xNon Typical
800045244	083586	Wheel 5.00x2.88x3.149x0.98
800045250	310131	Wheel 8.5x2.66x2.754xNon Typical
800045277	125070	Wheel 6.00x4.12x3.149x0.98
800045371	083879	Roller Load
800046166	073602	Wheel 5 Steel Assm
800046167	125069	Wheel 6.00x2.88x3.15x0.80
800050148	100462	Wheel 3.25x6.50x2.047x1.44
800050156	115032	Wheel 5.00x2.88x2.44x0.83
800076056	071894	Wheel 4 Poly
800076068	073602	Wheel 5 Steel Assm
800076205	082741	Wheel Nylon
800076404	082283	Wheel Assm (Poly)
800113692	044507	Roller Poly
800114768	072718	Wheel Assm Poly
800114775	071892	Wheel 5 dia
800114779	071665	Wheel Polyurethane
800114783	082021	Wheel 6.00x2.75x3.149x0.83
800114787	077084	Load Wheel Assm 3.25 x 3.25
800114787	092537	Wheel Assm 3.25x3.25x2.047x0.59
800114789	125069	Wheel 6.00x2.88x3.15x0.80
800114802	311520	Wheel 10x3 Caster
800114805	077084	Load Wheel Assm 3.25 x 3.25

OE Number	Crown Number	Description
800114805	092537	Wheel Assm 3.25x3.25x2.047x0.59
800114810	077086	Wheel 3.25x5.00x2.047x0.59
800114812	115033	Wheel 5.00x4.12x2.44x0.83
800114818	100462	Wheel 3.25x6.50x2.047x1.44
800114833	083179	Wheel 4.00x2.50x2.047x0.59
800114837	083585	Wheel 4.00x2.88x2.047x0.75
800114838	083585	Wheel 4.00x2.88x2.047x0.75
800114845	088628	Wheel 4.00x4.12x2.047x0.75
800114846	088628	Wheel 4.00x4.12x2.047x0.75
800114848	115032	Wheel 5.00x2.88x2.44x0.83
800114851	083587	Wheel 5.00x4.12x3.149x0.98
800114853	083586	Wheel 5.00x2.88x3.149x0.98
800114856	115033	Wheel 5.00x4.12x2.44x0.83
800114858	115033	Wheel 5.00x4.12x2.44x0.83
800120656	123603	Wheel 3.25x4.50x2.16x0.52
800120779	310131	Wheel 8.5x2.66x2.754xNon Typical
800120802	115032	Wheel 5.00x2.88x2.44x0.83
C32195	073961	Wheel 4.00x2.88x2.047x0.59
C-32195	073961	Wheel 4.00x2.88x2.047x0.59
C33557	310132	Wheel 6x3x2.047x0.595
C33735	310164	Wheel 5x2.88x2.047x0.59
C33746	077086	Wheel 3.25x5.00x2.047x0.59
C34835	077084	Wheel 3.25x3.25x2.047x0.59
C34836	310135	Wheel 3.25x3.25x2.047x0.825
C426173	310125	Wheel 3.25x2x2.047x0.59
C426174	310125	Wheel 3.25x2x2.047x0.59
C46239	310133	Wheel 5x2.88x2.44x0.775
C46239	310143	Wheel 5x2.88x2.44x0.75
C48320	310134	Wheel 6x3x2.44x0.775
C60088	310174	Wheel 3.25x4x1.85x0.551
C-60088	310174	Wheel 3.25x4x1.85x0.551
HYC-20196	077086	Wheel 3.25x5.00x2.047x0.59
HYC-20197	077086	Wheel 3.25x5.00x2.047x0.59
L309088	310116	Wheel 5x3.75x2.834x0.74
S143	310183	Wheel 4x2.75x2.44x0.843
S153	312360	Wheel 5x3.88x2.05x0.60
S420	310125	Wheel 3.25x2x2.047x0.59
S423	310174	Wheel 3.25x4x1.85x0.551
S425	310137	Wheel 3.25x4.28x2.047x0.825
S429	310138	Wheel 3.25x5.75x2.047x0.825
S434	077086	Wheel 3.25x5.00x2.047x0.59
S435	310145	Wheel 3.25x6.25x2.047x0.812
S438	310135	Wheel 3.25x3.25x2.047x0.825
S441	310136	Wheel 3.25x4.71x2.047x0.825
S442	310135	Wheel 3.25x3.25x2.047x0.825
S443	073961	Wheel 4.00x2.88x2.047x0.59
S444	310137	Wheel 3.25x4.28x2.047x0.825
S445	310136	Wheel 3.25x4.71x2.047x0.825
S446	310137	Wheel 3.25x4.28x2.047x0.825
S447	077086	Wheel 3.25x5.00x2.047x0.59
S448	310138	Wheel 3.25x5.75x2.047x0.825
S450	310133	Wheel 5x2.88x2.44x0.775
S451	310164	Wheel 5x2.88x2.047x0.59
S452	310094	Wheel 4x2x1.575x0.575
S456	310139	Wheel 5x2.5x1.939x0.95
S457	312360	Wheel 5x3.88x2.05x0.60
S459	310134	Wheel 6x3x2.44x0.775
S467	310132	Wheel 6x3x2.047x0.595
S487	310091	Wheel 7.88x2.48x2.047xNon Typical
S529	310144	Wheel 3.25x6x2.047x0.812
S553	310133	Wheel 5x2.88x2.44x0.775
S647	310094	Wheel 4x2x1.575x0.575
S648	310094	Wheel 4x2x1.575x0.575
S653	310164	Wheel 5x2.88x2.047x0.59
S673	310172	Wheel 6x3.63x2.44x0.668
S700	310178	Wheel 3.25x5.91x2.047x1.18
S815	310093	Wheel 3.25x6.5x1.98x1.177
S820	310185	Wheel 3.25x4.5x1.575x0.56
S9534	310174	Wheel 3.25x4x1.85x0.551
S9842	310181	Wheel 4x2.88x2.44x0.832

**Note:** You need to add the compound part number to the wheel base number listed above. See compounds listed on page 10.03 for the dash number. Complete part number format is XXXXX-XXX.

# Wheel & Tire Cross References by Manufacturer

OE Number	Crown Number	Description
<b>Jungheinrich (JU)</b>		
32086	310296-242-01	Tire Poly 9x2.75x1.77
000032086	310296-242-01	Tire Poly 9x2.75x1.77
822785	082285	Wheel (Nylon)
6311846	807557	Drive Tire Assy ESR4500
6314589	807557	Drive Tire Assy ESR4500
7180668	370231	Load Wheel Assembly
50136157	370231	Load Wheel Assembly
50460101	370220	JU50460101 Drive Tire
63118460	807557	Drive Tire Assy ESR4500
63145890	807557	Drive Tire Assy ESR4500
71305290	370231	Load Wheel Assembly
71806680	370231	Load Wheel Assembly
<b>Komatsu (KO)</b>		
8779048	136243	Tube 7.00-12 Tire - 700/825x12
8779866	355500-382-42	Solid Resi 500x8 3" TR
MIT27218501	355500-382-42	Solid Resi 500x8 3" TR
MIT42300000	136247	Tube 6.00-9 Tire - 600/690x9
MIT42400000	136243	Tube 7.00-12 Tire - 700/825x12
OP03000205	310029-341-01	Tire Poly 12X5X9
<b>Lansing (LA)</b>		
1004018-001	310125	Wheel 3.25x2x2.047x0.59
1410	310125	Wheel 3.25x2x2.047x0.59
1415	310174	Wheel 3.25x4x1.85x0.551
2029211-001	310142	Wheel 4x2.88x2.44x0.75
2029242-001	310096	Wheel 6x2x2.44x0.625
78435	310098	Wheel 4x2.75x1.938xThru
S1404	310174	Wheel 3.25x4x1.85x0.551
S1410	310125	Wheel 3.25x2x2.047x0.59
S1415	310174	Wheel 3.25x4x1.85x0.551
<b>Lift Rite (LR)</b>		
102	310182	Wheel 3x4x1.85x0.56
10210	310182	Wheel 3x4x1.85x0.56
10210P	310182	Wheel 3x4x1.85x0.56
302	310090	Wheel 8x2x2.047x0.595
302	310092	Wheel 8x2x2.047x0.67
783	310090	Wheel 8x2x2.047x0.595
783	310092	Wheel 8x2x2.047x0.67
82	310090	Wheel 8x2x2.047x0.595
82	310092	Wheel 8x2x2.047x0.67
B40220	310090	Wheel 8x2x2.047x0.595
B40220	310092	Wheel 8x2x2.047x0.67
S10210	310182	Wheel 3x4x1.85x0.56
S10212	310182	Wheel 3x4x1.85x0.56
S10237	310090	Wheel 8x2x2.047x0.595
S10237	310092	Wheel 8x2x2.047x0.67
<b>Linde (LI)</b>		
102	310189	Wheel 3 x 3.5 x 1.85 x 0.56
103	310141	Wheel 3.25x3x2.047x0.812
106	310146	Wheel 3.25x6.38x2.047x0.812
107	310140	Wheel 3.25x3.88x2.047x.812
109	310145	Wheel 3.25x6.25x2.047x0.812
111	310125	Wheel 3.25x2x2.047x0.59
117	310185	Wheel 3.25x4.5x1.575x0.56
138	310125	Wheel 3.25x2x2.047x0.59
202	310164	Wheel 5x2.88x2.047x0.59
203	073961	Wheel 4.00x2.88x2.047x0.59
207	071894	Wheel 4 Poly
306	310132	Wheel 6x3x2.047x0.595
306	310177	Wheel 6x3x2.047x0.67
319	310179	Wheel 8x4x2.44x0.656
377	310133	Wheel 5x2.88x2.44x0.775
377	310143	Wheel 5x2.88x2.44x0.75
443	073961	Wheel 4.00x2.88x2.047x0.59
502	310108	Wheel 4x1.88x2.44x0.76
532	310149	Wheel 3.25x3x2.047x0.656
534	310145	Wheel 3.25x6.25x2.047x0.812
535	310141	Wheel 3.25x3x2.047x0.812
538	310140	Wheel 3.25x3.88x2.047x.812

OE Number	Crown Number	Description
539	310190	Wheel 3.25x6.38x2.047x1.187
542	310142	Wheel 4x2.88x2.44x0.75
553	310133	Wheel 5x2.88x2.44x0.775
553	310143	Wheel 5x2.88x2.44x0.75
560	310132	Wheel 6x3x2.047x0.595
560	310177	Wheel 6x3x2.047x0.67
581	310179	Wheel 8x4x2.44x0.656
630	310162	Wheel 3.38x2.25x1.85x0.551
641	073961	Wheel 4.00x2.88x2.047x0.59
647	310094	Wheel 4x2x1.575x0.575
653	310164	Wheel 5x2.88x2.047x0.59
820	310185	Wheel 3.25x4.5x1.575x0.56
900	310147	Wheel 3.25x6x2.047x1.187
985	310080	Wheel 3x2x2.047x0.625
9143	083179	Wheel 4.00x2.50x2.047x0.59
9433	310189	Wheel 3 x 3.5 x 1.85 x 0.56
9841	071894	Wheel 4 Poly
3-4	310179	Wheel 8x4x2.44x0.656
4-1	310179	Wheel 8x4x2.44x0.656
116808	310207-243-02	Tire Poly 22x9x16
127223	310121-243-01	Tire Poly 21x8x15
138937	310142	Wheel 4x2.88x2.44x0.75
146735	083179	Wheel 4.00x2.50x2.047x0.59
152681	310218	Wheel 3.25x6.38x2.047x1.062
154423	310218	Wheel 3.25x6.38x2.047x1.062
160948	310231	Wheel 3.25x4.84x2.047x0.8
632078	310179	Wheel 8x4x2.44x0.656
703637	310108	Wheel 4x1.88x2.44x0.76
708086	310146	Wheel 3.25x6.38x2.047x0.812
708367	073961	Wheel 4.00x2.88x2.047x0.59
985189	310164	Wheel 5x2.88x2.047x0.59
993474	310132	Wheel 6x3x2.047x0.595
993474	310177	Wheel 6x3x2.047x0.67
994070	310179	Wheel 8x4x2.44x0.656
9904070	310179	Wheel 8x4x2.44x0.656
9815001933	310067-243-01	Tire Poly 18x5x12.125
106A	310144	Wheel 3.25x6x2.047x0.812
13HP	310189	Wheel 3 x 3.5 x 1.85 x 0.56
632-078	310179	Wheel 8x4x2.44x0.656
BHP014	310189	Wheel 3 x 3.5 x 1.85 x 0.56
LIAW-3-4	310179	Wheel 8x4x2.44x0.656
LIAW-4-1	310179	Wheel 8x4x2.44x0.656
LIS530	310250	Wheel 3.25x1.88x2.047x0.595
M0108	310080	Wheel 3x2x2.047x0.625
PAL 13	310145	Wheel 3.25x6.25x2.047x0.812
PAL13-A	310149	Wheel 3.25x3x2.047x0.656
PAL13-C	310149	Wheel 3.25x3x2.047x0.656
PAL13-GH	310140	Wheel 3.25x3.88x2.047x.812
PAL13-GL	310141	Wheel 3.25x3x2.047x0.812
PAL13-GLD	310149	Wheel 3.25x3x2.047x0.656
PAL13-K	310140	Wheel 3.25x3.88x2.047x.812
PAL13-KG	310140	Wheel 3.25x3.88x2.047x.812
PAL13-M	310144	Wheel 3.25x6x2.047x0.812
S443	073961	Wheel 4.00x2.88x2.047x0.59
S524	310162	Wheel 3.38x2.25x1.85x0.551
S525	310080	Wheel 3x2x2.047x0.625
S528	310146	Wheel 3.25x6.38x2.047x0.812
S529	310144	Wheel 3.25x6x2.047x0.812
S530	310250	Wheel 3.25x1.88x2.047x0.595
S532	310149	Wheel 3.25x3x2.047x0.656
S533	310189	Wheel 3 x 3.5 x 1.85 x 0.56
S534	310145	Wheel 3.25x6.25x2.047x0.812
S534-S	310146	Wheel 3.25x6.38x2.047x0.812
S535	310141	Wheel 3.25x3x2.047x0.812
S538	310140	Wheel 3.25x3.88x2.047x.812
S542	310142	Wheel 4x2.88x2.44x0.75
S544	073961	Wheel 4.00x2.88x2.047x0.59
S548	310094	Wheel 4x2x1.575x0.575
S552	310164	Wheel 5x2.88x2.047x0.59

**Note:** You need to add the compound part number to the wheel base number listed above. See compounds listed on page 10.03 for the dash number. Complete part number format is XXXXXX-XXX.

Linde Continued ▶

# Wheel & Tire Cross References by Manufacturer

Under Continued

OE Number	Crown Number	Description
S553	310133	Wheel 5x2.88x2.44x0.775
S553	310143	Wheel 5x2.88x2.44x0.75
S560	310132	Wheel 6x3x2.047x0.595
S560	310177	Wheel 6x3x2.047x0.67
S581	310179	Wheel 8x4x2.44x0.656
S591	310108	Wheel 4x1.88x2.44x0.76
S820	310185	Wheel 3.25x4.5x1.575x0.56
S985	310080	Wheel 3x2x2.047x0.625
W2-G	310080	Wheel 3x2x2.047x0.625
W3-6G	310132	Wheel 6x3x2.047x0.595
W3-6G	310177	Wheel 6x3x2.047x0.67
W413923	310162	Wheel 3.38x2.25x1.85x0.551
<b>Mitsubishi (MB)</b>		
67018	083179	Wheel 4.00x2.50x2.047x0.59
10092234	310178	Wheel 3.25x5.91x2.047x1.18
1009234	310178	Wheel 3.25x5.91x2.047x1.18
1009591	310178	Wheel 3.25x5.91x2.047x1.18
10236B	310092	Wheel 8x2x2.047x0.67
1029602	310178	Wheel 3.25x5.91x2.047x1.18
1029607	310178	Wheel 3.25x5.91x2.047x1.18
1029609	310178	Wheel 3.25x5.91x2.047x1.18
1029612	310178	Wheel 3.25x5.91x2.047x1.18
1050142	310179	Wheel 8x4x2.44x0.656
1050236	310179	Wheel 8x4x2.44x0.656
1075061	077086	Wheel 3.25x5.00x2.047x0.59
1075062	077086	Wheel 3.25x5.00x2.047x0.59
1075063	077086	Wheel 3.25x5.00x2.047x0.59
1075064	077086	Wheel 3.25x5.00x2.047x0.59
1201773	310178	Wheel 3.25x5.91x2.047x1.18
289069	310178	Wheel 3.25x5.91x2.047x1.18
301	310102	Wheel 5x3.62x2.834x0.76
302	310087	Wheel 7x2.86x2.047xNon Typical
353	310102	Wheel 5x3.62x2.834x0.76
4522-04620	083179	Wheel 4.00x2.50x2.047x0.59
4522-33000	310077	Wheel 3.25x5.88x2.047x0.599
4522-35050	310177	Wheel 6x3x2.047x0.67
452204620	083179	Wheel 4.00x2.50x2.047x0.59
4621-27282	310087	Wheel 7x2.86x2.047xNon Typical
4690-03540	310087	Wheel 7x2.86x2.047xNon Typical
4770-30250	310115	Wheel 5x3x2.834x0.74
4780-30230	310102	Wheel 5x3.62x2.834x0.76
4B43971	310102	Wheel 5x3.62x2.834x0.76
50136157	370231	Load Wheel Assembly
50179921	370231	Load Wheel Assembly
560	310177	Wheel 6x3x2.047x0.67
635	310077	Wheel 3.25x5.88x2.047x0.599
700	310178	Wheel 3.25x5.91x2.047x1.18
71305290	370231	Load Wheel Assembly
9143	083179	Wheel 4.00x2.50x2.047x0.59
9811	077086	Wheel 3.25x5.00x2.047x0.59
9827	310087	Wheel 7x2.86x2.047xNon Typical
MBNA067018	083179	Wheel 4.00x2.50x2.047x0.59
S353	310102	Wheel 5x3.62x2.834x0.76
S9751	310077	Wheel 3.25x5.88x2.047x0.599
S9752	083179	Wheel 4.00x2.50x2.047x0.59
S9754	310102	Wheel 5x3.62x2.834x0.76
S9755	310177	Wheel 6x3x2.047x0.67
S9773	310087	Wheel 7x2.86x2.047xNon Typical
S9827	310087	Wheel 7x2.86x2.047xNon Typical
W2050-11106	370231	Load Wheel Assembly
<b>Multiton (MT)</b>		
325P	310174	Wheel 3.25x4x1.85x0.551
90304	310174	Wheel 3.25x4x1.85x0.551
90326	310174	Wheel 3.25x4x1.85x0.551
9534	310174	Wheel 3.25x4x1.85x0.551
A212	310174	Wheel 3.25x4x1.85x0.551
MTA212	310174	Wheel 3.25x4x1.85x0.551
S9534	310174	Wheel 3.25x4x1.85x0.551
<b>Nissan (NI)</b>		
253	310144	Wheel 3.25x6x2.047x0.812

OE Number	Crown Number	Description
4035-FS000	310144	Wheel 3.25x6x2.047x0.812
SP0766-508	310199-243-01	Tire Poly 8X4X6.5
<b>Palletmaster (PS)</b>		
82	310090	Wheel 8x2x2.047x0.595
82	310092	Wheel 8x2x2.047x0.67
<b>Prime Mover (PM)</b>		
103	310150	Wheel 3.25x2.94x1.98xNon Typical
104	310149	Wheel 3.25x3x2.047x0.656
105	077086	Wheel 3.25x5.00x2.047x0.59
201	310153	Wheel 4x2.88x2.325x0.832
202	310152	Wheel 4x2.75x1.938xThru
203	310181	Wheel 4x2.88x2.44x0.832
206	310221	Wheel 4x1.92x1.781x.84
207	071894	Wheel 4 Poly
211	310186	Wheel 4x2.37x1.938x0.96
301	310148	Wheel 8x1.90x1.98x0.81
305	310151	Wheel 5x2.88x2.325x0.832
306	310154	Wheel 6x3.94x2.872x1.224
309	310155	Wheel 7x2.5x2.326xNon Typical
321	310104	Wheel 5x2.62x2.834x0.77
351	310104	Wheel 5x2.62x2.834x0.77
353	310102	Wheel 5x3.62x2.834x0.76
644	310221	Wheel 4x1.92x1.781x.84
824	310186	Wheel 4x2.37x1.938x0.96
900	310147	Wheel 3.25x6x2.047x1.187
901	310090	Wheel 8x2x2.047x0.595
2335	310244	Wheel 3.25x4.5x2.047x.594
9112	082443	Wheel
9143	083179	Wheel 4.00x2.50x2.047x0.59
9800	310212	Wheel 3.25x3x2.047x.590
9803	310153	Wheel 4x2.88x2.325x0.832
9804	310150	Wheel 3.25x2.94x1.98xNon Typical
9805	310151	Wheel 5x2.88x2.325x0.832
9806	310149	Wheel 3.25x3x2.047x0.656
9808	310152	Wheel 4x2.75x1.938xThru
9810	310085	Wheel 3.25x6x2.047x0.585
9811	077086	Wheel 3.25x5.00x2.047x0.59
9841	071894	Wheel 4 Poly
9842	310181	Wheel 4x2.88x2.44x0.832
9844	310235	Wheel 4x2.88x2.44x0.672
9862	310154	Wheel 6x3.94x2.872x1.224
9870	310155	Wheel 7x2.5x2.326xNon Typical
9880	310148	Wheel 8x1.90x1.98x0.81
13864	310148	Wheel 8x1.90x1.98x0.81
15881	310189	Wheel 3 x 3.5 x 1.85 x 0.56
20001	310186	Wheel 4x2.37x1.938x0.96
22006	107933-243-01	Tire Poly 10X5X6.5 Contour
25922	310020-243-01	Tire Poly 10.5x5x6.5
27625	310149	Wheel 3.25x3x2.047x0.656
27808	083179	Wheel 4.00x2.50x2.047x0.59
40868	310181	Wheel 4x2.88x2.44x0.832
42125	310102	Wheel 5x3.62x2.834x0.76
200015	310186	Wheel 4x2.37x1.938x0.96
204274	083179	Wheel 4.00x2.50x2.047x0.59
301738	310020-243-01	Tire Poly 10.5x5x6.5
303692	310104	Wheel 5x2.62x2.834x0.77
305622	310053-243-01	Tire Poly 13.5x5.5x10
305624	310039-142-01	Tire Poly 13.5x5.5x8
306752	310053-243-01	Tire Poly 13.5x5.5x10
306895	310017-243-01	Tire Poly 10.5X3.5X8
309826	310053-243-01	Tire Poly 13.5x5.5x10
312636	310244	Wheel 3.25x4.5x2.047x.594
1612413	310104	Wheel 5x2.62x2.834x0.77
2324109	310102	Wheel 5x3.62x2.834x0.76
20071-01	310020-243-01	Tire Poly 10.5x5x6.5
23041-00	077086	Wheel 3.25x5.00x2.047x0.59
24269-00	310003-243-01	Tire Poly 8X4.5X4.5
25202-02	310153	Wheel 4x2.88x2.325x0.832
25922-01	310020-243-01	Tire Poly 10.5x5x6.5
27626-02	310085	Wheel 3.25x6x2.047x0.585

**Note:** You need to add the compound part number to the wheel base number listed above. See compounds listed on page 10.03 for the dash number. Complete part number format is XXXXX-XXX.

Prime Mover Continued ▶

Wheels  
and  
Tires

# Wheel & Tire Cross References by Manufacturer

Prime Mover Continued

OE Number	Crown Number	Description
27626-03	310147	Wheel 3.25x6x2.047x1.187
27808-00	083179	Wheel 4.00x2.50x2.047x0.59
302623-002	310212	Wheel 3.25x3x2.047x.590
303692-00	310104	Wheel 5x2.62x2.834x0.77
305620-00	310227	Wheel 7x2.75x1.98
307110-03	310147	Wheel 3.25x6x2.047x1.187
314275-000	310179	Wheel 8x4x2.44x0.656
314334-000	310179	Wheel 8x4x2.44x0.656
40254-00	107933-243-01	Tire Poly 10X5X6.5 Contour
40254-01	310018-243-01	Tire Poly 10.5X4.5X8
40265-00	107933-243-01	Tire Poly 10X5X6.5 Contour
40266-01	310039-142-01	Tire Poly 13.5x5.5x8
40721-00	310155	Wheel 7x2.5x2.326xNon Typical
40868-2	310181	Wheel 4x2.88x2.44x0.832
42125-00	310102	Wheel 5x3.62x2.834x0.76
42136-00	310235	Wheel 4x2.88x2.44x0.672
4522-04620	083179	Wheel 4.00x2.50x2.047x0.59
A26327	071894	Wheel 4 Poly
B20755	310150	Wheel 3.25x2.94x1.98xNon Typical
B20972	310150	Wheel 3.25x2.94x1.98xNon Typical
B25195	310152	Wheel 4x2.75x1.938xThru
B25199	310153	Wheel 4x2.88x2.325x0.832
B25761	310151	Wheel 5x2.88x2.325x0.832
B26327	071894	Wheel 4 Poly
B26460	310154	Wheel 6x3.94x2.872x1.224
B27042	310149	Wheel 3.25x3x2.047x0.656
B27042	310212	Wheel 3.25x3x2.047x.590
B27049	071894	Wheel 4 Poly
B-27606	310212	Wheel 3.25x3x2.047x.590
B27626-00	310147	Wheel 3.25x6x2.047x1.187
B27626-01	310085	Wheel 3.25x6x2.047x0.585
B-27626-03	310147	Wheel 3.25x6x2.047x1.187
B27674	310221	Wheel 4x1.92x1.781x.84
MB-26460	310159	Wheel 5x2x2.047x0.59
P-13863	310148	Wheel 8x1.90x1.98x0.81
P-13864	310148	Wheel 8x1.90x1.98x0.81
P21038	310152	Wheel 4x2.75x1.938xThru
P25199	310153	Wheel 4x2.88x2.325x0.832
PMA-26327	071894	Wheel 4 Poly
S901	310090	Wheel 8x2x2.047x0.595
S9143	083179	Wheel 4.00x2.50x2.047x0.59
S9803	310153	Wheel 4x2.88x2.325x0.832
S9804	310150	Wheel 3.25x2.94x1.98xNon Typical
S9805	310151	Wheel 5x2.88x2.325x0.832
S9806	310149	Wheel 3.25x3x2.047x0.656
S9811	077086	Wheel 3.25x5.00x2.047x0.59
S9812	310085	Wheel 3.25x6x2.047x0.585
S9813	310152	Wheel 4x2.75x1.938xThru
S9814	077086	Wheel 3.25x5.00x2.047x0.59
S9815	310147	Wheel 3.25x6x2.047x1.187
S9817	083179	Wheel 4.00x2.50x2.047x0.59
S9818	310221	Wheel 4x1.92x1.781x.84
S9819	310186	Wheel 4x2.37x1.938x0.96
S9841	071894	Wheel 4 Poly
S9842	310181	Wheel 4x2.88x2.44x0.832
S9843	071894	Wheel 4 Poly
S9850	310104	Wheel 5x2.62x2.834x0.77
S9854	310102	Wheel 5x3.62x2.834x0.76
S9862	310154	Wheel 6x3.94x2.872x1.224
S9870	310155	Wheel 7x2.5x2.326xNon Typical
S9880	310148	Wheel 8x1.90x1.98x0.81
X29050-00	082443	Wheel
X301738-00	310020-243-01	Tire Poly 10.5x5x6.5
XP20262-02X	310020-243-01	Tire Poly 10.5x5x6.5
<b>Raymond (RA)</b>		
101	310162	Wheel 3.38x2.25x1.85x0.551
115	310178	Wheel 3.25x5.91x2.047x1.18
116	310078	Wheel 3.25x2.88x2.047x0.59

OE Number	Crown Number	Description
201	310099	Wheel 4x2.75x2.047x0.59
202	310164	Wheel 5x2.88x2.047x0.59
204	310159	Wheel 5x2x2.047x0.59
206	310160	Wheel 5x3.63x2.44x0.668
208	310158	Wheel 4x3.62x2.047x0.59
210	310176	Wheel 4x2x2.44xNon Typical
303	310112	Wheel 3.38x2.63x2.047x1.137
307	310165	Wheel 6x2x2.835xNon Typical
314	310161	Wheel 6x2.5x2.327x1.967
317	310166	Wheel 6x2.5x1.938x0.937
318	310167	Wheel 6x3x2.44x0.68
319	310169	Wheel 6x4x2.835x0.668
321	310163	Wheel 6.88x2x2.835x0.97
325	310172	Wheel 6x3.63x2.44x0.668
326	310177	Wheel 6x3x2.047x0.67
327	310179	Wheel 8x4x2.44x0.656
338	310101	Wheel 3.38x2.63x1.979x1.242
341	310103	Wheel 4.00x2.63x2.44x0.77
535	310141	Wheel 3.25x3x2.047x0.812
623	310220	Wheel 3.25x1.75x1.850x.551
629	310125	Wheel 3.25x2x2.047x0.59
630	310162	Wheel 3.38x2.25x1.85x0.551
631	310156	Wheel 3.25x2.25x1.85x0.551
632	310176	Wheel 4x2x2.44xNon Typical
633	310157	Wheel 3.25x2.88x1.85x0.551
635	310144	Wheel 3.25x6x2.047x0.812
636	310078	Wheel 3.25x2.88x2.047x0.59
638	310219	Wheel 3.25x4.2x2.047x.590
641	073961	Wheel 4.00x2.88x2.047x0.59
644	310221	Wheel 4x1.92x1.781x.84
645	310158	Wheel 4x3.62x2.047x0.59
647	310094	Wheel 4x2x1.575x0.575
648	310099	Wheel 4x2.75x2.047x0.59
650	310159	Wheel 5x2x2.047x0.59
651	310173	Wheel 5x2x2.44xNon Typical
653	310164	Wheel 5x2.88x2.047x0.59
654	310160	Wheel 5x3.63x2.44x0.668
656	310168	Wheel 5x1.12x2.047xNon Typical
660	310165	Wheel 6x2x2.835xNon Typical
663	310161	Wheel 6x2.5x2.327x1.967
664	310167	Wheel 6x3x2.44x0.68
666	310169	Wheel 6x4x2.835x0.668
667	310166	Wheel 6x2.5x1.938x0.937
671	310163	Wheel 6.88x2x2.835x0.97
673	310172	Wheel 6x3.63x2.44x0.668
684	310179	Wheel 8x4x2.44x0.656
699	310177	Wheel 6x3x2.047x0.67
700	310178	Wheel 3.25x5.91x2.047x1.18
7711	310180	Wheel 3.25x4.19x2.047x1.18
9111	082021	Wheel 6.00x2.75x3.149x0.83
9117	082020	Wheel 6.00x4.25x3.149x0.83
9119	310131	Wheel 8.5x2.66x2.754xNon Typical
9136	100462	Wheel 3.25x6.50x2.047x1.44
9143	083179	Wheel 4.00x2.50x2.047x0.59
9151	083587	Wheel 5.00x4.12x3.149x0.98
9433	310189	Wheel 3 x 3.5 x 1.85 x 0.56
9534	310174	Wheel 3.25x4x1.85x0.551
9811	077086	Wheel 3.25x5.00x2.047x0.59
224382	083179	Wheel 4.00x2.50x2.047x0.59
226864	310175	Wheel 3.25x5.91x2.047x0.590
226864	310178	Wheel 3.25x5.91x2.047x1.18
237271	073961	Wheel 4.00x2.88x2.047x0.59
310272	310272-243-01	Tire Poly 14.75x6.50x10.75
630051	310128	Wheel Poly 4x2.88x1.85x0.575
632139	310271-241-01	Tire Poly 14x8x10.25
632145	310463-341-01	Tire Poly 15x6.5x10.75
632163	310293-243-01	Tire Poly 9x7x6.25
939353	310244	Wheel 3.25x4.5x2.047x.594

Raymond Continued ▶

**Note:** You need to add the compound part number to the wheel base number listed above. See compounds listed on page 10.03 for the dash number. Complete part number format is XXXXX-XXX.



# Wheel & Tire Cross References by Manufacturer

Raymond Continued

OE Number	Crown Number	Description
632-204	077084	Wheel 3.25x3.25x2.047x0.59
632-204/CR1	077084	Wheel 3.25x3.25x2.047x0.59
632-241	083179	Wheel 4.00x2.50x2.047x0.59
632-258	310101	Wheel 3.38x2.63x1.979x1.242
632-258-CL1	310101	Wheel 3.38x2.63x1.979x1.242
632-278	075999	Wheel
632-314	310141	Wheel 3.25x3x2.047x0.812
632-314	310174	Wheel 3.25x4x1.85x0.551
632-314/BA	310141	Wheel 3.25x3x2.047x0.812
632-314/MT	310174	Wheel 3.25x4x1.85x0.551
632-314MT	310174	Wheel 3.25x4x1.85x0.551
632-321	100462	Wheel 3.25x6.50x2.047x1.44
632-321/CR	100462	Wheel 3.25x6.50x2.047x1.44
632-322	310112	Wheel 3.38x2.63x2.047x1.137
632-322/CL1	310112	Wheel 3.38x2.63x2.047x1.137
632-41	082020	Wheel 6.00x4.25x3.149x0.83
632-414	082020	Wheel 6.00x4.25x3.149x0.83
632-421	083179	Wheel 4.00x2.50x2.047x0.59
632-421/CR	083179	Wheel 4.00x2.50x2.047x0.59
632421CR1	083179	Wheel 4.00x2.50x2.047x0.59
632-421-CR7	083179	Wheel 4.00x2.50x2.047x0.59
632-541	083587	Wheel 5.00x4.12x3.149x0.98
632-541/CR	083587	Wheel 5.00x4.12x3.149x0.98
632-623	082021	Wheel 6.00x2.75x3.149x0.83
632-623/CR1	082021	Wheel 6.00x2.75x3.149x0.83
632-637	310171	Wheel 6x3x1.781x0.81
632-812	132359	Wheel Caster
632-812	310131	Wheel 8.5x2.66x2.754xNon Typical
632-955/CR1	310208-243-01	Tire Poly 9x5x5 Smooth Step
632-955-CR1	077848-243-01	Tire Poly 9 X 5 X 5
640-051	073961	Wheel 4.00x2.88x2.047x0.59
640-070	310164	Wheel 5x2.88x2.047x0.59
671-013	083179	Wheel 4.00x2.50x2.047x0.59
671-015-21	083179	Wheel 4.00x2.50x2.047x0.59
671-024	310221	Wheel 4x1.92x1.781x.84
671-024/25	310221	Wheel 4x1.92x1.781x.84
671-026/020	310094	Wheel 4x2x1.575x0.575
671-026-20	310094	Wheel 4x2x1.575x0.575
671-041	310189	Wheel 3 x 3.5 x 1.85 x 0.56
671-041-07	310189	Wheel 3 x 3.5 x 1.85 x 0.56
671-053	310166	Wheel 6x2.5x1.938x0.937
671-421	083179	Wheel 4.00x2.50x2.047x0.59
921-000-370	310175	Wheel 3.25x5.91x2.047x0.590
928-603	310164	Wheel 5x2.88x2.047x0.59
939-353-251	310244	Wheel 3.25x4.5x2.047x.594
950-WHL/ CENTER	310250	Wheel 3.25x1.88x2.047x0.595 I
950-WHL/ KIT	310250	Wheel Kit 3.25x1.88x2.047x0.595
950-WHL/ OUTER	310250	Wheel 3.25x1.88x2.047x0.595 O
D524334	310005-243-01	Tire Poly 9X3.5X6.5
M0203	073961	Wheel 4.00x2.88x2.047x0.59
RADS226864	310175	Wheel 3.25x5.91x2.047x0.590
S132	310180	Wheel 3.25x4.19x2.047x1.18
S158	310034-243-01	Tire Poly 13x6x10.5
S182	310056-341-01	Tire Poly 15X8X11.125 G
S621	310219	Wheel 3.25x4.2x2.047x.590
S623	310220	Wheel 3.25x1.75x1.850x.551
S624	310165	Wheel 6x2x2.835xNon Typical
S626	310078	Wheel 3.25x2.88x2.047x0.59
S627	310125	Wheel 3.25x2x2.047x0.59
S628	310144	Wheel 3.25x6x2.047x0.812
S629	310178	Wheel 3.25x5.91x2.047x1.18
S632	310176	Wheel 4x2x2.44xNon Typical
S633	310157	Wheel 3.25x2.88x1.85x0.551
S635	310144	Wheel 3.25x6x2.047x0.812
S636	077086	Wheel 3.25x5.00x2.047x0.59
S640	310221	Wheel 4x1.92x1.781x.84
S645	310158	Wheel 4x3.62x2.047x0.59
S647	310099	Wheel 4x2.75x2.047x0.59

OE Number	Crown Number	Description
S648	310094	Wheel 4x2x1.575x0.575
S650	310159	Wheel 5x2x2.047x0.59
S651	310173	Wheel 5x2x2.44xNon Typical
S653	310164	Wheel 5x2.88x2.047x0.59
S654	310160	Wheel 5x3.63x2.44x0.668
S656	310168	Wheel 5x1.12x2.047xNon Typical
S663	310161	Wheel 6x2.5x2.327x1.967
S664	310167	Wheel 6x3x2.44x0.68
S666	310169	Wheel 6x4x2.835x0.668
S667	310166	Wheel 6x2.5x1.938x0.937
S671	310163	Wheel 6.88x2x2.835x0.97
S673	310172	Wheel 6x3.63x2.44x0.668
S674	310172	Wheel 6x3.63x2.44x0.668
S675	310177	Wheel 6x3x2.047x0.67
S684	310179	Wheel 8x4x2.44x0.656
S699	310177	Wheel 6x3x2.047x0.67
S700	310178	Wheel 3.25x5.91x2.047x1.18
<b>RoL-Lift (RL)</b>		
101	310188	Wheel 3.25x3.75x1.75xThru
3-91002	310089	Wheel 8x2x1.75xThru
3-91023	310188	Wheel 3.25x3.75x1.75xThru
913393	310089	Wheel 8x2x1.75xThru
9330	310188	Wheel 3.25x3.75x1.75xThru
9380	310089	Wheel 8x2x1.75xThru
R0301	310089	Wheel 8x2x1.75xThru
S9330	310188	Wheel 3.25x3.75x1.75xThru
S9380	310089	Wheel 8x2x1.75xThru
T-23-A	310089	Wheel 8x2x1.75xThru
T-42A	310188	Wheel 3.25x3.75x1.75xThru
<b>Schreck (SC)</b>		
41-27083	073961	Wheel 4.00x2.88x2.047x0.59
<b>Still (SL)</b>		
5402294	082285	Wheel (Nylon)
<b>Toyota (TY)</b>		
636	310078	Wheel 3.25x2.88x2.047x0.59
700	310178	Wheel 3.25x5.91x2.047x1.18
9143	083179	Wheel 4.00x2.50x2.047x0.59
9811	077086	Wheel 3.25x5.00x2.047x0.59
310225	310225	Wheel 6x3x1.9687
5900281871	310172	Wheel 6x3.63x2.44x0.668
00590-00013-71	310178	Wheel 3.25x5.91x2.047x1.18
00590-00023-71	310178	Wheel 3.25x5.91x2.047x1.18
00590-00025-71	310178	Wheel 3.25x5.91x2.047x1.18
00590-00506-71	310078	Wheel 3.25x2.88x2.047x0.59
00590-00773-71	077086	Wheel 3.25x5.00x2.047x0.59
00590-00777-71	077086	Wheel 3.25x5.00x2.047x0.59
00590-00779-71	077086	Wheel 3.25x5.00x2.047x0.59
00590-02818-71	310172	Wheel 6x3.63x2.44x0.668
00590-04775-71	083179	Wheel 4.00x2.50x2.047x0.59
00590-04780-71	083179	Wheel 4.00x2.50x2.047x0.59
00590-05044-71	310102	Wheel 5x3.62x2.834x0.76
00590-05047-71	310235	Wheel 4x2.88x2.44x0.672
00590-40028-71	310053-243-01	Tire Poly 13.5x5.5x10
00590-40031-71	310053-341-01	Tire Poly 13.5x5.5x10
00590-41747-71	310225	Wheel 6x3x1.9687
00590-41998-71	310225	Wheel 6x3x1.9687
00590-42111-71	310178	Wheel 3.25x5.91x2.047x1.18
00590-43383-71	310244	Wheel 3.25x4.5x2.047x.594
00590-46419-71	310244	Wheel 3.25x4.5x2.047x.594
00590-46420-71	310244	Wheel 3.25x4.5x2.047x.594
00590-46421-71	310244	Wheel 3.25x4.5x2.047x.594
00591-04635-81	071665	Wheel Polyurethane
00591-04638-81	071894	Wheel 4 Poly
00591-04647-81	073602	Wheel 5 Steel Assm
00591-04828-81	080915	Wheel 8.00x3.75x3.15x0.83
00591-04838-81	081645	Wheel Poly
00591-04841-81	082020	Wheel 6.00x4.25x3.149x0.83
00591-04842-81	082021	Wheel 6.00x2.75x3.149x0.83
00591-04848-81	083879	Roller Load
00591-04849-81	083879	Roller Load

Toyota Continued ▶

Note: You need to add the compound part number to the wheel base number listed above. See compounds listed on page 10.03 for the dash number. Complete part number format is XXXXXX-XXX.





# Wheel & Tire Cross References by Manufacturer

Yale Continued

OE Number	Crown Number	Description
606	310091	Wheel 7.88x2.48x2.047xNon Typical
641	073961	Wheel 4.00x2.88x2.047x0.59
647	310094	Wheel 4x2x1.575x0.575
653	310164	Wheel 5x2.88x2.047x0.59
663	310161	Wheel 6x2.5x2.327x1.967
801	310138	Wheel 3.25x5.75x2.047x0.825
805	310185	Wheel 3.25x4.5x1.575x0.56
806	310245	Wheel 3.25x4.5x2.047x.710
815	310093	Wheel 3.25x6.5x1.98x1.177
816	310000	Wheel 3.25x6.5 Single Bearing
817	100462	Wheel 3.25x6.50x2.047x1.44
820	310185	Wheel 3.25x4.5x1.575x0.56
821	310187	Wheel 3.25x5.75x2.44x0.69
824	310186	Wheel 4x2.37x1.938x0.96
826	310103	Wheel 4.00x2.63x2.44x0.77
827	310149	Wheel 3.25x3x2.047x0.656
828	083179	Wheel 4.00x2.50x2.047x0.59
828	310114	Wheel 4x2.5x2.047x0.76
844	310235	Wheel 4x2.88x2.44x0.672
5581	310125	Wheel 3.25x2x2.047x0.59
8313	310116	Wheel 5x3.75x2.834x0.74
9110	310078	Wheel 3.25x2.88x2.047x0.59
9143	083179	Wheel 4.00x2.50x2.047x0.59
9145	081645	Wheel Poly
9330	310188	Wheel 3.25x3.75x1.75xThru
9380	310089	Wheel 8x2x1.75xThru
9534	310174	Wheel 3.25x4x1.85x0.551
11493	081645	Wheel Poly
156181	310093	Wheel 3.25x6.5x1.98x1.177
188457	310096	Wheel 6x2x2.44x0.625
301314	083585	Wheel 4.00x2.88x2.047x0.75
310530	310078	Wheel 3.25x2.88x2.047x0.59
325993	310174	Wheel 3.25x4x1.85x0.551
560524	310174	Wheel 3.25x4x1.85x0.551
569987	310149	Wheel 3.25x3x2.047x0.656
569987	310212	Wheel 3.25x3x2.047x.590
598215	310142	Wheel 4x2.88x2.44x0.75
598215	310235	Wheel 4x2.88x2.44x0.672
650546	310185	Wheel 3.25x4.5x1.575x0.56
1213591	310170	Wheel 3.38x2.75x2.047x0.91
1219933	310002-341-01	Tire Poly 8X4X6.25
1291933	310002-341-01	Tire Poly 8X4X6.25
3032897	310178	Wheel 3.25x5.91x2.047x1.18
3051525	310093	Wheel 3.25x6.5x1.98x1.177
3133017	310181	Wheel 4x2.88x2.44x0.832
5748215	310142	Wheel 4x2.88x2.44x0.75
5748215	310235	Wheel 4x2.88x2.44x0.672
5800091	132359	Wheel Caster
5932569	310101	Wheel 3.38x2.63x1.979x1.242
6057853	310184	Wheel 3.38x2.75x2.047x0.605
65269600	310185	Wheel 3.25x4.5x1.575x0.56
65269601	310185	Wheel 3.25x4.5x1.575x0.56
150015364	077086	Wheel 3.25x5.00x2.047x0.59
150015365	077086	Wheel 3.25x5.00x2.047x0.59
150015428	310179	Wheel 8x4x2.44x0.656
150015437	073961	Wheel 4.00x2.88x2.047x0.59
150015505	073961	Wheel 4.00x2.88x2.047x0.59
150015527	072718	Wheel Assm Poly
150015529	073602	Wheel 5 Steel Assm
150015530	073961	Wheel 4.00x2.88x2.047x0.59
150015531	071892	Wheel 5 dia
150015533	071665	Wheel Polyurethane
150015536	075999	Wheel
150015537	082021	Wheel 6.00x2.75x3.149x0.83
150015538	082443	Wheel
150015543	082020	Wheel 6.00x4.25x3.149x0.83
150015546	083879	Roller Load
150015549	077086	Wheel 3.25x5.00x2.047x0.59
150015550	100462	Wheel 3.25x6.50x2.047x1.44

OE Number	Crown Number	Description
150015552	083879	Roller Load
150015554	071665	Wheel Polyurethane
150015555	100462	Wheel 3.25x6.50x2.047x1.44
150015556	081645	Wheel Poly
150015557	083179	Wheel 4.00x2.50x2.047x0.59
150015558	081645	Wheel Poly
150015559	083585	Wheel 4.00x2.88x2.047x0.75
150015562	083587	Wheel 5.00x4.12x3.149x0.98
150015563	083586	Wheel 5.00x2.88x3.149x0.98
150015568	083879	Roller Load
150017803	107933-243-01	Tire Poly 10X5X6.5 Contour
150017805	107933-243-01	Tire Poly 10X5X6.5 Contour
150102610	107933-243-01	Tire Poly 10X5X6.5 Contour
150103694	310028-348-01	Tire Poly 12x5.5x8
150110132	310040-243-01	Tire Poly 13.5X6.5X8
150110144	107933-243-01	Tire Poly 10X5X6.5 Contour
150110192	077848-243-01	Tire Poly 9 X 5 X 5
150110322	107933-243-01	Tire Poly 10X5X6.5 Contour
150110666	107933-243-01	Tire Poly 10X5X6.5 Contour
150110683	107933-243-01	Tire Poly 10X5X6.5 Contour
220002190	310131	Wheel 8.5x2.66x2.754xNon Typical
220007770	083879	Roller Load
220007781	072718	Wheel Assm Poly
220007782	073602	Wheel 5 Steel Assm
220008327	073961	Wheel 4.00x2.88x2.047x0.59
220008610	083586	Wheel 5.00x2.88x3.149x0.98
220008615	100462	Wheel 3.25x6.50x2.047x1.44
220008657	071894	Wheel 4 Poly
220008659	075999	Wheel
220008660	082021	Wheel 6.00x2.75x3.149x0.83
220008661	082443	Wheel
220008662	080915	Wheel 8.00x3.75x3.15x0.83
220008663	082020	Wheel 6.00x4.25x3.149x0.83
220008666	083179	Wheel 4.00x2.50x2.047x0.59
220008667	081645	Wheel Poly
220008668	083585	Wheel 4.00x2.88x2.047x0.75
220008669	083587	Wheel 5.00x4.12x3.149x0.98
220012781	073961	Wheel 4.00x2.88x2.047x0.59
220012897	071892	Wheel 5 dia
220013557	132359	Wheel Caster
220013668	041269	Wheel Poly
220015006	115032	Wheel 5.00x2.88x2.44x0.83
220015019	115033	Wheel 5.00x4.12x2.44x0.83
220015044	100462	Wheel 3.25x6.50x2.047x1.44
220015049	088628	Wheel 4.00x4.12x2.047x0.75
220015058	082021	Wheel 6.00x2.75x3.149x0.83
220015616	073961	Wheel 4.00x2.88x2.047x0.59
220016967	082021	Wheel 6.00x2.75x3.149x0.83
220016976	077084	Wheel 3.25x3.25x2.047x0.59
220017453	082285	Wheel (Nylon)
220020717	082283	Wheel Assm (Poly)
220021096	081520	Wheel Caster Assm 10 x 3
220022590	073961	Wheel 4.00x2.88x2.047x0.59
220023602	083179	Wheel 4.00x2.50x2.047x0.59
220024613	115033	Wheel 5.00x4.12x2.44x0.83
220028022	077086	Wheel 3.25x5.00x2.047x0.59
220028358	083167	Wheel Moldon Assm
220034310	310131	Wheel 8.5x2.66x2.754xNon Typical
220043337	083179	Wheel 4.00x2.50x2.047x0.59
220044606	077086	Wheel 3.25x5.00x2.047x0.59
220052145	071665	Wheel Polyurethane
220052147	083879	Roller Load
500660502	310066-243-01	Tire Poly 16.25x7x11.25
500660503	310121-243-01	Tire Poly 21x8x15
500660506	310066-243-01	Tire Poly 16.25x7x11.25
500660507	310075-243-01	Tire Poly 22x8x16
500660511	310071-243-01	Tire Poly 18x8x12.125
500660512	310064-243-01	Tire Poly 16.25x5x11.25
500660513	310066-243-01	Tire Poly 16.25x7x11.25

**Note:** You need to add the compound part number to the wheel base number listed above. See compounds listed on page 10.03 for the dash number. Complete part number format is XXXXX-XXX.

Yale Continued ►



# Wheel & Tire Cross References by Manufacturer

Yale Continued

OE Number	Crown Number	Description
5017779-04	310028-348-01	Tire Poly 12x5.5x8
5020360-02	107933-243-01	Tire Poly 10X5X6.5 Contour
5035665-03	310187	Wheel 3.25x5.75x2.44x0.69
5042465-01	310088	Wheel 3.38x2.75x2.047x0.812
5042465-02	310184	Wheel 3.38x2.75x2.047x0.605
5044497-31	310164	Wheel 5x2.88x2.047x0.59
5045742-80	073961	Wheel 4.00x2.88x2.047x0.59
5045752-64	310283	Wheel 7.88x2.48x2.047xNon Typical
5046465-01	310184	Wheel 3.38x2.75x2.047x0.605
5046465-05	310187	Wheel 3.25x5.75x2.44x0.69
5048205-03	310138	Wheel 3.25x5.75x2.047x0.825
5049105-01	310184	Wheel 3.38x2.75x2.047x0.605
5049105-02	310184	Wheel 3.38x2.75x2.047x0.605
5049105-03	310138	Wheel 3.25x5.75x2.047x0.825
5049105-05	310184	Wheel 3.38x2.75x2.047x0.605
5049195-01	107933-243-01	Tire Poly 10X5X6.5 Contour
5055965-01	310093	Wheel 3.25x6.5x1.98x1.177
5066265-01	312360	Wheel 5x3.88x2.05x0.60
5066265-02	312360	Wheel 5x3.88x2.05x0.60
5067885-01	310164	Wheel 5x2.88x2.047x0.59
5067885-02	310164	Wheel 5x2.88x2.047x0.59
5067885-03	310095	Wheel 5x2.88x2.047x0.625
5067885-04	310164	Wheel 5x2.88x2.047x0.59
5067905-01	073961	Wheel 4.00x2.88x2.047x0.59
5157328-16	310089	Wheel 8x2x1.75xThru
5157328-30	310188	Wheel 3.25x3.75x1.75xThru
5157328-31	310188	Wheel 3.25x3.75x1.75xThru
5163538-10	310089	Wheel 8x2x1.75xThru
5188228-10	310186	Wheel 4x2.37x1.938x0.96
5188228-29	310186	Wheel 4x2.37x1.938x0.96
5203188-08	310094	Wheel 4x2x1.575x0.575
5225720-01	310093	Wheel 3.25x6.5x1.98x1.177
5241409-50	310000	Wheel 3.25x6.5 Single Bearing
5241409-51	100462	Wheel 3.25x6.50x2.047x1.44
5241487-50	310245	Wheel 3.25x4.71x2.047x0.825
5800467-42	310079	Wheel 5x2.875x2.44x0.67
590-01-004-7	310227	Wheel 7x2.75x1.98
62006131-00	310184	Wheel 3.38x2.75x2.047x0.605
6209821-00	310125	Wheel 3.25x2x2.047x0.59
7204650-01	310183	Wheel 4x2.75x2.44x0.843
721743-000	310103	Wheel 4.00x2.63x2.44x0.77
7232273-02	310198-243-01	Tire Poly 6X3X4
7303203-02	310133	Wheel 5x2.88x2.44x0.775
7303203-02	310143	Wheel 5x2.88x2.44x0.75
7527393-01	310142	Wheel 4x2.88x2.44x0.75
7527393-01	310235	Wheel 4x2.88x2.44x0.672
7544424-00	312360	Wheel 5x3.88x2.05x0.60
R0101	310188	Wheel 3.25x3.75x1.75xThru
S107	310174	Wheel 3.25x4x1.85x0.551
S124	310078	Wheel 3.25x2.88x2.047x0.59
S127	310188	Wheel 3.25x3.75x1.75xThru
S128	310188	Wheel 3.25x3.75x1.75xThru
S129	310185	Wheel 3.25x4.5x1.575x0.56
S130	310170	Wheel 3.38x2.75x2.047x0.91
S137	310184	Wheel 3.38x2.75x2.047x0.605
S138	310125	Wheel 3.25x2x2.047x0.59
S139	310125	Wheel 3.25x2x2.047x0.59
S143	310183	Wheel 4x2.75x2.44x0.843
S144	310187	Wheel 3.25x5.75x2.44x0.69
S149	310186	Wheel 4x2.37x1.938x0.96
S152	310186	Wheel 4x2.37x1.938x0.96
S153	312360	Wheel 5x3.88x2.05x0.60
S186	310089	Wheel 8x2x1.75xThru
S188	310091	Wheel 7.88x2.48x2.047xNon Typical
S230	310144	Wheel 3.25x6x2.047x0.812
S234	310193	Wheel 4x2.75x1.78x0.72
S420	310125	Wheel 3.25x2x2.047x0.59
S425	310137	Wheel 3.25x4.28x2.047x0.825
S441	310136	Wheel 3.25x4.71x2.047x0.825
S443	073961	Wheel 4.00x2.88x2.047x0.59

OE Number	Crown Number	Description
S446	310137	Wheel 3.25x4.28x2.047x0.825
S529	310144	Wheel 3.25x6x2.047x0.812
S542	310142	Wheel 4x2.88x2.44x0.75
S553	310133	Wheel 5x2.88x2.44x0.775
S553	310143	Wheel 5x2.88x2.44x0.75
S630	310185	Wheel 3.25x4.5x1.575x0.56
S653	310164	Wheel 5x2.88x2.047x0.59
S700	310178	Wheel 3.25x5.91x2.047x1.18
S819	310149	Wheel 3.25x3x2.047x0.656
S820	310185	Wheel 3.25x4.5x1.575x0.56
S821	310187	Wheel 3.25x5.75x2.44x0.69
S824	310186	Wheel 4x2.37x1.938x0.96
S825	310184	Wheel 3.38x2.75x2.047x0.605
S826	310103	Wheel 4.00x2.63x2.44x0.77
S827	310138	Wheel 3.25x5.75x2.047x0.825
S837	310174	Wheel 3.25x4x1.85x0.551
S844	310235	Wheel 4x2.88x2.44x0.672
S847	081645	Wheel Poly
S848	310116	Wheel 5x3.75x2.834x0.74
S850	310093	Wheel 3.25x6.5x1.98x1.177
S851	073961	Wheel 4.00x2.88x2.047x0.59
S857	310164	Wheel 5x2.88x2.047x0.59
S872	310198-243-01	Tire Poly 6X3X4
S888	310091	Wheel 7.88x2.48x2.047xNon Typical
S9143	083179	Wheel 4.00x2.50x2.047x0.59
S9330	310188	Wheel 3.25x3.75x1.75xThru
S9380	310089	Wheel 8x2x1.75xThru
S9534	310174	Wheel 3.25x4x1.85x0.551
S9811	077086	Wheel 3.25x5.00x2.047x0.59
S9842	310181	Wheel 4x2.88x2.44x0.832

**Note:** You need to add the compound part number to the wheel base number listed above. See compounds listed on page 10.03 for the dash number. Complete part number format is XXXXXX-XXX.

## Section 11

# Crown Operator and Service Training

### Contents

Operator Training Workshops	11.02
Operator Training Materials	11.03
Service Training Workshops	11.04
Supplemental Service Training Materials	11.05





### DP MoveSafe® - Train-the-Operator

Crown's nationwide network of factory-trained instructors offer full-service training programs. Conducted at your site, these highly trained instructor led sessions present the full gamut of powered industrial truck safety information with clear, understandable and highly visual video and animated presentations. Hands-on time is maximized and structured to assure your operators are trained not only in truck operation and task performance, but in safe operating habits and practices as well. These are crucial in the effective training of your operators.

*Contact your local Crown lift truck dealer for available dates and pricing.*

### DP LeadSafe® - Train-the-Supervisor

Supervisors of lift truck operators play a critical role in reinforcing the safe operating skills and habits taught during operator training sessions. To help them do this, Crown offers the award winning\* LeadSafe Program in a Demonstrated Performance format to help them learn and demonstrate how to effectively supervise lift truck operators and reinforce safe operating habits.

**The workshop covers topics such as:** Identifying Proper and Improper Operation, Recognizing Potential Hazards, Giving Feedback to Operators, Pedestrian Supervision, OSHA 29CFR 1910.178 Requirements, and Safety Metrics.

*Contact your local Crown lift truck dealer for available dates and pricing.*

\*2008 International Society for Performance Improvement Award of Excellence

### DP TrainSafe® - Train-the-Trainer

DP TrainSafe uses Crown's award winning, hands-on, Demonstrated Performance approach to deliver the best and most comprehensive operator train-the-trainer program in the industry. Participants in the two day TrainSafe program will learn and practice implementing Crown's MoveSafe operator training programs, 11 step hands-on training and safe skill and habit development process. Trainers will leave with the skills needed to conduct these workshops, as well as three year re-evaluations, safety refreshers (workshops), warehouse inspections, and much more.

In addition, participants in the 3-day TrainSafe class or the 1-day LeadSafe train-the-trainer class will learn to train supervisors utilizing Crown's DPLeadSafe supervisor training program.

#### **DP TrainSafe is offered at the following Crown regional training centers:**

**Atlanta, Ga.** (phone 770-381-4999; fax 770-381-0576)  
**Boston, Mass.** (phone 781-933-3366; fax 781-933-8155)  
**City of Industry, Calif.** (phone 626-968-0556; fax 626-961-0135)  
**Dallas, Texas** (phone 817-419-4000; fax 817-375-6525)  
**Dayton, Ohio** (phone 937-454-7545; fax 937-898-9452)  
**Joliet, Ill.** (phone 815-773-0022; fax 815-773-0033)

*Contact your local Crown lift truck dealer for available dates and pricing.*

*Available Operator Training Materials listed on page 11.03*

To view information videos on DP TrainSafe®, DP MoveSafe® and DP LeadSafe®, go to:  
<http://www.youtube.com/user/CrownEquipment>



# Demonstrated Performance

## Operator Training

# Operator Training Materials



**Crown offers the most comprehensive line of training tools to help maximize your resources for more effective Operator Training.** All lift truck programs come ready with both DVD video and materials in both English and Spanish. These are the same programs that form the foundation of Crown's entire line of operator training services and include Crown's 11 step hands-on training process.

Note: Downloadable media available. Contact the Education Center at Crown Equipment Corporation for information and pricing (419-629-2311).

### Operator Training Programs

**Note:** All programs except Wave® are bilingual, English and Spanish

Program Name	Part Number
<b>It's Up to You</b> (Required with programs marked with † below )	<b>SF18329-PRO</b>
GPW Series Walkit Pallet Trucks †	SF12480-PRO
PW3500 Series Walkie Pallet Trucks †	SF12481-PRO
WP2000 Series Walkie Pallet Trucks †	SF12858-PRO
WP2300-3000 Series Walkie Pallet Trucks	SF18995-PRO
B Series Power Lift Stackers †	SF12478-PRO
M Series Intermediate Duty Walkie Stackers †	SF12479-PRO
SH/SHR, ST/SX3000 and WE/WS2300 Series	SF18007-PRO
W/WR Series Walkie Stackers †	SF12486-PRO-W
WB Series Walkie Stackers †	SF12486-PRO-WB
WE/WS 2000 Series Walkie Stackers †	SF12617-PRO
PC3000-3600 Series Rider Pallet Trucks †	SF12483-PRO
PC4500 Series Rider Pallet Trucks	SF18534-PRO
PE3000 Series Walkie Pallet Trucks †	SF12482-PRO
PE3560 Series Rider Pallet Trucks †	SF12754-PRO
PE4000-4500 Series Rider Pallet Trucks †	SF14295-PRO
PR3000-4500 Series Rider Pallet Trucks †	SF12484-PRO
TR-TWR 3000-3600 Series Tow Tractors †	SF12485-PRO

Program Name	Part Number
RC3000 Series Stand-up Riders †	SF12487-PRO
RC5500 Series Stand-up Riders	SF14751-PRO
RR/RD 3000-3500 Series Reach Trucks †	SF12490-PRO
RR/RD-RM/RMD 5000-6000 Series Reach Trucks	SF18375-PRO
C5 Series Internal Combustion Class IV and V	SF18399-PRO
IC Class IV and V Internal Combustion Trucks	SF18092-PRO
FC-FP Series Four Wheel Sit-Down Trucks †	SF12489-PRO
FC4000-4500 Series Four Wheel Sit-Down Trucks †	SF14016-PRO
SC Series Three Wheel Sit-Down Lift Trucks †	SF12488-PRO
SC4000-4500 Series Three Wheel Sit-Down Trucks †	SF12755-PRO
SP36-48 Series Stockpickers †	SF12492-PRO
SP3000-4000 Series Stockpickers	SF18996-PRO
TS Series Turret Sideloaders †	SF12493-PRO
TSP Series Turret Sideloaders †	SF12494-PRO
TSP 6000-7000 Series Turret Sideloaders †	SF14559-PRO
Wave® Work Assist Vehicle - English	SF12811-PRO
Wave® Work Assist Vehicle - Sanish	SF12811-PRO-03

### Trainer's and Supervisor's Tools

Program Name	Part Number
Notice of Completion Certificates (Package of 100)	SF12464
Trainer's Resources CD	SF12756-8
Trainer's Binder	SF12756-PRO
Trainer's Binder Kit - Contains Operator Training Resource CD	SF12756-KIT
Triennial Evaluation Program	SF18025-PRO
Safety Awareness Topics Program	SF18026-PRO
Triennial/Safety Topics Bundle	SF18322-PKG

### Supervisor's Training

Program Name	Part Number
LeadSafe Student's Manual & DVD	SF14763-PRO
LeadSafe Instructor's Manual & DVD	SF14763-KIT

### Pedestrian Training

Program Name	Part Number
Pedestrian Safety Program	SF18590-PRO

### Stand-Up Safety

Program Name	Part Number
Stand-Up Safety	PF12396-DVD

Included in RC3000 & RR/RS/RD 3000/3500.

### Operator Manuals

See your local Crown dealer or find part numbers at this link:  
[http://www.crown.com/usa/parts/lookup\\_tool.html](http://www.crown.com/usa/parts/lookup_tool.html)



**DP Service Training - For your Lift Truck Technicians**

**Our award winning\* Demonstrated Performance service training workshops give your technicians the Crown-specific skills and knowledge they need to keep your Crown fleet up and running.** Since many technicians are hands-on learners, they're more likely to retain information learned through first-hand experience than material presented in a lecture. Crown's Demonstrated Performance Service Technician Training goes above and beyond traditional classroom training, allowing participants to work on trucks with instructor supervision. Technicians can move at their own pace and focus on the particular tasks and skill groups that best serve their organization's needs.

**Demonstrated Performance workshops are completely customizable to the needs of your technician.** They'll only spend time on what they need to learn, and only work on the trucks that apply to them. For example, they won't spend two hours learning about basic electricity if they already know it. Before the DP training course spend some time talking to your technician about what you want them to cover during the session. Do you want them to focus on mechanical topics, such as repairing or replacing components? Or do you want them to learn how to troubleshoot the electrical system? The answers to these questions will help Crown customize training to meet your needs.

**Learn It.  
Do It.  
Use It.<sup>®</sup>**

This defines the philosophy behind Crown DP training. Participants "Learn it" by reading the module, reviewing any reference material, and practicing the required skills. Then they "Do it" by performing what we call a "skill check" for the instructor to demonstrate their ability to perform the skill. This prepares them to bring their newly acquired skills back to their job and "Use it" to improve the uptime and reliability of Crown lift trucks.

**DP Service Training is offered at the following Crown locations:**

- Atlanta, Ga. (phone 770-381-4999; fax 770-381-0576)
- Boston, Mass. (phone 781-933-3366; fax 781-933-8155)
- City of Industry, Calif. (phone 626-968-0556; fax 626-961-0135)
- Dallas, Texas (phone 817-419-4000; fax 817-375-6525)
- Dayton, Ohio (phone 937-454-7545; fax 937-898-9452)
- Hebron, Ky. (859-334-9055; fax 859-334-9175)
- Joliet, Ill. (phone 815-773-0022; fax 815-773-0033)

\*2006 International Society for Performance Improvement Award of Excellence





The programs listed below cover fundamental principles and systems that can apply to many truck models.

For Crown DP Service Training contact one of Crown's Regional DP Service Training locations listed on the previous page.

## Supplemental Service Training Materials



### Service Training Programs PM Training

Program Name	Part Number
RR/RD5000-5700 - PM	PF18983-PRO
PE4000-4500 - PM	PF18984-PRO
PR4000-4500 - PM	PF18985-PRO
SP3000-4000 - PM	PF18986-PRO
RC5500 - PM	PF18987-PRO

### Legacy Programs

Program Name	Part Number
FC 4000 EV100	PF13437-PRO
RR 5000 Hydraulics	PF13044-PRO
RR 5000 Wiring Diagrams	PF13342-PRO
SC 4000 Series	PF12825-PRO
Basic Electricity, Hydraulics and Motor Theory	PF18660-102

Absorbent Products... 1.10, 1.14-1.16, 2.11-2.12  
Accelerator ..... 4.31  
Adhesives ..... 1.17-1.18  
Aerosols ..... 1.06-1.09  
Air Filters ..... 1.21-1.38  
Air Pneumatic Tires ..... 10.18  
Aircraft Cable ..... 3.14  
Alarms ..... 3.07  
Alternators ..... 4.12  
Antifreeze ..... 1.04  
Apron ..... 2.09  
Axles, Shafts & Pins ..... 3.27-3.31, 10.07-10.08  
Back-Up Alarms ..... 3.07  
Batteries ..... 7.05-7.08  
Battery  
  Acid Indicators ..... 7.10  
  Cable Retractor ..... 7.10  
  Capacity Indicator ..... 3.22-3.23  
  Caps ..... 7.10  
  Connectors ..... 7.14-7.17  
  Discharge Indicator ..... 3.22-3.23  
  Display Rack ..... 7.04  
  Monitoring Identification Device  
    ..... 7.03, 8.14-8.15  
  Spill Kit ..... 2.11  
  Strap ..... 7.10  
  Tools ..... 7.20, 7.23, 7.25-7.26  
  Watering ..... 7.18-7.24  
BDI ..... 3.22-3.23  
Bearings ..... 10.10-10.12  
Belts  
  Fan ..... 4.25-4.26  
  Safety ..... 2.02  
  Seat ..... 2.02, 4.06  
  Timing ..... 4.26  
Brake  
  Cylinders ..... 4.15  
  Disc ..... 3.40, 4.17  
  Fluid ..... 1.04  
  Pads ..... 4.18  
  Rotors ..... 3.40  
  Shoes ..... 4.16-4.17  
  Tail/Back-Up ..... 3.03  
  Tools ..... 8.18  
Breathing Protection ..... 2.08  
Brush  
  Spring ..... 3.50-3.52  
  Motor ..... 3.44-3.50  
Bulbs ..... 3.02  
Bushings ..... 3.32, 4.33  
Cable  
  Aircraft ..... 3.14  
  Control ..... 3.14  
  Power ..... 3.14  
  Retractors, Battery ..... 7.10  
  Ties ..... 1.11  
Caps, Distributor ..... 4.19-4.22  
Carabiners ..... 2.02 & 2.06  
Cards, Electronic ..... 3.20-3.21  
Caster, Wheels ..... 10.08-10.09  
Chain ..... 6.03-6.04  
Chain Wear Gauge ..... 6.04  
Chargers ..... 7.02-7.04  
Chemicals ..... 1.18-1.20  
Chocks, Wheel ..... 8.05  
Cleaners ..... 1.06-1.08  
Coils ..... 4.22  
Compressor Oil ..... 1.03

Cones, Traffic ..... 2.10  
Connectors  
  Battery ..... 7.14-7.17  
  Deutsch ..... 3.08  
Contactor, Tips ..... 3.19  
Contactors ..... 3.18-3.19  
Control Cable ..... 3.14  
Control Cards ..... 3.20-3.21  
Converters  
  DC/DC ..... 3.23  
  Propane ..... 4.07-4.09  
  Torque ..... 4.09  
Coolant ..... 1.04  
Couplings ..... 9.03-9.08  
Cover, Forklift ..... 5.12  
Coveralls ..... 2.09  
Crimping Tools ..... 8.08-8.09, 8.15-8.17  
Cross References  
  Battery ..... 7.06-7.08  
  Cascade Parts ..... 6.07-6.14  
  Electric Truck Components ..... 3.55-3.73  
  Filters ..... 1.21-1.38  
  IC ..... 4.37-4.65  
  Wheels & Tires ..... 10.24-10.40  
Cylinders ..... 3.40, 3.52, 4.15, 4.29-4.30, 4.35  
DC/DC Converters ..... 3.23  
Deionizers ..... 7.22  
Diaphragm Kit ..... 4.35-4.36  
DIN Connectors ..... 7.16  
Disc Brakes ..... 3.40  
Dispensers  
  Chemical ..... 1.06, 1.10-1.11  
  Towel ..... 1.15  
Disposable Clothing ..... 2.09  
Distributors & Caps ..... 4.19-4.22  
Dome Lights ..... 3.04  
Drive Motors ..... 3.41-3.44  
Drive Tools ..... 8.12  
Drive Unit Parts ..... 3.37-3.40  
Drum, 55 Gallon ..... 1.10  
Ear Protection ..... 2.08  
Electrical Tools ..... 8.15-8.17  
Electronic Cards ..... 3.20-3.21  
Exhaust Pipe ..... 4.18  
Extraction Tools ..... 8.15-8.17  
Eye  
  Wash ..... 2.07, 2.10  
  Wash Station ..... 2.07  
Face Shields ..... 2.09  
Fall Protection ..... 2.02-2.06  
Fan ..... 5.04  
  Belts ..... 4.25-4.26  
  Blades ..... 4.25  
Filters, Air, Fuel, Hydraulic & Oil ..... 1.21-1.38  
Fire Extinguisher ..... 2.10  
First Aid Kits ..... 2.09  
Flaps ..... 10.19  
Flashing Lights ..... 3.04, 5.06  
Fluids ..... 1.03-1.04  
Fork Labels ..... 6.05  
Fork Pin Kits ..... 6.04  
Fork Wear Calipers ..... 6.06  
Forklift Cover ..... 5.12  
Forklift Jack ..... 8.04  
Forklift Laser Guidance Systems ..... 5.11-5.12  
Forks ..... 6.05-6.06  
Fuel Filters ..... 1.21-1.38  
Fuel/Water Separators Filters ..... 1.21-1.38

Fuses ..... 3.15-3.17  
Gas Springs ..... 3.39, 4.36  
Gaskets ..... 1.20, 4.34  
Gear Oil ..... 1.02-1.03  
Glasses, Safety ..... 2.07  
Gloves ..... 1.12-1.14  
Goggles ..... 2.07  
Grease ..... 1.05, 1.09  
Grease Fittings ..... 3.33  
Grounding Strap ..... 3.07  
Hand Cleaners ..... 1.06  
Handles ..... 3.36, 3.38, 4.18  
Hard Hat ..... 2.10  
Harnesses  
  Body ..... 2.03-2.04, 2.06  
  Wire ..... 3.54  
Heat Shrink Tubing ..... 7.17  
Horn ..... 3.06  
  Contacts ..... 3.53  
  Plates ..... 3.53  
  Springs ..... 3.53  
Hose ..... 4.14-4.15, 7.19-7.22, 9.02, 9.05  
Hour Meters ..... 3.22-3.23  
Hubs ..... 10.16  
Hydraulic  
  Filters ..... 1.21-1.38  
  Fluid ..... 1.03-1.04  
  Oil ..... 1.02-1.03  
  Pump ..... 3.54  
  Tools ..... 8.08-8.11  
Hyster, Yale, Raymond Parts Breakdown  
  ..... 3.24-3.26, 3.36-3.37  
Ignition  
  Coils ..... 4.22  
  Rotors ..... 4.19-4.22  
  Switches ..... 3.12-3.13  
  Wire Sets ..... 4.19-4.22  
Injector ..... 4.36  
Intercell Shroud ..... 7.11  
Intercells ..... 7.11  
Jacks, Forklift ..... 8.04  
Jump Packs ..... 7.09  
Key Pad ..... 5.06  
Keys ..... 3.13  
Knife, Utility ..... 1.17  
Lamps ..... 3.02  
Lanyards ..... 2.05-2.06  
Lasers, Forklift Guidance System ..... 5.11-5.12  
Lead ..... 3.14  
Lead Sticks ..... 7.25  
Leadhead Shrouds ..... 7.11  
Leadheads ..... 7.12-7.13  
Leaf Chain ..... 6.03  
LED  
  Strobe ..... 3.02-3.03  
  Tail Lights ..... 3.03  
  Work Lights ..... 3.05-3.06  
Lights  
  Bulbs ..... 3.02  
  Dome ..... 3.04, 5.05  
  Flashing ..... 3.04, 5.06  
  LED ..... 3.02-3.03, 3.05-3.06  
  Spotlight ..... 3.06  
  Strobes ..... 3.02-3.03  
  Tail ..... 3.03  
  Work ..... 3.05, 5.06  
Lockout Box ..... 2.10  
LPG Safety Valve ..... 4.07

## Section 12 - Index

LPG Tanks.....4.07  
 Lubricants.....1.09, 1.19  
 Lugs.....7.17  
 Mask, Breathing.....2.08  
 Master Cylinders.....3.52, 4.35  
 Mechanical Tools.....8.04-8.07  
 Meters.....3.22-3.23  
 Mirrors.....2.12  
 Motor Oil.....1.02  
 Motors  
   Drive.....3.42-3.43  
   Pump.....3.41-3.42  
   Steer.....3.43-3.44  
 Neutralizing Wash.....1.10, 7.27  
 Oil Filters.....1.21-1.38  
 Oils.....1.02-1.03  
 Operator Programs.....11.2-11.3  
 Paint.....1.12  
 Pallet Trucks (PTH).....6.02  
 Pin Kits, Fork.....6.04  
 Pins, Axles & Shafts.....3.27-3.31, 10.07-10.08  
 Pipe.....4.18  
 Plug Kits.....3.07  
 Pneumatic Tires.....10.17-10.18  
 Pogo Stick.....7.10  
 Poly Tires.....10.13-10.15  
 Power Cable.....3.14  
 Power Supply.....3.23  
 Propane Parts.....4.07-4.09  
 Propane Tanks.....4.07  
 Pumps  
   Hand.....1.03, 1.06, 1.10  
   Hydraulic.....3.54  
   Motors.....3.41-3.42  
   Transmission Charging.....4.14  
   Water.....4.13  
 Quick Change Load Wheels.....10.07  
 Rack, Battery Display.....7.04  
 Radiators & Accessories.....4.14-4.15  
 Rags.....1.14-1.16  
 RAM Mounts.....5.07-5.10  
 Raymond, Hyster, Yale Parts Breakdown  
   .....3.24-3.26, 3.36-3.37  
 Regulator.....4.08  
 Rescue Booster Pack.....7.09  
 Reservoir.....3.52  
 Resilient Tires.....10.17-10.18  
 Respiratory  
   Cartridges.....2.08  
   Masks.....2.08  
 Rims.....10.19  
 Risers.....3.27

Roller, Chain.....6.04  
 Rotors  
   Brake.....3.40  
   Ignition.....4.19-4.22  
 Rubber Tires.....10.20-10.23  
 Safety  
   Belts.....2.02  
   Cones.....2.10  
   Glasses.....2.07  
   Vests.....2.09  
 Seals.....3.34, 3.52, 4.27-4.29  
 Seat Belts.....2.02, 4.06  
 Seats.....4.02-4.05  
 Self-Retracting Lanyard.....2.05  
 Self-Retracting Life Line.....2.06  
 Service Training.....11.4-11.5  
 Shafts, Axles & Pins.....3.27-3.31, 10.07-10.08  
 Shoe Covers.....2.09  
 Shoes, Brake.....4.16-4.17  
 Shrink Wrap.....1.17  
 Shrouds, Leadhead & Intercell.....7.11  
 Sleeving.....7.17  
 Solenoids.....3.52, 4.11, 4.36  
 Spark Plug Wires.....4.19-4.22  
 Spark Plugs.....4.23-4.24  
 Spill Kits.....2.11-2.12  
 Spotlights.....3.06  
 Spray Nozzle Quarts.....1.10  
 Sprayer.....1.11  
 Springs.....3.53, 4.33-4.34  
   Brake.....4.17  
   Brush.....3.50-3.52  
   Gas.....3.39, 4.36  
 Starters.....4.10-4.11  
 Static Strap.....3.07  
 Steer Motors.....3.43-3.44  
 Steering Tools.....8.19  
 Stretch Film.....1.17  
 Strobe Lights.....3.02-3.03  
 Switches.....3.9-3.13, 4.34-4.35  
 Tail Lights.....3.03  
 Tanks, LP.....4.07  
 Tape.....1.17  
   Caution.....2.10  
   Dispenser.....1.17  
 Terminal  
   Battery.....7.17  
   Lugs.....7.17  
   Mounting Plates.....5.03  
   Protectors.....7.10  
 Thermostats.....4.15  
 Ties, Cable.....1.11

Tips, Contactor.....3.19  
 Tires  
   Hole.....10.15  
   Poly.....10.13-10.15  
   Resilient/Pneumatic.....10.17-10.18  
   Rubber.....10.20-10.23  
 Tools  
   Battery.....7.20, 7.23-7.26  
   Brake.....8.18  
   Crimping.....8.08-8.09, 8.15-8.16  
   Crown Branded Tools.....8.02-8.03  
   Diagnostic.....8.13-8.15  
   Drive.....8.12  
   Electrical.....8.15-8.17  
   Extraction.....8.15-8.17  
   Hydraulic.....8.08-8.11  
   Mechanical.....8.04-8.07  
   Retractor.....5.06  
   Steering.....8.19  
 Towels.....1.14-1.16  
 Traffic Cones.....2.10  
 Training Programs.....11.2-11.5  
 Transmission  
   Filter.....1.21-1.38  
   Fluid.....1.03-1.04  
 Tubes, Tire.....10.19  
 Tubing, Heat Shrink.....7.17  
 Unigauges.....3.22-3.23  
 Utility Knife & Blades.....1.17  
 Vaporizer.....4.08  
 Vest, Safety.....2.09  
 Washer Fluid.....1.04  
 Water Pump.....4.13-4.14  
 Watering, Battery.....7.18-7.24  
 Wheel Axles.....3.27-3.31, 10.07-10.08  
 Wheels.....3.33, 10.2-10.09, 10.24-10.40  
   Caster.....10.08-10.09  
   Chocks.....8.05  
   Quick Change.....10.07  
   Triple.....10.07  
 Wiper  
   Blades.....1.11  
   Towels.....1.14-1.16  
 Wire.....3.14  
 Wire Sets, Ignition.....4.19-4.22  
 Work Assist®.....5.02-5.06  
 Work Lights.....3.05, 5.06  
 Yale, Hyster, Raymond Parts Breakdown  
   .....3.24-3.26, 3.36-3.37



# START UP YOUR SYSTEM OF SAVINGS.



## A full-service parts and service system provider.

Crown doesn't just want to sell parts. By observing how you use your forklift and understanding your specific needs, Crown collaborates to deliver the long-term durability and value you expect.

Combine all this with Crown's forklift quality, replacement part accessibility, part commonality, proven technical service and an operator-friendly, ergonomic design, and you'll experience uptime like no other.

With Crown and our retail network, you'll benefit from:

- ▶ A well-managed dealer parts inventory
- ▶ Quick delivery
- ▶ Online parts ordering
- ▶ Exceptional customer service

**These benefits add up to less downtime, easier and faster parts replacement and dramatically longer truck life.**

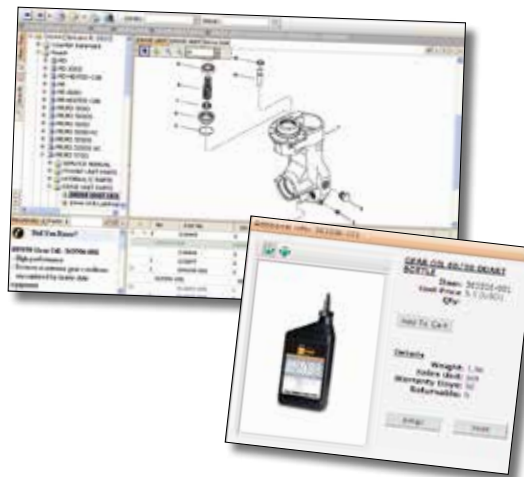

▶ Our online Parts and Service Resource Tool (PSRT) system allows customers to find exactly what they need.



**Contact Your Local Dealer:**

Note: 1910.178(q)(5) (1998) of the Occupational Safety and Health Act (OSHA) requires that “All parts of any such industrial truck requiring replacement shall be replaced only by parts equivalent as to safety with those used in the original design.”



**Crown Equipment Corporation**  
New Bremen, Ohio 45869 USA  
**Tel** 419-629-2311  
**Fax** 419-629-2099  
crown.com

Because Crown is continually improving its products, specifications are subject to change without notice.

Crown, the Crown logo, the color beige, Crown Integrity Parts, Integrity Parts System, Integrity Service System, Wave, Work Assist, Demonstrated Performance, V-Force, One Source Lift Truck Parts, and InfoLink, are trademarks of Crown Equipment Corporation.

Other trademarks are the property of their respective owners.

Copyright 2014 Crown Equipment Corporation  
PF14434 02/14 Vol. 18 Printed in U.S.A.