

## Installation Manual

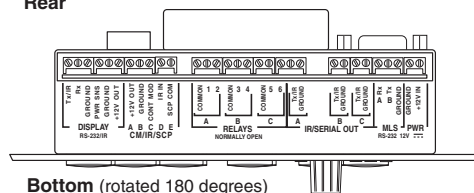
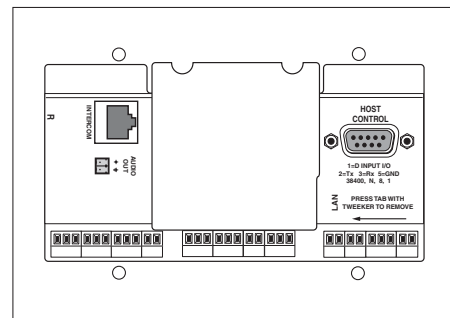
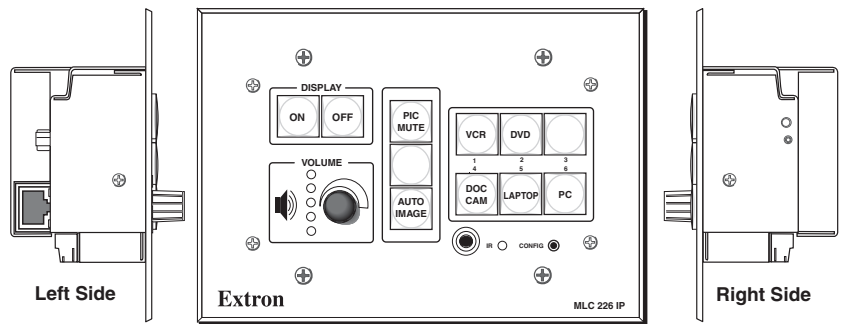

# MLC 226 IP Series

## MediaLink™ Controllers

# Precautions

## Safety Instructions • English



This symbol is intended to alert the user of important operating and maintenance (servicing) instructions in the literature provided with the equipment.



This symbol is intended to alert the user of the presence of uninsulated dangerous voltage within the product's enclosure that may present a risk of electric shock.

### Caution

**Read Instructions** • Read and understand all safety and operating instructions before using the equipment.

**Retain Instructions** • The safety instructions should be kept for future reference.

**Follow Warnings** • Follow all warnings and instructions marked on the equipment or in the user information.

**Avoid Attachments** • Do not use tools or attachments that are not recommended by the equipment manufacturer because they may be hazardous.

## Consignes de Sécurité • Français



Ce symbole sert à avertir l'utilisateur que la documentation fournie avec le matériel contient des instructions importantes concernant l'exploitation et la maintenance (réparation).



Ce symbole sert à avertir l'utilisateur de la présence dans le boîtier de l'appareil de tensions dangereuses non isolées posant des risques d'électrocution.

### Attention

**Lire les instructions** • Prendre connaissance de toutes les consignes de sécurité et d'exploitation avant d'utiliser le matériel.

**Conservier les instructions** • Ranger les consignes de sécurité afin de pouvoir les consulter à l'avenir.

**Respecter les avertissements** • Observer tous les avertissements et consignes marqués sur le matériel ou présentés dans la documentation utilisateur.

**Eviter les pièces de fixation** • Ne pas utiliser de pièces de fixation ni d'outils non recommandés par le fabricant du matériel car cela risquerait de poser certains dangers.

## Sicherheitsanleitungen • Deutsch



Dieses Symbol soll dem Benutzer in der im Lieferumfang enthaltenen Dokumentation besonders wichtige Hinweise zur Bedienung und Wartung (Instandhaltung) geben.



Dieses Symbol soll den Benutzer darauf aufmerksam machen, daß im Inneren des Gehäuses dieses Produktes gefährliche Spannungen, die nicht isoliert sind und die einen elektrischen Schock verursachen können, herrschen.

### Achtung

**Lesen der Anleitungen** • Bevor Sie das Gerät zum ersten Mal verwenden, sollten Sie alle Sicherheits- und Bedienungsanleitungen genau durchlesen und verstehen.

**Aufbewahren der Anleitungen** • Die Hinweise zur elektrischen Sicherheit des Produktes sollten Sie aufbewahren, damit Sie im Bedarfsfall darauf zurückgreifen können.

**Befolgen der Warnhinweise** • Befolgen Sie alle Warnhinweise und Anleitungen auf dem Gerät oder in der Benutzerdokumentation.

**Keine Zusatzgeräte** • Verwenden Sie keine Werkzeuge oder Zusatzgeräte, die nicht ausdrücklich vom Hersteller empfohlen wurden, da diese eine Gefahrenquelle darstellen können.

## Instrucciones de seguridad • Español



Este símbolo se utiliza para advertir al usuario sobre instrucciones importantes de operación y mantenimiento (o cambio de partes) que se desean destacar en el contenido de la documentación suministrada con los equipos.



Este símbolo se utiliza para advertir al usuario sobre la presencia de elementos con voltaje peligroso sin protección aislante, que puedan encontrarse dentro de la caja o alojamiento del producto, y que puedan representar riesgo de electrocución.

### Precaucion

**Leer las instrucciones** • Leer y analizar todas las instrucciones de operación y seguridad, antes de usar el equipo.

**Conservar las instrucciones** • Conservar las instrucciones de seguridad para futura consulta.

**Obedecer las advertencias** • Todas las advertencias e instrucciones marcadas en el equipo o en la documentación del usuario, deben ser obedecidas.

**Evitar el uso de accesorios** • No usar herramientas o accesorios que no sean específicamente recomendados por el fabricante, ya que podrían implicar riesgos.

## 安全须知 • 中文



这个符号提示用户该设备用户手册中有重要的操作和维护说明。



这个符号警告用户该设备机壳内有暴露的危险电压，有触电危险。

### 注意

**阅读说明书** • 用户使用该设备前必须阅读并理解所有安全和使用说明。

**保存说明书** • 用户应保存安全说明书以备将来使用。

**遵守警告** • 用户应遵守产品和用户指南上的所有安全和操作说明。

**避免追加** • 不要使用该产品厂商没有推荐的工具或追加设备，以避免危险。

## Warning

**Power sources** • This equipment should be operated only from the power source indicated on the product. This equipment is intended to be used with a main power system with a grounded (neutral) conductor. The third (grounding) pin is a safety feature, do not attempt to bypass or disable it.

**Power disconnection** • To remove power from the equipment safely, remove all power cords from the rear of the equipment, or the desktop power module (if detachable), or from the power source receptacle (wall plug).

**Power cord protection** • Power cords should be routed so that they are not likely to be stepped on or pinched by items placed upon or against them.

**Servicing** • Refer all servicing to qualified service personnel. There are no user-serviceable parts inside. To prevent the risk of shock, do not attempt to service this equipment yourself because opening or removing covers may expose you to dangerous voltage or other hazards.

**Slots and openings** • If the equipment has slots or holes in the enclosure, these are provided to prevent overheating of sensitive components inside. These openings must never be blocked by other objects.

**Lithium battery** • There is a danger of explosion if battery is incorrectly replaced. Replace it only with the same or equivalent type recommended by the manufacturer. Dispose of used batteries according to the manufacturer's instructions.

## Avertissement

**Alimentations** • Ne faire fonctionner ce matériel qu'avec la source d'alimentation indiquée sur l'appareil. Ce matériel doit être utilisé avec une alimentation principale comportant un fil de terre (neutre). Le troisième contact (de mise à la terre) constitue un dispositif de sécurité : n'essayez pas de la contourner ni de la désactiver.

**Déconnexion de l'alimentation** • Pour mettre le matériel hors tension sans danger, déconnectez tous les cordons d'alimentation de l'arrière de l'appareil ou du module d'alimentation de bureau (s'il est amovible) ou encore de la prise secteur.

**Protection du cordon d'alimentation** • Acheminer les cordons d'alimentation de manière à ce que personne ne risque de marcher dessus et à ce qu'ils ne soient pas écrasés ou pincés par des objets.

**Réparation-maintenance** • Faire exécuter toutes les interventions de réparation-maintenance par un technicien qualifié. Aucun des éléments internes ne peut être réparé par l'utilisateur. Afin d'éviter tout danger d'électrocution, l'utilisateur ne doit pas essayer de procéder lui-même à ces opérations car l'ouverture ou le retrait des couvercles risquent de l'exposer à de hautes tensions et autres dangers.

**Fentes et orifices** • Si le boîtier de l'appareil comporte des fentes ou des orifices, ceux-ci servent à empêcher les composants internes sensibles de surchauffer. Ces ouvertures ne doivent jamais être bloquées par des objets.

**Lithium Batterie** • Il a danger d'explosion s'il y a remplacement incorrect de la batterie. Remplacer uniquement avec une batterie du même type ou d'un type équivalent recommandé par le constructeur. Mettre au rebut les batteries usagées conformément aux instructions du fabricant.

## Vorsicht

**Stromquellen** • Dieses Gerät sollte nur über die auf dem Produkt angegebene Stromquelle betrieben werden. Dieses Gerät wurde für eine Verwendung mit einer Hauptstromleitung mit einem geerdeten (neutralen) Leiter konzipiert. Der dritte Kontakt ist für einen Erdschluß, und stellt eine Sicherheitsfunktion dar. Dieses sollte nicht umgangen oder außer Betrieb gesetzt werden.

**Stromunterbrechung** • Um das Gerät auf sichere Weise vom Netz zu trennen, sollten Sie alle Netzkabel aus der Rückseite des Gerätes, aus der externen Stromversorgung (falls dies möglich ist) oder aus der Wandsteckdose ziehen.

**Schutz des Netzkabels** • Netzkabel sollten stets so verlegt werden, daß sie nicht im Weg liegen und niemand darauf treten kann oder Objekte darauf- oder unmittelbar dagegengestellt werden können.

**Wartung** • Alle Wartungsmaßnahmen sollten nur von qualifiziertem Servicepersonal durchgeführt werden. Die internen Komponenten des Gerätes sind wartungsfrei. Zur Vermeidung eines elektrischen Schocks versuchen Sie in keinem Fall, dieses Gerät selbst öffnen, da beim Entfernen der Abdeckungen die Gefahr eines elektrischen Schlags und/oder andere Gefahren bestehen.

**Schlitze und Öffnungen** • Wenn das Gerät Schlitze oder Löcher im Gehäuse aufweist, dienen diese zur Vermeidung einer Überhitzung der empfindlichen Teile im Inneren. Diese Öffnungen dürfen niemals von anderen Objekten blockiert werden.

**Lithium-Batterie** • Explosionsgefahr, falls die Batterie nicht richtig ersetzt wird. Ersetzen Sie verbrauchte Batterien nur durch den gleichen oder einen vergleichbaren Batterietyp, der auch vom Hersteller empfohlen wird. Entsorgen Sie verbrauchte Batterien bitte gemäß den Herstelleranweisungen.

## Advertencia

**Alimentación eléctrica** • Este equipo debe conectarse únicamente a la fuente/tipo de alimentación eléctrica indicada en el mismo. La alimentación eléctrica de este equipo debe provenir de un sistema de distribución general con conductor neutro a tierra. La tercera pata (puesta a tierra) es una medida de seguridad, no puentearla ni eliminarla.

**Desconexión de alimentación eléctrica** • Para desconectar con seguridad la acometida de alimentación eléctrica al equipo, desenchufar todos los cables de alimentación en el panel trasero del equipo, o desenchufar el módulo de alimentación (si fuera independiente), o desenchufar el cable del receptáculo de la pared.

**Protección del cables de alimentación** • Los cables de alimentación eléctrica se deben instalar en lugares donde no sean pisados ni apretados por objetos que se puedan apoyar sobre ellos.

**Reparaciones/mantenimiento** • Solicitar siempre los servicios técnicos de personal calificado. En el interior no hay partes a las que el usuario deba acceder. Para evitar riesgo de electrocución, no intentar personalmente la reparación/mantenimiento de este equipo, ya que al abrir o extraer las tapas puede quedar expuesto a voltajes peligrosos u otros riesgos.

**Ranuras y aberturas** • Si el equipo posee ranuras o orificios en su caja/alojamiento, es para evitar el sobrecalentamiento de componentes internos sensibles. Estas aberturas nunca se deben obstruir con otros objetos.

**Batería de litio** • Existe riesgo de explosión si esta batería se coloca en la posición incorrecta. Cambiar esta batería únicamente con el mismo tipo (o su equivalente) recomendado por el fabricante. Descharrar las baterías usadas siguiendo las instrucciones del fabricante.

## 警告

**电源** • 该设备只能使用产品上标明的电源。设备必须使用有地线的供电系统供电。第三条线（地线）是安全设施，不能不用或跳过。

**拔掉电源** • 为安全地从设备拔掉电源，请拔掉所有设备后或桌面电源的电源线，或任何接到市电系统的电源线。

**电源线保护** • 妥善布线，避免被踩踏，或重物挤压。

**维护** • 所有维修必须由认证的维修人员进行。设备内部没有用户可以更换的零件。为避免出现触电危险不要自己试图打开设备盖子维修该设备。

**通风孔** • 有些设备机壳上有通风槽或孔，它们是用来防止机内敏感元件过热。不要用任何东西挡住通风孔。

**锂电池** • 不正确的更换电池会有爆炸的危险。必须使用与厂家推荐的相同或相近型号的电池。按照生产厂家的建议处理废弃电池。

# Table of Contents

---

<b>Chapter One • Introduction</b> .....	1-1
<b>About the MLC 226 IP Series MediaLink™ Controllers</b> .....	1-2
MLC 226 IP Series features.....	1-2
Controlling other devices.....	1-2
<b>System Requirements</b> .....	1-3
Hardware requirements.....	1-3
Software requirements .....	1-3
<b>How the MLC 226 IP Series Controllers Work: MLC Components and Interactions</b> .....	1-4
<b>Chapter Two • Installation</b> .....	2-1
<b>UL/Safety Requirements</b> .....	2-2
<b>Installing or Replacing Button Labels</b> .....	2-2
<b>Panels and Cabling</b> .....	2-3
Host/Config port cabling.....	2-3
Bottom/rear panel and cabling.....	2-5
Projector/display connections.....	2-5
Additional control connections.....	2-6
MLC 226 IP DV+ connections.....	2-9
Power connection.....	2-12
Intercom connection .....	2-13
Side panel cabling and features .....	2-13
<b>Resetting the Unit</b> .....	2-15
<b>Pinout Guide</b> .....	2-16
<b>Mounting the MLC</b> .....	2-16
Mounting the MLC to an electrical box or mud ring.....	2-17
Mounting the MLC to a wall or furniture .....	2-18
Rack mounting an MLC 226 IP L .....	2-18
UL rack mounting requirements.....	2-19
Mounting the MLC in a Euro Channel .....	2-19
<b>Chapter Three • Operation</b> .....	3-1
<b>Projector Control</b> .....	3-2
<b>Front Panel Features and Operation</b> .....	3-2
Buttons .....	3-2
Volume control.....	3-4
IR signal sensors.....	3-5
Configuration port.....	3-6
<b>Optional Control Modules and IR 402 Remote Control</b> .....	3-6

## Table of Contents, cont'd

---

<b>Front Panel Security Lockout (Executive Mode)</b> .....	3-7
Enabling and disabling front panel lockout via the embedded Web pages and the front panel.....	3-7
Using the Web pages.....	3-8
Using the front panel.....	3-9
Preparing the MLC for front panel lockout.....	3-10
Setting up and enabling or disabling PINs.....	3-10
Scheduling front panel lockouts.....	3-11

## **Chapter Four • Software-based Configuration and Control**..... 4-1

<b>Configuration and Control: an Overview</b> .....	4-2
---	-----

<b>The Basic Steps: a Guide to this Chapter and Other Resources</b> .....	4-2
---	-----

<b>Configuring the MLC for Network Communication</b> .....	4-3
--	-----

Configuring the MLC for network communication via Global Configurator software.....	4-4
Configuring the MLC for network communication using the ARP command.....	4-4
Configuring the MLC for network communication via a Web browser.....	4-5
Configuring the MLC for network communication using SIS commands.....	4-6
RS-232.....	4-6
Telnet.....	4-6
Setting up the PC for IP communication with an MLC.....	4-7

<b>Global Configurator Software for Windows®</b> .....	4-9
--	-----

Downloading the software and getting started.....	4-9
PC system requirements.....	4-10
Using Global Configurator: helpful tips.....	4-10
Resources and notes.....	4-10
A brief guide to Global Configurator's tabs.....	4-11

<b>Advanced Configuration</b> .....	4-12
-------------------------------------	------

IR learning to create customized IR driver files.....	4-12
Advanced configuration options in Global Configurator.....	4-12
Display power up/power down settings (Power Settings).....	4-13
Volume settings.....	4-14
Digital I/O port settings.....	4-15
Miscellaneous settings.....	4-15
Configuring an auxiliary switcher.....	4-16
Setting up passwords.....	4-17
Printing a wiring block diagram.....	4-18
Updating firmware.....	4-18
Saving and uploading the configuration.....	4-18

<b>Controlling the MLC</b> .....	4-19
----------------------------------	------

Embedded Web pages.....	4-19
Status.....	4-20
System Status.....	4-20
Statistics.....	4-21
Configuration.....	4-22
File Management.....	4-24
Control.....	4-26

GlobalViewer™ Web Pages.....	4-29
Control .....	4-30
Monitor .....	4-31
Schedule.....	4-32
Info .....	4-33
<b>Customizing the MLC's Control Web Pages .....</b>	<b>4-34</b>
<b>Chapter Five • SIS™ Programming and Control .....</b>	<b>5-1</b>
<b>Host-to-MLC Communications.....</b>	<b>5-2</b>
MLC-initiated messages.....	5-2
Password information .....	5-3
Error responses.....	5-3
Error response references .....	5-3
<b>Commands and Responses.....</b>	<b>5-4</b>
Using the command/response tables .....	5-4
Symbol definitions .....	5-5
Command/response table for SIS commands.....	5-8
Command/response table for special function SIS commands (accessible via RS-232 only) .....	5-34
<b>Chapter Six • Special Applications .....</b>	<b>6-1</b>
<b>Using Monitoring to Make Functions Track Actual Conditions.....</b>	<b>6-2</b>
Prerequisite setup steps .....	6-2
Setting up the front panel button .....	6-3
Setting up monitoring conditions .....	6-4
<b>Working With Combination Source Devices.....</b>	<b>6-7</b>
Available methods .....	6-7
Using an IRCM-DV+ control module and one MLC input button for DVD-VCR control .....	6-7
<b>Controlling Two Display Devices.....</b>	<b>6-11</b>
<b>Scheduling Front Panel Lockout Periods.....</b>	<b>6-14</b>
<b>Sending E-mail by Pressing a Button.....</b>	<b>6-14</b>
<b>Working With a Non-MediaLink Extron Switcher.....</b>	<b>6-17</b>
<b>Appendix A • Reference Material.....</b>	<b>A-1</b>
<b>Specifications .....</b>	<b>A-2</b>
<b>Part Numbers and Accessories.....</b>	<b>A-5</b>
Included parts.....	A-5
Accessories .....	A-5
<b>Glossary.....</b>	<b>A-7</b>
<b>File Types: a Key to Extron-specific File Names.....</b>	<b>A-9</b>

## Table of Contents, cont'd

---

<b>Appendix B • Firmware Updates</b> .....	B-1
<b>Determining the Firmware Version</b> .....	B-2
Using the Global Configurator software .....	B-2
Using a Web browser .....	B-2
<b>Updating the Main Firmware</b> .....	B-4
Locating and downloading the firmware .....	B-4
Updating firmware via the MLC's embedded Web page .....	B-4
Updating firmware via Extron Firmware Loader software .....	B-5
Updating firmware via Extron IP Link™ File Manager software .....	B-7
Resetting the MLC and restoring its configuration .....	B-9
<b>Appendix C • Index</b> .....	C-1

*All trademarks mentioned in this manual are the properties of their respective owners.*

68-955-01 B  
02 07



## MLC 226 IP Series

# 1 Chapter One

## Introduction

About the MLC 226 IP Series MediaLink™ Controllers

How the MLC 226 IP Series Controllers Work: MLC Components  
and Interactions

# Introduction

---

## About the MLC 226 IP Series MediaLink™ Controllers

The Extron MLC 226 IP Series MediaLink Controllers are capable of controlling a projector and various other items such as lights, a projector lift, or a screen motor. Throughout this manual they are referred to as the MLC 226, MLC, or controller. All models offer RS-232 and IR-based projector (display) control along with IR or serial control of other devices (typically A/V input sources); relays for controlling items such as a projector lift, motorized projection screen, and lights; and RS-232 remote control of an Extron switcher.

### MLC 226 IP Series features

All models can be configured and controlled via a host computer using RS-232 communication or via IP Link™ Ethernet control. Setup and control can be accomplished by simple ASCII commands (Simple Instruction Set, SIS™) or via the included Global Configurator™ program. The software offers many more setup options than does SIS programming.

All models offer front panel controls. The optional IR 402 remote control and optional SCP 226 Series hard-wired control pads can be used with the MLC, and they mimic the MLC's front panel controls. Additionally, the MLC 226 IP DV+ includes an IRCM-DV+ control module (for DVD and VCR control) installed in the faceplate.

Via Ethernet/IP communication the MLC 226 IP models can make use of the controller's embedded Web pages, which include online diagnostics and monitoring of basic control features. As an integrated part of the MLC 226 IP, IP Link provides the following advantages:

**Global compatibility** — The MLC uses standard Ethernet communication protocols, including ARP, DHCP, ICMP (ping), TCP/IP, Telnet, HTTP, and SMTP.

**Embedded Web page serving** — The MLC 226 IP offers up to 7.25 MB of flash memory for storing Extron and user-supplied Web pages, configuration settings, and device drivers. Data in flash memory is served at a transfer rate of 6 Mbits per second.

**Multi-user support** — Two hundred (200) simultaneous connections enable each IP Link device to support many concurrent users and improve system throughput by sending information in parallel.

**Management ability via Global Configurator 2.2 and higher** — The included software and the GlobalViewer Web pages associated with it allow you to control, monitor, and schedule various functions of products connected to IP Link products such as the MLC.

**E-mail notification** — The MLC 226 IP can be set up to send an e-mail when the projector has been disconnected or the projector's lamp has been used for a designated number of hours.

### Controlling other devices

The MLC 226 IP Series offers two methods of projector and source device control: RS-232 or infrared (IR). The MLC can learn IR signals from remote controls to communicate with sources such as VCRs and DVD players. Users can create their own device drivers (IR or RS-232) or go to the Extron Web site ([www.extron.com](http://www.extron.com)) to obtain device drivers.



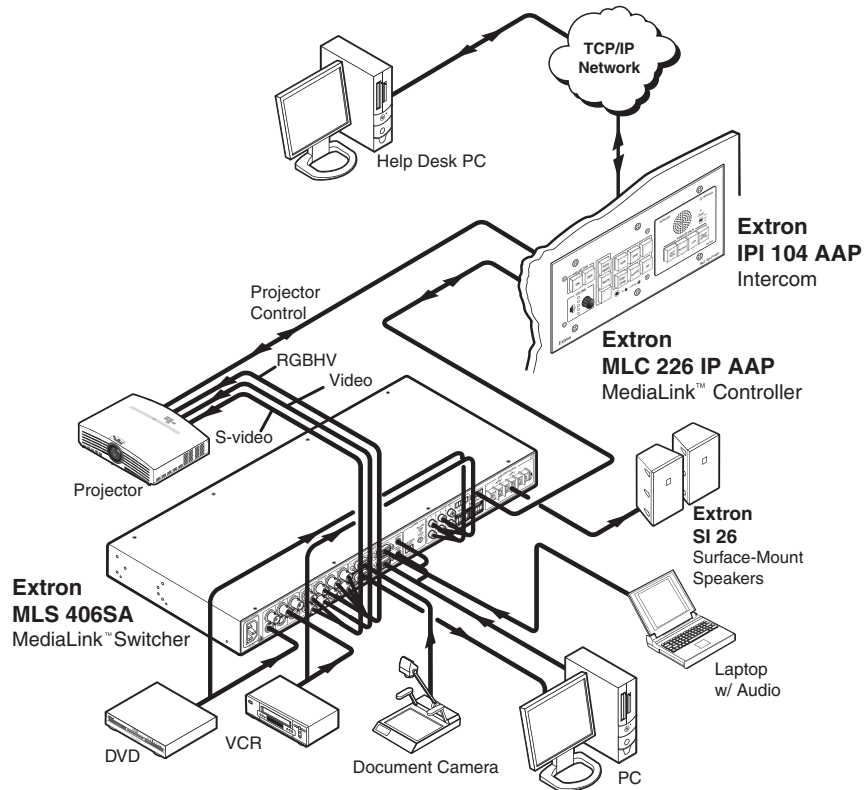

***A typical application for an MLC 226 IP MediaLink Controller***

## System Requirements

The MLC 226 IP and Global Configurator have the following hardware and software requirements.

### Hardware requirements

- Intel® Pentium® III 1 GHz processor
- 512 MB of RAM
- 50 MB of available hard disk space
- A network connection with a minimum data transfer rate of 10 Mbps (100 Mbps is recommended)

### Software requirements

- Microsoft® Windows® operating system
  - Windows NT service pack 4, or
  - Windows 2000 service pack 2, or
  - Windows XP service pack 2
- Microsoft Internet Explorer® 6.0 with ActiveX® enabled
- Microsoft Windows Script 5.6

**CAUTION** *Do not run Global Configurator software on a PC that uses an earlier version of Windows.*

### How the MLC 226 IP Series Controllers Work: MLC Components and Interactions

Unlike the Extron MediaLink Controller (MLC 206 Series), the MLC 226 IP Series requires and uses event files to perform all functions except basic input switching and volume control. The event files define, monitor, and govern how an MLC 226 IP Series controller works. Below is an example diagram of how the MLC interacts with accessories, event scripts, drivers, ports, and input and output devices.

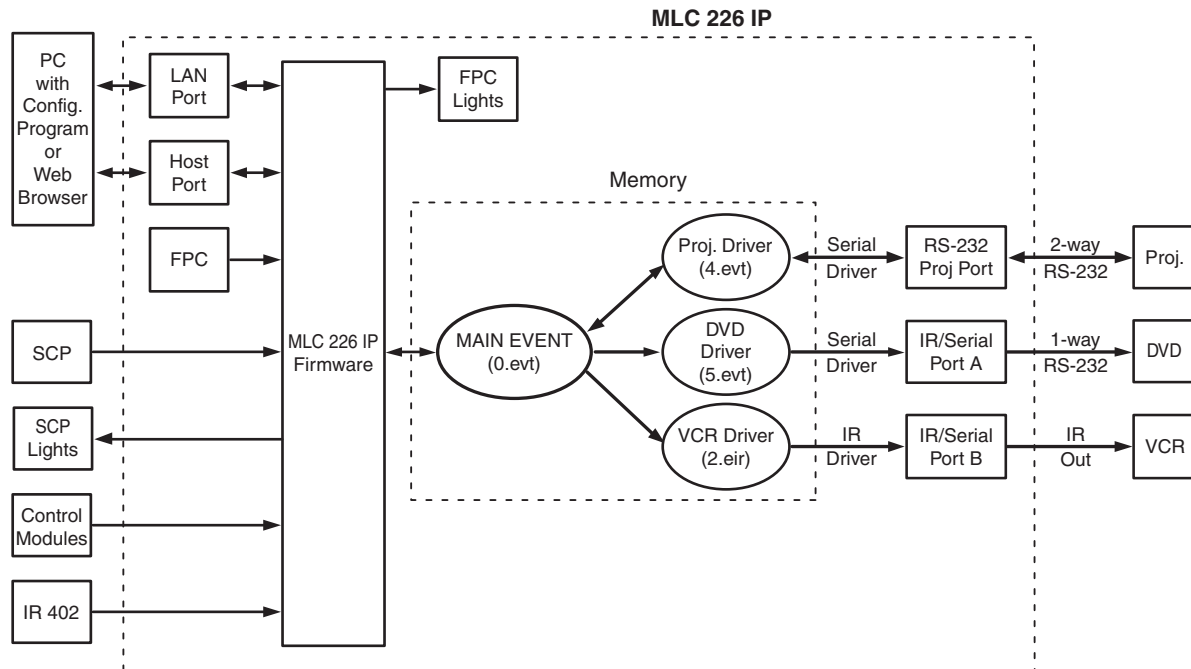

The MLC can be configured completely via the Extron Global Configurator software. Once you have set up how you want it to work (assigned drivers to ports, configured buttons and relays, and set up IP addresses and functions), that information is saved to a project file that is uploaded into the MLC.

The configuration information is used to create the “main event” (0.evt) script file that defines the MLC’s operation. The main event file also controls and monitors ports, optional SCP control pad(s), and changes made at the MLC’s front panel.

Each button on the MLC and on any connected SCPs, control modules (IRCMs, ACMs, RCMs, CMs, DVCM), or the IR 402 remote control, has two switch numbers assigned to it: one for the button press, one for release. Scripts are compiled to generate the main event file to monitor any button press or release and to generate the actions (issuing commands, triggering relays, switching inputs) associated with the buttons.



## MLC 226 IP Series

# 2 Chapter Two

## Installation

UL/Safety Requirements

Installing or Replacing Button Labels

Panels and Cabling

Resetting the Unit

Pinout Guide

Mounting the MLC

# Installation

## UL/Safety Requirements

The Underwriters Laboratories (UL) requirements listed below pertain to the safe installation and operation of a MediaLink™ Controller (MLC).

1. Do not use the MLC near water or expose it to liquids.

**WARNING** To reduce the risk of fire or electric shock, do not expose this apparatus to rain or moisture.

2. Clean the MLC only with a dry cloth.
3. Do not install the MLC near any heat source, such as a radiator, heat register, stove, or another apparatus (including amplifiers) that produces heat.
4. Unplug the MLC during lightning and thunder storms or when it will be unused for long periods.
5. For the installation to meet UL requirements and to comply with National Electrical Code (NEC), the MLC must be installed in a UL approved junction box. The end user or installer must furnish the junction box; it is not included with the MLC.

## Installing or Replacing Button Labels

For the MLC or the optional SCP control panel, you may wish to customize the button labels. The labels can be changed at any time. Follow these steps to change the translucent button labels:

1. Remove the button from the MLC or SCP; use a small, flat bladed screwdriver such as an Extron Tweeker to gently pry a button out from the front panel.
2. Locate the notch in the corner of one side of the clear button cap.
3. Separate the white backing (diffuser) from the clear button cap (lens); insert the blade of the small screwdriver into the corner notch and gently twist the blade.
4. Save the translucent, white diffuser, but remove the text/label insert from the transparent button cap.
5. Select one of the button labels from the printed label sheets included with the device (MLC or SCP). Remove the label from its backing, if applicable.
6. Insert the button label into the button cap. Check for correct label orientation.
7. Align the white diffuser plate with the cap. The bumps on the diffuser plate should be aligned (top and bottom) with the notches on the clear button cap. Firmly snap it into place.
8. Align the tabs on the MLC's plunger with the notches on the diffuser plate. Gently but firmly press the reassembled button into place in the MLC's or SCP's front panel.
9. Repeat steps 1 through 8 as needed to relabel other buttons.

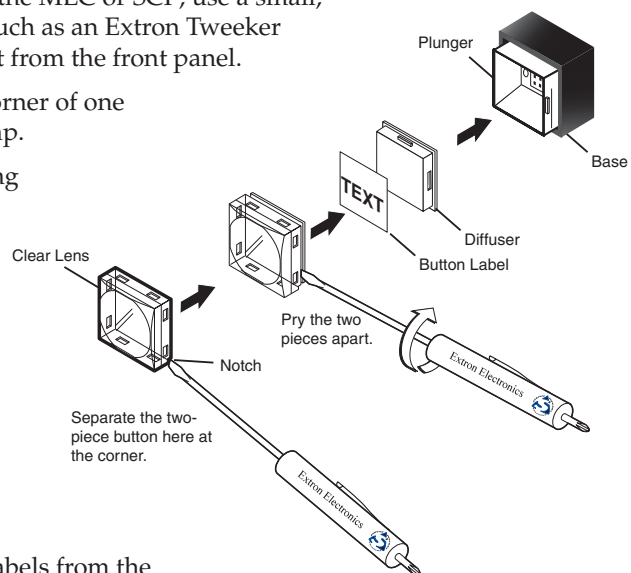

# Panels and Cabling

## Host/Config port cabling

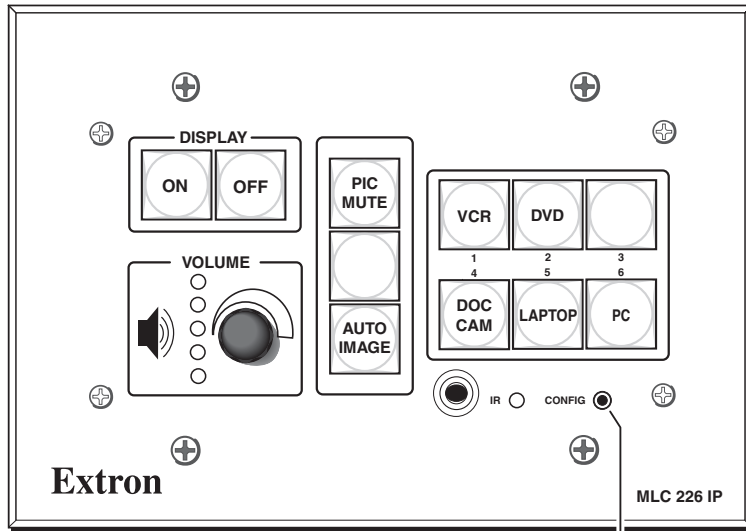

MLC 226 IP Front Panel

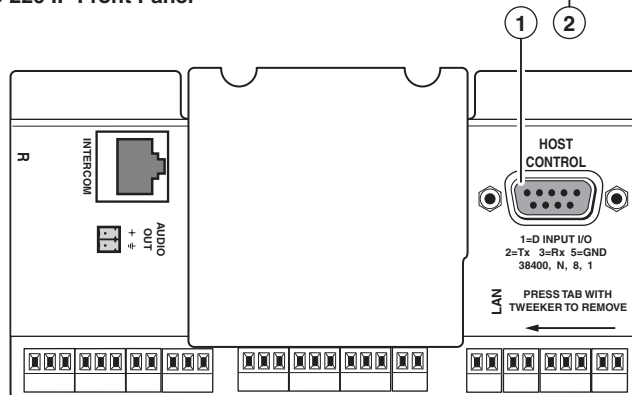

MLC 226 IP Rear Panel

- ① **Rear panel Host Control port** — For MLC configuration and control, connect a Windows®-based PC or an RS-232 control system to the MLC via this female, 9-pin D connector. This connector also has one pin designated for digital input/output.

**RS-232 protocol:**

- 38400 baud
- 1 stop bit
- no parity
- 8 data bits
- no flow control

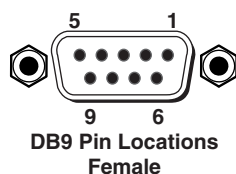

The pin assignments of this connector are as follows:

Pin	RS-232 function	Description
1	Digital I/O	Digital input/output
2	Tx	Transmit data
3	Rx	Receive data
4	—	No connection
5	Gnd	Signal ground
6	—	No connection
7	—	No connection
8	—	No connection
9	—	No connection

**NOTE** Extron recommends configuring and controlling the MLC via the LAN connector. Ethernet connections are faster and more reliable.

## Installation, cont'd

The front panel 2.5 mm mini stereo connector Config port serves the same RS-232 function as this rear panel port but is independent from it.

**NOTE** Both configuration ports require 38400 baud communication. This is a higher speed than many other Extron products use. The Global Configurator (GC) software automatically sets the connection for the appropriate speed. If using HyperTerminal or a similar application, make sure the PC or control system connected to these ports is set for 38400 baud.

**Digital input/output:** pin 1 and the ground pin together act as a digital input/output port (depending on configuration). This allows for an additional way to trigger events or functions (such as triggering relays, issuing commands, or sending an e-mail) that have been configured using GC.

**Digital input:** when this port is configured as a digital input, it is set to measure two states: high and low. The threshold voltages are as follows: a voltage below 2.0 VDC is measured as logic low, and a voltage above 2.8 VDC is measured as logic high. There is also an internal, +5 VDC, selectable, pull-up resistor for this circuit.

**Digital output** — When this port is configured as a digital output, it offers two output states: on and off. When the port is set to an “on” state, (the circuit is closed), the I/O pin is connected to ground. Each I/O port is capable of accepting 250 mA, maximum. When the port is set to the “off” state (the circuit is open), the output pin is floating.

If the application calls for TTL compatibility, the circuit can be set up to provide a 2k ohm pull-up resistor to +5 VDC.

② **Front panel Config (host control) port** — This 2.5 mm mini stereo jack serves the same RS-232 function as the rear panel Host Control port, but it is easier to access than the rear port after the MLC has been installed and cabled. The optional 9-pin D to 2.5 mm stereo mini TRS RS-232 cable (part #70-335-01, shown below) can be used for this connection. This port has the same protocol as the rear panel port mentioned above but does not offer digital input.

**RS-232 protocol:**

- 38400 baud
- 1 stop bit
- no parity
- 8 data bits
- no flow control

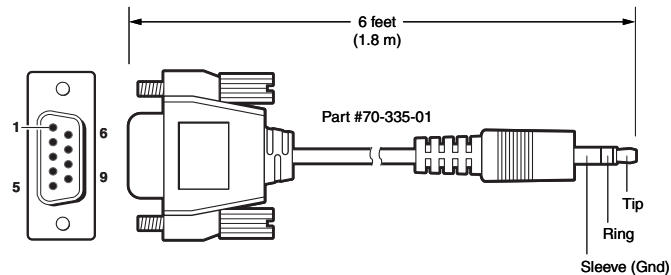

9-pin D	Connection	TRS Plug
Pin 2	Computer's RX line	Tip
Pin 3	Computer's TX line	Ring
Pin 5	Computer's signal ground	Sleeve

**NOTE** Both configuration ports require 38400 baud communication. This is a higher speed than many other Extron products use. Global Configurator software may automatically set the connection for the appropriate speed. If using HyperTerminal or a similar application, make sure the PC or control system connected to these ports is set for 38400 baud.

**NOTE** Extron recommends configuring and controlling the MLC via the LAN connector. Ethernet connections are faster and more reliable.

## Bottom/rear panel and cabling

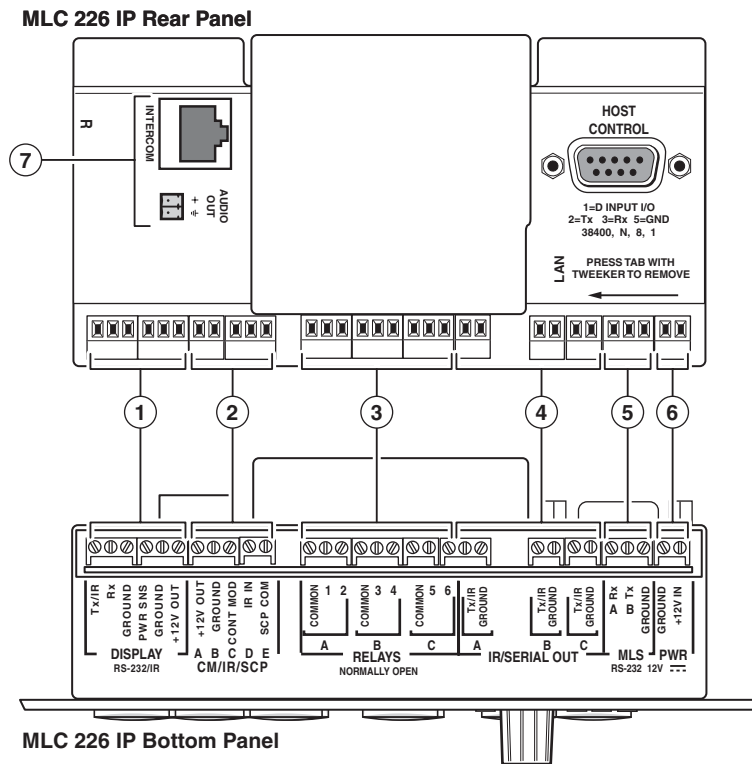

- ① Display control (Display RS-232/IR) and display power sensor port
- ② CM/IR/SCP port
- ③ Relay ports (24 V, 1 A)
- ④ IR/Serial Output ports
- ⑤ MLS connector
- ⑥ PWR (power) connector
- ⑦ Intercom connectors

### Projector/display connections

- ① **Display control (Display RS-232/IR) port (-5 VDC to +5 VDC)** — Connect a cable between the projector or display and the **left three poles** of this 3.5 mm direct insertion captive screw connector for bidirectional RS-232 control. Alternatively, the Tx/IR and Ground pins can be used for one-way infrared signal output. From this port, commands from a projector driver or user-defined command strings entered via Global Configurator can be sent to the display device.

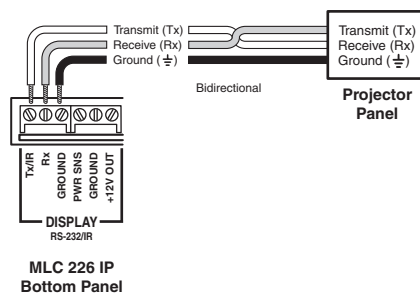

## Installation, cont'd

Connect a cable between the **right three poles** of the Display port and an optional Extron Display Power Sensor. The Power Sensor can be used to let the controller know when the projector/display is on or off. If these pins are *not* connected to a Power Sensor, the Pwr Sns and Ground pins can be used for digital input.

Use the following illustrations as a wiring guide. Wiring varies depending on the projector/display model. In most cases the drivers are bidirectional, but sometimes only the transmit (Tx) and ground connections will be needed for projector/display control. For bidirectional RS-232 communication, the transmit, ground, *and* receive pins must be wired at both the MLC and the projector or display.

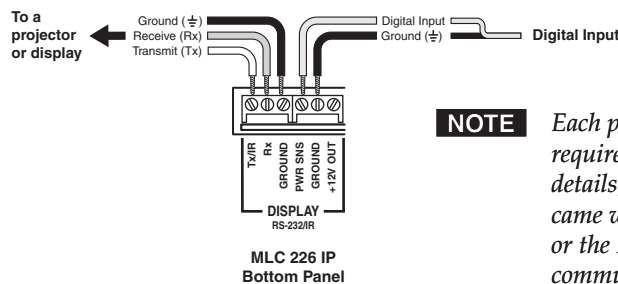
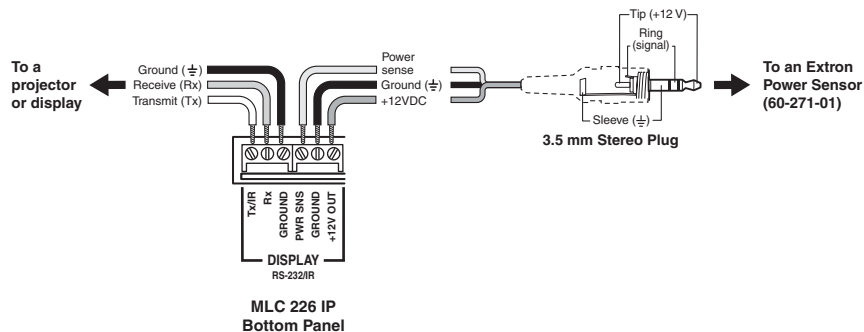

**NOTE** Each projector or display may require different wiring. For details, refer to the manual that came with the projector/display or the Extron device driver communication sheet.

**NOTE** Maximum distances from the MLC to the device being controlled may vary up to 200 feet (61 m). Factors such as cable gauge, baud rates, environment, and output levels (from the MLC and the device being controlled) all affect transmission distance. Distances of about 50 feet (15 m) are typically not a problem. In some cases the MLC may be capable of transmitting and controlling a given device via RS-232 up to 250 feet (76 m) away, but the RS-232 response levels of that device may be too low for the MLC to detect.

**Digital input** — The power sense (Pwr Sns) pin and the Ground pin together can act as a digital input port if configured that way via Global Configurator. This allows for an additional way to trigger events or functions (such as triggering relays, issuing commands, or sending an e-mail). When configured as a digital input, this port is in one of two states: 1 (on, high) or 2 (off, low). Threshold voltages are <2.0 VDC = low, >2.8 VDC = high.

### Additional control connections

- ② **CM/IR/SCP port** — You can connect up to four Extron control modules (IRCMs, ACMs, RCMs, CMs), one Extron infrared signal repeater (IRL 20 or IR Link), and/or up to two Extron SCP 226 control pads to this port to allow remote control of the MLC 226 controller or other items. A maximum of seven devices can be connected to this port.

The SCP 226 replicates the MLC's front panel controls. The SCP 226 and the IR signal repeater can receive IR signals from an optional IR 402 remote control and send them to the controller. Control modules can be used (once



the MLC is set up) to control VCRs, DVD players, tape decks, a projector lift, or screen control. Refer to the appropriate device's user's manual.

**NOTE** *If outside factors such as fluorescent light interfere with and affect the function of the MLC, you can disable IR control of the MLC. Using a special function SIS command (65#), you can turn off the MLC's ability to receive IR signals from IR signal repeaters and SCPs.*

The control modules, IR signal repeater, and SCPs can be daisy chained, as shown in the following diagram. Extron Comm-Link (CTL and CTLP) cable is recommended for these connections. Use the following diagrams as wiring guides.

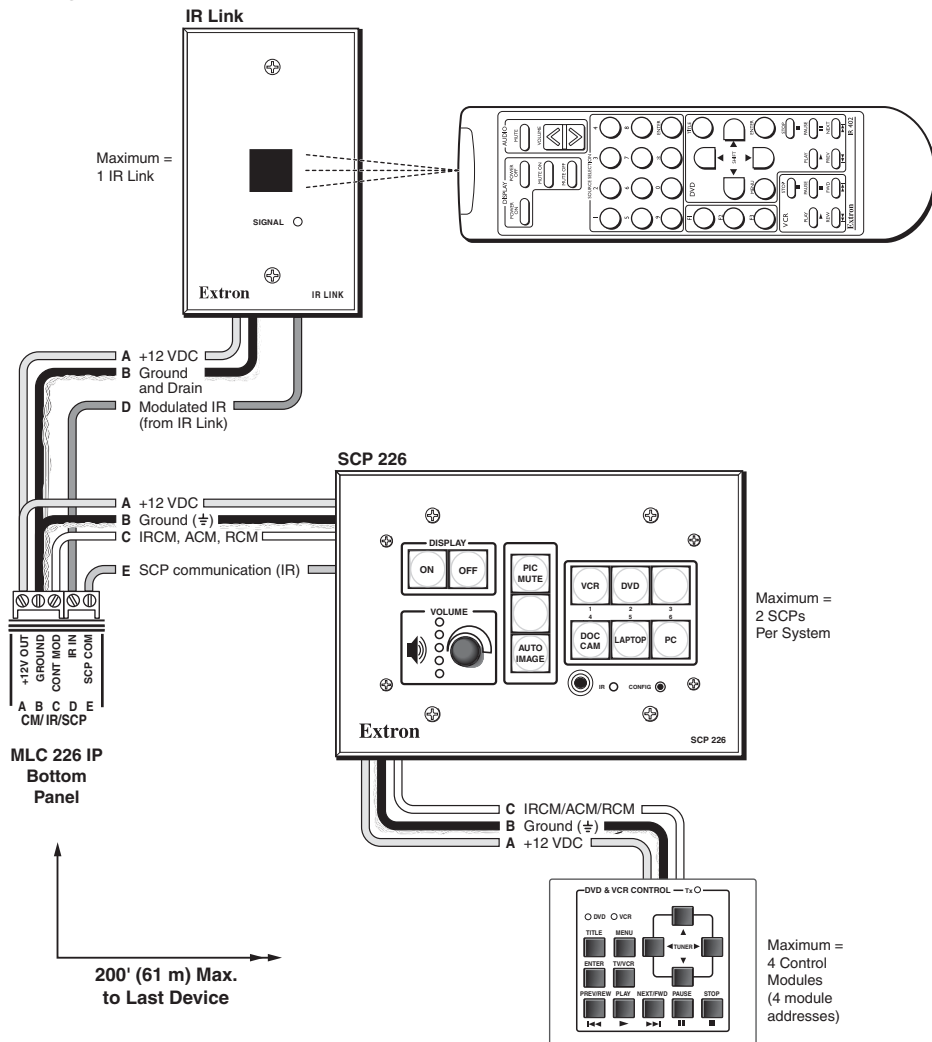

### Basic connections to an SCP, control module, and IR signal repeater

**NOTE** *The maximum total distance between the MLC 226 and a connected device is 200' (61 m).*

**NOTE** *This port provides up to 12 VDC for powering the SCP control pad or other devices. The automatic current protection circuit for this port limits the draw to 0.5 amperes.*

**NOTE** *SCP control pads or control modules (CM, IRCM, ACM, RCM) used with the MLC are affected by front panel security lockout (executive mode) status changes.*

# Installation, cont'd

**NOTE** Requirements for setting addresses for IRCM/RCM/ACM/CM control modules differ depending on how they are connected. If a control module is connected to the 3-pole connector on an SCP, it can be addressed differently than it would if connected to the SCP's 5-pole connector. Refer to the appropriate control module user's manual and the SCP 104/226 User's Manual for instructions on addressing the control modules.

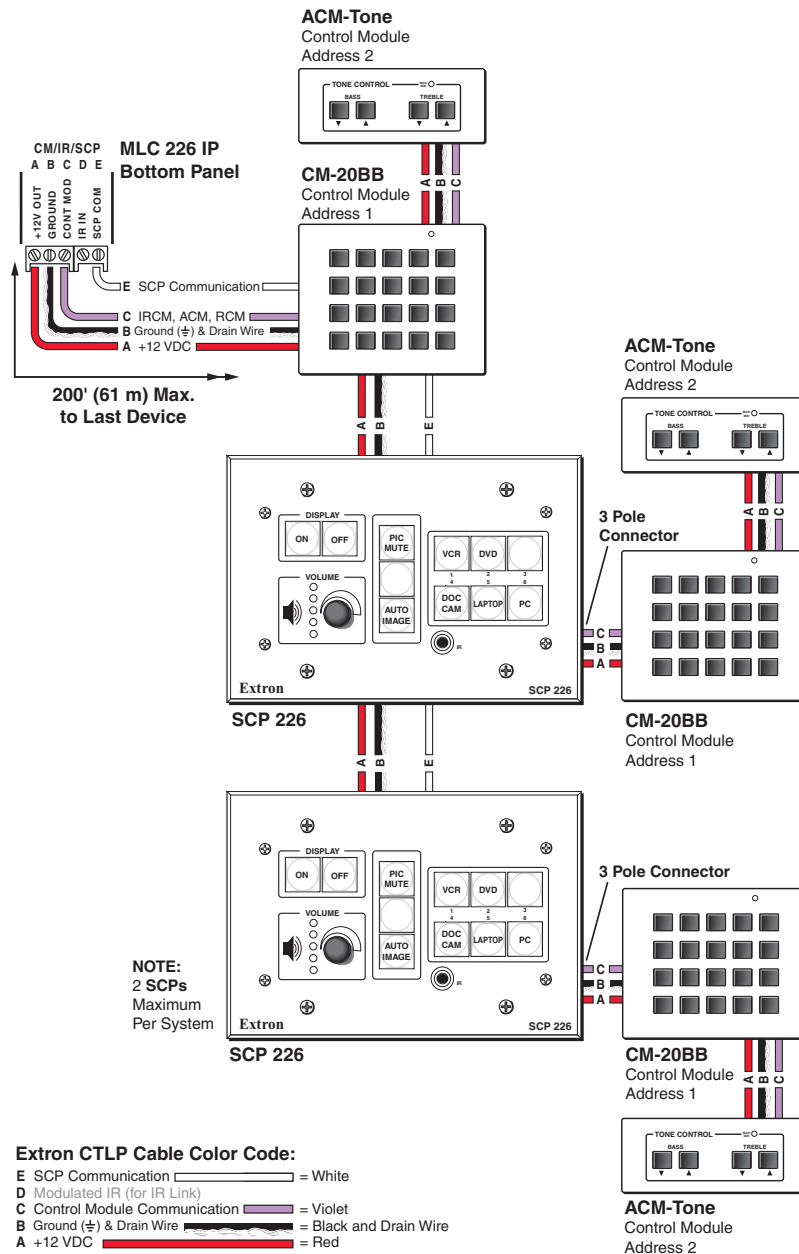

## Connections to SCP 226 control panels and control modules without an IR signal repeater

**NOTE** The control module(s) connected via an SCP's 3-pole connector must be the same models set to the same DIP switch addresses as the control modules connected directly to the MLC. For example, if an IRCM-VCR and a CM-5BB are connected to the MLC's port, each SCP should have an IRCM-VCR and a CM-5BB (and not other models) connected to its 3-pole connector.

### MLC 226 IP DV+ connections

The MLC 226 IP DV+ consists of an MLC 226 IP controller and an IRCM-DV+ installed in a high-impact plastic faceplate. The wiring is the same as in the previous diagram, except the IRCM-DV+ is cabled to the MLC at the factory and the IRCM-DV+ is the only type of control module that may be connected to each SCP's 3-pole connector. See the following diagram.

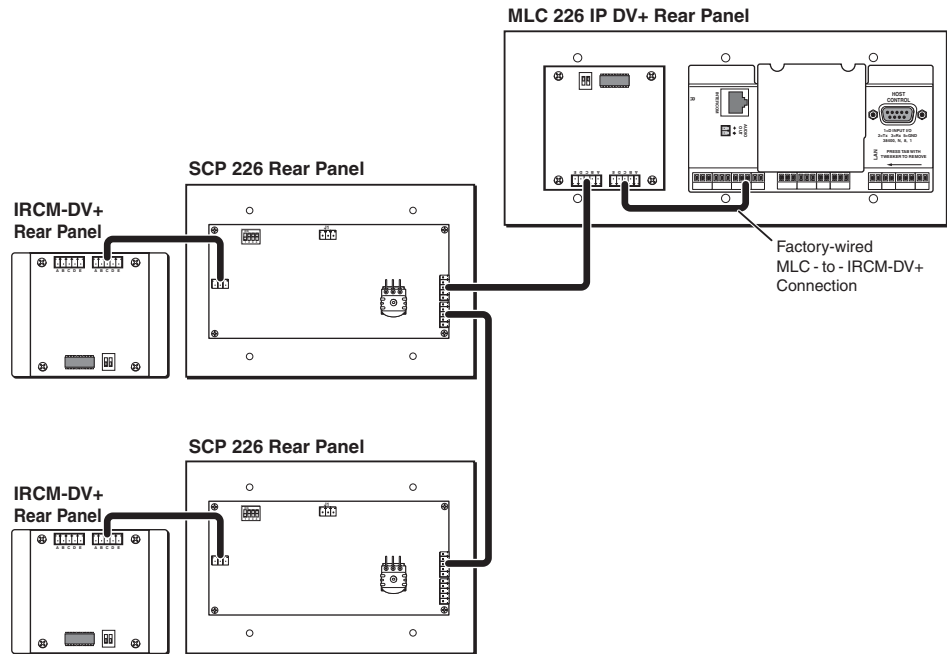

### An MLC 226 IP DV+ with SCPs and additional control modules

- ③ **Relay ports (24 V, 1 A)** — These six relays allow control of items such as room lighting, window coverings, and display screens. These contacts may be used to control any equipment as long as the contact specifications of a total of 24 volts at 1 ampere are not exceeded for each port. The pin assignments are shown in the following picture.

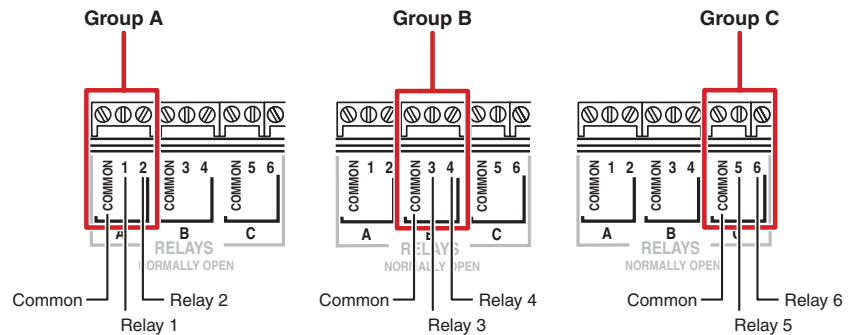

# Installation, cont'd

These relays are normally open by default. They will return to an open state if power is removed from the controller. They can be configured via SIS commands or the Global Configurator (GC) software to operate as follows:

- **on**—relay closes and stays closed until otherwise instructed
- **off**—relay opens and stays open until otherwise instructed
- **toggle**—relay changes from open to closed or from closed to open until otherwise instructed
- **pulse**—momentary (timed) (press to turn on, timeout to turn off)

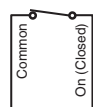
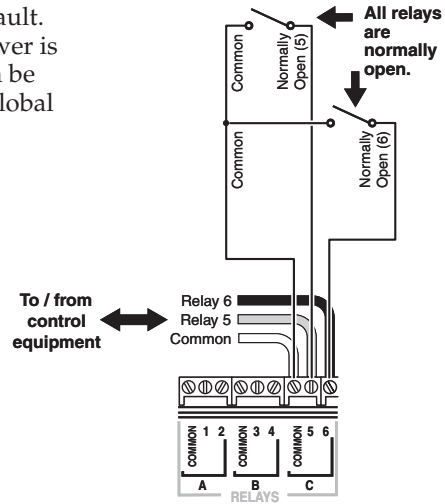

Relay On

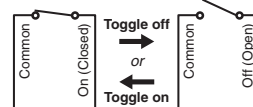

Relay Toggle

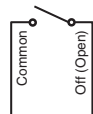

Relay Off

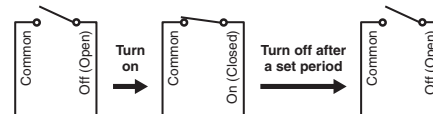

Relay Pulse

You can also use SIS commands or the GC software to specify pulse duration.

Via the GC software, each relay can be associated with a front panel button or it can be operated independently.

- ④ **IR/Serial Output ports** — Depending on how the MLC is configured, these ports output either infrared signals or unidirectional RS-232 signals for controlling various devices such as VCRs and DVD players. Before it can be used for controlling a device, each port must be set up via Global Configurator software for either IR or RS-232 communication and associated with a device driver.

For RS-232 output (-5 VDC to +5 VDC), use the illustration below as a wiring guide, then wire a serial cable into this captive screw connector.

**RS-232 default protocol:**

- 9600 baud
- no parity
- 8 data bits
- 1 stop bit
- no flow control

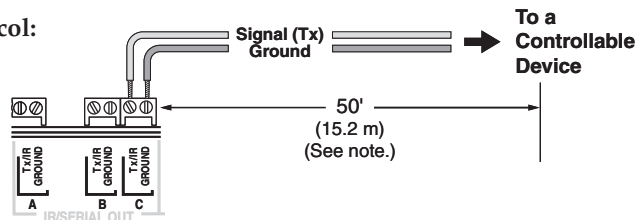

**NOTE** Maximum distances from the MLC to the device being controlled may vary up to 200 feet (61 m). Factors such as cable gauge, baud rates, environment, and output levels (from the MLC and the device being controlled) all affect transmission distance. Distances of about 50 feet (15 m) are typically not a problem. In some cases the MLC may be capable of transmitting and controlling a given device via RS-232 up to 250 feet (76 m) away.

**For infrared (IR) output (0 to +5 VDC), wire an IR Emitter (2 emitters, maximum, per port) as shown below for a modulated or demodulated signal and ground. For specific information about wiring more than one IR Emitter per port or about extending the length of the Emitter wires, refer to the Extron *IR Emitter Installation Guide*, part #68-808-01.**

**NOTE** *If installing two IR Emitters per port, wire them in series, not in parallel.*

Alternatively, an Extron IR Broadcaster can be connected here if you need to send out IR signals to a wider area than is possible for an IR Emitter. The IR Broadcaster requires a +12 VDC power connection. The +12 V Out and ground pins of the Display port can be used to provide this power.

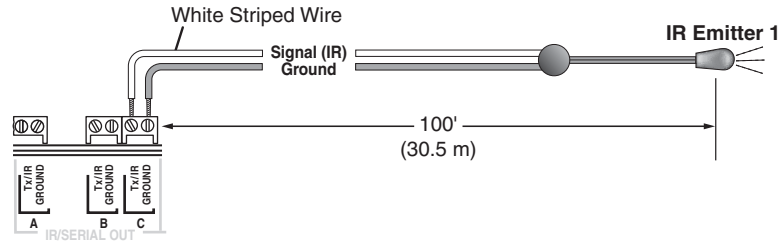

See chapter 4 for details on how to set up these ports for IR or RS-232 control.

- ⑤ **MLS connector** — For controlling an optional Extron switcher or other RS-232 controllable device, connect a cable between this 3.5 mm direct insertion captive screw connector and the RS-232 port of the other device. By default this port supports Extron MediaLink™ and PoleVault™ switchers (listed below) without additional drivers. If it is used to control other products, additional device drivers may be required.

**NOTE** *The commands issued from this port are standard Extron SIS™ commands, and they follow the typical Extron RS-232 protocol:*

- 9600 baud
- 8 data bits
- 1 stop bit
- no parity

**Supported Extron Devices**

MLS 304MA	MLS 506	MLS 103 V
MLS 304SA	MLS 506MA 70 V	MLS 103 SV
MLS 306	MLS 506MA 100 V	MLA-VC10
MLS 406	MLS 506SA	PVS 204SA
MLS 406MA	MLS 100 A	
MLS 406SA	MLS 102 VGA	

If you connect an optional switcher (such as an Extron MLS Series switcher) to the MLC, you **must** connect a ground wire between the switcher and the MLC, as shown in the following diagrams.

# Installation, cont'd

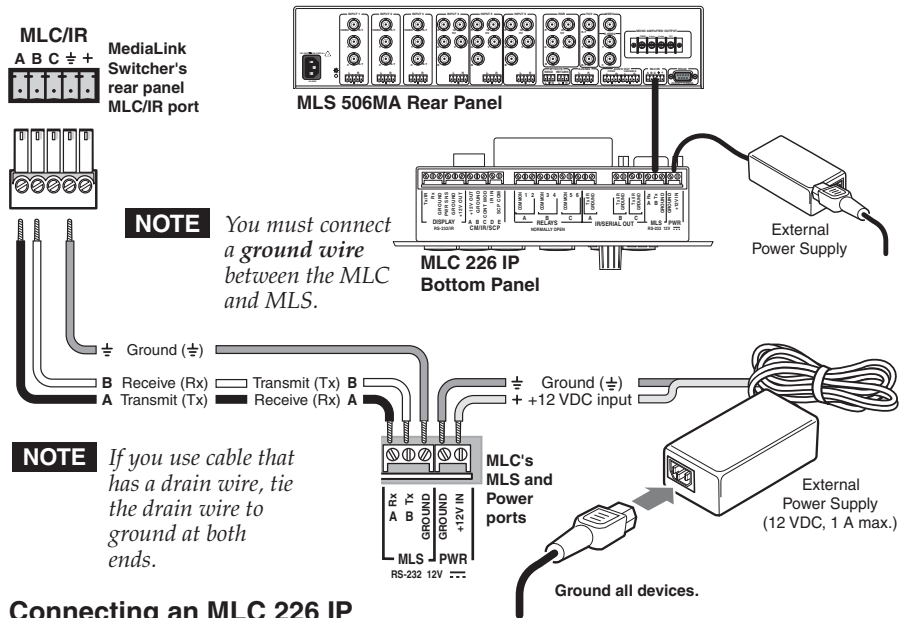

## Connecting an MLC 226 IP to a MediaLink Switcher and an external power supply

### Power connection

- 6 **PWR (power) connector** — To provide power to the MLC, connect a cable between this port and a 12 VDC, 1 amp (maximum) power supply. See the following diagram.

**NOTE** Power the controller via an external power supply, *not* from an Extron switcher. The controller requires a separate 12 VDC power supply.

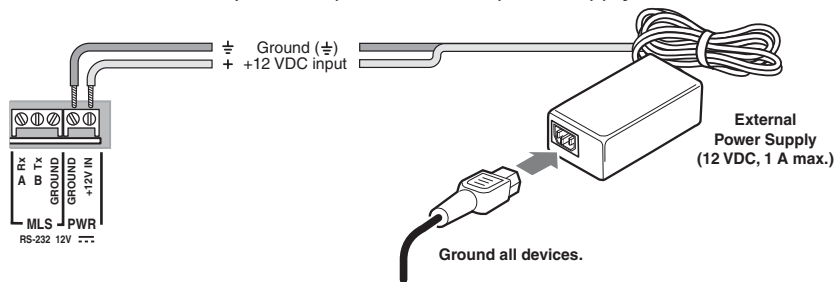

## Connecting an MLC 226 IP to an external power supply

**NOTE** Check the power supply's polarity before connecting it to the MLC. See the illustration at right.

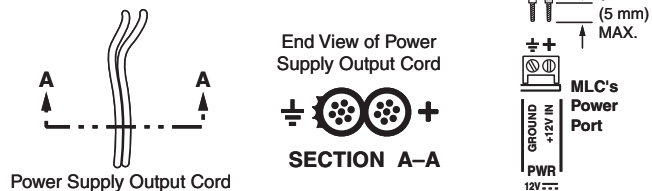

## Intercom connection

- ⑦ **Intercom connectors** — This port is used for power, control, and voice data communication between the MLC and an optional Extron IP Intercom (IPI 101 AAP or IPI 104 AAP). Plug one end of a standard, straight through, CAT 5, CAT 5e, or CAT 6 cable terminated with RJ-45 connectors into this port on the MLC. Plug the other end of the cable into the Intercom connector on the IP Intercom's rear panel, as shown below.

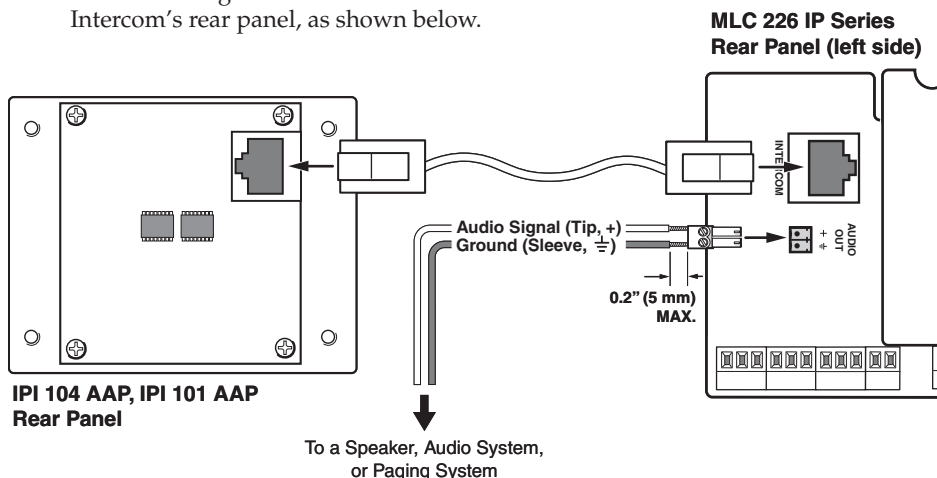

## Connecting an MLC 226 IP to an IP Intercom

**NOTE** A 12" (30.5 cm) CAT 6 cable is included with each IPI. If you choose to terminate your own cable, the cable must be no longer than 100' (30.4 m).

The MLC 226 IP Series controllers that support IPI intercom panels also have a rear panel, line level, unbalanced audio output port that can be connected to local, powered speakers or to any audio or paging system. See the wiring guide in the illustration above.

**NOTE** The volume for this audio output can be adjusted via IP Intercom HelpDesk™ software only.

## Side panel cabling and features

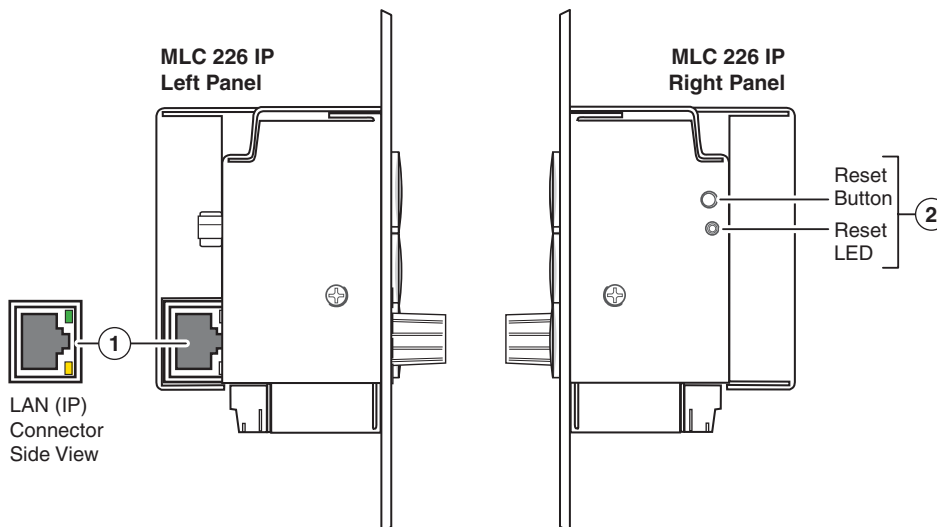

## Installation, cont'd

connected to it) in an Ethernet network. Plug a cable into this RJ-45 socket, and connect the other end of the cable to a network switch, hub, router, or PC connected to an Ethernet LAN or the Internet.

- For 10Base-T (10 Mbps) networks, use a Cat 3 or better cable.
- For 100 Base-T (max. 155 Mbps) networks, use a Cat 5 cable.

**You will also need to configure this port before using it.**

**Activity LED** — This yellow LED blinks to indicate network activity.

**Link LED** — This green LED lights to indicate a good network connection.

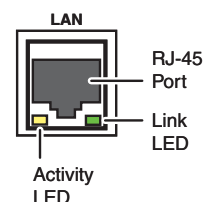

- Use a **straight-through cable** for connection to a switch, hub, or router.
- Use a **crossover cable** (included with the MLC) for connection directly to a PC. Wire the connector as shown in the tables at right.

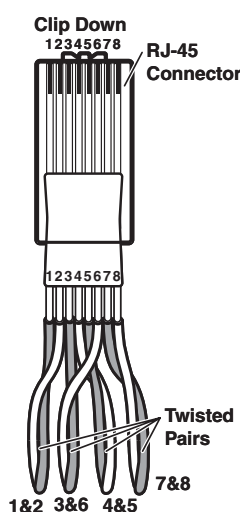

Configure the settings for this port via either SIS commands or Global Configurator. See the programming sections of this manual (chapters 4 and 5) for details.

### LAN port defaults:

- **MLC's IP address:** 192.168.254.254
- **gateway's IP address:** 0.0.0.0
- **subnet mask:** 255.255.0.0
- **DHCP:** off

- ② **Reset button and LED** — Pressing this recessed button causes various IP functions and Ethernet connection settings to be reset to the factory defaults. See "Resetting the Unit," in the next section of this manual, for details.

Straight-through Cable (for connection to a switch, hub, or router)			
Pin	End 1 Wire Color	Pin	End 2 Wire Color
1	white-orange	1	white-orange
2	orange	2	orange
3	white-green	3	white-green
4	blue	4	blue
5	white-blue	5	white-blue
6	green	6	green
7	white-brown	7	white-brown
8	brown	8	brown

Crossover Cable (for direct connection to a PC)			
Pin	End 1 Wire Color	Pin	End 2 Wire Color
1	white-orange	1	white-green
2	orange	2	green
3	white-green	3	white-orange
4	blue	4	blue
5	white-blue	5	white-blue
6	green	6	orange
7	white-brown	7	white-brown
8	brown	8	brown



## Resetting the Unit

There are four reset modes (numbered 1, 3, 4, and 5 for the sake of comparison with an Extron IPL product) that are available by pressing the Reset button on the side panel. The Reset button is recessed, so use a pointed stylus, ballpoint pen, or Extron Tweaker to access it. See the following table for a summary of the modes.

**CAUTION** Review the reset modes carefully. Using the wrong reset mode may result in unintended loss of flash memory programming, port reassignment, or a controller reboot.

**NOTE** The reset modes listed below close all open IP and Telnet connections and close all sockets. Also, the following modes are separate functions, not a continuation from Mode 1 to Mode 5.

Reset Mode Comparison/Summary			
Mode	Activation	Result	Purpose/Notes
1	<p>Hold down the recessed Reset button while applying power to the MLC.</p> <p><b>NOTE</b> After a mode 1 reset is performed, update the MLC's firmware to the latest version. Do not operate the MLC firmware version that results from the mode 1 reset. If you want to use the factory default firmware, you must upload that version again. See appendix B, "Firmware Updates," for details on uploading firmware.</p>	<p><b>The MLC reverts to the factory default firmware.</b> Event scripting will not start if the MLC is powered on in this mode. All user files and settings (drivers, adjustments, IP settings, etc.) are maintained.</p> <p><b>NOTE</b> If you do not want to update firmware, or you performed a mode 1 reset by mistake, cycle power to the MLC to return to the firmware version that was running prior to the mode 1 reset. Use the 0Q SIS command to confirm that the factory default firmware is no longer running (look for asterisks following the version number.)</p>	Use mode 1 to revert to the factory default firmware version if incompatibility issues arise with user-loaded firmware.
3	Hold down the Reset button for about 3 sec. until the Reset LED blinks once, then press Reset momentarily (<1 sec.) within 1 second.	<b>Mode 3 turns events on or off.</b> During resetting, the Reset LED flashes 2 times if events are starting, 3 times if events are stopping.	Mode 3 is useful for troubleshooting.
4	Hold down the Reset button for about 6 sec. until the Reset LED has blinked twice (once at 3 sec., again at 6 sec.). Then press Reset momentarily (for <1 sec.) within 1 second.	<p><b>Mode 4</b></p> <ul style="list-style-type: none"> <li>Enables ARP capability.</li> <li>Sets the IP address back to factory default.</li> <li>Sets the subnet back to factory default.</li> <li>Sets the default gateway address back to the factory default.</li> <li>Sets port mapping back to factory default.</li> <li>Turns DHCP off.</li> <li>Turns events off.</li> </ul> <p>Reset LED flashes 4 times in quick succession during reset.</p>	Mode 4 enables you to set IP address information using ARP and the MAC address.
5	Hold down the Reset button for about 9 sec. until the Reset LED has blinked three times (once at 3 sec., again at 6 sec., again at 9 sec.). Then press Reset momentarily (for <1 sec.) within 1 second.	<p><b>Mode 5 performs a complete reset to factory defaults (except the firmware).</b></p> <ul style="list-style-type: none"> <li>Does everything mode 4 does.</li> <li>Resets almost all the real time adjustments: all audio settings, limit initial power up volume, power up/down delay, auto power down, and misc. options. This does not affect an optional MLS switcher, however.</li> <li>Clears driver-port associations and port configurations (IR/RS-232).</li> <li>Removes button configurations.</li> <li>Resets all IP options.</li> <li>Removes scheduling settings.</li> <li>Removes/clears all files from switcher.</li> </ul> <p>The Reset LED flashes 4 times in quick succession during the reset.</p>	Mode 5 is useful if you want to start over with configuration and uploading, and also to replace events.

# Installation, cont'd

## Pinout Guide

The illustration below summarizes the pin assignments of all of the MLC's bottom panel connectors that are covered in detail on pages 2-5 to 2-14.

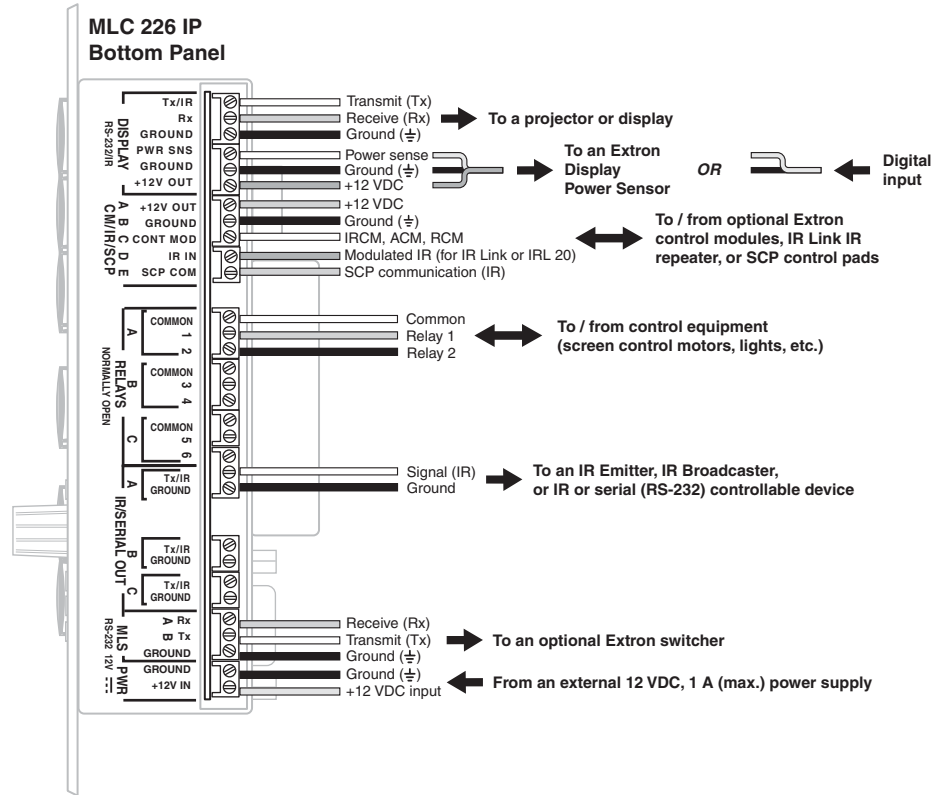

## Mounting the MLC

Once the system has been cabled, configured (see chapter 4), and tested, the controller can be installed in the wall, furniture, equipment rack, or Euro Channel.

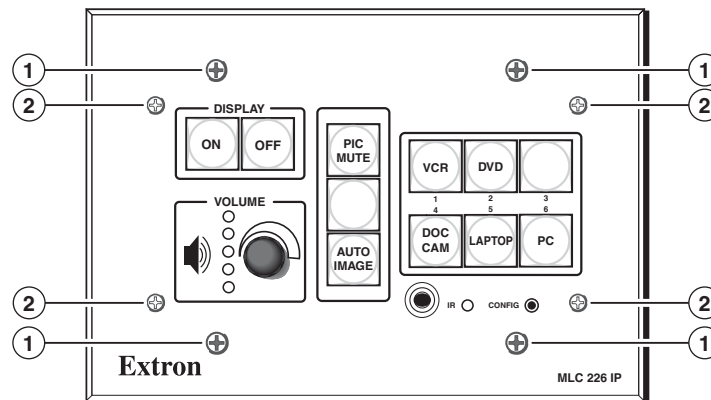

- ① **Mounting screws (4)** — Use these to attach the MLC to a wall, furniture, or other mounting surface.
- ② **Faceplate attachment screws (4)** — Do **not** remove these screws during or after mounting. They attach the faceplate to the MLC unit. Removing these screws during or after mounting will cause the MLC to detach, and it may then fall down into the wall or furniture.

## Mounting the MLC to an electrical box or mud ring

1. With power disconnected at the source, insert the MLC into the wall or furniture.
2. Mount the MLC to the wall box or mud ring mounting bracket with the provided machine screws (mounting screws, as shown in the following illustrations).

**NOTE** If the MLC (and any accessories such as control modules or an IR Link) is not mounted to a grounded metal wall box,

- Ground each faceplate directly to an earth ground. Or...
- Tie each faceplate to its circuit board and power supply via a ground pin on one of the connectors.

Do not tie a product's faceplate to both a separate earth ground and the circuit ground (via a connector pin). If you tie a product to two different ground sources, you may introduce ground loops or other grounding-related problems into the system.

**NOTE** For the installation to meet UL requirements and to comply with National Electrical Code (NEC), the MLC must be installed in a UL approved junction box. The end user or installer must furnish the junction box; it is not included with the MLC.

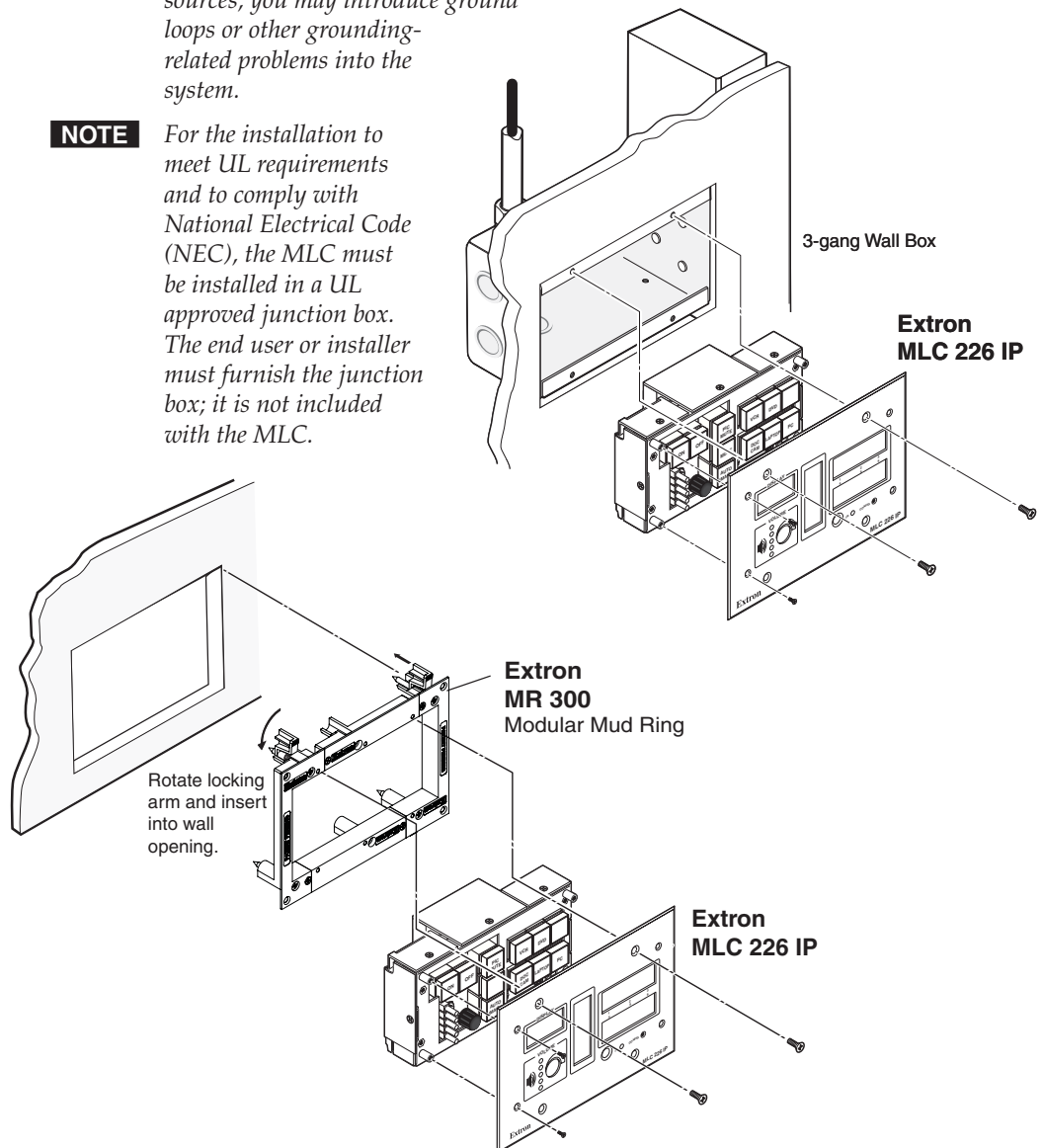

## Mounting the MLC to an electrical box or mud ring

# Installation, cont'd

## Mounting the MLC to a wall or furniture

1. If you have an MLC 226 IP Series model other than the MLC 226 IP L, remove the four faceplate attachment screws and remove the original faceplate, if applicable.
2. If you have a model other than the MLC 226 IP L, attach the optional lectern mounting faceplate to the MLC with the screws removed in step 1.
3. With power disconnected at the source, insert the MLC into the wall or furniture.
4. Fasten the MLC and faceplate directly to the furniture or wall using wood screws.

**NOTE** If the MLC (and any accessories such as control modules or an IR Link) is not mounted to a grounded metal wall box,

- Ground each faceplate directly to an earth ground. Or...
- Tie each faceplate to its circuit board and power supply via a ground pin on one of the connectors.

Do not tie a product's faceplate to both a separate earth ground and the circuit ground (via a connector pin). If you tie a product to two different ground sources, you may introduce ground loops or other grounding-related problems into the system.

**NOTE** For the installation to meet UL requirements and to comply with National Electrical Code (NEC), the MLC must be installed in a UL approved junction box. The end user or installer must furnish the junction box; it is not included with the MLC. See "Mounting the MLC to an electrical box or mud ring" on the previous page.

## Rack mounting an MLC 226 IP L

1. Attach an MLC 226 IP L to an optional rack mounting faceplate (UCM-RAAP) with the provided mounting machine screws and nuts.
2. With power disconnected at the source, fasten the MLC and faceplate to the rack using the supplied machine screws as shown in the following illustration.

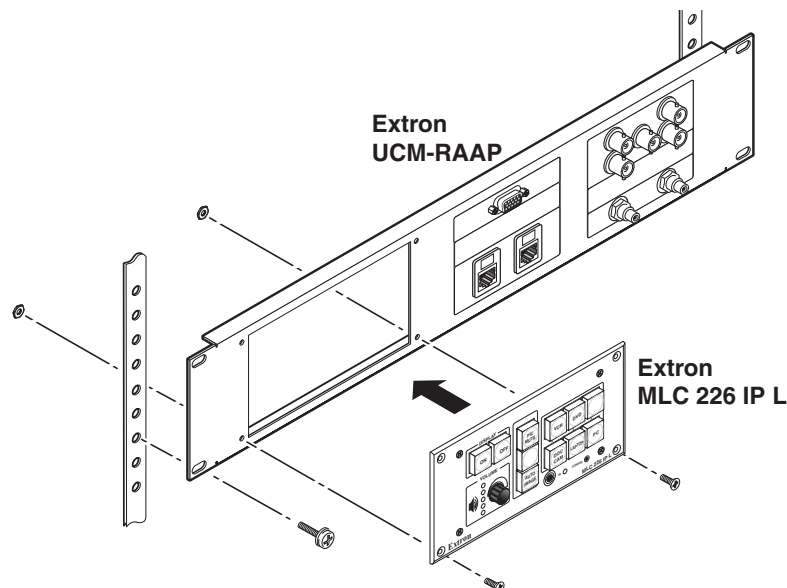

**Rack mounting the MLC 226 IP L**

---

## UL rack mounting requirements

The following Underwriters Laboratories (UL) requirements pertain to the safe installation of the MLC in a rack.

1. Elevated operating ambient temperature — If installed in a closed or multi-unit rack assembly, the operating ambient temperature of the rack environment may be greater than room ambient temperature. Therefore, install the MLC in an environment compatible with the maximum ambient temperature ( $T_{ma} = +122\text{ }^{\circ}\text{F}$ ,  $+50\text{ }^{\circ}\text{C}$ ) specified by Extron.
2. Reduced air flow — Install the equipment in a rack so that the amount of air flow required for safe operation of the equipment is not compromised.
3. Mechanical loading — Mount the equipment in the rack so that a hazardous condition is not achieved due to uneven mechanical loading.
4. Circuit overloading — Connect the equipment to the supply circuit and consider the effect that circuit overloading might have on overcurrent protection and supply wiring. Appropriate consideration of equipment nameplate ratings should be used when addressing this concern.
5. Reliable earthing (grounding) — Maintain reliable grounding of rack-mounted equipment. Pay particular attention to supply connections other than direct connections to the branch circuit (e.g. use of power strips).

## Mounting the MLC in a Euro Channel

1. Remove the four faceplate attachment screws and remove the original faceplate, if applicable.
2. Attach the optional MLM 226 EC or MLM 226 AAP EC faceplate to the MLC with the screws removed in step 1.
3. With power disconnected at the source, insert the MLC into the Euro Channel. For wider types of Euro Channels, you may need to insert a spacer plate first.
4. Mount the controller to the Euro Channel by attaching the faceplate to the two backing plates using four #4-40 mounting screws. See the illustration below.

**NOTE** *Make sure that the Euro Channel is grounded to an earth ground before completing the installation.*

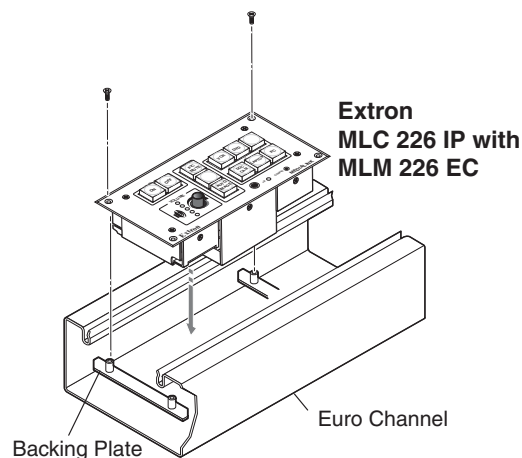

### Mounting the MLC 226 IP to a Euro Channel

# Installation, cont'd

---



## MLC 226 IP Series

# Chapter Three

## Operation

Projector Control

Front Panel Features and Operation

Optional Control Modules and IR 402 Remote Control

Front Panel Security Lockout (Executive Mode)

# Operation

## Projector Control

The MLC can control a projector or other display device by using IR or RS-232 control. The MLC must be configured for projector control in one of the following ways before it will send commands to the projector:

- An IR or an RS-232 driver file can be installed from a disk, downloaded from the Extron Web site ([www.extron.com](http://www.extron.com)), or downloaded from Extron using the driver subscription feature within Global Configurator. The driver is saved to a folder within C:\Program Files\Extron\Driver2, and it is uploaded to the MLC via Global Configurator.
- RS-232 command strings can be entered directly from a host computer using Extron Global Configurator software.
- IR commands can be entered directly from an IR remote control through IR learning and the Extron IR Learner software to create a driver that the MLC can use. IR learning is convenient for installing new or updated commands into the MLC in the field.

See chapter 4 and the Global Configurator help file or the IR Learner help file for details on setting up the MLC and for downloading, programming, or learning projector control commands.

## Front Panel Features and Operation

**NOTE** Many features must be set up in order for the MLC to function. See chapter 4, "Software-based Configuration and Control", and the MLC 226 IP Series Setup Guide for information about Global Configurator, which you must use to set up most features of the MLC.

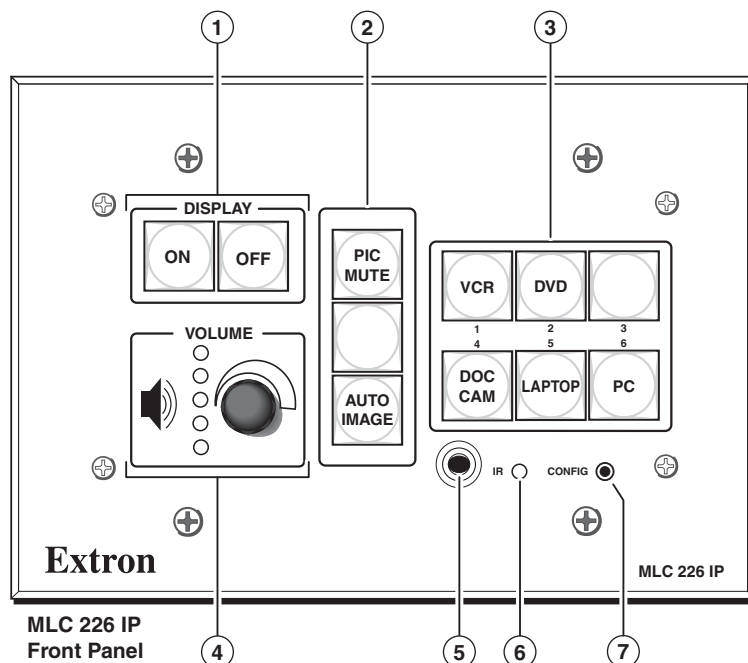

### Buttons

The MLC 226 IP Series controllers have backlit buttons. The functions, events, and scripts associated with these buttons are available in all models. Pressing the corresponding button on the Extron IR 402 remote control or an Extron SCP 226 keypad will cause that button's functions to be executed exactly as if you had pressed a front panel button.



Each Display On/Off, Function/Room, and Input button can be set up to perform several functions, which can be combinations of the following options:

- a **driver operation**—execute an RS-232 or IR control command that is part of a device driver (for a projector, VCR, DVD, audio source, etc.)
- a **relay operation**—turn relays on or off, or toggle or pulse a relay
- a **time delay operation**—insert delays between executed commands
- a **button light operation**—change a front panel button’s brightness, color, or flashing
- a **digital input/output operation**—turn the digital output on or off, toggle it, or pulse it
- a **user-defined RS-232 operation**—issue a non-driver-associated RS-232 command (one that you programmed separately) via a specific port (IR/Serial Out A, B, C; or the projector control port) or an internal command for the MLC, itself

By default all buttons illuminate brightly when selected (active), and light dimly when deselected. The button caps are removable so the button labels can be changed.

- ① **Display On/Off buttons** — After they have been configured, press the On button to turn the projector or display device on, and press the Off button to power it off. By default, only one of these two buttons can be selected (active) at once. Via Global Configurator (GC) software, other functions and relays can be associated with each of these buttons.
- ② **Function/room control buttons** and ③ **input selection buttons** — Each of these buttons can be assigned several functions apiece, depending on how the MLC is set up and what mode is active. Each button can be configured to control the MLC’s relays, execute the IR or RS-232 commands of your choice, or trigger event scripts and/or port monitoring.

The relays can be used to control items in the room such as a projector lift, screen motor, or lighting. For details on how the relays operate and can be configured, see the installation instructions in chapter 2 and the configuration software information in chapter 4.

- ② **Function/room control buttons** — These have the same capabilities as the input selection buttons (③), but are typically used for triggering commands and functions other than input selection. The F1, F2, and F3 buttons on the optional IR 402 remote control correspond to these buttons. By default these three buttons are each associated with a latching relay, as shown at right. However, any software-based configuration, regardless of whether the function buttons are configured or not, overrides the default associations between these buttons and the relays.

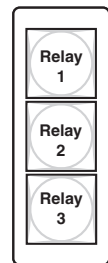

- ③ **Input selection buttons** — These buttons, labeled 1! through 6!, have the same capabilities as the function/room buttons (④) and can be configured to perform a variety of functions. By default they are a mutually exclusive group: only one of these buttons can be selected at a time. Also, by default each button is associated with an Extron input switching SIS command (1!, 2!, 3!, and so forth) and bidirectional communication via the MLC’s MLS RS-232 port. See the picture at right.

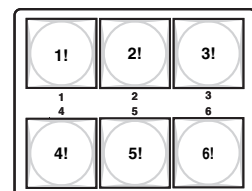

## Operation, cont'd

Alternatively, the buttons can be reconfigured (via software) to select different inputs and to trigger different commands to be issued. See chapters 4 and 5 for details.

Press an input selection button to select the desired audio and video input on the projector or an optional Extron switcher. The button lights brighter and remains lit while an audio-video input is selected.

**NOTE** *When these input selection buttons are configured for input switching, there is a default 0.5 second delay between when one input is selected and when a different input can be selected. This allows time for the projector to adjust to the change of sync signals. The delay period is adjustable.*

If the MLC is used without an optional switcher and the MLC has been set up for use with a projector, the selectable inputs on the MLC correspond to the number of inputs available on the projector. If an optional Extron switcher is connected to the MLC, all six input buttons are selectable. Which buttons are and aren't configured for input switching can be set via Global Configurator.

**NOTE** *When an input selection button is designated for input switching, pushing that button causes the MLC to send out an SIS input change command via the MLS RS-232 connector. In addition it can make the MLC send projector control commands through the Display RS-232/IR port, trigger a relay, or send an IR or serial command via an IR/Serial Out port.*

*The default Extron SIS commands sent for each input via the MLS connector are shown at right. If desired, you can reassign (remap) any input from 1 to 99 to these input buttons. Button remapping can be convenient if a switcher is slaved to the MLC.*

Button	Command
Input 1	1!
Input 2	2!
Input 3	3!
Input 4	4!
Input 5	5!
Input 6	6!

### Volume control

④ **Volume knob and LEDs** — Rotate this knob clockwise to increase the audio volume, counterclockwise to decrease volume. Volume can be adjusted via this front panel knob, the corresponding knob on an SCP control panel, the Volume up/down buttons on an IR 402 remote control, or via RS-232/Telnet/Web browser control.

The Global Configurator software lets you select whether this knob controls the projector's audio levels or the optional switcher's audio levels. If the knob controls the projector's audio levels, you can specify incremental adjustments or range-based adjustments (via device driver only). See chapter 4 and the software's help file for details.

**NOTE** *Not all devices that use RS-232 for audio level control can be properly controlled using the MLC's Volume knob. Some devices cannot respond quickly enough to the commands issued to them by the MLC.*

- *If the projector uses range adjustments, that can result in choppy audio level ramping (volume changing in jumps).*
- *If the projector uses incremental adjustments (volume up/down commands), that can result in slow audio ramping (requiring many turns of the knob to change the volume).*

*If you experience problems using range-based audio control with a projector or other device, try slowing down the MLC's volume knob command rate by using the 49# SIS command (see page 5-39 for details) or encoder scaling in Global Configurator (see page 4-14). If you need further assistance, contact Extron and ask to speak with an applications engineer.*

If the MLC is configured for use with a MediaLink Switcher or for some projectors, the MLC's LEDs light to indicate volume ranges (with steadily lit LEDs) and minimum/maximum volume limits (with flashing LEDs), as shown in the following diagram.

#### Range-based Volume Adjustment

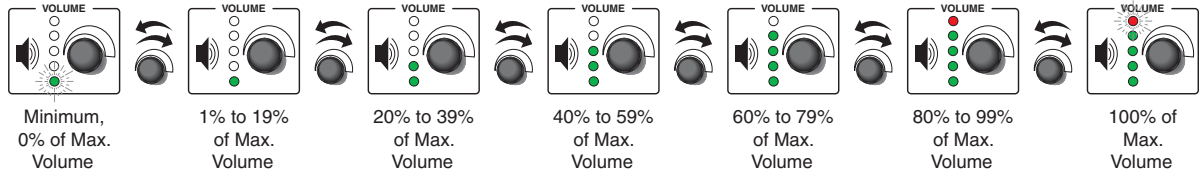

If the MLC is configured for increment/decrement volume adjustment, the LEDs scroll up/down briefly. See the example below.

#### Increment/Decrement-based Volume Adjustment

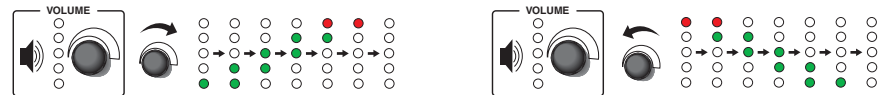

## IR signal sensors

These sensors allow for IR remote control of the MLC and for IR learning. The IR remote control must be pointed directly at these devices for best results.

- ⑤ **IR control receiver** — This larger infrared receiver accepts IR signals from the Extron IR 402 infrared remote control, which mimics the MLC's front panel controls.

**NOTE** *If outside interference (such as fluorescent lighting) affects the MLC's functioning, you may need to disable IR control. Front panel IR control can be disabled using the 65# special function SIS command. See page 5-40 for details.*

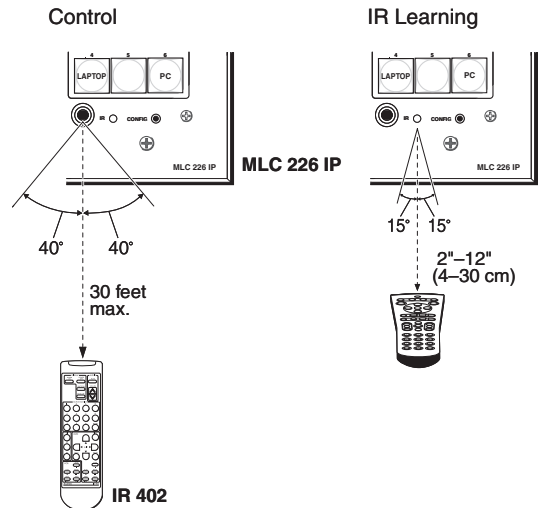

- ⑥ **IR learning receiver** — This smaller sensor receives and "learns" commands from other devices' infrared remotes in order to control the projector or input devices such as a VCR or DVD player. IR learning of projector control codes is only necessary if there are no RS-232 codes available for that projector or if you need to customize the driver. Refer to the IR Learner help file for IR learning procedures. This receiver accepts infrared signals of from 30 kHz to 62 kHz.

# Operation, cont'd

## Configuration port

- ⑦ **Config (host control) port** — This is a front panel version of the rear panel Host Control port (the 9-pin D connector), and it is independent of that port. This port makes it possible to upload and configure device drivers and also to initiate IR learning via a front panel connection after the MLC has been installed.

Connect a Windows-based PC or an RS-232 control system to this 2.5 mm mini stereo-style (tip-ring-sleeve) connector. You can use the Extron 9-pin D to 2.5 mm stereo mini TRS RS-232 cable (part #70-335-01) or make your own cable. See page 2-4 for a wiring diagram and port protocol.

**NOTE** This port requires 38400 baud communication, a higher speed than many other Extron products use. The MLC configuration software automatically sets the connection for the appropriate speed. If using HyperTerminal or a similar application, make sure the PC connected to these ports is set for 38400 baud.

**NOTE** Extron recommends configuring and controlling the MLC via the LAN connector. Ethernet connections are faster and more reliable.

## Optional Control Modules and IR 402 Remote Control

The MLC can “learn” IR commands from a VCR’s, DVD’s, tape deck’s or other device’s remote control, allowing you to create an IR driver file that can be incorporated into the MLC’s event scripts. A command can be associated with each of the buttons on an optional infrared control module (such as the Extron IRCM-VCR, IRCM-DVD, IRCM-DVD+, or IRCM-DV+) in order to allow limited control of source devices. ACM control modules provide limited remote control of adjustments to a slaved MediaLink Switcher (MLS).

A total of four control modules (a maximum of four control module addresses) can be installed with this MLC. Refer to the *Control Modules User’s Manual* and the *IRCM-DV+ Control Module User’s Manual* for installation details. See chapter 4 of this manual for special instructions for the IRCM-DV+.

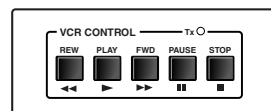

IRCM-VCR

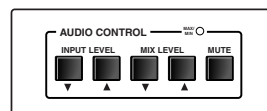

ACM-Level

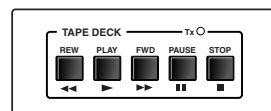

IRCM-Tape

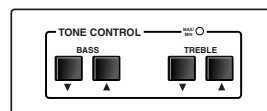

ACM-Tone

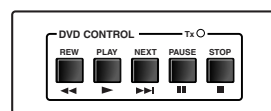

IRCM-DVD

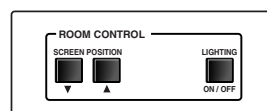

RCM-SCLT

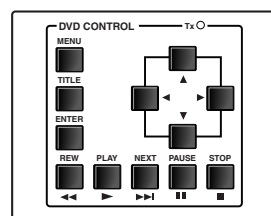

IRCM-DVD+

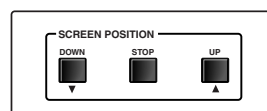

RCM-SC

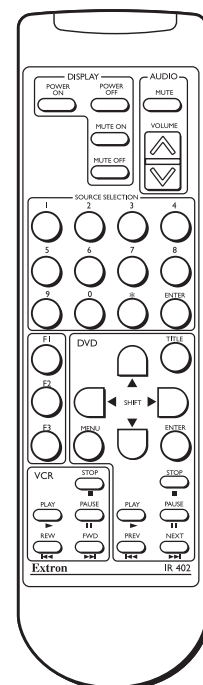

**IR 402**  
**IR remote control**

**A few optional IRCM, ACM, and RCM control modules**

---

The buttons on the optional IR 402 remote duplicate the MLC's front panel controls and also those of a VCR and a DVD player for normal operation. The IR 402 can also be used to control a MediaLink Switcher. The controller or switcher responds to commands from the IR 402 remote as if the corresponding button or knob were pressed or turned on the controller or switcher.

From a distance of no more than 30 feet and within 40° of the axis, the IR 402 sends infrared (IR) signals to

- a MediaLink Controller via the controller's front panel IR pickup device or the IR pickup device of an optional IR signal repeater.
- a MediaLink Switcher via a connected IR signal repeater. The switcher can receive signals from the IR 402 remote control only via an IR signal repeater.

**NOTE** *Setup operations cannot be performed from the remote control.*

The IR 402 remote's Display Power buttons, Display Mute buttons, and the VCR and DVD control buttons will not function until they have been programmed using GC version 2.2 or higher and uploaded into the MLC.

**NOTE** *Pressing the remote's Display Mute On and Display Mute Off buttons sends the 1M and 0M SIS commands (respectively) to the MLC.*

**NOTE** *To increase audio volume, press the Volume up (∧) button, rotate the MLC's Volume knob clockwise, or select a larger number in the Control tab of the MLC's embedded Web page.*

IR commands are transmitted from the MLC's Display RS-232/IR port and IR ports (via IR Emitters or optional IR Broadcaster) when the corresponding button is pressed on the remote or on the controller's, SCP's, or control module's front panel. Refer to the *Control Modules User's Manual*.

## Front Panel Security Lockout (Executive Mode)

To prevent accidental changes to settings, the MLC features front panel security lockout (executive) modes for disabling access to controls. When panel lockout is enabled, no one can make changes using the buttons or volume knobs on the MLC's front panel, an IR 402 remote control, SCP's control pad, or control modules. When the front panel is locked, functions and adjustments can be made only via RS-232, Telnet, or Web browser control. The Simple Instruction Set (SIS™) command 3X corresponds to this mode (see page 5-10). For details, see chapters 4 and 5. The only way to override a front panel lockout via the front panel is to enter a personal identification number (PIN) to unlock the panel, if conditions allow that.

### Enabling and disabling front panel lockout via the embedded Web pages and the front panel

When front panel lockout is enabled, if a button is pressed, the button flashes red, but no change occurs. Nothing—not input switching, projector control, room control, volume adjustment, or any other knob- or button-executable function—results from front panel actions when lockout is active. Changes can still be made via RS-232 or Ethernet (Telnet or Web browser) control.

Front panel lockout can be enabled/disabled using the embedded Web pages whether or not a PIN has been set. However, a PIN must be set up before you can enable or disable lockout using the front panel buttons.

## Operation, cont'd

### Using the Web pages

1. Using a Web browser, enter the MLC's IP address and open the MLC's embedded Web page. If an administrator password has been set and if you are prompted to do so, type in the administrator password.
2. Click on the **Configuration** tab, which opens to the System Settings page.
3. Select either **Off** or **Disable Front Panel, SCP, Control Modules and IR** in the Executive Mode settings area. See the following picture.

The screenshot displays the 'System Settings' web interface. At the top, there are navigation tabs for 'Status', 'Configuration', 'File Management', and 'Control'. The user is logged in as 'Admin' with a phone number '800.633.9876' and options for 'Log Off' and 'Contact Us'. The main content area is titled 'System Settings' and includes a brief introduction. Below this, there are three main sections: 'IP Settings', 'Date/Time Settings', and 'Executive Mode Settings'. The 'Executive Mode Settings' section is highlighted with a red border and shows the 'Disable Front Panel, SCP, Control Modules and IR' option selected.

IP Settings	
Unit Name:	MLC-226-IP-00-9A-BB
DHCP:	<input type="radio"/> On <input checked="" type="radio"/> Off
MAC Address:	00-05-A6-00-9A-BB
IP Address:	10.13.197.9
Firmware:	1.05
Gateway IP Address:	10.13.0.100
Model:	MLC 226 IP
Subnet Mask:	255.255.0.0
Part Number:	60-600-00

Date/Time Settings	
Date:	8 / 18 / 2006 Local Date/Time
Time:	1 : 38 PM
Zone:	(GMT-08:00) Pacific Time (US & Canada), Tijuana
Daylight Saving:	<input type="radio"/> Off <input checked="" type="radio"/> USA <input type="radio"/> Europe <input type="radio"/> Brazil

Executive Mode Settings	
Executive Mode:	<input type="radio"/> Off <input checked="" type="radio"/> Disable Front Panel, SCP, Control Modules and IR

**NOTE** If **Disable Front Panel, SCP, Control Modules and IR** is selected via the System Settings factory default Web page, front panel lockout can't be enabled/disabled via the front panel unless PIN Mode is enabled. See pages 5-39 to 5-40 to find the SIS commands for PIN enabling/disabling.

## Using the front panel

One or more PINs must be configured before this procedure can be used. See “Preparing the MLC for front panel lockout” later in this chapter.

**NOTE** Make sure the projector is off before using a PIN to lock the front panel.

### Locking the Front Panel of an MLC 226 IP Series Controller

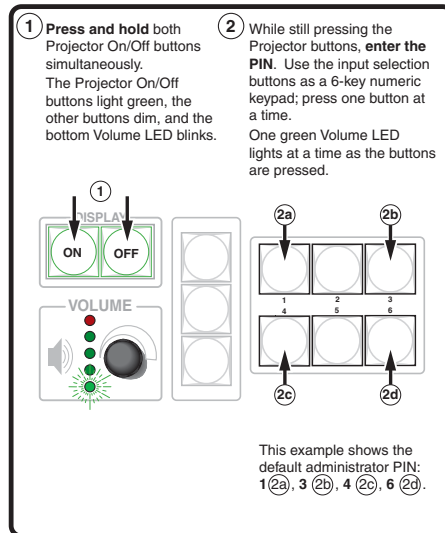

Release all buttons.

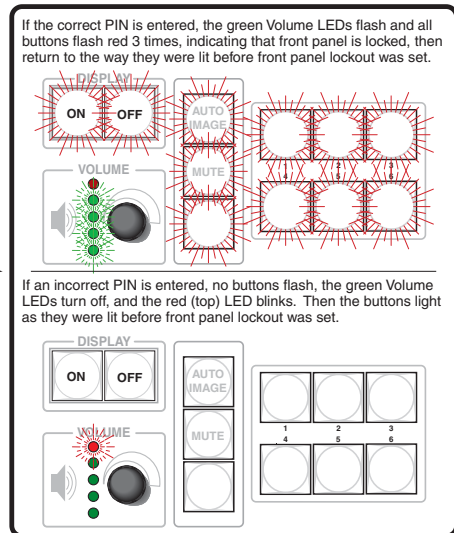

### Unlocking the Front Panel of an MLC 226 IP Series Controller

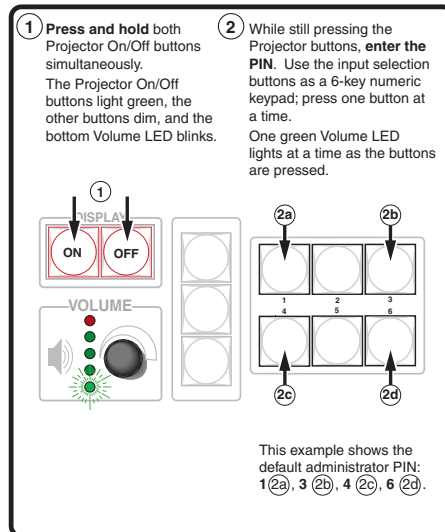

Release all buttons.

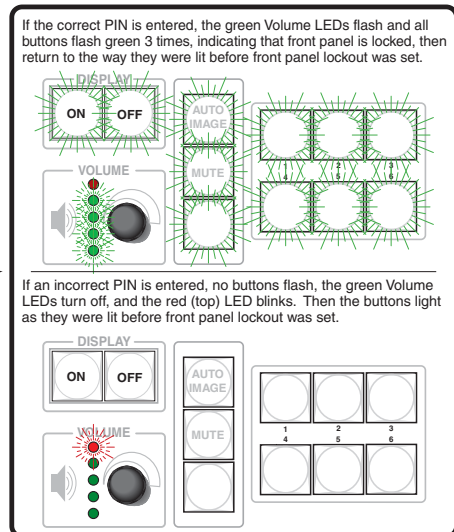

**NOTE** The PIN can be entered via either the MLC or the SCP.

**NOTE** Failure to configure the On or Off buttons to send display/projector commands upon button release (instead of button press) may cause problems with the PIN Mode feature. (If one On/Off button is pressed before the other, and the buttons are configured to send commands at the button press, the first button's actions can be executed, preventing you from locking the front panel until the display's warmup or cooldown period finishes.)

## Operation, cont'd

### Preparing the MLC for front panel lockout

To allow access to front panel changes to specific personnel while the front panel is locked, you can set a user and/or administrator PIN and set which type of PIN, if any, is allowed to unlock the panel.

#### Setting up and enabling or disabling PINs

1. Install and start the Extron Global Configurator (GC) software. See chapter 4.
2. Open an existing GC project or start a new project. Refer to the GC help file or the *MLC 226 IP Series Setup Guide* for instructions.
3. In the IP Link tab area on the left side of the screen, click on the name of the MLC you want to set up.
4. Click on the **Advanced Configuration** tab.
5. Select which PIN to enable (which PIN will be allowed to unlock the front panel), or disable both PINs so that no one can access the front panel during front panel lockout.

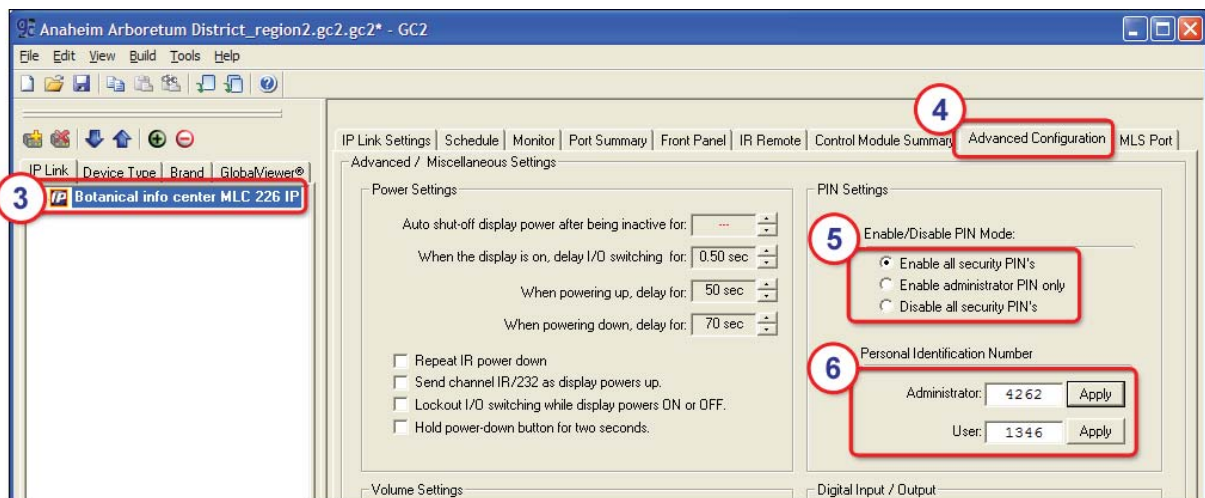

6. Type in the four-digit PINs for the administrator and for users. Each digit of the PIN must be a number from 1 to 6 because they represent the MLC's six input buttons, which will be used as a numeric keypad. By default, both PINs are set to 1346.
7. Complete the rest of the configuration, then save the project: click **File** and then **Save** or click the Save icon, shown at right.
8. Upload (build) the configuration to the MLC.





### Scheduling front panel lockouts

You can set the MLC's front panel to be automatically locked at certain times and days by setting up a schedule and uploading it to the MLC.

1. Start the Extron Global Configurator (GC) software. See chapter 4.
2. Open an existing GC project or start a new project. Refer to the GC help file or the *MLC 226 IP Series Setup Guide* for instructions.
3. In the IP Link tab area on the left side of the screen, click on the name of the MLC you want to set up.
4. Click on the **Schedule** tab in the right side of the screen, as shown below.

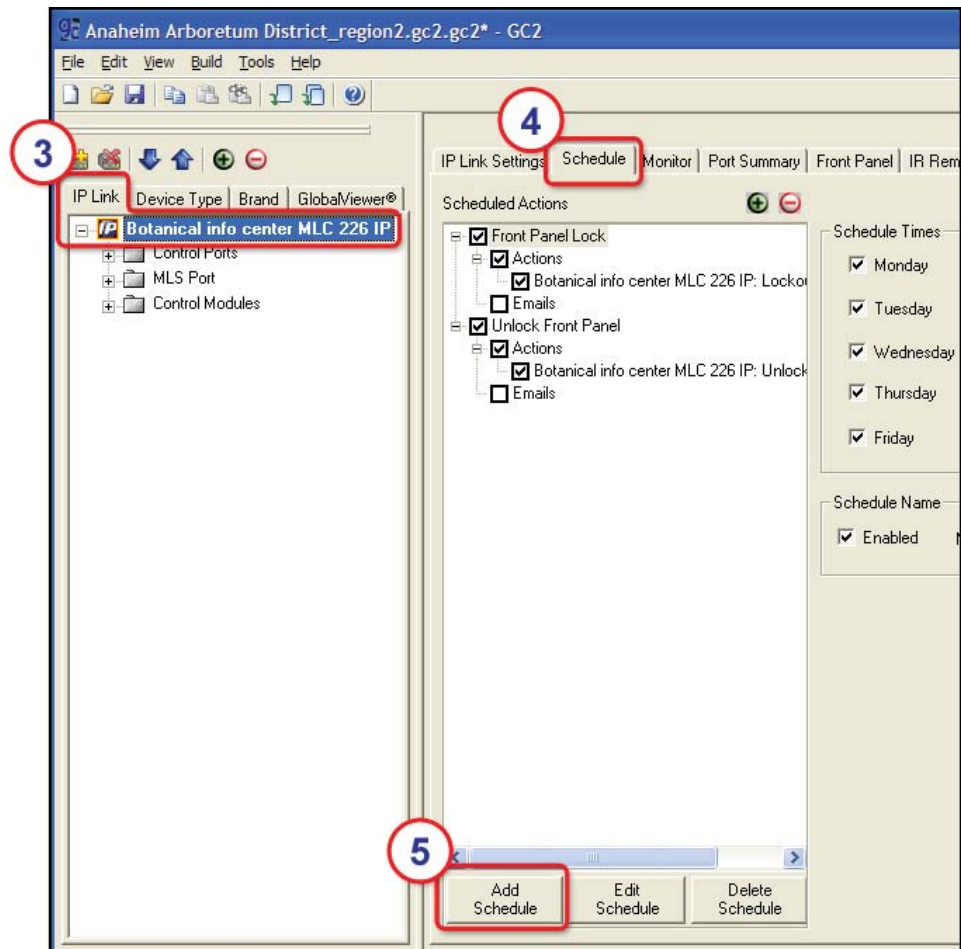

5. Click **Add Schedule**. The Scheduled Actions Wizard window appears.

## Operation, cont'd

6. Type in a name for the schedule that will automatically lock the MLC's panel.
7. In the Schedule Times area, select the days and hours when front panel lockout should start.

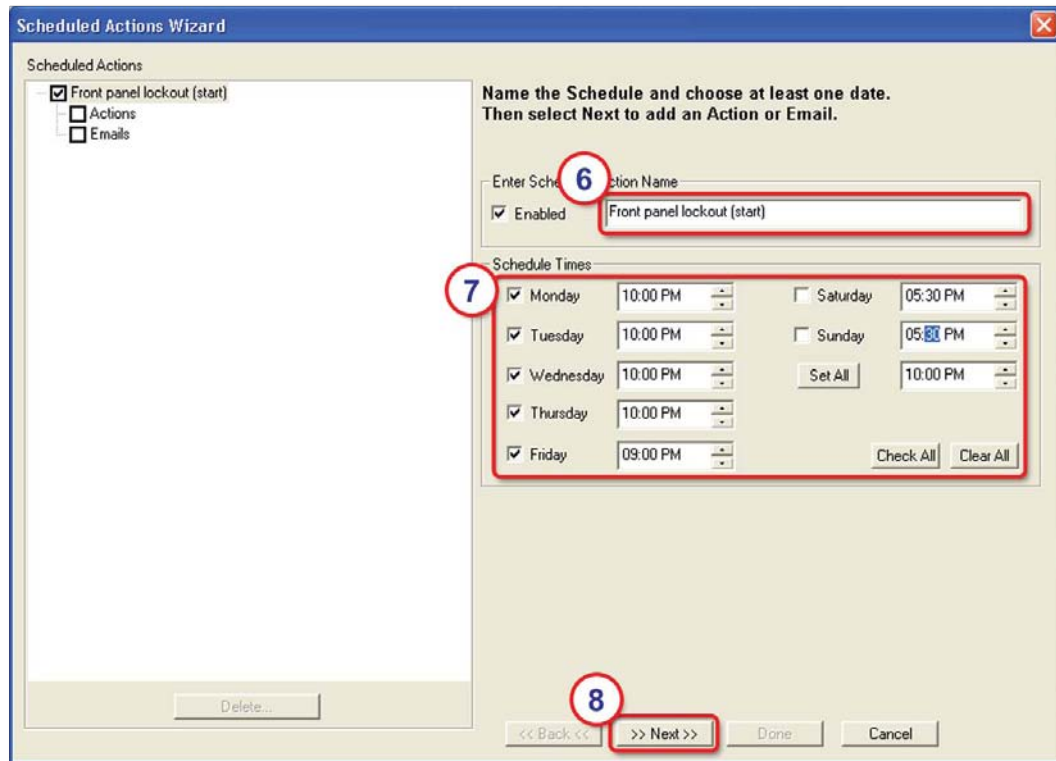

8. Click **Next**.
9. Set up the front panel lockout action for the MLC. See the illustration on the following page.
  - a. Check the **Action** check box.
  - b. Select the MLC, itself, from the Subject Ports list.
  - c. Click on **Lockout Front Panel** in the Available Options list. A default description appears in the Action Name area. If desired, you can change the name assigned to this action.
  - d. Click **Apply Action**.
  - e. Click **Done**. The Scheduled Actions Wizard window closes.

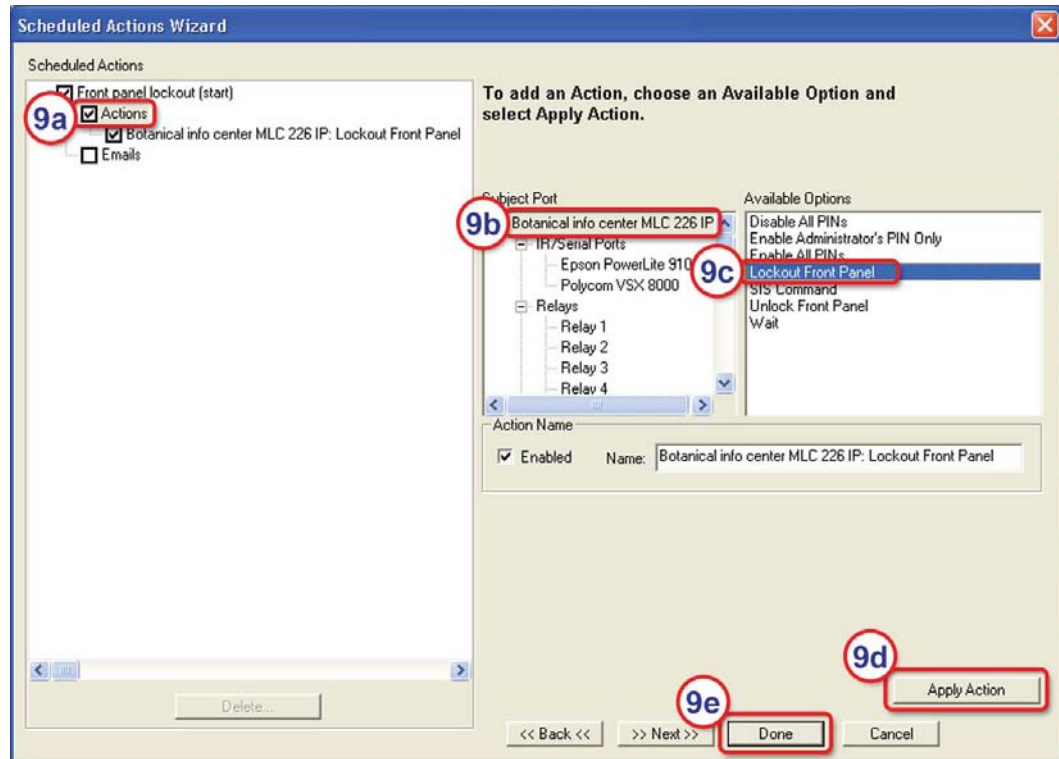

10. Click **Add Schedule**. The Scheduled Actions Wizard window reappears.
11. Type in a name for the schedule that will automatically unlock the MLC's panel.
12. In the Schedule Times area, select the days and hours when the front panel should be unlocked.
13. Click **Next**.
14. Set up the front panel unlock action for the MLC.
  - a. Check the **Action** check box.
  - b. Select the MLC, itself, from the Subject Ports list.
  - c. Click on **Unlock Front Panel** in the Available Options list. If desired, you can change the name assigned to this action in the Action Name area.
  - d. Click **Apply Action**.
  - e. Click **Done**. The Scheduled Actions Wizard window closes.
15. Save the project: click **File** and then **Save** or click the Save icon.
16. Upload the project to the MLC.
  - a. Click the **Build** menu and select one of the options (**Build Changed Configurations** or **Build All Configurations**).
  - b. Click the **Begin** button.
  - c. When the uploading is finished, click **Close**.

## **Operation, cont'd**

---



# 4 Chapter Four

## Software-based Configuration and Control

Configuration and Control: an Overview

The Basic Steps: A Guide to this Chapter and Other Resources

Configuring the MLC for Network Communication

Global Configurator Software for Windows®

Advanced Configuration

Controlling the MLC

Customizing the MLC's Control Web Pages

# Software-based Configuration and Control

---

## Configuration and Control: an Overview

An MLC 226 IP Series controller must be configured before use or it will not be able to control other devices. The MLC 226 IP can be configured and controlled via a host computer attached to the rear panel Host Control port or LAN port, or the front panel Config port. See chapter 2 for pin assignments and other details on the configuration and control ports.

**NOTE** *Extron recommends configuring and controlling the MLC via the LAN connector. Ethernet connections are faster and more reliable.*

- The primary means for configuring the controller is by using the Extron Global Configurator (GC) software. This method requires a properly configured PC with Windows® 2000, Windows XP, or a higher version of Windows installed. Global Configurator generates GlobalViewer™ Web pages that are uploaded to the MLC and can be used to control the MLC and make adjustments to its settings.

**NOTE** *Microsoft Internet Explorer is currently the only Web browser that supports GlobalViewer pages.*

- Alternatively, the default Web pages embedded within the MLC 226 IP provide a means to perform some setup, adjustment, and control via a Web browser (Netscape Navigator version 6.0+, Internet Explorer version 5.5+, or Mozilla Firefox version 1.0+) from any type of network-enabled computer.

**NOTE** *Netscape and Firefox cannot be used for viewing the Serial Control pages of the factory-embedded Web page. Run Internet Explorer to use those pages.*

- The third way to control and configure the controller is by using Simple Instruction Set (SIS) commands via Telnet, a Web browser, or RS-232. SIS commands are discussed in detail in chapter 5.

## The Basic Steps: a Guide to this Chapter and Other Resources

**1** **Configure the MLC for network communication.** See “Configuring the MLC for Network Communication” in this chapter.

**2** **Download or install Global Configurator and other Extron software (IR Learner) and device drivers.** See chapter 1 of the *MLC 226 IP Series Setup Guide*, the software disk(s) that were shipped with the unit, and the Extron Web site ([www.extron.com](http://www.extron.com)) for instructions.

**NOTE** *The printed MLC 226 IP Series Setup Guide is shipped with the MLC. It is also available as a PDF file on the Extron Web site ([www.extron.com](http://www.extron.com)). The CD included with the unit contains software, device drivers, a PDF file of the full user’s manual, and additional documentation available when the unit was shipped. The setup guide outlines most of the common tasks required to set up an MLC.*

**3** **Create a Global Configurator project and configure basic settings and functions.** See the *MLC 226 IP Series Setup Guide*, chapter 3, for step-by-step procedures.

**4** **Configure additional or advanced functions,** if desired. See “Advanced Configuration,” later in this chapter, for information on IR learning and on advanced configuration options in Global Configurator.

**5** **Save and upload the configuration to the MLC.** See the *MLC 226 IP Series Setup Guide*, chapter 3.

- 
- 6** Control the MLC and devices connected to it by using the MLC's embedded Web pages or its GlobalViewer (GV) Web pages. See "Controlling the MLC," later in this chapter.

## Configuring the MLC for Network Communication

To function together, both the PC and the MLC 226 IP must be configured correctly. Unless you use an RS-232 connection for all setup and communication with the controller, the PC must be network-capable with the proper protocols, and the MLC 226 IP must be set up so it can be connected to a LAN (local area network).

When you power on the MLC 226 IP for the first time, you have a choice of several ways to set up the controller's IP address:

- Use the Global Configurator software via an Ethernet connection.
- Use the ARP command with an Ethernet connection.
- Use a Web browser with an Ethernet connection.
- Use SIS commands via an RS-232 connection, or Telnet with an Ethernet connection.

If you use a Web browser or Telnet the first time you connect a PC to the controller via IP, you must temporarily configure the PC to communicate with the controller. See "Setting up the PC for IP communication with an MLC" later in this chapter. Then you must change the controller's default settings (IP address, subnet mask, and [optional] administrator name and password) in order to use the unit on an intranet (LAN) or on the Internet (WAN). After you have set up the MLC 226 IP for network communication, you can reset the PC to its original network configuration.

### MLC 226 IP's RS-232 protocol:

- 38400 baud
- 8 data bits
- 1 stop bit
- No parity
- No flow control

**NOTE** Both configuration ports require 38400 baud communication. This is a higher speed than many other Extron products use. The Global Configurator program automatically sets the connection for the appropriate speed. If using HyperTerminal or a similar application, make sure the PC or control system connected to these ports is set for 38400 baud.

### MLC 226's LAN port defaults:

- **MLC's IP address:** 192.168.254.254
- **Gateway's IP address:** 0.0.0.0
- **Subnet mask:** 255.255.0.0
- **DHCP:** off
- **Link speed and duplex level:** autodetected

Once the controller has been configured, an Ethernet (intranet or Internet) connection can subsequently be used to contact, configure, or control it.

**NOTE** Both your computer and the MLC must be connected to the same LAN. Alternatively, you can use a crossover Ethernet cable to connect the controller directly to your computer's Ethernet card.

The following instructions assume that you have already connected the Windows-based PC to the MLC 226 IP's LAN port or to the Host Control port or Config port, and powered on the controller and the PC.

# Software-based Configuration and Control, cont'd

## Configuring the MLC for network communication via Global Configurator software

You can configure the controller's IP address via an IP/Ethernet connection using the Extron Global Configurator (GC) Windows-based software.

Read the Global Configurator help file for basic information on using Global Configurator software and setting up a project. Also read the *MLC 226 IP Series Setup Guide*, revision B or higher, included with the controller, for step-by-step instructions of how to use GC to set up the MLC 226 IP's IP address.

## Configuring the MLC for network communication using the ARP command

You can use the ARP (address resolution protocol) command to set up an IP address for the controller. The ARP command tells your computer to associate the controller's MAC (media access control) address with the assigned IP address. You must then use the ping utility to access the controller, at which point the controller's IP address is reconfigured.

Use ARP to configure the MLC 226 IP's IP address as follows:

1. Obtain a valid IP address for the controller from your network administrator.
2. Obtain the controller's MAC address (UID #) from the label on its rear, top, or side panel. The MAC address should have this format: 00-05-A6-xx-xx-xx.
3. If the MLC has never been configured and is still set for factory defaults, go to step 4. If not, perform a Mode 4 system reset. For detailed information on reset modes, see "Resetting the Unit" in chapter 2, "Installation."

**CAUTION** *The MLC 226 IP must be configured with the factory default IP address (192.168.254.254) before the ARP command is executed, as described below.*

4. At the PC, access the MS-DOS command prompt, then enter the arp -s command. Enter the desired new IP address for the MLC and the MLC 226 IP's MAC address. For example:

```
arp -s 10.13.197.9 00-05-A6-00-9A-BB
```

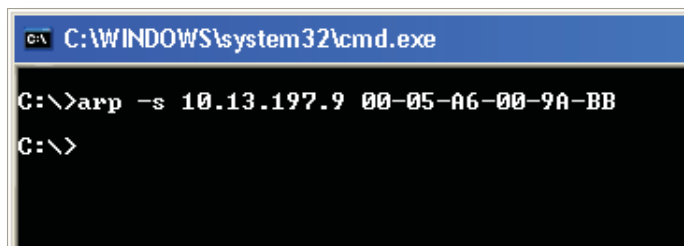

```
C:\WINDOWS\system32\cmd.exe
C:\>arp -s 10.13.197.9 00-05-A6-00-9A-BB
C:\>
```

**NOTE** *The MAC address is listed on the controller's rear or bottom panel.*

After the arp -s command is issued, the controller changes to the new address and starts responding to the ping requests, as described in the next step.

5. Execute a ping command by entering "ping" followed by a space and the new IP address at the command prompt. For example:

```
ping 10.13.197.9
```

You must ping the MLC in order for the IP address change to take place. The response should show the controller's new IP address, as shown in the following picture.



```
C:\WINDOWS\system32\cmd.exe
C:\>arp -s 10.13.197.9 00-05-A6-00-9A-BB
C:\>ping 10.13.197.9
Pinging 10.13.197.9 with 32 bytes of data:
Reply from 10.13.197.9: bytes=32 time=3ms TTL=64
Reply from 10.13.197.9: bytes=32 time=1ms TTL=64
Reply from 10.13.197.9: bytes=32 time<1ms TTL=64
Reply from 10.13.197.9: bytes=32 time<1ms TTL=64
Ping statistics for 10.13.197.9:
    Packets: Sent = 4, Received = 4, Lost = 0 (0% loss),
    Approximate round trip times in milli-seconds:
        Minimum = 0ms, Maximum = 3ms, Average = 1ms
C:\>_
```

You can reconnect using either Telnet or a Web browser to verify that the update was successful.

6. After verifying that the IP address change was successful, enter and issue the `arp -d` command at the DOS prompt. For example:  
`arp -d 10.13.197.9` removes 10.13.197.9 from the ARP table  
or  
`arp -d*` removes all static IP addresses from the ARP table.

## Configuring the MLC for network communication via a Web browser

The default Web pages that are preloaded on the MLC 226 IP are compatible with popular Web browsers such as Netscape Navigator (version 6.0 or higher), Internet Explorer (version 5.5 or higher), or Mozilla Firefox (version 1.0 or higher). However, the MLC and the PC must both be part of the same subnet before they can communicate via the LAN port. You must change the PC's IP address to one that is on the same subnet as the default IP address of the MLC (192.168.254.254).

**NOTE** This method requires a crossover cable. See page 2-14 for cabling details.

1. Temporarily change the host PC's IP address. See "Setting up the PC for IP communication with the MLC" later in this chapter for step-by-step instructions.
2. Obtain a valid IP address for the controller from your network administrator.
3. Launch the Web browser on the connected PC (for which you set up the network configuration earlier), and enter "http://192.168.254.254/" in the address box. The MLC 226 IP's default Web page is displayed.
4. Select the **Configuration** tab, then select **System Settings** from the menu on the left of the screen. A Web page appears. The top half of a typical screen is shown in the following picture.

## Software-based Configuration and Control, cont'd

The screenshot shows the Extron Electronics web interface for System Settings. The page title is "System Settings" and it displays various configuration fields for an MLC 226 IP. The fields include Unit Name (MLC-226-IP-00-9A-BB), DHCP (set to Off), IP Address (10.13.197.9), Gateway IP Address (10.13.0.100), Subnet Mask (255.255.0.0), MAC Address (00-05-A6-00-9A-BB), Firmware (1.05), Model (MLC 226 IP), and Part Number (60-600-00). There are "Submit" and "Cancel" buttons at the bottom of the form. The interface also shows navigation tabs for Status, Configuration, File Management, and Control, and a sidebar with links for System Settings, Passwords, Email Alerts, and Firmware Upgrade.

5. Set the MLC for the new IP address using either step 5a or step 5b.
  - a. Enter the new IP address for the MLC, the corresponding subnet mask, and the gateway address, then click on the **Submit** button. IP addresses, subnet mask, and e-mail addresses follow standard naming and numbering conventions/protocol. The IP network administrator should provide the IP addresses and subnet mask to be used with this controller. It takes a minute or so for the controller to store the new settings. Once the controller's IP address is changed, you lose communication with the controller.
  - b. Select **DHCP On**, then click **Submit**. It takes a minute or so for the controller to store the new settings. Once the controller's IP address is changed, you lose communication with the controller.
6. Close the browser.
7. After changing the controller's IP settings, change your PC's TCP/IP settings back to their original configuration.

### Configuring the MLC for network communication using SIS commands

#### RS-232

The MLC can also be configured using serial (RS-232) communication and a terminal emulation program such as HyperTerminal, which is installed with Windows. For information on RS-232 port requirements (including 38400 baud) and on Simple Instruction Set (SIS) commands, variables, and syntax, see chapter 5.

#### Telnet

The MLC and the PC must both be part of the same subnet before they can communicate via the LAN port. You must change the PC's IP address to one that is on the same subnet as the default IP address of the MLC (192.168.254.254).

**NOTE** This method requires connecting the MLC to the PC's LAN port using a *crossover* network cable. See pages 2-13 and 2-14 for cabling details.

1. Temporarily change the host PC's IP address. See "Setting up the PC for IP communication with an MLC" later in this chapter for step-by-step instructions.

2. Start Telnet on the PC
  - a. Click the **Start** menu and select **Run**. The Run dialog box appears.
  - b. Type *telnet*, a space, and the default IP address (192.168.254.254) into the Open area, and click **OK**.

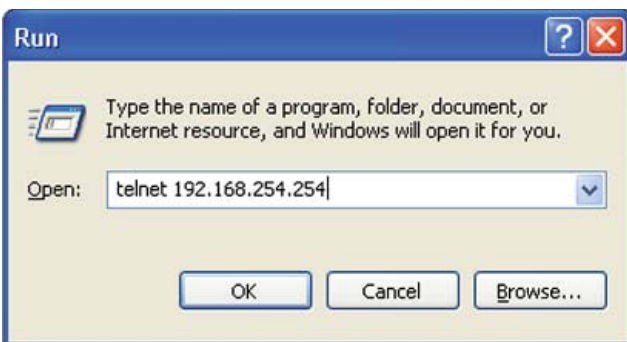

3. Set the MLC for the new IP address by doing **one** of the following:
  - Enter SIS command `[Esc] [X14] CI←`, where `[X14]` is the new IP address (see chapter 5, “SIS™ Programming and Control”) to set the IP address.

*or*

  - Enter SIS command `1DH←` to enable DHCP.
4. After changing the controller’s IP address, change your PC’s TCP/IP settings back to their original configuration.

## Setting up the PC for IP communication with an MLC

You need a Windows-based (Windows 2000, XP, or higher) PC equipped with an operating network adapter. To allow your PC to work with Extron’s Ethernet-controlled products, the TCP/IP protocol must be installed and properly configured.

When setting up the MLC for network communication via a Web browser or Telnet connection, you must change the IP address of the PC to one that is on the same subnet as the MLC. This is **not** required if you are setting up the MLC for network communication via Global Configurator, the ARP command, or SIS commands via an RS-232 connection.

If you use an existing Ethernet LAN intranet, your network administrator can provide you with a unique IP address for the controller or confirm whether you need to set up the MLC 226 IP for DHCP (Dynamic Host Configuration Protocol) to have an address assigned automatically when you sign on.

1. Open the Network Connections page as follows:

- Locate and right-click on **My Network Places** on the Windows (2000, XP, or higher) desktop, then click on **Properties**.

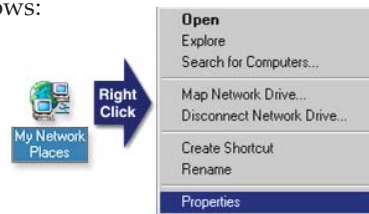

- or*
- Click on the **Start** menu, click on **Settings** (if needed), click on **Control Panel**, then double-click on **Network and Dial-up Connections** (Windows 2000) or **Network Connections** (Windows XP).

# Software-based Configuration and Control, cont'd

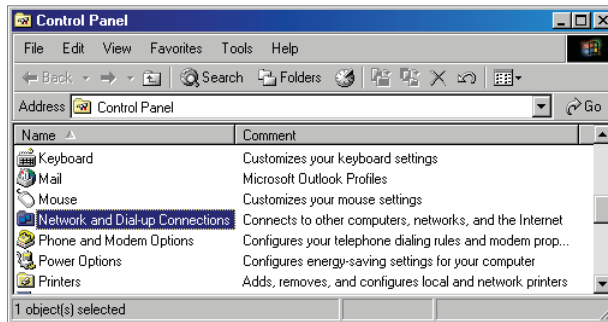

2. Right-click on **Local Area Connection**, then select **Properties**.

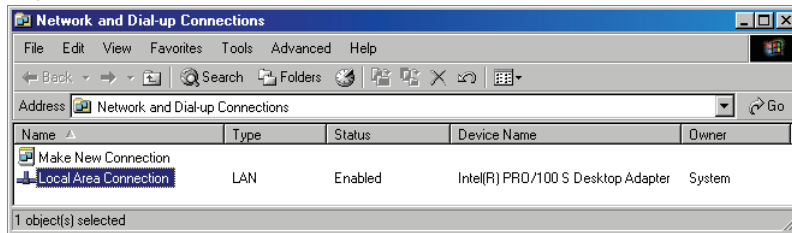

3. Select **Internet Protocol (TCP/IP)** and click on the **Properties** button. If **Internet Protocol (TCP/IP)** is not on the list, it must be added (installed). Refer to the Windows user's manual or the Windows online help system for information on how to install the TCP/IP protocol.

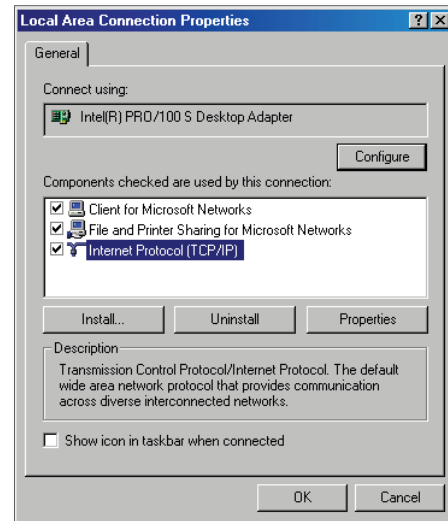

4. Write down the PC's current IP address and subnet mask below. If your PC is set to "Obtain an IP address automatically," make a note of that, instead. You will need to restore these settings to the PC later.

IP address:

. . . . .

Subnet mask:

. . . . .

5. Change the PC's IP address so it can communicate with the MLC 226 IP and change the controller's IP settings.
  - a. Select the "Use the following IP address:" radio button.
  - b. Enter the following values, as shown in the following picture:

**IP address:** 192.168.254.253

**Subnet mask:** 255.255.0.0

**Default gateway:** blank or 0.0.0.0

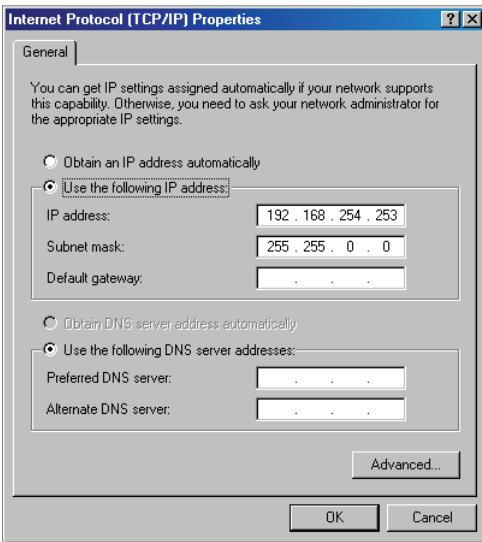

- c. Click the **OK** button to save the changes and exit the network setup. Reboot the PC, if required, for the changes to become effective.
6. Plug one end of a Category 5 network/Ethernet crossover cable into the MLC's Ethernet (LAN) connector. Refer to chapter 2 for RJ-45 LAN connector wiring. Plug the other end of the Ethernet cable into the Ethernet port on the PC.

**NOTE** *If a network hub or switch is used between the PC and the MLC 226 IP, use a straight-through Category 5 cable instead of a crossover cable.*

7. Set up the MLC's IP address using a Web browser or SIS commands as described earlier in this chapter.
8. Restore the PC's previous IP configuration by following steps 1, 2, 3, and 5 but using the PC's original IP address settings you wrote down in step 4.

## Global Configurator Software for Windows®

The included Extron Global Configurator (GC) program for Windows offers the most complete way to configure and customize the controller via either RS-232 or IP connection. GC provides the ability to generate a Web browser-based GlobalViewer™ (GV) application and Web pages for each IP Link-based device (IP Link interface, System 5 IP, MLC 226 IP, MLC 104 IP, or other Extron device) on a network. Once an MLC 226 IP is configured, its GlobalViewer Web pages allow the user to manage, monitor, and control the MLC and the devices connected to it.

Global Configurator offers the best and easiest way to configure the controller. Other setup options include using Simple Instruction Set (SIS™) commands and the MLC's factory-embedded Web pages, but many setup features are available only via Global Configurator. GC includes some functions found on the controller's front panel and many additional features that are available only through the software.

## Downloading the software and getting started

Global Configurator software is included with the controller. Global Configurator software updates and a large variety of device drivers can be downloaded at no charge from the Extron Web site (<http://www.extron.com>).

**NOTE** *Device drivers (for controlling projectors, VCRs, DVD players, etc.) can be used by other Extron IP Link™ products, so they may be listed on the Extron Web site as an IP Link driver package. You may also want to download the optional*

## Software-based Configuration and Control, cont'd

---

*IR Learner™, a free software utility for capturing infrared codes from a handheld IR remote control to create custom drivers for operating IR-controlled devices like the MLC that use IP Link® and GlobalViewer.*

**NOTE** *Do not change the directory or the name of the directory where the software files are installed by default.*

Refer to the *MLC 226 IP Series Setup Guide* for specific information on how to download the software. Refer to that guide and to the Global Configurator help file for details and step-by-step procedures on how to start a GC project and perform basic setup tasks for an MLC 226 IP. Both the setup guide and the help file contain instructions on how to set the **MLC's IP address, gateway IP address, subnet mask, mail server IP address, domain name, Telnet port, Web port, SMTP username, and SMTP password** so that the MLC is able to communicate with the network. Obtain these parameters from your network administrator before continuing.

### PC system requirements

The MLC 226 IP and Global Configurator have the following hardware and software requirements:

- Intel® Pentium® III 1 GHz processor
- Microsoft® Windows® operating system
  - Windows NT service pack 4, or
  - Windows 2000 service pack 2, or
  - Windows XP service pack 2
- Microsoft Internet Explorer® 6.0 with ActiveX® enabled
- Microsoft Windows Script 5.6
- 512 MB of RAM
- 50 MB of available hard disk space
- A network connection with a minimum data transfer rate of 10 Mbps (100 Mbps is recommended)

**CAUTION** *Do not run this software on a PC that uses an earlier version of Windows.*

### Using Global Configurator: helpful tips

#### Resources and notes

- Some items in Global Configurator correspond directly to the front panel controls. See chapter 3, "Operations," for features and settings.
- The Global Configurator help file provides information on settings and on how to use the Global Configurator program, itself.
- Basic setup steps are covered in the *MLC 226 IP Series Setup Guide*, which is shipped with the MLC. It includes instructions and examples on how to use the basic tabs in GC.
- If you will configure the MLC at the installation site, Extron recommends using the driver subscription function to download drivers for all manufacturer and device types before you go out into the field.
- The Global Configurator project file contains configuration settings, and it can be saved to a directory or folder for backup or for installation on another MLC 226 Series controller. Saving a configuration is recommended before you perform a firmware upgrade.

- The MLC can be set up to allow configuration access to administrators only, and to prevent other users from making changes to the controller's settings, events, and drivers. If an administrator password is set for the controller, non-administrator end users can select inputs and adjust output volume but are prevented from making any other changes using GlobalViewer Web pages.
- IP addresses, subnet mask, and e-mail addresses follow standard naming and numbering protocol. The network administrator provides the IP addresses and subnet mask to be used with this controller.
- The unit name is any name (e.g., Room107MLC226IP, Lab1234mlc226IP, ConfRoomSystem, LectureHall8-cntrlr, etc.) that you want to use to label a specific MLC controller unit. The default is a combination of the product name and part of the hardware address. This can be changed to your choice of alphanumeric characters and hyphens (-).
  - Spaces are not permitted within a unit's name.
  - Underscores (\_) are not permitted.
  - Valid characters are A-Z, a-z, 0-9, and - (hyphen).
  - The name cannot start with a number or a hyphen, and it cannot end with a hyphen.
  - Maximum name length is 24 characters.

### A brief guide to Global Configurator's tabs

In the upper right side of the GC software window are several tabs that divide the program into groups of functions you can view and configure. The left three, **IP Link Settings**, **Schedule**, and **Monitor**, are displayed for all IP Link-enabled products. Any tabs to the right of those three vary in quantity, type, and layout, depending on the product being configured. See the illustration below for an example of the tabs that may be available when you configure an MLC.



**IP Link Settings** shows all the IP-related settings, as well as the unit part number, MAC address and firmware version. You can view the IP address of the controller and the unit administrator and user passwords here. However, the IP address, passwords, and other items (gateway address, domain name, mail server; unit name; system time, and the like) must be set by selecting **Change Device Settings** from GC's **Tools** drop-down menu.

**Schedule** is the tab where you select the days of the week and times for the MLC to automatically turn the projector or other devices on and off, send e-mails, and lock/unlock the front panel.

**Monitor** is the tab where you set up conditions/ports for the MLC to monitor. You also use this part of the software to set up actions and configure appropriate e-mails to send out in response to various conditions like projector disconnection or excessive projector lamp hours.

**Port Summary** is an information-only tab. Click on it to display the following items:

- names of the MLC's ports (Display; IR/RS-232 output ports A, B, and C; and MLS) or the devices connected to them
- port signal type (IR or serial)
- serial communication mode (RS-232 or RS-422)
- any device driver associated with that port

## Software-based Configuration and Control, cont'd

**Front Panel** allows you to configure and label each front panel button and to associate actions, commands, drivers, and relay functions with the MLC's front panel buttons.

**NOTE** *Failure to configure the On or Off buttons to send their commands upon button release (instead of at the button press) may cause problems with the PIN Mode feature.*

**System Remote** is the tab where you can configure and label each button on the IR 402 remote control and associate commands, drivers, and assorted functions with the remote's buttons.

**Control Module Summary** displays a summary of which, if any, control modules (IRCMs, CMs, ACMs, RCMs) are to be used with the selected MLC, what their DIP switch addresses are, and how many (if any) commands have been associated with each module so far. This tab also lets you remove or add control modules to the system, as long as you don't exceed the four allowed addresses (up to four modules). A visual example of each control module appears when you click on the name of the module in the Available Control Modules area.

**Advanced Configuration** provides a way to configure power-up/power-down cycle settings, personal identification numbers (PINs) and PIN enabling, volume adjustment parameters, digital ports, and miscellaneous settings. See "Advanced configuration options in Global Configurator," later in this chapter.

**Auxiliary Port** allows you to select and configure a model of MediaLink Switcher (MLS) or PoleVault™ Switcher (PVS) to control using the MLC (via the MLC's MLS RS-232 port). See "Configuring an auxiliary switcher," later in this chapter.

## Advanced Configuration

### IR learning to create customized IR driver files

If you do not find a driver on the Extron Web site for the device you plan to use, you can create your own IR driver file. Extron IR Learner™ software lets you create a customized driver file of IR commands that can be used with the Global Configurator software for port setup and button configuration. Visit <http://www.extron.com> to download IR Learner and install it on your PC.

Once IR Learner is installed on the PC, you can start the program directly by double-clicking the IR Learner icon, shown at right.



Or, you can select **Run IR Learner** from Global Configurator's **Tools** menu, as shown at right. The IR Learner utility opens in a new window. With this tool you can create a driver file of IR commands that can then be loaded into the driver list and used for port setup and button configuration in the MLC.

Additional information on how to use the software is available in the IR Learner help file.

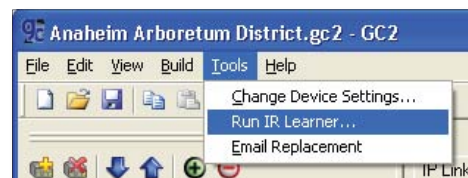

### Advanced configuration options in Global Configurator

In Global Configurator in the **Advanced Configuration** tab you can set

- what happens during power-up and power-down cycles and for how long
- personal identification numbers (PINs) and whether or not each PIN is enabled during front panel lockout (executive mode) (see page 3-9 for details)
- volume adjustment parameters
- configuration for each digital port



- miscellaneous settings, including whether to reset button statistics or upload the enhanced Web pages when the configuration is uploaded to the MLC

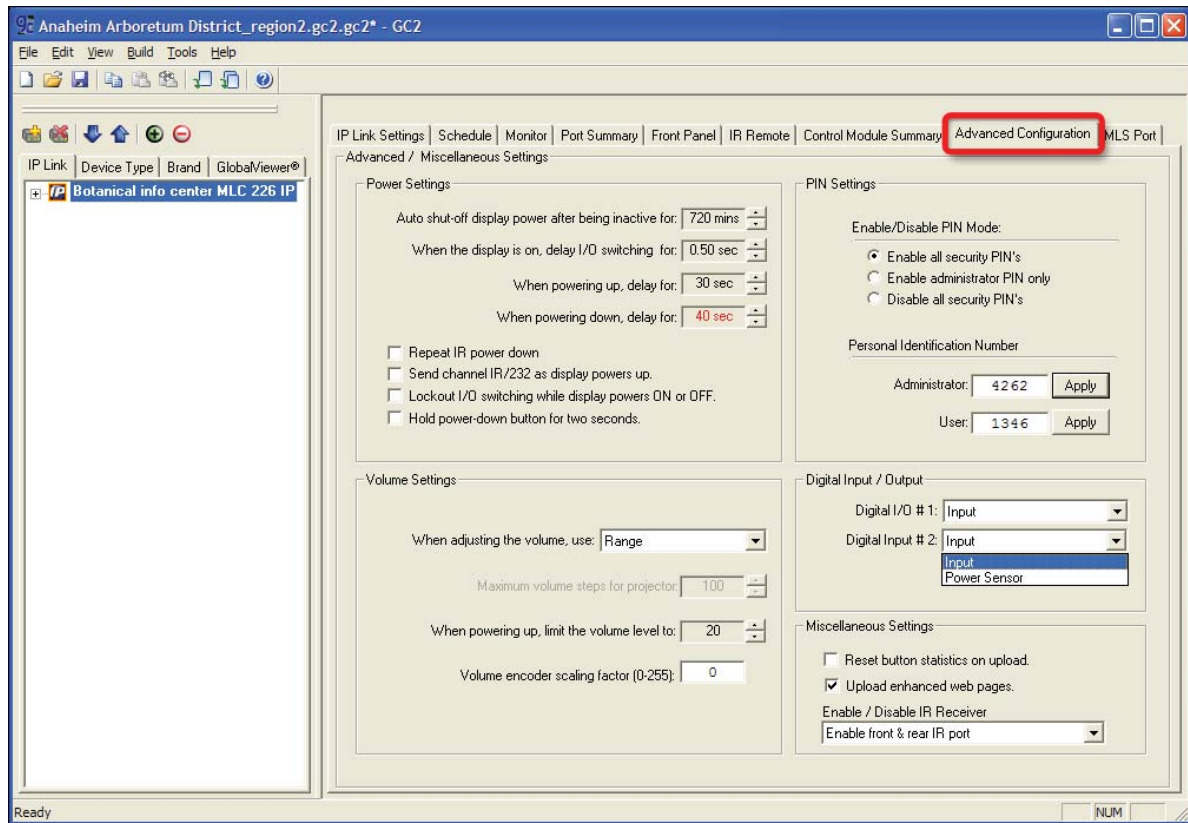

### Display power up/power down settings (Power Settings)

All the settings in this section affect what happens during display power on/up and power off/down cycles.

**Auto shut-off period** — This feature at the top of the Power Settings area lets you set the length of time that the display or projector can be inactive before the MLC automatically turns it off. Settings can be 30 to 720 minutes or -- (0).

**I/O switching delay periods** — The second item in this area controls whether and how long to prevent (lock out) input switching after an input has been switched. This delay can be set to 0 to 5 seconds in half-second intervals, and it is similar to special SIS command 54# on page 5-40.

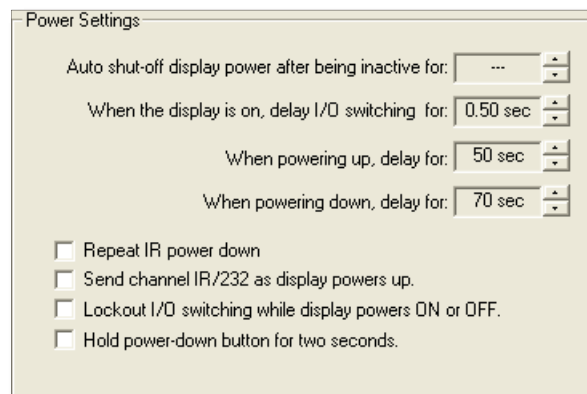

## Software-based Configuration and Control, cont'd

Most projectors do not accept commands during warm up and cool down periods. The next two settings in this area specify the amount of time (0 to 300 seconds in 2-second intervals) for the MLC to wait between issuing a projector power-on or power-off command and when the next input button press can occur. These delays can also be set using special SIS commands (see pages 5-34, and 5-39 through 5-40).

**Repeat IR power down** — Select this setting to have the MLC send out infrared power-off commands to the display or projector twice in a row instead of once. The MLC must be configured to send the IR power off command upon display power off button release (not at the button press).

**Send channel IR/232 as display powers up** — Select this setting to make the MLC send out commands associated with the currently selected input button while the projector or display is powering on. Using this setting ensures that the MLC's and the display device's inputs are coordinated.

**Lockout I/O switching while display powers On or Off** — To prevent users from changing inputs during the entire power-on or power-off period, select this setting.

**Hold power-down button for two seconds** — Select this setting to require users to press and hold the Display Off button for two seconds to start the display power-down process. This prevents users from shutting down the display or projector by accidentally pressing the button.

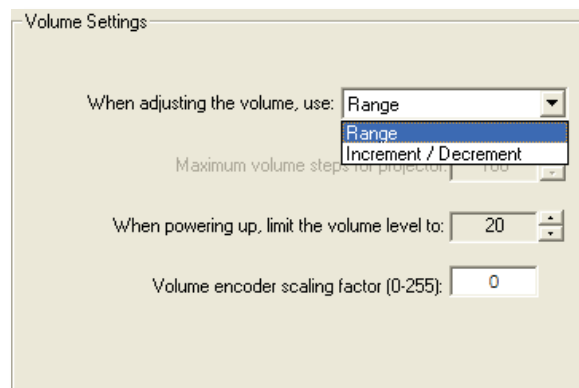

### Volume settings

**When adjusting the volume, use** — Volume control for a projector, display, or audio output device involves one of two methods: selecting a setting within a specific range of values, or sending a simple command to increase or decrease the volume by a fixed increment. Select the appropriate method for the equipment you are using. Refer to the user's manual for the display or audio device.

If you choose **Range**, you can set the maximum quantity of volume change steps. You can also set the specific level the audio output should not exceed when the projector/display is powered on.

**NOTE** *The power-up volume limit is limited by the maximum volume setting (SIS special command 47#). If the maximum volume (47# command) is set, the limit audio level feature (SIS special command 11#) is automatically set to 25% of the maximum volume (47#). See pages 5-34 and 5-39.*

**Volume encoder scaling factor (0-255)** — This feature allows you to slow down the volume knob (the encoder) on the MLC's front panel. The value entered in the encoder scale area is the encoder speed scaling factor. A value of 1 scales the speed down by a factor of 2 (the MLC issues commands at 1/2 speed), a value of 2 scales by a factor of 3 (the MLC issues volume commands 1/3 speed), and so forth. A factor of zero sets the MLC for no scaling: the volume encoder works at full speed.

This feature addresses a problem that occurs with some projectors that use range type volume control. When the MLC's knob controls projector volume, sometimes the MLC sends the volume commands faster than the projector can detect and process them. The projector does not detect some of the volume change commands, resulting in a choppy volume ramp.

Encoder scaling gives the programmer the ability to slow the knob down to a speed the projector can handle. The drawback is that users must turn the knob more times to change from minimum to maximum volume. It is up to the user to find a balance between smooth audio ramping and the number of knob turns needed to cover the volume range. This requires trial and error for each projector exhibiting this problem.

Although this feature is mainly for range type volume control, it applies to any range type command programmed to be executed by the volume knob.

### Digital I/O port settings

Digital input/output port 1 consists of pin 1 and the ground pin of the rear panel Host Control 15-pin HD connector. For digital I/O port 1, you can choose one of the four options (shown at right) for how the port will function. See pages 2-3 to 2-4 for details on wiring and using this port.

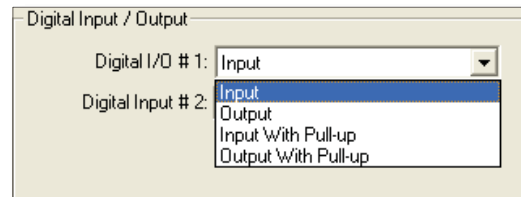

Digital Input / Output

Digital I/O # 1: Input

Digital Input # 2: Output With Pull-up

Digital input port 2 consists of the power sense (Pwr Sns) pin and the Ground pin of the bottom panel Display RS-232/IR port. Because these pins can be used either for digital input or for power sensing, you must use this setting in Global Configurator to select between digital input and the power sensor function. See pages 2-6 and 2-7 for details on wiring and using this port.

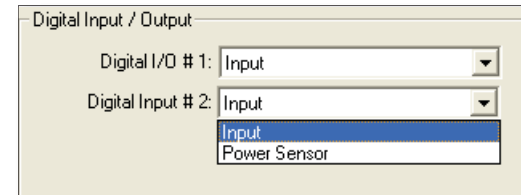

Digital Input / Output

Digital I/O # 1: Input

Digital Input # 2: Power Sensor

### Miscellaneous settings

In this area of the **Advanced Configuration** tab you can choose whether to reset button statistics (which track how many times each front panel button is pressed) when uploading the latest configuration file, and/or whether to upload the enhanced Web pages (which show photo-like versions of the MLC's and control modules' front panels) when the configuration is uploaded to the MLC.

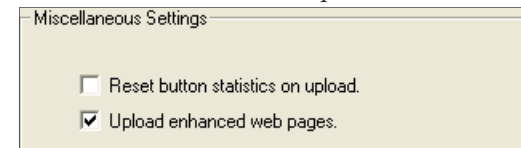

Miscellaneous Settings

Reset button statistics on upload.

Upload enhanced web pages.

For more information on button statistics, see "Statistics" on page 4-21. See page 4-25 for examples of both basic and enhanced Web pages.

## Software-based Configuration and Control, cont'd

### Configuring an auxiliary switcher

An Extron MediaLink Switcher (MLS) or PoleVault switcher (PVS) can be connected to the MLC to expand the number of inputs available to the projector/display. However, if the MLS or PVS switcher is disabled, the MLS RS-232 port can be used as an auxiliary, bidirectional RS-232 port, just like the Display port.

To enable and configure an auxiliary switcher, follow these steps:

1. In the Global Viewer **MLS Port** tab, select the **Enable MLS Support** radio button. If the MLC and its attached MLS or PVS switcher are powered on and connected to the network, GC automatically detects the switcher, and you can skip to step 4. If not, proceed to step 2.

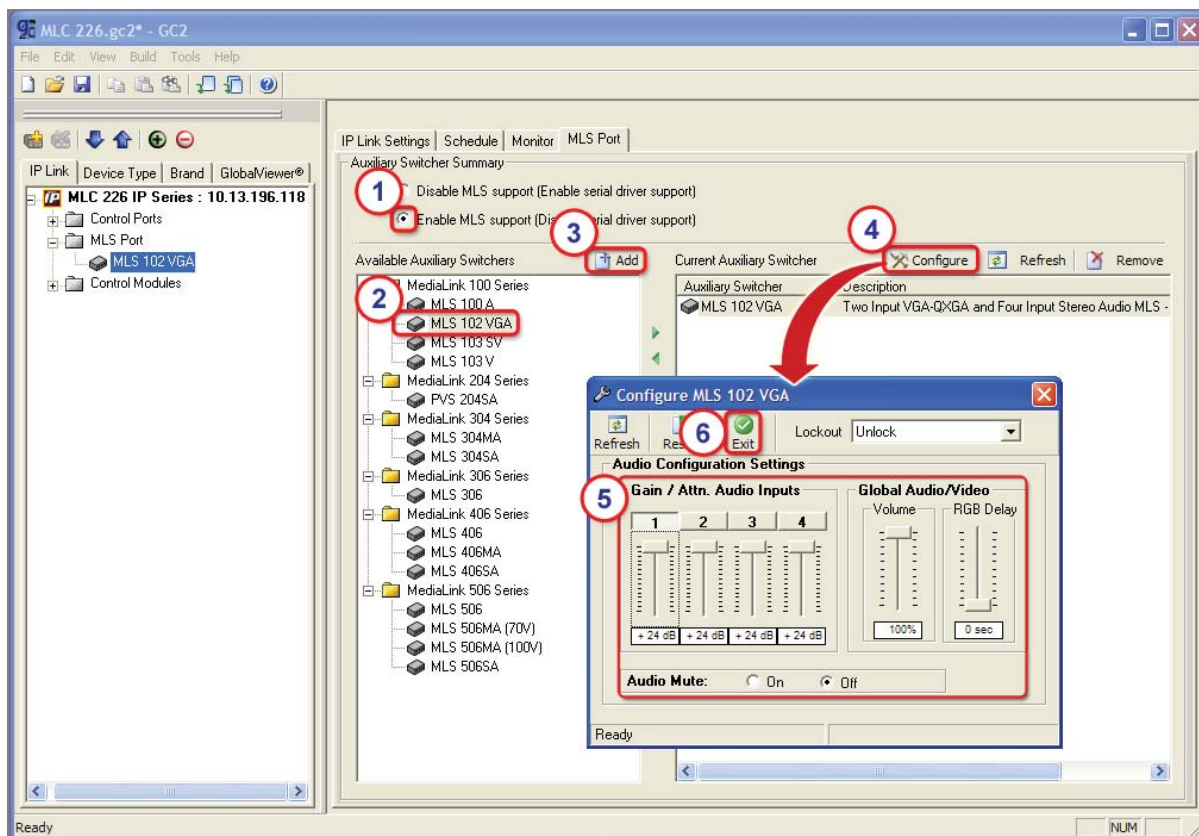

2. Click on a switcher's model name in the Available Auxiliary Switchers area.
3. Click the **Add** button.
4. Click the **Configure** button or double-click the switcher's name in the Current Auxiliary Switcher area. The Configure *MLS modelname* window appears.
5. Click and drag the slider bars to change the per-input audio input gain/attenuation, the overall audio volume, and the RGB switching delay time. Select Audio Mute **On** or **Off**.
6. Click **Exit** (at the top of the window) to return to GC, where you can continue configuring the MLC or save the project.

## Setting up passwords

1. Install and start the Extron Global Configurator (GC) software. See page 4-9.
2. Open an existing GC project or start a new project. Refer to the GC help file or the *MLC 226 IP Series Setup Guide* for instructions.
3. Click **Tools** and select **Change Device Settings** from the drop-down menu.

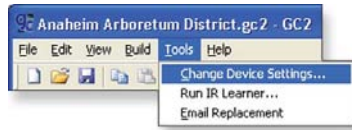

4. In the Device Settings window, select (click on) the desired MLC in the list that appears on screen.

5. Click **Settings** and choose **Set Administrator Password** from the drop-down menu, as shown at right. A Set for <IP address> window appears.



6. Type the Administrator password into both areas of the window and click **OK**.



The Set for... window closes.

7. Click the **Close** button.
8. Complete the rest of the configuration, then save the project: click **File** and then **Save** or click the Save icon, shown below



9. Upload (build) the configuration to the MLC. The Upload Manager window appears, as shown below.

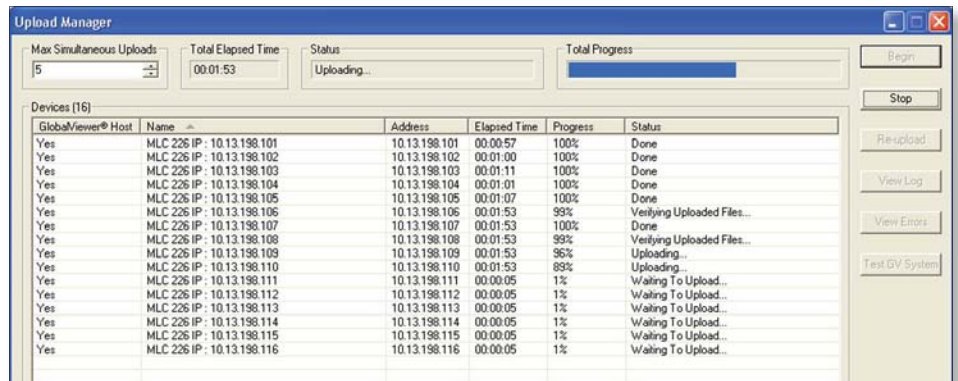

10. Click **Exit** after the files have been uploaded.

# Software-based Configuration and Control, cont'd

## Printing a wiring block diagram

Once you have configured a system using Global Configurator, you can generate and print a simple block diagram of what products to wire to which of the MLC's ports. The diagram includes model names, DIP switch settings for control modules, and the type of communication (IR or RS-232) configured for each port.

**NOTE** *This procedure requires Microsoft® Word software. The installer or user must provide that software. It is not an Extron product.*

1. In Global Configurator, click on the **File** drop-down menu and select **Print** and then **Wiring Diagram**, as shown below.

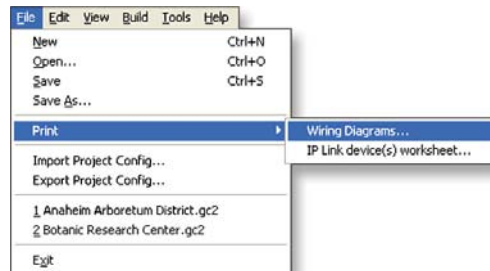

A Print Wiring Diagrams window appears, as shown at right.

2. Click on the check boxes to select one or more devices for which to generate diagrams. Or click the **Select All** button to select all of the listed devices.
3. Click the **Print** button at the bottom of the window. Global Configurator processes the information about the selected device(s), generates a document containing the wiring diagram, and opens that document in Word.
4. Print the diagram(s), save the file, if desired, and exit Word.
5. In the Global Configurator Print Wiring Diagrams window, click **Close**.

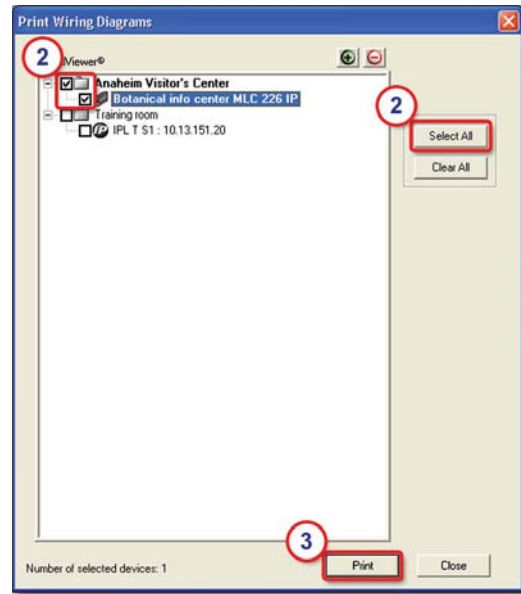

## Updating firmware

If the need arises, you can replace the MLC 226 IP's firmware without opening the unit or changing firmware chips. See appendix B, "Firmware Updates", for instructions on how to update the controller's firmware.

**NOTE** *Save the existing configuration project before replacing the firmware.*

## Saving and uploading the configuration

This is not an advanced configuration function, but when you finish creating the configuration in Global Configurator, you must save the GC project and upload the configuration to one or more MLC units. See chapter 3 of the *MLC 226 IP Series Setup Guide* (shipped with the MLC) for instructions.

---

## Controlling the MLC

You can control the MLC and devices connected to it by using the MLC's factory-embedded Web pages or its GlobalViewer (GV) Web pages that were created when you uploaded the GC configuration or a customized graphical user interface (GUI).

### Embedded Web pages

The MLC 226 IP features an embedded Web server, which includes factory set Web pages. These pages can be replaced with user-designed files, but the default Web pages provide many basic features for monitoring, configuring, and controlling the MLC via a Web browser. These Web pages provide some of the features of the configuration program. This section provides an overview of the embedded Web pages.

To access the embedded Web pages,

1. Launch a Web browser (Internet Explorer, Netscape Navigator, Mozilla Firefox) on the connected PC, and enter the MLC's IP address in the address field.
2. In the Enter Network Password dialog box, shown at right, enter the MLC's IP address or text of your choice in the User Name field, type in the administrator password in the Password field, and click **OK**. The MLC 226 IP's default Web page appears.



**NOTE** Passwords must contain 4 to 12 alphanumeric characters. Symbols and spaces are not allowed, and the passwords are case sensitive.

**NOTE** Administrators have access to all of the Web pages and are able to make changes to settings. Users can access the **System Status** and **Control: User Mode** pages only.

# Software-based Configuration and Control, cont'd

## Status

These Web pages provide only settings information. Changes must be made via the **Configuration** Web page or via the Global Configurator software or SIS programming. Personnel who have user access can view these pages but do not have access to configuration pages.

## System Status

The System Status page provides information about the MLC's model, part number, firmware level, voltages and internal temperatures, port and IP settings, and the status of projector lamp hours and the display connection, as shown in the following example. This information is useful when troubleshooting problems.

The screenshot shows the 'System Status' page of an Extron MLC 226 IP projector. The browser window title is 'MLC 226 IP Default Web Page - Microsoft Internet Explorer'. The address bar shows 'http://10.13.197.9/nortix\_index.html'. The page header includes the Extron Electronics logo and navigation tabs for Status, Configuration, File Management, and Control. The user is logged in as 'Admin'. The main content area is titled 'System Status' and contains the following information:

Below are your Unit's current system settings.  
To make changes, click on the 'Configuration' tab.

System Description			
Model:	MLC 226 IP	Input Voltage:	+11.5
Description:	MLC 226 w/ IP	Main Board Voltages:	+3.30 / -10.8
Part Number:	60-600-00	Internal Temperature:	86.0 F / +030 C
Firmware:	1.05	Lamp 1 Hours:	276
Date:	7/17/2006	Lamp 2 Hours:	N/A
Time:	11:08 AM	Display Status:	Disconnected

IP Settings			
Unit Name:	MLC-226-IP-00-9A-BB		
DHCP:	Off		
IP Address:	10.13.197.9		
Gateway IP Address:	10.13.0.100		
Subnet Mask:	255.255.0.0		
MAC Address:	00-05-A6-00-9A-BB		

RS-232 Port Settings					
Port:	Rear Host	Port:	Slave Switcher	Port:	Front Panel
Type:	RS-232	Type:	RS-232	Type:	RS-232
Baud Rate:	38400	Baud Rate:	9600	Baud Rate:	38400
Data Bits:	8	Data Bits:	8	Data Bits:	8
Parity:	None	Parity:	None	Parity:	None
Stop Bits:	1	Stop Bits:	1	Stop Bits:	1

IR/Serial Port Settings							
Port:	Display	Port:	A	Port:	B	Port:	C
Type:	RS-232	Type:	RS-232	Type:	IR	Type:	IR
Baud Rate:	9600	Baud Rate:	9600				
Data Bits:	8	Data Bits:	8				
Parity:	0	Parity:	N				
Stop Bits:	1	Stop Bits:	1				

Digital IO Port Settings			
Port	Mode	Pull-up Resistor	Status
1	Digital Input	<input type="checkbox"/>	Off
2	Digital Input	<input type="checkbox"/>	Off

**NOTE** Projector lamp hours are a reflection of time elapsed since the lamp was changed as determined by the driver/events associated with the MLC's Display RS-232/IR port.



## Statistics

The Statistics page is mainly for administrators and maintenance personnel. It shows information about system usage: the number of hours the system has been turned on, how many hours the projector lamp has been used, how much time per day and per week the system is turned on, and how many times each button on the MLC has been pressed, either physically or virtually (via configuration software, SIS commands, or event scripts). All of the button press and system use statistics (with the exception of lamp hours) can be reset to 0 by clicking the **Reset Statistics** button at the bottom of this screen.

**NOTE** This page is not available unless the MLC has been configured with Global Configurator ver. 2.x or higher.

The screenshot displays the Extron Electronics web interface for the Statistics page. The header includes the Extron logo and navigation tabs for Status, Configuration, File Management, and Control. The user is logged in as Admin. The main content area is titled 'Statistics' and contains the following sections:

- System Description:** Unit Name / Location: MLC-226-IP-00-9A-BB; Display Model: PlasmaSync PX-42MP1; Start Date of Statistics Collection: 07/17/06; Date: 07/17/06; Time: 11:33 AM.
- Total Usage:** Total On Time: 4 Hours; Average On Time per Day: 18 Hours; Average On Time per Week: 108 Hours.
- Button Statistics:** A table showing the number of presses and percentage of total presses for various buttons.
- Lamp Hours:** Lamp 1: 276; Lamp 2: N/A.
- Reset Statistics:** A button to reset the statistics, with a note that lamp hours will not be reset.

Button:	# Button Presses:	% Total Button Presses:
ON	4	57%
OFF	3	43%
PC	5	26%
DVD	2	11%
VCR	3	16%
Videoconf.	2	11%
LAPTOP	3	16%
DOC CAM	4	21%
PIC MUTE	2	40%
Room 2	2	40%
AUTO IMAGE	1	20%

# Software-based Configuration and Control, cont'd

## Configuration

There are four Configuration Web pages, which only administrators can access:

- **System Settings** for IP, date/time, and executive mode (front panel lockout) setting changes

The screenshot displays the Extron Electronics System Settings web interface. The page title is "System Settings" and it includes a navigation menu with "Status", "Configuration", "File Management", and "Control". The user is logged in as "Admin". The main content area is titled "System Settings" and contains three sections:

- IP Settings:** Unit Name: MLC-226-IP-00-9A-BB; DHCP: On (selected), Off; IP Address: 10.13.197.9; Gateway IP Address: 10.13.0.100; Subnet Mask: 255.255.0.0; MAC Address: 00-05-A6-00-9A-BB; Firmware: 1.05; Model: MLC 226 IP; Part Number: 60-600-00.
- Date/Time Settings:** Date: 7/14/2006; Time: 12:30 PM; Zone: (GMT-08:00) Pacific Time (US & Canada), Tijuana; Daylight Saving: USA (selected), Off, Europe, Brazil.
- Executive Mode Settings:** Executive Mode: Off (selected), Disable Front Panel, SCP, Control Modules and IR.

- NOTE** Unit Name is any name (e.g., Room107MLC226IP, Lab1234mlc226IP, ConfRoomSystem, LectureHall8-cntrlr) you use to label this specific MLC. The default is a combination of the product name and part of the hardware address. This can be changed to your choice of alphanumeric characters and hyphens (-).
- Spaces ( ) and underscores ( ) are not permitted within a unit's name.
  - Valid characters are A-Z, a-z, 0-9, and - (hyphen).
  - The name cannot start with a number or hyphen. It cannot end with a hyphen.
  - Maximum name length is 24 characters.

- **Passwords**, where you can change the administrator and/or user passwords



**NOTE** Passwords must contain 4 to 12 alphanumeric characters. Symbols and spaces are not allowed, and the passwords are case sensitive. A minimum of 4 characters are required when creating passwords via the Web pages.

- **Email Alerts**, in which you can specify the Web server’s IP address and domain name, set up SMTP verification credentials, and specify e-mail alert recipients’ addresses and which e-mail file they will be sent

**NOTE** The MLC must first be configured with Global Configurator before e-mail addresses and e-mail file names appear on this page.



## Software-based Configuration and Control, cont'd

- **Firmware Upgrade**, through which you can locate and load new firmware to the unit

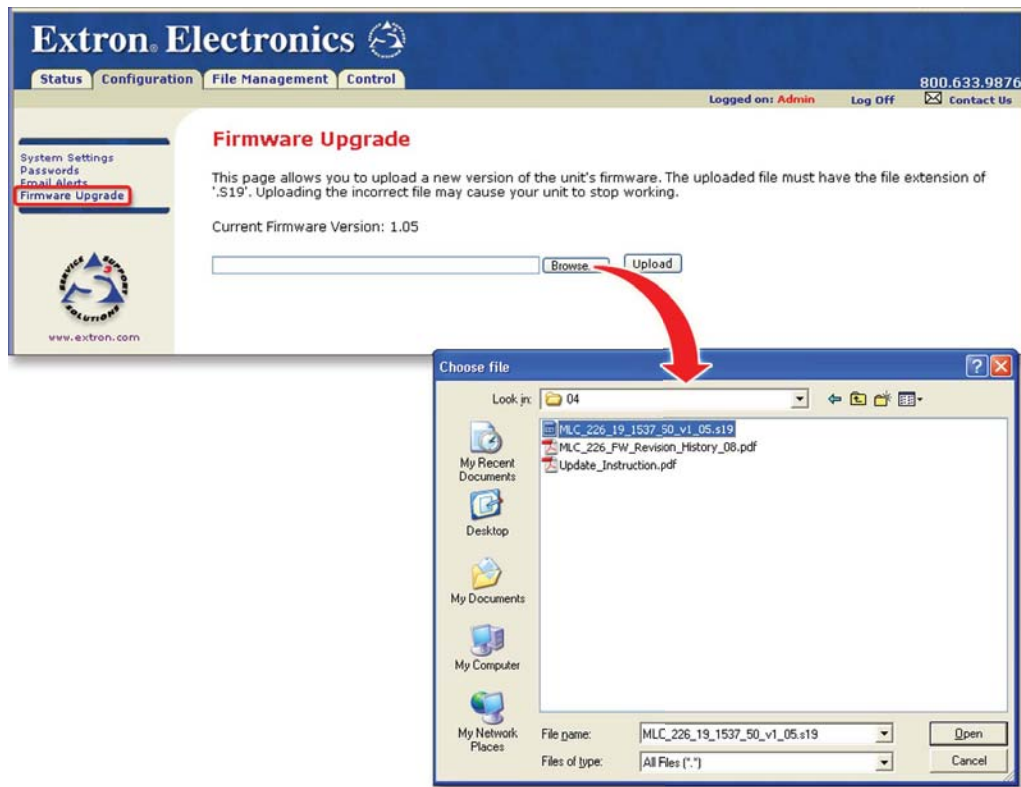

**NOTE** See appendix B, "Firmware Updates," for instructions on how to update the controller's firmware.

**NOTE** Save the existing configuration project before replacing the firmware.

### File Management

This Web page allows you to sort by file type (see the **Filter by File Extension** drop-down box). Personnel with administrator access can view these pages and make changes. Those with user-level privileges are not able to see this page. See appendix A for an explanation of file types.

Status Configuration File Management Control 800.633.9876  
 Logged on: Admin Log Off Contact Us

**File Management**

File Management allows you to upload and delete files from the server. File names must contain valid alpha-numeric characters. Special characters are not allowed in the file name. To add a Directory, enter the directory name in the field provided and click 'Add Dir'. Then 'Browse' and upload a file to the new directory. To delete a file or directory, click on the 'Delete' button next to the file or directory name. The 'Delete All' button deletes all contents of the current directory. If the current directory is 'ROOT', all files on the system will be deleted.

Dir: / Add Dir Browse Upload File

Filter by File Extension: All Files: 9 Bytes Left: 6,570,240

Files	Date	File size	Delete All
<a href="#">/extronintercom</a>			Delete
<a href="#">/gc2</a>			Delete
<b>CDC</b>			
<a href="#">filelog.cdc</a>	Mon 17 Jul 2006 20:35:24 GMT	2,249	Delete
<b>EJR</b>			
<a href="#">1.eir</a>	Mon 17 Jul 2006 20:35:22 GMT	3,318	Delete
<a href="#">2.eir</a>	Mon 17 Jul 2006 20:35:22 GMT	1,683	Delete
<a href="#">3.eir</a>	Mon 17 Jul 2006 20:35:22 GMT	516	Delete
<b>EVT</b>			
<a href="#">0.evt</a>	Mon 17 Jul 2006 20:35:22 GMT	11,287	Delete
<a href="#">4.evt</a>	Mon 17 Jul 2006 20:35:22 GMT	11,097	Delete
<a href="#">97.evt</a>	Mon 17 Jul 2006 20:35:22 GMT	2,438	Delete
<a href="#">98.evt</a>	Mon 17 Jul 2006 20:35:22 GMT	7,968	Delete
<b>HTML</b>			
<a href="#">index.html</a>	Tue 16 May 2006 20:35:09 GMT	968	Delete

**CAUTION** *\_\_\_\_.cdc files should NOT be deleted.*

**CAUTION** *Event files should NOT be deleted. They are necessary for the controller's operation. Never delete the main event file (0.evt).*

You can also view files in subfolders, including those containing GlobalViewer files or IP Intercom files, if they have been installed on the MLC.

Status Configuration File Management Control 800.633.9876  
 Logged on: Admin Log Off Contact Us

**File Management**

File Management allows you to upload and delete files from the server. File names must contain valid alpha-numeric characters. Special characters are not allowed in the file name. To add a Directory, enter the directory name in the field provided and click 'Add Dir'. Then 'Browse' and upload a file to the new directory. To delete a file or directory, click on the 'Delete' button next to the file or directory name. The 'Delete All' button deletes all contents of the current directory. If the current directory is 'ROOT', all files on the system will be deleted.

Dir: /gc2 Add Dir Browse Upload File

Filter by File Extension: All Files: 220 Bytes Left: 6,570,240

Files	Date	File size	Delete All
<a href="#">(root)</a>			
<a href="#">(back)</a>			
<b>CAB</b>			
<a href="#">weblib.cab</a>	Mon 17 Jul 2006 20:35:11 GMT	92,645	Delete
<b>CDC</b>			
<a href="#">config.cdc</a>	Mon 17 Jul 2006 20:34:56 GMT	34,865	Delete
<b>CSS</b>			
<a href="#">gv-styles.css</a>	Mon 17 Jul 2006 20:35:03 GMT	9,043	Delete
<a href="#">gv-xtree.css</a>	Tue 16 May 2006 20:34:50 GMT	1,284	Delete
<b>GC_</b>			
<a href="#">treeview.gc_</a>	Mon 17 Jul 2006 20:35:18 GMT	1,924	Delete
<b>GIF</b>			
<a href="#">blank.gif</a>	Tue 16 May 2006 20:34:54 GMT	580	Delete
<a href="#">bottom-border-1-28.gif</a>	Tue 16 May 2006 20:34:54 GMT	5,184	Delete

# Software-based Configuration and Control, cont'd

## Control

- **User Mode** — The first of the Control Web pages is User Mode, which is a representation of the controller's front panel buttons, volume control, and any optional control modules (IRCMs, RCMs, ACMs) that are part of the system. Clicking on a button on screen emulates a button press on the corresponding device. This page is accessible to both administrators and users.

From the factory, the MLC 226 IP comes with a preloaded Web page with a basic representation of the MLC 226's front panel controls and the buttons of any optional attached control modules. See the example below.

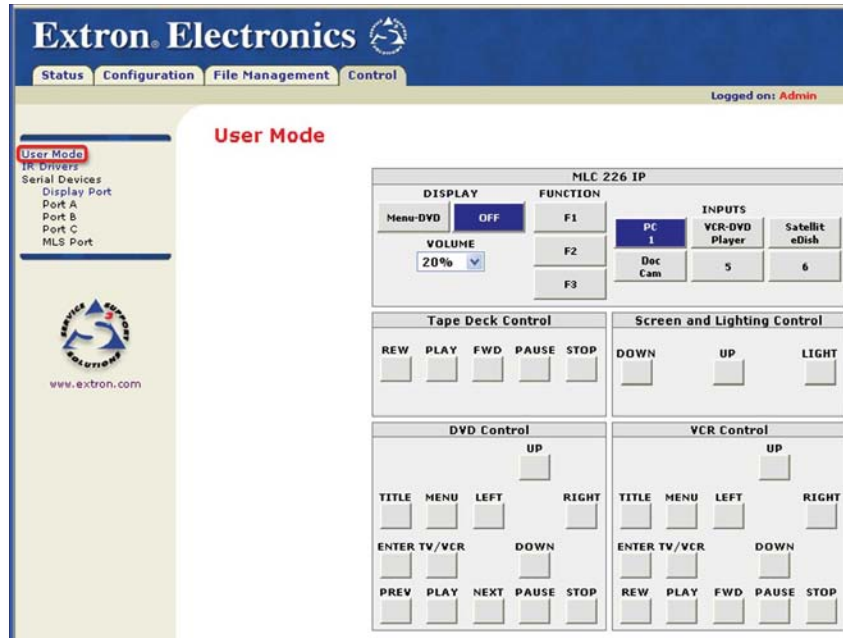

### Typical User Mode page

Web pages that show a more lifelike representation of the MLC's front panel and of control modules (as shown at right) are included with the configuration software. These pages (over 200 files) can be uploaded into the MLC if you select **Upload Enhanced Web Pages** from the **Advanced Configuration** page in Global Configurator before you build the configuration and load it into the MLC.

### Enhanced User Mode page

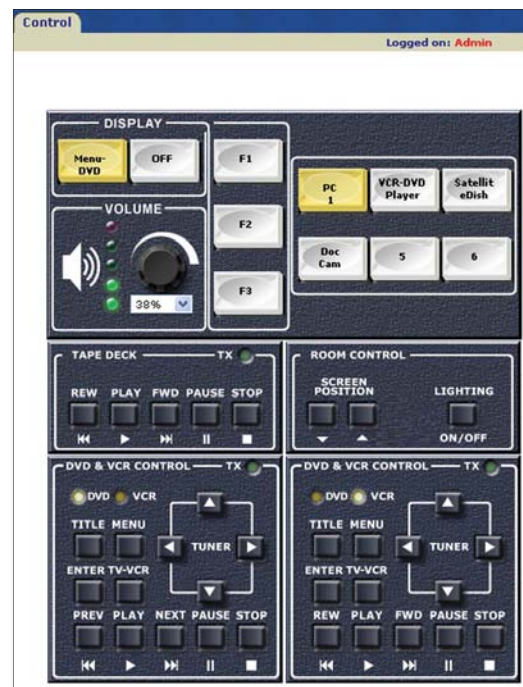

- **IR Drivers** — This Web page lists IR driver files only and allows you to select a file to see and execute the commands stored in them. This page is available only to those logged in with administrator level access.

**NOTE** *The MLC must first be configured with Global Configurator before this page can be used.*

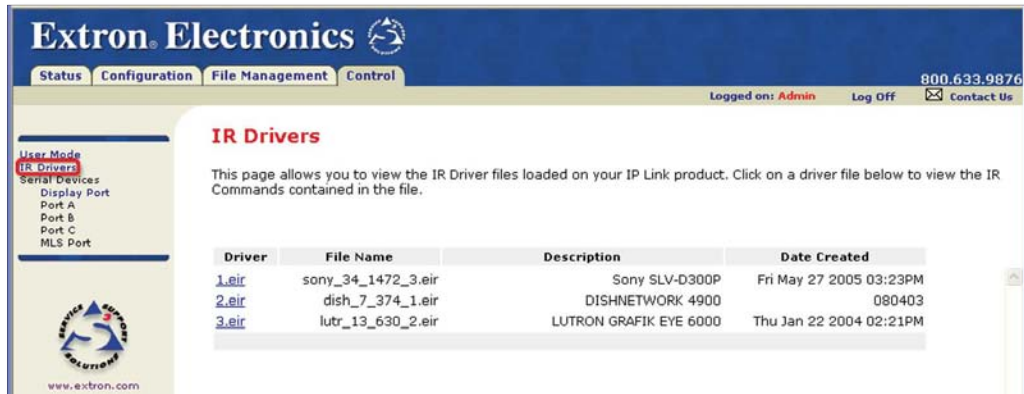

An example for a specific IR driver is shown below.



- **Serial Devices' Drivers** — Once the ports have been set up in the configuration program, each configured serial port (projector control port and any IR/Serial control ports) is listed in this section of the Control page menu.

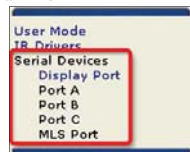

Click on a port name to bring up a page that shows the available commands for the device cabled to that port. See the sample screen shots on the next page.

If you want to execute a command that is available in the driver (whether associated with an MLC button or not) for a configured device, you can click on a button or select an option from a pull-down menu to execute that command.

**NOTE** *You must use Microsoft Internet Explorer version 6.0 or higher with Active X enabled in order to use the serial devices' control pages.*

## Software-based Configuration and Control, cont'd

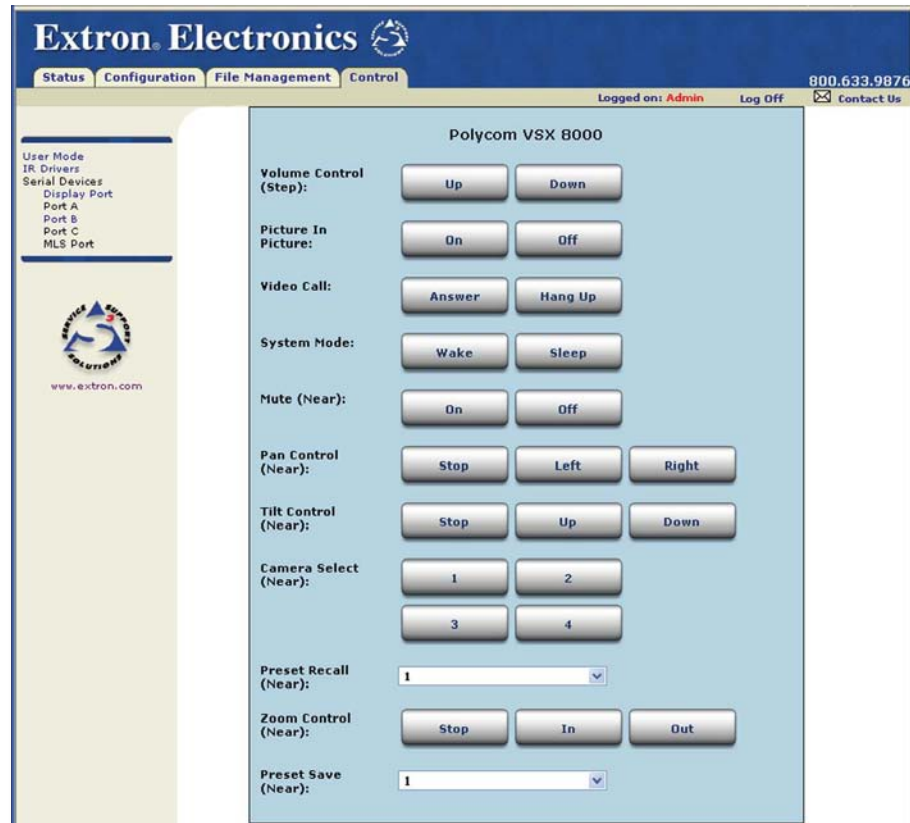

*Example of a page for an RS-232 controlled teleconferencing unit connected to the MLC's IR/Serial Out port B*

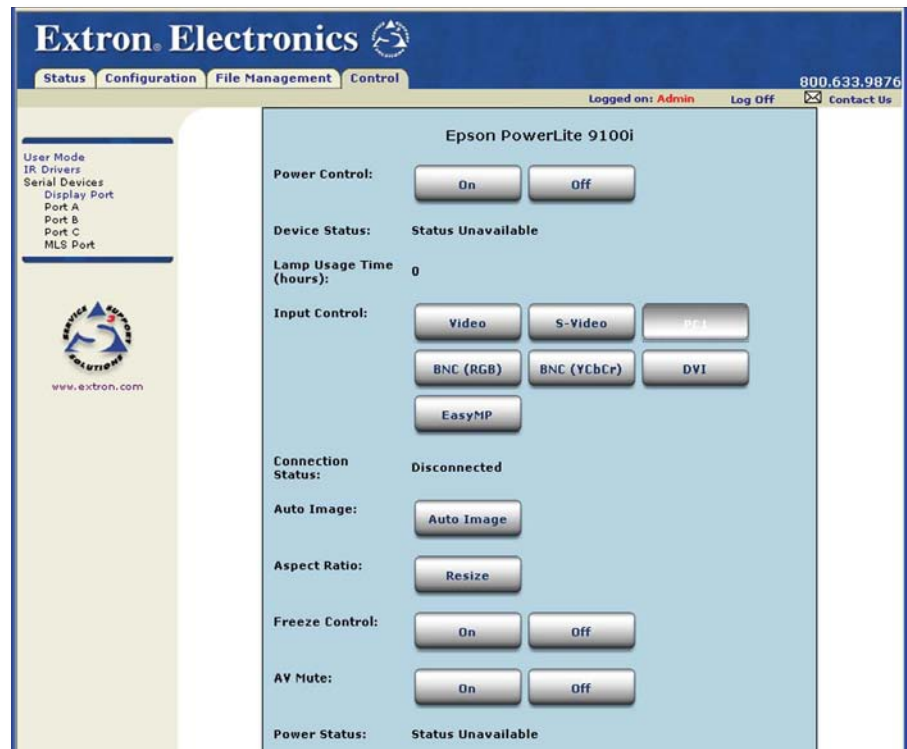

*Example of a page for a projector driver*



---

## GlobalViewer™ Web Pages

The MLC 226 IP controller can be used as part of a network of devices based on Extron IP Link™ technology, such as IP Link interfaces. Global Configurator (GC) is a Windows-based program used for configuring and customizing the Web browser-based GlobalViewer (GV) application for each IP Link interface, System 5 IP, MLC 226 IP, MLC 104 IP Plus, or other IP Link-based device on a network. Once an MLC 226 IP is configured, its GlobalViewer Web pages allow the user to manage, monitor, and control the MLC and the devices connected to it.

Refer to the Global Configurator help file and the *MLC 226 IP Series Setup Guide* for specific information on how to use the software and perform basic setup tasks for an MLC 226 IP.

**NOTE** *To work with Global Viewer Web pages, you must use Microsoft Internet Explorer version 6.0 or higher with Active X enabled.*

**NOTE** *If the MLC has been configured with passwords, the GlobalViewer Web pages are password protected. Although default embedded Web pages are accessible via the GlobalViewer Web pages, nonadministrators (people with only user access) are able to access the Control and Status pages only.*

Four screens for the MLC are available via Global Viewer: Control, Monitor, Schedule, and Info (). These screens are described on the following pages.

# Software-based Configuration and Control, cont'd

## Control

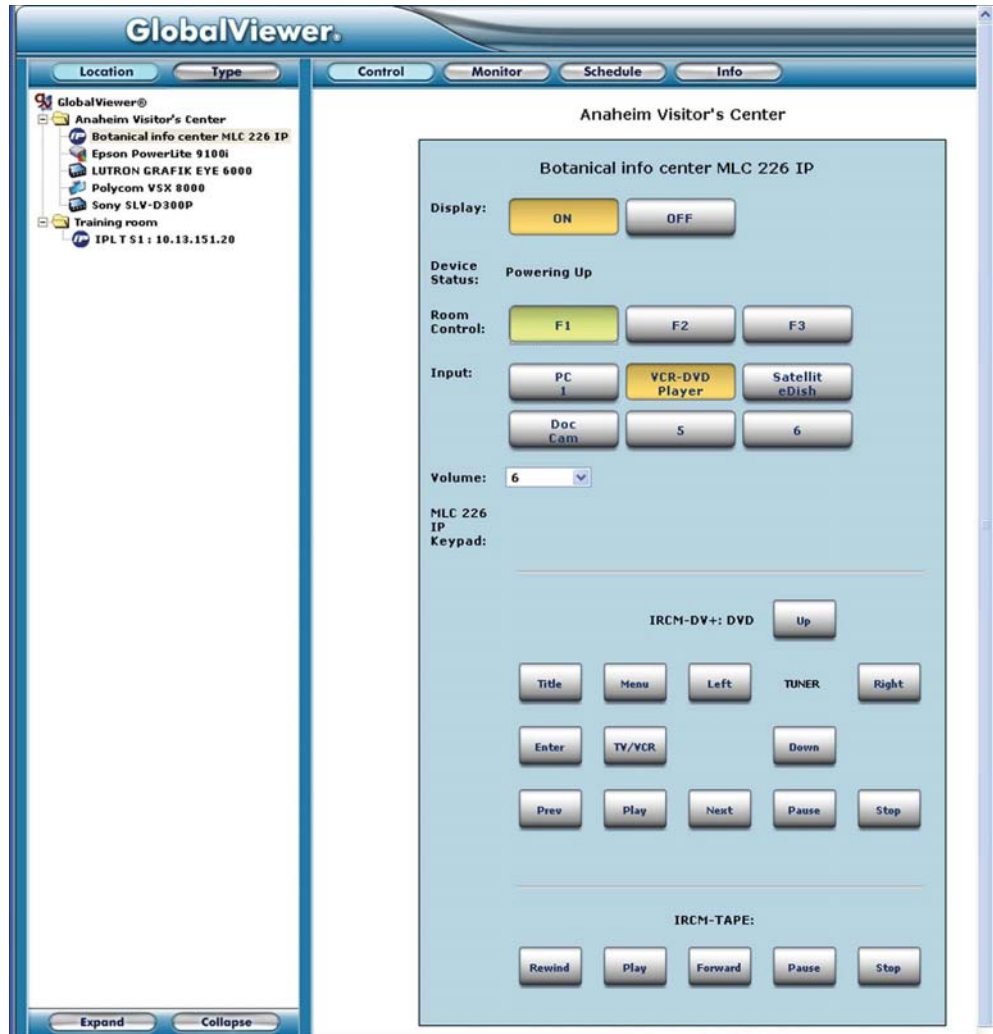

### ***A typical GlobalViewer Control page***

- The GlobalViewer tree view area at the left of the screen displays a list of other IP Link-based devices in the same network that have GlobalViewer Web pages installed. Listed beneath each device are any connected devices that can be remotely controlled or monitored.
- The larger Control window on the right side of the screen functions just like the Control embedded Web page. It provides buttons that correspond to those on the MLC's front panel, volume control, and additional buttons that let you execute any command uploaded for each connected and configured device (the projector/display and input devices).

## Monitor

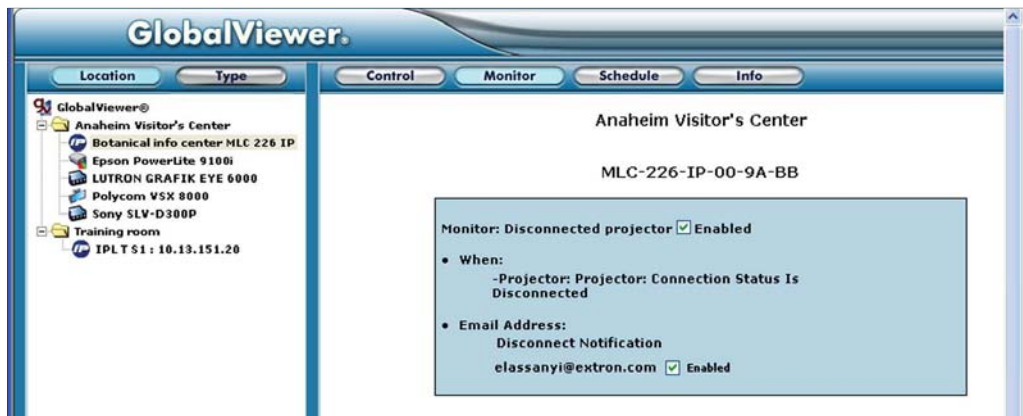

### ***A typical GlobalViewer Monitor page***

- The Monitor window on the right side of the screen displays information on what things (projector disconnection, lamp hours, and the like) are being monitored, under what conditions, and who will receive an e-mail notification about each condition. This information appears only if the MLC 226 IP has been configured to monitor such conditions.

# Software-based Configuration and Control, cont'd

## Schedule

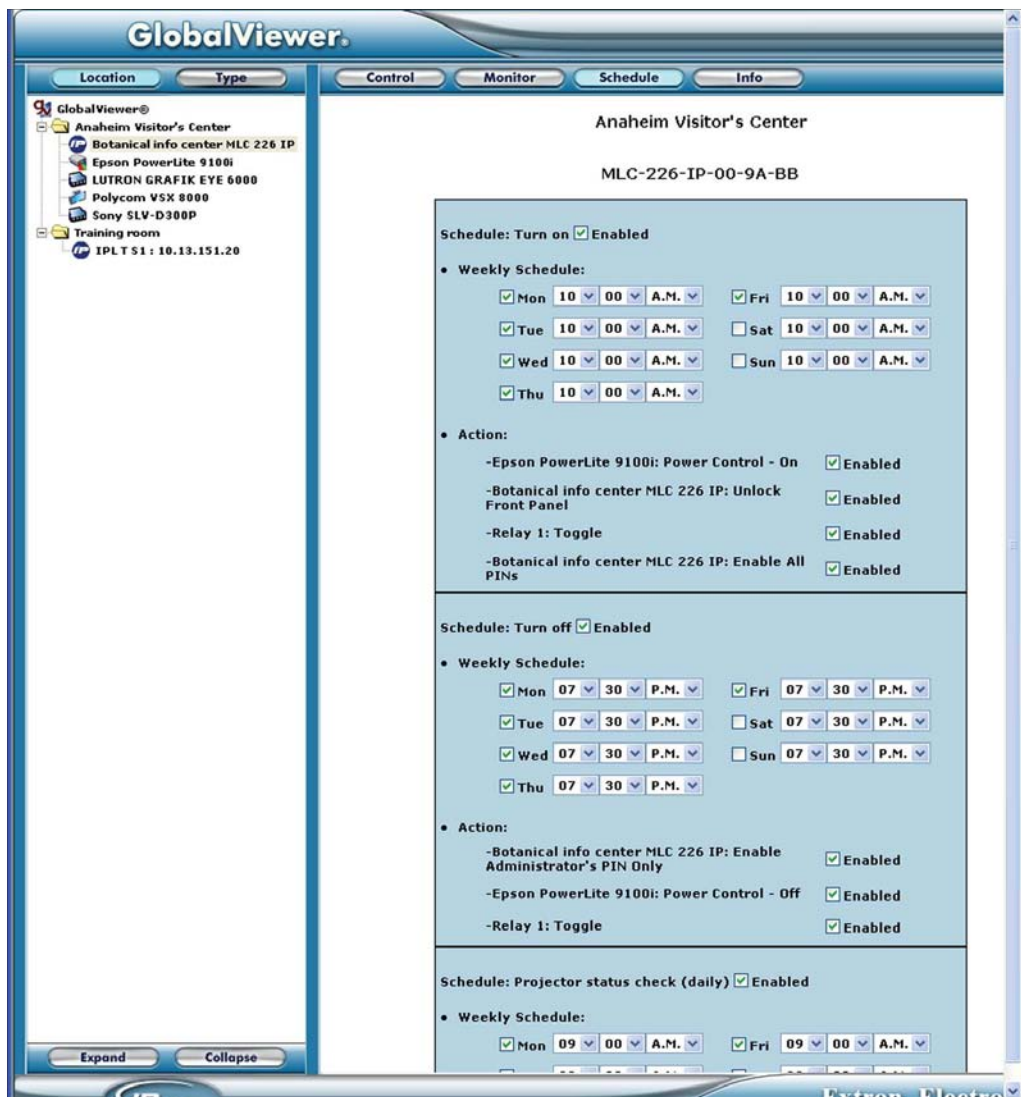

### ***A typical GlobalViewer Schedule page***

- The Schedule window on the right side of the screen displays and allows you to change (if you are logged in as an administrator) the times the projector or panel display is automatically powered down each day, and also the times when the MLC's front panel controls are locked and unlocked. You can also see what actions are associated with each schedule and to enable or disable each action.

## Info

**NOTE** To view the Info page, you must click on the location folder (in the GlobalViewer area on the left of the screen) rather than on the MLC's device name.

The screenshot shows the GlobalViewer interface for the 'Anaheim Visitors' Center'. The left sidebar lists the location and its contents: Epson PowerLite 9100i, LUTRON GRAFIK EYE 6000, Polycom VS4000, and Sony SLV-D300P. The main content area is titled 'Anaheim Visitors' Center' and includes a 'Refresh' button and the date 'Wed Jul 19 12:48:45 PDT 2006'. Below this, there are sections for 'Video Conference' and 'Video Projector'. The 'Video Projector' section contains a table with the following data:

Model Number	IPLink Unit Name	Power Control	Connection Status	Device Status
Polycom VS4000	Botanical info center MLC 226 IP	N/A		N/A

**A GlobalViewer Info page showing a disconnected projector**

The screenshot shows the GlobalViewer interface for a location. The left sidebar lists the location and its contents: MLC 226 IP : 10.13.196.79, Sharp XR-10X, Extron MVP 104GX, WolfVision PSM-10, and Extron MLS 1035V. The main content area is titled 'Location' and includes a 'Refresh' button and the date 'Thu Sep 28 17:50:39 PDT 2006'. Below this, there are sections for 'Switcher', 'Camera', 'Video Processor', 'Video Projector', and 'MediaLink Controller'. The 'Video Projector' section contains a table with the following data:

Model Number	IPLink Unit Name	Power Control	Connection Status	Device Status	Lamp Usage Time (hours)	Power Status
Sharp XR-10X	MLC 226 IP : 10.13.196.79	On Off		Normal	119	On



The 'MediaLink Controller' section contains a table with the following data:

Host Name	IP Address	Firmware	Display Status	Display Power	Lamp Hours
MLC 226 IP : 10.13.196.79	10.13.196.79	1.07	Connected	On Off	00119

**A GlobalViewer Info page showing a connected projector and other equipment**

## Software-based Configuration and Control, cont'd

---

- The GlobalViewer tree area at the left of the screen shows a list of IP Link-based devices within the network that have GlobalViewer Web pages installed.
- The larger Info window on the right side of the screen displays basic information about the MLC 226 IP, its IP settings, firmware version, attached devices, display/projector (or other device) connection status, display power status, and elapsed projector lamp hours.
- Projector or display power connection status is indicated by one of two icons: connected () or disconnected (). This status reflects information the MLC 226 IP obtains by power polling the display.
- The Power Status column indicates whether the projector/display is on, off, warming up, cooling down, or unavailable (either because the projector is disconnected or because it does not support power polling).

### Customizing the MLC's Control Web Pages

Extron offers Web page templates that can be customized using standard HTML editing tools to provide a different interface to the customer while still using GlobalViewer functions. An experienced Web developer can add images, modify text, and change background colors to create a look and feel that reflects your brand or your user's specific requirements. For example, a university with dozens of devices and rooms to control may wish to create customized Web pages with the university's school colors and logo. End users can control the system using these customized pages instead of the standard GV pages.

Alternatively, Extron can create a customized graphical user interface (GUI) for you to upload to each MLC in the system. End users can view the Web pages of this customized GUI while administrators and installers still have access to the factory-set Web pages and the standard GV Web pages in addition to the customized ones.

For a small, one-time fee, Extron will turn the following items into files ready to upload to the MLCs:

- your Global Viewer project file containing system configuration details
- your choice of available color schemes
- your choice of labels for panel buttons
- a company or institution logo

These customized Web pages, whether created by Extron or modified by an outside HTML developer from Extron-supplied templates, can also include button sets for any control modules (IRCMs, ACMs, RCMs, CMs, etc.) used in the system.

Visit the Extron Web site (<http://www.extron.com/product/archive.asp?id=customguijp>) or contact an Extron customer support representative for more information on this service and on available template options.



MLC 226 IP Series

# 5

## Chapter Five

### **SIS™ Programming and Control**

Host-to-MLC Communications

Commands and Responses

# SIS™ Programming and Control

---

The MLC 226 IP Series controller can be remotely set up and controlled via a host computer or other device (such as a control system) attached to the rear panel Config/RS-232 port or LAN port, or the front panel Config port.

**The MLC 226 IP must be configured before use.** As shipped the controller can trigger basic input switching on an optional MLS switcher, but it cannot control any other devices before being configured.

The MLC 226 IP can be set up and controlled by using Extron's Simple Instruction Set (SIS) commands or the Extron Global Configurator software (version 2.2 or higher), and both of those methods can be accessed via RS-232 or Ethernet LAN connection. See chapter 2, "Installation," for pin assignments and other details on the configuration and control ports. For information on the software and the MLC 226 IP's embedded Web pages, see chapter four.

## MLC 226 IP's RS-232 protocol:

- 38400 baud
- 8 data bits
- 1 stop bit
- no parity
- no flow control

**NOTE** *Both configuration ports require 38400 baud communication. This is a higher speed than many other Extron products use. The Global Configurator (version 2.2 or higher) software automatically sets the connection for the appropriate speed. If using HyperTerminal or a similar application, make sure the PC or control system connected to these ports is set for 38400 baud.*

## LAN port defaults:

- MLC's IP address: 192.168.254.254
- gateway's IP address: 0.0.0.0
- subnet mask: 255.255.0.0
- DHCP: off

## Host-to-MLC Communications

SIS commands consist of one or more characters per field. No special characters are required to begin or end a command sequence. When the MLC determines that a command is valid, it executes the command and sends a response to the host device. All responses from the MLC to the host end with a carriage return and a line feed (CR/LF = **↵**), which signals the end of the response character string. A string is one or more characters.

## MLC-initiated messages

If you are communicating with the MLC 226 IP via RS-232 or via a verbose Telnet connection, when a local event such as a front panel selection or adjustment takes place, the MLC responds by sending a message to the host. No response is required from the host. The MLC-initiated messages are listed here (underlined).

Chn $\overline{x1}$ ↵ (where  $\overline{x1}$  is the input number)

The unit sends this response when an input is switched.

(c)Copyright 2006, Extron Electronics, MLC 226 IP, Vx.xx, 60-600-00 ↵

Day, DD Mon YYYY HH:MM:SS

Vx.xx is the firmware version number.

The MLC sends the boot and copyright messages under the following circumstances:



- 
- If the MLC is off and an RS-232 connection is already set up (the PC is cabled to the MLC and a serial terminal emulation program such as HyperTerminal is open), the connected unit sends these messages via RS-232 when it is first powered on.
  - If the MLC is on, it sends the boot and copyright messages when you first open a Telnet connection to the MLC. You can see the day of the week, date, and time if the MLC is connected via Telnet, but not via RS-232. If you are using a Telnet connection, the copyright message, date, and time are followed by a password prompt.

Additional messages may be sent by the MLC in response to front panel selections and volume adjustments and when scripts are executed during scheduled events.

## Password information

The “←Password:” prompt requires a password (administrator level or user level) followed by a carriage return. The prompt is repeated if the correct password is not entered.

If the correct password is entered, the unit responds with “←Login Administrator ←” or “←Login User←”, depending on the password entered. If passwords are the same for both administrator and user, the unit will default to administrator privileges.

## Error responses

When the MLC 226 IP receives a valid SIS command, it executes the command and sends a response to the host device. If the MLC is unable to execute the command because the command is invalid or it contains invalid parameters, it returns an error response to the host.

The error response codes and their descriptions are as follows:

- E01 – Invalid input channel number (the number is too large)
- E12 – Invalid port number
- E13 – Invalid value (the number is out of range/too large)
- E14 – Not valid for this configuration
- E17 – System timed out
- E22 – Busy
- E24 – Privilege violation
- E25 – Device is not present
- E26 – Maximum number of connections has been exceeded
- E27 – Invalid event number
- E28 – Bad filename or file not found
- E30 – Hardware failure (followed by a colon and a descriptor number) (This is an unsolicited response.)

## Error response references

The following superscripted numbers are used within the command descriptions on the following pages to identify commands that may respond as shown:

- <sup>14</sup> = Commands that give an E14 (not valid for this configuration) response if the unit’s current configuration doesn’t support that command.
- <sup>22</sup> = Commands that yield an E22 (busy) response.
- <sup>24</sup> = Commands that give an E24 (privilege violation) response if you are not logged in at the administrator level.
- <sup>27</sup> = Commands that may yield an E27 (invalid event number) response.
- <sup>28</sup> = Commands that may give an E28 (file not found) response.

## Commands and Responses

### Using the command/response tables

The MLC 226 IP can be controlled via either a Telnet (port 23) or RS-232 connection using ASCII commands. Or it can be controlled via a Web browser (port 80) connection using URL-encoded commands. The ASCII and URL commands listed in the tables starting on page 5-8 perform the same functions, but they are encoded differently to accommodate the requirements of each port (Telnet or browser).

The ASCII to hexadecimal (HEX) conversion table shown at right is for use with the command/response tables.

ASCII to Hex Conversion Table				Esc 1B	CR 0D	LF 0A									
20	!	21	"	22	#	23	\$	24	%	25	&	26	'	27	
(	28	)	29	*	2A	+	2B	,	2C	-	2D	.	2E	/	2F
0	30	1	31	2	32	3	33	4	34	5	35	6	36	7	37
8	38	9	39	:	3A	;	3B	<	3C	=	3D	>	3E	?	3F
@	40	A	41	B	42	C	43	D	44	E	45	F	46	G	47
H	48	I	49	J	4A	K	4B	L	4C	M	4D	N	4E	O	4F
P	50	Q	51	R	52	S	53	T	54	U	55	V	56	W	57
X	58	Y	59	Z	5A	[	5B	\	5C	]	5D	^	5E	_	5F
`	60	a	61	b	62	c	63	d	64	e	65	f	66	g	67
h	68	i	69	j	6A	k	6B	l	6C	m	6D	n	6E	o	6F
p	70	q	71	r	72	s	73	t	74	u	75	v	76	w	77
x	78	y	79	z	7A	{	7B		7C	}	7D	~	7E	DEL	7F

**ASCII to Hex conversion table**

The command/response tables list valid ASCII (for Telnet or RS-232) command codes, the corresponding URL (uniform resource locator) encoded (for Web browsers) command codes, the MLC 226 IP's responses to the host, and a description of the command's function or the results of executing the command.

- Upper and lower case characters may be used interchangeably in the command field unless otherwise specified.
- Commands may be sent back-to-back without spaces (for example, 2!65V1Z).
- Numbers can be entered as 1, 2, or 3 digits, e.g., 8V = 08V = 008V.
- There are a few differences in how to enter the commands depending on whether you are using Telnet or a Web browser.
  - When using these commands through a Web browser, the URL reference is used to shorten the examples. "URL" refers to the full URL of the control interface and Web page reference including all path information (e.g., *http://192.168.100.10/myform.htm*).
  - To send any of the commands using a Web browser you must prefix them with the full URL followed by ?cmd=.
  - For control via a Web browser, all **non-alphanumeric characters** must be represented as the hexadecimal equivalent, %xx, where xx represents the two-character hex byte. A comma (,), for example, would be represented as %2C.

Characters such as %, +, and the space character ( ) *must* be encoded as hex bytes, or they will be misinterpreted by the MLC. For example, the ASCII command +V must be encoded as %2BV for Web browser use.

- Some characters differ depending on the method you use to send the commands:

**Telnet**

Escape (hex 1B)

Carriage return (hex 0D)

**Web browser**

W [must **not** be hex encoded]

Pipe character (|) [must **not** be hex encoded]

**NOTE** With Telnet you can use either an "Escape" (**Esc**) command or a "W" command, and the carriage return or the pipe character. With the Web browser, you are required to use a "W" command and the pipe character.

In either method, {Data} = data that will be directed to a specified port and **must** be hex encoded if non-alphanumeric.

**NOTE** If you make adjustments (changes to volume, etc.), whether via the front panel or via RS-232 or IP communication, it will take 1 minute 40 seconds (100 seconds) for the data in the MLC 226 IP's RAM to be saved to flash memory.

## Symbol definitions

↵ = CR/LF (carriage return/line feed) (hex 0D 0A)

← = Carriage return (no line feed, hex 0D)  
(For URL-encoded commands, use the pipe character, |, instead.)

• = Space character

| = Pipe (vertical bar) character

**Esc** = Escape key (hex 1B)  
(Use **W** instead of **Esc** for Web browsers.)

**X1** = Specific port number or relay number (01 – 99)

### Relays:

1 = relay 1, 2 = relay 2, 3 = relay 3,  
4 = relay 4, 5 = relay 5, 6 = relay 6

### Other ports:

1 = rear host (Config/RS-232 port)  
2 = front panel Config port  
3 = slaved switcher (MLS port)  
4 = display/projector port  
(Proj RS-232/IR)  
5 = IR/Serial port A  
6 = IR/Serial port B  
7 = IR/Serial port C

**X2** = Command data section.

**NOTE** For Web encoding only: data is directed to the specified port and **must** be encoded (URL encoding) if it is non-alphanumeric. Change any non-alphanumeric character (% , +, |, ←, etc.) within the data section into the corresponding hexadecimal equivalent, %xx, where xx represents the two-character hex byte. For example, a space (hex: 20) would be encoded as %20 (hex: 25 32 30) and a plus sign (hex: 2B) would be encoded as %2B or hex 25 32 42.

**X3** = Greenwich Mean Time (GMT) offset value (-12.00 to +14.00) represents the time difference in hours and minutes (+/-hh:mm) relative to Greenwich, England. The leading zero is optional. For example, 5:30 = 05:30. Do not use a plus (+) sign if the GMT offset is positive.

**X5** = On/off status  
0 = off/disable  
1 = on/enable

**X8** = Volume level (0 – 100 steps). The maximum volume level is limited by the max. volume range command (**X?**\*47#). Default volume = 25.

**X11** = Version (typically listed to two decimal places, e.g., x.xx)

**X12** = MLC's name. The name is a text string of up to 24 characters drawn from the alphabet (A-Z), digits (0-9), and minus sign/hyphen (-). No blank or space characters are permitted as part of a name. No distinction is made between upper and lower case. The first character **must** be a letter. The last character **must not** be a minus sign/hyphen.

**X13** = Local date and time format

Set format (MM/DD/YY-HH:MM:SS).

Example: 01/18/05-10:54:00.

Read format (day of week, date month year HH:MM:SS). Example: Tue, 18 Jan 2005 18:19:33.

**X14** = IP address (xxx.xxx.xxx.xxx). Leading zeros in each of four fields are optional in setting values, and they are suppressed in returned values. MLC's default address: 192.168.254.254  
Default broadcast address: 255.255.255.255.

**X15** = E-mail domain name; for example, *extron.com*

**X17** = Time in tens of milliseconds to wait until the first response character is received via a serial port before terminating the current receive operation (Default = 10 = 100 ms, max. = 32767.) The response includes leading zeros.

**NOTE** For commands that use both **X17** and **X20**, both variables must be zero or both must be non-zero. In the RS (send data) command, **X17** is optional as long as **X20** is also missing.

**X18** = Hardware (MAC) address (xx-xx-xx-xx-xx-xx) (00-05-A6-xx-xx-xx)

**X19** = Subnet mask (xxx.xxx.xxx.xxx). Leading zeros are optional in setting values in each of four fields, and they are suppressed in returned values. Default = 255.255.0.0.

**X20** = Time in tens of milliseconds to wait between characters being received via a serial port before terminating the current command or receive operation. The response includes leading zeros. (Default = 2 = 20 ms, max. = 32767)

**NOTE** For commands that use both **X17** and **X20**, both variables must be zero or both must be non-zero. In the RS (send data) command, **X17** is optional as long as **X20** is also missing.

# SIS™ Programming and Control, cont'd

- X21** = Parameter (#L or #D) to set either the Length of message to receive or the Delimiter value. # = byte count (for L) or # = a single ASCII character expressed in decimal form (for D).  
The parameter is case sensitive; you must use capital D or capital L.  
Byte count # can be from 0 to 32767, default = 0.  
The ASCII decimal # can be from 0 to 00255, default = 00000L.  
*Examples:*  
A 3-byte length = 3L.  
A delimiter of ASCII 0A = 10D.  
The response from the MLC includes leading zeros.
- X22** = Verbose/response mode status:  
0 = clear/none, default for Telnet connections; responses are not echoed to the host  
1 = verbose mode is on, default for RS-232 host control; responses are echoed to the host and displayed to the user  
2 = send tagged responses for queries  
3 = verbose mode is on and tagged responses are sent for queries
- NOTE** *If tagged responses are enabled, all read commands return the constant string + data, the same as for setting a value. For example, for [Esc] CN ←, the response is Ipn•X12 ← rather than just the data.*
- X23** = Priority status for receiving timeouts:  
0 = use send data string command parameters (0 = default)  
1 = use configure receive timeout command parameters
- X25** = Baud rate: 300, 600, 1200, 1800, 2400, 3600, 4800, 7200, 9600, 14400, 19200, 28800, 38400, 57600, or 115200
- X26** = Parity (only the first letter is needed):  
O odd  
E even  
N none (default)  
M mark  
S space
- X27** = Data bits: 7, 8 (default = 8)
- X28** = Stop bits: 1, 2 (default = 1)
- X33** = Password (minimum length = 4 characters, maximum length = 12 characters, no special characters are allowed)
- NOTE** *A user password cannot be assigned if no administrator password exists; the E14 error code will be returned. If the administrator password is cleared, then the user password is also removed.*
- X34** = Daylight saving time (DST) is a region-specific 1-hour offset that begins in spring and ends in fall.  
0 = off/ignore  
1 = USA on – traditionally starts on the first Sunday of April at 2 am and ends at 2 am on the last Sunday of October. For example, time in California is GMT -8:00 from April to October and GMT -7:00 from November to March. However, in 2007 DST starts on the second Sunday in March and ends the first Sunday in November. DST should be turned off in Hawaii, American Samoa, Guam, Puerto Rico, the Virgin Islands, the eastern time zone portion of the state of Indiana, and the state of Arizona (excluding the Navajo Nation).  
2 = Europe on – begins on the last Sunday in March, ends on the last Sunday in October. DST should be turned off for Iceland.
- X35** = Event number, range = 0 - 99  
(valid only while events are running)
- X40** = I/O mode  
0 = input  
1 = output (digital I/O on 9-pin D connector only)  
2 = input and pull-up resistor (digital I/O on 9-pin D connector only)  
3 = output and pull-up resistor (digital I/O on 9-pin D connector only)  
8 = power sensor digital input
- X41** = Password to display on screen (response to password query or set). When the MLC connects to a host device via RS-232, the password (X33), itself, is the response. When the connection is via IP, X41 is 4 asterisks (\*\*\*\*) if a password has been assigned, or it is an empty field ( ) if a password hasn't been assigned.
- X43** = I/O state  
0 = off  
1 = on
- X45** = E-mail event number or mailbox (1 - 64). The response is two digits with a leading zero.
- X46** = E-mail recipient's address (e.g., JDoe@extron.com) for the person to whom messages will be sent. The e-mail address has a 31 character maximum.
- X47** = Name (numeral) of e-mail file to be sent
- X49** = Default name: a combination of the model name and the last 3 pairs of the MLC's MAC address (e.g., MLC-226-IP-00-02-3D)
- X52** = Connection's security level  
11 = user  
12 = administrator
- X57** = IR playback file number (0 to 99) (no extension) The response includes leading zeros.
- X58** = IR playback function number (1 to 137) The response includes leading zeros. IR function numbers 0 and 127 or higher can return information only.  
0 = return all data  
129 = manufacturer  
130 = model  
131 = class  
132 = remote  
133 = creation date  
134 = comments  
137 = user file name (a descriptive name the user/installer gave the file).
- X59** = IR playback mode  
0 = play once  
1 = play continuously

- X63** = Pulse time in 20 ms per count. If this parameter is missing or = 0, then pulse length = default = 25 = 500 ms. 1 = 20 ms (minimum pulse time) to 65535 = 1310700 ms (maximum pulse time).
- X64** = Broadcast repetition interval in seconds (0 to 255, default = 0 = off)
- X65** = Date and time returned in 7 hex bytes for month, day, year, hour minutes, seconds, day of the week (1 = Sunday, 7 = Saturday)
- X69** = IP connection timeout period in seconds. Each step is specified in 10-second intervals (1 - 65000, default = 30 = 300 seconds). If no data is received during the specified period, the Ethernet connection closes. Responses are returned with leading zeros.
- X70** = The number to insert into an email message if a `____.eml` file has an embedded server-side include `"<!--#echo var = "WCR |" -->"` (the **Esc** CR ← command with no parameters.) The numeral is a 16-bit number to be employed as the user defines. This is an optional parameter. Use 0 as a placeholder if the optional **X47** variable is used but **X70** is not needed. Maximum = 65535.
- X73** = An e-mail account username of up to 31 characters. Do not use commas. This parameter is optional during setup and is used for SMTP authentication.
- X74** = An e-mail account password (for SMTP authentication) of up to 31 characters. Do not use commas. This parameter is optional during setup.
- X200** = Specific input number (1 - 6)  
 1 = input 1  
 2 = input 2  
 3 = input 3  
 4 = input 4  
 5 = input 5  
 6 = input 6
- X205** = Lamp hours elapsed (0 to 99999 hours)  
 The five-digit response includes leading zeros. The default is 99999 hours, which yields an "N/A" response.
- X206** = Voltage (in volts)
- X207** = Temperature in degrees Celsius (the response is 3 digits including leading zeros)
- X208** = Display (projector) power status  
 0 = display power is off  
 1 = display power is on  
 2 = display is powering down/off (cooling down)  
 3 = display is powering up/on (warming up)
- X209** = Front panel lockout (executive mode) status  
 0 = off/unlocked (default)  
 3 = on, disable/lock entire front panel (buttons, volume control) and optional connected SCP, control module(s), and IR remote control
- X210** = IR/serial port configuration  
 0 = IR ports (0 V - 5 V)  
 (default for IR/Serial Output ports A-C)  
 1 = RS-232 ports (±5 V)  
 (default for the Display RS-232/IR port)
- X211** = Status (in hexadecimal characters) of script or firmware button control. This variable is an 8-digit hexadecimal character calculated from a binary bit map. It is case-sensitive. Use capital letters. See page 5-30 for details.
- X212** = Status (in hexadecimal characters) of control of all button lights.  
 This variable is an 8-digit hexadecimal character calculated from a binary bit map, and it is case-sensitive. Use capital letters. See page 5-32 for details.
- X213** = Power sensor status:  
 00 = power sensor is connected and is not sensing projector power  
 01 = power sensor is connected and is sensing projector power  
 02 = power sensor is disconnected or sensor is connected but the sensitivity is set too high
- X214** = Power sensor signal pin status  
 00 = voltage is low  
 01 = voltage is high  
 Leading zeros are used in responses to commands that use this variable.
- X215** = IR/Serial Output port number  
 1 = projector/display port  
 2 = port A  
 3 = port B  
 4 = port C
- X216** = Display mute or connection status  
 0 = off/disconnected  
 1 = on/connected  
 2 = unknown/unavailable (default for connection status)
- X217** = Firmware's event status polling period from 0 to 255 in 20 ms increments. **X217** is optional: if it is not set, it defaults to 100 (2 seconds) and is not shown in the command's response. If **X217** is set to 0, the firmware does not poll for event status.
- NOTE** *The event number that is polled is set by **X35** in the EN command.*
- X223** = Digital I/O port (specifying which port)  
 1 = rear panel Host Control port (9-pin D connector)  
 2 = Pwr Sns pin on the Display RS-232/IR port

## Command/response table for SIS commands

Command	ASCII (Telnet) (host to switcher)	URL Encoded (Web) (host to switcher)	Response (switcher to host)	Additional description
<b>Input selection</b>				
Select an input <sup>14,22</sup>	X200!	X200%21	Chn X200 ↵	Select input X200 (X200 = 1, 2, 3, 4, 5, 6) (audio and video). <sup>14</sup> = The MLC responds with an E14 error code (invalid for this configuration) if the desired input is not set up to switch inputs (is not in input button mode). Events are still triggered, though. <sup>22</sup> = The MLC sends a "busy" response (E22) if switching functions are locked.
<b>Display (projector) power</b>				
Turn display power on	1P	1P	Pwr X208 ↵	On (discrete).
Turn display power off	0P	0P	Pwr X208 ↵	Off (discrete).
View display power status	P	P	X208 ↵	Show the display power status.
Example:	P	P	2 ↵	Example: the display is powering off.
Set power status	X208*0P	X208%2A0P	Pwr X208 ↵	This command is used only by scripts. It provides a way to set the power status to match the actual state of the projector. For X208, 0 = display power is off 1 = display power is on 2 = display is powering down/off 3 = display is powering on (warming up).
<b>NOTE</b>	This command does not trigger the warm up/cool down (power on/power off) sequences or the button's events.			
<b>Display mute</b>				
<b>NOTE</b>	The 1M and 0M commands emulate the IR 402's Display Mute On and Display Mute Off buttons. You must program these buttons on the remote for the 1M and 0M commands to function.			
Turn display mute on	1M	1M	Mut X216 ↵	Mute. X216 = 0 (off), 1 (on), or 2 (unknown).
Turn display mute off	0M	0M	Mut X216 ↵	Unmute.
View display mute status	M	M	X216 ↵	Show display mute status.
Set mute status	X216*0M	X216%2A0M	Mut X216 ↵	This command is used only by scripts. It provides a way to set the status to match the actual state of the projector.
<b>NOTE</b>	This command does not trigger button events.			

## Command/response table for SIS commands (continued)

Command	ASCII (Telnet) (host to switcher)	URL Encoded (Web) (host to switcher)	Response (switcher to host)	Additional description
<b>Volume adjustment (discrete, for volume mode = 0)</b>				
Set the overall output volume level <sup>14</sup>	[X8]V	[X8]V	Vol [X8]↵	This command sets a specific volume level for the audio output at either the display device or via an optional slaved Extron MediaLink (MLS) switcher. [X8] = volume level (0 to 100). Default volume = 25. When no MLS is detected at the MLS port, the maximum volume level is limited by the max. volume range command ([X7]*47#). <i>Example:</i> set volume to 27.
Increment the volume	+V	%2BV	Vol [X8]↵	Increase audio output.
Decrement the volume	-V	%2DV	Vol [X8]↵	Decrease audio output.
View the volume level	V	V	[X8]↵	Show the output volume.
<b>Volume adjustment (for volume mode = 1)</b>				
Increment the volume	+V	%2BV	Vol [X8]↵	Increase audio output.
<b>NOTE</b> The MLC responds with an E14 (not valid for this configuration) error if you attempt to set a discrete volume level while the MLC is in increment/decrement volume mode (volume mode 1).				
Decrement the volume	-V	%2DV	Vol [X8]↵	Decrease audio output.
View the volume level	V	V	[X8]↵	Show the output volume.
<b>Audio mute</b>				
Mute on	1Z	1Z	Amt1↵	Mute all audio outputs. This is <b>not</b> the same as selecting input 0.
Mute off	0Z	0Z	Amt0↵	Unmute all audio outputs.
View the audio mute status	Z	Z	[X5]↵	Show the status of audio mute. [X5] = 0 (off) or 1 (on).
<b>Relay functions</b>				
Force relay on	[X1]*10	[X1]%2A10	Rly [X1]*1	Turn relay number [X1] on. [X1] = 1-6, to match the corresponding relay number.
Force relay off	[X1]*00	[X1]%2A00	Rly [X1]*0↵	Turn relay number [X1] off.
Toggle relay	[X1]*20	[X1]%2A20	Rly [X1]*[X5]↵	Toggle relay [X1] on/off. [X5] = 1 (on) or 0 (off).

## Command/response table for SIS commands (continued)

Command	ASCII (Telnet) (host to switcher)	URL Encoded (Web) (host to switcher)	Response (switcher to host)	Additional description
Pulse relay	X1*3*X63 O	X1%2A3%2AX63 O	Rly X1 * X5 ← Rly X1 * X5 ←	Set a specific (X1) relay's pulse time (X63) in 20 ms increments from 1 (20 ms, minimum) to 65535 (1310700 ms, maximum). Default pulse length is 25 = 500 ms.
<p><b>NOTE</b> If the verbose mode is enabled, there are two responses from the unit because the relay is pulsed. During a pulse, the relay is toggled to its opposite state and then back to the original state.</p>				
View the relay state	X1 O	X1 O	X5 ←	
<b>Front panel security lockout modes (executive modes)</b>				
Disable lockout modes <sup>24</sup>	0X	0X	Exe 0 ←	Default setting. Adjustments and selections can be made from the front panel in addition to via RS-232, Telnet, or Web browser.
Enable lockout mode 3 <sup>24</sup>	3X	3X	Exe 3 ←	<sup>24</sup> = The MLC responds with an E24 error (privilege violation) if the connected user is not logged in at administrator security level.
View the lockout mode status	X	X	X209 ←	Lock all front panel selections and adjustments via MLC, control modules, SCP, and IR remote. Make selections, changes, and configure features via RS-232 or Web/Ethernet only. All front panels in the control system are locked.
Example:	X	X	0 ←	Show lockout (executive mode) status. X209 = 0 (off, unlocked) or 3 (front panels, control modules, and remote control locked / disabled). Executive mode is off.
<b>Status commands</b>				
View lamp hours status	6S	6S	X205 ← or X205 * X205 ←	X205 represents the number of elapsed hours of projector lamp use. The MLC responds with two sets of lamp hours only if two lamp hours have been set. If a lamp's status has not been set, it is shown as the default (99999 hours) or "N/A".



## Command/response table for SIS commands (continued)

Command	ASCII (Telnet) (host to switcher)	URL Encoded (Web) (host to switcher)	Response (switcher to host)	Additional description
Set lamp hours status for 1 lamp <sup>24</sup>	X205*6S	X205%/2A 6S	Lhr*X205 ←	X205 represents the five-digit numeric value for elapsed lamp use hours, and it is used by script to determine the number sent in response to the “view lamp hours” command (6S). <sup>24</sup> = The MLC responds with an E24 error (privilege violation) if the connected user is not logged in at administrator security level.
Set lamp hours status for 2 lamps <sup>24</sup>	X205*X205*6S	X205%/2A X205%/2A 6S	Lhr*X205 * X205 ←	
View connection status	7S	7S	X216 ←	This command lets you know whether the MLC’s scripts have determined if the display is still connected to the MLC. X216 = 0 (disconnected), 1 (connected), or 2 (unknown).
Set display connection status <sup>24</sup>	X216*7S	X216%/2A 7S	Pcs X216 ←	This command is used to reset the projector/display connection status flag (X216) used by scripts. 0 = projector not connected. 1 = projector is connected. 2 = undetermined status.
View power sensor status	8S	8S	X213 ←	If the MLC is connected to an Extron Power Sensor that monitors the projector/display, this tells you whether the display is still powered on. X213 is as follows: 00 = power sensor is connected and is not sensing projector power. 01 = power sensor is connected and sensing projector power. 02 = sensor is disconnected or sensor is connected but sensitivity is too high.
View power sensor signal pin status	9S	9S	X214 ←	Power sensor signal pin status (X214): 00 = voltage is low. 01 = voltage is high The response includes leading zeros.
View all voltage and temperature status	11S	11S	responses from commands 12S•13S•14S•15S•16S•20S ←	View all voltages and the MLC’s internal temperature at once.
View +12 V power supply voltage	12S	12S	+X206 ←	Display the operating voltage of the MLC’s power input. X206 = voltage in volts.

## Command/response table for SIS commands (continued)

Command	ASCII (Telnet) (host to switcher)	URL Encoded (Web) (host to switcher)	Response (switcher to host)	Additional description
View +5 V IR receiver port voltage	13S	13S	+X206↵	
View +3.3 V IP Link/FPGA voltage	14S	14S	+X206↵	
View +1.5 V FPGA voltage	15S	15S	+X206↵	
View -10 V IR/Serial bus voltage	16S	16S	-X206↵	Display the operating voltage for the IR/Serial and projector ports.
View internal temperature status	20S	20S	X207↵	Display the internal operating temperature. X207 = temperature in degrees Celsius (the response is 3 digits including leading zeros).

## Command/response table for SIS commands (continued)

Command	ASCII (Telnet) (host to switcher)	URL Encoded (Web) (host to switcher)	Response (switcher to host)	Additional description						
<b>Serial data port configuration and use</b>										
These commands apply to any port that uses RS-232 communication: both 1-way (output) and 2-way (bidirectional) RS-232 communication.										
Send data string	<code>[Esc][X1][X17]*[X20]*[X21]RS←[X2]</code>	<code>W[X1]%2A[X17]%2A[X20]%2A[X21]RS [X2]</code>	<i>response from command</i> ←	<p><b>[X1]</b> = specific port number (01 – 99)</p> <p>1 = rear host (Host Control RS-232 port)</p> <p>2 = front panel Config port</p> <p>3 = slaved switcher (MLS port)</p> <p>4 = display port (Projector RS-232 / IR)</p> <p>5 = IR / Serial port A</p> <p>6 = IR / Serial port B</p> <p>7 = IR / Serial port C</p> <p><b>[X2]</b> = command data section (&lt; 200 bytes).</p> <p><b>[X17]</b> = time in tens of ms for the MLC to wait until receipt of the first response character before terminating the current receive operation (default = 10 = 100 ms, max. = 32767). The response includes leading zeros.</p> <p><b>[X20]</b> = time in tens of ms for the MLC to wait between characters being received via a serial port before terminating the current receive operation (default = 2 = 20 ms, max. = 32767). The response includes leading zeros.</p> <p><b>[X21]</b> = #L or #D. The letter parameter is case sensitive (requires a capital "D" or capital "L"). The response includes leading zeros.</p> <p>L = <u>L</u>ength of the message to be received.</p> <p>D = <u>D</u>elimiter value.</p> <p># = byte count (for L) or a single ASCII character expressed in decimal form (for D).</p> <p>Byte count # can be from 0 to 32767, default = 0. The ASCII decimal delimiter # value can be from 0 to 00255, default = the byte count.</p> <p><i>Examples: A 3-byte length = 3L. A delimiter of ASCII 10A = 10D.</i></p>						
<b>NOTE</b>	* <b>[X17]</b> * <b>[X20]</b> * <b>[X21]</b> is optional. <b>[X17]</b> is optional only if <b>[X20]</b> is also missing. If these three variables are not specified, the default values are used. For this command, <b>[X17]</b> and <b>[X20]</b> must both a) equal zero or b) be nonzero.									
<b>NOTE</b>	For Web encoding for <b>[X2]</b> , convert nonalphanumeric characters to hex numbers. A space (hex = 20) is encoded as %20. A plus sign (hex = 2B) is encoded as %2B. Example: <code>[Esc]05*4*7*3LRS←&lt;data&gt;</code> <code>W05%2A4%2A7%2A3LRS &lt;data&gt;</code>									
<b>NOTE</b>	The data string <b>[X2]</b> in this RS command is limited to 200 bytes.									
<b>ASCII to Decimal Conversion Table</b>										
To find the decimal equivalent of the ASCII character, add the row heading and column heading numbers together.										
	0	1	2	3	4	5	6	7	8	9
10	LF									
20							Esc			
30			space	!	"	#	\$	%	&	'
40	(	)	*	+	,	-	.	/	0	1
50	2	3	4	5	6	7	8	9	:	;
60	<	=	>	?	@	A	B	C	D	E
70	F	G	H	I	J	K	L	M	N	O
80	P	Q	R	S	T	U	V	W	X	Y
90	Z	[	\	]	^	_	`	a	b	c
100	d	e	f	g	h	i	j	k	l	m
110	n	o	p	q	r	s	t	u	v	w
120	x	y	z	{		}	~	Del		

LF = line feed  
CR = carriage return (↵)  
Esc = escape  
Del = delete



## Command/response table for SIS commands (continued)

Command	ASCII (Telnet) (host to switcher)	URL Encoded (Web) (host to switcher)	Response (switcher to host)	Additional description
Get IR command info <sup>28</sup>	<code>[Esc] X57 [X58] IR ←←</code>	<code>W[X57]%;2C[X58]IR  </code>	<code>(descriptive text) ←←</code>	The response to this command is the name/description (e.g., Power On, Power Off, Enter, Play, Stop, RGB, Menu) of the specific command you ask about. <code>X57</code> = the IR file number (0-99), as in files <code>1.eir</code> , <code>2.eir</code> , <code>3.eir</code> , etc. stored in the controller. Each <code>__eir</code> file contains commands for a specific device. <code>X58</code> = IR function number (1-137), which corresponds to a specific function/command set contained within the file. If <code>X58</code> = 0, the MLC returns all data. See page 5-7 for additional details on <code>X58</code> . Command/function 1 in file <code>3.eir</code> is the Power command. Command/function 2 in file <code>3.eir</code> is not defined or does not exist, so the controller returns E13, the invalid value error number.
<i>Example:</i>	<code>[Esc] 3,1IR ←←</code>	<code>W3%;2C1IR  </code>	<code>POWER ←←</code>	
<i>Example:</i>	<code>[Esc] 3,2IR ←←</code>	<code>W3%;2C2IR  </code>	<code>E13 ←←</code>	
<b>NOTE</b>	<i>An IR driver must be loaded into the MLC before IR command information can be read.</i>			
Configure an IR/Serial Out port <sup>24</sup>	<code>[Esc] X215 [X210] IC ←←</code>	<code>W[X215]%;2A[X210]IC  </code>	<code>Irc[X215] [X210] ←←</code>	This command sets IR/Serial Output port number <code>X215</code> (1 = display port, 2 = port A, 3 = port B, 4 = port C) for either IR ( <code>X210</code> = 0) or RS-232 ( <code>X210</code> = 1) output. <code>X210</code> includes a placeholder zero in the response.
View an IR/Serial port's config.	<code>[Esc] X215 [IC] ←←</code>	<code>W[X215] IC  </code>	<code>[X210] ←←</code>	View the projector port's configuration, which is RS-232 in this example.
<i>Example</i>	<code>[Esc] 1 IC ←←</code>	<code>W1 IC  </code>	<code>01 ←←</code>	

## Command/response table for SIS commands (continued)

Command	ASCII (Telnet) (host to switcher)	URL Encoded (Web) (host to switcher)	Response (switcher to host)	Additional description
<b>Ethernet data port configuration and use</b>				
Set global IP port timeout period <sup>24</sup>	<code>[Esc]1*[X69]TC←←</code>	<code>W1%2A[X69]TC </code>	<code>Pti 1*[X69]←←</code>	The global port timeout is the default timeout period for all Telnet sessions. <code>[X69]</code> = IP connection timeout period in seconds. Each step is specified in 10-second intervals (1 - 65000, default = 30 = 300 seconds). If no data is received during the specified period, the Ethernet connection closes. Responses are returned with leading zeros. This timeout period is applicable only when the MLC is connected via Ethernet, and you must be logged in as an administrator to change this setting.
View global IP port timeout period	<code>[Esc]1TC←←</code>	<code>W1TC </code>	<code>[X69]←←</code>	
Set current port's timeout period <sup>13,24</sup>	<code>[Esc]0*[X69]TC←←</code>	<code>W0%2A[X69]TC </code>	<code>Pti 0*[X69]←←</code>	The current port timeout period applies to the currently open Telnet session only. When you start another Telnet session, it uses the default global port timeout period. <code>[X69]</code> = timeout period in seconds. See the description above. This variable is applicable only when the MLC is connected via Ethernet. If the MLC is connected via RS-232 protocol, only the global timeout commands apply, and any commands involving <code>[X69]</code> return the E13 error response.
View current port's timeout period <sup>13</sup>	<code>[Esc]0TC←←</code>	<code>W0TC </code>	<code>[X69]←←</code>	

## Command/response table for SIS commands (continued)

Command	ASCII (Telnet) (host to switcher)	URL Encoded (Web) (host to switcher)	Response (switcher to host)	Additional description
<b>Digital I/O data port (pin 1 of the 9-pin D connector, the Power Sense port on the bottom panel, or the dedicated Digital I/O ports) configuration and use</b>				
<b>NOTE</b> An input voltage below 2.0 VDC is considered to be logic low. An input voltage above 2.8 VDC is considered to be logic high. These thresholds are not adjustable.				
Set the input/output (I/O) mode <sup>24</sup>	<b>X223</b> * <b>X40</b>	<b>X223</b> %2A <b>X40</b> %5B	Iom <b>X223</b> * <b>X40</b> ←	Set the input/output mode ( <b>X40</b> ) for a specific port ( <b>X223</b> ). <b>X223</b> = 1 = rear panel Host Control port (9-pin D connector) Digital I/O port 1 2 = Pwr Sns pin on the Display RS-232/IR port Digital I/O port 2 3 = Digital I/O port 3 <b>X40</b> = 0 = input (default) 1 = output 2 = input and pull-up resistor 3 = output and pull-up resistor 8 = power sensor (used only with an Extron Display Power Sensor connected to the MLC's Pwr Sns port).
<b>NOTE</b> When set for input with pull-up resistor ( <b>X40</b> = 2), the digital input can be triggered by an external switch. When the switch closes, the voltage drops from 5 V to 0 V.				
When set for output with pull-up resistor, the MLC's digital I/O port can drive devices such as relays and LEDs.				
When set for power sensor, the input state is triggered when the optional Display Power Sensor connected to the power sense port detects a state change.				
View the digital I/O mode	<b>X223</b>	<b>X223</b> %5B	<b>X40</b> ←	
Pulse the digital I/O state <sup>14</sup>	<b>X223</b> *3* <b>X63</b>	<b>X223</b> %2A3%2A <b>X63</b> %5D	Sio <b>X223</b> * <b>X43</b> ←	Briefly change the I/O state. <b>X63</b> = Pulse time in 20 ms per count. If this parameter is missing or = 0, then pulse length = default (25 = 500 ms). 65535 (1310 s) = max. pulse time. <b>X43</b> = I/O state: 0 = off 1 = on
<b>NOTE</b> This and the following three commands are valid only when the port is in output mode or in output with pull-up mode.				
Toggle the I/O state <sup>14</sup>	<b>X223</b> *2	<b>X223</b> %2A2%5D	Sio <b>X223</b> * <b>X43</b> ←	Switch the input/output state from on to off or from off to on.
Set the I/O state to on <sup>14</sup>	<b>X223</b> *1	<b>X223</b> %2A1%5D	Sio <b>X223</b> *1←	
Set the I/O state to off <sup>14</sup>	<b>X223</b> *0	<b>X223</b> %2A0%5D	Sio <b>X223</b> *0←	
View the I/O state	<b>X223</b>	<b>X223</b> %5D	<b>X43</b> ←	

## Command/response table for SIS commands (continued)

Command	ASCII (Telnet) (host to switcher)	Q or 1Q	Q or 1Q	URL Encoded (Web) (host to switcher)	Response (switcher to host)	Additional description
<b>Firmware version, part number and information requests</b>						
<b>NOTE</b>	In a query response, an asterisk (*) after the version number indicates the version that is currently used.					
	A question mark (?) or ??? indicates that the factory default firmware is the only firmware loaded in the MLC.					
	A carat (^) indicates the version of firmware that should be running, but, since a mode 1 reset was performed, the factory default firmware version is loaded and running instead.					
	An exclamation point (!) indicates that the firmware is corrupted.					
<b>NOTE</b>	Responses to commands differ depending on which, if any, verbose response mode the MLC is in. See the CV command ( <b>Esc</b> X22CV ←) under IP setup commands later in this table.					
Query firmware version number	Q or 1Q	Q or 1Q	Q or 1Q		<b>X11</b> ← or Ver01* <b>X11</b> ← 1.01 or Ver01*1.01	Show the MLC's firmware version ( <b>X11</b> ) to two decimal places. This query yields the number of the currently running version of the user-updatable firmware
Example:	1Q	1Q	1Q			
Query verbose firmware version information	0Q	0Q	0Q		[response from 2Q]–[response from 3Q]–[response from 4Q] ← or Ver00*[response from 2Q]–[response from 3Q]–[response from 4Q] ←	Show the bootstrap, factory-installed, and updated firmware versions. See 2Q, 3Q, and 4Q below.
Example:	0Q	0Q	0Q		1.03-1.00(1.18-MLC226 -Thu, 20 Jan 2005 09:41:47 GMT)-1.01*(1.31-MLC226 -Tue, 14 Jun 2005 00:54:58 GMT) ←	
Query bootstrap firmware version	2Q	2Q	2Q		<b>X11</b> ← or Ver02* <b>X11</b> ← 1.03 ←	The bootstrap firmware is not user-replaceable, but you may need this information during troubleshooting.
Example:	2Q	2Q	2Q			
Query factory firmware version	3Q	3Q	3Q		<b>X11</b> (kernel version–model description–date time of upload) ← or Ver03* <b>X11</b> (kernel version–model description–date time of upload) ←	Factory-installed firmware is different from the bootstrap firmware, but it is also not user-replaceable. This firmware was installed at the factory; it is the version the controller reverts to after a mode 1 reset (see ch. 2).
Example:	3Q	3Q	3Q		1.00(1.18-MLC226 -Thu, 20 Jan 2005 09:41:47 GMT) ←	In this example the factory firmware version is 1.00 and the IP Link kernel version is 1.18 for the MLC 226, dated 20 January 2005.



## Command/response table for SIS commands (continued)

Command	ASCII (Telnet) (host to switcher)	URL Encoded (Web) (host to switcher)	Response (switcher to host)	Additional description
Query updated firmware version	4Q	4Q	X11 (kernel version-model description-date time of upload)↵ or Ver04*X11 (kernel version-model description-date time of upload)↵	Use this command to find out which version of the firmware, if any, was uploaded into the controller after it left the factory
<i>Example:</i>	4Q	4Q	1.01*(1.31-MLC226 -Mon, 28 Feb 2005 23:16:55 GMT) ↵	In this example the current firmware version is 1.01, the IP Link kernel version is 1.31, for the MLC 226 IP, dated 28 February, 2005.
Query FPGA version	32Q	32Q	X11 ↵	Show the field-programmable gate array (FPGA) firmware version to two decimal places (x.xx).
Request the MLC's part number	N	N	60-600-00 ↵ 60-818-00 ↵ or Pno60-600-00 ↵ 60-818-00 ↵	Show the MLC's part #.
Request A/V input number	I	I	Chn X200 ↵	Show which input is active (selected). X200 is the input number. The MLC responds with an E14 error if no input buttons are set up for firmware control (input switching).
Request the model name	1I	1I	MLC 226 IP ↵ or Inf01*MLC 226 IP ↵	MLC 226 IP
Request the model description	2I	2I	MLC 226 w / IP ↵ or Inf02*MLC 226 w / IP ↵	MLC 226 with IP control.
Request system memory usage	3I	3I	# bytes used out of # of kbytes ↵ or Inf03*# bytes used out of # of kbytes ↵	Show amount of memory used and total available memory for system operations.
Request user memory usage	4I	4I	# bytes used out of # of kbytes ↵ or Inf04*# bytes used out of # of kbytes ↵	Show amount of user memory used and total available user memory.
<i>Example:</i>	4I	4I	217856 Bytes Used out of 7232 KBytes	



## Command/response table for SIS commands (continued)

Command	ASCII (Telnet) (host to switcher)	URL Encoded (Web) (host to switcher)	Response (switcher to host)	Additional description
Set unit name to factory default <sup>24</sup>	<b>Esc</b> • CN ←	W%20CN	Ipn • <b>X49</b> ←	<b>X49</b> = the name the MLC was shipped with: MLC-226-IP-##-##-##, a combination of the model name and the last 3 pairs of hex numbers in the controller's MAC address (e.g., MLC-226-IP-00-02-3D).
Read the unit name	<b>Esc</b> CN ←	WCN	<b>X12</b> ← or <b>X49</b> ←	<b>X12</b> is the MLC's current, user-defined unit name. <b>X49</b> is the MLC's factory default name.
Set date/time <sup>24</sup>	<b>Esc</b> <b>X13</b> CT ←	W <b>X13</b> CT	Ipt • <b>X13</b> ←	<b>X13</b> = Local date and time format. The set format is MM/DD/YY-HH:MM:SS. <i>Example: 09/07/06-10:54:00.</i>
Read date/time	<b>Esc</b> CT ←	WCT	<b>X13</b> ←	<b>X13</b> = Local date and time format. The Read format is <i>day of week, DD month year HH:MM:SS.</i> <i>Example: Fri, 08 Sept 2006 18:19:33.</i>
Set GMT offset <sup>24</sup>	<b>Esc</b> <b>X3</b> CZ ←	W <b>X3</b> CZ	Ipz <b>X3</b> ←	Set the Greenwich Mean Time (GMT) offset value ( <b>X3</b> ) for the MLC's location. GMT offset (-12.00 to +14.00) represents the time difference in hours and minutes (+/-hh:mm) relative to Greenwich, England. The leading zero is optional. For example, 5:30 = 05:30. Do not use a plus (+) sign if the GMT offset is positive.
Read GMT offset	<b>Esc</b> CZ ←	WCZ	<b>X3</b> ←	
Set daylight saving time <sup>24</sup>	<b>Esc</b> <b>X34</b> CX ←	W <b>X34</b> CX	Ipx <b>X34</b> ←	
Read daylight saving time	<b>Esc</b> CX ←	WCX	<b>X34</b> ←	<b>X34</b> = Daylight saving time (DST) is a region-specific 1-hour offset that begins in spring and ends in fall. 0 = off/ignore 1 = USA on – starts on the first Sunday of April at 2 am and ends on the last Sunday of October. For example, time in California is GMT -8:00 from April to October and GMT -7:00 from November to March. However, in 2007 DST starts on the second Sunday in March and ends the first Sunday in November. DST should be turned off in Hawaii, American Samoa, most equatorial regions, Guam, Puerto Rico, the Virgin Islands, the eastern time zone portion of the state of Indiana, and the state of Arizona (excluding the Navajo Nation). 2 = Europe on – begins on the last Sunday in March, ends on the last Sunday in October. DST should be turned off in Iceland.

## Command/response table for SIS commands (continued)

Command	ASCII (Telnet) (host to switcher)	URL Encoded (Web) (host to switcher)	Response (switcher to host)	Additional description
Set DHCP on <sup>24</sup>	<b>Esc</b> 1 DH ←	W1DH	Idh 1 ←	
Set DHCP off <sup>24</sup>	<b>Esc</b> 0 DH ←	W0DH	Idh 0 ←	
<b>NOTE</b> Changing DHCP from on to off also resets the IP address to the factory default (192.168.254.254).				
View DHCP mode	<b>Esc</b> DH ←	WDH	<b>X5</b> ←	<b>X5</b> = 0 (off) or 1 (on).
Set IP address <sup>24</sup>	<b>Esc</b> <b>X14</b> CI ←	W <b>X14</b> CI	Ipi • <b>X14</b> ←	<b>X14</b> = IP address (xxx.xxx.xxx.xxx). Leading zeros in each of the four fields are optional in setting values.
Read IP address	<b>Esc</b> CI ←	WCI	<b>X14</b> ←	Leading zeros in each of the four fields are suppressed in returned values.
Read hardware address (MAC)	<b>Esc</b> CH ←	WCH	<b>X18</b> ← or Iph • <b>X18</b> ←	<b>X18</b> = hardware (MAC) address (xx-xx-xx-xx-xx-xx).
Set subnet mask <sup>24</sup>	<b>Esc</b> <b>X19</b> CS ←	W <b>X19</b> CS	Ips • <b>X19</b> ←	<b>X19</b> = subnet mask (xxx.xxx.xxx.xxx). Syntax is the same as for IP addresses. Leading zeros are optional in setting values.
Read subnet mask	<b>Esc</b> CS ←	WCS	<b>X19</b> ←	Leading zeros are suppressed.
Set gateway IP address <sup>24</sup>	<b>Esc</b> <b>X14</b> CG ←	W <b>X14</b> CG	Ipg • <b>X14</b> ←	<b>X14</b> = IP address (xxx.xxx.xxx.xxx). Leading zeros are optional.
Read gateway IP address	<b>Esc</b> CG ←	WCG	<b>X14</b> ←	
Set verbose response mode on/off <sup>24</sup>	<b>Esc</b> <b>X22</b> CV ←	W <b>X22</b> CV	Vrb <b>X22</b> ←	Enable or disable the verbose mode via this command. For <b>X22</b> : 0 = clear/none, default for Telnet connections; responses are not echoed to the host 1 = verbose mode is on, default for RS-232 host control; responses are echoed to the host and displayed to the user 2 = send tagged responses for queries 3 = verbose mode is on and tagged responses are sent for queries.
<b>NOTE</b> If tagged responses are enabled, all read commands return the constant string + data, the same as for setting a value. For example, for <b>Esc</b> CN ←, the response is Ipi • <b>X12</b> ← rather than just the data.				
<b>NOTE</b> Verbose mode is a communication mode in which the device responds with more information than it usually would—more than the device, itself, requires. For example, the controller can send out unsolicited information (such as notice of a volume or input change or a change in some other setting). That is an example of a verbose (wordy) relationship between the controller and a connected device. Verbose mode creates more network traffic than usual, which can slow down network performance. Verbose mode is usually enabled for troubleshooting and disabled for daily use.				
<ul style="list-style-type: none"> <li>For a direct RS-232 connection, the controller is set for verbose mode by default.</li> <li>When the MLC is connected via Ethernet, verbose mode is disabled (by default) in order to reduce the amount of communication traffic on the network. If you want to use the verbose mode with a controller connected via Ethernet, this mode must be set to “on” each time you reconnect to the controller.</li> </ul>				
Read verbose mode status	<b>Esc</b> CV ←	WCV	<b>X22</b> ←	

## Command/response table for SIS commands (continued)

Command	ASCII (Telnet) (host to switcher)	URL Encoded (Web) (host to switcher)	Response (switcher to host)	Additional description
Get a connection listing	<b>Esc</b> CC ←	WCC	[total number of client connections] ↵ or Icc [total number of client connections] ↵	
<i>Example:</i>	<b>Esc</b> CC ←	WCC	002 ↵	<i>Example:</i> This shows two client connections.
Set the broadcast mode <sup>24</sup>	<b>Esc</b> X64 X14 EB ←	W X64 %2C X14 EB	Bmd X64 X14 ↵	This command details how often and to what subnet work the MLC broadcasts a message. X64 = Broadcast repetition interval in seconds (0 to 255 [4.25 minutes], default = 0 = off). X14 = IP address (xxx.xxx.xxx.xxx). Leading zeros in each of four fields are optional in setting values, and they are suppressed in returned values. Default broadcast address: 255.255.255.255.
Set the broadcast mode to the default address <sup>24</sup>	<b>Esc</b> X64 EB ←	W X64 EB	Bmd X64,255.255.255.255 ↵	
Clear the broadcast mode <sup>24</sup>	<b>Esc</b> 0 EB ←	W 0 EB	Bmd 000,255.255.255.255 ↵	This command sets the repeat interval to zero, turning off the broadcast mode.
View the broadcast mode	<b>Esc</b> EB ←	WEB	X64 X14 ↵	
<b>Password and security settings</b>				
Read connection's security level	<b>Esc</b> CK ←	WCK	X52 ↵ or Pvl X52 ↵	For X52 11 = user 12 = administrator
Set administrator password <sup>24</sup>	<b>Esc</b> X33 CA ←	W X33 CA	Ipa • X41 ↵	Set the administrator access password (X33), 4 to 12 alphanumeric characters). The password is case sensitive. Special characters (spaces, symbols) are not allowed. X41 = Password to display on screen (response to password query). When the MLC connects to a host device via RS-232, the password (X33), itself, is the response. When the connection is via IP, X41 is 4 asterisks (****) if a password has been assigned, or it is an empty field ( ) if a password hasn't been assigned.

## Command/response table for SIS commands (continued)

Command	ASCII (Telnet) (host to switcher)	URL Encoded (Web) (host to switcher)	Response (switcher to host)	Additional description
Clear administrator password <sup>24</sup>	<b>Esc</b> • CA ←	W%20CA ↓	Ipa • ↓	Clear / remove all passwords (administrator and user).
<b>NOTE</b> A user password cannot be assigned if an administrator password does not exist. Also, if the administrator password is cleared, the user password is also cleared.				
Read administrator password	<b>Esc</b> CA ←	WCA	<b>X41</b> ↓	
Set user password <sup>41, 24</sup>	<b>Esc</b> <b>X33</b> CU ←	W <b>X33</b> CU	Ipu • <b>X41</b> ↓	Set the user password ( <b>X33</b> is 4 to 12 alphanumeric characters). The password is case sensitive. Special characters (spaces, symbols) are not allowed. <b>X41</b> = Password to display on screen.
<b>NOTE</b> A user password cannot be assigned if an administrator password does not exist. Also, if the administrator password is cleared, the user password is also cleared.				
Clear user password <sup>24</sup>	<b>Esc</b> • CU ←	W%20CU	Ipu • ↓	This clears the user password only.
Read user password	<b>Esc</b> CU ←	WCU	<b>X41</b> ↓	
<b>Remapping port designations</b>				
For security reasons the network administrator may wish to assign new / different port numbers to the controller's Telnet, Web browser, and direct access ports or to disable one or more ports. Typically Telnet uses port 23, Web access is via port 80 (HTTP), and direct access is via port 2001.				
<b>CAUTION</b> Do not set two or more ports to the same port number. Setting two ports to the same number could cause networking conflicts and will also result in an E13 (invalid parameter) error.				
<b>NOTE</b> If you remap a port, you must set the port number to 1024 or higher, unless you reset the port to the default number or disable the port by setting it to 0.				
Set the Telnet port map <sup>24</sup>	<b>Esc</b> {port#}MT ←	W{port#}MT	Pmt {port#} ↓	Select a number for the port that will not conflict with any other ports.
Reset the Telnet port map <sup>24</sup>	<b>Esc</b> 23MT ←	W23MT	Pmt 00023 ↓	This resets the Telnet port to port 23.
Disable the Telnet port map <sup>24</sup>	<b>Esc</b> 0MT ←	W0MT	Pmt 00000 ↓	Setting the port number to 0 disables the port.
Read the Telnet port map	<b>Esc</b> MT ←	WMT	{port#} ↓	
Set the Web port map <sup>24</sup>	<b>Esc</b> {port#}MH ←	W{port#}MH	Pmh {port#} ↓	
Reset the Web port map <sup>24</sup>	<b>Esc</b> 80MH ←	W80MH	Pmh 00080 ↓	This resets the Web port to port 80.
Disable the Web port <sup>24</sup>	<b>Esc</b> 0MH ←	W0MH	Pmh 00000 ↓	
Read the Web port map	<b>Esc</b> MH ←	WMH	{port#} ↓	
Set the Direct Access port map <sup>24</sup>	<b>Esc</b> {port#}MD ←	W{port#}MD	Pmd {port#} ↓	
Reset the Direct Access port map <sup>24</sup>	<b>Esc</b> 2001MD ←	W2001MD	Pmd 02001 ↓	This resets the direct access port to port 2001.
Disable the Direct Access port <sup>24</sup>	<b>Esc</b> 0MD ←	W0MD	Pmd 00000 ↓	
Read the Direct Access port map	<b>Esc</b> MD ←	WMD	{port#} ↓	

## Command/response table for SIS commands (continued)

Command	ASCII (Telnet) (host to switcher)	URL Encoded (Web) (host to switcher)	Response (switcher to host)	Additional description
<b>Directory commands</b>				
Change or create a directory	<b>Esc</b> path/directory/ C J ←	W path %2F directory %2F C J	Dir • path/directory/ ←	The directory's name must be composed of alphanumeric characters and may include the minus sign (hyphen, -) and the colon (:). The first character must be a letter. Case does not matter. No blank or space characters are permitted in the name. Include the <u>full</u> path, not just the name of the directory. Nonalphanumeric characters in the path (e.g. /) must be encoded to hex characters for use with a Web browser.
<b>NOTE</b> A directory does not fully exist until a file has been copied into that path. Also, the MLC operates differently from PC operating systems: files stored in and directories created in the MLC may have the same names.				
Example:	<b>Esc</b> majordirectory/subdirectory/next-level/ C J ←	W majordirectory %2F subdirectory %2F next-level %2F C J	Dir • majordirectory/subdirectory/next-level/ ←	In this case, the path is <i>majordirectory/subdirectory/</i> . The directory that was just created or changed to is called <i>next-level</i> .
Example:	<b>Esc</b> custompages/HTMLfiles/ C J ←	W custompages %2F HTMLfiles %2F C J	Dir • custompages/HTMLfiles/ ←	This example just created a subdirectory for storing the user's custom-made HTML files. The directory that was just created is called <i>HTMLfiles</i> .
Example:	<b>Esc</b> oak/ C J ←	W oak %2F C J	Dir • oak ←	
Change back to the root directory	<b>Esc</b> / C J ←	W %2F C J	Dir • / ←	
Go up one directory level	<b>Esc</b> . C J ←	W %2E %2E C J	Dir • path/directory/ ←	
View the current directory	<b>Esc</b> C J	W C J	path/directory/ ←	
<b>NOTE</b> The current directory is determined on a per-connection basis. At the beginning of each IP connection/session, the current directory is selected as the root directory.				
<b>File handling commands</b>				
Erase the user-supplied Web page and files <sup>24,28</sup>	<b>Esc</b> filename EF ←	W filename EF	Del • filename ←	
Erase the current directory and its files <sup>24,28</sup>	<b>Esc</b> / EF ←	W %2F EF	DdI ←	
Erase the current directory and its subdirectories <sup>24,28</sup>	<b>Esc</b> // EF ←	W %2F %2F EF	DdI ←	

## Command/response table for SIS commands (continued)

Command	ASCII (Telnet) (host to switcher)	URL Encoded (Web) (host to switcher)	Response (switcher to host)	Additional description
List files from the current directory	<b>[Esc]</b> DF←←	WDF	<pre> filename 1]• [day, date time of upload] GMT • [file size 1 in bytes]←← filename 2]• [day, date time of upload] GMT • [file size 2 in bytes]←← filename 3]• [day, date time of upload] GMT • [file size 3 in bytes]←← ... filename n]• [day, date time of upload] GMT • [file size n in bytes]←← [space remaining (to 7 digits)] • Bytes Left←←←←                     </pre>	Retrieve a list of files stored in the controller. Each line of the response lists a different filename and its corresponding file size. The last line of the response indicates how much available file space there is.
				When working with the MLC's embedded Web pages, the response visible in HTML source code follows this structure: <pre> var file=new Array(); file[1]="[filename 1],[day, date time1 of upload] GMT,[file size 1 in bytes]";←← file[2]="[filename 2],[day, date time2 of upload] GMT,[file size 2 in bytes]";←← file[3]="[filename 3],[day, date time3 of upload] GMT,[file size 3 in bytes]";←← ... file[n]="[filename n],[day, date timer n of upload] GMT,[file size n in bytes]";←← file[n+1]="[space remaining (to 7 digits)],Bytes Left;←←                     </pre>
<i>Example (via Telnet or Hyper Terminal):</i>	<b>[Esc]</b> DF←←	WDF	<pre> 4.evt Tue,01 Mar 2005 02:03:07 GMT 42233←← 1.eml Tue,01 Mar 2005 02:03:34 GMT 200←← 2.eml Tue,01 Mar 2005 02:03:34 GMT 300←← 2.eir Tue,01 Mar 2005 02:03:34 GMT 1683←← 6.evt Tue,01 Mar 2005 02:03:36 GMT 17956←← 4.eir Tue,01 Mar 2005 02:03:47 GMT 6849←← MLCmain.sc Tue,01 Mar 2005 02:03:52 GMT 8515←← 0.evt Tue,01 Mar 2005 02:03:56 GMT 34413←← 99.eml Tue,01 Mar 2005 02:04:19 GMT 178←← buttons.xml Tue,01 Mar 2005 02:04:19 GMT 17214←← MLC.cfg Wed,16 Mar 2005 21:34:45 GMT 7188←← 6568448 Bytes Left←←←←                     </pre>	
List files from the current directory and its subdirectories	<b>[Esc]</b> LF←←	WLF	(See responses to <b>[Esc]</b> DF←←, above.)	The response is the same except that the path / directory precedes filenames for files within the subdirectories.



## Command/response table for SIS commands (continued)

Command	ASCII (Telnet) (host to switcher)	URL Encoded (Web) (host to switcher)	Response (switcher to host)	Additional description
<b>File streaming commands</b>				
<b>NOTE</b>	<i>File streaming commands should be used by advanced programmers only.</i>			
Load a file to user flash memory via Telnet or RS-232 <sup>24, 28</sup>	<code>[Esc] + UF filesize, filename</code>	<code>{raw, unprocessed data in a file of up to filesize}</code>	<code>Up!</code>	
<b>NOTE</b>	<i>If the MLC has insufficient memory available to store the sent file, it responds with Fld (failed) instead of with Up!</i>			
<b>NOTE</b>	<i>Firmware can be updated by using this command to upload an ____s19 file to the MLC. If the MLC determines that the file is not intended for its model, the Up! response is followed by a Fwm (firmware mismatch) response.</i>			
Retrieve a file from user flash memory via Telnet or RS-232 <sup>28</sup>	<code>[Esc] filename SF</code>	<code>{4 bytes of filesize, and then raw data from the file}</code>		
Load a file to user flash memory via port 80 (HTTP, Web browser)	Send a Post command on port 80 followed by the delimited data to be written to the file in flash memory.			
Retrieve a file from user flash memory via port 80 (HTTP, Web browser)	Send a Page Get command on port 80 followed by WSF	<code>{The response is raw data from the file.}</code> <code>{data from the file mypage.html.}</code>		
<i>Example:</i>	<code>http://192.168.254.254/mypage.html?cmd=WSF  </code>			
<b>Web browser-specific commands</b>				
Read response from last URL command	<code>[Esc] UB</code>	WUB	<code>response from command</code>	
<b>E-mail</b>				
Configure e-mail events (mailbox) <sup>24</sup>	<code>[Esc] [X45] [X46] [X47] CR</code>	<code>W [X45]%2C [X46]%2C [X47] CR  </code>	<code>Ipr [X45] [X46] [X47]</code>	<code>[X45]</code> = e-mail event number (1 - 64). <code>[X46]</code> = e-mail recipient's address (e-g., JDoe@extron.com) for the person to whom messages will be sent. This address is limited to 31 characters. <code>[X47]</code> = name of e-mail file to be sent ( <i>1.eml, 2.eml, ... 64.eml</i> ) (first line of the file = the subject, the rest = the body of the e-mail).
<i>Example:</i>	<code>[Esc] 5, jdoe@extron.com, 7.eml CR</code> <code>W 5 %2C jdoe%40extron %2E com %2C 7%2Eeml CR  </code> <code>Ipr 5, jdoe@extron.com, 7.eml</code>			

## Command/response table for SIS commands (continued)

Command	ASCII (Telnet) (host to switcher)	URL Encoded (Web) (host to switcher)	Response (switcher to host)	Additional description
Read/view e-mail events	<code>[Esc][X45]CR←</code>	<code>W[X45]CR </code>	<code>[X46][X47]←</code>	<code>[X45]</code> = e-mail event number (1 - 64).
Send e-mail file specified in the e-mail event configuration <sup>24</sup>	<code>[Esc][X45]SM←</code>	<code>W[X45]SM </code>	<code>Eml [X45]←</code>	<code>[X70]</code> = The number to insert into an e-mail message if a <code>____.eml</code> file has an embedded server-side include " <code>&lt;!--#echo var = "WCR  " --&gt;</code> " (the <code>[Esc]←</code> command with no parameters.) The numeral is a 16-bit number to be employed as the user defines. This is an optional parameter. Use 0 as a placeholder if the optional <code>[X47]</code> variable is used but <code>[X70]</code> is not needed.
Send a different e-mail file (one not configured in an e-mail event) <sup>24</sup>	<code>[Esc][X45][X70][X47]SM←</code>	<code>W[X45]%2C[X70]%2C[X47]SM </code>	<code>Eml [X45]←</code>	<code>[X47]</code> = xxx, where xxx = a number 1 to 999 corresponding to the e-mail's filename (xxx.eml). If xxx = 0 or no parameter is given, the MLC sends the file that was set via the CR command.
<b>NOTE</b> If file <code>[X47].eml</code> is not found when the SM command is executed, the MLC sends a default e-mail message.				
Set e-mail server IP address and user domain name <sup>24</sup>	<code>[Esc][X14][X15][X73][X74]CM←</code>	<code>W[X14]%2C[X15]%2C[X73]%2C[X74]%2CCM </code>	<code>lpm • [X14][X15][X73][X74]←</code>	<code>[X14]</code> = IP address (xxx.xxx.xxx.xxx). Leading zeros are optional in setting values. Leading zeros are suppressed in returned values. <code>[X15]</code> = E-mail domain name, e.g., <code>extron.com</code> <code>[X73]</code> = An e-mail account username (for SMTP authentication) of up to 31 characters. Do not use commas. This parameter is optional during setup. <code>[X74]</code> = An e-mail account password (for SMTP authentication) of up to 31 characters. Do not use commas. This parameter is optional during setup. In a response, instead of the actual password, <code>[X74]</code> is displayed as 4 asterisks (****) if a password has been set up or as nothing ( ) if it has not.
Read/view e-mail server IP address and user domain name	<code>[Esc]CM←</code>	<code>WCM </code>	<code>[X14][X15][X73][X74]←</code>	

## Command/response table for SIS commands (continued)

Command	ASCII (Telnet) (host to switcher)	URL Encoded (Web) (host to switcher)	Response (switcher to host)	Additional description
<b>Event control</b>				
Start events <sup>27</sup>	<code>[Esc]1AE←</code>	<code>W1AE </code>	<code>Ego←</code>	
Stop events <sup>27</sup>	<code>[Esc]0AE←</code>	<code>W0AE </code>	<code>Est←</code>	
Query quantity of events running	<code>[Esc]AE←</code>	<code>WAE </code>	<code>####←</code> or <code>Enm #####←</code>	The response is the quantity of currently running events, and it includes leading zeros. For example, if two events are running, the response is 00002←.
Set the event number ( <code>X35</code> ) to hook to front panel button presses (hardware-script interactions) <sup>24</sup>	<code>[Esc]X35 * X217 EN ←</code>	<code>W X35 %zA X217 EN  </code>	<code>Ehk X35←</code> or <code>Ehk X35 * X217←</code>	If desired, use this command to designate an event script ( <code>X35.evt</code> ) to be used to track and react to hardware happenings and MLC/IRCM/SCP button presses. <code>X35</code> = event number (0 - 99). The default value of <code>X35</code> after a system reset is 255. <code>X217</code> = firmware's event status polling period from 0 to 255 in 20 ms increments. <code>X217</code> is optional: if it is not set, it defaults to 100 (2 seconds) and is not shown in the command's response. If <code>X217</code> is set to 0, the firmware does not poll for event status.
<b>NOTE</b>	"Hooking" an event involves associating the event with a specific button so that event will be automatically executed when the designated button is pressed.			
<b>NOTE</b>	This command is optional. You do <u>not</u> have to use this command to set up the MLC. By default during configuration, the configuration software associates the main event script file (0.EVT) with hardware events and button presses. Once that event file has been compiled, it is capable of receiving information from the MLC's register that tracks hardware actions and button presses. In response to a detected button press or other hardware happening, the event script can then tell the MLC to change relays, issue commands, or make some other change. You would use this command only to associate a different event script file with tracking and responding to hardware/button actions.			
Read the number of the event that is hooked to hardware/front panel changes	<code>[Esc]EN←</code>	<code>WEN </code>	<code>X35←</code> or <code>X35 * X217←</code>	Read the event number/event script ( <code>X35</code> ).

## Command/response table for SIS commands (continued)

Command	ASCII (Telnet) (host to switcher)	URL Encoded (Web) (host to switcher)	Response (switcher to host)	Additional description
Select firmware or script control of buttons <sup>24</sup>	Esc [X211] LZ ←	W [X211] LZ	Bse [X211] ←	This command determines whether the firmware or a script (software-generated instructions) controls the functions and lighting of a given button. [X211] = Status of which buttons are controlled by firmware. This variable is an 8-digit hexadecimal number. Refer to the diagram to see how this number is calculated. This variable is case-sensitive and requires capital letters.
<b>Binary bit map for script control of button enabling</b>				
<b>Example:</b> Change the Power On and Power Off buttons' functions from firmware control to script control.				
<p>Convert binary to hexadecimal. → 0000#### ←</p> <p>Insert number into command. → Esc 0000#### LZ ←</p> <p>Add 4 leading zeros to the hex characters for a total of 8 characters.</p>				
<p>Convert binary to hexadecimal. → 00000003 ←</p> <p>Insert number into command. → Esc 00000003 LZ ←</p> <p>Add 4 leading zeros for a total of 8 characters.</p>				

## Command/response table for SIS commands (continued)

Command	ASCII (Telnet) (host to switcher)	URL Encoded (Web) (host to switcher)	Response (switcher to host)	Additional description
<p><b>Example:</b> Change all three function buttons and the input 3 - 6 buttons from firmware control to script control.</p>	<p>0011100011100000</p>	<p>00003C70</p>	<p>00003C70</p>	<p>Insert number into command.</p>
<p><b>Example:</b> Change all front panel buttons from firmware control to script control.</p>	<p>0011100011100011</p>	<p>00003F73</p>	<p>00003F73</p>	<p>Insert number into command.</p>
<p>Read firmware/script button control status</p>	<p>Esc LZ ←</p>	<p>W L </p>	<p>X211 ↵</p>	

## Command/response table for SIS commands (continued)

Command	ASCII (Telnet) (host to switcher)	URL Encoded (Web) (host to switcher)	Response (switcher to host)	Additional description
Button LED control <sup>24</sup> (set button color/lighting)	<code>[Esc][X212]LC ←</code>	<code>W[X212]LC  </code>	<code>Lsc [X212] ←</code>	This command specifies which front panel buttons (Power On, Power Off, Function/Room, and/or input selection buttons) light and in what colors. You can change the lighting of one, several, or all buttons at once. <code>[X212]</code> = an 8-digit hexadecimal number representing the status of button lamp LEDs. It is case-sensitive, so use capital letters.
Binary bit map for button LED status				
Example	<p>Light buttons:</p> <ul style="list-style-type: none"> <li>• Power On = amber</li> <li>• Power Off = red</li> <li>• Function 1 = green</li> <li>• Function 2, 3 = off</li> <li>• Inputs 1, 2, 3, 5 = amber</li> <li>• Input 4 = green</li> <li>• Input 6 = red</li> <li>• Input 1 = red</li> </ul>			
	<p>Convert binary to hexadecimal. Add a leading zero to the numbers from the 7 hex nibbles for a total of 8 characters.</p> <p><code>[Esc] 0###0# LC ←</code></p>			
	<p>Convert to hex. Add a leading zero.</p> <p><code>[Esc] 0B7F010B LC ←</code></p>			
	<p>Insert number into command.</p> <p><code>[Esc] 0B7F010B LC ←</code></p>			
	<p>Insert number into command.</p> <p><code>[Esc] 0B7F010B LC ←</code></p>			

## Command/response table for SIS commands (continued)

Command	ASCII (Telnet) (host to switcher)	URL Encoded (Web) (host to switcher)	Response (switcher to host)	Additional description
Read button LED color status	<b>Esc</b> LC←←	WLC	<b>X212</b> ←←	See the previous command for how to determine <b>X212</b> .
Set button LEDs to blink slowly <sup>24</sup>	<b>Esc</b> 1* <b>X212</b>  X←←	W1%2A <b>X212</b>  X	Lbk*1 <b>X212</b> ←←	
Read which button LEDs are set to blink (whether slowly or fast)	<b>Esc</b> 1LX←←	W1LX	<b>X212</b> ←←	
Set button LEDs to blink fast <sup>24</sup>	<b>Esc</b> 2* <b>X212</b>  X←←	W2%2A <b>X212</b>  X	Lbk*2* <b>X212</b> ←←	
Read which button LEDs are set to blink fast	<b>Esc</b> 2LX←←	W2LX	<b>X212</b> ←←	
<b>NOTE</b> The command to make a button LED blink fast takes precedence over the command to make it blink slowly. If a button's LEDs are set to blink both fast and slowly, the LED will blink fast.				
<b>Reset (zap) commands and erase commands</b>				
Erase the flash memory <sup>24</sup>	<b>Esc</b> ZFFF←←	WZFFF	Zpf←←	
Reset all device settings to factory defaults <sup>24</sup>	<b>Esc</b> ZXXX←←	WZXXX	Zpx←←	The "reset all settings" command does not affect IP settings or flash memory.
<b>NOTE</b> The ZXXX command does not reset any IP-related settings such as the IP address, subnet mask, and gateway IP address. It also does not affect user files stored in flash memory.				
Reset all device settings and delete files <sup>24</sup>	<b>Esc</b> ZY←←	WZY	Zpy←←	
<b>NOTE</b> This command is intermediate between the ZXXX and ZQQQ commands. It is an absolute system reset excluding IP settings (IP address, subnet mask, gateway IP address, unit name, DHCP settings, port mapping). This allows you to maintain communication with the MLC. This reset is recommended after you perform a firmware update.				
<b>NOTE</b> This command is supported by MLCs with firmware of version 1.03 or higher.				
Absolute system reset <sup>24</sup> (mode 5 reset)	<b>Esc</b> ZQQQ←←	WZQQQ	Zpq←←	Reset all settings/memories. The ZQQQ command resets everything (all settings, adjustments, PINs, the IP address, and subnet mask) to the factory default values. Files in flash memory are also erased by this command. The firmware version doesn't change. The IP address is reset to 192.168.254.254, the subnet mask is reset to 255.255.0.0. This command is identical to reset mode 5, discussed in "Resetting the Unit" in chapter 2.

# SIS™ Programming and Control, cont'd

The syntax for setting a special function for an MLC is  $\boxed{x?} * \_ \#$  where  $\boxed{x?}$  is the value and  $\_$  is the function number. To view a function's setting, use  $\_ \#$ , where  $\_$  is the function number. In the following table the values of the  $\boxed{x?}$  variable are different for each command/function. These values are given in the rightmost column.

## Command/response table for special function SIS commands (accessible via RS-232 only)

Command	ASCII Command (host to MLC)	Response (MLC to host)	$\boxed{x?}$ values and additional descriptions
<b>Delay times</b>			
Most projectors require a certain amount of time during warm-up and cool-down during which they do not accept commands. Once you have set the input selection lock during power on/off command (53#, page 5-39), send this command (1#) to specify the amount of time for the MLC to wait between sending the projector a power-on or power-off command and when the next input button press can occur.			
Power on delay <sup>24</sup>	$\boxed{x?} * 1 \#$	WarmUp* $\boxed{x?}$ ← ↵	0 = 0 seconds, 1 = 2 seconds, 2 = 4 seconds, ... in 2 second steps up to 150 = 300 seconds (5 minutes). <i>Example:</i> set a 16 second power on delay.
<i>Example:</i>	8*1#	WarmUp*008	
<i>Example:</i>	1#	WarmUp*023	<i>Example:</i> view the power on delay setting.
Power off delay <sup>24</sup>	$\boxed{x?} * 2 \#$	CoolDown* $\boxed{x?}$ ← ↵	0 = 0 seconds, 1 = 2 seconds, 2 = 4 seconds,... in 2 second steps up to 150 = 300 seconds. <i>Example:</i> set a 46 second power off delay.
<i>Example:</i>	23*2#	CoolDown*023 ← ↵	
Power off button delay <sup>24</sup>	$\boxed{x?} * 22 \#$	PwrOffDly* $\boxed{x?}$ ← ↵	0 = the power off button requires no hold delay (default), 1 = the power off button requires a 2-second hold delay before starting the power-off sequence.
<b>Audio settings</b>			
Limit audio level on display power-on <sup>24</sup>	$\boxed{x?} * 11 \#$	VolLimit* $\boxed{x?}$ ← ↵	If this feature is enabled, the maximum initial power-up volume level does not exceed the level specified by this command. 0 = audio off, ..., 20 = default value, ..., 100 = no limit on audio level at power-on.
<b>NOTE</b>	The MLC responds with an E14 error code when volume mode = 1 (increment/decrement).		
<b>NOTE</b>	The maximum is limited by the maximum volume setting (47#). If the maximum volume (47# command) is set, the limit audio level feature (11# command) is automatically set to 25% of the maximum volume (47#). See page 5-39.		
<i>Example:</i>	28*11#	VolLimit*028 ← ↵	<i>Example:</i> limit power-up volume to 28% of maximum volume.



## Command/response table for special function SIS commands, continued

Command	ASCII Command (host to MLC)	Response (MLC to host)	X? values and additional descriptions				
<b>Button associations (virtual mapping) for an IRCM-DV+</b>							
<p>By design an IRCM-DV+ can be assigned paired <b>module addresses (by DIP switch)</b> of either 1&amp;2 <i>or</i> 3&amp;4 <i>only</i>. It cannot be assigned to addresses 2&amp;3 or 1&amp;4. The odd-numbered module address (1 or 3) is reserved for DVD control, the even-numbered module address (2 or 4) is for VCR control. The address DIP switches must be set in order for the MLC to recognize and reserve memory space for the module. Refer to the <i>Control Modules User's Manual</i>.</p> <p>To use an optional IRCM-DV+ with an MLC 226 IP, you need to <b>associate the DVD portion of this module with an MLC input selection butto</b>, and also <b>associate the VCR portion with a different MLC input selection button</b>. The associated button must be selected (pressed) in order to activate and use the VCR portion or the DVD portion of the module. You cannot activate both parts (VCR and DVD) at the same time. If you do not associate (map) the IRCM-DV+'s addresses (1&amp;2 or 3&amp;4) with MLC buttons, you cannot activate and use either the DVD or the VCR part of the IRCM-DV+.</p> <p><b>NOTE</b> For MLC 226 Series MediaLink Controllers, you <i>can</i> assign both the DVD and VCR portions of an IRCM-DV+ to the same input selection button. A and B must both be inputs that are set up for input switching mode (firmware control) via Global Configurator.</p>							
<p>Here is how to determine the value of X? for the following commands:</p> <div style="text-align: center;"> <math display="block">(A \times 16) + (B) = X?</math> <table style="margin: auto;"> <tr> <td style="border: 1px solid black; padding: 5px; text-align: center;">A</td> <td style="border: 1px solid black; padding: 5px; text-align: center;">B</td> </tr> <tr> <td style="text-align: center; font-size: small;">Button to associate the VCR half (even address, 2 or 4) with</td> <td style="text-align: center; font-size: small;">Button to associate the DVD half (odd address, 1 or 3) with</td> </tr> </table> <p style="text-align: right; font-size: small;">X? is a decimal number from 000 to 101.</p> </div>				A	B	Button to associate the VCR half (even address, 2 or 4) with	Button to associate the DVD half (odd address, 1 or 3) with
A	B						
Button to associate the VCR half (even address, 2 or 4) with	Button to associate the DVD half (odd address, 1 or 3) with						
<b>IRCM-DV+ address 2, address 1 button association</b>							
Associate MLC's buttons w /IRCM-DV+ <sup>24</sup>	X?*25#	DVA_VMap*X?←	Associate specific MLC 226 IP input selection buttons with the VCR and DVD halves of the IRCM-DV+ that has DIP switch-based addresses of 1 and 2. X? can be from 0 to 101.				
<i>Example:</i>	52*25#	DVA_VMap*052	Associate the MLC's input 4 button with IRCM-DV+ address 1 (DVD functions) and the MLC's input 3 button with IRCM-DV+ address 2 (VCR functions). See the illustration at left.				
<div style="text-align: center;"> <math display="block">X? = (3 \times 16) + (4) = 52</math> <table style="margin: auto;"> <tr> <td style="border: 1px solid black; padding: 5px; text-align: center;">3</td> <td style="border: 1px solid black; padding: 5px; text-align: center;">4</td> </tr> <tr> <td style="text-align: center; font-size: small;">Button to associate the VCR half (even address, 2) with</td> <td style="text-align: center; font-size: small;">Button to associate the DVD half (odd address, 1) with</td> </tr> </table> </div>				3	4	Button to associate the VCR half (even address, 2) with	Button to associate the DVD half (odd address, 1) with
3	4						
Button to associate the VCR half (even address, 2) with	Button to associate the DVD half (odd address, 1) with						
<b>IRCM-DV+ address 4, address 3 association</b>							
Associate MLC's buttons w /IRCM-DV+ <sup>24</sup>	X?*26#	DVB_VMap*X?←	Associate MLC 226 IP buttons with the VCR & DVD parts of an IRCM-DV+ that has DIP switch-set addresses of 3 and 4.				
<b>IRCM-DV+ activation</b>							
Force an IRCM-DV+ to activate one half (DVD or VCR) or to turn off	X?*Y?*24#	DV_Force*X?*Y?	X? = DIP switch address (1, 2, 3, or 4) of the IRCM-DV+. For Y?: 0 = turn off IRCM-DV+, 1 = force the DVD half on (make it active), 2 = force the VCR half on.				
<p><b>NOTE</b> This command overrides the 25# and 26# commands listed above.</p> <p><b>NOTE</b> This command also does not require each half of the IRCM-DV+ to be associated with an input button.</p>							
Read an IRCM-DV+'s status	X?*24#	Y?	See the X? and Y? values above.				

# SIS™ Programming and Control, cont'd

## Command/response table for special function SIS commands, continued

Command	ASCII Command (host to MLC)	Response (MLC to host)	X? values and additional descriptions
<b>Button press/release emulation</b>			
<p>Emulating a button press or release causes the commands and actions that are associated with the button via the main event script to be executed. Button emulation triggers only what has been set up via the Front Panel tab in Global Configurator. Emulation does not trigger the built-in SIS input switching commands (X200!) or the projector power on/off commands (1P or 0P).</p> <p>See the diagrams below and on the next page to determine the number of the memory block associated with each button.</p>			
<p><b>NOTE</b> The input button register numbering shown in the following illustrations is for a stand-alone MLC.</p>			
<p><b>Button/Switch Memory Block Numbering for the MLC 226 IP Series, SCP 226 Series, and IR 402</b></p>			
<p>The diagrams illustrate the mapping of physical buttons and switches to memory block numbers (1-128). The MLC 226 IP and SCP 226 series have buttons numbered 1-14. The IR 402 remote has buttons numbered 1-25. The MLC 226 IP Bottom Panel (rotated 180 degrees) has various ports and switches numbered 106-107.</p>			
Emulate a button/switch press	X?*42#	SwPrs*X?←	<p>This command causes the MLC to issue the commands associated with a button press.</p> <p>X? = the number of the memory block for the button/switch for which you want to emulate a press (1 - 128). See the diagrams above and on the next page.</p>

## Command/response table for special function SIS commands, continued

Command	ASCII Command (host to MLC)	Response (MLC to host)	X? values and additional descriptions
Emulate a button/switch release	X?*43#	SwRls*X?←	This makes the MLC issue the commands associated with a button release. X? = the button's/switch's memory block number (1-128).
Emulate a button press-and-release	X?*44 #	SwCmd*X?←	The MLC issues the commands associated with both the press and the release of the specified button. X? = the button's/switch's memory block number (1-128).
<i>Example:</i>	25*44#	SwCmd*25←	<i>Example:</i> emulate pressing and releasing the volume up button on the remote control or rotating the MLC's front panel Volume knob clockwise.
<i>Example:</i>	6*44#	SwCmd*6←	<i>Example:</i> emulate pressing and releasing the second room/function button. Actions associated with the button press are executed first, followed directly by actions associated with the button release.

Each control module (IRCM, ACM, RCM, CM) has 20 memory blocks reserved for it, no matter how many buttons are physically present on the module:

- module 1: blocks 26-45
- module 2: blocks 46-65
- module 3: blocks 66-85
- module 4: blocks 86-105

Memory block numbers are sequential from left to right, top row to bottom row, as shown below.

### Button/Switch Memory Block Numbering for Control Modules (IRCMs, ACMs, RCMs)

#### Memory Block Numbering Scheme for Any Type of Module (Example is for Control Module 1)

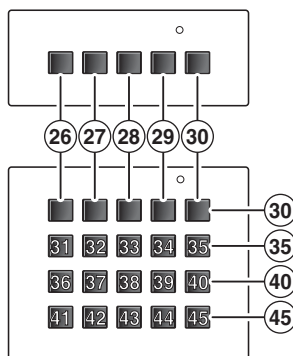

#### Memory Block Numbering Examples

##### RCM-SC with DIP switch set for address 2 (module 3)

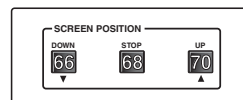

Module 3 has memory blocks 66 to 85.

##### IRCM-DV+ with DIP switch set for addresses 0 and 1 (modules 1 and 2)

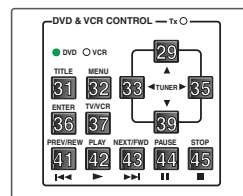

DVD Half (module 1)

Module 1 has memory blocks 26 to 45.

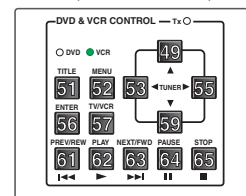

VCR Half (module 2)

Module 2 has memory blocks 46 to 65.

# SIS™ Programming and Control, cont'd

## Command/response table for special function SIS commands, continued

Command	ASCII Command (host to MLC)	Response (MLC to host)	X? values and additional descriptions
<b>Button control</b>			
Set slave map <sup>24</sup>	X?*3Y?# X? values Default: X? = Y? 00 = input 0 01 = input 1 02 = input 2 ... 98 = input 98 99 = input 99	SlaveMapY?*X?← Y? values 1 = input button 1 2 = input button 2 3 = input button 3 4 = input button 4 5 = input button 5 6 = input button 6	This command associates an MLC input button with a specific input on a connected switcher. X? is the actual input channel (including inputs on a slaved switcher) to select when button Y? is pressed. The values for these variables are shown at left. Map input 6 (an input on a slaved switcher) to the MLC's input button 4. When button 4 is pressed, the A/V system switches to input 6, and any instructions (DVD or VCR control commands, for example) associated with input button 4 on the MLC are executed.
Example:	6*34#	SlaveMap4*6←	
Set and trigger a button press repeat	X?*Y?*45 #	RptRate*X?*Y?←	This command tells the MLC to repeat a specific button's press commands at a fixed interval (a set frequency). X? = the number of the button/switch (1 - 128). See the diagrams on pages 5-36 and 5-37. Y? is the repeat interval: 0 to 65535, in 20 ms steps. 1 = 20 ms, 2 = 40 ms, 3 = 60 ms, ... 65535 = 1,310,700 ms = 21.845 minutes. If Y? = 0, the MLC stops repeating the selected button's commands.
Example:	9*850*45#	RptRate*9*850←	The commands associated with the input 1 button press are executed every 850x20 ms (= 17,000 ms = 17 seconds) until the repeat rate for that button is set to 0 ("cleared").
<b>NOTE</b>	The button repeat SIS command (X?*Y?*45 #) must be entered each time you want to have a button press trigger repeated command releases. Also, only one button at a time can be set to repeat: multiple buttons can not be in repeat mode simultaneously.		
<b>NOTE</b>	The Repeat Rate... feature found in Global Configurator is based on this command. However, through scripting the MLC sets the repeat mode to on in response to a specific button press, and it sets the repeat mode to 0 when the button is released or input is no longer selected.		
Query button repeat rate status	45#	X?*Y?←	See the variables for the command shown above.
Clear (turn off) the button repeat <sup>24</sup>	0*0*45#	RptRate*000*00000←	This command clears the button repeat setting and turns off the button repeat function.

## Command/response table for special function SIS commands, continued

Command	ASCII Command (host to MLC)	Response (MLC to host)	X? values and additional descriptions
Front panel button LED control <sup>24</sup>	X?*Y?*51# X? values 0 = all LEDs are off 1 = green LED is on 2 = red LED is on 3 = green & red LEDs are on (button glows amber) 4 = slowly blinking green 5 = slowly blinking red 6 = slowly blinking amber 7 = fast blinking green 8 = fast blinking red 9 = fast blinking amber	LmpY?*X?← Y? values 1 = power on button 2 = power off button 5 = room/function button 1 6 = room/function button 2 7 = room/function button 3 9 = input button 1 10 = input button 2 11 = input button 3 12 = input button 4 13 = input button 5 14 = input button 6	This command controls which LED(s) turn on or off or blink in a specific button. X? is the LED state, Y? is which projector power, input, or room/function button to control. See the list of values at left.
Query button LED control status	Y?*51#	X?←	See the variables for the command shown above.
<p><b>NOTE</b> If you used the LX command (see page 5-33) to set a button for an LED combination other than those listed above for X?, the MLC responds with a zero (0). For example, if a button is set for its green LED to blink slowly and its red LED to blink fast, the MLC sends 0 in response to the Y?*51# command.</p>			
<b>Miscellaneous settings</b>			
Enable switcher slaving	X?*41#	Slave*X?←	For X?, 0 = disable control of a slaved Extron MLS switcher, 1 = enable (default) MLS slaved switcher control.
Volume knob mode <sup>24</sup>	X?*46#	VolMode*X?←	For X?, 0 = discrete volume values, 1 = continuous increment/decrement.
Max. volume range <sup>24</sup>	X?*47#	VolMax*X?←	For maximum volume, X? is 1 to 100. 100 = default.
<p><b>NOTE</b> Maximum volume range cannot be changed while an MLS switcher is detected at the MLC's MLS slave switcher port.</p> <p><b>NOTE</b> When the maximum volume is changed, the volume level and the volume limit during display power-up (11#) are set to 25% of the new maximum volume setting.</p>			
Volume encoder scale <sup>24</sup>	X?*49#	EncScale*X?←	For X?: 0 = no scaling (default), 1 = decrease encoder speed by 2, 2 = decrease encoder speed by 3, ... 255 = decrease encoder speed by 256.
<b>Front panel lockout</b>			
Lock out input selection during power-on/power off <sup>24</sup>	X?*53#	PwrLock*X?←	For X?: 0 = off, 1 = on (default).
<p><b>NOTE</b> This command applies only to input selection buttons that are controlled by firmware and designated for input switching (input buttons that are set for input button mode via Global Configurator).</p>			

# SIS™ Programming and Control, cont'd

## Command/response table for special function SIS commands, continued

Command	ASCII Command (host to MLC)	Response (MLC to host)	[X?] values and additional descriptions
Set input switching lockout duration <sup>24</sup>	[X?]*54#	IODelay*[X?] ←	This command locks out (prevents changes to) input switching for the specified duration after an input has been switched. [X?] is the lockout duration of 0 to 65535, in 20 ms steps. 1 = 20 ms, 2 = 40 ms, 3 = 60 ms,... 65535 = 1,310,700 ms = 21.845 minutes. Default = 25 = 0.5 s.
<b>NOTE</b> This command applies to input selection buttons that are under firmware control (set up for input switching via Global Configurator) only.			
Example:	25*54#	IODelay*25 ←	Inputs cannot be switched for 0.5 seconds after an input change
Enable PIN <sup>24</sup>	[X?]*60#	PINEnable*[X?] ←	For [X?], 0 = personal identification number (PIN) access is enabled for all levels (administrator and user), 1 = only the administrator PIN is enabled, 2 = PIN access is disabled (default).
<b>NOTE</b> PIN access can be used only while display power is off.			
Set PIN <sup>24</sup>	[X?]*[Y?]*61#	PINNum*[X?]*[Y?] ←	For [X?], 0 = administrator level, 1 = user level. For [Y?], the PIN is any 4-digit combination of the numbers 1 through 6. Administrator default PIN = 1346. User default PIN = 0.
Query PIN <sup>24</sup>	[X?]*61#	[Y?] ←	For [X?], 0 = administrator level, 1 = user level. [Y?] is the corresponding 4-digit PIN.
IPI lockout <sup>24</sup>	[X?]*62#	IPILock*[X?] ←	For [X?], 0 = IPI buttons are always enabled (default), 1 = IPI button lockout status matches that of the MLC front panel lockout.
<b>IR receiver commands</b>			
Disable IR reception	[X?]*65#	IRDisable*[X?] ←	For [X?]: 0 = enable all IR ports (default), 1 = disable the front panel IR port, 2 = disable the rear panel IR ports (input from IR devices and SCPs through the CM/IR/SCP port), 3 = disable front and rear IR ports.



# 6

## **Chapter Six**

### **Special Applications**

Using Monitoring to Make Functions Track Actual Conditions

Working With Combination Source Devices

Controlling Two Display Devices

Scheduling Front Panel Lockout Periods

Sending E-mail by Pressing a Button

Working With a Non-MediaLink Extron Switcher

# Special Applications

---

There are numerous ways to use a MediaLink Controller to control and monitor A/V systems. The *MLC 226 IP Series Setup Guide* and chapters 3 and 4 of this manual cover typical uses and features. This chapter shows you how to set up the MLC for a few specialized applications:

- tracking conditions by using monitoring
- working with DVD-VCR combination devices
- controlling multiple displays or projectors using the MLS slave port as second projector port
- scheduling front panel lockout periods
- sending an e-mail by pressing a button on the front panel
- working with an Extron MPS 112 switcher

## Using Monitoring to Make Functions Track Actual Conditions

If users have access not only to the MLC but also to the control panels or remote controls of input and output devices, they can directly change various kinds of device status and settings without using the MLC. This can create a discrepancy between the device's actual status and the status known to the MLC. To avoid that discrepancy when configuring the MLC's button functions and scheduling events, you can set up a monitoring routine.

For example, let's say that you set up an MLC front panel button (F1) in toggle mode to send the projector a video mute command on one press and a video unmute command on the next press. If you press the F1 button once, the MLC sends the video mute command. The next time you press that button, the MLC sends the video unmute command. But what if someone uses the projector's remote control to unmute the video before the next MLC button press? The MLC issues a video unmute command when the F1 button is pressed, and the projector continues displaying video — there is no change in mute status.

However, if you also configure the MLC to check the projector's A/V mute status each time the F1 button is pressed, you can make the MLC act (or not) based on the actual device status. That way, the MLC executes the correct action regardless of what happened the last time the MLC's button was pressed. This keeps the toggle button synchronized with the status of the controlled device.

### Prerequisite setup steps

1. Connect cables between the MLC, the input/output devices, and the PC, as described in chapter 2, "Installation."
2. Install and start the Global Configurator software and create or open a GC project, and add an MLC to the project, if that hasn't already been done. For instructions, refer to chapter 3 of the *MLC 226 IP Series Setup Guide*, steps 1, 2, and 3.
3. In Global Configurator, add device drivers and assign them to the Projector RS-232/IR port or MLS port. For instructions on these tasks, refer to chapter 3, step 5, of the *MLC 226 IP Series Setup Guide*.

**NOTE** For monitoring, the device must be connected to one of the MLC's bidirectional ports.



## Setting up the front panel button

This section describes a procedure for setting up monitoring of audio and video muting status on the MLC, the example introduced on page 6-2. You can tailor this procedure to other functions that you may want to set up.

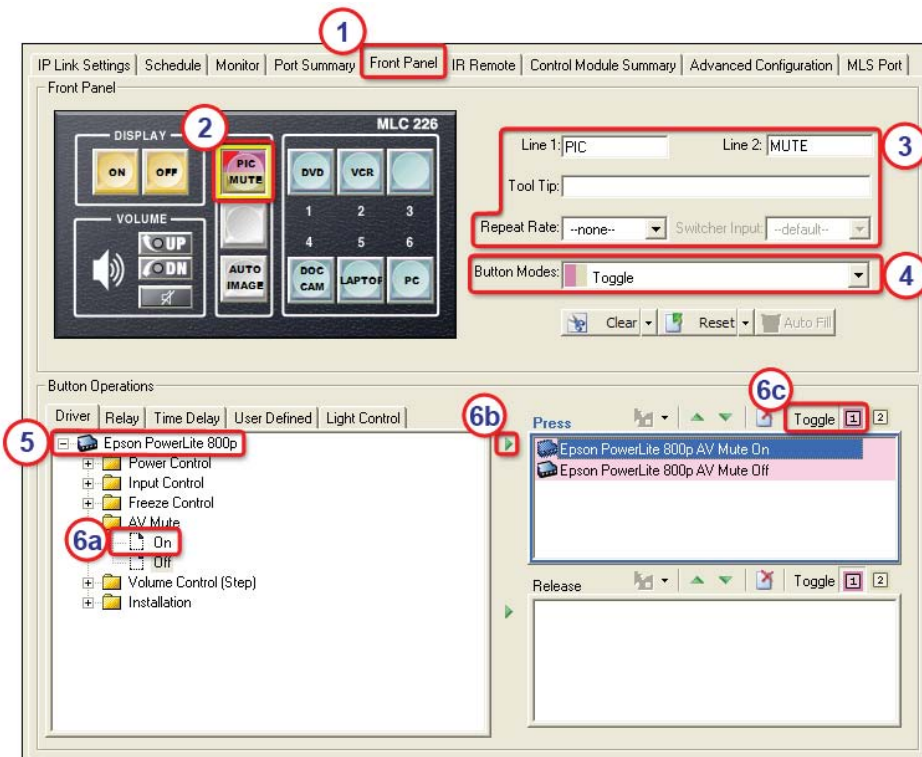

1. Click on the **Front Panel** tab.
2. Click function button 1.
3. If desired, type in text for the onscreen button label and the tool tip (text that appears when the mouse pointer hovers over that button).
4. In the **Button Mode** list box, select **Toggle**. This changes sets the button from single switch mode to toggle mode, which allows you to configure the button for two sets of presses and releases instead of the default of one press and release.
5. In the Button Operations area's **Driver** tab, double-click the name of the projector. A list of available driver functions is displayed below the driver name.
6. Set the button press actions for projector A/V mute.
  - a. Double-click **AV Mute** and click **On**.
  - b. Click the green arrow adjacent to the Press area or drag the command to the Press area
  - c. For **Toggle**, click **1** to associate the AV Mute On command with the first button press.
  - d. Click **AV Mute**, then click **Off**.

## Special Applications, cont'd

- e. Click the green arrow adjacent to the Press area or drag the command to the Press area.
  - f. For **Toggle**, click **2** to associate the AV Mute Off command with the second button press.
7. If desired, configure the button's lights.

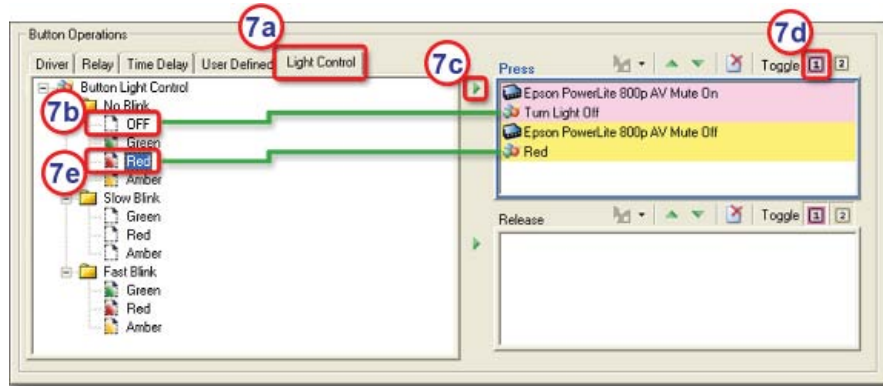

- a. In the Button Operations area, click the **Light Control** tab.
- b. Click on the desired button light setting, a combination of color and action (nonblinking, slowly blinking, fast blinking).
- c. Click the green arrow adjacent to the Release area.
- d. For **Toggle**, click **1** to associate that button lighting setting with the first button release.
- e. Repeat steps 7b and 7c to select a button light setting for the second button release.
- f. Click on the newly added button lighting command in the Press area.
- g. Click **Toggle 2**.

### Setting up monitoring conditions

1. Click the **Monitor** tab (IP Link Settings | Schedule | **Monitor** | Port Summary | Front Panel | ), then click **Add Monitor** (near the bottom of the GC window). The Monitor Conditions Wizard window appears.
2. Type in the name of the first monitored condition: *A/V Mute On*, as shown in the following illustration.

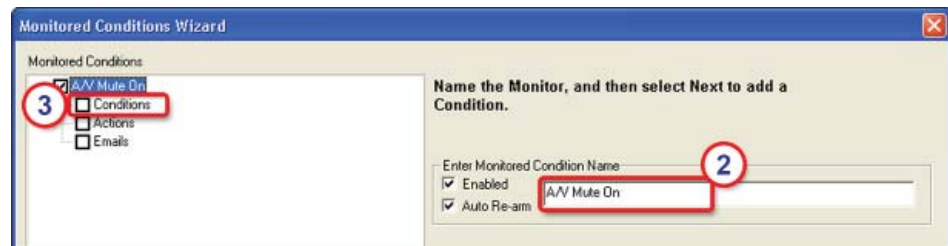

3. Select **Conditions** in the Monitored Conditions area.
4. Click on the name of the projector in the Subject Port area (Epson PowerLite 800p, in this example).

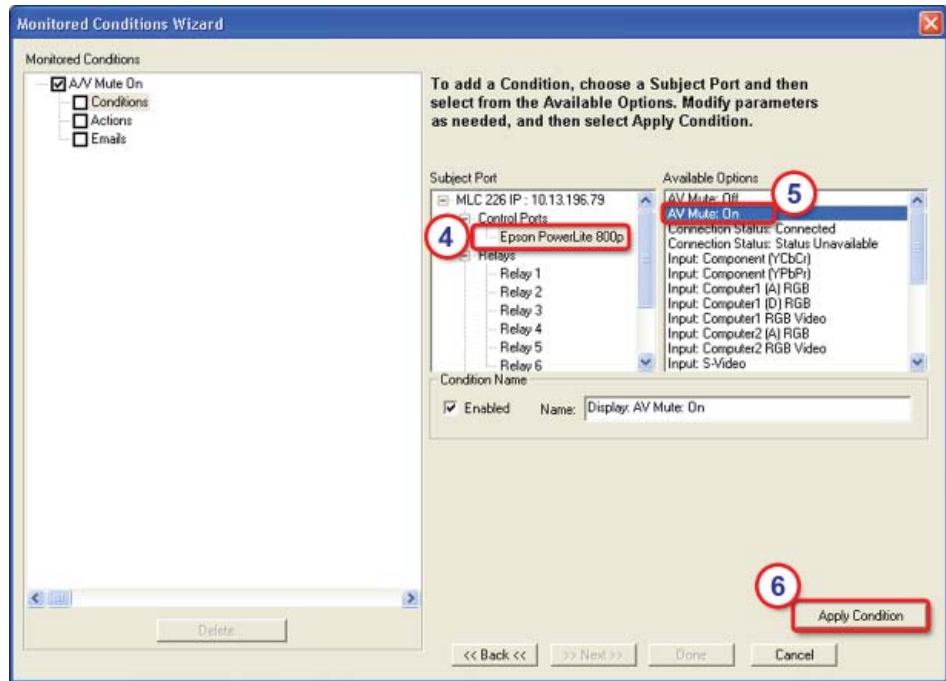

5. Click the **AV Mute: On** command in the Available Options area.
6. Click the **Apply Condition** button.
7. Click **Actions** in the Monitored Conditions area.

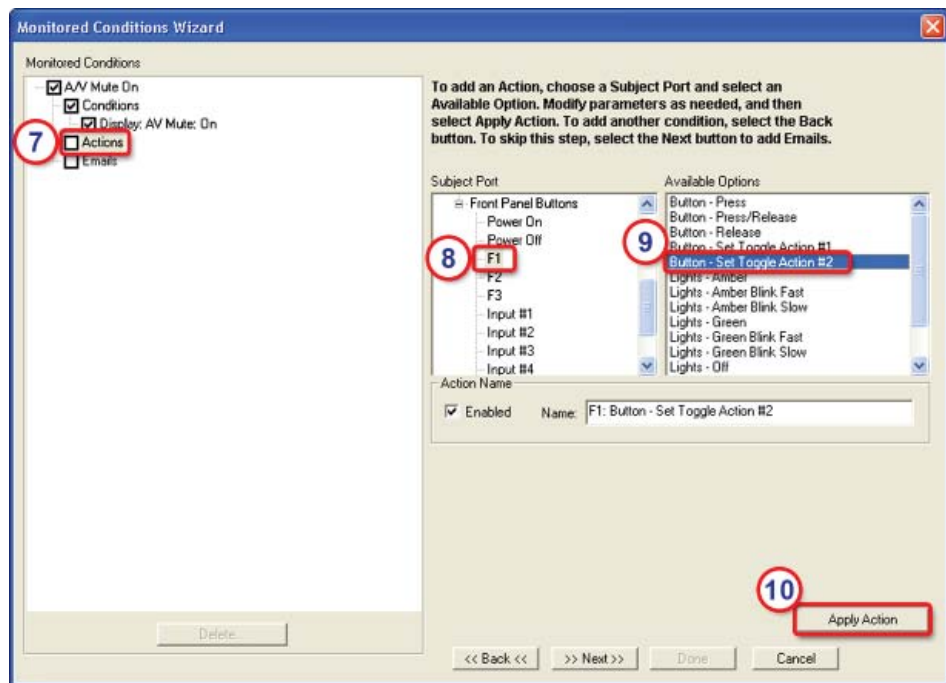

8. Scroll through the Subject Port area and click on **F1** in the Front Panel Buttons section.
9. Click **Button - Set Toggle Action #2** in the Available Options area. This sets the state of the F1 button so that the next press of F1 triggers the operations on toggle action #2.

## Special Applications, cont'd

10. Click the **Apply Action** button.
11. Scroll through the Subject Port area and click on **F1** in the Front Panel Buttons section.
12. Click **Lights - Red** in the Available Options area.
13. Click the **Apply Action** button.
14. Click **Done**. The Monitor Conditions Wizard window closes.
15. Click **Add Monitor** (near the bottom of the GC window). The Monitor Conditions Wizard window opens.
16. Type in the name of the second monitored condition: *A/V Mute Off*.
17. Select **Conditions** in the Monitored Conditions area.
18. Click on the name of the projector in the Subject Port area.
19. Click the **AV Mute: Off** command in the Available Options area.
20. Click the **Apply Condition** button.
21. Click **Actions** in the Monitored Conditions area.
22. Scroll through the Subject Port area and click on **F1** in the Front Panel Buttons section.
23. Click **Button - Set Toggle Action #1** (which triggers the A/V Mute On command) in the Available Options area.
24. Click the **Apply Action** button.
25. Scroll through the Subject Port area and click on **F1** in the Front Panel Buttons section.
26. Click **Lights - Off** in the Available Options area.
27. Click the **Apply Action** button.
28. Click **Done**. The Monitor Conditions Wizard window closes. The resulting monitored conditions are shown in the following image.

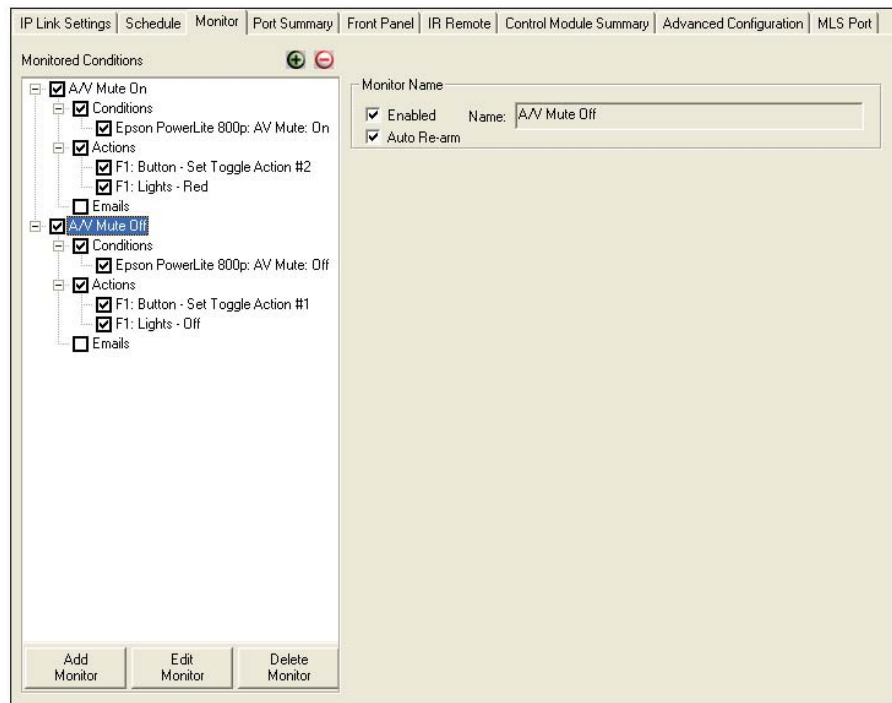

29. Complete the rest of the configuration as described in the *MLC 226 IP Series Setup Guide* and in chapter 4 of this manual, then save the project and build and upload the configuration to the MLC.

## Working With Combination Source Devices

Many combination DVD-VCR players can output the video signals from both the video tape and the DVD parts on a single port. If you connect this single output to one input on a switcher (or projector), the switcher has no way to automatically know whether it receives input from the DVD or from the VCR; the switcher treats it as one input device and does not switch between the two.

### Available methods

There are several ways to work around the single-input limitation to make both the DVD and VCR media accessible to the switcher, including the following methods:

- Using separate source output ports on the DVD-VCR player
- Using a distribution amplifier with the switcher
- Using separate IRCM control modules for DVD-VCR control
- Using an IRCM-DV+ control module for DVD-VCR control

### Using an IRCM-DV+ control module and one MLC input button for DVD-VCR control

If the combination DVD-VCR player has only one available output port and neither a distribution amplifier nor a pair of control modules [(IRCM-DVD or IRCM-DVD+) and IRCM-VCR] is available for use, you can create a special configuration to allow control via the MLC 226 IP or SCP 226 front panel and an optional IRCM-DV+.

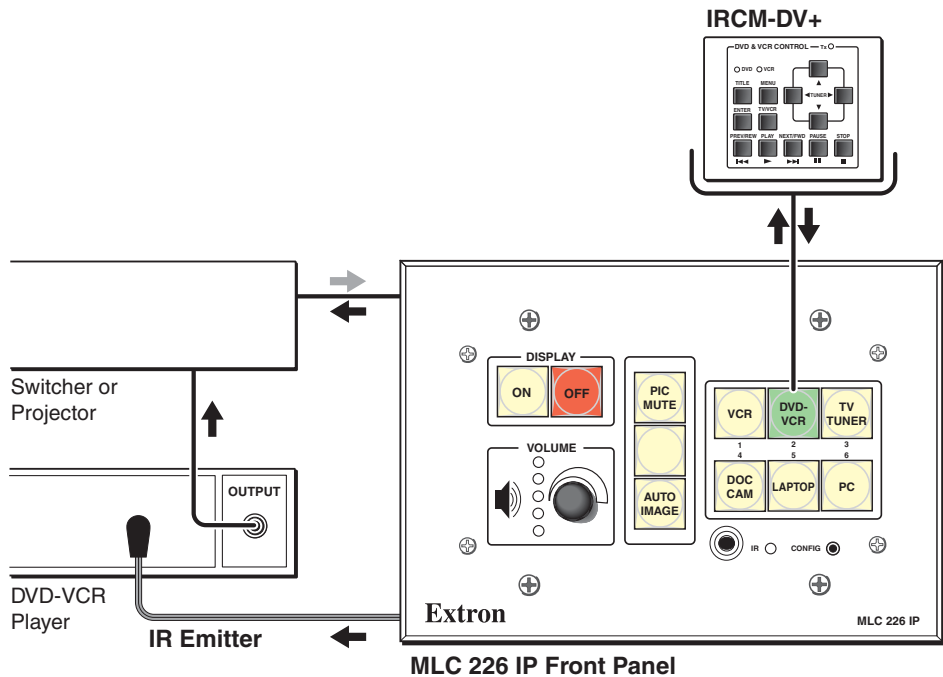

An IRCM-DV+ normally must be associated with two different MLC or projector inputs, one for the DVD half of the IRCM-DV+, one for the VCR half. However, in this installation example, both halves will be associated with the same input.

## Special Applications, cont'd

In this example (shown above and described in the following procedure), the DVD/VCR player's output is connected to switcher/projector input 2, which is associated with the MLC 226 IP's input 2 button.

**NOTE** Detailed instructions on basic configuration via software are available in the MLC 226 IP Series Setup Guide and in chapter 4 of this manual.

**NOTE** The numbers in the following sample screen images correspond to the procedure's step numbers.

To configure a single MLC 226 IP input button to control the IRCM-DV+ and DVD-VCR player, follow this procedure:

1. Connect cables between the MLC, input/output devices, and the PC as described in chapter 2, "Installation."
2. Install and start the Global Configurator software and create or open a GC project, and add an MLC to the project, if that has not already been done. For instructions, refer to chapter 3 of the *MLC 226 IP Series Setup Guide*, steps 1, 2, and 3.
3. In Global Configurator, add device drivers and assign them to the Projector RS-232/IR port and the IR/Serial Output ports. For instructions on these tasks, refer to chapter 3, step 5, of the *MLC 226 IP Series Setup Guide*. In this example the DVD-VCR player will be connected to IR/Serial Output port A.
4. Click on the **Front Panel** tab.

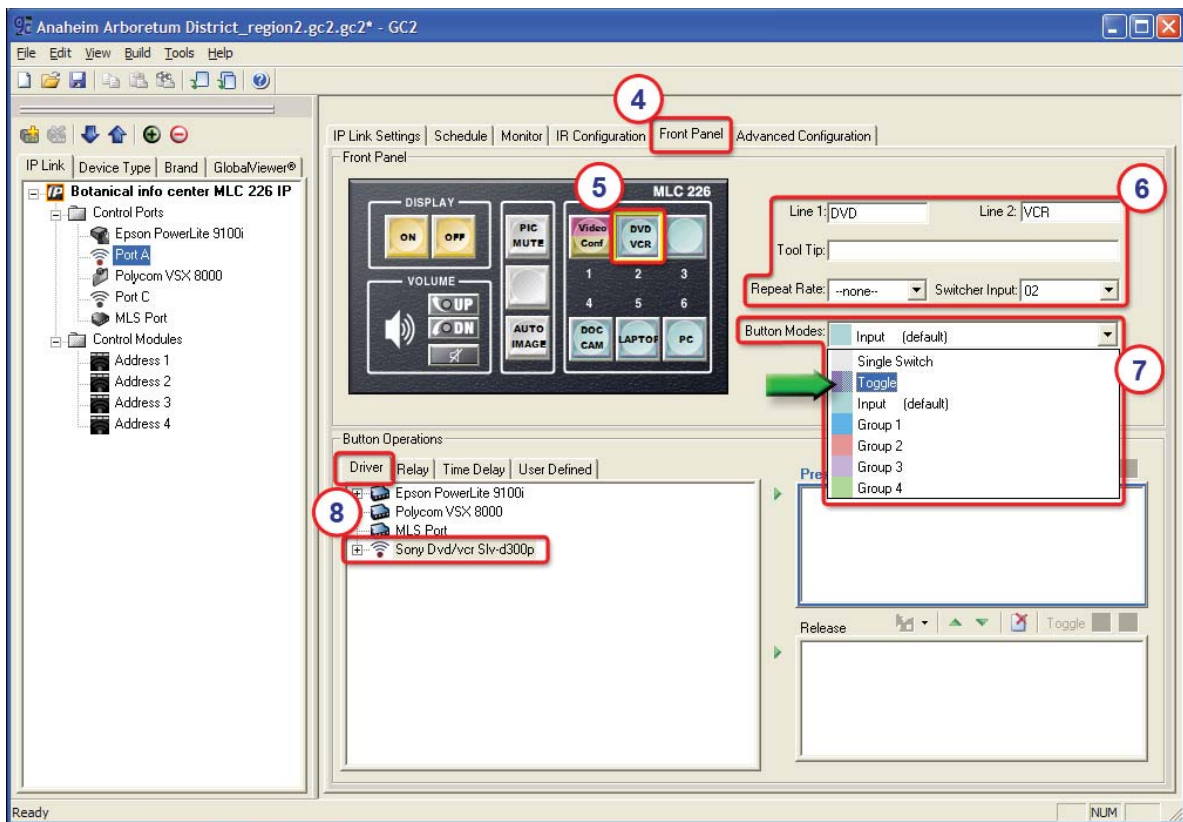

5. Click the input button (button 2 for this example) that will be used with the DVD-VCR player.

6. If desired, type in text for the onscreen button label, the tool tip (text that appears when the mouse pointer hovers over that button in GlobalViewer), and assign an input to the button.
7. In the **Button Mode** list box, select **Toggle**. This sets the button for toggle mode, which allows you to configure the button for two sets of presses and releases instead of the default of one press and release.
8. In the Button Operations area's **Driver** tab, double-click the name of the DVD-VCR player. A list of available driver functions is displayed below the driver name.
9. Set the actions for the DVD part of the player.

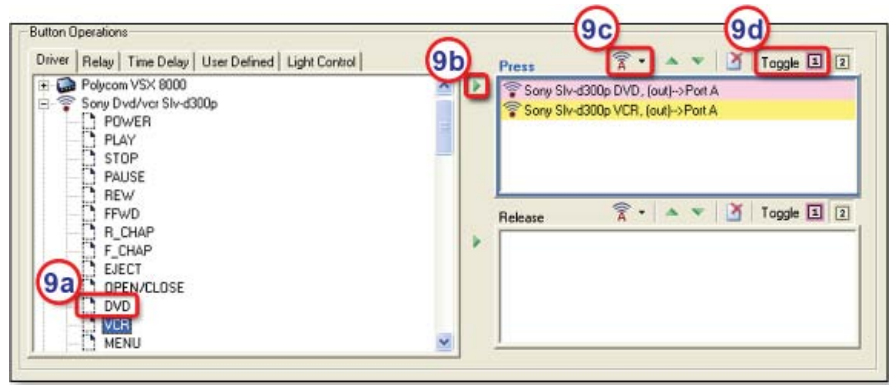

- a. Click **DVD**.
  - b. Click the green arrow adjacent to the Press area or drag the DVD command to the Press area
  - c. Click the **Port Select** button and choose the IR output port that will send commands to the DVD-VCR player, as shown at right.
 
  - d. For **Toggle**, click **1** to indicate which press (the first) to associate the DVD command with. In the example shown above, the DVD is associated with button press 1, the VCR is associated with button press 2.
10. Set the actions for the VCR part of the player using the procedure outlined in step 9 but selecting **VCR** and toggle **2**.
  11. Click the name of any other IR command that should be sent to the DVD/VCR player and assign it to the desired press or release.

## Special Applications, cont'd

### 12. Set up IRCM-DV+ control

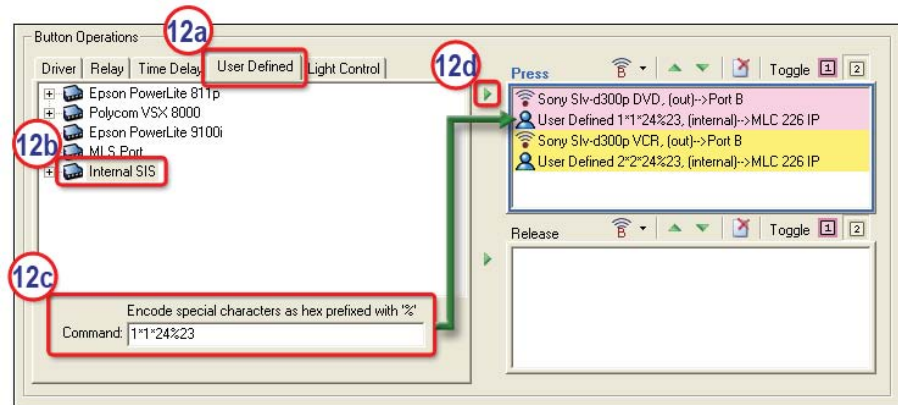

- a. In the Button Operations area, click the **User Defined** tab.
  - b. Click **Internal SIS**.
  - c. Type in the SIS command to activate the IRCM-DV+'s DVD half:  $\text{[X?]}^*1^*24\%23$  where  $\text{[X?]}$  is the IRCM-DV+'s DIP switch setting (1, 2, 3, or 4) and  $\%23$  is the URL-encoding for the pound symbol character (#).
  - d. Click the green arrow adjacent to the Press area.
  - e. For **Toggle**, click **1** to associate the IRCM-DV+'s DVD control with the first button press.
  - f. Click **Internal SIS**.
  - g. Type in the SIS command to activate the IRCM-DV+'s VCR half:  $\text{[X?]}^*2^*24\%23$  where  $\text{[X?]}$  is the IRCM-DV+'s DIP switch setting (1, 2, 3, or 4).
  - h. Click the green arrow adjacent to the Press area.
13. If desired, configure the button's lights.

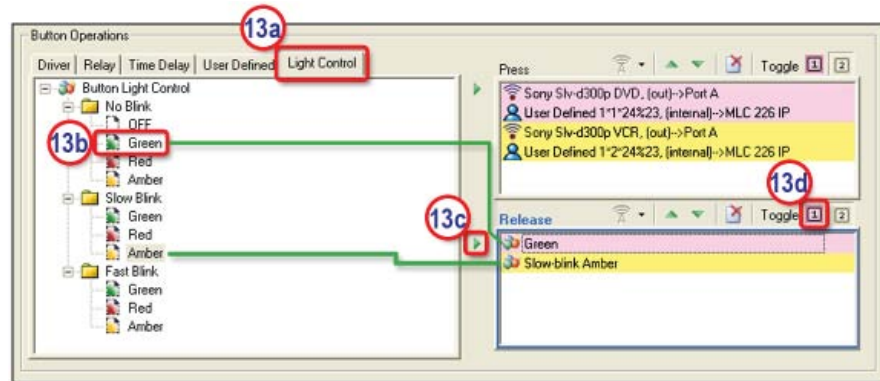

- a. In the Button Operations area, click the **Light Control** tab.
- b. Click on the desired button light setting, a combination of color and action (nonblinking, slowly blinking, fast blinking).
- c. Click the green arrow adjacent to the Release area.
- d. For **Toggle**, click **1** (or **2**) to associate that button lighting setting with the first (or second) button release. In this example, the button will light green (nonblinking) at the first button release.



- e. Repeat steps 13b through 13d to select a button light setting for the other (second) button release.
14. To each toggle action, add a command to switch the input of the projector or switcher.
15. Complete the rest of the configuration as described in the *MLC 226 IP Series Setup Guide* and in chapter 4 of this manual: configure all control ports for IR or RS-232 communication and select device drivers, configure the rest of the buttons (including IRCM-DV+ buttons). Configure e-mail settings and set scheduling as appropriate, then save the project and build and upload the configuration to the MLC.

## Controlling Two Display Devices

There are many ways you can use the MLC to control dual projectors or panel displays. One way is to use the Display On/Off buttons to control the first projector and configure two function buttons to act as On and Off buttons for the second projector.

For another way to control two projectors, set up the Display On/Off buttons to each control a different projector. The MLC is typically used to control a connected Extron switcher. However, you can disable the MediaLink switcher support mode, then add a driver to that port. This same general procedure can be used to make the MLC control any other device that uses RS-232 serial communication for control.

The following illustration shows how the MLC is wired for this example and which button is configured to control which projector and port.

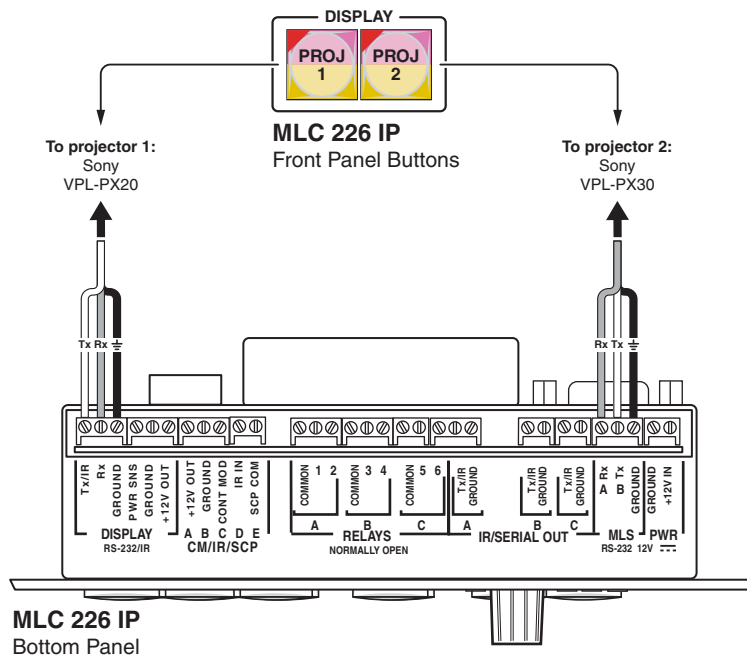

## Special Applications, cont'd

To configure the MLC to control two projectors using the MLC's Display power buttons, perform these steps:

1. Open or create a new Global Configurator project that includes an MLC.
2. In the IP Link tree view window, click on the MLC to be configured.

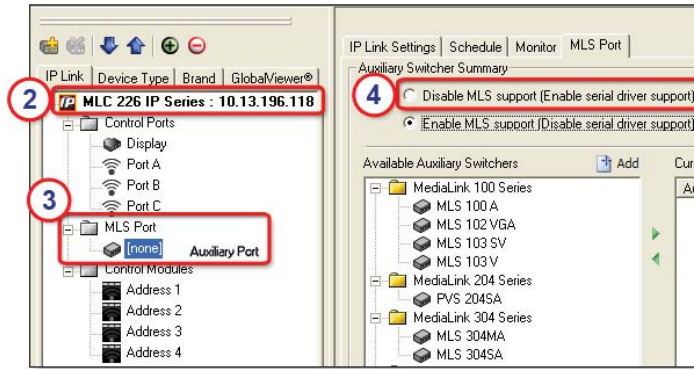

3. Click on **MLS Port**. The MLS Port tab displays in the right side of the window.

**NOTE** If you create a new project, this port is labeled as "MLS Port" in the IP Link tree view. If you open an existing project that was created with an earlier version of software, the port is labeled "Slave Switcher" instead.

4. Select the **Disable MLS support (Enable serial driver support)** radio button.
5. On the "Confirm auxiliary switcher port change" prompt that appears, click **OK**.
6. Under Control Ports in the IP Link tree window on the left, select **MLS Port**.
7. Select the **Driver Configuration** tab.
8. In the Serial Driver Selection area, select the device type and model of the projector that will be connected to the MLS port.
9. Click the **Add Driver** () button.
10. Click the **Front Panel** tab.

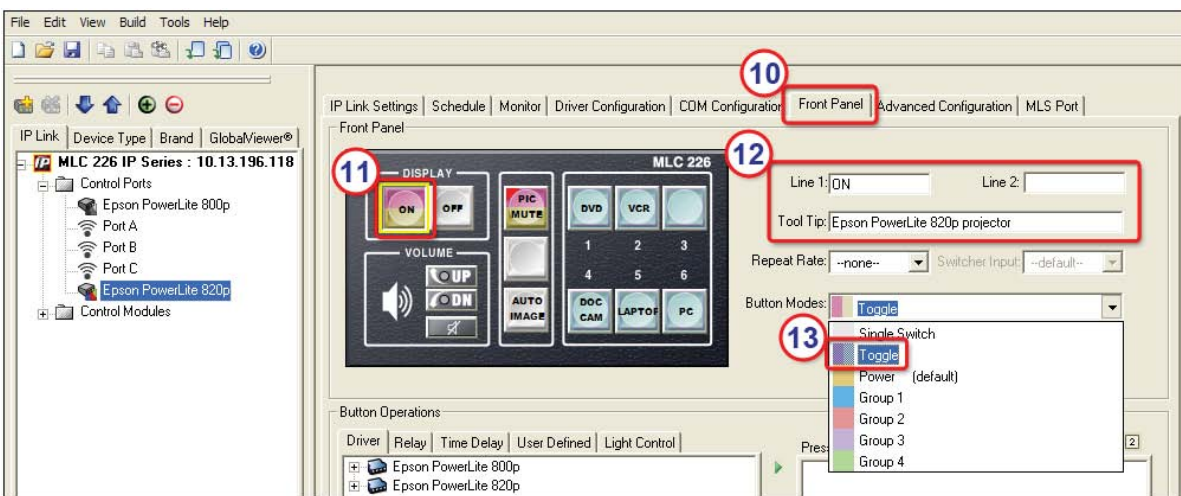

11. Click the **Display On** button.

12. If desired, type in text for the onscreen button label and the tool tip.
13. In the **Button Mode** list box, select **Toggle**.
14. In the **Driver** tab within the Button Operations area, double-click on the projector (Epson PowerLite 800p in this example) to control with the **Display On** button.

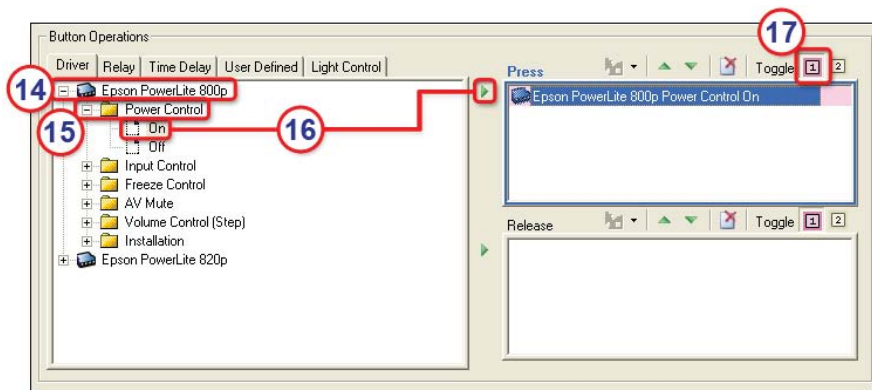

15. Double-click the **Power Control** folder.
16. Select **On** and click the green arrow next to the Press area.
17. Click on the command in the Press area, and click **1** to select the first toggle.
18. Select **Off** and click the green arrow next to the Press area.
19. Click on the command in the Press area and click **2** to select the second toggle.
20. Click the **Display Off** button.
21. Repeat steps 12 through 19, using the second projector (Epson PowerLite 820p in this example).
22. Configure the MLC's input buttons into two groups: one controlling inputs to projector 1, the other controlling inputs to projector 2.

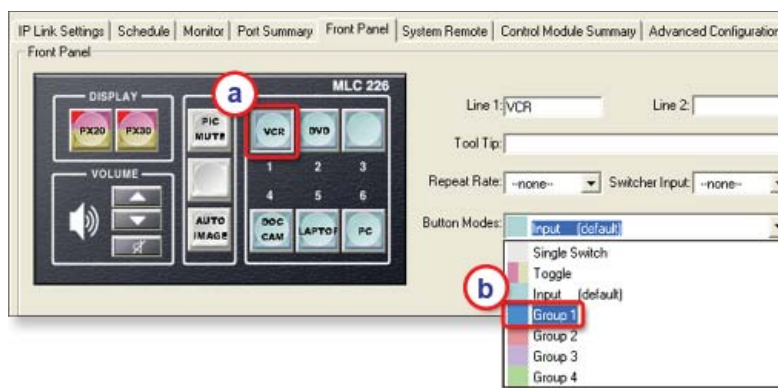

- a. Click input button 1.
- b. In the Input Modes list box, select **Group 1**.
- c. Repeat steps 22a and 22b for input buttons 2 and 3.
- d. Click input button 4.
- e. In the Input Modes list box, select **Group 2**.

## Special Applications, cont'd

- f. Repeat steps 22d and 22e for input buttons 5 and 6. When you are finished, the screen looks similar to the following picture:



23. Complete the rest of the configuration as desired, then save the project and build and upload the configuration to the MLC.

### Scheduling Front Panel Lockout Periods

For additional security you can set up an automated schedule to either completely prevent front panel changes or to restrict who can make front panel selections and adjustments during certain hours and days. For full details, including instructions on how to schedule front panel lockout periods, see “Front Panel Security Lockout (Executive Mode)” starting on page 3-7. Setup instructions begin on page 3-10.

### Sending E-mail by Pressing a Button

For some installations, you may want to set up an MLC button to send an e-mail requesting projector repairs or requesting assistance from the front office or the facility’s security or maintenance departments. Follow these steps to set up a monitor to track a button press and send an e-mail as the action.

**NOTE** This application requires Global Configurator version 2.2.1 or higher.

1. Connect cables between the MLC, input/output devices, and the PC as described in chapter 2.
2. Install and start the Global Configurator software version 2.2.1 or higher, create or open a GC project, and add an MLC to the project. For instructions, refer to chapter 3 of the *MLC 226 IP Series Setup Guide*, steps 1, 2, and 3.
3. In the IP Link tree view window, click on the MLC to be configured.

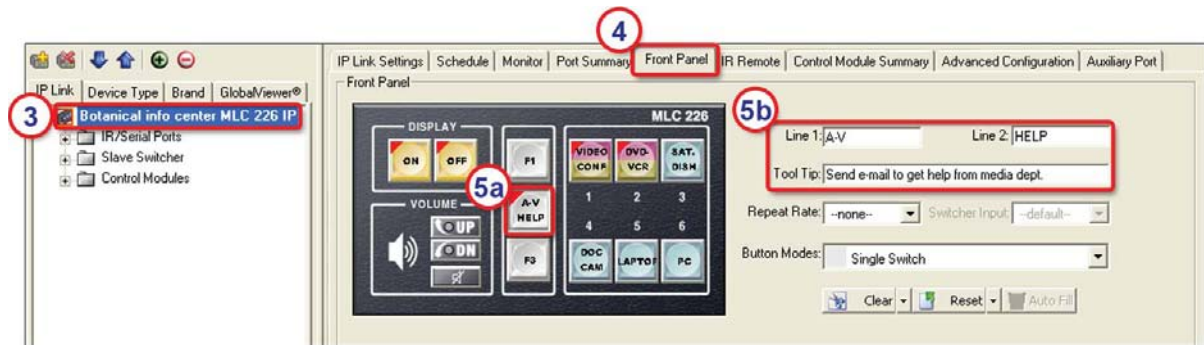

4. Click the **Front Panel** tab.
5. Configure the front panel button.
  - a. In the Front Panel area, click the button that will trigger the e-mail. For this example, use function button 2.
  - b. Type in text for the onscreen button label and the tool tip (text that appears when the mouse pointer hovers over that button).

- c. Click the **Light Control** tab in the Button Operations area

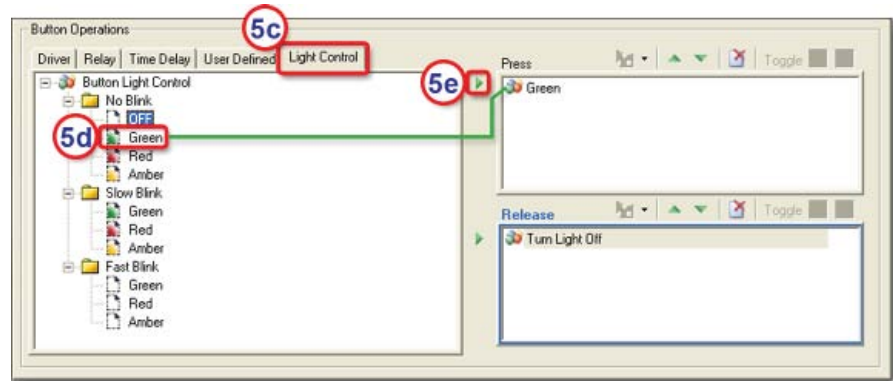

- d. Click on the desired combination of button light color and blink frequency.
  - e. Click the green Add Operation arrow next to the Press area.
  - f. Click on a different combination of button light color and blink frequency.
  - g. Click the green Add Operation arrow next to the Release area.
6. Click the **Monitor** tab ( IP Link Settings | Schedule | **Monitor** | Port Summary | Front Panel ) and click **Add Monitor** (near the bottom of the GC window). The Monitor Conditions Wizard window appears.
  7. Type in the name of the monitored condition: *Help Desk Request*, as shown in the following picture.

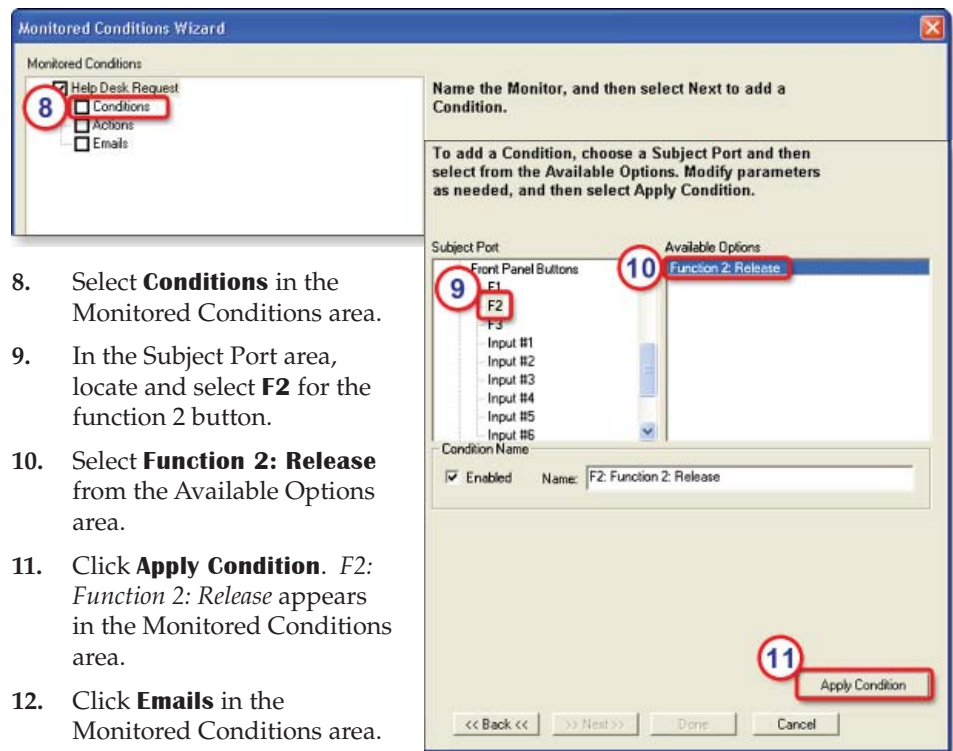

8. Select **Conditions** in the Monitored Conditions area.
9. In the Subject Port area, locate and select **F2** for the function 2 button.
10. Select **Function 2: Release** from the Available Options area.
11. Click **Apply Condition**. *F2: Function 2: Release* appears in the Monitored Conditions area.
12. Click **Emails** in the Monitored Conditions area.

## Special Applications, cont'd

13. Create the e-mail file that the F2 button will send.
  - a. Click **Email Manager...** near the bottom of the Monitor Conditions Wizard window. The Email Manager window opens.
  - b. Type in the e-mail name (this will appear in the list of available e-mails in GC), the subject (which appears as the set e-mail's subject line), and the body (the e-mail's contents).

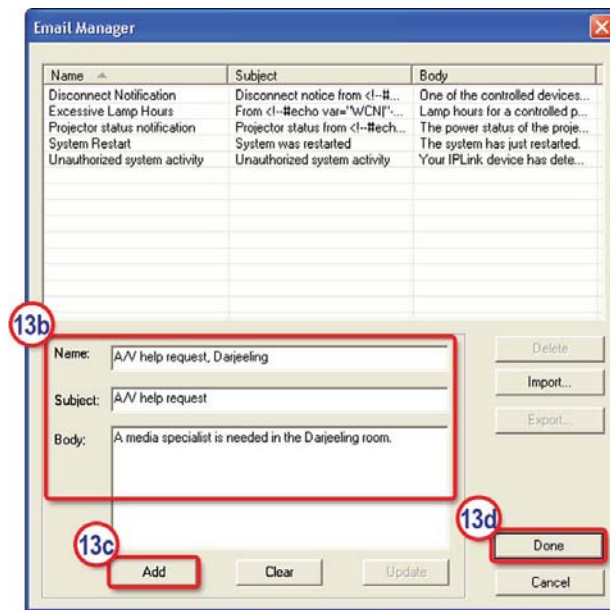

- c. Click **Add**.
  - d. Click **Done**. The Email Manager window closes.
14. Click to select one e-mail (the one you just created) in the Email Messages list, as shown at right.
15. Click to select one or more e-mail recipients in the Contacts list.
16. Click Apply **Email/Contacts**. The e-mail and the recipient name(s) appear in the Monitored Conditions area, as shown in the following screen excerpt.

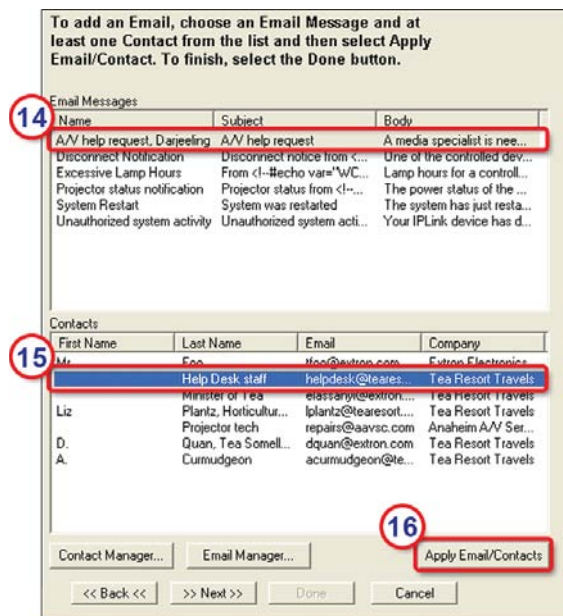
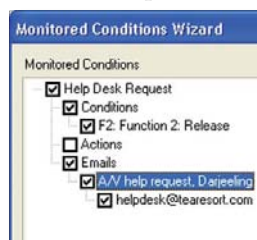

17. Click the **Done** button at the bottom of the Monitored Conditions Window, which then closes.
18. Complete the rest of the configuration as desired, then save the project and build and upload the configuration to the MLC.

## Working With a Non-MediaLink Extron Switcher

Although the MediaLink Controller's MLS port can be used as an auxiliary RS-232 port for controlling another type of device, it is usually used to connect an Extron MediaLink Switcher (MLS) or PoleVault Switcher (PVS). The MLC recognizes and communicates with MLS and PVS switchers without requiring additional drivers or configuration, unless you want to remap switcher inputs to the MLC's buttons.

The MLC can recognize Extron switchers other than MLS and PVS models, but as a single, generic type of switcher. For example, the MLC considers an MPS 112 switcher to be the same as an IN1508 or an SW 4AV. The MLC supports bidirectional communication for input switching and volume control, just as it does for the MLS and PVS switchers.

You can control an Extron switcher such as an MPS 112 or MPS 112 CS via the MLS port if all of the following conditions are met:

- The MPS switcher uses firmware version 1.12 or higher.
- The MPS is in single switcher mode. It must be in single switcher mode (not separate switcher mode) to be controlled by the MLC.
- The MLC uses firmware version 1.07 or higher. This is required in order to bidirectionally track inputs greater than 6.

Also, if the input buttons are in input mode, the MLC and MPS buttons track bidirectionally: an input button press on one device is indicated on the other device.

To set up the MLC to control an MPS 112 Series switcher, cable the MLC and connect the MPS switcher to the MLC's MLS port, then follow these steps:

1. Create a new Global Configurator project that includes an MLC.
2. In the IP Link tree view window, click on the MLC to be configured.

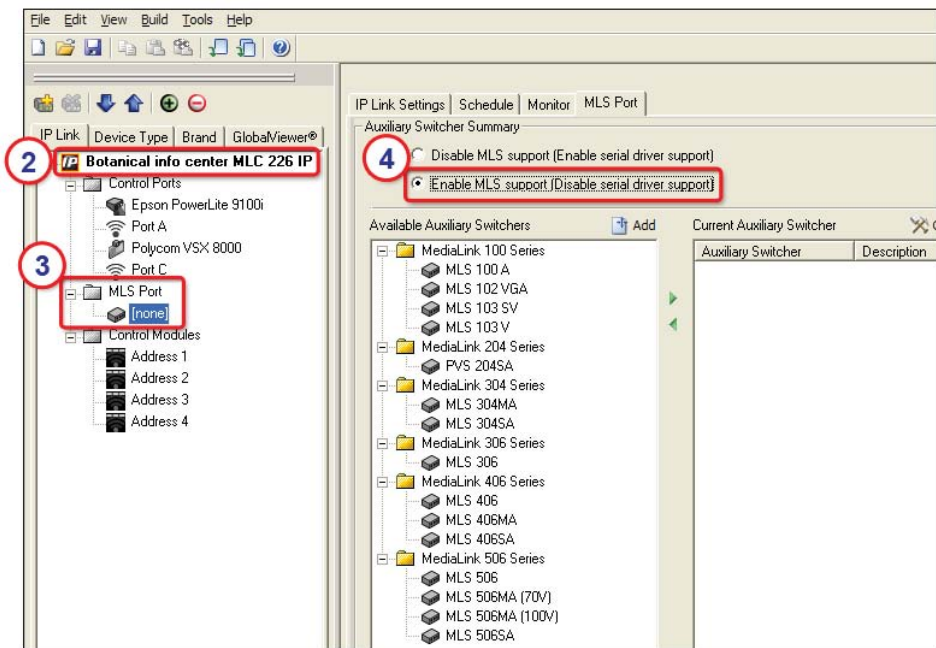

## Special Applications, cont'd

3. Click on the **MLS Port**. The MLS Port tab displays in the right side of the window.

**NOTE** *If you create a new GC project, this port is labeled as "MLS Port" in the IP Link tree view. If you open an existing project that was created with an earlier version of software, the port is labeled "Slave Switcher" instead.*

4. Make sure the port is set to support MediaLink switchers. The list of available switchers should be active and selectable. If not, click the **Enable MLS**

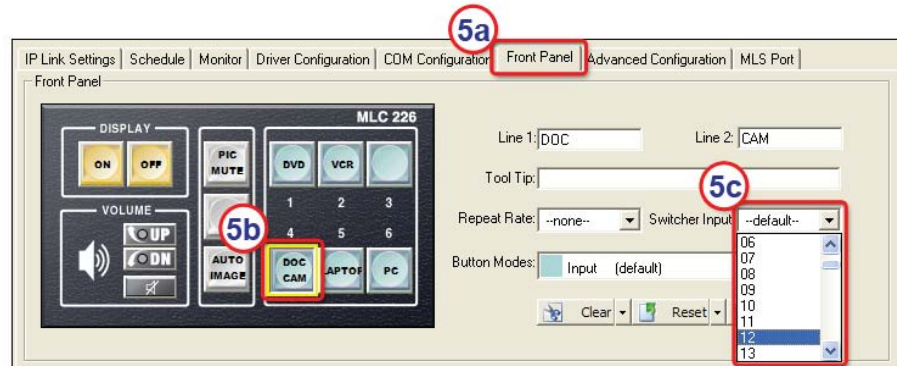

**support (Disable serial driver support) radio button.**

5. If you want to use the MLC's buttons to control MPS switcher inputs other than the default inputs 1-6, remap the front panel buttons.
  - a. Click the **Front Panel** tab.
  - b. Click an input button.
  - c. Select the desired MPS switcher input number from the Switcher Input list box.
  - d. Repeat steps 5b and 5c as desired to remap additional buttons to other switcher inputs.
6. Complete the rest of the configuration as desired, then save the project and build and upload the configuration to the MLC.





## MLC 226 IP Series

# A Appendix A

## Reference Material

Specifications

Part Numbers and Accessories

Glossary

File Types: a Key to Extron-specific File Names

Cut-out Templates

# Reference Material

---

## Specifications

### IP Intercom

Connection type (IPI-MLC).....	RJ-45 jack for CAT 5, CAT 5e, or CAT 6 cable
Audio	
Frequency response .....	20 Hz to 3.3 kHz, $\pm 1$ dB
Audio processing	
Audio format .....	PCM, $\mu$ -law companded
Sampling rate.....	8 kHz
Sample size.....	16 bit, $\mu$ -law companded to 8 bit
Audio latency.....	Software: 30 ms through 160 ms Network: <150 ms, typical
Audio output	
Number/signal type .....	1 mono (for use with an optional IP Intercom)
Line level output .....	-10 dBV (316 mVrms), unbalanced (via 3.5 mm captive screw connector, 2 pole)
Communication	
Transport bandwidth for IPI control and audio, half duplex	80 kbps (0.08% of 100Base-T)
Ethernet protocol.....	TCP/IP (control), UDP (audio)

### Control — host ports

Serial host port .....	2 bidirectional RS-232: 1 rear panel 9-pin female D connector (shared with digital input), 1 front panel 2.5 mm mini stereo jack
Baud rate and protocol .....	38400, 8 data bits, 1 stop bit, no parity
Serial control pin configurations.	9-pin female D connector: 2 = TX, 3 = RX, 5 = GND Mini stereo jack: tip = TX, ring = RX, sleeve = GND
Ethernet host port .....	1 RJ-45 female
Ethernet data rate for network communication	10/100Base-T, half/full duplex with autodetect
Ethernet protocol.....	ARP, DHCP, ICMP (ping), TCP/IP, Telnet, HTTP, SMTP
Ethernet default settings .....	Link speed and duplex level = autodetected IP address = 192.168.254.254, subnet mask = 255.255.0.0, default gateway = 0.0.0.0 DHCP = off
Web server.....	Up to 200 simultaneous sessions 7.25 MB nonvolatile user memory
Secondary control panel (SCP) ...	(1) 3.5 mm 5-pole direct insertion captive screw connector (shared with control module and IR Link port)
IR remote control.....	IR 402 (optional) Front panel: 30° maximum, 40 degrees off axis Rear panel: 38 kHz, hardwired, modulated
Program control.....	Extron's configuration program for Windows® Extron's Simple Instruction Set (SIS™) Microsoft® Internet Explorer, Telnet
IR learning frequencies.....	30 kHz to 62 kHz
IR learning distance .....	2" (5.1 cm) to 12" (30.5 cm) from the front panel

### Control — relay

Number/type .....	6 momentary or latching (configurable via software)
Connectors .....	(3) 3.5 mm captive screw connectors, 3 pole
Connector configuration .....	Groups A, B, C; each with 1 common and 2 normally open relays
Contact rating .....	24 V, 1 A

---

## Control — serial ports

Display control port.....	(1) 3.5 mm direct insertion captive screw connector, 3 pole, programmable for bidirectional RS-232 control ( $\pm 5$ V) or TTL level (0 to 5 V) infrared control up to 1 MHz
Switcher control port.....	(1) 3.5 mm direct insertion captive screw connector, 3 pole, for bidirectional RS-232 control ( $\pm 5$ V)
Baud rate and protocol (RS-232) .	115200 to 300 baud (9600 baud = default); 8 (default) or 7 data bits; 1 (default) or 2 stop bits; no parity (default), or even or odd parity

## Control — IR/serial ports

IR/serial control ports.....	(3) 3.5 mm direct insertion captive screw connectors, 2 pole Programmable: unidirectional RS-232 ( $\pm 5$ V) control, or TTL level (0 to 5 V) infrared control up to 1 MHz
Baud rate and protocol.....	115200 to 300 baud (9600 baud = default) ; 8 (default) or 7 data bits; 1 (default) or 2 stop bits; no parity (default), or even or odd parity

## Digital I/O control

Number/type .....	1 digital input/output (configurable), 1 digital input
Connector .....	1 rear panel 9-pin female D connector (shared with the serial host port) (1) 3.5 mm direct insertion captive screw connector (shared with power sense port)
Pin configuration.....	9-pin female D connector: 1 = digital input, 5 = GND; power sense = digital in, GND = GND
Digital inputs	
Input voltage range.....	0-12 VDC
Input impedance .....	28k ohms
Programmable pullup .....	2k ohms to +5 VDC
Threshold low to high .....	>2.8 VDC
Threshold high to low .....	<2.0 VDC
Digital output .....	250 mA sink from 24 VDC, maximum

## General

External power supply .....	100 VAC to 240 VAC, 50/60 Hz, external, autoswitchable; to 12 VDC, 1 A, regulated
Power input requirements	
MLC 226 IP DV+ .....	12 VDC, 0.515 A (includes MLC 226 IP and IRCM-DV+)
All other models .....	12 VDC, 0.495 A (0.515 A with 1 IRCM-DV+ connected)

**NOTE** *An MLC 226 Series controller must be powered by its own power supply. It cannot be powered by an MLS switcher.*

Temperature/humidity.....	Storage: -40 to +158 °F (-40 to +70 °C) / 10% to 90%, noncondensing Operating: +32 to +122 °F (0 to +50 °C) / 10% to 90%, noncondensing
Rack mount	
MLC 226 IP DV+ .....	No, but wall- and furniture-mountable
All other models .....	Yes, with optional rack mounting kits, and also wall- and furniture-mountable with optional mounting kits
Enclosure type	
MLC 226 IP DV+ .....	High-impact plastic
All other models .....	Metal

## Reference Material, cont'd

---

### Enclosure dimensions

MLC 226 faceplate..... 4.5" H x 6.4" W x 0.1" D (11.4 cm H x 16.3 cm W x 0.3 cm D) (3 gang)

MLC 226 AAP, MLC 226 IP DV+ faceplates  
4.5" H x 10.0" W x 0.1" D (11.4 cm H x 25.4 cm W x 0.3 cm D) (5 gang)

MLC 226 L faceplate ..... 3.15" H x 6.5" W x 0.1" D (8.0 cm H x 16.5 cm W x 0.3 cm D)

### Device

MLC 226 IP DV+ ..... 2.75" H x 5.3" W x 2.0" D (7.0 cm H x 13.5 cm W x 5.9 cm D) and  
2.7" H x 2.6" W x 0.9" D (6.9 cm H x 6.6 cm W x 2.3 cm D)  
(Depth excludes knob and buttons. Fits some 5 gang boxes. Allow at least  
2.1" (5.3 cm) depth in the wall/furniture.)

All other models ..... 2.75" H x 5.3" W x 2.0" D (7.0 cm H x 13.5 cm W x 5.9 cm D)  
(Depth excludes knob and buttons. Fits some 3 gang boxes)

### Product weight

MLC 226 IP DV+ ..... 2.1 lbs (1.0 kg)

All other models ..... 1.9 lbs (0.9 kg)

Shipping weight ..... 6 lbs (3 kg)

Vibration ..... ISTA 1A in carton (International Safe Transit Association)

Listings..... UL, CUL

Compliances..... CE, FCC Class A, VCCI, AS/NZS, ICES

MTBF..... 30,000 hours

Warranty ..... 3 years parts and labor

**NOTE** All nominal levels are at  $\pm 10\%$ .

**NOTE** Specifications are subject to change without notice.

## Part Numbers and Accessories

### Included parts

These items are included in each order for an MLC 226 IP:

Included parts	Replacement part number
MLC 226 IP (controller only)	60-600-00
MLC 226 IP (black, white, RAL9010 white)	60-600-02, -03, -05
MLC 226 IP AAP (black, white, RAL9010 white)	60-600-12, -13, -15
MLC 226 IP L (black, white, RAL9010 white)	60-600-32, -33, -35
MLC 226 IP DV+ (includes 1 black faceplate and 1 white faceplate)	60-600-82
12 VDC, 1 amp external power supply	70-055-01
Button labels (text)	33-954-01
Button labels (symbols/icons/pictures)	33-955-01
<i>MLC 226 IP Series Setup Guide</i>	
6' CAT 5 crossover patch cable (NETXC M-M)	26-591-01
MR Series mud ring/mounting bracket (for all models except the controller without faceplate and the MLC 226 IP L)	70-519-xx

### Accessories

These items can be ordered separately:

Adapters, power supplies, cables, labels	Part number
9-pin D to 2.5 mm stereo mini TRS RS-232 cable (3')	70-335-01
UC50' (50', 15 m) universal projector control cable	26-518-01
MLC PW/RS-232/VC-35' power/switcher communications/MPA volume control cable (35', 10.6 m)	26-626-35
12 VDC, 1 amp external power supply	70-055-01
Button labels (International/multilingual text)	33-956-01
Button cap and diffuser kit (set of 3 button cap assemblies)	70-352-01

Faceplates and frames	Part number
UCM RAAP (black, white)	70-344-02, -03
MLM-WB+ (black, white)	60-458-02, -03
MLM 226 7GWP (black, white, RAL9010 white)	70-340-02, -03, -05
MLM 226 EC AAP (RAL9010 white)	70-343-10
MLM 226 LAAP (black, white, RAL9010 white)	70-343-02, -03, -05
MLM 226 EC (RAL9010 white)	70-342-10

## Reference Material, cont'd

Electrical boxes and mud rings	Part number
EWB-3 three gang external wall box	60-454-0x
EWB-5 five gang external wall box	60-456-0x
EWB-10x8 external wall box	60-457-0x
SMB-3 three gang surface mount box	60-641-0x
SMB-5 five gang surface mount box	60-643-0x
SMB-7 seven gang surface mount box	60-645-0x

Control accessories	Part number
IR Emitter kit (single, dual)	70-283-01, -02
IR Broadcaster	60-272-01
Display Power Sensor	60-271-01
IR Link IR signal repeater (gray, black, white, RAL9010 white)	60-404-01, -02, -03, -05
IRL 20 IR signal repeater	60-580-01
IR Sensor remote IR receiver	70-223-01
IR 402 remote control (1)	70-207-01
SCP 226 (black, white, RAL9010 white)	60-671-02, -03, -05
SCP 226 AAP (black, white, RAL9010 white)	60-671-12, -13, -15
SCP 226L (black, white, RAL9010 white)	60-671-32, -33, -35
MLA-VC10 volume controller	60-502-01
IRCM-VCR (black, white, RAL9010 white)	70-148-02, -03, -05
IRCM-DVD (black, white, RAL9010 white)	70-149-02, -03, -05
IRCM-DVD+ (black, white, RAL9010 white)	70-179-02, -03, -05
IRCM-DV+ (black, white, RAL9010 white)	70-220-02, -03, -05
CM-3BLB (black, white, RAL9010 white)	70-493-02, -03, -05
CM-9BLB (black, white, RAL9010 white)	70-494-02, -03, -05
ACM-Tone (black, white, RAL9010 white)	70-181-02, -03, -05
ACM-Level (black, white, RAL9010 white)	70-182-02, -03, -05
CM-19AC (black, white, RAL9010 white)	70-556-02, -03, -05
CM-5BB (black, white, RAL9010 white)	70-185-02, -03, -05
CM-20BB (black, white, RAL9010 white)	70-205-02, -03, -05

Intercom and switcher products	Part number
IPI 104 AAP intercom (black, white, RAL9010 white)	70-502-02, -03, -05
IPI 101 AAP intercom (black, white, RAL9010 white)	70-501-02, -03, -05
MLS 406, MLC 406MA, MLS 406SA switcher	60-560-01, -02, -03
MLS 506, MLS 506 MA 70 V, MLS 506 MA 100 V, MLS 506SA switcher	60-386-02, -03, -13, -04

---

## Glossary

**10/100Base-T** is Ethernet which uses unshielded twisted pair (UTP - Cat 5, etc.) cable, where the amount of data transmitted between two points in a given amount of time is equal to either 10 Mbps or 100 Mbps.

**ARP (Address Resolution Protocol)** is a protocol which assigns an IP address to a device based on the device's MAC or physical machine address.

**Custom Web page** is any file that can be loaded into an MLC 226 IP and served by the MLC's internal Web server. The Web page provides a way to control the MLC and other devices attached to it without use of the software. This is true with or without an accompanying event script. Any number and size of graphics can be used, but if they are too large to fit in the MLC 226 IP's nonvolatile memory, you can create Web pages so that they can be served from another Web server. If you install Microsoft Internet Information Services (IIS) on your desktop, you can serve any page on its hard disk. The MLC 226 IP functions like a little computer with a Web server—you can use it for various Web-based tasks.

**DHCP (Dynamic Host Configuration Protocol)** is a standardized communications protocol that enables network administrators to locally and automatically manage the assignment of IP addresses in an organization's network.

**Driver** is a software package that controls the interface between the controller and peripheral devices.

**Ethernet** is a network protocol that uses MAC addresses instead of IP addresses to exchange data between computers. Using ARP (see above) with TCP/IP support, Ethernet devices can be connected to the Internet. An Ethernet LAN typically uses unshielded twisted pair (UTP) wires. Ethernet systems currently provide transmission speeds of 10 Mbps or 100 Mbps.

**Event script** is a program that controls an MLC 226 IP. Event scripts are written in the "Extron C" language (.sc), and compiled into an event script (.evt). The Global Configurator program performs this compilation and uploads the compiled event file onto the MLC 226 IP. The Extron C language is similar to ANSI C, with some differences. As long as event scripts are turned on, they run continuously on the unit.

**HTTP (HyperText Transfer Protocol)** is a Web protocol based on TCP/IP that is used to fetch HyperText objects from remote Web pages.

**IP (Internet Protocol)** is the protocol or standard used to send information from one computer to another on the Internet.

**IP address** is a unique, 32-bit, binary number (12 digit decimal number, xxx.xxx.xxx.xxx) that identifies each device or device port (an information sender and/or receiver) that is connected to a LAN, WAN, or the Internet. IP addresses can be static (see static IP) or dynamic (see DHCP).

**IP net mask/subnet mask** is a 32-bit binary number (12 digit decimal number, xxx.xxx.xxx.xxx) used on subnets (smaller, local networks) to help routers determine which network traffic gets routed internally (within the subnetwork) to local computers and which network traffic goes out to the rest of the network or the Internet.

**MAC (Media Access Control) Address** is a unique hardware number given to devices that connect to a network such as the Internet. When your computer or networking device (router, hub, interface, etc.) is connected to a LAN or the Internet, a table (see ARP) relates the device's IP address to its corresponding physical (MAC) address on the LAN.

## Reference Material, cont'd

---

**Ping** is a utility/diagnostic tool that tests network connections. It is used to determine if the host has an operating connection and is able to exchange information with another host. The term (ping) is a reference to submarine sonar, which sends out a signal and waits to hear it echo (“ping”) back from a submerged object, much like how the ping utility functions in a network.

**Port number** is a preassigned address within a server that provides a direct route from the application to the transport layer or from the transport layer to the application of a TCP/IP system.

**Static IP** refers to an IP address that has been specifically (instead of dynamically—see DHCP above) assigned to a device or system in a network configuration. This type of address requires manual configuration of the actual network device or system and can only be changed manually or by enabling DHCP.

**Subnet** — See **subnetwork**.

**Subnet address** is the portion of an IP address that is specifically identified by the subnet mask as the subnetwork.

**Subnet mask** A 32-bit address mask used in IP to identify the bits of an IP address that are used for the subnet address. Using a mask, the router does not need to examine all 32 bits, only those selected by the mask.

**Subnetwork** is a network that is part of a larger IP network and is identified by a subnet address. Networks can be segmented into subnetworks to provide a hierarchical, multilevel routing structure.

**Switcher slaving** is an old term sometimes used to indicate that a device such as the MLC or a main switcher unit is being used to control one or more A/V switchers.

**Switching rotation** is another term for the set of buttons that are controlled by the firmware. This is a mutually exclusive set of buttons controlled by firmware (not scripts) that causes an input switching SIS command (1!, 2!, 3!, and so forth) to be sent via the MLS port when each button is pressed. In Global Configurator, setting a button for input button mode is the same as designating that button as part of the switching rotation.

**TCP (Transmission Control Protocol)** is a connection-oriented protocol defined at the Transport layer of the OSI reference model. It provides reliable delivery of data.

**TCP/IP (Transmission Control Protocol/Internet Protocol)** is the communication protocol (language) of the Internet. Computers and devices with direct access to the Internet are provided with a copy of the TCP/IP program to allow them to send and receive information in an understandable form.

**Telnet** is a standard terminal emulation utility/protocol that allows a computer to communicate with a remote user/client. A user who wishes to access a remote system initiates a Telnet session using the address of the remote client. The user may be prompted to provide a user name and password if the client is set up to require them. Telnet enables users to log in on remote networks and use those resources as if they were locally connected.

**Tool tip** is text that appears when the mouse pointer hovers over a button or other item on screen.

**UDP (User Datagram Protocol)** is an Internet protocol for sending short packets of information quickly between networked devices. It is faster than TCP and is often used for broadcast and multicast communication, but it does not include data verification to ensure that all packets arrived at their destination.



---

**Verbose** refers to a wordy way of speaking. For the MLC and other IP-enabled products, verbose mode is a communication mode in which the device responds with more information than it usually would—more than the device, itself, needs to send. Verbose mode is usually enabled for troubleshooting and disabled for daily use. Verbose mode creates more network traffic than usual and can slow down performance.

## File Types: a Key to Extron-specific File Names

You must have a basic understanding of the types of files used by this MLC controller in order to decide what (if anything) to do with them.

\_\_\_\_.cdc — These are compressed device configuration files created and used by Global Configurator.

**CAUTION** \_\_\_\_ .cdc files should NOT be deleted.

\_\_\_\_.eir — These are driver files containing infrared commands. There is a separate \_\_\_\_ .eir file for each device the MLC controls via infrared communication. This is the type of file created during IR learning. Via Global Configurator, these files can be imported and associated with one of the controller's IR/Serial ports.

\_\_\_\_.eml — E-mail template files have the .eml extension. These files are used to generate e-mail messages such as those regarding projector disconnection and excessive projector lamp hours. The first line of the file is the subject. The rest of the file contains the body of the e-mail. For the MLC 226 IP, these files are numerically named (1 through 64). For example, *1.eml, 2.eml, 3.eml, ... 64.eml*.

\_\_\_\_.evt — These are event files, the most important files for the functioning of the MLC. Almost everything the MLC does is coordinated by the scripts in the main event file, *0.evt*. The other event files perform device driver functions. When the Windows-based configuration program creates event files, it names (numbers) the files according to port associations. For example, the main event file, *0.evt*, contains instructions for the MLC's internal operations, while *5.evt* is related to IR/Serial output port A.

**CAUTION** *Event files should NOT be deleted. They are necessary for the MLC's operation. Never delete the main event file (0.evt).*

\_\_\_\_.s19 — This is an Extron-supplied firmware update file. When the firmware is replaced, the MLC is also automatically reset to factory default settings. This file is not displayed on the File Manager page. See appendix B for details on firmware updates. Firmware can't be updated by loading an \_\_\_\_ .s19 file through the file manager.

## Reference Material, cont'd

### Cut-out Templates

This section includes templates for the MLC 226 IP, MLC 226 IP AAP, and the MLC 226 L. Templates for MLM 226 Series faceplates are available in the *MLM 226 Faceplates Installation Guide*, which you can download from <http://www.extron.com>.

### Cut-Out Template for Extron's MLC 226 IP

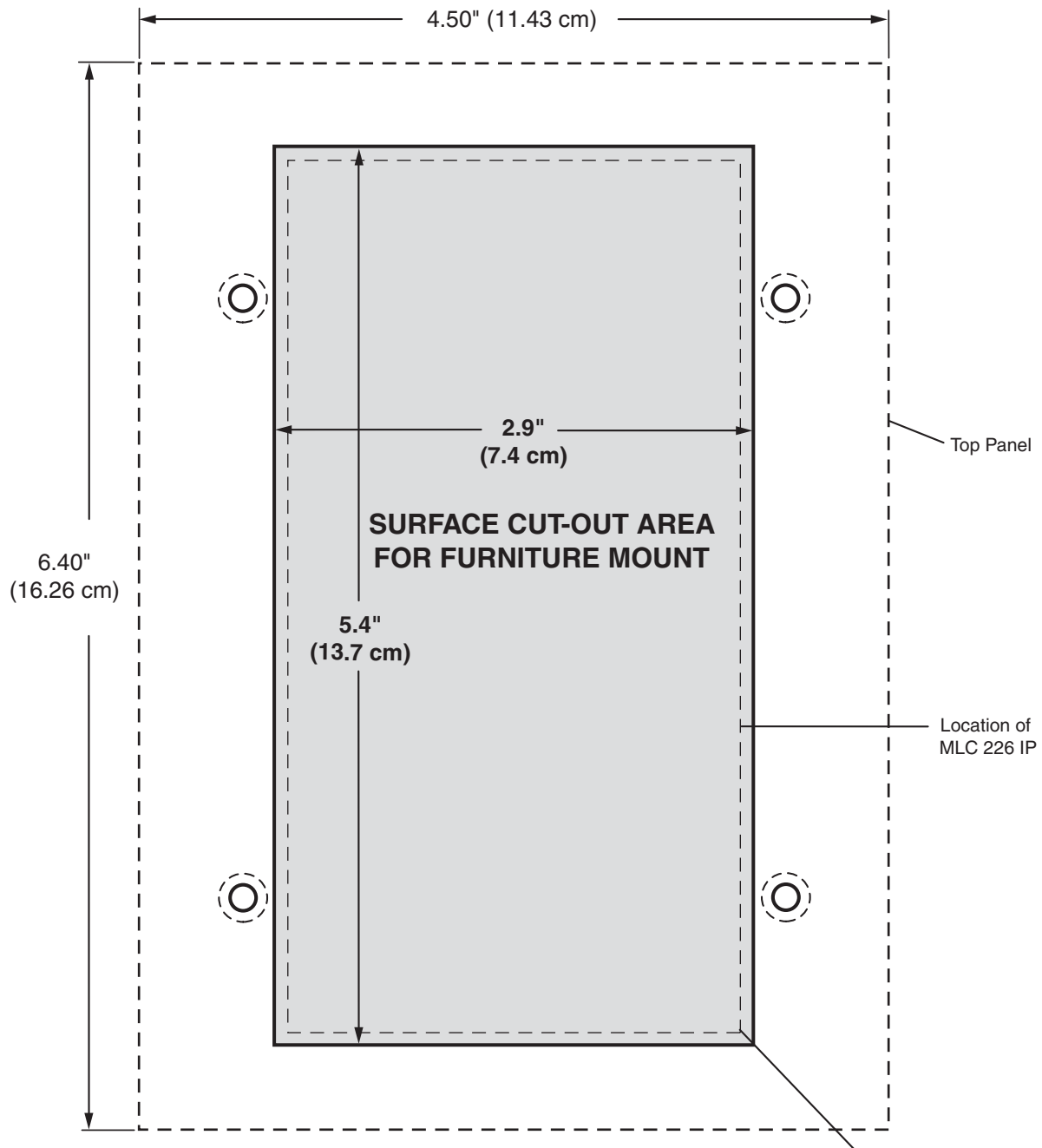

To install an MLC 226 IP directly into furniture, cut along this line.

PRINT TEMPLATE AT 100%.

Cut-Out Template for Extron's  
**MLC 226 IP AAP**

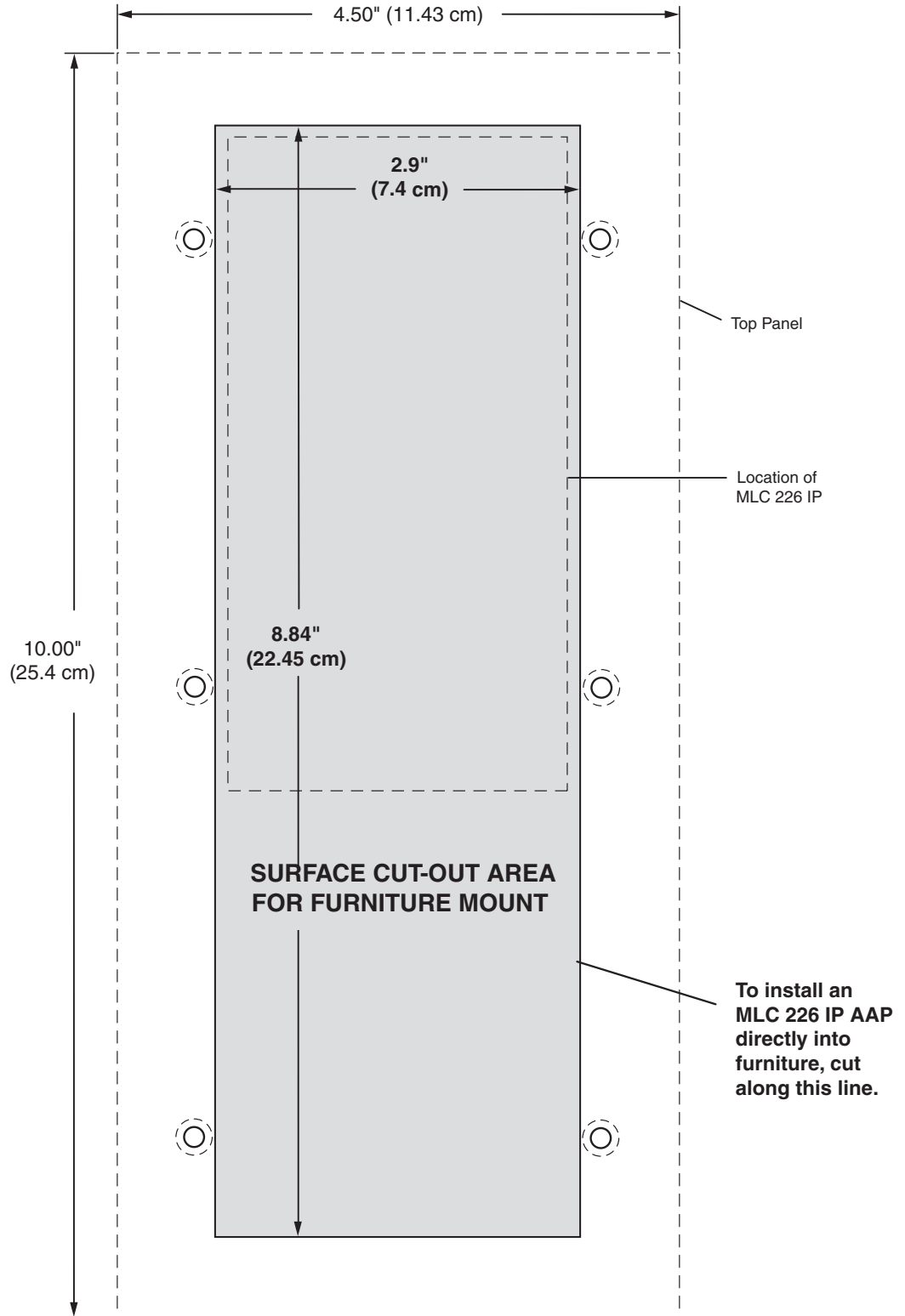

TEMPLATE IS **NOT** FULL SIZE.

# Reference Material, cont'd

Cut-Out Template for Extron's

## MLC 226 IP L

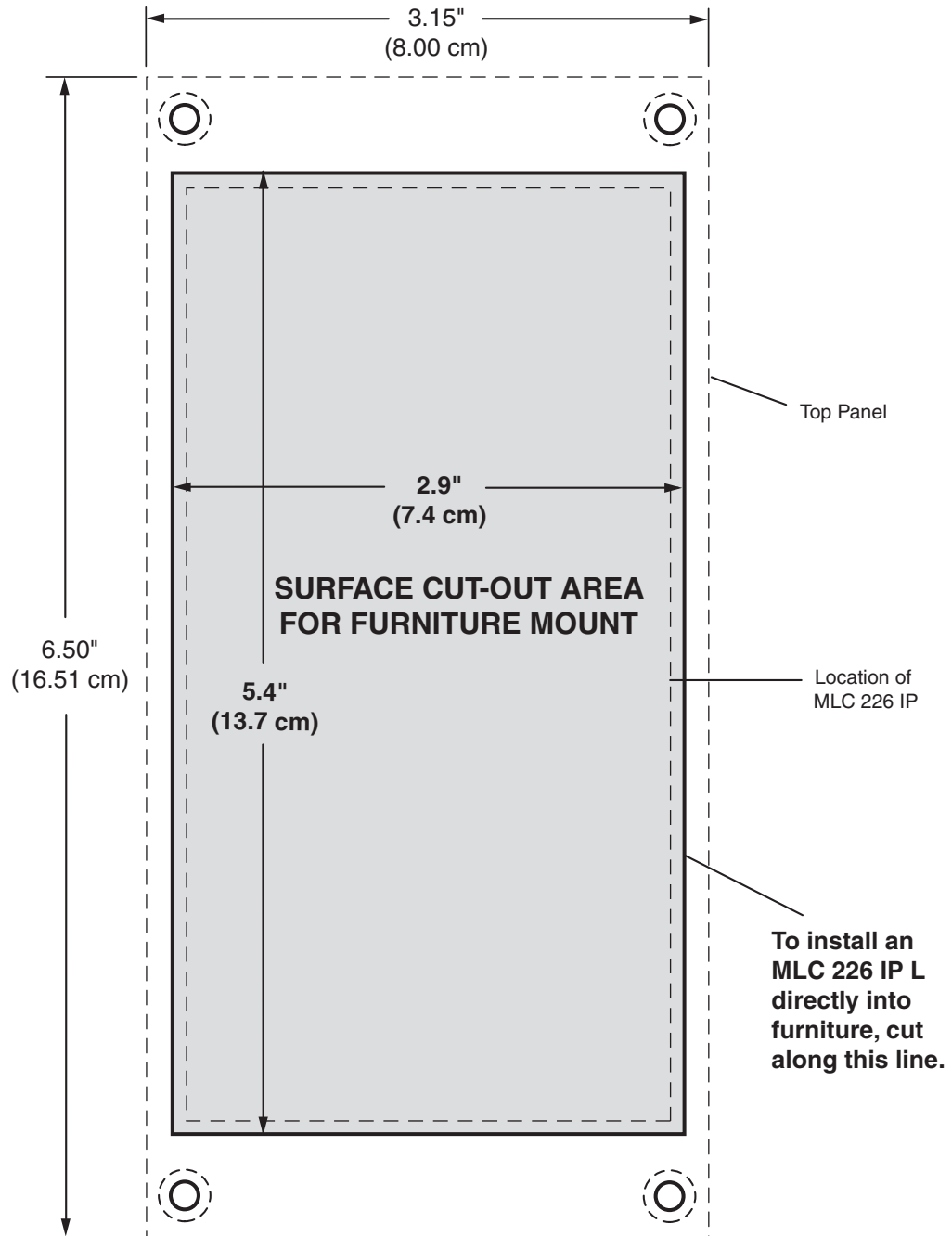

PRINT TEMPLATE AT 100%.



MLC 226 IP Series

# Appendix B

## Firmware Updates

Determining the Firmware Version

Updating the Main Firmware

# Firmware Updates

---

If the need arises, you can replace the Extron MLC controller's main firmware via an IP connection without opening the unit or changing firmware chips.

## Determining the Firmware Version

There are several ways to check which version of firmware the controller is using:

- the IP Link Settings tab within Extron Global Configurator software
- the System Status or the System Settings page of the controller's embedded Web pages
- the Info page of GlobalViewer® Web pages (if installed on the controller)
- the Version column within Extron IP Link® Device Manager software
- the response from the MLC to an SIS command of 1Q or 0Q (See chapter 5.)

## Using the Global Configurator software

1. Via RS-232 or Ethernet, connect a PC (on which the Global Configurator program has been installed) to the MLC.
2. Start the Global Configurator (GC) program and open a project. (See the *MLC 226 IP Setup Guide* and chapter 4 of this manual for details.)
3. In the window on the left side of the GC screen, click on the name of the MLC for which you want to check the firmware level.
4. In the right side of the GC screen, click the **IP Link Settings** tab.
5. Click the **Refresh** button. The firmware version is listed in the System Description area.

## Using a Web browser

The controller comes with a set of factory default embedded Web pages. Also, if the MLC controller is used as part of a network of devices based on Extron IP Link® technology, such as IP Link interfaces, the GlobalViewer application could be installed in the MLC as well as in other IP Link devices within the network. Refer to the Global Configurator help file for information on how to use that software and the resulting Web pages.

1. Connect the controller to a PC via an Ethernet connection, or connect the controller and the PC to a network/LAN. See chapters 2 and 4 of this manual and read the *MLC 226 IP Setup Guide* for details.
2. Start a Web browser program (such as Microsoft® Internet Explorer or Netscape® Navigator®).
3. Type the MLC's IP address into the browser's address area and log on to the MLC's internal Web page (see chapter 4) or to the optional GlobalViewer Web page stored in the MLC. (See the Global Configurator help file for details.)

**NOTE** *If GlobalViewer is installed in the MLC, the GlobalViewer Web pages appear by default.*

- *GlobalViewer Web pages are supported by Internet Explorer, but not by other browsers. GlobalViewer features may not work properly when viewed via Navigator, Firefox, or other browser programs.*
- *To reach the factory default Web pages on a controller that has been set up for GlobalViewer, type **http://<IP address>/nortxe\_index.html** into the browser's address area, substituting the unit's actual IP address for "<IP address>". For example, **http://10.13.196.42/nortxe\_index.html**.*

- In the factory default Web pages, select the **Status** tab, **System Status** page. The firmware version is listed in the System Description area of the System Status area, as shown below.

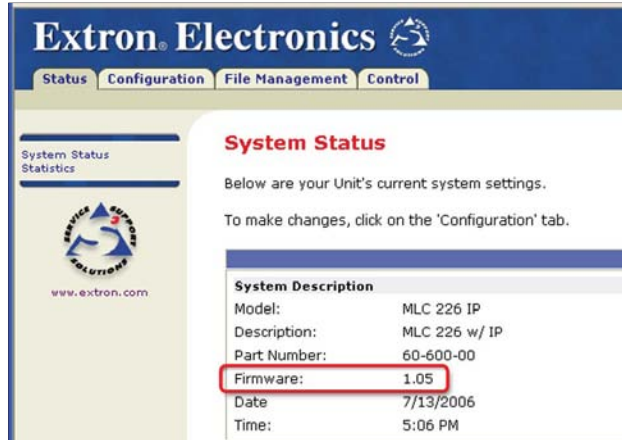

Or select the **System Settings** page within the **Configuration** tab. The firmware version is listed in the IP Settings area, as shown below.

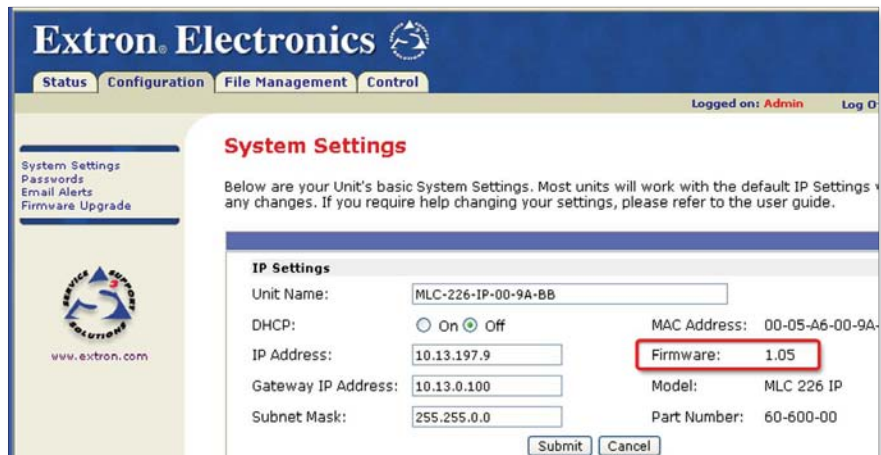

If using the GlobalViewer pages, click on the **Type** button and click on the **MediaLink Controller** folder. The firmware version is listed in the System Description area, as shown in the following picture.

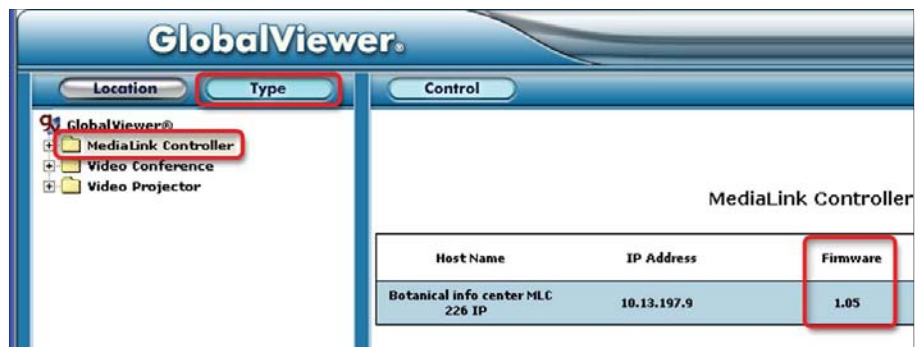

# Firmware Updates, cont'd

## Updating the Main Firmware

Most firmware upgrade tools (except Extron Firmware Loader) require the PC and the controller to both be connected to an Ethernet network. Firmware Loader offers the option to use either an IP or an RS-232 connection for the firmware upgrade.

The instructions for each method of updating the MLC's firmware assume you have installed the appropriate software on your PC first.

**NOTE** *Because the MLC must be reset after a firmware update, the existing configuration will be erased. You should save the existing configuration to a file (see chapter 4) before replacing the firmware. If the file is saved, the configuration can be restored to the MLC later using Global Configurator.*

**NOTE** *Check the Extron Web site ([www.extron.com](http://www.extron.com)) for firmware-related documents, instructions, patch files, and new firmware files before loading new firmware into the controller. We recommend that you read the firmware release notes (available from [www.extron.com](http://www.extron.com)) before beginning the firmware update.*

## Locating and downloading the firmware

1. Visit the Extron Web site ([www.extron.com](http://www.extron.com)) to find the latest, appropriate firmware file (MLC 226 IP) you want to update.
2. Download the executable installer file (\*.exe) from the Web site and run the installer program. The program automatically stores the firmware file on the PC in `C:\Program Files\Extron\Firmware\MLC_226_IP\xx` (a folder specific to that version).
3. Write down the firmware filename and location for later use. The filename ends in `.s19` such as `MLC226IPvxxx.s19` where `xxx` is the version number (x.xx) or `MLC_226_IP_yy_yyyy_yy_Vx_xx.S19` where `Vx_xx` indicates the version number (x.xx).

**NOTE** *The firmware update file must have a filename extension of `.s19`. If the file does not have that extension, it will not work properly.*

## Updating firmware via the MLC's embedded Web page

Firmware uploads may be performed via a Web browser and the MLC's internal Web page. This method allows you to update one MLC at a time via an IP connection.

1. Download the firmware file.
2. Launch a Web browser (Microsoft Internet Explorer or Netscape Navigator) on the connected PC and type the controller's IP address in the address area.
3. If a password was previously set for the MLC, an Enter Network Password or Connect to... dialog box appears. Type the controller's IP address or text of your choice in the User Name area, type in the administrator password in the Password area, and click **OK**. The MLC's default Web page appears.

**NOTE** *Passwords must contain 4 to 12 alphanumeric characters. Symbols and spaces are not allowed, and the passwords are case-sensitive.*





3. Click on the **Configuration** tab, then select **Firmware Upgrade** from the list on the left of the screen. A screen like the one shown below appears.
4. Click on the **Browse** button.

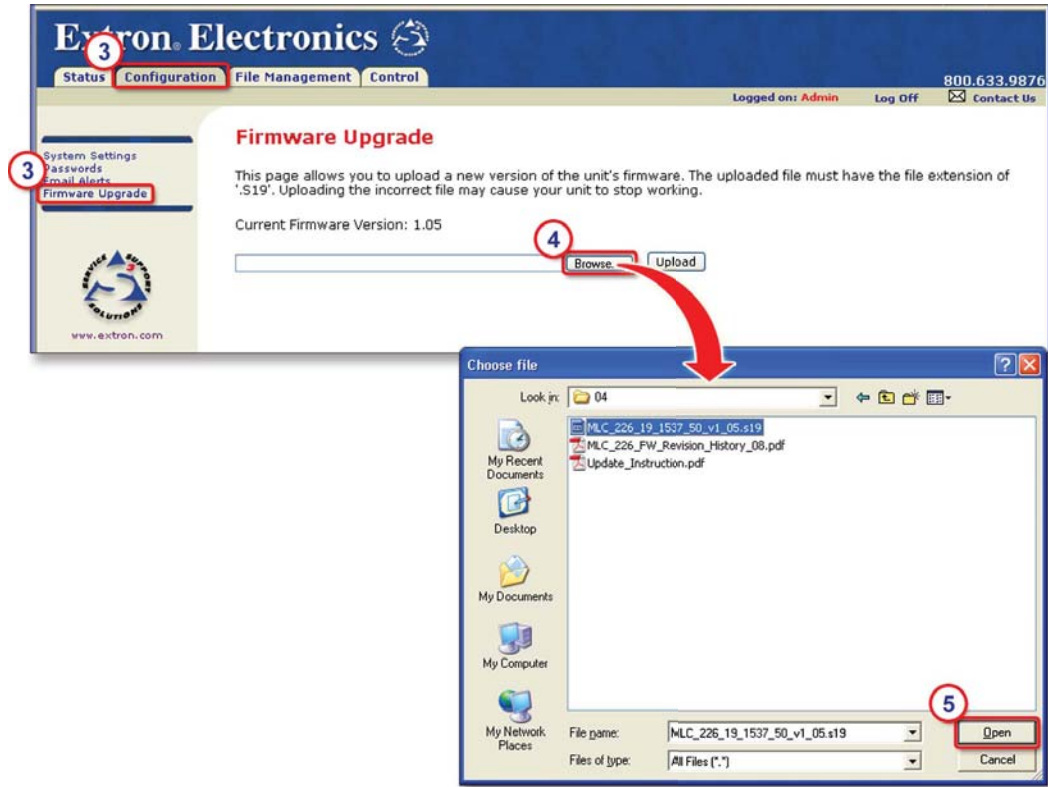

5. In the Choose file dialog box, locate and select the firmware file (\*.s19) you downloaded to C:\Program Files\Extron\Firmware\MLC\_226\_IP\xx, and click the **Open** button.
6. Click on the Web page's **Upload** button to upload the firmware into the controller. It takes a while to load the file into the controller. You will not see any on-screen indication when the upload has finished. Once the firmware upload is completed, all the front panel buttons on the MLC and on any connected optional SCPs light/flash as the controller performs a reset.
7. Follow the instructions in "Resetting the MLC and restoring its configuration," later in this chapter.

## Updating firmware via Extron Firmware Loader software

This method allows you to update one MLC at a time via either IP or RS-232 communication.

1. Download the firmware file.
2. Start the Firmware Loader (FWLoader) software on the connected PC.
3. Choose the communication type and settings.
  - a. For IP communication, select **TCP/IP** and set the communication settings. Enter the unit's IP address, verify or change the Telnet port number, and enter an administrator password if a password has been set for the unit.

**NOTE** Passwords must contain 4 to 12 alphanumeric characters. Symbols and spaces are not allowed, and the passwords are case-sensitive.

## Firmware Updates, cont'd

- b. For serial communication, select **RS-232** and set the communications settings to 38400 baud, no parity, 8 data bits, 1 stop bit.
4. Click the **OK** button. A window like the one shown at right appears. It shows the firmware version currently used by the MLC.

5. Type in the filename and path of the new firmware file or click the **Browse** button to view folders to find the file. If you click **Browse**, the Choose Firmware File window (shown below) appears. Locate and select the firmware file, and click the **Open** button.

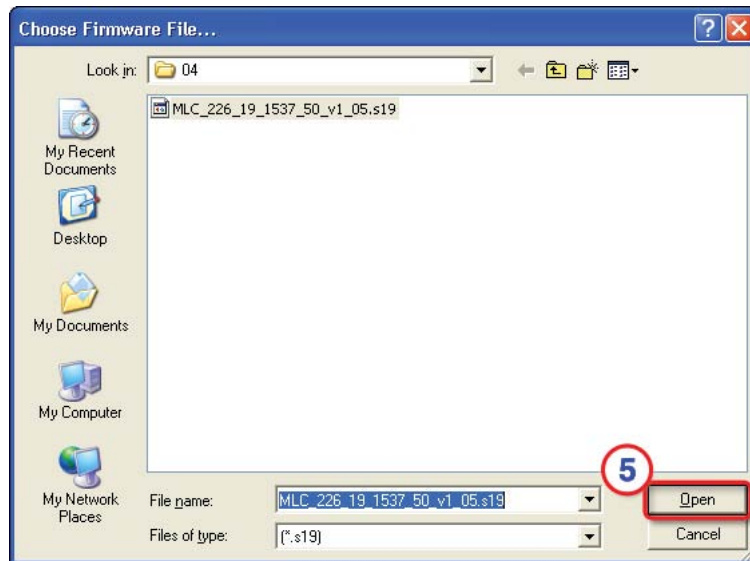
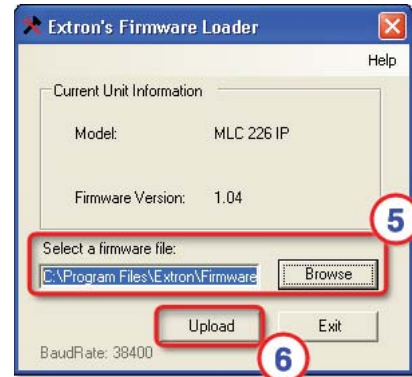

6. Click **Upload** in the Firmware Loader window. The PC uploads the new firmware into the MLC. Once the firmware is uploaded, the MLC resets itself and the front panel lights blink as they do during power-on. The Firmware Loader software displays the new firmware version, as shown at right.

7. Click **Exit** in that window, and click **Exit** in the Firmware Loader connections window.

8. Follow the instructions in "Resetting the MLC and restoring its configuration" later in this chapter.

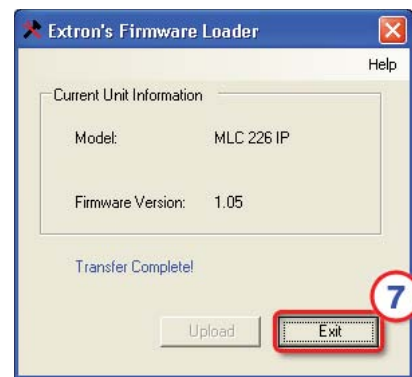

## Updating firmware via Extron IP Link™ File Manager software

This is the **recommended method** for updating an MLC's firmware. It allows you to update one MLC or several MLCs at a time via an IP connection.

1. Download the firmware file.
2. Start the IP Link File Manager (IPLFileManager) software on the connected PC. The main IP Link File Manager window appears on screen, as does the smaller Select Startup Mode window, shown below at right.
3. Click one of the Select Startup Mode buttons to choose how to add MLCs to the firmware update list, and follow any on-screen instructions to add MLCs.



IPLFileMana...

- Open Configuration File — Select this mode to open an existing configuration file.
- Import GC2.x Project (**recommended**) — Select this mode to import a GC2.x project file and the names and IP addresses of the devices in it.
- Manually Add IP Link Device(s) — Select this mode to add MLCs individually by IP address.
- Automatically Detect IP Link Device(s) — Select this mode to scan the network for IP Link devices, including MLCs. You may need to provide administrator passwords for some units.
- Use Previous Setup — Choose this to show IP Link devices from your previous session of IP Link File Manager.

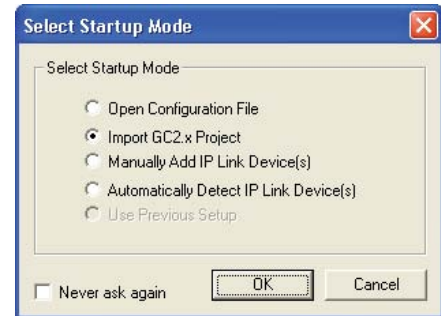

Refer to the IP Link File Manager's help file if you need additional details on how to use any of those modes.

4. Click on the **Options** menu and select **Reset Device After Firmware Update**.

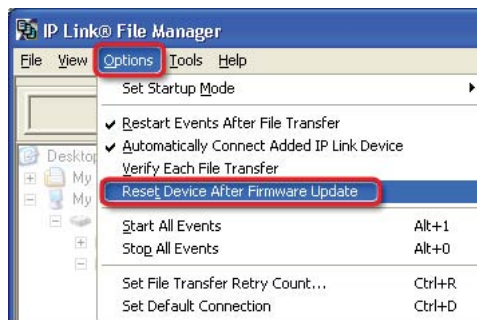

This option causes the MLC to perform a ZY reset, which resets all device settings and deletes all files from the MLC after the firmware is updated. See page 5-33 for ZY command details.

5. Click on the **Tools** menu and select **Firmware Update Manager**.

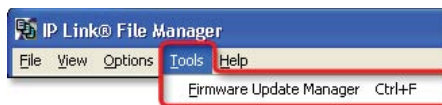

The Firmware Update Manager window appears.

## Firmware Updates, cont'd

- Set the maximum number of firmware uploads that can take place at the same time. The firmware files are uploaded to batches of this many units at a time until all units listed in the Select Device list have received new files. The default is 5 uploads at a time, and the upper limit is the total number of units shown in the Select Device list.

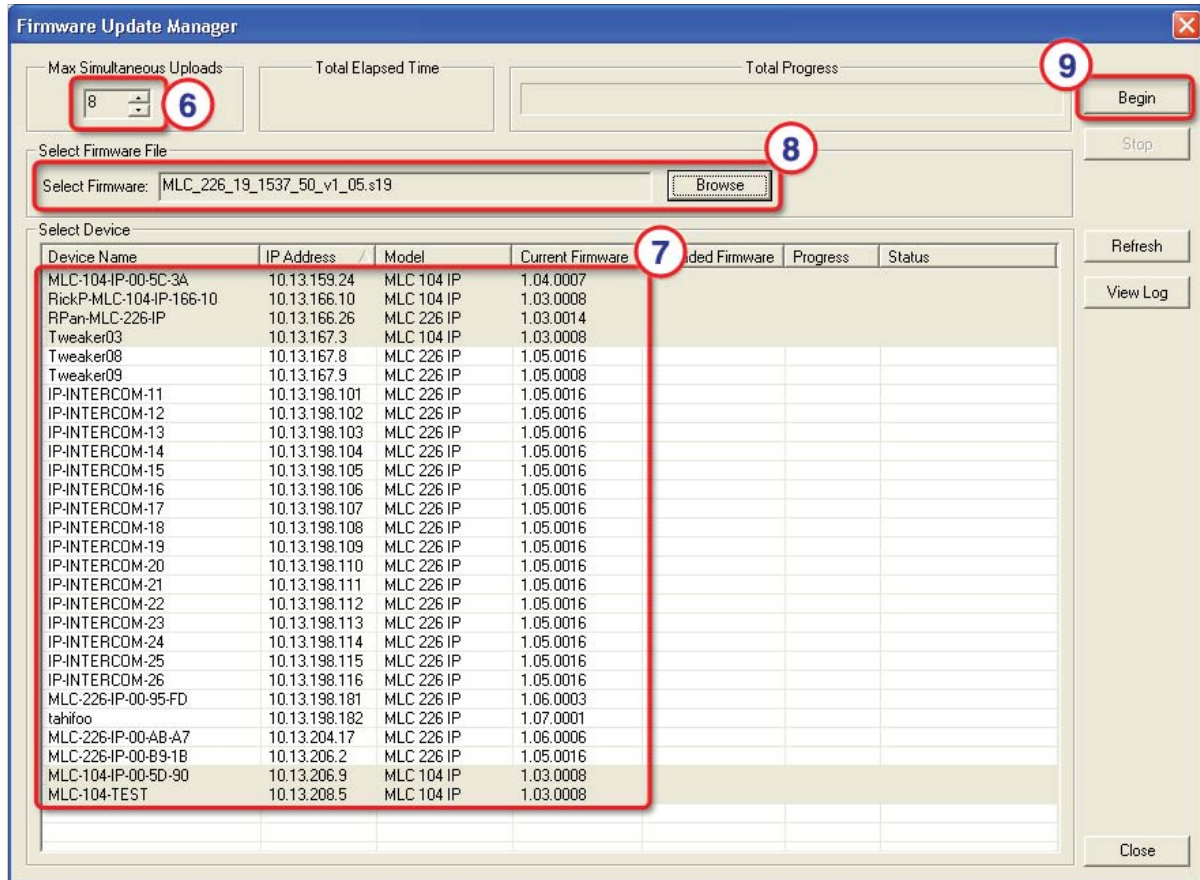

- Select the MLCs for the firmware update.
  - Ctrl-click on the names of several units.
  - Click on one unit's name and Shift-click on the name of another unit to select those two MLCs and the MLCs listed between them.
- Click **Browse**, then locate and select the firmware file you downloaded.
- Click **Begin**, then confirm that you want to start uploading the firmware. The software displays the progress and status of the firmware upload for each unit, then performs a firmware validation before finishing. If uploading fails, you can view the error log. If uploading is successful, the Status column indicates success for each unit.
- Click **Close**.
- Close the IP Link File Manager software.
- Restore the MLC's configuration from a previously saved file.

---

## Resetting the MLC and restoring its configuration

After a firmware update you must reset the unit. Resetting the MLC also removes configuration information, so replace the MLC's configuration after resetting.

1. Perform a ZY reset, which is an absolute system reset excluding IP settings (IP address, subnet mask, gateway IP address, unit name, DHCP settings, port mapping). This allows you to maintain communication with the MLC.
  - If using Telnet or HyperTerminal, enter `[Esc]ZY←`.
  - If using a Web browser connection, enter `WZY|`.

**NOTE** *This command is supported by MLCs with firmware of version 1.03 or higher.*

2. Using Global Configurator, restore (build) the previously saved project to the MLC.

# Firmware Updates, cont'd

---



MLC 226 IP Series

# Appendix C

**Index**

# Index

---

## Index

### A

- accessories, part numbers for A-6
- actions
  - enabling and disabling in GlobalViewer 4-32
- advanced configuration
  - options in Global Configurator 4-12
- ASCII to decimal conversion table 5-13
- ASCII to hex conversion table 5-4
- audio level, limiting on power-up
  - SIS command 5-34
- audio settings, SIS commands for
  - limit audio level on power-on 5-34
- auxiliary port. *See* MLS RS-232 (slave switcher) port
- See also* RS-232 protocol
- auxilliary switcher
  - configuring 4-16
  - enable slaving (SIS command) 5-39

### B

- button press/release emulation 5-36
- buttons
  - associations with IRCM-DV+ 5-35
  - button control SIS commands 5-38
  - button press repeat commands 5-38
  - default SIS commands for input buttons 3-4
  - front panel button LED control 5-39
  - press/release emulation (SIS commands) 5-36
  - slave map (button associations for a slaved switcher) 5-38
  - types, functions, and operation 3-2
  - virtual mapping for an IRCM-DV+ 5-35

### C

- cdc files 4-25
- Configuration
  - embedded Web page 4-22
- configuration
  - saving and uploading 4-18
- configuration ports
  - Config (host control) port 3-6
- connector pin assignments 2-15
- Control
  - embedded Web page 4-26
  - GlobalViewer Web page 4-30
- controlling the MLC 4-19
- controlling two display devices 6-11
- control modules
  - overview 3-6
- copyright message
  - sent by the MLC 5-2
- custom GUI service 4-34

- customizing control Web pages 4-34
- cut-out templates A-10
  - MLC 226 IP A-10

### D

- defaults
  - IP addresses 5-2
  - LAN port 2-14, 5-2
- delay times, SIS commands for 5-34
- device drivers
  - serial
    - viewing in embedded Web page 4-27
- digital I/O port
  - settings in Global Configurator 4-15
- display (projector) power
  - advanced settings in Global Configurator 4-13
  - power connection status in GlobalViewer 4-34
- display control 3-2

### E

- e-mail
  - sending by pressing a button (special application) 6-14
- eir file type A-9
- electrical box, mounting to 2-17
- electrical box or mud ring, mounting to 2-17
- Email Alerts
  - embedded Web page 4-23
- embedded Web pages
  - accessing 4-19
  - Configuration 4-22
  - Control 4-26
    - IR drivers 4-27
  - Email Alerts 4-23
  - File Management 4-24
  - Firmware Upgrade 4-24
  - IR drivers 4-27
  - Statistics 4-21
  - Status 4-20
    - Statistics 4-21
    - System Status 4-20
  - updating firmware via B-4
  - User Mode 4-26
    - enhanced Web pages example 4-26
- eml file type A-9
- enable PIN 5-40
  - SIS command 5-40
- encoder scaling 4-14
- enhanced Web pages
  - example 4-26
- error responses to SIS commands 5-3
- event files 4-25
  - .evt files A-9
    - main event file (0.evt) 4-25
- evt files A-9



---

executive mode. *See* front panel security lockout (executive mode)  
how to use 3-7, 6-14  
Extron Firmware Loader software B-5  
Extron IP Link File Manager software B-7

## F

file extension  
.cdc 4-25  
.s19 A-9  
filtering by 4-24  
File Management (embedded Web page) 4-24  
file names  
Extron-specific  
.cdc 4-25  
.eml A-9  
.evt A-9  
.s19 A-9  
event files 4-25  
main event file (0.evt) 4-25  
file types  
.cdc 4-25  
.eir A-9  
.eml A-9  
.evt A-9  
.s19 A-9  
event files 4-25  
main event file (0.evt) 4-25  
firmware  
.s19 file A-9  
locating and downloading B-4  
updating 4-18  
updating the main firmware B-4  
updating via embedded Web page 4-24, B-4  
updating via Extron Firmware Loader software B-5  
updating via IP Link File Manager software B-7  
Firmware Loader software B-5  
Firmware Upgrade (embedded Web page) 4-24  
front panel  
features and operation 3-2  
front panel button LED control 5-39  
front panel security lockout (executive mode)  
explanation of executive mode 3-7, 6-14  
scheduling 6-14  
SIS commands for 5-10, 5-39  
viewing, enabling, and scheduling in  
GlobalViewer 4-32

## G

GlobalViewer™ Web pages 4-29  
Control 4-30  
Info 4-33  
Monitor 4-31  
Schedule 4-32  
grounding, Euro Channel 2-19  
grounding-related problems 2-17

grounding the faceplate 2-17  
ground loops 2-17  
GUI  
customization 4-34

## H

HyperTerminal  
baud setting 5-2

## I

Info  
GlobalViewer Web page 4-33  
input selection  
default Extron SIS commands 3-4  
input switching lockout duration 5-40  
Intercom port  
Intercom connectors 2-13  
IP address  
defaults 5-2  
IP Intercom  
IPI-MLC connections 2-13  
IPI lockout SIS command 5-40  
IP Link File Manager software B-7  
IR-related settings, SIS commands for  
disable IR reception 5-40  
IR 402 remote control  
overview 3-6  
IRCM-DV+  
IRCM-DV+ activation (SIS commands) 5-35  
IRCMs  
overview 3-6  
IR driver files  
using IR learning to create customized drivers 4-12  
IR drivers  
embedded Web page 4-27  
IR learning 4-12  
IR reception  
disable IR reception SIS command 5-40  
IR signal sensors 3-5  
IR control receiver 3-5  
IR learning receiver 3-5

## L

lamp hours 4-20  
LAN port defaults 2-14, 5-2  
LEDs  
front panel button LED control 5-39  
limit audio level on display power-on 5-34  
lockout. *See also* front panel security lockout (executive mode)  
input switching lockout duration 5-40  
IPI lockout SIS command 5-40

# Index, cont'd

---

## M

- main event file (0.evt) 4-25
- miscellaneous settings (SIS commands) 5-39
- MLC-initiated messages 5-2
- MLC 226 IP
  - cut-out template A-10
- MLC 226 IP L 2-18
  - rack mounting 2-18
- modes, reset 2-15
- Monitor
  - GlobalViewer Web page 4-31
- mounting
  - electrical box 2-17
  - Euro Channel 2-19
  - mud ring 2-17
  - rack 2-18
  - wall or furniture 2-18
- mud ring, mounting to 2-17

## N

- National Electrical Code (NEC) 2-17

## P

- passwords
  - MLC's responses 5-3
  - prompts from MLC 5-3
  - requirements for 4-23
- Passwords embedded Web page 4-23
- personal identification number (PIN)
  - enable PIN (SIS command) 5-40
- pinout guide 2-15
- power connection status
  - as indicated in GlobalViewer 4-34
- projector control 3-2
  - power connection status in GlobalViewer 4-34

## R

- rack mounting 2-18
- reset (zap) commands and erase commands (SIS) 5-33
- Reset button 2-15
- Reset Device After Firmware Update B-7
  - reset (zap) commands and erase commands (SIS) 5-33
- reset modes 2-15
- resetting the unit
  - reset (zap) commands and erase commands (SIS) 5-33
  - Reset Device After Firmware Update B-7
  - resetting the MLC and restoring its configuration after a firmware update B-9
- RS-232 protocol 5-2

## S

- Schedule (GlobalViewer Web page) 4-32
- scheduling
  - front panel lockout periods 6-14

- sending e-mail by pressing a button 6-14
- serial devices' drivers 4-27
- SIS programming and control 5-1
- slave map 5-38
- slave switcher. *See* auxilliary switcher
- system requirements 1-3
- System Settings (GlobalViewer Web page) 4-22

## T

- tree view area in GlobalViewer Web pages 4-30, 4-33

## U

- UL requirements 2-17
  - UL rack mounting requirements 2-19
- unit name
  - definition and parameters 4-22
- updating the main firmware B-4
- User Mode (embedded Web page) 4-26

## V

- volume
  - control via front panel knob 3-4
  - encoder scaling 4-14
  - max. volume range (SIS command) 5-39
  - volume settings in Global Configurator 4-14
- volume adjustment
  - encoder scaling 4-14
  - max. volume range (SIS command) 5-39
  - via front panel knob 3-4

## W

- wall or furniture mounting 2-18
- wiring block diagram
  - printing 4-18

## FCC Class A Notice

Note: This equipment has been tested and found to comply with the limits for a Class A digital device, pursuant to part 15 of the FCC Rules. These limits are designed to provide reasonable protection against harmful interference when the equipment is operated in a commercial environment. This equipment generates, uses and can radiate radio frequency energy and, if not installed and used in accordance with the instruction manual, may cause harmful interference to radio communications. Operation of this equipment in a residential area is likely to cause harmful interference, in which case the user will be required to correct the interference at his own expense.

Note: This unit was tested with shielded cables on the peripheral devices. Shielded cables must be used with the unit to ensure compliance.

## Extron's Warranty

Extron Electronics warrants this product against defects in materials and workmanship for a period of three years from the date of purchase. In the event of malfunction during the warranty period attributable directly to faulty workmanship and/or materials, Extron Electronics will, at its option, repair or replace said products or components, to whatever extent it shall deem necessary to restore said product to proper operating condition, provided that it is returned within the warranty period, with proof of purchase and description of malfunction to:

**USA, Canada, South America,  
and Central America:**

Extron Electronics  
1001 East Ball Road  
Anaheim, CA 92805, USA

**Asia:**

Extron Electronics, Asia  
135 Joo Seng Road, #04-01  
PM Industrial Bldg.  
Singapore 368363

**Europe, Africa, and the Middle East:**

Extron Electronics, Europe  
Beeldschermweg 6C  
3821 AH Amersfoort  
The Netherlands

**Japan:**

Extron Electronics, Japan  
Kyodo Building  
16 Ichibancho  
Chiyoda-ku, Tokyo 102-0082  
Japan

This Limited Warranty does not apply if the fault has been caused by misuse, improper handling care, electrical or mechanical abuse, abnormal operating conditions or non-Extron authorized modification to the product.

*If it has been determined that the product is defective, please call Extron and ask for an Applications Engineer at (714) 491-1500 (USA), 31.33.453.4040 (Europe), 65.383.4400 (Asia), or 81.3.3511.7655 (Japan) to receive an RA# (Return Authorization number). This will begin the repair process as quickly as possible.*

Units must be returned insured, with shipping charges prepaid. If not insured, you assume the risk of loss or damage during shipment. Returned units must include the serial number and a description of the problem, as well as the name of the person to contact in case there are any questions.

Extron Electronics makes no further warranties either expressed or implied with respect to the product and its quality, performance, merchantability, or fitness for any particular use. In no event will Extron Electronics be liable for direct, indirect, or consequential damages resulting from any defect in this product even if Extron Electronics has been advised of such damage.

Please note that laws vary from state to state and country to country, and that some provisions of this warranty may not apply to you.



[www.extron.com](http://www.extron.com)

**Extron Electronics, USA**  
1230 South Lewis Street  
Anaheim, CA 92805  
800.633.9876 714.491.1500  
FAX 714.491.1517

**Extron Electronics, Europe**  
Beeldschermweg 6C  
3821 AH Amersfoort, The Netherlands  
+800.3987.6673 +31.33.453.4040  
FAX +31.33.453.4050

**Extron Electronics, Asia**  
135 Joo Seng Rd. #04-01  
PM Industrial Bldg., Singapore 368363  
+800.7339.8766 +65.6383.4400  
FAX +65.6383.4664

**Extron Electronics, Japan**  
Kyodo Building, 16 Ichibancho  
Chiyoda-ku, Tokyo 102-0082  
Japan  
+81.3.3511.7655 FAX +81.3.3511.7656