



Department of Administration
 Purchasing Division
 2019 Washington Street East
 Post Office Box 50130
 Charleston, WV 25305-0130

**State of West Virginia
 Solicitation Response**

Proc Folder: 764540
Solicitation Description: ADDENDUM #1
 63210000 AT&T FirstNet Compatible Cellular Wire
Proc Type: Agency Purchase Order

Solicitation Closes	Solicitation Response	Version
2020-09-16 14:30	SR 0803 ESR09162000000002062	1

VENDOR
 VS0000018832
 RCN COMMUNICATIONS LLC

Solicitation Number: ARFQ 0803 DOT2100000006
Total Bid: 12476.87999999999919964466243 **Response Date:** 2020-09-16 **Response Time:** 13:31:14

Comments:

FOR INFORMATION CONTACT THE BUYER

Tina L Lewis
 304-414-6859
 tina.l.lewis@wv.gov

Vendor Signature X **FEIN#** **DATE**

All offers subject to all terms and conditions contained in this solicitation

Line	Comm Ln Desc	Qty	Unit Issue	Unit Price	Ln Total Or Contract Amount
1	AT&T FirstNet Compatible Cellular Wireless Router	12.00000	EA	968.780000	11625.36

Comm Code	Manufacturer	Specification	Model #
43222609			

Commodity Line Comments:

Extended Description:

AT&T FirstNet Compatible Cellular Wireless Router for Traffic Signal System

Line	Comm Ln Desc	Qty	Unit Issue	Unit Price	Ln Total Or Contract Amount
2	Associate Power Supply for AT&T FirstNet Compatible Router	12.00000	EA	17.910000	214.92

Comm Code	Manufacturer	Specification	Model #
39121004			

Commodity Line Comments:

Extended Description:

Associate Power Supply for AT&T FirstNet Compatible Cellular Wireless Router for Traffic Signal Systems

Line	Comm Ln Desc	Qty	Unit Issue	Unit Price	Ln Total Or Contract Amount
3	Antenna for AT&T FirstNet Compatible Cellular Wireless Route	12.00000	EA	53.050000	636.60

Comm Code	Manufacturer	Specification	Model #
43221727			

Commodity Line Comments:

Extended Description:

Antenna for AT&T FirstNet Compatible Cellular Wireless Router for Traffic Signal



**State of West Virginia
Agency Request for Quote**

Proc Folder: 764540			Reason for Modification: Addendum #1 To Answer Vendor Questions
Doc Description: ADDENDUM #1 63210009 AT&T FirstNet Compatible Cellular Wire			
Proc Type: Agency Purchase Order			
Date Issued	Solicitation Closes	Solicitation No	Version
2020-09-14	2020-09-16 14:30	ARFQ 0803 DOT2100000006	2

BID RECEIVING LOCATION

FINANCE & ADMINISTRATION
 DIVISION OF HIGHWAYS
 BLDG 5, RM A-220
 1900 KANAWHA BLVD E
 CHARLESTON WV 25302
 US

VENDOR

Vendor Customer Code: VS0000018832
Vendor Name : RCN Communications LLC
Address : 200
Street : Jennings Avenue
City : Knoxville
State : TN **Country :** United States **Zip :** 37917
Principal Contact : Emily Schmidt
Vendor Contact Phone: (865) 293-0350 **Extension:**

FOR INFORMATION CONTACT THE BUYER
 Tina L Lewis
 304-414-6859
 tina.l.lewis@wv.gov

Vendor Signature X *Reed Perryman* **FEIN#** 46-2702490 **DATE** 9-15-2020

INVOICE TO	SHIP TO
DIVISION OF HIGHWAYS INFORMATION SERVICE DIVISION 1900 KANAWHA BLVD E, BLDG 5 RM 920 CHARLESTON WV 25305-0430 US	DIVISION OF HIGHWAYS INFORMATION SERVICE DIVISION 1900 KANAWHA BLVD E, BLDG 5 RM 920 CHARLESTON WV 25305-0430 US

Line	Comm Ln Desc	Qty	Unit Issue	Unit Price	Total Price
1	AT&T FirstNet Compatible Cellular Wireless Router	12.00000	EA	\$968.78	\$11,625.36

Comm Code	Manufacturer	Specification	Model #
43222609	Cradlepoint	IBR900	MA5-0900120B-NNA

Extended Description:
AT&T FirstNet Compatible Cellular Wireless Router for Traffic Signal System

INVOICE TO	SHIP TO
DIVISION OF HIGHWAYS INFORMATION SERVICE DIVISION 1900 KANAWHA BLVD E, BLDG 5 RM 920 CHARLESTON WV 25305-0430 US	DIVISION OF HIGHWAYS INFORMATION SERVICE DIVISION 1900 KANAWHA BLVD E, BLDG 5 RM 920 CHARLESTON WV 25305-0430 US

Line	Comm Ln Desc	Qty	Unit Issue	Unit Price	Total Price
2	Associate Power Supply for AT&T FirstNet Compatible Router	12.00000	EA	\$17.91	\$214.92

Comm Code	Manufacturer	Specification	Model #
39121004	Cradlepoint	Power Adapter	170716-000

Extended Description:
Associate Power Supply for AT&T FirstNet Compatible Cellular Wireless Router for Traffic Signal Systems

INVOICE TO	SHIP TO
DIVISION OF HIGHWAYS INFORMATION SERVICE DIVISION 1900 KANAWHA BLVD E, BLDG 5 RM 920 CHARLESTON WV 25305-0430 US	DIVISION OF HIGHWAYS INFORMATION SERVICE DIVISION 1900 KANAWHA BLVD E, BLDG 5 RM 920 CHARLESTON WV 25305-0430 US

Line	Comm Ln Desc	Qty	Unit Issue	Unit Price	Total Price
3	Antenna for AT&T FirstNet Compatible Cellular Wireless Route	12.00000	EA	\$53.05	\$636.60

Comm Code	Manufacturer	Specification	Model #
43221727	Panorama Antennas	MiMo 2xLTE+2xWifi	LGAM-7-27-24-58-1S

Extended Description:

Antenna for AT&T FirstNet Compatible Cellular Wireless Router for Traffic Signal

SCHEDULE OF EVENTS

Line	Event	Event Date
1	TECHNICAL QUESTIONS DUE BY 10:00AM	2020-09-09

	Document Phase	Document Description	Page
DOT2100000006	Final	ADDENDUM #1 63210009 AT&T FirstNet Compatible Cellular Wire	4

ADDITIONAL TERMS AND CONDITIONS

See attached document(s) for additional Terms and Conditions

ATTACHMENT A

FirstNet Modems (63210009)

Addendum #1

ARFQ DOT2100000006

Question #1

Should NetCloud Essentials be included in the Mobile Router solution and for how many years.

Answer #1:

Yes and for (5) five years.

ADDENDUM ACKNOWLEDGEMENT FORM

SOLICITATION NO.: ARFQ DOT2100000006

Instructions: Please acknowledge receipt of all addenda issued with this solicitation by completing this addendum acknowledgment form. Check the box next to each addendum received and sign below. Failure to acknowledge addenda may result in bid disqualification. Acknowledgment: I hereby acknowledge receipt of the following addenda and have made the necessary revisions to my proposal, plans and/or specification, etc.

Addendum Numbers Received:
(Check the box next to each addendum received)

- | | |
|--|--|
| <input checked="" type="checkbox"/> Addendum No. 1 | <input type="checkbox"/> Addendum No. 6 |
| <input type="checkbox"/> Addendum No. 2 | <input type="checkbox"/> Addendum No. 7 |
| <input type="checkbox"/> Addendum No. 3 | <input type="checkbox"/> Addendum No. 8 |
| <input type="checkbox"/> Addendum No. 4 | <input type="checkbox"/> Addendum No. 9 |
| <input type="checkbox"/> Addendum No. 5 | <input type="checkbox"/> Addendum No. 10 |

I understand that failure to confirm the receipt of addenda may be cause for rejection of this bid. I further understand that any verbal representation made or assumed to be made during any oral discussion held between Vendor's representatives and any state personnel is not binding. Only the information issued in writing and added to the specifications by an official addendum is binding.

RCN Communications LLC

Company

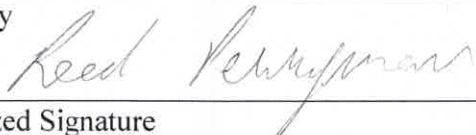

Authorized Signature

9-15-2020

Date

NOTE: This addendum acknowledgment should be submitted with the bid to expedite document processing.

**INSTRUCTIONS TO VENDORS SUBMITTING BIDS
(Agency Delegated Procurements Only)**

1. REVIEW DOCUMENTS THOROUGHLY: The attached documents contain a solicitation for bids. Please read these instructions and all documents attached in their entirety. These instructions provide critical information about requirements that if overlooked could lead to disqualification of a Vendor's bid. All bids must be submitted in accordance with the provisions contained in these instructions and the Solicitation. Failure to do so may result in disqualification of Vendor's bid.

2. MANDATORY TERMS: The Solicitation may contain mandatory provisions identified by the use of the words "must," "will," and "shall." Failure to comply with a mandatory term in the Solicitation will result in bid disqualification.

2A. PREBID MEETING: The item identified below shall apply to this Solicitation.

A pre-bid meeting will not be held prior to bid opening

A MANDATORY PRE-BID meeting will be held at the following place and time:

All Vendors submitting a bid must attend the mandatory pre-bid meeting. Failure to attend the mandatory pre-bid meeting shall result in disqualification of the Vendor's bid. No one individual is permitted to represent more than one vendor at the pre-bid meeting. Any individual that does attempt to represent two or more vendors will be required to select one vendor to which the individual's attendance will be attributed. The vendors not selected will be deemed to have not attended the pre-bid meeting unless another individual attended on their behalf. The required attribution of attendance to a single vendor should be addressed during the pre-bid but may occur at any time deemed appropriate by the Purchasing Division.

An attendance sheet provided at the pre-bid meeting shall serve as the official document verifying attendance. Any person attending the pre-bid meeting on behalf of a Vendor must list on the attendance sheet his or her name and the name of the Vendor he or she is representing.

Additionally, the person attending the pre-bid meeting should include the Vendor's E-Mail address, phone number, and Fax number on the attendance sheet. It is the Vendor's responsibility to locate the attendance sheet and provide the required information. Failure to complete the attendance sheet as required may result in disqualification of Vendor's bid.

All Vendors should arrive prior to the starting time for the pre-bid. Vendors who arrive after the starting time but prior to the end of the pre-bid will be permitted to sign in, but are charged with knowing all matters discussed at the pre-bid.

Questions submitted at least five business days prior to a scheduled pre-bid will be discussed at the pre-bid meeting if possible. Any discussions or answers to questions at the pre-bid meeting are preliminary in nature and are non-binding. Official and binding answers to questions will be published in a written addendum to the Solicitation prior to bid opening.

3. BID SUBMISSION: All bids must be submitted electronically through wvOASIS or signed and delivered by the Vendor to the Agency on or before the date and time of the bid opening. Any bid received by the Agency staff is considered to be in the possession of the Agency and will not be returned for any reason.

3A. BID SUBMISSION

A bid that is not submitted electronically through wvOASIS should contain the information listed below on the face of the envelope or the bid may be rejected by the Agency.

SEALED BID: 63210009 AT&T FirstNet Compatible Cellular Wireless Router
BUYER: Tina Lewis
SOLICITATION NO.: ARFQ DOT2100000006
BID OPENING DATE: 09/16/2020
BID OPENING TIME: 2:30PM
FAX NUMBER: N/A

4. ADDENDUM ACKNOWLEDGEMENT: Changes or revisions to this Solicitation will be made by an official addendum issued by the Agency. Vendor should acknowledge receipt of all addenda issued with this Solicitation by completing an Addendum Acknowledgment Form, a copy of which is included herewith. Failure to acknowledge addenda may result in bid disqualification. The addendum acknowledgement should be submitted with the bid to expedite document processing.

5. BID FORMATTING: Vendor should type or electronically enter the information onto its bid to prevent errors in the evaluation. Failure to type or electronically enter the information may result in bid disqualification.

6. ALTERNATE MODEL OR BRAND: Unless the box below is checked, any model, brand, or specification listed in this Solicitation establishes the acceptable level of quality only and is not intended to reflect a preference for, or in any way favor, a particular brand or vendor. Vendors may bid alternates to a listed model or brand provided that the alternate is at least equal to the model or brand and complies with the required specifications. The equality of any alternate being bid shall be determined by the State at its sole discretion. Any Vendor bidding an alternate model or brand should clearly identify the alternate items in its bid and should include manufacturer's specifications, industry literature, and/or any other relevant documentation demonstrating the equality of the alternate items. Failure to provide information for alternate items may be grounds for rejection of a Vendor's bid.

This Solicitation is based upon a standardized commodity established under West Virginia Code § 5A-3-61. Vendors are expected to bid the standardized commodity identified. Failure to bid the standardized commodity will result in your firm's bid being rejected.

7. EXCEPTIONS AND CLARIFICATIONS: The Solicitation contains the specifications that shall form the basis of a contractual agreement. Vendor shall clearly mark any exceptions, clarifications, or other proposed modifications in its bid. Exceptions to, clarifications of, or modifications of a requirement or term and condition of the Solicitation may result in bid disqualification.

8. REGISTRATION: Prior to Contract award, the apparent successful Vendor must be properly registered with the West Virginia Purchasing Division and must have paid the \$125 fee, if applicable.

9. UNIT PRICE: Unit prices shall prevail in cases of a discrepancy in the Vendor's bid.

10. PREFERENCE: Vendor Preference may be requested in purchases of motor vehicles or construction and maintenance equipment and machinery used in highway and other infrastructure projects. Any request for preference must be submitted in writing with the bid, must specifically identify the preference requested with reference to the applicable subsection of West Virginia Code § 5A-3-37, and must include with the bid any information necessary to evaluate and confirm the applicability of the requested preference. A request form to help facilitate the request can be found at: <http://www.state.wv.us/admin/purchase/vrc/Venpref.pdf>.

10A. RECIPROCAL PREFERENCE: The State of West Virginia applies a reciprocal preference to all solicitations for commodities and printing in accordance with W. Va. Code § 5A-3-37(b). In effect, if reciprocal preference is requested by a West Virginia resident vendor, non-resident vendors receiving a preference in their home states, will see that same preference granted to West Virginia resident vendors bidding against them in West Virginia. Any request for reciprocal preference must include with the bid any information necessary to evaluate and confirm the applicability of the preference. A request form to help facilitate the request can be found at: <http://www.state.wv.us/admin/purchase/vrc/Venpref.pdf>.

11. SMALL, WOMEN-OWNED, OR MINORITY-OWNED BUSINESSES: For any solicitations publicly advertised for bid, in accordance with West Virginia Code §5A-3-37(a)(7) and W. Va. CSR § 148-22-9, any non-resident vendor certified as a small, women-owned, or minority-owned business under W. Va. CSR § 148-22-9 shall be provided the same preference made available to any resident vendor. Any non-resident small, women-owned, or minority-owned business must identify itself as such in writing, must submit that writing to the Purchasing Division with its bid, and must be properly certified under W. Va. CSR § 148-22-9 prior to contract award to receive the preferences made available to resident vendors. Preference for a non-resident small, women-owned, or minority owned business shall be applied in accordance with W. Va. CSR § 148-22-9.

12. ELECTRONIC FILE ACCESS RESTRICTIONS: Vendor must ensure that its submission in *wvOASIS* can be accessed and viewed by the Agency staff immediately upon bid opening. The Agency will consider any file that cannot be immediately access and viewed at the time of the bid opening (such as, encrypted files, password protected files, or incompatible files) to be blank or incomplete as context requires, and therefore unacceptable. A vendor will not be permitted to unencrypt files, remove password protections, or resubmit documents after bid opening to make a file viewable if those documents are required with the bid. A Vendor may be required to provide document passwords or removed access restrictions

to allow the Agency to print or electronically save documents provided that those documents are viewable by the Agency prior to obtaining the password or removing the access restriction.

13. NON-RESPONSIBLE: The Purchasing Division Director reserves the right to reject the bid of any vendor as Non-Responsible in accordance with W. Va. Code of State Rules § 148-1-5.3, when the Director determines that the vendor submitting the bid does not have the capability to fully perform, or lacks the integrity and reliability to assure good-faith performance.”

14. ACCEPTANCE/REJECTION: The State may accept or reject any bid in whole, or in part in accordance with W. Va. Code of State Rules § 148-1-4.5. and § 148-1-6.4.b.”

15. YOUR SUBMISSION IS A PUBLIC DOCUMENT: Vendor’s entire response to the Solicitation and the resulting Contract are public documents. As public documents, they will be disclosed to the public following the bid/proposal opening or award of the contract, as required by the competitive bidding laws of West Virginia Code §§ 5A-3-1 et seq., 5-22-1 et seq., 5G-1-1 et seq. and the Freedom of Information Act in West Virginia Code §§ 29B-1-1 et seq.

DO NOT SUBMIT MATERIAL YOU CONSIDER TO BE CONFIDENTIAL, A TRADE SECRET, OR OTHERWISE NOT SUBJECT TO PUBLIC DISCLOSURE.

Submission of any bid, proposal, or other document to the Purchasing Division constitutes your explicit consent to the subsequent public disclosure of the bid, proposal, or document. The Purchasing Division will disclose any document labeled “confidential,” “proprietary,” “trade secret,” “private,” or labeled with any other claim against public disclosure of the documents, to include any “trade secrets” as defined by West Virginia Code § 47-22-1 et seq. All submissions are subject to public disclosure without notice.

**GENERAL TERMS AND CONDITIONS:
(Agency Delegated Procurements Only)**

1. CONTRACTUAL AGREEMENT: Issuance of a Award Document signed by the Agency and approved as to form by the Attorney General's office, if required, constitutes acceptance of this Contract made by and between the State of West Virginia and the Vendor. Vendor's signature on its bid signifies Vendor's agreement to be bound by and accept the terms and conditions contained in this Contract.

2. DEFINITIONS: As used in this Solicitation/Contract, the following terms shall have the meanings attributed to them below. Additional definitions may be found in the specifications included with this Solicitation/Contract.

2.1. "Agency" or "Agencies" means the agency, board, commission, or other entity of the State of West Virginia that is identified on the first page of the Solicitation or any other public entity seeking to procure goods or services under this Contract.

2.2. "Bid" or "Proposal" means the vendors submitted response to this solicitation.

2.3. "Contract" means the binding agreement that is entered into between the State and the Vendor to provide the goods or services requested in the Solicitation.

2.4. "Director" means the Director of the West Virginia Department of Administration, Purchasing Division.

2.5. "Purchasing Division" means the West Virginia Department of Administration, Purchasing Division.

2.6. "Award Document" means the document signed by the Agency that identifies the Vendor as the contract holder.

2.7. "Solicitation" means the official notice of an opportunity to supply the State with goods or services.

2.8. "State" means the State of West Virginia and/or any of its agencies, commissions, boards, etc. as context requires.

2.9. "Vendor" or "Vendors" means any entity submitting a bid in response to the Solicitation, the entity that has been selected as the lowest responsible bidder, or the entity that has been awarded the Contract as context requires.

3. CONTRACT TERM; RENEWAL; EXTENSION: The term of this Contract shall be determined in accordance with the category that has been identified as applicable to this Contract below:

Term Contract

Initial Contract Term: This Contract becomes effective on _____ and extends for a period of _____ year(s).

Renewal Term: This Contract may be renewed upon the mutual written consent of the Agency, and the Vendor. Any request for renewal should be delivered to the Agency thirty (30) days prior to the expiration date of the initial contract term or appropriate renewal term. A Contract renewal shall be in accordance with the terms and conditions of the original contract. Unless otherwise specified below, renewal of this Contract is limited to _____ successive one (1) year periods or multiple renewal periods of less than one year, provided that the multiple renewal periods do not exceed the total number of months available in all renewal years combined. Automatic renewal of this Contract is prohibited.

Alternate Renewal Term – This contract may be renewed for _____ successive _____ year periods or shorter periods provided that they do not exceed the total number of months contained in all available renewals. Automatic renewal of this Contract is prohibited. Renewals must be approved by the Vendor and Agency.

Delivery Order Limitations: In the event that this contract permits delivery orders, a delivery order may only be issued during the time this Contract is in effect. Any delivery order issued within one year of the expiration of this Contract shall be effective for one year from the date the delivery order is issued. No delivery order may be extended beyond one year after this Contract has expired.

Fixed Period Contract: This Contract becomes effective upon Vendor's receipt of the notice to proceed and must be completed within _____ days.

Fixed Period Contract with Renewals: This Contract becomes effective upon Vendor's receipt of the notice to proceed and part of the Contract more fully described in the attached specifications must be completed within _____ days. Upon completion of the work covered by the preceding sentence, the vendor agrees that maintenance, monitoring, or warranty services will be provided for _____ year(s) thereafter.

One Time Purchase: The term of this Contract shall run from the issuance of the Award Document until all of the goods contracted for have been delivered, but in no event will this Contract extend for more than one fiscal year.

Other: See attached.

4. NOTICE TO PROCEED: Vendor shall begin performance of this Contract immediately upon receiving notice to proceed unless otherwise instructed by the Agency. Unless otherwise specified, the fully executed Award Document will be considered notice to proceed.

5. QUANTITIES: The quantities required under this Contract shall be determined in accordance with the category that has been identified as applicable to this Contract below.

Open End Contract: Quantities listed in this Solicitation are approximations only, based on estimates supplied by the Agency. It is understood and agreed that the Contract shall cover the quantities actually ordered for delivery during the term of the Contract, whether more or less than the quantities shown.

Service: The scope of the service to be provided will be more clearly defined in the specifications included herewith.

Combined Service and Goods: The scope of the service and deliverable goods to be provided will be more clearly defined in the specifications included herewith.

One Time Purchase: This Contract is for the purchase of a set quantity of goods that are identified in the specifications included herewith. Once those items have been delivered, no additional goods may be procured under this Contract without an appropriate change order approved by the Vendor, Agency, Purchasing Division, and Attorney General's office.

6. EMERGENCY PURCHASES: The Purchasing Division Director may authorize the Agency to purchase goods or services in the open market that Vendor would otherwise provide under this Contract if those goods or services are for immediate or expedited delivery in an emergency. Emergencies shall include, but are not limited to, delays in transportation or an unanticipated increase in the volume of work. An emergency purchase in the open market, approved by the Purchasing Division Director, shall not constitute a breach of this Contract and shall not entitle the Vendor to any form of compensation or damages. This provision does not excuse the State from fulfilling its obligations under a One Time Purchase contract.

7. REQUIRED DOCUMENTS: All of the items checked below must be provided to the Agency by the Vendor as specified below.

PERFORMANCE BOND: The apparent successful Vendor shall provide a performance bond in the amount of 100% of the contract value. The performance bond must be received by the Agency prior to Contract award.

LABOR/MATERIAL PAYMENT BOND: The apparent successful Vendor shall provide a labor/material payment bond in the amount of 100% of the Contract value. The labor/material payment bond must be received by the Agency prior to Contract award.

MAINTENANCE BOND: The apparent successful Vendor shall provide a two (2) year maintenance bond covering the roofing system. The maintenance bond must be issued and delivered to the Agency prior to Contract award.

LICENSE(S) / CERTIFICATIONS / PERMITS: In addition to anything required under the Section of the General Terms and Conditions entitled Licensing, the apparent successful Vendor shall furnish proof of the following licenses, certifications, and/or permits upon request and in a form acceptable to the State. The request may be prior to or after contract award at the State's sole discretion.

The apparent successful Vendor shall also furnish proof of any additional licenses or certifications contained in the specifications regardless of whether or not that requirement is listed above.

8. INSURANCE: The apparent successful Vendor shall furnish proof of the insurance identified by a checkmark below and must include the State as an additional insured on each policy prior to Contract award. The insurance coverages identified below must be maintained throughout the life of this contract. Thirty (30) days prior to the expiration of the insurance policies Vendor shall provide the Agency with proof that the insurance mandated herein has been continued. Vendor must also provide Agency with immediate notice of any changes in its insurance policies, including but not limited to, policy cancelation, policy reduction, or change in insurers. The apparent successful Vendor shall also furnish proof of any additional insurance requirements contained in the specifications prior to Contract award regardless of whether or not that insurance requirement is listed in this section.

Vendor must maintain:

Commercial General Liability Insurance in at least an amount of:
1,000,000.00 _____ per occurrence.

Automobile Liability Insurance in at least an amount of: _____ per occurrence.

Professional/Malpractice/Errors and Omission Insurance in at least an amount of: _____ per occurrence. Notwithstanding the forgoing, Vendor's are not required to list the State as an additional insured for this type of policy.

Commercial Crime and Third Party Fidelity Insurance in an amount of: _____ per occurrence.

Cyber Liability Insurance in an amount of: _____ per occurrence.

Builders Risk Insurance in an amount equal to 100% of the amount of the Contract.

Pollution Insurance in an amount of: _____ per occurrence.

Aircraft Liability in an amount of: _____ per occurrence.

****STATE OF WV MUST BE LISTED AS ADDITIONAL INSURED ON INSURANCE CERTIFICATE**

****INSURANCE CERTIFICATE HOLDER SHOULD READ AS FOLLOWS:**
STATE OF WV
1900 KANAWHA BLVD E, BLDG 5, CHARLESTON, WV 25305

9. WORKERS' COMPENSATION INSURANCE: The apparent successful Vendor shall comply with laws relating to workers compensation, shall maintain workers' compensation insurance when required, and shall furnish proof of workers' compensation insurance upon request.

10. LIQUIDATED DAMAGES: This clause shall in no way be considered exclusive and shall not limit the State or Agency's right to pursue any other available remedy. Vendor shall pay liquidated damages in the amount specified below or as described in the specifications:

_____ for _____

Liquidated Damages Contained in the Specifications

11. ACCEPTANCE: Vendor's signature on its bid, or on the certification and signature page, constitutes an offer to the State that cannot be unilaterally withdrawn, signifies that the product or service proposed by vendor meets the mandatory requirements contained in the Solicitation for that product or service, unless otherwise indicated, and signifies acceptance of the terms and conditions contained in the Solicitation unless otherwise indicated.

12. PRICING: The pricing set forth herein is firm for the life of the Contract, unless specified elsewhere within this Solicitation/Contract by the State. A Vendor's inclusion of price adjustment provisions in its bid, without an express authorization from the State in the Solicitation to do so, may result in bid disqualification. Notwithstanding the foregoing, Vendor must extend any publicly advertised sale price to the State and invoice at the lower of the contract price or the publicly advertised sale price.

13. PAYMENT IN ARREARS: Payment in advance is prohibited under this Contract. Payment may only be made after the delivery and acceptance of goods or services. The Vendor shall submit invoices, in arrears.

14. PAYMENT METHODS: Vendor must accept payment by electronic funds transfer or P-Card. (The State of West Virginia's Purchasing Card program, administered under contract by a banking institution, processes payment for goods and services through state designated credit cards.)

15. ADDITIONAL FEES: Vendor is not permitted to charge additional fees or assess additional charges that were not either expressly provided for in the solicitation published by the State of West Virginia or included in the unit price or lump sum bid amount that Vendor is required by the solicitation to provide. Including such fees or charges as notes to the solicitation may result in rejection of vendor's bid. Requesting such fees or charges be paid after the contract has been awarded may result in cancellation of the contract.

16. TAXES: The Vendor shall pay any applicable sales, use, personal property or any other taxes arising out of this Contract and the transactions contemplated thereby. The State of West Virginia is exempt from federal and state taxes and will not pay or reimburse such taxes.

17. FUNDING: This Contract shall continue for the term stated herein, contingent upon funds being appropriated by the Legislature or otherwise being made available. In the event funds are not appropriated or otherwise made available, this Contract becomes void and of no effect beginning on July 1 of the fiscal year for which funding has not been appropriated or otherwise made available.

18. CANCELLATION: The State reserves the right to cancel this Contract immediately upon written notice to the vendor if the materials or workmanship supplied do not conform to the specifications contained in the Contract. The Agency may also cancel any purchase or Contract upon 30 days written notice to the Vendor in accordance with West Virginia Code of State Rules § 148-1-5.2.b.

19. TIME: Time is of the essence with regard to all matters of time and performance in this Contract.

20. APPLICABLE LAW: This Contract is governed by and interpreted under West Virginia law without giving effect to its choice of law principles. Any information provided in specification manuals, or any other source, verbal or written, which contradicts or violates the West Virginia Constitution, West Virginia Code or West Virginia Code of State Rules is void and of no effect.

21. COMPLIANCE WITH LAWS: Vendor shall comply with all applicable federal, state, and local laws, regulations and ordinances. By submitting a bid, Vendor acknowledges that it has reviewed, understands, and will comply with all applicable laws, regulations, and ordinances. Vendor shall notify all subcontractors providing commodities or services related to this Contract that as subcontractors, they too are required to comply with all applicable laws, regulations, and ordinances.

22. ARBITRATION: Any references made to arbitration contained in this Contract, Vendor's bid, or in any American Institute of Architects documents pertaining to this Contract are hereby deleted, void, and of no effect.

23. MODIFICATIONS: This writing is the parties' final expression of intent. Notwithstanding anything contained in this Contract to the contrary, no modification of this Contract shall be binding without mutual written consent of the Agency, and the Vendor.

24. WAIVER: The failure of either party to insist upon a strict performance of any of the terms or provision of this Contract, or to exercise any option, right, or remedy herein contained, shall not be construed as a waiver or a relinquishment for the future of such term, provision, option, right, or remedy, but the same shall continue in full force and effect. Any waiver must be expressly stated in writing and signed by the waiving party.

25. SUBSEQUENT FORMS: The terms and conditions contained in this Contract shall supersede any and all subsequent terms and conditions which may appear on any form documents submitted by Vendor to the Agency or Purchasing Division such as price lists, order forms, invoices, sales agreements, or maintenance agreements, and includes internet websites or other electronic documents. Acceptance or use of Vendor's forms does not constitute acceptance of the terms and conditions contained thereon.

26. ASSIGNMENT: Neither this Contract nor any monies due, or to become due hereunder, may be assigned by the Vendor without the express written consent of the Agency and any other government agency or office that may be required to approve such assignments.

27. WARRANTY: The Vendor expressly warrants that the goods and/or services covered by this Contract will: (a) conform to the specifications, drawings, samples, or other description furnished or specified by the Agency; (b) be merchantable and fit for the purpose intended; and (c) be free from defect in material and workmanship.

28. STATE EMPLOYEES: State employees are not permitted to utilize this Contract for personal use and the Vendor is prohibited from permitting or facilitating the same.

29. PRIVACY, SECURITY, AND CONFIDENTIALITY: The Vendor agrees that it will not disclose to anyone, directly or indirectly, any such personally identifiable information or other confidential information gained from the Agency, unless the individual who is the subject of the information consents to the disclosure in writing or the disclosure is made pursuant to the Agency's policies, procedures, and rules. Vendor further agrees to comply with the Confidentiality Policies and Information Security Accountability Requirements, set forth in <http://www.state.wv.us/admin/purchase/privacy/default.html>

30. YOUR SUBMISSION IS A PUBLIC DOCUMENT: Vendor's entire response to the Solicitation and the resulting Contract are public documents. As public documents, they will be disclosed to the public following the bid/proposal opening or award of the contract, as required by the competitive bidding laws of West Virginia Code §§ 5A-3-1 et seq., 5-22-1 et seq., and 5G-1-1 et seq. and the Freedom of Information Act West Virginia Code §§ 29B-1-1 et seq.

DO NOT SUBMIT MATERIAL YOU CONSIDER TO BE CONFIDENTIAL, A TRADE SECRET, OR OTHERWISE NOT SUBJECT TO PUBLIC DISCLOSURE.

Submission of any bid, proposal, or other document to the Purchasing Division constitutes your explicit consent to the subsequent public disclosure of the bid, proposal, or document. The Purchasing Division will disclose any document labeled "confidential," "proprietary," "trade secret," "private," or labeled with any other claim against public disclosure of the documents, to include any "trade secrets" as defined by West Virginia Code § 47-22-1 et seq. All submissions are subject to public disclosure without notice.

31. LICENSING: In accordance with West Virginia Code of State Rules § 148-1-6.1.e, Vendor must be licensed and in good standing in accordance with any and all state and local laws and requirements by any state or local agency of West Virginia, including, but not limited to, the West Virginia Secretary of State's Office, the West Virginia Tax Department, West Virginia Insurance Commission, or any other state agency or political subdivision. Obligations related to political subdivisions may include, but are not limited to, business licensing, business and occupation taxes, inspection compliance, permitting, etc. Upon request, the Vendor must provide all necessary releases to obtain information to enable the Purchasing Division Director or the Agency to verify that the Vendor is licensed and in good standing with the above entities. Vendor shall notify all subcontractors providing commodities or services related to this Contract that as subcontractors, they too are required to be licensed, in good standing, and up-to-date on all state and local obligations as described in this section.

32. ANTITRUST: In submitting a bid to, signing a contract with, or accepting an Award Document from any agency of the State of West Virginia, the Vendor agrees to convey, sell, assign, or transfer to the State of West Virginia all rights, title, and interest in and to all causes of action it may now or hereafter acquire under the antitrust laws of the United States and the State of West Virginia for price fixing and/or unreasonable restraints of trade relating to the particular commodities or services purchased or acquired by the State of West Virginia. Such assignment shall be made and become effective at the time the purchasing agency tenders the initial payment to Vendor.

33. VENDOR CERTIFICATIONS: By signing its bid or entering into this Contract, Vendor certifies (1) that its bid or offer was made without prior understanding, agreement, or connection with any corporation, firm, limited liability company, partnership, person or entity submitting a bid or offer for the same material, supplies, equipment or services; (2) that its bid or offer is in all respects fair and without collusion or fraud; (3) that this Contract is accepted or entered into without any prior understanding, agreement, or connection to any other entity that could be considered a violation of law; and (4) that it has reviewed this Solicitation in its entirety; understands the requirements, terms and conditions, and other information contained herein. Vendor's signature on its bid or offer also affirms that neither it nor its representatives have any interest, nor shall acquire any interest, direct or indirect, which would compromise the performance of its services hereunder. Any such interests shall be promptly presented in detail to the Agency. The individual signing this bid or offer on behalf of Vendor certifies that he or she is authorized by the Vendor to execute this bid or offer or any documents related thereto on

Vendor's behalf; that he or she is authorized to bind the Vendor in a contractual relationship; and that, to the best of his or her knowledge, the Vendor has properly registered with any State agency that may require registration.

34. VENDOR RELATIONSHIP: The relationship of the Vendor to the State shall be that of an independent contractor and no principal-agent relationship or employer-employee relationship is contemplated or created by this Contract. The Vendor as an independent contractor is solely liable for the acts and omissions of its employees and agents. Vendor shall be responsible for selecting, supervising, and compensating any and all individuals employed pursuant to the terms of this Solicitation and resulting contract. Neither the Vendor, nor any employees or subcontractors of the Vendor, shall be deemed to be employees of the State for any purpose whatsoever. Vendor shall be exclusively responsible for payment of employees and contractors for all wages and salaries, taxes, withholding payments, penalties, fees, fringe benefits, professional liability insurance premiums, contributions to insurance and pension, or other deferred compensation plans, including but not limited to, Workers' Compensation and Social Security obligations, licensing fees, etc. and the filing of all necessary documents, forms, and returns pertinent to all of the foregoing. Vendor shall hold harmless the State, and shall provide the State and Agency with a defense against any and all claims including, but not limited to, the foregoing payments, withholdings, contributions, taxes, Social Security taxes, and employer income tax returns.

35. INDEMNIFICATION: The Vendor agrees to indemnify, defend, and hold harmless the State and the Agency, their officers, and employees from and against: (1) Any claims or losses for services rendered by any subcontractor, person, or firm performing or supplying services, materials, or supplies in connection with the performance of the Contract; (2) Any claims or losses resulting to any person or entity injured or damaged by the Vendor, its officers, employees, or subcontractors by the publication, translation, reproduction, delivery, performance, use, or disposition of any data used under the Contract in a manner not authorized by the Contract, or by Federal or State statutes or regulations; and (3) Any failure of the Vendor, its officers, employees, or subcontractors to observe State and Federal laws including, but not limited to, labor and wage and hour laws.

36. PURCHASING AFFIDAVIT: In accordance with West Virginia Code §§ 5A-3-10a and 5-22-1(i), the State is prohibited from awarding a contract to any bidder that owes a debt to the State or a political subdivision of the State, Vendors are required to sign, notarize, and submit the Purchasing Affidavit to the Purchasing Division affirming under oath that it is not in default on any monetary obligation owed to the state or a political subdivision of the state.

37. CONFLICT OF INTEREST: Vendor, its officers or members or employees, shall not presently have or acquire an interest, direct or indirect, which would conflict with or compromise the performance of its obligations hereunder. Vendor shall periodically inquire of its officers, members and employees to ensure that a conflict of interest does not arise. Any conflict of interest discovered shall be promptly presented in detail to the Agency.

38. REPORTS: Vendor shall provide the Agency and/or the Purchasing Division with the following reports identified by a checked box below:

Such reports as the Agency and/or the Purchasing Division may request. Requested reports may include, but are not limited to, quantities purchased, agencies utilizing the contract, total contract expenditures by agency, etc.

Quarterly reports detailing the total quantity of purchases in units and dollars, along with a listing of purchases by agency. Quarterly reports should be delivered to the Purchasing Division via email at purchasing.requisitions@wv.gov.

39. BACKGROUND CHECK: In accordance with W. Va. Code § 15-2D-3, the Director of the Division of Protective Services shall require any service provider whose employees are regularly employed on the grounds or in the buildings of the Capitol complex or who have access to sensitive or critical information to submit to a fingerprint-based state and federal background inquiry through the state repository. The service provider is responsible for any costs associated with the fingerprint-based state and federal background inquiry. After the contract for such services has been approved, but before any such employees are permitted to be on the grounds or in the buildings of the Capitol complex or have access to sensitive or critical information, the service provider shall submit a list of all persons who will be physically present and working at the Capitol complex to the Director of the Division of Protective Services for purposes of verifying compliance with this provision. The State reserves the right to prohibit a service provider's employees from accessing sensitive or critical information or to be present at the Capitol complex based upon results addressed from a criminal background check.

Service providers should contact the West Virginia Division of Protective Services by phone at (304) 558-9911 for more information.

40. PREFERENCE FOR USE OF DOMESTIC STEEL PRODUCTS: Except when authorized by the Director of the Purchasing Division pursuant to W. Va. Code § 5A-3-56, no contractor may use or supply steel products for a State Contract Project other than those steel products made in the United States. A contractor who uses steel products in violation of this section may be subject to civil penalties pursuant to W. Va. Code § 5A-3-56. As used in this section:

a. "State Contract Project" means any erection or construction of, or any addition to, alteration of or other improvement to any building or structure, including, but not limited to, roads or highways, or the installation of any heating or cooling or ventilating plants or other equipment, or the supply of and materials for such projects, pursuant to a contract with the State of West Virginia for which bids were solicited on or after June 6, 2001.

b. "Steel Products" means products rolled, formed, shaped, drawn, extruded, forged, cast, fabricated or otherwise similarly processed, or processed by a combination of two or more or such operations, from steel made by the open heath, basic oxygen, electric furnace, Bessemer or other steel making process. The Purchasing Division Director may, in writing, authorize the use of foreign steel products if:

c. The cost for each contract item used does not exceed one tenth of one percent (.1%) of the total contract cost or two thousand five hundred dollars (\$2,500.00), whichever is greater. For the purposes of this section, the cost is the value of the steel product as delivered to the project; or

d. The Director of the Purchasing Division determines that specified steel materials are not produced in the United States in sufficient quantity or otherwise are not reasonably available to meet contract requirements.

41. PREFERENCE FOR USE OF DOMESTIC ALUMINUM, GLASS, AND STEEL: In Accordance with W. Va. Code § 5-19-1 et seq., and W. Va. CSR § 148-10-1 et seq., for every contract or subcontract, subject to the limitations contained herein, for the construction, reconstruction, alteration, repair, improvement or maintenance of public works or for the purchase of any item of machinery or equipment to be used at sites of public works, only domestic aluminum, glass or steel products shall be supplied unless the spending officer determines, in writing, after the receipt of offers or bids, (1) that the cost of domestic aluminum, glass or steel products is unreasonable or inconsistent with the public interest of the State of West Virginia, (2) that domestic aluminum, glass or steel products are not produced in sufficient quantities to meet the contract requirements, or (3) the available domestic aluminum, glass, or steel do not meet the contract specifications. This provision only applies to public works contracts awarded in an amount more than fifty thousand dollars (\$50,000) or public works contracts that require more than ten thousand pounds of steel products.

The cost of domestic aluminum, glass, or steel products may be unreasonable if the cost is more than twenty percent (20%) of the bid or offered price for foreign made aluminum, glass, or steel products. If the domestic aluminum, glass or steel products to be supplied or produced in a "substantial labor surplus area", as defined by the United States Department of Labor, the cost of

Revised 01/09/2020

domestic aluminum, glass, or steel products may be unreasonable if the cost is more than thirty percent (30%) of the bid or offered price for foreign made aluminum, glass, or steel products. This preference shall be applied to an item of machinery or equipment, as indicated above, when the item is a single unit of equipment or machinery manufactured primarily of aluminum, glass or steel, is part of a public works contract and has the sole purpose or of being a permanent part of a single public works project. This provision does not apply to equipment or machinery purchased by a spending unit for use by that spending unit and not as part of a single public works project.

All bids and offers including domestic aluminum, glass or steel products that exceed bid or offer prices including foreign aluminum, glass or steel products after application of the preferences provided in this provision may be reduced to a price equal to or lower than the lowest bid or offer price for foreign aluminum, glass or steel products plus the applicable preference. If the reduced bid or offer prices are made in writing and supersede the prior bid or offer prices, all bids or offers, including the reduced bid or offer prices, will be reevaluated in accordance with this rule.

42. PROHIBITION AGAINST USED OR REFURBISHED: Unless expressly permitted in the solicitation published by the State, Vendor must provide new, unused commodities, and is prohibited from supplying used or refurbished commodities, in fulfilling its responsibilities under this Contract.

ADDITIONAL TERMS AND CONDITIONS (Construction Contracts Only)

1. CONTRACTOR'S LICENSE: West Virginia Code § 21-11-2 requires that all persons desiring to perform contracting work in this state be licensed. The West Virginia Contractors Licensing Board is empowered to issue the contractor's license. Applications for a contractor's license may be made by contacting the West Virginia Division of Labor. West Virginia Code § 21-11-11 requires any prospective Vendor to include the contractor's license number on its bid. If an apparent low bidder fails to submit a license number in accordance with this section, the Purchasing Division will promptly request by telephone and electronic mail that the low bidder and the second low bidder provide the license number within one business day of the request. Failure of the bidder to provide the license number within one business day of receiving the request shall result in disqualification of the bid. Vendors should include a contractor's license number in the space provided below.

Contractor's Name: _____

Contractor's License No.: WV- _____

The apparent successful Vendor must furnish a copy of its contractor's license prior to the issuance of a contract award document

2. AIA DOCUMENTS: All construction contracts that will be completed in conjunction with architectural services procured under Chapter 5G of the West Virginia Code will be governed by the attached AIA documents, as amended by the Supplementary Conditions for the State of West Virginia, in addition to the terms and conditions contained herein.

2A. PROHIBITION AGAINST GENERAL CONDITIONS: Notwithstanding anything contained in the AIA Documents or the Supplementary Conditions, the State of West Virginia will not pay for general conditions, or winter conditions, or any other condition representing a delay in the contract. The Vendor is expected to mitigate delay costs to the greatest extent possible and any costs associated with Delays must be specifically and concretely identified. The state will not consider an average daily rate multiplied by the number of days extended to be an acceptable charge.

3. GREEN BUILDINGS MINIMUM ENERGY STANDARDS: In accordance with § 22-29-4, all new building construction projects of public agencies that have not entered the schematic design phase prior to July 1, 2012, or any building construction project receiving state grant funds and appropriations, including public schools, that have not entered the schematic design phase prior to July 1, 2012, shall be designed and constructed complying with the ICC International Energy Conservation Code, adopted by the State Fire Commission, and the ANSI/ASHRAE/IESNA Standard 90.1-2007: Provided, That if any construction project has a commitment of federal funds to pay for a portion of such project, this provision shall only apply to the extent such standards are consistent with the federal standards.

**ADDITIONAL TERMS AND CONDITIONS
(Architectural and Engineering Contracts Only)**

1. PLAN AND DRAWING DISTRIBUTION: All plans and drawings must be completed and available for distribution at least five business days prior to a scheduled pre-bid meeting for the construction or other work related to the plans and drawings.

2. PROJECT ADDENDA REQUIREMENTS: The Architect/Engineer and/or Agency shall be required to abide by the following schedule in issuing construction project addenda. The Architect/Engineer shall prepare any addendum materials for which it is responsible, and a list of all vendors that have obtained drawings and specifications for the project. The Architect/Engineer shall then send a copy of the addendum materials and the list of vendors to the State Agency for which the contract is issued to allow the Agency to make any necessary modifications. The addendum and list shall then be forwarded to the Purchasing Division buyer by the Agency. The Purchasing Division buyer shall send the addendum to all interested vendors and, if necessary, extend the bid opening date. Any addendum should be received by the Purchasing Division at least fourteen (14) days prior to the bid opening date.

3. PRE-BID MEETING RESPONSIBILITIES: The Architect/Engineer shall be available to attend any pre-bid meeting for the construction or other work resulting from the plans, drawings, or specifications prepared by the Architect/Engineer.

4. AIA DOCUMENTS: All construction contracts that will be completed in conjunction with architectural services procured under Chapter 5G of the West Virginia Code will be governed by the attached AIA documents, as amended by the Supplementary Conditions for the State of West Virginia, in addition to the terms and conditions contained herein. The terms and conditions of this document shall prevail over anything contained in the AIA Documents or the Supplementary Conditions.

5. GREEN BUILDINGS MINIMUM ENERGY STANDARDS: In accordance with West Virginia Code § 22-29-4, all new building construction projects of public agencies that have not entered the schematic design phase prior to July 1, 2012, or any building construction project receiving state grant funds and appropriations, including public schools, that have not entered the schematic design phase prior to July 1, 2012, shall be designed and constructed complying with the ICC International Energy Conservation Code, adopted by the State Fire Commission, and the ANSI/ASHRAE/IESNA Standard 90.1-2007: Provided, That if any construction project has a commitment of federal funds to pay for a portion of such project, this provision shall only apply to the extent such standards are consistent with the federal standards.

DESIGNATED CONTACT: Vendor appoints the individual identified in this Section as the Contract Administrator and the initial point of contact for matters relating to this Contract.

Emily Schmidt, Bid Desk Specialist

(Name, Title)

Emily Schmidt, Bid Desk Specialist

(Printed Name and Title)

200 Jennings Avenue, Knoxville, TN 39717

(Address)

865-293-0350

(Phone Number) / (Fax Number)

emily.schmidt@rcntechnologies.com

(E-mail address)

CERTIFICATION AND SIGNATURE: By signing below, or submitting documentation through wvOASIS, I certify that I have reviewed this Solicitation in its entirety; that I understand the requirements, terms and conditions, and other information contained herein; that this bid, offer or proposal constitutes an offer to the State that cannot be unilaterally withdrawn; that the product or service proposed meets the mandatory requirements contained in the Solicitation for that product or service, unless otherwise stated herein; that the Vendor accepts the terms and conditions contained in the Solicitation, unless otherwise stated herein; that I am submitting this bid, offer or proposal for review and consideration; that I am authorized by the vendor to execute and submit this bid, offer, or proposal, or any documents related thereto on vendor's behalf; that I am authorized to bind the vendor in a contractual relationship; and that to the best of my knowledge, the vendor has properly registered with any State agency that may require registration.

RCN Communications LLC DBA RCN Technologies
(Company)

Reed Perryman, Director Public Sector Sales
(Authorized Signature) (Representative Name, Title)

Reed Perryman, Director Public Sector Sales
(Printed Name and Title of Authorized Representative)

9-15-2020
(Date)

865-344-8413
(Phone Number) (Fax Number)

ADDENDUM ACKNOWLEDGEMENT FORM

SOLICITATION NO.: ARFQ 0803 DOT2100000006

Instructions: Please acknowledge receipt of all addenda issued with this solicitation by completing this addendum acknowledgment form. Check the box next to each addendum received and sign below. Failure to acknowledge addenda may result in bid disqualification. Acknowledgment: I hereby acknowledge receipt of the following addenda and have made the necessary revisions to my proposal, plans and/or specification, etc.

Addendum Numbers Received:
(Check the box next to each addendum received)

- | | |
|--|--|
| <input checked="" type="checkbox"/> Addendum No. 1 | <input type="checkbox"/> Addendum No. 6 |
| <input type="checkbox"/> Addendum No. 2 | <input type="checkbox"/> Addendum No. 7 |
| <input type="checkbox"/> Addendum No. 3 | <input type="checkbox"/> Addendum No. 8 |
| <input type="checkbox"/> Addendum No. 4 | <input type="checkbox"/> Addendum No. 9 |
| <input type="checkbox"/> Addendum No. 5 | <input type="checkbox"/> Addendum No. 10 |

I understand that failure to confirm the receipt of addenda may be cause for rejection of this bid. I further understand that any verbal representation made or assumed to be made during any oral discussion held between Vendor's representatives and any state personnel is not binding. Only the information issued in writing and added to the specifications by an official addendum is binding.

RCN Communications LLC

Company

Reed Pennington

Authorized Signature

9-15-2020

Date

NOTE: This addendum acknowledgment should be submitted with the bid to expedite document processing.

REQUEST FOR QUOTATION
AT&T FirstNet Compatible Cellular Wireless Routers for Traffic Signal Systems

SPECIFICATIONS

1. **PURPOSE AND SCOPE:** The West Virginia Purchasing Division is soliciting bids on behalf of WVDOH to establish a contract for the one time purchase of (36) Thirty-six AT&T FirstNet Compatible Cellular Wireless Routers for Traffic Signal Systems.
2. **DEFINITIONS:** The terms listed below shall have the meanings assigned to them below. Additional definitions can be found in section 2 of the General Terms and Conditions.
 - 2.1 **“Contract Item”** means item identified in Section 3.1 below and on the Pricing Page as more fully described by these specifications.
 - 2.2 **“Pricing Page”** means the pages, contained in wvOASIS or attached as Exhibit A, upon which Vendor should list its proposed price for the Contract Items.
 - 2.3 **“Solicitation”** means the official notice of an opportunity to supply the State with goods or services that is published by the Purchasing Division.
 - 2.4 **“WVDOH”** means West Virginia Division of Highways.
 - 2.5 **“Mbps”** means Megabits per second.
 - 2.6 **“AT&T”** means American Telephone and Telegraph.
 - 2.7 **“4G”** means fourth generation of cellular communications.
 - 2.8 **“LTE”** means Long Term Evolution
 - 2.9 **“FCC”** means Federal Communications Commission.
 - 2.10 **“Band 14”** means the frequency band provisioned by the 2012 Spectrum Act for first responders.
 - 2.11 **“AC”** means Alternating Current.
 - 2.12 **“SIM”** means Subscriber Identification Module.
 - 2.13 **“IP”** means Internet Protocol.
 - 2.14 **“GPS”** means Global Positioning System.

REQUEST FOR QUOTATION
AT&T FirstNet Compatible Cellular Wireless Routers for Traffic Signal Systems

3. GENERAL REQUIREMENTS:

3.1 Mandatory Contract Item Requirements: Contract Item must meet or exceed the mandatory requirements listed below.

3.1.1 Contract Item #1 – (12) Twelve AT&T FirstNet Compatible Cellular Wireless Router for Traffic Signal Systems

3.1.1.1 Contract Item #1 shall consist of a modular 4G LTE AT&T FirstNet compatible cellular wireless router.

3.1.1.2 Contract Item #1 shall meet the following specifications and requirements:

The modular 4G LTE AT&T FirstNet compatible cellular wireless router shall have a maximum download speed of 600 Mbps and a maximum upload speed of 150 Mbps. The router shall be certified with the FCC and shall support Band 14. The router shall be compatible with AT&T's North American FirstNet Network and SIM cards. The router shall be remote manageable, capable of port filtering to limit only certain ports from accessing the router while still being remote manageable, capable of setting trusted IP ranges to lock out all other IP addresses outside of a selected range, and capable of port forwarding. The router shall be a Cradlepoint Model #IBR900-1200M-B, or a Sierra Wireless Model #RV55, or a Digi International Model #WR54-A146, or equal. The router shall include a 5-year warranty. The router shall comply with the operating temperature range, shock and vibration specifications for NEMA TS2 requirements. The router must be compatible with the associated other components required (the power supply assembly and antenna, see the following Contract Items #2 and #3). It is the vendor's responsibility to address and ensure issues with compatibility.

Note: Detailed technical documentation shall be submitted with the bid response. Failure to provide documentation may result in disqualification. Adequate, acceptable documentation shall be provided in order that the item submitted may be evaluated and

REQUEST FOR QUOTATION
AT&T FirstNet Compatible Cellular Wireless Routers for Traffic Signal Systems

confirmation be made that the product submitted meets the requirements of the project specifications.

3.1.2 Contract Item #2 – (12) Twelve Associated Power Supply for AT&T FirstNet Compatible Cellular Wireless Router for Traffic Signal Systems

3.1.2.1 Contract Item #2 shall consist of the manufacturer's associated power supply for the modular 4G LTE AT&T FirstNet compatible cellular wireless router specified in preceding Section 3.1.1 for Contract Item #1.

3.1.2.2 Contract Item #2 shall meet the following specifications and requirements:

The manufacturer's associated power supply for the router (see Contract Item #1) will adapt/convert/transform 120-volt, single-phase AC line power to the appropriate power for the router and include the required AC line cord and plug for connection with a standard convenience outlet. The power supply and line cord/plug assembly shall comply with the operating temperature range, shock and vibration specifications for NEMA TS2 requirements. The power supply assembly must be compatible with the associated router. It is the vendor's responsibility to address and ensure issues with compatibility.

Note: Detailed technical documentation shall be submitted with the bid response. Failure to provide documentation may result in disqualification. Adequate, acceptable documentation shall be provided in order that the item submitted may be evaluated and confirmation be made that the product submitted meets the requirements of the project specifications.

3.1.3 Contract Item #3 – (12) Twelve Antenna for AT&T FirstNet Compatible Cellular Wireless Router for Traffic Signal Systems

3.1.3.1 Contract Item #3 shall consist of an antenna for the modular 4G LTE AT&T FirstNet compatible cellular wireless router specified in preceding Section 3.1.1 for Contract Item #1.

REQUEST FOR QUOTATION
AT&T FirstNet Compatible Cellular Wireless Routers for Traffic Signal Systems

3.1.3.2 Contract Item #3 shall meet the following specifications and requirements:

The antenna shall be a 5-in-1, low-profile, impact-resistant, vandal-resistant design product with integrated connecting cables that are a minimum of 1-meter long. The antenna will have two (2) cellular wireless connections, two (2) wi-fi connections, and one (1) GPS connection according to the router manufacturer's recommendations. The approved antennae manufacturers are Panorama Antennas, Sierra Wireless, MobileMark or equal. The antenna shall comply with the operating temperature range, shock and vibration specifications for NEMA TS2 requirements. The antenna must be compatible with the associated router (see Contract Item #1). It is the vendor's responsibility to address and ensure issues with compatibility.

Note: Detailed technical documentation shall be submitted with the bid response. Failure to provide documentation may result in disqualification. Adequate, acceptable documentation shall be provided in order that the item submitted may be evaluated and confirmation be made that the product submitted meets the requirements of the project specifications.

4. CONTRACT AWARD:

4.1 Contract Award: The Contract is intended to provide Agencies with a purchase price for the Contract Items. The Contract shall be awarded to the Vendor that provides the Contract Items meeting the required specifications for the lowest overall total cost as shown on the Pricing Pages.

4.2 Pricing Page: Vendor should complete the Pricing Page by providing a cost in the box listed as unit price and the calculated extended cost and grand total. Vendor should complete the Pricing Page in full as failure to complete the Pricing Page in its entirety may result in Vendor's bid being disqualified.

Vendor should type or electronically enter the information into the Pricing Page to prevent errors in the evaluation.

REQUEST FOR QUOTATION
AT&T FirstNet Compatible Cellular Wireless Routers for Traffic Signal Systems

5. PAYMENT:

5.1 Payment: Vendor shall accept payment in accordance with the payment procedures of the State of West Virginia.

6. DELIVERY AND RETURN:

6.1 Shipment and Delivery: Vendor shall ship the Contract Items immediately after being awarded this Contract and receiving a purchase order or notice to proceed. Vendor shall deliver the Contract Items within 30 working days after receiving a purchase order or notice to proceed. Contract Items must be delivered to Agency at WVDOH – Traffic Services Complex
180 Dry Branch Drive
Charleston, West Virginia 25306

6.2 Late Delivery: The Agency placing the order under this Contract must be notified in writing if the shipment of the Contract Items will be delayed for any reason. Any delay in delivery that could cause harm to an Agency will be grounds for cancellation of the Contract, and/or obtaining the Contract Items from a third party.

Any Agency seeking to obtain the Contract Items from a third party under this provision must first obtain approval of the Purchasing Division.

6.3 Delivery Payment/Risk of Loss: Vendor shall deliver the Contract Items F.O.B. destination to the Agency's location.

6.4 Return of Unacceptable Items: If the Agency deems the Contract Items to be unacceptable, the Contract Items shall be returned to Vendor at Vendor's expense and with no restocking charge. Vendor shall either make arrangements for the return within five (5) days of being notified that items are unacceptable, or permit the Agency to arrange for the return and reimburse Agency for delivery expenses. If the original packaging cannot be utilized for the return, Vendor will supply the Agency with appropriate return packaging upon request. All returns of unacceptable items shall be F.O.B. the Agency's location. The returned product shall either be replaced, or the Agency shall receive a full credit or refund for the purchase price, at the Agency's discretion.

6.5 Return Due to Agency Error: Items ordered in error by the Agency will be returned for credit within 30 days of receipt, F.O.B. Vendor's location. Vendor shall not charge a restocking fee if returned products are in a resalable condition. Items shall be deemed to be in a resalable condition if they are unused and in the original

REQUEST FOR QUOTATION
AT&T FirstNet Compatible Cellular Wireless Routers for Traffic Signal Systems

packaging. Any restocking fee for items not in a resalable condition shall be the lower of the Vendor's customary restocking fee or 5% of the total invoiced value of the returned items.

7 VENDOR DEFAULT:

7.1 The following shall be considered a vendor default under this Contract.

- 7.1.1 Failure to provide Contract Items in accordance with the requirements contained herein.
- 7.1.2 Failure to comply with other specifications and requirements contained herein.
- 7.1.3 Failure to comply with any laws, rules, and ordinances applicable to the Contract Services provided under this Contract.
- 7.1.4 Failure to remedy deficient performance upon request.

7.2 The following remedies shall be available to Agency upon default.

- 7.2.1 Immediate cancellation of the Contract.
- 7.2.2 Immediate cancellation of one or more release orders issued under this Contract.
- 7.2.3 Any other remedies available in law or equity.

EXHIBIT A

Item Number	Estimated Quantity	Unit of Measure	Description	UNSPC CODE	Unit Price	Extended Price
1	12	ea	AT&T FirstNet Compatible Cellular Wireless Router for Traffic Signal System	43222609	\$968.78	\$11,625.36
2	12	ea	Associated Power Supply for AT&T FirstNet Compatible Cellular Wireless Router for Traffic Signal Systems	39121004	\$17.91	\$214.92
3	12	ea	Antenna for AT&T FirstNet Compatible Cellular Wireless Router for Traffic Signal Systems	43221706	\$53.05	\$636.60
GRAND TOTAL					→	\$12,476.88

STATE OF WEST VIRGINIA
Purchasing Division

PURCHASING AFFIDAVIT

CONSTRUCTION CONTRACTS: Under W. Va. Code § 5-22-1(i), the contracting public entity shall not award a construction contract to any bidder that is known to be in default on any monetary obligation owed to the state or a political subdivision of the state, including, but not limited to, obligations related to payroll taxes, property taxes, sales and use taxes, fire service fees, or other fines or fees.

ALL CONTRACTS: Under W. Va. Code §5A-3-10a, no contract or renewal of any contract may be awarded by the state or any of its political subdivisions to any vendor or prospective vendor when the vendor or prospective vendor or a related party to the vendor or prospective vendor is a debtor and: (1) the debt owed is an amount greater than one thousand dollars in the aggregate; or (2) the debtor is in employer default.

EXCEPTION: The prohibition listed above does not apply where a vendor has contested any tax administered pursuant to chapter eleven of the W. Va. Code, workers' compensation premium, permit fee or environmental fee or assessment and the matter has not become final or where the vendor has entered into a payment plan or agreement and the vendor is not in default of any of the provisions of such plan or agreement.

DEFINITIONS:

"Debt" means any assessment, premium, penalty, fine, tax or other amount of money owed to the state or any of its political subdivisions because of a judgment, fine, permit violation, license assessment, defaulted workers' compensation premium, penalty or other assessment presently delinquent or due and required to be paid to the state or any of its political subdivisions, including any interest or additional penalties accrued thereon.

"Employer default" means having an outstanding balance or liability to the old fund or to the uninsured employers' fund or being in policy default, as defined in W. Va. Code § 23-2c-2, failure to maintain mandatory workers' compensation coverage, or failure to fully meet its obligations as a workers' compensation self-insured employer. An employer is not in employer default if it has entered into a repayment agreement with the Insurance Commissioner and remains in compliance with the obligations under the repayment agreement.

"Related party" means a party, whether an individual, corporation, partnership, association, limited liability company or any other form or business association or other entity whatsoever, related to any vendor by blood, marriage, ownership or contract through which the party has a relationship of ownership or other interest with the vendor so that the party will actually or by effect receive or control a portion of the benefit, profit or other consideration from performance of a vendor contract with the party receiving an amount that meets or exceeds five percent of the total contract amount.

AFFIRMATION: By signing this form, the vendor's authorized signer affirms and acknowledges under penalty of law for false swearing (W. Va. Code §61-5-3) that: (1) for construction contracts, the vendor is not in default on any monetary obligation owed to the state or a political subdivision of the state, and (2) for all other contracts, that neither vendor nor any related party owe a debt as defined above and that neither vendor nor any related party are in employer default as defined above, unless the debt or employer default is permitted under the exception above.

WITNESS THE FOLLOWING SIGNATURE:

Vendor's Name: RCN Communications LLC

Authorized Signature: *Reed Pennington* Date: 9-16-2020

State of TN

County of KNOX, to-wit:

Taken, subscribed, and sworn to before me this 16 day of September, 2020.

My Commission expires September 5, 2022.

AFFIX SEAL HERE



NOTARY PUBLIC *Christina M Ball*



NetCloud Services for Mobile



COR IBR900 Series Spec Sheet



Shown: COR IBR900-1200M-B

Cradlepoint COR IBR900 Series mobile routers are sold as part of an all-inclusive mobile networking package.

NetCloud Mobile Packages include:

- Ruggedized endpoints, purpose-built for mobile applications
- A NetCloud Service Plan tailored for mobile networking and set for a specific term
- 24x7 support and limited lifetime warranty

What to Buy

Description	Part Numbers
North America (U.S., Canada)	
— NetCloud Mobile Essentials Package with IBR900-1200M-B-NPS	MAx-0900120B-NNA
— NetCloud Mobile Essentials Package with IBR900-1200M-NPS	MAx-09001200-NNA
— NetCloud Mobile Essentials Package with IBR900-600M-NPS	MAx-0900600M-NNA
— NetCloud Mobile Essentials Package with IBR900	MAx-0900NM-0NA
Europe (EU)	
— NetCloud Mobile Essentials Package with IBR900-600M-EU-NPS	MAx-0900600M-EWA
— NetCloud Mobile Essentials Package with IBR900-EU	MAx-0900NM-0WA
Asia-Pacific (Australia, New Zealand, Singapore)	
— NetCloud Mobile Essentials Package with IBR900-600M-AP-NPS	MAx-0900600M-PWA
— NetCloud Mobile Essentials Package with IBR900LP5-NPS-AP	MAx-0900LP5-PWA
— NetCloud Mobile Essentials Package with IBR900-AP	MAx-0900NM-0WA
All Regions	
— NetCloud Mobile Advanced Plan	MAx-NCADV

x = 1, 3, or 5 years

NetCloud Mobile Essentials packages and plans contain all the features and capabilities required for a broad range of mobile or in-vehicle applications. Essentials packages include 24x7 support (phone support: 24 hour weekdays with emergency response on weekends, web: 24x7, chat: 24x5) and a limited lifetime warranty.

For additional capabilities, a **NetCloud Mobile Advanced Plan** can be added to the NetCloud Mobile Essentials Package at any time.

See additional details of what is included in the Essential and Advanced NetCloud software: cradlepoint.com/netcloud-manager

For more details on the COR IBR900 mobile router, included with the NetCloud Mobile Packages, see below.

What's in the Box

- Ruggedized high-performance router with embedded, business-class LTE modem; includes integrated mounting plate
- A 4-wire power/GPIO cable (3 meters)
- Two (2) extra SIM door screws
- Safety, Regulatory, and Warranty Guide

Models

- COR IBR900-1200M-B: LTE Advanced Pro 1 Gbps LTE/HSPA+ with SIM-based, auto carrier Selection
 - FirstNet® Ready (includes support for Band 14)
- COR IBR900-1200M: LTE Advanced Pro 1 Gbps LTE/HSPA+ (With SIM-based, auto carrier selection for AT&T/FirstNet® and Verizon)
 - FirstNet Ready (includes support for Band 14)
- COR IBR900-600M: LTE Advanced 600 Mbps LTE/HSPA+ (SIM-based, auto-carrier selection for all North American, European, and Asia Pacific carriers; includes support for 700 MHz Band 28 in Asia Pacific)
 - FirstNet Ready (does not support Band 14)
- COR IBR900LP6: LTE Advanced 600 Mbps LTE/HSPA+ (SIM-based, auto-carrier selection for all North American, European, and Asia Pacific carriers; includes support for 700 MHz Band 28 in Asia Pacific)
 - FirstNet Ready (does not support Band 14)
- COR IBR900LP5: 300 Mbps LTE Advanced for operators in Asia Pacific and Saudi Arabia (SIM-based, auto carrier selection)

Key Features

WAN

- Dual-modem capable with optional COR Extensibility Dock
- WiFi-as-WAN, with WPA2 Enterprise Authentication for WiFi-as-WAN
- Failover/Failback
- Load Balancing
- Advanced Modem Failure Check
- WAN Port Speed Control
- WAN/LAN Traffic Steering
- IP Passthrough
- Standby
- DynDNS
- QoS (DSCP and Priority Queuing)

LAN

- VLAN 802.1Q
- DHCP Server, Client, Relay²
- DNS and DNS Proxy
- UPnP
- DMZ
- Multicast/Multicast Proxy
- MAC Address Filtering

WiFi¹

- Dual-Band, dual-concurrent
- 802.11 a/b/g/n/ac wave 2—MU-MIMO and 256 QAM support
- Multiple SSIDs: 2 per radio (4 total)
- WPA2 Enterprise (WiFi)
- Hotspot/Captive Portal
- SSID-based Priority
- Client Mode for faster data offload
- Frequencies supported:
 - 2.4 GHz (2412 – 2472 MHz)
 - 5 GHz
 - U-NII-1 (5.150-5.250 GHz)
 - U-NII- 2a (5.250-5.350 GHz) North America IBR900-600M Only
 - U-NII-2c (5.470-5.725 GHz) North America IBR900-600M Only
 - U-NII-3 (5.7225-5.825 MHz) North America Only

Management

- Cradlepoint NetCloud Manager
- Web UI, API, CLI
- Active GPS support on all models
- Data Usage Alerts (router and per client)
- Advanced Troubleshooting (support)
- Device Alerts
- SNMP
- SMS control
- Serial Redirector
- Auto APN Recovery
- Syslog

VPN & Routing

- IPsec Tunnel – up to ten concurrent sessions
- L2TP
- GRE Tunnel
- OSPF/BGP/RIP
- Route Filters (Access Control Lists, Prefix Filters, Route Maps, Communities for BGP)
- Per-Interface Routing
- Routing Rules
- Policy-based Routing
- NAT-less Routing
- Virtual Server/Port Forwarding
- NEMO/DMNR
- IPv6
- VRRP
- STP
- NHRP
- VTI Tunnel support
- OpenVPN support
- CP Secure VPN compatible
- Serial PAD Mode

Security

- RADIUS and TACACS+ support*
- 802.1x authentication for Ethernet**
- Zscaler integration
- Certificate support
- ALGs
- MAC Address Filtering
- Advanced Security Mode (local user management only)
- FIPS 140-2 Inside version available
- Per-Client Web Filtering
- IP Filtering
- Content Filtering (basic)
- Website Filtering
- Zone-Based Object Firewall with host address (IP or FQDN), port, and MAC address

*Native support for authentication. Authorization and accounting support through hotspot/captive portal services.

**802.1x Authentication for Ethernet not available for FIPS SKUs.

Cloud Optimized IP Communications

- Automated WAN Failover/Failback support
- WAN Affinity and QoS allow prioritization of VoIP services
- Advanced VPN connectivity options to HQ
- SIP ALG and NAT to allow VoIP and UC communications to traverse firewall
- MAC Address Filtering
- 802.1p/q for LAN QoS segmentation and treatment of VoIP on LAN
- Private Network support (wired and 4G WAN)
- Cloud-based management

IoT Connector

- NetCloud Edge Connector for Microsoft® Azure IoT Central

1 — WiFi-related functions are only supported on IBR900 models

2 — DHCP Relay across a wide area network (WAN) only available on the LP3 and LP5 models. All other models require a VPN tunnel present for DHCP Relay to function properly.

Specifications

The following features are delivered through the hardware.

WAN:

- Dual-modem capable with optional COR Extensibility Dock
- Embedded 1200M LTE Advanced Pro modem (with DC-HSPA+ failover), delivering 1 Gbps**
- Embedded 600M LTE Advanced 600 Mbps modem (with DC-HSPA+ failover)
- Two LAN/WAN switchable 10/100/1000 Gigabit Ethernet ports – one default WAN (cable/DSL/T1/satellite/Metro Ethernet)
- WiFi-as-WAN, Metro WiFi; 2x2 MIMO “N” 2.4 GHz or 5 GHz; 802.11 a/b/g/n/ac wave 2 (IBR900 only)

LAN:

- Dual-band, dual-concurrent WiFi; 802.11 a/b/g/n/ac wave 2 (IBR900 only)
- Two LAN/WAN switchable 10/100/1000 Gigabit Ethernet ports – one default LAN
- Serial console support for Out-of-Band Management of a connected device

Ports:

- 4-Wire power/GPIO
- Add more GPIO ports with optional 9-wire power/GPIO cable or COR Extensibility Dock with 2x10-wire power/GPIO cable
- USB 2.0
- Two Ethernet LAN/WAN

- Two cellular antenna connectors (SMA)
- One active GPS antenna connector (SMA)
- Two WiFi antenna connectors (RP-SMA)
- 15-pin dock port for COR Extensibility Dock, 9-wire GPIO cable, or COR Extensibility Port to Serial Cable

Temperature:

- -30 °C to 70 °C (-22 °F to 158 °F) operating with optional* 9-wire power and GPIO cable (Part #170680-000)
- -30 °C to 70 °C (-22 °F to 158 °F) operating with optional extended temperature AC power supply (Part #170648-000; see this page for line cord details)
- -20 °C to 60 °C (-4 °F to 140 °F) operating with included† standard AC power supply
- -40 °C to 85 °C (-40 °F to 185 °F) storage

* Included with "-NPS" version, † - not included with "-NPS" version

Humidity (non-condensing):

- 5% to 95% operating
- 5% to 95% storage

Power:

- DC input steady state voltage range: 9–33 VDC (requires in-line fuse for vehicle installations)
 - For 9–24 VDC installations, use a 3 A fuse
 - For > 24 VDC installations, use a 2.5 A fuse
- Reverse polarity and transient voltage protection per ISO 7637-2
- Ignition sensing (automatic ON and time-delay OFF)
- Power consumption:
 - Idle: 4W
 - LTE Tx/Tx: 6.25W
 - WiFi Tx/Rx: 9W
 - 12 VDC / 2 A adapter recommended

WiFi Power:

- 2.4 GHz: 18 dBm conducted
- 5 GHz VHT20: 17.5 dBm conducted
- 5 GHz VHT40: 17 dBm conducted
- 5 GHz VHT80: 16.5 dBm conducted

Size: 4.6 × 4.5 × 1.2 in (118 × 113.5 × 29.3 mm)

Weight: 14 oz (400 g)

Certifications:

- WiFi Alliance (IBR900 only) – 802.11a/b/g/n/ac wave 2 certified
- Safety: UL/CUL, CB Scheme, EN60950-1
- Hazardous Locations: Class1, Div 2. IBR900-600M-NA only.
- Shock/Vibration/Humidity: Compliant with MIL STD 810G and SAEJ1455
- Ingress Protection: Compliant with IP54 (includes protection from dust and splashing water)
- Materials: WEEE, RoHS, RoHS-2, California Prop 65
- Telecom: PTCRB/CTIA, GCF-CC
- Regulatory Models: S5A643A, S5A644A, S5A648A, S5A701A, S5A706A, S5A843A, S5A848A
- FIPS 140-2 Inside

GPS:

- GPS Protocols: TAIP and NMEA 0183 V3.0
- Satellite channels: Maximum 55 channels, simultaneous tracking
- Concurrent standalone GPS, GLONASS, BeiDou and Galileo
- 1 Hz refresh rate
- Accuracy:
 - < 2 m: 50%
 - < 5 m: 90%
 - Horizontal: < 2 m (50%); < 5 m (90%)
 - Altitude: < 4 m (50%); < 8 m (90%)
 - Velocity: < 0.2 m/s
- Acquisition (measured with signal strength = -145 dBm):
 - Hot start: 1 second
 - Warm start: 29 seconds
 - Cold start: 32 seconds
- Sensitivity:
 - Tracking: -160 dBm (tracking sensitivity is the lowest GNSS signal level for which the device can still detect an in-view satellite 50% of the time when in sequential tracking mode)
 - Acquisition (standalone): -145 dBm (acquisition sensitivity is the lowest GNSS signal level for which the device can still detect an in-view satellite 50% of the time)
- Operational limits: Altitude < 6000 m or velocity < 100 m/s (either limit may be exceeded, but not both)

Router Performance

- Max Throughput (Default Configuration*): 940 Mbps
- Max Concurrent TCP Sessions: 16,000
- Recommended Max Client Count: 10**

Performance testing was conducted based off requirements as defined in RFC2544 using a mix of 64, 256, and 1500-byte packet sizes. Throughput is shown as bi-directional TCP traffic with less than a 1% packet loss using four wired clients.

Specifications and information in this datasheet are subject to change without notice.

*Cradlepoint defines client as any network connected device utilizing resources, such as bandwidth, on the local network.

**If CP Secure Threat Management or Application Analytics are enabled, the recommended max client count is 5.

Accessories

The IBR900 series mobile router do not include antennas and, therefore, requires the following accessories for optimal performance:

Required Accessories

- 3G/4G LTE cellular antennas (Qty. 2)
 - Recommended for bench test: 170760-000: Black, Universal 600MHz-6GHz 3G/4G/LTE 2dBi/3dBi 6" antenna with SMA connector (1x)
- 2.4/5GHz Dual Band WiFi antennas (Qty. 2)
 - Recommended for bench test: 170628-000 Dual-band 2.4/5.0 GHz external WiFi antenna
- An active (powered) GPS antenna
 - Recommended for bench test: 170760-000: Black, Universal 600MHz-6GHz 3G/4G/LTE 2dBi/3dBi 6" antenna with SMA connector (1x)

Additional Cradlepoint accessory options for extensibility, power, and antennas include:

Second Integrated LTE Modem with MC400:

- MC400-1200M-B
- MC400-1200M
- MC400LP6 (North America or EU)
- MC400LP5 (Asia Pacific or Saudi Arabia)
- MC400LP4 (AT&T, Verizon, T-Mobile, and Canada)

Extensibility

- COR Extensibility Dock (Part # 170700-000)
- 9-wire power/GPIO cable (Part # 170680-000)
- COR Extensibility Port to Serial Cable (Part # 170767-000)

Power:

Vehicle Options

- Vehicle locking power adapter for COR (Part # 170635-000)
- Two-meter 4-wire power/GPIO cable, direct wire (Part # 170585-000)

Power Supplies/Adapters

- North America COR IBR900/IBR950 power supply (Part # 170716-000)
- International power supply — includes adapters for US, EU, UK, AU (Part # 170717-000)
- Barrel to 4-pin power adapter (Part # 170665-000)
- Extended temperature AC power supply (Part # 170648-001; [see line cord details](#))

Antennas – 3G/4G Modem, WiFi & GPS:

- Black, Universal 600MHz-6GHz 3G/4G/LTE 2dBi/3dBi 6" antenna with SMA connector (1x) Part # 170760-000
- 2.4/5 GHz Dual-band, Dual-concurrent WiFi Antenna Part # 170628-000 (WiFi models only)

Vehicle Antennas:

See the [Cradlepoint Certified Antennas for Mobile](#) for more information about antennas. Also see the [Antenna Ordering and Installation Guide](#), also available in the Resources section of antenna and router product pages.

Enterprise-Class Modem Specifications

COR IBR900-1200M-B

COR IBR900-1200M-B models include an embedded, LTE Advanced Pro modem with SIM-based, auto carrier selection. Simply insert the SIM, and wait for the router to automatically detect the SIM and establish a connection.

- Technology: Category 18 LTE Advanced Pro, DC-HSPA+ with SIM-based auto carrier selection
- Downlink Rates: LTE 1000 Mbps, DC-HSPA+ 42.2 Mbps*
- Uplink Rates: LTE 150 Mbps, DC-HSPA+ 5.76 Mbps*
- MIMO: 2x2 MIMO
- 256 QAM support
- Frequency Bands:
 - LTE Bands
 - LTE FDD: 2(25), 4(66), 5(26), 12(17), 13, 14, 29, 71
- Carrier Aggregation: Up to 5CA.
 - AT&T:
 - LTE FDD: 2, 4, 5, 12, 13, 14, 17, 25, 26, 29 (DL), 66, 71 (FDD)
 - 3G DC-HSPA+: 1, 2, 4, 5, 8

- 2CA DL carrier aggregation combinations:
CA_2A-4A, CA_2A-5A, CA_2A-12A, CA_2A-14A, CA_2A-29A, CA_2A-66A, CA_2A-71A, CA_4A-5A, CA_4A-12A, CA_4A-29A, CA_4A-71A, CA_5A-66A, CA_12A-66A, CA_14A-66A, CA_25A-26A, CA_29A-66A, CA_66A-71A, CA_2A-2A, CA_4A-4A, CA_25A-25A, CA_66A-66A, CA_2C, CA_5B, CA_12B, CA_66B, CA_66C
- 3CA DL carrier aggregation combinations:
CA_2A-2A-5A, CA_2A-2A-12A, CA_2A-2A-66A, CA_2A-2A-71A, CA_2A-4A-4A, CA_2A-4A-5A, CA_2A-4A-12A, CA_2A-4A-29A, CA_2A-4A-71A, CA_2A-5A-66A, CA_2A-12A-66A, CA_2A-12B, CA_2A-14A-66A, CA_2A-66A-66A, CA_2A-66A-71A, CA_2A-66C, CA_2A-66C, CA_4A-4A-5A, CA_4A-4A-12A, CA_4A-4A-71A, CA_4A-12B, CA_5A-66A-66A, CA_5A-66C, CA_12A-66A-66A, CA_12A-66C, CA_14A-66A-66A, CA_25A-25A-26A, CA_29A-66A-66A, CA_66A-66A-71A
- 4CA DL carrier aggregation combinations:
CA_2A-2A-5A-66A, CA_2A-2A-12A-66A, CA_2A-2A-66A-66A, CA_2A-2A-66A-71A, CA_2A-2A-66C, CA_2A-4A-4A-12A, CA_2A-5A-66A-66A, CA_2A-5B-66A, CA_2A-12A-66A-66A, CA_2A-66A-66A-71A, CA_2A-66C-71A, CA_2C-66A-66A, CA_5B-66A-66A
- 5CA DL carrier aggregation combinations:
CA_2A-5B-66A-66A
- 2CA UL carrier aggregation combinations:
UL_2A-5A, UL_2A-12A, UL_4A-12A, UL_5A-66A, UL_5B

— Verizon

- LTE FDD: 2, 4(66), 5, 13
- 3G (Roaming): 1, 2, 4, 5, 8
- 2CA DL carrier aggregation combinations:
CA_2A-2A, CA_2A-4A, CA_2A-5A, CA_2A-13A, CA_2A-66A, CA_4A-4A, CA_4A-5A, CA_4A-13A, CA_5A-66A, CA_5B, CA_13A-66A, CA_66A-66A, CA_66B, CA_66C
- 3CA DL carrier aggregation combinations:
CA_2A-2A-5A, CA_2A-2A-13A, CA_2A-2A-66A, CA_2A-4A-5A, CA_2A-4A-13A, CA_2A-5A-66A, CA_2A-13A-66A, CA_2A-66A-66A, CA_2A-66B, CA_2A-66C, CA_4A-4A-5A, CA_4A-4A-13A, CA_5A-66A-66A, CA_5A-66B, CA_5A-66C, CA_13A-66A-66A, CA_13A-66B, CA_13A-66C, CA_66A-66C, CA_66D
- 2CA UL carrier aggregation combinations:
CA_2A-13A, CA_4A-13A

- Fallback: WCDMA/DC-HSPA+ (42/5.76 Mbps): Bands 1, 2, 4, 5, 8
- Power: LTE 23 dBm ± 1, DC-HSPA+ 23 dBm ± 1
- Antennas: SMA & RP-SMA male plugs, maximum torque not to exceed 4 in-lbs
- GPS: Active GPS support
- SMS: SMS support
- Industry Standards & Certs: FCC, PTCRB, AT&T, FirstNet, Verizon

COR IBR900-1200M-NA

COR IBR900-1200M models include an embedded LTE Advanced Pro 4G LTE modem with SIM-based, auto carrier selection for FirstNet, AT&T, and Verizon. Simply insert the SIM and wait for the router to automatically detect the SIM and establish a connection.

- Technology: Category 18 LTE Advanced Pro, DC-HSPA+
- Downlink Rates: LTE 1 Gbps, DC-HSPA+ 42.2 Mbps*
- Uplink Rates: LTE 150 Mbps, DC-HSPA+ 5.76 Mbps*

- MIMO: 2x2 MIMO
- 256 QAM support
- Frequency Bands:
 - LTE Bands
 - LTE FDD: 2, 4(66), 5, 12, 13, 14, 29
- Carrier Aggregation: Up to 5CA. [] indicates 4x4 MIMO
 - AT&T: 2,4,5,12,14,29,66; 3G 2, 5
 - 2CA DL carrier aggregation combinations:
CA_2A-2A, CA_2A-4A, CA_2A-5A, CA_2A-12A, CA_2A-14A, CA_2A29A, CA_2A-66A, CA_2C, CA_4A-4A, CA_4A-5A, CA_4A-12A, CA_4A-29A, CA_5A-66A, CA_5B, CA_12A-66A, CA_12B, CA_14A-66A, CA_29A-66A, CA_66^a-66A, CA_66B, CA_66C
 - 3CA DL carrier aggregation combinations:
CA_2A-2A-5A, CA_2A-2A-12A, CA_2A-2A-14A, CA_2A2A-66A, CA_2A-4A-4A, CA_2A-4A-4A, CA_2A-4A-5A, CA_2A-4A-5A, CA_2A-4A-12A, CA_2A-4A-12A, CA_2A-5A-66A, CA_2A-5A-66A, CA_2A-12A-66A, CA_2A-12A-66A, CA_2A-14A-66A, CA_2A-66A-66A, CA_4A-4A-5A, CA_4^a-4A-12A, CA_4A-12B, CA_5A-66A-66A, CA_5A-66C, CA_12A-66A-66A, CA_14A-66A-66A, CA_29A-66A-66A
 - 4CA DL carrier aggregation combinations:
CA_2A-2A-5A-66^a, CA_2A-2A12A-66A, CA_2A-2A-14A-66A, CA_2A-2A-66A-66A, CA_2A-4A-4A-12A, CA_2A-5A-66A-66A, CA_2A-5B-66A, CA_2A-12A-66A-66A, CA_2A-14A66A-66A, CA_5B-66A-66A
 - 5CA DL carrier aggregation combinations:
CA_2A-5B-66A-66A
 - 2CA UL carrier aggregation combinations:
CA_2A-12A, CA_2A-5A, CA_4A-12A, CA_5A-66A, CA_5B, CA_12A-66A
 - Verizon
 - LTE FDD: 2, 4(66), 5, 13
 - 3G (Roaming): 1, 2, 4, 5, 8
 - 2CA DL carrier aggregation combinations:
CA_2A-2A, CA_2A-4A, CA_2A-5A, CA_2A-13A, C_2A-66A, CA_4A-4A, CA_4A-5A, CA_4A-13A, CA_5A-66A, CA_5B, CA_13A-66A, CA_66A-66A, CA_66B, CA_66C,
 - 3CA DL carrier aggregation combinations:
CA_2A-2A-5A, CA_2A-2A-13A, CA_2A-2A-66A, CA_2A-2A-66A, CA_2A-4A-5A, CA_2A-4A-5A, CA_2A-4A-13A, CA_2A-4A-13A, CA_2A-5A-66A, CA_2A-5A-66A, CA_2A-13A-66A, CA_2A-13A-66A, CA_2A-66A-66A, CA_2A-66A-66A, CA_2A-66B, CA_2A-66C, CA_4A-4A-5A, CA_4A-4A-13A, CA_5A-66A-66A, CA_5A-66B, CA_5A-66C, CA_13A-66A-66A, CA_13A-66B, CA_13A-66C, CA_66A-66C, CA_66D
 - 2CA UL carrier aggregation combinations:
CA_2A-13A, CA_4A-13A
- Fallback: WCDMA/DC-HSPA+ (42/5.76 Mbps): Bands 1, 2, 4, 5, 8
- Power: LTE 23 dBm ± 1, DC-HSPA+ 23 dBm ± 1
- Antennas: SMA & RP-SMA male plugs, maximum torque not to exceed 4 in-lbs
- GPS: Active GPS support
- SMS: SMS support
- Industry Standards & Certs: FCC, PTCRB, AT&T, FirstNet, Verizon

COR IBR900-600M-NA / -EU

COR IBR900-600M models include an embedded LTE Advanced 600 Mbps 4G LTE modem. The 600M modems support worldwide, SIM-based, auto-carrier selection. Simply insert the SIM, and wait for the router to automatically detect the SIM and establish a connection.

- Technology: Category 11 LTE Advanced, HSPA+
- Downlink Rates: LTE 600 Mbps, HSPA+ 42.2 Mbps*
- Uplink Rates: LTE 75 Mbps, HSPA+ 5.76 Mbps*
- Frequency Bands:
 - LTE Bands
 - LTE FDD: 1-5, 7-8, 12-13, 17, 20, 25-26, 28-30, 66
 - LTE TDD: 38, 40-41
 - HSPA+: 1-2, 4-5, 8
 - LTE 2DL Carrier Aggregation Combinations:

B2+B2, B2+B4, B2+B5, B2+B12, B2+B13, B2+B17, B2+B29, B2+B30, B4+B4, B4+B5, B4+B7, B4+B12, B4+B13, B4+B17, B4+B29, B4+B30, B5+B30, B12+B12, B12+B30, B25+B25, B25+B26, B25+B41, B26+B41, B29+B30, B41+B41, B1+B20, B3+B3, B3+B7, B3+B20, B3+B38, B7+B7, B7+B8, B7+B20, B38+B38, B1+B3, B1+B7, B1+B28, B3+B8, B3+B28, B5+B7, B5+B40, B7+B8, B7+B20
 - LTE 3DL Carrier Aggregation Combinations:

B2+B2+B12/17, B2+B2+B13, B2+B2+B4, B2+B4+B5, B2+B4+B12, B2+B4+B13, B2+B4+B29, B2+B5+B30, B2+B12+B12, B2+B12+B30, B2+B29+B30, B4+B4+B5, B4+B4+B7, B4+B4+B12, B4+B4+B13, B4+B5+B30, B4+B12+B12, B4+B12+B30, B4+B29+B30, B25+B26+B41, B25+B41+B41, B26+B41+B41, B41+B41+B41, B1+B3+B20, B1+B7+B20, B3+B3+B7, B3+B3+B20, B3+B7+B20, B3+B7+B7, B3+B20+B38, B3+B38+B38, B3+B3+B5, B3+B3+B8, B3+B7+B7, B3+B7+B28, B7+B7+B28, B28+B40+B40, B40+B40+B40
- Fallback: WCDMA/DC-HSPA+ (42/5.76 Mbps): Bands 1, 2, 4, 5, 8
- Power: LTE 23 dBm ± 1, HSPA+ 23 dBm ± 1
- Antennas: SMA & RP-SMA male plugs, torque not to exceed 4 in-lbs
- GPS: Active GPS support
- SMS: SMS support
- Industry Standards & Certs: CE, FCC, GCF-CC, IC, PTCRB, AT&T, Sprint, Sprint Curiosity™ IoT, Verizon, Verizon NEMO/DMNR for Primary Wireless Access, AS, NZS, SGP (IMDA)

COR IBR900LP5-AP, COR IBR950LP5-AP

COR IBR900/IBR950LP5 models include an embedded LTE Advanced 300 Mbps 4G LTE modem, and support Asia Pacific and Saudi Arabia. The LP5 modems support SIM-based, auto-carrier selection. Simply insert the SIM, and wait for the router to automatically detect the SIM and establish a connection.

- Technology: FDD/TDD (300 Mbps) LTE Advanced, DC-HSPA+
- Downlink Rates: LTE 300 Mbps, DC-HSPA+ 42.2 Mbps*
- Uplink Rates: LTE 50 Mbps, DC-HSPA+ 5.76 Mbps*

- Frequency Bands:
 - LTE Bands: 1, 3, 5, 7, 8, 18, 19, 21, 28, 38, 39, 40, 41
 - TD-SCDMA 39
 - Carrier Aggregation:
 - 1 + 8/18/19/21, 3 + 5/7/19/28, 5 + 3/7, 7 + 3/5/7/28, 8 + 1, 18 + 1, 19 + 1/3/21, 21 + 1/19, 28 + 3/7, 38 + 38, 39 + 39, 40 + 40, 41 + 41
 - Fallback: WCDMA/DC-HSPA+ (42/5.76 Mbps): Bands 1, 5, 6, 8, 9, 19
 - Power: LTE: 23 dBm ± 1; DC-HSPA+: 23 dBm ± 1
 - Antennas: SMA & RP-SMA male plugs, maximum torque not to exceed 4 in-lbs
 - GPS: Active GPS support
 - SMS: SMS support
 - Industry Standards & Certs: CE, GCF-CC, RC Australia, others pending
-

*Theoretical

**Theoretical max speed with 2 LTE antennas

Support & Warranty

The COR IBR900 series endpoints are only sold as components of NetCloud Packages.

- NetCloud Packages include support for the full subscription term.
- All Cradlepoint hardware products are covered by a limited lifetime warranty for as long as they have a subscription license to an active NetCloud Service Plan.

FirstNet and FirstNet Ready are registered trademarks and service marks of the First Responder Network Authority, an independent authority within the U.S. Department of Commerce.



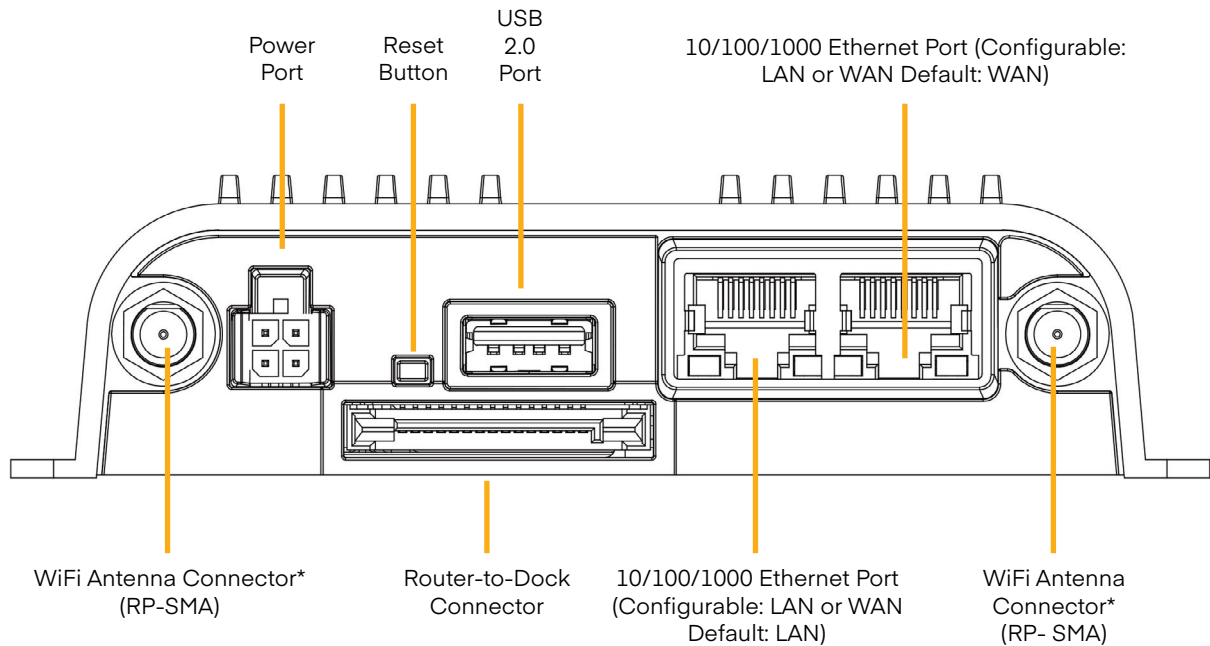
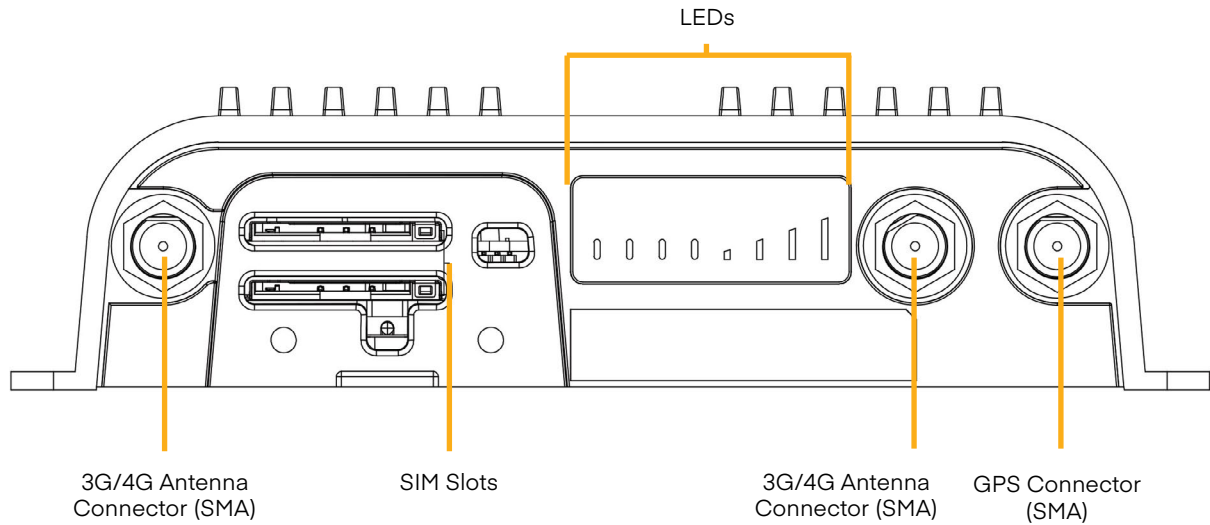

Hardware

COR IBR900-1200M-B & 600M



* Only on IBR900

LEDs

Indicator	Behavior
	<p>Power: The Cradlepoint IBR900/IBR950 must be powered using an approved 9–33 V DC power source.</p> <ul style="list-style-type: none"> — Green = Powered ON. — No Light = Not receiving power. Check the power source connection.
	<p>WiFi Broadcast: Indicates WiFi activity (IBR900 only).</p> <ul style="list-style-type: none"> — Green = On and operating normally. — Yellow = Attention.
	<p>GPS: Indicates the status of GPS connection.</p> <ul style="list-style-type: none"> — Blue = GPS locked. — Blinking Blue = Obtaining lock. — No Light = Off/no lock.
	<p>Embedded Modem: Indicates information about the embedded modem.</p> <ul style="list-style-type: none"> — Green = Modem has established an active connection. — Blinking Green = Modem is connecting. — Amber = Modem is not active. — Blinking Amber = Data connection error. No modem connection possible. — Blinking Red = Modem is in the process of resetting. — No Light = Modem not connected.
	<p>Signal Strength: Blue LED bars indicate the active modem’s signal strength.</p> <ul style="list-style-type: none"> — 4 Solid Bars = Strongest signal. — 1 Blinking Bar = Weakest signal. (A blinking bar indicates half of a bar.)
<p>Other</p>	<p>Additional LED Indicators:</p> <ul style="list-style-type: none"> — Several different LEDs blink when the factory reset button is detected. — Two of the modem LEDs blink red in unison for 10 seconds when there is an error during NCOS upgrade. — Dock Ethernet LEDs: only right LED will light up and/or blink with data. — When an external USB modem is plugged in, only the Signal Strength LEDs will light up.

Multifunction MiMo Antenna

L[G]AM-7-27-[X]24-58



Low Profile Design

MiMo 5G/4G/3G/2G + Single or 2x2 MiMo 2.4/ 5GHz

Optional GPS/GNSS

The L[G]PAM has a compact housing that contains 2x2 MiMo antenna function for 5G/4G/3G/2G and either single or 2x2 MiMo antenna function for 2.4/5GHz.

The LGAM version also includes an active antenna for GPS/GLONASS/Galileo/BeiDou with 26dB gain LNA.

This antenna range is ideal for vending machines, payment terminals and other M2M or IoT applications.



LPAM-7-27-24-58 shown

Technical Drawing

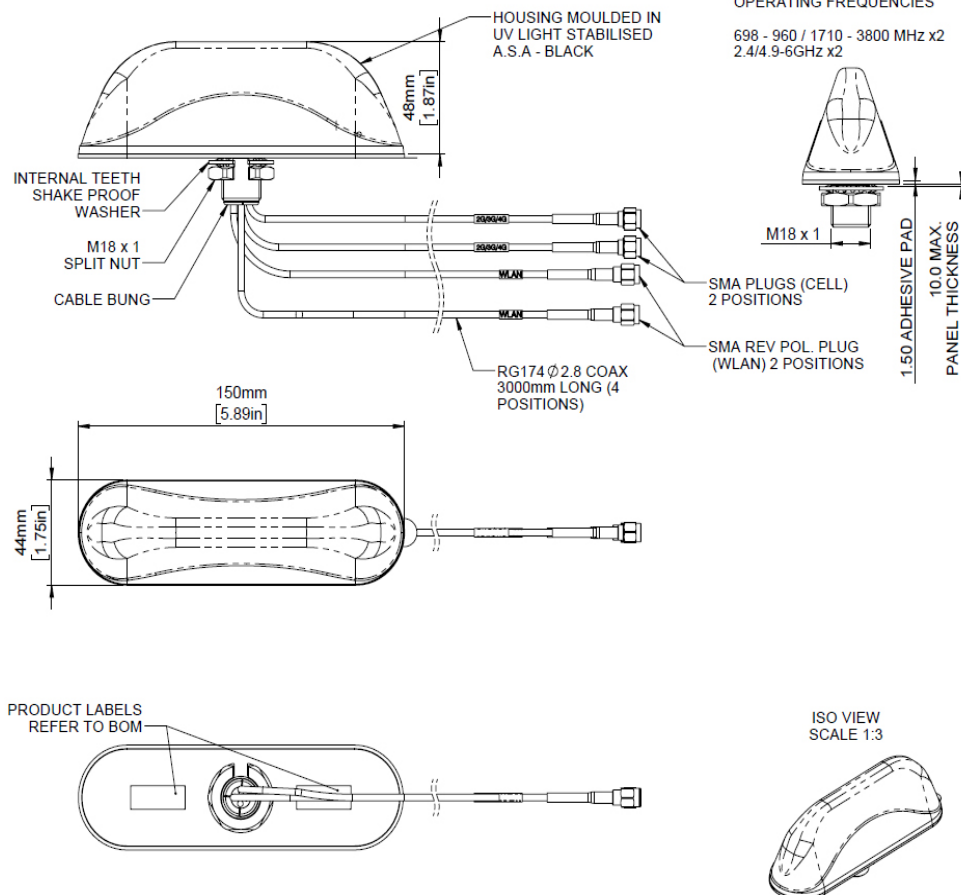

Multifunction MiMo Antenna

L[G]AM-7-27-[X]24-58

Product Data

Part No.		LPAM-7-27-24-58	LPAM-7-27-S24-58	LGAM-7-27-24-58	LGAM-7-27-S24-58
Electrical Data					
Frequency Range (MHz)	Element 1 (G Version)	1562-1612			
	Elements 2 & 3	698-960, 1710-2170, 2500-3800			
	Elements 4 & 5	2300-2500 & 4900-6000			
Operational Bands	Element 1 (G Version)	-	-	GPS/GNSS/Galileo/BeiDou	
	Elements 2 & 3	5G/4G/3G/2G			
		2x cell			
	Element 4 & 5	2.4 / 5.0GHz WiFi			
Peak gain: Isotropic*	Elements 2 & 3	2 x WiFi	1 x WiFi	2x WiFi	1x WiFi
	Elements 4 & 5	2dBi (698-960MHz) 5dBi (1710-3800MHz)			
Isolation <small>(with 5m (16') of RG174 cable)</small>	Cellular	>12dB			
	WiFi	> 20dB			
Typical Efficiency*	Elements 2 & 3	> 50%			
Correlation Co-efficient	Elements 2 & 3	<0.2			
Polarisation	Vertical				
Pattern	Omni-directional				
Impedance	50Ω				
Max Input Power (W)	Internal elements 25W				
GPS/GNSS Data					
Frequency Range (MHz)	1562-1612				
VSWR	<2:1 ± 4MHz				
Gain: LNA	26dB				
Polarisation	Right Hand Circular				
Operating Voltage	3-5V DC (fed via coax)				
Current	Typical <20mA				
Mechanical Data					
Dimensions (mm)	Total Height	50 (2.2")			
	Length	150 (5.9")			
	Width	44 (1.47")			
Operating Temp (°C)	-40° / +80°C (-40° / 176°F)				
Material	ASA				
Colour	Black				
Mounting Info					
Fixing	Panel Mount				
Hole Size (mm)	19 (3/4")				
Cable Data					
Cable Type - All Feeds		RG174			
Dimensions (mm)	Diameter	2.8 (0.11")			
	Length	3000 (10')			
	GPS/GNSS	-	-	SMA Plug	SMA Plug
Termination	2 x Cell	2 x SMA plug			
	WiFi	2 x SMA Rev Pol Plug	1 x SMA Rev Pol Plug	2 x SMA Rev Pol Plug	1 x SMA Rev Pol Plug

* without cable loss

Multifunction MiMo Antenna

L[G]AM-7-27-24[X]-58

Electrical Data

VSWR

Typical VSWR - 4G/3G/2G Elements 2&3*

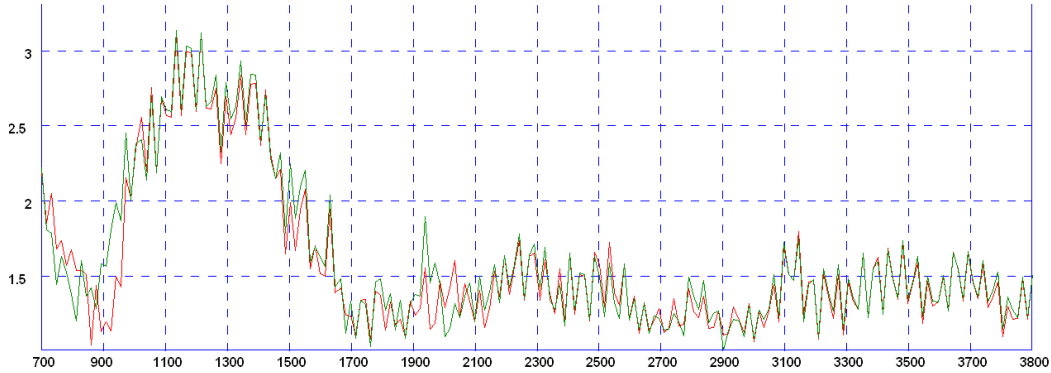

*VSWR measured with 3m (10') of RG174 cable a) Red: in free space b) Green: on a 400x 400mm (1'4') ground plane

Typical VSWR - WiFi Elements 4&5*

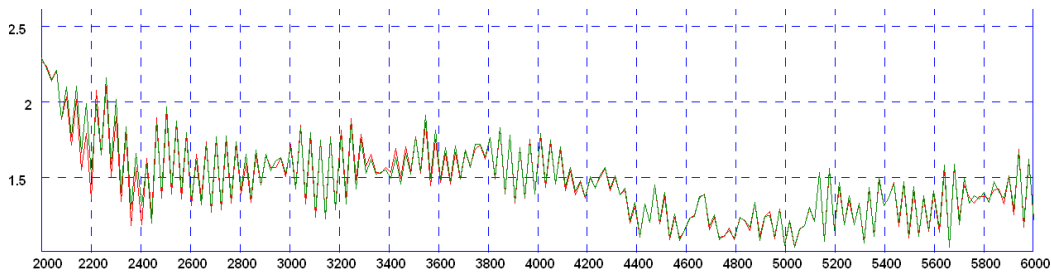

*VSWR measured with 3m (10') of RG174 cable a) Red: in free space b) Green: on a 400x 400mm (1'4') ground plane

Isolation

Typical Isolation - Cellular Elements 2&3*

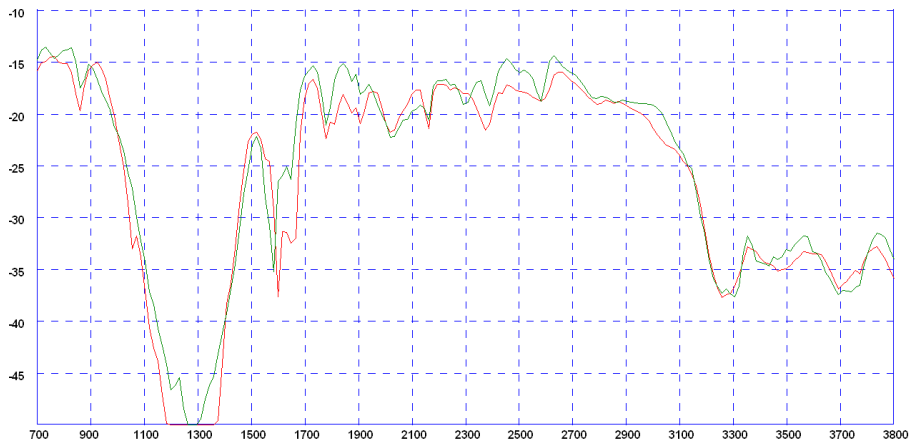

*Isolation measured with 3m (10') of RG174 cable a) Red: in free space b) Green: on a 400x 400mm (1'4') ground plane

Typical Isolation - WiFi Elements 4&5*

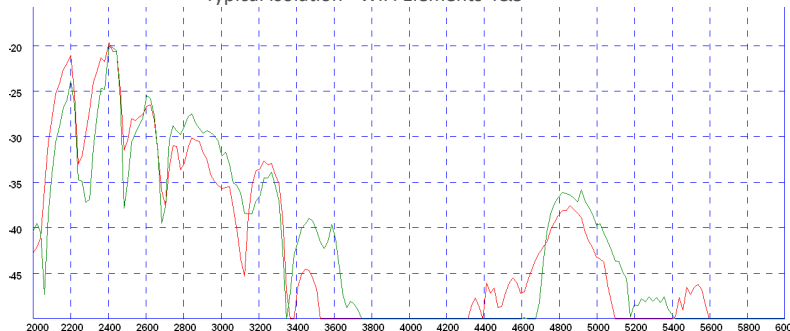

*Isolation measured with 3m (10') of RG174 cable a) Red: in free space b) Green: on a 400x 400mm (1'4') ground plane

Typical 3D Radiation Patterns - Cell / LTE Elements 2&3

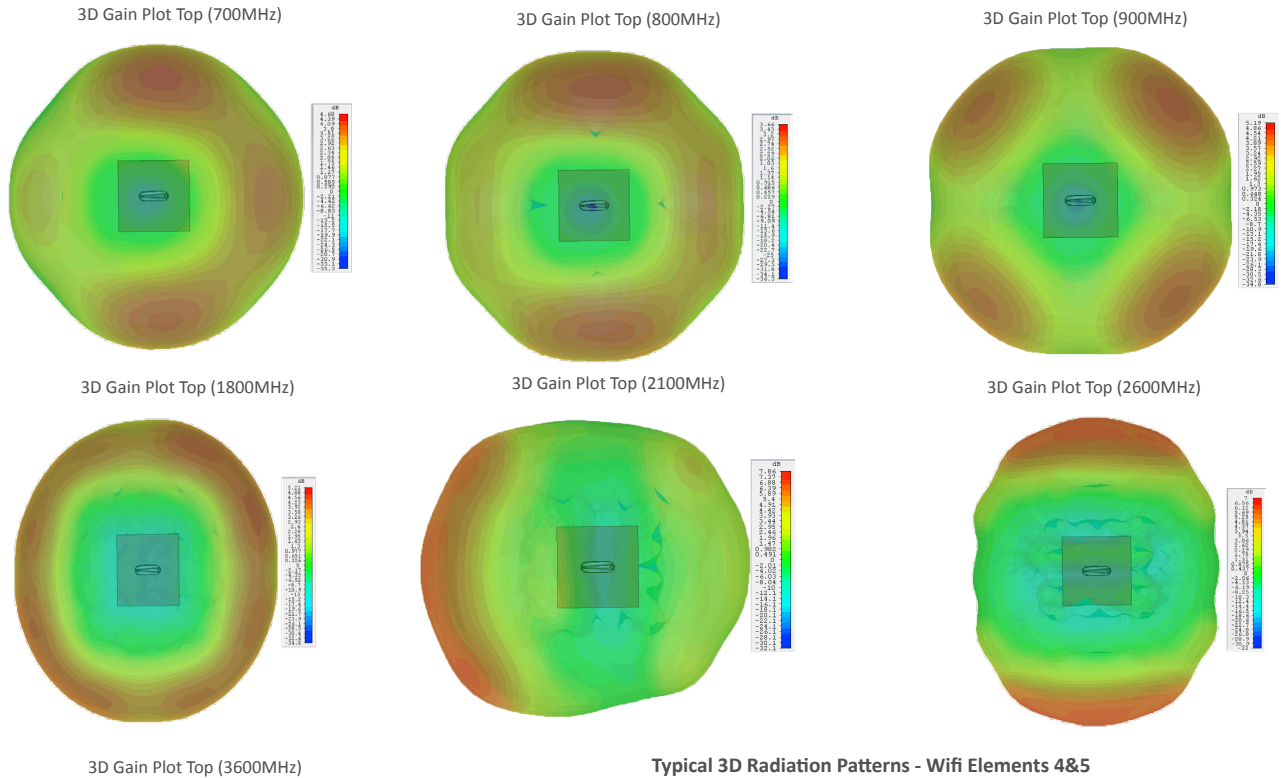

Typical 3D Radiation Patterns - Wifi Elements 4&5

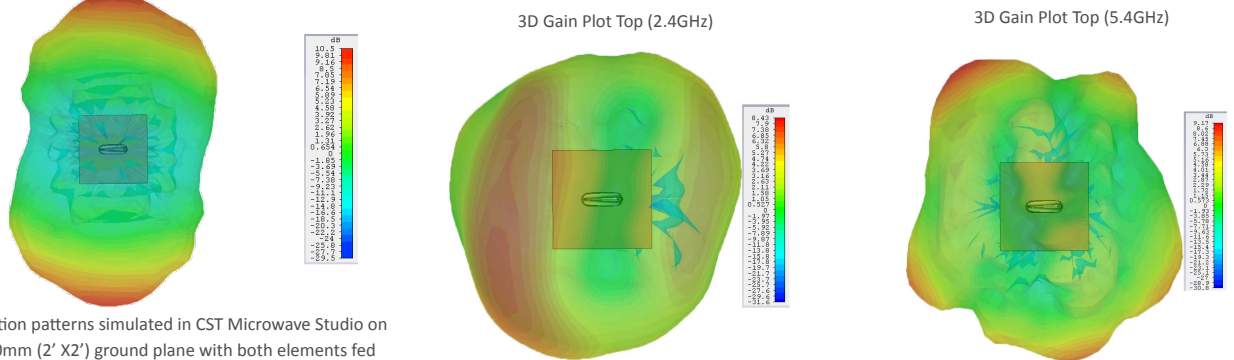

*3D radiation patterns simulated in CST Microwave Studio on a 600x600mm (2' X2') ground plane with both elements fed together.

Typical Radiation Patterns - GPS/GNSS Element 1

Element 3: Typical E Plane Pattern

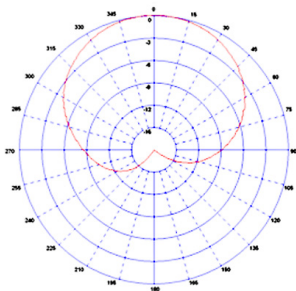

Typical 3D Radiation Patterns - Wifi Elements (Single Wifi)

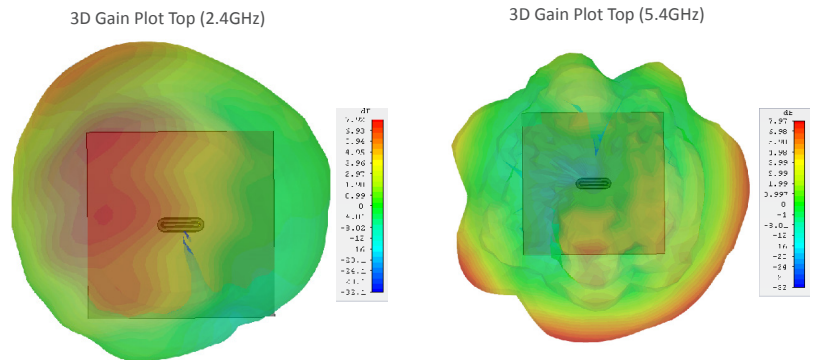

*3D radiation patterns simulated in CST Microwave Studio on a 600x600mm (2' X2') ground plane with a single element feed.



WOMEN'S BUSINESS ENTERPRISE NATIONAL COUNCIL

JOIN FORCES. SUCCEED TOGETHER.

HEREBY GRANTS WOMAN OWNED SMALL BUSINESS (WOSB) CERTIFICATION TO

RCN Communications, LLC DBA RCN Technologies

The identified small business is an eligible WOSB for the WOSB Program, as set forth in 13 C.F.R. part 127 and has been certified as such by an SBA approved Third Party Certifier pursuant to the Third Party Agreement, dated June 30, 2011, and available at www.sba.gov/wosb.

The WOSB Certification expires on the date herein unless there is a change in the SBA's regulation that makes the WOSB ineligible or there is a change in the WOSB that makes the WOSB ineligible. If either occurs, this WOSB Certification is immediately invalid. The WOSB must not misrepresent its certification status to any other party, including any local or State government or contracting official or the Federal government or any of its contracting officials.

NAICS: 517911 UNSPSC: 43223300
Certification Number: WOSB201279
Expiration Date: August 31, 2021



Phala Mire, Women's Business Enterprise Council - South President & CEO

Pamela Prince-Eason, WBENC President & CEO

Laura Taylor, WBENC Vice President

EXHIBIT A

Item Number	Estimated Quantity	Unit of Measure	Description	UNSPC CODE	Unit Price	Extended Price
1	12	ea	AT&T FirstNet Compatible Cellular Wireless Router for Traffic Signal System	43222609	\$ 968.78	\$ 11,625.36
2	12	ea	Associated Power Supply for AT&T FirstNet Compatible Cellular Wireless Router for Traffic Signal Systems	39121004	\$ 17.91	\$ 214.92
3	12	ea	Antenna for AT&T FirstNet Compatible Cellular Wireless Router for Traffic Signal Systems	43221706	\$ 53.05	\$ 636.60
GRAND TOTAL					→	\$ 12,476.88