

PFN Voltage Calibration UD3A1A2R41.

PFN Voltage Calibration [4.5.5.5](#)

The Goal is to make the meter read what is measured at TP1 of the modulator (PFN Voltage).

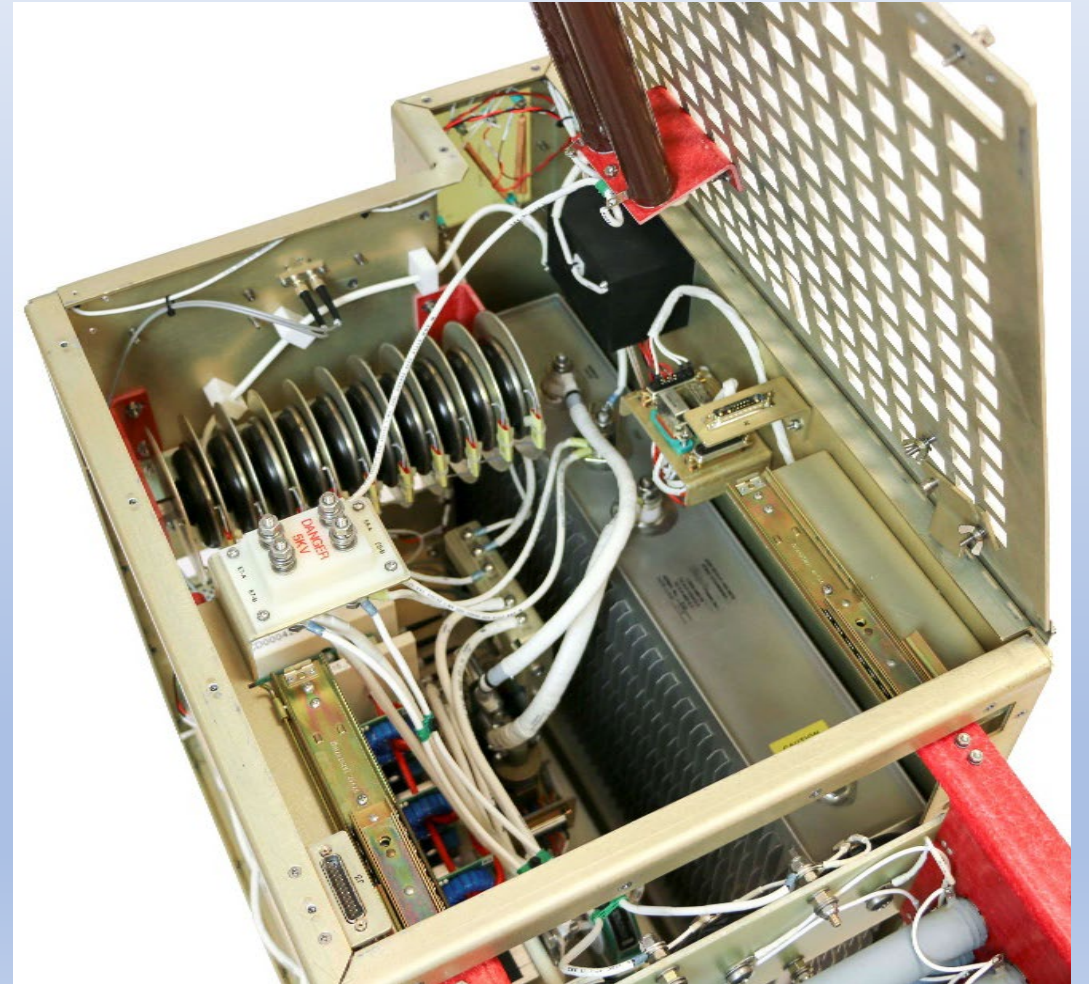
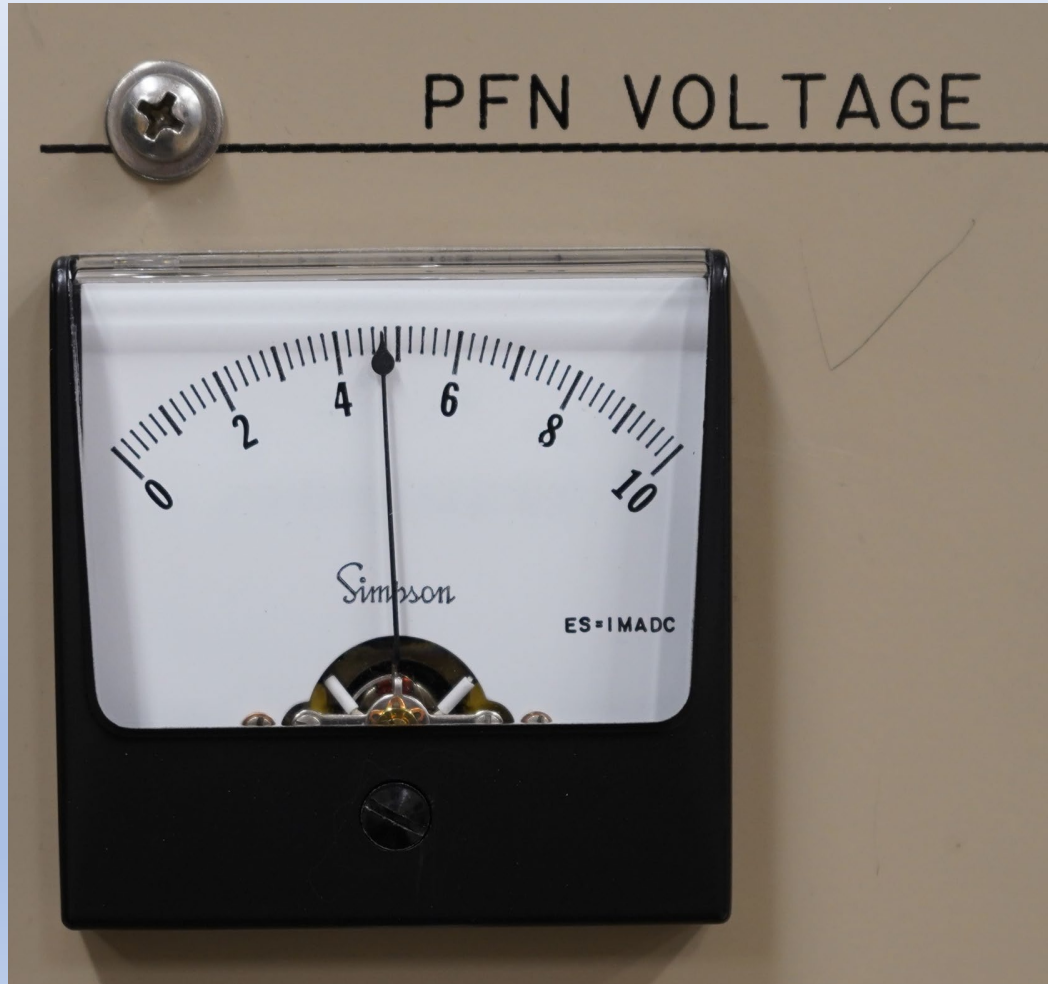

PFN Meter

The reading shown is the output of a sample and hold circuit that samples the PFN voltage while the PFN is charged.

This voltage is a measure of the energy that will drive the final amplifier output tube.

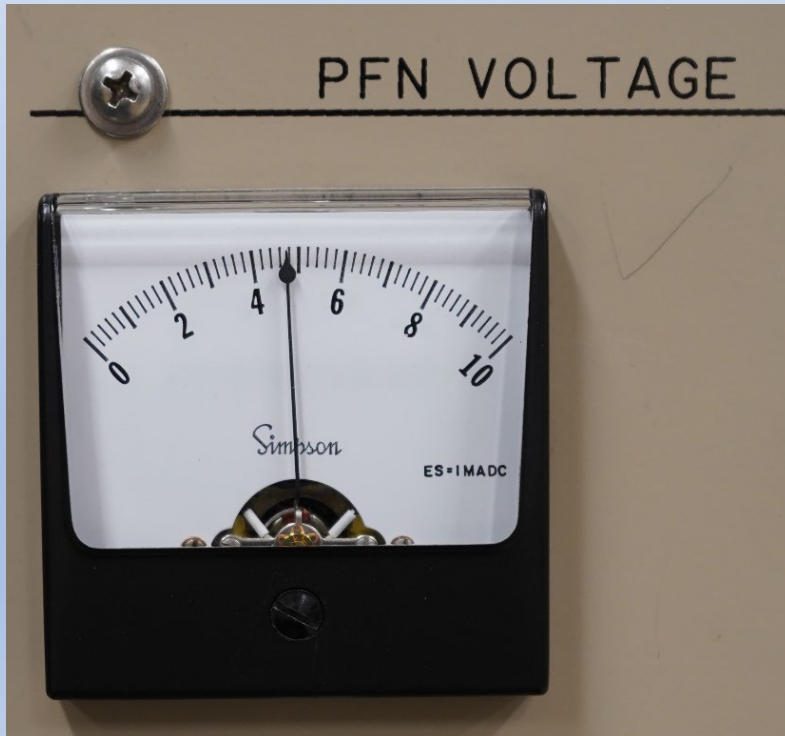

A15 Test Point 1 (A15TP1)

The sample at TP1 is the output of a voltage divider that is connected to the **Pulse Forming Network** in the A15 modulator.



4.5.5.5.2 Initial Conditions/Preliminary Setup.

1. Perform paragraph 3.4.1.2, steps 1 through 4 to power down the transmitter, lock HIGH VOLTAGE POWER CB1 circuit breaker, and remove the interlock key.

WARNING

Use extreme caution when working inside the transmitter cabinet left bay or behind Transmitter Control Panel A1 during this calibration procedure; 120 VAC is exposed in several places. Contact with 120 VAC could cause serious injury or **DEATH**.

NOTE

Ensure the PFN VOLTAGE meter dial reads zero.

2. Zero PFN VOLTAGE METER A1M5 by turning the screw adjustment CW or CCW on the meter face, as necessary.



NWSTC Note: We have noticed that the meter will drive negative with the breakers off and many people prefer to adjust it with the auxiliary power CB2 breaker on. This is how it would be read when troubleshooting.

3. Use the interlock key and open the left bay inner door.

4. Insert the interlock bypass tool into the slot on cabinet door Interlock Switch S4 per paragraph 5.1.4.1.

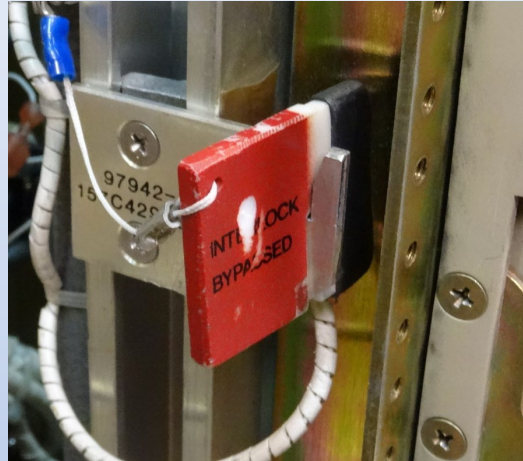

5. Remove panel stiffener from the back of Transmitter Control Panel A1 to gain access to Metering Interface Board A1A2.

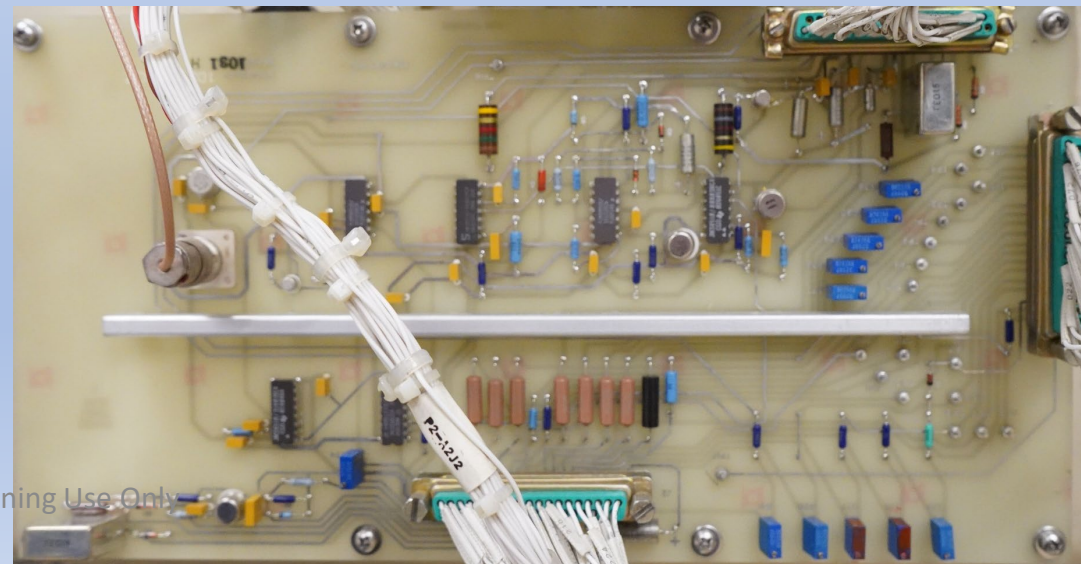
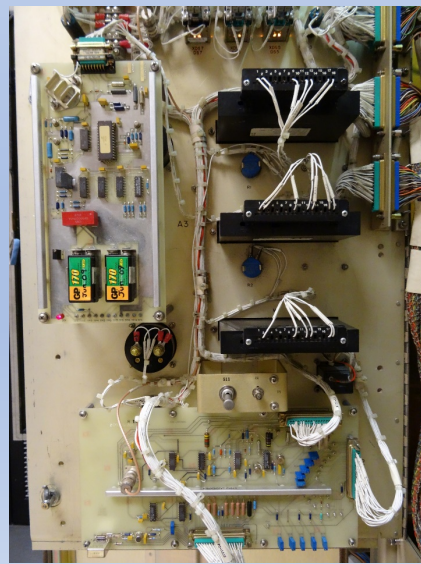

6. Connect oscilloscope to PFN Voltage Test Point A15TP1 (Figure FO11-28, Sheet 2). For optimum viewing, trigger oscilloscope at Transmitter Control Panel RF PULSE START. Ensure the oscilloscope input impedance is 1 M Ω .

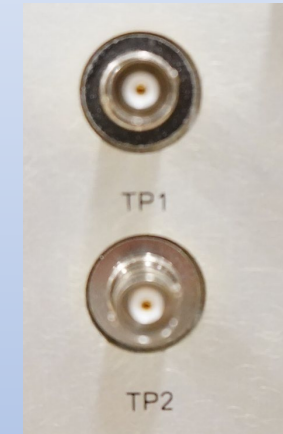
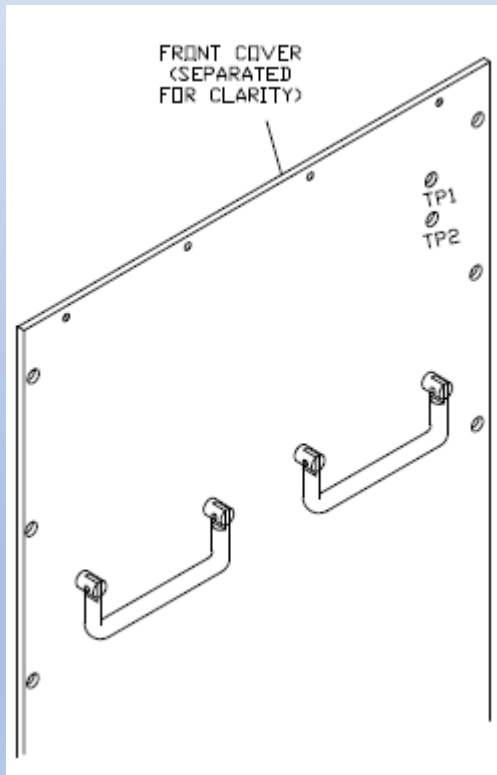

Turn the power on

- Return the interlock key to HIGH VOLTAGE POWER CB1 and rotate the key CCW.
- Set CABINET LIGHTS CB3, AUXILIARY POWER CB2, and HIGH VOLTAGE POWER CB1 to **ON**.



- Wait for the PREHEAT lamp to go out and the AVAILABLE lamp to illuminate (green).



10. On the Main RDA HCl, click on **System Test Software** and **Yes** to confirm. Click **Control ► AME/Receiver Control**; and select the following:

Test Source: **KLYSTRON OUTPUT**

Pulse Width: **Short Pulse**

PRF: **S1**

Click: **Inject Signal**

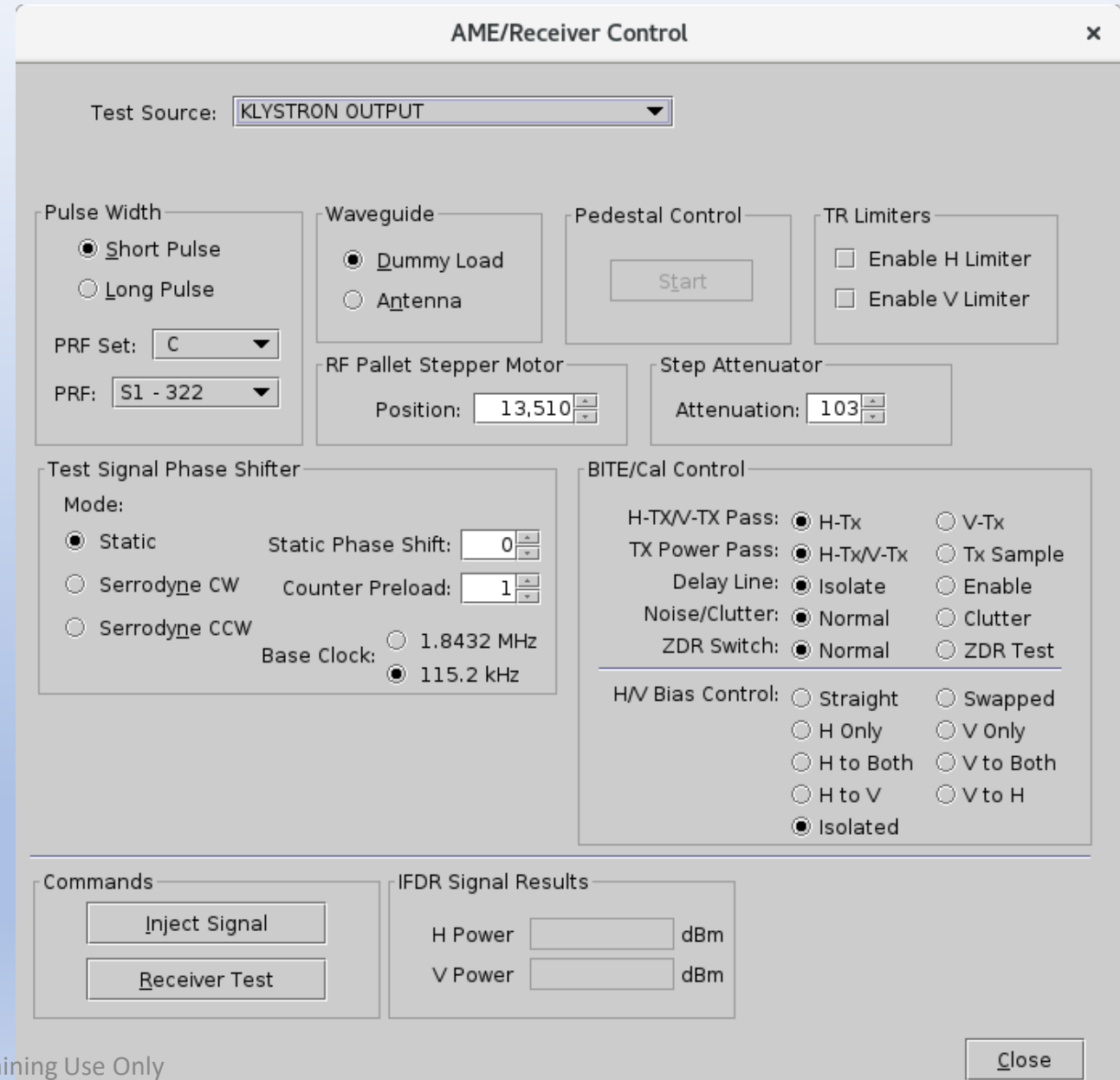
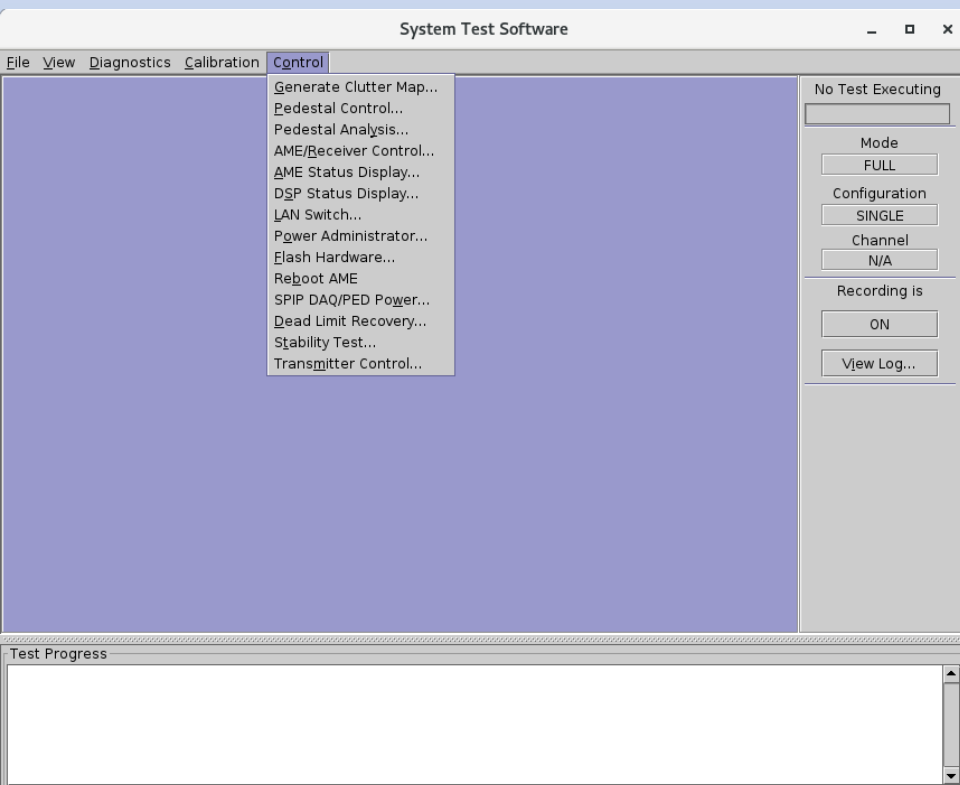
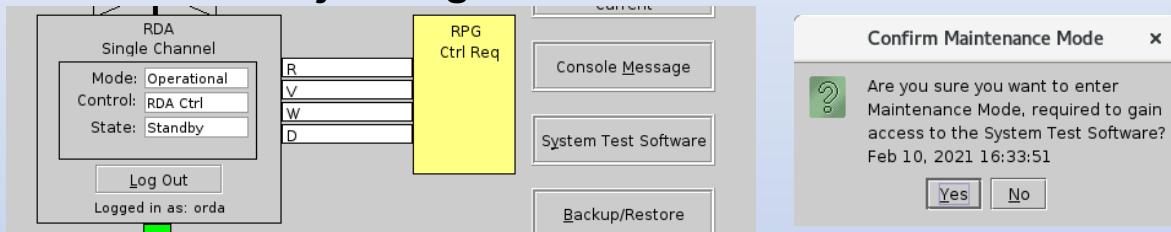

For Training Use Only

Close

11. See [Figure 4-12](#) and record PFN voltage waveform peak value.

_____ V

12. Calculate PFN voltage value by multiplying PFN voltage waveform peak value by 1000.

_____ V x 1000 = _____

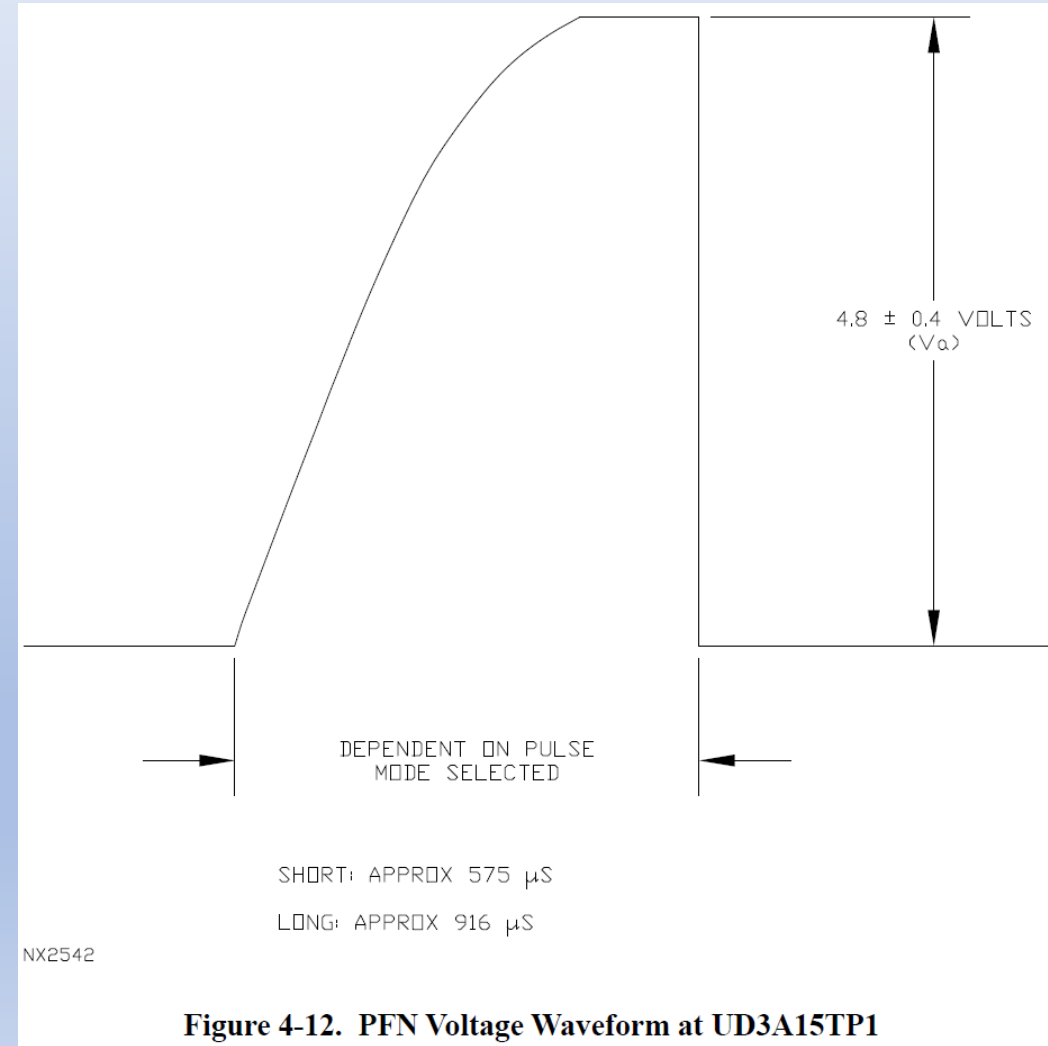
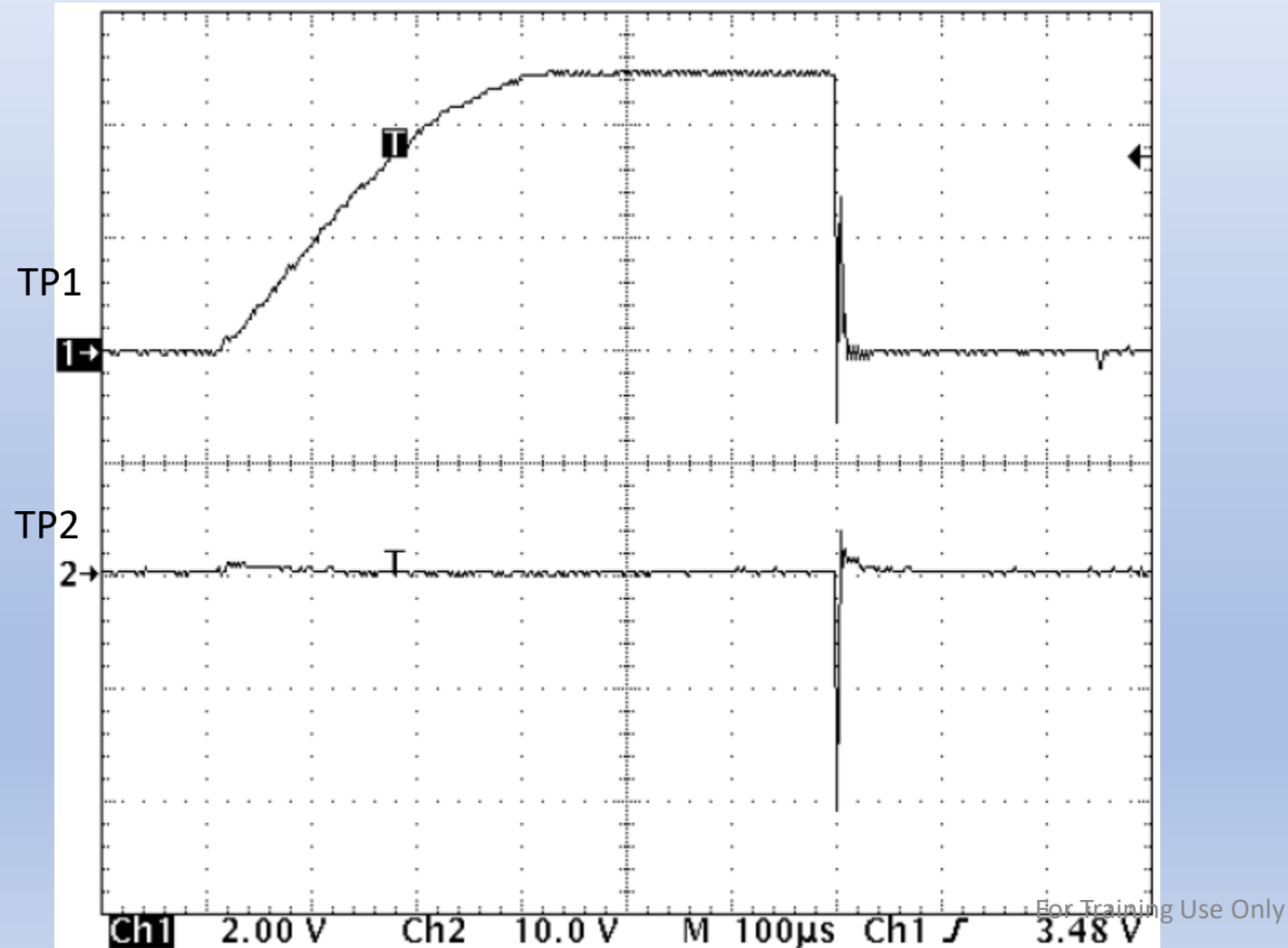
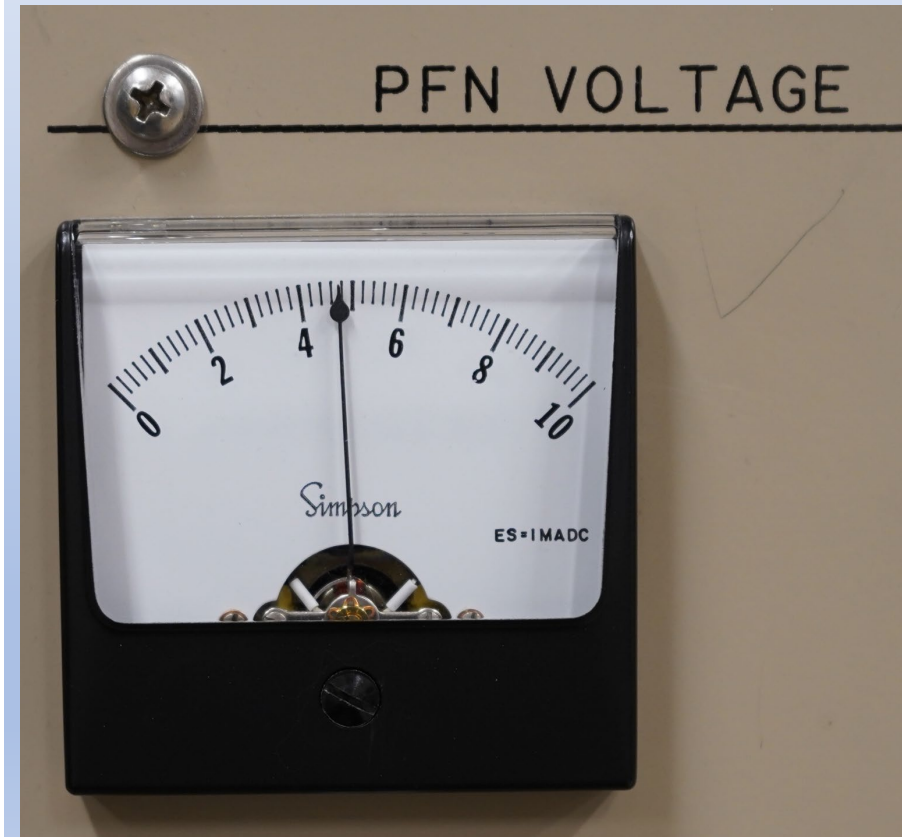
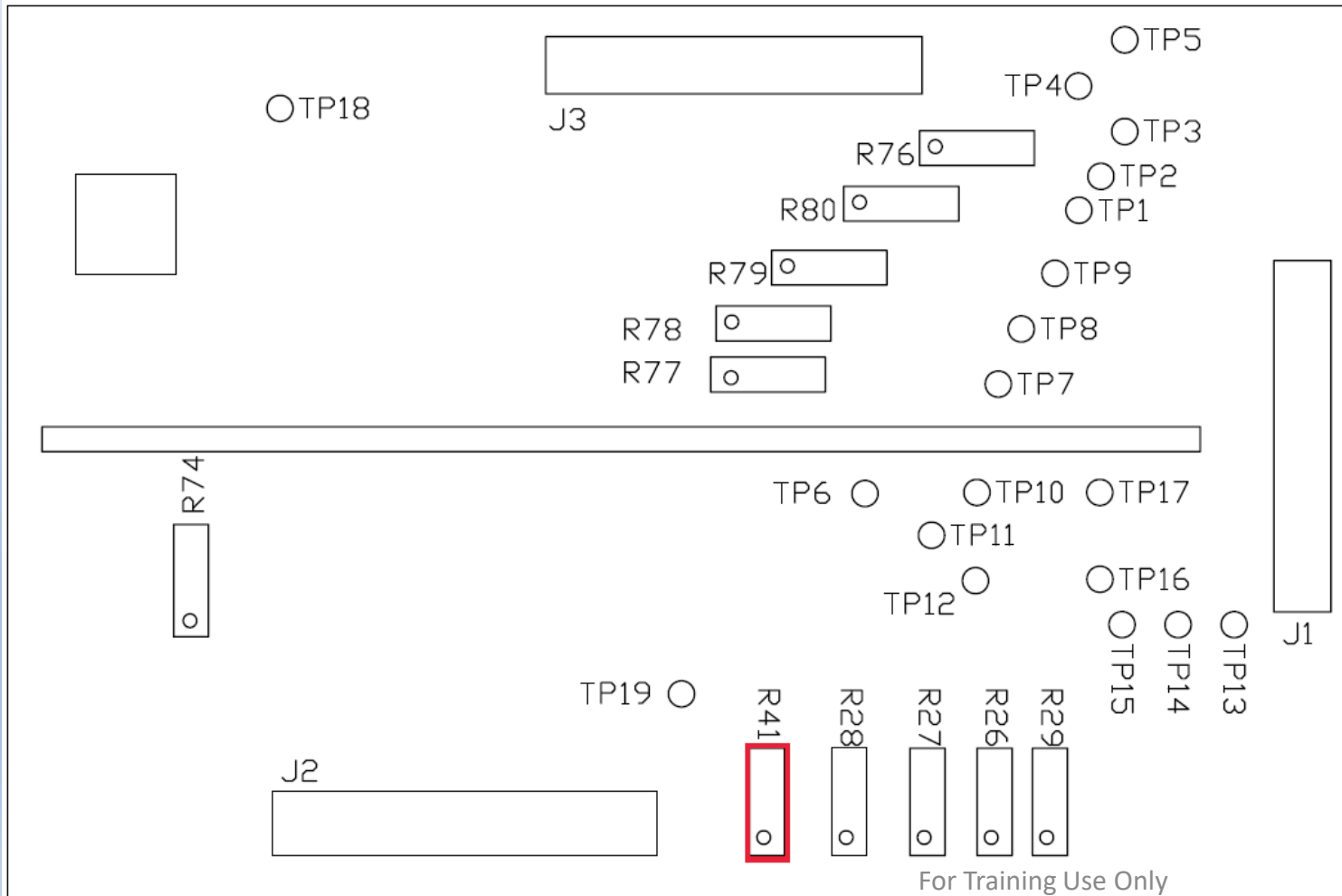

Figure 4-12. PFN Voltage Waveform at UD3A15TP1

4.5.5.5.3 Procedure.

1. On Metering Interface Board A1A2 (Figure 4-13 or Figure FO11-12), adjust Potentiometer R41 until voltage on PFN VOLTAGE Meter A1M5 reads calculated PFN voltage value.



If you were doing this as a stand-alone procedure you would normalize the system at this point.

2. In the AME/Receiver Control window, select the following:

Test Source: **NONE**

Click: **Inject Signal**

3. Close all System Test Software windows by clicking **Close**, **File**, and **Exit**. Click **Yes** and **OK** at pop-up windows.

4. Verify transmitter HV OFF indicator is illuminated (white), and set HIGH VOLTAGE POWER CB1 and AUXILIARY POWER CB2 to **OFF**.

5. Rotate HIGH VOLTAGE POWER CB1 interlock key CW and remove key.

6. Install panel stiffener to the back of Transmitter Control Panel A1.

7. Remove the interlock bypass tool from the interlock switch and lock the left bay inner door.

8. Refer to paragraph 3.4.1.5, steps 2 through 4 to power up and return transmitter to remote control.