

Catalogue
2021

PRO LINK

SUPPLY

Toll Free: 1-888-673-8839
Fax: 604-466-2023



Table of Contents

- About Us
- General Information and Forms
- Agricultural Products **** NEW PRODUCTS ****
- Chain Link Fittings
- Chain Link Mesh
- Pipe
- Flat Iron Ornamental **** PANELS DISCONTINUED ****
- Versai Rackable Ornamental **** NEW PRODUCTS ****
- V2 Rackable **** NEW PRODUCT ****
- Ornamental Railing Fencing **** DISCONTINUED ****
- Cantilever Hardware
- Vinyl **** NEW PRODUCT ****

About Us

Since 2005, ProLink Supply has been a growing and successful fencing supplier in British Columbia. Our company's commitment to working with our customers, as well as our ability to deliver products with a low turn around has defined the company over the years. This has been a leading formula for success.

Whether you're a chain link installer, a farm supply store, or even a landscaper, ProLink Supply has something for everyone. With great customer service and competitive pricing, it's no wonder we have been one of the fastest growing supply companies in B.C.

From signage to merchandisers, our company takes the lead in sales by working with our customers to ensure success with our products. We realize that your success is one of the most important facets of our business.

No one cares more about their customers success than we do.

General Information

Location

- 23416 River Road, Maple Ridge British Columbia
- We have a large yard which can accommodate any size truck in order to assist with all your shipping and delivery needs.

Hours of Operation

- Monday to Friday, with the exception of statutory holidays
- **OFFICE HOURS:** 7:00am to 4:00pm.
- **SHIPPING HOURS:** 7:00am to 3:00pm

Shipping Policies

- Unless otherwise arranged, all orders are to be picked up at our Maple Ridge location
- Where delivery has been arranged, a shipping charge will be added to the invoice.
- **ALL** Orders must be paid for in full before being loaded unless there is a credit account in good standing.
- **ALL** Pick Ups need to be scheduled in advance with our Shipping Department.

Credit Accounts

- ProLink Supply may offer credit terms of **NET 30 DAYS**, based on approval, to any customer in good standing
- We also reserve the right to suspend any accounts that do not comply with these terms.
- Our Credit Department will make every effort to collect all outstanding balances before any new orders will be released.
- A 2% interest charge (24% per annum) will be applied to overdue accounts.
- Any account which becomes inactive after a period of one year will be deleted from our system and will require a new credit application be submitted for approval.

General Information

Delivery Policies

- **All** items are considered the property of the Consignee as soon as the items are loaded.
- ProLink Supply is not responsible for any damage caused by a carrier.
- **All** shipments should be inspected upon arrival, and it is the responsibility of the customer to report any errors or damage within **5 BUSINESS DAYS**. (See Returned Goods Procedure)

Returned Goods Procedure

- **ANY MATERIALS** returned to our warehouse require prior approval from Sales Staff.
- Please call for a **RGA** (Return Goods Authorization), prior to returning the materials.
- ProLink Supply is not responsible for any returns that do not have a pre-approved RGA.
- **ALL** returned goods are subject to a 20% restocking fee.
- **ALL** returned goods must be returned at customer's expense.
- **SPECIAL ORDER OR NON-STOCKING ITEMS** are **NON REFUNDABLE** and are considered final sale at the time of purchase.
- **NO** Product will be accepted for return if:
 - The Material is a custom order or custom size.
 - The Material is not in resellable condition or packaging has been opened/installed.
 - The Material was purchased over 30 days prior to date of return.

New Products

PRO LINK **SUPPLY**

Agricultural



How to Read Agricultural Fencing Specs

Use the following example to decode the specifications for all our Farm Fence, Game Fence, and Horse Fence.

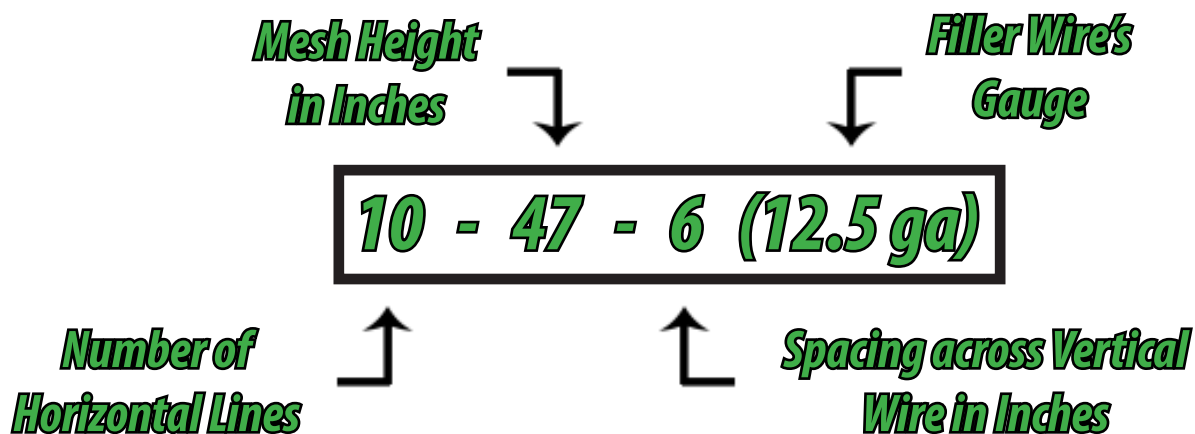

Agricultural Fence Knots

Hinge Joint Knot



The Hinge Joint Knot is a flexible knot that conforms to the terrain and minimizes damage caused by livestock and weather.

Fixed Knot



The Fixed Knot is designed to hold the vertical stay wires in place and is durable and resistant to animal damage.

Square Knot

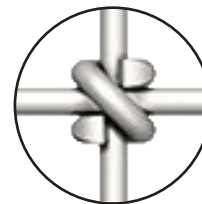

The Square Knot is ideal for the protection of livestock's skin and coats due to its smooth construction.

Graduated Agricultural Specifications

Game Fence - Fixed Knot

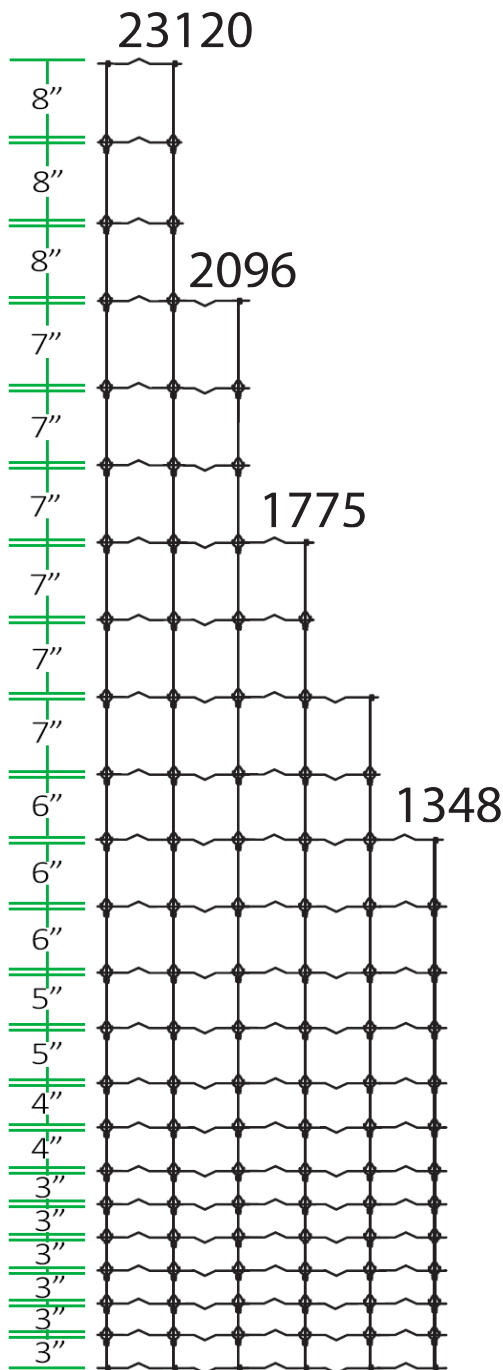

Field Fence - Hinge Joint Knot

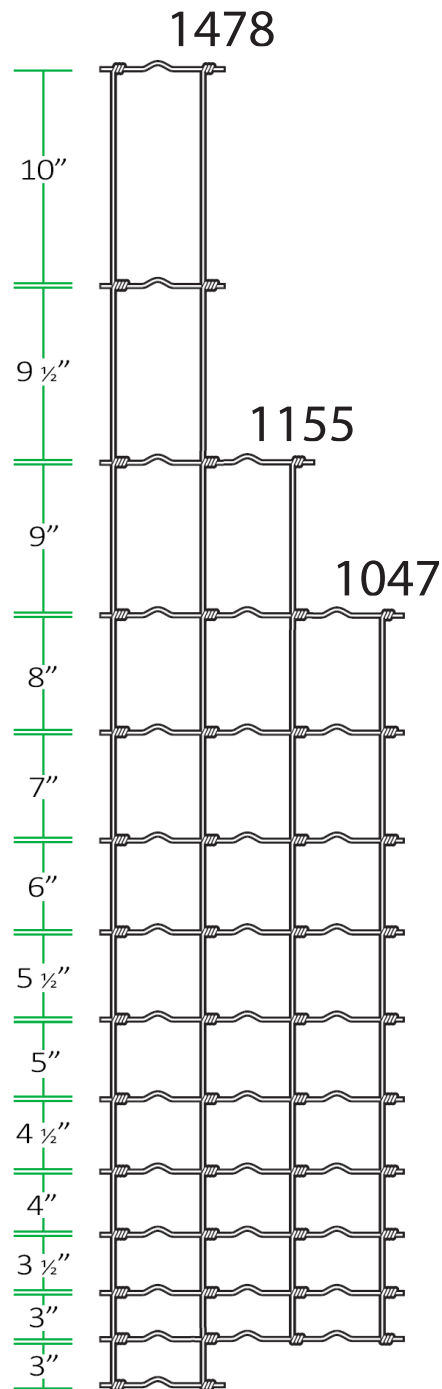

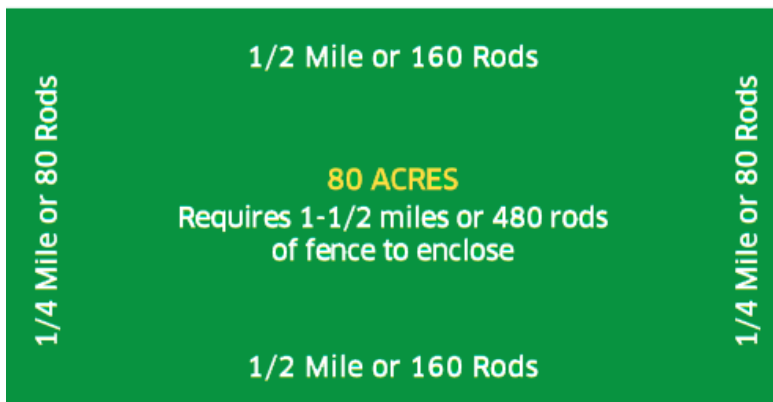
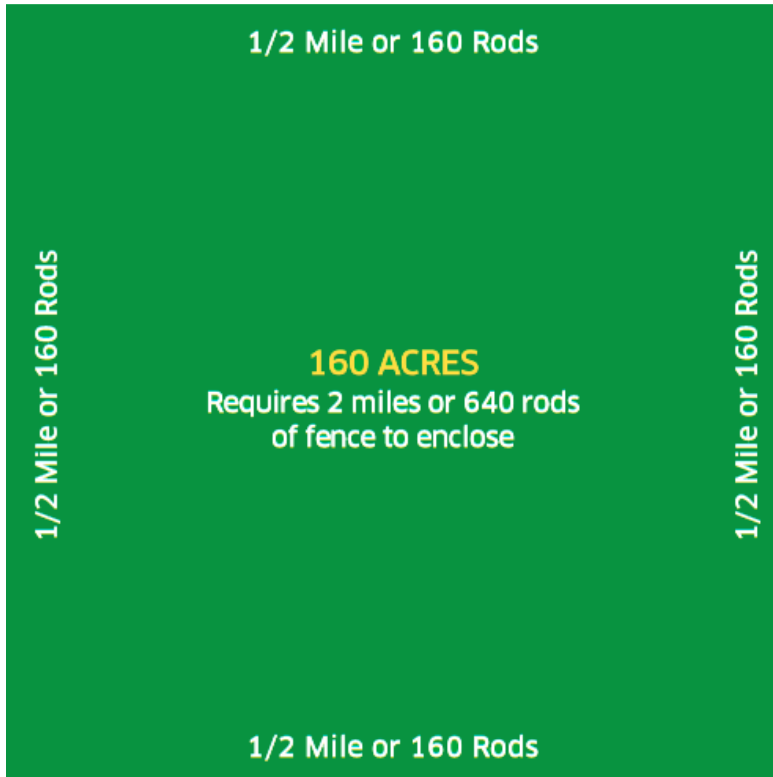

1/4 Mile = 1,320 ft or 80 Rods
 1/2 Mile = 2,640 ft or 160 Rods
 1 Mile = 5,280 ft or 320 Rods

1 Rod = 16 1/2 Ft
 10 Rods = 165 Ft
 20 Rods = 330 Ft

Farm Fence

Item No.	Description	Weight	Unit	Pallet Qty
18000	1155-6 Low Carb Galv. Farm Fence (12 1/2 Ga.)	213 lbs	Roll (330 ft)	9
18002	1047-6 Low Carb Galv. Farm Fence (12 1/2 Ga.)	194 lbs	Roll (330 ft)	9
18003	1047-6 Low Carb Galv. Farm Fence (12 1/2 Ga.)	95 lbs	Roll (165 ft)	16
18004	939-6 Low Carb Galv. Farm Fence (12 1/2 Ga.)	168 lbs	Roll (330 ft)	9
18006	832-6 Low Carb Galv. Farm Fence (12 1/2 Ga.) **	148 lbs	Roll (330 ft)	9
18033	2571-6 Low Carb Galv. Farm Fence (14 1/2 Ga.)	114 lbs	Roll (165 ft)	9

18010	1478-6 High Tensile Class 3 Galv. Farm Fence (12 1/2 Ga.)	265 lbs	Roll (330 ft)	9
18011	1478-12 High Tensile Class 3 Galv. Farm Fence (12 1/2 Ga.) **	165 lbs	Roll (330 ft)	9
18012	1047-6 High Tensile Class 3 Galv. Farm Fence (12 1/2 Ga.)	190 lbs	Roll (330 ft)	9
18014	939-6 High Tensile Class 3 Galv. Farm Fence (12 1/2 Ga.)	168 lbs	Roll (330 ft)	9
18016	832-6 High Tensile Class 3 Galv. Farm Fence (12 1/2 Ga.) **	148 lbs	Roll (330 ft)	9
18030	1047-6 High Tensile Class 3 Galv. Farm Fence (14 1/2 Ga.)	120 lbs	Roll (330 ft)	9
18032	939-6 High Tensile Class 3 Galv. Farm Fence (14 1/2 Ga.)	106 lbs	Roll (330 ft)	9

**** Call for Availability**



Game Fence

Item No.	Description	Weight	Unit	Pallet Qty
18102	2096-6 High Tensile Class 3 Galv. Solid Lock (12 1/2 Ga.)	396 lbs	Roll (330 ft)	4
18104	2096-12 High Tensile Class 3 Galv. Solid Lock (12 1/2 Ga.) **	264 lbs	Roll (330 ft)	1
18106	1775-6 High Tensile Class 3 Galv. Solid Lock (12 1/2 Ga.) **	327 lbs	Roll (330 ft)	6
18108	1775-12 High Tensile Class 3 Galv. Solid Lock (12 1/2 Ga.) **	243 lbs	Roll (330 ft)	6
18110	1060-6 High Tensile Class 3 Galv. Solid Lock (12 1/2 Ga.)	210 lbs	Roll (330 ft)	6
18112	1060-12 High Tensile Class 3 Galv. Solid Lock (12 1/2 Ga.) **	294 lbs	Roll (660 ft)	1
18114	949-6 High Tensile Class 3 Galv. Solid Lock (12 1/2 Ga.) **	182 lbs	Roll (330 ft)	6
18116	949-12 High Tensile Class 3 Galv. Solid Lock (12 1/2 Ga.) **	129 lbs	Roll (330 ft)	9
18035	1478-6 High Tensile Class 3 Galv. Solid Lock (14 1/2 Ga.)	105 lbs	Roll (165 ft)	16

**** Call for Availability**

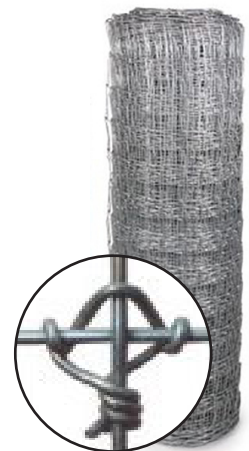

Crimped Lawn Fence

Item No.	Description	Weight	Unit	Pallet Qty
18360	36" Class 3 Galv. Crimped Lawn Fence (12 1/2 Ga.)	74 lbs	Roll (100 ft)	9
18362	48" Class 3 Galv. Crimped Lawn Fence (12 1/2 Ga.)	98 lbs	Roll (100 ft)	9
18364	60" Class 3 Galv. Crimped Lawn Fence (12 1/2 Ga.)	122 lbs	Roll (100 ft)	9
18366	72" Class 3 Galv. Crimped Lawn Fence (12 1/2 Ga.)	146 lbs	Roll (100 ft)	9

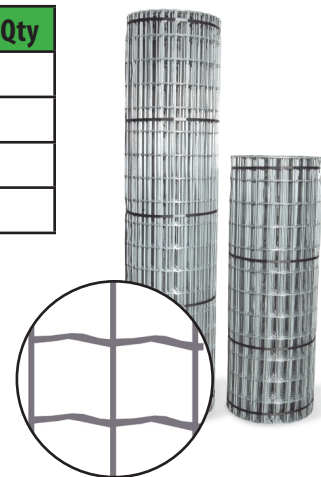

Poultry Wire/Hex Netting

Item No.	Description	Weight	Unit
18200	36" x 1" Hex Netting	6.3 lbs	Roll (25 ft)
18202	48" x 1" Hex Netting	8.5 lbs	Roll (25 ft)
18210	36" x 2" Hex Netting	3.25 lbs	Roll (25 ft)
18212	48" x 2" Hex Netting	4.42 lbs	Roll (25 ft)

18220	24" x 1" Hex Netting	6 lbs	Roll (50 ft)
18222	36" x 1" Hex Netting	12.6 lbs	Roll (50 ft)
18224	48" x 1" Hex Netting	17 lbs	Roll (50 ft)
18226	60" x 1" Hex Netting	21.25 lbs	Roll (50 ft)
18228	72" x 1" Hex Netting	25.5 lbs	Roll (50 ft)

18230	24" x 2" Hex Netting	4.5 lbs	Roll (50 ft)
18232	36" x 2" Hex Netting	6.5 lbs	Roll (50 ft)
18234	48" x 2" Hex Netting	8.84 lbs	Roll (50 ft)

18223	36" x 1" Hex Netting	10 lbs	Roll (100 ft)
-------	----------------------	--------	---------------



Multi-Purpose Mesh

Item No.	Description	Weight	Unit	Pallet Qty
18260	36" x 50' Galv. Multi-Purpose Mesh (14 Ga.)	24 lbs	Roll (50 ft)	16
18264	48" x 50' Galv. Multi-Purpose Mesh (14 Ga.)	32 lbs	Roll (50 ft)	16
18268	60" x 50' Galv. Multi-Purpose Mesh (14 Ga.)	40 lbs	Roll (50 ft)	16
18272	72" x 50' Galv. Multi-Purpose Mesh (14 Ga.)	48 lbs	Roll (50 ft)	16

18262	36" x 100' Galv. Multi-Purpose Mesh (14 Ga.)	48 lbs	Roll (100ft)	9
18266	48" x 100' Galv. Multi-Purpose Mesh (14 Ga.)	64 lbs	Roll (100ft)	9
18270	60" x 100' Galv. Multi-Purpose Mesh (14 Ga.)	80 lbs	Roll (100ft)	9
18274	72" x 100' Galv. Multi-Purpose Mesh (14 Ga.)	96 lbs	Roll(100ft)	9

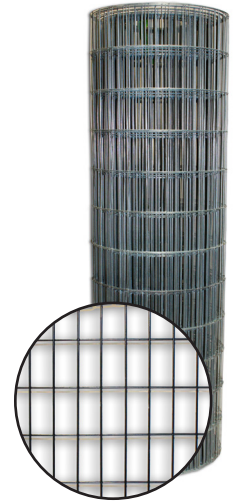

Horse Fence

Item No.	Description	Weight	Unit	Pallet Qty
18180	1348-2 (4" x 2") Galv. Stablemesh (12 1/2 Ga.)	122 lbs	Roll (100 ft)	9
18182	1660-2 (4" x 2") Galv. Stablemesh (12 1/2 Ga.)	151 lbs	Roll (100 ft)	9

18184	1348-2 (4" x 2") BLACK Stablemesh (12 1/2 Ga.)	122 lbs	Roll (100 ft)	8
18186	1660-2 (4" x 2") BLACK Stablemesh (12 1/2 Ga.)	151 lbs	Roll (100 ft)	8

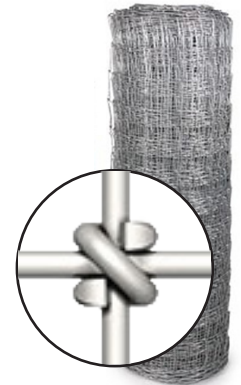

	STYLE	HORIZONTAL WIRES	HEIGHT	LINE/STAY WIRE GAUGE	EDGE WIRE GAUGE	ROLL LENGTH
STANDARD	726-6-12 1/2	7	26"	12 1/2	10	330'
	832-6-12 1/2	8	32"	12 1/2	10	330'
	939-6-12 1/2	9	39"	12 1/2	10	330'
	1047-6-12 1/2	10	47"	12 1/2	10	330'
	1155-6-12 1/2	11	55"	12 1/2	10	330'
	832-12-12 1/2	8	32"	12 1/2	10	330'
	939-12-12 1/2	9	39"	12 1/2	10	330'
	1047-12-12 1/2	10	47"	12 1/2	10	330'
HIGH TENSILE CLASS 3	832-6-14	8	32"	14	12 1/2	330'
	939-6-14	9	39"	14	12 1/2	330'
	1047-6-14	10	47"	14	12 1/2	330'

ASTM Commercial, Class 1, or Class 3 Galvanizing

Stucco Mesh

Item No.	Description	Weight	Unit	Pallet Qty
18379	2 x 2 x 48" Stucco Mesh (16 Ga.) - 50 ft Roll	27 lbs	Roll (50 ft)	36
18380	2 x 2 x 48" Stucco Mesh (16 Ga.) - 112 ft Roll	55 lbs	Roll (112 ft)	9
18382	2 x 2 x 54" Stucco Mesh (16 Ga.) - 100 ft Roll	55 lbs	Roll (100 ft)	16

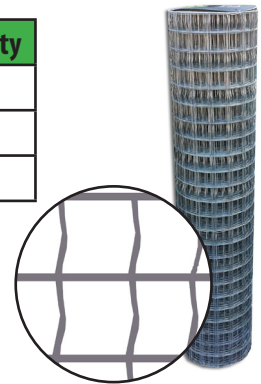

Hardware Cloth

Item No.	Description	Weight	Unit
18421	1/8" x 36" Galv. Hardware Cloth	25 lbs	Roll (50 ft)
18426	1/4" x 36" Galv. Hardware Cloth	52 lbs	Roll (100 ft)
18429	1/2" x 36" Galv. Hardware Cloth	31 lbs	Roll (50 ft)
18437	1" x 36" Galv. Hardware Cloth	16 lbs	Roll (50 ft)
18438	1" x 36" Galv. Hardware Cloth	32 lbs	Roll (100 ft)
18449	1/2" x 48" Galv. Hardware Cloth	41 lbs	Roll (50 ft)

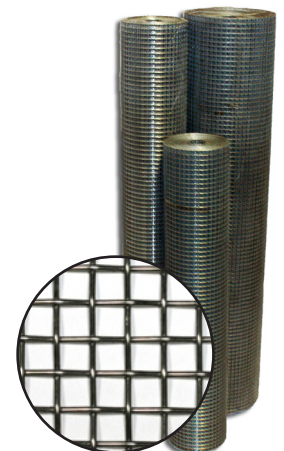

Safety Fence

Item No.	Description	Weight	Unit
17716-OR	1 1/2" x 1 1/2" x 48" Safety Fence - Orange	12 lbs	Roll (50 ft)
17716-GR	1 1/2" x 1 1/2" x 48" Safety Fence - Green	12 lbs	Roll (50 ft)



Merchant Coils

Item No.	Description	Weight	Unit	Approx FT per Roll
18496	16 Ga. Galv. Merchant Coils	10 lbs	Each	973 ft
18498	14 Ga. Galv. Merchant Coils	10 lbs	Each	580 ft
18502	12 Ga. Galv. Merchant Coils	10 lbs	Each	375 ft
18506	9 Ga. Galv. Merchant Coils	10 lbs	Each	180 ft

18500	14 Ga. Galv. Merchant Coils	50 lbs	Each	2900 ft
18504	12 Ga. Galv. Merchant Coils	50 lbs	Each	1875 ft
18508	9 Ga. Galv. Merchant Coils	50 lbs	Each	900 ft

18513	14 Ga. Black Annealed Merchant Coils	10 lbs	Each	650 ft
18512	12 Ga. Black Annealed Merchant Coils	10 lbs	Each	330 ft
18516	9 Ga. Black Annealed Merchant Coils	10 lbs	Each	170 ft

18510	12 Ga. Black Annealed Merchant Coils	50 lbs	Each	1650 ft
18518	9 Ga. Black Annealed Merchant Coils	50 lbs	Each	850 ft

18530	12.5 Ga. Galv. Hi-Tensile (Wood Spool)	100 lbs	Each	3800 ft
-------	--	---------	------	---------



Electric Fence Wire

Item No.	Description	Weight	Unit
18533	Electric Fence Wire 17 Ga. (4 x 1/4 mile spools per Box)	41lbs	Box
18534	Electric Fence Wire 14 Ga. (2 x 1/4 mile spools per Box)	45lbs	Box
18535	Electric Fence Wire 16 Ga. (4 x 1/4 mile spools per Box)	57lbs	Box



Fence Stays

Item No.	Description	Weight	Unit	Bundle Qty
18552	42" Barb Wire Droppers Fence Stays	41 lbs	Bundle	100
18554	48" Barb Wire Droppers Fence Stays	47 lbs	Bundle	100

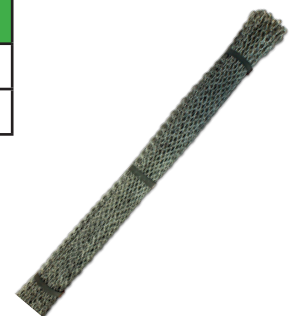

T Posts

Item No.	Description	Weight	Unit	Bundle Qty
18600	6' .95 lbs/Foot Painted "T" Post	6 lbs	Each	200
18602	7' .95 lbs/Foot Painted "T" Post	7 lbs	Each	200
18604	8' .95 lbs/Foot Painted "T" Post	8 lbs	Each	200
18606	9' 1.25 lbs/Foot Painted "T" Post - Heavy	11 lbs	Each	100
18608	10' 1.25 lbs/Foot Painted "T" Post - Heavy	13 lbs	Each	100



U Posts

***** NEW PRODUCT *****

Item No.	Description	Weight	Unit
18614	6' Black U Post	4 lbs	Each



Post Pounders

Item No.	Description	Weight	Unit
18628	Small (T Post) Pounder	50 lbs	Each
18630	4 1/2" x 24" Medium Post Pounder	50 lbs	Each
18632	6 5/8" x 24" Large Post Pounder	55 lbs	Each



Barbed Wire

Item No.	Description	Weight	Unit	Ft per Roll	Pallet Qty
06200-GA	15 1/2 Ga. Class 3 High Tensile Barbed Wire	37 lbs	Roll	1320 ft	27
06202-GA	12 1/2 Ga. Barbless Barbed Wire	70 lbs	Roll	1320 ft	48
06204-GA	12 1/2 Ga. Canadian Standard Barbed Wire	80 lbs	Roll	1320 ft	27
06206-GA	12 1/2 Ga. Class 3 Barbed Wire	81 lbs	Roll	1320 ft	27
06206-BL	12 1/2 Ga. Class 3 Barbed Wire- Black **	82 lbs	Roll	1320 ft	27



06203-GA	12 1/2 Ga. Canadian Standard Barbed Wire - Half Roll	40 lbs	Roll	660 ft	84
----------	--	--------	------	--------	----

**** Call for Availability**

Barbed Wire - Import

Item No.	Description	Weight	Unit	Ft per Roll	Pallet Qty
06204-IMP	12 1/2 Ga. Canadian Standard Barbed Wire IMPORT	80 lbs	Roll	1320 ft	27
06206-IMP	12 1/2 Ga. Class 3 Barbed Wire IMPORT	81 lbs	Roll	1320 ft	27

Fence Staples

Item No.	Description	Weight	Unit	Approx Staples
18562	7/8" Galv. Plastic Pail Fence Staples	8 lbs	Pail	2080
18564	1 1/4" Galv. Plastic Pail Fence Staples (Barbed)	8 lbs	Pail	752
18566	1 1/2" Galv. Plastic Pail Fence Staples (Barbed)	8 lbs	Pail	560
18568	1 3/4" Galv. Plastic Pail Fence Staples (Barbed)	8 lbs	Pail	440
18570	2" Galv. Plastic Pail Fence Staples (Barbed)	8 lbs	Pail	264
18574	1 1/4" Galv. Plastic Pail Fence Staples (Barbed)	30 lbs	Pail	2820
18576	1 1/2" Galv. Plastic Pail Fence Staples (Barbed)	30 lbs	Pail	2100
18578	1 3/4" Galv. Plastic Pail Fence Staples (Barbed)	30 lbs	Pail	1650
18580	2" Galv. Plastic Pail Fence Staples (Barbed)	30 lbs	Pail	990
18584	7/8" Galv. Plastic Pail Fence Staples	50 lbs	Box	13000
18586	1 1/4" Galv. Plastic Pail Fence Staples (Barbed)	50 lbs	Pail	4700
18588	1 1/2" Galv. Plastic Pail Fence Staples (Barbed)	50 lbs	Pail	3500
18590	1 3/4" Galv. Plastic Pail Fence Staples (Barbed)	50 lbs	Pail	2750
18592	2" Galv. Plastic Pail Fence Staples (Barbed)	50 lbs	Pail	1650



Square Corner Garden Gates

Item No.	Description	Weight	Unit
17005-GA	46" High x 42" Opening - Galv (1 3/8" Frame)	23 lbs	Each
17012-GA	58" High x 42" Opening - Galv (1 3/8" Frame)	26 lbs	Each
17005-BL	46" High x 42" Opening - Black (1 3/8" Frame)	23 lbs	Each
17012-BL	58" High x 42" Opening - Black (1 3/8" Frame)	26 lbs	Each



Garden Gate Hardware Needed:
2 Gate Post Hinges, 2 Gate Frame Hinges, a Latch of your choice, and Carriage Bolts



Round Corner Flat Iron Gate: Meshed

All Farm Gates are 50" tall

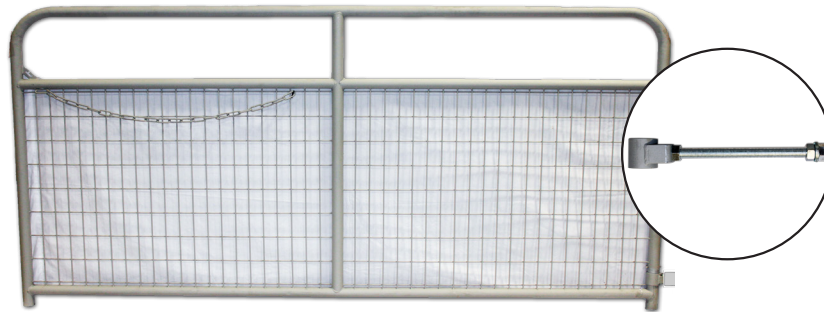

Item No.	Description	Powdercoated	Weight	Unit
18720	4' Round Corner Mesh Gate (4" x 2")	Grey	31 lbs	Each
18721	6' Round Corner Mesh Gate (4" x 2")	Grey	42 lbs	Each
18722	8' Round Corner Mesh Gate (4" x 2")	Grey	57 lbs	Each
18723	10' Round Corner Mesh Gate (4" x 2")	Grey	68 lbs	Each
18724	12' Round Corner Mesh Gate (4" x 2")	Grey	79 lbs	Each
18725	14' Round Corner Mesh Gate (4" x 2")	Grey	92 lbs	Each
18726	16' Round Corner Mesh Gate (4" x 2")	Grey	101 lbs	Each

Square Corner Flat Iron Gate: Meshed

All Farm Gates are 50" tall

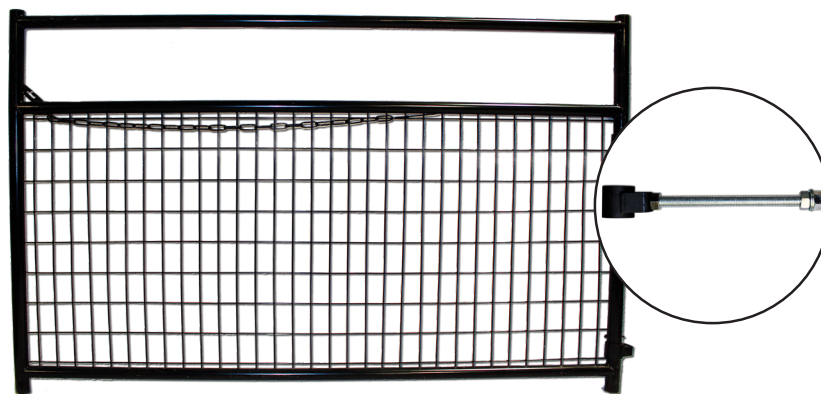

Item No.	Description	Powdercoated	Weight	Unit
18730-BL	3 1/2' Square Corner Mesh Gate	Black	29 lbs	Each
18731-BL	4' Square Corner Mesh Gate	Black	32 lbs	Each
18732-BL	6' Square Corner Mesh Gate	Black	42 lbs	Each
18733-BL	8' Square Corner Mesh Gate	Black	57 lbs	Each
18734-BL	10' Square Corner Mesh Gate	Black	68 lbs	Each
18735-BL	12' Square Corner Mesh Gate	Black	81 lbs	Each
18736-BL	14' Square Corner Mesh Gate	Black	103 lbs	Each
18737-BL	16' Square Corner Mesh Gate	Black	116 lbs	Each

Round Corner Flat Iron Gate: 5-Rail

All Farm Gates are 50" tall

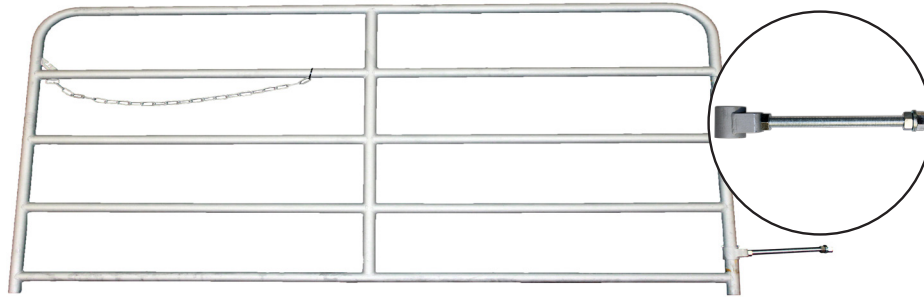

Item No.	Description	Powdercoated	Weight	Unit
18700	4' Round Corner Tube Gate	Grey	31 lbs	Each
18701	6' Round Corner Tube Gate	Grey	40 lbs	Each
18702	8' Round Corner Tube Gate	Grey	55 lbs	Each
18703	10' Round Corner Tube Gate	Grey	66 lbs	Each
18704	12' Round Corner Tube Gate	Grey	77 lbs	Each
18705	14' Round Corner Tube Gate	Grey	90 lbs	Each
18706	16' Round Corner Tube Gate	Grey	101 lbs	Each

Square Corner Flat Iron Gate: 5-Rail

All Farm Gates are 50" tall



Item No.	Description	Powdercoated	Weight	Unit
18750-BL	4' Square Corner 5 Rail Gate	Black	29 lbs	Each
18751-BL	6' Square Corner 5 Rail Gate	Black	38 lbs	Each
18752-BL	8' Square Corner 5 Rail Gate	Black	53 lbs	Each
18753-BL	10' Square Corner 5 Rail Gate	Black	63 lbs	Each
18754-BL	12' Square Corner 5 Rail Gate	Black	73 lbs	Each
18755-BL	14' Square Corner 5 Rail Gate	Black	87 lbs	Each
18756-BL	16' Square Corner 5 Rail Gate	Black	98 lbs	Each



Square Corner Deer Gate: 72"

*** NEW PRODUCT ***

Item No.	Description	Weight	Unit
18761	4'W x 72"H (1 5/8") Black Mesh Deer Gate	39 lbs	Each
18762	6'W x 72"H (1 5/8") Black Mesh Deer Gate	52.5 lbs	Each
18763	8'W x 72"H (1 5/8") Black Mesh Deer Gate	70.5 lbs	Each
18764	10'W x 72"H (1 5/8") Black Mesh Deer Gate	84.25 lbs	Each
18765	12'W x 72"H (1 5/8") Black Mesh Deer Gate	97.75 lbs	Each
18766	14'W x 72"H (1 5/8") Black Mesh Deer Gate	114.75 lbs	Each
18767	16'W x 72"H (1 5/8") Black Mesh Deer Gate	128.25 lbs	Each

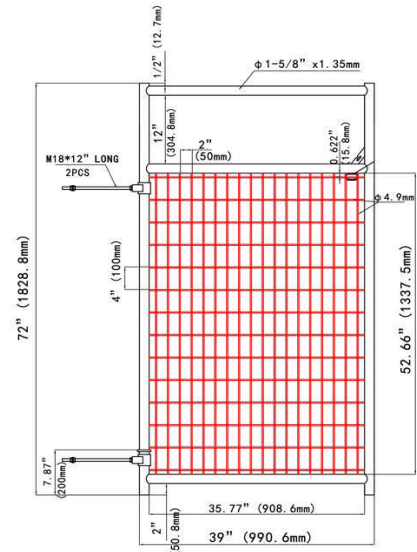

Square Corner Deer Gate: 90"

Item No.	Description	Weight	Unit
18771	4'W x 90"H (1 5/8") Black Mesh Deer Gate	45 lbs	Each
18772	6'W x 90"H (1 5/8") Black Mesh Deer Gate	60.5 lbs	Each
18773	8'W x 90"H (1 5/8") Black Mesh Deer Gate	82.25 lbs	Each
18774	10'W x 90"H (1 5/8") Black Mesh Deer Gate	97.75 lbs	Each
18775	12'W x 90"H (1 5/8") Black Mesh Deer Gate	113 lbs	Each
18776	14'W x 90"H (1 5/8") Black Mesh Deer Gate	133.25 lbs	Each
18777	16'W x 90"H (1 5/8") Black Mesh Deer Gate	149 lbs	Each

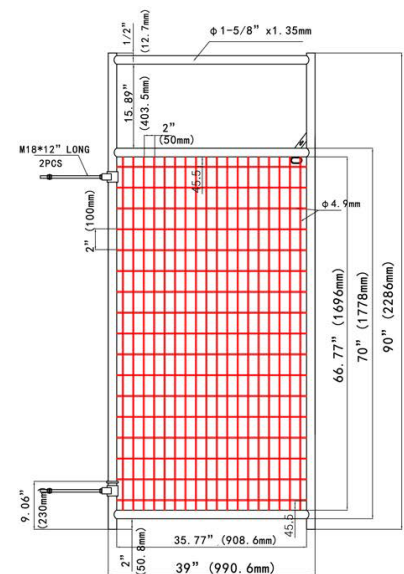

Ungulate Gate

Item No.	Description	Weight	Unit
18695	One-way Wildlife Gate**	500 lbs	Each

** Special Order

10'x10' Flat Iron Dog Kennel - Galv Meshed

Item No.	Description	Weight
17210	10' x 6' Dog Kennel Panel; 1 3/8" Frame 11ga Mesh	180 lbs
17210WD	10' x 6' Dog Kennel Panel with Door; 1 3/8" Frame 11ga Mesh	180 lbs

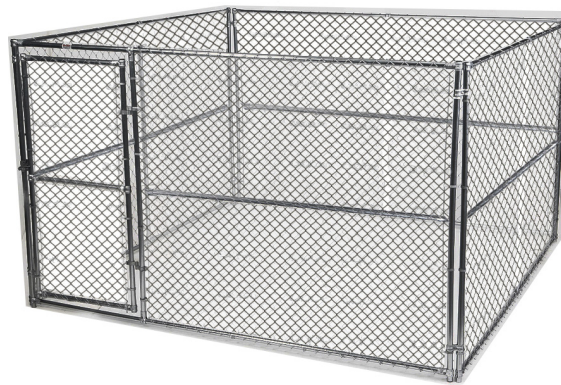

10'x10' Flat Iron Dog Kennel - Black Welded

Item No.	Description	Weight
17230PN	10' x 6' Dog Kennel Panel; 1 3/8" Frame Black Welded	70 lbs
17230DR	10' x 6' Dog Kennel Panel with Door; 1 3/8" Frame Black Welded	70 lbs

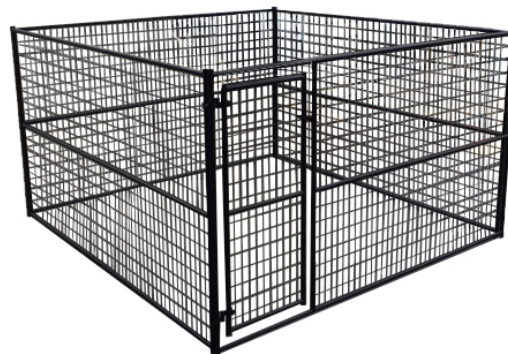

**Standard Dog Kennel Consists of:
3 Dog Kennel Panels & 1 Dog Kennel Panel with Door**



Flat Iron Corral Panel

Item No.	Description	Weight	Unit
18670-BL	Corral Panel (10' wide x 60" High) - Black	60 lbs	Each

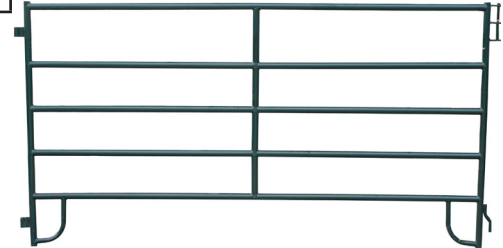

Flat Iron Corral Panels : Entrance Gate

Item No.	Description	Weight	Unit
18680-BL	Ride Through Gate (6' Opening x 114" High) - Black	65 lbs	Each



Flat Iron Corral Panels : Walk Through Gate

Item No.	Description	Weight	Unit
18682-BL	Walk Through Gate (10' wide x 90" High, 6' Opening) - Black	81 lbs	Each



Cattle Panel

Item No.	Description	Weight	Unit	Bundle Qty
17400	Cattle Panel (50" high x 16' wide)	34 lbs	Each	50

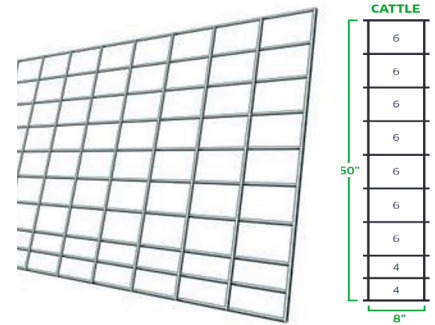

Galvanized Hog Panel

Item No.	Description	Weight	Unit	Bundle Qty
17410	Galv. Hog Panel (34" high x 16' wide)	33 lbs	Each	50

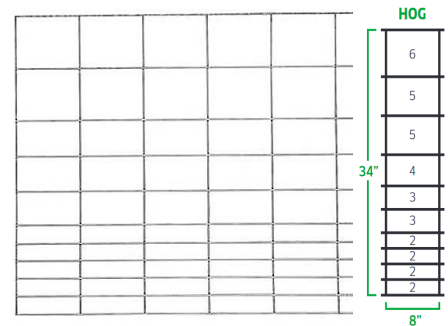

Fence Panel

Item No.	Description	Weight	Unit	Bundle Qty
17420	Galv. Fence Panel (48" high x 16' wide)	51 lbs	Each	50

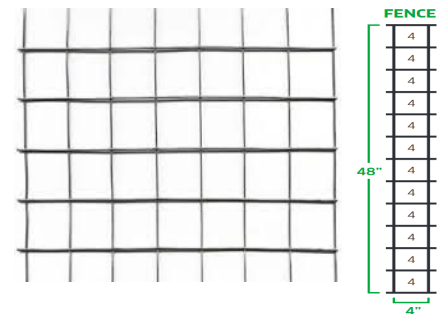

Latches

Item No.	Description	Weight	Unit
18660	Kiwi Latch	0.3 lbs	Each
18662	2 Way Gate Latch - Lockable**	0.3 lbs	Each

**** Call for Availability**

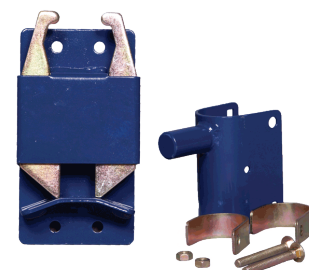

Ty-Ten Latch **** NEW PRODUCT ****

Item No.	Description	Weight	Unit
18667	Ty-Ten Lok Gate Latch	3 lbs	Each



Gate Frame Hinge

Item No.	Description	Type	/Bag	Weight
05100-XX	1 3/8" Gate Frame Hinge (5/8")	PS,BL	100	0.4 lbs
* 3/8" x 2" Bolt and Nut Required (AGR 16)				
05102-XX	1 5/8" Gate Frame Hinge (5/8")	PS,BL	50	0.5 lbs
* 3/8" x 2 1/4" Bolt and Nut Required (AGR 16)				
05104-PS	1 7/8" Gate Frame Hinge (5/8")	PS	50	0.9 lbs
* 3/8" x 2 1/2" Bolt and Nut Required (AGR 16)				



Gate Post Hinge

Item No.	Description	Type	/Bag	Weight
05110-PS	1 3/8" Gate Post Hinge (5/8")	PS	50	0.5 lbs
* 3/8" x 2 1/4" Bolt and Nut Required (AGR 16)				
05112-PS	1 5/8" Gate Post Hinge (5/8")	PS	50	0.5 lbs
* 3/8" x 2 1/4" Bolt and Nut Required (AGR 16)				
05114-XX	1 7/8" Gate Post Hinge (5/8")	PS,BL	50	0.7 lbs
* 3/8" x 2 1/2" Bolt and Nut Required (AGR 16)				
05116-XX	2 3/8" Gate Post Hinge (5/8")	PS,BL	50	0.9 lbs
* 3/8" x 3" Bolt and Nut Required (AGR 16)				
05118-XX	2 7/8" Gate Post Hinge (5/8")	PS,BL	50	1.1 lbs
* 3/8" x 3 1/2" Bolt and Nut Required (AGR 16)				
05120-PS	3 1/2" Gate Post Hinge (5/8")	PS	50	1.1 lbs
* 3/8" x 4" Bolt and Nut Required (AGR 16)				



Flat Back Pin Hinge

Item No.	Description	Type	/Bag	Weight
05126-PS	Flat Back Pin Hinge (5/8")	PS	50	1.1 lbs



Fork Latch

Item No.	Description	Type	/Bag	Weight
05010-PS	1 3/8" x 1 3/8"	PS	25	0.8 lbs
05011-PS	1 3/8" x 1 5/8"	PS	25	0.8 lbs
05012-XX	1 3/8" x 1 7/8"	PS,BL	25	1.0 lbs
05014-XX	1 3/8" x 2 3/8"	PS,BL,MA	25	1.1 lbs
05016-XX	1 3/8" x 2 7/8"	PS,MA	25	0.8 lbs
05017-PS	1 5/8" x 1 7/8"	PS	25	1.1 lbs
05018-XX	1 5/8" x 2 3/8"	PS,BL,BM,MA	25	1.1 lbs
05020-XX	1 5/8" x 2 7/8"	PS,BL,BM,MA	25	1.5 lbs
05022-XX	1 5/8" x 3 1/2"	PS,BL,BM,MA	25	1.8 lbs



Build-a-Fork-Latch

Item No.	Description	Type	/Bag	Weight
05002-PS	1 3/8" Two Piece Collar for Fork Latch	PS	100	0.4 lbs
05003-PS	1 5/8" Two Piece Collar for Fork Latch	PS	100	0.6 lbs

* Two 5/16" x 1 1/4" Bolt and Nut Required for Two Piece Collar (AGR 16)

05004-PS	1 3/8" Gate Forks for Collars	PS	100	0.4 lbs
05005-PS	1 5/8" Gate Forks for Collars	PS	100	0.6 lbs
05006-PS	1 7/8" Gate Forks for Collars	PS	100	0.8 lbs
05007-PS	2 3/8" Gate Forks for Collars	PS	100	1 lbs
05008-PS	2 7/8" Gate Forks for Collars	PS	50	1.2 lbs

05009-PS	Flat Back Bracket	PS	50	0.3 lbs
----------	-------------------	----	----	---------

* One 5/16" x 1 1/4" Bolt and Nut Required for Flat Back Bracket (AGR 16)



Flat Back Fork Latch

Item No.	Description	Type	/Bag	Weight
05000-PS	Flat Back Fork Latch with 1 3/8" Fork	PS	100	0.6 lbs

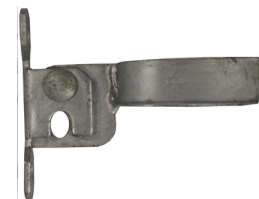

Butterfly Latch

Item No.	Description	Type	/Bag	Weight
05070-PS	1 3/8" x 1 7/8"	PS	25	1.2 lbs
05072-PS	1 3/8" x 2 3/8"	PS	25	1.3 lbs



Flat Back Butterfly Latch

Item No.	Description	Type	/Bag	Weight
05076-PS	1 3/8" Flat Back	PS	25	1.7 lbs



Carriage Bolts

Item No.	Description	Type	/Box	Weight
06070-PS	3/8" x 2" Carriage Bolt	PS	100	0.01 lbs
06072-XX	3/8" x 2 1/4" Carriage Bolt	PS,BL	100	0.01 lbs
06074-PS	3/8" x 2 1/2" Carriage Bolt	PS	100	0.01 lbs
06078-XX	3/8" x 3" Carriage Bolt	PS,BL	100	0.01 lbs
06082-XX	3/8" x 3 1/2" Carriage Bolt	PS, BL	100	0.01 lbs
06086-PS	3/8" x 4" Carriage Bolt	PS	100	0.01 lbs

06090-XX	5/16" x 1 1/4" Carriage Bolt	PS,BL	100	0.01 lbs
06092-PS	5/16" x 1 1/2" Carriage Bolt	PS	100	0.01 lbs
06098-PS	5/16" x 2 1/2" Carriage Bolt	PS	100	0.01 lbs
06099-PS	5/8" x 2 1/2" Carriage Bolt	PS	100	0.01 lbs



Lag Screws

Item No.	Description	/Bag	Weight	Unit
05210-PS	5/8" x 4 1/2" Lag Screw	100	1 lbs	Each
05212-PS	5/8" x 6" Lag Screw	100	1 lbs	Each
05222-PS	3/4" x 6" Lag Screw	100	1 lbs	Each



Hanger Bolt WS - With Seat WO - Without Seat

Item No.	Description	Type	/Bag	Weight	Unit
05172-WS	5/8" x 6" Hanger Bolt	WS	100	1 lbs	Each
05176-WS	5/8" x 10" Hanger Bolt	WS	50	1 lbs	Each
05178-WS	5/8" x 12" Hanger Bolt	WS	50	1 lbs	Each
05182-XX	3/4" x 6" Hanger Bolt	WS,WO	50	1 lbs	Each
05184-WO	3/4" x 9" Hanger Bolt	WO	25	1 lbs	Each
05188-XX	3/4" x 12" Hanger Bolt	WS,WO	25	1 lbs	Each
05194-WO	1" x 9" Hanger Bolt	WO	25	1 lbs	Each



Swivel Wheel

Item No.	Description	Type	/Bag	Weight
05820-PS	1 3/8" (Frame)	PS	4	4.65 lbs
05822-PS	1 5/8" (Frame)	PS	4	4.75 lbs



Single Wheel

Item No.	Description	Type	/Bag	Weight
05824-PS	1 5/8" x 1 7/8" Single Wheel	PS	4	2.81 lbs



Gripples

Item No.	Description	Weight	Qty/Bag
18650	Small Gripples (17-13Ga)	1.1lbs	20/Bag
18652	Medium Gripples (14-10Ga)	1.25lbs	20/Bag
18654	Large Gripples (10-7.5Ga)	2.25lbs	20/Bag



Farm Gate Hinge Bolts

Item No.	Description	Weight
10022	Hinge Bolts for Farm Gates	2 lbs



Wood



Red Cedar Split

Approx. Two Week Lead Time

Item No.	Description	Weight	Unit
09200	8' Standard (12-14")	16 lbs	Each
09202	10' Standard (12-14")	20 lbs	Each
09210	10' Jumbo (14-16")	24 lbs	Each
09220	5'4" 2 Rail Line Post (18")	23 lbs	Each
09222	5'4" 2 Rail End Post (18")	23 lbs	Each
09224	5'4" 2 Rail Corner Post (18")	25 lbs	Each
09230	6'6" 3 Rail Line Post (18")	29 lbs	Each
09232	6'6" 3 Rail End Post (18")	29 lbs	Each
09234	6'6" 3 Rail Corner Post (18")	32 lbs	Each

Round Wood Posts

Item No.	Description	Bundle Qty
09001	2-3" x 7' Pointed Post**	175
09002	2-3" x 8' Pointed Post**	175
09004	2-3" x 10' Blunt Rail**	150
09005	2-3" x 12' Blunt Rail**	150

09020	3-4" x 6' Pointed Post**	125
09021	3-4" x 7' Pointed Post**	125
09022	3-4" x 8' Pointed Post**	125
09023	3-4" x 9' Pointed Post**	100
09024	3-4" x 10' Pointed Post**	100
09025	3-4" x 12' Pointed Post**	100
09027	3-4" x 10' Blunt Rail**	100
09028	3-4" x 12' Blunt Rail**	100

09040	4-5" x 6' Pointed Post**	80
09041	4-5" x 7' Pointed Post**	80
09042	4-5" x 8' Pointed Post**	70
09043	4-5" x 9' Pointed Post**	70
09044	4-5" x 10' Pointed Post**	70
09045	4-5" x 12' Pointed Post**	70
09047	4-5" x 10' Blunt Rail**	70
09048	4-5" x 12' Blunt Rail**	70

09061	5-6" x 7' Pointed Post**	50
09062	5-6" x 8' Pointed Post**	50
09063	5-6" x 9' Pointed Post**	50

****Special Order. Sold in Full Bundles only.
Not Stocked.**



PRO LINK SUPPLY

Fittings



Tension Bands

Item No.	Description	Type	/Bag	Weight
04001-XX	1 3/8" Tension Band	PS,BL	250	0.1 lbs
04002-XX	1 5/8" Tension Band	PS,BL	250	0.2 lbs
04003-XX	1 7/8" Tension Band	PS,BL	250	0.2 lbs
04004-XX	2 3/8" Tension Band	PS,BL	250	0.2 lbs
04005-XX	2 7/8" Tension Band	PS,BL	100	0.3 lbs
04006-XX	3 1/2" Tension Band	PS,BL	100	0.4 lbs
04007-PS	4 1/2" Tension Band	PS	100	0.4 lbs
04008-PS	6 5/8" Tension Band	PS	50	0.7 lbs



Brace Bands

Item No.	Description	Type	/Bag	Weight
04020-XX	1 3/8" Brace Band	PS,BL	250	0.1 lbs
04021-XX	1 5/8" Brace Band	PS,BL	250	0.2 lbs
04022-XX	1 7/8" Brace Band	PS,BL	250	0.2 lbs
04023-XX	2 3/8" Brace Band	PS,BL	250	0.2 lbs
04024-XX	2 7/8" Brace Band	PS,BL	100	0.2 lbs
04025-XX	3 1/2" Brace Band	PS,BL	100	0.3 lbs
04026-PS	4 1/2" Brace Band	PS	100	0.4 lbs
04027-PS	6 5/8" Brace Band	PS	50	0.7 lbs



Dome Caps

Item No.	Description	Type	/Bag	Weight
04030-XX	1 3/8" Dome Cap	PS,BL,AL	250	0.1 lbs
04031-XX	1 5/8" Dome Cap	PS,BL,AL	250	0.1 lbs
04032-XX	1 7/8" Dome Cap	PS,BL,AL	200	0.2 lbs
04033-XX	2 3/8" Dome Cap	PS,BL,AL	125	0.3 lbs
04034-XX	2 7/8" Dome Cap	PS,BL,AL	100	0.3 lbs
04035-XX	3 1/2" Dome Cap	PS,BL	50	0.7 lbs
04036-XX	4 1/2" Dome Cap	PS,BL	50	0.9 lbs
04037-PS	6 5/8" Dome Cap	PS	25	1.9 lbs



Tension Bands - Square

Item No.	Description	Type	/Bag	Weight
04710-XX	1 1/2" Tension Band**	PS,BL	250	0.1 lbs
04712-XX	2" Tension Band**	PS,BL	250	0.2 lbs
04714-XX	2 1/2" Tension Band**	PS,BL	250	0.2 lbs
04716-XX	3" Tension Band**	PS,BL	250	0.2 lbs
04720-XX	4" Tension Band**	PS,BL	250	0.3 lbs
04722-XX	6" Tension Band**	PS,BL	250	0.4 lbs

**Call for Availability



Brace Bands - Square

Item No.	Description	Type	/Bag	Weight
04740-XX	1 1/2" Brace Band**	PS,BL	250	0.1 lbs
04742-XX	2" Brace Band**	PS,BL	250	0.2 lbs
04744-XX	2 1/2" Brace Band**	PS,BL	250	0.2 lbs
04746-XX	3" Brace Band**	PS,BL	250	0.3 lbs
04750-XX	4" Brace Band**	PS,BL	250	0.3 lbs
04752-XX	6" Brace Band**	PS,BL	100	0.3 lbs

**Call for Availability



Dome Caps - Square

Item No.	Description	Type	/Bag	Weight
04762-PS	2" Dome Cap**	PS	250	0.12 lbs
04764-PS	2 1/2" Dome Cap**	PS	200	0.14 lbs
04766-PS	3" Dome Cap**	PS	125	0.25 lbs
04770-PS	4" Dome Cap**	PS	100	0.28 lbs
04772-PS	6" Dome Cap**	PS	50	0.62 lbs

* See Ornamental Section for Black Square Dome Caps

**Call for Availability

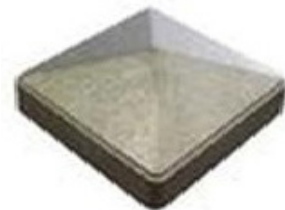

Line Post tops

Item No.	Description	Type	/Bag	Weight
04040-XX	1 5/8" x 1 3/8"	PS,BL,AL	100	0.4 lbs
04041-PS	1 5/8" x 1 5/8"	PS	100	0.4 lbs
04042-XX	1 7/8" x 1 3/8"	PS,BL,AL	100	0.4 lbs
04043-XX	1 7/8" x 1 5/8"	PS,BL	100	0.5 lbs
04044-XX	2 3/8" x 1 5/8"	PS,BL	50	0.6 lbs
04045-PS	2 7/8" x 1 5/8"	PS	50	0.6 lbs



Rail Ends

Item No.	Description	Type	/Bag	Weight
04050-XX	1 3/8" Rail End	PS,BL,AL	100	0.3 lbs
04051-XX	1 5/8" Rail End	PS,BL,AL	100	0.3 lbs
04053-PS	1 7/8" Rail End **	PS	100	0.4 lbs
04054-PS	2 3/8" Rail End **	PS	100	0.4 lbs

**** Call for Availability**

04052-PS	1 5/8" Rail End 2 hole	PS	100	0.5 lbs
----------	------------------------	----	-----	---------



Rail Sleeves

Item No.	Description	Type	/Bag	Weight
04060-XX	1 3/8" Rail Sleeve	PS,BL	100	0.5 lbs
04061-XX	1 5/8" Rail Sleeve	PS,BL	50	0.5 lbs



Tension Bars

Item No.	Description	Type	/Bundle	Weight
04210-PS	34" Tension Bar (3/16" x 5/8")	PS	25	0.9 lbs
04212-XX	46" Tension Bar (3/16" x 5/8")	PS,BL	25	1.3 lbs
04213-XX	58" Tension Bar (3/16" x 5/8")	PS,BL	25	1.6 lbs
04214-XX	70" Tension Bar (3/16" x 5/8")	PS,BL	25	2.0 lbs
04215-PS	82" Tension Bar (3/16" x 5/8")	PS	25	2.3 lbs
04216-PS	94" Tension Bar (3/16" x 5/8")	PS	25	2.7 lbs
04218-PS	118" Tension Bar (3/16" x 5/8")	PS	25	3.4 lbs
04221-PS	216" Tension Bar (3/16" x 5/8")	PS	25	6.2 lbs

04232-PS	46" Tension Bar (3/16" x 3/4")	PS	25	1.6 lbs
04233-PS	58" Tension Bar (3/16" x 3/4")	PS	25	1.9 lbs
04234-PS	70" Tension Bar (3/16" x 3/4")	PS	25	2.4 lbs
04235-PS	82" Tension Bar (3/16" x 3/4")	PS	25	2.8 lbs
04236-XX	94" Tension Bar (3/16" x 3/4")	PS,BL	25	3.2 lbs
04237-PS	118" Tension Bar (3/16" x 3/4")	PS	25	4.1 lbs
04238-PS	142" Tension Bar (3/16" x 3/4")	PS	25	4.8 lbs
04239-PS	216" Tension Bar (3/16" x 3/4")	PS	25	7.3 lbs



Truss Rods

Item No.	Description	Type	/Bag	Weight
04180-PS	12' Truss Rod (3/8")	PS	25	4.5 lbs
04184-PS	Truss Rod Tightener	PS	100	0.7 lbs



Panel Clamps

Item No.	Description	Type	/Bag	Weight
04080-PS	1 3/8" x 1 3/8" Panel Clamp	PS	100	0.5 lbs
04081-PS	1 5/8" x 1 5/8" Panel Clamp	PS	100	0.6 lbs
04082-PS	1 7/8" x 1 7/8" Panel Clamp	PS	100	0.8 lbs

* 3/8" x 2 1/4" Bolt and Nut Required (FIT 18)



Brace Clamps

Item No.	Description	Type	/Bag	Weight
04100-PS	2 3/8" x 1 5/8"	PS	50	0.6 lbs
04101-PS	2 7/8" x 1 5/8"	PS	50	0.6 lbs

* 3/8" x 2 1/4" Bolt and Nut Required (FIT 18)



Boulevard Clamps

Item No.	Description	Type	/Bag	Weight
04108-PS	1 7/8" x 1 3/8" Boulevard Clamp	PS	50	0.6 lbs
04110-PS	1 7/8" x 1 5/8" Boulevard Clamp	PS	50	0.7 lbs
04111-PS	2 3/8" x 1 5/8" Boulevard Clamp	PS	50	0.8 lbs
04112-PS	2 7/8" x 1 5/8" Boulevard Clamp	PS	50	0.9 lbs

* Two 3/8" x 2 1/2" Bolt and Nut Required (FIT 18) **OR**
Two 5/16" x 2 1/2" Bolt and Nut Required (FIT 18)



Automatic Gate Closer

Item No.	Description	Type	/Bag	Weight
05136-AL	1 7/8" Auto Gate Closer; Fits 1 3/8" Frame	AL	12	1.3 lbs
05138-AL	2 3/8" Auto Gate Closer; Fits 1 3/8" Frame	AL	12	1.5 lbs



Gate Frame Hinge

Item No.	Description	Type	/Bag	Weight
05100-XX	1 3/8" Gate Frame Hinge (5/8")	PS,BL	100	0.4 lbs
* 3/8" x 2" Bolt and Nut Required (FIT 18)				
05102-XX	1 5/8" Gate Frame Hinge (5/8")	PS,BL	50	0.5 lbs
* 3/8" x 2 1/4" Bolt and Nut Required (FIT 18)				
05104-PS	1 7/8" Gate Frame Hinge (5/8")	PS	50	0.9 lbs
* 3/8" x 2 1/2" Bolt and Nut Required (FIT 18)				



Gate Post Hinge

Item No.	Description	Type	/Bag	Weight
05110-PS	1 3/8" Gate Post Hinge (5/8")	PS	50	0.5 lbs
* 3/8" x 2 1/4" Bolt and Nut Required (FIT 18)				
05112-PS	1 5/8" Gate Post Hinge (5/8")	PS	50	0.5 lbs
* 3/8" x 2 1/4" Bolt and Nut Required (FIT 18)				
05114-XX	1 7/8" Gate Post Hinge (5/8")	PS,BL	50	0.7 lbs
* 3/8" x 2 1/2" Bolt and Nut Required (FIT 18)				
05116-XX	2 3/8" Gate Post Hinge (5/8")	PS,BL	50	0.9 lbs
* 3/8" x 3" Bolt and Nut Required (FIT 18)				
05118-XX	2 7/8" Gate Post Hinge (5/8")	PS,BL	50	1.1 lbs
* 3/8" x 3 1/2" Bolt and Nut Required (FIT 18)				
05120-PS	3 1/2" Gate Post Hinge (5/8")	PS	50	1.1 lbs
* 3/8" x 4" Bolt and Nut Required (FIT 18)				



Flat Back Pin Hinge

Item No.	Description	Type	/Bag	Weight
05126-PS	Flat Back Pin Hinge (5/8")	PS	50	1.1 lbs



Gravity Hinge

Item No.	Description	Type	/Bag	Weight
05132-PS	1 7/8" x 1 3/8" Gravity Hinge	PS	20	4.8 lbs
05134-PS	2 3/8" x 1 3/8" Gravity Hinge	PS	20	8.0 lbs



Industrial Post Collars: BackBolt

Item No.	Description	Type	/Bag	Weight
05142-BB	2 3/8" x 3/4" Ind. Gate Post Collar	BB	25	1.6 lbs
05144-BB	2 7/8" x 3/4" Ind. Gate Post Collar	BB	20	3.2 lbs
05146-BB	3 1/2" x 3/4" Ind. Gate Post Collar	BB	10	1.9 lbs
05147-BB	4 1/2" x 3/4" Ind. Gate Post Collar	BB	10	2.6 lbs
05150-BB	6 5/8" x 1" Ind. Gate Post Collar	BB	5	3.7 lbs



Industrial Post Collars: Hook and Eye

Item No.	Description	Type	/Bag	Weight
05142-HE	2 3/8" x 3/4" Ind. Gate Post Collar	HE	25	1.6 lbs
05144-HE	2 7/8" x 3/4" Ind. Gate Post Collar	HE	20	3.2 lbs
05146-HE	3 1/2" x 3/4" Ind. Gate Post Collar	HE	10	1.9 lbs
05147-HE	4 1/2" x 3/4" Ind. Gate Post Collar	HE	10	2.6 lbs

05158-PS	1 5/8" x 3/4" Gate Frame Collar	PS	25	1.6 lbs
----------	---------------------------------	----	----	---------



Hanger Bolt: WS - With Seat WO - Without Seat

Item No.	Description	Type	/Bag	Weight	Unit
05172-WS	5/8" x 6" Hanger Bolt	WS	100	0.7 lbs	Each
05176-WS	5/8" x 10" Hanger Bolt	WS	50	1.0 lbs	Each
05178-WS	5/8" x 12" Hanger Bolt	WS	50	1.2 lbs	Each
05182-XX	3/4" x 6" Hanger Bolt	WS,WO	50	1.1 lbs	Each
05184-XX	3/4" x 9" Hanger Bolt	WS,WO	25	1.6 lbs	Each
05188-XX	3/4" x 12" Hanger Bolt	WS,WO	25	1.7 lbs	Each
05194-WO	1" x 9" Hanger Bolt	WO	25	2.7 lbs	Each



Lag Screws

Item No.	Description	/Bag	Weight	Unit
05210-PS	5/8" x 4 1/2" Lag Screw	100	0.5 lbs	Each
05212-PS	5/8" x 6" Lag Screw	100	0.6 lbs	Each
05222-PS	3/4" x 6" Lag Screw	100	0.5 lbs	Each



Fork Latch

Item No.	Description	Type	/Bag	Weight
05010-PS	1 3/8" x 1 3/8"	PS	25	0.8 lbs
05011-PS	1 3/8" x 1 5/8"	PS	25	0.8 lbs
05012-XX	1 3/8" x 1 7/8"	PS,BL	25	1.0 lbs
05014-XX	1 3/8" x 2 3/8"	PS,BL,MA	25	1.1 lbs
05016-XX	1 3/8" x 2 7/8"	PS,MA	25	0.8 lbs
05017-PS	1 5/8" x 1 7/8"	PS	25	1.1 lbs
05018-XX	1 5/8" x 2 3/8"	PS,BL,BM,MA	25	1.1 lbs
05020-XX	1 5/8" x 2 7/8"	PS,BL,BM,MA	25	1.5 lbs
05022-XX	1 5/8" x 3 1/2"	PS,BL,BM,MA	25	1.8 lbs



Build-a-Fork-Latch

Item No.	Description	Type	/Bag	Weight
05002-PS	1 3/8" Two Piece Collar for Fork Latch	PS	100	0.4 lbs
05003-PS	1 5/8" Two Piece Collar for Fork Latch	PS	100	0.6 lbs

*** Two 5/16" x 1 1/4" Bolt and Nut Required for Two Piece Collar (FIT 18)**

05004-PS	1 3/8" Gate Forks for Collars	PS	100	0.4 lbs
05005-PS	1 5/8" Gate Forks for Collars	PS	100	0.6 lbs
05006-PS	1 7/8" Gate Forks for Collars	PS	100	0.8 lbs
05007-PS	2 3/8" Gate Forks for Collars	PS	100	1 lbs
05008-PS	2 7/8" Gate Forks for Collars	PS	50	1.2 lbs

05009-PS	Flat Back Bracket	PS	50	0.3 lbs
----------	-------------------	----	----	---------

*** One 5/16" x 1 1/4" Bolt and Nut Required for Flat Back Bracket (FIT 18)**



Flat Back Fork Latch

Item No.	Description	Type	/Bag	Weight
05000-PS	Flat Back Fork Latch with 1 3/8" Fork	PS	100	0.6 lbs



Kiwi Latch

Item No.	Description	Type	Weight
18660	Kiwi Latch	PS	0.3 lbs



Rolo Latch

Item No.	Description	Type	/Bag	Weight
05030-PS	1 5/8" Rolo Latch w/o Bands	PS	25	2.1 lbs

* Two Brace Band Required; Sized based on Gate Post (FIT 1)



Drop Latch Catch

Item No.	Description	Type	/Bag	Weight
05040-MA	1 5/8" Drop Latch Catch	MA	25	1.2 lbs
05042-MA	1 7/8" Drop Latch Catch	MA	25	1.5 lbs
05044-MA	2 3/8" Drop Latch Catch	MA	25	1.7 lbs
05046-MA	2 7/8" Drop Latch Catch	MA	25	2 lbs
05048-MA	3 1/2" Drop Latch Catch	MA	25	2.3 lbs



Drop Latch

Item No.	Description	Type	/Bag	Weight
05052-MA	1 5/8" Drop Latch	MA	25	1.2 lbs



Butterfly Latch

Item No.	Description	Type	/Bag	Weight
05070-PS	1 3/8" x 1 7/8"	PS	25	1.2 lbs
05072-PS	1 3/8" x 2 3/8"	PS	25	1.3 lbs



Flat Back Butterfly Latch

Item No.	Description	Type	/Bag	Weight
05076-PS	1 3/8" Flat Back	PS	25	1.7 lbs



Kennel Latch

Item No.	Description	Type	/Bag	Weight
05088-PS	1 3/8" x 1 3/8" Kennel Latch	PS	50	0.8 lbs

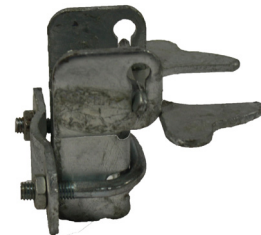

Frost Free Latch

Item No.	Description	Type	/Bag	Weight
05090-MA	1 5/8" Frame Assembly	MA	10	2.8 lbs



Pool Latch

Item No.	Description	Type	/Bag	Weight
05060-BL	1 3/8" x 1 7/8" Push Down Gate Latch	BL	1	3.0 lbs
05062-BL	1 3/8" x 2 3/8" Push Down Gate Latch	BL	1	3.5 lbs



Cane Bolt Assembly

Item No.	Description	Type	/Bag	Weight
05082-PS	3/4" x 24" Cane Bolt Assembly	PS	10	4.0 lbs



Drop Pin Latch Assembly

Item No.	Description	Type	/Bag	Weight
05084-PS	Drop Pin Latch Assembly	PS	25	1.2 lbs



E-Z Latch Assembly

Item No.	Description	Type	/Bag	Weight
05086-PS	1 3/8" x 42" E-Z Latch Assembly	PS	10	2.6 lbs



Industrial Drop Rod Assembly - Forks Only

Item No.	Description	Type	/Bag	Weight
05092-PS	Ind. Drop Rod (Forks Only) 1 5/8"	PS	25	0.5 lbs



Industrial Drop Rod Assembly - Guides Only

Item No.	Description	Type	/Bag	Weight
05093-PS	Ind. Drop Rod (Guides Only) 1 5/8"	PS	25	0.5 lbs

* 3/8" x 2 1/4" Bolt and Nut Required (FIT 18)

NOTE: One Fork and Two Guides (Three preferably) needed per Drop Rod



Gate Keeper

Item No.	Description	Type	/Bag	Weight
05750-XX	1 5/8" or 1 7/8" Gate Keeper	PS,MA	20	1.2 lbs



Drive In Plug

Item No.	Description	Type	/Bag	Weight
05754-MA	1 3/8" Drive In Plug	MA	200	0.2 lbs
05756-MA	1 5/8" Drive In Plug	MA	200	0.3 lbs
05758-MA	1 7/8" Drive In Plug	MA	200	0.4 lbs



Gate Clips

Item No.	Description	Type	/Bag	Weight
05760-XX	1 3/8" C Type Gate Clip	PS,BL	250	0.1 lbs
05764-PS	1 5/8" C Type Gate Clip	PS	250	0.1 lbs



Safe - T Rear Wheel : Malleable

Item No.	Description	Type	/Bag	Weight
05700-MA	1 5/8" x 5"	MA	4	4.9 lbs



Safe - T Rear Wheel : Pressed Steel

Item No.	Description	Type	/Bag	Weight
05700-PS	1 5/8" x 5"	PS	10	4.9 lbs



Safe - T Line Track Brackets

Item No.	Description	Type	/Bag	Weight
05710-XX	1 5/8" or 1 7/8" x 1 5/8"	PS,BL	20	2.4 lbs
05712-XX	2 3/8" or 2 7/8" x 1 5/8"	PS,BL	20	2.5 lbs
05716-PS	3 1/2" x 1 5/8"	PS	20	2.8 lbs

05718-PS	1 5/8" Flat Back Line Bracket	PS	20	1.8 lbs
----------	-------------------------------	----	----	---------

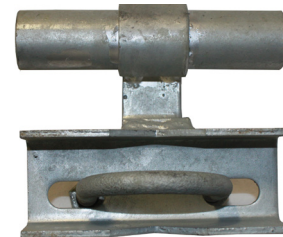

Cantilever Rollers

Item No.	Description	Type	/Bag	Weight
05732-XX	3 1/2" x 2 3/8" or 1 7/8"	MA,NY	4	16.3 lbs
05734-XX	4 1/2" x 2 3/8" or 1 7/8"	MA,NY	4	16.3 lbs



Tires

Item No.	Description	Type	/Bag	Weight
05800-PS	6" Rubber Tired Wheel	PS	10	2.0 lbs
05802-PS	8" Rubber Tired Wheel	PS	10	3.0 lbs
05804-PS	10" Rubber Tired Wheel	PS	5	4.0 lbs



Swivel Wheel

Item No.	Description	Type	/Bag	Weight
05820-PS	Fits 1 3/8" Frame	PS	4	4.7 lbs
05822-PS	Fits 1 5/8" Frame	PS	4	4.8 lbs

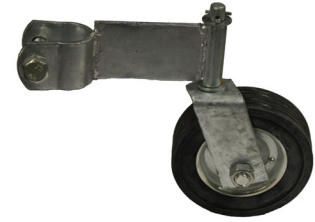

Single Wheel

Item No.	Description	Type	/Bag	Weight
05824-PS	1 5/8" x 1 7/8"	PS	4	2.8 lbs



Wheel Carriers

Item No.	Description	Type	/Bag	Weight
05832-PS	1 5/8" Frame, 8" Wheel	PS	4	7.0 lbs



Double Wheel Assembly

Item No.	Description	Type	/Box	Weight
05842-PS	1 5/8" or 1 7/8" Frame (12" x 8")	PS	4	11.5 lbs

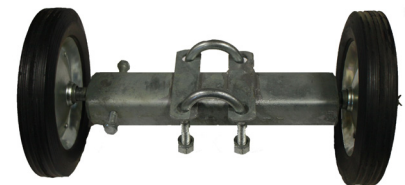

Pneumatic Wheel (Rut Runner)

Item No.	Description	Type	/Bag	Weight
05852-PS	1 5/8" Frame, 10" Wheel (12")	PS	1	14.1 lbs

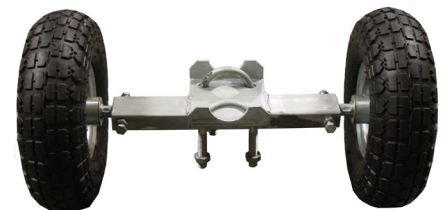

Barb Arms: Uprights

Item No.	Description	Type	/Bag	Weight
04303-PS	1 5/8" x 1 5/8" Barb Arm	PS	25	1.4 lbs
04300-PS	1 7/8" x 1 5/8" Barb Arm	PS	25	1.5 lbs
04302-PS	2 3/8" x 1 5/8" Barb Arm	PS	25	1.6 lbs



Barb Arms: 45 degrees

Item No.	Description	Type	/Bag	Weight
04311-PS	1 7/8" x 1 5/8" Barb Arm	PS	25	1.5 lbs
04312-PS	2 3/8" x 1 5/8" Barb Arm	PS	25	1.7 lbs
04313-PS	2 7/8" x 1 5/8" Barb Arm	PS	25	1.8 lbs



Barb Arms: "V"

Item No.	Description	Type	/Bag	Weight
04321-PS	1 7/8" x 1 5/8" Barb Arm	PS	25	2.1 lbs
04322-PS	2 3/8" x 1 5/8" Barb Arm	PS	25	2.2 lbs
04323-PS	2 7/8" x 1 5/8" Barb Arm	PS	25	3.3 lbs



Corner Barb Arms: 45 degrees

Item No.	Description	Type	/Bag	Weight
04330-PS	2 3/8" Corner Barb Arm	PS	25	3.0 lbs
04331-PS	2 7/8" Corner Barb Arm	PS	25	3.5 lbs
04332-PS	3 1/2" Corner Barb Arm	PS	25	3.7 lbs

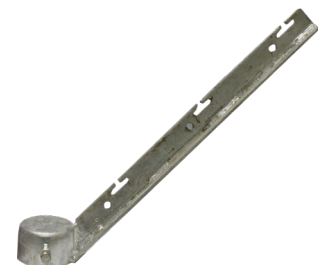

Corner Barb Arms: "V"s

Item No.	Description	Type	/Bag	Weight
04340-PS	2 3/8" Corner Barb Arm	PS	25	6.0 lbs
04341-PS	2 7/8" Corner Barb Arm	PS	25	6.2 lbs
04342-PS	3 1/2" Corner Barb Arm	PS	25	6.3 lbs
04343-PS	4 1/2" Corner Barb Arm	PS	25	6.6 lbs



Barb Arms: Bases

Item No.	Description	Type	/Bag	Weight
04350-PS	1 7/8" x 1 5/8" Barb Arm Base	PS	25	1.2 lbs
04351-PS	2 3/8" x 1 5/8" Barb Arm Base	PS	25	1.4 lbs
04352-PS	2 7/8" x 1 5/8" Barb Arm Base	PS	25	1.8 lbs



Barb Arms: Miscellaneous

Item No.	Description	Type	/Bag	Weight
04360-PS	V Barb Wire Ext Arm (Notched)	PS	25	0.8 lbs
04362-PS	S - Slot Barb Arm	PS	25	0.8 lbs



Wood to Steel Adaptors

Item No.	Description	Type	/Bag	Weight
04408-PS	1 7/8" x 6" Wood-Steel Adaptor**	PS	25	1.0 lbs
04409-PS	2 3/8" x 6" Adaptors - Line Post**	PS	25	4.5 lbs
04412-PS	2 7/8" x 8" Wood-Steel Adaptor**	PS	25	0.7 lbs

**Call for Availability



Wood to Steel: Corner Bracket

Item No.	Description	Type	/Bag	Weight
04411-PS	2 3/8" x 6" Wood-Steel Adaptor**	PS	25	4.5 lbs
04420-PS	1 7/8" Corner Wood Brackets**	PS	25	4.0 lbs

**Call for Availability

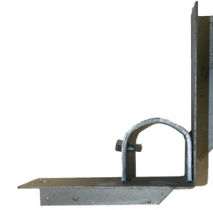

Wood to Steel: End Clamp

Item No.	Description	Type	/Bag	Weight
04430-PS	2 3/8" x 1 5/8" End Clamp - Wood**	PS	25	4 lbs
04432-PS	2 7/8" x 1 5/8" End Clamp - Wood**	PS	25	4 lbs

**Call for Availability



Tie Wires

Item No.	Description	Gauge	Type	/Bag	/Box	Weight
06000-AL	6 1/2"	9 Ga.	AL	100	3000	0.01 lbs
06000-BL	6 1/2"	9 Ga.	BL	100	2000	0.01 lbs
06000-PS	6 1/2"	12 Ga.	PS	100	3000	0.01 lbs
06002-AL	7 1/2"	9 Ga.	AL	100	2000	0.01 lbs
06002-BL	7 1/2"	9 Ga.	BL	100	2000	0.01 lbs
06002-PS	7 1/2"	12 Ga.	PS	100	2000	0.01 lbs
06004-AL	8 1/2"	9 Ga.	AL	100	2000	0.01 lbs
06004-BL	8 1/2"	9 Ga.	BL	100	2000	0.01 lbs
06006-AL	10 1/2"	9 Ga.	AL	100	2000	0.01 lbs



Hog Rings

Item No.	Description	Type	/Bag	Weight
06030-BL	9 Ga. - Black Vinyl Coated	BL	220	1 lbs
06030-AL	9 Ga. - Aluminum	AL	260	1 lbs



Bottom Wire

Item No.	Description	Type	Unit	Weight
06050-GA	11 Ga. Bottom Wire	GA	Foot	0.03 lbs
06052-XX	9 Ga. Bottom Wire	GA,BL	Foot	0.03 lbs
06056-XX	6 Ga. Bottom Wire	GA,BL	Foot	0.1 lbs



Carriage Bolts

Item No.	Description	Type	/Box	Weight
06070-PS	3/8" x 2" Carriage Bolt	PS	100	0.01 lbs
06072-XX	3/8" x 2 1/4" Carriage Bolt	PS,BL	100	0.01 lbs
06074-PS	3/8" x 2 1/2" Carriage Bolt	PS	100	0.01 lbs
06078-XX	3/8" x 3" Carriage Bolt	PS,BL	100	0.01 lbs
06082-XX	3/8" x 3 1/2" Carriage Bolt	PS,BL	100	0.01 lbs
06086-PS	3/8" x 4" Carriage Bolt	PS	100	0.01 lbs

06090-XX	5/16" x 1 1/4" Carriage Bolt	PS,BL	100	0.01 lbs
06092-PS	5/16" x 1 1/2" Carriage Bolt	PS	100	0.01 lbs
06098-PS	5/16" x 2 1/2" Carriage Bolt	PS	100	0.01 lbs



Base Plates

Item No.	Description	Type	/Bag	Weight
06122-PS	3" x 6" x 1/4" Base Plate	PS	25	1.15 lbs
06130-PS	4" x 4" x 1/4" Base Plate	PS	25	1.16 lbs
06132-PS	4" x 6" x 1/4" Base Plate	PS	25	1.5 lbs
06134-PS	6" x 6" x 1/4" Base Plate	PS	25	2.3 lbs
06136-PS	8" x 8" x 1/4" Base Plate	PS	10	4.25 lbs

06150-PS	4" x 4" x 1/2" Base Plate	PS	20	4.6 lbs
06152-PS	6" x 6" x 1/2" Base Plate	PS	10	4.6 lbs
06154-PS	8" x 8" x 1/2" Base Plate	PS	10	5.3 lbs



Anchor Bolts

Item No.	Description	Type	/Box	Weight
06176-PS	1/2" x 2 3/4" Anchor Bolt	PS	25	0.5 lbs
06178-PS	1/2" x 3 3/4" Anchor Bolt	PS	25	0.5 lbs



Luggs

Item No.	Description	Weight	/Bag	Unit
05778-PS	3/4" Weld On Lugg	0.3 lbs	25	Each



Barbed Wire

Item No.	Description	Weight	Unit	Ft per Roll	Pallet Qty
06200-GA	15 1/2 Ga. Class 3 High Tensile Barbed Wire	37 lbs	Roll	1320 ft	27
06202-GA	12 1/2 Ga. Barbless Barbed Wire	70 lbs	Roll	1320 ft	48
06204-GA	12 1/2 Ga. Canadian Standard Barbed Wire	80 lbs	Roll	1320 ft	27
06206-GA	12 1/2 Ga. Class 3 Barbed Wire	81 lbs	Roll	1320 ft	27
06206-BL	12 1/2 Ga. Class 3 Barbed Wire- Black**	82 lbs	Roll	1320 ft	27
06203-GA	12 1/2 Ga. Canadian Standard Barbed Wire - Half Roll	40 lbs	Roll	660 ft	84



****Call for Availability**

Barbed Wire - Import

Item No.	Description	Weight	Unit	Ft per Roll	Pallet Qty
06204-IMP	12 1/2 Ga. Canadian Standard Barbed Wire IMPORT	80 lbs	Roll	1320 ft	27
06206-IMP	12 1/2 Ga. Class 3 Barbed Wire IMPORT	81 lbs	Roll	1320 ft	27

Razor Ribbon

Item No.	Description	Weight	Unit
06210-PS	18" Diameter Razor Ribbon - 50' /Roll	40 lbs	Roll (50 ft)



Chain Link Hanger

Item No.	Description	Weight	Unit
06271-PS	Chain Link Hanger	1.0 lbs	Each



Turnbuckles

Item No.	Description	Weight	Unit
06272-PS	3/8" x 6" Zinc Plated Eye-to-Eye Turnbuckle	0.5 lbs	Each



Lock Boxes

Item No.	Description	Weight
06290-PS	Lock Box - 2 1/8" Hole 2 3/4" Offset	3.0 lbs
06289-PS	2 Hole Lock Box - 2 1/8" Hole 2 3/4" Offset	3.0 lbs



Paint

Item No.	Description	Weight
06294-BZ	12.5 Oz. Zinc Primer - Bright Zinc	1.0 lbs
06296-BL	16 Oz. Cold Galvanized Spray Paint - Black	1.0 lbs



Cement

Item No.	Description	Weight	Pallet Qty
06291	60 lbs Bag Cement Mix	60 lbs	56
06292-SS	50 lb Pail Cement Compounds - Superset	50 lbs	36
06293-QS	94 lb Bag Quikrete Portland Grey - Quick Set Concrete	94 lbs	35



Privacy Slats

See Next Page for Colour Options

Not All Sizes and Colours in stock

Please Call for Availability

Approx. Two Week Lead Time

Bottom Lock Slats: Fits 9 Ga. Chainlink

Item No.	Description	Weight
07500-XX	36" Bottom Lock Slats	5 lbs
07501-XX	42" Bottom Lock Slats	6 lbs
07502-XX	48" Bottom Lock Slats	8 lbs
07503-XX	60" Bottom Lock Slats	10 lbs
07504-XX	72" Bottom Lock Slats	12 lbs
07505-XX	84" Bottom Lock Slats	15 lbs
07506-XX	96" Bottom Lock Slats	21 lbs
07507-XX	120" Bottom Lock Slats	26 lbs
07508-XX	144" Bottom Lock Slats	28 lbs



* Each unit covers 10 ft

LiteLink Slats: Fits 9 Ga. Chainlink

Item No.	Description	Weight
07520-XX	36" LiteLink Slats	4 lbs
07521-XX	42" LiteLink Slats	4 lbs
07522-XX	48" LiteLink Slats	5 lbs
07523-XX	60" LiteLink Slats	7 lbs
07524-XX	72" LiteLink Slats	8 lbs
07525-XX	84" LiteLink Slats	10 lbs
07526-XX	96" LiteLink Slats	11 lbs



* Each unit covers 10 ft

Winged Slats: Fits 9 Ga. Chainlink

Item No.	Description	Weight
07560-XX	36" Winged Slats	5 lbs
07561-XX	42" Winged Slats	6 lbs
07562-XX	48" Winged Slats	8 lbs
07563-XX	60" Winged Slats	10 lbs
07564-XX	72" Winged Slats	12 lbs
07565-XX	84" Winged Slats	15 lbs
07566-XX	96" Winged Slats	21 lbs

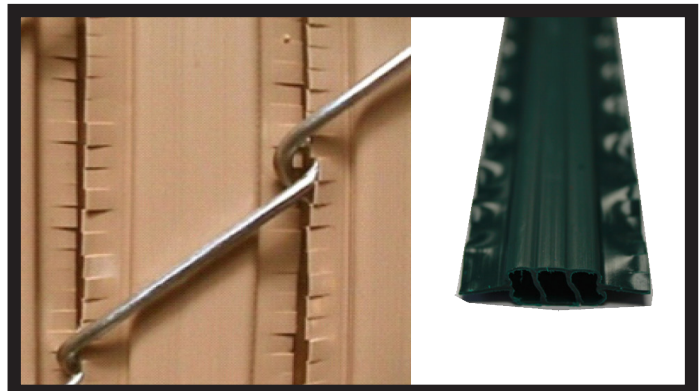

* Each unit covers 10 ft

Not All Sizes and Colours in stock
Please Call for Availability
Approx. Two Week Lead Time

FinLink Slats: Fits 11 Ga. Chainlink

Item No.	Description	Weight
07540-XX	36" FinLink Slats	5 lbs
07541-XX	42" FinLink Slats	6 lbs
07542-XX	48" FinLink Slats	8 lbs
07543-XX	60" FinLink Slats	10 lbs
07544-XX	72" FinLink Slats	12 lbs
07545-XX	84" FinLink Slats	15 lbs
07546-XX	96" FinLink Slats	21 lbs

* Each unit covers 10 ft



Hedge Link

Item No.	Description	Weight
07600	48" Hedge Link	8 lbs
07601	60" Hedge Link	10 lbs
07602	72" Hedge Link	12 lbs
07603	84" Hedge Link	15 lbs
07604	96" Hedge Link	21 lbs

**Green only

* Each unit covers 10 ft



Black (BL) - Brown (BR) - Green (GR) - Grey (GY) - White (WH)
Redwood (RW) - Sky Blue (SB) - Royal Blue (RB) - Tan (TA)
Note: Redwood, Sky Blue, Royal Blue and Tan are special order colors



TruClose Hinges for Square Posts

Item No.	D&D Part Number	Description	Unit
10002	TCA1L2S3BT	TruClose Hinge - Regular	Each

* For gates weighing no more than 30 kg/66 lbs

10011	TCHD1AS3BT	TruClose Hinge - Heavy Duty	Each
-------	------------	-----------------------------	------

* For gates weighing no more than 70 kg/154 lbs



TruClose Hinge for Round Posts

Item No.	D&D Part Number	Description	Unit
10010	TCHDRND1S3	TruClose Hinge for Round Posts - Heavy Duty	Each

* For gates with 1 3/8" or 1 5/8" Frames



Lokk Latch

Item No.	D&D Part Number	Description	Unit
10074SP	LLDAB	Lokk Latch Deluxe w/External Access Key	Each
10054SP	LLAAB	Lokk Latch W/ External Access Key	Each



Magna Safety Latch

Item No.	D&D Part Number	Description	Unit
05080-BL	ML3TPKA	Magna Safety Latch (Series Three)	Each

* For Square Posts
See Below for the Round Post Adapter Kit



Round Post Adaptor Kit

Item No.	D&D Part Number	Description	Unit
05079-BL	ML3RPK	Round Post Adapter Kit for MagnaLatch	Each

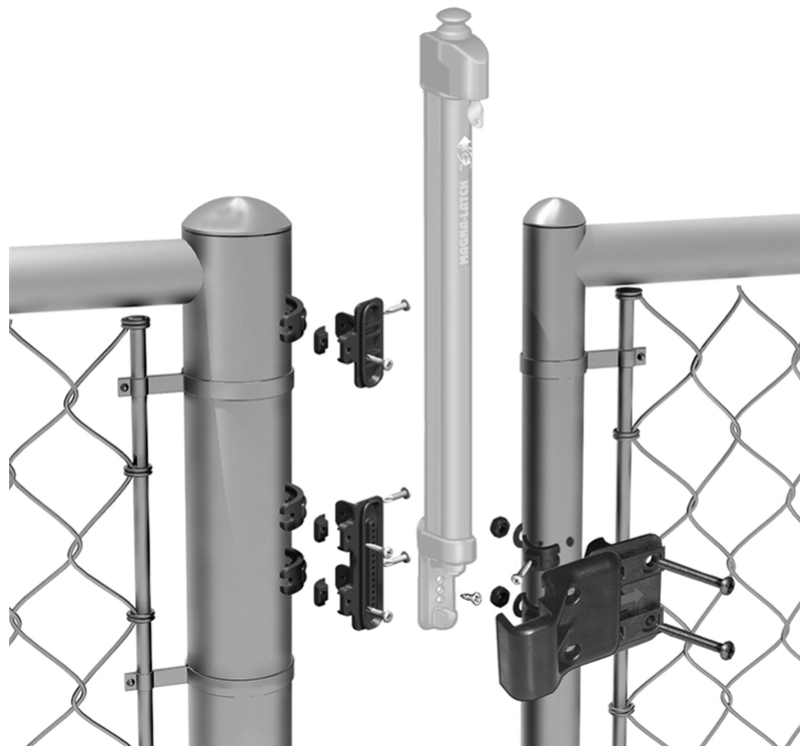

Tools

Pliers

Item No.	Description	Weight
06252	Large Hog Ring Pliers	1.0 lbs
06254	10" Square Nose Fence Pliers	0.8 lbs



Power Pull

Item No.	Description	Weight
06258	Cable Pow'r-Pull Massdam Power Pull	12 lbs



Pul-Jak

Item No.	Description	Weight
06260	A-2.5 Wire/Panel Stretcher Pul-Jak	20 lbs
06262	Pul-Jak Repair Kit	12 lbs

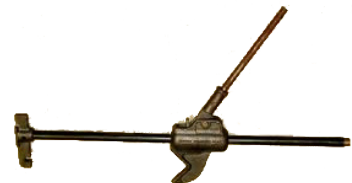

Fence Stretcher

Item No.	Description	Weight
06263SP	3' Fence Stretcher Bar - for mesh 3'-6' high	3 lbs



Digger Bar

Item No.	Description	Weight
06266	1 1/4" x 72" Round Digger Bar	12 lbs



Clamshell Diggers

Item No.	Description	Weight
06268	Wood Handle Digger - Blue	15 lbs
06270	Replacement Handles	5 lbs



Wire Dogs

Item No.	Description	Weight
06256	Wire Dogs	3.5 lbs



ProClamps

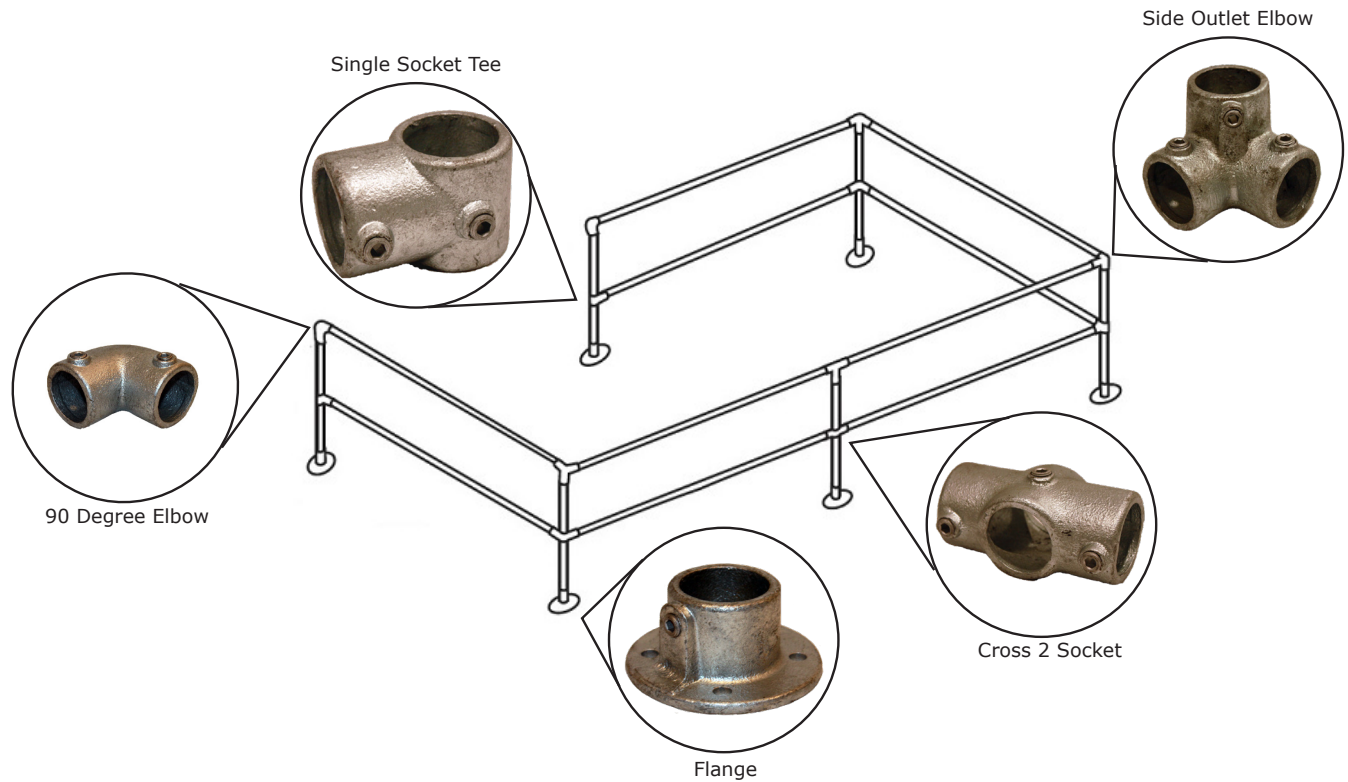

Straight Coupling

Item No.	Box No.	Manufacturer's No.	Description	Type	/Box
04510-MA	149-C	14-7	1 5/8"	MA	35
04512-MA	149-D	14-8	1 7/8"	MA	30



90 Degree Elbow

Item No.	Box No.	Manufacturer's No.	Description	Type	/Box
04520-MA	125-C	15-7	1 5/8"	MA	30
04522-MA	125-D	15-8	1 7/8"	MA	25



2 Socket Cross

Item No.	Box No.	Manufacturer's No.	Description	Type	/Box
04530-MA	119-C	26-7	1 5/8"	MA	30
04532-MA	119-D	26-8	1 7/8"	MA	20

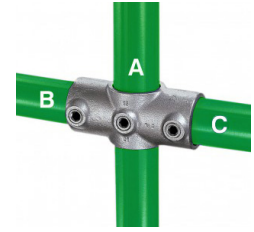

3 Socket Cross

Item No.	Box No.	Manufacturer's No.	Description	Type	/Box
04534-MA	176-C	35-7	1 5/8"	MA	20
04536-MA	176-D	35-8	1 7/8"	MA	15

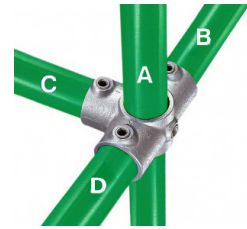

4 Socket Cross

Item No.	Box No.	Manufacturer's No.	Description	Type	/Box
04538-MA	138-C	40-7	1 5/8"	MA	15
04539-MA	138-D	40-8	1 7/8"	MA	10

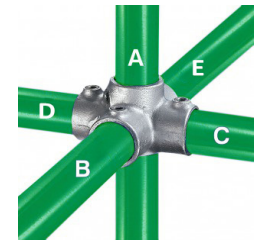

Single Socket Tee

Item No.	Box No.	Manufacturer's No.	Description	Type	/Box
04540-MA	101-C	10-7	1 5/8"	MA	40
04542-MA	101-D	10-8	1 7/8"	MA	30

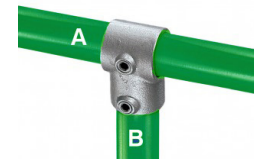

Flange

Item No.	Box No.	Manufacturer's No.	Description	Type	/Box
04550-MA	131-C	61-7	1 5/8"	MA	30
04552-MA	131-D	61-8	1 7/8"	MA	25



2 Hole Flange

Item No.	Box No.	Manufacturer's No.	Description	Type	/Box
04554-MA	132-C	62-7	1 5/8"	MA	30
04556-MA	132-D	62-8	1 7/8"	MA	15



Side Outlet Elbow

Item No.	Box No.	Manufacturer's No.	Description	Type	/Box
04560-MA	128-C	20-7	1 5/8"	MA	20
04562-MA	128-D	20-8	1 7/8"	MA	15

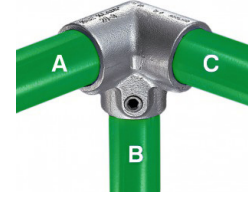

Side Outlet Tee: 90 Degree

Item No.	Box No.	Manufacturer's No.	Description	Type	/Box
04570-MA	116-C	21-7	1 5/8"	MA	30
04572-MA	116-D	21-8	1 7/8"	MA	20

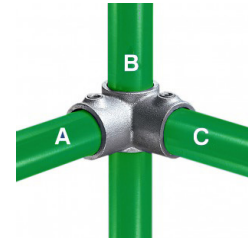

Three Socket Tee

Item No.	Box No.	Manufacturer's No.	Description	Type	/Box
04580-MA	104-C	25-7	1 5/8"	MA	20
04582-MA	104-D	25-8	1 7/8"	MA	15

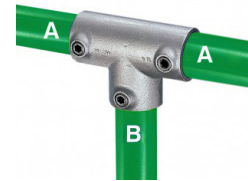

Eves Fitting for Roof

Item No.	Box No.	Manufacturer's No.	Description	Type	/Box
04610-MA	185-D	350-8	1 7/8"	MA	6

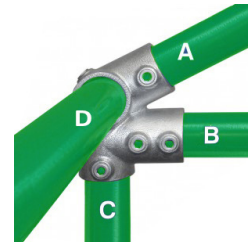

Ridge Fitting for Rooftop

Item No.	Box No.	Manufacturer's No.	Description	Type	/Box
04612-MA	191-D	351-9	1 7/8"	MA	6

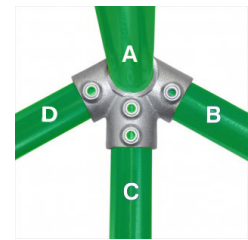

Eye Fitting

Item No.	Box No.	Manufacturer's No.	Description	Type	/Box
04636-MA	138-D	78-8	1 7/8"	MA	70



Double Swivel Socket

Item No.	Box No.	Manufacturer's No.	Description	Type	/Box
04620-MA	167-C	C51-777	1 5/8"	MA	15
04622-MA	167-D	C51-888	1 7/8"	MA	10

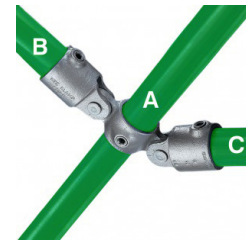

Single Swivel Socket

Item No.	Box No.	Manufacturer's No.	Description	Type	/Box
04624-MA	173-C	C50-777	1 5/8"	MA	35
04626-MA	173-D	C50-888	1 7/8"	MA	25

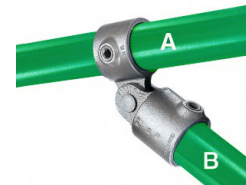

Male Single Socket Member

Item No.	Box No.	Manufacturer's No.	Description	Type	/Box
04628-MA	173-MD	M50-8	1 7/8"	MA	80



Offset Single Tab Panel Fitting w/Slot

Item No.	Box No.	Manufacturer's No.	Description	Type	/Box
04630-MA	199-D	P50-8	1 7/8"	MA	50



Offset Double Tab Panel Fitting w/Slot

Item No.	Box No.	Manufacturer's No.	Description	Type	/Box
04632-MA	198-D	P51-8	1 7/8"	MA	40

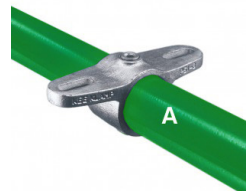

Rail Support

Item No.	Box No.	Manufacturer's No.	Description	Type	/Box
04634-MA	143-D	70-8	1 7/8"	MA	30

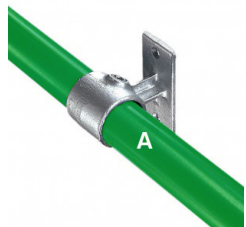



PRO LINK **SUPPLY**

Mesh





Re: Mesh Service Charges

Prolink Supply has made every effort to reduce operating costs; however despite our best efforts raw materials and manufacturing costs have continued to increase as a result Prolink Supply will be implementing service charges pertaining to our specialty mesh.

All non-stock specialty mesh will require \$150 set up fee with runs under 450'.

For further information and details please speak to your inside sales representatives.

Prolink Supply will continue its efforts to control costs and to provide the most competitive prices to you our valued customers. We thank you for your continued support and we look forward to serving you all in the future.

Kind Regards,

Your friends at Prolink Supply!

11 Gauge Galv (.106)

Item No.	Height	Square	Weight per FT	Roll	Pallet
00110-KK	36"	2"	1.14 lbs	50 FT	450 FT
00111-KK	42"	2"	1.33 lbs	50 FT	450 FT
00112-KK	48"	2"	1.52 lbs	50 FT	450 FT
00113-KK	60"	2"	1.9 lbs	50 FT	450 FT
00114-XX	72"	2"	2.28 lbs	50 FT	450 FT

9 Gauge Galv (.134)

Item No.	Height	Square	Weight per FT	Roll	Pallet
00200-KK	36"	2"	1.7 lbs	50 FT	450 FT
00201-KK	42"	2"	1.99 lbs	50 FT	450 FT
00202-KK	48"	2"	2.27 lbs	50 FT	450 FT
00202-KKC	48"	2"	2.27 lbs	50 FT	800 FT
00203-KK	60"	2"	2.84 lbs	50 FT	450 FT
00203-KKC	60"	2"	2.84 lbs	50 FT	800 FT
00204-XX	72"	2"	3.41 lbs	50 FT	450 FT
00204-KKC	72"	2"	3.41 lbs	50 FT	800 FT
00204-KBC	72"	2"	3.41 lbs	50 FT	800 FT
00205-XX	84"	2"	3.98 lbs	50 FT	450 FT
00206-XX	96"	2"	4.54 lbs	50 FT	450 FT
00207-XX	108"	2"	5.11 lbs	50 FT	450 FT
00208-XX	120"	2"	5.68 lbs	50 FT	450 FT
00210-XX	144"	2"	6.82 lbs	50 FT	450 FT

Compact rolls available for 2" Mesh Only
800 ft/Pallet

KK Compact

Compact Rolls



KK Compact

KK Compact

KB Compact

Full Rolls

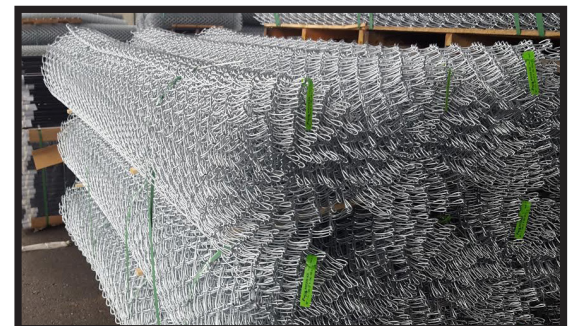

00250-KK	36"	1 3/4"	2.26 lbs	25 FT	400 FT	**
00251-KK	42"	1 3/4"	2.62 lbs	25 FT	400 FT	**
00252-KK	48"	1 3/4"	3 lbs	25 FT	400 FT	**
00253-KK	60"	1 3/4"	3.76 lbs	25 FT	400 FT	**
00254-XX	72"	1 3/4"	4.5 lbs	25 FT	400 FT	**
00255-XX	84"	1 3/4"	5.26 lbs	25 FT	400 FT	**
00256-XX	96"	1 3/4"	6 lbs	25 FT	400 FT	**
00257-XX	108"	1 3/4"	6.76 lbs	25 FT	400 FT	**
00258-XX	120"	1 3/4"	7.5 lbs	25 FT	400 FT	**
00260-XX	144"	1 3/4"	9 lbs	25 FT	400 FT	**

Please Specify Mesh Finish

KK - Knuckle Knuckle
KB - Knuckle Barb BB - Barb Barb

** May Require Setup Charge

9 Gauge Galv (.134)

Item No.	Height	Square	Weight per FT	Roll	Pallet	
00280-KK	36"	1 1/2"	2.61 lbs	25 FT	400 FT	**
00281-KK	42"	1 1/2"	3.12 lbs	25 FT	400 FT	**
00282-KK	48"	1 1/2"	3.56 lbs	25 FT	400 FT	**
00283-KK	60"	1 1/2"	4.46 lbs	25 FT	400 FT	**
00284-XX	72"	1 1/2"	5.34 lbs	25 FT	400 FT	**
00285-XX	84"	1 1/2"	6.24 lbs	25 FT	400 FT	**
00286-XX	96"	1 1/2"	7.12 lbs	25 FT	400 FT	**
00287-XX	108"	1 1/2"	8.02 lbs	25 FT	400 FT	**
00288-XX	120"	1 1/2"	9.1 lbs	25 FT	400 FT	**
00290-XX	144"	1 1/2"	10.68 lbs	25 FT	400 FT	**

00310-KK	36"	1 1/4"	3.58 lbs	25 FT	400 FT	**
00311-KK	42"	1 1/4"	4.16 lbs	25 FT	400 FT	**
00312-KK	48"	1 1/4"	4.76 lbs	25 FT	400 FT	**
00313-KK	60"	1 1/4"	5.96 lbs	25 FT	400 FT	**
00314-XX	72"	1 1/4"	7.14 lbs	25 FT	400 FT	**
00315-XX	84"	1 1/4"	8.34 lbs	25 FT	400 FT	**
00316-XX	96"	1 1/4"	9.52 lbs	25 FT	400 FT	**
00317-XX	108"	1 1/4"	10.72 lbs	25 FT	400 FT	**
00318-XX	120"	1 1/4"	11.9 lbs	25 FT	400 FT	**
00320-XX	144"	1 1/4"	14.28 lbs	25 FT	400 FT	**

00340-KK	36"	1"	3.96 lbs	25 FT	400 FT	**
00341-KK	42"	1"	4.62 lbs	25 FT	400 FT	**
00342-KK	48"	1"	5.28 lbs	25 FT	400 FT	**
00343-KK	60"	1"	6.6 lbs	25 FT	400 FT	**
00344-XX	72"	1"	7.92 lbs	25 FT	400 FT	**
00345-XX	84"	1"	9.24 lbs	25 FT	400 FT	**
00346-XX	96"	1"	10.56 lbs	25 FT	400 FT	**
00347-XX	108"	1"	11.88 lbs	25 FT	400 FT	**
00348-XX	120"	1"	13.2 lbs	25 FT	400 FT	**
00350-XX	144"	1"	15 lbs	25 FT	400 FT	**

** May Require Setup Charge

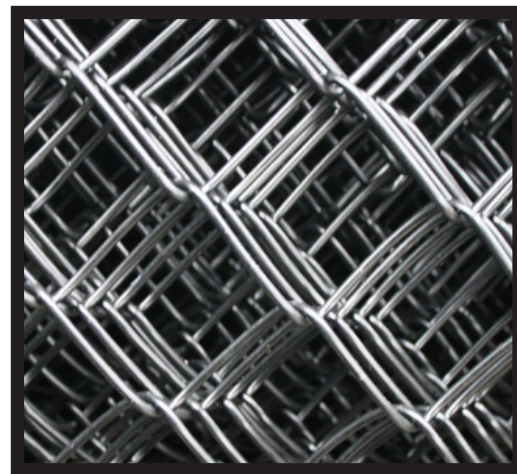

Please Specify Mesh Finish

KK - Knuckle Knuckle
KB - Knuckle Barb BB - Barb Barb

6 Gauge Galv (.192)

Item No.	Height	Square	Weight per FT	Roll	Pallet
00600-KK	36"	2"	3.64 lbs	25 FT	400 FT
00601-KK	42"	2"	4.24 lbs	25 FT	400 FT
00602-KK	48"	2"	4.84 lbs	25 FT	400 FT
00603-KK	60"	2"	6.06 lbs	25 FT	400 FT
00604-XX	72"	2"	7.26 lbs	25 FT	400 FT
00605-XX	84"	2"	8.48 lbs	25 FT	400 FT
00606-XX	96"	2"	8.73 lbs	25 FT	400 FT
00607-XX	108"	2"	10.9 lbs	25 FT	400 FT
00608-XX	120"	2"	12.1 lbs	25 FT	400 FT
00610-XX	144"	2"	14.52 lbs	25 FT	400 FT

00630-KK	36"	1 3/4"	4.38 lbs	25 FT	400 FT	**
00631-KK	42"	1 3/4"	5.12 lbs	25 FT	400 FT	**
00632-KK	48"	1 3/4"	5.84 lbs	25 FT	400 FT	**
00633-KK	60"	1 3/4"	7.3 lbs	25 FT	400 FT	**
00634-XX	72"	1 3/4"	8.76 lbs	25 FT	400 FT	**
00635-XX	84"	1 3/4"	10.2 lbs	25 FT	400 FT	**
00636-XX	96"	1 3/4"	11.68 lbs	25 FT	400 FT	**
00637-XX	108"	1 3/4"	13.14 lbs	25 FT	400 FT	**
00638-XX	120"	1 3/4"	14.6 lbs	25 FT	400 FT	**
00640-XX	144"	1 3/4"	17.52 lbs	25 FT	400 FT	**

00660-KK	36"	1 1/2"	5.7 lbs	25 FT	400 FT	**
00661-KK	42"	1 1/2"	6.65 lbs	25 FT	400 FT	**
00662-KK	48"	1 1/2"	7.6 lbs	25 FT	400 FT	**
00663-KK	60"	1 1/2"	9.5 lbs	25 FT	400 FT	**
00664-XX	72"	1 1/2"	11.4 lbs	25 FT	400 FT	**
00665-XX	84"	1 1/2"	13.3 lbs	25 FT	400 FT	**
00666-XX	96"	1 1/2"	15.2 lbs	25 FT	400 FT	**
00667-XX	108"	1 1/2"	17.1 lbs	25 FT	400 FT	**
00668-XX	120"	1 1/2"	22.8 lbs	25 FT	400 FT	**
00670-XX	144"	1 1/2"	26.35 lbs	25 FT	400 FT	**

** May Require Setup Charge



Please Specify Mesh Finish

KK - Knuckle Knuckle
KB - Knuckle Barb BB - Barb Barb

9 gauge Vinyl (.138)

Item No.	Height	Square	Weight per FT	Roll	Pallet
01000-XX	36"	2"	1.2 lbs	50 FT	450 FT
01001-XX	42"	2"	1.44 lbs	50 FT	450 FT
01002-XX	48"	2"	1.64 lbs	50 FT	450 FT
01002-BLC	48"	2"	1.64 lbs	50 FT	1000 FT
01003-XX	60"	2"	2.06 lbs	50 FT	450 FT
01003-BLC	60"	2"	2.06 lbs	50 FT	1000 FT
01004-XX	72"	2"	2.46 lbs	50 FT	450 FT
01004-BLC	72"	2"	2.46 lbs	50 FT	450 FT
01004-BLB	72"	2"	2.46 lbs	50 FT	1000 FT
01005-XX	84"	2"	3 lbs	50 FT	450 FT
01006-XX	96"	2"	3.28 lbs	50 FT	450 FT
01007-XX	108"	2"	3.7 lbs	50 FT	450 FT
01008-XX	120"	2"	4.1 lbs	50 FT	450 FT
01010-XX	144"	2"	4.92 lbs	25 FT	400 FT

Compact rolls available for 2" Mesh Only
1000 ft/Pallet

Black Compact

Black Compact

KB Black

Black Compact

Colours

In Stock

Special Order

Black
(BL)

Brown
(BR)

Green
(GR)

White
(WH)

01030-XX	36"	1 3/4"	1.5 lbs	25 FT	400 FT	**
01031-XX	42"	1 3/4"	1.72 lbs	25 FT	400 FT	**
01032-XX	48"	1 3/4"	1.96 lbs	25 FT	400 FT	**
01033-XX	60"	1 3/4"	2.46 lbs	25 FT	400 FT	**
01034-XX	72"	1 3/4"	2.94 lbs	25 FT	400 FT	**
01035-XX	84"	1 3/4"	3.5 lbs	25 FT	400 FT	**
01036-XX	96"	1 3/4"	3.92 lbs	25 FT	400 FT	**
01037-XX	108"	1 3/4"	4.42 lbs	25 FT	400 FT	**
01038-XX	120"	1 3/4"	4.1 lbs	25 FT	400 FT	**
01040-XX	144"	1 3/4"	4.92 lbs	25 FT	400 FT	**

** May Require Setup Charge

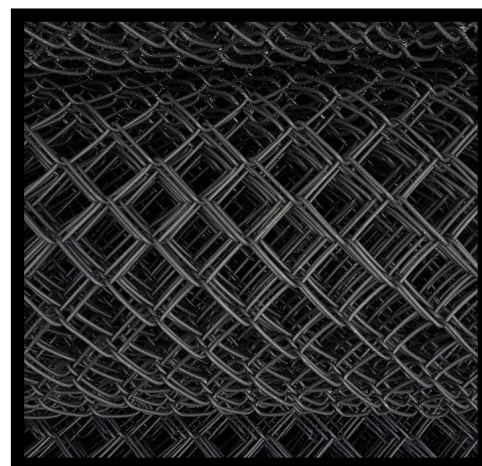

9 gauge Vinyl (.138)

Item No.	Height	Square	Weight per FT	Roll	Pallet	
01060-XX	36"	1 1/2"	1.8 lbs	25 FT	400 FT	**
01061-XX	42"	1 1/2"	2.1 lbs	25 FT	400 FT	**
01062-XX	48"	1 1/2"	2.4 lbs	25 FT	400 FT	**
01063-XX	60"	1 1/2"	3 lbs	25 FT	400 FT	**
01064-XX	72"	1 1/2"	3.6 lbs	25 FT	400 FT	**
01065-XX	84"	1 1/2"	5 lbs	25 FT	400 FT	**
01066-XX	96"	1 1/2"	6 lbs	25 FT	400 FT	**
01067-XX	108"	1 1/2"	6.6 lbs	25 FT	400 FT	**
01068-XX	120"	1 1/2"	7 lbs	25 FT	400 FT	**
01070-XX	144"	1 1/2"	7.2 lbs	25 FT	400 FT	**

01090-XX	36"	1 1/4"	2.2 lbs	25 FT	400 FT	**
01091-XX	42"	1 1/4"	2.62 lbs	25 FT	400 FT	**
01092-XX	48"	1 1/4"	3 lbs	25 FT	400 FT	**
01093-XX	60"	1 1/4"	3.76 lbs	25 FT	400 FT	**
01094-XX	72"	1 1/4"	4.5 lbs	25 FT	400 FT	**
01095-XX	84"	1 1/4"	5.2 lbs	25 FT	400 FT	**
01096-XX	96"	1 1/4"	6 lbs	25 FT	400 FT	**
01097-XX	108"	1 1/4"	6.76 lbs	25 FT	400 FT	**
01098-XX	120"	1 1/4"	7.5 lbs	25 FT	400 FT	**
01100-XX	144"	1 1/4"	9 lbs	25 FT	400 FT	**

01120-XX	36"	1"	2.76 lbs	25 FT	400 FT	**
01121-XX	42"	1"	3.22 lbs	25 FT	400 FT	**
01122-XX	48"	1"	3.68 lbs	25 FT	400 FT	**
01123-XX	60"	1"	4.6 lbs	25 FT	400 FT	**
01124-XX	72"	1"	5.52 lbs	25 FT	400 FT	**
01125-XX	84"	1"	6.44 lbs	25 FT	400 FT	**
01126-XX	96"	1"	7.36 lbs	25 FT	400 FT	**
01127-XX	108"	1"	8.28 lbs	25 FT	400 FT	**
01128-XX	120"	1"	9.2 lbs	25 FT	400 FT	**
01130-XX	144"	1"	11.04 lbs	25 FT	400 FT	**

** May Require Setup Charge

Colours

In Stock

Special Order

Black

(BL)

Green

(GR)

Brown

(BR)

White

(WH)

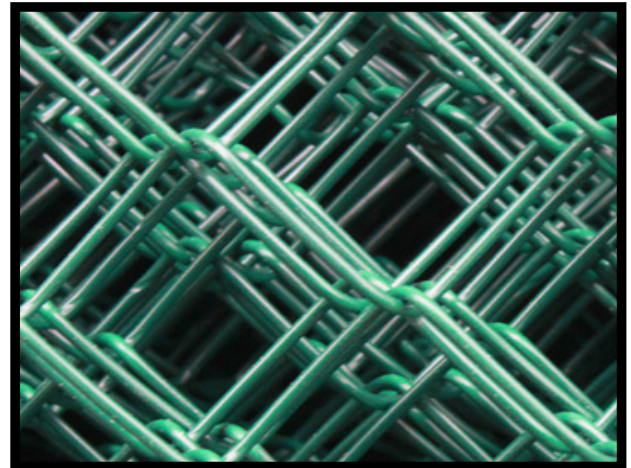

6 Gauge Vinyl (.192)

Item No.	Height	Square	Weight per FT	Roll	Pallet
01400-XX	36"	2"	2.4 lbs	25 FT	400 FT
01401-XX	42"	2"	2.72 lbs	25 FT	400 FT
01402-XX	48"	2"	3.1 lbs	25 FT	400 FT
01403-XX	60"	2"	3.88 lbs	25 FT	400 FT
01404-XX	72"	2"	4.66 lbs	25 FT	400 FT
01405-XX	84"	2"	5.42 lbs	25 FT	400 FT
01406-XX	96"	2"	6.2 lbs	25 FT	400 FT
01407-XX	108"	2"	6.98 lbs	25 FT	400 FT
01408-XX	120"	2"	7.76 lbs	25 FT	400 FT
01410-XX	144"	2"	9.3 lbs	25 FT	400 FT

01430-XX	36"	1 3/4"	2.4 lbs	25 FT	400 FT	**
01431-XX	42"	1 3/4"	2.9 lbs	25 FT	400 FT	**
01432-XX	48"	1 3/4"	3.34 lbs	25 FT	400 FT	**
01433-XX	60"	1 3/4"	4.16 lbs	25 FT	400 FT	**
01434-XX	72"	1 3/4"	5 lbs	25 FT	400 FT	**
01435-XX	84"	1 3/4"	5.8 lbs	25 FT	400 FT	**
01436-XX	96"	1 3/4"	6.66 lbs	25 FT	400 FT	**
01437-XX	108"	1 3/4"	7.5 lbs	25 FT	400 FT	**
01438-XX	120"	1 3/4"	8.34 lbs	25 FT	400 FT	**
01440-XX	144"	1 3/4"	10 lbs	25 FT	400 FT	**

01460-XX	36"	1 1/2"	3 lbs	25 FT	400 FT	**
01461-XX	42"	1 1/2"	3.54 lbs	25 FT	400 FT	**
01462-XX	48"	1 1/2"	4.04 lbs	25 FT	400 FT	**
01463-XX	60"	1 1/2"	5.06 lbs	25 FT	400 FT	**
01464-XX	72"	1 1/2"	6.06 lbs	25 FT	400 FT	**
01465-XX	84"	1 1/2"	7.07 lbs	25 FT	400 FT	**
01466-XX	96"	1 1/2"	8.5 lbs	25 FT	400 FT	**
01467-XX	108"	1 1/2"	7.5 lbs	25 FT	400 FT	**
01468-XX	120"	1 1/2"	10 lbs	25 FT	400 FT	**
01470-XX	144"	1 1/2"	12.2 lbs	25 FT	400 FT	**

** May Require Setup Charge

Colours

In Stock

Black

(BL)

Green

(GR)

Special Order

Brown

(BR)

White

(WH)

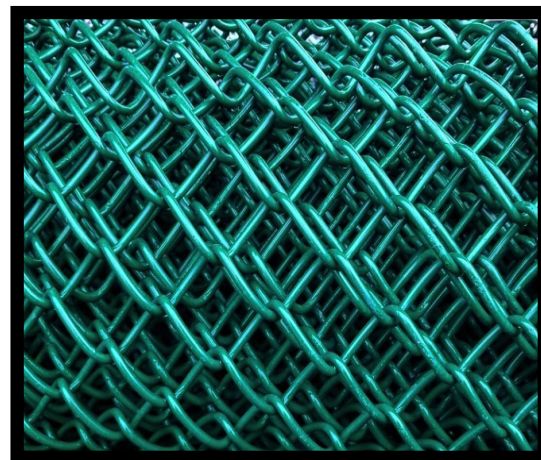

6 Gauge Vinyl (.192)

Item No.	Height	Square	Weight per FT	Roll	Pallet	
01490-XX	36"	1 1/4"	3 lbs	25 FT	400 FT	**
01491-XX	42"	1 1/4"	4.3 lbs	25 FT	400 FT	**
01492-XX	48"	1 1/4"	4.88 lbs	25 FT	400 FT	**
01493-XX	60"	1 1/4"	6.1 lbs	25 FT	400 FT	**
01494-XX	72"	1 1/4"	7.32 lbs	25 FT	400 FT	**
01495-XX	84"	1 1/4"	8.5 lbs	25 FT	400 FT	**
01496-XX	96"	1 1/4"	9.7 lbs	25 FT	400 FT	**
01497-XX	108"	1 1/4"	10.98 lbs	25 FT	400 FT	**
01498-XX	120"	1 1/4"	11 lbs	25 FT	400 FT	**
01500-XX	144"	1 1/4"	13 lbs	25 FT	400 FT	**

01520-XX	36"	1"	4.7 lbs	25 FT	400 FT	**
01521-XX	42"	1"	4.8 lbs	25 FT	400 FT	**
01522-XX	48"	1"	5.56 lbs	25 FT	400 FT	**
01523-XX	60"	1"	6.95 lbs	25 FT	400 FT	**
01524-XX	72"	1"	8.34 lbs	25 FT	400 FT	**
01525-XX	84"	1"	9.73 lbs	25 FT	400 FT	**
01526-XX	96"	1"	11.12 lbs	25 FT	400 FT	**
01527-XX	108"	1"	12.51 lbs	25 FT	400 FT	**
01528-XX	120"	1"	13.9 lbs	25 FT	400 FT	**
01530-XX	144"	1"	16.68 lbs	25 FT	400 FT	**

** May Require Setup Charge

Colours

In Stock

Special Order

Black

(BL)

Brown

(BR)

Green

(GR)

White

(WH)





PRO LINK **SUPPLY**

Pipe

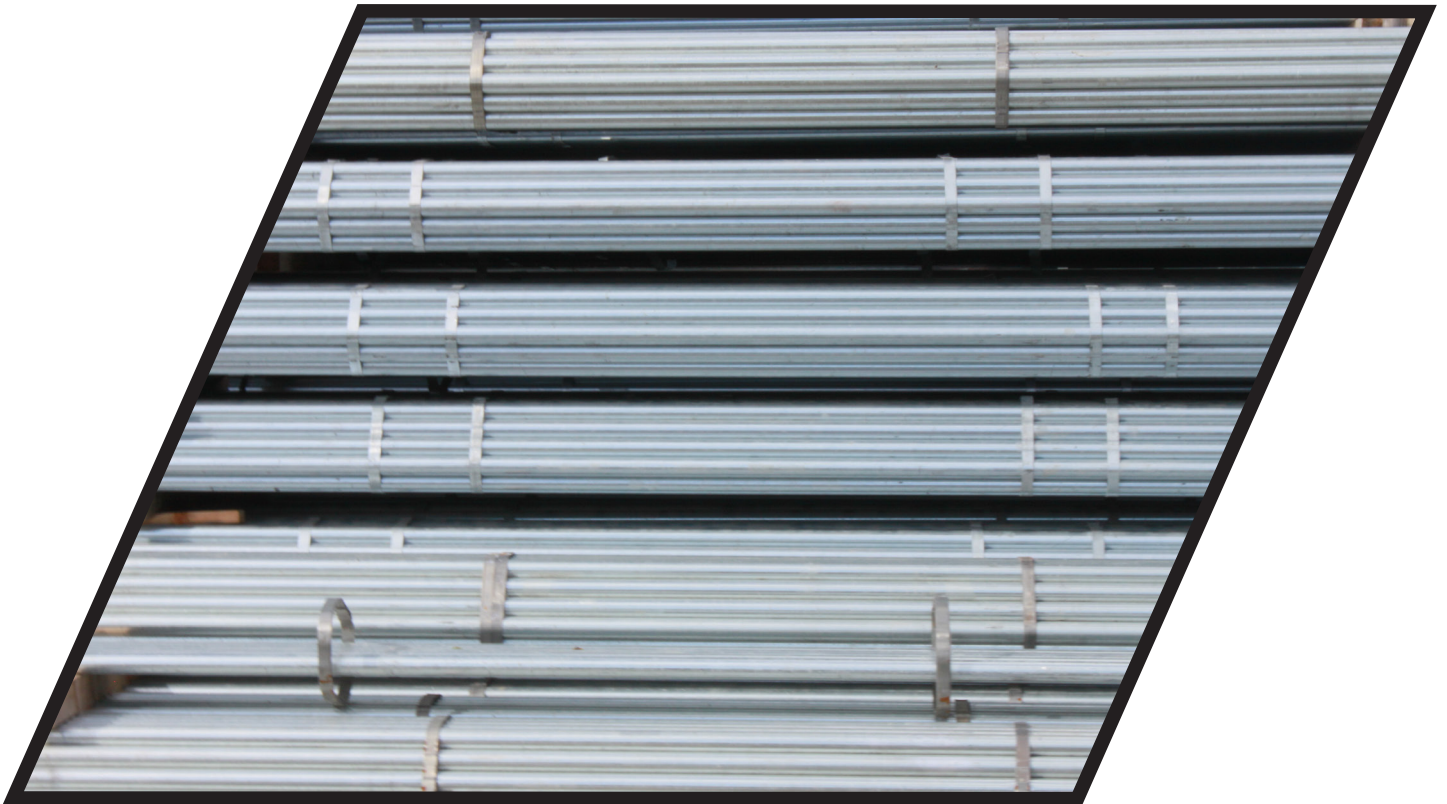

Commercial Galv. Pipe - Full lengths

Item No.	Gauge (O.D.)	Length	Weight	/Bundle
02065	1 3/8"	10' 6" S.E.	11 lbs	91 pcs
02020	1 3/8"	21' S.E.	22 lbs	91 pcs
02022	1 3/8"	21'	22 lbs	91 pcs
02024	1 3/8"	24'	25 lbs	91 pcs

02105	1 5/8"	10' 6" S.E.	13.8 lbs	61 pcs
02026	1 5/8"	21' S.E.	27.7 lbs	61 pcs
02028	1 5/8"	21'	27.7 lbs	61 pcs
02030	1 5/8"	24'	31.7 lbs	61 pcs

02032	1 7/8"	21'	32.1 lbs	61 pcs
02034	1 7/8"	24'	36.7 lbs	61 pcs

02036	2 3/8"	21'	40.1 lbs	37 pcs
02038	2 3/8"	24'	46.8 lbs	37 pcs

02040	2 7/8"	21'	72 lbs	19 pcs
02042	2 7/8"	24'	82.1 lbs	19 pcs

02044	3 1/2"	21'	88.4 lbs	14 pcs
02046	3 1/2"	24'	101 lbs	14 pcs



Commercial Galv. Pipe - Cut Pipe

Item No.	Gauge (O.D.)	Length	Weight	/Bundle
02154	1 7/8"	6'	9.2 lbs	61 pcs
02156	1 7/8"	7'	10.7 lbs	61 pcs
02158	1 7/8"	8'	12.2 lbs	61 pcs
02160	1 7/8"	9'	13.8 lbs	61 pcs
02163	1 7/8"	10' 6"	16.1 lbs	61 pcs
02166	1 7/8"	12'	18.4 lbs	61 pcs

02194	2 3/8"	6'	11.7 lbs	37 pcs
02196	2 3/8"	7'	13.7 lbs	37 pcs
02198	2 3/8"	8'	15.6 lbs	37 pcs
02200	2 3/8"	9'	17 lbs	37 pcs
02203	2 3/8"	10' 6"	20.5 lbs	37 pcs
02206	2 3/8"	12'	23.4 lbs	37 pcs

02234	2 7/8"	6'	20.5 lbs	19 pcs
02236	2 7/8"	7'	23.9 lbs	19 pcs
02238	2 7/8"	8'	27.3 lbs	19 pcs
02240	2 7/8"	9'	30.7 lbs	19 pcs
02243	2 7/8"	10' 6"	35.9 lbs	19 pcs
02246	2 7/8"	12'	41.1 lbs	19 pcs

02274	3 1/2"	6'	25.3 lbs	14 pcs
02276	3 1/2"	7'	29.5 lbs	14 pcs
02278	3 1/2"	8'	33.7 lbs	14 pcs
02280	3 1/2"	9'	37.89 lbs	14 pcs
02283	3 1/2"	10' 6"	44.2 lbs	14 pcs
02286	3 1/2"	12'	50.5 lbs	14 pcs



Custom Pipe Cuts Available.

Please Phone for more information

Powdercoated Black Commercial Pipe

Item No.	Gauge (O.D.)	Length	Weight	/Bundle
03502	1 3/8"	21' S.E.	20.1 lbs	91 pcs
03531	1 3/8"	10' 6" S.E.	8 lbs	91 pcs

03505	1 5/8"	21' S.E.	25.5 lbs	61 pcs
03547	1 5/8"	10' 6" S.E.	10 lbs	61 pcs
03542	1 5/8"	6'	7.9 lbs	61 pcs
03544	1 5/8"	7'	9.2 lbs	61 pcs

03562	1 7/8"	6'	9.2 lbs	61 pcs
03564	1 7/8"	7'	10.7 lbs	61 pcs
03566	1 7/8"	8'	12.2 lbs	61 pcs

03582	2 3/8"	6'	11.7 lbs	37 pcs
03584	2 3/8"	7'	13.7 lbs	37 pcs
03586	2 3/8"	8'	15.6 lbs	37 pcs
03590	2 3/8"	10'	19.6 lbs	37 pcs
03594	2 3/8"	12'	23.4 lbs	37 pcs

03612	2 7/8"	7'	23.9 lbs	19 pcs
03614	2 7/8"	8'	27.3 lbs	19 pcs
03616	2 7/8"	9'	31.0 lbs	19 pcs
03618	2 7/8"	10'	34.3 lbs	19 pcs
03624	2 7/8"	13'	41.1 lbs	19 pcs



**Custom Black Pipe Cuts Available
via Powder coating**

Please Phone for more information

Galvanized Schedule 40 Pipe - Powdercoated Black

Item No.	Gauge (O.D.)	Length	Weight	/Bundle
03704	1 5/8"	21'	47.7 lbs	42 pcs

03786	2 3/8"	8'	15.6 lbs	26 pcs
03790	2 3/8"	10'	17.6 lbs	26 pcs

03819	2 7/8"	10' 6"	60.8 lbs	18 pcs
03821	2 7/8"	12' 6"	72.4 lbs	18 pcs

03839	3 1/2"	10' 6"	23.9 lbs	14 pcs
03842	3 1/2"	12'	27.3 lbs	14 pcs

**Custom Black Pipe Cuts Available
via Powder coating**

Please Phone for more information



Schedule 40 Galv. Pipe - Full lengths

Item No.	Gauge (O.D.)	Length	Weight	/Bundle
02520	1 3/8"	21'	35.3 lbs	61 pcs

02528	1 5/8"	21'	47.7 lbs	42 pcs
02530	1 5/8"	24'	54.5 lbs	42 pcs

02532	1 7/8"	21'	57 lbs	36 pcs
02534	1 7/8"	24'	65.2 lbs	36 pcs

02536	2 3/8"	21'	76.7 lbs	26 pcs
02538	2 3/8"	24'	87.6 lbs	26 pcs

02540	2 7/8"	21'	121.6 lbs	18 pcs
02542	2 7/8"	24'	139 lbs	18 pcs

02544	3 1/2"	21'	159.1 lbs	14 pcs
02546	3 1/2"	24'	181.9 lbs	14 pcs

02548	4 1/2"	21'	226.5 lbs	10 pcs
02550	4 1/2"	24'	259 lbs	10 pcs

02552	6 5/8"	21'	399 lbs	4 pcs
02554	6 5/8"	24'	455.2 lbs	4 pcs

02556	8 5/8"	21' **	600 lbs	N/A
02558	8 5/8"	24' **	685.2 lbs	N/A

**** Call for Availability**



Schedule 40 Galv. Pipe - Cut Lengths

Item No.	Gauge (O.D.)	Length	Weight	/Bundle
02684	2 3/8"	6'	21.9 lbs	26 pcs
02686	2 3/8"	7'	25.5 lbs	26 pcs
02688	2 3/8"	8'	29.2 lbs	26 pcs
02690	2 3/8"	9'	36.5 lbs	26 pcs
02693	2 3/8"	10'6"	38.3 lbs	26 pcs
02696	2 3/8"	12'	43.8 lbs	26 pcs

02724	2 7/8"	6'	34.74 lbs	18 pcs
02726	2 7/8"	7'	40.53 lbs	18 pcs
02728	2 7/8"	8'	46.32 lbs	18 pcs
02730	2 7/8"	9'	52.1 lbs	18 pcs
02733	2 7/8"	10'6"	60.8 lbs	18 pcs
02736	2 7/8"	12'	69.48 lbs	18 pcs

02764	3 1/2"	6'	45.4 lbs	14 pcs
02766	3 1/2"	7'	53.1 lbs	14 pcs
02768	3 1/2"	8'	60.6 lbs	14 pcs
02770	3 1/2"	9'	68.2 lbs	14 pcs
02773	3 1/2"	10'6"	79.6 lbs	14 pcs
02776	3 1/2"	12'	91.4 lbs	14 pcs



**Custom Pipe Cuts Also Available for 1 5/8", 1 7/8",
4 1/2", & 6 5/8" Sched 40 pipe**

Please Phone for more information

Galvanized Square Tubing

Item No.	Size	Gauge	Weight	Bundle Qty
08050	3/4" x 3/4" x 24'	16 Ga.	15.3 lbs	144
08060	1" x 1" x 24'	16 Ga.	19.5 lbs	121
08070	1 1/2" x 1 1/2" x 24'	16 Ga.	32 lbs	81
08080	2" x 2" x 24'	14 Ga.	60 lbs	36
08090	3" x 3" x 24'	12.5 Ga.	92 lbs	25
08100	4" x 4" x 24'	12.5 Ga.	123 lbs	16
08120	1" x 2" x 24'	16 Ga.	29.9 lbs	72
08140	2" x 4" x 24' **	12.5 Ga.	92 lbs	36

**** Call for Availability**

Pre Galvanized Zinc Coating
ASTM A653, G90/0.90 oz per Square Foot



Panels Discontinued

PRO LINK **SUPPLY**

Flat Iron Ornamental



Prolink Supply warrants its Prolink Brand Ornamental Iron Fence and Flat Iron Products and accessories to be free from manufacturing related structural defects in material and workmanship to the original consumer/purchaser for a period of 1 year from the date of purchase. In addition to manufacturing related structural defects, this Limited Warranty covers cracking, peeling, blistering, fading of the finish, and extensive corrosion of the Prolink Brand Ornamental Iron Fence and Flat Iron Products and accessories protected by Prolink Supply for 1 year. Corrosion is termed extensive when multiple rust-through perforation instances occur on the same fence section or component.

This Limited Warranty does not cover damage caused by abnormal or improper use, improper product application, accident, alteration, welding, neglect, abuse, lawn care equipment damage, abrasion, exposure to harsh chemicals such as chlorine, lawn or garden fertilizers, chemical, salt or mineral laden irrigation water sources, chemicals used for ice removal, surface corrosion from nicks and scratches, air pollutants, improper service or installation or lack of service, or damage caused by flood, fire or acts of God.

In order for this Limited Warranty to apply to any failure related to modification of the length of the panel, panels which have been cut to custom length must be properly cleaned, re-coated and touched up with Prolink Supply's field powder coating process and Prolink Supply's black touch up paint as per Manufacturer's instructions.

This Limited Warranty does not cover Prolink Brand Ornamental Iron Fence and Flat Iron Products that are in direct or incidental contact with salt water including water from saltwater swimming pools or other saltwater bodies of water. For installations located 1 mile or less from the ocean or other saltwater bodies of water this Limited Warranty is applicable for a period of 6 month from date of purchase. The original consumer/purchaser must contact Prolink Supply directly via phone at (888) 673-8839 or 604-466-8839 or via e-mail at info@prolinksupply.com to submit a claim. The original Consumer/Purchaser will be notified by Prolink Supply as to whether the warranty claim is approved or denied.

Conditions and Exclusions of this Warranty

THIS WARRANTY IS NOT TRANSFERABLE. THE AMOUNT OF YOUR RESTITUTION WILL NOT INCLUDE LABOR TO REMOVE EXISTING COMPONENTS OR INSTALL THE REPLACEMENT COMPONENTS, SHIPPING CHARGES, SALES TAX OR ANY OTHER CHARGES, NOR IS PROLINK SUPPLY REQUIRED TO PROVIDE SUCH LABOR OR SERVICE. THIS LIMITED WARRANTY IS IN LIEU OF ALL OTHER EXPRESS WARRANTIES. PROLINK SUPPLY MAKES NO OTHER EXPRESS WARRANTIES AND DOES NOT AUTHORIZE ANY OTHER PERSON OR AGENT TO MAKE ANY OTHER EXPRESS WARRANTIES. PROLINK SUPPLY NEITHER ASSUMES NOR AUTHORIZES ANY OTHER LIABILITY OR OBLIGATION IN WARRANTY, INCLUDING WITHOUT LIMITATION, THE IMPLIED WARRANTIES OF MERCHANTABILITY AND FITNESS FOR A PARTICULAR PURPOSE WITH RESPECT TO THIS PRODUCT, IS LIMITED IN DURATION TO THE ONE YEAR TERM OF THIS LIMITED WARRANTY. IN NO EVENT SHALL PROLINK SUPPLY BE LIABLE FOR ANY CONSEQUENTIAL, SPECIAL, OR INCIDENTAL DAMAGES ARISING OUT OF OR CONNECTED WITH THE PURCHASE OR USE OF THIS PRODUCT OR FOR ANY BREACH OF WARRANTY.

This Agreement shall be governed by and construed in accordance with the laws of the province of BC. Any legal action arising out of this agreement shall be litigated and enforced under the laws of the Province of BC.

This warranty is only applicable to Prolink Brand Ornamental Iron Fence and Flat Iron Products installed within Canada.

Flat Iron Ornamental Fence Panels: Fortress

Each panel requires 6 Brackets

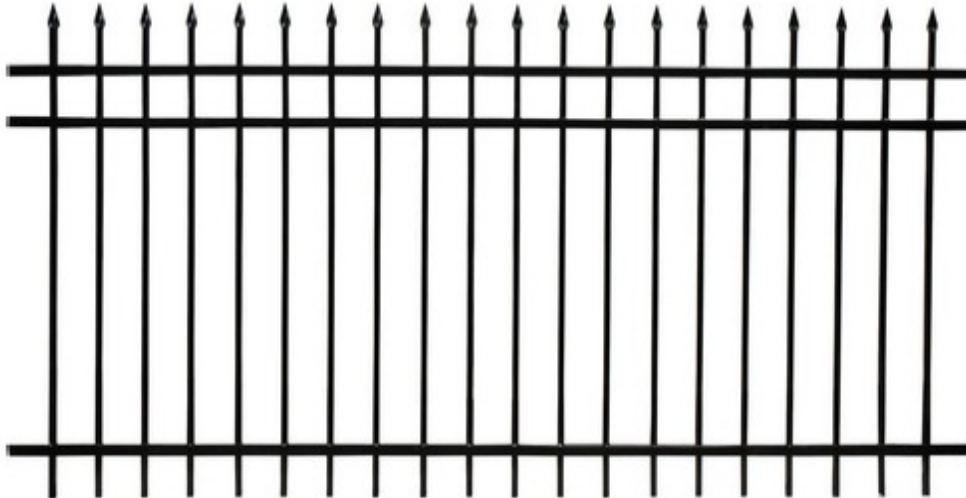

Item No.	Description	Weight
15000-FT	94" wide x 4' high Fortress Panel**	50 lbs
15002-FT	94" wide x 5' high Fortress Panel**	60 lbs

****Limited Stock**

Flat Iron Ornamental Fence Panels: Royal

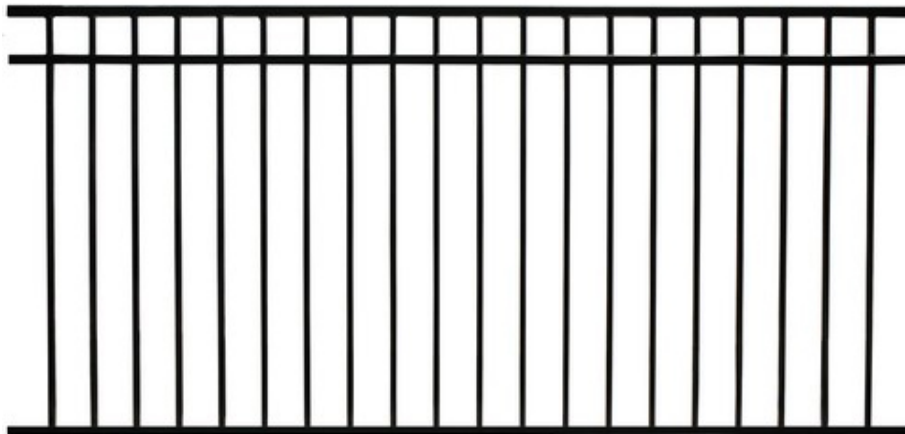

Item No.	Description	Weight
15002-RY	94" wide x 5' high Royal Panel**	55 lbs
15004-RY	94" wide x 6' high Royal Panel**	63 lbs

****Limited Stock**

Flat Iron Ornamental Man Gates: Fortress

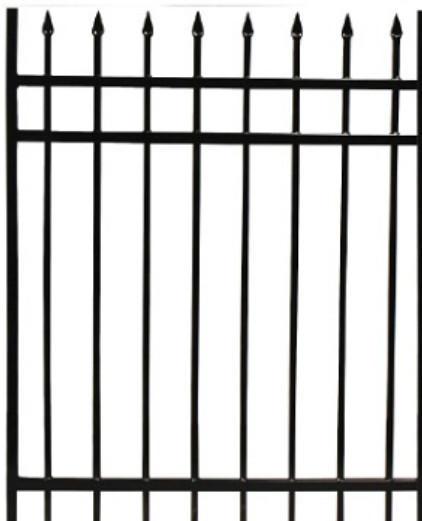

Item No.	Description	Weight
15020-FT	39" wide x 4' high Black Ornamental Gate	26 lbs
15022-FT	39" wide x 5' high Black Ornamental Gate	31 lbs
15024-FT	39" wide x 6' high Black Ornamental Gate	36 lbs

Flat Iron Ornamental Man Gates: Royal

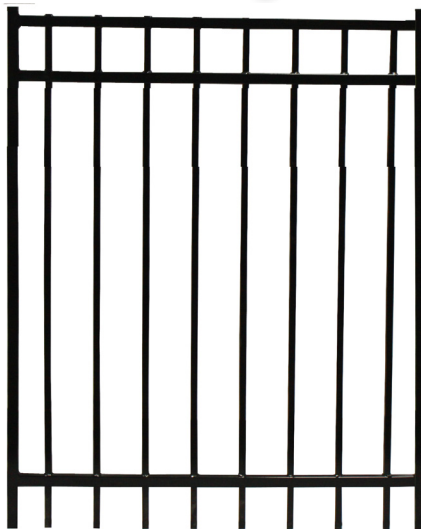

Item No.	Description	Weight
15020-RY	39" wide x 4' high Black Ornamental Gate	26 lbs
15022-RY	39" wide x 5' high Black Ornamental Gate	31 lbs
15024-RY	39" wide x 6' high Black Ornamental Gate	36 lbs

Flat Iron Ornamental Infinity Gates: Fortress

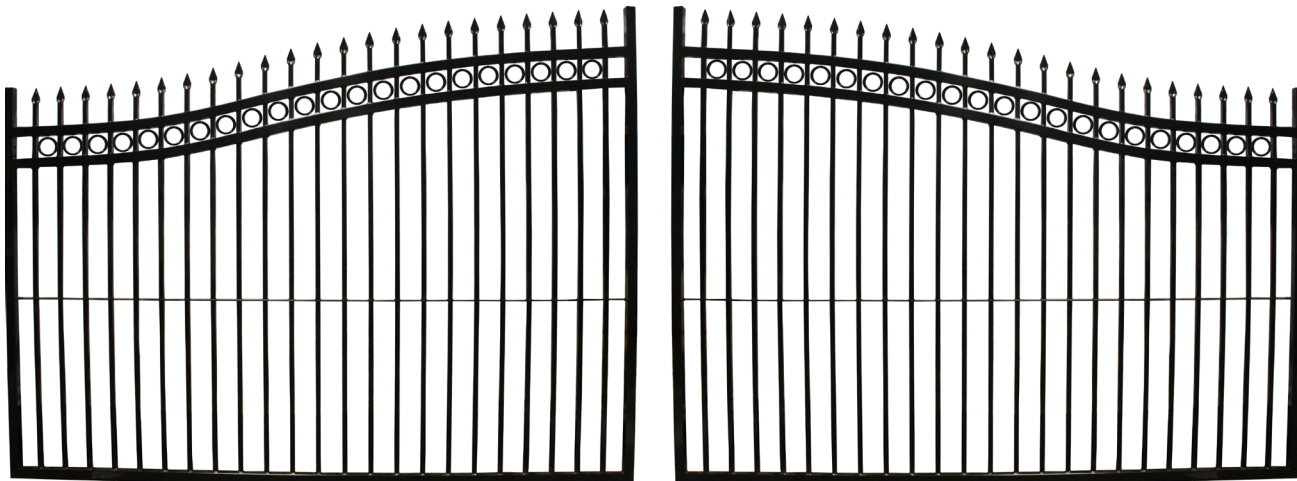

Item No.	Description	Unit	Weight
15502-FT	14' length x 6' high (Peak) Double Swing Gate	2 Panels	257 lbs
15512-FT	16' length x 6' high (Peak) Double Swing Gate	2 Panels	298 lbs

Flat Iron Ornamental Infinity Gates: Royal



Item No.	Description	Unit	Weight
15500-RY	14' length x 6' high (Peak) Double Swing Gate	2 Panels	257 lbs
15510-RY	16' length x 5' high (Peak) Double Swing Gate	2 Panels	246 lbs
15512-RY	16' length x 6' high (Peak) Double Swing Gate	2 Panels	294 lbs
15536-RY	20' length x 7' high (Peak) Double Swing Gate	2 Panels	374 lbs

Posts

Item No.	Description	Gauge	Weight
15100	2" x 2" x 6' Black Ornamental Post	0.065	9 lbs
15102	2" x 2" x 7' Black Ornamental Post	0.065	11 lbs
15104	2" x 2" x 8' Black Ornamental Post	0.065	13 lbs

15120	2.5" x 2.5" x 6' Black Ornamental Post**	0.083	15 lbs
15122	2.5" x 2.5" x 7' Black Ornamental Post**	0.083	17 lbs
15124	2.5" x 2.5" x 8' Black Ornamental Post	0.083	19 lbs

15144	4" x 4" x 8' Black Ornamental Post	0.120	53 lbs
-------	------------------------------------	-------	--------

15164	6" x 6" x 8' Black Ornamental Post	0.165	80 lbs
15166	6" x 6" x 10' Black Ornamental Post	0.165	100 lbs

****Call for availability**



Post Cap

Item No.	Description	Weight
15200	2" x 2" Black Post Cap	0.1 lbs
15202	2.5" x 2.5" Black Post Cap	0.2 lbs
15204	3" x 3" Black Post Cap	0.2 lbs
15206	4" x 4" Black Post Cap	0.3 lbs
15208	6" x 6" Black Post Cap	0.4 lbs



Floor Flange

Item No.	Description	Weight
15220	2" x 2" Floor Flange with Set Screw	2 lbs
15222	2.5" x 2.5" Floor Flange with Set Screw	2 lbs



Panel Hardware

End Bracket w/ Bolts

Item No.	Description	Weight
15300	2" x 1" End Bracket with Bolts	0.4 lbs
15302	2.5" x 1" End Bracket with Bolts	0.4 lbs

***6 Required for Each Panel**



Swivel End Bracket w/ Bolts

Item No.	Description	Weight
15310	2" x 1" Swivel End Bracket w/ Bolts	0.4 lbs

***6 Required for Each Panel**



Mounting Bracket w/ Tech Screw

Item No.	Description	Weight
15312	Ornamental Fence Mounting Bracket with Tech Screw	0.5 lbs

***6 Required for Each Panel**

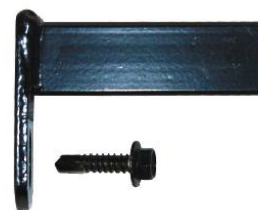

Gate Hardware

Clamp On Hinges

Item No.	Description	Weight
15250	1" Clamp on Frame Hinge	1 lbs
15252	2" Clamp On Post Hinge	2 lbs
15254	2.5" Clamp On Post Hinge	2 lbs



Light Duty Infinity Hinges

Item No.	Description	Weight
15270	4" x 1.5" Light Duty Infinity Hinge	2 lbs

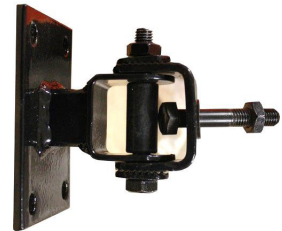

Heavy Duty Infinity Hinge

Item No.	Description	Weight
15272	4" Heavy Duty Infinity Hinge	6 lbs
15274	6" Heavy Duty Infinity Hinge	7 lbs



Latches

Item No.	Description	Weight
15350	2" x 1" Striker Bar Ornamental Latch Kit	2 lbs



Fork Latches

Item No.	Description	Weight
15360	2" x 1" Fork Assembly Latch	2 lbs
15362	2.5" x 1" Fork Assembly Latch	2 lbs



Drop Rod Assembly

Item No.	Description	Weight
15368	Drop Rod Assembly	5 lbs



Products Discontinued

PRO LINK
SUPPLY

Versai Rackable Ornamental



Version III



Versai™ Products Protected by FortressShield 20 Year Limited Warranty



Fortress Fence Products warrants its FortressShield protected Versai™ fence products and accessories to be free from manufacturing related structural defects in material and workmanship to the original consumer purchaser for a period of 20 years from the date of purchase. In addition to manufacturing related structural defects, this Limited Warranty covers cracking, peeling, blistering, excessive fading of the finish, and extensive corrosion of the Versai™ fence products and accessories protected by FortressShield for a period of 20 years. Corrosion is termed extensive when multiple rust-through perforation instances occur on the same fence section or component.

This warranty does not cover damage caused by abnormal or improper use, improper product application, accident, alteration, welding, neglect, abuse, lawn care equipment damage, abrasion, exposure to harsh chemicals such as chlorine, lawn or garden fertilizers, chemical or mineral laden irrigation water sources, chemicals used for ice removal, air pollutants, improper service or installation or lack of service, or damage caused by flood, fire or acts of God. In order for this warranty to apply to any failure related to modification of the length of the panel, panels which have been cut to custom length must be properly cleaned, recoated and touched up with Fortress Fence Products' field powder coating process and Fortress Fence Products' black touch up paint as per Manufacturer's instructions. See website for required treatment and method for recoating of cut ends.

Surface corrosion from scratches, nicks and dents are not covered. For installations located 1 mile or less from the ocean or other saltwater bodies of water, this Limited Warranty is applicable for a period of 3 years from the date of purchase. This limited warranty does not cover FortressShield protected Versai fence products that are in direct or incidental contact with salt water including water from saltwater swimming pools or other saltwater bodies of water.

The original consumer purchaser must contact Fortress Fence Products customer service directly via phone at (866) 323-4766 or via e-mail at warranties@fortressfence.com to obtain necessary warranty claim forms and official claim process. The original consumer purchaser will be notified by Fortress Fence Products as to whether the warranty claim is approved or denied. **THE MANUFACTURER'S IDENTIFICATION TAG or STAMPED MANUFACTURING IDENTIFICATION CODE INCLUDED WITH ALL VERSAI™ FORTRESSSHIELD PRODUCTS AND ORIGINAL PROOF OF PURCHASE MUST ACCOMPANY ALL WARRANTY CLAIMS.**

Conditions and Exclusions of this warranty

THIS WARRANTY IS NOT TRANSFERABLE. THE AMOUNT OF YOUR RESTITUTION WILL NOT INCLUDE LABOR TO REMOVE EXISTING COMPONENTS OR INSTALL THE REPLACEMENT COMPONENTS, SHIPPING CHARGES, SALES TAX OR ANY OTHER CHARGES, NOR IS FORTRESS FENCE PRODUCTS REQUIRED TO PROVIDE SUCH LABOR OR SERVICE.

THIS LIMITED WARRANTY IS IN LIEU OF ALL OTHER EXPRESS WARRANTIES. FORTRESS FENCE PRODUCTS MAKES NO OTHER EXPRESS WARRANTIES AND DOES NOT AUTHORIZE ANY OTHER PERSON OR AGENT TO MAKE ANY OTHER EXPRESS WARRANTIES. FORTRESS FENCE PRODUCTS NEITHER ASSUMES NOR AUTHORIZES ANY OTHER LIABILITY OR OBLIGATION IN WARRANTY, INCLUDING WITHOUT LIMITATION, THE IMPLIED WARRANTIES OF MERCHANTABILITY AND FITNESS FOR A PARTICULAR PURPOSE WITH RESPECT TO THIS PRODUCT, IS LIMITED IN DURATION TO THE TWENTY (20) YEAR TERM OF THIS LIMITED WARRANTY. IN NO EVENT SHALL FORTRESS FENCE PRODUCTS BE LIABLE FOR ANY CONSEQUENTIAL, SPECIAL, OR INCIDENTAL DAMAGES ARISING OUT OF OR CONNECTED WITH THE PURCHASE OR USE OF THIS PRODUCT OR FOR ANY BREACH OF WARRANTY.

This Agreement shall be governed by and construed in accordance with the laws of the State of Texas, without regard to its conflict of laws. Any legal action arising out of this Agreement shall be litigated and enforced under the laws of the State of Texas. In addition, you agree to submit to the jurisdiction of the courts of the State of Texas, and that any legal action pursued by you shall be within the exclusive jurisdiction of the courts in the State of Texas, U.S.A.

SOME STATES DO NOT ALLOW LIMITATIONS ON HOW LONG AN IMPLIED WARRANTY LASTS, OR THE EXCLUSION OR LIMITATION OF INCIDENTAL OR CONSEQUENTIAL DAMAGES, SO THE ABOVE LIMITATIONS OR EXCLUSION MAY NOT APPLY TO YOU. THIS WARRANTY GIVES YOU SPECIFIC LEGAL RIGHTS, AND YOU MAY HAVE OTHER RIGHTS THAT VARY FROM STATE TO STATE. THIS WARRANTY IS APPLICABLE ONLY TO SYSTEMS INSTALLED WITHIN THE CONTINENTAL UNITED STATES AND CANADA.



Installation Instructions for Cutting Fortress Fence Products

It is the responsibility of the installer to meet all code and safety requirements as well as obtain all required building permits. The installer should determine and implement appropriate installation techniques for each installation situation. The Fortress Company and its distributors shall not be held liable for improper or unsafe installations.

Read Instructions Completely Before Starting Installation

Note

Not following the below steps could result in oxidation at cut points and will void the warranty. When cutting Fortress Fence Products, complete the following at cut points:

- Cut material to length and remove all metal shavings from the cut area
- File any sharp edges left by cutting. Thoroughly wipe and remove any filings, grime or dirt from the panel.
- Apply two coats of Fortress zinc based touch-up paint to the cut area. If touch up is at rail ends, allow paint to dry before connecting bracket to post.
- Be sure to remove any metal shavings from the work surface to prevent oxidation on the surface.

Required Materials

Metal Cutting Saw, File, Brush or Rags, Cardboard, Fortress Zinc Based Touch-Up Paint.

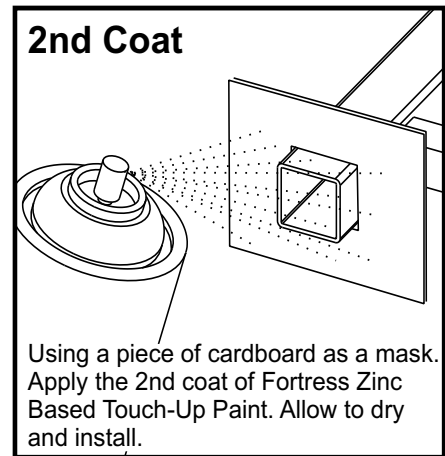
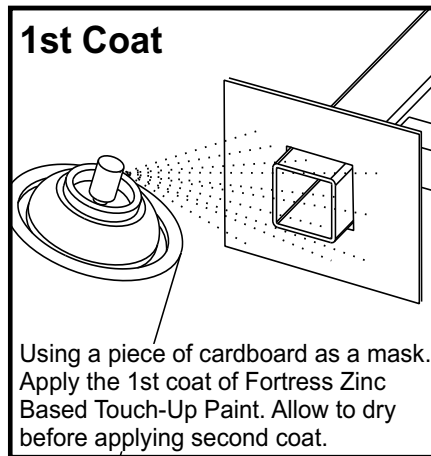
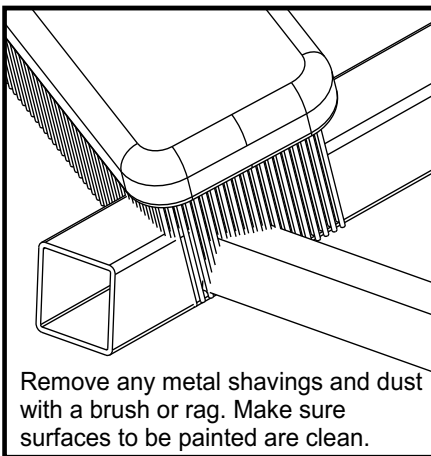
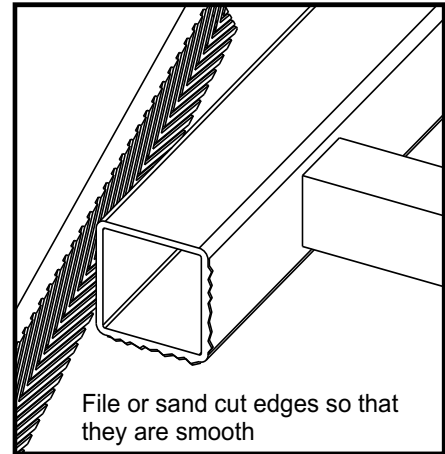
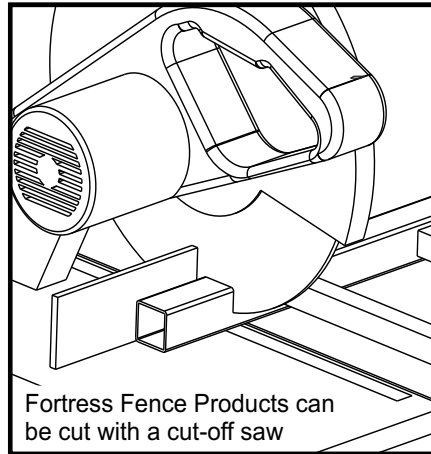
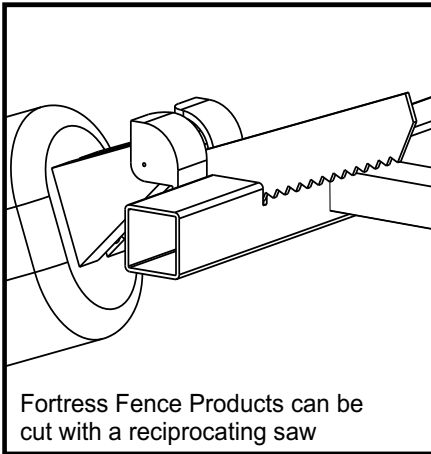



Before you set your posts, confirm rail length, bracket type, and on center spacing

VERSAI

RAIL LENGTH, BRACKET & ON CENTER SPACING

OC BASED ON USING 2" POSTS	90 1/2" Rail	
	Min OC Spacing	Max OC Spacing
EX-104 / EXW-204 / EXW-304	92 5/8"	93 3/8"
EXS-104	95 1/4"	96"
OMNI-104	92 3/4"	93 3/8"
EX 104 - 96" OC / EXW 304 - 96" OC / EXW 304 - 96" OC	94 7/8"	96"

On center spacing applies on flat installations. If biased, the OC spacing distances must be adjusted according to grade

VERSAI

SPECIFICATIONS

PICKETS	5/8" x 5/8" x 18 Gauge
RAILS	1" x 1 3/16" x 16 Gauge
POSTS	2" x 2" x 16 Gauge
PICKET SPACING	3 7/8" Air Space
HEIGHTS Available	* 34", 46", 54", 58", 70"
WIDTHS Available	90.5"
ALLOY	G60 Galvanized Steel
FULLY ASSEMBLED	93" or 96" On Center Spacing depending on bracket
<p><i>Styles: 2, 3 Rails - Flat Top, Flat Top/Flat Bottom, Extended Picket, Extended Picket/Flat Bottom Pressed Spear, Pressed Spear/Flat Bottom</i></p>	

*** INTENDED USE NOTICE FOR 34" FENCE POSTS**

This fence product is intended for use on fence installation only

This product has not been tested or approved for use as railing.

Fortress Railing Products & Fortress Fence Products assumes no liability for improper use.

Ornamental Fence Panels and Gates: Versai - Pressed Spear

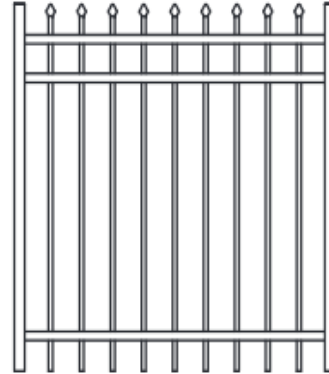
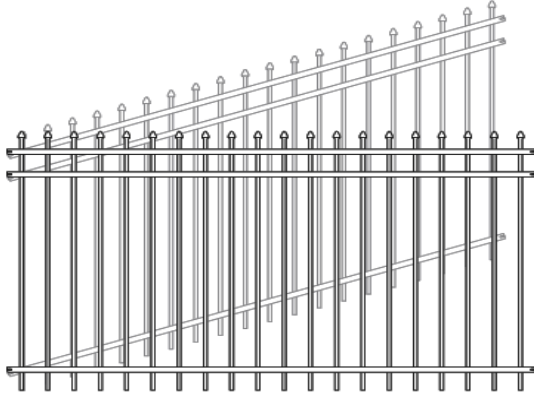

Item No.	Description	Weight
16144VP	46" high x 90.5" wide Pressed Spear Panel	40 lbs
16145VP	58" high x 90.5" wide Pressed Spear Panel	45 lbs
16146VP	70" high x 90.5" wide Pressed Spear Panel	52 lbs
16146VW	70" high x 46.5" wide Pressed Spear Walk Gate	40 lbs

* Each Panel requires 6 Brackets

Ornamental Fence Panels and Gates: Versai - Flat Top/Extended Bottom

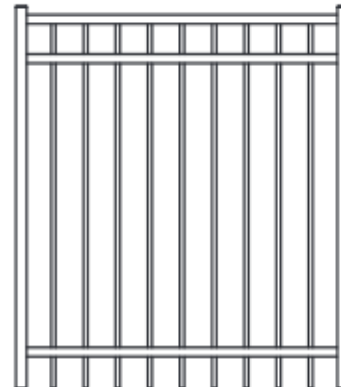
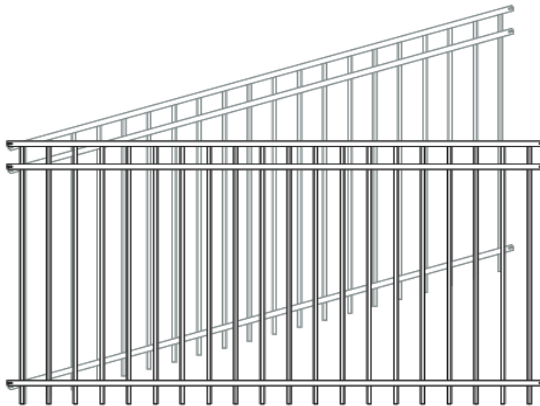

Item No.	Description	Weight
16114VP	46" high x 90.5" wide Flat Top/Extended Bottom Panel	40 lbs
16115VP	58" high x 90.5" wide Flat Top/Extended Bottom Panel	45 lbs
16116VP	70" high x 90.5" wide Flat Top/Extended Bottom Panel	52 lbs
16114VW	46.5" wide x 46" high Flat Top/Extended Bottom Walk Gate	30 lbs
16115VW	46.5" wide x 58" high Flat Top/Extended Bottom Walk Gate	36 lbs
16116VW	46.5" wide x 70" high Flat Top/Extended Bottom Walk Gate	40 lbs

* Each Panel requires 6 Brackets

Ornamental Fence Panels and Gates: Versai - Extended Picket (Upper/Lower)

* Each Panel requires 6 Brackets

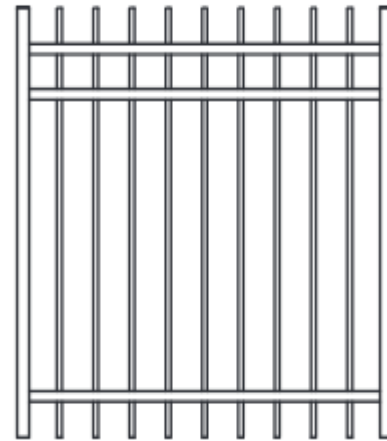
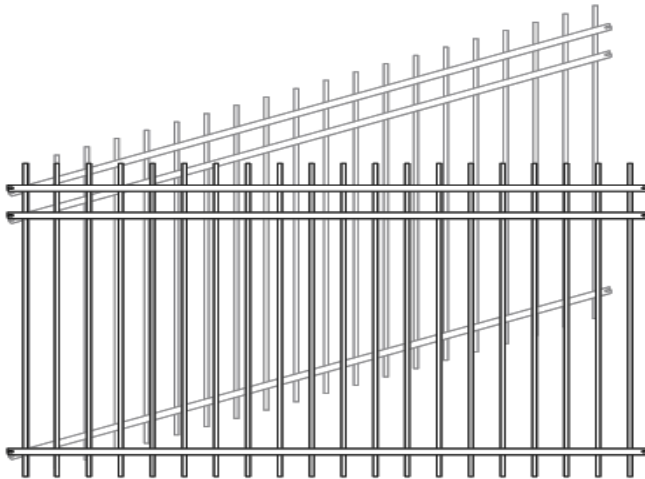

Item No.	Description	Weight
16155VP	58" high x 90.5" wide Extended Picket Panel**	45 lbs
16155VW	58" high x 46.5" wide Extended Picket Walk Gate**	36 lbs
16156VW	70" high x 46.5" wide Extended Picket Walk Gate**	40 lbs

** Limited Stock

Ornamental Fence Arched Walk Gates: Versai - Pressed Spear

Item No.	Description	Weight
16146VG	70" high x 46.5" wide Pressed Spear Arched Walk Gate**	40 lbs

****Special Order**

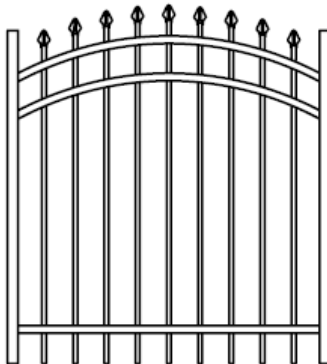

Ornamental Fence Arched Walk Gates: Versai - Flat Top/Extended Bottom

Item No.	Description	Weight
16114VG	46.5" wide x 46" high Flat Top/Extended Bottom Arched Walk Gate**	30 lbs
16115VG	46.5" wide x 58" high Flat Top/Extended Bottom Arched Walk Gate**	36 lbs
16116VG	46.5" wide x 70" high Flat Top/Extended Bottom Arched Walk Gate**	40 lbs

****Special Order**

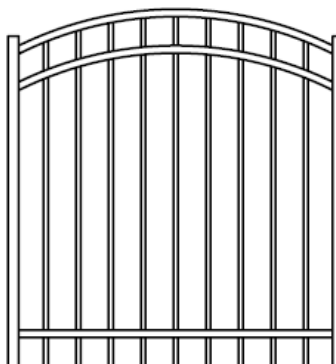

Versai Hardware

Versai Brackets

Item No.	Description	Weight
16181XD	Exterior One Direction Brackets - EX-104 (3 Sets)	0.8 lbs
16182XD	Exterior Two Direction Brackets - EXW-204 (3 Sets)	0.8 lbs
16183XT	Exterior Three Direction Bracket - EXW-304 (3 sets)	1.20 lbs
16181XS	Exterior Swivel Bracket - EXS-104 (3 sets)	1.70 lbs



**EXTERIOR ONE
DIRECTION
(EX-104)**

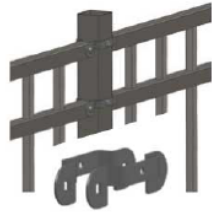

**EXTERIOR TWO
DIRECTION
(EXW-204)**



**EXTERIOR THREE
DIRECTION
(EXW-304)**



**EXTERIOR SWIVEL
BRACKET
(EXS-104)**

Gate Post Hinge

Item No.	Description	Weight
16613	2" Gate Post Hinge (Pair)	2 lbs
16614	2.5" Gate Post Hinge (Pair)	2.5 lbs



Gate Frame Hinge

Item No.	Description	Weight
16611	1.5" Gate Frame Hinge (Pair)	2 lbs



Fork Latch

Item No.	Description	Weight
16633	1.5" x 2" Fork Latch	1 lbs
16634	1.5" x 2.5" Fork Latch	1.5 lbs



Lock & Latch

Item No.	Description	Weight
16603LL	Lock & Latch	5 lbs



Gravity Latches

Item No.	Description	Weight
16620	Gravity Latch Striker Plate 2"	0.6 lbs
16623	Latch Arm 1.5" Frame	0.7 lbs

Gate Kit Hardware

Item No.	Description	Weight
16607	1.5" x 47" Gate Upright	5.2 lbs
16608	1.5" x 59" Gate Upright	6.5 lbs
16609	1.5" x 71" Gate Upright	7.9 lbs

16540GC	1.5" x 1.5" Black Post Cap for Gate Uprights	0.1 lbs
---------	--	---------

16607GE	1.5" Versai Gate Ells (6 Pairs)	8.2 lbs
---------	---------------------------------	---------



Versai Posts

Item No.	Description	Gauge	Weight
16514	2" x 2" x 72" Black Ornamental Post	16	9 lbs
16516	2" x 2" x 84" Black Ornamental Post	16	10 lbs
16517	2" x 2" x 96" Black Ornamental Post	16	11 lbs
16524	2.5" x 2.5" x 96" Black Ornamental Post	16	17.2 lbs



Pressed Dome Cap for Versai Posts

Item No.	Description	Weight
16540BD	2" x 2" Black Post Cap	0.1 lbs
16541BD	2.5" x 2.5" Black Post Cap	0.17 lbs



New Product

PRO LINK **SUPPLY**

V2 Ornamental
2021

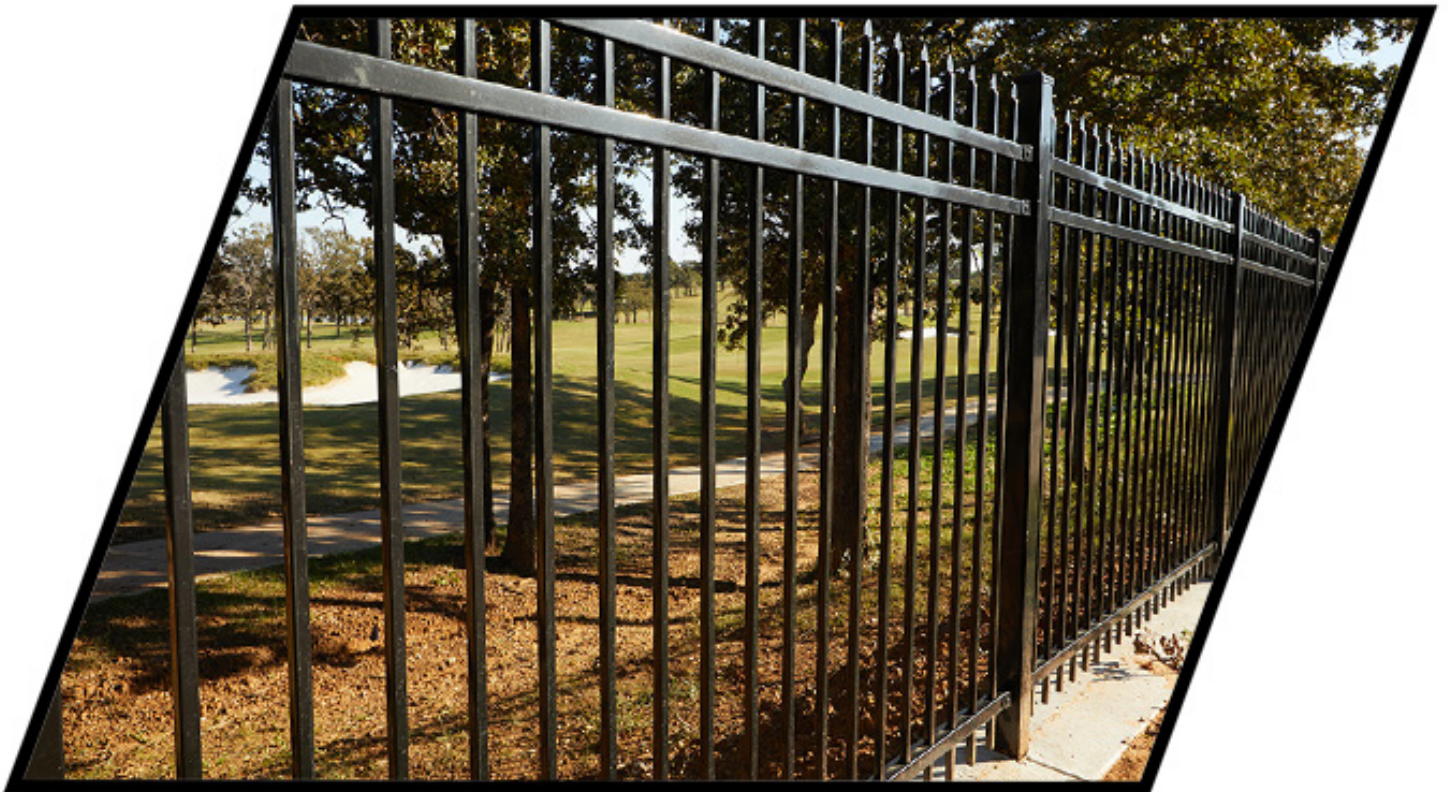

Version III



Versai™ Products Protected by FortressShield 20 Year Limited Warranty



Fortress Fence Products warrants its FortressShield protected Versai™ fence products and accessories to be free from manufacturing related structural defects in material and workmanship to the original consumer purchaser for a period of 20 years from the date of purchase. In addition to manufacturing related structural defects, this Limited Warranty covers cracking, peeling, blistering, excessive fading of the finish, and extensive corrosion of the Versai™ fence products and accessories protected by FortressShield for a period of 20 years. Corrosion is termed extensive when multiple rust-through perforation instances occur on the same fence section or component.

This warranty does not cover damage caused by abnormal or improper use, improper product application, accident, alteration, welding, neglect, abuse, lawn care equipment damage, abrasion, exposure to harsh chemicals such as chlorine, lawn or garden fertilizers, chemical or mineral laden irrigation water sources, chemicals used for ice removal, air pollutants, improper service or installation or lack of service, or damage caused by flood, fire or acts of God. In order for this warranty to apply to any failure related to modification of the length of the panel, panels which have been cut to custom length must be properly cleaned, recoated and touched up with Fortress Fence Products' field powder coating process and Fortress Fence Products' black touch up paint as per Manufacturer's instructions. See website for required treatment and method for recoating of cut ends.

Surface corrosion from scratches, nicks and dents are not covered. For installations located 1 mile or less from the ocean or other saltwater bodies of water, this Limited Warranty is applicable for a period of 3 years from the date of purchase. This limited warranty does not cover FortressShield protected Versai fence products that are in direct or incidental contact with salt water including water from saltwater swimming pools or other saltwater bodies of water.

The original consumer purchaser must contact Fortress Fence Products customer service directly via phone at (866) 323-4766 or via e-mail at warranties@fortressfence.com to obtain necessary warranty claim forms and official claim process. The original consumer purchaser will be notified by Fortress Fence Products as to whether the warranty claim is approved or denied. **THE MANUFACTURER'S IDENTIFICATION TAG or STAMPED MANUFACTURING IDENTIFICATION CODE INCLUDED WITH ALL VERSAI™ FORTRESSSHIELD PRODUCTS AND ORIGINAL PROOF OF PURCHASE MUST ACCOMPANY ALL WARRANTY CLAIMS.**

Conditions and Exclusions of this warranty

THIS WARRANTY IS NOT TRANSFERABLE. THE AMOUNT OF YOUR RESTITUTION WILL NOT INCLUDE LABOR TO REMOVE EXISTING COMPONENTS OR INSTALL THE REPLACEMENT COMPONENTS, SHIPPING CHARGES, SALES TAX OR ANY OTHER CHARGES, NOR IS FORTRESS FENCE PRODUCTS REQUIRED TO PROVIDE SUCH LABOR OR SERVICE.

THIS LIMITED WARRANTY IS IN LIEU OF ALL OTHER EXPRESS WARRANTIES. FORTRESS FENCE PRODUCTS MAKES NO OTHER EXPRESS WARRANTIES AND DOES NOT AUTHORIZE ANY OTHER PERSON OR AGENT TO MAKE ANY OTHER EXPRESS WARRANTIES. FORTRESS FENCE PRODUCTS NEITHER ASSUMES NOR AUTHORIZES ANY OTHER LIABILITY OR OBLIGATION IN WARRANTY, INCLUDING WITHOUT LIMITATION, THE IMPLIED WARRANTIES OF MERCHANTABILITY AND FITNESS FOR A PARTICULAR PURPOSE WITH RESPECT TO THIS PRODUCT, IS LIMITED IN DURATION TO THE TWENTY (20) YEAR TERM OF THIS LIMITED WARRANTY. IN NO EVENT SHALL FORTRESS FENCE PRODUCTS BE LIABLE FOR ANY CONSEQUENTIAL, SPECIAL, OR INCIDENTAL DAMAGES ARISING OUT OF OR CONNECTED WITH THE PURCHASE OR USE OF THIS PRODUCT OR FOR ANY BREACH OF WARRANTY.

This Agreement shall be governed by and construed in accordance with the laws of the State of Texas, without regard to its conflict of laws. Any legal action arising out of this Agreement shall be litigated and enforced under the laws of the State of Texas. In addition, you agree to submit to the jurisdiction of the courts of the State of Texas, and that any legal action pursued by you shall be within the exclusive jurisdiction of the courts in the State of Texas, U.S.A.

SOME STATES DO NOT ALLOW LIMITATIONS ON HOW LONG AN IMPLIED WARRANTY LASTS, OR THE EXCLUSION OR LIMITATION OF INCIDENTAL OR CONSEQUENTIAL DAMAGES, SO THE ABOVE LIMITATIONS OR EXCLUSION MAY NOT APPLY TO YOU. THIS WARRANTY GIVES YOU SPECIFIC LEGAL RIGHTS, AND YOU MAY HAVE OTHER RIGHTS THAT VARY FROM STATE TO STATE. THIS WARRANTY IS APPLICABLE ONLY TO SYSTEMS INSTALLED WITHIN THE CONTINENTAL UNITED STATES AND CANADA.





V2 Commercial Rackable Welded Ornamental Fence Section 32 31 19

PART 1 GENERAL

1.01 SECTION INCLUDES:

Ornamental rackable welded steel fence system.

1.02 Related Sections:

Section 03 30 00 Cast-in-Place Concrete

Section 31 30 00 Earthwork

1.03 REFERENCES:

ASTM A123 Hot Dip Electroplating

ASTM A500 Seamless Grade A Metal Tubing

ASTM B117-97 Salt Spray Corrosion Test

ASTM F1908 Residential Outdoor Swimming Pools

ASTM F2049 Standard Safety Performance for Fence

ASTM F2408 Standard Specification for Ornamental Fences

1.04 WARRANTY

Fortress Fence Products V2 materials include a 20-year limited warranty, from the date of purchase, for defects in material and workmanship, including protection against cracking, peeling, blistering and corrosion (rusting). Refer to 20 Year Warranty Sheet.

PART 2 PRODUCTS

2.01 MANUFACTURER:

Fortress Fence Products

1720 North First Street

Garland, TX 75040

Phone: (844) 909-1999 Fax: (972) 644-3720

Website: www.FortressFence.com

Email: Specifications@FortressFence.com

2.02 MATERIALS:

Rails and Pickets are Grade A cold rolled 45,000 psi steel. Rails are formed U-Channel and Pickets are rolled formed and welded tubing. Both conforming to ASTM A500 with G-60 zinc coating (0.60 oz/ft²) total inside and outside surfaces in accordance with the ASTM A123 hot dipped electroplating process.

2.03 COMPONENTS:

A. Rails: 1 ⁹/₁₆" x 1 ³/₁₆" (Leg x Web), 14 gauge formed U-Channel ASTM 500 galvanized steel.

B. Pickets: ³/₄" square 16 gauge ASTM A500 galvanized welded and formed steel tubing for 4' 5' & 6' tall panels, 14 gauge ASTM A500 galvanized welded and formed steel tubing for 7' & 8' tall panels.

C. Posts: 2 ¹/₂" square 16 gauge, 14 gauge, or 3" square 14 gauge ASTM A500 galvanized formed and welded steel tubing with powder coated factory finish.

D. Available Colors: Black Sand, Gloss Black, Bronze, Green Sand, Green.

E. Other colors available upon request.

2.04 STYLE:

A. Fortress Fence Product's V2 COMMERCIAL Fence is made in: Flat Top (FT), Flat Top Flat Bottom (FT/FB) Pool (PL), Extended Picket (EXT), Extended Picket Flat Bottom (EXT/FB), Pressed Spear (SP), Pressed Spear Flat Bottom (SPFB), Curved Top (CT), and Curved Top Flat Bottom (CT/FB).

B. 3 ¹⁵/₁₆" air space between pickets.

C. VERSAI ASSURANCE (V2) COMMERCIAL panel, 3" air space between pickets.

2.05 FABRICATION:

A. Fence panels are fully assembled and fabricated with rail length of 90 ¹/₂" and picket heights of 34", 40", 46", 54", 58", 70", 82", and 94". All panels comply with requirements indicated for materials, thickness, design and details of construction.

B. Pickets are welded to the rails with a patented pin hinge system which allows the panel to rake without metal fatigue or damage to the finish.

C. All welded connections comply with AWS standards for recommended practice in shop welding.

D. All components are accurately cut and drilled to receive hardware, fasteners and accessories.

E. Panels shall be capable of supporting a 300 lb. load (applied at mid-span) without permanent deformation. Panels shall be rackable to a 30" change in grade.

2.06 FINISH:

A. Materials are coated with the Fortress Shield process including galvanization, nano ceramic coating, electrodeposition (E-coat), and architectural grade powder coat.

B. Metal parts are assembled and finished individually prior to shipment.

C. Galvanized steel fence components are cleaned with a non-petroleum solvent followed by the application of a sealing nano ceramic coating.

D. Immediately after sealing, a two-step finishing process consisting of:

1. An electrostatic dipping process in a lead free high corrosion resistant epoxy resin leaving a coating of approximately 20 microns.
2. A thermosetting carboxyl polyester resin top coat with a minimum dry film thickness of 60 to 70 microns. The second coating will be applied by the electrostatic spray process.

PART 3 EXECUTION

3.01 PREPARATION

Stake layout showing locations of all gates and posts. Contact "CALL BEFORE YOU DIG" prior to beginning any excavation work.

3.02 INSTALLATION

- A. Install fences in accordance with written instructions and in accordance with authorities having jurisdiction.
- B. Concrete Set Posts: Drill hole in firm soil. Posts holes will be a minimum of 36" deep (environmental conditions or local codes may require a greater depth). Fence post shall be spaced 95" ± 1/4" on-center to accommodate installation of brackets on 2 1/2" square post. For non-level installations, the on-center post spacing must be measured along the grade.
- C. Installation is to conform to the specifications referenced in Section 1.02 of this specification.
- D. Install Fortress brackets onto fence section and posts as indicated in printed instructions for specific fence style. Attach fence sections to brackets with approved fasteners and techniques to ensure that fence sections are parallel to grade within 1/4" in 12 feet.
- E. Gate Installation: Install in accordance with printed instructions. Do not mount gate from wall of a structure. Provide gate post on both sides of a gate. For double drive gate installation, provide concrete center drop to foundation depth and drop rod retainers at center. Lubricate to insure smooth operation and verify proper latch operation.

3.03 CLEANING

- A. Remove all cutting and drilling chips that are attached to the fencing, post, brackets or additions to prevent corrosion.
- B. Repair scratches and other installation-incurred damage. Using a spray paint of the appropriate color that includes a zinc additive, repaint and seal any scratches or holes drilled in the fencing, post, brackets, or additions to prevent rust from forming. Clean up debris and unused material and remove from site.

Table 1

Minimum Post Sizes for V2 Commercial

<u>Line of Fence Posts</u>	<u>Panel Heights</u>
2.5" x 16ga	Up to & Including 6' height
2.5" x 14ga	7' & 8'

Table 2

V2 Commercial Post Spacing by Bracket Type

Spacing	Flat Top, Spear Top, Extended Picket and Curved Top 8' Nominal (90.5" Rail)					
	2.5"	3"	2.5"	2.5"	2.5"	3"
Bracket Type	One Direction Flat Mount (EX-106)		Two direction Line (EX-206)	Three Direction Universal (EX-306)	Swivel Flat Mount (EXS-106)	
Post Settings ± 1/4" O.C.	95"	95.5"	95"	95"	95"	95.5"

Table 3

V2 Commercial Gate Posts Sizes

<u>Gate Leaf</u>	<u>Gate Height</u>		
	<u>Up to & Including 4'</u>	<u>Over 4' Up to & Including 6'</u>	<u>7' & 8'</u>
Up to 4'	2.5" x 14ga	3" x 12ga	3" x 12ga
4'1" to 6'	3" x 12ga	3" x 12ga	4" x 11ga
6'1" to 8'	3" x 12ga	4" x 11ga	4" x 11ga

Installation Instructions for Cutting Fortress Fence Products

It is the responsibility of the installer to meet all code and safety requirements as well as obtain all required building permits. The installer should determine and implement appropriate installation techniques for each installation situation. The Fortress Company and its distributors shall not be held liable for improper or unsafe installations.

Read Instructions Completely Before Starting Installation

Note

Not following the below steps could result in oxidation at cut points and will void the warranty. When cutting Fortress Fence Products, complete the following at cut points:

- Cut material to length and remove all metal shavings from the cut area
- File any sharp edges left by cutting. Thoroughly wipe and remove any filings, grime or dirt from the panel.
- Apply two coats of Fortress zinc based touch-up paint to the cut area. If touch up is at rail ends, allow paint to dry before connecting bracket to post.
- Be sure to remove any metal shavings from the work surface to prevent oxidation on the surface.

Required Materials

Metal Cutting Saw, File, Brush or Rags, Cardboard, Fortress Zinc Based Touch-Up Paint.

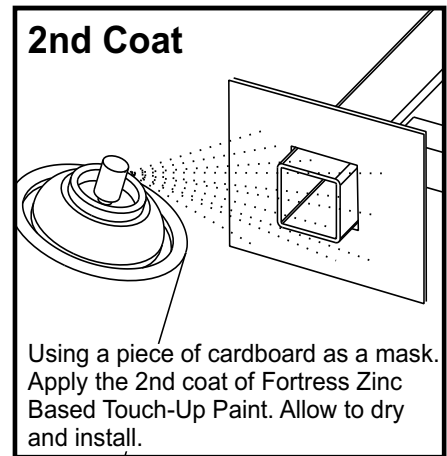
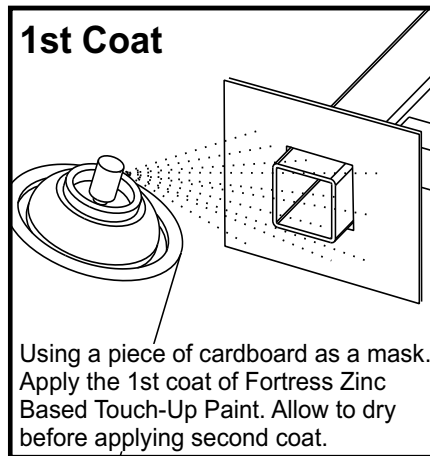
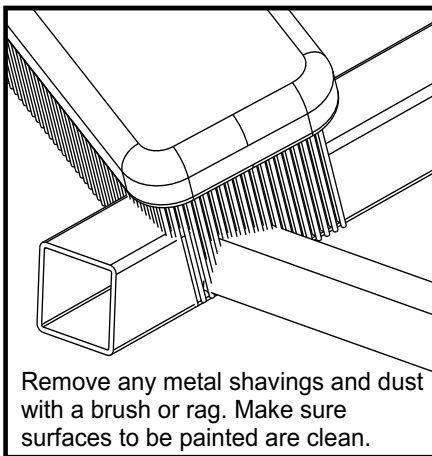
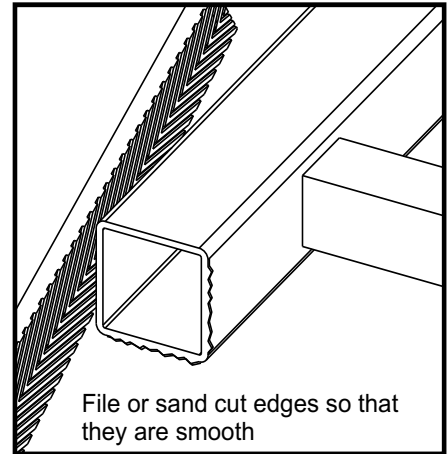
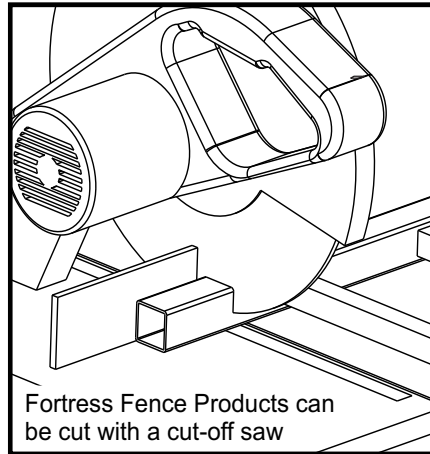
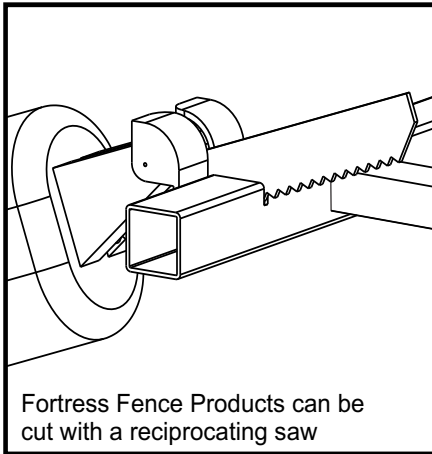

Ornamental Fence Panels: Versai - V2 Pressed Spear

Item No.	Description	Weight
16248VP	94" x 90.5" V2 Panel - Pressed Spear (3-Rail)	114 lbs

* Each Panel requires 6 Brackets

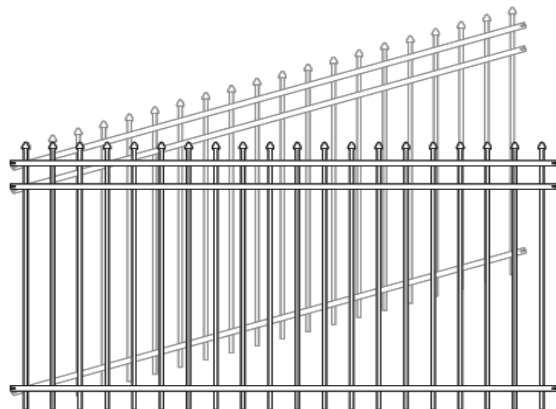

V2 Fittings

Item No.	Description	Weight
16524	2.5" x 96" Post (16 ga) - FORTRESS	30 lbs
16536	3" X 132" Post (12 ga) - FORTRESS	52.3 lbs
16541BD	2.5" X 2.5" Ornamental Black Dome Cap	0.17 lbs
15204	3" X 3" Ornamental Black Dome Cap	0.2 lbs

16281XD	Exterior One Direction Bracket (EX-106) 6/bag	2 lbs
16282XD	Exterior Two Direction Bracket (EX-206) 6/bag	2 lbs
16283XT	Exterior Three Direction Bracket (EX-306) 6/Bag**	2.5 lbs

** Call for Availability



**EXTERIOR ONE
DIRECTION**



**EXTERIOR TWO
DIRECTION**



**EXTERIOR THREE
DIRECTION**

Discontinued

PRO LINK **SUPPLY**

Ornamental Railing



Ornamental Railing Panels - Matte Black

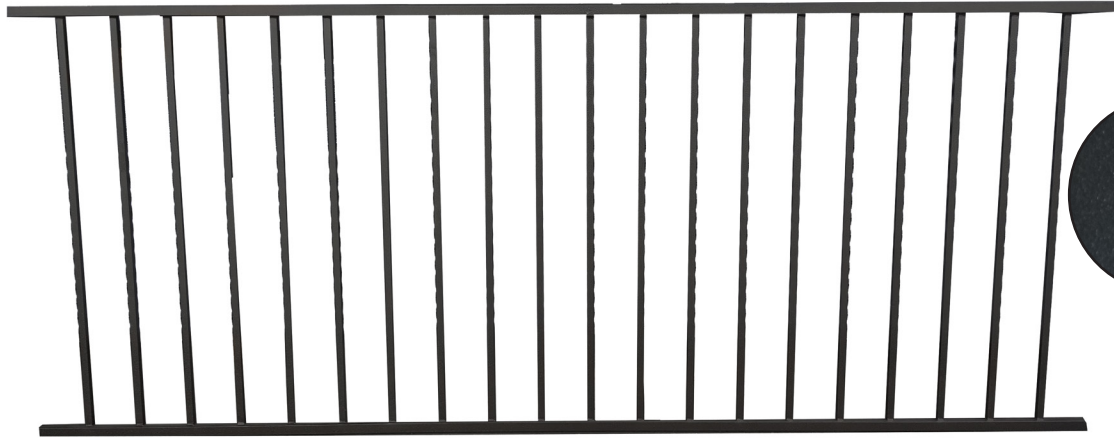

Item No.	Description	Weight
15600BL	70" x 38" Railing Panel - Matte Black	25.5 lbs

Ornamental Railing Panels - Antique Bronze



Item No.	Description	Weight
15600BZ	70" x 38" Railing Panel - Antique Bronze	25.5 lbs
15602BZ	94" x 38" Railing Panel - Antique Bronze	34.1 lbs

Ornamental Rackable Railing Panels - Matte Black

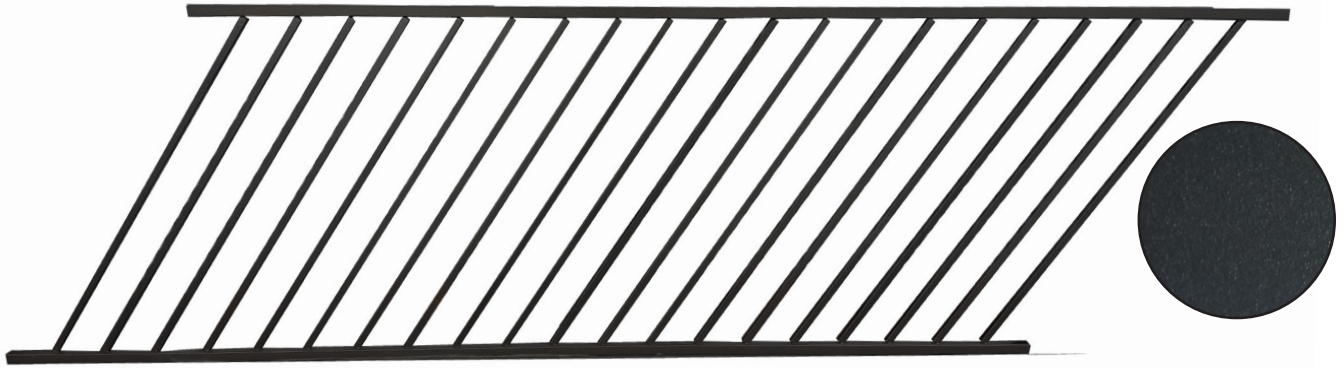

Item No.	Description	Weight
15604BL	70" x 38" Rackable Railing Panel - Matte Black	25.5 lbs
15606BL	94" x 38" Rackable Railing Panel - Matte Black	34.1 lbs

Ornamental Rackable Railing Panels - Antique Bronze



Item No.	Description	Weight
15604BZ	70" x 38" Rackable Railing Panel - Antique Bronze	25.5 lbs
15606BZ	94" x 38" Rackable Railing Panel - Antique Bronze	34.1 lbs

Posts

Item No.	Description	Weight
15610BL	2" x 2" x 45.5" Post with 4" Plate - Matte Black	9.2 lbs
15610BZ	2' x 2" x 45.5" Post with 4" Plate - Antique Bronze	9.2 lbs
15612BL	3" x 3" x 45.5" Post with 5.25" Plate - Matte Black	14.9 lbs

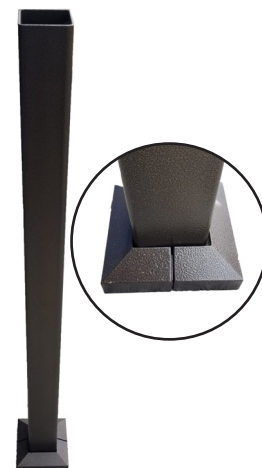

Post Caps

Item No.	Description	Weight
15616BL	2" x 2" Steel Dome Cap - Matte Black	0.1 lbs
15616BZ	2" x 2" Steel Dome Cap - Antique Bronze	0.1 lbs
15618BL	3" x 3" Steel Dome Cap - Matte Black	0.3 lbs
15620BL	2" x 2" Aluminum Dome Cap - Matte Black	0.6 lbs
15620BZ	2" x 2" Aluminum Dome Cap - Antique Bronze	0.6 lbs
15622BL	3" x 3" Aluminum Dome Cap - Matte Black	1.1 lbs
15622BZ	3" x 3" Aluminum Dome Cap - Antique Bronze	1.1 lbs



Panel Hardware

Straight Brackets

Item No.	Description	Weight
15630BL	Straight Bracket (HD-104-1") - Matte Black (4/Bag)	0.6 lbs
15630BZ	Straight Bracket (HD-104-1") - Antique Bronze (4/Bag)	0.6 lbs



Angle Brackets

Item No.	Description	Weight
15632BZ	Angle Bracket (SM-08-1") - Antique Bronze (4/Bag)	0.6 lbs



Superior Brackets

Item No.	Description	Weight
15634BL	Superior Bracket (1") - Matte Black (4/Carton)	1.1 lbs
15634BZ	Superior Bracket (1") - Antique Bronze (4/Carton)	1.1 lbs



Superior Stair Brackets

Item No.	Description	Weight
15636BL	Superior Stair Bracket (1") - Matte Black (4/Carton)	2.9 lbs
15636BZ	Superior Stair Bracket (1") - Antique Bronze (4/Carton)	2.9 lbs



Superior Side Brackets

Item No.	Description	Weight
15638BL	Superior Side Bracket (1") - Matte Black	2.9 lbs
15638BZ	Superior Side Bracket (1") - Antique Bronze	2.9 lbs



Base Covers

Item No.	Description	Weight
15640BL	Aluminum Base Cover for 2" x 2" Post - Matte Black (1/Bag)	2.9 lbs
15640BZ	Aluminum Base Cover for 2" x 2" Post - Antique Bronze (1/Bag)	2.9 lbs
15642BL	Aluminum Base Cover for 3" x 3" Post - Matte Black (1/Bag)	2.9 lbs

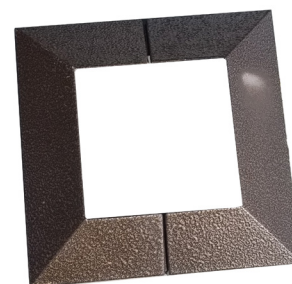

PRO LINK SUPPLY

Cantilever Hardware

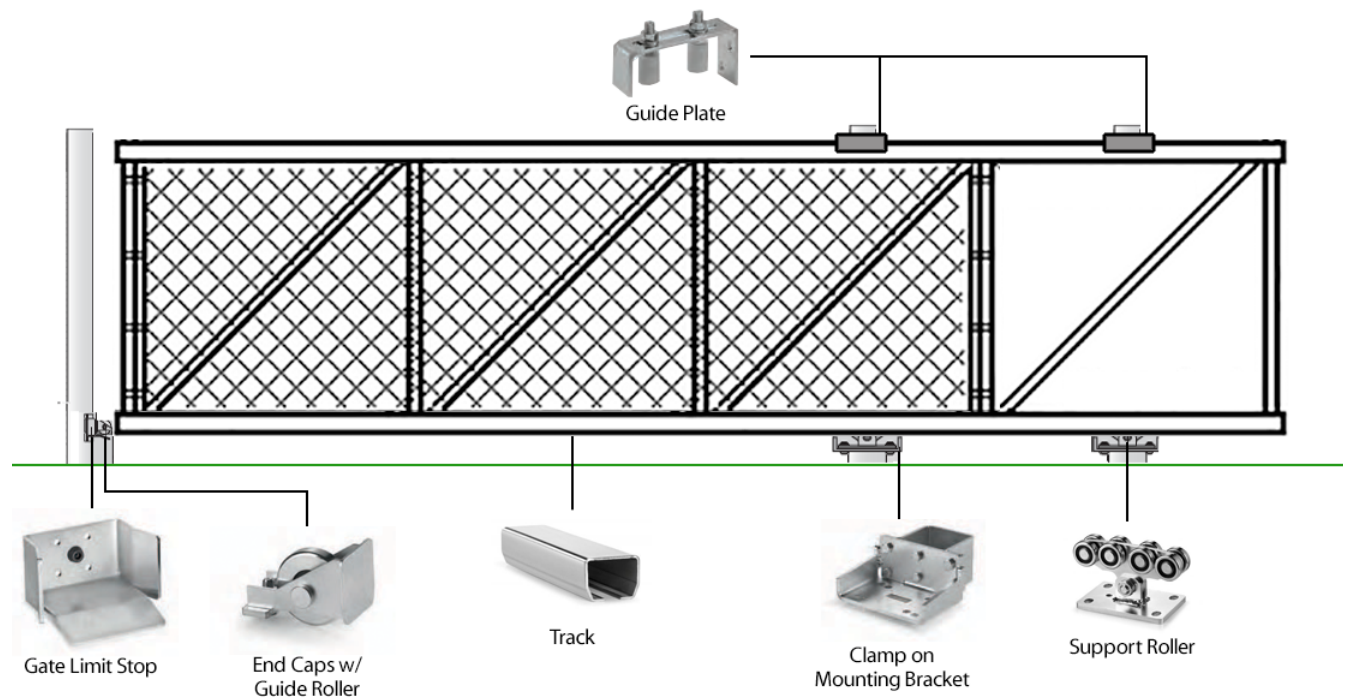

Gate Installation and Measurement Legend

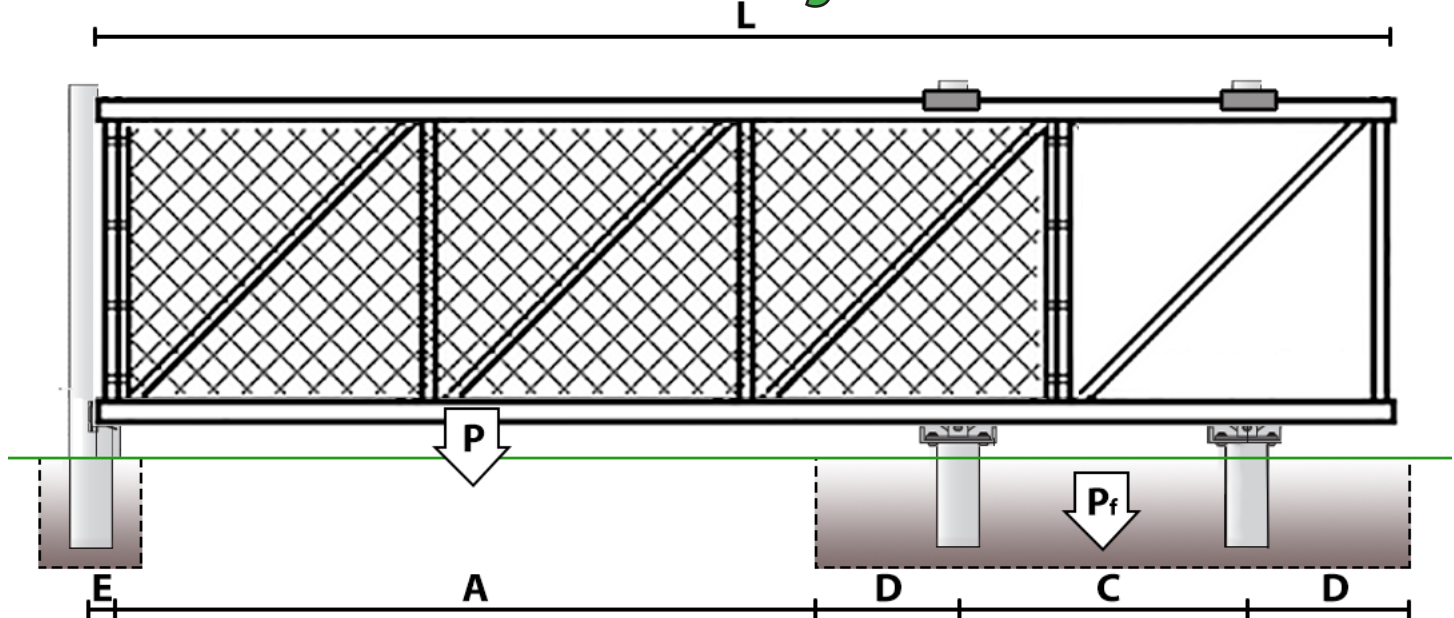

Legend

A	Clear Opening (ft)
P	Gate Weight including track (lbs) $P=PS+PM$
C	Distance between Support Rollers centre
D	Minimum distance from Support Roller centre to Track end for Support Roller housing
E	Minimum space for Support Wheel Positioning
L	Overall Gate Length $L=A+E+C+2*D$
PS	Gate Weight without Track (lbs)
PM	Track's Weight (lbs)
Pf	Minimum weight of the foundation to compensate stress on both Carriages, produced by cantilever part (lbs)
Fmax	Max compression load applied (sum of stress on Rollers and Gate's weight) to any single Carriage, when cantilevered part is on its side

Medium Cantilever System - Measurements

D = 0.72 ft. (minimum)

E = 0.49 ft. (minimum)

Gate's Weight

A (ft)	300 lbs					400 lbs				
	C min	L (ft)	PM	P	Pf (lbs)	C min	L (ft)	PM	P	Pf (lbs)
12	1.40	15.34	57	405	3510	1.92	15.86	59	523	3273
14	1.65	17.59	65	407	3507	2.25	18.19	67	523	3275
16	1.91	19.85	73	410	3500	2.60	20.54	76	524	3271
18	2.18	22.12	82	414	3492	2.95	22.89	85	528	3264
20	2.46	24.4	90	419	3481	3.33	25.27	93	532	3255
22	2.76	26.7	99	425	3470	3.71	27.65	102	538	3245
24	3.07	3.07	107	432	3457	4.11	30.05	111	544	3233

Gate's Weight

A (ft)	500 lbs					600 lbs				
	C min	L (ft)	PM	P	Pf (lbs)	C min	L (ft)	PM	P	Pf (lbs)
12	2.51	16.45	61	642	3037	3.19	17.13	63	760	2799
14	2.94	18.88	70	639	3042	3.73	19.67	73	756	2808
16	3.38	21.32	79	640	3041	4.28	22.22	82	755	2810
18	3.84	23.78	88	642	3036	4.85	24.79	92	756	2807
20	4.31	26.25	97	646	3029	5.44	27.38	101	760	2801
22	4.80	28.74	106	650	3019	6.05	29.99	111	764	2792
24	5.30	31.24	116	656	3008	6.67	32.61	121	769	2782

Medium Cantilever System

Posts should be set in a concrete bed for extra stability

Track

Item No.	Hi Motion No.	Description	Weight
11000	323.6	Hi Motion M Track - 20'	80 lbs



Gate Limit Stops

Item No.	Hi Motion No.	Description	Weight
11002	310.M	Hi Motion M End Cup (Gate Limit Stop)	2 lbs



End Plates

Item No.	Hi Motion No.	Description	Weight
11006	309.M	Hi Motion M End Plate (Steel Cap)	1 lbs



End Caps w/ Guide Rollers

Item No.	Hi Motion No.	Description	Weight
11007	307.M	Hi Motion M Carriage - End Cap w/ Guide Roller	2 lbs



Support Roller

Item No.	Hi Motion No.	Description	Weight
11008	301.8M	Hi Motion M Carriage - 8 Wheels (Support Roller)	10 lbs

No Bolts Included



Mounting Plates

Item No.	Hi Motion No.	Description	Weight
11009	303.M	Hi Motion M Carriage - Mounting Plate/Support Roller	1 lbs

No Bolts Included



Gate Installation and Measurement Legend

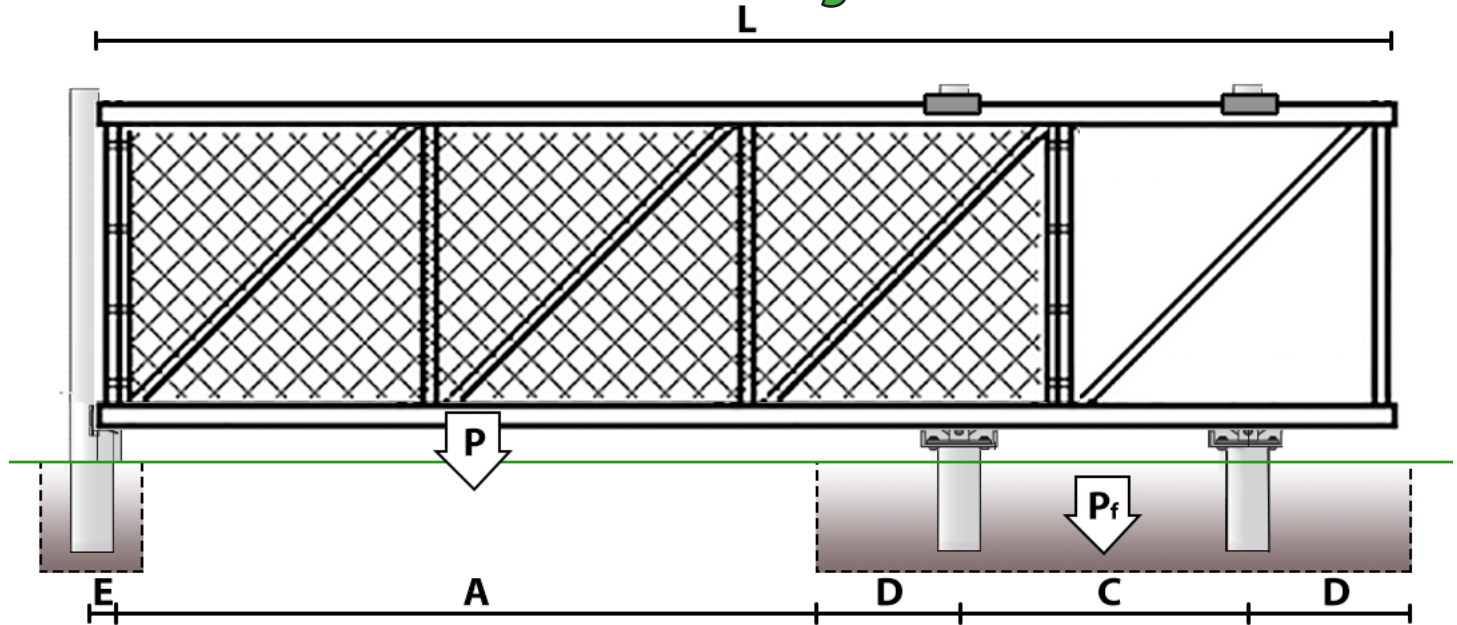

Legend

A	Clear Opening (ft)
P	Gate Weight including track (lbs) $P=PS+PM$
C	Distance between Support Rollers centre
D	Minimum distance from Support Roller centre to Track end for Support Roller housing
E	Minimum space for Support Wheel Positioning
L	Overall Gate Length $L=A+E+C+2*D$
PS	Gate Weight without Track (lbs)
PM	Track's Weight (lbs)
P_f	Minimum weight of the foundation to compensate stress on both Carriages, produced by cantilever part (lbs)
F_{max}	Max compression load applied (sum of stress on Rollers and Gate's weight) to any single Carriage, when cantilevered part is on its side

Large Cantilever System - Measurements

D = 1.15 ft. (minimum)

E = 0.52 ft. (minimum)

Gate's Weight

A (ft)	400 lbs					600 lbs				
	C min	L (ft)	PM	P	Pf (lbs)	C min	L (ft)	PM	P	Pf (lbs)
15	2.11	19.93	157	688	4697	3.22	21.04	165	1007	4255
20	2.98	25.80	203	719	4611	4.48	27.30	215	1033	4169
25	3.98	31.80	250	759	4524	5.89	33.71	265	1074	4082
30	5.11	37.93	298	804	4437	7.47	40.29	317	1122	3995
40	7.83	50.65	398	905	4263	11.19	54.01	424	1235	3821
50	11.21	64.03	503	1015	4089	15.73	68.55	539	1361	3647

Gate's Weight

A (ft)	800 lbs					1000 lbs				
	C min	L (ft)	PM	P	Pf (lbs)	C min	L (ft)	PM	P	Pf (lbs)
15	3.72	21.18	171	1102	4406	4.99	22.45	181	1345	3920
20	5.10	27.56	222	1121	4369	6.81	29.27	236	1359	3892
25	6.63	34.09	275	1153	4303	8.81	36.27	292	1391	3829
30	8.32	40.78	329	1194	4221	11.01	43.47	350	1432	3745
40	12.23	54.69	441	1290	4030	16.07	58.53	472	1533	3544
50	16.91	69.37	559	1399	3813	22.10	74.56	601	1650	3310

Large Cantilever System

Posts should be set in a concrete bed for extra stability

Track

Item No.	Hi Motion No.	Description	Weight
11030	328.6	Hi Motion Track - 20'	162 lbs



Gate Limit Stops

Item No.	Hi Motion No.	Description	Weight
11012	310.L	Hi Motion L End Cup (Gate Limit Stop)	4 lbs



End Plates

Item No.	Hi Motion No.	Description	Weight
11016	309.L	Hi Motion L End Plate (Steel Cap)	1 lbs



End Caps w/ Guide Rollers

Item No.	Hi Motion No.	Description	Weight
11017	307.L	Hi Motion L Carriage - End Cap w/ Guide Roller	4 lbs



Support Roller

Item No.	Hi Motion No.	Description	Weight
11018	301.8L	Hi Motion L Carriage - 8 Wheels (Support Roller)	25 lbs

No Bolts Included



Mounting Plates

Item No.	Hi Motion No.	Description	Weight
11019	303.8L	Hi Motion L Carriage - Mounting Plate/Support Roller	2 lbs

No Bolts Included



Gate Installation and Measurement Legend

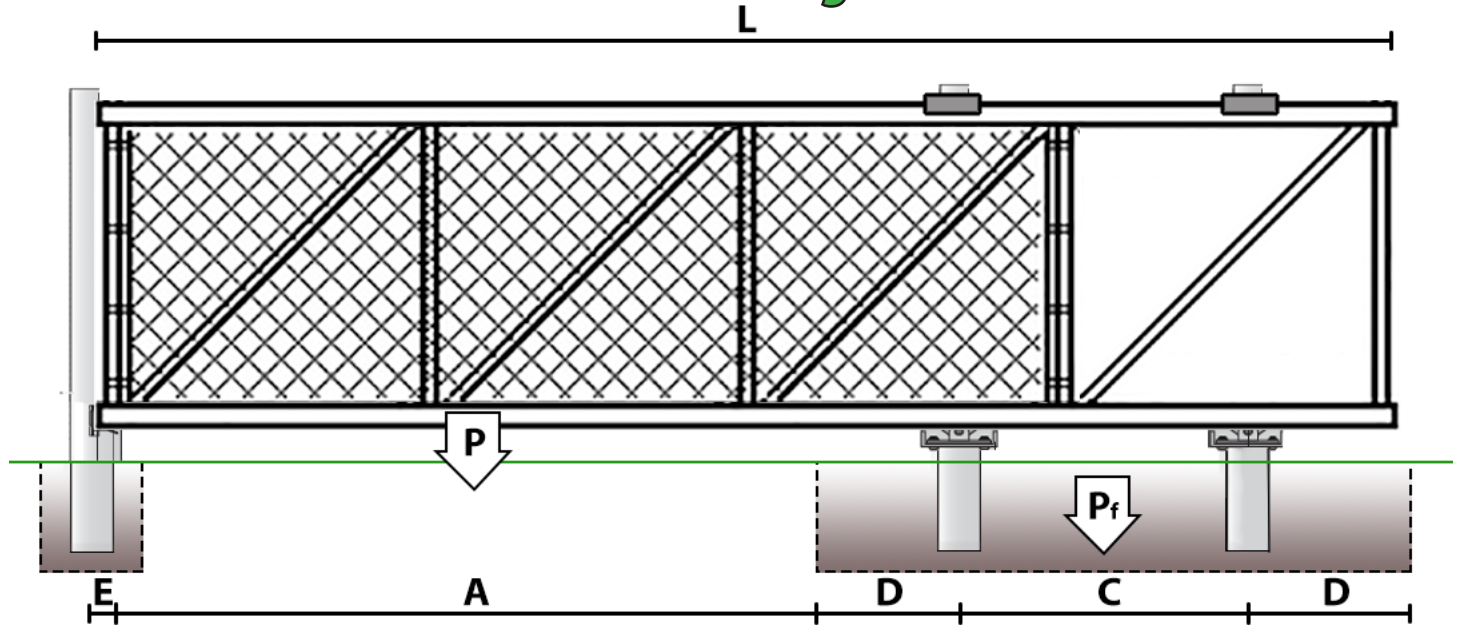

Legend

A	Clear Opening (ft)
P	Gate Weight including track (lbs) $P=PS+PM$
C	Distance between Support Rollers centre
D	Minimum distance from Support Roller centre to Track end for Support Roller housing
E	Minimum space for Support Wheel Positioning
L	Overall Gate Length $L=A+E+C+2*D$
PS	Gate Weight without Track (lbs)
PM	Track's Weight (lbs)
P_f	Minimum weight of the foundation to compensate stress on both Carriages, produced by cantilever part (lbs)
F_{max}	Max compression load applied (sum of stress on Rollers and Gate's weight) to any single Carriage, when cantilevered part is on its side

Extra Large Cantilever System - Measurements

D = 1.48 ft. (minimum)

E = 0.72 ft. (minimum)

Gate's Weight

A (ft)	800 lbs					1000 lbs				
	C min	L (ft)	PM	P	Pf (lbs)	C min	L (ft)	PM	P	Pf (lbs)
20	1.81	25.49	394	1341	14918	2.20	25.88	400	1584	14432
30	3.02	36.70	567	1466	14669	3.60	37.28	576	1699	14202
40	4.52	48.20	745	1619	14362	5.32	49.00	758	1850	13901
50	6.33	60.01	928	1787	14027	7.36	61.04	944	2017	13566
60	8.46	72.14	1115	1964	13671	9.74	73.42	1135	2196	13207
70	10.94	84.62	1308	2150	13299	12.51	86.19	1332	2385	12830

Gate's Weight

A (ft)	1200 lbs					1400 lbs				
	C min	L (ft)	PM	P	Pf (lbs)	C min	L (ft)	PM	P	Pf (lbs)
20	2.61	26.29	406	1827	13946	3.04	26.72	413	2071	13459
30	4.22	37.90	586	1933	13734	4.88	38.56	596	2168	13264
40	6.16	49.84	771	2081	13438	7.06	50.74	785	2313	12973
50	8.45	62.13	961	2249	13102	9.62	63.30	979	24.82	12637
60	11.11	74.79	1156	2430	12740	12.57	76.25	1179	2665	12271
70	14.17	87.85	1358	2621	12357	15.96	89.64	1386	2859	11881

Extra Large Cantilever System

Posts should be set in a concrete bed for extra stability

Track

Item No.	Hi Motion No.	Description	Weight
11020	333.6	Hi Motion XL Track - 20'	290 lbs



Gate Limit Stops

Item No.	Hi Motion No.	Description	Weight
11022	310.XL	Hi Motion XL End Cup (Gate Limit Stop)	6 lbs



End Plates

Item No.	Hi Motion No.	Description	Weight
11026	309.XL	Hi Motion XL End Plate (Steel Cap)	2 lbs



End Caps w/ Guide Rollers

Item No.	Hi Motion No.	Description	Weight
11027	307.XL	Hi Motion XL Carriage - End Cap w/ Guide Roller	12 lbs



Support Roller

Item No.	Hi Motion No.	Description	Weight
11028	301.8XL	Hi Motion XL Carriage - 8 Wheels (Support Roller)	75 lbs

No Bolts Included



Mounting Plates

Item No.	Hi Motion No.	Description	Weight
11029	303.8XL	Hi Motion XL Carriage - Mounting Plate/Support Roller	5 lbs

No Bolts Included



Clamp on Mounting Bracket

Item No.	Hi Motion No.	Description	Weight
11057	304.M73	2 7/8" Flanged Bracket for M Support Roller	2 lbs
11058	304.8M89	3 1/2" Flanged Bracket for M Support Roller	2.25 lbs
11059	304.8L89	3 1/2" Flanged Bracket for L Support Roller	2.8 lbs
11054	304.8L102	4" Flanged Mounting Bracket for L Support Roller	2.5 lbs
11055	304.8L114	4 1/2" Flanged Mounting Bracket for L Support Roller	2.8 lbs

11056	304.8L102Q	4" Sq. Flanged Mounting Bracket for L Support Roller	2.5 lbs
-------	------------	--	---------

Carriage Mounting Bolts included



Guide Plate

Item No.	Hi Motion No.	Description	Weight
11036	203.2	220mm Weld-On Guide Plate (8")	2 lbs
11038	204.2	350mm Bolt-On Guide Plate (14")	10 lbs

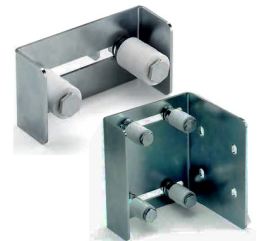

Rubber Rollers

Item No.	Hi Motion No.	Description	Weight
11014	225.03	Hi Motion Rubber Roller w/ Bracket (3")	1 lbs
11024	225.06	Hi Motion Rubber Roller w/ Bracket (6")	2 lbs
11044	225.12	Hi Motion Rubber Roller w/ Bracket (12")	4 lbs



Sliding Track Rollers w/ Bearings



Track

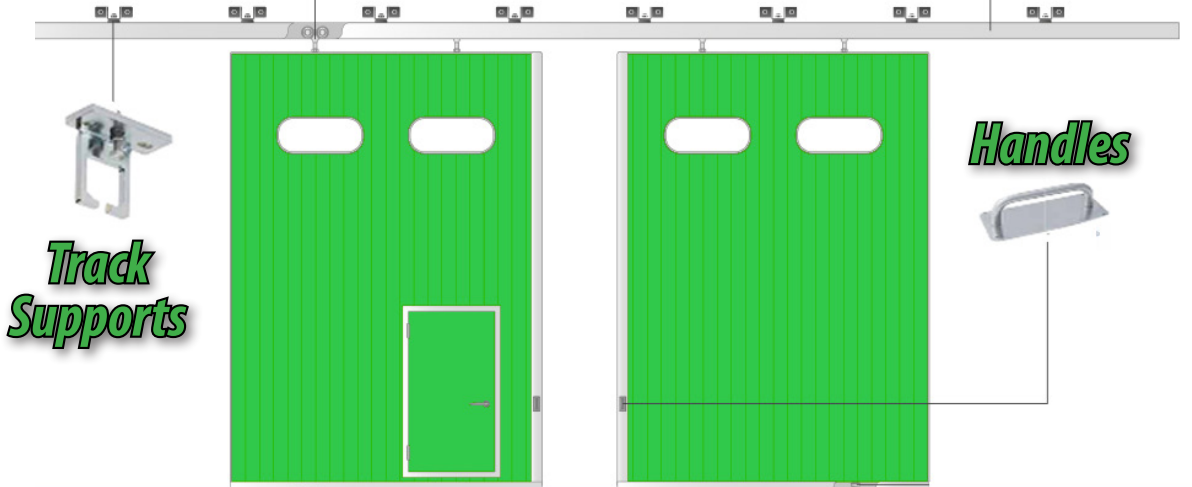

Track Supports

Handles



Track

Item No.	Hi Motion No.	Description	Weight
11080	626.42	Galvanized Track (54mm x 42mm) - 20'	40 lbs



Sliding Rollers

Item No.	Hi Motion No.	Description	Weight
11082	604.42	Sliding Track Rollers w/Bearings	10 lbs



Track Support

Item No.	Hi Motion No.	Description	Weight
11100	631.42	Track Support w/Ceiling Mounting System	10 lbs
11090	630.11	Clamp for Track Support	10 lbs



Door Handles

Item No.	Hi Motion No.	Description	Weight
11110	651.11	Handles for Doors	2 lbs

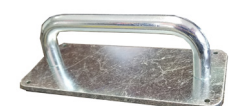



PRO LINK **SUPPLY**

Vinyl





Technology & Quality



National Vinyl Products (NVP) has been manufacturing vinyl fence systems in the USA since 2004.

We take great pride in producing high quality, long-lasting and durable fence materials and back them with a lifetime warranty.

Product Manufacturing

NVP utilizes the latest technology to manufacture our vinyl fencing materials.

One of the processes we utilize is called 'co-extrusion', which creates two distinct layers in our fence materials. The outer layer is formulated to prevent weathering and hold up to the elements while the inner layer has additional strength properties.



White Privacy Fence



Weathered Aspen with Dark Walnut Accent

Raw Materials

- All ingredients are sourced in the USA
- NVP proprietary PVC formula that includes 8 micro-ingredients is blended on-site at NVP's facility
- 100% virgin materials on all exposed surfaces
- Recycled vinyl fence and window material is utilized in some profiles and passes same rigorous testing as virgin materials
- Privacy T&G slats are produced with 100% virgin materials, inside and out.

Quality Control

- Meets ASTM F-964 standards
- 3rd Party weatherability testing
- 3rd Party wind tunnel testing

www.nvpfence.com



2-Rail PVC (0.135 Wall Thickness) - 36" Tall

Item No.	Description	Colour	Bundle
VL500060PL-XX	5" x 5" x 5' 2-Rail Line Post	WH,TN,DF,DW	54
VL500060PE-XX	5" x 5" x 5' 2-Rail End Post	WH,TN,DF,DW	54
VL500060PC-XX	5" x 5" x 5' 2-Rail Corner Post	WH,TN,DF,DW	54
VL500060PT-XX	5" x 5" x 5' 2-Rail 3-way	WH,TN,DF,DW	54



3-Rail PVC (0.135 Wall Thickness) - 54" Tall

Item No.	Description	Colour	Bundle
VL500078PL-XX	5" x 5" x 6'3" 3-Rail Line Post	WH,TN,DF,DW	54
VL500078PE-XX	5" x 5" x 6'6" 3-Rail End Post	WH,TN,DF,DW	54
VL500078PC-XX	5" x 5" x 6'6" 3-Rail Corner Post	WH,TN,DF,DW	54
VL500078PT-XX	5" x 5" x 6'6" 3-Rail 3-way	WH,TN,DF,DW	54



4-Rail PVC (0.135 Wall Thickness) - 54" Tall

Item No.	Description	Colour	Bundle
VL504078PL-XX	5" x 5" x 6'3" 4-Rail Line Post	WH,TN,DF,DW	54
VL504078PE-XX	5" x 5" x 6'6" 4-Rail End Post	WH,TN,DF,DW	54
VL504078PC-XX	5" x 5" x 6'6" 4-Rail Corner Post	WH,TN,DF,DW	54
VL504078PT-XX	5" x 5" x 6'6" 4-Rail 3-way	WH,TN,DF,DW	54



Ranch Rails (0.080 Wall Thickness)

Item No.	Description	Colour	Bundle
VL155516RL-XX	1 1/2" x 5 1/2" x 16' (.080" wall) - Notched	WH,TN,DF,DW	120
VL500CFT-XX	5" External Flat Cap	WH,TN,DF,DW	50



WH - White TN - Tan DF - Driftwood DW - Dark Walnut

Privacy Panel Gates

Item No.	Description	Colour	Bundle
VLGT0604-XX	6'H X 4'W Solid Privacy Single Gate	WH,TN,DF,DW,CY,SG	Each
VLGT0606-XX	6'H X 6'W Solid Privacy Single Gate	WH,TN,DF,DW,CY,SG	Each



Privacy Posts

Item No.	Description	Colour	Bundle
VL500084PL-XX	5" x 5" x 7' Privacy Line Post (0.135" wall)	WH,TN,DF,DW,CY,SG	54
VL500084PE-XX	5" x 5" x 7' Privacy End Post (0.135" wall)	WH,TN,DF,DW,CY,SG	54
VL500084PC-XX	5" x 5" x 7' Privacy Corner Post (0.135" wall)	WH,TN,DF,DW,CY,SG	54
VL500084PT-XX	5" x 5" x 7' Privacy 3-Way Post (0.135" wall)	WH,TN,DF,DW,CY,SG	54
VL500096PL-XX	5" x 5" x 8' Privacy Line Post (0.135" wall)	WH,TN,DF,DW,CY,SG	54
VL500096PE-XX	5" x 5" x 8' Privacy End Post (0.135" wall)	WH,TN,DF,DW,CY,SG	54
VL500096PC-XX	5" x 5" x 8' Privacy Corner Post (0.135" wall)	WH,TN,DF,DW,CY,SG	54
VL500096PT-XX	5" x 5" x 8' Privacy 3-Way Post (0.135" wall)	WH,TN,DF,DW,CY,SG	54



Privacy Panel Components

Item No.	Description	Colour	Bundle
VL155595RL-XX	1 1/2" x 5 1/2" x 95" Pocket Rail (.090 wall)	WH,TN,DF,DW,CY,SG	112
VL155571RL-XX	1 1/2" x 5 1/2" x 71 1/2" Pocket Rail (.090 wall)	WH,TN,DF,DW,CY,SG	112
VL781150TG-XX	7/8" x 11.3" x 50 1/4" T&G Picket- (5' privacy)	WH,TN,DF,DW,CY,SG	137
VL781162TG-XX	7/8" x 11.3" x 62 1/4" T&G Picket- (6' privacy)	WH,TN,DF,DW,CY,SG	137
VL78059UC-XX	59" U-Channel	WH,TN,DF,DW,CY,SG	70

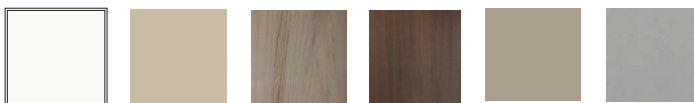

WH - White TN - Tan DF - Driftwood DW - Dark Walnut CY - Clay SG - Slate Gray

Semi-Privacy Panels Wide Picket

Item No.	Description	Colour	Bundle
VL050878SP-XX	5' h x 8' w Semi Privacy Panel (7/8" x 3" Picket)	WH,TN	Each
VL060878SP-XX	6' h x 8' w Semi Privacy Panel (7/8" x 3" Picket)	WH,TN	Each



Semi-Privacy Panels Narrow Picket

Item No.	Description	Colour	Bundle
VL050812SP-XX	5' h x 8' w Semi Privacy Panel (7/8" x 1-1/2" Picket)	WH,TN	Each
VL060812SP-XX	6' h x 8' w Semi Privacy Panel (7/8" x 1-1/2" Picket)	WH,TN	Each

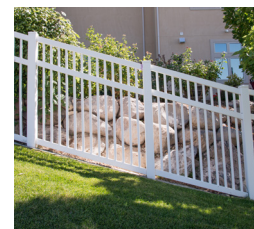

Semi-Privacy Panels Alternating Picket

Item No.	Description	Colour	Bundle
VL050816SP-XX	5' h x 8' w Semi Privacy Alternate (3" & 1-1/2" Picket)	WH,TN	Each
VL060816SP-XX	6' h x 8' w Semi Privacy Alternate (3" & 1-1/2" Picket)	WH,TN	Each



Semi-Privacy Posts

Item No.	Description	Colour	Bundle
VL8405SL-XX	5" x 5" x 7' Line Post (.135" wall)	WH,TN	54
VL8405SE-XX	5" x 5" x 7' End Post (.135" wall)	WH,TN	54
VL8405SC-XX	5" x 5" x 7' Corner Post (.135" wall)	WH,TN	54
VL9605SL-XX	5" x 5" x 8' Line Post (.135" wall)	WH,TN	54
VL9605SE-XX	5" x 5" x 8' End Post (.135" wall)	WH,TN	54
VL9605SC-XX	5" x 5" x 8' Corner Post (.135" wall)	WH,TN	54

Picket Panel Components

Item No.	Description	Colour	Bundle
VL781216PK-XX	7/8" x 1 1/2" x 192" Picket (.110" wall)	WH,TN	112
VL783192PK-XX	7/8" x 3" x 192" Picket (.110" wall)	WH,TN	112
VL235096RL-XX	2" x 3 1/2" x 96" Rail (.110" wall) Top, Bottom, Middle Routed	WH,TN	137



WH - White TN - Tan

Picket Panels - Wide

Item No.	Description	Colour	Bundle
VL030678PP-XX	3' h x 6' w Wide (3") Picket Panel	WH,TN	Each
VL420678PP-XX	42" h x 6' w Wide (3") Picket Panel	WH,TN	Each
VL040678PP-XX	4' h x 6' w Wide (3") Picket Panel - White	WH,TN	Each
VL030878PP-XX	3' h x 8' w Wide (3") Picket Panel w/Rail Insert	WH,TN	Each
VL420878PP-XX	42" h x 8' w Wide (3") Picket Panel w/Rail Insert	WH,TN	Each
VL040878PP-XX	4' h x 8' w Wide (3") Picket Panel w/Rail Insert	WH,TN	Each



Picket Panels - Narrow

Item No.	Description	Colour	Bundle
VL030612PP-XX	3' h x 6' w Narrow (1-1/2") Picket Panel	WH,TN	Each
VL420612PP-XX	42" h x 6' w Narrow (1-1/2") Picket Panel	WH,TN	Each
VL040612PP-XX	4' h x 6' w Narrow (1-1/2") Picket Panel	WH,TN	Each
VL030812PP-XX	3' h x 8' w Narrow (1-1/2") Picket Panel w/ Rail Insert	WH,TN	Each
VL420812PP-XX	42" h x 8' w Narrow (1-1/2") Picket Panel w/ Rail Insert	WH,TN	Each
VL040812PP-XX	4' h x 8' w Narrow (1-1/2") Picket Panel w/ Rail Insert	WH,TN	Each

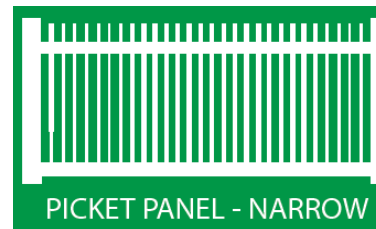

Picket Posts

Item No.	Description	Colour	Bundle
VL400060PL-XX	4" x 4" x 5' Picket Line Post (.140" wall)	WH,TN	55
VL400060PE-XX	4" x 4" x 5' Picket End Post (.140" wall)	WH,TN	55
VL400060PC-XX	4" x 4" x 5' Picket Corner Post (.140" wall)	WH,TN	55
VL400066PL-XX	4" x 4" x 5'6" Picket Line Post (.140" wall)	WH,TN	55
VL400066PE-XX	4" x 4" x 5'6" Picket End Post (.140" wall)	WH,TN	55
VL400066PC-XX	4" x 4" x 5'6" Picket Corner Post (.140" wall)	WH,TN	55
VL400072PL-XX	4" x 4" x 6' Picket Line Post (.140" wall)	WH,TN	55
VL400072PE-XX	4" x 4" x 6' Picket End Post (.140" wall)	WH,TN	55
VL400072PC-XX	4" x 4" x 6' Picket Corner Post (.140" wall)	WH,TN	55



WH - White TN - Tan

Scallop Picket Panels - Wide

Item No.	Description	Colour	Bundle
VL030678PS-XX	3' h x 6' w Scallop Wide (3") Picket Panel	WH,TN	Each
VL420678PS-XX	42" h x 6' w Scallop Wide (3") Picket Panel	WH,TN	Each
VL040678PS-XX	4' h x 6' w Scallop Wide (3") Picket Panel - White	WH,TN	Each
VL030878PS-XX	3' h x 8' w Scallop Wide (3") Picket Panel w/Rail Insert	WH,TN	Each
VL420878PS-XX	42" h x 8' w Scallop Wide (3") Picket Panel w/Rail Insert	WH,TN	Each
VL040878PS-XX	4' h x 8' w Scallop Wide (1-1/2") Picket Panel w/Rail Insert	WH,TN	Each



Scallop Picket Panels - Narrow

Item No.	Description	Colour	Bundle
VL030612PS-XX	3' h x 6' w Scallop Narrow (1-1/2") Picket Panel	WH,TN	Each
VL420612PS-XX	42" h x 6' w Scallop Narrow (1-1/2") Picket Panel	WH,TN	Each
VL040612PS-XX	4' h x 6' w Scallop Narrow (1-1/2") Picket Panel	WH,TN	Each
VL030812PS-XX	3' h x 8' w Scallop Narrow (1-1/2") Picket Panel w/ Rail Insert	WH,TN	Each
VL420812PS-XX	42" h x 8' w Scallop Narrow (1-1/2") Picket Panel w/Rail Insert	WH,TN	Each
VL040812PS-XX	4' h x 8' w Scallop Narrow (1-1/2") Picket Panel w/Rail Insert	WH,TN	Each



Scallop Picket Posts

Item No.	Description	Colour	Bundle
VL400060SL-XX	4" x 4" x 5' Scallop Picket Line Post (.140" wall)	WH,TN	55
VL400060SE-XX	4" x 4" x 5' Scallop Picket End Post (.140" wall)	WH,TN	55
VL400060SC-XX	4" x 4" x 5' Scallop Picket Corner Post (.140" wall)	WH,TN	55
VL400066SL-XX	4" x 4" x 5'6" Scallop Picket Line Post (.140" wall)	WH,TN	55
VL400066SE-XX	4" x 4" x 5'6" Scallop Picket End Post (.140" wall)	WH,TN	55
VL400066SC-XX	4" x 4" x 5'6" Scallop Picket Corner Post (.140" wall)	WH,TN	55
VL400072SL-XX	4" x 4" x 6' Scallop Picket Line Post (.140" wall)	WH,TN	55
VL400072SE-XX	4" x 4" x 6' Scallop Picket End Post (.140" wall)	WH,TN	55
VL400072SC-XX	4" x 4" x 6' Scallop Picket Corner Post (.140" wall)	WH,TN	55



WH - White TN - Tan

Arched Picket Panels - Wide

Item No.	Description	Colour	Bundle
VL030678PA-XX	3' h x 6' w Arched Narrow (3") Picket Panel	WH,TN	Each
VL420678PA-XX	42" h x 6' w Arched Narrow (3") Picket Panel	WH,TN	Each
VL040678PA-XX	4' h x 6' w Arched Narrow (3") Picket Panel	WH,TN	Each
VL030878PA-XX	3' h x 8' w Arched Wide (3") Picket Panel w/Rail Insert	WH,TN	Each
VL420878PA-XX	42" h x 8' w Arched Wide (3") Picket Panel w/Rail Insert	WH,TN	Each
VL040678PA-XX	4' h x 8' w Arched Wide (3") Picket Panel w/Rail Insert	WH,TN	Each

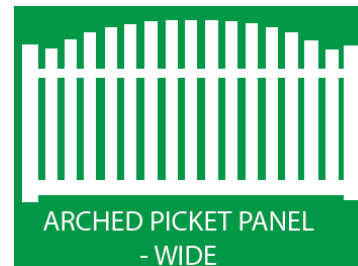

Arched Picket Panels - Narrow

Item No.	Description	Colour	Bundle
VL030612PA-XX	3' h x 6' w Arched Narrow (1-1/2") Picket Panel	WH,TN	Each
VL420612PA-XX	42" h x 6' w Arched Narrow (1-1/2") Picket Panel	WH,TN	Each
VL040612PA-XX	4' h x 6' w Arched Narrow (1-1/2") Picket Panel	WH,TN	Each
VL030812PA-XX	3' h x 8' w Arched Wide (1-1/2") Picket Panel w/Rail Insert	WH,TN	Each
VL420812PA-XX	42" h x 8' w Arched Wide (1-1/2") Picket Panel w/Rail Insert	WH,TN	Each
VL040812PA-XX	4' h x 8' w Arched Wide (1-1/2") Picket Panel w/Rail Insert	WH,TN	Each

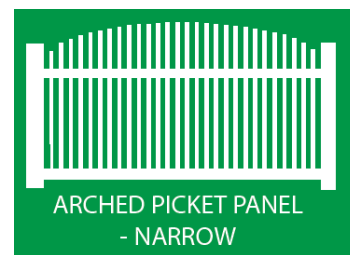

Arched Picket Posts

Item No.	Description	Colour	Bundle
VL400060AL-XX	4" x 4" x 5' Arched Picket Line Post (.140" wall)	WH,TN	55
VL400060AE-XX	4" x 4" x 5' Arched Picket End Post (.140" wall)	WH,TN	55
VL400060AC-XX	4" x 4" x 5' Arched Picket Corner Post (.140" wall)	WH,TN	55
VL400066AL-XX	4" x 4" x 5'6" Arched Picket Line Post (.140" wall)	WH,TN	55
VL400066AE-XX	4" x 4" x 5'6" Arched Picket End Post (.140" wall)	WH,TN	55
VL400066A-XX	4" x 4" x 5'6" Arched Picket Corner Post (.140" wall)	WH,TN	55
VL400072AL-XX	4" x 4" x 6' Arched Picket Line Post (.140" wall)	WH,TN	55
VL400072AE-XX	4" x 4" x 6' Arched Picket End Post (.140" wall)	WH,TN	55
VL400072ACXX	4" x 4" x 6' Arched Picket Corner Post (.140" wall)	WH,TN	55



WH - White TN - Tan

Flat Top Picket Panels - Wide

Item No.	Description	Colour	Bundle
VL030678FT-XX	3' h x 6' w Flat Top Wide (3") Picket Panel	WH,TN	Each
VL420678FT-XX	42" h x 6' w Flat Top Wide (3") Picket Panel	WH,TN	Each
VL040678FT-XX	4' h x 6' w Flat Top Wide (3") Picket Panel	WH,TN	Each
VL030878FT-XX	3' h x 8' w Flat Top Wide (3") Picket Panel w/Rail Insert	WH,TN	Each
VL420878FT-XX	42" h x 8' w Flat Top Wide (3") Picket Panel w/Rail Insert	WH,TN	Each
VL040878FT-XX	4' h x 8' w Flat Top Wide (3") Picket Panel w/Rail Insert	WH,TN	Each



Flat Top Picket Panels - Narrow

Item No.	Description	Colour	Bundle
VL030612FT-XX	3' h x 6' w Flat Top Narrow (1-1/2") Picket Panel	WH,TN	Each
VL420612FT-XX	42" h x 6' w Flat Top Narrow (1-1/2") Picket Panel	WH,TN	Each
VL040612FT-XX	4' h x 6' w Flat Top Narrow (1-1/2") Picket Panel	WH,TN	Each
VL030812FT-XX	3' h x 8' w Flat Top Narrow (1-1/2") Picket Panel w/Rail Insert	WH,TN	Each
VL420812FT-XX	42" h x 8' w Flat Top Narrow (1-1/2") Picket Panel w/Rail Insert	WH,TN	Each
VL040812FT-XX	4' h x 8' w Flat Top Narrow (1-1/2") Picket Panel w/Rail Insert	WH,TN	Each



Flat Top Picket Posts

Item No.	Description	Colour	Bundle
VL400060FL-XX	4" x 4" x 5' Flat Top Picket Line Post (.140" wall)	WH,TN	55
VL400060FE-XX	4" x 4" x 5' Flat Top Picket End Post (.140" wall)	WH,TN	55
VL400060FC-XX	4" x 4" x 5' Flat Top Picket Corner Post (.140" wall)	WH,TN	55
VL400066FL-XX	4" x 4" x 5'6" Flat Top Picket Line Post (.140" wall)	WH,TN	55
VL400066FE-XX	4" x 4" x 5'6" Flat Top Picket End Post (.140" wall)	WH,TN	55
VL400066FC-XX	4" x 4" x 5'6" Flat Top Picket Corner Post (.140" wall)	WH,TN	55
VL400072FL-XX	4" x 4" x 6' Flat Top Picket Line Post (.140" wall)	WH,TN	55
VL400072FE-XX	4" x 4" x 6' Flat Top Picket End Post (.140" wall)	WH,TN	55
VL400072FC-XX	4" x 4" x 6' Flat Top Picket Corner Post (.140" wall)	WH,TN	55



WH - White TN - Tan

Blank Posts

Item No.	Description	Colour	Bundle
VL400060BP-XX	4" x 4" x 5' Blank Post (.140 wall)	WH,TN	55
VL400066BP-XX	4" x 4" x 5'6" Blank Post (.140 wall)	WH,TN	55
VL400072BP-XX	4" x 4" x 6' Blank Post (.140 wall)	WH,TN	55
VL500060BP-XX	5" x 5" x 5' Blank Post (.135 wall)	WH,TN	54
VL500072BP-XX	5" x 5" x 6' Blank Post (.135 wall)	WH,TN	54
VL500078BP-XX	5" x 5" x 6'6" Blank Post (.135 wall)	WH,TN	54
VL500084BP-XX	5" x 5" x 7' Blank Post (.135 wall)	WH,TN	54
VL500096BP-XX	5" x 5" x 8' Blank Post (.135 wall)	WH,TN	54
VL500108BP-XX	5" x 5" x 9' Blank Post (.135 wall)	WH,TN	54



Picket Caps

Item No.	Description	Colour	Bundle
VL78112CDE-XX	7/8" x 1-1/2" Dog Eared	WH,TN	100
VL78300CDE-XX	7/8" x 3" Dog Eared (Locking)	WH,TN	100
VL78112CSP-XX	7/8" x 1 1/2" Pointed	WH,TN	100
VL78112CSP-XX	7/8" x 3" Pointed (Locking)	WH,TN	100

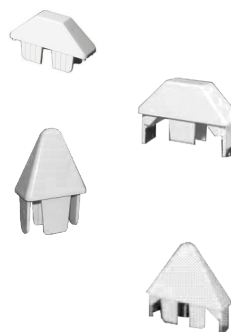

Post Caps

Item No.	Description	Colour	Bundle
VL400CFT-XX	4" External Flat Cap **	WH,TN	50
VL400CGO-XX	4" Gothic Post Cap**	WH,TN	50
VL400CBL-XX	4" Ball Post Cap**	WH,TN	50
VL500CFT-XX	5" External Flat Cap**	WH,TN	50
VL500CGO-XX	5" Gothic Post Cap**	WH,TN	50
VL500CBL-XX	5" Ball Post Cap**	WH,TN	50



****More Colours Available**



WH - White TN - Tan

Rail Caps

Item No.	Description	Colour	Bundle
VL2312EC-XX	2" x 3 1/2" Flat End Rail Cap**	WH,TN	100
VL1555EC-XX	1 1/2" x 5 1/2" Flat End Rail Cap**	WH,TN	100

****More Colours Available**



Snap Caps

Item No.	Description	Colour	Bundle
VLSNAPCP-XX	Snap Cap**	WH,TN	1000

****More Colours Available**



PVC Glue

Item No.	Description	Colour	Bundle
VL150CRHG	1.5oz Tube - Christy's Red Hot PVC Glue	Clear	24
VL800CRHG	8oz Tube - Christy's Red Hot PVC Glue	Clear	24



Gate Hardware

Item No.	Description	Colour	Bundle
VLPADLATBK	Paddle Latch	Black	20
VLHGNSNBK	Non Self-Closing Steel Hinge (Narrow to Narrow)	Black	12
VLHGSCSNBK	Self-Closing Steel Hinge (Standard to Narrow)	Black	20
GH024DROP	24" Drop Bolt	Black	15

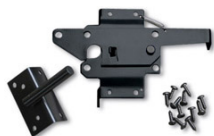

Steel Inserts

Item No.	Description	Colour	Bundle
VLRAILSTEL	Steel Rail Insert For: 1 1/2" x 5 1/2" x 8'	Galvanized	Each
VL2358RSTEL	Steel Rail Insert For: 2" x 3 1/2" x 8'	Galvanized	Each
VL4408LSTEL	4" x 4" x 8' Steel Post Insert (L-Style)	Galvanized	Each
VL5508LSTEL	5" x 5" x 8' Steel Post Insert (L-Style)	Galvanized	Each
VL4406HALUM	4" x 4" x 6' Aluminum Post Insert (H-Style)	Aluminum	Each
VL4408HALUM	4" x 4" x 8' Aluminum Post Insert (H-Style)	Aluminum	Each
VL5508HALUM	5" x 5" x 8' Aluminum Post Insert (H-Style)	Aluminum	Each



Vinyl Post Anchors & Ties

Item No.	Description	Colour	Bundle
VL400PTOW	4" Post Tower	Galvanized	Each
VLPOSTTOWR	5" Post Tower	Galvanized	Each
VL500TRT	DFS® Top Rail Tie (TRT)	Red	Each
VLPTLVLCOL	DFS® Post Leveling Collars (PLC)	Red	Each



Tools

Item No.	Description	Bundle
TLVINYLNOT	Rail Notcher	Each

