

EBU

OPERATING EUROVISION AND EURORADIO

TR 027

DELIVERY OF BROADCAST CONTENT OVER LTE NETWORKS

TECHNICAL REPORT

Geneva
July 2014

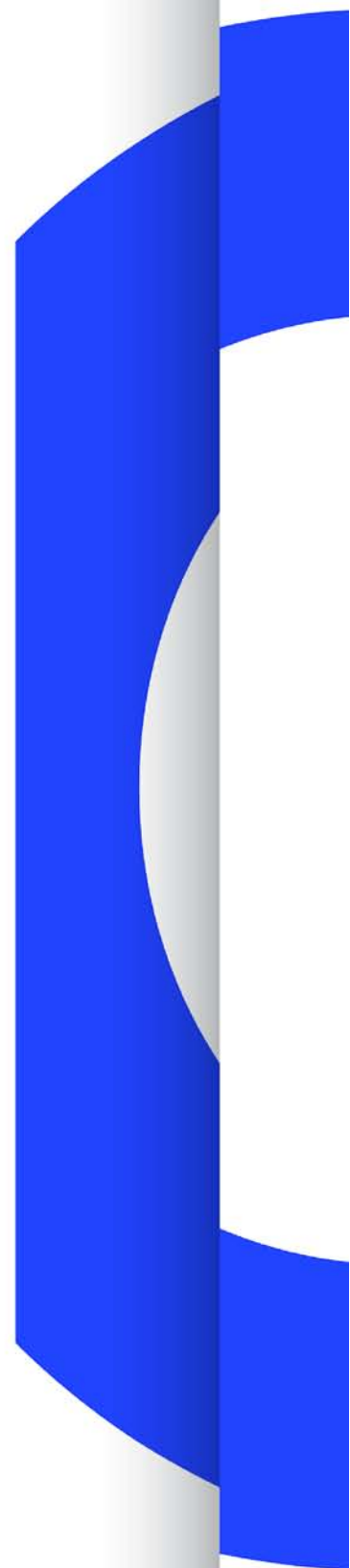

Summary

This report contains the outcome of the study on the delivery of broadcast content and services over LTE networks that was carried out in the EBU Project group CTN-Mobile. It is a result of cooperation between representatives from the broadcast and the mobile industry. Whilst the mobile equipment manufacturers and broadcasters have actively contributed to this study, mobile network operators did not take part in the preparation of this report.

Set out at the beginning of the report are a number of use cases of primary importance to broadcasters. These are indicative of the way in which broadcasters' content is consumed by audiences, and as such define the requirements that different technologies would have to meet. This report has focused solely on whether LTE/eMBMS could suitably enable these use cases. Nevertheless, it is recognised that LTE could provide additional benefits by delivering on-demand services which are increasingly important.

In the course of the study a number of technical issues were addressed, including:

- The LTE features that are relevant for enabling the use cases, in particular eMBMS
- Network deployment scenarios
- Some aspects of spectrum utilisation and spectrum efficiency

Of primary importance is the possibility of free-to-air delivery of broadcast services and to reach all LTE users irrespective of whether or not they have a mobile subscription. The following are the main technical findings of the study related to LTE:

- Given that there are normally multiple operators present in any given country, LTE eMBMS makes it possible to deliver the required TV services only once per area, thereby potentially reaching all users without the need for multiple LTE network operators (LNO) to deliver the same services at the same time. This is possible from a technical point of view because the available spectrum and/or infrastructure can be shared between LNOs as the LTE standard provides all necessary means for implementation.
- Broadcast services can be delivered either free-to-air or via conditional access. Free-to-air or equivalent as defined in the requirements is possible. Unencrypted content delivered via LTE eMBMS can be received without a SIM card whereas in case it is delivered via LTE unicast a SIM card is required. The SIM card may be specifically configured by the provider to enable access only to the TV service and can also be provided for free. The associated regulatory, operational and business aspects need to be addressed.
- Service discovery can be enabled without the need for an uplink capability of the terminal. Information about how to access the broadcast content is contained in the so-called User Service Description (USD) which is provided separately either by using a preconfigured device or a USB stick. In case there is an uplink available, e.g. a WLAN connection, the USD can be requested directly.
- According to the technical specifications an LTE networks can carry both linear TV and non-linear TV services at the same time by employing broadcast and unicast modes, respectively.

The performance of an LTE eMBMS system was analysed based on various studies. A number of issues have a significant impact on the performance, mainly in terms of spectral efficiency, such as:

- The terminal and its location, signal attenuation when being e.g. indoor and its antenna gain (e.g. for set top box scenarios or when a directed antenna is mounted on the roof)
- The required coverage
- Terrain, land usage, buildings
- The network topology, including density and height of antenna sites

Studies based on a methodology normally used for mobile service coverage assessment indicate, that the topology of the existing cellular networks in urban areas is suitable to achieve eMBMS portable indoor coverage. In this case a spectral efficiency in the range between 1 and 2 bit/s/Hz seems achievable for an

individual carrier and hence a value of 1.5 bit/s/Hz has been chosen to assess spectrum requirements. This value could be achieved by an inter-site distance up to 5 km.

In the course of the studies it became also clear, that the spectral efficiency, one of the most prominent parameters for the performance of a large scale deployment, can have a wide range of values, between as low as some 0.1 bit/s/Hz up to more than 3 bit/s/Hz and that the value that can be achieved in a real network deployment will be dependent on the parameters mentioned above. So far no final answer can be given on the spectral efficiency of the individual radio link.

The overall spectrum demand was considered based on a model of Blocked Spectrum. The model estimates the amount of spectrum blocked by any given transmission system, taking into account the size of coverage area, border shape, the corresponding re-use distances, and the assumed spectrum efficiency on the radio link. Blocked spectrum is not available to other possible use.

Based on the Blocked Spectrum model an example comparison shows that Low-Power-Low-Tower (LPLT) network topology may require less spectrum than High-Power-High-Tower (HPHT) topology. Smaller inter-site distance may enable higher spectrum efficiency and smaller geographical separation distances between areas of co-channel delivery of different broadcast content. If the same spectrum is used on both sides of the border the impact of the coverage loss may then be easier to mitigate. Currently, a typical network topology of LTE is LPLT while DVB-T2 networks are usually deployed as HPHT.

In addition, the report identifies the need for a methodology of assessing the LTE eMBMS network coverage in order to ensure that broadcasters' requirements are met. Such a methodology would need to take into consideration network parameters, appropriate propagation models and reception scenarios.

Additionally providing TV services from the existing LTE sites may require additional bandwidth and site engineering measures. This may require additional development efforts, developing the respective antennas and power amplifiers with the required characteristics, while observing the national RF exposure limits.

Furthermore, the capability of LTE to combine unicast and eMBMS transmission has been indicated as a potential new way of delivering broadcast services for example delivering niche programmes via unicast while using broadcast mode for the delivery of mass programmes. This possibility requires to be further studied.

It was noted that multi-operator scenarios are in principle enabled in the LTE standards. However, the details how the cooperation between different operators (e.g. handover issues, unicast distribution of niche programmes, etc.) can actually be implemented is an open question. Thus, there is a need for additional clarification of associated technical, regulatory and operational issues.

Costs are a crucial factor that defines the suitability of a system for the distribution of TV programmes, in particular if LTE were to be considered as a replacement of the current DTT networks. Whilst this study has identified the main elements of a cost model, detailed cost calculations have not been performed. Broadcasters remain concerned that the delivery costs over LTE networks may be significantly higher than the current costs of TV distribution. It has been suggested by the mobile industry that the delivery costs of providing broadcast services over LTE may be reduced by an efficient combination of unicast and eMBMS capabilities and as a result of economies of scale that could be achieved. However, this has not been investigated in detail. At this point in time the available evidence is insufficient for any conclusion on the issue of costs.

From a technical point of view, the examined use cases and free-to-air delivery could in principle be enabled by LTE eMBMS, noting that further development is required. In particular, the implication of a combination of unicast and eMBMS with respect to free-to-air delivery has not been studied. However, it has been identified that regulatory constraints, business and operational models including free-to-air, costs and availability of user equipment need to be better understood to finally judge on the viability of delivering broadcast content via LTE.

Thus, the implementation of an LTE network for a large scale TV distribution is not envisaged in the short term.

Contents

Summary	3
1. Introduction	7
2. Use Cases and the Associated Requirements	8
2.1 Description of Use Cases.....	8
2.2 Broadcasters' Requirements.....	10
2.2.1 General requirements	10
2.2.2 Specific requirements	10
3. Technical Description of LTE Features relevant for broadcast services.....	12
4. LTE networks for Broadcasters' Services	13
4.1 Network Deployment Scenarios	13
4.1.1 Coverage for Broadcast Services	13
4.1.2 Infrastructure Sharing	15
4.1.3 Dynamic Allocation of Radio Resources for eMBMS and Unicast	16
4.1.4 LTE Broadcast Reception from other than the Home Network.....	17
4.1.5 Spectrum Sharing and Pooling	18
4.2 Spectrum Considerations	18
4.2.1 The Concept of the Blocked Spectrum Space and the Reuse Blocking Factor	19
4.2.2 Spectrum Requirements for the Distribution of the TV Programmes of the PSBs if carried by an eMBMS Network in Germany	20
4.2.3 Distribution of Linear TV Programmes over LTE Combining Broadcast and Unicast.....	21
4.2.4 The 'Border Challenge' Between Different Editorial Regions	23
4.2.5 Spectrum Planning, Overall Efficiency	24
4.3 Further Technical Considerations	25
4.3.1 Backhaul	25
4.3.2 Antenna System.....	25
4.3.3 RF Exposure Limits	25
5. Cost Considerations.....	26
6. Open issues to be further addressed	27
7. Conclusions	28
8. References.....	30
Annex 1: List of Acronyms.....	33
Annex 2: Detailed Description of LTE Features	37
A2.1 Service Framework	37
A2.2 Service Discovery	39
A2.3 LTE Downlink Physical Layer.....	39

A2.4	Segmentation/Concatenation Across Protocol Layers.....	41
A2.5	MBSFN.....	41
A2.6	eMBMS Architecture.....	42
A2.7	Synchronisation.....	43
A2.8	eMBMS Area Concept.....	44
A2.9	eMBMS / unicast multiplexing.....	45
A2.10	User Counting for MBSFN Activation.....	45
A2.11	Service Acquisition and Continuity in Multi-carrier Networks.....	46
A2.12	Quality of Service.....	46
A2.13	Standardization Outlook.....	47
A2.14	Performance.....	47
A2.15	Carrier Aggregation.....	50
Annex 3: eMBMS Performance Assessment.....		51
Annex 4: Blocked Spectrum Space and the Reuse Blocking Factor.....		55
A4.1	General Method.....	55
A4.2	Principle of the Method.....	55
A4.3	Available and Blocked Spectrum Space.....	56
A4.4	Spectrum Space Blocked by Transmission Systems.....	56
A4.5	Distribution in Broadcast Mode and the Reuse Blocking Factor.....	57
A4.6	Distribution in Unicast Mode.....	58
A4.7	Application of the Method to TV Distribution.....	59
A4.8	Distribution by Mobile Radio Networks.....	59
A4.9	Distribution by Broadcast Networks.....	63
A4.10	Results for TV Distribution in Germany as an Example.....	65
Annex 5: The 'Border Challenge'.....		67
A5.1	Basic Solution Options and Variants.....	67
A5.2	Case A) SFN area per editorial region: different content on same resources (reuse 1).....	69
A5.3	Case B) SFN area per editorial region: different content on orthogonal resources (reuse > 1).....	69
A5.4	Case C) Separate SFN area for guard stripe between editorial regions (reuse >1 only in guard stripes).....	70
A5.5	Reuse between SFNs.....	71
A5.6	Reuse between Broadcast and Other Services.....	74
Annex 6: Antenna system.....		79
Annex 7: RF exposure limits.....		81
Annex 8: A Case Study on eMBMS Performance Assessment.....		83
Annex 9: MBMS User Service Discovery.....		89

Delivery of Broadcast Content over LTE Networks

1. Introduction

The EBU Strategic Programme on Cooperative Terrestrial Networks (CTN) has established a Project Group CTN-Mobile in December 2011 with the purpose of assessing the potential of mobile broadband, in particular LTE networks to be used for the delivery of linear as well as non-linear broadcasting services. The group was open to interested participants from the broadcast and the mobile industries. The work in CTN-Mobile was focused primarily on the relevant technical issues.

Apart from the detailed technical work CTN-Mobile has provided a valuable opportunity for broadcasters and the mobile industry to actively cooperate. For the EBU Members this has provided an opportunity to build a knowledge base on mobile broadband technologies and their potential benefits for broadcasters. The mobile industry could gain insight into broadcasters' service requirements and receive a feedback on their proposals on how to meet a growing user demand for media services.

This report contains the main outcome of the study on the delivery of broadcast content and services over LTE networks. The study was based on a set of representative use cases and the associated requirements defined in Section 2. All selected use cases include linear TV as this is currently the EBU Members' main service proposition. Nevertheless, it is recognised that LTE could provide additional benefits by delivering on-demand services which are increasingly important.

Section 3 presents the relevant technical features of LTE, in particular eMBMS that are required to enable the use cases described in Section 2. For convenience the detailed technical information on these LTE features is gathered in **Annex 2**.

Several possibilities for LTE network deployment are outlined in Section 4 to the extent that they address the broadcasters' requirements. It is to be noted that some eMBMS deployment scenarios may differ from those for the unicast networks. In addition to "network deployment scenarios" this section also includes some aspects of spectrum use. Consistently with section 3, the technical details are provided in the related **Annexes 3 - 9**.

The study has also briefly touched upon cost issues. A discussion on cost elements is provided in Section 5 without detailed cost estimations.

During the preparation of this report a number of important issues have been identified that may require further work and have not been covered in detail in the Report. These issues are described in Section 6.

The main findings of the study are presented in Section 7.

2. Use Cases and the Associated Requirements

2.1 Description of Use Cases

Analysis of the current and future use cases provides a good starting point for examining the capabilities of a given distribution mechanism. The term “use case” should be understood to represent a combination of:

- a broadcaster’s service
- the environment in which the service is used; and
- a receiving device.

A number of different use cases are considered to be highly relevant for broadcasters. While many of them could possibly be enabled via LTE only a small set has been selected for this study.

All selected use cases involve linear TV as a service. A linear service is the traditional way of offering TV services where the viewers tune in to the content organised as a scheduled sequence that may consist of e.g. news, shows, drama or movies. The sequence of programmes is set up by a broadcaster who retains editorial responsibility for the content and the schedule cannot be changed by a listener or a viewer. Linear broadcast services are not confined to a particular distribution technology. For example, terrestrial or satellite TV channels as well as a live TV stream on the Internet are all examples of a linear service.

Linear TV services are particularly important for broadcasters today and it is assumed that they will remain a cornerstone also in the foreseeable future. It is on the other hand assumed that they could be challenging for broadband networks in particular for serving large audiences if not handled efficiently. Thus they provide a suitable basis for examining the relevant features of LTE networks.

The following user devices are considered to be representative with regard to access to linear TV services:

- stationary TV set
- portable TV set
- TV receiver in a vehicle
- desktop computer
- portable ('laptop') computer
- smartphone
- tablet

These device categories describe how services are consumed. For the purpose of this analysis it was assumed that all considered devices are capable of connecting to an LTE network, noting that it may not always be the case. With the above assumption the study could usefully be limited to LTE networks without the need to consider the issues related to user devices at the same time.

Two different user environments are considered:

- *Permanent* - In this environment the user is within a non-public location that they use very regularly and have a high degree of control over, for example the home or an indoor work environment (office, workshop, etc.)
- *Transient* - In this environment the user is in a public space that they use occasionally and have little control over, for example an airport, a train station or a shopping mall, or is travelling (in cars, trains, etc.).

Combining different user devices with each of the two receiving environments gives rise to a large number of combinations. However, not every combination represents a realistic use case. Figure 1 illustrates in which environment each of the above listed devices is normally used.

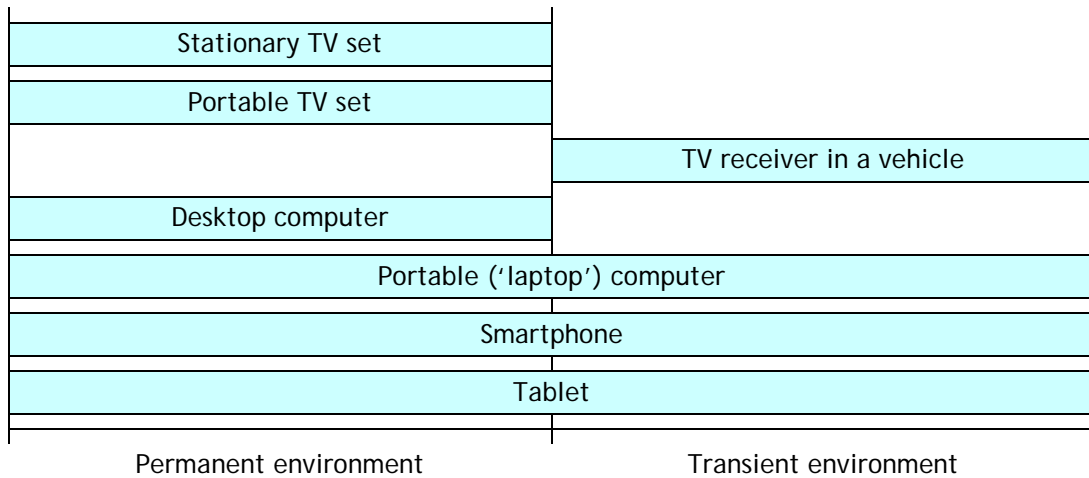

Figure 1: Receiving devices and user environments

Furthermore, not all realistic combinations are equally important to broadcasters. The list in Table 1 includes those use case that are considered to be highly relevant. Their relevance is determined by taking into account the current situation as well as the short to medium term future (e.g. next 5 - 10 years). For instance, a use case is considered highly relevant if it is already important or it is foreseen to become important in the future. Elements to be considered may include the size of the audience, availability of suitable devices or the programme offer.

Table 1: Highly relevant use cases

Use case	Service: Linear TV		Remark
	Environment	User device	
1	Permanent	Stationary TV set	This use case includes any situation where linear TV is delivered to stationary TV sets, including not only home and office but also such cases as public indoor spaces, outdoor public viewing, etc.
2	Permanent	Portable TV set	
3	Permanent	Desktop computer	
4	Permanent	Portable computer	<ul style="list-style-type: none"> – Less convenient than smartphones and tablets – In the home laptops are not the first choice devices for linear TV
5	Permanent	Smartphone	<ul style="list-style-type: none"> – Increasingly important device in the future due to its widespread adoption and ease of use – High relevance because e.g. in the home smartphones can be connected to a large screen.
6	Permanent	Tablet	<ul style="list-style-type: none"> – Provided that tablets will be widely used in the future it is an increasingly important device due to its capabilities and size of the screen. – Marketing and demographic aspects
7	Transient	TV in a vehicle	
8	Transient	Smartphone	For short programmes such as news
9	Transient	Tablet	<ul style="list-style-type: none"> – Provided that tablets will be widely used in the future it is an increasingly important device due to its capabilities and size of the screen – Marketing and demographic aspects

2.2 Broadcasters' Requirements

For every use case a set of requirements has been defined that need to be fulfilled by an LTE network. The requirements are service focused, i.e. defined in such a way as to ensure the desired availability and quality of service. Furthermore, they do not reflect the current constraints of a network technology or user device. The distribution options are assessed in terms of their ability to satisfy the requirements.

Two types of requirements have been defined:

- general requirements which are common to all use cases, and
- specific requirements for each use case

Firstly, LTE networks need to be evaluated with respect to the general requirements. Then, the evaluation has to be carried for each use case taking into account the respective specific requirements.

2.2.1 General requirements

General requirements reflect the basic principles which determine the business model of Public Service Media (PSM). The following general requirements are considered relevant for the assessment of distribution options:

- Possibility for free-to-air or equivalent, no additional costs for the viewers and listeners. As is current practice, equipment costs are out of scope.
- Deliver the services of public service broadcasters to the public without blocking or filtering the service offer, i.e. no gate keeping.
- Content and service integrity - no modification of content or service by the network operator, e.g. TV content must be displayed on screen without unauthorised modifications.
- For each service, quality requirements to be defined by the broadcaster, such as
 - QoS when the network is up and running
 - availability of network: robustness, up-time, reliability
- Quality of Service for each user shall stay above the specified minimum, regardless of the size of the audience.
- Geographical extent of the service area (e.g. national, regional, local) is to be defined by the broadcaster.
- Users shall have the possibility to choose from a minimum of 25 TV programmes at any time.
- Ease of use - straightforward accessibility of broadcast offer.
- Low barrier for access to broadcasters' content and services for people with disabilities.
- Ability to reach audience in emergency situations

Any distribution platform needs to allow implementation of these principles in order to be suitable for Public Service Media.

2.2.2 Specific requirements

Specific requirements are defined for each use case and they should be fulfilled in addition to the general requirements specified above. The following parameters are specified:

- **Data rate**

To ensure high quality user experience the average bit rates per programme are specified, while

the actual data rate must not at any time drop below certain minimum levels. It is assumed that TV services may be provided in HDTV quality and encoded by means of MPEG-4 / H.264¹, which leads to the following data rate requirements:

- average 8 Mbit/s, minimum 5 Mbit/s: for stationary and portable TV set
- average 5 Mbit/s, minimum 2.5 Mbit/s: for TV set in a vehicle, desktop and portable computer, smartphone, and tablet.

- **Error rate**

The error rate of a programme or services must be maintained within predefined limits to achieve a high quality of experience with nominally no visual artefacts on the screen. Typically this is referred to as quasi error free. This means that after decoding the incoming signal, a maximum bit (or block) error rate shall not be exceeded. For comparison: in current television systems (DVB-T2) a bit error rate of 10^{-11} is considered the required value.

- **Targeted peak size of the concurrent audience**

A viable distribution option must be able to serve all users that wish to access a given service with a required quality of experience. It is assumed that serving large audiences is more challenging than the small ones. Furthermore, the number of concurrent users is not static but varies from one moment to another. The quality of experience shall be provided independent from the number of receivers actually following an individual service.

Therefore, the LTE networks should be assessed with regard to their ability to support the expected maximum number of concurrent users (peak demand). In other words, the expected peak demand should be specified for each use case.

For linear TV services all viewers or listeners will tune in at the same time (e.g. at the time of broadcast). Hence, the peak demand is the maximum cumulative number of concurrent users that tune in to any and all linear services within a given use case. Note that this is not the same as a peak audience of any particular individual linear service. It is also different from on-demand services.

Table 2: Specific Requirements

	Use case: - service - environment - device	Data rate requirements per TV programme		Peak size of the concurrent audience
		Average	Minimum	
1	linear TV permanent stationary TV set	8 Mbit/s	5 Mbit/s	80% of the population
2	linear TV permanent portable TV set	8 Mbit/s	5 Mbit/s	30% of the population
3	linear TV permanent desktop computer	5 Mbit/s	2.5 Mbit/s	10% of the population
4	linear TV permanent portable computer	5 Mbit/s	2.5 Mbit/s	10% of the population

¹ Different values are applicable for other encoding standards (e.g. MPEG-2, HEVC) and picture formats (e.g. SDTV, UHDTV, 3DTV). Furthermore, live content requires real-time encoding while for on-demand content more sophisticated non-real-time encoding algorithms can be employed giving rise to lower required bit rate for the same perceived picture quality.

	Use case: - service - environment - device	Data rate requirements per TV programme		Peak size of the concurrent audience
		Average	Minimum	
5	linear TV permanent smartphone	5 Mbit/s	2.5 Mbit/s	5% of the population
6	linear TV permanent tablet	5 Mbit/s	2.5 Mbit/s	10% of the population
7	linear TV transient TV in a vehicle	5 Mbit/s	2.5 Mbit/s	10% of the population
8	linear TV transient smartphone	5 Mbit/s	2.5 Mbit/s	5% of the population
9	linear TV transient tablet	5 Mbit/s	2.5 Mbit/s	10% of the population

3. Technical Description of LTE Features relevant for broadcast services

The rapid adoption of smartphones and tablet computers with built-in support for high quality video has enabled mobile access to multimedia services including high quality mobile audio and-video recording and uploading for the mass market. The majority of today's mobile video services are delivered over the mobile broadband (MBB) service of existing 3G and LTE networks, since this is the fastest and easiest way to deploy them. The service is provided by packet-switched streaming (PSS) on radio bearers that are dedicated to the individual users. If services such as linear TV will be offered across mobile networks, there will be situations in which many users want to watch the same content at the same time. Examples are live events of high interest like soccer matches, game shows, etc. For those cases, multicasting, known from the internet, or broadcasting are clearly more appropriate technologies.

A Multimedia Broadcast/Multicast Service (MBMS) was standardized by 3GPP and since Release 9 it is called 'evolved MBMS' or eMBMS. eMBMS traffic is time multiplexed with unicast traffic, which can be used to enable interactivity for broadcast services or upcoming "Hybrid-Digital-TV" services. In the time multiplexed configuration, up to 6 out of the 10 sub-frames of a radio frame can be dedicated to MBMS in the FDD mode (or up to 5 in the TDD mode). eMBMS can employ a single-frequency network configuration, like DVB-T, establishing a so-called MBSFN. Cells in an MBSFN area have to be tightly time synchronized, similar to e.g. DVB-T/T2 single frequency networks. eMBMS is built on the LTE downlink OFDM physical layer with a cyclic prefix of 16.7 μ s. This is longer than what is typically used for LTE unicast. In a further configuration, the cyclic prefix is increased to 33.3 μ s². This implies that, for two otherwise isolated transmitter sites separated by up to 10 km, no interference would occur at any point between them, although in practical networks interference from further transmitters beyond 10 km would have to be taken into account.

A cell can belong to up to 8 MBSFN areas, allowing for overlapping national, regional, and local MBSFN areas. Each cell supports 16 Multicast Channels (MCH), each of which can be configured with a different modulation and code rate to support tailored robustness in different reception

² Currently, signalling to identify which sub frames use the CP of 33.3 μ s is missing from the standard, therefore UEs cannot be assumed to understand this mode yet, see Annex 3

conditions. Up to 29 multicast traffic channels can be configured per MCH. Further details can be found in Annex 2 section A2.5.

On the transport layer, eMBMS employs IP packets. eMBMS provides a streaming and a file download service type. As fast retransmissions are not supported in eMBMS, increased transmission robustness can be achieved by additional forward error correction on the application layer (AL-FEC) working on IP packets. This also achieves increased time diversity as large AL-FEC blocks are supported.

A very basic requirement for the terminal is the capability to find the content, i.e. the TV programmes. Service discovery can be enabled without the need for an uplink capability of the terminal. Information about how to access the broadcast content is contained in the so-called User Service Description (USD) which is provided separately, either by using a preconfigured device or a USB stick. In case there is an uplink available, e.g. a WLAN connection, the USD can be requested directly. Access to Electronic Programme Guides can be enabled in a similar manner. Further details and the respective consecutive steps than run in the background can be found in Annex 9.

A detailed technical description of the LTE features that are relevant for the distribution of broadcast services is provided in Annex 2, whilst performance assessment of eMBMS is described in Annex 3.

4. LTE networks for Broadcasters' Services

A set of representative use cases for linear TV services has been defined in Section 2. In order to enable these with LTE, potential network deployment scenarios have been considered on the basis of the following assumptions:

- The available spectrum is shared between LTE network operators (LNOs)
- The necessary network infrastructure would be available
- Broadcast services defined in the above mentioned use cases fall in two broad categories:
 - National broadcast services (NBS) that need to be available to the entire population of a country
 - Regional and local broadcast services (RBS) that need to be universally available in a given region within a country
- Broadcast services could be delivered either free-to-air or via conditional access
- LTE networks will carry linear TV services in addition to other traffic in either unicast or broadcast mode.

Network deployment scenarios have been analysed in terms of coverage and capacity requirements, allocation of network resources, and their utilisation of infrastructure and the radio spectrum. Furthermore, relevant technical and commercial constraints and trade-offs have been identified.

In addition to enabling the use cases that are based on linear TV services LTE networks could potentially be used to deliver other types of broadcast services.

4.1 Network Deployment Scenarios

4.1.1 Coverage for Broadcast Services

Coverage requirements for broadcast services are normally defined by regulatory obligations (i.e. for public service media) or by commercial objectives (e.g. in case of commercial broadcasters), or a combination of both. For the purpose of this analysis it is assumed that every linear TV service needs to be delivered within a particular geographical area called the 'service area'. Each service area is served by different TV content and can be covered by one or more LTE radio access

networks (RAN). Furthermore, for the sake of simplicity it is assumed that there is no overlap between service areas, although in reality this is generally not the case.

Two scenarios are considered for the delivery of linear TV services:

- 1) Regional split where coverage is provided by multiple RANs (Scenario 1)
- 2) A single RAN provides coverage in multiple service areas (Scenario 2)

Scenario 1: Regional split into multiple RANs

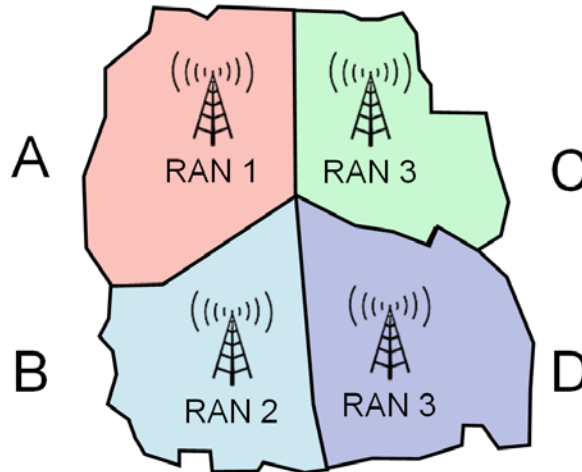

Figure 2: Example of Scenario 1 - Service areas are served by three different RANs

In this scenario, the service areas, i.e., areas with different TV broadcast content are served by different RANs. In the example shown in Figure 2 there are four service areas (A, B, C, and D) and three different RANs (RAN 1, RAN 2 and RAN 3).

Different TV services are provided in each respective service area. They are denoted as:

- RBS A - regional broadcast services in service area A
- RBS B - regional broadcast services in service area B
- RBS C - regional broadcast services in service area C
- RBS D - regional broadcast services in service area D

In this example the RBS in each service area is provided by an LTE network operator (LNO) using its own RAN. Each LNO can, in principle, use the entire available spectrum within its respective area, with some constraints in the bordering areas between different RANs. For instance, RBS A of service area A is provided by LNO-I using RAN 1, RBS B of service area B by LNO-II using RAN 2 and so on.

It is also possible that different RBS are delivered by the same LNO. Moreover, the RAN deployment does not necessarily have to match the service area. In the example above RAN 3 spans the service area C and D.

In addition, a nationwide layer, i.e. the service area with the same TV content for the whole country (NBS), could be delivered by a single or multiple LNOs. In this example the NBS is provided by LNO-IV.

If linear TV services are delivered in a broadcast mode (i.e. eMBMS) the unrelated unicast traffic is delivered independently but over the same LTE network.

Each LNO is associated with a single core network (CN) as shown in Figure 3. Additional information about eMBMS network architecture is provided in Annex 2, section A2.6.

The pooled spectrum in each RAN is split among the RBS, the NBS and the unicast traffic. Moreover, the MBSFN data transmission can be time multiplexed with LTE unicast traffic as described in Annex 2 section A2.9. The percentage of sub-frames of a radio frame which can be used for MBMS transmission is configurable by the Operation & Maintenance (O&M) centre. In general, the number of sub-frames required for TV broadcast services is rather static as the number of offered TV channels would not change so often. Therefore, the percentage of the sub-frames of a radio frame used for MBMS transmission can be configured such that a certain picture quality is guaranteed for the providers of the RBS and the NBS.

Scenario 2: A common RAN

The editorial regions of this scenario are operated by a common RAN which spans all editorial regions. In practice this would mean the entire country. An example of this scenario is shown in Figure 3:

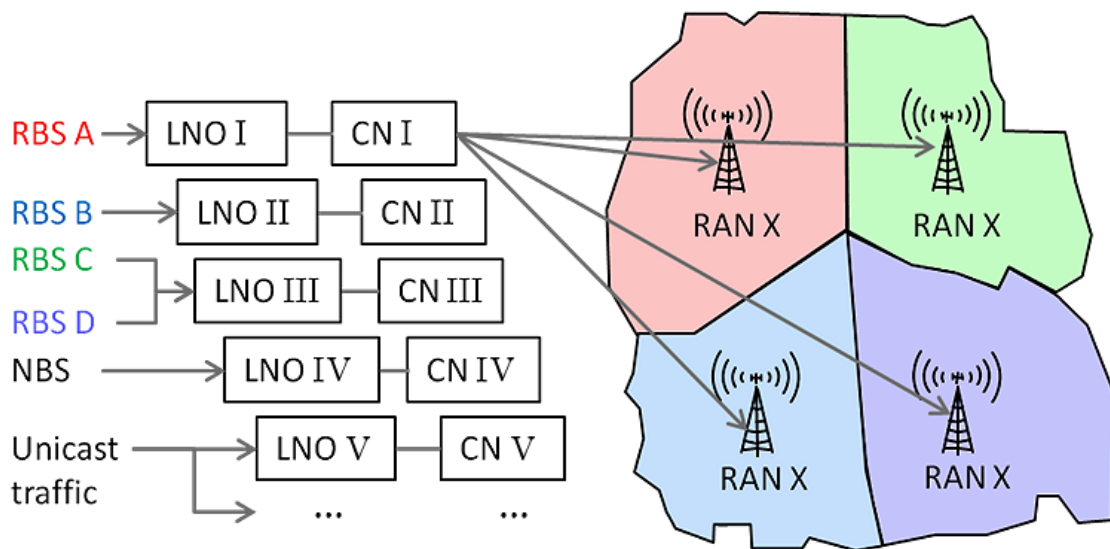

Figure 3: Example of Scenario 2: A common RAN X for all service areas.

In this example the four editorial regions (A, B, C and D) with their respective but different TV regional broadcast services (RBS) are all served by RAN X, which is common throughout the entire area. Moreover, the same RAN X can be used to deliver the national broadcast services (NBS) and the other traffic. The common RAN would normally use the entire available spectrum.

Each service area could be served by a single MBSFN. In the two scenarios above it is assumed that the MBSFN area consists only of cells which belong to the same RAN. However, it could happen that an editorial region exceeds the coverage of a single RAN and it is intended to be provided by an MBSFN area comprising cells that belong to multiple RANs. In this case, the synchronization of the cells belonging to different RANs is an issue that is not yet addressed and requires further investigations.

4.1.2 Infrastructure Sharing

LTE network operators will face the challenge of rolling-out cost-effective networks while meeting the coverage and capacity requirements, in particular for linear TV services. One way of reducing substantially the capital and operational expenditures is to share the network infrastructure with other operators. Initially, network sharing included only passive installation such as sites, antenna masts, power generators and air conditioning [17]. More recently, new advancements in technology and modification to regulatory regimes have allowed active sharing in which operators share network equipment such as base stations and even radio resources. 3GPP has specified [18] two approaches for sharing the radio access network (RAN) between operators:

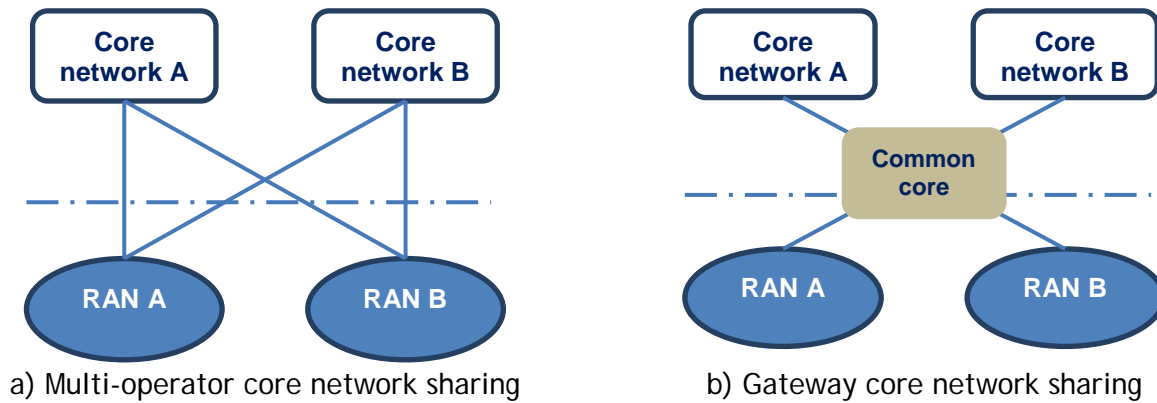

Figure 4: Two approaches for network sharing

In the first approach (Figure 4a) each network operator has its own core network which is connected to the RANs of other operators. Keeping the core networks separate from RANs allows operators to maintain a high level of service differentiation and interworking with legacy networks [17]. In the second approach (Figure 4b) the operators share a common part of the core networks, e.g. mobility management entity (MME), which is in turn connected to the RANs of other operators. This approach enables operators to further reduce their costs by sharing a common part of the core networks, but it is associated with increased complexity and a signalling overhead as well as a reduced flexibility in service differentiation between operators.

The transmissions of the cells in an MBSFN area are synchronized see Annex 2 section A2.7. This synchronization has not yet been investigated in the case where an MBSFN area comprises cells that belong to different RANs. New interfaces might be required for this kind of multiple RAN synchronization. It is, however, possible to define separate MBSFN areas for each RAN, which would avoid this synchronisation requirement.

Interference coordination between MBSFN areas has to be employed as described in Annex 2, section A2.8.

4.1.3 Dynamic Allocation of Radio Resources for eMBMS and Unicast

Broadcast and unicast traffic may coexist in the same cell and share the radio resources available within it. In such cases the total cell capacity is divided between eMBMS and unicast services in a flexible way, depending on the demand. Up to a 60% of the available resources can be allocated to eMBMS. In a scenario comprising multiple LNOs sharing or pooling the spectrum, the dynamic allocation of radio resources between eMBMS and unicast requires prior agreements among these operators.

If several users within a given cell request the same service at the same time (as it is normally the case for popular linear TV services) it is more efficient to deliver these services in a broadcast mode instead of independent unicast connections. 3GPP has specified the procedures that enable eMBMS counting which is used to determine if there are a sufficient number of users requesting a particular service. [17] Vice-versa, if the number of users requesting a specific service decreases below a certain threshold the radio resources which have been used for broadcast can be reallocated to unicast, while still providing the same services to the users. Furthermore, variable bitrate broadcast service do not make full use of the allocated eMBMS resources. Such short-term variations can be exploited without changing the eMBMS resource allocation, by dynamically scheduling unicast traffic in unused eMBMS resources.

Resource allocation between unicast and broadcast is done at a level of individual cells. For providing the same services over larger geographical areas multiple cells can be synchronised and operate in an SFN configuration (e.g. MBSFN). Enabling a single frequency network (SFN) for better coverage and higher efficiency limits the freedom of flexibly shifting resources between broadcast

and unicast as the demand for certain content needs to be evaluated over an entire SFN area rather than on a cell by cell basis.

eMBMS (and MBSFN) can be activated for a period of time which can be adjusted in accordance to service requirements and the user demand. This feature may for instance be useful for delivery of linear TV services where the capacity required to meet peak demand could be used at other times to deliver different content such as unicast.

The amount of radio network resources allocated to broadcast versus unicast can vary over time and space which gives a lot of freedom to network operators. However this flexibility may be constrained in some cases where infrastructure and spectrum are shared.

4.1.4 LTE Broadcast Reception from other than the Home Network³

LTE user devices are usually connected to a particular mobile network called the home network or other networks with which the home network operator has a roaming agreement. In any given situation services requested by a user are provided by a single network, either the home network or a 'visited network'.

For general interest TV services there may be a desire to make the service accessible regardless of the home network that a user is subscribed to. In principle, two ways of enabling this are conceivable:

- 1) The TV service is provided by a network that also provides unicast services and this network has a roaming agreement with the home network of the subscriber. The user would have to roam to the "TV hosting network" in order to receive a TV service. If the user would like to simultaneously use a unicast service then this has to be provided by the TV hosting network as well, because the user would not be registered on their home network when they were accessing the TV services from the alternative network.
- 2) The UE remains registered in the home network but at the same time it receives an LTE broadcast on a carrier of a different network. This approach is further discussed in hereafter.

Since LTE broadcast reception is possible in idle mode⁴ and the signal is not ciphered by the LTE network, it is possible to receive LTE broadcast in any LTE network. A UE can access a network for which no roaming agreement exists, i.e. in the Limited Service State. In this state, only emergency services (emergency calls and emergency alert message broadcasts) are accessible and LTE broadcast services if made available without SIM card.

A network that provides LTE broadcast services also transmits broadcast system information (SIB15) that identifies LTE carrier frequencies on which these broadcast services are available. SIB15 information can be received by any terminal without prior registration to that particular network. Furthermore, the LTE broadcast transmission can then be accessed by any terminal whether registered to the network providing SIB15 or another LTE network.

In the future, most UEs will be capable of carrier aggregation. The term carrier aggregation has recently been used in a generic way in some literature when discussing the conceivable options of receiving LTE broadcast on one carrier and unicast on another.

³ A home network is a mobile network a user is contracted to and to which a SIM card is uniquely associated.

⁴ Idle mode means that there is no unicast connection established nor is the position of the UE known to the networks on a cell level - see also section A2.10 in Annex 2.

4.1.5 Spectrum Sharing and Pooling

Radio spectrum is licensed to network operators who deploy it in their radio access networks. Operators are free to use their respective spectrum portfolios subject to the license conditions.

Nevertheless, in some cases sharing or pooling the spectrum amongst operators can increase efficiency and in turn improve the service provided to the users. Spectrum sharing and pooling are as much regulatory and business issues as they are technical. Thus, both broadcast and telecom regulations would need to be addressed, but this exceeds the scope of this document. Three ways are envisaged for sharing and pooling the spectrum:

- One operator is assigned the entire spectrum and shares it with other operators.
- Each operator is assigned a part of the spectrum and shares it with other operators.
- A number of operators pool their assigned spectrum and share the total spectrum even with operators without any own assigned spectrum.

In the last two cases where more than one operator is involved, some technical issues such as dynamically allocating the radio resources between eMBMS and unicast or distributing the same content synchronously over multiple operators require agreements among operators and the details need further consideration.

The pooled spectrum in each RAN can be divided between the unicast traffic and eMBMS, where it is deployed.

Spectrum related issues are further discussed in section 4.2.

4.2 Spectrum Considerations

Spectrum requirements are an important characteristic of a transmission system that can be used to compare and contrast one system with another. To this end it is necessary to be able to quantify spectrum requirements of different systems in an equitable way. This is a complex task. For LTE it would require a number of input assumptions including for instance:

- detailed parameters of the LTE network(s)
- the coverage and bit rate requirements for each TV service
- the geographical distribution of the viewers, the equipment they use and their viewing habits
- the popularity of each service

Such analysis exceeds the scope of this study, and even if it had been possible the results would always be specific to a particular LTE network implementation and a combination of service and user requirements.

It is understood that spectrum requirements depend on network topology. High-power-high-tower (HPHT) networks with large inter-site distances require larger re-use distances than low-power-low-tower (LPLT) networks with cellular architecture. However, HPHT networks give rise to interleaved spectrum (the 'white spaces') which can be used by secondary users. With LPLT configuration there will be less interleaved spectrum. For the purpose of this study the use of secondary applications such as PMSE are out of scope.

In addition, there is a trade-off between the network density, spectral efficiency and cost. While cellular networks may use less spectrum their deployment and operational cost depend on the required network topology and may exceed the costs of HPHT networks. This should be further studied.

Three aspects have been analysed in more detail:

- A proposed method that enables comparison between different transmission systems and network deployments in terms of their overall spectrum use,
- a proposed method of distributing linear TV services between unicast and eMBMS mode on the basis of viewing figures and calculating the corresponding spectrum requirements,
- spectrum arrangements in an MBSFN cellular network, in particular in border areas between different editorial regions.

4.2.1 The Concept of the Blocked Spectrum Space and the Reuse Blocking Factor

For the purpose of this study and to compare technologies and topologies, the spectrum requirements of a transmission system can be specified by answering three questions:

- What's the size of the required spectrum?
- How large is the area where it is needed?
- For what time is it needed?

Spectrum, area (or more generally space), and time are the dimensions of a spectrum space where the requirements of a transmission system can be quantified by the overall size of the part of this space the system requires. Systems have equivalent spectrum requirements if in order to fulfil the same purpose they each block a spectrum space of the same size, i.e. exclude other systems from simultaneously using the same spectrum space. In this way transmission systems with heterogeneous spectrum requirements (e. g. much spectrum required in certain areas of the region to be covered, little spectrum required in others) can be directly compared.

To get an idea of what a certain size of blocked spectrum space means, it makes sense to answer this question: which bandwidth ΔB , if homogeneously used (i.e. the spectrum requirements are the same everywhere) in the whole area to be continuously covered by the transmission system would block the same size of the spectrum space? This bandwidth ΔB may be identified with the spectrum requirement of the transmission system and the values of ΔB for various systems may be used to compare their requirements.

Two parameters play a key role for the spectrum requirements of a broadcast system:

- The spectral efficiency. This indicates the size of the spectrum required to transmit a certain data rate in case of a homogeneous coverage of an area. This parameter is typical of the transmission system.
- The reuse blocking factor. This indicates the increase of the spectrum requirement of the system due to the fragmentation of the area to be covered into sub-areas where different contents shall be provided. This factor is determined by the respective structure of the coverage and the reuse distance of the system, i.e. the minimum distance between two areas where the same frequency can be used for the transmission of different content.

A detailed description of the method and some illustrative calculation results are provided in **Annex 3**.

The method can be applied in order to compare the spectrum requirements of different topologies and transmission technologies, e.g. eMBMS (LTLP) with HTHP broadcast networks. For eMBMS the key parameter is the inter site distance (ISD) of the network: the smaller the ISD, the higher the spectral efficiency and the smaller is the reuse blocking factor resulting in a lower value of the blocked spectrum. If the ISD is small enough, spectrum can be saved in comparison with an HTHP broadcast network which has a high spectrum efficiency but a larger reuse blocking factor than an LTLP network.

4.2.2 Spectrum Requirements for the Distribution of the TV Programmes of the PSBs if carried by an eMBMS Network in Germany⁵

In order to get an idea of how the results of the method may look like in a concrete case, Table 3 presents the results found by the application of this method to the distribution of the TV programmes of the public broadcasters in Germany by a hypothetical eMBMS network. It has to be emphasized that these results are only valid for Germany and the specific task of the distribution of the public programmes in this country.

The table specifies the key parameters mentioned above (spectral efficiency, reuse blocking factor) and the resulting blocked spectrum ΔB as a function of the inter site distance of the eMBMS network for one regional and two national layers. In the bottom line it is indicated how much spectrum could be saved by the use of the eMBMS network instead of a DVB-T2 HTHP network performing the same task (the only difference is that the LPLT eMBMS network would also provide portable indoor reception in rural areas while the HPHT DVB-T2 network would be limited to portable outdoor reception, like the DVB-T networks today in Germany).

The results show that spectrum could indeed be saved by the use of an eMBMS LTLP network for ISDs of 2 or 5 km, but not for an ISD of 10 km (the negative value indicates that the LTLP network would require more spectrum than the HTHP network).

The detailed parameter values these results are based on are given in Annex 4.

Table 3: Blocking factors and blocked spectrum ΔB for various inter site distances of mobile radio networks

Inter site distance (ISD)	2 km	5 km	10 km
Spectrum efficiency (bit/s/Hz) ⁶ [13]	3	1.5	0.4
Reuse distance (km)	4	10	20
NATIONAL LAYER:			
Reuse blocking factor	1.04	1.10	1.22
Blocked spectrum ΔB (MHz)	8.32	17.64	73.01
REGIONAL LAYER:			
Reuse blocking factor	1.15	1.40	1.89
Blocked spectrum ΔB (MHz)	9	22	113
Blocked spectrum ΔB (MHz) for 1 regional and 2 national layers	23	58	259
<i>Reduction of blocked spectrum ΔB (MHz) compared with distribution by DVB-T2 broadcast networks. For the amount of blocked spectrum by DVB-T2 see Annex 4, Table A4-3.</i>	62	27	-174

⁵ Additional studies have been recently made available to CTN-Mobile based on different set of input parameters and reporting a different spectral efficiency. Neither study attempted to optimize the eMBMS network performance. It is evident that the network performance depends on some key parameters further explained in table A3-2 in Annex 3 section A3.14. For a thorough understanding a clear agreement on the common simulation assumptions are needed for all studies. Further investigation on that issue is necessary.

⁶ See [13], p. 6, Fig.5, in-car-case. The decrease of the spectrum efficiency with increasing ISD reflects the fact that the robustness of the MCS (modulation and coding scheme) has to be increased under the constraint of constant probability of coverage (95%). It is not taken into account that not more than 60% of the overall bandwidth of a channel can be used for eMBMS according to the present state of the LTE standard. There is evidence that the spectrum efficiency could be lower than indicated in the table, e.g. [12], p. 69, Fig. 10, reproduced in Figure A4-4 in Annex 4

Table 4: Summary of key assumptions used in performance simulations for the spectrum efficiency values assumed in Table 3

Parameter	Default Values	Remarks
Shadowing fading	Log-normal, $\sigma=8$ dB	
Cross correlation between cell sites and sectors	0.5 (between different cell sites) 1.0 (between sectors on same cell site)	Correlated shadow fading values generated using a common random variable approach
Penetration loss	6 dB	in-car reception
Cell site height	15 m above roof top	
Receive antenna height	1.5 m	
Channel model	3GPP Spatial Channel Model C (SCM-C); 15° angle spread	SMC-C: "urban macro"
Propagation loss	3GPP TR 36.942 urban	no terrain or clutter
Noise figure	9 dB	
UE locations	Dropped randomly within the simulated area	
Area coverage	95%	% of uniformly distributed users have BLER < BLER target
BLER target	1e-3	
Cyclic prefix	16.7 μ s	
Number of site rings	2	19 sites, 3 sectors each, wrap around

The results show that an inter site distance (ISD) of 10 km will hardly be worth considering because it would require too much spectrum. An ISD of 2 km would yield a high advantage with respect to the blocked spectrum but may be too expensive. An ISD of 5 km appears most realistic.

The advantage of the comparatively small reuse distance of an LTLP network with respect to the larger reuse distance of a HTHP network depends on the ratio between the reuse distances on the one hand and the size of the country and the various regions to be covered by different TV programmes on the other hand. For a larger country (e.g. Russia) with larger regional structures than Germany, the difference is less important, less spectrum could be saved by the use of a LTLP network than in the case of Germany. More spectrum could be saved for a smaller country with smaller regional structures (e.g. Luxemburg).

To avoid any misunderstanding, it shall be emphasized that this approach is not a tool for spectrum planning. It is meant to facilitate the comparison of the spectrum requirements of alternative distribution systems like HTHP in comparison with LTLP networks.

4.2.3 Distribution of Linear TV Programmes over LTE Combining Broadcast and Unicast

Broadcasting a TV programme over a geographic area is more spectrally efficient than unicasting if the number of users simultaneously interested in a given programme exceeds a threshold which depends on network topology, user distribution, service requirement of the requested TV programme, etc. For the unicast mode the efficiency depends strongly on the average level of inter-cell interference, which in turn depends on the traffic load. For defining the unicast/broadcast (UC/BC) threshold, a conservative assumption is that in the unicast mode the network is highly loaded (otherwise the optimal choice between eMBMS and unicast would be less relevant). For these assumptions and eMBMS using MBSFN the threshold is between 1 and 4 users per cell.

The threshold is towards the lower end of the range for small Inter-Site-Distance (ISD) where unicast gets strongly interference limited in contrast to the noise limited MBSFN mode.

In the following we analyse at the example of the German TV market for how many programmes

the UC/BC threshold is exceeded. We use the following assumptions:

- 25% of total TV viewing is via terrestrial access (current localized peak DVB-T share).
- 45% of population watch TV at peak time (21:15 h)
- day-average market share per programme [19]

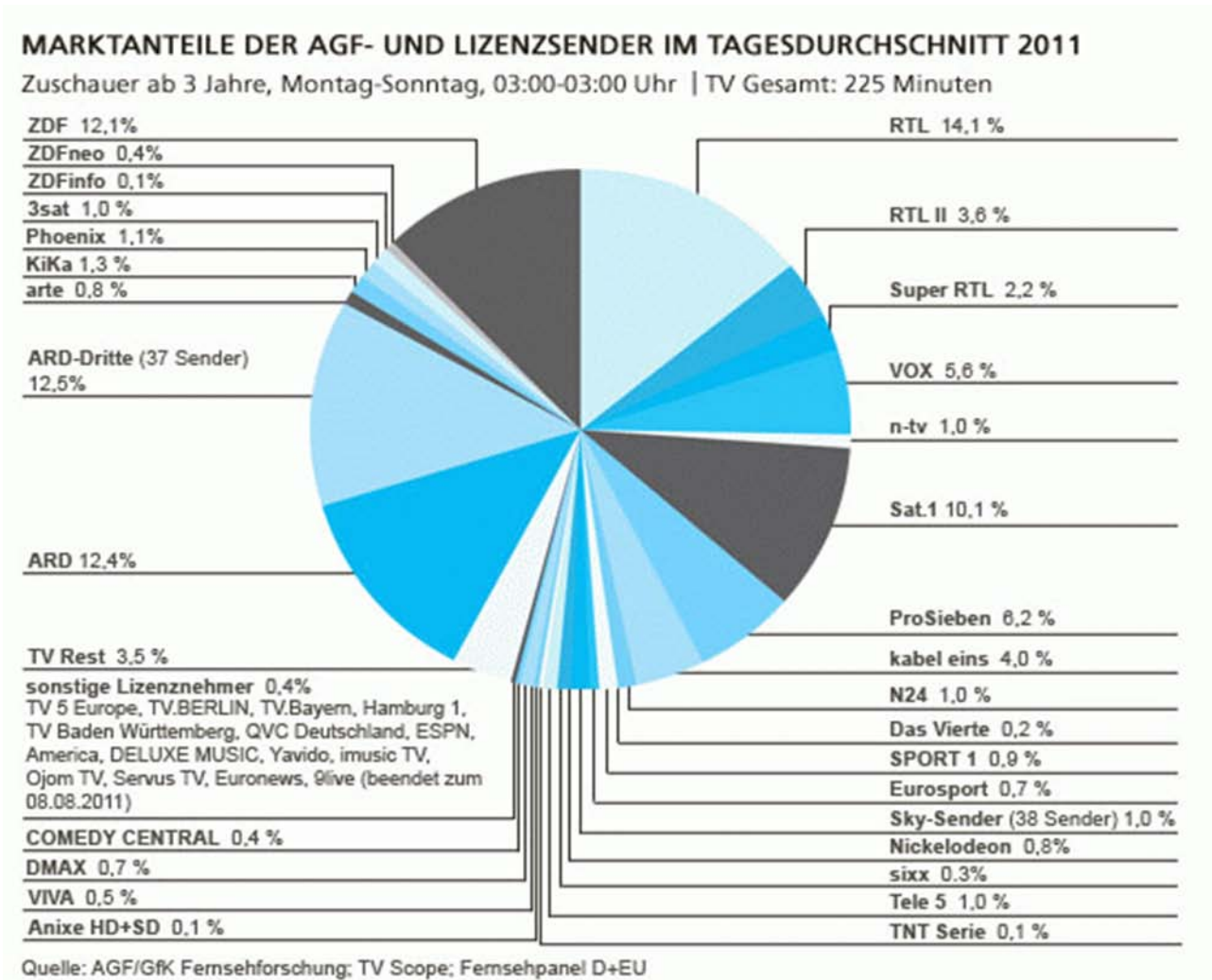

Figure 5: Viewing shares of German TV programmes, daily averages.

Note the pie-chart piece for 'ARD-Dritte' (see Figure 5) represents an aggregated number for a collection of regional programmes. The share of one of these programmes in its nominal region is 7.2%. Source: <http://www.mdr.de/tv/quoten/index.html> (retrieved 2013-04-24).

From Figure 5, 50% of the viewing is concentrated on 5 programmes. The numbers are day averages, for any particular point in time during the course of a day the viewing is likely even more focused on fewer programmes.

The choice between broadcast and unicast in LTE can be made separately for each TV programme. It can actually be done dynamically, therefore it is actually possible to change the set of programmes delivered via broadcast during the course of a day. Due to the lack of dynamic viewing share data, we assume each programme is statically associated with either broadcast or unicast delivery.

In order to determine for which programmes there are enough viewers per cell to make broadcasting efficient we need to know the number of inhabitants per cell. From the area of downtown Stockholm we know each cell covers 80 inhabitants on average.

For the broadcast delivery we assume each programme is broadcast by just one cell covering the cell area, regardless of the number of MNOs providing coverage in the area. For the unicast delivery we assume there are 4 MNOs and in each network each cell is responsible for the above stated 80 inhabitants on average.

For the broadcast mode we assume a spectral efficiency of 1.5 bit/s/Hz (see also **Annex 3**) that is achievable with existing cellular sites in an urban area for indoor users. For the unicast spectral efficiency we assume 2.4 bit/s/Hz⁷ for LTE advanced (i.e. 3GPP Release 10) for macro-cell network with outdoor users (4 x 2 MIMO, ISD=500 m). For indoor users no macro-cell result is provided, however, for micro-cell deployment a value of about 3.1 bit/s/Hz is reported for 50% indoor users. Based on the ratio 2.4 bit/s/Hz / 1.5 bit/s/Hz we consider unicast in a given geographical area is more efficient than broadcast for a TV programme that attracts on average less than 1.5 users per geographical cell area. If the average number of users is below this threshold, e.g. on average 1 user per geographical cell, the programme is provided on-demand using unicast only in cells where users are actually present. Since we assume 4 MNOs, each MNO for this example will serve on average 0.25 users per cell, i.e. a user is present only in every 4th cell.

Next, we need to convert the threshold of 1.5 users per geographical cell area to viewing shares. With 4 MNOs there are 320 inhabitants per geographical cell area. With 25% of total TV viewing using terrestrial access and 45% of population watching TV at peak time, there are 36 viewers per geographical cell area. The threshold of 1.5 viewers therefore corresponds to a viewing share of 4.17%. From **Figure 5**, there are 7 programmes above that threshold, so these programmes should be broadcast. The remaining ones are more efficiently made available on-demand via unicast.

The calculation does not take into account the spectrum situation along the border of a broadcast (MBSFN) area. Among the top-7 programmes there are 6 nation-wide programmes (except for short local news windows and possibly regionalized advertising) and only one regional programme (ARD Dritte), i.e. there is one per region out of the main regional programmes (see **Figure 5**).

In a less dense deployment, assuming four times the number of users per geographical cell area, the viewing share threshold would decrease to 1.04% and there are 12 programmes above that threshold.

In conclusion, in a dense cellular network and under the assumptions used in this example, it may not be efficient to continuously broadcast linear TV programmes with low viewing shares. These programmes may be better provided on-demand using unicast only in cell where users request them. However such a distribution would require a SIM-card. The threshold in the considered scenario is a viewing share of about 1 - 4%. There are only 7 - 12 programmes with a yearly average viewing share above this threshold. The short term viewing shares may be more concentrated on fewer programmes and an attempt should be made to acquire corresponding statistics and apply the outlined analysis to those.

4.2.4 The 'Border Challenge' Between Different Editorial Regions

The spectral efficiency of MBSFN transmission and the resulting coverage of the transmitted broadcast services rely on the constructive combination of the signals received from surrounding cells and on the absence of significant interference received from those cells on the same time-frequency resources. In the centre of a large SFN area these conditions are ensured by the synchronous transmission of the same content from all surrounding cells (e.g. in all directions) and propagation delay differences that fall within the cyclic prefix length of the OFDM access scheme to avoid inter-symbol interference at least for the most significant received signal components. The modulation and coding scheme (MCS) selection for a broadcast service in the SFN area has to make a trade-off between the spectral efficiency (i.e. the amount of resources occupied for this service)

⁷ This value is reported by ITU-R M.2198. Further details can be found in 3GPP TR36.912

and the size of the coverage are (i.e. the fraction of the network coverage area in which the service can be received with sufficient quality) – in other words, the target coverage limits the spectral efficiency that can be achieved in a SFN area.

However, for the distribution of linear TV services, at least for Public Service Broadcast, different regions must be served with different content, e.g. national TV programmes need to be limited to the corresponding country area or regional programmes that are transmitted only in certain regions (e.g. states of a country) and differ from the programme in other regions. Not all of these services need to be available in every place, only in the respective service area. It suffices that national services are provided only within a particular country and regional services only in the corresponding sub-region. Applying eMBMS for the TV distribution means that SFN areas would be configured to cover the corresponding service area for a set of (national or regional) TV services. This leads to the introduction of borders between neighbouring SFN areas in which different content is transmitted.

This presents additional requirements for the design and efficient operation of the eMBMS network to optimize the broadcast performance and minimize the impacted border areas. In general, three different approaches are possible:

- a) Each editorial region is served by a separate SFN. All SFNs transmit on the same frequency (so-called reuse 1). When different content is transmitted using the same time-frequency resources interference occurs from one SFN area into the other with two possible consequences:
 - degradation of coverage (in case the MCS is maintained)
 - reduced spectral efficiency (when a MCS is adjusted to a more robust one in order to compensate for the lower SINR caused by the interference).
- b) Each editorial region is served by a separate SFN. In the border areas different SFN transmitted on different (orthogonal) time-frequency resources. In order to maintain consistent service capacity across the whole SFN area additional frequency resources are required at least in areas along the borders, which in turn degrades the spectral efficiency (reuse >1).
- c) Separate SFN areas in guard strips along the borders between editorial regions. In all editorial regions the same frequency is used in the inner SFN areas (reuse 1) while the guard stripes are served on orthogonal resources (reuse >1). The width of the guard strips needs to be sufficiently wide to protect the main SFN areas on either side from mutual interference. This solution can be regarded as an intermediate between the two base options a) and b).

These options, their respective merits and impact are discussed in more details in Annex 5.

4.2.5 Spectrum Planning, Overall Efficiency

When discussing the spectral efficiency of a wide area deployment one needs to take into account the requirement to align the spectrum use in that area with other areas nearby, which may have different needs. For example, the spectrum use in one country, or region, would need to be aligned with its use in a neighbouring country, or region. Generally, this leads to spectrum use being planned in a coordinated way. For DVB-T this led to the Geneva 06 frequency plan.

LPLT networks also need such coordinated planning, but they can introduce greater flexibility with respect to international, regional or editorial borders. ECC Recommendation ECC/REC/(11)04 [20] is an example of how cross-border coordination can be undertaken for LTE whereby the planning is mainly based on field strength levels. Under this recommendation planning and coordination can usually be done bilaterally, without the need for wider international agreements, which would lead

towards flexibility and the ability to react to the need of a particular area. Although the recommendation is appropriate for unicast, the main mechanisms within it would also be applicable to LPLT broadcast and should therefore be taken into account more generally when considering spectral requirements.

It should be noted that under this recommendation time-frequency resources are shared at border areas. At some locations only one in three or four of these may be available to any one country. When time sharing is not possible, as would be the case in an SFN, frequencies would have to be shared between the neighbouring countries.

4.3 Further Technical Considerations

4.3.1 Backhaul

The LTE base station backhaul capacity for the broadcast service is slightly larger than the media net bitrate, because of the sync protocol and the application layer FEC. The sync protocol adds an overhead of 11 byte per IP packet. Given that most IP packets have a size equal to the Maximum Transfer Unit (MTU) which is typically 1500 byte, the overhead of the sync protocol is only 0.7%. The AL-FEC overhead in typical deployment cases is below 25% and usually significantly smaller.

The backhaul has to be dimensioned for the peak data rate that can be provided on a given base station, taking into account that eMBMS capacity requirements in terms of time and availability may be different from those for the unicast services.

If the backhaul is dimensioned for the peak rate of 100 Mbit/s per a 20 MHz carrier that is often advertised for LTE (current smartphone peak rates, LTE Cat 3) then this implies spectrum efficiency of 5 bit/s/Hz which is higher than what can be achieved with eMBMS. Therefore, a backhaul dimensioned for this unicast peak rate would have sufficient capacity also for a mix of eMBMS and unicast. The backhaul capacity needs to take into account all carriers on a given site, including both unicast and broadcast.

4.3.2 Antenna System

In order to provide capacity for TV services additional spectrum bandwidth has to be used.

Antennas currently used for cellular base stations typically have a bandwidth of up to 20 - 25% relative to their nominal centre frequency and a limited maximum power they can deliver. These antennas have been developed for the current LTE bands. If additional bands will be specified for LTE, then more wideband antennas may be developed, with a tendency for a lower overall gain, or additional antennas may be deployed. If a part of a band will be used exclusively for eMBMS then this can be taken into account in the antenna design optimization (e.g. with respect to down-tilt). As usual, the new antennas may differ in some parameters to the currently deployed antennas, including the antenna gain and gain ripple over frequency. When additional antennas need to be installed then also the installation statics (wind load) has to be reviewed and possibly adjusted. Further information can be found in **Annex 6**.

4.3.3 RF Exposure Limits

National and international regulation defines the safety limits for human exposure to the electromagnetic radiation. This may constrain the deployment of cellular networks, in particular in and close to the populated areas. This is especially true if a relatively broad overall bandwidth is needed for LTE eMBMS in order to carry a certain data rate.

Additional information about RF exposure limits is provided in **Annex 7**.

5. Cost Considerations

Costs are a crucial factor of the suitability of a system for the distribution of TV programmes. Broadcasters are severely concerned that the costs of distribution using LTE may be higher than the current costs of TV distribution using DVB-T/T2. One of the indications for this is the mere number of transmitters, which is significantly higher in a LTP network than in a classical HTP broadcasting network. However, distribution costs alone may not be sufficient to fully assess the issue. An LTE network offers unicast communications which may support access to nonlinear broadcast content thereby influencing the business model. The content of this section is intended to be a first step towards a detailed cost model and concrete calculation of the costs of a possible TV distribution via an LTE radio network. Further studies are required to achieve this objective. At the moment it is only possible to identify some trends for relevant elements to be taken into consideration because the necessary technical, operational and regulatory conditions for large scale TV distribution over LTE networks are not established.

It is assumed that at any given point in time the overall costs will be determined by:

- Technological developments.
- OPEX and CAPEX of network roll-out and operation.
- Market and regulatory conditions.

The technical capabilities of mobile network equipment are developing quickly and there is a general downward trend of equipment prices. In any case, cost estimates would need to be carried out for the time of a conceivable introduction of eMBMS for distribution of broadcast services.

Besides technical and market information, country-specific characteristics (e.g. topography, distribution of the population) and the applicable regulatory framework have to be taken into account for a realistic cost model for a certain country⁸.

The annual expenditure on an LTE network for TV distribution would be composed of the long-term investments in the infrastructure (CAPEX) divided by the TCO (Total Cost of Ownership) time period (normally assumed duration: 7 years) and the ongoing operating costs (OPEX).

For both components (CAPEX, OPEX), the costs of the LTE base stations and of the backhaul of the LTE network have to be taken into account. Both, LTE base stations and the backhaul, are very likely to be used simultaneously for other services, mainly for communication in unicast mode.

Important contributions to the CAPEX are:

- Equipment (HW/SW, antennas, eMBMS SW, core, NMS).
- Planning, installation, commissioning and implementation.
- Acquisition of new sites and site preparation (civil works).
- Equipment and site preparation for backhaul.

Important contributions to the OPEX are:

- Site rental.
- Operation and maintenance (incl. transport network capacity).
- Electricity.
- Operation and maintenance for backhaul.
- Annual fees (licenses/spectrum usage).

⁸ Figure 1 in [21] provides a good overview of the categories of factors to be considered.

Costs depend among other things on the topography of the network (High Tower High Power or Low Tower Low Power). For this entire report, only LTLP topography was taken into consideration (the analysis might be extended in this respect in the future). It is to be expected that existing LTLP infrastructure will be used as much as possible. But depending on targeted coverage, site restrictions and regulatory issues, additional new base stations, core and backhaul capacities may be required for a national LTE network.

Existing and newly created parts of the network will be used simultaneously for TV distribution, other possibilities of the use of an LTE network (e. g. the distribution of software updates) and conventional unicast communication. Consequently, the costs to be charged for the TV service will depend as well on the sharing option chosen by the operators involved (see section 4.1 of the report). For each existing or new element of the network, an adequate proportion of the costs of the function of TV distribution has to be determined. It is a difficult technical and economic problem to determine these proportions. In any case, it is not realistic to assume that the network operator would only take into account the incremental costs caused by the LTE system but adequate proportions of all other network costs (e.g. of site rental) should be included as well. A generally valid answer to this question is not possible because the proportions of the costs of TV distribution depend on the business model of the operator, or all operators involved. Different network operators may face different cost positions. Various realistic scenarios should be taken into consideration. A cooperation of technical and business experts is required to perform this task.

6. Open issues to be further addressed

The following issues for further evaluation have been identified:

- Better understanding the benefit of a combination of unicast and eMBMS for efficient delivery of broadcast services suitable use cases.
- Pilot projects would be helpful for practical evaluation of eMBMS. A number of trials are under preparation and some results are expected to be published within the next 1 - 2 years. A review of published results could be included in a future EBU report.
- Further study the spectrum efficiency in an SFN network.
- Define a common LTE eMBMS coverage assessment methodology in order to allow broadcasters and LTE network operators to properly design networks, based on relevant ITU-R Recommendations and Reports, as appropriate. This would include required input parameters, the appropriate propagation models and the reception scenarios.
- Elaborate on the business and operational models, taking into account cost estimates.
- Identify relevant regulatory issues to foster market development.

It is recalled that the previous chapters of this report have introduced the current features of LTE and network scenarios for delivery of broadcast content, as of 3GPP Release 12. Some enhancements have been mentioned, which are currently being proposed:

- Longer cyclic prefix to support larger inter-site distances (ISDs).
- Dedicated carrier, allocated to broadcast only, no reservation for unicast.
- Standalone carrier, which can be defined as a dedicated carrier that provides all necessary signalling, so no cross-carrier signalling is required.
- Possible enhancements to synchronisation issues with regard to multi-operator scenarios.

For specific use cases, further optimizations may be possible, different for fixed and for mobile reception.

To continue the work on LTE features for broadcast content delivery in 3GPP, support from a sufficient number of 3GPP members needs to be achieved. In particular, 3GPP members would have

to prioritize a related work item high enough amongst the many other proposed work items. Accordingly, 3GPP members would have to attribute a high value to these LTE features. Enhancements to 3GPP specifications would be facilitated through a coordinated action including manufacturers, network operators and broadcasters.

7. Conclusions

Set out at the beginning of the report are a number of use cases of primary importance to broadcasters. These are indicative of the way in which broadcasters' content is consumed by audiences, and as such define the requirements that different technologies would have to meet. This report has focused solely on whether LTE/eMBMS could suitably enable these use cases.

Of primary importance is the possibility of free-to-air delivery of broadcast services and to reach all LTE users irrespective of whether or not they have a mobile subscription. The following are the main technical findings of the study related to LTE:

- Given that there are normally multiple operators present in any given country, LTE eMBMS makes it possible to deliver the required TV services only once per area, thereby potentially reaching all users without the need for multiple LTE network operators (LNO) to deliver the same services at the same time. This is possible from the technical point of view because the available spectrum and/or infrastructure can be shared between LNOs as the LTE standard provides all necessary means for implementation.
- Broadcast services can be delivered either free-to-air or via conditional access. Free-to-air or equivalent as defined in the requirements is possible. Unencrypted content delivered via LTE eMBMS can be received without a SIM card whereas in case it is delivered via LTE unicast a SIM card is required. The SIM card may be specifically configured by the provider to enable access only to the TV service and can also be provided for free. The associated regulatory, operational and business aspects need to be addressed - see section 6.
- Service discovery can be enabled without the need for an uplink capability of the terminal. Information about how to access the broadcast content is contained in the so-called User Service Description (USD) which is provided separately either by using a preconfigured device or a USB stick. In case there is an uplink available, e.g. a WLAN connection, the USD can be requested directly.
- According to the technical specifications an LTE network can carry both linear and non-linear TV services concurrently by employing both broadcast and unicast modes, respectively.

The performance of an LTE eMBMS system was analysed based on various studies. A number of issues have a significant impact on the performance, mainly in terms of spectral efficiency:

- The terminal and its location, signal attenuation when being e.g. indoor and its antenna gain e.g. for set top box scenarios or when a directed antenna is mounted on the roof.
- The required coverage.
- Terrain, land usage, buildings.
- The network topology, including density and height of antenna sites.

Studies based on a methodology normally used for mobile service coverage assessment⁹ indicate, that the topology of the existing cellular networks in urban areas is suitable to achieve eMBMS portable indoor coverage. In this case a spectral efficiency in the range between 1 and 2 bit/s/Hz seems achievable for an individual carrier and hence a value of 1.5 bit/s/Hz has been chosen to

⁹ This methodology differs substantially from what is used for broadcast coverage assessment, i.e. based on location probability.

assess spectrum requirements. This value could be achieved by an inter-site distance up to 5 km.

In the course of the studies it became also clear, that the spectral efficiency, one of the most prominent parameters for the performance of a large scale deployment, can have a wide range of values, between as low as some 0.1 bit/s/Hz up to more than 3 bit/s/Hz and that the value that can be achieved in a real network deployment will be dependent on the parameters mentioned above. So far no final answer can be given on the spectral efficiency of the individual radio link.

The overall spectrum demand was considered based on a model of Blocked Spectrum. The model estimates the amount of spectrum blocked by any given transmission system, taking into account the size of coverage area, border shape, the corresponding re-use distances, and the assumed spectrum efficiency on the radio link. Blocked spectrum is not available to other possible use.

Based on the Blocked Spectrum model an example comparison shows that a Low-Power-Low-Tower (LPLT) network topology may require less spectrum than a High-Power-High-Tower (HPHT) topology. Smaller inter-site distances may enable higher spectrum efficiency and smaller geographical separation distances between areas of co-channel delivery of different broadcast content. If the same spectrum is used on both sides of the border the impact of the coverage loss may then be easier to mitigate. Currently, a typical network topology of LTE is LPLT while DVB-T2 networks are usually deployed as HPHT.

The report also identifies the need for a methodology of assessing the LTE eMBMS network coverage, to ensure that broadcasters' requirements are met. Such methodology would need to take into consideration network parameters, appropriate propagation models and reception scenarios.

Additionally providing TV services from the existing LTE sites may require additional bandwidth and site engineering measures. This may require additional development efforts, developing the respective antennas and power amplifiers with the required characteristics, while observing the national RF exposure limits.

Furthermore, the capability of LTE to combine unicast and eMBMS transmission has been indicated as a potential new way of delivering broadcast services, for example delivering niche programmes via unicast while using broadcast mode for the delivery of mass programmes. This possibility requires to be further studied.

It was noted that multi-operator scenarios are in principle enabled in the LTE standards. However, detail concerning cooperation between different operators (handover issues, unicast distribution of niche programmes, etc.) can actually be implemented is lacking. Thus, there is a need for additional clarification of associated technical, regulatory and operational issues.

Costs are a crucial factor that defines the suitability of a system for the distribution of TV programmes, in particular if LTE were to be considered as a replacement of the current DTT networks. Whilst this study has identified the main elements of a cost model, detailed cost calculations have not been performed. Broadcasters remain concerned that the delivery costs over LTE networks may be significantly higher than the current costs of TV distribution. It has been suggested by the mobile industry that the delivery costs of providing broadcast services over LTE may be reduced by an efficient combination of unicast and eMBMS capabilities and as a result of economies of scale that could be achieved. However, this has not been investigated in detail. At this point in time the available evidence is insufficient for any conclusion on the issue of costs.

From a technical point of view, the examined use cases and free-to-air delivery could in principle be enabled by LTE eMBMS, noting that further development is required. In particular, the implication of a combination of unicast and eMBMS with respect to free-to-air delivery has not been studied. However, it has been identified that regulatory constraints, business and operational models including free-to-air, costs and availability of user equipment need to be better understood to finally judge on the viability of delivering broadcast content via LTE.

Thus, implementation of an LTE network for a large scale TV distribution is not envisaged in the short term.

8. References

Note: These references also apply to the Annexes.

- [1] E. Dahlman, S. Parkvall, J. Sköld, and P. Beming, "3G Evolution: HSPA and LTE for Mobile Broadband", Academic Press, 2008.
- [2] 3GPP TS 26.346, "Multimedia Broadcast/Multicast Service (MBMS); Protocols and Codecs".
- [3] ISO/IEC DIS 23009-1.2, "Dynamic Adaptive Streaming over HTTP (DASH)", Nov. 2011.
- [4] A. Shokrollahi, "Raptor Codes", IEEE Trans. on Information Theory, vol. 52, no. 6, pp. 2551-2567, June 2006.
- [5] M. Luby, T. Gasiba, T. Stockhammer, and M. Watson, "Reliable Multimedia Download Delivery in Cellular Broadcast Networks", IEEE Trans. on Broadcasting, vol. 53, no. 1, pp. 235-246, March 2007.
- [6] T. Lohmar and M. Elisova, "Evaluation of the File Repair Operations for Multicast/Broadcast Download Deliveries", Proc. European Wireless, Nicosia, Cyprus, 2005.
- [7] T. Lohmar and J. Huschke, "Radio Resource Optimization for MBMS File Transmissions", Proc. IEEE International Symposium on Broadband Multimedia Systems and Broadcasting (BMSB), Bilbao, Spain, 2009.
- [8] H. Schulzrinne, et al., "RTP: A Transport Protocol for Real-Time Applications", IETF RFC 3550, July 2003.
- [9] 3GPP TR 25.814 v.7.1.0, "Physical Layer Aspects for Evolved UTRA", Oct. 2010.
- [10] E. Dahlman, S. Parkvall, and J. Skold, "4G: LTE/LTE-Advanced for Mobile Broadband", Academic Press, 2011.
- [11] 3GPP TS 25.446 v.10.2.0, "MBMS Synchronisation protocol (SYNC)", Dec. 2011.
- [12] A. Urie, A. Rudrapatna, C. Raman, J-M. Hanriot, "Evolved Multimedia Broadcast Multicast Service in LTE: An Assessment of System Performance Under Realistic Radio Network Engineering Conditions", Bell Labs Technical Journal, Volume 18, Issue 2, pages 57 - 76, September 2013.
- [13] Lohmar, Slsingar, Kenehan, Puustinen: "Delivering content with LTE Broadcast", in Ericsson Review 2013 - 1, 11 February 2013, http://www.ericsson.com/res/thecompany/docs/publications/ericsson_review/2013/er-lte-broadcast.pdf
- [14] Dudda, T., et al., "eMBMS: Broadcast-Dienste über LTE", in FKT 1-2/2013, p. 10ff
- [15] Lei Shi1 et al., "CellTV - on the Benefit of TV Distribution over Cellular Networks: A Case Study", IEEE Trans. BC 60(2014)73; 2014
- [16] 3GPP, "Investigations on Pilot Channel Structure for MBMS in E-UTRA Downlink", DoCoMo, Mitsubishi Electric, NEC, Sharp, Toshiba Corporation, Tdoc R1-060779
- [17] Alastair Brydon, "3GPP Network sharing enhancements for LTE", <http://www.unwiredinsight.com/2013/3gpp-lte-ran-sharing-enhancements>
- [18] 3GPP TS 23.251, "Technical specification group services and system aspects; network sharing; architecture and functional description", (Release 11), 3GPP, v11.5.0.

- [19] AGF/GFK Fernsehforschung, "TV Scope ; Fernsehpanel D+EU".
- [20] ECC/REC/(11)04, "Frequency planning and frequency coordination for terrestrial systems for mobile/fixed communication networks (MFCN)", www.eroocdb.dk/doks/filedownload.aspx?fileid=3767&fileurl=http://www.eroocdb.dk/Docs/doc98/official/pdf/REC1104.pdf.
- [21] PricewaterhouseCoopers AG, "Mobile network cost study - Analysis of cost drivers related to the construction, operation and maintenance of mobile networks", 04 September 2013, http://www.asut.ch/fr/publications/etudes/doc_download/272-mobile-cost-study.
- [22] Qualcomm Research, "LTE eMBMS Technology Overview", San Diego, Nov. 2012, http://s3.amazonaws.com/sdieee/222-eMBMS_tech_overview_IEEE_112712.pdf.
- [23] EBU Tech 3348, "Frequency and Network Planning Aspects of DVB-T2, Version 3.0", Nov. 2013, <https://tech.ebu.ch/docs/tech/tech3348.pdf>.
- [24] 3GPP TS 36.300 v11.1.0, "Evolved Universal Terrestrial Radio Access (E-UTRA) and Evolved Universal Terrestrial Radio Access Network (E-UTRAN); Overall description; Stage 2", March 2012.
- [25] David Gómez-Barquero (ed.), "Next Generation Mobile Broadcasting, Boca Raton, Florida", Taylor & Francis Group, LLC, 2013.
- [26] 3rd Generation Partnership Project, "Evolved Universal Terrestrial Radio Access (E-UTRA), Further Advancements for E-UTRA Physical Layer Aspects (Release 9)", 3GPP TR 36.814, v9.0.0, Mar. 2010, Annex A, <http://www.3gpp.org/ftp/Specs/html-info/36814.htm>.
- [27] 3rd Generation Partnership Project, "Selection Procedures for the Choice of Radio Transmission Technologies of the UMTS (UMTS 30.03 version 3.2.0)", 3GPP TR 30.03U, Apr. 1998, <http://www.3gpp.org/ftp/Specs/html-info/3003U.htm>.
- [28] L. A. Berry, "Spectrum metrics and spectrum efficiency: Proposed definition. IEEE Transactions on Electromagnetic Compatibility", Vol. 19 (1977), pp. 254-259;
- [29] A. Jahn, "Ressourcenverwaltung in Kommunikationsnetzen mit niedrigfliegenden Satelliten, Herbert Utz Verlag", 2000, p. 30

Annex 1: List of Acronyms

Term	Description
3G	The third generation mobile communications system (i.e. UMTS)
3GPP	The Third Generation Partnership Project
AL-FEC	Application Layer Forward Error Correction
AWGN	Additive white Gaussian noise
BC	Broadcast
BLER	Block Error Rate
BM-SC	Broadcast Multicast Service Centre
CA	Carrier Aggregation
CAPEX	Capital Expenditures
CEPT	European Conference of Postal and Communications Administrations
CN	Core Network
CoMP	Coordinated Multipoint Transmission
CP	Cyclic Prefix
CRC	Cyclic Redundancy Check
CSA	Common Subframe Allocation
CTN	Cooperative Terrestrial Networks
DASH	Dynamic Adaptive Streaming over HTTP
DL-SCH	Downlink-Shared Channel
DRM	Digital Rights Management
DVB	Digital Video Broadcasting
DVB-T	Digital Video Broadcasting - Terrestrial
DVB-T2	Digital Video Broadcasting - Terrestrial, 2nd generation
EBU	European Broadcasting Union
ECC	Electronic Communications Committee of the CEPT
eMBMS	Evolved Multimedia Broadcast Multicast Services
eNB	Evolved Node B
EPLMN	Equivalent Public Land Mobile Network
E-UTRA	Evolved Universal Terrestrial Radio Access
FDD	Frequency Division Duplex
FEC	Forward Error Correction
FLUTE	File Delivery over Unidirectional Transport
GBR	Guaranteed Bitrate
GW	Gateway
HARQ	Hybrid Automatic Repeat Request
HDTV	High Definition Television

HEVC	High Efficiency Video Coding / H.265
HPHT	High Power High Tower network configuration
HPLMN	Home Public Land Mobile Network
HTTP	Hypertext Transfer Protocol
HW/SW	Hardware / Software
IETF	Internet Engineering Task Force
IP	Internet Protocol
ISD	Inter-Site Distance
ITU	International Telecommunication Union
LNO	LTE Network Operator
LPLT	Low Power Low Tower network configuration
LTE	Long Term Evolution
MAC	Medium Access Control
MBB	Mobile Broadband
MBMS	Multimedia Broadcast Multicast Services
Mbps	Megabit per second
MBSFN	Multicast-Broadcast Single Frequency Network
MBMS GW	MBMS Gateway
MCE	Multicell Coordination Entity
MCH	Multicast channels
MCS	Modulation and Coding Scheme
MHz	Megahertz
MIMO	Multiple Input Multiple Output
MME	Mobility Management Entity
MNO	Mobile Network Operator
MPEG	Moving Picture Experts Group
MPEG-4 / AVC	Advanced Video Coding, MPEG compression standard / H264
MTK	MBMS Traffic Key
MTU	Maximum Transfer Unit
MU-MIMO	Multi User MIMO
NBS	National Broadcast Service
NCT	New Carrier Type
OFDM	Orthogonal Frequency Division Multiplexing
OPEX	Operational Expenditures
PCell	Primary Cell
PDCCP	Packet Data Convergence Protocol
PLMN	Public Land Mobile Network
PSM	Public Service Media

PSS	Packet-Switched Streaming
PTP	Point-to-Point
PTM	Point-to-Multipoint
QAM	Quadrature Amplitude Modulation
QCI	QoS Class Identifier
QoE	Quality of Experience
QoS	Quality of Service
QPSK	Quadrature Phase Shift Keying
RBF	Reuse Blocking Factor
RAN	Radio Access Network
RBS	Regional or local broadcast service
RF	Radio Frequency
RLC	Radio Link Control
RTP	Real Time Protocol
SAI	Service Area Identity
SCell	Secondary Cell
SCM-C	Spatial Channel Model C
SDL	Supplemental Downlink
SDTV	Standard Definition Television
SE	Spectral Efficiency
SFN	Single Frequency Network
SFN	System Frame Number
SIB	System Information Block
SIM	Subscriber Identity Module
SINR	Signal to Interference plus Noise Ratio
TCO	Total Cost of Ownership
TDD	Time Division Duplex
TTI	Transmit Time Interval
TV	Television
UC	Unicast
UDP	User Datagram Protocol
UE	User Equipment
UHDTV	Ultra High Definition Television
USD	User Service Description
USIM	Universal Subscriber Identity Module
VPLMN	Visited Public Land Mobile Network
WLAN	Wireless Local Area Network

Annex 2: Detailed Description of LTE Features

Some material is used by permission from Jörg Huschke and Mai-Anh Phan, "An Overview of the Cellular Broadcasting Technology eMBMS in LTE," in David Gómez-Barquero (ed.), *Next Generation Mobile Broadcasting*, Boca Raton, Florida: Taylor & Francis Group, LLC, 2013. [25]

A Multimedia Broadcast/Multicast Service (MBMS) has been standardized by 3GPP. For LTE MBMS has been standardized in 3GPP Release 9 and is often called eMBMS. The LTE standard consists of a number of specification documents each of which covering a functional category or protocol layer. While [2] defines a set of media codecs, formats and transport/application protocols to enable the deployment of MBMS user services, there is no single dedicated specification document for eMBMS, the related additions are included in the appropriate documents of the LTE specifications. Section 15 of [9] provides an overall technical description of the radio-level functionality.

A2.1 Service Framework

The MBMS user service addresses service layer protocols and procedures above the IP layer. The MBMS user service includes a streaming and a download delivery method. Both the "Download" and the "Streaming" method deliver media data encoded in various formats, e.g. video in H.264 and audio in AMR or AAC format.

The MBMS download delivery method has originally been intended to increase the efficiency of file distributions, e.g. for media files that are cached in the user equipment (UE) after reception so that user have offline access to the content at any time (within the constraints defined by DRM). The download delivery method can also be used for DASH based streaming, as explained in subsequent sections. The streaming delivery method has been intended for RTP based continuous reception and play-out used e.g. in mobile TV applications.

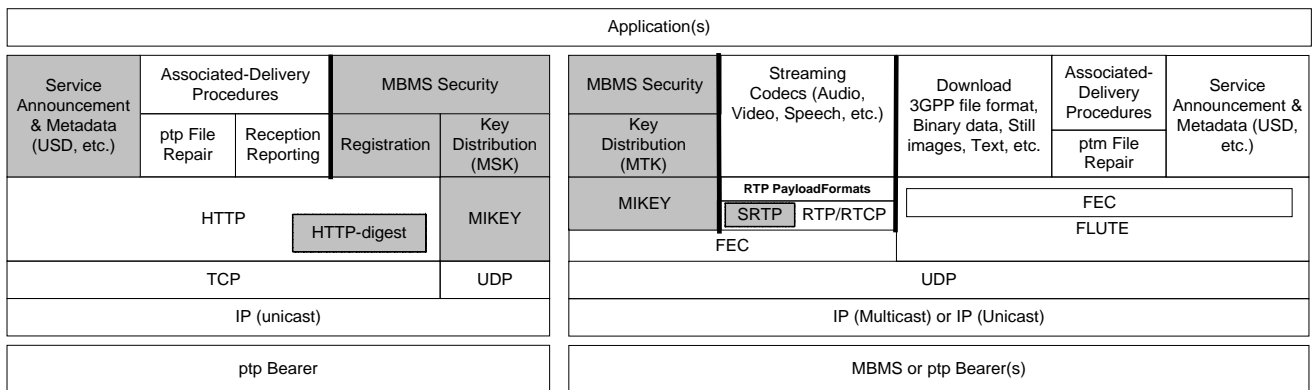

Figure A2-1: Protocol stacks used for MBMS delivery methods [2].

Figure A2-1 shows the protocol stacks which are used for MBMS as specified in [2] (gray boxes are defined therein by reference). The left side depicts the part of the protocol stack which requires an IP unicast bearer. The right side shows the part of the protocol stack which was designed for multicast/broadcast bearers built over UDP (LTE MBMS is not carried over multicast bearers though). Since UDP packets can also be sent over unicast bearers, the right side of the protocol stack can also be implemented on top of a unicast bearer.

It can be seen that service announcements and other metadata can be delivered both over unicast and broadcast/multicast connections. This means that a client can for instance download service announcement related information from a web page, or it receives the information via a broadcast/multicast bearer. Unicast and broadcast/multicast delivery of service announcement information can also be combined.

For the associated delivery procedures, certain procedures such as point-to-point file repair and reception reporting require a unicast connection whereas other procedures such as point-to-multipoint file repair (e.g. broadcasting of missing packets) can be executed over a broadcast bearer.

The download delivery method can be used for file distribution services, which store the received data locally in the UE. Some recent video services on the internet appear to the end user as streaming services, but actually, they use file based transmission where the entire media file is divided into fragment files that are transmitted sequentially, using e.g. the DASH protocol [3]. In contrast, the original MBMS streaming delivery method is based on the Real Time Protocol (RTP [8]). Meanwhile the main trends, unlike currently deployed DVB-T, are to implement video delivery using DASH rather than RTP. Therefore we will not discuss the RTP based MBMS streaming delivery method here. With DASH, a video stream is segmented into segment files, each one containing the data for a short playout interval, typically 1 s.

During the MBMS data transfer phase, certain terminals may experience packet losses due to fading conditions or handovers. Naturally, full reliability cannot be offered in a pure unidirectional distribution scheme because the packet loss rate can be excessive for some users. Therefore, three packet error recovery schemes are foreseen for the download delivery method. The most important one is the use of Application Layer Forward Error Correction (AL-FEC) code, which allows recovery of lost packets without any server interaction already during the MBMS data transfer phase. The other two recovery schemes use file repair procedures, where the first scheme is a point-to-point (PTP) repair mechanism using interactive bearers and the other one is a point-to-multipoint (PTM) repair mechanism using MBMS bearers.

The Raptor AL-FEC code [4] was chosen as a basis for FEC protection of the files [5] and has also been adopted by DVB. The Raptor AL-FEC code generates a number of redundant FEC symbols for each source block. The FEC symbols are assembled into IP packets. A broadcast of newly created FEC packets during the MBMS data transfer (phase 1) is of benefit for all receivers, which have not successfully reconstructed the original source block. The Raptor code can encode data files of almost virtual size. When Raptor is used with DASH, then typically each video segment file forms a source block. Using segments covering of e.g. 1s playout time and ensuring that the transmission on the radio interface is distributed as uniformly as possible over each interval of 1s, this scheme achieves time diversity of 1s, because the Raptor code can recover any IP packet that a receiver failed to receive during that interval. In order to tolerate longer burst losses the video segment length can be increased, however, this implies an increase in end-to-end delay as well as the time it takes for a receiver to switch between separately encoded video segment streams.

During a file repair procedure, further Raptor AL-FEC packets are transmitted to the receivers. If an interactive bearer is used, the repair data is independently sent to different receivers and can even be tailored to the actual losses of that receiver. On the contrary, if the MBMS bearer is used, the same repair data is sent only once to multiple receivers and the repair data should be useful for all receivers with losses. Therefore, the rateless property of the Raptor code is very beneficial for the PTM repair mechanism.

If a file repair procedure is used (phase 2), the MBMS client waits until the end of the transmission of files or sessions and then identifies the missing data from the MBMS download. Afterwards, it calculates a random back-off time and selects a file repair server randomly out of a list. Then, a repair request message is sent to the selected file repair server at the calculated time. The file repair server responds with a repair response message either containing the requested data (interactive bearer), redirecting the client to an MBMS download session (MBMS bearer), redirecting the client to another server, or alternatively, describing an error case. The repair data may also be sent on a MBMS bearer (possibly the same MBMS bearer as the original download) as a function of the repair process. The performance of the post-delivery file repair procedures described above has been analysed in [6],[7].

A2.2 Service Discovery

The availability of a scheduled transmission is usually shown to the user by an application (app) that implements e.g. an Electronic Programme Guides. Each transmission session is defined by a User Service Description (USD) which contains all information necessary for the UE to find the content data in the overall LTE signal.

Content can be protected on the application layer using standardized DRM methods such as MBMS service keys (MSK) and MBMS traffic keys (MTK). eMBMS does not make use of the LTE specific ciphering. Therefore, it is in principle possible to receive eMBMS services without a SIM card of an operator. A precondition is that the UE supports this operation mode and the USDs of the scheduled services are made available to the UE by other means (as mobile broadband access is not available without a SIM card), e.g. through a home WLAN. In case the content is encrypted by application layer DRM either, the decryption keys also have to be made available to the UE this way.

A2.3 LTE Downlink Physical Layer

In the following, we provide a brief introduction to the E-UTRA downlink physical layer. [1],[9][1] Like other broadcasting standards, the E UTRA downlink uses OFDM, because it efficiently supports flexible carrier bandwidth, allows frequency domain scheduling, is resilient to propagation delays, which is particularly beneficial for SFN broadcasting configurations, and is well suited for multiple-input multiple-output (MIMO) processing.

The possibility to operate in vastly different spectrum allocations is essential. Different bandwidths are realized by varying the number of subcarriers used for transmission, while the subcarrier spacing remains unchanged. In this way operation in spectrum allocations of 1.4, 3, 5, 10, 15, and 20 MHz can be supported. Due to the fine frequency granularity offered by OFDM, a smooth migration of, for example, 2G spectrum is possible. Frequency-division duplex (FDD), time-division duplex (TDD), and combined FDD/TDD, are supported to allow for operation in paired as well as unpaired spectrum.

To minimize delays, the transmit time interval (TTI) is only 1 ms, corresponding to one sub-frame. A subframe can carry several transport blocks, the physical layer payload unit that has a checksum attached (CRC) for error detection. Each sub-frame consists of two slots of length $T_{\text{slot}} = 0.5$ ms. Each slot consists of several OFDM symbols. A subcarrier spacing $\Delta f = 15$ kHz corresponds to a useful symbol time $T_u = 1/\Delta f \approx 66.7$ μ s. The overall OFDM symbol time is then the sum of the useful symbol time and the cyclic prefix length TCP. Signals from eNBs arriving within the cyclic prefix (CP) duration of the UE synchronization point contribute useful signal energy and thereby improve the coverage. Signals arriving outside the CP produce interference. Since the CP does not contain user data, its length is a trade-off between the time fraction available for user data and the SINR value achievable with the desired error probability. In order to cope with different propagation delays caused by different cell sizes, LTE defines two CP lengths for a typical subcarrier spacing of $\Delta f = 15$ kHz, the normal CP and an extended CP, corresponding to seven and six OFDM symbols per slot, respectively.

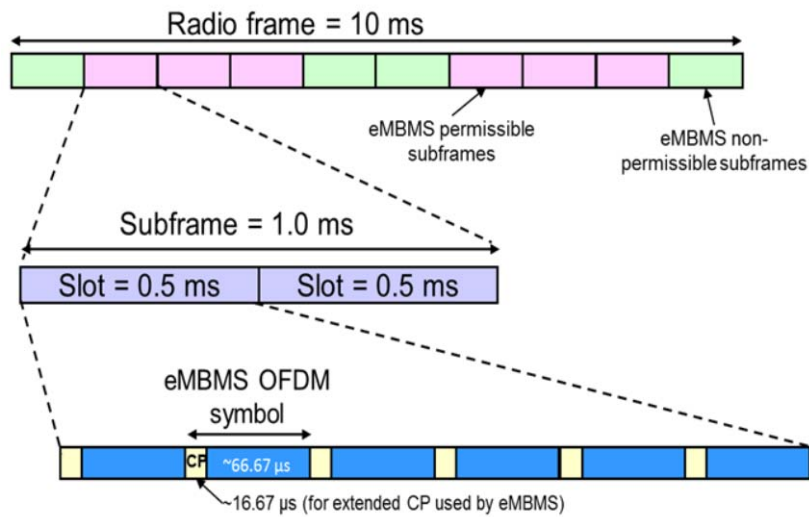

Figure A2-2: LTE symbol/slot/frame structure [12]

By extending the CP from 4.7 μs to 16.7 μs, it is possible to handle very high delay spreads that can occur in a large cell with a very large radius or when several cells transmit the same signal synchronously as in the MBSFN mode described in the next section. For larger distances, the extended CP can even be increased by a factor of two resulting in 33.3 μs. In order to limit the relative overhead imposed by this extended long CP, the OFDM useful symbol time is also doubled for the configuration with the long extended CP of 33 μs. In order to maintain the same capacity with an unchanged carrier bandwidth, the subcarrier spacing is also reduced by a factor of two, resulting in $\Delta f_{low} = 7.5$ kHz. Currently, signalling to identify which subframes use the CP of 33 μs is missing from the standard, therefore UEs cannot be assumed to understand this mode yet. These parameters differ from e.g. DVB-T, as LTE networks use small cells and therefore propagation delay differences are smaller, which in turn allows for smaller CP and accordingly smaller OFDM symbol sizes. This in turn allows for larger subcarrier spacing, which allows for the larger Doppler spread that result when using some of the high frequency bands defined for LTE.

Table A2-1: Resource block parameters.

Configuration			# subcarriers	# OFDM symbols
Normal CP	$T_{CP} = 4.7 \mu s$	$\Delta f = 15$ kHz	12	7
Extended CP	$T_{CP} = 16.7 \mu s$	$\Delta f = 15$ kHz		6
Extended CP	$T_{CP} = 33.3 \mu s$	$\Delta f_{low} = 7.5$ kHz	24	3

A resource block is defined as a two-dimensional time-frequency resource that has time duration of one 0.5 ms slot and a frequency bandwidth of 180 kHz. For a normal CP a resource block consists of 12 subcarriers during a 0.5 ms slot, as illustrated in Figure A2-2. In case of normal CP each resource block thus consists of $12 \cdot 7 = 84$ resource elements and in case of extended CP the resource block consists of 72 resource elements for a subcarrier spacing of $\Delta f = 15$ kHz ($12 \cdot 6$) and also for $\Delta f_{low} = 7.5$ kHz ($24 \cdot 3$). Each subcarrier of each OFDM symbol can be modulated by Quadrature Phase Shift Keying (QPSK), 16-QAM or 64-QAM modulation schemes.

A subframe can be used for MBMS transmission or unicast transmission. The downlink shared channel (DL-SCH) transport channel uses the physical layer to provide unicast radio bearers with feedback from the UEs. The feedback enables the use of HARQ retransmission and also the UE individual adaptation of transmission parameters to the particular radio conditions, including MIMO transmission. The unicast transmission is more efficient than MBSFN transmission only for services with a very small number of users per cell, for small cells even for less than 1 user per cell on average. The reason for the superior efficiency of MBSFNs is the elimination of inter-cell interference.

A2.4 Segmentation/Concatenation Across Protocol Layers.

Figure A2-3 shows the processing of DASH media data segments in terms of segmentation/concatenation across protocol layers including in this order the AL-FEC layer, working internally with so called symbols, the IP layer (FLUTE, UDP, IP) and finally the physical layer transport blocks (omitting for brevity the LTE PDCP/RLC/MAC layers, which are also largely and largely irrelevant in the eMBMS context). Transport block error rate (BLER) is often used as a physical layer performance criterion. There are several factor impacting the relation between DASH segment error rate and transport block BLER, in particular the relative size of all the involved data block units on each layer, and the amount of application layer FEC repair data.

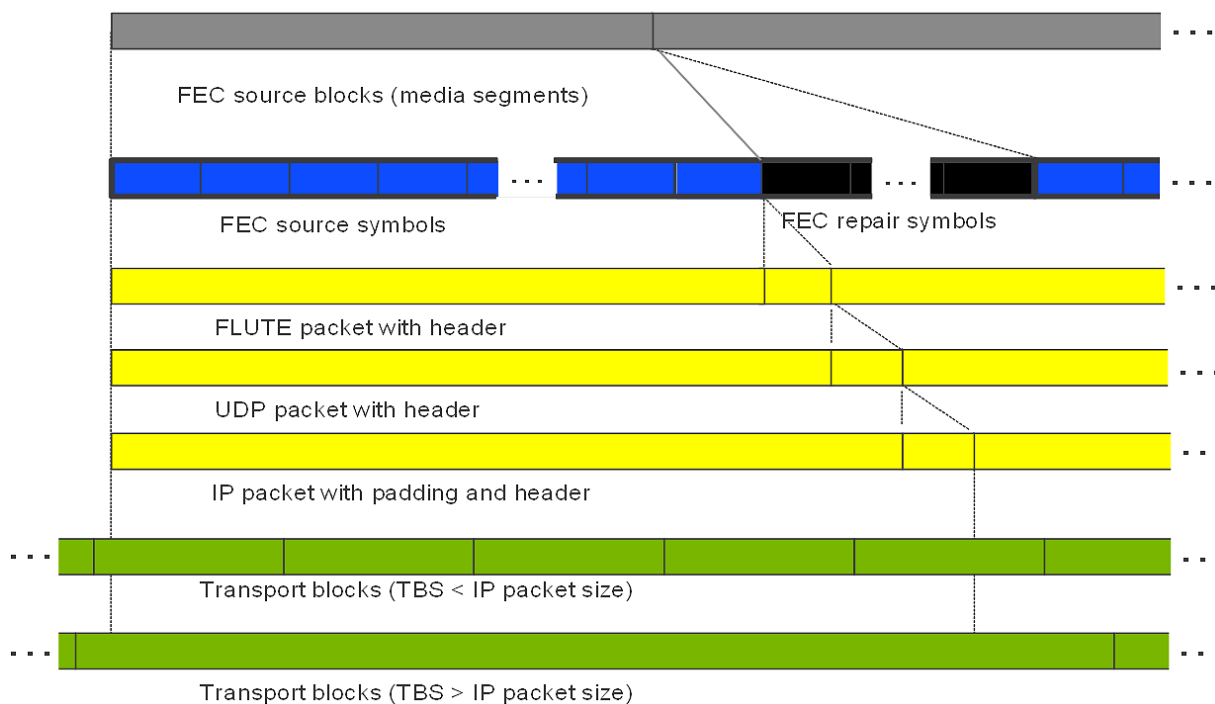

Figure A2-3: Segmentation/concatenation across protocol layers.

A2.5 MBSFN

If a larger number of users of a particular MBMS service are present in a cell, broadcast radio transmission in the cell is more suitable, which can be used either in single cell or multi-cell transmission mode. For PTM transmission in both single-cell and multi-cell mode, a new transport channel, the Multicast Channel (MCH) was defined. The MCH can be time multiplexed on a sub-frame granularity of 1 ms with other transport channels such as the DL-SCH. Thus, in contrast to MBSFN configured in WCDMA, it is not necessary, nor by the current standard possible, to use an MBSFN dedicated carrier in LTE.

A multi-cell transmission essentially means that the cells transmitting the MBMS service are configured to form an MBSFN. If an MBSFN with multiple cells is established using a particular MCH, then the same MCH information is transmitted time aligned from these cells using identical transport formats, identical resource allocations and identical scrambling. From a UE point-of-view, such multi-cell MCH transmission will appear as a single MCH transmission. However, it is a channel aggregated from all cells involved in the MBSFN transmission and will typically have a large delay spread due to the differences in the propagation delay as well as residual transmit-timing differences as indicated in Figure A2-4. In order to be able to properly demodulate the multi-cell MCH transmission, the UE needs an estimate of the aggregated channel. For this to be possible, MCH specific reference signals are needed that are identical for all cells involved in the MBSFN, i.e. identical time/frequency locations and identical reference signal sequences are used. By the current standard, only the CP of 16.7 μ s can be used for MCH transmission. In case sites with higher

power and/or a higher tower are available or deployments in low frequency bands, good coverage can be achieved with even higher distance between sites, and in this case the extended long CP of $33.3 \mu s$ should be used. For this CP, there is currently a missing piece in the standard that there is no signalling which subframes use this CP and the UE is not required to blindly detect it. An appropriate mechanism has to be defined to make the UE known where this CP is used.

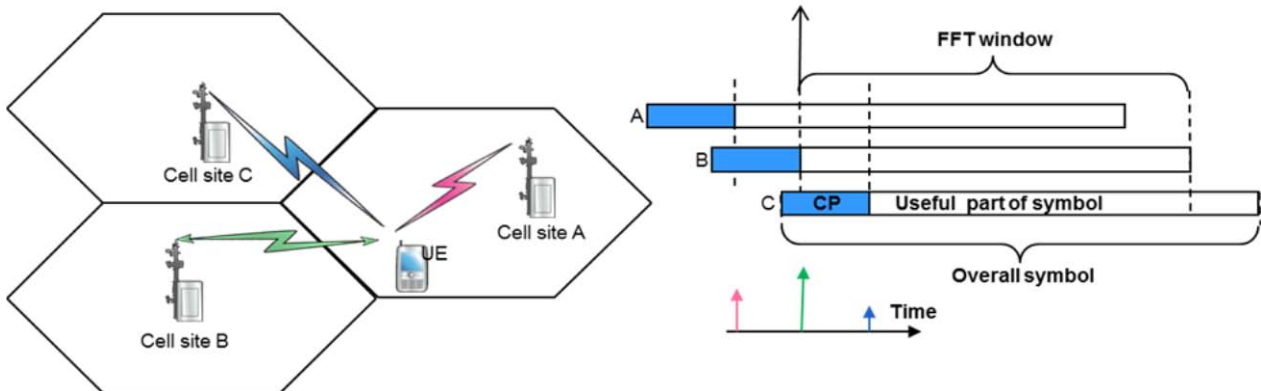

Figure A2-4: Illustration of OFDM reception of SFN transmission from 3 cell sites [12]

A2.6 eMBMS Architecture

MBMS in LTE uses an evolved architecture in order to support MBSFNs with high flexibility, which was an important design goal of LTE from the start. Furthermore, for LTE it is desired to support MBSFN transmission and user individual services on the same carrier. The architecture needs to support the coordinated allocation of radio resources within the carrier for MBSFN transmission across all cells participating in the particular MBSFN. Figure A2-5 shows the eMBMS architecture, which is based on enhancements to the LTE Release 8 architecture. The default architecture is shown to the left. The alternative to the right is discussed along with the MCE below. The architecture defines a functional split. Several functions can be co-located or even integrated in the same hardware box.

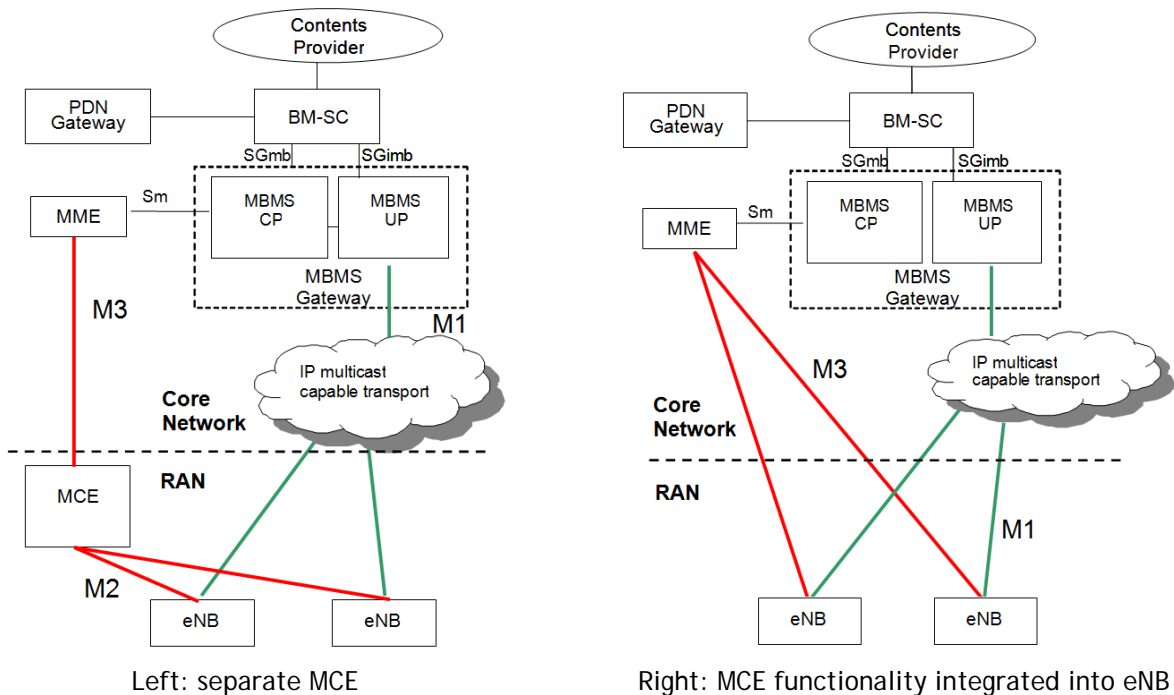

Figure A2-5: MBMS architecture in SAE / LTE.

The following logical entities are defined:

- **BM-SC.** The broadcast / multicast service centre (BM-SC) controls MBMS sessions and corresponding MBMS bearers.
- **MBMS GW.** The MBMS Gateway (GW) is an entity that is located between the content provider and the evolved base stations (eNode Bs, or eNBs). The control plane (CP) of the MBMS GW is involved in the MBMS session start/setup towards the LTE radio access network (RAN) via the Mobility Management Entity (MME). The user plane (UP) is responsible for delivering the user data over the IP multicast capable transport network to the eNBs and participates in the content synchronization for MBMS services using MBSFN. The MBMS GW is part of the Evolved Packet Core (EPC).
- **MME.** In the context of MBMS, the MME is responsible for session control signalling.
- **MCE.** The Multi-cell/multicast Coordination Entity (MCE) is an entity responsible for coordinating the usage of MBSFN transmission within the same MBSFN area in the LTE RAN. Therefore, in the architecture alternative shown to the right of Figure where the MCE is integrated to each eNB, the necessary parameters must be consistently configured by O&M for all cells of an MBSFN area, since there is no interface for coordination between MCEs. Otherwise, an MBSFN area can only cover the cells served by the respective eNB.
- **eNB.** The eNB is the evolved base station in LTE responsible for multiplexing, framing, channel coding, modulation and transmission.

The following logical interfaces are defined:

- **M1.** Is a logical interface between the MBMS GW and the eNBs. The transport on this interface will be based on IP multi-cast. The MBMS content is transported in a frame or tunnel protocol, in order to support content synchronization and other functionalities. IP multicast signalling is supported in the transport network layer in order to allow the eNBs to join an IP multicast group.
- **M2.** Is a logical control interface between the MCE and the eNBs. This interface is used to coordinate the setting up of an MBMS service in the eNBs for MBSFN operation. The signalling transport layer is based on IP.
- **M3.** Interface between MME and MCE. Supports MBMS Session Control Signalling, including the QoS attributes of each service (does not convey radio configuration data). The procedures comprise e.g. MBMS Session Start and Stop. SCTP is used as signalling transport i.e. point-to-point signalling is applied.
- It is not precluded that M3 interface can be terminated in eNBs. In this case MCE is considered as being part of eNB. Therefore M2 does not exist in this scenario. This is depicted in Figure , which depicts two envisaged deployment alternatives. In the scenario depicted on the left, MCE is deployed in a separate node. In the scenario on the right MCE is part of the eNBs.
- **Sm.** The reference point for the control plane between MME and MBMS GW.
- **SGmb.** The reference point for the control plane between BM-SC and MBMS GW.
- **SGi-mb.** The reference point for the user plane between the BM-SC and MBMS GW.

A2.7 Synchronisation

Within a so called MBSFN area, all eNBs need to be synchronized with a μ s tolerance and the radio frames need to be aligned. The method of achieving the required tight synchronization is not defined in the LTE specifications; this is left to the implementation of the eNodeBs. Typical implementations are likely to use satellite-based solutions, e.g. GPS, or possibly synchronized backhaul protocols, e.g. IEEE 1588. Tight synchronisation is not only required for MBSFN operation but also for other LTE features, e.g. TDD operation, time-domain inter-cell interference coordination or coordinated multipoint transmission (a form of very small SFN for unicast), the

latter has similarly tight synchronization requirements as MBSFNs, though only involving a few transmit antennas.

The MCE is responsible for configuring identical MBSFN sub-frame allocations and MCH scheduling periods (MSP) in all cells of an MBSFN area, as well as the MCH modulation and coding scheme, satisfying the guaranteed bitrate of the MBMS bearer. The MCE also defines the common order in which services are scheduled in all eNBs of an MBSFN area.

Finally, content synchronization needs to ensure that the IP packet multiplexing and mapping to transport blocks in MBSFN subframes is identical in all these cells, taking into account that IP packets have varying size and packet losses can occur between the BM-SC and the eNB. This is achieved by the SYNC protocol [11] where the packet flow is grouped into synchronization sequences. A separate instance of the SYNC protocol is associated with each MBMS bearer. For each synchronization sequence, the BM-SC tries to ensure that it does not send more packets to the eNB than allowed by the guaranteed bitrate of the MBMS bearer, discarding packets if necessary. The BM-SC labels all packets of a synchronization sequence with an identical time stamp telling the eNB when to start the transmission of the first packet of that synchronization sequence. The time stamp has to cover transfer delays between the BM-SC and all eNBs in the MBSFN area to ensure that all of them have received and buffered the packets of an MSP before any of the eNBs is allowed to transmit the first packet. The MSP is configured by the MCE, but must be an integer multiple of the synchronization sequence duration to make this concept work.

The transmission delay differences from the BM-SC to the eNBs are typically smaller than 100 ms, even with a single BM-SC and an MBMS service area involving all eNBs of a country. The SYNC protocol can handle this delay, i.e. the data will be delayed by up to 100 ms in the first eNB receiving the data first from the BM-SC, to transmit them synchronously with the last eNB when it has received the data.

A2.8 eMBMS Area Concept

For the MBMS service provisioning, the MBSFN area and MBMS service area need to be distinguished. The MBMS service area defines a geographic area where a service shall be broadcasted. Within the network, the operator identifies each MBMS service area by one or more MBMS service area identities (MBMS SAIs), and each MBMS SAI defines a group of cells. A cell can belong to and is therefore addressable by one or more MBMS SAIs.

An MBSFN area defines the set of cells participating in the transmission of signals for one or more services in MBSFN mode. An MBMS service area (identity) may comprise one or more complete MBSFN areas. Overlap between MBSFN areas as well as between MBMS service areas, is supported. This also enables a smaller MBSFN area to overlap a large MBSFN area, so that e.g. regional and nation-wide MBSFN areas can coexist. Overlapping MBSFN areas can be implemented using frequency or time multiplexing. Time multiplexing means that MBSFN areas are separated by different sub-frame patterns.

The relationship between MBMS Service Areas, MBMS Service Area Identities (MBMS SAIs), and MBSFN areas is illustrated in Figure A2-6. MBMS Service Area A consists of MBMS SAI#1 and MBMS SAI#2. MBMS SAI#1 covers MBSFN areas 1a and 1b. The MBMS services that are provided in MBSFN area 1a and 1b, belonging to the MBMS SAI#1 do not have to schedule the MBMS data synchronously. The synchronization requirement is only valid within the same MBSFN area.

Within an MBSFN area there can be reserved cells that do not advertise the MBSFN area. These cells may nevertheless transmit the MBMS signals in MBMS sub-frames, in order to support neighbour cells that are not classified as reserved. UEs in cells at the border of an MBSFN area will suffer from a high level of interference if the neighbour cells not belonging to the MBSFN area transmit different signals in the sub-frames used by the MBSFN area. Such border cells inside the MBSFN area may therefore be configured as reserved cells, such that UEs located in these cells do not expect the

availability of the MBMS service, due to the lack of essential MBMS signalling. Reserved cells at the border can thereby serve as an interference guard zone. Thanks to the low height of the eNB antenna towers and the low transmit power, typically only a few rings of cells around an MBSFN area are needed for the guard zone, depending on the used MCS. Therefore, the sub-frames can be reused for another MBSFN area or unicast traffic already a few kilometre or few tens of kilometres away. Section 4.2.4 provides further analysis of the guard zone sizes.

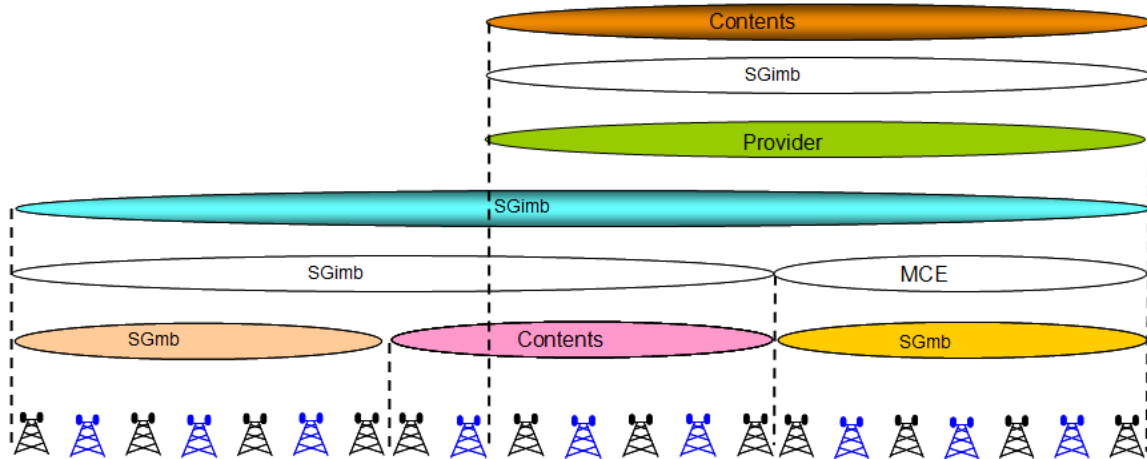

Figure A2-6: MBMS related area concept.

A2.9 eMBMS / unicast multiplexing

MBMS data transmission in MBSFN mode is time multiplexed with other LTE unicast traffic. This is an advantage over WCDMA based MBMS transmission, where the use of MBSFN was confined to a dedicated carrier. Up to 6 of the 10 sub-frames of a radio frame are configurable for MBMS in the FDD mode and up to 5 in the TDD mode. Figure A2-7 shows which of the sub-frames can be used for MBMS transmission and which are reserved for unicast. The MBMS subframes use MBSFN transmission whereas in unicast subframes each cell can transmit different information. In FDD mode, the subframes that are allocated for MBMS in the downlink can be used for unicast transmission in the uplink. Subframes reserved for MBMS but with no content to transmit e.g. due to varying content bitrate can be used for certain transmission mode of unicast transmission. Different MBSFN subframe patterns can be allocated to different MBSFN areas. Due to time multiplexing, a UE can receive MBMS services and simultaneously use unicast services. This enables interactive broadcast services as well as hybrid broadcast/unicast delivery of content. The latter means content is delivered using eMBMS only in areas where the average number of users per cell interested in the content is high, otherwise it is delivered in unicast mode.

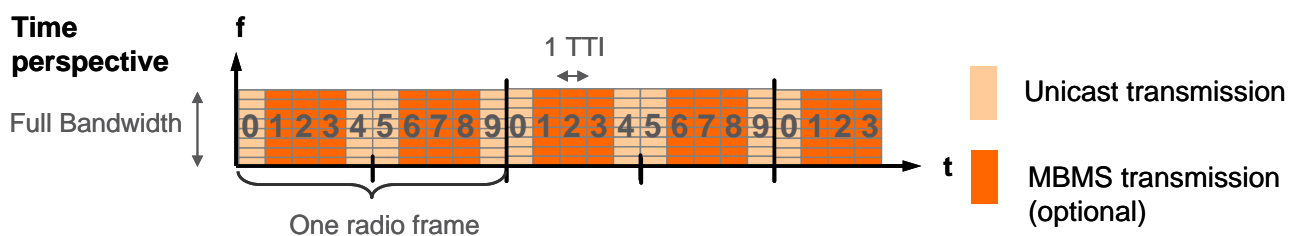

Figure A2-7: Time multiplexing of MBMS and unicast transmissions.

A2.10 User Counting for MBSFN Activation

The audience density can either be predicted from the density seen for similar, previous content (e.g. earlier episodes of the same TV series) or based on real-time user counting. The user counting procedure enables the MCE to autonomously activate/deactivate MBMS services in a predefined

MBSFN area depending on user interest. The counting procedure is triggered by the MCE if the network operator has configured it to do so. Counting is possible for Release-10-compatible MBMS UEs in so called RRC_CONNECTED mode, i.e. for UEs that already have a signalling connection with the LTE network, e.g. because the UE has recently received or transmitted unicast data. The fraction of UEs that can be addressed this way is typically high enough to enable statistically significant estimation of the total number of UEs in each cell that are interested in the considered MBMS service.

If the number of UEs responding as being interested in a service exceeds an operator-set threshold, the MCE can enable the preconfigured MBSFN area so that the service gets broadcasted. The actual reception of the broadcast is also possible in the RRC_IDLE mode where the UE does not have any signalling context with the network. If the threshold is not exceeded, then the number of users interested in the service is considered to be so low that delivering the service in unicast mode only in the cells with interested users is more efficient from a radio resource perspective.

If the MCE based counting procedure is not used, the set of cells to include in an MBSFN area and the services to be broadcast in an MBSFN service area need to be configured manually by the network operator. The decisions need to be taken based on audience density information from the past. Such information can be gathered in the BM-SC from UE reception reports which can optionally include a cell ID of a cell that has been used for reception.

A2.11 Service Acquisition and Continuity in Multi-carrier Networks

An MBMS service that is provided via MBSFN is generally provided only on one frequency, while multiple frequencies can be deployed in a geographic area to cope with increasing unicast and MBMS traffic.

In order to provide the UE with sufficient information to find the frequency where an eMBMS service of interest is transmitted without having to scan all frequencies, in LTE Release 11 so-called MBMS assistance information is provided to the UE by both the USD (from the service layer) and the network. The USD of a service contains information in which MBMS SAIs and on which frequencies the service is provided. Each cell in the network broadcasts in its system information the MBMS SAIs of cells for its own frequency and for the frequencies used by overlapping (or neighbouring) cells. If the UE finds a match between the MBMS SAI in the USD of the service of interest and in the system information, it can derive the frequency where the service is provided. Based on the MBMS SAI information, the UE in RRC_IDLE can prioritize this frequency as that of the only cell to monitor, and the UE in RRC_CONNECTED mode can send its MBMS interest indication to the network. This interest indication contains a list of one or more MBMS frequencies according to the UE's interest and capability of parallel MBMS reception on different frequencies, and also a priority bit. In case the cell transmitting the eMBMS service of interest is overloaded in the unicast subframes and a user wants to simultaneously receive the eMBMS service and other unicast services, the network can then decide based on the priority bit to keep the UE on the current cell even though the user then can experience reduced unicast performance, rather than handing over the UE to another cell which would imply the loss of the eMBMS service of interest for the user, unless the UE is capable of receiving on 2 cells (one per frequency) simultaneously.

A2.12 Quality of Service

For unicast services, LTE provides a QoS framework. A service is associated with a QoS Class Identifier (QCI) [36, section 6.1.7.2]. Each QCI implies specific values of maximum transfer delay and the maximum Service Data Unit error rate. The LTE radio network then tries to ensure these QoS requirements are met, by appropriate prioritization in the UE scheduling and choice of retransmission rate operating point, provided the radio link quality enables this.

For eMBMS, the LTE subframes are reserved in a periodic pattern. This means eMBMS does not

compete for radio resources with unicast traffic on a best-effort basis. Each service is mapped to a guaranteed bitrate bearer (GBR). The MCE allocates the required density of eMBMS subframes to achieve a total bitrate that supports the sum of the bitrates for all services that are multiplexed on one MCH, given the chosen modulation and coding scheme (MCS) of the MCH and AL-FEC code rate of each service. These parameters need to be configured to achieve the targeted low AL-FEC block loss rates with the targeted high geographical coverage. The BM-SC applies rate control to each service in order to not exceed the guaranteed bitrates in each synchronization sequence.

After the transmission of a file has finished, a file repair procedure can ensue where UEs cannot having received a sufficient number of packets to enable successful AL-FEC decoding can request delivery of additional packets. This is not useful in the case of DASH based streaming because this kind of retransmissions takes too long and would not arrive at the UE in time for the continuous playout, and the rare loss of a DASH segment only leads to a temporal loss of the playout. The file repair can however be very efficient for the distribution of large files and where integrity is a must.

Due to the unidirectional nature of eMBMS services, the network operator cannot easily know from the session if end-user devices have correctly received the data or the user experience of a streaming session was good.

Gathering of Quality of experience (QoE) metrics from receiving MBMS clients to the BM-SC were defined for this purpose [13]. The service announcement information configured by the operator describes the parameters for QoE metrics. The announcements can be configured such that only samples of end-user devices report them. In the case of DASH, the QoE metrics indicates the number of lost HTTP streaming segments.

Finally, LTE supports UE radio link quality reporting for network optimization, e.g. for the detection of coverage hole. This feature is called Minimization of Drive Tests (MDT).

A2.13 Standardization Outlook

LTE is continuously further developed by 3GPP in a release cycle. A cycle takes about 1.5 years. Currently 3GPP is working on Release 12 which is scheduled to be finalized in autumn 2014. The work is organized in the form of work items. The main work items where unicast video delivery can benefit from are improvements in the areas of (distributed) multi-antenna (MIMO) methods and small cell support (including 256-QAM) for traffic hotspots.

For eMBMS enhancements there is a proposed work item to cover longer cyclic prefix to support larger inter-site-distances, support of eMBMS on dedicated carriers, i.e. using 100% of carrier resources for eMBMS, and MIMO. 3GPP RAN work items can be adopted by the 3GPP RAN plenary which meets every 3 months. Apart from the dedicated eMBMS work item proposal, discussions have started whether 3GPP should work on supporting eMBMS on the so called New Carrier Type (NCT) which is mainly being developed for performance increase and energy saving for unicast services, but also presents an opportunity to increase the limit of the percentage of sub-frames usable for eMBMS from 60% to 80%.

A2.14 Performance

The performance of LTE and especially of MBSFN is of a key relevance to assess the suitability of LTE as a technology to support broadcasters' requirements as given in Section 2. Whilst the capabilities of LTE in the unicast mode are rather well known, the focus here will be on the SFN based broadcast option of LTE.

The performance of a system is mainly defined by the following set of parameters:

- **Bandwidth/capacity.** This depends essentially on the available spectrum, the spectral

efficiency and the proportion of MBMS within the allocated spectrum. Whilst in 3GPP Release 11 the proportion of the resources used for MBMS are limited to 60%, it is expected that Release 12 will introduce more flexibility.

- **Reach or intersite distances.** This depends essentially on the chosen modulation and coding scheme, the sensitivity of the receiver, the transmitted power and, in the case of the SFN, on the size of the cyclic prefix as compared to the delay variations in combination with propagation properties.
- **Spectral efficiency.** Here we need to distinguish between two approaches: the SE within an SFN and the SE within a region. Since typically the planning of spectrum allocation is done on a regional basis, the regional SE should be emphasized, which takes the frequency re-use into account.
- **Frequency re-use:** multiple SFN would interfere with each other if a different content is transmitted via the same frequency. Thus the same piece of spectrum cannot be used in areas of overlap of the signals. This leads to the fact, that, depending on the technology, only a part of the overall regionally allocated spectrum can be used for a specific SFN. This factor is called re-use factor and a high re-use factor means that a small portion of the spectrum can be used.
- **Error rates:** the radio transmission leads to errors in the transmitted data due to statistical fluctuations in the signal. For OFDM this leads to block errors. To reduce the BLER forward error correction mechanisms are applied. Since the perceived Quality of experience essentially takes visual artefacts into account, application layer coding can be used to improve the QoE. Since this would imply additional delay and channel switching times, the deployment of application layer coding depends on the overall system optimization.
- **Coverage / service continuity:** the objective is to provide good service to all users everywhere in a defined area. In reality some places in the coverage area would be unsuitable for TV reception, since topology, shadowing, manmade noise or other factor.

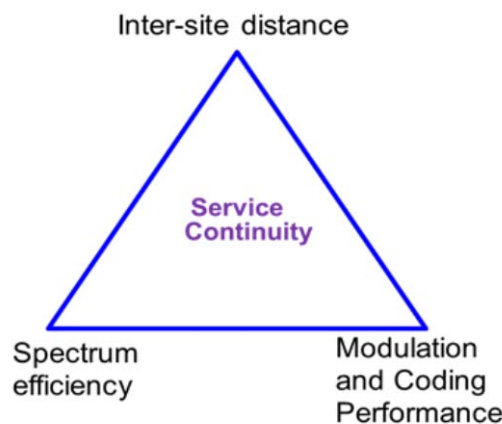

Figure A2-8: Interrelation between the inter-site distance, spectrum efficiency and modulation and coding performance in an eMBMS network

The performance of a system like eMBMS will be a result of an optimization process. Here the expected spectral efficiency can be reached by using the most appropriate Modulation and Coding Scheme (e.g. 64-QAM, rate 1/2).

In addition the "Border effect", i.e. the effect that a receiver gets a different signal at the border of an SFN than inside the SFN (see also Annex 5) may degrade performance and the choice of the appropriate MCS needs to be selected to achieve the required Block Error Rate target (e.g. 1%).

The performance for unicast has been continuously improved with 3GPP Releases over time. For the unicast spectral efficiency is 2.4 bit/s/Hz for LTE advanced (i.e. 3GPP Release 10) for macro-cell network with outdoor users (4 x 2 MIMO, ISD=500 m), according to ITU-R M.2198. For indoor users no macro-cell result is provided, however, dense deployments are usually interference limited even indoor so that the spectral efficiency will not be significantly smaller. For micro-cell deployment a

value of about 3.1 bit/s/Hz is reported for 50% indoor users. The assumption for these results is a proportional-fair scheduler in each eNB that leads to a user throughput that is proportional to its SINR compared to other users. Multi-User MIMO (MU-MIMO) has been used where the 4 antennas of each cell can be used to transmit to 2 users simultaneously (separate by beam forming) and at the same time 2 streams per user (spatial multiplexing).

Since Release 10 features have been added that increase the spectral efficiency, in particular:

- Higher order MIMO, up to 8 antennas for each cell that can be configured for up to 4 parallel (spatially multiplexed) data streams.
- Support for coordinated multipoint transmission (CoMP) that coordinates and thereby reduces interference between cells and in some flavours also configures them dynamically as small SFN separately for individual users.
- Interference cancellation, both intra-cell (for MU-MIMO) and inter-cell.
- Finally, an important track through several recent releases is the enhanced support of small cells that can be established indoors or on low-elevation structures outdoors where traffic hotspots require this.
- Elevation beam forming: Previously beam forming was only applied in the azimuthal plane. The next step is to apply it also in the elevation plane, which further improves the focussing of signal power in the direction of the intended user, reducing interference to other users. The most sophisticated flavour of this feature requires new antennas with individually controllable antenna elements in the vertical plane. The actual work on this has not yet started in 3GPP, currently the appropriate 3D channel models are being defined that are needed for the evaluation.

An assessment of system performance of eMBMS under realistic radio network engineering conditions based on [12] is provided in Annex 3. The coverage target is deep indoor with receive antennas integrated in the device. Further important details of assumptions are summarized in Table A2-2.

Table A2-2: Summary of key assumptions used in performance simulations

Parameter	Default Values	Remarks
Shadowing fading	Log-Normal, $\sigma=8$ dB	
Cross correlation between cell sites and sectors	0.5 (between different cell sites) 1.0 (between sectors on same cell site)	Correlated shadow fading values generated using a common random variable approach
Penetration loss	10 and 20 dB	indoor reception
Cell site height	15 and 50 m	
Channel Model	ETU	Extended Typical Urban
Receive antenna height	1.5 m	
Noise Figure	9 dB	
UE locations	Dropped randomly within the simulated area	Statistics only collected from centre cell-site UEs.
Area coverage	95%	% of uniformly distributed users have BLER<1e-2
Propagation loss		Aligned to 3GPP Macro model (no terrain or clutter)
Cyclic Prefix	16.7 μ s	
BLER	1e-2	
Number of site rings	2	19 sites, 3 sectors each

It is concluded that eMBMS may efficiently be used up to an ISD of about 3 km across an entire metropolitan area and the surrounding rural areas when using a low radio band such as 700 MHz or 800 MHz, offering a spectral efficiency of 1.5 bit/s/Hz.

Spectral efficiency for eMBMS has been determined based on the net payload (i.e. excluding pilots, CRCs, ...) on the physical layer. The spectral efficiency for eMBMS is determined by physical layer modulation and coding scheme as well as block error rate operating point (for further parameters see Table A2-2). To obtain bitrates the spectral efficiency needs to be multiplied with the used channel bandwidth (e.g. 10 MHz) and the sub-frame ratio allocated to eMBMS (currently at most 60%).

Recently, additional studies have been made available to CTN-Mobile based on different set of input parameters and reporting a different spectral efficiency. Neither study attempted to optimize the eMBMS network performance. It is evident that the network performance depends on some key parameters further explained in Section 1.14. For a thorough understanding a clear agreement on the common simulation assumptions are needed for all studies. Further investigation on that issue is necessary.

For rural areas with higher ISD, unicast can be an option for TV delivery. The rural ISD then has to satisfy the unicast capacity requirements depending on the user density and the share of TV delivery via LTE compared to other technologies such as satellite or cable.

A2.15 Carrier Aggregation

In the future, most UEs will be capable of carrier aggregation. The term carrier aggregation has recently been used in a generic way in some literature when discussing the conceivable options of receiving LTE broadcast on one carrier and unicast on another.

Not all these options are possible with carrier aggregation (CA) as it is defined by 3GPP. CA means a primary cell (PCell) can be combined with several secondary cells (SCell). CA requires that all cells (using different carriers) have their System Frame Number (SFN) aligned and their sub-frames synchronized with a time offset tolerance of 130 - 260 ns. This can be ensured if both carriers belong to the same network. Synchronization does, however, in general not exist for cells belonging to different LTE networks. For CA between 2 carriers belonging to different 3GPP frequency band ("inter-band" CA), the UE should cope with a delay spread of up to 30.26 μ s among the component carriers according to 3GPP specification TS 36.300. For intra-band CA no propagation delay difference is assumed between the component carriers.

Furthermore, for intra-band CA the feasibility for the UE to receive 2 signals from different carriers simultaneously depends on the power difference of the received signals, because of the limited dynamic range of the UE receiver and the specification is currently in progress.

UEs that are capable of carrier aggregation and eMBMS are, however, required to receive eMBMS on any cell using a frequency compatible with the UE's unicast frequency (as defined by the UE's RF parameter *supportedBandCombination*). In order to support eMBMS reception on any compatible frequency operated in another PLMN, the UEs should not expect the eMBMS cell to be synchronized with the unicast cell. Furthermore, such UEs have the additional 3GPP requirement to support acquisition of relevant system information from the broadcast frequency, i.e. they do not rely on cross-carrier system information.

Supplemental Downlink (SDL) is a special case of carrier aggregation. It is basically an LTE FDD cell without an associated uplink carrier. Therefore, UEs cannot camp on that frequency, since an SDL is linked to a downlink. The term "camp" refers to the unicast-specific operation where the UE monitors for a possible downlink paging message addressed to it, whereby the network requests the UE to respond in uplink to initiate unicast-connection establishment (the most typical reason being an incoming voice call). Not being able to camp on a frequency does not prevent reception of MBMS broadcast from that frequency as discussed in the introduction to Section 4. Such a cell can be configured as additional SCell that can be used for unicast or eMBMS. SDL is currently defined only for a small number of the 3GPP bands.

Annex 3: eMBMS Performance Assessment

Often a first-level performance comparison among broadcast systems is made based on the AWGN channel model, though this channel model is not realistic, in particular for mobile or portable channels. We provide here the spectral efficiency vs. SNR for AWGN. It has been obtained for a transport block error rate (BLER) of 10^{-2} and 10^{-3} .

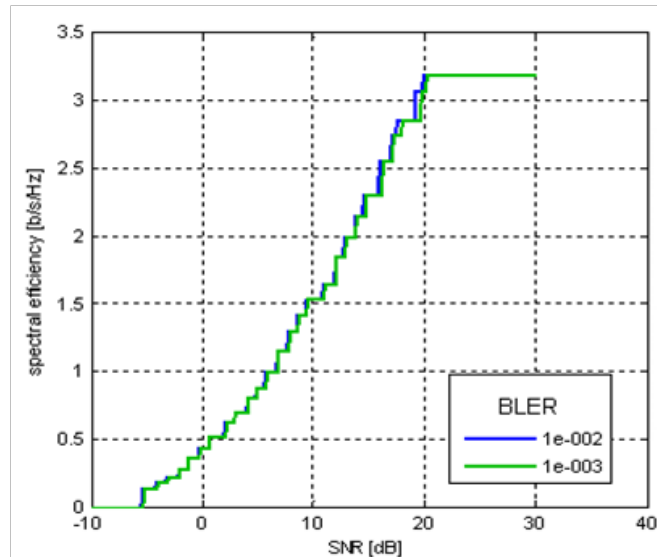

Figure A3-1: Spectral efficiency vs. SNR for AWGN

One example of a thorough performance assessment under realistic radio network engineering conditions has been conducted and reported in [12].

Figures A3-1 and A3-2 provide the mapping of (limit) SINR to spectral efficiency (SE) in bit/s/Hz which has been assumed for this study. It has been obtained for the ETU channel model for each transmitter, and a receiver at a position where an SINR equal to the 5%-percentile SINR is perceived, as specified in [16]. As usual, the spectral efficiency here is lower than for the AWGN channel.

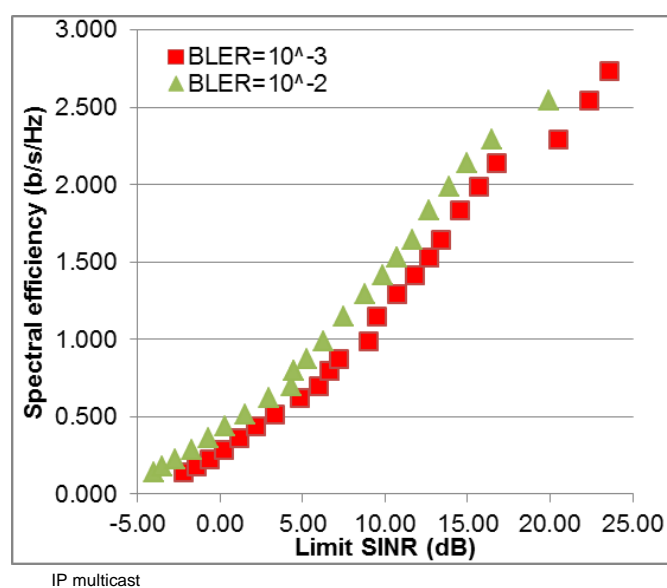

Figure A3-2: Assumed mapping of limit SINR to spectral efficiency

Usual simulation assumptions were taken from 3GPP specifications TR 36.814 [26], TR 25.814 [9],

and TR 30.03 [27], and are summarized in Table A3-1.

Particular attention has been paid to the modelling of distant cell sites contributing and/or interfering in the SFN transmission.

Table A3-1: Summary of key assumptions used in performance simulations

Parameter	Default Values	Remarks
Shadowing fading	Log-normal, $\sigma=8$ dB	
Cross correlation between cell sites and sectors	0.5 (between different cell sites) 1.0 (between sectors on same cell site)	Correlated shadow fading values generated using a common random variable approach
Penetration loss	10 and 20 dB	indoor reception
Cell site height	15 and 50 m	
Channel model	ETU	Extended Typical Urban
Receive antenna height	1.5 m	
Noise figure	9 dB	
UE locations	Dropped randomly within the simulated area	Statistics only collected from
Centre cell-site UEs.		
Area coverage	95%	% of uniformly distributed users have BLER <1e-2
Propagation loss (no terrain or clutter)		Aligned to 3GPP Macro model
Cyclic prefix	16.7 μ s	
BLER	1e-2	
Number of site rings	2	19 sites, 3 sectors each

The resulting eMBMS performance estimations have been reported in Figures A3-3 and A3-4, for the assumption that 95% of users have a BLER smaller than 1e-2. These results are comparable with figures previously published in the literature for the bands 900 MHz and 2 GHz.

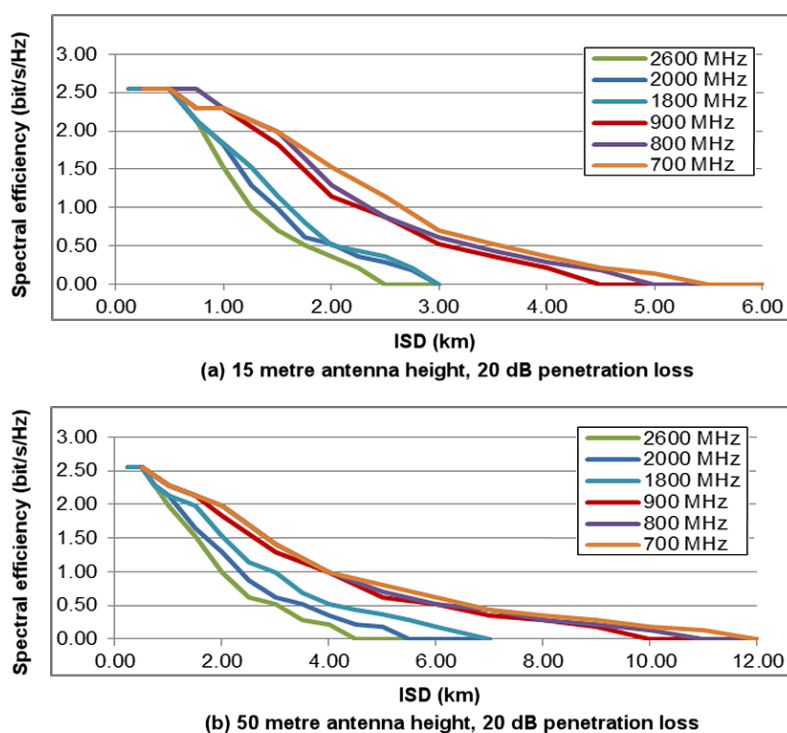

Figure A3-3: MBMS performance over a range of carrier frequencies

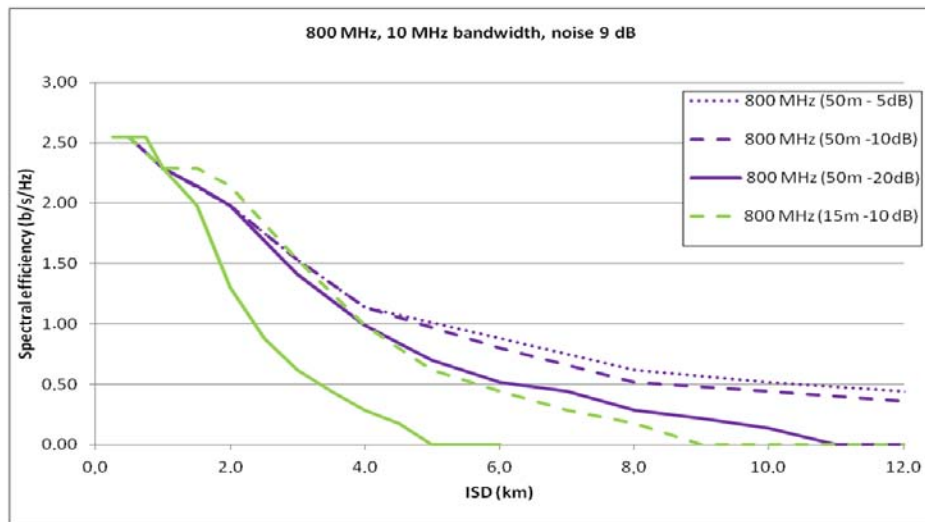

Figure A3-4: Impact of penetration loss allowance

Table A3-2 presents typical radio network engineering parameters, and typical ISD for Dense Urban, Urban, Suburban and Rural morphologies, with the later zone split into an “inner” region designed to meet a capacity limit and an “outer” region designed to meet only the coverage limit.

Table A3-2: Typical radio network engineering design parameters

Parameter	Dense urban (DU)	Urban (U)	Suburban (SU)	RU (inner)	RU (outer)
Antenna height (m)	15	15	50	50	50
Penetration loss (dB)	20	20	20	10	10
Coverage limit (km)					
800 MHz	1.6	2.5	5.5	15	15
1800 MHz	0.8	1.2	2.7	9	9
2600 MHz	0.5	0.8	1.9	6.5	6.5
Typical cell site grid ISD (km)	0.5	1.0	2.0	3.0	15.0

Table A3-3 summarizes the performance estimations with antenna height of 15 m (DU and RU) and 50 m (SU and RU), obtained by the model when applied to these typical radio engineering values using the results presented in Figures A3-3 and A3-4 above.

Table A3-3: Estimated eMBMS performance per morphology

Parameter	Dense urban (DU)	Urban (U)	Suburban (SU)	RU (inner)	RU (outer)
Typical cell site grid ISD (km)	0.5	1.0	2.0	3.0	15.0
MBMS performance (bit/s/Hz)					
800 MHz	2.55	2.3	2.0	1.5	-
1800 MHz	2.55	1.8	1.5	1.0	-
2600 MHz	2.55	1.5	1.0	0.5	-

ISD = Inter-Site Distance

Spectral efficiency for eMBMS is determined based on the net payload (i.e. excluding pilots, CRCs...) on the physical layer. The spectral efficiency for eMBMS is determined by physical layer modulation and coding scheme as well as block error rate operating point (further parameters see Table A3-1 above). To obtain bitrates the spectral efficiency needs to be multiplied with the used channel bandwidth (e.g. 10 MHz) and the sub-frame ratio allocated to eMBMS (currently at most 60%).

A realistic radio network design has to account for a mixed environment for neighbouring zones designed to meet DU, U, SU, and/or RU needs at applicable performance limits. Therefore the practical design of a common MBSFN area offering an appropriate grade of service and supportable data rates requires the selection of a common eMBMS operating mode based on the worst case in the desired service area. It can be seen from Table A3-3 that a spectral efficiency of 1.5 bit/s/Hz is achievable across an entire metropolitan area and the surrounding rural areas when using a low radio band such as 700 MHz or 800 MHz. For rural areas with higher ISD, unicast can be an option for TV delivery. The rural ISD then has to satisfy the unicast capacity requirements depending on the user density and the share of TV delivery via LTE compared to other technologies.

eMBMS configurations and performance for different deployments have also been investigated for example in [13][14][15]. Assumptions and results from a study by Qualcomm [22] are reproduced in Figures A3-5 and A3-6. Further performance results are provided in a case study in Annex 8.

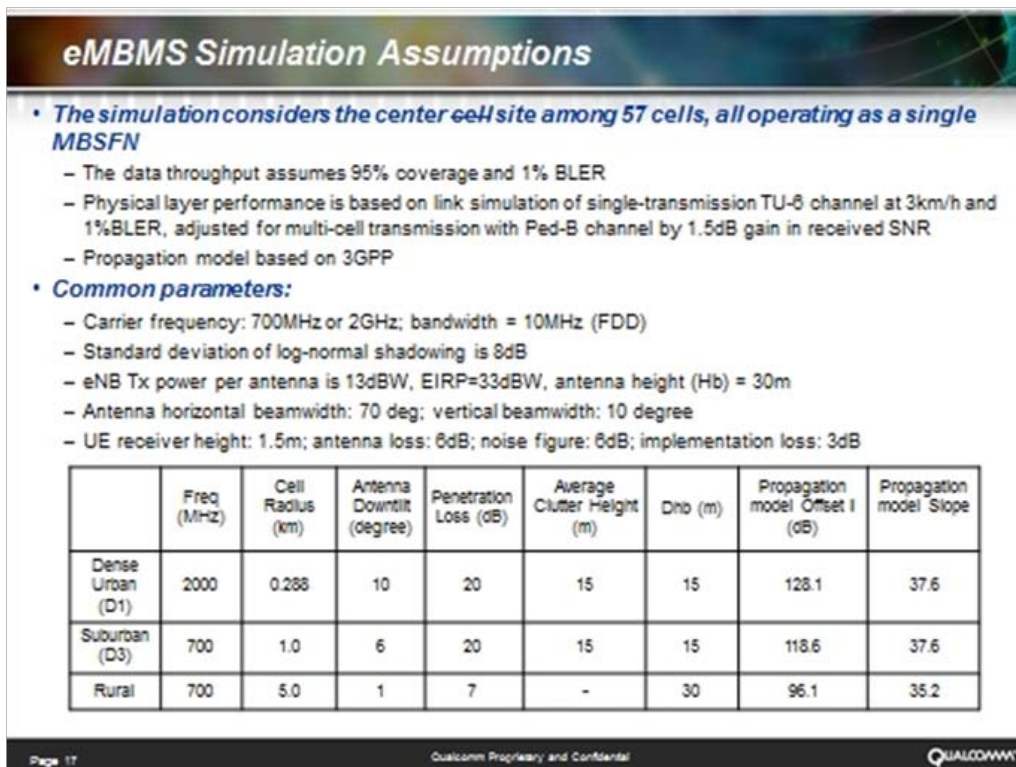

Figure A3-5: eMBMS configuration and performance for different deployments

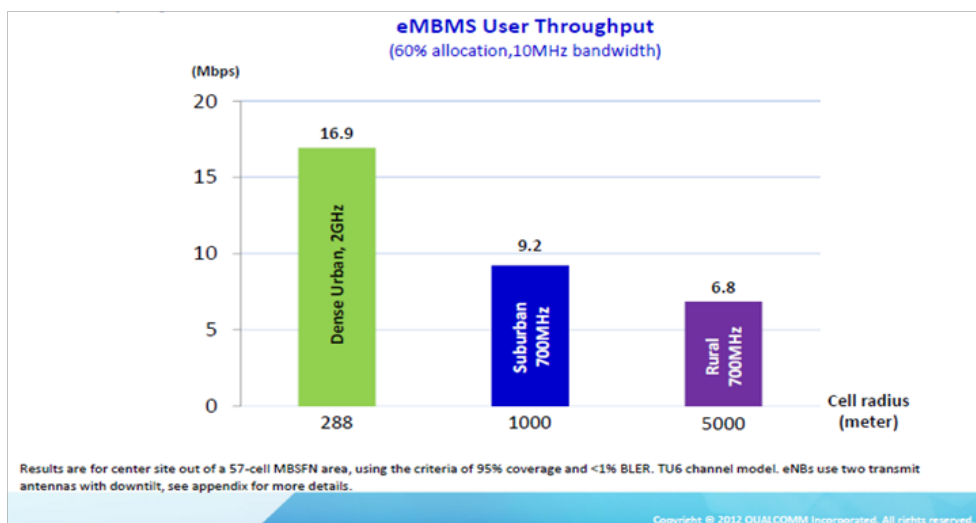

Figure A3-6: eMBMS configuration and performance for different deployments [22]

Annex 4: Blocked Spectrum Space and the Reuse Blocking Factor

A method of comparing the spectrum requirements of different transmission systems with geographically inhomogeneous spectrum requirements.

A4.1 General Method

Spectrum is a valuable resource. If the distribution of a service (e.g. television) can be achieved by several different transmission systems (e.g. mobile radio or broadcast), a method is required that allows a direct comparison of the spectrum requirements of those systems.

Such method has to take into consideration the fact that various systems may use a certain range of spectrum simultaneously in different parts of a coverage area or alternately in the same parts. Consequently, whilst the permission to use a certain range of spectrum in a large contiguous geographical area for 24 hours a day has an economic value, each element of spectrum usage in time and space is also an asset.

A4.2 Principle of the Method

The operation of a particular transmission system implies a certain geographical pattern of the use of the spectrum. Figure A4-1 a shows an arbitrarily chosen example. In system (a), Channel 1 is blocked everywhere by the transmission system (i.e. either actively used for transmission or blocked for any use in order to avoid interference), channel 2 is blocked in two stripes, channel 3 is blocked in the square where the stripes intersect each other. Another transmission system (b) may imply quite a different pattern of spectrum requirements. Because of the heterogeneity of the patterns it is not evident how the spectrum requirements of those systems could be compared.

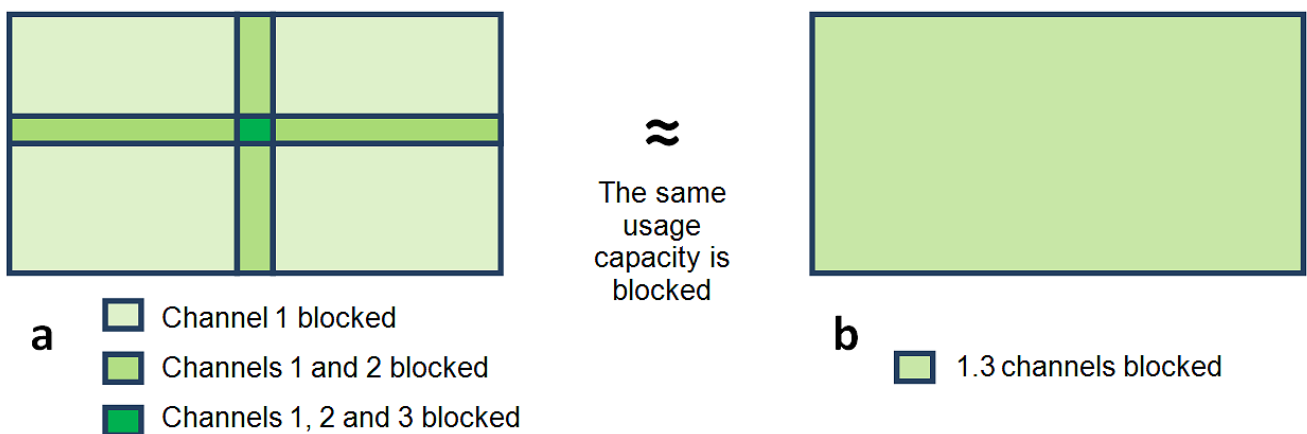

Figure A4-1: Heterogeneous use of spectrum by a particular transmission system (a) and corresponding homogeneous use (b) requiring the same usage capacity

Figure A4-1 shows the principle of the method proposed here which facilitates such a comparison of transmission systems with heterogeneous spectrum requirements. For both systems, **the size of the spectrum space** which is blocked by the system is calculated. From this result, it can be concluded how many channels would be blocked by a system which is supposed to use its spectrum homogeneously (use of the same number of channels everywhere) while blocking the same usage capacity as the system with heterogeneous use of spectrum. Consequently, the spectrum requirements of two transmission systems can be compared directly according to the size of the spectrum space blocked by them.

A4.3 Available and Blocked Spectrum Space

Generally, the product of the size of the available spectrum, the space where it is available and the period of time when it is available can be referred to as the part of the spectrum space which is available for one or several users [28], [29] :

$$(1) \quad \Delta SP = \Delta b * \Delta a * \Delta t$$

Where:

ΔSP = size of the available part of the spectrum space

Δa = area where the spectrum is available¹⁰

Δb = size of the spectrum which is available

Δt = time when the spectrum is available

Example:

In Germany, the 5 MHz block between 796 MHz and 801 MHz is assigned to the Deutsche Telekom for mobile radio (downlink) for the whole country for 24 hours a day. The overall blocked spectrum space is the product of 5 MHz, the area of Germany and 24 hours.

The proportionality of the size of the blocked spectrum space to the three parameters means that these parameters are on equal footing. To have e.g. three times as much spectrum is just as good as being able to use the same spectrum for an area three times as large or for a time which is three times as long. If this is not considered to be realistic under the given circumstances, the definition of the blocked spectrum space should be modified accordingly. E.g. it may be useful to take the population density into consideration as well.

An available size of the spectrum space, ΔSP , can be shared by several users for different purposes, each of them blocking part of the available section of the spectrum space as long as the sum of the blocked parts of the spectrum is smaller than or equal to the overall section of the spectrum space:

$$(2) \quad \Delta SP \leq \Delta SP_{b,1} + \Delta SP_{b,2} + \dots + \Delta SP_{b,n}$$

Where:

$\Delta SP_{b,i}$ = spectrum space blocked for transmission purpose i

However, the system designer is not free in choosing where, when and which parts of the spectrum shall be used. He can only plan the use of the specific capacities not blocked by the uses already in operation.

A4.4 Spectrum Space Blocked by Transmission Systems

The overall spectrum space blocked by a transmission system using several transmission channels is calculated in this way:

$$(3) \quad \Delta SP_b = \sum_{\text{all channels } i} \Delta b_i * \Delta a_i * \Delta t_i$$

It should be noted that the index i refers to a channel i . Δa_i may be a complex, irregular area where channel i is blocked (i.e. it is used actively or its use is forbidden in order to avoid

¹⁰ In the most general form of the definition, this is part of the three-dimensional space. The third dimension is not needed for the purposes dealt with here.

interference). Of course the areas Δa_i can overlap resulting in different numbers of blocked channels at different points.

For purposes of comparison, it is useful to define a bandwidth ΔB in this way:

$$\Delta B * A * T = \sum_{\text{all channels } i} \Delta b_i * \Delta a_i * \Delta t_i$$

Where:

A = complete area to be covered by the transmission system

T = complete time of coverage

(To be noted: $\sum_{\text{all channels } i} a_i \geq A$ because all areas shall be covered and there are sub-areas where certain channels must not be used in order to avoid interference).

The product on the left side of this equation is the size of the spectrum space blocked by the homogeneous use of a bandwidth ΔB on the whole coverage area A during the time T (24 hours a day).

Consequently:

$$(4) \quad \Delta B = \frac{\sum_{\text{all channels } i} \Delta b_i * \Delta a_i * \Delta t_i}{A * T}$$

By definition, ΔB specifies the "spectrum requirement" of the transmission system in the usual way: a section of the electromagnetic spectrum which can be used always and everywhere in the area to be covered. In reality, the size of the blocked spectrum varies from place to place in the covered area and ΔB is the spectrum requirement in terms of "always-everywhere spectrum".

Up to this point the formalism is quite general. It is possible e.g. that transmission in broadcast and unicast mode is used within the same system.

A4.5 Distribution in Broadcast Mode and the Reuse Blocking Factor

In broadcast mode, the transmission takes place continuously: $\Delta t_i = T = 24 \text{ h/day}$.

Mostly, channels of equal size are used: $\Delta B_i = \Delta B$

Insertion of these conditions into equation (3) yields:

$$(5) \quad \Delta SP_b = \Delta b * T * \sum_{\text{all channels } i} \Delta a_i$$

Which bandwidth ΔB homogeneously used in the whole coverage area A corresponds to this blocked size of spectrum space?

$$\Delta SP_b = \Delta b * T * \sum_{\text{all channels } i} \Delta a_i = \Delta B * A * T$$

$$\Delta B = \Delta b * \frac{\sum_{\text{all channels } i} \Delta a_i}{A} = \Delta b * RBF$$

$$(6) \quad \Delta B = \Delta b * RBF$$

$$(7) \quad RBF = \frac{\sum_{\text{all channels } i} a_i}{A}$$

It is proposed to call this parameter RBF the “Reuse blocking factor” because it depends only on the reuse value of the transmission system and the required geographical structure of the coverage (e.g.: which TV programmes shall be available where?). Consequently, the reuse factor is the only system-specific quantity on which this parameter depends.

The spectrum efficiency of the transmission system is defined as

$$(8) \quad SE = \frac{D}{\Delta b}$$

$$\Delta b = \frac{D}{SE}$$

Where:

D = data rate delivered by the transmission system.

Insertion into equation (6) yields:

$$(9) \quad \Delta B = D * \frac{RBF}{SE}$$

This equation makes clear that for any broadcast transmission system the spectrum requirement depends on the ratio of the reuse blocking factor (which itself depends on the reuse distance of that system) and the spectrum efficiency of the system.

A4.6 Distribution in Unicast Mode

The spectrum space blocked by a broadcast network or by a mobile radio network in broadcast mode is constant in time. In contrast, the size of the spectrum space blocked by a mobile radio network in unicast mode varies all the time. If the details of this variation are not of interest, this case can be dealt with in a statistical way:

$$(10) \quad \overline{\Delta SP_b} = \overline{\Delta b} * A * T$$

(averaged over a whole day or part of it, depending on the interest in the study)

Where:

$\overline{\Delta b}$ = average size of spectrum used in each cell for coverage in unicast mode

A = overall area covered in unicast mode

This is true if the average (over time) size of the spectrum used in each cell is the same in the whole area covered in unicast mode.

A4.7 Application of the Method to TV Distribution

The role of the layer structure

A network for TV distribution is designed e.g. to cover a country by national (everywhere the same content) and regional (content varying from one region to the other) layers of TV programmes. It makes sense to calculate the sizes of the blocked sections of the spectrum space separately for these layers because a given layer structure implies a certain reuse blocking factor (in broadcast mode). The spectrum efficiencies may also be different for national and regional layers if certain transmission parameters (e.g. the guard interval for single frequency networks) are adapted to their basic structure (e.g. the maximum distance between antennas).

A4.8 Distribution by Mobile Radio Networks

For broadcast mode only

As explained above the blocked spectrum space and ΔB can easily be calculated if the reuse blocking factor RBF is known. In order to determine the reuse blocking factor RBF for such a system, the details of the coverage have to be defined. It is assumed in the following that sub-areas of different TV content are separated as shown by Figure A4-2. In order to avoid interference, a channel $f(1)$ can be used everywhere except for a stripe at the border between the sub-areas where a different channel $f(2)$ is used instead. The $f(2)$ -stripe is accompanied on both sides by a stripe where $f(2)$ must not be used.

This geographical coverage pattern only makes sense because it can be assumed that the reuse distance is small compared to the diameter of the sub-areas. This is indeed the case because mobile radio networks consist of many low towers of low transmitting power resulting in a short reuse distance.

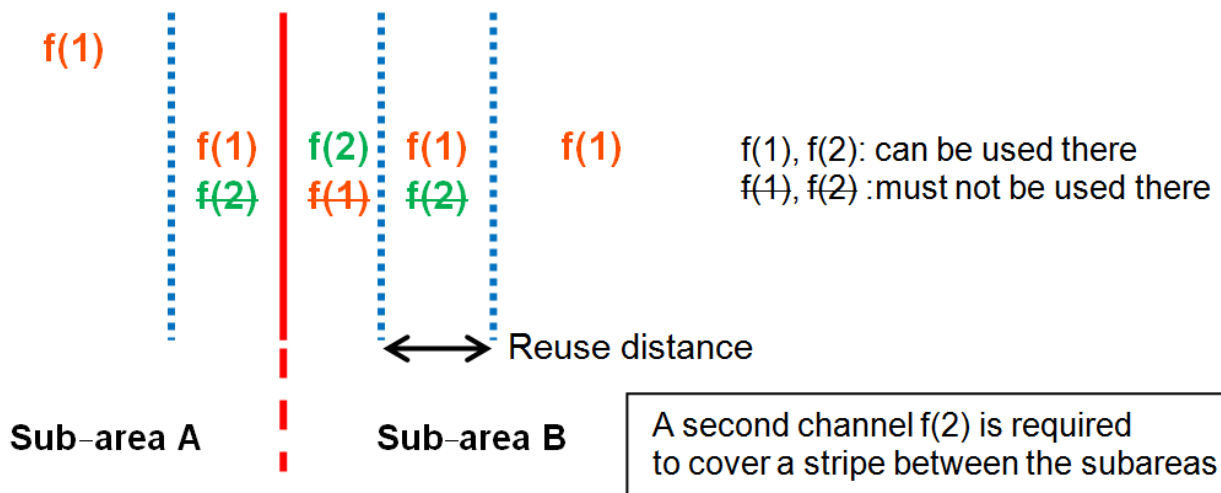

Figure A4-2: Separation of sub-areas of different content for mobile radio distribution: stripes

It has to be taken into consideration as well that three sub-areas may be adjacent. A third channel $f(3)$ is required to complete a coverage at such points as shown in Figure A4-3. Around the area where $f(3)$ is used, there is a guard zone where the use of $f(3)$ is not possible.

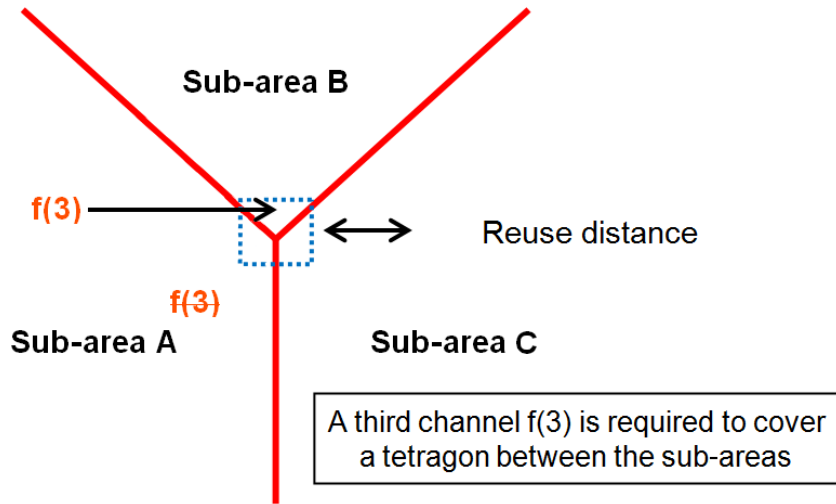

Figure A4-3: Separation of sub-areas of different content for mobile radio distribution: edges

From the conditions shown by Figures A4-2 and A4-3, the reuse blocking factor (RBF) can be calculated for a national and for a regional layer.

For a national layer, only national borders and edges have to be taken into consideration:

$$(11) \quad RBF = \frac{\sum_{\text{all channels } i} a(i)}{A} = \frac{a(1) + a(2) + a(3)}{A} = \frac{A + \frac{3 * L_{ext} * r}{2} + \frac{C_{ext} * (3 * r)^2}{3}}{A}$$

Where:

A = complete area of coverage

a(1) = channel to be used everywhere except for stripes along the national borders

a(2) = channel to be used inside the stripes along the national borders

a(3) = channel to be used inside the corners

L_{ext} = length of national borders

r = reuse distance

C_{ext} = numbers of corners at the national borders (three countries involved)

Division by 2 resp. 3 = loss divided between neighbouring countries

For a **regional layer**, internal borders between sub-areas of different content have to be considered too:

$$(12) \quad RBF = \frac{\sum_{\text{all channels } i} a(i)}{A} = \frac{a(1) + a(2) + a(3) + a(4)}{A} = \frac{A + \frac{3 * L_{ext} * r}{2} + 3 * L_{int} * r + \frac{C_{ext} * (3 * r)^2}{3} + C_{int} * (3 * r)^2}{A}$$

Where:

A = area to be covered by the layer

a(1) = channel to be used everywhere except for stripes along the national borders

a(2) = channel to be used inside the stripes along the national borders

a(3) = channel to be used inside the corners

L_{ext} = length of national borders

L_{int} = length of internal borders

r = reuse distance

C_{ext} = number of corners at the national borders (three countries involved)

C_{int} = number of corners at the internal borders (three provinces involved)

For unicast mode only

For TV programmes watched by very few people, unicast distribution can be suitable. For this case, equation (10) is valid:

$$\overline{\Delta SP_b} = \overline{\Delta b} * A * T$$

(averaged over a whole day or part of it, depending on the interest in the study)

Where:

A = overall area covered in unicast mode

This is true if the average size of spectrum used in each cell is the same in the whole area covered in unicast mode.

$$\overline{\Delta b} = \frac{\overline{D_u}}{\overline{SE}}$$

Where:

$\overline{\Delta D_u}$ = average data rate to be distributed in one cell of the network for all simultaneous users of TV programmes distributed in unicast mode

\overline{SE} = average unicast spectrum efficiency

$$\overline{\Delta D_u} = \overline{p_u} * d$$

Where:

$\overline{p_u}$ = average number of users per cell of TV programmes distributed in unicast mode

d = data rate per TV programme

Consequently:

$$\overline{\Delta b} = \frac{\overline{D_u}}{\overline{SE}} = \frac{d * \overline{p_u}}{\overline{SE}}$$

Insertion into equation (10) yields:

$$(13) \quad \overline{\Delta SP_b} = \frac{d * \overline{p_u}}{\overline{SE}} * A * T$$

Which bandwidth ΔB homogeneously used in the whole coverage area A corresponds to this blocked spectrum space? This definition of ΔB implies the following equation:

$$\Delta B * T * A = \frac{d * \overline{p_u}}{\overline{SE}} * A * T$$

(14)

$$\Delta B = \frac{d * \overline{p_u}}{\overline{SE}}$$

Where:

d = data rate per TV programme

\overline{SE} = average unicast spectrum efficiency

$\overline{p_u}$ = average number of users per cell of TV programmes distributed in unicast mode

Combination of Broadcast and Unicast Mode

It may be reasonable to create patchwork layers of unicast mode and broadcast mode:

$$\Delta SP_b = \Delta SP_b(broadcast) + \Delta SP_b(unicast)$$

For example, the same set of TV programmes may be distributed in broadcast mode in urban areas and in unicast mode in rural areas.

If the variation in time (due to the unicast part of the distribution) of the blocked spectrum space is not of interest, this case can be dealt with in a statistical way:

$$(15) \quad \overline{\Delta SP_b} = \Delta SP_b(broadcast) + \overline{\Delta SP_b(unicast)}$$

(averaged over time)

There may be regional borders for different content within each area. For unicast distribution, such borders don't matter but for broadcast distribution they do (guard distance required where different channel is used).

It has to be taken into consideration that a guard distance is needed to separate unicast areas from broadcast areas. *It is understood in the following that such an outer guard zone is part of each broadcast area.*

In broadcast mode, the transmission takes place continuously: $\Delta t_i = T = 24 \text{ h/day}$

Mostly, channels of equal size are used: $\Delta b_{bi} = \Delta b_b$

Consequently according to equation (5):

$$\Delta SP_b(broadcast) = \Delta b * T * \sum_{\text{all channels } i} \Delta a_i$$

Where:

Δa_i = sub-area where broadcast channel i is used, or must not be used to avoid interference

Spectrum space blocked by unicast distribution according to equation (13):

$$\overline{\Delta SP_b(unicast)} = \frac{d * \overline{p_u}}{SE} * A_u * T$$

Where:

d = data rate per TV programme

$\overline{p_u}$ = average number of users per cell of TV programmes distributed in unicast mode

\overline{SE} = average unicast spectrum efficiency

A_u = overall area to be covered in unicast mode

A_u is a part of the overall area A which is covered by the combined broadcast / unicast system.

Consequently, from equation (15):

$$\overline{\Delta SP_b} = \Delta SP_b(broadcast) + \overline{\Delta SP_b(unicast)} = \Delta b * T * \sum_{\text{all channels } i} \Delta a_i + \frac{d * \overline{p_u}}{SE} * A_u * T$$

What bandwidth ΔB homogeneously used in the whole coverage area A corresponds to this blocked

size of spectrum space?

$$\Delta B * A * T = \Delta b * T * \sum_{all\ channels\ i} \Delta a_i + \frac{d * \overline{p_u}}{SE} * A_u * T$$

$$\Delta B = \Delta b * \frac{\sum_{all\ channels\ i} \Delta a_i}{A} + \frac{A_u}{A} * \frac{d * \overline{p_u}}{SE}$$

$$(16) \quad \Delta B = \Delta b * RBF + \frac{A_u}{A} * \frac{d * \overline{p_u}}{SE}$$

Where:

Δb = size of broadcast channel

RFB = reuse blocking factor for the areas covered in broadcast mode

$\frac{A_u}{A}$ = ratio of unicast part of the overall area to be covered by the system

d = data rate per TV programme

$\overline{p_u}$ = average number of users per cell of TV programmes distributed in unicast mode

\overline{SE} = average unicast spectrum efficiency

Condition (already mentioned above): an outer guard zone is part of each broadcast area.

The correctness of equation (16) is evident; the spectrum requirement of the combined broadcast/unicast system is the sum of the requirements of the broadcast and the unicast subsystems. The requirement of the broadcast part is the product of the channel size and the reuse blocking factor, not different from equation (6). The fact that the broadcast part of the system covers only part of the overall area to be covered by the combined broadcast/unicast system is taken into account by the reuse blocking factor that contains only sub-areas in the broadcast part of the overall area. The requirement of the unicast part is the average (over time) size of spectrum blocked in a cell weighted by the share of the area where the programmes are distributed in unicast mode.

A4.9 Distribution by Broadcast Networks

The formulas (11) and (12) cannot be applied for broadcast distribution because the condition that the reuse distance is small compared to the diameter of the sub-areas is not met by a high tower high power transmission network. Consequently, there is no analytical formula for this case and the calculation of the reuse blocking factor has to be done in a more experimental way. The following figures show the principle¹¹.

¹¹ Study by J. Frank, S. Prokesch and R. Brugger (IRT), 2013

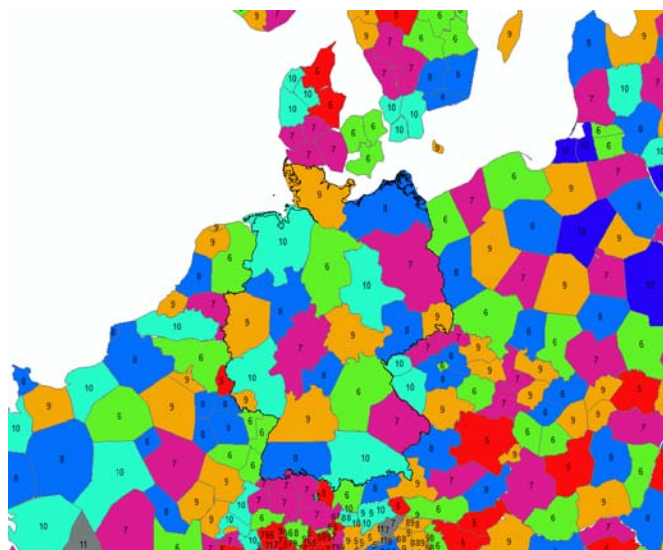

Six channels required (but not everywhere)

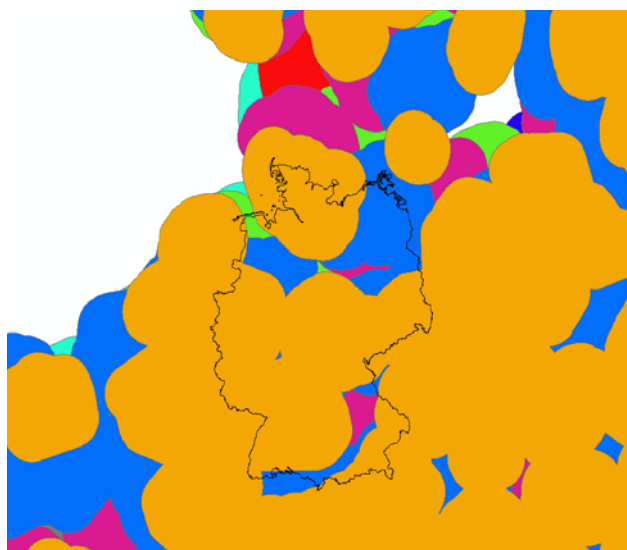

Belt around each allotment shows where the channel is blocked

Figure A4-4: How to calculate the reuse blocking factor for a broadcast (High Tower High Power) network: step 1

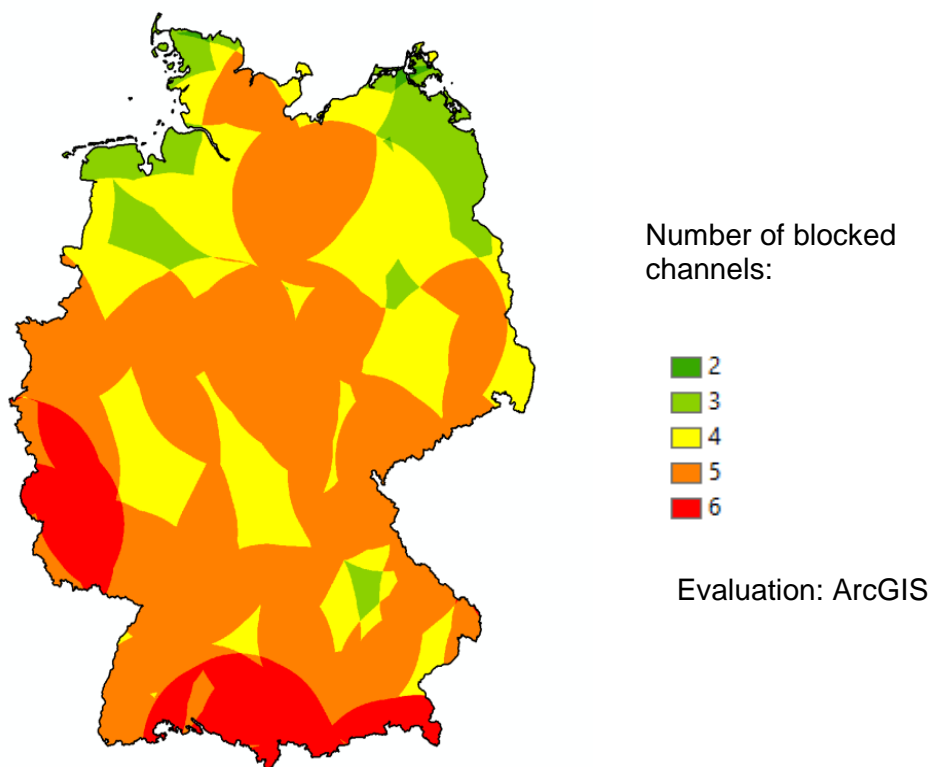

Figure A4-5: How to calculate the reuse blocking factor for a broadcast (High Tower High Power) network: step 2

As an example, Figure A4-4 shows a layer structure given by RRC-06¹² allotments. In a first step, a belt is defined around each allotment indicating where a channel is blocked which is used inside the allotment. As an example, the RBF shall be calculated for Germany. Consequently, the results for Germany are dealt with separately in a second step. The question is how many channels are blocked for each point within this country. From this intermediate result, the RBF can be derived.

¹² RRC-06 = Regional Radio Conference of the ITU in 2006

The evaluation was done at the IRT by means of the software ArcGIS¹³. Topography and morphology of the respective areas were not taken into consideration in this calculation.

A4.10 Results for TV Distribution in Germany as an Example

Distribution by mobile radio networks

The following analysis is done for broadcast mode only.

It is assumed that two national layers and one regional layer are required. The data rate to be transmitted for each layer is 24 Mbit/s.

The following data are rough estimates for Germany.

- Overall length of the national borders (smoothed): 2300 km
- Overall lengths of internal borders between the Bundeslaender (smoothed): 3200 km
- Number of corners at the national borders (three countries involved): 7
- Number of corners at the internal borders (three provinces involved): 13
- Overall area: 357000 square kilometres

The blocking factors were calculated according to equations (11) and (12) for various inter-site distances (ISD). The reuse distance was assumed to be twice the ISD. Table A5-1 shows the results.

Table A4-1: Blocking factors and blocked spectrum ΔB for various inter site distances of mobile radio networks

Inter-site distance (ISD)	2 km	5 km	10 km
Spectrum efficiency (bit/s/Hz) ¹⁴	3	1.5	0.4
Reuse distance (km)	4	10	20
NATIONAL LAYER:			
Reuse blocking factor	1.04	1.10	1.22
Blocked spectrum ΔB (MHz)	8.32	17.64	73.01
REGIONAL LAYER:			
Reuse blocking factor	1.15	1.40	1.89
Blocked spectrum ΔB (MHz)	9	22	113
Blocked spectrum ΔB (MHz) for 1 regional and 2 national layers	23	58	259
<i>Reduction of blocked spectrum ΔB (MHz) compared with distribution by d DVB-T2 broadcast network (see section "Distribution by broadcast networks") - See also Table A4-3</i>	62	27	-174

¹³ ArcGIS is a software for processing of geospatial data developed by the company ESRI (<http://www.esri.com/software/arcgis/>)

¹⁴ Reference [14], p. 13, fig. 6

Table A4-2: Summary of key assumptions used in performance simulations for the spectrum efficiency values assumed in the table above

Parameter	Default Values	Remarks
Shadowing fading	Log-normal, $\sigma=8$ dB	
Cross correlation between cell sites and sectors	0.5 (between different cell sites) 1.0 (between sectors on same cell site)	Correlated shadow fading values generated using a common random variable approach
Penetration loss	6 dB	in-car reception
Cell site height	15 m above roof top	
Receive antenna height	1.5 m	
Channel model	3GPP Spatial Channel Model C (SCM-C); 15° angle spread	SMC-C: "urban macro"
Propagation loss	3GPP TR 36.942 urban	no terrain or clutter
Noise figure	9 dB	
UE locations	Dropped randomly within the simulated area	
Area coverage	95%	% of uniformly distributed users have BLER <BLER target
BLER target	1e-3	
Cyclic prefix	16.7 μ s	
Number of site rings	2	19 sites, 3 sectors each, wrap around

The values of blocked spectrum ΔB were calculated according to the principles explained above (section A4.4 "Spectrum space blocked by transmission systems") in the following way:

- Calculate the reuse blocking factor.
- Calculate the spectrum space blocked by the transmission system.
- Calculate the bandwidth ΔB homogeneously used in the whole coverage area A corresponding to this blocked size of spectrum space.

The results show that an inter site distance (ISD) of 10 km will hardly be worth considering because it would require too much spectrum. An ISD of 2 km would yield a high advantage with respect to the blocked spectrum but may be too expensive. An ISD of 5 km appears most realistic.

Distribution by broadcast networks

Table A4-3: Blocking factor & blocked spectrum ΔB for DVB-T2 broadcast networks in Germany

Spectrum efficiency for a regional layer (bit/s/Hz)	3.3
Spectrum efficiency for a national layer (bit/s/Hz)	2.1
Reuse distance (km)	120
NATIONAL LAYER:	
Reuse blocking factor	2.14
Blocked spectrum ΔB (MHz)	24
REGIONAL LAYER:	
Reuse blocking factor	5.00
Blocked spectrum ΔB (MHz)	36
Blocked spectrum ΔB (MHz) for 1 regional and 2 national layers	85

The results are valid for portable indoor reception in urban areas and for portable outdoor/mobile reception in rural areas.

Annex 5: The 'Border Challenge'

The spectral efficiency of MBSFN transmission and the resulting coverage of the transmitted broadcast services rely on the constructive combination of the signals received from surrounding cells and on the absence of significant interference received from those cells on the same time-frequency resources. In the centre of a large SFN area these conditions are guaranteed by the synchronous transmission of equal content from all surrounding cells (in all directions) and propagation delay differences that fall within the cyclic prefix length of the OFDM access scheme to avoid inter-symbol interference at least for the most significant received signal components. The MCS selection for a broadcast service in the SFN area has to make a trade-off between the spectral efficiency (i.e. the amount of resources occupied for this service) and the coverage (i.e. the fraction of the area in which the service can be received with sufficient quality) - in other words, the target coverage limits the spectral efficiency that can be achieved in a SFN area. There is no principle limit for the size of an MBSFN area if properly designed.

However, for the distribution of linear TV services, at least for Public Service Broadcast, different regions must be served with different content, e.g. national TV programmes need to be limited to the corresponding country area or regional programmes that are transmitted only in certain regions (e.g. states of a country) and differ from the programme in other regions. Not all of these services need to be available in every place, only in the respective service area. It suffices that national services are provided only in a particular country area, and regional services only in the corresponding sub-region. Applying eMBMS for the TV distribution means that SFN areas would be configured to cover the corresponding service area for a set of (national or regional) TV services. This leads to the introduction of borders between neighbouring SFN areas in which different content is transmitted.

This presents requirements for the design and efficient operation of the broadcast network to optimize the broadcast performance and minimize the impacted border areas; two alternatives are:

- (1) Different content is transmitted on the same time-frequency resources - then it introduces interference for the service received in the neighbour cell and thereby degrades its coverage (when the MCS is maintained) or its spectral efficiency (when the MCS must be reduced to compensate the lower SINR), or,
- (2) different content is transmitted on other (orthogonal) time-frequency resources - then the spectral efficiency is degraded by using twice the amount of resources for the service distribution (at least in part of the area).

We will discuss these options and assess their impacts and merits in more detail below.

A5.1 Basic Solution Options and Variants

In the following considerations for the treatment of borders between SFN areas, the concept of reuse of radio resources plays a major role. Radio resources in OFDM systems (such as LTE or DVB-T) are resource units in the time-frequency domain that are typically assumed as (approximately) orthogonal - meaning that transmissions on different resource units do not interfere with each other.

For eMBMS, the resource units on a single OFDM carrier are subframes (of 1 ms) over the entire carrier bandwidth and they can be split in the time domain between broadcast and unicast subframes (as illustrated in Figure A5-1).

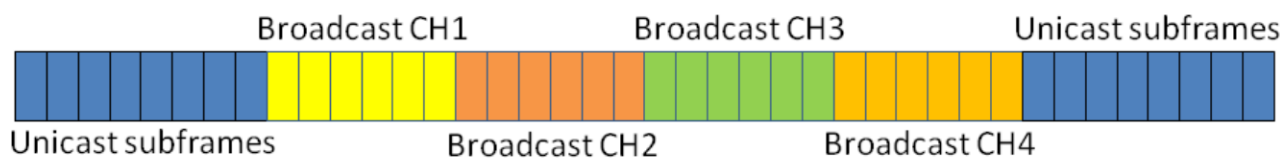

Figure A5-1: Example for MBMS CSA pattern (Common Subframe Allocation).

Cells of different SFN areas may have different CSA patterns for their unicast and broadcast subframes, but to take advantage of time domain resource reuse between adjacent SFN areas they must use aligned unicast subframes and orthogonal subsets of broadcast subframes within the same CSA pattern (as shown in Figure A5-2).



Figure A5-2: Broadcast resource reuse in the time domain

Alternatively, the resource reuse can be applied in the frequency domain by allocating the adjacent SFN areas on different carriers - in this case each SFN area can use all broadcast resources on the respective carrier, but the corresponding subframes on the carrier(s) of the neighbouring SFN area must remain unused (as shown in Figure A5-3).



Figure A5-3: Broadcast resource reuse in the frequency domain

Note that the current 3GPP standards do not support Carrier Aggregation for MBMS, so every single broadcast channel must be allocated on a single carrier, whereas multiple channels in a SFN area can be mapped on different carriers. In this way, the limited broadcast capacity on a single carrier and the required capacity per channel restrict the maximum reuse level in the time domain, whereas frequency-domain reuse can scale with the available spectrum and thus provides the more flexible approach.

In the following description we do not care about this distinction, but consider the reuse only in the abstract sense, i.e. by just relying on the orthogonality of the used broadcast resources in neighbouring SFN areas that may be in different sub-frames or on different carriers or both.

As already indicated in the introductory section, there are two principal options how the border between regions with different broadcast content can be treated: either on the same resources (so-called reuse 1) or on orthogonal resources as illustrated above (reuse 2 or higher) or applying a guard stripe between the areas. These cases will now be discussed in more detail.

A5.2 Case A) SFN area per editorial region: different content on same resources (reuse 1)

If the same resources are applied for different broadcast content in a direct neighbour cell, this leads to a reduction of the MBSFN SINR in the affected border cell and thus a reduced coverage of the broadcast service compared with a cell in the centre of the same SFN area. This effect is shown in the SINR heatmap plot below, where the red, yellow and green colours indicate sufficient coverage and the blue colours service outage.

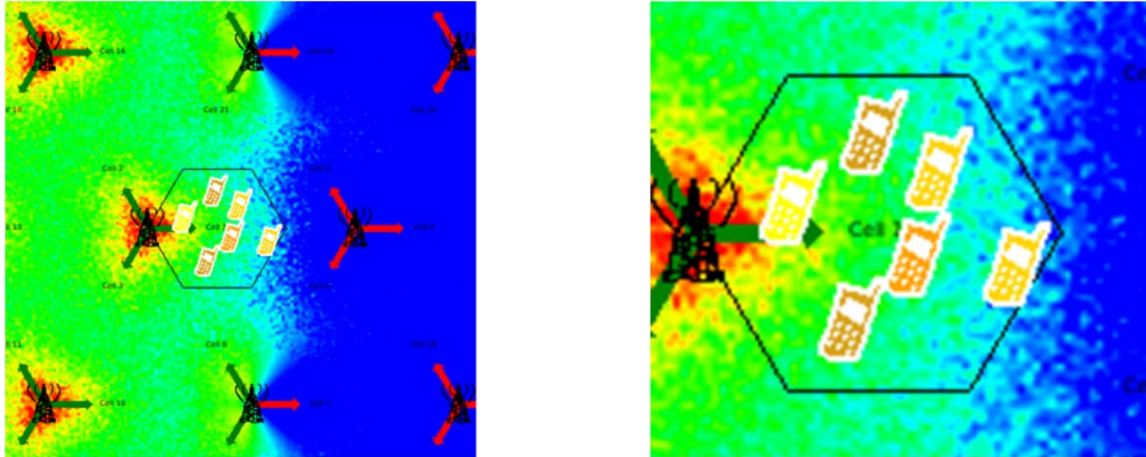

Figure A5-4: Heat map plot of MBSFN SINR at SFN area border with reuse 1

Note that the green arrows indicate cells that belong to the target SFN area, whereas the red arrows are cells that transmit interfering content from the neighbouring area. In this example we see that more than half of the area in the immediate border cell is in outage (for the broadcast service in the target SFN area), when applying a MCS with ~ 1.5 bit/s/Hz spectral efficiency.

So the reuse 1 can be applied in cases where the border area is lowly populated. The TV service coverage for the remaining few users in this area can be further improved either by unicast transmission of only the actually requested services in an affected cell. Or directed antennas for roof top reception or set top boxes can be used to avoid interference.

The possibility of complementing insufficient broadcast coverage with local demand-driven unicast (in orthogonal resources) is a solution that may also be beneficially applied in other scenarios, e.g. in areas with large ISD that may suffer from reduced coverage, but are also sparsely populated. This solution requires that the terminals are equipped with full unicast capability (including UL transmitter), and the network supports service continuity between broadcast and unicast transmission (and vice versa). Note that such capabilities may be in the interest of the operator and consumer in multiple scenarios to improve services and coverage.

A5.3 Case B) SFN area per editorial region: different content on orthogonal resources (reuse > 1)

If the coverage reduction or the unicast service provision in the previous option is not acceptable or possible, the reuse of broadcast resources in the immediate neighbourhood of a SFN area must be avoided and hence, orthogonal resources must be allocated for broadcast provision in the adjacent SFN area.

The first and obvious solution for such resource reuse follows the same principle as in conventional TV broadcast systems with HPHT deployment: use different (orthogonal) resource sets for the broadcast in adjacent regions with different content. In this way, the border cells in such a region do not suffer from interference on the own broadcast resources that would more or less destroy the border coverage as in the reuse 1 option, but they have fewer surrounding cells that contribute to the SFN reception - in fact they get fewer constructive contributions on the received signal, but

also less ISI from farther distant cells.

Simulations show that there is indeed a slight coverage degradation in a border cell compared with a cell in the centre of the SFN area, but this can effectively be compensated by configuring the SFN areas for the neighbouring editorial regions with a (small) overlap, such that the immediate border cells of both regions transmit the content of both regions simultaneously in the respective orthogonal resource sets of the corresponding SFN areas (see Figure A5-5). In this way, the border cells of an SFN area can achieve the same coverage as the centre cells, so they do not imply stronger constraints on the MCS selection and the resulting spectral efficiency for the broadcast services.

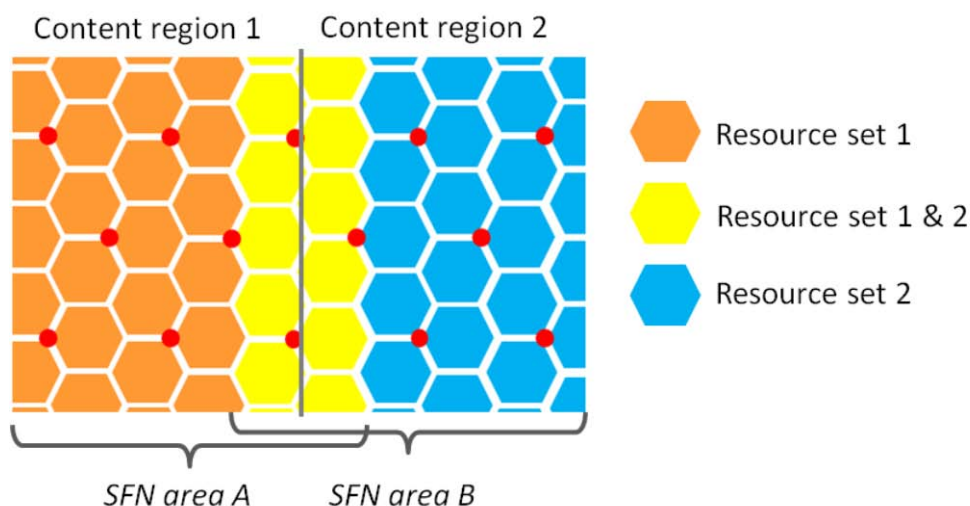

Figure A5-5: Reuse between SFN areas with overlap

It is worth noting that this overlap solution does not require any additional resources assigned for the broadcast services, as it just applies active transmissions on the other resource set that without the overlap would remain muted. The extension of the SFN area into the neighbour region may have some impact on the reuse of the same resources for other (unicast) purpose in the neighbour region - this will be discussed in the later section on Blocking Areas. It should also be noted that the overlap approach can typically not be applied on national borders - unless the same operator serves both countries and has the same spectrum licensed in both countries. However, on region borders within a national network it can be well applied and achieve its merits.

A5.4 Case C) Separate SFN area for guard stripe between editorial regions (reuse >1 only in guard stripes)

For the reuse option with interference avoidance between neighbouring SFN areas there is another solution variant that can be regarded as an intermediate between the two base options:

In this variant all editorial regions apply the same set of resources (reuse 1) in their inner area like in the first option, but introduce guard areas along the borders in-between that are served on orthogonal resources (reuse >1) and protect the borders of the main areas on either side from mutual interference (as shown in Figure 6-6).

Note that the guard stripe in this example belongs entirely to one of the editorial regions, so the associated SFN area C transmits the same broadcast content as SFN area B, but on orthogonal resources. To make the configuration symmetric, another guard stripe with yet another set of orthogonal resources would need to be introduced at the other side of the border in editorial region 1 - but this would just require higher reuse factor without further improving the interference conditions and service coverage, so it is rather recommended to stay with the asymmetric solution and the guard stripe on only one side of the border.

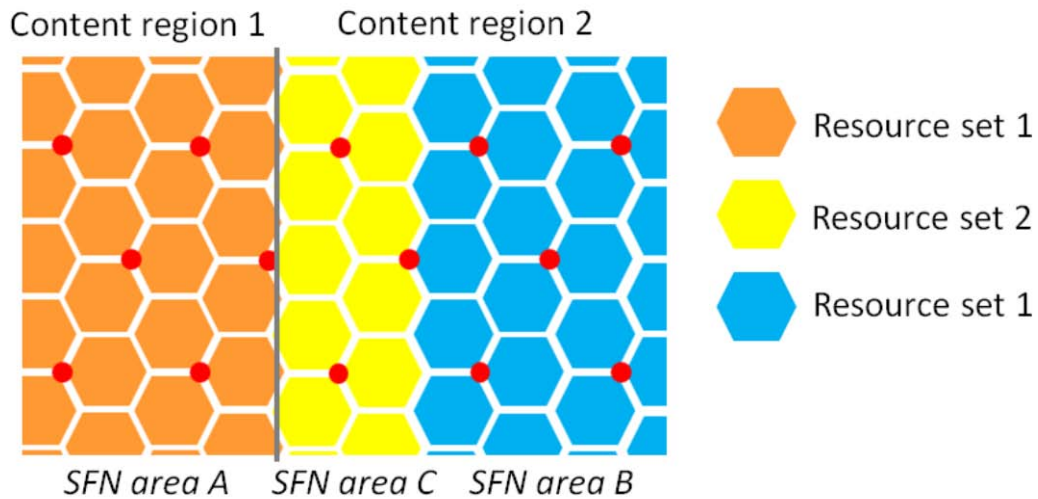

Figure A5-6: Reuse between SFN areas with guard stripe

As in the previous case the borders between the directly neighbouring SFN areas may have slightly lower coverage due to the missing constructive signal contributions from one side. This problem can be mitigated in the same way as in *Case B*) by configuring an overlap between the neighbouring SFN areas (A and C as well as B and C) and letting the immediate border cells of each SFN area also transmit the content of its neighbour area on the respective other set of resources.

The basic options have here been shown for the example of a straight border between two editorial regions. Looking at an entire country with many sub-regions or even across multiple country borders it will be necessary to also consider border areas where more than two editorial regions meet. In the following sections we will discuss the issues of resource utilization efficiency - namely the overall reuse factor for broadcast resources taken over entire countries and clusters of countries including their contained sub-regions with different broadcast content, and particularly the fractional reuse of the multiple reserved broadcast resource sets for other purposes (such as unicast or local broadcast transmission) in parts of the area in sufficient distance from their primary broadcast usage.

A5.5 Reuse between SFNs

Clearly the *Case A*) option described above with reuse 1 across all neighbour regions and TV service coverage by unicast in the border areas is the favourable solution to achieve optimal usage of spectrum resources but may not be applicable for all border cases. We need to take a closer look at the options with reuse > 1 at the borders and assess the overall reuse factor (= number of required orthogonal resource sets) that is needed for the entire area of a country or a cluster of countries sharing a common block of spectrum for their (national and regional) broadcast services.

We assume that in each country a certain amount of broadcast capacity C_N is required for the national layer of services that are distributed country-wide in a single SFN area, and another amount of capacity C_R is needed for regional services that are only provided in sub-regions of the country covered by separate SFN areas, such that any location in the country can receive all national services of that country and the regional services of one region to which it belongs. (In border areas it may also receive services from the neighbour region or country, but these need not be guaranteed with any coverage targets like for the own region and country).

For simplifying the assessment we assume that the required broadcast capacity C_N is the same in all countries, and C_R the same in all regions. This is not true in reality, but when taking these capacities as the maximum over all countries (or regions, respectively) in the considered cluster, we can at least determine an upper bound for the total spectrum requirements.

For the broadcast capacities C_N and C_R in the national and regional layers, depending on the spectral efficiency of the SFN transmissions a certain amount of resources (subframes in the time domain and carriers in the frequency domain) must be reserved for this layer in any of the regions. This determines the minimum amount of required broadcast spectrum S_N and S_R for the national and regional layers that would be sufficient when reuse 1 is applied (as described for *Case A*), but does not take into account the additional unicast resources needed to provide the actually requested TV services to those users that are out of broadcast coverage in the border areas. In contrast, for the reuse solution described in *Case B*) no unicast resources are required, but instead different orthogonal resource sets are applied to avoid interference between neighbouring countries or regions, so the total spectrum requirement is n times S_N and S_R , respectively, when the reuse factor is n .

Generally, determining the required reuse factor for the neighbourhood relations in a given region topology corresponds to solving a colouring problem for that region topology, where regions must be assigned different colours whenever they share a common border. It is well known that such colouring can in nearly all cases be achieved with a maximum of four colours, corresponding to four orthogonal sets of resources for each of the layers (i.e. national and regional).

Typically, in most cases with only simple two-region borders or 3-region corners, even 3 colours will do.

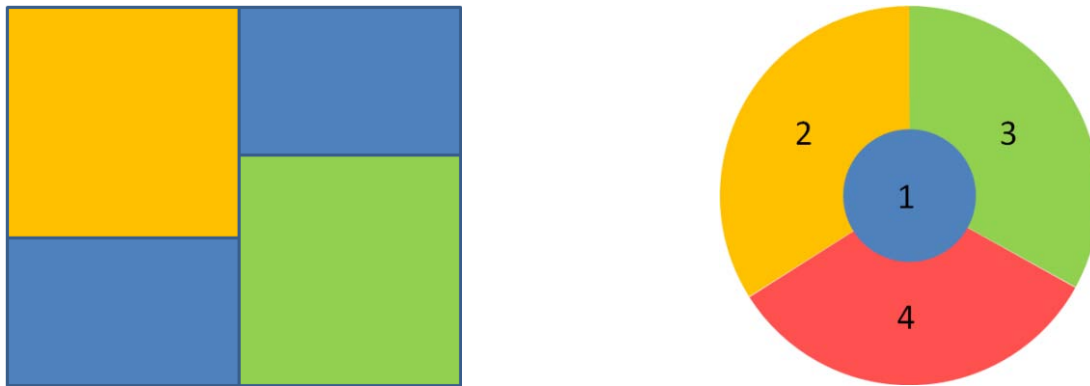

Figure A5-7: Region colouring problem: a) 3 colours, b) 4 colours

In fact, the colouring and the resource reuse problem for neighbouring SFN areas are not quite equivalent: for the reuse of same broadcast resources the corresponding SFN areas should not only have no common border, but also be far enough apart that they don't significantly interfere with each other and mutually degrade the spectral efficiencies obtained in these areas. This critical distance will be discussed and assessed in more detail in the following chapter, but obviously it is much smaller for an eMBMS deployment with ISD of only a few kilometres than in an HPHT deployment of DVB-T(2) with coverage ranges in the order of 100 km around the antenna sites. For example, in the topology depicted in Figure A5-7a a fourth resource set would be required for one of the blue areas, if the two 3-region corners were less than about 1.5 ISDs apart, which can be easily avoided for region layouts when the ISD is less than 10 km (like in LTE deployment), but not for ISDs of 50 km or more.

Similarly when considering a further outer neighbour region in the 4-colour example of Figure A5-7b, this can be assigned the same resource set as the inner region (blue colour) if the width of the intermediate regions 2, 3 and 4 is larger than the critical distance - which is highly probable for LTE deployments - but in an HPHT deployment may easily require (at least) a fifth resource set, when only one of the intermediate regions is smaller than the reach of the transmitters covering the blue inner region.

So depending on the topology and region size on the national and regional layer, typically four sets of orthogonal resources are needed for each of these layers. In favourable topologies (more probable for LPLT deployment in LTE) three orthogonal sets may do - in unfavourable cases (more

probable for HPHT) five or more sets may be necessary. However, this difference is compensated by the higher spectral efficiency of DVB-T2 over LTE MBSFN that requires less spectrum for each of the orthogonal resource sets - so the overall spectrum need (size of resource set * reuse factor, not considering the actual utilization!) will be the same or rather higher for the LTE deployment with reuse according to *Case B*).

Considering reuse according to *Case C*) with orthogonal broadcast resources only applied in the guard stripes along the borders and reuse 1 with same resource sets in the inner area of all regions, we achieve a more favourable topology for the SFN areas that make a maximum reuse factor of 3 possible for a LTE deployment with sufficiently small ISD. This is illustrated in Figure A5-8 for the same region layouts as in corresponding Figure A5-10:

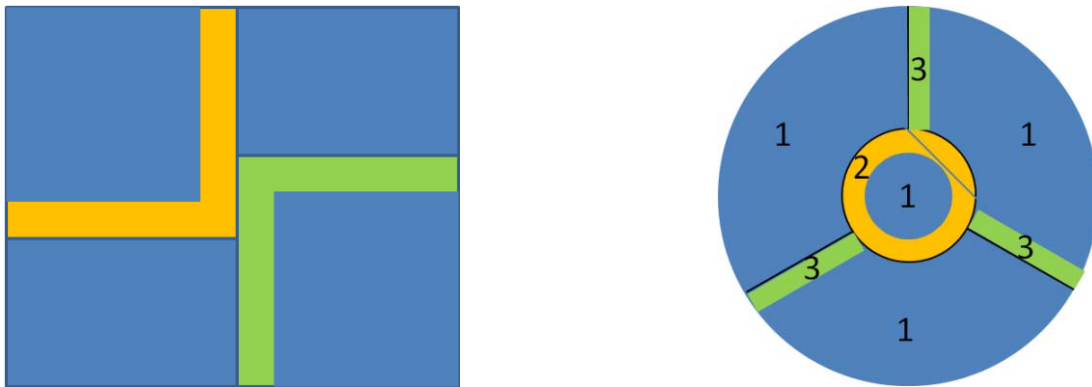

Figure A5-8: Region colouring with guard stripes: a) 3 colours, b) 3 colours

Here in both cases, 3 colours are sufficient: one for the inner areas of all regions and two more for the guard stripes. A fourth colour would only be needed, if any two of the 3-region corners would be closer together than the critical distance for mutual interference - which is rather unlikely for the typical ISDs in LTE deployment. In fact, two different colours (corresponding to orthogonal resource sets) in guard stripes are necessary only at 3-region corners where guard stripes with different transmitted content meet in a rather small area. Applying only one instead of two resource sets for all guard stripes would thus create harmful interference only in rather small areas that can more easily be covered by unicast TV service (as discussed for *Case A*).

So with the *Case C*) reuse scheme the demand for orthogonal resource sets can be reduced to reuse factor 3 - and in combination with the *Case A*) unicast solution for critical 3-region corners even to reuse factor 2 - which makes the overall spectrum needs on par or even lower than for a HPHT deployment with reuse factor 6 (or higher), in spite of a factor 2 lower spectral efficiency for the SFN transmission.

For the national layer with different content in each country, the spectrum resources for reuse must be planned across all countries in a cluster to exclude interference across the borders. Hence, the total spectrum demand is $S_N * n$ where n is the reuse factor according to the deployment case (B or C) as discussed above. For the regional layer the spectrum assignment within each country can be planned according to the same rules adding up to $S_R * n$ in one country, but the same group of n resource sets can be re-applied in all countries of the cluster as long as the immediate neighbouring regions in different countries are assigned different resource sets out of this group. Such an optimal assignment with the same reuse factor n can always be achieved, when the spectrum assignment for the regional layer is coordinated (harmonized) across the entire multi-country cluster. When such a harmonized assignment is not possible, the regional spectrum assignment in one country must respect constraints for the regions at the border to neighbouring countries and this may lead to a somewhat higher reuse factor (and total spectrum need) for the overall regional layer.

Note that this coarse assessment only considered the amount of total spectrum resources needed for the assignment to broadcast editorial regions with no (or only little) interference impact

between the SFN areas. This does not mean that this (rather large) amount of spectrum is entirely blocked for other use, but in fact much of it can be reused in most of the area for local broadband services. This will be discussed in more detail in the following section.

A5.6 Reuse between Broadcast and Other Services

In every region typically only one resource set for the national layer and one resource set for the regional layer is actually occupied by active broadcast transmissions. The other (n-1) orthogonal resource sets reserved for the respective layer need to be kept free of (any) transmissions only near the borders to neighbour regions that actively transmit SFN content on these resources in order to avoid destructive impact on the spectral efficiency for these SFN transmissions.

In a certain distance from the border, such impact on the neighbour region becomes negligible due to path loss, so further inside a region all (n-1) orthogonal resource sets can be used for other broadband services like single-cell unicast transmissions or local broadcast services in smaller SFNs that need not be covered up to and across the region border. Near the border to any single neighbour region, two of the resource sets for the respective layer are blocked - namely those of the own and of the immediate neighbour region) - but in case of reuse factor > 2 the remaining (n-2) resource sets can even be used for other services directly at and across the respective border. Note that only a small area around the 3-region border cannot reuse any of the three resource sets for unicast or other local purpose - in case of a 4-fold reuse, the fourth resource set can be additionally reassigned in all sub-areas of Figure A5-9b.

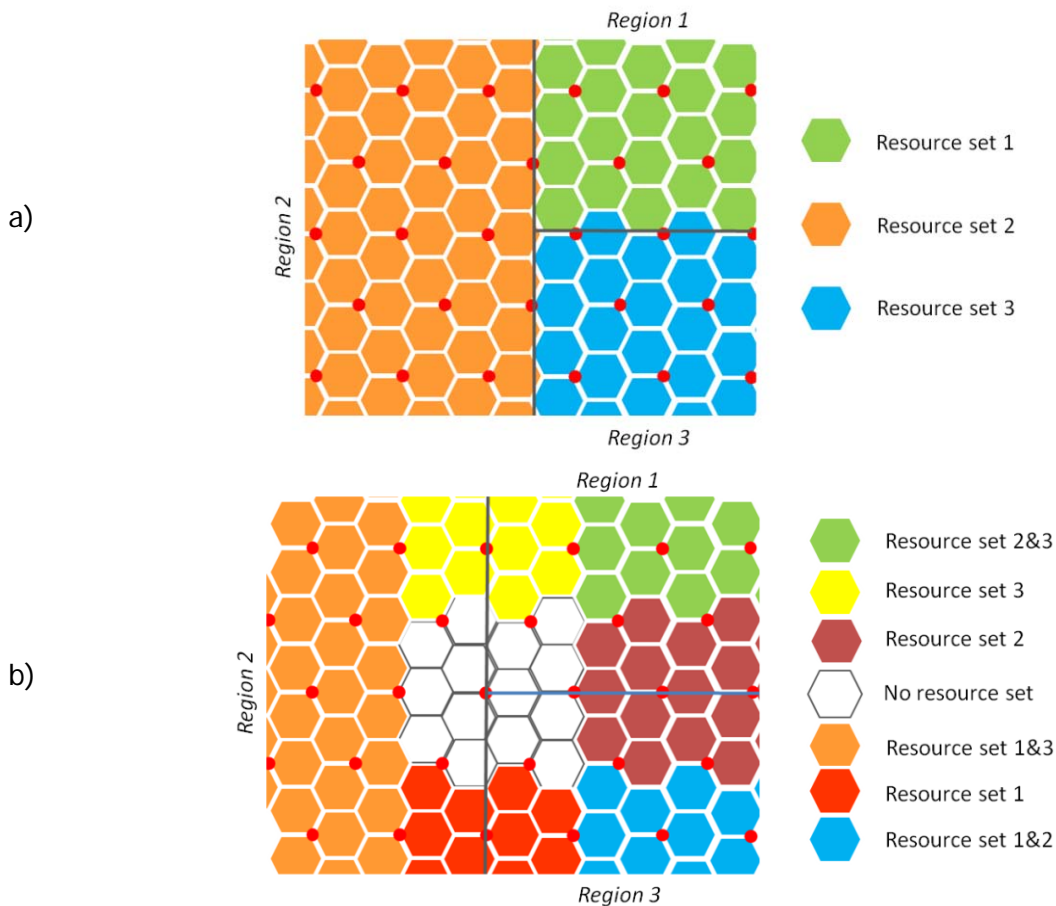

Figure A5-9: Assignment of resource sets a) for SFN broadcast b) for unicast (or other) local use

It remains to be assessed the required width of the guard stripes around the region borders, in which the resource set that is assigned for the broadcast SFN area in the neighbour region may not be reassigned for unicast or other local use, but must remain muted to protect the neighbouring

SFN area from excessive interference.

Note that the same assessment holds for interference from unicast transmissions or from SFN broadcast transmissions with different content on the same resources from a neighbouring region. So the guard stripe that must be kept free of interfering local unicast transmissions in the reuse *Case B*) is effectively the same width as the guard stripe with SFN transmission on orthogonal resources that is introduced between SFN areas with equal resources in the reuse *Case C*).

Simulations with different ISD (between 1 km and 5 km) have shown that a blocking distance of $1.5 * ISD$ is sufficient to achieve approximately the same spectral efficiency and coverage in the border cell (towards the guard stripe) than in the centre of a large SFN area. Figure A5-10 illustrates this configuration where the guard stripe separates a SFN area on the left from an area on the right where the same resources are reused by an area where the resources are muted.

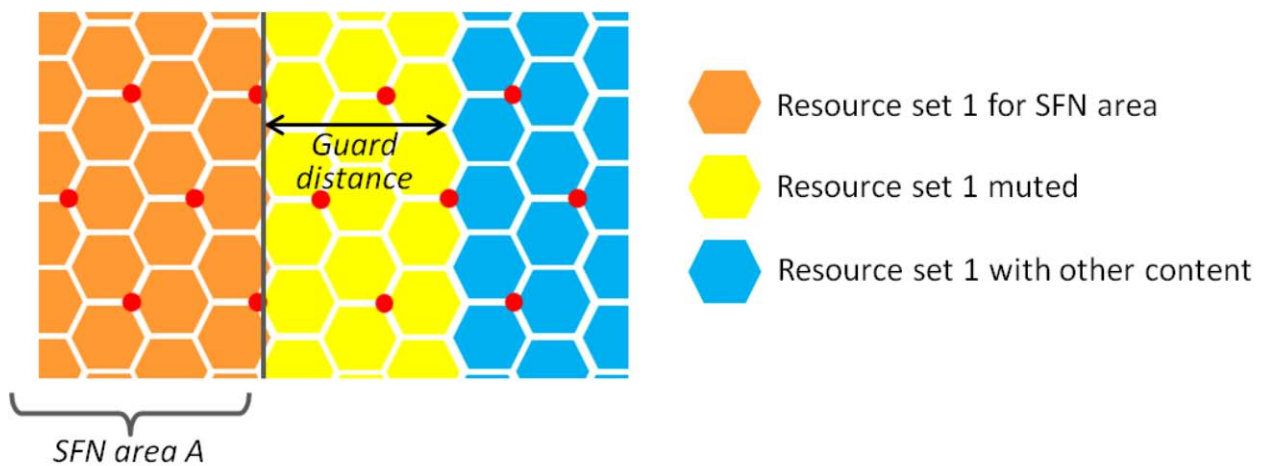

FigureA5-10: Reuse of SFN resources in guard distance from the SFN border

Figure A5-11 shows the corresponding SINR heat map plot for the same configuration (the three areas here indicated by the green, white and red arrow colours) The right picture is a zoomed in view on the target cell showing a high coverage up to the cell border towards the guard stripe.

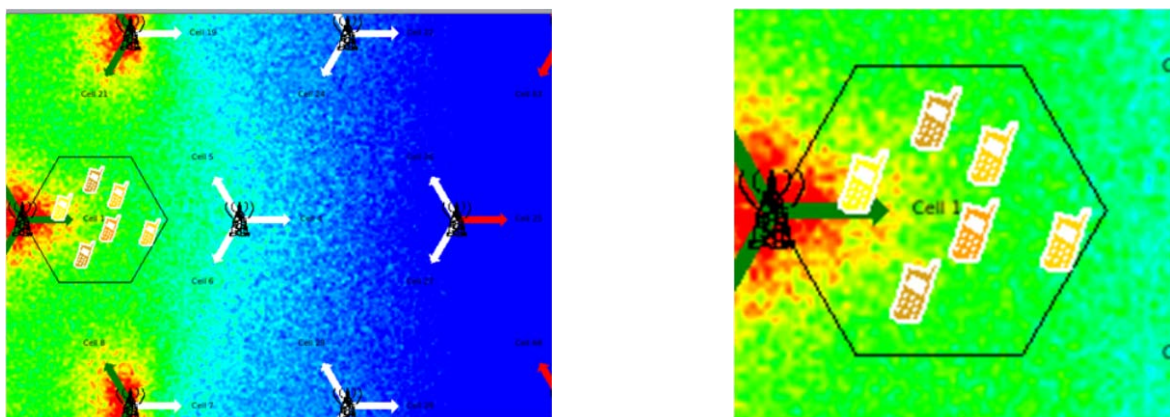

Figure A5-11: SINR heat map plot for the SFN border cell towards a guard stripe of $1.5 * ISD$

Note that the width of the guard stripe in this example is $1.5 * ISD$, here shown for an ISD of 3.5 km. A more detailed analysis of the SINR cdf reveals that the outage at the cell border is indeed somewhat higher than for a cell in the centre of a large SFN area (under same ISD). This cannot be fully compensated by further increasing the guard width, but it can by introducing an overlap (as described for *Case B*) where the first layer of cells in the guard stripe extends the immediately neighbouring SFN area (as supporting cells) and transmits the same content instead of just muting the corresponding resources as illustrated in Figure A5-12 below.

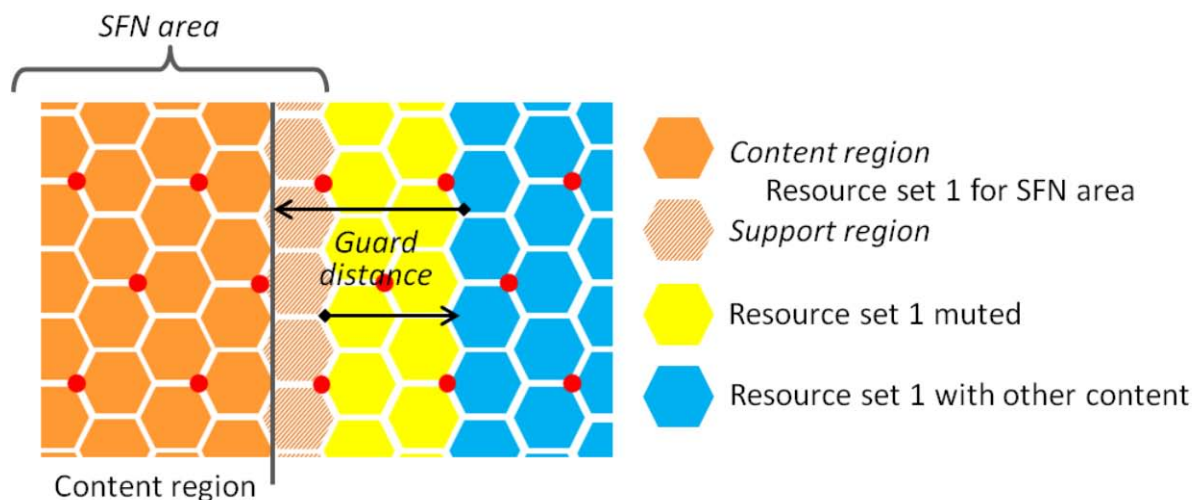

Figure A5-12: Overlap configuration for improved SFN coverage

The following Figure A5-13 shows the effect of such overlap deployment on the coverage in the target cell which now is equal or even better than in the centre of the SFN area:

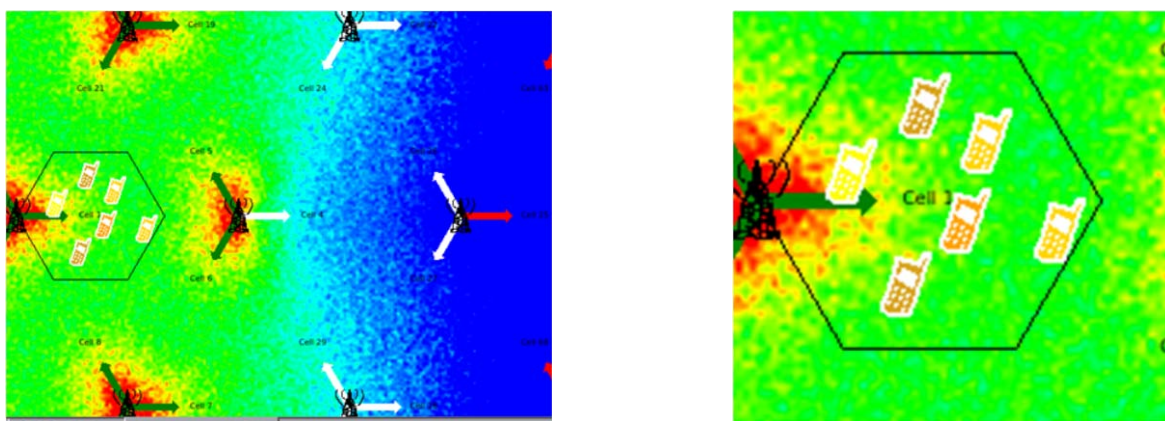

Figure A5-13: SINR heat map plot for a reuse configuration with overlap

While having a positive impact on the region border coverage for the extended SFN area, the transmissions in the overlap part of the guard stripe reduce the effective guard distance to the other side (as indicated in Figure A5-12) where the resources are muted and protect the other border from interference. In the *Case B*) reuse variant, the cells on the other side of the guard stripe (here shown with red arrows) use the resources for unicast transmissions and can compensate the higher interference by dynamic MCS adjustment. This is only a soft degradation and can be kept rather small - by limiting the transmissions in the overlap area to only those cells which transmit in the direction of the supported SFN area.

In a reuse deployment according to *Case C*) where the "red-arrow" cells on the other side of the guard stripe transmit different broadcast content on the same resources, the degradation from a guard distance of only $1 \cdot \text{ISD}$ would again reduce coverage. This may be acceptable if the border area is lowly populated - otherwise it can be compensated by extending the guard stripe by one more cell layer to a width of $2 \cdot \text{ISD}$ and applying the overlap principle on both sides of the guard stripe as illustrated in Figure A5-14.

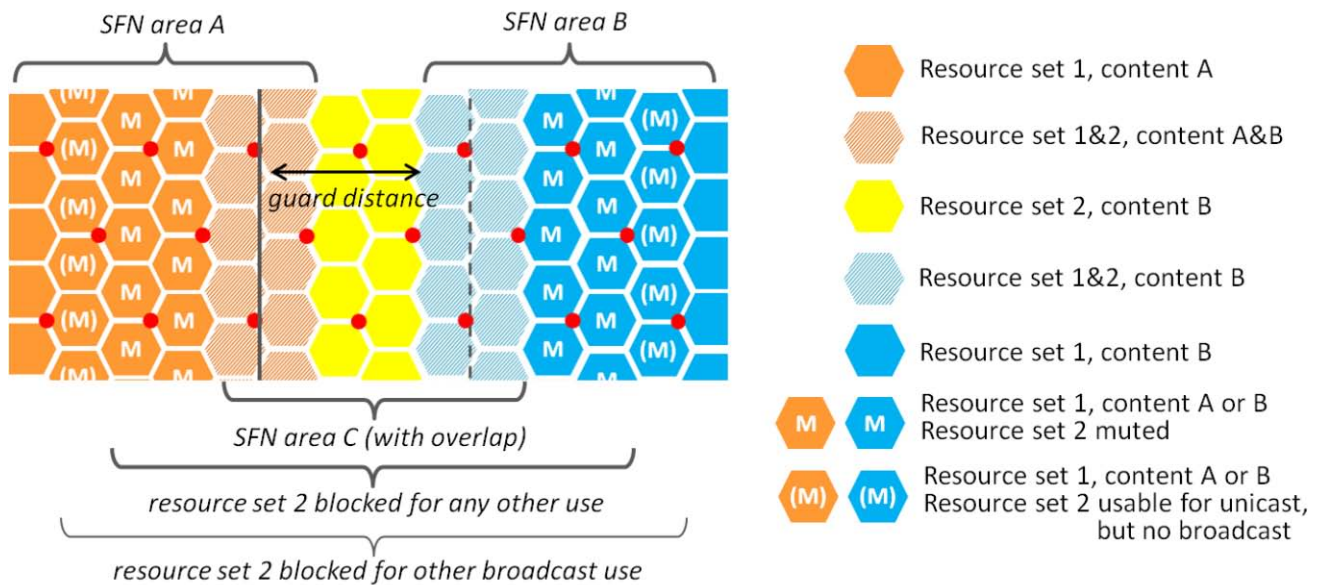

Figure A5-14: Reuse configuration according to Case C) with SFN area overlap on either side of the guard stripe

In this configuration the area between the two vertical bars is served with broadcast content B on resource set 2, the areas left of the solid and right of the dashed bar are served on resource set 1 with content A or B, respectively. The cells immediately left and right of the bars transmit on both resource sets in order to improve border reception, but they need to receive the broadcast service only on one resource set. The cells in the main SFN Areas A and B transmit their corresponding broadcast content on resource set 1 and can in principle reuse resource set 2 for other (unicast or broadcast) transmissions.

However, some guard distance must be maintained where the reuse of resource set 2 is blocked in order to protect the broadcast reception of SFN Area C in the region between the two vertical bars. When muting resource set 2 in those cells marked with M, a sufficient guard distance of 1.5 ISDs is maintained towards the reception region of SFN Area C. So the total area where resource set 2 is blocked for other service (either by active transmission in SFN Area C or by muting for interference protection) has a width of 10 sector cell columns or 5*ISD in such a Case C) configuration. Outside of that range, resource set 2 can in principle be reused for other transmissions of different content. In the cells marked with (M), however, these other transmissions may still suffer from interference from the nearest cells of SFN Area C that are only 1 ISD away. This is uncritical for unicast transmissions that can apply user specific link adaptation, but may restrict the reuse for other broadcast transmissions. So for unrestricted reuse, the blocking area would be 6 ISDs wide.

All these considerations on the guard distance for resource reuse have been made for the target that the coverage in a border cell of an SFN area is no worse than in the centre of the SFN area. If the coverage requirements can be relaxed to allow for a higher outage in border areas (e.g. due to low population density and based on the assumption that transmission points are anyway located nearer to population clusters while outage areas are rather farther away from the transmission points), then even smaller guard distances of only 1*ISD might suffice and provide a higher reuse efficiency of the reserved resources.

Annex 6: Antenna system

Antennas currently used for cellular base stations typically have a relative bandwidth (3 dB bandwidth versus centre frequency) of about 20-25% and maximum powers per input of about 500 W. A frequently used modern antenna device is cross-polarized, i.e. there is one input per polarization direction, so in total the input power is about 1000 W. Assuming 40 W per LTE carrier this would allow for radiation of 25 carriers. However, assuming 20 MHz per carrier this would correspond to a total bandwidth 500 MHz, which is larger than what typical cellular antennas support.

Antenna devices for the frequency range below 1 GHz support up to 260 MHz, e.g. Kathrein ultra-broadband 698 - 960 MHz.

eMBMS uses single-stream transmission. Typical LTE sites currently have 2 antenna ports for each of 3 sectors, so in total 6 antenna ports. For those antenna panels that see correlated channels (due to spacing less than a few wavelength apart and co-polarization), the resulting antenna pattern can have a wide-band ripple if all the panels are fed with equal delay. In this case, the single stream can be mapped to the correlated antenna ports, e.g. by using a form of delay diversity. This causes the ripple to be narrow-band so that frequency diversity within an LTE channel is achieved.

Cellular antennas are often configured with a down-tilt in order to reduce the reach of interference into neighbouring cell areas. Down-tilt is typically higher where the inter-site-distance is low. For MBSFN broadcasting interference between adjacent sites is inherently avoided, so that actually a smaller tilt could be optimal. The use of lower tilt for broadcasting is however not a requirement but merely an optimization that could e.g. allow to increase the transmit rate for a given coverage requirement. A tilt can be implemented either mechanically or electrically. However, in either case the tilt is long-term static in current antenna installations, therefore it cannot be changed between subframes used for unicast and those used for broadcast. In certain topologies and propagation conditions a small tilt can still be beneficial to reduce the radiated power to more remote sites that could arrive outside the guard interval and thereby generate interference.

Annex 7: RF exposure limits

RF exposure limits specified by the International Commission on Non-Ionizing Radiation Protection (ICNIRP) have been adopted by EU in the European Council Recommendation 1999/519/EC and are applied in most European countries. Some countries have established additional limitations that are more stringent than ICNIRP. Harmonized RF exposure assessment standards have been developed by CENELEC for demonstrating compliance with the relevant essential requirements of the R&TTE Directive.

The ICNIRP limits (reference levels) are frequency dependent, and given in terms of power density S (W/m^2), or in terms of electric field strength E (V/m) and magnetic field strength H (A/m).

At operating frequencies of mobile communications base stations, measurements or calculations of the electric field strength in far-field conditions is in most cases sufficient.

Equation (1) shows the relationship between the power density and the electric field strength, whereas equation (2) shows the relationship between the minimum distance to the general public from the base station in the main-beam direction of the antenna (compliance distance), the EIRP and the power density limit.

$$(1) \quad S = \frac{E^2}{377\Omega}$$

$$(2) \quad D_{\min} = \sqrt{\frac{EIRP}{4\pi \cdot S_{\lim}}}$$

The ICNIRP electric field strength limit at 700 MHz is 36 V/m, corresponding to a power density limit of $3.5 W/m^2$.

Table A7-1 shows the compliance distance for different EIRP values at 700 MHz. Table A7-2 shows the maximum EIRP for given compliance distances.

Table A7-1: Compliance distances (m) based on ICNIRP limit

EIRP	@ 700 MHz	EIRP	@ 700 MHz
60 dBW	151 m	30 dBW	< 5 m
50 dBW	49 m	20 dBW	< 2 m
40 dBW	16 m	10 dBW	< 1 m

Table A7-2: Maximum EIRP (dBW) ICNIRP limit

Compliance Distance	@ 700 MHz	Compliance Distance	@ 700 MHz
20 m	42 dBW	75 m	53 dBW
35 m	47 dBW	150 m	59 dBW
50 m	50 dBW	300 m	65 dBW

Depending on the location of the site (mast, roof-top, etc.), different transmit power levels are possible due to different distances to general public access areas.

As an example, if 16 LTE carriers of 20 MHz are used where each carrier transmits 40 W, the total conducted power transmitted would be 640 W. With an assumed antenna gain of 17 dBi this would result in a compliance distance of about 27 m using the power density exposure limit at 700 MHz.

Annex 8: A Case Study on eMBMS Performance Assessment

The following text is based on [14].

The performance of eMBMS is assessed here for a hypothetical LTE deployment, exemplified in the area of Cologne, Germany, a city of about 1million inhabitants in a radius of 11.3 km.

The service quality requirements are often applied using the so called Quasi Error Free (QEF) reception, meaning less than one uncorrected error-event per transmission hour. For eMBMS it is assumed Dynamic Adaptive Streaming over HTTP (DASH) based video transmission with DASH segments of 1 s and each segment forms a source block for the Application Layer Forward Error Correction (AL-FEC). The tolerable AL-FEC block error rate is therefore $1 \text{ s}/3600 \text{ s} = 2.78\text{e-}4$.

Table A8-1: eMBMS simulation parameters

Parameter	Default Values	Remarks
Shadowing fading	Log-normal, $\sigma=8$ dB	
Cross correlation between cell sites and sectors	0.5 (between different cell sites) 1.0 (between sectors on same cell site)	Correlated shadow fading values generated using a common random variable approach
Penetration loss	8 dB	indoor reception
Cell site height	32 m	
Channel model	3GPP Spatial Channel Model	Urban Macro high angular spread
Receive antenna height	1.5 m	
Noise figure	9 dB	
UE locations	Dropped randomly within the simulated area	Signal maximizing position along ± 50 cm on a line centred on drop
Propagation loss		Aligned to 3GPP Macro model (no terrain or clutter)
Cyclic prefix	16.7 μ s	
Error rate	1/3600	1 erroneous second per hour
Number of site rings	2	19 sites, 3 sectors each
Carrier frequency	700 MHz	
Bandwidth	5 MHz	
Transmit power	20 W	

For digital terrestrial TV in Germany, good portable indoor coverage is a planning goal. The coverage verification test established by the national regulator in order to verify minimum requirements of license conditions¹⁵ specifies that the receiver antenna is placed at optimum position in a disk of 0.5 m radius (Reference 1). This is mimicked in the eMBMS simulations presented in [5] by choosing the optimal position within a 1 m straight line of the random initial user position. Once optimal position has been selected, the channel is assumed to be static¹⁶. For this case study one of the existing 3G networks was used. In the Cologne area there are 240 sites in a 10 km radius and 431 in a 20 km radius. These are too numerous to model all sites in detail in an eMBMS radio network and protocol simulation. Therefore, from the site data only the inter-site-distance (ISD) is taken into account as the major factor that impacts the service

¹⁵ It is noted that this is not related to coverage planning and/or service quality.

¹⁶ It is noted that this is not true for reception in a portable environment (e.g. on a bigger screen by using a small indoor antenna), where the corresponding radio channel is a time-varying Rayleigh channel.

probability. eMBMS simulations are performed for a uniform ISDs and the uniform ISD is varied between simulations. Table A8-1 shows the eMBMS simulation parameters. The antenna heights and propagation model are according to 3GPP case 1 (Reference 2), but scaled to 700 MHz and using only 8 dB indoor loss, taken from DVB-T assumptions.

The DVB-T transmitter covering the Cologne area uses an ERP of 20 kW and is configured for a transmission rate of 13.27 Mbit/s, which corresponds to a spectral efficiency of 1.66 bit/s/Hz. For DVB-T2, the use of the same transmitter(s) is planned but they will provide a higher data rate. Rates of 18 Mbit/s to 26 Mbit/s are under discussion.

For eMBMS, all the considered sites are assumed to belong to one Multicast-Broadcast Single Frequency Network (MBSFN). Therefore the same physical layer Modulation and Coding Scheme (MCS) and AL-FEC code rate has to be chosen for all sites. The AL-FEC code rate is set to 0.98, i.e. applying only a minimal amount of redundancy on the application layer, because it has turned out it is more efficient to apply most redundancy on the physical layer in this static reception scenario. A small amount of AL-FEC here ensures an error floor of the physical layer is compensated for. Finally the MCS is chosen so as to most closely match the spectral efficiency of DVB-T: MCS index 18, using 64-QAM, gives a payload spectral efficiency of 1.6 bit/s/Hz.

From the simulation the eMBMS service probability is obtained, i.e. the percentage of randomly distributed users for which the QEF criterion is met. The results indicate technology potential. No implementation margins have been considered. Figure A8-1 shows the service probability versus the ISD. For small ISD up to 5 km, the service probability is about 95% and then decreases with increasing ISD. Note that the methodology for the calculation of coverage in the mobile community and the broadcasting community is different and limits the comparability of results.

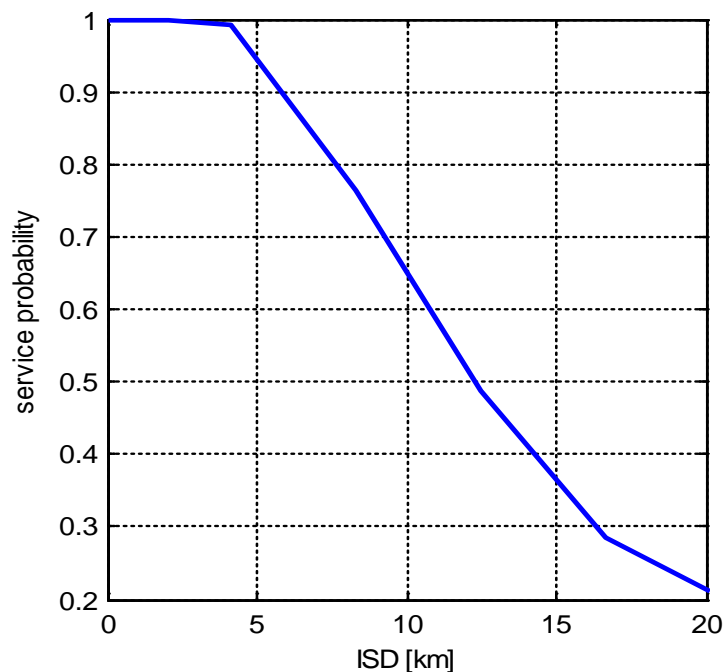

Figure A8-1: Service probability versus the ISD

Figure A8-2 shows the map of greater Cologne with a 10 km radius circle and Figure A8-3 shows the ISD Cumulative Distribution Function of the 3G sites in the 20 km radius as well as in a 10 km radius. In the centre 10 km radius the ISD is obviously smaller as the network is more dense due to increased 3G mobile broadband capacity requirements.

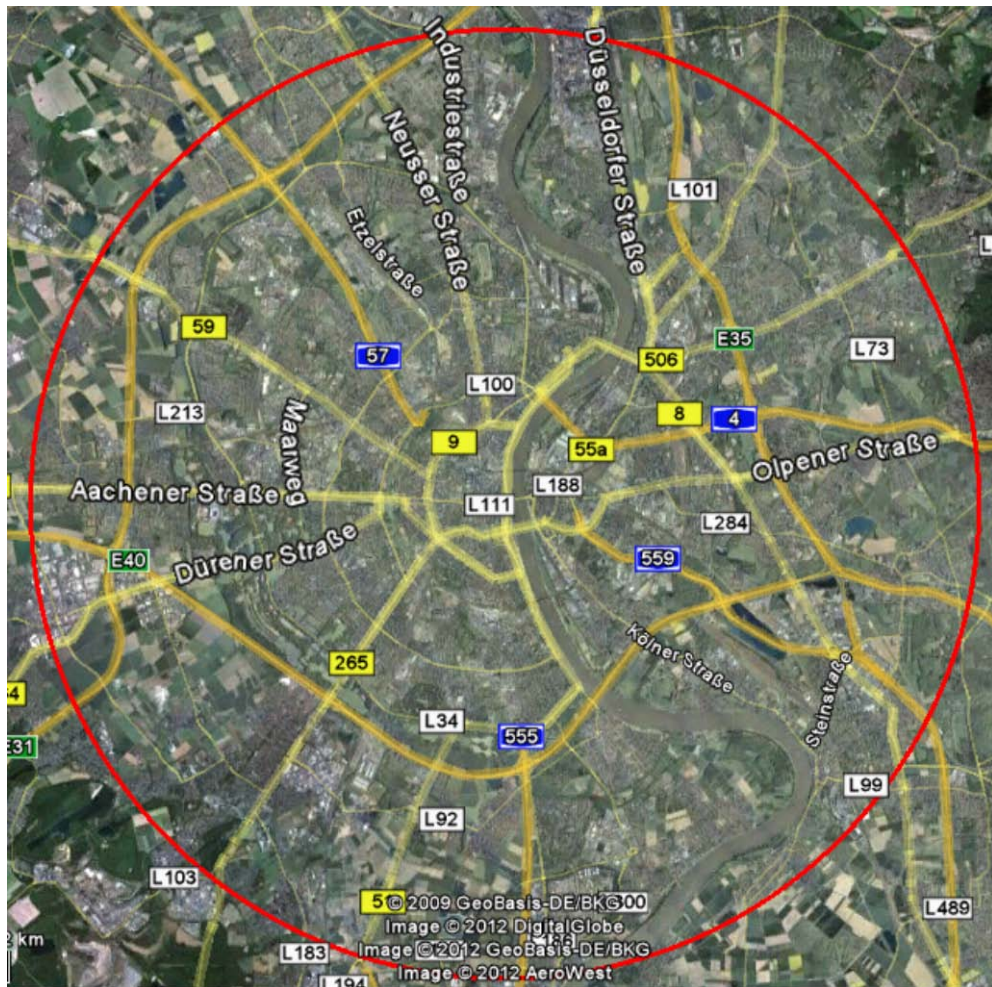

Figure A8-2: Map (© Google) of greater Cologne, Germany, with a 10 km radius circle.

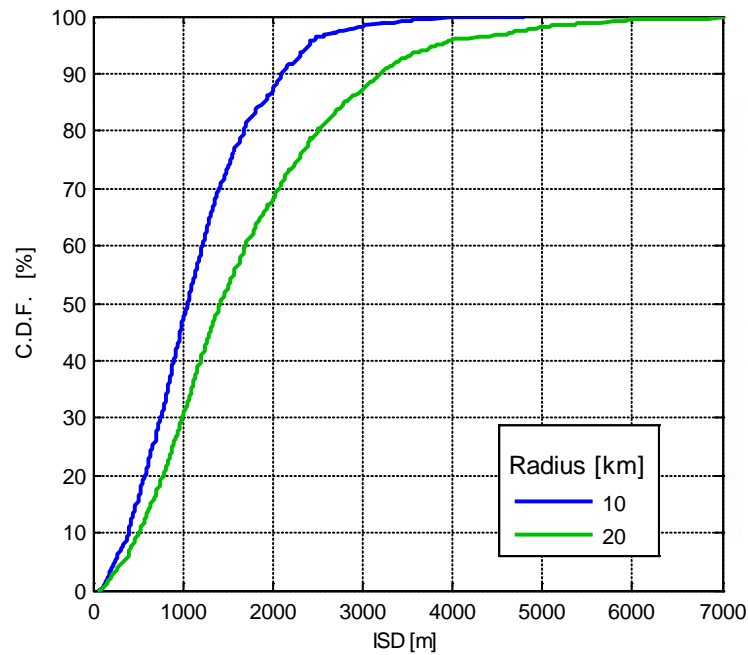

Figure A8-3: ISD Cumulative Distribution Function (CDF) of the 3G sites in the 20 km radius as well as in a 10 km radius.

For each site the mean ISD is determined to its neighbouring sites (defined by Voronoi tessellation). Then the corresponding service probability of each site is determined using the graph in

Figure A8-1. Figure A8-4 shows a map of the area with the polygons served by each site coloured according to the service probability. In the centre 10 km radius where most of the population lives, the service probability from all sites is above 95%. In the ring between 10 km and 20 km the probability decreases as the ISD is larger here but still 93% of the sites provide service probability better than 95%.

For mobile broadband capacity requirement reasons, the networks will also be further increased in density in the future, and the eMBMS service probability will then also benefit.

Using DVB-T2 we consider a mid-point of 22 Mbit/s given range under discussion. This corresponds to a spectral efficiency of 2.74 bit/s/Hz. When selecting at MCS index 26 for LTE, a similar spectral efficiency of 2.78 bit/s/Hz can be achieved. As the transmission in eMBMS is less robust than in the previously discussed case the service probability provided by each LTE site decreases if the ISD is large. Figure A8-5 shows the resulting service probability map. Still all sites in the 10 km radius provide service indoor probability above 95% and all sites in the 20 km ring provide indoor service probability above 70%.

Current coverage probability maps for the current DVB-T services in Germany can be generated from <http://www.ueberallfernsehen.de/empfangsprognose/index.html>. It is noted that predictions were made according to the methodology used by broadcasters (see [23]) for reception of public programs (channel 26 at 514 MHz) and for reception of commercial programs (channel 53 at 730 MHz). Both predictions were made for a time-varying Rayleigh channel and took into account real antenna diagrams as well as additional margins (i.e. 'the worst case').

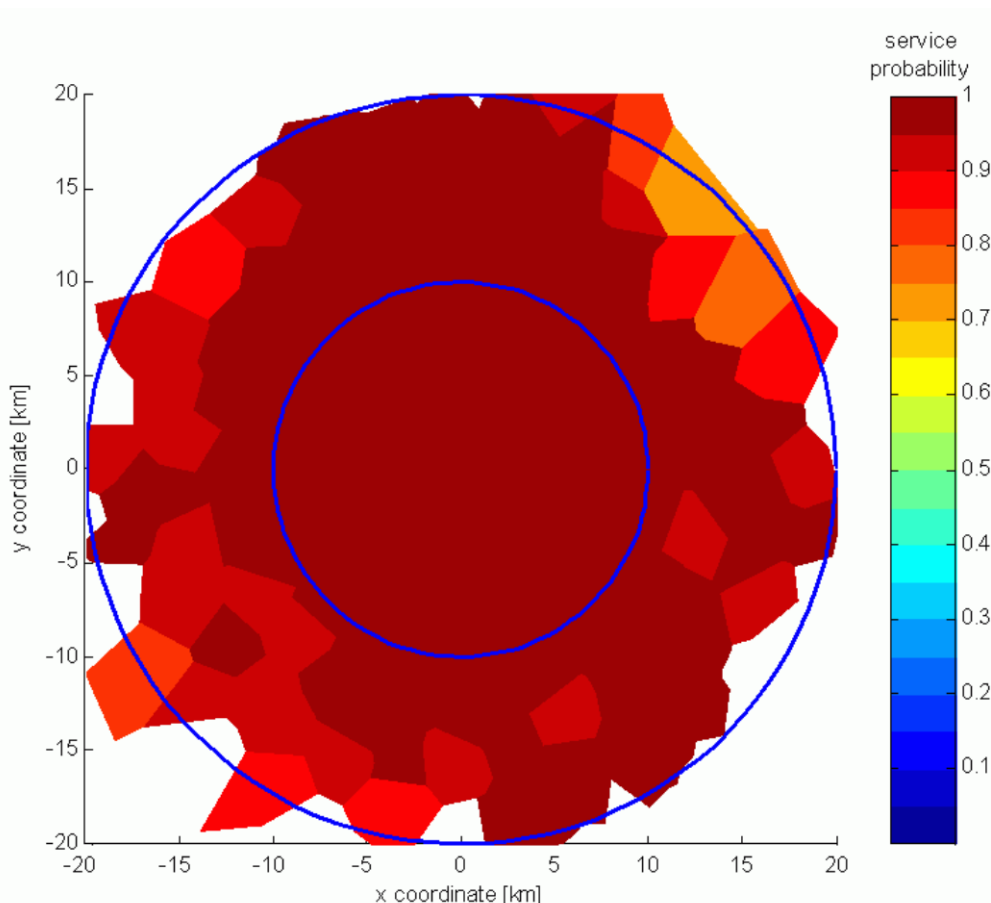

Figure A8-4: Coverage map with the polygons served by each site coloured according to the service probability.

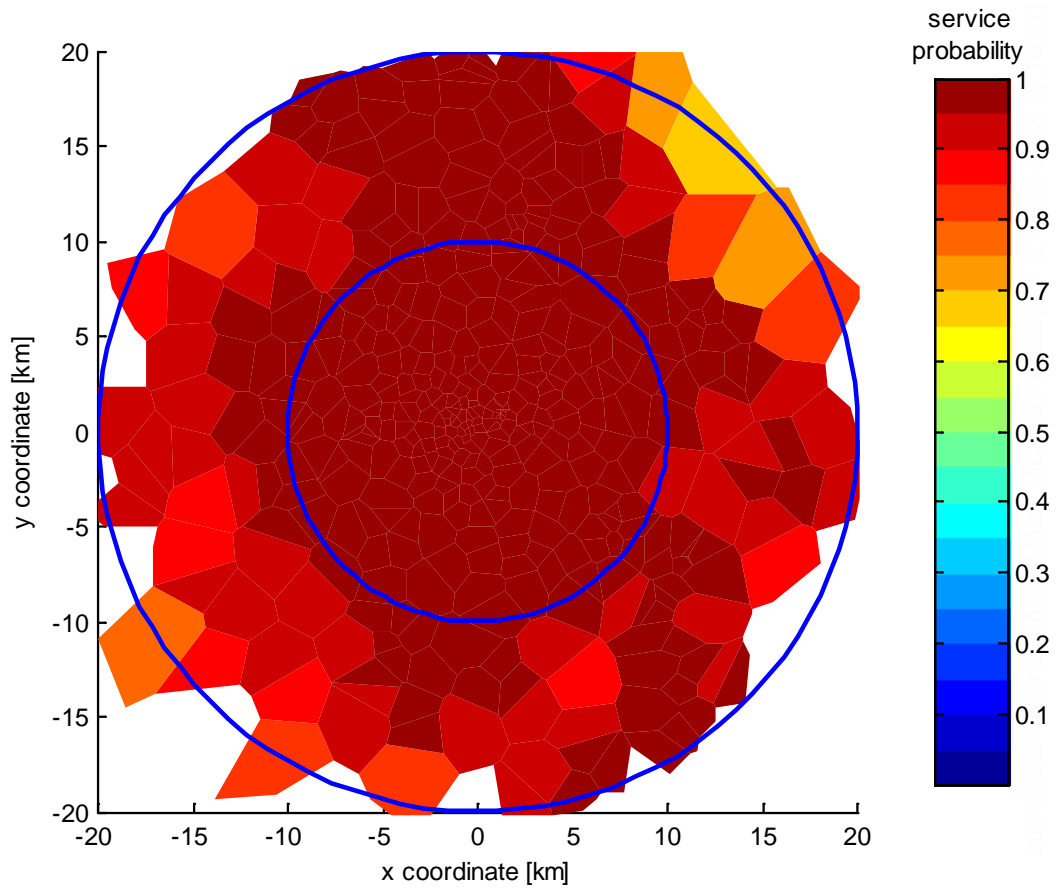

Figure A8-5: LTE broadcast coverage map with the polygons for MCS selected to achieve spectral efficiency of 2.78 bit/s/Hz.

Annex 9: MBMS User Service Discovery

Since eMBMS does not make use of the LTE specific ciphering it is according to standards possible to receive eMBMS services without having the SIM card of the operator providing the service. This enables anonymous and free-to-air reception independently from any subscription.

Content can be protected on the application layer using standardized encryption methods such as MBMS service keys (MSK) and MBMS traffic keys (MTK) but this is an implementation and service agreement issue and would not be done if free-to-air is required.

In order to allow the terminal to find the service the User Service Description of the scheduled services are made available to the UE. 3GPP has developed a standard for exactly this purpose: TS 26.346. As illustrated in Figure A9-1, the User Service Discovery / Announcement provides service description information, which may be delivered via the MBMS Session and Transmission function over MBMS bearer or via the Interactive Announcement function over HTTP and other transportation such as SMS. This layer of Discovery mechanism allow users to find individual TV program, their start times etc.

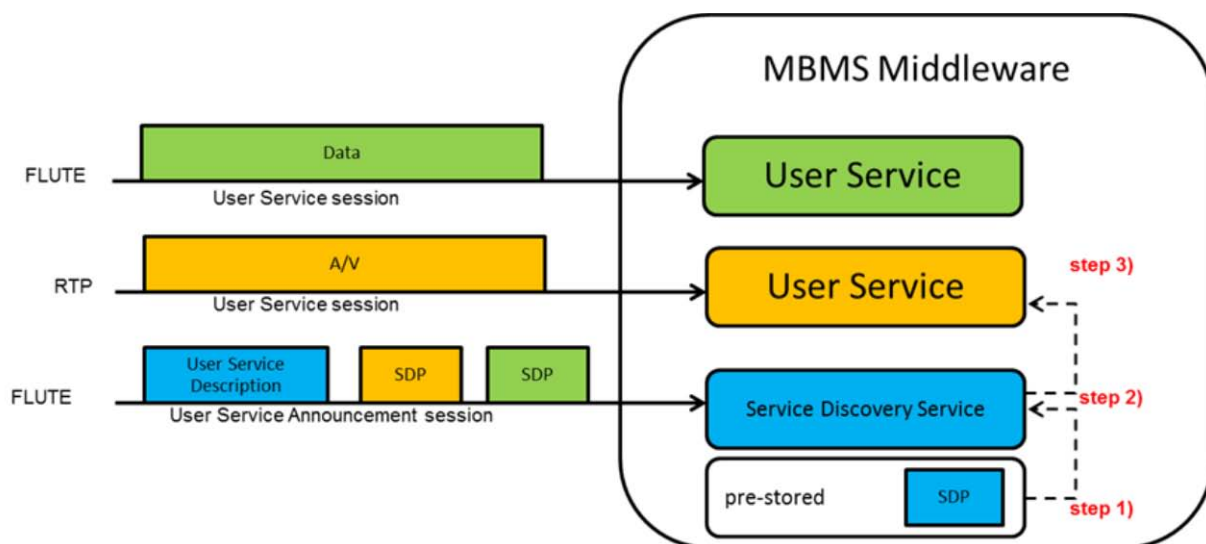

Figure A9-1: MBMS User Service Discovery

To receive a User Service Announcement over MBMS bearer the client shall obtain the session parameters for the related MBMS download session transport (step 1). This may be achieved by pre-storing the related session parameters in the MBMS UE. Note that when sending User Service Announcement over MBMS, the announcement bearer is also described through a USD and an SDP, like any other bearer. This information is rather static and will not change frequently in time. It contains elements such as the Frequency Band and addresses within the core network. This set of information can come to the terminal in many ways, e.g. it can be preconfigured, downloaded via LAN, WLAN, Bluetooth, USB stick or remotely configured through network management interfaces.

Once the UE joined the User Service Announcement session it can receive the user service description which essential is comprised of metadata fragments delivered over FLUTE (step 2). The user service description can consist of a list of available MBMS user services or user service bundles (including session information to access those) along with information on the user services which may be presented to the user to enable service selection (step 3). This actual program information can be updated frequently according to the need and actual situation in the broadcasting program, reflect changes in programme, etc.

Overall the process is very similar to current solutions for IPTV or Web Radio where it is supported by public and private service broadcasters on a broad range.