



3U Rack or Tower UPS RT5.0kVA
and RT6.0kVA
Installation and User's Guide



Note:

Before using this information and the product it supports, read the general information in Appendix B “Getting help and technical assistance” on page 49, Appendix C “Notices” on page 53, the safety information, warranties, and licenses information on the Lenovo Web site at:
<https://support.lenovo.com/documents/LNVO-DOCS>

Third Edition (December 2020)

© Copyright Lenovo 2015, 2020.

LIMITED AND RESTRICTED RIGHTS NOTICE: If data or software is delivered pursuant to a General Services Administration “GSA” contract, use, reproduction, or disclosure is subject to restrictions set forth in Contract No. GS-35F-05925

Contents

Safety	iii	Setting High Efficiency mode.....	28
Guidelines for trained service technicians	iv	Configuring Bypass settings.....	28
Inspecting for unsafe conditions.....	iv	Bypass transfer out of tolerance	28
Guidelines for servicing electrical equipment . . .	v	Interrupt time	28
Safety statements	vi	Configuring battery settings.....	28
Product safety.....	x	Retrieving the Event log.....	29
		Retrieving the Fault log.....	29
Chapter 1. Introduction	1	Chapter 6. Communication	31
Notices and statements.....	1	Communication ports.....	31
Environmental protection.....	1	Connecting the RS232 or USB communication	
		port	31
Chapter 2. Presentation	5	Relay output contacts.....	31
Standard installations.....	5	Remote On/Off	32
Rear panels	6	Remote Power Off	32
Accessories	7	Replacing the communication card.....	34
Control panel.....	7	UPS Power Management suite.....	34
LCD description	8		
Display functions.....	9	Chapter 7. UPS maintenance	35
User settings.....	10	Equipment care	35
		Storing the equipment.....	35
Chapter 3. Installation	15	Replacing battery packs.....	35
Inspecting the equipment	15	Replacing the internal battery pack.....	36
Unpacking the unit	15	Replacing the EBM(s)	37
Checking the accessory kit.....	16	Testing a new battery pack.....	38
Connecting the internal battery pack.....	17	Recycling the used equipment	38
Connecting the EBM(s)	18		
Rack installation.....	18	Chapter 8. Troubleshooting	39
Preparing the UPS for rack mounting	18	Alarms and faults.....	39
Rack mounting of the UPS and EBM.....	19	Silencing the alarm	42
Tower installation	20	Service and support.....	42
Installing the communication card.....	21		
Installation requirements	21	Chapter 9. Parts listing	43
		Appendix A. UPS model	
Chapter 4. Power cables		specifications	45
connection	23	Appendix B. Getting help and	
Access to terminal blocks.....	23	technical assistance	49
Input/Output connection.....	23	Before you call.....	49
		Using the documentation	50
Chapter 5. Operation	25	Getting help and information from the World Wide	
UPS startup and shutdown.....	25	Web	50
Starting the UPS	25	How to send DSA data	50
Starting the UPS on battery power	25	Creating a personalized support web page . . .	50
Shutting down the UPS	26	Software service and support	51
Monitoring the UPS operating mode.....	26	Hardware service and support	51
Operating modes: descriptions.....	26	Taiwan product service	51
Operating modes: summary	27		
Transferring the UPS between modes.....	27		

Appendix C. Notices	53
Trademarks	54
Important notes	54
Recycling information	54
Particulate contamination.....	55
Telecommunication regulatory statement	55
Electronic emission notices.....	55
Federal Communications Commission (FCC) statement	55
Industry Canada Class A emission compliance statement	56
Avis de conformité à la réglementation d'Industrie Canada.....	56
Australia and New Zealand Class A statement	56

European Union EMC Directive conformance statement.....	56
Germany Class A statement	56
Japanese electromagnetic compatibility statements	57
Korea Communications Commission (KCC) statement.....	58
Russia Electromagnetic Interference (EMI) Class A statement.....	58
People's Republic of China Class A electronic emission statement	59
Taiwan Class A compliance statement	59
Taiwan BSMI RoHS declaration	60
Index	61

Safety

Before installing this product, read the Safety Information.

قبل تركيب هذا المنتج، يجب قراءة الملاحظات الأمنية

Antes de instalar este produto, leia as Informações de Segurança.

在安装本产品之前，请仔细阅读 **Safety Information**
(安全信息)。

安裝本產品之前，請先閱讀「安全資訊」。

Prije instalacije ovog produkta obavezno pročitajte Sigurnosne Upute.

Před instalací tohoto produktu si přečtěte příručku bezpečnostních instrukcí.

Læs sikkerhedsforskrifterne, før du installerer dette produkt.

Lees voordat u dit product installeert eerst de veiligheidsvoorschriften.

Ennen kuin asennat tämän tuotteen, lue turvaohjeet kohdasta Safety Information.

Avant d'installer ce produit, lisez les consignes de sécurité.

Vor der Installation dieses Produkts die Sicherheitshinweise lesen.

Πριν εγκαταστήσετε το προϊόν αυτό, διαβάστε τις πληροφορίες ασφάλειας (safety information).

לפני שתתקינו מוצר זה, קראו את הוראות הבטיחות.

A termék telepítése előtt olvassa el a Biztonsági előírásokat!

Prima di installare questo prodotto, leggere le Informazioni sulla Sicurezza.

製品の設置の前に、安全情報をお読みください。

본 제품을 설치하기 전에 안전 정보를 읽으십시오.

Пред да се инсталира овој продукт, прочитајте информацијата за безбедност.

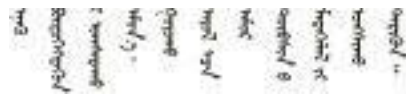

Les sikkerhetsinformasjonen (Safety Information) før du installerer dette produktet.

Przed zainstalowaniem tego produktu, należy zapoznać się z książką "Informacje dotyczące bezpieczeństwa" (Safety Information).

Antes de instalar este produto, leia as Informações sobre Segurança.

Перед установкой продукта прочтите инструкции по технике безопасности.

Pred inštaláciou tohto zariadenia si pečítajte Bezpečnostné predpisy.

Pred namestitvijo tega proizvoda preberite Varnostne informacije.

Antes de instalar este producto, lea la información de seguridad.

Läs säkerhetsinformationen innan du installerar den här produkten.

ཐོན་ཁུངས་འདི་བདེ་སྤྱོད་མ་བྱས་གོང་། ལྷན་གྱི་ཡིད་གཟབ་
བྱ་འདུ་མིན་ཡིད་པའི་འོད་མེར་བརྟ་དགོས།

Bu ürünü kurmadan önce güvenlik bilgilerini okuyun.

بىز كۆرۈۋاتقان مەھسۇلاتنى ئورنىتىشتىن بۇرۇن بىخەتەرلىك ئۆلچەملىرىنى ئوقۇپ چىقىڭ.

Youq mwngz yungh canjbinj neix gaxgonq, itdingh aeu doeg aen
canjbinj soengq cungj vahgangj ancien siusik.

Guidelines for trained service technicians

This section contains information for trained service technicians.

Inspecting for unsafe conditions

Use this information to help you identify potential unsafe conditions in a Lenovo product that you are working on.

Each Lenovo product, as it was designed and manufactured, has required safety items to protect users and service technicians from injury. The information in this section addresses only those items. Use good judgment to identify potential unsafe conditions that might be caused by alterations or attachment of non- Lenovo features or optional devices that are not addressed in this section. If you identify an unsafe condition, you must determine how serious the hazard is and whether you must correct the problem before you work on the product.

Consider the following conditions and the safety hazards that they present:

- Electrical hazards, especially primary power. Primary voltage on the frame can cause serious or fatal electrical shock.
- Explosive hazards, such as a damaged CRT face or a bulging capacitor.
- Mechanical hazards, such as loose or missing hardware.

To inspect the product for potential unsafe conditions, complete the following steps:

1. Make sure that the power is off and the power cords are disconnected.
2. Make sure that the exterior cover is not damaged, loose, or broken, and observe any sharp edges.
3. Check the power cords:
 - Make sure that the third-wire ground connector is in good condition. Use a meter to measure third-wire ground continuity for 0.1 ohm or less between the external ground pin and the frame ground.
 - Make sure that the power cords are the correct type.

- Make sure that the insulation is not frayed or worn.
- 4. Remove the cover.
- 5. Check for any obvious non-Lenovo alterations. Use good judgment as to the safety of any non-Lenovo alterations.
- 6. Check inside the system for any obvious unsafe conditions, such as metal filings, contamination, water or other liquid, or signs of fire or smoke damage.
- 7. Check for worn, frayed, or pinched cables.
- 8. Make sure that the power-supply cover fasteners (screws or rivets) have not been removed or tampered with.

Guidelines for servicing electrical equipment

Observe these guidelines when you service electrical equipment.

- Check the area for electrical hazards such as moist floors, nongrounded power extension cords, and missing safety grounds.
- Use only approved tools and test equipment. Some hand tools have handles that are covered with a soft material that does not provide insulation from live electrical current.
- Regularly inspect and maintain your electrical hand tools for safe operational condition. Do not use worn or broken tools or testers.
- Do not touch the reflective surface of a dental mirror to a live electrical circuit. The surface is conductive and can cause personal injury or equipment damage if it touches a live electrical circuit.
- Some rubber floor mats contain small conductive fibers to decrease electrostatic discharge. Do not use this type of mat to protect yourself from electrical shock.
- Do not work alone under hazardous conditions or near equipment that has hazardous voltages.
- Locate the emergency power-off (EPO) switch, disconnecting switch, or electrical outlet so that you can turn off the power quickly in the event of an electrical accident.
- Disconnect all power before you perform a mechanical inspection, work near power supplies, or remove or install main units.
- Before you work on the equipment, disconnect the power cord. If you cannot disconnect the power cord, have the customer power-off the wall box that supplies power to the equipment and lock the wall box in the off position.
- Never assume that power has been disconnected from a circuit. Check it to make sure that it has been disconnected.
- If you have to work on equipment that has exposed electrical circuits, observe the following precautions:
 - Make sure that another person who is familiar with the power-off controls is near you and is available to turn off the power if necessary.
 - When you work with powered-on electrical equipment, use only one hand. Keep the other hand in your pocket or behind your back to avoid creating a complete circuit that could cause an electrical shock.
 - When you use a tester, set the controls correctly and use the approved probe leads and accessories for that tester.
 - Stand on a suitable rubber mat to insulate you from grounds such as metal floor strips and equipment frames.
- Use extreme care when you measure high voltages.
- To ensure proper grounding of components such as power supplies, pumps, blowers, fans, and motor generators, do not service these components outside of their normal operating locations.

- If an electrical accident occurs, use caution, turn off the power, and send another person to get medical aid.

Safety statements

These statements provide the caution and danger information that is used in this documentation.

Each caution and danger statement in this documentation is labeled with a number. This number is used to cross reference an English-language caution or danger statement with translated versions of the caution or danger statement in the *Safety Information* document.

For example, if a danger statement is labeled D005, translations for that caution statement are in the *Safety Information* document under D005.

Be sure to read all caution and danger statements in this documentation before you perform the procedures. Read any additional safety information that comes with your system or optional device before you install the device.

L001



Hazardous voltage, current, or energy levels are present inside any component that has this label attached. Do not open any cover or barrier that contains this label. There are no serviceable parts inside these components. If you suspect a problem with one of these parts, contact a service technician.

DO NOT open up the chassis or any other parts of any UPS unit. This will void the unit warranty. Only replace parts for which a serviceable part exists, that is servicing any UPS unit is limited to FRU / CRU replacement parts.

(L001)

D005



When working on or around the system, observe the following precautions: Electrical voltage and current from power, telephone, and communication cables are hazardous. To avoid a shock hazard:

- If Lenovo supplied a power cord(s), connect power to this unit only with the Lenovo-provided power cord. Do not use the Lenovo-provided power cord for any other product.
- Do not open or service any power supply assembly.
- Do not connect or disconnect any cables or perform installation, maintenance, or reconfiguration of this product during an electrical storm.
- The product might be equipped with multiple power cords. To remove all hazardous voltages, disconnect all power cords.

- Connect all power cords to a properly wired and grounded electrical outlet. Ensure that the outlet supplies proper voltage and phase rotation according to the system rating plate.
- Connect any equipment that will be attached to this product to properly wired outlets.
- When possible, use one hand only to connect or disconnect signal cables.
- Never turn on any equipment when there is evidence of fire, water, or structural damage.
- Disconnect the attached power cords, telecommunications systems, networks, and modems before you open the device covers, unless instructed otherwise in the installation and configuration procedures.
- Connect and disconnect cables as described in the following procedures when installing, moving, or opening covers on this product or attached devices. To disconnect:
 1. Turn off everything (unless instructed otherwise).
 2. Remove the power cords from the outlets.
 3. Remove the signal cables from the connectors.
 4. Remove all cables from the devices.To connect:
 1. Turn off everything (unless instructed otherwise).
 2. Attach all cables to the devices.
 3. Attach the signal cables to the connectors.
 4. Attach the power cords to the outlets.
 5. Turn on the devices.
- Sharp edges, corners and joints might be present in and around the system. Use care when handling equipment to avoid cuts, scrapes and pinching. (D005)

C004



CAUTION:

Lead-acid batteries can present a risk of electrical burn from high, short-circuit current. Avoid battery contact with metal materials; remove watches, rings, or other metal objects, and use tools with insulated handles. To avoid possible explosion, do not burn.

Exchange only with the Lenovo-approved part. Recycle or discard the battery as instructed by local regulations. In the United States, Lenovo has a process for the collection of this battery. For information, call 1-800-426-4333. Have the Lenovo part number for the battery unit available when you call.

DO NOT mix old and new batteries in an Uninterruptible Power Supply unit.

DO NOT open up any battery pack retrieved from an Uninterruptible Power Supply unit.

Wear safety goggles for your own protection when replacing batteries of an Uninterruptible Power Supply unit. (C004)

C009



CAUTION:



or or The weight of this part or unit is between 18 and 32 kg (39.7 and 70.5 lb). It takes two persons to safely lift this part or unit. (C009)

C011



CAUTION:



or or The weight of this part or unit is more than 55 kg (121.2 lb). It takes specially trained persons, a lifting device, or both to safely lift this part or unit. (C011)

C022



CAUTION:

This product might be equipped with a hard-wired power cable. Ensure that a licensed electrician performs the installation per the national electrical code. (C022)

R001

Important: The following general safety information should be used for all rack-mounted devices:



 **DANGER**

Observe the following precautions when working on or around your IT rack system:

- Heavy equipment—personal injury or equipment damage might result if mishandled.
- Always lower the leveling pads on the rack cabinet.
- Always install stabilizer brackets on the rack cabinet.
- To avoid hazardous conditions due to uneven mechanical loading, always install the heaviest devices in the bottom of the rack cabinet. Always install servers and optional devices starting from the bottom of the rack cabinet.

- Rack-mounted devices are not to be used as shelves or work spaces. Do not place objects on top of rack-mounted devices.



- Each rack cabinet might have more than one power cord. Be sure to disconnect all power cords in the rack cabinet when directed to disconnect power during servicing.
- Connect all devices installed in a rack cabinet to power devices installed in the same rack cabinet. Do not plug a power cord from a device installed in one rack cabinet into a power device installed in a different rack cabinet.
- An electrical outlet that is not correctly wired could place hazardous voltage on the metal parts of the system or the devices that attach to the system. It is the responsibility of the customer to ensure that the outlet is correctly wired and grounded to prevent an electrical shock.

(R001 part 1 of 2)



CAUTION:

- Do not install a unit in a rack where the internal rack ambient temperatures will exceed the manufacturer's recommended ambient temperature for all your rack-mounted devices.
- Do not install a unit in a rack where the air flow is compromised. Ensure that air flow is not blocked or reduced on any side, front, or back of a unit used for air flow through the unit.
- Consideration should be given to the connection of the equipment to the supply circuit so that overloading of the circuits does not compromise the supply wiring or overcurrent protection. To provide the correct power connection to a rack, refer to the rating labels located on the equipment in the rack to determine the total power requirement of the supply circuit.
- *(For sliding drawers)* Do not pull out or install any drawer or feature if the rack stabilizer brackets are not attached to the rack. Do not pull out more than one drawer at a time. The rack might become unstable if you pull out more than one drawer at a time.
- *(For fixed drawers)* This drawer is a fixed drawer and must not be moved for servicing unless specified by the manufacturer. Attempting to move the drawer partially or completely out of the rack might cause the rack to become unstable or cause the drawer to fall out of the rack.

(R001 part 2 of 2)

Output power and ampere ratings

Important: Make sure that the power receptacle is near the equipment and is easily accessible so that the uninterruptible power supply (UPS) can be disconnected quickly.

To reduce the risk of fire, connect only to a circuit provided with branch circuit overcurrent protection with an ampere rating in accordance with the National Electrical Code (NEC), ANSI/NFPA 70 or your local electrical code:

UPS output power	120 V	208 V	230 V
1500 VA	15 A	Not applicable	10 A
2200 VA	20 A	Not applicable	10 A
3000 VA	30 A	20 A	16 A

Product safety

- The UPS connection instructions and operations described in the manual must be followed in the indicated order.
- **Important:** To reduce the risk of fire, the unit connects only to a circuit provided with branch circuit overcurrent protection as described in this manual, in accordance with the National Electric Code, ANSI/NFPA 70.
The upstream circuit breaker for Normal AC and Bypass AC must be easily accessible. The unit can be disconnected from AC power source by opening this circuit breaker. This circuit breaker is used for backfeed protection and must comply with IEC/EN 62040-1 (the creepage and clearance distances shall meet the basic insulation requirements for pollution degree 2).
- Disconnection and overcurrent protection devices shall be provided by others for permanently connected AC input (Normal AC and Bypass AC) and AC output circuits.
- Check that the indications on the rating plate correspond to your AC powered system and to the actual electrical consumption of all the equipment to be connected to the system.
- For PLUGGABLE EQUIPMENT, the socket-outlet shall be installed near the equipment and shall be easily accessible.
- Never install the system near liquids or in an excessively damp environment.
- Never let a foreign body penetrate inside the system.
- Never block the ventilation grates of the system.
- Never expose the system to direct sunlight or source of heat.
- If the system must be stored prior to installation, storage must be in a dry place.
- The admissible storage temperature range is -15°C to +50°C.
- This unit is not designed to conform to ANSI/NFPA 75 and therefore is not for use in ANSI/NFPA 75-certified data centers.
- Although the UPS does not contain anti-backfeed (ABF) relays, some backfeed protection is provided. For example, if some components are damaged in battery mode, the output voltage may feed back to the input. In this case, a current transformer (CT) is used to detect the bypass current feedback voltage. If a current backfeed fault condition is detected, the UPS will terminate the inverter output to avoid personal injury.

Chapter 1. Introduction

Thank you for selecting a Lenovo product to protect your electrical equipment.

Read this manual to take full advantage of the features of your equipment.

Before installing your equipment, read the safety instructions. Then, follow the instructions in this manual for setting up and using the product.

To discover the entire range of Lenovo products and the options available for the Lenovo UPS device, we invite you to visit our website or contact your Lenovo representative.

Notices and statements

The caution and danger statements in this document are also in the multilingual *Safety Information* document, which is on the Lenovo Web site at <https://support.lenovo.com/documents/LNVO-DOCS>. Each statement is numbered for reference to the corresponding statement in the *Safety Information* document.

Notices and statements in this document

The following notices and statements are used in this document:

- **Note:** These notices provide important tips, guidance, or advice.
- **Important:** These notices provide information or advice that might help you avoid inconvenient or problem situations.
- **Attention:** These notices indicate possible damage to programs, devices, or data. An attention notice is placed just before the instruction or situation in which damage might occur.
- **Caution:** These statements indicate situations that can be potentially hazardous to you. A caution statement is placed just before the description of a potentially hazardous procedure step or situation.
- **Danger:** These statements indicate situations that can be potentially lethal or hazardous to you. A danger statement is placed just before the description of a potentially lethal or hazardous procedure step or situation.

Environmental protection

Lenovo has implemented an environmental-protection policy. Products are developed according to an eco-design approach.

Substances

This product does not contain CFCs, HCFCs or asbestos.

Packing

To improve waste treatment and facilitate recycling, separate the various packing components.

- The cardboard we use comprises over 50% of recycled cardboard.
- Sacks and bags are made of polyethylene.

- Packing materials are recyclable and bear the appropriate identification symbol .

Materials	Abbreviations	Number in the symbols 
Polyethylene terephthalat	PET	01
High-density polyethylene	HDPE	02
Polyvinyl chloride	PVC	03
Low-density polyethylene	LDPE	04
Polypropylene	PP	05
Polystyrene	PS	06

Follow all local regulations for the disposal of packing materials.

Refer to the *Lenovo Environmental Notices and User's Guide*, provided on the Lenovo Web site at <https://support.lenovo.com/documents/LNVO-DOCS>.

End of life

Lenovo will process products at the end of their service life in compliance with local regulations. Lenovo works with companies in charge of collecting and eliminating our products at the end of their service life.

Product

The product is made up of recyclable materials. Dismantling and destruction must take place in compliance with all local regulations concerning waste. At the end of its service life, the product must be transported to a processing center for electrical and electronic waste.

Battery

The product contains lead-acid batteries that must be processed according to applicable local regulations concerning batteries.

The battery pack can be removed to comply with regulations and in view of correct disposal.

With the Lenovo UPS device, you can eliminate the effects of power disturbances and guard the integrity of your equipment. Providing outstanding performance and reliability, the Lenovo UPS device's unique benefits include:

- True online double-conversion technology with high power density, utility frequency independence, and power generator compatibility.
- Advanced Battery Management (®ABM) technology that uses advanced battery management to increase battery service life, optimize recharge time, and provide a warning before the end of useful battery life.
- Selectable High Efficiency mode of operation.
- Standard communication options: one RS-232 communication port, one USB communication port, and relay output contacts.
- UPS Network Management Card with enhanced communication capabilities.
- Extended runtime with up to four Extended Battery Modules (EBMs) per UPS.
- Firmware that is easily upgradable without a service call.
- Remote On/Off control through Remote On/Off (ROO) and Remote Power Off (RPO) ports.

Chapter 2. Presentation

Standard installations

Machine types and models	Weights	Dimensions (inch/mm)
	(lb/kg)	D x W x H
5594-5KX	106 / 48	28.4 x 17.3 x 5.1 / 722 x 440 x 130
5594-6KX	106 / 48	27.0 x 17.3 x 5.1 / 685 x 440 x 130
5594-6BX	150 / 68	25.4 x 17.3 x 5.1 / 645 x 440 x 130

Rack installation

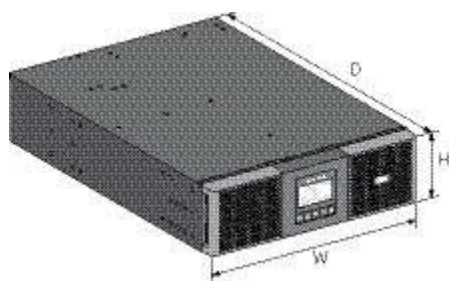

Tower installation

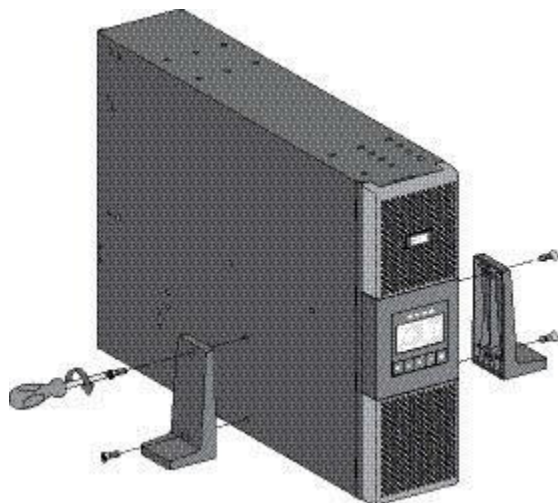

Shipping bracket kit

If you are shipping the UPS and its associated EBMs preinstalled in a rack, you must use the shipping bracket kit to prevent damage during shipment. The kit is available from Lenovo. Refer to the instructions in the kit to install the brackets properly. The brackets are not required when the UPS and EBMs are installed in a pre-positioned rack.

Rear panels

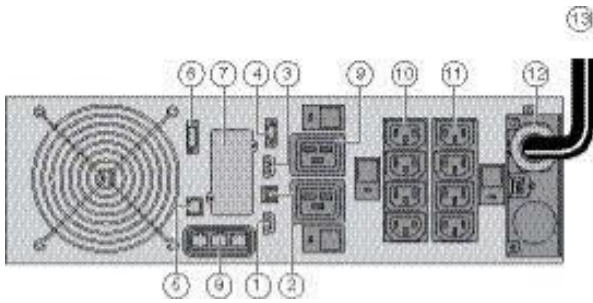

Figure 1. 5594-5KX

- ① RS232 communication port
- ② USB communication port
- ③ Dry (relay) contacts communication port
- ④ Connector for Remote On/Off (ROO) control
- ⑤ Connector for automatic recognition of an additional battery module
- ⑥ Connector for remote Power Off (RPO) control
- ⑦ Slot for UPS Network Management Card
- ⑧ Connector for additional battery modules
- ⑨ Primary group: 16A outlets for connection of critical equipment
- ⑩ Group 1: (4) 10A programmable outlets for connection of equipment
- ⑪ Group 2: (4) 10A programmable outlets for connection of equipment
- ⑫ Input/Output terminal blocks
- ⑬ Input power cable with L6-30P plug

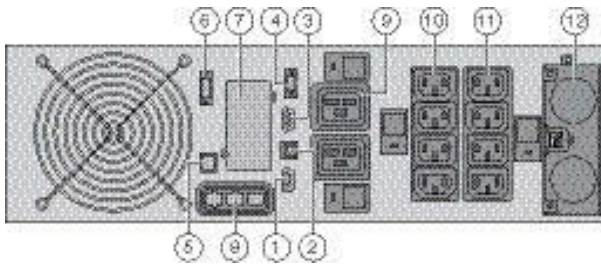

Figure 2. 5594-6KX

- ① RS232 communication port
- ② USB communication port
- ③ Dry (relay) contacts communication port
- ④ Connector for Remote On/Off (ROO) control
- ⑤ Connector for automatic recognition of an additional battery module
- ⑥ Connector for remote Power Off (RPO) control
- ⑦ Slot for UPS Network Management Card
- ⑧ Connector for additional battery modules
- ⑨ Primary group: 16A outlets for connection of critical equipment
- ⑩ Group 1: (4) 10A programmable outlets for connection of equipment
- ⑪ Group 2: (4) 10A programmable outlets for connection of equipment

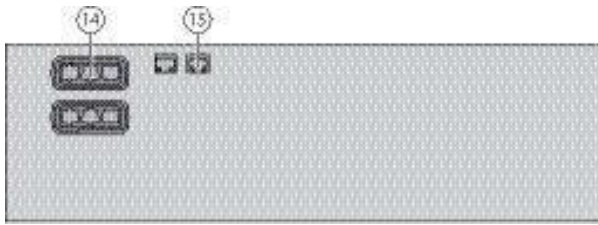

Figure 3. 5594-6BX

- ⑫ Input/Output terminal blocks
- ⑭ Connectors for battery modules (to the UPS or to the other battery modules)
- ⑮ Connectors for automatic recognition of battery modules

Accessories



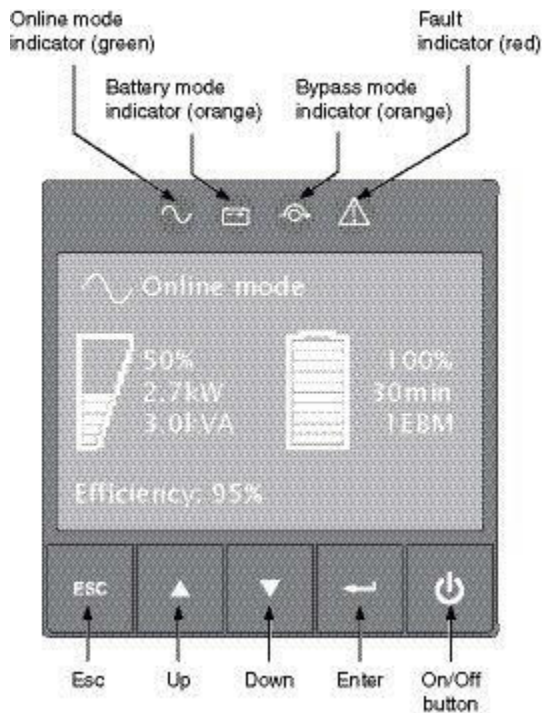

Part number	Description
55946BX	Extended Battery Module

Control panel

The UPS has a five-button graphical LCD. It provides useful information about the UPS itself, load status, events, measurements and settings.



The following table shows the indicator status and description:

Indicator	Status	Description
 Green	On	The UPS is operating normally on Online or on High Efficiency mode.
 Orange	On	The UPS is on Battery mode.
 Orange	On	The UPS is on Bypass mode.
 Red	On	The UPS has an active alarm or fault. See Chapter 8 "Troubleshooting" on page 39 for additional information.

LCD description

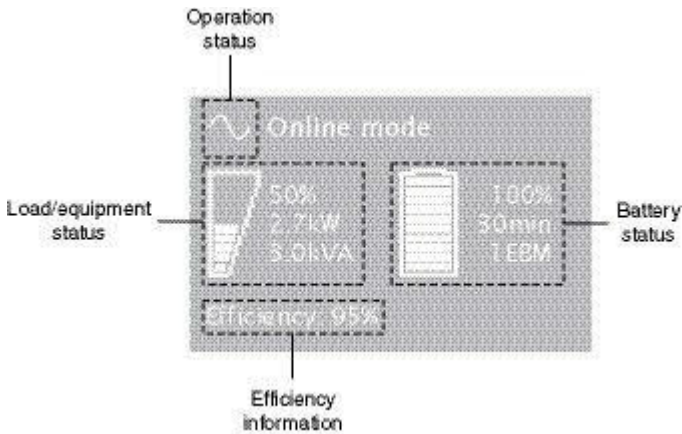

After 5 minutes of inactivity, the LCD displays the screen saver.

The LCD backlight automatically dims after 10 minutes of inactivity. Press any button to restore the screen.

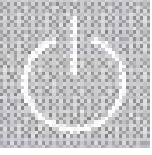

The following table describes the status information provided by the UPS.

Note: If an other indicator appears, see Chapter 8 "Troubleshooting" on page 39 for additional information.

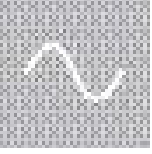
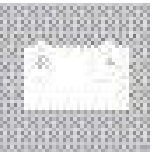
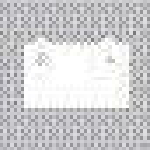
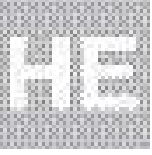
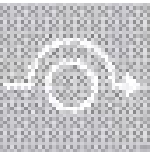
Operation status	Cause	Description
Standby mode 	The UPS is Off.	Equipment is not powered until power () button is pressed.
Online mode 	The UPS is operating normally.	The UPS is powering and protecting the equipment.
Battery mode  1 beep every 10 seconds	A utility failure has occurred and the UPS is on Battery mode.	The UPS is powering the equipment with the battery power. Prepare your equipment for shutdown.
End of backup time  1 beep every 3 seconds	The UPS is on Battery mode and the battery packs are running low.	This warning is approximate, and the actual time to shut down might vary significantly. Depending on the UPS load and number of Extended Battery Modules (EBMs), the "Battery Low" warning might occur before the battery packs reach 20% capacity.
High Efficiency mode 	The UPS is operating on High Efficiency mode.	The UPS is powering and protecting the equipment.
Bypass mode 	An overload or a fault has occurred or a command has been received, and the UPS is in Bypass mode.	Equipment is powered but not protected by the UPS.

Display functions

Press the Enter (↵) button to activate the menu options. Use the two middle buttons (▲ and ▼) to scroll through the menu structure. Press the Enter (↵) button to select an option. Press the ESC button to cancel or return to the previous menu.

Main menu	Submenu	Display information or Menu function
Measurements		[Load] W VA A pf / [Input/Bypass] V Hz / [Output/Efficiency] V Hz / [Battery] % min V n° / [DCbus] V / [Average power usage] Wh / [Cumulat. power usage] Wh since date
Control	Go to Bypass	Transfers the UPS on Bypass mode
	Start battery test	Starts a manual battery test
	Reset fault state	Clears active fault
	Restore factory settings	Returns all settings to original values
	Reset average power	Clears power usage measurements
	Reset cumul. power	Clears cumulated power usage measurement
	Dry contacts test	Tests dry contact relay outputs
Settings	Local settings	Sets product general parameters
	In/Out settings	Sets output parameters
	On/Off settings	Sets On/Off conditions
	Battery settings	Sets battery configuration
Event log	Event filter	Selects faults, alarms and/or events to display
	Event list	Displays the events stored
	Reset event list	Clears events
Fault log	Fault list	Displays event log or alarms
Identification		[Product type/model] / [Part/Serial number] / [UPS/NMC firmware] / [Com card IPv4], [Com card IPv6], [Com card MAC] / [Detected accessories]
Register product		Links to Lenovo registration website

User settings

The following table displays the options that can be changed by the user.

	Submenu	Available settings	Default settings
Local settings	Language	[<i>language_name</i>] Select the desired language from the list. Menus, status, notices and alarms, UPS fault, Event Log data and settings are in all supported languages.	[English] User selectable when UPS is powered for the first time.
	Date/time	Format: [International] [US]	[US]
	LCD	Modify LCD screen brightness and contrast to be adapted to room light conditions.	
	Audible alarm	[Enabled] [Disabled on battery] [Always disabled]	[Enabled]

	Submenu	Available settings	Default settings
		Enable or disable the buzzer if an alarm occurs.	
In/Out settings	Output voltage	[200V] [208V] [220V] [230V] [240V] Can be changed only in Standby mode	[208V]
	Output frequency	Frequency converter: [Enabled] [Disabled] Frequency settable in frequency converter mode	[Disabled]
	Output mode	[Industrial] [Network] Set UPS behavior regarding transfer on Bypass	[Network]
	Input volt hysteresis	Sets input voltage hysteresis from 1 to 10V	[10V]
	High Efficiency mode	[Enabled] [Disabled] Power the output from Bypass for high efficiency	[Disabled]
	Bypass transfer	[Transfer if BP AC NOK] [Enabled] [Disabled] Allow transfer on Bypass out of tolerance	[Disabled]
	Interrupt time	If Bypass transfer is enabled, Interrupt time: [10ms] [20ms] Define break duration when transfer on Bypass	[10ms]
	Overload prealarm	[10%] ... [102%] Load % when overload alarm occurs	[102%]
	Redundancy mode	[Unitary UPS] [Hot Standby] Force slew rate value to 0.5Hz/s	[Unitary UPS]

	Submenu	Available settings	Default settings
On/Off settings	Cold start	[Enabled] [Disabled] Authorize the product to start on battery power.	[Enabled]
	Forced reboot	[Enabled] [Disabled] If mains recover during a shutdown sequence: If set to Enabled, shutdown sequence will complete and wait 10 seconds prior to restart, if set to Disabled, shutdown sequence will not complete and restart will occur immediately.	[Enabled]
	Auto restart	[Enabled] [Disabled] Authorize the product to restart automatically when mains recovers after a complete battery discharge.	[Enabled]
	Auto start	[Enabled] [Disabled] The UPS automatically starts up as soon as mains power is available (no need to press the  button).	[Disabled]
	Energy saving	[Disabled] [100W] ... [1000W] If Enabled, UPS will shut down after 5 min. of back-up time, if load is less than threshold.	[Disabled]
On/Off settings (continued)	Sleep mode	[Enabled] [Disabled] If Disabled, LCD and communication will turn OFF immediately after UPS is OFF. If Enabled, LCD and communication stays ON 1h 30 min. after UPS is OFF.	[Enabled]
	Remote command	[Enabled] [Disabled] If Enabled, shutdown or restart commands from software are authorized.	[Enabled]

	Submenu	Available settings	Default settings
	Bypass standby	[Enabled] [Disabled] Define if output is powered from Bypass in Standby mode.	[Disabled]
Battery settings	Automatic battery test	In constant charge mode: [No test] [Every day] [Every week] [Every month] In ABM cycling mode: [No test] [Every ABM cycle]	[Every ABM cycle]
	Low battery warning	[0%] ... [100%] The alarm triggers when the set percentage of battery-pack capacity is reached during back-up time.	[20%]
	Restart battery level	[0%] ... [100%] If set, automatic restart will occur only when percentage of battery charge is reached.	[0%]
	Battery charge mode	[ABM cycling] [Constant charge]	[ABM cycling]
	External battery	[Auto detection] [Manual EBM set.] [Manual battery set.] [No battery]	[Auto detection] Using standard EBM, UPS detects automatically the number of EBM connected
	Deep discharge protection	[Yes] [No] If set to Yes, the UPS automatically prevents batteries from deep discharge by adapting end of back-up time voltage threshold. Warranty void if set to No.	[Yes]

Chapter 3. Installation

Inspecting the equipment

If any equipment has been damaged during shipment, keep the shipping cartons and packing materials and contact your place of purchase.

Note: Check the battery recharge date on the shipping carton label. If the date has passed and the battery packs were never recharged, do not use the UPS. Contact your service representative.

Unpacking the unit

Important: Unpacking the unit in a low-temperature environment might cause condensation to occur in and on the unit. Do not install the unit until the inside and outside of the unit are absolutely dry (hazard of electric shock).

Step 1. Unpack the equipment and remove all packing materials and the shipping carton.

Note: Do not lift the UPS or EBM from the front panel.

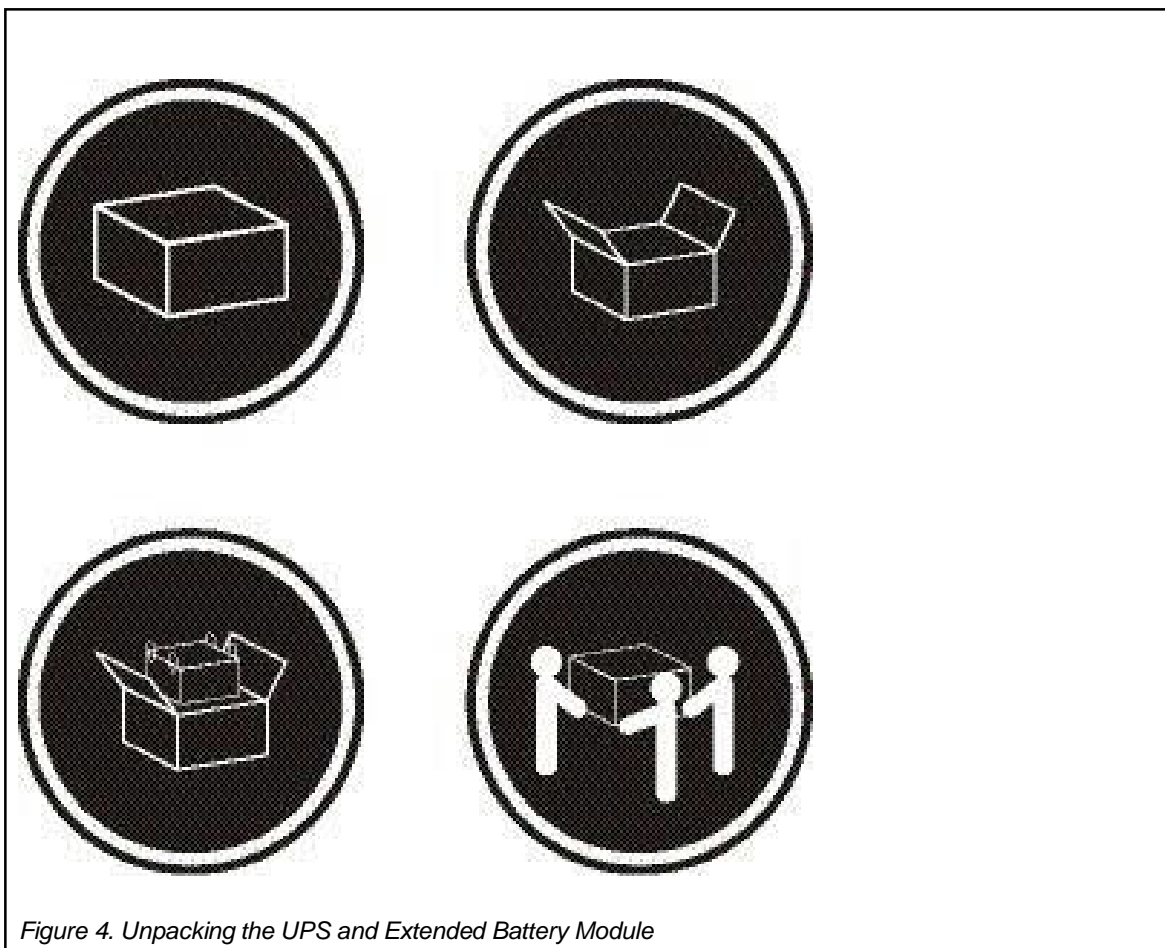

Step 2. Discard or recycle the packaging in a responsible manner, or store it for future use.

Note: Packing materials must be disposed of in compliance with all local regulations concerning waste. Recycling symbols are printed on Lenovo the packing materials to facilitate sorting.

Checking the accessory kit

Verify that the following additional items are included with the UPS:

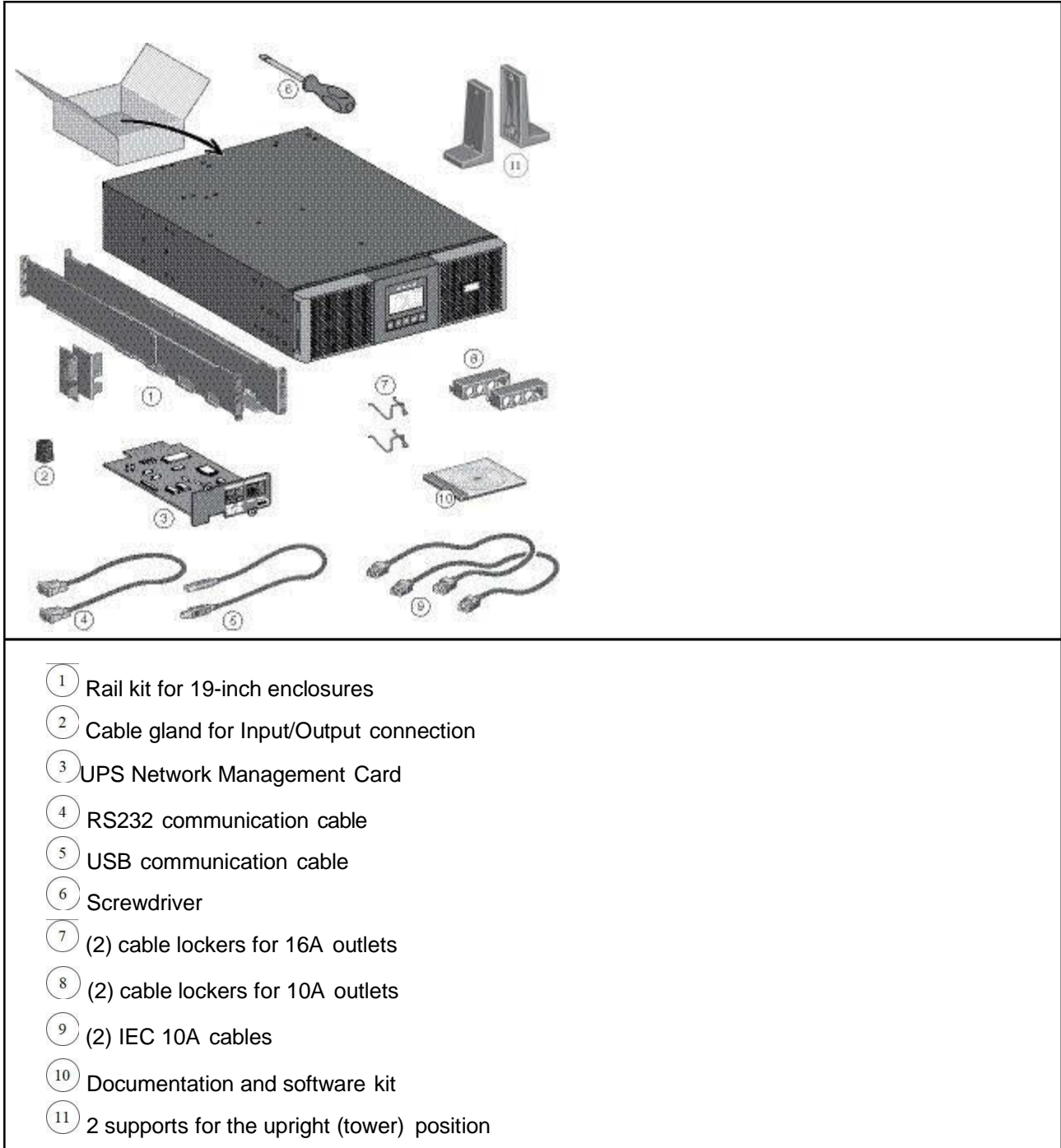

Verify that the following additional items are included with each EBM:

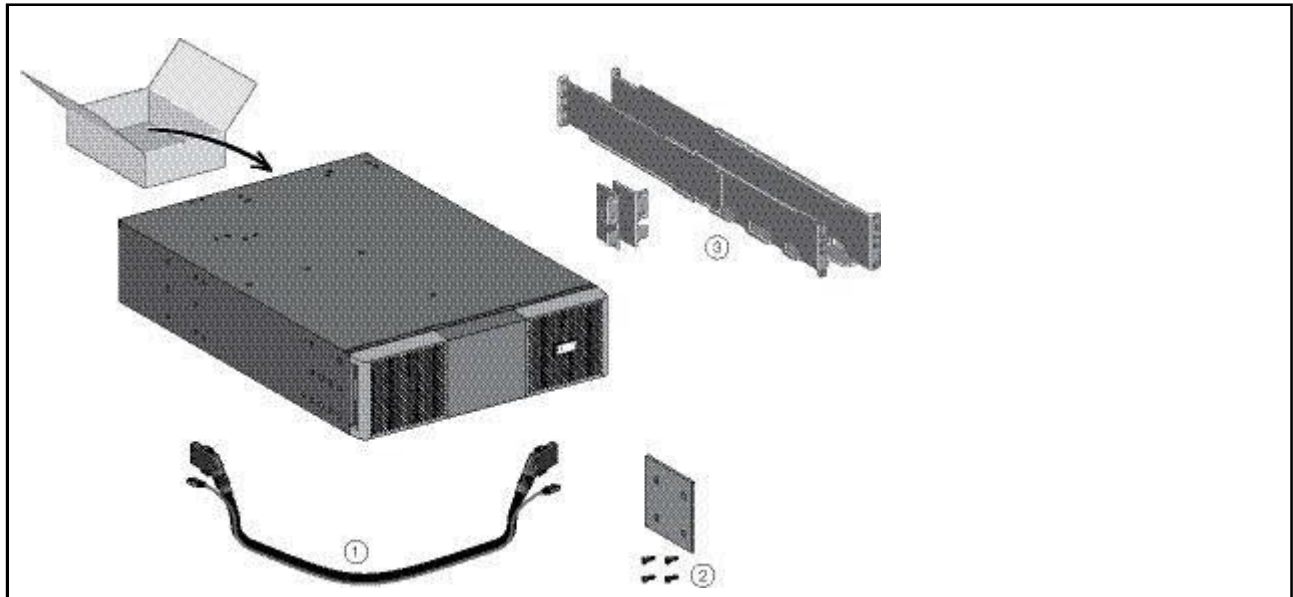

- ① Battery power cable, attached with battery detection cable
- ② Stabilizer bracket (4 screws included)
- ③ Rail kit for 19-inch enclosures

Note: Disregard the EBM installation instructions if you are installing the EBM with a new UPS at the same time. Use the UPS instructions to install both the UPS and the EBM.

If you ordered other UPS accessories, refer to specific user manuals to check the packing contents.

Connecting the internal battery pack

Note: Do not make unauthorized changes to the UPS; otherwise, damage might occur to your equipment and void your warranty. Do not connect the UPS to utility power until installation is completed.

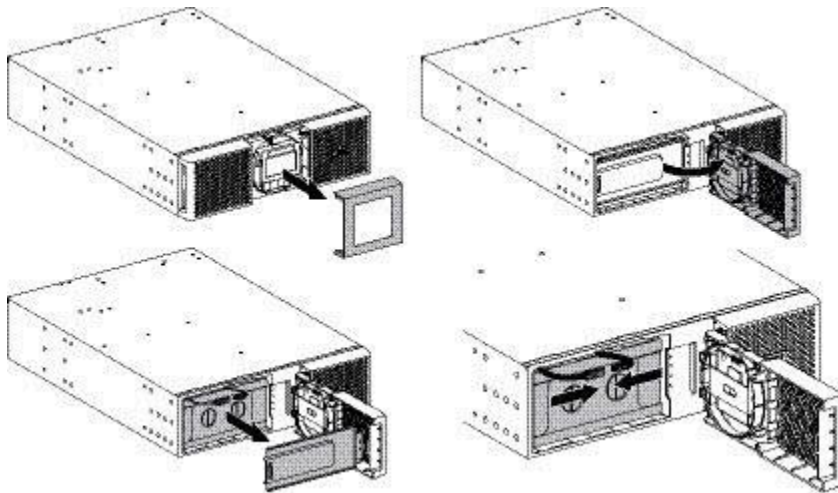

To install the UPS:

- Step 1. Remove the center cover of the front bezel.
- Step 2. Loosen the two screws to open the left side of the front bezel.
- Step 3. Remove the two screws to pull out the metal protection cover of the battery pack.

Note: A ribbon cable connects the LCD control panel to the UPS. Do not pull on the cable or disconnect it.

Note: A small amount of arcing might occur when connecting the battery pack. This is normal and does not damage the UPS or present any safety concern.

- Step 4. Connect the two battery-pack connectors together.
- Step 5. Screw back the metal protection cover and the front bezel, then clip the center cover.

Connecting the EBM(s)

Note: A small amount of arcing might occur when connecting EBMs. This is normal and will not harm personnel. Insert the EBM cable into the battery connector quickly and firmly.

- Step 1. Plug the EBM power cable(s) into the battery connector(s). Up to four EBMs can be connected to the UPS.
- Step 2. Verify that the EBM connections are tight and that strain relief exists for each cable.
- Step 3. Connect the battery detection cable(s) to the connector of the UPS and of the EBM(s).

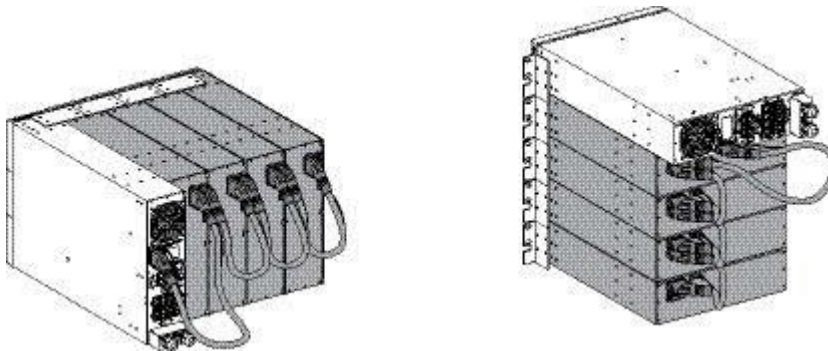

Rack installation

Preparing the UPS for rack mounting

Note: This step requires two people.

The UPS is heavy. To ease its rack mounting, you can remove the battery packs from the UPS as explained below.

- Step 1. Remove the center cover of the front bezel.
- Step 2. Loosen the two screws to open the left side of the front bezel.
- Step 3. Remove the two screws to pull out the metal protection cover of the battery pack.

Note: A ribbon cable connects the LCD control panel to the UPS. Do not pull on the cable or disconnect it.

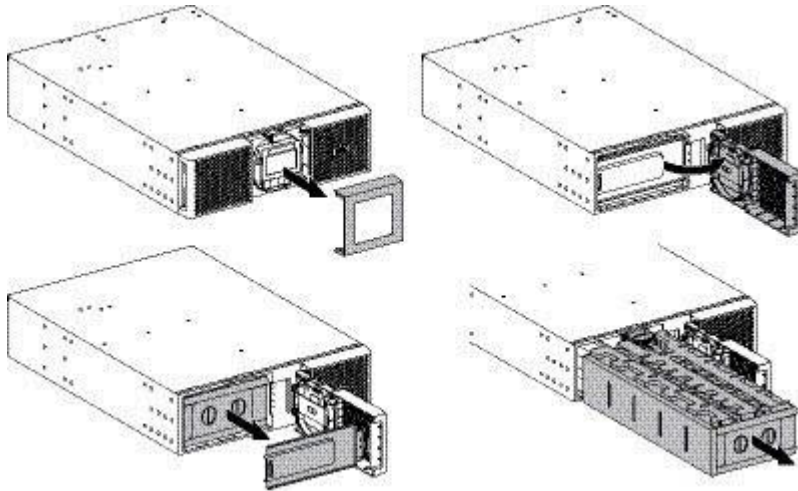

- Step 4. Pull out the plastic handle of the battery pack, and slide the packs out slowly on to a flat and stable surface. Use two hands to support the battery packs. Set them aside for reinstalling after that the UPS is rack mounted.
- Step 5. Mount the UPS on rack.
- Step 6. Put back the battery packs, screw back the metal protection cover and the front panel, then clip the center cover.

Rack mounting of the UPS and EBM

The UPS and connected EBMs must be installed no higher than 5 feet (1.5m) above the floor to allow for easy installation and servicing.

- Step 1. Follow steps 1 to 4 in the illustration for module mounting on the rails.

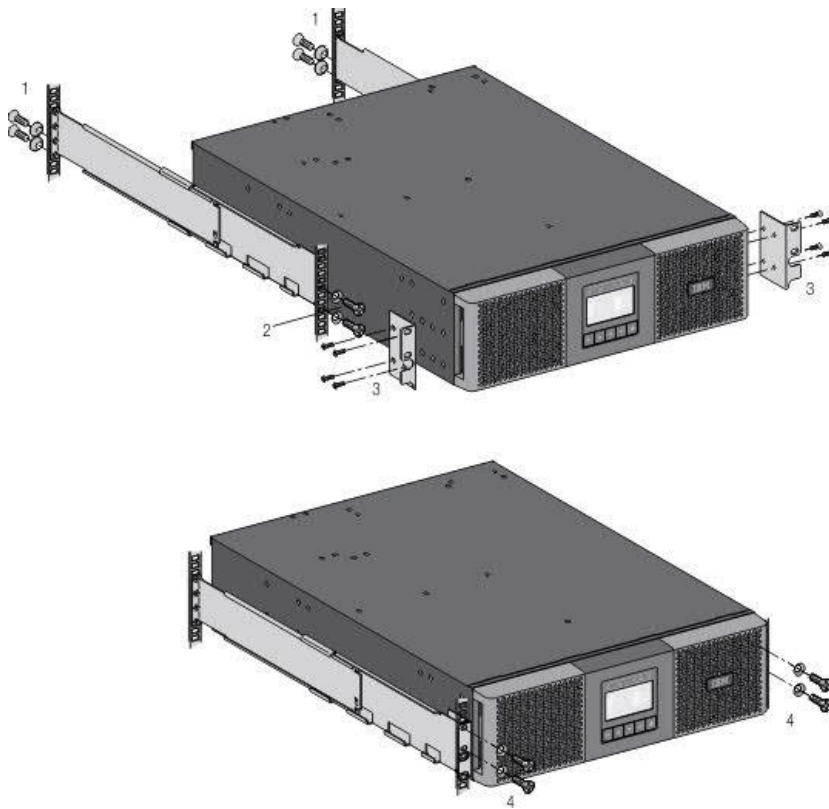

The rails and necessary hardware are supplied by Lenovo.

Tower installation

To install the unit in a tower configuration:

- Step 1. Place the UPS on a flat, stable surface, in its final location.
- Step 2. Always keep 150 mm of free space behind the UPS rear panel.
- Step 3. If installing additional units, place them next to the UPS in their final location.

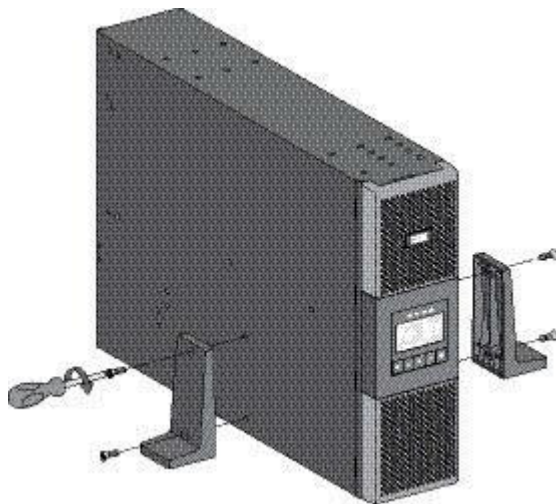

- Adjustment of the orientation of the LCD panel and of the logo.

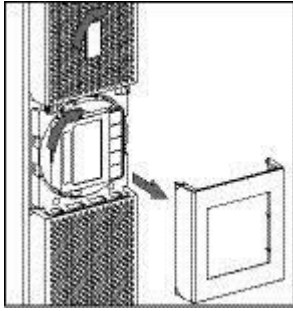

- Adjustment of the angle of vision of the LCD panel.

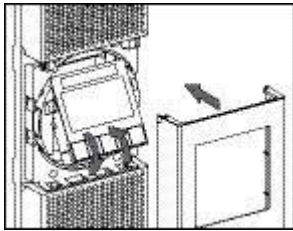

Installing the communication card

Follow these steps to install the UPS Network Management Card if it is not preinstalled.

Note: It is not necessary to shut down the UPS before installing the card.

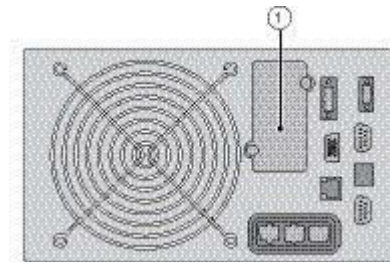

- Step 1. Remove the connector panel blank (1), which is secured by two screws.
- Step 2. Insert the UPS Network Management Card into the slot. Secure the panel by tightening the two screws.

Installation requirements

Recommended protective devices and cable cross-sections

1. Recommended upstream protection

UPS power rating	Upstream circuit breaker
5000VA	D curve 30A or D curve RCD 30A, 300 mA leak current
6000VA	D curve 30A or D curve RCD 30A, 300 mA leak current

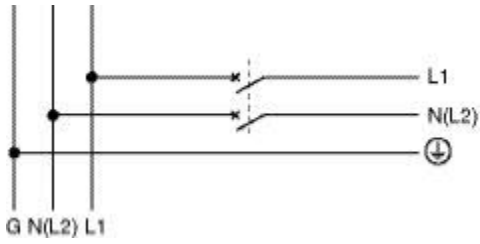

2. Recommended cable cross-sections

Terminal position	Wire function	Terminal wire size rating	Minimum input wire size	Tightening torque
L1	Phase	4-16 mm ² (12-6 AWG)	6 mm ² (10 AWG) 105°C	10 lb in / 1.13 Nm
N(L2)	Neutral			
⊕	Ground		10 mm ² (8 AWG) 75°C	

Copper wire, solid or stranded.

Chapter 4. Power cables connection

CAUTION:



This product might be equipped with a hard-wired power cable. Ensure that a licensed electrician performs the installation per the national electrical code. (C022)

Important: This connection must be carried out by qualified electrical personnel. Before carrying out any connection, check that the upstream protection devices (Normal AC source and Bypass AC source) are open "O" (off).

Always connect the ground wire first.

Important: Before connecting the HotSwap MBP to the UPS, make sure the UPS has been properly shut down. **Always connect the ground wire first.**

Access to terminal blocks

Step 1. Remove the terminal blocks cover (one screw).

Step 2. Punch the knockouts and insert the cables/conduits inside.

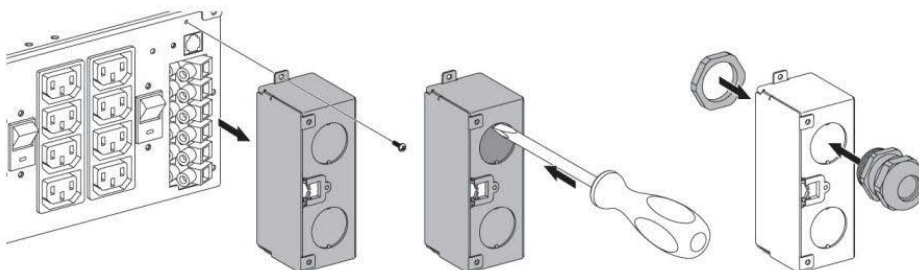

Important: High leakage current: An earth connection is essential before connecting to the power supply.

Input/Output connection

Important: This type of connection must be carried out by qualified electrical personnel. Before carrying out any connection, check that the upstream protection device (Normal AC source) is open "O" (off).

Always connect the ground wire first.

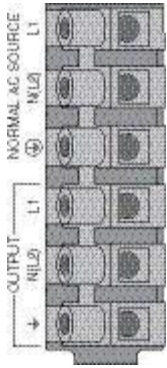

1. Insert the Normal AC cable through the cable gland.
2. Connect the three cables to the Normal AC source terminal blocks.
3. Insert the Output cable through the cable gland.
4. Connect the three cables to the Output terminal blocks.
5. Put back and secure the terminal blocks cover with the screw.
6. Tighten the cable glands.

Chapter 5. Operation



UPS startup and shutdown

Follow these instructions to start and stop the UPS.

Starting the UPS

Note: Verify that the total equipment ratings do not exceed the UPS capacity to prevent an overload alarm.

To start the UPS:

- Step 1. Verify that the internal batteries are connected. See “Connecting the internal battery pack” on page 17.
- Step 2. If optional EBMs are installed, verify that the EBM are connected to the UPS. See “Connecting the EBM(s)” on page 18.
- Step 3. Verify that the UPS terminal blocks are connected to the AC source.
- Step 4. Set the upstream circuit breaker (not provided) to the "I" (on) position to switch on the utility power. The UPS front panel display illuminates and shows the Lenovo logo.
- Step 5. Verify that the UPS status screen shows , press  to restart.
- Step 6. Press the  button on the UPS front panel for at least 3 seconds.

The UPS front panel display changes status to "UPS starting...".

- Step 7. Check the UPS front panel display for active alarms or notices. Resolve any active alarms before continuing. See the Troubleshooting section.

If the  indicator is on, do not proceed until all alarms are clear. Check the UPS status from the front panel to view the active alarms. Correct the alarms and restart if necessary.

- Step 8. Verify that the  indicator illuminates solid, indicating that the UPS is operating normally and powering the equipment.

Note: The internal batteries charge to 90% capacity in less than 3 hours. However, the batteries should charge for 48 hours after installation or long-term storage.

Starting the UPS on battery power

Note: Before using this feature, the UPS must have been powered by utility power with output enabled at least once. Battery start can be disabled. See “Cold start” on page 12.

To start the UPS on battery power:

- Step 1. Press the power () button on the UPS front panel until the UPS front panel display illuminates and shows a status of "UPS starting...".

The UPS cycles through Standby mode to Battery mode. The  indicator illuminates solid. The UPS supplies power to your equipment using batteries.

- Step 2. Check the front panel display for active alarms or notices besides the "Battery mode" notice and notices that indicate missing utility power. Resolve any active alarms before continuing. See the Troubleshooting section.
- Step 3. Check the UPS status from the front panel to view the active alarms. Correct the alarms and restart if necessary.

Shutting down the UPS

To shut down the UPS:

- Step 1. Press the  button on the UPS front panel. The UPS transfers to Standby mode.
- Step 2. Set the upstream circuit breaker (not provided) to the "O" position (Off) to switch off the utility power.

Monitoring the UPS operating mode

The Lenovo UPS front panel indicates the UPS status through the UPS indicators. See "Control panel" on page 7.

Operating modes: descriptions

Online mode

When the UPS is operating from utility power, the UPS is in Online mode: the  indicator illuminates solid. The UPS monitors and charges the battery packs as needed and provides filtered power protection to your equipment. High Efficiency and Energy Saving settings take the UPS out of online mode to minimize heat contribution to the rack environment, but reduce the protection of your equipment. See "User settings" on page 10.

Battery mode

When the UPS is operating without utility power, the alarm beeps once every ten seconds and the  indicator illuminates solid. The necessary energy is provided by the battery packs. When the utility power returns, the UPS goes to Online mode.

If battery capacity becomes low while in Battery mode, the audible alarm beeps once every 3 seconds. This warning is approximate, and the actual time to shut down might vary significantly. Shut down all applications on the connected equipment because automatic UPS shutdown is imminent. When utility power is restored after the UPS shuts down, the UPS automatically restarts.

Bypass mode

In the event of a UPS overload or internal failure, the UPS powers your equipment directly from utility power. Battery mode is not available and your equipment is not protected; however, the utility power continues to be passively filtered by the UPS. The  indicator illuminates.

Depending on overload conditions, the UPS remains in Bypass mode for at least 5 seconds and will stay in this mode if three transfers to Bypass occur within 20 minutes.

The UPS transfers to Bypass mode when:

- the user activates Bypass mode through the front panel
- the UPS detects an internal failure

- the UPS has an overtemperature condition
- the UPS has an overload condition listed in the *Specifications* section

Note: The UPS stops operating after a specified delay for overload conditions listed in the *Specifications* section. However, the UPS remains on to alarm the fault.

Standby mode

When the UPS is turned off and remains connected to the AC source, the UPS is in Standby mode ( indicator). Depending if Bypass Standby setting is enabled, the output is powered but not protected. The battery packs recharge when necessary and the communication ports are powered.

Operating modes: summary

The following table summarizes the characteristics of your UPS unit in each operating mode.

Table 1. Operating modes

Mode	Online	Battery	Bypass	Standby
Load	powered	powered	powered	no power
Batteries	charging	discharging	charging	charging
Protection features:				
Power failure	yes	n/a	no	no
Power sag	yes	n/a	no	no
Power surge	yes	n/a	no	no
Under voltage	yes	n/a	no	no
Over voltage	yes	n/a	no	no
Line noise	yes	n/a	no	no
Frequency variation	yes	n/a	no	no
Switching transients	yes	n/a	no	no
Harmonic distortion	yes	n/a	no	no
Other features:				
Frequency conversion	yes	n/a	no	no

Note: In High Efficiency mode, the UPS is in Bypass mode and transfers to Battery mode in less than 10 microseconds (ms) when utility power fails. Transfers to High Efficiency (HE) mode will be active after 5 minutes of Bypass voltage monitoring: if Bypass quality is not in tolerance, then the UPS will remain in Online mode.

Transferring the UPS between modes

From Online or Battery to Bypass mode. Press any button to activate the menu options, then select **Control** and **Go to Bypass**.

From Bypass to Online or Battery mode. Press any button to activate the menu options, then select **Control** and **Go back normal**.

Setting High Efficiency mode

In High Efficiency mode, the UPS is in Bypass mode and transfers to Battery mode in less than 10 microseconds (ms) when utility power fails. Transfers to High Efficiency (HE) mode will be active after 5 minutes of Bypass voltage monitoring: if Bypass quality is not in tolerance, then the UPS will remain in Online mode.

To set High Efficiency mode:

- Step 1. Put the UPS on Bypass: press any button to activate the menu options, select **Control** → **Go to Bypass**.
- Step 2. Then, press **Escape** and select **Settings** → **In/Out settings** → **High Efficiency mode**.
- Step 3. Select **Enabled** and **Enter** to confirm.
The UPS goes into Bypass mode and transfers to Battery mode in the event utility power fails.

Configuring Bypass settings

The following settings are available for configuring Bypass operation for special situations. Normally, these settings will not need to be changed.

Bypass transfer out of tolerance

- Step 1. Press any button to activate the menu options, then select **Settings** → **Output settings** → **Bypass transfer**.
- Step 2. Select **Enabled** or **Disabled** for **BP AC NOK**, and **Enter** to confirm. If **Enabled**, the UPS transfers to Bypass even if Bypass AC source is out of tolerance, depending on output mode. If **Disabled**, the UPS output is shut down.

Interrupt time

This setting is displayed to define the break duration during transfer to Bypass, only if transfer out of tolerance is enabled. 10 ms or 20 ms can be selected.

Configuring battery settings

Automatic battery test

Automatic battery tests are done every week in automatic charging mode and at each cycle in Advanced Battery Management (ABM) mode. The frequency of the tests can be modified using the LCD panel: see "Automatic battery test" in "User settings" on page 10.

During the test, the UPS goes into Battery mode and discharges the battery packs for 25 seconds under load.

Note: Battery mode is not displayed and battery low alarm does not activate during a battery test.

The battery test might be cancelled due to bad conditions, or fail.

Low battery warning

During discharge, the low battery alarm is activated if the battery capacity goes below 20%. This threshold can be modified using the LCD panel.

External battery setting

The number of Extended Battery Modules (EBMs) is automatically detected, or it can be set manually using the LCD panel: see "External battery" in "User settings" on page 10.

Deep discharge protection

This setting is recommended to avoid damaging the battery packs. The warranty is void if deep discharge protection is disabled.

Retrieving the Event log

To retrieve the Event log through the display:

- Step 1. Press any button to activate the menu options, then select **Event log**.
- Step 2. Scroll through the listed events.

Retrieving the Fault log

To retrieve the Fault log through the display:

- Step 1. Press any button to activate the menu options, then select **Fault log**.
- Step 2. Scroll through the listed faults.

Chapter 6. Communication

Communication ports

Connecting the RS232 or USB communication port

Note: The RS232 and USB communication ports cannot operate simultaneously.

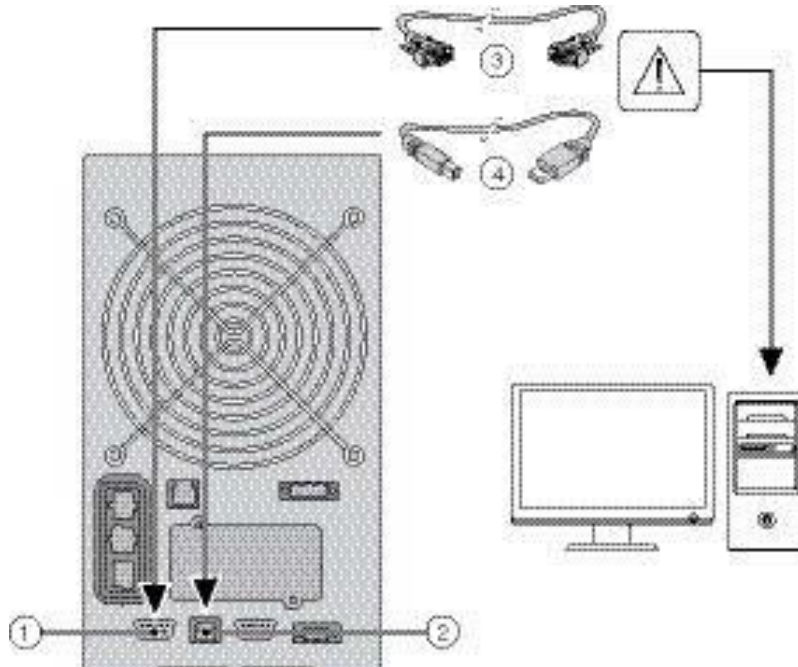

- Step 1. Connect the RS232 (3) or USB (4) communication cable to the serial or USB port on the computer equipment.
- Step 2. Connect the other end of the communication cable (3) or (4) to the RS232 (1) or USB (2) communication port on the UPS.

The UPS can now communicate with Lenovo power management software.

Relay output contacts

The UPS incorporates four relay outputs; each one is available with a normally closed or open contact.

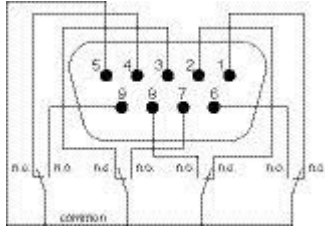

n.o.: contact normally open

n.c.: contact normally closed

Status active information: (if contact between pin and common is closed)

- Pin 1: not on Bypass
- Pin 2: load not protected
- Pin 3: not low battery
- Pin 4: not on Battery
- Pin 5: user common
- Pin 6: on Bypass
- Pin 7: low battery
- Pin 8: load protected
- Pin 9: on Battery

Important: The relay output contacts must not be connected to any utility connected circuits. Reinforced insulation to the utility is required. The relay output contacts have a maximum rating of 250 Vac/5A.

Remote On/Off

Remote On/Off allows remote control of the power () button to switch the UPS on and off.

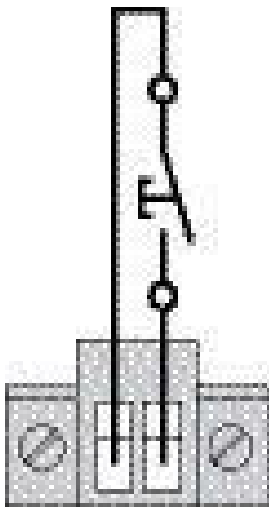

Normally open

When contact changes from open to closed, the UPS is switched on (or stays on).

When contact changes from closed to open, the UPS is switched off (or stays off).

Note: On/Off control using the power () button has priority over the remote control.

Remote Power Off

RPO is used to disable the UPS remotely. This feature can be used for unpowering the load and shutting down the UPS by an external event, for example when the room temperature is too high. When RPO is activated, the UPS disables the output and all its power converters immediately. The UPS remains on, to alarm the fault.

Important: The RPO circuit is an IEC 60950 safety extra low voltage (SELV) circuit. This circuit must be separated from any hazardous voltage circuits.

Notes: Important notes:

- The RPO must not be connected to any utility-connected circuits. The RPO switch must have a minimum rating of 27 Vdc and 20 mA and be a dedicated latching-type switch not tied into any other circuit. The RPO signal must remain active for at least 250 ms for proper operation.
- To ensure the UPS stops supplying power to the load during any mode of operation, the input power must be disconnected from the UPS when the Remote Power Off function is activated.

Note: Leave the RPO jumper wire installed in the RPO port on the UPS if the RPO function is not needed.

RPO connections:

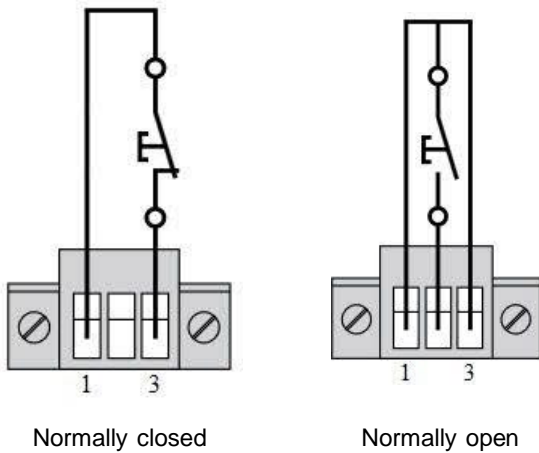

Terminal wire size rating is 0.32-4 mm² (22-12 AWG).

Remote control connection and test

1. Ensure that the UPS is shut down and the utility power is disconnected.
2. Remove the RPO connector from the UPS by loosening the screws.
3. Connect a normally closed volt-free contact between pins 1 and 3 of the connector.

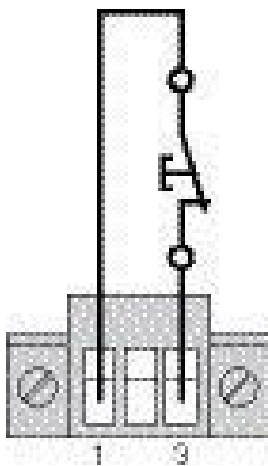

Contact open: shut down of UPS

To return to normal operation, close the external remote shut down contact and restart the UPS from the front panel.

Normally closed

4. Plug the RPO connector into the back of the UPS and fix the screws.
5. Connect and restart the UPS.
6. Open the external remote shut down contact to test the function.

Note: Always test the RPO function before applying your critical load to avoid accidental load loss.

Replacing the communication card

Follow these steps to replace the UPS Network Management Card.

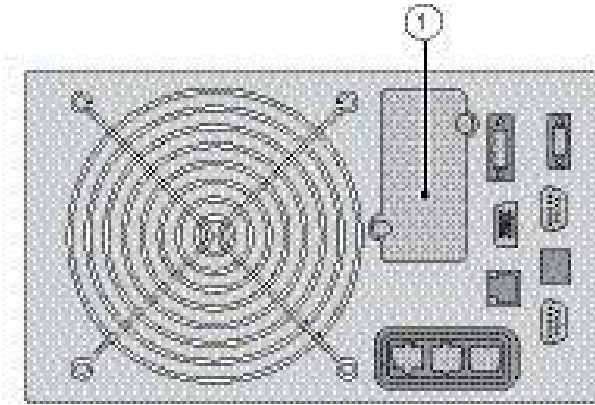

- Step 1. Turn off the UPS.
- Step 2. Disconnect the network cable.
- Step 3. Remove the connector panel blank (1), which is secured by two screws.
- Step 4. Insert the UPS Network Management Card into the slot.
- Step 5. Secure the panel by tightening the two screws.

UPS Power Management suite

The UPS ships with the UPS Power Management suite. It operates on a computer running Windows or Linux, plugged into the UPS output.

To begin installing, see the UPS Power Management suite CD.

The UPS Power Management suite provides real-time graphics of UPS power data. It also gives you a complete record of critical power events, and it notifies you of important UPS or power information.

If there is a utility power outage and the UPS battery power becomes low, the UPS Power Management suite can attempt to shut down your computer before the UPS shutdown occurs.

Chapter 7. UPS maintenance

Equipment care

For the best preventive maintenance, keep the area around the equipment clean and dust free. If the atmosphere is very dusty, clean the outside of the system with a vacuum cleaner. For full battery life, keep the equipment at an ambient temperature of 25°C (77°F).

Note: If the UPS requires any type of transportation, verify that the UPS is disconnected and turned off and then disconnect the UPS internal battery-pack connector, see “Connecting the internal battery pack” on page 17. The battery packs are rated for a 3-5 year service life. The length of service life varies, depending on the frequency of usage and ambient temperature. Battery packs used beyond expected service life will often have severely reduced runtimes. Replace battery packs at least every 4 years to keep units running at peak efficiency.

Storing the equipment

If you store the equipment for a long period, recharge the battery packs every 6 months by connecting the UPS to utility power. The EBM will charge to 90% capacity in less than 3 hours. However, the battery packs should be allowed to charge for 48 hours after long-term storage.

Check the battery recharge date on the shipping carton label. If the date has passed and the battery packs were never recharged, do not use them. Contact your service representative.

Replacing battery packs

When the battery replacement screen is displayed (see illustration), replace the battery packs. Contact your service representative to order new battery packs.

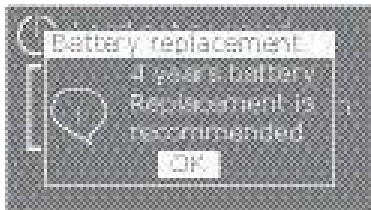

Replace all battery packs in the UPS and any EBMs connected to the UPS at the same time. The replacement battery packs must have no more than 12 month variation between their dates of manufacture and should not have reached or exceeded their shelf life. Dispose of battery packs in accordance with local regulations.

Battery packs can be replaced without turning off the UPS or disconnecting the load. If you prefer to power down to change the battery packs, see *Shutting down the UPS*.

Note: DO NOT DISCONNECT a battery pack while the UPS is in Battery mode. Be aware that the UPS can switch to Battery mode at any time and without warning.

Consider all warnings, cautions, and notes before replacing battery packs.

Important:

- Servicing should be performed by qualified service personnel knowledgeable of batteries and required precautions. Keep unauthorized personnel away from batteries.

- Batteries can present a risk of electrical shock or burn from high short circuit current. Observe the following precautions:
 1. Remove watches, rings, or other metal objects,
 2. Use tools with insulated handles,
 3. Do not lay tools or metal parts on top of battery packs,
 4. Wear rubber gloves and boots.
- When replacing battery packs, replace with the same type and number. Contact your service representative to order new battery packs.
- Proper disposal of battery packs is required. Refer to your local codes for disposal requirements.
- Never dispose of batteries in a fire. Batteries might explode when exposed to flame.
- Do not open or mutilate batteries. Released electrolyte is harmful to the skin and eyes and can be extremely toxic.
- Determine if the battery pack is inadvertently grounded. If inadvertently grounded, remove source from ground. Contact with any part of a grounded battery can result in electrical shock. The likelihood of such shock can be reduced if such grounds are removed during installation and maintenance (applicable to equipment and remote battery supplies not having a grounded supply circuit).
- **ELECTRIC ENERGY HAZARD.** Do not attempt to alter any battery wiring or connectors. Attempting to alter wiring can cause injury.

Replacing the internal battery pack

CAUTION:



The weight of this part or unit is more than 55 kg (121.2 lb). It takes specially trained persons, a lifting device, or both to safely lift this part or unit. (C011)

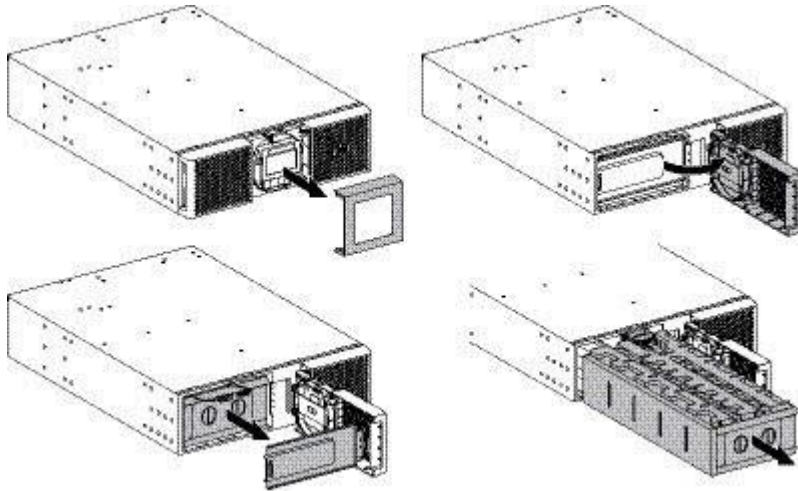

To replace the battery pack:

- Step 1. Remove the center section of the front bezel.
- Step 2. Loosen the two screws to open the left side of the front bezel.
- Step 3. Remove the two screws to pull out the metal protective cover of the battery pack.

Note: A ribbon cable connects the LCD control panel to the UPS. Do not pull on the cable or disconnect it.
- Step 4. Pull out the plastic handle of the battery pack, and slide the pack out slowly on to a flat and stable surface. Use two hands to support the battery pack. See “Recycling the used equipment” on page 38 for proper disposal.
- Step 5. Verify that the replacement batteries have the same rating as the batteries being replaced.
- Step 6. Slide the new battery pack into the UPS. Push the battery pack firmly to ensure a proper connection.
- Step 7. Screw the metal protective cover back onto the unit.
- Step 8. Reinstall the front bezel.
- Step 9. Continue to “Testing a new battery pack” on page 38.

Replacing the EBM(s)

CAUTION:



The weight of this part or unit is more than 55 kg (121.2 lb). It takes specially trained persons, a lifting device, or both to safely lift this part or unit. (C011)

To replace the EBM(s):

- Step 1. Unplug the EBM power cable and battery detection cable from the UPS. If additional EBM(s) are installed, unplug the EBM power cable and battery detection cable from each EBM.
- Step 2. Replace the EBM(s). See "Recycling the used equipment" on page 38 for proper disposal.

Note: A small amount of arcing might occur when connecting EBMs. This is normal and will not harm personnel. Insert the EBM cable into the battery connector quickly and firmly.

- Step 3. Plug the EBM cable(s) into the battery connector(s). Up to four EBMs can be connected to the UPS.
- Step 4. Verify that the EBM connections are tight and that adequate strain relief exists for each cable.
- Step 5. Connect the battery detection cable(s) to the connector of the UPS and of the EBM(s).

Testing a new battery pack

To test a new battery pack:

- Step 1. Allow the batteries to charge for 48 hours.
- Step 2. Press any button to activate the menu options.
- Step 3. Select **Control** → **Start a battery test**.

The UPS starts a battery test if the battery pack is fully charged, the UPS is in Normal mode with no active alarms, and the bypass voltage is acceptable.

During the battery test, the UPS transfers to Battery mode and discharges the battery pack for 25 seconds. The front panel displays "Battery test in progress" and the percentage of the test completed.

Recycling the used equipment

Contact your local recycling or hazardous waste center for information on proper disposal of the used equipment. Refer to the *Lenovo Systems Environmental Notices and User Guide* on the *Lenovo Documentation* CD for more information.

Important:

- Do not dispose of batteries in a fire or expose them to temperatures higher than 100°C (212°F). Battery packs might explode.
- Do not open or mutilate the batteries. Released electrolyte is harmful to the skin and eyes. It can be toxic.
- Dispose of the battery as required by local ordinances or regulations.

	<p>Do not discard waste electrical or electronic equipment (WEEE) in the trash. For proper disposal, contact your local recycling/reuse or hazardous waste center.</p> <p>Do not discard the UPS or the UPS batteries in the trash. This product contains sealed lead acid batteries and must be disposed of properly. For more information, contact your local recycling/reuse or hazardous waste center.</p>
-------------------------------------------------------------------------------------	----------------------------------------------------------------------------------------------------------------------------------------------------------------------------------------------------------------------------------------------------------------------------------------------------------------------------------------------------------------------------------------------------------------

Chapter 8. Troubleshooting



The Lenovo UPS is designed for durable, automatic operation. It will alert you whenever operating problems occur. Usually the alarms shown by the control panel do not mean that the output power is affected. Instead, they are preventive alarms intended to alert the user.

- Events are silent status information that are recorded in the Event log. Example = "AC freq in range".
- Alarms are recorded in the Event log and displayed on the LCD status screen with the logo blinking. Some alarms are announced by a beep every 3 seconds. Example = "Battery low".
- Faults are announced by a continuous beep and red LED, recorded in the Fault log and displayed on the LCD with a specific message box. Example: "Out. short circuit."



Use the following troubleshooting chart to interpret alarm conditions.

Alarms and faults

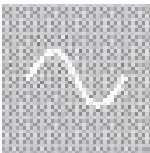

To check the Event log or Fault log:

1. Press any button on the front panel display to activate the menu options.
2. Press the  button to select Event log or Fault log.
3. Press Enter () to review the selected log.
4. Scroll through the listed events or faults.

The following table describes conditions that are logged..

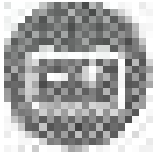
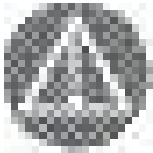
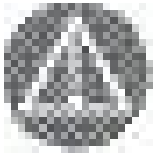
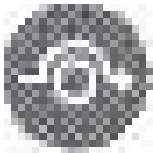
Conditions	Possible cause	Action
Online mode 	Normal operation.	None.
Battery mode  LED is On. 1 beep every 10 seconds.	A utility power failure has occurred, an upstream circuit breaker is tripped, or the input power cord (if so wired) is unplugged.	Check the input power source and connections.

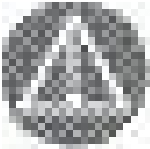
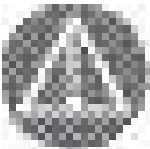
Conditions	Possible cause	Action
<p>Battery low</p>  <p>LED is On.</p> <p>1 beep every 3 seconds.</p>	<p>The UPS has been in Battery mode too long.</p> <p>This warning is approximate, and the actual time to shut down might vary significantly.</p> <p>Depending on the UPS load and the number of Extended Battery Modules (EBMs), the "Battery Low" warning might occur before the battery packs reach 20% capacity.</p>	<p>Shut down equipment.</p>
<p>No battery</p>  <p>LED is On.</p> <p>Beep continuous.</p>	<p>The batteries are not connected, or the circuit breaker on the batteries is off.</p>	<p>Connect all EBMs properly. Both battery power and battery detection cables must be connected.</p> <p>If the condition persists, contact your service representative.</p>
<p>Battery fault (Battery test failed)</p>  <p>LED is On.</p> <p>Beep continuous.</p>	<p>The battery test is failed because of a bad battery pack, because the battery pack is not connected battery pack, or because the battery minimum voltage is reached in Advanced Battery Management (ABM) cycling mode.</p>	<p>Verify that all battery packs are properly connected. Start a new battery test: if the condition persists, contact your service representative.</p>
<p>The UPS does not provide the expected backup time.</p>	<p>The battery pack needs charging or replacement; the load is greater than expected.</p>	<p>Apply utility power for 48 hours to charge the batteries.</p> <p>Using the LCD panel, measure the load power that is being drawn.</p>
<p>Bypass mode</p>  <p>LED is on.</p>	<p>An overload or a fault has occurred, or a command has been received to put the UPS into Bypass mode.</p>	<p>Check for one of the following alarms: overtemperature, overload or UPS failure.</p> <p>Check whether a remote operator has issued a command the UPS into Bypass mode.</p>

Conditions	Possible cause	Action
<p>Power overload</p>  <p>LED is On.</p> <p>Beep continuous.</p>	<p>Power requirements exceed the UPS capacity (greater than 100% of nominal; see Appendix A “UPS model specifications” on page 45 for specific output overload ranges).</p>	<p>Remove some of the equipment from the UPS.</p> <p>The UPS continues to operate, but it might switch to Bypass mode or shut down if the load increases.</p> <p>The alarm resets when the condition becomes inactive.</p>
<p>UPS overtemperature</p>  <p>LED is On.</p> <p>1 beep every 3 seconds.</p> <p>At the warning level, the UPS generates the alarm but remains in the current operating state.</p> <p>If the temperature rises another 10°C, the UPS transfers to Bypass mode or shuts down if Bypass is unusable.</p>	<p>The UPS internal fan has failed.</p>	<p>If the UPS transferred to Bypass mode, the UPS will return to normal operation when the temperature drops 5°C below the warning level.</p> <p>If the condition persists, shut down the UPS.</p> <p>Clear vents and remove any heat sources. Allow the UPS to cool. Ensure the airflow around the UPS is not restricted. Restart the UPS.</p> <p>If the condition continues to persist, contact your service representative.</p>
<p>The UPS does not start.</p>	<p>A utility power failure has occurred, an upstream circuit breaker is tripped, or the input power cord (if so wired) is unplugged.</p>	<p>Check utility power, circuit breakers, and input connections.</p>
	<p>The Remote Power Off (RPO) switch is active or the RPO connector is missing.</p>	<p>If the UPS Status menu displays the "Remote Power Off" notice, inactivate the RPO input.</p>
<p>Input wiring bad / Output wiring bad</p>  <p>LED is On.</p> <p>Beep continuous.</p>	<p>Input/Output cables are not connected to the correct terminal blocks.</p>	<p>Check wiring connections and ensure that all Input/Output cables are connected correctly -- for example, neutral-to-neutral and ground-to-ground.</p>
<p>MBP disconnected</p>	<p>The HotSwap MBP is not detected.</p>	<p>If the HotSwap MBP is connected to the UPS, check that the detection connector is correctly plugged.</p>

Silencing the alarm

- Step 1. Press the **ESC** (Escape) button on the front panel display to silence the alarm.
- Step 2. Perform the applicable action to resolve the alarm condition. If the alarm status changes, the alarm beeps again, overriding the previous alarm silencing.

Service and support

If you have any questions or problems with the UPS, call your Local Distributor or your local service representative and ask for a UPS technical representative.

Have the following information ready when you call for service:

- Equipment type and model number
- Serial number
- Firmware version number
- Date of failure or problem
- Symptoms of failure or problem
- Customer address and contact information

If repair is required, you will be given a Returned Material Authorization (RMA) number. This number must appear on the outside of the package and on the Bill Of Lading (if applicable). Use the original packaging or request packaging from your local service representative or distributor. Units damaged in shipment as a result of improper packaging are not covered under warranty. A replacement or repair unit will be shipped, freight prepaid for all warrantied units.

Note: For critical applications, immediate replacement might be available. Call your local service representative or the distributor nearest you.

Chapter 9. Parts listing

The following replaceable components are available for the product.

For an updated parts listing on the web, go to <http://www.lenovo.com/support>.

Replaceable components consist of consumable parts, structural parts, and customer replaceable units (CRUs):

- **Consumable parts:** Purchase and replacement of consumable parts (components such as printer cartridges, that have depletable life) is your responsibility. If Lenovo acquires or installs a consumable part at your request, you will be charged for the installation.
- **Structural parts:** Purchase and replacement of structural parts (components such as the top cover) is your responsibility. If Lenovo acquires or installs a structural part at your request, you will be charged for the installation.
- **Tier 1 customer replaceable unit (CRU):** Replacement of Tier 1 CRUs is your responsibility. If Lenovo installs a Tier 1 CRU at your request without a service contract, you will be charged for the installation.
- **Tier 2 customer replaceable unit:** You may install a Tier 2 CRU yourself or request Lenovo to install it, at no additional charge, under the type of warranty service that is designated for your compute node.

For information about the terms of the warranty and getting service and assistance, see the *Warranty Information* document.

Table 2. Parts listing table: UPS units

Description	Type	Part No.	55945KX	55946KX
9PX 5KVA IEC (without batteries)	Tier 2 CRU	00FP729	x	
9PX 6KVA IEC (without batteries)	Tier 2 CRU	00FP730		x
9PX 11KVA UPS Bezel Spare (includes LCD)	Tier 1 CRU	00FP792	x	x
EBM Power Cord 6 Feet 180V	Tier 1 CRU	00FP794	x	x
4 Post Rail Kit	Tier 2 CRU	00FP796	x	x
9PX 5/6K UPS Battery Module Spare	Tier 2 CRU	00FP797	x	x
Tower pedestal feet	Tier 1 CRU	00FP825	x	x
Ship Bracket for 9PX	Tier 1 CRU	00FP827	x	x

Table 3. Parts listing table: Extended battery module

Description	Type	Part No.	55946BX
9PX EBM 180V9000-1329-00P 48V 2U EBM (includes batteries)	Tier 2 CRU	00FP731	x
9PX EBM Bezel Spare	Tier 1 CRU	00FP793	x
EBM Power Cord 6 Feet 180V	Tier 1 CRU	00FP794	x
4 Post Rail Kit	Tier 2 CRU	00FP796	x
9PX 5/6K UPS Battery Module Spare	Tier 2 CRU	00FP797	x
Tower pedestal feet	Tier 1 CRU	00FP825	x
Ship Bracket for 9PX	Tier 1 CRU	00FP827	x

Appendix A. UPS model specifications

The Lenovo 3U Rack or Tower UPS, model 5594-5KX and model 5594-6KX, is a single-phase UPS unit.

Table 4. Power Module model list

Model	Power Ratings
5594-5KX	5000VA / 4500W at 200V, 208V, 220V, 230V, and 240V output
5594-6KX	5200VA / 4600W at 200V output
	5400VA / 4800W at 208V output
	5700VA / 5100W at 220V output
	6000VA / 5300W at 230V output
	6000VA / 5400W at 240V output

Table 5. EBM model list

Model	Configuration	EBM voltage	For power ratings
5594-6BX	Rack / Tower	180Vdc	5000-6000VA

Table 6. Electrical input

Nominal frequency	50/60Hz auto-sensing
Frequency range	50Hz : 40-60Hz before transfer to battery 60Hz : 50-70Hz before transfer to battery
Bypass voltage range	-20% / +15% of nominal value (default)
Noise filtering	MOV for normal and common mode noise
Maximum leak current	5 % of input current; 5594-5KX max. 1250 mA, 5594-6KX max. 1500 mA

Table 7. Electrical input (models)

Model	Default input (Voltage/Current)	Selectable input Voltage range	Voltage at 100% Load
5594-5KX	208V / 23.3A	200V, 208V, 220V, 230V, 240V	176-276V
5594-6KX	208V / 24.8A		

Table 8. Electrical input connections

Model	Input connection
5594-5KX	Selectable input cord
5594-6KX	Hardwired

Table 9. Electrical output

All models	Normal mode	Battery mode
Voltage regulation	±1%	±1%
Efficiency	> 98% (High Efficiency mode) > 93%	> 91%

Table 9. Electrical output (continued)

All models	Normal mode	Battery mode
Frequency regulation	Sync with line $\pm 5\%$ of nominal line frequency (outside this range: $\pm 0.5\%$ of auto-selected nominal frequency)	$\pm 0.5\%$ of auto-selected nominal frequency
Frequency	50 or 60Hz, autosensing or configurable as a frequency converter	
Output overload	100-102% : no alarm 102-110% : load transfers to Bypass mode after 2 minutes 110-125% : load transfers to Bypass mode after 1 minute 125-150% : load transfers to Bypass mode after 10s > 150% : load transfers to Bypass mode after 500ms	
Output overload (Bypass mode)	100-125% : no alarm 125-150% : UPS shuts down after 1 minute > 150% : UPS shuts down after 1s	
Voltage waveform	Sinewave	
Harmonic distortion	< 2% THDV on linear load < 5% THDV on non-linear load	
Transfer time	Online mode: 0 ms (no break) High Efficiency mode: 10ms maximum (due to loss of utility)	
Power factor	0.9	
Load crest ratio	3 to 1	

Table 10. Electrical output connections

Model	Output connection	Output cable
5594-5KX	Hardwired (2) IEC 16A (4) IEC 10A group 1 (4) IEC 10A group 2	(2) IEC 10A
5594-6KX		

Table 11. AC input and output

	5594-5KX	5594-6KX
AC Input power	200-240VAC, 50/60Hz, 1ph, 25A max	200-240VAC, 50/60Hz, 1ph, 30A max
AC Output power	50/60Hz, 1ph; 200VAC, 5000VA, 4500W, 25.0A; 208VAC, 5000VA, 4500W, 24.0A; 220VAC, 5000VA, 4500W, 22.7A;	50/60Hz, 1ph; 200VAC, 6000VA, 5400W, 30.0A; 208VAC, 6000VA, 5400W, 28.8A; 220VAC, 6000VA, 5400W, 27.3A;

Table 11. AC input and output (continued)

	5594-5KX	5594-6KX
	230VAC, 5000VA, 4500W, 21.7A; 240VAC, 5000VA, 4500W, 20.8A	230VAC, 6000VA, 5400W, 26.1A; 240VAC, 6000VA, 5400W, 25.0A

Table 12. Weights and dimensions (UPS)

Model (UPS)	Dimensions D x W x H (mm / inch)	Weight (lb / kg)
5594-5KX	722 x 440 x 130 (28.4 x 17.3 x 5.1)	106 / 48
5594-6KX	685 x 440 x 130 (27.0 x 17.3 x 5.1)	106 / 48

Table 13. Weights and dimensions (EBM)

Model (EBM)	Dimensions D x W x H (mm / inch)	Weight (lb / kg)
5594-6BX	645 x 440 x 130 (25.4 x 17.3 x 5.1)	150 / 68

Table 14. Environmental and safety standards

EMC certifications	IEC/EN 62040-1: 2008 IEC/EN 62040-2: 2006 Cat. C2 IEC/EN 62040-3: 2011 IEC 60950-1 UL 1778 4 th CSA 22.2
EMC (Emissions) - for output cable < 10m	CISPR22 Class A AS/NZS 22 Class A IEC 61000-3-2 (-3-12) IEC 61000-3-3 (-3-11) FCC part 15 Class A
EMC (Immunity)	IEC 61000-2-2 IEC 61000-4-2, Level 3 IEC 61000-4-3, Level 3 IEC 61000-4-4, Level 4 (also on signal ports) IEC 61000-4-5, Level 4, Criteria B IEC 61000-4-6, Level 3 IEC 61000-4-8, Level 4 IEC 61000-4-11
Agency markings	CE / cULus / NOM

Table 14. Environmental and safety standards (continued)

Operating temperature	0 to 40°C (32 to 104°F) in Online mode, with linear derating for altitude Note: Thermal protection switches load to Bypass in case of overheating.
Storage temperature	0 to 40°C (32 to 104°F) with batteries -15 to 60°C (5 to 140°F) without batteries
Transit temperature	-25 to 55°C (-13 to 130°F)
Relative humidity	0 to 95% no condensing
Operating altitude	Up to 3,000 meters (9,843 ft) above sea level with 10% derating per 1000m
Transit altitude	Up to 10,000 meters (32,808 ft) above sea level
Audible noise	< 45 dBA at 1 meter typical

Table 15. Battery

	Internal batteries	EBMs
Rack / Tower configuration	5000/6000VA: 180Vdc	5594-6BX: 180Vdc
Type	Sealed, maintenance-free, valve-regulated, lead-acid, with minimum 3-year float service life at 25°C (77°F). Lifetime is reduced above 30°C.	
Monitoring	Advanced monitoring for earlier failure detection and warning	
Battery port	External three-pole SBS75G Black connector on UPS for connecting to EBM	
EBM battery cable length	40cm (15.7in)	

Table 16. Communication options

Communication bay	(1) available independent communication bay for connectivity cards
Compatible connectivity cards	UPS Network Management Card
Communication ports	RS-232 (DB9): 1200-19200 bps USB: 19200 bps
Relay output contacts	(4) relay outputs (normally open or normally closed)
Remote On/Off	2 pins jumper (normally open)
Remote Power Off	3 pins jumper (normally open or normally closed)

Appendix B. Getting help and technical assistance

If you need help, service, or technical assistance or just want more information about Lenovo products, you will find a wide variety of sources available from Lenovo to assist you.

Use this information to obtain additional information about Lenovo and Lenovo products, and determine what to do if you experience a problem with your Lenovo system or optional device.

Note: This section includes references to IBM web sites and information about obtaining service. IBM is Lenovo's preferred service provider for the System x, Flex System, and NeXtScale System products.

Before you call

Before you call, make sure that you have taken these steps to try to solve the problem yourself.

If you believe that you require warranty service for your Lenovo product, the service technicians will be able to assist you more efficiently if you prepare before you call.

- Check all cables to make sure that they are connected.
- Check the power switches to make sure that the system and any optional devices are turned on.
- Check for updated software, firmware, and operating-system device drivers for your Lenovo product. The Lenovo Warranty terms and conditions state that you, the owner of the Lenovo product, are responsible for maintaining and updating all software and firmware for the product (unless it is covered by an additional maintenance contract). Your service technician will request that you upgrade your software and firmware if the problem has a documented solution within a software upgrade.
- If you have installed new hardware or software in your environment, check <http://www.lenovo.com/serverproven/> to make sure that the hardware and software is supported by your product.
- Go to <http://www.lenovo.com/support> to check for information to help you solve the problem.
- Gather the following information to provide to the service technician. This data will help the service technician quickly provide a solution to your problem and ensure that you receive the level of service for which you might have contracted.
 - Hardware and Software Maintenance agreement contract numbers, if applicable
 - Machine type number (Lenovo 4-digit machine identifier)
 - Model number
 - Serial number
 - Current system UEFI and firmware levels
 - Other pertinent information such as error messages and logs
- Go to http://www.ibm.com/support/entry/portal/Open_service_request to submit an Electronic Service Request. Submitting an Electronic Service Request will start the process of determining a solution to your problem by making the pertinent information available to the service technicians. The IBM service technicians can start working on your solution as soon as you have completed and submitted an Electronic Service Request.

You can solve many problems without outside assistance by following the troubleshooting procedures that Lenovo provides in the online help or in the Lenovo product documentation. The Lenovo product documentation also describes the diagnostic tests that you can perform. The documentation for most systems, operating systems, and programs contains troubleshooting procedures and explanations of error messages and error codes. If you suspect a software problem, see the documentation for the operating system or program.

Using the documentation

Information about your Lenovo system and preinstalled software, if any, or optional device is available in the product documentation. That documentation can include printed documents, online documents, readme files, and help files.

See the troubleshooting information in your system documentation for instructions for using the diagnostic programs. The troubleshooting information or the diagnostic programs might tell you that you need additional or updated device drivers or other software. Lenovo maintains pages on the World Wide Web where you can get the latest technical information and download device drivers and updates. To access these pages, go to <http://www.lenovo.com/support>.

Getting help and information from the World Wide Web

Up-to-date information about Lenovo products and support is available on the World Wide Web.

On the World Wide Web, up-to-date information about Lenovo systems, optional devices, services, and support is available at <http://www.lenovo.com/support>. The most current version of the product documentation is available in the following product-specific Information Centers:

- **Flex System products:**
<http://pic.dhe.ibm.com/infocenter/flexsys/information/index.jsp>
- **System x products:**
<http://publib.boulder.ibm.com/infocenter/systemx/documentation/index.jsp>
- **NeXtScale System products:**
<http://pic.dhe.ibm.com/infocenter/nxtscale/documentation/index.jsp>

How to send DSA data

You can use the Enhanced Customer Data Repository to send diagnostic data to IBM.

Before you send diagnostic data to IBM, read the terms of use at <http://www.ibm.com/de/support/ecurep/terms.html>.

You can use any of the following methods to send diagnostic data:

- **Standard upload:**
http://www.ibm.com/de/support/ecurep/send_http.html
- **Standard upload with the system serial number:**
http://www.ecurep.ibm.com/app/upload_hw
- **Secure upload:**
http://www.ibm.com/de/support/ecurep/send_http.html#secure
- **Secure upload with the system serial number:**
https://www.ecurep.ibm.com/app/upload_hw

Creating a personalized support web page

You can create a personalized support web page by identifying Lenovo products that are of interest to you.

To create a personalized support web page, go to <http://www.ibm.com/support/mynotifications>. From this personalized page, you can subscribe to weekly email notifications about new technical documents, search for information and downloads, and access various administrative services.

Software service and support

Through IBM Support Line, you can get telephone assistance, for a fee, with usage, configuration, and software problems with your Lenovo products.

For more information about Support Line and other IBM services, see <http://www.ibm.com/services> or see <http://www.ibm.com/planetwide> for support telephone numbers. In the U.S. and Canada, call 1-800-IBM-SERV (1-800-426-7378).

Hardware service and support

IBM is Lenovo's preferred service provider for the System x, Flex System and NeXtScale System products.

You can receive hardware service through your Lenovo reseller or from IBM. To locate a reseller authorized by Lenovo to provide warranty service, go to <http://www.ibm.com/partnerworld> and click **Business Partner Locator**. For IBM support telephone numbers, see <http://www.ibm.com/planetwide>. In the U.S. and Canada, call 1-800-IBM-SERV (1-800-426-7378).

In the U.S. and Canada, hardware service and support is available 24 hours a day, 7 days a week. In the U.K., these services are available Monday through Friday, from 9 a.m. to 6 p.m.

Taiwan product service

Use this information to contact product service for Taiwan.

委製商/進口商名稱: 荷蘭商聯想股份有限公司台灣分公司
進口商地址: 台北市內湖區堤頂大道2段89號5樓
進口商電話: 0800-000-702 (代表號)

Appendix C. Notices

Lenovo may not offer the products, services, or features discussed in this document in all countries. Consult your local Lenovo representative for information on the products and services currently available in your area.

Any reference to a Lenovo product, program, or service is not intended to state or imply that only that Lenovo product, program, or service may be used. Any functionally equivalent product, program, or service that does not infringe any Lenovo intellectual property right may be used instead. However, it is the user's responsibility to evaluate and verify the operation of any other product, program, or service.

Lenovo may have patents or pending patent applications covering subject matter described in this document. The furnishing of this document does not give you any license to these patents. You can send license inquiries, in writing, to:

*Lenovo (United States), Inc.
1009 Think Place - Building One
Morrisville, NC 27560
U.S.A.
Attention: Lenovo Director of Licensing*

LENOVO PROVIDES THIS PUBLICATION "AS IS" WITHOUT WARRANTY OF ANY KIND, EITHER EXPRESS OR IMPLIED, INCLUDING, BUT NOT LIMITED TO, THE IMPLIED WARRANTIES OF NON-INFRINGEMENT, MERCHANTABILITY OR FITNESS FOR A PARTICULAR PURPOSE. Some jurisdictions do not allow disclaimer of express or implied warranties in certain transactions, therefore, this statement may not apply to you.

This information could include technical inaccuracies or typographical errors. Changes are periodically made to the information herein; these changes will be incorporated in new editions of the publication. Lenovo may make improvements and/or changes in the product(s) and/or the program(s) described in this publication at any time without notice.

The products described in this document are not intended for use in implantation or other life support applications where malfunction may result in injury or death to persons. The information contained in this document does not affect or change Lenovo product specifications or warranties. Nothing in this document shall operate as an express or implied license or indemnity under the intellectual property rights of Lenovo or third parties. All information contained in this document was obtained in specific environments and is presented as an illustration. The result obtained in other operating environments may vary.

Lenovo may use or distribute any of the information you supply in any way it believes appropriate without incurring any obligation to you.

Any references in this publication to non-Lenovo Web sites are provided for convenience only and do not in any manner serve as an endorsement of those Web sites. The materials at those Web sites are not part of the materials for this Lenovo product, and use of those Web sites is at your own risk.

Any performance data contained herein was determined in a controlled environment. Therefore, the result obtained in other operating environments may vary significantly. Some measurements may have been made on development-level systems and there is no guarantee that these measurements will be the same on generally available systems. Furthermore, some measurements may have been estimated through extrapolation. Actual results may vary. Users of this document should verify the applicable data for their specific environment.

Trademarks

Lenovo, the Lenovo logo, Flex System, System x, NeXtScale System, and x Architecture are trademarks of Lenovo in the United States, other countries, or both.

Intel and Intel Xeon are trademarks of Intel Corporation in the United States, other countries, or both.

Internet Explorer, Microsoft, and Windows are trademarks of the Microsoft group of companies.

Linux is a registered trademark of Linus Torvalds.

Other company, product, or service names may be trademarks or service marks of others.

Important notes

Processor speed indicates the internal clock speed of the microprocessor; other factors also affect application performance.

CD or DVD drive speed is the variable read rate. Actual speeds vary and are often less than the possible maximum.

When referring to processor storage, real and virtual storage, or channel volume, KB stands for 1 024 bytes, MB stands for 1 048 576 bytes, and GB stands for 1 073 741 824 bytes.

When referring to hard disk drive capacity or communications volume, MB stands for 1 000 000 bytes, and GB stands for 1 000 000 000 bytes. Total user-accessible capacity can vary depending on operating environments.

Maximum internal hard disk drive capacities assume the replacement of any standard hard disk drives and population of all hard-disk-drive bays with the largest currently supported drives that are available from Lenovo.

Maximum memory might require replacement of the standard memory with an optional memory module.

Each solid-state memory cell has an intrinsic, finite number of write cycles that the cell can incur. Therefore, a solid-state device has a maximum number of write cycles that it can be subjected to, expressed as **total bytes written** (TBW). A device that has exceeded this limit might fail to respond to system-generated commands or might be incapable of being written to. Lenovo is not responsible for replacement of a device that has exceeded its maximum guaranteed number of program/erase cycles, as documented in the Official Published Specifications for the device.

Lenovo makes no representations or warranties with respect to non-Lenovo products. Support (if any) for the non-Lenovo products is provided by the third party, not Lenovo.

Some software might differ from its retail version (if available) and might not include user manuals or all program functionality.

Recycling information

Lenovo encourages owners of information technology (IT) equipment to responsibly recycle their equipment when it is no longer needed. Lenovo offers a variety of programs and services to assist equipment owners in recycling their IT products. For information on recycling Lenovo products, go to: <http://www.lenovo.com/recycling>.

Particulate contamination

Attention: Airborne particulates (including metal flakes or particles) and reactive gases acting alone or in combination with other environmental factors such as humidity or temperature might pose a risk to the device that is described in this document.

Risks that are posed by the presence of excessive particulate levels or concentrations of harmful gases include damage that might cause the device to malfunction or cease functioning altogether. This specification sets forth limits for particulates and gases that are intended to avoid such damage. The limits must not be viewed or used as definitive limits, because numerous other factors, such as temperature or moisture content of the air, can influence the impact of particulates or environmental corrosives and gaseous contaminant transfer. In the absence of specific limits that are set forth in this document, you must implement practices that maintain particulate and gas levels that are consistent with the protection of human health and safety. If Lenovo determines that the levels of particulates or gases in your environment have caused damage to the device, Lenovo may condition provision of repair or replacement of devices or parts on implementation of appropriate remedial measures to mitigate such environmental contamination. Implementation of such remedial measures is a customer responsibility.

Table 17. Limits for particulates and gases

Contaminant	Limits
Particulate	<ul style="list-style-type: none">• The room air must be continuously filtered with 40% atmospheric dust spot efficiency (MERV 9) according to ASHRAE Standard 52.2¹.• Air that enters a data center must be filtered to 99.97% efficiency or greater, using high-efficiency particulate air (HEPA) filters that meet MIL-STD-282.• The deliquescent relative humidity of the particulate contamination must be more than 60%².• The room must be free of conductive contamination such as zinc whiskers.
Gaseous	<ul style="list-style-type: none">• Copper: Class G1 as per ANSI/ISA 71.04-1985³• Silver: Corrosion rate of less than 300 Å in 30 days

¹ ASHRAE 52.2-2008 - *Method of Testing General Ventilation Air-Cleaning Devices for Removal Efficiency by Particle Size*. Atlanta: American Society of Heating, Refrigerating and Air-Conditioning Engineers, Inc.

² The deliquescent relative humidity of particulate contamination is the relative humidity at which the dust absorbs enough water to become wet and promote ionic conduction.

³ ANSI/ISA-71.04-1985. *Environmental conditions for process measurement and control systems: Airborne contaminants*. Instrument Society of America, Research Triangle Park, North Carolina, U.S.A.

Telecommunication regulatory statement

This product may not be certified in your country for connection by any means whatsoever to interfaces of public telecommunications networks. Further certification may be required by law prior to making any such connection. Contact a Lenovo representative or reseller for any questions.

Electronic emission notices

When you attach a monitor to the equipment, you must use the designated monitor cable and any interference suppression devices that are supplied with the monitor.

Federal Communications Commission (FCC) statement

Note: This equipment has been tested and found to comply with the limits for a Class A digital device, pursuant to Part 15 of the FCC Rules. These limits are designed to provide reasonable protection against harmful interference when the equipment is operated in a commercial environment. This equipment

generates, uses, and can radiate radio frequency energy and, if not installed and used in accordance with the instruction manual, may cause harmful interference to radio communications. Operation of this equipment in a residential area is likely to cause harmful interference, in which case the user will be required to correct the interference at his own expense.

Properly shielded and grounded cables and connectors must be used in order to meet FCC emission limits. Lenovo is not responsible for any radio or television interference caused by using other than recommended cables and connectors or by unauthorized changes or modifications to this equipment. Unauthorized changes or modifications could void the user's authority to operate the equipment.

This device complies with Part 15 of the FCC Rules. Operation is subject to the following two conditions: (1) this device may not cause harmful interference, and (2) this device must accept any interference received, including interference that might cause undesired operation.

Industry Canada Class A emission compliance statement

This Class A digital apparatus complies with Canadian ICES-003.

Avis de conformité à la réglementation d'Industrie Canada

Cet appareil numérique de la classe A est conforme à la norme NMB-003 du Canada.

Australia and New Zealand Class A statement

Attention: This is a Class A product. In a domestic environment this product may cause radio interference in which case the user may be required to take adequate measures.

European Union EMC Directive conformance statement

This product is in conformity with the protection requirements of EU Council Directive 2014/30/EU on the approximation of the laws of the Member States relating to electromagnetic compatibility. Lenovo cannot accept responsibility for any failure to satisfy the protection requirements resulting from a non-recommended modification of the product, including the installation of option cards from other manufacturers.

This product has been tested and found to comply with the limits for Class A equipment according to European Standards harmonized in the Directives in compliance. The limits for Class A equipment were derived for commercial and industrial environments to provide reasonable protection against interference with licensed communication equipment.

Lenovo, Einsteinova 21, 851 01 Bratislava, Slovakia



Warning: This is a Class A product. In a domestic environment this product may cause radio interference in which case the user may be required to take adequate measures.

Germany Class A statement

Deutschsprachiger EU Hinweis: Hinweis für Geräte der Klasse A EU-Richtlinie zur Elektromagnetischen Verträglichkeit

Deutschsprachiger EU Hinweis: Hinweis für Geräte der Klasse A EU-Richtlinie zur Elektromagnetischen Verträglichkeit Dieses Produkt entspricht den Schutzanforderungen der EU-Richtlinie 2014/30/EU zur Angleichung der Rechtsvorschriften über die elektromagnetische Verträglichkeit in den EU-Mitgliedsstaaten und hält die Grenzwerte der Klasse A der Norm gemäß Richtlinie.

Um dieses sicherzustellen, sind die Geräte wie in den Handbüchern beschrieben zu installieren und zu betreiben. Des Weiteren dürfen auch nur von der Lenovo empfohlene Kabel angeschlossen werden. Lenovo übernimmt keine Verantwortung für die Einhaltung der Schutzanforderungen, wenn das Produkt ohne Zustimmung der Lenovo verändert bzw. wenn Erweiterungskomponenten von Fremdherstellern ohne Empfehlung der Lenovo gesteckt/eingebaut werden.

Deutschland:

Einhaltung des Gesetzes über die elektromagnetische Verträglichkeit von Betriebsmitteln Dieses Produkt entspricht dem „Gesetz über die elektromagnetische Verträglichkeit von Betriebsmitteln“ EMVG (früher „Gesetz über die elektromagnetische Verträglichkeit von Geräten“). Dies ist die Umsetzung der EU-Richtlinie 2014/30/EU in der Bundesrepublik Deutschland.

Zulassungsbescheinigung laut dem Deutschen Gesetz über die elektromagnetische Verträglichkeit von Betriebsmitteln, EMVG vom 20. Juli 2007 (früher Gesetz über die elektromagnetische Verträglichkeit von Geräten), bzw. der EMV EU Richtlinie 2014/30/EU, für Geräte der Klasse A.

Dieses Gerät ist berechtigt, in Übereinstimmung mit dem Deutschen EMVG das EG-Konformitätszeichen - CE - zu führen. Verantwortlich für die Konformitätserklärung nach Paragraf 5 des EMVG ist die Lenovo (Deutschland) GmbH, Meitnerstr. 9, D-70563 Stuttgart.

Informationen in Hinsicht EMVG Paragraf 4 Abs. (1) 4: **Das Gerät erfüllt die Schutzanforderungen nach EN 55024 und EN 55032 Klasse A.**

Nach der EN 55032: „Dies ist eine Einrichtung der Klasse A. Diese Einrichtung kann im Wohnbereich Funkstörungen verursachen; in diesem Fall kann vom Betreiber verlangt werden, angemessene Maßnahmen durchzuführen und dafür aufzukommen.“

Nach dem EMVG: „Geräte dürfen an Orten, für die sie nicht ausreichend entstört sind, nur mit besonderer Genehmigung des Bundesministers für Post und Telekommunikation oder des Bundesamtes für Post und Telekommunikation betrieben werden. Die Genehmigung wird erteilt, wenn keine elektromagnetischen Störungen zu erwarten sind.“ (Auszug aus dem EMVG, Paragraph 3, Abs. 4). Dieses Genehmigungsverfahren ist nach Paragraph 9 EMVG in Verbindung mit der entsprechenden Kostenverordnung (Amtsblatt 14/93) kostenpflichtig.

Anmerkung: Um die Einhaltung des EMVG sicherzustellen sind die Geräte, wie in den Handbüchern angegeben, zu installieren und zu betreiben.

Japanese electromagnetic compatibility statements

Japan VCCI Class A statement

この装置は、クラスA情報技術装置です。この装置を家庭環境で使用すると電波障害を引き起こすことがあります。この場合には使用者が適切な対策を講ずるよう要求されることがあります。 V C C I - A

Japanese Electrical Appliance and Material Safety Law statement (for detachable AC power cord)

本製品およびオプションに電源コード・セットが付属する場合は、それぞれ専用のものになっていますので他の電気機器には使用しないでください。

JEITA harmonics guideline - Japanese Statement for AC power consumption (W)

定格入力電力表示

(社) 電子情報技術参照委員会 家電・汎用品高調波抑制対策ガイドライン
実行計画書に基づく定格入力電力値： W

お手持ちのユニットの定格入力電力値(W)はユニットの電源装置に貼付
されている電源仕様ラベルをご参照下さい

JEITA harmonics guideline - Japanese Statement of Compliance for Products Less than or Equal to 20A per phase

JEITA 高調波電流抑制対策適合品表示 (JEITA harmonics statements– Japan)

定格電流が 20A/相以下の機器 (For products where input current is less than or equal to 20A per phase)

日本の定格電流が 20A/相 以下の機器に対する高調波電流規制高調波電流規格
JIS C 61000-3-2 適合品

JEITA harmonics guideline - Japanese Statement of Compliance for Products More than 20A

定格電流が 20A/相を超える機器 (For products where input current is less than 20A/Phase of one PSU, but total system power is over 20A/Phase)

本製品は、1相当たり20Aを超える機器ですが、個々のユニットが「高調波電流規格 JIS C 61000-3-2適合品」であり、
本製品はその組み合わせであるため、「高調波電流規格 JIS C 61000-3-2適合品」としてあります

Korea Communications Commission (KCC) statement

이 기기는 업무용(A급)으로 전자파적합기기로서 판매자 또는 사용자는 이 점을 주의하시기 바라며, 가정외의 지역에서 사용하는 것을 목적으로 합니다.

This is electromagnetic wave compatibility equipment for business (Type A). Sellers and users need to pay attention to it. This is for any areas other than home.

Russia Electromagnetic Interference (EMI) Class A statement

ВНИМАНИЕ!

Настоящее изделие относится к оборудованию класса А. При использовании в бытовой обстановке это оборудование может нарушать функционирование других технических средств в результате создаваемых промышленных радиопомех. В этом случае от пользователя может потребоваться принятие адекватных мер.

People's Republic of China Class A electronic emission statement

中华人民共和国“A类”警告声明

声明

此为A级产品，在生活环境中，该产品可能会造成无线电干扰。在这种情况下，可能需要用户对其干扰采取切实可行的措施。

Taiwan Class A compliance statement

警告使用者：
這是甲類的資訊產品，在居住的環境中使用時，可能會造成射頻干擾，在這種情況下，使用者會被要求採取某些適當的對策。

Taiwan BSMI RoHS declaration

單元 Unit	限用物質及其化學符號 Restricted substances and its chemical symbols					
	鉛Lead (Pb)	汞Mercury (Hg)	鎘Cadmium (Cd)	六價鉻 Hexavalent chromium (Cr ⁶⁺)	多溴聯苯 Polybrominated biphenyls (PBB)	多溴二苯醚 Polybrominated diphenyl ethers (PBDE)
機架	○	○	○	○	○	○
外部蓋板	○	○	○	○	○	○
機械組合作件	-	○	○	○	○	○
空氣傳動設備	-	○	○	○	○	○
冷卻組合作件	-	○	○	○	○	○
內存模塊	-	○	○	○	○	○
處理器模塊	-	○	○	○	○	○
鍵盤	-	○	○	○	○	○
調製解調器	-	○	○	○	○	○
監視器	-	○	○	○	○	○
滑鼠	-	○	○	○	○	○
電纜組合作件	-	○	○	○	○	○
電源	-	○	○	○	○	○
儲備設備	-	○	○	○	○	○
電池匣組合作件	-	○	○	○	○	○
電池	-	○	○	○	○	○
有mech的電路卡	-	○	○	○	○	○
無mech的電路卡	-	○	○	○	○	○
雷射器	-	○	○	○	○	○
<p>備考1. “超出0.1 wt %” 及 “超出0.01 wt %” 係指限用物質之百分比含量超出百分比含量基準值。 Note1: “exceeding 0.1 wt%” and “exceeding 0.01 wt%” indicate that the percentage content of the restricted substance exceeds the reference percentage value of presence condition.</p> <p>備考2. “○” 係指該項限用物質之百分比含量未超出百分比含量基準值。 Note2: “○” indicates that the percentage content of the restricted substance does not exceed the percentage of reference value of presence.</p> <p>備考3. “-” 係指該項限用物質為排除項目。 Note3: The “-” indicates that the restricted substance corresponds to the exemption.</p>						

Index

A

assistance, getting 49
Australia Class A statement 56

C

Canada Class A electronic emission statement 56
China Class A electronic emission statement 59
Class A electronic emission notice 56
contamination, particulate and gaseous 55
creating a personalized support web page 51
custom support web page 51

D

documentation
 using 50
DSA, sending data 50

E

electrical equipment, servicing v
electronic emission Class A notice 56
European Union EMC Directive conformance statement 56

F

FCC Class A notice 56

G

gaseous contamination 55
Germany Class A statement 56
guidelines
 servicing electrical equipment v
 trained service technicians iv

H

hardware service and support telephone numbers 51
help
 from the World Wide Web 50
 from World Wide Web 50
 sending diagnostic data 50
 sources of 49

I

important notices 54
information center 50
inspecting for unsafe conditions iv

J

Japanese electromagnetic compatibility statements 57

K

Korea Class A electronic emission statement 58

N

New Zealand Class A statement 56
notes, important 54
notices 1, 53
 electronic emission 56
 FCC, Class A 56

P

particulate contamination 55
People's Republic of China Class A electronic emission statement 59
product service, Taiwan 51

R

Russia Class A electronic emission statement 58

S

safety iii
safety statements iii, vi
sending diagnostic data 50
service and support
 before you call 49
 hardware 51
 software 51
servicing electrical equipment v
software service and support telephone numbers 51
statements and notices 1
support web page, custom 51

T

Taiwan BSMI RoHS declaration 60
Taiwan Class A electronic emission statement 59
Taiwan product service 51
telecommunication regulatory statement 55
telephone numbers 51
trademarks 54
trained service technicians, guidelines iv

U

United States FCC Class A notice 56
unsafe conditions, inspecting for iv

Lenovo[™]