



2U Rack or Tower UPS RT1.5kVA, RT2.2kVA, and RT3.0kVA Installation and User's Guide



Note:

Before using this information and the product it supports, read the general information in Appendix B “Getting help and technical assistance” on page 41, Appendix C “Notices” on page 45, the safety information, warranties, and licenses information on the Lenovo Web site at:
<https://support.lenovo.com/documents/LNVO-DOCS>

Second Edition (February 2017)

© Copyright Lenovo 2015, 2017.

LIMITED AND RESTRICTED RIGHTS NOTICE: If data or software is delivered pursuant to a General Services Administration “GSA” contract, use, reproduction, or disclosure is subject to restrictions set forth in Contract No. GS-35F-05925

Contents

Safety	iii	Connecting the RS232 or USB communication port (optional)	29
Guidelines for trained service technicians	iv	Characteristics of the contact communication port (optional)	29
Inspecting for unsafe conditions	iv	Replacing the communication card	30
Guidelines for servicing electrical equipment	v	Chapter 6. UPS maintenance	31
Safety statements	vi	Battery pack replacement	31
Product safety	ix	Safety considerations	31
Chapter 1. Introduction	1	Removing the battery pack	32
Notices and statements	1	Mounting the new battery pack	32
Environmental protection	1	Chapter 7. Troubleshooting and maintenance	33
Chapter 2. Presentation	5	Alarms and faults.	33
Standard installations	5	Chapter 8. Parts listing	35
Standard positions	6	Appendix A. Specifications	37
Rear panels: 100V/120V models.	7	Technical specifications: 100V/120V models	37
Rear panels: 200V/230V models.	8	Technical specifications: 200V/230V models	38
Control panel	9	Appendix B. Getting help and technical assistance	41
LCD description	10	Before you call.	41
Display functions.	11	Using the documentation	42
User settings	12	Getting help and information from the World Wide Web	42
Chapter 3. Installation	17	How to send DSA data	42
Unpacking and contents check: 100V/120V models.	17	Creating a personalized support web page	42
Unpacking and contents check: 200V/230V models.	18	Software service and support.	43
Battery module connection.	18	Hardware service and support	43
Rack installation	19	Taiwan product service	43
Tower installation.	19	Appendix C. Notices.	45
Installing the communication card	20	Trademarks	46
UPS connection: AX models	21	Important notes	46
UPS connection: KX models	21	Recycling information	46
Installing the Extended Battery Module (EBM)	22	Particulate contamination	47
Chapter 4. Operation	25	Telecommunication regulatory statement	47
UPS startup and shutdown.	25	Electronic emission notices.	47
Startup and Normal operation	25	Federal Communications Commission (FCC) statement	47
Starting the UPS on battery power	25	Industry Canada Class A emission compliance statement	48
Shutting down the UPS	26	Avis de conformité à la réglementation d'Industrie Canada	48
Operation on battery power	26	Australia and New Zealand Class A statement	48
Return of AC input power	26		
UPS remote control functions.	26		
Remote control connection and test	27		
Operating modes: summary	27		
Chapter 5. Communication	29		
Communication ports	29		

European Union EMC Directive conformance statement 48

Germany Class A statement 48

Japanese electromagnetic compatibility statements 49

Korea Communications Commission (KCC) statement 50

Russia Electromagnetic Interference (EMI) Class A statement 50

People's Republic of China Class A electronic emission statement 51

Taiwan Class A compliance statement 51

Taiwan BSMI RoHS declaration 52

Index. 53

Safety

Before installing this product, read the Safety Information.

قبل تركيب هذا المنتج، يجب قراءة الملاحظات الأمنية

Antes de instalar este produto, leia as Informações de Segurança.

在安装本产品之前，请仔细阅读 Safety Information (安全信息)。

安裝本產品之前，請先閱讀「安全資訊」。

Prije instalacije ovog produkta obavezno pročitajte Sigurnosne Upute.

Před instalací tohoto produktu si přečtěte příručku bezpečnostních instrukcí.

Læs sikkerhedsforskrifterne, før du installerer dette produkt.

Lees voordat u dit product installeert eerst de veiligheidsvoorschriften.

Ennen kuin asennat tämän tuotteen, lue turvaohjeet kohdasta Safety Information.

Avant d'installer ce produit, lisez les consignes de sécurité.

Vor der Installation dieses Produkts die Sicherheitshinweise lesen.

Πριν εγκαταστήσετε το προϊόν αυτό, διαβάστε τις πληροφορίες ασφάλειας (safety information).

לפני שתתקינו מוצר זה, קראו את הוראות הבטיחות.

A termék telepítése előtt olvassa el a Biztonsági előírásokat!

Prima di installare questo prodotto, leggere le Informazioni sulla Sicurezza.

製品の設置の前に、安全情報をお読みください。

본 제품을 설치하기 전에 안전 정보를 읽으십시오.

Пред да се инсталира овој продукт, прочитајте информацијата за безбедност.

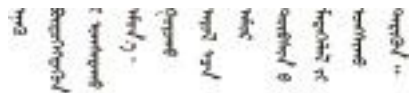

Les sikkerhetsinformasjonen (Safety Information) før du installerer dette produktet.

Przed zainstalowaniem tego produktu, należy zapoznać się z książką "Informacje dotyczące bezpieczeństwa" (Safety Information).

Antes de instalar este produto, leia as Informações sobre Segurança.

Перед установкой продукта прочтите инструкции по технике безопасности.

Pred inštaláciou tohto zariadenia si pečítajte Bezpečnostné predpisy.

Pred namestitvijo tega proizvoda preberite Varnostne informacije.

Antes de instalar este producto, lea la información de seguridad.

Läs säkerhetsinformationen innan du installerar den här produkten.

ཐོན་ཇས་འདི་བདེ་སྤྱོད་མ་བྱས་གོང་། སྐྱར་གྱི་ཡིད་གཟབ་
བྱ་འདུ་མིན་ཡིད་པའི་འོད་ཟླར་བརྟེན་དགོས།

Bu ürünü kurmadan önce güvenlik bilgilerini okuyun.

بۇ ئۈنۈنۈ مۇھىم سۇلالىنى ئورنىتىشتىن بۇرۇن بىخەتەرلىك ئۇچۇرلىرىنى ئوقۇپ چىقىڭ.

Youq mwngz yungh canjbinj neix gaxgong, itdingh zeu doeg aen
canjbinj soengq cungj vahgangj ancien slusik.

Guidelines for trained service technicians

This section contains information for trained service technicians.

Inspecting for unsafe conditions

Use this information to help you identify potential unsafe conditions in a Lenovo product that you are working on.

Each Lenovo product, as it was designed and manufactured, has required safety items to protect users and service technicians from injury. The information in this section addresses only those items. Use good judgment to identify potential unsafe conditions that might be caused by alterations or attachment of non-Lenovo features or optional devices that are not addressed in this section. If you identify an unsafe condition, you must determine how serious the hazard is and whether you must correct the problem before you work on the product.

Consider the following conditions and the safety hazards that they present:

- Electrical hazards, especially primary power. Primary voltage on the frame can cause serious or fatal electrical shock.
- Explosive hazards, such as a damaged CRT face or a bulging capacitor.
- Mechanical hazards, such as loose or missing hardware.

To inspect the product for potential unsafe conditions, complete the following steps:

1. Make sure that the power is off and the power cords are disconnected.
2. Make sure that the exterior cover is not damaged, loose, or broken, and observe any sharp edges.
3. Check the power cords:
 - Make sure that the third-wire ground connector is in good condition. Use a meter to measure third-wire ground continuity for 0.1 ohm or less between the external ground pin and the frame ground.
 - Make sure that the power cords are the correct type.

- Make sure that the insulation is not frayed or worn.
- 4. Remove the cover.
- 5. Check for any obvious non-Lenovo alterations. Use good judgment as to the safety of any non-Lenovo alterations.
- 6. Check inside the system for any obvious unsafe conditions, such as metal filings, contamination, water or other liquid, or signs of fire or smoke damage.
- 7. Check for worn, frayed, or pinched cables.
- 8. Make sure that the power-supply cover fasteners (screws or rivets) have not been removed or tampered with.

Guidelines for servicing electrical equipment

Observe these guidelines when you service electrical equipment.

- Check the area for electrical hazards such as moist floors, nongrounded power extension cords, and missing safety grounds.
- Use only approved tools and test equipment. Some hand tools have handles that are covered with a soft material that does not provide insulation from live electrical current.
- Regularly inspect and maintain your electrical hand tools for safe operational condition. Do not use worn or broken tools or testers.
- Do not touch the reflective surface of a dental mirror to a live electrical circuit. The surface is conductive and can cause personal injury or equipment damage if it touches a live electrical circuit.
- Some rubber floor mats contain small conductive fibers to decrease electrostatic discharge. Do not use this type of mat to protect yourself from electrical shock.
- Do not work alone under hazardous conditions or near equipment that has hazardous voltages.
- Locate the emergency power-off (EPO) switch, disconnecting switch, or electrical outlet so that you can turn off the power quickly in the event of an electrical accident.
- Disconnect all power before you perform a mechanical inspection, work near power supplies, or remove or install main units.
- Before you work on the equipment, disconnect the power cord. If you cannot disconnect the power cord, have the customer power-off the wall box that supplies power to the equipment and lock the wall box in the off position.
- Never assume that power has been disconnected from a circuit. Check it to make sure that it has been disconnected.
- If you have to work on equipment that has exposed electrical circuits, observe the following precautions:
 - Make sure that another person who is familiar with the power-off controls is near you and is available to turn off the power if necessary.
 - When you work with powered-on electrical equipment, use only one hand. Keep the other hand in your pocket or behind your back to avoid creating a complete circuit that could cause an electrical shock.
 - When you use a tester, set the controls correctly and use the approved probe leads and accessories for that tester.
 - Stand on a suitable rubber mat to insulate you from grounds such as metal floor strips and equipment frames.
- Use extreme care when you measure high voltages.
- To ensure proper grounding of components such as power supplies, pumps, blowers, fans, and motor generators, do not service these components outside of their normal operating locations.

- If an electrical accident occurs, use caution, turn off the power, and send another person to get medical aid.

Safety statements

These statements provide the caution and danger information that is used in this documentation.

Each caution and danger statement in this documentation is labeled with a number. This number is used to cross reference an English-language caution or danger statement with translated versions of the caution or danger statement in the *Safety Information* document.

For example, if a danger statement is labeled D005, translations for that caution statement are in the *Safety Information* document under D005.

Be sure to read all caution and danger statements in this documentation before you perform the procedures. Read any additional safety information that comes with your system or optional device before you install the device.

L001



Hazardous voltage, current, or energy levels are present inside any component that has this label attached. Do not open any cover or barrier that contains this label. There are no serviceable parts inside these components. If you suspect a problem with one of these parts, contact a service technician.

DO NOT open up the chassis or any other parts of any UPS unit. This will void the unit warranty. Only replace parts for which a serviceable part exists, that is servicing any UPS unit is limited to FRU / CRU replacement parts.

(L001)

D005



When working on or around the system, observe the following precautions: Electrical voltage and current from power, telephone, and communication cables are hazardous. To avoid a shock hazard:

- **If Lenovo supplied a power cord(s), connect power to this unit only with the Lenovo-provided power cord. Do not use the Lenovo-provided power cord for any other product.**
- **Do not open or service any power supply assembly.**
- **Do not connect or disconnect any cables or perform installation, maintenance, or reconfiguration of this product during an electrical storm.**
- **The product might be equipped with multiple power cords. To remove all hazardous voltages, disconnect all power cords.**

- Connect all power cords to a properly wired and grounded electrical outlet. Ensure that the outlet supplies proper voltage and phase rotation according to the system rating plate.
- Connect any equipment that will be attached to this product to properly wired outlets.
- When possible, use one hand only to connect or disconnect signal cables.
- Never turn on any equipment when there is evidence of fire, water, or structural damage.
- Disconnect the attached power cords, telecommunications systems, networks, and modems before you open the device covers, unless instructed otherwise in the installation and configuration procedures.
- Connect and disconnect cables as described in the following procedures when installing, moving, or opening covers on this product or attached devices. To disconnect:
 1. Turn off everything (unless instructed otherwise).
 2. Remove the power cords from the outlets.
 3. Remove the signal cables from the connectors.
 4. Remove all cables from the devices.To connect:
 1. Turn off everything (unless instructed otherwise).
 2. Attach all cables to the devices.
 3. Attach the signal cables to the connectors.
 4. Attach the power cords to the outlets.
 5. Turn on the devices.
- Sharp edges, corners and joints might be present in and around the system. Use care when handling equipment to avoid cuts, scrapes and pinching. (D005)

C004



CAUTION:

Lead-acid batteries can present a risk of electrical burn from high, short-circuit current. Avoid battery contact with metal materials; remove watches, rings, or other metal objects, and use tools with insulated handles. To avoid possible explosion, do not burn.

Exchange only with the Lenovo-approved part. Recycle or discard the battery as instructed by local regulations. In the United States, Lenovo has a process for the collection of this battery. For information, call 1-800-426-4333. Have the Lenovo part number for the battery unit available when you call.

DO NOT mix old and new batteries in an Uninterruptible Power Supply unit.

DO NOT open up any battery pack retrieved from an Uninterruptible Power Supply unit.

Wear safety goggles for your own protection when replacing batteries of an Uninterruptible Power Supply unit. (C004)

C022



CAUTION:

This product might be equipped with a hard-wired power cable. Ensure that a licensed electrician performs the installation per the national electrical code. (C022)

R001

Important: The following general safety information should be used for all rack-mounted devices:



 **DANGER**

Observe the following precautions when working on or around your IT rack system:

- Heavy equipment—personal injury or equipment damage might result if mishandled.
- Always lower the leveling pads on the rack cabinet.
- Always install stabilizer brackets on the rack cabinet.
- To avoid hazardous conditions due to uneven mechanical loading, always install the heaviest devices in the bottom of the rack cabinet. Always install servers and optional devices starting from the bottom of the rack cabinet.
- Rack-mounted devices are not to be used as shelves or work spaces. Do not place objects on top of rack-mounted devices.



- Each rack cabinet might have more than one power cord. Be sure to disconnect all power cords in the rack cabinet when directed to disconnect power during servicing.
- Connect all devices installed in a rack cabinet to power devices installed in the same rack cabinet. Do not plug a power cord from a device installed in one rack cabinet into a power device installed in a different rack cabinet.
- An electrical outlet that is not correctly wired could place hazardous voltage on the metal parts of the system or the devices that attach to the system. It is the responsibility of the customer to ensure that the outlet is correctly wired and grounded to prevent an electrical shock.

(R001 part 1 of 2)



CAUTION:

- Do not install a unit in a rack where the internal rack ambient temperatures will exceed the manufacturer's recommended ambient temperature for all your rack-mounted devices.
- Do not install a unit in a rack where the air flow is compromised. Ensure that air flow is not blocked or reduced on any side, front, or back of a unit used for air flow through the unit.
- Consideration should be given to the connection of the equipment to the supply circuit so that overloading of the circuits does not compromise the supply wiring or overcurrent protection. To provide the correct power connection to a rack, refer to the rating labels located on the equipment in the rack to determine the total power requirement of the supply circuit.

- (For sliding drawers) **Do not pull out or install any drawer or feature if the rack stabilizer brackets are not attached to the rack. Do not pull out more than one drawer at a time. The rack might become unstable if you pull out more than one drawer at a time.**
- (For fixed drawers) **This drawer is a fixed drawer and must not be moved for servicing unless specified by the manufacturer. Attempting to move the drawer partially or completely out of the rack might cause the rack to become unstable or cause the drawer to fall out of the rack.**

(R001 part 2 of 2)

Output power and ampere ratings

Important: Make sure that the power receptacle is near the equipment and is easily accessible so that the uninterruptible power supply (UPS) can be disconnected quickly.

To reduce the risk of fire, connect only to a circuit provided with branch circuit overcurrent protection with an ampere rating in accordance with the National Electrical Code (NEC), ANSI/NFPA 70 or your local electrical code:

UPS output power	120 V	208 V	230 V
1500 VA	15 A	Not applicable	10 A
2200 VA	20 A	Not applicable	10 A
3000 VA	30 A	20 A	16 A

Product safety

- The UPS connection instructions and operations described in the manual must be followed in the indicated order.
- **Important:** To reduce the risk of fire, the unit connects only to a circuit provided with branch circuit overcurrent protection as described in this manual, in accordance with the National Electric Code, ANSI/NFPA 70.
The upstream circuit breaker for Normal AC and Bypass AC must be easily accessible. The unit can be disconnected from AC power source by opening this circuit breaker. This circuit breaker is used for backfeed protection and must comply with IEC/EN 62040-1 (the creepage and clearance distances shall meet the basic insulation requirements for pollution degree 2).
- Disconnection and overcurrent protection devices shall be provided by others for permanently connected AC input (Normal AC and Bypass AC) and AC output circuits.
- Check that the indications on the rating plate correspond to your AC powered system and to the actual electrical consumption of all the equipment to be connected to the system.
- For PLUGGABLE EQUIPMENT, the socket-outlet shall be installed near the equipment and shall be easily accessible.
- Never install the system near liquids or in an excessively damp environment.
- Never let a foreign body penetrate inside the system.
- Never block the ventilation grates of the system.
- Never expose the system to direct sunlight or source of heat.
- If the system must be stored prior to installation, storage must be in a dry place.
- The admissible storage temperature range is -15°C to +50°C.
- This unit is not designed to conform to ANSI/NFPA 75 and therefore is not for use in ANSI/NFPA 75-certified data centers.

- Although the UPS does not contain anti-backfeed (ABF) relays, some backfeed protection is provided. For example, if some components are damaged in battery mode, the output voltage may feed back to the input. In this case, a current transformer (CT) is used to detect the bypass current feedback voltage. If a current backfeed fault condition is detected, the UPS will terminate the inverter output to avoid personal injury.

Chapter 1. Introduction

Thank you for selecting a Lenovo product to protect your electrical equipment.

Read this manual to take full advantage of the features of your equipment.

Before installing your equipment, read the safety instructions. Then, follow the instructions in this manual for setting up and using the product.

To discover the entire range of Lenovo products and the options available for the Lenovo UPS device, we invite you to visit our website or contact your Lenovo representative.

Notices and statements

The caution and danger statements in this document are also in the multilingual *Safety Information* document, which is on the Lenovo Web site at <https://support.lenovo.com/documents/LNVO-DOCS>. Each statement is numbered for reference to the corresponding statement in the *Safety Information* document.

Notices and statements in this document

The following notices and statements are used in this document:

- **Note:** These notices provide important tips, guidance, or advice.
- **Important:** These notices provide information or advice that might help you avoid inconvenient or problem situations.
- **Attention:** These notices indicate possible damage to programs, devices, or data. An attention notice is placed just before the instruction or situation in which damage might occur.
- **Caution:** These statements indicate situations that can be potentially hazardous to you. A caution statement is placed just before the description of a potentially hazardous procedure step or situation.
- **Danger:** These statements indicate situations that can be potentially lethal or hazardous to you. A danger statement is placed just before the description of a potentially lethal or hazardous procedure step or situation.

Environmental protection

Lenovo has implemented an environmental-protection policy. Products are developed according to an eco-design approach.

Substances

This product does not contain CFCs, HCFCs or asbestos.

Packing

To improve waste treatment and facilitate recycling, separate the various packing components.

- The cardboard we use comprises over 50% of recycled cardboard.
- Sacks and bags are made of polyethylene.

- Packing materials are recyclable and bear the appropriate identification symbol .

Materials	Abbreviations	Number in the symbols 
Polyethylene terephthalat	PET	01
High-density polyethylene	HDPE	02
Polyvinyl chloride	PVC	03
Low-density polyethylene	LDPE	04
Polypropylene	PP	05
Polystyrene	PS	06

Follow all local regulations for the disposal of packing materials.

Refer to the *Lenovo Environmental Notices and User's Guide*, provided on the Lenovo Web site at <https://support.lenovo.com/documents/LNVO-DOCS>.

End of life

Lenovo will process products at the end of their service life in compliance with local regulations. Lenovo works with companies in charge of collecting and eliminating our products at the end of their service life.

Product

The product is made up of recyclable materials. Dismantling and destruction must take place in compliance with all local regulations concerning waste. At the end of its service life, the product must be transported to a processing center for electrical and electronic waste.

Battery

The product contains lead-acid batteries that must be processed according to applicable local regulations concerning batteries.

The battery pack can be removed to comply with regulations and in view of correct disposal.

With the Lenovo UPS device, you can eliminate the effects of power disturbances and guard the integrity of your equipment. Providing outstanding performance and reliability, the Lenovo UPS device's unique benefits include:

- True online double-conversion technology with high power density, utility frequency independence, and power generator compatibility.
- Advanced Battery Management (©ABM) technology that uses advanced battery management to increase battery service life, optimize recharge time, and provide a warning before the end of useful battery life.
- Selectable High Efficiency mode of operation.
- Standard communication options: one RS-232 communication port, one USB communication port, and relay output contacts.
- UPS Network Management Card with enhanced communication capabilities.
- Extended runtime with up to four Extended Battery Modules (EBMs) per UPS.
- Firmware that is easily upgradable without a service call.
- Remote On/Off control through Remote On/Off (ROO) and Remote Power Off (RPO) ports.

Chapter 2. Presentation

Standard installations

Machine types and models	Weights	Dimensions (inch/mm)
	(lb/kg)	D x W x H
5594-1AX	64.70 / 29.36	20.6 x 17.4 x 3.4 / 522 x 441.2 x 86.2
5594-2AX	65.30 / 29.61	
5594-3AX	87.20 / 39.54	25.5 x 17.4 x 3.4 / 647 x 441.2 x 86.2
5594-2BX	72.30 / 32.80	20.6 x 17.4 x 3.4 / 522 x 441.2 x 86.2
5594-3BX	102.3 / 46.39	25.5 x 17.4 x 3.4 / 647 x 441.2 x 86.2

Rack installation

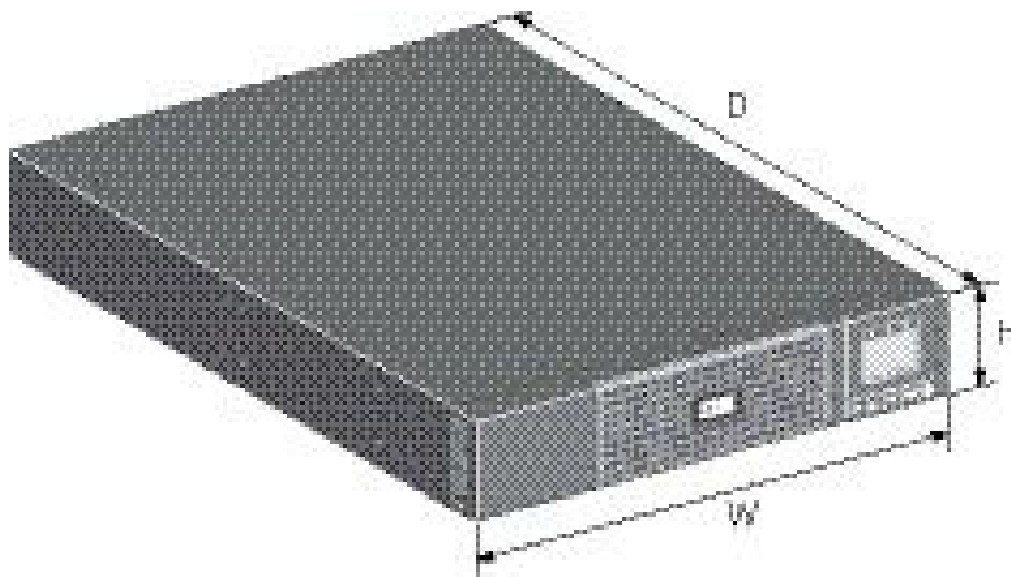

Tower installation

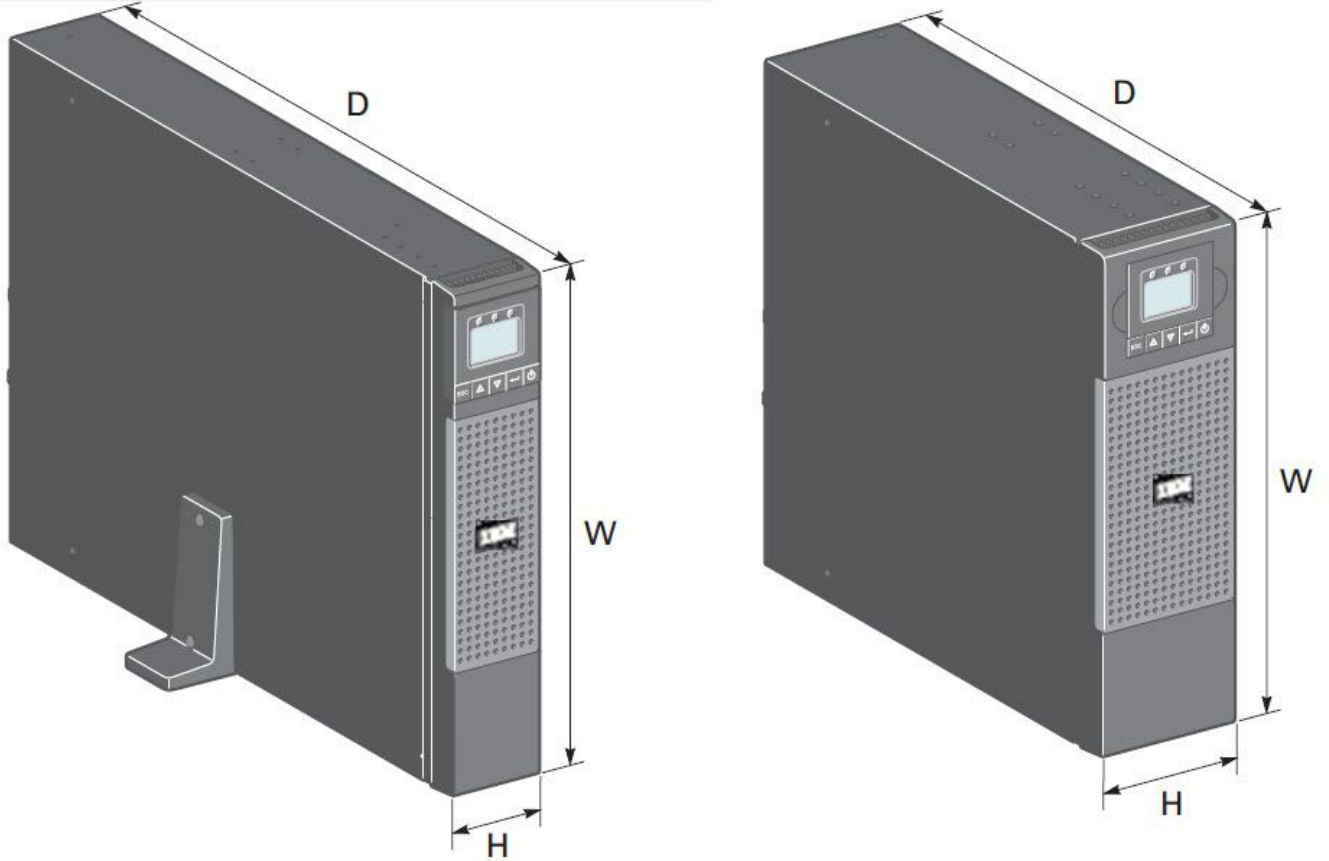

Shipping bracket kit

If you are shipping the UPS and its associated EBMs preinstalled in a rack, you must use the shipping bracket kit to prevent damage during shipment. The kit is available from Lenovo. Refer to the instructions in the kit to install the brackets properly. The brackets are not required when the UPS and EBMs are installed in a pre-positioned rack.

Standard positions

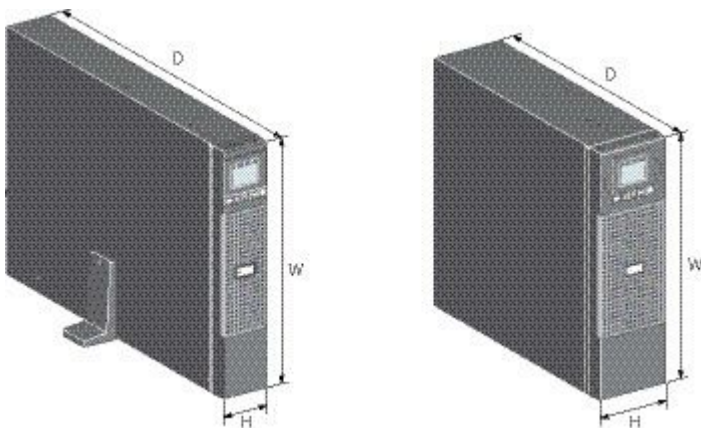

Figure 1. Tower position

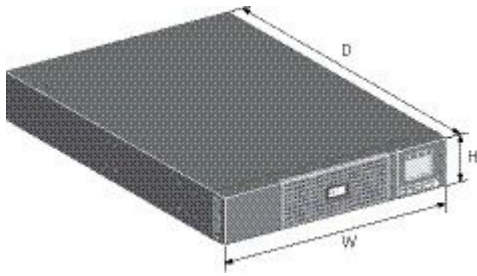

Figure 2. Rack position

Machine types and models	Weights (kg/lb)	Dimensions (mm/inch) D x W x H
5594-1KX	27.60 / 60.90	522 x 441.2 x 86.2 / 20.6 x 17.4 x 3.4
5594-2KX	28.50 / 62.80	
5594-3KX	38.08 / 84.00	647 x 441.2 x 86.2 / 25.5 x 17.4 x 3.4
5594-2BX	32.80 / 72.30	522 x 441.2 x 86.2 / 20.6 x 17.4 x 3.4
5594-3BX	46.39 / 102.30	647 x 441.2 x 86.2 / 25.5 x 17.4 x 3.4

Rear panels: 100V/120V models

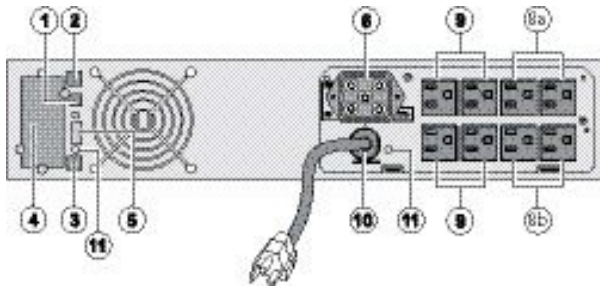

Figure 3. 5594-1AX

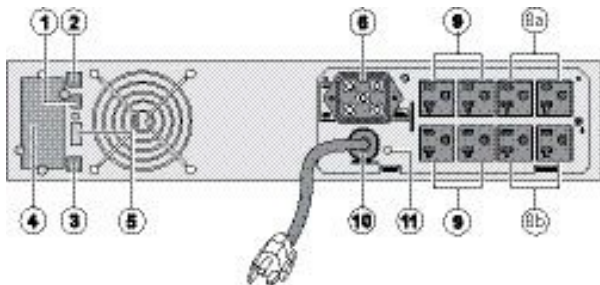

Figure 4. 5594-2AX

- ① USB communication port
- ② RS232 communication port
- ③ Connector for automatic recognition of an additional battery pack
- ④ Slot where UPS Network Management Card is installed
- ⑤ Connector for Remote On/Off (ROO) control or Remote Power Off (RPO) control
- ⑥ Connector for additional battery pack
- ⑦ 30A outlet (L5-30R) for connection of equipment (for 5PX 3000 only)
- ⑧a Outlet Group 1: 2 programmable outlets for connection of equipment
- ⑧b Outlet Group 2: 2 programmable outlets for connection of equipment
- ⑨ Primary outlet group: outlets for connection of critical equipment
- ⑩ Attached 8 ft. (2.5m) input power cord for

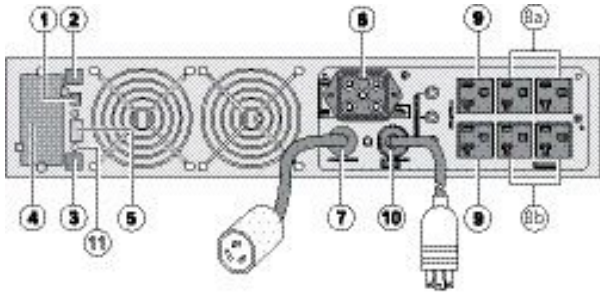

Figure 5. 5594-3AX

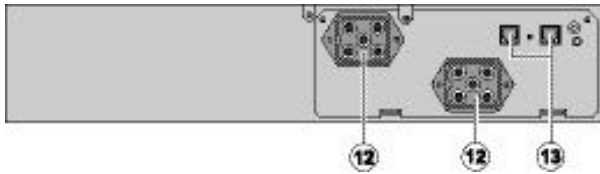

Figure 6. 5594-2BX, 5594-3BX (optional battery pack)

AC-power source:

5-15P for 1000 / 1500

5-20P for 2200

L5-30P for 3000

⑪ LED indicating site wiring fault (SWF) alarm

⑫ Connectors for battery packs (to the UPS or to the other battery packs)

⑬ Connectors for automatic recognition of battery packs

Rear panels: 200V/230V models

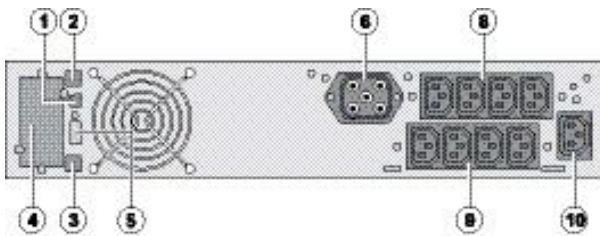

Figure 7. 5594-1KX

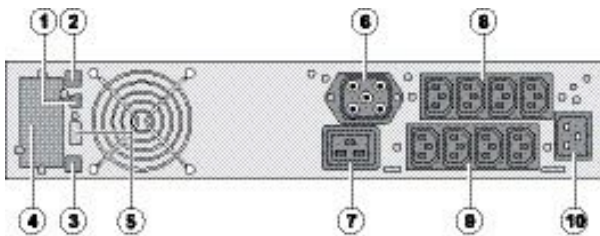

Figure 8. 5594-2KX

① USB communication port

② RS232 communication port

③ Connector for automatic recognition of battery packs

④ Slot where UPS Network Management Card is installed

⑤ Connector for Remote On/Off (ROO) control or Remote Power Off (RPO) control

⑥ Connector for battery packs

⑦ 16A outlet for connection of equipment (Primary outlet group)

⑧ Two groups of two programmable outlets for connection of equipment (Outlet Groups 1 and 2)

⑨ Groups of four outlets for connection of equipment (primary outlet group)

⑩ Socket for connection to AC power source

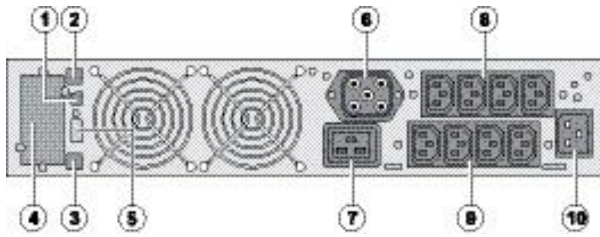

Figure 9. 5594-3KX

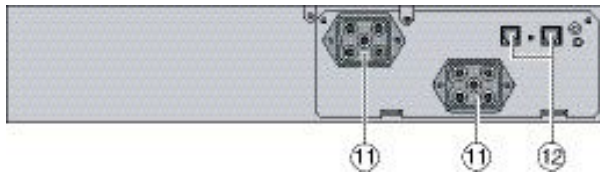
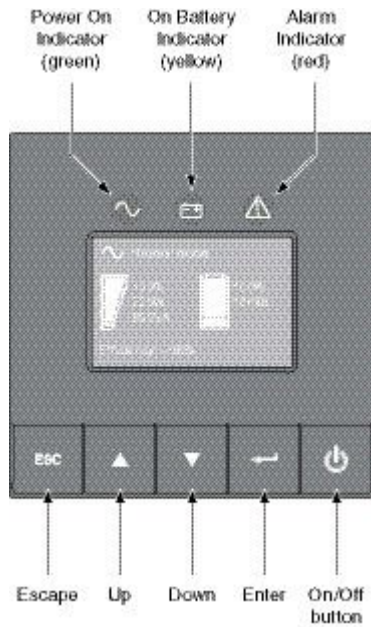

Figure 10. 5594-2BX, 5594-3BX



- ⑪ Connectors for battery packs (to the UPS or to the other battery packs)
- ⑫ Connectors for automatic recognition of battery packs

Control panel

The UPS has a five-button graphical LCD. It provides useful information about the UPS itself, load status, events, measurements and settings.



The following table shows the indicator status and description:

Indicator	Status	Description
 Green	On	The UPS is operating normally.
 Yellow	On	The UPS is on Battery mode.
 Red	On	The UPS has an active alarm or fault. See Chapter 7 “Troubleshooting and maintenance” on page 33 for additional information.

LCD description

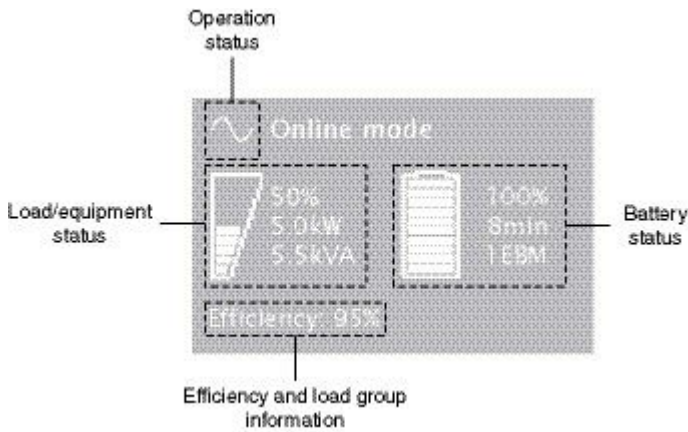

After 5 minutes of inactivity, the LCD displays the screen saver.

The LCD backlight automatically dims after 10 minutes of inactivity. Press any button to restore the screen.

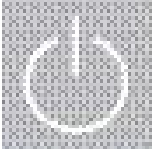

The following table describes the status information provided by the UPS.

Note: If another indicator appears, see Chapter 7 “Troubleshooting and maintenance” on page 33 for additional information.

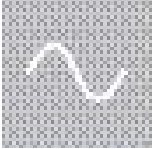
Operation status	Cause	Description
Standby mode 	The UPS is OFF, waiting for start-up command from the user.	Equipment is not powered until  button is pressed.
Normal mode 	The UPS is operating normally.	The UPS is powering and protecting the equipment.

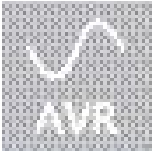
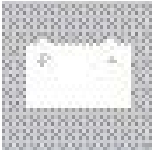
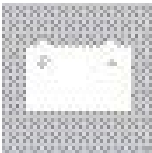
Operation status	Cause	Description
In AVR mode  Load protected LED is on No beep	The UPS is operating normally but the utility voltage is outside normal mode thresholds.	The UPS is powering the equipment through an Automatic Voltage Regulation device. The equipment is still normally protected.
On Battery  Battery LED is on 1 beep every 10 seconds	A utility failure has occurred and the UPS is in Battery mode.	The UPS is powering the equipment with the battery power. Prepare your equipment for shutdown.
End of backup time  Battery LED is blinking 1 beep every 3 seconds	The UPS is on Battery mode and the battery packs are running low.	This warning is approximate, and the actual time to shut down might vary significantly. Depending on the UPS load and number of Extended Battery Modules (EBMs), the "Battery Low" warning might occur before the battery packs reach 25 % capacity.

Display functions

Press the Enter (↵) button to activate the menu options. Use the two middle buttons (▲ and ▼) to scroll through the menu structure. Press the Enter (↵) button to select an option. Press the ESC button to cancel or return to the previous menu.

Main menu	Submenu	Display information or Menu function
Measurements		Load W VA / Load A pf / Output V Hz / Input V Hz / Battery V min / Efficiency / Power usage
Control	Load Segments	Outlet Group 1: ON / OFF Outlet Group 2: ON / OFF These commands overrule user settings for load segments.
	Start battery test	Starts a manual battery test
	Reset fault state	Clears active fault (UPS restart required)
	Restore factory settings	Returns all settings to original values

Main menu	Submenu	Display information or Menu function
	Reset power usage	Clears power usage measurements
Settings	Local settings	Sets product general parameters
	Input/output settings	Sets input and output parameters
	On/Off settings	Sets On/Off conditions
	Battery settings	Sets battery configuration
Fault log		Displays event log or alarms
Identification		UPS Type / Part Number / Serial Number / Firmware release / Com. card address

User settings

The following table displays the options that can be changed by the user.

Table 1. User settings

	Submenu	Available settings	Default settings
Local settings	Language	[<i>language_name</i>] Select the desired language from the list. Menus, status, notices and alarms, UPS fault, Event Log data and settings are in all supported languages.	[English] User selectable when UPS is powered for the first time.
	LCD settings	Modify LCD screen brightness and contrast to be adapted to room light conditions.	
	Audible alarm	[Yes] [No] Enable or disable the buzzer if an alarm occurs.	[Yes]
In/Out settings	Output voltage	Low voltage: [100 V] [120 V] [125 V] High voltage: [200 V] [208 V] [220 V] [230 V] [240 V]	Low Voltage model: 110 V High Voltage model: 230 V User selectable when UPS is powered for the first time.
	Input thresholds	[Normal mode] [Extended mode] Extended mode authorizes lower input voltage (70 V) without transferring to battery. This can be used if the load can withstand low voltage supply.	[Normal mode]
	Sensitivity	[High] [Low] High: for sensitive equipment, UPS will easily transfer to battery	[High]

Table 1. User settings (continued)

	Submenu	Available settings	Default settings
		<p>when utility conditions are becoming bad.</p> <p>Low: for equipment that can withstand bad utility conditions, in that case, the UPS will not transfer to battery.</p>	
In/Out settings (continued)	Load segments - Auto start delay	<p>[No Delay] [1 s] [2 s]...[65354 s]</p> <p>The unit is powered on with the specified delay relative to the primary outlet group.</p>	<p>Outlet Group 1: [3 s]</p> <p>Outlet Group 2: [6 s]</p>
	Load segments - Auto shutdown delay	<p>[Disabled] [0s] [1 s] [2 s]...[65354 s]</p> <p>During a power outage, authorizes UPS to turn off power to equipment connected to Group 1 and/or Group 2 outlets.</p> <p>This feature allows the shedding of non-critical loads in order to conserve battery power for critical loads connected to the Primary outlet group.</p>	<p>Outlet Group 1: [Disabled]</p> <p>Outlet Group 2: [Disabled]</p>
	Overload prealarm	<p>[5 %] [10 %] [15 %] [20 %] ... [100 %] [105 %]</p> <p>Sets critical percentage of load where alarm overload alarm occurs.</p>	[105%]
On/Off settings	Cold start	<p>[Enabled] [Disabled]</p> <p>Authorize the unit to start on battery power.</p>	[Enabled]
	Forced reboot	<p>[Enabled] [Disabled]</p> <p>If mains recover during a shutdown sequence:</p> <p>If set to Enable, shutdown sequence will complete and wait 10 seconds prior to restart, if set to Disable, shutdown sequence will not complete and restart will occur immediately.</p>	[Enabled]
	Auto restart	<p>[Enabled] [Disabled]</p> <p>Authorize the unit to restart automatically when mains</p>	[Enabled]

Table 1. User settings (continued)

	Submenu	Available settings	Default settings
		recover after a complete battery discharge.	
	Energy saving	[Enabled] [Disabled] If Enabled, UPS will shut down after 5 min. of back-up time, if no load is detected on the output.	[Disabled]
	Sleep mode	[Enabled] [Disabled] If Disabled, LCD and communication will turn OFF immediately after UPS is OFF. If Enabled, LCD and communication stays ON 1h30 min. after UPS is OFF.	[Disabled]
	Remote command	[Enabled] [Disabled] If Enabled, shutdown or restart commands from software are authorized.	[Enabled]
Battery settings	Automatic battery test	[No test] [Every day] [Every week] [Every month] Available only if battery charge mode is set to constant charge.	Every week (in constant charge) otherwise following ABM
	Low battery warning	[10 %] [20 %] [30 %] [40 %] [50 %] [60 %] [70 %] [80 %] [90 %] The alarm triggers when the set percentage of battery capacity is reached during a back-up time.	[20%]
	Restart battery level	[10 %] [20 %] [30 %] [40 %] [50 %] [60 %] [70 %] [80 %] [90 %] [100 %] If set, automatic restart will occur only when percentage of battery charge is reached.	[0%]
	Battery charge mode	[ABM cycling] [Constant charge]	[ABM cycling]
	EBM number setting	[0] [1] [2] [3] [4] Using standard EBM, UPS detects automatically the amount of EBM connected.	EBM automatic detection, otherwise [0]

Table 1. User settings (continued)

	Submenu	Available settings	Default settings
	Deep discharge protection	[Yes] [No] If set to Yes, the UPS automatically prevents battery from deep discharge by adapting end of back-up time voltage threshold.	[Yes]

Chapter 3. Installation

Unpacking and contents check: 100V/120V models

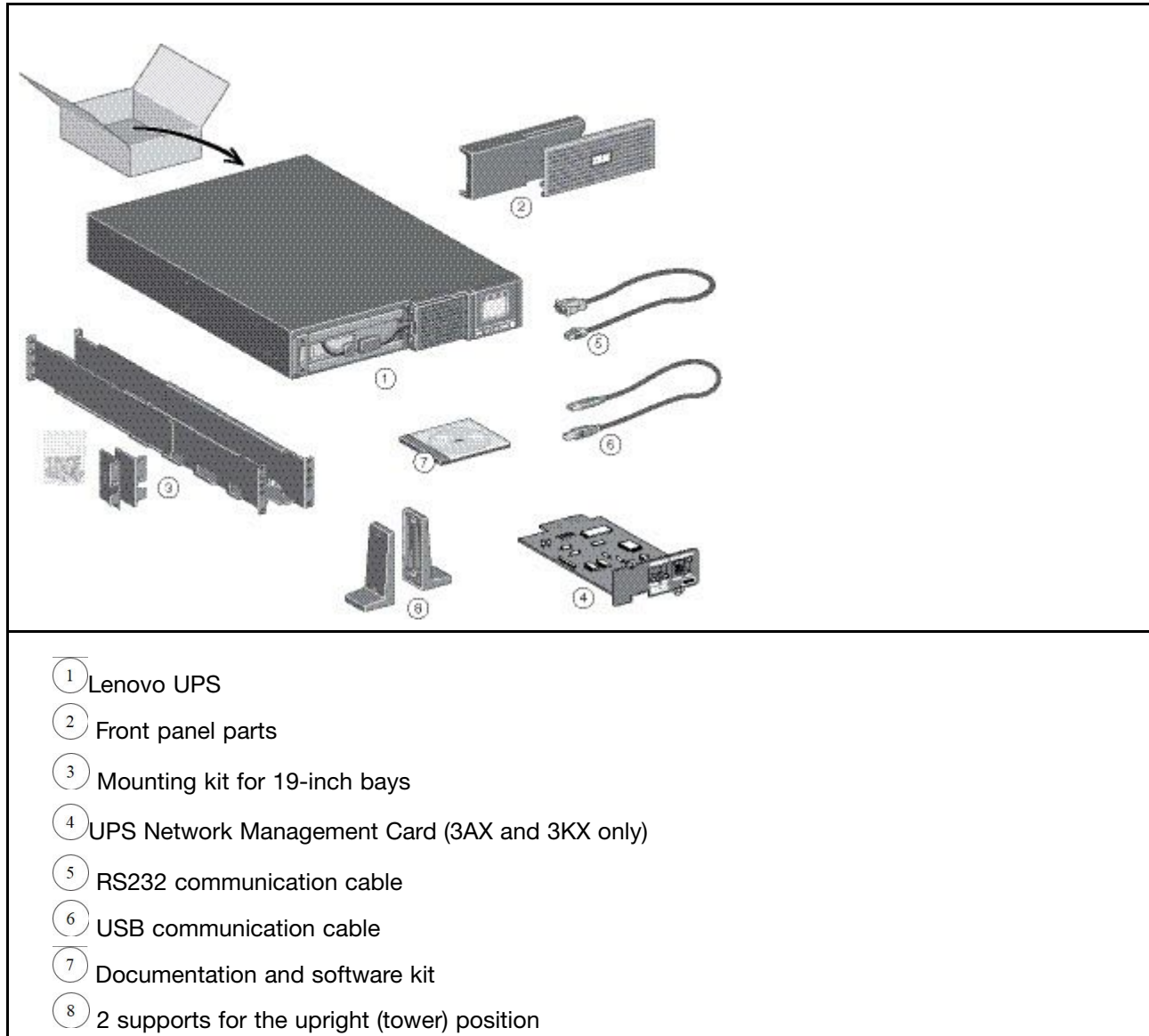

Note: Packing materials must be disposed of in compliance with all local regulations concerning waste. Recycling symbols are printed on the packing materials to facilitate sorting.

Unpacking and contents check: 200V/230V models

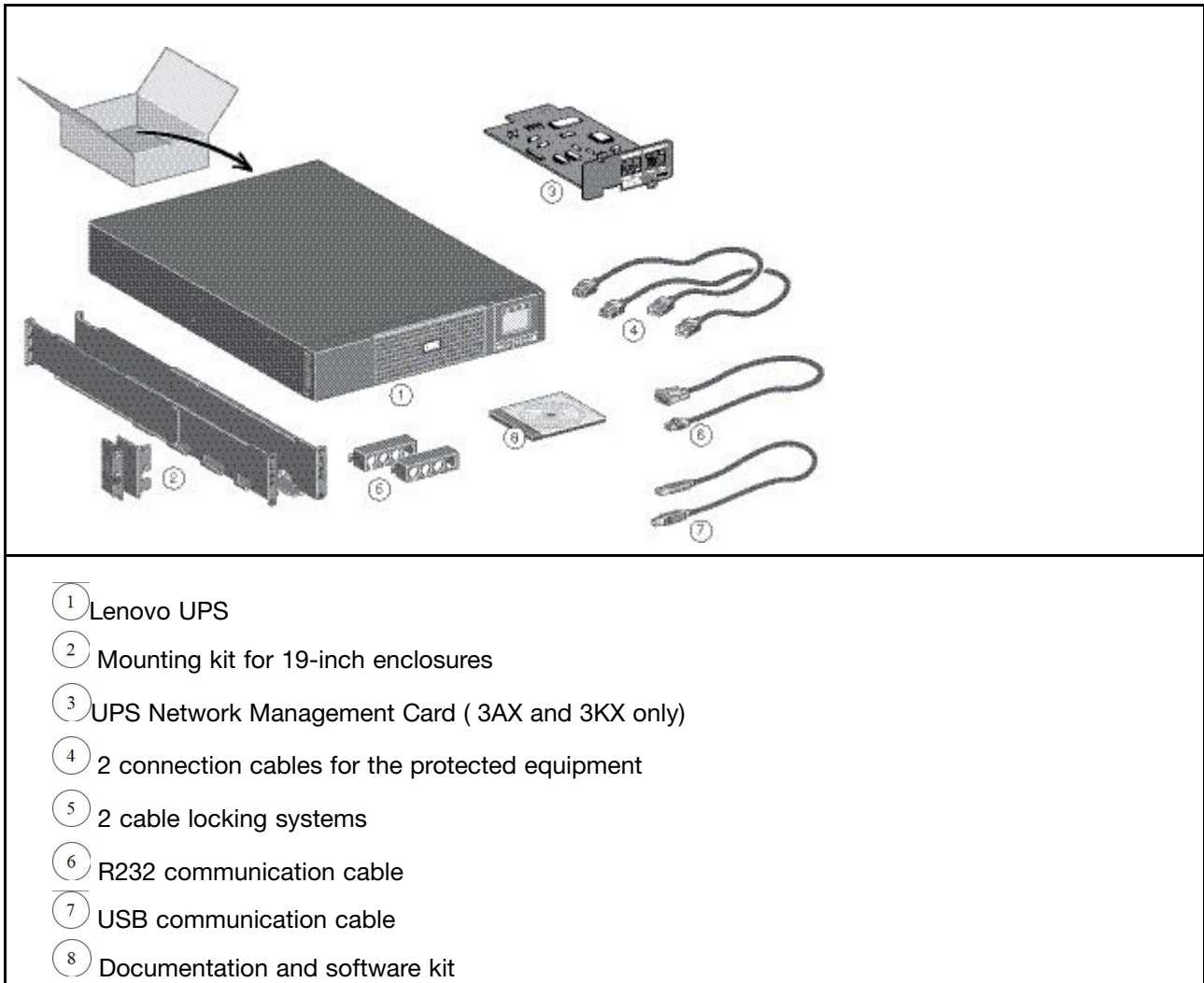

Note: Packing materials must be disposed of in compliance with all local regulations concerning waste. Recycling symbols are printed on the packing materials to facilitate sorting.

Battery module connection

Important: Before starting the UPS, connect the internal battery pack.

Note: A small amount of arcing might occur when connecting the battery pack. This is normal and does not damage the UPS or present any safety concern.

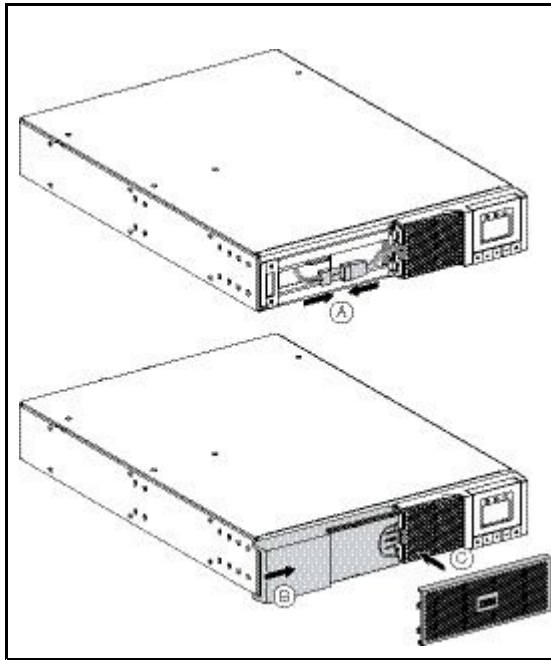

1. Remove the two bezel sections.
2. (A) Connect the battery module (never pull on the wires).
3. (B) Attach the left-hand side of the front panel by sliding it, then by locking the push button.
4. (C) Attach the center panel by inserting the tabs on the left side into the slots and rotating it closed.

Rack installation

The UPS and connected EBMs must be installed no higher than 5 feet (1.5m) above the floor to allow for easy installation and servicing.

Step 1. For mounting on rails, follow steps 1 to 4 in the illustration.

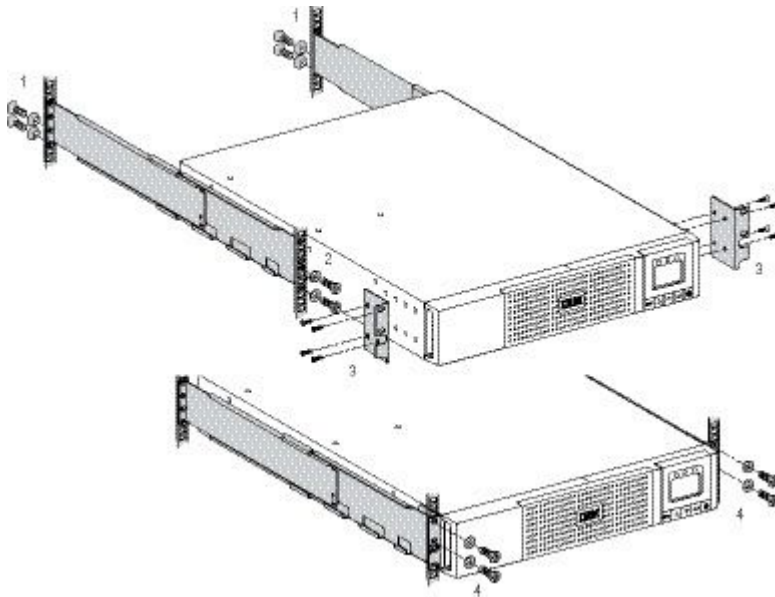

Note: The rails and necessary hardware are supplied by Lenovo.

Tower installation

Step 1. Attach tower supports as shown.

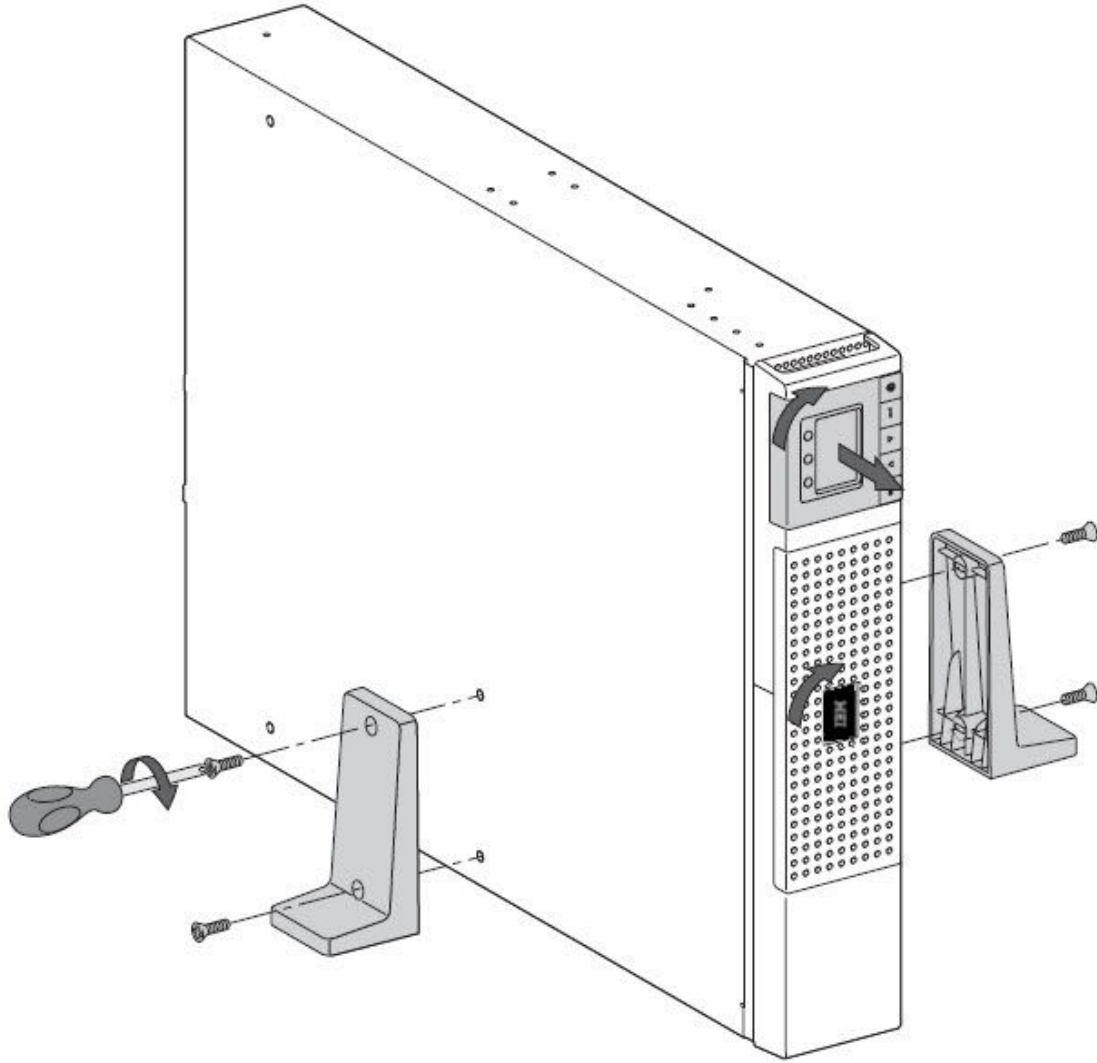

Step 2. Adjust the orientation of the LCD panel and the logo, as shown.

Installing the communication card

Note: It is not necessary to shut down the UPS before installing the UPS Network Management Card.

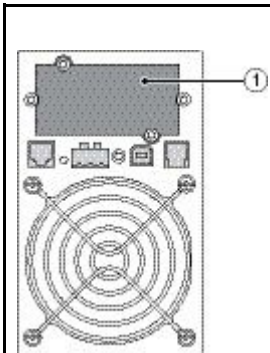

1. Remove the connector panel blank (1), which is secured by two screws.
2. Insert the UPS Network Management Card into the slot.
3. Secure the panel by tightening the two screws.

UPS connection: AX models

Note: Check that the indications on the name plate located on the back of the UPS correspond to the AC-power source and the true electrical consumption of the total load.

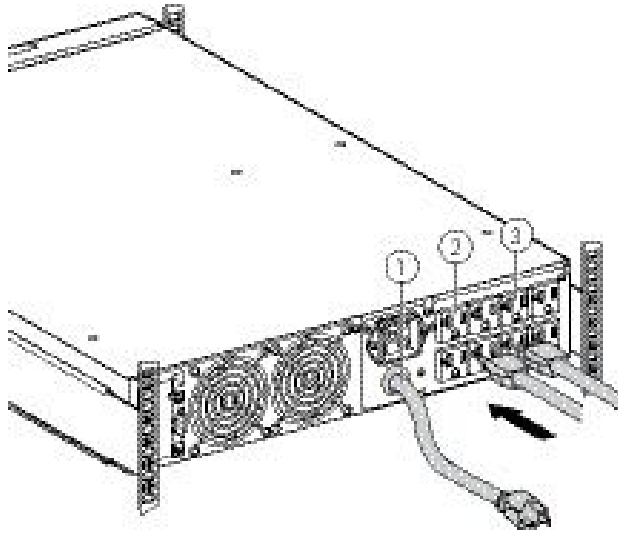

Note: The UPS charges the battery packs as soon as it is connected to the AC-power source, even if the  button is not pressed.

- Step 1. Connect the UPS input plug (1) to the AC-power source.
- Step 2. Connect the loads to the UPS. It is preferable to connect the critical loads to the Primary outlet group shown as (2) and the non-critical loads to either the Group 1 or Group 2 outlets shown as (3). Group 1 and Group 2 outlets can be programmed to shed loads as desired. For the **5594-3AX, 3kVA** models, connect any high-power device to the 30 A outlet.
- Step 3. To program shutdown of outlets (3) during operation on battery power to optimize the available backup time, check the in/out settings (described in Table 1 “User settings” on page 12).

After the UPS is connected to the AC power source, eight hours of charging is required before the battery packs can supply the rated backup time.

UPS connection: KX models

Note: Check that the indications on the name plate located on the back of the UPS correspond to the AC-power source and the true electrical consumption of the total load.

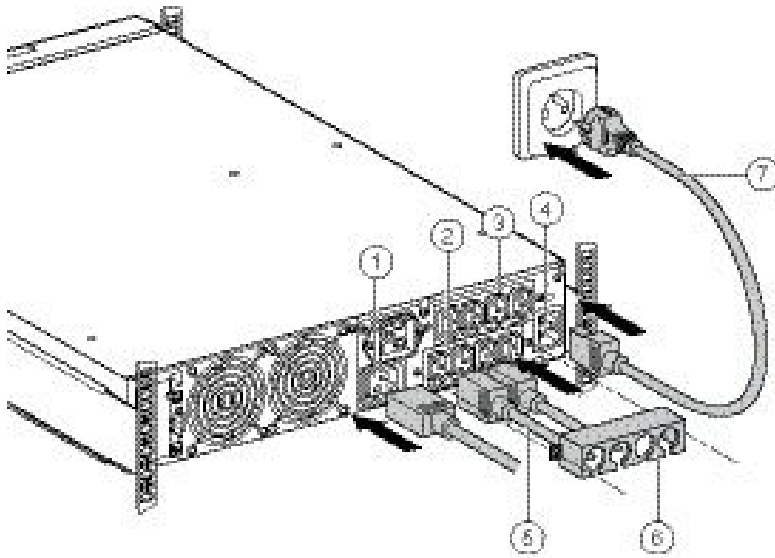

Note: The UPS charges the battery packs as soon as it is connected to the AC-power source, even if the  button is not pressed.

Step 1. Connect the UPS input socket (4) to the AC-power source using the cable of the protected equipment. Connect a 250 V - 16 A cable to the socket (4), then to the AC-power source.

Step 2. Connect the loads to the UPS using the cables (5). It is preferable to connect the priority loads to the four outlets marked (9) and the non-priority loads to the four outlets marked (2) that can be programmed in pairs (1 and 2).

For the 2AX, 2KX, 3AX, and 3KX models, connect any high-power devices to the 16 A outlet (1).

To program shutdown of outlets (2) during operation on battery power to optimize the available backup time, check the in/out settings (described in Table 1 “User settings” on page 12).

Step 3. Fit the connection securing system (6) that prevents the plugs from being pulled out accidentally.

After the UPS is connected to the AC power source, eight hours of charging is required before the battery packs can supply the rated backup time.

Installing the Extended Battery Module (EBM)

Machine Types and Models	Weights (kg/lb)	Dimensions (mm/inch) D x W x H
5594-2BX	72.30 / 32.80	20.6 x 17.4 x 3.4 / 522 x 441.2 x 86.2
5594-3BX	102.3 / 46.39	25.5 x 17.4 x 3.4 / 647 x 441.2 x 86.2

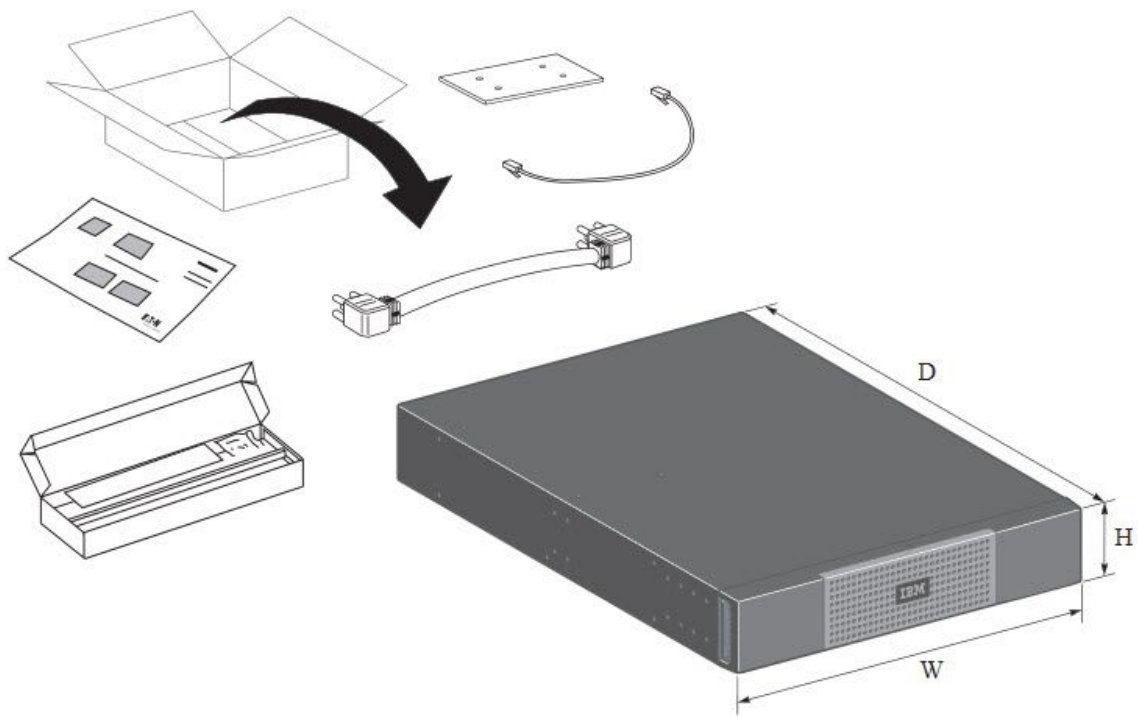

Figure 11. Unpacking the EBM

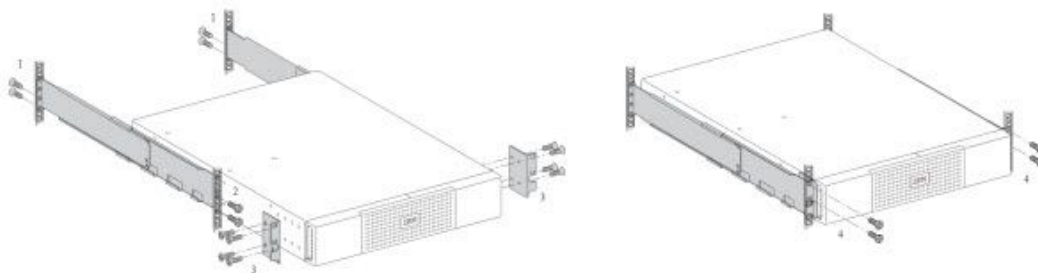
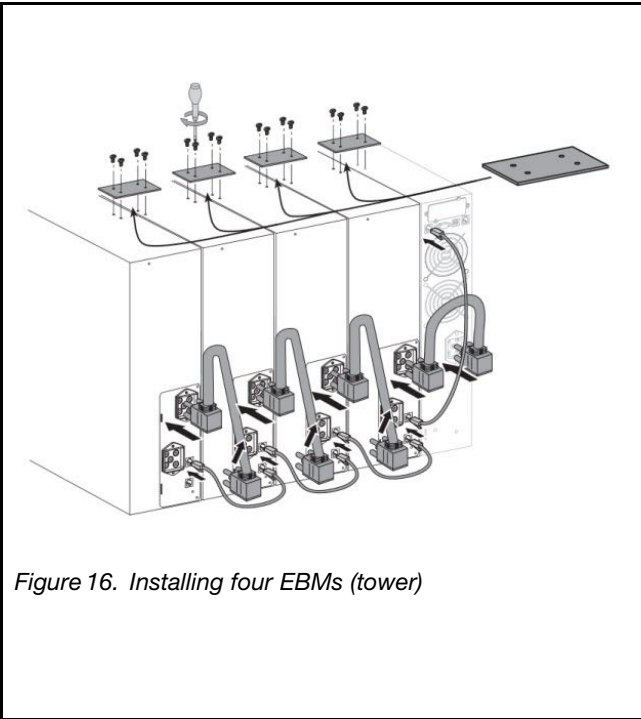
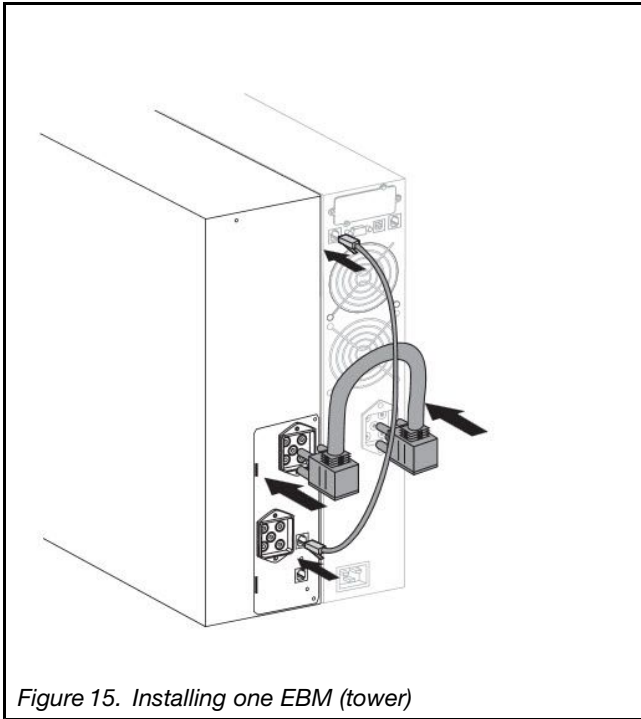
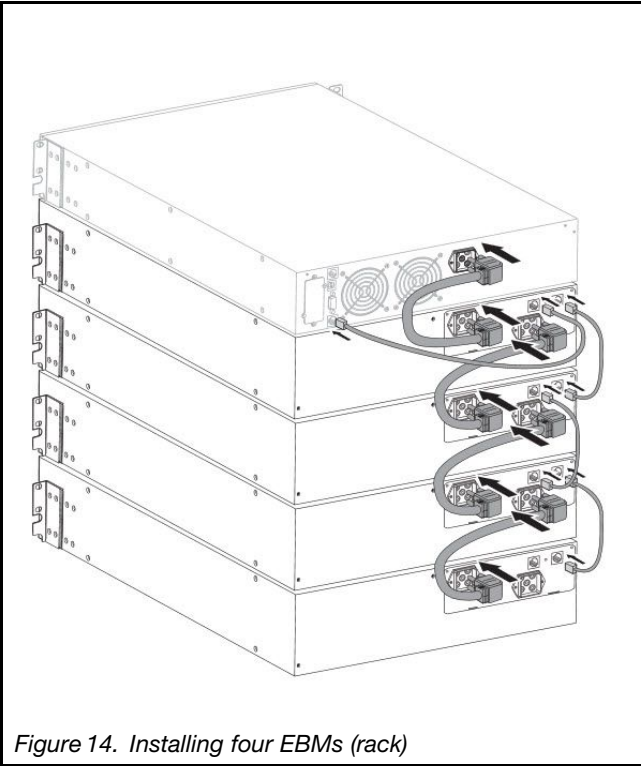
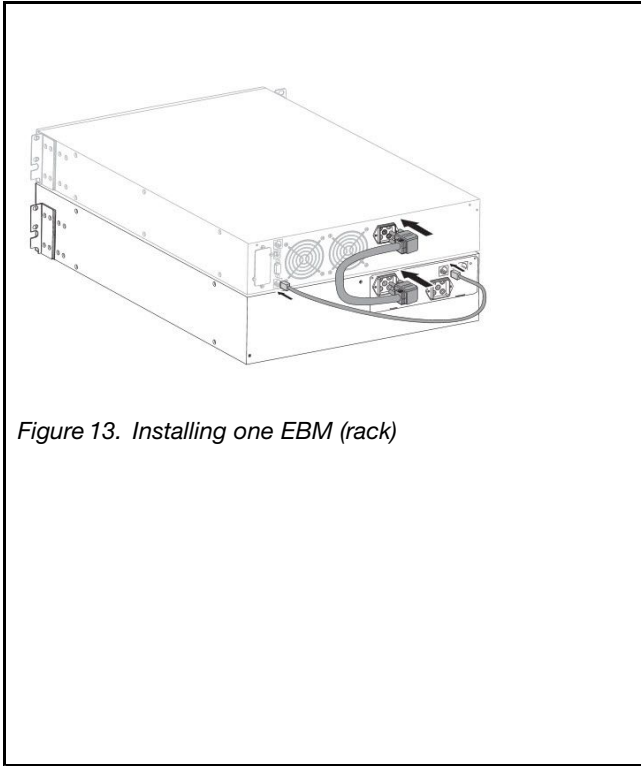

Figure 12. Rack installation using rails





Chapter 4. Operation

UPS startup and shutdown

Follow these instructions to start and stop the UPS.

Startup and Normal operation

To start the UPS:

- Step 1. Verify that the UPS power cord is plugged in.
- Step 2. The UPS front panel display illuminates and shows the Lenovo logo.
- Step 3. Verify that the UPS status screen shows .
- Step 4. Press the  button on the UPS front panel for at least 3 seconds.

The UPS front panel display changes status to "UPS starting...".

- Step 5. Check the UPS front panel display for active alarms or notices. Resolve any active alarms before continuing. See the Troubleshooting section.

If the  indicator is on, do not proceed until all alarms are clear. Check the UPS status from the front panel to view the active alarms. Correct the alarms and restart if necessary.

- Step 6. Verify that the  indicator illuminates solid, indicating that the UPS is operating normally and any loads are powered and protected.

The UPS should be in Normal mode.

Starting the UPS on battery power

Note: Before using this feature, the UPS must have been powered by utility power with output enabled at least once. Battery start can be disabled. See "Cold start" on page 13 .

To start the UPS on battery power:

- Step 1. Press the power () button on the UPS front panel until the UPS front panel display illuminates and shows a status of "UPS starting...".

The UPS cycles through Standby mode to Battery mode. The  indicator illuminates solid. The UPS supplies power to your equipment using batteries.

- Step 2. Check the front panel display for active alarms or notices besides the "Battery mode" notice and notices that indicate missing utility power. Resolve any active alarms before continuing. See the Troubleshooting section.

Step 3. Check the UPS status from the front panel to view the active alarms. Correct the alarms and restart if necessary.

Shutting down the UPS



To shut down the UPS:

Step 1. Press the  button on the UPS front panel for three seconds.

The UPS starts to beep and shows a status of "UPS shutting OFF...". The UPS then transfers to Standby mode, and the  indicator turns off.

Operation on battery power

Transfer to battery power

- The connected devices continue to be supplied by the UPS when AC input power is no longer available. The necessary energy is provided by the battery packs.
- The  and  indicator illuminates solid.
- The audio alarm beeps every ten seconds.

Note: The connected devices are supplied by the battery pack.

Low-battery warning

- The  and  indicator illuminates solid.
- The audio alarm beeps every three seconds.

Note: The remaining battery power is low. Shut down all applications on the connected equipment because automatic UPS shutdown is imminent.

End of battery backup time

- LCD displays "End of backup time".
- All the LEDs go OFF.
- The audio alarm stops.
- The UPS shuts down.

Return of AC input power

Following an outage, the UPS restarts automatically when AC input power returns (unless the restart function has been disabled) and the load is supplied again.

UPS remote control functions

Lenovo UPS offers a choice between two remote control functions.

Remote Power Off (RPO): allows a remote contact to be used to disconnect all the equipment connected to the UPS. Restarting the UPS requires manual intervention.

Remote ON/OFF (ROO): allows remote action of the  button to restart the UPS after shutdown.

These functions are obtained by opening a contact connected between the appropriate pins of connector **5** on the rear panel of the UPS (see the figures in “Remote control connection and test” on page 27).

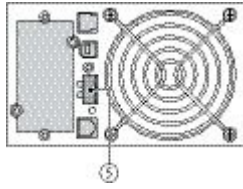

Remote control connection and test

- Step 1. Check that the UPS is OFF and disconnected from the AC input source -- for example, by turning off the utility power circuit breaker to which the UPS is attached.
- Step 2. Remove connector **5**.
- Step 3. Connect a normally closed volt-free contact (60 V DC / 30 V AC max., 20 mA max., 0.75 mm² (18 AWG) cable cross-section) between the two pins of connector **5** (see diagram).

<p>RCO</p>	<p>Contact open: UPS shutdown</p> <p>Contact closed: UPS start-up (UPS connected to AC power and AC power is available)</p> <p>Note: The local ON/OFF control using the button overrides the remote-control function.</p>
<p>RPO</p>	<p>Contact open: UPS shutdown, LED goes ON.</p> <p>To return to normal operation, deactivate the remote external contact and restart the UPS by pressing the button.</p>

- Step 4. Plug connector **5** into the back of the UPS.
- Step 5. Connect and restart the UPS following the previously described procedures.
- Step 6. Activate the external remote shutdown contact to test the function. This connector must be connected only to Safety Extra-Low Voltage (SELV) circuits.

Operating modes: summary

The following table summarizes the characteristics of your UPS unit in each operating mode.

Table 2. Operating modes

Mode	Online	Battery	Standby	High Efficiency*
Load	powered	powered	no power	powered
Batteries	charging	discharging	charging	charging

Table 2. Operating modes (continued)

Mode	Online	Battery	Standby	High Efficiency*
Protection features:				
Power failure	yes	n/a	no	yes
Power sag	yes	n/a	no	yes
Power surge	yes	n/a	no	yes
Under voltage	yes	n/a	no	yes
Over voltage	yes	n/a	no	yes

Note: (*) High Efficiency mode introduces a delay between loss of input power and switching to battery power.

Chapter 5. Communication

Communication ports

Connecting the RS232 or USB communication port (optional)

Note: The RS232 and USB communication ports cannot operate simultaneously.

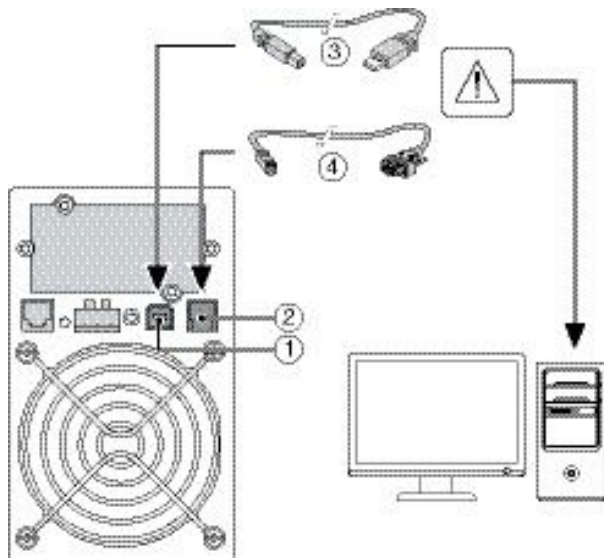

Step 1. Connect the RS232 (4) or USB (3) communication cable to the serial or USB port on the computer equipment.

Step 2. Connect the other end of the communication cable (4) or (3) to the USB (1) or RS232 (2) communication port on the UPS.

The UPS can now communicate with Lenovo power management software.

Characteristics of the contact communication port (optional)

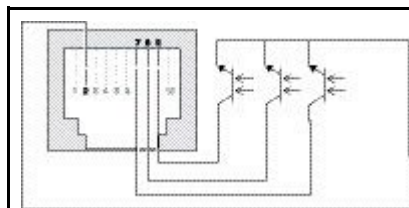

Pins 1, 3, 4, 5, 6, 10: not used
Pin 2: common (user)
Pin 7: low battery
Pin 8: operation on battery power
Pin 9: UPS ON, equipment supplied
n.o.: normally open contact

When a signal is activated, the contact is closed between the common (pin 2) and the pin for the corresponding signal.

Contact characteristics (optocoupler):

- Voltage: 48 V DC max

- Current: 25 mA max
- Power: 1.2 W

Replacing the communication card

Follow these steps to replace the UPS Network Management Card.

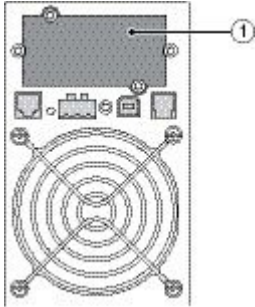

1. Turn off the UPS.
2. Disconnect the network cable.
3. Remove the connector panel blank (1), which is secured by two screws.
4. Insert the UPS Network Management Card into the slot.
5. Secure the panel by tightening the two screws.

Chapter 6. UPS maintenance

Battery pack replacement

When the battery replacement screen is displayed (see illustration), replace the battery packs. Contact your service representative to order new battery packs.

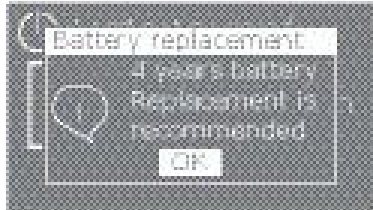

Replace all battery packs in the UPS and any EBMs connected to the UPS at the same time. The replacement battery packs must have no more than 12 month variation between their dates of manufacture and should not have reached or exceeded their shelf life. Dispose of battery packs in accordance with local regulations.

Battery packs can be replaced without turning off the UPS or disconnecting the load. If you prefer to power down to change the battery packs, see *Shutting down the UPS*.

Note: DO NOT DISCONNECT a battery pack while the UPS is in Battery mode. Be aware that the UPS can switch to Battery mode at any time and without warning.

Safety considerations

The battery packs can cause electrocution and high short-circuit currents. The following safety precautions are required before servicing the battery components:

- Remove watches, rings, bracelets and all other metal objects from the hands and arms
- Use tools with an insulated handle

Removing the battery pack

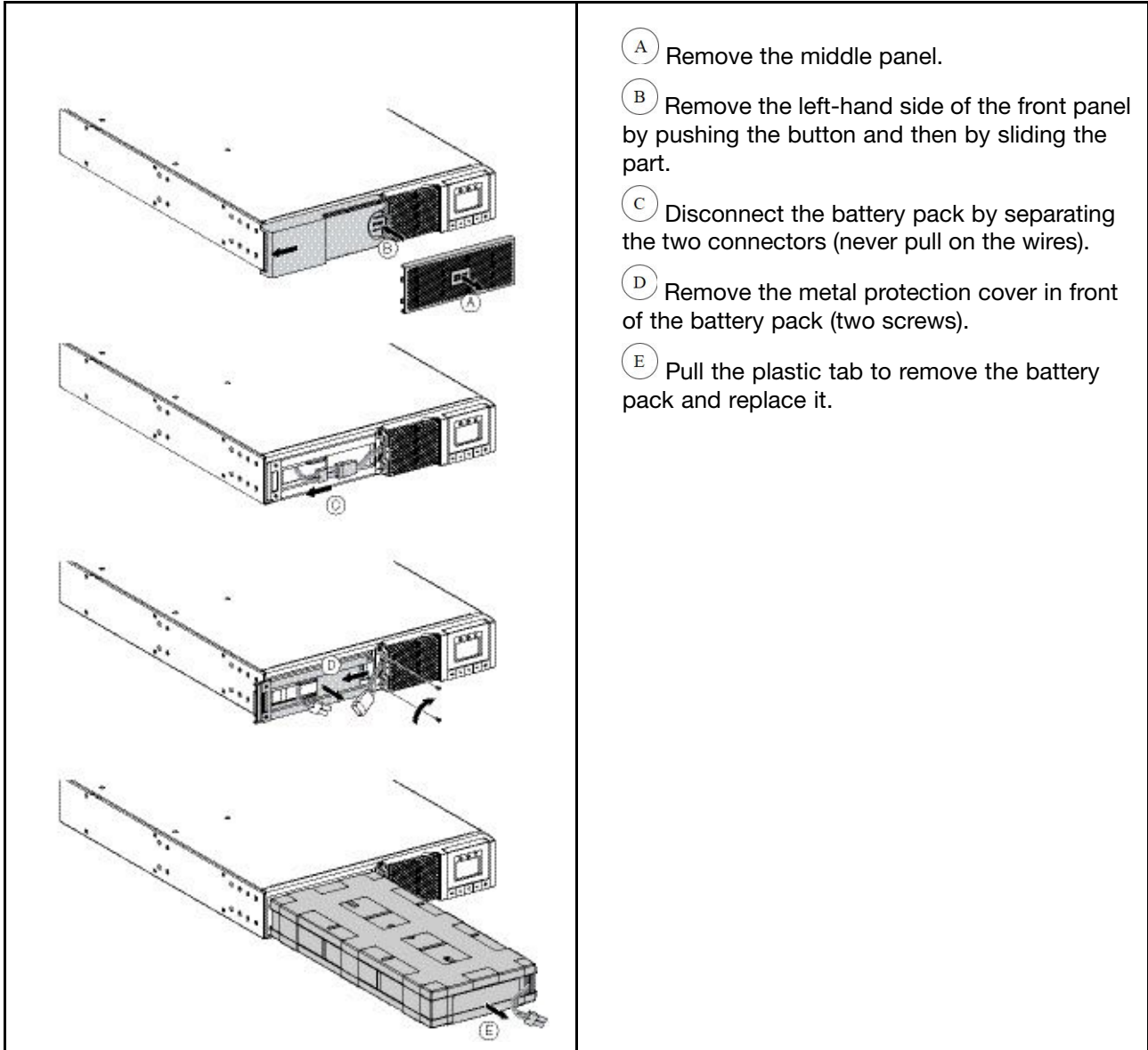

Mounting the new battery pack

Step 1. Carry out the instructions in “Removing the battery pack” on page 32 in reverse order.



Note: To ensure safety and high performance, use only battery packs supplied by Lenovo.

Important: Take care to firmly press together the two parts of the connector during remounting.



Chapter 7. Troubleshooting and maintenance

Alarms and faults

To check the Event log or Fault log:

1. Press any button on the front panel display to activate the menu options.
2. Press the  button to select Event log or Fault log.
3. Press Enter () to review the selected log.
4. Scroll through the listed events or faults.

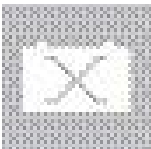
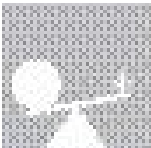
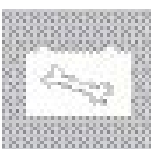
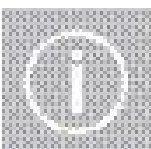
The following table describes conditions that are logged.

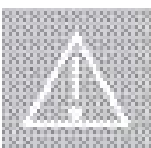
Conditions	Possible cause	Action
Batteries disconnected 	The UPS does not recognize the internal battery packs.	If the condition persists, contact your service representative.
	The battery packs are not connected.	Verify that all battery packs are connected properly. If the condition persists, contact your service representative.
Overload 	Power requirement exceeds the UPS capacity (greater than 105 % of nominal).	Remove some of the equipment from the UPS. The UPS continues to operate, but it might shut down if the load increases. The alarm resets when the condition becomes inactive.
End of battery life 	The battery has reached end-of-life.	Contact your service representative for battery-pack replacement.
Event 	A UPS event occurs. Example: During remote Power off, the RPO contact has been activated to shut down the UPS and now prevents restart.	Set the contact back to its normal position and press the power () button to restart.
UPS fault 	An internal failure occurred.	Record the alarm message and the UPS serial number, then contact your service representative.

Chapter 8. Parts listing

The following replaceable components are available for the product.

For an updated parts listing on the web, go to <http://www.lenovo.com/support>.

Replaceable components consist of consumable parts, structural parts, and customer replaceable units (CRUs):

- **Consumable parts:** Purchase and replacement of consumable parts (components such as printer cartridges, that have depletable life) is your responsibility. If Lenovo acquires or installs a consumable part at your request, you will be charged for the installation.
- **Structural parts:** Purchase and replacement of structural parts (components such as the top cover) is your responsibility. If Lenovo acquires or installs a structural part at your request, you will be charged for the installation.
- **Tier 1 customer replaceable unit (CRU):** Replacement of Tier 1 CRUs is your responsibility. If Lenovo installs a Tier 1 CRU at your request without a service contract, you will be charged for the installation.
- **Tier 2 customer replaceable unit:** You may install a Tier 2 CRU yourself or request Lenovo to install it, at no additional charge, under the type of warranty service that is designated for your compute node.

For information about the terms of the warranty and getting service and assistance, see the *Warranty Information* document.

Table 3. Parts listing table: RT1500 VA and RT2200 VA models

The parts listing table is a four-column table that lists customer replaceable units (CRUs) for the product. Column 1 lists the index number of the CRU in the parts listing illustration. Column 2 contains the CRU description. Columns 3 and 4 identify the CRU part number.

Description	Type	Part No.	5594-1AX	5594-1KX	5594-2AX	5594-2KX
1500 VA / 1350W 120V 2U Rack (without batteries)	Tier 1 CRU	00FP721	x			
1500 VA / 1350W 230V 2U Rack (without batteries)	Tier 1 CRU	00FP722		x		
2200 VA / 1980W 120V 2U Rack (without batteries)	Tier 1 CRU	00FP723			x	
2200 VA / 1980W 230V 2U Rack (without batteries)	Tier 1 CRU	00FP724				x
Battery spare - 1000 / 1500 VA	Tier 1 CRU	00FP780	x	x		
Battery spare - 2200 VA	Tier 1 CRU	00FP781			x	x
5PX Rail Kit Spare	Tier 2 CRU	00FP785	x	x	x	x
Cable accessory bag (5PX)	Tier 1 CRU	00FP802	x	x	x	x
5PX 2U Bezel (RT2U models)	Tier 1 CRU	00FP803	x	x	x	x
Tower pedestal feet	Tier 1 CRU	00FP825	x	x	x	x
Ship Bracket for 5PX	Tier 1 CRU	00FP826	x	x	x	x

Table 4. Parts listing table: RT3000 VA models

Description	Type	Part No.	5594-3AX	5594-3KX
3000 VA / 2700W 120V 2U Rack (without batteries)	Tier 1 CRU	00FP725	x	
3000 VA / 2700W 230V 2U Rack (without batteries)	Tier 1 CRU	00FP726		x
Battery spare - 3000 VA 2U	Tier 1 CRU	00FP782	x	x
5PX Rail Kit Spare	Tier 2 CRU	00FP785	x	x
Cable accessory bag (5PX)	Tier 1 CRU	00FP802	x	x
5PX 2U Bezel (RT2U models)	Tier 1 CRU	00FP803	x	x
Tower pedestal feet	Tier 1 CRU	00FP825	x	x
Ship Bracket for 5PX	Tier 1 CRU	00FP826	x	x

Table 5. Parts listing table: Extended battery modules

Description	Type	Part No.	5594-2BX	5594-3BX
9000-1329-00P 48V 2U EBM (includes batteries)	FRU	00FP727	x	
9000-1330-00P 48V 2U EBM (includes batteries)	FRU	00FP728		x
5PX Rail Kit Spare	Tier 2 CRU	00FP785	x	x
Cable accessory bag (5PX)	Tier 1 CRU	00FP802	x	x
5PX 2U Bezel (RT2U models)	Tier 1 CRU	00FP803	x	x
Tower pedestal feet	Tier 1 CRU	00FP825	x	x
Ship Bracket for 5PX	Tier 1 CRU	00FP826	x	x

Appendix A. Specifications

Technical specifications: 100V/120V models

The Lenovo 2U Rack or Tower UPS, 100V model and 120V model, is a single-phase UPS unit.

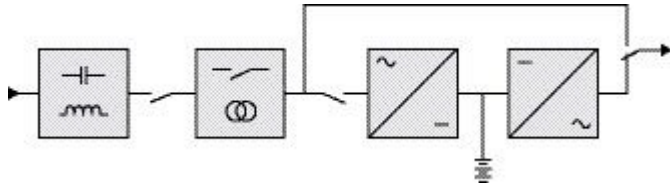

	5594-1AX	5594-2AX	5594-3AX
Output Power	1440 VA 1440 W	1950 VA 1920 W	2880 VA - 2700 W
Output Power Capacity	1500 VA 1500 W	2200 VA 1980 W	3000 VA - 2700 W
AC Input power	100-125VAC, 50/60Hz, 1ph, 12A max	100-125VAC, 50/60Hz, 1ph, 16A max	100-125VAC, 50/60Hz, 1ph, 24A max
AC Output power	50/60Hz, 1ph; 100VAC, 1200VA, 1200W, 12.0A; 120VAC, 1440VA, 1440W, 12.0A; 125VAC, 1440VA, 1440W, 11.5A	50/60Hz, 1ph; 100VAC, 1330VA, 1300W, 13.3A; 120VAC, 1950VA, 1920W, 16.0A; 125VAC, 1950VA, 1920W, 15.6A	50/60Hz, 1ph; 100VAC, 2400VA, 2160W, 24.0A; 120VAC, 3000VA, 2700W, 25.0A; 125VAC, 3000VA, 2700W, 24.0A
Output on battery power • Voltage • Frequency	120 V (-10/+6 %) ⁽¹⁾ 50/60 Hz ±0.1 Hz		
Battery (sealed lead acid, maintenance free) • Standard • Additional modules possible (up to 4 EBMs)	4 x 12 V 7.2 Ah	4 x 12 V 9 Ah	6 x 12V 9Ah
	5594-2BX ⁽²⁾		5594-3BX ⁽³⁾
Environment	Operating temperature: 0 to +40 °C (32 to 104 °F) Storage temperature: -15 to +50 °C (5 to 122 °F) Relative humidity: 20 to 90 % (without condensation)		
	Noise level: < 45 dBA		Noise level: < 50 dBA

⁽¹⁾Adjustable to 100 V (17 % derating at 100 V on 1.5 kVA / 3 kVA, 32 % derating at 100 V on 2.2 kVA) 120/125 V.

⁽²⁾5594-2BX: 2 strings, each 4 x 12 V / 9 Ah.

(3)5594-3BX: 2 strings, each 6 x 12 V / 9 Ah.

When the appliance is used in the EU, use an external circuit breaker in front of line with rating 16 A, 250 V which is IEC/EN 60898-1 standard compliant.

When the appliance is used in American area, use an external circuit breaker in front of line with rating 20 A, 250 V.

This product is designed for IT power distribution systems.

Technical specifications: 200V/230V models

The Lenovo 2U Rack or Tower UPS, 200V model and 230V model, is a single-phase UPS unit.

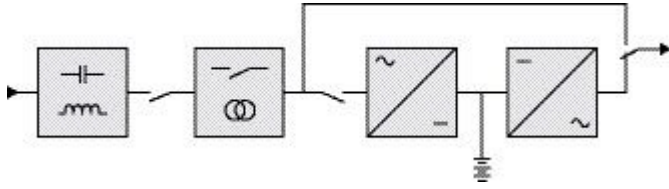

	5594-1KX	5594-2KX	5594-3KX
Output Power	1500 VA 1350 W	2200 VA 1980 W	3000 VA 2700 W
AC Input power	200-240VAC, 50/60Hz, 1ph, 10A max	200-240VAC, 50/60Hz, 1ph, 16A max	200-240VAC, 50/60Hz, 1ph, 16A max
AC Output power	50/60Hz, 1ph; 200VAC, 1550VA, 1100W, 7.5A; 208VAC, 1550VA, 1100W, 7.3A; 220VAC, 1550VA, 1100W, 6.9A; 230VAC, 1550VA, 1100W, 6.6A; 240VAC, 1550VA, 1100W, 6.3A	50/60Hz, 1ph; 200VAC, 1700VA, 1530W, 8.5A; 208VAC, 1980VA, 1780W, 9.5A; 220VAC, 2200VA, 1980W, 10.0A; 230VAC, 2200VA, 1980W, 9.6A; 240VAC, 2200VA, 1980W, 9.2A	50/60Hz, 1ph; 200VAC, 2700VA, 2430W, 13.5A; 208VAC, 3000VA, 2700W, 14.5A; 220VAC, 3000VA, 2700W, 13.7A; 230VAC, 3000VA, 2700W, 13.0A; 240VAC, 3000VA, 2700W, 12.5A
Output on battery power	230 V (-10/+6 %) ⁽¹⁾		
<ul style="list-style-type: none"> • Voltage • Frequency 	50/60 Hz ±0.1 Hz		
Battery (sealed lead acid, maintenance free)	4 x 12 V	4 x 12 V	6 x 12V
<ul style="list-style-type: none"> • Standard • Additional modules possible (up to 4 EBMs) 	7.2 Ah	9 Ah	9Ah
	5594-2BX ⁽²⁾		5594-3BX ⁽³⁾

	5594-1KX	5594-2KX	5594-3KX
Environment	Operating temperature: 0 to +40 °C (32 to 104 °F)		
	Storage temperature: -15 to +50 °C (5 to 122 °F)		
	Relative humidity: 20 to 90 % (without condensation)		
	Noise level: < 45 dBA		Noise level: < 50 dBA

(1)Adjustable to 200/208/220/230/240 V (23 % derating at 200 V, 10 % derating at 208 V on 2.2 kVA, and 17 % derating at 200 V on 3 kVA).

(2)5594-2BX: 2 strings, each 4 x 12 V / 9 Ah.

(3)5594-3BX: 2 strings, each 6 x 12 V / 9 Ah.

Appendix B. Getting help and technical assistance

If you need help, service, or technical assistance or just want more information about Lenovo products, you will find a wide variety of sources available from Lenovo to assist you.

Use this information to obtain additional information about Lenovo and Lenovo products, and determine what to do if you experience a problem with your Lenovo system or optional device.

Note: This section includes references to IBM web sites and information about obtaining service. IBM is Lenovo's preferred service provider for the System x, Flex System, and NeXtScale System products.

Before you call

Before you call, make sure that you have taken these steps to try to solve the problem yourself.

If you believe that you require warranty service for your Lenovo product, the service technicians will be able to assist you more efficiently if you prepare before you call.

- Check all cables to make sure that they are connected.
- Check the power switches to make sure that the system and any optional devices are turned on.
- Check for updated software, firmware, and operating-system device drivers for your Lenovo product. The Lenovo Warranty terms and conditions state that you, the owner of the Lenovo product, are responsible for maintaining and updating all software and firmware for the product (unless it is covered by an additional maintenance contract). Your service technician will request that you upgrade your software and firmware if the problem has a documented solution within a software upgrade.
- If you have installed new hardware or software in your environment, check <http://www.lenovo.com/serverproven/> to make sure that the hardware and software is supported by your product.
- Go to <http://www.lenovo.com/support> to check for information to help you solve the problem.
- Gather the following information to provide to the service technician. This data will help the service technician quickly provide a solution to your problem and ensure that you receive the level of service for which you might have contracted.
 - Hardware and Software Maintenance agreement contract numbers, if applicable
 - Machine type number (Lenovo 4-digit machine identifier)
 - Model number
 - Serial number
 - Current system UEFI and firmware levels
 - Other pertinent information such as error messages and logs
- Go to http://www.ibm.com/support/entry/portal/Open_service_request to submit an Electronic Service Request. Submitting an Electronic Service Request will start the process of determining a solution to your problem by making the pertinent information available to the service technicians. The IBM service technicians can start working on your solution as soon as you have completed and submitted an Electronic Service Request.

You can solve many problems without outside assistance by following the troubleshooting procedures that Lenovo provides in the online help or in the Lenovo product documentation. The Lenovo product documentation also describes the diagnostic tests that you can perform. The documentation for most systems, operating systems, and programs contains troubleshooting procedures and explanations of error messages and error codes. If you suspect a software problem, see the documentation for the operating system or program.

Using the documentation

Information about your Lenovo system and preinstalled software, if any, or optional device is available in the product documentation. That documentation can include printed documents, online documents, readme files, and help files.

See the troubleshooting information in your system documentation for instructions for using the diagnostic programs. The troubleshooting information or the diagnostic programs might tell you that you need additional or updated device drivers or other software. Lenovo maintains pages on the World Wide Web where you can get the latest technical information and download device drivers and updates. To access these pages, go to <http://www.lenovo.com/support>.

Getting help and information from the World Wide Web

Up-to-date information about Lenovo products and support is available on the World Wide Web.

On the World Wide Web, up-to-date information about Lenovo systems, optional devices, services, and support is available at <http://www.lenovo.com/support>. The most current version of the product documentation is available in the following product-specific Information Centers:

- **Flex System products:**
<http://pic.dhe.ibm.com/infocenter/flexsys/information/index.jsp>
- **System x products:**
<http://publib.boulder.ibm.com/infocenter/systemx/documentation/index.jsp>
- **NeXtScale System products:**
<http://pic.dhe.ibm.com/infocenter/nxtscale/documentation/index.jsp>

How to send DSA data

You can use the Enhanced Customer Data Repository to send diagnostic data to IBM.

Before you send diagnostic data to IBM, read the terms of use at <http://www.ibm.com/de/support/ecurep/terms.html>.

You can use any of the following methods to send diagnostic data:

- **Standard upload:**
http://www.ibm.com/de/support/ecurep/send_http.html
- **Standard upload with the system serial number:**
http://www.ecurep.ibm.com/app/upload_hw
- **Secure upload:**
http://www.ibm.com/de/support/ecurep/send_http.html#secure
- **Secure upload with the system serial number:**
https://www.ecurep.ibm.com/app/upload_hw

Creating a personalized support web page

You can create a personalized support web page by identifying Lenovo products that are of interest to you.

To create a personalized support web page, go to <http://www.ibm.com/support/mynotifications>. From this personalized page, you can subscribe to weekly email notifications about new technical documents, search for information and downloads, and access various administrative services.

Software service and support

Through IBM Support Line, you can get telephone assistance, for a fee, with usage, configuration, and software problems with your Lenovo products.

For more information about Support Line and other IBM services, see <http://www.ibm.com/services> or see <http://www.ibm.com/planetwide> for support telephone numbers. In the U.S. and Canada, call 1-800-IBM-SERV (1-800-426-7378).

Hardware service and support

IBM is Lenovo's preferred service provider for the System x, Flex System and NeXtScale System products.

You can receive hardware service through your Lenovo reseller or from IBM. To locate a reseller authorized by Lenovo to provide warranty service, go to <http://www.ibm.com/partnerworld> and click **Business Partner Locator**. For IBM support telephone numbers, see <http://www.ibm.com/planetwide>. In the U.S. and Canada, call 1-800-IBM-SERV (1-800-426-7378).

In the U.S. and Canada, hardware service and support is available 24 hours a day, 7 days a week. In the U.K., these services are available Monday through Friday, from 9 a.m. to 6 p.m.

Taiwan product service

Use this information to contact product service for Taiwan.

委製商/進口商名稱: 荷蘭商聯想股份有限公司台灣分公司
進口商地址: 台北市內湖區堤頂大道2段89號5樓
進口商電話: 0800-000-702 (代表號)

Appendix C. Notices

Lenovo may not offer the products, services, or features discussed in this document in all countries. Consult your local Lenovo representative for information on the products and services currently available in your area.

Any reference to a Lenovo product, program, or service is not intended to state or imply that only that Lenovo product, program, or service may be used. Any functionally equivalent product, program, or service that does not infringe any Lenovo intellectual property right may be used instead. However, it is the user's responsibility to evaluate and verify the operation of any other product, program, or service.

Lenovo may have patents or pending patent applications covering subject matter described in this document. The furnishing of this document does not give you any license to these patents. You can send license inquiries, in writing, to:

*Lenovo (United States), Inc.
1009 Think Place - Building One
Morrisville, NC 27560
U.S.A.
Attention: Lenovo Director of Licensing*

LENOVO PROVIDES THIS PUBLICATION "AS IS" WITHOUT WARRANTY OF ANY KIND, EITHER EXPRESS OR IMPLIED, INCLUDING, BUT NOT LIMITED TO, THE IMPLIED WARRANTIES OF NON-INFRINGEMENT, MERCHANTABILITY OR FITNESS FOR A PARTICULAR PURPOSE. Some jurisdictions do not allow disclaimer of express or implied warranties in certain transactions, therefore, this statement may not apply to you.

This information could include technical inaccuracies or typographical errors. Changes are periodically made to the information herein; these changes will be incorporated in new editions of the publication. Lenovo may make improvements and/or changes in the product(s) and/or the program(s) described in this publication at any time without notice.

The products described in this document are not intended for use in implantation or other life support applications where malfunction may result in injury or death to persons. The information contained in this document does not affect or change Lenovo product specifications or warranties. Nothing in this document shall operate as an express or implied license or indemnity under the intellectual property rights of Lenovo or third parties. All information contained in this document was obtained in specific environments and is presented as an illustration. The result obtained in other operating environments may vary.

Lenovo may use or distribute any of the information you supply in any way it believes appropriate without incurring any obligation to you.

Any references in this publication to non-Lenovo Web sites are provided for convenience only and do not in any manner serve as an endorsement of those Web sites. The materials at those Web sites are not part of the materials for this Lenovo product, and use of those Web sites is at your own risk.

Any performance data contained herein was determined in a controlled environment. Therefore, the result obtained in other operating environments may vary significantly. Some measurements may have been made on development-level systems and there is no guarantee that these measurements will be the same on generally available systems. Furthermore, some measurements may have been estimated through extrapolation. Actual results may vary. Users of this document should verify the applicable data for their specific environment.

Trademarks

Lenovo, the Lenovo logo, Flex System, System x, NeXtScale System, and x Architecture are trademarks of Lenovo in the United States, other countries, or both.

Intel and Intel Xeon are trademarks of Intel Corporation in the United States, other countries, or both.

Internet Explorer, Microsoft, and Windows are trademarks of the Microsoft group of companies.

Linux is a registered trademark of Linus Torvalds.

Other company, product, or service names may be trademarks or service marks of others.

Important notes

Processor speed indicates the internal clock speed of the microprocessor; other factors also affect application performance.

CD or DVD drive speed is the variable read rate. Actual speeds vary and are often less than the possible maximum.

When referring to processor storage, real and virtual storage, or channel volume, KB stands for 1 024 bytes, MB stands for 1 048 576 bytes, and GB stands for 1 073 741 824 bytes.

When referring to hard disk drive capacity or communications volume, MB stands for 1 000 000 bytes, and GB stands for 1 000 000 000 bytes. Total user-accessible capacity can vary depending on operating environments.

Maximum internal hard disk drive capacities assume the replacement of any standard hard disk drives and population of all hard-disk-drive bays with the largest currently supported drives that are available from Lenovo.

Maximum memory might require replacement of the standard memory with an optional memory module.

Each solid-state memory cell has an intrinsic, finite number of write cycles that the cell can incur. Therefore, a solid-state device has a maximum number of write cycles that it can be subjected to, expressed as total bytes written (TBW). A device that has exceeded this limit might fail to respond to system-generated commands or might be incapable of being written to. Lenovo is not responsible for replacement of a device that has exceeded its maximum guaranteed number of program/erase cycles, as documented in the Official Published Specifications for the device.

Lenovo makes no representations or warranties with respect to non-Lenovo products. Support (if any) for the non-Lenovo products is provided by the third party, not Lenovo.

Some software might differ from its retail version (if available) and might not include user manuals or all program functionality.

Recycling information

Lenovo encourages owners of information technology (IT) equipment to responsibly recycle their equipment when it is no longer needed. Lenovo offers a variety of programs and services to assist equipment owners in recycling their IT products. For information on recycling Lenovo products, go to: <http://www.lenovo.com/recycling>.

Particulate contamination

Attention: Airborne particulates (including metal flakes or particles) and reactive gases acting alone or in combination with other environmental factors such as humidity or temperature might pose a risk to the device that is described in this document.

Risks that are posed by the presence of excessive particulate levels or concentrations of harmful gases include damage that might cause the device to malfunction or cease functioning altogether. This specification sets forth limits for particulates and gases that are intended to avoid such damage. The limits must not be viewed or used as definitive limits, because numerous other factors, such as temperature or moisture content of the air, can influence the impact of particulates or environmental corrosives and gaseous contaminant transfer. In the absence of specific limits that are set forth in this document, you must implement practices that maintain particulate and gas levels that are consistent with the protection of human health and safety. If Lenovo determines that the levels of particulates or gases in your environment have caused damage to the device, Lenovo may condition provision of repair or replacement of devices or parts on implementation of appropriate remedial measures to mitigate such environmental contamination. Implementation of such remedial measures is a customer responsibility.

Table 6. Limits for particulates and gases

Contaminant	Limits
Particulate	<ul style="list-style-type: none">The room air must be continuously filtered with 40% atmospheric dust spot efficiency (MERV 9) according to ASHRAE Standard 52.2¹.Air that enters a data center must be filtered to 99.97% efficiency or greater, using high-efficiency particulate air (HEPA) filters that meet MIL-STD-282.The deliquescent relative humidity of the particulate contamination must be more than 60%².The room must be free of conductive contamination such as zinc whiskers.
Gaseous	<ul style="list-style-type: none">Copper: Class G1 as per ANSI/ISA 71.04-1985³Silver: Corrosion rate of less than 300 Å in 30 days

¹ ASHRAE 52.2-2008 - *Method of Testing General Ventilation Air-Cleaning Devices for Removal Efficiency by Particle Size*. Atlanta: American Society of Heating, Refrigerating and Air-Conditioning Engineers, Inc.

² The deliquescent relative humidity of particulate contamination is the relative humidity at which the dust absorbs enough water to become wet and promote ionic conduction.

³ ANSI/ISA-71.04-1985. *Environmental conditions for process measurement and control systems: Airborne contaminants*. Instrument Society of America, Research Triangle Park, North Carolina, U.S.A.

Telecommunication regulatory statement

This product may not be certified in your country for connection by any means whatsoever to interfaces of public telecommunications networks. Further certification may be required by law prior to making any such connection. Contact a Lenovo representative or reseller for any questions.

Electronic emission notices

When you attach a monitor to the equipment, you must use the designated monitor cable and any interference suppression devices that are supplied with the monitor.

Federal Communications Commission (FCC) statement

Note: This equipment has been tested and found to comply with the limits for a Class A digital device, pursuant to Part 15 of the FCC Rules. These limits are designed to provide reasonable protection against harmful interference when the equipment is operated in a commercial environment. This equipment

generates, uses, and can radiate radio frequency energy and, if not installed and used in accordance with the instruction manual, may cause harmful interference to radio communications. Operation of this equipment in a residential area is likely to cause harmful interference, in which case the user will be required to correct the interference at his own expense.

Properly shielded and grounded cables and connectors must be used in order to meet FCC emission limits. Lenovo is not responsible for any radio or television interference caused by using other than recommended cables and connectors or by unauthorized changes or modifications to this equipment. Unauthorized changes or modifications could void the user's authority to operate the equipment.

This device complies with Part 15 of the FCC Rules. Operation is subject to the following two conditions: (1) this device may not cause harmful interference, and (2) this device must accept any interference received, including interference that might cause undesired operation.

Industry Canada Class A emission compliance statement

This Class A digital apparatus complies with Canadian ICES-003.

Avis de conformité à la réglementation d'Industrie Canada

Cet appareil numérique de la classe A est conforme à la norme NMB-003 du Canada.

Australia and New Zealand Class A statement

Attention: This is a Class A product. In a domestic environment this product may cause radio interference in which case the user may be required to take adequate measures.

European Union EMC Directive conformance statement

This product is in conformity with the protection requirements of EU Council Directive 2014/30/EU on the approximation of the laws of the Member States relating to electromagnetic compatibility. Lenovo cannot accept responsibility for any failure to satisfy the protection requirements resulting from a non-recommended modification of the product, including the installation of option cards from other manufacturers.

This product has been tested and found to comply with the limits for Class A equipment according to European Standards harmonized in the Directives in compliance. The limits for Class A equipment were derived for commercial and industrial environments to provide reasonable protection against interference with licensed communication equipment.

Lenovo, Einsteinova 21, 851 01 Bratislava, Slovakia



Warning: This is a Class A product. In a domestic environment this product may cause radio interference in which case the user may be required to take adequate measures.

Germany Class A statement

Deutschsprachiger EU Hinweis: Hinweis für Geräte der Klasse A EU-Richtlinie zur Elektromagnetischen Verträglichkeit

Deutschsprachiger EU Hinweis: Hinweis für Geräte der Klasse A EU-Richtlinie zur Elektromagnetischen Verträglichkeit Dieses Produkt entspricht den Schutzanforderungen der EU-Richtlinie 2014/30/EU zur Angleichung der Rechtsvorschriften über die elektromagnetische Verträglichkeit in den EU-Mitgliedsstaaten und hält die Grenzwerte der Klasse A der Norm gemäß Richtlinie.

Um dieses sicherzustellen, sind die Geräte wie in den Handbüchern beschrieben zu installieren und zu betreiben. Des Weiteren dürfen auch nur von der Lenovo empfohlene Kabel angeschlossen werden. Lenovo übernimmt keine Verantwortung für die Einhaltung der Schutzanforderungen, wenn das Produkt ohne Zustimmung der Lenovo verändert bzw. wenn Erweiterungskomponenten von Fremdherstellern ohne Empfehlung der Lenovo gesteckt/eingebaut werden.

Deutschland:

Einhaltung des Gesetzes über die elektromagnetische Verträglichkeit von Betriebsmitteln Dieses Produkt entspricht dem „Gesetz über die elektromagnetische Verträglichkeit von Betriebsmitteln“ EMVG (früher „Gesetz über die elektromagnetische Verträglichkeit von Geräten“). Dies ist die Umsetzung der EU-Richtlinie 2014/30/EU in der Bundesrepublik Deutschland.

Zulassungsbescheinigung laut dem Deutschen Gesetz über die elektromagnetische Verträglichkeit von Betriebsmitteln, EMVG vom 20. Juli 2007 (früher Gesetz über die elektromagnetische Verträglichkeit von Geräten), bzw. der EMV EU Richtlinie 2014/30/EU, für Geräte der Klasse A.

Dieses Gerät ist berechtigt, in Übereinstimmung mit dem Deutschen EMVG das EG-Konformitätszeichen - CE - zu führen. Verantwortlich für die Konformitätserklärung nach Paragraf 5 des EMVG ist die Lenovo (Deutschland) GmbH, Meitnerstr. 9, D-70563 Stuttgart.

Informationen in Hinsicht EMVG Paragraf 4 Abs. (1) 4: **Das Gerät erfüllt die Schutzanforderungen nach EN 55024 und EN 55032 Klasse A.**

Nach der EN 55032: „Dies ist eine Einrichtung der Klasse A. Diese Einrichtung kann im Wohnbereich Funkstörungen verursachen; in diesem Fall kann vom Betreiber verlangt werden, angemessene Maßnahmen durchzuführen und dafür aufzukommen.“

Nach dem EMVG: „Geräte dürfen an Orten, für die sie nicht ausreichend entstört sind, nur mit besonderer Genehmigung des Bundesministers für Post und Telekommunikation oder des Bundesamtes für Post und Telekommunikation betrieben werden. Die Genehmigung wird erteilt, wenn keine elektromagnetischen Störungen zu erwarten sind.“ (Auszug aus dem EMVG, Paragraph 3, Abs. 4). Dieses Genehmigungsverfahren ist nach Paragraph 9 EMVG in Verbindung mit der entsprechenden Kostenverordnung (Amtsblatt 14/93) kostenpflichtig.

Anmerkung: Um die Einhaltung des EMVG sicherzustellen sind die Geräte, wie in den Handbüchern angegeben, zu installieren und zu betreiben.

Japanese electromagnetic compatibility statements

Japan VCCI Class A statement

この装置は、クラスA情報技術装置です。この装置を家庭環境で使用すると電波障害を引き起こすことがあります。この場合には使用者が適切な対策を講ずるよう要求されることがあります。 V C C I - A

Japanese Electrical Appliance and Material Safety Law statement (for detachable AC power cord)

本製品およびオプションに電源コード・セットが付属する場合は、それぞれ専用のものになっていますので他の電気機器には使用しないでください。

JEITA harmonics guideline - Japanese Statement for AC power consumption (W)

定格入力電力表示

(社) 電子情報技術参照委員会 家電・汎用品高調波抑制対策ガイドライン
実行計画書に基づく定格入力電力値： W

お手持ちのユニットの定格入力電力値(W)はユニットの電源装置に貼付
されている電源仕様ラベルをご参照下さい

JEITA harmonics guideline - Japanese Statement of Compliance for Products Less than or Equal to 20A per phase

JEITA 高調波電流抑制対策適合品表示 (JEITA harmonics statements– Japan)

定格電流が 20A/相以下の機器 (For products where input current is less than or equal to 20A per phase)

日本の定格電流が 20A/相 以下の機器に対する高調波電流規制高調波電流規格
JIS C 61000-3-2 適合品

JEITA harmonics guideline - Japanese Statement of Compliance for Products More than 20A

定格電流が 20A/相を超える機器 (For products where input current is less than 20A/Phase of one PSU, but total system power is over 20A/Phase)

本製品は、1相当たり20Aを超える機器ですが、個々のユニットが「高調波電流規格 JIS C 61000-3-2適合品」であり、
本製品はその組み合わせであるため、「高調波電流規格 JIS C 61000-3-2適合品」としてあります

Korea Communications Commission (KCC) statement

이 기기는 업무용(A급)으로 전자파적합기기로
서 판매자 또는 사용자는 이 점을 주의하시기
바라며, 가정외의 지역에서 사용하는 것을 목
적으로 합니다.

This is electromagnetic wave compatibility equipment for business (Type A). Sellers and users need to pay attention to it. This is for any areas other than home.

Russia Electromagnetic Interference (EMI) Class A statement

ВНИМАНИЕ!

Настоящее изделие относится к оборудованию класса А. При использовании в бытовой обстановке это оборудование может нарушать функционирование других технических средств в результате создаваемых промышленных радиопомех. В этом случае от пользователя может потребоваться принятие адекватных мер.

People's Republic of China Class A electronic emission statement

中华人民共和国“A类”警告声明

声明

此为A级产品，在生活环境中，该产品可能会造成无线电干扰。在这种情况下，可能需要用户对其干扰采取切实可行的措施。

Taiwan Class A compliance statement

警告使用者：
這是甲類的資訊產品，在居住的環境中使用時，可能會造成射頻干擾，在這種情況下，使用者會被要求採取某些適當的對策。

Taiwan BSMI RoHS declaration

單元 Unit	限用物質及其化學符號 Restricted substances and its chemical symbols					
	鉛Lead (Pb)	汞Mercury (Hg)	鎘Cadmium (Cd)	六價鉻 Hexavalent chromium (Cr ⁶⁺)	多溴聯苯 Polybrominated biphenyls (PBB)	多溴二苯醚 Polybrominated diphenyl ethers (PBDE)
機架	○	○	○	○	○	○
外部蓋板	○	○	○	○	○	○
機械組零件	-	○	○	○	○	○
空氣傳動設備	-	○	○	○	○	○
冷卻組零件	-	○	○	○	○	○
內存模塊	-	○	○	○	○	○
處理器模塊	-	○	○	○	○	○
鍵盤	-	○	○	○	○	○
調製解調器	-	○	○	○	○	○
監視器	-	○	○	○	○	○
滑鼠	-	○	○	○	○	○
電纜組零件	-	○	○	○	○	○
電源	-	○	○	○	○	○
儲備設備	-	○	○	○	○	○
電池匣組零件	-	○	○	○	○	○
電池	-	○	○	○	○	○
有mech的電路卡	-	○	○	○	○	○
無mech的電路卡	-	○	○	○	○	○
雷射器	-	○	○	○	○	○
<p>備考1. “超出0.1 wt %” 及 “超出0.01 wt %” 係指限用物質之百分比含量超出百分比含量基準值。 Note1 : “exceeding 0.1wt%” and “exceeding 0.01 wt%” indicate that the percentage content of the restricted substance exceeds the reference percentage value of presence condition.</p> <p>備考2. “○” 係指該項限用物質之百分比含量未超出百分比含量基準值。 Note2 : “○” indicates that the percentage content of the restricted substance does not exceed the percentage of reference value of presence.</p> <p>備考3. “-” 係指該項限用物質為排除項目。 Note3 : The “-” indicates that the restricted substance corresponds to the exemption.</p>						

Index

A

assistance, getting 41
Australia Class A statement 48

C

Canada Class A electronic emission statement 48
China Class A electronic emission statement 51
Class A electronic emission notice 48
contamination, particulate and gaseous 47
creating a personalized support web page 43
custom support web page 43

D

documentation
 using 42
DSA, sending data 42

E

electrical equipment, servicing v
electronic emission Class A notice 48
European Union EMC Directive conformance statement 48

F

FCC Class A notice 48

G

gaseous contamination 47
Germany Class A statement 48
guidelines
 servicing electrical equipment v
 trained service technicians iv

H

hardware service and support telephone numbers 43
help
 from the World Wide Web 42
 from World Wide Web 42
 sending diagnostic data 42
 sources of 41

I

important notices 46
information center 42
inspecting for unsafe conditions iv

J

Japanese electromagnetic compatibility statements 49

K

Korea Class A electronic emission statement 50

N

New Zealand Class A statement 48
notes, important 46
notices 1, 45
 electronic emission 48
 FCC, Class A 48

P

particulate contamination 47
People's Republic of China Class A electronic emission statement 51
product service, Taiwan 43

R

Russia Class A electronic emission statement 50

S

safety iii
safety statements iii, vi
sending diagnostic data 42
service and support
 before you call 41
 hardware 43
 software 43
servicing electrical equipment v
software service and support telephone numbers 43
statements and notices 1
support web page, custom 43

T

Taiwan BSMI RoHS declaration 52
Taiwan Class A electronic emission statement 51
Taiwan product service 43
telecommunication regulatory statement 47
telephone numbers 43
trademarks 46
trained service technicians, guidelines iv

U

United States FCC Class A notice 48
unsafe conditions, inspecting for iv

Lenovo[™]