

GL622/GL612

GL622/GL612



User Guide



SOLD & SERVICED BY  
**Survey Instrument Sales**  
 Helping You Measure the World  
 24037 Acacia Redford, MI 48239 313-535-5252

Survey Instrument Sales  
24037 Acacia  
Redford, MI 48239

+1-313-535-5252 Phone

www.surveyinstrumentsales.com



© 2012, Trimble Navigation Limited. All rights reserved.  
PN Q104848 Rev. D(05/13)



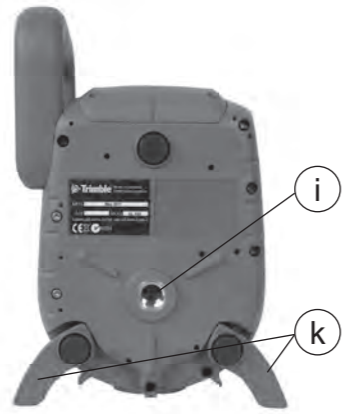
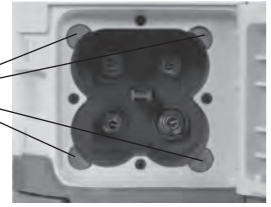
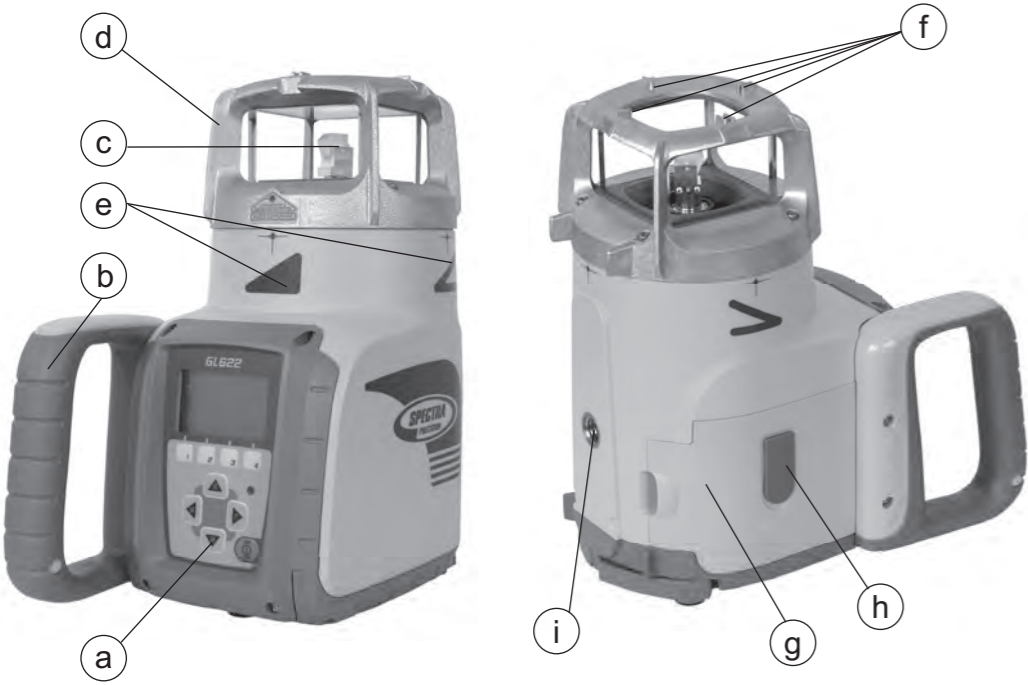

Ürün Açıklaması ve Kullanıcı  
 El Kitabı  
 Ürün Açıklaması ve Kullanıcı  
 El Kitabı  
 Ürün Açıklaması ve Kullanıcı  
 El Kitabı

Introduction	2
FOR YOUR SAFETY	2
COMPONENTS	2
How to use the Laser System	3
Powering the Laser	3
RC602 Radio Remote Control	3
Turning On/Off the RC602	3
LASER SETUP	4
Turning On/Off the Laser	4
Features and functions	4
Standard Features	5
X-Y-grade entering mode	5
Using the Rotation mode	6
Manual mode	6
Special MENU Features	7
Menu Functions (Radio controlled)	7
Automatic PlaneLok mode	8
Automatic Grade Match	9
Automatic Axis Alignment (only GL622)	10
Activating/Deactivating Standby mode	10
Start Reference Check	10
Setting Menu	10
Info	11
Service menu	11
Special Features - Vertical Setup	12
Line Scan	12
Setting menu details	12
Pairing	12
Pairing the transmitter with remote control	13
Pairing the transmitter with receiver	13
Mask mode	13
Grade Entry	14
Grade Display	14
Sensitivity	14
HI-alert selection	14
User Name	15
Set Password	15
Password On/Off	15
Radio (RF-Channel)	15
Select Language	16
CALIBRATION	16
Checking Calibration of the Y- and X-Axes	16
Checking Calibration of the Z-(vertical) Axis	16
Troubleshooting	17
PROTECTING THE UNIT	18
CLEANING AND MAINTENANCE	18
PROTECTING THE ENVIRONMENT	18
WARRANTY	18
TECHNICAL DATA	19
ELECTROMAGNETICAL COMPATIBILITY	20

## Introduction

Thank you for choosing one of the Spectra Precision Lasers from the Trimble family of precision lasers.

The grade laser is an easy-to-use tool that offers accurate horizontal, vertical and sloped laser reference up to 1300 ft (400 m) away using a receiver.

## For Your Safety

For hazardless and safe operation, read all the user guide instructions.



- Use of this product by people other than those trained on this product may result in exposure to hazardous laser light.
- Do not remove warning labels from the unit.
- The GL622/GL612 is a class 2 laser (<3.4mW) IEC 60825-1:2007)
- Never look into the laser beam or direct it to the eyes of other people.
- Always operate the unit in a way that prevents the beam from getting into people's eyes.
- If initial service is required, which results in the removal of the outer protective cover, removal must only be performed by factory-trained personnel.



**Caution:** Use of other than the described user and calibration tools or other procedures may result in exposure to hazardous laser light.

**Caution:** Using different than described at the GL6X2 user guide, may result in unsafe operation.

## COMPONENTS

- a Keypad/LCD-Display
- b Handle
- c Rotor
- d Sunshade
- e Axes-Alignment-Marks
- f Sighting Guides/Scope Mounts
- g Battery door
- h Rubber Cover/Recharge Jack
- i 5/8" x 11 Tripod Mounts
- j Rubber Feet
- k Turnable Legs
- l Plus and Minus Battery Diagrams

## HOW TO USE THE LASER SYSTEM

### POWERING THE LASER

#### Batteries

##### WARNING

Ni-MH batteries may contain small amounts of harmful substances. Be sure to charge the battery before using it for the first time, and after not using it for an extended length of time. Charge only with specified chargers according to device manufacturer's instructions. Do not open the battery, dispose of in fire or short circuit; it may ignite, explode, leak or get hot causing personal injury. Dispose in accordance with all applicable federal, state, and local regulations. Keep the battery away from children. If swallowed, do not induce vomiting. Seek medical attention immediately.

#### Recharging the Batteries

The laser is shipped with a rechargeable Ni-MH battery pack.

**Note:** The approximate charge of the batteries is shown at the left top side of the LCD.

The charger requires approx. 10 hours to charge empty rechargeable batteries.

For charging, connect the plug of the charger to the recharge jack of the battery pack.

New or long-time out-of-use rechargeable batteries reach their best performance after being charged and recharged five times. For Indoor applications the charger can be used as a power supply for the GL.

Alkaline batteries can be used as a backup. Insert 4 D-cell batteries noting the plus (+) and minus (-) diagrams inside the battery housing.



**The batteries should only be charged when the laser is between 50° F and 104° F (10°C to 40°C). Charging at a higher temperature may damage the batteries. Charging at a lower temperature may increase the charge time and decrease the charge capacity, resulting in loss of performance and shortened life expectancy.**

### RC602 Radio Remote Control

#### Powering the RC602

1. Open the battery door using a coin or similar pry device to release the battery door tab on the RC602. RC602 will be shipped with alkaline batteries. Rechargeable batteries can be used optional but need to be charged externally.
2. Insert two AA batteries noting the plus (+) and minus (-) diagrams inside the battery housing.
3. Close the battery door. Push down until it "clicks" into the locked position.



#### Turning On/Off the Radio Remote Control

The radio remote control is a hand-held device that allows you to send operational commands to the laser from a remote location.

Press the power button to turn on the radio remote control. A "T" and additional vertical bars appear in the right corner of the remote's top display line indicating the radio connection status between the laser and the remote control.

**Note:** When the remote control is initially turned on, the standard display (model number and software version) appear for the first 3 seconds, then the axes symbols and last-entered grade for each axis briefly appear in the LCD.

With every button press, the LCD backlight is activated and turns off automatically if no button is pressed for 8 seconds.

To turn off the radio remote control, press and release the power button.

**Note:** 5 minutes after the last button press, the remote control turns off automatically.

## LASER SETUP

Position the laser horizontally (tripod mount and rubber feet downward!) on a **stable** platform, wall mount or tripod at the desired elevation.

The laser recognizes automatically whether it is used horizontally or vertically when switched on.

### Turning On/Off the laser

Press the power button to turn On/Off the laser.

**Note:** Depending on the setup (horizontal or vertical) and if a grade value has been dialed in, the unit starts the temperature/reference check while the thermometer symbol is flashing.

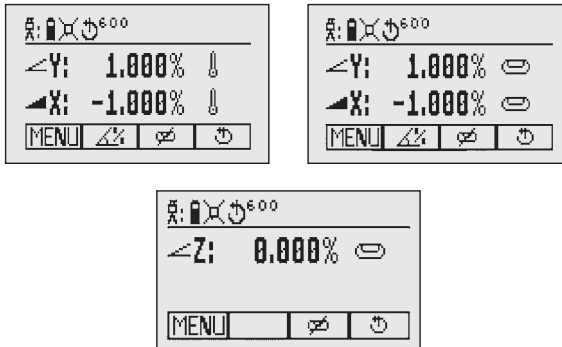

When the temperature/reference check has been finished, the standard display appears and the bubble symbols flash until self-leveling has been completed.

If the self-leveling can't be finished based on the selected sensitivity, an error message appears.

## Features and Functions

### Standard Display

The remote control mirrors the functionality of the GL keypad.



- Button 1:** Quickly press and release starts the **MENU** entry.
- Button 2:** Quickly press and release starts the grade entering mode.
- Button 3:** Quickly press and release activates/deactivates the manual mode.
- Button 4:** Quickly press and release to toggle through the pre-selected rotation speeds.
- Button 5, 8:** up/down arrow buttons.
- Button 6, 7:** left/right arrow buttons.
- Button 9:** ON/OFF button - press for 1 second to turn on the unit; press and hold for 2 seconds to turn off the unit.
- Leveling/Standby – LED** (green/red)

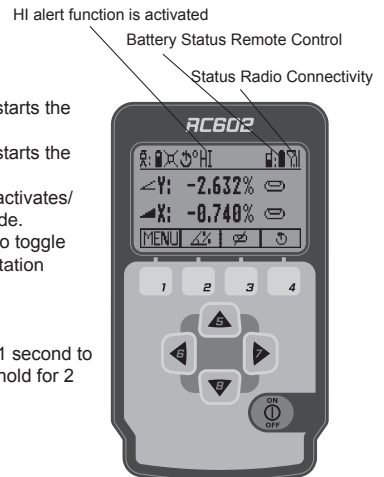

## Standard Features

### X-Y-grade entering – Step and Go mode

Quickly press and release button **2** starts the grade entering mode. Both grade values will be shown.

Press/release button **1** ⇨ grade reverse Y

Press/release button **2** ⇨ grade reverse X (only GL622)

Press/release button **3** ⇨ return to the standard display

Quickly press and release button **4** to confirm the selected grade value and return to the standard display

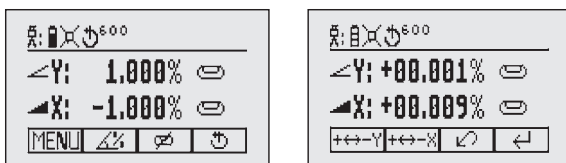

Press and hold button **6** or **7** (left/right) to change X- axis grade value (only GL622) after the comma; press and hold buttons **6 + 7** simultaneously starts X-axis quick change mode where the grade value in front of the comma will be set to 0% and then starts changing in 1% increments.

Press and hold button **5** or **8** (up/down) for changing Y -axis grade value; press and hold buttons **5 + 8** simultaneously starts Y - axis quick change mode where the grade value in front of the comma will be set to 0% and then starts changing in 1% increments.

**Note:** The speed of the grade value change increases with the amount of time the button is held down.

**Note:** The grade value for both axes increases in 1.00% increments. When the grade value for either axis reaches its highest amount, the grade value switches to the lowest value for that axis. For example, the value switches from +25% to -25%.

The laser will self-level to the required grade position after confirming the grade change with button **4**.

**Note:** The bubble symbols at the laser's LCD will flash until the laser has been self-leveled to the requested grade position.

### X-Y-grade entering – Digit Select mode (Default)

Quickly press and release button **2** starts the grade entering mode. .

Both grade values will be shown.

Press/release button **1** ⇨ quick set to 0%

Press/release button **2** ⇨ change the sign in front of the grade value

Press/release button **3** ⇨ return to the standard display.

Quickly press and release button **4** to confirm the selected grade value and return to the standard display.

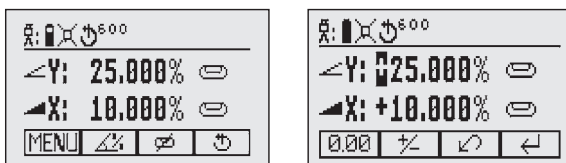

Press and release button **5** or **8** (down or up) to move the cursor to the X- (only GL622) or Y-axis

Pressing and releasing button **6** or **7** (right or left) moves the cursor to the right/left.

Use button **1** or **2** (Plus or Minus) to set the desired digit.

The laser will self-level to the required grade position after confirming the grade change with button **4**.

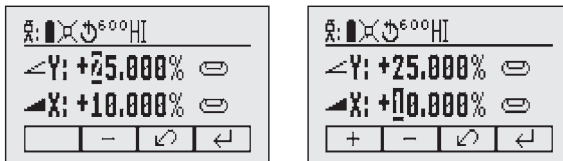

**Note:** The bubble symbols at the laser's LCD will flash until the laser has been self-leveled to the requested grade position.

### Using the Rotation mode



Repeatedly pressing the button **4** toggles through 300, 600, 900 rpm regardless if the unit is in automatic or manual mode.

### Manual mode



Pressing and releasing button **3** at the Standard Display activates/deactivates the manual mode regardless if set up horizontal or vertical. Manual mode is indicated by horizontal lines next to the axes symbols.

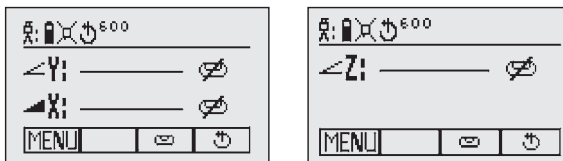

In Manual mode (horizontal), the Y-axis can be sloped by pressing the Up-(**5**) and Down-Arrow-(**8**) buttons on the laser's keypad or the remote control. Additionally, the X-axis can be sloped by pressing the Left-(**6**) and Right-(**7**) Arrow-buttons on the laser or remote control.

In vertical mode, the up and down arrow buttons adjust the Z-axis slope, and the left and right arrow buttons align the laser beam to the right/left side.

To resume automatic self-leveling mode, press the manual button again.

### Special MENU Features

#### Menu Functions (Radio controlled)

Press and release button **1** at the Standard Display to enter the MENU.

**The menu offers always only the features which can be selected depending on the setup (horizontal or vertical).**

The icon of the selected function will be highlighted.

A down arrow at the the right site indicates that the user can scroll down through the menu using the button **8** (down arrow).

After going to the next menu row, an up/down arrow at the the right site indicates that the user can scroll up/down through the menu (4 different screens) using the buttons **5/8** (up/down arrows).

Pressing and releasing button **3** changes the unit always back to the standard or previous display.

Press and release the buttons **6/7** until the desired icon at the selected menu row is highlighted.

Press and release button **4** to open the submenu OR start the selected function.



## Menu functions when set up horizontal

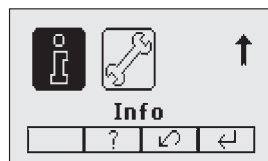
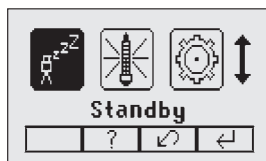
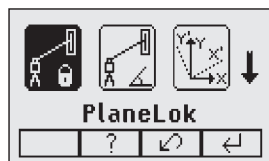

## Menu functions when set up vertical

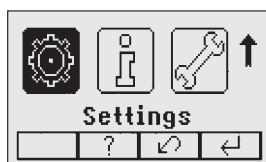
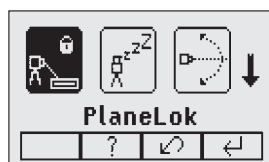

**Note:** Pairing function is needed to pair an already paired remote with a new transmitter.

The new transmitter has to be set to the pairing dialog for this operation. Otherwise the pairing can not be successful processed.

The pairing information of the previous pairing is still stored in the previous paired transmitter and should be deleted in the pairing dialog of this transmitter

## Automatic PlaneLok mode

The PlaneLok mode can be activated in horizontal and vertical automatic and manual mode.

In PlaneLok mode when set up horizontal, the beam will be locked to a fixed elevation point (up to 80 m (260 ft) located on one axis at each side of the laser).

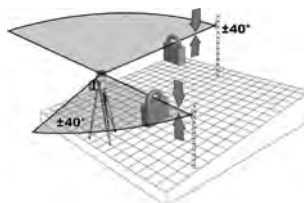

For keeping vertical alignments fixed to a direction point, PlaneLok can be used in both directions on the X-axis.

1. Set up the laser over the reference point.
2. Attach the HL750 receiver to a grade rod. Place the receiver at the second point and adjust it to the On-grade position. The receiver should be permanently mounted at this location and at the desired elevation.
3. Use the sighting guides on the top of the laser to align the laser to the receiver. Turn the laser on the tripod until it is roughly aligned to the receiver's position (the alignment range for both axes is  $\pm 40^\circ$ ).
4. Press and release the MENU button at the Standard Display and select PlaneLok.  
In vertical mode, PlaneLok can be started immediately by pressing button 4.



Horizontal setup



Vertical setup

5. When set up horizontally, press and release button 4 to open the PlaneLok submenu; select the desired PlaneLok axis (X- only GL622) then press button 4 to start PlaneLok.



**Note:** The laser starts to search for the receiver. A flashing Receiver and Lock symbol appears at the selected axis and becomes solid when PlaneLok has been completed.



**Note:** When used in vertical mode, the receiver has to be placed with the **photocell on the bottom side**.

The HL750 display shows a flashing **-PL-** during the time the laser is searching and adjusting the beam to the on-grade position.

When PlaneLok is complete, **-PL-** stops flashing at the HL750 display.

**Note:** The laser continues to servo to the receiver's signals.

6. Exiting of PlaneLok can be done by pressing button 3 (ESC).

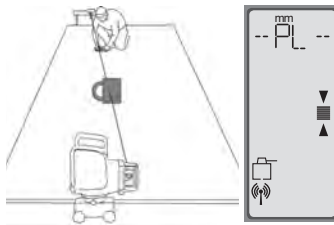

## Automatic Grade Match

The Grade Match mode can be activated in horizontal automatic and manual mode.

In Grade Match mode, the laser can be used to measure the existing grade value between two known elevation points (up to 80 m (260 ft) located on one axis at each side of the laser)

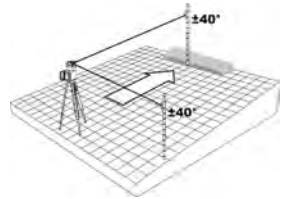

1. Set up the laser over the reference point.
2. Attach the HL750 receiver to a grade rod. Check the laser's elevation next to the laser then position the receiver at the second point WITHOUT changing the receiver's elevation on the rod.
3. Use the sighting guides on the top of the laser to align the laser to the receiver. Turn the laser on the tripod until it is roughly aligned to the receiver's position (the alignment range for both axes is  $\pm 40^\circ$ ).
4. Press and release the MENU button at the Standard Display and select Grade Match.



5. Select the desired Grade Match axis (X- only GL622) then press button 4 to start Grade Match.

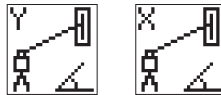

**Note:** The laser starts to search for the receiver. A flashing Receiver and angle symbol appears at the selected axis and disappears when Grade Match has been completed.

While the laser is searching and adjusting the beam to the on-grade position, the HL750 display shows a flashing **-GM-**.

When Grade Match has been completed, the HL750 goes back to the standard elevation display. The remote control as well as the laser will display the final measured grade value.



**Note:** If Grade match can't be completed by checking the limits, the laser comes with an Error message (Grade Match has Failed) which can be deleted with button 4 (OK). The HL750 goes back to standard elevation indication.

## Automatic Axis Alignment (only GL622)

Automatic Axis Alignment mode adjusts automatically the direction the grade axis is pointing to the receiver's location by an electronically simulation of rotating the unit on its base to match the hub. Using Axis Alignment, the laser axis can be aligned to one direction hub (up to 80 m (260 ft) located on one axis at each side of the laser.

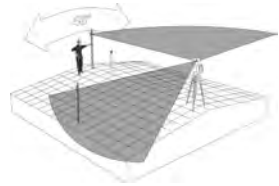

1. Set up the laser over the reference point.
2. Place the grade rod with the attached HL750 receiver at the desired direction hub.
3. Use the sighting guides on the top of the laser to align the laser to the receiver. Turn the laser on the tripod until it is roughly aligned to the receiver's position (the alignment range for both axes is  $\pm 40^\circ$ ).
4. Press and release the MENU button at the Standard Display and select Axis Align.
5. Select the desired axis then press button **4** to start Axis Align.

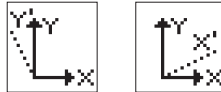

**Note:** Adjusting the receiver into the beam before starting the automatic Axis Alignment reduces the time needed for finishing the alignment.

## Activating/Deactivating Standby mode



Press and release the MENU button at the Standard Display and select Standby.

Pressing and releasing button **4** activates the Standby mode.

The self-leveling will be stopped and the beam will be turned off while the HI alert is still active.

The display shows the standby symbol and the Level/Standby LED flashes red every 5 seconds.

To deactivate Standby mode and restore full operation of the laser, press and release button **4**.

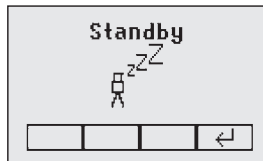

## Start Reference Check



Before starting some grade work which is very sensitive an additional Reference Check can be started manually. Press and release the MENU button at the Standard Display and select Reference Check.

Pressing and releasing button **4** starts the Reference Check considering the current temperature inside the housing. While the rotor checks the correct position the rotation will be stopped.

## Setting Menu



Press and release the MENU button at the Standard Display and select Settings.

Press and release button **4** to open the Setting Menu; select the desired function then press button **4** to open the selected submenu function OR start the selected function.

Please see the Setting Menu details at the end of the user guide.

## Info



Press and release the MENU button at the Standard Display and select Info.

Buttons **6/7** can be used to toggle between GL, RC and Runtime.

Press and release button **4** to confirm the selection.

The GL/RC information (software version, ID, etc.) or the runtime of the GL will be displayed.

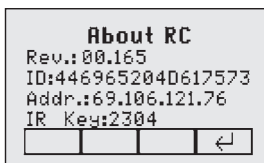

## Service



Press and release the MENU button at the Standard Display and select Service. Buttons **6/7** can be used to toggle between **Calibration Y** and **Calibration X** OR **Calibration Z** when set up vertically.



Press and release button **4** to confirm the selection. The calibration at the selected axis starts the field calibration procedure.

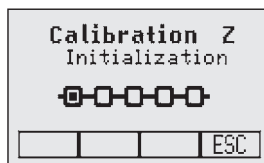
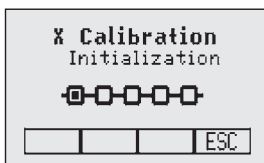
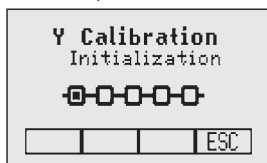

The RC602 Service menu offers one additional feature:

## RF Connectivity



Press and release button **4** to get a status of the current Radio connectivity.

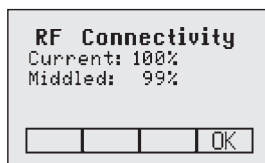

## Special Features - Vertical Setup

### Line Scan



Line Scan centers the rotor horizontally and can be used to align the plumb beam to a desired horizontal position. Press and release the MENU button at the Standard Display and select Line Scan. Pressing and releasing button **4** activates the Line Scan mode while the rotor checks the limits of the X- axis and stops at the center position.

Pressing button **3** (ESC) stops the movement and changes the unit into manual mode.

Corrections up and down can be done using button **5/8**; for left/right corrections use button **6/7**.



Press and release the manual button to change the unit back to full automatic mode.

### Setting Menu



Press and release the MENU button at the Standard Display and select Settings.

Press and release button **4** to open the Setting Menu; select the desired function then press button **4** to open the selected submenu function OR start the selected function.

The Setting Menu offers the following functions:



Pairing



Mask Mode



Grade Entry



Grade Display



Sensitivity



HI-Alert



User Name



Set Password



Password On/Off



RF-Channel



Select Language

### Pairing



When in Settings, press and release button **4** to open the Pairing menu. The display shows the currently paired units (up to two receivers and two remote controls). If already 2 remote controls have been paired, one of them has to be deleted using button **1** (CLR). Turn on the RC602 and select the Pairing menu and press button **4**.

The GL6X2 pairs now automatically with the new remote control.

## Pairing the transmitter with remote control

The chain symbol at button 1 indicates the remote has never been paired before which means no radio connectivity is given. Pressing the pairing button 1 will initiate a pairing request. The transmitter has to be in pairing mode as shown above.

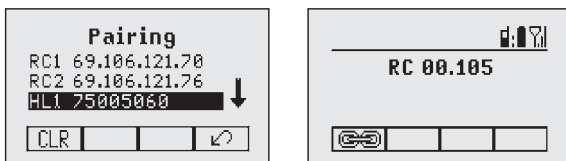

**Note:** Make sure that pairing mode is selected only at one transmitter which is within the radio range of the remote during a pairing request. Otherwise pairing procedure can be confused.

## Pairing the transmitter with receiver

To pair the transmitter and the receiver select Settings and press and release button 4 to open the Pairing menu. The display shows the currently paired units (up to 2 receivers). If already 2 receivers have been paired, one or both of them have to be deleted using button 1 (CLR).

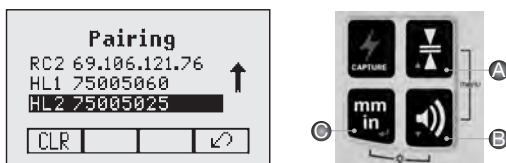

Next, turn on the receiver then press and hold the Deadband (A) and the Audio (B) buttons for two seconds. After two seconds the display shows MENU first, then RDIO.

Press and release the Units (C) button – display shows the current radio mode.



If not already set to **LS**, press Units button and then press Deadband or Audio button until **LS** is displayed. Press Units button again to enter selection. Press and release the Audio button – display shows PAIR. Press the Units button again – the display shows PAIR and a rotating bar. After completing PAIR, OK will be displayed. The GL6X2 pairs now automatically with the new receiver. Press and release the Power button two times to exit the menu. A laser symbol is lit to confirm the receiver can communicate with the laser.

## Mask mode



Select the Mask icon and press and release button 4 to open the Mask setting menu. Depending on which side or corner the beam should be turned off, the required sector can be selected. Press and release the buttons 5 to 8 for moving a short flashing line around the mask mode symbol. For selecting the sector where the bar is flashing, press and release button 1 (SET). After setting the first sector, button 1 changes to show CLR which offers the capability of deleting the selected mask sector again. Use button 5 to 8 to move the flashing bar to other required areas and repeat the setting process. When all areas have been set, press button 4 to store the mask sector selection until the unit will be turned off.

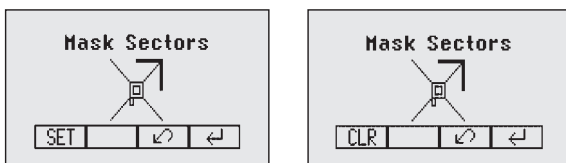

**Hinweis:** The unit always powers up with the mask mode deactivated (default).

## Grade Entry



Select the Grade Entry icon and press and release button **4** to open the Grade Entry menu.

Buttons **6/7** can be used to toggle between Step and Go and Digit Select.

Press and release button **4** to confirm the selection.



Step and Go



Digit Select

## Grade Display



Select the Grade Display icon and press and release button **4** to open the Grade Display menu.

The desired Grade Display Mode (Percent/ Permil/ Degree) can be selected using the buttons **6/7**.

Press and release button **4** to confirm the selected display mode.



## Sensitivity Selection



Select the Sensitivity icon and press and release button **4** to open the Sensitivity menu. The desired Sensitivity: Low, Mid (Default) and High) can be selected using the buttons **6/7**. Press and release button **4** to confirm the selected Sensitivity.



## HI-alert Selection



Select the HI icon and press and release button **4** to open the HI-alert menu. The desired HI-alert: 5 min.(Default), 30 seconds and HI-Off) can be selected using the buttons **6/7**. Press and release button **4** to confirm the selected HI-alert.





## User Name



Select the User name icon and press and release button **4** to open the User name menu. One row for typing names in big font (15) and one row in small font (18) for letters or numbers are available. Button **5** and **8** can be used to toggle between both rows. Changing the characters can be done using the buttons **1** and **2**. Press and release button **4** to confirm the selected user name. The display falls back to the main menu. Any time the unit will be powered up, the User info will be displayed for couple seconds.

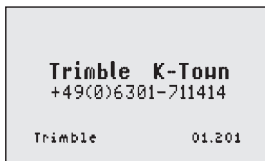

## Set Password



Select the Set Password icon and press and release button **4** to open the Password menu. Use Button **1** to **8** to type in a password containing of 4 digits and repeat the password at the second row. Press and release button **4** to store the selected password; unit falls back to the standard menu. After powering up the unit, the standard display comes up if the correct password will be entered, otherwise the unit turns off automatically.

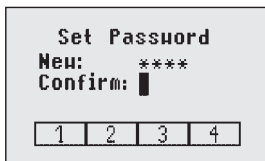
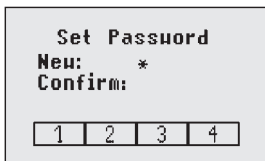

## Password On/Off



Select the Set Password ON-Off icon and press and release button **4** to open the Password menu. Buttons **6/7** can be used to toggle between Password On and Password Off if a Password has been entered before. Press and release button **4** to confirm the selection.



Password on



Password off

## Radio (RF) Channel



Select the RF Channel icon and press and release button **4** to open the Radio Channel menu. The desired RF Channel: Low, Mid (Default), and High can be selected using the buttons **6/7**. Press and release button **4** to confirm the selected RF Channel. After changing the RF channel, the RC and HL needs to be paired again.



## Select Language



Select the Language icon and press and release button **4** to open the Language menu. Use button **5** to **8** to select the required local language (EN, DE, IT, FR, ES, PT, NL, DA, NO, SV, FI, PL, TR, CZ). Press and release button **4** to store the selected Language; unit falls back to the standard menu.

## CALIBRATION

### Checking Calibration of the Y- and X-Axes

1. Set up the laser 30 m (100 ft) from a wall and allow it to level.
2. Set the grade to 0.000% in both axes.
3. Raise/lower the receiver until you get an on-grade reading for the +Y axis. Using the on-grade marking notch as a reference, make a mark on the wall.

**Note:** For increased precision, use the fine-sensitivity setting (1.5 mm/ 1/16 in.) on the receiver.

4. Rotate the laser 180° (-Y axis toward the wall) and allow the laser to re-level.
5. Raise/lower the receiver until you get an on-grade reading for the -Y axis. Using the on-grade marking notch as a reference, make a mark on the wall.
6. Measure the difference between the two marks. If they differ more than 3 mm at 30 m (1/8 inch at 100 feet), the laser needs calibrating.
7. After checking the Y-axis, rotate the laser 90°. Repeat the above starting with the + X axis facing the wall.

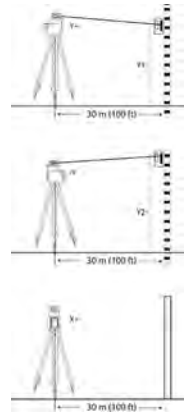

### Checking Calibration of the Z-(vertical) Axis

To check vertical calibration, you need a plumb bob with at least 10m (30ft) of string.

1. Suspend the plumb bob in front of a house i.e., attached to a window frame whose window height is at least 10m (30ft).
2. Set up the laser in vertical so that the laser beam strikes the receiver's on-grade position at the top of the string.
3. Look for any deviation using the receiver from the top of the string to the bottom of it. If the deviation is more than 1mm (<1/16 in.), the vertical axis needs calibrating.

**Note:** If calibration is required, please, refer to the calibration instructions on our Trimble website [www.trimble.com/support.shtml](http://www.trimble.com/support.shtml).

## Troubleshooting

Any error message can be deleted with a short press of button 4 (OK). The table shows the related description and possible solutions. The next service center should be contacted if a different error message as shown at the table will be displayed.

Error codes	Description	Solution
21	Temporary EEPROM problem	Repeat pairing and re-enter the customer settings
120	HI alert - Unit Height changed	Check laser beam elevation after deleting the HI alert
130	Mechanical Limit during Axis Alignment, Grade Match or Spot Match	Re-align the closer to the alignment point; check if existing slope is above +/-25%
131	Rake Angle Limit	Re-align the unit closer to the alignment point
140	Laser beam blocked	Make sure there are no obstacles between the transmitter and the HL750
141	Time Out - Function could not be completed in the allowed time	Check radio operating range/ connection; check stable laser setup
150	No receiver - Receiver not available for single axis automatic function	Make sure the receiver is on and paired
152	No receiver - The laser searched for the receiver but could not find it	Check the operating range for auto function and restart the auto alignment
153	Lost Receiver - The laser searched and found the receiver but then lost it	Check the operating range for auto function and restart the auto alignment
160	X or Y level sensor defect	Contact service center

## PROTECTING THE UNIT

Do not expose the unit to extreme temperatures or temperature changes (do not leave inside the car). The unit is very robust and can resist damage if dropped even from tripod height. Before continuing your work, always check the leveling accuracy. See Checking Calibration section. The laser is water proof and can be used indoors and outdoors.

## CLEANING AND MAINTENANCE

Dirt and water on the glass parts of laser or prism will influence beam quality and operating range considerably. Clean with cotton swabs. Remove dirt on the housing with a lint-free, warm, wet and smooth cloth. Do not use harsh cleansers or solvents. Allow the unit to air dry after cleaning it.

## PROTECTING THE ENVIRONMENT

The unit, accessories and packaging ought to be recycled. This manual is made of non-chlorine recycling paper. All plastic parts are marked for recycling according to material type.



**Do not throw used batteries into the garbage, water or fire. Remove them in compliance with environmental requirements. Hinweis für Kunden in der EU**

### Notice to Our European Union Customers

For product recycling instructions and more information, please go to:

**[www.trimble.com/environment/summary.html](http://www.trimble.com/environment/summary.html)**

Recycling in Europe: To recycle Trimble WEEE,  
Call +31 497 53 2430, and ask for the "WEEE Associate"

or

Mail a request for recycling instructions to:  
Trimble Europe BV  
c/o Menlo Worldwide Logistics  
Meerheide 45  
5521 DZ Eersel, NL



## Warranty

Trimble warrants the GL622/GL612 to be free of defects in material and workmanship for a period of 5 years. Trimble or its authorized service center will repair or replace, at its option, any defective part, or the entire product, for which notice has been given during the warranty period. If required, travel and per diem expenses to and from the place where repairs are made will be charged to the customer at the prevailing rates. Customers should send the product to Trimble Navigation Ltd. or the nearest authorized service center for warranty repairs or exchange, freight prepaid. Any evidence of negligent, abnormal use, accident, or any attempt to repair the product by other than factory-authorized personnel using Trimble certified or recommended parts, automatically voids the warranty. Special precautions have been taken to ensure the calibration of the laser; however, calibration is not covered by this warranty. Maintenance of the calibration is the responsibility of the user. The foregoing states the entire liability of Trimble regarding the purchase and use of its equipment. Trimble will not be held responsible for any consequential loss or damage of any kind. This warranty is in lieu of all other warranties, except as set forth above, including any implied warranty merchantability of fitness for a particular purpose, are hereby disclaimed.

This warranty is in lieu of all other warranties, expressed or implied.

## TECHNICAL DATA

### GL622/GL612

Leveling accuracy <sup>1,3</sup> :	± 0.5 mm/10 m, 1/16" @ 100 ft, 10 arc seconds
Grade accuracy <sup>1,3</sup> :	± 1.0 mm/10 m, 1/8" @ 100 ft, 20 arc seconds
Rotation:	300, 600, 900 rpm
Operational area <sup>1,2</sup> :	appr. 400 m (1300 feet) radius with detector
Laser type:	red diode laser 650 nm
Laser class:	class 2, <3.2 mW
Self-leveling range:	appr. ± 14°
Grade range (Y, X-GL622):	± 25% both axes (not simultaneously)
Leveling indicators:	LCD indications and LED flashes
Radio range (HL750):	up to 80 m (260 ft)
Power source:	NiMH battery pack
Battery life <sup>1</sup> :	35 hours NiMH; 40 hours alkaline
Operating temp.:	-20°C to 50°C (-4°F to 122°F)
Storage temp.:	-20°C to 70°C (-4°F to 158°F)
Tripod attachments:	5/8 x 11 horizontally and vertically
Dust and Water proof:	IP67
Weight:	3.1 kg (6.8 lbs)
Low voltage indication:	LCD battery indicator
Low voltage disconnection:	unit shuts off

1) at 21°Celsius

2) under optimal atmospheric circumstances

3) along the axis

### Remote Control RC602

Radio Operating range <sup>1,3</sup> :	up to 100 m (330 ft)
Power source:	2 x 1.5V AA alkaline batteries
Battery life <sup>1</sup> :	130 hours
Dust and Water proof:	IP66
Weight:	0.26 kg (0.4 lbs)

## DECLARATION OF CONFORMITY

Please disregard the declaration of conformity within the manual.

Following is the valid declaration:

We

**Trimble Kaiserslautern GmbH**

Declare under our sole responsibility that the products

**GL622/GL612 and RC602**

To which this declaration relates is in conformity with the following standards:

**EN 50371:2002, EN 60825-1:2007, ETSI EN 300328 V1.7.1:2006, ETSI EN 301489-1 V1.9.2:2011, ETSI EN 301489-3 V1.4.1:2002**

following the provisions of directive **R&TTE 1999/5/EC**.

The managing director

## ELECTRO-MAGNETIC COMPATIBILITY

Compliance statement (part 15.19) This device complies with part 15 of the FCC Rules and Industry Canada licence-exempt RSS standard(s). Operation is subject to the following two conditions: (1) this device may not cause harmful interference, and (2) this device must accept any interference received, including interference that may cause undesired operation. Warning (part 15.21) Changes or modifications not expressly approved by the party responsible for compliance could void the user's authority to operate the equipment. This in particular is applicable for the antenna which has been delivered with the GL622/GL612 and RC602 Under Industry Canada regulations, this radio transmitter may only operate using an antenna of a type and maximum (or lesser) gain approved for the transmitter by Industry Canada. To reduce potential radio interference to other users, the antenna type and its gain should be so chosen that the equivalent isotropically radiated power (e.i.r.p.) is not more than that necessary for successful communication.