

Solutions
Ophthalmology

MSI
PRECISION INSTRUMENTS





Expert advice on demand

Our experienced medical instrument specialist work in conjunction with your personal MSI Precision account manager, lending expertise on specific technologies and product categories, including disposable instruments and most specialty surgical instrument services.

Your alternative to high prices

MSI Precision is the new NAME Brand Without the Name Brand PRICE. We are so sure of our quality that we offer a 100 % Surgeon Satisfaction Guarantee. If you are dissatisfied with any of MSI Precision Products for any reason, you may return for full credit. (Please See Return Policy At The Back Of The Catalog)



Take a closer look at MSI Precision

When MSI Precision was launched, we made a conscious decision to be a lean small company. We chose to honor your desire for quality products at the right price and we've been resolute in that promise. So, what you get is truly bigger in value.

The word "PRECISION" is taken very seriously at MSI Precision and it shows it in our quality control. And, since we carry a huge product inventory, our selection assures you of getting the exact pattern you specify.

Information at your fingertips

Our interactive msiprecision.com is not only a valuable resource for the latest product information, but is also the place to find out about your past orders, special events, white papers, archived articles from our catalog and more.



msiprecision.com

Available when you need us

We make it easy for you to contact us at MSI Precision, whether you choose our online LIVE support, our Toll-Free Customer Support numbers or our interactive website, you'll always be our highest priority.



Celebrating 18
Years of the
right technology,
right away.
(Thank you!)

At MSI Precision, we believe understanding how our customers work is just as important as understanding technology. That's why we've spent the last 18 years building a company with you in mind. Like account managers who not only answer calls, but answer questions. And the brand name technology products you want in stock and ready to ship. Listening hard and responding with urgency has brought us 18 years of success. What can we do for you next?

Learn more. Call or visit us
online today.

msiprecision.com
800.322.4674

OPHTHALMOLOGY
PRODUCTS CATALOG



Toll-Free Phone: 800.322.4674
800.633.7283
Toll-Free Fax: 800.699.2839
e-mail: sales@msiprecision.com

MSI Precision Instruments
1220 Valley Forge Road
Building 34
Phoenixville, PA 19460

092407

Ophthalmology Products **CATALOG**



Terms of Sale

All prices are F.O.B. Phoenixville, Pennsylvania, subject to change without notice. Our terms for Domestic Accounts are Net 30 days for approved accounts.

List prices are subject to change.

All MSI Precision instruments are guaranteed to be free of defects in materials and workmanship. Any instrument which proves defective in workmanship or material will be repaired or replaced at our discretion without charge. This guarantee is void for instruments serviced by any company other than MSI instrument repair service.

All MSI instruments are carefully inspected before shipment. Any claims must be made within (2) two days of receipt of shipment. Most orders are shipped the same day and, at the latest, by UPS within 72 hours.

One call does it all

Our Vast array of instruments for all specialty's offers you over 50,000 different product patterns. With this large selection we can ship over 5000 patterns the same day up to 72 hours. With shipments from Germany every week our inventory just keeps growing so call us to clear up your back orders.

Remember Quality is number 1 at MSI Precision. Just to highlight most orders are shipped the same day. If not in stock we usually ship within 1-4 weeks depending on the popularity of the instrument. We offer the best quality repair facility in the country. If you have never tried MSI Precision Instrument Repair. We will repair one instrument for you at NO Charge ABSOLUTELY FREE just so you can see for yourself that we are the BEST in the industry. We will refurbish your instruments to look like NEW. Quality you can count on at a fair price. We can also customize or make any instrument to meet your needs

The Best by
Design

800.322.4674 or 800.633.7283

www.msiprecision.com





Table of Contents

Alger Brush	1-1
Bi-Manual and IA Instruments	1-2
Blade Breakers	1-10
Calipers	2-1
Cannulas	
Air Injection	3-1
Viscoelastic	3-3
Anterior Chamber	3-4
Lacrimal	3-7
Hydrodissection	3-9
Cortex Extractor	3-15
Lasik	3-20
Irrigating Aspirating	3-25
Irrigating	3-27
Aspirating	3-35
Infusion	3-39
Chamber Maintainer	3-41
Anesthesia	3-42
Needles	3-42
Spatulas	3-43
Cystotomes	3-45
Capsule Polisher	3-48
Irrigating Vectus	3-52
Infusion Handle	3-53
Bipolar Forceps	4-1
Bipolar Cords and Trays	4-11

Table of Contents



Forceps	
Suture	5-1
Fixation	5-11
Capsulorhexis	5-17
Colibri	5-23
Tying	5-31
Pierse	5-42
Nucleus Cracker	5-43
Capsule	5-43
Dressing	5-44
Tissue	5-47
Jewelers	5-51
Chalazion	5-54
Muscle	5-57
Cilia	5-60
Muscle Clamps	5-62
Utility	5-63
Hemostat	5-65
Iris	5-67
IOL	5-68
Retinal	5-71
Foreign	5-72
Miscellaneous	5-73
Handled Instruments	
Bi-Manual and IA Instruments	6-1
Collar Button	7-1
Curettes	7-2



Table of Contents

Depressors	7-4
Dilators	7-7
Fixation Hooks and Loops	8-1
Fixation Rings	8-3
Intubation Set	8-8
Intralase	8-8
Kansas Style Instruments	9-1
Knives (reusable)	9-3
Lid Plates	9-4
Lens Loops	10-1
Manipulating Hooks	10-5
Markers	11-1
Muscle Hooks	11-10
Phaco Chops	11-12
Polishers	12-1
Retinal	13-1
Retractors	13-2
Rongeurs	13-5
Rotator Globe	13-6
Ruler	13-6
Serrifines	13-7
Spatulas	13-8
Spoons	13-17
Spuds	13-17
Needle Holders	14-1
Probes	14-18
Punches	14-22
Pupil Dilators	14-23

800.322.4674 or 800.633.7283

www.msiprecision.com





Table of Contents

Scissors	
Super Cut Scissors	15-1
Precision Iris	15-1
Precision Plastic	15-1
Precision Stevens Tenotomy	15-2
Ring Handle Scissors	15-3
Precision Iris	15-3
Aebli Corneal	15-3, 15-9
Precision Eye	15-6
Wilmer Conjunctival and Utility	15-8
McReynolds Pterygium	15-8
Precision Stitch	15-9
Reeh Stitch	15-9
McGuire Corneal	15-9
Anis Micro	15-10
Stevens Tenotomy	15-10
Precision Stabismus	15-12
Knapp Stabismus	15-12
Littler Dissecting	15-13
Precision Utility	15-14
Precision Light	15-14
Spring Handled Scissors	16-1
Capsulotomy	16-1
Iris	16-4, 16-12
Fine Stitch	16-5, 16-10
Capsule	16-7
Tenotomy	16-8
Utility	16-11
Conjunctival	16-12
Vitreous	16-12
Corneal	16-13
Corneal Transplant	16-18
Keratoplasty and Keratectomy	16-19



Table of Contents

Speculums	17-1
Tendon Tuckers	17-32
Trephines	18-1
Cleaning Brushes	19-1
Disposable Blades	19-5
Flexible Iris Retractors	19-7
Wipes and Spears	19-8
Eye Protection	19-14
Indentification Labels	20-1
Phaco Accessories	20-4
Phaco Needles	20-6
Stainless Steelware	20-8
Instruments Trays	20-18
Case and Tray Solutions	20-20
Autoclaves	20-27
Sutures	21-1
Diamond Knives	22-1
Index	IND-1
Terms of Sale	
Order Form	
Repair Form	

800.322.4674 or 800.633.7283

www.msiprecision.com



Versatile.
Dependable.
Proven.



5-1920

Algerbrush 2 Corneal Rust Ring Remover

Battery Operated Single Speed Motorized Handpiece With Tip Cover and 0.5mm Tip Carbide Burr And One "AA" Battery, And Overall Length Of 4 1/8" (105mm)

Rust Ring Removers

5-1921

Algerbrush 2 Corneal Rust Ring Remover, Battery Operated Single Speed Motorized Handpiece With Tip Cover and 1.0mm Tip Carbide Burr And One "AA" Battery, And Overall Length Of 4 1/8" (105mm)

5-1922

Algerbrush 2 Pteryguim, Battery Operated Single Speed Motorized Handpiece With Tip Cover and 3.5mm Tip Round Diamond Burr Fine Grit And One "AA" Battery, And Overall Length Of 4 1/8" (105mm)

5-1923

Algerbrush 2 Pteryguim, Battery Operated Single Speed Motorized Handpiece With Tip Cover and 3.5mm Tip Round Diamond Burr Medium Grit And One "AA" Battery, And Overall Length Of 4 1/8" (105mm)

5-1924

Algerbrush 2 Pteryguim, Battery Operated Single Speed Motorized Handpiece With Tip Cover and 4.0mm Tip Wheel Shaped Diamond Burr Fine Grit And One "AA" Battery, And Overall Length Of 4 1/8" (105mm)

5-1925

Algerbrush 2 Pteryguim, Battery Operated Single Speed Motorized Handpiece With Tip Cover and 5.0mm Tip Wheel Shaped Diamond Burr Medium Grit And One "AA" Battery, And Overall Length Of 4 1/8" (105mm)

Accessories

5-1920-A

Algerbrush 2 Replacement 0.5mm Carbide Burr and Chuck only

5-1921-A

Algerbrush 2 Replacement 1.0mm Carbide Burr and Chuck only

5-1922-A

Algerbrush 2 Replacement 3.5mm Fine Grit Diamond Bur and Chuck Only

5-1923-A

Algerbrush 2 Replacement 3.5mm Medium Grit Diamond Bur and Chuck Only

5-1924-A

Algerbrush 2 Replacement 4.0mm Fine Grit Diamond Wheel and Chuck Only

5-1925-A

Algerbrush 2 Replacement 5.0mm Medium Grit Diamond Wheel and Chuck Only

5-1920-C

Algerbrush 2 Replacement 0.5mm Carbide Burr 5 Each Per Package

5-1921-C

Algerbrush 2 Replacement 1.0mm Carbide Burr 5 Each Per Package

5-1926

Algerbrush 2 Replacement Motor

5-1927

Algerbrush 2 Replacement Chuck

5-1928

Algerbrush 2 Replacement Cap

5-1929

Algerbrush 2 Replacement Housing



800.322.4674 or 800.633.7283

www.msiprecision.com

1-1

IA Instruments



BI-302

Bi-Manual Hand-Piece

21 Gauge Curved Aspiration 0.3mm Single Port Gold Color, With An Overall Length Of 4 3/8" (11.1cm). Overall Weight 0.3 oz



BI-322

Bi-Manual Hand-Piece

23 Gauge Curved Aspiration 0.3mm Single Port Gold Color, With An Overall Length Of 4 3/8" (11.1cm). Overall Weight 0.3 oz



BI-323

Bi-Manual Hand-Piece

23 Gauge Curved Aspiration 0.3mm Single Port With Capsule Polisher Gold Color, With An Overall Length Of 4 3/8" (11.1cm). Overall Weight 0.3 oz



BI-501

Bi-Manual Hand-Piece

21 Gauge Straight Irrigating 0.5mm Dual Port Blue Color, With An Overall Length Of 4 3/8" (11.1cm). Overall Weight 0.3 oz





BI-502

Bi-Manual Hand-Piece

21 Gauge Curved Irrigating 0.5mm Dual Port Blue Color, With An Overall Length Of 4 3/8" (11.1cm). Overall Weight 0.3 oz



BI-521

Bi-Manual Hand-Piece

23 Gauge Straight Irrigating 0.4mm Dual Port Blue Color, With An Overall Length Of 4 3/8" (11.1cm). Overall Weight 0.3 oz



BI-522

Bi-Manual Hand-Piece

23 Gauge Curved Irrigating 0.4mm Dual Port Blue Color, With An Overall Length Of 4 3/8" (11.1cm). Overall Weight 0.3 oz



IA301

Irrigation/Aspiration 45 Degree Handpiece

1-Piece Design With An Overall Length Of 5 1/2" (14cm). Overall Weight of 1.8 oz.

IA Instruments



IA302

Irrigation/Aspiration Curved Handpiece

1-Piece Design, With An Overall Length Of 5 1/2" (13.8cm). Overall Weight 0.9 oz



IA303

Irrigation/Aspiration 45 Degree Handpiece

1-Piece Design With An Overall Length Of 5 1/2" (14cm). Overall Weight 0.9 oz



IA304

Irrigation/Aspiration 90 Degree Handpiece

1-Piece Design With An Overall Length Of 5 1/2" (14cm). Overall Weight 0.9 oz



IA306

Irrigation/Aspiration 180 Degree Handpiece

1-Piece Design With An Overall Length Of 5 1/2" (14cm). Overall Weight 0.9 oz



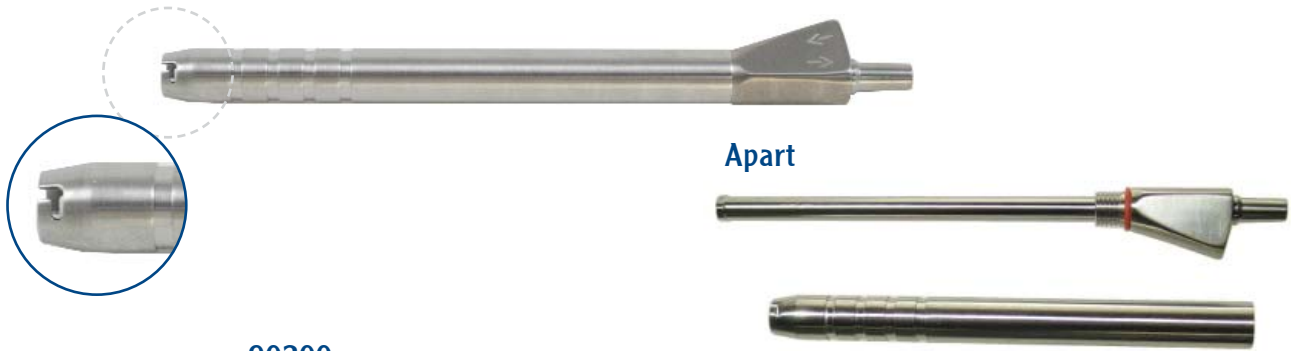

90200

ROUND I/A HANDLE

I/A Stainless Steel Round Handle, Overall Length Of 4 1/4" (11cm)



90301

Stainless Steel I/A Tip

Straight 0.3mm With An Overall Length Of 1 3/4" (4.5cm)



90302

Stainless Steel I/A Tip

Curved 0.3mm With An Overall Length Of 1 3/4" (4.5cm)



90303

Stainless Steel I/A Tip

Angled 45 Degree 0.3mm With An Overall Length Of 1 3/4" (4.5cm)

800.322.4674 or 800.633.7283

www.msiprecision.com



IA Instruments



90304

Stainless Steel I/A Tip

Angled 90 Degree 0.3mm With An Overall Length Of 1 3/4" (4.5cm)



90306

Stainless Steel I/A Tip

Angled 180 Degree 0.3mm (Known As Binkhorst) With An Overall Length Of 1 3/4" (4.5cm)

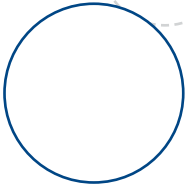

90307

Stainless Steel I/A Tip

Straight 0.3mm Used With Silicone Sleeve With An Overall Length Of 1 7/8" (4.7cm)

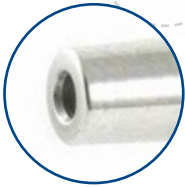

90308

Stainless Steel Luer Adaptor

Tip For Irrigation With An Overall Length Of 1 1/4" (3cm)

90309

Stainless Steel I/A Tip

Curved 0.3mm Port To Be Used With Silicone Sleeve Overall Length Of 1 3/4" (4.5cm)



90313

Stainless Steel I/A Tip

Angled 45 Degree 0.3mm To Be Used With Silicone Sleeve With An Overall Length Of 1 3/4" (4.5cm)

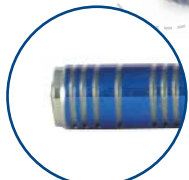

93100

I/A Titanium

With A Round Handle And An Overall Length Of 4 1/4" (11cm). Overall Weight 0.6 oz



93301

Titanium I/A Tip

Straight 0.3mm With An Overall Length Of 1 3/4" (4.5cm). Overall Weight 0.1 oz



93302

Titanium I/A Tip

Curved 0.3mm With An Overall Length Of 1 3/4" (4.5cm). Overall Weight 0.1 oz



93303

Titanium I/A Tip

Angled 45 Degree 0.3mm With An Overall Length Of 1 3/4" (4.5cm). Overall Weight 0.3 oz

800.322.4674 or 800.633.7283

www.msiprecision.com



IA Instruments



93304

Titanium I/A Tip

Angled 90 Degree 0.3mm With An Overall Length Of 1 3/4" (4.5cm)



93306

Titanium I/A Tip

Angled 180 Degree 0.3mm (Known As Binkhorst) With An Overall Length Of 1 3/4" (4.5cm)



93307

Titanium I/A Tip

Straight 0.3mm Used With Silicone Sleeve With An Overall Length Of 1 7/8" (4.7cm)

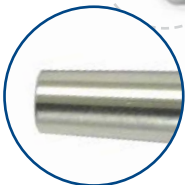

93308

Titanium Luer Adaptor

Tip For Irrigation With An Overall Length Of 1 1/4" (3cm). Overall Weight 0.1 oz



93309

Titanium I/A Tip

Curved 0.3mm Port Used With Silicone Sleeve Overall Length Of 1 7/8" (4.7cm)



93313

Titanium I/A Tip

Angled 45 Degrees 0.3mm Port Used With Silicone Sleeve Overall Length Of 1 7/8" (4.7cm)

Blade Breakers



5-1169

Castroviejo Blade Breaker And Holder

Has Straight And Electro-Dusted 13mm Wafer-Thin Jaws, Round And Knurled Handle With Slide Lock And Polished Finish, Supplied With Package Of Ten Stainless Steel Blades, And Overall Length Of 4 7/8" (12.3cm). Overall Weight 1 oz

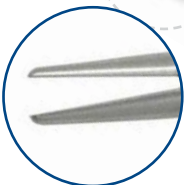

5-1173

Swiss Blade Breaker And Holder

Has Conical Serrated 13mm Jaws, Round And Knurled Handle With End Lock And Polished Finish, Supplied With Package Of Ten Stainless Steel Blades, And Overall Length Of 4 3/4" (12.1cm). Overall Weight 0.6 oz

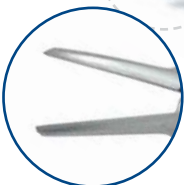

5-1179

Barraquer Blade Breaker And Holder

Has 12mm Serrated Heavy Jaws, Flat And Grooved Handle With Spring Clip Lock And Dull Finish, Supplied With Package Of Ten Stainless Steel Blades, And Overall Length Of 4 1/2" (11.5cm). Overall Weight 0.8 oz

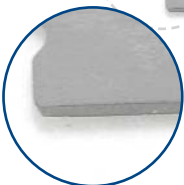
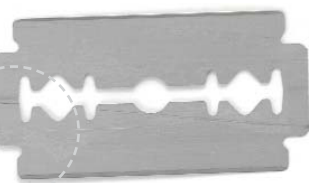

5-1182

Stainless Steel Breakable Blades

Package Of Ten Stainless Steel Blades Made To Break Cleanly, Each With Overall Length Of 1 3/4" (4.5cm). Overall Weight 0.1 oz





5-3512

Stahl Caliper

Dull Finish, Measures: 7.0mm, 10.0mm, 10.5mm, 11.0mm, 11.5mm, 12.0mm, 12.5mm, And 13.0mm, And Overall Length Of 1.6" (40mm)



11-4-0411 (Shown)

Stahl A/C Caliper Square

For Measuring corneal Diameter From "White to White" With Size Markings on Both Sides; Measures: 10.0mm, 10.5mm, 11.0mm, 11.5mm, 12.0mm, 12.5mm, And 13.0mm

11-4-0412

Stahl A/C Caliper Square

For Measuring corneal Diameter From "White to White" With Size Markings on Both Sides; Measures: 10.25mm, 10.75mm, 11.25mm, 11.75mm, 12.25mm, 12.75mm, And 13.25mm



5-3513

Braunstein Fixed Caliper

Double Ended Fine Points Overall Length 3 1/4" 83mm With 3.5mm One End And 4.0mm On The Other End

Calipers



5-3514

Braunstein Fixed Caliper

Double Ended Fine Points Overall Length 3 1/4" 83mm With 3.0mm One End And 3.5mm On The Other End



5-3515

Castroviejo Caliper

Polished Finish, Measures From 0mm To 20mm In 1mm Increments With Scale Readings On Both Sides, Thumb Screw Hold Caliper in Place for Correct Measurement, With 3.8cm Mid Screw To Tip, And Overall Length Of 3 3/8" (8.6cm). Overall Weight 0.6 oz



5-3515-T

Castroviejo Caliper

Titanium, Polished Finish, Measures From 0mm To 20mm In 1mm Increments With Scale Readings On Both Sides, Thumb Screw Hold Caliper in Place for Correct Measurement, With 3.8cm Mid Screw To Tip, And Overall Length Of 3 3/8" (8.6cm). Overall Weight 0.6 oz



5-3516

Castroviejo Marking Caliper

Polished Finish, 45 Degree Curved Shafts With Grooves, Measures From 0mm To 20mm In 1mm Increments With Scale Readings On Both Sides, Thumbscrew Holds Tips Apart At Desired Setting, And Overall Length Of 3 1/4" (8.3cm). Overall Weight 0.7 oz

5-3516-D

Castroviejo Angled Caliper

Polished Finish, 45 degree Curved Shafts With Grooves, Measures From 0mm To 20mm In 1mm Increments On Both Sides, Fine Tips, Thumbscrew Holds Tips Apart, And Overall Length Of 3 3/8" (8mm)



5-3520

Osher Internal Caliper

Dull Finish, Measures Up To 10mm In 1mm increments, Uses Fine Pointed Tips, And Overall Length Of 2 3/4" (68mm)



5-3521

Jameson Caliper

Dull Finish, Measures 0mm To 80mm In 1mm Increments And 0" To 3" In 1/16" Increments, Narrow Flat 3mm Tips, Thumbscrew For Locking Caliper, And Overall Length Of 3 3/4" (9.4cm). Overall Weight 1.2 oz



5-3525

Thorpe Caliper

Dull Finish, Measures Up To 80mm with 1mm Increments And 3" In 1/16" Increments, Fine 3mm Wide Angulated Tips And Overall Length Of 4 3/4" (122mm).



5-3531

Stainless Steel Flexible Ruler

Dull Finish, Deeply Etched Graduations, Measures Up To 152mm In 1mm Increments, 6" In 1/32" Increments, And Overall Length Of 6 1/4" (16cm). Overall Weight 0.3 oz

800.322.4674 or 800.633.7283

www.msiprecision.com

2-3



Calipers



5-3532

Mendez Degree Gauge

Stainless, Round And Knurled Handle with Dull finish, Calibrated Every 10 Degrees From 0 Degrees To 180 Degrees, Inner Dimensions Are 3/4" (12mm), And Overall Length Of 4 5/8" (11.7cm). Overall Weight 0.5 oz





MSI Precision

Cannulas



Contents

Cannulas	Pages
Air Injection	3-1
Viscoelastic	3-3
Anterior Chamber	3-4
Lacrimal	3-7
Hydrodissection	3-9
Cortex Extractor	3-15
Lasik	3-20
Irrigating Aspirating	3-25
Irrigating	3-27
Aspirating	3-35
Infusion	3-39
Chamber Maintainer	3-41
Anesthesia	3-42
Needles	3-42
Spatulas	3-43
Cystotomes	3-45
Capsule Polisher	3-48
Irrigating Vectus	3-52
Infusion Handle	3-53



800.322.4674 or 800.633.7283

www.msiprecision.com



5-1500-23

Air Injection Cannula

23 Gauge, Angled 45 Degrees Shaft, 5mm From Tip To Bend, With Polished Finish, Overall Length Of 1 3/8" (3.6cm). Overall Weight 0.1 oz



5-1500-25

Air Injection Cannula

25 Gauge, Angled 45 Degrees Shaft, 5mm From Tip To Bend, With Polished Finish, Overall Length Of 1 3/8" (3.6cm). Overall Weight 0.1 oz

5-1500-23-2	2mm From Tip To Bend
5-1500-23-3	3mm From Tip To Bend
5-1500-23-4	4mm From Tip To Bend
5-1500-23-6	6mm From Tip To Bend
5-1500-23-7	7mm From Tip To Bend
5-1500-23-8	8mm From Tip To Bend
5-1500-23-9	9mm From Tip To Bend
5-1500-23-10	10mm From Tip To Bend
5-1500-23-11	11mm From Tip To Bend
5-1500-23-12	12mm From Tip To Bend

5-1500-25-2	2mm From Tip To Bend
5-1500-25-3	3mm From Tip To Bend
5-1500-25-4	4mm From Tip To Bend
5-1500-25-6	6mm From Tip To Bend
5-1500-25-7	7mm From Tip To Bend
5-1500-25-8	8mm From Tip To Bend
5-1500-25-9	9mm From Tip To Bend
5-1500-25-10	10mm From Tip To Bend
5-1500-25-11	11mm From Tip To Bend
5-1500-25-12	12mm From Tip To Bend



5-1500-27

Air Injection Cannula

27 Gauge, Angled 45 Degrees Shaft, 5mm From Tip To Bend, With Polished Finish, Overall Length Of 1 1/2" (3.7cm). Overall Weight 0.1 oz



5-1500-30

Air Injection Cannula

30 Gauge, Angled 45 Degrees Shaft, 5mm From Tip To Bend, With Polished Finish, Overall Length Of 1 1/2" (4cm). Overall Weight 0.1 oz

5-1500-27-2	2mm From Tip To Bend
5-1500-27-3	3mm From Tip To Bend
5-1500-27-4	4mm From Tip To Bend
5-1500-27-6	6mm From Tip To Bend
5-1500-27-7	7mm From Tip To Bend
5-1500-27-8	8mm From Tip To Bend
5-1500-27-9	9mm From Tip To Bend
5-1500-27-10	10mm From Tip To Bend
5-1500-27-11	11mm From Tip To Bend
5-1500-27-12	12mm From Tip To Bend

5-1500-30-2	2mm From Tip To Bend
5-1500-30-3	3mm From Tip To Bend
5-1500-30-4	4mm From Tip To Bend
5-1500-30-6	6mm From Tip To Bend
5-1500-30-7	7mm From Tip To Bend
5-1500-30-8	8mm From Tip To Bend
5-1500-30-9	9mm From Tip To Bend
5-1500-30-10	10mm From Tip To Bend
5-1500-30-11	11mm From Tip To Bend
5-1500-30-12	12mm From Tip To Bend

800.322.4674 or 800.633.7283

www.msiprecision.com

3-1



Cannulas

Air Injection



11-8-4681

Rainin Air Injection Cannula

30 Gauge With Flat 45 Degree Angled Tip Bend To Tip 7mm



11-8-4691

Rainin Air Injection Cannula

27 Gauge With Flat 45 Degree Angled Tip Bend To Tip 7mm





11-8-4661

Viscoelastic Aspirating

22 Gauge Cannula Angled 10mm Bend To Tip, Overall Length Of 1" (25mm)



11-8-4663

Viscoelastic Aspirating

19 Gauge Cannula Angled 10mm Bend To Tip, Overall Length Of 1" (25mm)

11-8-4664

Viscoelastic Aspirating

18 Gauge Cannula Angled 10mm Bend To Tip, Overall Length Of 1" (25mm)

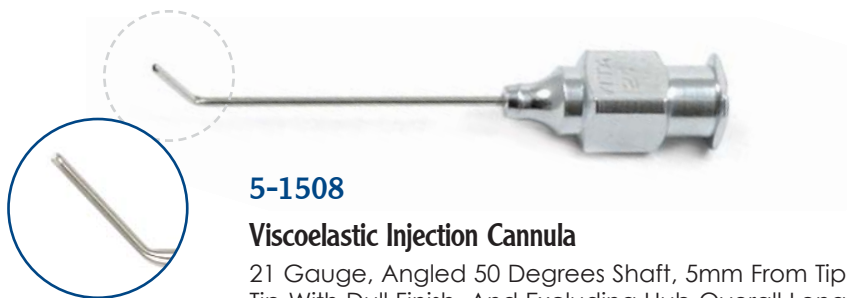

5-1508

Viscoelastic Injection Cannula

21 Gauge, Angled 50 Degrees Shaft, 5mm From Tip To Bend, Rounded Flattened Tip With Dull Finish, And Excluding Hub Overall Length Of 29mm, 1 3/4" (4.5cm). Overall Weight 0.1 oz

5-1508-PK

Viscoelastic Injection Cannula-3 Pack

Pack Of Three, 21 Gauge, Angled 50 Degrees Shaft, 5mm From Tip To Bend, Rounded Flattened Tip With Dull Finish, And Excluding Hub Overall Length Of 1 1/8"(29mm)

Cannulas

Anterior Chamber



5-5032

Bishop-Harmon Anterior Chamber Irrigator

Includes One Of Each: Bishop-Harmon Irrigating Cannula, Adapter For Irrigators, Silicone Bulb 5-5033, 5-5053 and 5-5055



5-5033

Bishop-Harmon Irrigating Cannula

19 Gauge With Polished Finish, 30 Degree Angled Shaft, 7mm From Tip To Bend, Flattened Blunt Tip, Overall Length Of 1 3/4" (4.4cm). Overall Weight 0.1 oz

5-5033-16

Bishop-Harmon Irrigating Cannula

16 Gauge With Polished Finish, 30 Degree Angled Shaft, 5mm From Tip To Bend, Flattened Blunt Tip, An Overall Length Of 25mm. Overall Weight 0.1 oz



5-5033-S

Bishop-Harmon Irrigating Cannula

19 Gauge With Polished Finish, Straight Shaft, Flattened Blunt Tip, Overall Length Of 1 3/4" (4.4cm). Overall Weight 0.1 oz



5-5053

Adapter For Irrigators

Polished Finish, Adapts Bulbs To Cannula Hubs, And Overall Length Of 1 1/8" (3cm). Overall Weight 0.3 oz





5-5055

Silicone Bulb

Translucent Silicone, Diameter Of 25mm, And Overall Length Of 2 1/2" (63mm)



Gills-Welsh Cannula

25 Gauge (Or As Indicated) With Polished Finish, 45 Degree Angled Shaft, Overall Length Of 1 3/8" (3.5cm). Overall Weight 0.1 oz

- 5-5042-5 (Shown)** 5mm From Tip To Bend
- 5-5042-6** 6mm From Tip To Bend
- 5-5042-7** 7mm From Tip To Bend
- 5-5042-7-27** 7mm From Tip To Bend, 27 Gauge
- 5-5042-7-30** 7mm From Tip To Bend, 30 Gauge
- 5-5042-8** 8mm From Tip To Bend
- 5-5042-9** 9mm From Tip To Bend
- 5-5042-10** 7mm From Tip To Bend
- 5-5042-10-26** 10mm From Tip To Bend, 26 Gauge
- 5-5042-10-27** 10mm From Tip To Bend, 27 Gauge



5-5406-19

McIntyre Straight Anterior Chamber Cannula

23 Gauge With Polished Finish, Straight And Blunt Tip, An Overall Length Of 17mm. Overall Weight 0.1 oz

5-5406-21 (Shown)

McIntyre Straight Anterior Chamber Cannula

26 Gauge With Polished Finish, Straight And Blunt Tip, Overall Length Of 17mm, 1 3/8" (3.5cm). Overall Weight 0.1 oz

5-5406-23

McIntyre Straight Anterior Chamber Cannula

30 Gauge With Polished Finish, Straight And Blunt Tip, Overall Length Of 17mm. Overall Weight 0.1 oz

800.322.4674 or 800.633.7283

www.msiprecision.com

3-5



Cannulas



5-5406-20 (Shown)

McIntyre Angled Anterior Chamber Cannula

23 Gauge With Polished Finish, Blunt Tip, 45 Degree Angled Shaft, 12mm From Tip To Bend, Overall Length Of 1 1/4" (3cm). Overall Weight 0.1 oz

5-5406-22

McIntyre Angled Anterior Chamber Cannula

26 Gauge With Polished Finish, Blunt Tip, 45 Degree Angled Shaft, 12mm From Tip To Bend, And Overall Length Of 1 1/2" (3.8cm). Overall Weight 0.1 oz

5-5406-24

McIntyre Angled Anterior Chamber Cannula

30 Gauge With Polished Finish, Blunt Tip, 45 Degree Angled Shaft, 12mm From Tip To Bend, Overall Length Of 1 1/4" (3.1cm) . Overall Weight 0.1 oz



5-5012-23

Knolle Anterior Chamber Irrigating Cannula

23 Gauge Cannula With Polished Finish, Blunt Tip, 45 Degree Angled Shaft, 2mm From Tip To Bend, Overall Length Of 1 1/2" (3.7cm). Overall Weight 0.1 oz

5-5012-25

25 Gauge Cannula

5-5012-27

27 Gauge Cannula

5-5012-30

30 Gauge Cannula



5-5039

Scheie Anterior Chamber Cannula

27 Gauge With Polished Finish, Straight And Blunt Tip, Overall Length Of 1 1/2" (3.8cm). Overall Weight 0.1 oz

5-5041

Bracken Anterior Chamber Cannula

19 Gauge With Polished Finish, 90 Degree Curved Flattened Beveled Tip, Overall Length Of 3/4" (21mm)



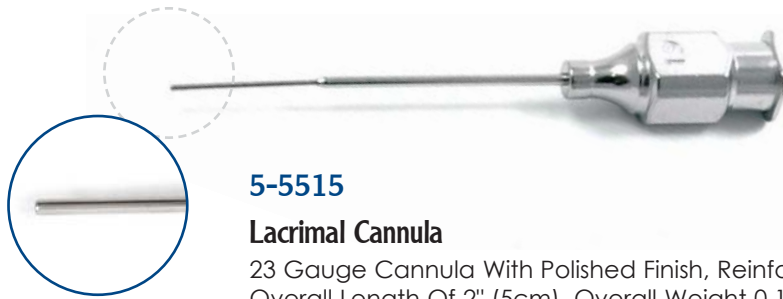

5-5515

Lacrimal Cannula

23 Gauge Cannula With Polished Finish, Reinforced Shaft, Straight 10mm Tip, Overall Length Of 2" (5cm). Overall Weight 0.1 oz

5-5515-7

Lacrimal Cannula Straight

23 Gauge 7mm Tip With Polished Finish, Reinforced In A 19 Gauge Shaft. Overall Length Including Hub Of 2" (5cm), Hub Length 20mm And Working Length Is (29mm)



5-5517

Lacrimal Cannula

23 Gauge Cannula With Polished Finish, Reinforced Shaft, Curved 10mm Tip, Overall Length Of 2 1/8" (5cm). Overall Weight 0.1 oz

5-5517-7

Lacrimal Cannula

23 Gauge 7mm Tip With Polished Finish, Reinforced In A 19 Gauge Shaft. Overall Length Including Hub Of 2" (5cm), Hub Length 20mm Working Length Is (29mm)



5-5511

Lacrimal Cannula

23 Gauge Cannula With Polished Finish, Blunt Tip, Straight Shaft, Overall Length Of 1 3/4" (4.4cm). Overall Weight 0.1 oz



5-5406-8

McIntyre Straight Lacrimal Cannula

23 Gauge Cannula With Polished Finish, Straight Shaft, Blunt Tip, Side Port, Overall Length Of 2 3/8" (6.1cm). Overall Weight 0.1 oz

Cannulas

Lacrimal



5-5406-9

McIntyre Curved Lacrimal Cannula

23 Gauge Cannula With Polished Finish, Curved Shaft, Blunt Tip, Side Port, Overall Length Of 2 3/8" (6.1cm). Overall Weight 0.1 oz



5-5512

Shahinian Lacrimal Cannula

23 Gauge Cannula With Polished Finish, Straight Shaft, Blunt Tapered Tip, Side Port, Overall Length Of 1 1/8" (2.9cm). Overall Weight 0.1 oz

5-5527

Lacrimal Cannula

19 Gauge Cannula With Polished Finish, Blunt Tip, Side Opening, Straight shaft, Overall Length Of 1 1/8" (28mm)



5-5529

West Lacrimal Cannula

23 Gauge Cannula With Polished Finish, Blunt Tip, Bottom Port, Gently Curved Shaft, Overall Length Of 1 7/8" (4.8cm). Overall Weight 0.1 oz

5-5519

Weil Lacrimal Cannula

21 Gauge Cannula With Polished Finish, Blunt Tip, Top Port, Curved Shaft, Overall Length Of 1 1/4" (34mm)



5-5522

Bailey Lacrimal Cannula

23 Gauge Cannula With Polished Finish, Reinforced Shaft, Blunt 6mm Tip, Overall Length Of 15mm. Overall Weight 0.1 oz

5-5521

Lacrimal Cannula

22 Gauge Cannula With Polished Finish, Blunt Flared Probe Point, Malleable Shaft, Overall Length Of 3/4" (19mm)





5-5532-H

Nichamin Hydrodissection Cannula

25 Gauge With Unique Flattened Tip Vaulted, The Length From Bend To Tip Is 12mm And Straight Portion Is 13mm Long, Overall Length Of 25mm. Overall Weight 0.1 oz

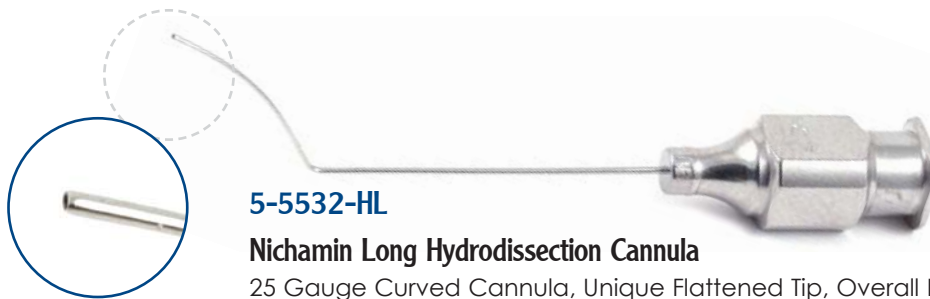

5-5532-HL

Nichamin Long Hydrodissection Cannula

25 Gauge Curved Cannula, Unique Flattened Tip, Overall Length Of 35mm. Overall Weight 0.1 oz

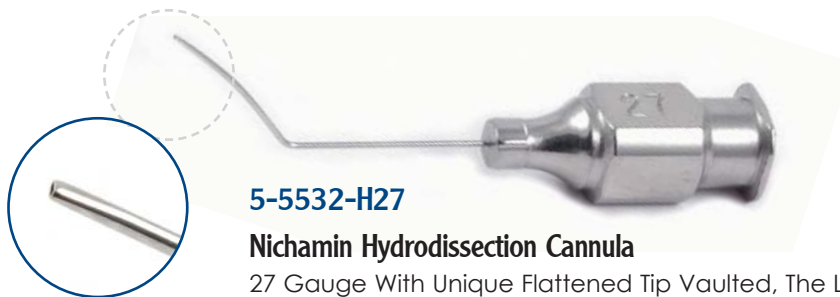

5-5532-H27

Nichamin Hydrodissection Cannula

27 Gauge With Unique Flattened Tip Vaulted, The Length From Bend To Tip Is 12mm And Straight Portion Is 13mm Long, Overall Length Of 25mm. Overall Weight 0.1 oz. Overall Weight 0.1 oz

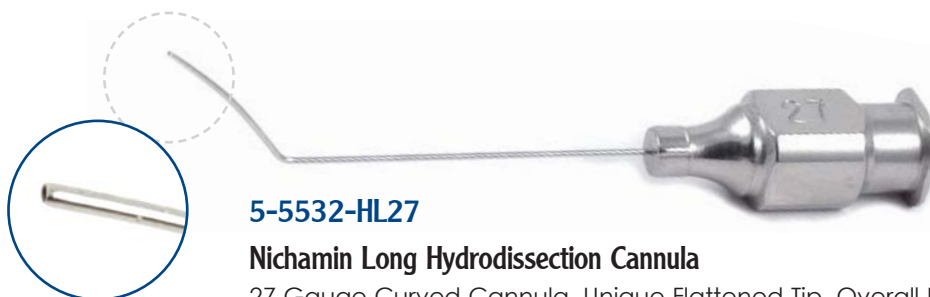

5-5532-HL27

Nichamin Long Hydrodissection Cannula

27 Gauge Curved Cannula, Unique Flattened Tip, Overall Length Of 35mm. Overall Weight 0.1 oz

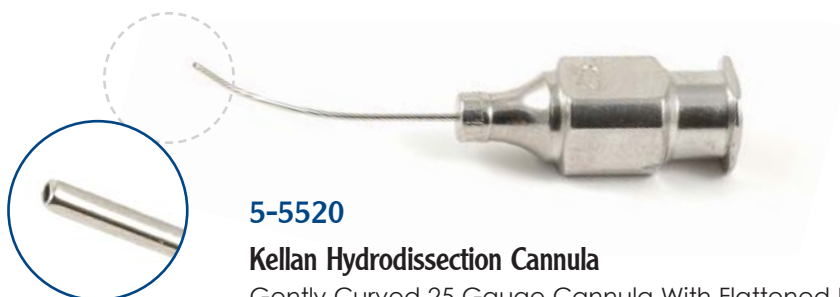

5-5520

Kellan Hydrodissection Cannula

Gently Curved 25 Gauge Cannula With Flattened Blunt Tip, Overall Length Of 18mm. Overall Weight 0.1 oz

Cannulas



5-5514

Kellan Hydrodissect Cannula

Flat With An Overall Length Of 1 11/16" (4.3cm). Overall Weight 0.1 oz



5-5906

Gimbel Forward Irrigating Cannula

27 Gauge Cannula With Angled Shaft, Slightly Curved 10mm From Bend To Tip, Overall Length Of 7/8" (23mm)



5-5905

Gimbel Irrigating Cannula

30 Gauge Cannula With Polished Finish, U Tip, Overall Length Of 1 1/2" (4cm). Overall Weight 0.1 oz



11-8-6165

Hydro Dissecting

25 Gauge Cannula With Flat Tip, 8mm From Tip To Bend, Overall Length Of 3/4" (20mm). Overall Weight 0.1 oz

11-8-6165-18

Hydro Dissecting

18 Gauge Cannula With Flat Tip, 8mm From Tip To Bend, Overall Length Of 3/4" (20mm). Overall Weight 0.1 oz

11-8-6165-23

Hydro Dissecting

23 Gauge Cannula With Flat Tip, 8mm From Tip To Bend, Overall Length Of 3/4" (20mm). Overall Weight 0.1 oz

11-8-6165-27

Hydro Dissecting

27 Gauge Cannula With Flat Tip, 8mm From Tip To Bend, Overall Length Of 3/4" (20mm). Overall Weight 0.1 oz

11-8-6165-30

Hydro Dissecting

30 Gauge Cannula With Flat Tip, 8mm From Tip To Bend, Overall Length Of 3/4" (20mm). Overall Weight 0.1 oz





11-8-6167

Seeley Hydrodiss Cannula

26 Gauge Angled, Overall Length Of 3/4" (20mm). Overall Weight 0.1 oz

11-8-6167-27

Seeley Hydrodiss Cannula

27 Gauge Angled, Overall Length Of 3/4" (20mm). Overall Weight 0.1 oz

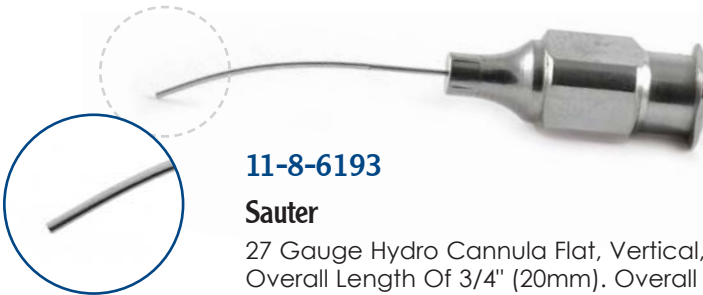

11-8-6193

Sauter

27 Gauge Hydro Cannula Flat, Vertical, And Curved, And Excluding Hub An Overall Length Of 3/4" (20mm). Overall Weight 0.1 oz

5-5524-BAR

Barrett Hydrodissection

25 Gauge Cannula With Beveled Tip Shaft Is Curved Working Length Of 20mm. Overall Weight 0.1 oz

5-5524-BAR-23

Barrett Hydrodissection

23 Gauge Cannula With Beveled Tip Shaft Is Curved Working Length Of 20mm. Overall Weight 0.1 oz

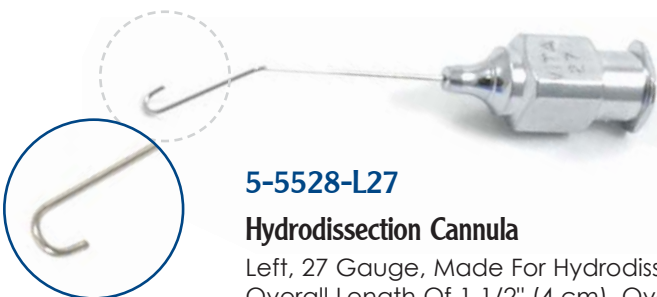

5-5528-L27

Hydrodissection Cannula

Left, 27 Gauge, Made For Hydrodissection Of Lens Nucleus, 3mm "U" Tip, And Overall Length Of 1 1/2" (4 cm). Overall Weight 0.1 oz

5-5528-L

Hydrodissection Cannula

Left, 25 Gauge, Made For Hydrodissection Of Lens Nucleus, 3mm "U" Tip, And Overall Length Of 1 1/2" (4 cm). Overall Weight 0.1 oz

Cannulas

Hydrodissection



5-5528-R27

Hydrodissection Cannula

Right, 27 Gauge, 3mm "U" Tip, Overall Length Of 1 5/8" (4.1cm). Overall Weight 0.1 oz

5-5528-R

Hydrodissection Cannula

Right, 25 Gauge, 3mm "U" Tip, Overall Length Of 1 5/8" (4.1cm). Overall Weight 0.1 oz



5-5528-S27

Hydrodissection Cannula

Straight 27 Gauge, 3mm "U" Tip, Overall Length Of 1 3/4" (4.4cm). Overall Weight 0.1 oz

5-5528-S

Hydrodissection Cannula

Straight 25 Gauge, 3mm "U" Tip, Overall Length Of 1 3/4" (4.4cm). Overall Weight 0.1 oz



5-5528-L

Hydrodissection Cannula

Left, 25 Gauge, Made For Hydrodissection Of Lens Nucleus, 3mm "U" Tip, Overall Length Of 1 5/8" (4cm). Overall Weight 0.1 oz

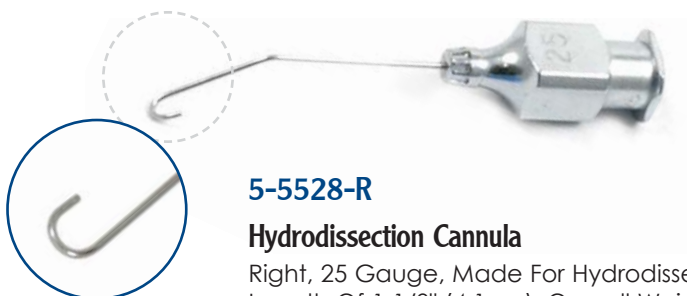

5-5528-R

Hydrodissection Cannula

Right, 25 Gauge, Made For Hydrodissection Of Lens Nucleus, 3mm "U" Tip, Overall Length Of 1 1/8" (4.1cm). Overall Weight 0.1 oz



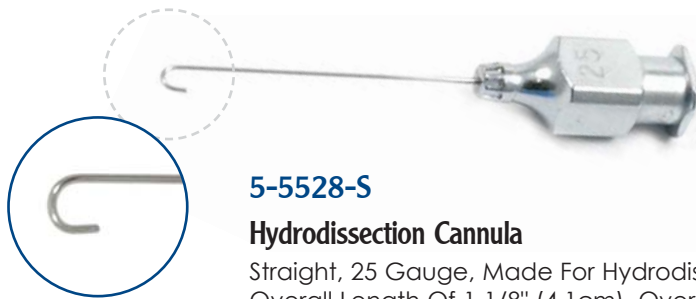

5-5528-S

Hydrodissection Cannula

Straight, 25 Gauge, Made For Hydrodissection Of Lens Nucleus, 3mm "U" Tip, Overall Length Of 1 1/8" (4.1cm). Overall Weight 0.1 oz

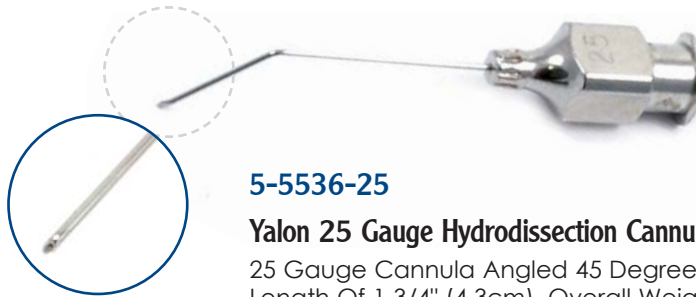

5-5536-25

Yalon 25 Gauge Hydrodissection Cannula

25 Gauge Cannula Angled 45 Degrees, Tip With Irrigation Port On Side, Overall Length Of 1 3/4" (4.3cm). Overall Weight 0.1 oz



11-8-6571

Precision Wedge Hydrodissection

25 Gauge Cannula Angled 45 Degrees, Closed Wedge Tip With 2 Ports On Each Side Of Tip Also Known As Feaster. Overall Weight 0.1 oz



18081

Croydon J Cannula Left (New)

With An Overall Length Of 1 3/8" (3.6cm). Overall Weight 0.1 oz

18081-27

27 Gauge Cannula

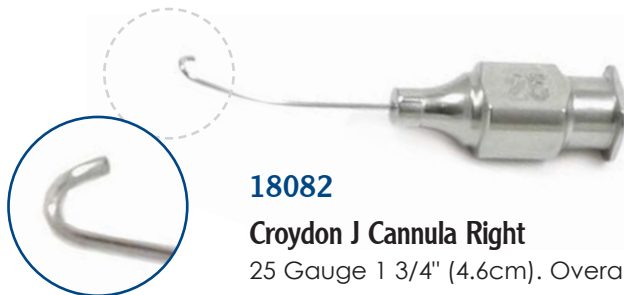

18082

Croydon J Cannula Right

25 Gauge 1 3/4" (4.6cm). Overall Weight 0.1 oz

18082-27

27 Gauge Cannula

800.322.4674 or 800.633.7283

www.msiprecision.com

3-13



Cannulas

Hydrodissection

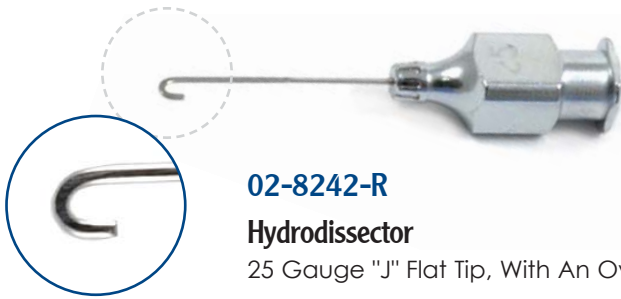

02-8242-R

Hydrodissector

25 Gauge "J" Flat Tip, With An Overall Length Of 1 1/2" (3.7cm). Overall Weight 0.1 oz



02-8244-R

Hydrodissector

27 Gauge, "J" Flat Tip, With An Overall Length Of 1 7/8" (3.6cm). Overall Weight 0.1 oz



15-8738AS

Kellan Hydrodissection Cannula

25 Gauge Curved Vertically Flattened Overall Length 1 1/2" (3.8cm). Overall Weight 0.1 oz





Gills-Welsh Cannula

25 Gauge (Or As Indicated) With Polished Finish, 45 Degree Angled Shaft, Overall Length Of 1 3/8" (3.5cm). Overall Weight 0.1 oz

5-5042-5 (Shown)

5mm From Tip To Bend

5-5042-6

6mm From Tip To Bend

5-5042-7

7mm From Tip To Bend

5-5042-7-27

7mm From Tip To Bend, 27 Gauge

5-5042-7-30

7mm From Tip To Bend, 30 Gauge

5-5042-8

8mm From Tip To Bend

5-5042-9

9mm From Tip To Bend

5-5042-10

7mm From Tip To Bend

5-5042-10-26

10mm From Tip To Bend, 26 Gauge

5-5042-10-27

10mm From Tip To Bend, 27 Gauge



5-5906

Gimbel Forward Irrigating Cannula

27 Gauge Cannula With Angled Shaft, Slightly Curved 10mm From Bend To Tip, Overall Length Of 7/8" (23mm)



5-5531

Osher "J" Cannula

27 Gauge W/ 2.75mm Wide 2.5mm Long "J" Tip, Overall Length 1 3/4" (4.3cm). Overall Weight 0.1 oz

Cannulas



5-5070

Simcoe Cortex Extractor

23 Gauge Gently Curved Cannula With Polished Finish, 0.33mm Aspiration Port, And Overall Length Of 1 1/4" (3cm). Overall Weight 0.1 oz



5-5070-L

Simcoe Cortex Extractor

Long Model 23 Gauge Gently Curved Cannula With Polished Finish, 0.33mm Aspiration Port, Overall Length Of 1 1/2" (3.8cm). Overall Weight 0.1 oz



5-5070-W

Welsh Model Of Simcoe Cortex Extractor

23 Gauge Cannula With Polished Finish, 0.33mm Aspiration Port, 10mm From Shaft To Bend, Angled 45 Degrees, And An Overall Length Of 1 1/2" (3.8cm). Overall Weight 0.1 oz

5-5075

Anis Cortex Aspirating Cannula

23 Gauge Thin Wall With Polished Finish, Straight, 0.3mm Aspiration Port, 2mm Sandblasted Tip, Overall Length Of 1" (25mm). Overall Weight 0.1 oz



5-5075-C

Anis Cortex Aspirating Cannula

23 Gauge Thin Wall With Polished Finish, Angled But Available Straight, 0.3mm Aspiration Port, 2mm Sandblasted Tip, Overall Length Of 1 5/8" (4.3cm). Overall Weight 0.1 oz



**5-5523-BR****Binkhorst Hooked Cannula**

Right, 22 Gauge With Polished Finish, 30 Degree Angled Shaft 13mm From Bend to Tip By Height Overall Bend to Tip 15mm, 2.5mm "J" Shaped Hook Straight Part Of Shaft 22mm, Excluding Hub Overall Length Of 1 3/8" (35mm)

5-5523-BL**Binkhorst Hooked Cannula**

Left, 22 Gauge With Polished Finish, 30 Degree Angled Shaft 13mm From Bend to Tip By Height Overall Bend to Tip 15mm, 2.5mm "J" Shaped Hook Straight Part Of Shaft 22mm, Excluding Hub Overall Length Of 1 3/8" (35mm)

5-5525-WL**Welsh Cortex Extractor**

Left, 25 Gauge With Polished Finish, 45 Degree Angled Shaft, 8mm From Tip To Bend, Olive Tip 90 Degree Angled Left And Flat, Overall Length Of 7/8" (23mm). Overall Weight 0.1 oz

5-5525-WR**Welsh Cortex Extractor**

Right, 25 Gauge With Polished Finish, 45 Degree Angled Shaft, 8mm From Tip To Bend, Olive Tip 90 Degree Angled Left And Flat, Overall Length Of 7/8" (23mm). Overall Weight 0.1 oz

11-8-6521**Binkhorst Hooked Cannula**

Left, 22 Gauge With Polished Finish, 30 Degree Angled Shaft 13mm From Bend to Tip By Height Overall Bend to Tip 15mm, 2.5mm "J" Shaped Hook Straight Part Of Shaft 17mm, Excluding Hub Overall Length Of 1 1/4" (32mm)

11-8-6531**Binkhorst Hooked Cannula**

Right, 22 Gauge With Polished Finish, 30 Degree Angled Shaft 13mm From Bend to Tip By Height Overall Bend to Tip 15mm, 2.5mm "J" Shaped Hook Straight Part Of Shaft 17mm, Excluding Hub Overall Length Of 1 1/4" (32mm)

**5-5525-WS****Welsh Cortex Extractor**

25 Gauge With Polished Finish, 45 Degree Angled Shaft, 8mm From Tip To Bend, Straight And Flat Olive Tip, Overall Length Of 1" (25mm). Overall Weight 0.1 oz

5-5525-H**Hirschman Hooked Cannula**

25 Gauge With Polished Finish, Malleable Olive Tip, Shaft, Overall Length Of 1 1/4" (30mm). Overall Weight 0.1 oz

Cannulas



5-5085

Lewicky Cortex Extractor

23 Gauge With Polished Finish, 13mm Curved Shaft, 0.3mm Aspiration Port Set At 45 Degrees Right, Overall Length Of 1 1/8" (3.4cm). Overall Weight 0.1 oz



5-5085-L

Lewicky Cortex Extractor

23 Gauge With Polished Finish, 21mm Curved Shaft, 0.3mm Aspiration Port Set At 45 Degrees Right, Overall Length Of 1 1/8" (3.4cm). Overall Weight 0.1 oz

11-8-6331

Simcoe Cortex Extractor

23 Gauge Gently Curved Cannula With Polished Finish, 0.33mm Aspiration Port, Overall Length Of 1/2" (13mm). Overall Weight 0.1 oz



11-8-6341

Simcoe Cortex Extractor Long Model

23 Gauge Gently Curved Cannula With Polished Finish, 0.33mm Aspiration Port, Overall Length Of 3/4" (21mm). Overall Weight 0.1 oz



11-8-6332

Simcoe Cortex Extractor

23 Gauge Gently Curved Cannula With Polished Finish, 0.33mm Aspiration Port, Overall Length Of 1/2" (13mm) Cannula Tip Is Sandblasted. Overall Weight 0.1 oz





11-8-6342

Simcoe Cortex Extractor Long Model

23 Gauge Gently Curved Cannula With Polished Finish, 0.33mm Aspiration Port, Overall Length Of 1/2" (21mm) Cannula Tip Is Sandblasted. Overall Weight 0.1 oz

11-8-6351

Anis Cortex Aspirating Cannula

Straight, Overall Weight 0.1 oz

11-8-6352

Anis Cortex Aspirating Cannula

Angled, Overall Weight 0.1 oz

Cannulas

Lasik



11-8-6217

Precision Slade Lasik Flattened Spatulated Cannula

26 Gauge Angled And Vaulted With Front Opening. Overall Weight 0.1 oz

11-8-6217-27

Precision Slade Lasik Flattened Spatulated Cannula

27 Gauge Angled And Vaulted With Front Opening. Overall Weight 0.1 oz



11-8-6219

Precision Fukasaku Lasik Cannula

23 Gauge Angled And Vaulted Flattened Low Profile Tip With One Front Port, Overall Length Of 1" (25mm). Overall Weight 0.1 oz

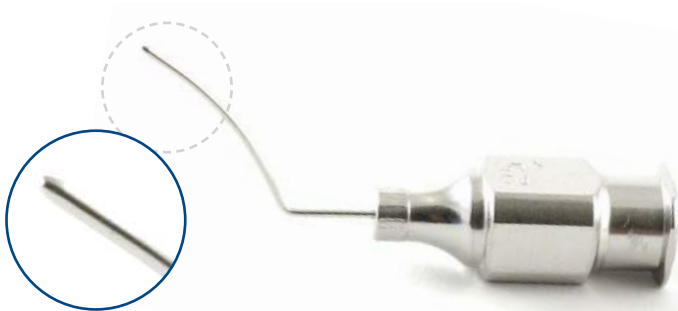

11-8-6221

Precision Gimbel Lasik Fountain Cannula

25 Gauge Right Angled And Vaulted Smooth Bullet Shaped Tip With Single Center Port, Overall Length Of 1/2" (13mm). Overall Weight 0.1 oz



11-8-6222

Precision Gimbel Lasik Fountain Cannula

25 Gauge Left Angled And Vaulted Smooth Bullet Shaped Tip With Single Center Port, Overall Length Of 1/2" (13mm) Overall Weight 0.1 oz





11-8-6223

Banaji Lasik Cannula

25 Gauge Smooth And With 6 Port, Overall Length Of 5/8" (15mm). Overall Weight 0.1 oz



11-8-6224

Banaji Lasik Cannula

25 Gauge Sandblasted And With 6 Port, Overall Length Of 5/8" (15mm). Overall Weight 0.1 oz



11-8-6225

Salz Aspirating Cannula Straight

23 Gauge, Overall Length Of 1/2" (15mm). Overall Weight 0.1 oz



11-8-6226

Brierley Lasik Cannula

25 Gauge, Overall Length Of 5/8" (15mm). Overall Weight 0.1 oz



11-8-6227

Carter Lasik Cannula

25 Gauge Vaulted Flattened 10mm Tip Open End, Overall Length Of 1" (25mm). Overall Weight 0.1 oz

800.322.4674 or 800.633.7283

www.msiprecision.com



Cannulas



11-8-6228

Precision Burrato Lasik Cannula

25 Gauge Angled And Vaulted Semi Closed Tip With One Front Port And Two Side Ports, Overall Length Of 7/8" (22mm). Overall Weight 0.1 oz



11-8-6229

Precision Burrato Lasik Cannula

23 Gauge Angled And Vaulted Semi Closed Tip With One Front Port And Two Side Ports, Overall Length Of 1" (25mm). Overall Weight 0.1 oz

11-8-6229-F

Precision Wedge Lasik

23 Gauge Cannula Angled 45 Degrees Vaulted Design, Closed Wedge Tip With 2 Ports On Each Side Of Tip, Overall Length Of 1" (25mm) Also Known As Feaster. Overall Weight 0.1 oz



11-8-6287

Precision Gimbel Lasik Polishing Cannula

30 Gauge Left, Double Angled With Flattened Sandblasted Tip, Overall Length Of 1/2" (12mm). Overall Weight 0.1 oz



11-8-6291

Precision Vidaurri Lasik Cannula

25 Gauge Angled Double Armed With Eight Irrigating Ports The Double Arms Are Set Vertical And Are 12mm In Length, Overall Length Of 1" (25mm). Overall Weight 0.1 oz





11-8-6292

Precision Vidaurri Lasik Cannula

25 Gauge Angled Double Armed With Eight Irrigating Ports The Double Arms Are Set Horizontal And Are 12mm In Length, Overall Length Of 1" (25mm). Overall Weight 0.1 oz

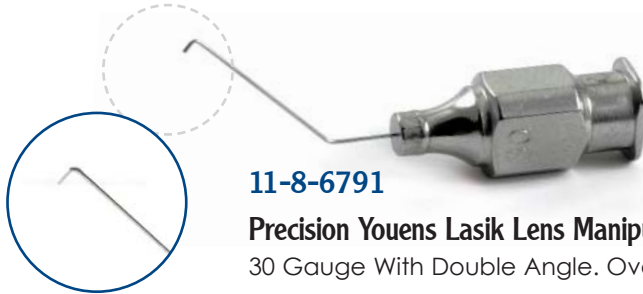

11-8-6791

Precision Youens Lasik Lens Manipulating Cannula

30 Gauge With Double Angle. Overall Weight 0.1 oz

5-5090

Lane LASIK Cannula

25 Gauge Smooth Cannula Curved. Overall Weight 0.1 oz

15-8380AS

Precision Dishler Lasik Irrigation Cannula

30 Gauge, 7mm Bend, With An Overall Length Of 1 1/8" (2.9cm) Working Length 15mm Vaulted Tip Has 4 Ports With 2 On Each Side. Overall Weight 0.1 oz



15-8389AS

Precision Dishler Lasik Irrigation Cannula

30 Gauge, 9mm Bend, With An Overall Length Of 1 1/8" (2.9cm) Working Length 15mm Vaulted Tip Has 4 Ports With 2 Ports On Each Side. Overall Weight 0.1 oz



15-8391AS

Precision Bansal Lasik

25 Gauge Cannula Overall Length 1 1/2" (4cm) Tip Is Beveled Smooth Single Port Front Opening. Overall Weight 0.1 oz

800.322.4674 or 800.633.7283

www.msiprecision.com



3-23

Cannulas

15-8392AS

Precision Manche Lasik

24 Gauge Cannula Wedge Spatulated Tip Overall Length 1 1/3" (3.4cm) With 3 Total Ports 1 On Bottom Of Tip With One On Each Side. Overall Weight 0.1 oz



15-8393AS

Precision Slade LASIK

26 Gauge Cannula With Overall Length Of 1 1/2" (3.8cm) Working Length 20mm Vaulted Tip Has 1 Front End Port. Overall Weight 0.1 oz



15-8394AS

Precision Slade LASIK

27 Gauge Cannula With Overall Length Of 1 1/4" (3.3cm) Working Length 20mm Vaulted Tip Has 1 Front End Port. Overall Weight 0.1 oz

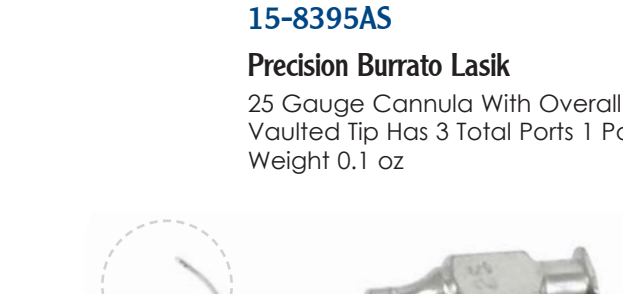

15-8395AS

Precision Burrato Lasik

25 Gauge Cannula With Overall Length Of 1 5/8" (4.2cm) Working Length 24mm Vaulted Tip Has 3 Total Ports 1 Port Front Opening And 1 One Each Side. Overall Weight 0.1 oz



15-8398AS

Precision Manche Lasik

25 Gauge Cannula Wedge Spatulated Tip Overall Length 1 1/3" (3.4cm) With 3 Total Ports 1 On Bottom Of Tip With One On Each Side. Overall Weight 0.1 oz

15-8399AS

Precision Guell Lasik

25 Gauge Cannula Overall Length 1 5/8" (4.2cm) With 7 Total Ports 1 Port Front Opening And 3 Ports On Each Side. Overall Weight 0.1 oz





5-5082

Simcoe Double-Barreled Irrigating-Aspirating Unit

23 Gauge Thin Wall, Aspiration Through 0.3mm Top Port, Irrigation Through 0.3 Side Port, Curved Shaft, Polished Finish, Excluding Hub Overall Length Of 5/8" (15mm)



5-5082-R

Simcoe Reverse Double-Barreled Irrigating-Aspirating Unit

23 Gauge Thin Wall 0.3mm Top Port And Curved Shaft, Polished Finish, Overall Length Of 15mm

5-5070-LC

Simcoe Irrigating-Aspirating Unit

23 Gauge Cannula With Polished Finish, 0.3mm Aspiration Port, Curved Shaft, Irrigating Sleeve, Overall Length Of 3/4" (21mm)

Cannulas

5-5044-L

Gills-Welsh Irrigating-Aspirating Cannula

With Flat Olive Tip, Left, Polished Finish, 23 Gauge Thin Wall Irrig., 25 Gauge Thin Wall Aspir., Angled 20 Degrees 10mm Bend To Tip, Overall Length Of 7/8" (23mm)

5-5044-R

Gills-Welsh Irrigating-Aspirating Cannula

With Flat Olive Tip, Right, Polished Finish, 23 Gauge Thin Wall Irrigation, 25 Gauge Thin Wall Aspiration, Angled 20 Degrees 10mm Bend To Tip, Silicone Tubing, Exclude Hub Overall Length Of 7/8" (23mm)

5-5043-T

Gills-Welsh Double-Barreled Irrigating-Aspirating Cannula

23 Gauge Thin Wall Irrigation, 25 Gauge Thin Wall Aspiration, Polished Finish, 30 Degree Shaft 8mm Tip To Bend, Irrigation Tip 0.5mm Behind Aspiration Tip, Side Taper I-A Through Hub, Overall Length 23mm. Overall Weight 0.2 oz

5-5043-23

Gills Irrigating-Aspirating Cannula

23 Gauge Thin Wall Irrigation, 25 Gauge Thin Wall Aspiration, Polished Finish, Dual Hub Construction, Angled 30 Degree Shaft, 8mm From Tip To Bend, And Excluding Hub Overall Length Of 7/8" (23mm)

5-1618-J

Precision Style Jensen Thomas Anterior Capsule Irrigating-Aspirating Cannula

23 Gauge Irrigation And Aspiration Side By Side With 0.3mm Irrigation And Aspiration Ports Through Sides Of Cannulas, Polished Finish, Overall Length Of 1 1/4"(32mm)





5-5525

Troutman Alpha-Chymotrypsin Cannula

25 Gauge With Polished Finish, Curved Shaft, 1mm Smooth Bulbous Tip, Overall Length Of 1 3/4" (4.5cm). Overall Weight 0.1 oz

5-1621

Park Irrigating Cannula

19 Gauge Cannula With Polished Finish, Angled 30 Degrees Shaft 12mm From Tip To Bend, Flattened Tip With 5 Ports, Overall Length Of 1 1/4"(32mm)



5-5525-GW10

Park Irrigating Cannula

19 Gauge Cannula With Polished Finish, Angled 30 Degrees Shaft 12mm From Tip To Bend, Flattened Tip With 5 Ports, Overall Length Of 1 1/4" (32mm)



5-5036

Shepard Incision Irrigating Cannula

30 Gauge Cannula, Flattened 5mm Angled Tip For Corneal Wounds, Overall Length Of 1 1/2" (3.7cm). Overall Weight 0.1 oz

11-8-6569

Gimbel Irrigating Cannula

26 Gauge Blunt Tip, Angled to Side, End Opening. Overall Weight 0.1 oz

11-8-4911

Troutman Olive Tip Cannula

25 Gauge With Polished Finish, Angled Shaft, 1mm Smooth Bulbous Tip, Overall Length Of 1 3/4" (4.5cm). Overall Weight 0.1 oz

Cannulas



11-8-4931

Welsh Flat Olive Tip

25 Gauge Cannula Angled Forward, Overall Length Of 1" (25mm). Overall Weight 0.1 oz

11-8-4941

Welsh Flat Olive Tip Left

25 Gauge Cannula Angled Left, Overall Length Of 1" (25mm). Overall Weight 0.1 oz

11-8-4951

Welsh Flat Olive Tip Right

25 Gauge Cannula Angled Right And Excluding Hub An Overall Length Of 1" (25mm). Overall Weight 0.1 oz



11-8-6551 (Shown)

McIntyre Binkhorst Right

26 Gauge Cannula Right With Open End. Overall Weight 0.1 oz

11-8-6551-27

McIntyre Binkhorst Right

27 Gauge Cannula Right With Open End. Overall Weight 0.1 oz

11-8-6551-30

McIntyre Binkhorst Right

30 Gauge Cannula Right With Open End. Overall Weight 0.1 oz



**11-8-6556 (Shown)****McIntyre Binkhorst Straight**

26 Gauge Cannula Straight With Open End. Overall Weight 0.1 oz

11-8-6556-27**McIntyre Binkhorst Straight**

27 Gauge Cannula Straight With Open End. Overall Weight 0.1 oz

11-8-6556-30**McIntyre Binkhorst Straight**

30 Gauge Cannula Straight With Open End. Overall Weight 0.1 oz

**11-8-6561 (Shown)****McIntyre Binkhorst Left**

26 Gauge Cannula Left With Open End. Overall Weight 0.1 oz

11-8-6561-27**McIntyre Binkhorst Left**

27 Gauge Cannula Left With Open End. Overall Weight 0.1 oz

11-8-6561-30**McIntyre Binkhorst Left**

30 Gauge Cannula Left With Open End. Overall Weight 0.1 oz

11-8-6541**Wilbrandt Binkhorst Straight**

23 Gauge Cannula Straight With Open End. Overall Weight 0.1 oz

11-8-6542**Wilbrandt Binkhorst Left**

23 Gauge Cannula Left With Open End. Overall Weight 0.1 oz

11-8-6543**Wilbrandt Binkhorst Right**

23 Gauge Cannula Right With Open End. Overall Weight 0.1 oz

800.322.4674 or 800.633.7283

www.msiprecision.com

3-29



Cannulas



5-5406-19

McIntyre Straight Anterior Chamber Cannula

23 Gauge With Polished Finish, Straight And Blunt Tip, An Overall Length Of 17mm. Overall Weight 0.1 oz

5-5406-21 (Shown)

McIntyre Straight Anterior Chamber Cannula

26 Gauge With Polished Finish, Straight And Blunt Tip, Overall Length Of 17mm, 1 3/8" (3.5cm). Overall Weight 0.1 oz

5-5406-23

McIntyre Straight Anterior Chamber Cannula

30 Gauge With Polished Finish, Straight And Blunt Tip, Overall Length Of 17mm. Overall Weight 0.1 oz



5-5406-20 (Shown)

McIntyre Angled Anterior Chamber Cannula

23 Gauge With Polished Finish, Blunt Tip, 45 Degree Angled Shaft, 12mm From Tip To Bend, Overall Length Of 1 1/4" (3cm). Overall Weight 0.1 oz

5-5406-22

McIntyre Angled Anterior Chamber Cannula

26 Gauge With Polished Finish, Blunt Tip, 45 Degree Angled Shaft, 12mm From Tip To Bend, And Overall Length Of 1 1/2" (3.8cm). Overall Weight 0.1 oz

5-5406-24

McIntyre Angled Anterior Chamber Cannula

30 Gauge With Polished Finish, Blunt Tip, 45 Degree Angled Shaft, 12mm From Tip To Bend, Overall Length Of 1 1/4" (3.1cm) . Overall Weight 0.1 oz



5-5012-23

Knolle Anterior Chamber Irrigating Cannula

23 Gauge Cannula With Polished Finish, Blunt Tip, 45 Degree Angled Shaft, 2mm From Tip To Bend, Overall Length Of 1 1/2" (3.7cm). Overall Weight 0.1 oz

5-5012-25

25 Gauge Cannula

5-5012-27

27 Gauge Cannula

5-5012-30

30 Gauge Cannula





5-5036

Shepard Incision Irrigating Cannula

30 Gauge Cannula, Flattened 5mm Angled Tip For Corneal Wounds, Overall Length Of 1 1/2" (3.7cm). Overall Weight 0.1 oz



5-5039

Scheie Anterior Chamber Cannula

27 Gauge With Polished Finish, Straight And Blunt Tip, Overall Length Of 1 1/2" (3.8cm). Overall Weight 0.1 oz



5-5906

Gimbel Forward Irrigating Cannula

27 Gauge Cannula With Angled Shaft, Slightly Curved 10mm From Bend To Tip, Overall Length Of 7/8" (23mm). Overall Weight 0.1 oz

11-8-5113

Precision Style Fukasaku Anesthesia

24 Gauge Cannula Gental Curve Open End

11-8-6107

Precision Irrigating

21 Gauge Cannula Curved With 2 Side Ports 0.5mm. Overall Weight 0.1 oz

11-8-6106

Precision Irrigating

23 Gauge Cannula Curved With 2 Side Ports 0.4mm. Overall Weight 0.1 oz

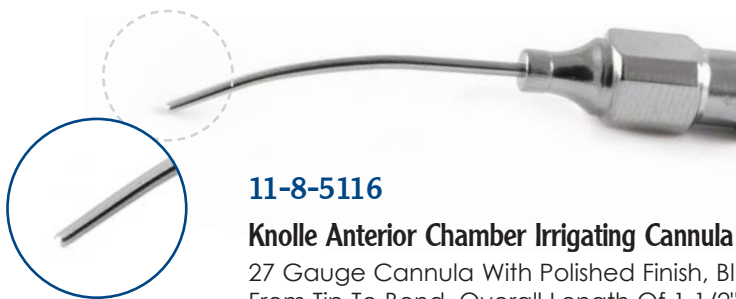

11-8-5116

Knolle Anterior Chamber Irrigating Cannula

27 Gauge Cannula With Polished Finish, Blunt Tip, 45 Degree Angled Shaft, 2mm From Tip To Bend, Overall Length Of 1 1/2" (3.7cm). Overall Weight 0.1 oz

800.322.4674 or 800.633.7283

www.msiprecision.com

3-31



Cannulas



5-5406

McIntyre Basic Coaxial Cannula Connector System

With An Overall Length Of 2 1/2" (6.3cm), And Includes: 23 Gauge Inner Cannula, Truncated Outer Cannula, Nylon Connector, And 2 Infusion Sets. It is Compatible With: 23 Gauge Inner Cannula, 23 Gauge Straight Inner Cannula, And 19 Gauge Outer Cannula

5-5406-2

McIntyre Inner Cannula

23 Gauge Inner Cannula With Polished Finish, 0.2mm Side Port, Overall Length Of 1 3/4" (46mm). Overall Weight 0.1 oz



5-5406-3

McIntyre Inner Cannula

23 Gauge Inner Cannula With Polished Finish, 0.3mm Side Port, Overall Length Of 1 3/4" (46mm). Overall Weight 0.1 oz

5-5406-4

McIntyre Straight Inner Cannula

23 Gauge Inner Cannula With Polished Finish, Straight End Opening, Overall Length Of 1 3/4" (46mm). Overall Weight 0.1 oz



5-5406-5

McIntyre Truncated Outer Cannula

19 Gauge Truncated Outer Cannula With Polished Finish, Tapered Tip, And Two Side Openings, Overall Length Of 1 3/4" (4.5cm). Overall Weight 0.1 oz





5-5406-6

McIntyre Straight Outer Cannula

19 Gauge Outer Cannula With Polished Finish, Straight Untapered End, Overall Length Of 1 3/8" (3.5cm). Overall Weight 0.1 oz



5-5406-10

McIntyre Inner Cannula

20 Gauge With Polished Finish, With .7mm Side Port And Overall Length Of 1 3/4" (46mm), Overall Weight 0.1 oz



5-5082

Simcoe Double-Barreled Irrigating-Aspirating Unit

23 Gauge Thin Wall Both I-A, Aspiration Through .3mm Top Port, Irrigating Through Side Opening, Curved Shaft, Polished Finish, Overall Length Of 5/8" (15mm)

5-5082-R

Simcoe Reverse Double-Barreled Irrigating-Aspirating Unit

23 Gauge Thin Wall 0.3mm Top Port And Curved Shaft, Polished Finish, Overall Length Of 15mm



11-8-5415

Gess Irrigating And Aspirating

23 Gauge Thin Wall Cannula Curved Right U-shaped aspiration tip, Overall Weight 0.1 oz

Cannulas

Irrigating

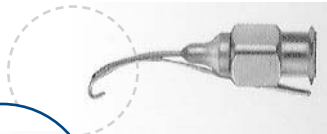

11-8-5416

Gess Irrigating And Aspirating

23 Gauge Thin Wall Cannula Curved Left U-shaped aspiration tip, Overall Weight 0.1 oz



11-8-5419

Simcoe Irrigating And Aspirating

23 Gauge Cannula Curved Right U-shaped Tip 0.3mm, Overall Length Of 5/8" (15mm). Overall Weight 0.1 oz

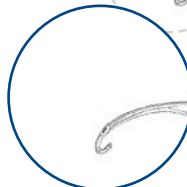
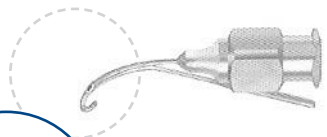

11-8-5410

Simcoe Irrigating And Aspirating

23 Gauge Cannula Curved Left U-shaped Tip 0.3mm, Overall Length Of 5/8" (15mm). Overall Weight 0.1 oz



5-5988

Simcoe Nucleus Delivery Cannula Right

25 Gauge Thin Wall Cannula With Polished Finish, 4mm Wide X 13mm Long Loop With Serrations, Two Irrigating Ports, For Right-Handed Use, Overall Length Of 1 1/8" (2.8cm). Overall Weight 0.1 oz

5-5988-L

Simcoe Nucleus Delivery Cannula Left

25 Gauge Thin Wall Cannula With Polished Finish, 4mm Wide X 13mm Long Loop With Serrations, Two Irrigating Ports, For Left-Handed Use, Overall Length Of 1 1/8" (2.8cm). Overall Weight 0.1 oz



3-34

800.322.4674 or 800.633.7283

www.msiprecision.com

5-1642**Osher Lens Vacuuming Cannula**

27 Gauge Cannula With Polished Finish, Straight Shaft With Curved Tip, Overall Length Of 1"(25mm). Overall Weight 0.1 oz

5-5088-S**Fish Aspirating Straight**

25 Gauge Cannula, Ski Shaped Tip With Polished Finish, Shaft Angled 11mm From Tip, Overall Length Of 1 1/8" (27mm). Overall Weight 0.1 oz

5-5088-S-27**Fish Aspirating Straight**

27 Gauge Cannula, Ski Shaped Tip With Polished Finish, Shaft Angled 11mm From Bend To Tip, Overall Length Of 1 1/8" (27mm)

5-5089**Infusion Cannula**

Beveled 25 Gauge Tip, Beveled 14 Gauge Shaft, Polished Finish, Working Length Of 1/4" (7mm)

**5-5528-T****Thornton Aspirating Capsule Polisher**

Aspirating 27 Gauge Cannula With "U" Shape Sandblasted Tip To, Overall Length Of 7/8" (23mm). Overall Weight 0.1 oz

11-8-6285**Gimbel Cortex**

30 Gauge Aspiration Cannula Shaft Angled Twice With Open End. Overall Weight 0.1 oz

**11-8-6471****Gills Cannula**

25 Gauge With Polished Finish, 45 Degree Angled Shaft, 5mm From Tip To Bend. Overall Weight 0.1 oz

800.322.4674 or 800.633.7283

www.msiprecision.com

3-35



Cannulas

11-8-6481

Gills Cannula

25 Gauge With Polished Finish, 45 Degree Angled Shaft, 7mm From Tip To Bend.
Overall Weight 0.1 oz

11-8-6491

Gills Cannula

25 Gauge With Polished Finish, 45 Degree Angled Shaft, 8mm From Tip To Bend.
Overall Weight 0.1 oz

11-8-6401

Gills Cannula

25 Gauge With Polished Finish, 45 Degree Angled Shaft, 10mm From Tip To Bend.
Overall Weight 0.1 oz

11-8-6404

Morrison Aspirating

23 Gauge Cannula With Polished Finish, 45 Degree Angled Shaft, 7mm From Tip To Bend. Overall Weight 0.1 oz

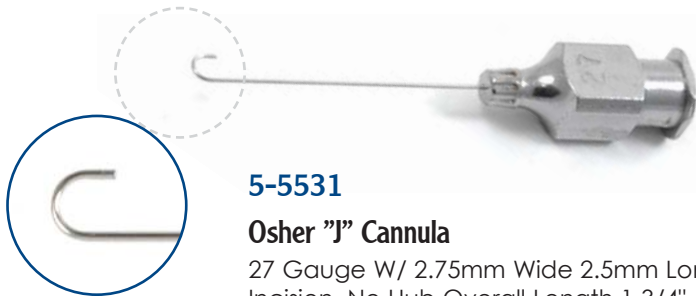

5-5531

Osher "J" Cannula

27 Gauge W/ 2.75mm Wide 2.5mm Long "J" Tip For Going Through 3mm Phaco Incision, No Hub Overall Length 1 3/4" (4.3cm). Overall Weight 0.1 oz

5-5075

Anis Cortex Aspirating Cannula

23 Gauge Thin Wall With Polished Finish, Straight 0.3mm Aspiration Port, 2mm Sandblasted Tip, Overall Length Of 1" (25mm). Overall Weight 0.1 oz



5-5075-C

Anis Cortex Aspirating Cannula

23 Gauge Thin Wall With Polished Finish, Angled But Available Straight, 0.3mm Aspiration Port, 2mm Sandblasted Tip, Overall Length Of 1 5/8" (4.3cm). Overall Weight 0.1 oz



5-5076

Anis Cortex Aspirating Cannula

23 Gauge Thin Wall With Polished Finish, Angled 0.3mm Aspiration Port, 2mm Sandblasted Tip, Overall Length Of 1 5/8" (4.3cm). Overall Weight 0.1 oz

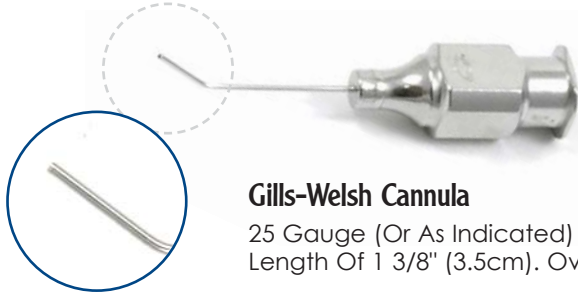

Gills-Welsh Cannula

25 Gauge (Or As Indicated) With Polished Finish, 45 Degree Angled Shaft, Overall Length Of 1 3/8" (3.5cm). Overall Weight 0.1 oz

5-5042-5 (Shown)

5mm From Tip To Bend

5-5042-6

6mm From Tip To Bend

5-5042-7

7mm From Tip To Bend

5-5042-7-27

7mm From Tip To Bend, 27 Gauge

5-5042-7-30

7mm From Tip To Bend, 30 Gauge

5-5042-8

8mm From Tip To Bend

5-5042-9

9mm From Tip To Bend

5-5042-10

7mm From Tip To Bend

5-5042-10-26

10mm From Tip To Bend, 26 Gauge

5-5042-10-27

10mm From Tip To Bend, 27 Gauge

11-8-6285

Gimbel Cortex 30 Gauge Aspiration Cannula

Shaft Angled Twice With Open End



5-5069

Maumenee Vitreous Aspirating Needle

18 Gauge Thin Wall With Polished Finish, Straight Needle, Blunt Tip, Markings 10mm, 15mm, 20mm On Shaft From Tip, Overall Length Of 1 1/2" (3.8cm) . Overall Weight 0.1 oz

Cannulas

Aspirating



11-8-6225

Salz Aspirating Cannula

Straight 23 Gauge, Overall Length Of 1/2" (15mm). Overall Weight 0.1 oz

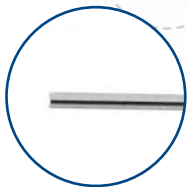

11-8-4661

Viscoelastic Aspirating

22 Gauge Cannula Angled 10mm Bend To Tip, Overall Length Of 1" (25mm). Overall Weight 0.1 oz



11-8-4663

Viscoelastic Aspirating

19 Gauge Cannula Angled 10mm Bend To Tip, Overall Length Of 1" (25mm). Overall Weight 0.1 oz



5-1508

Viscoelastic Injection Cannula

21 Gauge, Angled 50 Degrees Shaft, 5mm From Tip To Bend, Rounded Flattened Tip With Dull Finish, Overall Length Of 29mm, 1 3/4" (4.5cm). Overall Weight 0.1 oz



11-8-7824

Lewickey Infusion

20 Gauge Cannula. Overall Weight 0.1 oz



11-8-7811

Heslin Infusion

25 Gauge Cannula With Grip For Holding In the Incision. Overall Weight 0.1 oz



11-8-7821

Heslin Infusion

23 Gauge Cannula With Grip For Holding In the Incision. Overall Weight 0.1 oz

Cannulas

Infusion



132219-2142

Infusion Cannula

20 Gauge With 2.5mm Tip



132219-2144

Infusion Cannula

20 Gauge With 4.0mm Tip



3-40

800.322.4674 or 800.633.7283

www.msiprecision.com

Surgical Advantage

1-800-948-7994

order@surgicaladvantage.net



132219-2146

Infusion Cannula

20 Gauge With 6.0mm Tip

5-5092

Blumenthal Anterior Chamber Maintainer

20 Gauge Unique Anterior Chamber Maintainer Featuring A Threaded Tip, Overall Length Of 13mm. Overall Weight 0.1 oz

5-5093

Precision Anterior Chamber Cannula

25 Gauge Anterior Chamber Maintenance Cannula, 3mm Long Beveled Tip, Overall Weight 0.1 oz

5-5066

Girard Anterior Chamber Needle Set

23 Gauge With Polished Finish, Beveled Blunt Tip, 7.5mm Long Working End, Overall Length Of 5/8" (14mm). Overall Weight 0.1 oz

Cannulas

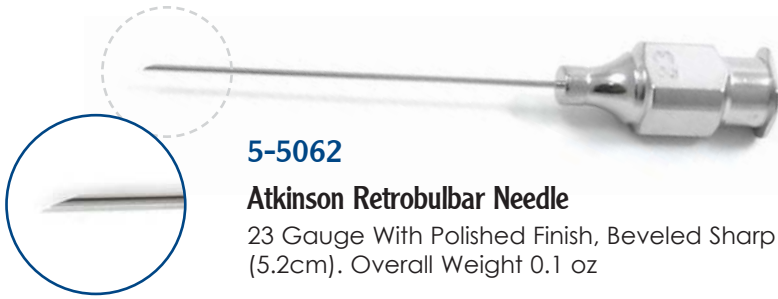

5-5062

Atkinson Retrobulbar Needle

23 Gauge With Polished Finish, Beveled Sharp Rounded Point, Overall Length Of 2" (5.2cm). Overall Weight 0.1 oz

5-5062-25

Atkinson Retrobulbar Needle

25 Gauge With Polished Finish, Beveled Sharp Rounded Point, Overall Length Of 2" (5.2cm). Overall Weight 0.1 oz

5-5000

Connor Anesthesia Cannula

23 Gauge Cannula With 3 Forward-Spraying Side Ports, Has Polished/Rounded Tip, Slightly Bent, Overall Length Of 20mm. Overall Weight 0.1 oz

11-8-5113

Precision Style Fukasaku Anesthesia

24 Gauge Cannula Gental Curve Open End. Overall Weight 0.1 oz

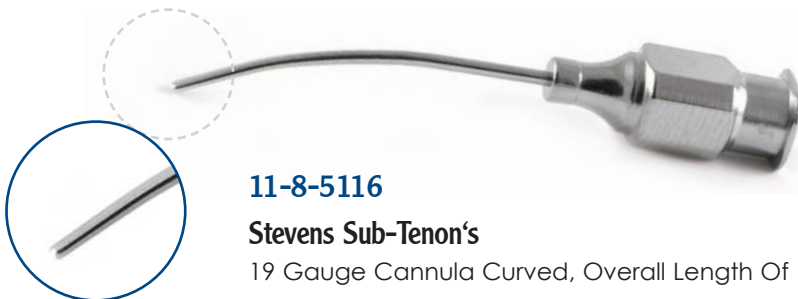

11-8-5116

Stevens Sub-Tenon's

19 Gauge Cannula Curved, Overall Length Of 1 1/8" (28mm). Overall Weight 0.1 oz

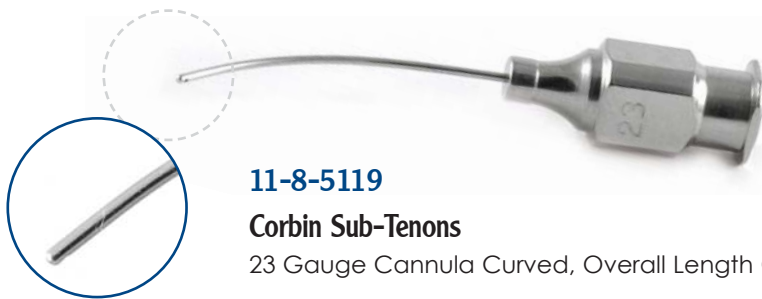

11-8-5119

Corbin Sub-Tenons

23 Gauge Cannula Curved, Overall Length Of 1" (25mm). Overall Weight 0.1 oz

11-8-5121

Gross Sub-Tenon's

21 Gauge Cannula Curved, Overall Length Of 1 1/8" (28mm). Overall Weight 0.1 oz





5-1669-SN

Simcoe Suturing Needle

30 Gauge Cannula With Polished Finish And Beveled Sharp Tip, Hole For Intraocular Suturing, Overall Length Of 3/4" (2cm). Overall Weight 0.1 oz

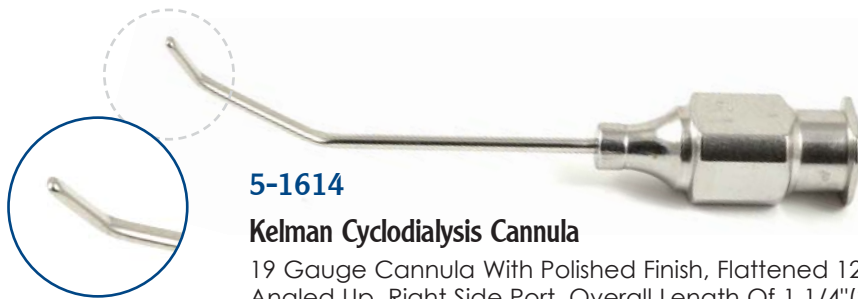

5-1614

Kelman Cyclodialysis Cannula

19 Gauge Cannula With Polished Finish, Flattened 12mm Tip With Last 2 1/2mm Angled Up, Right Side Port, Overall Length Of 1 1/4"(32mm)

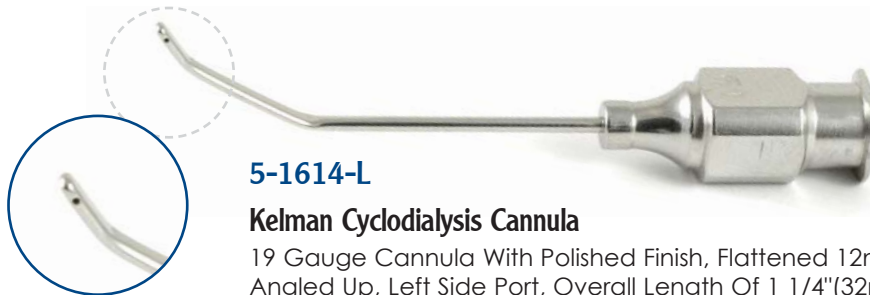

5-1614-L

Kelman Cyclodialysis Cannula

19 Gauge Cannula With Polished Finish, Flattened 12mm Tip With Last 2 1/2mm Angled Up, Left Side Port, Overall Length Of 1 1/4"(32mm)

5-1615

Randolph Cyclodialysis Cannula

19 Gauge Cannula With Polished Finish, Flattened Shaft 12mm From Tip To Bend, Flattened Tip With Opening, Overall Cannula Length Of 1 1/8"(27mm)

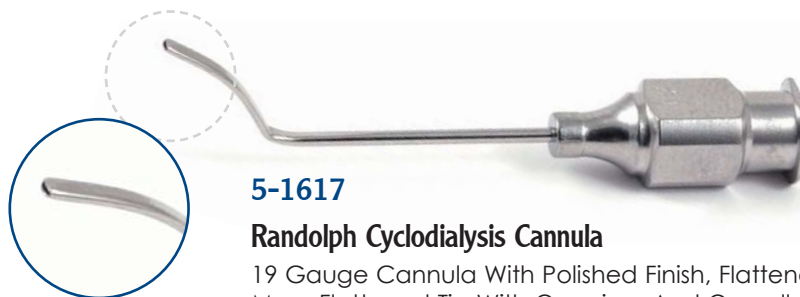

5-1617

Randolph Cyclodialysis Cannula

19 Gauge Cannula With Polished Finish, Flattened Shaft 12mm From Tip To Bend, More Flattened Tip With Opening, And Overall Cannula 26mm, With An Overall Length Of 1 7/8" (4.7cm). Overall Weight 0.1 oz

Cannulas

11-8-4711

Randolph Cyclodialysis Cannula

21 Gauge Cannula With Polished Finish, Flattened Shaft 12mm From Tip To Bend, Flattened Tip With Opening, Overall Cannula Length Of 1 1/4"(32mm)

11-8-4731

Randolph Cyclodialysis Cannula

19 Gauge Cannula With Polished Finish, Flattened Shaft 12mm From Tip To Bend, Flattened Tip With Opening, Overall Cannula Length Of 1 1/4"(32mm)

11-8-4791

Sheets Cyclodialysis Spatula

19 Gauge Cannula With Polished Finish, Flattened 13mm Tip With Last 2mm Angled Up, Front And Side Ports, Overall Length Of 1 1/4"(31mm)

5-1667-N

Newell Nucleus Spatula

22 Gauge Cannulated Spatula With Polished Finish, Shaft Angled 14mm From Tip To Bend, Overall Length Of 1 1/8" (29mm)

5-1660

Simcoe Nucleus Spatula

25 Gauge Cannula With Polished Finish, 2mm Vertical Spatula Tip With Opening On Right Side, 10mm From Tip To Bend, Overall Cannula Length Of 3/4" (17mm)





Item is not a cannula, it is a handled cystotome.



5-1251

Lewicky Cystotome

Angled Tip With Sharpened Triangular Blades And 10mm From Angle To Tip, Hexagonal Handle With Dull Finish, Overall Length Of 4" (10.2cm). Overall Weight 0.3 oz



5-1252-2B

Kelman Cystotome Knife-Blunt

22 Gauge Cannula Shaft With Polished Finish And Blunt Edge, Overall Length Of 2" (5cm). Overall Weight 0.1 oz

5-1252-2S

Kelman-Cystotome Knife-Sharp

22 Gauge Cannula Shaft With Polished Finish And Sharp Edge, Overall Length Of 1 1/8"(32mm). Overall Weight 0.1 oz



5-1252-L

Nevyas Double Sharp Cystotome

22 Gauge Cannula Shaft With Polished Finish And Sharp Front And Back Edges, Overall Length Of 1 7/8" (4.8cm). Overall Weight 0.1 oz



5-1254

Knolle-Kelman Sharp Cystotome

22 Gauge Cannula Shaft With Polished Finish And Sharp Tip, Overall Length Of 32mm, 2" (5cm). Overall Weight 0.1 oz

Cannulas

5-1255-27

Drews Cystotome

27 Gauge Cannula Shaft With Polished Finish And Sharp Tip, 10mm From Tip To First 50 Degrees Bend, 5mm To Second 10 Degrees Bend, 4mm From Tip To Hub, Overall Length Of 5/8"(14mm). Overall Weight 0.1 oz

5-1255-30

Drews Cystotome

20 Gauge Cannula Shaft With Polished Finish And Sharp Tip, 10mm From Tip To First 50 Degrees Bend, 5mm To Second 10 Degrees Bend, 4mm From Tip To Hub, Overall Length Of 5/8"(14mm). Overall Weight 0.1 oz

5-1256

Kelman Cystotome

22 Gauge Irrigating Cystotome With Sharp Tip And Double-Bladed. Overall Weight 0.1 oz

5-1257

Kratz Cystotome

22 Gauge Cannula Shaft With Polished Finish And Sharp Tip, Shaft Angled 60 Degrees, 12mm From Angle To Tip, Overall Length Of 1/2"(13mm). Overall Weight 0.1 oz



5-1259

Lieppman Cystotome With Cystotome Guard

22 Gauge Cannula Shaft With Polished Finish And Small Cutting Tip, Supplied With Tip Guard, Overall Length Of 1 5/8" (4.2cm). Overall Weight 0.1 oz

11-8-5751

Double Edge Bladed Cystotome

22 Gauge Small

11-8-5753

Double Edge Bladed Cystotome

22 Gauge Micro





11-8-5771

Knolle-Kelman Cystotome

22 Gauge Straight, Overall Length Of 1 1/4" (33mm). Overall Weight 0.1 oz



11-8-5791

McIntyre Cystotome

23 Gauge Angled, Overall Length Of 5/8" (17mm). Overall Weight 0.1 oz

Cannulas



5-1619

Kratz Capsule Scraper

23 Gauge Cannula With Polished Finish And Angled 1mm Sandblasted Tip, And Overall Length Of 3/4" (2cm). Overall Weight 0.1 oz

5-1619-ED

Kratz Capsule Scraper

23 Gauge Cannula With Polished Finish And Angled 1mm Electro-Dusted Tip, Working Length Of 3/4"(21mm) Overall Length Of 1 7/8" (3.6cm), Overall Weight 0.1 oz

5-1619-D

Kratz Capsule Scraper

23 Gauge Cannula With Polished Finish, 1mm Angled Diamond Dusted Tip, Working Length 3/4" (21mm) Overall Length Of 1 7/8" (3.6cm), Overall Weight 0.1 oz



11-8-5011

Kratz Scratcher

22 Gauge SandBlasted, Overall Length Of 3/4" (20mm), Overall Weight 0.1 oz



11-8-5031

Jensen Capsule Polisher

25 Gauge Curved, Overall Length Of 1 1/8" (28mm), Overall Weight 0.1 oz



11-8-5041

Jensen Capsule Polisher

23 Gauge, Overall Length Of 1 1/8" (28mm), Overall Weight 0.1 oz



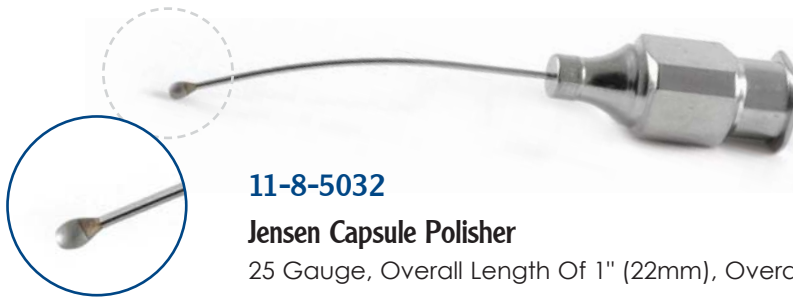

11-8-5032

Jensen Capsule Polisher

25 Gauge, Overall Length Of 1" (22mm), Overall Weight 0.1 oz

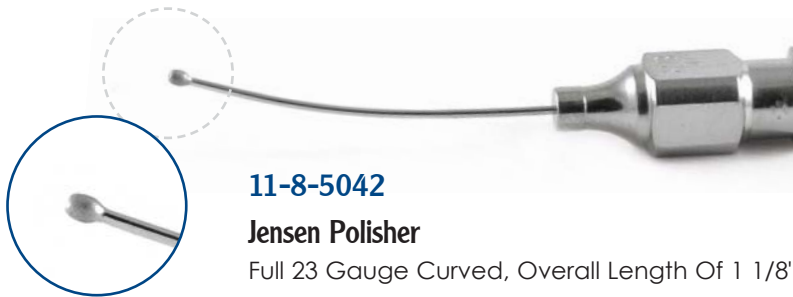

11-8-5042

Jensen Polisher

Full 23 Gauge Curved, Overall Length Of 1 1/8" (27mm), Overall Weight 0.1 oz

5-1622-D

Jensen Capsule Polisher

27 Gauge Cannula With Polished Finish, Gently Curved Shaft, Olive Tip With Lower Half Diamond Dusted, Overall Length Of 1 1/8"(27mm). Overall Weight 0.1 oz



5-1622-ED

Jensen Capsule Polisher

27 Gauge Cannula With Polished Finish, Gently Curved Shaft And Electro-Dusted Lower Half Of Olive Tip, Overall Length Of 1 3/4" (4.5cm). Overall Weight 0.1 oz



11-8-5051

Knolle Capsule Polisher

30 Gauge, Overall Length Of 3/4" (20mm). Overall Weight 0.1 oz

Cannulas



11-8-5061

Knolle Capsule Polisher

23 Gauge, Overall Length Of 3/4" (20mm). Overall Weight 0.1 oz



5-5070-R

Simcoe Posterior Capsule Scrubber

23 Gauge Cannula With Polished Finish, Curved Shaft, Overall Length Of 1 1/8" (3cm). Overall Weight 0.1 oz

5-1624

Freeman Posterior Capsule Polisher "Tennessee" Polisher

19 Gauge Cannula With Polished Finish, Flattened Angled 12mm Tip, 4mm Sandblasted Tip With Irrigating Holes On Tip And Sides, And Overall Length 1 1/4"(32mm). Overall Weight 0.1 oz

11-8-5017

Shapiro Capsule Polisher

23 Gauge Curved With Two 0.3mm Side Port Carbide Impregnated Tip, Overall Weight 0.1 oz

11-8-5013

Rubman-Katzin Capsule Polisher

22 Gauge Curved With Side Port Positioned In The Curved With Carbide Impregnated With A Smooth Closed End, Overall Weight 0.1 oz



11-8-5961

Shammas Irrigating Polisher-Curette

Overall Length Of 1" (25mm), Overall Weight 0.1 oz

5-1633

Drews Capsule Polisher

25 Gauge Cannula With Polished Finish, 2 1/2 Diameter Angled Ring With Port On Inside At 6 o'clock, Sandblasted





11-8-5991

Kraff Capsule Polish Curette

Curved Overall Length Of 1 1/8" (28mm). Overall Weight 0.1 oz

11-8-5993

Capsule Polish Curette

25GA. Overall Weight 0.1 oz

Cannulas



5-1726

Sheets Irrigating Vectus

21 Gauge Thin Wall Shaft With Polished Finish, 6mm Wide X 9mm Long Loop, Three Irrigating Ports At 12, 9, And 3 o'clock, Serrations On Top Of Vectus, Overall Length Of 1 1/4" (3.2cm). Overall Weight 0.1 oz

5-1742

Knolle-Pearce Irrigating Lens Loop

23 Gauge Thin Wall Shaft With Polished Finish, 6mm Wide X 9mm Long Loop, Three Irrigating Ports At 12, 10, And 2 o'clock, And Tip To Hub Overall Length Of 1 1/2"

5-1743

Clayman-Knolle Irrigating Lens Loop

24 Gauge Thin Wall Shaft With Polished Finish, 6mm Wide X 9mm Long Loop, Three Irrigating Ports At 12, 10, And 2 o'clock, And Tip To Hub Overall Length Of 1 1/2" (38mm)

5-1744

Drews-Knolle Reverse Irrigating Vectus

23 Gauge Thin Wall Shaft With Polished Finish, 6mm Wide X 9mm Long Loop, Three Irrigating Ports At 12, 10, And 2 o'clock, And Tip To Hub Overall Length Of 1 1/2"

5-1745

Anis Irrigating Vectus

Polished Finish, Two Irrigating Ports, 5mm Wide X 7mm Long 26 Gauge Loop, Dimple At Top Of Loop, Overall Length 1 3/4" (46mm)

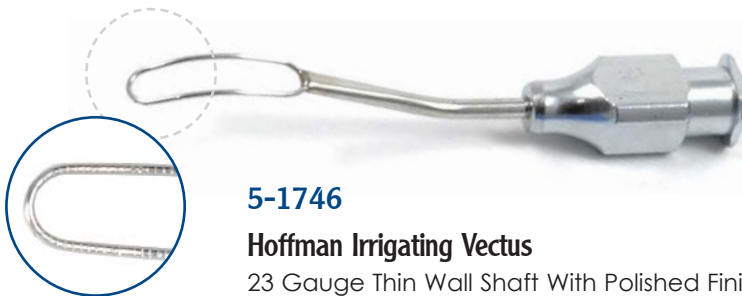

5-1746

Hoffman Irrigating Vectus

23 Gauge Thin Wall Shaft With Polished Finish, 6mm Wide X 9mm Long Loop, And Three Irrigating Ports At 12, 10, And 2 o'clock, And Tip To Hub Overall Length Of 2" (5.1cm). Overall Weight 0.1 oz





132219-2133

Infusion Handle

Delron Male To Female Connector 7.5cm Overall Length

11-8-7861

McIntyre Handpiece

Aspirating Or Irrigating Handpiece, Luer Connector, 8mm Diameter Handle, And Overall Length Of 3" (76mm)

11-8-7806

Kansas Infusion Handle

7.5cm

11-8-7911

Infusion Handle

Stainless Steel Male To Tubing Connector 11.5cm Overall Length



11-8-7912

Infusion Handle

Stainless Steel Male To Tubing Connector 7.5cm Overall Length



11-8-7916

Infusion Handle

Stainless Steel Male To Male Connector 10.0cm Overall Length



11-8-7917

Infusion Handle

Stainless Steel Male To Female Connector 10.0cm Overall Length

800.322.4674 or 800.633.7283

www.msiprecision.com



3-53

Unlike typical Surgical Instrument Companies -
MSI Precision is the industry leader in offering the highest quality
surgical instruments at significant savings.

If you would like to **Receive**
any of our **Product Catalogs...**

Call Us at
800-633-7283
800-322-4674



or **Fax your order to**
800-699-2839

Bipolar
Disposable
ENT Solutions
Mallets
Neuro / Orthopedic
Ophthalmology
Plastic Surgery
Retractors
Stainless Steel
Trepines

For a Complete List of
Product Catalogs visit our website

www.MSIPrecision.com



800.322.4674 or 800.633.7283

www.msiprecision.com

Surgical Advantage

1-800-948-7994

order@surgicaladvantage.net



MSI Precision

Forceps



Contents

Stainless Steel Bipolar Forceps

	Pages
Adson	4-3
Adson Tissue	4-3
Coaptation	4-6
Coaptation Nadler	4-6
Colibri	4-7
Iris	4-4
Jewelers	4-1
McCullough	4-7
McPherson	4-5
Nadler	4-6
Osher	4-7
Shepard	4-5
Tenzel	4-2

Titanium Bipolar Forceps

	Pages
Coaptation	4-6
Iris	4-9
Jewelers	4-8

Bipolar Cords

	Pages
Disposable	4-11
Reusable	4-11

Sterilization Trays

	Pages
Sterilization Tray	4-11

Forceps

	Pages
Other Forcep Products	5-1



800.322.4674 or 800.633.7283

www.msiprecision.com



122-000

Jewelers Style Bipolar Forcep Straight

With A (High Polished 10mm Long Area) With A Tip Size Of 0.4mm. Overall Length 4" (101.6mm).

122-000-3

Jewelers Style Bipolar Forcep Straight

With A (High Polished 10mm Long Area) With A Tip Size Of 0.3mm. Overall Length 4" (101.6mm). Overall Weight 0.5 oz



122-200

Jewelers Style Bipolar Forcep Straight

Overall Length 4" (101.6mm) Insulated With A (High Polished 10mm Long Area) With A Tip Size Of 0.4mm. Overall Weight 0.6 oz

19-3161-1D

Jewelers Style Bipolar Forcep Straight

Insulated With A (High Polished 10mm Long Area) With A Tip Size Of 0.4mm. Overall Length 4.7" (119.38mm)

417827C

Jewelers Style Bipolar Forcep #5 Straight

Overall Length 4 3/4" (120.65mm) With A (High Polished 10mm Long Area) With A Tip Size 0.5mm. Overall Weight 0.6 oz



122-100

Jewelers Style Bipolar Forcep Curved In

Overall Length 4" (101.6mm) With A (High Polished 10mm Long Area) With A Tip Size Of 0.4mm And Both Tips Angled In 15 Degrees Towards Each Other



122-100-3

Jewelers Style Bipolar Forcep Curved In

Overall Length 4" (101.6mm) With A (High Polished 10mm Long Area) With A Tip Size Of 0.3mm And Both Tips Angled In 15 Degrees Towards Each Other. Overall Weight 0.5 oz

Bipolar Forceps



122-150

Jewellers Style Bipolar Forcep Angled

Overall Length 4" (101.6mm) With A (High Polished 10mm Long Area) With A Tip Size Of 0.4mm And Both Tips Angled 45 Degrees.



122-250

Jewellers Style Bipolar Forcep Angled

Overall Length 4" (101.6mm) Insulated With A (High Polished 10mm Long Area) With A Tip Size (0.4mm) And Both Tips Angled 45 Degrees



122-300

Tenzel Style Bipolar Forcep Straight

Overall Length 4" (101.6mm) With A (High Polished 10mm Long Area) With A Tip Size Of 0.4mm And Both Tips Angled In Towards Each Other With A Spacer Stop To Create A 0.5mm Gap Between Tips. Overall Weight 0.5 oz



122-400

Jewellers Style Bipolar Forcep #7 Curved

Overall Length 4 3/4" (120.65mm) With A (High Polished 10mm Long Area) With A Tip Size Of 0.4mm. Overall Weight 0.6 oz



Bipolar Forceps



122-500

Adson Style Bipolar Forcep

Wide Serrated Handle Overall Length 4 3/4" (120.65mm) With A (High Polished 10mm Long Area) With A Tip Size Of 1.0mm. Overall Weight 0.8 oz



122-500-1.5

Adson Style Bipolar Forcep

Wide Serrated Handle Overall Length 4 3/4" (120.65mm) With A (High Polished 10mm Long Area) With A Tip Size Of 1.5mm. Overall Weight 0.8 oz



19-3161-11

Adson Style Bipolar Forcep

Wide Serrated Handle Overall Length 4 3/4" (120.65mm) With A (High Polished 10mm Long Area) With A Tip Size Of 1.0mm, Inside Jaws Is Serrated.



122-600

Adson Style Bipolar Forcep

Wide Serrated Handle Overall Length 4 3/4" (120.65mm) Insulated With A (High Polished 10mm Long Area) With A Tip Size Of 1.0mm

122-650

Adson Tissue Style Bipolar Forcep

Wide Serrated Handle Overall Length 4 3/4" (120.65mm) Insulated With A (High Polished 10mm Long Area) With 1 x 2 Teeth.

800.322.4674 or 800.633.7283

www.msiprecision.com

4-3



Bipolar Forceps



19-3161-11D

Adson Style Bipolar Forcep

Wide Serrated Handle Overall Length 4 3/4" (120.65mm) Insulated With A (High Polished 10mm Long Area) With A Tip Size Of 1.0mm, Inside Jaws Is Serrated



320-800

Iris Style Bipolar Forcep Straight

Overall Length 3 1/2" (88.9mm) With A (High Polished 10mm Long Area) With A Tip Size Of 0.4mm. Overall Weight 0.4 oz

912317C

Iris Style Bipolar Forcep Straight

Overall Length 3 5/8" (92.08mm) With A (High Polished 10mm Long Area) With A Tip Size Of 0.6mm. Overall Weight 0.4 oz



320-850

Iris Style Bipolar Forcep Straight

Overall Length 3 1/2" (88.9mm) Insulated With A (High Polished 10mm Long Area) With A Tip Size Of 0.4mm. Overall Weight 0.4 oz



320-900

Iris Style Bipolar Forcep Angled

Overall Length 3 1/2" (88.9mm) With A (High Polished 10mm Long Area) With A Tip Size Of 0.4mm Tip Is Angled 45 Degrees. Overall Weight 0.4 oz

912318C

Iris Style Bipolar Forcep Curved

Overall Length 3 5/8" (92.08mm) With A (High Polished 10mm Long Area) With A Tip Size Of 0.6mm. Overall Weight 0.4 oz



Bipolar Forceps



320-950

Iris Style Bipolar Forcep Angled

Overall Length 3 1/2" (88.9mm) Insulated With A (High Polished 10mm Long Area) With A Tip Size Of 0.4mm Tip Is Angled 45 Degrees.

912315C

Jewelers Style Bipolar Forcep Straight

Overall Length 3 5/8" (92.08mm) With A (High Polished 10mm Long Area) With A 0.5mm Angled Tips. Overall Weight 0.4 oz



19-3161-10A

Mcpherson Style Bipolar Forcep Angled

Angled 3 1/2" (88.9mm) With A (High Polished 10mm Long Area) With A Tip Size Of 0.5mm And 4mm Tying Platforms, Tip Is Angled 45 Degrees.



19-3161-10S

Mcpherson Style Bipolar Forcep Straight

Straight 3 1/2" (88.9mm) With A (High Polished 10mm Long Area) With A Tip Size Of 0.5mm And 4mm Tying Platforms. Overall Weight 0.4 oz

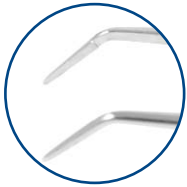

19-3161-14A

Shepard Style Bipolar Forcep Angled

Angled 4 1/2" (114.3mm) With A (High Polished 10mm Long Area) With A Tip Size Of 0.5mm And 4mm Tying Platforms, Tip Is Angled 45 Degrees. Overall Weight 0.6 oz



19-3161-14S

Shepard Style Bipolar Forcep Straight

Straight 4 1/2" (114.3mm) With A (High Polished 10mm Long Area) With A Tip Size Of 0.5mm And 4mm Tying Platforms. Overall Weight 0.5 oz

800.322.4674 or 800.633.7283

www.msiprecision.com

4-5



Bipolar Forceps



321-120

Nadler Style Coaptation Bipolar Forcep

With Removable Spacer Stop Overall Length 4 1/4" (107.95mm) With A (High Polished 10mm Long Area) With A Tip Size Of 0.2mm. Overall Weight 0.5 oz

912310C

Nadler Style Coaptation Straight Bipolar Forcep

Overall Length 4" (101.60mm) With A (High Polished 10mm Long Area) With A Tip Size Of 0.25mm. Overall Weight 0.5 oz

321-140 (Shown)

Nadler Style Coaptation Bipolar Forcep

With Removable Spacer Stop Overall Length 4 1/4" (107.95mm) With A (High Polished 10mm Long Area) With A Tip Size Of 0.4mm. Overall Weight 0.5 oz

321-150

Nadler Style Coaptation Bipolar Forcep

With Removable Spacer Stop Overall Length 4 1/4" (107.95mm) With A (High Polished 10mm Long Area) With A Tip Size Of 0.5mm. Overall Weight 0.5 oz



321-020

Precision Style Coaptation Bipolar Forcep

Overall Length 4 1/4" (107.95mm) With A (High Polished 10mm Long Area) With A Tip Size Of 0.2mm, Tip Length From Bend To Tip Is 3mm Long. Overall Weight 0.5 oz

321-030

Precision Style Coaptation Bipolar Forcep

Overall Length 4 1/4" (107.95mm) With A (High Polished 10mm Long Area) With A Tip Size Of 0.3mm, Tip Length From Bend To Tip Is 3mm Long.

321-040

Precision Style Coaptation Bipolar Forcep

Overall Length 4 1/4" (107.95mm) With A (High Polished 10mm Long Area) With A Tip Size Of 0.4mm, Tip Length From Bend To Tip Is 3mm Long. Overall Weight 0.5 oz

321-050

Precision Style Coaptation Bipolar Forcep

Overall Length 4 1/4" (107.95mm) With A (High Polished 10mm Long Area) With A Tip Size Of 0.5mm, Tip Length From Bend To Tip Is 3mm Long. Overall Weight 0.5 oz

19-3161-9

Coaptation Bipolar Forcep Curved

With A Wide Serrated Handle Overall Length 4 3/5" (117mm) With A (High Polished 10mm Long Area) With A Tip Size Of 0.4mm And 3.5mm Tying Platforms. Overall Weight 0.5 oz





321-220

Precision Style Coaptation Bipolar Forcep

Overall Length 4 1/4" (107.95mm) With A (High Polished 10mm Long Area) With A Tip Size Of 0.2mm, Tip Length From Bend To Tip Is 2mm Long. Overall Weight 0.5 oz

321-240 (Shown)

Precision Style Coaptation Bipolar Forcep

Overall Length 4 1/4" (107.95mm) With A (High Polished 10mm Long Area) With A Tip Size Of 0.4mm, Tip Length From Bend To Tip Is 2mm Long. Overall Weight 0.5 oz

321-250

Precision Style Coaptation Bipolar Forcep

Overall Length 4 1/4" (107.95mm) With A (High Polished 10mm Long Area) With A Tip Size Of 0.5mm, Tip Length From Bend To Tip Is 2mm Long. Overall Weight 0.5 oz

19-3161-15

Osher Style Coaptation Bipolar Forcep

Overall Length 4 1/2" (114.3mm) With A (High Polished 10mm Long Area) With A Tip Size Of 0.4mm, Tip Length From Bend To Tip Is 2mm. Overall Weight 0.5 oz



19-3161-13

Cozean Style Colibri Bipolar Forcep

Overall Length 3 3/8" (85.73mm) With A (High Polished 10mm Long Area) With A 1.5mm Angled Tip With 0.12mm Teeth. Overall Weight 0.4 oz



19-3161-16

McCullough Style Jewelers Bipolar Forcep Straight

Overall Length 4 1/2" (114.3mm) With A (High Polished 10mm Long Area) With A Rounded Tip Size Of 1.0mm. Overall Weight 0.5 oz

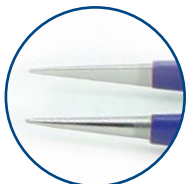

19-3161-16I

McCullough Style Jewelers Bipolar Forcep Straight

Overall Length 4 1/2" (114.3mm) Insulated With A (High Polished 10mm Long Area) With A Rounded Tip Size Of 1.0mm.

Bipolar Forceps

Pencils Super Reusable / Titanium Forceps



421-100

Reusable Bipolar Pencil

18 Gauge Straight Tip

421-120

Reusable Bipolar Pencil

18 Gauge With Wide Tip Curved 45 Degrees

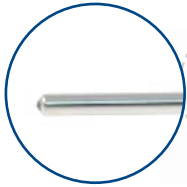

421-140

Reusable Bipolar Pencil

20 Gauge With Straight Tip. Overall Weight 0.3 oz

421-160

Reusable Bipolar Pencil

23 gauge With Tapered Sharp Tip. Overall Weight 0.3 oz

421-170

Reusable Bipolar Pencil

23 Gauge With Tapered Blunt Tip.

421-180

Reusable Bipolar Pencil

18 Gauge With Wide Tip



520-100

Blue Titanium Jewelers Bipolar Forcep

3 1/2" (88.9mm) With A (High Polished Gold 10mm Long Area) With A 0.4mm Tip
30 Degree Angled. Overall Weight 0.3 oz



520-200

Blue Titanium Jewelers Bipolar Forcep Curved

3 1/2" (88.9mm) With A (High Polished Gold 10mm Long Area) With A 0.4mm Tip
Curved In. Overall Weight 0.3 oz



Bipolar Forceps

Titanium Forceps



520-300

Blue Titanium Jewelers Bipolar Forcep Straight

3 1/2" (88.9mm) With A (High Polished Gold 10mm Long Area) With A 0.4mm Tip Straight. Overall Weight 0.3 oz

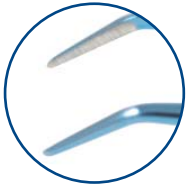

520-400

Blue Titanium Iris Angled Bipolar Forcep

3 3/4" (95.25mm) With A (High Polished Gold 10mm Long Area) With A 0.5mm Tip. Overall Weight 0.3 oz

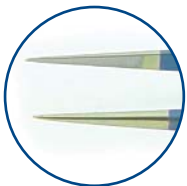

520-500

Blue Titanium Jewelers Angled Bipolar Forcep

Angled 15 Degree 3 3/4" (95.25mm) With A (High Polished Gold 10mm Long Area) With A 0.4mm Tip.



520-600

Blue Titanium Coaptation Bipolar Forcep

4" (101.6mm) With A (High Polished Gold 10mm Long Area) With A 0.5mm Tip. Overall Weight 0.3 oz



520-700

Blue Titanium Jewelers Bipolar Forcep Straight

Wide Serrated Handle Straight Overall Length 4 3/4" (120.65mm) With A (High Polished Gold 10mm Long Area) With A 0.4mm Straight Tip. Overall Weight 0.5 oz

800.322.4674 or 800.633.7283

www.msiprecision.com



4-9

Bipolar Forceps

Titanium Forceps

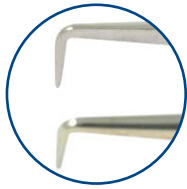

520-800

Blue Titanium Jewelers Bipolar Forcep

4 1/4" (107.95mm) With A (High Polished Gold 10mm Long Area) With A 0.4mm Tip
90 Degree Angled. Overall Weight 0.3 oz



520-900

Blue Titanium Jewelers Bipolar Forcep

4 1/4" (107.95mm) With A (High Polished Gold 10mm Long Area) With A 0.4mm.
Overall Weight 0.3 oz

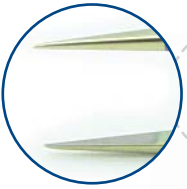

521-000

Blue Titanium Jewelers Bipolar Forcep

With Fine Serrations 4 3/4" (120.65mm) With A (High Polished Gold 10mm Long
Area) With A 0.4mm Tip.



521-100

Blue Titanium Jewelers Bipolar Forcep

4 1/2" (114.3mm) With A (High Polished Gold 10mm Long Area) With A 0.4mm
Reversed Tip. Overall Weight 0.3 oz

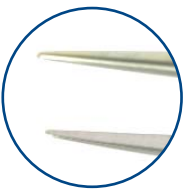

521-200

Blue Titanium Jewelers Bipolar Forcep

4 1/2" (114.3mm) With A (High Polished Gold 10mm Long Area) With A 0.4mm.
Overall Weight 0.3 oz



Bipolar Forceps

Bipolar Cords / Sterilization Tray

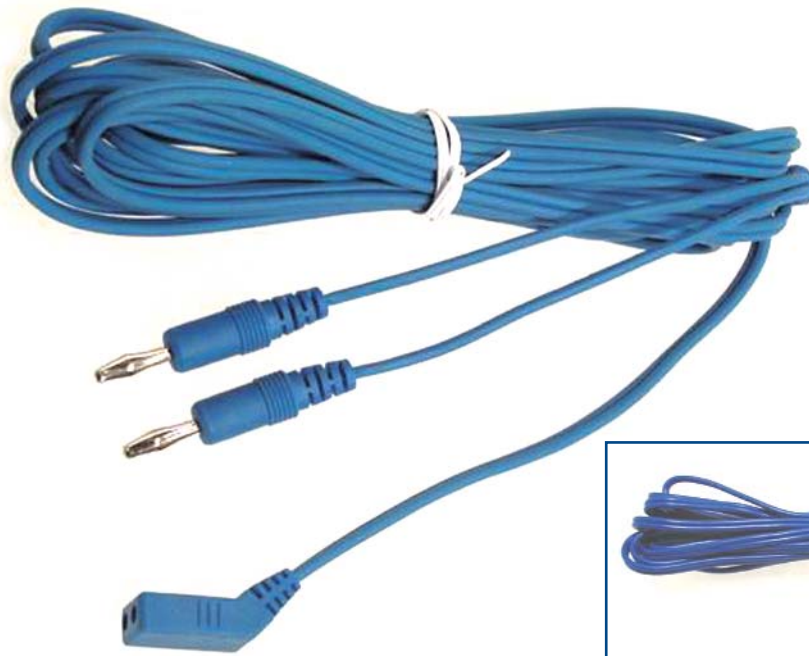

Bipolar Cords

201102

Disposable Bipolar Cord Blue
10 Sterile Cords Per Box

201103

Reusable Bipolar Cord Blue Angled Instrument End
1 Non-Sterile Cords Per Box

201103-3

Reusable Blue Bipolar Cord
With Angled Instrument End Sold Non-Sterile 3 Per Package

Bipolar Sterilization Tray

T-4000

Bipolar Forcep Sterilization Tray With Lid
Holds 6 Forceps. Dimensions 9 5/8" x 5 1/8" x 1"
For Both Titan And MSi

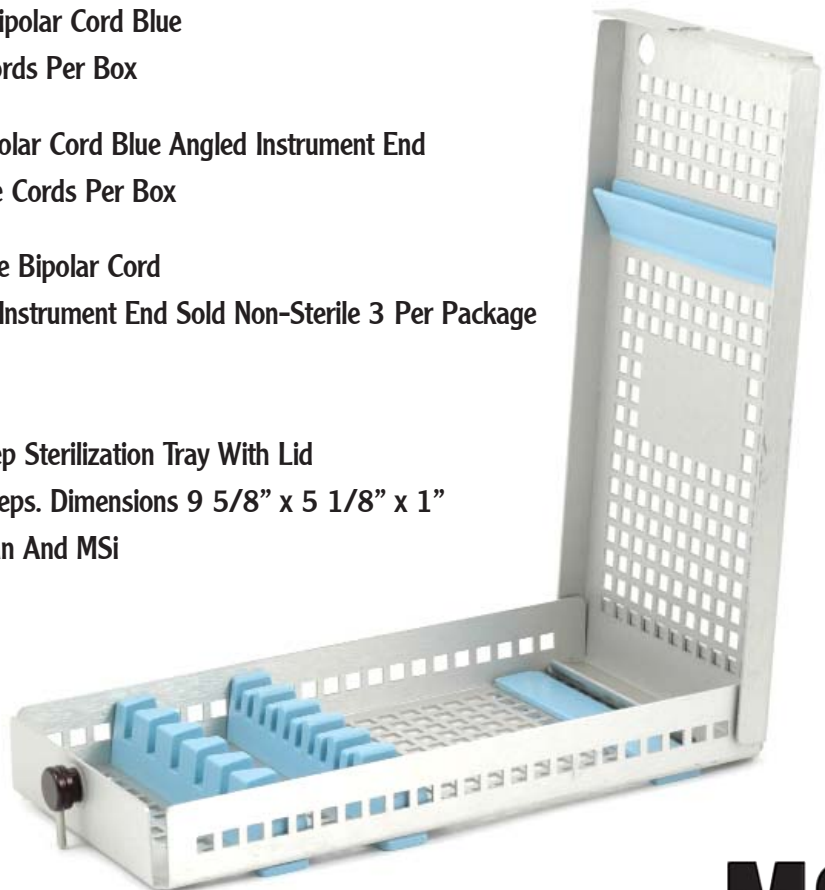

800.322.4674 or 800.633.7283

www.msiprecision.com

4-11



Contents

Forceps	Pages
Suture	5-1
Fixation	5-11
Capsulorhexis	5-17
Colibri	5-23
Tying	5-31
Pierse	5-42
Nucleus Cracker	5-43
Capsule	5-43
Dressing	5-44
Tissue	5-47
Jewelers	5-51
Chalazion	5-54
Muscle	5-57
Cilia	5-60
Muscle Clamps	5-62
Utility	5-63
Hemostat	5-65
Iris	5-67
IOL	5-68
Retinal	5-71
Foreign Body	5-72
Miscellaneous	5-73



800.322.4674 or 800.633.7283

www.msiprecision.com

TDK-3-221

Titanium Flat Handled Square Grip Suture Forcep

Straight 0.12mm 1 x 2 Teeth 6mm Platforms, Overall Length 85mm

TDK-3-221-1

Titanium Flat Handled Square Grip Suture Forcep

Straight 0.10mm 1 x 2 Teeth 6mm Platforms, Overall Length 85mm



TDK-3-222

Titanium Flat Handled Square Grip Suture Forcep

Curved 0.12mm 1 x 2 Teeth 6mm Platforms, Overall Length 83.5mm

TDK-3-224

Titanium Flat Handled Square Grip Suture Forcep

Curved 0.12mm 1 x 2 Teeth 6mm Platforms, Overall Length 113.5mm

TDK-3-225

Titanium Flat Handled Square Grip Suture Forcep

Straight 0.12mm 1 x 2 Teeth 6mm Platforms, Overall Length 115mm

TDK-3-227

Titanium Flat Handled Square Grip Suture Forcep

Straight 0.3mm 1 x 2 Teeth 6mm Platforms, Overall Length 115mm

TDK-3-228

Titanium Flat Handled Square Grip Suture Forcep

Straight 0.3mm 1 x 2 Teeth 6mm Platforms, Overall Length 115mm

TDK-3-253

Titanium Flat Handled Square Grip Suture Forcep

Angled 45 Degrees 0.12mm 1 x 2 Teeth 6mm Platforms 7mm Bend To Tip, Overall Length 82mm

Forceps

Suture

TDK-3-255

Titanium Flat Handled Square Grip Suture Forcep

Angled 45 Degrees 0.12mm 1 x 2 Teeth 6mm Platforms 10mm Bend To Tip, Overall Length 82mm

TDK-3-259

Titanium Flat Handled Square Grip Suture Forcep

Angled 45 Degrees 0.12mm 1 x 2 Teeth 6mm Platforms 10mm Bend To Tip, Overall Length 111mm

TDK-3-268

Titanium Flat Handled Square Grip Suture Forcep

Angled 45 Degrees 0.12mm 1 x 2 Teeth 6mm Platforms 7mm Bend To Tip, Overall Length 112mm

5-2894

Castroviejo Suturing Forcep

Wide Serrated Handle With Polished Finish, Bayonet Shafts, 0.3mm Teeth, 6mm Tying Platform, And Overall Length Of 4 1/4" (106mm)



5-2896

Castroviejo Suturing Forcep

Castroviejo Suturing Forcep, Wide Serrated Handle With Polished Finish, Bayonet Shafts, 0.5mm Teeth, And 6mm Tying Platform, And Overall Length Of 4 1/4" (11cm)



5-2899

Castroviejo Suturing Forcep

Castroviejo Suturing Forcep, Wide Serrated Handle With Polished Finish, 40 Degree Angled Shafts, 0.3mm Teeth, 6mm Tying Platform, And Overall Length Of 4 1/8" (10.5cm)





5-2807

Castroviejo Suturing Forcep

Castroviejo Suturing Forcep, Wide Serrated Handle With Polished Finish, Straight Shafts, 0.12mm Teeth, 5.5mm Tying Platform, And Overall Length Of 4 3/8" (11cm). Overall Weight Of 0.5 oz

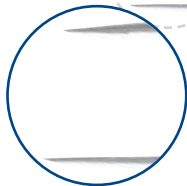

5-2807-S

Sanders-Castroviejo Suturing Forcep

Wide Serrated Handle With Polished Finish, Straight And Heavy Shafts, 0.12mm Teeth, 5.5mm Tying Platform, And Overall Length Of 4 1/4" (11cm). Overall Weight Of 0.4 oz

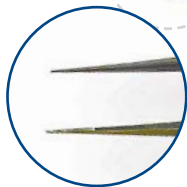

5-2807-T

Castroviejo Suturing Forcep

Titanium, Wide Serrated Handle With Polished Finish, Straight Shafts, 0.12mm Teeth, 5.5mm Tying Platform, And Overall Length Of 4 1/4" (11cm). Overall Weight Of 0.5 oz



11-6-3611

Castroviejo Suturing Forcep

0.12mm 1 x 2 Teeth On A Three-Holed Handle, 20mm Straight Shafts, And An Overall Length Of 4 1/4" (11cm)



11-6-3611-T

Castroviejo Titanium Forcep

Three-holed handle, Straight and Sharp 17mm Shafts, 0.12mm Teeth, And Overall Length Of 4 1/4" (11cm).

Forceps

Suture

11-6-3661

Snider-Castroviejo Suture Forcep

On Three Hole 0.12mm 1 x 2 Teeth With Tying Platform And Guide Pin



5-2808

Castroviejo Suturing Forcep

Wide Serrated Handle With Polished Finish, Straight Shafts, 0.3mm Teeth, 5.5mm Tying Platform, And Overall Length Of 4 3/8" (11cm). Overall Weight Of 0.4 oz



5-2808-T

Castroviejo Suturing Forcep

Wide Serrated Handle With Polished Finish, Straight Shafts, 0.3mm Teeth, 5.5mm Tying Platform, And Overall Length Of 4 1/4" (11cm)



11-6-3621

Castroviejo Suturing Forcep

0.3mm with Three-Holed Handle, 20mm Straight Shafts, 1x2 Teeth, And Overall Length Of 4 1/4" (11cm).



11-6-3621-T

Castroviejo Suturing Forcep

Titanium, 0.3mm with Three-Holed Handle, 20mm Straight Shafts, 1x2 Teeth, And Overall Length Of 4 1/4" (11cm).



5-2809

Castroviejo Suturing Forcep

Wide Serrated Handle With Polished Finish, Straight Shafts, 0.5mm Teeth, 5.5mm Tying Platform, And Overall Length Of 4 3/8" (11cm). Overall Weight Of 0.5 oz



5-2809-T

Castroviejo Suturing Forcep

Titanium, Wide Serrated Handle With Polished Finish, Straight Shafts, 0.5mm Teeth, 5.5mm Tying Platform, And Overall Length Of 4 3/8" (11cm)



11-6-3631

Castroviejo Suturing Forcep

0.5mm with Three-Holed Handle, 20mm Straight Shafts, 1x2 Teeth, Tying Platform, And Overall Length Of 4 1/4" (11cm).

11-6-3631-T

Castroviejo Suturing Forcep

Titanium, 0.5mm with Three-Holed Handle, 20mm Straight Shafts, 1x2 Teeth, Tying Platform, And Overall Length Of 4 1/4" (11cm).



5-2809-S

Stern-Castroviejo Suturing Forcep

Wide Serrated Handle With Thumb Catch Lock And Polished Finish, Straight Shafts, 1 x 2 (0.5mm) Teeth, 6mm Tying Platform, And Overall Length Of 4 1/2" (11.5cm). Overall Weight Of 0.5 oz



11-6-3663

Stern-Castroviejo Suturing Forcep

With Three-Holed Handle, 1 x 2 (0.5mm)Teeth, Tying Platform With Lock, Straight Shafts, And An Overall Length Of 4 1/4" (11cm)



11-6-3641

Castroviejo Suturing Forcep

0.9mm with Three-Holed Handle, 20mm Straight Shafts, 1x2 Teeth, And Overall Length Of 4 1/4" (11cm)

11-6-3211

Thorpe Corneal Fixation Forcep

On A 3 Hold Handle With 0.12mm, 2 x 3 Teeth With 6mm Tying Platform

800.322.4674 or 800.633.7283

www.msiprecision.com

5-5



Forceps



5-2800

Castroviejo Suturing Forcep

Wide Serrated Handle With Polished Finish, Straight Shafts, 1.5mm Teeth, 5.5mm Tying Platform, And Overall Length Of 4 1/2" (11.5cm). Overall Weight Of 0.4 oz



5-2911

Castroviejo Suturing Forcep

Serrated Handle With Polished Finish, Straight Shafts, 0.5mm Teeth, 5.5mm Tying Platform, And Overall Length Of 4 1/4" (10.9cm). Overall Weight Of 0.5 oz

5-2913

Castroviejo Suturing Forcep

Serrated Handle With Polished Finish, Straight Shafts, 0.9mm Teeth, 5.5mm Tying Platform, And Overall Length Of 4 1/4" (10.9cm)

5-2916

Fine-Castroviejo Suturing Forcep

Serrated Handle With Polished Finish, Straight Shafts, 0.22mm Teeth, 5.5mm Tying Platform, And Overall Length Of 4 1/4" (10.9cm)



5-2916-XD

Fine-Castroviejo Suturing Forceps

Serrated Handle With Polished Finish, Straight Shafts, 0.12mm Teeth, 6mm Tying Platform, And Overall Length Of 3 3/4" (9.5cm). Overall Weight Of 0.3 oz

5-2916-XDWH

Fine-Castroviejo Suturing Forcep

Wide Serrated Handle With Polished Finish, Straight Shafts, 0.12mm Teeth, 6mm Tying Platform, And Overall Length Of 4 1/4" (11cm)



5-2917

Fine-Castroviejo Suturing Forcep

Polished Finish, 45 Degree Angled Shafts, 0.5mm Teeth, 6mm Tying Platform, And Overall Length Of 4 1/4" (11cm)



5-2910

Bonn Suturing Forceps

Serrated Handle With Polished Finish, Straight Shafts, 0.12mm Teeth, Tying Platform, And Overall Length Of 3" (8cm)



11-6-3111

Bonn Suture Forcep

Short Fat 3 Hole Handle Design Delicate 1 x 2 Teeth Without Tying Platforms



5-2922

Precision Bonn Suturing Forcep

Serrated Handle With Polished Finish, Straight Shafts, 0.12mm Teeth, 5mm Tying Platform, And Overall Length Of 3 3/4" (9.5cm). Overall Weight Of 0.3 oz



11-6-3131

Bonn Suture Forcep

Long Design, 3 Hole Handle Design, Straight 20mm Shafts, Delicate with 1x2 Teeth, Tying Platforms, And Overall Length Of 4 1/4" (11cm)



Forceps

Suture

5-2924-S

McPherson Straight Suturing-Corneal Forceps

Serrated Handle with Dull Finish, Straight Shafts, 1x2 Teeth, 5mm Tying Platform, Overall Length Of 3 3/8 " (87mm)

11-6-3411

McPherson Straight Suture Forcep

.44 mm On a 3-Hole Handle Design With 5mm Tying Platforms 1 x 2 Teeth



5-2924-A

McPherson Angled Suturing-Corneal Forcep

Serrated Handle With Dull Finish, 45 Degree Angled Shafts, 1 x 2 Teeth, 5mm Tying Platform, And Overall Length Of 3 1/4" (8.3cm). Overall Weight Of 0.2 oz

11-6-3421

McPherson Angled Suture Forcep

On a 3-Hole Handle Design With Tying Platforms 7mm Bend To Tip Angled 45 Degree 0.4mm 1 x 2 Teeth

5-2924-AK

Kelman-McPherson Angled Suturing-Corneal Forcep

Serrated Handle With Dull Finish, 45 degree Angled Shafts 8mm Long, 1 x 2 Teeth, 5mm Tying Platform, And Overall Length Of 3 1/4" (85mm)

11-6-3441

Mcpherson Angled Suture Forcep

On a 3-Hole Handle Design With 6mm Tying Platform 8mm Bend To Tip Angled 45 Degree 0.3mm 1 x 2 Teeth

11-6-3461

Hoeffler Angled Suture Forcep

On a 3-Hole Handle Design With 6mm Tying Platform 11mm Bend To Tip Angled 45 Degree 0.3mm 1 x 2 Teeth



5-2927

Berens Curved Suturing Forcep

Serrated Handle With Polished Finish, Heavy Curved Shafts, 2 X 2 Teeth, Crisscross Serrated 6mm Tying Platforms, And Overall Length Of 4 1/4" (11cm). Overall Weight Of 0.5 oz



5-2935

McCullough Suturing Forcep

Serrated Handle With Polished Finish, Straight Shafts, 6mm Crisscross Serrated Tying Surfaces, And Overall Length Of 3 5/8" (92mm)

5-2939

Precision Fixation / Suture Forcep

1 by 2 Teeth On A Thin Serrated Handle Overall Length 4 3/8"



5-2941

Sauer Suturing Forcep

Wide Serrated Handle With Polished Finish, Straight Shafts, 1 x 2 Teeth, And Overall Length Of 3 3/8" (8.7cm). Overall Weight Of 0.3 oz



5-2942

Sauer Suturing Forcep

Wide Serrated Handle With Polished Finish, Straight Shafts, 1 x 2 Teeth, And Overall Length Of 3 3/8" (8.7cm). Overall Weight Of 0.3 oz



5-2943

ManHattan Eye And Ear Suturing Forcep

Smooth And Wide Handle With Polished Finish, Straight Shafts, 1 x 2 Teeth, 6mm Tying Platform, And Overall Length Of 3 1/2" (9cm). Overall Weight Of 0.3 oz

5-2992-12C

O'Gawa Curved Suture-Fixation Forcep-0.12mm

Round Handle In Closed Position With Polished Finish, Curved Shafts, 5.5mm Tying Platform, 0.3mm Gap At Platform Heel, Tips With 1 x 2 Teeth (0.12mm), And Overall Length Of 4 1/4" (108mm)

Forceps

Suture



5-2992-3S

O'Gawa Suture And Fixation Forcep-0.3mm

Round Handle With Polished Finish, Curved Shafts, 5.5mm Tying Platform, 0.3mm Gap At Platform Heel, Tips With 0.3mm Teeth, And Overall Length Of 4 1/4" (108mm)

5-2992-12S (Shown)

O'Gawa Straight Suture-Fixation Forcep-0.12mm

Round Handle In The Closed Position, Straight Shafts, 5.5mm Tying Platform, 0.3mm Gap At Platform Heel, Tips With 0.12mm Teeth, And Overall Length Of 4 1/4" (10.8cm). Overall Weight Of 0.5 oz

5-2992-S

O'Gawa Straight Suture-Fixation Forcep

Round And Knurled Handle In The Closed Position, Straight Shafts, 5.5mm Tying Platform, 0.3mm Gap At Platform Heel, And Overall Length Of 4 1/4" (108mm)

5-2992-PS

O'Gawa Straight Suture-Fixation Forcep-0.12mm

Round And Knurled Handle In The Closed Position With Polished Finish, Straight Shafts, 5.5mm Tying Platform, 0.3mm Gap At Platform Heel, And Overall Length of 4 1/4" (108mm)



5-2990-S

Paton Suture Forcep

Extra Delicate Straight Sharp Pointed Tips, 4.5mm Tying Jaw, With A Castroviejo Grip Handle, With An Overall Length Of 3 1/2" (9cm). Overall Weight Of 0.4 oz



5-10

800.322.4674 or 800.633.7283

www.msiprecision.com

TDK-3-211

Pierce Titanium Suture Forcep

Flat Handled Square Grip Straight 0.25mm Notched Tip With 6mm Tying Platforms, Overall Length 85mm

TDK-3-212

Pierce Titanium Suture Forcep

Flat Handled Square Grip Curved 0.25mm Notched Tip With 6mm Tying Platforms, Overall Length 85mm

TDK-3-214

Pierce Titanium Suture Forcep

Flat Handled Square Grip Curved 0.25mm Notched Tip With 6mm Tying Platforms, Overall Length 114mm

TDK-3-215

Pierce Titanium Suture Forcep

Flat Handled Square Grip Straight 0.25mm Notched Tip With 6mm Tying Platforms, Overall Length 115mm

TDK-3-217

Precision Rabkin Style Titanium Suture Forcep

Flat Handled Square Grip Straight 0.7mm Notched Tip With 6mm Tying Platforms, Overall Length 115mm



5-2804

Castroviejo Fixation Forcep

Wide Serrated Handle With Polished Finish, Straight Shafts, 1 x 2 (0.3mm) Teeth, And Overall Length Of 4 1/4" (11 cm). Overall Weight Of 0.5 oz



5-2806

Castroviejo Fixation Forcep

Wide Serrated Handle With Polished Finish, Straight Shafts, 1 x 2 (0.5mm) Teeth, And Overall Length Of 4 1/2" (11.5 cm). Overall Weight Of 0.5 oz

Forceps

5-2664

Moody Curved Fixation Forcep

Serrated Handle With Slide Lock And Polished Finish, Curved Shafts, 1 x 2 0.5mm Teeth, And Overall Length Of 4 1/4" (108mm)

11-6-3664

Moody Curved Left Fixation Forcep

On A 3 Hole Handle With Lock And Polished Finish, Curved Shafts, 0.5mm, 1 x 2 Teeth, And Overall Length Of 4 1/4" (108mm)

11-6-3665

Moody Curved Right Fixation Forcep

On A 3 Hole Handle With Lock And Polished Finish, Curved Shafts, 0.5mm, 1 x 2 Teeth, And Overall Length Of 4 1/4" (108mm)

5-2843

Thorpe Corneal Fixation Forcep

Serrated Handle With Polished Finish, Straight Shafts, 45 Degree 2 X 3 (0.12mm) Teeth, Tying Platform, And Overall Length Of 3 3/4" (94mm)

5-2841

Thorpe Conjunctival Fixation Forcep

Serrated Handle With Polished Finish, Straight Shafts, 90 Degree 2 X 3 Teeth, Tying Platform, And Overall Length Of 3 3/4" (94mm)

5-2828

Osher Conjunctival Fixation Forcep

Serrated And Wide Handle With Polished Finish, Straight Shafts, 45 Degree, 1 x 2 (0.3mm) Teeth, 5.5mm Tying Platform, And Overall Length Of 4 1/4" (108mm)

5-2675

Osher 0.12mm Forcep-Elschnig Teeth

Delicate Tying Platform, 1 x 2 (0.12mm) Teeth, And Overall Length Of 4 1/8" (104mm)

5-2912

Thorton Angled Fixation Forcep

With Wide Serrated Handle With Polished Finish, Straight Shafts With 25 Degrees Angled 1.5mm Tips, 4mm Platform With 0.12mm 1 x 2 Teeth, And An Overall Length Of 4.3" (109mm)





5-2835

Iowa State Fixation Forcep

Flat Handle With Polished Finish, Straight Shafts, 1 x 2 Teeth, And Overall Length Of 3 3/8" (8.6cm). Overall Weight Of 0.2 oz



5-2795

Elschnig Fixation Forceps

Serrated And Narrow Handle With Polished Finish, Straight Shafts, 1 x 2 (2.0mm) Elschnig Style Teeth, And Overall Length Of 4 3/8" (11cm) . Overall Weight Of 0.3 oz



5-2796

Elschnig Fixation Forcep

Wide Serrated Handle With Polished Finish, Straight Shafts, 1 x 2 (2mm) Elschnig Style Teeth, And Overall Length Of 4 1/4" (11cm). Overall Weight Of 0.4 oz

5-3367

O'Connor-Elschnig Fixation Forcep

Serrated And Flat Handle With Slide Style Lock And Polished Finish, Straight Shafts, Heavy Elschnig 1 x 2 Teeth, And Overall Length Of 4 1/4" (109mm)

Forceps

Fixation



5-2765

Lester Fixation Forcep

Serrated Handle With Polished Finish, Straight Shafts, Fine 1 x 2 Teeth, And Overall Length Of 3 1/2" (9cm). Overall Weight Of 0.2 oz

5-2767

Lester Fixation Forcep

Serrated Handle With Polished Finish, Straight Shafts, Fine 2 X 3 teeth, And Overall Length Of 3 3/4" (96mm)

5-2731

Kuhnt Fixation Forcep

Serrated Handle With Polished Finish, Straight Shafts, Curved 1 x 2 Teeth, And Overall Length Of 4 1/4" (107mm)



5-2781

Bracken Fixation Forcep

Serrated Handle With Polished Finish, Straight Shafts, Delicate 1 x 2 (0.7mm) Teeth, And Overall Length Of 4 1/4" (11cm). Overall Weight Of 0.3 oz



5-2781-FN

Bracken-Farkas Corneal Forcep

With Neumann Modification, Serrated Handle, Straight Shafts, Delicate 1 x 2 (0.12mm) Teeth, Stabilization Pin, And Overall length Of 4 1/2" (11cm) . Overall Weight Of 0.3 oz

5-2782

Bores Corneal Fixation Forcep

Wide Serrated Handle With Dull Finish, Straight Shafts With Two Point Fixation, Tips Separated By 3mm, Each Tip Has 1 x 2 (0.12mm) Teeth, And Overall Length Of 4 1/4" (110mm)



5-2785

O'Brien Fixation Forcep

Serrated And Wide Handle With Polished Finish, Straight Shafts, 1 x 2 Elschmig Style Teeth, And Overall Length Of 4 1/4" (109mm)



5-2671

Graefe Fixation Forcep

Serrated Handle Without Slide Lock But With Polished Finish, Narrow 3.5mm Jaws, Fine Teeth, And Overall Length Of 4 1/4" (10.9cm). Overall Weight Of 0.3 oz

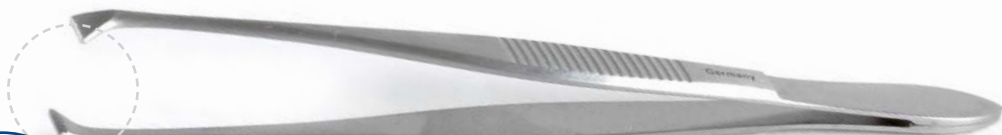

5-2673

Graefe Fixation Forcep

Serrated Handle Without Slide Lock But With Polished Finish, Wide 4.5mm Jaws, Fine Teeth, And Overall Length Of 4 1/4" (108mm)



5-2683

Graefe Fixation Forcep

Serrated Handle With Slide Lock But With Polished Finish, Wide 4.5mm Jaws, Fine Teeth, And Overall Length Of 4 1/4" (108mm)



5-2711

Green Fixation Forcep

Serrated Handle With Polished Finish, Narrow 12mm T-Shaped Jaws, Fine Teeth, And Overall Length Of 4" (10cm). Overall Weight Of 0.5 oz



Forceps

Fixation



5-2715

Green Fixation Forcep

Serrated Handle With Polished Finish, Narrow 5mm T-Shaped Jaws, Fine Teeth, And Overall Length Of 4" (10cm). Overall Weight Of 0.5 oz

5-2731

Kuhnt Fixation Forcep

Serrated Handle With Polished Finish, Straight Shafts, Curved 1 x 2 Teeth, And Overall Length Of 4 1/4" (107mm)

5-2782

Bores Corneal Fixation Forcep

Wide Serrated Handle With Dull Finish, Straight Shafts With Two Point Fixation, Tips Separated By 3mm, Each Tip Has 1 x 2 (0.12mm) Teeth, And Overall Length Of 4 1/4" (110mm)

11-6-4361

Bores Corneal Fixation Forcep

Wide Serrated Handle With Dull Finish, Straight Shafts With Two Point Fixation, Tips Separated By 3mm, Each Tip Has (0..3mm) 1 x 2 Teeth, And Overall Length Of 4 1/4" (110mm)

5-2770

Kremer Fixation Forcep

Serrated And Wide Handle With Slide Lock And Dull Finish, Two Point Fixation, Tips Separated By 13mm, Each Tip Has 1 x 2 0.12mm Teeth, Straight Shafts, And Overall Length Of 4 1/8" (105mm)

5-2770-A

Kremer Angled Fixation Forcep

Serrated And Wide Handle With Slide Lock And Dull Finish, Two Point Fixation, Tips Separated By 13mm, Each Tip Has 1 x 2 (0.12mm) Teeth, Angled Shafts, And Overall Length of 4 1/8" (105mm)



5-16

800.322.4674 or 800.633.7283

www.msiprecision.com



PIU-2

Original Kraff Capsulorhexis Utrata

With An Overall Length Of 4" (10.1cm)



5-3113

Utrata Capsulorhexis Forcep

Flat Handle With Dull Finish, Fine Angled Tips, Angled Shaft, 12mm From Bend To Tip, With Iris Stop, And Overall Length Of 3 1/4" (8.3cm)



5-3113-S

Utrata Capsulorhexis Forcep

Flat Handle With Dull Finish, With Fine Angled Sharp Cystotome Tips, 12mm Angled Shafts With Iris Stop, And Overall Length Of 3 1/4" (80mm)



5-3113-C

Lehner-Utrata Capsulorhexis Forcep

Flat Handle With Dull Finish, Utrata-Like Fine Angled Tips, Gently Curved Shaft, 12mm From Bend To Tip, And Overall Length Of 3 1/4 (8.3cm). Overall Weight Of 0.2 oz



5-3113-G

Precision Gimbel Style Capsulorhexis Forcep

Flat Handle With Dull Finish, Similar In Construction To Utrata Capsulorhexis Forcep, And Overall Length Of 3 1/4" (80mm)

Forceps



5-3113-R

O'Gawa-Utrata Capsulorhexis Forcep

Round Handle With Dull Finish, Fine Angled Tips, Angled Shaft, 12mm From Bend To Tip, And Iris Stop, And Overall Length Of 4" (10cm)



5-3113-RC

Precision Lehner Style Utrata Capsulorhexis Forcep

Round Handle With Dull Finish, Utrata-Like Fine Angled Tips, Gently Curved Shaft, 12mm From Bend To Tip, And Overall length Of 4 3/8" (112mm)



5-3115

Kellan Capsulorhexis Forcep

Round Handle With Dull Finish, Delicate 45 Degree Angled Shaft, 12mm From Bend To Tip Arruga Style Tips, And Overall Length Of 3 7/8" (10cm). Overall Weight Of 0.4 oz

5-3116

Precision Lehner Style Capsulorhexis Forcep

Flat Handle With Dull Finish, Gently Curved Shaft, 2mm Platform, And Overall Length Of 3 1/4" (80mm)



28274M

Lerner Croy Utrata

11.5mm Vaulted Shanks With A Cystotome Tip, Ergonomic Fenestrated Handle

11-6-6181

Precision Style Inamura Capsulorhexis Forcep

On A 3 Hole Spring Handle Design Very Delicate Short Tapered Shanks

11-6-6183

Precision Style Inamura Capsulorhexis Forcep

On A 3 Hole Spring Handle Design Very Delicate Long Tapered Shanks





11-6-6191

Kraff Capsule Tag Forcep

With 3 Hole Handle, Long Extremely Thin Shafts Angled 11mm From Bend To Tip, And An Overall Length Of 4 1/4" (11cm)



11-6-6192

Utrata Capsulorhexis Forcep

With 3 Hole Handle, Long Extremely Thin Shafts Angled 11mm From Bend To Tip, Small Bent Tips, And An Overall Length Of 4" (10cm)



11-6-6192-T

Titanium Utrata Capsulorhexis Forcep

With 3 Hole Handle, Long Extremely Thin Shafts Angled 11mm From Bend To Tip, Small Bent Tips, And An Overall Length Of 4" (10cm)



11-6-6193

Utrata Capsulorhexis Forcep

With Round Handle With Longitudinal Grooves, Long Extremely Thin Shafts Angled 11mm From Bend To Tip, Small Bent Tips, And An Overall Length Of 4" (10cm)

11-6-6193-V

Utrata Capsulorhexis Forcep

With Round Handle With Longitudinal Grooves, Long Extremely Thin Shafts Angled 11mm From Bend To Tip Vaulted, Small Bent Tips, And An Overall Length Of 4" (10cm)

Forceps

11-6-6194

Precision Nevyas Style Utrata Capsulorhexis Forcep

With 3 Hole Handle, Long Extremely Thin Shafts Angled 11mm From Bend To Tip, Small Sharp Cystotome Tips, And An Overall Length Of 4" (10cm)

11-6-6194-T

Titanium Nevyas Capsulorhexis Forcep

On A 3 Hole Handle With Extremely Thin Shafts, 11mm From Tip To Bend, Cystotome Shaped Tips, And An Overall Length Of 4" (10cm)



11-6-6195

Precision Masket Style Utrata Capsulorhexis Forcep

With 3 Hole Handle, Long Extremely Very Delicate Thin Shafts Angled 11mm From Bend To Tip Vaulted, Small Bent Triangular Tips, And An Overall Length Of 4" (10cm)

11-6-6197

Precision Masket Style Utrata Capsulorhexis Forcep

With Round Handle, Long Extremely Very Delicate Thin Shafts Angled 11mm From Bend To Tip Vaulted, Small Bent Triangular Tips, And An Overall Length Of 4" (10cm)

11-6-6199

Precision Jaffe Style Utrata Capsulorhexis Forcep

With 3 Hole Handle, Long Extremely Very Delicate Thin Shafts Angled 11mm From Bend To Tip Small Bent Round Tips, And An Overall Length Of 4" (10cm)

11-6-8722

Titanium Micro Capsulorhexis Forcep

20 Gauge Curved Shaft With Micro Triangular Tips

11-6-8723

Titanium Micro Capsulorhexis Forcep

20 Gauge Straight Shaft With Micro Triangular Tips

11-6-8762

Titanium Micro Capsulorhexis Forcep

23 Gauge Curved Shaft With Micro Grasping Tips



15-5406-ST

Titanium Capsulorhexis Forcep

On A Round Handle With Round Grooves For Grip With Extremely Thin Shanks, 11mm From Tip To Bend, Cystotome Shaped Tips, And An Overall Length Of 4" (10cm)

16-3433-R

Titanium Precision Kershner Style Capsulorhexis Forcep

On A Diamond Knurling Round Handle With Extremely Thin Shanks, 11.5mm From Tip To Bend, Cystotome Shaped Tips, And An Overall Length Of 4" (10cm)

16-3434-R

Titanium Precision Kershner Style Capsulorhexis Forcep

On A Diamond Knurling Round Handle With Extremely Thin Vaulted Shanks, 11.5mm From Tip To Bend, Cystotome Shaped Tips, And An Overall Length Of 4" (10cm)

TDK-3-820

Titanium Utrata Flat Handled Square Grip

With 8.5mm Platforms, 45°angled shafts, 13mm Bend To Tip Overall Length 83mm

TDK-3-820-1

Titanium Utrata Flat Handled Square Grip

With 8.5mm Platforms, 45°angled shafts, 13mm Bend To Tip Overall Length 114mm

TDK-3-814

Titanium Precision Bloomberg Style

Utrata Flat Handled Square Grip Without Platforms, 45°angled shafts, 14mm Bend To Tip Angled 45 Degree Tip (0.12) 1 x 2 Teeth Overall Length 83mm

TDK-3-825

Titanium Utrata

Round Handled Square Grip With 8.5mm Platforms, 45°angled shafts, 13mm Bend To Tip Overall Length 115mm

TDK-3-826

Titanium Precision Bloomberg Pierce Style Utrata

Flat Handled Square Grip Without Platforms, 45°angled shafts, 14mm Bend To Tip Angled 45 Degree Tip (0.25) NotchTeeth Overall Length 84mm

Forceps

Capsulorhexis



TDK-3-827

Titanium Precision Inamura Style Utrata

Flat Spring Handled Square Grip With Cross Action Design Without Platforms, 45° Angled Slightly Curved Shafts, 14mm Bend To Tip Overall Length 105mm

TDK-3-827-R

Titanium Precision Inamura Style Utrata

Round Spring Handled With Cross Action Design Without Platforms, 45° Angled Slightly Curved Shafts, 14mm Bend To Tip Overall Length 126mm

TDK-3-829

Titanium Utrata

Flat Handled Square Grip With 8.5mm Platforms, 45°Angled Curved Shafts, 13mm Bend To Tip Overall Length 83mm



5-22

800.322.4674 or 800.633.7283

www.msiprecision.com

TDK-3-243

Titanium Troutman Barraquer Colibri Forcep

Flat Handled Square Grip (.12mm) 1 x 2 Teeth 6mm Platforms, 2.0mm Tip Length, Overall Length 84mm

TDK-3-246

Titanium Troutman Barraquer Colibri Forcep

Flat Handled Square Grip (.12mm) 1 x 2 Teeth 6mm Platforms, 2.0mm Tip Length, Overall Length 115mm

TDK-3-554

Titanium Precision Nordan Style Colibri Forcep

Round Handled With Small Flat Grip (.12mm) 1 x 2 Teeth 6mm Platforms, 2.0mm Tip Length, Overall Length 115mm

TDK-3-241

Titanium Precision Pierse Style Colibri

Flat Handled Square Grip, With 6.0mm Tying Platforms, 45°angled shafts Angled 45 Degree Tip (0.25) Notch Teeth 2.0mm Tip Length Overall Length 84mm

TDK-3-247

Titanium Precision Pierse Style Colibri

Flat Handled Square Grip, With 6.0mm Tying Platforms, 45°angled shafts Angled 45 Degree Tip (0.25) Notch Teeth 2.0mm Tip Length Overall Length 115mm



5-4200

Troutman-Barraquer Corneal Utility Forcep

Colibri Style, Serrated Handle With Polished Finish, 1 x 2 (0.12mm) Teeth, And Overall Length Of 3" (7.5cm). Overall Weight Of 0.2 oz



5-4201

Katzin-Barraquer Corneal Utility Forcep

Colibri Style, Serrated Handle With Polished Finish, 1 x 2 (0.4mm) Teeth, 7mm Tying Platform, And Overall Length Of 2 7/8" (73mm)

Forceps

Colibri



5-4202

Troutman-Barraquer Corneal Utility Forcep

Colibri Style, Serrated Handle With Polished Finish, 1 x 2 (0.3mm) Teeth, 6mm Tying Platform, And Overall Length Of 2 7/8" (73mm)

5-4315

Harms Corneal Utility Forceps

Colibri Style, Serrated Handle With Polished Finish, 1 x 2 (0.12mm) Teeth Set At 45 Degrees, 4.5mm Tying Platform, And Overall Length Of 2 3/4" (70mm)

11-6-2561

Gills Colibri Forcep

Short Handle Design With 17mm x 5.5mm Finger Grip Cut-Out Very Delicate Fine Sharp Pointed Tips With Tying Platforms Overall Length Of 2.9" (75.6mm)



11-6-2611

Precision Barraquer Style Colibri Forcep

Short Handle Design With 17mm x 5.5mm Finger Grip Cut-Out Very Delicate 1 x 2 (0.12mm) Teeth Without Tying Platforms Overall Length Of 2.9" (75.6mm)



11-6-2631

Precision Harms Style Colibri Forcep

Short Handle Design With 17mm x 5.5mm Finger Grip Cut-Out Very Delicate 1 x 2 (0.12mm) Teeth With Tying Platforms Overall Length Of 2.9" (75.6mm)

11-6-2633

Precision Dyson Style Colibri Forcep

Short Handle Design With 17mm x 5.5mm Finger Grip Cut-Out Very Delicate Short Tip Very Thin Shaft 1 x 2 (0.12mm) Teeth With Tying Platforms Overall Length Of 2.9" (75.6mm)



5-24

800.322.4674 or 800.633.7283

www.msiprecision.com

11-6-2661

Precision Barraquer Style Colibri Forcep

Short Handle Design With 17mm x 5.5mm Finger Grip Cut-Out (0.4mm) 1 x 2 Teeth With Tying Platforms Overall Length Of 2.9" (75.6mm)



5-4316

Precision Corneal Forcep

Colibri Style, Serrated And Wide Handle With Polished Finish, 1 x 2 (0.12mm) Teeth Set At 45 Degrees, 6mm Tying Platform, And Overall Length Of 4" (10.9cm). Overall Weight Of 0.4 oz



11-6-2011

Castroviejo Colibri Forcep

0.12mm With 1 x 2 Teeth, On A Three Hole Handle Design, 1 x 2 (0.12mm) Teeth Set At 45 Degrees, Without Tying Platform, Overall Length Of 4 1/8" (105mm)



11-6-2013

Precision Harms Style Colibri Forcep

0.12mm With 1 x 2 Teeth, On A Three Hole Handle Design, 1 x 2 (0.12mm) Teeth Set At 45 Degrees, With Tying Platform, Overall Length Of 4 1/8" (105mm)



5-4314-12

University Of Kansas Corneal Forcep

Colibri Style, Serrated Handle With Polished Finish, 7mm Tying Platform, 2 x 2 (0.12mm) Teeth Set At 45 Degrees, And Overall Length Of 4 3/8" (11cm). Overall Weight Of 0.4 oz

Forceps

Colibri



5-4314-25

University Of Kansas Corneal Forcep

Colibri Style, Serrated Handle With Polished Finish, 7mm Tying Platform, 2 x 2 (0.25mm) Teeth Set At 45 Degrees, And Overall Length Of 4 1/4" (10.8cm). Overall Weight Of 0.4 oz

11-6-2031

Hyde Corneal Forcep

2x2 Teeth .12

5-4324

Precision Pierse Double Corneal Forcep

Colibri Style, Serrated Handle With Dull Finish, Two 3mm Long Tips Separated 1mm, With 0.2mm Pierse Tips, And Overall Length Of 2 3/4" (71mm)

5-4326

Polack Double Corneal Forcep

Colibri Style, Serrated Handle With Dull Finish, Two 2.75mm Long Tips Separated 1mm, 1 x 2 Teeth, And Overall Length Of 2 3/4" (71mm)

11-6-2671

Precision Polack Double Corneal Forcep

Colibri Style Short Handle Design With 17mm x 5.5mm Finger Grip Cut-Out With Two Tips Spaced 1mm Apart, 1 x 2 (0.12mm) Teeth, Without Tying Platforms Overall Length Of 2.9" (75.6mm)

11-6-2677

Precision Hoffman Polack Double Corneal Forcep

Colibri Style Long 3 Hole Handle Design With Two Tips Spaced 1mm Apart, (0.2mm) 1 x 1 Teeth, Without Tying Platforms Overall Length Of 4 1/8" (105mm)



5-4204

Girard Comeoscleral Forcep

Colibri Style, Round And Knurled Handle With Polished Finish, For Left-Handed Use, 6mm Tying Platform, 1 x 2 (0.12mm) Teeth, And Overall Length Of 4 1/4" (11cm). Overall Weight Of 0.7 oz



5-26

800.322.4674 or 800.633.7283

www.msiprecision.com

5-4205

Girard Corneoscleral Forcep

Colibri Style, Round And Knurled Handle With Polished Finish, For Left-Handed Use, 6mm Tying Platform, 1 x 2 (0.3mm) Teeth, And Overall Length Of 4 1/4" (107mm)



5-4206

Girard Corneoscleral Forcep

Colibri Style, For Right-Handed Use, With Round And Knurled Handle, Polished Finish, 6mm Tying Platform, 1 x 2 (0.12mm) Teeth, And An Overall Length Of 4 1/4" (11cm)

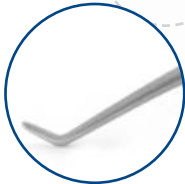

5-4207

O'Gawa Colibri Forcep

Round And Knurled Handle With Polished Finish, Alignment Pin, Colibri Style Tips, 1 x 2 (0.12mm) Teeth, And Overall Length Of 4 1/4" (106mm)



5-4208

Troutman-Barraquer Corneal Utility Forcep

Colibri Style, Serrated Handle With Polished Finish, 6mm Tying Platform, 1 x 2 (0.5mm) Teeth Set At 45 Degrees, And Overall Length Of 2 3/4" (7cm). Overall Weight Of 0.2 oz



5-2429-12

Catalano Corneal Scleral Forcep

Round Handle With Polished Finish, 1 x 2 Teeth, Cross Serrated 5mm 60 Degree Angled With Platforms, And Overall Length Of 4 1/4" (107mm)

5-2429-3

Catalano Corneal Scleral Forcep

Round And Knurled Handle With Dull Finish, 1 x 2 0.3mm Teeth, 5.5mm Tying Platform, And Overall Length Of 4 3/8" (113mm)

Forceps

Colibri



5-4318-45

Maumenee Corneal Forcep

Colibri Style, Serrated Cross Action Handle With Polished Finish, 1 x 2 (0.1mm) Teeth Set At 45 Degrees, 5mm Tying Platform, And Overall Length Of 4 3/4" (121mm)



5-4318-90

Maumenee Corneal Forcep

Colibri Style, Serrated Cross Action Handle With Polished Finish, 1 x 2 (0.1mm) Teeth Set At 90 Degrees, 5mm Tying Platform, 21mm Mid Screw To Tip Length, And Overall Length Of 4 1/2" (11.5cm). Overall Weight Of 0.4 oz



11-6-4111

Maumenee Corneal Forcep

Colibri Style, Cross Action Squeeze Spring 3 Hole Handle Design Very Delicate (0.12mm) 1 x 2 Teeth Set At 90 Degrees, Without Tying Platforms Overall Length Of 4 1/8" (105mm)

5-2427

Kirby Corneoscleral Forcep

Round And Knurled Handle With Polished Finish, 1mm x 2mm Teeth, Cross Serrated 5mm 60 Degree Angled Platform, And Overall Length Of 4 1/4" (107mm)

5-2577

Gill-Hess Iris Forcep

Serrated Handle With Polished Finish, Bayonet Tips, 1 x 2 Teeth, And Overall Length Of 2 3/4" (71mm)



5-2527

Bracken Curved Iris Forcep

Serrated Handle With Polished Finish, Delicate Cross-Serrated Lightly Curved Tips, And Overall Length Of 7/8" (98mm)



5-28

800.322.4674 or 800.633.7283

www.msiprecision.com



5-2535

Curved Iris Forcep

Serrated Handle With Polished Finish, Delicate Lightly Curved Tips, 1 x 2 Mouse Style Teeth, And Overall Length Of 3 7/8" (10cm). Overall Weight Of 0.2 oz

5-2585

Gill Curved Iris Forcep

Serrated Handle With Polished Finish, Curved Shafts, Delicate 1 x 2 Teeth, And Overall Length Of 2 3/4" (72mm)

5-2586

Gill Curved Iris Forcep With Serrations

Serrated Handle With Polished Finish, Delicate Curved Shafts With Light Crisscross Serrations, And Overall Length Of 2 3/4" (72mm)

5-2588

Botvin Iris Forcep

Serrated Handle With Polished Finish, Bayonet Tips, Delicate Crisscross Serrations, And Overall Length Of 2 3/4" (71mm)

11-6-2151

Botvin Iris Forcep Bayonet Design

Short Colibri Style Handle With 17mm x 5.5mm Finger Grip Cut-Out, Bayonet Tips, Delicate Crisscross Serrations, And Overall Length Of 2.9" (75.6mm)

5-2587

Botvin Iris Forcep

Serrated Handle With Polished Finish, Bayonet Tips, Delicate 1 x 2 Teeth, And Overall Length Of 2 3/4" (71mm)

11-6-2161

Botvin Iris Forcep Bayonet Design

Short Colibri Style Handle With 17mm x 5.5mm Finger Grip Cut-Out, Bayonet Tips, Delicate 1 x 2 Teeth, Overall Length Of 2.9" (75.6mm)

5-2594

Graefe Straight Iris Forcep With Serrations

Serrated Handle With Polished Finish, Straight Tips With Delicate Serrations, And Overall Length Of 2 5/8" (67mm)

Forceps

Colibri



5-2595

Graefe Straight Iris Forcep With Teeth

Serrated Handle With Polished Finish, Straight Tips, Fine 1 x 2 Teeth, And Overall Length Of 2 7/8" (7cm)

5-2598

Graefe Curved Iris Forcep

Serrated Handle With Polished Finish, Curved Shafts, Delicate Crisscross Serrations, And Overall Length Of 2 5/8" (66mm)



5-30

800.322.4674 or 800.633.7283

www.msiprecision.com

TDK-3-611

Titanium Flat Handled Square Grip Tying Forcep

Straight 6mm Tying Platforms, Overall Length 3 1/3" (85mm)

TDK-3-612

Titanium Flat Handled Square Grip Tying Forcep

Curved 6mm Tying Platforms, Overall Length 3 1/4" (83mm)



TDK-3-615

Titanium Flat Handled Square Grip Tying Forcep

Straight 6mm Tying Platforms, Overall Length 4 1/2" (115mm)

TDK-3-616

Titanium Flat Handled Square Grip Tying Forcep

Curved 6mm Tying Platforms, Overall Length 4 1/2" (114mm)

TDK-3-616-1

Titanium Flat Handled Square Grip Tying Forcep

Curved Extra Delicate Design 6mm Tying Platforms, Overall Length 4 1/2" (114mm)

TDK-3-631

Titanium Flat Handled Square Grip Tying Forcep

Angled 45 Degees 5mm From Bend To Tip With A 4mm Tying Platforms, Overall Length 3 1/4" (82mm)

TDK-3-633

Titanium Flat Handled Square Grip Tying Forcep

Angled 45 Degees 7mm From Bend To Tip With A 6mm Tying Platforms, Overall Length 3 1/4" (82mm)



TDK-3-635

Titanium Flat Handled Square Grip Tying Forcep

Angled 45 Degees 10mm From Bend To Tip With A 6mm Tying Platforms, Overall Length 3 1/4" (82mm)

TDK-3-635-1

Titanium Flat Handled Square Grip Tying Forcep

Angled 45 Degees 10mm From Bend To Tip With A 10mm Tying Platforms, Overall Length 3 1/4" (82mm)

Forceps

Tying

TDK-3-636

Titanium Flat Handled Square Grip Tying Forcep

Angled 45 Degees 5mm From Bend To Tip With A 4mm Tying Platforms, Overall Length 4 3/8" (112mm)

TDK-3-637

Titanium Flat Handled Square Grip Tying Forcep

Angled 45 Degees 12mm From Bend To Tip With A 6mm Tying Platforms, Overall Length 3 1/4" (82mm)

TDK-3-638

Titanium Flat Handled Square Grip Tying Forcep

Angled 45 Degees 7mm From Bend To Tip With A 6mm Tying Platforms, Overall Length 4 3/8" (112mm)



TDK-3-630

Titanium Flat Handled Square Grip Tying Forcep

Angled 45 Degees 10mm From Bend To Tip With A 6mm Tying Platforms, Overall Length 4 3/8" (112mm)



5-2807-WO

O'Gawa Castroviejo Tying Forcep

Serrated And Wide Handle With Polished Finish, Straight Shafts, 6mm Tying Platform, And Overall Length Of 4 1/4" (11cm). Overall Weight Of 0.4 oz

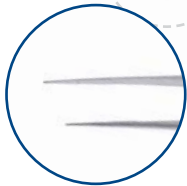

5-2926-S

McPherson Straight Tying Forcep

Serrated Handle with Dull Finish, Straight Shafts, 4mm Tying Platform, And Overall Length Of 3 1/2" (9cm). Overall Weight Of 0.3 oz





11-6-6111

McPherson Tying Forcep

On A Three Hole Handle Design With 18mm Straight Shafts With 5mm Tying Platforms, And An Overall Length Of 4 1/8" (10.5cm)

11-6-6111-T

Titanium McPherson Tying Forcep

On A Three Hole Handle Design With 18mm Straight Shafts With 5mm Tying Platforms, And An Overall Length Of 4 1/8" (10.5cm)



5-2926-A

McPherson Angled Tying Forcep

Serrated Handle With Dull Finish, Angled Shafts, 4mm Tying Platform, And Overall Length Of 3 1/4" (8.3cm). Overall Weight Of 0.2 oz

11-6-6121

McPherson Angled Tying Forcep

On A Three Hole Handle Design With 5mm Tying Platforms, And An Overall Length Of 4 1/8" (10.5cm)

11-6-6121-T

Titanium McPherson Angled Tying Forcep

On A Three Hole Handle Design With 5mm Tying Platforms, And An Overall Length Of 4 1/8" (10.5cm)



5-2926-AK

Kelman-McPherson Angled Tying Forcep

Serrated Handle With Dull Finish, 45 Degree Angled Shafts, 8mm From Tip To Bend, 5mm Tying Platform, And Overall Length Of 3 1/4" (8.3cm). Overall Weight Of 0.3 oz

Forceps

Tying



11-6-6141

McPherson Angled Tying Forcep

On A Three Hole Handle Design With 7.5mm Tying Platforms, And An Overall Length Of 4 1/8" (10.5cm)

11-6-6141-T

Titanium McPherson Angled Tying Forcep

On A Three Hole Handle Design With 7.5mm Tying Platforms, And An Overall Length Of 4 1/8" (10.5cm)



11-6-6141-T-UF

Kelman McPherson Titanium Angled Tying Forcep

Ultra Fine With Three Holed Handle, 8mm From Tip To Bend, And An Overall Length Of 4" (10cm)



5-2926-AB

Bechert-McPherson Angled Tying Forcep

Serrated Handle With Dull Finish, 45 Degree Angled Shafts, 10mm Tying Platforms, And Overall Length Of 3 1/4" (8.3cm). Overall Weight Of 0.2 oz

11-6-6150

Bechert McPherson Angled Tying Forcep

On A Three Hole Handle Design With 10mm Tying Platforms, And An Overall Length Of 4 1/8" (10.5cm)

11-6-6150-T

Titanium Bechert McPherson Angled Tying Forcep

On A Three Hole Handle Design With 10mm Tying Platforms, And An Overall Length Of 4 1/8" (10.5cm)

5-2920

Clayman-McPherson Angled Tying Forcep

Smooth Handle With Dull Finish, 45 Degree Angled Shafts, 8mm From Bend To Tip, 4mm Tying Platforms, And Overall Length Of 3 1/4" (80mm)



5-34

800.322.4674 or 800.633.7283

www.msiprecision.com



5-2918

Sheets-McPherson Angled Tying Forcep

Serrated Handle With Dull Finish, 45 Degree Angled Shafts, 10.5mm Tying Platform, 1mm Of Tip Is Crisscross Serrated, And Overall Length Of 3 1/2" (9cm). Overall Weight Of 0.2 oz



5-2846

MacGregor Conjunctiva Forcep

Serrated Handle With Polished Finish, Straight Shafts, 5.5mm Tying Platform, 1mm Crisscross Serrated Tips, And Overall Length Of 4" (10cm). Overall Weight Of 0.4 oz



5-4203-TS

Girard Tying Forcep

Round And Knurled Handle With Dull Finish, Straight Shafts, 5mm Tying Platform, And Overall Length Of 4" (10.2cm). Overall Weight Of 0.4 oz



5-4203-T

Girard Tying Forcep

Round And Knurled Handle With Dull Finish, Curved Shafts, 5mm Tying Platform, And Overall Length Of 3 7/8" (99mm). Overall Weight Of 0.4 oz



5-4203-FT

Girard Fine Tying Forcep

Round And Knurled Handle, Curved Shafts, Ultra-Fine Tying Platform, And Overall Length Of 3 7/8" (100mm)

Forceps

Tying



5-4203-FTS

Girard Fine Tying Forcep

Round And Knurled Handle, Straight Shafts, Ultra-Fine Tying Platform, And Overall Length Of 4" (10.2cm). Overall Weight Of 0.4 oz



11-6-6331

Tennant Tying Forcep

With Straight 19mm Shafts, With Longitudinal Serrated Handle Design, And An Overall Length Of 4" (10cm)

11-6-6341

Tennant Tying Forcep

With Curved 19mm Shafts, With Longitudinal Serrated Handle Design, And An Overall Length Of 4" (10cm)



5-2992

O'Gawa Curved Tying Forcep

Round And Knurled Handle , With Polished Finish, Curved Shafts, Tips, 5.5mm Tying Platform, 0.3mm Gap At Platform Heel, And Overall Length Of 4 1/8" (10.5cm). Overall Weight Of 0.4 oz

5-2992-S

O'Gawa Straight Tying Forcep

Round And Knurled Handle , Straight Shafts, Tips, 5.5mm Tying Platform, 0.3mm Gap At Platform Heel, And Overall Length Of 4 1/4" (108mm)

5-2967

Catalano Straight Micro Tying Forcep

Round And Knurled Handle With Polished Finish, Straight Shafts, 6mm Tying Platform, Crisscross Serrated Tips, And Overall Length Of 4 1/2" (114mm)

5-2967-C

Catalano Angled Micro Tying Forcep

Round And Knurled Handle With Dull Finish, 45 Degree Angled Shafts, 6mm Tying Platform, Crisscross Serrated Tips, And Overall Length Of 4 3/8" (111mm)



5-36

800.322.4674 or 800.633.7283

www.msiprecision.com



5-2999-S

Harms-Tubingen Straight Tying Forcep

Serrated Handle With Polished Finish, Straight Shafts, 6mm Tying Platform, And Overall Length Of 4" (10cm). Overall Weight Of 0.4 oz



5-2999-C

Harms-Tubingen Curved Tying Forcep

Serrated Handle With Polished Finish, Curved Shafts And Tips, 7mm Tying Platform, And Overall Length Of 4" (10.1cm). Overall Weight Of 0.4 oz



5-2919

Osher Tying Forcep

Serrated And Flat Handle With Dull Finish, Curved Shafts, Tips, 6 1/2 Tying Platform, And Overall Length Of 4" (10cm). Overall Weight Of 0.4 oz



5-2921

Osher Ultra Fine Tying Forcep

Serrated And Flat Handle With Dull Finish, Curved Shafts, Tips, 6.5mm Tying Platform, And Overall Length Of 4" (10cm). Overall Weight Of 0.4 oz



11-6-6511

Harms Straight Tying Forcep

On A Three Hole Handle Design, Straight 23mm Shafts, Overall Length Of 4 1/4" (11cm)

Forceps

Tying



11-6-6521

Harms Curved Tying Forcep

On A Three Hole Handle Design, Curved 20mm Shafts, An Overall Length Of 4" (10cm)



11-6-6311

Jaffe Straight Tying Forcep

On A Three Hole Handle Design, Straight 23mm Shafts, Overall Length Of 4" (10cm)



11-6-6321

Jaffe Curved Tying Forcep

On A Three Hole Handle Design Straight 23mm Shafts, Overall Length Of 4" (10cm)



11-6-6201

Freeman Jaffe Curved Lens Holding Forcep

On A Three Hole Handle Design With Longitudinal Groove In Jaw, Overall Length Of 4" (10cm)



5-2966

Shepard Straight Tying Forcep

Serrated And Wide Handle With Dull Finish, Straight Shafts, 4mm Tying Platform, And Overall Length Of 4 1/4" (111mm). Overall Weight Of 0.4 oz





5-2966-A

Shepard Angled Tying Forcep

Serrated And Wide Handle With Dull Finish, 45 Degree Angled Shafts, Tying Platform, And Overall Length Of 4 1/4" (11cm). Overall Weight Of 0.4 oz



5-2966-C

Shepard Curved Tying Forcep

Serrated And Wide Handle With Dull Finish, Curved Shafts, Tips, 6mm Tying Platform, And Overall Length Of 4 1/4" (11cm). Overall Weight Of 0.4 oz



5-2908

Precision Straight Tying Forcep

Wide Handle With Dull Finish, Straight Shafts, 5mm Tying Platform, And Overall Length Of 4 3/8" (11cm). Overall Weight Of 0.4 oz



5-2936

Sinskey Straight Tying Forcep

Smooth Flat Cross Action Handle With Dull Finish, Straight Fine 7mm Tying Platform, And Overall Length Of 4 3/8" (111mm)

5-2909-CM

Anis Curved Tying Forcep

Round And Knurled Handle With Dull Finish, Curved Delicate 5mm Tying Platforms, And Overall Length Of 4 5/8" (118mm)

Forceps

Tying

11-6-6223

Anis Tying Forcep

Straight, On A Round Spring Handle Straight Smooth Jaw

11-6-6224

Anis Tying Forcep

Curved, On A Round Spring Handle Straight Smooth Jaw



5-2996

Fine Tying Forcep

Serrated And Wide Handle With Dull Finish, Curved Shafts, Tips, Tying Surfaces, And Overall Length Of 4 1/4" (11cm). Overall Weight Of 0.5 oz

11-6-6661

Precision Fine Style Curved Tying Forcep

On A Three Hole Handle Design Overall Length Of 4 1/4" (11cm)

5-2907

Precision Tying Forceps

Round And Knurled Handle With Dull Finish, Straight Shafts, 4mm V-Groove Tying Platform, And Overall Length Of 4 1/4" (108mm)

11-6-6345

Precision Maumenee Style Straight Tying Forcep

On A Round Longitudinal Serrated Handle Design, Inside Jaw Has V Shaped Groove Overall Length Of 4" (10cm)

11-6-6346

Precision Maumenee Style Angled Tying Forcep

On A Round Longitudinal Serrated Handle Design, Inside Jaw Has V Shaped Groove Overall Length Of 4" (10cm)

5-2998

Precision Tying Forcep

Serrated And Wide Handle With Polished Finish, Straight And Heavy Shaft, 7mm Tying Surfaces, And Overall Length Of 4 1/4" (106mm)



5-40

800.322.4674 or 800.633.7283

www.msiprecision.com



5-2995

Puntenney Curved Tying Forcep

Serrated Handle With Polished Finish, Curved Shafts, 12mm Tying Platform, And Overall Length Of 4" (10.2cm)

5-2993

Troutman Tying Forcep

Serrated Cross Action Handle With Polished Finish, Slightly Curved 10mm Jaws, And Overall Length Of 4 5/8" (118mm)

11-6-6167

Kurstin Flap Stretching Forcep

On A 3 Hole Handle

11-6-6169

Buratto Lasik Flap Forcep

On A 3 hole Handle With Serrated Disk Shaped Tips With Curved Shaft

11-6-6171

Mendez Lasik Forcep

On A 3 hole Handle With Spatulated Jaw, Smooth Tips Vaulted Shaft

Forceps

Pierce

5-2053-15

Pierce Type Micro Forcep

Smooth And Flat Handle With Dull Finish, Straight Shafts, Fine Pierce Type Tips, And Overall Length Of 3 3/4" (94mm)

5-2053-16

Pierce Type Micro Forcep

Serrated And Flat Open Handle With Dull Finish, Curved Shafts, Micro Pierce Type Tips, And Overall Length Of 3 3/8" (86mm)

5-2053-18

Pierce Type Fine Skeleton Forcep

Serrated And Flat Open Handle With Dull Finish, Straight Shafts, Fine Pierce Type Tips, And Overall Length Of 3 1/4" (82mm)

5-2053-19

Pierce Type Micro Skeleton Forcep

Serrated And Flat Open Handle With Dull Finish, Straight Shafts, Micro Pierce Type Tips, And Overall Length Of 3 1/4" (82mm)

5-2053-22

Pierce Type Colibri Forcep

Serrated And Flat Open Handle With Dull Finish, Micro Pierce Type Tips, 2mm Angled Colibri Style Jaws, And Overall Length Of 3 1/8" (80mm)

5-2053-30

Pierce Type Colibri Forcep

Serrated And Flat Open Handle With Dull Finish, Mini-Micro Pierce Type Tips, 2mm Angled Colibri Style Jaws, And Overall Length Of 3 1/8" (80mm)

5-2054-15

Pierce Micro Forcep

Straight 0.1mm Pierce Tips Overall Length 3 1/4" (82mm)

5-2054-16

Pierce Colibri Style Micro Forcep

Straight 0.1mm Pierce Tips Overall Length 3 1/4" (82mm)

5-2054-21

Pierce Type Colibri Forcep

Flat And Open Handle With Dull Finish, Colibri Style 0.3mm Pierce Tips, And Overall Length Of 3 1/8" (78mm)

5-2054-22

Pierce Type Colibri Micro Forcep

Flat And Open Handle With Dull Finish, Colibri Style 0.1mm Pierce Tips, And Overall Length Of 3 1/8" (78mm)





16-3446-R

Titanium Salz Nucleus Splitter

Short Colibri Style Handle Squeeze Cross Action Design For Paddles To Be Spread Apart

TDK-3-911

Titanium B Nucleus Cracker

Cross Action Spring Squeeze Square Grip Handle With Two Paddle Tips

5-3188

Osher Capsule-Foreign Body Forcep

Serrated Handle With Dull Finish, Fine 3mm Platform Angled 60 Degrees, 10mm From Angled To Tip, And Overall Length Of 3 1/8" (80mm)



5-4200-GW

Gills-Welsh Capsule Forcep

Colibri Style, Serrated Handle With Polished Finish, Smooth Colibri Tip, And Overall Length Of 2 7/8" (73mm)

5-3139

Castroviejo Curved Capsule Forcep

Serrated Cross Action Handle With Polished Finish, 50 Degree Angled 2.5mm Cups, 10mm From Angle To Tip, And Overall Length Of 4 1/8" (104mm)



5-3134

Arruga Curved Capsule Forcep

Serrated Handle With Polished Finish, 50 Degree Angled 2.5mm Cups, 10mm From Angled To Tip, And Overall Length Of 4 1/4" (106mm)

Forceps

Dressing



5-2511

Straight Dressing Forcep With Serrations

Serrated Handle With Polished Finish, Delicate 11mm Straight Tips, And Overall Length Of 4" (10cm). Overall Length Of 0.3 oz



5-2515

Straight Dressing Forcep With Serrations

Serrated Handle With Polished Finish, Heavy 12mm Straight Tips, And Overall Length Of 3 7/8" (9.9cm). Overall Length Of 0.2 oz



5-2517

Curved Dressing Forcep With Serrations

Serrated Handle With Polished Finish, Gently Curved Delicate Tips, And Overall Length Of 3 7/8" (9.8cm) . Overall Length Of 0.2 oz

5-2519

Curved Dressing Forcep With Serrations

Serrated Handle With Polished Finish, Delicate Strong Curved Serrated Tips, And Overall Length Of 3 3/4" (97mm)



5-2521

Curved Dressing Forcep With Serrations

Serrated Handle With Polished Finish, Gently Curved Heavy Tips, And Overall Length Of 3 7/8" (10cm). Overall Weight Of 0.3 oz



5-44

800.322.4674 or 800.633.7283

www.msiprecision.com



5-2617

Bishop-Harmon Dressing Forcep

Flat Handle With Holes And Polished Finish, Straight Crisscross Serrated Tips, And Overall Length Of 3 3/8" (9cm). Overall Weight Of 0.2 oz



15-11120

Adson Dressing Forcep

4 3/4" Delicate



15-11150

Adson Dressing Forcep

6" Delicate



15-12120

Adson Dressing Forcep

4 3/4" Standard

Forceps

Dressing



15-12150

Adson Dressing Forcep

6" Standard

15-13120

Adson Dressing Forcep

4 3/4" Standard Cross Serrated Jaw

15-14120

Adson Ewald Dressing Forcep

4 3/4" Heavy

15-15120

Micro Adson Dressing Forcep

4 3/4" Very Delicate



15-15150

Micro Adson Dressing Forcep

6" Very Delicate

15-16120

Adson Dressing Forcep

4 3/4" Narrow

86-12120

Adson TC Dressing Forcep

4 3/4" Standard With Tungsten Carbide Inserts

86-12150

Adson TC Dressing Forcep

6" Standard With Tungsten Carbide Inserts



5-46

800.322.4674 or 800.633.7283

www.msiprecision.com



5-2611

Bishop-Harmon Straight Tissue Forcep

Flat Handle With Holes And Polished Finish, Straight Shafts, Fine 1 x 2 Teeth, 0.8mm Tip, With An Overall Length Of 3 3/8" (8.5cm). Overall Weight Of 0.2 oz



5-2613

Bishop-Harmon Straight Tissue Forcep

Flat Handle With Holes And Polished Finish, Straight Shafts, Delicate 1 x 2 Teeth, 0.3mm Tip, And Overall Length Of 3 1/2" (9cm). Overall Weight Of 0.2 oz



5-2611-C

Bishop-Harmon Curved Tissue Forcep

Flat Handle With Holes And Polished Finish, Curved Shafts, Fine 1 x 2 Teeth, And Overall Length of 3 3/8" (8.5cm) 0.8mm Tip. Overall Weight Of 0.2 oz



5-2617

Bishop-Harmon Dressing Forcep

Flat Handle With Holes And Polished Finish, Straight Crisscross Serrated Tips, And Overall Length Of 3 3/8" (9cm). Overall Weight Of 0.2 oz

Forceps

Tissue



5-2531

Straight Tissue Forcep

Serrated Handle With Polished Finish, Straight Shafts, 1 x 2 Delicate Teeth, And Overall Length Of 3 7/8" (10cm). Overall Weight Of 0.2 oz



5-2533

Tissue Forcep

Heavy 1 x 2 Teeth With An Overall Length Of 4 1/8" (10.4cm). Overall Weight Of 0.4 oz

21-14120

Adson Tissue Forcep

1 x 2 Teeth 4 3/4" Delicate

21-14150

Adson Tissue Forcep

1 x 2 Teeth 6" Delicate



21-15120

Adson Tissue Forcep

1x2 Teeth Standard 4 3/4" Overall Length

21-15150

Adson Tissue Forcep

1x2 Teeth Standard 6" Overall Length



5-48

800.322.4674 or 800.633.7283

www.msiprecision.com



21-16120

Adson Tissue Forcep

Serrated With 1 x 2 Teeth And Overall Length Of 4 3/4" (12.1cm)

21-17120

Adson Ewald Tissue Forcep

1 x 2 Teeth 4 3/4" Heavy



21-18120

Adson Ewald Tissue Forcep

2 x 3 Teeth 4 3/4" Heavy

21-18150

Adson Ewald Tissue Forcep

2 x 3 Teeth 6" Heavy



22-10120

Micro Adson Tissue Forcep

1 x 2 Teeth 4 3/4" Delicate

22-10150

Micro Adson Tissue Forcep

1 x 2 Teeth 6" Delicate

22-11120

Adson Tissue Forcep

1 x 2 Teeth 4 3/4" Narrow

Forceps

Tissue



22-13120

Adson Brown Tissue Forcep

With 7 x 7 Teeth Overall Length Of 4 3/4" (12.1cm)

22-14120

Adson Brown Tissue Forcep

With 7 x 7 Teeth Angled Overall Length Of 4 3/4" (12.1cm)



22-15120

Adson Brown Tissue Forcep

With 9 x 9 Teeth Overall Length Of 4 3/4"



22-16120

Adson Brown Tissue Forcep

With 9 x 9 Teeth Angled Overall Length Of 4 3/4" (12.1cm)

5-2058-0

Swiss Fine Pointed Jewelers Forcep #0

With An Overall Length Of 4 5/8" (11.7cm)



5-2058-1

Swiss Jeweler Forcep #1

Smooth Handle With Dull Finish, Straight Shafts, Fine Pointed Tips, And Overall Length Of 4 3/4" (12cm). Overall Weight Of 0.4 oz



5-50

800.322.4674 or 800.633.7283

www.msiprecision.com



5-2058-2

Swiss Jeweler Forceps #2

With Dull Finish, Straight Shafts, Fine-Pointed Tips, And An Overall Length Of 4 3/4" (12cm). Overall Weight Of 0.5 oz



5-2058-3

Swiss Jeweler Forceps #3

Smooth Handle With Dull Finish, Straight Shafts, Extra Fine Pointed Tips, And Overall Length Of 5" (12.7cm). Overall Weight Of 0.5 oz



5-2058-3C

Swiss Jeweler Forceps #3C

Smooth Handle With Dull Finish, Straight Shafts, Extra Fine Pointed Tips, And Overall Length Of 4 3/8" (11cm). Overall Weight Of 0.4 oz



5-2058-4

Swiss Jeweler Forceps #4

Smooth Handle With Dull Finish, Straight And Narrowed Shafts, Extra Fine Pointed Tips, And Overall Length Of 4 1/4" (11cm). Overall Weight Of 0.4 oz



5-2058-5

Swiss Jeweler Forceps #5

Smooth Handle With Dull Finish, Straight And Narrowed Shafts, Extra Fine Pointed Tips, And Overall Length Of 4 1/4" (110mm)

Forceps

Jewelers

5-2058-5H

Swiss Hirschman Jeweler Forcep #5H

Smooth Handle With Dull Finish, Straight And Narrowed Shafts, Extra Fine Blunted Tips, And Overall Length Of 4 1/4" (110mm)



5-2058-7

Swiss Jeweler Forcep #7

Smooth Handle With Dull Finish, Curved Shafts, Fine Pointed Tips, And Overall Length Of 4 1/2" (11.5cm). Overall Weight Of 0.5 oz



11-6-7611

Utility And Splinter Forcep

With Sharp Tips And An Overall Length Of 3 1/2" (9cm)



11-6-7621

German Jeweler Fine Pointed Forcep #1

Smooth And Flat Handle, And An Overall Length Of 4 3/4" (12cm)

11-6-7631

German Jeweler Fine Pointed Forcep #3C

Smooth And Flat Handle, And An Overall Length Of 4 3/4" (12cm)



11-6-7641

German Jeweler Forcep #3

With Extra-Fine Pointed Tips, Smooth And Flat Handle, And An Overall Length Of 4 3/4" (12cm)





11-6-7651

German Jeweler Forcep #4

With Smooth Handle, Fine Points, Straight Shafts, And An Overall Length Of 4 1/4" (11cm)



11-6-7661

German Jewelers Forcep #5

With Extra-Fine Pointed Tips, Straight 28mm Shafts, Smooth And Flat Handle, And An Overall Length Of 4 1/4" (11cm)

11-6-7681

German Jewelers Forcep #7

Curved Fine Pointed Tips Smooth And Flat Handle, And An Overall Length Of 4 1/4" (11cm)



11-6-7686

Suture Removal Forcep

With Very Fine Pointed Tips, Carbide Impregnated Jaws, And An Overall Length Of 4 1/2" (11.5cm)



11-6-7711

Jaffe Utility Forcep

With Curved Shafts, Three-Holed Handle, And An Overall Length Of 4 1/4" (11cm)

Forceps

Chalazion



5-3691

Wies Chalazion Forcep

Serrated Handle With Polished Finish, Solid Lower Plate With Outside Width Of 15mm, Open Serrated Upper Plate With Inside Dimensions Of 9mm x 12mm, Locking Thumb Screw, And Overall Length Of 3 3/4" (9.5cm). Overall Weight Of 0.5 oz



5-3711

Desmarres Chalazion Forcep

Serrated Cross Action Handle With Polished Finish, Oval Solid 16mm Wide Lower Plate, Open Upper Plate With Inside Dimensions Of 12mm x 14mm, And Overall Length Of 3 3/4" (9.5cm). Overall Weight Of 0.4 oz



5-3715

Desmarres Chalazion Forcep

Serrated Handle With Polished Finish, Locking Thumb Screw, Oval Solid 24mm Wide Lower Plate, Open Upper Plate With Inside Dimensions Of 12mm x 20mm, And Overall Length Of 3 1/2" (9cm). Overall Weight Of 0.5 oz



5-3721

Francis Chalazion Forcep

Serrated Handle With Polished Finish, Locking Thumb Screw, Oval Solid 17mm Wide Lower Plate, Open Upper Plate With Inside Dimensions Of 12mm x 14mm, And Overall Length Of 3 3/4" (97mm)



5-54

800.322.4674 or 800.633.7283

www.msiprecision.com



5-3725

Heath Chalazion Forcep

Serrated Handle With Polished Finish, Locking Thumb Screw, Oval Solid 16mm Wide Lower Plate, Open Upper Plate With Inside Dimensions Of 12mm x 14mm, And Overall Length Of 3 3/4" (96mm)



5-3729

Hunt Chalazion Forcep

Serrated Handle With Polished Finish, Locking Thumb Screw, Round Solid 15mm Wide Lower Plate, Open Upper Plate With Inside Diameter Of 12mm, And Overall Length Of 3 3/4" (97mm)



5-3741

Lambert Chalazion Forcep

Small, Serrated Handle With Polished Finish, Locking Thumb Screw, Round Solid 10mm Wide Lower Plate, Open Upper Plate With Inside Diameter Of 8mm, And Overall Length Of 3 5/8" (92mm)



5-3743

Lambert Chalazion Forcep

Large, Serrated Handle With Polished Finish, Locking Thumb Screw, Round Solid Lower Plate, Open Upper Plate With Inside Diameter Of 15mm, And Overall Length Of 3 3/4" (97mm)

Forceps

Chalazion



5-3751

Baird Chalazion Forcep

Serrated Handle With Polished Finish, Locking Thumb Screw, Oval Solid 15mm Wide Lower Plate, Open Upper Plate With Inside Dimensions Of 11mm x 8mm, And Overall Length Of 3 3/4" (97mm)



5-3625

Ehrhardt Lid Forcep

Serrated Handle With Polished Finish, 14mm Oval Solid Lower Plate, Straight 9mm Serrated Upper Jaw, Locking Thumb Screw, And Overall Length Of 3 1/2" (9cm). Overall Weight Of 0.4 oz

5-3633

Snellen Entropion Forcep

Left, Serrated Handle With Polished Finish, Solid Lower Plate With Outside Width Of 28mm, Open Upper Plate, Locking Thumb Screw, And Overall Length Of 3 1/2" (88mm)

5-3634

Snellen Entropion Forcep

Left, Serrated Handle With Polished Finish, Solid Lower Plate With Outside Width Of 28mm, Open Upper Plate, Locking Thumb Screw, And Overall Length Of 3 1/2" (88mm)



5-2797

Troutman Superior Rectus Forcep

Serrated Handle With Polished Finish, 45 Degree Angled Shafts, 10mm From Tip To Bend, 1 x 2 Teeth, And Overall Length Of 4 1/4" (106mm)



5-2798

Osher Superior Rectus Forcep

Serrated Handle With Polished Finish, 45 Degrees Angled Shafts, 10mm From Tip To Bend, Tips Curved With 1 x 2 (0.5mm) Teeth, And Overall Length Of 4 1/8" (10.5cm). Overall Weight Of 0.4 oz



5-2703

Rizzuti Superior Rectus Forcep

Serrated Cross Action Handle With Polished Finish, 45 Degree Angled Shafts, 7mm From Tip To Bend, Tips Curved With 1 x 2 Teeth, And Overall Length Of 3 3/4" (9.6cm). Overall Weight Of 0.3 oz



5-3415

Bishop Tendon Tucker

Round And Knurled Handle With Polished Finish, Triangular Shaped Tips, Marked For 5mm And 10mm Tucks, And Overall Length Of 4 1/4" (10.8cm)



5-3441

Jameson Muscle Forcep-Adult Left

Left, Serrated Handle With Slide Lock And Polished Finish, Angled Shafts, 12mm Jaws From Bend To Tip, 1mm Teeth On One Jaw Fit Into Holes On Other Jaw, And Overall Length Of 4" (10cm). Overall Weight Of 0.4 oz



800.322.4674 or 800.633.7283

www.msiprecision.com

5-57



Forceps

Muscle



5-3442

Jameson Muscle Forcep-Adult Right

Right, Serrated Handle With Slide Lock And Polished Finish, Angled Shafts, 12mm Scaled Jaws From Bend To Tip, 1mm Teeth On One Jaw Fit Into Holes On Other Jaw, And Overall Length Of 4" (10cm). Overall Weight Of 0.4 oz



5-3445

Jameson Muscle Forcep-Child Left

Child Size, Left, Serrated Handle With Slide Lock And Polished Finish, Angled Shafts, 9mm Jaw From Bend To Tip, 1mm Teeth On One Jaw Fit Into Holes On Other Jaw, And Overall Length Of 3 7/8" (99mm)



5-3446

Jameson Muscle Forcep-Child Right

Child Size, Right, Serrated Handle With Slide Lock And Polished Finish, Angled Shafts, 9mm Jaw From Bend To Tip, 1mm Teeth On One Jaw Fit Into Holes On Other Jaw, And Overall Length Of 3 7/8" (99mm)

5-3451

Gunderson Muscle Forcep

Serrated Handle With Slide Lock And Polished Finish, Angled Shafts, 11mm Long Tips, Jaws With Longitudinal Meeting Serrations, And Overall Length Of 3 7/8" (100mm)



5-58

800.322.4674 or 800.633.7283

www.msiprecision.com

5-3461

Berens Muscle Clamp

Round And Knurled Handle With Polished Finish, 13.5mm Angled Adjustable Blades, Teeth In Lower Jaw Fit Into Holes In Upper Jaw, Grooves In Lower Jaw, And Overall Length f 3 1/2" (89mm)



5-3611

Berke Ptosis Forcep

Serrated Handle With Slide Lock And Polished Finish, Multi-Curved Shafts, Straight 20mm Blades, Longitudinal Serrations, And Overall Length Of 4 1/4" (11cm). Overall Weight Of 0.6oz



5-3615

Berke Ptosis Forcep

Serrated Handle With Slide Lock And Polished Finish, Multi-Curved Shafts, Straight 27mm Blades, Longitudinal Serrations, And Overall Length Of 4" (10cm). Overall Weight Of 0.6 oz

5-3618

Iliff Blepharochalasis Forcep

Serrated Handle With Polished Finish, Slide Lock, Multi-Curved Shafts, Curved 28mm Serrated Jaws, And Overall Length Of 4 1/4" (107mm)

Forceps

Cilia

5-3267

Precision Cilia Forcep

Serrated Handle With Polished Finish, Wide 1mm x 3mm Smooth Platform, And Overall Length Of 3" (76mm)



5-3271

Precision Cilia Forcep

Serrated Handle With Polished Finish, Narrow Smooth Jaws, And Overall Length Of 3 1/4" (8.2cm). Overall Weight Of 0.2 oz



5-3273

Barraquer Cilia Forcep

Serrated Handle With Polished Finish, Slightly Curved 6mm Long Platform, And Overall Length Of 4" (10.2cm) . Overall Weight Of 0.3 oz



5-3275

Ziegler Cilia Forcep

Serrated Handle With Polished Finish, Slender 4.5mm Long Rounded Platform, And Overall Length Of 3 1/2" (9cm). Overall Weight Of 0.3 oz



5-3277

Drews Cilia Forcep

Serrated Handle With Polished Finish, Narrow 4mm Long Smooth Platform, And Overall Length Of 4 1/8" (104mm)

5-3281

Gradle Cilia Forcep

Serrated Cross Action Handle With Metal Tip Guard And Polished Finish, Fine 2mm Wide Platform, And Overall Length Of 3 3/4" (97mm)



50-10090

Douglas Cilia Forcep

Narrow Longer Serrated Tip Overall Length 3 1/2" (89mm)



50-11090

Douglas Cilia Forcep

Wide Short Serrated Tip Overall Length 3 1/2" (89mm)



51-10090

Ziegler Cilia Forcep

Rounded Pointed Tips With Smooth Platforms Overall Length 3 1/2" (89mm)

52-10080

Beer Cilia Forcep

Rounded Blunt Tips With Smooth Platforms Overall Length 3 1/6" (80mm)

52-10090

Beer Cilia Forcep

Rounded Blunt Tips With Smooth Platforms Overall Length 3 1/2" (89mm)



54-10090

Bergh Cilia Forcep

Angled Pointed Tip Serrated Jaw Beveled On The Outside Of Jaw Overall Length 3 1/2" (89mm)



54-12080

Littauer Cilia Forcep

Bowed Out Upside Down Triangular Tip Serrated Jaw Beveled On The Outside Of Jaw Overall Length 3 1/2" (89mm)

54-15105

Barraquer Cilia Forcep,

Serrated Handle Slightly Angled 6mm Smooth Platforms, Overall Length Of 4 1/2" (11.5cm)

55-10105

Bergh Cilia Forcep

Angled Pointed Tip Serrated Jaw Beveled On The Outside Of Jaw Overall Length 4 1/2" (114mm)

Forceps



P7201I

MSI Precision "Mueller Putterman Style 3 Pins"

Ptosis Muscle Clamp For Fasanella Procedure

Overall Length 3 3/4" (95mm) 3 Pins On Top Jaw With 3 Aligned Holes On Bottom Jaw, Jaw Has 4 Inside Interlocking Grooves, Jaw Head Is Concave And 22mm Wide

P7201T

MSI Precision Titanium "Mueller Putterman Style 3 Pins"

Ptosis Muscle Clamp For Fasanella Procedure

Overall Length 3 3/4" (95mm) 3 Pins On Top Jaw With 3 Aligned Holes On Bottom Jaw, Jaw Has 4 Inside Interlocking Grooves, Jaw Head Is Concave And 22mm Wide



P7202I

MSI Precision "Mueller Putterman Style 6 Pins"

Muscle Conjunctiva Resection Blepharoptosis Clamp

Overall Length 3 3/4" (95mm) 3 Pins On Top And 3 Pins On Bottom Jaw With 3 Aligning Holes On Both Jaws, Jaw Has 4 Inside Interlocking Grooves, Jaw Head Is Concave And 24mm Wide

P7202T

MSI Precision Titanium "Mueller Putterman Style 6 Pins"

Muscle Conjunctiva Resection Blepharoptosis Clamp

Overall Length 3 3/4" (95mm) 3 Pins On Top And 3 Pins On Bottom Jaw With 3 Aligning Holes On Both Jaws, Jaw Has 4 Inside Interlocking Grooves, Jaw Head Is Concave And 24mm Wide



5-2986

Collis Micro Utility Forcep

Serrated And Wide Handle With Polished Finish, Straight Shafts, 3mm Platform, And Overall Length Of 4 1/4" (109mm)



5-2901

Nugent Utility Forcep

Serrated Handle With Polished Finish, 45 Degree Angled Shafts, 10mm Smooth Jaws, And Overall Length Of 4 1/4" (11cm). Overall Weight Of 0.3 oz



5-2903

Nugent Utility Forcep

Serrated Handle With Polished Finish, 45 Degree Angled Shafts, 10mm Smooth Jaws, And Overall Length Of 4 1/4" (11cm). Overall Weight Of 0.3 oz



5-2912

Thornton Angled Fixation Forcep

With Wide Serrated Handle With Polished Finish, Straight Shafts With 25 Degrees Angled 1.5mm Tips, 4mm Platform With (0.12mm) 1 x 2 Teeth, And An Overall Length Of 4.3" (109mm)

5-2917

Castroviejo Suturing Forcep

Polished Finish, 45 Degree Angled Shafts, 0.5mm Teeth, 6mm Tying Platform, And Overall Length Of 4 1/4" (108mm)



5-2919

Osher Tying Forcep

Serrated And Flat Handle With Dull Finish, Curved Shafts, Tips, 6 1/2 Tying Platform, And Overall Length Of 4" (10cm). Overall Weight Of 0.4 oz

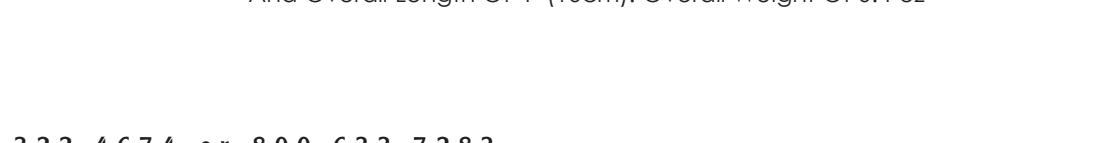

Forceps

Utility

5-2925

O'Gawa Angled Tying Forcep

Round And Knurled Handle Bottom of Platform With Polished Finish, Angled Shafts, 10mm Tying Platform, And Overall Length Of 4 1/4" (106mm)



5-2029

Osher Tying Forcep

Serrated And Flat Handle With Dull Finish, Curved Shafts, Tips, 6 1/2 Tying Platform, And Overall Length Of 4" (10cm). Overall Weight Of 0.4 oz



5-64

800.322.4674 or 800.633.7283

www.msiprecision.com



5-4026

Hartman Straight Hemostatic Mosquito Forcep

Ring Handle With Dull Finish, Ratchet Lock, Straight 20mm Serrated Jaws, And Overall Length Of 3 7/8" (99mm)



5-4027

Hartman Curved Hemostatic Mosquito Forcep

Ring Handle With Dull Finish, Ratchet Lock, Curved 20mm Serrated Jaws, And Overall Length Of 3 7/8" (99mm)

Forceps

Hemostat



5-4031

Halstead Straight Hemostatic Mosquito Forcep

Ring Handle With Dull Finish, Ratchet Lock, Straight 22mm Serrated Jaws, And Overall Length Of 4 7/8" (125mm)



5-4033

Halstead Curved Hemostatic Mosquito Forcep

Ring Handle With Dull Finish, Ratchet Lock, Curved 21mm Serrated Jaws, And Overall Length Of 4 3/4" (120mm)



5-66

800.322.4674 or 800.633.7283

www.msiprecision.com

5-2585

Gill Curved Iris Forcep

Serrated Handle With Polished Finish, Curved Shafts, Delicate 1 x 2 Teeth, And Overall Length Of 2 3/4" (72mm),

5-2586

Gill Curved Iris Forcep With Serrations

Serrated Handle With Polished Finish, Delicate Curved Shafts With Light Crisscross Serrations, And Overall Length Of 2 3/4" (72mm)

5-2594

Graefe Straight Iris Forcep With Serrations

Serrated Handle With Polished Finish, Straight Tips With Delicate Serrations, And Overall Length Of 2 5/8" (67mm)



5-2595

Graefe Straight Iris Forcep

With Teeth, Serrated Handle With Polished Finish, Straight Tips, Fine 1 x 2 Teeth, And Overall Length Of 2 7/8" (7cm). Overall Weight Of 0.2 oz

Forceps

IOL

5-3006

Kellan Intraocular Lens Forcep

Round Handle With Delicate Angled 8mm Jaws, Small groove On Interior Portion Of Platform Is Aligned With Handle, And Overall Length Of 3 7/8" (100mm)

5-3077

Knolle-Shepard Lens Forcep

Serrated Cross Action Handle With Dull Finish, Curved Shafts, 2mm Wide Serrated Tips, 0.4mm Pin In Upper Jaw, And Overall Length Of 4 3/4" (121mm)

5-3081

Sinskey Ridged Intraocular Lens Forcep

Flat Cross Action Handle With Holes And Dull Finish, 45 Degree Angled Tips, 9mm Long x 2mm Wide Lower Jaw, Notched Upper Jaw, And Overall Length Of 4 1/2" (115mm)

5-3084

Hall Lens Inserter With Lock

5-3086

Shepard Curved Intraocular Lens Forcep,

Serrated Cross Action Handle With Slide Lock And Polished Finish, Curved Shafts, Serrated 1.5mm Upper And 2mm Lower Jaws, And Overall Length Of 3 5/8" (91mm)

5-3086-2

Shepard Curved Intraocular Lens Forcep

Serrated And Wide Cross Action Handle With Lock And Polished Finish, Curved Shafts, 0.5mm Notch In Tip, And Overall Length Of 4 3/4" (120mm)

5-3086-WOL

Shepard Curved Intraocular Lens Forcep

Without Lock Serrated Cross Action Handle With Polished Finish, Curved Shafts, Serrated 1.5mm Upper And 2mm Lower Jaws, And Overall Length Of 3 5/8" (91mm)

5-3087

Osher Seibel Folding Forcep

Serrated Handle Gently Curved Forcep Overall Length Of 4 1/4" (107mm)



OA-224-422

Buratto II Acrylic IOL Implantation Forcep

Angled To Tip 8mm Thin Version With An Overall Length Of 4 1/4" (11cm)



5-3092

Universal Folding Forcep

Notched Jaws Align Grasping Platform At The Tip

5-3093

Clayman Lens Forcep

Flat Cross Action Handle With Dull Finish, Curved Shafts, 70 Degree Angled 3mm Tips, And Overall Length Of 4 3/4" (119mm)



5-3093-S

Clayman Lens Forcep

Serrated Cross Action Handle With Dull Finish, Curved Shafts, 70 Degree Angled 3mm Tips, And Overall Length Of 4 3/4" (119mm)



5-3095

Blaydes Angled Lens Forcep

Flat Cross Action Handle With Holes And Dull Finish, Shafts Angled 8mm From Tip To Bend, Smooth Jaws, And Overall Length Of 4 5/8" (117mm)



5-3095-S

Blaydes Angled Lens Forcep

Flat Serrated Handle, Cross Action Design With Holes And Dull Finish, Shafts Angled 12mm From Tip To Bend, Smooth Jaws, And Overall Length Of 4 5/8" (117mm)

Forceps

IOL



5-3098

Osher Haptic Forcep

Delicate And Used To Lift Haptic Of Lens Out Of Implant Package, Groove in Platform, Angled 45 Degrees, 5mm From Tip, And Overall Length of 3 1/2" (8.2cm). Overall weight of 0.2 oz

5-3099

Thornton Intraocular Lens Forcep

Smooth Flat Cross Action Handle Angled 45 Degrees 11mm Jaws Placed In Same Vertical Plane As Handle, And Overall Length Of 3 3/8" (86mm)

PI12255I

Steinert Universal II Lens Forcep

With Curved Tips, Three Ridges On The Handle, Overall Length Of 4 1/4" (11cm), Overall Weight Of 0.4 oz

11-6-8343

Akahoshi Phaco PreChopper

4.5mm Long Delicate Jaws With Sharp Tips On A Round Knurled Handle

11-6-8346

Precision Style Phaco PreChopper

On A 3 Hole Handle

11-6-8364

Alfonso Nucleus Grasping Forcep

Two Rows Of Delicate Teeth

11-6-8366

Precision Style D Nucleus Extraction & Soft IOL Insertion Forcep

11-6-9121

Rosenwasser Donor Lamella Inserting Forceps

On A 3 Hole Handle With Thin Vaulted 12mm Long Shafts

11-6-9291

Cartridge Loading Forcep

11mm Long Shaft Smooth Jaw



5-70

800.322.4674 or 800.633.7283

www.msiprecision.com

5-2094

Landers Vitrectomy Lens Forcep

Polished Finish, 45 Degree Angled Shafts, Curved Grooved Blades For Holding Landers Vitrectomy Lenses, And Overall Length Of 4 1/8" (103mm)



132219-2157

Scleral Plug Forcep Wide Serrated Handle

Cross Action Design With Small Cup Shape In The Inside Of Jaw Overall Length Is 4 1/8" (105mm)

Forceps



5-2071

Schaaf Foreign Body Forcep

Finger Grip Style Handle With Dull Finish, Fine Pointed Grooved Jaws With Smooth Curve From Tip To Handle, And Overall Length Of 3 3/4" (9.5cm). Overall Weight Of 0.3 oz

5-2072

Rappazzo Intraocular Foreign Body Forcep

Lightweight Squeeze Handle With Dull Finish, 2mm Jaws, 2mm Inner Jaw, Angled 45 Degree Tip 20 Gauge Diameter Shaft, Overall Length Of 6 3/8" (163mm)



5-2072-A

Rappazzo Intraocular Foreign Body Scissors

Lightweight Squeeze Handle With Dull Finish, Sharp Pointed Tips With Guillotine Action, 20 Gauge Diameter Shaft, 1mm Jaw, Overall Length Of 6 3/8" (163mm)



5-2072-D

Rappazzo Intraocular Foreign Body Forcep

Lightweight Squeeze Handle With Dull Finish, Stationary Distal Jaw, 20 Gauge Diameter Shaft, 1.5mm Diamond Dusted Jaw, Inner Jaw Space 2mm, 45 Degree Angled Tip, And Overall Length Of 5 3/4" (14.5cm). Overall Weight Of 0.6 oz

5-2072-ED

Rappazzo Intraocular Foreign Body Forcep

Lightweight Squeeze Handle, 1.5mm ED Jaw, Tip Angled 45 Degree 20 Gauge Diameter Shaft Jaw, And Overall Length 6 3/8" (164mm)

5-2072-S

Rappazzo Intraocular Foreign Body Forcep

Lightweight Squeeze Handle, 1.5mm Jaw, Tip Angled 45 Degree 20 Gauge Diameter Shaft Jaw, And Overall Length 6 3/8" (164mm)





5-6489

Watzke Sleeve Spreading Forcep

Serrated Cross-Action Handle With Polished Finish, Serrated 30 Degree Angled 10mm Tips, And Overall Length Of 4 3/4" (12cm). Overall Weight Of 0.9 oz

5-6487

Lambert Sleeve Spreader

Tip Angled 90 Degrees Smooth Jaw Cross Action Design With Post And Thumb Screw Locking Device Overall Length 4 1/8" (105mm)



5-6763

Carter Sphere Introducer



5743K65

Surgical Instrument Handheld Demagnetizing Probe

800.322.4674 or 800.633.7283

www.msiprecision.com

5-73



Need a Repair?

Call MSI at **800-322-4674** today,
or complete and print our Repair Form online at

www.MSIPrecision.com

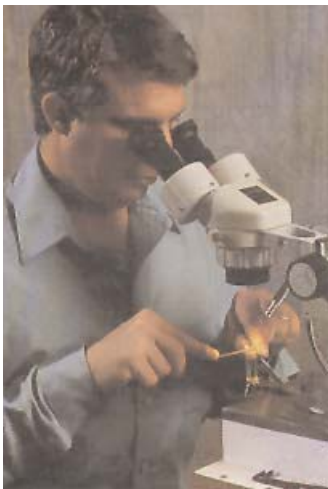

At MSI Precision, our repair professionals give you expert, cost effective repair alternatives for your delicate surgical instruments.

- Receive a Free Evaluation
- Most Instruments repaired and shipped back in two business days.
- We have the ability to repair instruments from any manufacturer.
- Our Technicians are specialists in micro-eye and ENT instruments.
- All Instruments are examined by technicians with over 15 years experience.
- Receive an Estimate prior to doing work.
- All parts cleaned and lubricated.
- Quality control evaluation.



800.322.4674 or 800.633.7283

www.msiprecision.com



MSI Precision

Handled

Instruments



Contents

Handled Instruments

Pages

Bi-Manual / IA Instruments	6-1
Collar Button	7-1
Curettes	7-2
Depressors	7-4
Dilators	7-7
Fixation Hooks / Loops	8-1
Fixation Rings	8-3
Intubation Set	8-8
Intralase	8-8
Kansas Style Instruments	9-1
Knives (reusable)	9-3
Lid Plates	9-4
Lens Loops	10-1
Manipulating Hooks	10-5
Markers	11-1
Muscle Hooks	11-10
Phaco Chops	11-12
Polishers	12-1
Retinal	13-1
Retractors	13-2
Rongeurs	13-5
Rotator Globe	13-6
Ruler	13-6
Serrefines	13-7
Spatulas	13-8
Spoons	13-17
Spuds	13-17
Needle Holders	14-1
Probes	14-18
Punches	14-22
Pupil Dilators	14-23



800.322.4674 or 800.633.7283

www.msiprecision.com



BI-302

Bi-Manual Hand-Piece

21 Gauge Curved Aspiration 0.3mm Single Port Gold Color, With An Overall Length Of 4 3/8" (11.1cm). Overall Weight 0.3 oz



BI-322

Bi-Manual Hand-Piece

23 Gauge Curved Aspiration 0.3mm Single Port Gold Color, With An Overall Length Of 4 3/8" (11.1cm). Overall Weight 0.3 oz



BI-323

Bi-Manual Hand-Piece

23 Gauge Curved Aspiration 0.3mm Single Port With Capsule Polisher Gold Color, With An Overall Length Of 4 3/8" (11.1cm). Overall Weight 0.3 oz



BI-501

Bi-Manual Hand-Piece

21 Gauge Straight Irrigating 0.5mm Dual Port Blue Color, With An Overall Length Of 4 3/8" (11.1cm). Overall Weight 0.3 oz

IA Instruments



BI-502

Bi-Manual Hand-Piece

21 Gauge Curved Irrigating 0.5mm Dual Port Blue Color, With An Overall Length Of 4 3/8" (11.1cm). Overall Weight 0.3 oz



BI-521

Bi-Manual Hand-Piece

23 Gauge Straight Irrigating 0.4mm Dual Port Blue Color, With An Overall Length Of 4 3/8" (11.1cm). Overall Weight 0.3 oz



BI-522

Bi-Manual Hand-Piece

23 Gauge Curved Irrigating 0.4mm Dual Port Blue Color, With An Overall Length Of 4 3/8" (11.1cm). Overall Weight 0.3 oz



IA301

Irrigation/Aspiration 45 Degree Handpiece

1-Piece Design With An Overall Length Of 5 1/2" (14cm). Overall Weight of 1.8 oz.





IA302

Irrigation/Aspiration Curved Handpiece

1-Piece Design, With An Overall Length Of 5 1/2" (13.8cm). Overall Weight 0.9 oz



IA303

Irrigation/Aspiration 45 Degree Handpiece

1-Piece Design With An Overall Length Of 5 1/2" (14cm). Overall Weight 0.9 oz



IA304

Irrigation/Aspiration 90 Degree Handpiece

1-Piece Design With An Overall Length Of 5 1/2" (14cm). Overall Weight 0.9 oz



IA306

Irrigation/Aspiration 180 Degree Handpiece

1-Piece Design With An Overall Length Of 5 1/2" (14cm). Overall Weight 0.9 oz

IA Instruments

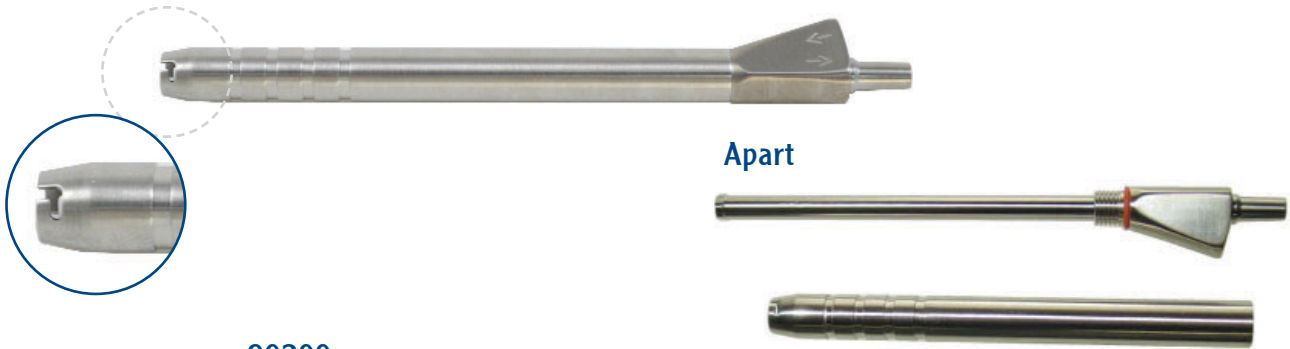

90200

ROUND I/A HANDLE

I/A Stainless Steel Round Handle, Overall Length Of 4 1/4" (11cm)



90301

Stainless Steel I/A Tip

Straight 0.3mm With An Overall Length Of 1 3/4" (4.5cm)



90302

Stainless Steel I/A Tip

Curved 0.3mm With An Overall Length Of 1 3/4" (4.5cm)



90303

Stainless Steel I/A Tip

Angled 45 Degree 0.3mm With An Overall Length Of 1 3/4" (4.5cm)





90304

Stainless Steel I/A Tip

Angled 90 Degree 0.3mm With An Overall Length Of 1 3/4" (4.5cm)



90306

Stainless Steel I/A Tip

Angled 180 Degree 0.3mm (Known As Binkhorst) With An Overall Length Of 1 3/4" (4.5cm)

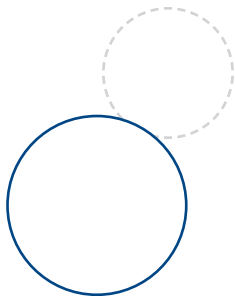

90307

Stainless Steel I/A Tip

Straight 0.3mm Used With Silicone Sleeve With An Overall Length Of 1 7/8" (4.7cm)

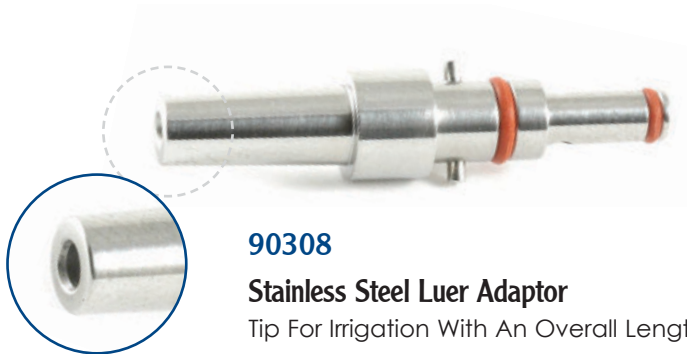

90308

Stainless Steel Luer Adaptor

Tip For Irrigation With An Overall Length Of 1 1/4" (3cm)

90309

Stainless Steel I/A Tip

Curved 0.3mm Port To Be Used With Silicone Sleeve Overall Length Of 1 3/4" (4.5cm)



IA Instruments

90313

Stainless Steel I/A Tip

Angled 45 Degree 0.3mm To Be Used With Silicone Sleeve With An Overall Length Of 1 3/4" (4.5cm)



93100

I/A Titanium

With A Round Handle And An Overall Length Of 4 1/4" (11cm). Overall Weight 0.6 oz



93301

Titanium I/A Tip

Straight 0.3mm With An Overall Length Of 1 3/4" (4.5cm). Overall Weight 0.1 oz



93302

Titanium I/A Tip

Curved 0.3mm With An Overall Length Of 1 3/4" (4.5cm). Overall Weight 0.1 oz



93303

Titanium I/A Tip

Angled 45 Degree 0.3mm With An Overall Length Of 1 3/4" (4.5cm). Overall Weight 0.3 oz





93304
Titanium I/A Tip
Angled 90 Degree 0.3mm With An Overall Length Of 1 3/4" (4.5cm)



93306
Titanium I/A Tip
Angled 180 Degree 0.3mm (Known As Binkhorst) With An Overall Length Of 1 3/4" (4.5cm)



93307
Titanium I/A Tip
Straight 0.3mm Used With Silicone Sleeve With An Overall Length Of 1 7/8" (4.7cm)



93308
Titanium Luer Adaptor
Tip For Irrigation With An Overall Length Of 1 1/4" (3cm). Overall Weight 0.1 oz



IA Instruments

93309

Titanium I/A Tip

Curved 0.3mm Port Used With Silicone Sleeve Overall Length Of 1 7/8" (4.7cm)



93313

Titanium I/A Tip

Angled 45 Degrees 0.3mm Port Used With Silicone Sleeve Overall Length Of 1 7/8" (4.7cm)





5-1677-S

Graether Collar Button

Round And Knurled Handle With Polished Finish, Straight Shaft, And Overall Length Of 4 3/4" (12cm). Overall Weight 0.3 oz



5-1677-SA

Graether Collar Button

Round And Knurled Handle With Polished Finish, Angled 45 Degrees Shaft, 10mm From Tip To Bend, And Overall Length Of 4 1/2" (11.5cm). Overall Weight 0.3 oz



5-1677

Graether Collar Button

Graether Collar Button, 23 Gauge Cannula With Polished Finish And Straight Shaft, And Including Hub Overall Length Of 1 5/8" (4cm)



5-1677-A

Graether Collar Button

Graether Collar Button, 23 Gauge Cannula With Polished Finish, Angled 45 Degrees, 10mm From Tip To Bend, And Excluding Hub An Overall Length Of 7/8"

Curettes



5-1801

Skeele Curette

Flat Handle With Polished Finish, Straight 31mm shaft, 2mm Cup With Serrated Edge, And Overall Length Of 4 7/8" (12.5cm). Overall Weight 0.5 oz



5-1895

Meyerhoeffer Chalazion Curette

Flat Handle With Polished Finish, #4, 3.5mm Cup, Straight 31mm Shaft, And Overall Length Of 5 1/8" (13cm). Overall Weight 0.5 oz



5-1891

Meyerhoeffer Chalazion Curette

Flat Handle With Polished Finish, #0, 1.5mm Cup, Straight 31mm Shaft, And Overall Length Of 5 1/8" (13cm). Overall Weight 0.5 oz

5-1892

Meyerhoeffer Chalazion Curette

Flat Handle With Polished Finish, #1, 1.75mm Cup, Straight 31mm Shaft, And Overall Length Of 5 1/8" (12.9cm). Overall Weight 0.5 oz

5-1893

Meyerhoeffer Chalazion Curette

Flat Handle With Polished Finish, #2, 2mm Cup, Straight 31mm Shaft, And Overall Length Of 5" (13cm). Overall Weight 0.5 oz

5-1894

Meyerhoeffer Chalazion Curette

Flat Handle With Polished Finish, #3, 2.5mm Cup, Straight 31mm Shaft, And Overall Length Of 5" (12.7cm). Overall Weight 0.5 oz



5-1893-GW

Gills-Welsh Curette Capsule Polisher

Flat Handle With Polished Finish, 2mm Cup, 45 Degrees Angled Shaft 8mm From Tip To Bend, And Overall Length Of 5" (12.7cm). Overall Weight 0.5 oz



11-4-2191

Gills Polishing Curette

Flat Handle With Polished Finish, 1.75mm Cup Sandblasted 45 Degrees Angled Shaft 8mm From Tip To Bend, And Overall Length Of 5" (12.7cm)



5-1918

Foreign Body Curette

Flat Handle With Polished Finish, Straight 31mm Shaft, 0.5mm Cup, And Overall Length Of 5" (12.9cm). Overall Weight 0.4 oz

5-1919

Foreign Body Curette

Flat Handle With Polished Finish, Straight 31mm Shaft, 1mm Cup, And Overall Length Of 5" (13cm). Overall Weight 0.5 oz



5-1912

Foreign Body Curette

Round And Knurled Handle With Polished Finish, Straight 33mm Shaft, #1, 1mm Ring Curette 1.5mm High, And Overall Length Of 4 1/2" (11.5cm). Overall Weight 0.4 oz

5-1913 (Shown)

Heath Chalazion Curette

Round And Knurled Handle With Polished Finish, Straight 34mm Shaft, #2, 2mm Ring Curette 1.5mm High, And Overall Length Of 4 1/2" (11.4cm). Overall Weight 0.4 oz

5-1914

Foreign Body Curette

Round And Knurled Handle With Polished Finish, Straight 35mm Shaft, #3, 3mm Ring Curette 1.5mm High, And Overall Length Of 4 1/2" (11.4cm). Overall Weight 0.4 oz

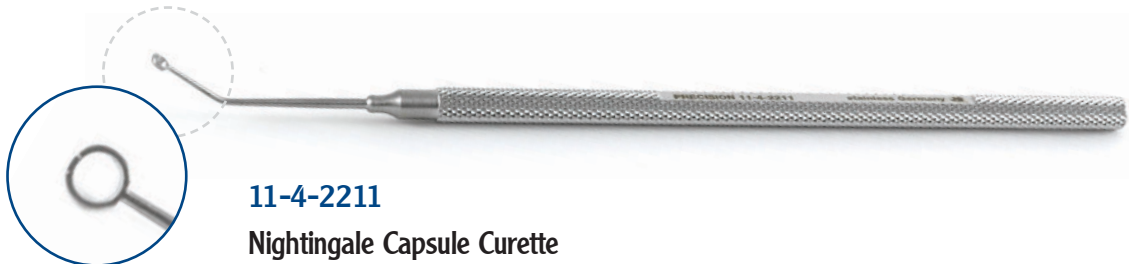

11-4-2211

Nightingale Capsule Curette

With Knurled Handle, 10mm Tip To Bend, And An Overall Length Of 4 3/4" (12cm). Overall Weight 0.3 oz

Depressors



5-6211-8 (Shown)

Schepens Scleral Depressor

Polished Depressor With 8mm Wide Tip, Dull Finish Size 08mm Large Thimble, With Overall Length Of 1 3/4" (43mm). Overall Weight 0.2 oz

5-6211-10

Schepens Scleral Depressor

Polished Depressor With 8mm Wide Tip, Dull Finish Size 10mm Large Thimble, With Overall Length Of 1 3/4" (43mm). Overall Weight 0.2 oz

5-6211-12

Schepens Scleral Depressor

Polished Depressor With 8mm Wide Tip, Dull Finish Size 12mm Large Thimble, With Overall Length Of 1 3/4" (43mm). Overall Weight 0.2 oz



11-2-8911

Schepens Laser Scleral Depressor

Ebonized Depressor With 8mm Wide Tip, Dull Finish Size 08mm Large Thimble, With Overall Length Of 1 3/4" (43mm). Overall Weight 0.2 oz

11-2-8921 (Shown)

Schepens Laser Scleral Depressor

Ebonized Depressor With 8mm Wide Tip, Dull Finish Size 10mm Large Thimble, With Overall Length Of 1 3/4" (43mm). Overall Weight 0.2 oz

11-2-8931

Schepens Laser Scleral Depressor

Ebonized Depressor With 8mm Wide Tip, Dull Finish Size 12mm Large Thimble, With Overall Length Of 1 3/4" (43mm). Overall Weight 0.2 oz





5-6222

Gass Scleral Marker

With 1.5mm Wide Diameter Marking Tip, Dull Finish Size 12mm Large Thimble, With Overall Length Of 1 7/8" (3.4cm)

11-2-8801

Gass Laser Scleral Marker Ebonized

With 1.5mm Wide Diameter Marking Tip, Dull Finish Size 12mm Large Thimble, With Overall Length Of 1 7/8" (3.4cm). Overall Weight 0.2 oz



5-6216

Wilder Scleral Depressor

Serrated And Flat Handle With Polished Finish, Pocket Clip, 2.5mm Diameter X 15mm Long Angled Tip, And Overall Length Of 5" (13cm). Overall Weight 0.6 oz



5-6217

Urretts-Zavalía Depressor And Fixation Pick

Serrated And Flat Handle With Polished Finish, Sufficient Sharpness, And Overall Length Of 4 3/4" (12cm)



5-6218

Flynn Scleral Depressor

Serrated And Flat Handle With Polished Finish, Lens Loop Style Tip, And Overall Length Of 3 1/4" (8cm). Overall Weight 0.2 oz

Depressors



5-6219

Schocket Double Ended Scleral Depressor

Serrated Handle With Pocket Clip Double-End Depressor And Marker With Rounded End, 6mm Wide Bar, With A 2.5mm Teardrop Shape Tips, And Overall Length Of 5 1/4" ((13.5cm). Overall Weight 0.4 oz

11-2-8936

Schocket Double Ended Scleral Depressor

Smooth Handle With Pocket Clip Double-End Depressor And Marker With Rounded End, 6mm Wide Bar, With A 2.5mm Teardrop Shape Tips, And Overall Length Of 5 1/4" ((13.5cm). Overall Weight 0.4 oz

5-62193751

Shimshak Double Ended Scleral Depressor

On Serrated Handle With Pocket Clip Double-End Depressor And Marker With Rounded End, 6mm Wide By 10mm Long Convexed Jellybean Shaped Depressor With A 2..5mm Teardrop Shape Marker, And Overall Length Of 5 1/4" ((13.5cm)



5-6210

O'Connor Scleral Depressor-Marker

Serrated And Flat Handle With Polished Finish, 3mm Teardrop Shape End, 1.5mm Gass Marker End, And Overall Length Of 5 1/4" (13.4cm). Overall Weight 0.4 oz



5-6221

Gonnin-Amsler Marker

With An Overall Length Of 5 1/4" (13.3cm). Overall Weight 0.5 oz



5-6223

Spaide Pediatric Scleral Depressor

Serrated And Flat Handle With Polished Finish, Curved Tip, Serrated Surface, Tip Of Foot Used For Depressing Sclera, And Overall Length Of 5" (12.7cm)





11-8-3111

Infant Lachrymal Dilator

With Knurled Handle And Overall Length Of 3" (8cm). Overall Weight 0.1 oz



5-5471

Wilder Lacrimal Dilator

Round And Knurled Handle With Polished Finish, Stainless Steel, Short 19mm Taper, Blunt Tip, And Overall Length Of 4" (10.1cm). Overall Weight 0.3 oz

5-5472

Wilder Lacrimal Dilator

Round And Knurled Handle With Polished Finish, Stainless Steel, Medium 23mm Taper, Blunt Tip, And Overall Length Of 4" (10cm). Overall Weight 0.3 oz

5-5473

Wilder Lacrimal Dilator

Round And Knurled Handle With Polished Finish, Stainless Steel, Long 32mm Taper, Blunt Tip, And Overall Length Of 4" (10cm). Overall Weight 0.3 oz



5-5447

Ziegler Double Ended Lacrimal Dilator

Round And Knurled Handle With Polished Finish, Stainless Steel, Double Ended Dilator Probes With Gentle Curve, And Overall Length Of 5 1/4" (13.5cm). Overall Weight 0.2 oz



5-5451

Castroviejo Double Ended Lacrimal Dilator

Round And Knurled Handle With Polished Finish, Stainless Steel, Needle Point On One End, Medium Taper On Other End, And Overall Length Of 5 1/2" (14cm). Overall Weight 0.2 oz

Dilators



5-5481

Muldoon Lacimal Dilator

Round And Knurled Handle With Polished Finish, Stainless Steel, Medium 27mm Taper, Distal End Straight, And Overall Length Of 4" (10cm). Overall Weight 0.2 oz



5-5457

Hosford Double Ended Lacrimal Dilator

23 Gauge Curved Aspiration 0.3mm Single Port Gold Color, With An Overall Length Of . Overall Weight 0.2 oz



5-5477

Ruedemann Lacrimal Dilator

Round And Smooth Handle With Polished Finish, Stainless Steel, Short 12mm Taper With Needle Type Tip, And Overall Length Of 2 3/4" (7cm). Overall Weight 0.1 oz

5-1532

Harms Trabeculotome Set

Round And Knurled Handle With Polished Finish, 9mm Long And Pointed Tips With 3mm Spread, Pair Consisting Of Left And Right, And Overall Length Of 1 3/4" (46mm). Overall Weight 0.1 oz





5-1639

Burch Fixation Pick

Flat Handle With Dull Finish, Straight, 3mm Spread Between Tips, And Overall Length Of 5 1/4" (13.2cm). Overall Weight 0.5 oz

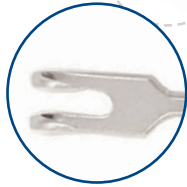

5-1643

Precision Double Fixation Hook

Serrated And Flat Handle With Polished Finish, 1 1/2mm Curved Tips Spread, And Overall Length Of 5" (12.7cm). Overall Weight 0.5 oz



5-1644

Precision Double Fixation Hook

Serrated And Flat Handle With Polished Finish, 2mm Curved Tips Spread, And Overall Length Of 5" (12.8cm). Overall Weight 0.5 oz



5-1654-L

Precision Twist Fixation Hook

Serrated And Flat Handle With Polished Finish, 2mm Curved Tips Spread, And Overall Length Of 4 3/8" (11cm). Overall Weight 0.3 oz

5-1654-S

Precision Twist Fixation Hook

Round And Knurled Handle With Polished Finish, Right And Clockwise 0.3mm Small Twist Hook, And Overall Length Of 4 3/8" (11.1cm). Overall Weight 0.3 oz

Fixation Hooks/Loops



5-1655-L

Precision Twist Fixation Hook

Round And Knurled Handle With Polished Finish, Left And Counterclockwise 0.3mm Small Twist Hook, And Overall Length Of 4 3/8" (11.1 cm). Overall Weight 0.3 oz

5-1655-S

Precision Twist Fixation Hook

Round And Knurled Handle With Polished Finish, Left And Counterclockwise 0.5mm Large Twist Hook, And Overall Length Of 4 1/8" (11.1cm). Overall Weight 0.3 oz

11-4-7226

Anis Scleral Twist Fixation Cone

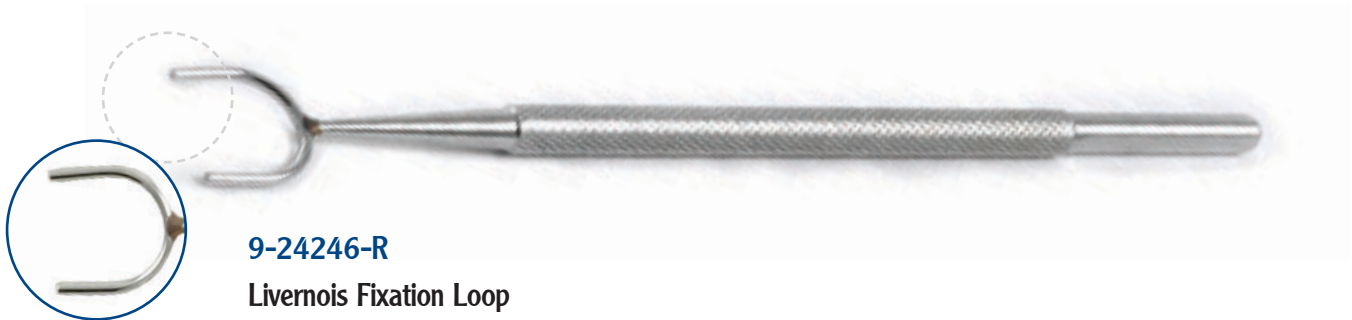

9-24246-R

Livernois Fixation Loop

With An Overall Length Of 4 1/8 (10.5cm)





11-4-7264

Precision Lasik Globe Fixation Ring

With Circular Rings For Fixating The Eye With Minimal Trama

11-4-7265

Precision Clear Cornea Globe Fixation Ring

With Cutout And Circular Rings For Fixating The Eye With Minimal Trama

11-4-7269

Lu-Mendez Fixation Ring

and Incision Guide for Placement of Limbel Relaxation Incisions

11-4-7271

Precision Dual Gimbel Style Swivel Fixation Ring

With Cut-Out Ring Size Is 13mm With Blunt Teeth On Both Sides Of The Ring, Ring Is Offset

11-4-7272

Precision Clear Cornea Swivel Fixation Ring

On A Flat Handle Ring Is 13mm With A 8mm Cut Out Ring Has 9 Fixation Blunt Teeth and 15 Degree Marks On The Top Of The Ring

800.322.4674 or 800.633.7283

www.msiprecision.com

8-3



Fixation Rings



11-4-7274-R

Precision Clear Cornea Swivel Fixation Ring

On A Round Handle, Ring is 16mm With A 8mm Cut Out Ring Has Blunt Fixation Teeth and 15 Degree Marks On The Top Of The Ring Overall Length Of 5 1/2" (14cm)

11-4-7274

Precision Clear Cornea Swivel Fixation Ring

On A Flat Handle, Ring is 16mm With A 8mm Cut Out Ring Has Blunt Fixation Teeth and 15 Degree Marks On The Top Of The Ring Overall Length Of 5 1/2" (14cm)



11-4-7276

Precision Thornton Style Fixation Ring

Ring Diameter 16mm With Blunt Teeth

11-4-7279

Precision Hofmann-Thornton Style Swivel Fixation Ring

With 16mm Diameter Ring

5-0127

Precision Thornton Style Fixation Ring

With Handle, 16mm Internal Diameter Ring With Atraumatic Teeth, Providing Pressure And Stabilization On Globe, Round And Knurled Handle With Dull Finish, And Overall Length Of 3"(75mm)

5-0127-T

Precision Titanium Thornton Style Fixation Ring

With Handle, 16mm Internal Diameter Ring With Atraumatic Teeth, Providing Pressure And Stabilization On Globe, Round And Knurled Handle With Dull Finish, And Overall Length Of 3"(75mm)





5-0129
Precision Fine-Thornton Style Fixation Ring

Design Is Open Ring, 16mm Diameter Ring With Shaft Angled 45 Degrees, Blunt Teeth And Round And Knurled Handle With Dull Finish, And Overall Length Of 4 3/4" (12cm)



5-0129-13
Precision Fine-Thornton Style Fixation Ring

Design Is Open Ring, 13mm Diameter Ring With Shaft Angled 45 Degrees, Blunt Teeth And Round And Knurled Handle With Dull Finish, And Overall Length Of 4 3/4" (12cm)



TDK-0-621
Precision Thornton Style Swivel Fixation Ring

With 13mm Ring And 8mm Cutout, Titanium, Round And Knurled Handle, And Overall Length Of 5" (13cm)



TDK-0-621-11
Precision Thornton Style Swivel Fixation Ring

With 13mm Ring And 11mm Cutout, Titanium, Round And Knurled Handle, And Overall Length Of 5" (13cm)

TDK-0-621-12
Precision Thornton Style Swivel Fixation Ring

With 12mm Ring And 7mm Cutout, Titanium, Round And Knurled Handle, And Overall Length Of 5" (13cm)



Fixation Rings



9-24246-R

Livernois Style Fixation Loop

With An Overall Length Of 4 1/8 (10.5cm)

5-5145

Flieringa Fixation Ring

Stainless Steel With Polished Finish, Set Sold In 1mm Increments Sizes 12mm To 20mm

11-2-8211

Flieringa Fixation Ring

Stainless Steel With Polished Finish, Set Sold In 1mm Increments Sizes 15mm To 22mm



5-5145-09

5-5145-10

5-5145-11

5-5145-12

5-5145-13

5-5145-14

5-5145-15

5-5145-16

5-5145-17

5-5145-18

5-5145-19

5-5145-20

5-5145-21

5-5145-22

5-5145-23

5-5145-24



Flieringa Fixation Rings

- Stainless Steel With Polished Finish
- Over Weight of 0.1oz



8-6

800.322.4674 or 800.633.7283

www.msiprecision.com



5-9002

Mertz Keratotomy Ring

Round And Knurled Handle With Dull Finish, 35 Degree Angled Shaft, 5mm Diameter Ring, And Overall Length Of 3 1/8" (8cm)

5-5144

McNeil-Goldman Scleral And Blepharostat Ring

Adult Size With Polished Finish, Inner Diameter Of 17mm, Outer Diameter Of 25mm, And Loops Retract Lids



5-5144-P

McNeil-Goldman Scleral And Blepharostat Ring

Pediatric Size With Polished Finish, Inner Diameter Of 15mm, Outer Diameter Of 24mm, And Loops Retract Lids



11-2-8422

McNeill Global Fixation Ring

Small, Inner Ring Diameter Of 15mm, Outer Ring Diameter Of 7/8" (2.3cm)



11-2-8423

McNeill Global Fixation Ring

Medium, Inner Diameter Of 16mm, Outer Diameter Of 15/16" (2.4cm)



11-2-8424

McNeill Global Fixation Ring

Large, Inner Diameter Of 16mm, Outer Diameter Of 15/16" (2.4cm)



Intubation Set

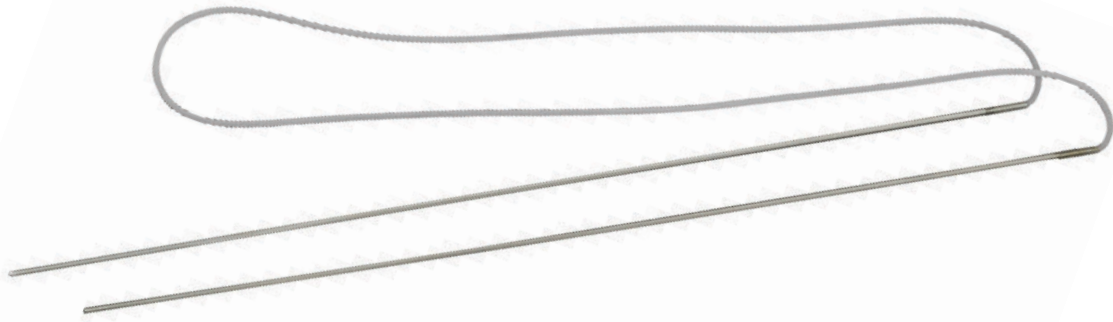

5-6762

Jackson Lacrimal Intubation Set

Single Use Item, Malleable Stainless Steel With Polished Finish, Blunt Tip, Set Consisting Of Two 20 Gauge Thin Wall Jackson Probes, 155mm (6 1/10") Long With 300mm (11 4/5") Of Silicone Tubing Fastened Onto Probe, And Overall Length Of 24" (61cm)

Intralase



9-27283-R

Siebel Intralase Flap Lifter with Spatula End

9-27283-BR

Siebel-Belin Intralase Flap Lifter Modified with Spatula End

20% Shorter and Angled Up 15 Degrees



8-8

800.322.4674 or 800.633.7283

www.msiprecision.com



5-1822

Kansas Nucleus Trisector

Round And Knurled Handle, For Left-Handed Use, And Overall Length Of 4 3/8" (11cm)

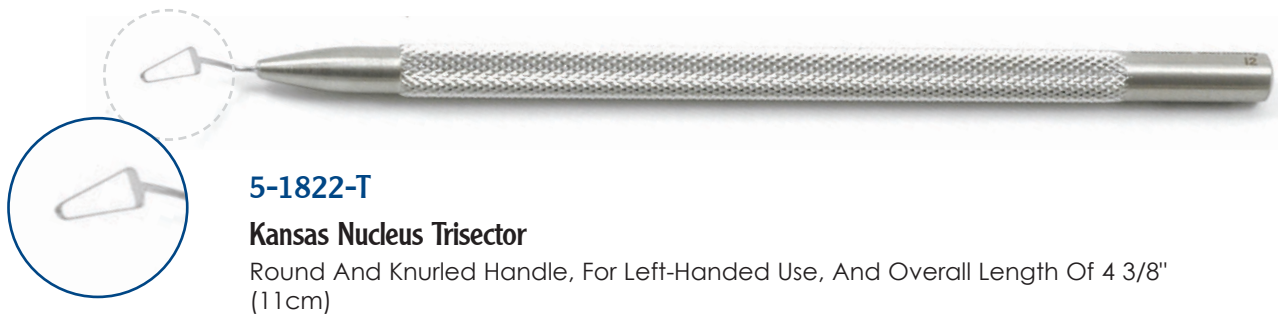

5-1822-T

Kansas Nucleus Trisector

Round And Knurled Handle, For Left-Handed Use, And Overall Length Of 4 3/8" (11cm)



5-1822-TR

Kansas Nucleus Trisector

Round And Knurled Handle, For Right-Handed Use, And Overall Length Of 4 1/4" (10.9cm)

11-4-5257

Bucher Kansas Nucleus Trisector

2.5mm Wide Angled Tip

Kansas Style Instruments



11-4-5259

Kansas Nucleus Trisector

2.5mm Right-Handed, With A Round And Knurled Handle, And An Overall Length Of 4 1/4" (11cm)



11-4-5261

Kansas Nucleus Bisector Curved

With A Round And Knurled Handle, 10mm From Tip To Bend, And An Overall Length Of 4 1/4" (11cm)



11-4-5263

Kansas Nucleus Vectus

3mm Solid Right-Handed With A Smooth And Flat Handle, And An Overall Length Of 4 3/4" (12cm)



11-4-5264

Kasnsas Nucleus Vectus

3mm Solid Left-Handed With A Smooth And Flat Handle, and An Overall Length Of 4 3/4" (12cm)





5-1106

Ziegler Knife Needle-5mm

Serrated Flat Handle With Polished Finish, 5mm Blade, And Overall Length Of 4 1/2" (11.4cm)



5-1563

Barkan Goniotomy Knife

Serrated Flat Handle With Polished Finish, 2mm Blade, And Overall Length Of 4 1/2" (11.5cm)



5-4122

Resection Scleral Knife (Hockey Stick Style)

Angled At 45 Degrees 3m by 5mm On Flat Serrated Handle Overall Length 4 5/8" (12cm)



5-4125

Paufigue Duredge Knife

Serrated And Flat Handle With Polished Finish, 1.5mm X 3mm Sharp Angled Blades, And Overall Length of 4 1/8" (11.2cm)



5-1401

Tooke Corneal Knife

Serrated Flat Handle With Polished Finish, 3mm X 18mm Smooth Blade, And Overall Length Of 4 3/4" (12cm)

Lid Plates



5-2170

Berke-Jaeger Lid Plate

Dull Finish, Curved Over Length and Width, 20mm And 23mm Wide Blades, Overall Length of 4 1/4" (11cm)

5-2170-L

Berke-Jaeger Lid Plate

Laser With Dull Finish, Curved Over Length And Width, 20mm And 23mm Wide Blades, And Overall Length Of 4 1/4" (109mm)

5-2170-P

Berke-Jaeger Lid Plate

Pediatric, Dull Finish, Curved Over Length And Width, 10mm And 15mm Wide Blades, And Overall Length Of 4 1/4" (109mm)

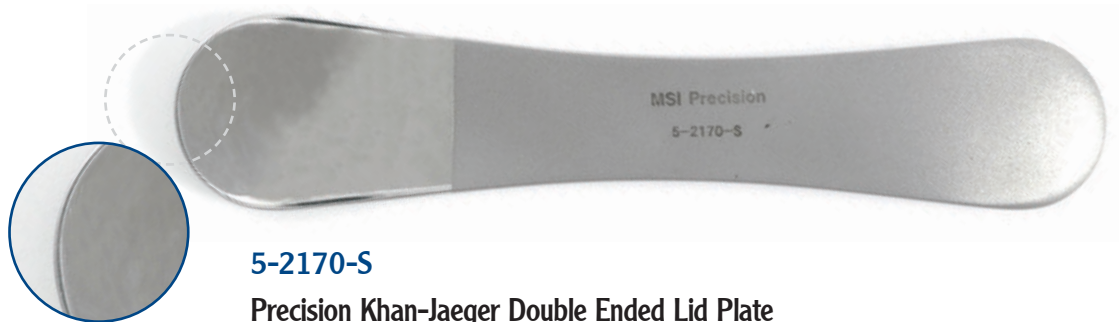

5-2170-S

Precision Khan-Jaeger Double Ended Lid Plate

Style Which Has A More Concave Ergonomic Design vs Standard Jaeger Lid Plate. It has A New High Polished Inside Smooth Surface With A Sandblasted Non-Reflective Finish For The Rest Of The Lid Plate. Overall Length Is 4 1/4" (109mm) Blade Width is 20mm On One End And 23mm On The Other End





5-1755

Wilder Lens Loop

Serrated And Flat Handle With Polished Finish, 4mm Wide X 15mm Long Loop With Serrations On Loop Top, And Overall Length Of 5 1/4" (13.4cm)



11-4-5211

Wilder Lens Loop With Smooth Flat Handle

Serrated 3mm Wide X 17mm Long Loop, And An Overall Length Of 5 1/4" (13.5cm)



5-1797

Knapp Lens Spoon

Serrated And Flat Handle With Polished Finish, 5mm Wide Spoon Shape Tip, Solid Middle, And Overall Length Of 5 1/4" (13.5cm)



5-1775

New Orleans Eye And Ear Lens Loop

Serrated And Flat Handle With Polished Finish, 5mm Wide X 10mm Long Oval Loop, And Overall Length Of 5 3/8" (13.6cm)

Lens Loops



5-1750

Gills-Welsh Lens Loop With Olive Tip

Serrated And Flat Handle With Polished Finish, 5mm Wide X 7mm Long Ultra Thin Loop, Olive Tip On Opposite End, And Overall Length Of 4 3/4" (121mm)



5-1750-EC

Gills-Welsh Morrison Lens Loop With Olive Tip

Serrated And Flat Handle With Polished Finish, 5mm Wide X 7mm Long Ultra Thin Loop With 20 Degrees Additional Curvature, Olive Tip On Opposite End, And Overall Length Of 4 3/4" (12cm)



11-4-5229

Gills-Welsh Loop And Probe

With A Serrated And Flat Handle, 5mm Serrated Loop, And An Overall Length Of 4 3/4" (12cm)



5-1759-GW

Gills-Welsh Modified Lens Loop

Serrated And Flat Handle With Polished Finish, 6mm Wide X 7mm Long Ultra Thin Loop, And Overall Length Of 5 3/8" (13.6cm)





5-1761

Simcoe Nucleus Loop

Round And Knurled Handle With Polished Finish, 4mm Wide X 20mm Long Left And Right Double-Ended Loops With Serrations On Loop Top, And Overall Length Of 4 5/8" (11.6cm)



11-4-5241

Simcoe Nucleus Loop Double-Ended With A Round And Knurled Handle

13mm Long X 4mm Wide Serrated Loops, And An Overall Length Of 4 1/2" (11.5cm)



5-2327

Kirby Intra-Capsular Lens Loop

Round And Knurled Handle With Polished Finish, 5mm Wide X 10mm Long Loop, And Overall Length Of 5 1/4" (13.5cm)

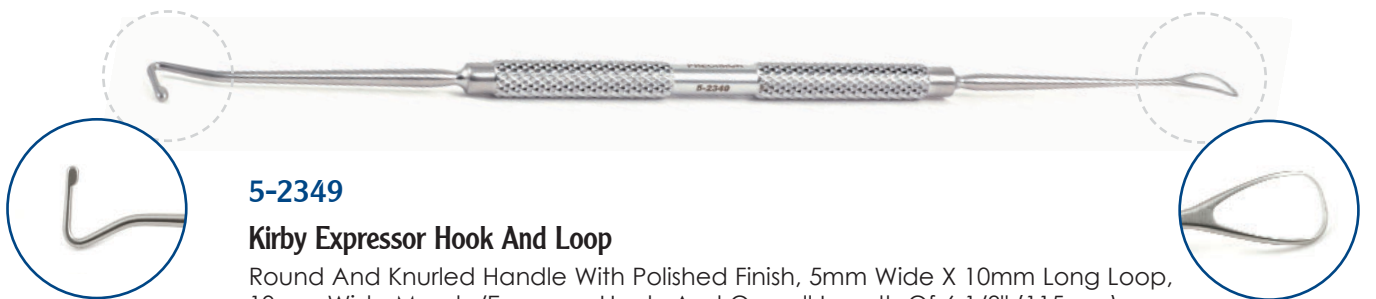

5-2349

Kirby Expressor Hook And Loop

Round And Knurled Handle With Polished Finish, 5mm Wide X 10mm Long Loop, 10mm Wide Muscle/Expressor Hook, And Overall Length Of 6 1/8" (115mm)

Lens Loops



11-4-5216

Kirby Lens Loop And Expressor

With A Round And Knurled Handle, 5mm Lens Loop, 2mm Expressor With 10mm Tip To Bend, And An Overall Length Of 6" (15cm)



11-4-5231

Morrison Lens Loop And Probe

With A Round And Knurled Handle, 5mm Wire Loop, And An Overall Length Of 5 3/4" (14.5cm)

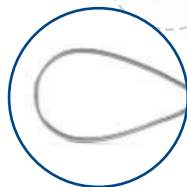

11-4-5252

Keener-Art Lens Loop

With 15mm Long X 3mm Wide Serrated Loop, Smooth Square Handle, And An Overall Length Of 5 1/4" (13.5cm)



Manipulating Hooks



5-1656

Sinskey Iris And IOL Hook

Serrated And Flat Handle With Polished Finish, 0.2mm Hook With Straight Shaft, And Overall Length Of 4 3/4" (12.1cm)



5-1656-A

Sinskey Iris And IOL Hook

Serrated And Flat Handle With Polished Finish, 0.2mm Angled Hook, And Overall Length Of 4 5/8" (11.7cm)



5-1656-M

Sinskey Hook Modified

Serrated And Flat Handle With Polished Finish, 0.2mm Hook With Curved Shaft, And Overall Length Of 4 3/4" (12cm)



5-1656-T-A

Sinskey Iris And IOL Hook Titanium

Serrated And Flat Handle, 0.2mm Angled Hook, And Overall Length Of 4 1/2" (11.4cm)



11-4-6331

Sinskey II Hook

0.2mm Straight With A Smooth And Flat Handle, 22mm Shaft, And An Overall Length Of 4 3/4" (12cm)

800.322.4674 or 800.633.7283

www.msiprecision.com

10-5



Manipulating Hooks



11-4-6341

Sinksey Hook

0.2mm Angled With A Flat And Smooth Handle, 10mm From Tip To Bend, And An Overall Length Of 4 3/4" (12cm)



11-4-6343

Sinskey Hook

0.2mm What A Round And Knurled Handle, 18mm Straight Shaft, And An Overall Length Of 4 1/2" (11.5cm)



11-4-6291

Sinskey Hook Straight

0.25mm With Flat Handle And Overall Length Of 4 3/4" (12cm)



11-4-6203

Sinskey Hook

0.25mm Straight With A Round And Knurled Handle, And An Overall Length Of 4 3/8" (11cm)



11-4-6204

Sinskey Hook

0.25mm Angled With A Round An Knurled Handle, 10mm From Tip To Bend, And An Overall Length Of 4 3/8" (11cm)



Manipulating Hooks



11-4-6201

Harris Sinskey Hook

Angled 0.25mm, With Smooth Flat Handle, 9mm Tip To Bend, And An Overall Length Of 4 3/4" (12cm)



5-1653

Clayman Guide

Smooth And Flat Handle With Polished Finish, Angled 45 Degrees 0.2mm Sinskey Hook With Shaft Angled 45 Degrees, 10mm From Tip To Bend, And Overall Length Of 4 5/8" (11.9cm)



11-4-6281

Clayman Jaffe Lens Hook

15mm And Angled, With Smooth And Flat Handle, 10mm From Tip To Bend, And An Overall Length Of 4 3/4" (12cm)



11-4-6341

Sinksey Hook

0.2mm Angled With A Flat And Smooth Handle, 10mm From Tip To Bend, And An Overall Length Of 4 3/4" (12cm)



11-4-6271

Jaffe Hook

0.15mm Straight With A Flat And Smooth Handle, 21mm Shaft, And An Overall Length Of 4 3/4" (12cm)

800.322.4674 or 800.633.7283

www.msiprecision.com

10-7



Manipulating Hooks



11-4-6241

Jaffe Iris Hook Small And Blunt

With Smooth And Flat Handle, 26mm Straight Shaft, And An Overall Length Of 5" (12.7cm)



5-1678

Kuglen Iris Hook And Lens Manipulator

Smooth And Flat Handle With Dull Finish, 0.5mm "K" Hook With Straight Shaft, And Overall Length Of 4 3/4" (11.9cm)



5-1678-A

Kuglen Iris Hook And Lens Manipulator

Smooth And Flat Handle With Dull Finish, 0.5mm "K" Hook With Angled Shaft, And Overall Length Of 4 5/8" (117mm)



11-4-6621

Kuglen Iris Hook With Clover Leaf

Smooth And Flat Handle, 20mm Straight Shaft, And An Overall Length Of 4 5/8" (11.7cm)



11-4-6621-A

Kuglen Iris Hook With Clover Leaf

Smooth And Flat Handle, 10mm From Tip To Bend, And An Overall Length Of 4 1/2" (11.5cm)



10-8

800.322.4674 or 800.633.7283

www.msiprecision.com

Manipulating Hooks



11-4-6631

Kuglen Iris Hook Angled 1mm

With Smooth Flat Handle, 10mm Tip To Bend, And An Overall Length Of 4 3/4" (12cm)



11-4-6633

Kuglen Hook Push-Pull

With A Round And Knurled Handle, 20mm Straight Shaft, And An Overall Length Of 4 3/4" (12cm)



11-4-6634

Kuglen Iris Hook Manipulator Angled

With A Round And Knurled Handle, 10mm From Tip To Bend, And An Overall Length Of 4 3/8" (11cm)



5-1682

Lester Lens Manipulator

Round And Knurled Handle With Dull Finish, Straight Shaft With 0.2mm Hourglass Shape Tip, And Overall Length Of 4 1/2" (11.5cm)



5-1682-A

Lester Lens Manipulator

Round And Knurled Handle With Dull Finish, Angled Shaft With 0.2mm Hourglass Shape Tip, And Overall Length Of 4 3/8" (11.2cm)

800.322.4674 or 800.633.7283

www.msiprecision.com

10-9



Manipulating Hooks



11-4-3791

Lester Manipulator Straight With Guard

Knurled And Round Handle, And An Overall Length of 4 3/4" (12cm)



11-4-3701

Lester IOL Manipulator Angled

With Round And Knurled Handle, 9mm From Tip To Bend, And An Overall Length Of 4 1/2" (11.5cm)



11-4-3702

Lester Manipulator With Vaulted Angle

Round And Knurled Handle, 10mm Curved From Tip To Bend, And An Overall Length Of 4 1/2" (11.5cm)



5-1688

Osher "Y" Hook

Round And Knurled Handle With Dull Finish, Straight Shaft With "Y" Shaped Tip, And "Y" Hook, And Overall Length Of 4 3/4" (12cm)



10-10

800.322.4674 or 800.633.7283

www.msiprecision.com

Manipulating Hooks



11-4-6639

Osher "Y" Hook

With Round And Knurled Handle, 23mm Straight Shaft, And An Overall Length Of 4 1/2" (11.5cm)



5-1683

Fenzl Insertion Hook

Round And Knurled Handle With Dull Finish, 45 Degrees Angled 10mm Shaft With 0.2mm Tip, And Overall Length Of 4 3/4" (12cm)



5-1866

Fenzl Iris Retractor

Round And Knurled Handle With Polished Finish, Angled 10mm From Tip To Bend With Curved Shaft, And Overall Length Of 4 1/2" (115mm)



11-4-6641

Fenzel Lens Hook

0.15mm Straight With A Round And Knurled Handle, 24mm Shaft, And An Overall Length Of 4 1/2" (11.5cm)

800.322.4674 or 800.633.7283

www.msiprecision.com

10-11



Manipulating Hooks



11-4-6642

Fenzel Lens Hook

0.15mm Angled With A Round And Knurled Handle, 10mm From Tip To Bend, And An Overall Length Of 4 5/8" (11.7cm)

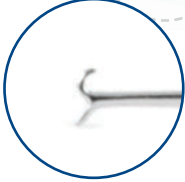

11-4-6637

Retsch Boat Hook With Guard

Round And Knurled Handle, 20mm Straight Shaft, And An Overall Length Of 4 1/2" (11.5cm)



11-4-6361

Lewicky Lens Hook Angled

With Round And Knurled Handle, 10mm From Tip To Bend, And An Overall Length Of 5" (12.7cm)



5-1646

Azar Lens Manipulation Hook

Smooth And Flat Handle With Polished Finish, Angled 90 Degrees 1/5mm Tip, And Overall Length Of 4 5/8" (11.7cm)

5-1650

Maumenee Iris Hook

Serrated And Flat Handle With Polished Finish, Sharp 1 1/2mm Hook, And Overall Length Of 4 3/4"(123mm)



5-1650-A

Maumenee Iris Hook

Serrated And Flat Handle With Polished Finish, Sharp 1 1/2mm Hook, And Overall Length Of 4 3/4" (123mm)

5-1650-B

Shepard Iris Hook

Serrated And Flat Handle With Polished Finish, Curved And Blunt 1mm Hook, And Overall Length Of 4 3/4" (123mm)



11-4-6221

Shepard Iris Hook

Blunt With Smooth And Flat Handle, 27mm Straight Shaft, And An Overall Length Of 5" (12.7cm)

5-1650-D

Bonn Iris Hook

Serrated And Flat Handle With Dull Finish, Curved And Blunt 3/10mm Hook, And Overall Length Of 4 3/4" (123mm)



11-4-6171

Bonn Iris Hook

With A Smooth And Flat Handle, 28mm Shaft, And An Overall Length Of 5" (12.7cm)



5-1650-H

Hirschman Iris Hook

Round And Knurled Handle With Polished Finish, Angled 45 Degrees H-Shaped 3/4mm Hook, 9mm From Tip To Bend, And Overall Length Of 122mm, 4 3/4" (12.2cm)

Manipulating Hooks



5-1657

Precision Iris Hook

Serrated And Flat Handle With Polished Finish, Blunt Hook, And Overall Length Of 4 7/8" (12.3cm)



5-1658

Maumenee Iris Hook

Serrated And Flat Handle With Polished Finish, Blunt 1mm Hook, And Overall Length Of 4 7/8" (12.5cm)



5-1659

Tyrell Iris Hook

Serrated And Flat Handle With Polished Finish, Sharp 2mm Hook, And Overall Length Of 4 3/4" (12cm)



5-1687-M

Minami "M" Hook

Round And Knurled Handle, Multi-Angled Shaft With Teardrop-Shaped Tip, And Overall Length Of 4 3/4" (12cm)



Manipulating Hooks



11-4-6211

Knolle Iris Hook

Blunt And Straight With A Round And Knurled Handle, A Small Hook, 28mm Shaft, And An Overall Length Of 4 3/4" (12cm)



5-1679

Kratz "K" Iris Push-Pull Hook

30 Gauge Cannula With Dull Finish, 23 Gauge Reinforced Shaft Angled 60 Degrees, Front Portion 18mm Long, 14mm From Tip To Bend, "K" Shape Tip On Right Side Of Cannula, And Overall Length Of 4 1/2" (11.5cm)

800.322.4674 or 800.633.7283

www.msiprecision.com

10-15



Titanium Pin Cutter

available in stainless

Our quality pin cutters are offered in 3 new designs:

- All Stainless Steel
- All Stainless Steel with removable handles
- Titanium Nitride coated with Titanium handles

The Titanium Nitride coated jaws have specially hardened cutting edges (approx. 60 HRC) and a handle of titanium.

Using titanium allows the instrument to be 30% lighter and has a longer durability against corrosion.

Our Pin Cutter is the perfect instrument for cutting off wires, bolts and pins up to 6mm in diameter!



103-0601T
103-0601

Titanium Pin Cutter
Stainless Steel Pin Cutter

For further product details and ordering information please contact the MSI Precision Instrument sales team. We will help you to find the appropriate product.

- Also ask about our other Titanium instruments!

285-9022206

Super Pin Cutter

Super Pin Cutter 22 7/16" (57cm) with removable handles for easier sterilization and storage specially designed spring make it 30% easier to cut pins up to 6mm than any other Pin Cutter - 1/4" diameter Cut.



800.322.4674 or 800.633.7283

www.msiprecision.com

Surgical Advantage

1-800-948-7994

order@surgicaladvantage.net

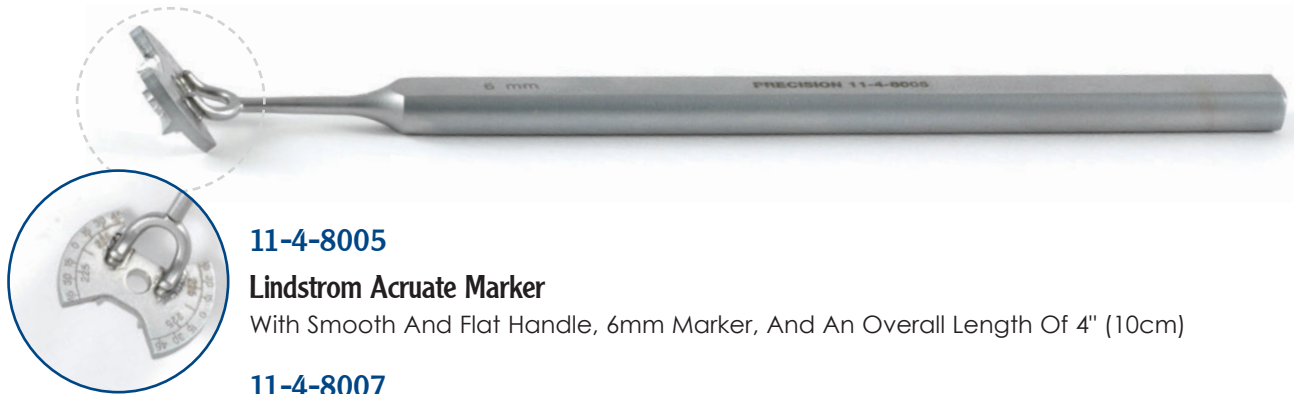

11-4-8005

Lindstrom Acruate Marker

With Smooth And Flat Handle, 6mm Marker, And An Overall Length Of 4" (10cm)

11-4-8007

Lindstrom Acruate Marker

With Smooth And Flat Handle, 7mm Marker, And An Overall Length Of 4" (10cm)

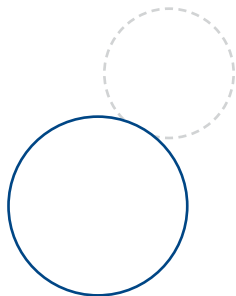

11-4-8011

Mendez Degree Gauge

Stainless, With Smooth And Flat Handle Dull finish, Calibrated Every 10 Degrees From 0 Degrees To 180 Degrees, Inner Dimensions Are 3/4" (12mm), And Overall Length Of 4 5/8" (11.7cm) Works With 11-4-8021



11-4-8021

Bores Axis Marker

With A Smooth And Flat Handle, 12mm Long Marker, And An Overall Length Of 4" (10cm) Works With 11-4-8011



5-3532

Mendez Degree Gauge

Stainless, Round And Knurled Handle with Dull finish, Calibrated Every 10 Degrees From 0 Degrees To 180 Degrees, Inner Dimensions Are 3/4" (12mm), And Overall Length Of 4 5/8" (11.7cm)

Markers



5-0111

Thornton Corneal Press On Ruler For Limbal Incisions

Curved Marking Blade With 2mm Lines 1mm Apart Measuring Up To 10mm, Round And Knurled Handle With Dull Finish, And Overall Length of 4 1/4" (11cm)



11-4-8053

Grandon T Incision Marker

With Round And Knurled Handle, 2.5 Incision Marker, And An Overall Length Of 4 1/4" (11cm)



11-4-8054

Grandon T Incision Marker

With A Smooth And Flat Handle, 3.0mm Marker Blade, And An Overall Length Of 4 1/4" (11cm)



11-4-8831

Mendez Corneal Marker

With Smooth And Flat Handle, 4mm Inner Diameter Marker, And An Overall Length Of 4 1/4" (11cm)



11-4-8841

Chayet Lasik Corneal Marker

With A Smooth And Flat Handle, With 3mm Inner Diameter And 9mm Outer Diameter Marker, And An Overall Length Of 4 1/4" (11cm)





11-4-8846

LU Lasik Corneal Marker

With Smooth And Flat Handle, 2.5mm Inner Diameter And 11.5mm Outer Diameter Marker, and An Overall Length Of 4 1/4" (11cm)



11-4-8848

Dulaney Lasik Marker

With A Smooth And Flat Handle, 5mm Long Marker, And An Overall Length Of 4" (10cm)

11-4-8903

Mandel Keratometer

With 3.5mm Ring Used To Project A Circular Shadow On The Cornea For Quantitative Evaluation Of Surgically Induced Astigmatism

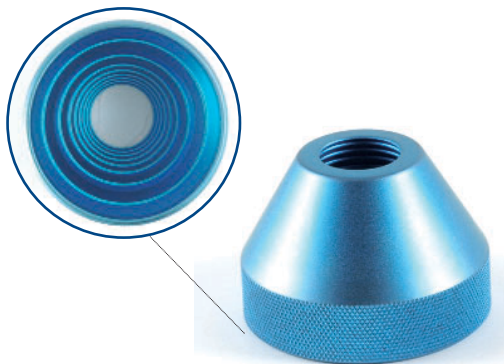

11-4-8999

Maloney Keratometer

Titanium With A Bottom Diameter Of 30mm, Upper Diameter Of 10mm, And An Overall Length Of 1" (2.5cm)



11-4-9212

Greene Visual Axis Marker

With Smooth And Flat Handle, 1.5mm Bend At Tip, And An Overall Length Of 4 1/2" (11.5cm)

Markers

11-4-9228

Precision Mcdonald Style Laser Optical Zone Marker

With Cross Hairs Double Ended Size 6.50mm and 7.00mm



Bores O-Z Marker

With Smooth Handle, 2.00mm to 9.5mm Diameter Marker, And An Overall Length Of 4" (10cm)

11-4-9237	2.00mm Diameter Marker	Overall Length Of 4" (10cm)
11-4-9238	2.25mm Diameter Marker	Overall Length Of 4" (10cm)
11-4-9239	2.50mm Diameter Marker	Overall Length Of 4" (10cm)
11-4-9230	2.75mm Diameter Marker	Overall Length Of 4" (10cm)
11-4-9241	3.00mm Diameter Marker	Overall Length Of 4" (10cm)
11-4-9242	3.25mm Diameter Marker	Overall Length Of 4" (10cm)
11-4-9243	3.50mm Diameter Marker	Overall Length Of 4" (10cm)
11-4-9244	3.75mm Diameter Marker	Overall Length Of 4" (10cm)
11-4-9245	4.00mm Diameter Marker	Overall Length Of 4" (10cm)
11-4-9246	4.25mm Diameter Marker	Overall Length Of 4" (10cm)
11-4-9247	4.50mm Diameter Marker	Overall Length Of 4" (10cm)
11-4-9248	4.75mm Diameter Marker	Overall Length Of 4" (10cm)
11-4-9249	5.00mm Diameter Marker	Overall Length Of 4" (10cm)
11-4-9240	5.25mm Diameter Marker	Overall Length Of 4" (10cm)
11-4-9251	5.50mm Diameter Marker	Overall Length Of 4" (10cm)
11-4-9252	5.75mm Diameter Marker	Overall Length Of 4" (10cm)
11-4-9253	6.00mm Diameter Marker	Overall Length Of 4 1/4" (11cm)
11-4-9255	6.50mm Diameter Marker	Overall Length Of 4" (10cm)
11-4-9257	7.00mm Diameter Marker	Overall Length Of 4 1/4" (11cm)
11-4-9259	7.50mm Diameter Marker	Overall Length Of 4" (10cm)
11-4-9261	8.00mm Diameter Marker	Overall Length Of 4" (10cm)
11-4-9263	8.50mm Diameter Marker	Overall Length Of 4" (10cm)
11-4-9267	9.50mm Diameter Marker	Overall Length Of 4 1/4" (11cm)



11-4

800.322.4674 or 800.633.7283

www.msiprecision.com



Berkeley Marker

With Smooth And Flat Handle, 3.00mm And 3.25mm to 5.0mm And 6.00mm Diameter Marker, And An Overall Length Of 4 3/8" (11cm)

11-4-9281	3.0mm And 3.25mm Diameter Marker
11-4-9283	3.5mm And 3.75mm Diameter Marker
11-4-9285	4.0mm And 4.25mm Diameter Marker
11-4-9286	4.0mm And 4.50mm Diameter Marker
11-4-9287	4.5mm And 5.00mm Diameter Marker
11-4-9289	5.0mm And 6.00mm Diameter Marker



Thomton Low Profile Optical Zone Marker

Round And Knurled Handle With Dull Finish, Size 3.00mm to 11mm , 1.5mm Ring Height Beveled To Outside, And Overall Length Of 3 1/8" (8cm)

5-0141-3.00	Size 3.00mm
5-0141-3.25	Size 3.25mm
5-0141-3.50	Size 3.50mm
5-0141-3.75	Size 3.75mm
5-0141-4.00	Size 4.00mm
5-0141-4.25	Size 4.25mm
5-0141-4.50	Size 4.50mm
5-0141-4.75	Size 4.75mm
5-0141-5.00	Size 5.00mm
5-0141-5.25	Size 5.25mm
5-0141-5.50	Size 5.50mm
5-0141-5.75	Size 5.75mm
5-0141-6.00	Size 6.00mm
5-0141-7.00	Size 7.00mm
5-0141-8.00	Size 8.00mm
5-0141-9.00	Size 9.00mm
5-0141-10.00	Size 10.00mm
5-0141-11.00	Size 11.00mm

Markers

5-0142

Neumann 6mm X 9mm Double Optical Zone Marker

Concentric 6mm And 9mm Rings, Ring Height Is 3mm, Round And Knurled Handle With Dull Finish, And Overall Length Of 3 1/4"(82mm)



Hoffer O-Z Marker

With Smooth And Flat Handle, 3.00mm to 9.00mm Diameter Marker

11-4-9441	3.00mm Diameter	Extra Fine Cross Hairs	Overall Length Of 4" (10cm)
11-4-9451	3.25mm Diameter	Extra Fine Cross Hairs	Overall Length Of 4" (10cm)
11-4-9461	3.50mm Diameter	Extra Fine Cross Hairs	Overall Length Of 4" (10cm)
11-4-9471	3.75mm Diameter	Extra Fine Cross Hairs	Overall Length Of 4" (10cm)
11-4-9481	4.00mm Diameter	Extra Fine Cross Hairs	Overall Length Of 4" (10cm)
11-4-9491	4.25mm Diameter	Extra Fine Cross Hairs	Overall Length Of 4" (10cm)
11-4-9501	4.50mm Diameter	Extra Fine Cross Hairs	Overall Length Of 4" (10cm)
11-4-9511	4.75mm Diameter	Cross Hairs	Overall Length Of 4" (10cm)
11-4-9521	5.00mm Diameter	Extra Fine Cross Hairs	Overall Length Of 4" (10cm)
11-4-9523	5.50mm Diameter	Extra Fine Cross Hairs	Overall Length Of 4" (10cm)
11-4-9525	6.00mm Diameter	Extra Fine Cross Hairs	Overall Length Of 4" (10cm)
11-4-9527	6.50mm Diameter	Cross Hairs	Overall Length Of 4" (10cm)
11-4-9529	7.00mm Diameter	Extra Fine Cross Hairs	Overall Length Of 4 1/4" (11cm)
11-4-9531	7.50mm Diameter	Cross Hairs	Overall Length Of 4 1/4" (11cm)
11-4-9533	8.00mm Diameter	Cross Hairs	Overall Length Of 4 1/4" (11cm)
11-4-9537	9.00mm Diameter	Cross Hairs	Overall Length Of 4 1/4" (11cm)



11-6

800.322.4674 or 800.633.7283

www.msiprecision.com



5-0122-3.50

Hoffer Optical Zone Marker

With Cross Hairs- Size 3.00mm to 9.50mm, Ring Height Is 3mm Beveled To Outside, Round And Knurled Handle With Dull Finish, And Overall Length Of 4 1/4" (11cm)

5-0122-3.00	With Cross Hairs- Size 3.00mm
5-0122-3.25	With Cross Hairs- Size 3.25mm
5-0122-3.50	With Cross Hairs- Size 3.50mm
5-0122-3.75	With Cross Hairs- Size 3.75mm
5-0122-4.00	With Cross Hairs- Size 4.00mm
5-0122-4.25	With Cross Hairs- Size 4.25mm
5-0122-4.50	With Cross Hairs- Size 4.50mm
5-0122-4.75	With Cross Hairs- Size 4.75mm
5-0122-5.00	With Cross Hairs- Size 5.00mm
5-0122-5.25	With Cross Hairs- Size 5.25mm
5-0122-5.50	With Cross Hairs- Size 5.50mm
5-0122-6.00	With Cross Hairs- Size 6.00mm
5-0122-7.00	With Cross Hairs- Size 7.00mm
5-0122-8.00	With Cross Hairs- Size 8.00mm
5-0122-9.00	With Cross Hairs- Size 9.00mm
5-0122-9.50	With Cross Hairs- Size 9.50mm

Markers



5-0133-16



5-0133-4

Osher Neuman Corneal Marker

4 Lines And Marking 4mm Long Radial Lines, 4.5mm Inner Diameter Of Blades, And Overall Length Of 4 5/8" (11.6cm)

5-0133-6

6 Lines And Marking 4mm Long Radial Lines

Overall Length Of 4 1/2" (11.5cm)

5-0133-8

8 Lines And Marking 4mm Long Radial Lines

Overall Length Of 4 5/8" (11.6cm)

5-0133-10

10 Lines And Marking 4mm Long Radial Lines

Overall Length Of 4 1/2" (11.5cm)

5-0133-12

12 Lines And Marking 4mm Long Radial Lines

Overall Length Of 4 1/2" (11.5cm)

5-0133-16

16 Lines And Marking 4mm Long Radial Lines

Overall Length Of 4 1/2" (11.5cm)



11-4-9636

Ellis Astigmatism Marker

Double-Ended With A Smooth And Flat Handle, 6mm Diameter And 7mm Diameter Markers, And An Overall Length Of 4 1/2" (11.5cm)



11-8

800.322.4674 or 800.633.7283

www.msiprecision.com



11-4-9966

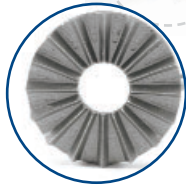

11-4-9961

Anis Radial Marker

With 04 Blades, Smooth And Flat Handle, And An Overall Length Of 4 1/4" (11cm)

11-4-9962 With 06 Blades

11-4-9963 With 08 Blades

11-4-9964 With 10 Blades

11-4-9965 With 12 Blades

11-4-9966 With 16 Blades



5-0144

Pettigrove PRK Scraper And Marker

6.5mm Marker End, Highly Polished Stainless Steel Spatula Tip, And Overall Length Of 4" (10cm)

Muscle Hooks



5-1602

Graefe Strabismus Hook

Serrated Flat Handle With Polished Finish, Flattened Hook #1 size 8mm Overall Length Of 5 3/8" (135mm)

5-1603

Graefe Strabismus Hook

Serrated Flat Handle With Polished Finish, Flattened Hook #2 size 10mm Overall Length Of 5 1/2" (140mm)

5-1604

Graefe Strabismus Hook

Serrated Flat Handle With Polished Finish, Flattened Hook #3 size 10mm Overall Length Of 5 5/8" (143mm)



5-1675

Scobee Oblique Muscle Hook

Serrated And Flat Handle With Polished Finish, Curved Shaft With Flat 4.5mm Hook, And Overall Length Of 5 1/4" (13.3cm)



5-1691

Culler Rectus Muscle Hook

Serrated And Flat Handle With Polished Finish, 7mm Flattened Hook, And Overall Length Of 5" (13cm)

5-1693

Culler Rectus Muscle Hook

Serrated And Flat Handle With Polished Finish, Flattened 10mm Hook With Angled Tip, And Overall Length Of 4 13/16" (122mcm)



11-10

800.322.4674 or 800.633.7283

www.msiprecision.com



5-1697

Jameson Muscle Hook

Serrated And Flat Handle With Polished Finish, 2mm Bulbous Tip With 6mm Flat Portion, And Overall Length Of 5 1/4" (13.4cm)



5-1697-S

Jameson Muscle Hook

Serrated And Flat Handle With Polished Finish, Small Bulbous Tip With Flat Sides, And Overall Length Of 5 1/4" (13.5cm)



5-1699

Green Strabismus Hook

Serrated And Flat Handle With Polished Finish, Flat 7mm Hook, And Overall Length Of 5 1/8" (13cm)

- 11-4-7871 Helveston Finder Hook Large**
- 11-4-7872 Helveston Finder Hook Small**
- 11-4-7889 Helveston Muscle Hook 8mm**
- 11-4-7891 Helveston Muscle Hook 10mm**
- 11-4-7893 Helveston Muscle Hook 12mm**

Phaco Chops



18228

Precision Style Haefliger Phaco Chop

Left, With An Overall Length Of 4 3/4" (12cm)



18227SPT

Precision Style Haefliger Phaco

Right Handed, 45 Degree Angle, With An Overall Length Of 4 5/8" (11.6cm)



5-1681-N

Nichamin Style Triple Chop and Castroviejo Spatula

0.5mm With Knurled Handle And Overall Length Of 5 1/2" (14cm)

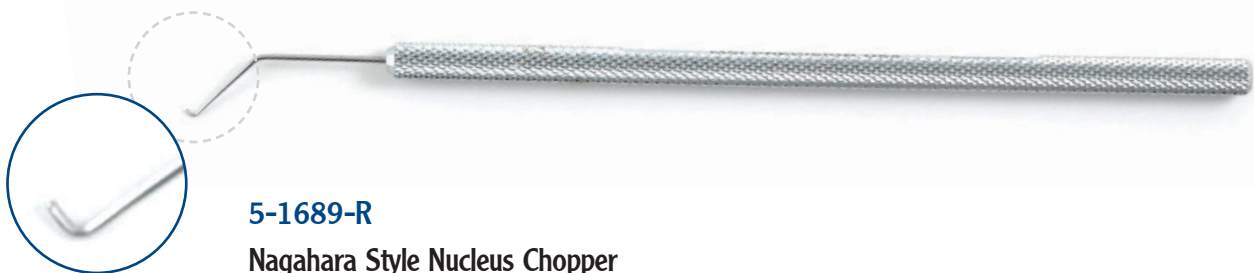

5-1689-R

Nagahara Style Nucleus Chopper

Round And Knurled Handle, Nucleus Divider With 1.25mm Tip And Blade Offset At 60 Degrees Angle, For Right-Handed Use, And Overall Length Of 4 1/2" (11.5cm)

5-1689-L

Nagahara Style Nucleus Chopper-Left

Round And Knurled Handle, Nucleus Divider With 1.25mm Tip And Blade Offset At 60 Degrees Angle, For Left-Handed Use, And Overall Length Of 4 1/2" (11.5cm)





5-1689-LT

Nagahara Style Phaco Chop

Titanium, Round And Knurled Handle, Nucleus Divider With 1.25mm Tip And Blade Offset At 60 Degrees Angle, For Right-Handed Use, And Overall Length Of 4 1/2" (11.5cm)

5-1689-RT

Nagahara Style Phaco Chop

Titanium, Round And Knurled Handle, Nucleus Divider With 1.25mm Tip And Blade Offset At 60 Degrees Angle, For Left-Handed Use, And Overall Length Of 4 1/2" (11.5cm) And Blade Offset At 60 Degrees Angle, For Right-Handed Use, And Overall Length Of 4 1/2" (11.5cm)



11-4-3479

Chang Style Phaco Chop Right And Double-Ended

With A Round And Knurled Handle, 1mm Bent Tip And A 2mm Bent Tip, And An Overall Length Of 5 1/8" (13cm)



11-4-3470

Chang Style Phaco Chopper Left And Double-Ended

With Knurled Handle, 10mm Tips To Bends, And An Overall Length Of 5 1/8" (13cm)

11-4-3491

Precision Style Brierley Nucleus Splitter Single Ended

11-4-3495

Precision Style Dodick-Kammann Nucleus Chopper

Straight, 2mm Long

11-4-3496

Precision Style Dodick-Kammann Nucleus Chopper

Angled 2mm Long Tip

11-4-3401

Precision Style Nagahara Nucleus Spatula With Flat Edge

Phaco Chops

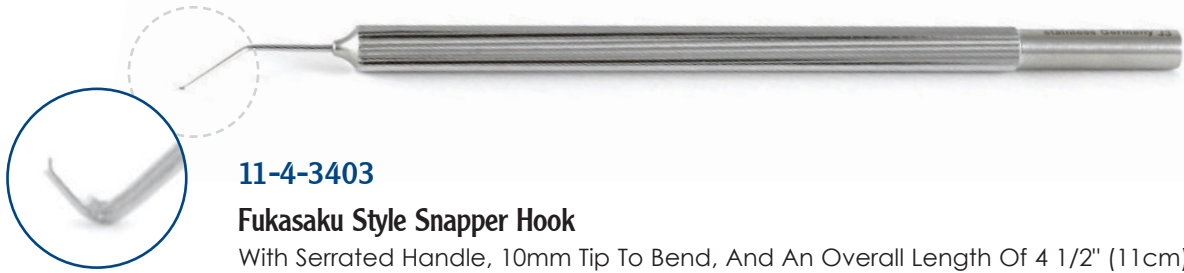

11-4-3403

Fukasaku Style Snapper Hook

With Serrated Handle, 10mm Tip To Bend, And An Overall Length Of 4 1/2" (11cm)



11-4-3404

Fukasaku Style Pupil Snapper

Small With Knurled Handle, 10mm Tip To Bend, And An Overall Length Of 4 3/8" (11cm)



11-4-3406

Rosen Style Phaco

Splitter 90 Degrees With Knurled Handle, 10mm Tip To Bend, And Overall Length Of 4 3/8" (11cm))



11-4-3407

Rosen Style Phaco

Splitter 60 Degrees With A Knurled Handle, 10mm Tip To Bend, And An Overall Length Of 4 3/8" (11cm))



11-4-3409

Rowen Style Phaco

Spatula Double-Ended With Knurled Handle, 10mm Tips To Bends, And An Overall Length Of 5 3/8" (13.5cm)



11-14

800.322.4674 or 800.633.7283

www.msiprecision.com



11-4-3511

Bechert Nucleus Rotator

With Round And Knurled Handle, 7mm Tip To Bend, And An Overall Length Of 4 1/4" (11cm)

9-18222-R

Precision Style Goldberg Single Ended Side Port Nucleus Splitter And Manipulator



9-18225-R

Precision II Ball Nucleus Chopper

Straight Shaft With An Overall Length Of 4 1/2" (11.5cm)

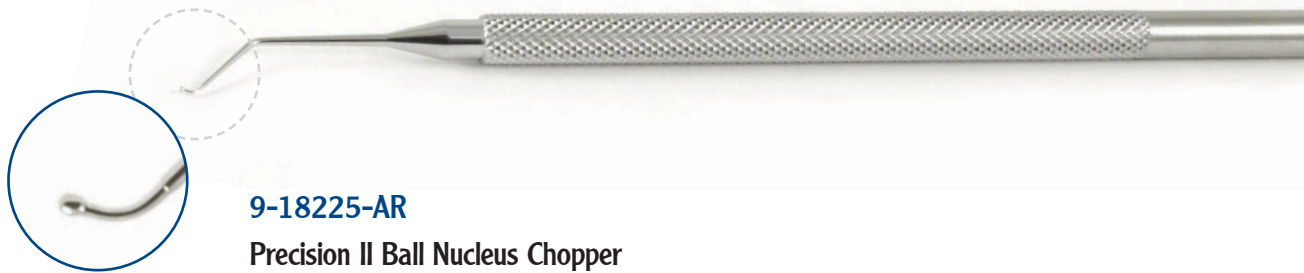

9-18225-AR

Precision II Ball Nucleus Chopper

Angled Shaft With An Overall Length Of 4 1/2" (11.5cm))



9-18225-CR

Precision II Ball Nucleus Chopper

Curved Shaft With An Overall Length Of 4 1/2" (11.5cm)



9-24246-R

Livemois Style Fixation Loop

With An Overall Length Of 4 1/8 (10.5cm)

Phaco Chops

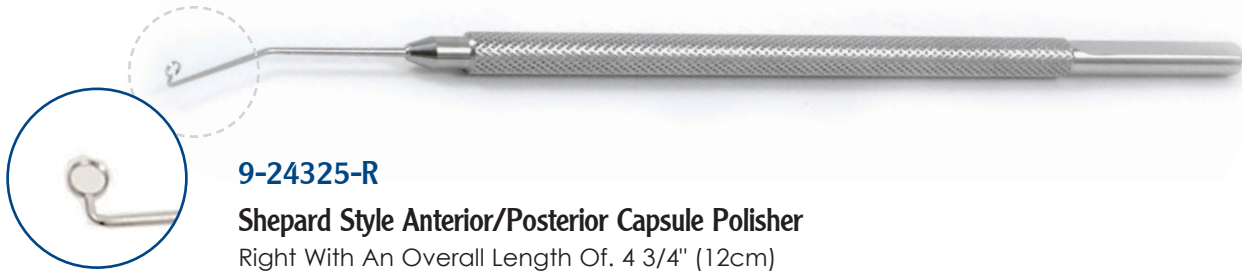

9-24325-R

Shepard Style Anterior/Posterior Capsule Polisher

Right With An Overall Length Of. 4 3/4" (12cm)

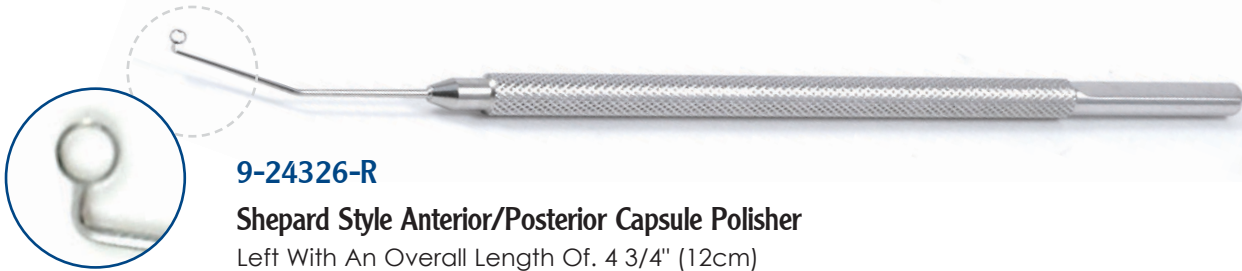

9-24326-R

Shepard Style Anterior/Posterior Capsule Polisher

Left With An Overall Length Of. 4 3/4" (12cm)



9-25613-R

Nagahara Style Phaco-Chopper

Right With Serrated Handle And Overall Length Of 4 1/2" (11.5cm)



9-25614-L-R

Fine Nagahara Style Phaco Chop Left

With An Overall Length Of 4 1/2" (11.5cm)



9-25614-R-R

Fine Nagahara Style Phaco Chopper Right

With An Overall Length Of 4 7/8" (12.4cm)



11-16

800.322.4674 or 800.633.7283

www.msiprecision.com

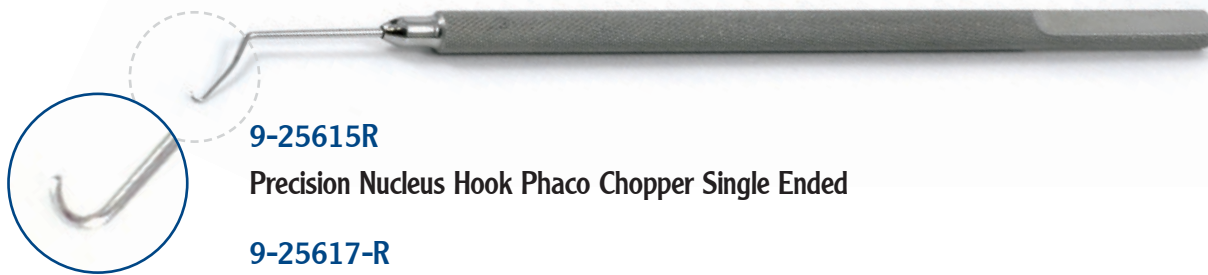

9-25615R

Precision Nucleus Hook Phaco Chopper Single Ended

9-25617-R

Precision Style Nichamin Triple Chopper Double Ended

9-25627

Precision Style Ball Seibel Nucleus Chopper

9-25627-L-R

Precision Style Ball Seibel Nucleus Chopper

Left, Angled Shaft, Stainless Steel



9-25632-R

Precision Style Nichamin Style Vertical Nucleus Chopper

Ambidextrous, Stainless, With An Overall Length Of 4 7/8" (12.4cm)

9-25640-R

Precision Style Vergus Style Phaco Chopper

9-25641-LR

Precision Style Nichamin Style Quick Chopper

Left

9-25641-R

Precision Style Nichamin Style Quick Chopper

Right

9-25643-R

Precision Style Nichamin Style Triple Chopper + Nichamin Quick Chopper

Right Hand Dominant Stainless Steel

9-25646-LR

Precision Style Seibel Style Vertical Quick Chopper

Left

9-25647-RR

Seibel Style Nucleus Chopper & Safety Quick Chopper

Right Hand Dominant

9-25648-L-R

Fine Nagahara Style & Nichamin Style I Quick Double Chopper

Left Hand Dominant Stainless Steel

9-25648-R-R

Fine Nagahara Style & Nichamin Style I Quick Double Chopper

Right Hand Dominant Stainless Steel

16-5151-L

Seibel Style Nucleus Chopper

Titanium Left

16-5151-R

Seibel Style Nucleus Chopper

Titanium Right

16-5154-R

Nichamin Style Titanium Quick Chopper

Right Hand Dominant



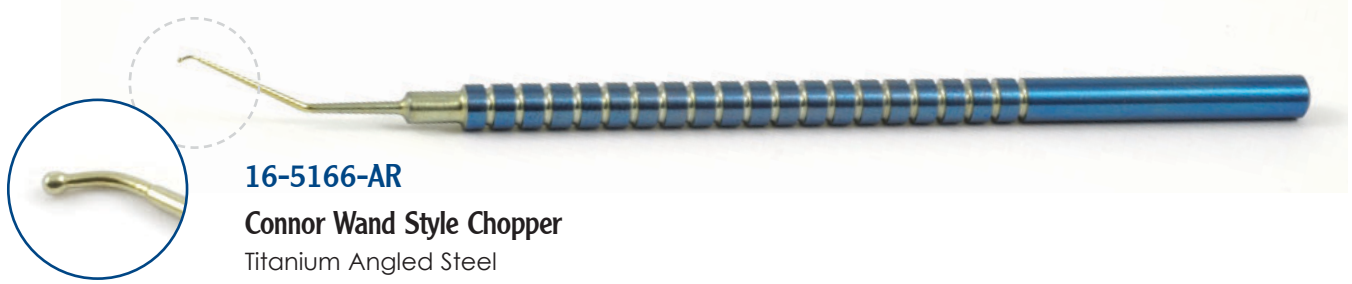

16-5166-AR
Connor Wand Style Chopper
Titanium Angled Steel

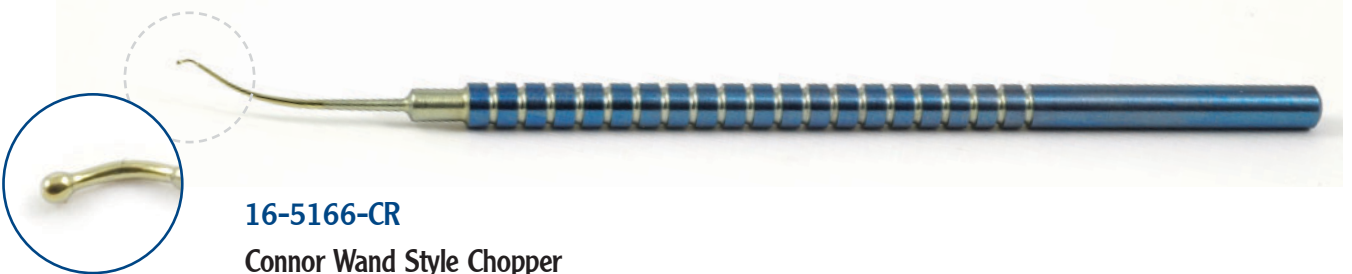

16-5166-CR
Connor Wand Style Chopper
Titanium Curved

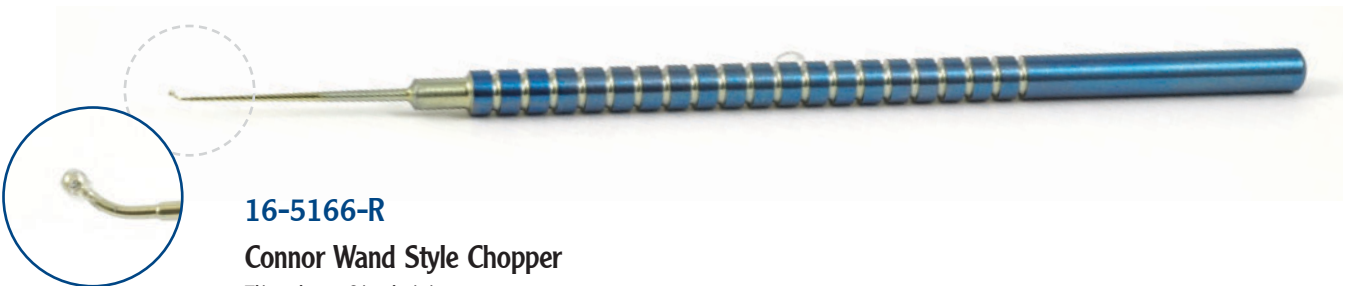

16-5166-R
Connor Wand Style Chopper
Titanium Straight

16-5168-R
Nichamin Style Quick Chopper
Nucleus Pick Double Ended Titanium Right Hand Dominant

16-5176-L-R
Seibel Style Nucleus Double Ended SC Chopper And Spatula
Left Handed

16-5176-RR
Seibel Style Nucleus Double Ended SC Chopper And Spatula
Right Handed

You've just found the best kept secret!

Precision Surgical
Instruments made
exact to the name brands
without the high price!
MSI Precision quality you
can count on!



Stringent quality standards are the most important aspect in the development of MSI Precision Specialty Instruments.

Our Instruments are designed, manufactured and tested to provide surgeons with superior performance and dependability.

All MSI Instruments are unconditionally guaranteed against defects in material and workmanship. MSI will, at its option and without charge, either repair or replace any instrument which MSI determines to be defective in material or workmanship when used for its intended surgical purpose.



800.322.4674 or 800.633.7283

www.msiprecision.com

Surgical Advantage

1-800-948-7994

order@surgicaladvantage.net

5-1629

Anis Disk Capsule Polisher

Round And Knurled Handle With Dull Finish, Tip Guard, 1 1/2mm Flat Disk Shape Sandblasted Tip, Flexible 18mm Gently Curved Shaft, And Overall Length Of 4 1/2" (11.5cm)



9-24325-R

Shepard Anterior/Posterior Capsule Polisher

Right With An Overall Length Of. 4 3/4" (12cm)

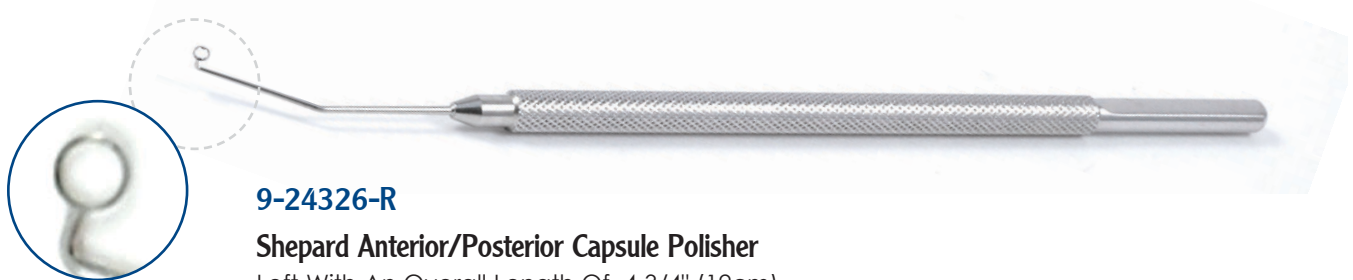

9-24326-R

Shepard Anterior/Posterior Capsule Polisher

Left With An Overall Length Of. 4 3/4" (12cm)



5-1619

Kratz Capsule Scraper

23 Gauge Cannula With Polished Finish And Angled 1mm Sandblasted Tip, And Overall Length Of 3/4" (2cm)

Polishers

5-1619-ED

Kratz Capsule Scraper

23 Gauge Cannula With Polished Finish And Angled 1mm Electro-Dusted Tip, And Overall Length Of 3/4"(21mm)



11-8-5011

Kratz Scratcher

22 Gauge SandBlasted And Excluding Hub An Overall Length Of 3/4" (20mm)



5-1610-23

Knolle Capsule Scraper

23 Gauge Cannula With 2mm Angled Sandblasted Tip And Polished Finish, And Excluding Hub Overall Length Of 3/4" (2cm)

5-1610-23-ED

5-1610-30

Knolle Capsule Scraper

30 Gauge Cannula With Angled 2mm Sandblasted Tip And Polished Finish, And Overall Length Of 18mm, 3/4"(18mm)



11-8-5031

Jensen Capsule Polisher

25 Gauge Curved And Excluding Hub An Overall Length Of 1 1/8" (28mm)



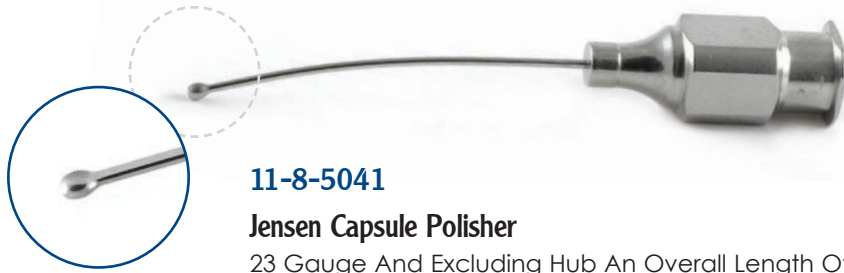

11-8-5041

Jensen Capsule Polisher

23 Gauge And Excluding Hub An Overall Length Of 1 1/8" (28mm)



11-8-5032

Jensen Capsule Polisher

25 Gauge And Excluding Hub An Overall Length Of 1" (22mm)



11-8-5042

Jensen Polisher

Full 23 Gauge Curved And Excluding Hub An Overall Length Of 1 1/8" (27mm)

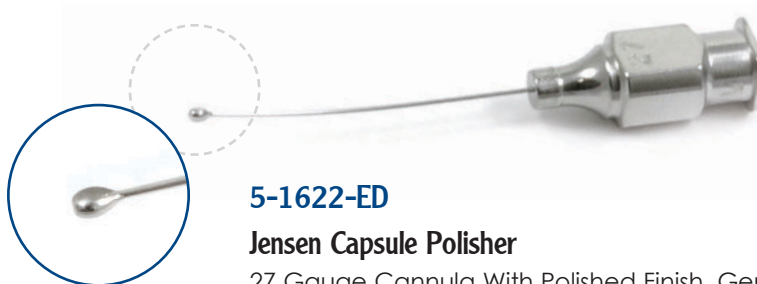

5-1622-ED

Jensen Capsule Polisher

27 Gauge Cannula With Polished Finish, Gently Curved Shaft And Electro-Dusted Lower Half Of Olive Tip, And Overall Length Of 1 3/4" (4.5cm)

11-8-6331

Simcoe Cortex Extractor

23 Gauge Gently Curved Cannula With Polished Finish, 0.33mm Aspiration Port, And Excluding Hub Overall Length Of 1/2" (13mm)

Polishers

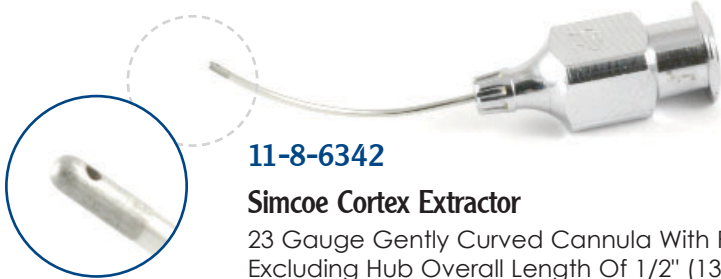

11-8-6342

Simcoe Cortex Extractor

23 Gauge Gently Curved Cannula With Polished Finish, 0.33mm Aspiration Port, And Excluding Hub Overall Length Of 1/2" (13mm)

5-1624

Freeman Posterior Capsule Polisher "Tennessee" Polisher

19 Gauge Cannula With Polished Finish, Flattened Angled 12mm Tip, 4mm Sandblasted Tip With Irrigating Holes On Tip And Sides, And Overall Length 1 1/4"(32mm)

5-1633

Drews Capsule Polisher

25 Gauge Cannula With Polished Finish, 2 1/2 Diameter Angled Ring With Part On Inside At 6 o'clock, Sandblasted



11-8-5991

Kraff Capsule Polish

Curette Curved And Excluding Hub An Overall Length Of 1 1/8" (28mm)

5-1669-PS

Simcoe Posterior Capsule Polisher

23 Gauge Cannula With Polished Finish And Sandblasted Tip, Angled 45 Degrees Shaft, 14mm From Tip To Bend, And Overall Length Of 5/8" (16mm)



5-5528-T

Thornton Aspirating Capsule Polisher

Aspirating 27 Gauge Cannula With "U" Shape Sandblasted Tip To, And Excluding Hub Overall Length Of 7/8" (23mm)

11-8-5013

Rubman-Katzin Capsule Polisher

11-8-5017

Rubman-Katzin Capsule Polisher





5-1710

Olk Angled Retinal Pick

Round And Knurled Handle With Dull Finish, 0.5mm 150 Degree Angled Tip, And Overall Length Of 4 7/8" (12.3cm). Overall Weight Of 0.5 oz



5-1719

Olk Angled Retinal Pick

Round And Knurled Handle With Dull Finish, 0.5mm 110 Degree Angled Tip, And Overall Length Of 4 7/8" (12.5cm). Overall Weight Of 0.5 oz



5-1722

Olk Angled Retinal Spatula

Round And Knurled Handle With Dull Finish, Triangular 0.5mm 150 Degree Angled Tip With 4mm Flat Surface, And Overall Length Of 5" (12.5cm). Overall Weight Of 0.5 oz

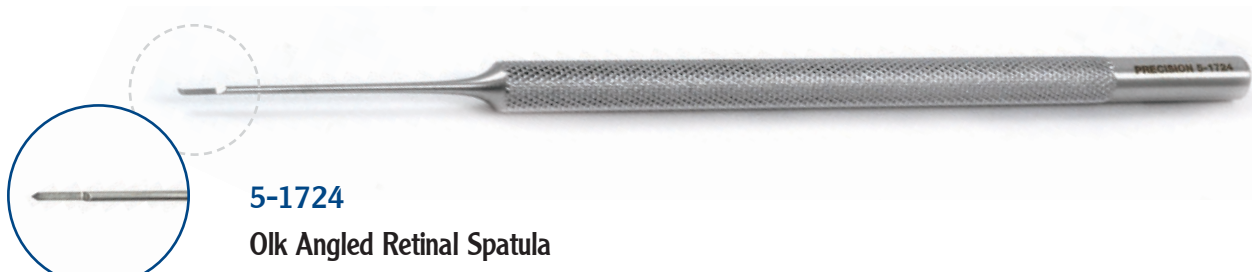

5-1724

Olk Angled Retinal Spatula

Round And Knurled Handle With Dull Finish, Triangular 0.5mm 130 Degree Angled Tip With 4mm Flat Surface, And Overall Length Of 5" (12.6cm). Overall Weight Of 0.5 oz

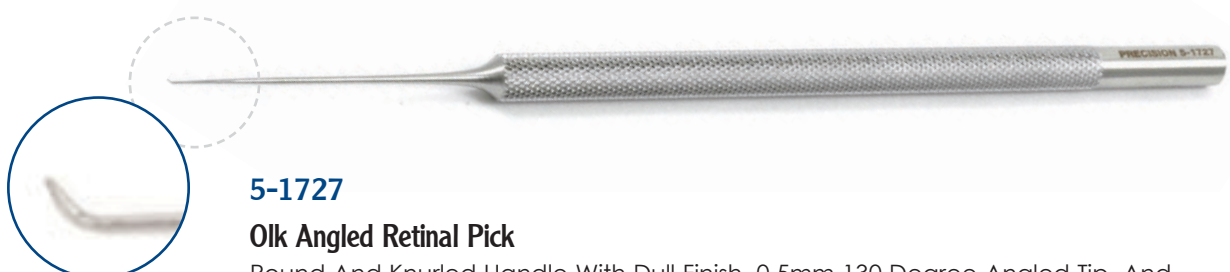

5-1727

Olk Angled Retinal Pick

Round And Knurled Handle With Dull Finish, 0.5mm 130 Degree Angled Tip, And Overall Length Of 5 1/8" (12.9cm) . Overall Weight Of 0.5 oz

Retractors



5-6141

Arruga Retractor

Serrated And Flat Handle With Dull Finish, 10mm Wide X 18mm Cupped Retractor Blade, And Overall Length Of 5 3/4" (14.5cm). Overall Weight Of 0.8 oz



5-6119

Schepens Orbital Retractor

With Flat Handle, 15mm X 15mm Retractor Blade, And An Overall Length Of 6" (15cm). Overall Weight Of 0.6 oz



5-1091

Desmarres Lid Retractor-Size 0

Flat Handle With Matte Finish, 11mm Wide Retractor Blade Size 0 Overall Length Of 5 1/2" (14cm)

- 5-1092** **Size 1, 13mm Wide Retractor Blade**
- 5-1093** **Size 2, 15mm Wide Retractor Blade**
- 5-1094** **Size 3, 177mm Wide Retractor Blade**



5-1091-I

Desmarres Lid Retractor-Size 0

Insulated, Flat Handle With Matte Finish, 11mm Wide Retractor Blade Size 0, Overall Length Of 5 1/2"(14cm)

- 5-1092-I** **Size 1, 13mm Wide Retractor Blade**
- 5-1093-I** **Size 2, 15mm Wide Retractor Blade**
- 5-1094-I** **Size 3, 177mm Wide Retractor Blade**



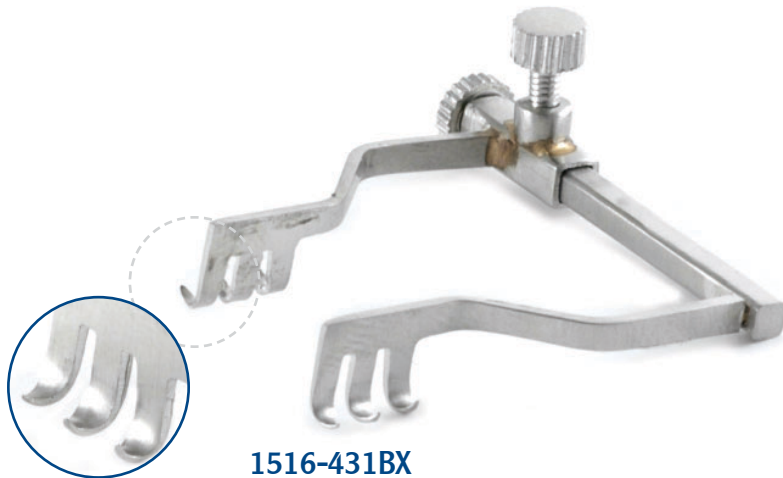

1516-431BX

Goldstein Lacrimal Retractor

With Blade Spread Of 15mm, Blade Length 7mm, And An Overall Length Of 1 1/4" (3cm). Overall Weight Of 0.1 oz

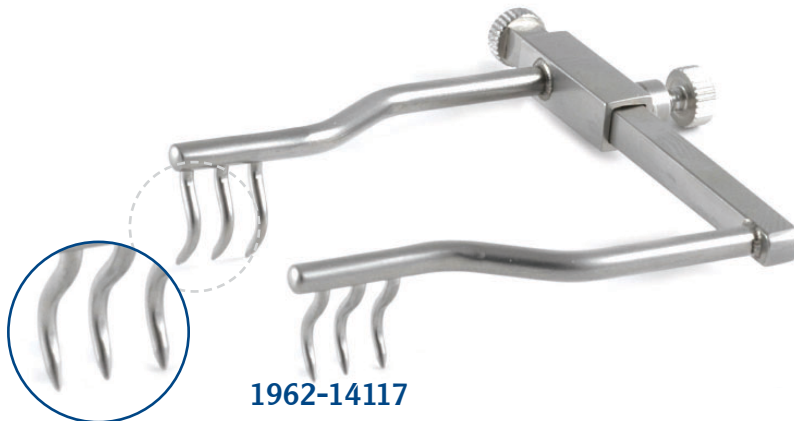

1962-14117

Goldstein Infant Lacrimal Sac Retractor

Overall Length 1 1/2" (3.8cm) , Overall Spread 7/8" (2.2cm) 3 by 3 Sharp Teeth Blade Height 7mm Blade Depth 9mm. Overall Weight Of 0.1 oz

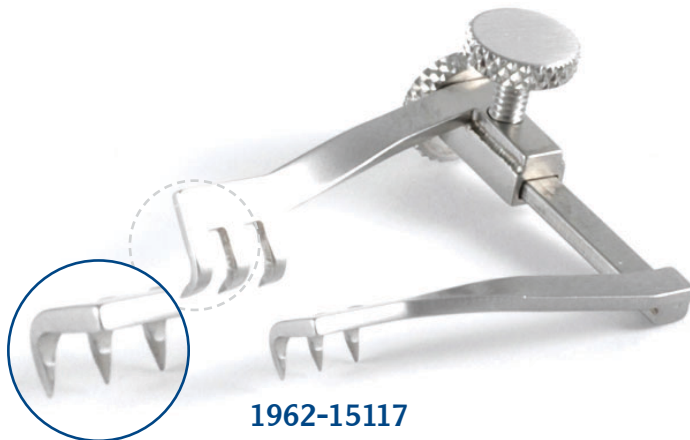

1962-15117

Goldstein Super Small Infant Lacrimal Sac Retractor

Overall Length 7/8" (2.2cm) , Overall Spread 1/4" (6mm) 3 by 3 Sharp Teeth Blade Height 5.5mm Blade Depth 5.25mm. Overall Weight Of 0.1 oz

Retractors





232-G00-08 (Shown)

Kerrison Bone Rongeur Size 0

Working Length Is 100mm With A 8mm Jaw Opening, Jaw Size Is 3.5mm Wide By 2.5mm High, In Closed Position Outside Demension is 5.0mm Wide. Overall Length Of 8 1/4" (21cm). Overall Weight Of 5.6 oz

232-G00-09

Kerrison Bone Rongeur Size 1

Working Length Is 100mm With A 8mm Jaw Opening, Jaw Size Is 4mm Wide By 3mm High, In Closed Position Outside Demension is 4mm Wide. Overall Length Of 8 1/4" (21cm). Overall Weight Of 5.6 oz

232-G00-10

Kerrison Bone Rongeur Size 2

Working Length Is 100mm With A 8mm Jaw Opening, Jaw Size Is 4.5mm Wide By 3mm High, In Closed Position Outside Demension is 54.5mm Wide. Overall Length Of 8 1/4" (21cm). Overall Weight Of 5.6 oz

232-G00-11

Kerrison Bone Rongeur Size 3

Working Length Is 100mm With A 8mm Jaw Opening, Jaw Size Is 5mm Wide By 3.5mm High, In Closed Position Outside Demension is 5.0mm Wide. Overall Length Of 8 1/4" (21cm). Overall Weight Of 5.6 oz

Rotator Globe



5-9259

Osher Globe Rotator

Round And Knurled Handle With Polished Finish, 1mm Curved Tip, Conforms To Curvature Of Globe And Distributes Even Pressure In Cul-De-Sac During Rotation, And Overall Length Of 3" (7.6cm). Overall Weight Of 0.2 oz

Ruler

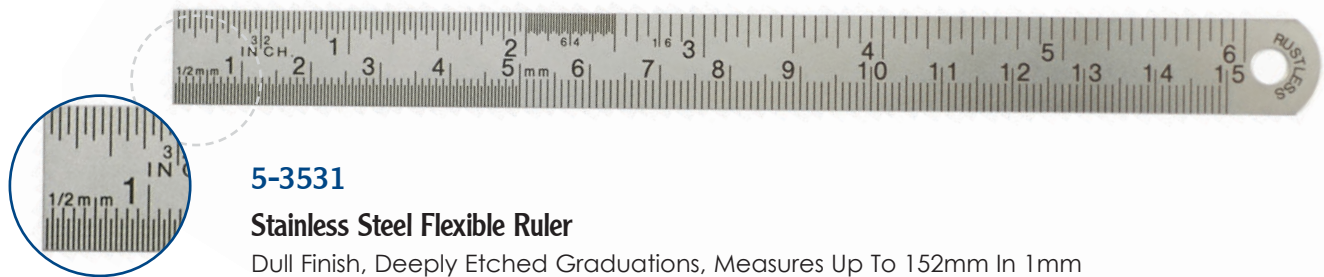

5-3531

Stainless Steel Flexible Ruler

Dull Finish, Deeply Etched Graduations, Measures Up To 152mm In 1mm Increments, 6" In 1/32" Increments, And Overall Length Of 6 1/4" (16cm). Overall Weight Of 0.3 oz



13-6

800.322.4674 or 800.633.7283

www.msiprecision.com



5-4011

Precision Serrefine

Polished Finish, 10mm Serrated Jaws, And Overall Length Of 1 3/8" (3.5cm).
Overall Weight Of 0.1 oz



5-4015

Dieffenbach Serrefine

Polished Finish, 20mm Jaws, And Overall Length Of 2 1/4" (6cm). Overall Weight
Of 0.2 oz

Spatulas



5-1585

Castroviejo Double Ended Synchia Spatula

Serrated Square Handle With Polished Finish, Double Ended With Sharp, Gently Curved 1/2mm X 10mm And 1/2mm X 15mm Blades, With Overall Length Of 5 1/8" (13cm)

5-1590

Castroviejo Double Ended Cyclodialysis Spatula

Serrated Square Handle With Polished Finish, Double Ended With Gently Curved 1/2mm X 10mm And 1/2mm X 15mm Blades, And Overall Length Of 4 7/8" (12.5cm)



11-4-4311

Castroviejo Spatula 0.25mm Double-Ended

With Serrated Handle, 10mm Tip To Bend On One End, 15mm Tip To Bend On Other End, And Overall Length Of 5" (13cm)

5-1592

Clayman Spatula

Smooth Flat Handle With Polished Finish, 1/2mm X 10mm Angled Blade With Blunt Tip, And Overall Length Of 5" (12.7cm)



5-1595

Barraquer Cyclodialysis Spatula

Round And Knurled Handle With Polished Finish, 1/2mm X 15mm Angled Blade With Smoothly Pointed Tip And Gently Curved Blade, And Overall Length Of 4 3/4" (12.2cm)

5-1596

Barraquer Iris Spatula

Short And Hexagonal Handle With Polished Finish, Angled 1/2mm X 15mm Tip With Gently Curved Blade, And Overall Length Of 3 1/2" (9cm)



13-8

800.322.4674 or 800.633.7283

www.msiprecision.com



5-1596-25

Barraquer Iris Spatula

Short And Hexagonal Handle With Polished Finish, Angled 1/4mm X 15mm Tip With Gently Curved Blade, And Overall Length Of 3 1/2" (9cm)



5-1596-25-T

Barraquer Iris Spatula

Titanium, Short And Hexagonal Handle With Polished Finish, Angled 1/4mm X 15mm Tip With Gently Curved Blade, And Overall Length Of 4 3/4" (12.2cm)



11-4-3478

Masket Phaco Spatula Double-Ended

With Knurled Handle, 10mm Tip To Bend On One End, 12mm Tip To Bend On Other End, And An Overall Length Of 5 1/2" (13.5cm)



5-1596-C

Cleasby Iris Spatula

Short And Hexagonal Handle With Polished Finish, Angled 12mm Tip With Gently Curved Blade, And Overall Length Of 3 1/2"(90mm)

5-1597-M

Maumenee-Barraquer Vitreous Sweep Spatula-Right

Round And Knurled Handle With Polished Finish, Angled 10mm Tip With Indentation On Right Side And Gently Curved Blade, And Overall Length Of 4 3/4"(119mm)

5-1598-M

Maumenee-Barraquer Vitreous Sweep Spatula-Left

Round And Knurled Handle With Polished Finish, Angled 10mm Tip With Indentation On Left Side And Gently Curved Blade, And Overall Length Of 4 3/4"(119mm)

Spatulas



5-1599

Elschnig Cyclodialysis Spatula

Serrated And Flat Handle With Polished Finish, Angled 11mm Tip With Gently Curved Blade, And Overall Length Of 5 1/4" (13.3cm)

5-1503

Castroviejo Cyclodialysis Spatula

Serrated Flat Handle With Polished Finish, Angled 1mm X 10mm Blade, And Overall Length Of 5 3/8"(136mm)



5-1504

Castroviejo Cyclodialysis Spatula

Serrated Flat Handle With Polished Finish, Angled 1/4mm x 10mm Blade, And Overall Length Of 5 1/4" (13.3cm)



5-1505

Castroviejo Cyclodialysis Spatula

Serrated Flat Handle With Polished Finish, Angled 1mm X 16mm Blade, Overall Length Of 5 1/4" (13.3cm), Weight: 0.5 oz



5-1841

Johnson Spatula

Round And Knurled Handle With Polished Finish, .25mm X 10mm, Perfect For imanual Phaco Procedure, And Overall Length Of 4 5/8" (11.7cm)



5-1823

Koch Phacoemulsification Spatula

Round Knurled Handle, Duckbill Spatula Enters Side-Port Stab Incision, Broad Tip, And Overall Length Of 4 5/8" (117mm)



13-10

800.322.4674 or 800.633.7283

www.msiprecision.com



5-1823-T

Koch Phacoemulsification Spatula

Titanium, Round Knurled Handle, Duckbill Spatula Enters Side-port Stab Incision, Broad Tip, With Overall Length Of 5" (12.7cm)

5-1823-II

Koch Phacoemulsification Spatula

Round Knurled Handle, Duckbill Spatula Enters Side-Port Stab Incision, Broad Tip, Rounded Tip With Notch And Curved Shaft, And Overall Length Of 4 5/8" (117mm)

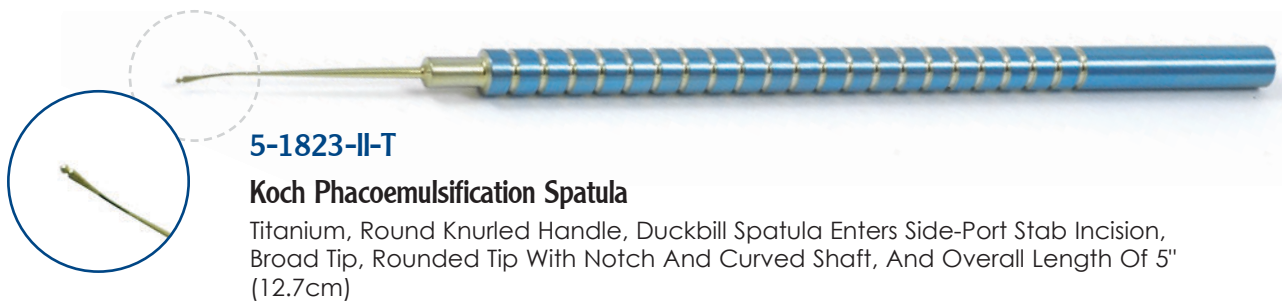

5-1823-II-T

Koch Phacoemulsification Spatula

Titanium, Round Knurled Handle, Duckbill Spatula Enters Side-Port Stab Incision, Broad Tip, Rounded Tip With Notch And Curved Shaft, And Overall Length Of 5" (12.7cm)



5-4157

Paton Double Ended Spatula

, Serrated And Flat Handle With Polished Finish, 6mm Wide X 15mm Long Thin Blade With Three Grooves, 2mm Wide X 31mm Blade With Last 7mm Angled Tip, And Overall Length Of 5 3/4" (14.5cm)

5-2101

Platinum Spatula

Serrated And Flat Handle With Polished Finish, Flared 3mm Wide X 14mm Long Platinum Blade, 35mm Shaft, And Overall Length Of 5 1/2" (140mm)

5-2101-SS

5-2102

Kimura Platinum Spatula

Serrated And Flat Handle With Polished Finish, 4mm Wide X 17.5mm Flat Platinum Spatula, 34mm Shaft, And Overall Length Of 5 3/4" (14.5cm)

Spatulas



5-2102-SS

Kimura Stainless Steel Spatula

Serrated And Flat Handle With Polished Finish, 4mm Wide X 17.5mm Flat Spatula, 34mm Shaft, And Overall Length Of 5 1/2" (14cm)



5-1859

Fisher Spoon And Needle

Serrated And Flat Handle With Polished Finish, Double Ended With Needle Point And 5mm X 14mm Thin Curved Blade, And Overall Length Of 5 3/8" (13.3cm)



5-1842

Thornton Phacoemulsification Spatula

Serrated And Round Handle, Short Handled For Use Through Side-Port Stab Incision, Malleable Silver 0.5mm Tip, And Overall length Of 3 3/8" (8.6cm)



5-1811

Iris Spatula

Serrated And Flat Handle With Polished Finish, 2mm Wide X 33mm Long Sterling Silver Blade, And Overall Length Of 5 1/2" (13.5cm)



5-1815

Culler Iris Spatula

Serrated And Flat Handle With Polished Finish, 1mm Wide X 28mm Long Sterling Silver Blade, And Overall Length Of 5" (128mm)





5-1817

Iris Spatula

Serrated And Flat Handle With Polished Finish, 1mm Wide X 30mm Long Malleable Blade, And Overall Length Of 5 1/8" (13cm)



5-1818

Knolle Lens Nucleus Spatula And Anterior Chamber Gauge

Round And Knurled Handle With Polished finish, Flat And Curved 1mm Spatula Blade 30mm Long With Marks 7mm, 6mm, And 5mm From Tip, And Overall Length Of 4 7/8" (12.3cm)



5-1819

Sinsky Nucleus Spatula

Round And Knurled Handle With Polished Finish, Narrow 31mm Long Spatula Blade, And Overall Length Of 4 7/8" (12.3cm)



5-1825

Hirschman Iris Lens Spatula

Round And Knurled Handle With Polished Finish, Angled 10mm Blade With Notches On Tip And Sides, And Overall Length Of 4 7/8" (12.5cm)

Spatulas



5-1835

Wheeler Cyclodialysis Spatula

Serrated And Flat Handle With Polished Finish, 1.75mm X 30mm Double-Ended Sterling Silver Blade, And Overall Length Of 5 1/2" (139mm)



5-1835-M

Wheeler Cyclodialysis Spatula

Serrated And Flat Handle With Polished Finish, 1.75mm X 30mm Double-Ended Sterling Silver Blade, And Overall Length Of 5 1/2" (139mm) One Blade Is Strongly Curved 1/3 From End And The Other Is Angled At Beginning Of Blade



5-1614

Kelman Cyclodialysis Cannula

19 Gauge Cannula With Polished Finish, Flattened Shaft 12mm From Tip To Bend With Last 2 1/2mm Angled Up And Right Side Port, And Overall Cannula Length Of 1 1/8"(27mm)

5-1615

Randolph Cyclodialysis Cannula

19 Gauge Cannula With Polished Finish, Flattened Shaft 12mm From Tip To Bend, Flattened Tip With Opening, And Overall Cannula Length Of 1 1/8"(27mm)



13-14

800.322.4674 or 800.633.7283

www.msiprecision.com



5-1617

Randolph Cyclodialysis Cannula

19 Gauge Cannula With Polished Finish, Flattened Shaft 12mm From Tip To Bend, More Flattened Tip With Opening, And Overall Cannula 26mm, With An Overall Length Of 1 7/8" (4.7cm)

11-8-4791

Sheets Cyclodialysis Spatula

19 Gauge Cannula With Polished Finish, Flattened 13mm Tip With Last 2mm Angled Up, Front And Side Ports, And Overall Length Of 1 1/4"(31mm)

5-1667-N

Newell Nucleus Spatula

22 Gauge Cannulated Spatula With Polished Finish, Shaft Angled 14mm From Tip To Bend, And Overall Length Of 1 1/8" (29mm)

5-1660

Simcoe Nucleus Spatula

25 Gauge Cannula With Polished Finish, 2mm Vertical Spatula Tip With Opening On Right Side, 10mm From Tip To Bend, And Overall Cannula Length Of 3/4" (17mm)

5-1721

Olk Angled Retinal Spatula

Round And Knurled Handle With Dull Finish, Triangular 0.5mm 110 Degree Angled Tip With 4mm Flat Surface, And Overall Length Of 4 7/8" (125mm)

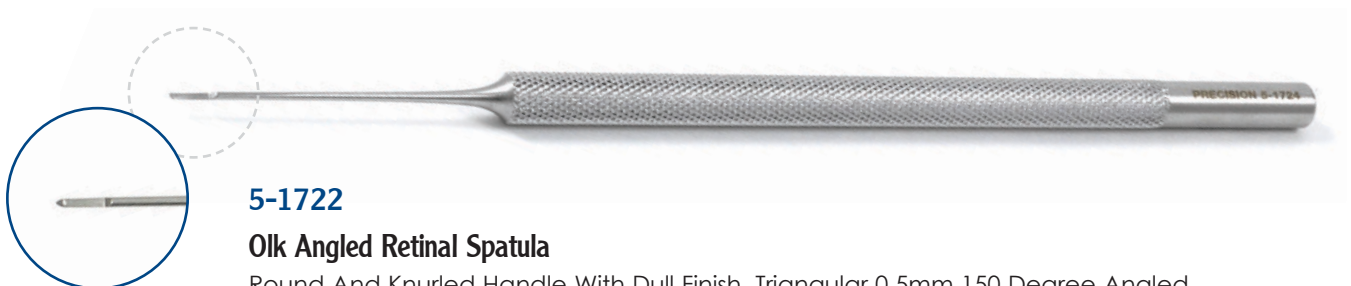

5-1722

Olk Angled Retinal Spatula

Round And Knurled Handle With Dull Finish, Triangular 0.5mm 150 Degree Angled Tip With 4mm Flat Surface, And Overall Length Of 5" (12.5cm)

Spatulas



5-1724

Olk Angled Retinal Spatula

Round And Knurled Handle With Dull Finish, Triangular 0.5mm 130 Degree Angled Tip With 4mm Flat Surface, And Overall Length Of 5" (12.6cm)

5-1728

Lambert Rake Membrane Spatula

20 Gauge Shaft With Dark Finish For Reduced Flat, Balanced Titanium Handle, Delicate Membrane Spatula With Serrate Rake Tip, And Overall Length Of 4 1/2" (115mm)

5-1736

Rake Membrane Spatula

20 Gauge Shaft With Black Finish For Reduced Glare, Serrated Rake Tip Spatula, And Overall Length Of 5 1/8" (130mm)

5-1737

Membrane Spatula

20 Gauge Shaft With Black Finish For Reduced Glare, Rounded Tip Spatula, And Overall Length Of 5 1/8" (130mm)

5-1738

Membrane Spatula Blunt Tip

Blunt Tear Drop Shaped Tip, Black Finish For Reduced Glare, And Overall Length Of 5 1/8" (130mm)



Spoons



5-1797

Knapp Lens Spoon

Serrated And Flat Handle With Polished Finish, 5mm Wide Spoon Shape Tip, Solid Middle, And Overall Length Of 5 1/4" (13.5cm). Overall Weight Of 0.5 oz

Spuds



5-1957

Ellis Foreign Body Spud

Serrated And Flat Handle With Polished Finish, Small And Curved Rounded Blade, And Overall Length Of 4 3/4" (12cm). Overall Weight Of 0.5 oz



5-1961

Francis Spud

Serrated And Flat Handle With Polished Finish, Flat Shaped Sharp Tip, And Overall Length Of 4 3/4" (12cm). Overall Weight Of 0.4 oz

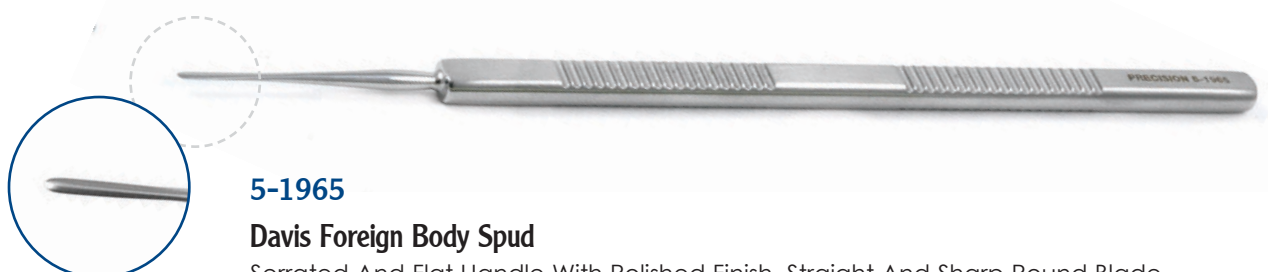

5-1965

Davis Foreign Body Spud

Serrated And Flat Handle With Polished Finish, Straight And Sharp Round Blade, And Overall Length Of 4 7/8" (12.5cm). Overall Weight Of 0.4 oz

800.322.4674 or 800.633.7283

www.msiprecision.com

13-17



Tebbetts

Fiber Optic Retractor

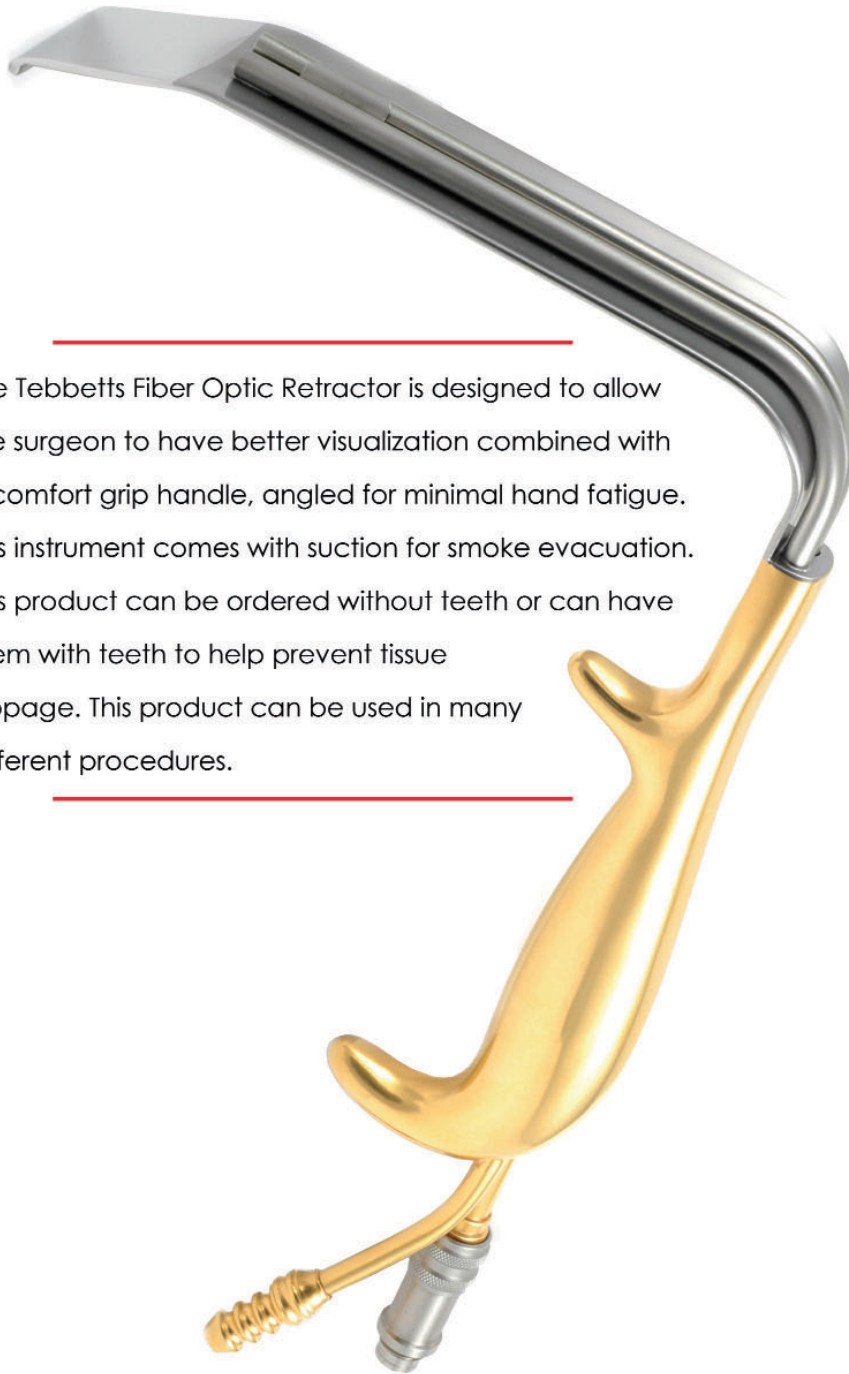

The Tebbetts Fiber Optic Retractor is designed to allow the surgeon to have better visualization combined with a comfort grip handle, angled for minimal hand fatigue. This instrument comes with suction for smoke evacuation. This product can be ordered without teeth or can have them with teeth to help prevent tissue slippage. This product can be used in many different procedures.



For more Plastic Surgery Products
Call Us to request your FREE Catalog

800.322.4674 or 800.633.7283

www.msiprecision.com



Needle Holders



5-4939-CW

Barraquer Needle Holder

Round Knurled Handle With Dull Finish, With Lock, Delicate 9mm Straight Jaws, Overall Length Of 5 1/4" (13.3cm)



5-4939-CW0

Barraquer Needle Holder

Round Knurled Handle With Dull Finish, Without Lock, Delicate 9mm Straight Jaws, Overall Length Of 5 1/8" (13cm)



5-4939-SW

Barraquer Needle Holder

Round Knurled Handle With Dull Finish, With Lock, Delicate 9mm Straight Jaws, Overall Length Of 5" (12.7cm)



5-4939-SW0

Barraquer Needle Holder

Round Knurled Handle With Dull Finish, Without Lock, Delicate 9mm Straight Jaws, Overall Length Of 5 1/4" (13.3cm)

800.322.4674 or 800.633.7283

www.msiprecision.com

14-1



Needle Holders

5-4953

Barraquer Needle Holder

Round Knurled Large Handle With Dull Finish, Without Lock, Fine 10mm Moderately Curved Jaws, Overall Length Of 5 3/8" (137mm)

5-4954

Barraquer Needle Holder

Round Knurled Large Handle With Dull Finish, With Lock, Fine 10mm Moderately Curved Jaws, Overall Length Of 5 3/8" (137mm)

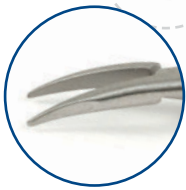

5-4955

Barraquer Needle Holder

Round Knurled Medium Handle With Dull Finish, Fine 10mm Gently Curved Jaws, Overall Length Of 5 1/4" (13.5cm)

5-4956

Barraquer Needle Holder

Serrated Round Large Handle With Polished Finish, Fine 10mm Gently Curved Jaws, Overall Length Of 4 7/8" (125mm)



11-7-3002

Drew's Needle Holder

On Round Knurled Handle Straight Without Lock, With , Mid Screw To Tip Length Of 15mm, Overall Length Of 4" (10cm)



11-7-3003

Drew's Needle Holder

Curved With Lock, Knurled Handle, 12mm Mid Screw To Tip Length, Overall Length Of 4 3/4" (12cm)



11-7-4111

Barraquer Needle Holder Delicate Short Model

Delicate Straight Jaw, On Round Knurled Handle With Lock Jaw 14mm From Mid Screw To Tip Overall Length Of 3 3/4" (9.5cm)



11-7-4121

Barraquer Needle Holder Delicate Short Model

Delicate Straight Jaw, On Round Knurled Handle Without Lock Jaw 14mm From Mid Screw To Tip Overall Length Of 3 3/4" (9.5cm)



11-7-4131

Baby Barraquer Needle-Holder

Curved With Lock, Knurled Handle, 12mm Mid Screw To Tip Length, Overall Length Of 4 1/8" (10.5cm)



11-7-4141

Baby Barraquer Needle-Holder

Curved Without Lock, With Knurled Handle, 15mm Mid Screw To Tip Length, Overall Length Of 4" (10cm)

Needle Holders

5-4940

Troutman Needle Holder

Medium Round And "Horizontally" Serrated Handle With Dull Finish, No Lock, Medium 10mm Gently Curved Jaws, And Overall Length Of 4 3/4" (122mm)



5-4940-X

Troutman Needle Holder

Medium Round "Horizontally" Serrated Handle With Dull Finish, Lock, Medium 10mm Gently Curved Jaws, And Overall Length Of 4 3/4" (122mm)



11-7-4361

Troutman Needle-Holder

Curved Without Lock, With Knurled Handle, 15mm Mid Screw To Tip Length, And An Overall Length Of 4 7/8" (12.5cm)

11-7-4371

Troutman Needle-Holder

Curved With Lock, With Knurled Handle, 15mm Mid Screw To Tip Length, And An Overall Length Of 4 7/8" (12.5cm)

11-7-4911

Precision Needle Holder

Extra Delicate Straight Jaw With Lock

11-7-4921

Precision Needle Holder

Extra Delicate Straight Jaw Without Lock

11-7-4931

Precision Needle Holder

Extra Delicate Curved Jaw With Lock



11-7-4941

Precision Needle Holder

Extra Delicate Curved Jaw Without Lock



11-7-4411

Barraquer Needle-Holder

Delicate And Curved With Lock, Knurled Handle, 12mm Mid Screw To Tip Length, Overall Length Of 5 1/4" (13.5cm)



11-7-4611

Barraquer Needle-Holder

Straight With Lock, Knurled Handle, 13mm Mid Screw To Tip Length, Overall Length Of 5 1/4" (13.5cm)



11-7-4621

Barraquer Needle-Holder

Straight Without Lock, With Knurled Handle, Mid Screw To Tip Length Of 14mm, Overall Length Of 5 1/4" (13.5cm)

Needle Holders

11-7-4631

Barraquer Needle-Holder

Delicate Curved With Lock, Knurled Handle, 15mm Mid Screw To Tip Length, Overall Length Of 5 1/4" (13.5cm)

11-7-4641

Barraquer Needle-Holder

Delicate Curved Without Lock, With Knurled Handle, 15mm Mid Screw To Tip Length, Overall Length Of 5 1/4" (13.5cm)



11-7-4731

Barraquer Needle-Holder

Standard Curved With Lock, Knurled Handle, 15mm Mid Screw To Tip Length, Overall Length Of 5 1/4" (13.5cm)



11-7-4741

Barraquer Needle-Holder

Curved Without Lock, With Knurled Handle, 15mm Mid Screw To Tip Length, And An Overall Length Of 5 1/4" (13.5cm)



5-4906

Precision Needle Holder

Straight With Lock, Large And Round And Knurled Handle With Polished Finish, Medium 9mm Jaws, Overall Length Of 5 5/8" (14.3cm)



5-4807

Precision Needle Holder

Straight Without Lock, Large And Round And Knurled Handle With Polished Finish, Medium 9mm Jaws, Overall Length Of 5 5/8" (14.3cm)



5-4808

Precision Needle Holder

Curved With lock, Large and Round And Knurled Handle With Polished Finish, Lock, Medium 9mm Curved Jaws, Overall Length Of 5 3/8" (13.6cm)



5-4808-X

Precision Needle Holder

Curved Without lock, Large and Round And Knurled Handle With Polished Finish, Medium 9mm Curved Jaws, Overall Length Of 5 3/8" (13.6cm)

5-4808-LC

Precision Needle Holder

Curved With Lock, Large And Round And knurled Handle With Polished Finish Fine 9mm Gently Curved Jaws, Overall Length Of 5 1/8" (130mm)

Needle Holders

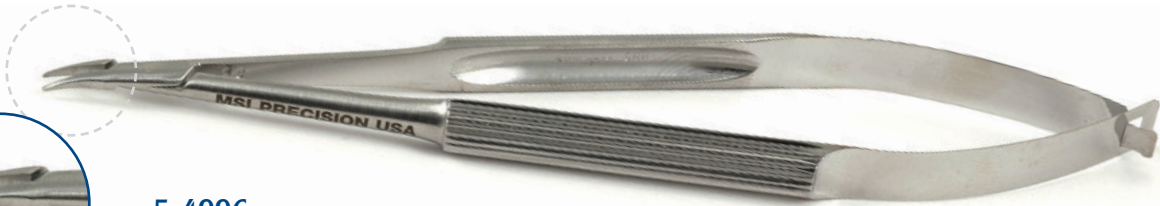

5-4996

Precision Needle Holder

Round Knurled Small Handle With Dull Finish, No Lock, Delicate 6mm Moderately Curved Jaws, 12mm Mid=Screw To Tip Length, And Overall Length Of 4 7/8" (12.5cm)



5-4915-WLM

Anis Needle Holder

Round Knurled Handle With Dull Finish With Lock, Delicate 8mm Straight Jaw Overall Length Of 4 5/8" (11.7cm)

5-4915-M

Anis Needle Holder

Round Knurled Handle With Dull Finish Without Lock, Delicate 8mm Straight Jaw Overall Length Of 4 5/8" (11.7cm)



5-4916-M

Anis Needle Holder

Round Knurled Handle With Dull Finish Without Lock, Delicate 8mm Gently Curved Jaw Overall Length Of 4 5/8" (11.7cm)

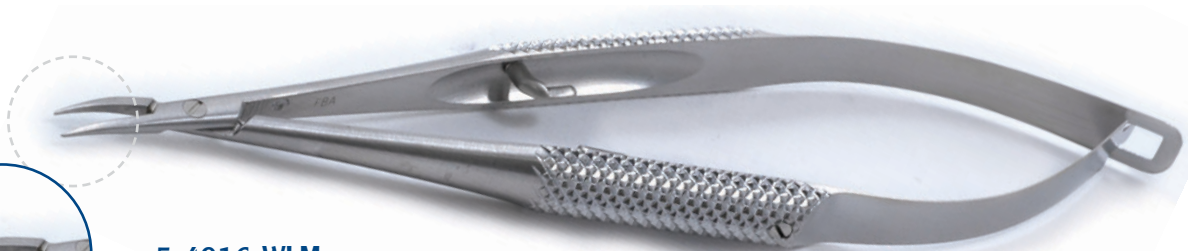

5-4916-WLM

Anis Needle Holder

Round Knurled Handle With Dull Finish With Lock, Delicate 8mm Gently Curved Jaw Overall Length Of 4 5/8" (11.7cm)



5-4918-W

Osher Needle Holder

Round And Knurled Handle With Lock, Delicate Curved And Tapered 9mm Jaw, Overall Length Of 4 1/4" (110mm)

5-4918-W0

Osher Needle Holder

Round And Knurled Handle Without Lock, Delicate Curved And Tapered 9mm Jaw Overall Length Of 4 1/4" (110mm)



5-4938

Bechert-Sinskey Needle Holder

Straight With Lock Round And Knurled Large Handle With Dull Finish Delicate 9mm Jaws, Overall Length Of 5 1/8" (12.9cm)

5-4938-CW

Bechert-Sinskey Needle Holder

Curved With Lock, Round And Knurled Large Handle With Dull Finish Delicate 9mm Jaws, Overall Length Of 5 1/8" (12.9cm)



5-4947-C

Cohan Needle Holder

Round And Knurled Medium Handle With Dull Finish, No Lock, Fine 8mm Gently Mini-Curved Jaws, And Overall Length Of 4" (10.2cm)

Needle Holders



5-4947-CW

Cohan Needle Holder

Round And Knurled Medium Handle With Dull Finish, Lock, Fine 8mm Gently Mini-Curved Jaws, 18mm Mid Screw To Tip Length, And Overall Length Of 4" (10cm)

5-4958-C

Catalano Needle Holder

Round And Knurled Large Handle With Dull Finish, Lock, Fine 9mm Moderately Curved Jaws With Flattened Bottom, And Overall Length Of 5 1/4" (135mm)

5-4801

Precision Castroviejo Needle Holder

Straight With Lock, Round And Knurled Handle, Straight 9mm Medium Jaws, And Overall Length Of 5 1/4" (134mm)



5-4972-A

Castroviejo Needle Holder

Straight With Lock, Serrated And Flat Handle, 12mm Jaws, 18mm Mid Screw To Tip Length, And Overall Length Of 5 3/4" (14.5cm)



5-4972

Castroviejo Needle Holder

Serrated And Flat Handle With Polished Finish, Lock, Medium 10mm Straight Jaws, And Overall Length Of 5 5/8" (14.4cm)



Needle Holders



5-4972-WH

Castroviejo Needle Holder

Serrated And Wide Handle With Polished Finish, Lock, Fine 9mm Straight Jaws, 14mm Mid Screw To Tip Length, And An Overall Length Of 5 1/2" (140mm)



5-4972-WHMC

Castroviejo Needle Holder

Curved With Lock, Serrated And Wide Handle With Polished Finish, Lock, Fine 9mm Curved Jaws, And Overall Length Of 5 1/8" (13cm)



5-4972-WHMS

Castroviejo Needle Holder

Serrated And Wide Handle With Polished Finish, Lock, Fine 9mm Curved Jaws, And Overall Length Of 5 1/8" (13cm)



5-4940-XWH

Troutman Needle Holder

Serrated And Wide Handle With Polished Finish, Lock, Fine 9mm Moderately Curved Jaws, And Overall Length Of 5 1/8" (130mm)

800.322.4674 or 800.633.7283

www.msiprecision.com

14-11



Needle Holders

5-4949-WH

Collis Needle Holder

Serrated And Handle With Lock And Dull Finish, Fine 7mm Jaws Angled 30 Degrees, And Overall Length Of 5" (128mm)



5-4963

Castroviejo Needle Holder

Serrated And Flat Handle With Dull Finish, Lock, Medium 9mm Tungsten Carbide Inlaid Straight Jaws, And Overall Length Of 6" (15cm)



5-4963-WO

Castroviejo Needle Holder

Tungsten-Carbide Straight With Lock, 9mm Medium Smooth Jaws, 16mm Mid Screw To Tip Length, And Overall Length Of 5 3/4" (14.5cm)



5-4973

Castroviejo Needle Holder

Serrated And Flat Handle With Polished Finish, Fine 10mm Straight Jaws, And Overall Length Of 5 3/8" (136mm)



5-4959

Castroviejo Needle Holder

Serrated And Flat Handle With Polished Finish, Lock, Medium 11mm Gently Curved Jaws, And Overall Length Of 5 3/8" (137mm)



5-4950

Castroviejo Needle Holder

Serrated And Flat Handle With Polished Finish, No Lock, Medium 11mm Gently Curved Jaws, And Overall Length Of 5 3/4" (14.5cm)



5-4961

Castroviejo Needle Holder

Serrated And Flat Handle With Polished Finish, Lock, Heavy 12mm Straight Jaws, 18mm Mid Screw To Tip Length, And Overall Length Of 5 3/4" (14.5cm)



5-4975

Castroviejo Needle Holder

Serrated And Flat Handle With Polished Finish, Lock, Heavy 16mm Straight Jaws, And Overall Length Of 5 7/8" (14.8cm)

800.322.4674 or 800.633.7283

www.msiprecision.com

14-13



Needle Holders



5-4962

Azar Needle Holder

Flat And Scalloped Handle With Dull Finish, Lock, Fine 11m Gently Curved Jaws, And Overall Length Of 5 1/8" (13cm)

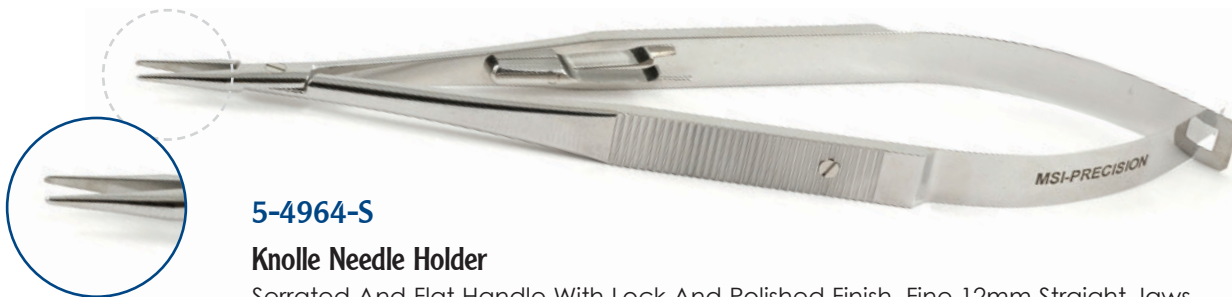

5-4964-S

Knolle Needle Holder

Serrated And Flat Handle With Lock And Polished Finish, Fine 12mm Straight Jaws, 18mm Mid Screw To Tip Length, And Overall Length Of 5 3/4" (14.5cm)



5-4945

McPherson Needle Holder

Serrated And Flat Handle With Polished Finish, Lock, Fine 11mm Straight Jaws, And Overall Length Of 4" (10.2cm)



5-4946

McPherson Needle Holder

Serrated And Flat Handle With Polished Finish, Lock, Fine 11mm Strongly Curved Jaws, And Overall Length Of 4 1/4" (107mm)



Needle Holders



5-4957

Paton Needle Holder

Serrated And Flat Handle With Satin Finish, Heavy 11mm Serrated Jaws With Length Wise Groove, And Overall Length Of 4 5/8" (11.8cm)



5-4809

Kalt Needle Holder

Serrated And Flat Locking Handle With Dull Finish, Heavy 12mm Straight Serrated Jaws, Tungsten Carbide Inserts, And Overall Length Of 5 5/8" (141mm)



5-4911

Kalt Needle Holder

Serrated And Flat Locking Handle With Polished Finish, Heavy 12mm Straight Jaws, Serrated Top Jaw Edges, And Overall Length Of 5 5/8" (141mm)

800.322.4674 or 800.633.7283

www.msiprecision.com

14-15



Needle Holders



5-4913

Kalt Needle Holder

Serrated And Flat Locking Handle With Polished Finish, Medium 10mm Straight Serrated Jaws, And Overall Length Of 5 5/8" (141mm)



5-4914

Kalt Needle Holder

Serrated And Flat Locking Handle With Polished Finish, Medium 10mm Serrated Straight 20% Finer Than Original Model Jaws, And Overall Length Of 5 3/8" (13.8cm)



Needle Holders



11-7-2611

Castroviejo Needle-Holder

Straight With Lock, Serrated Handle, 15mm Mid Screw To Tip Length, And An Overall Length Of 5 1/2" (14cm)



11-7-2631

Castroviejo Needle-Holder

Curved With Serrated Handle, 13mm Mid Screw To Tip Length, And An Overall Length Of 5 1/2 (14cm)



11-7-2911

Kalt Needle Holders

With Smith Jaws, Serrated Handle, 15mm Mid Screw To Tip Length, And An Overall Length Of 5 3/8" (13.7cm)



11-7-4862

Anis Needle-Holder

Straight Without Lock, With Knurled Handle, 14mm Mid Screw To Tip Length, And An Overall Length Of 5" (12.7cm)

800.322.4674 or 800.633.7283

www.msiprecision.com

14-17



Probes



5-5209

Bowman Stainless Probe

Malleable Stainless Steel With Polished Finish, Sizes 0000 And 000, And Overall Length Of 5 5/8" (14.2cm). Overall Weight 0.1 oz



5-5312

Precision Bowman Lacrimal Probe

Malleable Sterling Silver With Polished Finish, Sizes 00 And 0, And Overall Length Of 5 1/2" (14cm). Overall Weight 0.0 oz



5-5313

Precision Bowman Lacrimal Probe

Malleable Sterling Silver With Polished Finish, Sizes 1 And 2, And Overall Length Of 5 1/2" (14mm). Overall Weight 0.0 oz



5-5314

Precision Bowman Lacrimal Probe

Malleable Sterling Silver With Polished Finish, Sizes 1 And 2, And Overall Length Of 5 1/2" (14mm). Overall Weight 0.0 oz



5-5315

Precision Bowman Lacrimal Probe

Malleable Sterling Silver With Polished Finish, Sizes 5 And 6, And Overall Length Of 5" (13cm). Overall Weight 0.1 oz





5-5316

Precision Bowman Lacrimal Probe

Malleable Sterling Silver With Polished Finish, Sizes 7 And 8, And Overall Length Of 5 1/2" (14cm). Overall Weight 0.1 oz



5-5321

Williams Lacrimal Probe

Malleable Sterling Silver With Polished Finish, Sizes 00 And 0, And Overall Length Of 5 5/8" (142mm). Overall Weight 0.0 oz

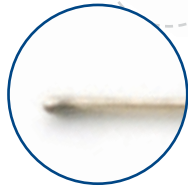

5-5322

Williams Lacrimal Probe

Malleable Sterling Silver With Polished Finish, Sizes 1 And 2, And Overall Length Of 5 5/8" (14.2 cm). Overall Weight 0.1 oz



5-5323

Williams Lacrimal Probe

Malleable Sterling Silver With Polished Finish, Sizes 3 And 4, And Overall Length Of 5 5/8" (14cm). Overall Weight 0.0 oz



5-5324

Williams Lacrimal Probe

Malleable Sterling Silver With Polished Finish, Sizes 5 And 6, And Overall Length Of 5 1/2" (14cm). Overall Weight 0.1 oz



Probes



5-5325

Williams Lacrimal Probe

Malleable Sterling Silver With Polished Finish, Sizes 7 And 8, And Overall Length Of 5 1/2" (14cm). Overall Weight 0.1 oz

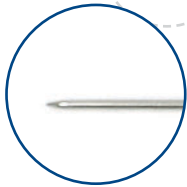

5-5331-0

Quickert Lacrimal Intubation Probe

Malleable Sterling Silver With Polished Finish, Jones Taper Point On One End, Regular Bowman Point On Other End, Size 0, And Overall Length Of 5 7/8" (15cm). Overall Weight 0.0 oz

5-5331-00

Quickert Lacrimal Intubation Probe

Malleable Sterling Silver With Polished Finish, Jones Taper Point On One End, Regular Bowman Point On Other End, Size 00, And Overall Length Of 5 1/4" (14cm). Overall Weight 0.0 oz



5-5331-15

Quickert Groove Director

With An Overall Length Of 5 1/2" (14cm). Overall Weight 0.2 oz



5-5333

Benger Probe Hook

Straight 63mm Shaft With Dull Finish, And Overall Length Of 5 1/8" (13.1cm). Overall Weight 0.3 oz



14-20

800.322.4674 or 800.633.7283

www.msiprecision.com

11-8-3731

Crawford lacrimal intubation set

Includes: 2 olive tip 0.6mm diameter probes attached to 30.5cm long silicone tubing, .020" I.D., .037" O.D.

11-8-3734

Crawford retrieving hook

for Crawford lacrimal intubation tubes



5-5362

Worst Pigtail Probe

Round And Knurled Handle With Polished Finish, Stainless Steel, 9mm Diameter Pigtail Curved Blunt Probes, Including Pre-Cut Polyethylene Tubes, And Overall Length Of 5 1/2" (14cm). Overall Weight 0.5 oz



5-5362-C

Precision Pigtail Probe

Round And Knurled Handle With Polished Finish, Stainless Steel, 8mm Diameter Pigtail Curved Probes, Suture Eyes Just Back Of Blunt Ends, And Overall Length Of 6" (15cm). Overall Weight 0.6 oz

Punches



5-3809

Kelly Decemet Membrane Punch

Serrated Squeeze Action Handle, And Overall Length Of 5 1/8" (130mm)



11-3-0611

Gass Scleral Punch

With Three Holed Handle, 360 Degrees And 1.5mm, And Overall Length Of 3 1/2" (8.5cm)



11-3-0616

Luntz-Dodick Trabeculectomy Punch

1.0mm Diameter Bite With Rotatable Head

5-3800-R1.5

Gass Sclerotomy Punch

Right, Polished Finish, Action Is Piston And Cylinder With Handle Set At 90 Degrees To The Punch, And Overall Length Of 3 1/2" (90mm)

5-3800-L&R1.5

Gass Sclerotomy Punch

Left & Right, Rotates 360 Degrees with a 1.5mm Diameter Bite Polished Finish, Action Is Piston And Cylinder With Handle Set At 90 Degrees Overall Length Of 3 1/2" (90mm)



14-22

800.322.4674 or 800.633.7283

www.msiprecision.com



238018

Precision "B" Pupil Dilator Expander

With An Overall Length Of 5 1/8" (13cm). Overall Weight 0.7 oz



7 1/4" Utility Scissors

320B	Medicut Utility Scissors 7 1/4"	Blue
320BD	Medicut Utility Scissors 7 1/4"	Burgundy
320BK	Medicut Utility Scissors 7 1/4"	Black
320GR	Medicut Utility Scissors 7 1/4"	Green
320HG	Medicut Utility Scissors 7 1/4"	Hunter Green
320M	Medicut Utility Scissors 7 1/4"	Magenta
320N	Medicut Utility Scissors 7 1/4"	Navy
320NO	Medicut Utility Scissors 7 1/4"	Neon Orange
320NP	Medicut Utility Scissors 7 1/4"	Neon Pink
320NY	Medicut Utility Scissors 7 1/4"	Neon Yellow
320O	Medicut Utility Scissors 7 1/4"	Orange
320R	Medicut Utility Scissors 7 1/4"	Red
320RB	Medicut Utility Scissors 7 1/4"	Royal Blue
320TL	Medicut Utility Scissors 7 1/4"	Teal
320V	Medicut Utility Scissors 7 1/4"	Purple
320W	Medicut Utility Scissors 7 1/4"	White

5 1/2" Utility Scissors

321B	Medicut Utility Scissors 5 1/2"	Blue
321BD	Medicut Utility Scissors 5 1/2"	Burgundy
321BK	Medicut Utility Scissors 5 1/2"	Black
321GR	Medicut Utility Scissors 5 1/2"	Green
321HG	Medicut Utility Scissors 5 1/2"	Hunter Green
321M	Medicut Utility Scissors 5 1/2"	Magenta
321N	Medicut Utility Scissors 5 1/2"	Navy
321NO	Medicut Utility Scissors 5 1/2"	Neon Orange
321NP	Medicut Utility Scissors 5 1/2"	Neon Pink
321NY	Medicut Utility Scissors 5 1/2"	Neon Yellow
321O	Medicut Utility Scissors 5 1/2"	Orange
321R	Medicut Utility Scissors 5 1/2"	Red
321RB	Medicut Utility Scissors 5 1/2"	Royal Blue
321TL	Medicut Utility Scissors 5 1/2"	Teal
321V	Medicut Utility Scissors 5 1/2"	Purple
321W	Medicut Utility Scissors 5 1/2"	White



MSI Precision

Scissors



Contents

Super Cut Scissors

	Pages
Precision Iris	15-1
Precision Plastic	15-1
Precision Stevens Tenotomy	15-2

Ring Handled Scissors

	Pages
Precision Iris	15-3
Aebli Corneal	15-3, 15-9
Precision Eye	15-6
Wilmer Conjunctival and Utility	15-8
McReynolds Pterygium	15-8
Precision Stitch	15-9
Reeh Stitch	15-9
McGuire Corneal	15-9
Anis Micro	15-10
Stevens Tenotomy	15-10
Precision Stabismus	15-12
Knapp Stabismus	15-12
Little Dissecting	15-13
Precision Utility	15-14
Precision Light	15-14

Spring Handled Scissors

	Pages
Capsulotomy	16-1
Iris	16-4, 16-12
Fine Stitch	16-5, 16-10
Capsule	16-7
Tenotomy	16-8
Utility	16-11
Conjunctival	16-12
Vitreous	16-12
Corneal	16-13
Corneal Transplant	16-18
Keratoplasty and Keratectomy	16-19



800.322.4674 or 800.633.7283

www.msiprecision.com

Super Cut Scissors



19-133110

Precision Iris Scissors Straight

4 1/2" (14.5cm) Pure Super Cut With Black Colored Rings For Identification



19-133111

Precision Iris Scissors Curved

4 1/2" (14.5cm) Pure Super Cut With Black Colored Rings For Identification



19-133142

Precision Plastic Scissors Straight

4 7/8" (12.5cm) Pure Super Cut With Black Colored Rings For Identification.

800.322.4674 or 800.633.7283

www.msiprecision.com

15-1



Super Cut Scissors

19-133143

Precision Plastic Scissors Curved

4 7/8" (12.5cm) Pure Super Cut With Black Colored Rings For Identification



19-133166

Precision Stevens Tenotomy Scissors Straight

4 1/2" (14.5cm) Pure Super Cut With Black Colored Rings For Identification



19-133168

Precision Stevens Tenotomy Scissors Curved

4 1/2" (14.5cm) Pure Super Cut With Black Colored Rings For Identification



15-2

800.322.4674 or 800.633.7283

www.msiprecision.com

Surgical Advantage

1-800-948-7994

order@surgicaladvantage.net



5-4407

Precision Straight Iris Scissors

Ribbon Style Ring Handle With Polished Finish On Blades, Pointed Tips, 18mm From Mid-Screw To Tip, And Overall Length Of 3 7/8" (98mm)



5-4408

Precision Curved Iris Scissors

Ribbon Style Ring Handle With Polished Finish On Blades, Pointed Tips, 18mm From Mid-Screw To Tip, And Overall Length Of 3 7/8" (98mm)

5-4501

Aebli Straight Corneal Scissors

Ring Handle, Universal Standard Pattern, Straight Blades With Polished Finish, Blunt Tips, 19mm Mid Screw To Tip, And Overall Length Of 3 5/8" (92mm)

Ring Handled Scissors



5-4511

Precision Straight Iris Scissors

Ribbon Style Ring Handle, Polished Finish On Blades, Pointed Tips, 25mm Mid Screw To Tip, And Overall Length Of 4 1/8" (105mm)



5-4513

Precision Curved Iris Scissors

Ribbon Style Ring Handle, Polished Finish On Blades, Pointed Tips, 25mm Mid Screw To Tip, And Overall Length Of 4 1/8" (105mm)



5-4515

Precision Straight Iris Scissors

Ring Handle, Polished Finish On Blades, Pointed Tips, 28mm Mid Screw To Tip, And Overall Length Of 3 7/8" (100mm)



15-4

800.322.4674 or 800.633.7283

www.msiprecision.com

Ring Handled Scissors



5-4516

Precision Curved Iris Scissors

Ring Handle, Polished Finish On Blades, Pointed Tips, 28mm Mid Screw To Tip, And Overall Length Of 3 7/8" (100mm)



5-4517

Precision Straight Iris Scissors

Ring Handle, Polished Finish On Blades, Light Standard Pattern, Pointed Tips, 25mm Mid Screw To Tip, And Overall Length Of 3 7/8" (98mm)



5-4519

Precision Curved Iris Scissors

Ring Handle, Polished Finish On Blades, Light Standard Pattern, Pointed Tips, 25mm Mid Screw To Tip, And Overall Length Of 3 7/8" (98mm)

800.322.4674 or 800.633.7283

www.msiprecision.com

15-5



Surgical Advantage

1-800-948-7994

order@surgicaladvantage.net

Ring Handled Scissors



5-4521

Precision Straight Eye Scissors

Ribbon Style Ring Handle, Polished Finish On Blades, Pointed Tips, 29mm Mid Screw To Tip, And Overall Length Of 4 1/4" (109mm)



5-4523

Precision Curved Eye Scissors

Ribbon Style Ring Handle, Polished Finish On Blades, Pointed Tips, 29mm Mid Screw To Tip, And Overall Length Of 4 1/4" (109mm)



5-4527

Precision Straight Eye Scissors

Ribbon Style Ring Handle With Polished Finish, Blunt Tips, 29mm Mid Screw To Tip, And Overall Length Of 4 1/4" (107mm)



15-6

800.322.4674 or 800.633.7283

www.msiprecision.com

Ring Handled Scissors



5-4529

Precision Curved Eye Scissors

Ribbon Style Ring Handle With Polished Finish, Blunt Tips, 30mm Mid Screw To Tip, And Overall Length Of 4 1/4" (107mm)



5-4535

Precision Straight Eye Scissors

Ring Handle, Polished Finish On Blades, Sharp Tips, 32mm Mid Screw To Tip, And Overall Length Of 4 1/4" (109mm)



5-4537

Precision Curved Eye Scissors

Ring Handle, Polished Finish On Blades, Sharp Tips, 32mm Mid Screw To Tip, And Overall Length Of 4 1/4" (109mm)

800.322.4674 or 800.633.7283

www.msiprecision.com

15-7



Ring Handled Scissors



5-4547

Precision Eye Scissors

Ring Handle, Polished Finish On Blades, Blunt Probe Points, Angled Shafts, 26mm Mid Screw To Tip, And Overall Length Of 4 5/8" (116mm)



5-4561

Wilmer Angled Conjunctival And Utility Scissors

Ring Handle, Serrated Blades With Polished Finish, Sharp Pointed Tips, 18mm Mid Screw To Tip, And Overall Length of 3 3/4" (94mm)

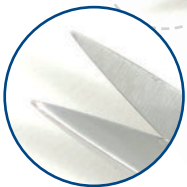

5-4571

McReynolds Pterygium Scissors

Ring Handle, Polished Finish On Blades, Blunt Angled Tips, 18mm Mid Screw To Tip, And Overall Length Of 4 1/8" (105mm)



15-8

800.322.4674 or 800.633.7283

www.msiprecision.com

5-4591

Aebli Straight Corneal Scissors

Ribbon Style Ring Handle, Polished Finish On Blades, Blunt Tips, 21mm Mid Screw To Tip, And Overall Length Of 3 7/8" (100mm)

5-4593

Aebli Angled Corneal Scissors

Ribbon Style Ring Handle, Polished Finish On Blades, Blunt Tips, 21mm Mid Screw To Tip, And Overall Length Of 3 7/8" (100mm)



5-4601

Precision Curved Stitch Scissors

Precision Curved Stitch Scissors, Ribbon Style Ring Handle With Polished Finish, Sharp Pointed Tips, 18mm Mid Screw To Tip, And Overall Length Of 3 3/4" (97mm)

5-4603

Precision Original Stitch Scissors

Ribbon Style Ring Handle With Polished Finish, Sharp Pointed Tips, 22mm Mid Screw To Tip, And Overall Length Of 4" (102mm)



5-4606

Reeh Stitch Scissors

Ribbon Style Ring Handle With Polished Finish, Sharp Pointed Tips, Very Small Hook At End Of One Blade, 19mm Mid Screw To Tip, And Overall Length Of 3 7/8" (98mm)

5-4617

McGuire Corneal Scissors

Ring Handle, Polished Finish On Angled And Curved Blades, Right Orientation, 21mm Mid Screw To Tip, And Overall Length Of 4 1/8" (104mm)

800.322.4674 or 800.633.7283

www.msiprecision.com

15-9



Ring Handled Scissors

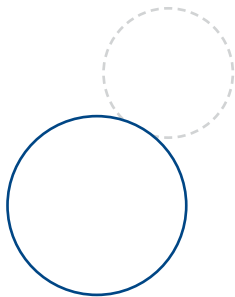

5-4621

Anis Micro Scissors

Squeeze Action Handle, 20mm Long 23 Gauge Very Fine Shaft, And Overall Length Of 6 1/4" (160mm)

5-4661

Stevens Straight Tenotomy Scissors

Ribbon Style Ring Handle, Polished Finish On Straight Blades, Heavy Model, Blunt Tips, 19mm Mid Screw To Tip, And Overall Length Of 3 3/4" (98mm)



5-4663

Stevens Curved Tenotomy Scissors

Ribbon Style Ring Handle, Polished Finish On Curved Blades, Heavy Model, Blunt Tips, 19mm Mid Screw To Tip, And Overall Length Of 3 3/4" (98mm)



5-4665

Stevens Straight Tenotomy Scissors

Ribbon Style Ring Handle, Polished Finish on Straight Blades, light Model, Blunt Tips, And Overall Length Of 3 3/4" (98mm)



15-10

800.322.4674 or 800.633.7283

www.msiprecision.com

Ring Handled Scissors



5-4667

Stevens Curved Tenotomy Scissors

Ribbon Style Ring Handle, Polished Finish On Curved Blades, Light Model, Blunt Tips, 19mm Mid Screw To Tip, And Overall Length Of 3 3/4" (98mm)



5-4671

Stevens Straight Tenotomy Scissors

Ring Handle, Polished Finish On Straight Blades, Standard Model, Blunt Tips, 30mm Mid Screw To Tip, Overall Length Of 4 3/8" (112mm)



5-4673

Stevens Curved Tenotomy Scissors

Ring Handle, Polished Finish On Curved Blades, Standard model, Blunt Tips, 30mm Mid Screw To Tip, And Overall Length Of 4 3/8" (112mm)

800.322.4674 or 800.633.7283

www.msiprecision.com

15-11



Ring Handled Scissors

5-4681

Precision Straight Strabismus Scissors

Ribbon Style Ring Handle, Polished Finish On Rounded Blades, Blunt Tips, 29mm Mid Screw To Tip, And Overall Length Of 4 1/4" (109mm)



5-4682

Precision Curved Strabismus Scissors

Ribbon Style Ring Handle, Polished Finish On Rounded Blades, Blunt Tips, 29mm Mid Screw To Tip, And Overall Length Of 4 1/4" (109mm)

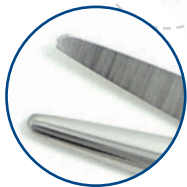

5-4683

Precision Curved Strabismus Scissors

Ribbon Style Ring Handle, Polished Finish On Rounded Blades, Strong Curve, Blunt Tips, 27mm Mid Screw To Tip, And Overall Length Of 4 1/4" (106mm)



5-4687

Knapp Straight Strabismus Scissors

Ring Handle, Polished Finish On Rounded Blades, Blunt Or Lightly Curved Blunt Tips, 25mm Mid Screw To Tip, And Overall Length Of 4 5/8" (118mm)



15-12

800.322.4674 or 800.633.7283

www.msiprecision.com

Ring Handled Scissors

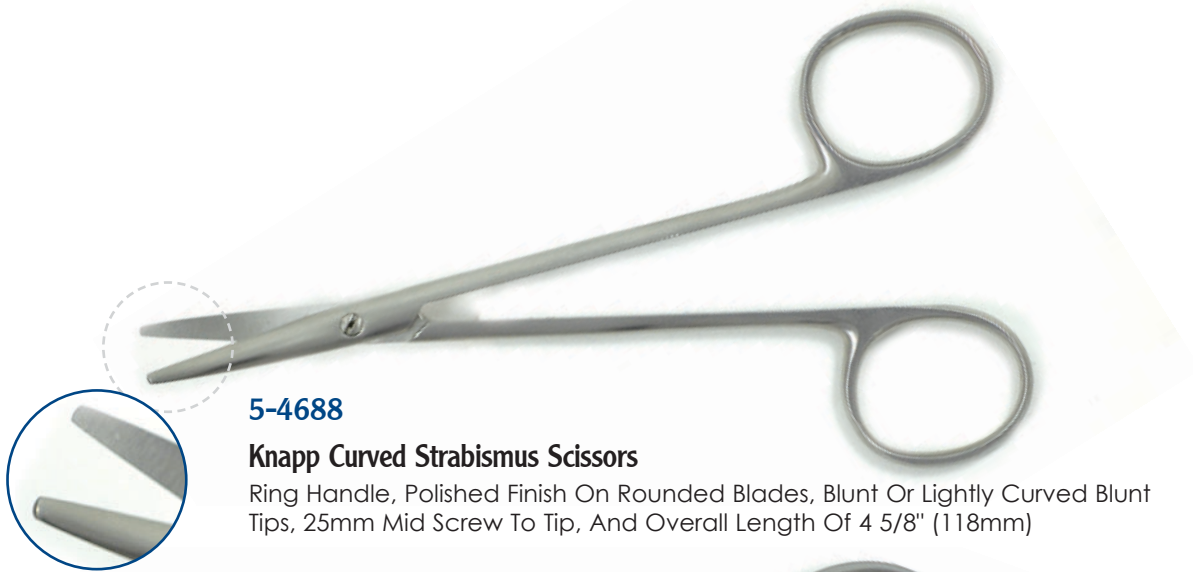

5-4688

Knapp Curved Strabismus Scissors

Ring Handle, Polished Finish On Rounded Blades, Blunt Or Lightly Curved Blunt Tips, 25mm Mid Screw To Tip, And Overall Length Of 4 5/8" (118mm)



5-4689

Knapp Curved Strabismus Scissors

Ring Handle, Polished Finish On Rounded Blades, Strong Curve, Blunt Tips, 25mm Mid Screw To Tip, And Overall Length Of 4 5/8" (118mm)



5-4691

Littler Curved Dissecting Scissors

Ring Handle With Polished Finish, Lightly Curved, Blunt Tips, Rounded Blades, Eye In Blades In Place Of Eye Probe, 27mm Mid Screw To Tip, And Overall Length Of 4 3/4" (119mm)

800.322.4674 or 800.633.7283

www.msiprecision.com

15-13



Ring Handled Scissors



5-4695

Precision Straight Utility Scissors,

Serrated And Flat Handle With Polished Finish, Blunt Tips, 25mm Mid Screw To Tip, And Overall Length Of 5 1/8" (131mm)

5-4696

Precision Curved Utility Scissors

Ribbon Style Ring Handle With Polished Finish, Blunt Tips, 24mm Mid Screw To Tip, And Overall Length Of 4 1/4" (109mm)



5-4699

Precision Curved Light Scissors

Ribbon Style Ring Handle With Polished Finish, Blunt Tips, 18mm Mid Screw To Tip, And Overall Length Of 7/8" (99mm)



15-14

800.322.4674 or 800.633.7283

www.msiprecision.com

Spring Handled Scissors



5-4497

Vannas Straight Capsulotomy Scissors

Serrated Handle With Polished Finish, 6mm Blades, Sharp Pointed Tips, 8mm Mid Screw To Tip, And Overall Length Of 3 1/4" (84mm)



11-5-6111

Vannas Scissor

Straight Serrated Handle With Sharp 5mm Blades

5-4497-B

Vannas Straight Capsulotomy Scissors

Serrated Handle With Polished Finish, 6mm Blades, Blunt Tips, 8mm Mid Screw To Tip, And Overall Length Of 3 1/4" (84mm)



5-4498

Vannas Curved Capsulotomy Scissors

Serrated Handle With Polished Finish, 6mm Blades, Sharp Pointed Tips, 8mm Mid Screw To Tip, And Overall Length Of 3 1/8" (8cm)



11-5-6121

Vannas Scissors

With Curved Blades And Sharp Tips, Serrated Handle, Mid Screw To Tip length Of 10mm, And An Overall Length Of 3 1/4" (8.3cm)

5-4498-B

Vannas Curved Capsulotomy Scissors

Serrated Handle With Polished Finish, 6mm Blades, Blunt Tips, 8mm Mid Screw To Tip, And Overall Length Of 3 1/4" (84mm)

800.322.4674 or 800.633.7283

www.msiprecision.com

16-1



Spring Handled Scissors



5-4494-S

Clayman-Vannas Straight Scissors

Smooth Handle With Polished Finish, Sharp Pointed Tips, 7mm Mid Screw To Tip, And Overall Length Of 3 1/4" (83mm)

5-4494-C

Clayman-Vannas Curved Scissors

Smooth Handle With Polished Finish, Sharp Pointed Tips, 7mm Mid Screw To Tip, And Overall Length Of 3 1/4" (83mm)



11-5-6161

Gills-Vannas Extra Long Thin Straight Scissors

Blade Length Of 7mm, Overall Length Of 3 1/8" (8.1cm)

11-5-6171

Gills-Vannas Extra Long Thin Curved Scissors

Blade Length Of 7mm, Overall Length Of 3 1/8" (8.1cm)



5-4499

Vannas Angled Capsulotomy Scissors

Serrated Handle With Polished Finish, 6mm Blades, Sharp Pointed Tips, 9mm Mid Screw To Tip, And Overall Length Of 3 3/8" (8.5cm)



11-5-6131

Vannas Scissors Angled Forward

Scissors Blade Length Of 7mm, Overall Length Of 3" (7.8cm)



Spring Handled Scissors



5-4499-GW

Gills-Welsh Vannas Angled Micro Scissors

Serrated Handle With Polished Finish, 5mm Blades, Sharp Pointed Tips, 11mm Mid Screw To Tip, And Overall Length Of 3 3/8" (86mm)



11-5-6181

Gills-Vannas Extra Long Thin Angled Forward Scissors

Blade Length Of 7mm, Overall Length Of 3 1/8" (8.1cm)



5-4499-GWL

Gills-Welsh Angled Vannas Micro Scissors

Serrated Handle With Polished Finish, 11mm Blades, Sharp Pointed Tips, 13mm Mid Screw To Tip, And Overall Length Of 3 3/8" (86mm)



5-4490

Vannas Angled Capsulotomy Scissors

Serrated Handle With Polished Finish, 6mm Blades, Sharp Pointed Tips, 9mm Mid Screw To Tip, And Overall Length Of 3 1/4" (8cm)



11-5-6141

Vannas Scissors

Angled To The Side, Scissors Blade Length Of 7mm, Overall Length Of 3" (7.8cm)

800.322.4674 or 800.633.7283

www.msiprecision.com

16-3



Spring Handled Scissors

5-4450

Cohan-Vannas Curved Iris Scissors

Serrated And Flat Handle With Dull Finish, Sharp Pointed Tips, 12mm Mid Screw To Tip, And Overall Length Of 2 1/4" (57mm)



5-4454

Straight Iris Scissors

Serrated And Flat Handle With Polished Finish, Sharp Pointed Tips, 21mm Mid Screw To Tip, And Overall Length Of 4 1/2" (11.5cm)



5-4455

Curved Iris Scissors

Serrated And Flat Handle With Polished Finish, Sharp Pointed Tips, 21mm Mid Screw To Tip, And Overall Length Of 4 1/2" (11.5cm)



5-4458

McPherson-Vannas Curved Iris Scissors

Serrated And Flat Handle With Polished Finish, Sharp Pointed Tips, 11mm Mid Screw To Tip, And Overall Length Of 3 3/8" (8.5cm)



11-5-5511

Iris Scissors With Small Blades And Sharp Tips

Three Holed Handle, Mid Screw To Tip Length Of 10mm, And An Overall Length Of 4 1/4" (11cm)



Spring Handled Scissors



11-5-5521

Iris Scissors With Curved Sharp Tips

Small Blades, Mid Screw To Tip Length Of 1/2" (12mm), And An Overall Length Of 4 1/2" (11.5cm)



5-4451

Precision Fine Straight Stitch Scissors

Serrated And Flat Handle With Polished Finish, Sharp Pointed Tips, 17mm Mid Screw To Tip, And Overall Length Of 4 1/4" (10.7cm)



11-5-5611

Fine Stitch Scissors Medium

With Straight And Sharp Blades, Three-Holed Handle, Mid Screw To Tip Length Of 20mm, And An Overall Length Of 4 3/4" (12cm)



5-4451-WH

Precision Fine Straight Stitch Scissors

Serrated And Wide Handle With Polished Finish, Sharp Pointed Tips, 16mm Mid Screw To Tip, And Overall Length Of 5 1/4" (13cm)

800.322.4674 or 800.633.7283

www.msiprecision.com

16-5



Spring Handled Scissors



11-5-5621

Fine Stitch Scissors Medium With Curved And Sharp Tips

Three-Holed Handle, Mid Screw To Tip Length Of 20mm, And An Overall Length Of 4 3/4" (12cm)



11-5-6221

Precision-Vannas Scissors With Straight And Extra-Thin Tips,

Three-Holed Handle, Mid Screw To Tip Length Of 10mm, Blade Length 7mm And An Overall Length Of 4 1/2" (11cm)



11-5-6222

Precision-Vannas Scissors With Curved And Extra-Thin Tips,

Three-Holed Handle, Mid Screw To Tip Length Of 10mm, Blade Length 7mm And An Overall Length Of 4 1/2" (11cm)



11-5-6223

Precision-Vannas Scissors With Angled Forward And Extra-Thin Tips

Three-Holed Handle, Mid Screw To Tip Length Of 10mm, Blade Length 7mm And An Overall Length Of 4 1/2" (11cm)



16-6

800.322.4674 or 800.633.7283

www.msiprecision.com

5-4401-A

Capsule Scissors 10mm Angled Blades

Delicate 10mm Blades Angled 45 Degrees, And Overall Length of 4 1/4" (110mm)

5-4401-C

Capsule Scissors 10mm Curved Blades

Delicate 10mm Blade Angled 45 Degrees, Gently Curved Blades, And Overall Length Of 4 1/4" (110mm)



11-5-6231

Precision-Vannas Scissors With Straight And Extra-Thin Tips

Precision-Vannas Scissors With Straight And Extra-Thin Tips, Three-Holed Handle, Mid Screw To Tip Length Of 13mm, Blade Length 10mm And An Overall Length Of 4 1/2" (11cm)



11-5-6232

Precision-Vannas Scissors With Curved And Extra-Thin Tips

Three-Holed Handle, Mid Screw To Tip Length Of 13mm, Blade Length 10mm And An Overall Length Of 4 1/2" (11cm)



11-5-6233

Precision Stern-Gills Style Vannas Scissor With Angled Forward And Straight Extra-Thin Tips

Three-Holed Handle, Mid Screw To Tip Length Of 13mm, Blade Length 10mm And An Overall Length Of 4 1/2" (11cm)

Spring Handled Scissors



11-5-6234

Precision Uribe-Stern Style Vannas Scissor

Angled Forward Blades With Curved Extra-Thin Tips On A 3 Hole Handle, Mid Screw To Tip Length Of 13mm, Blade Length 10mm And An Overall Length Of 4 1/2" (11cm)

11-5-6234-XC NEW Scissors Design

Precision Uribe-Stern (XC) Style Vannas Scissor

Angled Forward With Extra Curved Extra-Thin Blades Tips On A 3 Hole Handle, Mid Screw To Tip Length Of 13mm, Blade Length 10mm And An Overall Length Of 4 1/2" (11cm)



11-5-6235

Precision Hoffer-Stern Style Vannas Scissor Angled Forward Vaulted Curved Extra-Thin Sharp Tips

Three-Holed Handle, Mid Screw To Tip Length Of 13mm, Blade Length 10mm And An Overall Length Of 4 1/2" (11cm)

11-5-6236

Precision Gills Capsulotomy Scissor

Angled Forward Blades With Curved Extra-Thin Sharp Tips On A 3 Hole Handle Mid Screw To Tip Length Of 13mm, Blade Length 10mm And An Overall Length Of 4 1/2" (11cm)

11-5-6237

Precision Uthoff-Gills Style Vannas Scissor

Angled Forward Blades With Curved Extra-Thin Blunt Tips, On A 3 Hole Handle Mid Screw To Tip Length Of 13mm, Blade Length 10mm And An Overall Length Of 4 1/2" (11cm)

11-5-6239

Precision Dahan Style Vannas Scissor Angled To The Side And Curved Extra-Thin Blunt Tips

Three-Holed Handle, Mid Screw To Tip Length Of 12mm, Blade Length 9mm And An Overall Length Of 4 1/2" (11cm)



5-4431-R

Westcott Curved Tenotomy Scissors

Right, Serrated And Flat Handle With Polished Finish, Rounded Westcott Blades, Blunt Tips, 19mm Mid Screw To Tip, And Overall Length Of 4 1/2" (11.4cm)



Spring Handled Scissors



5-4431-L

Westcott Curved Tenotomy Scissors

Left, Serrated And Flat Handle With Polished Finish, Rounded Westcott Blades, Blunt Tips, 19mm Mid Screw To Tip, And Overall Length Of 4 1/2" (11.4cm)



5-4431-RWH

Westcott Curved Tenotomy Scissors

Serrated And Wide Handle With Polished Finish, Right Model, Rounded Westcott Blades, Blunt Tips, 23mm Mid Screw To Tip, And Overall Length Of 5 1/2" (14cm)



11-5-4115

Westcott Tenotomy Scissors,

Curved Forward, Blade Length Of 15mm, Overall Length Of 4 1/4" (10.9cm)



5-4431-RS

Shepard-Westcott Curved Tenotomy Scissors

Serrated And Flat Handle With Polished Finish, Right Model, Westcott Blades, Blunt Tips, Serrated Upper Blade, 21mm Mid Screw To Tip, And Overall Length Of 4 5/8" (11.7cm)

800.322.4674 or 800.633.7283

www.msiprecision.com

16-9



Spring Handled Scissors



11-5-4111

McPherson-Westcott Tenotomy Scissors With Three-Holed Handle

Curved, Sharp Tips, Mid Screw To Tip Length Of 3/8" (10mm), And An Overall Length Of 4 3/8" (11cm)

5-4431-RX

Westcott Curved Tenotomy Scissors

Serrated Handle With Polished Finish, Right Sub-Miniature Model, Round Westcott Blades, Blunt Tips, 9mm Mid Screw To Tip, And Overall Length Of 3 3/8" (88mm)

5-4431-RXC

Cohan-Westcott Curved Tenotomy scissors

Serrated Handle With Dull Finish, Sub-Miniature Model, Westcott Blades, 8mm Mid Screw To Tip, And Overall Length Of 2 1/8" (54mm)



5-4354

Clayman-Westcott Curved Scissors

Smooth Handle With Dull Finish, Blunt Tips, 11mm From Mid-Screw To Tip, And Overall Length Of 4 1/4" (107mm)



5-4432

Westcott Type Stitch Scissors

Serrated And Flat Handle With Polished Finish, Sharp Pointed Tips, 21mm Mid Screw To Tip, And Overall Length Of 4 3/4" (12cm)



16-10

800.322.4674 or 800.633.7283

www.msiprecision.com

Spring Handled Scissors



5-4432-WH

Westcott Type Stitch Scissors

Serrated And Wide Handle With Polished Finish, Sharp Pointed Tips, 22mm MidScrew To Tip, And Overall Length Of 5 1/2" (140mm)



11-5-5111

McPherson Westcott Stitch Scissor

With Small And Very Sharp Blade, Three-Holed Handle, Mid Screw To Tip Length Of 3/8" (10mm), And An Overall Length Of 4 3/8" (11cm)



11-5-5261

Jaffe Stitch Scissors

Medium, Very Sharp, 1/2" (1.3cm) Mid Screw To Tip Length, And Overall Length Of 4 1/2" (11.5cm)



5-4432-MWH

Castroviejo Mini Keratoplasty-Utility-Stitch Scissors

Serrated And Wide Handle With Polished Finish, Very Small Pointed Tips, 13mm Mid Screw To Tip, And Overall Length Of 4 7/8" (12.4cm)

5-4432-C

Collis Micro Utility Scissors

Serrated And Wide Handle With Polished Finish, Curved, Sharp Pointed Tips, 12mm From Mid Screw To Tip, And Overall Length Of 5" (128mm)

800.322.4674 or 800.633.7283

www.msiprecision.com

16-11



Spring Handled Scissors



5-4433

Westcott Type Utility Scissors

Serrated And Flat Handle With Polished Finish, Rounded Sharp Tips, 25mm Mid Screw To Tip, And Overall Length Of 4 1/2" (11.5cm)



5-4427

Precision Westcott Conjunctival Scissors

Serrated And Wide Handle With Polished Finish, Lightly Curved Blunt Tips, 16mm Mid Screw To Tip, And Overall Length Of 4 7/8" (12.4cm)

5-4426

Clayman-Westcott Curved Scissors

Smooth Handle With Dull Finish, Blunt Tips, 11mm From Mid-Screw To Tip, And Overall Length Of 4 1/4" (107mm)



5-4477

Barraquer Iris Scissors

Serrated Grip With Small Small Hole In Center, Squeeze Action Handle With Polished Finish, Blunt Tips, 8mm From Bend To Tip, And Overall Length Of 2 1/8" (54mm)

5-4478

Barraquer Vitreous Scissors

Serrated Grip With Small Small Hole In Center, Squeeze Handle With Polished Finish, Delicate Angled 10mm Blades, Blunt Tips, And Overall Length Of 2 1/8" (54mm)



16-12

800.322.4674 or 800.633.7283

www.msiprecision.com



11-5-5011

Barraquer Iris Scissor Round Looped Fenestrated Squeeze Action Handles

Blades Are Angled With A 7mm Blunt Tips

5-4470

Nadler Superior Radial Scissor

Serrated Grip With Small Small Hole In Center, Squeeze Handle With Polished Finish, Delicate Angled 7mm Blade, Blunt Tips, And Overall Length Of 2 1/8" (54mm)

5-4471

DeWecker Iris Scissors

Serrated And Flat Squeeze Action Handle With Dull Finish, Blunt And Sharp Points, 12mm From Bend To Tip, And Overall Length Of 4 1/2" (114mm)

5-4472

DeWecker Iris Scissors

Serrated And Flat Squeeze Action Handle With Dull Finish, Blunt And Blunt Points, 11mm From Tip To Bend, And Overall Length Of 4 1/2" (114mm)



5-4415

Castroviejo Corneal Section Scissors

Right, Serrated And Flat Handle With Polished Finish, Lower Blade 0.5mm Longer Than Upper Blade, 14mm Mid Screw To Tip, And Overall Length Of 4" (10.3cm)



5-4415-M

Castroviejo Corneal Section Scissors

Right, Serrated And Flat Handle With Polished Finish, Mid-Miniature Model With Curved Blades, Blunt Tips, Lower Blade 0.5mm Longer Than Upper Blade, 13mm Mid Screw To Tip, And Overall Length Of 4" (10cm)

Spring Handled Scissors

5-4415-MC

McPherson-Castroviejo Miniature Corneal Section Scissors

Right, Serrated And Flat Handle With Polished Finish, Miniature Model Has Curved Blades, Blunt Tips, Lower Blade 0.5mm Longer Than Upper Blades, 13mm From Mid Screw To Tip, And Overall Length Of 3 3/4" (93mm)

5-4415-WH

Castroviejo Corneal Section Scissors

Right, Serrated And Wide Handle With Polished Finish, Miniature Model Had Curved Blades, Blunt Tips, 10mm Mid Screw To Tip, And Overall Length Of 4 7/8" (125mm)



5-4415-X

Castroviejo Corneal Section Scissors

Right, Serrated Handle With Polished Finish, Sub-Miniature Model Has Curved Blades, Blunt Tips, Lower Blade 0.5mm Longer Than Upper Blades, 9mm Mid Screw To Tip, And Overall Length Of 4 1/8" (103mm)

5-4415-XWH

Castroviejo Corneal Section Scissors

Right, Serrated And Wide Handle With Polished Finish, Sub-Miniature Model Had Curved Blades, Blunt Tips, Lower Blade 0.5mm Longer Than Upper Blade, 7mm Mid Screw To Tip, And Overall Length Of 4 3/4" (120mm)



5-4416

Castroviejo Corneal Section Scissors

Left, Serrated And Flat Handle With Polished Finish, Lower Blade 0.5mm Longer Than Upper Blade, 14mm Mid Screw To Tip, And Overall Length Of 4 1/8" (10.5cm)





5-4416-M

Castroviejo Corneal Section Scissors

Left, Serrated And Flat Handle With Polished Finish, Mid-Miniature Model With Curved Blades, Blunt Tips, Lower Blade 0.5mm Longer Than Upper Blade, 13mm Mid Screw To Tip, And Overall Length Of 4" (10.2cm)

5-4416-MC

McPherson-Castroviejo Miniature Corneal Section scissors

Left, Serrated And Flat Handle With Polished Finish, Miniature Model Has Curved Blades, Blunt Tips, Lower Blade 0.5mm Long Than Upper Blade, 13mm Mid Screw To Tip, And Overall Length Of 3 3/4" (93mm)

5-4416-WH

Castroviejo Corneal Section Scissors

Left, Serrated And Wide Handle With Polished Finish, Miniature Model Has Curved Blades With Blunt Tips, 10mm Mid Screw To Tip, And Overall Length Of 4 7/8" (125mm)



5-4416-X

Castroviejo Corneal Section Scissors

Left, Serrated Handle With Polished Finish, Sub-Miniature Model Has Curved Blades, Blunt Tips, Lower Blade 0.5mm Longer Than Upper Blade, 9mm Mid Screw To Tip, And Overall Length Of 4 1/8" (103mm)

5-4416-XWH

Castroviejo Corneal Section Scissors

Left, Serrated And Wide Handle With Polished Finish, Sub-Miniature Model Has Curved Blades, Blunt Tips, Lower Blade 0.5mm Longer Than Upper Blade, 7mm Mid Screw To Tip, And Overall Length Of 4 3/4" (120mm)

5-4411

Castroviejo Corneal Section Scissors

Castroviejo Corneal Section Scissors, Right Serrated Flat Handle, Polished Finish, Angled Blade And Curved, Lower Blade 1mm Long Than Upper Blade And Rounded Like Spatula, 18mm MidScrew To Tip, And Overall Length Of 4 1/4" (110mm)

Spring Handled Scissors



5-4412

Castroviejo Corneal Section Scissors

Left Serrated Flat Handle, Polished Finish, Angulated Blade And Curved, Lower Blade 1mm Longer Than Upper Blade And Rounded Like Spatula, 18mm MidScrew To Tip, And Overall Length Of 4 1/4" (110mm)



5-4417

Troutman-Castroviejo Corneal Section Scissors

Right, Serrated And Flat Handle With Polished Finish, Barraquer Stop/Lock, Miniature Model Has Curved Blades, Blunt Tips, Both Blades Of Equal Length, And Overall Length Of 4 5/8" (116mm)



5-4418

Troutman-Castroviejo Corneal Section Scissors

Left, Serrated And Flat Handle With Polished Finish, Barraquer Stop/Lock, Miniature Model Has Curved Blades, Blunt Tips, Equal Length 10mm Blades, 13mm Mid Screw To Tip Length, And Overall Length of 4" (10cm)



5-4329-R

Castroviejo Curved Corneal Scissors

Right, Serrated And Flat Handle With Polished Finish, Miniature Model With Blunt Tips, 11mm From Mid-Screw To Tip, And Overall length Of 4 1/8" (10.5cm)





5-4329-L

Castroviejo Curved Corneal Scissors

Left, Serrated And Flat Handle With Polished Finish, Miniature Model With Blunt Tips, 11mm From Mid-Screw To Tip, And Overall Length Of 4 1/8" (10.5cm)



5-4329-MM

Castroviejo Mini Corneal Scissors

Serrated And Flat Handle With Polished Finish, Universal Miniature model With Blunt Tips, 11mm From Mid-Screw To Tip, And Overall Length Of 4 1/4" (106mm)



5-4342-R

Precision Miniature Corneal Scissors

Right, Delicate Corneal Scissors, 9mm Blades With Lower Blade Extended 0.5mm, And Overall Length Of 3 7/8" (100mm)

5-4342-L

Precision Miniature Corneal Scissors

Left, Delicate Corneal Scissors, 9mm Blades With Lower Blade Extended 0.5mm, And Overall Length Of 3 7/8" (100mm)

Spring Handled Scissors

11-5-2111

Castroviejo Corneal Scleral Scissor

On 3 Hole Handle Small Blades Curved Right

11-5-2121

Castroviejo Corneal Scleral Scissor

On 3 Hole Handle Small Blades Curved Left

11-5-2131

Castroviejo Corneoscleral Scissors Medium

Right, On 3 Hole Handle, Mid Screw To Tip Length Of 12mm, And An Overall Length Of 4" (10cm)

11-5-2141

Castroviejo Corneoscleral Scissors Medium

Left, On 3 Hole Handle, Mid Screw To Tip Length Of 12mm, And An Overall Length Of 4" (10cm)

11-5-2311

Troutman Castroviejo Corneoscleral Scissor

On 3 Hole Handle With Stop Small Blades Curved Right

11-5-2321

Troutman Castroviejo Corneoscleral Scissor

On 3 Hole Handle With Stop Small Blades Curved Left

11-5-2331

Troutman Castroviejo Corneoscleral Scissor

On 3 Hole Handle With Stop Medium Blades Curved Right

11-5-2341

Troutman Castroviejo Corneoscleral Scissor

On 3 Hole Handle With Stop Medium Blades Curved Left



11-5-3111

Troutman Katzin Corneal Transplant Scissor

On 3 Hole Handle With Stop Small Blades Curved Right

11-5-3121

Troutman Katzin Corneal Transplant Scissor

On 3 Hole Handle With Stop Small Blades Curved Left

11-5-3125

Rich Corneal Transplant Scissor

On 3 Hole Handle Extra Delicate Blades Curved Right

11-5-3126

Rich Corneal Transplant Scissor

On 3 Hole Handle Extra Delicate Blades Curved Left



5-4344

Katzin Curved Corneal Transplant Scissors

Right, Serrated And Flat Handle With Polished Finish, Miniature Model With Strongly Curved Blunt Blades Of Uneven Lengths, Lower Blade 12mm, Upper Blade 11mm (From Mid-Screw To Tip), And Overall Length Of 4" (10cm)

11-5-3131

Katzin Corneal Transplant Scissor

On 3 Hole Handle Medium Blades Curved Right



5-4343

Katzin Curved Corneal Transplant Scissors

Left, Serrated And Flat Handle With Polished Finish, Miniature Model With Strongly Curved Blunt Blades Of Uneven Lengths, Lower Blade 12mm, Upper Blade 11mm (From Mid-Screw To Tip), And Overall Length Of 4" (10cm)

800.322.4674 or 800.633.7283

www.msiprecision.com

16-19



Spring Handled Scissors

11-5-3141

Katzin Corneal Transplant Scissor

On 3 Hole Handle Medium Blades Curved Left

11-5-3152

Rosenwasser Scissor

On 3 Hole Handle Medium Curved Blades

11-5-3153

Rosenwasser Scissor

On 3 Hole Handle Strong Curved Blades

5-4338

Azar Curved Calibrated Corneal Scissors

Flat Scalloped Handle With Dull Finish, Universal Medium Model With Blunt Blades, Calibration Markings Of 1mm To 6mm, 16mm From Mid-Screw To Tip, And Overall Length Of 4 1/2" (114mm)



5-4331

Castroviejo Curved Corneal Scissors

Serrated Flat Handle With Polished Finish, Universal Medium Model With Blunt Tips, 16mm From Mid-Screw To Tip, And Overall Length Of 4 1/2" (115mm)



11-5-3311

Castroviejo Corneal Scissors Curved With Small Blunt Jaws

Three-Holed Handle, 10mm Mid Screw To Tip Length, And An Overall Length Of 4 3/8" (111mm)



16-20

800.322.4674 or 800.633.7283

www.msiprecision.com

5-4331-WH

Castroviejo Keratoplasty And Keratectomy Scissors

Serrated And Wide Handle With Polished Finish, Universal Miniature Model With Medium Curved Blades, 17mm From Mid-Screw To Tip, And Overall Length Of 5 1/4" (133mm)



11-5-3331

Castroviejo Corneal Scissors Curved

Blunt, Medium, With Mid Screw To Tip Length Of 10mm, And An Overall Length Of 4 3/8" (11cm)



11-5-3351

Castroviejo Corneal Scissors Large Blades With Curved And Blunt Tips

Three-Holed Handle, Mid Screw To Tip Length Of 15mm, And An Overall Length Of 4 1/2" (11.5cm)

11-5-3371

Castroviejo Corneal Scissors Large Blades With Strong Curve And Blunt Tips

Three-Holed Handle, Mid Screw To Tip Length Of 15mm, And An Overall Length Of 4 1/2" (11.5cm)



5-4334

Castroviejo Angled Corneal Scissors

Serrated And Flat Handle With Polished Finish, Universal Miniature Model With Blunt Blades, 19mm From Midscrew To Tip, And An Overall Length Of 4 1/4" (106mm)

Spring Handled Scissors

11-5-3961

Castro Keratoplasty Scissor

Angled Blade To Side On A Three Hole Handle With Medium Blunt Blades

5-4332

Castroviejo Kertoplasty Scissors

Serrated And Flat Handle With Polished Finish, Universal With Blunt Angled Blades, Lower Blade 1mm Longer Than Upper Blade, 16mm From Mid-Screw To Tip, And Overall Length Of 4 1/4" (110mm)

5-4390

Aebli Corneal Section Scissors

Right, Serrated And Flat Handle With Polished Finish, Angled Blades With Blunt Tips, 18mm From Mid-Screw To Tip, And Overall Length Of 4 3/4" (120mm)

5-4301

Aebli Corneal Section Scissors

Left, Serrated And Flat Handle With Polished Finish, Angled Blade With Blunt Tips, 18mm From Mid-Screw To Tip, And Overall Length Of 4 3/4" (120mm)



16-22

800.322.4674 or 800.633.7283

www.msiprecision.com

5-5217

Barraquer Eye Speculum

Wire 14mm Blades With Dull Finish, 20mm Spread, And Overall Length Of 1 1/2" (3.8cm). Overall Weight Of 0.1 oz

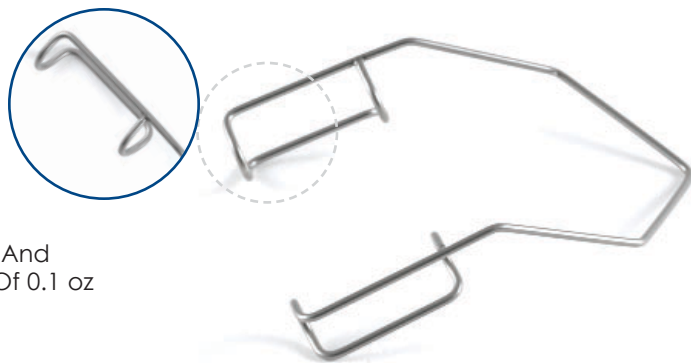

11-2-6121

Barraquer Wire Speculum

Large, V-Shaped End Angled Upward, Round Blades, Blade Length Of 16mm, Spread Of 29mm, Overall Length Of 1 1/2" (3.9cm). Overall Weight Of 0.1 oz

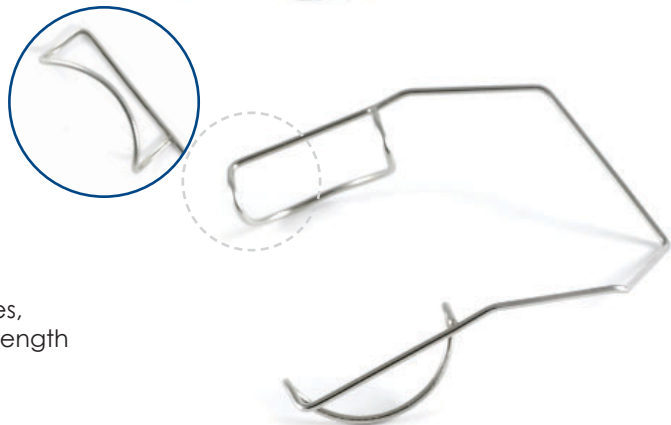

5-5217-15

Barraquer Eye Speculum

Wire 15mm Blades With Dull Finish, 18.5mm Spread, And Overall Length Of 1 1/2" (3.8cm)

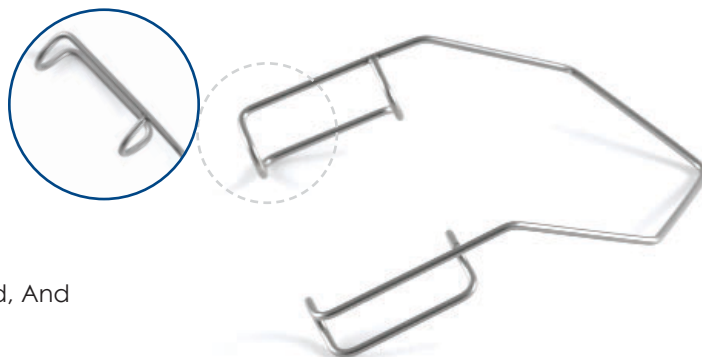

5-5217-H

Barraquer Eye Speculum

Open 14mm Blades Of Heavy 1mm Wire With Dull Finish, 16mm Spread, And Overall Length Of 1 5/8" (4cm) Overall Weight Of 0.1 oz

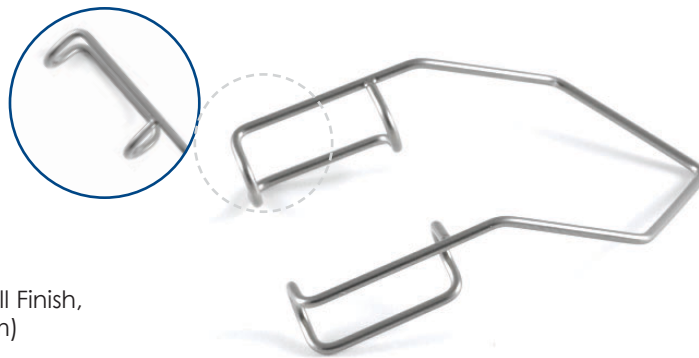

Speculums

11-2-6110

Barraquer Speculum Large

Heavy Wire, U-Shaped Blades, V-Shaped End, Blade Length Of 15mm, Spread Of 24mm, Overall Length Of 1 3/4" (4.3cm) Overall Weight Of 0.1 oz

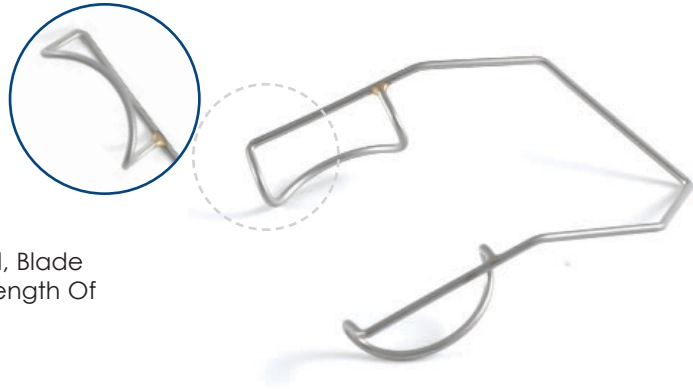

5-5218

Barraquer Eye Speculum

Open 1mm Blades With Dull Finish, 19mm Spread, And Overall Length Of 1 3/8" (3.6cm) Overall Weight Of 0.1 oz

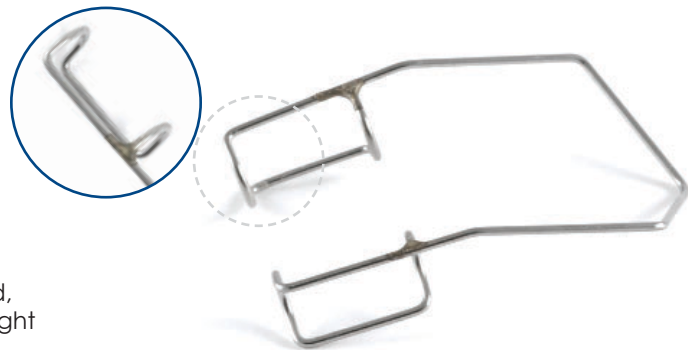

11-2-6111

Barraquer Speculum Small

Curved, Open Wire Blades, V-Shaped End, Blade Length Of 13mm, Spread Of 14mm, Overall Length Of 1 1/4" (3.3cm) Overall Weight Of 0.1 oz

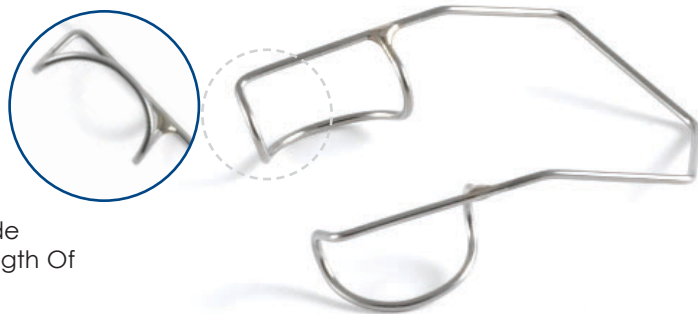

5-5218-P

Barraquer Pediatric Speculum

Closed Wire 5mm Blade With An Overall Length Of 1 1/4" (30mm) Overall Weight Of 0.1 oz

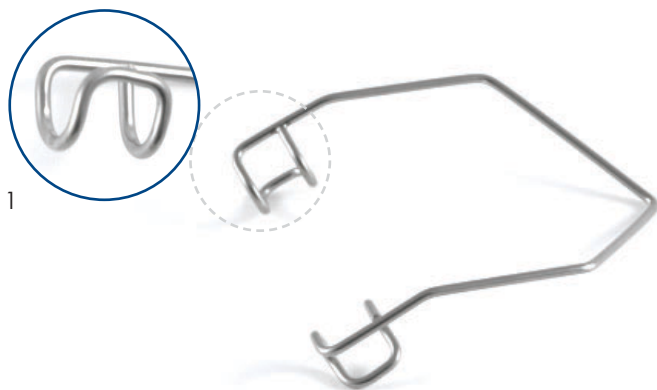

5-5217-M

Connor Barraquer Eye Speculum

Wire With 14mm Blades, Dull Finish, 25mm Spread, And An Overall Length Of 1 1/2" (40mm) Overall Weight Of 0.1 oz

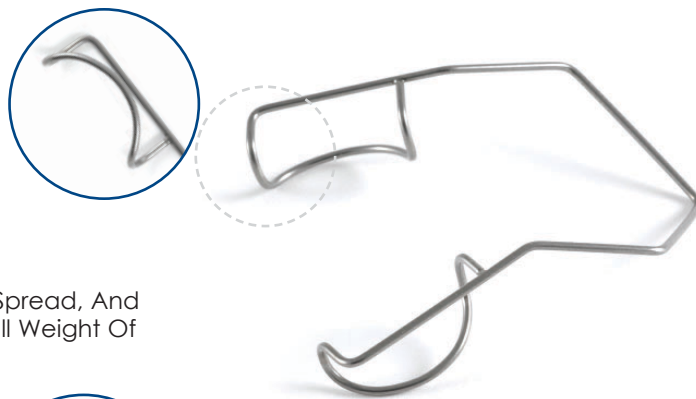

5-5217-MT

Connor Barraquer Temporal Approach Lid Speculum

Wire With 14mm Rounded Blades For Patient Comfort, Dull Finish, 25mm Spread, Angled, And Overall Length Of 1 1/2" (40mm) Overall Weight Of 0.1 oz

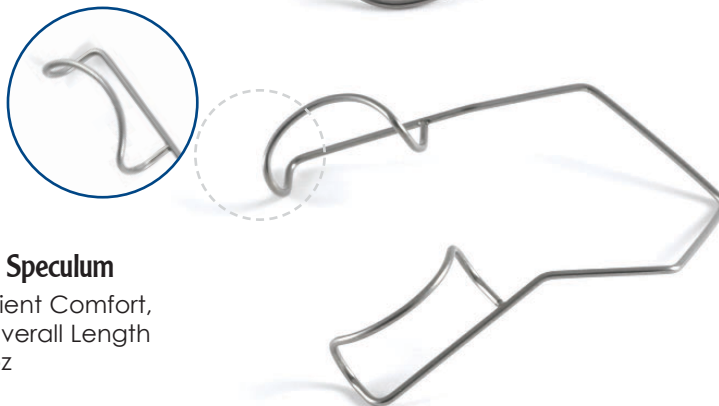

5-5217-K

Kratz-Barraquer Eye Speculum

Open 14mm Blades With Dull Finish, 18mm Spread, And Overall Length Of 1 5/8" (41mm) Overall Weight Of 0.1 oz

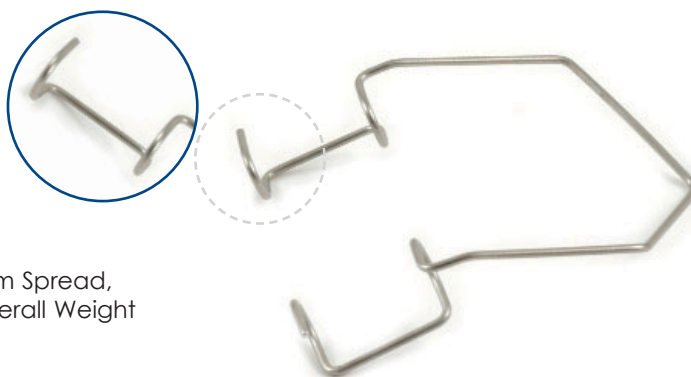

11-2-6161

Kratz-Barr Wire Speculum Large

V-Shaped End Slanted Sharply Upward, Open Wire Blades, Blade Length Of 16mm, Spread Of 15mm, Overall Length Of 1 5/8" (4.2cm) Overall Weight Of 0.1 oz

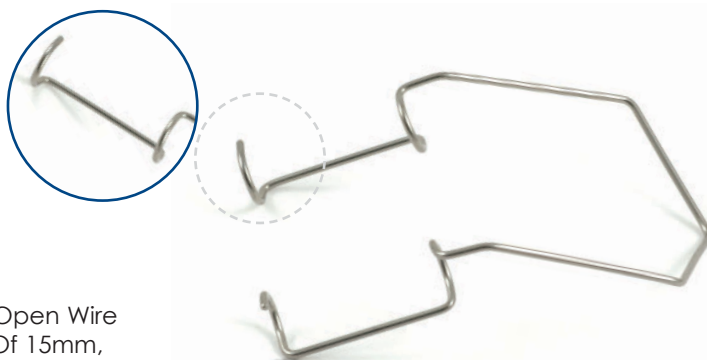

Speculums

5-5217-KH

Kratz-Barraquer Eye Speculum

Open 14mm Blades With Dull Finish, Heavy 1mm Wire, 18mm Spread, And Overall Length Of 1 5/8" (41mm)
Overall Weight Of 0.1 oz



11-2-6150

Kratz-Barraquer Speculum

Large, Heavy Wire, Straight, V-Shaped End, Blade Length Of 16mm, Spread Of 19mm, Overall Length Of 1 1/2" (3.7cm)
Overall Weight Of 0.1 oz

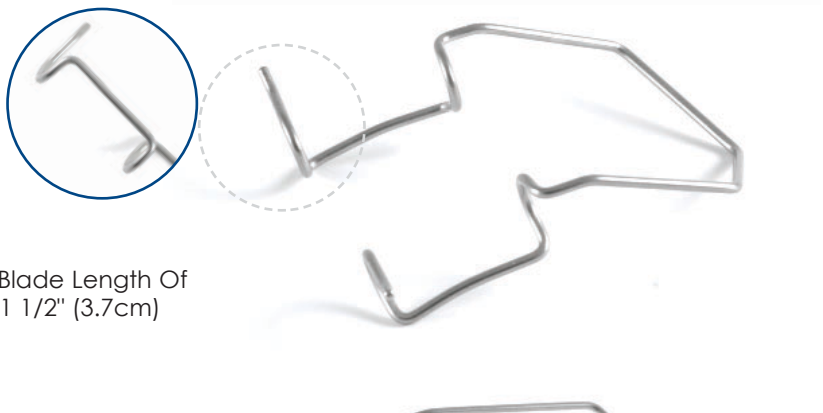

5-5218-K

Kratz-Barraquer Eye Speculum

Open 11mm Blades With Dull Finish, 1gmm Spread, And Overall Length Of 1 3/8" (3.6cm), Overall Weight Of 0.1 oz

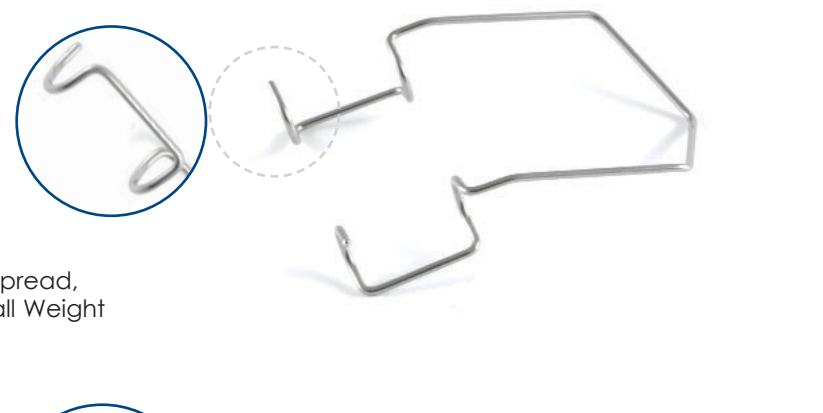

11-2-6162

Kratz-Barraquer Speculum

Small, Straight, V-Shaped End, Blade Length Of 12mm, Spread Of 16mm, Overall Length Of 1 1/4" (3.1cm), Overall Weight Of 0.1 oz

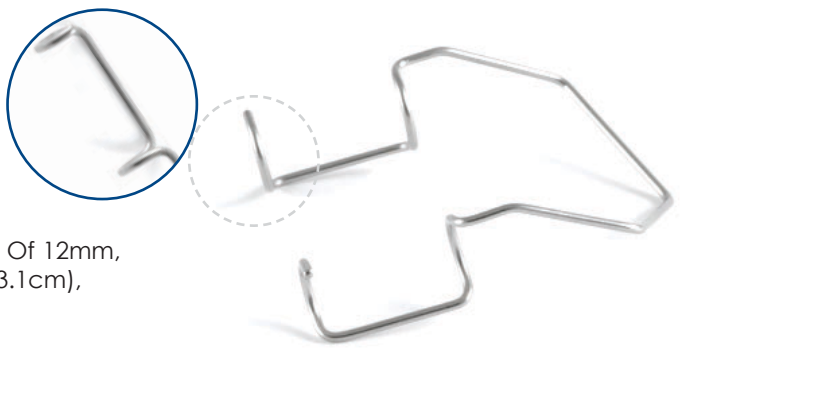

5-5218-PK

Kratz Barraquer Pediatric Speculum

Open Wire 5mm Blade With Wing Tip Twist, Spread Of 16mm, And Overall Length Of 1" (2.6cm), Overall Weight Of 0.1 oz

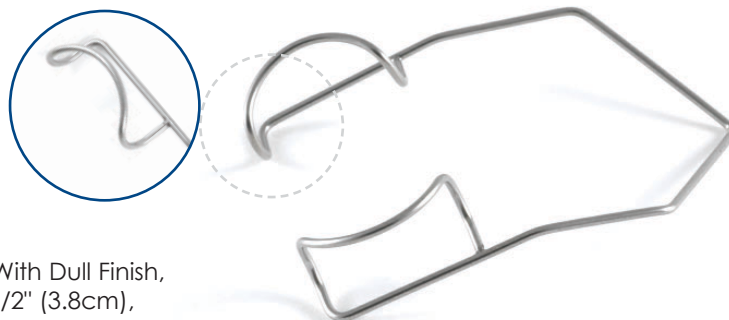

5-5217-T

Temporal Approach Lid Specul

Wire 14mm Rounded Blades For Patient Comfort With Dull Finish, 16mm Spread, Angled, And Overall Length Of 1 1/2" (3.8cm), Overall Weight Of 0.1 oz



11-2-6123

Temporal Closed Wire Speculum

U-Shaped Blades, Blade Length Of 16mm, Spread Of 18mm, Overall Length Of 1 1/2" (3.8cm), Overall Weight Of 0.1 oz

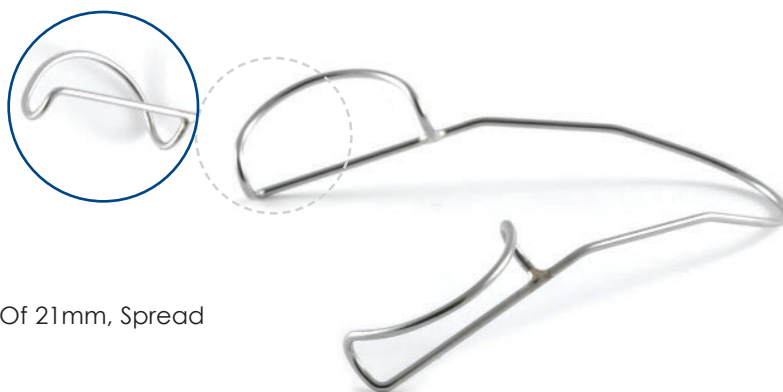

11-2-6123-W

Temporal Closed Wire Speculum

Wide Model, U-Shaped Blades, Blade Length Of 21mm, Spread Of 40mm, Overall Length Of 2 1/4" (5.6cm)

5-5216

Lehner Temporal Speculum

Open 14mm Blades With 18mm Spread, And Angled 45 Degrees Upward For Temporal Approach, Overall Weight Of 0.1 oz

Speculums

5-5217-KT

Kratz Barraquer Temporal Approach Lid Speculum

Open 14mm Rounded Blades With Dull Finish, 18mm Spread, Angled, And Overall Length Of 1 5/8" (41mm), Overall Weight Of 0.1 oz

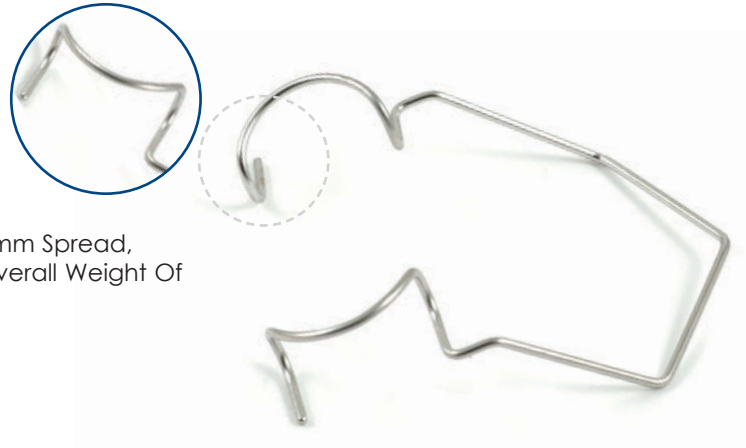

11-2-6126

Temporal Speculum With C-Shaped End

Open Wire Blades, Blade Length Of 16mm, Spread Of 21mm, Overall Length Of 1 5/8" (4cm), Overall Weight Of 0.1 oz

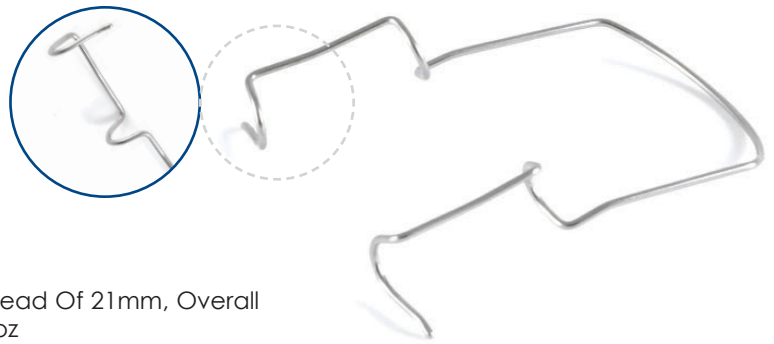

11-2-6126-R

Temporal Open Wire Speculum

Round Blades, V-Shaped End, Blade Length Of 15mm, Spread Of 17mm, Overall Length Of 1 3/4" (4.4cm), Overall Weight Of 0.1 oz

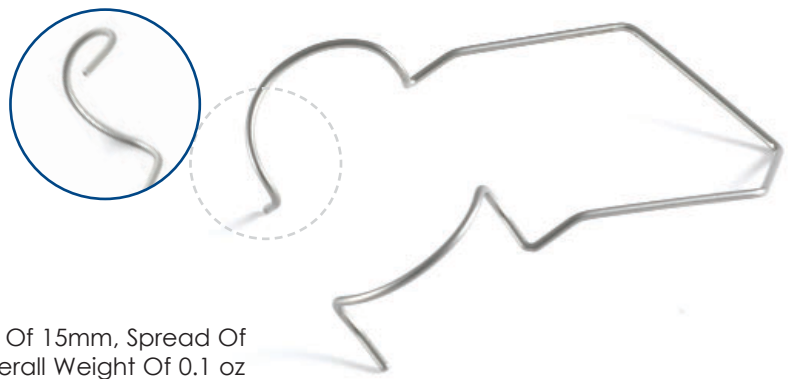

5-5218-KT

Temporal Speculum

Kratz Type, Blade Length Of 12mm, Spread Of 15mm, And An Overall Length Of 1 1/2" (3.7cm), Overall Weight Of 0.1 oz



5-5218-KTR

Temporal Speculum

Kratz Type, Round Blade, V-Shaped End, Blade Length Of 11mm, Spread Of 16mm, Overall Length Of 1 5/8" (4cm), Overall Weight Of 0.1 oz

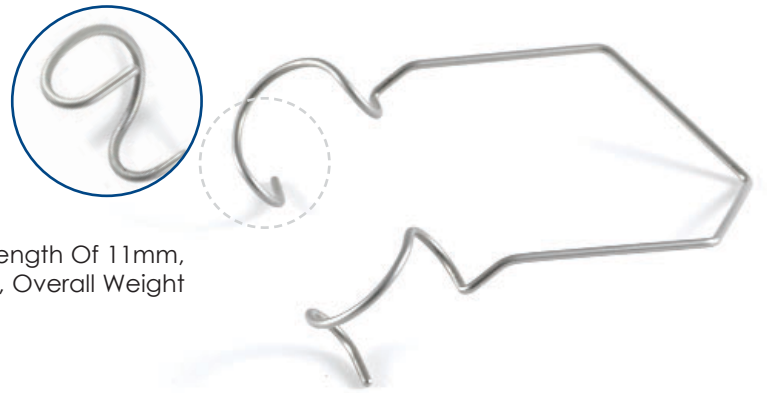

5-5217-N

Kratz-Nichamin Speculum

Open Wire Style 14mm Blade With Wing Tip Twist, Spread Of 24mm, And Overall Length Of 1 5/8" (4cm), Overall Weight Of 0.1 oz

11-2-6261

Kratz-Barraquer Wire Speculum Large

U-Shaped End With Open Wire Blades, Blade Length Of 16mm, Spread Of 15mm, Overall Length Of 1 5/8" (4.2cm) With Silicone Tubing And Luer Lock Adaptor

5-5217-S

Barraquer Eye Speculum

Solid 14mm Blades With Dull Finish, 19mm Spread, And Overall Length Of 1 5/8" (41mm), Overall Weight Of 0.1 oz

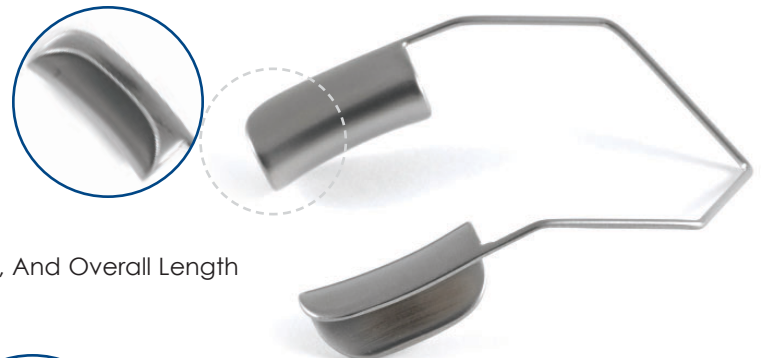

11-2-6131

Small Solid Blade Speculum With V-Shaped End

Blade Length Of 12mm, Spread Of 20mm, Overall Length Of 1 3/8" (3.6cm), Overall Weight Of 0.1 oz

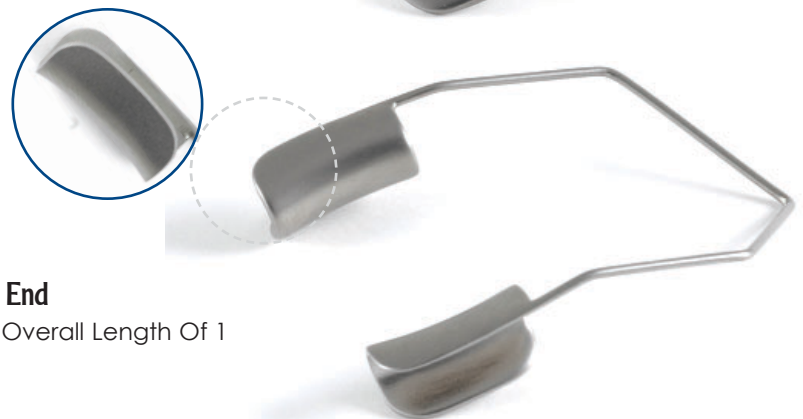

5-5218-PS

Barraquer Pediatric Speculum

Solid 6mm Blade Speculum For Newborn Or Pediatric Use, And Overall Length Of 1 1/4" (30mm)

Speculums



11-2-6143

Feast-Barr Speculum With Wide

Solid Blades, V-Shaped End, Blade Length Of 19mm, Spread Of 20mm, Overall Length Of 1 3/4" (4.3cm), Overall Weight Of 0.1 oz

11-2-6155

Kratz-Barraquer Wire Eye Speculum Right

With One Solid 14mm Blade Right Side and Left Side With Open Wire Blades, Blade Length Of 16mm Dull Finish, 15m Spread, And Overall Length Of 1 5/8" (41mm)

11-2-6156

Kratz-Barraquer Wire Eye Speculum Left

With One Solid 14mm Blade Left Side and Right Side With Open Wire Blades, Blade Length Of 16mm Dull Finish, 15m Spread, And Overall Length Of 1 5/8" (41mm)



5-5217-ST

Temporal Approach Lid Speculum

Solid 14mm Blades With Dull Finish, 19mm Spread, Angled, And Overall Length Of 1 5/8" (4.1cm), Overall Weight Of 0.1 oz

11-2-6125

Temporal Approach Lid Speculum

Solid 14mm Blades With Dull Finish, 16mm Spread, Angled Up With U Shape Wire Back, And Overall Length Of 1 5/8" (4.1cm)





11-2-6311

Tenant Solid Lid Retractor

Sold In A Pair, Blade Length Is 14mm, Overall Length Is 1" (2.5cm), Overall Weight Of 0.1 oz

5-5219

Floyd-Barraquer Eye Speculum

Open 14mm Blades With Dull Finish, 6mm Lifting Wings, 18mm Spread, And Overall Length Of 1 5/8" (40mm), Overall Weight Of 0.1 oz

5-5227

Thornton Open Wire Lid Speculum With Lifting Wings

Open 15mm Blades, Dull Finish, 16mm Lifting Wings, 24mm Spread, And Overall Length Of 1 1/2" (40mm), Overall Weight Of 0.1 oz

5-5225

Rappazzo Lid Speculum

Open 15mm Blades With Dull Finish, 44mm Spread, Screw Locking Mechanism, Lifting Wings, And Overall Length Of 2 1/10" (53mm), Overall Weight Of 0.1 oz

11-2-6171

Kratz Barraquer Open Wire Lid Speculum With Lifting Wings,

Open 15mm Round Bar Blades, Dull Finish, 16mm Lifting Wings, 24mm Spread, And Overall Length Of 1 1/2" (40mm)

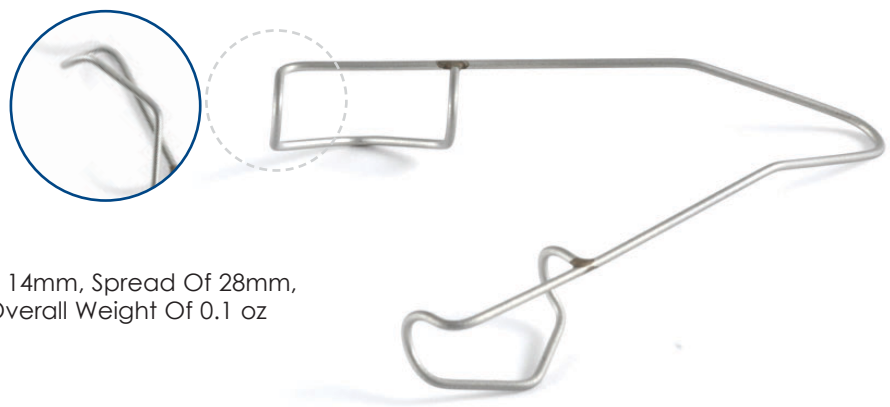

11-2-6181

McIntyre Closed Wire Eye Speculum

V Shaped Blades, Blade Length Of 14mm, Spread Of 28mm, Overall Length Of 1 3/4" (4.5cm), Overall Weight Of 0.1 oz

Speculums



11-2-6182

McIntyre Open Wire Speculum

V Shaped Blades, Blade Length Of 16mm, Spread Of 27mm, Overall Length Of 1 3/4" (4.5cm), Overall Weight Of 0.1 oz

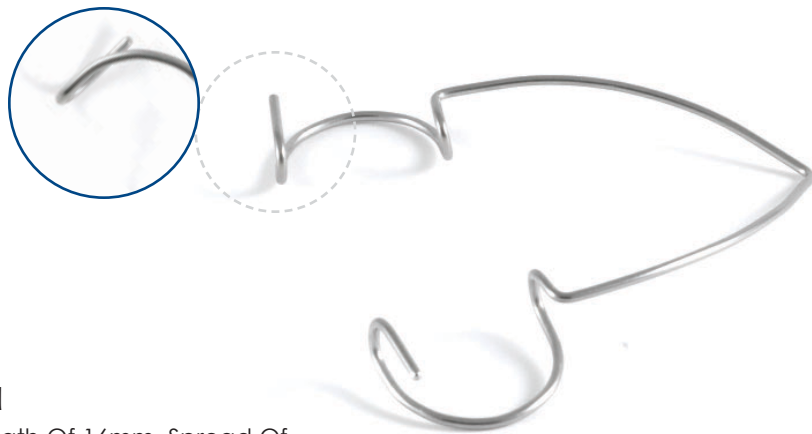

11-2-6184

Nevyas Speculum With V-Shaped End

Round Open Wire Blades, Blade Length Of 16mm, Spread Of 31mm, Overall Length Of 1 7/8" (4.7cm), Overall Weight Of 0.1 oz

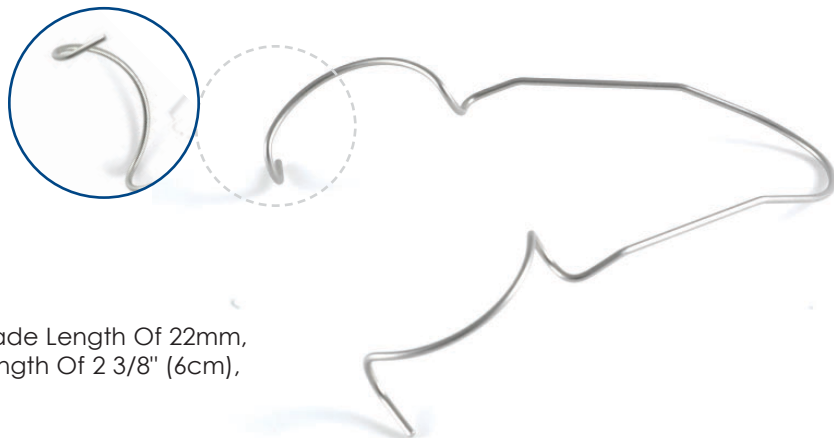

11-2-6184-U

Nevyas Wire Speculum

U-Shaped End, U-Shaped Blades, Blade Length Of 22mm, Spread Length Of 40mm, Overall Length Of 2 3/8" (6cm), Overall Weight Of 0.1 oz



17-10

800.322.4674 or 800.633.7283

www.msiprecision.com

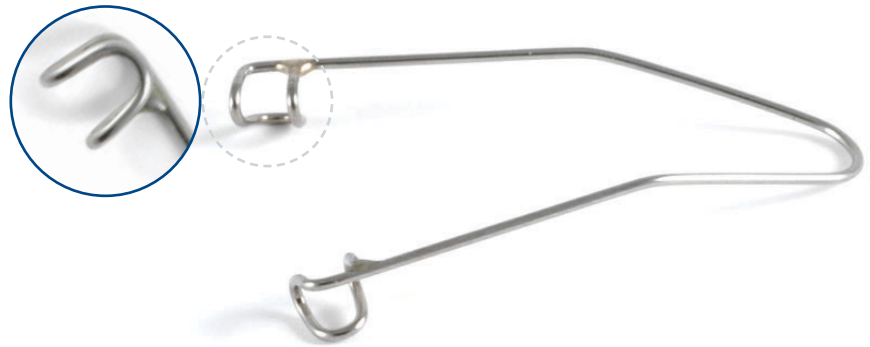

11-2-6461

Infant Wire Speculum

U-Shaped End Angled Slightly Upward, Round Blades, Blade Length Of 4mm, Spread Of 20mm, Overall Length Of 1 1/2" (3.8cm), Overall Weight Of 0.1 oz



5-5210

Pierse Eye Speculum

Open 11mm Blades With Polished Finish, 20mm Spread, And Overall Length Of 1 1/4" (30mm), Overall Weight Of 0.1 oz



5-5223

Alfonso Eye Speculum

Open 5mm Blades With Dull Finish, 27mm Spread, And Overall Length Of 1 3/4" (45mm), Overall Weight Of 0.1 oz

Speculums



5-54918S

Premature Infant Self Retaining Retractor Small

Overall Length 1 1/2" (3.8cm) With Round Wire Blades,
Blade Length Of 4mm

5-54919S

Premature Infant Self Retaining Retractor Small

Overall Length 1 1/2" (3.8cm) With Round Wire Blades,
Blade Length Of 5mm

5-54920S

Premature Infant Self Retaining Retractor Small

Overall Length 1 1/2" (3.8cm) With Round Wire Blades,
Blade Length Of 6mm

5-54921S

Infant Self Retaining Retractor Small

Overall Length 1 1/2" (3.8cm) With Round Wire Blades,
Blade Length Of 7mm

5-54922S

Infant Self Retaining Retractor Small

Overall Length 1 1/2" (3.8cm) With Round Wire Blades,
Blade Length Of 8mm

5-54923S

Infant Self Retaining Retractor Small

Overall Length 1 1/2" (3.8cm) With Round Wire Blades,
Blade Length Of 9mm

5-54924S

Child Self Retaining Retractor Small

Overall Length 1 1/2" (3.8cm) With Round Wire Blades,
Blade Length Of 10mm

5-54924S

Child Self Retaining Retractor Small

Overall Length 1 1/2" (3.8cm) With Round Wire Blades,
Blade Length Of 11mm

5-54924S

Child Self Retaining Retractor Small

Overall Length 1 1/2" (3.8cm) With Round Wire Blades,
Blade Length Of 12mm





5-5221

Sauer Infant (A) Eye Speculum

Solid 8mm Blades With Dull Finish, 20mm Spread, Overall Length Of 1 3/8" (35mm)

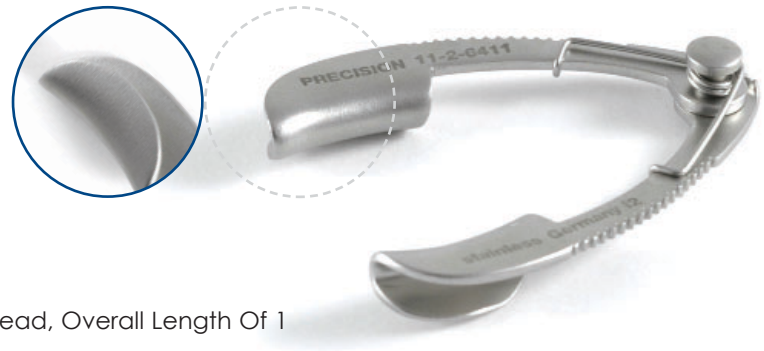

11-2-6411

Sauer Infant (B) Eye Speculum

Solid 11mm Blades With Dull Finish, 18mm Spread, Overall Length Of 1 3/8" (34mm)

11-2-6413

Sauer Premature Infant Lid Speculum

Tiny Small Solid Blades, Blade Length Of Blank mm, Spread Of 20mm, Overall Length Of 1 1/8" (2.8cm)

11-2-6421

Frankel Infant Adjustable Twist Lid Speculum

Small Solid Blades, Blade Length Of Blank mm, Spread Of Blank mm, Overall Length Of Blank" (Blankcm)

Speculums

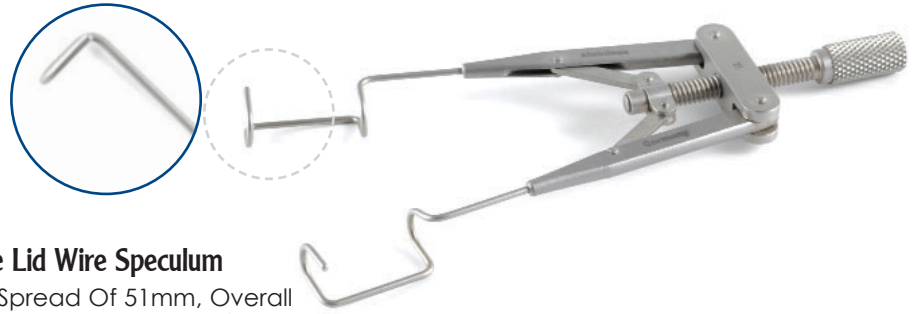

5-5224

Precision Maloney Style Adjustable Lid Wire Speculum

Straight, Blade Length Of 15mm, Spread Of 51mm, Overall Length Of 3 1/4" (8.4cm), Overall Weight Of 0.1 oz

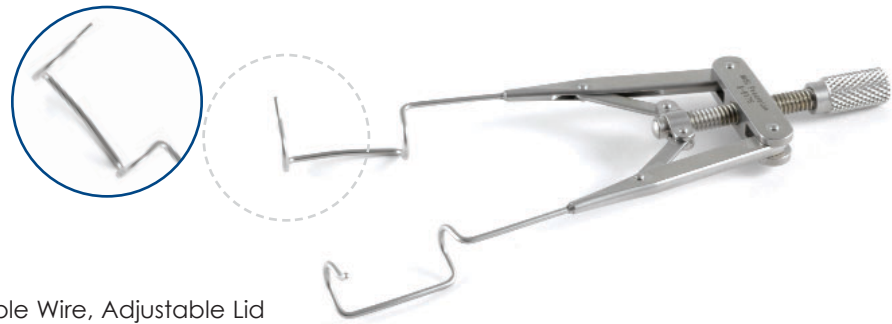

5-5176

Lieberman Open Wire Speculum

Open 17mm Blades With Adjustable Wire, Adjustable Lid Tension With Thumb Screw Control, And Available With Straight Shaft Or Angled 45 Degrees, 50mm Spread And Overall Length Of 3 3/8" (8.4cm), Overall Weight Of 0.1 oz

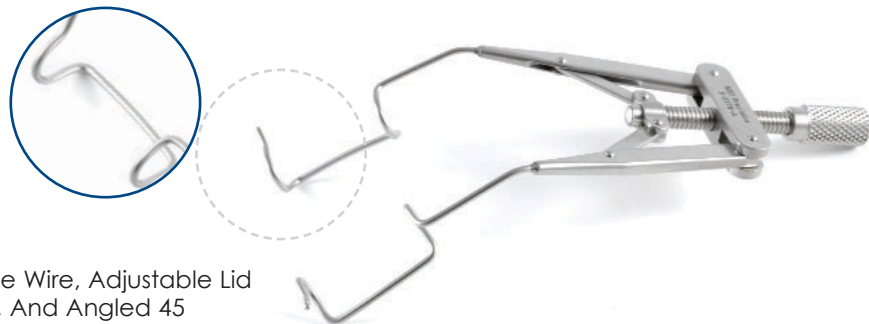

5-5176-A

Lieberman Open Wire Speculum

Open 17mm Blades With Adjustable Wire, Adjustable Lid Tension With Thumb Screw Control, And Angled 45 Degrees, Spread Of 37mm, Overall Length Of 3 1/8" (8.1cm), Overall Weight Of 0.1 oz



17-14

800.322.4674 or 800.633.7283

www.msiprecision.com

5-5176-AT

Lieberman Open Wire Temporal Speculum

Open 16mm Blades With Adjustable Wire, Adjustable Lid Tension With Thumb Screw Control, Angled 45 Degrees, In Titanium, With An Overall Length Of 3 1/4" (8.4cm), Overall Weight Of 0.1 oz

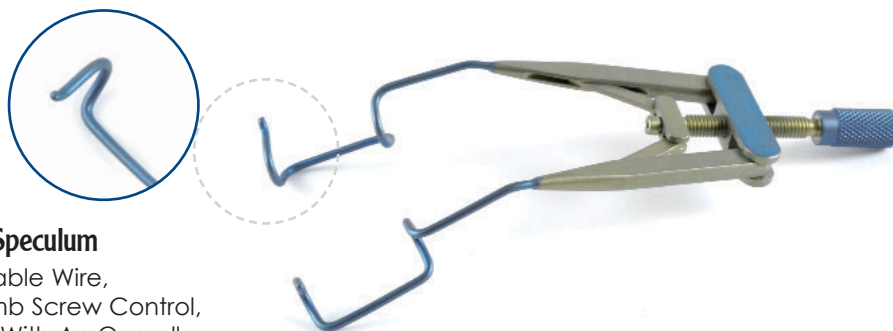

11-2-6782

Lieberman Adult K-Wire Speculum With Adjustable Mechanism

Kratz-Style Open Wire Blades Angled Downward Towards The Temple, Blade Length Of 15mm, Overall Length Of Speculum Is 3" (7.6cm)



11-2-6782-R

Lieberman Adult Round-Wire Speculum With Adjustable Mechanism

Kratz Round Style Open Wire Blades Angled Downward Towards The Temple, Blade Length Of 15mm Overall Length Of Speculum Is 3" (7.6cm)

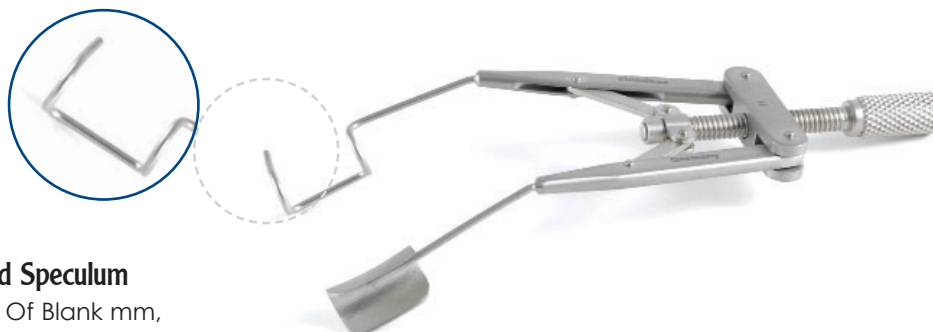

11-2-6782-LS

Special Order Item*

Frankel Infant Adjustable Twist Lid Speculum

Small Solid Blades, Blade Length Of Blank mm, Spread Of Blank mm, Overall Length Of Blank" (Blankcm)

*Special Order Items are Non-Cancelable

800.322.4674 or 800.633.7283

www.msiprecision.com

17-15



Speculums

11-2-6782-RS

Special Order Item*

Lieberman Adult K-Wire And Solid Blade Speculum With Adjustable Mechanism

Kratz-Style Open Wire Left Blade And Solid Adult Right Blade Angled Downward Towards Towards The Temple, Both Blade 15mm, Overall Length Of Speculum Is 3" (7.6cm)

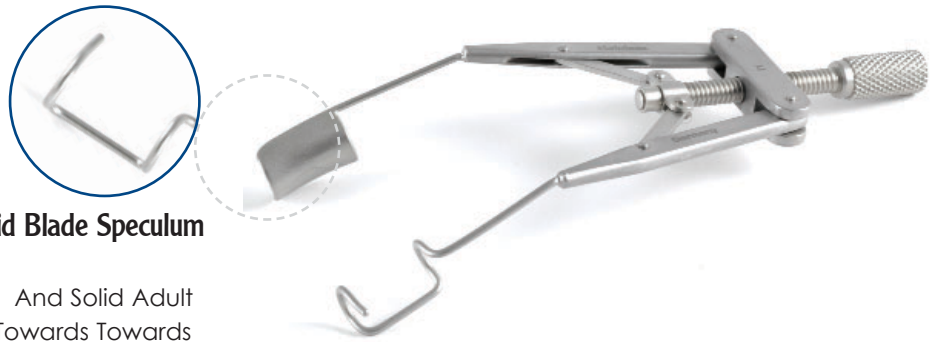

11-2-6782-C

Lieberman Child K-Wire Speculum With Adjustable Mechanism

Kratz-Style Open Wire Blades Angled Downward Towards The Temple, Blade Length Of 11mm, Overall Length Of Speculum Is 3" (7.6cm)



11-2-6782-LSC **Special Order Item***

Lieberman Child K-Wire And Solid Blade Speculum With Adjustable Mechanism

Kratz-Style Open Wire Right Blade And Solid Adult Left Blade Angled Downward Towards Towards The Temple, Both Blade 11mm, Overall Length Of Speculum Is 3" (7.6cm)

11-2-6782-RSC **Special Order Item***

Lieberman Child K-Wire And Solid Blade Speculum With Adjustable Mechanism

Kratz-Style Open Wire Left Blade And Solid Adult Right Blade Angled Downward Towards Towards The Temple, Both Blade 11mm, Overall Length Of Speculum Is 3" (7.6cm)

11-2-6782-N

Lieberman Nasal Adult K-Wire Speculum With Adjustable Mechanism

Kratz-Style Open Wire Blades Angled Upward For The Bridge Of The Nose, Blade Length Of 15mm, Overall Length Of Speculum Is 3" (7.6cm)



17-16

***Special Order Items are Non-Cancelable**

800.322.4674 or 800.633.7283

www.msiprecision.com

11-2-6782-NLS

Special Order Item*

Lieberman Nasal Adult K-Wire And Solid Blade

Speculum With Adjustable Mechanism

Kratz-Style Open Wire Right Blade And Solid Adult Left Blade Angled Upward For The Bridge Of The Nose, Blade Length Of 15mm, Overall Length Of Speculum Is 3" (7.6cm)

11-2-6782-NRS

Special Order Item*

Lieberman Nasal Child K-Wire And Solid Blade Speculum With Adjustable Mechanism

Kratz-Style Open Wire Left Blade And Solid Adult Right Blade Angled Upward For The Bridge Of The Nose, Blade Length Of 11mm, Overall Length Of Speculum Is 3" (7.6cm)

11-2-6782-NC

Lieberman Nasal Child K-Wire Speculum With Adjustable Mechanism

Kratz-Style Open Wire Blades Angled Upward For The Bridge Of The Nose, Blade Length Of 11mm, Overall Length Of Speculum Is 3" (7.6cm)

11-2-6782-NLSC

Special Order Item*

Lieberman Nasal Child K-Wire And Solid Blade

Speculum With Adjustable Mechanism

Kratz-Style Open Wire Right Blade And Solid Adult Left Blade Angled Upward For The Bridge Of The Nose, Blade Length Of 11mm, Overall Length Of Speculum Is 3" (7.6cm)

11-2-6782-NRSC

Special Order Item*

Lieberman Nasal Child K-Wire And Solid Blade

Speculum With Adjustable Mechanism

Kratz-Style Open Wire Left Blade And Solid Adult Right Blade Angled Upward For The Bridge Of The Nose, Blade Length Of 11mm, Overall Length Of Speculum Is 3" (7.6cm)

11-2-6782-P

Lieberman Pediatric K-Wire Speculum With Adjustable Mechanism

Kratz-Style Open Wire Blades Angled Downward Towards The Temple, Blade Length Of 5mm, Overall Length Of Speculum Is 3" (7.6cm)

11-2-6782-R

Lieberman Adult Round-Wire Speculum With Adjustable Mechanism

Kratz-Style Open Wire Blades Angled Downward Towards Towards The Temple, Blade Length Of 15mm Overall Length Of Speculum Is 3" (7.6cm)

*Special Order Items are Non-Cancelable

800.322.4674 or 800.633.7283

www.msiprecision.com

17-17



Speculums

11-2-6782-RC

Lieberman Child Round-Wire Speculum With Adjustable Mechanism

Kratz-Style Open Wire Blades Angled Downward Towards The Temple, Blade Length Of 11mm Overall Length Of Speculum Is 3" (7.6cm)

11-2-6782-NR

Lieberman Nasal Adult Round-Wire Nasal Speculum With Adjustable Mechanism

Round Open Wire Blades Angled Upward For The Bridge Of The Nose, Blade Length Of 15mm Overall Length Of Speculum Is 3" (7.6cm)

11-2-6782-NRC

Lieberman Nasal Child Round-Wire Nasal Speculum With Adjustable Mechanism

Round Open Wire Blades Angled Upward For The Bridge Of The Nose, Blade Length Of 11mm Overall Length Of Speculum Is 3" (7.6cm)

11-2-6782-T

Titanium Lieberman Adult K-Wire Speculum With Adjustable Mechanism

Kratz-Style Open Wire Blades Angled Downward Towards Towards The Temple, Blade Length Of 15mm, Overall Length Of Speculum Is 3" (7.6cm)

11-2-6786

Lieberman Adult V-Wire Speculum With Adjustable Mechanism

V-Shaped Style Open Wire Blades Angled Downward Towards Towards The Temple, Blade Length Of 14mm, Overall Length Of Speculum Is 3" (7.6cm)



11-2-6786-LS **Special Order Item***

Lieberman Adult V-Wire And Solid Blade Speculum With Adjustable Mechanism

V-Shaped Style Open Wire Right Blade And Solid Child Left Blade Angled Downward Towards Towards The Temple, Both Blade 14mm, Overall Length Of Speculum Is 3" (7.6cm)

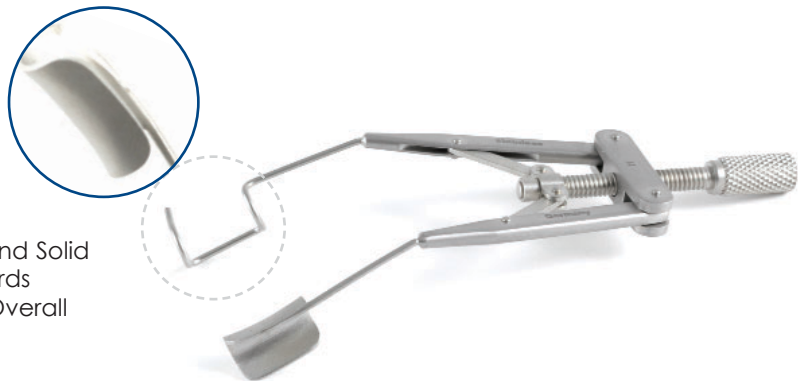

11-2-6786-RS **Special Order Item***

Lieberman Adult V-Wire And Solid Blade Speculum With Adjustable Mechanism

Mechanism

V-Shaped Style Open Wire Left Blade And Solid Child Right Blade Angled Downward Towards Towards The Temple, Both Blade 14mm, Overall Length Of Speculum Is 3" (7.6cm)



11-2-6786-C

Lieberman Child V-Wire Speculum With Adjustable Mechanism

V-Shaped Style Open Wire Blades Angled Downward Towards Towards The Temple, Blade Length Of 10mm, Overall Length Of Speculum Is 3" (7.6cm)



11-2-6786-LSC

Special Order Item*

Lieberman Child V-Wire And Solid Blade Speculum With Adjustable Mechanism

V-Shaped Style Open Wire Right Blade And Solid Child Left Blade Angled Downward Towards Towards The Temple, Both Blade 11mm, Overall Length Of Speculum Is 3" (7.6cm)

11-2-6786-RSC

Special Order Item*

Lieberman Child V-Wire And Solid Blade Speculum With Adjustable Mechanism

V-Shaped Style Open Wire Left Blade And Solid Child Right Blade Angled Downward Towards Towards The Temple, Both Blade 11mm, Overall Length Of Speculum Is 3" (7.6cm)

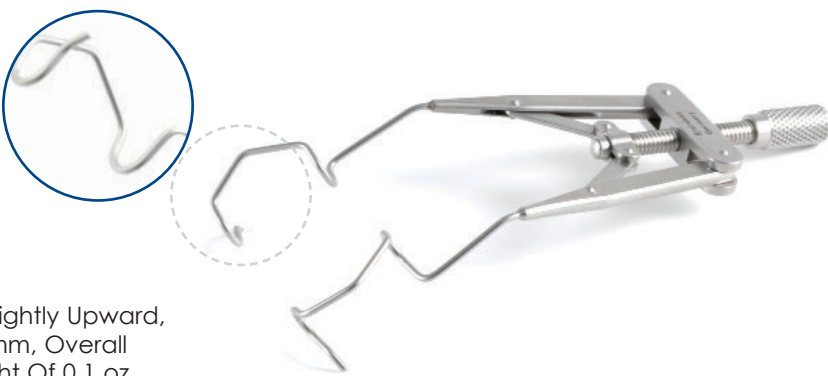

11-2-6786-N

Lieberman Nasal Wire Speculum

Open Wire V-Shaped Blades Angled Slightly Upward, Blade Length Of 15mm, Spread Of 44mm, Overall Length Of 3 1/8" (8.1cm), Overall Weight Of 0.1 oz

***Special Order Items are Non-Cancelable**

800.322.4674 or 800.633.7283

www.msiprecision.com

17-19



Speculums

11-2-6786-NLS **Special Order Item***

Lieberman Nasal Adult V-Wire And Solid Blade Speculum With Adjustable Mechanism

V-Shaped Style Open Wire Right Blade And Solid Adult Left Blade Angled Upward For The Bridge Of The Nose, Blade Length Of 14mm, Overall Length Of Speculum Is 3" (7.6cm)

11-2-6786-NRS **Special Order Item***

Lieberman Nasal Adult V-Wire And Solid Blade Speculum With Adjustable Mechanism

V-Shaped Style Open Wire Left Blade And Solid Adult Right Blade Angled Upward For The Bridge Of The Nose, Blade Length Of 14mm, Overall Length Of Speculum Is 3" (7.6cm)

11-2-6786-NC

Lieberman Nasal Child V-Wire Speculum With Adjustable Mechanism

V-Shaped Style Open Wire Blades Angled Upward For The Bridge Of The Nose, Blade Length Of 10mm, Overall Length Of Speculum Is 3" (7.6cm)

11-2-6786-NLSC

Lieberman Nasal Child V-Wire And Solid Blade Speculum With Adjustable Mechanism

V-Shaped Style Open Wire Left Blade And Solid Adult Right Blade Angled Upward For The Bridge Of The Nose, Blade Length Of 10mm, Overall Length Of Speculum Is 3" (7.6cm)

11-2-6786-NRSC

Lieberman Nasal Child V-Wire And Solid Blade Speculum With Adjustable Mechanism

V-Shaped Style Open Wire Right Blade And Solid Adult Left Blade Angled Upward For The Bridge Of The Nose, Blade Length Of 10mm, Overall Length Of Speculum Is 3" (7.6cm)

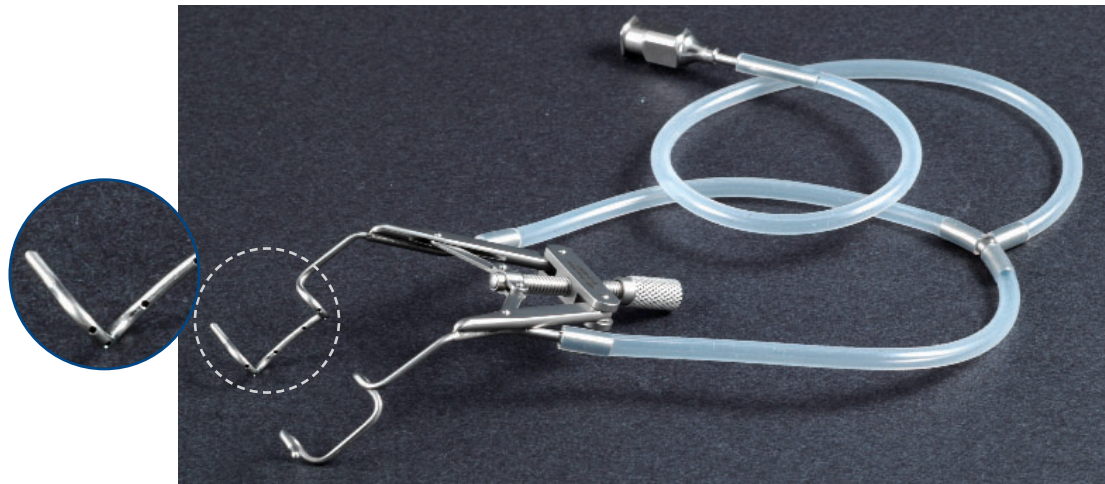

11-2-6282

Lieberman Aspirating Adult K-Wire Speculum With Adjustable Mechanism

Kratz-Style Open Wire Blades Angled Downward Towards Towards The Temple, Blade Length Of 15mm, Spread Of 31mm, Overall Length Of Speculum Is 3" (7.6cm), Includes Silicone Tubing And Cannula (Length Of 1 7/8" 3.8cm)



17-20

***Special Order Items are Non-Cancelable**

800.322.4674 or 800.633.7283

www.msiprecision.com



11-2-6282-C

Lieberman Aspirating Child K-Wire Speculum With Adjustable Mechanism

Kratz-Style Open Wire Blades Angled Downward Towards The Temple, Blade Length Of 11mm, Spread Of 31mm, Overall Length Of Speculum Is 3" (7.6cm), Includes Silicone Tubing And Cannula (Length Of 1 7/8" 3.8cm)

11-2-6282-N

Lieberman Nasal Aspirating Adult K-Wire Speculum With Adjustable Mechanism

Kratz-Style Open Wire Blades Angled Upward For The Bridge Of The Nose, Blade Length Of 15mm, Spread Of 31mm, Overall Length Of Speculum Is 3" (7.6cm), Includes Silicone Tubing And Cannula (Length Of 1 7/8" 3.8cm)

11-2-6282-NC

Lieberman Nasal Aspirating Child K-Wire Speculum With Adjustable Mechanism

Kratz-Style Open Wire Blades Angled Upward For The Bridge Of The Nose, Blade Length Of 11mm, Spread Of 31mm, Overall Length Of Speculum Is 3" (7.6cm), Includes Silicone Tubing And Cannula (Length Of 1 7/8" 3.8cm)

11-2-6282-NR

Lieberman Nasal Aspirating Adult Round-Wire Nasal Speculum

With Adjustable Mechanism

Round Open Wire Blades Angled Upward For The Bridge Of The Nose, Blade Length Of 15mm, Spread Of 31mm, Overall Length Of Speculum Is 3" (7.6cm), Includes Silicone Tubing)

11-2-6282-NRC

Lieberman Nasal Aspirating Child Round-Wire Nasal Speculum

With Adjustable Mechanism

Round Open Wire Blades Angled Upward For The Bridge Of The Nose, Blade Length Of 11mm, Spread Of 31mm, Overall Length Of Speculum Is 3" (7.6cm), Includes Silicone Tubing)

Speculums

11-2-6286-N

Lieberman Nasal Aspirating Child V-Wire Speculum With Adjustable Mechanism

V-Shaped Style Open Wire Blades Angled Upward For The Bridge Of The Nose, Blade Length Of 14mm, Spread Of 31mm, Overall Length Of Speculum Is 3" (7.6cm), Includes Silicone Tubing And Cannula (Length Of 1 7/8" 3.8cm)

11-2-6286-NC

Lieberman Nasal Aspirating Adult V-Wire Speculum With Adjustable Mechanism

V-Shaped Style Open Wire Blades Angled Upward For The Bridge Of The Nose, Blade Length Of 11mm, Spread Of 31mm, Overall Length Of Speculum Is 3" (7.6cm), Includes Silicone Tubing And Cannula (Length Of 1 7/8" 3.8cm)



11-2-6282-R

Lieberman Aspirating Adult Round-Wire Speculum With Adjustable Mechanism

Kratz-Style Open Wire Blades Angled Downward Towards Towards The Temple, Blade Length Of 15mm, Spread Of 31mm, Overall Length Of Speculum Is 3" (7.6cm), Includes Silicone Tubing And Cannula (Length Of 1 7/8" 3.8cm)

11-2-6282-RC

Lieberman Aspirating Child Round-Wire Speculum With Adjustable Mechanism

Kratz-Style Open Wire Blades Angled Downward Towards The Temple, Blade Length Of 11mm, Spread Of 31mm, Overall Length Of Speculum Is 3" (7.6cm), Includes Silicone Tubing And Cannula (Length Of 1 7/8" 3.8cm)



17-22

800.322.4674 or 800.633.7283

www.msiprecision.com

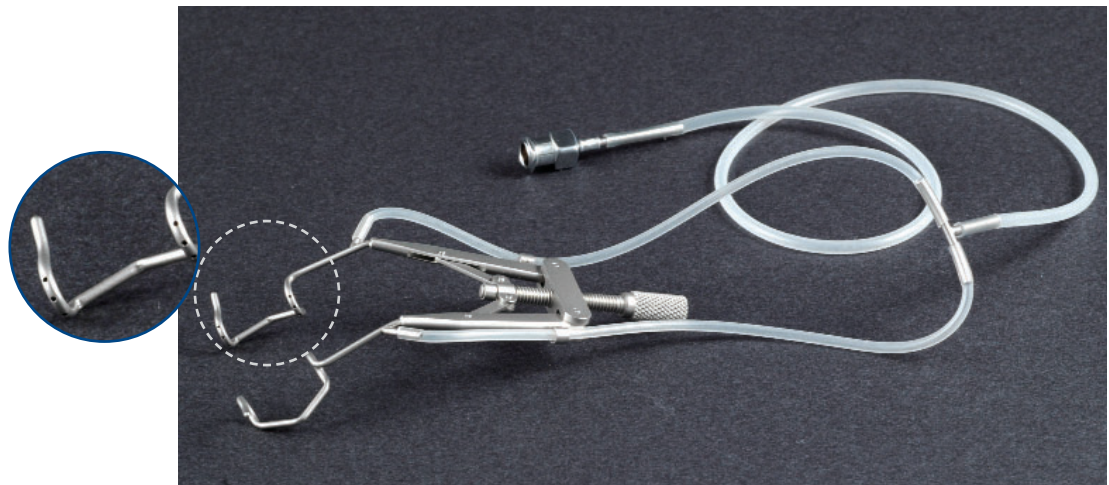

11-2-6286

Lieberman Aspirating Adult V-Wire Speculum With Adjustable Mechanism

V-Shaped Style Open Wire Blades Angled Downward Towards Towards The Temple, Blade Length Of 14mm, Spread Of 31mm, Overall Length Of Speculum Is 3" (7.6cm), Includes Silicone Tubing And Cannula (Length Of 1 7/8" 3.8cm)

11-2-6286-C

Lieberman Aspirating Child V-Wire Speculum With Adjustable Mechanism

V-Shaped Style Open Wire Blades Angled Downward Towards The Temple, Blade Length Of 11mm, Spread Of 31mm, Overall Length Of Speculum Is 3" (7.6cm), Includes Silicone Tubing And Cannula (Length Of 1 7/8" 3.8cm)



11-2-6780

Ginsberg Adjustable Wire Eye Speculum

Blades Half Solid, Half Open-Wire, Angled Upward, Blade Length Of 15mm, Spread Of 47mm, Overall Length Of 3 1/8" (8.1cm)

11-2-6788

Lieberman Child Solid Blade Speculum With Adjustable Mechanism

Angled Downward Towards The Temple, Blade Length Of 10mm, Overall Length Of Speculum Is 3" (7.6cm)

Speculums

11-2-6789

Lieberman Adult Solid Blade Speculum

With Adjustable Mechanism

Angled Downward Towards The Temple, Blade Length Of 14mm, Overall Length Of Speculum Is 3" (7.6cm)



11-2-6789-N

Lieberman Adult Solid Blade Speculum

With Adjustable Mechanism

Angled Upward Towards The Bridge Of The Nose, Blade Length Of 14mm, Overall Length Of Speculum Is 3" (7.6cm)



11-2-6791

Lieberman Reversible Adult Solid Blade Speculum With Adjustable Mechanism

Can Be Used For Both Temporal Or Nasal Approach, Blade Length Of 14mm, Overall Length Of Speculum Is 3" (7.6cm)



11-2-6791-C

Lieberman Reversible Child Solid Blade Speculum

With Adjustable Mechanism

Can Be Used For Both Temporal Or Nasal Approach, Blade Length Of 10mm, Overall Length Of Speculum Is 3" (7.6cm)

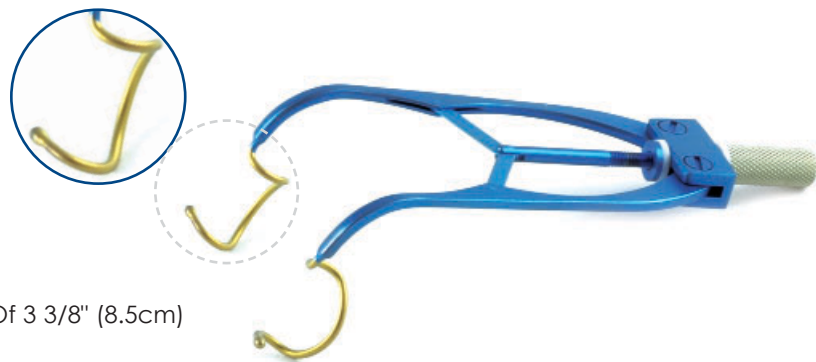

TDK-2036-ES

Schapira Twist Speculum Titanium And Curved With Barraquer Style

13mm Blades, And An Overall Length Of 3 3/8" (8.5cm)



17-24

800.322.4674 or 800.633.7283

www.msiprecision.com

5-5222

Saunders Eye Speculum

Solid 5mm Blades With Dull Finish, 15mm Spread, Locking Thumb Screw, Holes In Bar, And Overall Length Of 1 1/8" (3cm), Overall Weight Of 0.1 oz

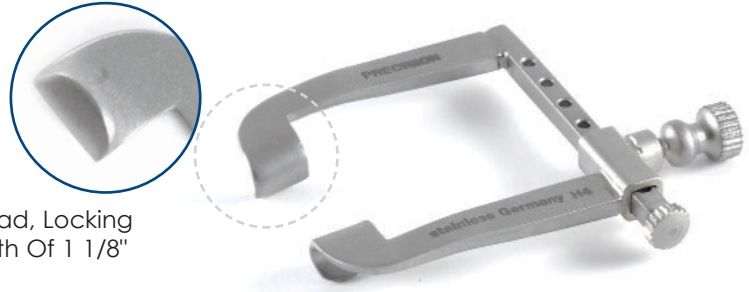

5-5193

Cook Eye Speculum

Pediatric Model With Dull Finish, Solid 11mm Blades, 26mm Spread, Locking-Mechanism, And Overall Length Of 1 1/8" (4cm), Overall Weight Of 0.1 oz



11-2-6512

Cook Speculum

Small #1, Lock Screw, Round Solid Blades Curved Slightly Upward, Blade Length Of 8mm, Spread Of 22mm, Overall Length Of 1 1/2" (3.8cm), Overall Weight Of 0.1 oz



11-2-6513

Cook Speculum

Medium #2, Lock Screw, Round Solid Blades, Blade Length Of 11mm, Spread Of 26mm, Overall Length Of 1 3/4" (4.3cm), Overall Weight Of 0.1 oz



Speculums

11-2-6514

Cook Speculum

Large With #3 Lock Screw, Round Solid Blades Curved Upward, Blade Length Of 16mm, Spread Of 32mm, Overall Length Of 1 3/4" (4.5cm), Overall Weight Of 0.1 oz



5-5197

McKinney Eye Speculum

Solid 15mm Blades With Dull Finish, 31mm Spread, Self-Locking Mechanism, And Overall Length Of 2 3/8" (60mm), Overall Weight Of 0.1 oz



5-5105

Murdoch Eye Speculum

Fenestrated 16mm Blades With Dull Finish, 25mm Spread, Self-Locking Mechanism, And Overall Length Of 2 3/8" (6cm), Overall Weight Of 0.1 oz

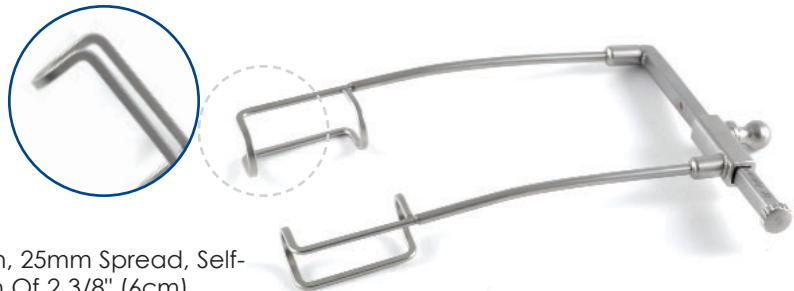

11-2-6517

Murdoch Eye Speculum

#2 With Lock Screw, Round Open-Wire Blades Curved Slightly Upward, Blade Length Of 15mm, Spread Of 26mm, Overall Length Of 1 3/4" (4.6cm), Overall Weight Of 0.1 oz

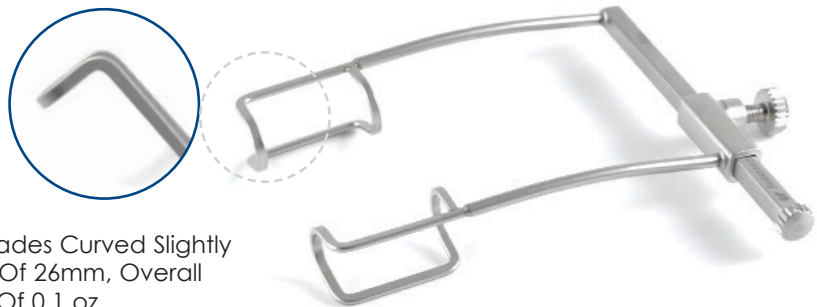

17-26

800.322.4674 or 800.633.7283

www.msiprecision.com

11-2-6518

Murdoch Eye Speculum

#3 With Lock Screw, Open-Wire Blades Curved Slightly Upward, Blade Length Of 17mm, Spread Of 27mm, Overall Length Of 1 3/4" (4.6cm), Overall Weight Of 0.1 oz

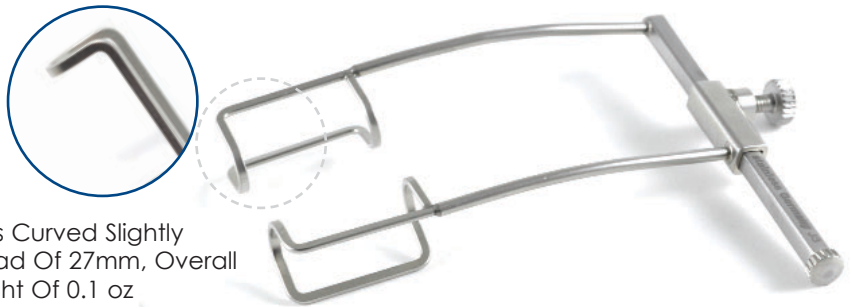

11-2-6611

Williams Small Speculum

Open Wire Blades Curved Slightly Upward, Blade Length Of 12mm, Spread Of 30mm, Overall Length Of 2 3/8" (6.6cm), Overall Weight Of 0.1 oz

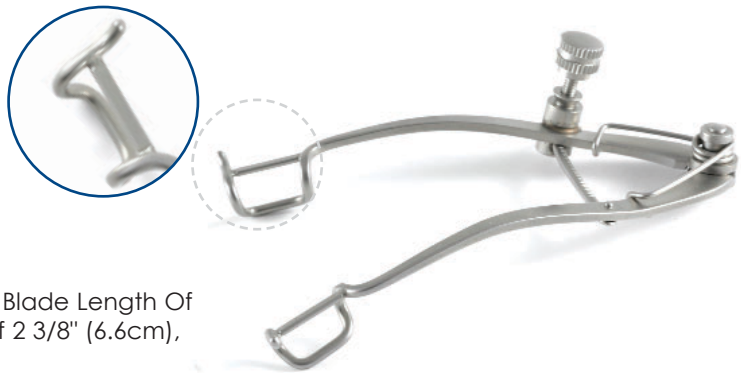

5-5211

Wiener Eye Speculum

Fenestrated 14mm Blades With Dull Finish, 22mm Spread, Wide Extension Of Blade For Lid Protection, Self-Locking Mechanism, And Overall Length Of 3 1/4" (8.2cm), Overall Weight Of 0.1 oz



5-5215

Osher Lid Speculum

Open Wire Style Blades, And Overall Length Of 5 7/8" (150mm), Overall Weight Of 0.1 oz

5-5183

Mellinger Eye Speculum

Fenestrated 17mm Blades With Dull Finish, 29mm Spread, Self-Locking Mechanism, And Overall Length Of 2 5/8" (6.6cm), Overall Weight Of 0.1 oz

Speculums

5-5183-G

Gimble-Mellinger Speculum

Fenestrated 16mm Blades With Dull Finish, 29mm Spread, Self-Locking Mechanism, And Overall Length Of 2 5/8" (6.6cm), Overall Weight Of 0.1 oz



5-5184

Mellinger Eye Speculum

Solid 16mm Blades With Dull Finish, 30mm Spread, Self-Locking Mechanism, And Overall Length Of 2 5/8" (6.8cm), Overall Weight Of 0.1 oz



5-5161

Williams Eye Speculum

Adult Model With Dull Finish, 14mm Blades With Spring-Controlled 34mm Spread And Locking Mechanism, And Overall Length Of 3" (7.7cm), Overall Weight Of 0.1 oz

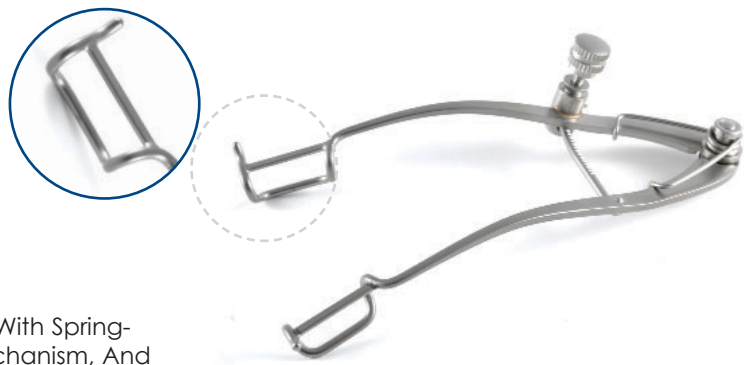

5-5162

Williams Eye Speculum

Pediatric Model With Dull Finish, 11mm Blades With Spring-Controlled 41mm Spread And Locking Mechanism, And Overall Length Of 2 3/4" (7cm), Overall Weight Of 0.1 oz



5-5175

Knapp Eye Speculum

Open 13mm Blades With 60mm Spread, With Thumb Screw Locking Mechanism, Dull Finish, And Overall Length Of 3 1/4" (85mm)



5-5167

Lancaster Eye Speculum

Solid 16mm Blades. Screw Controlled Locking Mechanism with Stabilizing Disk. Blade Spread 38mm. Dull Finish, Overall Length 3" (7.7cm), Overall Weight Of 0.1 oz



5-5171

Lester-Burch Eye Speculum

Solid 21mm Blades With 32mm Spread, With Thumb Screw Locking Mechanism, Dull Finish, And Overall Length Of 3 1/8" (80mm)



5-5169

Lancaster K Eye Speculum

Solid 15mm Blades With 8mm Groove, 30mm Spread, With Thumb Screw Dull Finish, And Overall Length Of 3 1/4" (82mm)



5-5151

Castroviejo Speculum

Fenestrated 15mm Blades With With Thumb Screw 28mm Spread And Dull Finish, And Overall Length Of 3" (75mm)

Speculums

5-5152

Castroviejo Speculum

Fenestrated 16mm Blades With With Thumb Screw 31mm Spread And Dull Finish, And Overall Length Of 3 1/4" (82mm)



5-5117

Maumenee-Park Speculum

Fenestrated 14mm Blades With Dull Finish, 36mm Spread, Center Retractor Blade With Tighening Screw, Adjustable Blade Locking Thumb Screws On Outside Of Retractor Blades And Overall Length Of 3 1/8" (80mm)



5-5118

Maumenee-Park Speculum

Solid 14mm Blades With Dull Finish, 36mm Spread, Center Retractor Blade With Tighening Screw, Adjustable Blade Locking Thumb Screws On Outside Of Retractor Blades And Overall Length Of 3 1/8" (80mm)



5-5111

Guyton-Park Speculum

Fenestrated 14mm Blades With Dull Finish, 53mm Spread, Suture Posts, Canthus Bar, And Overall Length Of 3 1/4" (8.2cm), Overall Weight Of 0.1 oz



17-30

800.322.4674 or 800.633.7283

www.msiprecision.com

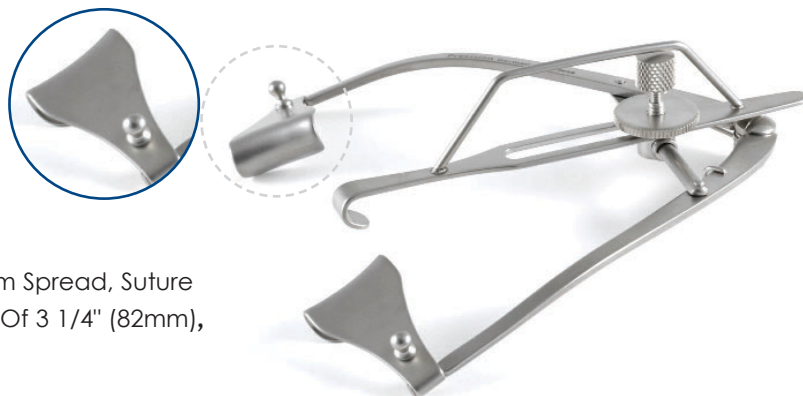

5-5112

Guyton-Park Speculum

Solid 14mm Blades With Dull Finish, 45mm Spread, Suture Posts, Canthus Bar, And Overall Length Of 3 1/4" (82mm), Overall Weight Of 0.1 oz

5-5119

Park Speculum

Fenestrated 15mm Blades With Dull Finish, 36mm Spread, Adjustable Blade Locking Thumb Screws On Outside Of Retractor Blades, And Overall Length Of 3 1/4" (82mm)

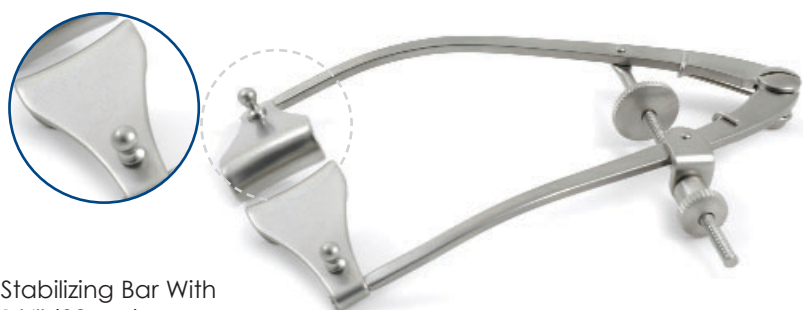

5-5125

McPherson Solid Blade Speculum

Blades Are 14mm Wide, 30mm Spread, Stabilizing Bar With Thumb Screw, And Overall Length Of 3 1/4" (82mm)

11-2-6066

Schott Eye Speculum Wire Blade

With Rotatable Adjustment

11-2-6061

Smirmaul Eye Speculum Solid Blade

With Adjustable Blades

11-2-6062

Smirmaul Eye Speculum Wire Blade

With Adjustable Blades

Tendon Tuckers



5-3415

Bishop Tendon Tucker

Round And Knurled Handle With Polished Finish, Triangular Shaped Tips, Marked For 5mm And 10mm Tucks, Overall Length Of 4 1/4" (10.8cm), Weight: 0.4 oz



17-32

800.322.4674 or 800.633.7283

www.msiprecision.com

Disposable Trephine Blades

MSI Trephine Blade Corneal Instruments

MSI Precision offers a comprehensive selection of corneal trephine blades and handles. Handcrafted, sharp, uniform blade edges promote a symmetrical and vertical cut of all corneal layers.

We designed a corneal trephine that permits a full view of the cornea while cutting. The drive mechanism of the trephine enables the surgeon to keep the central cutting axis of the instrument stable while the trephine is rotated. The instrument accepts variable sizes of disposable trephine blades, making it versatile and economical. We also devised a lamellar dissector with two blades to negate the splitting force that occurs during a closed lamellar dissection. It enables the surgeon to perform a closed lamellar dissection with minimal force applied to the globe and minimal risk of perforation.



Available from Size 3 to 16 in
non-sterile and Sterile

800.322.4674 or 800.633.7283

www.msiprecision.com

18-1



Trephines

Sterile Disposable Trephines / Long

SDTL-3.00	Disposable Trephine 3.00mm Dia., Long Style	SDTL-8.50	Disposable Trephine 8.50mm Dia., Long Style
SDTL-3.50	Disposable Trephine 3.50mm Dia., Long Style	SDTL-8.75	Disposable Trephine 8.75mm Dia., Long Style
SDTL-4.00	Disposable Trephine 4.00mm Dia., Long Style	SDTL-9.00	Disposable Trephine 9.00mm Dia., Long Style
SDTL-4.50	Disposable Trephine 4.50mm Dia., Long Style	SDTL-9.50	Disposable Trephine 9.50mm Dia., Long Style
SDTL-5.00	Disposable Trephine 5.00mm Dia., Long Style	SDTL-10.00	Disposable Trephine 10.00mm Dia., Long Style
SDTL-5.50	Disposable Trephine 5.50mm Dia., Long Style	SDTL-10.50	Disposable Trephine 10.50mm Dia., Long Style
SDTL-6.00	Disposable Trephine 6.00mm Dia., Long Style	SDTL-11.00	Disposable Trephine 11.00mm Dia., Long Style
SDTL-6.25	Disposable Trephine 6.25mm Dia., Long Style	SDTL-11.50	Disposable Trephine 11.50mm Dia., Long Style
SDTL-6.50	Disposable Trephine 6.50mm Dia., Long Style	SDTL-12.00	Disposable Trephine 12.00mm Dia., Long Style
SDTL-6.75	Disposable Trephine 6.75mm Dia., Long Style	SDTL-12.50	Disposable Trephine 12.50mm Dia., Long Style
SDTL-7.00	Disposable Trephine 7.00mm Dia., Long Style	SDTL-13.00	Disposable Trephine 13.00mm Dia., Long Style
SDTL-7.25	Disposable Trephine 7.25mm Dia., Long Style	SDTL-13.50	Disposable Trephine 13.50mm Dia., Long Style
SDTL-7.50	Disposable Trephine 7.50mm Dia., Long Style	SDTL-14.00	Disposable Trephine 14.00mm Dia., Long Style
SDTL-7.75	Disposable Trephine 7.75mm Dia., Long Style	SDTL-14.50	Disposable Trephine 14.50mm Dia., Long Style
SDTL-8.00	Disposable Trephine 8.00mm Dia., Long Style	SDTL-15.00	Disposable Trephine 15.00mm Dia., Long Style
SDTL-8.25	Disposable Trephine 8.25mm Dia., Long Style	SDTL-15.50	Disposable Trephine 15.50mm Dia., Long Style
		SDTL-16.00	Disposable Trephine 16.00mm Dia., Long Style



Sterile Disposable Trephines / Short

SDTS-3.00	Disposable Trephine 3.00mm Dia., Short Style	SDTS-8.50	Disposable Trephine 8.50mm Dia., Short Style
SDTS-3.50	Disposable Trephine 3.50mm Dia., Short Style	SDTS-8.75	Disposable Trephine 8.75mm Dia., Short Style
SDTS-4.00	Disposable Trephine 4.00mm Dia., Short Style	SDTS-9.00	Disposable Trephine 9.00mm Dia., Short Style
SDTS-4.50	Disposable Trephine 4.50mm Dia., Short Style	SDTS-9.50	Disposable Trephine 9.50mm Dia., Short Style
SDTS-5.00	Disposable Trephine 5.00mm Dia., Short Style	SDTS-10.00	Disposable Trephine 10.00mm Dia., Short Style
SDTS-5.50	Disposable Trephine 5.50mm Dia., Short Style	SDTS-10.50	Disposable Trephine 10.50mm Dia., Short Style
SDTS-6.00	Disposable Trephine 6.00mm Dia., Short Style	SDTS-11.00	Disposable Trephine 11.00mm Dia., Short Style
SDTS-6.25	Disposable Trephine 6.25mm Dia., Short Style	SDTS-11.50	Disposable Trephine 11.50mm Dia., Short Style
SDTS-6.50	Disposable Trephine 6.50mm Dia., Short Style	SDTS-12.00	Disposable Trephine 12.00mm Dia., Short Style
SDTS-6.75	Disposable Trephine 6.75mm Dia., Short Style	SDTS-12.50	Disposable Trephine 12.50mm Dia., Short Style
SDTS-7.00	Disposable Trephine 7.00mm Dia., Short Style	SDTS-13.00	Disposable Trephine 13.00mm Dia., Short Style
SDTS-7.25	Disposable Trephine 7.25mm Dia., Short Style	SDTS-13.50	Disposable Trephine 13.50mm Dia., Short Style
SDTS-7.50	Disposable Trephine 7.50mm Dia., Short Style	SDTS-14.00	Disposable Trephine 14.00mm Dia., Short Style
SDTS-7.75	Disposable Trephine 7.75mm Dia., Short Style	SDTS-14.50	Disposable Trephine 14.50mm Dia., Short Style
SDTS-8.00	Disposable Trephine 8.00mm Dia., Short Style	SDTS-15.00	Disposable Trephine 15.00mm Dia., Short Style
SDTS-8.25	Disposable Trephine 8.25mm Dia., Short Style	SDTS-15.50	Disposable Trephine 15.50mm Dia., Short Style
		SDTS-16.00	Disposable Trephine 16.00mm Dia., Short Style

Trephines

Non-Sterile Disposable Trephines / Long

DTL-3.00	Disposable Trephine 3.00mm Dia., Long Style
DTL-3.50	Disposable Trephine 3.50mm Dia., Long Style
DTL-4.00	Disposable Trephine 4.00mm Dia., Long Style
DTL-4.50	Disposable Trephine 4.50mm Dia., Long Style
DTL-5.00	Disposable Trephine 5.00mm Dia., Long Style
DTL-5.50	Disposable Trephine 5.50mm Dia., Long Style
DTL-6.00	Disposable Trephine 6.00mm Dia., Long Style
DTL-6.25	Disposable Trephine 6.25mm Dia., Long Style
DTL-6.50	Disposable Trephine 6.50mm Dia., Long Style
DTL-6.75	Disposable Trephine 6.75mm Dia., Long Style
DTL-7.00	Disposable Trephine 7.00mm Dia., Long Style
DTL-7.25	Disposable Trephine 7.25mm Dia., Long Style
DTL-7.50	Disposable Trephine 7.50mm Dia., Long Style
DTL-7.75	Disposable Trephine 7.75mm Dia., Long Style
DTL-8.00	Disposable Trephine 8.00mm Dia., Long Style
DTL-8.25	Disposable Trephine 8.25mm Dia., Long Style

DTL-8.50	Disposable Trephine 8.50mm Dia., Long Style
DTL-8.75	Disposable Trephine 8.75mm Dia., Long Style
DTL-9.00	Disposable Trephine 9.00mm Dia., Long Style
DTL-9.50	Disposable Trephine 9.50mm Dia., Long Style
DTL-10.00	Disposable Trephine 10.00mm Dia., Long Style
DTL-10.50	Disposable Trephine 10.50mm Dia., Long Style
DTL-11.00	Disposable Trephine 11.00mm Dia., Long Style
DTL-11.50	Disposable Trephine 11.50mm Dia., Long Style
DTL-12.00	Disposable Trephine 12.00mm Dia., Long Style
DTL-12.50	Disposable Trephine 12.50mm Dia., Long Style
DTL-13.00	Disposable Trephine 13.00mm Dia., Long Style
DTL-13.50	Disposable Trephine 13.50mm Dia., Long Style
DTL-14.00	Disposable Trephine 14.00mm Dia., Long Style
DTL-14.50	Disposable Trephine 14.50mm Dia., Long Style
DTL-15.00	Disposable Trephine 15.00mm Dia., Long Style
DTL-15.50	Disposable Trephine 15.50mm Dia., Long Style
DTL-16.00	Disposable Trephine 16.00mm Dia., Long Style



Non-Sterile Disposable Trephines / Short

DTL-3.00	Disposable Trephine 3.00mm Dia., Short Style
DTS-3.50	Disposable Trephine 3.50mm Dia., Short Style
DTS-4.00	Disposable Trephine 4.00mm Dia., Short Style
DTS-4.50	Disposable Trephine 4.50mm Dia., Short Style
DTS-5.00	Disposable Trephine 5.00mm Dia., Short Style
DTS-5.50	Disposable Trephine 5.50mm Dia., Short Style
DTS-6.00	Disposable Trephine 6.00mm Dia., Short Style
DTS-6.25	Disposable Trephine 6.25mm Dia., Short Style
DTS-6.50	Disposable Trephine 6.50mm Dia., Short Style
DTS-6.75	Disposable Trephine 6.75mm Dia., Short Style
DTS-7.00	Disposable Trephine 7.00mm Dia., Short Style
DTS-7.25	Disposable Trephine 7.25mm Dia., Short Style
DTS-7.50	Disposable Trephine 7.50mm Dia., Short Style
DTS-7.75	Disposable Trephine 7.75mm Dia., Short Style
DTS-8.00	Disposable Trephine 8.00mm Dia., Short Style
DTS-8.25	Disposable Trephine 8.25mm Dia., Short Style

DTS-8.50	Disposable Trephine 8.50mm Dia., Short Style
DTS-8.75	Disposable Trephine 8.75mm Dia., Short Style
DTS-9.00	Disposable Trephine 9.00mm Dia., Short Style
DTS-9.50	Disposable Trephine 9.50mm Dia., Short Style
DTS-10.00	Disposable Trephine 10.00mm Dia., Short Style
DTS-10.50	Disposable Trephine 10.50mm Dia., Short Style
DTS-11.00	Disposable Trephine 11.00mm Dia., Short Style
DTS-11.50	Disposable Trephine 11.50mm Dia., Short Style
DTS-12.00	Disposable Trephine 12.00mm Dia., Short Style
DTS-12.50	Disposable Trephine 12.50mm Dia., Short Style
DTS-13.00	Disposable Trephine 13.00mm Dia., Short Style
DTS-13.50	Disposable Trephine 13.50mm Dia., Short Style
DTS-14.00	Disposable Trephine 14.00mm Dia., Short Style
DTS-14.50	Disposable Trephine 14.50mm Dia., Short Style
DTS-15.00	Disposable Trephine 15.00mm Dia., Short Style
DTS-15.50	Disposable Trephine 15.50mm Dia., Short Style
DTS-16.00	Disposable Trephine 16.00mm Dia., Dts Style

Register Online Today!



Register today and get complete access to our
online catalog resource and product search.

www.MSIPrecision.com

■ Precise

■ Accurate

■ Exact



800.322.4674 or 800.633.7283

www.msiprecision.com

Surgical Advantage

1-800-948-7994

order@surgicaladvantage.net

Tube Brushes

Protect Your Investment With The Right Brush For The Job! SafeClean Instrument and Channel Cleaning Brushes are designed to clean surgical/medical instruments and endoscopic devices. The complete line of SafeClean Cleaning Brushes are strong enough to effectively remove surgical residue, yet gentle enough to use on the most delicate instruments and devices. MSI brushes are re-usable and autoclaveable making them cost-effective.

- Sure-grip plastic and stainless steel handles
- Specialty models and custom designs available upon request
- Individual models two per package
- Economical assortment packs include lumen or utility brushes in assorted dimensions



Product #	Brush Material	Brush Dia. in. (cm) (FR)	Length in. (cm).	Overall Length in. (cm)
-----------	----------------	-------------------------------	---------------------	----------------------------

Tube Brushes

attached to stainless steel wire for cleaning lumens

13-1010	Nylon	1/16 (0.16)	4.5 1/2 (1.3)	18 (45)
13-1015	Nylon	5/64 (0.18)	5.0 1/2 (1.3)	18 (45)
13-1020	Nylon	3/32 (0.22)	6.6 1/2 (1.3)	18 (45)
13-1025	Nylon	1/10 (0.27)	8.0 1 (2.5)	18 (45)
13-1030	Nylon	1/8 (0.32)	9.0 2 (5.0)	18 (45)
13-1035	Nylon	3/16 (0.5)	15. 2 1/2 (6.3)	16 (40)
13-1040	Nylon	1/4 (0.6)	18. 2 1/2 (6.3)	16 (40)
13-1045	Nylon	1/16 (1.1)	33. 2 1/2 (6.3)	16 (40)
13-1050	Nylon	31/64 (1.2)	36. 2 1/2 (6.3)	16 (40)
13-1055	Nylon	19/32 (1.5)	45. 2 1/2 (6.3)	16 (40)
13-1060	Nylon	51/64 (2.0)	60. 2 1/2 (6.3)	16 (40)
16-1100	Nylon	Asst. Pack. One each.of.18" overall length models		
16-1200	Nylon	Asst. Pack. One each.of.16" overall length models		
16-1300	Nylon	Asst. Pack. One each.of.all.11 brush models		

"Micro / Mini Line"

13-1007	Nylon	1/32 (0.1)	3 1/2 (1.3)	18 (45)
13-1041	Nylon	1/4 (0.6)	6 2 1/2 (6.3)	24 (60)
13-1046	Nylon	7/16 (1.1)	11 2 1/2 (6.3)	24(60)

Tube Brushes

Product #	Brush Material	Brush Dia. in. (cm) (FR)	Length in. (cm).	Overall Length in. (cm)
-----------	----------------	-------------------------------	---------------------	----------------------------

FAN STYLE TUBE BRUSHES

46-2001	Nylon	3/16 - 1/2 na	(0.5 - 1.3) na	3 (7.5) 7 (18)
46-2002	Nylon	1/2 (1.3) na	3 (7.5)	6 (15)
46-2003	Nylon	3/8 (1.6) na	2 1/2 (6.3)	5 (13)
46-1100	Nylon	Asst. Pack. One each.of.all.3.fan tip brush models		

"Micro / Mini Line"

46-2046	NylonExtra	Stiff Bristle and Handle		
		7/16 (1.1)	11 2 1/2 (6.3)	24 (60)

RADIAL TIP TUBE BRUSHES

"Micro / Mini Line"

46-6010	Black Bristle	1 3/4 (4.37)	437 4.5 (11.2)	11.6 (29)
----------------	---------------	--------------	----------------	-----------

TOOTHBRUSH STYLE

46-3001	Nylon	1/2 (1.3) na	1 1/2 (3.8)	7 1/4 (18)
46-3002	Soft Brass	1/2 (1.3) na	1 1/2 (3.8)	7 1/4 (18)
46-3003	Stainless Steel	1/2 (1.3) na	1 1/2 (3.8)	7 1/4 (18)
46-3100	Nylon Asst. Pack. One each.of.all.3.finish material models			
46-3004	2-End,	Nylon na	7 (70)	
	Full End	6/12 (1.0) na	7/8 (9)	
	Small End	15/12 (1.2) na	1 3/8 (14)	

NAIL STYLE

Product#	Brush Material	Trim	Brush Size	Block Size
46-4001	Nylon (black)	5/8 (1.6)	1 1/8 x 3 3/4 (2.8 x 9.3)	7 (18)

CHANNEL BRUSHES

(to clean devices used in endoscopis procedures)

Product#	Brush Material	Sheath Diameter	Sheath Length
46-8107	Nylon-Tapered	3/16 (.16) 1.6	28" (70) 700
46-8115	Nylon-Tapered	3/16 (.16) 1.6	46" (115) 1500
46-8160	Nylon-Tapered	3/16 (.16) 1.6	64" (160) 1600
46-8180	Nylon-Tapered	1/4 (.18) 1.8	92" (230) 2300
46-8182	Nylon-Tapered (Double Ended)	1/4 (.18) 1.8	92" (230) 2300
46-8185	Nylon-Tapered (Teflon Coated)	1/4 (.18) 1.8	92" (230) 2300
46-8190	Nylon-Tapered	1/4 (.18) 1.8	48" (120) 1200



	Material	Diameter	Length	Overall Length
Tracheostomy Brushes				
46-7001	Nylon	3/8 (.9) I (00-5)	1 7/8 (4.7)	4 3/4 (9)
46-7002	Nylon	1/2 (1.3) I (6-12)	3 3/4 (9.3)	8 (20)

Specialty Brushes for Endoscopic Devices

46-8001	Anti-Static	1 1/4 (3.1)	11 1/4 (3.1)	2 5/8 (7)
46-8002	Camel Hair	1/2 (1.3)	7/8 (2.2)	17 (18)

Instrument Brush Storage

Product#	Description	Size	Quantity per Pack
46-6003	Acrylic Brush Rack w/ Drip Tray	Large	1
46-1600	Brush Refill Pack for 16-6003BBG	General	45
46-1700	Brush Refill Pack for 16-6001BBG	Micro/Mini	18
46-6001	Acrylic Brush Rack w/o Drip Tray	Medium	1

Cleaning Brushes

For Large Surgical Instruments

Proper cleaning can substantially increase the life for your surgical instruments. Soaking in cleaning solution alone doesn't always get the job done. That's because an instrument's small serrations and crevices can trap particles that require hand scrubbing.

Our specialty brushes are the answer. They're perfect for precleaning serrated surfaces and box locks before sterilization in the Autoclave. The more delicate nylon bristles can be safely used on any instrument surface. The more rugged stainless steel bristles are recommended for brushing rasps, files and burs. Why not take every precaution? Make these cleaning brushes part of your daily maintenance routine.

Stainless Steel Brushes

12-1000	Stainless Steel Bristles	3/pack
12-1005	Stainless Steel Bristles	12/pack
12-1010	Stainless Steel Bristles	24/pack

Nylon Brushes

12-2000	Nylon Bristles	3/pack
12-2005	Nylon Bristles	12/pack
12-2010	Nylon Bristles	24/pack

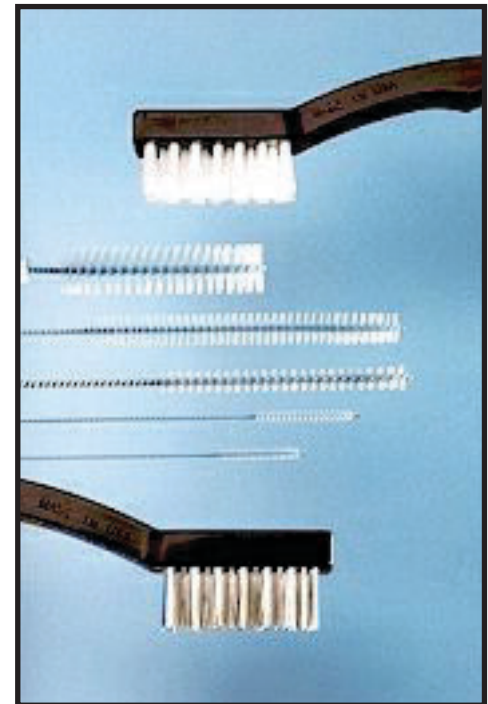



MSI Precision offers a complete line of

Diagnostic Lens

Products

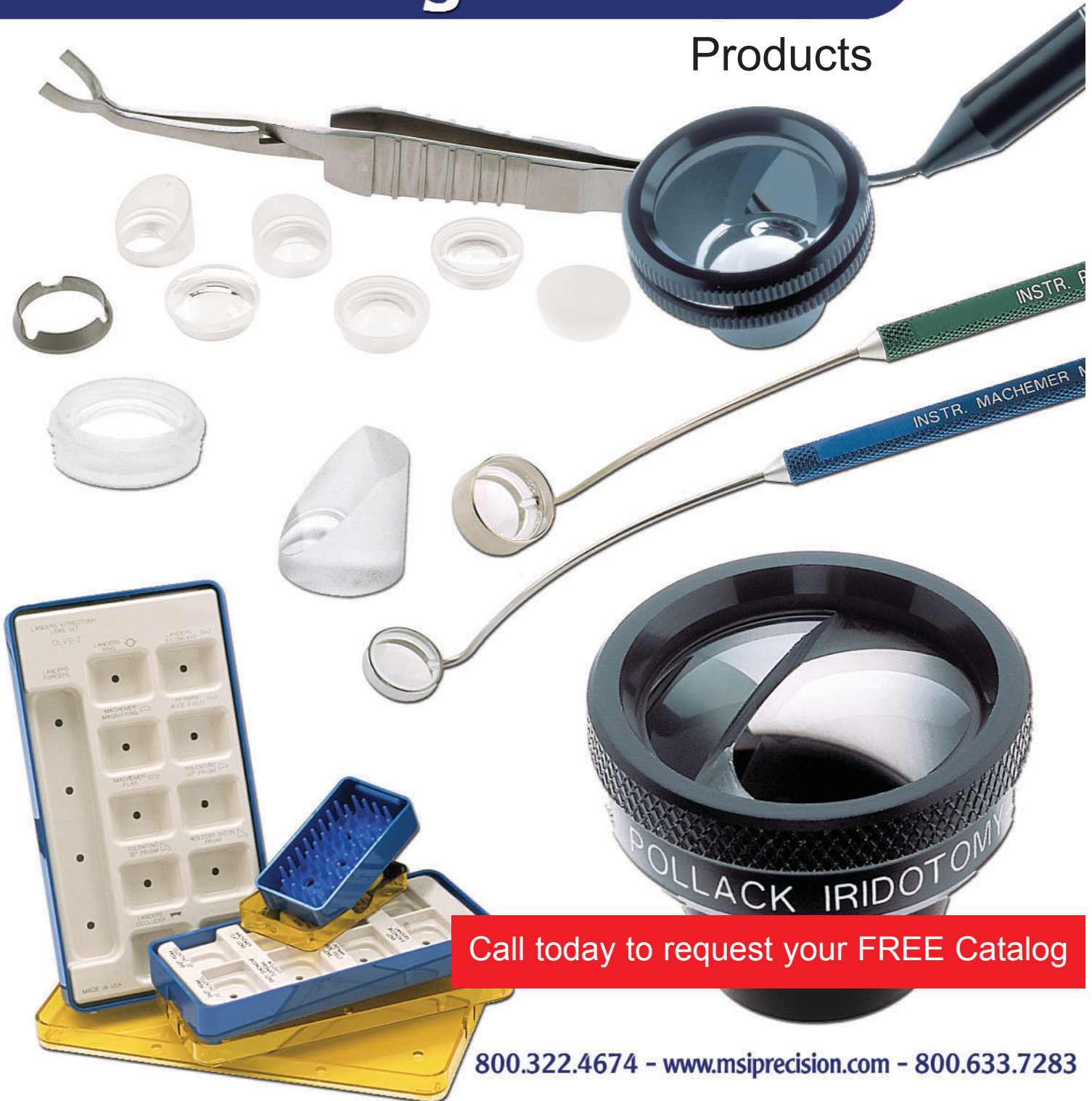

Call today to request your FREE Catalog

800.322.4674 - www.msiprecision.com - 800.633.7283

Sterile Ophthalmic Blades & Knives

MSI Precision Knives utilize a precise proprietary process, Infinite Edge™ Technology, to manufacture incision products that are consistently sharp and dimensionally true.

Infinite Sharpness.

MSI Precision's Infinite Edge™ Technology's non-grinding sharpening process begins by obtaining a high quality stainless steel that is hardened and tempered to a uniform tensile strength and toughness.

Infinite Consistency.

MSI Precision's Infinite Edge™ Technology virtually assures that the 100th blade is as sharp and dimensionally consistent as the first. The process to form the various configurations utilizes high purity carbon tools that produce a consistent product dimension. These precision tools are relatively wear-free compared to the continued variations experienced in using traditional grinding manufacturing methods. MSI Precision's Infinite Edge™ Technology's automated manufacturing mini-

mizes operator handling to produce unparalleled consistency.

Infinite Design.

MSI Precision's Infinite Edge™ Technology offers unlimited geometric shapes not readily achievable with traditional manufacturing methods used to fabricate most steel and diamond incision products. These endless geometric shapes are attained with unprecedented thinness and strict tolerances.



**PRECISION
MICRO KNIVES**



**PRECISION
SharpPoint**



MSI Precision
ExactEtch™
Microsurgical Blades

Call today to request your FREE Catalog

800.322.4674 or 800.633.7283

www.msiprecision.com

19-5



MSI Precision Cannulas

MSI Precision has established itself as one of the highest quality surgical instrument companies in the industry while continuing to offer fair prices. Our disposable cannulas are no different. We have gone to great lengths to offer the largest variety of cannulas which you can see from our cross references listings. This allows for consolidation of your ordering from a single supplier. With this consolidation all of the surgeons can find what they need. Because of our US manufacturing capabilities we can offer custom cannulas. Getting the best quality and a fair price is very unusual for most medical companies. Please note that we have created a hot pink label for easy identification so that you know that you are using and MSI Precision made product.

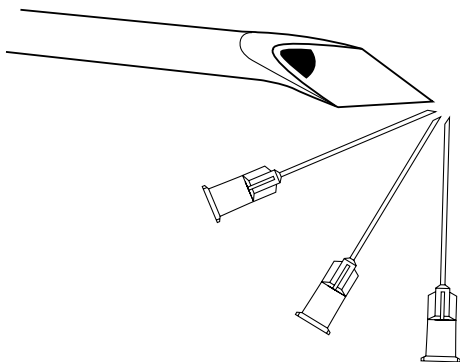

MSI Precision Offers a complete line of Disposable Cannulas ask your sales agent to send you our “Disposbale Products Catalog” today.

Retrobulbars and Peribulbars

- Atkinson
- Non Atkinson
- Sub Tenon Anesthesia Cannulas

Anterior Chamber Cannulas

Anterior Chamber Cannulas, Thin Wall

I/A Cannulas and Cortex Removal

Button Coaxial I/A System

“J” Shaped Cannulas

Cystotomes

- Irrigating Cystotomes
- Capsulorhexis Cystotomes
- Irrigating Sharp Cystotomes

Capsule Polishers

Hydrodissection and Hydrodelineation

Miscellaneous Instruments

Chamber Maintainers and Retinal Cannulas

Lasik Cannulas

The **Best** by
Design



Flexible Iris Retractors

- Ideal for temporary iris enlargement
- Easy insertions through 0.5mm, self-sealing incision
- Flat, easy to adjust silicone stopper
- Colored fiber for easy identification
- User friendly packaging

Single Use Iris Retractors

30-134-1	1 unit 5 pcs (5 retractors), Sterile
30-134-5	5 unit 5 pcs (25 retractors), Sterile
30-134-6	6 unit 5 pcs (30 retractors), Sterile

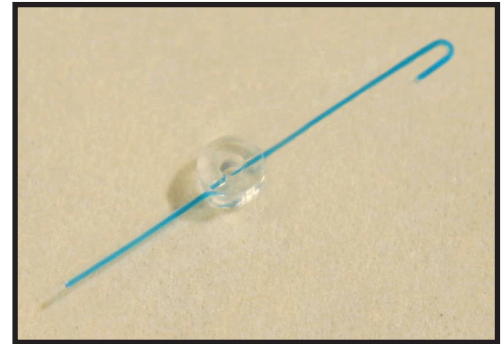
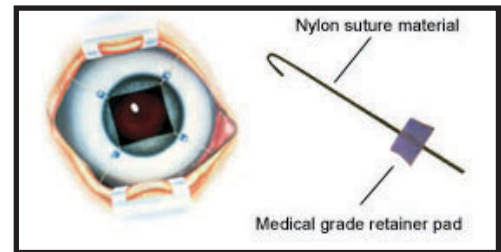

Reusable Iris Retractors

Supplied in reusable, steam autoclavable sterilization container.

30-254	1 unit 6pcs (6 retractors), Sterile
---------------	-------------------------------------



800.322.4674 or 800.633.7283

www.msiprecision.com

19-7



Disposable Ophthalmic Sponges

MSI Precision Ophthalmic products are constructed using a highly absorbent, unique hydroxylated polyvinyl acetal (PVAc) sponge. Several densities of sponge are available to meet the demands of a variety of ophthalmic procedures. Certain products are configured using an extremely soft, pliable sponge while others possess a more dense material that allows the surgeon to push or paint delicate tissue.

MSI Precision Ophthalmic products meet the demanding requirements for use in LASIK and refractive surgery. Each product provides a unique combination of lint/fiber-free characteristics with fast wicking and exceptional fluid absorption to enhance surgical outcomes.

- Soft, highly absorbent, and fast wicking
- Clean, lint and fiber-free

MSI Precision Contour™ and LASIK eye sponges are the only products manufactured using a proprietary cleaning process that removes microscopic debris and particles. This feature benefits the surgeon and patient by greatly reducing complications associated with introduction of particles and debris into corneal procedures.

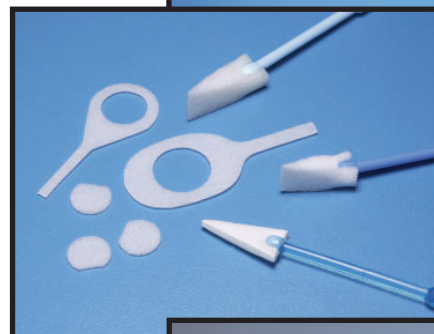

18-400 / 18-405 Lint Free PVA Surgical Spears

Provides rapid recovery of fluids during ophthalmic and microsurgical procedures.

- Fiber free construction will not introduce lint into the surgical site
- Can be cut into custom shapes to reach recesses during procedures
- Gentle to tissue and highly absorbent
- Ideal for microsurgical procedures

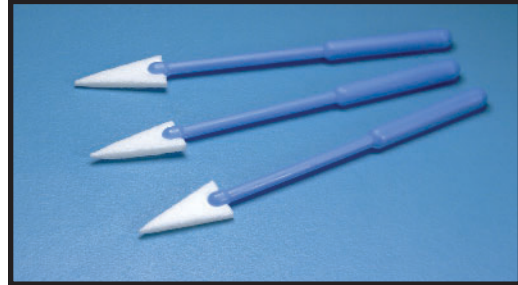

18-410 / 18-415 Cellulose Surgical Spears

Used during ophthalmic and microsurgical procedures to provide rapid recovery of fluids

- Made from all natural hydrocellular material
- Highly absorbent and fast wicking
- Soft, yet with enough rigidity to withstand gentle pressure
- Can be gas sterilized (unused Spears or Points)
- Cost effective

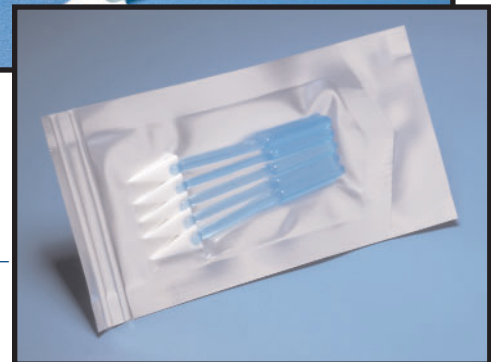
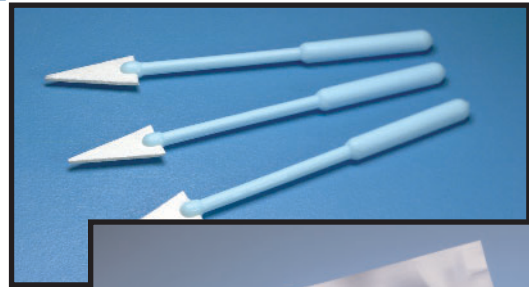

18-417 / 18-417e 18-418 / 18-418e

Lasik Pure Spear / Extended Lasik Pure Spear / Extended

Product Number	Description	Quantity
18-400	Sterile PVA Surgical Spears	5/pack, 20 pkg/box
18-405	Sterile PVA Surgical Spears	10/pack, 20 pkg/box
18-410	Sterile Cellulose Spears	5/pack, 20 pkg/box
18-415	Sterile Cellulose Spears	10/pack, 20 pkg/box
18-417	Sterile Lasik Pure Spears	3/pack, 20pkg/box (60)
18-417E	Sterile Lasik Pure Spears - Expanded	2/pack, 20pkg/box (40)
18-418	Sterile Lasik Pure Spears	10/pack, 20pkg/box (200)
18-418E	Sterile Lasik Pure Spears - Expanded	10/pack, 10pkg/box (100)

Wipes and Spears

18-419 Lasik Pure Disk on Handle

18-420 Corneal Light Shields

Smaller pore size blocks excessive light that can be damaging to the retina

- Hydrophilic sponge retains moisture on cornea
- Contours to the surface of the cornea, will not slip out of position
- Fiber free construction will not introduce lint into the surgical site
- Makes an excellent platform for retrieving sutures



18-421 / 18-422 / 18-423 / 18-424 18-425 / 18-426 / 18-427 Lasik Eye Shield

This sponge is put in place after corneal flap is created to drain irrigating fluids from the orbit; eliminates fluid buildup in corneal bed.

- PVAc construction will not introduce lint into the surgical site
- Soft, pliable sponge easily conforms to the cornea
- Fast wicking sponge reduces fluid build-up in the canal bed

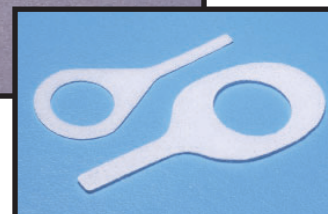
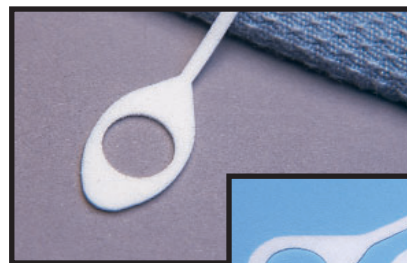

Product Number	Description	Quantity
18-419	Lasik Pure Disk On Handle (2mm x 9mm)	1/pack, 20pkg/box
18-420	Sterile Corneal Light Shields (1mm thick, 7mm diameter)	1/pack, 20pkg/box
18-421	Lasik Pure Shield With 6mm Flat Spot on Disk (8mm Diameter By 1mm Thick)	1/pack, 20pkg/box (20 units)
18-422	Chayet Shield (12.5mm)	1/pack, 20pkg/box
18-423	Lasik Pure Shield with 7mm Flat Spot on Disk (9mm Diameter By 1mm Thick)	1/pack, 20pkg/box (20 units)
18-424	Lasik Pure Drain with Round Hole on Oval (10.5mm) (40mm Long By 14mm Wide)	1/pack, 20pkg/box (20 units)
18-425	Lasik Eye Shield (10mm)	1/pack, 20pkg/box
18-426	Lasik Eye Shield (12mm)	1/pack, 20pkg/box
18-427	Lasik Pure Drain 11.5mm Round Hole in an Oval (42mm Long By 17mm Wide)	1/pack, 20pkg/box
18-428	Pled-Gets Sponge	10/pack, 20pkg/box



Wipes and Spears

18-430 / 18-431 / 18-435 Precision Eye Drains 80cc / 400cc

Collects and controls excess fluids during ophthalmic procedures

- Wick material creates a self-wicking drainage system which removes irrigating and body fluids from the site
- Adhesive backed collection bag adheres to the surgical drape to eliminate any interference with the procedure
- Easily trimmed to fit all patient sizes

18-440 Bloomberg Ophthalmic Ring

- Was designed to retain moisture on the sclera
- Has a unique small pore construction which allows it to contour to the surface of the eye.
- Is highly absorbant, holding many times its weight in liquid
- Will not slip out of positions
- Contains no fibers there will not shed fibrous debris into the surgical site.
- Has a central opening that permits irrigation of the cornea.

18-450 Eye Kit

This two piece kit contains 1 Wipe/Wick 18-470 and a Corneal Light Shield 18-420 procedures to provide rapid recovery of fluids

- The Wipe/Wick consists of an instrument Wipe and has a 3" removable Eye Wick to clear fluids (see page 7 for full description of the Wipe/Wick)
- The Corneal Light Shield blocks excessive light that can damage the retina (see page 4 for full description of the Corneal Light Shield)
- Combination Kit saves time, money and offers easier inventory control

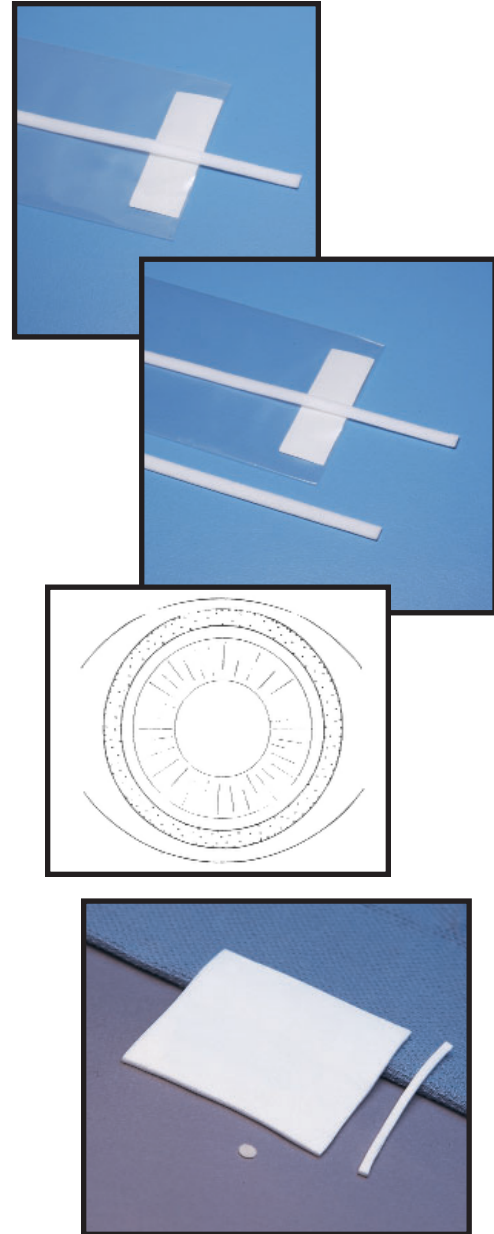

Product Number	Description	Quantity
18-430	Sterile EyeDrain, 80cc	1/pack, 20 pkg/box
18-435	Sterile Eye Drain, 400cc	1/pack, 10 pkg/box
18-431	Sterile Eye Wicks, w/o bag, 8 inches (20 cm)	2/pack, 10 pkg/box
18-440	Sterile Bloomberg Ophthalmic Ring	1/pkg, 20 pkg/box
18-450	Sterile Precision Eye Kit (2mm 3.25 x 3.25)	1/pack, 20 pkg/box

800.322.4674 or 800.633.7283

www.msiprecision.com

19-11



Wipes and Spears

18-451

All-in-One Cataract Kit

This 4-product kit contains 5 Cellulose Eye Spears 18-410, 1 Corneal Light Shield 18-420, 1 Eye Drain 18-430 and 1 Instrument Wipe 18-900

(For product descriptions: Cellulose Eye Spears —page 72; Corneal Light Shield —page 71; Eye Drain —page 70; Instrument Wipe —page 74)

- Provides an easy-to-use one unit system when performing cataract surgery
- Saves time ordering and setting up for procedures
- Offers easier inventory control
- More economical than ordering individual items

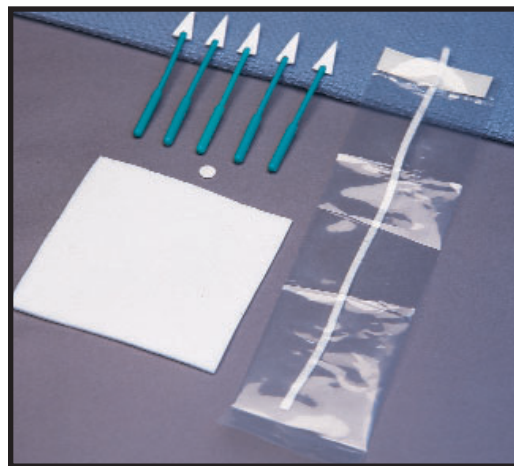

18-460

PVA Diamond Knife Cleaning Block

Removes debris from the diamond which prevents the blade from dragging in the tissue

- 4.5cm long block made of hydroxylated polyvinyl acetate
- Continuous cell structure contains no fibers and, therefore, will not shed fibrous debris
- Small pore structure especially suited for absorbing bodily fluids, while applying ample pressure to wipe the diamond clean



Product Number	Description	Quantity
18-451	Sterile Cataract Kit	1/pack, 10 pkg/box
18-460	Knife Cleaning Block	1/pack, 10pkg/box



18-900 / 18-910 Instrument Wipe

Ideal for procedures where gentle cleaning of a delicate surgical instrument is important

- 100% fiber-free material will not shed fibrous debris onto the instrument
- Soft chamois-like feel will not damage sensitive instruments or optics
- Will not snag on the box locks or serrations of an instrument's jaws when moistened
- Especially gentle on the sharps, fine points, and tips of delicate micro instruments
- Available in two different thicknesses - 2mm and 1mm

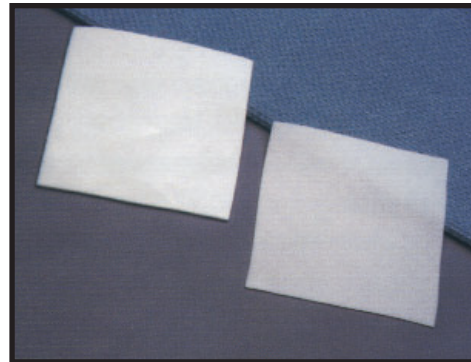

18-470 Wipe / Wick

Separates into two products; a standard 3"x 3" Instrument Wipe and a 3" long Eye Wick. The Wick is placed in the lower canthal fold to continually drain excess fluid from the surgical site.

- Contains no fibers
- Saves time and money
- Makes inventory control easier

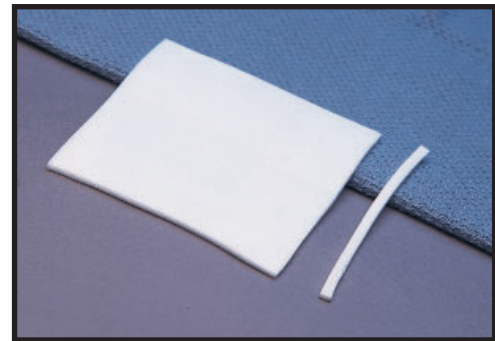

18-990 Lasik Wipe

Product No.	Description	Quantity
18-900	Sterile Instrument Wipe (2mm thick) (3 x 3 x 2mm)	1 pack, 20 pkg/box
18-910	Sterile Instrument Wipe (1mm thick) (3 x 3 x 1mm)	1 pack, 20 pkg/box
18-470	Sterile Wipe/Wick	1 pack, 20 pkg/box
18-990	Lasik Instrument Wipe (2mm thick) (2 x 3 x 2mm)	1 pack, 20 pkg/box

Eye Protection

MSI Precision offers a complete line of Eye Protective wear and Post Surgical Eye protection systems.

- High Impact Polycarbonate Lenses
- Grey Tinted or Clear Lenses
- 100% Maximum UVA/UVB Protection
- Flash Mirror to Reduce Photophobia
- Post LASIK or Post Photo Dynamic Therapy
- Foam Cushioned Frame
- Flexible Nasal Bridge for Better Fit
- Secure, Adjustable, Wide Elastic Strap
- Quality Wear to Keep for Sports & Leisure

Eye Garter™ Total Eye Protection System

Easy Shields™

17-251-25 Easy Shield™ Colored
(Adult) 25/box

17-252-25 Easy Shield™ White
(Adult) 25/box

17-421-25 Easy Shield™ Colored
(Youth) 25/box

17-422-25 Easy Shield™ White
(Youth) 25/box

17-451-25 Easy Shield™ Colored
(Pediatric) 25/box

17-452-25 Easy Shield™ White
(Pediatric) 25/box

17-350-25 Easy Shield™
(Adult Plastic) 25/box

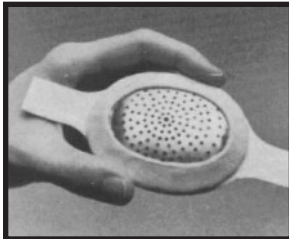
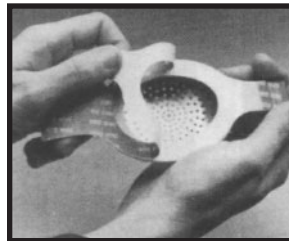

• Easy Shield™ combination aluminum eye shield (fox style) with colored or white Eye Garter™ shield covers and adhesives.

• Complete package for ease of application

• Easy Shield™ eliminates the need for awkward taping.

• Increases patient compliance

• Adult, youth, or pediatric sizes available.

• Neat, comfortable, gentle and secure - Easy Shield™ is preferred by patients.

• Each pack contains a 7 day supply of replacement adhesives.

• Patient instructions enclosed.

• Easy removal and replacement by patient without assistance.

• Available in boxes of;
• 12 Units (1 week's supply for 12 patients)

• 25 Units (1 week's supply for 25 patients)

Easy Shields™ Adhesives

17-257-12 Easy Shield™ Adhesives
(Adult/Youth)
12 packs/box (84 Units)

17-257-25 Easy Shield™ Adhesives
(Adult/Youth)
25 packs/box (175 Units)

17-457-12 Easy Shield™ Adhesives
(Pediatric)
12 packs/box (84 Units)

17-457-25 Easy Shield™ Adhesives
(Pediatric)
25 packs/box (175 Units)

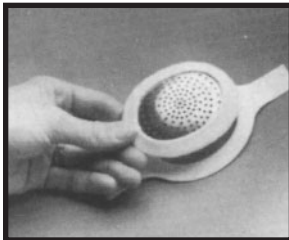
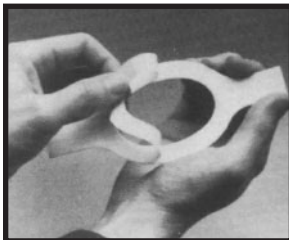

Eye Garter™ Total Eye Protection System

Eye Garter™ Aluminum Eye Shields

Adult

17-201-50	Without Covers
17-202-50	Assorted Color Covers
17-203-50	White Covers

Youth

17-411-50	Without Covers
17-412-50	Assorted Color Covers
17-413-50	White Covers

Pediatric

17-401-50	Without Covers
17-402-50	Assorted Color Covers
17-403-50	White Covers

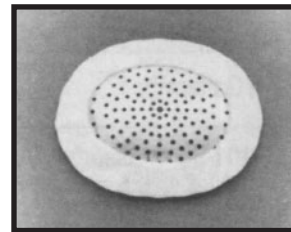
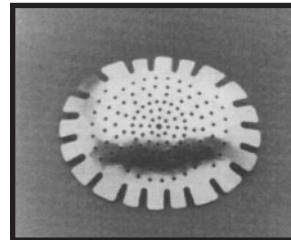

- The ultimate in post operative and post trauma eye protection.

- Highest quality (fox style) eye shield available.

- Adult, youth, or pediatric sizes available.

- Covers available in white or color.

Eye Garter™ Plastic Eye Shields

Deep Shield allows safe placement of eye pad

White Plastic

Deep Shield allows safe placement of eye pad

17-301-50	Without Covers
17-302-50	Assorted Color Covers
17-303-50	White Covers

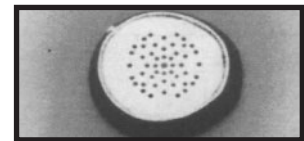
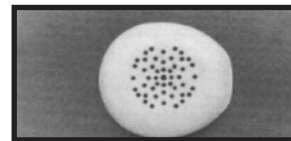

White Plastic

Clear Plastic - Universal

Clear universal eye shield. Holes prevent fog with minimal vision distortion.

17-701-50	Without Covers
17-702-50	Assorted Color Covers
17-703-50	White Covers

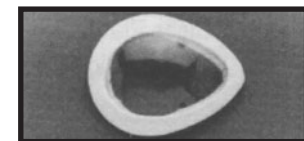
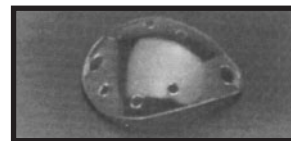

Clear Plastic

Blue Plastic

Right, Left and universal configuration offer selection with ultimate protection. Blue color eliminates all bright light and sunlight glare.

17-501-50L	Left - Without Covers
17-501-50R	Right - Without Covers
17-502-50	Universal - Without Cover
17-503-50	Universal - With Cover

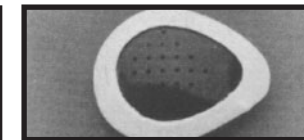
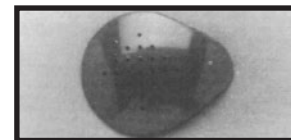

Blue Plastic

- The highest quality, high impact plastic eye shields.
- Available in white, blue and clear plastic
- Adult sizes only.
- Boxes of 50

Eye Protection

Eye Garter™ Total Eye Protection System

Sterile Eye Garter™ Eye Shields

- Available in the Easy Shield™ combination shield and Eye Garter™ cover.
- Clear and Blue Plastic also available

17-254-25 **Easy Shield™ Universal**
25/box

17-504-50 **Blue Plastic Universal**
50/box

Eye Garters™

- Patented shield covers for a soft clean edge on all eye shields.
- Avoids the need to tape the sharp edges of aluminum shields.
- Assorted colors or white.
- Adult and youth only (interchangeable).

17-101-50 **Assorted Color Covers**
50/box

17-102-50 **White Covers**
50/box

17-704-50 **Clear Plastic Universal**
50/box

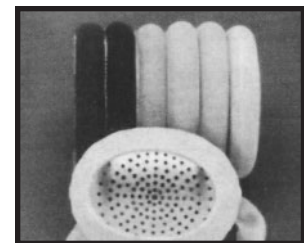

Omni-Patch™

- Perfect for Daytime Post-op protection.
- Soft elastic head band.
- velcro fasteners make adjustment safe and simple.
- Not for nighttime use.
- Adult Sizes Only.
- Clear and Blue plastic available in boxes of 12.

17-575-12 **Blue Plastic**
With Elastic Strap and Velcro Closure

17-775-12 **Clear Plastic**
With Elastic Strap and Velcro Closure



19-16

800.322.4674 or 800.633.7283

www.msiprecision.com

Duo-Shades®

Bilateral LASIK Protection With Style And Comfort

- High Impact Polycarbonate Lenses
- Foam Cushioned Frame
- Grey Tinted or Clear Lenses
- Flexible Nasal Bridge for Better Fit
- 100% Maximum UVA/UVB Protection
- Secure, Adjustable, Wide Elastic Strap
- Flash Mirror to Reduce Photophobia
- Quality Wear to Keep for Sports & Leisure
- Post LASIK or Post Photo Dynamic Therapy

Grey Tint Duo-Shades

Grey Tinted Polycarbonate Lenses, Pewter Frame, hinged nasal allows google to fold, 400 UV coating, Plash Mirror

DS1T-12 Box of 12
DS1T-1 Single Unit



Clear Duo-Shades

Clear Polycarbonate Lenses, Pewter Frame, hinged nasal allows google to fold, 400 UV coating, Plash Mirror

DS2C-12Box of 12
DS2C-1 Single Unit



Grey Tint Duo-Shades 2

One piece frame with flexible nasal bridge and neoprene foam lining. Extra foam around nose area makes this style extra comfortable, Grey tinted polycarbonate lenses, 400 UV coating, adjustable elastic headband

DS4T-12 Box of 12
DS4T-1 Single Unit



Clear Duo-Shades 2

Clear One piece frame with flexible nasal bridge and neoprene foam lining. Extra foam around nose area makes this style extra comfortable, Clear polycarbonate lenses, 400 UV coating, adjustable elastic headband

DS5C-12Box of 12
DS5C-1 Single Unit



Eye Protection

DuoShield®

Advances In Post-Op LASIK Care

- Polycarbonate Lenses For Protection
- Larger Design For More Stable Fit
- Smooth Foam Lining
- Tinted And Pinhole Styles Reduce Photophobia
- Adjustable Head Band
- Six Styles From Which To Choose

DuoShield®

Brushed Aluminum, Pinhole Design, w/Foam Lining

G972A-25 Box of 25

G972A-1 Single



DuoShield®

Blue Polycarbonate, Pinhole Design, w/Foam Lining

G972B-25 Box of 25

G972B-1 Single



DuoShield®

Clear Polycarbonate, Vented No Foam

G972C-25 Box of 25

G972C-1 Single



DuoShield®

Clear VENTED Polycarbonate, w/Comfortable Foam Lining

G972CV-25 Box of 25

G972CV-1 Single



DuoShield®

Clear MOISTURE RETENTION, Polycarbonate w/Foam Lining

G974MR-25 Box of 25

G974MR-1 Single



DuoShield®

Grey Tinted MOISTURE RETENTION, Polycarbonate, w/Foam Lining

G975MT-25 Box of 25

G975MT-1 Single



DuoShield®

Grey Tinted VENTED, Polycarbonate, w/Foam Lining

G976VT-25 Box of 25

G976VT-1 Single



Solo-Shields

Advances In Post-Op LASIK Care

- Polycarbonate Lenses For Protection
- Larger Design For More Stable Fit
- Smooth Foam Lining
- Tinted And Pinhole Styles Reduce Photophobia
- Adjustable Head Band
- Four Styles From Which To Choose

SSA-25

**Solo-Shields Single
Aluminum Pinhole**
w/ Foam Lining
Box of 25



SSB-25

**Solo-Shields Single
Blue Polycarbonate**
w/ Foam Lining
Box of 25



SSC-25

**Solo-Shields Single
Clear Vented Polycarbonate**
w/ Foam Lining
Box of 25



SSX-25

**Solo-Shields Single
Clear Vented Polycarbonate**
(No Foam)
Box of 25



Eye Protection

Blue Eye Shields

Universal Eye Shields

Blue Polycarbonate Pinhole Design Eye Shield

BP1-50 Box of 50
BP1-500 Case of 500



Blue Polycarbonate Pinhole, Foam Lined

BPF-48 Box of 48



Blue Polystyrene, Pinhole, Deep Shell

BP2-50U Box of 50
BP2-500U Case of 500



Blue Polycarbonate Pinhole, Deep Shell

BP3-50U Box of 50
BP3-500U Case of 500

Left Or Right Choice Eye Shields

Blue Polycarbonate Pinhole, Deep Shell,

Choice of Right or Left Eye
BP2-50R (right eye) Box of 50
BP2-50L (left eye) Box of 50



Polycarbonate Eye Shields

White Polycarbonate Shield

Deep Shell w/Pinholes, Right and Left Eye

WP-50R Box of 50

WP-50L Box of 50

Deep Shell w/Pinholes, Universal

WP-50U Box of 50



Clear and Gray Polycarbonate Eye Shields

Clear Vented Shield, Universal

CV-50 Box of 50

CV-500 10 Boxes of 50

CV-1000 Case of 1000

Clear Vented Shield, Universal, Deep Shell

CV2-50 Box of 50

CV2-1000 Case of 1000

Clear Vented Shield w/ Latex Free Foam Lining, Universal

CVF-50 Box of 50

Clear Vented Shields (25) with Center Hole,

Foam Lining, with Softab Adhesives (50)

CHST-2550 Box of 25

Gray Tinted Vented Shield with Latex Free Foam Lining,

Universal NEW TINTED

CVT-50 Box of 50

Clear Polycarbonate Moisture Retention, Universal

CMR-50 Box of 50

Clear Moisture Retention Style w/ Latex Free Foam Lining,

Universal

CMF-50 Box of 50

Gray Tinted Polycarbonate Moisture Retention with Foam Lining,

Universal NEW TINTED ITEM

CMT-50 Box of 50

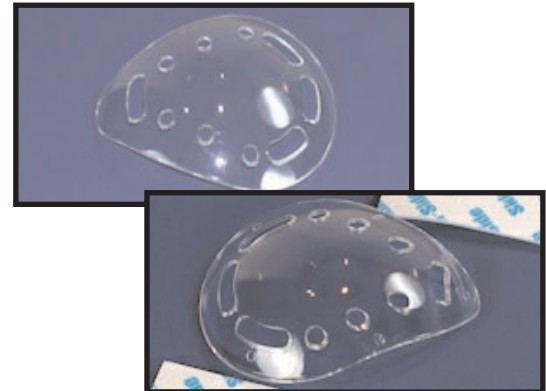

Eye Protection

Polycarbonate Eye Shields

Clear and Gray Polycarbonate Eye Shields (cont.)

Clear Polycarbonate w/ Foam Lining, Universal Youth Size NEW SIZE FOR YOUTH
CYF-25 Sleeve of 25

Clear Polycarbonate Shield Combined
w/ Loop Shield Cover (Specify White or Colors)
CL-50 Box of 50



Aluminum Eye Shields

Brushed Aluminum - LATEX FREE -
Pinhole Design Shield with White Foam Lining
FSUF-48 Box of 48

EST Fox
Aluminum Pinhole Shield
FSC-50 Box of 50



EST Fox Aluminum
Pinhole Shield Combined with your choice of the following:

Assorted Color Cover
FSCL-50AC Box of 50

White Cover, Latex Thread
FSCL-50W Box of 50

Royal Blue, Latex Thread
FSCL-50RB Box of 50

Royal Blue Cover, Latex Thread
FSCL-100RB Box of 100



EST Fox Aluminum
Pinhole Shield with Assorted Color Loops
(50 ea.) and SofTab Adhesives (100 ea.)
FLST-50-100 Box of 50



Aluminum Eye Shields

EST Pediatric Fox

Aluminum Pinhole Shield with your choice of the following:

White Shield Covers, Latex Thread
FSPD-50W Box of 50
Pink and Blue Covers, Latex Thread
FSPD-50 Box of 50

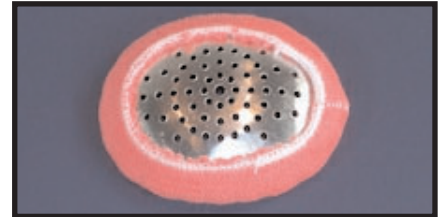

“One Step” Sterile

Aluminum Pinhole Foam Lined Shield
with Cotton Pad and SofTabs
G270-12 Box of 12

“Safe Edge” Aluminum Eye Shield

with Thermoplastic Edge, LATEX FREE
SE-120 Bag of 20



“Safe Edge” Aluminum Eye Shields

(20 ea.) with Thermoplastic Edge,
Combined with SofTab Adhesives (40 ea.)
SEST-2040 Bag of 20

FABRIC SHIELD COVERS* LOOPS

for Aluminum or Plastic Eye Shields
(Contains Latex Thread) EST Loop Shield Covers

Assorted Colors (10-15)
L-50AC Box of 50

White
L-50W Box of 50

Royal Blue
L-50RB Box of 50

Assorted Colors (10-15)
L-500AC Box of 500

Eye Protection

Post-Op & Polycarbonate Safety Glasses

400 UV Post Op Gray Tinted Polycarbonate

Fits Over Glasses, Side Vents

UV101C (with drawstring case) One

UV101-1 One

UV101-12 Box of 12



400 UV Clear Polycarbonate Glasses

Fits Over Glasses, Side Vents

UV102-1 One

UV102-12 Box of 12



Yellow Night Driving Polycarbonate

Fits Over Glasses, Side Vents

UV103-1 One

UV103-12 Box of 12



Clear Polycarbonate Special Purpose Lenses

Hardcoat, Fits Over Glasses, 400 UV, (No Side Vents)

UV104-12 Box of 12



19-24

800.322.4674 or 800.633.7283

www.msiprecision.com

Post-Op & Polycarbonate Safety Glasses

Safety Polycarbonate Glasses

Contemporary Style, Gray or Amber Tint

UV50G-12 (Gray Tint) Box of 12

UV50A-12 (Amber Tint) Box of 12

Safety Polycarbonate Glasses in Yellow

for Night Driving or Contrast Vision

UV50ND-12 Box of 12

Safety Glass, Clear Polycarbonate

with Assorted Color Temples, Red, Blue, Black, Yellow

UV51C-12 Box of 12

Safety Glass, Clear Polycarbonate or Gray Tinted

with Black Temples, Tapered Wrap Style

UV52C-12 (Clear) Box of 12

UV52G-12 (Gray) Box of 12

Safety Glass, Clear Polycarbonate

with Adjustable Length Temples, Square Wrap Style

UV53C-12 Box of 12

Gray Tinted Wrap Style

with Adjustable Length Temples

UV517-12 Box of 12

Blue Buster or Amber Driving Polycarbonate Lenses,

Fits Over Glasses, Side Vents, 400 UV

UV83BB-12 (Blue Buster) Box of 12

UV83DR-12 (Amber Driving) Box of 12



Gray Tinted Polycarbonate, Fits Over Glasses,

400 UV (No Side Vents)

UV84G-12 Box of 12

Contemporary Style Gray Tinted Lenses

Spring Temples

A119-12 Box of 12

Eye Protection

LASIK & Cataract Surgical Supplies

Duo-Tape™

Sterile, 1 Upper & 1 Lower Lid/Lash Tape Drape/Sterile Pack
G991-2 Box of 50
G991-T Pkg. of 12

Duo-Flo™

for Cataract Surgery; 2 Large Eyelid/Lash Tapes & 1 Fluid Retention Bag with Adhesive Strip, Sterile
G990-3 Box of 15

Fluid Retention Bag with Adhesive Strip

to attach to drape, One per Sterile Pack
G993-1 Box of 25

DUOclude™

10 Aluminum Occluder Universal Shields,
w/30 Covers & 60 SofTab Adhesives
G973A-10 Pkg. of 10

DUOclude

25 Polycarbonate Occluder Shields with
50 SofTab Adhesives NEW! Disposable

Blue

G973B-25 Box of 25

White

G973W-25 Box of 25

Trident Brand Drape Support

TD-20 Pkg. of 20

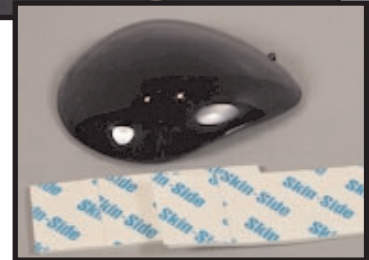

Write-On ID Labels

MSI Precision Write-On Identification Labels are ideal when you need to provide specific identification on certain instruments, trays or other items during sterilization. These color-coded labels are formatted on 8.5" x 11" sheets, with three different sizes on each sheet. Use permanent markers only.

WRITE-ON IDENTIFICATION LABELS

Product #	Description
56-1002	Blue Border
56-1003	Green Border
56-1004	Red Border
56-1005	Yellow Border

Labels are formatted as follows:
8.5" x 11" sheet with 44 labels;
(22) 2.5" (6.4cm), (11) 2" (5.1cm)
and (11) 1.5" (3.8cm)



Retractor Guards

All models non-sterile

Retractor Guards protect the sharp tips of retractors during storage, handling and sterilization by steam or EIO gas. The guards are designed to fit a variety of instruments that previously had no guards available.

Product #	Color	Length	Quantity
16-6109	Clear	38.1	55
16-6129	Clear	50.8	45
16-6139	Clear	76.2	40



Identification Labels

Color-Coded ID Locking Tags

MSI Precision Color-Coded Identification Locking Tags replace confusing methods for identifying instruments, carts, trays, cabinets and other equipment.

- Available in 8 easy-to-see colors
- Three colors are pre-printed for easy usage (Red: "Repair", Green: "Good", Yellow: "Sharpen")
- All tags provide a write-on surface for specific identification
- Simple, tamper-proof, single-handed locking mechanism
- Steam, ETO and autoclavable
- Packaged in economical 100-unit and 150-unit packs.



PREPRINTED PLUS WRITABLE AREA

Number	Color	Imprint	Qty
26-1001	Red	Repair	100
26-1002	Yellow	Sharpen	100
26-1003	Green	Good	100

BLANK PLUS WRITABLE AREA









Number	Color	Imprint	Qty
26-1004	Blue	Blank	100
26-1005	White	Blank	100
26-1006	Green	Blank	100
26-1007	Black	Blank	100
26-1008	Purple	Blank	100
26-1009	Orange	Blank	100
26-1010	Assorted	Assorted	150
	(26-1001, 26-1002, 26-1003)		30
	(26-1004, 26-1005, 26-1006)		10
	(26-1007, 26-1008, 26-1009)		10



Identification Roll Tape

MSI Precision Identification Roll Tape is ideal for marking and identifying all kinds of instruments and other items in your department. The colors are easy to see and apply, so the right instrument can be identified every time.

1 Roll Per Case 1/4" Tape (.635 cm)

15-1001	White	
15-1002	Blue	
15-1003	Green	
15-1004	Red	
15-1005	Yellow	
15-1006	Purple	
15-1007	Orange	
15-1008	Brown	
15-1009	Black	



ALL ROLLS ARE 1/4" x 300" (0.6cm x 762cm)



Identification Sheet Tape

Identification Sheet Tape helps you color code instruments with pre-cut strips (1/4" h. x varied widths, total 374" of tape). Each 8.5" x 11" sheet contains: (44) 2" strips, (44) 1.5" strips, and (220) 1" strips.

1/4" SOLID COLORS

15-2001	White	15-2009	Black
15-2002	Royal Blue	15-2010	Gray
15-2003	Kelly Green	15-2011	Lavender
15-2004	Red	15-2012	Beige
15-2005	Yellow	15-2013	Light Blue
15-2006	Purple	15-2014	Lime Green
15-2007	Orange	15-2015	Pink
15-2008	Brown	15-2017	Plum



1/4" STRIPE

15-6003	Blue/Green
15-6004	Blue/Red
15-7002	Yellow/Blue
15-7003	Yellow/Green
15-7004	Yellow/Red

1/4" TRI-COLOR STRIPE

15-5061	Red/White/Blue
15-5062	Red/White/Black
15-5063	Red/Yellow/Black
15-5064	Red/Black/Green

1/4" FOUR COLOR SHEET

15-2032	Blue, White, Black and Green
15-2031	Red, Yellow, Purple and Orange

1/4" WHITE STRIPE

15-4002	Royal Blue	15-4009	Black
15-4003	Kelly Green	15-4011	Lavender
15-4004	Red	15-4013	Light Blue
15-4005	Yellow	15-4014	Lime Green
15-4007	Orange	15-4015	Pink
15-4008	Brown	15-4017	Plum

1/4" STARS 1/4" DOTS

15-8030	Fuchsia	15-8040	Fuchsia
15-8031	Medical Blue	15-8041	Medical Blue
15-8032	Emerald Green	15-8042	Emerald Green
15-8033	Violet	15-8043	Violet

1/4" TRIANGLES 1/4" NUMBERS

15-8050	Fuchsia	15-8020	Fuchsia
15-8051	Medical Blue	15-8021	Medical Blue
15-8052	Emerald Green	15-8022	Emerald Green
15-8053	Violet	15-8023	Violet

1/4" BLACK STRIPE

15-3001	White	15-3011	Lavender
15-3003	Kelly Green	15-3012	Beige
15-3004	Red	15-3013	Light Blue
15-3005	Yellow	15-3014	Lime Green
15-3007	Orange	15-3015	Pink
15-3010	Gray	15-3017	Plum

1/4" TWO COLOR DIAGONAL STRIPE

15-9001	Purple/Black	15-9004	Rubine/Black
15-9002	Orange/Black	15-9005	Yellow/Black
15-9003	Blue/Black	15-9006	Green/Black

1/4" ALPHA

15-8030	A-E Alpha in Fuchsia
---------	----------------------

1/4" HEARTS 1/4" SMILEY FACES

15-8060	White with Red Hearts
15-8070	Yellow with Black Smiley Faces
15-8061	Red with White Hearts

Phaco Accessories

Scleral Plugs

- Ergonomically designed holder
- 19 Gauge plugs - gold plated for identification
- Cross action forceps reduces and fatigue

Scleral Plugs

30-156

Scleral Plugs (5 holders per box, sterile)

20 Gauge - 10 pieces

19 Gauge - 10 pieces



30-170

Scleral Plugs (5 holders per box, sterile)

20 Gauge - 20 pieces

19 Gauge - 20 pieces



30-196

Scleral Plugs (5 holders per box, sterile)

20 Gauge - 20 pieces

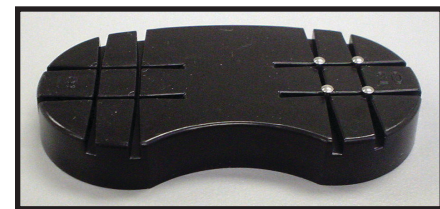

Scleral Plugs Forceps

30-172

Scleral Plugs Forceps

(1 per package, non-sterile)



A175

Phaco Tip Remover Titanium For
20000

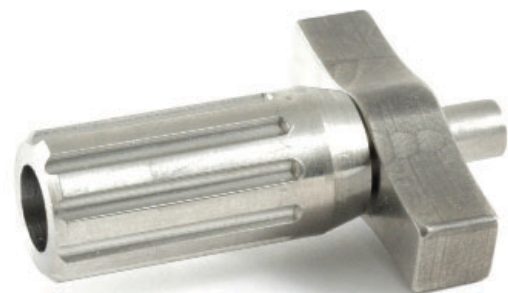

30-016 **Silicone Irrigation Sleeve**
for 19Ga phaco needles
(6 per package, non-sterile)

30-230 **Silicone Irrigation Sleeve**
for 20Ga phaco needles
(6 per package, non-sterile)

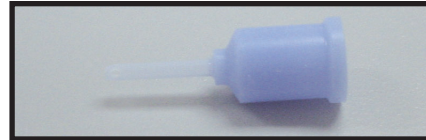

30-018 **Phaco Test Chamber**
(6 per package, non-sterile)



30-014 **Steel Wrench for
Standard Phaco Needles**
(1 per package, non-sterile)

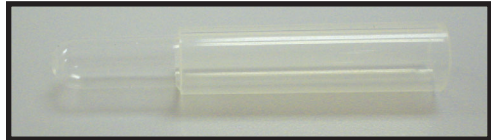

30-080 **Plastic Wrench for
Standard Phaco Needles**
(5 per package, non-sterile)

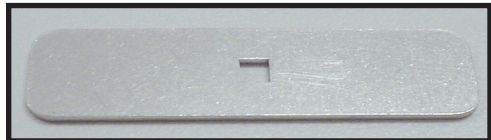

30-088 **Plastic Wrench for
Low Turbulence Phaco Needles**
(5 per package, non-sterile)

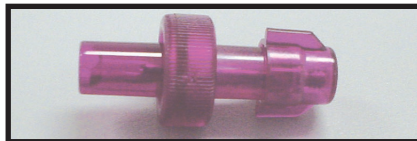

30-104 **Phaco Handpieces**
(1 per package, non-sterile)

Compatible with the following systems:
Alcon STTO® ; Alcon Legacy®; AMO®; OMS®;
Bausch & Lomb Surgical® ,D.O.R.C.®, Fritz Ruck®;
IOLTech®

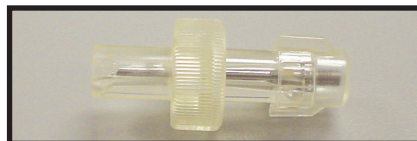

Phaco Needles

Supplied with reusable wrench

Standard Phaco Needles

- 30-002** Standard Phaco Needle 19Ga 15°
(1 per pack, non-sterile)
- 30-004** Standard Phaco Needle 19Ga 30°
(1 per pack, non-sterile)
- 30-006** Standard Phaco Needle 19Ga 45°
(1 per pack, non-sterile)



Alcon® Models: Series Ten Thousand®, Universal®
Baush & Lomb Surgical® Models: Premiere®, Millenium®, Protégé®
AMO®, OMS®, American Optisurgical®, Corneal®, D.O.R.C.®, Fritz Ruck®,
IOLTech®, Geuder®, Mediphacos®, Mentor®, Paradigm Medical®, Staar Surgical®

Small Incision Phaco Needles

- 30-008** Small Incision Phaco Needle 20Ga 15°
(1 per pack, non-sterile)
- 30-010** Small Incision Phaco Needle 20Ga 30°
(1 per pack, non-sterile)
- 30-012** Small Incision Phaco Needle 20Ga 45°
(1 per pack, non-sterile)



Alcon® Models: Series Ten Thousand®, Universal®
Baush & Lomb Surgical® Models: Premiere®, Millenium®, Protégé®
AMO®, OMS®, American Optisurgical®, Corneal®, D.O.R.C.®, Fritz Ruck®,
IOLTech®, Geuder®, Mediphacos®, Mentor®, Paradigm Medical®, Staar Surgical®

Standard Phacvo Needles

- 30-210** Standard Phaco Needle 19Ga 15°
(1 per pack, non-sterile)
- 30-212** Standard Phaco Needle 19Ga 30°
(1 per pack, non-sterile)
- 30-214** Standard Phaco Needle 19Ga 45°
(1 per pack, non-sterile)

Alcon® Models: Legacy®, Accurus®



Low Turbulence Phaco Needles

- 30-082** Low Turbulence Phaco Needle 19Ga 15°
(1 per pack, non-sterile)
- 30-084** Low Turbulence Phaco Needle 19Ga 30°
(1 per pack, non-sterile)
- 30-086** Low Turbulence Phaco Needle 19Ga 45°
(1 per pack, non-sterile)



Alcon® Models: Series Ten Thousand®, Universal®
Baush & Lomb Surgical® Models: Premiere®, Millenium®, Protégé®
AMO®, OMS®, American Optisurgical®, Corneal®, D.O.R.C.®, Fritz Ruck®,
IOLTech®, Geuder®, Mediphacos®, Mentor®, Paradigm Medical®, Staar
Surgical®

Low Turbulence Phaco Needles - Metric

- 30-216** Low Turbulence Phaco Needle - Metric 19Ga 15°
(1 per pack, non-sterile)
- 30-218** Low Turbulence Phaco Needle - Metric 19Ga 30°
(1 per pack, non-sterile)
- 30-220** Low Turbulence Phaco Needle - Metric 19Ga 45°
(1 per pack, non-sterile)



Baush & Lomb Surgical® Model: Phacotron Gold®
Optikon Model: Phacovisc®
United Surgical® Model: Systems Plus II®

Low Turbulence Phaco Needles - Optikon

- 30-222** Low Turbulence Phaco Needle - Optikon 19Ga 15°
(1 per pack, non-sterile)
- 30-224** Low Turbulence Phaco Needle - Optikon 19Ga 30°
(1 per pack, non-sterile)
- 30-226** Low Turbulence Phaco Needle - Optikon 19Ga 45°
(1 per pack, non-sterile)



Optikon Models: Pulsar®, Antares®, Quasar®, P4000®

Fragmentation Phaco Needles

- 30-084** Fragmentation Phaco Needle 20Ga 15°
(1 per pack, non-sterile)
- 30-096** Fragmentation Phaco Needle 20Ga 30°
(1 per pack, non-sterile)
- 30-098** Fragmentation Phaco Needle 20Ga 45°
(1 per pack, non-sterile)



Alcon® Models: Series Ten Thousand®, Universal®
Baush & Lomb Surgical® Models: Premiere®, Millenium®, Protégé®
D.O.R.C.®, Fritz Ruck®, IOLTech®, Geuder®

Stainless Steelware

Laboratory Products

Instrument Trays and Covers

Surgical Products

Patient Care Products

Clinic / Office Products

Plastic Patient Care Products

Dietary Products

Instrument Guards

Case and Tray Solutions



***From Lab Products, to
Surgical Utensils, to Patient
Care Products...***

MSI Precision offers you a variety of quality stainless steel and plastic products to meet your everyday needs.

Couple this with a Customer Service Department rated as one of the best in the business, and you have a company that gives YOU, the customer Priority Status.

**The Best
by
Design**



20-8

800.322.4674 or 800.633.7283

www.msiprecision.com

Surgical Advantage

1-800-948-7994

order@surgicaladvantage.net

E. SOLUTION PAILS

Pails are tapered for easy pouring. "Ears" for handles are an integral part of pail, resisting break off and allowing for easy cleaning.

PART #	CAPACITY	DIMENSIONS (IN.)	CASE LOT/WT.
12N	13 Qt	11 5/8 x 9 1/4	3- 9.0 lbs
16N	16 Qt	11 3/4 x 10 1/8	3-11.0 lbs
12N-2 Solid Cover--Fits Both Pails			3-3.8 lbs

E



F. STORAGE CONTAINERS AND COVERS

Heavy duty containers/tanks have welded handles for safe, easy transport. Cover handles recessed to permit space-saving stacking.

PART #	DESCRIPTION	CAPACITY	DIMENSIONS (IN.)	CASE LOT/WT.
88-WC	Pot w/ Cover	8 Qt. or 2 Gal	9 3/4 x 7 5/8	1-4.3 lbs
88	Pot	8 Qt. or 2 Gal	9 3/4 x 7 5/8	1-4.0 lbs
88-2	Cover (Solid)			6-4.3 lbs
120-WC	Pot w/Cover	12 Qt. or 3 Gal	10 13/16 x 9	1-6.0 lbs
120-2	Cover(Solid)			6-6.8 lbs
160-WC	Pot w/Cover	16 Qt. or 4 Gal	13 x 9	1-6.8 lbs
160	Pot	16 Qt. or 4 Gal	13 x 9	1-6.0 lbs
240-2	Cover (Solid)	<i>(Fits 160 Pot)</i>		6-7.8 lbs
200 WC	Pot w/ Cover	20 Qt. or 5 Gal	13 x 11	1-8.5 lbs
200	Pot	20 Qt. or 5 Gal	13 x 11	1-7.0 lbs
240-2	Cover (Solid)	<i>(Fits 200 Pot)</i>		6-7.8 lbs
240-WC.	Pot w/Cover	24 Qt. or 6 Gal	13 x 13	1-9 lbs
240	Pot	24Qt. or 6 Gal	13 x 13	1-7.8 lbs
240-2	Cover (Solid)			6-8.5 lbs
320-WC.	Pot w/Cover	32 Qt. or 8 Gal	15 x 12 1/2	1-11.4 lbs
360-2	Cover (Solid)	<i>(Fits 320 Pot)</i>		6-12.9 lbs
360-WC.	Pot w/Cover	40 Qt. or 10 Gal	15 x 16	1-12.5 lbs
360	Pot	40 Qt. or 10 Gal	15 x 16	1-10.9 lbs
360-2	Cover (Solid)			6-12.9 lbs
600-WC.	Pot w/ Cover	60 Qt. or 15 Gal	18 3/4 x 13 3/4	1-19.6 lbs
600-2	Cover (Solid)			6-21.9 lbs
800-WC.	Pot w/ Cover	80 Qt. or 20 Gal	18 3/4 x 19	1-24.1 lbs
800	Pot	80 Qt. or 20 Gal	18 3/4 x 19	1-21.3 lbs
600-2	Cover (Solid)	<i>(Fits 800 Pot)</i>		6-21.9 lbs



F



G

G. LAB / UTILITY SCOOP

Heavy duty scoop has seamless body and strong, tubular handle for easy handling and cleaning.

PART #	CAPACITY	DIMENSIONS (IN.)	LENGTH	CASE LOT/WT.
T7010	40 Oz	5 x 7 1/2	12"	6-7.0 lbs

H. IODINE/OIL CUPS

PART #	CAPACITY	DIMENSIONS (IN.)	CASE LOT/WT
6G	6 Oz	3 7/16 x 2	24-3.5 lbs
14G	14 Oz	4 3/8 x 2 5/8	24-6.8 lbs

H



Stainless Steelware

A. INSTRUMENT TRAYS AND FLAT / SOLID COVERS

Wide assortment of heavy duty, seamless trays have covered corners for easy sterilization. Covers have recessed strap handles for ease in handling and storing.

ORDER SETS BY COMPONENT PARTS.

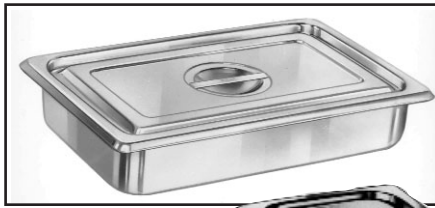

A



PART #	DIMENSIONS (IN.)	CASE LOT/WT.
43	5 3/8 x 4 x 2 5/8	12-5.0 lbs
43-2	Cover Fits 43 Tray	12-3.5 lbs
63	6 1/4 x 6 1/4 x 2 7/8	12-7.3 lbs
63-2	Cover Fits 63 Tray	12-5.1 lbs
952	8 7/8 x 5 x 2	12-7.3 lbs
953	8 7/8 x 5 x 3	12-8.6 lbs
952-2	Cover Fits above two trays	12-5.8 lbs
1002	10 x 6 1/2 x 2	12-10.3 lbs
1002-2	Cover Fits 1002 Tray	12-8.5 lbs
1202	12 1/4 x 7 3/4 x 2 1/4	12-16.0 lbs
1202-2	Cover Fits 1202 Tray	12-11.3 lbs
E1082	10 x 8 1/4 x 2 1/2	6-7.2 lbs
E1084	10 x 8 1/4 x 4	6-8.5 lbs
1082-2	Cover Fits above two trays	6-6.7 lbs
E1650	16 1/2 x 10 x 2 1/2	6-12.5 lbs
E1654	16 1/2 x 10 x 4	4-9.7 lbs
1650-2	Cover Fits above two trays	6-9.3 lbs
E902	6 7/9 x 4 1/4 x 2	12-6.0 lbs
E904	6 7/8 x 4 1/4 x 4	12-8.1 lbs
902-2	Cover Fits above two trays	12-2.9 lbs
E2302	13 7/8 x 12 7/8 x 2 1/2	6-14.3 lbs
E2304	13 7/8 x 12 7/8 x 4	6-17.3 lbs
E2306	13 7/8 x 12 7/8 x 6	6-20.4 lbs
2302-2	Cover Fits above three trays	6-10.9 lbs
E06062	6 7/8 x 6 3/8 x 2 1/2	6-3.2 lbs
E06064	6 7/8 x 6 3/8 x 4	6-5.0 lbs
E06066	6 7/8 x 6 3/8 x 6	6-6.6 lbs
602-2	Cover Fits above three trays	6-2.4 lbs
E10062	10 3/8 x 6 3/8 x 2 1/2	6-5.3 lbs
E10064	10 3/8 x 6 3/8 x 4	6-7.5 lbs
E10066	10 3/8 x 6 3/8 x 6	6-9.5 lbs
402-2	Cover Fits above three trays	6-3.4 lbs



B

B. INSTRUMENT TRAYS AND FLAT/SOLID COVERS

PART #	DIMENSIONS (IN.)	CASE LOT/WT.
STANDARD WEIGHT (22 Ga.)		
E12062	12 3/4 x 6 7/8 x 2 1/2	6-6.5 lbs
E12064	12 3/4 x 6 7/8 x 4	6-9.3 lbs
E12066	12 3/4 x 6 7/8 x 6	6-11.7 lbs
HEAVY WEIGHT (20 Ga.)		
S12062	12 3/4 x 6 7/8 x 2 1/2	6-7.5 lbs
S12064	12 3/4 x 6 7/8 x 4	6-10.8 lbs
S12066	12 3/4 x 6 7/8 x 6	6-13.5 lbs
302-2	Cover Fits above six trays	6- 4.6 lbs
STANDARD WEIGHT (22 Ga.)		
E12102	12 3/4 x 10 3/8 x 2 1/2	6-8.8 lbs
E12104	12 3/4 x 10 3/8 x 4	6- 12.4 lbs
E12106	12 3/4 x 10 3/8 x 6	6-14.8 lbs
HEAVY WEIGHT (20 Ga.)		
S12102	12 1/4 x 10 3/8 x 2 1/2	6-10.4 lbs
S12104	12 3/4 x 10 3/8 x 4	6-14.5 lbs
S12106	12 3/4 x 10 3/8 x 6	6-17.3 lbs
I311-2	Cover Fits above six trays	6-8.0 lbs
STANDARD WEIGHT (22 Ga.)		
E20122	20 3/4 x 12 3/4 x 2 1/2	6-17.0 lbs
E20124	20 3/4 x 12 3/4 x 4	6-23.3 lbs



20-10

800.322.4674 or 800.633.7283

www.msiprecision.com

C. P M P SERIES-PERFORATED INSTRUMENT TRAYS

Constructed of heavy-duty 301 8-8 stainless steel, PMP perforated instrument trays are finished to provide a tough, clean and corrosion-resistant surface for long term use in a variety of applications.

PART #	DIMENSIONS (IN.)	CASE LOT/WT.
PERFORATED MAYO TRAY -		
For excellent steam sterilization without moisture build-up.		
10F-PMT	10 x 6 1/2 X 3/4	6-3.5 lbs
13F-PMT	13 11/16 x 9 13/16 x 3/4	6-9.9 lbs
15F-PMT	15 1/8 x 10 5/8 x 3/4	6-10.0 lbs
17F-PMT	17 x 11 5/8 x 3/4	6-12.5lbs
19F-PMT	19 1/8 x 12% x 3/4	6-14.5 lbs
1520-PMT	21 1/4 x 16 1/4 x 7/8	6-22.8 lbs

HIGH-SIDED PERFORATED TRAYS -

High sides protect fragile instruments during set-up and procedures.

952-HPT	8 7/8 x 5 x 2	12-7.3 lbs
1002-HPT	10 x 6 1/2 x 2	12-10.3 lbs
1202-HPT	12 1/4 x 7 3/4 x 2 1/4	12-16.0 lbs
S12102-HPT	12 3/4 x 10 3/8 x 2 1/2	6-10.4 lbs
E1650-HPT	12 1/2 x 10 x 2 1/2	6-12.5 lbs
S20122-HPT	20 3/4 x 12 3/4 x 2 1/2	6-20.3 lbs

FLASH PANS -

End handles allow for safe, easy and secure removal from autoclave.

952-FPP	8 7/8 x 5 x 2	12- 7.3 lbs
1002-FPP	10 x 6 1/2 x 2	12- 10.3 lbs



D. CATHETER TRAYS AND DOME COVERS

Heavy duty and seamless, these trays feature dome covers with strap handles for easy handling.

ORDER SETS BY COMPONENT PARTS.

PART #	DIMENSIONS (IN.)	CASE LOT/WT.
83	8 3/4 x 3 1/4 x 1 1/2	24-90 lbs
83-2	Cover for 83 Tray	30-8.3 lbs
170	17 1/4 x 4 1/2 x 2	12-15.0 lbs
170-2	Cover for 170 Tray	12-10.3 lbs.
9528	7/8 x 5 x 2	12-7.3 lbs
953	8 7/8 x 5 x 3	12-86 lbs
952D-2	Cover for 952 and 953 Trays	12-7.0 lbs



E. STERILIZATION TRAYS / BATH SETS (HOT / COLD)

Tray units can be used for either hot or cold sterilization. Covers feature recessed strap handle for ease and safety in transporting, handling and storing.

ORDER SETS BY COMPONENT PARTS.

PART #	DESCRIPTION	DIMENSIONS (IN.)	CASE LOT/WT.LIST
E20124	Solid Tray	20 3/4 x 12 3/4 x 4	6-23.3 lbs
P20122	Perforated Tray	20 3/4 x 12 3/4 x 2 1/2	6-15.4 lbs
2000-2	Flat, Solid Cover		6-15.4 lbs
E20126	Solid Tray	20 3/4 x 12 3/4 x 6	6-27.7 lbs



Stainless Steelware

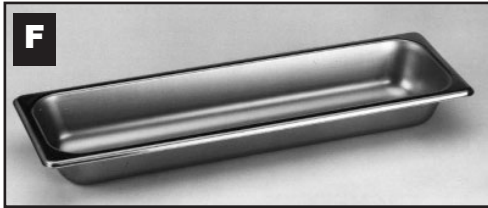

F. STERILIZATION TRAYS (HOT/COLD)

Tray units can be used for either hot or cold sterilization. Covers feature recessed strap handle for ease and safety in transporting, handling and storing.

ORDER SETS BY COMPONENT PARTS.

PART #	CAPACITY	DIMENSIONS (In.)	CASE LOT/WT.
E20062	4 Qt	20 3/4 x 6 3/8 x 2 1/2	6-9.9 lbs
E20064	6 Qt	20 3/4 x 6 3/8 x 4	6-12.4 lbs
E20066	9 Qt	20 3/4 x 6 3/8 x 6	6-16.5 lbs
2006-2	Flat, Solid Cover-Fits all above pans		6-8.2 lbs



G. OBLONG INSTRUMENT DRYING TRAYS

The user of these trays benefits from covered corners and large, open beads which allow for easy handling, stacking and cleaning.

PART # / DESCRIPTION	DIMENSIONS (In.)	CASE LOT/WT.
10F w/Rolled Bead	10 x 6 1/2 x 3/4	6-3.5 lbs
13F w/Rolled Bead	13 11/16 x 9 13/16 x 3/4	6-9.9 lbs
1SF w/Rolled Bead	15 1/8 x 10 5/8 x 1/4	6-10.0 lbs
17F w/Rolled Bead	17 x 11 5/8 x 3/4	6-12.5 lbs
19F w/Rolled Bead	19 1/8 x 12 5/8 x 3/4	6-14.5 lbs
1520 w/Rolled Bead	21 1/4 x 16 1/4 x 7/8	6-22.8 lbs
1525 w/Flat Flange	25 x 15 x 5/8	6-24.5 lbs
E12101	12 3/4 x 10 3/8 x 1 1/4	6-6.9 lbs
E20121	20 3/4 x 12 3/4 x 11/4	6-14.9 lbs



H. PERFORATED INSTRUMENT TRAYS

1/4" diameter holes in tray bottom and sides enhance sterilizing liquid flow Tray edges are rounded to aid in handling.

PART #	DIMENSIONS (In.)	CASE LOT/WT.
P20121	20 3/4 x 12 3/4 x 1 1/4	6-13.8 lbs
P20122	20 3/4 x 1 12 3/4 x 21/2	6-15.4 lbs
P20124	20 3/4 x 12 3/4 x 4	6-16.8 lbs
P20126	20 3/4 x 12 3/4 x 6	6-17.4 lbs
P12101	12 3/4 x 10 3/8 x 1 1/4	6-6.8 lbs
P12102	12 3/4 x 10 3/8 x 2 1/2	6-8.5 lbs
P12104	12 3/4 x 10 3/8 x 4	6-10.7 lbs
P12106	12 3/4 x 10 3/8 x 6	6-14.2 lbs



I-J. INSTRUMENT TRAYS WITHOUT COVERS

All trays feature flat bottoms, open beads and covered corners.

PART #	DIMENSIONS (IN.)	CASE LOT/WT.
I. WITH ROLLED BEAD		
1302	13 7/8 x 9 7/8 x 2 1/4	6-11.9 lbs



K. MESH BOTTOM STERILIZATION TRAYS

The new sterilization trays feature a strong, 18-8 stainless steel mesh bottom with 1/8" perforations to protect delicate instrument tips while providing excellent steam permeation without condensation build up. The mesh bottom is offset from the tray by four strong, impact resistant, smooth perforated round ball feet to enhance drainage and drying. Extra sanitary, retractable handles set on top of tray bead promote easy grasping and lifting as well as conserve on space.

PART #	DIMENSIONS (IN.)	CASE LOT/WT.
E20124-IST	20 3/4 x 12 3/4 x 4	6-23.3 lbs
E12104-IST	12 1/4 x 10 3/8 x 4	6-12.4 lbs
E1654-IST	16 1/2 x 10 x 4	4-9.7 lbs

- **Constructed from 18-8 stainless steel for extra strength and durability**
- **Nesting feature for compact storage when not in use**
- **Retractable handles for easy grasping and space conservation**

L. PERFORATED CLEANING BASKETS

This new line of cleaning baskets boasts 74 holes on bottom and sides to provide excellent penetration of cleaning solutions, Easy-to-clean retractable handles are set on top of basket to promote safe, easy handling. The bottom is offset from the surface by four feet to enhance draining and drying.

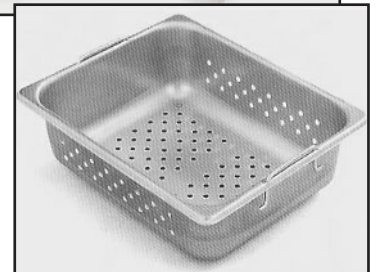
**K****L**

Stainless Steelware

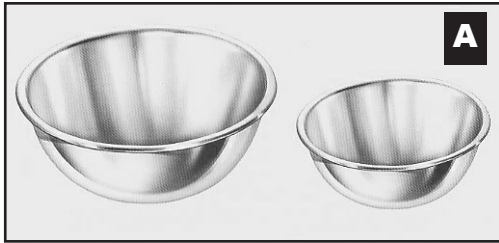

A. MIXING/SOLUTION BOWLS

Tapered sides and rounded bead design make these basins ideal for storing and pouring.

PART #	CAPACITY	DIMENSIONS (IN.)	CASE LOT/WT.
12A	7/8 Qt	6 5/8 x 2 1/2	12-5.3 lbs
18A	5/8 Qt	8 1/8 x 3	12-7.2 lbs
22A	3 Qt	9 3/4 x 4	12-10.8 lbs
26A	5 Qt	11 7/8 x 4 1/2	12-14.0 lbs
30A	6 3/4 Qt	12 3/4 x 5 1/4	6-9.1 lbs
32A	8 Qt	13 5/16 x 5 7/16	6-10.0 lbs



B. SOLUTION BASINS

Constructed with easy-to-clean large rounded radius corners for easy pouring, and no spin recessed bottom for stability on flat surfaces.

PART #	CAPACITY	DIMENSIONS (IN.)	CASE LOT/WT.
130	4 1/2 Qt.	12 x 4 1/4	12-18.5 lbs
132	6 Qt	12 3/4 x 4 1/4	12-20.8 lbs
134	7 Qt	13 5/8 x 4 5/8	6-12.2 lbs

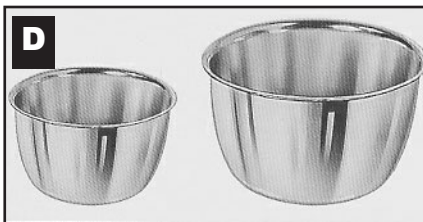

C. PERFORATED SOAKING / STERILIZATION BASIN

PART #	CAPACITY	DIMENSIONS (IN.)	CASE LOT/WT.
137P	7 Qt	13 5/8 x 4 5/8	6-12.0 lbs

Fits inside the 134 solution basin shown above.



D. IODINE CUPS

PART #	CAPACITY	DIMENSIONS (IN.)	CASE LOT/WT.
6G	6 Oz	3 7/16 x 2	24-3.5 lbs
14G	14 Oz	4 3/8 x 2 5/8	24-6.8 lbs

E. SPONGE BOWLS

Flat bottom and straight sides provide for extra stability in use.

PART #	CAPACITY	DIMENSIONS (IN.)	CASE LOT/WT.
52	12 Oz	4 1/4 x 2	12-3.8 lbs
75	22 Oz	5 x 2 3/8	12-5.1 lbs
100	29 Oz	5 9/16 x 2 9/16	12-5.5 lbs
106	36 Oz	6 1/4 x 2 3/4	12-6.7 lbs
107	64 Oz	7 9/16 x 3	12-9.5 lbs



F. APPLICATOR JAR WITH SLIP-OVER COVER

PART #	CAPACITY	DIMENSIONS (IN.)	CASE LOT/WT.
257	28 Oz.	3 1/8 x 7	12-8.3 lbs



H. DRESSING JARS WITH SLIP-OVER COVERS

Vessels feature easy-to-clean seamless design with recessed lid handles.

PART #	CAPACITY	DIMENSIONS (IN.)	CASE LOT/WT.
0J	1/2 Qt	4 1/8 x 2 1/4	12-7.3 lbs
1J	1 1/4 Qt	4 7/8 x 6 1/4	12-14.9 lbs
3J	3 Qt	5 7/8 x 6 3/4	12- 21.3 lbs
4J	4 3/4 Qt	6 3/4 x 7 3/4	12-27.8 lbs
6J	6 Qt	7 1/4 x 8 3/8	6-16.6 lbs
8J	8 Qt	8 x 9 3/8	6-19.4 lbs



I. OINTMENT JARS WITH SLIP-OVER COVERS

PART # / DESCRIPTION	CAPACITY	DIMENSIONS (IN)	CASE
25 w/ Strap Handle Cover	9 Oz	3 1/2 x 2 3/4	12-4.3 lbs
25P w/ Plain Cover	9 Oz	3 1/8 x 2 3/4	12-4.0 lbs



J. MEDICINE CUP GRADUATED

PART #	CAPACITY	DIMENSIONS (IN.)	CASE LOT/WT.
2	2 Oz	2 1/8 x 2	12-1.1 lbs



K. FORCEPS JARS

PART #	DIMENSIONS (IN.)	BASE DIAMETER	CASE LOT/WT.
T0014K	1 x 4	2 7/16"	12- 3.0 lbs
32K	2 1/4 x 4 1/2	3 5/8"	12- 11.0 lbs
72K	2 1/4 x 7	3 11/16"	12- 13.0 lb

L. GRADUATED MEASURES

Graduated in ounces and cc's, measures have easy grip handles and large, smooth pouring spouts.

PART #	CAPACITY	DIMENSIONS (IN.)	CASE LOT/WT.
T1062	16 Oz	3 3/4 x 4 5/8	12-6.0 lbs
T1063	32 Oz	4 3/4 x 5 1/4	12-8.4 lbs
T1064	64 Oz	5 1/2 x 6 1/2	12-12.0 lbs



M. HOSPITAL BUCKETS AND COVER

Pails are tapered, and ears for handles are an integral part of pail, resisting break off and allowing for easy cleaning.

PART #	CAPACITY	DIMENSIONS (IN.)	CASE LOT/WT.
12N	13 Qt	11 5/8 x 9 1/4	3-9.0 lbs
16N	16 Qt	11 3/4 x 10 1/8	3-11.0 lbs
12N	2 Solid Cover-Fits Both Pails		3-3.8 lbs

SEE PAGE 2 FOR PHOTO OF COVER



Stainless Steelware



A

A. EWESIS BASINS

PART #	CAPACITY	DIMENSIONS (IN.)	CASE LOT/WT.(EA.)
6	10 Oz	6 5/8 x 3 1/2 x 1 1/2	12-3.3 lbs
8	12 Oz	8 1/8 x 3 5/8 x 1 5/8	12-4.3 lbs
10	26 Oz	9 7/8 x 4 1/2 x 2 1/8	12-6.9 lbs
12	48 Oz	12 x 5 1/2 x 2 3/8	12-11.0 lbs

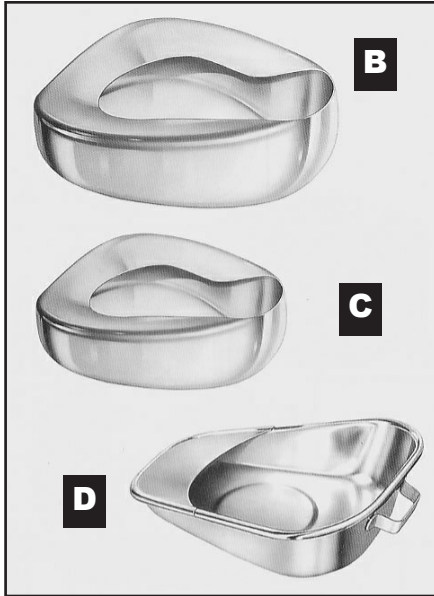

B

C

D

B-D. BEDPANS

PART #	DIMENSIONS (IN.)	CASE LOT/WT.
B. ADULT		
T0015R	13 3/4 x 11 1/2 x 4	6-85 lbs
C. CHILD		
T0000R	12 1/8 x 9 3/4 x 3	6-14.4 lbs
C. FRACTURE		
T0023R	11 7/8 x 9 1/2 x 2 7/8	6-9.5 lbs
T0023R IS MADE TO ORDER		

E-F. MALE URINALS

Heavy urinals available in two styles for use in any application.



E

F

PART #	CAPACITY	DIMENSIONS (IN.)	CASE LOT/WT.
E. HORIZONTAL AND VERTICAL			
T5G	1 3/4 Qt	4 1/2 x 9 1/8	6-84 lbs
F. VERTICAL ONLY			
11G	1 1/2 Qt	4 1/2 x 9 1/8	16-21.5 lbs

BOTH STYLES ARE MADE TO ORDER

G. THERMOMETER JAR

PART #	DIMENSIONS (IN.)	BASE DIAMETER	CASE LOT/WT.
T0014K	1 x 4	2 7/16"	12-3.0 lbs

H. MEDICINE CUP - GRADUATED

PART #	CAPACITY	DIMENSIONS (IN.)	CASE LOT/WT.(EA.)
2	2 Oz	2 1/8 x 2	12- 1.1 lbs

G

H



20-16

800.322.4674 or 800.633.7283

www.msiprecision.com

Stainless Steelware

I. WASH BASINS

PART #	CAPACITY	DIMENSIONS (In.)	CASE LOT/WT.
30	4 Qt	12 3/8 x 3 3/4	12-16.7 lbs
32	4 7/8 Qt	13 1/8 x 3 1/2	12-18.5 lbs



J. SOAP DISH

PART #	DIMENSIONS (IN.)	CASE LOT/WT.
80	5 1/2 x 4 1/8 x 1 1/8	24-5.3 lbs



K. BEDSIDE TRAYS

PART # /	DESCRIPTION	DIMENSIONS (IN.)	CASE LOT/WT.
10F	w/Rolled Bead	10 x 6 1/2 x 3/4	6-3.5 lbs
13F	w/Rolled Bead	13 11/16 x 9 13/16 x 3/4	6-9.9 lbs

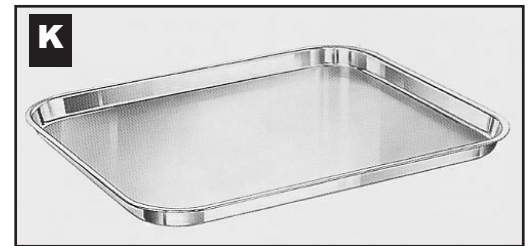

L. STRAIGHT SIDED PITCHERS

PART #	CAPACITY	DIMENSIONS (IN.)	CASE LOT/WT.
2W	2 Qt	5 1/6 x 6 5/8	4-5.0 lbs
3W	3 Qt	6 1/15 x 7	4-6.3 lbs



M. TUMBLERS

PART#	CAPACITY	DIMENSIONS (IN.)	CASE LOT/WT.
T2107	7 Oz	278 x 3 1/8	12-2.5 lbs
T2112	12 Oz	3 3/16 x 4	12-3.4lbs



N. MENU HOLDER

PART #	DESCRIPTION	DIMENSIONS (IN.)	CASE LOT/WT.
T1002	Clip-type	2 1/4 x 1 3/4	12-0.6 lbs



800.322.4674 or 800.633.7283

www.msiprecision.com

20-17



Instrument Trays



MINI TRAYS - 1300 Series

Part No.	Description	Approx. Size (MM)	Approx. Size (IN.)
P0278	Mini Tray - Base, Lid, & Mat	3.8 x 6.8 x 1.9	1.5 x 2.7 x 0.75
P027815	Mini Tray - Base & Lid	3.8 x 6.8 x 1.9	1.5 x 2.7 x 0.75
P027810	Mini Tray - Base (deep), Lid, & Mat	3.8 x 6.8 x 2.5	1.5 x 2.7 x 1.0
P02781015	Mini Tray - Base (deep) & Lid	3.8 x 6.8 x 2.5	1.5 x 2.7 x 1.0
P0278125	Mini Tray - Base (deep), Lid, & Mat	3.8 x 6.8 x 3.2	1.5 x 2.7 x 1.25
P27812515	Mini Tray - Base (deep) & Lid	3.8 x 6.8 x 3.2	1.5 x 2.7 x 1.25
A027811	Base Only	3.8 x 6.8 x 1.9	1.5 x 2.7 x 0.75
A02781011	Base Only (deep)	3.8 x 6.8 x 2.5	1.5 x 2.7 x 1.0
A27812511	Base Only (deep)	3.8 x 6.8 x 3.2	1.5 x 2.7 x 1.25
A027812	Lid for 1300 Series Base	3.8 x 6.8	1.5 x 2.7
A027813	Mat, Silicone for 1300 Series Base	3.8 x 6.8	1.5 x 2.7

Large Microsurgical Instrument Trays - 1500 Series

P101510	Instrument Tray - Base, Lid, & Mat	25.4 x 38.1 x 1.9	10 x 15 x 0.75
A10151011	Base for 1500	25.4 x 38.1 x 1.9	10 x 15 x 0.75
A101512	Lid for 1500 & 1520	25.4 x 38.1	10 x 15
A101513	Mat, Silicone for 1500 & 1520 Base	25.4 x 38.1	10 x 15
P10151015	Instrument Tray - Base & Lid	25.4 x 38.1 x 1.9	10 x 15 x 0.75
P101525	Instrument Tray - Base, Insert Tray, Lid, & 2 mats	25.4 x 38.1 x 3.8	10 x 15 x 1.5
A10152511	Base for 1520 (deep)	25.4 x 38.1 x 3.8	10 x 15 x 1.5
A101514	Insert Tray for 1520	25.4 x 38.1	10 x 15
A101515	Mat, Silicone for 1520I Insert Tray	25.4 x 38.1	10 x 15
P10152515	Instrument Tray - Base (deep) & Lid	25.4 x 38.1 x 3.8	10 x 15 x 1.5
P1015251	Instrument Tray - Base (deep), Lid, & Mat	25.4 x 38.1 x 3.8	10 x 15 x 1.5
P1015252	Instrument Tray - Base, Insert Tray, Lid, & 1 Base Mat	25.4 x 38.1 x 3.8	10 x 15 x 1.5
P1015254	Instrument Tray - Base, Insert Tray, Lid, & 1 Insert Mat	25.4 x 38.1 x 3.8	10 x 15 x 1.5
P75415P	Phaco Tray - Base, Lid, & 2 Bars / 1 slot	10.1 x 19 x 3.8	4.0 x 7.5 x 1.5
P75415P3	Phaco Tray - Base, Lid, & 2 Bars / 3 Slot	10.1 x 19 x 3.8	4.0 x 7.5 x 1.5
P100615P	Phaco Tray - Base, Lid, & 2 Bars / 1 Slot	15.2 x 25.4 x 3.8	6.0 x 10 x 1.5
P100615P3	Phaco Tray - Base, Lid, & 2 Bars / 3 Slot	15.2 x 25.4 x 3.8	6.0 x 10 x 1.5

DIAMOND KNIFE TRAYS - 2500 Series

P0625K1	Knife Tray, 1 Slot - Base, Lid, & 2 Bars	6.4 x 15.2 x 1.9	2.5 x 6.0 x 0.75
P0625K2	Knife Tray, 2 Slot - Base, Lid, & 2 Bars	6.4 x 15.2 x 1.9	2.5 x 6.0 x 0.75
P0625K3	Knife Tray, 3 Slot - Base, Lid, & 2 Bars	6.4 x 15.2 x 1.9	2.5 x 6.0 x 0.75
P0625K5	Knife Tray, 5 Slot - Base, Lid, & Bars	10.2 x 16.2 x 1.9	4.0 x 6.5 x 0.75
P7525K1	Knife Tray, 1 Slot - Base, Lid, & 2 Bars	6.3 x 19 x 1.9	2.5 x 7.5 x 0.75
P7525K2	Knife Tray, 2 Slot - Base, Lid, & 2 Bars	6.3 x 19 x 1.9	2.5 x 7.5 x 0.75
P7525K3	Knife Tray, 3 Slot - Base, Lid, & 2 Bars	6.3 x 19 x 1.9	2.5 x 7.5 x 0.75



MICROSURGICAL INSTRUMENT TRAYS - 2600 Series

P0625	Micro Tray - Base, Lid, & Mat	6.4 x 15.2 x 1.9	2.5 x 6.0 x 0.75
P062515	Micro Tray - Base & Lid	6.4 x 15.2 x 1.9	2.5 x 6.0 x 0.75
P0625125	Micro Tray - Base, Lid, & Mat	6.4 x 15.2 x 3.2	2.5 x 6.0 x 1.25
P62512515	Micro Tray - Base & Lid	6.4 x 15.2 x 3.2	2.5 x 6.0 x 1.25
A062511	Base for 2500 & 2600 Series	6.4 x 15.2 x 1.9	2.5 x 6.0 x 0.75
A62512511	Base for 2610	6.4 x 15.2 x 3.2	2.5 x 6.0 x 1.25
A062512	Lid for 2500 & 2600 Series	6.4 x 15.2	2.5 x 6.0
A062513	Mat, Silicone for 2500 & 2600 Series	6.4 x 15.2	2.5 x 6.0

MICROSURGICAL INSTRUMENT TRAYS - 2700 Series

P7525	Micro Tray - Base, Lid, & Mat	6.3 x 19 x 1.9	2.5 x 7.5 x 0.75
P752515	Micro Tray - Base & Lid	6.3 x 19 x 1.9	2.5 x 7.5 x 0.75
A752511	Base for 2700	6.3 x 19 x 1.9	2.5 x 7.5 x 0.75
A752512	Lid for 2700	6.3 x 19	2.5 x 7.5
A752513	Mat, Silicone for 2700	6.3 x 19	2.5 x 7.5

MICROSURGICAL INSTRUMENT TRAYS - 4600 Series

P6540	Micro Tray - Base, Lid, & Mat	10.2 x 16.2 x 1.9	4.0 x 6.5 x 0.75
A654011	Base for 4600	10.2 x 16.2 x 1.9	4.0 x 6.5 x 0.75
A654012	Lid for 4600	10.2 x 16.2	4.0 x 6.5
A654013	Mat, Silicone for 4600	10.2 x 16.2	4.0 x 6.5
P654015	Micro Tray - Base & Lid	10.2 x 16.2 x 1.9	4.0 x 6.5

MICROSURGICAL INSTRUMENT TRAYS - 4700 Series

P7540	Micro Tray - Base, Lid, & Mat	10.1 x 19 x 1.9	4.0 x 7.5 x 0.75
P754015	Micro Tray - Base & Lid	10.1 x 19 x 1.9	4.0 x 7.5 x 0.75
P75415	Micro Tray - Base, Lid, & Mat	10.1 x 19 x 3.8	4.0 x 7.5 x 1.5
P7541515	Micro Tray - Base & Lid	10.1 x 19 x 3.8	4.0 x 7.5 x 1.5
A754011	Base for 4700	10.1 x 19 x 1.9	4.0 x 7.5 x 0.75
A7541511	Base for 4710	10.1 x 19 x 3.8	4.0 x 7.5 x 1.5
A754012	Lid for 4700 & 4710	10.1 x 19	4.0 x 7.5
A754013	Mat, Silicone for 4700B & 4710B	10.1 x 19	4.0 x 7.5

MICROSURGICAL INSTRUMENT TRAYS - 6100 Series

P100675	Micro Tray - Base, Lid, & Mat	15.2 x 25.4 x 1.9	6.0 x 10 x 0.75
A100611	Base for 6100	15.2 x 25.4 x 1.9	6.0 x 10 x 0.75
A100612	Lid for 6100 & 6120	15.2 x 25.4	6.0 x 10
A100613	Mat, Silicone for 6100 Base	15.2 x 25.4	6.0 x 10
P100614	Micro Tray - Base & Lid	15.2 x 25.4 x 1.9	6.0 x 10 x 0.75
P1006153	Micro Tray - Base, Insert Tray, Lid, & 2 mats	15.2 x 25.4 x 3.8	6.0 x 10 x 1.5
A100610	Base (deep) for 6120	15.2 x 25.4 x 3.8	6.0 x 10 x 1.5
A100614	Insert Tray for 6120	15.2 x 25.4	6.0 x 10
A100615	Mat, Silicone for Insert Tray 6120	15.2 x 25.4	6.0 x 10
P100615	Micro Tray - Base (deep) & Lid	15.2 x 25.4 x 3.8	6.0 x 10 x 1.5
P1006152	Micro Tray - Base, Insert Tray, Lid, & 1 Mat for Base	15.2 x 25.4 x 3.8	6.0 x 10 x 1.5
P1006154	Micro Tray - Base, Lid, Insert Tray & 1 Mat for Insert	15.2 x 25.4 x 3.8	6.0 x 10 x 1.5
P1006151	Micro Tray - Base (deep), Lid, & Mat	15.2 x 25.4 x 3.8	6.0 x 10 x 1.5
P100616	Micro Tray - Base, Lid, & Insert Tray	15.2 x 25.4 x 3.8	6.0 x 10 x 1.5

SCOPE TRAYS - 6500 Series

P261615	Scope Tray - Base, Lid, & 2 Bars	6.6 x 40.6 x 3.8	2.6 x 16 x 1.5
A261611	Base for 6510	6.6 x 40.6 x 3.8	2.6 x 16 x 1.5
A261612	Lid for 6510	6.6 x 40.6	2.6 x 16
A261613	Mat, Silicone for 6510	6.6 x 40.6	2.6 x 16
P26161515	Scope Tray - Base & Lid	6.6 x 40.6 x 3.8	2.6 x 16 x 1.5
P261615M	Scope Tray -Base, Lid, & Mat	6.6 x 40.6 x 3.8	2.6 x 16 x 1.5
New	Scope Tray-Base,Lid & Bars	7.6 X 55.9 X 3.8	3.0 x 22 x 1.5
New	Scope Tray - Base & Lid	7.6 X 55.9 X 3.8	3.0 x 22 x 1.5
P651815	Scope Tray - Base, Lid, & Bars	16.5 x 45.7 x 3.8	6.5 x 18 x 1.5
A65181511	Base for 6550	16.5 x 45.7 x 3.8	6.5 x 18 x 1.5
A651812	Lid for 6550 & 6560	16.5 x 45.7	6.5 x 18
A651813	Mat, Silicone for Base 6550B	16.5 x 45.7	6.5 x 18
P65181515	Scope Tray - Base & Lid	16.5 x 45.7 x 3.8	6.5 x 18 x 1.5
P651815M	Scope Tray - Base, Lid, & Mat	16.5 x 45.7 x 3.8	6.5 x 18 x 1.5
P651830	Scope Tray - Base, Lid, & Bars	16.5 x 45.7 x 7.6	6.5 x 18 x 3.0
A65183011	Base (deep)	16.5 x 45.7 x 7.6	6.5 x 18 x 3.0
A65183013	Mat, Silicone for Base 6560B	16.5 x 45.7	6.5 x 18
P65183015	Scope Tray - Base & Lid	16.5 x 45.7 x 7.6	6.5 x 18 x 3.0
P651830M	Scope Tray - Base, Lid, & Mat	16.5 x 45.7 x 7.6	6.5 x 18 x 3.0

800.322.4674 or 800.633.7283

www.msiprecision.com

20-19



Case and Tray Solutions

Endoscopic Solutions

A. Camera case with brackets

Part No.: 30109 Approx Size: 9x10x3

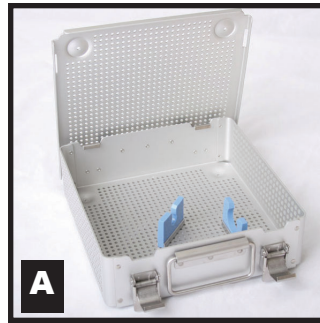

B. Light cord case

Part No.: 30109-125 Approx Size: 9x9x1.5

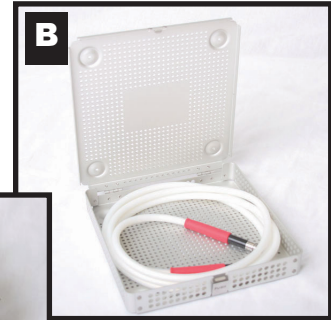

C. Scope case 11" without brackets

Part No.: 30111 Approx Size: 3x11x2.5

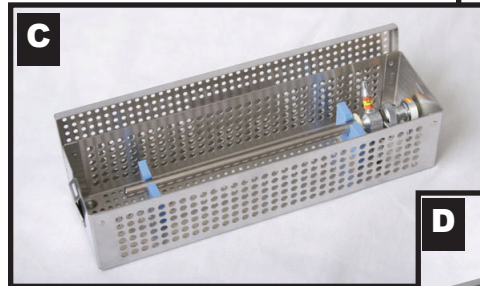

D. Scope case 18" without brackets

Part No.: 30118 Approx Size: 3x18x2.5

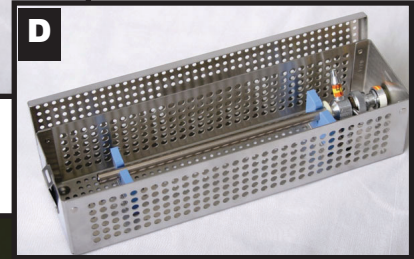

E. Scope case two level with brackets, camera & light cord compartments

Part No.: 30320 Approx Size: 9x20.5x3.5

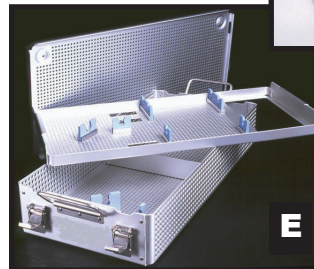

F. Scope case two level without brackets and dividers

Part No.: 30320-OPT Approx Size: 9x20.5x.05

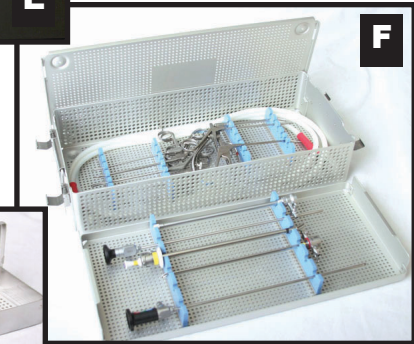

G. Scope case for 2-4 scopes with brackets

Part No.: 30418 Approx Size: 4x18x1.5

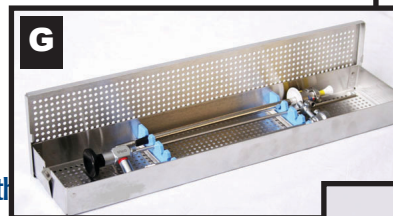

H. Lap chole case with insert and brackets shown with base for additional instrument storage, for up to 65 cm or 26" instruments

Part No.: 51527 Approx Size: 11x27x8

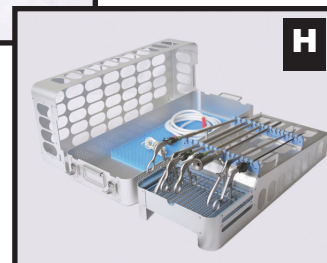

20-20

800.322.4674 or 800.633.7283

www.msiprecision.com

Bariatric Solutions

A. Scope case for single Bariatric scope with brackets

Part No.: 30126 Approx Size: 3.5x26x3.5

B. Scope case for up to five scopes and or instruments

Part No.: 30630 Approx Size: 6x30x3

C. Lap chole case with insert and brackets shown with optional pin mat in the base for additional instrument storage, for up to 65 cm or 26" instruments

Part No.: 51527 Approx Size: 11x27x8

Rongeur Forcep Solutions

A. Forcep case for up to 8 Rongeurs designed for size 4&5 sized handles with handle guide

Part No.: 30812 Approx Size: 10x12x6

B. Forcep case for up to 16 arthroscopic and or sinus forceps interlacing 8 forceps in one direction and eight in the other

Part No.: 31615 Approx Size: 9x14x5

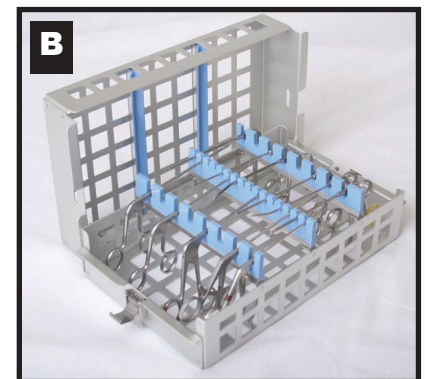
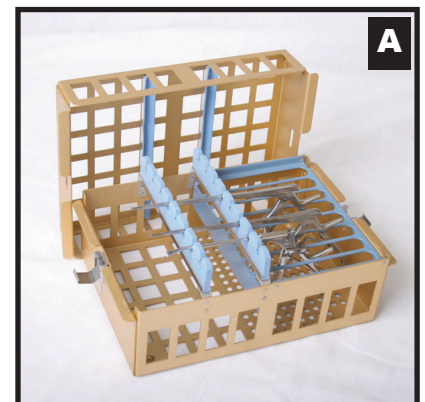
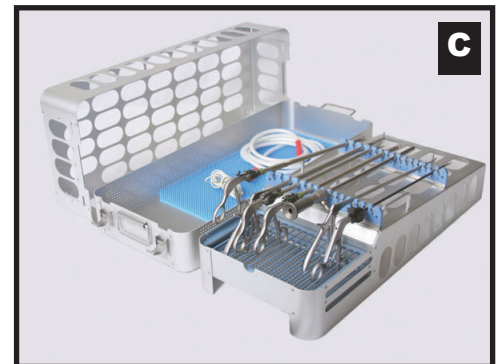
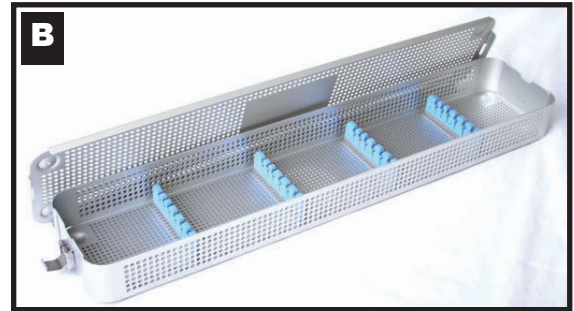

Case and Tray Solutions

Lab chole Instrument Solutions

A. Lap chole 14 instrument insert, 8" A-type container

Part No.: 31420-0800 Approx Size: 10x20x6

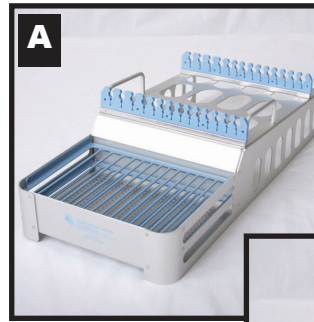

B. Lap chole 14 instrument insert special assembly for

Part No.: 31420-8A Approx Size: 10x20x6

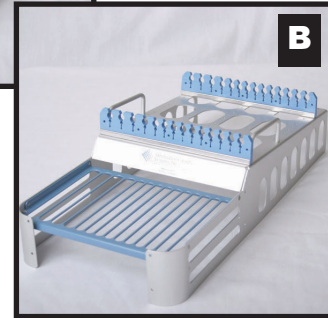

C. Lap chole case with insert, brackets and or pin mat may be added to the base for additional instrument storage, for 35cm or 13.5" instruments

Part No.: 51523 Approx Size: 11x23x8

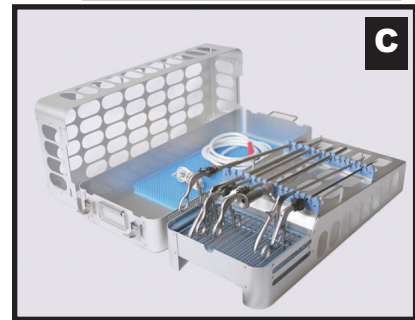

D. Lap chole case with insert and brackets shown with optional pin mat in the base for additional instrument storage, for up to 65 cm or 26" instruments.

Part No.: 51527 Approx Size: 11x27x8

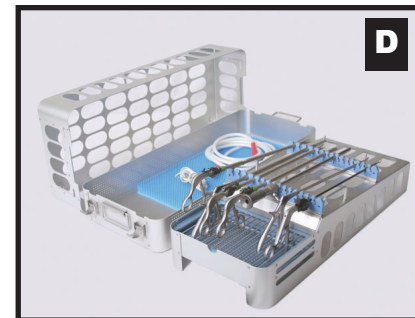

Osteotome Solutions

Osteotome case for curved and straight Lambotts

Part No.: SP-3014 Approx Size: 9x11x3



Microsurgical Instrument Solutions

A. Microsurgical case two level with pin mat and retainers

Part No.: 31010 Approx Size: 10x10x3

B. Microsurgical case single level with pin mat and retainers

Part No.: 31010-0 Approx Size: 10x10x1.5

C. Microsurgical case single level with pin mat and retainers

Part No.: 31015-0 Approx Size: 10x15x1.5

D. Microsurgical case two level with pin mat and retainers with long tray and half height accessory area

Part No.: 31015-L Approx Size: 10x15x3

E. Microsurgical case two level with pin mat and retainers with short tray and full height accessory area

Part No.: 31015-S Approx Size: 10x15x3

F. Microsurgical case two level with pin mat and retainers with long tray and half height accessory area

Part No.: 31020-L Approx Size: 10x20x3.5

G. Microsurgical case two level with pin mat and retainers with short tray and full height accessory area

Part No.: 31020-S Approx Size: 10x20x3.5

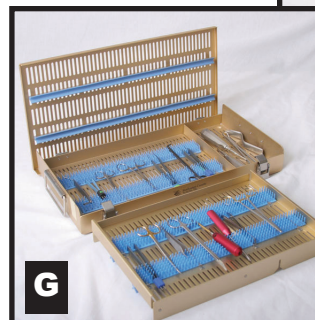
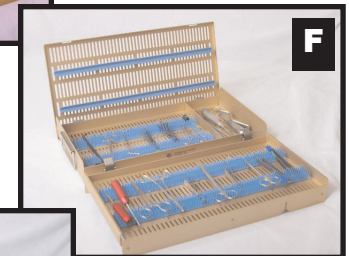
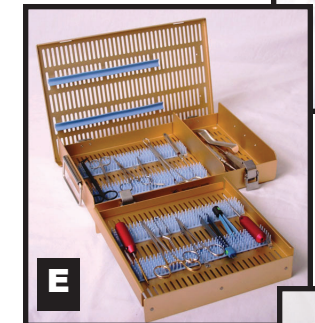
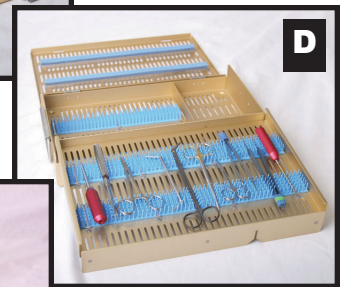
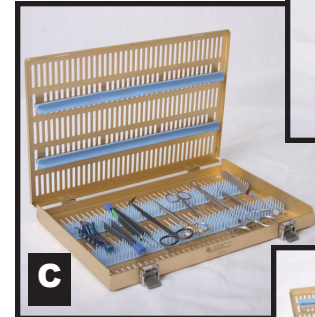
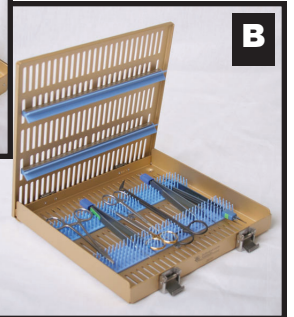
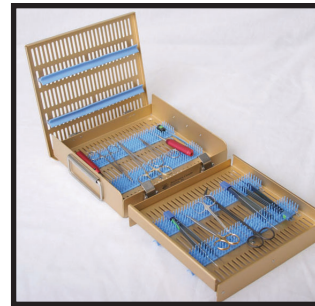

Case and Tray Solutions

General Surgical Instrument Solutions

A. Surgical utility case

Part No.: 30011 Approx Size: 5x10x2

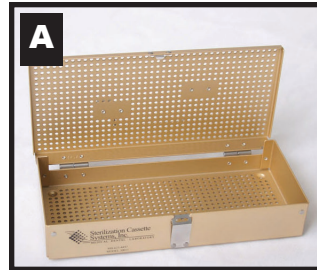

B. Surgical utility case with full pin mat and center lid retainer

Part No.: 30011-PM Approx Size: 5x10x2

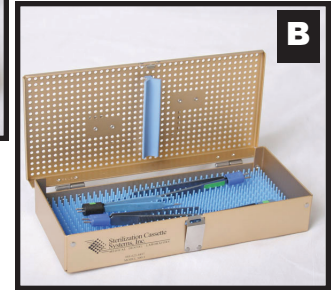

C. Surgical case with lid but without brackets or pin mat

Part No.: 31123 Approx Size: 11x23x3.5



D. Surgical case tray for 31123 or 31123-0500

Part No.: 31123-03 Approx Size: 10.5x21.5x2.25

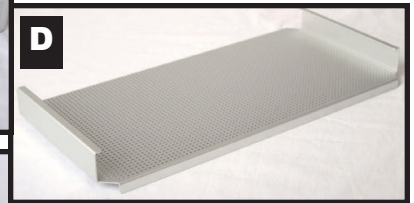

E. Surgical case 5" deep with lid but without brackets or pin mat

Part No.: 31123-0500 Approx Size: 11x23x5



F. Surgical case 5" deep with lid and optional tray / support brackets but without brackets or pin mat

Part No.: 31123-0500-T1 Approx Size:

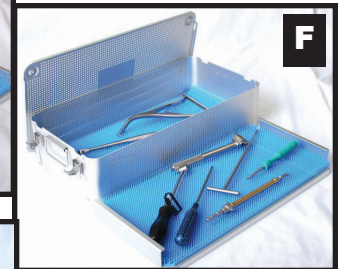

G. Surgical case 5" deep with lid and two optional tray / support brackets but without brackets or pin mat

Part No.: 31123-0500-T2 Approx Size: 11x23x5x5

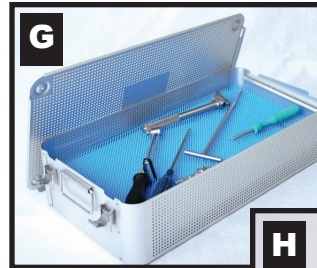

H. Surgical case with lid and optional tray / support brackets but without brackets or pin mat

Part No.: 31123-T Approx Size: 11x23x3.5

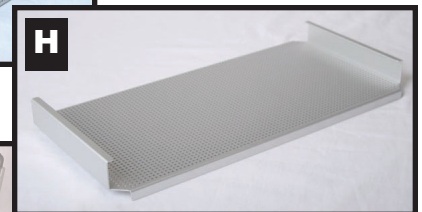

I. Surgical case with lid but without brackets or pin mat

Part No.: 31127 Approx Size: 11x27x3.5

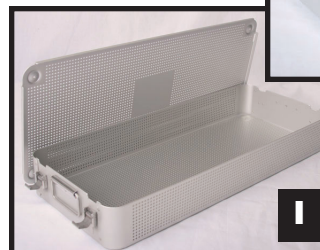

J. Surgical case with lid but without brackets or pin mat

Part No.: 31421 Approx Size: 10x21x2.5

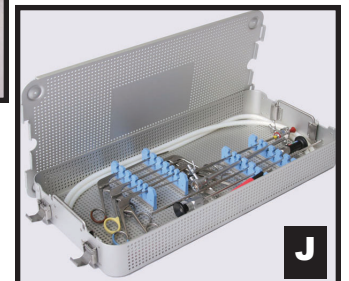

Accessories

A. Keyhole Brackets

Part No.:	SP40300-30	Approx Size:	(2mm) 1.5"
	SP40300-1		(3 mm) 1.5"
	SP40300-31		(4 mm) 1.5"
	SP40300-4		(5 mm) 1.5"
	SP40300-32		(6 mm) 1.5"
	SP40300-5		(7 mm) 1.5"
	SP40300-7		(10 mm) 1.5"
	SP40300-9		(12 mm) 1.5"
	SP40300-11		(13 mm) 1.5"
	SP40300-33		(15 mm) 1.5"
	SP40300-13		(19 mm) 1.5"
	SP40300-15		(22 mm) 1.5"
	SP40300-16		(25 mm) 1.5"
	SP40300-40		(2 mm) 1.5"
	SP40300-2		(3 mm) 1.5"
	SP40300-41		(4 mm) 1.5"
	SP40300-4		(5 mm) 1.5"
	SP40300-6		(7 mm) 1.5"
	SP40300-42		(6 mm) 1.5"
	SP40300-8		(10 mm) 1.5"
	SP40300-10		(12 mm) 1.5"
	SP40300-43		

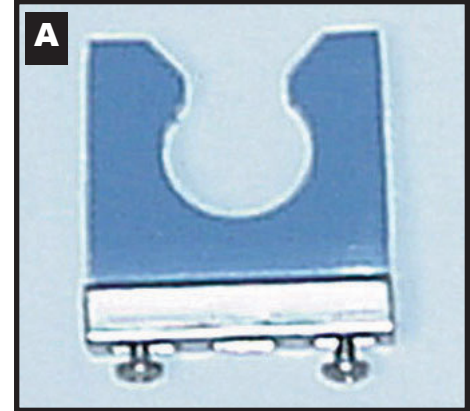

B. Pass Thru Brackets

Part No.	SP40350-1	Approx Size:	(6mm) 1.5"
	SP40350-30		(7mm) 1.5"
	SP40350-31		(9mm) 1.5"
	SP40350-3		(10mm) 1.5"
	SP40350-5		(12mm) 1.5"
	SP40350-32		(13mm) 1.5"
	SP40350-2		(6mm) 1.0"
	SP40350-40		(7mm) 1.0"
	SP40350-41		(9mm) 1.0"
	SP40350-4		(10mm) 1.0"
	SP40350-6		(12mm) 1.0"
	SP40350-42		(13mm) 1.0"

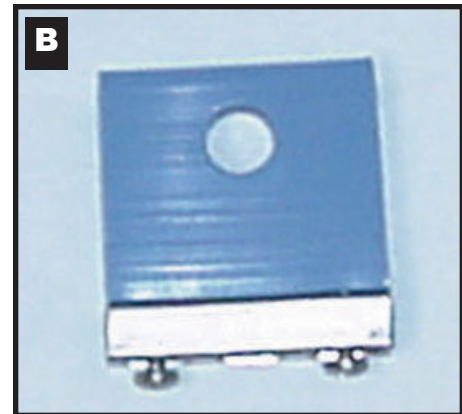

C. Pin Mats

Part No.:	SP40400-1	Approx Size:	1" x 4.5"
	SP40400-2		1" x 9.63"
	SP40400-3		1" x 14.25"
	SP40400-4		1" x 18"
	SP40400-5		1.5" x 4.5"
	SP40400-6		1.5" x 7.13"

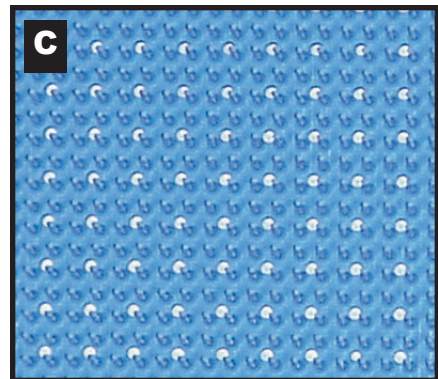

Case and Tray Solutions

Accessories

D. Slotted U Brackets

Part No.:	SP40375-30	Approx Size:	(2mm) 1.5"
	SP40375-1		(3 mm) 1.5"
	SP40375-31		(4mm) 1.5"
	SP40375-3		(5 mm) 1.5"
	SP40375-32		(6mm) 1.5"
	SP40375-5		(7 mm) 1.5"
	SP40375-7		(10 mm) 1.5"
	SP40375-9		(12 mm) 1.5"
	SP40375-40		(2mm) 1.0"
	SP40375-2		(3 mm) 1.0"
	SP40375-41		(4mm) 1.0"
	SP40375-4		(5 mm) 1.0"
	SP40375-42		(6mm) 1.0"
	SP40375-6		(7 mm) 1.0"
	SP40375-8		(10 mm) 1.0"
	SP40375-10		(12 mm) 1.0"

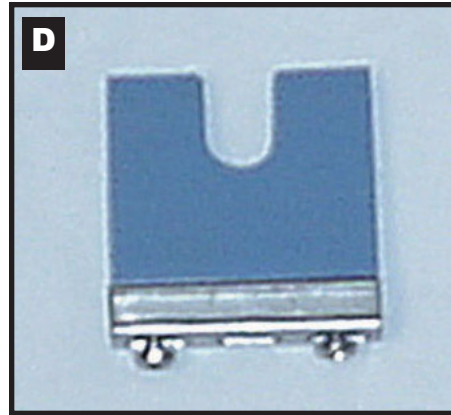

E. Accessory Box

Part No.:	SP21000-H	Approx Size:	
-----------	-----------	--------------	--



F. L Brackets for tray suspension

Part No.:	SPL-SPRT-BRKT	Approx Size:	
-----------	---------------	--------------	--

G. Riser L Brackets

Part No.:	SPRISER-15	Approx Size:	
-----------	------------	--------------	--

H. Universal Brackets

Part No.:	SP30320-S-01	Approx Size:	7.5" long, 10 position
	SP30575		5" long, 6 position
	SP31420-04-ASY		9.25" long, 14 position
	SP31523-SIL-04		10" long, 15 position

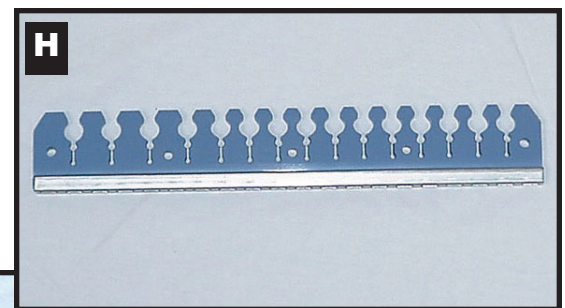

I. V-Silicone Retainers

Part No.:	SP40450-1	Approx Size:	3.38"
	SP40450-2		4.25"
	SP40450-3		8.25"
	SP40450-4		9.50"
	SP40450-5		14.25"
	SP40450-6		18.25"

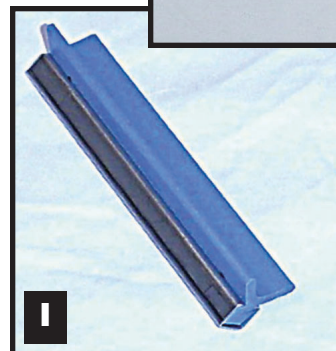

MSI Precision presents the Statim Cassette Autoclaves

The Statim Cassette Autoclave represents state of the art sterilization technology for the healthcare profession. Statim's unique steam injection technology allows the unit to be fast, compact, and reliable, yet remain gentle on expensive instruments. Handpiece manufacturers' testing showed Statim safely sterilized handpieces up to 3000 times without damage. Tests conducted by leading universities in North America and Europe have proven the Statim effectiveness for dental and medical sterilization. Additionally, it is easy to use and maintain. The unique steam injection system expels 98% of the air in the sterilization cassette which helps achieve as close to hospital-level sterilization as possible in an office environment.



Stat-Dri



STAT/M 2000
Complete Cassette



The Best
by
Design

800.322.4674 or 800.633.7283

www.msiprecision.com

20-27



MSI Precision Ophthalmic Sutures

Perform exactly how
you expect them to.
Again. And
Again. And Again.

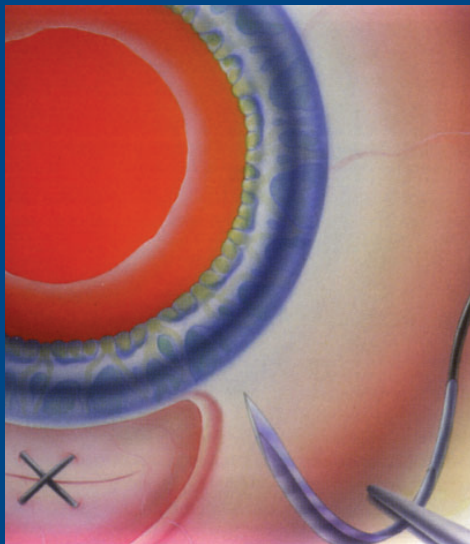

High-Quality, Consistently Sharp Needles

- Extra sharp cutting edges extending from the point to its widest portion reduce tissue drag.
- Precise, smooth penetration through tissue minimizes trauma.
- Needle channel is fitted to specific size of the suture material.

MSI Precision Black Monofilament Nylon

Monofilament Nylon is a polyamid suture with characteristic high tensile strength. The uniform smooth surface permits easy passage through tissue.



MSI Precision Polypropylene

Inert, smooth, and easy to handle and knot securely, MSI Precision Polypropylene is our most versatile monofilament suture. Tensile strength is superior to other true monofilaments. In addition, a unique extruding technique ensures a uniformly round cross section and a strand that passes easily through tissue with better knot security with less throws.



MSI Precision Catgut

Made of first quality raw material, Msi precision Catgut ensures a dependable and predictable absorption and an extremely high tensile strength. every strand is precision polished to a uniform diameter, permitting smooth and secure knotting. Available in plain and chromic.



MSI Precision Black Braided Silk

Noncapillary, serumproof, MSI Precision Silk has excellent handling and tying characteristics. Modern braiding technique provides a uniform smooth surface and greater tensile strength.



Sutures

OPHTHAMLIC NEEDLE CURVATURES

Anterior Segment Surgery Needles: 5, 6, 7, and 8 mil

140 Degree Needle	For half depth placement
175 Degree Needle	For half to two-thirds depth placement
160 Degree Needle	For two-thirds to full depth placement
160 Degree Short Chord Length Needle	For two-thirds to full depth placement Facilitates short bites of tissue
Bicurve Needle	For two-thirds to full depth placement Facilitates short, deep bites of tissue, equidistant from the edges of the incision
Compound Curve Needle	For two-thirds to full depth placement Greatly facilitates short, deep bites of tissue, equidistant from the edges of the incision

NEEDLE CROSS REFERENCE GUIDE OPHTHALMIC SURGERY NEEDLES

MSI PRECISION

SHARPOINT	ALCON	ETHICON
DSL6	CU1, AU1	TG140-6
HSL7	CU2	TG175-8
HSL5	CU5, AU5	TG160-6
BSL5	CU8, AU8	TG6-C
DSL7	C3	TG140-8
DR12	P1	C1
DR12	P5	**
DRT14	PC1	**
DRT14	PC5	**
DSM11	B01	P1
DSM13	B02	P3
DSCM13		PC-1

MSI PRECISION

SHARPOINT	ALCON	ETHICON
VSP8	T1	S14
DS12		C-2
DS13	B02	C3
DSM7	B1	G6
VSL7		TG100-8
BGL5	NU8	CSB-6, CSC-6
DGL6	NU1	CS140-6
HGL5	NU5	CS160-6
CO1	B1	G6
T12a	P5	C1
Y5	PC1	V5
D05	T-1	S-14

If you would like to place an order or require assistance cross-referencing one of our products, please call 800.322.4674 or 800.633.7283



OPHTHALMIC SUTURES

CHROMIC GUT

PRECISION REVERSE CUTTING

Needle	Description	Radius	Chord	Length	Suture Size									
					11-0	10-0	9-0	8-0	7-0	6-0	5-0	4-0		
DSM11	3/8 Circle Curvature 130 Length 11.05 mm	4.75 mm	8.87 mm	12"/30 cm						CA-2699N				
DSM13	3/8 Circle Curvature 155 Length 13.00 mm	4.52 mm	9.30 mm	18"/45 cm						CA-2279N CA-2380N				

PLAIN GUT

PRECISION CONVENTIONAL CUTTING

Needle	Description	Radius	Chord	Length	Suture Size									
					11-0	10-0	9-0	8-0	7-0	6-0	5-0	4-0		
DSCM13	3/8 Circle Curvature 135 Length 13.00 mm	5.51 mm	10.35 mm	18"/45 cm						BA-2711N				

PLAIN GUT

PRECISION REVERSE CUTTING

Needle	Description	Radius	Chord	Length	Suture Size									
					11-0	10-0	9-0	8-0	7-0	6-0	5-0	4-0		
DSM11	3/8 Circle Curvature 130 Length 11.05 mm	4.75 mm	8.87 mm	12"/30 cm						BA-2698N				
DSM13	3/8 Circle Curvature 155 Length 13.00 mm	4.52 mm	9.30 mm	18"/45 cm						BA-2430N BA-2416N				

NYLON BLACK MONO

PRECISION REVERSE CUTTING

Needle	Description	Radius	Chord	Length	Suture Size									
					11-0	10-0	9-0	8-0	7-0	6-0	5-0	4-0		
DSM11	3/8 Circle Curvature 130 Length 11.05 mm	4.75 mm	8.87 mm	18"/45 cm						AA-2316N AA-2175N				
DSM13	3/8 Circle Curvature 155 Length 13.00 mm	4.52 mm	9.30 mm	18"/45 cm						BA-2430N BA-2416N				

Sutures

OPHTHALMIC SUTURES

Needle	Description	Length	Suture Size					
			11-0	10-0	9-0	8-0	7-0	6-0

NYLON BLACK MONO

PRECISION CONVENTIONAL CUTTING

DSCM13	3/8 Circle	Radius 5.51 mm	18"/45 cm							AA-2191N
	Curvature 135	Chord 10.35 mm								
	Length 13.00 mm	Wire .38 mm								

			11-0	10-0	9-0	8-0	7-0	6-0	5-0	4-0
--	--	--	------	------	-----	-----	-----	-----	-----	-----

NYLON BLACK MONO

CENTER POINT SPATULA

2xD05	1/4 Circle	Radius 5.10 mm	18"/45 cm							AA-2684N
	Curvature 90	Chord 6.00 mm								
	Length 8.00 mm	Wire .33 mm								

			11-0	10-0	9-0	8-0	7-0	6-0	5-0	4-0
--	--	--	------	------	-----	-----	-----	-----	-----	-----

NYLON BLACK MONO

SIDE CUTTING LANCET

BSL5	Bicurve	Rad 1.52/2.79 mm	6"/15 cm							AA-2687N
	Curvature 90/50	Chord 3.71 mm								
	Length 4.88 mm	Wire .15 mm								

BSL5	Bicurve	Rad 1.52/2.79 mm	12"/30 cm							AA-2522N
	Curvature 90/50	Chord 3.71 mm								
	Length 4.88 mm	Wire .15 mm								

2xBSL5	Bicurve	Rad 1.52/2.79 mm	8"/20 cm							AA-2524N
	Curvature 90/50	Chord 3.71 mm								
	Length 4.88 mm	Wire .15 mm								

2xBSL5	Bicurve	Rad 1.52/2.79 mm	12"/30 cm							AA-2525N
	Curvature 90/50	Chord 3.71 mm								
	Length 4.88 mm	Wire .15 mm								



OPHTHALMIC SUTURES

Needle	Description	Length	Suture Size							
			11-0	10-0	9-0	8-0	7-0	6-0	5-0	4-0
NYLON BLACK MONO (Continued)										
SIDE CUTTING LANCET										
DSL6	3/8 Circle Curvature 135 Length 6.15 mm	Radius 2.54 mm Chord 4.83 mm Wire .15 mm	6"/15 cm		AA-2683N					
										
DSL6	3/8 Circle Curvature 135 Length 6.15 mm	Radius 2.54 mm Chord 4.83 mm Wire .15 mm	12"/30 cm		AA-2533N					
										
2xDSL6	3/8 Circle Curvature 135 Length 6.15 mm	Radius 2.54 mm Chord 4.83 mm Wire .15 mm	12"/30 cm		AA-2518N					
										
DSL7	3/8 Circle Curvature 130 Length 6.60 mm	Radius 2.79 mm Chord 5.26 mm Wire .20 mm	12"/30 cm		AA-2533N					
										
2xDSL7	3/8 Circle Curvature 130 Length 6.60 mm	Radius 2.79 mm Chord 5.26 mm Wire .20 mm	12"/30 cm		AA-2516N	AA-2517N				
										
HSL5	1/2 Circle Curvature 160 Length 5.51 mm	Radius 2.03 mm Chord 4.07 mm Wire .15 mm	6"/15 cm		AA-2534N	AA-2681N				
										
HSL5	1/2 Circle Curvature 160 Length 5.51 mm	Radius 2.03 mm Chord 4.07 mm Wire .15 mm	12"/30 cm		AA-2510N					
										
2xHSL5	1/2 Circle Curvature 160 Length 5.51 mm	Radius 2.03 mm Chord 4.07 mm Wire .15 mm	6"/15 cm	AA-2520N	AA-2521N					
										
2xHSL5	1/2 Circle Curvature 160 Length 5.51 mm	Radius 2.03 mm Chord 4.07 mm Wire .15 mm	12"/30 cm		AA-0228N	AA-2523N				
										
2xHSL7	1/2 Circle Curvature 175 Length 7.04 mm	Radius 2.29 mm Chord 4.71 mm Wire .15 mm	12"/30 cm		AA-2519N					
										

800.322.4674 or 800.633.7283

www.msiprecision.com

21-5









Sutures

OPHTHALMIC SUTURES

Needle	Description	Length	Suture Size						
			11-0	10-0	9-0	8-0	7-0	6-0	5-0

NYLON BLACK MONO

ULTRA-GLIDE

	2xBGL5 Bicurve	Radius 1.52/2.79 mm	8"/20 cm	AA-2716N
	Curvature 90/50	Chord 3.71 mm		
	Length 4.83 mm	Wire .15 mm		
	2xBGL5 Bicurve	Radius 1.52/2.79 mm	12"/30 cm	AA-2675N
	Curvature 90/50	Chord 3.71 mm		
	Length 4.83 mm	Wire .15 mm		
	DGL6 3/8 Circle	Radius 2.54 mm	4"/10 cm	AA-2673N
	Curvature 135	Chord 4.82 mm		
	Length 6.15 mm	Wire .15 mm		
	2xDGL6 3/8 Circle	Radius 2.54 mm	12"/30 cm	AA-2627N
	Curvature 135	Chord 4.82 mm		
	Length 6.15 mm	Wire .15 mm		
	HGL5 1/2 Circle	Radius 2.03 mm	4"/10 cm	AA-2674N
	Curvature 160	Chord 4.06 mm		
	Length 5.51 mm	Wire .15 mm		
	2xHGL5 1/2 Circle	Radius 2.03 mm	6"/15 cm	AA-2713N AA-2712N
	Curvature 160	Chord 4.06 mm		
	Length 5.51 mm	Wire .15 mm		
	2xHGL5 1/2 Circle	Radius 2.03 mm	12"/30 cm	AA-2626N
	Curvature 160	Chord 4.06 mm		
	Length 5.51 mm	Wire .15 mm		
	2xHGL7 1/2 Circle	Radius 2.29 mm	12"/30 cm	AA-2714N
	Curvature 175	Chord 4.57 mm		
	Length 6.99 mm	Wire .15 mm		



OPHTHALMIC SUTURES

Needle	Description	Length	Suture Size							
			11-0	10-0	9-0	8-0	7-0	6-0	5-0	4-0

SILK BLACK BRAIDED





TAPER CUTTING

	DRT14	3/8 Circle	Radius 5.94 mm	18"/45 cm									DC-2530N
		Curvature 130	Chord 11.14 mm										
		Length 14.00 mm	Wire .35 mm										
	DRT14	3/8 Circle	Radius 5.94 mm	18"/45 cm									DC-2513N
		Curvature 130	Chord 11.15 mm										
		Length 14.00 mm	Wire .38 mm										
Y5		1/2 Circle	Radius 5.00 mm	18"/45 cm									DA-2682N
		Curvature 180	Chord 11.00 mm										
		Length 16.00 mm	Wire .38 mm										

11-0 10-0 9-0 8-0 7-0 6-0 5-0 4-0

SILK BLACK BRAIDED

PRECISION REVERSE CUTTING

C01		3/8 Circle	Radius 3.20 mm	12"/30 cm									DA-2680N
		Curvature 130	Chord 6.00 mm										
		Length 7.10 mm	Wire .28 mm										
	2xDSM7	3/8 Circle	Radius 3.18 mm	18"/45 cm									DA-0191N DA-2622N
		Curvature 125	Chord 5.79 mm										
		Length 7.11 mm	Wire .20mm										
	DSM11	3/8 Circle	Radius 4.75 mm	18"/45 cm									DA-0187N
		Curvature 130	Chord 8.87 mm										
		Length 11.05 mm	Wire .35 mm										
	2xDSM11	3/8 Circle	Radius 4.75 mm	18"/45 cm									DA-0188N
		Curvature 130	Chord 8.87 mm										
		Length 11.05 mm	Wire .35 mm										
	2xDSM13	3/8 Circle	Radius 4.52 mm	18"/45 cm									DA-2621N
		Curvature 155	Chord 9.30 mm										
		Length 13.00 mm	Wire .45 mm										

800.322.4674 or 800.633.7283

www.msiprecision.com

21-7





Sutures

OPHTHALMIC SUTURES

Needle	Description	Length	Suture Size							
			11-0	10-0	9-0	8-0	7-0	6-0	5-0	4-0
SILK BLACK BRAIDED REVERSE CUTTING			11-0	10-0	9-0	8-0	7-0	6-0	5-0	4-0
DS12	3/8 Circle Curvature 130 Length 11.99 mm	Radius 5.08 mm Chord 9.59 mm Wire .45 mm	18"/45 cm							DC-0204N
2xDS13	3/8 Circle Curvature 130 Length 12.95 mm	Radius 5.51 mm Chord 10.34 mm Wire .38mm	18"/45 cm							DC-2620N
SILK BLACK BRAIDED SIDE CUTTING LANCET			11-0	10-0	9-0	8-0	7-0	6-0	5-0	4-0
2xDSL7	3/8 Circle Curvature 130 Length 6.60 mm	Radius 2.79 mm Chord 5.26 mm Wire .20 mm	12"/30 cm							DA-2526N
2xDSL7	3/8 Circle Curvature 130 Length 6.60 mm	Radius 2.79 mm Chord 5.26 mm Wire .20 mm	18"/45 cm							DA-2527N
2xVSL7	1/2 Circle Curvature 95 Length 6.60 mm	Radius 3.94 mm Chord 5.89 mm Wire .20 mm	18"/45 cm							DA-2623N
2xVSP8	1/2 Circle Curvature 90 Length 8.00 mm	Radius 5.08 mm Chord 7.24 mm Wire .35 mm	18"/45 cm							DA-2624N



OPHTHALMIC SUTURES

Needle	Description	Length	Suture Size							
			11-0	10-0	9-0	8-0	7-0	6-0	5-0	4-0
SILK BLACK BRAIDED			11-0	10-0	9-0	8-0	7-0	6-0	5-0	4-0
TAPER POINT										
DR12	3/8 Circle Curvature 130 Length 12.32 mm	Radius 5.16 mm Chord 9.77 mm Wire .38 mm	18"/45 cm							DC-2515N
										
DR12	3/8 Circle Curvature 130 Length 12.32 mm	Radius 5.16 mm Chord 9.77 mm Wire .38 mm	18"/45 cm					DC-2510N		
										
T12a	3/8 Circle Curvature 135 Length 12.30 mm	Radius 5.21 mm Chord 9.00 mm Wire .43 mm	30"/75 cm							DA-2679N
T12a	3/8 Circle Curvature 135 Length 12.30 mm	Radius 5.21 mm Chord 9.00 mm Wire .43 mm	18"/45 cm							DA-2692N

POLYPROPYLENE BLUE MONO

11-0 10-0 9-0 8-0 7-0 6-0 5-0 4-0





PRECISION REVERSE CUTTING

DSM13	3/8 Circle Curvature 155 Length 13.00 mm	Radius 4.52 mm Chord 9.30 mm Wire .45 mm	18"/45 cm							JA-2200N JA-2441N
										

POLYPROPYLENE BLUE MONO

11-0 10-0 9-0 8-0 7-0 6-0 5-0 4-0

SIDE CUTTING LANCET

2xDSL6	3/8 Circle Curvature 135 Length 6.15 mm	Radius 2.54 mm Chord 4.83 mm Wire .15 mm	12"/30 cm	JA-2528N						
										
2xHSL5	1/2 Circle Curvature 160 Length 5.51 mm	Radius 2.03 mm Chord 4.07 mm Wire .15 mm	12"/30 cm		JA-2529N					
										
2xSSL5	1/8 Circle Curvature 50 Length 5.51 mm	Radius 6.35 mm Chord 5.35 mm Wire .15 mm	2"/5 cm	JA-2560N						
										
2xSSL15	1/8 Circle Curvature 50	Radius 16.51 mm Chord 14.49 mm	3"/7.5 cm	JA-2559N						
										

800.322.4674 or 800.633.7283

www.msiprecision.com

21-9



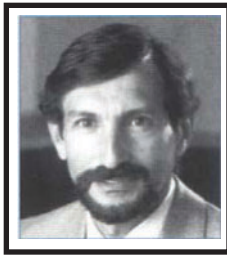

"The simplest and safest method which I have ever seen for the selection and removal of any foldable lens."

Richard J. Mackool, M.D.



Catalog Number
RM9000



Catalog Number
Set / RM9400

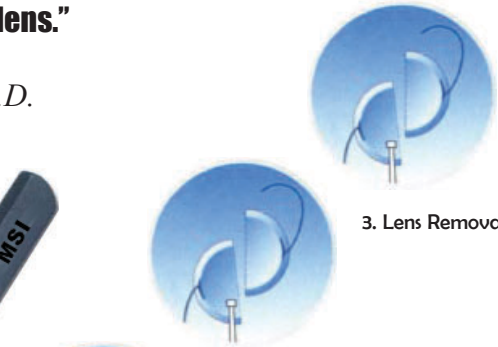

2. Lens Cutting



1. Holding Cutting



3. Lens Removal

Catalog Number
RM9200

Mackool Foldable Lens Removal System

Patent Pending

NEW INSTRUMENTS

- Tri-Hinge design for comfortable grip and reliable cutting of any SILICONE and ACRYLIC lens.
- Both instruments can be DISASSEMBLED for cleaning and sterilization.
- Curved forceps with TANDEM teeth firmly hold IOL against TURNING and ROTATING.
- All MSI Precision instruments are reusable, autoclaveable and GUARANTEED for LIFE against manufacturing defects.



800.322.4674 or 800.633.7283

www.msiprecision.com

Surgical Advantage

1-800-948-7994

order@surgicaladvantage.net

1200 Series Precision Push Pen Style Diamond Knife Handle



1200 Series Precision Titanium Neuro Diamond Knife Handle



1300 Series Precision Bayonet C-Slot Style Diamond Knife Handle



1300J Series Precision INOX Bayonet C-Slot Style Diamond Knife Handle



1300 Series Precision Titanium Retina Diamond Knife Handle



1400 Series Precision PEEK Bayonet C-Slot Style Diamond Knife Handle



1500 Series Precision Titanium Micrometer Diamond Knives



1800 Series Precision Titanium Seven Step Diamond Knives



2200 / 2300 Series Precision Titanium One Step Diamond Knives



Diamond Knives

DIAMOND CUTTING INSTRUMENTS FOR MICROSURGERY



• Handles are made out of best quality TITANIUM and MEDICAL STEEL material.

• Each diamond blade goes with a straight blade holder, or 30 degree angled holder (A in the product No. means 30 degree angled)

1200 Series Precision Push Pen Style Diamond Knife Handle

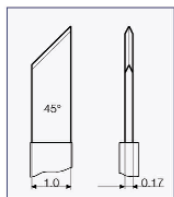

STANDARD BLADES

Diamond Knife

No. 1211 / straight
No. 1211A / straight, angled

Diamond Blade

No. 11
No. 11

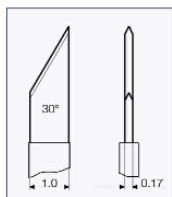

STANDARD BLADES

Diamond Knife

No. 1212 / straight
No. 1212A / straight, angled

Diamond Blade

No. 12
No. 12

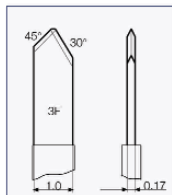

STANDARD BLADES

Diamond Knife

No. 1213 / tri-facet
No. 1213A / tri-facet, angled

Diamond Blade

No. 13
No. 13

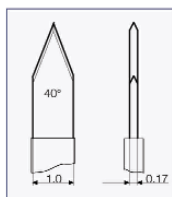

STANDARD BLADES

Diamond Knife

No. 1271 / lance with blunt sides
No. 1271A / lance with blunt sides, angled

Diamond Blade

No. 71
No. 71

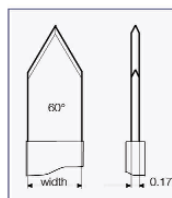

STANDARD BLADES

Diamond Knife

No. 1248 / lance with blunt sides, width 0.9 mm
No. 1248A / lance with blunt sides, width 0.9 mm, angled
No. 1220 / lance with blunt sides, width 1.0 mm
No. 1220A / lance with blunt sides, width 1.0 mm, angled
No. 1214 / lance with blunt sides, width 1.4 mm
No. 1214A / lance with blunt sides, width 1.4 mm, angled

Diamond Blade

No. 48
No. 48
No. 20
No. 20
No. 14
No. 14



1200 Series Precision Push Pen Style Diamond Knife Handle

Diamond Knives

DIAMOND CUTTING INSTRUMENTS FOR MICROSURGERY

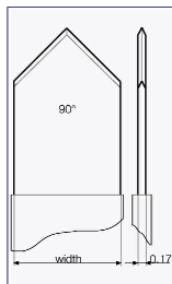

PHACO BLADES

Diamond Knife

No. 1208 / spear with blunt sides, width 2.5 mm
 No. 1208A / spear with blunt sides, width 2.5 mm, angled
 No. 1243 / spear with blunt sides, width 2.8 mm
 No. 1243A / spear with blunt sides, width 2.8 mm, angled
 No. 1222 / spear with blunt sides, width 3.0 mm
 No. 1222A / spear with blunt sides, width 3.0 mm, angled
 No. 1223 / spear with blunt sides, width 3.2 mm
 No. 1223A / spear with blunt sides, width 3.2 mm, angled

Diamond Blade

No. 08
 No. 08
 No. 43
 No. 43
 No. 22
 No. 22
 No. 23
 No. 23

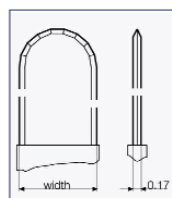

TUNNEL BLADES

Diamond Knife

No. 1239 / NEW tunnel 9 facets, width 1.4 mm
 No. 1239A / NEW tunnel 9 facets, width 1.4 mm, angled
 No. 1254 / tunnel 9 facets, width 2.0 mm
 No. 1254A / tunnel 9 facets, width 2.0 mm, angled

Diamond Blade

No. 39
 No. 39
 No. 54
 No. 54

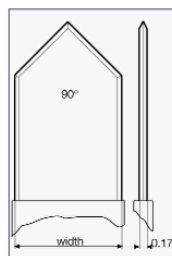

CLEAR CORNEA BLADES

Diamond Knife

No. 1298 / clear cornea with sharp sides, width 2.5 mm
 No. 1298A / clear cornea with sharp sides, width 2.5 mm, angled
 No. 1295 / clear cornea with sharp sides, width 2.6 mm
 No. 1295A / clear cornea with sharp sides, width 2.6 mm, angled
 No. 1277 / clear cornea with sharp sides, width 2.8 mm
 No. 1277A / clear cornea with sharp sides, width 2.8 mm, angled
 No. 1273 / clear cornea with sharp sides, width 3.0 mm
 No. 1273A / clear cornea with sharp sides, width 3.0 mm, angled
 No. 1274 / clear cornea with sharp sides, width 3.2 mm
 No. 1274A / clear cornea with sharp sides, width 3.2 mm, angled

Diamond Blade

No. 98
 No. 98
 No. 95
 No. 95
 No. 77
 No. 77
 No. 73
 No. 73
 No. 74
 No. 74

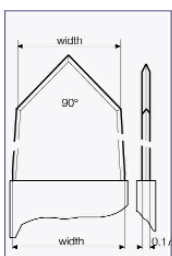

TAPERED SPEAR BLADES

Diamond Knife

No. 1290 / spear 4 facets with sharp sides, width 2.5-3.0 mm
 No. 1290A / spear 4 facets with sharp sides, width 2.5-3.0 mm, angled
 No. 1232 / spear 4 facets with sharp sides, width 2.75-3.2 mm
 No. 1232A / spear 4 facets with sharp sides, width 2.75-3.2 mm, angled
 No. 1240 / spear 4 facets with sharp sides, width 3.0-3.2 mm
 No. 1240A / spear 4 facets with sharp sides, width 3.0-3.2 mm, angled
 No. 1289 / spear 4 facets with sharp sides, width 3.2-3.5 mm
 No. 1289A / spear 4 facets with sharp sides, width 3.2-3.5 mm, angled

Diamond Blade

No. 90
 No. 90
 No. 32
 No. 32
 No. 40
 No. 40
 No. 89
 No. 89

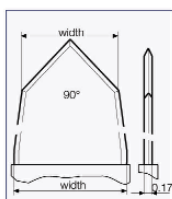

TAPERED SPEAR BLADES

Diamond Knife

No. 1288 / spear 6 facets with sharp sides, width 2.65-3.2 mm
 No. 1288A / spear 6 facets with sharp sides, width 2.65-3.2 mm, angled

Diamond Blade

No. 88
 No. 88

800.322.4674 or 800.633.7283

www.msiprecision.com

22-3



Diamond Knives

DIAMOND CUTTING INSTRUMENTS FOR MICROSURGERY

1200 Series Precision Titanium Neuro Diamond Knife Handle

STANDARD BLADES

Diamond Knife

No. N1267 / straight, 45 deg single sided, 1.0 x 0.17 x 6 mm
No. N1268 / Lance 60 deg single sided, 1.0 x 0.17 . 6 mm
No. N1269 / round 7 facets, single sided, 1.0 x 0.17 x 6 mm
No. N1281 / special straight, 60 deg, 1.45 x 0.17 x 1.8 mm

Diamond Blade

No. 67
No. 68
No. 69
No. 81

1300 Series Precision Bayonet C-Slot Style Diamond Knife Handle

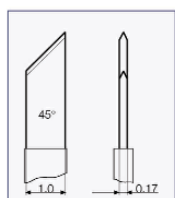

STANDARD BLADES

Diamond Knife

No. 1311 / straight
No. 1311A / straight, angled

Diamond Blade

No. 11
No. 11

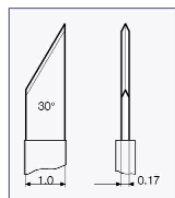

STANDARD BLADES

Diamond Knife

No. 1312 / straight
No. 1312A / straight, angled

Diamond Blade

No. 12
No. 12

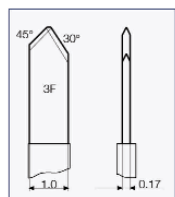

STANDARD BLADES

Diamond Knife

No. 1313 / tri-facet
No. 1313A / tri-facet, angled

Diamond Blade

No. 13
No. 13

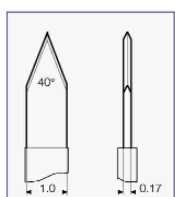

STANDARD BLADES

Diamond Knife

No. 1371 / lance with blunt sides
No. 1371A / lance with blunt sides, angled

Diamond Blade

No. 71
No. 71

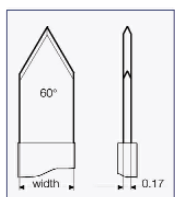

STANDARD BLADES

Diamond Knife

No. 1348 / lance with blunt sides, width 0.9 mm
No. 1348A / lance with blunt sides, width 0.9 mm, angled
No. 1320 / lance with blunt sides, width 1.0 mm
No. 1320A / lance with blunt sides, width 1.0 mm, angled
No. 1314 / lance with blunt sides, width 1.4 mm
No. 1314A / lance with blunt sides, width 1.4 mm, angled

Diamond Blade

No. 48
No. 48
No. 20
No. 20
No. 14
No. 14



1300 Series Precision Bayonet C-Slot Style Diamond Knife Handle

Diamond Knives

DIAMOND CUTTING INSTRUMENTS FOR MICROSURGERY

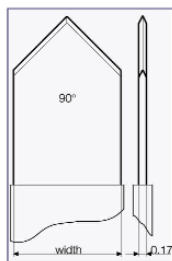

PHACO BLADES

Diamond Knife

No. 1308 / spear with blunt sides, width 2.5 mm
 No. 1308A / spear with blunt sides, width 2.5 mm, angled
 No. 1343 / spear with blunt sides, width 2.8 mm
 No. 1343A / spear with blunt sides, width 2.8 mm, angled
 No. 1322 / spear with blunt sides, width 3.0 mm
 No. 1322A / spear with blunt sides, width 3.0 mm, angled
 No. 1323 / spear with blunt sides, width 3.2 mm
 No. 1323A / spear with blunt sides, width 3.2 mm, angled

Diamond Blade

No. 08
 No. 08
 No. 43
 No. 43
 No. 22
 No. 22
 No. 23
 No. 23

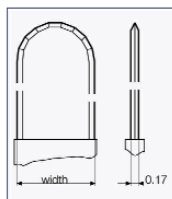

TUNNEL BLADES

Diamond Knife

No. 1339 / NEW tunnel 9 facets, width 1.4 mm
 No. 1339A / NEW tunnel 9 facets, width 1.4 mm, angled
 No. 1354 / tunnel 9 facets, width 2.0 mm
 No. 1354A / tunnel 9 facets, width 2.0 mm, angled

Diamond Blade

No. 39
 No. 39
 No. 54
 No. 54

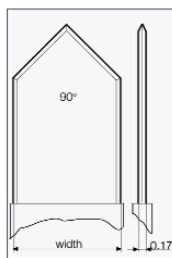

CLEAR CORNEA BLADES

Diamond Knife

No. 1398 / clear cornea with sharp sides, width 2.5 mm
 No. 1398A / clear cornea with sharp sides, width 2.5 mm, angled
 No. 1395 / clear cornea with sharp sides, width 2.6 mm
 No. 1395A / clear cornea with sharp sides, width 2.6 mm, angled
 No. 1377 / clear cornea with sharp sides, width 2.8 mm
 No. 1377A / clear cornea with sharp sides, width 2.8 mm, angled
 No. 1373 / clear cornea with sharp sides, width 3.0 mm
 No. 1373A / clear cornea with sharp sides, width 3.0 mm, angled
 No. 1374 / clear cornea with sharp sides, width 3.2 mm
 No. 1374A / clear cornea with sharp sides, width 3.2 mm, angled

Diamond Blade

No. 98
 No. 98
 No. 95
 No. 95
 No. 77
 No. 77
 No. 73
 No. 73
 No. 74
 No. 74

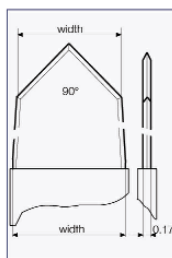

TAPERED SPEAR BLADES

Diamond Knife

No. 1390 / spear 4 facets with sharp sides, width 2.5-3.0 mm
 No. 1390A / spear 4 facets with sharp sides, width 2.5-3.0 mm, angled
 No. 1332 / spear 4 facets with sharp sides, width 2.75-3.2 mm
 No. 1332A / spear 4 facets with sharp sides, width 2.75-3.2 mm, angled
 No. 1340 / spear 4 facets with sharp sides, width 3.0-3.2 mm
 No. 1340A / spear 4 facets with sharp sides, width 3.0-3.2 mm, angled
 No. 1389 / spear 4 facets with sharp sides, width 3.2-3.5 mm
 No. 1389A / spear 4 facets with sharp sides, width 3.2-3.5 mm, angled

Diamond Blade

No. 90
 No. 90
 No. 32
 No. 32
 No. 40
 No. 40
 No. 89
 No. 89

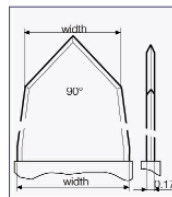

TAPERED SPEAR BLADES

Diamond Knife

No. 1388 / spear 6 facets with sharp sides, width 2.65-3.2 mm
 No. 1388A / spear 6 facets with sharp sides, width 2.65-3.2 mm, angled

Diamond Blade

No. 88
 No. 88

- The MSI Precision one-step handle is made out of best quality TITANIUM and MEDICAL STEEL material.
- Available with the pencil mechanism (No. 1200) or the bayonet mechanism (No. 1300).
- With a depth of 0.28 mm or 0.3 mm.

800.322.4674 or 800.633.7283

www.msiprecision.com

22-5



Diamond Knives

DIAMOND CUTTING INSTRUMENTS FOR MICROSURGERY

1300J Series Precision INOX Bayonet C-Slot Style Diamond Knife Handle

- MSI Precision inox bayonet handle is made out of best quality INOX and PEEK material.
- Each diamond blade goes with a straight blade holder, or 30 degree angled holder (A in the Article No. means 30 degree angled)

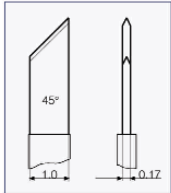

STANDARD BLADES

Diamond Knife

No. 1311J / straight
No. 1311AJ / straight, angled

Diamond Blade

No. 11
No. 11

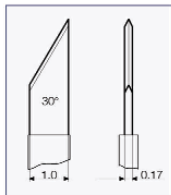

STANDARD BLADES

Diamond Knife

No. 1312J / straight
No. 1312AJ / straight, angled

Diamond Blade

No. 12
No. 12

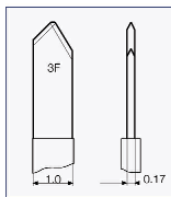

STANDARD BLADES

Diamond Knife

No. 1313J / tri-facet
No. 1313AJ / tri-facet, angled

Diamond Blade

No. 13
No. 13

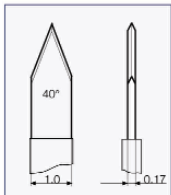

STANDARD BLADES

Diamond Knife

No. 1371J / lance with blunt sides
No. 1371AJ / lance with blunt sides, angled

Diamond Blade

No. 71
No. 71

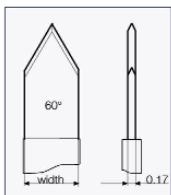

STANDARD BLADES

Diamond Knife

No. 1348J / lance with blunt sides, width 0.9 mm
No. 1348AJ / lance with blunt sides, width 0.9 mm, angled
No. 1320J / lance with blunt sides, width 1.0 mm
No. 1320AJ / lance with blunt sides, width 1.0 mm, angled
No. 1314J / lance with blunt sides, width 1.4 mm
No. 1314AJ / lance with blunt sides, width 1.4 mm, angled

Diamond Blade

No. 48
No. 48
No. 20
No. 20
No. 14
No. 14



1300J Series Precision INOX Bayonet C-Slot Style Diamond Knife Handle

Diamond Knives

DIAMOND CUTTING INSTRUMENTS FOR MICROSURGERY

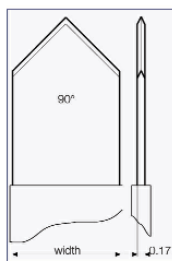

PHACO BLADES

Diamond Knife

No. 1308J / spear with blunt sides, width 2.5 mm
 No. 1308AJ / spear with blunt sides, width 2.5 mm, angled
 No. 1343J / spear with blunt sides, width 2.8 mm
 No. 1343AJ / spear with blunt sides, width 2.8 mm, angled
 No. 1322J / spear with blunt sides, width 3.0 mm
 No. 1322AJ / spear with blunt sides, width 3.0 mm, angled
 No. 1323J / spear with blunt sides, width 3.2 mm
 No. 1323AJ / spear with blunt sides, width 3.2 mm, angled

Diamond Blade

No. 08
 No. 08
 No. 43
 No. 43
 No. 22
 No. 22
 No. 23
 No. 23

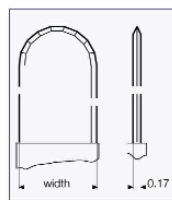

TUNNEL BLADES

Diamond Knife

No. 1339J / NEW tunnel 9 facets, width 1.4 mm
 No. 1339AJ / NEW tunnel 9 facets, width 1.4 mm, angled
 No. 1354J / tunnel 9 facets, width 2.0 mm
 No. 1354AJ / tunnel 9 facets, width 2.0 mm, angled

Diamond Blade

No. 39
 No. 39
 No. 54
 No. 54

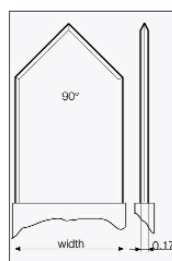

CLEAR CORNEA BLADES

Diamond Knife

No. 1398J / clear cornea with sharp sides, width 2.5 mm
 No. 1398AJ / clear cornea with sharp sides, width 2.5 mm, angled
 No. 1395J / clear cornea with sharp sides, width 2.6 mm
 No. 1395AJ / clear cornea with sharp sides, width 2.6 mm, angled
 No. 1377J / clear cornea with sharp sides, width 2.8 mm
 No. 1377AJ / clear cornea with sharp sides, width 2.8 mm, angled
 No. 1373J / clear cornea with sharp sides, width 3.0 mm
 No. 1373AJ / clear cornea with sharp sides, width 3.0 mm, angled
 No. 1374J / clear cornea with sharp sides, width 3.2 mm
 No. 1374AJ / clear cornea with sharp sides, width 3.2 mm, angled

Diamond Blade

No. 98
 No. 98
 No. 95
 No. 95
 No. 77
 No. 77
 No. 73
 No. 73
 No. 74
 No. 74

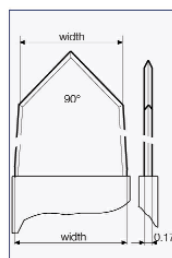

TAPERED SPEAR BLADES

Diamond Knife

No. 1390J / spear 4 facets with sharp sides, width 2.5-3.0 mm
 No. 1390AJ / spear 4 facets with sharp sides, width 2.5-3.0 mm, angled
 No. 1332J / spear 4 facets with sharp sides, width 2.75-3.2 mm
 No. 1332AJ / spear 4 facets with sharp sides, width 2.75-3.2 mm, angled
 No. 1340J / spear 4 facets with sharp sides, width 3.0-3.2 mm
 No. 1340AJ / spear 4 facets with sharp sides, width 3.0-3.2 mm, angled
 No. 1389J / spear 4 facets with sharp sides, width 3.2-3.5 mm
 No. 1389AJ / spear 4 facets with sharp sides, width 3.2-3.5 mm, angled

Diamond Blade

No. 90
 No. 90
 No. 32
 No. 32
 No. 40
 No. 40
 No. 89
 No. 89

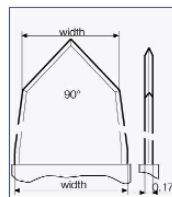

TAPERED SPEAR BLADES

Diamond Knife

No. 1388J / spear 6 facets with sharp sides, width 2.65-3.2 mm
 No. 1388AJ / spear 6 facets with sharp sides, width 2.65-3.2 mm, angled

Diamond Blade

No. 88
 No. 88

800.322.4674 or 800.633.7283

www.msiprecision.com

22-7



Diamond Knives

DIAMOND CUTTING INSTRUMENTS FOR MICROSURGERY

1300 Series Precision Titanium Retina Handle

- The MSI Precision retina handle is made out of TITANIUM bayonet and used predominantly for Glaucoma surgery.
- We also manufacture to client specifications.

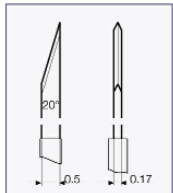

STANDARD BLADES

Diamond Knife

No. 1301 / NEW retina straight

Diamond Blade

No. 01

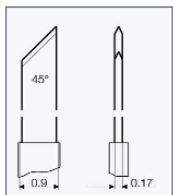

STANDARD BLADES

Diamond Knife

No. 1302 / NEW retina straight

Diamond Blade

No. 02

1400 Series Precision PEEK Bayonet C-Slot Style Diamond Knife Handle

- The MSI Precision peek bayonet handle is made out of best quality POLI ETHER ETHER KETON (PEEK) material.
- PEEK is a high warmth resistant synthetic material and is absolutely able to sustain sterilization and is resistant to all the usual solvents and also to nearly all usual organic and nonorganic liquids. PEEK has no danger of corrosion.
- Each diamond blade goes with a straight blade holder, or 30 degree angled holder.

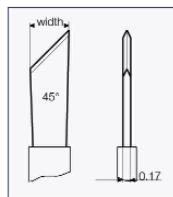

STANDARD BLADES

Diamond Knife

No. 1415 / straight, width 0.7 mm, not resharable
No. 1415A / straight, width 0.7 mm, angled, not resharable
No. 1486 / straight, width 1.0 mm, not resharable
No. 1486A / straight, width 1.0 mm, angled, not resharable

Diamond Blade

No. 15
No. 15
No. 86
No. 86

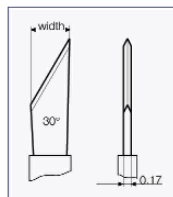

STANDARD BLADES

Diamond Knife

No. 1416 / straight, width 0.7 mm, not resharable
No. 1416A / straight, width 0.7 mm, angled, not resharable
No. 1487 / straight, width 1.0 mm, not resharable
No. 1487A / straight, width 1.0 mm, angled, not resharable

Diamond Blade

No. 16
No. 16
No. 87
No. 87



22-8

800.322.4674 or 800.633.7283

www.msiprecision.com

1400 Series Precision PEEK Bayonet C-Slot Style Diamond Knife Handle

Diamond Knives

DIAMOND CUTTING INSTRUMENTS FOR MICROSURGERY

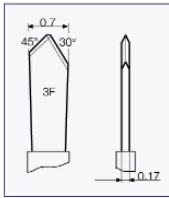

STANDARD BLADES

Diamond Knife

No. 1417 / tri-facet, not resharpable
No. 1417A / tri-facet, angled, not resharpable

Diamond Blade

No. 17
No. 17

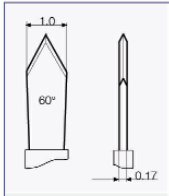

STANDARD BLADES

Diamond Knife

No. 1418 / lance, not resharpable
No. 1418A / lance, angled, not resharpable

Diamond Blade

No. 18
No. 18

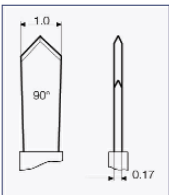

STANDARD BLADES

Diamond Knife

No. 1430 / spear, not resharpable
No. 1430A / spear, angled, not resharpable

Diamond Blade

No. 30
No. 30

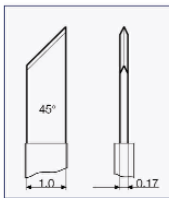

STANDARD BLADES

Diamond Knife

No. 1411 / straight
No. 1411A / straight, angled

Diamond Blade

No. 11
No. 11

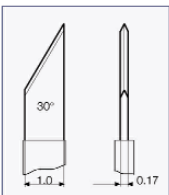

STANDARD BLADES

Diamond Knife

No. 1412 / straight
No. 1412A / straight, angled

Diamond Blade

No. 12
No. 12

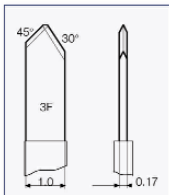

STANDARD BLADES

Diamond Knife

No. 1413 / tri-facet
No. 1413A / tri-facet, angled

Diamond Blade

No. 13
No. 13

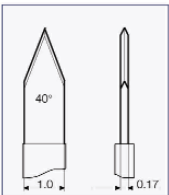

STANDARD BLADES

Diamond Knife

No. 1471 / lance with blunt sides
No. 1471A / lance with blunt sides, angled

Diamond Blade

No. 71
No. 71

800.322.4674 or 800.633.7283

www.msiprecision.com

22-9



Diamond Knives

DIAMOND CUTTING INSTRUMENTS FOR MICROSURGERY

1400 Series Precision PEEK Bayonet C-Slot Style Diamond Knife Handle

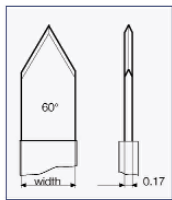

STANDARD BLADES

Diamond Knife

No. 1448 / lance with blunt sides, width 0.9 mm
No. 1448A / lance with blunt sides, width 0.9 mm, angled
No. 1420 / lance with blunt sides, width 1.0 mm
No. 1420A / lance with blunt sides, width 1.0 mm, angled
No. 1414 / lance with blunt sides, width 1.4 mm
No. 1414A / lance with blunt sides, width 1.4 mm, angled

Diamond Blade

No. 48
No. 48
No. 20
No. 20
No. 14
No. 14

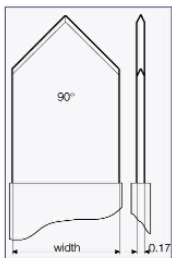

PHACO BLADES

Diamond Knife

No. 1408 / spear with blunt sides, width 2.5 mm
No. 1408A / spear with blunt sides, width 2.5 mm, angled
No. 1443 / spear with blunt sides, width 2.8 mm
No. 1443A / spear with blunt sides, width 2.8 mm, angled
No. 1422 / spear with blunt sides, width 3.0 mm
No. 1422A / spear with blunt sides, width 3.0 mm, angled
No. 1423 / spear with blunt sides, width 3.2 mm
No. 1423A / spear with blunt sides, width 3.2 mm, angled

Diamond Blade

No. 08
No. 08
No. 43
No. 43
No. 22
No. 22
No. 23
No. 23

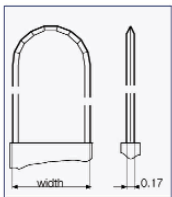

TUNNEL BLADES

Diamond Knife

No. 1439 / NEW tunnel 9 facets, width 1.4 mm
No. 1439A / NEW tunnel 9 facets, width 1.4 mm, angled
No. 1454 / tunnel 9 facets, width 2.0 mm
No. 1454A / tunnel 9 facets, width 2.0 mm, angled

Diamond Blade

No. 39
No. 39
No. 54
No. 54

CLEAR CORNEA BLADES

Diamond Knife

No. 1498 / clear cornea with sharp sides, width 2.5 mm
No. 1498A / clear cornea with sharp sides, width 2.5 mm, angled
No. 1495 / clear cornea with sharp sides, width 2.6 mm
No. 1495A / clear cornea with sharp sides, width 2.6 mm, angled
No. 1477 / clear cornea with sharp sides, width 2.8 mm
No. 1477A / clear cornea with sharp sides, width 2.8 mm, angled
No. 1473 / clear cornea with sharp sides, width 3.0 mm
No. 1473A / clear cornea with sharp sides, width 3.0 mm, angled
No. 1474 / clear cornea with sharp sides, width 3.2 mm
No. 1474A / clear cornea with sharp sides, width 3.2 mm, angled

Diamond Blade

No. 98
No. 98
No. 95
No. 95
No. 77
No. 77
No. 73
No. 73
No. 74
No. 74



22-10

800.322.4674 or 800.633.7283

www.msiprecision.com

1400 Series Precision PEEK Bayonet C-Slot Style Diamond Knife Handle

Diamond Knives

DIAMOND CUTTING INSTRUMENTS FOR MICROSURGERY

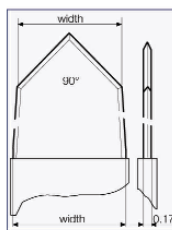

TAPERED SPEAR BLADES

Diamond Knife

No. 1490 / spear 4 facets with sharp sides, width 2.5-3.0 mm
 No. 1490A / spear 4 facets with sharp sides, width 2.5-3.0 mm, angled
 No. 1432 / spear 4 facets with sharp sides, width 2.75-3.2 mm
 No. 1432A / spear 4 facets with sharp sides, width 2.75-3.2 mm, angled
 No. 1440 / spear 4 facets with sharp sides, width 3.0-3.2 mm
 No. 1440A / spear 4 facets with sharp sides, width 3.0-3.2 mm, angled
 No. 1489 / spear 4 facets with sharp sides, width 3.2-3.5 mm
 No. 1489A / spear 4 facets with sharp sides, width 3.2-3.5 mm, angled

Diamond Blade

No. 90
 No. 90
 No. 32
 No. 32
 No. 40
 No. 40
 No. 89
 No. 89

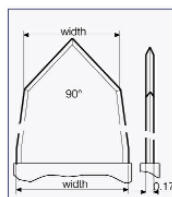

TAPERED SPEAR BLADES

Diamond Knife

No. 1488 / spear 6 facets with sharp sides, width 2.65-3.2 mm
 No. 1488A / spear 6 facets with sharp sides, width 2.65-3.2 mm, angled

Diamond Blade

No. 88
 No. 88

- The MSI Precision micrometer handle is made out of best quality TITANIUM and MEDICAL STEEL material.
- Each depth of the blade can be adjusted without steps. The scale is divided each hundredth millimeter.

1500 Series Precision Titanium Micrometer Diamond Knives

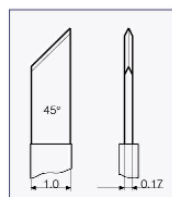

STANDARD BLADES

Diamond Knife

No. 1511 / straight
 No. 1511T / straight, angled

Diamond Blade

No. 11
 No. 11

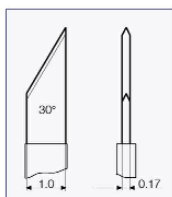

STANDARD BLADES

Diamond Knife

No. 1512 / straight
 No. 1512T / straight, angled

Diamond Blade

No. 12
 No. 12

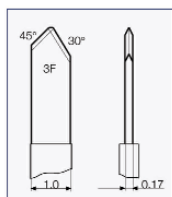

STANDARD BLADES

Diamond Knife

No. 1513 / tri-facet
 No. 1513T / tri-facet, angled

Diamond Blade

No. 13
 No. 13

800.322.4674 or 800.633.7283

www.msiprecision.com

22-11



Diamond Knives

DIAMOND CUTTING INSTRUMENTS FOR MICROSURGERY

1500 Series Precision Titanium Micrometer Diamond Knives

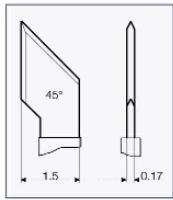

STANDARD BLADES

Diamond Knife

No. 1525 / axe

No. 1525T / axe

Diamond Blade

No. 25

No. 25

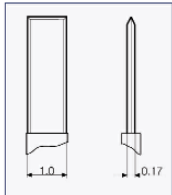

STANDARD BLADES

Diamond Knife

No. 1526 / triple edge vertical

No. 1526T / triple edge vertical

Diamond Blade

No. 26

No. 26

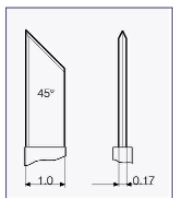

STANDARD BLADES

Diamond Knife

No. 1527 / double edge vertical

No. 1527T / double edge vertical

No. 1528 / single edge vertical

No. 1528T / single edge vertical

Diamond Blade

No. 27

No. 27

No. 28

No. 28

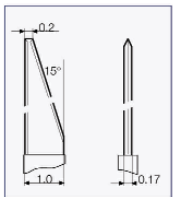

STANDARD BLADES

Diamond Knife

No. 1533T / arcuate (Thornton)

Diamond Blade

No. 33

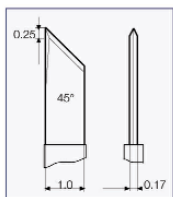

STANDARD BLADES

Diamond Knife

Blade No. 1566 / Precision Trak

Diamond

No. 66



22-12

800.322.4674 or 800.633.7283

www.msiprecision.com

1800 Series Precision Titanium Seven Step Diamond Knives

Diamond Knives

DIAMOND CUTTING INSTRUMENTS FOR MICROSURGERY

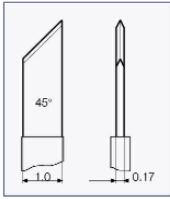

STANDARD BLADES

Diamond Knife

No. 1811 / straight, depth at 0/0.3/0.4/0.5/0.6/0.8/1.0/2.5 mm

Diamond Blade

No. 11

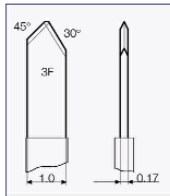

STANDARD BLADES

Diamond Knife

No. 1813 / tri-facet, depth at 0/0.3/0.4/0.5/0.6/0.8/1.0/2.5 mm

Diamond Blade

No. 13

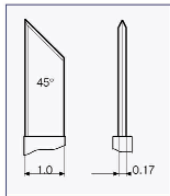

STANDARD BLADES

Diamond Knife

No. 1827 / double edge vertical, depth at 0/0.3/0.4/0.5/0.6/0.8/1.0/2.5 mm

Diamond Blade

No. 27

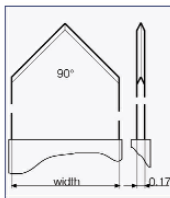

PHACO BLADES

Diamond Knife

No. 1822 / spear with blunt sides, width 3.0 mm
No. 1823 / spear with blunt sides, width 3.2 mm

Diamond Blade

No. 22
No. 23

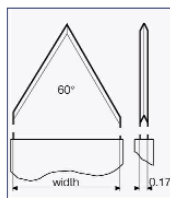

PHACO BLADES

Diamond Knife

No. 1885 / lance with blunt sides, width 3.0 mm
No. 1821 / lance with blunt sides, width 3.2 mm

Diamond Blade

No. 85
No. 21

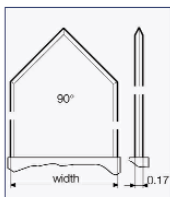

CLEAR CORNEA BLADES

Diamond Knife

No. 1898 / clear cornea with sharp sides, width 2.5 mm
No. 1895 / clear cornea with sharp sides, width 2.6 mm
No. 1877 / clear cornea with sharp sides, width 2.8 mm
No. 1873 / clear cornea with sharp sides, width 3.0 mm
No. 1874 / clear cornea with sharp sides, width 3.2 mm

Diamond Blade

No. 98
No. 95
No. 77
No. 73
No. 74

- Superior performance, unmatched precision
- For more information, contact us today!

800.322.4674 or 800.633.7283

www.msiprecision.com

22-13



Diamond Knives

2200 / 2300 Series Precision Titanium One Step Diamond Knives

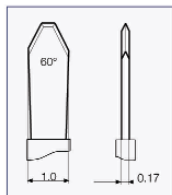

STANDARD BLADES

Diamond Knife (ECONOMY)

No. 2309 / tri-facet, depth at 0.28 mm
No. 2209 / tri-facet, depth at 0.3 mm

Diamond Blade

No. 09
No. 09

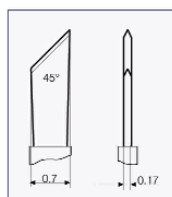

STANDARD BLADES

Diamond Knife

No. 2315 / straight, depth at 0.28 mm
No. 2215 / straight, depth at 0.3 mm

Diamond Blade

No. 15
No. 15



22-14

800.322.4674 or 800.633.7283

www.msiprecision.com

Numerical Index



Part Number	Page	Part Number	Page	Part Number	Page	Part Number	Page
160	20-9	11-2-6286-NC	17-22	11-2-8423	8-7	11-4-6291	10-6
02-8242-R	3-14	11-2-6311	17-9	11-2-8424	8-7	11-4-6331	10-5
02-8244-R	3-14	11-2-6411	17-13	11-2-8801	7-5	11-4-6341	10-6
OJ	20-15	11-2-6413	17-13	11-2-8911	7-4	11-4-6341	10-7
10	20-16	11-2-6421	17-13	11-2-8921	7-4	11-4-6343	10-6
100	20-14	11-2-6461	17-11	11-2-8931	7-4	11-4-6361	10-12
1002	20-10	11-2-6512	17-25	11-2-8936	7-6	11-4-6621	10-8
1002-2	20-10	11-2-6513	17-25	11-3-0611	14-22	11-4-6621-A	10-8
1002-FPP	20-11	11-2-6514	17-26	11-3-0611	14-22	11-4-6631	10-9
1002-HPT	20-11	11-2-6517	17-26	11-4-0411	2-1	11-4-6633	10-9
106	20-14	11-2-6518	17-27	11-4-0412	2-1	11-4-6634	10-9
107	20-14	11-2-6611	17-27	11-4-2191	7-3	11-4-6637	10-12
1082-2	20-10	11-2-6780	17-23	11-4-2211	7-3	11-4-6639	10-11
10F	20-17	11-2-6782	17-15	11-4-2211	12-1	11-4-6641	10-11
10F w/Rolled Bead	20-12	11-2-6782-C	17-16	11-4-3401	11-13	11-4-6642	10-12
10F-PMT	20-11	11-2-6782-LS	17-15	11-4-3403	11-14	11-4-7226	8-2
11-2-6061	17-31	11-2-6782-LSC	17-16	11-4-3404	11-14	11-4-7264	8-3
11-2-6062	17-31	11-2-6782-N	17-16	11-4-3406	11-14	11-4-7265	8-3
11-2-6066	17-31	11-2-6782-NC	17-17	11-4-3407	11-14	11-4-7269	8-3
11-2-6110	17-2	11-2-6782-NLS	17-17	11-4-3409	11-14	11-4-7271	8-3
11-2-6111	17-2	11-2-6782-NLSC	17-17	11-4-3470	11-13	11-4-7272	8-3
11-2-6121	17-1	11-2-6782-NR	17-18	11-4-3478	13-9	11-4-7274	8-4
11-2-6123	17-5	11-2-6782-NRC	17-18	11-4-3479	11-13	11-4-7274-R	8-4
11-2-6123-W	17-5	11-2-6782-NRS	17-17	11-4-3491	11-13	11-4-7276	8-4
11-2-6125	17-8	11-2-6782-NRSC	17-17	11-4-3495	11-13	11-4-7279	8-4
11-2-6126	17-6	11-2-6782-P	17-17	11-4-3496	11-13	11-4-7871	11-11
11-2-6126-R	17-6	11-2-6782-R	17-15	11-4-3511	11-15	11-4-7872	11-11
11-2-6131	17-7	11-2-6782-R	17-17	11-4-3701	10-10	11-4-7889	11-11
11-2-6143	17-8	11-2-6782-RC	17-18	11-4-3702	10-10	11-4-7891	11-11
11-2-6150	17-4	11-2-6782-RS	17-16	11-4-3791	10-10	11-4-7893	11-11
11-2-6155	17-8	11-2-6782-RSC	17-16	11-4-4311	13-8	11-4-8005	11-1
11-2-6156	17-8	11-2-6782-T	17-18	11-4-5211	10-1	11-4-8007	11-1
11-2-6161	17-3	11-2-6786	17-18	11-4-5216	10-4	11-4-8011	11-1
11-2-6162	17-4	11-2-6786-C	17-19	11-4-5229	10-2	11-4-8021	11-1
11-2-6171	17-9	11-2-6786-LS	17-18	11-4-5231	10-4	11-4-8053	11-2
11-2-6181	17-9	11-2-6786-LSC	17-19	11-4-5241	10-3	11-4-8054	11-2
11-2-6182	17-10	11-2-6786-N	17-19	11-4-5252	10-4	11-4-8831	11-2
11-2-6184	17-10	11-2-6786-NC	17-20	11-4-5257	9-1	11-4-8841	11-2
11-2-6184-U	17-10	11-2-6786-NLS	17-20	11-4-5259	9-2	11-4-8846	11-3
11-2-6261	17-7	11-2-6786-NLSC	17-20	11-4-5261	9-2	11-4-8848	11-3
11-2-6282	17-20	11-2-6786-NRS	17-20	11-4-5263	9-2	11-4-8903	11-3
11-2-6282-C	17-21	11-2-6786-NRSC	17-20	11-4-5264	9-2	11-4-8999	11-3
11-2-6282-N	17-21	11-2-6786-RS	17-19	11-4-6171	10-13	11-4-9212	11-3
11-2-6282-NC	17-21	11-2-6786-RSC	17-19	11-4-6201	10-7	11-4-9228	11-4
11-2-6282-NR	17-21	11-2-6788	17-23	11-4-6203	10-6	11-4-9230	11-4
11-2-6282-NRC	17-21	11-2-6789	17-24	11-4-6204	10-6	11-4-9237	11-4
11-2-6282-R	17-22	11-2-6789-N	17-24	11-4-6211	10-15	11-4-9238	11-4
11-2-6282-RC	17-22	11-2-6791	17-24	11-4-6221	10-13	11-4-9239	11-4
11-2-6286	17-23	11-2-6791-C	17-24	11-4-6241	10-8	11-4-9240	11-4
11-2-6286-C	17-23	11-2-8211	8-6	11-4-6271	10-7	11-4-9241	11-4
11-2-6286-N	17-22	11-2-8422	8-7	11-4-6281	10-7	11-4-9242	11-4

800.322.4674 or 800.633.7283

www.msiprecision.com

IND-1



Numerical Index



Part Number	Page	Part Number	Page	Part Number	Page	Part Number	Page
11-4-9243	11-4	11-5-2341	16-18	11-6-2671	5-26	11-6-6331	5-36
11-4-9244	11-4	11-5-3111	16-19	11-6-2677	5-26	11-6-6341	5-36
11-4-9245	11-4	11-5-3121	16-19	11-6-3111	5-7	11-6-6345	5-40
11-4-9246	11-4	11-5-3125	16-19	11-6-3131	5-7	11-6-6346	5-40
11-4-9247	11-4	11-5-3126	16-19	11-6-3211	5-5	11-6-6511	5-37
11-4-9248	11-4	11-5-3131	16-19	11-6-3411	5-8	11-6-6521	5-38
11-4-9249	11-4	11-5-3141	16-20	11-6-3421	5-8	11-6-6661	5-40
11-4-9251	11-4	11-5-3152	16-20	11-6-3441	5-8	11-6-7611	5-52
11-4-9252	11-4	11-5-3153	16-20	11-6-3461	5-8	11-6-7621	5-52
11-4-9253	11-4	11-5-3311	16-20	11-6-3611	5-3	11-6-7631	5-52
11-4-9255	11-4	11-5-3331	16-21	11-6-3611-T	5-3	11-6-7641	5-52
11-4-9257	11-4	11-5-3351	16-21	11-6-3621	5-4	11-6-7651	5-53
11-4-9259	11-4	11-5-3371	16-21	11-6-3621-T	5-4	11-6-7661	5-53
11-4-9261	11-4	11-5-3961	16-22	11-6-3631	5-5	11-6-7681	5-53
11-4-9263	11-4	11-5-4111	16-10	11-6-3631-T	5-5	11-6-7686	5-53
11-4-9267	11-4	11-5-4115	16-9	11-6-3641	5-5	11-6-7711	5-53
11-4-9281	11-5	11-5-5011	16-13	11-6-3661	5-4	11-6-8343	5-70
11-4-9283	11-5	11-5-5111	16-11	11-6-3663	5-5	11-6-8346	5-70
11-4-9285	11-5	11-5-5261	16-11	11-6-3664	5-12	11-6-8364	5-70
11-4-9286	11-5	11-5-5511	16-4	11-6-3665	5-12	11-6-8366	5-70
11-4-9287	11-5	11-5-5521	16-5	11-6-4111	5-28	11-6-8722	5-20
11-4-9289	11-5	11-5-5611	16-5	11-6-4361	5-16	11-6-8723	5-20
11-4-9441	11-6	11-5-5621	16-6	11-6-6111	5-33	11-6-8762	5-20
11-4-9451	11-6	11-5-6111	16-1	11-6-6111-T	5-33	11-6-9121	5-70
11-4-9461	11-6	11-5-6121	16-1	11-6-6121	5-33	11-6-9291	5-70
11-4-9471	11-6	11-5-6131	16-2	11-6-6121-T	5-33	11-7-2611	14-17
11-4-9481	11-6	11-5-6141	16-3	11-6-6141	5-34	11-7-2631	14-17
11-4-9491	11-6	11-5-6161	16-2	11-6-6141-T	5-34	11-7-2911	14-17
11-4-9501	11-6	11-5-6171	16-2	11-6-6141-T-UF	5-34	11-7-3002	14-2
11-4-9511	11-6	11-5-6221	16-6	11-6-6150	5-34	11-7-3003	14-2
11-4-9521	11-6	11-5-6222	16-6	11-6-6150-T	5-34	11-7-4111	14-3
11-4-9523	11-6	11-5-6223	16-6	11-6-6167	5-41	11-7-4121	14-3
11-4-9525	11-6	11-5-6231	16-7	11-6-6169	5-41	11-7-4131	14-3
11-4-9527	11-6	11-5-6232	16-7	11-6-6171	5-41	11-7-4141	14-3
11-4-9529	11-6	11-5-6233	16-7	11-6-6181	5-18	11-7-4361	14-4
11-4-9531	11-6	11-5-6234	16-8	11-6-6183	5-18	11-7-4371	14-4
11-4-9533	11-6	11-5-6234-XC	16-8	11-6-6191	5-19	11-7-4411	14-5
11-4-9537	11-6	11-5-6235	16-8	11-6-6192	5-19	11-7-4611	14-5
11-4-9636	11-8	11-5-6236	16-8	11-6-6192-T	5-19	11-7-4621	14-5
11-4-9961	11-9	11-5-6237	16-8	11-6-6193	5-19	11-7-4631	14-6
11-4-9962	11-9	11-5-6239	16-8	11-6-6193-V	5-19	11-7-4641	14-6
11-4-9963	11-9	11-6-2011	5-25	11-6-6194	5-20	11-7-4731	14-6
11-4-9964	11-9	11-6-2013	5-25	11-6-6194-T	5-20	11-7-4741	14-6
11-4-9965	11-9	11-6-2031	5-26	11-6-6195	5-20	11-7-4862	14-17
11-4-9966	11-9	11-6-2151	5-29	11-6-6197	5-20	11-7-4911	14-4
11-5-2111	16-18	11-6-2161	5-29	11-6-6199	5-20	11-7-4921	14-4
11-5-2121	16-18	11-6-2561	5-24	11-6-6201	5-38	11-7-4931	14-4
11-5-2131	16-18	11-6-2611	5-24	11-6-6223	5-40	11-7-4941	14-5
11-5-2141	16-18	11-6-2631	5-24	11-6-6224	5-40	11-8-1508	3-38
11-5-2311	16-18	11-6-2633	5-24	11-6-6311	5-38	11-8-1622-D	3-49
11-5-2331	16-18	11-6-2661	5-25	11-6-6321	5-38	11-8-3111	7-7



IND-2

800.322.4674 or 800.633.7283

www.msiprecision.com

Numerical Index



Part Number	Page	Part Number	Page	Part Number	Page	Part Number	Page
11-8-3731	14-21	11-8-6106	3-31	11-8-6556-27	3-29	1223	22-3
11-8-3734	14-21	11-8-6107	3-31	11-8-6556-30	3-29	122-300	4-2
11-8-4661	3-3	11-8-6165	3-10	11-8-6561	3-29	1223A	22-3
11-8-4661	3-38	11-8-6165-18	3-10	11-8-6561-27	3-29	122-400	4-2
11-8-4663	3-3	11-8-6165-23	3-10	11-8-6561-30	3-29	122-500	4-3
11-8-4663	3-38	11-8-6165-27	3-10	11-8-6569	3-27	122-500-1.5	4-3
11-8-4664	3-3	11-8-6165-30	3-10	11-8-6571	3-13	122-600	4-3
11-8-4681	3-2	11-8-6167	3-11	11-8-6791	3-23	122-650	4-3
11-8-4691	3-2	11-8-6167-27	3-11	11-8-7806	3-53	1232	22-3
11-8-4711	3-44	11-8-6193	3-11	11-8-7811	3-39	1232A	22-3
11-8-4731	3-44	11-8-6217	3-20	11-8-7821	3-39	1239	22-3
11-8-4791	3-44	11-8-6217-27	3-20	11-8-7824	3-39	1239A	22-3
11-8-4791	13-15	11-8-6219	3-20	11-8-7861	3-53	1240	22-3
11-8-4911	3-27	11-8-6221	3-20	11-8-7911	3-53	1240A	22-3
11-8-4931	3-28	11-8-6222	3-20	11-8-7912	3-53	1243	22-3
11-8-4941	3-28	11-8-6223	3-21	11-8-7916	3-53	1243A	22-3
11-8-4951	3-28	11-8-6224	3-21	11-8-7917	3-53	1248	22-2
11-8-5011	3-48	11-8-6225	3-21	11G	20-16	1248A	22-2
11-8-5011	12-2	11-8-6225	3-38	12	20-16	1254	22-3
11-8-5013	3-50	11-8-6226	3-21	1202	20-10	1254A	22-3
11-8-5013	12-4	11-8-6227	3-21	120-2	20-9	1271	22-2
11-8-5017	3-50	11-8-6228	3-22	1202-2	20-10	1271A	22-2
11-8-5017	12-4	11-8-6229	3-22	1202-HPT	20-11	1273	22-3
11-8-5031	3-48	11-8-6229-F	3-22	1208	22-3	1273A	22-3
11-8-5031	12-2	11-8-6285	3-35	1208A	22-3	1274	22-3
11-8-5032	3-49	11-8-6285	3-37	120-WC	20-9	1274A	22-3
11-8-5032	12-3	11-8-6287	3-22	12-1000	19-3	1277	22-3
11-8-5041	3-48	11-8-6291	3-22	12-1005	19-3	1277A	22-3
11-8-5041	12-3	11-8-6292	3-23	12-1010	19-3	1288	22-3
11-8-5042	3-49	11-8-6331	3-18	1211	22-2	1288A	22-3
11-8-5042	12-3	11-8-6331	12-3	1211A	22-2	1289	22-3
11-8-5051	3-49	11-8-6332	3-18	1212	22-2	1289A	22-3
11-8-5061	3-50	11-8-6341	3-18	1212 A	22-2	1290	22-3
11-8-5113	3-31	11-8-6342	3-19	1213	22-2	1290A	22-3
11-8-5113	3-42	11-8-6342	12-4	1213A	22-2	1295	22-3
11-8-5116	3-31	11-8-6351	3-19	1214	22-2	1295A	22-3
11-8-5116	3-42	11-8-6352	3-19	1214A	22-2	1298	22-3
11-8-5119	3-42	11-8-6401	3-36	1220	22-2	1298A	22-3
11-8-5121	3-42	11-8-6404	3-36	12-2000	19-3	12A	20-14
11-8-5410	3-34	11-8-6471	3-35	122-000	4-1	12N	20-9
11-8-5415	3-33	11-8-6481	3-36	122-000-3	4-1	12N	20-15
11-8-5416	3-34	11-8-6491	3-36	12-2005	19-3	12N	20-15
11-8-5419	3-34	11-8-6521	3-17	12-2010	19-3	12N-2	20-9
11-8-5751	3-46	11-8-6531	3-17	1220A	22-2	130	20-14
11-8-5753	3-46	11-8-6541	3-29	122-100	4-1	1301	22-8
11-8-5771	3-47	11-8-6542	3-29	122-100-3	4-1	1302	20-12
11-8-5791	3-47	11-8-6543	3-29	122-150	4-2	1302	22-8
11-8-5961	3-50	11-8-6551	3-28	1222	22-3	1308	22-5
11-8-5991	3-51	11-8-6551-27	3-28	122-200	4-1	1308A	22-5
11-8-5991	12-4	11-8-6551-30	3-28	122-250	4-2	1308AJ	22-7
11-8-5993	3-51	11-8-6556	3-29	1222A	22-3	1308J	22-7

800.322.4674 or 800.633.7283

www.msiprecision.com

IND-3



Numerical Index



Part Number	Page	Part Number	Page	Part Number	Page	Part Number	Page
13-1007	19-1	134	20-14	1395A	22-5	1473A	22-10
13-1010	19-1	1340	22-5	1395AJ	22-7	1474	22-10
13-1015	19-1	1340A	22-5	1395J	22-7	1474A	22-10
13-1020	19-1	1340AJ	22-7	1398	22-5	1477	22-10
13-1025	19-1	1340J	22-7	1398A	22-5	1477A	22-10
13-1030	19-1	1343	22-5	1398AJ	22-7	1486	22-8
13-1035	19-1	1343A	22-5	1398J	22-7	1486A	22-8
13-1040	19-1	1343AJ	22-7	13F	20-17	1487	22-8
13-1041	19-1	1343J	22-7	13F w/Rolled Bead	20-12	1487A	22-8
13-1045	19-1	1348	22-4	13F-PMT	20-11	1488	22-11
13-1046	19-1	1348A	22-4	1408	22-10	1488A	22-11
13-1050	19-1	1348A	22-4	1408A	22-10	1489	22-11
13-1055	19-1	1348A	22-4	1411	22-9	1489A	22-11
13-1060	19-1	1348A	22-4	1411A	22-9	1490	22-11
1311	22-4	1348A	22-4	1412	22-9	1490A	22-11
1311-2	20-10	1348AJ	22-6	1412A	22-9	1495	22-10
1311A	22-4	1348J	22-6	1413	22-9	1495A	22-10
1311AJ	22-6	1354	22-5	1413A	22-9	1498	22-10
1311J	22-6	1354A	22-5	1414	22-10	1498A	22-10
1312	22-4	1354AJ	22-7	1414A	22-10	14G	20-9
1312A	22-4	1354J	22-7	1415	22-8	14G	20-14
1312AJ	22-6	1371	22-4	1415A	22-8	15-1001	20-2
1312J	22-6	1371A	22-4	1416	22-8	15-1002	20-2
1313AJ	22-6	1371AJ	22-6	1416A	22-8	15-1003	20-2
1313J	22-6	1371J	22-6	1417	22-9	15-1004	20-2
1314AJ	22-6	1373	22-5	1417A	22-9	15-1005	20-2
1314J	22-6	1373A	22-5	1418	22-9	15-1006	20-2
132	20-14	1373AJ	22-7	1418A	22-9	15-1007	20-2
1320AJ	22-6	1373J	22-7	1420	22-10	15-1008	20-2
1320J	22-6	1374	22-5	1420A	22-10	15-1009	20-2
1322	22-5	1374A	22-5	1422	22-10	15-11120	5-45
132219-2133	3-53	1374AJ	22-7	1422A	22-10	15-11150	5-45
132219-2142	3-40	1374J	22-7	1423	22-10	15-12120	5-45
132219-2144	3-40	1377	22-5	1423A	22-10	15-12150	5-46
132219-2146	3-41	1377A	22-5	1430	22-9	15-13120	5-46
132219-2157	5-71	1377AJ	22-7	1430A	22-9	15-14120	5-46
1322A	22-5	1377J	22-7	1432	22-11	15-15120	5-46
1322AJ	22-7	137P	20-14	1432A	22-11	15-15150	5-46
1322J	22-7	1388	22-5	1439	22-10	15-16120	5-46
1323	22-5	1388A	22-5	1439A	22-10	1516-431BX	13-3
1323A	22-5	1388AJ	22-7	1440	22-11	1520 w/Rolled Bead	20-12
1323AJ	22-7	1388J	22-7	1440A	22-11	15-2001	20-3
1323J	22-7	1389	22-5	1443	22-10	15-2002	20-3
1332	22-5	1389A	22-5	1443A	22-10	15-2003	20-3
1332A	22-5	1389AJ	22-7	1448	22-10	15-2004	20-3
1332AJ	22-7	1389J	22-7	1448A	22-10	15-2005	20-3
1332J	22-7	1390	22-5	1454	22-10	15-2006	20-3
1339	22-5	1390A	22-5	1454A	22-10	15-2007	20-3
1339A	22-5	1390AJ	22-7	1471	22-9	15-2008	20-3
1339AJ	22-7	1390J	22-7	1471A	22-9	15-2009	20-3
1339J	22-7	1395	22-5	1473	22-10	15-2010	20-3



IND-4

800.322.4674 or 800.633.7283

www.msiprecision.com

Numerical Index



Part Number	Page	Part Number	Page	Part Number	Page	Part Number	Page
15-2011	20-3	15-7002	20-3	16-5166-AR	11-19	17F-PMT	20-11
15-2012	20-3	15-7003	20-3	16-5166-CR	11-19	18081	3-13
15-2013	20-3	15-7004	20-3	16-5166-R	11-19	18081-27	3-13
15-2014	20-3	15-8020	20-3	16-5168-R	11-19	18082	3-13
15-2015	20-3	15-8021	20-3	16-5176-L-R	11-19	1811	22-13
15-2017	20-3	15-8022	20-3	16-5176-RR	11-19	1813	22-13
15-2031	20-3	15-8023	20-3	16-6109	20-1	1821	22-13
15-2032	20-3	15-8030	20-3	16-6129	20-1	1822	22-13
1520-PMT	20-11	15-8030	20-3	16-6139	20-1	18227SPT	11-12
1525	22-12	15-8031	20-3	16N	20-9	18228	11-12
1525 w/Flat Flange	20-12	15-8032	20-3	16N	20-15	1823	22-13
1525T	22-12	15-8033	20-3	170	20-11	1827	22-13
1526	22-12	15-8040	20-3	170-2	20-11	18-400	19-9
1526T	22-12	15-8041	20-3	17-101-50	19-16	18-405	19-9
1527	22-12	15-8042	20-3	17-102-50	19-16	18-410	19-9
1527T	22-12	15-8043	20-3	17-201-50	19-15	18-410/18-415	19-9
1528	22-12	15-8050	20-3	17-202-50	19-15	18-415	19-9
1528T	22-12	15-8051	20-3	17-203-50	19-15	18-417	19-9
15-3001	20-3	15-8052	20-3	17-251-25	19-14	18-417 / 18-417e	19-9
15-3003	20-3	15-8053	20-3	17-252-25	19-14	18-417E	19-9
15-3004	20-3	15-8060	20-3	17-254-25	19-16	18-418	19-9
15-3005	20-3	15-8061	20-3	17-257-12	19-14	18-418 / 18-418e	19-9
15-3007	20-3	15-8070	20-3	17-257-25	19-14	18-418E	19-9
15-3010	20-3	15-8380AS	3-23	17-301-50	19-15	18-419	19-10
15-3011	20-3	15-8389AS	3-23	17-301-50	19-15	18-419	19-10
15-3012	20-3	15-8391AS	3-23	17-303-50	19-15	18-420	19-10
15-3013	20-3	15-8392AS	3-24	17-350-25	19-14	18-420	19-10
15-3014	20-3	15-8393AS	3-24	17-401-50	19-15	18-421	19-10
15-3015	20-3	15-8394AS	3-24	17-402-50	19-15	18-421	19-10
15-3017	20-3	15-8395AS	3-24	17-403-50	19-15	18-422	19-10
1533T	22-12	15-8398AS	3-24	17-411-50	19-15	18-422	19-10
15-4002	20-3	15-8399AS	3-24	17-412-50	19-15	18-423	19-10
15-4003	20-3	15-8738AS	3-14	17-413-50	19-15	18-423	19-10
15-4004	20-3	15-9001	20-3	17-421-25	19-14	18-424	19-10
15-4005	20-3	15-9002	20-3	17-422-25	19-14	18-425	19-10
15-4007	20-3	15-9003	20-3	17-451-25	19-14	18-425	19-10
15-4008	20-3	15-9004	20-3	17-452-25	19-14	18-426	19-10
15-4009	20-3	15-9005	20-3	17-457-12	19-14	18-426	19-10
15-4011	20-3	15-9006	20-3	17-457-25	19-14	18-427	19-10
15-4013	20-3	15F-PMT	20-11	17-501-50L	19-15	18-427	19-10
15-4014	20-3	160-WC	20-9	17-501-50R	19-15	18-428	19-10
15-4015	20-3	16-1100	19-1	17-502-50	19-15	18-430	19-11
15-4017	20-3	16-1200	19-1	17-503-50	19-15	18-430	19-11
15-5061	20-3	16-1300	19-1	17-504-50	19-16	18-431	19-11
15-5062	20-3	16-3433-R	5-21	17-575-12	19-16	18-431	19-11
15-5063	20-3	16-3434-R	5-21	17-701-50	19-15	18-435	19-11
15-5064	20-3	16-3446-R	5-43	17-702-50	19-15	18-435	19-11
15-5406-ST	5-21	1650-2	20-10	17-703-50	19-15	18-440	19-11
15-6003	20-3	16-5151-L	11-18	17-704-50	19-16	18-440	19-11
15-6004	20-3	16-5151-R	11-18	17-775-12	19-16	18-450	19-11
1566	22-12	16-5154-R	11-18	17F w/Rolled Bead	20-12	18-450	19-11

800.322.4674 or 800.633.7283

www.msiprecision.com

IND-5



Numerical Index



Part Number	Page	Part Number	Page	Part Number	Page	Part Number	Page
18-451	19-12	201103-3	4-11	26A	20-14	30109-125	20-20
18-460	19-12	21-14120	5-48	28274M	5-18	30111	20-20
18-470	19-13	21-14150	5-48	2W	20-17	30118	20-20
18-470	19-13	21-15120	5-48	2xBGL5	21-6	30126	20-21
1873	22-13	21-15150	5-48	2xBGL5	21-6	30-134-1	19-7
1874	22-13	21-16120	5-49	2xBSL5	21-4	30-134-5	19-7
1877	22-13	21-17120	5-49	2xBSL5	21-4	30-134-6	19-7
1885	22-13	21-18120	5-49	2xDGL6	21-6	30-156	20-4
18-900	19-13	21-18150	5-49	2xDO5	21-4	30-170	20-4
18-900	19-13	2209	22-14	2xDS13	21-8	30-172	20-4
18-910	19-13	22-10120	5-49	2xDSL6	21-5	30-196	20-4
18-910	19-13	22-10150	5-49	2xDSL6	21-9	30-210	20-6
1895	22-13	22-11120	5-49	2xDSL7	21-5	30-212	20-6
1898	22-13	22-13120	5-50	2xDSL7	21-8	30-214	20-6
18-990	19-13	22-14120	5-50	2xDSL7	21-8	30-216	20-7
18A	20-14	2215	22-14	2xDSM11	21-7	30-218	20-7
19-133110	15-1	22-15120	5-50	2xDSM13	21-7	302-2	20-10
19-133111	15-1	22-16120	5-50	2xDSM7	21-7	30-220	20-7
19-133142	15-1	22A	20-14	2xHGL5	21-6	30-222	20-7
19-133143	15-2	2302-2	20-10	2xHGL5	21-6	30-224	20-7
19-133166	15-2	2309	22-14	2xHGL7	21-6	30-226	20-7
19-133168	15-2	2315	22-14	2xHSL5	21-5	30-230	20-5
19-1361-9	4-6	232-G00-08	13-5	2xHSL5	21-5	30-254	19-7
19-3161-10A	4-5	232-G00-09	13-5	2xHSL5	21-9	30320	20-20
19-3161-10S	4-5	232-G00-10	13-5	2xHSL7	21-5	30320-OPT	20-20
19-3161-11	4-3	232-G00-11	13-5	2xSSL15	21-9	30418	20-20
19-3161-11D	4-4	238018	14-23	2xSSL5	21-9	30630	20-21
19-3161-13	4-7	240-2	20-9	2xVSL7	21-8	30812	20-21
19-3161-14A	4-5	240-2	20-9	2xVSP8	21-8	30A	20-14
19-3161-14S	4-5	25	20-15	30	20-17	31010	20-23
19-3161-15	4-7	257	20-14	30-002	20-6	31010-0	20-23
19-3161-16	4-7	25P	20-15	30-004	20-6	31015-0	20-23
19-3161-16l	4-7	26-1001	20-2	30-006	20-6	31015-L	20-23
19-3161-1D	4-1	26-1001	20-2	30-008	20-6	31015-S	20-23
1962-14117	13-3	26-1002	20-2	30-010	20-6	31020-L	20-23
1962-15117	13-3	26-1002	20-2	30011	20-24	31020-S	20-23
1994-54317	13-4	26-1003	20-2	30011-PM	20-24	31123	20-24
1994-54918	13-4	26-1003	20-2	30-012	20-6	31123-03	20-24
1994-56122	13-4	26-1004	20-2	30-014	20-5	31123-0500	20-24
19F w/Rolled Bead	20-12	26-1004	20-2	30-016	20-5	31123-0500-T1	20-24
19F-PMT	20-11	26-1005	20-2	30-018	20-5	31123-0500-T2	20-24
1J	20-15	26-1005	20-2	30-080	20-5	31123-T	20-24
1SF w/Rolled Bead	20-12	26-1006	20-2	30-082	20-7	31127	20-24
2	20-15	26-1006	20-2	30-084	20-7	31420-0800	20-22
2	20-16	26-1007	20-2	30-084	20-7	31420-8A	20-22
200	20-9	26-1007	20-2	30-086	20-7	31421	20-24
200 WC	20-9	26-1008	20-2	30-088	20-5	31615	20-21
2000-2	20-11	26-1008	20-2	30-096	20-7	32	20-17
2006-2	20-12	26-1009	20-2	30-098	20-7	320-800	4-4
201102	4-11	26-1009	20-2	30-104	20-5	320-850	4-4
201103	4-11	26-1010	20-2	30109	20-20	320-900	4-4



IND-6

800.322.4674 or 800.633.7283

www.msiprecision.com

Numerical Index



Part Number	Page	Part Number	Page	Part Number	Page	Part Number	Page
320-950	4-5	402-2	20-10	5-0122-5.50	11-7	5-1252-2B	3-45
320B	14-24	417827C	4-1	5-0122-6.00	11-7	5-1252-2S	3-45
320BD	14-24	421-100	4-8	5-0122-7.00	11-7	5-1252-L	3-45
320BK	14-24	421-120	4-8	5-0122-8.00	11-7	5-1254	3-45
320GR	14-24	421-140	4-8	5-0122-9.00	11-7	5-1255-27	3-46
320HG	14-24	421-160	4-8	5-0122-9.50	11-7	5-1255-30	3-46
320M	14-24	421-170	4-8	5-0127	8-4	5-1256	3-46
320N	14-24	421-180	4-8	5-0127-T	8-4	5-1257	3-46
320NO	14-24	43	20-10	5-0129	8-5	5-1259	3-46
320NP	14-24	43-2	20-10	5-0129-13	8-5	5-1401	9-3
320NY	14-24	46-1100	19-2	5-0133-10	11-8	5-1500-23	3-1
320O	14-24	46-1600	19-3	5-0133-12	11-8	5-1500-23-10	3-1
320R	14-24	46-1700	19-3	5-0133-16	11-8	5-1500-23-11	3-1
320RB	14-24	46-2001	19-2	5-0133-4	11-8	5-1500-23-12	3-1
320TL	14-24	46-2002	19-2	5-0133-6	11-8	5-1500-23-2	3-1
320V	14-24	46-2003	19-2	5-0133-8	11-8	5-1500-23-3	3-1
320W	14-24	46-2046	19-2	5-0141-10.00	11-5	5-1500-23-4	3-1
320-WC.	20-9	46-3001	19-2	5-0141-11.00	11-5	5-1500-23-6	3-1
321-020	4-6	46-3002	19-2	5-0141-3.00	11-5	5-1500-23-7	3-1
321-030	4-6	46-3003	19-2	5-0141-3.25	11-5	5-1500-23-8	3-1
321-040	4-6	46-3004	19-2	5-0141-3.50	11-5	5-1500-23-9	3-1
321-050	4-6	46-3100	19-2	5-0141-3.75	11-5	5-1500-25	3-1
321-120	4-6	46-4001	19-2	5-0141-4.00	11-5	5-1500-25-10	3-1
321-140	4-6	46-6001	19-3	5-0141-4.25	11-5	5-1500-25-11	3-1
321-150	4-6	46-6003	19-3	5-0141-4.50	11-5	5-1500-25-12	3-1
321-220	4-7	46-6010	19-2	5-0141-4.75	11-5	5-1500-25-2	3-1
321-240	4-7	46-7001	19-3	5-0141-5.00	11-5	5-1500-25-3	3-1
321-250	4-7	46-7002	19-3	5-0141-5.25	11-5	5-1500-25-4	3-1
321B	14-24	46-8001	19-3	5-0141-5.50	11-5	5-1500-25-6	3-1
321BD	14-24	46-8002	19-3	5-0141-5.75	11-5	5-1500-25-7	3-1
321BK	14-24	46-8115	19-2	5-0141-6.00	11-5	5-1500-25-8	3-1
321GR	14-24	46-8160	19-2	5-0141-7.00	11-5	5-1500-25-9	3-1
321HG	14-24	46-8170	19-2	5-0141-8.00	11-5	5-1500-27	3-1
321M	14-24	46-8180	19-2	5-0141-9.00	11-5	5-1500-27-10	3-1
321N	14-24	46-8182	19-2	5-0142	11-6	5-1500-27-11	3-1
321NO	14-24	46-8185	19-2	5-0144	11-9	5-1500-27-12	3-1
321NP	14-24	46-8190	19-2	5-1091	13-2	5-1500-27-2	3-1
321NY	14-24	4J	20-15	5-1091-I	13-2	5-1500-27-3	3-1
321O	14-24	50-10090	5-60	5-1092	13-2	5-1500-27-4	3-1
321R	14-24	50-11090	5-61	5-1092-I	13-2	5-1500-27-6	3-1
321RB	14-24	5-0111	11-2	5-1093	13-2	5-1500-27-7	3-1
321TL	14-24	5-0122-3.00	11-7	5-1093-I	13-2	5-1500-27-8	3-1
321V	14-24	5-0122-3.25	11-7	5-1094	13-2	5-1500-27-9	3-1
321W	14-24	5-0122-3.50	11-7	5-1094-I	13-2	5-1500-30	3-1
32A	20-14	5-0122-3.75	11-7	51-10090	5-61	5-1500-30-10	3-1
32K	20-15	5-0122-4.00	11-7	5-1106	9-3	5-1500-30-11	3-1
360	20-9	5-0122-4.25	11-7	5-1169	1-10	5-1500-30-12	3-1
360-2	20-9	5-0122-4.50	11-7	5-1173	1-10	5-1500-30-2	3-1
360-2	20-9	5-0122-4.75	11-7	5-1179	1-10	5-1500-30-3	3-1
3J	20-15	5-0122-5.00	11-7	5-1182	1-10	5-1500-30-4	3-1
3W	20-17	5-0122-5.25	11-7	5-1251	3-45	5-1500-30-6	3-1

800.322.4674 or 800.633.7283

www.msiprecision.com

IND-7



Numerical Index



Part Number	Page	Part Number	Page	Part Number	Page	Part Number	Page
5-1500-30-7	3-1	5-1633	12-4	5-1699	11-11	5-1894	7-2
5-1500-30-8	3-1	5-1639	8-1	5-1710	13-1	5-1895	7-2
5-1500-30-9	3-1	5-1642	3-35	5-1719	13-1	5-1912	7-3
5-1503	13-10	5-1643	8-1	5-1721	13-15	5-1913 (Shown)	7-3
5-1504	13-10	5-1644	8-1	5-1722	13-1	5-1914	7-3
5-1505	13-10	5-1646	10-12	5-1722	13-15	5-1918	7-3
5-1508	3-3	5-1650	10-12	5-1724	13-1	5-1919	7-3
5-1508-PK	3-3	5-1650-A	10-13	5-1724	13-16	5-1920	1-1
51523	20-22	5-1650-B	10-13	5-1726	3-52	5-1920-A	1-1
51527	20-20	5-1650-D	10-13	5-1727	13-1	5-1920-C	1-1
51527	20-21	5-1650-H	10-13	5-1728	13-16	5-1921	1-1
51527	20-22	5-1653	10-7	5-1736	13-16	5-1921-A	1-1
5-1532	7-8	5-1654-L	8-1	5-1737	13-16	5-1921-C	1-1
5-1563	9-3	5-1654-S	8-1	5-1738	13-16	5-1922	1-1
5-1585	13-8	5-1655-L	8-2	5-1742	3-52	5-1922-A	1-1
5-1590	13-8	5-1655-S	8-2	5-1743	3-52	5-1923	1-1
5-1592	13-8	5-1656	10-5	5-1744	3-52	5-1923-A	1-1
5-1595	13-8	5-1656-A	10-5	5-1745	3-52	5-1924	1-1
5-1596	13-8	5-1656-M	10-5	5-1746	3-52	5-1924-A	1-1
5-1596-25	13-9	5-1656-T-A	10-5	5-1750	10-2	5-1925	1-1
5-1596-25-T	13-9	5-1657	10-14	5-1750-EC	10-2	5-1925-A	1-1
5-1596-C	13-9	5-1658	10-14	5-1755	10-1	5-1926	1-1
5-1597-M	13-9	5-1659	10-14	5-1759-GW	10-2	5-1927	1-1
5-1598-M	13-9	5-1660	3-44	5-1761	10-3	5-1928	1-1
5-1599	13-10	5-1660	13-15	5-1775	10-1	5-1929	1-1
5-1602	11-10	5-1667-N	3-44	5-1797	10-1	5-1957	13-17
5-1603	11-10	5-1667-N	13-15	5-1797	13-17	5-1961	13-17
5-1604	11-10	5-1669-PS	12-4	5-1801	7-2	5-1965	13-17
5-1610-23	12-2	5-1669-SN	3-43	5-1811	13-12	52	20-14
5-1610-23-ED	12-2	5-1675	11-10	5-1815	13-12	520-100	4-8
5-1610-30	12-2	5-1677	7-1	5-1817	13-13	520-200	4-8
5-1614	3-43	5-1677-A	7-1	5-1818	13-13	5-2029	5-64
5-1614	13-14	5-1677-S	7-1	5-1819	13-13	520-300	4-9
5-1614-L	3-43	5-1677-SA	7-1	5-1822	9-1	520-400	4-9
5-1615	3-43	5-1678	10-8	5-1822-T	9-1	520-500	4-9
5-1615	13-14	5-1678-A	10-8	5-1822-TR	9-1	5-2053-15	5-42
5-1617	3-43	5-1679	10-15	5-1823	13-10	5-2053-16	5-42
5-1617	13-15	5-1681-N	11-12	5-1823-II	13-11	5-2053-18	5-42
5-1618-J	3-26	5-1682	10-9	5-1823-II-T	13-11	5-2053-19	5-42
5-1619	3-48	5-1682-A	10-9	5-1823-T	13-11	5-2053-22	5-42
5-1619	12-1	5-1683	10-11	5-1825	13-13	5-2053-30	5-42
5-1619-D	3-48	5-1687-M	10-14	5-1835	13-14	5-2054-15	5-42
5-1619-ED	3-48	5-1688	10-10	5-1835-M	13-14	5-2054-16	5-42
5-1619-ED	12-2	5-1689-L	11-12	5-1841	13-10	5-2054-21	5-42
5-1621	3-27	5-1689-LT	11-13	5-1842	13-12	5-2054-22	5-42
5-1622-ED	3-49	5-1689-R	11-12	5-1859	13-12	5-2058-0	5-50
5-1622-ED	12-3	5-1689-RT	11-13	5-1866	10-11	5-2058-1	5-50
5-1624	3-50	5-1691	11-10	5-1891	7-2	5-2058-2	5-51
5-1624	12-4	5-1693	11-10	5-1892	7-2	5-2058-3	5-51
5-1629	12-1	5-1697	11-11	5-1893	7-2	5-2058-3C	5-51
5-1633	3-50	5-1697-S	11-11	5-1893-GW	7-2	5-2058-4	5-51



IND-8

800.322.4674 or 800.633.7283

www.msiprecision.com

Surgical Advantage

1-800-948-7994

order@surgicaladvantage.net

Numerical Index



Part Number	Page	Part Number	Page	Part Number	Page	Part Number	Page
5-2058-5	5-51	5-2595	5-67	5-2903	5-63	5-2996	5-40
5-2058-5H	5-52	5-2598	5-30	5-2907	5-40	5-2998	5-40
5-2058-7	5-52	5-2611	5-47	5-2908	5-39	5-2999-C	5-37
520-600	4-9	5-2611-C	5-47	5-2909-CM	5-39	5-2999-S	5-37
520-700	4-9	5-2613	5-47	5-2910	5-7	5-3006	5-68
5-2071	5-72	5-2617	5-45	5-2911	5-6	5-3077	5-68
5-2072	5-72	5-2617	5-47	5-2912	5-12	5-3081	5-68
5-2072-A	5-72	5-2664	5-12	5-2912	5-63	5-3084	5-68
5-2072-D	5-72	5-2671	5-15	5-2913	5-6	5-3086	5-68
5-2072-ED	5-72	5-2673	5-15	5-2916	5-6	5-3086-2	5-68
5-2072-S	5-72	5-2675	5-12	5-2916-XD	5-6	5-3086-WOL	5-68
520-800	4-10	5-2683	5-15	5-2916-XDWH	5-6	5-3087	5-68
520-900	4-10	5-2703	5-57	5-2917	5-7	5-3092	5-69
5-2094	5-71	5-2711	5-15	5-2917	5-63	5-3093	5-69
521-000	4-10	5-2715	5-16	5-2918	5-35	5-3093-S	5-69
52-10080	5-61	5-2731	5-14	5-2919	5-37	5-3095	5-69
52-10090	5-61	5-2731	5-16	5-2919	5-63	5-3095-S	5-69
5-2101	13-11	5-2765	5-14	5-2920	5-34	5-3098	5-70
5-2101-SS	13-11	5-2767	5-14	5-2921	5-37	5-3099	5-70
5-2102	13-11	5-2770	5-16	5-2922	5-7	5-3113	5-17
5-2102-SS	13-12	5-2770-A	5-16	5-2924-A	5-8	5-3113-C	5-17
521-100	4-10	5-2781	5-14	5-2924-AK	5-8	5-3113-G	5-17
521-200	4-10	5-2781-FN	5-14	5-2924-S	5-8	5-3113-R	5-18
5-2170	9-4	5-2782	5-14	5-2925	5-64	5-3113-RC	5-18
5-2170-L	9-4	5-2782	5-16	5-2926-A	5-33	5-3113-S	5-17
5-2170-P	9-4	5-2785	5-15	5-2926-AB	5-34	5-3115	5-18
5-2170-S	9-4	5-2795	5-13	5-2926-AK	5-33	5-3116	5-18
5-2327	10-3	5-2796	5-13	5-2926-S	5-32	5-3134	5-43
5-2349	10-3	5-2797	5-57	5-2927	5-8	5-3139	5-43
5-2427	5-28	5-2798	5-57	5-2935	5-9	5-3188	5-43
5-2429-12	5-27	5-2800	5-6	5-2936	5-39	5-3267	5-60
5-2429-3	5-27	5-2804	5-11	5-2939	5-9	5-3271	5-60
5-2511	5-44	5-2806	5-11	5-2941	5-9	5-3273	5-60
5-2515	5-44	5-2807	5-3	5-2942	5-9	5-3275	5-60
5-2517	5-44	5-2807-S	5-3	5-2943	5-9	5-3277	5-60
5-2519	5-44	5-2807-T	5-3	5-2966	5-38	5-3281	5-60
5-2521	5-44	5-2807-WO	5-32	5-2966-A	5-39	5-3367	5-13
5-2527	5-28	5-2808	5-4	5-2966-C	5-39	5-3415	5-57
5-2531	5-48	5-2808-T	5-4	5-2967	5-36	5-3415	17-32
5-2533	5-48	5-2809	5-4	5-2967-C	5-36	5-3441	5-57
5-2535	5-29	5-2809-S	5-5	5-2986	5-63	5-3442	5-58
5-2577	5-28	5-2809-T	5-5	5-2990-S	5-10	5-3445	5-58
5-2585	5-29	5-2828	5-12	5-2992	5-36	5-3446	5-58
5-2585	5-67	5-2835	5-13	5-2992-12C	5-9	5-3451	5-58
5-2586	5-29	5-2841	5-12	5-2992-12S	5-10	5-3461	5-59
5-2586	5-67	5-2843	5-12	5-2992-3S	5-10	5-3512	2-1
5-2587	5-29	5-2846	5-35	5-2992-PS	5-10	5-3513	2-1
5-2588	5-29	5-2894	5-2	5-2992-S	5-10	5-3514	2-2
5-2594	5-29	5-2896	5-2	5-2992-S	5-36	5-3515	2-2
5-2594	5-67	5-2899	5-2	5-2993	5-41	5-3515-T	2-2
5-2595	5-30	5-2901	5-63	5-2995	5-41	5-3516	2-2

800.322.4674 or 800.633.7283

www.msiprecision.com

IND-9



Numerical Index



Part Number	Page	Part Number	Page	Part Number	Page	Part Number	Page
5-3516-D	2-2	5-4301	16-22	5-4431-RXC	16-10	5-4665	15-10
5-3520	2-3	5-4314-12	5-25	5-4432	16-10	5-4667	15-11
5-3521	2-3	5-4314-25	5-26	5-4432-C	16-11	5-4671	15-11
5-3525	2-3	5-4315	5-24	5-4432-MWH	16-11	5-4673	15-11
5-3531	2-3	5-4316	5-25	5-4432-WH	16-10	5-4681	15-12
5-3531	13-6	5-4318-45	5-28	5-4433	16-12	5-4682	15-12
5-3532	2-4	5-4318-90	5-28	5-4450	16-4	5-4683	15-12
5-3532	11-1	5-4324	5-26	5-4451	16-5	5-4687	15-12
5-3611	5-59	5-4326	5-26	5-4451-WH	16-5	5-4688	15-13
5-3615	5-59	5-4329-L	16-17	5-4454	16-4	5-4689	15-13
5-3618	5-59	5-4329-MM	16-17	5-4455	16-4	5-4691	15-13
5-3625	5-56	5-4329-R	16-16	5-4458	16-4	5-4695	15-14
5-3633	5-56	5-4331	16-20	5-4470	16-13	5-4696	15-14
5-3634	5-56	5-4331-WH	16-21	5-4471	16-13	5-4699	15-14
5-3691	5-54	5-4332	16-22	5-4472	16-13	5-4801	14-10
5-3711	5-54	5-4334	16-21	5-4477	16-12	5-4807	14-7
5-3715	5-54	5-4338	16-20	5-4478	16-12	5-4808	14-7
5-3721	5-54	5-4342-L	16-17	5-4490	16-3	5-4808-LC	14-7
5-3725	5-55	5-4342-R	16-17	5-4494-C	16-2	5-4808-X	14-7
5-3729	5-55	5-4343	16-19	5-4494-S	16-2	5-4809	14-15
5-3741	5-55	5-4344	16-19	5-4497	16-1	5-4906	14-7
5-3743	5-55	5-4354	16-10	5-4497-B	16-1	5-4911	14-15
5-3751	5-56	5-4390	16-22	5-4498	16-1	5-4913	14-16
5-3800-I&R1.5	14-22	5-4401-A	16-7	5-4498-B	16-1	5-4914	14-16
5-3800-R1.5	14-22	5-4401-C	16-7	5-4499-GW	16-3	5-4915	14-8
5-3809	14-22	5-4407	15-3	5-4499-GWL	16-3	5-4915-WLM	14-8
5-4011	13-7	5-4408	15-3	5-4501	15-3	5-4916-M	14-8
5-4015	13-7	5-4411	16-15	5-4511	15-4	5-4916-WLM	14-8
5-4026	5-65	5-4412	16-16	5-4513	15-4	5-4918-W	14-9
5-4027	5-65	5-4415	16-13	5-4515	15-4	5-4918-WO	14-9
5-4031	5-66	5-4415-M	16-13	5-4516	15-5	5-4938	14-9
5-4033	5-66	5-4415-MC	16-14	5-4517	15-5	5-4938-CW	14-9
54-10090	5-61	5-4415-MC	16-14	5-4519	15-5	5-4939-CW	14-1
54-12080	5-61	5-4415-WH	16-14	5-4521	15-6	5-4939-CWO	14-1
5-4122	9-3	5-4415-X	16-14	5-4523	15-6	5-4939-SW	14-1
5-4125	9-3	5-4415-XWH	16-14	5-4527	15-6	5-4939-SWO	14-1
54-15105	5-61	5-4416	16-14	5-4529	15-7	5-4940	14-4
5-4157	13-11	5-4416-M	16-15	5-4535	15-7	5-4940-X	14-4
5-4200	5-23	5-4416-MC	16-15	5-4537	15-7	5-4940-XWH	14-11
5-4200-GW	5-43	5-4416-WH	16-15	5-4547	15-8	5-4945	14-14
5-4201	5-23	5-4416-X	16-15	5-4561	15-8	5-4946	14-14
5-4202	5-24	5-4416-XWH	16-15	5-4571	15-8	5-4947-C	14-9
5-4203-FT	5-35	5-4417	16-16	5-4591	15-9	5-4947-CW	14-10
5-4203-FTS	5-36	5-4418	16-16	5-4593	15-9	5-4949-WH	14-12
5-4203-T	5-35	5-4426	16-12	5-4601	15-9	5-4950	14-13
5-4203-TS	5-35	5-4427	16-12	5-4603	15-9	5-4953	14-2
5-4204	5-26	5-4431-L	16-9	5-4606	15-9	5-4954	14-2
5-4205	5-27	5-4431-R	16-8	5-4617	15-9	5-4955	14-2
5-4206	5-27	5-4431-RS	16-9	5-4621	15-10	5-4956	14-2
5-4207	5-27	5-4431-RWH	16-9	5-4661	15-10	5-4957	14-15
5-4208	5-27	5-4431-RX	16-10	5-4663	15-10	5-4958-C	14-10



IND-10

800.322.4674 or 800.633.7283

www.msiprecision.com

Numerical Index



Part Number	Page	Part Number	Page	Part Number	Page	Part Number	Page
5-4959	14-13	5-5042-7	3-37	5-5144	8-7	5-5313	14-18
5-4961	14-13	5-5042-7-27	3-5	5-5144-P	8-7	5-5314	14-18
5-4962	14-14	5-5042-7-27	3-15	5-5145	8-6	5-5315	14-18
5-4963	14-12	5-5042-7-30	3-5	5-5151	17-29	5-5316	14-19
5-4963-WO	14-12	5-5042-7-30	3-15	5-5152	17-30	5-5321	14-19
5-4964-S	14-14	5-5042-8	3-5	5-5161	17-28	5-5322	14-19
5-4972	14-10	5-5042-8	3-15	5-5162	17-28	5-5323	14-19
5-4972-A	14-10	5-5042-8	3-37	5-5167	17-29	5-5324	14-19
5-4972-WH	14-11	5-5042-9	3-5	5-5169	17-29	5-5325	14-20
5-4972-WHMC	14-11	5-5042-9	3-15	5-5171	17-29	5-5331-0	14-20
5-4972-WHMS	14-11	5-5042-9	3-37	5-5175	17-29	5-5331-00	14-20
5-4973	14-12	5-5043-23	3-26	5-5176	17-14	5-5331-15	14-20
5-4975	14-13	5-5043-T	3-26	5-5176-A	17-14	5-5333	14-20
5-4996	14-8	5-5044-L	3-26	5-5176-AT	17-15	5-5362	14-21
5-5000	3-42	5-5044-R	3-26	5-5183	17-27	5-5362-C	14-21
5-5012-23	3-6	5-5053	3-4	5-5183-G	17-28	5-5406	3-32
5-5012-23	3-30	5-5055	3-5	5-5184	17-28	5-5406-10	3-33
5-5012-25	3-6	5-5062	3-42	5-5193	17-25	5-5406-19	3-5
5-5012-25	3-30	5-5062-25	3-42	5-5197	17-26	5-5406-19	3-30
5-5012-27	3-6	5-5066	3-41	5-5209	14-18	5-5406-2	3-32
5-5012-27	3-30	5-5069	3-37	5-5210	17-11	5-5406-20	3-6
5-5012-30	3-6	5-5070	3-16	5-5211	17-27	5-5406-20	3-30
5-5012-30	3-30	5-5070-L	3-16	5-5215	17-27	5-5406-21	3-5
5-5032	3-4	5-5070-LC	3-25	5-5216	17-5	5-5406-21	3-30
5-5033	3-4	5-5070-R	3-50	5-5217	17-1	5-5406-22	3-6
5-5033-16	3-4	5-5070-W	3-16	5-5217-15	17-1	5-5406-22	3-30
5-5033-S	3-4	5-5075	3-16	5-5217-H	17-1	5-5406-23	3-5
5-5036	3-27	5-5075	3-36	5-5217-K	17-3	5-5406-23	3-30
5-5036	3-31	5-5075-C	3-16	5-5217-KH	17-4	5-5406-24	3-6
5-5039	3-6	5-5075-C	3-36	5-5217-KT	17-6	5-5406-24	3-30
5-5039	3-31	5-5076	3-37	5-5217-M	17-3	5-5406-3	3-32
5-5041	3-6	5-5082	3-25	5-5217-MT	17-3	5-5406-4	3-32
5-5042-10	3-5	5-5082	3-33	5-5217-N	17-7	5-5406-5	3-32
5-5042-10	3-15	5-5082-R	3-25	5-5217-S	17-7	5-5406-6	3-33
5-5042-10	3-37	5-5082-R	3-33	5-5217-ST	17-8	5-5406-8	3-7
5-5042-10-26	3-5	5-5085	3-18	5-5217-T	17-5	5-5406-9	3-8
5-5042-10-26	3-15	5-5085-L	3-18	5-5218	17-2	5-5447	7-7
5-5042-10-26	3-37	5-5088-S	3-35	5-5218-K	17-4	5-5451	7-7
5-5042-10-27	3-5	5-5088-S-27	3-35	5-5218-KT	17-6	5-5457	7-8
5-5042-10-27	3-15	5-5089	3-35	5-5218-KTR	17-7	5-5471	7-7
5-5042-10-27	3-37	5-5090	3-23	5-5218-P	17-2	5-5472	7-7
5-5042-27	3-37	5-5092	3-41	5-5218-PK	17-5	5-5473	7-7
5-5042-30	3-37	5-5093	3-41	5-5218-PS	17-7	5-5477	7-8
5-5042-5	3-5	55-10105	5-61	5-5219	17-9	5-5481	7-8
5-5042-5	3-15	5-5105	17-26	5-5221	17-13	5-54918S	17-12
5-5042-5	3-37	5-5111	17-30	5-5222	17-25	5-54919S	17-12
5-5042-6	3-5	5-5112	17-31	5-5223	17-11	5-54920S	17-12
5-5042-6	3-15	5-5117	17-30	5-5224	17-14	5-54921S	17-12
5-5042-6	3-37	5-5118	17-30	5-5225	17-9	5-54922S	17-12
5-5042-7	3-5	5-5119	17-31	5-5227	17-9	5-54923S	17-12
5-5042-7	3-15	5-5125	17-31	5-5312	14-18	5-54924S	17-12

800.322.4674 or 800.633.7283

www.msiprecision.com

IND-11



Numerical Index



Part Number	Page	Part Number	Page	Part Number	Page	Part Number	Page
5-54924S	17-12	56-1004	20-1	90301	6-4	93100	6-6
5-54924S	17-12	56-1005	20-1	90302	1-5	93301	1-7
5-5511	3-7	5-6119	13-2	90302	6-4	93301	6-6
5-5512	3-8	5-6141	13-2	90303	1-5	93302	1-7
5-5514	3-10	5-6210	7-6	90303	6-4	93302	6-6
5-5515	3-7	5-6211-10	7-4	90304	1-6	93303	1-7
5-5515-7	3-7	5-6211-12	7-4	90304	6-5	93303	6-6
5-5517	3-7	5-6211-8 (Shown)	7-4	90306	1-6	93304	1-8
5-5517-7	3-7	5-6216	7-5	90306	6-5	93304	6-7
5-5519	3-8	5-6217	7-5	90307	1-6	93306	1-8
5-5520	3-9	5-6218	7-5	90307	6-5	93306	6-7
5-5521	3-8	5-6219	7-6	90308	1-6	93307	1-8
5-5522	3-8	5-62193751	7-6	90308	6-5	93307	6-7
5-5523-BL	3-17	5-6221	7-6	90309	1-6	93308	1-8
5-5523-BR	3-17	5-6222	7-5	90309	6-5	93308	6-7
5-5524-BAR	3-11	5-6223	7-6	90313	1-7	93309	1-9
5-5524-BAR-23	3-11	5-6487	5-73	90313	6-6	93309	6-8
5-5525	3-27	5-6489	5-72	912310C	4-6	93313	1-9
5-5525-GW10	3-27	5-6762	8-8	912315C	4-5	93313	6-8
5-5525-H	3-17	5-6763	5-73	912317C	4-4	952	20-10
5-5525-WL	3-17	5743K65	5-73	912318C	4-4	952-2	20-10
5-5525-WR	3-17	5-9002	8-7	9-18222-R	11-15	9528	20-11
5-5525-WS	3-17	5-9259	13-6	9-18225-AR	11-15	952D-2	20-11
5-5527	3-8	6	20-16	9-18225-CR	11-15	952-FPP	20-11
5-5528-L	3-11	600-2	20-9	9-18225-R	11-15	952-HPT	20-11
5-5528-L	3-12	600-2	20-9	9-24246-R	8-2	953	20-10
5-5528-L27	3-11	600-WC.	20-9	9-24246-R	8-6	953	20-11
5-5528-R	3-12	602-2	20-10	9-24246-R	11-15	A02781011	20-18
5-5528-R	3-12	63	20-10	9-24325-R	11-16	A027811	20-18
5-5528-R27	3-12	63-2	20-10	9-24325-R	12-1	A027812	20-18
5-5528-S	3-12	6G	20-9	9-24326-R	11-16	A027813	20-18
5-5528-S	3-13	6G	20-14	9-24326-R	12-1	A062511	20-19
5-5528-S27	3-12	6J	20-15	9-25613-R	11-16	A062512	20-19
5-5528-T	3-35	72K	20-15	9-25614-L-R	11-16	A062513	20-19
5-5528-T	12-4	75	20-14	9-25614-R-R	11-16	A100610	20-19
5-5529	3-8	8	20-16	9-25615R	11-17	A100611	20-19
5-5531	3-15	80	20-17	9-25617-R	11-17	A100612	20-19
5-5531	3-36	800	20-9	9-25627	11-17	A100613	20-19
5-5532-H	3-9	800-WC.	20-9	9-25627-L-R	11-17	A100614	20-19
5-5532-H27	3-9	83	20-11	9-25632-R	11-17	A100615	20-19
5-5532-HL	3-9	83-2	20-11	9-25640-R	11-17	A10151011	20-18
5-5532-HL27	3-9	86-12120	5-46	9-25641-LR	11-17	A101512	20-18
5-5536-25	3-13	86-12150	5-46	9-25641-R	11-17	A101513	20-18
5-5905	3-10	88	20-9	9-25643-R	11-17	A101514	20-18
5-5906	3-10	88-2	20-9	9-25646-LR	11-17	A101515	20-18
5-5906	3-15	88-WC	20-9	9-25647-RR	11-18	A10152511	20-18
5-5906	3-31	8J	20-15	9-25648-L-R	11-18	A119-12	19-25
5-5988	3-34	90200	1-5	9-25648-R-R	11-18	A175	20-4
5-5988-L	3-34	90200	6-4	9-27283-BR	8-8	A261611	20-19
56-1002	20-1	902-2	20-10	9-27283-R	8-8	A261612	20-19
56-1003	20-1	90301	1-5	93100	1-7	A261613	20-19



IND-12

800.322.4674 or 800.633.7283

www.msiprecision.com

Numerical Index



Part Number	Page	Part Number	Page	Part Number	Page	Part Number	Page
A27812511	20-18	CVF-50	19-21	DTL-6.25	18-4	E1082	20-10
A62512511	20-19	CVT-50	19-21	DTL-6.50	18-4	E1084	20-10
A651812	20-19	CYF-25	19-22	DTL-6.75	18-4	E12062	20-10
A651813	20-19	DGL6	21-6	DTL-7.00	18-4	E12064	20-10
A65181511	20-19	DR12	21-9	DTL-7.25	18-4	E12066	20-10
A65183011	20-19	DR12	21-9	DTL-7.50	18-4	E12101	20-12
A65183013	20-19	DRT14	21-7	DTL-7.75	18-4	E12102	20-10
A654011	20-19	DRT14	21-7	DTL-8.00	18-4	E12104	20-10
A654012	20-19	DS12	21-8	DTL-8.25	18-4	E12104-IST	20-13
A654013	20-19	DS1T-1	19-17	DTL-8.50	18-4	E12106	20-10
A752511	20-19	DS1T-12	19-17	DTL-8.75	18-4	E1650	20-10
A752512	20-19	DS2C-1	19-17	DTL-9.00	18-4	E1650-HPT	20-11
A752513	20-19	DS2C-12	19-17	DTL-9.50	18-4	E1654	20-10
A754011	20-19	DS4T-1	19-17	DTS-10.00	18-5	E1654-IST	20-13
A754012	20-19	DS4T-12	19-17	DTS-10.50	18-5	E20062	20-12
A754013	20-19	DS5C-1	19-17	DTS-11.00	18-5	E20064	20-12
A7541511	20-19	DS5C-12	19-17	DTS-11.50	18-5	E20066	20-12
BI-302	1-2	DSCM13	21-3	DTS-12.00	18-5	E20121	20-12
BI-302	6-1	DSCM13	21-4	DTS-12.50	18-5	E20122	20-10
BI-322	1-2	DSL6	21-5	DTS-13.00	18-5	E20124	20-10
BI-322	6-1	DSL6	21-5	DTS-13.50	18-5	E20124	20-11
BI-323	1-2	DSL7	21-5	DTS-14.00	18-5	E20124-IST	20-13
BI-323	6-1	DSM11	21-3	DTS-14.50	18-5	E20126	20-11
BI-501	1-2	DSM11	21-3	DTS-15.00	18-5	E2302	20-10
BI-501	6-1	DSM11	21-3	DTS-15.50	18-5	E2304	20-10
BI-502	1-3	DSM11	21-7	DTS-16.00	18-5	E2306	20-10
BI-502	6-2	DSM13	21-3	DTS-3.50	18-5	E902	20-10
BI-521	1-3	DSM13	21-3	DTS-4.00	18-5	E904	20-10
BI-521	6-2	DSM13	21-3	DTS-4.50	18-5	FLST-50-100	19-22
BI-522	1-3	DSM13	21-9	DTS-5.00	18-5	FSC-50	19-22
BI-522	6-2	DTL-10.00	18-4	DTS-5.50	18-5	FSCL-100RB	19-22
BP1-50	19-20	DTL-10.50	18-4	DTS-6.00	18-5	FSCL-50AC	19-22
BP1-500	19-20	DTL-11.00	18-4	DTS-6.25	18-5	FSCL-50RB	19-22
BP2-500U	19-20	DTL-11.50	18-4	DTS-6.50	18-5	FSCL-50W	19-22
BP2-50L (left eye)	19-20	DTL-12.00	18-4	DTS-6.75	18-5	FSPD-50	19-23
BP2-50R (right eye)	19-20	DTL-12.50	18-4	DTS-7.00	18-5	FSPD-50W	19-23
BP2-50U	19-20	DTL-13.00	18-4	DTS-7.25	18-5	FSUF-48	19-22
BP3-500U	19-20	DTL-13.50	18-4	DTS-7.50	18-5	G270-12	19-23
BP3-50U	19-20	DTL-14.00	18-4	DTS-7.75	18-5	G972A-1	19-18
BPF-48	19-20	DTL-14.50	18-4	DTS-8.00	18-5	G972A-25	19-18
BSL5	21-4	DTL-15.00	18-4	DTS-8.25	18-5	G972B-1	19-18
BSL5	21-4	DTL-15.50	18-4	DTS-8.50	18-5	G972B-25	19-18
CO1	21-7	DTL-16.00	18-4	DTS-8.75	18-5	G972C-1	19-18
CHST-2550	19-21	DTL-3.00	18-4	DTS-9.00	18-5	G972C-25	19-18
CL-50	19-22	DTL-3.00	18-5	DTS-9.50	18-5	G972CV-1	19-18
CMR-50	19-21	DTL-3.50	18-4	E06062	20-10	G972CV-25	19-18
CV-1000	19-21	DTL-4.00	18-4	E06064	20-10	G973A-10	19-26
CV2-1000	19-21	DTL-4.50	18-4	E06066	20-10	G973B-25	19-26
CV-50	19-21	DTL-5.00	18-4	E10062	20-10	G973W-25	19-26
CV-500	19-21	DTL-5.50	18-4	E10064	20-10	G974MR-1	19-18
CVF-50	19-21	DTL-6.00	18-4	E10066	20-10	G974MR-25	19-18

800.322.4674 or 800.633.7283

www.msiprecision.com

IND-13



Numerical Index



Part Number	Page	Part Number	Page	Part Number	Page	Part Number	Page
G975MT-1	19-18	P100615P3	20-18	S12102	20-10	SDTS-3.00	18-3
G975MT-25	19-18	P100616	20-19	S12102-HPT	20-11	SDTS-3.50	18-3
G976VT-1	19-18	P100675	20-19	S12104	20-10	SDTS-4.00	18-3
G976VT-25	19-18	P101510	20-18	S12106	20-10	SDTS-4.50	18-3
G990-3	19-26	P10151015	20-18	S20122-HPT	20-11	SDTS-5.00	18-3
G991-2	19-26	P101525	20-18	SDTL-10.00	18-2	SDTS-5.50	18-3
G991-T	19-26	P1015251	20-18	SDTL-10.50	18-2	SDTS-6.00	18-3
G993-1	19-26	P10152515	20-18	SDTL-11.00	18-2	SDTS-6.25	18-3
HGL5	21-6	P1015252	20-18	SDTL-11.50	18-2	SDTS-6.50	18-3
HSL5	21-5	P1015254	20-18	SDTL-12.00	18-2	SDTS-6.75	18-3
HSL5	21-5	P12101	20-12	SDTL-12.50	18-2	SDTS-7.00	18-3
IA301	1-3	P12102	20-12	SDTL-13.00	18-2	SDTS-7.25	18-3
IA301	6-2	P12104	20-12	SDTL-13.50	18-2	SDTS-7.50	18-3
IA302	1-4	P12106	20-12	SDTL-14.00	18-2	SDTS-7.75	18-3
IA302	6-3	P20121	20-12	SDTL-14.50	18-2	SDTS-8.00	18-3
IA303	1-4	P20122	20-11	SDTL-15.00	18-2	SDTS-8.25	18-3
IA303	6-3	P20122	20-12	SDTL-15.50	18-2	SDTS-8.50	18-3
IA304	1-4	P20124	20-12	SDTL-16.00	18-2	SDTS-8.75	18-3
IA304	6-3	P20126	20-12	SDTL-3.00	18-2	SDTS-9.00	18-3
IA306	1-4	P261615	20-19	SDTL-3.50	18-2	SDTS-9.50	18-3
IA306	6-3	P26161515	20-19	SDTL-4.00	18-2	SE-120	19-23
L-500AC	19-23	P261615M	20-19	SDTL-4.50	18-2	SEST-2040	19-23
L-50AC	19-23	P27812515	20-18	SDTL-5.00	18-2	SP21000-H	20-26
L-50RB	19-23	P62512515	20-19	SDTL-5.50	18-2	SP-3014	20-22
L-50W	19-23	P651815	20-19	SDTL-6.00	18-2	SP30320-S-01	20-26
N1267	22-4	P65181515	20-19	SDTL-6.25	18-2	SP30575	20-26
N1268	22-4	P651815M	20-19	SDTL-6.50	18-2	SP31420-04-ASY	20-26
N1269	22-4	P651830	20-19	SDTL-6.75	18-2	SP31523-SIL-04	20-26
N1281	22-4	P65183015	20-19	SDTL-7.00	18-2	SP40300-1	20-25
New	20-19	P651830M	20-19	SDTL-7.25	18-2	SP40300-10	20-25
New	20-19	P6540	20-19	SDTL-7.50	18-2	SP40300-11	20-25
OA-224-422	5-68	P654015	20-19	SDTL-7.75	18-2	SP40300-13	20-25
P0278	20-18	P72001	5-62	SDTL-8.00	18-2	SP40300-15	20-25
P027810	20-18	P72011	5-62	SDTL-8.25	18-2	SP40300-16	20-25
P02781015	20-18	P72021	5-62	SDTL-8.50	18-2	SP40300-2	20-25
P0278125	20-18	P7525	20-19	SDTL-8.75	18-2	SP40300-30	20-25
P027815	20-18	P752515	20-19	SDTL-9.00	18-2	SP40300-31	20-25
P0625	20-19	P7525K1	20-18	SDTL-9.50	18-2	SP40300-32	20-25
P0625125	20-19	P7525K2	20-18	SDTS-10.00	18-3	SP40300-33	20-25
P062515	20-19	P7525K3	20-18	SDTS-10.50	18-3	SP40300-4	20-25
P0625K1	20-18	P7540	20-19	SDTS-11.00	18-3	SP40300-4	20-25
P0625K2	20-18	P754015	20-19	SDTS-11.50	18-3	SP40300-40	20-25
P0625K3	20-18	P75415	20-19	SDTS-12.00	18-3	SP40300-41	20-25
P0625K5	20-18	P7541515	20-19	SDTS-12.50	18-3	SP40300-42	20-25
P100614	20-19	P75415P	20-18	SDTS-13.00	18-3	SP40300-43	20-25
P100615	20-19	P75415P3	20-18	SDTS-13.50	18-3	SP40300-5	20-25
P1006151	20-19	PI122551	5-70	SDTS-14.00	18-3	SP40300-6	20-25
P1006152	20-19	PIU-2	5-17	SDTS-14.50	18-3	SP40300-7	20-25
P1006153	20-19	S12062	20-10	SDTS-15.00	18-3	SP40300-8	20-25
P1006154	20-19	S12064	20-10	SDTS-15.50	18-3	SP40300-9	20-25
P100615P	20-18	S12066	20-10	SDTS-16.00	18-3	SP40350-1	20-25



IND-14

800.322.4674 or 800.633.7283

www.msiprecision.com

Numerical Index



Part Number	Page	Part Number	Page	Part Number	Page	Part Number	Page
SP40350-2	20-25	T1062	20-15	TDK-3-820-1	5-21		
SP40350-3	20-25	T1063	20-15	TDK-3-825	5-21		
SP40350-30	20-25	T1064	20-15	TDK-3-826	5-21		
SP40350-31	20-25	T12a	21-9	TDK-3-827	5-22		
SP40350-32	20-25	T12a	21-9	TDK-3-827-R	5-22		
SP40350-4	20-25	T2107	20-17	TDK-3-829	5-22		
SP40350-40	20-25	T2112	20-17	TDK-3-911	5-43		
SP40350-41	20-25	T-4000	4-11	UV101-1	19-24		
SP40350-42	20-25	T5G	20-16	UV101-12	19-24		
SP40350-5	20-25	T7010	20-9	UV101C	19-24		
SP40350-6	20-25	TD-20	19-26	UV102-1	19-24		
SP40375-1	20-26	TDK-0-621	8-5	UV102-12	19-24		
SP40375-10	20-26	TDK-0-621-11	8-5	UV103-1	19-24		
SP40375-2	20-26	TDK-0-621-12	8-5	UV103-12	19-24		
SP40375-3	20-26	TDK-2036-ES	17-24	UV104-12	19-24		
SP40375-30	20-26	TDK-3-211	5-11	UV50A-12	19-25		
SP40375-31	20-26	TDK-3-212	5-11	UV50G-12	19-25		
SP40375-32	20-26	TDK-3-214	5-11	UV50ND-12	19-25		
SP40375-4	20-26	TDK-3-215	5-11	UV517-12	19-25		
SP40375-40	20-26	TDK-3-217	5-11	UV51C-12	19-25		
SP40375-41	20-26	TDK-3-221	5-1	UV52C-12	19-25		
SP40375-42	20-26	TDK-3-221-1	5-1	UV52G-12	19-25		
SP40375-5	20-26	TDK-3-222	5-1	UV53C-12	19-25		
SP40375-6	20-26	TDK-3-224	5-1	UV83BB-12	19-25		
SP40375-7	20-26	TDK-3-225	5-1	UV83DR-12	19-25		
SP40375-8	20-26	TDK-3-227	5-1	UV84G-12	19-25		
SP40375-9	20-26	TDK-3-228	5-1	WP-50L	19-21		
SP40400-1	20-25	TDK-3-241	5-23	WP-50R	19-21		
SP40400-2	20-25	TDK-3-243	5-23	WP-50U	19-21		
SP40400-3	20-25	TDK-3-246	5-23	Y5	21-7		
SP40400-4	20-25	TDK-3-247	5-23				
SP40400-5	20-25	TDK-3-253	5-1				
SP40400-6	20-25	TDK-3-255	5-2				
SP40450-1	20-26	TDK-3-259	5-2				
SP40450-2	20-26	TDK-3-268	5-2				
SP40450-3	20-26	TDK-3-554	5-23				
SP40450-4	20-26	TDK-3-611	5-31				
SP40450-5	20-26	TDK-3-612	5-31				
SP40450-6	20-26	TDK-3-615	5-31				
SPL-SPRT-BRKT	20-26	TDK-3-616	5-31				
SPRISER-15	20-26	TDK-3-616-1	5-31				
SSA-25	19-19	TDK-3-630	5-32				
SSB-25	19-19	TDK-3-631	5-31				
SSC-25	19-19	TDK-3-633	5-31				
SSX-25	19-19	TDK-3-635	5-31				
T0000R	20-16	TDK-3-635-1	5-31				
T0014K	20-15	TDK-3-636	5-32				
T0014K	20-16	TDK-3-637	5-32				
T0015R	20-16	TDK-3-638	5-32				
T0023R	20-16	TDK-3-814	5-21				
T1002	20-17	TDK-3-820	5-21				

800.322.4674 or 800.633.7283

www.msiprecision.com



IND-15

Terms of Sale

- This price list supersedes all price lists.
- All prices are F.O.B. Phoenixville, Pennsylvania, subject to change without notice
- Our terms are Net 30 days to approved accounts
- List prices are subject to change
- All MSI Precision instruments are guaranteed to be free of defects in materials and workmanship. Any instrument which proves defective in workmanship or material will be repaired or replaced at our discretion with out charge. This guarantee is void for instruments serviced by any company other than MSI Precision instrument repair service.
- All MSI Precision instruments are carefully inspected before shipment. Any claims must be made within (2) two days of receipt of shipment. Most orders are shipped same day and, at the latest, by UPS within 72 hours.

Return Policy

- With our prior written authorization, returns may be made within 30 days of purchase for full credit. Instruments must be unused and in their original package.
- To insure proper credit, you must request our "Return Authorization Form" and return the completed to us. A restocking and inspection charge of 20% will be charged on all authorized returns more than (30) days after invoice date. No returns will be accepted after 90 days. A restocking charge may be assess on any return that in our determination was not an error of MSI.
- A restocking and inspection charge of 35% will be charged for on all authorized returns more than (60) sixty days after our invoice date.
- Goods accepted for return will be on a merchandise credit basis only and we can only accept prepaid shipments.
- Any merchandise returned without approval will be subject to an automatic restocking fee with a minimum of 35%.

Procedure

1. Notify our Customer Service Department in writing or by phone of your request for return authorization.
2. We will mail a "Return Authorization Request" form. Please complete the form with the following information:
 - (A) Our stock number
 - (B) Invoice Number
 - (C) Date of invoice
 - (D) Reason for return
3. When your form has been approved, we will issue you an authorization to return and a label.
4. The following types of goods are not eligible for credit:
 - (A) Custom designed instruments
 - (B) Instruments which have been used, marked or altered in anyway
 - (C) Engraved instruments
 - (D) Discontinued products
 - (E) Sterile products
 - (F) Color coated instruments

Prices subject to change without notice. MSI Precision is not accountable for any errors or omissions that may appear in the catalog.



MSI Precision Specialty Instruments

1220 Valley Forge Road, Building 34

Phoenixville, PA 19460-2628

Phone: 1-800-633-7283 • 1-800-322-4674 • Fax: 1-800-699-2839

Solutions Ophthalmology

- Alger Brush
- Autoclaves
- Bi-Manual
- Bipolar Cords
- Bi-Polar Forceps
- Blade Breakers
- Calipers
- Cannulas
- Cleaning Brushes
- Collar Button
- Curettes
- Depressors
- Diagnostic Lens
- Diamond Knives
- Dilators
- Disposable Blades
- Disposable Cannulas
- Eye Shield Protection
- Fascia Needles
- Fiberoptic Illuminators
- Fixation Hooks
- Fixation Loops
- Fixation Rings
- Forceps
- H Series Products
- Hohnan Balloon
- Identification Labels
- Identification Products
- Instrument Guards
- Intubation Set
- Iris Retractors
- I/A Handpieces
- Kansas Style Instruments
- Knives (reusable)
- Lens Loops
- Manipulating Hooks
- Manipulators
- Markers
- Micro Instruments
- Micro I/A Instruments
- Muscle Hooks
- Needle Holders
- Fascia Needles
- Occlusion Therapy
- Phaco Accessories
- Phaco Chops
- Polishers
- Probes
- Puntal Plugs
- Pupil Dilators
- Repair Services
- Retinal Instruments
- Retractors
- Rongeurs
- Rotators
- Rulers
- Ring Handle Scissors
- Spring Handle Scissors
- Utility Scissors
- Scleral Plugs
- Serrefine
- Sutures
- Spatulas
- Spatulas - Iris
- Eye Speculums
- Nasal Speculums
- Spoons
- Spreaders
- Spuds
- Stainless Steelware
- Plastic Sterilization Trays
- Aluminum Sterilization
- Tendon Tuckers
- Tenometer
- Tenotomy Hooks
- Towel Clamp
- Trephines
- Ultrasonic Cleaners
- Vitreoretinal Cannulas
- Vitrectors
- Wipes and Spears



MSI Precision Instruments

1220 Valley Forge Road, Bldg 34 / Phoenixville PA 19460
www.msiprecision.com

To Order Call

800-322-4674

or 800-633-7283

Surgical Advantage

1-800-948-7994

order@surgicaladvantage.net