



# SC-P900 Series SC-P700 Series

## User's Guide

---

# Contents

## Guide to This Manual

Introduction to the Manuals. . . . .	6
Guide to Video Manuals. . . . .	6
Searching for Information. . . . .	6
Printing Only the Pages You Need. . . . .	7
About This Manual. . . . .	7
Marks and Symbols. . . . .	7
Notes on Screenshots and Illustrations. . . . .	8
Operating System References. . . . .	8
Trademarks. . . . .	8
Copyright. . . . .	9

## Important Instructions

Safety Instructions. . . . .	11
Safety Instructions for Ink. . . . .	11
Printer Advisories and Warnings. . . . .	12
Advisories and Warnings for Setting Up the Printer. . . . .	12
Advisories and Warnings for Using the Printer. . . . .	12
Advisories and Warnings for Using the Printer with a Wireless Connection. . . . .	13
Advisories and Warnings for Using the Touchpad. . . . .	13
Advisories and Warnings for Transporting or Storing the Printer. . . . .	13
Protecting Your Personal Information. . . . .	14

## Part Names and Functions

Front. . . . .	16
Rear. . . . .	17
Opening the Port Cover. . . . .	18

## Guide to the Control Panel

Home Screen Configuration. . . . .	20
Internal Light. . . . .	21
Guide to the Network Icon. . . . .	21
Switching the Screen View. . . . .	22
Entering Characters. . . . .	24

## Loading Papers and CD/DVDs

Loading Paper. . . . .	26
Paper Handling Precautions. . . . .	26
Paper Loading Precautions. . . . .	27

Paper Size and Type Settings. . . . .	27
Loading Paper in the Rear Paper Feeder. . . . .	29
Loading Paper in the Front Paper Feeder. . . . .	31
Loading Roll Paper. . . . .	33
Loading a CD/DVD. . . . .	35
Printable CD/DVDs. . . . .	35
CD/DVD Handling Precautions. . . . .	35
Loading a CD/DVD. . . . .	36
Removing a CD/DVD. . . . .	37

## Printing

Printing Photos. . . . .	40
Tips when Printing Photo Projects. . . . .	40
Printing with Epson Print Layout. . . . .	41
Printing Using the Application and Printer Driver. . . . .	48
Printing Varieties (Windows). . . . .	53
Printing Varieties (Mac OS). . . . .	58
Printing Using Epson Photo+. . . . .	63
Printing Information About Photo Printing. . . . .	66
Printing Documents. . . . .	67
Printing from a Computer - Windows. . . . .	67
Printing from a Computer - Mac OS. . . . .	87
Printing Documents from Smart Devices (iOS). . . . .	95
Printing Documents from Smart Devices (Android). . . . .	96
Printing Using a Cloud Service. . . . .	98
Registering to Epson Connect Service from the Control Panel. . . . .	98

## Maintaining the Printer

Checking the Status of Consumables. . . . .	100
Checking the Status of Consumables (Control Panel). . . . .	100
Checking the Status of Consumables (Windows). . . . .	100
Checking the Status of Consumables (Mac OS). . . . .	100
Improving Paper Feeding Problems (Rear Paper Feeder). . . . .	100
Improving Print Quality. . . . .	101
Checking and Cleaning the Print Head. . . . .	101
Running Power Cleaning. . . . .	103
Preventing nozzle clogging. . . . .	105
Aligning the Print Head. . . . .	105
Cleaning the Paper Path for Ink Smears. . . . .	106
Saving Power. . . . .	106

Installing or Uninstalling Applications Separately. . . . .	107
Installing the Applications Separately. . . . .	107
Adding the Printer (for Mac OS Only). . . . .	109
Uninstalling Applications. . . . .	109
Updating Applications and Firmware. . . . .	111
Transporting and Storing the Printer. . . . .	112
Cleaning the Cooling Fan Filter. . . . .	114

## **Solving Problems**

The Printer Does Not Work as Expected. . . . .	116
The Printer Does Not Turn On or Off. . . . .	116
Paper Does Not Feed Properly. . . . .	116
Cannot Print. . . . .	120
Cannot Operate the Printer as Expected. . . . .	137
A Message is Displayed on the LCD Screen. . . . .	139
Paper Gets Jammed. . . . .	140
Preventing Paper Jams. . . . .	141
It is Time to Replace the Ink Cartridges. . . . .	141
Ink Cartridge Handling Precautions. . . . .	141
Replacing Ink Cartridge. . . . .	143
It is Time to Replace the Maintenance Box. . . . .	143
Maintenance Box Handling Precautions. . . . .	143
Replacing a Maintenance Box. . . . .	143
Print Quality is Poor. . . . .	144
Color Missing, Banding, or Unexpected Colors Appear in Printout. . . . .	144
Blurry Prints, Vertical Banding, or Misalignment. . . . .	145
Printout Comes Out as a Blank Sheet. . . . .	146
Paper Is Smearred or Scuffed. . . . .	146
Printed Photos are Sticky. . . . .	147
Images or Photos are Printed in Unexpected Colors. . . . .	148
Colors in the Printout Differ from Those on the Display. . . . .	148
Cannot Print Without Margins. . . . .	149
Edges of the Image are Cropped During Borderless Printing. . . . .	150
The Position, Size, or Margins of the Printout Are Incorrect. . . . .	150
Printed Characters Are Incorrect or Garbled. . . . .	151
The Printed Image Is Inverted. . . . .	151
Mosaic-Like Patterns in the Prints. . . . .	152
Vertical lines Appears on Roll Paper. . . . .	152
White Dots Appear in Printouts. . . . .	152
The Top Edge of the Paper is Scratched. . . . .	153
Cannot Solve Problem. . . . .	153
Cannot Solve Printing Problems. . . . .	153

## **Adding or Replacing the Computer or Devices**

Connecting to a Printer that has been Connected to the Network. . . . .	156
Using a Network Printer from a Second Computer. . . . .	156
Using a Network Printer from a Smart Device. . . . .	157
Re-setting the Network Connection. . . . .	157
When Replacing the Wireless Router. . . . .	157
When Changing the Computer. . . . .	158
Changing the Connection Method to the Computer. . . . .	159
Making Wi-Fi Settings from the Control Panel. . . . .	161
Connecting a Smart Device and Printer Directly (Wi-Fi Direct). . . . .	164
About Wi-Fi Direct. . . . .	164
Connecting to an iPhone, iPad or iPod touch using Wi-Fi Direct. . . . .	165
Connecting to Android Devices using Wi-Fi Direct. . . . .	167
Connecting to Devices other than iOS and Android using Wi-Fi Direct. . . . .	169
Disconnecting Wi-Fi Direct (Simple AP) Connection. . . . .	172
Changing the Wi-Fi Direct (Simple AP) Settings Such as the SSID. . . . .	172
Checking the Network Connection Status. . . . .	173
Checking the Network Connection Status from the Control Panel. . . . .	174
Printing a Network Connection Report. . . . .	174
Printing a Network Status Sheet. . . . .	180

## **Product Information**

Paper Information. . . . .	182
Available Paper and Capacities. . . . .	182
Unavailable Paper Types. . . . .	191
Printing to Paper Types Other than Genuine Paper. . . . .	191
Consumable Products Information. . . . .	196
Ink Cartridge Codes for SC-P900 Series. . . . .	196
Ink Cartridge Codes for SC-P700 Series. . . . .	197
Maintenance Box Code. . . . .	199
Software Information. . . . .	199
Software for Printing. . . . .	199
Software for Making Settings or Managing Devices. . . . .	204
Software for Updating. . . . .	205
Menu List. . . . .	206
General Settings. . . . .	206

Screen Customization. . . . .	206
Printer Settings. . . . .	207
Basic Settings. . . . .	208
Network Settings. . . . .	209
Web Service Settings. . . . .	210
Customer Research. . . . .	211
Restore Default Settings. . . . .	211
Printer Status/Print. . . . .	211
Firmware Update. . . . .	212
Product Specifications. . . . .	212
Printer Specifications. . . . .	212
Interface Specifications. . . . .	214
Network Specifications. . . . .	214
Supported Third Party Services. . . . .	217
Dimensions. . . . .	217
Electrical Specifications. . . . .	217
Environmental Specifications. . . . .	218
Installation Location and Space. . . . .	219
System Requirements. . . . .	220
Regulatory Information. . . . .	220
Standards and Approvals. . . . .	220
Restrictions on Copying. . . . .	221

## **Where to Get Help**

Technical Support Web Site. . . . .	224
Contacting Epson Support. . . . .	224
Before Contacting Epson. . . . .	224
Help for Users in Europe. . . . .	224
Help for Users in Taiwan. . . . .	224
Help for Users in Australia. . . . .	225
Help for Users in New Zealand. . . . .	225
Help for Users in Singapore. . . . .	226
Help for Users in Thailand. . . . .	226
Help for Users in Vietnam. . . . .	227
Help for Users in Indonesia. . . . .	227
Help for Users in Hong Kong. . . . .	229
Help for Users in Malaysia. . . . .	229
Help for Users in India. . . . .	229
Help for Users in the Philippines. . . . .	230

---

# Guide to This Manual

Introduction to the Manuals. . . . .	6
Guide to Video Manuals. . . . .	6
Searching for Information. . . . .	6
Printing Only the Pages You Need. . . . .	7
About This Manual. . . . .	7
Trademarks. . . . .	8
Copyright. . . . .	9

## Introduction to the Manuals

The following manuals are supplied with your Epson printer. As well as the manuals, check the various types of help information available from the printer itself or from the Epson software applications.

### ❑ Start Here (paper manual)

Provides you with information on setting up the printer, installing the software, using the printer, solving problems, and so on.

To obtain the latest version, visit the Epson Europe support website at <http://www.epson.eu/Support>, or the Epson worldwide support website at <http://support.epson.net/>.

### ❑ User's Guide (digital manual)

This manual. This manual is available as PDF and Web manuals. Provides overall information and instructions on using the printer, on network settings when using the printer on a network, and on solving problems.

To view the Web manual, visit the following website, enter the product name, and then go to **Support**.

<http://epson.sn>

## Guide to Video Manuals

You can view video manuals to learn how to connect to the printer over Wi-Fi, or how to use the software. Access the following website. The contents of the video manuals are subject to change without prior notice.

SC-P900 Series: [https://support.epson.net/p\\_doc/785/](https://support.epson.net/p_doc/785/)

SC-P700 Series: [https://support.epson.net/p\\_doc/784/](https://support.epson.net/p_doc/784/)

## Searching for Information

The PDF manual allows you to search for information you are looking for by keyword, or jump directly to specific sections using the bookmarks. This section explains how to use a PDF manual that has been opened in Adobe Reader X on your computer.

### Searching by keyword

Click **Edit > Advanced Search**. Enter the keyword (text) for information you want to find in the search window, and then click **Search**. Hits are displayed as a list. Click one of the displayed hits to jump to that page.

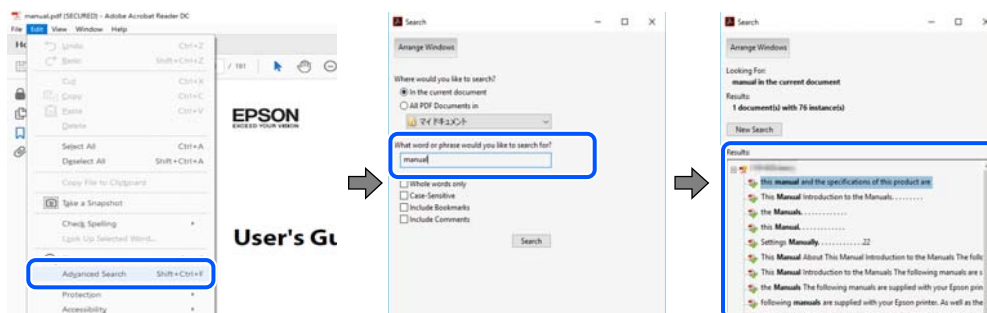

## Jumping directly from bookmarks

Click a title to jump to that page. Click + or > to view the lower level titles in that section. To return to the previous page, perform the following operation on your keyboard.

- Windows: Hold down **Alt.** and then press **<**.
- Mac OS: Hold down the command key, and then press **<**.

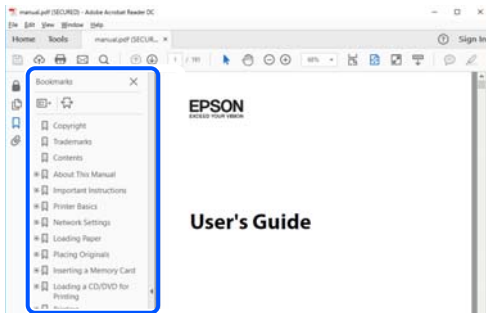

---

## Printing Only the Pages You Need

You can extract and print only the pages you need. Click **Print** in the **File** menu, and then specify the pages you want to print in **Pages in Pages to Print**.

- To specify a series of pages, enter a hyphen between the start page and the end page.  
Example: 20-25
- To specify pages that are not in series, divide the pages with commas.  
Example: 5, 10, 15

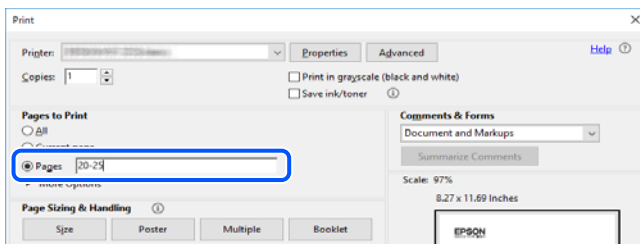

---

## About This Manual

This section explains the meaning of marks and symbols, notes on descriptions, and operating system reference information used in this manual.

## Marks and Symbols



**Caution:**

*Instructions that must be followed carefully to avoid bodily injury.*



**Important:**

*Instructions that must be observed to avoid damage to your equipment.*

**Note:**

*Provides complementary and reference information.*

**Related Information**

➔ Links to related sections.

## Notes on Screenshots and Illustrations

- Screenshots of the printer driver are from Windows 10 or macOS High Sierra. The content displayed on the screens varies depending on the model and situation.
- Illustrations used in this manual are examples only. Although there may be slight differences depending on the model, the method of operation is the same.
- Some of the menu items on the LCD screen vary depending on the model and settings.
- You can read the QR code using dedicated app.

## Operating System References

### Windows

In this manual, terms such as "Windows 10", "Windows 8.1", "Windows 8", and "Windows 7" refer to the following operating systems. Additionally, "Windows" is used to refer to all versions.

- Microsoft® Windows® 10 operating system
- Microsoft® Windows® 8.1 operating system
- Microsoft® Windows® 8 operating system
- Microsoft® Windows® 7 operating system

### Mac OS

In this manual, "Mac OS" is used to refer to macOS Catalina, macOS Mojave, macOS High Sierra, macOS Sierra, OS X El Capitan, OS X Yosemite, and OS X Mavericks.

---

## Trademarks

- EPSON® is a registered trademark, and EPSON EXCEED YOUR VISION or EXCEED YOUR VISION is a trademark of Seiko Epson Corporation.
- QR Code is a registered trademark of DENSO WAVE INCORPORATED in Japan and other countries.
- Microsoft®, Windows®, and Windows Vista® are registered trademarks of Microsoft Corporation.
- Apple, Mac, macOS, OS X, Bonjour, ColorSync, Safari, AirPrint, iPad, iPhone, iPod touch, and iTunes are trademarks of Apple Inc., registered in the U.S. and other countries.



- ❑ Use of the Works with Apple badge means that an accessory has been designed to work specifically with the technology identified in the badge and has been certified by the developer to meet Apple performance standards.
- ❑ Chrome, Google Play, and Android are trademarks of Google LLC.
- ❑ Adobe, Adobe RGB, Lightroom, Photoshop, and Photoshop Elements are either registered trademarks or trademarks of Adobe Systems Incorporated in the United States and/or other countries.
- ❑ The SuperSpeed USB Trident Logo is a registered trademark of USB Implementers Forum, Inc.
- ❑ Firefox is a trademark of the Mozilla Foundation in the U.S. and other countries.
- ❑ Mopria® and the Mopria® Logo are registered and/or unregistered trademarks and service marks of Mopria Alliance, Inc. in the United States and other countries. Unauthorized use is strictly prohibited.
- ❑ General Notice: Other product names used herein are for identification purposes only and may be trademarks of their respective owners. Epson disclaims any and all rights in those marks.

---

## Copyright

No part of this publication may be reproduced, stored in a retrieval system, or transmitted in any form or by any means, electronic, mechanical, photocopying, recording, or otherwise, without the prior written permission of Seiko Epson Corporation. No patent liability is assumed with respect to the use of the information contained herein. Neither is any liability assumed for damages resulting from the use of the information herein. The information contained herein is designed only for use with this Epson product. Epson is not responsible for any use of this information as applied to other products.

Neither Seiko Epson Corporation nor its affiliates shall be liable to the purchaser of this product or third parties for damages, losses, costs, or expenses incurred by the purchaser or third parties as a result of accident, misuse, or abuse of this product or unauthorized modifications, repairs, or alterations to this product, or (excluding the U.S.) failure to strictly comply with Seiko Epson Corporation's operating and maintenance instructions.

Seiko Epson Corporation and its affiliates shall not be liable for any damages or problems arising from the use of any options or any consumable products other than those designated as Original Epson Products or Epson Approved Products by Seiko Epson Corporation.

Seiko Epson Corporation shall not be held liable for any damage resulting from electromagnetic interference that occurs from the use of any interface cables other than those designated as Epson Approved Products by Seiko Epson Corporation.

© 2020 Seiko Epson Corporation

The contents of this manual and the specifications of this product are subject to change without notice.

---



# Important Instructions

Safety Instructions. . . . .	11
Printer Advisories and Warnings. . . . .	12
Protecting Your Personal Information. . . . .	14

## Safety Instructions

Read and follow these instructions to ensure safe use of this printer. Make sure you keep this manual for future reference. Also, be sure to follow all warnings and instructions marked on the printer.

- Some of the symbols used on your printer are to ensure safety and proper use of the printer. Visit the following Web site to learn the meaning of the symbols.  
<http://support.epson.net/symbols>
- Use only the power cord supplied with the printer and do not use the cord with any other equipment. Use of other cords with this printer or the use of the supplied power cord with other equipment may result in fire or electric shock.
- Be sure your AC power cord meets the relevant local safety standard.
- Never disassemble, modify, or attempt to repair the power cord, plug, printer unit, or options by yourself, except as specifically explained in the printer's manuals.
- Unplug the printer and refer servicing to qualified service personnel under the following conditions:  
The power cord or plug is damaged; liquid has entered the printer; the printer has been dropped or the casing damaged; the printer does not operate normally or exhibits a distinct change in performance. Do not adjust controls that are not covered by the operating instructions.
- Place the printer near a wall outlet where the plug can be easily unplugged.
- Do not place or store the printer outdoors, near excessive dirt or dust, water, heat sources, or in locations subject to shocks, vibrations, high temperature or humidity.
- Take care not to spill liquid on the printer and not to handle the printer with wet hands.
- Keep the printer at least 22 cm away from cardiac pacemakers. Radio waves from this printer may adversely affect the operation of cardiac pacemakers.
- If the LCD screen is damaged, contact your dealer. If the liquid crystal solution gets on your hands, wash them thoroughly with soap and water. If the liquid crystal solution gets into your eyes, flush them immediately with water. If discomfort or vision problems remain after a thorough flushing, see a doctor immediately.

## Safety Instructions for Ink

- If ink contacts your skin, eyes, or mouth, take the following actions.
  - If ink gets on your skin, wash the area thoroughly with soap and water.
  - If ink gets into your eyes, flush them immediately with water. If discomfort or vision problems continue after a thorough flushing, see a doctor immediately.
  - If ink gets into your mouth, see a doctor right away.
- Do not disassemble the ink cartridge and the maintenance box; otherwise ink may get into your eyes or on your skin.
- Do not shake ink cartridges too vigorously; otherwise ink may leak from the cartridge.
- Keep ink cartridges and maintenance box out of the reach of children.

## Printer Advisories and Warnings



Read and follow these instructions to avoid damaging the printer or your property. Make sure you keep this manual for future reference.

### Advisories and Warnings for Setting Up the Printer

- Do not block or cover the vents and openings in the printer.
- When placing the printer on a desk that is easily scratched, place a desk mat or the like on the desk first before placing the printer.
- Use only the type of power source indicated on the printer's label.
- Avoid using outlets on the same circuit as photocopiers or air control systems that regularly switch on and off.
- Avoid electrical outlets controlled by wall switches or automatic timers.
- Keep the entire computer system away from potential sources of electromagnetic interference, such as loudspeakers or the base units of cordless telephones.
- The power-supply cords should be placed to avoid abrasions, cuts, fraying, crimping, and kinking. Do not place objects on top of the power-supply cords and do not allow the power-supply cords to be stepped on or run over. Be particularly careful to keep all the power-supply cords straight at the ends and the points where they enter and leave the transformer.
- If you use an extension cord with the printer, make sure that the total ampere rating of the devices plugged into the extension cord does not exceed the cord's ampere rating. Also, make sure that the total ampere rating of all devices plugged into the wall outlet does not exceed the wall outlet's ampere rating.
- If you plan to use the printer in Germany, the building installation must be protected by a 10 or 16 amp circuit breaker to provide adequate short-circuit protection and over-current protection for the printer.
- When connecting the printer to a computer or other device with a cable, ensure the correct orientation of the connectors. Each connector has only one correct orientation. Inserting a connector in the wrong orientation may damage both devices connected by the cable.
- Place the printer on a flat, stable surface that extends beyond the base of the printer in all directions. The printer will not operate properly if it is tilted at an angle.
- Allow space above the printer so that you can fully raise the printer cover.
- Leave enough space in front of the printer for the paper to be fully ejected.
- Avoid places subject to rapid changes in temperature and humidity. Also, keep the printer away from direct sunlight, strong light, or heat sources.

### Advisories and Warnings for Using the Printer

- Do not insert objects through the slots in the printer.
- Do not put your hand inside the printer during printing.
- Do not touch the white flat cable inside the printer.
- Do not use aerosol products that contain flammable gases inside or around the printer. Doing so may cause fire.
- Do not move the print head by hand; otherwise, the printer may be damaged.

- ❑ Always turn the printer off using the  button. Do not unplug the printer or turn off the power at the outlet until the  light stops flashing.
- ❑ If you are not going to use the printer for a long period, be sure to unplug the power cord from the electrical outlet.

## **Advisories and Warnings for Using the Printer with a Wireless Connection**

- ❑ Radio waves from this printer may negatively affect the operation of medical electronic equipment, causing them to malfunction. When using this printer inside medical facilities or near medical equipment, follow directions from the authorized personnel representing the medical facilities, and follow all posted warnings and directions on the medical equipment.
- ❑ Radio waves from this printer may negatively affect the operation of automatically controlled devices such as automatic doors or fire alarms, and could lead to accidents due to malfunction. When using this printer near automatically controlled devices, follow all posted warnings and directions on these devices.

## **Advisories and Warnings for Using the Touchpad**

- ❑ The touchpad only responds when touched directly with your finger.
- ❑ The touchpad may not respond if your fingers are wet, if you are wearing gloves, or if there is a protective sheet or sticker on the touchpad.
- ❑ Do not use sharp objects such as a ballpoint pen or mechanical pencil to perform operations. The touchpad may be damaged.
- ❑ If the touchpad gets dirty, wipe it with a soft cloth. If it is very dirty, dip a soft cloth in a solution diluted with neutral detergent, squeeze it well, wipe off the dirt, and then wipe it with a soft dry cloth. Do not use volatile chemicals such as thinner, benzene, or alcohol. The surface of the touchpad may be damaged.
- ❑ Avoid locations subject to rapid changes in temperature and humidity. Condensation will form inside the touchpad, and may cause performance to deteriorate.
- ❑ The LCD screen may contain a few small bright or dark spots, and because of its features it may have an uneven brightness. These are normal and do not indicate that it is damaged in any way.
- ❑ Do not press the touchpad with too much force or subject it to heavy impacts. The touchpad could break. Contact your dealer if the touchpad surface chips or cracks, and do not touch or attempt to remove the broken pieces.

## **Advisories and Warnings for Transporting or Storing the Printer**

- ❑ When storing or transporting the printer, avoid tilting it, placing it vertically, or turning it upside down; otherwise ink may leak.
- ❑ Before transporting the printer, make sure that the print head is in the home (far right) position.

---

## Protecting Your Personal Information

When you give the printer to someone else or dispose of it, erase all the personal information stored in the printer's memory by selecting  > **General Settings** > **Restore Default Settings** > **Clear All Data and Settings** on the control panel.

---

# Part Names and Functions

Front. ....	16
Rear. ....	17

## Front

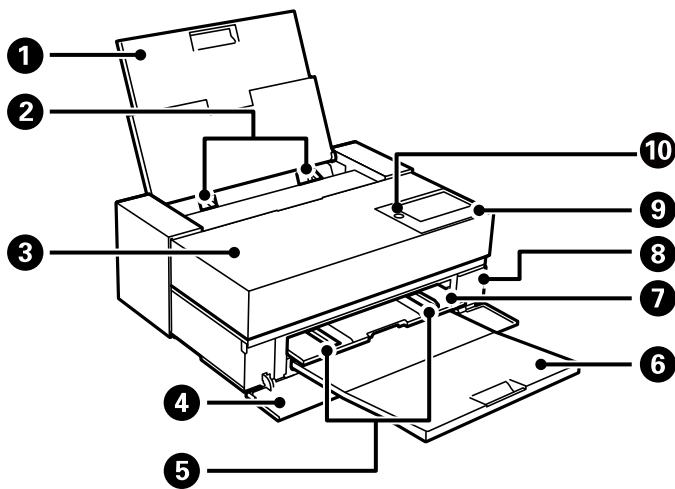

1	Rear paper feeder	Loads paper.
2	Edge guide	Feeds the paper straight into the printer. Slide to the edges of the paper.
3	Printer cover	Open to replace the ink cartridges or to remove jammed paper.
4	Front cover	Open when sliding out the front paper feeder and output tray or replacing the maintenance box.
5	Edge guide	Feeds the paper straight into the printer. Slide to the edges of the paper. Do not slide the edge guide below the A4-size mark on the front paper feeder. Otherwise, the edge guide could be damaged.
6	Output tray	Holds the ejected paper.
7	Front paper feeder	Loads fine art media, poster board, or the CD/DVD tray.
8	Maintenance box cover	Open when replacing the maintenance box. The maintenance box is a container that collects a very small amount of surplus ink during cleaning or printing.
9	Control panel	Allows you to make settings and perform operations on the printer. Also displays the printer's status. Press the control panel with your thumb and pull it with your other finger to change the angle of the control panel.
10	 (Power button/light)	Turns the printer on or off. Unplug the power cord after checking that the power light is off.



# Rear

SC-P900 Series

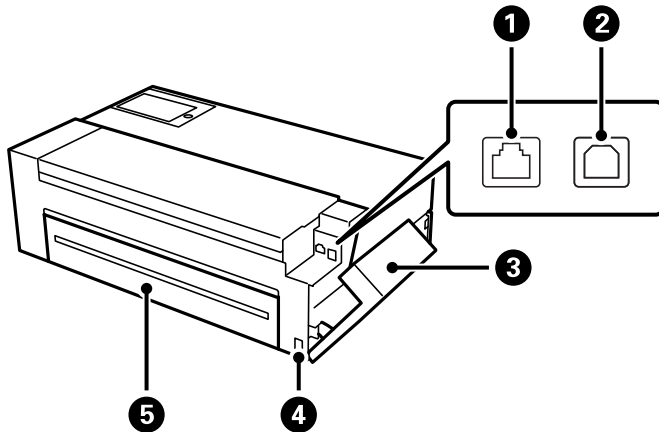

1	LAN port	Connects a LAN cable.
2	USB port	Connects a USB cable.
3	Port cover	Open to connect a USB cable or LAN cable. See the related information link below for details on how to open the cover. <a href="#">"Opening the Port Cover" on page 18</a>
4	AC inlet	Connects the power cord.
5	Rear cover	Open to install the optional roll paper unit.

SC-P700 Series

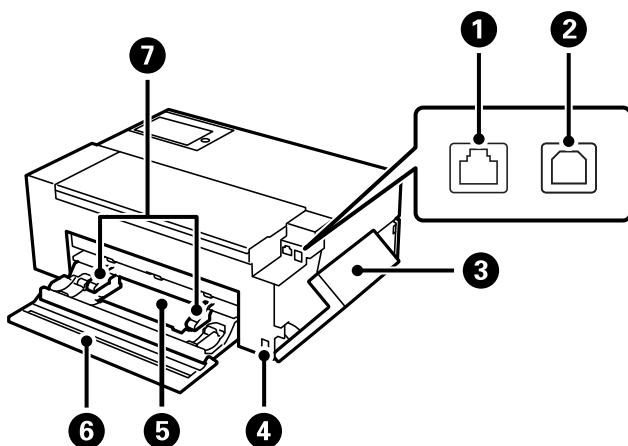

1	LAN port	Connects a LAN cable.
2	USB port	Connects a USB cable.
3	Port cover	Open to connect a USB cable or LAN cable. See the related information link below for details on how to open the cover. <a href="#">"Opening the Port Cover" on page 18</a>

④	AC inlet	Connects the power cord.
⑤	Roll paper unit	Loads roll paper.
⑥	Rear cover	Open to load roll paper.
⑦	Edge guide	Feeds the paper straight into the printer. Slide to the edges of the paper.

## Opening the Port Cover

Open the rear paper feeder and then open the port cover.

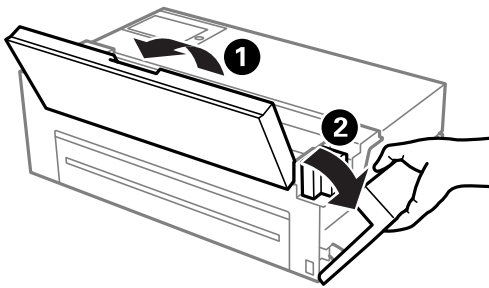









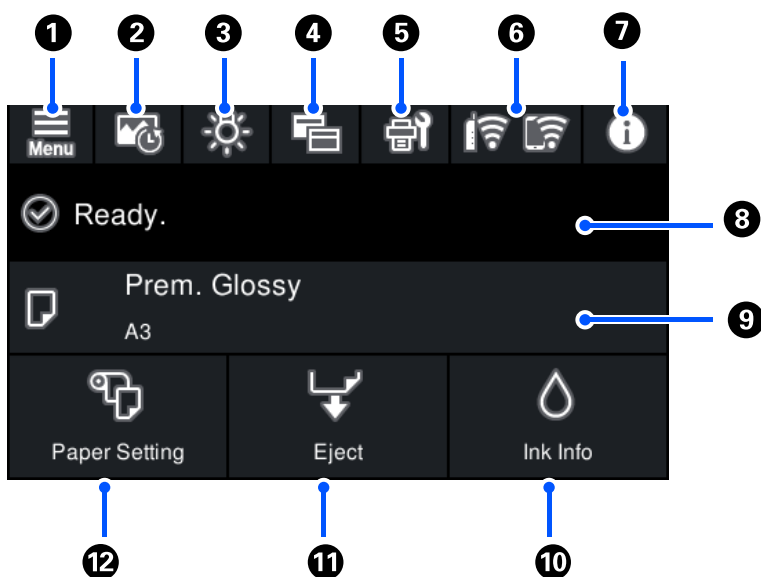

---



# Guide to the Control Panel

Home Screen Configuration. . . . .	20
Switching the Screen View. . . . .	22
Entering Characters. . . . .	24

## Home Screen Configuration



1		Displays the Menu screen. You can make settings related to printer features and operations.
2		Displays the Print Information Sheet screen. You can check the last 12 print histories. For example, if you print three copies of a photo, the printer saves three print histories. See the related link information for details on how to print the photo information sheet.
3		Allows you to turn on or off the printer's interior light.
		 Indicates the light is on.
		 Indicates the light is off.
4		Allows you to switch the view of the home screen and the printing screen. See the related link information for more details.
5		Displays the Maintenance screen. Displays the menus recommended to improve the quality of your printouts such as unclogging nozzles by printing a nozzle check pattern and performing head cleaning, and improving blurring or banding in your printouts by aligning the print head.
6		Displays the network connection status. See the following for more details. <a href="#">"Guide to the Network Icon" on page 21</a>
7		Displays the Printer Status screen. The number displayed indicates the number of notifications.
8	Displays the printer status.	
9	Displays the paper settings.	
10		Displays the Supply Status screen. You can check the approximate ink levels and the approximate service life of the maintenance box.

11		<p>You can eject paper that has been loaded.</p> <p>The following can be performed when roll paper is loaded.</p> <ul style="list-style-type: none"> <li><input type="checkbox"/> Move roll paper to the cutting position.</li> <li><input type="checkbox"/> Eject paper after moving the roll paper to the cutting position.</li> <li><input type="checkbox"/> Eject roll paper</li> </ul>
12		<p>Displays the Paper Setting screen. You can select the paper size and paper type by selecting <b>Paper Setting</b> when paper is loaded.</p>

### Related Information

- ➔ [“Switching the Screen View” on page 22](#)
- ➔ [“Printing Information About Photo Printing” on page 66](#)

## Internal Light

When printing starts, the internal light turns on allowing you to view printing as it happens through the printer cover. To turn off the light, make settings from the home screen as described below.







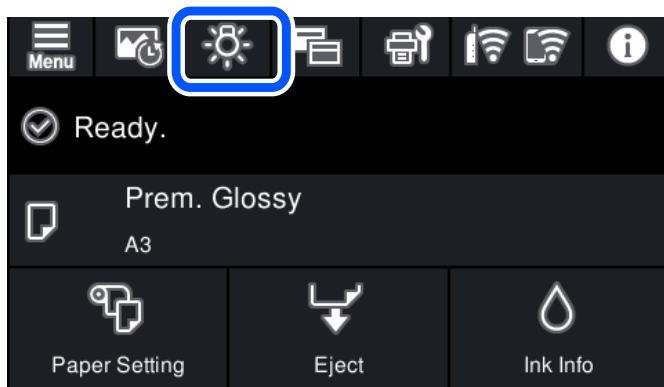

**Menu** > **General Settings** > **Basic Settings** > **Inside Light** > **Manual**

You can also turn the light on or off by selecting  on the home screen.



## Guide to the Network Icon

	The printer is not connected to a wired (Ethernet) network or unset it.
	The printer is connected to a wired (Ethernet) network.
	The printer is not connected to a wireless (Wi-Fi) network.
	The printer is searching for SSID, unset IP address, or having a problem with a wireless (Wi-Fi) network.

	<p>The printer is connected to a wireless (Wi-Fi) network.</p> <p>The number of bars indicates the signal strength of the connection. The more bars there are, the stronger the connection.</p>
	<p>The printer is not connected to a wireless (Wi-Fi) network in Wi-Fi Direct (Simple AP) mode.</p>
	<p>The printer is connected to a wireless (Wi-Fi) network in Wi-Fi Direct (Simple AP) mode.</p>

## Switching the Screen View

When you select  while the home screen or printing screen is displayed, the screen view is switched.

### Home screen

Standard mode

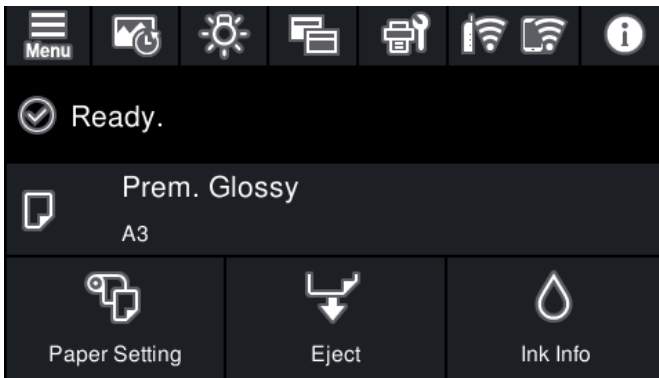

Consumables information mode

You can check the approximate ink levels and the approximate service life of the maintenance box.

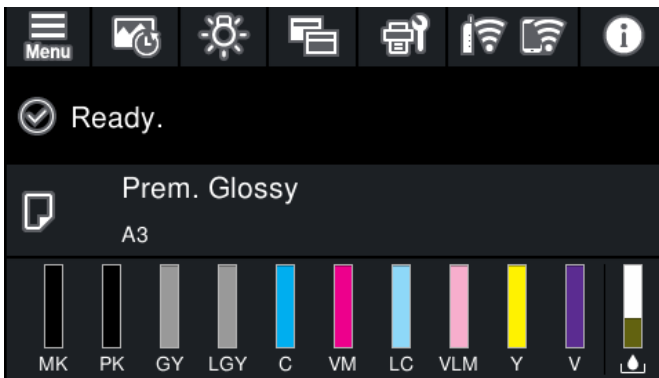

### Printing screen

Photo display mode

Displays thumbnails of images when you print using the printer driver and Epson Print Layout.

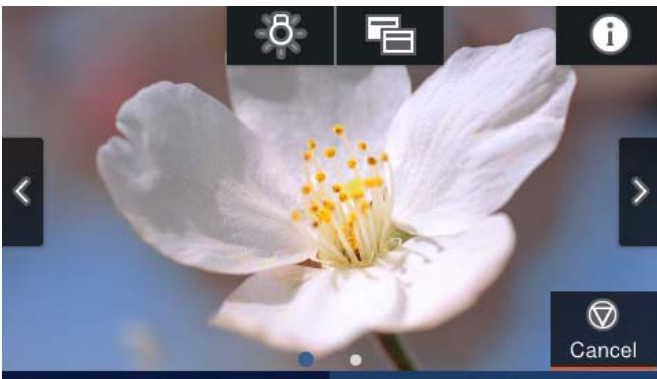

Print status display mode

Displays ink levels and a progress bar when printing.

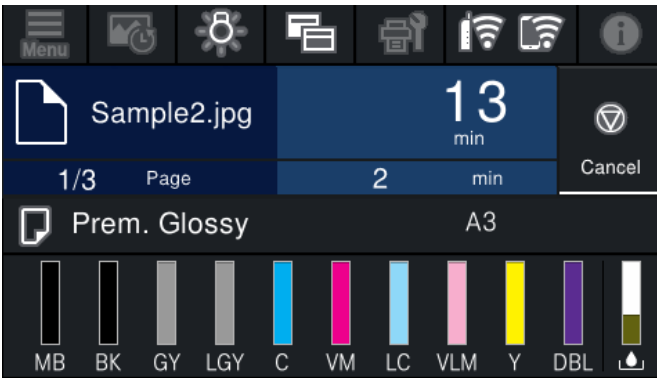

Print setting display mode

Displays print settings for the printer driver and Epson Print Layout.



## Entering Characters

You can enter characters and symbols by using on-screen keyboard when you make network settings, and so on.

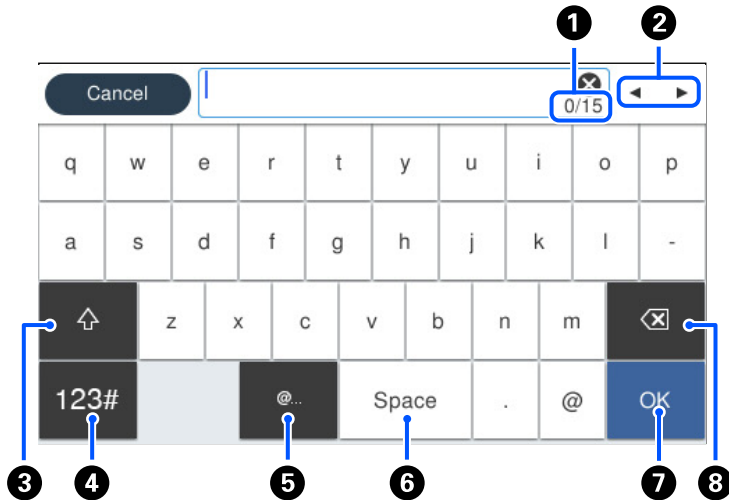

1	Indicates the character count.
2	Moves the cursor to the input position.
3	Switches between upper case and lower case or numbers and symbols.
4	Switches the character type. <div style="display: flex; flex-direction: column; gap: 5px;"> <div><span style="background-color: #ccc; padding: 2px;">123#</span> : You can enter numbers and symbols.</div> <div><span style="background-color: #ccc; padding: 2px;">ABC</span> : You can enter letters.</div> </div>
5	Enters frequently used email domain addresses or URLs by simply selecting the item.
6	Enters a space.
7	Enters character.
8	Deletes a character to the left.



---

# Loading Papers and CD/DVDs

Loading Paper. . . . .	26
Loading a CD/DVD. . . . .	35

## Loading Paper

### Paper Handling Precautions

Note the following points when handling and storing the paper. If the paper is not in good condition, print quality may decline.

Check the manuals supplied with each paper.

### Handling Precautions

- Use Epson special media under normal room conditions (temperature: 15 to 25°C; humidity: 40 to 60%).
- Do not fold the paper or scratch the surface of the paper.
- Avoid touching the printable surface of the paper with your bare hands. Moisture and oils from your hands can affect print quality.
- Paper may be wavy or slack if the temperature and humidity change. Be careful not to scratch or soil the paper, and flatten it before loading it in the printer.
- Do not wet the paper.
- Do not throw away the paper packaging as you can use it for storing the paper.
- Avoid locations that are subject to direct sunlight, excessive heat, or humidity.
- Keep paper in their original package after opening, and keep them in a flat place.

### Printed Paper Handling Precautions

To maintain long lasting, high quality print results, note the following points.

- Do not rub or scratch the printed surface. If they are rubbed or scratched, the ink may peel off.
- Do not touch the printed surface; otherwise, the ink may peel off.
- Make sure the print outs are completely dry before folding or stacking; otherwise, the color may change where they touch (leaves a mark). These marks will disappear if they are separated immediately and dried; however, they will remain if not separated.
- If you put the print outs in an album before they are completely dry, they may be blurred.
- Do not use a dryer to dry the print outs.
- Avoid direct sunlight.
- Prevent color distortion while displaying or storing the print outs by following the instructions in the paper's manual.
- To keep your printouts from discoloring, store them in a dark place, away from high temperatures, high humidity, and direct sunlight.

**Note:**

Typically, print outs and photos fade over time (color distortion) due to the effects of light and various constituents in the air. This also applies to Epson special media. However, with the correct storage method, the degree of color distortion can be minimized.

- ❑ See the manuals supplied with Epson special media for detailed information on handling the paper after printing.
- ❑ The colors of photos, posters, and other printed materials appear different under different lighting conditions (light sources\*). The colors of print outs from this printer may also appear different under different light sources.

\* Light sources include sunlight, fluorescent light, incandescent light, and other types.

## Paper Loading Precautions

This printer has three paper sources. Load paper of the appropriate size and type to suit your printing needs.

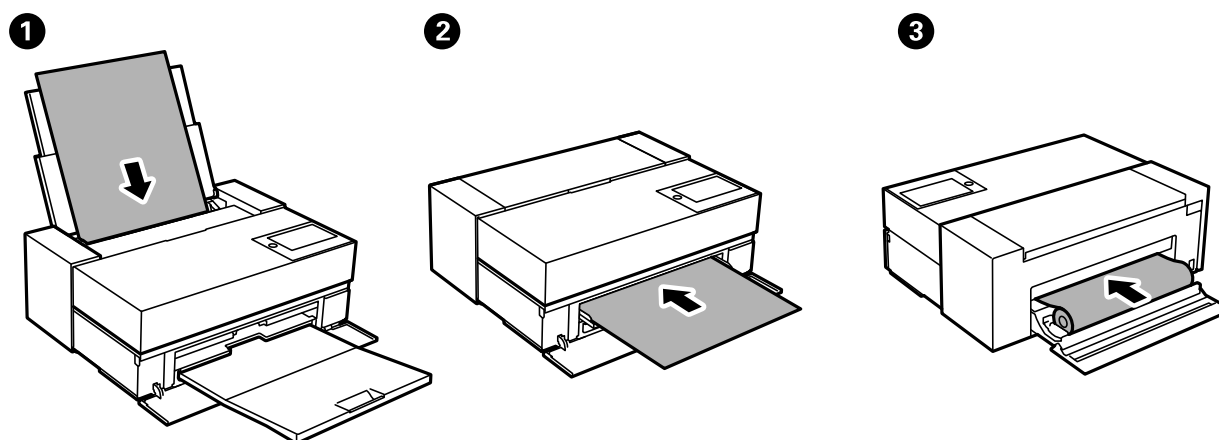

①	Rear paper feeder	Normally, load paper in the rear paper feeder. (Except for roll paper, poster board, or paper that is over 0.5 mm thick.)
②	Front paper feeder	Load paper into the front paper feeder when printing on poster board or paper that is over 0.5 mm thick, or when you are unable to feed commercially available fine art paper from the rear paper feeder.
③	Roll paper unit	Load roll paper into the roll paper unit. For the SC-P700 Series, roll paper unit is stored in the rear of the printer. For the SC-P900 Series, use an optional roll paper unit.

## Paper Size and Type Settings

If you register the paper size and type on the screen displayed when you load the paper, the printer informs you when the registered information and print settings differ. This prevents you from wasting paper and ink by making

sure you are not printing on the wrong paper size or printing in the wrong color due to using settings that do not match the paper type.

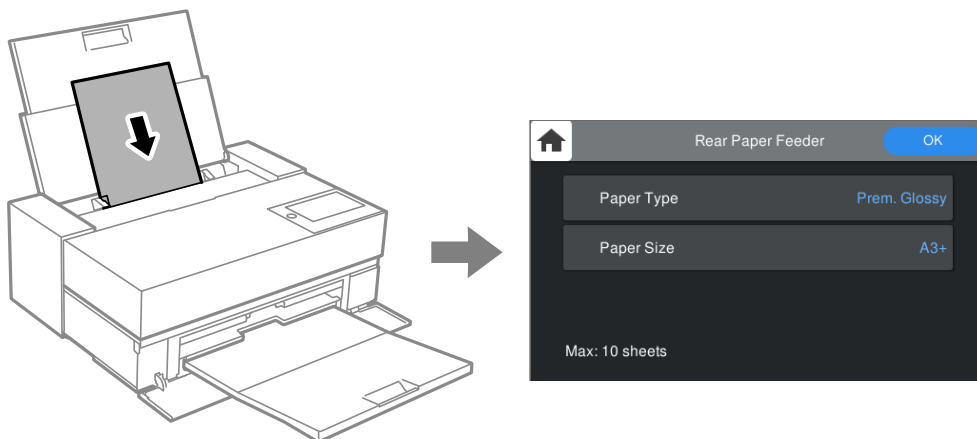

If displayed paper size and type differ from the loaded paper, select the item to change. If the settings match the loaded paper, close the screen.

## List of Paper Types

To obtain optimum printing results, select the paper type that suits the paper. When using commercially available paper other than genuine Epson paper, select the paper type that closest to that paper.

Media Name	Media Type	
	Control Panel	Printer Driver
Bright White Ink Jet Paper	Plain paper	Plain Paper / Bright White Paper
Premium Glossy Photo Paper	Prem. Glossy	Epson Premium Glossy
Premium Semigloss Photo Paper	Prem. Semigloss	Epson Premium Semigloss
Photo Paper Glossy	Glossy	Photo Paper Glossy
Watercolor Paper - Radiant White	Watercolor Paper Radiant White	Watercolor Paper Radiant White
Velvet Fine Art Paper	Velvet Fine Art Paper	Velvet Fine Art Paper
UltraSmooth Fine Art Paper	Epson UltraSmooth Fine Art paper	UltraSmooth Fine Art Paper
Matte Paper-Heavyweight Archival Matte Paper	Archival Matte	Epson Archival Matte
Photo Quality Ink Jet Paper	Photo Quality Ink Jet	Epson Photo Quality Ink Jet
Epson Proofing Paper White Semimatte	Proofing Semimatte	Epson Proofing Paper White Semimatte
Premium Glossy Photo Paper (250)	Prem. Glossy	Epson Premium Glossy
Premium Semigloss Photo Paper (250)	Prem. Semigloss	Epson Premium Semigloss
Premium Luster Photo Paper (260)	Prem. Luster	Premium Luster Photo Paper

Media Name	Media Type	
	Control Panel	Printer Driver
Premium Semimatte Photo Paper (260)	Prem. Semigloss	Epson Premium Semigloss
Enhanced Matte Paper	Archival Matte	Epson Archival Matte
Plain Paper (cut sheets)	Plain paper	Plain Paper / Bright White Paper

## Loading Paper in the Rear Paper Feeder

1. Open and slide out the rear paper feeder to its maximum position.

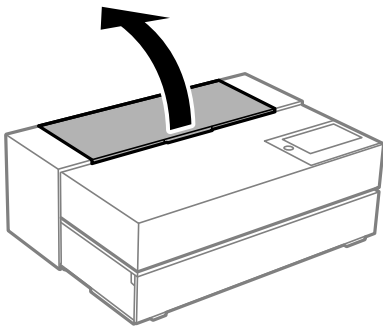

**Important:**

*Be careful not to trap your fingers at the points shown in the illustration.*

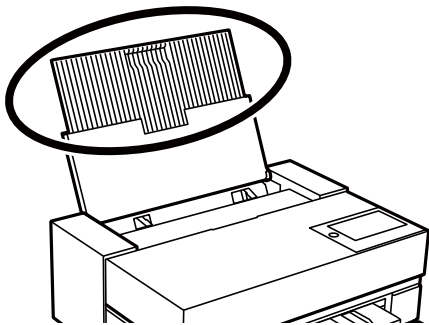

- Slide out the edge guides.

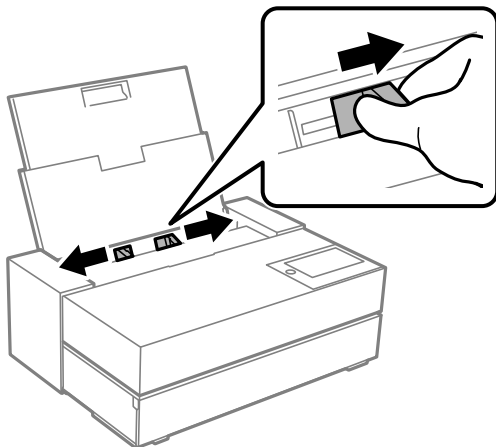

- Load paper with the printable side facing up.

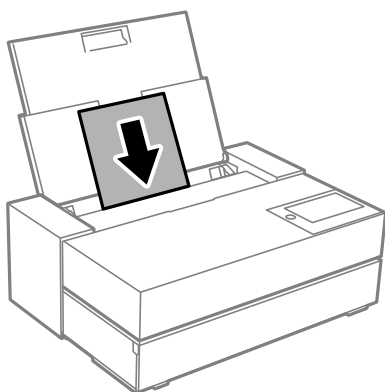

- Slide the parts of the edge guides indicated by (a) to the edges of the paper.

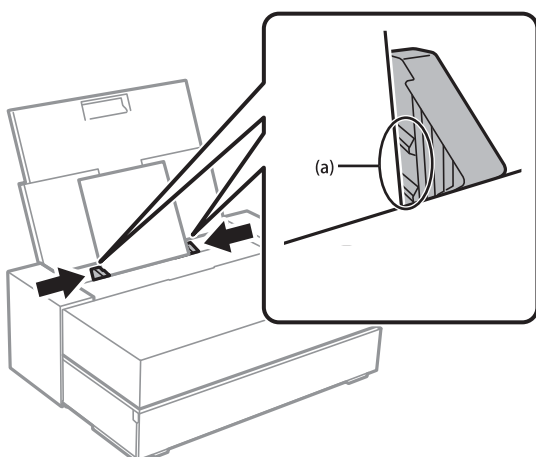

- The paper setting screen is displayed on the printer's control panel.  
Select the paper size and paper type and then select **OK**. When using commercially available paper other than genuine Epson paper, select the paper type that closest to that paper.

**Note:**

If you have registered paper information to your printer, the printer informs you if the registered information and the print settings differ. This prevents you from making the misprints.

If you have not used the register function, select  > **General Settings** > **Printer Settings**, and then disable the **Paper Setup Auto Display** setting. If you disable this setting, some functions will be unavailable. See *Related Information* for more details.

6. Open the front cover.

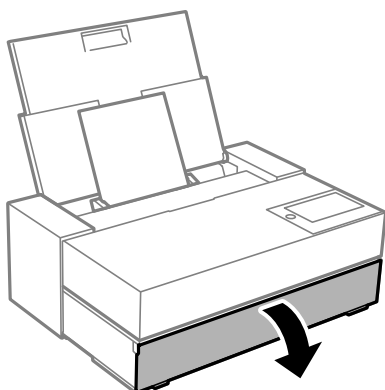

7. Slide out the output tray to its maximum position.

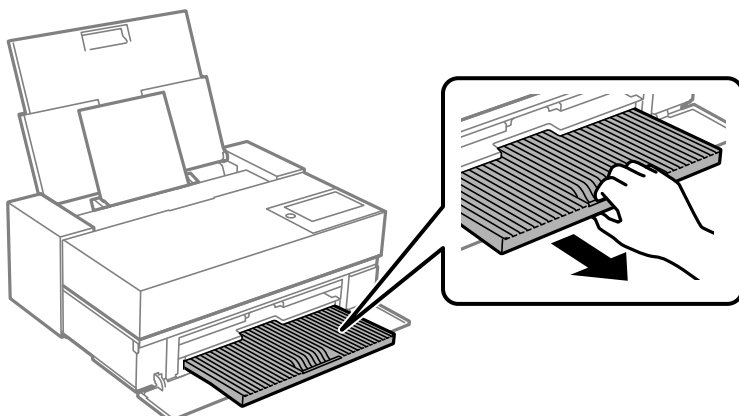

 **Important:**

To avoid paper jams, make sure you open the front paper feeder and extend the output tray before printing.

**Related Information**

- ➔ [“Paper Setup Auto Display:” on page 207](#)
- ➔ [“Available Paper and Capacities” on page 182](#)
- ➔ [“Paper Size and Type Settings” on page 27](#)

## Loading Paper in the Front Paper Feeder

You can load paper into the front paper feeder by referring to the animations displayed on the printer's control panel.

Paper sticks out from the rear of the printer when it is loaded from the front paper feeder. Leave a space (A) between the rear of the printer and the nearest wall as shown in the figure.

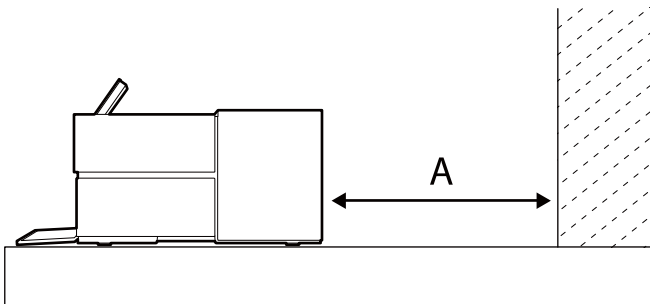

SC-P900 Series: 405 mm or above

SC-P700 Series: 330 mm or above

**! Important:**

- An error may occur if you perform the following operations during initialization movement.
  - Extend the front paper feeder.
  - Load poster board.
- Inserting paper from the rear may cause a malfunction or error.

1. Select **Paper Setting** on the printer's control panel.

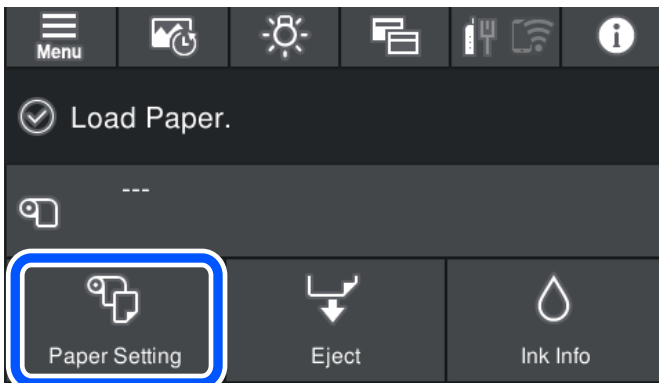

2. Select **Front Paper Feeder - Fine Art (Thick)** or **Front Paper Feeder - Poster Board**.

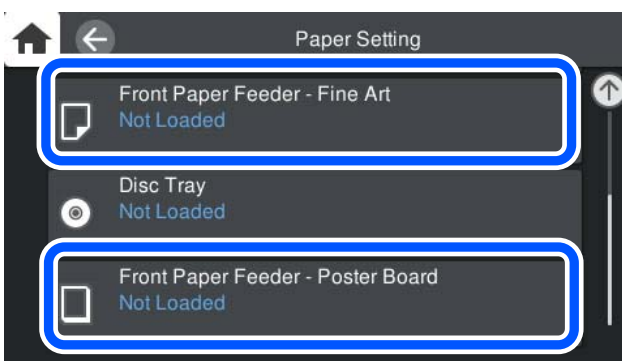



3. Pull out the front paper feeder by referring to the animations displayed on the screen.

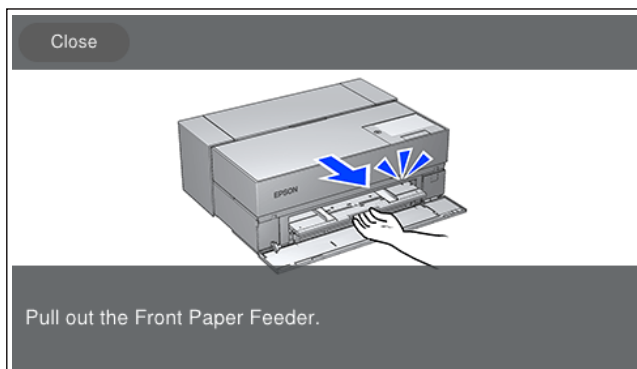

Load paper by referring to the animations displayed on the screen.

4. The paper setting screen is displayed on the printer's control panel.

Select the paper size and paper type and then select **OK**. When using commercially available paper other than genuine Epson paper, select the paper type that closest to that paper.

**Note:**

If you have registered paper information to your printer, the printer informs you if the registered information and the print settings differ. This prevents you from making the misprints.

If you have not used the register function, select  > **General Settings** > **Printer Settings**, and then disable the **Paper Setup Auto Display** setting. If you disable this setting, some functions will be unavailable. See Related Information for more details.

**Related Information**

- ➔ “Paper Setup Auto Display:” on page 207
- ➔ “Available Paper and Capacities” on page 182
- ➔ “Paper Size and Type Settings” on page 27

## Loading Roll Paper

You can load a roll paper by referring to the animations displayed on the printer's control panel.

1. Select **Paper Setting** on the printer's control panel.

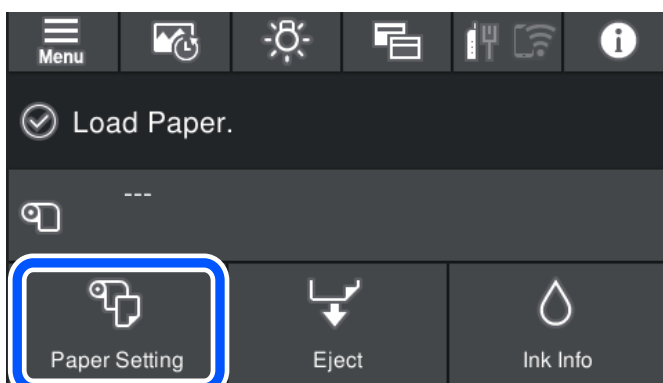

2. Select **Roll Paper**.

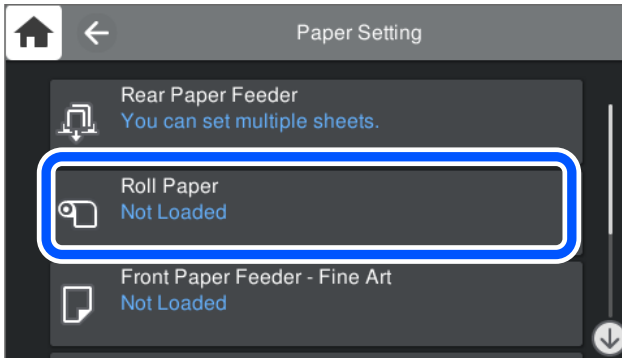

3. Pull out the roll paper unit by referring to the animations displayed on the screen.

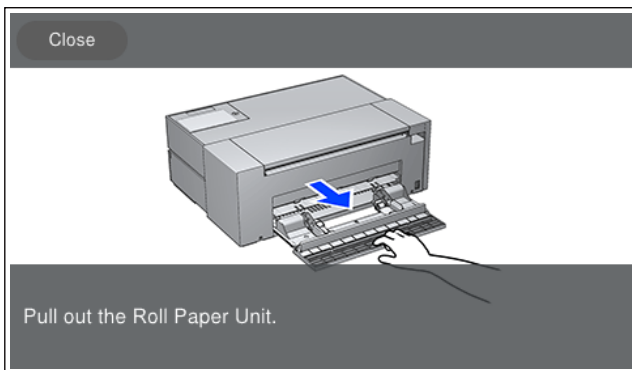

Load the roll paper by referring to the animations displayed on the screen.

4. The paper setting screen is displayed on the printer's control panel.  
Select the paper size and paper type and then select **OK**. When using commercially available paper other than genuine Epson paper, select the paper type that closest to that paper.

**Note:**

If you have registered paper information to your printer, the printer informs you if the registered information and the print settings differ. This prevents you from making the misprints.

If you have not used the register function, select  > **General Settings** > **Printer Settings**, and then disable the **Paper Setup Auto Display** setting. If you disable this setting, some functions will be unavailable. See *Related Information* for more details.

**Related Information**

- ➔ “Paper Setup Auto Display:” on page 207
- ➔ “Available Paper and Capacities” on page 182
- ➔ “Paper Size and Type Settings” on page 27

**Cutting and Removing the Roll Paper**

After printing on the roll paper, follow the steps below to remove the roll paper.

1. Select **Cut/Eject** on the printer's control panel.

2. Select **Cut and Eject**.  
The roll paper is moved to the cutting position.
3. Cut the ejected paper using scissors.
4. Select **Done**.
5. Open the roll paper unit. (Only for SC-P900 Series users)

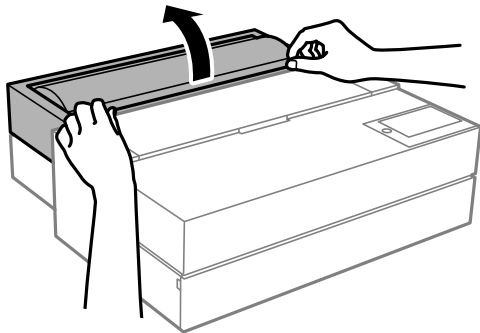

6. Remove the roll paper.

---

## Loading a CD/DVD

### Printable CD/DVDs

You can print on a circular 12-cm CD/DVD labelled as suitable for printing, for example "printable on the label surface" or "printable with ink jet printers."

You can also print on Blu-ray Discs™.

### CD/DVD Handling Precautions

- See the documentation provided with your CD/DVD for more information on handling the CD/DVD or writing data.
- Do not print on the CD/DVD before writing your data to it. If you do, fingerprints, dirt, or scratches on the surface may cause errors while writing data.
- Depending on the CD/DVD type or printing data, smearing may occur. Try making a test print on a spare CD/DVD. Check the printed surface after waiting for one full day.
- Compared to printing on genuine Epson paper, the print density is lowered to prevent ink from smearing on the CD/DVD. Adjust the print density as necessary.
- Allow the printed CD/DVDs at least 24 hours to dry avoiding direct sunlight. Do not stack or insert the CD/DVDs into your device until they are completely dry.
- If the printed surface is sticky even after it has dried, lower the print density.
- Reprinting on the same CD/DVD may not improve the print quality.

- If the disc tray or the internal transparent compartment are accidentally printed on, immediately wipe off the ink.
- Depending on the print area setting, the CD/DVD or disc tray may get dirty. Make settings to print on the printable area.
- You can set the print range for the CD/DVD to a minimum of 18 mm for the inner diameter, and a maximum of 120 mm for the outer diameter. Depending on the settings, the CD/DVD or disc tray may be smeared. Set within the print range for the CD/DVD you want to print.

## Loading a CD/DVD

You can load the CD/DVD by referring to the animations displayed on the printer's control panel.

**! Important:**

- Do not turn the printer on or off while the tray is inserted. This could cause a malfunction.
- Store the tray flat. Malfunction could result if the tray is curled or deformed.
- An error may occur if you perform the following operations during printing.
  - Extend the front paper feeder.
  - Load poster board.
- Use the disk tray supplied with the printer. Using a different tray could damage the printer, tray, or disc or cause printer malfunction.
- Inserting the disk tray from the rear may cause a malfunction or error.

1. Select **Paper Setting** on the printer's control panel.

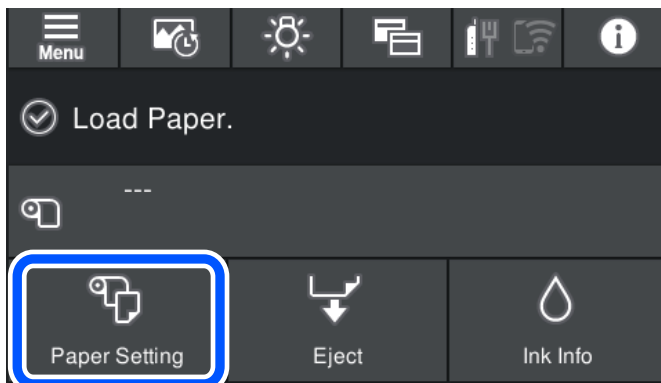

2. Select **Disc Tray**.

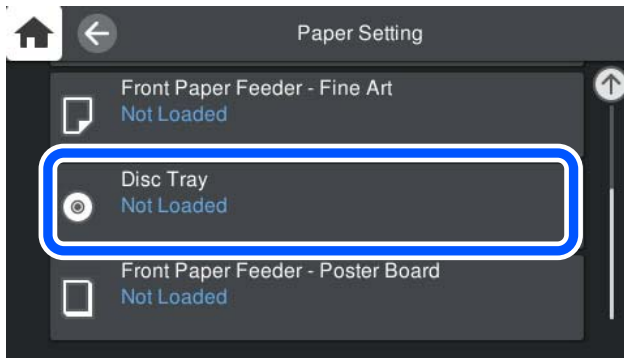

3. Pull out the front paper feeder by referring to the animations displayed on the screen.

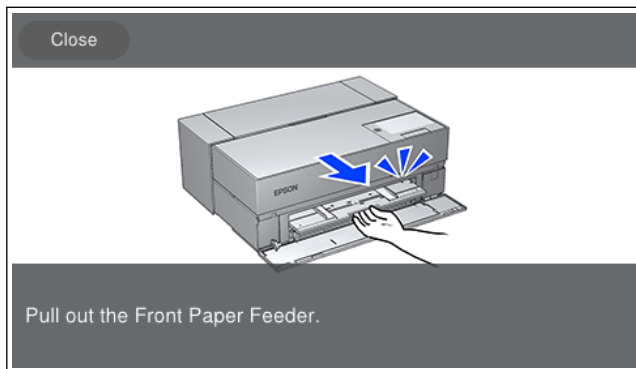

Load the CD/DVD by referring to the animations displayed on the screen.

### Related Information

➔ [“Available Paper and Capacities” on page 182](#)

## Removing a CD/DVD

1. When the disk tray is ejected after printing, hold the end of the tray and pull it straight out.

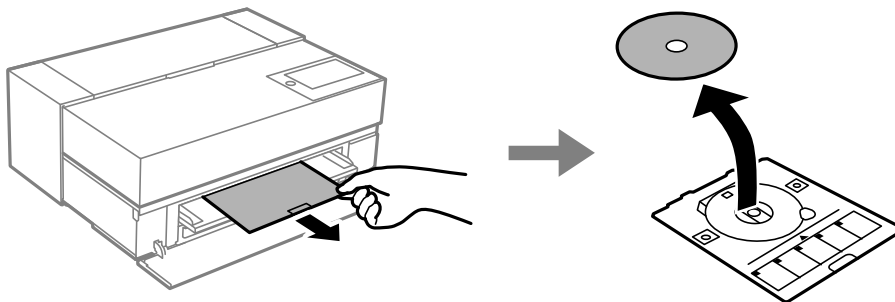

2. Store the front paper feeder.

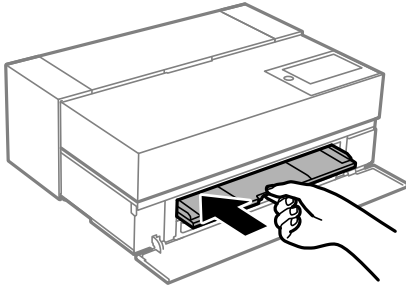

3. Close the front cover.

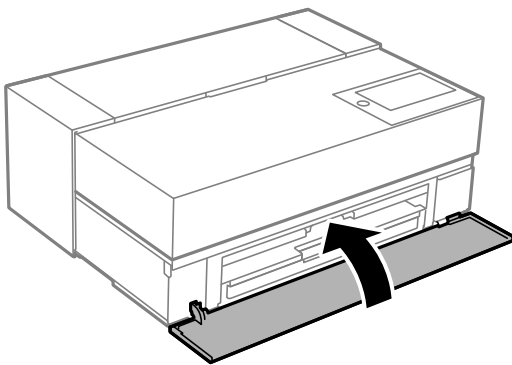

**Important:**

*After printing is finished, make sure you remove the disk tray. If you do not remove the tray and turn the printer on or off, or run head cleaning, the disk tray will strike the print head and may cause the printer to malfunction.*

**Note:**

*Select **Remove** on the printer's control panel to remove the disk tray without printing.*

---



# Printing

Printing Photos. . . . .	40
Printing Documents. . . . .	67
Printing Using a Cloud Service. . . . .	98

# Printing Photos

## Tips when Printing Photo Projects

This section explains important points to note when creating photo projects.

### Shooting (Camera Settings)

Creating a photo project begins with shooting. The data storage format and size (resolution) are also important points.

Some items only need to be set for the first time, while some items need to be set every time according to the subject.

#### Items that only need to be set the first time

- Color spaces: Select sRGB if you are unsure.
- Storage size: We recommend saving at a resolution that suits the paper size you will use for printing, using the table below as a guide.

Print Size	Number of Pixels
A2/entire sheet	24 million (5830 x 4120)
A3/half sheet	18 million (5050 x 3570)
A4/8x10 in/10x12 in	12 million (4120 x 2920)

- Data format: We recommend selecting RAW when editing and printing photo data, or select JPEG just printing.

#### Items that need to be set every time

Set the following appropriately according to the subject.

- Select A mode (aperture priority auto) from shooting mode and control the F value (aperture) to set the amount of blurring.
- Exposure: Set an approximate value to avoid halation or black defects.
- Shutter speed: Set the speed to avoid blurring.
- ISO speed: We recommend setting this as low as possible.
- White balance: Set an approximate setting according to the subject.

### Raw Development and Editing (Printed Finish)

This process is as important as shooting to complete photo projects.

This allows you to edit photos (or perform color correction, gradation correction, cropping, and so on) with applications\* such as Adobe Photoshop or Lightroom, and save them in JPEG or TIFF format.

\*You can also perform RAW development using the camera software.

- Adjust the color temperature to match the subject or the scene.



- Maintain a rich gradation and do not increase the intensity of red and yellow.
- Adjust the black level and create a sharp photo.

## Printing (Selecting the Paper and Print Settings Correctly)

You can create more attractive photos by selecting paper that suits the subject of the photo.

Most people think that glossy paper is the best for printing all photos, but there other textures available such as semigloss and matte paper. These provide a wide variety of finished photos.

Also, the soft texture of fine art paper allows you to print photos that look like paintings.

The following pages introduce the characteristics and recommended uses of typical Genuine Epson paper.

[“Available Paper and Capacities” on page 182](#)

When you print a photo, select from the following three methods depending on your knowledge and purpose of photo printing.

- If you want to easily print photos that have been edited in an application (color correction and so on).  
[“Printing with Epson Print Layout” on page 41](#)
- If you want to print using an application or the printer driver.  
[“Printing Using the Application and Printer Driver” on page 48](#)
- If you want to print photos quickly and leave color reproduction to the printer.  
[“Printing Using Epson Photo+” on page 63](#)

### To bring the display color closer to the color of the printed material

The image on the display is expressed with the three primary colors of light (RGB), and the printed matter output by the printer is expressed by the three primary colors (CMY) + K. Therefore, it is difficult to strictly produce the same color.

The following three points can help to bring the colors as close as possible.

- Use a calibrated display
- Check under a light that allows you to see the correct color of the photo
- Set the color management settings\* and print settings correctly

\*Settings for matching colors displayed on different devices such as displays, digital cameras, and printers. When you import photos taken with a digital camera and output them on the printer or display, each color may look slightly different. This is because the color characteristics differ from device to device.

### When printing using commercial paper

Add the paper information when you want to print easily using color matching on ordinary commercial paper.

[“Printing to Paper Types Other than Genuine Paper” on page 191](#)

## Printing with Epson Print Layout

Epson Print Layout allows you to make print settings to be performed by the application and the printer driver on one screen.

## Summary of Epson Print Layout

Epson Print Layout is an application that allows you to print retouched or developed photos in a few easy steps. It can also be used as a plug-in for Adobe Photoshop, Adobe Lightroom, Nikon ViewNX-i, and SILKYPIX. See the Epson Print Layout manual for details on supported applications and data formats.

You can download Epson Print Layout from the Epson Web site.



**Note:**

You can download the manual for Epson Print Layout for iPad from the App Store. The manual for iPhone will be released around July 2020. The release date is subject to change without notice.

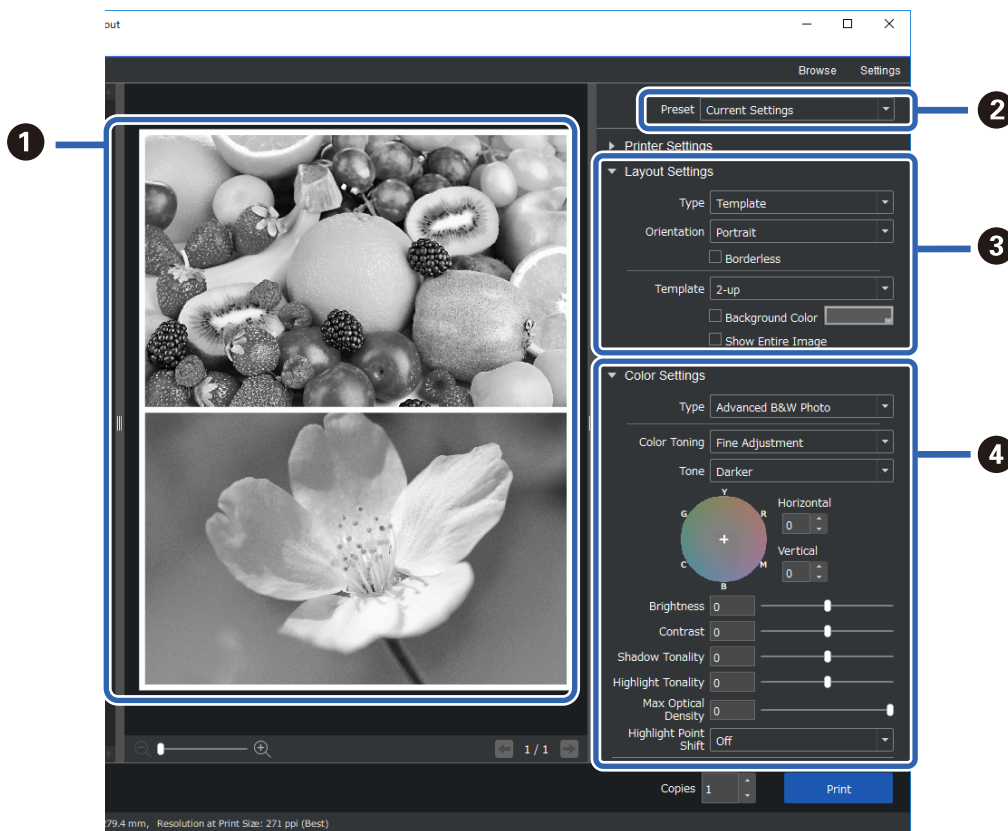
### Screen Composition



<b>1</b>	Check the print results using the selected settings before printing.
<b>2</b>	Save your favorite print settings and use them repeatedly.

<p>3</p>	<p>Set the print layout.</p> <p>You can also select multiple photo templates and special layouts.</p> <p>Template</p>  <p>Panorama</p>  <p>Gallery Wrap</p> 
<p>4</p>	<p>Select the color management method or Advanced B&amp;W Photo print mode.</p>

## Making Print Settings

This section explains the procedure for printing one photo using a standard layout.

1. Start Epson Print Layout.

This section explains the procedure for starting directly from the photo to be printed.

See the Epson Print Layout manual for details on how to start from your applications.

❑ Windows

Right-click the photo and select **Send to > Epson Print Layout**.

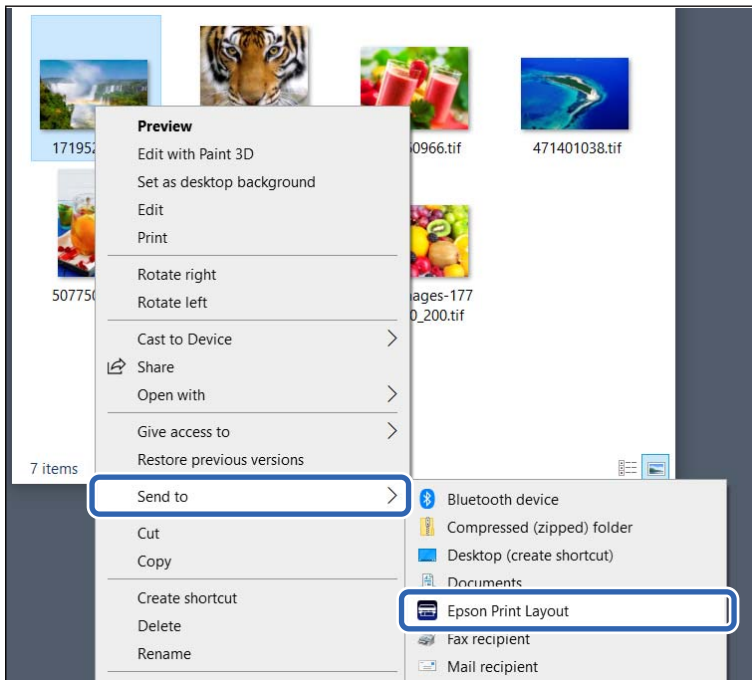

❑ Mac OS

Click the photo to be printed while holding down the **Ctrl** key, and then select **Open With > Epson Print Layout**.

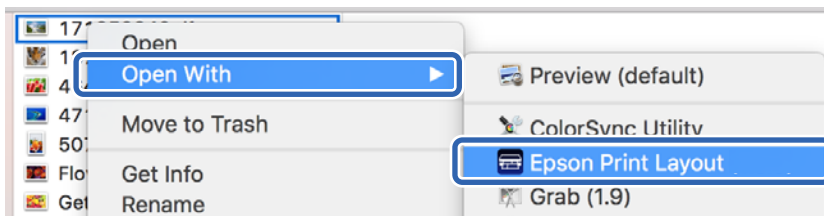

2. Set the paper information and print quality from **Printer Settings**.

Make sure that your printer is selected and select the correct paper type, size, and paper source.

Load fine art paper in the **Rear Paper Feeder** except for some commercial paper (paper except for genuine Epson paper).

Select **Standard** as the print quality. **Standard** is the mode with the best balance between image quality and speed.

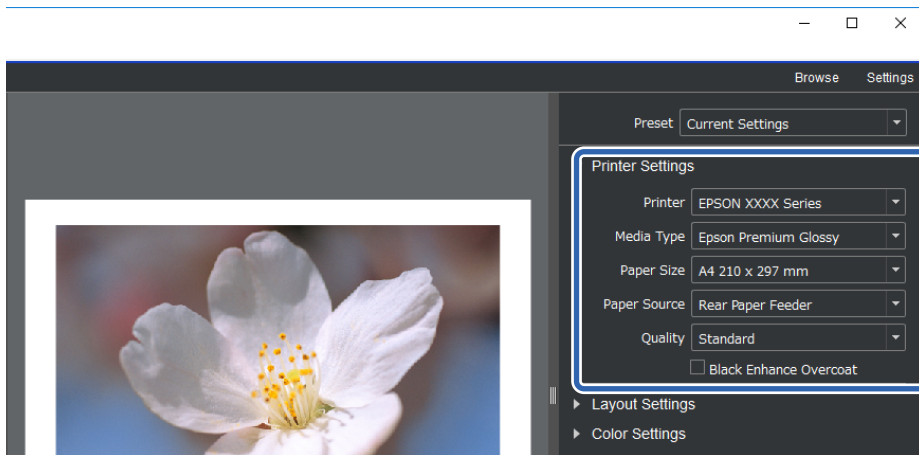

3. Set the print layout in **Layout Settings**.

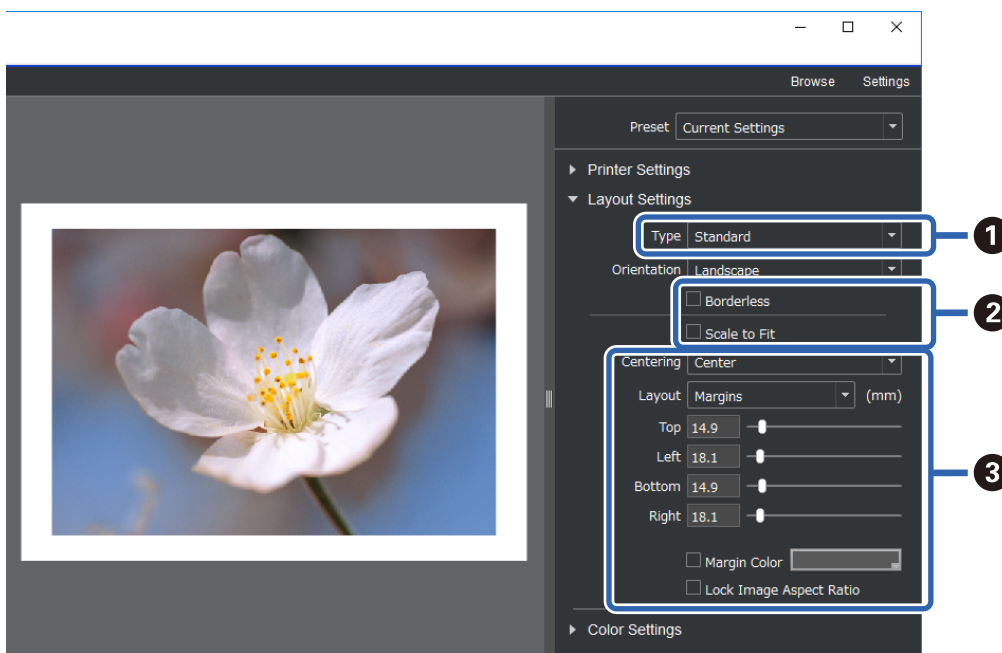

<b>1</b>	Select <b>Standard</b> .
<b>2</b>	<ul style="list-style-type: none"> <li><input type="checkbox"/> When performing borderless printing Select <b>Borderless</b> and <b>Scale to Fit</b>.</li> <li><input type="checkbox"/> When adding a margin Clear both checkboxes, and then set the following margin.</li> </ul>
<b>3</b>	<ul style="list-style-type: none"> <li><input type="checkbox"/> Select <b>Center</b>.</li> <li><input type="checkbox"/> Select <b>Image Size</b> or <b>Margins</b> and adjust the margin size.</li> <li><input type="checkbox"/> Select <b>Margin Color</b> to change the color of the margins.</li> </ul>

4. Set the color management method from **Color Settings**.

Set one of the following methods, and then click **Print**.

- Manage color using the printer driver (this uses the recommended setting to make the best of the printer color gamut\*)

\*Use the following setting method when using paper added in Epson Media Installer: Manage color using an application.

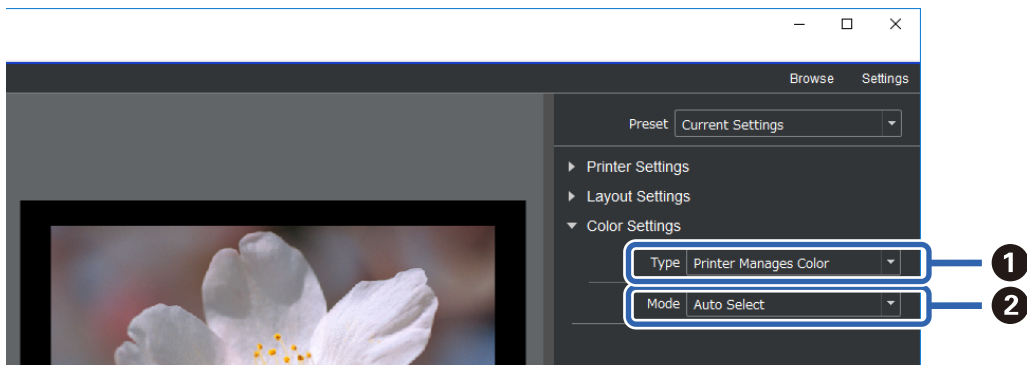

<b>1</b>	Select <b>Printer Manages Color</b> .
<b>2</b>	Select <b>Auto Select</b> .

- Manage color using an application (For users with knowledge of color management and specialized equipment)

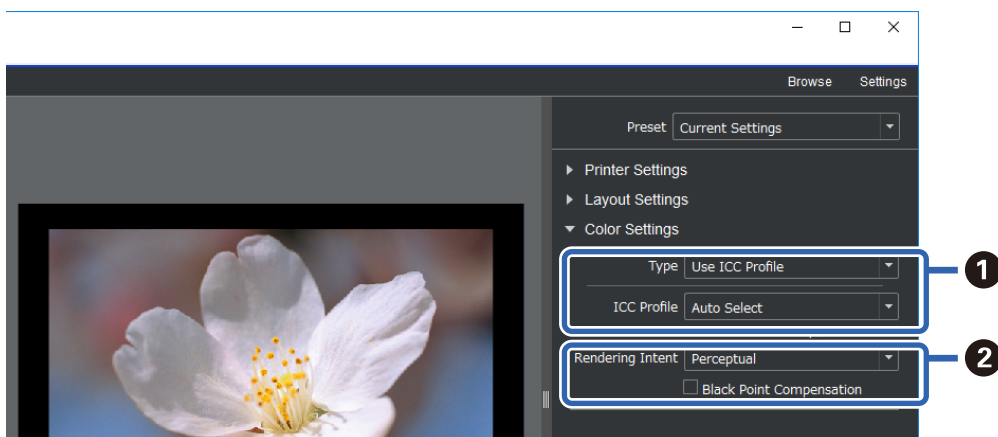

<b>1</b>	Select <b>Use ICC Profile</b> from <b>Type</b> . When you select <b>Auto Select</b> from <b>Output ICC Profile</b> , the ICC profile for the paper selected in step 2 is set automatically.
<b>2</b>	Select <b>Perceptual</b> .

## Printing Black and White Photos Easily

In **Advanced B&W Photo**, you can make adjustments while checking the results in the preview area to easily create beautiful black and white print outs. The photo data itself can be either color or monochrome.

Depending on the paper selected in **Media Type** from **Printer Settings**, **Advanced B&W Photo** may not be displayed.

1. Select **Advanced B&W Photo** from **Type** in **Color Settings**.

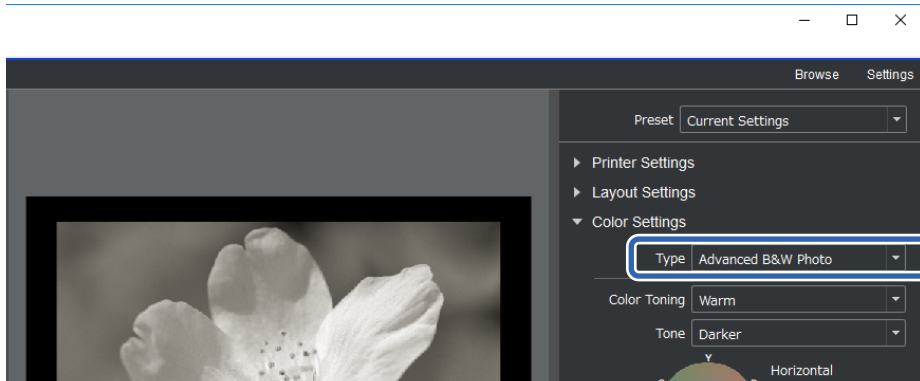

2. Make any necessary detailed settings, and then click **Print**.

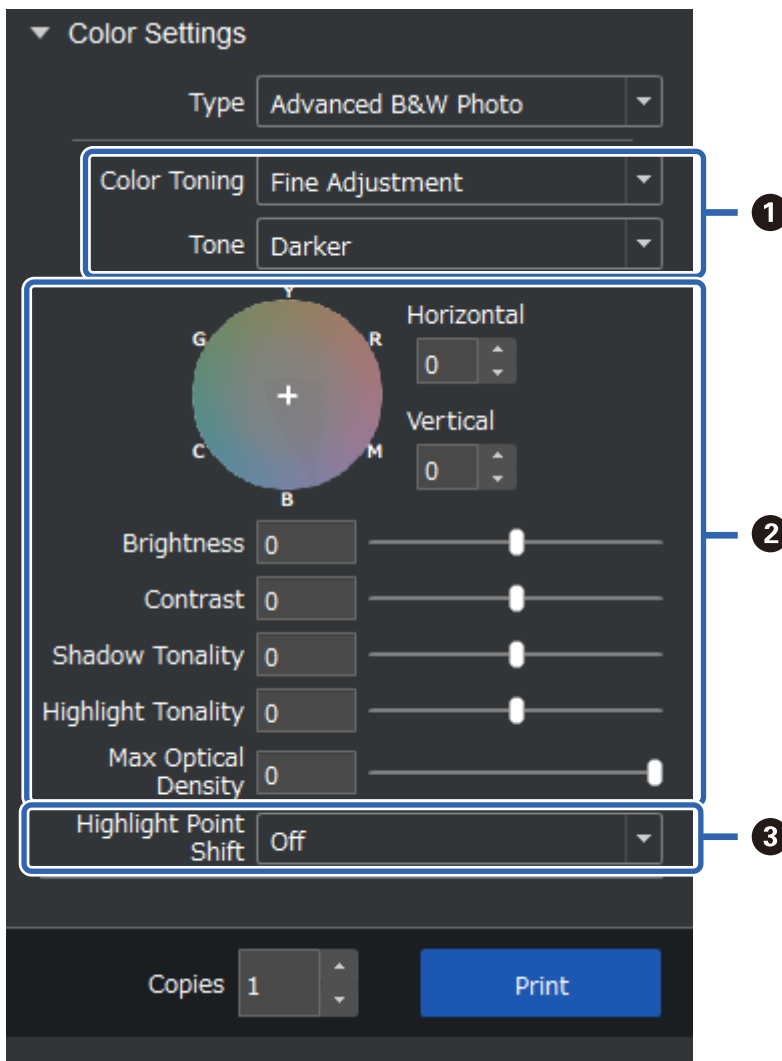

<b>1</b>	<p>Color Toning: Select your favorite black from the following four types.</p> <ul style="list-style-type: none"> <li><input type="checkbox"/> Neutral: Standard black</li> <li><input type="checkbox"/> Cool: Bluish black</li> <li><input type="checkbox"/> Warm: Reddish black</li> <li><input type="checkbox"/> Sepia: Brownish with a retro texture</li> </ul> <p>Tone: You can adjust the modulation of black and white.</p>
<b>2</b>	<p>You can adjust the black tone.</p> <ul style="list-style-type: none"> <li><input type="checkbox"/> When you make an adjustment, <b>Color Toning</b> above changes to <b>Fine Adjustment</b>. If you save and select <b>Save Custom Toning</b>, you can print the same black and white tone next time.</li> <li><input type="checkbox"/> Note that adjustments will be undone if you change <b>Color Toning</b> or <b>Tone</b> after making adjustments.</li> </ul>
<b>3</b>	<p>Switch on and off as needed.</p> <p>On: Slightly adds color to the highlights of the image and reduces blown out highlights.</p> <p>On (Full Page): The entire paper is coated with the adjusted color and the texture makes it look like it was printed on light-colored paper.</p>

## Printing Using the Application and Printer Driver

Some features such as various layouts in Adobe Photoshop and advanced adjustments in the printer driver cannot be realized with Epson Print Layout. In this case, you can make settings individually in the application and printer driver. This section explains how to make color management settings in situations such as these.

### Printing Using Color Management in Applications (Windows)

This is recommended when you want to print colors on the display correctly. You need the correct environmental conditions such as screen calibration and surrounding lighting to view the correct print colors. The following two points are important for color management settings.

- Enable the color management settings in the application and disable those in the printer driver.
- Select the ICC profile for the paper in the application and select the corresponding paper name in the printer driver.

See the following for the paper names of genuine Epson paper and their corresponding ICC profiles.

[“Available Paper and Capacities” on page 182](#)

1. Make settings in the application.

Setting example for Adobe Photoshop Elements 2020

Click **More Options** on the print screen.



Select **Color Management**, and then select **Photoshop Manages Colors** from **Color Handling**. Select the ICC profile of the paper from **Printer Profile** and click **Printer Preferences**.

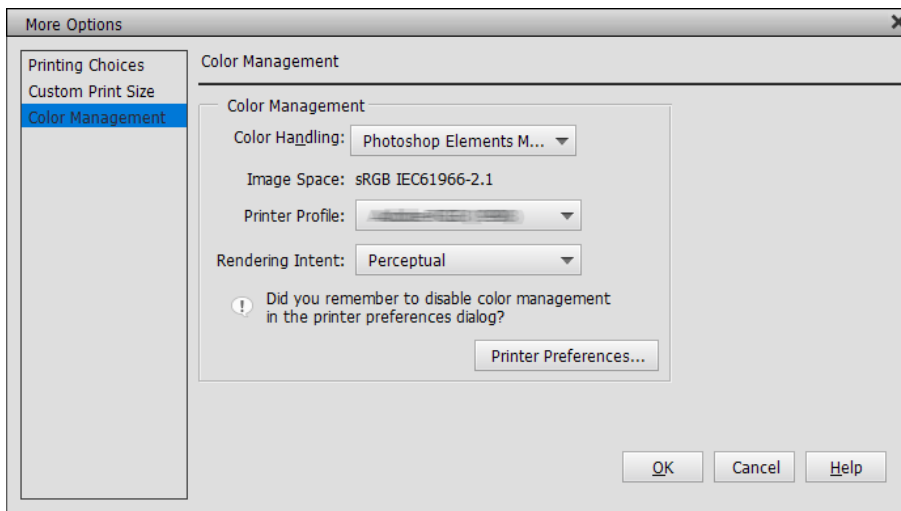

2. Display the printer driver's setting screen.
3. Make the following settings on the **Main** tab.
  - Media Type: Select the paper name corresponding to the ICC profile selected as the **Printer Profile** in step 1.
  - Mode: Select **Off (No Color Adjustment)**.

**Note:**

For Windows 7, **Off (No Color Adjustment)** is selected automatically.

4. Check other settings, and then start printing.

## Printing Using Color Management in the Printer Driver (Windows)

This is recommended when you want to make the most of wide color spaces and the printer's gradation. This reduces matching colors on the display. Color management set in the printer driver is not saved to the image data.

The following two points are important for color management settings.

- Disable the color management settings in the application and enable those in the printer driver.
- Set **Mode** to match the color space of the image (sRGB/Adobe RGB) to print in the printer driver.

1. When using applications featuring a color management function, specify how to adjust colors from these applications.

When using applications without a color management function, start from step 2.

Depending on the type of the application, make the settings following the table below.

Application	Color Management Settings
Adobe Photoshop CS3 or later Adobe Photoshop Lightroom 1 or later Adobe Photoshop Elements 6 or later	Printer Manages Colors

Application	Color Management Settings
Other applications	No Color Management

**Note:**

For information on the operating systems supported by each application, visit the distributor's website.

Setting example for Adobe Photoshop Elements 2020

Click **More Options** on the print screen.

Select **Color Management**, and then select **Printer Manages Colors** from **Color Handling**. Make a note of what is displayed in the **Image Space**, and then click **Printer Preferences**.

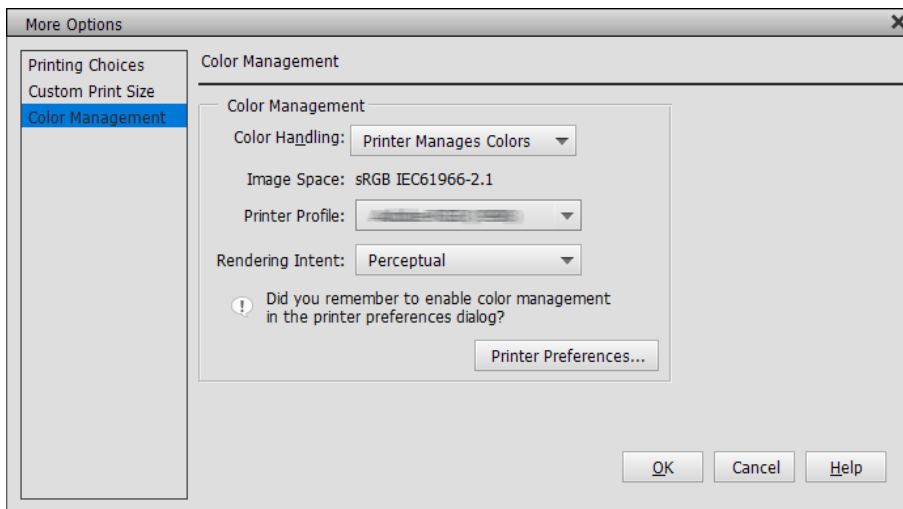

2. On the printer driver's **Main** tab, select the **Media Type** and **Mode** option.  
 For the **Mode**, select either of the following depending on what you noted in step 1.
  - sRGB: EPSON Standard (sRGB)
  - Adobe RGB: Adobe RGB

To adjust manually, click **Advanced** to display the **Color Controls** screen.

3. If you displayed the **Color Controls** screen in step 2, make settings for each item.  
See the printer driver help for more details on each item.

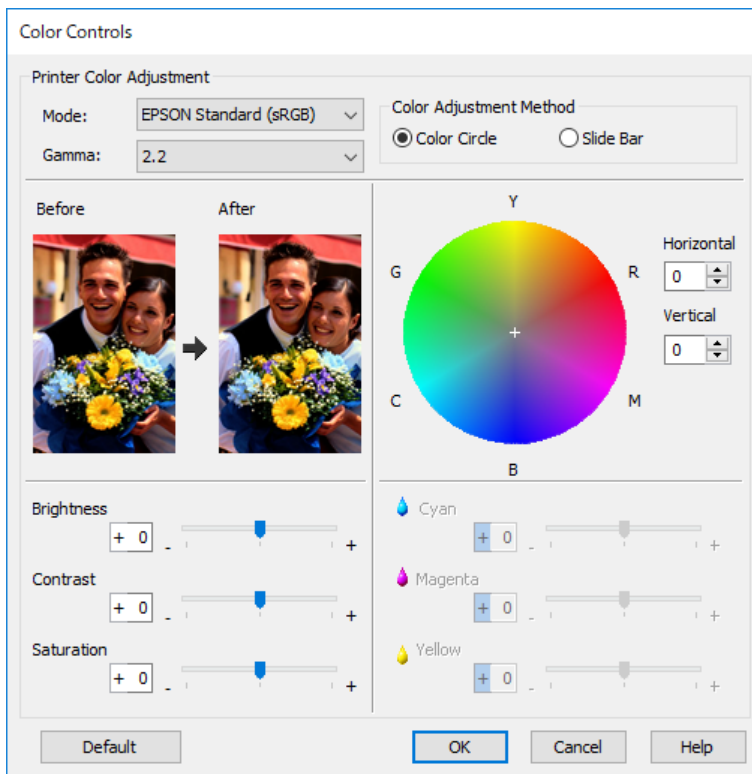

**Note:**

You can adjust values while checking the sample image on the left of the screen. You can also make fine adjustments to the color balance by using the color circle.

4. Check other settings, and then start printing.

## Printing Using Color Management in Applications (Mac OS)

This is recommended when you want to print colors on the display correctly. You need the correct environmental conditions such as screen calibration and surrounding lighting to view the correct print colors. The following two points are important for color management settings.

- Enable the color management settings in the application and disable those in the printer driver.
- Select the ICC profile for the paper in the application and select the corresponding paper name in the printer driver.

See the following for the paper names of genuine Epson paper and their corresponding ICC profiles.

[“Available Paper and Capacities” on page 182](#)

1. Make settings in the application.

Setting example for Adobe Photoshop Elements 2020

Click **More Options** on the print screen.

Select **Color Management**, and then select **Photoshop Manages Colors** from **Color Handling**. Select the ICC profile of the paper from **Printer Profile**, click **OK**, and then click **Print** on the print screen.

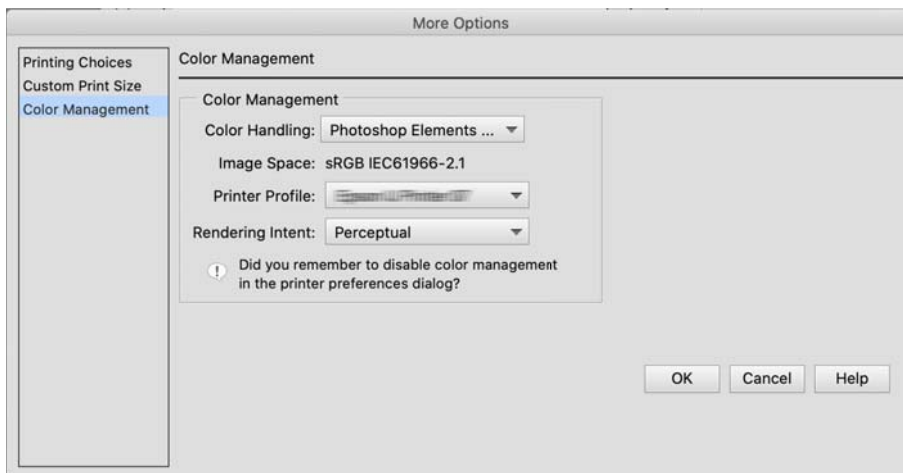

2. On the printer driver's print dialog, select **Print Settings** from the pop-up menu.
3. Make the following settings.
  - Media Type: Select the paper name corresponding to the ICC profile selected as the **Printer Profile** in step 1
  - Color Settings: Select **Off (No Color Adjustment)**.
4. Check other settings, and then start printing.

## Printing Using Color Management in the Printer Driver (Mac OS)

This is recommended when you want to make the most of wide color spaces and the printer's gradation. This reduces matching colors on the display. Color management set in the printer driver is not saved to the image data.

The following two points are important for color management settings.

- Disable the color management settings in the application and enable those in the printer driver.
- Set **Color Settings** to match the color space of the image (sRGB/Adobe RGB) to print in the printer driver.

1. When using applications featuring a color management function, specify how to adjust colors from these applications.

When using applications without a color management function, start from step 2.

Depending on the type of the application, make the settings following the table below.

Application	Color Management Settings
Adobe Photoshop CS3 or later Adobe Photoshop Lightroom 1 or later Adobe Photoshop Elements 6 or later	Printer Manages Colors
Other applications	No Color Management

**Note:**

For information on the operating systems supported by each application, visit the distributor's website.

Setting example for Adobe Photoshop Elements 2020

Click **More Options** on the print screen.

Select **Color Management**, and then select **Printer Manages Colors** from **Color Handling**. Make a note of what is displayed in the **Image Space**, click **OK**, and then click **Print** on the print screen.

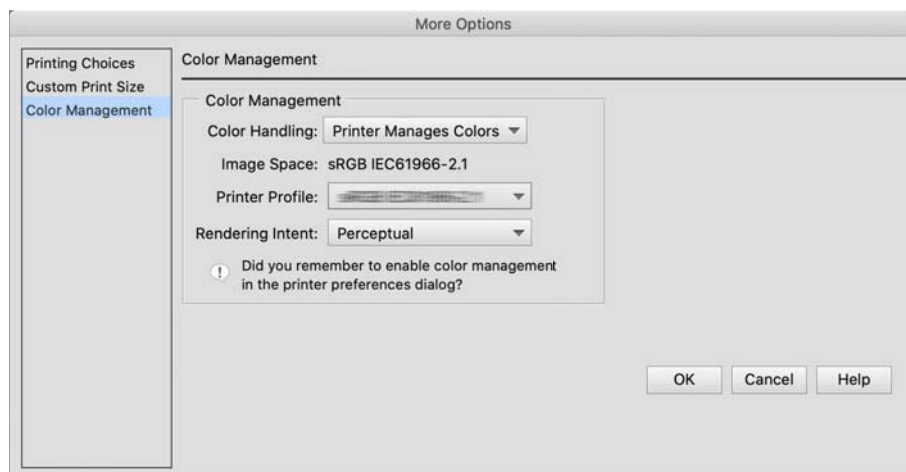

2. On the printer driver's print dialog, select **Color Matching** from the pop-up menu, and then click **EPSON Color Controls**.

**Note:**

For the following applications, you need to make settings in step 1 to select **EPSON Color Controls**.

- Adobe Photoshop CS3 or later
- Adobe Photoshop Lightroom 1 or later
- Adobe Photoshop Elements 6 or later

3. Select **Print Settings** from the pop-up menu, and then select **Color Settings** option.

For the **Color Settings**, select either of the following depending on what you noted in step 1.

- sRGB: EPSON Standard (sRGB)
- Adobe RGB: Adobe RGB

To adjust the value manually, click **Advanced Color Settings**.

4. Set each item in basic settings.
5. Check other settings, and then start printing.

## Printing Varieties (Windows)

### Printing Black and White Photos

You can print black and white photos with rich gradation by adjusting the image data color by the printer driver. The original data is not affected.

You can correct image data when printing without processing the data from applications.

**Note:**

*It is recommended that you use images with a color space of sRGB.*

1. When using applications featuring a color management function, specify how to adjust colors from these applications.

When using applications without a color management function, start from step 2.

Depending on the type of the application, make the settings following the table below.

Application	Color Management Settings
Adobe Photoshop CS3 or later Adobe Photoshop Lightroom 1 or later Adobe Photoshop Elements 6 or later	Printer Manages Colors
Other applications	No Color Management

**Note:**

*For information on the operating systems supported by each application, visit the distributor's website.*

Setting example for Adobe Photoshop Elements 2020

Click **More Options** on the print screen.

Select **Color Management**, and then select **Printer Manages Colors** from **Color Handling**. Click **Printer Preferences**.

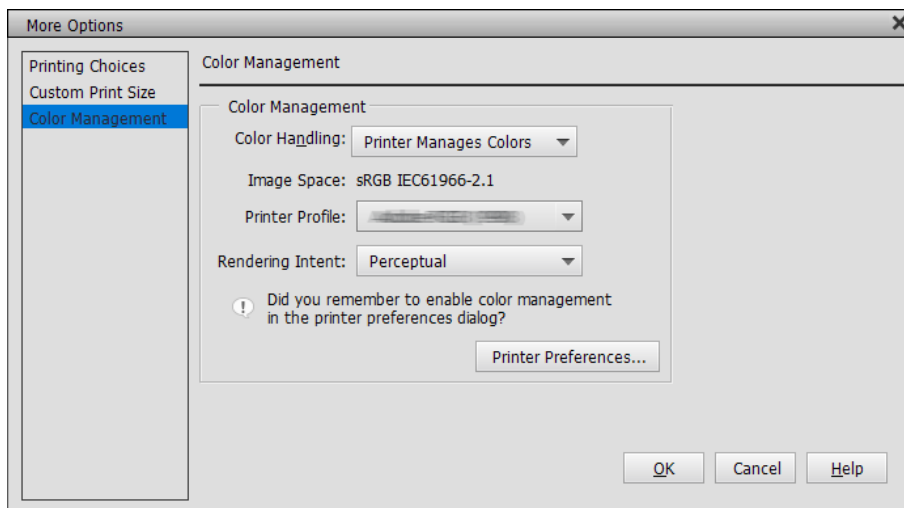

2. Display the printer driver's **Main** tab and select **Advanced B&W Photo** as the **Print Mode**.
3. Click **Advanced** for **Mode**.
4. Make the settings for each item on the **Color Controls** screen.  
See the printer driver help for more details on each item.
5. Check other settings, and then start printing.

## Printing with Auto Color Correction

The printer driver for this printer comes with the Epson proprietary function PhotoEnhance that makes the most efficient use of the color reproduction area, corrects image data to improve colors before printing.

By using PhotoEnhance, you can correct photo colors to match the subject types such as people, scenery, or night view. You can print color data in sepia or black and white. Colors are automatically corrected simply by selecting the print mode.

**Note:**

*It is recommended that you use images with a color space of sRGB.*

1. When using applications featuring a color management function, specify how to adjust colors from these applications.

When using applications without a color management function, start from step 2.

Depending on the type of the application, make the settings following the table below.

Application	Color Management Settings
Adobe Photoshop CS3 or later Adobe Photoshop Lightroom 1 or later Adobe Photoshop Elements 6 or later	Printer Manages Colors
Other applications	No Color Management

**Note:**

*For information on the operating systems supported by each application, visit the distributor's website.*

Setting example for Adobe Photoshop Elements 2020

Click **More Options** on the print screen.

Select **Color Management**, and then select **Printer Manages Colors** from **Color Handling**. Click **Printer Preferences**.

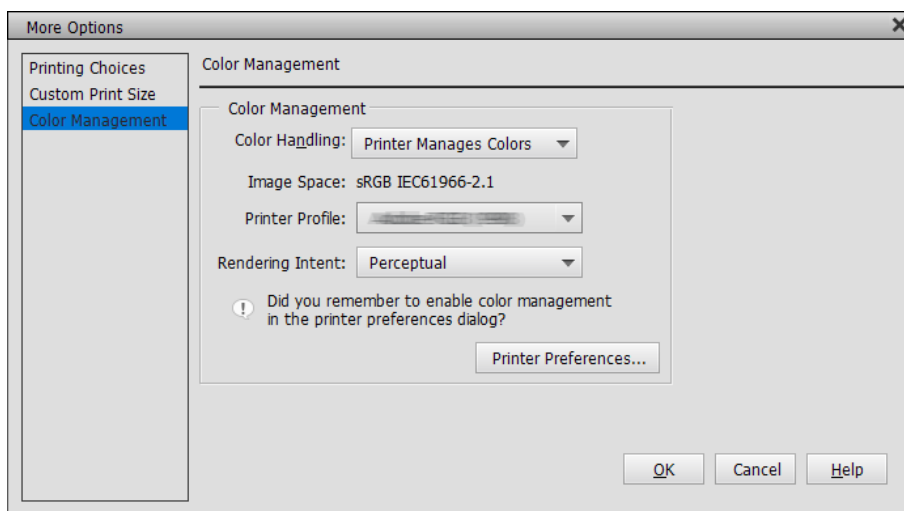

2. Display the **Main** tab in the printer driver, select **PhotoEnhance** for **Mode**, and click **Advanced**.

3. On the **PhotoEnhance** screen, you can set effects to apply to the print data.  
See the printer driver help for more details on each item.
4. Check other settings, and then start printing.

## Printing Banners

You can print banners and panoramic pictures if you create and set print data for banner printing in your application. When printing using document preparation software, image editing software, and so on, create print data with the same length and width ratio as the size you want to print.



The following printing sizes are available.

Width	SC-P900 Series: 431.8mm SC-P700 Series: 330.2mm
Length*	Max. 18m

\*: The paper length can be longer if using applications that support banner printing. However, the actual print size depends on the application, the paper size loaded in the printer, and the computer environment.

1. In the printer driver's **Main** tab, select **Media Type**.
2. Select **Roll Paper** from the **Source** list.
3. Click **User Defined** and match the paper size to the size of the data if necessary.
4. Make sure the **Optimize Enlargement** check box is selected on the **Layout** tab.
5. Check other settings, and then start printing.

## Printing by Increasing Black Density

To print by increasing black density, use black enhance overcoat in the printer driver. This feature overcoats light gray ink on the dark parts of printouts to increase the maximum density of black and to increase the dynamic range.

Black enhance overcoat is only available for glossy paper. Note that it is not available for all types of glossy paper.



Image effects for black enhance overcoat

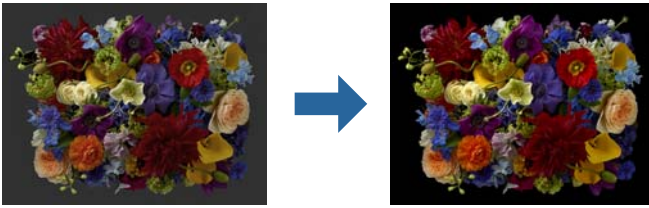

**Note:**

Enabling black enhance overcoat increases black density, and disabling it increases print speed.

1. When using applications featuring a color management function, specify how to adjust colors from these applications.

When using applications without a color management function, start from step 2.

Depending on the type of the application, make the settings following the table below.

Application	Color Management Settings
Adobe Photoshop CS3 or later Adobe Photoshop Lightroom 1 or later Adobe Photoshop Elements 6 or later	Printer Manages Colors
Other applications	No Color Management

**Note:**

For information on the operating systems supported by each application, visit the distributor's website.

Setting example for Adobe Photoshop Elements 2020

Click **More Options** on the print screen.

Select **Color Management**, and then select **Printer Manages Colors** from **Color Handling**. Click **Printer Preferences**.

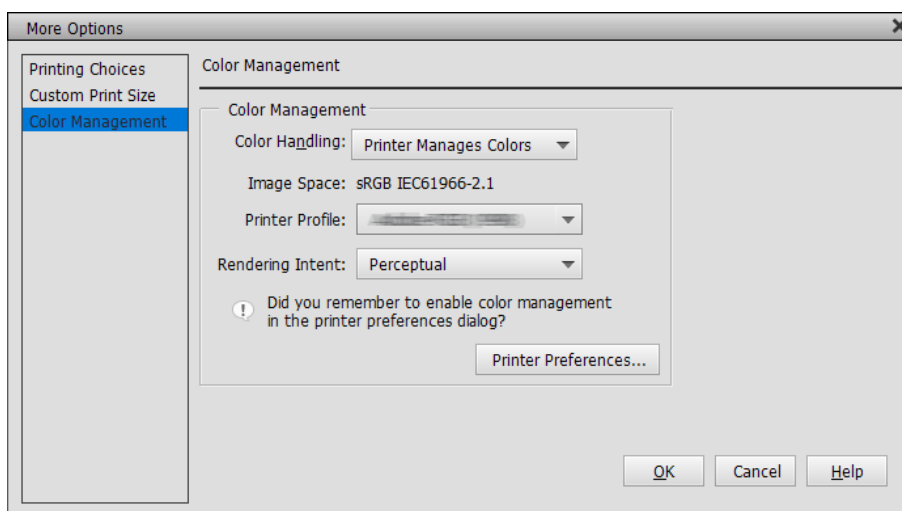

2. Make sure that **Black Enhance Overcoat** is selected as the **Level** on the printer driver's **Main** tab.  
**Black Enhance Overcoat** is automatically enabled when anything other than **Standard** is selected as the **Level**.

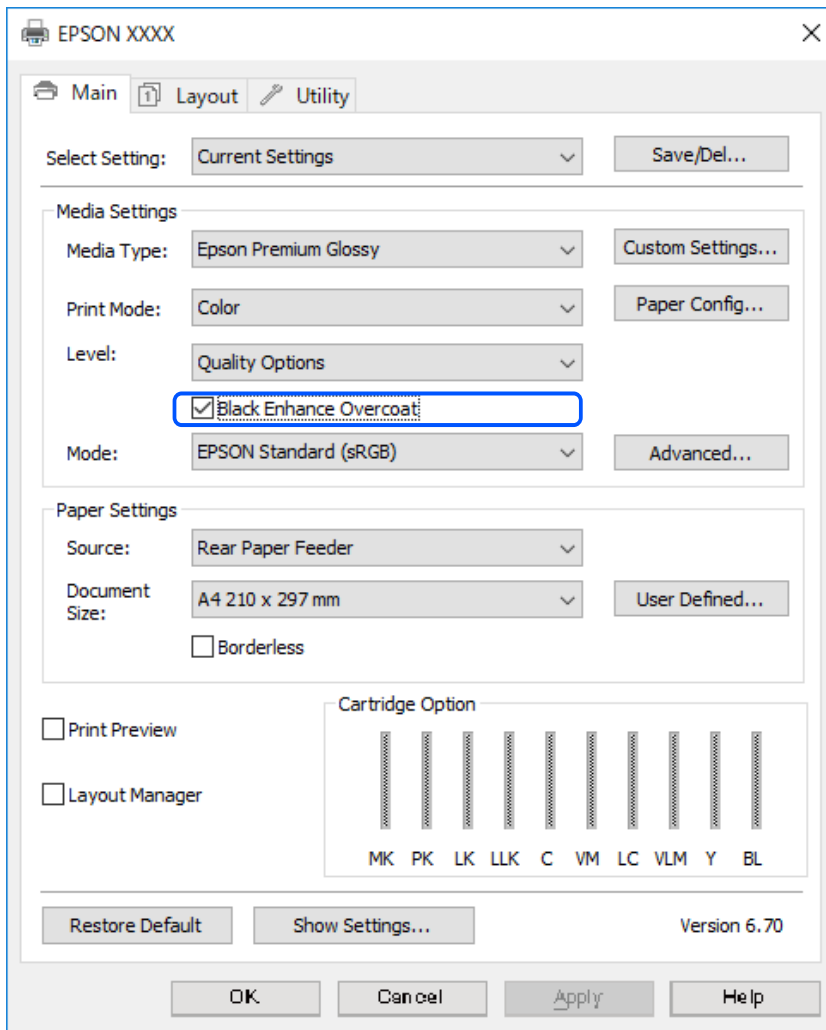

3. If you want to further increase black density, select **Max Quality (Carbon Black)** as the **Level**.
4. Check other settings, and then start printing.

## Printing Varieties (Mac OS)

### Printing Black and White Photos

You can print black and white photos with rich gradation by adjusting the image data color by the printer driver. The original data is not affected.

You can correct image data when printing without processing the data from applications.

**Note:**

*It is recommended that you use images with a color space of sRGB.*

1. When using applications featuring a color management function, specify how to adjust colors from these applications.

When using applications without a color management function, start from step 2.

Depending on the type of the application, make the settings following the table below.

Application	Color Management Settings
Adobe Photoshop CS3 or later Adobe Photoshop Lightroom 1 or later Adobe Photoshop Elements 6 or later	Printer Manages Colors
Other applications	No Color Management

**Note:**

For information on the operating systems supported by each application, visit the distributor's website.

Setting example for Adobe Photoshop Elements 2020

Click **More Options** on the print screen.

Select **Color Management**, and then select **Printer Manages Colors** from **Color Handling**. Click **OK**, and then click **Print** on the print screen.

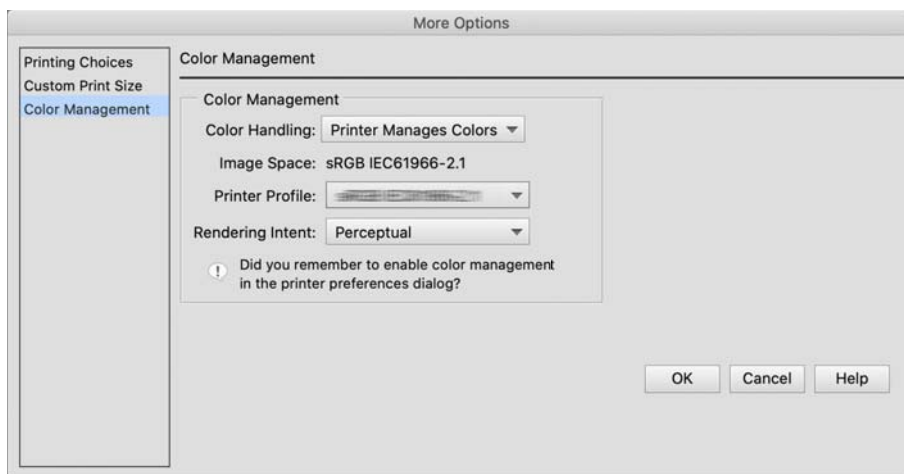

2. On the printer driver's print dialog, select **Print Settings** from the pop-up menu, and then select **Advanced B&W Photo** as the **Color** setting.
3. Click **Advanced Color Settings**.
4. Check other settings, and then start printing.

## Printing with Auto Color Correction

The printer driver for this printer comes with the Epson proprietary function PhotoEnhance that makes the most efficient use of the color reproduction area, corrects image data to improve colors before printing.

By using PhotoEnhance, you can correct photo colors to match the subject types such as people, scenery, or night view. You can print color data in sepia or black and white. Colors are automatically corrected simply by selecting the print mode.

**Note:**

*It is recommended that you use images with a color space of sRGB.*

1. When using applications featuring a color management function, specify how to adjust colors from these applications.

When using applications without a color management function, start from step 2.

Depending on the type of the application, make the settings following the table below.

Application	Color Management Settings
Adobe Photoshop CS3 or later Adobe Photoshop Lightroom 1 or later Adobe Photoshop Elements 6 or later	Printer Manages Colors
Other applications	No Color Management

Setting example for Adobe Photoshop Elements 2020

Click **More Options** on the print screen.

Select **Color Management**, and then select **Printer Manages Colors** from **Color Handling**. Click **OK**, and then click **Print** on the print screen.

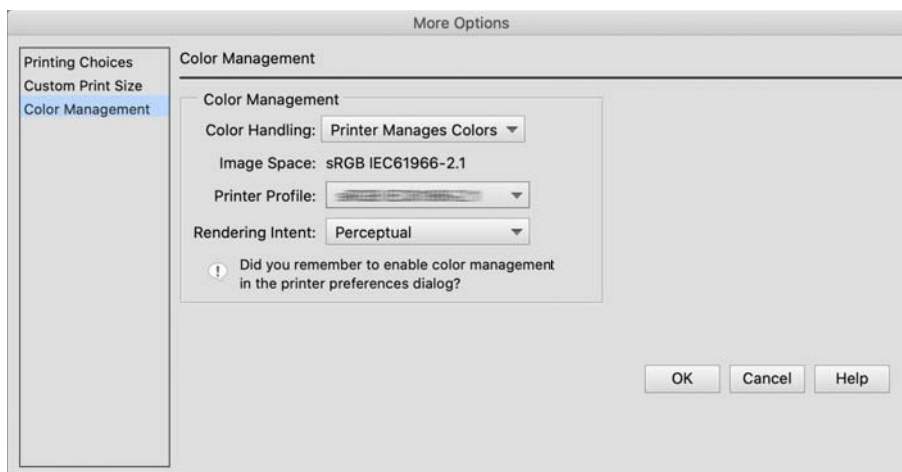

2. On the printer driver's print dialog, select **Color Matching** from the pop-up menu, and then click **EPSON Color Controls**.

**Note:**

*EPSON Color Controls is unavailable in Adobe Photoshop CS3 or later, Adobe Photoshop Lightroom 1 or later, and Adobe Photoshop Elements 6 or later unless the setting in step 1 is made.*

3. Select **Print Settings** from the pop-up menu, select **PhotoEnhance** from **Color Settings**, and then click **Advanced Color Settings**.
4. Choose the effects that will be applied to the print data in the **Advanced Color Settings** screen.

5. Check other settings, and then start printing.

## Printing Banners

You can print banners and panoramic pictures if you create and set print data for banner printing in your application.



To print banners, select **Roll Paper** as the **Paper Source** in the printer driver.

You can print data created by document preparation software, image editing software, and so on. If you use image editing software, create print data at a size supported by the given application while maintaining the printing length and width ratio.

The following printing sizes are available.

Width	SC-P900 Series: 431.8mm SC-P700 Series: 330.2mm
Length*	Max. 18m

\*: The paper length can be longer if using applications that support banner printing. However, the actual print size depends on the application, the paper size loaded in the printer, and the computer environment.

1. On the printer driver's print dialog, select the size of the data created with the application in **Paper Size**.  
If items on the **Page Setup** screen are not displayed on the **Print** screen due to the application being used, display the **Page Setup** screen and make settings.
2. Check other settings, and then start printing.

## Printing by Increasing Black Density

To print by increasing black density, use black enhance overcoat in the printer driver. This feature overcoats light gray ink on the dark parts of printouts to increase the maximum density of black and to increase the dynamic range.

Black enhance overcoat is only available for glossy paper. Note that it is not available for all types of glossy paper.

Image effects for black enhance overcoat

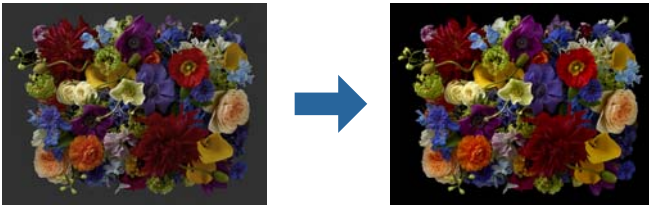

**Note:**

Enabling black enhance overcoat increases black density, and disabling it increases print speed.

1. When using applications featuring a color management function, specify how to adjust colors from these applications.

When using applications without a color management function, start from step 2.

Depending on the type of the application, make the settings following the table below.

Application	Color Management Settings
Adobe Photoshop CS3 or later Adobe Photoshop Lightroom 1 or later Adobe Photoshop Elements 6 or later	Printer Manages Colors
Other applications	No Color Management

**Note:**

For information on the operating systems supported by each application, visit the distributor's website.

Setting example for Adobe Photoshop Elements 2020

Click **More Options** on the print screen.

Select **Color Management**, and then select **Printer Manages Colors** from **Color Handling**. Click **OK**, and then click **Print** on the print screen.

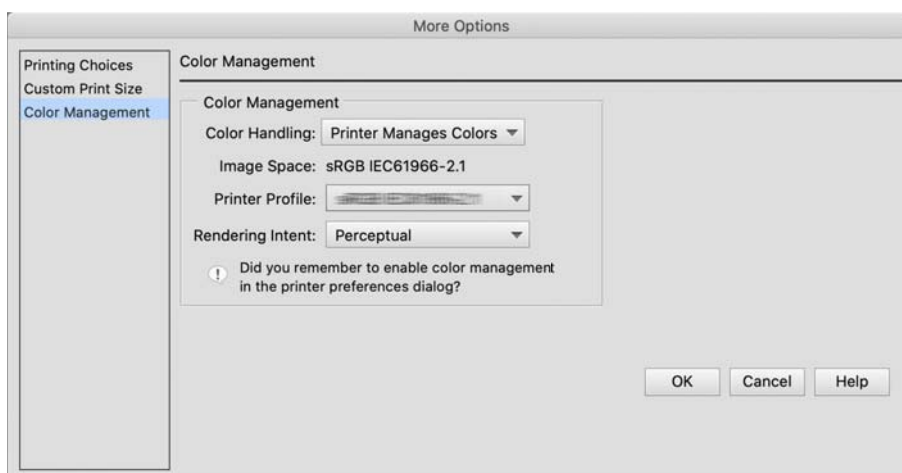

2. On the printer driver's print dialog, select **Print Settings** from the pop-up menu, and then select **Quality Options** as **Print Quality**.

3. Select **Black Enhance Overcoat**.

If the check box is grayed out, move the slider for the quality level to **Speed** to enable the check box.

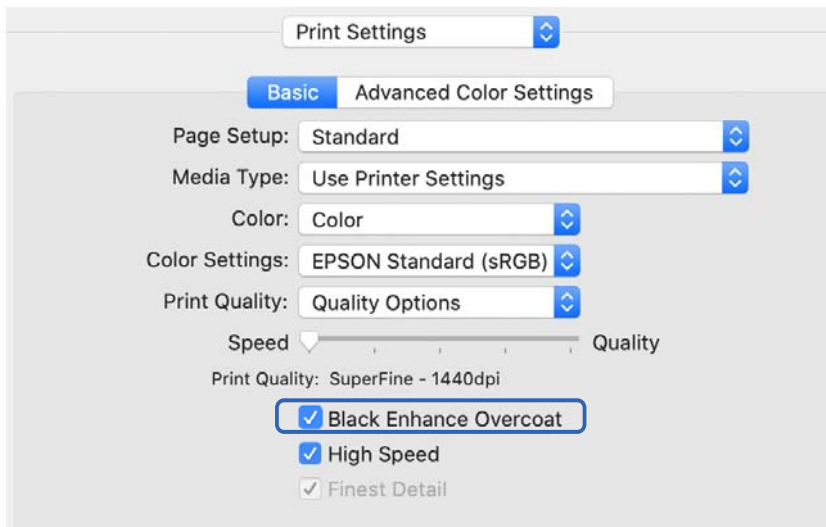

4. If you want to further increase black density, select **Max Quality (Carbon Black)** as the **Print Quality**.
5. Check other settings, and then start printing.

## Printing Using Epson Photo+

Epson Photo+ is an application that performs easy edits such as automatic color correction, while also allowing you to make manual corrections or adjust the layout.

You can install Epson Photo+ from the Epson Web site.

Epson Photo+ automatically corrects backlight and subtle skin colors allowing you to print beautiful photos easily. You can also turn off auto correction (PhotoEnhance).

The following four steps are the main operations. For details on each operation, access the Help from the button at the top-right of the Epson Photo+ screen. (The screenshots used in the following examples are from Windows 10.)

1. Select a menu according to your needs.

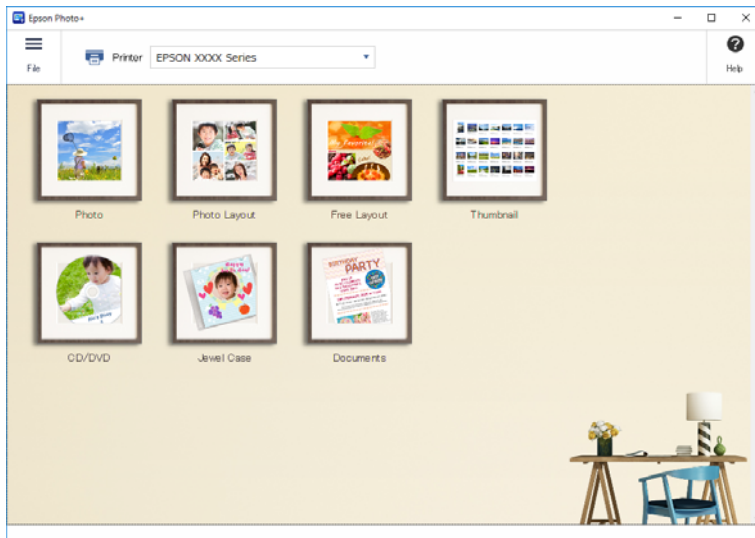

2. Select the template or paper size depending on the selected menu.





3. Select the photo you want to print.

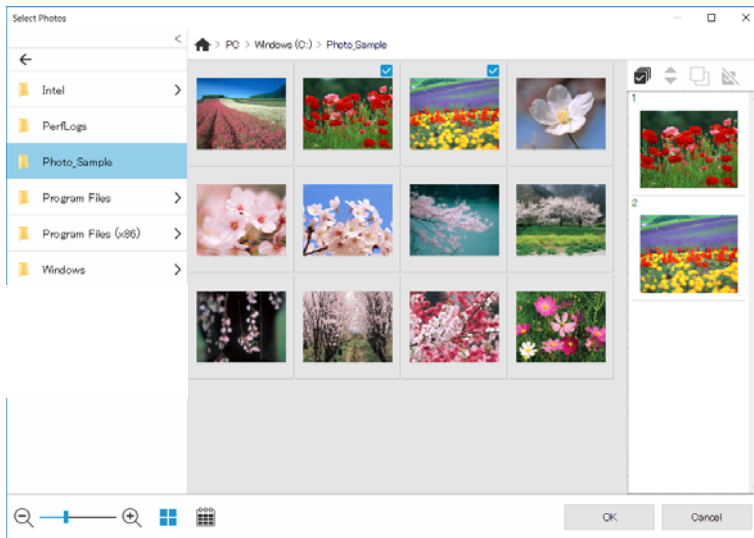

4. Edit and print.

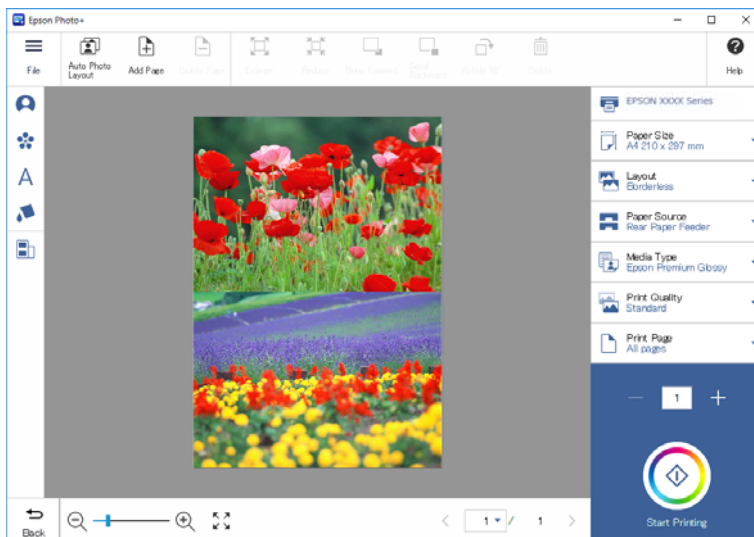

You can perform the following edits.

- Color correction (light, contrast, intensity)
- Adjust layout
- Add to/crop the screen
- Input text
- Add stamps (Pictographs, emoticons, some types of LINE stamps)

## Printing Information About Photo Printing

Photo print information for the last 12 sheets is saved in the printer. For example, if you print three copies of a photo, the printer saves three print histories. You can print photo information by selecting the information you want to print. However, information about photo printing is deleted when the printer is turned off.



Thumbnails and print setting are printed for each photo. You can cut these out and save them as notes about the print job.

1. Load the A4 size paper in the printer.

Information for three photos is printed on one A4 size paper. To print 12 sets of information, load four sheets of paper.

2. Select  on the home screen.
3. Check the thumbnails of the photos that you want to print on the Print Information Sheet screen.



4. Select **Done** and then start printing on the next screen.

# Printing Documents

## Printing from a Computer - Windows

### Printing Using Easy Settings



**Note:**

*Operations may differ depending on the application. See the application's help for details.*

1. Load paper in the printer.
2. Open the file you want to print.
3. Select **Print** or **Print Setup** from the **File** menu.
4. Select your printer.

5. Select **Preferences** or **Properties** to access the printer driver window.

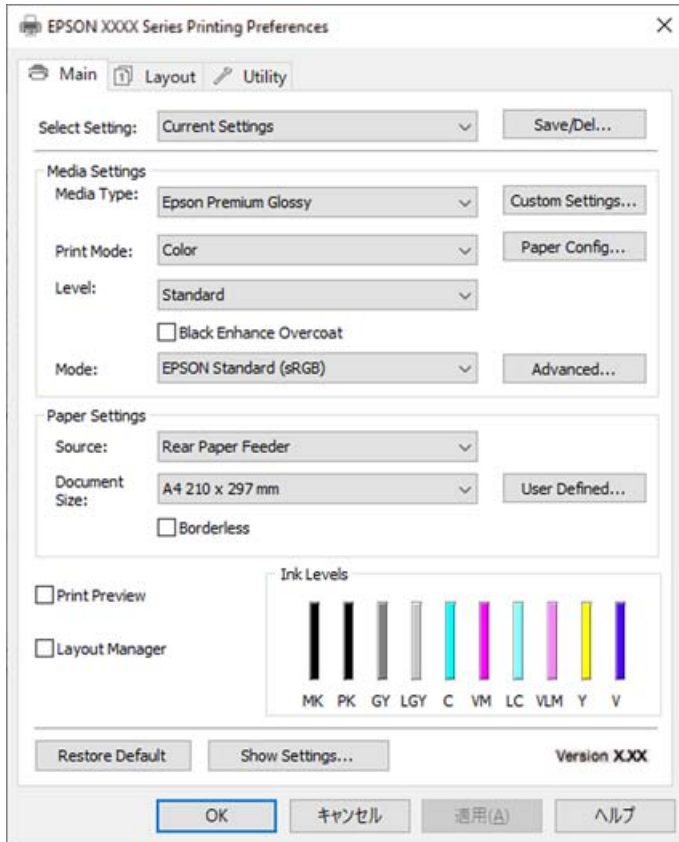

6. Change the settings as necessary.

See the menu options for the printer driver for details.

**Note:**

- You can also see the online help for explanations of the setting items. Right-clicking an item displays **Help**.
- When you select **Print Preview**, you can see a preview of your document before printing.

7. Click **OK** to close the printer driver window.

8. Click **Print**.

**Note:**

- When you select **Print Preview**, a preview window is displayed. To change the settings, click **Cancel**, and then repeat the procedure from step 3.
- If you want to cancel printing, on your computer right-click on your printer in **Devices and Printers**, **Printer**, or in **Printers and Faxes**. Click **See what's printing**, right-click on the job you want to cancel, and then select **Cancel**. However, you cannot cancel a print job from the computer once it has been completely sent to the printer. In this case, cancel the print job by using the printer's control panel.

**Related Information**

- ➔ [“Available Paper and Capacities” on page 182](#)
- ➔ [“Menu Options for the Printer Driver” on page 69](#)

## Menu Options for the Printer Driver

Open the print window in an application, select the printer, and then access the printer driver window.

### Note:

Menus vary depending on the option you selected.

## Main Tab

### Select Setting:

#### Save/Del:

You can add or remove your own presets for frequently used print settings. Select the preset you want to use from the list.

### Media Type:

Select the type of paper on which you print.

### Print Mode:

Select whether to print in color or in monochrome.

### Level:

Select the print quality you want to use for printing. Available settings depend on the paper type you select. When selecting higher quality, the printing speed may be slower. If you select **Quality Options**, you can make detailed settings.

### Gloss Smoothing:

Select this option when printing on photo paper to reduce the amount of light that is reflected off black areas and achieve a smoother gloss. However, black density may decrease. **Gloss Smoothing** is available when you have selected Photo Paper as the **Media Type**. This option may not be available depending on the print quality settings.

### Black Enhance Overcoat:

Select to print with enhanced image contrast and tones of black. This option can only be selected for supported paper.

### Mode:

Make the color tone settings for the prints. Available options depend on the Print Mode setting.

Clicking **Advanced** opens the **Color Controls** screen where you can select a detailed method of color correction.

### Source:

Select the paper source from which the paper is fed.

### Document Size:

Select the size of the print file set in the application. If a predefined paper size is not available, click **User Defined** to set your own paper size.

### Borderless:

Enlarges the print data slightly more than the paper size so that no margins are printed around the edges of the paper. Click **Expansion** to select the amount of enlargement.

**Print Preview:**

Displays a preview of your document before printing.

**Layout Manager:**

When you check this box and start printing, the print jobs are arranged and displayed on the Layout Manager dialog box. You can arrange data created by different applications in order of preference and combine them into a single print job.

**Note:**

*You cannot make settings other than **Document Size** when **Layout Manager** is checked. Make the detailed print settings on the **Layout Manager** dialog box.*

**Ink Levels:**

Displays the approximate ink level.

**Restore Default:**

Return all settings to their factory default values. The settings on the **Layout** tab are also reset to their defaults.

**Show Settings:**

Displays a list of items currently set on the **Main** and **Layout** tabs. You can show or hide the current setting list screen.

## **Layout Tab**

**Select Setting:**

Save/Del:

You can add or remove your own presets for frequently used print settings. Select the preset you want to use from the list.

**Orientation:**

Select the orientation you want to use to print.

**Rotate 180°:**

Rotates pages 180 degrees before printing.

**Mirror Image:**

Inverts the image so that it prints as it would appear in a mirror.

**Copies:**

Set the number of copies you want to print.

**Collate:**

Prints multi-page documents collated in order and sorted into sets.

**Reverse Order:**

Allows you to print from the last page so that the pages are stacked in the correct order after printing.

**Paper Size:**

Select the size of the print file set in the application.

**Output Size:**

Select the paper size on which you want to print. If the **Paper Size** differs from the **Output Size**, **Reduce/Enlarge** is selected automatically. You do not have to select it when printing without reducing or enlarging the size of a document.

**Reduce/Enlarge:**

Allows you to reduce or enlarge the size of a document.

**Fit to Output Size:**

Automatically reduce or enlarge the document to fit to the paper size selected in **Output Size**.

**Fit to Roll Paper WidthFit to Output Size:**

Automatically reduce or enlarge the document to fit to the roll paper size selected in **Output Size**. This option is available when **Roll Paper** is selected as the **Source**.

**Specify Size:**

Prints with a specific percentage.

**Page Layout:**

Allows you to print several pages on one sheet or perform poster printing. Click **Settings** to specify the order in which pages are printed.

**2-sided printing:**

Allows you to perform 2-sided printing.

**Margins:**

You can specify the binding edge and the binding margins.

**Folded Booklet:**

Select this check box if you wish to print a single-fold booklet.

**Optimize Enlargement:**

Select this check box to optimize an enlargement to achieve long poster or panoramic printing without using a particular application. Clear this check box if text or graphics are distorted; however, output length may be limited depending on the application.

**Print Bckg Color:**

Select this check box to print a background color. Click **Color Settings** to select a background color.

**Job Settings:**

Select this check box to print the settings items. Click **Details** to open the Job Settings dialog box to select the setting items to print.

**Reset Defaults:**

Return all settings to their factory default values. The settings on the **Main** tab are also reset to their defaults.

#### Show Settings:

Displays a list of items currently set on the **Main** and **Layout** tabs. You can show or hide the current setting list screen.

### Utility Tab

#### Nozzle Check:

Prints a nozzle check pattern to check if the print head nozzles are clogged.

#### Print Head Cleaning:

Cleans the clogged nozzles in the print head. Because this feature uses some ink, clean the print head only if the nozzles are clogged. Print a nozzle check pattern and then select **Cleaning** if there are just a few defects in the pattern. **Power Cleaning** consumes more ink than **Cleaning**. Only use this if there are many defects in the nozzle check pattern.

#### EPSON Status Monitor 3:

Opens the EPSON Status Monitor 3 window. Here you can confirm the status of the printer and the consumables.

#### Monitoring Preferences:

Allows you to make settings for items on the EPSON Status Monitor 3 window.

#### Print Queue:

Displays the jobs waiting to be printed. You can check, pause, or resume print jobs.

#### Printer and Option Information:

Click to display the Printer and Option Information dialog box. You can view and make settings for the optional information.

#### Speed and Progress:

Allows you to make a variety of settings related to printing speed and progress. Right-click each item to view the online help for more details.

#### Menu Arrangement:

You can arrange the **Select Setting**, **Media Type**, and **Paper Size** list items. Arrange the items as you prefer, or classify the items into groups. You can also hide the items you are not using.

#### Export or Import:

You can export or import the printer driver settings. It is convenient to use this feature when you want to make the same printer driver settings to multiple computers.

#### Epson Media Installer:

You can add media setting to printers and printer drivers from the Internet. Click when you cannot find the media you want to print on in the driver's media types. Depending on the media you are using, you may not be able to download media settings.

See the related information link below for details.



#### Language:

Changes the language to be used on the printer driver window. To apply the settings, close the printer driver, and then open it again.

#### Software Update:

Starts EPSON Software Updater to check for the latest version of applications on the Internet.

#### Related Information

➔ [“Printing to Paper Types Other than Genuine Paper” on page 191](#)

## Adding Printing Presets for Easy Printing

If you create your own preset of frequently used print settings on the printer driver, you can print easily by selecting the preset from the list.

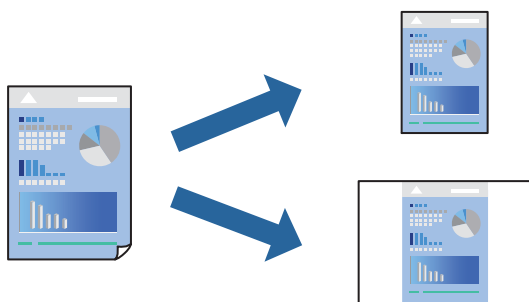

1. On the printer driver's **Main** or **Layout** tab, set each item (such as **Media Type** and **Source**).

[“Main Tab” on page 69](#)

[“Layout Tab” on page 70](#)

2. Click **Save/Del** in Select Setting.
3. Enter a **Name** and, if necessary, enter a comment.
4. Click **Save**.

**Note:**

To delete an added preset, click **Save/Del**, select the preset name you want to delete from the list, and then delete it.

5. Click **Print**.

The next time you want to print using the same settings, select the registered setting name from Select Setting, and click **OK**.

#### Related Information

➔ [“Printing Using Easy Settings” on page 67](#)

## Printing on 2-Sides

The printer driver will automatically print odd pages and even pages separately. When the odd pages have been printed, turn over the paper according to the instructions and print the even pages.

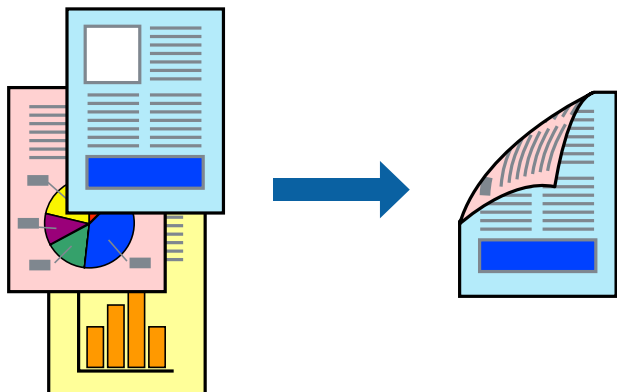

### Note:

- This feature is not available for borderless printing.
- 2-sided printing is supported with the rear paper feeder only.
- If you do not use paper that is suitable for 2-sided printing, the print quality may decline and paper jams may occur.
- Depending on the paper and the data, ink may bleed through to the other side of the paper.
- You cannot perform manual 2-sided printing unless **EPSON Status Monitor 3** is enabled. If **EPSON Status Monitor 3** is disabled, access the printer driver window, click **Speed and Progress** on the **Utility** tab, and then clear **Disable EPSON Status Monitor 3**.
- However, it may not be available when the printer is accessed over a network or is used as a shared printer.

1. On the printer driver's **Layout** tab, select **2-sided printing**.

When **Roll Paper** is selected as the **Source** setting, you cannot select **2-sided printing**. In this case, set the **Source** first from the **Main** screen.

2. Click **Margins**, make the appropriate settings, and then click **OK**.
3. Set the other items on the **Main** and **Layout** tabs as necessary, and then click **OK**.

[“Main Tab” on page 69](#)

[“Layout Tab” on page 70](#)

4. Click **Print**.

When the first side has finished printing, a pop-up window is displayed on the computer. Follow the on-screen instructions.

### Related Information

- ➔ [“Available Paper and Capacities” on page 182](#)
- ➔ [“Printing Using Easy Settings” on page 67](#)

## Printing a Booklet

You can also print a booklet that can be created by re-ordering the pages and folding the printout.

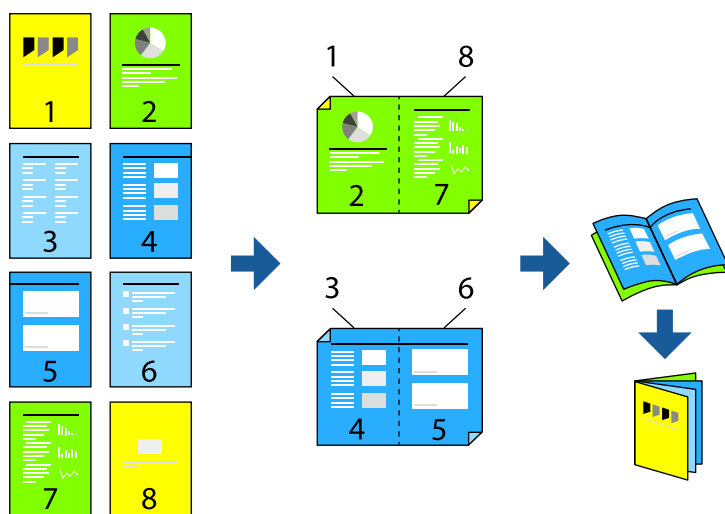

### Note:

- This feature is not available with borderless printing.
- 2-sided printing is supported with the rear paper feeder only.
- If you do not use paper that is suitable for 2-sided printing, the print quality may decline and paper jams may occur.
- Depending on the paper and the data, ink may bleed through to the other side of the paper.
- You cannot perform manual 2-sided printing unless **EPSON Status Monitor 3** is enabled. If **EPSON Status Monitor 3** is disabled, access the printer driver window, click **Speed and Progress** on the **Utility** tab, and then clear **Disable EPSON Status Monitor 3**.
- However, it may not be available when the printer is accessed over a network or is used as a shared printer.

1. On the printer driver's **Layout** tab, select **2-sided printing** and **Folded Booklet**.
2. Click **Margins**, and then specify the binding edge and the binding margins.
3. Click **OK**.
4. Set the other items on the **Main** and **Layout** tabs as necessary, and then click **OK**.  
[“Main Tab” on page 69](#)  
[“Layout Tab” on page 70](#)
5. Click **Print**.

### Related Information

- ➔ [“Available Paper and Capacities” on page 182](#)
- ➔ [“Printing Using Easy Settings” on page 67](#)

## Printing Several Pages on One Sheet

You can print several pages of data on a single sheet of paper.

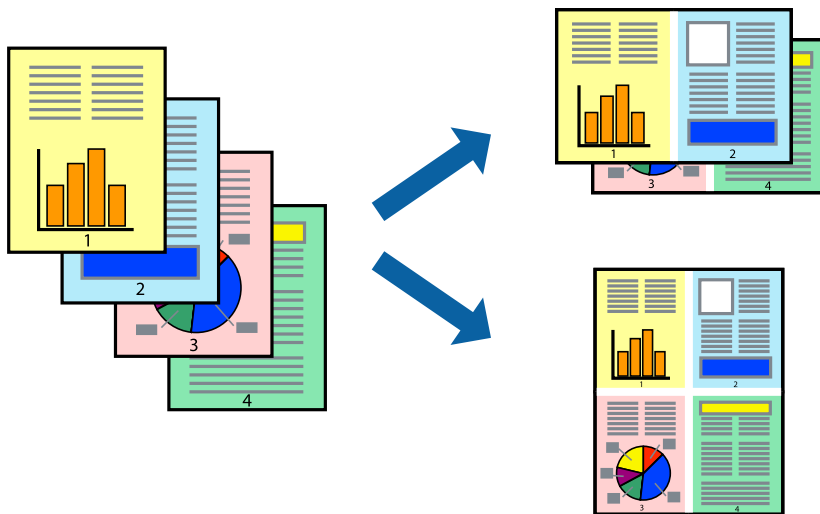

**Note:**

*This feature is not available with borderless printing.*

1. On the printer driver's **Layout** tab, and then select **Page Layout** and **N-up**.
2. Click **Settings**, make the appropriate settings, and then click **OK**.
3. Set the other items on the **Main** and **Layout** tabs as necessary, and then click **OK**.  
    [“Main Tab” on page 69](#)  
    [“Layout Tab” on page 70](#)
4. Click **Print**.

### Related Information

➔ [“Printing Using Easy Settings” on page 67](#)

## Printing to Fit the Paper Size

Select the paper size you loaded in the printer as the **Output Size** setting.

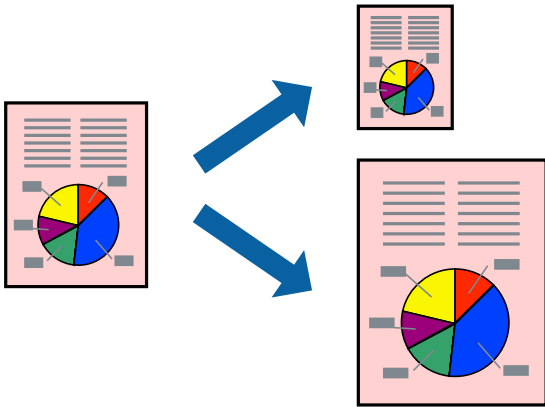

1. On the printer driver's **Layout** tab, make the following settings.
  - Paper Size: Select the size of the print file set in the application.
  - Output Size: Select the paper size you loaded in the printer.  
**Fit to Output Size** is automatically selected.
2. Set the other items on the **Main** and **Layout** tabs as necessary, and then click **OK**.
  - [“Main Tab” on page 69](#)
  - [“Layout Tab” on page 70](#)
3. Click **Print**.

### Related Information

➔ [“Printing Using Easy Settings” on page 67](#)

## Printing to Fit to Roll Paper Width

You can print according to the width of the roll paper loaded in the printer.

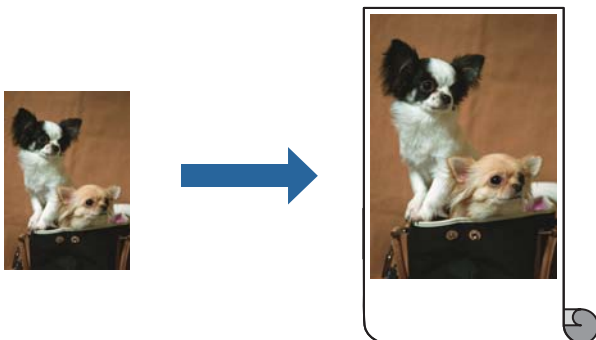

1. On the printer driver's **Main** tab, select **Roll Paper** from **Source**.
2. Select the **Layout** tab, and then select a paper size from **Page Size** that matches the document size.

3. Select **Reduce/Enlarge** and click **Fit to Roll Paper Width**.
4. Select the width of the roll paper loaded in the printer from **Roll Width**.
5. Set the other items on the **Main** and **Layout** tabs as necessary, and then click **OK**.  
[“Main Tab” on page 69](#)  
[“Layout Tab” on page 70](#)
6. Click **Print**.

### Related Information

- ➔ [“Printing Using Easy Settings” on page 67](#)

## Printing a Reduced or Enlarged Document at any Magnification

You can reduce or enlarge the size of a document by a specific percentage.



### Note:

*This feature is not available with borderless printing.*

1. On the printer driver's **Layout** tab, select the document size from the **Paper Size** setting.
2. Select the paper size you want to print on from the **Output Size** setting.
3. Select **Reduce/Enlarge**, **Specify Size**, and then enter a percentage.
4. Set the other items on the **Main** and **Layout** tabs as necessary, and then click **OK**.  
[“Main Tab” on page 69](#)  
[“Layout Tab” on page 70](#)
5. Click **Print**.

### Related Information

➔ [“Printing Using Easy Settings” on page 67](#)

## Printing One Image on Multiple Sheets for Enlargement (Creating a Poster)

This feature allows you to print one image on multiple sheets of paper. You can create a larger poster by taping them together.

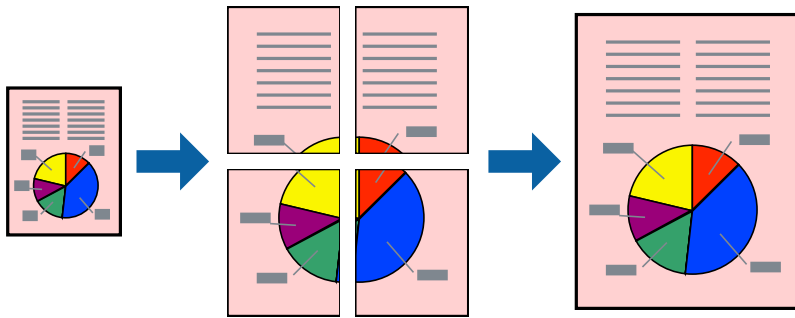

1. On the printer driver's **Layout** tab, select **Page Layout** and **Poster**.
2. Click **Settings**, make the appropriate settings, and then click **OK**.  
*Note:*  
*Print Cutting Guides* allows you to print a cutting guide.
3. Set the other items on the **Main** and **Layout** tabs as necessary, and then click **OK**.  
[“Main Tab” on page 69](#)  
[“Layout Tab” on page 70](#)
4. Click **Print**.

### Related Information

➔ [“Printing Using Easy Settings” on page 67](#)

### Making Posters Using Overlapping Alignment Marks

Here is an example of how to make a poster when 2x2 is selected, and **Overlapping Alignment Marks** is selected in **Print Cutting Guides**.

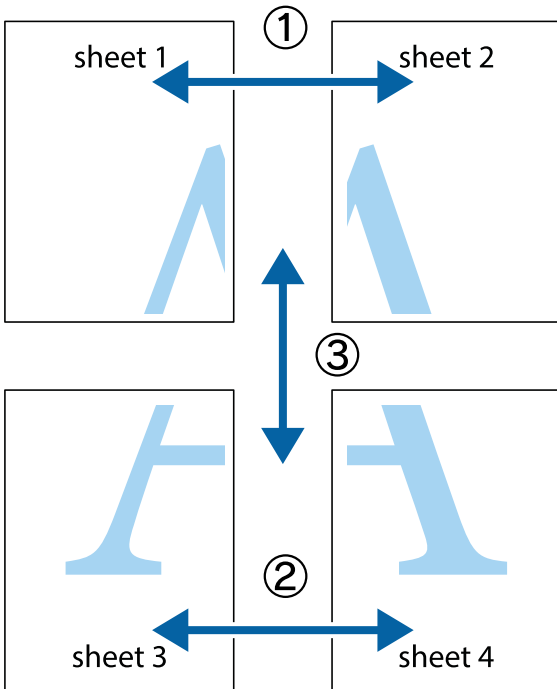

1. Prepare Sheet 1 and Sheet 2. Cut off the margins of Sheet 1 along the vertical blue line through the center of the top and bottom cross marks.

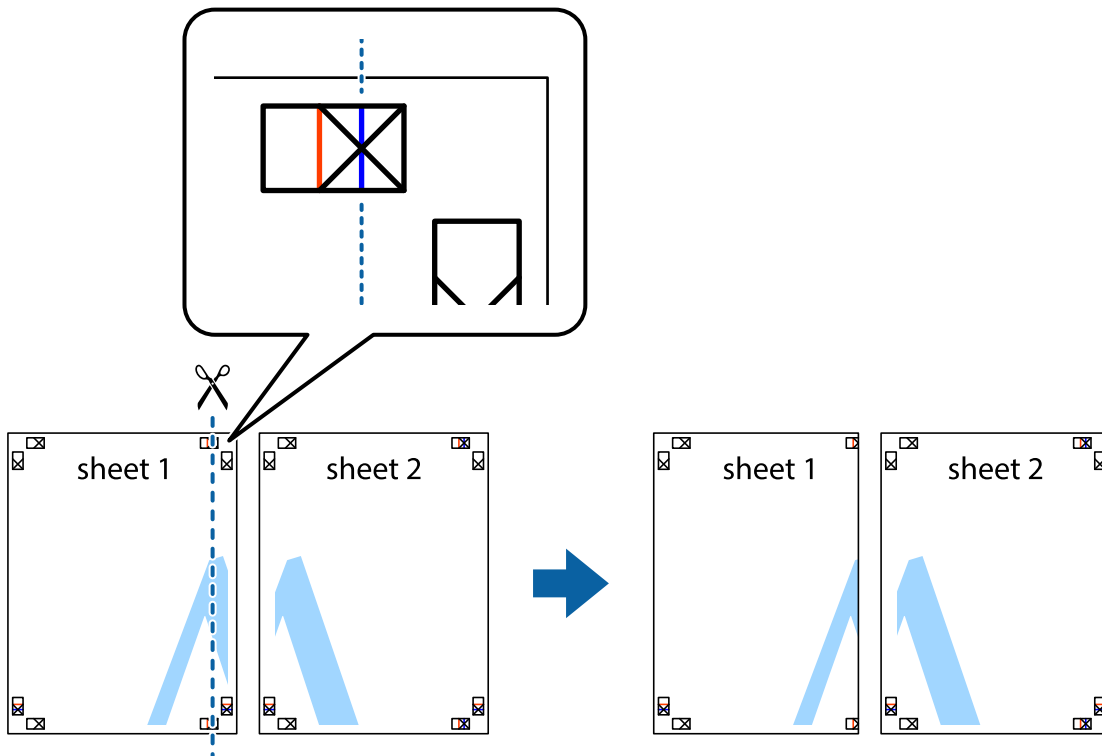



2. Place the edge of Sheet 1 on top of Sheet 2 and align the cross marks, then temporarily tape the two sheets together from the back.

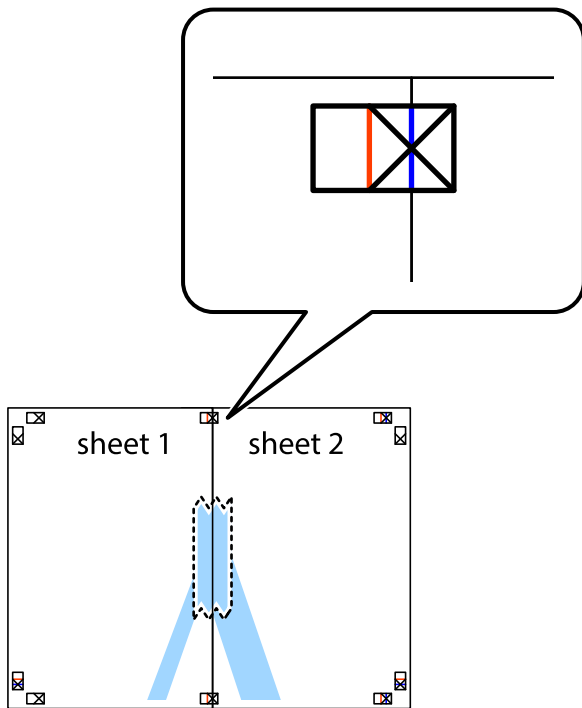

3. Cut the taped sheets in two along the vertical red line through the alignment markers (this time, the line to the left of the cross marks).

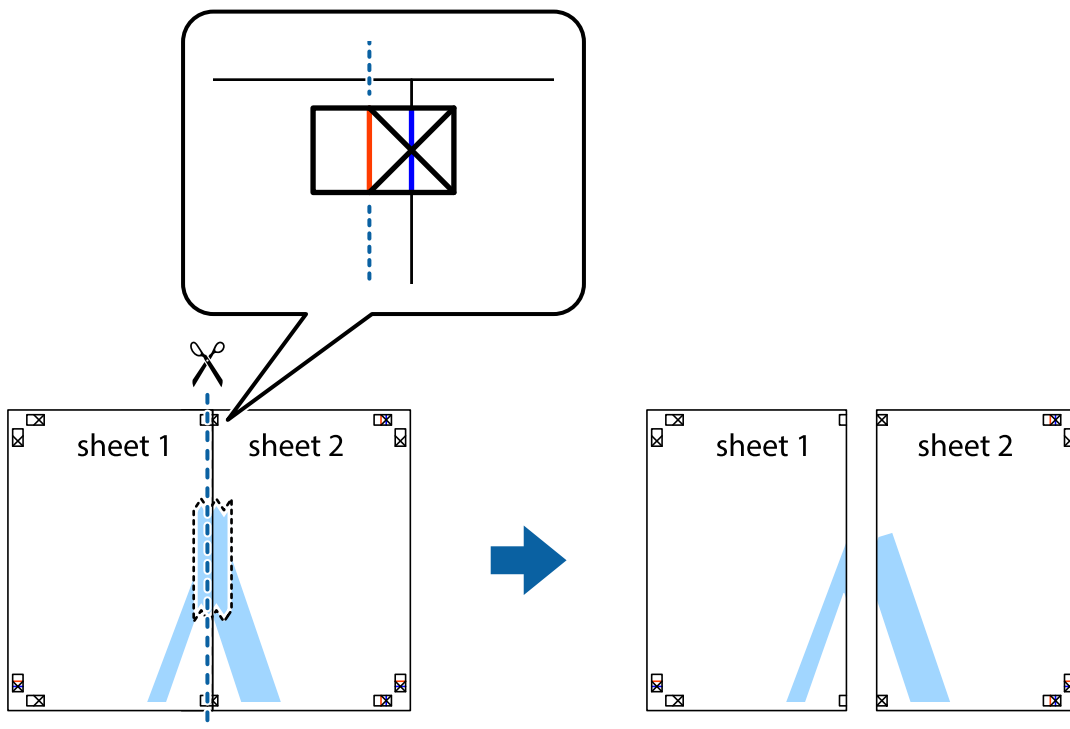

4. Tape the sheets together from the back.

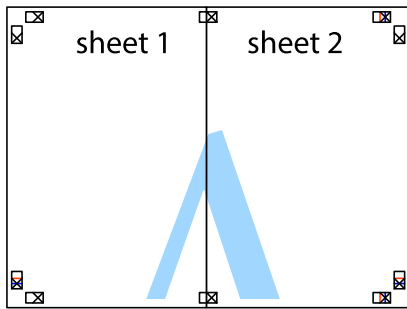

5. Repeat steps 1 to 4 to tape Sheet 3 and Sheet 4 together.
6. Cut off the margins of Sheet 1 and Sheet 2 along the horizontal blue line through the center of the left and right side cross marks.

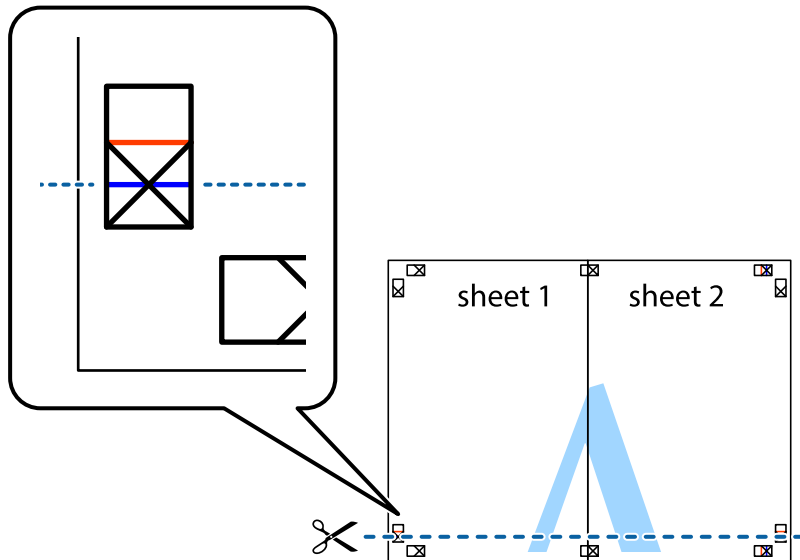

7. Place the edge of Sheet 1 and Sheet 2 on top of Sheet 3 and Sheet 4 and align the cross marks, and then temporarily tape them together from the back.

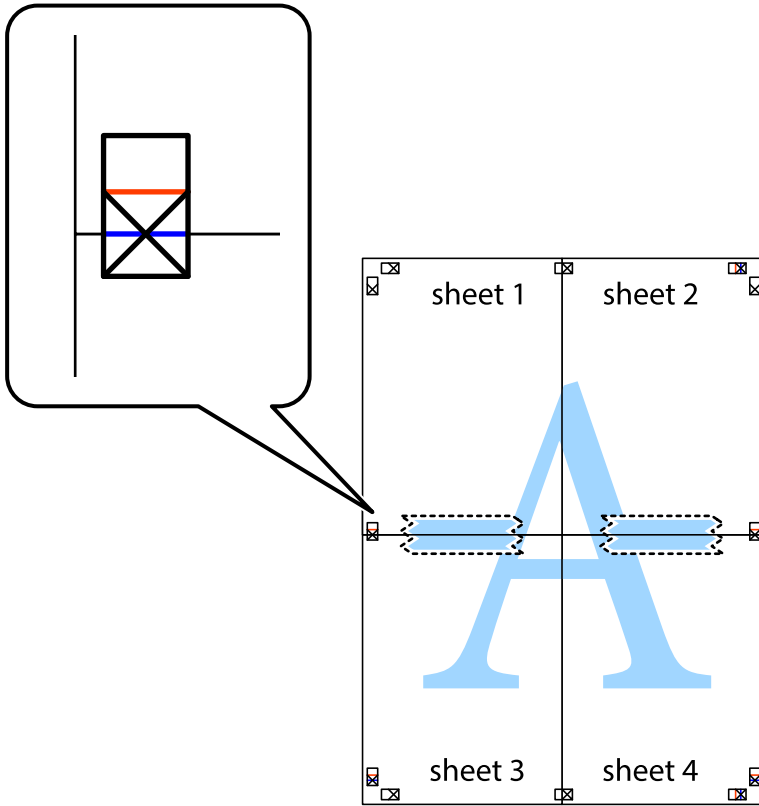

- Cut the taped sheets in two along the horizontal red line through the alignment markers (this time, the line above the cross marks).

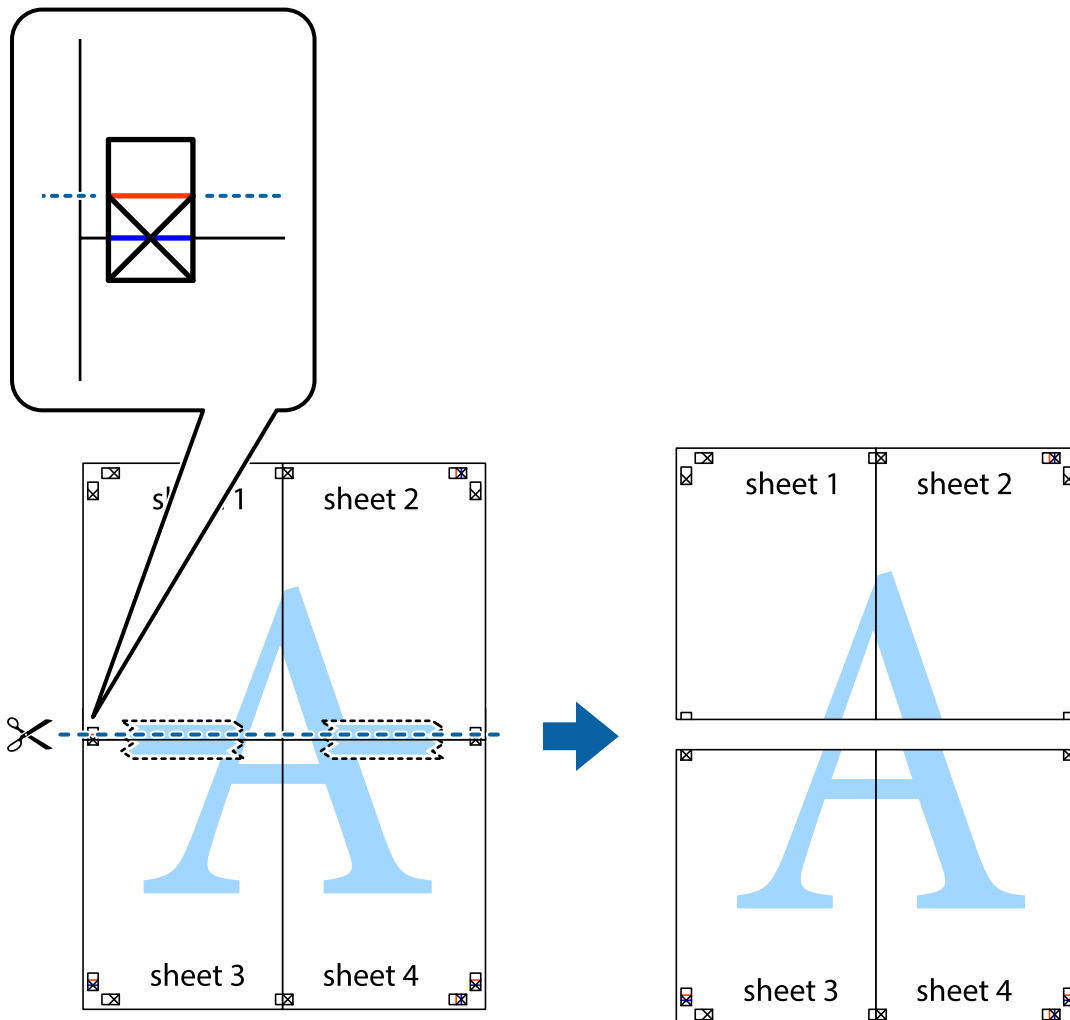

- Tape the sheets together from the back.

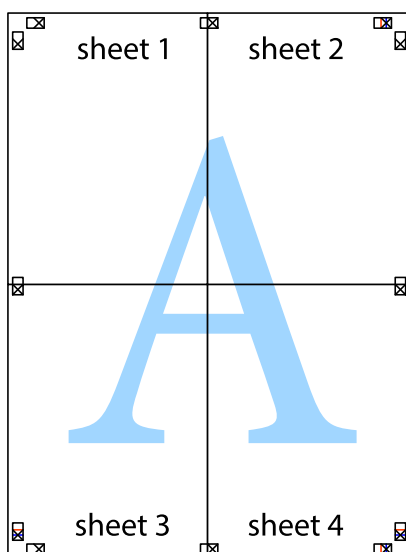

10. Cut off the remaining margins along the outer guide.

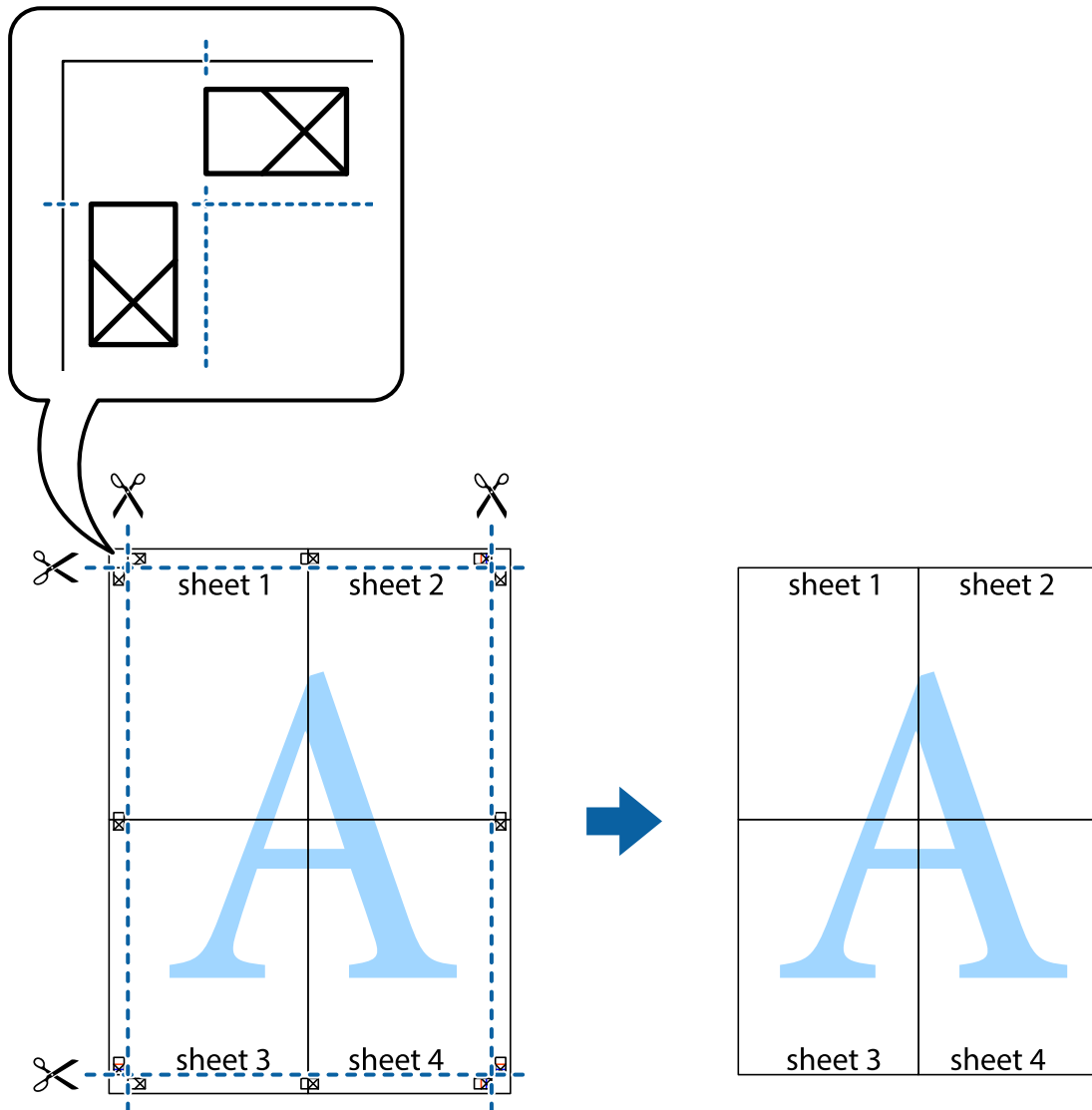

## Adjusting the Print Color

You can adjust the colors used in the print job. These adjustments are not applied to the original data.



You can select from the following color correction modes.

1. On the printer driver's **Main** tab, select the method of color correction from the **Mode** setting.

- EPSON Standard (sRGB)

Increases the contrast in images. Use this setting for color photographs.

Adobe RGB

Matches image color to the Adobe RGB. Use this setting for data that contains Adobe RGB color space information.

PhotoEnhance

PhotoEnhance is a feature that uses Epson's proprietary image analysis and processing technology to automatically print images at a higher quality.

ICM

Select this setting when you use the Windows ICM (Image Color Matching) feature to match colors between devices such as the printer and screen display.

Click **Advanced** if you want to make your own settings.

2. Set the other items on the **Main** and **Layout** tabs as necessary, and then click **OK**.

[“Main Tab” on page 69](#)

[“Layout Tab” on page 70](#)

3. Click **Print**.

### Related Information

➔ [“Printing Using Easy Settings” on page 67](#)

## Printing Multiple Files Together (Layout Manager)

The Layout Manager function allows you to place multiple pieces of print data created in different applications on the paper freely and print them at once.

You can create a poster or display material by placing multiple pieces of print data where you like. Also, Layout Manager allows you to use paper effectively.

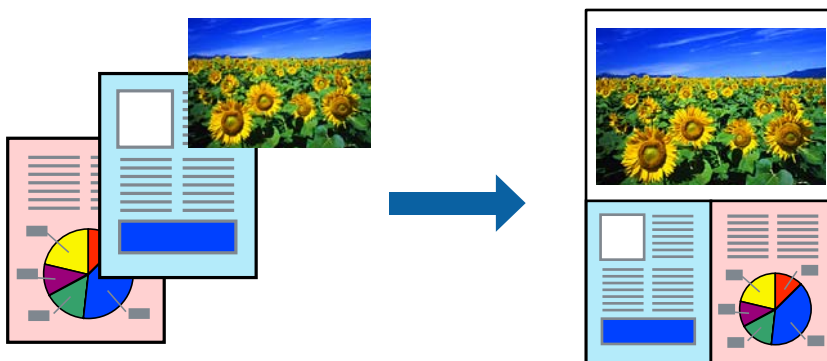

1. Open the file you want to print in your application.
2. On the printer driver's **Main** tab, select **Layout Manager** and in **Document Size** set the paper size created using the application.

**Note:**

*The option selected for Size is the size used in the Layout Manager. The actual printing paper size is set in the screen in step 6.*

3. Click **OK**. When printing with an application, the Layout Manager screen opens.  
The print data is not printed, but one page is placed on the paper of the Layout Manager screen as one object.
4. Leave the Layout Manager screen open and repeat steps 1 to 3 to arrange the next pieces of data.  
The objects are added to the Layout Manager screen.
5. Arrange the objects on the Layout Manager screen.  
You can drag objects to move and resize them, use tool buttons and the **Object** menu to align and rotate objects on the Layout Manager screen.  
You can resize and replace whole objects in the Preference or Arrangement Settings screens.  
See the Layout Manager screen help for more details on each feature.
6. Click **File > Properties**, and make print settings on the printer driver screen.  
Set **Media Type**, **Source**, **Document Size**, and so on.
7. Click the **File** menu on the Layout Manager screen, and then click **Print**.

#### Related Information

➔ [“Printing Using Easy Settings” on page 67](#)

## Printing from a Computer - Mac OS

### Printing Using Easy Settings



#### Note:

*Operations and screens differ depending on the application. See the application's help for details.*

1. Load paper in the printer .
2. Open the file you want to print.
3. Select **Print** from the **File** menu or another command to access the print dialog.  
If necessary, click **Show Details** or ▼ to expand the print window.
4. Select your printer.

5. Select **Print Settings** from the pop-up menu.

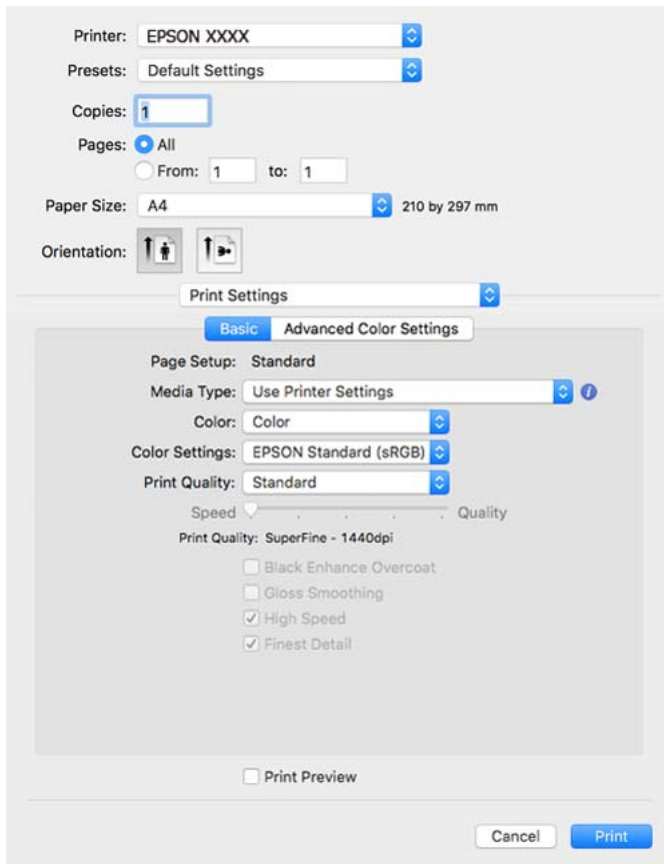

**Note:**

If the **Print Settings** menu is not displayed on macOS High Sierra, macOS Sierra, OS X El Capitan, OS X Yosemite, OS X Mavericks, the Epson printer driver has not been installed correctly. Enable it from the following menu.

Select **System Preferences** from the Apple menu > **Printers & Scanners** (or **Print & Scan**, **Print & Fax**), remove the printer, and then add the printer again. See the following to add a printer.

[“Adding the Printer \(for Mac OS Only\)” on page 109](#)

macOS Mojave or later cannot access **Print Settings** in applications made by Apple such as TextEdit.

6. Change the settings as necessary.  
See the menu options for the printer driver for details.
7. Click **Print**.

**Note:**

If you want to cancel printing, on your computer click the printer icon in the **Dock**. Select the job you want to cancel, and then click  next to the progress meter. However, you cannot cancel a print job from the computer once it has been completely sent to the printer. In this case, cancel the print job by using the printer's control panel.

**Related Information**

- ➔ [“Available Paper and Capacities” on page 182](#)
- ➔ [“Menu Options for the Printer Driver” on page 89](#)



### **Menu Options for the Printer Driver**

Open the print window in an application, select the printer, and then access the printer driver window.

**Note:**

*Menus vary depending on the option you selected.*

### **Menu Options for Layout**

**Pages per Sheet:**

Select the number of pages to be printed on one sheet.

**Layout Direction:**

Specify the order in which the pages will be printed.

**Border:**

Prints a border around the pages.

**Reverse page orientation:**

Rotates pages 180 degrees before printing.

**Flip horizontally:**

Inverts an image to print as it would appear in a mirror.

### **Menu Options for Color Matching**

**ColorSync/EPSON Color Controls:**

Select the method for color adjustment. These options adjust colors between the printer and the computer display to minimize the difference in color.

### **Menu Options for Paper Handling**

**Collate pages:**

Prints multi-page documents collated in order and sorted into sets.

**Pages to Print:**

Select to print only odd pages or even pages.

**Page Order:**

Select to print from the top or the last page.

**Scale to fit paper size:**

Prints to fit to the paper size you loaded.

**Destination Paper Size:**

Select the paper size to print on.

Scale down only:

Select this when you want to reduce the size only if the print data is too large for the paper size loaded in the printer.

### Menu Options for Cover Page

Print Cover Page:

Select whether or not to print a cover page. When you want to add a back cover, select **After document**.

Cover Page Type:

Select the contents of the cover page.

### Menu Options for Print Settings

#### Basic:

Page Setup:

Displays the paper setting or **Standard** selected in **Paper Size**.

Media Type:

Select the type of paper on which you print.

Color:

Select whether to print in color or in monochrome.

Color Settings:

Make the color tone settings for the prints. If Advanced B&W Photo is selected as the Color setting, set the color tone for Color Toning.

Print Quality:

Select the print quality you want to use for printing. The options vary depending on the paper type.

Black Enhance Overcoat:

Select to print with enhanced image contrast and tones of black. Black Enhance Overcoat can only be selected for supported paper.

Gloss Smoothing:

Select this option when printing on photo paper to reduce the amount of light that is reflected off black areas and achieve a smoother gloss. However, black density may decrease. **Gloss Smoothing** is available when you have selected Photo Paper as the **Media Type**. This option may not be available depending on the print quality settings.

High Speed:

Prints when the print head moves in both directions. The print speed is faster, but the quality may decline.

**Finest Detail:**

Depending on the **Print Quality** setting you select, you can turn on **Finest Detail** to print text, solid graphics, and line art with very sharp edges.

**Print Preview:**

Displays a preview of your document before printing.

**Advanced Color Settings:**

You can set the gamma and adjust brightness, contrast, and saturation.

**Print Preview:**

Displays a preview of your document before printing.

**Menu Options for Page Layout Settings**

**Roll Paper Option:**

You can make settings related to roll paper printing, such as **Auto Rotate** and **Print page frame**.

**Expansion:**

You can adjust the amount of protrusion during borderless printing.

**Menu Options for Paper Configuration**

**Color Density:**

Adjusts the strength of Color Density. Drag the slider to the right or left with your mouse to adjust the setting. You can also type a number in the box next to the slider.

**Menu Options for Supply Levels**

Displays the approximate ink level.

**Adding Printing Presets for Easy Printing**

If you create your own preset of frequently used print settings on the printer driver, you can print easily by selecting the preset from the list.

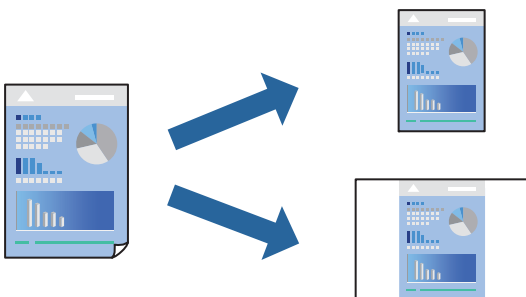

1. Set each item such as **Print Settings** and **Layout (Media Type, Color, and so on)**.
2. Click **Presets** to save the current settings as a preset.
3. Click **OK**.

**Note:**

To delete an added preset, click **Presets > Show Presets**, select the preset name you want to delete from the list, and then delete it.

4. Click **Print**.

The next time you want to print using the same settings, select the registered preset name from the **Presets**.

**Related Information**

➔ [“Printing Using Easy Settings” on page 87](#)

## Printing Several Pages on One Sheet

You can print several pages of data on a single sheet of paper.

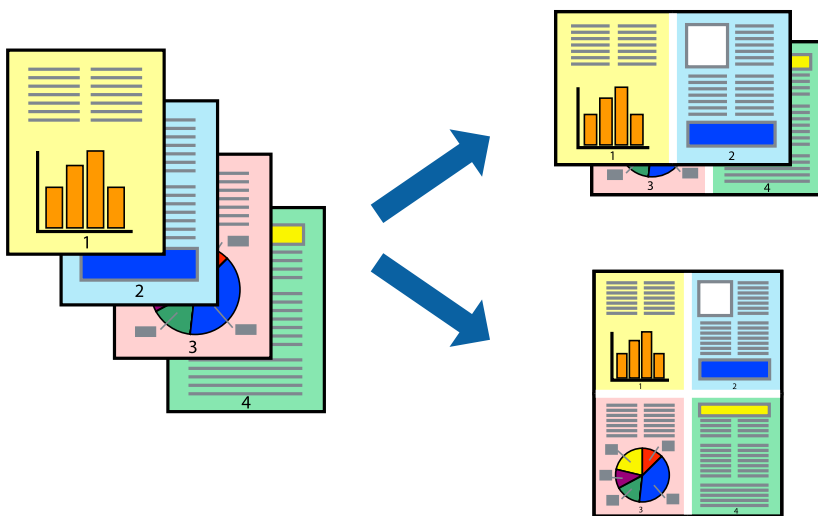

1. Select **Layout** from the pop-up menu.
2. Set the number of pages in **Pages per Sheet**, the **Layout Direction** (page order), and **Border**.  
[“Menu Options for Layout” on page 89](#)
3. Set the other items as necessary.
4. Click **Print**.

**Related Information**

➔ [“Printing Using Easy Settings” on page 87](#)

## Printing to Fit the Paper Size

Select the paper size you loaded in the printer as the Destination Paper Size setting.

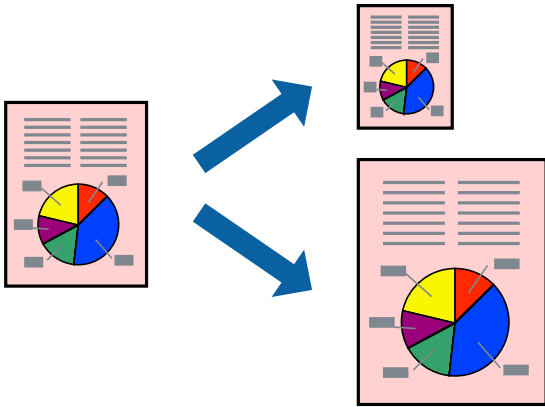

1. Select **Paper Handling** from the pop-up menu.
2. Select **Scale to fit paper size**.
3. Select the paper size you loaded in the printer as the **Destination Paper Size** setting.
4. Set the other items as necessary.
5. Click **Print**.

### Related Information

➔ [“Printing Using Easy Settings” on page 87](#)

## Printing a Reduced or Enlarged Document at any Magnification

You can reduce or enlarge the size of a document by a specific percentage.



1. Select **Print** from the **File** menu or another command to access the print dialog.

2. Select **Page Setup** from the **File** menu of the application.
3. Select **Printer**, **Paper Size**, enter percentage in **Scale**, and then click **OK**.

**Note:**

Select the paper size you set in the application as the **Paper Size** setting.

4. Set the other items as necessary.
5. Click **Print**.

### Related Information

➔ [“Printing Using Easy Settings” on page 87](#)

## Adjusting the Print Color

You can adjust the colors used in the print job. These adjustments are not applied to the original data.

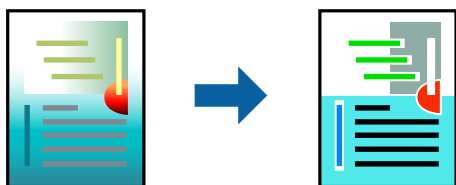

**PhotoEnhance** produces sharper images and more vivid colors by automatically adjusting the contrast, saturation, and brightness of the original image data.

**Note:**

**PhotoEnhance** adjusts the color by analyzing the location of the subject. Therefore, if you have changed the location of the subject by reducing, enlarging, cropping, or rotating the image, the color may change unexpectedly. Selecting the borderless setting also changes the location of the subject resulting in changes in color. If the image is out of focus, the tone may be unnatural. If the color is changed or becomes unnatural, print in a mode other than **PhotoEnhance**.

1. Select **Color Matching** from the pop-up menu, and then select **EPSON Color Controls**.
2. Select **Print Settings** from the pop-up menu.
3. On the **Basic** tab, select **Print Settings**, and then select the type of color correction from **Color Settings**.
4. Select the **Advanced Color Settings** tab, and then set the Gamma, Brightness, Contrast, Saturation, and so on.
5. Set the other items as necessary.
6. Click **Print**.

### Related Information

➔ [“Printing Using Easy Settings” on page 87](#)

## Printing Documents from Smart Devices (iOS)

You can print documents from a smart device such as a smartphone or tablet.

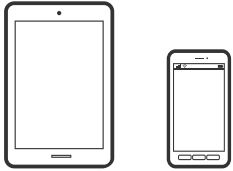

## Printing Documents Using Epson Smart Panel

**Note:**

*Operations may differ depending on the device.*

1. Load paper in the printer.  
[“Loading Paper” on page 26](#)
2. Set up your printer for wireless printing.
3. If Epson Smart Panel is not installed, install it.  
[“Application for Easily Operating the Printer from a Smart device \(Epson Smart Panel\)” on page 202](#)
4. Connect your smart device to the same wireless network as your printer.
5. Start Epson Smart Panel.
6. Tap **Print Documents** on the home screen.
7. Tap **Select Document**.
8. Tap the location of the document you want to print, and then select the document.
9. Tap **Print**.

## Printing Documents Using AirPrint

AirPrint enables instant wireless printing from iPhone, iPad, iPod touch, and Mac without the need to install drivers or download software.



**Note:**

*If you disabled paper configuration messages on your printer control panel, you cannot use AirPrint. See the link below to enable the messages, if necessary.*

1. Load paper in the printer.  
[“Loading Paper” on page 26](#)
2. Set up your printer for wireless printing. See the link below.  
<http://epson.sn>
3. Connect your Apple device to the same wireless network that your printer is using.
4. Print from your device to your printer.

**Note:**

*For details, see the AirPrint page on the Apple website.*

### Related Information

- ➔ [“Cannot Print Even Though a Connection has been Established \(iOS\)” on page 135](#)

## Printing Documents from Smart Devices (Android)

You can print documents from a smart device such as a smartphone or tablet.

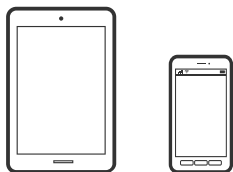

## Printing Documents Using Epson Smart Panel

**Note:**

*Operations may differ depending on the device.*

1. Load paper in the printer.  
[“Loading Paper” on page 26](#)
2. Set up your printer for wireless printing.
3. If Epson Smart Panel is not installed, install it.  
[“Application for Easily Operating the Printer from a Smart device \(Epson Smart Panel\)” on page 202](#)
4. Connect your smart device to the same wireless network as your printer.
5. Start Epson Smart Panel.
6. Tap **Print Documents** on the home screen.
7. Tap **Select Document**.
8. Tap the location of the document you want to print, and then select the document.



9. Tap **Print**.

## Printing Using Mopria Print Service

Mopria Print Service enables instant wireless printing from Android smart phones or tablets.



1. Install Mopria Print Service from Google Play.
2. Load paper in the printer.
3. Set up your printer for wireless printing. See the link below.  
<http://epson.sn>
4. Connect your Android device to the same wireless network that your printer is using.
5. Print from your device to your printer.

**Note:**

For more details, access the Mopria Web site at <https://mopria.org>.

### Related Information

- ➔ [“Loading Paper” on page 26](#)

## Printing Using a Cloud Service

By using Epson Connect service available on the Internet, you can print from your smartphone, tablet PC, or laptop, anytime and practically anywhere. To use this service, you need to register the user and the printer in Epson Connect.

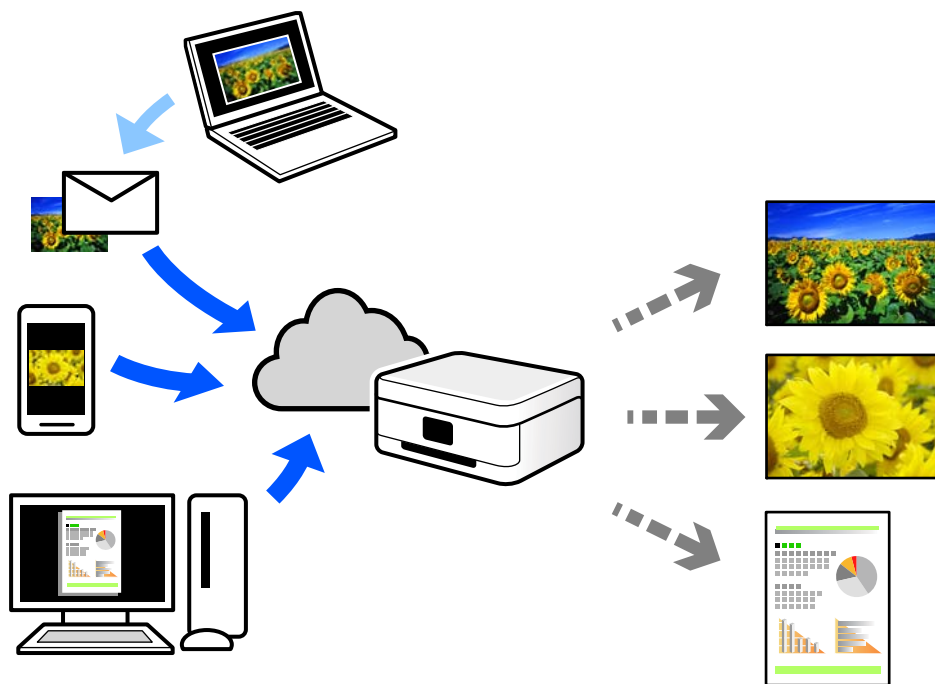

The features available on the Internet are as follows.

Email Print

When you send an email with attachments such as documents or images to an email address assigned to the printer, you can print that email and the attachments from remote locations such as your home or office printer.

Remote Print Driver

This is a shared driver supported by Remote Print Driver. When printing using a printer in a remote location, you can print by changing the printer on the usual applications window.

See the Epson Connect web portal for details on how to setup or print.

<https://www.epsonconnect.com/>

<http://www.epsonconnect.eu> (Europe only)

## Registering to Epson Connect Service from the Control Panel

Follow the steps below to register the printer.

1. Select  on the control panel.
2. Select **General Settings > Web Service Settings > Epson Connect Services > Register > Start Setup** to print the registration sheet.
3. Follow the instructions on the registration sheet to register the printer.

---

# Maintaining the Printer

Checking the Status of Consumables. . . . .	100
Improving Paper Feeding Problems (Rear Paper Feeder). . . . .	100
Improving Print Quality. . . . .	101
Saving Power. . . . .	106
Installing or Uninstalling Applications Separately. . . . .	107
Transporting and Storing the Printer. . . . .	112
Cleaning the Cooling Fan Filter. . . . .	114

## Checking the Status of Consumables

You can check the approximate ink levels and the approximate service life of the maintenance box from the control panel or the computer.

**Note:**

*You can continue printing while the ink low message is displayed. Replace the ink cartridges when required.*

### Checking the Status of Consumables (Control Panel)

Select  on the printer's control panel.

### Checking the Status of Consumables (Windows)

1. Access the printer driver window.
2. Click **EPSON Status Monitor 3** on the **Utility** tab.

**Note:**

*If EPSON Status Monitor 3 is disabled, click **Speed and Progress** on the **Utility** tab, and then clear **Disable EPSON Status Monitor 3**.*

### Checking the Status of Consumables (Mac OS)

1. Select **System Preferences** from the Apple menu > **Printers & Scanners** (or **Print & Scan, Print & Fax**), and then select the printer.
2. Click **Options & Supplies** > **Utility** > **Open Printer Utility**.
3. Click **EPSON Status Monitor**.

### Related Information

- ➔ [“It is Time to Replace the Ink Cartridges” on page 141](#)
- ➔ [“It is Time to Replace the Maintenance Box” on page 143](#)

---

## Improving Paper Feeding Problems (Rear Paper Feeder)

If you have a paper feed problem from the rear paper feeder, and if you have a cleaning sheet that came with Epson genuine paper, load the cleaning sheet and clean the inside of the printer. For details on using the cleaning sheet, see the instructions that came with the sheet.

1. Remove any paper for printing loaded in the rear paper feeder.

2. Remove the protective sheet from the cleaning sheet.

The cleaning sheet has adhesive tape under the protective sheet. Be careful not to touch the surface of the cleaning sheet or attach it to anything else.

3. Load the cleaning sheet in the rear paper feeder.

4. Select  on the printer's control panel.
5. Select **Maintenance > Paper Guide Cleaning**.
6. Follow the on-screen instructions to clean the paper path.  
Repeat this procedure two or three times.

**Note:**

*The cleaning sheet loses effect when used three times or more.*

---

## Improving Print Quality

### Checking and Cleaning the Print Head

If the nozzles are clogged, the printouts become faint, there is visible banding, or unexpected colors appear. If the nozzles are severely clogged, a blank sheet will be printed. When print quality has declined, first use the nozzle check feature to check if the nozzles are clogged. If the nozzles are clogged, clean the print head.



**Important:**

- Do not open the printer cover or turn off the printer during head cleaning. If the head cleaning is incomplete, you may not be able to print.
- Head cleaning consumes ink and should not be performed more than necessary.
- When ink is low, you may not be able to clean the print head.
- If print quality has not improved after repeating nozzle check and head cleaning 3 times, wait for at least 6 hours without printing, and then run the nozzle check again and repeat the head cleaning if necessary. We recommend turning off the printer by using the  button. If print quality has still not improved, run Power Cleaning.
- To prevent the print head from drying out, do not unplug the printer while the power is on.

### Checking and Cleaning the Print Head (Control Panel)

1. Load A4-size plain paper in the printer.  
[“Loading Paper in the Rear Paper Feeder” on page 29](#)
2. Select  on the printer's control panel.
3. Select **Maintenance**.
4. Select **Print Head Nozzle Check**.
5. Follow the on-screen instructions to print the nozzle check pattern.

6. Check the printed pattern to see if the print head nozzles are clogged.

**A) OK**

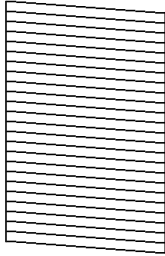

**B) NG**

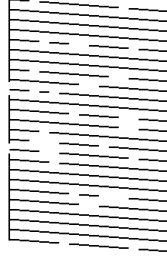

**C) NG**

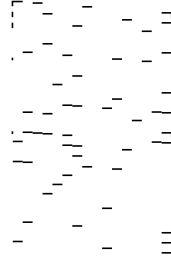

- A:

All lines are printed. Select . No further steps are needed.

- B or close to B:

Some nozzles are clogged. Select , and then select **Head Cleaning** on the next screen.

- C or worse than C:

If most lines are missing or not printed, this indicates most nozzles are clogged. Select , and then select **Power Cleaning** on the next screen.

7. Follow the on-screen instructions to perform print head cleaning or Power Cleaning.
8. When cleaning is finished, print the nozzle check pattern again. Repeat cleaning and printing the pattern until all lines are printed completely.

 **Important:**

*If print quality has not improved after repeating nozzle check and head cleaning 3 times, wait for at least 6 hours without printing, and then run the nozzle check again and repeat the head cleaning if necessary. We recommend turning off the printer using the  button. If print quality has still not improved, run Power Cleaning.*

**Related Information**

➔ [“Running Power Cleaning” on page 103](#)

## Checking and Cleaning the Print Head (Windows)

1. Load A4 -size plain paper in the printer.  
[“Loading Paper in the Rear Paper Feeder” on page 29](#)
2. Access the printer driver window.
3. Click **Print Head Nozzle Check** on the **Utility** tab.

4. Follow the on-screen instructions.

 **Important:**

*If print quality has not improved after repeating nozzle check and head cleaning 3 times, wait for at least 6 hours without printing, and then run the nozzle check again and repeat the head cleaning if necessary. We recommend turning off the printer using the  button. If print quality has still not improved, run Power Cleaning.*

#### Related Information

- ➔ [“Running Power Cleaning” on page 103](#)

## Checking and Cleaning the Print Head (Mac OS)

1. Load A4 -size plain paper in the printer.  
[“Loading Paper in the Rear Paper Feeder” on page 29](#)
2. Select **System Preferences** from the Apple menu > **Printers & Scanners** (or **Print & Scan, Print & Fax**), and then select the printer.
3. Click **Option & Supplies** > **Utility** > **Open Printer Utility**.
4. Click **Print Head Nozzle Check**.
5. Follow the on-screen instructions.

 **Important:**

*If print quality has not improved after repeating nozzle check and head cleaning 3 times, wait for at least 6 hours without printing, and then run the nozzle check again and repeat the head cleaning if necessary. We recommend turning off the printer using the  button. If print quality has still not improved, run Power Cleaning.*

#### Related Information

- ➔ [“Running Power Cleaning” on page 103](#)

## Running Power Cleaning

The Power Cleaning feature may improve print quality in the following cases.

- When most nozzles are clogged.
- When you have performed a nozzle check and head cleaning 3 times and waited for at least 6 hours without printing, but print quality still did not improve.

 **Important:**

*The Power Cleaning uses more ink than the print head cleaning.*

## Running Power Cleaning (Control Panel)

1. Load A4 -size plain paper in the printer.  
[“Loading Paper in the Rear Paper Feeder” on page 29](#)
2. Select  on the printer's control panel.
3. Select **Maintenance**.
4. Select **Print Head Cleaning > Power Cleaning**.
5. When cleaning is finished, print the nozzle check pattern again. Check that all of the lines in the nozzle check pattern are printed correctly.



**Important:**

*If print quality has not improved after running Power Cleaning, wait for at least 6 hours without printing, and then print the nozzle check pattern again. Run Head Cleaning or Power Cleaning again depending on the printed pattern. If quality still does not improve, contact Epson support.*

### Related Information

➔ [“Checking and Cleaning the Print Head” on page 101](#)

## Running Power Cleaning (Windows)

1. Access the printer driver window.
2. Click **Print Head Cleaning** on the **Utility** tab.
3. Select **Power Cleaning**.
4. Follow the on-screen instructions.



**Important:**

*If print quality has not improved after running Power Cleaning, wait for at least 6 hours without printing, and then print the nozzle check pattern again. Run Cleaning or Power Cleaning again depending on the printed pattern. If quality still does not improve, contact Epson support.*

### Related Information

➔ [“Checking and Cleaning the Print Head” on page 101](#)

## Running Power Cleaning (Mac OS)

1. Select **System Preferences** from the Apple menu > **Printers & Scanners** (or **Print & Scan, Print & Fax**), and then select the printer.
2. Click **Option & Supplies > Utility > Open Printer Utility**.



3. Click **Print Head Cleaning**.
4. Select **Power Cleaning**.
5. Follow the on-screen instructions.



**Important:**

*If print quality has not improved after running Power Cleaning, wait for at least 6 hours without printing, and then print the nozzle check pattern again. Run Cleaning or Power Cleaning again depending on the printed pattern. If quality still does not improve, contact Epson support.*

### **Related Information**

- ➔ [“Checking and Cleaning the Print Head” on page 101](#)

## **Preventing nozzle clogging**

Always use the power button when turning the printer on and off.

Check that the power light is off before you disconnect the power cord.

The ink itself can dry out if it is not covered. Just like placing a cap on a fountain pen or an oil pen to prevent it from drying, make sure the print head is capped properly to prevent the ink from drying.

When the power cord is unplugged or a power outage occurs while the printer is in operation, the print head may not be capped properly. If the print head is left as it is, it will dry out causing nozzles (ink outlets) to clog.

In these cases, turn the printer on and off again as soon as possible to cap the print head.

## **Aligning the Print Head**

1. Load A4-size Photo Quality Ink Jet Paper in the printer.

You can also use plain paper instead.

[“Loading Paper in the Rear Paper Feeder” on page 29](#)

2. Select  on the printer's control panel.
3. Select **Maintenance > Print Head Alignment**.

4. Follow the on-screen instructions to print an alignment pattern and select the number for the optimum pattern.

Find and select the number for the most solid pattern in each group.

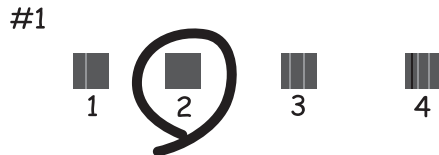

## Cleaning the Paper Path for Ink Smears

When the printouts are smeared or scuffed, clean the paper path inside. Cleaning sheets cannot be used for this purpose.



**Important:**

*Do not use tissue paper to clean the inside of the printer. The print head nozzles may be clogged with lint.*

1. Load plain paper of the following size in the rear paper feeder.

SC-P900 Series: A2

SC-P700 Series: A3 or A3+

[“Loading Paper in the Rear Paper Feeder” on page 29](#)

2. Select  on the printer's control panel.
3. Select **Maintenance > Paper Guide Cleaning**.
4. Follow the on-screen instructions to clean the paper path.

**Note:**

*Repeat this procedure until the paper is not smeared with ink.*

---

## Saving Power

The printer enters sleep mode or turns off automatically if no operations are performed for a set period. You can adjust the time before power management is applied. Any increase will affect the product's energy efficiency. Please consider the environment before making any change.

1. Select  on the printer's control panel.
2. Select **General Settings**.
3. Select **Basic Settings**.

4. Do one of the following.

**Note:**

Your product may have the **Power Off Settings** or **Power Off Timer** feature depending on the location of purchase.

- Select **Sleep Timer** or **Power Off Settings** > **Power Off If Inactive** or **Power Off If Disconnected**.
- Select **Sleep Timer** or **Power Off Timer**.

5. Select the setting.

---

## Installing or Uninstalling Applications Separately

Connect your computer to the network and install the latest version of applications from the website. Log in to your computer as an administrator. Enter the administrator password if the computer prompts you.

### Installing the Applications Separately

**Note:**

When reinstalling an application, you need to uninstall it first.

1. Make sure the printer and the computer are available for communication, and the printer is connected to the Internet.
2. Start EPSON Software Updater.

The screenshot is an example on Windows.

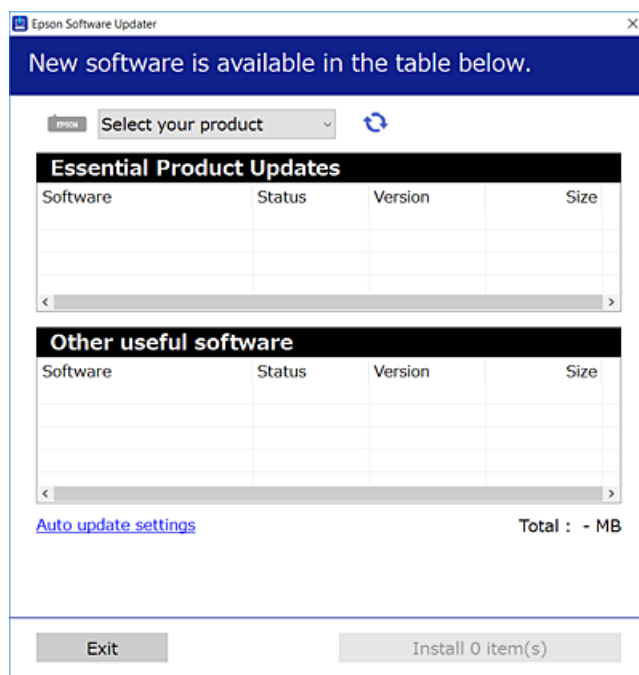

3. For Windows, select your printer, and then click  to check for the latest available applications.

4. Select the items you want to install or update, and then click the install button.



**Important:**

Do not turn off or unplug the printer until the update is complete. Doing so may result in malfunction of the printer.

**Note:**

You can download the latest applications from the Epson website.

<http://www.epson.com>

**Related Information**

- ➔ “Application for Updating Software and Firmware (EPSON Software Updater)” on page 205
- ➔ “Uninstalling Applications” on page 109

## Checking if a genuine Epson printer driver is installed - Windows

You can check if a genuine Epson printer driver is installed on your computer by using one of the following methods.

Select **Control Panel > View devices and printers (Printers, Printers and Faxes)**. Next, click the printer icon and then click **Print server properties** at the top of the screen to display the properties window.

Click the **Driver** tab. If your printer name is displayed in the list, a genuine Epson printer driver is installed on your computer.

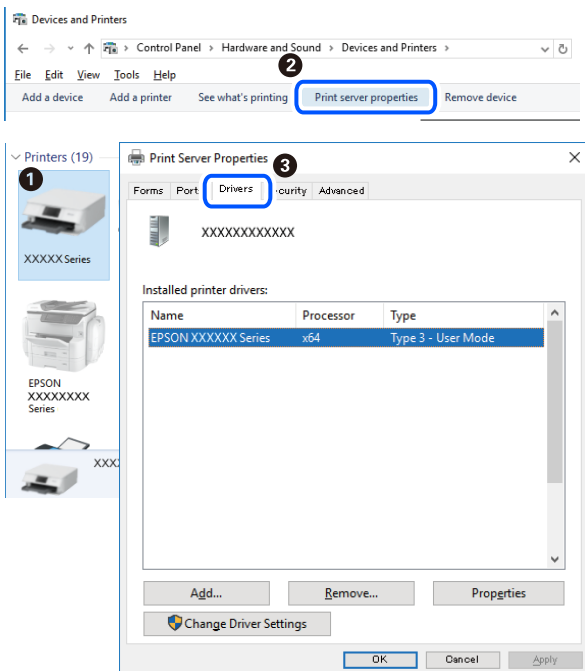

**Related Information**

- ➔ “Installing the Applications Separately” on page 107

## Checking if a genuine Epson printer driver is installed - Mac OS

You can check if a genuine Epson printer driver is installed on your computer by using one of the following methods.

Select **System Preferences** from the Apple menu > **Printers & Scanners** (or **Print & Scan**, **Print & Fax**), and then select the printer. Click **Options & Supplies**, and if the **Options** tab and **Utility** tab are displayed on the window, a genuine Epson printer driver is installed on your computer.



### Related Information

➔ [“Installing the Applications Separately” on page 107](#)

## Adding the Printer (for Mac OS Only)

1. Select **System Preferences** from the Apple menu > **Printers & Scanners** (or **Print & Scan**, **Print & Fax**).
2. Click +, and then select your printer on the screen displayed.
3. Select your printer from **Use**.
4. Click **Add**.

**Note:**

*If your printer is not listed, check that it is correctly connected to the computer and that the printer is on.*

## Uninstalling Applications

Log in to your computer as an administrator. Enter the administrator password if the computer prompts you.

### Uninstalling Applications - Windows

1. Press the  button to turn off the printer.

2. Quit all running applications.
3. Open **Control Panel**:
  - Windows 10  
Click on the start button, and then select **Windows System > Control Panel**.
  - Windows 8.1/Windows 8  
Select **Desktop > Settings > Control Panel**.
  - Windows 7  
Click the start button and select **Control Panel**.
4. Open **Uninstall a program** (or **Add or Remove Programs**):  
Select **Uninstall a program** in **Programs**.
5. Select the application you want to uninstall.  
You cannot uninstall the printer driver if there is any print jobs. Delete or wait to be printed the jobs before uninstalling.
6. Uninstall the applications:  
Click **Uninstall/Change** or **Uninstall**.  
**Note:**  
*If the **User Account Control** window is displayed, click **Continue**.*
7. Follow the on-screen instructions.

## Uninstalling Applications - Mac OS

1. Download the Uninstaller using EPSON Software Updater.  
Once you have downloaded the Uninstaller, you do not need to download it again each time you uninstall the application.
2. Press the  button to turn off the printer.
3. To uninstall the printer driver, select **System Preferences** from the Apple menu > **Printers & Scanners** (or **Print & Scan, Print & Fax**), and then remove the printer from the enabled printers list.
4. Quit all running applications.
5. Select **Go > Applications > Epson Software > Uninstaller**.
6. Select the application you want to uninstall, and then click **Uninstall**.



**Important:**

*The Uninstaller removes all drivers for Epson inkjet printers on the computer. If you use multiple Epson inkjet printers and you only want to delete some drivers, delete all of them first, and then install the necessary printer driver again.*

**Note:**

If you cannot find the application you want to uninstall in the application list, you cannot uninstall using the Uninstaller. In this situation, select **Go > Applications > Epson Software**, select the application you want to uninstall, and then drag it to the trash icon.

**Related Information**

➔ “Application for Updating Software and Firmware (EPSON Software Updater)” on page 205

## Updating Applications and Firmware

You may be able to clear certain problems and improve or add functions by updating the applications and the firmware. Make sure you use the latest version of the applications and firmware.

1. Make sure that the printer and the computer are connected, and the computer is connected to the internet.
2. Start EPSON Software Updater, and update the applications or the firmware.



**Important:**

Do not turn off the computer or the printer until the update is complete; otherwise, the printer may malfunction.

**Note:**

If you cannot find the application you want to update in the list, you cannot update using the EPSON Software Updater. Check for the latest versions of the applications from your local Epson website.

<http://www.epson.com>

**Related Information**

➔ “Application for Updating Software and Firmware (EPSON Software Updater)” on page 205

## Updating the Printer's Firmware Using the Control Panel

If the printer is connected to the Internet, you can update the printer's firmware using the control panel. By updating the firmware, the printer's performance may improve, or new functions may be added. You can also set the printer to regularly check for firmware updates and notify you if any are available.

1. Select  on the printer's control panel.
2. Select **General Settings > Firmware Update > Update**.

**Note:**

Enable **Notification** to set the printer to regularly check for available firmware updates.

3. Check the message displayed on the screen and select **Start Checking**.
4. Check the message displayed on the screen and select **Start**.

The firmware is updated when new firmware is found. Once the update has started, it cannot be interrupted.

**!** **Important:**

- ❑ Do not turn off or unplug the printer until the update is complete. Doing so may result in malfunction of the printer.
- ❑ If the firmware update is not completed or is unsuccessful, the printer does not start up normally and "Recovery Mode" is displayed on the LCD screen the next time the printer is turned on. In this situation, you need to update the firmware again using a computer. Connect the printer to the computer with a USB cable. While "Recovery Mode" is displayed on the printer, you cannot update the firmware over a network connection. On the computer, access your local Epson website, and then download the latest printer firmware. See the instructions on the website for the next steps.

## Transporting and Storing the Printer

When you need to store the printer or transport it when moving or for repairs, follow the steps below to pack the printer.

1. Turn off the printer by pressing the  button.
2. Make sure the power light turns off, and then unplug the power cord.

**!** **Important:**

*Unplug the power cord when the power light is off. Otherwise, the print head may not return to the home position causing the ink to dry, and printing may become impossible.*

3. Disconnect all cables such as the power cord and USB cable.
4. Remove all of the paper from the printer.
5. Open the printer cover. Secure the print head to the case with tape.

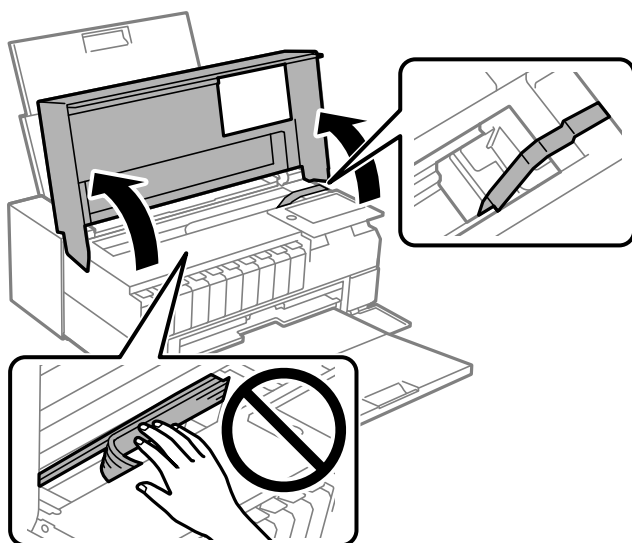



6. Close the printer cover.

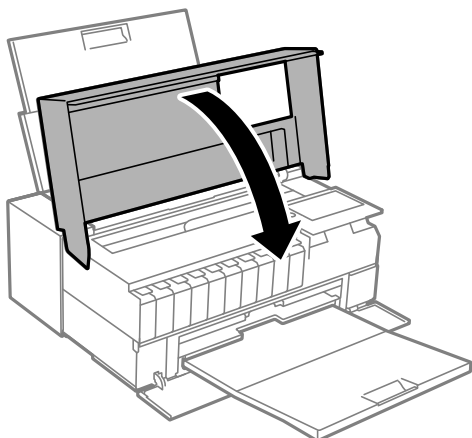

7. Prepare to pack the printer as shown below.

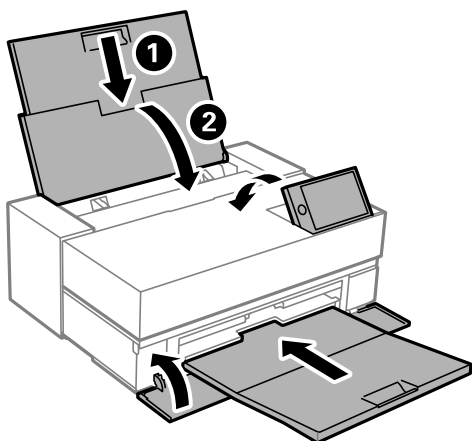

8. Pack the printer in its box, using the protective materials.

**!** *Important:*

- When storing or transporting the printer, avoid tilting it, placing it vertically, or turning it upside down; otherwise ink may leak.*

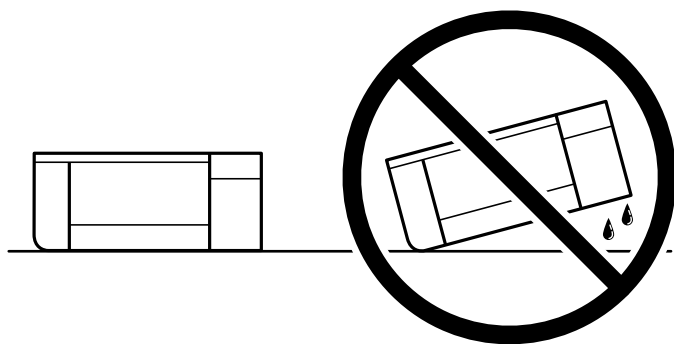

- Do not remove the ink cartridges from the product when storing or transporting the product.*

When you use the printer again, make sure you remove the tape securing the print head. If print quality has declined the next time you print, clean and align the print head.

**Related Information**

- ➔ [“Checking and Cleaning the Print Head” on page 101](#)
- ➔ [“Aligning the Print Head” on page 105](#)

---

## Cleaning the Cooling Fan Filter

If there is excessive dust on the cooling fan filter, the printer may not cool properly. This can cause unstable printer behavior and lead to print quality deterioration. Use a cleaning tool like a small vacuum cleaner to regularly remove dust from the filter.

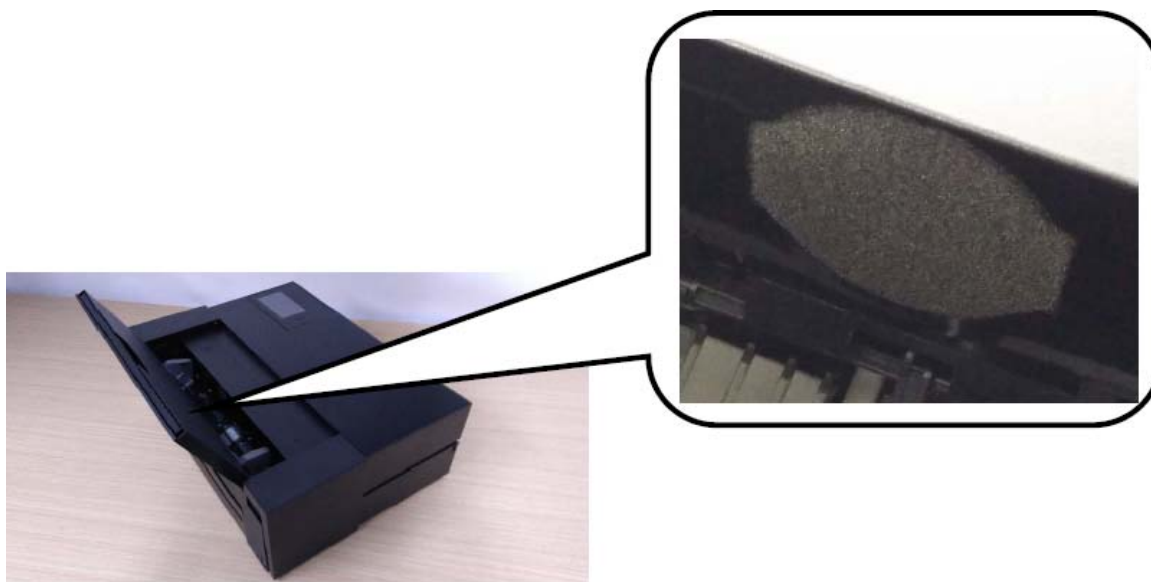

---

# Solving Problems

The Printer Does Not Work as Expected. . . . .	116
A Message is Displayed on the LCD Screen. . . . .	139
Paper Gets Jammed. . . . .	140
It is Time to Replace the Ink Cartridges. . . . .	141
It is Time to Replace the Maintenance Box. . . . .	143
Print Quality is Poor. . . . .	144
Cannot Solve Problem. . . . .	153

## The Printer Does Not Work as Expected

### The Printer Does Not Turn On or Off

#### Power Does Not Turn On

The following causes can be considered.

##### ■ The power cord is not plugged in properly to the electrical outlet.

###### Solutions

Make sure the power cord is securely plugged in.

##### ■ The button was not pressed for long enough.



###### Solutions

Hold down the  button for a little longer.

#### Power Does Not Turn Off

##### ■ The button was not pressed for long enough.



###### Solutions

Hold down the  button for a little longer. If you still cannot turn off the printer, unplug the power cord. To prevent the print head from drying out, turn the printer back on and turn it off by pressing the  button.

#### Power Turns Off Automatically

##### ■ The Power Off Settings or Power Off Timer feature is enabled.

###### Solutions

- Select  > **General Settings** > **Basic Settings** > **Power Off Settings**, and then disable the **Power Off If Inactive** and **Power Off If Disconnected** settings.
- Select  > **General Settings** > **Basic Settings**, and then disable the **Power Off Timer** Setting.

###### Note:

Your product may have the **Power Off Settings** or **Power Off Timer** feature depending on the location of purchase.

### Paper Does Not Feed Properly

#### No Paper Feeds

The following causes can be considered.

■ **The installation location is inappropriate.**

**Solutions**

Place the printer on a flat surface and operate in the recommended environmental conditions.

➔ [“Environmental Specifications” on page 218](#)

■ **Unsupported paper is being used.**

**Solutions**

Use paper supported by this printer.

➔ [“Available Paper and Capacities” on page 182](#)

➔ [“Unavailable Paper Types” on page 191](#)

■ **Paper handling is inappropriate.**

**Solutions**

Follow paper handling precautions.

➔ [“Paper Handling Precautions” on page 26](#)

■ **Too many sheets are loaded in the printer.**

**Solutions**

Do not load more than the maximum number of sheets specified for the paper.

➔ [“Available Paper and Capacities” on page 182](#)

■ **The paper settings on the printer are incorrect.**

**Solutions**

Make sure the paper size and paper type settings match the actual paper size and paper type loaded in the printer.

➔ [“Paper Size and Type Settings” on page 27](#)

## **Paper Feeds at a Slant**

The following causes can be considered.

■ **The installation location is inappropriate.**

**Solutions**

Place the printer on a flat surface and operate in the recommended environmental conditions.

➔ [“Environmental Specifications” on page 218](#)

■ **Unsupported paper is being used.**

**Solutions**

Use paper supported by this printer.

➔ [“Available Paper and Capacities” on page 182](#)

➔ [“Unavailable Paper Types” on page 191](#)

■ **Paper handling is inappropriate.**

**Solutions**

Follow paper handling precautions.

➔ [“Paper Handling Precautions” on page 26](#)

■ **The paper is loaded incorrectly.**

**Solutions**

Load paper in the correct direction, and slide the edge guide against the edge of the paper.

➔ [“Loading Paper” on page 26](#)

■ **Too many sheets are loaded in the printer.**

**Solutions**

Do not load more than the maximum number of sheets specified for the paper.

➔ [“Available Paper and Capacities” on page 182](#)

■ **The paper settings on the printer are incorrect.**

**Solutions**

Make sure the paper size and paper type settings match the actual paper size and paper type loaded in the printer.

➔ [“Paper Size and Type Settings” on page 27](#)

## **Several Sheets of Paper are Fed at a Time**

The following causes can be considered.

■ **The installation location is inappropriate.**

**Solutions**

Place the printer on a flat surface and operate in the recommended environmental conditions.

➔ [“Environmental Specifications” on page 218](#)

■ **Unsupported paper is being used.**

**Solutions**

Use paper supported by this printer.

➔ [“Available Paper and Capacities” on page 182](#)

➔ [“Unavailable Paper Types” on page 191](#)

■ **Paper handling is inappropriate.**

**Solutions**

Follow paper handling precautions.

➔ [“Paper Handling Precautions” on page 26](#)

■ **The paper is moist or damp.**

**Solutions**

Load new paper.

■ **Static electricity is causing sheets of paper to stick to each other.**

**Solutions**

Fan the paper before loading. If the paper still does not feed, load one sheet of paper at a time.

■ **Too many sheets are loaded in the printer.**

**Solutions**

Do not load more than the maximum number of sheets specified for the paper.

➔ [“Available Paper and Capacities” on page 182](#)

■ **The paper settings on the printer are incorrect.**

**Solutions**

Make sure the paper size and paper type settings match the actual paper size and paper type loaded in the printer.

➔ [“Paper Size and Type Settings” on page 27](#)

■ **Multiple sheets of paper feed at the same time during manual 2-sided printing.**

**Solutions**

Remove any paper that is loaded in the paper source before you reload the paper.

## **Paper Does Not Feed Properly from the Front Paper Feeder**

■ **Paper has been fed at an angle from the front paper feeder.**

**Solutions**

After inserting paper, make sure the railing edge of the paper is aligned with the line on the front paper feeder.

## **Roll Paper Does Not Feed Properly**

■ **Front paper feeder opens when loading roll paper.**

**Solutions**

Close the front paper feeder, and load roll paper.

## CD/DVD Tray is Ejected when You Try to Load It

### ■ The disc has not been placed properly.

#### Solutions

Place the disc again properly.

➔ [“Loading a CD/DVD” on page 36](#)

### ■ The CD/DVD tray was inserted before the printer was ready.

#### Solutions

Do not insert the CD/DVD tray until you are instructed to do so. Otherwise, an error occurs and the tray is ejected.

## Cannot Print

### Cannot Print from Windows

Make sure the computer and the printer are connected correctly.

The cause and solution to the problem differ depending on whether or not they are connected.

#### **Checking the Connection Status**

Use EPSON Status Monitor 3 to check the connection status for the computer and the printer.

1. Access the printer driver.

Windows 10

Click on the start button, and then select **Windows System > Control Panel > View devices and printers in Hardware and Sound**. Right-click on your printer, or press and hold it and then select **Printing preferences**

Windows 8.1/Windows 8

Select **Desktop > Settings > Control Panel > View devices and printers in Hardware and Sound**. Right-click on your printer, or press and hold it and then select **Printing preferences**

Windows 7

Click the start button, and select **Control Panel > View devices and printers in Hardware and Sound**. Right-click on your printer and select **Printing preferences**.

2. Click the **Utility** tab.

3. Click **EPSON Status Monitor 3**.

If **EPSON Status Monitor 3** is disabled, click **Speed and Progress** on the **Utility** tab, and then clear **Disable EPSON Status Monitor 3**.

When the remaining ink levels are displayed, a connection has been successfully established between the computer and the printer.

Check the following if a connection has not been established.



- ❑ The printer is not recognized over a network connection

[“Cannot connect to a Network” on page 121](#)

- ❑ The printer is not recognized using a USB connection

[“The Printer Cannot Connect by USB \(Windows\)” on page 123](#)

Check the following if a connection has been established.

- ❑ The printer is recognized, but printing cannot be performed.

[“Cannot Print Even Though a Connection has been Established \(Windows\)” on page 124](#)

## Cannot connect to a Network

The problem could be one of the following issues.

### ■ Something is wrong with the network devices for Wi-Fi connection.

#### Solutions

Turn off the devices you want to connect to the network. Wait for about 10 seconds, and then turn on the devices in the following order; wireless router, computer or smart device, and then printer. Move the printer and computer or smart device closer to the wireless router to help with radio wave communication, and then try to make network settings again.

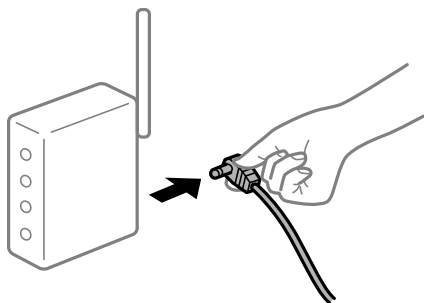

### ■ Devices cannot receive signals from the wireless router because they are too far apart.

#### Solutions

After moving the computer or the smart device and the printer closer to the wireless router, turn off the wireless router, and then turn it back on.

### ■ When changing the wireless router, the settings do not match the new router.

#### Solutions

Make the connection settings again so that they match the new wireless router.

➔ [“When Replacing the Wireless Router” on page 157](#)

### ■ The SSIDs connected from the computer or smart device and computer are different.

#### Solutions

When you are using multiple wireless routers at the same time or the wireless router has multiple SSIDs and devices are connected to different SSIDs, you cannot connect to the wireless router.

Connect the computer or smart device to the same SSID as the printer.

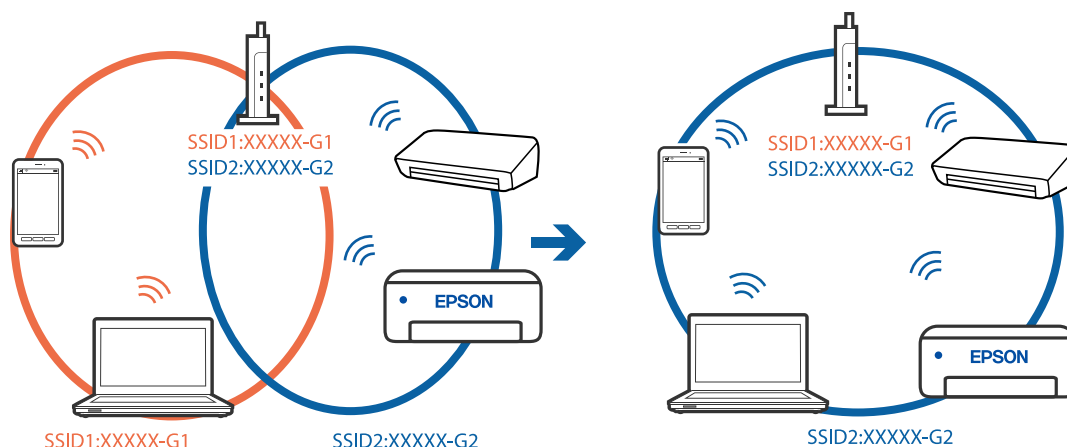

**A privacy separator on the wireless router is available.**

**Solutions**

Most wireless routers have a privacy separator feature that blocks communication between connected devices. If you cannot communicate between the printer and the computer or smart device even if they are connected to the same network, disable the privacy separator on the wireless router. See the manual provided with the wireless router for details.

**The IP address is incorrectly assigned.**

**Solutions**

If the IP address assigned to the printer is 169.254.XXX.XXX, and the subnet mask is 255.255.0.0, the IP address may not be assigned correctly.

Select  > **General Settings** > **Network Settings** > **Advanced** on the printer's control panel, and then check the IP address and the subnet mask assigned to the printer.

Restart the wireless router or reset the network settings for the printer.

➔ [“Re-setting the Network Connection” on page 157](#)

**There is a problem with the network settings on the computer.**

**Solutions**

Try accessing any website from your computer to make sure that your computer's network settings are correct. If you cannot access any website, there is a problem on the computer.

Check the network connection of the computer. See the documentation provided with the computer for details.

**The printer has been connected by Ethernet using devices that support IEEE802.3az (Energy Efficient Ethernet).**

**Solutions**

When you connect the printer by Ethernet using devices that support IEEE802.3az (Energy Efficient Ethernet), the following problems may occur depending on the hub or router that you are using.

- Connection becomes unstable, the printer is connected and disconnected again and again.
- Cannot connect to the printer.

- ❑ The communication speed becomes slow.

Follow the steps below to disable IEEE802.3az for the printer and then connect.

1. Remove the Ethernet cable connected to the computer and the printer.
  2. When IEEE802.3az for the computer is enabled, disable it.  
See the documentation provided with the computer for details.
  3. Connect the computer and the printer with an Ethernet cable directly.
  4. On the printer, print a network connection report.  
[“Printing a Network Connection Report” on page 174](#)
  5. Check the printer's IP address on the network connection report.
  6. On the computer, access Web Config.  
Launch a Web browser, and then enter the printer's IP address.  
[“Running Web Config on a Web Browser” on page 204](#)
  7. Select the **Network** tab > **Wired LAN**.
  8. Select **OFF** for **IEEE 802.3az**.
  9. Click **Next**.
  10. Click **OK**.
  11. Remove the Ethernet cable connected to the computer and the printer.
  12. If you disabled IEEE802.3az for the computer in step 2, enable it.
  13. Connect the Ethernet cables that you removed in step 1 to the computer and the printer.
- If the problem still occurs, devices other than the printer may be causing the problem.

## **The Printer Cannot Connect by USB (Windows)**

The following causes can be considered.

### **■ The USB cable is not plugged into the electrical outlet correctly.**

#### **Solutions**

Connect the USB cable securely to the printer and the computer.

### **■ There is a problem with the USB hub.**

#### **Solutions**

If you are using a USB hub, try to connect the printer directly to the computer.

## ■ There is a problem with the USB cable or the USB inlet.

### Solutions

If the USB cable cannot be recognized, change the port, or change the USB cable.

## Cannot Print Even Though a Connection has been Established (Windows)

The following causes can be considered.

## ■ A genuine Epson printer driver has not been installed.

### Solutions

If a genuine Epson printer driver (EPSON XXXXX) has not been installed, the available functions are limited. We recommend using a genuine Epson printer driver.

➔ [“Checking if a genuine Epson printer driver is installed - Windows” on page 108](#)

➔ [“Checking if a genuine Epson printer driver is installed - Mac OS” on page 109](#)

## ■ There is a problem with the software or data.

### Solutions

If you are printing a large data size image, the computer may run out of memory. Print the image at a lower resolution or a smaller size.

If you have tried all of the solutions and have not solved the problem, try uninstalling and then reinstalling the printer driver

➔ [“Installing or Uninstalling Applications Separately” on page 107](#)

## ■ There is a problem with the printer's status.

### Solutions

Click **EPSON Status Monitor 3** on the printer driver's **Utility** tab, and then check the printer status. If **EPSON Status Monitor 3** is disabled, click **Speed and Progress** on the **Utility** tab, and then clear **Disable EPSON Status Monitor 3**.

**There is still a job waiting to be printed.**

**Solutions**

Click **Print Queue** on the printer driver's **Utility** tab. If unnecessary data remains, select **Cancel all documents** from the **Printer** menu.

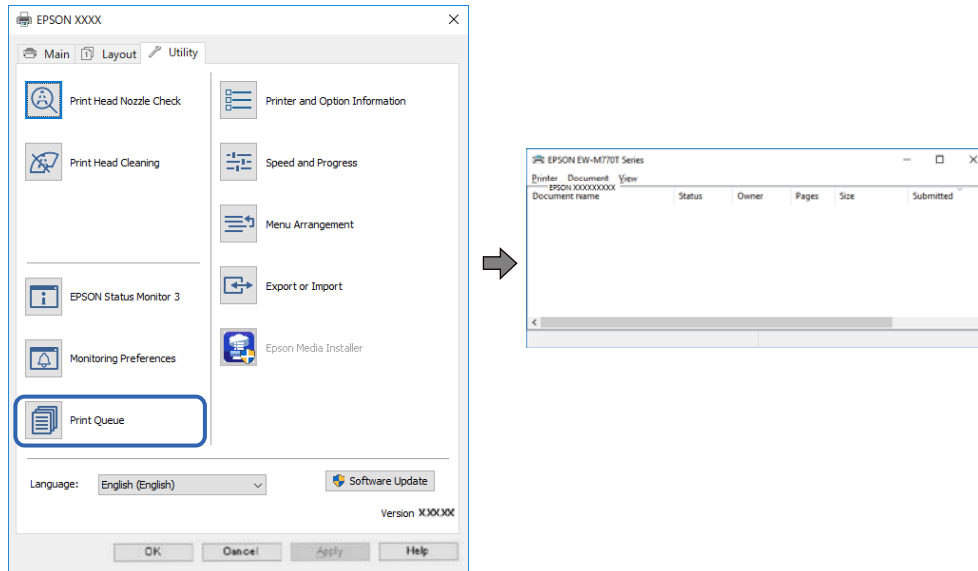

**The printer is pending or offline.**

**Solutions**

Click **Print Queue** on the printer driver's **Utility** tab.

If the printer is offline or pending, clear the offline or pending setting from the **Printer** menu.

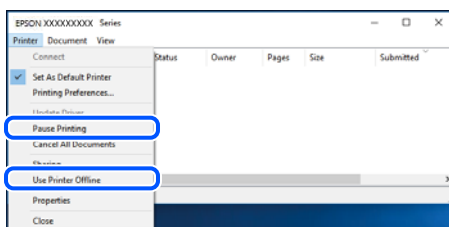

**The printer is not selected as the default printer.**

**Solutions**

Right-click the printer icon in **Control Panel > View devices and printers** (or **Printers, Printers and Faxes**) and click **Set as default printer**.

**Note:**

*If there are multiple printer icons, see the following to select the correct printer.*

Example)

USB connection: EPSON XXXX Series

Network connection: EPSON XXXX Series (network)

If you install the printer driver multiple times, copies of the printer driver may be created. If copies such as "EPSON XXXX Series (copy 1)" are created, right-click the copied driver icon, and then click **Remove Device**.

## ■ The printer port is not set correctly.

### Solutions

Click **Print Queue** on the printer driver's **Utility** tab.

Make sure the printer port is set correctly as shown below in **Property > Port** from the **Printer** menu.

USB connection: **USBXXX**, Network connection: **EpsonNet Print Port**

## Suddenly the Printer Cannot Print over a Network Connection

The problem could be one of the following issues.

## ■ The network environment has been changed.

### Solutions

When you have changed the network environment, such as the wireless router or provider, try making network settings for the printer again.

Connect the computer or smart device to the same SSID as the printer.

➔ [“Re-setting the Network Connection” on page 157](#)

## ■ Something is wrong with the network devices for Wi-Fi connection.

### Solutions

Turn off the devices you want to connect to the network. Wait for about 10 seconds, and then turn on the devices in the following order; wireless router, computer or smart device, and then printer. Move the printer and computer or smart device closer to the wireless router to help with radio wave communication, and then try to make network settings again.

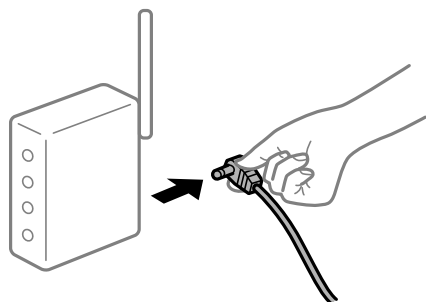

## ■ The printer is not connected to the network.

### Solutions

Select  > **General Settings > Network Settings > Connection Check**, and then print the network connection report. If the report shows that the network connection failed, check the network connection report and then follow the printed solutions.

➔ [“Printing a Network Connection Report” on page 174](#)

## ■ There is a problem with the network settings on the computer.

### Solutions

Try accessing any website from your computer to make sure that your computer's network settings are correct. If you cannot access any website, there is a problem on the computer.

Check the network connection of the computer. See the documentation provided with the computer for details.

## There is still a job waiting to be printed.

### Solutions

Click **Print Queue** on the printer driver's **Utility** tab. If unnecessary data remains, select **Cancel all documents** from the **Printer** menu.

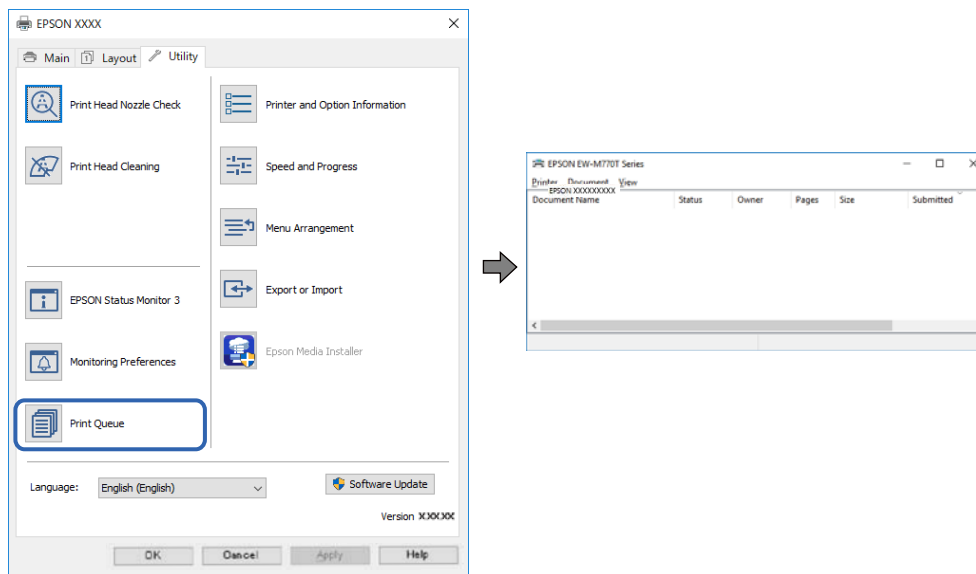

## The printer is pending or offline.

### Solutions

Click **Print Queue** on the printer driver's **Utility** tab.

If the printer is offline or pending, clear the offline or pending setting from the **Printer** menu.

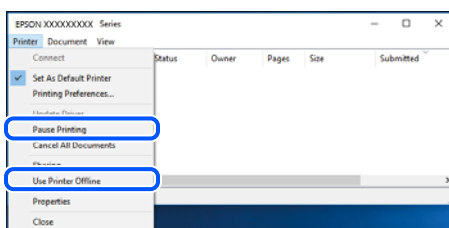

## The printer is not selected as the default printer.

### Solutions

Right-click the printer icon in **Control Panel > View devices and printers** (or **Printers, Printers and Faxes**) and click **Set as default printer**.

#### Note:

If there are multiple printer icons, see the following to select the correct printer.

Example)

USB connection: EPSON XXXX Series

Network connection: EPSON XXXX Series (network)

If you install the printer driver multiple times, copies of the printer driver may be created. If copies such as "EPSON XXXX Series (copy 1)" are created, right-click the copied driver icon, and then click **Remove Device**.

## ■ The printer port is not set correctly.

### Solutions

Click **Print Queue** on the printer driver's **Utility** tab.

Make sure the printer port is set correctly as shown below in **Property > Port** from the **Printer** menu.

USB connection: **USBXXX**, Network connection: **EpsonNet Print Port**

## Cannot Print from Mac OS

Make sure the computer and the printer are connected correctly.

The cause and solution to the problem differ depending on whether or not they are connected.

### Checking the Connection Status

Use EPSON Status Monitor to check the connection status for the computer and the printer.

1. Select **System Preferences** from the Apple menu > **Printers & Scanners** (or **Print & Scan**, **Print & Fax**), and then select the printer.
2. Click **Options & Supplies > Utility > Open Printer Utility**.
3. Click **EPSON Status Monitor**.

When the remaining ink levels are displayed, a connection has been successfully established between the computer and the printer.

Check the following if a connection has not been established.

- The printer is not recognized over a network connection  
[“Cannot connect to a Network” on page 128](#)
- The printer is not recognized using a USB connection  
[“The Printer Cannot Connect by USB \(Mac OS\)” on page 131](#)

Check the following if a connection has been established.

- The printer is recognized, but printing cannot be performed.  
[“Cannot Print Even Though a Connection has been Established \(Mac OS\)” on page 132](#)

## Cannot connect to a Network

The problem could be one of the following issues.



**Something is wrong with the network devices for Wi-Fi connection.**

**Solutions**

Turn off the devices you want to connect to the network. Wait for about 10 seconds, and then turn on the devices in the following order; wireless router, computer or smart device, and then printer. Move the printer and computer or smart device closer to the wireless router to help with radio wave communication, and then try to make network settings again.

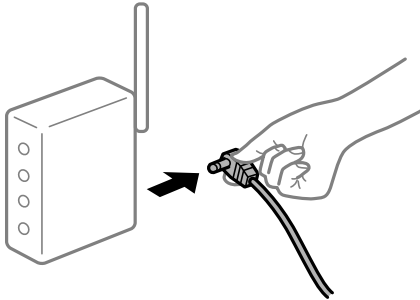

**Devices cannot receive signals from the wireless router because they are too far apart.**

**Solutions**

After moving the computer or the smart device and the printer closer to the wireless router, turn off the wireless router, and then turn it back on.

**When changing the wireless router, the settings do not match the new router.**

**Solutions**

Make the connection settings again so that they match the new wireless router.

→ [“When Replacing the Wireless Router” on page 157](#)

**The SSIDs connected from the computer or smart device and computer are different.**

**Solutions**

When you are using multiple wireless routers at the same time or the wireless router has multiple SSIDs and devices are connected to different SSIDs, you cannot connect to the wireless router.

Connect the computer or smart device to the same SSID as the printer.

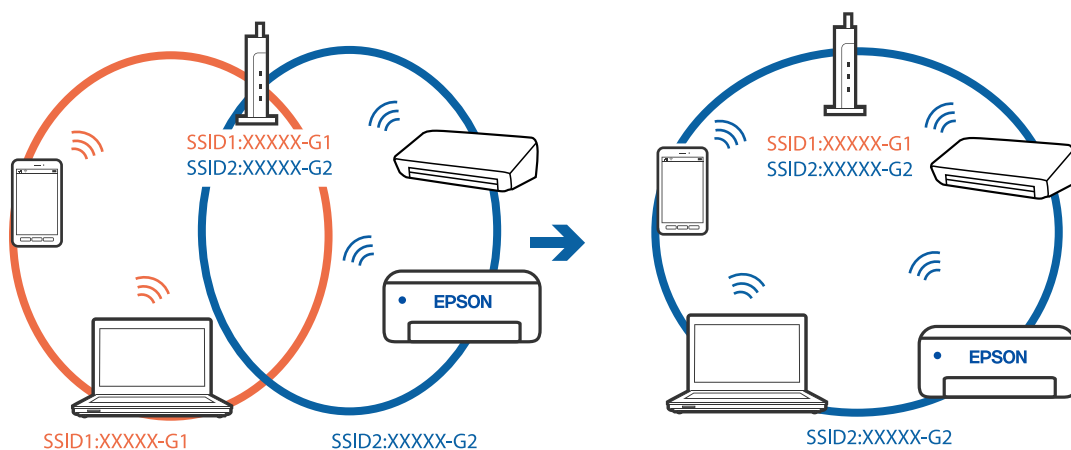

### ■ A privacy separator on the wireless router is available.

#### Solutions

Most wireless routers have a privacy separator feature that blocks communication between connected devices. If you cannot communicate between the printer and the computer or smart device even if they are connected to the same network, disable the privacy separator on the wireless router. See the manual provided with the wireless router for details.

### ■ The IP address is incorrectly assigned.

#### Solutions

If the IP address assigned to the printer is 169.254.XXX.XXX, and the subnet mask is 255.255.0.0, the IP address may not be assigned correctly.

Select  > **General Settings** > **Network Settings** > **Advanced** on the printer's control panel, and then check the IP address and the subnet mask assigned to the printer.

Restart the wireless router or reset the network settings for the printer.

➔ [“Re-setting the Network Connection” on page 157](#)

### ■ There is a problem with the network settings on the computer.

#### Solutions

Try accessing any website from your computer to make sure that your computer's network settings are correct. If you cannot access any website, there is a problem on the computer.

Check the network connection of the computer. See the documentation provided with the computer for details.

### ■ The device connected to the USB 3.0 port causes radio frequency interference.

#### Solutions

When you connect a device to the USB 3.0 port on a Mac, radio frequency interference may occur. Try the following if you cannot connect to wireless LAN (Wi-Fi) or if operations become unstable.

- Place the device that is connected to the USB 3.0 port further away from the computer.
- Connect to the SSID for the 5 GHz range.

➔ [“Making Wi-Fi Settings by Entering the SSID and Password” on page 161](#)

### ■ The printer has been connected by Ethernet using devices that support IEEE802.3az (Energy Efficient Ethernet).

#### Solutions

When you connect the printer by Ethernet using devices that support IEEE802.3az (Energy Efficient Ethernet), the following problems may occur depending on the hub or router that you are using.

- Connection becomes unstable, the printer is connected and disconnected again and again.
- Cannot connect to the printer.
- The communication speed becomes slow.

Follow the steps below to disable IEEE802.3az for the printer and then connect.

1. Remove the Ethernet cable connected to the computer and the printer.

2. When IEEE802.3az for the computer is enabled, disable it.  
See the documentation provided with the computer for details.
3. Connect the computer and the printer with an Ethernet cable directly.
4. On the printer, print a network connection report.  
[“Printing a Network Connection Report” on page 174](#)
5. Check the printer's IP address on the network connection report.
6. On the computer, access Web Config.  
Launch a Web browser, and then enter the printer's IP address.  
[“Running Web Config on a Web Browser” on page 204](#)
7. Select the **Network** tab > **Wired LAN**.
8. Select **OFF** for **IEEE 802.3az**.
9. Click **Next**.
10. Click **OK**.
11. Remove the Ethernet cable connected to the computer and the printer.
12. If you disabled IEEE802.3az for the computer in step 2, enable it.
13. Connect the Ethernet cables that you removed in step 1 to the computer and the printer.  
If the problem still occurs, devices other than the printer may be causing the problem.

## **The Printer Cannot Connect by USB (Mac OS)**

The following causes can be considered.

### **■ The USB cable is not plugged into the electrical outlet correctly.**

#### **Solutions**

Connect the USB cable securely to the printer and the computer.

### **■ There is a problem with the USB hub.**

#### **Solutions**

If you are using a USB hub, try to connect the printer directly to the computer.

### **■ There is a problem with the USB cable or the USB inlet.**

#### **Solutions**

If the USB cable cannot be recognized, change the port, or change the USB cable.

## Cannot Print Even Though a Connection has been Established (Mac OS)

The following causes can be considered.

### ■ A genuine Epson printer driver has not been installed.

#### Solutions

If a genuine Epson printer driver (EPSON XXXXX) has not been installed, the available functions are limited. We recommend using a genuine Epson printer driver.

➔ [“Checking if a genuine Epson printer driver is installed - Windows” on page 108](#)

➔ [“Checking if a genuine Epson printer driver is installed - Mac OS” on page 109](#)

### ■ There is a problem with the software or data.

#### Solutions

If you are printing a large data size image, the computer may run out of memory. Print the image at a lower resolution or a smaller size.

If you have tried all of the solutions and have not solved the problem, try uninstalling and then reinstalling the printer driver

➔ [“Installing or Uninstalling Applications Separately” on page 107](#)

### ■ There is a problem with the status of the printer.

#### Solutions

Make sure the printer status is not **Pause**.

Select **System Preferences** from the **Apple** menu > **Printers & Scanners** (or **Print & Scan**, **Print & Fax**), and then double-click the printer. If the printer is paused, click **Resume**.

## Suddenly the Printer Cannot Print over a Network Connection

The problem could be one of the following issues.

### ■ The network environment has been changed.

#### Solutions

When you have changed the network environment, such as the wireless router or provider, try making network settings for the printer again.

Connect the computer or smart device to the same SSID as the printer.

➔ [“Re-setting the Network Connection” on page 157](#)

### ■ Something is wrong with the network devices for Wi-Fi connection.

#### Solutions

Turn off the devices you want to connect to the network. Wait for about 10 seconds, and then turn on the devices in the following order; wireless router, computer or smart device, and then printer. Move the

printer and computer or smart device closer to the wireless router to help with radio wave communication, and then try to make network settings again.

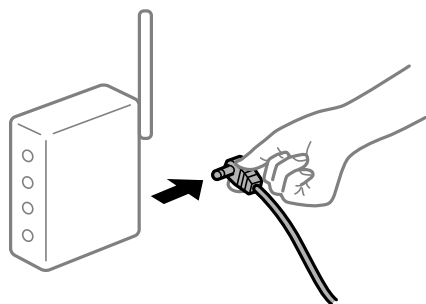

### ■ The printer is not connected to the network.

#### Solutions

Select  > **General Settings** > **Network Settings** > **Connection Check**, and then print the network connection report. If the report shows that the network connection failed, check the network connection report and then follow the printed solutions.

➔ [“Printing a Network Connection Report” on page 174](#)

### ■ There is a problem with the network settings on the computer.

#### Solutions

Try accessing any website from your computer to make sure that your computer's network settings are correct. If you cannot access any website, there is a problem on the computer.

Check the network connection of the computer. See the documentation provided with the computer for details.

## Cannot Print from Smart Device

Make sure the smart device and the printer are connected correctly.

The cause and solution to the problem differ depending on whether or not they are connected.

### **Checking the Connection Status**

Use Epson Smart Panel to check the connection status for the smart device and the printer.

Search for and install Epson Smart Panel from App Store or Google Play if it is not already installed.

1. On the smart device, start Epson Smart Panel.
2. Check that the printer image or the remaining ink levels are displayed on the home screen.

When the printer image or the remaining ink levels are displayed, a connection has been successfully established between the smart device and the printer.

If the they are not displayed, a connection has not been established between the smart device and the printer.

Check the following if a connection has not been established.

- ❑ The printer is not recognized over a network connection

[“Cannot connect to a Network” on page 134](#)

Check the following if a connection has been established.

- ❑ The printer is recognized, but printing cannot be performed.

[“Cannot Print Even Though a Connection has been Established \(iOS\)” on page 135](#)

## Cannot connect to a Network

The problem could be one of the following issues.

### ■ Something is wrong with the network devices for Wi-Fi connection.

#### Solutions

Turn off the devices you want to connect to the network. Wait for about 10 seconds, and then turn on the devices in the following order; wireless router, computer or smart device, and then printer. Move the printer and computer or smart device closer to the wireless router to help with radio wave communication, and then try to make network settings again.

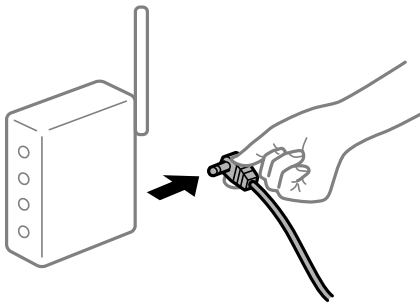

### ■ Devices cannot receive signals from the wireless router because they are too far apart.

#### Solutions

After moving the computer or the smart device and the printer closer to the wireless router, turn off the wireless router, and then turn it back on.

### ■ When changing the wireless router, the settings do not match the new router.

#### Solutions

Make the connection settings again so that they match the new wireless router.

➔ [“When Replacing the Wireless Router” on page 157](#)

### ■ The SSIDs connected from the computer or smart device and computer are different.

#### Solutions

When you are using multiple wireless routers at the same time or the wireless router has multiple SSIDs and devices are connected to different SSIDs, you cannot connect to the wireless router.

Connect the computer or smart device to the same SSID as the printer.

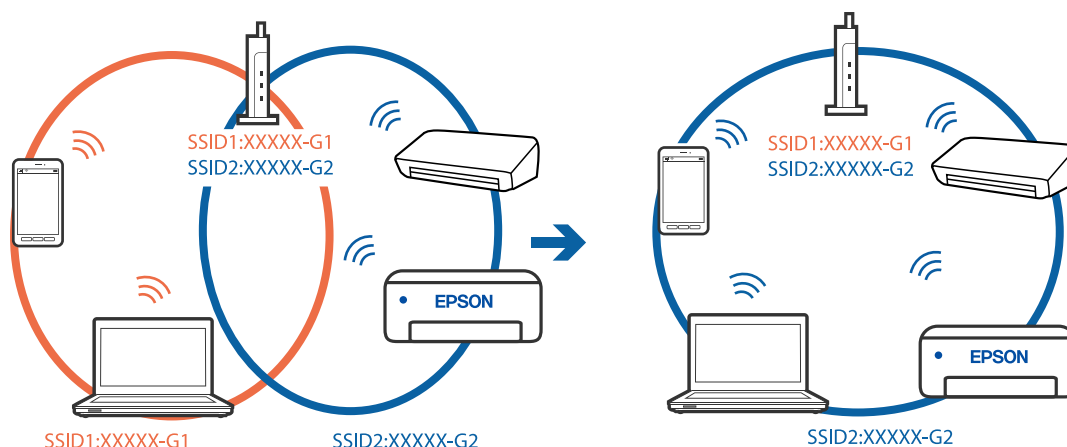

**A privacy separator on the wireless router is available.**

**Solutions**

Most wireless routers have a privacy separator feature that blocks communication between connected devices. If you cannot communicate between the printer and the computer or smart device even if they are connected to the same network, disable the privacy separator on the wireless router. See the manual provided with the wireless router for details.

**The IP address is incorrectly assigned.**

**Solutions**

If the IP address assigned to the printer is 169.254.XXX.XXX, and the subnet mask is 255.255.0.0, the IP address may not be assigned correctly.

Select  > **General Settings** > **Network Settings** > **Advanced** on the printer's control panel, and then check the IP address and the subnet mask assigned to the printer.

Restart the wireless router or reset the network settings for the printer.

➔ [“Re-setting the Network Connection” on page 157](#)

**There is a problem with the network settings on the smart device.**

**Solutions**

Try accessing any website from your smart device to make sure that your smart device's network settings are correct. If you cannot access any website, there is a problem on the smart device.

Check the network connection of the computer. See the documentation provided with the smart device for details.

**Cannot Print Even Though a Connection has been Established (iOS)**

The following causes can be considered.

**Paper Setup Auto Display is disabled.**

**Solutions**

Enable **Paper Setup Auto Display** in the following menu.

 > General Settings > Printer Settings > Paper Setup Auto Display

### **AirPrint is disabled.**

#### **Solutions**

Enable the AirPrint setting on Web Config.

➔ [“Application for Configuring Printer Operations \(Web Config\)” on page 204](#)

### **Suddenly the Printer Cannot Print over a Network Connection**

The problem could be one of the following issues.

### **The network environment has been changed.**

#### **Solutions**

When you have changed the network environment, such as the wireless router or provider, try making network settings for the printer again.

Connect the computer or smart device to the same SSID as the printer.

➔ [“Re-setting the Network Connection” on page 157](#)

### **Something is wrong with the network devices for Wi-Fi connection.**

#### **Solutions**

Turn off the devices you want to connect to the network. Wait for about 10 seconds, and then turn on the devices in the following order; wireless router, computer or smart device, and then printer. Move the printer and computer or smart device closer to the wireless router to help with radio wave communication, and then try to make network settings again.

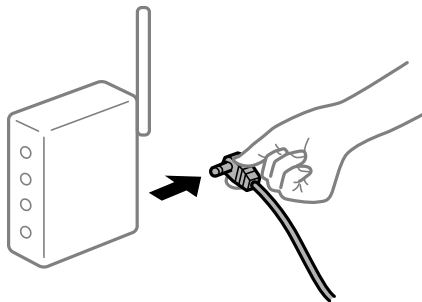

### **The printer is not connected to the network.**

#### **Solutions**

Select  > General Settings > Network Settings > Connection Check, and then print the network connection report. If the report shows that the network connection failed, check the network connection report and then follow the printed solutions.

➔ [“Printing a Network Connection Report” on page 174](#)



## ■ There is a problem with the network settings on the smart device.

### Solutions

Try accessing any website from your smart device to make sure that your smart device's network settings are correct. If you cannot access any website, there is a problem on the smart device.

Check the network connection of the computer. See the documentation provided with the smart device for details.

## Cannot Operate the Printer as Expected

### Operations are Slow

#### Printing Is Too Slow

The following causes can be considered.

## ■ Unnecessary applications are running.

### Solutions

Close any unnecessary applications on your computer or smart device.

## ■ The print quality is set to high.

### Solutions

Lower the quality setting.

## ■ Bidirectional printing is disabled.

### Solutions

Enable the bidirectional (or high speed) setting. When this setting is enabled, the print head prints while moving in both directions, and the printing speed increases.

#### Windows

Select **Quality Options** as the **Level** setting on the printer driver's **Main** tab, and then select **High Speed**.

#### Mac OS

Select **Print Settings** from the print dialog's pop-up menu, and then select **High Speed**.

## ■ There may be network connection problems with the wireless router.

### Solutions

Reboot the wireless router while taking into consideration other users connected to the network. If this does not solve the problem, place the printer closer to your wireless router or see the documentation provided with the access point.

### ■ The printer is printing high density data such as photos on plain paper.

#### Solutions

If you are printing high-density data such as photos on plain paper, printing may take some time to maintain print quality. This is not a malfunction.

## Printing Slows Down Dramatically During Continuous Printing

### ■ The function that prevents the printer mechanism from overheating and being damaged is operating.

#### Solutions

You can continue printing. To return to normal printing speed, leave the printer idle for at least 30 minutes. Printing speed does not return to normal if the power is off.

## LCD Screen Gets Dark

### ■ The printer is in sleep mode.

#### Solutions

Press the  button on the control panel to return the LCD screen to its former state.

## The Output Tray has Come Off

Insert the output tray straight into the printer. If the output tray stops halfway, insert and remove it several times.

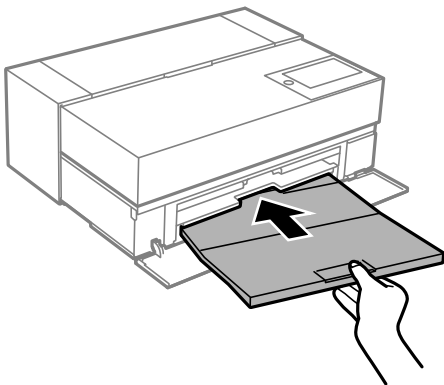

## The Root Certificate Needs to be Updated

### ■ The root certificate has expired.

#### Solutions

Run Web Config, and then update the root certificate.

## Cannot Cancel Printing from a Computer Running Mac OS X v10.6.8

### There is a problem with your AirPrint setup.

#### Solutions

Run Web Config, and then select **Port9100** as the **Top Priority Protocol** setting in **AirPrint Setup**. Select **System Preferences** from the Apple menu > **Printers & Scanners** (or **Print & Scan, Print & Fax**), remove the printer, and then add the printer again.

➔ [“Application for Configuring Printer Operations \(Web Config\)” on page 204](#)

## A Message is Displayed on the LCD Screen

If an error message is displayed on the LCD screen, follow the on-screen instructions or the solutions below to solve the problem.

Error Messages	Solutions
The combination of the IP address and the subnet mask is invalid. See your documentation for more details.	Enter the correct IP address or default gateway. Contact the person who setup the network for assistance.
Ink is low.	You can continue printing until you are prompted to replace the ink cartridges. However, note that the printer cannot print if any of the ink cartridges is expended. Prepare new cartridges as soon as possible.
Ink cartridge(s) are low. Print job may not print completely.	<p>Select <b>Continue printing</b> or <b>Replace before printing</b>.</p> <p>When you select <b>Continue printing</b>, the printer may stop printing indicating that it is time to replace the ink cartridge. In this case, follow the solutions below.</p> <ul style="list-style-type: none"> <li><input type="checkbox"/> When printing fails and paper is ejected                     <ul style="list-style-type: none"> <li>Select <b>No, cancel printing</b>, and then replace the cartridge. If you select <b>Replace now</b>, printing continues after you replace the cartridge and more paper is wasted.</li> </ul> </li> <li><input type="checkbox"/> When paper is not ejected                     <ul style="list-style-type: none"> <li>Select <b>Replace now</b>, and then replace the cartridge. Printing is resumed after you replace the cartridge, but the color may differ slightly. To avoid this, select <b>No, cancel printing</b>.</li> </ul> </li> </ul>
You need to replace Ink Cartridge(s).	<p>To ensure you receive premium print quality and to help protect your print head, a variable ink safety reserve remains in the cartridge when your printer indicates it is time to replace the cartridge. Replace the cartridge when you are prompted to do so.</p> <p><a href="#">“Replacing Ink Cartridge” on page 143</a></p>
To use cloud services, update the root certificate from the Epson Web Config utility.	<p>Run Web Config, and then update the root certificate.</p> <p><a href="#">“Running Web Config on a Web Browser” on page 204</a></p>
<p>The printer's Ink Pad is nearing the end of its service life. It is not a user-replaceable part. Please contact Epson support.</p> <p>If it reached the end, borderless printing becomes unavailable. Printing with border is available.</p>	<p>Contact Epson or an authorised Epson service provider to replace the ink pad. It is not a user-serviceable part.</p> <p>Tap <b>OK</b> to resume printing.</p> <p><a href="#">“Where to Get Help” on page 223</a></p>

Error Messages	Solutions
<p>The printer's Ink Pad has reached the end of its service life. It is not a user-replaceable part. Please contact Epson support.</p> <p>Cannot run borderless printing until the part is replaced. Printing with border is available.</p>	<p>Contact Epson or an authorised Epson service provider to replace the ink pad. It is not a user-serviceable part.</p> <p>You cannot perform borderless printing until the part is replaced. You can still print with borders. However, if you use it as it is, the printing speed on glossy paper may be reduced.</p>
<p>The ink pad has reached the end of its service life. It is not a user-replaceable part. Please contact Epson support. If you use it as is, printing speed on XX may slow down.</p>	<p><a href="#">"Where to Get Help" on page 223</a></p>
<p>Printer error. Turn the power off and on again. If the problem persists, contact Epson Support.</p>	<p>Do the following.</p> <ol style="list-style-type: none"> <li>1. Open the printer cover and remove any paper or protective material inside the printer. Insert the front paper feeder completely.</li> </ol> <p><a href="#">"Paper Gets Jammed" on page 140</a></p> <ol style="list-style-type: none"> <li>2. Close the printer cover and turn the power off and on again.</li> </ol> <p>If the error message is still displayed after turning the power off and on again, contact Epson support.</p> <p><a href="#">"Where to Get Help" on page 223</a></p>
<p>Paper Setup Auto Display is set to Off. Some features may not be available. For details, see your documentation.</p>	<p>If <b>Paper Setup Auto Display</b> is disabled, you cannot use AirPrint.</p>
<p>Recovery Mode Update Firmware</p>	<p>The printer has started in recovery mode because the firmware update failed. Follow the steps below to try to update the firmware again.</p> <ol style="list-style-type: none"> <li>1. Connect the computer and the printer with a USB cable. (During recovery mode, you cannot update the firmware over a network connection.)</li> <li>2. Visit your local Epson website for further instructions.</li> </ol>

## Paper Gets Jammed

Check the error displayed on the control panel and follow the instructions to remove the jammed paper including any torn pieces. Next, clear the error. The LCD screen displays an animation that shows you how to remove jammed paper.



**Caution:**

*Never touch the buttons on the control panel while your hand is inside the printer. If the printer starts operating, it could cause an injury. Be careful not to touch the protruding parts to avoid injury.*



**Important:**

*Remove the jammed paper carefully. Removing the paper vigorously may cause damage to the printer.*

**Note:**

*When removing jammed paper from the inside of the printer, pull out the front paper feeder so that you can easily remove the jammed paper.*

## Preventing Paper Jams

Check the following if paper jams occur frequently.

- Place the printer on a flat surface and operate in the recommended environmental conditions.  
“Environmental Specifications” on page 218
- Use the paper supported by this printer.  
“Available Paper and Capacities” on page 182
- Follow paper handling precautions.  
“Paper Handling Precautions” on page 26
- Load paper in the correct direction, and slide the edge guide against the edge of the paper.  
“Loading Paper” on page 26
- Do not load more than the maximum number of sheets specified for paper.
- Load one sheet of paper at a time if you have loaded several sheets of paper.
- Make sure the paper size and paper type settings match the actual paper size and paper type loaded in the printer.  
“List of Paper Types” on page 28
- Insert the front paper feeder completely while you are not using it. If it is not inserted completely, paper may get jammed when the printer feeds paper from the rear paper feeder.

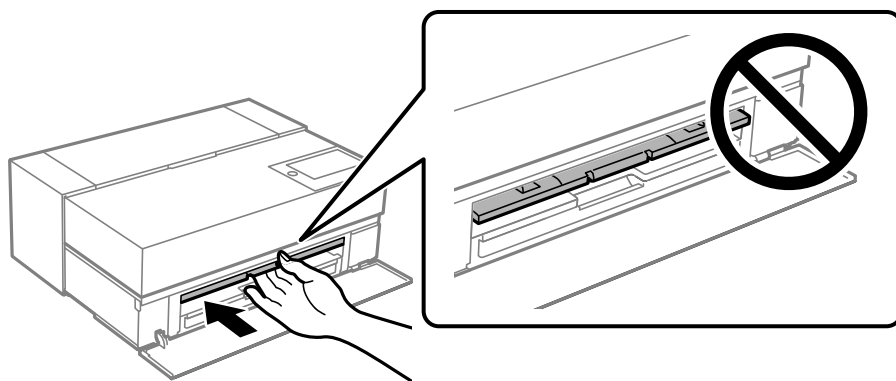

---

## It is Time to Replace the Ink Cartridges

### Ink Cartridge Handling Precautions

#### Storing precautions for ink

- Epson recommends storing ink cartridges in a cool and dark place.
- For best results, Epson recommends using up ink cartridges before the best before date printed on the package, or within six months of opening the package, whichever is earlier.
- After bringing an ink cartridge inside from a cold storage site, allow it to warm up at room temperature for at least three hours before using it.
- Do not open an ink cartridge package until you are ready to install the ink cartridge in the product.

- Do not drop or knock it against hard objects; otherwise, the ink may leak.

### **Handling precautions for replacing ink cartridges**

- Do not touch the IC chip in the ink cartridge. Otherwise, you may not be able to perform operations or print properly.
- Install all ink cartridges; otherwise you cannot print.
- Do not turn off the printer during ink charging. If the ink charging is incomplete, you may not be able to print.
- Removed ink cartridges may have ink around the ink supply port, so be careful not to get any ink on the surrounding area when removing the cartridges.
- This printer uses ink cartridges equipped with a green chip that monitors information such as the amount of remaining ink for each cartridge. This means that even if the cartridge is removed from the printer before it is expended, you can still use the cartridge after reinserting it back into the printer.
- To ensure you receive premium print quality and to help protect your print head, a variable ink safety reserve remains in the cartridge when your printer indicates to replace the cartridge. The yields quoted for you do not include this reserve.
- Do not disassemble or remodel the ink cartridge, otherwise you may not be able to print normally.
- Do not move the print head by hand; otherwise, the printer may be damaged.
- While cartridges are in storage, keep the ink supply ports free of dust. The ink supply port has a valve in it so it does not need to be capped.
- Do not allow foreign objects to fall into the cartridge installation section.
- When the printer is powered off with the  (power) button, the print head is automatically capped to prevent the ink from drying. Do not pull out the power plug or turn off the breaker while the power is on.
- If one of the installed ink cartridges is expended, printing cannot be performed.
- If an ink cartridge is expended while printing, you can continue printing after replacing the ink cartridge.
- If you continue to use ink cartridges that are running low, you may need to replace the ink cartridge while printing. If you replace the ink cartridge while printing, colors may look different depending on how the ink dries. If you want to avoid issues such as this, we recommend replacing the cartridge before printing.
- You can still use the removed ink cartridge in the future until the ink cartridge is expended.

### **Consumption of ink**

- All colors of ink are used during head cleaning and other non-printing maintenance operations to ensure that the print heads remain in good condition.
- Even for monochrome printing, all the ink colors are used in an operation designed to maintain the printing and print head quality.
- Depending on the paper type and print quality settings, colored inks may also be used for high-density blacks in monochrome or grayscale printing.
- The ink supplied with your printer is used during initial setup. In order to produce the highest quality prints, the printer needs to be and will be fully charged with ink. After setup is complete, the ink remaining in the cartridges, and the service life of the maintenance box will be limited. Even if ink levels are low, or the service life of the maintenance box is nearing an end, you can continue to print until the printer displays replacement instructions. However, we recommend being prepared with replacement ink cartridges and a maintenance box.
- Quoted yields may vary depending on the images that you are printing, the paper type that you are using, the frequency of your prints and environmental conditions such as temperature.

## Replacing Ink Cartridge

When a message is displayed prompting you to replace the ink cartridge, select **How To** and then view the animations displayed on the control panel to learn how to replace the ink cartridge.

### Related Information

- ➔ [“Ink Cartridge Codes for SC-P900 Series” on page 196](#)
- ➔ [“Ink Cartridge Codes for SC-P700 Series” on page 197](#)
- ➔ [“Ink Cartridge Handling Precautions” on page 141](#)

---

## It is Time to Replace the Maintenance Box

### Maintenance Box Handling Precautions

Read the following instructions before replacing the maintenance box.

- Do not touch the green chip on the side of the maintenance box. Doing so may prevent normal operation and printing.
- Do not replace the maintenance box during printing; otherwise, ink may leak.
- Do not remove the maintenance box or open its cover except when replacing the maintenance box; otherwise ink may leak.
- Do not reuse a maintenance box which has been removed and left detached for a long period. Ink inside the box will have solidified and no more ink can be absorbed.
- Do not tilt the used maintenance box until after it is sealed in the plastic bag; otherwise ink may leak.
- Do not store the maintenance box in high or freezing temperatures.
- Keep the maintenance box out of direct sunlight.
- Do not drop the maintenance box or subject it to strong shocks.
- Do not touch the openings in the maintenance box as you may get smeared with ink.

### Replacing a Maintenance Box

In some print cycles a very small amount of surplus ink may be collected in the maintenance box. To prevent ink leakage from the maintenance box, the printer is designed to stop printing when the absorbing capacity of the maintenance box has reached its limit. Whether and how often this is required will vary according to the number of pages you print, the type of material that you print and the number of cleaning cycles that the printer performs.

When a message is displayed prompting you to replace the maintenance box, refer to the animations displayed on the control panel. The need for replacement of the box does not mean that your printer has ceased to operate in

accordance with its specifications. The Epson warranty does not cover the cost of this replacement. It is a user-serviceable part.

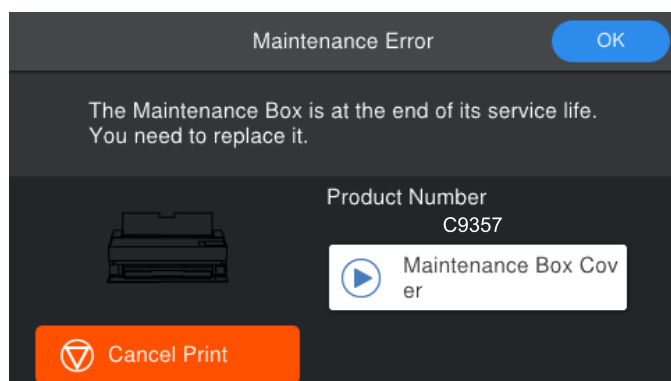

**Note:**

- ❑ When it is full, you cannot print and clean the print head until the maintenance box is replaced to avoid ink leakage.
- ❑ When the following screen is displayed, the part cannot be replaced by users. Contact Epson support. You cannot perform borderless printing until the part is replaced. You can still print with borders. However, if you use it as it is, the printing speed on glossy paper may be reduced.

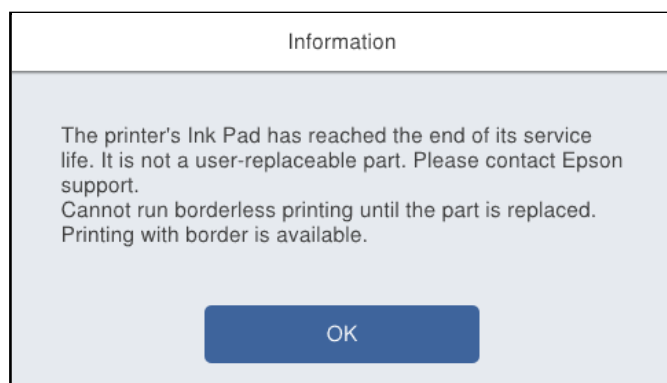

**Related Information**

- ➔ ["Maintenance Box Code" on page 199](#)
- ➔ ["Maintenance Box Handling Precautions" on page 143](#)

---

## Print Quality is Poor

### Color Missing, Banding, or Unexpected Colors Appear in Printout





## ■ The print head nozzles may be clogged.

### Solutions

Perform a nozzle check to see if the print head nozzles are clogged. Perform a nozzle check, and then clean the print head if any of the print head nozzles are clogged. If you have not used the printer for a long time, the print head nozzles may be clogged and ink drops may not be discharged.

➔ [“Checking and Cleaning the Print Head” on page 101](#)

## ■ Printing is paused.

### Solutions

Do not open the printer cover or the front paper feeder during printing. If you open the printer cover or the front paper feeder during printing, printing is paused and it may cause unexpected colors in the printout.

## Blurry Prints, Vertical Banding, or Misalignment



enthalten alle  
Aufdruck. W  
↓ 5008 "Regel

The following causes can be considered.

## ■ The print head position is out of alignment.

### Solutions

On the printer's control panel, select  > **Maintenance** > **Print Head Alignment** to align the print head.

## ■ The bidirectional printing setting is enabled.

### Solutions

If print quality does not improve even after aligning the print head, disable the bidirectional setting.

During bidirectional (or high speed) printing, the print head prints while moving in both directions, and vertical lines may be misaligned. Disabling this setting may slow down printing speed but improve print quality.

#### Windows

Select **Quality Options** as the **Level** setting on the printer driver's **Main** tab, and then clear **High Speed**.

#### Mac OS

Select **Print Settings** from the print dialog's pop-up menu, and then clear **High Speed**.

## Printout Comes Out as a Blank Sheet

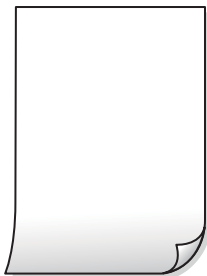

### ■ The print settings and the paper size loaded in the printer are different.

#### Solutions

Change the print settings according to the paper size loaded in the printer. Load paper in the printer that matches the print settings.

### ■ Multiple sheets of paper are fed into the printer at the same time.

#### Solutions

See the following to prevent multiple sheets of paper being fed into the printer at the same time.

➔ [“Several Sheets of Paper are Fed at a Time” on page 118](#)

### ■ The print head nozzles may be clogged.

#### Solutions

Perform the nozzle check, and then run the head cleaning or Power Cleaning if the print head nozzles are clogged.

➔ [“Checking and Cleaning the Print Head” on page 101](#)

## Paper Is Smearred or Scuffed



The following causes can be considered.

### ■ Paper is loaded incorrectly.

#### Solutions

When horizontal banding (perpendicular to the printing direction) appears, or the top or bottom of the paper is smeared, load paper in the correct direction and slide the edge guides to the edges of the paper.

➔ [“Loading Paper” on page 26](#)

### ■ The paper path is smeared.

#### Solutions

When vertical banding (horizontal to the printing direction) appears, or the paper is smeared, clean the paper path.

➔ [“Cleaning the Paper Path for Ink Smears” on page 106](#)

### ■ The paper is curled.

#### Solutions

Place the paper on a flat surface to check if it is curled. If it is, flatten it.

### ■ The print head is rubbing the surface of the paper.

#### Solutions

When printing on thick paper, the print head is close to the printing surface and the paper may be scuffed. In this case, enable the reduce scuff setting.

On the printer's control panel, select  > **General Settings** > **Printer Settings**, and then enable **Thick Paper**.

If the edge of the paper is folded or curled, it may be scuffed by the print head. Flatten the paper if necessary.

### ■ The back of the paper was printed before the side that had already been printed was dry.

#### Solutions

When performing manual 2-sided printing, make sure that the ink is completely dry before reloading the paper.

## Printed Photos are Sticky



### ■ The print was made on the wrong side of the photo paper.

#### Solutions

Make sure you are printing on the printable side. When printing on the wrong side of the photo paper, you need to clean the paper path.

➔ [“Cleaning the Paper Path for Ink Smears” on page 106](#)

## Images or Photos are Printed in Unexpected Colors



The following causes can be considered.

### ■ The print head nozzles may be clogged.

#### Solutions

Perform a nozzle check to see if the print head nozzles are clogged. Perform a nozzle check, and then clean the print head if any of the print head nozzles are clogged. If you have not used the printer for a long time, the print head nozzles may be clogged and ink drops may not be discharged.

➔ [“Checking and Cleaning the Print Head” on page 101](#)

### ■ Color correction has been applied.

#### Solutions

When printing from the Windows printer driver, the Epson auto photo adjustment setting (PhotoEnhance) is applied by default depending on the paper type. Try change the setting.

On the Windows printer driver's **Main** tab, select **Advanced** in **Mode**. Change the **Scene Correction** setting from **Auto Correct** to any other option. If changing the setting does not work, use any color correction method other than **PhotoEnhance** in **Mode**.

➔ [“Adjusting the Print Color” on page 85](#)

## Colors in the Printout Differ from Those on the Display



### ■ The color properties for the display device you are using have not been adjusted correctly.

#### Solutions

Display devices such as computer screens have their own display properties. If the display is unbalanced, the image are not displayed with proper brightness and colors. Adjust the properties of the device. Next, perform the following.

Windows

Select **EPSON Standard (sRGB)** as the **Mode** setting on the printer driver's **Main** tab.

Mac OS

Select **EPSON Standard (sRGB)** as the **Color Settings** setting from the print dialog's **Print Settings** menu.

■ **The display device is reflecting external light.**

**Solutions**

Avoid direct sunlight and confirm the image where an appropriate illuminance is assured.

■ **The display device has a high resolution.**

**Solutions**

Colors may differ from what you see on smart devices such as smart phones or tablets with high-resolution displays.

■ **The display device and the printer have a different process of producing colors.**

**Solutions**

Colors on a display are not quite identical to those on paper because the display device and the printer have a different process of producing colors. Adjust the color properties so that the colors are identical.

## Cannot Print Without Margins



■ **Borderless is not set in the print settings.**

**Solutions**

Make borderless setting in the print settings. If you select a paper type that does not support borderless printing, you cannot select **Borderless**. Select a paper type that supports borderless printing.

Windows

Select **Borderless** on the printer driver's **Main** tab.

Mac OS

Select a borderless paper size from **Paper Size**.

➔ [“Available Paper and Capacities” on page 182](#)

## Edges of the Image are Cropped During Borderless Printing



■ **Because the image is slightly enlarged, the protruding area is cropped.**

### Solutions

Select a smaller enlargement setting.

Windows

Click **Expansion** next to the **Borderless** checkbox on the printer driver's **Main** tab, and then change the settings.

Mac OS

Change the **Expansion** setting from the print dialog's **Page Layout Settings** menu.

## The Position, Size, or Margins of the Printout Are Incorrect



The following causes can be considered.

■ **The paper is loaded incorrectly.**

### Solutions

Load paper in the correct direction, and slide the edge guide against the edge of the paper.

➔ [“Loading Paper” on page 26](#)

■ **The size of the paper is set incorrectly.**

### Solutions

Select the appropriate paper size setting.

■ **The margin setting in the application software is not within the print area.**

### Solutions

Adjust the margin setting in the application so that it falls within the printable area.

➔ [“Printable Area” on page 212](#)



## Mosaic-Like Patterns in the Prints



### ■ Images or photos with a low resolution were printed.

#### Solutions

When printing images or photos, print using high-resolution data. Images on web sites are often low resolution although they look good enough on the display, and so print quality may decline.

## Vertical lines Appear on Roll Paper



### ■ Rollers on the roll paper unit are smeared.

#### Solutions

If you are printing on glossy roll paper with the SC-P900 Series printer and uneven vertical lines appear, remove the paper from the roll paper unit, and clean the rollers using a dry, soft, clean cloth. Rotate the rollers as you wipe them to clean the entire surface.

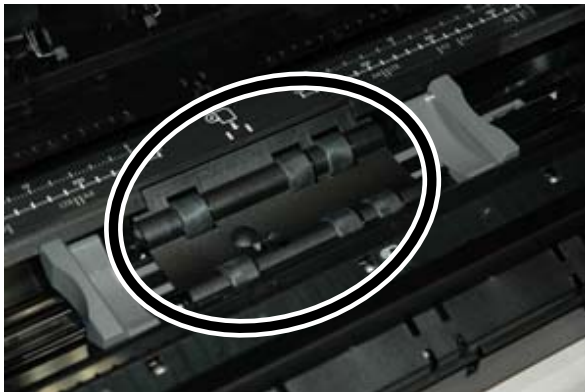

## White Dots Appear in Printouts





### ■ There is dust or other debris on the paper.

#### Solutions

Remove the dust or debris from the surface of your paper before loading it.

### The Top Edge of the Paper is Scratched

### ■ If multiple sheets of paper are loaded, they may scratch each other.

#### Solutions

Load one sheet of paper at a time.

---

## Cannot Solve Problem

If you cannot solve the problem after trying all of the solutions, contact Epson support.

If you cannot solve printing problems, see the following related information.

#### Related Information

➔ [“Cannot Solve Printing Problems” on page 153](#)

## Cannot Solve Printing Problems

Try the following problems in order starting at the top until you solve the problem.

- Make sure you match the paper type loaded in the printer and the paper type set on the printer to the paper type settings in the printer driver.  
[“Paper Size and Type Settings” on page 27](#)
- Use a higher quality setting on the control panel or the printer driver.
- Reinstall the ink cartridges already installed in the printer.  
Reinstalling the ink cartridges may clear clogging in the print head nozzles and allow the ink to flow smoothly. However, because the ink is consumed when the ink cartridge is reinstalled, a message asking you to replace the ink cartridge may be displayed depending on the amount of ink remaining.  
[“It is Time to Replace the Ink Cartridges” on page 141](#)
- Align the print head.  
[“Aligning the Print Head” on page 105](#)
- Run a nozzle check to see if the print head nozzles are clogged.  
If there are missing segments in the nozzle check pattern, the nozzles may be clogged. Repeat head cleaning and the nozzle check alternately 3 times and check if the clogging has cleared.  
Note that print head cleaning uses some ink.  
[“Checking and Cleaning the Print Head” on page 101](#)
- Turn off the printer, wait for at least 6 hours, and then check if the clogging has cleared.  
If the problem is clogging, leaving the printer for a while without printing may solve the problem.  
You can check the following items while the printer is off.

- ❑ Check that you are using genuine Epson ink cartridges.

Try to use genuine Epson ink cartridges. This product is designed to adjust colors based on the use of genuine Epson ink cartridges. The use of non-genuine ink cartridges may cause print quality to decline.

[“Consumable Products Information” on page 196](#)

- ❑ Make sure that there are no paper fragments left inside the printer.

When you remove the paper, do not touch the translucent film with your hand or the paper.

- ❑ Check the paper.

Check if the paper is curled or loaded with the printable side facing up.

[“Paper Handling Precautions” on page 26](#)

[“Available Paper and Capacities” on page 182](#)

[“Unavailable Paper Types” on page 191](#)

- ❑ Make sure that you are not using an old ink cartridge.

For best results, Epson recommends using up ink cartridges before the best before date printed on the package, or within six months of opening the package, whichever is earlier.

- ❑ If you turn off the printer, wait for at least 6 hours, and if print quality has still not improved, run Power Cleaning.

[“Running Power Cleaning” on page 103](#)

If you cannot solve the problem by checking the solutions above, you may need to request repairs. Contact Epson support.

#### **Related Information**

- ➔ [“Before Contacting Epson” on page 224](#)
- ➔ [“Contacting Epson Support” on page 224](#)

---

# Adding or Replacing the Computer or Devices

Connecting to a Printer that has been Connected to the Network. . . . .	156
Re-setting the Network Connection. . . . .	157
Connecting a Smart Device and Printer Directly (Wi-Fi Direct). . . . .	164
Checking the Network Connection Status. . . . .	173

## Connecting to a Printer that has been Connected to the Network

When the printer has already been connected to the network, you can connect a computer or a smart device to the printer over the network.

### Using a Network Printer from a Second Computer

We recommend using the installer to connect the printer to a computer. You can run the installer using one of the following methods.

- Setting up from the website

Access the following website, and then enter the product name. Go to **Setup**, and then start setting up.

<http://epson.sn>

- Setting up using the software disc (only for the models that come with a software disc and users with Windows computers with disc drives.)

Insert the software disc into the computer, and then follow the on-screen instructions.

### Selecting the Printer

Follow the on-screen instructions until the following screen is displayed, select the printer name you want to connect to, and then click **Next**.

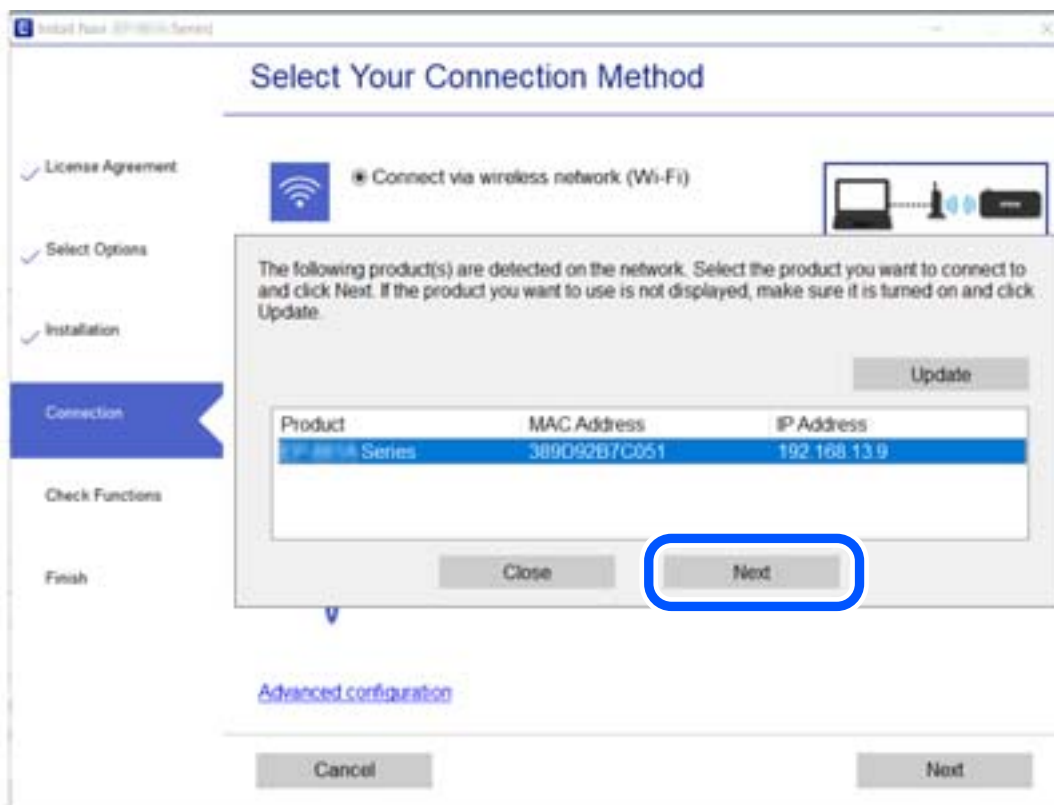

Follow the on-screen instructions.

## Using a Network Printer from a Smart Device

You can connect a smart device to the printer using one of the following methods.

### Connecting over a wireless router

Connect the smart device to the same Wi-Fi network (SSID) as the printer.

See the following for more details.

[“Making Settings for Connecting to the Smart Device” on page 158](#)

### Connecting by Wi-Fi Direct

Connect the smart device to the printer directly without a wireless router.

See the following for more details.

[“Connecting a Smart Device and Printer Directly \(Wi-Fi Direct\)” on page 164](#)

---

## Re-setting the Network Connection

This section explains how to make the network connection settings and change the connection method when replacing the wireless router or the computer.

### When Replacing the Wireless Router

When you replace the wireless router, make settings for the connection between the computer or the smart device and the printer.

You need to make these settings if you change your Internet service provider and so on.

### Making Settings for Connecting to the Computer

We recommend using the installer to connect the printer to a computer. You can run the installer using one of the following methods.

- Setting up from the website

Access the following website, and then enter the product name. Go to **Setup**, and then start setting up.

<http://epson.sn>

- Setting up using the software disc (only for the models that come with a software disc and users with Windows computers with disc drives.)

Insert the software disc into the computer, and then follow the on-screen instructions.

### Selecting the Connection Methods

Follow the on-screen instructions until the following screen is displayed.

Select **Change connection method for printer (for new network router or changing USB to network, etc.)** on the Select Your Operation screen, and then click **Next**.

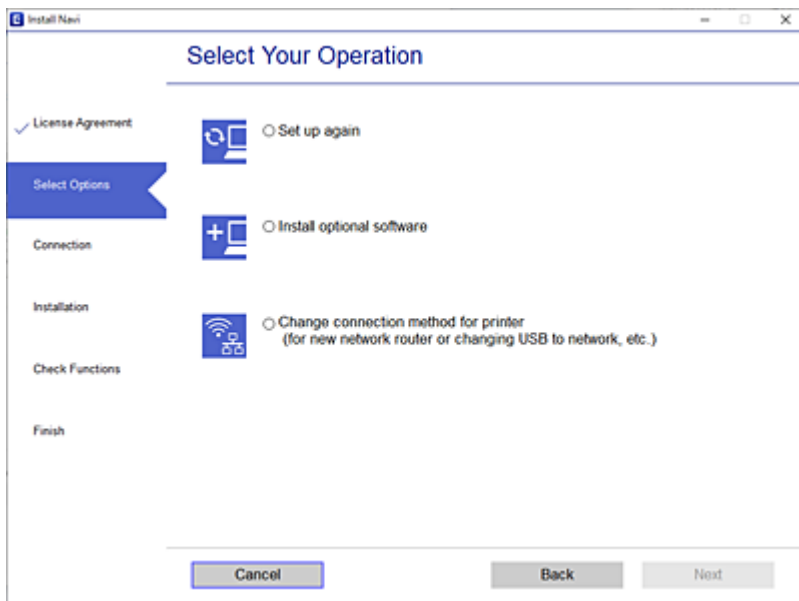

Follow the on-screen instructions.

If you cannot connect, see the following to try to solve the problem.

- Windows: [“Cannot connect to a Network” on page 121](#)
- Mac OS: [“Cannot connect to a Network” on page 128](#)

## Making Settings for Connecting to the Smart Device

You can use the printer from a smart device when you connect the printer to the same Wi-Fi network (SSID) as the smart device. To use the printer from a smart device, set up from the following website. Access to the website from the smart device that you want to connect to the printer.

<http://epson.sn> > Setup

## When Changing the Computer

When changing the computer, make connection settings between the computer and the printer.

## Making Settings for Connecting to the Computer

We recommend using the installer to connect the printer to a computer. You can run the installer using one of the following methods.

- Setting up from the website  
Access the following website, and then enter the product name. Go to **Setup**, and then start setting up.  
<http://epson.sn>

- Setting up using the software disc (only for the models that come with a software disc and users with Windows computers with disc drives.)

Insert the software disc into the computer, and then follow the on-screen instructions.

Follow the on-screen instructions.

## Changing the Connection Method to the Computer

This section explains how to change the connection method when the computer and the printer have been connected.

### Changing the Network Connection from Ethernet to Wi-Fi

Change the Ethernet connection to Wi-Fi connection from the printer's control panel. The changing connection method is basically the same as the Wi-Fi connection settings.

#### Related Information

➔ [“Making Wi-Fi Settings from the Control Panel” on page 161](#)

### Changing the Network Connection from Wi-Fi to Ethernet

Follow the steps below to change from a Wi-Fi connection to an Ethernet connection.

1. Tap  on the printer's control panel.
2. Tap **General Settings** > **Network Settings** > **Wired LAN Setup**.
3. Tap **Start Setup**.
4. Check the message, and then tap **OK**.
5. Connect the printer to the router with an Ethernet cable.

### Changing from USB to a Network Connection

Using the installer and re-set up in a different connection method.

- Setting up from the website

Access the following website, and then enter the product name. Go to **Setup**, and then start setting up.

<http://epson.sn>

- Setting up using the software disc (only for the models that come with a software disc and users with Windows computers with disc drives.)

Insert the software disc into the computer, and then follow the on-screen instructions.

#### Selecting Change the Connection Methods

Follow the on-screen instructions until the following screen is displayed.

Select **Change connection method for printer (for new network router or changing USB to network, etc.)** on the Select Your Operation screen, and then click **Next**.

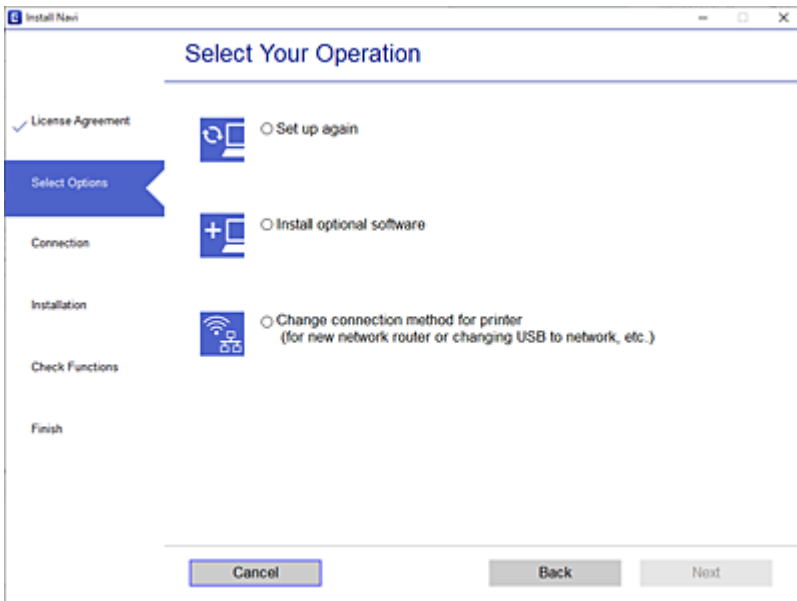

Select the network connection that you want to use, **Connect via wireless network (Wi-Fi)** or **Connect via wired LAN (Ethernet)**, and then click **Next**.

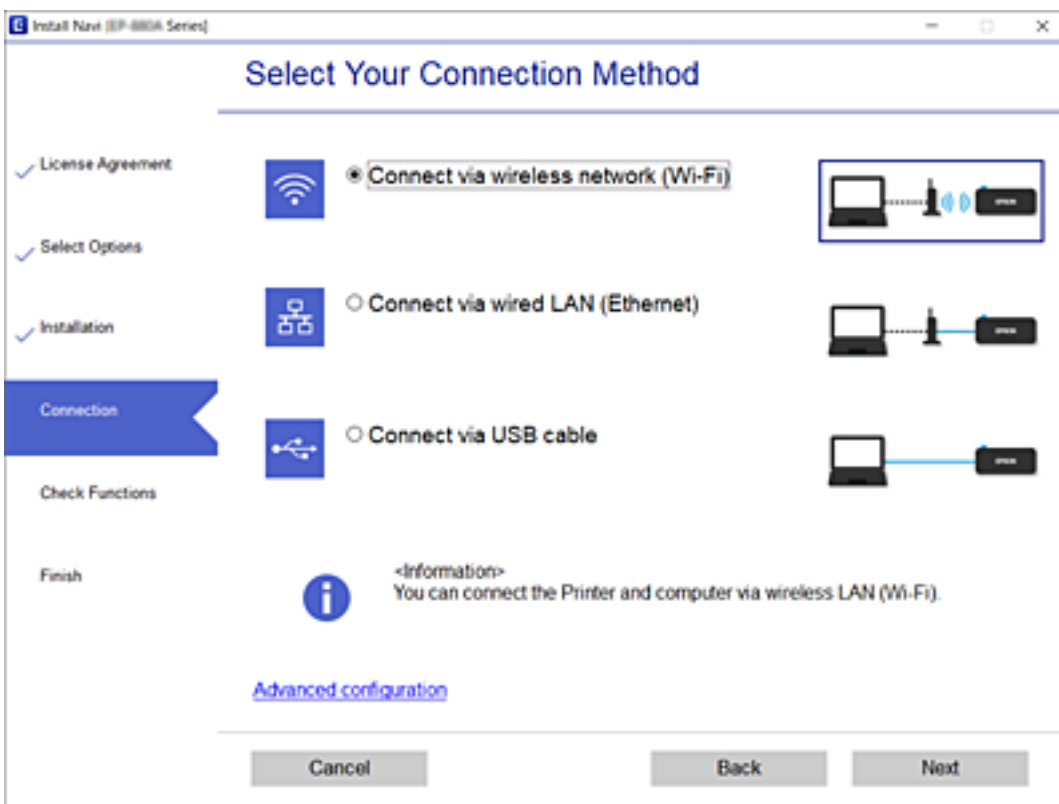

Follow the on-screen instructions.



## Making Wi-Fi Settings from the Control Panel

You can make network settings from the printer's control panel in several ways. Choose the connection method that matches the environment and conditions that you are using.

If you know the information for the wireless router such as SSID and password, you can make settings manually.

If the wireless router supports WPS, you can make settings by using push button setup.

After connecting the printer to the network, connect to the printer from the device that you want to use (computer, smart device, tablet, and so on.)

## Making Wi-Fi Settings by Entering the SSID and Password

You can set up a Wi-Fi network by entering the information necessary to connect to a wireless router from the printer's control panel. To set up using this method, you need the SSID and password for a wireless router.

**Note:**

*If you are using a wireless router with its default settings, the SSID and password are on the label. If you do not know the SSID and password, see the documentation provided with the wireless router.*

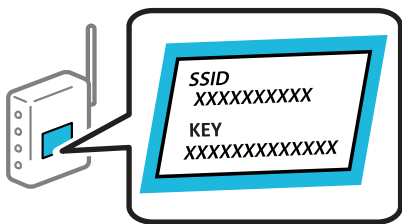

1. Tap  on the home screen.

2. Tap **Wi-Fi (Recommended)**.

If the printer has already been connected by Ethernet, tap **Router**.

3. Tap **Start Setup**.

If the network connection is already set up, the connection details are displayed. Tap **Change Settings** to change the settings.

If the printer has already been connected by Ethernet, tap **Change to Wi-Fi connection.**, and then tap **Yes** after confirming the message.

4. Tap **Wi-Fi Setup Wizard**.

5. Select the SSID for the wireless router.

**Note:**

*If the SSID you want to connect to is not displayed on the printer's control panel, tap **Search Again** to update the list. If it is still not displayed, tap **Enter Manually**, and then enter the SSID directly.*

*If you do not know the network name (SSID) check if the information is written on the label of the wireless router. If you are using the wireless router with its default settings, use the SSID on the label. If you cannot find any information, see the documentation provided with the wireless router.*

6. Tap the **Enter Password** field, and then enter the password.

**Note:**

*The password is case-sensitive.*

*If you do not know the password, check if the information is written on the label of the wireless router. On the label, the password may be written "Network Key", "Wireless Password", and so on. If you are using the wireless router with its default settings, use the password written on the label.*

7. When you have setup finished, tap **Start Setup**.

8. Tap **Close**.

The screen automatically closes after a specific length of time if you do not tap **Close**.

**Note:**

*If you fail to connect, load A4 size plain paper, and then tap **Print Check Report** to print a connection report.*

9. Tap **Close** on the network connection settings screen.

### Related Information

➔ ["Entering Characters" on page 24](#)

➔ ["Checking the Network Connection Status" on page 173](#)

## Making Wi-Fi Settings by Push Button Setup (WPS)

You can automatically set up a Wi-Fi network by pressing a button on the wireless router. If the following conditions are met, you can set up by using this method.

- The wireless router is compatible with WPS (Wi-Fi Protected Setup).
- The current Wi-Fi connection was established by pressing a button on the wireless router.

1. Tap  on the home screen.

2. Tap **Wi-Fi (Recommended)**.

If the printer has been already connected by Ethernet, tap **Router**.

3. Tap **Start Setup**.

If the network connection is already set up, the connection details are displayed. Tap **Change Settings** to change the settings.

If the printer has been already connected by Ethernet, tap **Change to Wi-Fi connection.**, and then tap **Yes** after confirming the message.

4. Tap **Push Button Setup(WPS)**.

5. Hold down the [WPS] button on the wireless router until the security light flashes.

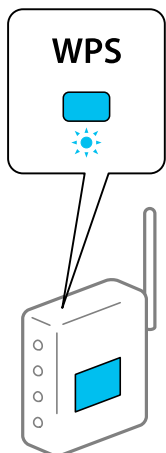

If you do not know where the [WPS] button is, or there are no buttons on the wireless router, see the documentation provided with your wireless router for details.

6. Tap **Start Setup**.

7. Tap **Close**.

The screen automatically closes after a specific length of time if you do not tap **Close**.

**Note:**

*If connection fails, restart the wireless router, move it closer to the printer, and try again. If it still does not work, print a network connection report and check the solution.*

8. Tap **Close** on the network connection settings screen.

**Related Information**

➔ [“Checking the Network Connection Status” on page 173](#)

## **Making Wi-Fi Settings by PIN Code Setup (WPS)**

You can automatically connect to an wireless router by using a PIN code. You can use this method to set up if an wireless router is capable of WPS (Wi-Fi Protected Setup). Use a computer to enter a PIN code into the wireless router.

1. Tap  on the home screen.

2. Tap **Wi-Fi (Recommended)**.

If the printer has been already connected by Ethernet, tap **Router**.

3. Tap **Start Setup**.

If the network connection is already set up, the connection details are displayed. Tap **Change Settings** to change the settings.

If the printer has been already connected by Ethernet, tap **Change to Wi-Fi connection.**, and then tap **Yes** after confirming the message.

4. Tap **Others** > **PIN Code Setup(WPS)**.
5. Use your computer to enter the PIN code (an eight digit number) displayed on the printer's control panel into the wireless router within two minutes.

**Note:**

See the documentation provided with your wireless router for details on entering a PIN code.

6. Tap **Start Setup** on the printer's control panel.
7. Tap **Close**.

The screen automatically closes after a specific length of time if you do not tap **Close**.

**Note:**

If connection fails, restart the wireless router, move it closer to the printer, and try again. If it still does not work, print a connection report and check the solution.

8. Tap **Close** on the network connection settings screen.

### Related Information

➔ [“Checking the Network Connection Status” on page 173](#)

---

## Connecting a Smart Device and Printer Directly (Wi-Fi Direct)

Wi-Fi Direct (Simple AP) allows you to connect a smart device directly to the printer without a wireless router and print from the smart device.

### About Wi-Fi Direct

Use this connection method when you are not using Wi-Fi at home or at the office, or when you want to connect the printer and the computer or smart device directly. In this mode, the printer acts as an wireless router and you can connect the devices to the printer without having to use a standard wireless router. However, devices directly connected to the printer cannot communicate with each other through the printer.

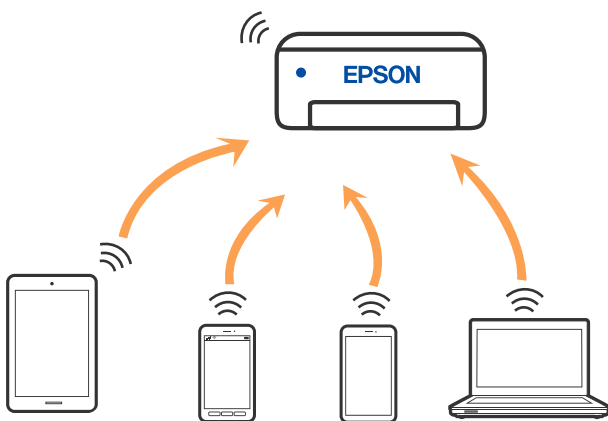

The printer can be connected by Wi-Fi or Ethernet, and Wi-Fi Direct (Simple AP) connection simultaneously. However, if you start a network connection in Wi-Fi Direct (Simple AP) connection when the printer is connected by Wi-Fi, the Wi-Fi is temporarily disconnected.

### Connecting to an iPhone, iPad or iPod touch using Wi-Fi Direct

This method allows you to connect the printer directly to an iPhone, iPad or iPod touch without a wireless router. The following conditions are required to use this function. If your environment does not match these conditions, you can connect by selecting **Other OS Devices**. See the related information link below for details on connecting.

- iOS 11 or later
- Using the standard camera application to scan the QR code
- Epson Smart Panel version 1.0 or later

Epson printing app, such as Epson Smart Panel, is used to print from a smart device. Install Epson printing app on the smart device in advance.

**Note:**

*You only need to make these settings for the printer and the smart device that you want to connect to once. Unless you disable Wi-Fi Direct or restore the network settings to their defaults, you do not need to make these settings again.*

1. Tap  on the home screen.
2. Tap **Wi-Fi Direct**.
3. Tap **Start Setup**.
4. Tap **iOS**.

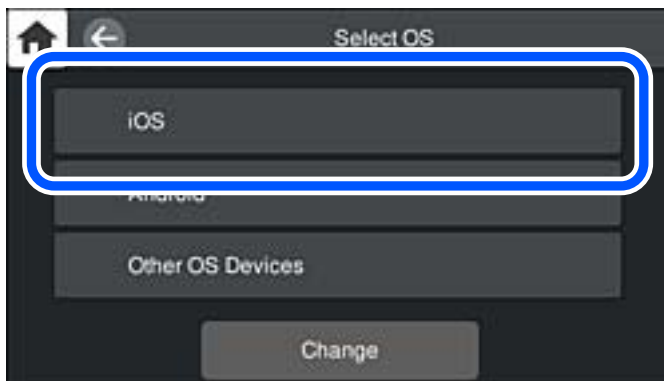

The QR code is displayed on the printer's control panel.

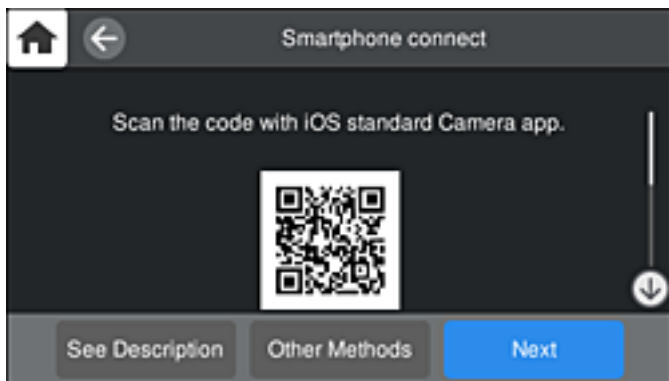

5. On your iPhone, iPad or iPod touch, start the standard Camera app, and then scan the QR code displayed on the printer's control panel in PHOTO mode.

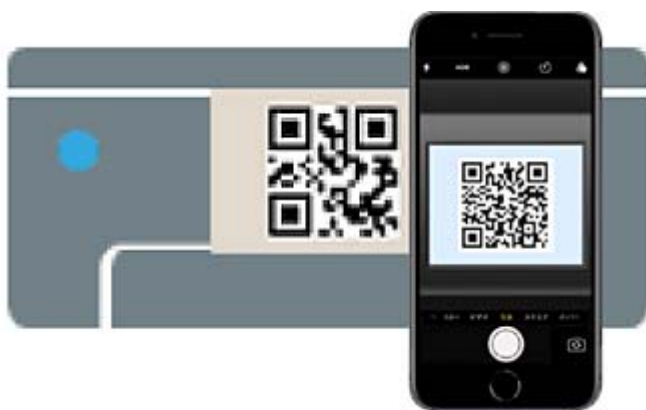

Use the Camera app for iOS 11 or later. You cannot connect to the printer using the Camera app for iOS 10 or earlier. Also, you cannot connect using an app for scanning QR codes. If you cannot connect, select **Other Methods** on the printer's control panel. See the related information link below for details on connecting.

6. Tap the notification displayed on the screen of the iPhone, iPad or iPod touch.

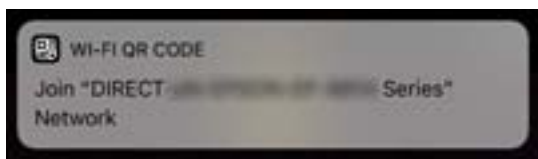

7. Tap **Join**.

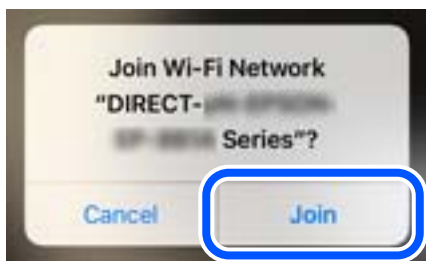

8. On the printer's control panel, select **Next**.
9. On the iPhone, iPad or iPod touch, start Epson printing app.

Examples of Epson printing apps



Epson Smart  
Panel

10. On the Epson printing app screen, tap **Printer is not selected..**  
On the Epson Smart Panel, the smart device automatically connects to the printer when it starts.
11. Select the printer that you want to connect to.  
See the information displayed on the printer's control panel to select the printer.

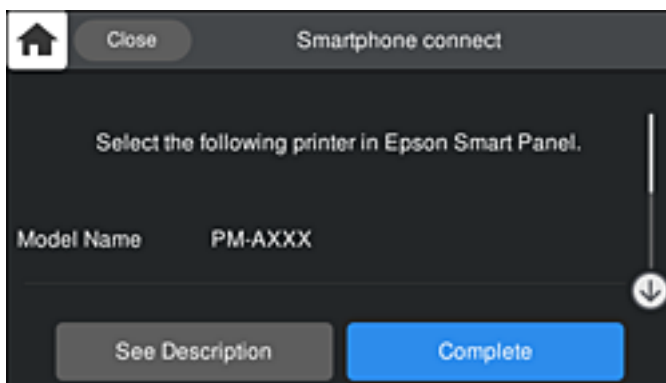

12. On the printer's control panel, select **Complete**.  
For smart devices that have been connected to the printer before, select the network name (SSID) on the smart device's Wi-Fi screen to connect them again.

#### Related Information

- ➔ [“Application for Easily Operating the Printer from a Smart device \(Epson Smart Panel\)” on page 202](#)
- ➔ [“Connecting to Devices other than iOS and Android using Wi-Fi Direct” on page 169](#)

## Connecting to Android Devices using Wi-Fi Direct

This method allows you to connect the printer directly to your Android device without a wireless router. The following conditions are required to use this function.

- Android 4.4 or later
- Epson Smart Panel version 1.0 or later

Epson Smart Panel is used to print from a smart device. Install Epson Smart Panel on the smart device in advance.

**Note:**

*You only need to make these settings for the printer and the smart device that you want to connect to once. Unless you disable Wi-Fi Direct or restore the network settings to their defaults, you do not need to make these settings again.*

1. Tap  on the home screen.
2. Tap **Wi-Fi Direct**.
3. Tap **Start Setup**.
4. Tap **Android**.

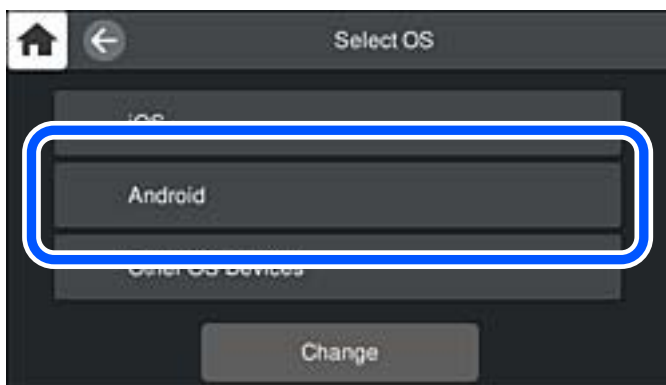

5. On the smart device, start Epson printing app.  
Examples of Epson printing apps



Epson Smart  
Panel

6. On the Epson printing app screen, tap **Printer is not selected..**  
On the Epson Smart Panel, the smart device automatically connects to the printer when it starts.



7. Select the printer that you want to connect to.  
See the information displayed on the printer's control panel to select the printer.

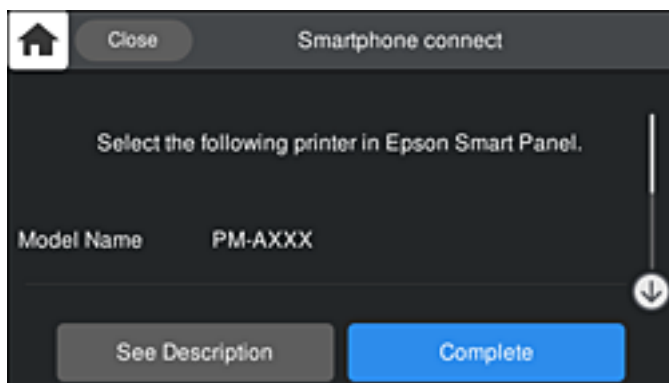

**Note:**

Printers may not be displayed depending on the Android device. If printers are not displayed, connect by selecting **Other OS Devices**. See the related information link below for connecting.

8. When the device connection approval screen is displayed, select **Approve**.
9. On the printer's control panel, select **Complete**.

For smart devices that have been connected to the printer before, select the network name (SSID) on the smart device's Wi-Fi screen to connect them again.

**Related Information**

- ➔ [“Application for Easily Operating the Printer from a Smart device \(Epson Smart Panel\)” on page 202](#)
- ➔ [“Connecting to Devices other than iOS and Android using Wi-Fi Direct” on page 169](#)

## Connecting to Devices other than iOS and Android using Wi-Fi Direct

This method allows you to connect the printer directly to smart devices without a wireless router.

**Note:**

You only need to make these settings for the printer and the smart device that you want to connect to once. Unless you disable Wi-Fi Direct or restore the network settings to their defaults, you do not need to make these settings again.

1. Tap  on the home screen.
2. Tap **Wi-Fi Direct**.
3. Tap **Start Setup**.

4. Tap **Other OS Devices**.

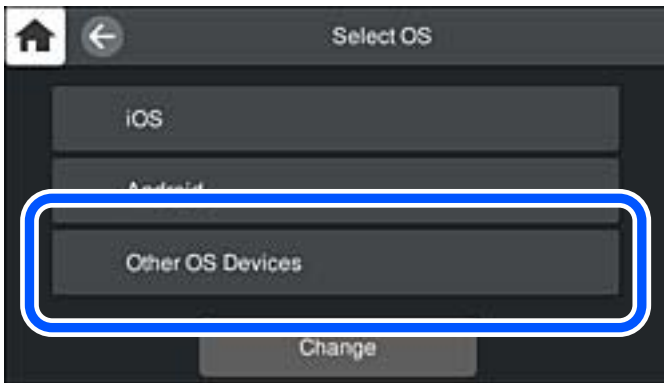

The Network Name (SSID) and Password for Wi-Fi Direct for the printer are displayed.

5. On the smart device's Wi-Fi screen, select the SSID shown on the printer's control panel, and then enter the password.

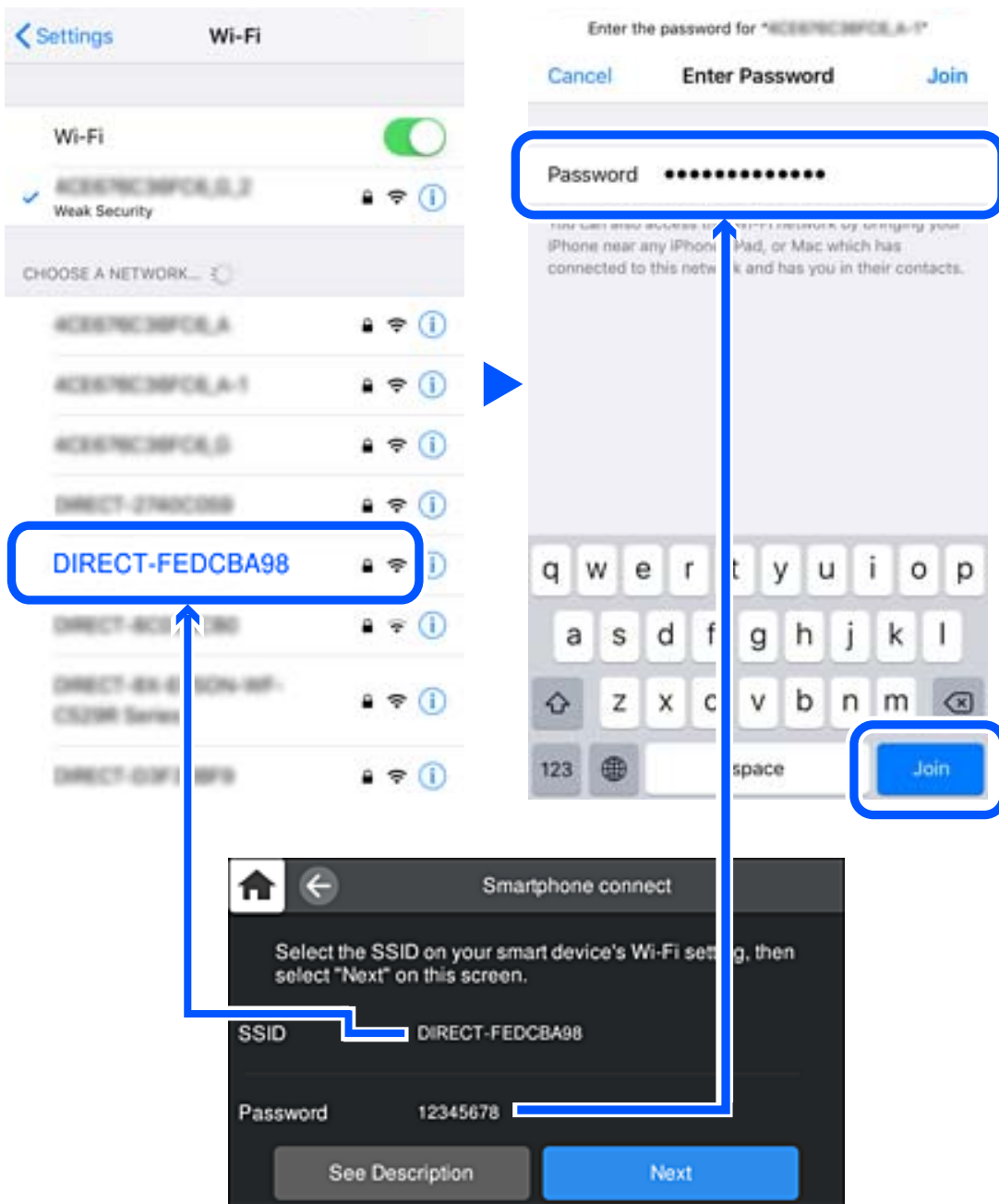

6. On the printer's control panel, select **Next**.

7. On the printing app screen for the smart device, select the printer that you want to connect to.  
See the information displayed on the printer's control panel to select the printer.

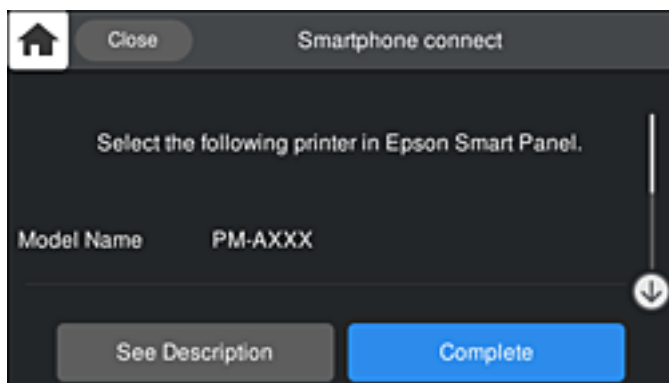

8. On the printer's control panel, select **Complete**.

For smart devices that have been connected to the printer before, select the network name (SSID) on the smart device's Wi-Fi screen to connect them again.

## Disconnecting Wi-Fi Direct (Simple AP) Connection

There are two methods available to disable a Wi-Fi Direct (Simple AP) connection; you can disable all connections by using the printer's control panel, or disable each connection from the computer or the smart device. When you want to disable all connections, see the related information link below for details.

**Important:**

*When Wi-Fi Direct (Simple AP) connection disabled, all computers and smart devices connected to the printer in Wi-Fi Direct (Simple AP) connection are disconnected.*

**Note:**

*If you want to disconnect a specific device, disconnect from the device instead of the printer. Use one of the following methods to disconnect the Wi-Fi Direct (Simple AP) connection from the device.*

- Disconnect the Wi-Fi connection to the printer's network name (SSID).
- Connect to another network name (SSID).

### Related Information

➔ [“Changing the Wi-Fi Direct \(Simple AP\) Settings Such as the SSID” on page 172](#)

## Changing the Wi-Fi Direct (Simple AP) Settings Such as the SSID

When Wi-Fi Direct (simple AP) connection is enabled, you can change the settings from  > **Wi-Fi Direct** > **Start Setup** > **Change**, and then the following menu items are displayed.

### Change Network Name

Change the Wi-Fi Direct (simple AP) network name (SSID) used for connecting to the printer to your arbitrary name. You can set the network name (SSID) in ASCII characters that is displayed on the software keyboard on the control panel. You can enter up to 22 characters.

When changing the network name (SSID), all connected devices are disconnected. Use the new network name (SSID) if you want to re-connect the device.

### Change Password

Change the Wi-Fi Direct (simple AP) password for connecting to the printer to your arbitrary value. You can set the password in ASCII characters that is displayed on the software keyboard on the control panel. You can enter 8 to 22 characters.

When changing the password, all connected devices are disconnected. Use the new password if you want to re-connect the device.

### Change Frequency Range

Change the frequency range of Wi-Fi Direct used for connecting to the printer. You can select 2.4 GHz or 5 GHz.

When changing the frequency range, all connected devices are disconnected. Re-connect the device.

Note that you cannot re-connect from devices that do not support 5 GHz frequency range when changing to 5 GHz.

Depending on the region, this setting may not be displayed.

### Disable Wi-Fi Direct

Disable Wi-Fi Direct (simple AP) settings of the printer. When disabling it, all devices connected to the printer in Wi-Fi Direct (Simple AP) connection are disconnected.

### Restore Default Settings

Restore all Wi-Fi Direct (simple AP) settings to their defaults.

The Wi-Fi Direct (simple AP) connection information of the smart device saved to the printer is deleted.

**Note:**

You can also set up from the **Network** tab > **Wi-Fi Direct** on Web Config for the following settings.

- Enabling or disabling Wi-Fi Direct (simple AP)
- Changing network name (SSID)
- Changing password
- Changing the frequency range  
*Depending on the region, this setting may not be displayed.*
- Restoring the Wi-Fi Direct (simple AP) settings

---

## Checking the Network Connection Status

You can check the network connection status in the following way.

## Checking the Network Connection Status from the Control Panel

You can check the network connection status using the network icon or the network information on the printer's control panel.

### Checking the Network Connection Status using the Network Icon

You can check the network connection status and strength of the radio wave using the network icon on the printer's home screen.



#### Related Information

➔ [“Guide to the Network Icon” on page 21](#)

## Displaying Detailed Network Information on the Control Panel

When your printer is connected to the network, you can also view other network-related information by selecting the network menus you want to check.

1. Tap  on the printer's control panel.
2. Select **General Settings > Network Settings > Network Status**.
3. To check the information, select the menus that you want to check.
  - Wired LAN/Wi-Fi Status**  
Displays the network information (device name, connection, signal strength, obtain IP address, and so on) for Ethernet or Wi-Fi connections.
  - Wi-Fi Direct Status**  
Displays whether Wi-Fi Direct (Simple AP) is enabled or disabled for Wi-Fi Direct (Simple AP) connections.
  - Print Status Sheet**  
Prints a network status sheet. The information for Ethernet, Wi-Fi, Wi-Fi Direct (Simple AP), and so on is printed on two or more pages.

## Printing a Network Connection Report

You can print a network connection report to check the status between the printer and the wireless router.

1. Load papers.
2. Tap  on the printer's control panel.

3. Tap **General Settings** > **Network Settings** > **Connection Check**.  
The connection check starts.
4. Tap **Print Check Report**.
5. Follow the instructions on the printer's screen to print the network connection report.  
If an error has occurred, check the network connection report, and then follow the printed solutions.
6. Tap **Close**.

## Messages and Solutions on the Network Connection Report

Check the messages and error codes on the network connection report, and then follow the solutions.

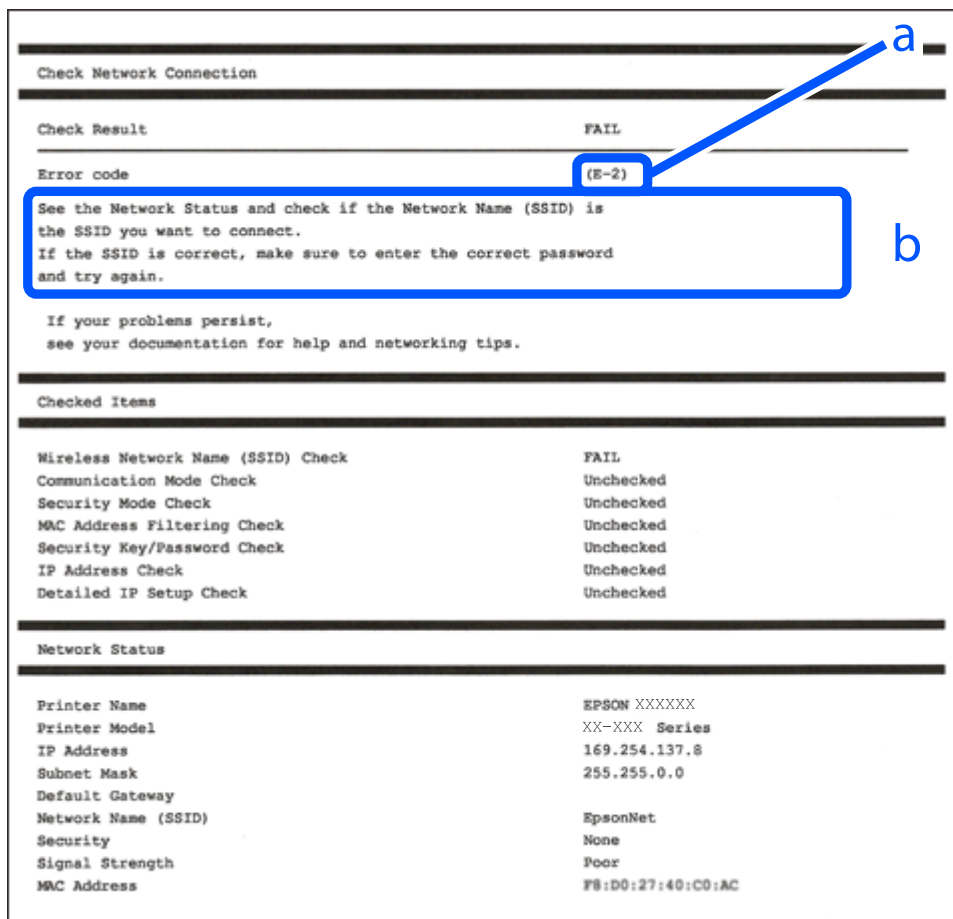

- a. Error code
- b. Messages on the Network Environment

### Related Information

- ➔ "E-1" on page 176
- ➔ "E-2, E-3, E-7" on page 176
- ➔ "E-5" on page 177

- ➔ “E-6” on page 177
- ➔ “E-8” on page 177
- ➔ “E-9” on page 178
- ➔ “E-10” on page 178
- ➔ “E-11” on page 178
- ➔ “E-12” on page 179
- ➔ “E-13” on page 179
- ➔ “Message on the Network Environment” on page 180

## E-1

### Solutions:

- Make sure the Ethernet cable is securely connected to your printer and to your hub or other network device.
- Make sure your hub or other network device is turned on.
- If you want to connect the printer by Wi-Fi, make Wi-Fi settings for the printer again because it is disabled.

## E-2, E-3, E-7

### Solutions:

- Make sure your wireless router is turned on.
- Confirm that your computer or device is connected correctly to the wireless router.
- Turn off the wireless router. Wait for about 10 seconds, and then turn it on.
- Place the printer closer to your wireless router and remove any obstacles between them.
- If you have entered the SSID manually, check if it is correct. Check the SSID from the **Network Status** part on the network connection report.
- If an wireless router has multiple SSIDs, select the SSID that is displayed. When the SSID is using a non-compliant frequency, the printer does not display them.
- If you are using push button setup to establish a network connection, make sure your wireless router supports WPS. You cannot use push button setup if your wireless router does not support WPS.
- Make sure your SSID uses only ASCII characters (alphanumeric characters and symbols). The printer cannot display an SSID that contains non-ASCII characters.
- Make sure you know your SSID and password before connecting to the wireless router. If you are using a wireless router with its default settings, the SSID and password are located on a label on the wireless router. If you do not know your SSID and password, contact the person who set up the wireless router, or see the documentation provided with the wireless router.
- If you are connecting to an SSID generated from a tethering smart device, check for the SSID and password in the documentation provided with the smart device.
- If your Wi-Fi connection suddenly disconnects, check for the conditions below. If any of these conditions are applicable, reset your network settings by downloading and running the software from the following website.  
<http://epson.sn> > **Setup**
  - Another smart device was added to the network using push button setup.
  - The Wi-Fi network was set up using any method other than push button setup.



### Related Information

- ➔ [“Making Settings for Connecting to the Computer” on page 158](#)
- ➔ [“Making Wi-Fi Settings from the Control Panel” on page 161](#)

## E-5

### Solutions:

Make sure the wireless router's security type is set to one of the following. If it is not, change the security type on the wireless router, and then reset the printer's network settings.

- WEP-64 bit (40 bit)
- WEP-128 bit (104 bit)
- WPA PSK (TKIP/AES)\*
- WPA2 PSK (TKIP/AES)\*
- WPA (TKIP/AES)
- WPA2 (TKIP/AES)
- WPA3-SAE (AES)

\* WPA PSK is also known as WPA Personal. WPA2 PSK is also known as WPA2 Personal.

## E-6

### Solutions:

- Check if MAC address filtering is disabled. If it is enabled, register the printer's MAC address so that it is not filtered. See the documentation provided with the wireless router for details. You can check the printer's MAC address from the **Network Status** part on the network connection report.
- If your wireless router is using shared authentication with WEP security, make sure the authentication key and index are correct.
- If the number of connectable devices on the wireless router is less than the number of network devices that you want to connect, make settings on the wireless router to increase the number of connectable devices. See the documentation provided with the wireless router to make settings.

### Related Information

- ➔ [“Making Settings for Connecting to the Computer” on page 158](#)

## E-8

### Solutions:

- Enable DHCP on the wireless router if the printer's Obtain IP Address setting is set to Auto.
- If the printer's Obtain IP Address setting is set to Manual, the IP address you manually set is invalid due to out of range (for example: 0.0.0.0). Set a valid IP address from the printer's control panel.

### Related Information

➔ [“Network Settings” on page 209](#)

## E-9

### Solutions:

Check the following.

- Devices are turned on.
- You can access the Internet and other computers or network devices on the same network from the devices you want to connect to the printer.

If still does not connect your printer and network devices after confirming the above, turn off the wireless router. Wait for about 10 seconds, and then turn it on. Then reset your network settings by downloading and running the installer from the following website.

<http://epson.sn> > Setup

### Related Information

➔ [“Making Settings for Connecting to the Computer” on page 158](#)

## E-10

### Solutions:

Check the following.

- Other devices on the network are turned on.
- Network addresses (IP address, subnet mask, and default gateway) are correct if you have set the printer's Obtain IP Address to Manual.

Reset the network address if they are incorrect. You can check the IP address, subnet mask, and default gateway from the **Network Status** part on the network connection report.

If DHCP is enabled, change the printer's Obtain IP Address setting to Auto. If you want to set the IP address manually, check the printer's IP address from the **Network Status** part on the network connection report, and then select Manual on the network settings screen. Set the subnet mask to [255.255.255.0].

If still does not connect your printer and network devices, turn off the wireless router. Wait for about 10 seconds, and then turn it on.

### Related Information

➔ [“Network Settings” on page 209](#)

## E-11

### Solutions:

Check the following.

- The default gateway address is correct if you set the printer's TCP/IP Setup setting to Manual.

- The device that is set as the default gateway is turned on.

Set the correct default gateway address. You can check the default gateway address from the **Network Status** part on the network connection report.

#### **Related Information**

- ➔ [“Network Settings” on page 209](#)

## **E-12**

#### **Solutions:**

Check the following.

- Other devices on the network are turned on.
- The network addresses (IP address, subnet mask, and default gateway) are correct if you are entering them manually.
- The network addresses for other devices (subnet mask and default gateway) are the same.
- The IP address does not conflict with other devices.

If still does not connect your printer and network devices after confirming the above, try the following.

- Turn off the wireless router. Wait for about 10 seconds, and then turn it on.
- Make network settings again using the installer. You can run it from the following website.  
<http://epson.sn> > **Setup**
- You can register several passwords on a wireless router that uses WEP security type. If several passwords are registered, check if the first registered password is set on the printer.

#### **Related Information**

- ➔ [“Network Settings” on page 209](#)
- ➔ [“Making Settings for Connecting to the Computer” on page 158](#)

## **E-13**

#### **Solutions:**

Check the following.

- Network devices such as a wireless router, hub, and router are turned on.
- The TCP/IP Setup for network devices has not been set up manually. (If the printer's TCP/IP Setup is set automatically while the TCP/IP Setup for other network devices is performed manually, the printer's network may differ from the network for other devices.)

If it still does not work after checking the above, try the following.

- Turn off the wireless router. Wait for about 10 seconds, and then turn it on.
- Make network settings on the computer that is on the same network as the printer using the installer. You can run it from the following website.  
<http://epson.sn> > **Setup**

- ❑ You can register several passwords on a wireless router that uses the WEP security type. If several passwords are registered, check if the first registered password is set on the printer.

**Related Information**

- ➔ [“Network Settings” on page 209](#)
- ➔ [“Making Settings for Connecting to the Computer” on page 158](#)

**Message on the Network Environment**

Message	Solution
The Wi-Fi environment needs to be improved. Turn the wireless router off and then turn it on. If the connection does not improve, see the documentation for the wireless router.	After moving the printer closer to the wireless router and removing any obstacles between them, turn off the wireless router. Wait for about 10 seconds, and then turn it on. If it still does not connect, see the documentation supplied with the wireless router.
*No more devices can be connected. Disconnect one of the connected devices if you want to add another one.	Computer and smart devices that can be connected simultaneously are connected in full in the Wi-Fi Direct (Simple AP) connection. To add another computer or smart device, disconnect one of the connected devices or connect it to the other network first.  You can confirm the number of wireless devices which can be connected simultaneously and the number of connected devices by checking the network status sheet or the printer’s control panel.
The same SSID as Wi-Fi Direct exists in the environment. Change the Wi-Fi Direct SSID if you cannot connect a smart device to the printer.	On the printer’s control panel, go to Wi-Fi Direct Setup screen and select the menu to change the setting. You can change the network name following after DIRECT-XX-. Enter within 22 characters.

**Printing a Network Status Sheet**

You can check the detailed network information by printing it.

1. Load papers.
2. Tap  on the printer's control panel.
3. Tap **General Settings > Network Settings > Network Status**.
4. Tap **Print Status Sheet**.
5. Check the message, and then print the network status sheet.
6. Tap **Close**.

---

# Product Information

Paper Information. . . . .	182
Consumable Products Information. . . . .	196
Software Information. . . . .	199
Menu List. . . . .	206
General Settings. . . . .	206
Product Specifications. . . . .	212
Regulatory Information. . . . .	220

# Paper Information

## Available Paper and Capacities

### Genuine Epson Paper for SC-P900 Series

Epson recommends using genuine Epson paper to ensure high-quality printouts.

**Note:**

The availability of paper varies by location. For the latest information on paper available in your area, contact Epson support.

Even if "✓" is attached to borderless printing availability, borderless printing may not be possible depending on the **Level** selected in the printer driver.

#### Paper suitable for printing documents

Media Name	Size	Loading Capacity (Sheets)	ICC Profile	Borderless	Black ink
Bright White Ink Jet Paper	A3	40	Epson_SC-P900_700_Standard.icc	✓*	Matte Black
	A4	80			

\* You can specify and perform borderless printing; however, margins may appear or the print quality may decline due to the paper expanding or contracting.

#### Paper suitable for printing photos

Media Name	Size	Loading Capacity (Sheets)	ICC Profile	Borderless	Black ink
Premium Glossy Photo Paper	A2	1	Epson_SC-P900_700_EpsonPremiumGlossy.icc	✓	Photo Black
	A3+, A3	10			
	Letter, A4, 16:9 wide size(102x181 mm)	20			
	13x18 cm (5x7in.), 10x15 cm (4x6 in.)	30			
Premium Semigloss Photo Paper	A2	1	Epson_SC-P900_700_EpsonPremiumSemigloss.icc	✓	Photo Black
	A3+, A3	10			
	Letter, A4, 13x18 cm (5x7in.)	20			
	10x15 cm (4x6 in.)	30			

Media Name	Size	Loading Capacity (Sheets)	ICC Profile	Borderless	Black ink
Photo Paper Glossy	A3+, A3, 11x17in.	10	Epson_SC-P900_700_PhotoPaperGlossy.icc	✓	Photo Black
	Letter, A4, 13x18 cm (5x7in.), 10x15 cm (4x6 in.)	30			
Watercolor Paper - Radiant White	A3+	1	Epson_SC-P900_700_WatercolorPaperRadiantWhite.icc	✓	Matte Black
Velvet Fine Art Paper	17x22 in., A2, A3+, A3, Letter, A4	1	Epson_SC-P900_700_VelvetFineArtPaper.icc	✓	Matte Black
UltraSmooth Fine Art Paper	17x22 in., A2, A3+	1	Epson_SC-P900_700_UltraSmoothFineArtPaper.icc	✓	Matte Black
Matte Paper-Heavyweight	A3+, A3	10	Epson_SC-P900_700_ArchivalMattePaper.icc	✓	Matte Black
	Letter, A4, 8x10in	30			
Epson Premium Luster Photo Paper	A3+, A3	10	Epson_SC-P900_700_PremiumLusterPhotoPaper.icc	✓	Photo Black
	A4	30			

**Paper suitable for printing documents and photos** 

Media Name	Size	Loading Capacity (Sheets)	ICC Profile	Borderless	Black ink
Archival Matte Paper	17x22 in., A2	1	Epson_SC-P900_700_ArchivalMattePaper.icc	✓	Matte Black
	A3+, A3, 11x14in.	10			
	Letter, A4, 8x10in	30			
Photo Quality Ink Jet Paper	17x22 in., A2	10	Epson_SC-P900_700_Standard.icc	✓*	Matte Black
	A3+, A3, 11x17in., Legal	50			
	Letter, A4	60			
Double-Sided Matte Paper	Letter, A4	1	Epson_SC-P900_700_ArchivalMattePaper.icc	-	Matte Black

\* Depending on the image you are printing and the condition of the paper, ink may adhere to the edges of the paper and cause stains or print quality deterioration on borderless printouts. If you see print quality issues, disable the borderless printing feature and try printing again.

**Various other paper types** 

Media Name	Size	Loading Capacity (Sheets)	ICC Profile	Borderless	Black ink
Photo Quality Self Adhesive Sheets	A4	1	Epson_SC-P900_700_ArchivalMattePaper.icc	-	Matte Black
Epson Proofing Paper White Semimatte	A3+	1	Epson_SC-P900_700_ProofingPaperWhiteSemimatte.icc	✓	Photo Black

**Roll Paper** 

Media Name	Size	Size	Borderless	Black ink
Premium Glossy Photo Paper (250)	406 mm/16"	Epson_SC-P900_700_EpsonPremiumGlossy.icc	✓*	Photo Black
Premium Semigloss Photo Paper (250)	406 mm/16"	Epson_SC-P900_700_EpsonPremiumSemigloss.icc	✓*	Photo Black
Premium Luster Photo Paper (260)	406 mm/16"	Epson_SC-P900_700_PremiumLusterPhotoPaper.icc	✓*	Photo Black
Premium Semimatte Photo Paper (260)	406 mm/16"	Epson_SC-P900_700_PremiumLusterPhotoPaper.icc	✓*	Photo Black
Enhanced Matte Paper	432 mm/17"	Epson_SC-P900_700_ArchivalMattePaper.icc	✓*	Matte Black
Epson Proofing Paper White Semimatte	329 mm/13", 432 mm/17"	Epson_SC-P900_700_ProofingPaperWhiteSemimatte.icc	✓*	Photo Black

\* There are no left and right borders.



## Genuine Epson Paper for SC-P700 Series

Epson recommends using genuine Epson paper to ensure high-quality printouts.

**Note:**

The availability of paper varies by location. For the latest information on paper available in your area, contact Epson support.

Even if "✓" is attached to borderless printing availability, borderless printing may not be possible depending on the **Level** selected in the printer driver.

### Paper suitable for printing documents

Media Name	Size	Loading Capacity (Sheets)	ICC Profile	Borderless	Black ink
Bright White Ink Jet Paper	A3	40	Epson_SC-P900_700_Standard.icc	✓*	Matte Black
	A4	80			

\* You can specify and perform borderless printing; however, margins may appear or the print quality may decline due to the paper expanding or contracting.

### Paper suitable for printing photos

Media Name	Size	Loading Capacity (Sheets)	ICC Profile	Borderless	Black ink
Premium Glossy Photo Paper	A3+, A3	10	Epson_SC-P900_700_EpsonPremiumGlossy.icc	✓	Photo Black
	Letter, A4, 16:9 wide size(102x181 mm)	20			
	13x18 cm (5x7in.), 10x15 cm (4x6 in.)	30			
Premium Semigloss Photo Paper	A3+, A3	10	Epson_SC-P900_700_EpsonPremiumSemigloss.icc	✓	Photo Black
	Letter, A4, 13x18 cm (5x7in.)	20			
	10x15 cm (4x6 in.)	30			
Photo Paper Glossy	A3+, A3, 11x17in	10	Epson_SC-P900_700_PhotoPaperGlossy.icc	✓	Photo Black
	Letter, A4, 13x18 cm (5x7in.), 10x15 cm (4x6 in.)	30			
Watercolor Paper - Radiant White	A3+	1	Epson_SC-P900_700_WatercolorPaperRadiantWhite.icc	✓	Matte Black

Media Name	Size	Loading Capacity (Sheets)	ICC Profile	Borderless	Black ink
Velvet Fine Art Paper	A3+, A3, Letter, A4	1	Epson_SC-P900_700_VelvetFineArtPaper.icc	✓	Matte Black
UltraSmooth Fine Art Paper	A3+	1	Epson_SC-P900_700_UltraSmoothFineArtPaper.icc	✓	Matte Black
Matte Paper-Heavyweight	A3+, A3	10	Epson_SC-P900_700_ArchivalMattePaper.icc	✓	Matte Black
	Letter, A4, 8x10in	30			
Epson Premium Luster Photo Paper	A3+, A3	10	Epson_SC-P900_700_PremiumLusterPhotoPaper.icc	✓	Photo Black
	A4	30			

**Paper suitable for printing documents and photos** 

Media Name	Size	Loading Capacity (Sheets)	ICC Profile	Borderless	Black ink
Archival Matte Paper	A3+, A3, 11x14in.	10	Epson_SC-P900_700_ArchivalMattePaper.icc	✓	Matte Black
	Letter, A4, 8x10in	30			
Photo Quality Ink Jet Paper	A3+, A3, 11x17in., Legal	50	Epson_SC-P900_700_Standard.icc	✓*	Matte Black
	Letter, A4	60			
Double-Sided Matte Paper	Letter, A4	1	Epson_SC-900_700_ArchivalMattePaper.icc	-	Matte Black

\* Depending on the image you are printing and the condition of the paper, ink may adhere to the edges of the paper and cause stains or print quality deterioration on borderless printouts. If you see print quality issues, disable the borderless printing feature and try printing again.

**Various other paper types** 

Media Name	Size	Loading Capacity (Sheets)	ICC Profile	Borderless	Black ink
Photo Quality Self Adhesive Sheets	A4	1	Epson_SC-P900_700_ArchivalMattePaper.icc	-	Matte Black

Media Name	Size	Loading Capacity (Sheets)	ICC Profile	Borderless	Black ink
Epson Proofing Paper White Semimatte	A3+	1	Epson_SC-P900_700_ProofingPaperWhiteSemimatte.icc	✓	Photo Black

### Roll Paper

Media Name	Size	Size	Borderless	Black ink
Epson Proofing Paper White Semimatte	329 mm/13"	Epson_SC-P900_700_ProofingPaperWhiteSemimatte.icc	✓*	Photo Black

\* There are no left and right borders.

## Commercially Available Paper for SC-P900 Series

Even if "✓" is attached to borderless printing availability, borderless printing may not be possible depending on the **Level** selected in the printer driver.

### Important:

- Although plain paper and recycled paper manufactured by other companies can be loaded and fed in the printer as long as they meet the following specifications, Epson cannot guarantee the print quality.
- Although other paper types manufactured by other companies can be loaded in the printer as long as they meet the following specifications, Epson cannot guarantee the paper feeding and print quality.

Name	Size	Capacity	Thickness	Source	Borderless
Plain paper (cut sheets)	US C (17x22 in.), US B (11x17 in.), A2, A3+	50* <sup>1</sup>	0.08 to 0.11mm (64 to 90g/m <sup>2</sup> )	Rear paper feeder	✓* <sup>2</sup>
	B3, B4				-
	A3	40* <sup>1</sup>			✓* <sup>2</sup>
	Half Letter, Legal, B5, A5, A6	120* <sup>3</sup>			-
	Letter				✓* <sup>2</sup>
	A4	80* <sup>3</sup>			✓* <sup>2</sup>
	Non-standard sizes Width: 89 to 431.8 mm Length: 127 to 1200 mm * <sup>4</sup>	50* <sup>1</sup>			-

Name	Size	Capacity	Thickness	Source	Borderless
Roll paper	210 mm (A4) to 431.8 mm (17") (Outer diameter: smaller than 150mm)	1	0.08 to 0.7 mm	Roll paper unit	✓*2, 5
Thick paper	US C (17x22 in.), A2, 41x51 cm (16x20 in.), A3+, US B (11x17 in.), A3, 279x356 mm (11x14 in.), 254x305 mm (10x12 in.), Letter, A4, 20x25 cm (8x10 in.), 13x20 cm (5x8in.), 13x18 cm (5x7in.), 16:9 wide size(102x181 mm), 10x15 cm (4x6 in.), 9x13 cm (3.5x5 in.), Postcard	1	0.11 to 0.5 mm	Rear paper feeder*6	✓*2
	36x43 cm (14x17 in.), 30x30 cm (12x12 in.), JIS B3, JIS B4, Legal, Half Letter, JIS B5, Postcard Double, A5, A6				-
	Non-standard sizes Width: 89 to 431.8 mm Length: 127 to 1200 mm*4				-
Thick paper	US C (17x22 in.), A2, 41x51 cm (16x20 in.), A3+, US B (11x17 in.), A3, 279x356 mm (11x14 in.), 254x305 mm (10x12 in.), Letter, A4	1	0.5 to 0.7 mm	Front paper feeder (Fine Art)	✓*2
	36x43 cm (14x17 in.), 30x30 cm (12x12 in.), JIS B3, Legal, JIS B4				-
	Non-standard sizes Width: 203.2 to 431.8 mm Length: 279.4 to 3276.7 mm*4				-
Thick paper	US C (17x22 in.), A2, 41x51 cm (16x20 in.), JIS B3, 36x43 cm (14x17 in.), 30x30 cm (12x12 in.), A3+, US B (11x17 in.), A3, 279x356 mm (11x14 in.), JIS B4, 254x305 mm (10x12 in.), Legal, Letter, A4	1	0.7 to 1.5 mm	Front paper feeder (Poster Board)	-
	Non-standard sizes Width: 203.2 to 431.8 mm Length: 279.4 to 3276.7 mm*4				-
Premium surface CD/DVD	12 cm	1	-	Disk tray	-
CD/DVD	12 cm	1	-	Disk tray	-

- \*1: The number of sheets that can be set varies depending on the paper thickness. The total thickness of the loaded paper must not exceed 5mm.
- \*2: You can specify and perform borderless printing; however, margins may appear or the print quality may decline due to the paper expanding or contracting. See the manual supplied with the paper and adjust settings as appropriate.
- \*3: The number of sheets that can be set varies depending on the paper thickness. The total thickness of the loaded paper must not exceed 12mm.
- \*4: The max length you can set in printer driver is 18000 mm.
- \*5: There are no left and right borders.
- \*6: If feeding fails, load paper into the front paper feeder.

## Commercially Available Paper for SC-P700 Series

Even if "✓" is attached to borderless printing availability, borderless printing may not be possible depending on the **Level** selected in the printer driver.



**Important:**

- ❑ Although plain paper and recycled paper manufactured by other companies can be loaded and fed in the printer as long as they meet the following specifications, Epson cannot guarantee the print quality.
- ❑ Although other paper types manufactured by other companies can be loaded in the printer as long as they meet the following specifications, Epson cannot guarantee the paper feeding and print quality.

Name	Size	Capacity	Thickness	Source	Borderless
Plain paper (cut sheets)	US B (11x17 in.), A3+	50* <sup>1</sup>	0.08 to 0.11mm (64 to 90g/m <sup>2</sup> )	Rear paper feeder	✓* <sup>2</sup>
	B4				-
	A3	40* <sup>1</sup>			✓* <sup>2</sup>
	Half Letter, Legal, B5, A5, A6	120* <sup>3</sup>			-
	Letter				✓* <sup>2</sup>
	A4	80* <sup>3</sup>			✓* <sup>2</sup>
	Non-standard sizes Width: 89 to 330.2 mm Length: 127 to 1200 mm* <sup>4</sup>	50* <sup>1</sup>			-
Roll paper	210 mm (A4) to 330.2 mm (13")  (Outer diameter: smaller than 84mm)	1	0.08 to 0.7 mm	Roll paper unit	✓* <sup>2, 5</sup>

Name	Size	Capacity	Thickness	Source	Borderless	
Thick paper	A3+, US B (11x17 in.), A3, 279x356 mm (11x14 in.), 254x305 mm (10x12 in.), Letter, A4, 20x25 cm (8x10 in.), 13x20 cm (5x8in.), 13x18 cm (5x7in.), 16:9 wide size(102x181 mm) , 10x15 cm (4x6 in.), 9x13 cm (3.5x5 in.), Postcard	1	0.11 to 0.5 mm	Rear paper feeder* <sup>6</sup>	✓* <sup>2</sup>	
	30x30 cm (12x12 in.), JIS B4, Legal, Half Letter, JIS B5, Postcard Double, A5, A6				-	
	Non-standard sizes Width: 89 to 330.2 mm Length: 127 to 1200 mm* <sup>4</sup>				-	
	A3+, US B (11x17 in.), A3, 279x356 mm (11x14 in.), 254x305 mm (10x12 in.), Letter, A4	1	0.5 to 0.7 mm	Front paper feeder (Fine Art)	✓* <sup>2</sup>	
					30x30 cm (12x12 in.), Legal, JIS B4	-
					Non-standard sizes Width: 203.2 to 330.2 mm Length: 279.4 to 3276.7 mm* <sup>4</sup>	-
	30x30 cm (12x12 in.), A3+, US B (11x17 in.), A3, 279x356 mm (11x14 in.), JIS B4, 254x305 mm (10x12 in.), Legal, Letter, A4	1	0.7 to 1.5 mm	Front paper feeder (Poster Board)	-	
					Non-standard sizes Width: 203.2 to 330.2 mm Length: 279.4 to 3276.7 mm* <sup>4</sup>	-
	Premium surface CD/DVD	12 cm	1	-	Disk tray	-
	CD/DVD	12 cm	1	-	Disk tray	-

\*1: The number of sheets that can be set varies depending on the paper thickness. The total thickness of the loaded paper must not exceed 5mm.

\*2: You can specify and perform borderless printing; however, margins may appear or the print quality may decline due to the paper expanding or contracting. See the manual supplied with the paper and adjust settings as appropriate.

\*3: The number of sheets that can be set varies depending on the paper thickness. The total thickness of the loaded paper must not exceed 12mm.

\*4: The max length you can set in printer driver is 18000 mm.

\*5: There are no left and right borders.

\*6: If feeding fails, load paper into the front paper feeder.

## Unavailable Paper Types

Do not use the following papers. Using these types of paper causes paper jams and smears on the printout.

- Papers that are wavy
- Papers that are torn or cut
- Papers that are folded
- Papers that are damp
- Papers that are too thick or too thin
- Papers that have stickers
- Printing on anything except for inkjet paper, which is slow-drying, may cause print stains.

## Printing to Paper Types Other than Genuine Paper

### Adding paper information (print settings)

You need the optimum paper settings to make full use of the paper's capabilities. When printing on paper other than genuine paper, add the paper information (media settings) to the printer and select the paper setting that best suits the paper.



**Important:**

- Use a computer that is connected to the Internet, and perform operations after connecting your computer to the printer.
- Paper information is added to your computer and printer over the Internet from a dedicated Epson server.

1. Display the add paper information screen from Epson Print Layout or the printer driver.

- Epson Print Layout

Select **Media Type > Download Media**.

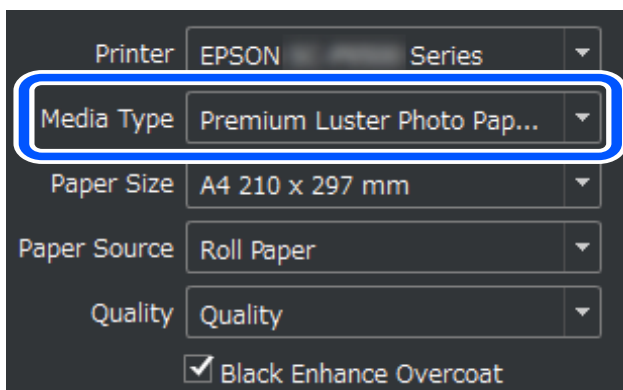

❑ Windows

Select Epson Media Installer on the **Utility** tab.

You can also start it from a shortcut icon on the computer's desktop.



❑ Mac OS

Start Epson Media Installer as shown below.

**Applications > Epson Software > Epson Utilities > Epson Media Installer.app**

A list of paper information that can be added is displayed.

Media Management		Media Download				
Printer	Region	Media Vendor	Media Type	Notifications	Status	Last Updated
EPSON SC-P7500 Series	Local	EPSON	All			
EPSON	Backlit (High density print)	Other			Not Registered	1/22/2020 9:56:00 AM
EPSON	Backlit	Other			Not Registered	1/22/2020 9:56:00 AM
EPSON	Proof Paper 3	Proofing Paper			Not Registered	1/21/2020 6:30:00 PM
EPSON	Proof Paper 2	Proofing Paper			Not Registered	1/21/2020 6:30:00 PM
EPSON	Proof Paper 1	Proofing Paper			Not Registered	1/21/2020 6:30:00 PM
EPSON	Premium Semigloss Photo Paper(170)	Photo Paper			Not Acquired	12/10/2019 3:05:00 PM
EPSON	Premium Luster Photo Paper(260)	Photo Paper			Not Acquired	12/10/2019 2:55:00 PM
EPSON	Plain Paper	Plain Paper			Not Acquired	12/10/2019 3:25:00 PM
EPSON	Backlight Film Roll PK	Other			Not Acquired	12/10/2019 3:35:00 PM
EPSON	Backlight Film Roll MK	Other			Not Acquired	12/10/2019 3:32:00 PM
EPSON	Fine Art Matte	FineArt Paper			Not Acquired	12/10/2019 3:22:00 PM
EPSON	Washi	FineArt Paper			Not Acquired	12/10/2019 3:21:00 PM
EPSON	Washi <Thin>	FineArt Paper			Not Acquired	12/10/2019 3:20:00 PM
EPSON	Baryta	Photo Paper			Not Acquired	12/10/2019 3:06:00 PM
EPSON	Canvas Matte	Canvas			Not Acquired	12/10/2019 3:24:00 PM
EPSON	Canvas Satin	Canvas			Not Acquired	12/10/2019 3:22:00 PM
EPSON	Enhanced Low Adhesive Synthetic Paper	Other			Not Acquired	12/10/2019 3:31:00 PM
EPSON	Enhanced Adhesive Synthetic Paper	Other			Not Acquired	12/10/2019 3:31:00 PM
EPSON	Enhanced Synthetic Paper	Other			Not Acquired	12/10/2019 3:30:00 PM
EPSON	Enhanced Matte Poster Board	Other			Not Acquired	12/10/2019 3:28:00 PM
EPSON	Velvet Fine Art Paper	FineArt Paper			Not Acquired	12/10/2019 3:19:00 PM
EPSON	UltraSmooth Fine Art paper	FineArt Paper			Not Acquired	12/10/2019 3:17:00 PM
EPSON	Watercolor Paper - Radiant White	FineArt Paper			Not Acquired	12/10/2019 3:12:00 PM
EPSON	Epson Proofing Paper Commercial	Proofing Paper			Not Acquired	12/10/2019 3:06:00 PM
EPSON	Epson Proofing Paper White Semimatte	Proofing Paper			Not Acquired	12/10/2019 3:06:00 PM
EPSON	Photo Quality Inkjet Paper	Matte Paper			Not Acquired	12/10/2019 3:11:00 PM
EPSON	Singleweight Matte Paper	Matte Paper			Not Acquired	12/10/2019 3:10:00 PM
EPSON	Archival Matte Paper	Matte Paper			Not Acquired	12/10/2019 3:09:00 PM

If the target paper information is not available, see the paper manufacturer's website and set the paper.



2. Add the paper information.

Select the target paper and click **Download and Register**.

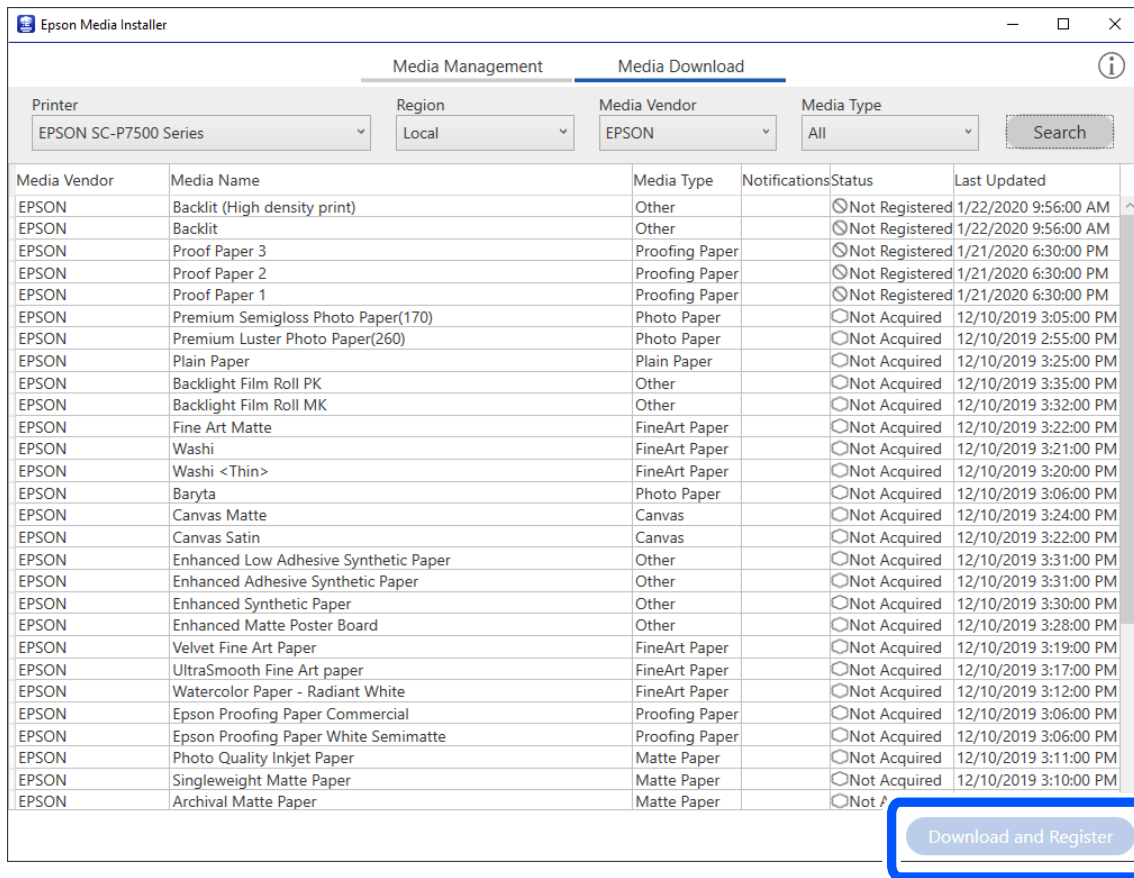

You can select the added paper information from Epson Print Layout, printer drivers, and the paper setting menus on the printer's control panel.

3. Select the target paper in the paper type setting in Epson Print Layout or the printer driver, and then print.

If you have added paper information, you can use the added paper's ICC profile in Epson Print Layout, printer drivers, and other applications.

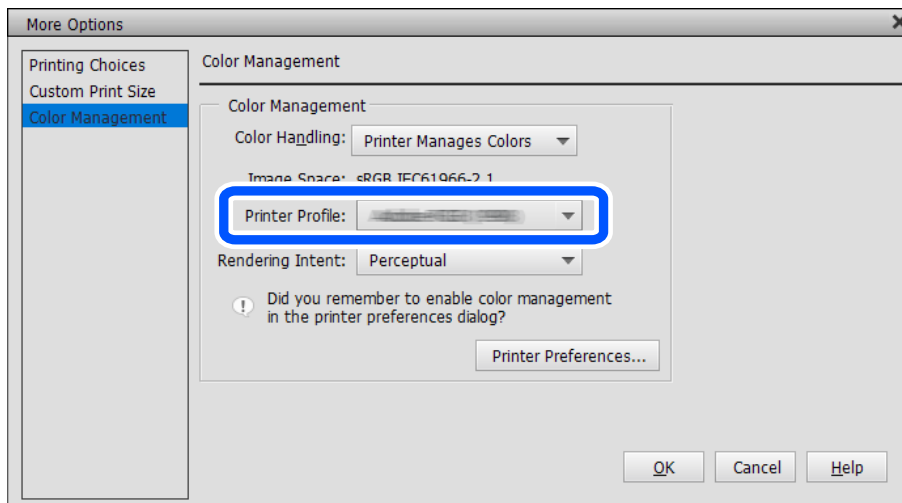



## Editing paper information

You can edit the paper information and print using your favorite settings.

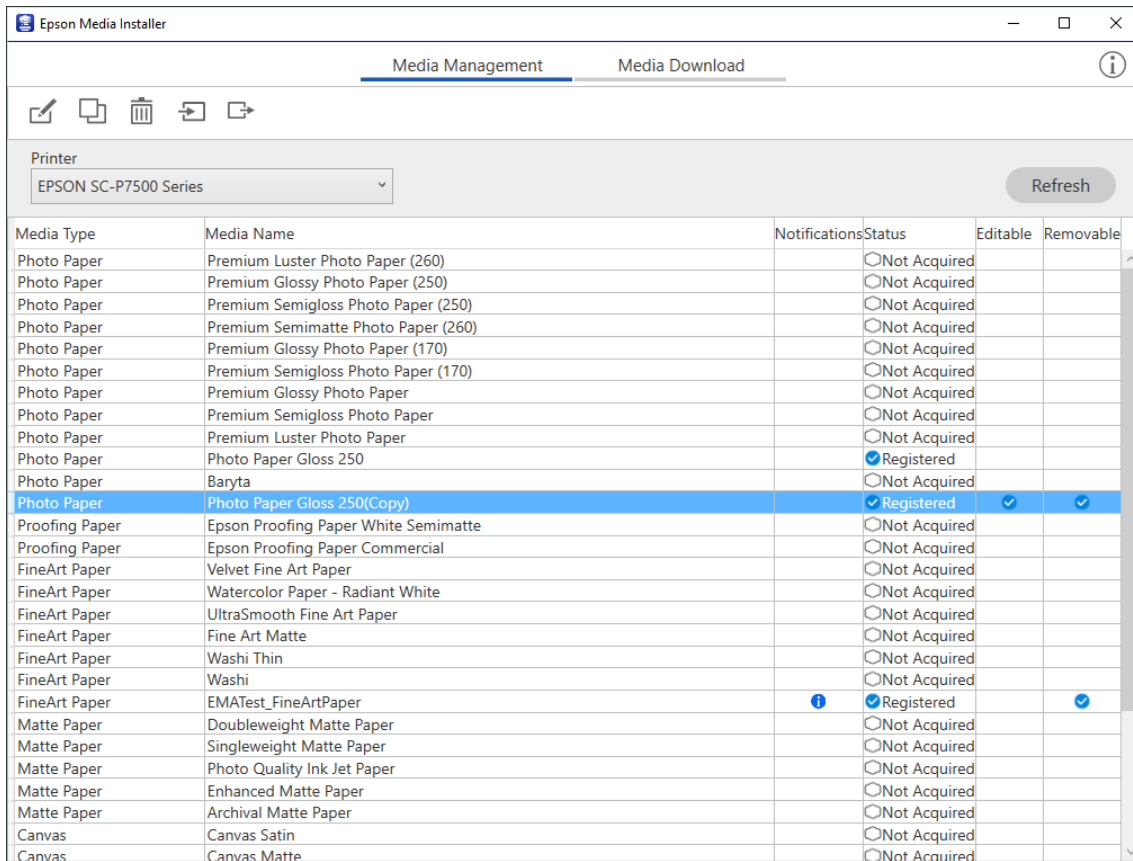
1. Start Epson Media Installer, and select **Media Management**. Select the paper settings (media settings) that you want to edit, and then select .



Media Type	Media Name	Notifications	Status	Editable	Removable
Photo Paper	Premium Luster Photo Paper (260)		<input type="radio"/> Not Acquired		
Photo Paper	Premium Glossy Photo Paper (250)		<input type="radio"/> Not Acquired		
Photo Paper	Premium Semigloss Photo Paper (250)		<input type="radio"/> Not Acquired		
Photo Paper	Premium Semimatte Photo Paper (260)		<input type="radio"/> Not Acquired		
Photo Paper	Premium Glossy Photo Paper (170)		<input type="radio"/> Not Acquired		
Photo Paper	Premium Semigloss Photo Paper (170)		<input type="radio"/> Not Acquired		
Photo Paper	Premium Glossy Photo Paper		<input type="radio"/> Not Acquired		
Photo Paper	Premium Semigloss Photo Paper		<input type="radio"/> Not Acquired		
Photo Paper	Premium Luster Photo Paper		<input type="radio"/> Not Acquired		
Photo Paper	Photo Paper Gloss 250		<input checked="" type="radio"/> Registered		
Photo Paper	Baryta		<input type="radio"/> Not Acquired		
Photo Paper	Photo Paper Gloss 250(Copy)		<input checked="" type="radio"/> Registered	<input checked="" type="checkbox"/>	<input checked="" type="checkbox"/>
Proofing Paper	Epson Proofing Paper White Semimatte		<input type="radio"/> Not Acquired		
Proofing Paper	Epson Proofing Paper Commercial		<input type="radio"/> Not Acquired		
FineArt Paper	Velvet Fine Art Paper		<input type="radio"/> Not Acquired		
FineArt Paper	Watercolor Paper - Radiant White		<input type="radio"/> Not Acquired		
FineArt Paper	UltraSmooth Fine Art Paper		<input type="radio"/> Not Acquired		
FineArt Paper	Fine Art Matte		<input type="radio"/> Not Acquired		
FineArt Paper	Washi Thin		<input type="radio"/> Not Acquired		
FineArt Paper	Washi		<input type="radio"/> Not Acquired		
FineArt Paper	EMATest_FineArtPaper		<input checked="" type="radio"/> Registered		<input checked="" type="checkbox"/>
Matte Paper	Doubleweight Matte Paper		<input type="radio"/> Not Acquired		
Matte Paper	Singleweight Matte Paper		<input type="radio"/> Not Acquired		
Matte Paper	Photo Quality Ink Jet Paper		<input type="radio"/> Not Acquired		
Matte Paper	Enhanced Matte Paper		<input type="radio"/> Not Acquired		
Matte Paper	Archival Matte Paper		<input type="radio"/> Not Acquired		
Canvas	Canvas Satin		<input type="radio"/> Not Acquired		
Canvas	Canvas Matte		<input type="radio"/> Not Acquired		

2. Select the paper information that you copied, and then select .

**Note:**

The edits are only performed on the copied paper information (media settings). You cannot edit the original paper information directly. You can copy paper information for paper with the status Registered.

- Specify each setting on the editing screen, and then select **OK**.

Items	Setting Explanation
Media Setting Name	Specify a name for the media settings.
Media Type	Set the category name for the paper. This is displayed to the paper type display in the printer driver or on the printer's control panel.
Platen Gap	Specify the interval (platen gap) of the print head and the paper. If the paper is smeared, increase the value. If running <b>Print Head Alignment</b> on the printer does not improve graininess or blurring in the print outs, decrease the value.
Drying Time per Pass	Specify the length of time to stop the print head after each pass to help the ink dry. Depending on the paper, the ink may not dry easily. Specify a longer drying time when ink dripping or bleeding occurs in the print outs. Note that setting a longer drying time will increase the overall print time.
Paper Thickness	Specify the paper thickness.
Paper Size Check	We recommend selecting this setting. Clear this checkbox if a paper error is displayed even if you have loaded the paper correctly. Note that if you clear this checkbox, printing may be performed beyond the edges of the paper and the inside of the printer may be stained with ink.
Paper Feed Offset	Specify this setting when banding (horizontal band-like patterns or uneven colors) cannot be resolved even after checking and cleaning the print head or performing <b>Print Head Alignment</b> on the printer. If the speed of the paper feed is too slow, dark banding will occur. In this situation, adjust the paper feed in the positive (+) direction. If the paper feed is too fast, white banding will occur. In this situation, adjust the paper feed in the negative (-) direction.
Paper Feed Offset(Bottom)	Specify the value for paper feed offset for the printing area up to approximately 39 mm from the end of cut paper.
ICC Profile	Allows you to specify the ICC profile for other paper types.

- Select the edited paper from paper type in Epson Print Layout or the printer driver, and then print.

## Consumable Products Information

### Ink Cartridge Codes for SC-P900 Series

The following are the codes for genuine Epson ink cartridges.

For Europe, Australia and New Zealand

Ink color	Product number
PK (Photo Black)	T47A1
C (Cyan)	T47A2
VM(Vivid Magenta)	T47A3
Y (Yellow)	T47A4
LC (Light Cyan)	T47A5
VLM(Vivid Light Magenta)	T47A6
GY(Gray)	T47A7
MK(Matte Black)	T47A8
LGY(Light Gray)	T47A9
V(Violet)	T47AD

For Hong Kong and Mongolia

Ink color	Product number
PK (Photo Black)	T47C1
C (Cyan)	T47C2
VM(Vivid Magenta)	T47C3
Y (Yellow)	T47C4
LC (Light Cyan)	T47C5
VLM(Vivid Light Magenta)	T47C6
GY(Gray)	T47C7
MK(Matte Black)	T47C8
LGY(Light Gray)	T47C9
V(Violet)	T47CD

For Asian Countries except Hong Kong and Mongolia

Ink color	Product number
PK (Photo Black)	T47E1
C (Cyan)	T47E2
VM(Vivid Magenta)	T47E3
Y (Yellow)	T47E4
LC (Light Cyan)	T47E5
VLM(Vivid Light Magenta)	T47E6
GY(Gray)	T47E7
MK(Matte Black)	T47E8
LGY(Light Gray)	T47E9
V(Violet)	T47ED

Epson recommends the use of genuine Epson ink cartridges. Epson cannot guarantee the quality or reliability of non-genuine ink. The use of non-genuine ink may cause damage that is not covered by Epson's warranties, and under certain circumstances, may cause erratic printer behavior. Information about non-genuine ink levels may not be displayed.

**Note:**

- Ink cartridge codes may vary by location. For the correct codes in your area, contact Epson support.
- Not all cartridges are available in all regions.
- For users in Europe, visit the following website for information on Epson's ink cartridge yields.  
<http://www.epson.eu/pageyield>
- Although the ink cartridges may contain recycled materials, this does not affect printer function or performance.
- Specifications and appearance of the ink cartridge are subject to change without prior notice for improvement.

## Ink Cartridge Codes for SC-P700 Series

The following are the codes for genuine Epson ink cartridges.

For Europe, Australia and New Zealand

Ink color	Product number
PK (Photo Black)	T46S1
C (Cyan)	T46S2
VM(Vivid Magenta)	T46S3
Y (Yellow)	T46S4
LC (Light Cyan)	T46S5
VLM(Vivid Light Magenta)	T46S6
GY(Gray)	T46S7

Ink color	Product number
MK(Matte Black)	T46S8
LGY(Light Gray)	T46S9
V(Violet)	T46SD

For Hong Kong

Ink color	Product number
PK (Photo Black)	T46V1
C (Cyan)	T46V2
VM(Vivid Magenta)	T46V3
Y (Yellow)	T46V4
LC (Light Cyan)	T46V5
VLM(Vivid Light Magenta)	T46V6
GY(Gray)	T46V7
MK(Matte Black)	T46V8
LGY(Light Gray)	T46V9
V(Violet)	T46VD

For Asian Countries except Hong Kong

Ink color	Product number
PK (Photo Black)	T46X1
C (Cyan)	T46X2
VM(Vivid Magenta)	T46X3
Y (Yellow)	T46X4
LC (Light Cyan)	T46X5
VLM(Vivid Light Magenta)	T46X6
GY(Gray)	T46X7
MK(Matte Black)	T46X8
LGY(Light Gray)	T46X9
V(Violet)	T46XD

Epson recommends the use of genuine Epson ink cartridges. Epson cannot guarantee the quality or reliability of non-genuine ink. The use of non-genuine ink may cause damage that is not covered by Epson's warranties, and under certain circumstances, may cause erratic printer behavior. Information about non-genuine ink levels may not be displayed.

**Note:**

- ❑ Ink cartridge codes may vary by location. For the correct codes in your area, contact Epson support.
- ❑ Not all cartridges are available in all regions.
- ❑ For users in Europe, visit the following website for information on Epson's ink cartridge yields.  
<http://www.epson.eu/pageyield>
- ❑ Although the ink cartridges may contain recycled materials, this does not affect printer function or performance.
- ❑ Specifications and appearance of the ink cartridge are subject to change without prior notice for improvement.

## Maintenance Box Code

The maintenance box can be purchased and replaced by the user. Epson recommends the use of a genuine Epson maintenance box.

The following is the code for the genuine Epson maintenance box.

C9357



**Important:**

Once a maintenance box has been installed in a printer it cannot be used with other printers.

---

## Software Information

This section introduces the network services and software products available for your printer from the Epson website.

### Software for Printing

#### Application for Printing from a Computer (Windows Printer Driver)

The printer driver controls the printer according to the commands from an application. Making settings on the printer driver provides the best printing results. You can also check the status of the printer or keep it in top operating condition using the printer driver utility.

You can change the language of the printer driver. Select the language you want to use from the **Language** setting on the **Utility** tab.

##### Accessing the printer driver from applications

To make settings that apply only to the application you are using, access from that application.

Select **Print** or **Print Setup** from the **File** menu. Select your printer, and then click **Preferences** or **Properties**.

**Note:**

Operations differ depending on the application. See the application's help for details.

##### Accessing the printer driver from the control panel

To make settings that apply to all of the applications, access from the control panel.

❑ Windows 10

Click on the start button, and then select **Windows System > Control Panel > View devices and printers in Hardware and Sound**. Right-click on your printer, or press and hold it and then select **Printing preferences**

❑ Windows 8.1/Windows 8

Select **Desktop > Settings > Control Panel > View devices and printers in Hardware and Sound**. Right-click on your printer, or press and hold it and then select **Printing preferences**

❑ Windows 7

Click the start button, and select **Control Panel > View devices and printers in Hardware and Sound**. Right-click on your printer and select **Printing preferences**.

### Accessing the printer driver from the printer icon on the task bar

The printer icon on the desktop task bar is a shortcut icon allowing you to quickly access the printer driver.

If you click the printer icon and select **Printer Settings**, you can access the same printer settings window as the one displayed from the control panel. If you double-click this icon, you can check the status of the printer.

**Note:**

*If the printer icon is not displayed on the task bar, access the printer driver window, click **Monitoring Preferences** on the **Utility** tab, and then select **Register the shortcut icon to the taskbar**.*

### Starting the utility

Access the printer driver window. Click the **Utility** tab.

### Related Information

➔ [“Menu Options for the Printer Driver” on page 69](#)

### Making Operation Settings for the Windows Printer Driver

You can make settings such as enabling **EPSON Status Monitor 3**.

1. Access the printer driver window.
2. Click **Speed and Progress** on the **Utility** tab.
3. Make the appropriate settings, and then click **OK**.  
See the online help for explanations of the setting items.

## Application for Printing from a Computer (Mac OS Printer Driver)

The printer driver controls the printer according to the commands from an application. Making settings on the printer driver provides the best printing results. You can also check the status of the printer or keep it in top operating condition using the printer driver utility.

### Accessing the printer driver from applications

Click **Page Setup** or **Print** on the **File** menu of your application. If necessary, click **Show Details** (or ▼) to expand the print window.



**Note:**

Depending on the application being used, **Page Setup** may not be displayed in the **File** menu, and the operations for displaying the print screen may differ. See the application's help for details.

**Starting the utility**

Select **System Preferences** from the Apple menu > **Printers & Scanners** (or **Print & Scan, Print & Fax**), and then select the printer. Click **Options & Supplies > Utility > Open Printer Utility**.

**Related Information**

➔ [“Menu Options for the Printer Driver” on page 89](#)

**Guide to Mac OS Printer Driver**

**Epson Printer Utility**

You can run a maintenance feature such as nozzle check and print head cleaning, and by starting **EPSON Status Monitor**, you can check printer status and error information.

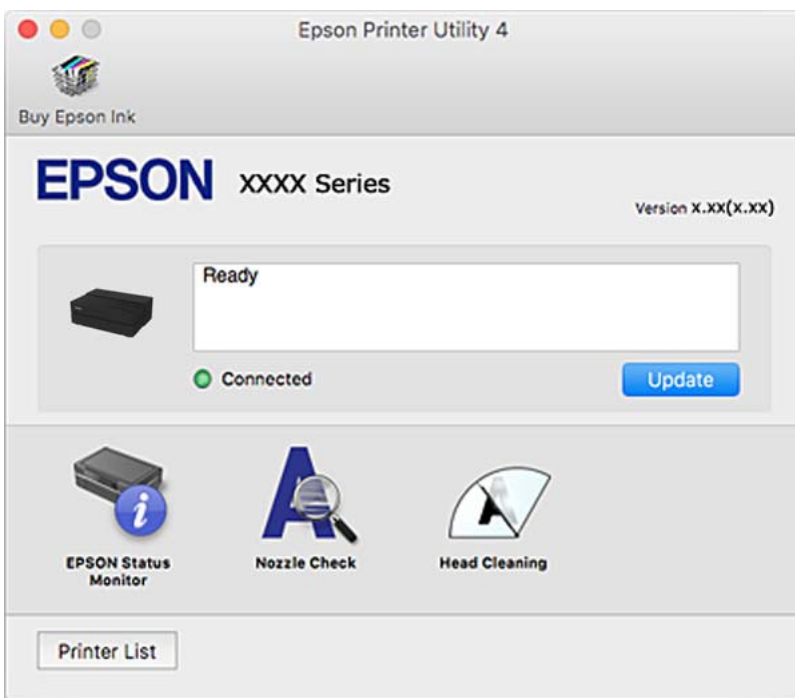

**Application for Printing to Easily Layout and Print Photos (Epson Print Layout)**

Epson Print Layout is an application that allows you to print retouched and processed photos using a simple procedure. It can also be used as plug-in software for Adobe Photoshop, Adobe Lightroom, Nikon ViewNX-i, and SILKYPIX. For details on supported applications and supported data formats, see the manual that supplied with Epson Print Layout.

You can download Epson Print Layout from the Epson website.

<http://www.epson.com>

**Note:**

- To use this application the printer driver for this printer must be installed.
- See to the software manual for details on how to start from commercially available application software such as Adobe Photoshop and Adobe Lightroom.
- You can use Epson Print Layout on iPad. This allows you to move your project to other locations.
- Search for and install Epson Print Layout from the App Store.

**Related Information**

- ➔ [“Installing the Applications Separately” on page 107](#)

## Application for Quick and Fun Printing from a Computer (Epson Photo+)

Epson Photo+ is an application that allows you to easily print images with a variety of layouts. You can also perform image correction and adjust the position while viewing a preview of your document. You can also brighten up your images by adding text and stamps wherever you like. You can also print a CD/DVD jacket for CD/DVD case. When printing on genuine Epson photo paper, the ink performance is maximized creating a beautiful finish with excellent coloring.

See the application's help for details. You can download Epson Photo+ from the Epson website.

<http://www.epson.com>

**Note:**

To use this application the printer driver for this printer must be installed.

### Starting on Windows

- Windows 10  
Click the start button, and then select **Epson Software > Epson Photo+**.
- Windows 8.1/Windows 8  
Enter the application name in the search charm, and then select the displayed icon.
- Windows 7  
Click the start button, and select **All Programs** or **Programs > Epson Software > Epson Photo+**.

### Starting on Mac OS

Select **Go > Applications > Epson Software > Epson Photo+**.

**Related Information**

- ➔ [“Installing the Applications Separately” on page 107](#)

## Application for Easily Operating the Printer from a Smart device (Epson Smart Panel)

Epson Smart Panel is an application that allows you to perform printer operations easily including printing from a smart device such as a smartphone or tablet. You can connect the printer and smart device over a wireless network, check the ink levels and printer status, and check for solutions if an error occurs.

Search for and install Epson Smart Panel from App Store or Google Play.



### Guide to the Epson Smart Panel Screen

Start Epson Smart Panel from your smart device and select the item you want to use from the home screen.

The following screens are subject to change without notice. The contents may vary depending on the product.



1	☰ displays notices and how to use the application. + starts registering a printer.
2	Displays the printer name and ink levels.
3	When you select the menu you want to use, the screen of the menu is displayed.
4	i displays the printer information. ⚙ allows you to make application settings such as changing the screen display.

## Software for Making Settings or Managing Devices

### Application for Configuring Printer Operations (Web Config)

Web Config is an application that runs in a web browser, such as Internet Explorer and Safari, on a computer or smart device. You can confirm the printer status or change the network service and printer settings. To use the Web Config, connect the printer and the computer or device to the same network.

The following browsers are supported.

Microsoft Edge, Internet Explorer 8 or later, Firefox\*, Chrome\*, Safari\*

\* Use the latest version.

### Running Web Config on a Web Browser

1. Check the printer's IP address.

Select the network icon on the printer's home screen, and then select the active connection method to confirm the printer's IP address.

**Note:**

*You can also check the IP address by printing the network connection report.*

2. Launch a Web browser from a computer or smart device, and then enter the printer's IP address.

Format:

IPv4: `http://the printer's IP address/`

IPv6: `http://[the printer's IP address]/`

Examples:

IPv4: `http://192.168.100.201/`

IPv6: `http://[2001:db8::1000:1]/`

Since the printer uses a self-signed certificate when accessing HTTPS, a warning is displayed on the browser when you start Web Config; this does not indicate a problem and can be safely ignored.

### Related Information

➔ [“Printing a Network Connection Report” on page 174](#)

### Running Web Config on Windows

When connecting a computer to the printer using WSD, follow the steps below to run Web Config.

1. Open the printer list on the computer.

Windows 10

Click on the start button, and then select **Windows System > Control Panel > View devices and printers** in **Hardware and Sound**.

Windows 8.1/Windows 8

Select **Desktop > Settings > Control Panel > View devices and printers** in **Hardware and Sound** (or **Hardware**).

Windows 7

Click the start button, and select **Control Panel > View devices and printers** in **Hardware and Sound**.

2. Right-click on your printer and select **Properties**.

3. Select the **Web Service** tab and click the URL.

Since the printer uses a self-signed certificate when accessing HTTPS, a warning is displayed on the browser when you start Web Config; this does not indicate a problem and can be safely ignored.

### **Running Web Config on Mac OS**

1. Select **System Preferences** from the Apple menu > **Printers & Scanners** (or **Print & Scan, Print & Fax**), and then select the printer.

2. Click **Options & Supplies > Show Printer Webpage**.

Since the printer uses a self-signed certificate when accessing HTTPS, a warning is displayed on the browser when you start Web Config; this does not indicate a problem and can be safely ignored.

## **Software for Updating**

### **Application for Updating Software and Firmware (EPSON Software Updater)**

EPSON Software Updater is an application that installs new software, and updates firmware and manuals over the Internet. If you want to check for update information regularly, you can set the interval for checking for updates in EPSON Software Updater's Auto Update Settings.

#### **Starting on Windows**

Windows 10

Click the start button, and then select **Epson Software > EPSON Software Updater**.

Windows 8.1/Windows 8

Enter the application name in the search charm, and then select the displayed icon.

Windows 7

Click the start button, and then select **All Programs (or Programs) > Epson Software > EPSON Software Updater**.

**Note:**

*You can also start EPSON Software Updater by clicking the printer icon on the task bar on the desktop, and then selecting **Software Update**.*

#### **Starting on Mac OS**

Select **Go > Applications > Epson Software > EPSON Software Updater**.

#### **Related Information**

➔ [“Installing the Applications Separately” on page 107](#)

## Menu List

Select  on the home screen of the printer to view the menus.

### Paper Setting:

You can also display this menu by selecting  on the home screen.

### Cut/Eject:

You can also display this menu by selecting  on the home screen.

### Ink Levels:

You can also display this menu by selecting  on the home screen.

### Maintenance:

You can also display this menu by selecting  on the home screen.

### Print Information Sheet:

You can also display this menu by selecting  on the home screen.

### General Settings:

You can make various settings.

### Web Movie Manuals:

Scan the displayed QR code to access instructional videos.

### Related Information

- ➔ [“Home Screen Configuration” on page 20](#)
- ➔ [“General Settings” on page 206](#)

---

## General Settings

Select **General Settings** from  on the home screen of the printer to make various settings.

## Screen Customization

Select the menus on the control panel as described below.

 > **General Settings** > **Screen Customization**

**Background Color:**

Change the background color of the LCD screen.

**Home Screen:**

Set the default screen you want to display as the home screen.

**Standard:**

Displays information such as paper settings, ejection status, and ink info.

**Supply Status:**

Displays the approximate ink levels and the approximate service life of the maintenance box.

**Print Screen:**

Set the default screen you want to display when printing.

**Photo:**

Displays thumbnails of images when you print using printer driver and Epson Print Layout.

**Print Settings:**

Displays print settings for the printer driver and Epson Print Layout.

**Print Status:**

Displays the approximate ink levels and a progress bar when printing.

## Printer Settings

Select the menus on the control panel as described below.

 > **General Settings** > **Printer Settings**

**Paper Setup Auto Display:**

Select **On** to display the **Paper Setting** screen when loading paper in the rear paper feeder. If you disable this feature, you cannot print from an iPhone, iPad, or iPod touch using AirPrint.

**Error Notice:**

**Paper Mismatch:**

Displays a warning if the paper settings (print settings) for the print job do not match the printer's paper settings made when you loaded the paper. This setting prevents misprinting. However, the paper setting screen is not displayed when **Paper Setup Auto Display** is disabled in the following menus. If you disable this feature, you cannot print from an iPhone, iPad, or iPod touch using AirPrint.

**Detect Paper Meandering:**

Select **On** to display a message when paper is fed at an angle.

**Horizontal Centered:**

Select **On** to print the image in the center of the paper.

#### Thick Paper:

Select **On** to prevent ink from smearing on your printouts.

## Basic Settings

Select the menus on the control panel as described below.

 > **General Settings** > **Basic Settings**

#### Inside Light:

Select **Auto** to turn on the interior light automatically when printing.

#### LCD Brightness:

Adjust the brightness of the LCD screen.

#### Sounds:

Adjust the volume and select the type of the sound.

- Mute
- Button Press
- Error Tone
- Sound Type

#### Sleep Timer:

Adjust the time period to enter a sleep mode (energy saving mode) when the printer has not performed any operations. The LCD screen turns black when the setting time passes.

#### Power Off Settings:

Your product may have this feature or the **Power Off Timer** feature depending on the location of purchase.

##### Power Off If Inactive

Select this setting to turn the printer off automatically if it is not used for a specified period of time. Any increase will affect the product's energy efficiency. Please consider the environment before making any change.

##### Power Off If Disconnected

Select this setting to turn the printer off after 30 minutes when all ports including the USB port are disconnected. This feature may not be available depending on your region.

#### Power Off Timer:

Your product may have this feature or the **Power Off Settings** feature depending on the location of purchase.

Select this setting to turn the printer off automatically when it is not used for a specified period of time. You can adjust the time before power management is applied. Any increase will affect the product's energy efficiency. Please consider the environment before making any change.



Date/Time Settings:

Date/Time

Enter the current date and time.

Daylight Saving Time

Select the summer time setting that applies to your area.

Time Difference

Enter the time difference between your local time and UTC (Coordinated Universal Time).

Language:

Select the language used on the LCD screen.

Length Unit:

Select the length unit.

**Related Information**

➔ [“Menu List” on page 206](#)

➔ [“Saving Power” on page 106](#)

## Network Settings

Select the menus on the control panel as described below.



> **General Settings > Network Settings**

Wi-Fi Setup:

Set up or change wireless network settings. Choose the connection method from following and then follow the instructions on the control panel.

Wi-Fi (Recommended):

Wi-Fi Setup Wizard

Push Button Setup(WPS)

Others

PIN Code Setup(WPS)

Wi-Fi Auto Connect

Disable Wi-Fi

You may be able to resolve network problems by disabling the Wi-Fi settings or making the Wi-Fi settings again. Tap  > **Wi-Fi (Recommended) > Change Settings > Others > Disable Wi-Fi > Start Setup.**

Wi-Fi Direct:

iOS

Android

Other OS Devices

- Change
  - Change Network Name
  - Change Password
  - Disable Wi-Fi Direct
  - Restore Default Settings

#### Wired LAN Setup:

Set up or change a network connection that uses a LAN cable and router. When this is being used, Wi-Fi connections are disabled.

#### Network Status:

Displays or prints the current network settings.

- Wired LAN/Wi-Fi Status
- Wi-Fi Direct Status
- Print Status Sheet

#### Connection Check:

Checks the current network connection and prints a report. If there are any problems with the connection, see the report to solve the problem.

#### Advanced:

Make the following detailed settings.

- Device Name
- TCP/IP
- Proxy Server

## Web Service Settings

Select the menus on the control panel as described below.

 > **General Settings** > **Web Service Settings**

#### Epson Connect Services:

Displays whether the printer is registered and connected to Epson Connect. You can register to the service by selecting **Register** and follow the instructions. When you have registered, you can change the following settings.

- Suspend/Resume
- Unregister

For details, see the following web site.

<https://www.epsonconnect.com/>

<http://www.epsonconnect.eu> (Europe only)

## Customer Research

Select the menus on the control panel as described below.



> **General Settings > Customer Research**

Select **Approve** to provide product usage information such as the number of prints to Seiko Epson Corporation.

## Restore Default Settings

Select the menus on the control panel as described below.



> **General Settings > Restore Default Settings**

Reset the settings in the following menus to their defaults.

- Network Settings
- All Except Network Settings
- Clear All Data and Settings

## Printer Status/Print

Select the menus on the control panel as described below.



> **General Settings > Printer Status/Print**

Print Status Sheet:

Configuration Status Sheet:

Print information sheets showing the current printer status and settings.

Supply Status Sheet:

Print information sheets showing the status of consumables.

Usage History Sheet:

Print information sheets showing the usage history of the printer.

Network:

Displays the current network settings. You can also print the status sheet.

Problem Checklist:

Print sheets to check for printer problems. If the printer malfunctions, print the "customer diagnosis sheets (3 sheets)" and fill in the required information on the first and second sheets. Including the third nozzle check result with the first two sheets can make repairs smoother.

Firmware Version:

Displays the current firmware version of your printer.

## Firmware Update

Select the menus on the control panel as described below.

 > **General Settings** > **Firmware Update**

Update:

Check if the latest version of the firmware has been uploaded to the network server. The firmware is updated when new firmware is found. Once the update has started, it cannot be interrupted.

Notification:

Select **On** to receive a notification if a firmware update is available.

### Related Information

➔ [“Updating the Printer's Firmware Using the Control Panel” on page 111](#)

## Product Specifications

### Printer Specifications

Type Printer	Inkjet
Print Head Nozzle Placement	Black ink nozzles: 360 Color ink nozzles: 180 for each color

### Printable Area

#### Printable Area for Single Sheets

Print quality may decline in the shaded areas due to the printer's mechanism.

#### Printing with borders

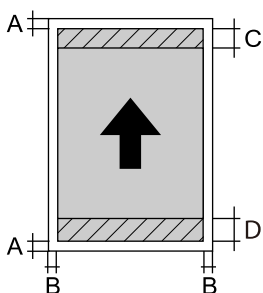
	A *	3 mm
	B	3 mm
	C	33 mm
	D	36 mm

\*: Poster board is printed with 20.0 mm margins.

**Borderless printing\***

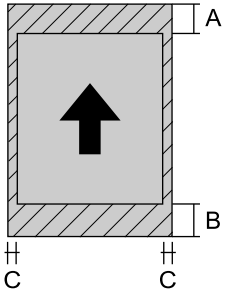
	A	36 mm
	B	39 mm
	C	3 mm

\*: Borderless printing is not supported with poster board.

**Printable Area for Roll Paper**

Print quality may decline in the shaded areas due to the printer's mechanism.

**Printing with borders**

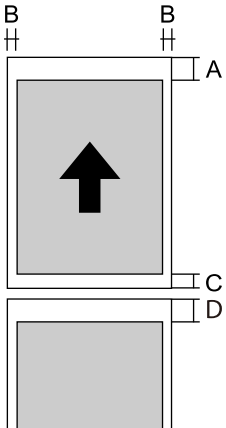
	A	50mm
	B	3mm
	C*	14mm
	D*	50mm

\*: 0 mm for continuous print jobs.

**Borderless printing**

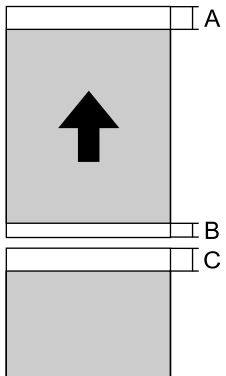
	A	50mm
	B*	14mm
	C*	50mm

\*: 0 mm for continuous print jobs.

### Printable Area for CD/DVD

Print quality may decline in the shaded areas due to the printer's mechanism.

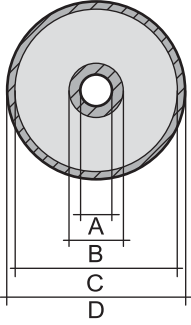
	A	18 mm (0.71 in.)
	B	43 mm (1.69 in.)
	C	116 mm (4.57 in.)
	D	120 mm (4.72 in.)



## Interface Specifications

For Computer	SuperSpeed USB
--------------	----------------

## Network Specifications

### Wi-Fi Specifications

See the following table for Wi-Fi specifications.

Countries or regions except for those listed below	Table A
Ireland, UK, Austria, Germany, Liechtenstein, Switzerland, France, Belgium, Luxemburg, Netherlands, Italy, Portugal, Spain, Denmark, Finland, Norway, Sweden, Iceland, Australia, New Zealand, China, Hong Kong, Mongolia, Taiwan, South Korea	Table B
Guade Loupe, Martinique, Mayotte, New Caledonia, SaintPierre,Miquelon, Reunion, French Polynesia, French Guyana, Wallis Futuna	<p>If you can select the following menu, see Table B. If you cannot, see Table A.</p> <p> &gt; <b>General Settings &gt; Network Settings &gt; Wi-Fi Setup &gt; Wi-Fi Direct &gt; Start Setup &gt; Change &gt; Change Frequency Range</b></p> <p>*When you select the menu above, Wi-Fi Direct turns on.</p> <p>If you want to turn off Wi-Fi Direct, select  &gt; <b>General Settings &gt; Network Settings &gt; Wi-Fi Setup &gt; Wi-Fi Direct &gt; Start Setup &gt; Change &gt; Disable Wi-Fi Direct</b></p>

**Table A**

Standards	IEEE802.11b/g/n* <sup>1</sup>
Frequency Range	2.4 GHz
Channels	1/2/3/4/5/6/7/8/9/10/11/12/13

Coordination Modes	Infrastructure, Wi-Fi Direct (Simple AP) <sup>*2*3</sup>
Security Protocols <sup>*4</sup>	WEP (64/128bit), WPA2-PSK (AES) <sup>*5</sup> , WPA3-SAE (AES)

\*1: Only available for the HT20

\*2: Not supported for IEEE 802.11b

\*3: Infrastructure and Wi-Fi Direct modes or an Ethernet connection can be used simultaneously.

\*4: Wi-Fi Direct supports WPA2-PSK (AES) only.

\*5: Complies with WPA2 standards with support for WPA/WPA2 Personal.

**Table B**

Standards	IEEE802.11a/b/g/n <sup>*1</sup> /ac		
Frequency Ranges	IEEE802.11b/g/n: 2.4 GHz, IEEE802.11a/n/ac: 5 GHz		
Channels	Wi-Fi	2.4 GHz	1/2/3/4/5/6/7/8/9/10/11/12 <sup>*2</sup> /13 <sup>*2</sup>
		5 GHz <sup>*3</sup>	W52 (36/40/44/48), W53 (52/56/60/64), W56 (100/104/108/112/116/120/124/128/132/136/140), W58 (149/153/157/161/165)
	Wi-Fi Direct	2.4 GHz	1/2/3/4/5/6/7/8/9/10/11/12 <sup>*2</sup> /13 <sup>*2</sup>
		5 GHz <sup>*3</sup>	W52 (36/40/44/48) W58 (149/153/157/161/165)
Connection Modes	Infrastructure, Wi-Fi Direct (Simple AP) <sup>*4*5</sup>		
Security Protocols <sup>*6</sup>	WEP (64/128bit), WPA2-PSK (AES) <sup>*7</sup> , WPA3-SAE (AES)		

\*1: Only available for the HT20

\*2: Not available in Taiwan

\*3: The availability of these channels and use of the product outdoors over these channels varies by location. For more information, see <http://support.epson.net/wifi5ghz/>

\*4: Not supported for IEEE 802.11b

\*5: Infrastructure and Wi-Fi Direct modes or an Ethernet connection can be used simultaneously.

\*6: Wi-Fi Direct only supports WPA2-PSK (AES) .

\*7: Complies with WPA2 standards with support for WPA/WPA2 Personal.

## Ethernet Specifications

Standards	IEEE802.3i (10BASE-T) <sup>*1</sup> IEEE802.3u (100BASE-TX) <sup>*1</sup> IEEE802.3az (Energy Efficient Ethernet) <sup>*2</sup>
-----------	---

Communication Mode	Auto, 10Mbps Full duplex, 10Mbps Half duplex, 100Mbps Full duplex, 100Mbps Half duplex
Connector	RJ-45

\*1 Use a category 5e or higher STP (Shielded twisted pair) cable to prevent risk of radio interference.

\*2 The connected device should comply with IEEE802.3az standards.

## Network Functions and IPv4/IPv6

Functions			Supported	Remarks
Network Printing	EpsonNet Print (Windows)	IPv4	✓	-
	Standard TCP/IP (Windows)	IPv4, IPv6	✓	-
	WSD Printing (Windows)	IPv4, IPv6	✓	Windows Vista or later
	Bonjour Printing (Mac OS)	IPv4, IPv6	✓	-
	IPP Printing (Windows, Mac OS)	IPv4, IPv6	✓	-
	PictBridge Printing (Wi-Fi)	IPv4	✓	Digital camera
	Epson Connect (Email Print, Remote Print)	IPv4	✓	-
	AirPrint (iOS, Mac OS)	IPv4, IPv6	✓	iOS 5 or later, Mac OS X v10.7 or later
Network Scanning	Epson Scan 2	IPv4, IPv6	-	-
	Event Manager	IPv4	-	-
	Epson Connect (Scan to Cloud)	IPv4	-	-
	AirPrint (Scan)	IPv4, IPv6	-	-
Fax	Send a fax	IPv4	-	-
	Receive a fax	IPv4	-	-
	AirPrint (Faxout)	IPv4, IPv6	-	-

## Security Protocol

SSL/TLS	HTTPS Server/Client, IPPS
SNMPv3	



## Supported Third Party Services

AirPrint	iOS 5 or later/Mac OS X v10.7.x or later
----------	--

## Dimensions

### SC-P900 Series

Dimensions	<p>Storage</p> <ul style="list-style-type: none"> <li><input type="checkbox"/> Width: 615 mm (24.2 in.)</li> <li><input type="checkbox"/> Depth: 368 mm (14.5 in.)</li> <li><input type="checkbox"/> Height: 199 mm (7.8 in.)</li> </ul> <p>Printing</p> <ul style="list-style-type: none"> <li><input type="checkbox"/> Width: 615 mm (24.2 in.)</li> <li><input type="checkbox"/> Depth: 905 mm (35.6 in.)</li> <li><input type="checkbox"/> Height: 520 mm (20.5 in.)</li> </ul>
Weight	<p>Approx. 14.8 kg (32.6 lb) (Without the ink cartridges and the power cord.)</p> <p>Approx. 15.9 kg (35.1 lb) (With the ink cartridges and the power cord.)</p>

### SC-P700 Series

Dimensions	<p>Storage</p> <ul style="list-style-type: none"> <li><input type="checkbox"/> Width: 515 mm (20.3 in.)</li> <li><input type="checkbox"/> Depth: 368 mm (14.5 in.)</li> <li><input type="checkbox"/> Height: 185 mm (7.3 in.)</li> </ul> <p>Printing</p> <ul style="list-style-type: none"> <li><input type="checkbox"/> Width: 515 mm (20.3 in.)</li> <li><input type="checkbox"/> Depth: 769 mm (30.3 in.)</li> <li><input type="checkbox"/> Height: 420 mm (16.5 in.)</li> </ul>
Weight	<p>Approx. 12.6 kg (27.8 lb) (Without the ink cartridges and the power cord.)</p> <p>Approx. 13.7 kg (30.2 lb) (With the ink cartridges and the power cord.)</p>

## Electrical Specifications

### SC-P900 Series

Model	100 to 240 V Model	100 to 120V Model	220 to 240 V Model
Rated Frequency Range	50 to 60 Hz	50 to 60 Hz	50 to 60 Hz
Rated Current	1.3 to 0.7 A	1.2 A	0.7 A

Power Consumption (with USB Connection)	Printing: Approx. 24.0 W (ISO/IEC24712) Ready mode: Approx. 8.0 W Sleep mode: Approx. 1.1 W Power off: Approx. 0.14 W	Printing: Approx. 24.0 W (ISO/IEC24712) Ready mode: Approx. 8.0 W Sleep mode: Approx. 1.1 W Power off: Approx. 0.08 W	Printing: Approx. 24.0 W (ISO/ IEC24712) Ready mode: Approx. 8.0 W Sleep mode: Approx. 1.1 W Power off: Approx. 0.18 W
--	---	---	--

**Note:**

- Check the label on the printer for its voltage.
- For European users, see the following Website for details on power consumption.  
<http://www.epson.eu/energy-consumption>

**SC-P700 Series**

Model	100 to 240 V Model	100 to 120V Model	220 to 240 V Model
Rated Frequency Range	50 to 60 Hz	50 to 60 Hz	50 to 60 Hz
Rated Current	1.3 to 0.7 A	1.2 A	0.7 A
Power Consumption (with USB Connection)	Printing: Approx. 22.0 W (ISO/IEC24712) Ready mode: Approx. 8.0 W Sleep mode: Approx. 1.1 W Power off: Approx. 0.14 W	Printing: Approx. 22.0 W (ISO/IEC24712) Ready mode: Approx. 8.0 W Sleep mode: Approx. 1.1 W Power off: Approx. 0.08 W	Printing: Approx. 22.0 W (ISO/ IEC24712) Ready mode: Approx. 8.0 W Sleep mode: Approx. 1.1 W Power off: Approx. 0.18 W

**Note:**

- Check the label on the printer for its voltage.
- For European users, see the following Website for details on power consumption.  
<http://www.epson.eu/energy-consumption>

## Environmental Specifications

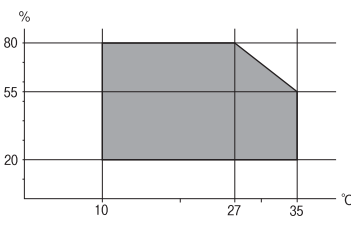
Operation	Use the printer within the range shown in the following graph.  Temperature: 10 to 35°C (50 to 95°F) Humidity: 20 to 80% RH (without condensation)
Storage	Temperature: -20 to 40°C (-4 to 104°F)* Humidity: 5 to 85% RH (without condensation)

\* You can store for one month at 40°C (104°F).

## Environmental Specifications for Ink Cartridges

Storage Temperature	-20 to 40 °C (-4 to 104 °F)*
Freezing Temperature	0 °C (32 °F) Ink thaws and is usable after approximately 3 hours at 25 °C (77 °F).

\* You can store for one month at 40 °C (104 °F).

## Installation Location and Space

Secure enough place to install and operate the printer correctly.

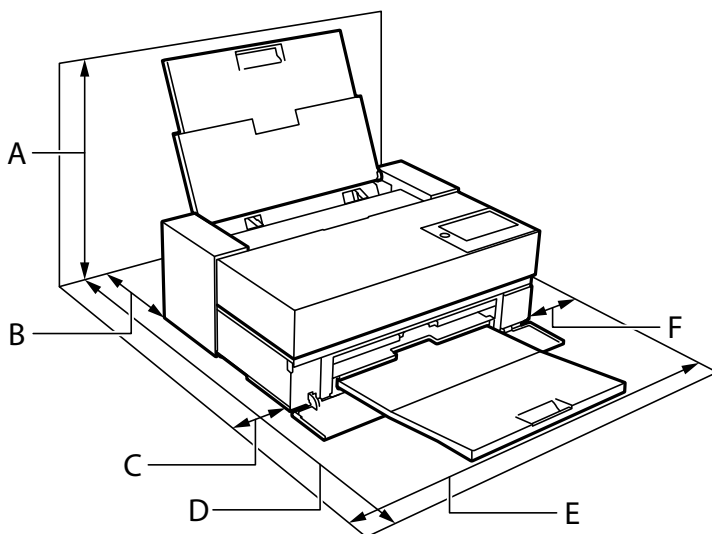

Product Name	SC-P900 Series	SC-P700 Series
A	576 mm	507 mm
B	173 mm* <sup>1</sup>	143 mm* <sup>2</sup>
C	110 mm	108 mm
D	964 mm	858 mm
E	825 mm	723 mm
F	100 mm	100 mm

\*1: When you load paper in the front paper feeder, secure more than 405 mm, and when you set the optional roll paper unit and load roll paper, secure more than 332 mm behind the printer.

\*2: When you load paper in the front paper feeder, secure more than 330 mm, and when you load roll paper, secure more than 164 mm behind the printer.

See "Safety Instructions" in this manual to confirm the environmental conditions.

## Related Information

➔ [“Safety Instructions” on page 11](#)

## System Requirements

- Windows 10 (32-bit, 64-bit)/Windows 8.1 (32-bit, 64-bit)/Windows 8 (32-bit, 64-bit)/Windows 7 (32-bit, 64-bit)
- macOS Catalina(10.15)/macOS Mojave(10.14)/macOS High Sierra(10.13)/macOS Sierra(10.12)/OS X El Capitan(10.11)/OS X Yosemite(10.10)/OS X Mavericks(10.9)

### Note:

- Mac OS may not support some applications and features.
- The UNIX File System (UFS) for Mac OS is not supported.

---

## Regulatory Information

### Standards and Approvals

#### Standards and Approvals for U.S. Model

Safety	UL62368-1 CAN/CSA-C22.2 No.62368-1
EMC	FCC Part 15 Subpart B Class B CAN ICES-3 (B)/NMB-3 (B)

This equipment contains the following wireless module.

Manufacturer: Seiko Epson Corporation

Type: J26H005

This product conforms to Part 15 of the FCC Rules and RSS-210 of the IC Rules. Epson cannot accept responsibility for any failure to satisfy the protection requirements resulting from a non-recommended modification of the product. Operation is subject to the following two conditions: (1) this device may not cause harmful interference, and (2) this device must accept any interference received, including interference that may cause undesired operation of the device.

To prevent radio interference to the licensed service, this device is intended to be operated indoors and away from windows to provide maximum shielding. Equipment (or its transmit antenna) that is installed outdoors is subject to licensing.

This equipment complies with FCC/IC radiation exposure limits set forth for an uncontrolled environment and meets the FCC radio frequency (RF) Exposure Guidelines in Supplement C to OET65 and RSS-102 of the IC radio frequency (RF) Exposure rules. This equipment should be installed and operated so that the radiator is kept at least 7.9 inches (20 cm) or more away from a person's body (excluding extremities: hands, wrists, feet and ankles).

## Standards and Approvals for European Model

For European users

Hereby, Seiko Epson Corporation declares that the following radio equipment model is in compliance with Directive 2014/53/EU. The full text of the EU declaration of conformity is available at the following website.

<http://www.epson.eu/conformity>

K371A

For use only in Ireland, UK, Austria, Germany, Liechtenstein, Switzerland, France, Belgium, Luxemburg, Netherlands, Italy, Portugal, Spain, Denmark, Finland, Norway, Sweden, Iceland, Croatia, Cyprus, Greece, Slovenia, Malta, Bulgaria, Czech, Estonia, Hungary, Latvia, Lithuania, Poland, Romania, and Slovakia.

Epson cannot accept responsibility for any failure to satisfy the protection requirements resulting from a non-recommended modification of the products.

Frequency	Maximum Radio-Frequency Power Transmitted
2400-2483.5 MHz	20 dBm (EIRP)
5150-5250 MHz	20 dBm (EIRP)
5250-5350 MHz	20 dBm (EIRP)
5470-5725 MHz	20 dBm (EIRP)



## Standards and Approvals for Australian Model

EMC	AS/NZS CISPR32 Class B
-----	------------------------

Epson hereby declares that the following equipment Models are in compliance with the essential requirements and other relevant provisions of AS/NZS4268:

K371A

Epson cannot accept responsibility for any failure to satisfy the protection requirements resulting from a non-recommended modification of the products.

## Restrictions on Copying

Observe the following restrictions to ensure the responsible and legal use of the printer.

Copying of the following items is prohibited by law:

- Bank bills, coins, government-issued marketable securities, government bond securities, and municipal securities
- Unused postage stamps, pre-stamped postcards, and other official postal items bearing valid postage
- Government-issued revenue stamps, and securities issued according to legal procedure

Exercise caution when copying the following items:

- Private marketable securities (stock certificates, negotiable notes, checks, etc.), monthly passes, concession tickets, etc.
- Passports, driver's licenses, warrants of fitness, road passes, food stamps, tickets, etc.

**Note:**

*Copying these items may also be prohibited by law.*

Responsible use of copyrighted materials:

Printers can be misused by improperly copying copyrighted materials. Unless acting on the advice of a knowledgeable attorney, be responsible and respectful by obtaining the permission of the copyright holder before copying published material.

---



# Where to Get Help

Technical Support Web Site. . . . .	224
Contacting Epson Support. . . . .	224

---

## Technical Support Web Site

If you need further help, visit the Epson support website shown below. Select your country or region and go to the support section of your local Epson website. The latest drivers, FAQs, manuals, or other downloadables are also available from the site.

<http://support.epson.net/>

<http://www.epson.eu/Support> (Europe)

If your Epson product is not operating properly and you cannot solve the problem, contact Epson support services for assistance.

---

## Contacting Epson Support

### Before Contacting Epson

If your Epson product is not operating properly and you cannot solve the problem using the troubleshooting information in your product manuals, contact Epson support services for assistance. If Epson support for your area is not listed below, contact the dealer where you purchased your product.

Epson support will be able to help you much more quickly if you give them the following information:

- Product serial number  
(The serial number label is usually on the back of the product.)
- Product model
- Product software version  
(Click **About**, **Version Info**, or a similar button in the product software.)
- Brand and model of your computer
- Your computer operating system name and version
- Names and versions of the software applications you normally use with your product

**Note:**

*Depending on the product, network settings may be stored in the product's memory. Due to breakdown or repair of a product, settings may be lost. Epson shall not be responsible for the loss of any data, for backing up or recovering settings even during a warranty period. We recommend that you make your own backup data or take notes.*

### Help for Users in Europe

Check your Pan-European Warranty Document for information on how to contact Epson support.

### Help for Users in Taiwan

Contacts for information, support, and services are:

**World Wide Web**

<http://www.epson.com.tw>



Information on product specifications, drivers for download, and products enquiry are available.

### **Epson HelpDesk**

Phone: +886-2-80242008

Our HelpDesk team can help you with the following over the phone:

- Sales enquiries and product information
- Product usage questions or problems
- Enquiries on repair service and warranty

### **Repair service center:**

<http://www.tekcare.com.tw/branchMap.page>

TekCare corporation is an authorized service center for Epson Taiwan Technology & Trading Ltd.

## **Help for Users in Australia**

Epson Australia wishes to provide you with a high level of customer service. In addition to your product manuals, we provide the following sources for obtaining information:

### **Internet URL**

<http://www.epson.com.au>

Access the Epson Australia World Wide Web pages. Worth taking your modem here for the occasional surf! The site provides a download area for drivers, Epson contact points, new product information and technical support (e-mail).

### **Epson Helpdesk**

Phone: 1300-361-054

Epson Helpdesk is provided as a final backup to make sure our clients have access to advice. Operators on the Helpdesk can aid you in installing, configuring and operating your Epson product. Our Pre-sales Helpdesk staff can provide literature on new Epson products and advise where the nearest dealer or service agent is located. Many types of queries are answered here.

We encourage you to have all the relevant information on hand when you ring. The more information you prepare, the faster we can help solve the problem. This information includes your Epson product manuals, type of computer, operating system, application programs, and any information you feel is required.

### **Transportation of Product**

Epson recommends retaining product packaging for future transportation.

## **Help for Users in New Zealand**

Epson New Zealand wishes to provide you with a high level of customer service. In addition to your product documentation, we provide the following sources for obtaining information:

### **Internet URL**

<http://www.epson.co.nz>

Access the Epson New Zealand World Wide Web pages. Worth taking your modem here for the occasional surf! The site provides a download area for drivers, Epson contact points, new product information and technical support (e-mail).

### **Epson Helpdesk**

Phone: 0800 237 766

Epson Helpdesk is provided as a final backup to make sure our clients have access to advice. Operators on the Helpdesk can aid you in installing, configuring and operating your Epson product. Our Pre-sales Helpdesk staff can provide literature on new Epson products and advise where the nearest dealer or service agent is located. Many types of queries are answered here.

We encourage you to have all the relevant information on hand when you ring. The more information you prepare, the faster we can help solve the problem. This information includes your Epson product documentation, type of computer, operating system, application programs, and any information you feel is required.

### **Transportation of Product**

Epson recommends retaining product packaging for future transportation.

## **Help for Users in Singapore**

Sources of information, support, and services available from Epson Singapore are:

### **World Wide Web**

<http://www.epson.com.sg>

Information on product specifications, drivers for download, Frequently Asked Questions (FAQ), Sales Enquiries, and Technical Support via e-mail are available.

### **Epson HelpDesk**

Toll Free: 800-120-5564

Our HelpDesk team can help you with the following over the phone:

- Sales enquiries and product information
- Product usage questions or problem troubleshooting
- Enquiries on repair service and warranty

## **Help for Users in Thailand**

Contacts for information, support, and services are:

### **World Wide Web**

<http://www.epson.co.th>

Information on product specifications, drivers for download, Frequently Asked Questions (FAQ), and e-mail are available.

### **Epson Call Centre**

Phone: 66-2685-9899

Email: support@eth.epson.co.th

Our Call Centre team can help you with the following over the phone:

- Sales enquiries and product information
- Product usage questions or problems
- Enquiries on repair service and warranty

## Help for Users in Vietnam

Contacts for information, support, and services are:

### Epson Service Center

65 Truong Dinh Street, District 1, Ho Chi Minh City, Vietnam.

Phone(Ho Chi Minh City): 84-8-3823-9239, 84-8-3825-6234

29 Tue Tinh, Quan Hai Ba Trung, Hanoi City, Vietnam

Phone(Hanoi City): 84-4-3978-4785, 84-4-3978-4775

## Help for Users in Indonesia

Contacts for information, support, and services are:

### World Wide Web

<http://www.epson.co.id>

- Information on product specifications, drivers for download
- Frequently Asked Questions (FAQ), Sales Enquiries, questions through e-mail

### Epson Hotline

Phone: +62-1500-766

Fax: +62-21-808-66-799

Our Hotline team can help you with the following over the phone or fax:

- Sales enquiries and product information
- Technical support

### Epson Service Center

Province	Company Name	Address	Phone E-mail
DKI JAKARTA	ESS JAKARTA MANGGADUA	Ruko Mall Mangga Dua No. 48 Jl. Arteri Mangga Dua, Jakarta Utara - DKI JAKARTA	(+6221) 62301104 jkt-admin@epson-indonesia.co.id
NORTH SUMATERA	ESC MEDAN	Jl. Bambu 2 Komplek Graha Niaga Nomor A-4, Medan - North Sumatera	(+6261) 42066090 / 42066091 mdn-adm@epson-indonesia.co.id

Province	Company Name	Address	Phone E-mail
WEST JAWA	ESC BANDUNG	Jl. Cihampelas No. 48 A Bandung Jawa Barat 40116	(+6222) 4207033 bdg-admin@epson-indonesia.co.id
DI YOGYAKARTA	ESC YOGYAKARTA	YAP Square, Block A No. 6 Jl. C Simanjutak Yogyakarta - DIY	(+62274) 581065 ygy-admin@epson-indonesia.co.id
EAST JAWA	ESC SURABAYA	Hitech Mall Lt. 2 Block A No. 24 Jl. Kusuma Bangsa No. 116 - 118 Surabaya - JATIM	(+6231) 5355035 sby-admin@epson-indonesia.co.id
SOUTH SULAWESI	ESC MAKASSAR	Jl. Cendrawasih NO. 3A, kunjung mae, mariso, MAKASSAR - SULSEL 90125	(+62411) 8911071 mksr-admin@epson-indonesia.co.id
WEST KALIMANTAN	ESC PONTIANAK	Komp. A yani Sentra Bisnis G33, Jl. Ahmad Yani - Pontianak Kalimantan Barat	(+62561) 735507 / 767049 pontianak-admin@epson-indonesia.co.id
RIAU	ESC PEKANBARU	Jl. Tuanku Tambusai No.459A Pekanbaru Riau	(+62761) 8524695 pkb-admin@epson-indonesia.co.id
DKI JAKARTA	ESS JAKARTA SUDIRMAN	Wisma Keiai Lt. 1 Jl. Jenderal Sudirman Kav. 3 Jakarta Pusat - DKI JAKARTA 10220	(+6221) 5724335 ess@epson-indonesia.co.id
EAST JAWA	ESS SURABAYA	Ruko Surya Inti Jl. Jawa No 2-4 Kav. 29 Surabaya - Jawa Timur	(+6231) 5014949 esssby@epson-indonesia.co.id
BANTEN	ESS SERPONG	Ruko Mall WTC Matahari No. 953, Serpong-Banten	(+6221) 53167051 / 53167052 esstag@epson-indonesia.co.id
CENTRAL JAWA	ESS SEMARANG	Komplek Ruko Metro Plaza Block C20 Jl. MT Haryono No 970 Semarang - JAWA TENGAH	(+6224) 8313807 / 8417935 esssmg@epson-indonesia.co.id
EAST KALIMANTAN	ESC SAMARINDA	Jl. KH. Wahid Hasyim (M. Yamin) Kelurahan Sempaja Selatan Kecamatan Samarinda UTARA - SAMARINDA - KALTIM	(+62541) 7272904 escsmd@epson-indonesia.co.id
SOUTH SUMATERA	ESC PALEMBANG	Jl. H.M Rasyid Nawawi No. 249 Kelurahan 9 Ilir Palembang Sumatera Selatan	(+62711) 311330 escplg@epson-indonesia.co.id
EAST JAVA	ESC JEMBER	JL. Panglima Besar Sudirman Ruko no.1D Jember-Jawa Timur (Depan Balai Penelitian & Pengolahan Kakao)	(+62331) 488373 / 486468 jmr-admin@epson-indonesia.co.id
NORTH SULAWESI	ESC MANADO	Tekno Megamall Lt LG 11 TK 21, Kawasan Megamas Boulevard, Jl Piere Tendean, Manado - SULUT 95111	(+62431) 8890996 MND-ADMIN@EPSON-INDONESIA.CO.ID

For other cities not listed here, call the Hot Line: 08071137766.

## Help for Users in Hong Kong

To obtain technical support as well as other after-sales services, users are welcome to contact Epson Hong Kong Limited.

### Internet Home Page

<http://www.epson.com.hk>

Epson Hong Kong has established a local home page in both Chinese and English on the Internet to provide users with the following information:

- Product information
- Answers to Frequently Asked Questions (FAQs)
- Latest versions of Epson product drivers

### Technical Support Hotline

You can also contact our technical staff at the following telephone and fax numbers:

Phone: 852-2827-8911

Fax: 852-2827-4383

## Help for Users in Malaysia

Contacts for information, support, and services are:

### World Wide Web

<http://www.epson.com.my>

- Information on product specifications, drivers for download
- Frequently Asked Questions (FAQ), Sales Enquiries, questions through e-mail

### Epson Call Centre

Phone: +60 1800-8-17349

- Sales enquiries and product information
- Product usage questions or problems
- Enquiries on repair services and warranty

### Head Office

Phone: 603-56288288

Fax: 603-5628 8388/603-5621 2088

## Help for Users in India

Contacts for information, support, and services are:

### **World Wide Web**

<http://www.epson.co.in>

Information on product specifications, drivers for download, and products enquiry are available.

### **Helpline**

- Service, product information, and ordering consumables (BSNL Lines)

Toll-free number: 18004250011

Accessible 9am to 6pm, Monday through Saturday (Except public holidays)

- Service (CDMA & Mobile Users)

Toll-free number: 186030001600

Accessible 9am to 6pm, Monday through Saturday (Except public holidays)

## **Help for Users in the Philippines**

To obtain technical support as well as other after sales services, users are welcome to contact the Epson Philippines Corporation at the telephone, fax numbers and e-mail address below:

### **World Wide Web**

<http://www.epson.com.ph>

Information on product specifications, drivers for download, Frequently Asked Questions (FAQ), and E-mail Enquiries are available.

### **Epson Philippines Customer Care**

Toll Free: (PLDT) 1-800-1069-37766

Toll Free: (Digital) 1-800-3-0037766

Metro Manila: (+632)441-9030

Web Site: <https://www.epson.com.ph/contact>

E-mail: [customercare@epc.epson.com.ph](mailto:customercare@epc.epson.com.ph)

Accessible 9am to 6pm, Monday through Saturday (Except public holidays)

Our Customer Care team can help you with the following over the phone:

- Sales enquiries and product information
- Product usage questions or problems
- Enquiries on repair service and warranty

### **Epson Philippines Corporation**

Trunk Line: +632-706-2609

Fax: +632-706-2663