

AISIN

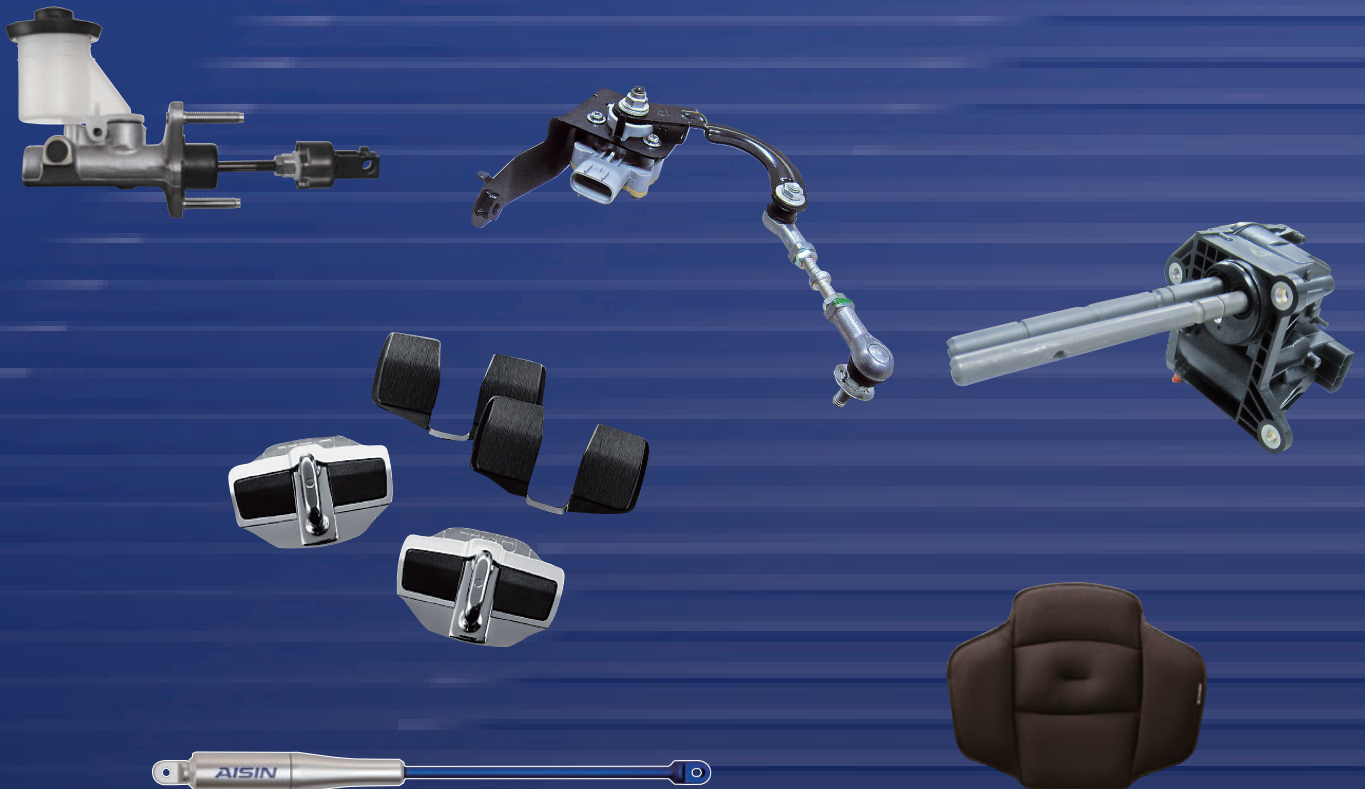

2016-2017 Aftermarket Products CATALOG





Clutch Disc



Clutch Cover



Flywheel Damper



Free Wheel Hub

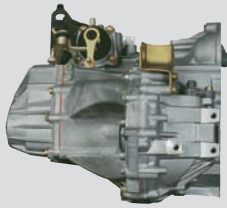

Manual Transmission

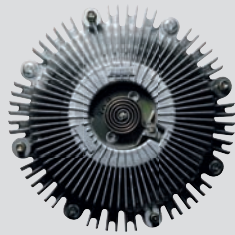

Fan Clutch



Fan Blade



Fan Pulley Bracket



Water Pump

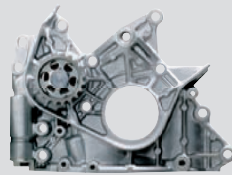

Oil Pump

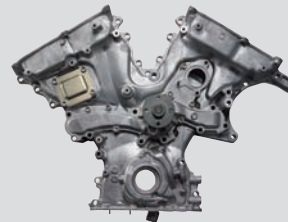

Timing Chain Cover



Hydraulic Belt Tensioner

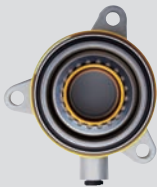

Concentric Slave Cylinder

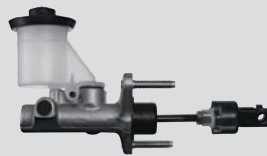

Clutch Master Cylinder



Clutch Release Cylinder



ATF

Meet the AISIN Family





Aftermarket Products

Brand Policy	2
Aftermarket Products Line-up	4
IMPORTANT NOTICE	6
Products Catalog	7
	8 Clutch
	9 Water Pump
	10 ATF
	13 Oil Pump
	14 Timing Chain Cover
	15 Fan Clutch
	16 Fan Blade
	17 Hydraulic Belt Tensioner
	18 Fan Pulley Bracket
	19 Hydraulics
	20 Concentric Slave Cylinder
	21 Free Wheel Hub
	22 Flywheel Damper
	23 Manual Transmission
	24 Height Control Sensor
	25 Motor Transfer Shift Actuator
	26 Motion Control Beam
	27 Door Stabilizer
	28 Finerevo Comfort Cushion
Sales Office	29
Aftermarket Website	30
Reference List	31
	32 Oil Pump
	55 Timing Chain Cover
	60 Fan Clutch
	73 Fan Blade
	80 Hydraulic Belt Tensioner
	81 Fan Pulley Bracket
	82 Hydraulics
	133 Concentric Slave Cylinder
	135 Free Wheel Hub
	137 Flywheel Damper
	138 Height Control Sensor
	144 Motor Transfer Shift Actuator
	146 Variave Valve Timing
	147 Oil Control Valve
	148 Manual Transmission (ASSY)
	151 Manual Transmission (Parts)

Brand Promotion

40 Years as ASCO, future as AISIN

As one of the prominent leaders in Original Equipment automotive parts manufacturing, AISIN is over 73,000 employees strong in 140 associated global subsidiaries, and is the 4th ranked in the world by FOURIN's "Monthly Report on the World Automotive Industry". Developed using AISIN OE Manufacturing Technology, Aftermarket Merchandising announced the discontinuance of the ASCO brand, and as of 2005, the products will be marketed under the original AISIN name. New logos, packaging, and marketing signify a celebration of 40 years and commemorate a new outlook into the future.

Proactive Supplier of Value

If AISIN Aftermarket were a person, its character would be summed up in the phrase of "Proactive Supplier of Value". With a constantly autonomous and active stance, this personality is based on the essence of two important aspects: "a proactive supplier that appeals to the customer and market" and "that provides not only "things" to customers, but value that goes along with the products and service".



Brand Protection

"No Counterfeit Parts"

AISIN has been actively involved in preventing the manufacturing and sale of counterfeit products. In addition to our own efforts, AISIN is also participating with the "NO Counterfeit Parts" movement in conjunction with the Japan Auto Parts Industries Association (JAPIA).

Our goal is to eliminate counterfeit parts through individual and organized group efforts. If you have any information on the sale or production of counterfeit items, please contact your local representatives immediately or you may send us information directly using the Counterfeit Report Form.



Design of the AISIN Logo

The initial letter "A" in AISIN is the first letter of the alphabet, and it often expresses leadership and superiority. AISIN's advanced originality is expressed by the open shape of the "A," which symbolizes open mindedness.

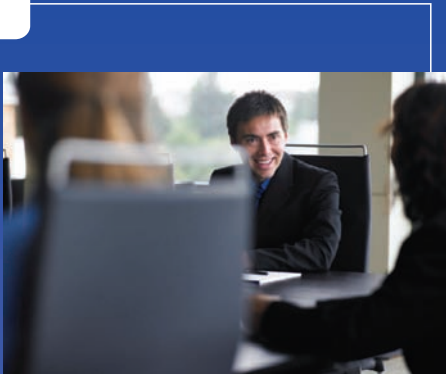

"Quality First"

Since our very beginning, Aisin Seiki has been built on a long-standing dedication to "quality first." It's a principle that defines the organization, from product development and assurance through customer satisfaction, the environment and our sense of social responsibility and contribution.



"Don't Produce! Don't Sell! Don't Buy!"

Japan Auto Parts Industries Association (JAPIA) is providing a series of posters as part of the "No Counterfeit Parts" movement. To provide international awareness of illegal activities, posters are available in several key languages: English, French, Spanish, Chinese, and Arabic. Please contact your local sales representatives to receive posters and additional information. You may also apply directly using the Request Form.





Clutch Set



Clutch Cover



Clutch Disc



Flywheel Damper



Free Wheel Hub

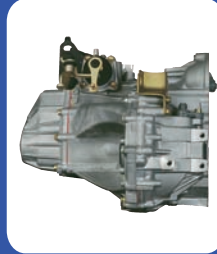

Manual Transmission

Drivetrain



Water Pump



Fan Pulley Bracket

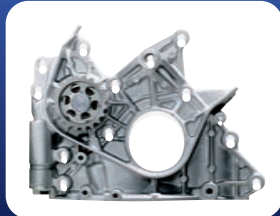

Oil Pump



Oil Pump Rotor



Timing Chain Cover



Fan Clutch



Fan Blade



Hydraulic Belt Tensioner

Engine

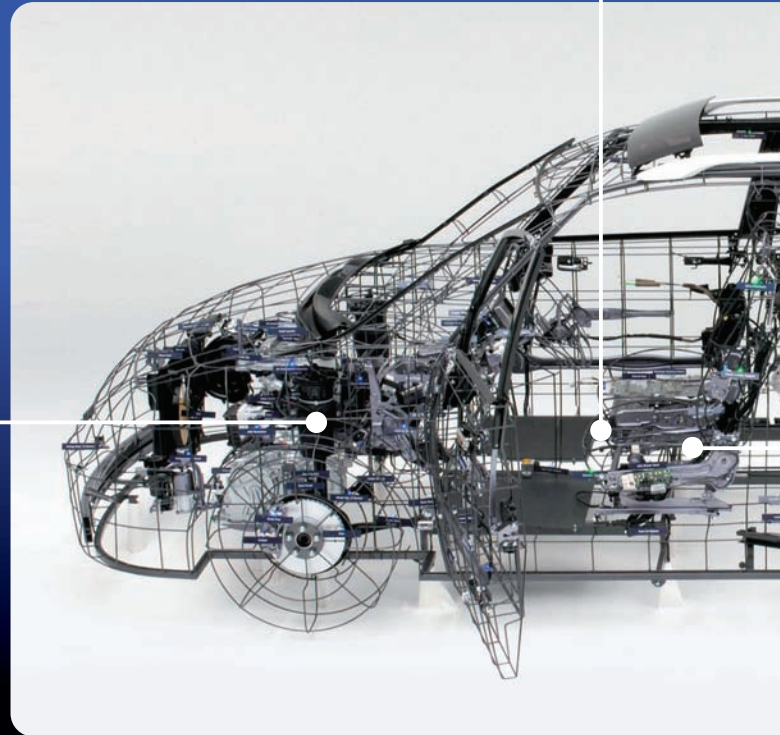

ISIN Family

AISIN



Concentric Slave Cylinder

Clutch Master Cylinder

Clutch Release Cylinder

Torque Converter

AT Solenoid

Motor Transfer Shift Actuator



Spoiler



Roof Rail



Comfort Cushion



Comfort Mat



Door Stabilizer



Motion Control Beam

Accessories



AFW+



CFEx

Automatic Transmission Fluid Series



Height Control Sensor

Others



IMPORTANT NOTICE

The purpose of this catalog is to furnish our customers with as complete a listing of parts requirements as possible.

All listings, applications or interchanges contained in this catalog are based on the latest information available at the time of printing. Every effort has been made to ensure that the information contained in this catalog is correct, but we do not assume any responsibility for errors which may occur.

All references to manufactures names or part numbers are only used as a guide when ordering parts.

Products Catalog

Clutch



AISIN's original equipment technology and know-how is used to ensuring product quality.

Cover Features

- Aisin's "Hot Seating" process stabilizes performance of the diaphragm spring.
- Diaphragm Spring Turnover (DST) type cover improves release of pressure plate.
- Higher load capacity, achieved by the latest designs enables an increase in vehicle application.

Disc Features:

- Premium quality, heat resistant and less abrasive facings ensures
- extended service life of clutch components.
- Aisin's disc spring design enhances engagement and release performance.
Floating rubber cushions or twin-hub types ensure low twisting rigidity to reduce noise, vibration and harshness.

Water Pump



AISIN, the No. 1 original equipment manufacturer of water pumps in the world, manufactures for the aftermarket to protect engines from severe heat.

Features

- Engine specific water pressure is achieved without excessive load to engine.
- Aisin's aluminum die-casting technology allows for size and weight reduction.
- Improved strength in body design and carbon ceramic mechanical seals assures leak prevention.



High precision machining process for Water Pumps

ATF

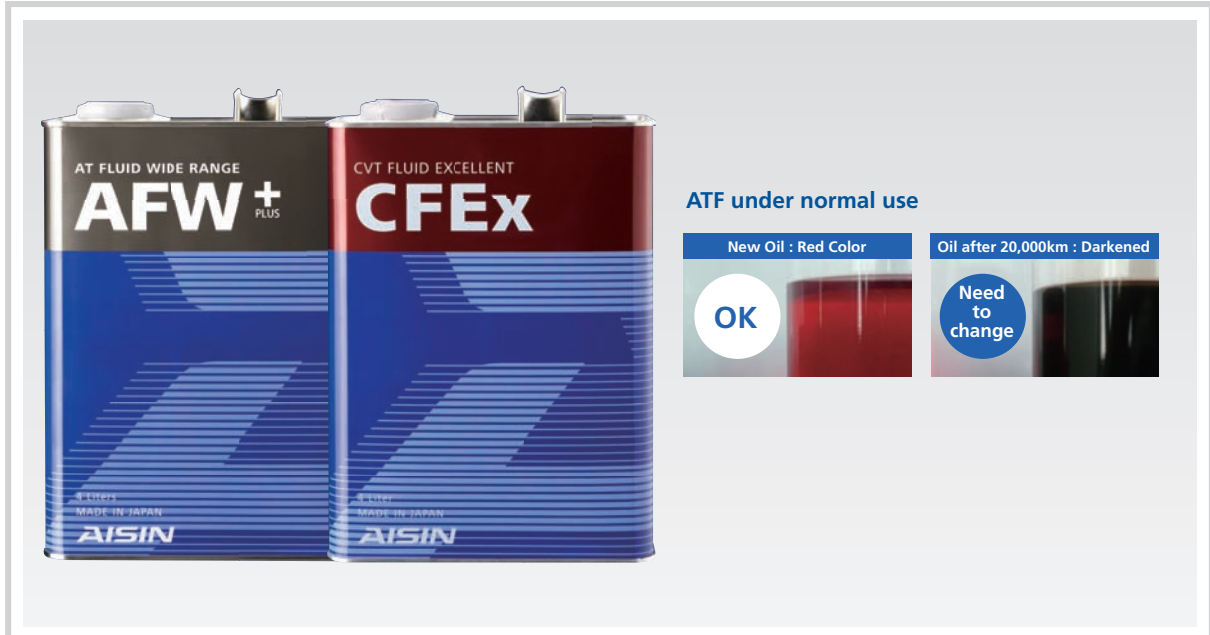

Automatic Transmission, one of Aisin's main products, has been widely used by more than 40 carmakers around the world. One out of every five A/T vehicles uses Aisin's Automatic Transmission. Aisin is the world largest A/T supplier. Amongst the makers who have capability to design and manufacture A/T as well as high quality ATF, AISIN is one of the best choice. Ever since the development of A/T, the electronic and hydraulic components have become more complicated. Therefore it is very important to service A/T regularly.

AISIN recommends car owners to change ATF every 2 years or 20000km. Without proper maintenance for the ATF, your car performance will be worsened, more fuel will be consumed and the transmission may be damaged.

AISIN supplying Automatic Transmission to the following client

- Japan
 - TOYOTA
 - Mitsubishi
 - Isuzu
 - Mazda
 - Suzuki
 - Daihatsu
- Europe
 - Volvo
 - Opel
 - Vauxhall
 - Volkswagen
 - Porsche
 - Audi
 - Peugeot Citroen
 - Ford
 - Skoda
 - BMW
 - Jaguar
- USA
 - Chrysler
 - GM

Features

- Smooth starts under the coldest conditions: Eliminates start delays at low temperatures with superior low temperature flow characteristics.
- Improved shift feel: Optimum friction properties deliver seamless gear changes without harsh shift shock.
- Responsive starts and increased performance: Optimum friction properties reduce power loss, improve responses, and ensure reliability.

Advantages of regular ATF maintenance:



AISIN ATF Application List

Car Maker	Car Model	Genuine ATF	AFW+	CFEx
Toyota	FF 4WD: COROLLA, CARINA, SPRINTER, CARIB, CAMRY, VISTA, IPSUM, SPACIO, RAV4, CALDINA, CORONA	AutoFluid T	○	×
	More than 3000cc cars (Engine: 1UZ/2Z) CELSIOR, CROWN, SOARER, MAJESTA, ARISTO, SUPRA	AutoFluid T- II	○	×
	Flex lock up cars	Auto Fluid T- III	○	×
	More than 3000cc cars & Flex lock up cars TypeT II, TypeT III: after year 1997 June; IV	Auto Fluid T- IV (T II, T III can apply IV)	○	×
	Super CVT: OPA, PREMIO, ALLION, ESTIMA HIBRID, WISH, ALPHARD HIBRID, SIENTA, VITZ	CVT Fluid TC	×	○
	General AT cars (GAIA 2WD = DEXRON II)	Auto Fluid DEXRON II-E	○	×
	CAVALIER, DUET	Auto Fluid DEXRONIII	○	×
Hino	year 2003 Aug. - CELSIOR, CROWN (6AT), LANDCRUISER 100(5AT), PRIUS	Auto Fluid WS	○	×
	General Small AT Trucks & Buses (less than 4t) *⑥	Auto Fluid DEXRON II/T- IV	○	×
Nissan	General Small AT Trucks & Buses (less than 4t) *⑥	Auto Fluid DEXRON II/T- IV	○	×
	General AT cars (Window sticker on the back side of E-AT)	Matic FluidD *⑤	○	×
	March(K10), Figaro(FK10), PRAIRIE JOY(HM11/HNM11), DATSUN TRUCK(FD21)	Matic Fluid C	○	×
	X-TRAIL, CIMA(VK Engine), SKYLINE5AT, FAIRLADY Z	Matic FluidJ	○	×
	N-CVT cars RE0F05A MARCH, CUBE	Matic FluidD *⑤	×	○
	year 2007 Oct. - SKYLINE COUPE, ELGRAND, FUGA(5AT)	Matic FluidS	○	×
	Hiper CVT cars RE0F21A MARCH, CUBE	CVT Fluid NS- 1	×	○
	Xtoronic CVT cars	CVT Fluid NS- 2	×	○
	2002 Oct. - CUBE, 2003 Feb. - TEANA, 2003 JUL. - PRESAGE, 2003 SEP. - CUBE CUBIC	CVT Fluid NS- 1	×	○
	Hiper CVT...RE0F06A RE0F06AV: PRIMERA, PRIMERA CAMINO, PRIMERA WAGON, BLUEBIRD, SUNNY, TINO, AVENIR, PRAIRIE LIBERTY, R'NESSA, WINGROAD, SERENA	CVT Fluid KTF- 1*①	×	×
UD	year 1999 Oct. - CEDRIC 300LX-Z/VP-Z, GLORIA 300 ALTIMA-Z year 2002 Jan. - SKYLINE 3500GT- 8	Mission oil R35 Special	×	×
	year 2007 Dec. - GT-R(6AMT)	Matic FluidC D/ATF M- III	○	×
	VANETTE	Besco ATFIII	○	×
Honda	General Small AT Trucks & Buses (less than 4t) *⑥	Besco ATFIII	○	×
	General AT cars (S matic, F matic, including 5AT)	Honda UltraATF	○	×
Mitsubishi	General AT cars (except light automobile only AT)	Honda UltraATF DW1	○	×
	Multi matic, Multi maticS *④	Honda UltraATF/Honda UltraATF-Z1/HMMF*⑤	×	×
	CVT (year 2003 OCT. -) ODYSSEY	Honda UltraATF-Z1*⑤	×	○
Mitsubishi Fuso	year 2006 Dec. - General AT cars	Honda UltraATF-Z1*⑤	○	×
	- year 99 Jun. All FF cars, FR cars (Except CVT cars)	Dia Queen ATF SP II/SP II M*⑤	○	×
	year 99 Jun. -	Dia Queen ATF SP III *⑤	○	×
	PAJERO io	Dia Queen ATF II *⑤	○	×
	DELICA VAN TRUCK	Dia Queen ATF SK	○	×
	OUTLANDER(6AT)	Dia Queen ATF J2	○	×
	DELICA D:5	Dia Queen ATF J3	○	×
	PAJERO 3200cc(V88W)	Dia Queen ATF PA	○	×
	OUTLANDER(CVT)	Dia Queen CVT Fluid J1	×	○
	INVECSIII-CVT...COLT, DION, MIRAGE, LANCER	Dia Queen ATF SP III *⑤	×	○
Mazda	LANCER EVOLUTION(6AMT) GALANT FORTIS (6DCT)	Dia Queen SSTF- 1	×	×
	General Small AT Trucks & Buses (less than 4t) *⑥	Fuso ATF/ATF-PA	○	×
Mazda	General AT cars (ATF S1/N is unified MIII)	ATF-MIII	○	×
	RX- 8 MPV CX- 7 ROADSTAR(6AT), SCRUM(4AT)	ATF JWS3317	○	×
	year 2007 Jul. DEMIO, AXELA(CVT)	Mobil CVTF 3320	×	○
	PREMACY, ATENZA, DEMIO, MPV, AXELA	ATF M-V	○	×
Subaru	TRIBUTE	ATF F- 1	○	×
	General Small AT Trucks & Buses (less than 4t) *⑥	Besco ATFIII	○	×
	General AT cars	Subaru ATF	○	×
	SAMBAR, JUSTY, DOMINGO, REX(ECVT cars/ Suport ECVT cars only)	ECVT Fluid (except ECVT) *⑤	○	×
	PLEO (i-CVT/ Suport i-CVT)	ECVT Fluid*⑤	×	○
Subaru	STELLA R1 R2 (i-CVT)	i-CVT Fluid	×	○
	LEGACY, LEGACYGA (linac CVT cars)	Subaru i-CVT FG	×	○
	TRAVIQ	Subaru CVT Fluid (Lineatronic)	×	×
Isuzu	General AT cars	Opel original ATF09117946/93160393	○	×
	NAVI- 5	Besco DEXRON II-E	○	×
	General Small AT Trucks & Buses (less than 4t) *⑥	Besco ATFIII	○	×
Suzuki	General AT cars	Besco NAVI- 5*②	×	×
	year 90/91 ESCUDO, ALTO, CERVO, CARRY, JIMNY, WAGON R, X- 90 (3AT)	Besco ATFIII	○	×
	S-CVT cars(CULTUS CONVERTIBLE)	Besco DEXRON II-E	○	×
	CULTUS CRESCENT G(CVT)	ATF5D06	○	×
	year 1996- ESCUDE, CULTUS, year 1997- ALTO, WAGON R	S-CVT Fluid	×	○
	Electronnic Control 4AT	Suzuki CVT oil	×	○
	Electronnic Control 4AT year 2001-	ATF2384K	○	×
	year 2006 Sep. - WAGON R (CVT)	ATF3314	○	×
year 2007 May. - SWIFT (CVT)	ATF3317	○	×	
Daihatsu	Compound Belt (Dry type) CVT (WAGON R RX/FX, ALTO SC LINE BURN)	Suzuki CVT Fluid green1/green1V	×	○
	General AT cars	Suzuki CVT Fluid3320	×	○
	General AT cars	Gear oil *③	×	×
	General AT cars(year 2002 Jul. -)	Ammix ATF Multi	○	×
Daihatsu	year 2006. Jun. - SONICA, MOVE, MIRA(CVT)	Friend ATF DIII Blend	○	×
	ECO CVT (year 98- MIRA TX/TV, OPTI BEEEX 2WD/4WD)	Ammix ATF DIII- SP	○	×
Daihatsu		Ammix CVT Fluid - DC	×	○
		Gear oil *③	×	×

*①Please use only genuine CVTF when you change the fluid.

*②Do not change ATF fluid. Different fluid is used.

*③Old type CVT for Suzuki and Daihatsu do not use CVTF.

*④Do not use AISIN CVTF for multimatic and multimatic S.

*⑤Varies depending on the genuine oil and Aisin ATF.

*⑥General small AT trucks and buses are equipped with "Step AT". Use of AISIN ATF is prohibited for INOMAT, SMOTHER E/G(Mitsubishi) and PROSHIFT (HINO) because of the mechanical Clutch.

AISIN ATF Application List

Car Maker	Car Model	Genuine ATF	AFW+	CFEx
GM	General AT Cars	DEXRONVI	○	×
	Old Standard	DEXRONIII/III-G	○	×
Ford	General AT Cars	DEXRON II-E	○	×
	Old Standard	MERCONV	○	×
	year 1997- Explorer	MERCON	○	×
Chrysler	General AT Cars	M2C33-F*④	×	×
	Precia JEEP Cherokee	ORIGINAL STANDARD (MERCENV)	○	×
Audi	General AT Cars	Mopar ATF +4	○	×
		DEXRON II-E	○	×
		ORIGINAL STANDARD (TYPE7176/ATF+3)	×	×
		G 052162 A1	○	×
		G 052162 A2	○	×
		G 052162 A6	○	×
		G 055005 A1	○	×
Mercedes Benz	year 1996- A4/A6/A8	G 055005 A2	○	×
	General AT Cars	G 055005 A6	○	×
	3AT/4AT	DEXRON II-E	○	×
BMW	5AT	ORIGINAL STANDARD*⑦	○	×
	General AT Cars	8322 0142516	○	×
	3 series318	DEXRON II-E	○	×
	Except below info. 3/5/7/8 series	DEXRON II-E	○	×
	320(2. 0L 91-94/96-98) 323(2. 5L 95-98) 325(2. 5L 91-94) 328(2. 8L 95-98) 525(2. 5L 91-98) 520(2. 0L 91-94) 528(2. 8L 95-98)	ORIGINAL STANDARD (ATF-D3)	×	×
VW	year 1995- 750il 1996- 540i/735i/740i/840ci year 1997- L7 5/7/8 series more than 3L (ZF5H24 5AT)	ORIGINAL STANDARD*①	○	×
	year 2002 model 745i 745Li 760Li 6AT	ORIGINAL STANDARD *⑥	×	×
Opel	General AT Cars	DEXRON II-E	○	×
	year 1996- (USA 1995-) 01M/01P Transaxle	ORIGINAL STANDARD (G 052 162 A2) *②	×	×
PERODUA	General AT Cars	DEXRON II-E	○	×
	Kacil, Viva, Kelisa, Kenari, Kembara	ORIGINAL STANDARD	○	×
Porsche	Myvi, New Myvi, Nautica, Alza	ATD DIII	○	×
	General AT Cars	P2-ATF D3-SP	○	×
		999_917_547_00	○	×
Renault	General AT Cars	JWS 3309	○	×
	Including Tiptronic	DEXRON II-E	○	×
Peugeot	General AT Cars	DEXRON II-E	○	×
		Z 000169756	○	×
Citroen	General AT Cars	DEXRON II-E	○	×
		169756	○	×
Volvo	year 1993- 1994 850	DEXRON II-E/MERCON	○	×
	year 1998- S70/V70/C70/S80	DEXRON III-G	○	×
	year 1999- V70	VOLVO GENUINE 1161540	×	×
Saab	900 3 Speed/3AT	M2C33-G*③	×	×
	900 9000 4Speed 4AT	DEXRON II-E	○	×
Rolls Royce	General AT Cars	PL 31493PA	○	×
Bentley	General AT Cars	PY112995PA	○	×
Maserati	General AT Cars	231603	○	×
Land Rover	General AT Cars	TYK 500050	○	×
		DEXRON II-E	○	×
	100/200 series Coupe Cabriolet Tourer	ORIGINAL STANDARD UNIPART SUPERFLOW CVT FLUID	×	○
Jaguar	General AT Cars	JLM 20238	○	×
	year 1993- 1994 all cars	Jaguar Fluid 8432	○	×
	year 1985- 1992 Borg Warner	DEXRON II-E	○	×
	HYDRA-MATIC ZF	M2C33-F*④	×	×
	XK8(5HP24 5AT)	DEXRON II-E	○	×
Fiat	General AT Cars	ORIGINAL STANDARD*①	○	×
Alfaromeo	General AT Cars	DEXRON II-E	○	×
	156Q System: 2. 5 V6-24V/AT Cars	DEXRON II-E	○	×
Lancia	156series speed: 2. 0 TWIN SPARK/SS Cars	ORIGINAL STANDARD TUTELA CS SPPED *⑤	×	×
Hyundai	General AT Cars	DEXRON II-E	○	×
	General AT Cars	Diamond ATF SP- II M/III	○	×
		040000C90SG	○	×

*①ATF for LT711411 is sometimes mentioned as "SYNTHETIC", but you can use GENERAL ATF.

*②In case of replenishment, mixing oil or fluid (less than 1L) can be accepted by the DEXRON Standard.

*③Do not change the fluid because this is the old standard for Ford.

*④Do not change the fluid because this is the European Standard for Ford.

*⑤Do not change the fluid because this is a clutch oil for serres speed.

*⑥The car maker states that the exchange of ATF is not necessary. As the structure of AT is complicated, please be careful if you need to change the fluid.

*⑦Number is No. MB326.7 but we recommend the ATF fluid be changed depending on the components. Not for 7AT.

■Do not change the fluid if ATF has not been chaged at all for the last 5 years, it a car was imported parallel, or if a car is old but its total driven distance is short.

Oil Pump

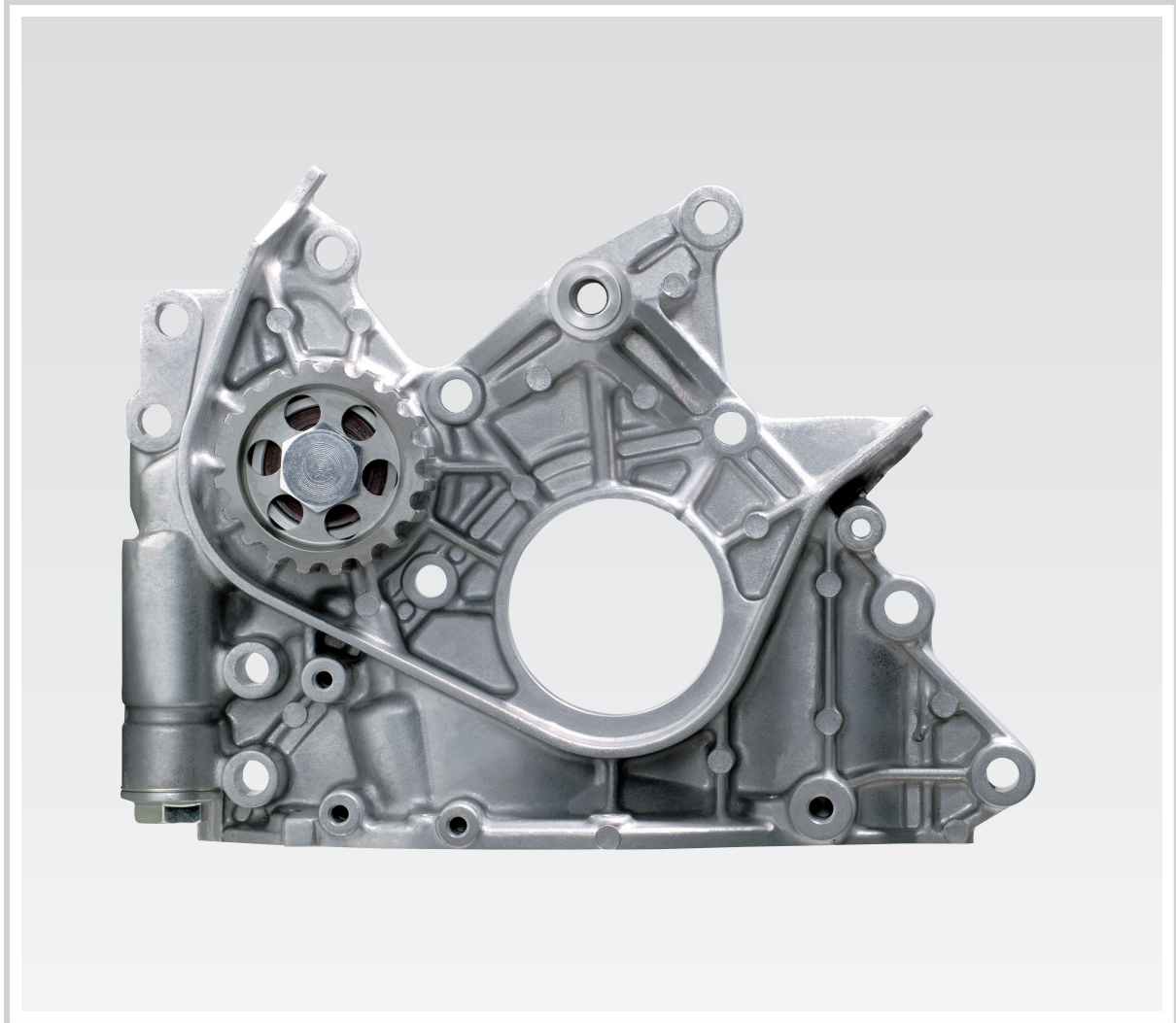

Engineered to exacting OE specifications, AISIN Oil Pumps deliver ideal oil pressure to the engine without creating excess load. Lubricating critical components to extend the life of the engine, AISIN Oil Pumps are always OE Matched.

Features

- Delivers ideal oil pressure to the engine without creating excess load.
- AISIN aluminum die-casting technology allows for size and weight reduction.
- Lubricates critical components to maximize the life of the engine.



Oil pump test on engine dynamometer

Timing Chain Cover

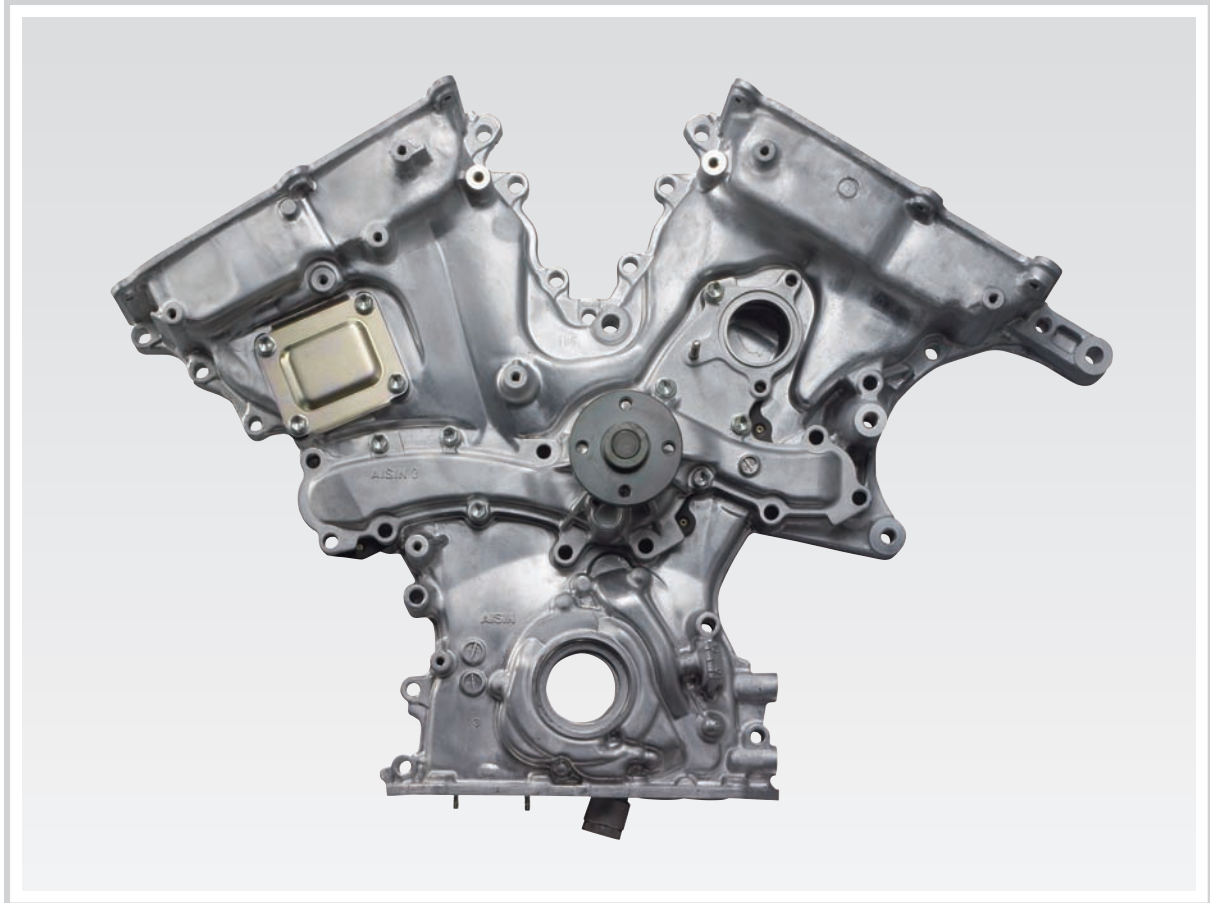

Engineered to exacting OE specifications, AISIN Timing Chain Cover, equipped with an AISIN brand Water Pump, Oil Pump and Fan Clutch, offers precise fitment, optimal cooling and lubrication. Providing protection for vital moving parts, AISIN Timing Chain Cover are always OE Matched.

Features

- Precision fitment to protect the timing chain and gears from debris.
- Module-Oriented assembly allow for easy, one step replacement of the timing chain cover, water pump, oil pump and fan clutch (when applicable).
- Optimal cooling and lubrication to exacting OE specifications.

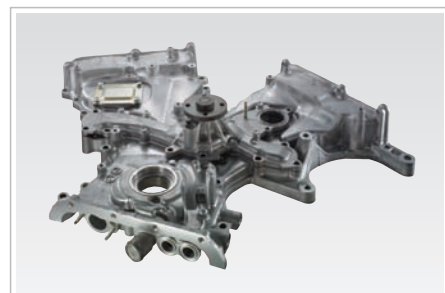

Fan Clutch

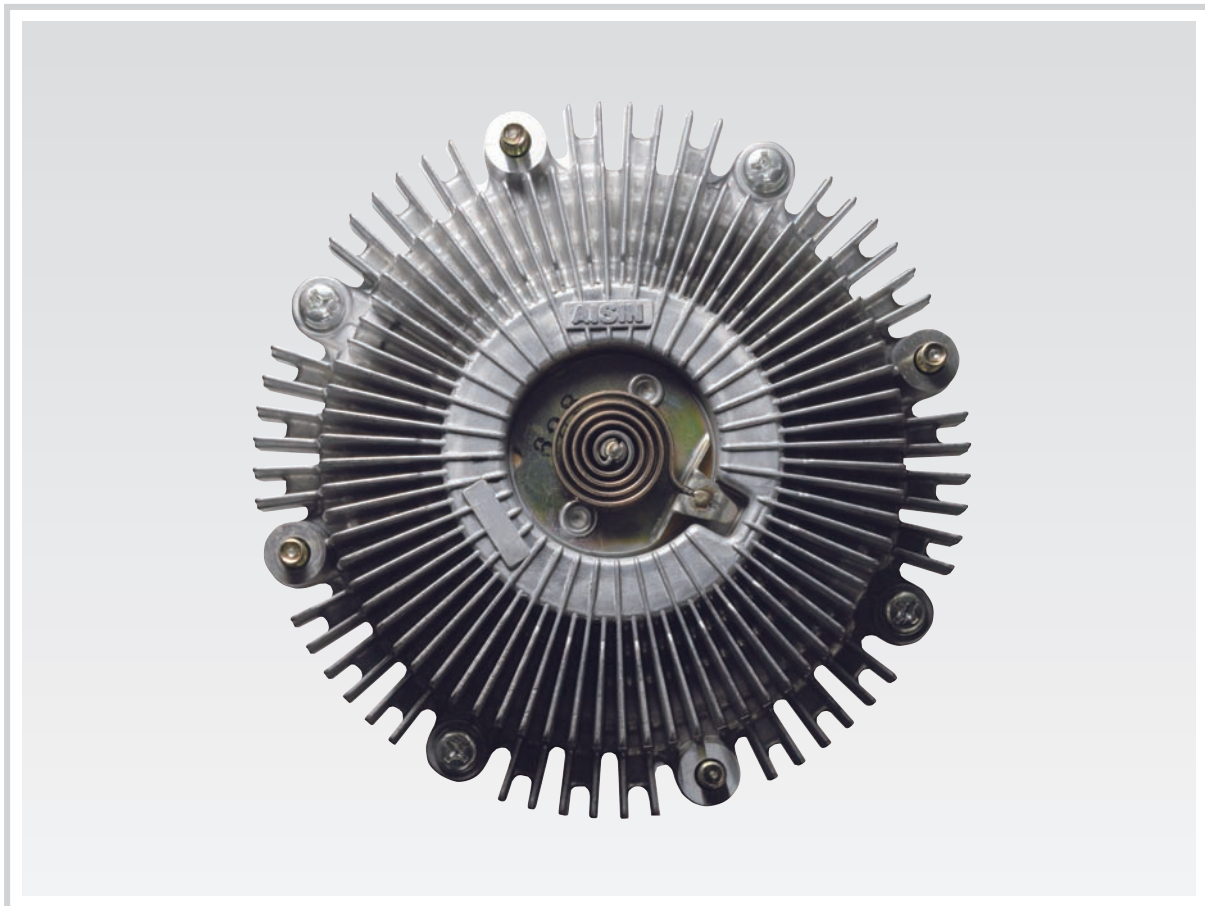

Engineered to exacting OE specifications, AISIN Fan Clutch quickly adjusts to temperature changes to provide efficient, controlled cooling. Providing optimal cooling performance without sacrificing engine efficiency, AISIN Fan Clutches are always OE Matched.

Features

- Manufactured with the highest quality materials to withstand heat and vibration while adjusting coolant temperature for optimal engine efficiency.
- Delivers precise fan speeds in proportion to engine RPM, providing optimal cooling to exacting OE specifications.
- As a vital cooling component, the installer and user will have the peace of mind that the parts are manufactured by one of the leading Tier 1 suppliers in the world.



Fan Blade



Engineered to exacting OE specifications, our fan blade makes cars lighter in weight and higher in performance through diversity of products for drive systems, engines, and vehicle bodies.

Features

- Reduce air pressure between fan and radiator by fan rotation.
 - Cooling of radiator with air ventilation from pressure fluctuation.
-

Hydraulic Belt Tensioner



Engineered to exacting OE specifications, AISIN Hydraulic Belt Tensioners deliver ideal tension to the timing belt. Maintaining reliability by automatically adjusting belt tension, AISIN Hydraulic Timing Belt Tensioners are always OE Matched.

Features

- Utilizes hydraulic pressure to deliver optimal belt tension, automatically adjusting throughout the RPM range.
- AISIN OE Engineering developed pressurizing mechanism efficiently dampens timing belt vibrations.
- Manufactured with the highest quality materials to maximize durability.



Fan Pulley Bracket



Engineered to exacting OE specifications, AISIN Fan Pulley Brackets are built with the highest quality materials and robust design. Maintaining structure and supporting the clutch fan, AISIN Fan Pulley Brackets are always OE Matched.

Features

- Optimal geometrical design maintains structural integrity, ensuring fan clutch stability.
- Equipped with the highest quality bearings to support extreme clutch fan rotations.
- AISIN aluminum die-casting technology allows for size and weight reduction.



Hydraulics

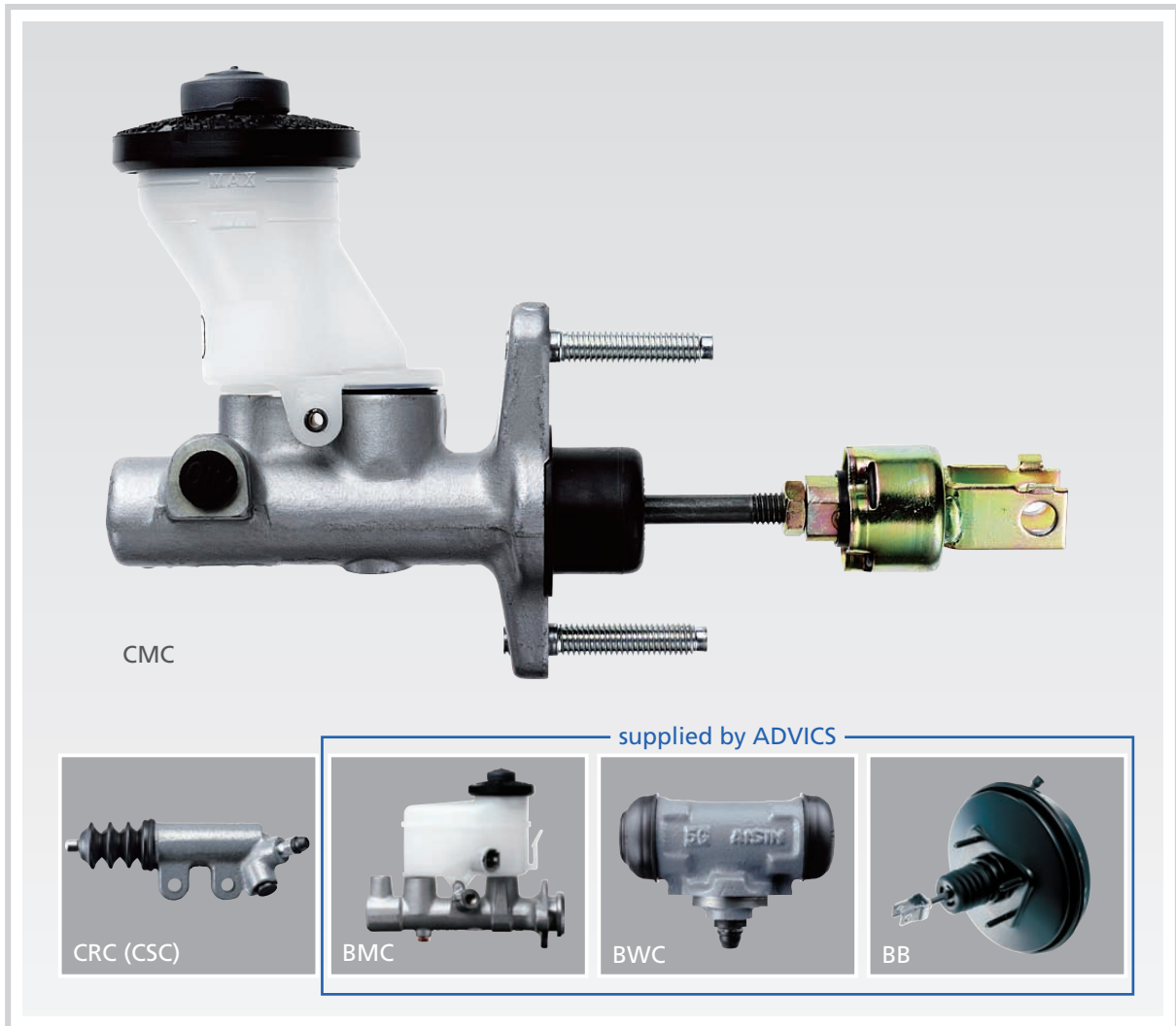

AISIN's original equipment technology and know-how is applied to design and engineer hydraulics. Each part is manufactured vehicle specific, ensuring product quality and reliability.

Features

- Precision honing of hydraulic cylinders are monitored under OE quality control standards.
- Anodizing and "Kanizen" plating of cylinder bodies strengthens surface, ensuring smooth operation of the piston, and resists corrosion.
- Heat resistant and extended life Ethylene Propylene Rubber (EPDM) seals prevent leakage.
- Quick response design reacts to driver's clutch and brake pedal input.



All weather performance testing for vehicle Hydraulics

Concentric Slave Cylinder

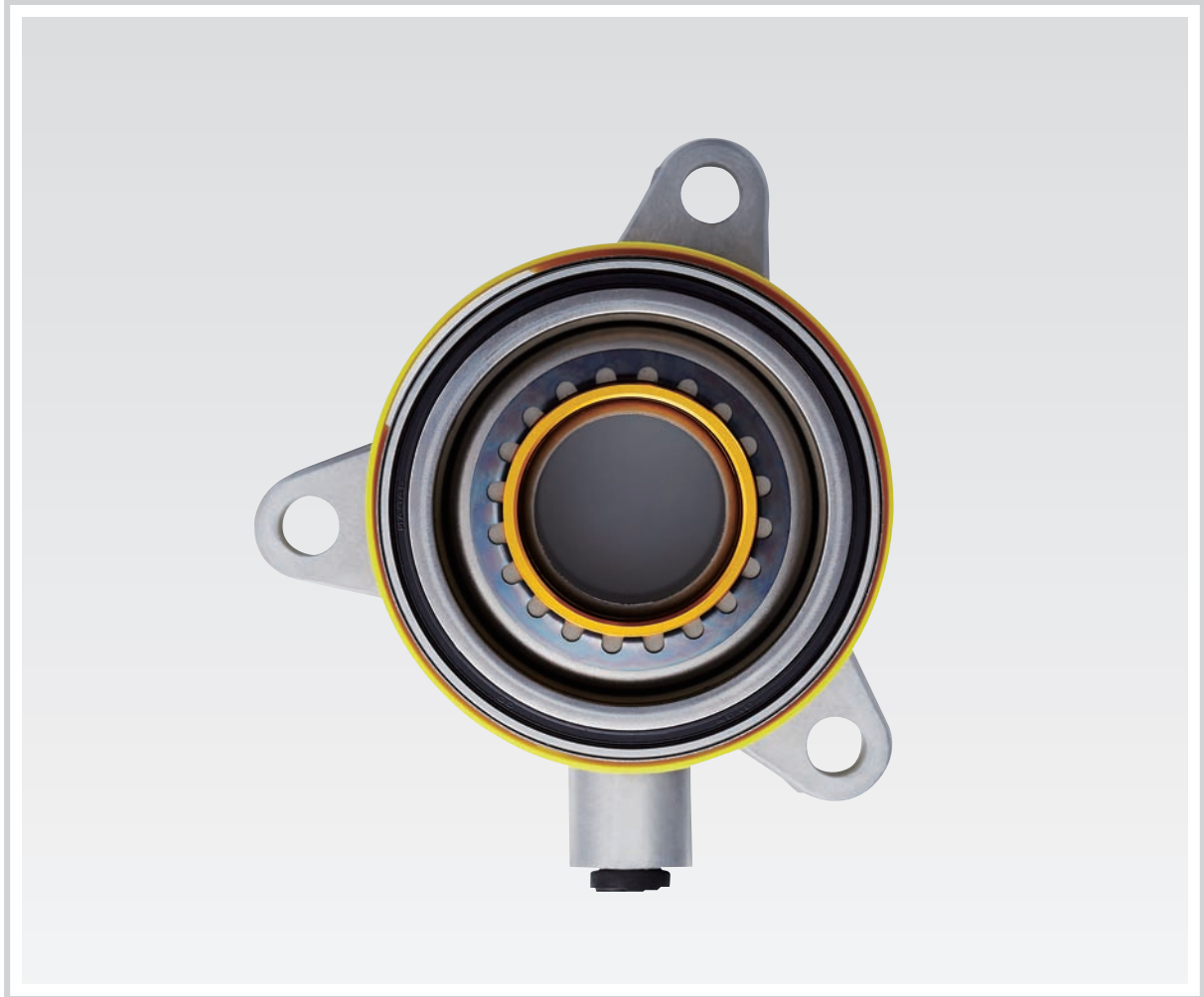

- CSC has the function of clutch release cylinder and release bearing.
- Benefit of CSC clutch system
 - ① Decrease the force on pedal
 - ② Decrease stroke weight for disconnecting clutch
 - ③ Avoid degradation of quality due to friction coefficient increase
 - ④ Reducing the number of component (Merge component)

Features

- AISIN's CSC has less loss stroke in CMC compared with other products. A clutch can be controlled with weaker pedal power



Free Wheel Hub



Engineered to exacting OE specifications, AISIN Free Wheel Hubs efficiently transfers and disconnects drivetrain power to part time 4 Wheel Drive applications. Compact in design and durable against the toughest terrain, AISIN Freewheel Hubs are manufactured to the highest standards and are always OE Matched.

Features

- Compact and durable design withstands the same rugged terrain tests performed by the vehicle manufactures.
- Robust locking mechanism provides reliable connection of the drivetrain power to the wheels in 4 Wheel Drive mode.
- Large manual dial allows the user to effortlessly change from 2 Wheel Drive to 4 Wheel Drive mode.



Flywheel Damper



Engineered to exacting OE specifications, AISIN Flywheel Dampers are designed to reduce torsional vibration created by diesel or high performance engine. Sometimes they are called Dual Mass Flywheel, AISIN Flywheel Dampers are always OE matched.

Features

- AISIN OE Engineering developed, the flywheel is divided into two portions, one for the engine (primary flywheel), and the other for the transmission (secondary flywheel).
- Between them, lightweight coilsprings are laid out in-line, with both ends of each coil spring supported by sheets.

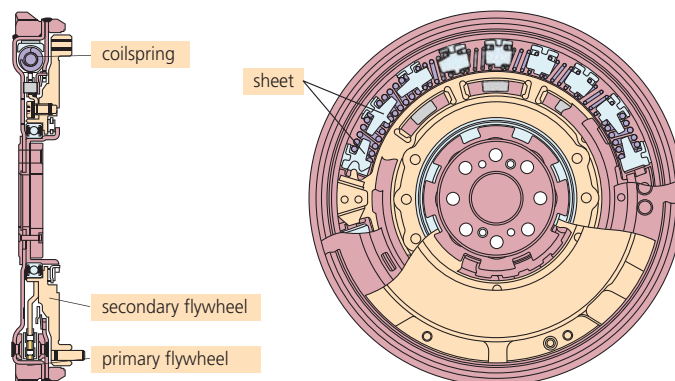

Manual Transmission

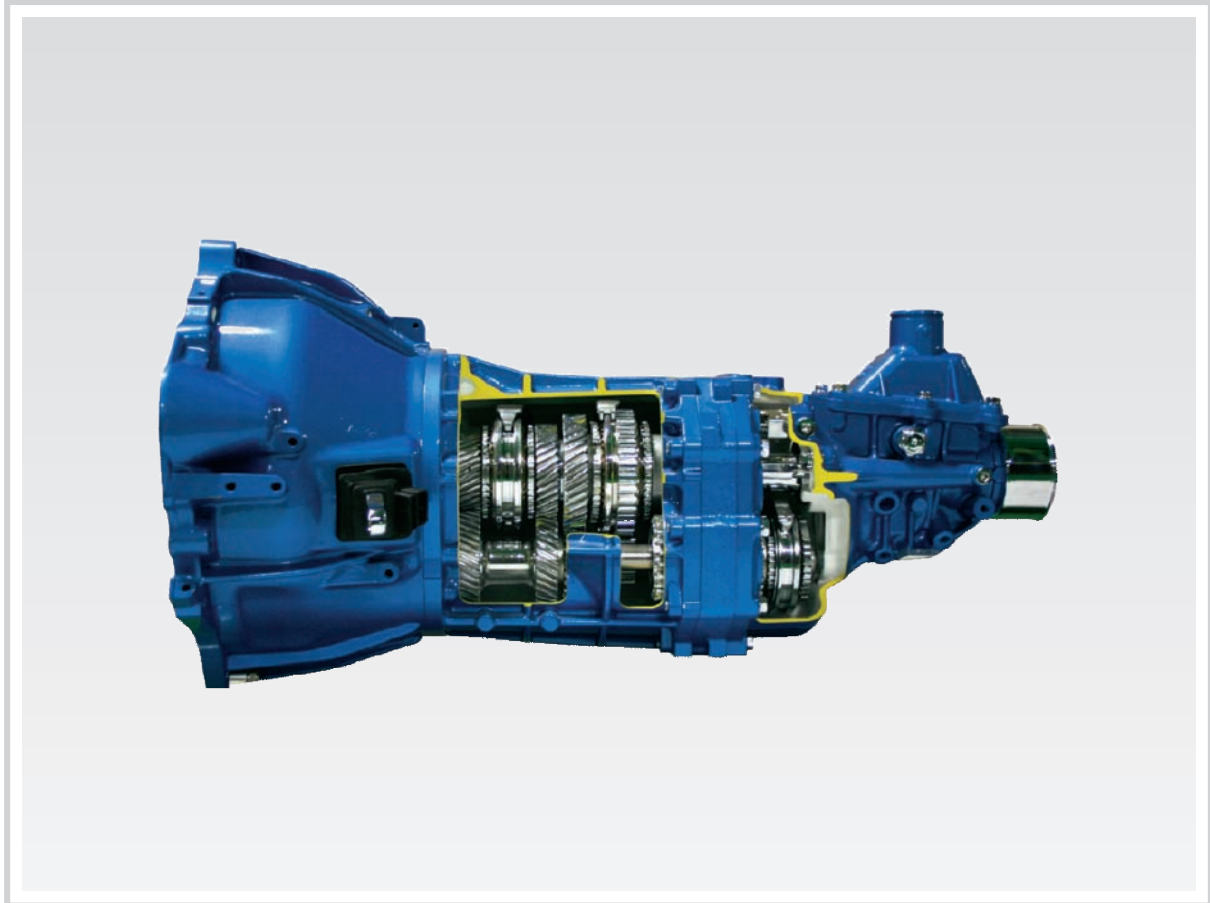

Based on AISIN's original equipment technology and experience, AISIN Manual Transmissions are designed for each vehicle. AISIN Manual Transmissions perfectly work as well as Genuine Transmissions.

Features

- Evaluated best material and process for each component. Gives best performance to vehicle power train system and extend its service life.



Height Control Sensor



Engineered to exacting OE specifications, AISIN Height Control Sensor is a vital component of the HID Automatic Light Leveling Control System.

Features

- It detects changes of pitching angle of the vehicle during driving, enables the HID system to adjust the headlight pitching angle accordingly to always aim at the targeted area.



Motor Transfer Shift Actuator

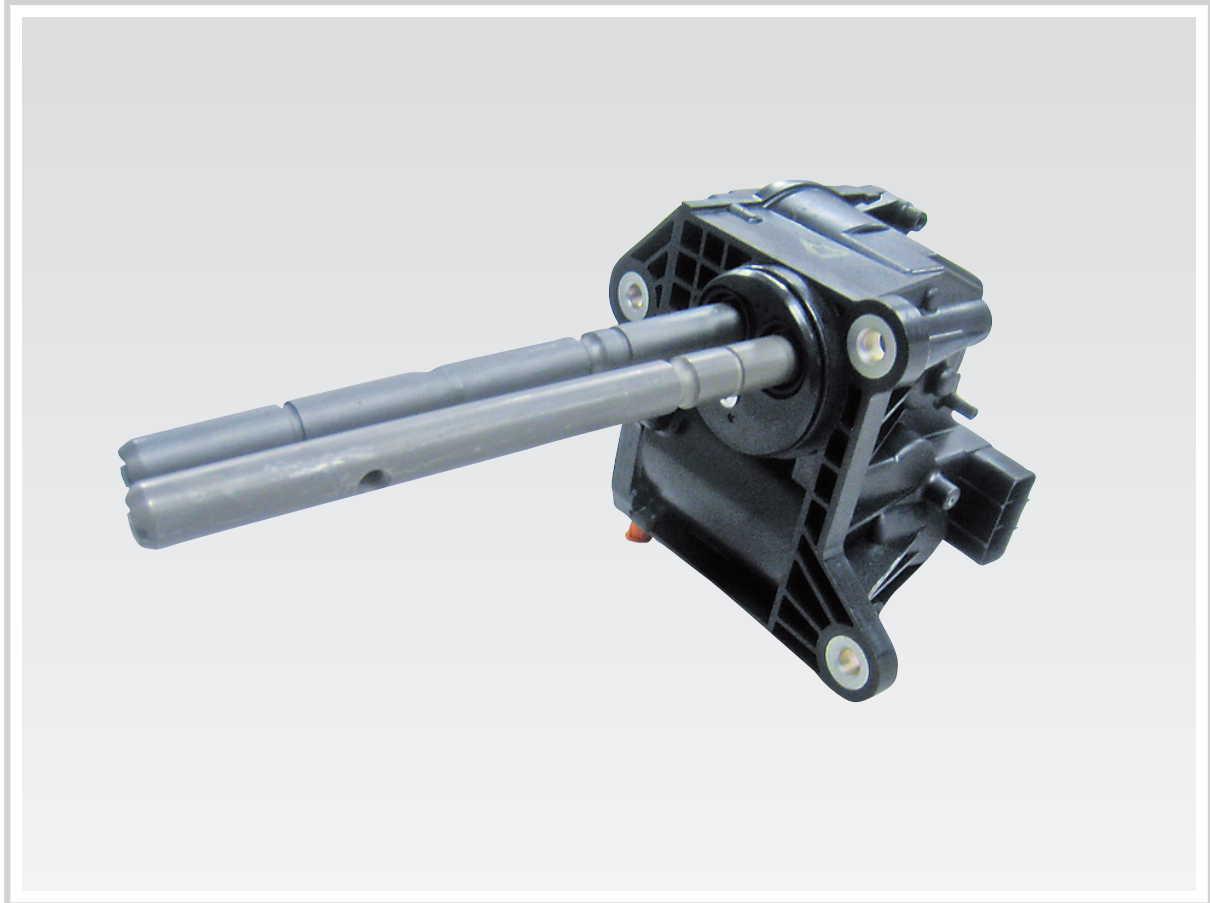

Engineered to exacting OE specifications, AISIN Motor Transfer Shift Actuator alternates High-Low mode of the Transfer and Free-Lock mode of the Center Differential.

Features

- With the build-in multiple switches, this device can detect and alternate the status of Transfer and Center Differential. It has dual motors to respectively control and alternate High-Low mode of the Transfer and Free-Lock mode of the Center Differential.

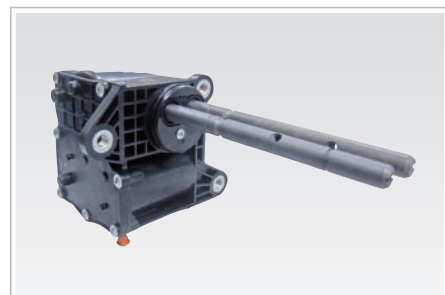

Motion Control Beam

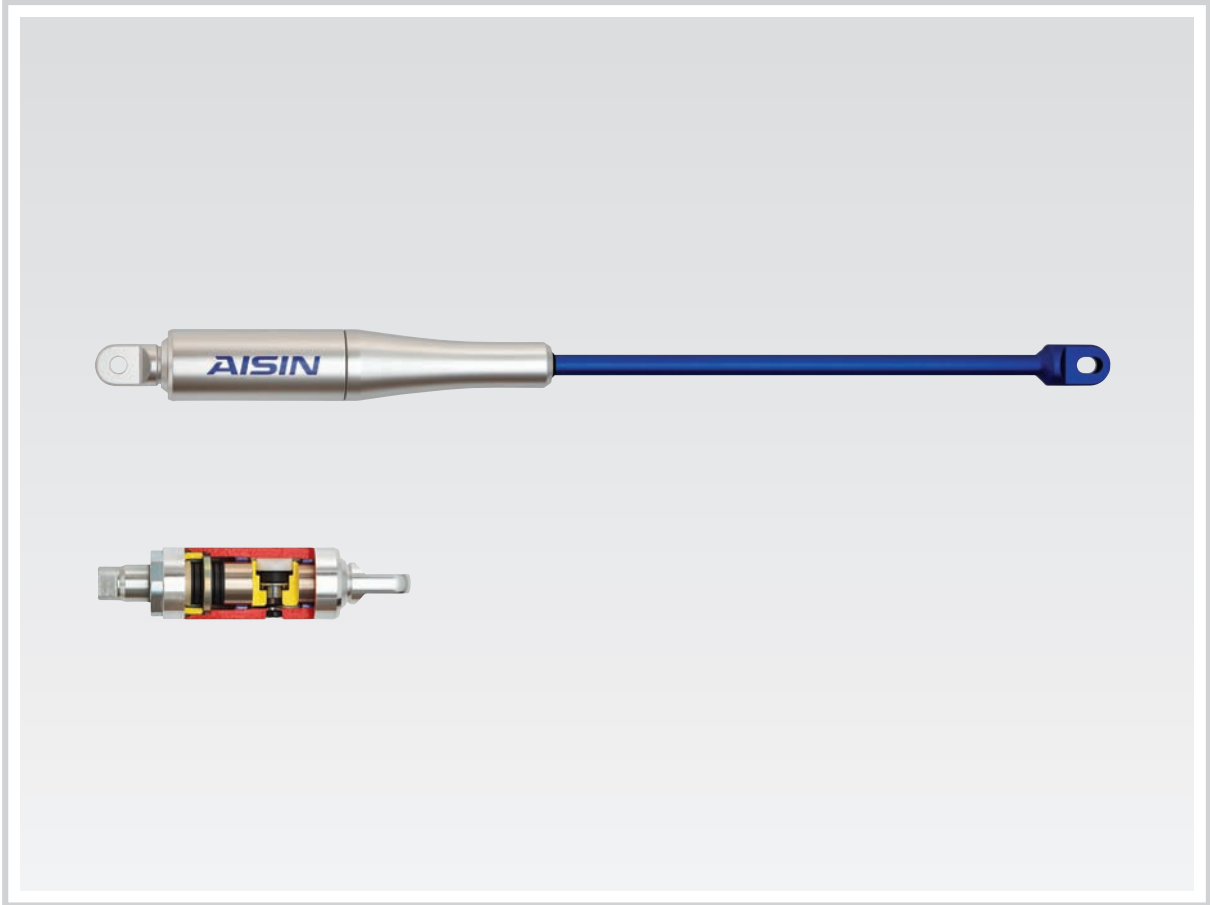

Features

- Motion Control Beam will enhance the driving performance and conformability by installing on front/rear of a car body.
It also achieves the effect which almost is equal to the tuning of suspension and robustness, so will lead the stability during high speed driving and the easiness of driving .

Internal Structure

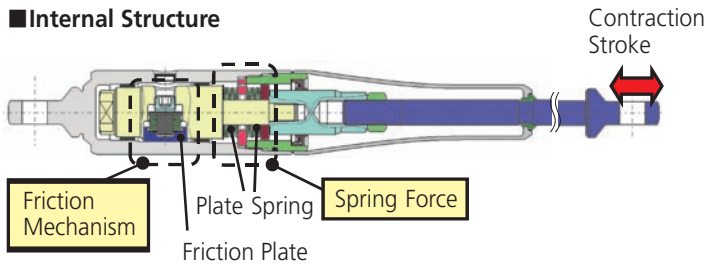

Mounted Sample

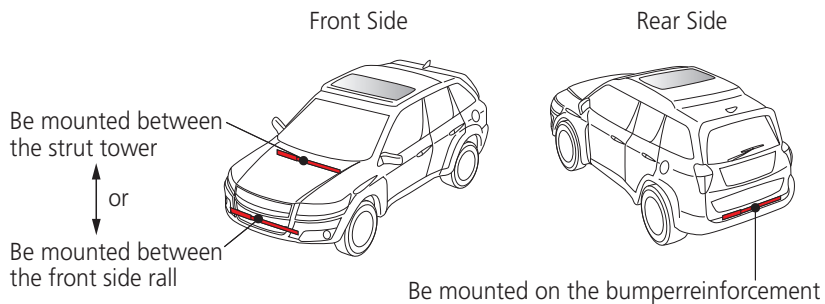

Door Stabilizer



Features

- It is filling the gaps in between door and body, and it reduce the delay of vehicle response during operation. It makes a quick response of the vehicle operation.



Improvement of the steer ability

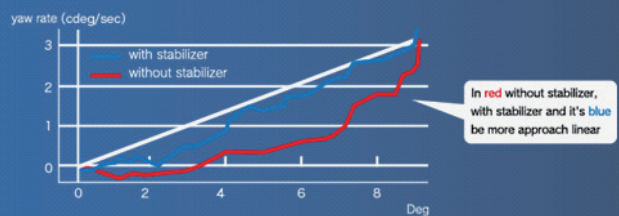

Finerevo Comfort Cushion



Features

- This comfort cushion can maintain a good posture of its user. With the application Aisin Seiki's innovative resin-elastic "FINE REVO", it can offer a comfortable ride to you.

Specifications

■ Feeling of Fitting

Bony pelvis is well supported by Fine Revo, for a comfortable seating position.



■ Feeling of Stability

Aisin is one of the leading suppliers of automobile seats. With the optimal design technology of Aisin, this cushion can fit on the seat and maintain its stable position.

Honeycomb knit Material



Sales Office



AISIN SEIKI CO., LTD

aftermarket dept.

2-1, Asahi-machi, Kariya, Aichi, 448-8650 JAPAN

Telephone +81-566-24-8523 Facsimile +81-566-24-8996

www.aisinaftermarket.jp

AISIN WORLD CORP. OF AMERICA

24330 Garnier Street, Torrance, California 90505, U.S.A.

Telephone +1-310-326-8681 Facsimile +1-310-533-8271

www.aisinworld.com

AISIN ASIA PTE. LTD

10 Anson Road, #31-08, International Plaza,

Singapore 079903, SINGAPORE

Telephone +65-6222-0592 Facsimile +65-6225-0911

www.aisin.com.sg

AISIN ASIA (THAILAND) Co., Ltd.

1 MD Tower, Room E,F, 4th Floor, Soi Bangna-Trad 25,

Bangna-Trad Road,

Kwang Bangna, Khet Bangna Bangkok 10260 Thailand

Telephone +66 2 186 4904 Facsimile +66 2 398 6213

www.aisin-asia-thailand.com

Commercial Representative

Office of AISIN PTE.LTD(CAMBODIA)

Unit#502, HAMPTONS Apartment, #24-26, 332

Street Corner of 57 Street,

Sangkat Boeung Keng Kang 1, Khan Chamkarmorn,

Phnom Penh, Kingdom of Cambodia

Telephone +855-(0)77-45-4106

(Tomatsu san's Mobile Phone)

AISIN EUROPE S.A.

Avenue de L'Industrie 21, Parc Industriel,

1420 Braine-L'Alleud, BELGIUM

Telephone +32-2-387-0136 Facsimile +32-2-387-0633

www.be.aisin-europe.com

AISIN ASIA MIDDLE EAST BRANCH

6WA 109, Dubai Airport Free Zone,

P.O Box 54416, Dubai, U.A.E.

Telephone +97-14-299-3925

Facsimile +97-14-299-3926

AISIN SEIKI(CHINA) INVESTMENT CO., LTD

Guangzhou Branch

3201, Tower A, G.T.Land Plaza, 85 Huacheng Avenue,
Zhujiang New Town, Tianhe District, Guangzhou, PRC.

Telephone +86-20-8387-8835

Facsimile +86-20-8384-9456

AISIN ASIA PTE. LTD.,

(MALAYSIA REPRESENTATIVE OFFICE)

No.23, Jalan DBP 1, Dolomite Business Park,

68100 Batu Caves, Selangor Darul Ehsan

Telephone +603 6122 3333

Facsimile +603 6178 1068

AISIN ASIA PTE. LTD

(INDONESIA REPRESENTATIVE OFFICE)

Crosscoop Jakarta Mulia, Menara Mulia, Lantai 27,

Jl. Jend. Gatot Subroto Kav. 9-11 Jakarta 12930

Telephone +62 21 2953 9528

AISIN ASIA PTE LIMITED (KENYA BRANCH)

Toyota Kenya Business Park, Popo Road,

South C P.O. Box 4469 - 00506, Nairobi, Kenya.

Telephone +254 711 050 128

www.aisinaftermarket.jp

4 New Features

- 1 Quick Search Part Number Interchange
- 2 Catalog Download
- 3 New Topics
- 4 Product Details



1 Quick Search

Shorten application
look up time!

Look up Genuine No. to AISIN No. directly and shorten product inquiry time by accessing our online part number interchange.

2 Catalog Download

Direct access to sales
promotion tools!

Catalogs, bulletins, diagnostic manuals, and other helpful marketing items that may help in promoting AISIN products.

3 Product Detail

Expanded AISIN Aftermarket
Product Line-Up!

AISIN, known world-wide as a leader in clutch technology, has other OE Matched quality parts available. Check out our other product lines for your aftermarket needs.

4 New Topics

News from around the world!

Keep up to date with developments from AISIN affiliates across the globe. The ideal place for international information exchange for the ever expanding global market.



Reference List

● Oil Pump	32
● Timing Chain Cover	55
● Fan Clutch	60
● Fan Blade	73
● Hydraulic Belt Tensioner	80
● Fan Pulley Bracket	81
● Hydraulics	82
● Concentric Slave Cylinder	133
● Free Wheel Hub	135
● Flywheel Damper	137
● Height Control Sensor	138
● Motor Transfer Shift Actuator	144
● Variave Valve Timing	146
● Oil Control Valve	147
● Manual Transmission (ASSY)	148
● Manual Transmission (Parts)	151

Oil Pump System

Operation Diagram

The oil pump is the vital component that provides the circulation of oil which cools, cleans and lubricates internal engine components. In some engines, the oil pump also provides hydraulic power to valve lifters and valve timing components. Driven by crankshaft power, the pump creates suction to draw oil from the oil pan through the strainer. The suction by the pump creates the pressure where oil is driven through the oil filter, oil cooler, internal moving parts, provide hydraulic power, then collected back into the oil pan.

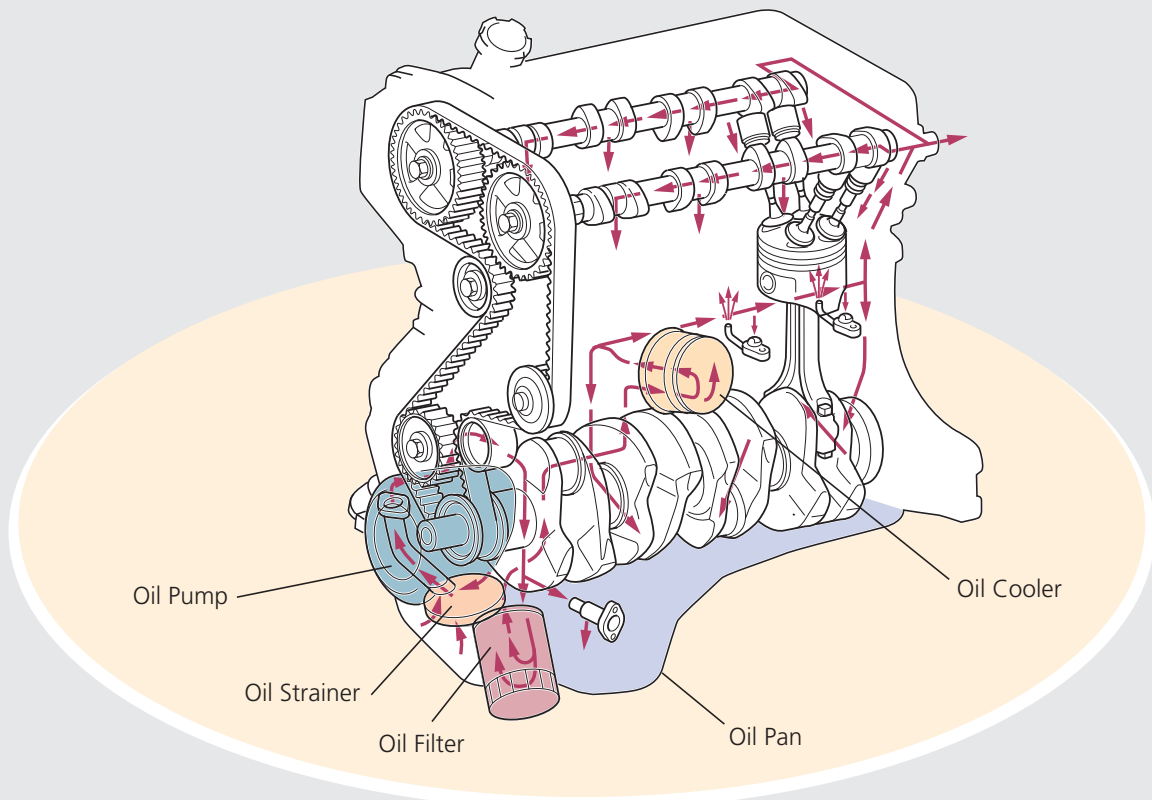

Drive Systems

Various systems are utilized to transfer power from the crankshaft to the oil pump. The type of drive system influences the configuration and location of the oil pump.



Direct Crankshaft Drive



Integral Unit with W/P
(Front Module)

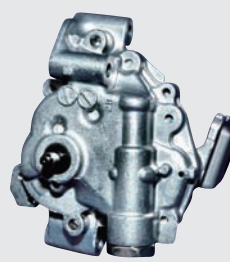

Chain Drive

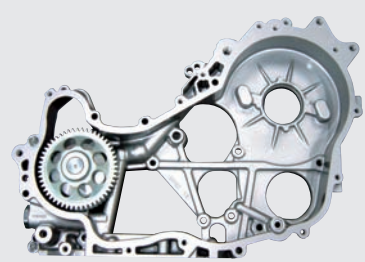

Gear Drive
(Integral Unit with Gear Case)

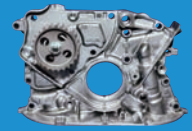

Structure and Components

The basic structure of the oil pump consists of a sprocket (drive rotor) which revolves within a housing (driven rotor). The complex geometry of the rotor and the housing creates suction. Depending on the type of oil pump drive system, the rotor can receive power through a shaft that is connected to a pulley, a gear, a sprocket or directly into the crankshaft. When the rotor is revolved, oil is drawn in from the suction port and expelled into the discharge port. This process creates oil pressure to supply oil to the moving components of the engine. A relief valve is strategically configured in between the ports to prevent excessive pressure build-up and maintain optimal operating oil pressure.

Oil Pump Configuration

Chain Drive / Gear Drive

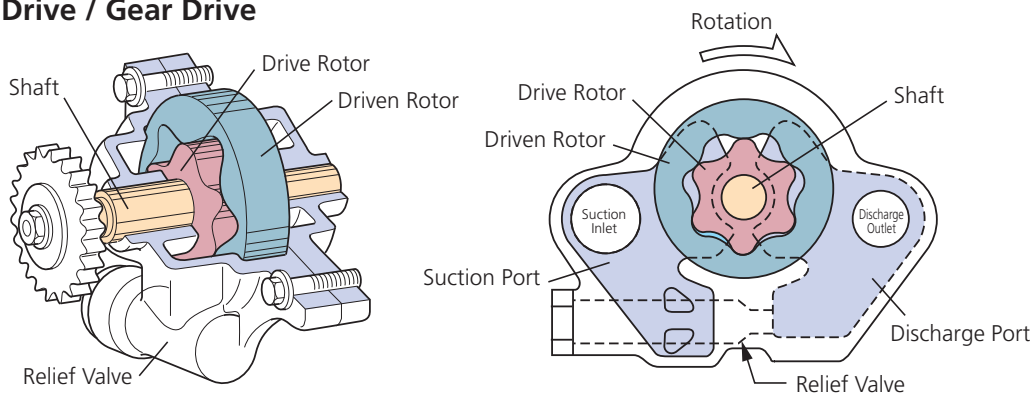

Direct Crankshaft Drive

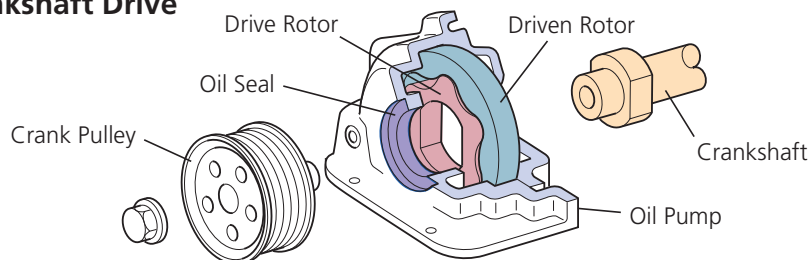

Relief Valve Configuration

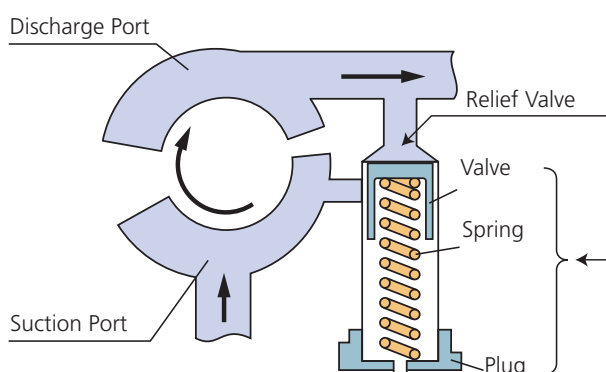

The relief valve is configured to prevent excessive oil pressure. The excess pressure along the discharge port compresses the relief valve spring to open the valve, relieving pressure by re-circulating the oil back into the suction port.

Installation Procedure

CAUTION!

Failure to follow recommended procedures may cause engine failure and injury. Always consult the manufacturer's vehicle specific service manual for reference.

1

Remove old pump, gaskets and foreign materials left on the mounting surface. Thoroughly clean with non-abrasive solvent. Confirm that the mounting surfaces are free of damage, deformation, and debris.

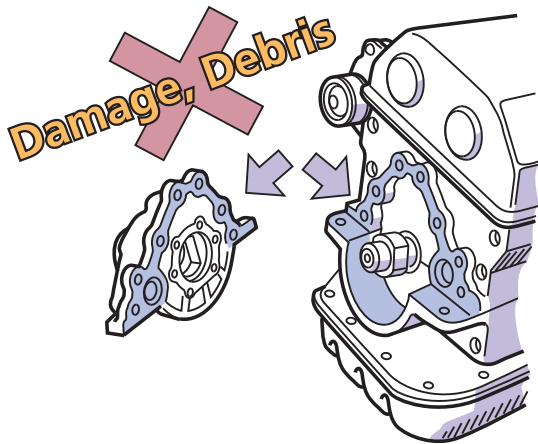

Damage, deformation, and debris on mounting surfaces may cause seal malfunction which will create oil leakage and lower oil pressure.

2

Always use engine oil to lubricate the sliding and rotating components of the oil pump when installing, disassembling, or cleaning.

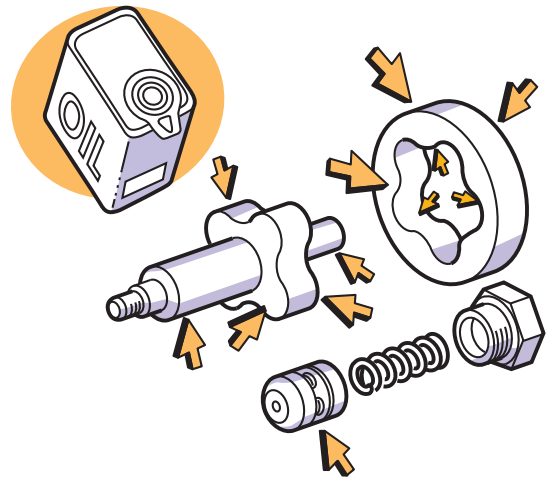

Lubricating surfaces will prevent pump seizure and suction failure.

3

Ensure that there are no contaminants or debris in the pump before installation.

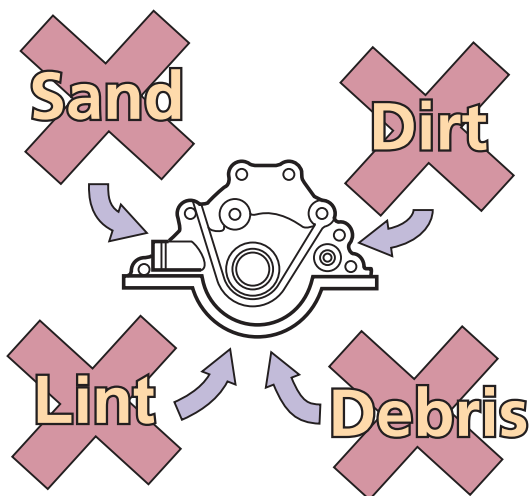

Contaminants and debris will cause damage to rotors. Consequently, improper valve operations and abnormal pressure may occur.

4

Check for damage, deformation, and debris along the oil seal mounting areas. Install oil seal and confirm proper seating.

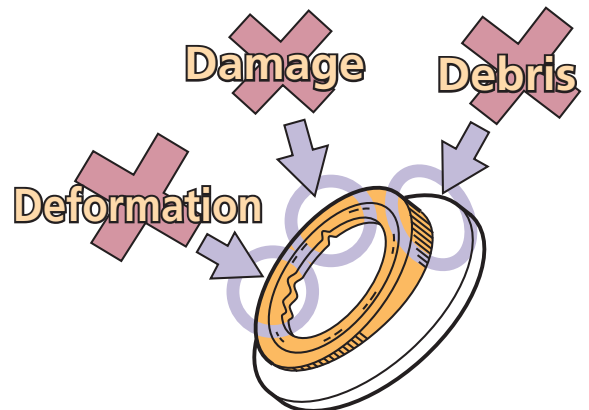

Improper seating will cause oil leakage and loss of oil pressure.



CAUTION! Failure to follow recommended procedures may cause engine failure and injury. Always consult the manufacturer's vehicle specific service manual for reference.

5

Always use new O-rings and gaskets when installing an oil pump. Ensure the O-ring does not pinch between mounting surfaces during installation.

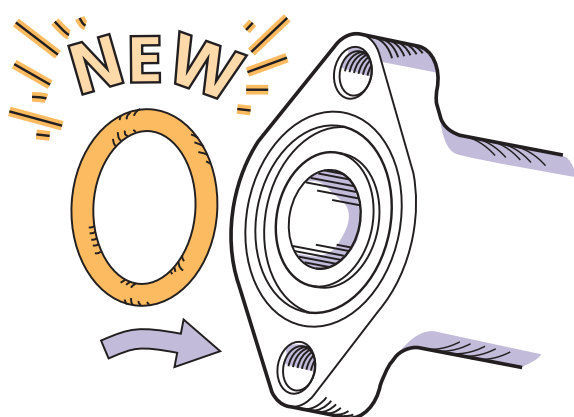

Pinched oil rings will cause oil leaks and lower oil pressure.

6

Oil pump rotors are precision components that require care in handling. Take extreme caution when inspecting and installing.

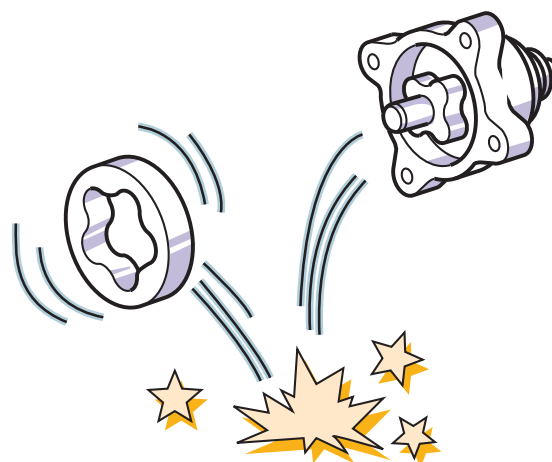

Damaged rotors will cause improper rotation and incorrect oil pressure.

7

Install the oil pump in a diagonal (star) pattern. Always follow the manufacturer's vehicle specific recommended torque tools, procedures, and specifications.

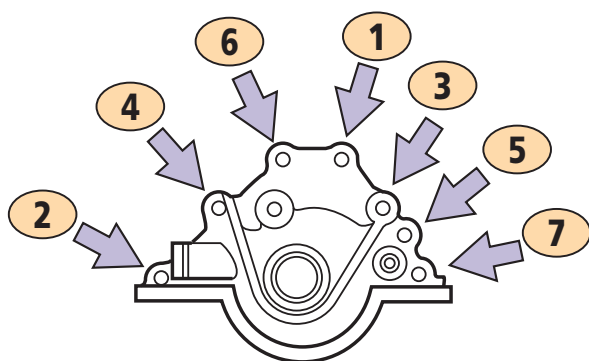

Following correct procedures prevents leakage from the mounting surface, oil pump body, and body fractures caused by over-torque.

8

After the installation of the oil pump, start and idle the engine until operating temperature has been reached. Stop the engine and check the oil level. Add oil to proper level.

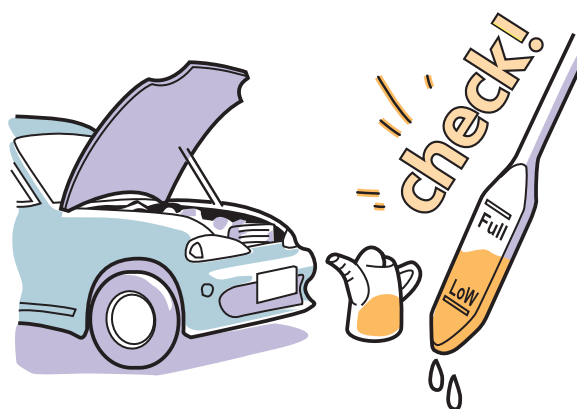

Circulating the oil after replacing the pump bleeds trapped air within the engine. Adding oil to the proper level prevents engine damage and ensures optimal performance.

Reference List / Oil Pump

Model	Year	Engine Type	Body Type	Reference	AISIN No.	Genuine No.
4RUNNER / HILUX SURF	3000	90.08~95.11	3VZE	VZN130		OPT-027 15100-65020
	3400	95.11	5VZFE	VZN18#		OPT-022 15100-62050
		02.11	5VZFE	VZN21#		OPT-021 15100-62040
ALPHARD G / V	2400	02.05	2AZFE	ANH1#		OPT-110 15100-28020
	3000	02.05~05.04	1MZFE	MNH1#		OPT-100 15100-20050
		05.04	1MZFE	MNH1#		OPT-100 15100-20050
ALPHARD HV	2400	03.07	2AZFXE	ATH10	HYBRID	OPT-110 15100-28020
AURIS	1600	08.12	1ZRFAE	ZRE15#		OPT-120 15100-37020
	1800	07.06	2ZRFE	ZRE15		OPT-113 15100-37030
		08.12	2ZRFAE	ZRE15#		OPT-120 15100-37020
		10.06	2ZRFXE	ZWE150	AURIS HV	OPT-118 15100-37040
AVANZA	1300	03.12~09.11	K3VE	F601		15100-97401
AVENSIS	1600	11.11	1ZRFAE	ZRT270		OPT-120 15100-37020
	1800	11.11	2ZRFAE	ZRT271		OPT-120 15100-37020
	2000	03.07	1AZFSE	AZT250,255		15100-28040
		03.07~05.06	1AZFSE	AZT250	LI	15100-28040
		05.06	2AZFSE	AZT251		OPT-110 15100-28020
11.11	3ZRFAE	ZRT272		OPT-120 15100-37020		
BELTA	1300	05.11	2NZFE	NCP96		15100-21030
		06.05	2SZFE	SCP92		OPT-121 15100-23040
BREVIS	2500	01.05	1JZFSE	JCG10		15100-46111
	3000	01.10	1JZFSE	JCG15		15100-46100
		01.05	2JZFSE	JCG11		15100-46111
CALDINA	1800	96.01~97.08	7AFE	AT191		OPT-035 15100-16070
		97.08~02.09	7AFE	AT211		OPT-035 15100-16070
		02.09	1ZZFE	ZZT241		OPT-044 15100-22041
	2000	95.08~96.01	3SFE,4SFE	ST19#		OPT-076 15100-74060
		96.01~02.06	3SFE	ST19#		OPT-075 15100-74050
		97.08~02.09	3SFE	ST21#		OPT-075 15100-74050
		02.09	3SGTE	ST246	TURBO	15100-88561
		02.09~05.01	1AZFSE	AZT24#		OPT-048 15100-28030
05.01	1AZFSE	AZT24#		15100-28040		
CAMI	1300	00.08	K3VT	J102		15100-97402
CAMRY	2400	06.01	2AZFE	ACV4#		OPT-110 15100-28020
CAMRY / VISTA	2000	88.08~90.07	1VZFE	VZV20		OPT-019 15100-62020
	2500	90.07~94.06	1VZFE,4VZFE	VZV3#		OPT-019 15100-62020
CAMRY GRACIA	2500	96.12~01.09	2MZFE	MCV2#		15100-20030
CARINA	1600	88.05~92.11	4AFE,4AFHE	AT17#	FF	OPT-097 15100-15050
CARINA E	2000	94.02~96.01	3SGE	ST191		OPT-119 15100-88460
CARINA ED	2000	93.09~98.04	3SGE	ST202,205		OPT-119 15100-88460
CELICA	2000	93.11~99.08	3SG#	ST20#		OPT-119 15100-88460
		94.02~99.08	3SGTE	ST205		OPT-119 15100-88460
CELSIOR / LEXUS LS430	4300	00.08	3UZFE	UCF3#		OPT-103 15100-50040
CHASER	1800	80.09~82.08	13TU	TX60D		OPT-046 15100-25020
	2000	81.10~84.07	MTEU	MX61D		OPT-062 15100-43010
		96.09~98.08	1GFEE	GX100		OPT-029 15100-70030
3000	89.08~92.10	7MGE	MX83		OPT-061 15100-42060	
COASTER	2400	82.05~82.12	22R	RB20	WC	OPT-053 15100-35010
		82.05~82.12	22R	RB20	W/PS	OPT-053 15100-35010

Model	Year	Engine Type	Body Type	Reference	AISIN No.	Genuine No.
COASTER	2400	82.12~84.08	22R	RB20		OPT-053 15100-35010
		84.08~93.01	22R	RB2#		OPT-054 15100-35020
COROLLA	1300	00.08	2NZFE	NZE120		15100-21030
		00.08	2ZZGE	ZZE123		OPT-111 15100-88600
		11.10	2NZFE	NZE140		OPT-116 15100-21032
	1400	07.10	1NDTV	NDE150		OPT-114 15100-33040
		1500	00.08	1NZFE	NZE124	
	00.08~04.04		1NZFE	NZE121	4FC	15100-21040
	04.04		1NZFE	NZE121	4FC	OPT-109 15100-21060
	11.11		1NZFE	NZE141	4FC	OPT-115 15100-21042
	1600	79.03~83.08	2TGEU,12TJ,13TU	TE7#		OPT-046 15100-25020
		87.05~92.05	4AF,4AFE,5A#	AE91,95		OPT-097 15100-15050
		91.06~95.05	4AGE	AE101		OPT-036 15100-19036
		08.12	1ZRFAE	ZRE151		OPT-120 15100-37020
	1800	00.08~02.06	1ZZFE	ZZE122,124		OPT-044 15100-22040
		02.06	1ZZFE	ZZE122,124		OPT-044 15100-22041
		07.06	2ZRFE	ZRE152		OPT-113 15100-37030
2200	00.08~04.04	3CE	CE121		OPT-025 15100-64042	
COROLLA II	1500	98.11~99.07	1NT	NL50	TURBO	OPT-013 15100-55011
COROLLA ALLEX	1500	01.01	1NZFE	NZE124		15100-21040
		01.01~04.04	1NZFE	NZE121		15100-21040
		04.04	1NZFE	NZE121		OPT-109 15100-21060
	1800	01.01	2ZZGE	ZZE123		OPT-111 15100-88600
02.09		1ZZFE	ZZE122,124		OPT-044 15100-22041	
COROLLA FIELDER	1300	00.08	2NZFE	NZE120		15100-21030
		00.08	2ZZGE	ZZE123		OPT-111 15100-88600
	1500	00.08	1NZFE	NZE124	5F	15100-21040
		00.08~04.04	1NZFE	NZE121	4FC	15100-21040
		04.04	1NZFE	NZE121	4FC	OPT-109 15100-21060
	1800	00.08~02.06	1ZZFE	ZZE122,124		OPT-044 15100-22040
		02.06	1ZZFE	ZZE122,124		OPT-044 15100-22041
2200	00.08~04.04	3CE	CE121		OPT-025 15100-64042	
COROLLA LEVIN	1500	87.05~91.06	5A#	AE91		OPT-097 15100-15050
COROLLA RUNX	1500	01.01	1NZFE	NZE124		15100-21040
		01.01~04.04	1NZFE	NZE121		15100-21040
		04.04	1NZFE	NZE121		OPT-109 15100-21060
	1800	01.01	2ZZGE	ZZE123		OPT-111 15100-88600
		02.09	1ZZFE	ZZE122,124		OPT-044 15100-22041
COROLLA SPACIO	1500	01.05	1NZFE	NZE121		15100-21040
	1800	01.05~02.06	1ZZFE	ZZE12#		OPT-044 15100-22040
		02.06	1ZZFE	ZZE12#		OPT-044 15100-22041
CORONA	1500	85.11~87.12	3AU	AT140		OPT-031 15100-15020
	1600	82.01~83.10	3TEU,12TJ	TT14#		OPT-047 15100-26020
		87.12~92.02	4AFE,5A#	AT17#		OPT-097 15100-15050
		96.01~01.12	4AFE	AT210		OPT-033 15100-15080
CORONA EXIV	2000	93.09~98.04	3SGE	ST202,205		OPT-119 15100-88460
CRESSIDA / MARK II	1800	80.09~82.08	13T#	TX6#		OPT-046 15100-25020
	2000	80.09~82.08	MU	MX60X		OPT-058 15100-41030
		81.10~84.07	MTEU	MX61X	TURBO	OPT-062 15100-43010

Model	Year	Engine Type	Body Type	Reference	AISIN No.	Genuine No.	
CRESSIDA / MARK II	2000	82.08~84.07	MU,MPU	MX60X	VAN,WG		15100-43030
		88.10~97.04	1GFE	GX70		OPT-029	15100-70030
		96.09~98.08	1GFE	GX100		OPT-029	15100-70030
	2500	90.08~91.08	1JZGE	JZX81	WAGON		15100-46020
		97.04~01.12	2MZFE	MCV21,25			15100-20030
	2800	80.09~82.08	5MEU	MX63X		OPT-058	15100-41030
	3000	89.08~93.02	7MGE	MX83	WG	OPT-061	15100-42060
97.04~99.08		1MZFE	MCV20	OPT-037		15100-20020	
CRESTA	1800	80.03~82.08	13TU	TX50Y		OPT-046	15100-25020
	2000	81.10~84.07	MTEU	MX51Y,61Y	TURBO	OPT-062	15100-43010
		96.09~98.08	1GFE	GX100		OPT-029	15100-70030
	3000	89.08~92.10	7MGE	MX83		OPT-061	15100-42060
CROWN / CROWN MAJESTA	2000	79.09~83.07	MU,MEU,MJ,5MEU	MS11#		OPT-069	15100-45021
		83.08~84.08	MPU	MS120		OPT-069	15100-45021
		87.09~89.08	1GE	GS13#		OPT-028	15100-70011
		87.09~89.08	MP	MS130		OPT-066	15100-43070
		95.08~98.08	1GFE	GS151		OPT-029	15100-70030
		00.04~01.08	1GFE	GS171		OPT-106	15100-70050
		02.07~03.12	1GFE	GS171		OPT-106	15100-70050
	2500	90.08~91.08	1JZGE	JZS13#	WG	OPT-071	15100-46020
		99.09~01.08	1JZGE,2JZGE	JZS173,179			15100-46100
		01.05~01.08	1JZGE	JZS171			15100-46091
		01.08	1JZFSE,2JZFSE	JZS171,175			15100-46111
		01.08	1JZGE	JZS173			15100-46100
		01.08~03.12	1JZFSE,2JZFSE	JZS175,JZS171,175			15100-46111
		01.08~03.12	1JZGE,2JZGE	JZS173,179			15100-46100
	3000	84.08~87.08	6MGEU	MS125		OPT-029	15100-42010
		91.10~99.04	1GFE	GS13#			15100-70030
		01.04~01.08	2JZFSE	JZS175,177			15100-46111
01.08~04.06		2JZFSE	JZS177	15100-46111			
4000	99.09~01.08	1UZFE	UZS17#		OPT-103	15100-50040	
	01.08~04.06	1UZFE	UZS17#		OPT-103	15100-50040	
4300	04.06	3UZFE	UZS18#		OPT-103	15100-50040	
CROWN COMFORT	2000	95.12	3YPE	YXS1#	SED	OPT-030	15100-71010
		95.12~02.10	1GGPE	SXS10	SED		15100-70040
		01.08	1GFE	GXS12	SED	OPT-106	15100-70050
		02.10	1GFE	GBS12	SED		15100-70060
DYNA / TOYOACE	2000	77.08~84.08	5R	RU2#,3#		OPT-068	15100-44030
	2500	79.04~80.08	2J	JU20			15100-48021
	3600	77.08~80.08	H	HU30		OPT-072	15100-47030
GRANVIA / GRAND HIACE	3400	97.08~99.07	5VZFE	VCH1#		OPT-022	15100-62050
		99.07~02.05	5VZFE	VCH1#		OPT-022	15100-62050
		99.07~05.01	5VZFE	VCH2#		OPT-022	15100-62050
HARRIER	2400	03.02	2AZFE	ACU3#		OPT-110	15100-28020
HIACE TRUCK	1600	82.11~85.07	12RJ	RH24		OPT-050	15100-31040
HIGH LANDER / KLUGER HV	3300	05.03	3MZFE	MHU28	HYBRID	OPT-100	15100-20050
HIGH LANDER / KLUGER L / V	2400	00.11	2AZFE	ACU2#		OPT-110	15100-28020
	3000	00.11	1MZFE	MCU2#		OPT-100	15100-20050
HILUX	1600	78.08~88.09	12RJ	RN30,33,35,4#		OPT-050	15100-31040

Model	Year	Engine Type	Body Type	Reference	AISIN No.	Genuine No.	
HILUX	1600	81.08~83.10	18RJ	RN36,39	OPT-052	15100-34021	
IS200 / ALTEZZA / ALTEZZA GITA	2000	98.10	1GF6	GXE1#	OPT-106	15100-70050	
		98.10	3SGE	SXE10		15100-88570	
IS300 / ALTEZZA / ALTEZZA GITA	3000	01.06	2JZGE	JCE10	OPT-071	15100-46091	
		01.06	2JZGE	JCE15		15100-46100	
ISIS	1800	04.09	1ZZFE	ZNM10	OPT-044	15100-22041	
	2000	04.09	1AZFSE	ANM1#		15100-28040	
IST	1300	02.04	2NZFE	NCP60	F	15100-21030	
		05.05	2NZFE	NCP60	AEROF	15100-21030	
	1500	02.04	1NZFE	NCP61,65	F,S	15100-21040	
		05.05	1NZFE	NCP61,65	AEROF,AEROS	15100-21040	
LAND CRUISER	3000	79.11	B	BJ4#	OPT-014	15100-56010	
	4000	79.11	F	FJ4#,55	OPT-017	15100-60012	
		87.08~90.01	3F,3FE	FJ62	OPT-018	15100-61011	
		90.06~92.08	3F	FJ 75	S/ T,H/ T	15100-61020	
	4700	98.01~02.08	2UZFE	UZJ100	OPT-012	15100-50050	
02.08		2UZFE	UZJ100	OPT-012	15100-50050		
LAND CRUISER PRADO	3400	96.04~02.11	5VZFE	VZJ9#	OPT-022	15100-62050	
		02.09~05.08	5VZFE	VZJ12#	OPT-021	15100-62040	
LEVIN / TORENO / MRN / CRE	1600	91.06~95.05	4AG#	AE101	OPT-036	15100-19036	
LEXUS CT200h	1800	10.12	2ZRFXE	ZWA10	OPT-118	15100-37040	
		10.12	5ZRFXE	ZWA10	OPT-118	15100-37040	
LEXUS ES250 / WINDOM	2500	93.08~96.08	4VZFE	VCV11	OPT-019	15100-62020	
		96.08~01.07	2MZFE	MCV21		15100-20030	
LEXUS ES300 / WINDOM	3000	91.10~96.08	3VZFE	VCV10	OPT-020	15100-62030	
		96.08~98.08	1MZFE	MCV20		OPT-037	15100-20020
LEXUS GS300 / ARISTO	3000	97.08~05.01	2JZGTE	JZS161	TURBO	15100-46052	
		01.05~05.01	2JZGE	JZS160	OPT-071	15100-46091	
LEXUS GS430 / 350	4300	05.08	3UZFE	UZS190	OPT-103	15100-50040	
LEXUS RX300 / HARRIER	3000	97.12~03.02	1MZFE	MCU1#	OPT-107	15100-20040	
		03.02~06.01	1MZFE	MCU3#		OPT-100	15100-20050
LEXUS RX330 / HARRIER HV	3300	05.03	3MZFE	MHU38	OPT-100	15100-20050	
LEXUS SC400 / SOARER	4000	93.12~96.08	1UZFE	UZZ32	OPT-011	15100-50031	
		94.09~97.09	1UZFE	UZZ31		15100-50022	
LEXUS SC430 / SOARER	4300	01.04~05.08	3UZFE	UZZ40	OPT-103	15100-50040	
		05.08	3UZFE	UZZ40		OPT-103	15100-50040
LITE / TOWNACE TRUCK	1800	79.10~82.10	13TU	TM20	OPT-046	15100-25020	
MARK II / MARK II BLIT	2000	00.10	1GF6	GX11#	IR	OPT-106	15100-70050
		00.10~04.11	1GF6	GX11#	GD	OPT-106	15100-70050
		02.10~04.11	1GF6	GX110	GDS	OPT-106	15100-70050
	2500	00.10	1JZGE	JZX115	IRS		15100-46100
		00.10~04.11	1JZGE	JZX115	GDG		15100-46100
		01.04	1JZFSE	JZX110	IRS		15100-46111
01.04~04.11	1JZFSE	JZX110	SED		15100-46111		
MR2	2000	89.12~91.05	3SGTE	SW20	TURBO	OPT-079	15100-88381
		89.12~93.11	3SGE	SW20		OPT-078	15100-88360
		91.05~93.11	3SGTE	SW20	TURBO	OPT-080	15100-88382
		93.11~99.08	3SGE	SW20		OPT-119	15100-88460
		93.11~99.08	3SGTE	SW20		OPT-119	15100-88460

Model	Year	Engine Type	Body Type	Reference	AISIN No.	Genuine No.
NADIA	2000	98.07~01.04	3SF5E	SXN10		15100-74070
NOAH / VOXY	2000	01.11~04.08	1AZF5E	AZR6#		OPT-048 15100-28030
		04.08	1AZF5E	AZR6#		15100-28040
		07.06	3ZRFAE	ZRR7#		OPT-120 15100-37020
		08.08	3ZRFE	ZRR70		OPT-113 15100-37030
PICNIC / IPSUM	2400	01.05	2AZFE	ACM2#		OPT-110 15100-28020
PORTE	1300	04.07	2NZFE	NNP10		15100-21030
		1500	04.07	1NZFE	NNP11,15	
PREMIO / ALLION	1500	01.12	1NZFE	NZT240		15100-21040
		1800	01.12~02.06	1ZZFE	ZZT24#	
	02.06		1ZZFE	ZZT24#	OPT-044 15100-22041	
	2000	01.12~04.12	1AZF5E	AZT240		OPT-048 15100-28030
04.12		1AZF5E	AZT240	15100-28040		
PREVIA / ESTIMA	2400	06.01	2AZFE	ACR5#		OPT-110 15100-28020
PRIUS	1500	97.12~00.05	1NZFXE	NHW10	HYBRID	15100-21021
		03.08	1NZFXE	NHW20	HYBRID	15100-21050
		11.10	1NZFXE	NHW20		OPT-117 15100-21052
	1800	09.04	2ZRFXE	ZVW30		OPT-118 15100-37040
		09.12	2ZRFXE	ZVW35		OPT-118 15100-37040
	11.12	5ZRFXE	ZVW30	CHINA	OPT-118 15100-37040	
PRIUS V	1800	11.09	2ZRFXE	ZVW41		OPT-118 15100-37040
		12.03	2ZRFXE	ZVW40		OPT-118 15100-37040
PROBOX / SUCCEED	1300	02.06	2NZFE	NCP50		15100-21030
		1400	02.06	1NDTV	NLP51	
	1500	02.06	1NZ#	NCP51,52,55,58,59		15100-21040
PROGRES	2500	99.12	1JZ#	JCG15		15100-46100
		01.04	1JZF5E	JCG10		15100-46111
	3000	01.04	2JZF5E	JCG11		15100-46111
RACTIS	1300	06.05	2SZFE	SCP100		OPT-121 15100-23040
		1500	05.09	1NZFE	NCP100	
	05.09		1NZFE	NCP105		15100-21040
RAUM	1500	03.04	1NZFE	NCZ2#		15100-21040
RAV4	2000	08.12	3ZRFAE	ZSA3#		OPT-120 15100-37020
	2400	05.11	2AZFE	ACA3#		OPT-110 15100-28020
RUSH	1300	06.01	3SZVE	J200,210		OPD-001 15100-B1010
SCEPTER	3000	92.07~96.07	3VZFE	VCV15	WG,CP	OPT-020 15100-62030
		92.11~96.08	3VZFE	VCV10	SED	OPT-020 15100-62030
SIENTA	1500	03.09	1NZFE	NCP81		OPT-109 15100-21060
		03.09	1NZFE	NCP85		15100-21040
SOARER	2000	81.02~84.08	MTEU	MZ1#	TURBO	OPT-062 15100-43010
		88.01~89.01	1GEU	GZ20		OPT-028 15100-70011
	2800	81.02~84.08	5MGEU	MZ1#	TURBO	OPT-062 15100-43010
		84.08~85.12	5MGEU	MZ11		OPT-063 15100-43020
	3000	84.08~85.12	6MGEU	MZ12		OPT-063 15100-43020
		90.07~91.04	7MGTEU	MZ2#	CP,TURBO	OPT-059 15100-42021
SPRINTER	1600	79.03~83.04	2TGEU,13TU	TE7#		OPT-046 15100-25020
		87.05~90.08	4AF,4AFE,5A#	AE91,95		OPT-097 15100-15050
		90.08~91.06	4AFE,5AFE,5AFHE	AE91,95	DX,LX,MX,SE	OPT-097 15100-15050
		91.06~95.05	4AGE	AE101		OPT-036 15100-19036

Model	Year	Engine Type	Body Type	Reference	AISIN No.	Genuine No.		
SPRINTER CARIB	1600	90.09~94.08	4AFHE	AE95	OPT-097	15100-15050		
		95.08~02.07	4AFE	AE111,114		OPT-032	15100-15060	
		96.05~02.07	4AGE	AE111		OPT-101	15100-19045	
	1800	95.08~99.10	7AFE	AE115	OPT-034	15100-16040		
		99.10~02.07	7AFE	AE115		15100-16090		
SPRINTER TRUENO	1500	87.05~91.06	5A#		OPT-097	15100-15050		
STARLET	1300	86.01~86.04	2ETELU	EP71		15100-11020		
	1500	98.11~99.07	1N	NP90	OPT-013	15100-55011		
STOUT	2000	79.03~86.03	5R	RK11#	OPT-067	15100-44020		
SUPRA	3000	90.07~90.08	7MGTEU	MA70	TURBO	OPT-059	15100-42021	
		96.02~02.08	2JZGE	JZA80		OPT-070	15100-46042	
SUPRA / CELICA XX	2000	81.07~84.08	MTEU	MA6#	TURBO	OPT-062	15100-43010	
		2800	81.07~84.08	5MGEU		MA6#	OPT-062	15100-43010
		84.08~85.12	5MGEU	MA61	OPT-063	15100-43020		
TERCEL / CORSA	1500	98.11~99.07	1NT	NL50	TURBO	OPT-013	15100-55011	
TOWN / MASTERACE	1600	78.08~82.10	12RJ	RR1#,2#	V,WG	OPT-050	15100-31040	
	1800	76.10~82.10	2TJ,12T,13TU	TR1#	V,WG	OPT-046	15100-25020	
TOYOACE	1600	79.03~85.07	12R	RY2#		OPT-050	15100-31040	
	2000	79.03~85.07	5R	RY3#		OPT-068	15100-44030	
	2500	79.04~83.08	2J	JY30			15100-48021	
VEROSSA	2000	01.06~04.02	1GFEE	GX11#		OPT-106	15100-70050	
	2500	01.06~04.04	1JZFSE	JZX110	TURBO		15100-46111	
VERSO	1600	09.02	1ZRFAE	ZGR2#		OPT-120	15100-37020	
	1800	09.02	2ZRFAE	ZGR2#		OPT-120	15100-37020	
VIOS	1300	11.10	2ZRFE	ZSP92		OPT-116	15100-21032	
	1600	08.02	1ZRFE	ZSP92		OPT-113	15100-37030	
VISTA / VISTA ARDEO	2000	98.06~01.08	3SFSE	SV50			15100-74070	
VITZ/YARIS		01.01	1NZFE	NCP13			15100-21040	
	1300	05.01	2NZFE	NCP95			15100-21030	
		06.05	2SZFE	SCP90			OPT-121	15100-23040
		11.10	2NZFE	NCP130			OPT-116	15100-21032
		11.10	2NZFE	NCP90	China		OPT-116	15100-21032
		11.10	2NZFE	NCP92			OPT-116	15100-21032
	1400	05.11	1ADFTV	ADE150L		OPT-114	15100-33040	
	1500	05.01	1NZFE	NCP91			OPT-109	15100-21060
		11.11	1NZFE	NCP131			OPT-115	15100-21042
		11.11	1NZFE	NCP93			OPT-115	15100-21042
	1600	08.05	1ZRFE	ZSP91		OPT-113	15100-37030	
WISH	1800	03.01	1ZZFE	ZNE1#		OPT-044	15100-22041	
		09.03	2ZRFAE	ZGE2#		OPT-120	15100-37020	
	2000	03.04	1AZFSE	ANE1#			15100-28040	
		09.03	3ZRFAE	ZGE2#		OPT-120	15100-37020	
xb / bB	1500	06.01	3SZVE	GNC21		OPD-001	15100-B1010	

Model	Year	Engine Type	Body Type	Reference	AISIN No.	Genuine No.
CARAVAN, HOMOY	3200	04.09	QD32	E24		
					OPN-002	15010-1W402
CEDRIC, GLORIA	2300	87.09	TD23	Y31		
	2500	91.06~95.07	TD25	SY31		
					OPN-003	15010-43G06
	2700	95.04	TD27	SY31		
					OPN-003	15010-43G06
F2# CABSTAR, HOMER, ATLAS	2300	86.10	TD23	F22		
	2500	88.10	TD25	F22		
		92.07	TD25	F23		
					OPN-003	15010-43G06
	2700	86.10	TD27	F22		
		92.07	TD27	F23		
					OPN-003	15010-43G06
	3200	02.08	QD32	F23		
					OPN-002	15010-1W402
FORK LIFT	2700	93.06	TD27	J01, J02		
					OPN-003	15010-43G06
	3000	93.06	BD30	J02		
					OPN-003	15010-43G06
H4# ATLAS, CONDOR	2700	86.11~89.02	TD27	H40		
	3000	89.02	BD30	H40		
		92.07	BD30	H41		
					OPN-003	15010-43G06
MISTRAL	2700	93.02	TD27T	R20		
					OPN-003	15010-43G06
TRUCK	2500	87.08	TD25	D21		
		89.11	BD25	D21		
	2700	87.08	TD27	D21		
		99.10	TD27	D22		
					OPN-003	15010-43G06
Unknown	1500	04	HR15DE			
		06~12	HR			
					OPN-001	15010-0ANBA
					OPN-004	15010-10NBA

Reference List (Genuine No.→ AISIN No.)

Genuine No.	AISIN No.	Make
15100-11090	OPT-009	TOYOTA
15100-15020	OPT-031	TOYOTA
15100-15050	OPT-097	TOYOTA
15100-15060	OPT-032	TOYOTA
15100-15080	OPT-033	TOYOTA
15100-16040	OPT-034	TOYOTA
15100-16070	OPT-035	TOYOTA
15100-19036	OPT-036	TOYOTA
15100-19045	OPT-101	TOYOTA
15100-20020	OPT-037	TOYOTA
15100-20040	OPT-107	TOYOTA
15100-20050	OPT-100	TOYOTA
15100-21032	OPT-116	TOYOTA
15100-21042	OPT-115	TOYOTA
15100-21052	OPT-117	TOYOTA
15100-21060	OPT-109	TOYOTA
15100-22040	OPT-044	TOYOTA
15100-22041	OPT-044	TOYOTA
15100-23040	OPT-121	TOYOTA
15100-25012	OPT-045	TOYOTA
15100-25020	OPT-046	TOYOTA
15100-26020	OPT-047	TOYOTA
15100-27010	OPT-098	TOYOTA
15100-27020	OPT-105	TOYOTA
15100-27030	OPT-099	TOYOTA
15100-28020	OPT-110	TOYOTA
15100-28030	OPT-048	TOYOTA
15100-31030	OPT-049	TOYOTA
15100-31040	OPT-050	TOYOTA
15100-33012	OPT-051	TOYOTA
15100-33040	OPT-114	TOYOTA
15100-34021	OPT-052	TOYOTA
15100-35010	OPT-053	TOYOTA
15100-35020	OPT-054	TOYOTA
15100-36011	OPT-056	TOYOTA

Genuine No.	AISIN No.	Make
15100-37020	OPT-120	TOYOTA
15100-37021	OPT-120	TOYOTA
15100-37030	OPT-113	TOYOTA
15100-37040	OPT-118	TOYOTA
15100-38010	OPT-057	TOYOTA
15100-41030	OPT-058	TOYOTA
15100-42021	OPT-059	TOYOTA
15100-42031	OPT-060	TOYOTA
15100-42060	OPT-061	TOYOTA
15100-43010	OPT-062	TOYOTA
15100-43020	OPT-063	TOYOTA
15100-43070	OPT-066	TOYOTA
15100-44020	OPT-067	TOYOTA
15100-44030	OPT-068	TOYOTA
15100-45021	OPT-069	TOYOTA
15100-46042	OPT-070	TOYOTA
15100-46091	OPT-071	TOYOTA
15100-47030	OPT-072	TOYOTA
15100-50040	OPT-103	TOYOTA
15100-50050	OPT-012	TOYOTA
15100-55011	OPT-013	TOYOTA
15100-56010	OPT-014	TOYOTA
15100-61011	OPT-017	TOYOTA
15100-61020	OPT-018	TOYOTA
15100-62020	OPT-019	TOYOTA
15100-62030	OPT-020	TOYOTA
15100-62040	OPT-021	TOYOTA
15100-62050	OPT-022	TOYOTA
15100-64032	OPT-024	TOYOTA
15100-64042	OPT-025	TOYOTA
15100-65020	OPT-027	TOYOTA
15100-70011	OPT-028	TOYOTA
15100-70030	OPT-029	TOYOTA
15100-70050	OPT-106	TOYOTA
15100-71010	OPT-030	TOYOTA

Genuine No.	AISIN No.	Make
15100-74040	OPT-074	TOYOTA
15100-76031	OPT-077	TOYOTA
15100-88360	OPT-078	TOYOTA
15100-88381	OPT-079	TOYOTA
15100-88382	OPT-080	TOYOTA
15100-88460	OPT-119	TOYOTA
15100-88600	OPT-111	TOYOTA
15100-97401	OPT-112	TOYOTA

Genuine No.	AISIN No.	Make
15010-0ANBA	OPN-001	NISSAN
15010-10NBA	OPN-004	NISSAN
15010-1W402	OPN-002	NISSAN
15010-43G03	OPN-003	NISSAN
15010-43G04	OPN-003	NISSAN
15010-43G05	OPN-003	NISSAN
15010-43G06	OPN-003	NISSAN
15010-G2401	OPN-003	NISSAN
15100-B1010	OPD-001	DAIHATSU
8-94202-463-1	OPG-007	ISUZU
8-94215-637-0	OPG-005	ISUZU
8-94366-091-0	OPG-004	ISUZU
8-97103-865-0	OPG-008	ISUZU
8-97136-463-0	OPG-011	ISUZU
8-97136-464-0	OPG-009	ISUZU
8-97288-755-1	OPG-012	ISUZU
8-97288-756-1	OPG-010	ISUZU
MD001400	OPM-001	MITSUBISHI
MD005400	OPM-002	MITSUBISHI
MD011430	OPM-003	MITSUBISHI
16100-82605	OPS-001	SUZUKI
16100-86502	OPS-002	SUZUKI
15100-75002-71	OPT-082	INDUSTRIAL VEHICLE
15100-76001-71	OPT-081	INDUSTRIAL VEHICLE
15100-76003-71	OPT-083	INDUSTRIAL VEHICLE
15100-76004-71	OPT-084	INDUSTRIAL VEHICLE
15100-76006-71	OPT-086	INDUSTRIAL VEHICLE
15100-76009-71	OPT-095	INDUSTRIAL VEHICLE
15100-78200-71	OPT-090	INDUSTRIAL VEHICLE
15100-78201-71	OPT-093	INDUSTRIAL VEHICLE
15100-78202-71	OPT-094	INDUSTRIAL VEHICLE
15100-78300-71	OPT-087	INDUSTRIAL VEHICLE
15100-78330-71	OPT-088	INDUSTRIAL VEHICLE
15100-78331-71	OPT-089	INDUSTRIAL VEHICLE
15100-78332-71	OPT-092	INDUSTRIAL VEHICLE

Genuine No.	AISIN No.	Make
15100-78700-71	OPT-091	INDUSTRIAL VEHICLE

Illustrations (TOYOTA)



OPT-012

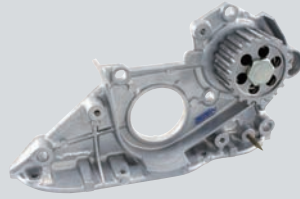

OPT-013



OPT-014



OPT-017

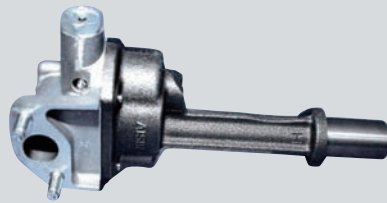

OPT-018



OPT-019

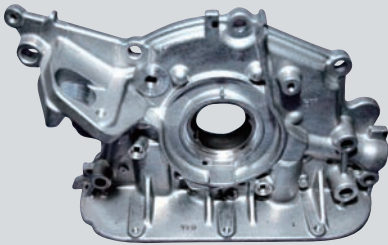

OPT-020



OPT-021



OPT-022

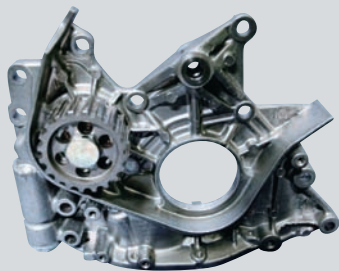

OPT-024



OPT-025



OPT-027

Illustrations (TOYOTA)



OPT-028



OPT-029



OPT-030

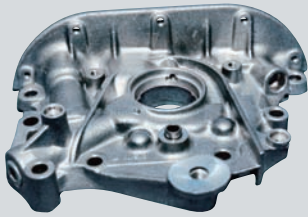

OPT-031



OPT-032

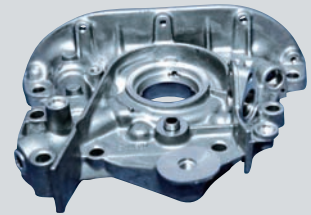

OPT-033



OPT-034

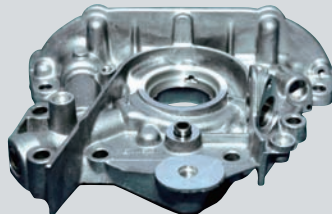

OPT-035



OPT-036

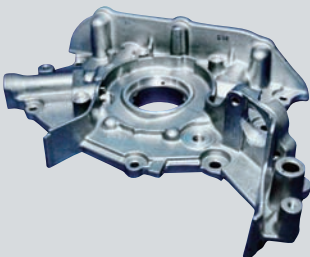

OPT-037



OPT-042



OPT-044

Illustrations (TOYOTA)



OPT-045

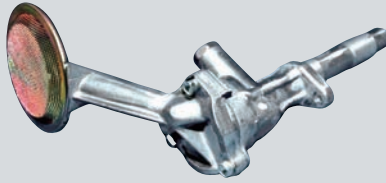

OPT-046



OPT-047

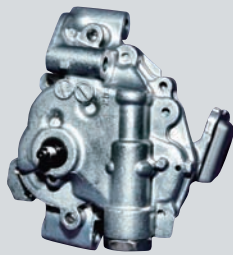

OPT-048

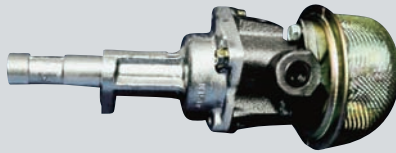

OPT-049

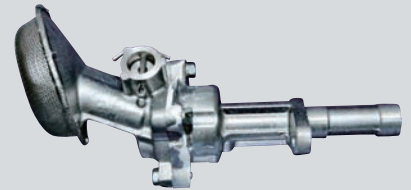

OPT-050

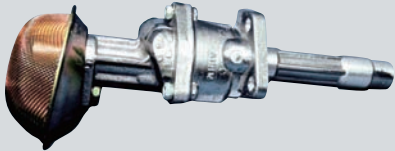

OPT-051



OPT-052



OPT-053

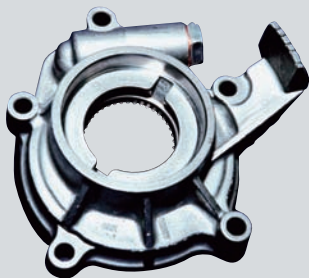

OPT-054

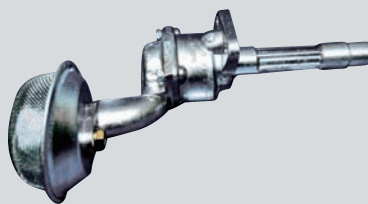

OPT-056



OPT-058

Illustrations (TOYOTA)

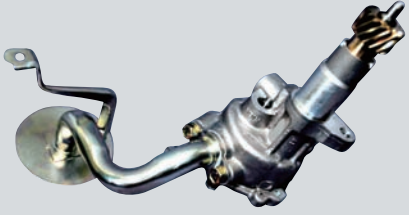

OPT-059



OPT-060

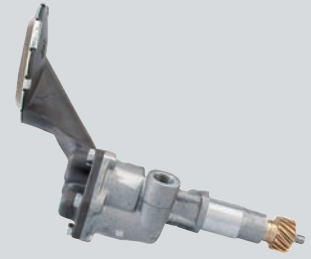

OPT-061



OPT-062

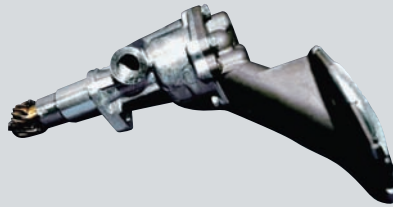

OPT-063



OPT-066

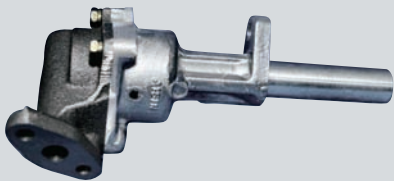

OPT-067

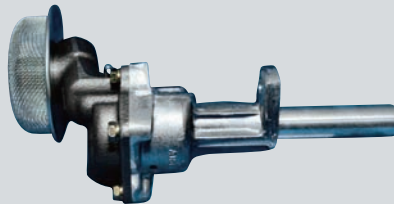

OPT-068



OPT-069

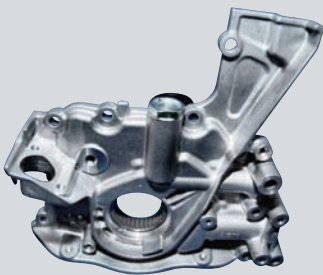

OPT-070

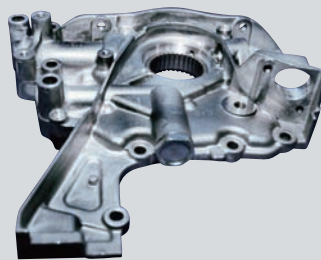

OPT-071



OPT-072

Illustrations (TOYOTA)

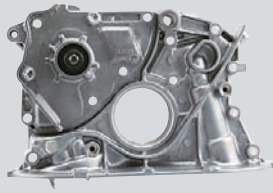

OPT-078

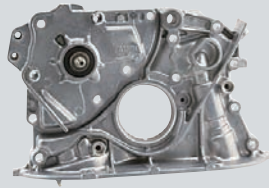

OPT-079

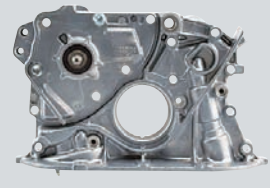

OPT-080



OPT-097



OPT-098



OPT-099



OPT-100



OPT-103



OPT-105



OPT-106



OPT-107



OPT-109

Illustrations (TOYOTA)



OPT-110



OPT-111



OPT-112



OPT-113



OPT-114



OPT-115



OPT-116



OPT-117

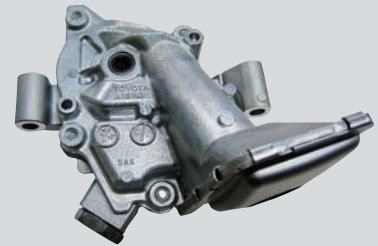

OPT-118



OPT-119



OPT-120



OPT-121

Illustrations (TOYOTA)



Illustrations (Others)



Illustrations (Others)



OPT-092



OPT-093



OPT-094



OPT-095

Reference List / Timing Chain Cover

Genuine No.	Aisin No.	Make	Application				Component Parts		
			Model	Year	Engine Type	Body Type	Case	Water Pump	Oil Pump
11301-17011	TCT-001	TOYOTA	LAND CRUISER	94.08~98.05	1HZ	HZJ7#	●	×	●
				94.08~99.01	1HZ	HZJ80			
				94.08~95.01	1PZ	PZJ75			
11301-17021	TCT-002	TOYOTA	COASTER	94.08~97.05	1HZ#	HZB50	●	×	●
				94.08~01.03	1HDT	HDJ80			
			LAND CRUISER	94.08~98.05	1HZ	HZJ7#			
				94.08~01.03	1HZ	HZJ80			
11301-17030	TCT-003	TOYOTA	COASTER	97.05~99.07	1HZ	HZB50	●	×	●
				LAND CRUISER	95.01~98.01	1HDFT	HDJ80		
			98.05~99.08		1HZ	HZJ7#			
			98.01~02.08		1HDT	HDJ100			
			02.08~05.05	1HZ	HZJ105				
11301-58031	TCT-022	TOYOTA	COASTER	99.05~01.08	15BFT	BB43, 50	●	×	●
			COASTER (CHINA)	03.10~07.01	15BFT	BB5#			
			DYNA200	99.05~	15BFT	BU102, 142, 212, 222			
11301-68011	TCT-012	TOYOTA	LAND CRUISER	84.11~85.06	2H	HJ47	●	×	●
				84.11~85.10	2H	HJ60, HJ75			
11301-68020	TCT-013	TOYOTA	COASTER	86.10~90.01	12HT, 2H	HB3#	●	×	●
				LAND CRUISER	85.10~90.01	12HT, 2H	HJ6#		
			85.10~90.01		2H	HJ75			
11301-71010	TCT-067	TOYOTA	CORONA FR	86.12~99.07	2Y	YT140	●		
			CRESSIDA	85.02~88.08	2Y	YX70			
			CRESSIDA WAGON	88.12~92.05	3Y	YX72			
			CROWN	83.08~87.08	3Y	YS120			
				87.09~95.12	4Y	YS132			
			CROWN COMFORT	99.08~08.08	3YPE	YXS10			
			DYNA	84.09~87.08	3Y, 4Y	YU6#, 7#, 8#			
			DYNA 100	95.05~	2Y	YY100			
			DYNA 150	95.05~	3Y	YY211			
			DYNA 200	87.08~95.05	4Y	YU6#, 71, 8#			
			DYNA100	85.08~87.08	1Y, 2Y	YH8#			
				87.08~95.05	2Y	YH81			
			DYNA150	85.08~87.08	2Y, 3Y	YY5#, 6#			
	87.08~95.05	3Y	YY52, 61						

Oil Pump

Timing Chain Cover

Genuine No.	Aisin No.	Make	Application				Component Parts					
			Model	Year	Engine Type	Body Type	Case	Water Pump	Oil Pump			
11301-75011	TCT-068	TOYOTA	DYNA200	95. 05~	4Y	YU210						
			HIACE VAN, COMUTER	82. 12~88. 07	2Y#, 3Y, 4Y	YH5#, 6#, 71						
				87. 08~	2Y, 3Y, 4Y	YH5#, 6#, 73						
			HILUX	83. 08~98. 07	1Y#, 2Y, 3Y, 4YC, 4YE	YN5#, 60, 63, 65						
				98. 08~00. 10	2Y	YN140						
				83. 08~98. 07	4Y	YN58, 62, 63, 67						
			HILUX 2WD	88. 08~99. 09	2Y, 3Y, 4Y	YN8#, 9#						
			HILUX/ 4RUNNER (4WD)	88. 08~97. 08	4Y#	YN106, 13#						
			LITEACE	83. 11~85. 08	1Y, 2YC	YM2#						
				85. 09~88. 08	2Y#, 3YC	YM3#, 4#						
				88. 08~98. 04	2Y#	YM3#						
			LITEACE VAN WAGON	92. 01~00. 07	3Y#, 4YEC	YR2#, 39						
			MODEL-F	82. 11~88. 08	2Y#, 3Y#, 4YEC	YR2#, 31						
				88. 08~90. 01	3Y#, 4YEC	YR2#, 31						
			STOUT	86. 09~00. 02	4Y	YK110						
			T. U. V	00. 04~03. 06	2Y	YF60, 80						
			11301-75021	TCT-069	TOYOTA	HIACE VAN, COMUTER	94. 01~95. 08	1RZ, 2RZ#	RZH10#, 11#, 125	●	×	●
						4RUNNER	97. 04~	3RZFE	RZN18#	●	×	●
						COASTER	97. 04~99. 07	3RZF	RZB40, 50			
							99. 07~07. 08	3RZFE	RZB40, 50			
			COASTER (CHINA)	00. 12~07. 01	3RZFE	RZB5#						
			DYNA200	97. 04~	3RZFE	RZU100						
			HIACE/ HIACE S. B. V	98. 04~06. 05	3RZFE	RCH13, 19, 23, 29						
			HILUX	97. 08~01. 12	3RZF	RZN144, 149, 154, 169						
				97. 08~05. 11	3RZFE	RZN144, 149, 154, 169, 174, 194						
			HILUX 2WD	01. 06~04. 12	3RZFE	RZN200						
			LAND CRUISER 90	97. 04~	3RZF, 3RZFE	RZJ9#						
			LAND CRUISER PRADO	02. 09~04. 08	3RZFE	RZJ12#						
11301-75050	TCT-070	TOYOTA	HIACE VAN, COMUTER	99. 07~	1RZ	RZH112	●	×	●			
				95. 08~	1RZ#, 2RZ	RZH10#, 112, 113						
					1RZ, 2RZ#	RZH10#, 113, 114, 115, 125, 135, 15#						

Genuine No.	Aisin No.	Make	Application				Component Parts		
			Model	Year	Engine Type	Body Type	Case	Water Pump	Oil Pump
11301-76011	TCT-071	TOYOTA	HIACE/ HIACE S. B. V	95. 07~99. 07	2RZ	RZH115			
				95. 08~03. 11	2RZE	RZH105, 113, 115			
11302-35010	TCT-072	TOYOTA	HILUX	01. 08~05. 06	1RZ#	RZN142, 147		×	●
				94. 01~99. 12	2TZFE	TCR1#, 2#			
11310-66020	TCT-073	TOYOTA	CELICA	84. 08~85. 07	21R#, 22REC	RA6#	●		
				84. 08~93. 01	22R	RB20			
				84. 08~86. 12	22REC	RT142			
				84. 08~85. 04	21R	RX60			
				84. 08~88. 08	21R, 22R	RX7#			
				88. 08~96. 08	22R	RX8#			
				88. 10~93. 02	22R	RX7#			
				84. 09~87. 08	22R	RU75, 85			
				87. 08~95. 05	22R	RU85			
				94. 07~98. 07	22R	RN58, 67			
				86. 01~89. 03	22R#	RN5#, 61			
				88. 08~99. 09	22R#	RN125, 8#, 90			
				88. 08~99. 09	22R#	RN10#, 110, 13#			
				84. 11~96. 04	22R	RJ7#			
				93. 05~04. 05	1FZ#	FZJ70, 73, 75			
				92. 01~99. 08	1FZF	FZJ80			
				92. 01~93. 05	1FZ	FZJ70, 73, 75			
				92. 08~	1FZ#	FZJ80			
				92. 01~93. 05	1FZFE	FZJ70, 71, 74, 75, 78, 79			
				99. 08~08. 08	1FZFE	FZJ71, 74, 78, 79			
07. 01~09. 07	1FZE	FZJ7#							
05. 05~	1FZFE	FZJ10#							
11310-75073	TCT-079	TOYOTA	COASTER	09. 02~14. 06	2TRFE	TRB40, 50	●	●	●
				09. 02~13. 01	2TRFE	TRB53			
				13. 01~14. 06	3TRFE	TRB53			
				09. 02~10. 06	2TRFE	TGN51, TGN61			
				09. 02~14. 06	2TRFE	TRH20#, 213, 22#			

Timing Chain Cover

Genuine No.	Aisin No.	Make	Application				Component Parts		
			Model	Year	Engine Type	Body Type	Case	Water Pump	Oil Pump
11310-75074	TCT-079	TOYOTA	HILUX	09. 02~10. 05	2TRFE	TGN16, 26, 36	●	×	
11311-54052	TCT-075		LAND CRUISER PRADO	09. 02~	2TRFE	TRJ12#			
				14. 06~14. 11	2TRFE	TRJ15#			
			CROWN	95. 05~95. 12	2L	LS130			
			CROWN COMFORT	96. 01~01. 08	2L, 5L	LXS1#			
				01. 08~06. 07	5L	LXS12			
			DYNA	01. 07~	5L	LY22#, 23#			
			DYNA 100	95. 05~	2L	LY100			
			DYNA 150	95. 05~	3L, 5L	LY21#			
			FORTUNER	06. 05~	5LE	LAN50			
			HIACE	05. 01~	5LE	LH20#, 212, 222			
			HIACE VAN, COMUTER	99. 07~02. 10	2L	LH112			
				95. 05~99. 07	2L, 3L, 5L	LH10#, 11#, 125, 166, 17#, 184			
				99. 07~00. 08	2L, 3L, 5L	LH102, 105, 112, 174			
				99. 07~04. 08	2L, 5L	LH102, 104, 16#, 176			
				99. 07~05. 01	2L, 5L	LH112, 154, 184			
				99. 07~	2L, 5L	LH114, 172			
				99. 07~00. 08	3L	LH103, 113, 115, 125			
				99. 07~04. 08	5L	LH162			
				99. 07~05. 01	5L	LH172			
				99. 07~	5L	LH174			
				01. 08~05. 01	5LE	LH172			
			HIACE/ HIACE S. B. V	95. 08~01. 08	2L#	LXH1#, 2#			
			HILUX	00. 08~	2L	LN145			
				01. 09~02. 12	2L	LN150, 155			
				00. 00~01. 01	2L, 3L	LN141, 146, 171, 191			
			02. 03~	2L, 3L	LN145, 166				
	95. 08~98. 07	2L, 3L	LN5#, 67						
	97. 08~99. 05	2L, 3L, 5L	LN14#, 16#, 17#, 19#						
	99. 05~00. 08	2L, 3L, 5L	LN141, 145, 146, 147, 16#, 17#, 191						
	01. 08~	2L, 3L, 5LE	LN140, 141, 145, 146, 166, 171, 19#						
	00. 08~00. 09	2L, 5L	LN140, 145, 147, 15#, 167, 172, 192						
	99. 05~00. 05	2L, 5L	LN140, 145, 15#, 192						
	98. 06~99. 05	2L, 5L	LN145, 15#, 192						

Genuine No.	Aisin No.	Make	Application				Component Parts		
			Model	Year	Engine Type	Body Type	Case	Water Pump	Oil Pump
			HILUX 2WD	00. 09~01. 08	2L, 5LE	LN140, 147, 150, 155, 172			
				01. 08~01. 09	2L, 5LE	LN140, 155, 167, 172, 192			
				98. 06~00. 08	5L	LN147, 167, 172			
				00. 09~01. 08	5L#	LN152, 167, 192			
				05. 07~	5LE	LAN15, 25, 35			
				01. 08~	5LE	LN147, 152, 167, 172			
				96. 08~97. 01	2L	LN85			
				95. 05~96. 08	2L, 3L	LN8#			
				97. 01~01. 06	2L, 3L	LN8#, 9#			
				96. 08~97. 01	2L, 3L	LN80, 81, 86, 90			
			HILUX/4RUNNER (4WD)	01. 06~03. 12	5L	LN200			
				95. 05~01. 06	3L	LN10#, 111, 13#			
				01. 06~03. 12	5L	LN205			
			LAND CRUISER	95. 05~96. 04	3L	LJ7#			
			LAND CRUISER 90	96. 04~02. 09	3L	LJ9#			
			LAND CRUISER PRADO	02. 09~	5LE	LJ12#			
			QUALIS	09. 08~	5LE	LJ150			
				99. 12~	2L	LF50			
			T. U. V	03. 06~04. 06	2L	LF60, 80, 82			
				98. 04~98. 05	2L	LF80			
				03. 06~05. 01	2L	LF82			
				98. 05~02. 12	2L, 5L	LF61, 80, 81, 85			
				02. 12~05. 03	5L	LF61, 81, 85			
15115-75010	TCT-077	TOYOTA	HIACE VAN, COMUTER	89. 08~95. 08	1RZ, 2RZ#	RZH10#, 11#, 125	●	×	
11310-47030	TCT-080						●	●	●
11310-40041	TCT-081						●	×	●
11302-26020	TCT-082						●	×	●
11310-36020	TCT-083						●	×	●

Timing Chain Cover

Reference List / Fan Clutch

Genuine No.	AISIN No.	Make	Model	Engine Type	Body Type
16210-05010	FCTS-002	TOYOTA	HIACE VAN, COMUTER HILUX QUALIS T.U.V	5LE 2L 2L 2L	LH172 LN145,150,155 LF50 LF6#,7#,8#
16210-0C010	FCTS-003	TOYOTA	FORTUNER HILUX	2TRFE 1TRFE,2TRFE	TGN51,61 TGN1#,2#,3#,4#
16210-0F010	—	TOYOTA	SEQUOIA/TUNDRA	2UZ	UCK3#,4#
16210-0L010	FCTS-001	TOYOTA	FORTUNER/HILUX INNOVA/ KIJANG INNOVA	1KDFTV, 2KDFTV 2KDFTV	KUN1#~6# KUN40
16210-0L011	—	TOYOTA	FORTUNER/HILUX	1KDFTV, 2KDFTV	KUN1#~6#
16210-0P010	—	TOYOTA	TACOMA TUNDRA	1GRFE 1GRFE	GRN2## GSK30,5#
16210-13010	FCT-045	TOYOTA	LITE/TOWNACE TRUCK	4K,5K	KM3#,50,KR26
16210-13030	FCT-031	TOYOTA	DELIBOY LITE/TOWNACE VAN, WAGON LITEACE T.U.V	5K 5K,7K 5K# 7K#	KXC10 KR2#,4# KM3# KF60,7#,8#
16210-13040	FCT-089	TOYOTA	LITE/TOWNACE LITE/TOWNACE NOAH, V	7KE 7KE	KM7#,8# KR42,52
16210-13050	—	TOYOTA	LITE/TOWNACE	7KE	KM7#,8#
16210-17010	FCT-034	TOYOTA	LAND CRUISER LAND CRUISER VAN	1PZ 1HD#,1HZ	PZJ7# HDJ80,HZJ80
16210-17021	FCT-016	TOYOTA	LAND CRUISER	1HZ,1PZ	HZJ7#,8#,PZJ7#
16210-17030	FCT-040	TOYOTA	COASTER	1HZ	HDB2#~5#, HZB4#,5#
16210-17040	—	TOYOTA	COASTER	12HT,2H	HB3#
16210-17050	FCT-039	TOYOTA	LAND CRUISER	1HDFTE,1HZ	HDJ10#,HZJ7#, 10#
16210-17060	—	TOYOTA	COASTER	1HDFT	HDB5#
16210-17070	FCT-030	TOYOTA	LAND CRUISER LAND CRUISER 100	1H#,1HZ 1HD#,1HZ	HDJ7#,HZJ7# HDJ100,HZJ10#
16210-17080	FCT-074	TOYOTA	COASTER	1HDFTE,1HZ	HDB5#,HZB4#, 5#
16210-30010	FCT-070	TOYOTA	DYNA/ TOYOACE	1KDFTV, 2KDFTV	KDY2##

Genuine No.	AISIN No.	Make	Model	Engine Type	Body Type
			HIACE/ HIACE S.B.V HILUX HILUX SURF LAND CRUISER PRADO	2KDFTV 2KDFTV 1KDFTV 1KDFTV	KLH1#,2# KDN1## KDN215 KDJ1##
16210-30011	FCT-070				
16210-30030	FCT-082	TOYOTA	FORTUNER HILUX INNOVA/ KIJANG	1KDFTV, 2KDFTV 1KDFTV, 2KDFTV 2KDFTV	KUN5#,6# KUN1#~6# KUN40
16210-30031	FCT-082				
16210-31010	FCT-019	TOYOTA	HILUX HILUX (JPP/ VWP) LITEACE MARK 2 VAN,WG MODEL-F T.U.V TOWN/ MASTERACE VAN,WG	12R,1YC,2Y, 2Y#,3Y,4Y# 2Y,4Y 2Y 3YE 3Y# 2Y 2YJ	RN30,40,YN140, 5#,6# YN8#~11# YM3#,YR2#,3# YX78 YR21 YF60,80 YR25
16210-31020	FCT-072	TOYOTA	4RUNNER FJ CRUISER FORTUNER HILUX HILUX SURF LAND CRUISER/ PRADO TACOMA TUNDRA	1GRFE 1GRFE 1GRFE 1GRFE 1GRFE 1GRFE 1GRFE 1GRFE	GRN21# GSJ1# GGN50,60 GGN15,25,35 GRN215 GRJ12#,200,7# GRN2## GSK30
16210-31040	FCT-086	TOYOTA	4RUNNER FJ CRUISER LAND CRUISER LAND CRUISER PRADO TUNDRA	1GRFE 1GRFE 1GRFE 1GRFE 1GRFE	GRN28# GSJ1# GRJ200 GRJ15# GSK5#
16210-35011	FCT-068	TOYOTA	COASTER DYNA200	22R 22R	RB2# RU85
16210-35020	FCT-043	TOYOTA	4-RUNNER TRUCK HILUX 2WD	22RE 22RE	RN8#,9# RN85

Genuine No.	AISIN No.	Make	Model	Engine Type	Body Type
16210-38050	FCT-001	TOYOTA	4-RUNNER TRUCK CRESSIDA/ WAGON DELIBOY LITE/ TOWNACE LITE/ TOWNACE NOAH, V LITEACE VAN, WAGON	22R# 22R 5K 5K, 7KE 5K, 7K, 7KE 5K, 5KJ	RN8#, 9# RX7#, 8# KXC10 KM7#, 8# KR4# KM3#, KR2#, 4#
16210-38060	FCT-003	TOYOTA	4-RUNNER TRUCK HILUX LAND CRUISER LITEACE	22R# 22R 22R# 5K#	RN8#~13# RN5#~13# RJ7# KM3#
16210-38070	FCT-087	TOYOTA	LAND CRUISER LEXUS LX460/ 570, GX460 LEXUS LX460/ 570 SEQUOIA TUNDRA	1URFE, 3URFE 1URFE 3URFE 1URFE, 3UR# 1URFE, 3UR#	URJ20# URJ150, 20# URJ20# UPK6#, USK6# UPK5#, USK5#
16210-42060	FCT-007	TOYOTA	CRESSIDA/ CHASER CRESSIDA WAGON CRESTA/ MARK 2 SUPRA	5ME, 7MGE 7MGE 7MGE 7MG#	MX8# MX75 MX83 MA70
16210-42070	FCT-050	TOYOTA	SOARER	7MGTEU	MZ2#
16210-42090	—	TOYOTA	CROWN	7MGE	MS13#
16210-43021	—	TOYOTA	CRESSIDA SUPRA	7MGE 7MG#	MX83 MA70
16210-43032	FCT-032	TOYOTA	CROWN	5M#	MS13#
16210-46010	—	TOYOTA	CHASER/ CRESTA/ MARK 2 CROWN	1JZGE 1JZGE	JZX81 JZS13#
16210-46030	FCT-023	TOYOTA	LEXUS GS300 LEXUS SC300/ 400 SUPRA/ SOARER	2JZGE 2JZGE 2JZ#	JZS147 JZZ31 JZA80, JZZ31
16210-46042	FCT-006	TOYOTA	CHASER/ CRESTA/ MARK 2 CROWN/ ARISTO CROWN/ CROWN MAJESTA LEXUS GS300 PROGRES	1JZGE, 2JZGE 1JZGE, 2JZGE 1JZGE, 2JZGE 2JZGE 2JZGE	JZX9#, 101 JZS13#, 14# JZS14#, 15# JZS147 JCG11

Genuine No.	AISIN No.	Make	Model	Engine Type	Body Type
16210-46051	—	TOYOTA	CROWN/ CROWN MAJESTA	1JZGE	JZS151
16210-46052	FCT-080	TOYOTA	BREVIS CHASER/ CRESTA/ MARK 2 CROWN CROWN/ CROWN MAJESTA MARK 2/ MARK 2 BLIT ORIGIN PROGRES SOARER VEROSSA	1JZ,2JZ 1JZ,2JZ# 1JZGE,2JZGE 1JZGE,2JZGE 1JZFSE, 1JZGE 2JZGE 1JZGE, 1JZFSE, 2JZGE, 2JZFSE 1JZGTE 1JZFSE	JCG1# JZX10# JZS175,13# JZS15#,17# JZX11# JCG17 JCG1# JZZ30 JZX110
16210-50021	FCT-014	TOYOTA	CROWN/ CROWN MAJESTA LEXUS LS400	1UZFE 1UZFE	UZS15# UCF10,20
16210-50030	—	TOYOTA	CROWN	1UZFE	UZS131
16210-50040	FCT-066	TOYOTA	LEXUS LS400	1UZFE	UCF10,20
16210-50051	FCT-021	TOYOTA	LAND CRUISER LEXUS LX470	2UZFE 2UZFE	UZJ100 UZJ100
16210-50061	FCT-076	TOYOTA	LEXUS LS400	1UZFE	UCF20
16210-50072	FCT-005	TOYOTA	LAND CRUISER 100 LEXUS LX470	2UZFE 2UZFE	UZJ100 UZJ100
16210-50080	FCT-024	TOYOTA	TUNDRA	2UZFE	UCK30,40
16210-50090	FCT-018	TOYOTA	4RUNNER LEXUS GX470 SEQUOIA TUNDRA	2UZFE 2UZFE 2UZFE 2UZFE	UZN21# UZJ120 UCK35,45 UCK3#,4#
16210-50102	FCT-075	TOYOTA	4RUNNER LAND CRUISER 100 LEXUS LX470 SEQUOIA TUNDRA	2UZFE 2UZFE 2UZFE 2UZFE 2UZFE	UZN21# UZJ100,200 UZJ100,120 UCK35,45,6# UCK3#,4#,5#
16210-50110	FCT-091	TOYOTA	LAND CRUISER	2UZFE	UZJ200
16210-51013	—	TOYOTA	CENTURY	3V	VG20
16210-51020	FCT-083	TOYOTA	LAND CRUISER	1VDFTV	VDJ7#,200

Genuine No.	AISIN No.	Make	Model	Engine Type	Body Type
16210-52022	FCT-063	TOYOTA	CENTURY	5VEU	VG4#
16210-54070	FCT-025	TOYOTA	BLIZZARD HILUX LAND CRUISER	2L# L,2L 2L#	LD2# LN5#,6# LJ7#
16210-54130	FCT-051	TOYOTA	CHASER/CRESTA/MARK 2 CROWN CROWN COMFORT CROWN/CROWN MAJESTA DYNA150/TOYOACE G15 HIACE QUICK DELIVERY HIACE TRUCK LAND CRUISER MARK 2 VAN,WG QUICK DELIVERY	2L# 2L 2L#,5L 2LT# 3L,5L 2L 2L,3L 3L 2L 3L	LX80,90,100 LS130 LXS1# LS141,151 LY13#,21# LH8# LH8#,9#,LY101, 111 LJ7# LX76 LH81
16210-54141	FCT-028	TOYOTA	HILUX	2L	LN8#
16210-54150	FCT-011	TOYOTA	DYNA100 DYNA150 DYNA150/TOYOACE G15 HILUX LAND CRUISER 90 QUICK DELIVERY T.U.V TOYOACE/DYNA	2L 3L,5L 3L,5L 2L,3L 3L 3L,5L 2L 2L,3L	LH80,100 LY21#,61 LY10#,11#,16# LN5#~19# LJ9# LH8# LF60,70,80 LY5#,6#
16210-54180	FCT-012	TOYOTA	HIACE VAN, COMUTER HIACE/HIACE S.B.V	2L,3L 2L	LH10#,11#,12# LXH12,22
16210-54200	FCT-029	TOYOTA	DYNA/TOYOACE DYNA100 HIACE QUICK DELIVERY HIACE TRUCK HIACE VAN, COMUTER HILUX LAND CRUISER QUICK DELIVERY	5L 2L,3L,5L 2L 2L,3L 2L#,3L,5L 2L# 3B,2LT,2LTE 3L	LY220~280 LY10#~21# LH80 LH80,90,1## LH10#~17# LN13#,85 BJ73,LJ7# LH81,LY151
16210-54210	FCT-020	TOYOTA	HIACE/HIACE S.B.V	2LT	LXH1#,2#

Genuine No.	AISIN No.	Make	Model	Engine Type	Body Type
			HILUX	2L#,5L	LN10#~19#
16210-54220	FCT-008	TOYOTA	DYNA DYNA/TOYOACE HIACE VAN, COMUTER HILUX LAND CRUISER PRADO QUALIS QUICK DELIVERY/URBAN SUP QUICK DELIVERY REGIUS/TOURING HIACE T.U.V	5L 5L 2LT,5L# 2L,3L,5L 5LE 2L 5L 5L 5L 2L,5L	LY22#,23# LY10#~29# LH16#~18# LN14#~19# LJ12#~15# LF50 LY228,270 LH82 LXH4# LF6#~8#
16210-54230	FCT-069	TOYOTA	FORTUNER HILUX	5LE 2LT,5LE,5L#	LAN50 LN14#~20#, LAN15,25,35
16210-54240	—	TOYOTA	HIACE VAN, COMUTER	5L	LH17#
16210-56040	—	TOYOTA	LAND CRUISER	3B,13BT	BJ7#
16210-58012	FCT-057	TOYOTA	LAND CRUISER	3B,13BT,2H	BJ7#,HJ75
16210-58021	—	TOYOTA	LAND CRUISER	3B	BJ73
16210-58030	FCT-033	TOYOTA	DYNA/TOYOACE DYNA/TOYOACE QUICK DYNA200 DYNA200/TOYOACE G25 QUICK DELIVERY	11B,14B#, 15B# 15BCNG, 15LPG,1BZ# B B,11B,13B, 14B,15B# 15BFP,3B 3B	BU6#~9# XZV30#~34#, 412 BZV30#~60# BU60 BU6#~22# BU10#~22#, RZU100 BU68
16210-58041	FCT-055	TOYOTA	COASTER	3B,14B,15B# 1BZFPE,15BFT	BB2#~5#, BZB40,50
16210-58050	—	TOYOTA	DYNA200/TOYOACE G25 MEGA CRUISER	15BFT 15B#,15BFT	BU297 BXD20
16210-58070	FCT-079	TOYOTA	COASTER DYNA DYNA/TOYOACE DYNA200	15BFTE 15BFTE 15BFTE,4B 15BFTE	BB5# BU30#~42#, XZU30#~34# BU30#~34#, 40#~43# BU213,223

Genuine No.	AISIN No.	Make	Model	Engine Type	Body Type
			QUICK DELIVERY/ URBAN SUP	4B	BU28#
16210-61121	FCT-017	TOYOTA	LAND CRUISER	3F	FJ6#,7#
16210-61130	—	TOYOTA	COASTER	3F	FB30
16210-61140	—	TOYOTA	LAND CRUISER/ VAN	3FE	FJ62
16210-61150	FCT-015	TOYOTA	LAND CRUISER	3F	FJ7#,8#
16210-62011	FCT-013	TOYOTA	4-RUNNER TRUCK LAND CRUISER 90/ PRADO T100 TACOMA TUNDRA	3VZE,5VZFE 5VZFE 5VZFE 5VZFE 5VZFE	VZN12#~18# VZJ9# VCK11,21 VZN15#~19# VCK30,40
16210-62020	—	TOYOTA	GRANVIA/ GRAND HIACE	5VZFE	VCH1#,2#
16210-62030	FCT-067	TOYOTA	HILUX SURF LAND CRUISER PRADO TACOMA	5VZFE 5VZFE 5VZFE	VZN18#~21# VZJ9#,12# VZN15#~19#
16210-62040	—	TOYOTA	HILUX	5VZFE	VZN167,172
16210-64010	FCT-053	TOYOTA	CORONA LITE/ TOWNACE TRUCK LITE/ TOWNACE VAN, WAGON LITEACE VAN,WAGON	1C,2C 1C 2C 2C,2C#	CT14# CM5#,6# CR2#,3# CM3#,4#,CR2#,3#
16210-64020	FCT-047	TOYOTA	DELIBOY LITE/ TOWNACE NOAH, V LITE/ TOWNACE TRUCK LITE/ TOWNACE VAN, WAGON LITEACE	2C 2C,3C# 2C,3CE 2C#,3C# 2C#	CXC10 CR4#,5# CM5#,6#,7#,8# CR2#,3#,4# CM3#,4#
16210-64030	FCT-077	TOYOTA	ESTIMA EMINA/ LUCIDA	3CT#	CXR1#,2#
16210-64041	—	TOYOTA	LITE/ TOWNACE VAN, WAGON	2CT,3CT	CR3#
16210-64050	—	TOYOTA	LITE/ TOWNACE NOAH, V	3CTE	CR40,50
16210-64060	—	TOYOTA	LITE/ TOWNACE	3CE	CM7#,8#
16210-65020	FCT-009	TOYOTA	4-RUNNER TRUCK HILUX/ 4RUNNER (4WD) T100	3VZE 3VZE 3VZE	VZN8#~13# VZN130 VCK10,20
16210-65030	FCT-038	TOYOTA	4-RUNNER TRUCK HILUX/ 4RUNNER (4WD) T100	3VZE 3VZE 3VZE	VZN90~13# VZN130 VCK10,20

Genuine No.	AISIN No.	Make	Model	Engine Type	Body Type
16210-66020	FCT-004	TOYOTA	LAND CRUISER LAND CRUISER 100/VAN LEXUS LX450	1FZ# 1FZE 1FZFE	FZJ7#,8# FZJ10#,80 FZJ80
16210-66030	—	TOYOTA	LAND CRUISER 100	1FZFE	FZJ105
16210-66040	FCT-065	TOYOTA	LAND CRUISER 100	1FZFE	FZJ10#
16210-66060	FCT-088	TOYOTA	LAND CRUISER 100	1FZFE	FZJ100
16210-67010	FCT-036	TOYOTA	GRANVIA/ GRAND HIACE HIACE/ REGIUSACE HILUX (JPP/VWP) LAND CRUISER S/T,H/T REGIUS/ TOURING HIACE	1KZTE 1KZTE 1KZT# 1KZTE 1KZTE	KCH1# KZH10#,11#,12#, 13# KZN130 KZJ7# KCH4#
16210-67030	FCT-010	TOYOTA	4RUNNER HILUX HILUX SURF LAND CRUISER 90 LAND CRUISER PRADO	1KZ# 1KDFTV, 2KDFTV 1K# 1KZT#,1K# 1KZTE,1K#	KZN185,215 KDN14#~19# KDN185,KZN185 KDJ9#,KZJ9# KDJ9#,KZJ9#,120
16210-67040	FCT-071	TOYOTA	HILUX LAND CRUISER 90	1KZTE 1KZTE	KZN165,190 KZJ95
16210-67050	—	TOYOTA	HILUX/ 4RUNNER (4WD)	1KZTE	KZN205
16210-68011	FCT-058	TOYOTA	LAND CRUISER VAN	12HT,2H	HJ6#,7#
16210-68021	—	TOYOTA	LAND CRUISER	12HT,2H	HJ6#
16210-68030	—	TOYOTA	LAND CRUISER	1HZ	HZJ8#
16210-70031	—	TOYOTA	CROWN	1GGZE	GS13#
16210-70040	FCT-035	TOYOTA	CHASER/ CRESSIDA/ CRESTA/ MARK 2 CROWN/ CROWN MAJESTA SOARER SUPRA	1GFE 1GFE 1GFE 1GFE	GX81,90,100 GS141,151 GZ20 GA70
16210-70060	—	TOYOTA	CRESSIDA WAGON MARK 2 VAN,WG	1GFE 1GFE	GX71 GX70
16210-70080	—	TOYOTA	CROWN CROWN COMFORT/ SED CROWN/ CROWN MAJESTA	1GGP 1GGP 1GGPE	GS130 GXS10 GS151
16210-70090	FCT-081	TOYOTA	CHASER/ CRESTA/ MARK 2	1GFE	GX10#,11#

Genuine No.	AISIN No.	Make	Model	Engine Type	Body Type
			CROWN COMFORT/ SED CROWN/ CROWN MAJESTA	1GFE 1GFE	GXS12 GS151,171
16210-70100	—	TOYOTA	CROWN COMFORT/ SED	1GGPE	GXS10
16210-72010	FCT-054	TOYOTA	CHASER/ MARK 2 CORONA CRESSIDA WAGON CRESTA CROWN MARK 2 VAN,WG	3YP 2Y,2YPU 3Y 3YP 3YP# 2YJ	YX80 YT140 YX72 YX80 YS130 YX76
16210-73010	FCT-037	TOYOTA	CROWN DYNA/ TOYOACE DYNA100 DYNA150 DYNA150/ TOYOACE G15 DYNA200 HIACE TRUCK HILUX/ 4RUNNER (4WD) LITE/ TOWNACE VAN, WAGON LITEACE LITEACE VAN,WAGON MODEL-F/ VAN TOWN/ MASTERACE VAN,WG TOWNACE/ DYNA	4Y 3Y# 2Y 3Y# 3YP 4Y 2Y,3Y 3YE,4YE 2YJ,3YEU 2Y#,3Y# 3YC,4YEC 3YC,4YEC 2YU,3YEU 2Y,3Y#	YX132 YU6#,7# YH81 YY6#~21# LY16# YU85,210 YH81,YY101 YN130 YR2#,30 YM3#,4# YR2#,3# YR2#,3# YR2#,3# YY5#,6#
16210-73041	FCT-093	TOYOTA	CROWN COMFORT/ SED VAN	3YPE 4YEC	YXS1# YR3#
16210-74020	—	TOYOTA	LITE/ TOWNACE NOAH, V	3SFE	SR40,50
16210-75010	FCT-027	TOYOTA	HIACE VAN, COMUTER HILUX	1RZ#,2RZ# 1RZE	RZH10#~15# RZN14#,15#,16#
16210-75020	FCT-042	TOYOTA	HIACE VAN, COMUTER HIACE/ REGIUSACE	1RZ,2RZE 1RZE	RZH10#,11# RZH100,110
16210-75030	—	TOYOTA	HIACE/ REGIUSACE	2RZE	RZH10E~18#
16210-75050	FCT-026	TOYOTA	HIACE VAN, COMUTER HIACE/ HIACE S.B.V HILUX REGIUS/ TOURING HIACE	2RZ# 2RZE 1RZ 1RZE	RZH10#,11# RCH1#,2# RZN14# RCH42

Genuine No.	AISIN No.	Make	Model	Engine Type	Body Type
16210-75060	FCT-002	TOYOTA	4RUNNER	3RZFE	RZN18#
			COASTER	3RZF#	RZB40,50
			DYNA/ TOYOACE	27LPG,3RZ#, 3RZFPE	BU68,LY230,280, RZU30#~34#, RZY231,281
			DYNA200/ TOYOACE G25	3RZ#	RZU100,140
			GRANVIA/ GRAND HIACE	3RZFE	RCH1#,2#
			HILUX	1RZ,2RZ#	RZN14#~19#
			HILUX 2WD	3RZFE	RZN200
			HILUX SURF	3RZFE	RZN18#,21#
			LAND CRUISER 90/ PRADO	3RZF#	RZJ9#, 12#
			QUALIS	1RZE	RZF50
			QUICK DELIVERY/ URBAN SUP	3RZFPE	BU280,XZU281
			QUICK DELIVERY	3RZFP	RZU68,280
			REGIUS/ TOURING HIACE	3RZFE	RCH41,47
			T.U.V	1RZE,2RZE	RZF6#,7#,8#
			T100	3RZF#	RCK10
TACOMA	2RZFE,3RZFE	RZN14#~19#			
16210-75070	—	TOYOTA	DYNA/ TOYOACE	1RZE	RZY220,230
			HIACE/ REGIUSACE	1RZE	RZH10#~18#
			HILUX	1RZE	RZN147,152
16210-75090	—	TOYOTA	DYNA/ TOYOACE	1TR#	TRY22#~28#
			HIACE/ REGIUSACE	1TRFE	TRH10#,11#,12#
16210-75100	FCT-085	TOYOTA	HILUX SURF	2TRFE	TRN21#
			INNOVA/ KIJANG INNOVA	1TRFE	TGN40
			LAND CRUISER PRADO	2TRFE	TRJ12#,15#
			TACOMA	2TRFE	TRN22#~28#
16210-75111	FCT-073	TOYOTA	CROWN COMFORT/ SED	1TR#	TSS1#
			DYNA/ TOYOACE	2TRFE	TRC600, TRU30#~50#, 600
			HILUX SURF	2TRFE	TRN21#
			LAND CRUISER PRADO	2TRFE	TRJ12#
			TACOMA	2RZFE	TRN22#~26#, RZN14#~19#
16210-75120	FCT-078	TOYOTA	COASTER	2TRFE	TRB4#,5#

Genuine No.	AISIN No.	Make	Model	Engine Type	Body Type
			FORTUNER HILUX	2TRFE 1TRFE,2TRFE	TGN5#,6# TGN1#,2#,3#
16210-76010	FCT-022	TOYOTA	ESTIMA/ PREVIA	2TZ#	TCR1#,2#
16210-87106	FCD-002	TOYOTA	CAMI	HCEJ	J100
16210-88300	—	TOYOTA	CHASER/ CRESTA/ MARK 2 SOARER SUPRA	1GGE 1GGEU 1GGEU	GX81 GZ20 GA70
16210-88341	—	TOYOTA	CHASER/ CRESTA/ MARK 2 CROWN SOARER SUPRA	1GGTE 1GGE 1GGTEU 1GGTEU	GX81 GS131 GZ20 GA70
16210-88400	—	TOYOTA	SOARER	1JZGTE	JZZ30
16250-78031	—	TOYOTA	DYNA/ TOYOACE	1W	WU7#,8#,9#
16250-78072	—	TOYOTA	DYNA/ TOYOACE	S05#	XZU36#,37#,38#
16250-78080	—	TOYOTA	DYNA	S05#	XZU402,411,412, 30#~42#
16250-78090	—	TOYOTA	DYNA DYNA/ TOYOACE	J05C S05#,J05C	XZU411,430 XZU30#~43#
16250-78100	FCR-017	TOYOTA	DYNA	S05C	XZU40#~43#
16250-78111	—	TOYOTA	DYNA/ TOYOACE DYNA/ TOYOACE HV QUICK DELIVERY/ URBAN SUP	N04C N04C N04C	XZU30#~56# XKU30#~50# XKU280
16250-78130	—	TOYOTA	DYNA/ TOYOACE	S05#	XZU30#~42#
16250-78140	—	TOYOTA	DYNA/ TOYOACE	J05C	XZU30#~43#
16250-78150	—	TOYOTA	DYNA/ TOYOACE QUICK DELIVERY/ URBAN SUP	N04C N04C	XZU30#~38# XZU28#
16250-78160	—	TOYOTA	DYNA/ TOYOACE	S05D	XZU30#~42#
16250-78200	—	TOYOTA	DYNA	W04D	WU30#~42#
16250-78210	—	TOYOTA	DYNA/ TOYOACE HV	N04C	XKU304
16250-78230	—	TOYOTA	DYNA/ TOYOACE	J05D	XZU413,423,433
16250-78231	—	TOYOTA	DYNA/ TOYOACE	J05D	XZU413,423,433
16250-89101	—	TOYOTA	DYNA200/ TOYOACE G25	J05C	XZU130,140
16250-E0251	—	TOYOTA	DYNA/ TOYOACE DYNA/ TOYOACE HV	N04C N04C	XZU30#~77# XKC60#~65#, XKU30#~50#, 60#~72#

Genuine No.	AISIN No.	Make	Model	Engine Type	Body Type
			QUICK DELIVERY/ URBAN SUP QUICK DELIVERY 200	N04C N04C	XKU280 XZU282
16250-E0280	—	TOYOTA	DYNA	W04D	WU710,720
16250-E0540	—	TOYOTA	DYNA/ TOYOACE	N04C	XZU600,640,685
S1625-01850	FCR-016	TOYOTA	COASTER	N04C	XZB4#,5#
16210-56020-000	FCD-004	DAIHATSU	DELTA		
16210-87101-000	FCD-001	DAIHATSU	ROCKY		
16210-87103-000	FCD-003	DAIHATSU	TERIOS,ROCKY		
16210-87106	FCD-002	DAIHATSU	TERIOS		
16250-1021B	FCR-004	HINO	BUS RAINBOW	EF100	
16250-1160C	FCR-003	HINO	RANGER,BUS RAINBOW	EH700	
16250-E0040	FCR-005	HINO	RANGER,BUS RAINBOW	J08C	
16250-E0150	FCR-010	HINO	TRUCK	EK100	
16250-E0160	FCR-006	HINO	RANGER,BUS RAINBOW	H06C-T	
17120-57B01	FCS-001	SUZUKI	ESCUDO		
17120-60A01	FCS-002	SUZUKI	ESCUDO		
17120-80C00	FCS-004	SUZUKI	JIMNY/ SAMURAI,CULTUS,SA413		
17120-81A00	FCS-003	SUZUKI	JIMNY 1300		
1-21650-2041	FCG-020	ISUZU	Unkown	6WA1	
8-94171-813-0	FCG-002	ISUZU	MU	4ZD1	
8-94311-252-0	FCG-018	ISUZU	MU	4ZE1	
8-94391-701-0	FCG-006	ISUZU	FORWARD	6HE1	
8-94391-702-0	FCG-008	ISUZU	FORWARD	6HE1	
8-94395-254-1	FCG-015	ISUZU	FORWARD	6HH1	
8-94412-030-0	FCG-001	ISUZU	MU	4ZD1	
8-97039-034-0	FCG-013	ISUZU	TROOPER/ BIG FORN	4JG2	
8-97069-783-0	FCG-012	ISUZU	MU,WIZARD	4JG2	
8-97130-362-1	FCG-003	ISUZU	TROOPER/ BIG FORN	6VD1	
8-97135-167-0	FCG-004	ISUZU	TROOPER/ BIG FORN	6VD1	
8-97144-874-1	FCG-016	ISUZU	TROOPER/ BIG FORN,MU,WIZARD	4JX1	
8-97145-322-0	FCG-014	ISUZU	ELF 150	4JA1	
8-97148-797-0	FCG-007	ISUZU	ELF 350	4HE1	
8-97222-421-0	FCG-017	ISUZU	TROOPER/ BIG FORN	4JX1	
8-97302-291-0	FCGS-001	ISUZU	D-MAX	4JA1,4JH1	

Genuine No.	AISIN No.	Make	Model	Engine Type	Body Type
8-97318-936-1	FCGS-002	ISUZU	D-MAX	4JA1,4JA1-T, 4JH1	
8-97920-296-0	FCGS-003	ISUZU	D-MAX		
MD034204	FCM-003	MITSUBISHI	DELICA		
MD104576	FCM-002	MITSUBISHI	FORTE	4G5	
MD108270	FCM-001	MITSUBISHI	DELICA	4G6	
MD361311	FCM-004	MITSUBISHI	DELICA	4G6	
ME065700	FCM-012	MITSUBISHI FUSO	TRUCK	8DC	
ME065701	FCM-010	MITSUBISHI FUSO	TRUCK	8DC	
ME065702	FCM-005	MITSUBISHI FUSO	TRUCK	8DC	
ME075005	FCM-008	MITSUBISHI FUSO	TRUCK	6D1	
ME075013	FCM-007	MITSUBISHI FUSO	TRUCK	6D1	
ME150690	FCM-011	MITSUBISHI FUSO	TRUCK	6D40	
ME400563	FCM-006	MITSUBISHI FUSO	TRUCK	6D1	
ME400564	FCM-013	MITSUBISHI FUSO	TRUCK	6D1	

Reference List / Fan Blade

Genuine No.	Aisin No.	Make	Model	Engine Type	Year	Body Type
16361-17010	FNT-010	TOYOTA	COASTER	1H#	90.01~93.01	HDB30
			LAND CRUISER	1PZ	90.01~90.11	PZJ7#
16361-17030	FNT-015	TOYOTA	COASTER	1HZ	04.08	HZB50
			LAND CRUISER	1HZ	99.08~01.08	HZJ7#
16361-17040	FNT-024	TOYOTA	COASTER	1HZ	99.07~04.08	HZB50
			LAND CRUISER	1HZ	99.08~06.02	HZJ78, 79
			LAND CRUISER 100	1HDFTE	00.08~02.08	HDJ100
16361-31060	FNT-007	TOYOTA	4RUNNER	1GRFE	02.11~04.08	GRN21#
			FJ CRUISER	GSJ1#	06.01	1GRFE
			FORTUNER	1GRFE	05.07~08.08	GGN50
			HILUX	1GRFE	05.02~08.10	GGN25
			LAND CRUISER 120	1GRFE	03.01	GRJ12#
			LAND CRUISER PRADO	1GRFE	09.08	GRJ150
			LAND CRUISER(CHINA)	1GRFE	07.12	GRJ200
			TACOMA	1GRFE	04.09~08.05	GRN225, 245, 250, 265, 270
16361-38010	FNT-003	TOYOTA	TUNDRA	1GRFE	04.08	GSK30
			4-RUNNER TRUCK	22R#	83.08~89.03	RN5#, 6#, 7#
			CARINA	1C	82.04~83.09	CA60
			CELICA	20R, 22R	77.08~81.07	RA4#
			COASTER	20R, 22R	77.08~82.04	RB11, 13
			COROLLA	1C	82.10~87.07	CE70
			CORONA	1X	79.08~83.01	XT130
			CORONA FR	2Y	86.12~99.07	YT140
			CRESSIDA	L	80.09~85.04	LX60
			CRESSIDA WAGON	22R	88.10~93.02	RX7#
			CROWN	L	79.09~83.07	LS110
			CROWN COMFORT	3YPE	99.08	YXS10
			DYNA 100	2Y	85.05~93.08	YH81
			HIACE VAN, COMUTER	3Y	84.01~86.08	YH61
			HIACE/HIACE S. B. V	2RZE	95.08~99.07	RCH12, 18, 22, 28
			HILUX 2WD	2Y	88.08~97.08	YN85
			HILUX/ 4RUNNER(4WD)	22R#	88.08~99.09	RN10#, 110, 13#
			LAND CRUISER	22R	90.04~93.05	RJ7#
			LITEACE	1C	82.10~85.08	CM20
			LITEACE VAN, WAGON	1C	85.10~88.08	CM35

Fan Clutch

Fan Blade

Genuine No.	Aisin No.	Make	Model	Engine Type	Year	Body Type
16361-41090	FNT-013	TOYOTA	MODEL-F	2C	82. 11~87. 08	CR21
			PICKUP	20R, 22R	78. 08~83. 07	RT13#
			T. U. V	7KE, 7K#	96. 12~03. 02	KF60, 7#, 80, 82
			TOWNACE/LITEACE	5K, 7K	96. 11~98. 12	KR4#
			VAN	3YEC, 4YEC	83. 08~87. 08	YR2#, 3#
			CELICA	5M#	81. 12~85. 12	MA61
			COASTER	12HT, 2H	86. 10~90. 01	HB3#
			CRESSIDA	5ME	80. 08~85. 04	MA6#
			CRESSIDA WAGON	7MGE	88. 12~92. 05	MX75
			CROWN	4M, 5M#	79. 09~83. 07	MS11#
16361-44032	FNT-027	TOYOTA	MEGA CRUISER	15BFT	96. 10	BXD20
			SUPRA	7MG#	86. 01~88. 08	MA70
			CROWN	5R	79. 09~83. 07	RS110
			DYNA 100	1Y	85. 08~87. 08	YH80
			HIACE VAN, COMUTER	3Y	86. 08~87. 08	YH51, 61
			HILUX	1Y, 3Y, 4Y	83. 08~86. 08	YN50, 52, 55, 57, 6#
			HILUX 2WD	2Y, 3Y, 4Y	88. 08~99. 09	YN8#, 9#
			HILUX/ 4RUNNER(4WD)	4Y	88. 08~97. 08	YN106, 135
16361-46040	FNT-008	TOYOTA	LITEACE	5K	85. 09~88. 08	KM3#
			STOUT	4Y	86. 09~00. 02	YK110
16361-50020	FNT-028	TOYOTA	CROWN	2JZGE	93. 05~96. 05	JZA80
			SUPRA	2JZGE	93. 05~96. 05	JZA80
16361-50040	FNT-012	TOYOTA	CROWN / CROWN MAJESTA	1UZFE	95. 08	UZS15#
16361-50080	FNT-016	TOYOTA	LAND CRUISER	2UZFE	98. 01~02. 08	UZJ100
16361-50110	FNT-014	TOYOTA	4RUNNER	2UZFE	02. 08~04. 11	UZN21#
			SEQUOIA	2UZFE	00. 09~04. 08	UCK35, 45
			TUNDRA	2UZFE	02. 08~04. 08	UCK3#, 4#
			4RUNNER	2UZFE	04. 11~05. 08	UZN21#
			LAND CRUISER	1VDFTV	07. 09	VDJ200
			LAND CRUISER	2UZFE	07. 12	UZJ200
16361-54020	FNT-019	TOYOTA	SEQUOIA	2UZFE	04. 08	UCK35, 45
			TUNDRA	2UZFE	04. 08	UCK3#, 4#
			4-RUNNER TRUCK	2L#	85. 08~87. 08	LN56, 66
			CROWN	2L	87. 09~89. 08	LS130
			DYNA 100	2L	85. 08~87. 08	LH80

Genuine No.	Aisin No.	Make	Model	Engine Type	Year	Body Type			
16361-54040	FNT-001	TOYOTA	HIACE VAN, COMUTER	2L	85. 08~87. 08	LH5#			
			HIACE/HIACE S. B. V	2L	99. 07~01. 08	LXH12			
			HILUX	2L	84. 08~85. 08	LN5#, 6#			
			HILUX 2WD	2L	88. 08~91. 08	LN85			
			LAND CRUISER	2LT	85. 10~90. 01	LJ7#			
			DYNA 100	2L	88. 08~95. 05	LH80			
			HILUX	2L, 3L	97. 08~05. 06	LN5#, 67			
			HILUX 2WD	2L, 3L	88. 08~01. 06	LN80, 81, 85, 86, 9#			
			HILUX/ 4RUNNER(4WD)	3L	88. 08~01. 06	LN10#, 111, 13#			
			LAND CRUISER	3B	89. 04	BJ73, VM			
16361-54070	FNT-006	TOYOTA	T. U. V	2L	96. 12~98. 01	LF60, 70, 80			
			DYNA 100	2L	95. 05	LY100			
			HIACE VAN, COMUTER	3L	98. 08~99. 07	LH115			
			HILUX	2L#	97. 08~01. 08	LN145, 150, 165, 170			
			LAND CRUISER	3B	89. 01	BJ73			
			QUALIS	2L	99. 12~04. 12	LF50			
16361-54111	FNT-021	TOYOTA	T. U. V	2L	98. 01~01. 02	LF60, 7#, 80, 82			
			HILUX	3L, 5L	97. 08~01. 08	LN147, 152, 157, 16#, 172, 192			
16361-54131	FNT-020	TOYOTA	T. U. V	5L	00. 04~03. 06	LF61, 81, 85			
			FORTUNER	5LE	06. 05~08. 10	LAN50			
			HILUX	2LT	00. 08~01. 08	LN190			
			HILUX 2WD	5L	01. 06~04. 12	LN200			
16361-56070	FNR-004	TOYOTA	HILUX/ 4RUNNER(4WD)	5L	01. 06~04. 12	LN205			
			16361-60101	FNT-017	TOYOTA	HEAVY DUTY TRUCK	F	76. 04~82. 07	FA100, 115
						LAND CRUISER	2F	80. 08~86. 04	FJ4#, 55
16361-61020	FNT-022	TOYOTA	LAND CRUISER	2F	80. 08~84. 10	FJ40, 45			
16361-61050	FNT-018	TOYOTA	LAND CRUISER	3FE	90. 01~92. 08	FJ80			
16361-62010	FNT-005	TOYOTA	4RUNNER	5VZFE	95. 11	VZN18#			
			HILUX	5VZFE	02. 08~05. 02	VZN18#			
			LAND CRUISER 90	5VZFE	99. 06~02. 09	VZJ9#			
			T100	5VZFE	94. 08	VCK11, 21			
			TACOMA	5VZFE	95. 01~00. 09	VZN160, 170			
			TUNDRA	5VZFE	01. 08	VCK30, 40			
16361-65010	FNT-011	TOYOTA	4-RUNNER TRUCK	3VZE	87. 11~89. 03	VZN6#			

Genuine No.	Aisin No.	Make	Model	Engine Type	Year	Body Type
16361-65020	FNT-029	TOYOTA	HILUX/ 4RUNNER(4WD)	3VZE	90. 08~93. 08	VZN130
			T100	3VZE	92. 08~93. 08	VCK10, 20
			4-RUNNER TRUCK	3VZE	93. 08~95. 11	VZN120, 90
			HILUX/ 4RUNNER(4WD)	3VZE	93. 08~95. 11	VZN130
16361-66020	FNT-004	TOYOTA	T100	3VZE	93. 08~94. 08	VCK10, 20
			LAND CRUISER	1FZFE	92. 08~98. 01	FZJ80
16361-67020	FNT-009	TOYOTA	4RUNNER	1KZ#	95. 11	KZN185
			DYNA 150	1KDFTV, 2KDFTV	01. 08	KDY22#, 23#, 25#, 26#
16361-67030	FNT-023	TOYOTA	HIACE/ HIACE S. B. V	2KDFTV	06. 08	KLH1#, 2#
			HILUX	2KDFTV	01. 08~05. 08	KDN145, 150, 165, 170, 190
			LAND CRUISER	1KZT	93. 05~96. 04	KZJ7#
			LAND CRUISER PRADO	1K#	02. 09	KDJ120, KZJ120
			DYNA 150	5L	01. 07	LY22#, 23#
			HIACE VAN, COMUTER	5L	98. 08~99. 07	LH166, 17#, 184
			HIACE/ HIACE S. B. V	2LT	99. 07~01. 08	LXH1#, 2#
			COASTER	NO4C	06. 08~09. 08	XZB50
16361-67040	FNT-026	TOYOTA	COASTER(CHINA)	NO4C	07. 01	XZB53
			HILUX	1KZTE	01. 09~05. 04	KZN165, 190
			HILUX/ 4RUNNER(4WD)	1KZTE	01. 08~04. 12	KZN205
			LAND CRUISER 90	1KZTE	00. 08~02. 09	KZJ95
16361-70040	FNT-030	TOYOTA	CRESSIDA	1GFE	88. 08~93. 02	GXS1
			CROWN	1GFE	88. 12~91. 10	GS131
16361-75020	FNT-002	TOYOTA	4RUNNER	3RZFE	95. 11~00. 08	RZN18#
			CROWN COMFORT	1TRFPE	08. 08	TSS10
			HIACE/ HIACE S. B. V	3RZFE	98. 04~99. 10	RCH13, 19, 23, 29
			HILUX	2RZFE	97. 08~01. 08	RZN168, 173
			HILUX 2WD	3RZFE	01. 06~04. 12	RZN200
			LAND CRUISER 90	3RZFE	99. 06~02. 09	RZJ90, 95
			LAND CRUISER PRADO	2TRFE	04. 08	TRJ12#
			QUALIS	1RZE	02. 01~04. 12	RZE50
			T. U. V	1RZE, 2RZE	99. 11~03. 06	RZF71, 80, 81, 84, 85
			T100	3RZF	95. 04~96. 08	RCK10
			T100	3RZFE	95. 04	RCK10
			TACOMA	3RZFE	95. 01~00. 09	RZN161, 171
			16361-76060	FNT-025	TOYOTA	PREVIA

Genuine No.	Aisin No.	Make	Model	Engine Type	Year	Body Type
16306-1861	FNM-025	mitsubishi				
30948-32400	FNM-013	mitsubishi				
31248-34100	FNM-017	mitsubishi				
31248-39100	FNM-015	mitsubishi				
91201-10200	FNM-026	mitsubishi				
MD011149	FNM-011	mitsubishi				
MD023696	FNM-004	mitsubishi				
ME005002	FNM-010	mitsubishi				
ME005162	FNM-007	mitsubishi				
ME015750	FNM-005	mitsubishi				
ME035139	FNM-003	mitsubishi				
ME035219	FNM-008	mitsubishi				
ME035309	FNM-009	mitsubishi				
ME039861	FNM-018	mitsubishi				
ME039960	FNM-019	mitsubishi				
ME039970	FNM-022	mitsubishi				
ME055056	FNM-016	mitsubishi				
ME055140	FNM-023	mitsubishi				
ME055319	FNM-020	mitsubishi				
ME060129	FNM-021	mitsubishi				
ME065378	FNM-014	mitsubishi				
ME075027	FNM-006	mitsubishi				
ME075091	FNM-002	mitsubishi				
ME075190	FNM-024	mitsubishi				
ME075202	FNM-012	mitsubishi				
SSA43-1B001	FNM-028	mitsubishi				
SSA43-1B004	FNM-029	mitsubishi				
XM438474	FNM-027	mitsubishi				
1-13660-140-0	FNG-006	isuzu				
1-13660-148-0	FNG-004	isuzu				
1-13660-156-0	FNG-007	isuzu				
16306-2480	FNG-011	isuzu				
5-13660-046-1	FNG-008	isuzu				
5-13660-236-0	FNG-010	isuzu				
5-13660-300-0	FNG-001	isuzu				

Genuine No.	Aisin No.	Make	Model	Engine Type	Year	Body Type
5-13660-308-0	FNG-005	ISUZU				
5-13662-012-0	FNG-003	ISUZU				
8-94117-866-0	FNG-002	ISUZU				
8-94393-117-0	FNG-009	ISUZU				
897049-4991	FNG-012	ISUZU				
16361-87502	FND-001	DAIHATSU				
16361-87505A	FNS-004	DAIHATSU				
MD041078	FND-002	DAIHATSU				
17110-60A00	FNS-006	SUZUKI				
17110-77300	FNS-005	SUZUKI				
17110-83000	FNS-004	SUZUKI				
17111-73000	FNS-003	SUZUKI				
17111-73010	FNS-008	SUZUKI				
16306-1041A	FNR-006	HINO				
16306-1062A	FNR-009	HINO				
16306-1130	FNR-007	HINO				
16306-1183A	FNR-012	HINO				
16306-1341	FNR-020	HINO				
16306-1933B	FNR-017	HINO				
16306-1942	FNR-018	HINO				
16306-1981A	FNR-019	HINO				
16306-2050	FNR-015	HINO				
16306-2060	FNR-021	HINO				
16306-2080A	FNR-022	HINO				
16306-2140	FNR-024	HINO				
16306-2160B	FNR-003	HINO				
16306-2220B	FNR-005	HINO				
16306-2280	FNR-001	HINO				
16306-2390	FNR-011	HINO				
16306-2410B	FNR-023	HINO				
16306-2420A	FNR-025	HINO				
16306-2430A	FNR-029	HINO				
16306-2451	FNR-013	HINO				
16306-2490	FNR-026	HINO				
16306-2500	FNR-016	HINO				

Genuine No.	Aisin No.	Make	Model	Engine Type	Year	Body Type
16306-2522	FNR-014	HINO				
16306-2600	FNR-002	HINO				
16306-2671A	FNR-008	HINO				
16361-78060	FNR-032	HINO				
16361-E0020	FNR-031	HINO				
16361-E0050	FNR-030	HINO				
S1630-62300	FNR-004	HINO				
S1630-62351	FNR-010	HINO				
S1630-62590	FNR-004	HINO				
S1630-62610	FNR-027	HINO				
S1630-62700	FNR-032	HINO				
16311-31220-71	FNW-003	INDUSTRIAL VEHICLE				
16361-22020-71	FNW-008	INDUSTRIAL VEHICLE				
16361-22040-71	FNW-005	INDUSTRIAL VEHICLE				
16361-23060-71	FNW-006	INDUSTRIAL VEHICLE				
16361-23860-71	FNW-002	INDUSTRIAL VEHICLE				
16361-31620-71	FNW-004	INDUSTRIAL VEHICLE				
16361-32080-71	FNW-007	INDUSTRIAL VEHICLE				
16361-33900-71	FNW-009	INDUSTRIAL VEHICLE				
16361-40120-71	FNW-010	INDUSTRIAL VEHICLE				
16361-42800-71	FNW-011	INDUSTRIAL VEHICLE				
16361-78501-71	FNW-001	INDUSTRIAL VEHICLE				
121950-44741	FNW-001	YAMAHA				

Reference List / Hydraulic Belt Tensioner

Genuine No.	AISIN No.	Make	Model	Engine Type
13540-62020	BTT-001	TOYOTA	CAMRY, WINDOM/ ES300	1VZFE, 3VZFE, 4VZFE
13540-62021	BTT-002	TOYOTA	WINDOM/ ES300, HILUX	3VZFE, 4VZFE, 5VZFE
13540-65010	BTT-003	TOYOTA	HILUX	3VZFE
14520-RCA-A01	BTH-001	HONDA	INSPIRE, LEGEND	J30A, J35A, J37A
14520-P8E-A01	BTH-002	HONDA	ODYSSEY, LAGREAT	J25A, J30A, J32A, J35A
MR984375	BTM-001	MINISUBISHI	CANTER, LANCER	4G63, 4G69
MD180051	BTM-002	MINISUBISHI		4G9#
MD308086	BTM-003	MINISUBISHI	CANTER, GALANT	4D33, 4G63, 4G64, 4M40
MD309999	BTM-004	MINISUBISHI	PAJERO io, MIRAGE	4G92, 4G93
13068AA051	BTF-002	SUBARU	IMPREZA, LEGACY	EJ#(92. 11~93. 08)
1271808	BTV-001	VOLVO	V90, S90	B6304S2
3517998	BTV-002	VOLVO	850, 960	B5234T, B5254FS (E/ N : ~131154)
3531187	BTV-003	VOLVO	740, 940	B230F, B230FT
9135033	BTV-004	VOLVO	960	B6304F (E/ N : 131035~)
9146693	BTV-005	VOLVO	V40, V70	B4204T, B5234T3, B5254S, B5254T
9207900	BTV-006	VOLVO	S80	B6284T, B6304S

Reference List / Fan Pulley Bracket

Genuine No.	Aisin No.	Make	Model	Engine Type	Reference				
					Component Parts				
					Fan Pulley Bracket	Fan Clutch	Pulley	Gasket	Nut
16307-50011	FBT-001	TOYOTA	CROWN/ CROWN MAJESTA	1UZ-FE	●	—	—	—	—
16307-50012	FBT-002	TOYOTA	CROWN/ CROWN MAJESTA	1UZ-FE	●	—	—	—	—
16307-50020	FBT-003	TOYOTA	CROWN/ CROWN MAJESTA	1UZ-FE	●	—	—	—	—
16307-62011	FBT-004	TOYOTA	T100, TACOMA, 4RUNNER	5VZ-FE	●	●	●	●	●
16307-62021	FBT-005	TOYOTA	HILUX SURF, 4RUNNER, LAND CRUISER PRADO	5VZ-FE	●	●	●	●	●
16307-62030	FBT-004	TOYOTA	T100	5VZ-FE	●	●	●	●	●
16307-62040	FBT-004	TOYOTA	T100	5VZ-FE	●	●	●	●	●
16307-64011	FBT-008	TOYOTA	CORONA	1C	●	—	—	—	—
16307-64012	FBT-009	TOYOTA	CORONA, LITE/ TOWNACE TRUCK	2C	●	—	—	—	—
16307-64040	FBT-010	TOYOTA	LITE/ TOWNACE NOAH VAN	3C-TE	●	—	—	—	—
16307-65020	FBT-006	TOYOTA	HI-LUX, PICKUP	3VZ-E	●	●	●	●	●
16307-65030	FBT-007	TOYOTA	HI-LUX, T100	3VZ-E	●	●	●	●	●
16307-65040, -65050	FBT-007	TOYOTA	HI-LUX, T100	3VZ-E	●	●	●	●	●
16380-50014	FBT-002	TOYOTA		1UZ-FE, 2UZ-FE	●	●	●	—	●
16380-50034, -50014	FBT-002	TOYOTA		1UZ-FE, 2UZ-FE	●	●	●	—	●
16380-50052, -50070	FBT-002	TOYOTA		1UZ-FE, 2UZ-FE	●	●	●	—	●
16380-50081	FBT-002	TOYOTA		1UZ-FE, 2UZ-FE	●	●	●	—	●
16630-50011	FBT-011	TOYOTA	CROWN/ LEXUS LS, SC, GS	1UZ-FE, 3UZ-FE	●	—	—	—	—
8-97108-785-1	FBG-001	ISUZU	RODEO, TROOPER		●	—	—	—	—
8-97231-718-0	FBG-002	ISUZU			●	—	—	—	—
MD143208	FBM-001	MINIBISHI	MONTERO		●	—	—	—	—

ATTENTION:
 - Genuine No.'s listed are part numbers for reference only.
 - Representative Genuine No.'s may include components that are NOT included with the associated AISIN No.'s.
 - AISIN No.'s listed designate part numbers for the Fan Pulley Bracket only.

Hydraulic Belt Tensioner
Fan Pulley Bracket

Clutch Master Cylinder

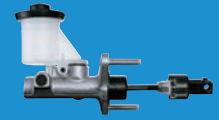

Function

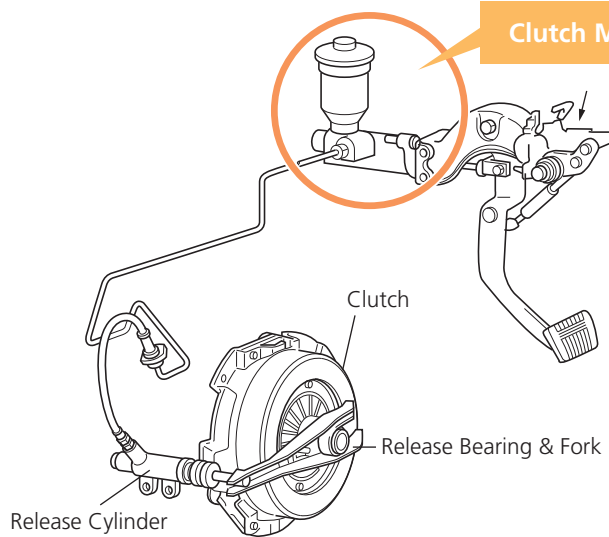

The clutch master cylinder is a device that transforms mechanical force into hydraulic pressure. As the driver presses the clutch pedal, the pedal lever applies force to the clutch master cylinder which transmits hydraulic pressure to the clutch release (slave) cylinder that disconnects engine power to the transmission.

Structure and Components

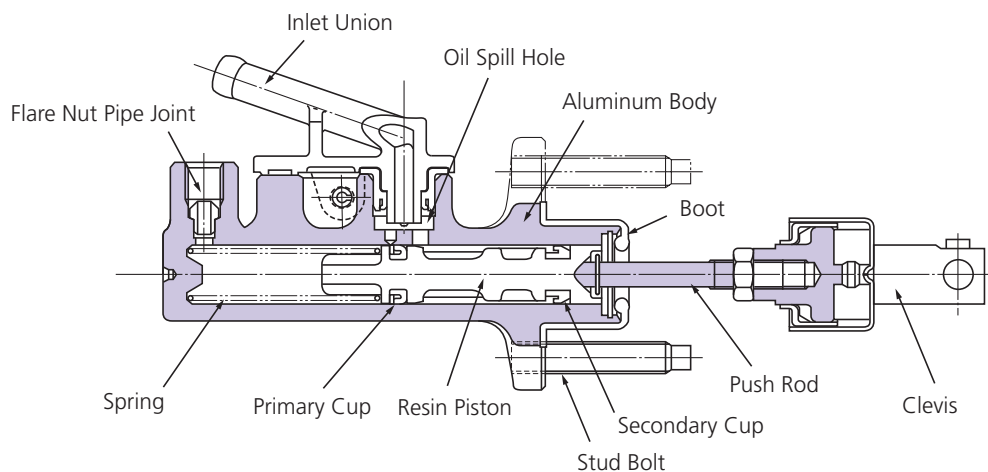

The clutch master cylinder structure consists of the piston, cups, and springs, built within a precision machined body. The primary cup, positioned on the leading side of the body, functions to create hydraulic pressure when fluid is forced inside by the piston. Located on the trailing side is the secondary cup, which guides the piston and prevents fluid from leaking. When the clutch pedal is pressed, the primary cup is blocked away by the piston from the oil spill port leading to the reservoir tank, pressure in the cylinder rises as the fluid is fed through the pipeline. When the clutch pedal is released, the hydraulic pressure and the force of the return spring pulls back the piston to relieve fluid back into the reservoir. The clutch master cylinder is what provides the necessary force to control the application of drivetrain power.

Variations



Clutch Master Cylinder Variations

- Conventional Type
- Integrated Reservoir Type

[Conventional Type]

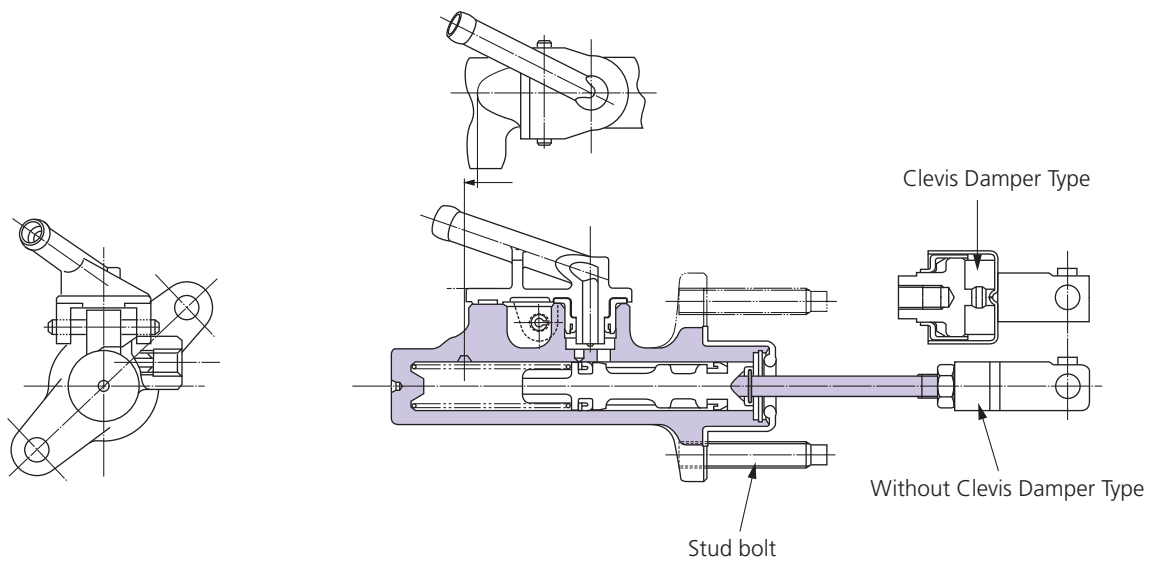

[Integrated Reservoir Type]

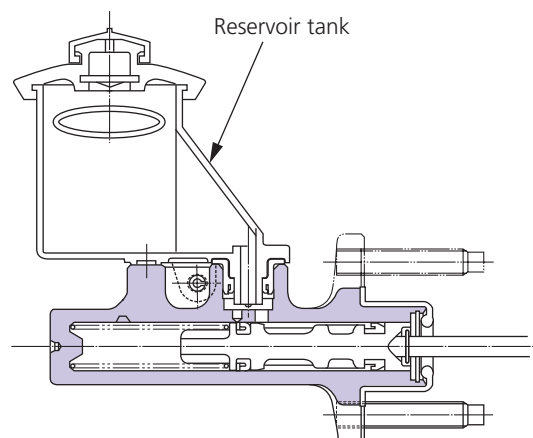

Installation Procedure

CAUTION!

Failure to follow recommended procedures may cause clutch failure and injury. Always consult the manufacturer's vehicle specific service manual for reference.

1

Do not allow dust, dirt, and debris to enter the cylinder or reservoir tank.

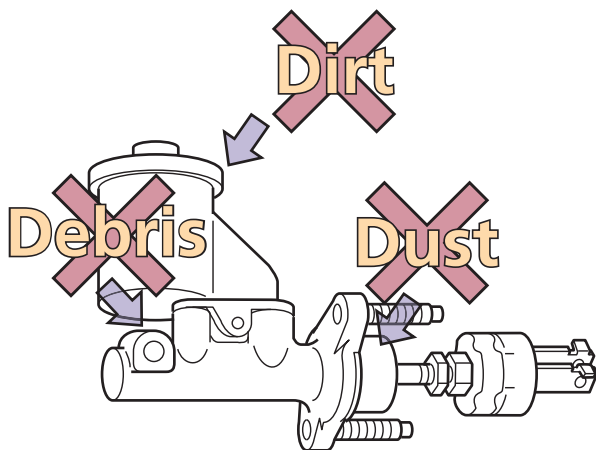

Internal damage may occur, resulting in fluid leakage and improper hydraulic pressure.

2

Always use vehicle manufacturer specified fluid.

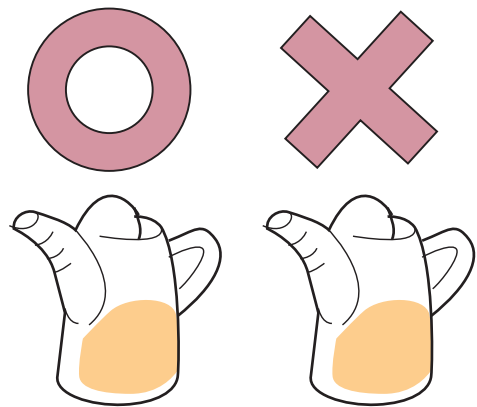

Specified brake fluid Other brake fluids

Sealing can be impaired if mineral additives are mixed with fluid which can cause clutch failure.

3

Tighten bolts, nuts, and screws as specified by the manufacturer's vehicle specific manual.

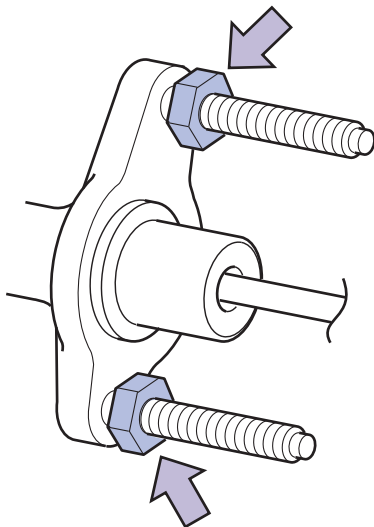

Damage of screws and threads may cause improper function.

4

Adjust the clutch pedal lever according to the method specified by the manufacturer's vehicle specific manual.

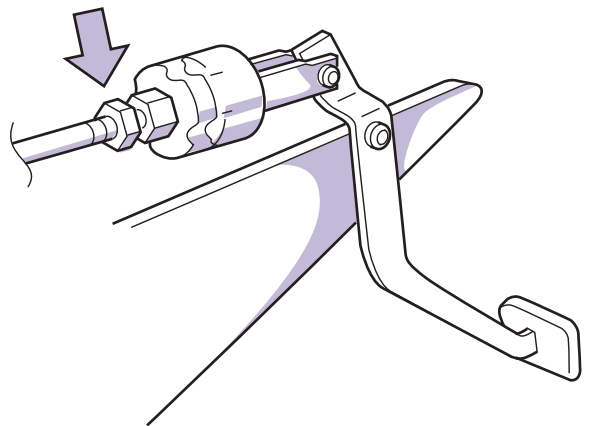

Improper adjustment will cause poor clutch engagement and release.

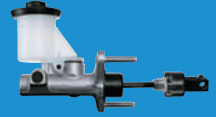

CAUTION! Failure to follow recommended procedures may cause clutch failure and injury. Always consult the manufacturer's vehicle specific service manual for reference.

5

Handle with care. Clutch master cylinders are precision manufactured. Do not drop or deform. Never use a damaged unit.

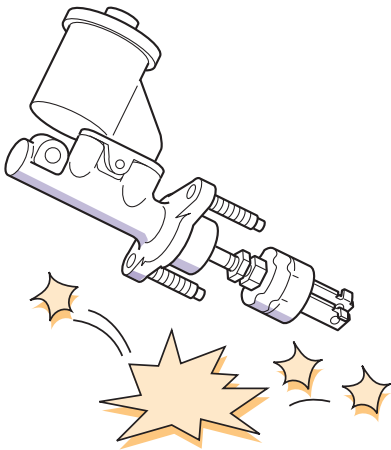

Optimal hydraulic pressure may not be achieved due to damaged internal parts, resulting in incorrect operation and injury.

Clutch Release Cylinder



Function

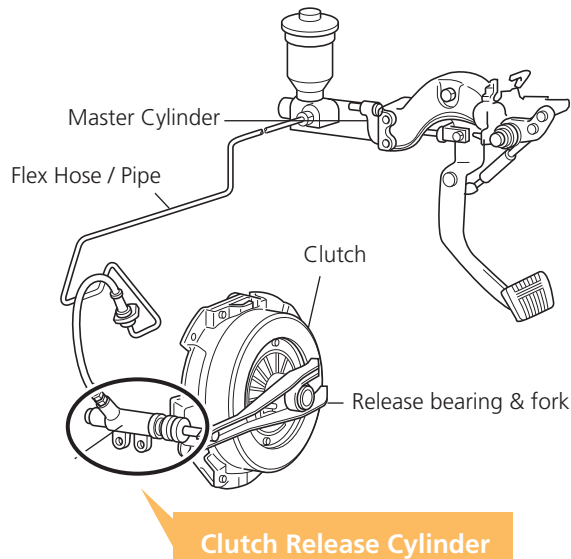

The clutch release cylinder (also known as the clutch slave cylinder) is the component that transfers hydraulic pressure, achieved through the clutch master cylinder, into a mechanical force to control the clutch fork. The force from the release cylinder engages and releases engine power to the transmission.

Structure and Components

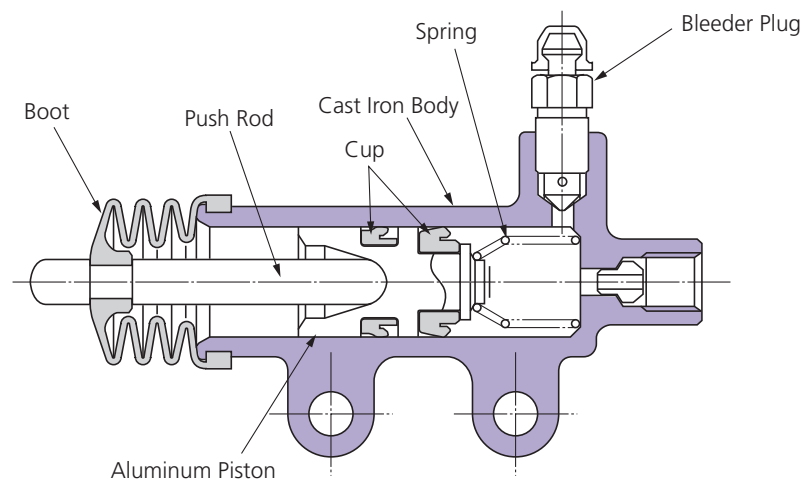

The clutch release cylinder is composed of the piston, cups, spring, and push rod, built within a precision machined body and covered with a boot. The boot provides protection from dirt, dust and debris from contaminating the push rod and piston. When the clutch pedal is pressed and the fluid pressure reaches the release cylinder, the piston moves the push rod out to apply force onto the clutch fork which releases the clutch. When the clutch pedal is released, the hydraulic pressure and the force of the return spring pulls back the push rod and sends back the fluid to the master cylinder, therefore engaging the clutch.

Installation Procedure



CAUTION!

Failure to follow recommended procedures may cause clutch failure and injury. Always consult the manufacturer's vehicle specific service manual for reference.

1

Do not allow dust, dirt, and debris to enter the cylinder or reservoir tank.

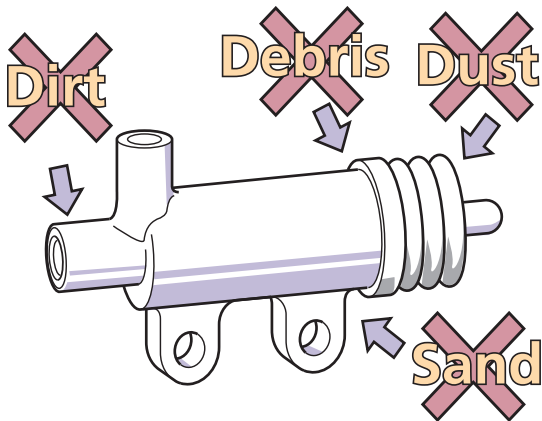

Internal damage may occur, resulting in fluid leakage and improper hydraulic pressure

2

Always use vehicle manufacturer specified fluid.

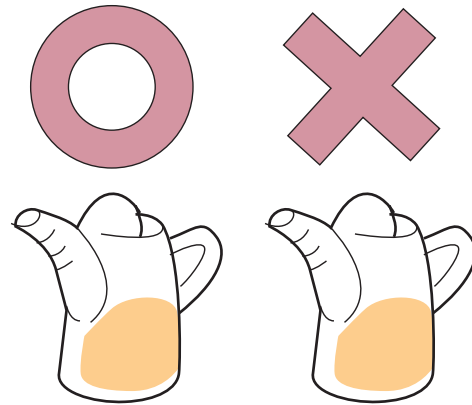

Sealing can be impaired if mineral additives are mixed with fluid which can cause clutch failure.

3

Tighten bolts, nuts, and screws as specified by the manufacturer's vehicle specific manual.

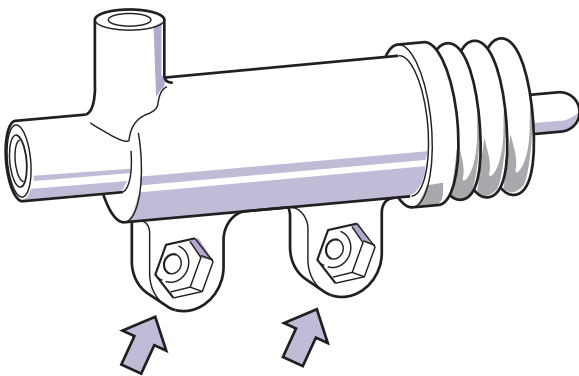

Damage of screws and threads may cause improper function.

4

Handle with care. Clutch release cylinders are precision manufactured. Do not drop or deform. Never use a damaged unit.

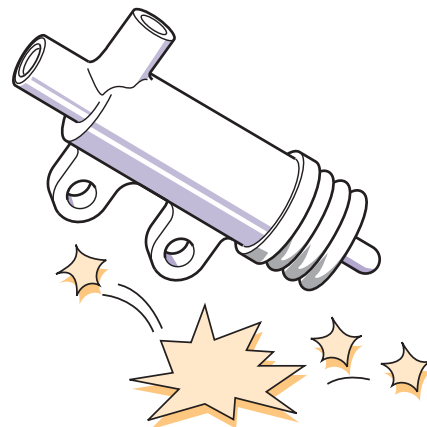



Optimal hydraulic pressure may not be achieved due to damaged internal parts, resulting in incorrect operation.



SPECIFIC INDEX

CAR NAME	PAGE
STARLET	89
CAMI	89
SERA	89
CYNOS	89
PASEO	89
TERCEL	89
TERCEL (JAPAN Application)	89
CORSA	89
COROLLA II	90
YARIS/ ECHO/ VIOS	90
Will VS	91
COROLLA/ AURIS	91
COROLLA (JAPAN Application)	93
COROLLA FX (JAPAN Application)	94
COROLLA CERES	94
COROLLA FIELDER	94
COROLLA RUNX	94
COROLLA LEVIN	94
ALLEX	94
SPRINTER	94
SPRINTER MARINO	95
SPRINTER TRUENO	95
SPRINTER CARIB 4WD	95
SUCCEED	95
PROBOX	95
CARINA	96
CORONA	96
CORONA PREMIO	97
CARINA ED	97
CORONA EXiV	97
CURREN	97
CELICA (US Application)	97
CELICA (JAPAN Application)	97
CALDINA	97
MR2 (US Application)	98
MR2 (JAPAN Application)	98
MR-S	98

CAR NAME	PAGE
VOLTZ	98
CAMRY	98
CAMRY (JAPAN Application)	98
SOARER	99
VISTA	99
CRESSIDA / MARK II	99
CHASER	100
CRESTA	100
VEROSSA	100
CROWN	100
COMFORT	100
CROWN COMFORT	100
ALTEZZA	100
LEXUS ES250	101
SUPRA	101
ESTIMA EMINA / LUCIDA	101
LITE-ACE	101
LITE-ACE NOAH	102
TOWN-ACE VAN	102
TOWN-ACE	102
TOWN-ACE NOAH	103
MASTER-ACE	103
HI-ACE	103
REGIUS	105
REGIUS-ACE	105
RAV 4J / L (JAPAN Application)	106
RAV 4J / L	106
HI-LUX SURF	106
HI-LUX	106
LAND CRUISER	107
LAND CRUISER PRADO	108
DYNA	108
TOYO-ACE	113
QUICKDELIVERY	118
COASTER	119
COASTER R	120
URBAN SUPPORTER	120



Reference List / Hydraulics



Model	Year	Engine Type	Body Type	Reference					
					Aisin No.	Genuine No.	Aisin No.	Genuine No.	
STARLET	1300	84.10~89.12	2EELU	EP71	with Booster	CMT-024	31410-10013	CRT-002	31470-10012
		84.10~89.12	2ELU/J	EP71/ 76V		CMT-024	31410-10013	CRT-002	31470-10012
		86.01~89.12	2ETELU	EP71	with Booster	CMT-024	31410-10013	CRT-002	31470-10012
		89.12~96.01	4EF/ FE/ FTE	EP82		CMT-025	31410-10050	CRT-002	31470-10012
		90.08~96.01	4EF/ FE	EP85		CMT-025	31410-10050	CRT-002	31470-10012
		96.01~99.07	4EFE/ FTE	EP91		CMT-025	31410-10050	CRT-047	31470-10040
		96.01~99.07	4EFE	EP95		CMT-025	31410-10050	CRT-047	31470-10040
	1500	86.12~89.12	1N	NP70/ 76V	with Booster		31410-10023		31470-10031
		89.12~95.09	1N	NP80		CMT-025	31410-10050		31470-10031
		96.01~99.07	1N	NP90		CMT-025	31410-10050		31470-16012
CAMI	1300	00.05~06.02	K3VE	J102E		CMD-004	31420-87402	CRD-005	31470-87401
		00.05~06.02	K3VE	J122E		CMD-004	31420-87402	CRD-005	31470-87401
SERA	1500	90.03~95.12	5EFHE	EXY10		CMT-025	31410-10050	CRT-005	31470-12093
CYNOS	1300	95.08~97.12	4EFE	EL52		CMT-025	31410-10050	CRT-002	31470-10012
		96.10~98.02	4EFE	EL52C		CMT-025	31410-10050	CRT-047	31470-10040
	1500	91.01~95.08	5EFE	EL44		CMT-025	31410-10050	CRT-002	31470-10012
		91.01~95.08	5EFHE	EL44		CMT-025	31410-10050	CRT-005	31470-12093
		95.08~99.07	5EFHE	EL54		CMT-025	31410-10050	CRT-005	31470-12093
PASEO	1500	91.04~95.08	5EFE	EL44		CMT-008	31410-16040	CRT-002	31470-10012
						CMT-025	31410-10050	CRT-002	31470-10012
		95.08~95.09	5EFE	EL54		CMT-008	31410-16040	CRT-002	31470-10012
						CMT-025	31410-10050	CRT-002	31470-10012
		95.09~	5EFE	EL54		CMT-008	31410-16040	CRT-002	31470-10012
					CMT-025	31410-10050	CRT-002	31470-10012	
TERCEL	1500	86.08~89.05	3E-E	EL31		CMT-058	31420-10013	CRT-002	31470-10012
		89.05~90.09	3E-E	EL31		CMT-043	31410-10060	CRT-002	31470-10012
		90.09~94.09	5E-FE	EL40	LHD	CMT-008	31410-16040	CRT-002	31470-10012
		90.09~94.09	5E-FE	EL40	RHD	CMT-025	31410-10050	CRT-002	31470-10012
		90.09~94.09	3E-E	EL42		CMT-008	31410-16040	CRT-002	31470-10012
		94.09~95.09	5E-FE	EL5#	LHD	CMT-008	31410-16040	CRT-002	31470-10012
		94.09~95.09	5E-FE	EL50	RHD	CMT-025	31410-10050	CRT-002	31470-10012
		95.09~	5E-FE	EL5#	LHD	CMT-008	31410-16040	CRT-047	31470-10040
		95.09~	5E-FE	EL50	RHD	CMT-025	31410-10050	CRT-047	31470-10040
TERCEL (JAPAN Application)	1300	90.09~99.07	4EFE	EL41/ 51		CMT-025	31410-10050	CRT-002	31470-10012
	1500	90.09~94.09	1NT	NL40		CMT-025	31410-10050		31470-16012
		90.09~94.09	5EFE	EL43/ 45		CMT-025	31410-10050	CRT-002	31470-10012
		90.09~94.09	5EFHE	EL43		CMT-025	31410-10050	CRT-005	31470-12093
		94.09~99.07	1NT	NL50		CMT-025	31410-10050		31470-16012
		94.09~99.07	5EFE	EL53/ 55		CMT-025	31410-10050	CRT-002	31470-10012
		94.09~99.07	5EFE	EL55		CMT-025	31410-10050	CRT-002	31470-10012
CORSA	1300	90.09~99.07	4EFE	EL41/ 51		CMT-025	31410-10050	CRT-002	31470-10012
		94.09~99.07	4EFE	EL51		CMT-025	31410-10050	CRT-002	31470-10012
	1500	90.09~94.09	1NT	NL40		CMT-025	31410-10050		31470-16012
		90.09~94.09	5EFE	EL43/ 45		CMT-025	31410-10050	CRT-002	31470-10012



Model	Year	Engine Type	Body Type	Reference				
					Aisin No.	Genuine No.	Aisin No.	Genuine No.
CORSA	1500	90.09~94.09	5EFE	EL45				
		90.09~94.09	5EFHE	EL43				
		94.09~99.07	1NT	NL50				
		94.09~99.07	5EFE	EL53/ 55				
COROLLA II	1300	90.09~99.07	4EFE	EL41/ 51				
		90.09~94.09	1NT	NL40				
	1500	90.09~94.09	5EFE	EL43/ 45				
		90.09~94.09	5EFHE	EL43				
		94.09~99.07	1NT	NL50				
		94.09~99.07	5EFE	EL53/ 55				
YARIS/ECHO/VIOS	1000	99.01~02.12	1SZFE	SCP10	YARIS			
		99.08~	1SZFE	SCP10	ECHO			
		05.08~	1KRFE	KSP90	YARIS (RHD)			
		05.08~09.10	1KRFE	KSP90	YARIS (LHD)			
		11.08~12.08	1KRFE	KSP130	YARIS (RHD)			
		11.08~12.08	1KRFE	KSP130	YARIS (LHD)			
	1300	05.08~07.05	2NZFE	NCP90	YARIS			
		07.05~08.08	2NZFE	NCP90	YARIS			
	1400	01.09~	1NDTV	NLP10	YARIS			
		01.09-05.09	1NDTV	NLP2#	ECHO VERSO			
		08.11~.	1NDTV	NLP90	YARIS			
	1500	99.08~01.09	1NZFE	NCP12	ECHO			
		01.09~	1NZFE	NCP12	ECHO			
		02.12~.	1NZFE	NCP13	YARIS			
		03.06~.	1NZFE	NCP13	ECHO			
		99.08~01.09	1NZFE	NCP2#	ECHO VERSO			
		01.09~05.09	1NZFE	NCP2#	ECHO VERSO			
		03.04~.	1NZFE	NCP31	SCION XB			
		03.05~07.09	1NZFE	NCP4#	SOLUNA VIOS			
		03.04~06.05	1NZFE	NCP61	SCION XA			
		03.08~06.05	1NZFE	NCP61	TOYOTA XA			
		05.08~07.08	1NZFE	NCP91	YARIS			
		06.01~06.12	1NZFE	NCP91	YARIS			
		07.08~10.11	1NZFE	NCP91	YARIS			
		10.11~	1NZFE	NCP91	YARIS			
		06.02~07.05	1NZFE	NCP93	YARIS			
		07.05~10.10	1NZFE	NCP93	YARIS			
		10.11~.	1NZFE	NCP93	YARIS			
11.08~		1NZFE	NCP131	YARIS				
13.05~	1NZFE	NCP131	YARIS					
1800	06.11~07.05	2ZRFE	ZSP90	YARIS (RHD)				
	07.05~08.09	2ZRFE	ZSP90	YARIS (RHD)				
	06.11~07.05	2ZRFE	ZSP90	YARIS (LHD)				
	07.05~08.09	2ZRFE	ZSP90	YARIS (LHD)				



Model	Year	Engine Type	Body Type	Reference	Clutch Master Cylinder		Clutch Release Cylinder		
					Aisin No.	Genuine No.	Aisin No.	Genuine No.	
YARIS/ECHO/VIOS	1800	07.06~14.07	ZZRFE	ZSP110	SCION XD	CMT-150	31420-52070	CRT-124	31470-52111
WILL VS	1800	01.04~04.04	ZZZGE	ZZE128		CMT-137	31420-12010	CRT-049	31470-12111
COROLLA/AURIS	1300	84.10~85.12	2E	EE80	LHD	CMT-007	31410-20421	CRT-047	31470-10040
		84.10~85.12	2E	EE80	RHD	CMT-027	31410-12152	CRT-047	31470-10040
		85.12~87.07	2E	EE80	LHD	CMT-007	31410-20421	CRT-002	31470-10012
		85.12~88.04	2E	EE80	RHD	CMT-027	31410-12152	CRT-002	31470-10012
		87.05~89.05	2E	EE90	LHD	CMT-013	31410-12221	CRT-002	31470-10012
		89.05~92.07	2E	EE90	LHD	CMT-004	31410-12381	CRT-002	31470-10012
		87.05~89.05	2E	EE90	RHD	CMT-028	31410-16023	CRT-002	31470-10012
		89.05~93.08	2E	EE90	RHD	CMT-051	31410-12312	CRT-002	31470-10012
		92.05~95.09	2E	EE100/ 1	RHD	CMT-051	31410-12312	CRT-002	31470-10012
		92.05~95.09	2E	EE100	LHD	CMT-004	31410-12381	CRT-002	31470-10012
		95.09~97.10	2E	EE100/ 1	RHD	CMT-051	31410-12312	CRT-047	31470-10040
		95.09~97.10	2E	EE100	LHD	CMT-004	31410-12381	CRT-047	31470-10040
		95.09~02.07	4E	EE110/ 1	RHD	CMT-051	31410-12312	CRT-047	31470-10040
		95.09~02.08	4E	EE110/ 1	LHD	CMT-004	31410-12381	CRT-047	31470-10040
		00.08~	2NZ	NZE120	ALTIS RHD	CMT-137	31420-12010	CRT-052	31470-12200
		00.08~	2NZ	NZE120	ALTIS LHD	CMT-141	31420-20070	CRT-052	31470-12200
		08.01~11.04	2NZ	NZE140	ALTIS	CMT-138	31420-12030	CRT-052	31470-12200
		12.12~.	2NZ	NZE140	ALTIS		31420-02080	CRT-052	31470-12200
		08.09~09.10	1NRFE	NRE150	AURIS 6F LHD	CMT-138	31420-12030		
		08.09~09.10	1NRFE	NRE150	AURIS 6F RHD	CMT-139	31420-12050		
		09.12~	1NRFE	NRE150	AURIS 6F LHD		31420-02031		
		08.11~	1NRFE	NRE150	AURIS		31420-02042		
		08.12~	1NRFE	NRE150	RHD	CMT-139	31420-12050		
		09.02~14.01	1NRFE	NRE150	LHD		31420-02031		
		09.02~14.01	1NRFE	NRE150	6F RHD		31420-02042		
		12.10~15.03	1NRFE	NRE180	AURIS HYBRID		31420-02031		
		15.03~	1NRFE	NRE180	AURIS HYBRID		31420-02051		
		12.08~	1NRFE	NRE180	6F	CMT-139	31420-12050		
		13.06~15.04	1NRFE	NRE180	LHD		31420-02031		
		15.05~	1NRFE	NRE180	LHD		31420-02051		
		14.01~.	1NRFE	NRE180	6F		31420-02042		
	1400	04.05~.	1NDTV	NDE120		CMT-141	31420-20070	CRT-114	31470-12180
		04.06~	1NDTV	NDE120	LHD		31420-05021	CRT-114	31470-12180
		06.09~.	1NDTV	NDE120	6F		31420-05021	CRT-114	31470-12180
		04.06~	1NDTV	NDE120	RHD		31420-05011	CRT-114	31470-12180
		08.01~	1NDTV	NDE140	ALTIS	CMT-138	31420-12030		
		06.10~	1NDTV	NDE150	AURIS LHD	CMT-138	31420-12030	CRT-114	31470-12180
		06.10~	1NDTV	NDE150	AURIS RHD	CMT-139	31420-12050	CRT-114	31470-12180
		07.02~	1NDTV	NDE150	AURIS HYBRID LHD		31420-02031	CRT-114	31470-12180
		07.02~	1NDTV	NDE150	AURIS HYBRID RHD		31420-02042	CRT-114	31470-12180
		06.11~	1NDTV	NDE150	LHD	CMT-138	31420-12030	CRT-114	31470-12180
		06.11~	1NDTV	NDE150	RHD	CMT-139	31420-12050	CRT-114	31470-12180



Model	Year	Engine Type	Body Type	Reference	Clutch Master Cylinder		Clutch Release Cylinder		
					Aisin No.	Genuine No.	Aisin No.	Genuine No.	
COROLLA/AURIS	1400	07.10~	1NDTV	NDE150	LHD		31420-02031		
		08.02~	1NDTV	NDE150	RHD		31420-02042		
		12.10~	1NDTV	NDE180	LHD		31420-02031		
		12.10~	1NDTV	NDE180	RHD		31420-02042		
		06.10~08.12	4ZZFE	ZZE150	AURIS LHD	CMT-138	31420-12030	CRT-049	31470-12140
		06.10~08.12	4ZZFE	ZZE150	AURIS RHD	CMT-139	31420-12050	CRT-049	31470-12140
	1500	92.02~97.04	5A	AE100		CMT-051	31410-12312	CRT-005	31470-12093
		92.02~02.07	5A	AE110		CMT-051	31410-12312	CRT-005	31470-12093
		92.02~93.11	3E	EE108		CMT-051	31410-12312		
		07.04~	1NZ	NZE141		CMT-138	31420-12030	CRT-052	31470-12200
		12.04~	1NZ	NZE161		CMT-151	31420-52050	CRT-115	31470-52121
		14.07~.	1NZ	NZE170	ALTIS		31420-02080	CRT-052	31470-12200
	1600	83.08~88.08	4AG	AE82	LHD	CMT-007	31410-20421	CRT-011	31470-12043
		85.05~88.04	4AG	AE82	RHD	CMT-027	31410-12152	CRT-011	31470-12043
		87.05~89.05	4A/ 4AGE	AE95/ 92	RHD	CMT-028	31410-16023	CRT-005	31470-12093
		87.05~89.05	4A/ 4AGE	AE95/ 92	LHD	CMT-013	31410-12221	CRT-005	31470-12093
		89.05~92.07	4A/ 4AGE	AE95/ 92	RHD	CMT-051	31410-12312	CRT-005	31470-12093
		89.05~92.07	4A/ 4AGE	AE95/ 92	LHD	CMT-004	31410-12381	CRT-005	31470-12093
		91.08~	4AGE/ FE	AE101	RHD	CMT-051	31410-12312	CRT-005	31470-12093
		92.05~	4AFE	AE101	LHD	CMT-004	31410-12381	CRT-005	31470-12093
		92.08~97.10	4AFE	AE102	RHD	CMT-051	31410-12312	CRT-005	31470-12093
		92.05~98.07	4AFE	AE102	LHD	CMT-004	31410-12381	CRT-005	31470-12093
		97.04~98.12	4AFE	AE111	RHD	CMT-051	31410-12312	CRT-005	31470-12093
		97.04~99.10	4AFE	AE111	LHD	CMT-004	31410-12381	CRT-005	31470-12093
		07.05~	1ZR	ZRE120			31420-02020		31470-02021
		1800	97.04~02.07	7A	AE112	RHD	CMT-051	31410-12312	CRT-005
	97.04~02.08		7A	AE112	LHD	CMT-004	31410-12381	CRT-005	31470-12093
	87.05~88.06		1C	CE90	RHD	CMT-028	31410-16023	CRT-085	31470-32023
	87.05~89.05		1C	CE90	LHD	CMT-013	31410-12221	CRT-085	31470-32023
	89.05~92.05		1C	CE90	RHD	CMT-051	31410-12312	CRT-085	31470-32023
	89.05~92.06		1C	CE90	LHD	CMT-004	31410-12381	CRT-085	31470-32023
	97.08~98.07		1ZZFE	ZZE110		CMT-004	31410-12381	CRT-034	31470-12100
00.08~02.09	1ZZFE		ZZE122	ALTIS LHD	CMT-141	31420-20070	CRT-049	31470-12140	
00.08~	1ZZFE		ZZE122	ALTIS RHD	CMT-137	31420-12010	CRT-049	31470-12140	
07.08~.	1ZZFE		ZZE142		CMT-138	31420-12030	CRT-049	31470-12140	
08.01~	2ZR		ZRE142	MATRIX	CMT-138	31420-12030	CRT-113	31470-12161	
08.01~	2ZR		ZRE142		CMT-138	31420-12030	CRT-113	31470-12161	
07.03~	2ZR		ZRE152	6F	CMT-139	31420-12050	CRT-113	31470-12161	
2000	92.05~	2C	CE100	RHD	CMT-069	31410-12362	CRT-085	31470-32023	
	92.05~	2C	CE100	LHD	CMT-004	31410-12381	CRT-085	31470-32023	
	97.04~99.10	2C	CE110	RHD	CMT-069	31410-12362	CRT-085	31470-32023	
	97.04~02.08	2C	CE110	LHD	CMT-004	31410-12381	CRT-085	31470-32023	
	00.08~04.04	2C	CE120	ALTIS LHD	CMT-141	31420-20070	CRT-085	31470-32023	
	01.10~	2C	CE120	ALTIS RHD		31420-12020	CRT-085	31470-32023	



Model	Year	Engine Type	Body Type	Reference						
					Aisin No.	Genuine No.	Aisin No.	Genuine No.		
COROLLA/AURIS	2000	08.01~12.12	2C	CE140	ALTIS	CMT-138	31420-12030	CRT-085	31470-32023	
		99.12~01.11	1CDFTV	CDE110	RHD	CMT-069	31410-12362	CRT-010	31470-32032	
		98.07~01.11	1CDFTV	CDE110	LHD	CMT-004	31410-12381	CRT-010	31470-32032	
		01.09~04.05	1CDFTV	CDE120	RHD	CMT-137	31420-12010	CRT-085	31470-32023	
		01.10~04.08	1CDFTV	CDE120	LHD	CMT-141	31420-20070	CRT-085	31470-32023	
		06.10~09.10	1ADFTV	ADE150	AURIS LHD	CMT-151	31420-52050	CRT-087	31470-12190	
		06.11~10.02	1ADFTV	ADE150	LHD	CMT-151	31420-52050	CRT-087	31470-12190	
		06.11~10.02	1ADFTV	ADE150	RHD		31420-12060	CRT-087	31470-12190	
	2400	08.01~ 07.03~	2AZFE	AZE141/ 6	MATRIX	CMT-138	31420-12030		31470-42040	
			2AZFE	AZE151	SCION XB	CMT-138	31420-12030		31470-42040	
	COROLLA (JAPAN Application)	1300	87.05~89.05	2E	EE90		CMT-028	31410-16023	CRT-002	31470-10012
			87.08~89.08	2E	EE96V/ 97G		CMT-028	31410-16023	CRT-002	31470-10012
			89.08~94.01	2E	EE96V/ 106V		CMT-051	31410-12302	CRT-002	31470-10012
			91.06~95.05	4EFE	EE101		CMT-051	31410-12302	CRT-002	31470-10012
94.01~98.04			4EFE	EE102V		CMT-051	31410-12302	CRT-002	31470-10012	
95.05~00.08			4EFE	EE111		CMT-051	31410-12302	CRT-002	31470-10012	
98.04~02.06			4EFE	EE102V		CMT-051	31410-12312	CRT-047	31470-10040	
00.08~06.02			2NZFE	NZE120		CMT-137	31420-12010	CRT-052	31470-52011	
1500		87.05~89.08	5AF	AE91/ 91G		CMT-028	31410-16023	CRT-005	31470-12093	
			3E	EE98V		CMT-028	31410-16023	CRT-002	31470-10012	
			5AFE	AE91		CMT-028	31410-16023	CRT-005	31470-12093	
		89.05~91.06	5AFHE	AE91		CMT-051	31410-12302	CRT-005	31470-12093	
			3E	EE98V		CMT-051	31410-12302	CRT-002	31470-10012	
		89.08~95.05	5AFE	AE91G/ 100		CMT-051	31410-12302	CRT-005	31470-12093	
			3E	EE107V/ 8G		CMT-051	31410-12302	CRT-002	31470-10012	
		91.09~94.01	5AFE	AE100G		CMT-051	31410-12302	CRT-005	31470-12093	
			5EFE	EE103V		CMT-051	31410-12302	CRT-002	31470-10012	
		94.01~98.04	5EFE	EE104G		CMT-051	31410-12302	CRT-002	31470-10012	
			5AFE	AE110		CMT-051	31410-12302	CRT-005	31470-12093	
		98.04~02.06	5EFE	EE103V		CMT-051	31410-12312	CRT-047	31470-10040	
			5EFE	EE104G		CMT-051	31410-12312	CRT-047	31470-10040	
		00.08~02.09	1NZFE	NZE121		CMT-137	31420-12010	CRT-052	31470-52011	
			04.04~04.12	1NZFE	NZE121		CMT-137	31420-12010	CRT-052	31470-52011
1600		87.05~89.05	4AGE	AE92		CMT-028	31410-16023	CRT-005	31470-12093	
			4AF	AE95		CMT-028	31410-16023	CRT-005	31470-12093	
		89.05~91.06	4AFE	AE95		CMT-051	31410-12312	CRT-005	31470-12093	
			4AFE	AE101		CMT-051	31410-12302	CRT-005	31470-12093	
		91.09~95.05	4AFE	AE104	with ABS	CMT-051	31410-12312	CRT-005	31470-12093	
			4AFE	AE111		CMT-051	31410-12302	CRT-005	31470-12093	
		95.05~00.08	4AFE	AE104G		CMT-051	31410-12312	CRT-005	31470-12093	
			4AFE	AE114		CMT-051	31410-12312	CRT-005	31470-12093	
		96.05~00.08	4AGE	AE101G		CMT-051	31410-12302	CRT-005	31470-12093	
			4AFE	AE109V		CMT-051	31410-12312	CRT-005	31470-12093	



Model	Year	Engine Type	Body Type	Reference					
					Aisin No.	Genuine No.	Aisin No.	Genuine No.	
COROLLA (JAPAN Application)	1600	97.04~00.08	4AGE	AE111		CMT-051	31410-12312	CRT-005	31470-12093
	1800	87.05~89.08	1C	CE9#		CMT-028	31410-16023	CRT-085	31470-32023
	2000	89.10~91.06	2C	CE95		CMT-051	31410-12312	CRT-085	31470-32023
		91.06~98.04	2C	CE100/ 100G		CMT-069	31410-12362	CRT-085	31470-32023
		91.09~98.04	2C	CE106V		CMT-069	31410-12362	CRT-085	31470-32023
		91.09~98.04	2C	CE109V		CMT-069	31410-12362	CRT-085	31470-32023
		91.09~95.05	2C	CE104	with ABS	CMT-069	31410-12362	CRT-085	31470-32023
		91.09~98.04	2C	CE108G		CMT-069	31410-12362	CRT-085	31470-32023
		95.05~98.04	2C	CE110		CMT-069	31410-12362	CRT-085	31470-32023
		95.05~98.04	2C	CE114		CMT-069	31410-12362	CRT-085	31470-32023
	2200	98.04~00.08	3CE	CE101G		CMT-069	31410-12362	CRT-085	31470-32023
		98.04~02.06	3CE	CE105V		CMT-069	31410-12362	CRT-085	31470-32023
		98.04~00.08	3CE	CE113/ 116		CMT-069	31410-12362	CRT-085	31470-32023
		98.04~02.06	3CE	CE102G		CMT-069	31410-12362	CRT-085	31470-32023
		98.04~02.06	3CE	CE107V		CMT-069	31410-12362	CRT-085	31470-32023
00.08~02.09		3CE	CE121			31420-12020	CRT-085	31470-32023	
COROLLA FX (JAPAN Application)	1300	87.05~89.05	2E	EE90		CMT-028	31410-16023	CRT-002	31470-10012
	1500	87.05~89.05	5AF/ FE	AE91		CMT-028	31410-16023	CRT-005	31470-12093
		89.05~92.05	5AFHE	AE91		CMT-051	31410-12302	CRT-005	31470-12093
	1600	87.05~89.05	4AGE	AE92		CMT-028	31410-16023	CRT-005	31470-12093
92.05~95.05		4AFE/ GE	AE101		CMT-051	31410-12302	CRT-005	31470-12093	
COROLLA CERES	1500	92.05~98.08	5AFE	AE100		CMT-051	31410-12302	CRT-005	31470-12093
	1600	92.05~98.08	4AGE/ FE	AE101		CMT-051	31410-12312	CRT-005	31470-12093
COROLLA FIELDER	1500	00.08~04.12	1NZFE	NZE121G		CMT-137	31420-12010	CRT-052	31470-52011
	1800	00.08~02.09	1ZZFE	ZZE122G		CMT-137	31420-12010	CRT-049	31470-12111
		00.08~02.09	2ZZGE	ZZE123G		CMT-137	31420-12010	CRT-049	31470-12111
COROLLA RUNX	1800	01.01~02.09	2ZZGE	ZZE123		CMT-137	31420-12010	CRT-049	31470-12111
COROLLA LEVIN	1500	87.05~89.05	5AF/ FE	AE91		CMT-028	31410-16023	CRT-005	31470-12093
		89.05~91.06	5AFHE	AE91		CMT-051	31410-12302	CRT-005	31470-12093
		91.06~00.08	5AFE	AE100/ 110		CMT-051	31410-12302	CRT-005	31470-12093
	1600	87.05~89.05	4AGE/ GZE	AE92		CMT-028	31410-16023	CRT-005	31470-12093
		91.06~95.05	4AFE/ GE/ GZE	AE101		CMT-051	31410-12302	CRT-005	31470-12093
		95.05~00.08	4AGE/ FE	AE111		CMT-051	31410-12312	CRT-005	31470-12093
ALLEX	1800	01.01~02.09	2ZZGE	ZZE123		CMT-137	31420-12010	CRT-049	31470-12111
SPRINTER	1300	87.05~89.05	2E	EE90		CMT-028	31410-16023	CRT-002	31470-10012
		88.08~89.08	2E	EE96V		CMT-028	31410-16023	CRT-002	31470-10012
		89.08~91.08	2E	EE96V		CMT-051	31410-12302	CRT-002	31470-10012
		91.06~95.05	4EFE	EE101		CMT-051	31410-12302	CRT-002	31470-10012
		91.09~94.01	2E	EE106V				CRT-002	31470-10012
		94.01~02.06	4EFE	EE102V		CMT-051	31410-12302	CRT-002	31470-10012
		95.05~00.08	4EFE	EE111		CMT-051	31410-12302	CRT-002	31470-10012
		1500	87.05~89.05	5AF/ FE	AE91		CMT-028	31410-16023	CRT-005
	88.08~89.08		3E	EE98V		CMT-028	31410-16023	CRT-002	31470-10012
	89.05~91.06		5AFHE	AE91		CMT-051	31410-12302	CRT-005	31470-12093



Model	Year	Engine Type	Body Type	Reference						
					Aisin No.	Genuine No.	Aisin No.	Genuine No.		
SPRINTER	1500	89.08~91.08	3E	EE98V		CMT-051	31410-12302	CRT-002	31470-10012	
		91.06~95.05	5AFE	AE100		CMT-051	31410-12302	CRT-005	31470-12093	
		91.09~94.01	3E	EE107V/ 108G		CMT-051	31410-12302	CRT-002	31470-10012	
		94.01~98.04	5EFE	EE103V/ 104G		CMT-051	31410-12302	CRT-002	31470-10012	
		95.05~00.08	5AFE	AE110		CMT-051	31410-12302	CRT-005	31470-12093	
		98.04~02.06	5EFE	EE103V		CMT-051	31410-12312	CRT-047	31470-10040	
		98.04~02.06	5EFE	EE104G		CMT-051	31410-12312	CRT-047	31470-10040	
	1600	87.05~89.05	4AGE	AE92		CMT-028	31410-16023	CRT-005	31470-12093	
		87.10~89.05	4AF	AE95		CMT-028	31410-16023	CRT-005	31470-12093	
		89.05~95.05	4AFE	AE95/ 101		CMT-051	31410-12312	CRT-005	31470-12093	
		91.06~95.05	4AGE	AE101		CMT-051	31410-12312	CRT-005	31470-12093	
		91.09~95.05	4AFE	AE104		CMT-051	31410-12312	CRT-005	31470-12093	
		95.05~98.04	4AFE	AE111/ 114		CMT-051	31410-12302	CRT-005	31470-12093	
		96.05~02.06	4AFE	AE109V		CMT-051	31410-12312	CRT-005	31470-12093	
	1800	87.05~89.05	1C	CE90		CMT-028	31410-16023	CRT-085	31470-32023	
		88.08~89.08	1C	CE96V			31410-20441	CRT-085	31470-32023	
	2000	89.10~91.06	2C	CE95		CMT-051	31410-12312	CRT-085	31470-32023	
		91.06~95.05	2C	CE100/ 104		CMT-069	31410-12362	CRT-085	31470-32023	
		91.09~98.04	2C	CE106V		CMT-069	31410-12362	CRT-085	31470-32023	
		91.09~98.04	2C	CE109V		CMT-069	31410-12362	CRT-085	31470-32023	
		91.09~98.04	2C	CE108G		CMT-069	31410-12362	CRT-085	31470-32023	
		95.05~98.04	2C	CE110/ 114		CMT-069	31410-12362	CRT-085	31470-32023	
	2200	98.04~02.06	3CE	CE105V		CMT-069	31410-12362	CRT-085	31470-32023	
		98.04~00.08	3CE	CE113/ 116		CMT-069	31410-12362	CRT-085	31470-32023	
		98.04~02.06	3CE	CE102G/ 107V		CMT-069	31410-12362	CRT-085	31470-32023	
	SPRINTER MARINO	1500	92.05~98.08	5AFE	AE100		CMT-051	31410-12302	CRT-005	31470-12093
		1600	92.05~98.08	4AGE/ FE	AE101		CMT-051	31410-12312	CRT-005	31470-12093
	SPRINTER TRUENO	1500	87.05~89.05	5AF/ FE	AE91		CMT-028	31410-16023	CRT-005	31470-12093
89.05~91.06			5AFHE	AE91	CMT-051		31410-12302	CRT-005	31470-12093	
91.06~00.08			5AFE	AE100/ 110	CMT-051		31410-12302	CRT-005	31470-12093	
1600		87.05~91.06	4AGE/ GZE	AE92		CMT-028	31410-16023	CRT-005	31470-12093	
		91.06~95.05	4AFE/ GE	AE101		CMT-051	31410-12302	CRT-005	31470-12093	
		91.06~95.05	4AGZE	AE101		CMT-051	31410-12312	CRT-005	31470-12093	
		95.05~00.08	4AGE/ FE	AE111		CMT-051	31410-12312	CRT-005	31470-12093	
SPRINTER CARIB 4WD	1600	88.02~90.09	4AFE	AE95G		CMT-028	31410-16023	CRT-005	31470-12093	
		90.09~95.08	4AFHE	AE95G		CMT-051	31410-12312	CRT-005	31470-12093	
		95.08~02.07	4AFE	AE114G/ 111G		CMT-051	31410-12312	CRT-005	31470-12093	
	1800	95.08~02.07	7AFE	AE115G		CMT-051	31410-12312	CRT-005	31470-12093	
SUCCEED	1400	02.06~06.02	1NDTV	NLP51V	with ABS	CMT-055	31420-52030		31470-52061	
	1500	02.06~06.02	1NZFE	NCP51V/ 55V	with ABS	CMT-055	31420-52030	CRT-052	31470-52011	
PROBOX	1300	02.06~06.02	2NZFE	NCP50V	with ABS	CMT-055	31420-52030	CRT-052	31470-52011	
	1400	02.06~06.02	1NDTV	NLP51V	with ABS	CMT-055	31420-52030		31470-52061	
	1500	02.06~06.02	1NZFE	NCP51V/ 55V	with ABS	CMT-055	31420-52030	CRT-052	31470-52011	



Model	Year	Engine Type	Body Type	Reference						
					Aisin No.	Genuine No.	Aisin No.	Genuine No.		
PROBOX	1500	02.06~06.02	1NZFE	NCP58G/ 59G	with ABS	CMT-055	31420-52030	CRT-052	31470-52011	
CARINA	1500	82.01~87.12	5K-J	KT147	MTM	CMT-037	31410-20411	CRT-033	31470-20151	
		88.05~89.11	3E	ET176V				CRT-002	31470-10012	
		88.05~90.05	5AF	AT170/ 170G				CRT-005	31470-12093	
		89.11~92.11	3E	ET176V				CRT-002	31470-10012	
		90.05~92.11	5AFE	AT170G				CRT-005	31470-12093	
		92.08~96.08	5AFE	AT192				CRT-005	31470-12093	
	1600	96.08~01.12	5AFE	AT212				31410-20520	CRT-005	31470-12093
		88.05~90.05	4AFE	AT171	with ABS & 14inch Disc Wheel	CMT-037	31410-20411	CRT-005	31470-12093	
		88.05~92.08	4AGE	AT171		CMT-037	31410-20411	CRT-005	31470-12093	
		88.08~92.08	4AFE	AT175	with ABS & 14inch Disc Wheel	CMT-037	31410-20411	CRT-005	31470-12093	
		90.05~92.08	4AFHE	AT171	with ABS & 14inch Disc Wheel	CMT-019	31410-20500	CRT-005	31470-12093	
		92.08~96.08	4AFE	AT190			31410-20520	CRT-005	31470-12093	
	1800	96.08~01.12	4AGE	AT210				31410-20540	CRT-005	31470-12093
		88.05~90.05	4SFI	ST170/ 170G		CMT-037	31410-20411	CRT-010	31470-32032	
		90.05~92.08	4SFE	ST170/ 170G		CMT-019	31410-20500	CRT-010	31470-32032	
		92.08~94.08	4SFE	ST190			31410-20520	CRT-010	31470-32032	
		94.08~96.08	7AFE	AT191			31410-20520	CRT-005	31470-12093	
	2000	96.08~01.12	7AFE	AT211				31410-20520	CRT-005	31470-12093
		88.05~92.11	2C	CT170/ 176V		CMT-019	31410-20431	CRT-085	31470-32023	
		90.05~92.11	2C	CT170G			31410-20500	CRT-085	31470-32023	
		91.06~92.08	2C	CT170			31410-20500	CRT-085	31470-32023	
		92.08~94.08	2C	CT190/ 195			31410-20570	CRT-085	31470-32023	
		92.08~96.08	3SFE	ST195			31410-20540	CRT-010	31470-32032	
94.08~96.08		2C	CT190/ 195		31410-20570		CRT-085	31470-32023		
96.08~98.08		2CT	CT210/ 215		31410-20570		CRT-085	31470-32023		
96.08~01.12	3SFE	ST215		31410-20540	CRT-050		31470-20210			
2200	98.08~01.12	3CTE	CT211			31410-20570	CRT-085	31470-32023		
CORONA	1500	87.12~89.11	3E	ET176V		CMT-037	31410-20411	CRT-002	31470-10012	
		87.12~89.11	5AF	AT170		CMT-037	31410-20411	CRT-005	31470-12093	
		89.11~92.02	5AFE	AT170		CMT-019	31410-20500	CRT-005	31470-12093	
		89.11~92.11	3E	ET176V		CMT-019	31410-20500	CRT-002	31470-10012	
	1600	83.10~85.08	4A-G	AT141					CRT-039	31470-12050
		88.08~89.11	4AFE	AT175		CMT-037	31410-20411	CRT-005	31470-12093	
		92.02~96.01	4AFE	AT190			31410-20520	CRT-005	31470-12093	
	1800	82.01~87.12	3T	TT14#	MTM				CRT-033	31470-20151
		87.12~89.11	4SFI	ST170		CMT-037	31410-20411	CRT-010	31470-32032	
		89.11~92.02	4SFE	ST170		CMT-019	31410-20500	CRT-010	31470-32032	
		92.02~96.01	4SFE	ST190			31410-20520	CRT-010	31470-32032	
	2000	87.12~89.11	2C	CT170			31410-20431	CRT-085	31470-32023	
		87.12~89.11	2C	CT176V			31410-20431	CRT-085	31470-32023	
		87.12~89.11	3SFE	ST171		CMT-037	31410-20411	CRT-010	31470-32032	
		87.12~89.11	3SGE	ST171		CMT-037	31410-20411	CRT-085	31470-32023	
		88.11~91.11	2C	CT141	MTM	CMT-065	31410-14183			



Model	Year	Engine Type	Body Type	Reference					
					Aisin No.	Genuine No.	Aisin No.	Genuine No.	
CORONA	2000	91.06~92.02	2C	CT170	CMT-019	31410-20500	CRT-085	31470-32023	
		92.02~96.01	2C	CT190/ 195		31410-20570	CRT-085	31470-32023	
		92.02~96.01	3SFE	ST195		31410-20540	CRT-010	31470-32032	
CORONA PREMIO	1600	96.01~01.12	4AFE	AT210		31410-20520	CRT-005	31470-12093	
		1800	96.01~01.12	7AFE	AT211		31410-20520	CRT-005	31470-12093
	2000	96.01~97.12	2CT	CT210/ 215		31410-20570	CRT-085	31470-32023	
		96.01~01.12	3SFE	ST215		31410-20540	CRT-050	31470-20210	
	2200	97.12~01.12	3CTE	CT211		31410-20570	CRT-085	31470-32023	
CARINA ED	1800	87.10~89.08	1S	ST16#	MTM	CMT-062	31410-20282		
		89.09~93.09	4SFI	ST180		CMT-089	31410-20380	CRT-010	31470-32032
		89.09~93.09	4SFI	ST181		CMT-089	31410-20380	CRT-010	31470-32032
		93.09~95.08	4SFE	ST200/ 201		CMT-070	31410-20580	CRT-010	31470-32032
	2000	89.09~93.09	3SFE	ST182/ 183		CMT-089	31410-20380	CRT-010	31470-32032
		89.09~93.09	3SGE	ST182/ 183		CMT-089	31410-20380	CRT-091	31470-20200
		93.09~95.08	3SFE	ST202/ 3		CMT-070	31410-20580	CRT-010	31470-32032
93.09~95.08	3SGE	ST202/ 205		CMT-070	31410-20580	CRT-091	31470-20200		
CORONA EXiV	1800	87.10~89.08	1S	ST16#	MTM	CMT-062	31410-20282		
		89.09~93.09	4SFI	ST180/ 181		CMT-089	31410-20380	CRT-010	31470-32032
		93.09~95.08	4SFE	ST200/ 201		CMT-070	31410-20580	CRT-010	31470-32032
	2000	89.09~93.09	3SFE	ST182/ 3		CMT-089	31410-20380	CRT-010	31470-32032
		89.09~93.09	3SGE	ST182/ 3		CMT-089	31410-20380	CRT-091	31470-20200
		93.09~95.08	3SFE	ST202/ 3		CMT-070	31410-20580	CRT-010	31470-32032
		93.09~95.08	3SGE	ST202/ 5		CMT-070	31410-20580	CRT-091	31470-20200
CURREN	1800	95.09~98.07	4SFE	ST208		CMT-070	31410-20580	CRT-010	31470-32032
		2000	94.02~97.12	3SFE	ST206/ 7		CMT-070	31410-20580	CRT-010
	2000	94.02~98.07	3SGE	ST206		CMT-070	31410-20580	CRT-091	31470-20200
CELICA (US Application)	2400	84-85	22REC	GT/ GTS/ ST		CMT-007	31410-20421		
CELICA (JAPAN Application)	1800	87.10~89.08	1S	ST16#		CMT-062	31410-20282		
		99.08~06.02	1ZZ/ 2ZZ	ZZT230/ 1			31420-20080	CRT-092	31470-20231
	2000	89.09~93.09	3SFE	ST182/ 3		CMT-089	31410-20380	CRT-010	31470-32032
		89.09~93.09	3SGE	ST182/ 3		CMT-089	31410-20380	CRT-091	31470-20200
		89.10~93.09	3SGTE	ST185/ H			31410-20510	CRT-050	31470-20210
		90.09~93.09	3SGE	ST183C		CMT-089	31410-20380	CRT-091	31470-20200
		93.09~99.08	3SFE	ST202/ 3		CMT-070	31410-20580	CRT-010	31470-32032
		93.09~99.08	3SGE	ST202/ C		CMT-070	31410-20580	CRT-091	31470-20200
94.02~99.08	3SGTE	ST205		CMT-070	31410-20580	CRT-050	31470-20210		
CALDINA	1500	92.11~98.05	5EFE	ET196V			31410-20520	CRT-002	31470-10012
		98.05~02.06	5EFE	ET196V			31410-20520	CRT-047	31470-10040
	1800	92.11~96.01	4SFE	ST190G			31410-20520	CRT-010	31470-32032
		96.01~06.02	7AFE	AT191G/ 211G			31410-20520	CRT-005	31470-12093
	2000	92.11~98.05	2C/ CT	CT19#			31410-20570	CRT-085	31470-32023
		92.11~97.08	3SFE	ST195G			31410-20540	CRT-010	31470-32032
		95.02~97.08	3SGE	ST195G			31410-20540	CRT-091	31470-20200
		97.08~06.02	3SFE	ST215G			31410-20540	CRT-050	31470-20210



Model	Year	Engine Type	Body Type	Reference					
					Aisin No.	Genuine No.	Aisin No.	Genuine No.	
CALDINA	2000	97.08~06.02	3SGTE	ST215W		31410-20540	CRT-022	31470-42020	
	2200	98.05~02.06	3CE	CT197V/ 9V		31410-20570	CRT-085	31470-32023	
MR2 (US Application)	2000	91~95	3SGTE		CMT-060	31410-17080			
	2200	91~95	5SFE		CMT-060	31410-17080			
MR2 (JAPAN Application)	1500	84.06~89.12	3ALU	AW10		31410-17012	CRT-009	31470-17011	
	1600	84.06~89.12	4AGELU	AW11		CMT-085	31410-17053	CRT-009	31470-17011
		86.08~89.12	4AGZE	AW11		CMT-085	31410-17053	CRT-089	31470-17022
	2000	89.12~99.08	3SGE/ GTE	SW20		CMT-086	31410-17070	CRT-031	31470-17040
MR-S	1800	99.10~02.08	1ZZFE	ZZW30		31410-17110		31470-17051	
VOLTZ	1800	02.05~04.02	2ZZGE	ZZE137		CMT-137	31420-12010	CRT-049	31470-12111
CAMRY	1800	82.10~86.10	1CT	CV10		CMT-031	31410-32032	CRT-085	31470-32023
		82.10~86.10	1S	SV1#	RHD	CMT-007	31410-20421	CRT-085	31470-32023
		82.10~86.10	1S	SV1#	LHD	CMT-031	31410-32032	CRT-085	31470-32023
		86.10~88.08	1S	SV20		CMT-031	31410-32032	CRT-085	31470-32023
	2000	83.01~86.07	2SE	SV11		CMT-031	31410-32032	CRT-085	31470-32023
		88.08~91.06	3SFE	SV2#		CMT-031	31410-32032	CRT-010	31470-32032
		86.08~91.09	3SFE	SV21	LHD	CMT-031	31410-32032	CRT-010	31470-32032
		86.10~91.06	3SFE	SV21	RHD		31410-32072	CRT-010	31470-32032
		86.10~91.06	3SFE	SV25			31410-32072	CRT-010	31470-32032
		86.10~91.06	2CT	CV20	LHD	CMT-031	31410-32032	CRT-085	31470-32023
		86.10~91.06	2CT	CV20	RHD		31410-32072	CRT-085	31470-32023
		2200	92.08~97.08	5SFE	SXV1#			31410-33040	CRT-026
	97.08~		5SFE	SXV1#			31410-33040	CRT-010	31470-32032
	91.06~96.08		5SFE	SXV10	LHD	CMT-023	31410-33012	CRT-026	31470-33020
	92.03~96.07		5SFE	SXV10	RHD		31410-33040	CRT-026	31470-33020
	96.07~		5SFE	SXV20	LHD	CMT-020	31410-33030	CRT-010	31470-32032
	96.08~		5SFE	SXV20	RHD	CMT-157	31420-33010	CRT-010	31470-32032
	2400	01.07~03.07	2AZFE	ACV30		CMT-141	31420-20070	CRT-097	31470-28081
		03.07~	2AZFE	ACV30		CMT-141	31420-20070	CRT-082	31470-42031
		02.08~03.08	2AZFE	ACV36		CMT-144	31420-33020	CRT-097	31470-28081
		03.08~	2AZFE	ACV36		CMT-144	31420-33020	CRT-082	31470-42031
		06.01~	2AZFE	ACV40			31420-33030	CRT-082	31470-42031
	2500	87.11~91.09	2VZFE	VZV21		CMT-031	31410-32032	CRT-010	31470-32032
	3000	91.06~95.02	3VZFE	VCV10	LHD	CMT-023	31410-33012	CRT-026	31470-33020
		95.02~96.08	3VZFE	VCV10	LHD	CMT-023	31410-33012		31470-33030
		92.08~95.02	3VZFE	VCV10	RHD		31410-33040	CRT-026	31470-33020
		95.02~97.08	3VZFE	VCV10	RHD		31410-33040		31470-33030
96.07~99.04		1MZFE	MCV20		CMT-020	31410-33030	CRT-050	31470-20210	
99.04~01.07		1MZFE	MCV20		CMT-020	31410-33030	CRT-010	31470-32032	
	02.08~	1MZFE	MCV36		CMT-144	31420-33020		31470-33060	
CAMRY (JAPAN Application)		96.08		SXV20					
	1800	90.07~98.06	4SFE	SV30/ 40		31410-32122	CRT-010	31470-32032	
	2000	90.07~92.06	1VZFE	VZV30/ 31			31410-32132	CRT-010	31470-32032
		90.07~92.06	1VZFE	VZV31			31410-32132	CRT-010	31470-32032



Model	Year	Engine Type	Body Type	Reference					
					Aisin No.	Genuine No.	Aisin No.	Genuine No.	
CAMRY (JAPAN Application)	2000	90.07~92.06	3SFE	SV35		31410-32122	CRT-010	31470-32032	
		90.07~92.06	3SGE	SV32		31410-32122	CRT-091	31470-20200	
		90.07~92.06	3SGE	SV33		31410-32122	CRT-091	31470-20200	
		90.07~94.06	3SFE	SV32		31410-32122	CRT-010	31470-32032	
		90.07~94.06	3SFE	SV33		31410-32122	CRT-010	31470-32032	
		92.06~94.06	2CT	CV30		31410-32132	CRT-085	31470-32023	
		94.06~98.06	3SFE	SV43		31410-32150	CRT-010	31470-32032	
2200	94.06~98.06	3CT	CV40		31410-32160	CRT-085	31470-32023		
SOARER	2000	86.01~88.01	1GEU/ GEU	GZ20		CMT-059 31410-14193	CRT-007	31470-30222	
		86.01~88.01	1GGTEU	GZ20		CMT-115 31410-14213	CRT-007	31470-30222	
		89.01~91.04	1GFE	GZ20		CMT-059 31410-14193			
	2200	99-01	5SFE			CMT-020 31410-33030			
		2400	02-03	2AZFE		CMT-020 31410-33030			
	2500	91.05~99.08	1JZGTE	JZZ30		CMT-120 31410-24050	CRT-024	31470-14050	
		99.08~00.12	1JZGTE	JZZ30	with ABS	CMT-120 31410-24050	CRT-024	31470-14050	
	3000	86.01~88.01	7MGTEU	MZ20		CMT-115 31410-14213	CRT-024	31470-14050	
		86.01~88.01	7MGTEU	MZ21	with ESC	CMT-115 31410-14213	CRT-024	31470-14050	
		99	1MZFE			CMT-020 31410-33030			
	00-02	1MZFE		with ABS & Traction Control	CMT-020 31410-33030				
VISTA	1800	90.07~94.06	4SFE	SV30	with ABS		31410-32122	CRT-010	31470-32032
		94.06~98.06	4SFE	SV40			31410-32140	CRT-010	31470-32032
	2000	90.07~92.06	2CT	CV30			31410-32132	CRT-085	31470-32023
		90.07~92.06	3SFE	SV32/ 3	with ABS		31410-32122	CRT-010	31470-32032
		90.07~92.06	3SGE	SV32	with ABS		31410-32122	CRT-091	31470-20200
		90.07~92.06	3SGE	SV33	with ABS			CRT-091	31470-20200
		90.07~94.06	2CT	CV30	with ABS		31410-32132	CRT-085	31470-32023
		90.07~94.06	3SFE	SV35	with ABS		31410-32122	CRT-010	31470-32032
		94.06~98.06	3SFE	SV43			31410-32150	CRT-010	31470-32032
		2200	94.06~98.06	3CT	CV40			31410-32160	CRT-085
CRESSIDA / MARK II	1800	88.08~90.08	4SFI	SX80		CMT-117 31410-22270	CRT-007	31470-30222	
		88.12~93.02	2YJ	YX76V			31410-22104	CRT-020	31470-20191
		90.08~93.02	4SFE	SX80		CMT-117 31410-22270	CRT-007	31470-30222	
		92.10~96.09	4SFE	SX90			31410-22302		31470-22170
	2000	88.08~90.08	1GGTE	GX81			31410-22132		31470-22101
		88.08~93.02	1GFE/ GE	GX81		CMT-117 31410-22270	CRT-007	31470-30222	
		88.08~95.12	3YP	YX80		CMT-117 31410-22270	CRT-001	31470-30260	
		88.10~97.04	1GFE	GX70G		CMT-011 31410-22240	CRT-007	31470-30222	
		92.10~96.09	1GFE	GX90			31410-22302		31470-22190
		93.02~97.04	3YE	YX78V		CMT-117 31410-22270	CRT-028	31470-22150	
		96.09~00.10	1GFE	GX100		CMT-119 31410-22320		31470-22190	
		2200	80.09~84.07	L	LX60X,67X	MTM			CRT-015
	2400	88.08~93.08	2L/ 2LT	LX80		CMT-117 31410-22270	CRT-055	31470-22112	
		88.12~94.09	2L	LX76V		CMT-011 31410-22240	CRT-055	31470-22112	
		92.10~96.09	2LTE	LX90			31410-22312	CRT-055	31470-22112



Model	Year	Engine Type	Body Type	Reference							
					Aisin No.	Genuine No.	Aisin No.	Genuine No.			
CRESSIDA / MARK II	2500	92.10~96.09	1JZGTE	JZX90	CMT-118	31410-22292	CRT-024	31470-14050			
		96.09~00.10	1JZGTE	JZX100	CMT-119	31410-22320	CRT-024	31470-14050			
		02.10~04.11	1JZGTE	JZX110		31410-22330	CRT-024	31470-14050			
CHASER	1800	88.08~92.10	4SFI/ FE	SX80	CMT-117	31410-22270	CRT-007	31470-30222			
		92.10~96.09	4SFE	SX90					31410-22302	31470-22170	
	2000	88.08~90.08	1GGTE	GX81	CMT-117	31410-22270	CRT-007	31470-30222			
		88.08~92.10	1GFE/ GE	GX81					31410-22302	31470-22190	
		92.10~96.09	1GFE	GX90					CMT-119	31410-22320	31470-22190
		96.09~01.06	1GFE	GX100							
	2200	80.09~84.07	L	LX60D	MTM		CRT-015	31470-22090			
	2400	88.08~92.10	2L/ 2LT	LX80	CMT-117	31410-22270	CRT-055	31470-22112			
		92.10~96.09	2LTE	LX90					31410-22312	31470-22112	
	2500	92.10~96.09	1JZGTE	JZX90	CMT-118	31410-22292	CRT-024	31470-14050			
96.09~01.06		1JZGTE	JZX100	CMT-119	31410-22320	CRT-024	31470-14050				
CRESTA	1800	88.08~92.10	4SFI/ FE	SX80	CMT-117	31410-22270	CRT-007	31470-30222			
		92.10~96.09	4SFE	SX90					31410-22302	31470-22170	
	2000	88.08~90.08	1GGTE	GX81	CMT-117	31410-22270	CRT-007	31470-30222			
		88.08~92.10	1GFE/ GE	GX81					31410-22302	31470-22190	
		92.10~96.09	1GFE	GX90					CMT-119	31410-22320	31470-22190
		96.09~98.08	1GFE	GX100							
	2200	80.09~84.07	L	LX60Y	MTM		CRT-015	31470-22090			
	2400	88.08~92.10	2L/ 2LT	LX80	CMT-117	31410-22270	CRT-055	31470-22112			
		92.10~96.09	2LTE	LX90					31410-22312	31470-22112	
	2500	92.10~96.09	1JZGTE	JZX90	CMT-118	31410-22292	CRT-024	31470-14050			
VEROSSA	2500	01.06~04.04	1JZGTE	JZX110		31410-22330	CRT-024	31470-14050			
CROWN	2000	87.09~89.08	1GE	GS13#	FRONT DISC BRAKE	31410-30282	CRT-007	31470-30222			
		87.09~89.08	3YP	YS130		31410-30272	CRT-001	31470-30260			
		87.09~89.08	MP	MS130		31410-30231	CRT-007	31470-30222			
		87.09~91.10	1GGE/ FE	GS13#		31410-30282	CRT-007	31470-30222			
		89.08~91.10	1GGP	GS130		31410-30282	CRT-007	31470-30222			
		89.08~91.10	3YPE	YS130		31410-30272	CRT-001	31470-30260			
		95.12~99.09	1GFE	GS151		31410-22302		31470-22190			
	95.12~99.04	1GFE	GS136V	31410-30381		31470-22140					
	2400	80.10~81.08	2L	JS11#	MTM		CRT-015	31470-22090			
		81.08~83.07	2L	JS11#			CRT-015	31470-22090			
87.09~91.10		2L	LS130	FRONT DISC BRAKE		31410-30282	CRT-007	31470-30222			
87.09~91.10		2L	LS136V	FRONT DISC BRAKE		31410-30282	CRT-007	31470-30222			
2400	87.09~91.10	2LT	LS130/ 1	FRONT DISC BRAKE	31410-30282	CRT-007	31470-30222				
	87.09~91.10	2LT	LS130/ 1	FRONT DISC BRAKE	31410-30282	CRT-007	31470-30222				
COMFORT	2000	95.12~01.08	3YPE	YXS11		31410-43010	CRT-028	31470-22150			
		01.08~06.02	3YPE	YXS11			CRT-028	31470-22150			
CROWN COMFORT	2000	95.12~06.02	3YPE	YXS10		31410-43010	CRT-028	31470-22150			
		01.08~04.06	3YPE	YXS10			CMT-128	31410-43010	CRT-028	31470-22150	
ALTEZZA	2000	98.10~01.05	3SGE	SXE10		31410-53010	CRT-043	31470-30230			
		01.05~05.07	1GFE	GXE10				31410-53010	CRT-037	31470-30270	



Model	Year	Engine Type	Body Type	Reference				
					Aisin No.	Genuine No.	Aisin No.	Genuine No.
ALTEZZA	2000	01.05~05.07	3SGE	SXE10		31410-53010		31470-53010
		01.06~05.07	1GFE	GXE10W		31410-53010		31470-53020
LEXUS ES250	2500	90~91	2VZFE		CMT-031	31410-32032		
SUPRA	2000	86.02~88.08	1GEU/ GEU	GA70	CMT-059	31410-14193	CRT-007	31470-30222
		86.02~88.08	1GGTEU	GA70	CMT-115	31410-14213	CRT-007	31470-30222
		88.08~90.08	1GFE	GA70	CMT-059	31410-14193	CRT-007	31470-30222
		89.08~93.05	1GGTEU	GA70H	CMT-115	31410-14213		31470-22101
	2500	90.08~93.05	1JZGTE	JZA70		31410-14280	CRT-024	31470-14050
	2800	84	5MGE		CMT-007	31410-20421		
	3000	86.02~88.08	7MGTEU	MA70	CMT-115	31410-14213	CRT-024	31470-14050
		93.05~02.08	2JZGE	JZA80	CMT-120	31410-24050	CRT-093	31470-22120
		93.05~02.08	2JZGTE	JZA80	CMT-120	31410-24050	CRT-088	31470-14060
	ESTIMA EMINA / LUCIDA	2200	92.01~93.08	3CT	CXR10G/ 11G	CMT-049	31420-28101	CRT-013
92.01~93.08			3CT	CXR20G/ 21G	CMT-049	31420-28101	CRT-013	31470-28051
93.08~95.01			3CTE	CXR10G/ 20G	CMT-049	31420-28101	CRT-013	31470-28051
95.01~99.08			3CTE	CXR10G/ 20G	CMT-049	31420-28101	CRT-013	31470-28051
2400		92.01~93.08	2TZFE	TCR21G	CMT-049	31420-28101	CRT-013	31470-28051
		92.01~98.01	2TZFE	TCR10G/ 20G	CMT-049	31420-28101	CRT-013	31470-28051
LITE-ACE	1500	85.09~88.08	5KJ	KM31V/ 36V		31420-27052	CRT-004	31470-35100
		85.09~88.08	5KU	KM30G		31420-27052	CRT-004	31470-35100
		86.10~99.06	5K	KM51		31420-27052	CRT-004	31470-35100
		90.08~92.01	5KJ	KM31V/ 36V		31420-27052	CRT-004	31470-35100
		92.01~96.10	5KJ	KR27V	CMT-111	31420-37050	CRT-004	31470-35100
	1800	85.09~88.08	1C	CM35V		31420-27072	CRT-003	31470-28040
		85.09~88.08	2YU	YM30G		31420-27072	CRT-001	31470-30260
		86.10~89.10	1C	CM50		31420-27072	CRT-003	31470-28040
		86.10~99.06	2Y	YM55		31420-27072	CRT-001	31470-30260
		86.10~99.06	2Y	YM60/ 65		31420-27072	CRT-001	31470-30260
		90.08~92.01	2YJ	YM31V		31420-27072	CRT-043	31470-30230
		92.01~96.10	2YJ	YR25V	CMT-111	31420-37050	CRT-001	31470-30260
		99.06~06.02	7KE	KM70	CMT-160	31420-27100	CRT-043	31470-30230
		99.06~06.02	7KE	KM75	CMT-160	31420-27100	CRT-043	31470-30230
		99.06~06.02	7KE	KM80	CMT-160	31420-27100	CRT-043	31470-30230
	2000	85.09~87.08	2C/ 2CT	CM30G		31420-27072	CRT-003	31470-28040
		85.10~86.08	2C/ 2CT	CM41V/ 40G		31420-27072	CRT-003	31470-28040
		85.10~88.08	3YU	YM40G		31420-27072	CRT-001	31470-30260
		86.10~99.06	2C	CM55		31420-27072	CRT-003	31470-28040
		86.10~93.10	2C	CM60		31420-27072	CRT-003	31470-28040
		86.10~93.10	2C	CM65		31420-27072	CRT-003	31470-28040
		87.08~88.08	2C/ 2CT	CM30G/ 40G		31420-27072	CRT-003	31470-28040
		87.08~88.08	2C	CM36V/ 41V		31420-27072	CRT-003	31470-28040
87.08~99.06		2C	CM51/ 2		31420-27072	CRT-003	31470-28040	
88.08~92.01	2C	CM31V		31420-27072	CRT-003	31470-28040		



Model	Year	Engine Type	Body Type	Reference					
					Aisin No.	Genuine No.	Aisin No.	Genuine No.	
LITE-ACE	2000	91.10~93.10	2C	CM61		31420-27072	CRT-003	31470-28040	
		92.01~93.09	2C	CR27V	CMT-001	31420-37040	CRT-003	31470-28040	
		92.01~93.09	2C	CR36V	CMT-001	31420-37040	CRT-003	31470-28040	
		92.01~93.09	2CT	CR21G/ 28G	CMT-001	31420-37040	CRT-003	31470-28040	
		92.01~93.09	2CT	CR30G/ 37G	CMT-001	31420-37040	CRT-003	31470-28040	
		92.01~96.10	3YEU	YR21G	CMT-001	31420-37040	CRT-043	31470-30230	
		93.09~96.10	2C	CR27V	CMT-001	31420-37040	CRT-003	31470-28040	
		93.09~96.10	2C	CR36V	CMT-001	31420-37040	CRT-095	31470-28060	
		93.10~99.06	2C	CM60		31420-27072	CRT-095	31470-28060	
	93.10~99.06	2C	CM61		31420-27072	CRT-095	31470-28060		
	93.10~99.06	2C	CM65		31420-27072	CRT-095	31470-28060		
	2200	93.09~96.10	3CT	CR22G		CMT-001	31420-37040	CRT-095	31470-28060
		93.09~94.08	3CT	CR29G		CMT-001	31420-37040		
		93.09~96.10	3CT	CR31G		CMT-001	31420-37040	CRT-095	31470-28060
93.09~96.10		3CT	CR38G		CMT-001	31420-37040	CRT-095	31470-28060	
94.08~96.10		3CT	CR29G		CMT-001	31420-37040	CRT-095	31470-28060	
99.06~04.08		3CE	CM70/ 75			31420-27110		31470-27020	
99.06~04.08	3CE	CM80/ 85			31420-27110		31470-27020		
LITE-ACE NOAH	1500	96.11~98.12	5K	KR41V		CMT-075	31420-20010	CRT-043	31470-30230
		1800	96.11~06.02	7K/ 7KE	KR42V/ 52V		CMT-075	31420-20010	CRT-043
	2000	96.10~01.07	3SFE	SR40G		CMT-140	31420-20020	CRT-096	31470-28070
		96.11~98.12	2C	CR41V	with ABS	CMT-140	31420-20020	CRT-003	31470-28040
		96.11~98.12	2C	CR51V		CMT-140	31420-20020	CRT-096	31470-28070
	2200	96.11~98.12	3CT	CR40G/ 50G	with ABS	CMT-140	31420-20020	CRT-096	31470-28070
98.12~04.07		3CE	CR42V/ 52V		CMT-140	31420-20020	CRT-096	31470-28070	
TOWN-ACE VAN	2000	84.01~85.08	3YEC	YR21	LHD	CMT-054	31420-28072	CRT-043	31470-30230
		84.01~85.08	3YEC	YR21	RHD	CMT-052	31420-28092	CRT-043	31470-30230
	2200	85.08~90.01	4YEC	YR31	LHD	CMT-054	31420-28072	CRT-001	31470-30260
		85.08~90.01	4YEC	YR31	RHD	CMT-052	31420-28092	CRT-001	31470-30260
TOWN-ACE	1500	86.10~95.08	5K	KM51			31420-27052	CRT-004	31470-35100
		92.01~96.10	5KJ	KR27V		CMT-111	31420-37050	CRT-004	31470-35100
		95.08~99.06	5K	KM51			31420-27052	CRT-004	31470-35100
	1600	78.08~82.10	12R	RR1#,2#				CRT-036	31470-35030
		82.11~88.08	1YJ	YR26V		CMT-052	31420-28092	CRT-001	31470-30260
	1800	82.11~87.08	1C	CR26V		CMT-052	31420-28092		31470-12080
		82.11~88.08	2YU	YR20G/ 28G		CMT-052	31420-28092	CRT-001	31470-30260
		86.10~89.10	1C	CM50			31420-27072	CRT-003	31470-28040
		86.10~99.06	2Y	YM55			31420-27072	CRT-001	31470-30260
		86.10~99.06	2Y	YM60			31420-27072	CRT-001	31470-30260
		87.08~88.08	1C	CR26V		CMT-052	31420-28092	CRT-003	31470-28040
		90.08~99.06	2Y	YM65			31420-27072	CRT-001	31470-30260
		92.01~96.10	2YJ	YR25V		CMT-111	31420-37050	CRT-001	31470-30260
		99.06~06.02	7KE	KM70/ 75			31420-27100	CRT-043	31470-30230
99.06~06.02	7KE	KM80/ 85			31420-27100	CRT-043	31470-30230		



Model	Year	Engine Type	Body Type	Reference					
					Aisin No.	Genuine No.	Aisin No.	Genuine No.	
TOWN-ACE	2000	84.08~87.08	2C	CR21G	CMT-052	31420-28092		31470-12080	
		85.08~87.08	2C	CR28G	CMT-052	31420-28092	CRT-003	31470-28040	
		85.08~87.08	2CT	CR21G/ 30G	CMT-052	31420-28092	CRT-003	31470-28040	
		85.10~87.08	2C	CR36V	CMT-052	31420-28092	CRT-003	31470-28040	
		86.08~88.08	3YEU	YR36G	CMT-052	31420-28092	CRT-043	31470-30230	
		86.10~93.10	2C	CM55		31420-27072	CRT-003	31470-28040	
		86.10~93.10	2C	CM60/ 61		31420-27072	CRT-003	31470-28040	
		86.10~93.10	2C	CM65		31420-27072	CRT-003	31470-28040	
		87.08~93.10	2C	CM51/ 52		31420-27072	CRT-003	31470-28040	
		92.01~93.09	2C	CR27V/ 36V		CMT-001	31420-37040	CRT-003	31470-28040
		92.01~93.09	2CT	CR21G/ 28G		CMT-001	31420-37040	CRT-003	31470-28040
		92.01~93.09	2CT	CR30G/ 37G		CMT-001	31420-37040	CRT-003	31470-28040
		92.01~96.10	3YEU	YR21G		CMT-001	31420-37040	CRT-043	31470-30230
		92.01~96.10	3YEU	YR30G		CMT-052	31420-28092	CRT-043	31470-30230
		93.09~96.10	2C	CR27V		CMT-001	31420-37040	CRT-003	31470-28040
		93.09~96.10	2C	CR36V		CMT-001	31420-37040	CRT-095	31470-28060
	93.10~99.06	2C	CM51/ 52/ 55			31420-27072	CRT-003	31470-28040	
	93.10~99.06	2C	CM60/ 61/ 65			31420-27072	CRT-095	31470-28060	
	2200	93.09~96.10	3CT	CR22G/ 29G		CMT-001	31420-37040	CRT-095	31470-28060
		93.09~96.10	3CT	CR31G/ 38G		CMT-001	31420-37040	CRT-095	31470-28060
99.06~04.08		3CE	CM70/ 75			31420-27110		31470-27020	
99.06~04.08		3CE	CM80/ 85			31420-27110		31470-27020	
TOWN-ACE NOAH	1500	96.11~98.12	5K	KR41V	CMT-075	31420-20010	CRT-043	31470-30230	
	1800	96.11~06.02	7K/ 7KE	KR42V/ 52V	CMT-075	31420-20010	CRT-043	31470-30230	
	2000	96.10~01.11	3SFE	SR40G		CMT-140	31420-20020	CRT-096	31470-28070
		96.11~98.12	2C	CR41V		CMT-140	31420-20020	CRT-003	31470-28040
	2200	96.11~98.12	2C	CR51V		CMT-140	31420-20020	CRT-096	31470-28070
		96.10~98.12	3CT	CR40G/ 50G		CMT-140	31420-20020	CRT-096	31470-28070
MASTER-ACE	1600	78.08~82.10	12R	RR1#,2#			CRT-036	31470-35030	
		82.11~88.08	2YU	YR20G/ 28G	CMT-052	31420-28092	CRT-001	31470-30260	
	2000	83.05~88.08	3YEU	YR21G		CMT-052	31420-28092	CRT-043	31470-30230
		84.08~87.08	2C	CR21G		CMT-052	31420-28092		31470-12080
		85.08~87.08	2C	CR28G		CMT-052	31420-28092	CRT-003	31470-28040
		85.08~87.08	2CT	CR21G/ 30G		CMT-052	31420-28092	CRT-003	31470-28040
		85.10~88.08	3YEU	YR30G/ 36G		CMT-052	31420-28092	CRT-043	31470-30230
		87.08~88.08	2CT	CR21G/ 28G		CMT-052	31420-28092	CRT-003	31470-28040
		87.08~88.08	2CT	CR30G/ 37G		CMT-052	31420-28092	CRT-003	31470-28040
		HI-ACE	1600	05.01		TRH20#,213,22#			CRT-119
82.11~85.07	12R			RH24			CRT-036	31470-35030	
85.08~87.08	1YJ			YH80	CMT-101	31420-26142	CRT-001	31470-30260	
1800	85.08~87.08		2Y/ 3YP	YH50V		CMT-018	31420-26092	CRT-001	31470-30260
	87.08~95.05	2Y	YH81		CMT-101	31420-26142	CRT-001	31470-30260	
2000	82.12~87.08	3Y	YH61V		CMT-018	31420-26092	CRT-001	31470-30260	



Model	Year	Engine Type	Body Type	Reference					
					Aisin No.	Genuine No.	Aisin No.	Genuine No.	
HI-ACE	2000	82.12~87.08	3YU	YH51G/ 61G	FRONT DISC BRAKE	CMT-044	31420-26103	CRT-001	31470-30260
		84.01~85.08	3YJ	YH52V		CMT-018	31420-26092	CRT-001	31470-30260
		85.08~87.08	3Y	YH51V		CRT-001	31470-30260		
		85.08~87.08	3Y	YH61VH		CMT-018	31420-26092	CRT-001	31470-30260
		85.08~87.08	3Y	YH71V		CMT-018	31420-26092	CRT-003	31470-28040
		85.08~87.08	3YJ	YH62V/ 71B		CMT-018	31420-26092	CRT-001	31470-30260
		85.08~87.08	3YP	YH61V		CMT-018	31420-26092	CRT-001	31470-30260
		87.08~89.08	3YU	YH57G		CMT-044	31420-26103	CRT-004	31470-35100
		89.08~93.08	1RZ	RZH102V		CMT-111	31420-37050	CRT-003	31470-28040
		89.08~93.08	1RZ	RZH112K/ V		CMT-111	31420-37050	CRT-003	31470-28040
		89.08~93.08	1RZ	RZH122V		CMT-111	31420-37050	CRT-003	31470-28040
		89.08~93.08	1RZ	RZH124B		CMT-111	31420-37050	CRT-003	31470-28040
		89.08~93.08	1RZE	RZH110G		CMT-078	31420-36130	CRT-003	31470-28040
		89.08~95.08	1RZE	RZH100G		CMT-078	31420-36130	CRT-003	31470-28040
		93.08~95.08	1RZE	RZH102V		CMT-078	31420-36130	CRT-003	31470-28040
		93.08~95.08	1RZE	RZH112K/ V		CMT-078	31420-36130	CRT-003	31470-28040
		93.08~95.08	1RZE	RZH124B		CMT-078	31420-36130	CRT-003	31470-28040
		94.10~95.04	1RZE	RZH100/ 2		5F MTM	CRT-040	31470-26090	
		94.10~95.04	1RZE	RZH112/ 124		5F MTM	CRT-040	31470-26090	
		95.05~96.10	3Y	YY101		CMT-111	31420-37050	CRT-001	31470-30260
	95.08~03.07	1RZE	RZH102V	CMT-078	31420-36130	CRT-040	31470-26110		
	95.08~03.07	1RZE	RZH112K/ V	CMT-078	31420-36130	CRT-040	31470-26110		
	95.08~03.07	1RZE	RZH124B	CMT-078	31420-36130	CRT-040	31470-26110		
	00.12~03.07	1RZE	RZH182K	CMT-078	31420-36130	CRT-040	31470-26110		
	03.07~04.08	1TRFE	TRH102V	CMT-078	31420-36130	CRT-040	31470-26110		
	03.07~04.08	1TRFE	TRH112K/ V	CMT-078	31420-36130	CRT-040	31470-26110		
	03.07~05.01	1TRFE	TRH122K/ 124B	CMT-078	31420-36130	CRT-040	31470-26110		
	04.08~06.02	1TRFE	TRH200K/ V	CMT-142	31420-26200	CRT-040	31470-26110		
	2200	82.12~84.01	L	LH50G/ 60G	FRONT DISC BRAKE	CMT-044	31420-26103	CRT-041	31470-26050
		82.12~84.01	L	LH60B/ V		CMT-044	31420-26103	CRT-041	31470-26050
		82.12~84.01	L	LH70B/ V		CMT-044	31420-26103	CRT-041	31470-26050
		82.12~85.08	L	LH50V		CMT-044	31420-26103	CRT-041	31470-26050
2400	84.01~87.08	2L	LH51G/ V		CMT-044	31420-26103	CRT-007	31470-30222	
	84.01~87.08	2L	LH61B/ G		CMT-044	31420-26103	CRT-007	31470-30222	
	84.01~87.08	2L	LH61V/ VH		CMT-044	31420-26103	CRT-007	31470-30222	
	84.01~87.08	2L	LH71B/ V		CMT-044	31420-26103	CRT-007	31470-30222	
	85.08~87.08	2L	LH80		CMT-101	31420-26142	CRT-007	31470-30222	
	85.08~89.08	2LT/ 2L	LH51G		CMT-044	31420-26103	CRT-007	31470-30222	
	86.08~87.08	2L	LH56V/ 66V		CMT-044	31420-26103	CRT-018	31470-35110	
	87.08~89.08	2L	LH61G/ 71G		CMT-044	31420-26103	CRT-007	31470-30222	
	87.10~89.10	2L	LH85		CMT-101	31420-26142	CRT-018	31470-35110	
	88.08~95.05	2L	LH80		CMT-001	31420-37040	CRT-007	31470-30222	
	89.08~90.10	2LT	LH100G		CMT-078	31420-36130	CRT-018	31470-35110	
	89.08~93.08	2L	LH100G		CMT-078	31420-36130	CRT-008	31470-26061	



Model	Year	Engine Type	Body Type	Reference					
					Aisin No.	Genuine No.	Aisin No.	Genuine No.	
HI-ACE	2400	89.08~93.08	2L	LH102V		CMT-078	31420-36130	CRT-008	31470-26061
		89.08~93.08	2L	LH110G		CMT-078	31420-36130	CRT-008	31470-26061
		89.10~95.05	2L	LH85		CMT-001	31420-37040	CRT-018	31470-35110
		90.10~93.08	2L	LH140G		CMT-078	31420-36130	CRT-008	31470-26061
		90.10~93.08	2LTE	LH100G		CMT-078	31420-36130	CRT-018	31470-35110
		90.10~93.08	2LTE	LH120G		CMT-078	31420-36130	CRT-018	31470-35110
		91.09~95.05	2L	LH90		CMT-001	31420-37040	CRT-007	31470-30222
		91.09~95.05	2L	LH95		CMT-001	31420-37040	CRT-018	31470-35110
	2500	04.08~06.02	2KDFTV	KDH200K/ V		CMT-142	31420-26200	CRT-107	31470-60201
		04.08~06.02	2KDFTV	KDH205V		CMT-142	31420-26200	CRT-107	31470-60201
	2800		89.08~93.08	3L	LH107G/ 115B	CMT-078	31420-36130	CRT-008	31470-26061
			89.08~95.08	3L	LH109V/ 119V	CMT-078	31420-36130	CRT-008	31470-26061
			89.08~95.08	3L	LH113K/ V	CMT-078	31420-36130	CRT-008	31470-26061
			89.08~95.08	3L	LH123V/ 125B	CMT-078	31420-36130	CRT-008	31470-26061
			90.10~93.08	3L	LH117G	CMT-078	31420-36130	CRT-008	31470-26061
			90.10~95.08	3L	LH129V	CMT-078	31420-36130	CRT-008	31470-26061
			93.08~95.08	3L	LH103V	CMT-078	31420-36130	CRT-008	31470-26061
			95.05~96.10	3L	LY101/ 111	CMT-001	31420-37040	CRT-007	31470-30222
			95.05~96.10	3L	LY151/ 161	CMT-001	31420-37040	CRT-018	31470-35110
			95.08~98.08	3L	LH103V/ 09V	CMT-078	31420-36130	CRT-008	31470-26061
			95.08~98.08	3L	LH113K/ V	CMT-078	31420-36130	CRT-008	31470-26061
			95.08~98.08	3L	LH119V/ 123V	CMT-078	31420-36130	CRT-008	31470-26061
			95.08~98.08	3L	LH125B/ 129V	CMT-078	31420-36130	CRT-008	31470-26061
	3000		93.08~95.08	1KZTE	KZH100G/ 110G	CMT-078	31420-36130	CRT-094	31470-26081
			93.08~95.08	1KZTE	KZH106G/ W	CMT-078	31420-36130	CRT-094	31470-26081
			93.08~95.08	1KZTE	KZH116G/ 120G	CMT-078	31420-36130	CRT-094	31470-26081
			93.08~95.08	1KZTE	KZH126G	CMT-078	31420-36130	CRT-094	31470-26081
			95.08~96.08	1KZTE	KZH100G/ 106G	CMT-078	31420-36130	CRT-094	31470-26081
			95.08~99.07	1KZTE	KZH106W/ 110G	CMT-078	31420-36130	CRT-094	31470-26081
			95.08~99.07	1KZTE	KZH116G/ 126G	CMT-078	31420-36130	CRT-094	31470-26081
3000		98.08~04.08	5L	LH162V/ 168V	CMT-078	31420-36130	CRT-008	31470-26061	
		98.08~04.08	5L	LH172K/ V	CMT-078	31420-36130	CRT-008	31470-26061	
		98.08~04.08	5L	LH178V	CMT-078	31420-36130	CRT-008	31470-26061	
		98.08~04.08	5L	LH18##	CMT-078	31420-36130	CRT-008	31470-26061	
		01.08~06.08		KLH1#,2#/	CRT-117			31470-25040	
REGIUS	2000	97.06~99.07	1RZE	RCH42V		CMT-102	31420-26182	CRT-057	31470-26100
	3000	97.06~02.05	5L	LXH43V/ 49V			31420-26190	CRT-008	31470-26061
REGIUS-ACE	2000	94.10~95.04	1RZE	RZH1##	5F MTM			CRT-040	31470-26090
		99.07~03.07	1RZE	RZH102V		CMT-078	31420-36130	CRT-040	31470-26110
		00.12~03.07	1RZE	RZH112K/ V		CMT-078	31420-36130	CRT-040	31470-26110
		00.12~03.07	1RZE	RZH182K		CMT-078	31420-36130	CRT-040	31470-26110
		03.07~04.08	1TRFE	TRH102V		CMT-078	31420-36130	CRT-040	31470-26110
		03.07~04.08	1TRFE	TRH112K/ V		CMT-078	31420-36130	CRT-040	31470-26110
		03.07~05.01	1TRFE	TRH122K		CMT-078	31420-36130	CRT-040	31470-26110



Model	Year	Engine Type	Body Type	Reference				
					Aisin No.	Genuine No.	Aisin No.	Genuine No.
REGIUS-ACE	2000	04.08~06.02	1TRFE	TRH200K/V				
	2500	04.08~06.02	2KDFTV	KDH200K/V	CMT-142	31420-26200	CRT-040	31470-26110
		04.08~06.02	2KDFTV	KDH205K	CMT-142	31420-26200	CRT-107	31470-60201
	3000	99.07~04.08	5L	LH162V/ 168V	CMT-078	31420-36130	CRT-008	31470-26061
		99.07~04.08	5L	LH172K/V	CMT-078	31420-36130	CRT-008	31470-26061
		99.07~04.08	5L	LH178V	CMT-078	31420-36130	CRT-008	31470-26061
01.08~04.08		5L	LH182K/ 188K	CMT-078	31420-36130	CRT-008	31470-26061	
RAV 4J / L (JAPAN Application)	2000	94.04~98.08	3SFE	SXA10G	CMT-045	31410-42010	CRT-050	31470-20210
		97.12~00.05	3SFE	SXA10C	CMT-045	31410-42010	CRT-022	31470-42020
		97.12~98.08	3SFE	SXA10W	CMT-045	31410-42010	CRT-022	31470-42020
		98.08~00.05	3SFE	SXA10G	CMT-045	31410-42010	CRT-022	31470-42020
RAV 4J / L	2000	95.04~98.08	3SFE	SXA11G	CMT-045	31410-42010	CRT-050	31470-20210
		96.08~98.08	3SGE	SXA10W	CMT-045	31410-42010		31470-42010
		96.08~98.08	3SGE	SXA11W	CMT-045	31410-42010		31470-42010
		97.09~98.08	3SFE	SXA15G/ 16G	CMT-045	31410-42010	CRT-022	31470-42020
		97.12~00.05	3SFE	SXA11W/ 10W	CMT-045	31410-42010	CRT-022	31470-42020
		98.08~00.05	3SFE	SXA11G/ W	CMT-045	31410-42010	CRT-022	31470-42020
		98.08~00.05	3SFE	SXA15G/ 16G	CMT-045	31410-42010	CRT-022	31470-42020
		98.08~00.05	3SGE	SXA10W/ 11W	CMT-045	31410-42010		31470-42010
		00.05~03.07	1AZFSE	ACA20W/ 21W	CMT-145	31420-42020	CRT-082	31470-42031
HI-LUX SURF	2000	84.05~85.08	3YJ	YN60V	CMT-003	31410-35142	CRT-001	31470-30260
		85.08~89.03	3YJ	YN61V	CMT-011	31410-22240	CRT-001	31470-30260
		86.08~89.03	3YEJ	YN61G	CMT-011	31410-22240	CRT-001	31470-30260
		89.04~91.08	3YE	YN130G	CMT-005	31410-35271	CRT-001	31470-30260
	2400	84.05~85.08	2L	LN60V	CMT-011	31410-22240	CRT-007	31470-30222
		84.11~86.08	2LT	LN60V/ 61V		31410-35153	CRT-007	31470-30222
		85.08~89.03	2L	LN61V	CMT-011	31410-22240	CRT-007	31470-30222
		89.04~93.08	2LT/ LTE	LN130G/ W	CMT-006	31410-35360	CRT-018	31470-35110
	2700	95.11~00.08	3RZFE	RZN185W	CMT-093	31410-35310	CRT-029	31470-35130
	2800	89.04~93.08	3L	LN131V	CMT-122	31410-35420	CRT-007	31470-30222
	3000	90.08~91.08	3VZE	VZN130G		31420-35060	CRT-004	31470-35100
		93.08~95.11	1KZTE	KZN130G	CMT-122	31410-35420	CRT-107	31470-60201
		93.08~95.11	1KZTE	KZN130W	CMT-122	31410-35420	CRT-107	31470-60201
95.11~00.08		1KZTE	KZN185G/ W	CMT-071	31410-35320	CRT-060	31470-35140	
97.02~98.07		1KZTE	KZN185	CMT-073	31410-60571			
HI-LUX	1600	78.08~85.08	12R	RN30,33,35,4#			CRT-036	31470-35030
		81.06~83.10	12R	RN36,39			CRT-044	31470-26020
	1800	83.11~85.08	2YJ/ 3YP	YN56	CMT-003	31410-35142	CRT-001	31470-30260
		84.11~85.08	2YJ	YN51	CMT-003	31410-35142	CRT-001	31470-30260
		88.09~94.08	2Y	YN80/ 85	CMT-006	31410-35360	CRT-001	31470-30260
	2000	83.11~88.08	3YJ	YN60/ 65	CMT-003	31410-35142	CRT-001	31470-30260
		88.09~94.08	3Y	YN100/ 105	CMT-005	31410-35271	CRT-001	31470-30260
		91.08~97.08	3Y/ 3YE	YN107	CMT-005	31410-35271	CRT-001	31470-30260
		94.08~97.08	3YE	YN81/ 86	CMT-005	31410-35271	CRT-028	31470-22150

Model	Year	Engine Type	Body Type	Reference					
					Aisin No.	Genuine No.	Aisin No.	Genuine No.	
HI-LUX	2000	97.08~01.08	1RZE	RZN147	with ABS	CMT-030	31410-34012	CRT-029	31470-35130
		97.08~99.08	1RZE	RZN167		CMT-030	31410-34012	CRT-029	31470-35130
	2200	84.11~85.08	L	LN50/ 55	CMT-011	31410-22240	CRT-007	31470-30222	
		2400	83.11~88.08	2L	LN5#/ 6#	CMT-011	31410-22240	CRT-007	31470-30222
	88.09~94.08		2L	LN80/ 85	CMT-005	31410-35271	CRT-007	31470-30222	
	2800	88.09~97.08	3L	LN10#	CMT-005	31410-35271	CRT-007	31470-30222	
		94.08~97.08	3L	LN81/ 86	CMT-005	31410-35271	CRT-007	31470-30222	
	3000	97.08~04.07	5L	LN147/ 167	CMT-030	31410-34012	CRT-007	31470-30222	
97.11~04.07		5L	LN172H	with ABS	CMT-030	31410-34012	CRT-007	31470-30222	
LAND CRUISER	98.01~05.05		HDJ100				CRT-116	31470-60270	
		07.01		FZJ71,78,79,VDJ7#	CMT-158	31410-60650	CRT-019	31470-60081	
		07.09		GRJ200,VDJ200	CMT-159	31420-60060			
	2400	85.10~90.01	2LT	LJ71G		31410-60332	CRT-018	31470-35110	
		3400	70.07~75.01	2B	BJ4#	CMT-041	31410-60022		
	81.10~84.10		2B	BJ4#/ BJ6#			CRT-030	31470-60110	
	84.11~87.08		3B	BJ7#	CMT-036	31410-60292		31470-60120	
	85.10~90.01		13BT	BJ71V		31401-60042	CRT-070	31470-60140	
	85.10~90.01		13BT	BJ74V		31401-60042	CRT-070	31470-60140	
	87.08~90.01		3B	BJ7#	CMT-036	31410-60292	CRT-106	31470-60130	
	3500	90.01~94.01	1PZ	PZJ70	CMT-033	31410-60432	CRT-027	31470-60171	
		90.01~94.01	1PZ	PZJ70V	CMT-081	31401-60060	CRT-027	31470-60171	
		90.04~92.08	1PZ	PZJ77HV	CMT-081	31401-60060	CRT-027	31470-60171	
		90.04~94.01	1PZ	PZJ77V	CMT-081	31401-60060	CRT-027	31470-60171	
		91.08~94.01	1PZ	PZJ77V	CMT-081	31401-60060	CRT-027	31470-60171	
	4000	87.08~90.01	3F	FJ62	CMT-032	31410-60282			
		87.08~90.01	3F	FJ62					
		90.01~92.08	3F	FJ75	CMT-098	31410-60620	CRT-021	31470-60102	
		90.06~92.08	3F	FJ75	CMT-098	31410-60400			
	4200	70.07~75.01	2F	FJ4#	CMT-041	31410-60022			
		71.09~75.01	2F	FJ55	CMT-041	31410-60022			
		74.08~80.07	2F	FJ4#			CRT-012	31470-60071	
		74.08~80.07	2F	FJ5#			CRT-012	31470-60071	
		84	2F		CMT-012	31410-60061			
		85	2F		CMT-012	31410-60061			
		90.01~91.08	1HZ	HZJ73HV	CMT-081	31401-60060	CRT-023	31470-60161	
		90.01~92.08	1HDT	HDJ81V		31401-60070	CRT-023	31470-60161	
		90.01~92.08	1HZ	HZJ81V		31410-60371	CRT-023	31470-60161	
		90.01~95.01	1HZ	HZJ73HV	CMT-081	31401-60060	CRT-023	31470-60161	
		90.04~95.01	1HZ	HZJ77HV	CMT-081	31401-60060	CRT-023	31470-60161	
		90.05~91.08	1HZ	HZJ73V	CMT-081	31401-60060	CRT-023	31470-60161	
		91.08~94.01	1HZ	HZJ73V	CMT-081	31401-60060	CRT-023	31470-60161	
92.01~92.08		1HDFT	HDJ81	MTM		CRT-053	31470-60190		
92.01~92.08		1HZ	HZJ81	MTM		CRT-053	31470-60190		
92.08~95.01	1HDFT	HDJ81	MTM		CRT-053	31470-60190			



Model	Year	Engine Type	Body Type	Reference					
					Aisin No.	Genuine No.	Aisin No.	Genuine No.	
LAND CRUISER	4200	92.08~95.01	1HZ	HZJ81	MTM			CRT-053	31470-60190
		92.12~95.01	1HZ	HZJ75		CMT-081	31401-60060	CRT-023	31470-60161
		94.01~95.01	1HZ	HZJ70V		CMT-081	31401-60060	CRT-023	31470-60161
		94.01~95.01	1HZ	HZJ77V		CMT-081	31401-60060	CRT-023	31470-60161
		94.01~96.08	1HZ	HZJ70		CMT-033	31410-60432	CRT-027	31470-60171
		94.01~96.08	1HZ	HZJ70V		CMT-081	31401-60060	CRT-023	31470-60161
		94.01~96.08	1HZ	HZJ73V		CMT-081	31401-60060	CRT-023	31470-60161
		95.01~96.08	1HZ	HZJ81V		CMT-040	31410-60372	CRT-025	31470-60180
		95.01~98.01	1HDFT	HDJ81V		CMT-040	31410-60372	CRT-025	31470-60180
		95.01~99.08	1HZ	HZJ70V		CMT-081	31401-60060	CRT-023	31470-60161
		95.01~99.08	1HZ	HZJ73HV		CMT-081	31401-60060	CRT-023	31470-60161
		95.01~99.08	1HZ	HZJ73V		CMT-081	31401-60060	CRT-023	31470-60161
		95.01~99.08	1HZ	HZJ75		CMT-081	31401-60060	CRT-023	31470-60161
		95.01~99.08	1HZ	HZJ77HV		CMT-081	31401-60060	CRT-023	31470-60161
		95.01~99.08	1HZ	HZJ77V		CMT-081	31401-60060	CRT-023	31470-60161
		96.08~99.08	1HZ	HZJ70		CMT-033	31410-60432	CRT-027	31470-60171
		98.01~02.08	1HDFTE	HDJ101K		CMT-136	31410-60610	CRT-116	31470-60270
		99.08~04.08	1HZ	HZJ71		CMT-081	31401-60060	CRT-073	31470-60290
		99.08~04.08	1HZ	HZJ71V		CMT-081	31401-60060	CRT-073	31470-60290
		99.08~04.08	1HZ	HZJ74K		CMT-081	31401-60060	CRT-073	31470-60290
		99.08~04.08	1HZ	HZJ74V		CMT-081	31401-60060	CRT-073	31470-60290
		99.08~04.08	1HZ	HZJ76K		CMT-081	31401-60060	CRT-073	31470-60290
		99.08~04.08	1HZ	HZJ76V		CMT-081	31401-60060	CRT-073	31470-60290
99.11~04.08	1HZ	HZJ79		CMT-081	31401-60060	CRT-073	31470-60290		
4500	92.08~98.01	1FZFE	FZJ80G		CMT-053	31410-60550	CRT-025	31470-60180	
LAND CRUISER PRADO	02.09~04.08		KDJ12#				CRT-118	31470-60300	
		07.07		LJ150,TRJ150,GRJ150,KDJ150		CMT-156	31420-35070		
	2400	90.04~93.05	2LTE	LJ71G78G		CMT-132	31410-60460	CRT-098	31470-35091
		91.08~93.05	2LTE	LJ78W		CMT-132	31410-60460	CRT-098	31470-35091
	3000	93.05~95.01	1KZTE	KZJ71G/W		CMT-133	31410-60530	CRT-107	31470-60201
		93.05~95.01	1KZTE	KZJ78G/W		CMT-133	31410-60530	CRT-107	31470-60201
		95.01~96.04	1KZTE	KZJ71G/W		CMT-133	31410-60530	CRT-107	31470-60201
		95.01~96.04	1KZTE	KZJ78G/W		CMT-133	31410-60530	CRT-107	31470-60201
		96.04~00.08	1KZTE	KZJ90W		CMT-135	31410-60560	CRT-060	31470-35140
		96.04~00.08	1KZTE	KZJ95W		CMT-135	31410-60560	CRT-060	31470-35140
00.08~02.11	1KDFTV	KDJ90W/95W		CMT-135	31410-60560	CRT-060	31470-35140		
3400	96.04~02.09	5VZFE	VZJ90W		CMT-074	31410-60580	CRT-014	31470-35120	
DYNA	1600	85.08~87.08	1Y	YY50		CMT-101	31420-26142	CRT-001	31470-30260
		87.08~90.08	2Y	YY51		CMT-101	31420-26142	CRT-001	31470-30260
	1800	90.08~93.09	2Y	YY51		CMT-001	31420-37040	CRT-001	31470-30260
		84.09~87.08	3Y/3YP	YU60		CMT-039	31420-36072		31470-36160
	2000	84.09~87.08	3Y	YU70V		CMT-039	31420-36072		31470-36160
		84.09~87.08	3YP	YU80		CMT-039	31420-36072		31470-36160
85.08~87.08		3Y	YY52		CMT-101	31420-26142	CRT-004	31470-35100	



Model	Year	Engine Type	Body Type	Reference					
					Aisin No.	Genuine No.	Aisin No.	Genuine No.	
DYNA	2000	85.08~87.08	3Y/ 3YP	YY61		CMT-101	31420-26142	CRT-004	31470-35100
		86.01~87.08	3Y	YU61D		CMT-039	31420-36072	CRT-079	31470-36230
		90.08~93.09	3Y	YU60		CMT-078	31420-36130	CRT-079	31470-36230
		90.08~93.09	3Y	YU61D		CMT-078	31420-36130	CRT-079	31470-36230
		90.08~93.09	3Y	YU70V		CMT-078	31420-36130	CRT-079	31470-36230
		90.08~93.09	3Y	YY52		CMT-001	31420-37040	CRT-004	31470-35100
		90.08~93.09	3Y	YY61		CMT-001	31420-37040	CRT-004	31470-35100
		93.09~95.05	3Y	YU60		CMT-078	31420-36130	CRT-066	31470-36300
		93.09~95.05	3Y	YY52		CMT-001	31420-37040	CRT-001	31470-30260
		93.09~95.05	3Y	YY61		CMT-001	31420-37040	CRT-004	31470-35100
		94.06~95.05	3YP	YY61		CMT-001	31420-37040	CRT-004	31470-35100
		95.05~96.10	3Y	YY201		CMT-111	31420-37050	CRT-001	31470-30260
		95.05~99.05	3Y/ 3YP	YY211		CMT-111	31420-37050	CRT-004	31470-35100
		96.10~01.07	3Y	YY101		CMT-111	31420-37050	CRT-001	31470-30260
		96.10~01.07	3Y	YY121		CMT-111	31420-37050	CRT-004	31470-35100
		96.10~01.07	3Y	YY131		CMT-111	31420-37050	CRT-004	31470-35100
		98.05~01.07	3YP	LY161/ 2		CMT-111	31420-37050	CRT-004	31470-35100
		99.05~01.07	3Y	YY201		CMT-111	31420-37050	CRT-004	31470-35100
		99.05~01.07	3Y/ 3YP	YY211		CMT-111	31420-37050	CRT-004	31470-35100
		01.07~06.02	1RZE	RZY220/ 230		CMT-077	31420-25040	CRT-057	31470-26100
03.05~06.02	1TRFE	TRY220/ 230	CMT-077	31420-25040	CRT-057	31470-26100			
2400	85.08~87.08	2L	LY50		CMT-101	31420-26142	CRT-018	31470-35110	
		2L	LY60		CMT-101	31420-26142	CRT-018	31470-35110	
		2L	LY50		CMT-001	31420-37040	CRT-007	31470-30222	
2500	04.08~06.02	2KDFTV	KDY2##		CMT-077	31420-25040	CRT-117	31470-25040	
2700	93.11~95.05	27LPG	BU68DH	FRONT DISC BRAKE		31401-36050		31470-37030	
		3RZFE	RZU100		CMT-111	31420-37050	CRT-081	31470-36311	
		3RZFP	RZU100A		CMT-111	31420-37050	CRT-081	31470-36311	
		3RZFP	RZU100H		CMT-111	31420-37050	CRT-081	31470-36311	
		3RZFE	RZU100A		CMT-111	31420-37050	CRT-081	31470-36311	
		3RZFE	RZU140		CMT-111	31420-37050	CRT-081	31470-36311	
		3RZFE	RZU300/ 340			31401-36061	CRT-081	31470-36311	
		3RZFPE	RZU300			31401-36061	CRT-081	31470-36311	
		3RZFPE	LY230/ 280		CMT-077	31420-25040			
		3RZFPE	RZY231H/ 281H		CMT-077	31420-25040	CRT-057	31470-26100	
		3RZFPE	RZU301			31401-36061	CRT-081	31470-36311	
		3RZFE	RZU300/ 340			31401-37011	CRT-081	31470-36311	
		3RZFPE	RZU300			31401-37011	CRT-081	31470-36311	
3RZFE	RZU300A		31401-37011	CRT-081	31470-36311				
2800	88.08~95.05	3L	LY51/ 61		CMT-001	31420-37040	CRT-018	31470-35110	
		3L	LY201/ 101		CMT-001	31420-37040	CRT-007	31470-30222	
		3L	LY211/ 121		CMT-001	31420-37040	CRT-018	31470-35110	
		3L	LY111		CMT-001	31420-37040	CRT-007	31470-30222	
		3L	LY131/ 151		CMT-001	31420-37040	CRT-018	31470-35110	



Model	Year	Engine Type	Body Type	Reference					
					Aisin No.	Genuine No.	Aisin No.	Genuine No.	
DYNA	2800	96.10~99.05	3L	LY161					
	3000	84.09~87.08	B	BU60/ 80		CMT-001	31420-37040	CRT-018	31470-35110
		84.09~87.08	B	BU70V/ VH		CMT-039	31420-36072	CRT-045	31470-36130
		85.01~87.08	11B	BU61/ 81		CMT-039	31420-36072	CRT-045	31470-36130
		88.08~93.09	B	BU83		CMT-078	31420-36130	CRT-006	31470-36213
		88.08~95.05	11B	BU61/ 84		CMT-078	31420-36130	CRT-006	31470-36213
		90.08~95.05	B	BU60		CMT-078	31420-36130	CRT-006	31470-36213
		90.08~95.05	B	BU70V/ VH		CMT-078	31420-36130	CRT-006	31470-36213
		99.05~01.07	5L	LY102/ 112		CMT-001	31420-37040	CRT-007	31470-30222
		99.05~01.07	5L	LY122/ 132		CMT-001	31420-37040	CRT-018	31470-35110
		99.05~01.07	5L	LY152/ 162		CMT-001	31420-37040	CRT-018	31470-35110
		99.05~01.07	5L	LY202/ 212		CMT-001	31420-37040	CRT-018	31470-35110
		01.07~04.08	5L	LY220		CMT-077	31420-25040	CRT-018	31470-35110
		01.07~04.08	5L	LY230		CMT-077	31420-25040	CRT-007	31470-30222
		01.07~04.08	5L	LY230		CMT-077	31420-25040	CRT-018	31470-35110
		01.07~04.08	5L	LY240V		CMT-077	31420-25040	CRT-018	31470-35110
		01.07~04.08	5L	LY270/ 280		CMT-077	31420-25040	CRT-018	31470-35110
		01.07~04.08	5L	LY290V		CMT-077	31420-25040	CRT-018	31470-35110
	3400	84.09~87.08	13B	BU62#		CMT-039	31420-36072	CRT-045	31470-36130
		84.09~87.08	13B	BU64/ 64D		CMT-039	31420-36072	CRT-045	31470-36130
		84.09~87.08	13B	BU82		CMT-039	31420-36072	CRT-045	31470-36130
		84.09~87.08	13B	BU85/ 85V		CMT-039	31420-36072	CRT-045	31470-36130
		84.09~87.08	13BT	BU85/ 90/ 95	W/ CLUTCH BOOSTER	CMT-063	31401-36013		31470-36151
		85.10~87.08	13B	BU77	FRONT DISC BRAKE	CMT-039	31420-36072	CRT-016	31470-36221
		85.10~87.08	13B	BU98		CMT-039	31420-36072	CRT-016	31470-36221
		86.03~87.08	13B	BU93		CMT-039	31420-36072	CRT-016	31470-36221
		89.10~95.05	3B	BU68DH			31401-36050	CRT-006	31470-36213
		95.05~97.08	3B	BU140		CMT-001	31420-37040	CRT-006	31470-36213
95.05~99.05		3B	BU100		CMT-001	31420-37040	CRT-006	31470-36213	
95.05~99.05		3B	BU100A	FRONT DISC BRAKE	CMT-001	31420-37040	CRT-006	31470-36213	
95.05~99.05		3B	BU120V		CMT-001	31420-37040	CRT-006	31470-36213	
97.08~99.05		3B	BU105	FRONT DISC BRAKE	CMT-001	31420-37040	CRT-006	31470-36213	
97.08~99.05		3B	BU145	FRONT DISC BRAKE	CMT-001	31420-37040	CRT-006	31470-36213	
3700		88.08~95.05	14B	BU66#		CMT-063	31401-36013	CRT-006	31470-36213
		88.08~95.05	14B	BU67#		CMT-063	31401-36013	CRT-006	31470-36213
	88.08~95.05	14B	BU87		CMT-063	31401-36013	CRT-006	31470-36213	
	88.08~95.05	14B	BU87V		CMT-078	31420-36130	CRT-006	31470-36213	
	88.08~95.05	14B	BU88		CMT-063	31401-36013	CRT-006	31470-36213	
	88.08~95.05	14B	BU9#		CMT-063	31401-36013	CRT-006	31470-36213	
	89.10~92.10	14B	BU7##			31401-36050	CRT-006	31470-36213	
	89.10~95.05	14BT	BU88			31401-36050	CRT-006	31470-36213	
	89.10~95.05	14BT	BU91			31401-36050	CRT-006	31470-36213	
	89.10~95.05	14BT	BU96			31401-36050	CRT-006	31470-36213	
	90.08~95.05	14B	BU66DH			31401-36050	CRT-006	31470-36213	



Model	Year	Engine Type	Body Type	Reference					
					Aisin No.	Genuine No.	Aisin No.	Genuine No.	
DYNA	3700	90.08~95.05	14BT	BU94		31401-36050	CRT-006	31470-36213	
		99.05~04.06	4B	BU306		31401-36061	CRT-006	31470-36213	
		99.05~04.06	4B	BU306V		31401-36061	CRT-006	31470-36213	
		99.05~04.06	4B	BU346		31401-36061	CRT-006	31470-36213	
		99.07~04.06	4B	BU301/ 301A		31401-36061	CRT-006	31470-36213	
	4000	84.09~87.08	1W	WU75D		CMT-039	31420-36072		31470-36140
		84.09~87.08	1W	WU90		CMT-039	31420-36072		31470-36140
		84.09~87.08	1W	WU95		CMT-039	31420-36072		31470-36140
		89.10~95.05	1W	WU75D			31401-36050		31470-36281
		89.10~95.05	1W	WU85			31401-36050	CRT-006	31470-36213
		89.10~95.05	1W	WU90					31470-36281
		89.10~95.05	1W	WU95			31401-36050		31470-36281
		91.09~95.05	1W	WU93			31401-36050	CRT-006	31470-36213
	4100	95.05~96.10	15BF	BU102/ 142			31401-36061	CRT-006	31470-36213
		95.05~97.08	15BF	BU122V			31401-36061	CRT-006	31470-36213
		95.05~97.08	15BF	BU212/ 222			31401-36061	CRT-006	31470-36213
		95.05~97.08	15BFT	BU212/ 222			31401-36061	CRT-035	31470-37040
		95.05~97.10	15B	FB5BCAT			S3142-01660		S3142-01730
		95.05~97.10	15B	FB5BEAT			S3142-01660		S3142-01730
		95.05~97.10	15B	FB5BGAT			S3142-01660		S3142-01730
		95.05~99.05	15BF	BU102A/ H	FRONT DISC BRAKE		31401-36061	CRT-006	31470-36213
		95.05~99.05	15BF	BU102D			31401-36061	CRT-006	31470-36213
		95.05~99.05	15BF	BU112/ D			31401-36061	CRT-006	31470-36213
		95.05~99.05	15BF	BU132			31401-36061	CRT-006	31470-36213
		95.05~99.05	15BF	BU162#			31401-36061	CRT-006	31470-36213
		95.05~99.05	15BF	BU172			31401-36061	CRT-006	31470-36213
		95.05~99.05	15BF	BU202			31401-36061	CRT-006	31470-36213
		96.05~99.05	15BFP	BU142	FRONT DISC BRAKE		31401-36061	CRT-035	31470-37040
		96.10~99.05	15BF	BU112A			31401-36061	CRT-035	31470-37040
		96.10~99.05	15BF	BU137			31401-36061	CRT-006	31470-36213
		97.08~99.05	15BF	BU107	FRONT DISC BRAKE		31401-36061	CRT-006	31470-36213
		97.08~99.05	15BF	BU147	FRONT DISC BRAKE		31401-36061	CRT-006	31470-36213
		97.08~99.05	15BF	BU182			31401-36061	CRT-006	31470-36213
97.08~99.05		15BF	BU212K			31401-36061	CRT-102	31470-37050	
97.08~99.05		15BFP	BU102A	FRONT DISC BRAKE		31401-36061	CRT-035	31470-37040	
97.08~99.05		15BFP	BU102H	FRONT DISC BRAKE		31401-36061	CRT-035	31470-37040	
97.11~99.05		15B	FB4JEAT			S3222-81031		S3142-01730	
99.05~00.07		15BFP	RZU100A			31401-36061	CRT-081	31470-36311	
99.05~00.07		15BFP	RZU100H			31401-36061	CRT-081	31470-36311	
99.08~02.06		15BFTE	BU400~430			31401-36061	CRT-102	31470-37050	
00.05~04.06	15BLPG	XZU301A/ H			31401-36061	CRT-102	31470-37050		
00.05~04.06	15BLPG	XZU341			31401-36061	CRT-102	31470-37050		
00.10~04.06	15BCNG	XZU301A			31401-36061	CRT-102	31470-37050		
00.10~04.06	15BCNG/ LPG	XZU302			31401-36061	CRT-102	31470-37050		

Model	Year	Engine Type	Body Type	Reference	Clutch Master Cylinder		Clutch Release Cylinder	
					Aisin No.	Genuine No.	Aisin No.	Genuine No.
DYNA	4100	01.08~03.06	15BCNG/ LPG	XZU412		31401-36061	CRT-102	31470-37050
		01.08~04.06	15BCNG/ LPG	XZU342		31401-36061	CRT-102	31470-37050
		03.06~06.02	1BZFNE/ FPE	BZU300		31401-36061	CRT-102	31470-37050
		03.06~06.02	1BZFNE	BZU300A		31401-36061	CRT-102	31470-37050
		03.06~06.02	1BZFNE/ FPE	BZU340		31401-36061	CRT-102	31470-37050
		03.06~06.02	1BZFNE/ FPE	BZU410		31401-36061	CRT-102	31470-37050
		03.06~06.02	1BZFPE	BZU300A		31401-36061	CRT-102	31470-37050
		03.10~06.02	N04C	XKU304H		31401-36061	CRT-051	31470-37080
		03.10~06.02	N04C	XKU344		31401-36061	CRT-051	31470-37080
		03.10~06.02	N04C	XKU414/ 24		31401-36061	CRT-051	31470-37080
		03.10~06.02	N04C	XZU304#		31401-36061	CRT-051	31470-37080
		03.10~06.02	N04C	XZU305A		31401-36061	CRT-051	31470-37080
		03.10~06.02	N04C	XZU344		31401-36061	CRT-051	31470-37080
		03.10~06.02	N04C	XZU414/ 15		31401-37011	CRT-051	31470-37080
		04.06~06.02	N04C	XZU308/ V		31401-37011	CRT-051	31470-37080
		04.06~06.02	N04C	XZU314D		31401-37011	CRT-051	31470-37080
		04.06~06.02	N04C	XZU334/ 8		31401-37011	CRT-051	31470-37080
		04.06~06.02	N04C	XZU348		31401-37011	CRT-051	31470-37080
		04.06~06.02	N04C	XZU354D		31401-37011	CRT-051	31470-37080
		04.06~06.02	N04C	XZU354H		31401-37011	CRT-051	31470-37080
	04.06~06.02	N04C	XZU368		31401-37011	CRT-051	31470-37080	
	04.06~06.02	N04C	XZU368D		31401-37011	CRT-051	31470-37080	
	04.06~06.02	N04C	XZU378/ 388		31401-37011	CRT-051	31470-37080	
	04.06~06.02	N04C	XZU404#		31401-37011	CRT-051	31470-37080	
	04.06~06.02	N04C	XZU424		31401-37011	CRT-051	31470-37080	
	4600	99.05~02.06	S05C	XZU412		31401-36061		31470-37061
		99.05~04.06	S05C	XZU302#		31401-36061	CRT-051	31470-37080
		99.05~04.06	S05C	XZU307		31401-36061	CRT-051	31470-37080
		99.05~04.06	S05C	XZU322/ D		31401-36061	CRT-051	31470-37080
		99.05~04.06	S05C	XZU337/ 47		31401-36061	CRT-051	31470-37080
		99.05~04.06	S05C	XZU352D		31401-36061	CRT-051	31470-37080
		99.05~04.06	S05C	XZU402		31401-36061		31470-37061
		99.07~04.06	S05C	XZU302		31401-36061	CRT-051	31470-37080
99.07~04.06		S05C	XZU362#		31401-36061	CRT-051	31470-37080	
99.08~04.06		S05C	XZU307V		31401-36061	CRT-051	31470-37080	
99.08~04.06		S05C	XZU312D		31401-36061	CRT-051	31470-37080	
99.08~04.06		S05C	XZU372		31401-36061	CRT-051	31470-37080	
99.08~04.06		S05C	XZU382		31401-36061	CRT-035	31470-37040	
00.05~04.06	S05C	XZU342		31401-36061	CRT-051	31470-37080		
4800	04.06~06.02	J05D	XZU413/ 23/ 33		31401-37011	CRT-051	31470-37080	
4900	99.05~02.06	S05D	XZU311A		31401-36061	CRT-035	31470-37040	
	99.05~02.06	S05D	XZU321A		31401-36061	CRT-035	31470-37040	
	99.05~02.06	S05D	XZU321D		31401-36061	CRT-051	31470-37080	
	99.05~02.06	S05D	XZU411/ 21		31401-36061		31470-37061	



Model	Year	Engine Type	Body Type	Reference						
					Aisin No.	Genuine No.	Aisin No.	Genuine No.		
DYNA	4900	99.05~04.06	S05D	XZU301#		31401-36061	CRT-051	31470-37080		
		99.05~04.06	S05D	XZU306		31401-36061	CRT-051	31470-37080		
		99.05~04.06	S05D	XZU331		31401-36061	CRT-051	31470-37080		
		99.05~04.06	S05D	XZU341		31401-36061	CRT-051	31470-37080		
		99.05~04.06	S05D	XZU346		31401-36061	CRT-051	31470-37080		
		99.05~04.06	S05D	XZU351D		31401-36061	CRT-051	31470-37080		
		99.05~04.06	S05D	XZU401		31401-36061		31470-37061		
		99.08~02.06	S05D	XZU311D		31401-36061	CRT-051	31470-37080		
		99.08~04.06	S05D	XZU371		31401-36061	CRT-051	31470-37080		
		00.05~04.06	S05D	XZU301		31401-36061	CRT-051	31470-37080		
		04.06~06.02	S05D	XZU301#		31401-37011	CRT-051	31470-37080		
		04.06~06.02	S05D	XZU306		31401-37011	CRT-051	31470-37080		
		04.06~06.02	S05D	XZU306V		31401-37011	CRT-051	31470-37080		
		04.06~06.02	S05D	XZU311D		31401-37011	CRT-051	31470-37080		
		04.06~06.02	S05D	XZU321D		31401-37011	CRT-051	31470-37080		
		04.06~06.02	S05D	XZU331		31401-37011	CRT-051	31470-37080		
		04.06~06.02	S05D	XZU336		31401-37011	CRT-051	31470-37080		
		04.06~06.02	S05D	XZU341		31401-37011	CRT-051	31470-37080		
		04.06~06.02	S05D	XZU346		31401-37011	CRT-051	31470-37080		
		04.06~06.02	S05D	XZU351D		31401-37011	CRT-051	31470-37080		
		04.06~06.02	S05D	XZU401		31401-37011	CRT-051	31470-37080		
		04.06~06.02	S05D	XZU411		31401-37011		31470-37061		
		04.06~06.02	S05D	XZU421		31401-37011	CRT-051	31470-37080		
		5300		95.05~97.10	J05C	FB4JCAD		S3142-01660		S3142-01730
				95.05~97.10	J05C	FB4JEAT		S3142-01660		S3142-01730
				95.05~97.10	J05C	FB4JGAK		S3142-01660		S3142-01730
95.05~97.10	J05C			FB4JGAT		S3142-01660		S3142-01730		
95.10~99.05	J05C			XZU130A		31401-36061	CRT-035	31470-37040		
97.08~99.05	J05C			XZU140		31401-36061	CRT-035	31470-37040		
99.05~04.06	J05C			XZU400		31401-36061		31470-37061		
99.05~04.06	J05C			XZU400A		31401-36061		31470-37061		
99.05~04.06	J05C			XZU410		31401-36061		31470-37061		
99.05~04.06	J05C			XZU420		31401-36061		31470-37061		
99.05~04.06	J05C			XZU430		31401-36061		31470-37061		
99.06~02.06	J05C			XZU320A		31401-36061	CRT-035	31470-37040		
99.06~04.06	J05C			XZU300H		31401-36061	CRT-051	31470-37080		
99.06~04.06	J05C			XZU330		31401-36061	CRT-051	31470-37080		
99.06~04.06	J05C			XZU340		31401-36061	CRT-051	31470-37080		
99.06~04.06	J05C			XZU350H		31401-36061	CRT-051	31470-37080		
TOYO-ACE	1600	85.08~87.08	1Y	YY50		CMT-101	31420-26142	CRT-001	31470-30260	
		87.08~90.08	2Y	YY51		CMT-101	31420-26142	CRT-001	31470-30260	
	2000	90.08~93.09	2Y	YY51		CMT-001	31420-37040	CRT-001	31470-30260	
		85.08~87.08	3Y	YU60		CMT-039	31420-36072	CRT-079	31470-36230	
		85.08~87.08	3Y	YY52		CMT-101	31420-26142	CRT-004	31470-35100	

Model	Year	Engine Type	Body Type	Reference					
					Aisin No.	Genuine No.	Aisin No.	Genuine No.	
TOYO-ACE	2000	85.08~87.08	3Y	YY61		CMT-101	31420-26142	CRT-004	31470-35100
		85.08~87.08	3YP	YU60		CMT-039	31420-36072	CRT-079	31470-36230
		85.08~87.08	3YP	YU80		CMT-039	31420-36072	CRT-079	31470-36230
		85.08~87.08	3YP	YY61		CMT-101	31420-26142	CRT-004	31470-35100
		86.01~87.08	3Y	YU61D		CMT-039	31420-36072	CRT-079	31470-36230
		90.08~93.09	3Y	YU60		CMT-078	31420-36130	CRT-079	31470-36230
		90.08~93.09	3Y	YU61D		CMT-078	31420-36130	CRT-079	31470-36230
		90.08~93.09	3Y	YY52		CMT-001	31420-37040	CRT-004	31470-35100
		90.08~95.05	3Y/ 3YP	YY61		CMT-001	31420-37040	CRT-004	31470-35100
		93.09~95.05	3Y	YU60		CMT-078	31420-36130	CRT-057	31470-26100
		93.09~95.05	3Y	YY52		CMT-001	31420-37040	CRT-001	31470-30260
		95.05~01.07	3Y	YY201		CMT-111	31420-37050	CRT-001	31470-30260
		95.05~01.07	3Y/ 3YP	YY211		CMT-111	31420-37050	CRT-004	31470-35100
		96.10~01.07	3Y	YY101		CMT-111	31420-37050	CRT-001	31470-30260
		96.10~01.07	3Y	YY121		CMT-111	31420-37050	CRT-004	31470-35100
		96.10~01.07	3Y	YY131		CMT-111	31420-37050	CRT-004	31470-35100
		98.05~99.05	3YP	LY161		CMT-111	31420-37050	CRT-004	31470-35100
	99.05~01.07	3YP	LY162	CMT-111	31420-37050	CRT-004	31470-35100		
	01.07~06.02	1RZE	RZY220/ 230	CMT-077	31420-25040	CRT-057	31470-26100		
	03.05~06.02	1TRFE	TRY220/ 230	CMT-077	31420-25040	CRT-057	31470-26100		
	2400	85.08~87.08	2L	LY50/ 60		CMT-101	31420-26142	CRT-018	31470-35110
		88.08~95.05	2L	LY50		CMT-001	31420-37040	CRT-007	31470-30222
	2500	81.07~83.08	2J	JY30				CRT-044	31470-26020
		04.08~06.02	2KDFTV	KDY220/ 230		CMT-077	31420-25040	CRT-117	31470-25040
		04.08~06.02	2KDFTV	KDY240V		CMT-077	31420-25040	CRT-117	31470-25040
		04.08~06.02	2KDFTV	KDY270/ 280		CMT-077	31420-25040	CRT-117	31470-25040
	04.08~06.02	2KDFTV	KDY290V	CMT-077	31420-25040	CRT-117	31470-25040		
2700	93.11~95.05	27LPG	BU68DH	FRONT DISC BRAKE		31401-36050		31470-37030	
	95.05~00.07	3RZFE	RZU100		CMT-111	31420-37050	CRT-081	31470-36311	
	95.05~99.05	3RZFP	RZU100A		CMT-111	31420-37050	CRT-081	31470-36311	
	95.05~99.05	3RZFP	RZU100H		CMT-111	31420-37050	CRT-081	31470-36311	
	97.08~00.07	3RZFE	RZU100A		CMT-111	31420-37050	CRT-081	31470-36311	
	97.08~00.07	3RZFE	RZU140		CMT-111	31420-37050	CRT-081	31470-36311	
	99.05~00.07	3RZFP	RZU100A		CMT-111	31420-37050	CRT-081	31470-36311	
	99.05~00.07	3RZFP	RZU100H		CMT-111	31420-37050	CRT-081	31470-36311	
	00.05~04.06	3RZFE/ FPE	RZU300			31401-36061	CRT-081	31470-36311	
	00.05~04.06	3RZFE	RZU340			31401-36061	CRT-081	31470-36311	
	01.07~04.08	3RZFPE	LY230/ 280		CMT-077	31420-25040			
	03.05~06.02	3RZFPE	RZY231H		CMT-077	31420-25040	CRT-057	31470-26100	
	03.05~06.02	3RZFPE	RZY281H		CMT-077	31420-25040	CRT-057	31470-26100	
	03.06~06.02	3RZFPE	RZU301			31401-36061	CRT-081	31470-36311	
	04.06~06.02	3RZFE/ FPE	RZU300			31401-37011	CRT-081	31470-36311	
	04.06~06.02	3RZFE	RZU340			31401-37011	CRT-081	31470-36311	
	05.05~06.02	3RZFE	RZU300A			31401-37011	CRT-081	31470-36311	



Model	Year	Engine Type	Body Type	Reference					
					Aisin No.	Genuine No.	Aisin No.	Genuine No.	
TOYO-ACE	2800	88.08~95.05	3L	LY51		CMT-001	31420-37040	CRT-018	31470-35110
		88.08~95.05	3L	LY61		CMT-001	31420-37040		
		95.05~96.10	3L	LY201		CMT-001	31420-37040		
		95.05~96.10	3L	LY211		CMT-001	31420-37040	CRT-018	31470-35110
		96.10~99.05	3L	LY101		CMT-001	31420-37040	CRT-007	31470-30222
		96.10~99.05	3L	LY111		CMT-001	31420-37040		
		96.10~99.05	3L	LY121		CMT-001	31420-37040		
		96.10~99.05	3L	LY131		CMT-001	31420-37040	CRT-018	31470-35110
		96.10~99.05	3L	LY151		CMT-001	31420-37040		
	96.10~99.05	3L	LY161		CMT-001	31420-37040	CRT-018	31470-35110	
	3000	85.08~87.08	11B	BU61		CMT-039	31420-36072		
		85.08~87.08	11B	BU81		CMT-039	31420-36072	CRT-016	31470-36221
		85.08~87.08	B	BU60		CMT-039	31420-36072		
		85.08~87.08	B	BU80/ 81		CMT-039	31420-36072	CRT-016	31470-36221
		88.08~93.09	B	BU83		CMT-078	31420-36130	CRT-006	31470-36213
		88.08~95.05	11B	BU61		CMT-078	31420-36130	CRT-006	31470-36213
		88.08~95.05	11B	BU84		CMT-078	31420-36130	CRT-006	31470-36213
		90.08~95.05	B	BU60		CMT-078	31420-36130	CRT-006	31470-36213
		99.05~01.07	5L	LY102		CMT-001	31420-37040		
		99.05~01.07	5L	LY112		CMT-001	31420-37040	CRT-007	31470-30222
		99.05~01.07	5L	LY122		CMT-001	31420-37040		
		99.05~01.07	5L	LY132		CMT-001	31420-37040	CRT-018	31470-35110
		99.05~01.07	5L	LY152		CMT-001	31420-37040		
		99.05~01.07	5L	LY162		CMT-001	31420-37040	CRT-018	31470-35110
		99.05~01.07	5L	LY202		CMT-001	31420-37040	CRT-018	31470-35110
		99.05~01.07	5L	LY212		CMT-001	31420-37040		
		01.07~04.08	5L	LY220		CMT-077	31420-25040	CRT-018	31470-35110
		01.07~04.08	5L	LY230		CMT-077	31420-25040	CRT-018	31470-35110
		01.07~04.08	5L	LY230		CMT-077	31420-25040	CRT-007	31470-30222
		01.07~04.08	5L	LY240V		CMT-077	31420-25040	CRT-018	31470-35110
		01.07~04.08	5L	LY270/ 280		CMT-077	31420-25040	CRT-018	31470-35110
		01.07~04.08	5L	LY290V		CMT-077	31420-25040	CRT-018	31470-35110
		3400	85.08~87.08	13B	BU62#		CMT-039	31420-36072	CRT-016
85.08~87.08			13B	BU64#		CMT-039	31420-36072	CRT-016	31470-36221
85.08~87.08	13B		BU82/ 85		CMT-039	31420-36072	CRT-016	31470-36221	
85.08~87.08	13B		BU98		CMT-039	31420-36072	CRT-016	31470-36221	
85.08~87.08	13BT		BU85	W/ CLUTCH BOOSTER	CMT-063	31401-36013	CRT-006	31470-36213	
85.08~87.08	13BT		BU90	W/ CLUTCH BOOSTER	CMT-063	31401-36013	CRT-006	31470-36213	
85.08~87.08	13BT		BU95	W/ CLUTCH BOOSTER	CMT-063	31401-36013	CRT-006	31470-36213	
85.10~87.08	13B		BU77	FRONT DISC BRAKE	CMT-039	31420-36072	CRT-016	31470-36221	
86.03~87.08	13B		BU93		CMT-039	31420-36072	CRT-016	31470-36221	
89.10~95.05	3B		BU68DH			31401-36050	CRT-006	31470-36213	
95.05~97.08	3B		BU140		CMT-001	31420-37040	CRT-006	31470-36213	
95.05~99.05	3B		BU100		CMT-001	31420-37040	CRT-006	31470-36213	

Model	Year	Engine Type	Body Type	Reference					
					Aisin No.	Genuine No.	Aisin No.	Genuine No.	
TOYO-ACE	3400	95.05~99.05	3B	BU100A	FRONT DISC BRAKE	CMT-001	31420-37040	CRT-006	31470-36213
		97.08~99.05	3B	BU105	FRONT DISC BRAKE	CMT-001	31420-37040	CRT-006	31470-36213
		97.08~99.05	3B	BU145		CMT-001	31420-37040	CRT-006	31470-36213
	3700	88.08~95.05	14B	BU66#		CMT-063	31401-36013	CRT-006	31470-36213
		88.08~95.05	14B	BU67#		CMT-063	31401-36013	CRT-006	31470-36213
		88.08~95.05	14B	BU87/ 88		CMT-063	31401-36013	CRT-006	31470-36213
		88.08~95.05	14B	BU91		CMT-063	31401-36013	CRT-006	31470-36213
		88.08~95.05	14B	BU94		CMT-063	31401-36013	CRT-006	31470-36213
		88.08~95.05	14B	BU96		CMT-063	31401-36013	CRT-006	31470-36213
		89.10~95.05	14B	BU72#			31401-36050	CRT-006	31470-36213
		89.10~95.05	14B/ BT	BU74/ 78/ 88			31401-36050	CRT-006	31470-36213
		89.10~95.05	14BT	BU91			31401-36050	CRT-006	31470-36213
		89.10~95.05	14BT	BU96			31401-36050	CRT-006	31470-36213
		90.08~95.05	14B	BU66DH			31401-36050	CRT-006	31470-36213
		90.08~95.05	14BT	BU94			31401-36050	CRT-006	31470-36213
		91.09~95.05	14B	BU73			31401-36050	CRT-006	31470-36213
		99.05~04.06	4B	BU306			31401-36061	CRT-006	31470-36213
		99.05~04.06	4B	BU306V			31401-36061	CRT-006	31470-36213
		99.05~04.06	4B	BU346			31401-36061	CRT-006	31470-36213
		99.07~02.06	4B	BU301A			31401-36061	CRT-006	31470-36213
	99.07~04.06	4B	BU301			31401-36061	CRT-006	31470-36213	
	4000	85.08~87.08	1W	WU75D		CMT-039	31420-36072		31470-36140
		85.08~87.08	1W	WU90		CMT-039	31420-36072		31470-36140
		85.08~87.08	1W	WU95		CMT-039	31420-36072		31470-36140
		89.10~95.05	1W	WU75D			31401-36050		31470-36281
		89.10~95.05	1W	WU85			31401-36050	CRT-006	31470-36213
		89.10~95.05	1W	WU90			31401-36050		31470-36281
		89.10~95.05	1W	WU95			31401-36050		31470-36281
		91.09~95.05	1W	WU93			31401-36050	CRT-006	31470-36213
	4100	95.05~96.10	15BF	BU102			31401-36061	CRT-006	31470-36213
		95.05~96.10	15BF	BU142			31401-36061	CRT-006	31470-36213
		95.05~97.08	15BF	BU212	with ABS		31401-36061	CRT-006	31470-36213
		95.05~97.08	15BF	BU222			31401-36061	CRT-006	31470-36213
95.05~97.08		15BFT	BU212	with ABS		31401-36061	CRT-035	31470-37040	
95.05~97.08		15BFT	BU222			31401-36061	CRT-035	31470-37040	
95.05~97.10		15B	FB5BCAT			S3142-01660		S3142-01730	
95.05~97.10		15B	FB5BEAT			S3142-01660		S3142-01730	
95.05~97.10		15B	FB5BGAT			S3142-01660		S3142-01730	
95.05~99.05		15BF	BU102A	FRONT DISC BRAKE		31401-36061	CRT-006	31470-36213	
95.05~99.05		15BF	BU102D			31401-36061	CRT-006	31470-36213	
95.05~99.05		15BF	BU102H	FRONT DISC BRAKE		31401-36061	CRT-035	31470-37040	
95.05~99.05		15BF	BU112/ 112D			31401-36061	CRT-006	31470-36213	
95.05~99.05		15BF	BU132			31401-36061	CRT-006	31470-36213	
95.05~99.05		15BF	BU162#			31401-36061	CRT-006	31470-36213	

Model	Year	Engine Type	Body Type	Reference				
					Aisin No.	Genuine No.	Aisin No.	Genuine No.
TOYO-ACE	4100	95.05~99.05	15BF	BU172		31401-36061	CRT-006	31470-36213
		95.05~99.05	15BF	BU182		31401-36061	CRT-006	31470-36213
		95.05~99.05	15BF	BU202		31401-36061	CRT-006	31470-36213
		96.05~99.05	15BFP	BU142	FRONT DISC BRAKE	31401-36061	CRT-035	31470-37040
		96.10~99.05	15BF	BU112A		31401-36061	CRT-035	31470-37040
		96.10~99.05	15BF	BU137/ 147		31401-36061	CRT-006	31470-36213
		97.08~99.05	15BF	BU107	FRONT DISC BRAKE	31401-36061	CRT-006	31470-36213
		97.08~99.05	15BFP	BU102A	FRONT DISC BRAKE	31401-36061	CRT-035	31470-37040
		97.08~99.05	15BFP	BU102H	FRONT DISC BRAKE	31401-36061	CRT-035	31470-37040
		97.11~99.05	15B	FB4JEAT		S3222-81031		S3142-01730
		97.12~99.06	15BF	BU212K		31401-36061	CRT-102	31470-37050
		99.05~00.07	15BFP	RZU100A/ H		31401-36061	CRT-081	31470-36311
		99.08~02.06	15BFTE	BU400~430		31401-36061	CRT-102	31470-37050
		00.05~04.06	15BLPG/ CNG	XZU301A		31401-36061	CRT-102	31470-37050
		00.05~04.06	15BLPG	XZU301H		31401-36061	CRT-102	31470-37050
		00.05~04.06	15BLPG	XZU341		31401-36061	CRT-102	31470-37050
		00.10~04.06	15BCNG/ LPG	XZU302		31401-36061	CRT-102	31470-37050
		01.08~03.06	15BCNG/ LPG	XZU412		31401-36061	CRT-102	31470-37050
		01.08~04.06	15BCNG/ LPG	XZU342		31401-36061	CRT-102	31470-37050
		03.06~06.02	1BZFNE/ FPE	BZU300		31401-36061	CRT-102	31470-37050
		03.06~06.02	1BZFNE/ FPE	BZU300A		31401-36061	CRT-102	31470-37050
		03.06~06.02	1BZFNE/ FPE	BZU340		31401-36061	CRT-102	31470-37050
		03.06~06.02	1BZFNE/ FPE	BZU410		31401-36061	CRT-102	31470-37050
		03.10~06.02	N04C	XKU304H		31401-36061	CRT-051	31470-37080
		03.10~06.02	N04C	XKU344		31401-36061	CRT-051	31470-37080
		03.10~06.02	N04C	XKU414		31401-36061	CRT-051	31470-37080
		03.10~06.02	N04C	XKU424		31401-36061	CRT-051	31470-37080
		03.10~06.02	N04C	XZU304#		31401-36061	CRT-051	31470-37080
		03.10~06.02	N04C	XZU305A		31401-36061	CRT-051	31470-37080
		03.10~06.02	N04C	XZU344		31401-36061	CRT-051	31470-37080
		03.10~06.02	N04C	XZU414/ 5		31401-37011	CRT-051	31470-37080
		04.06~06.02	N04C	XZU308/ V		31401-37011	CRT-051	31470-37080
		04.06~06.02	N04C	XZU314D		31401-37011	CRT-051	31470-37080
		04.06~06.02	N04C	XZU334		31401-37011	CRT-051	31470-37080
		04.06~06.02	N04C	XZU338/ 48		31401-37011	CRT-051	31470-37080
		04.06~06.02	N04C	XZU354D		31401-37011	CRT-051	31470-37080
		04.06~06.02	N04C	XZU354H		31401-37011	CRT-051	31470-37080
		04.06~06.02	N04C	XZU368		31401-37011	CRT-051	31470-37080
		04.06~06.02	N04C	XZU368D/ 378/ 388		31401-37011	CRT-051	31470-37080
		04.06~06.02	N04C	XZU404/ A		31401-37011	CRT-051	31470-37080
04.06~06.02	N04C	XZU424		31401-37011	CRT-051	31470-37080		
4600	99.05~02.06	S05C	XZU412			31401-36061		31470-37061
		S05C	XZU302#			31401-36061	CRT-051	31470-37080
		S05C	XZU307/ V			31401-36061	CRT-051	31470-37080

Model	Year	Engine Type	Body Type	Reference				
					Aisin No.	Genuine No.	Aisin No.	Genuine No.
TOYO-ACE	4600	99.05~04.06	S05C	XZU322/ D		31401-36061	CRT-051	31470-37080
		99.05~04.06	S05C	XZU337/ 47		31401-36061	CRT-051	31470-37080
		99.05~04.06	S05C	XZU352D		31401-36061	CRT-051	31470-37080
		99.05~04.06	S05C	XZU402		31401-36061		31470-37061
		99.07~04.06	S05C	XZU302		31401-36061	CRT-051	31470-37080
		99.07~04.06	S05C	XZU362#		31401-36061	CRT-051	31470-37080
		99.08~04.06	S05C	XZU312D		31401-36061	CRT-051	31470-37080
		99.08~04.06	S05C	XZU372		31401-36061	CRT-051	31470-37080
		99.08~04.06	S05C	XZU382		31401-36061	CRT-035	31470-37040
	00.05~04.06	S05C	XZU342		31401-36061	CRT-051	31470-37080	
	4800	04.06~06.02	J05D	XZU413/ 23/ 33		31401-37011	CRT-051	31470-37080
	4900	99.05~02.06	S05D	XZU311A/ 21A		31401-36061	CRT-035	31470-37040
		99.05~02.06	S05D	XZU411/ 21		31401-36061		31470-37061
		99.05~04.06	S05D	XZU301#		31401-36061	CRT-051	31470-37080
		99.05~04.06	S05D	XZU306		31401-36061	CRT-051	31470-37080
		99.05~04.06	S05D	XZU321D		31401-36061	CRT-051	31470-37080
		99.05~04.06	S05D	XZU331		31401-36061	CRT-051	31470-37080
		99.05~04.06	S05D	XZU341/ 6		31401-36061	CRT-051	31470-37080
		99.05~04.06	S05D	XZU351D		31401-36061	CRT-051	31470-37080
		99.05~04.06	S05D	XZU401		31401-36061		31470-37061
		99.08~02.06	S05D	XZU311D		31401-36061	CRT-051	31470-37080
		99.08~04.06	S05D	XZU371		31401-36061	CRT-051	31470-37080
		00.05~06.02	S05D	XZU301#		31401-36061	CRT-051	31470-37080
		04.06~06.02	S05D	XZU306#		31401-37011	CRT-051	31470-37080
		04.06~06.02	S05D	XZU311D/ 321D		31401-37011	CRT-051	31470-37080
		04.06~06.02	S05D	XZU331/ 6		31401-37011	CRT-051	31470-37080
		04.06~06.02	S05D	XZU341/ 6		31401-37011	CRT-051	31470-37080
		04.06~06.02	S05D	XZU351D		31401-37011	CRT-051	31470-37080
		04.06~06.02	S05D	XZU401		31401-37011	CRT-051	31470-37080
	04.06~06.02	S05D	XZU411		31401-37011		31470-37061	
	04.06~06.02	S05D	XZU421		31401-37011	CRT-051	31470-37080	
	5300	95.05~97.10	J05C	FB4JCAD		S3142-01660		S3142-01730
		95.05~97.10	J05C	FB4JEAT		S3142-01660		S3142-01730
95.05~97.10		J05C	FB4JGAK		S3142-01660		S3142-01730	
95.05~97.10		J05C	FB4JGAT		S3142-01660		S3142-01730	
95.10~99.05		J05C	XZU130A		31401-36061	CRT-035	31470-37040	
97.08~99.05		J05C	XZU140		31401-36061	CRT-035	31470-37040	
99.05~04.06		J05C	XZU400/ A		31401-36061		31470-37061	
99.05~04.06		J05C	XZU410~30		31401-36061		31470-37061	
99.06~02.06		J05C	XZU320A		31401-36061	CRT-035	31470-37040	
99.06~04.06		J05C	XZU300H		31401-36061	CRT-051	31470-37080	
99.06~04.06		J05C	XZU330/ 340		31401-36061	CRT-051	31470-37080	
99.06~04.06	J05C	XZU350H		31401-36061	CRT-051	31470-37080		
QUICKDELIVERY	2700	96.10~99.08	3RZFP	RZU68VH		31401-36061	CRT-081	31470-36311

Model	Year	Engine Type	Body Type	Reference	Clutch Master Cylinder		Clutch Release Cylinder		
					Aisin No.	Genuine No.	Aisin No.	Genuine No.	
QUICKDELIVERY	2700	00.01~03.06	3RZFPE	BU280K		31401-36061	CRT-081	31470-36311	
		03.06~04.06	3RZFPE	RZU280K		31401-36061	CRT-081	31470-36311	
		04.06~06.02	3RZFPE	XZU281K		CMT-064	31401-36092	CRT-081	31470-36311
	2800	95.05~99.05	3L	LH81VH			31420-26152	CRT-007	31470-30222
		95.05~99.05	3L	LY151			31420-26152	CRT-018	31470-35110
	3000	99.05~01.08	5L	LH82K			31420-26152	CRT-007	31470-30222
		99.05~01.08	5L	LY152			31420-26152	CRT-018	31470-35110
	3400	95.05~99.08	3B	BU68VH			31401-36061	CRT-006	31470-36213
	3700	99.08~04.06	4B	BU280K			31401-36061	CRT-103	31470-37070
		00.03~04.06	4B	BU281K			31401-36061	CRT-103	31470-37070
	4100	04.06~06.02	N04C	XZU280K		CMT-064	31401-36092	CRT-051	31470-37080
		04.06~06.02	N04C	XZU281K		CMT-064	31401-36092	CRT-051	31470-37080
COASTER	2400	82.05~90.01	22R	RB20		CMT-017	31420-36170	CRT-077	31470-36080
		84.08~88.08	22R	RB26V		CMT-017	31420-36170		31470-36120
		90.01~93.01	22R	RB20	FRONT DISC BRAKE	CMT-017	31420-36170	CRT-079	31470-36230
	3400	82.05~83.02	3B	BB20	FRONT DISC BRAKE	CMT-017	31420-36170	CRT-032	31470-36050
		82.05~83.02	3B	BB30	FRONT DISC BRAKE	CMT-017	31420-36170	CRT-032	31470-36050
		83.02~90.01	3B	BB21/ 31		CMT-017	31420-36170	CRT-032	31470-36050
		84.08~88.08	3B	BB36V		CMT-017	31420-36170	CRT-045	31470-36130
		84.08~90.01	3B	BB26V		CMT-017	31420-36170	CRT-045	31470-36130
		90.01~93.01	3B	BB21	FRONT DISC BRAKE		31401-36070	CRT-016	31470-36221
		90.01~93.01	3B	BB26V	FRONT DISC BRAKE		31401-36070	CRT-016	31470-36221
		90.01~93.01	3B	BB31	FRONT DISC BRAKE		31401-36070	CRT-016	31470-36221
		93.01~95.05	3B	BB40		CMT-110	31420-36230	CRT-016	31470-36221
		93.01~95.05	3B	BB46V		CMT-110	31420-36230	CRT-016	31470-36221
		95.05~99.07	3B	BB40		CMT-110	31420-36230	CRT-016	31470-36221
		95.05~99.07	3B	BB46V		CMT-110	31420-36230	CRT-016	31470-36221
	3700	88.08~93.01	14B	BB23	FRONT DISC BRAKE	CMT-017	31420-36170	CRT-006	31470-36213
		88.08~93.01	14B	BB24	FRONT DISC BRAKE	CMT-017	31420-36170	CRT-006	31470-36213
	4000	82.05~90.01	2H	HB30		CMT-017	31420-36170		31470-36090
		84.08~90.01	2H	HB36V		CMT-017	31420-36170		31470-36180
		85.10~90.01	12HT	HB31	FRONT DISC BRAKE		31401-36022	CRT-065	31470-36240
		88.08~90.01	12HT	HB32	FRONT DISC BRAKE		31401-36022	CRT-065	31470-36240
	4100	02.03~06.02	1BZFPE	BZB40		CMT-064	31401-36092	CRT-035	31470-37040
		02.03~06.02	1BZFPE	BZB50		CMT-064	31401-36092	CRT-035	31470-37040
		04.08~06.02	N04C	XZB40		CMT-064	31401-36092	CRT-051	31470-37080
		04.08~06.02	N04C	XZB50	with ABS	CMT-064	31401-36092	CRT-051	31470-37080
		04.08~06.02	N04C	XZB51	with ABS	CMT-064	31401-36092	CRT-051	31470-37080
	4200	90.01~93.01	1HDT	HDB30	FRONT DISC BRAKE		31401-36070	CRT-046	31470-36291
		90.01~93.01	1HDT	HDB31	FRONT DISC BRAKE		31401-36070	CRT-046	31470-36291
		90.01~93.01	1HZ	HZB30	FRONT DISC BRAKE		31401-36070	CRT-046	31470-36291
		90.01~93.01	1HZ	HZB31	FRONT DISC BRAKE		31401-36070	CRT-046	31470-36291
		90.01~93.01	1HZ	HZB36V	FRONT DISC BRAKE		31401-36070	CRT-046	31470-36291
		93.01~95.05	1HDT	HDB50/ 51		CMT-064	31401-36092	CRT-046	31470-36291

Model	Year	Engine Type	Body Type	Reference						
					Aisin No.	Genuine No.	Aisin No.	Genuine No.		
COASTER	4200	93.01~95.05	1HZ	HZB40/ 41		CMT-064	31401-36092	CRT-046	31470-36291	
		93.01~95.05	1HZ	HZB50/ 56V		CMT-064	31401-36092	CRT-046	31470-36291	
		95.05~97.05	1HDFT	HDB50/ 51		CMT-064	31401-36092	CRT-046	31470-36291	
		95.05~99.07	1HZ	HZB40/ 41		CMT-064	31401-36092	CRT-046	31470-36291	
		95.05~99.07	1HZ	HZB50/ 56V		CMT-064	31401-36092	CRT-046	31470-36291	
		99.07~04.08	1HDFTE	HDB50		with ABS	CMT-064	31401-36092	CRT-046	31470-36291
		99.07~04.08	1HZ	HZB40/ 46V			CMT-064	31401-36092	CRT-046	31470-36291
		99.07~04.08	1HZ	HZB50/ 56V		with ABS	CMT-064	31401-36092	CRT-046	31470-36291
		01.08~04.08	1HDFTE	HDB51			CMT-064	31401-36092	CRT-046	31470-36291
		01.08~04.08	1HZ	HZB41			CMT-064	31401-36092	CRT-046	31470-36291
	5300	96.05~99.05	J05C	RX4JFAT	Air Brake		S3221-01811		S3142-01670	
		96.05~99.05	J05CTI	RX4JFAT	Air Brake		S3221-01811		S3142-01670	
COASTER R	5300	99.05~05.03	J05C	RX4JFET	ASR		S3222-81011		S3142-01760	
		99.05~05.03	J05CTI	RX4JFET	ASR		S3222-81011		S3142-01760	
		01.07~05.03	J05CTG	RX4JFET	ASR		S3222-81011		S3142-01760	
URBAN SUPPORTER	3000	01.08~04.07	5L	LY228K		CMT-064	31401-36092	CRT-018	31470-35110	
		01.08~04.07	5L	LY270		CMT-064	31401-36092	CRT-018	31470-35110	

Reference List / Genuine No. → AISIN No.

Genuine No.	AISIN No.	Make
31401-36013	CMT-063	TOYOTA
31401-36052	CMT-061	TOYOTA
31401-36062	CMT-080	TOYOTA
31401-36072	CMT-114	TOYOTA
31401-36092	CMT-064	TOYOTA
31401-60022	CMT-016	TOYOTA
31401-60050	CMT-068	TOYOTA
31401-60060	CMT-081	TOYOTA
31410-10013	CMT-024	TOYOTA
31410-10050	CMT-025	TOYOTA
31410-10060	CMT-043	TOYOTA
31410-12072	CMT-047	TOYOTA
31410-12092	CMT-038	TOYOTA
31410-12152	CMT-027	TOYOTA
31410-12221	CMT-013	TOYOTA
31410-12302	CMT-051	TOYOTA
31410-12312	CMT-051	TOYOTA
31410-12362	CMT-069	TOYOTA
31410-12381	CMT-004	TOYOTA
31410-14183	CMT-065	TOYOTA
31410-14193	CMT-059	TOYOTA
31410-14213	CMT-115	TOYOTA
31410-14310	CMT-116	TOYOTA
31410-16023	CMT-028	TOYOTA
31410-16040	CMT-008	TOYOTA
31410-17024	CMT-084	TOYOTA
31410-17053	CMT-085	TOYOTA
31410-17070	CMT-086	TOYOTA
31410-17080	CMT-060	TOYOTA
31410-20282	CMT-062	TOYOTA
31410-20303	CMT-088	TOYOTA
31410-20380	CMT-089	TOYOTA
31410-20411	CMT-037	TOYOTA
31410-20421	CMT-007	TOYOTA
31410-20470	CMT-009	TOYOTA

Genuine No.	AISIN No.	Make
31410-20500	CMT-019	TOYOTA
31410-20560	CMT-066	TOYOTA
31410-20580	CMT-070	TOYOTA
31410-20590	CMT-091	TOYOTA
31410-20640	CMT-026	TOYOTA
31410-22240	CMT-011	TOYOTA
31410-22261	CMT-056	TOYOTA
31410-22270	CMT-117	TOYOTA
31410-22292	CMT-118	TOYOTA
31410-22320	CMT-119	TOYOTA
31410-24050	CMT-120	TOYOTA
31410-27022	CMT-002	TOYOTA
31410-30122	CMT-048	TOYOTA
31410-30261	CMT-092	TOYOTA
31410-30390	CMT-034	TOYOTA
31410-32032	CMT-031	TOYOTA
31410-33012	CMT-023	TOYOTA
31410-33030	CMT-020	TOYOTA
31410-34012	CMT-030	TOYOTA
31410-34020	CMT-121	TOYOTA
31410-35102	CMT-010	TOYOTA
31410-35142	CMT-003	TOYOTA
31410-35231	CMT-067	TOYOTA
31410-35271	CMT-005	TOYOTA
31410-35310	CMT-093	TOYOTA
31410-35320	CMT-071	TOYOTA
31410-35350	CMT-050	TOYOTA
31410-35360	CMT-006	TOYOTA
31410-35420	CMT-122	TOYOTA
31410-35451	CMT-123	TOYOTA
31410-38020	CMT-124	TOYOTA
31410-38030	CMT-125	TOYOTA
31410-38040	CMT-022	TOYOTA
31410-38050	CMT-072	TOYOTA
31410-38060	CMT-126	TOYOTA

Genuine No.	AISIN No.	Make
31410-38080	CMT-127	TOYOTA
31410-42010	CMT-045	TOYOTA
31410-43010	CMT-128	TOYOTA
31410-43020	CMT-129	TOYOTA
31410-55042	CMT-130	TOYOTA
31410-60022	CMT-041	TOYOTA
31410-60041	CMT-014	TOYOTA
31410-60061	CMT-012	TOYOTA
31410-60192	CMT-094	TOYOTA
31410-60282	CMT-032	TOYOTA
31410-60292	CMT-036	TOYOTA
31410-60340	CMT-029	TOYOTA
31410-60372	CMT-040	TOYOTA
31410-60400	CMT-098	TOYOTA
31410-60432	CMT-033	TOYOTA
31410-60460	CMT-132	TOYOTA
31410-60470	CMT-057	TOYOTA
31410-60510	CMT-095	TOYOTA
31410-60530	CMT-133	TOYOTA
31410-60540	CMT-134	TOYOTA
31410-60550	CMT-053	TOYOTA
31410-60560	CMT-135	TOYOTA
31410-60571	CMT-073	TOYOTA
31410-60580	CMT-074	TOYOTA
31410-60590	CMT-096	TOYOTA
31410-60600	CMT-097	TOYOTA
31410-60610	CMT-136	TOYOTA
31410-60620	CMT-098	TOYOTA
31410-60630	CMT-162	TOYOTA
31410-60650	CMT-158	TOYOTA
31420-10013	CMT-058	TOYOTA
31420-10023	CMT-046	TOYOTA
31420-11060	CMT-152	TOYOTA
31420-12010	CMT-137	TOYOTA
31420-12030	CMT-138	TOYOTA

Genuine No.	AISIN No.	Make
31420-12050	CMT-139	TOYOTA
31420-20010	CMT-075	TOYOTA
31420-20020	CMT-140	TOYOTA
31420-20050	CMT-076	TOYOTA
31420-20070	CMT-141	TOYOTA
31420-25040	CMT-077	TOYOTA
31420-26092	CMT-018	TOYOTA
31420-26103	CMT-044	TOYOTA
31420-26142	CMT-101	TOYOTA
31420-26182	CMT-102	TOYOTA
31420-26200	CMT-142	TOYOTA
31420-27092	CMT-042	TOYOTA
31420-27100	CMT-160	TOYOTA
31420-28072	CMT-054	TOYOTA
31420-28092	CMT-052	TOYOTA
31420-28101	CMT-049	TOYOTA
31420-28151	CMT-143	TOYOTA
31420-33010	CMT-157	TOYOTA
31420-33020	CMT-144	TOYOTA
31420-35070	CMT-156	TOYOTA
31420-36032	CMT-015	TOYOTA
31420-36072	CMT-039	TOYOTA
31420-36130	CMT-078	TOYOTA
31420-36170	CMT-017	TOYOTA
31420-36230	CMT-110	TOYOTA
31420-37040	CMT-001	TOYOTA
31420-37050	CMT-111	TOYOTA
31420-42010	CMT-112	TOYOTA
31420-42020	CMT-145	TOYOTA
31420-42030	CMT-146	TOYOTA
31420-42051	CMT-148	TOYOTA
31420-42070	CMT-153	TOYOTA
31420-44011	CMT-079	TOYOTA
31420-52010	CMT-055	TOYOTA
31420-52030	CMT-055	TOYOTA

Genuine No.	AISIN No.	Make
31420-52050	CMT-151	TOYOTA
31420-52060	CMT-149	TOYOTA
31420-52070	CMT-150	TOYOTA
31420-52080	CMT-161	TOYOTA
31420-53030	CMT-163	TOYOTA
31420-53040	CMT-164	TOYOTA
31420-60030	CMT-113	TOYOTA
31420-60050	CMT-155	TOYOTA
31420-60060	CMT-159	TOYOTA
31420-74010	CMT-154	TOYOTA
31420-87402	CMD-004	TOYOTA
31410-87312	CMD-002	DAIHATSU
31410-87322	CMD-003	DAIHATSU
31410-87323	CMD-001	DAIHATSU
31410-B3020	CMD-001	DAIHATSU
31420-87402	CMD-004	DAIHATSU
31420-B4010	CMD-007	DAIHATSU
31401-37011	CMR-001	HINO
31420-37141	CMR-002	HINO
31410-13000-71	CMW-001	INDUSTRIAL VEHICLE
31410-23320-71	CMW-002	INDUSTRIAL VEHICLE
31410-23321-71	CMW-006	INDUSTRIAL VEHICLE
31410-23600-71	CMW-003	INDUSTRIAL VEHICLE
31410-26600-71	CMW-008	INDUSTRIAL VEHICLE
3EC36-11212	CMW-004	INDUSTRIAL VEHICLE

Genuine No.	AISIN No.	Make
31470-10012	CRT-002	TOYOTA
31470-10040	CRT-047	TOYOTA
31470-12043	CRT-011	TOYOTA
31470-12050	CRT-039	TOYOTA
31470-12093	CRT-005	TOYOTA
31470-12100	CRT-034	TOYOTA
31470-12111	CRT-049	TOYOTA
31470-12130	CRT-086	TOYOTA
31470-12140	CRT-049	TOYOTA
31470-12161	CRT-113	TOYOTA
31470-12180	CRT-114	TOYOTA
31470-12190	CRT-087	TOYOTA
31470-12200	CRT-052	TOYOTA
31470-14050	CRT-024	TOYOTA
31470-14060	CRT-088	TOYOTA
31470-17011	CRT-009	TOYOTA
31470-17022	CRT-089	TOYOTA
31470-17030	CRT-090	TOYOTA
31470-17040	CRT-031	TOYOTA
31470-20151	CRT-033	TOYOTA
31470-20191	CRT-020	TOYOTA
31470-20200	CRT-091	TOYOTA
31470-20210	CRT-050	TOYOTA
31470-20231	CRT-092	TOYOTA
31470-22090	CRT-015	TOYOTA
31470-22112	CRT-055	TOYOTA
31470-22120	CRT-093	TOYOTA
31470-22150	CRT-028	TOYOTA
31470-25040	CRT-117	TOYOTA
31470-26010	CRT-038	TOYOTA
31470-26020	CRT-044	TOYOTA
31470-26030	CRT-056	TOYOTA
31470-26050	CRT-041	TOYOTA
31470-26061	CRT-008	TOYOTA
31470-26081	CRT-094	TOYOTA

Genuine No.	AISIN No.	Make
31470-26090	CRT-040	TOYOTA
31470-26100	CRT-057	TOYOTA
31470-26110	CRT-040	TOYOTA
31470-26120	CRT-119	TOYOTA
31470-28040	CRT-003	TOYOTA
31470-28051	CRT-013	TOYOTA
31470-28060	CRT-095	TOYOTA
31470-28070	CRT-096	TOYOTA
31470-28081	CRT-097	TOYOTA
31470-30222	CRT-007	TOYOTA
31470-30230	CRT-043	TOYOTA
31470-30260	CRT-001	TOYOTA
31470-30270	CRT-037	TOYOTA
31470-32023	CRT-085	TOYOTA
31470-32032	CRT-010	TOYOTA
31470-33020	CRT-026	TOYOTA
31470-35030	CRT-036	TOYOTA
31470-35041	CRT-017	TOYOTA
31470-35091	CRT-098	TOYOTA
31470-35100	CRT-004	TOYOTA
31470-35110	CRT-018	TOYOTA
31470-35120	CRT-014	TOYOTA
31470-35130	CRT-029	TOYOTA
31470-35140	CRT-060	TOYOTA
31470-35150	CRT-099	TOYOTA
31470-35170	CRT-100	TOYOTA
31470-35180	CRT-121	TOYOTA
31470-35181	CRT-121	TOYOTA
31470-35190	CRT-111	TOYOTA
31470-36050	CRT-032	TOYOTA
31470-36080	CRT-077	TOYOTA
31470-36130	CRT-045	TOYOTA
31470-36213	CRT-006	TOYOTA
31470-36221	CRT-016	TOYOTA
31470-36230	CRT-079	TOYOTA

Genuine No.	AISIN No.	Make
31470-36240	CRT-065	TOYOTA
31470-36271	CRT-101	TOYOTA
31470-36291	CRT-046	TOYOTA
31470-36300	CRT-066	TOYOTA
31470-36311	CRT-081	TOYOTA
31470-37040	CRT-035	TOYOTA
31470-37050	CRT-102	TOYOTA
31470-37070	CRT-103	TOYOTA
31470-37080	CRT-051	TOYOTA
31470-37082	CRT-120	TOYOTA
31470-38010	CRT-042	TOYOTA
31470-42020	CRT-022	TOYOTA
31470-42031	CRT-082	TOYOTA
31470-43010	CRT-029	TOYOTA
31470-52010	CRT-052	TOYOTA
31470-52011	CRT-052	TOYOTA
31470-52100	CRT-112	TOYOTA
31470-52101	CRT-112	TOYOTA
31470-52102	CRT-112	TOYOTA
31470-52110	CRT-124	TOYOTA
31470-52111	CRT-124	TOYOTA
31470-52120	CRT-115	TOYOTA
31470-52121	CRT-115	TOYOTA
31470-53032	CRT-104	TOYOTA
31470-55041	CRT-068	TOYOTA
31470-60050	CRT-069	TOYOTA
31470-60071	CRT-012	TOYOTA
31470-60081	CRT-019	TOYOTA
31470-60091	CRT-105	TOYOTA
31470-60102	CRT-021	TOYOTA
31470-60110	CRT-030	TOYOTA
31470-60130	CRT-106	TOYOTA
31470-60140	CRT-070	TOYOTA
31470-60151	CRT-083	TOYOTA
31470-60161	CRT-023	TOYOTA

Genuine No.	AISIN No.	Make
31470-60171	CRT-027	TOYOTA
31470-60180	CRT-025	TOYOTA
31470-60190	CRT-053	TOYOTA
31470-60201	CRT-107	TOYOTA
31470-60210	CRT-108	TOYOTA
31470-60230	CRT-084	TOYOTA
31470-60240	CRT-071	TOYOTA
31470-60250	CRT-072	TOYOTA
31470-60270	CRT-116	TOYOTA
31470-60280	CRT-109	TOYOTA
31470-60290	CRT-073	TOYOTA
31470-60300	CRT-118	TOYOTA
31470-60320	CRT-110	TOYOTA
31470-60340	CRT-125	TOYOTA
31470-60370	CRT-123	TOYOTA
31470-60371	CRT-123	TOYOTA
31470-60380	CRT-122	TOYOTA
31470-87401	CRD-005	TOYOTA
31470-E0042	CRT-120	HINO
MB670211	CRM-001	MITSUBISHI
MB670290	CRM-002	MITSUBISHI
MB937019	CRM-003	MITSUBISHI
MD671468	CRM-004	MITSUBISHI
MD672677	CRM-005	MITSUBISHI
MD673441	CRM-006	MITSUBISHI
MD704251	CRM-027	MITSUBISHI
MD711471	CRM-008	MITSUBISHI
MD712383	CRM-009	MITSUBISHI
MD733228	CRM-012	MITSUBISHI
MD733339	CRM-013	MITSUBISHI
MD733620	CRM-014	MITSUBISHI
MD737189	CRM-015	MITSUBISHI
MD748617	CRM-029	MITSUBISHI
MD749822	CRM-016	MITSUBISHI
MD749823	CRM-017	MITSUBISHI

Genuine No.	AISIN No.	Make
MD770482	CRM-018	MITSUBISHI
MD770486	CRM-019	MITSUBISHI
MD770488	CRM-031	MITSUBISHI
MD770676	CRM-020	MITSUBISHI
MR111585	CRM-032	MITSUBISHI
MR145150	CRM-021	MITSUBISHI
MR165176	CRM-033	MITSUBISHI
MR165177	CRM-022	MITSUBISHI
MR176324	CRM-023	MITSUBISHI
MR176895	CRM-024	MITSUBISHI
MR357821	CRM-034	MITSUBISHI
MR389050	CRM-040	MITSUBISHI
MR410188	CRM-035	MITSUBISHI
MR470217	CRM-036	MITSUBISHI
MR470768	CRM-037	MITSUBISHI
MR553373	CRM-040	MITSUBISHI
MR553469	CRM-038	MITSUBISHI
MR953772	CRM-039	MITSUBISHI
MR980563	CRM-025	MITSUBISHI
MR980566	CRM-026	MITSUBISHI
31470-87309	CRD-001	DAIHATSU
31470-87312	CRD-003	DAIHATSU
31470-87313	CRD-004	DAIHATSU
31470-87401	CRD-005	DAIHATSU
31470-B0010	CRD-006	DAIHATSU
31420-23320-71	CRW-002	INDUSTRIAL VEHICLE
3EB-10-21211	CRW-003	INDUSTRIAL VEHICLE
153-10-21180	CRW-003	INDUSTRIAL VEHICLE

Cylinder Bore Diameter (inches)

* : Unit is a millimeter

AISIN No.	Cylindr Bore Dia. (Unit : inch)
CMD-001	5/8
CMD-002	5/8
CMD-003	5/8
CMD-004	5/8
CMD-005	5/8
CMD-007	5/8
CMR-001	5/8
CMR-002	5/8
CMT-001	5/8
CMT-002	5/8
CMT-003	5/8
CMT-004	5/8
CMT-005	5/8
CMT-006	5/8
CMT-007	5/8
CMT-008	5/8
CMT-009	5/8
CMT-010	5/8
CMT-011	5/8
CMT-012	3/4
CMT-013	5/8
CMT-014	3/4
CMT-015	5/8
CMT-016	3/4
CMT-017	5/8
CMT-018	5/8
CMT-019	5/8
CMT-020	5/8
CMT-021	5/8
CMT-022	5/8
CMT-023	5/8
CMT-024	5/8
CMT-025	5/8
CMT-026	5/8
CMT-027	5/8

AISIN No.	Cylindr Bore Dia. (Unit : inch)
CMT-028	5/8
CMT-029	5/8
CMT-030	5/8
CMT-031	5/8
CMT-032	3/4
CMT-033	3/4
CMT-034	5/8
CMT-035	3/4
CMT-036	3/4
CMT-037	5/8
CMT-038	5/8
CMT-039	5/8
CMT-040	3/4
CMT-041	3/4
CMT-042	5/8
CMT-043	5/8
CMT-044	5/8
CMT-045	5/8
CMT-046	5/8
CMT-047	5/8
CMT-048	5/8
CMT-049	5/8
CMT-050	5/8
CMT-051	5/8
CMT-052	5/8
CMT-053	3/4
CMT-054	5/8
CMT-055	5/8
CMT-056	5/8
CMT-057	5/8
CMT-058	5/8
CMT-059	5/8
CMT-060	5/8
CMT-061	5/8
CMT-062	5/8

* : Unit is a millimeter

AISIN No.	Cylindr Bore Dia. (Unit : inch)
CMT-063	5/8
CMT-064	5/8
CMT-065	5/8
CMT-066	5/8
CMT-067	5/8
CMT-068	3/4
CMT-069	5/8
CMT-070	5/8
CMT-071	5/8
CMT-072	5/8
CMT-073	5/8
CMT-074	5/8
CMT-075	5/8
CMT-076	5/8
CMT-077	5/8
CMT-078	5/8
CMT-079	5/8
CMT-080	5/8
CMT-081	3/4
CMT-082	
CMT-083	
CMT-084	5/8
CMT-085	5/8
CMT-086	5/8
CMT-087	
CMT-088	5/8
CMT-089	5/8
CMT-090	
CMT-091	5/8
CMT-092	5/8
CMT-093	5/8
CMT-094	5/8
CMT-095	5/8
CMT-096	3/4
CMT-097	5/8

AISIN No.	Cylindr Bore Dia. (Unit : inch)
CMT-098	3/4
CMT-099	
CMT-100	
CMT-101	5/8
CMT-102	5/8
CMT-103	
CMT-104	
CMT-109	
CMT-110	5/8
CMT-111	5/8
CMT-112	5/8
CMT-113	3/4
CMT-114	5/8
CMT-115	5/8
CMT-116	5/8
CMT-117	5/8
CMT-118	5/8
CMT-119	5/8
CMT-120	5/8
CMT-121	5/8
CMT-122	5/8
CMT-123	5/8
CMT-124	5/8
CMT-125	5/8
CMT-126	5/8
CMT-127	5/8
CMT-128	5/8
CMT-129	5/8
CMT-130	3/4
CMT-132	5/8
CMT-133	5/8
CMT-134	3/4
CMT-135	5/8
CMT-136	3/4
CMT-137	5/8

* : Unit is a millimeter

AISIN No.	Cylindr Bore Dia. (Unit : inch)
CMT-138	* 16.5
CMT-139	* 6.5
CMT-140	5/8
CMT-141	5/8
CMT-142	* 16.5
CMT-143	5/8
CMT-144	5/8
CMT-145	5/8
CMT-146	5/8
CMT-148	* 16.5
CMT-149	* 16.5
CMT-150	* 16.5
CMT-151	* 16.5
CMT-152	* 16.5
CMT-153	* 16.5
CMT-154	* 16.5
CMT-155	3/4
CMT-156	3/4
CMT-157	5/8
CMT-158	3/4
CMT-159	3/4
CMT-160	5/8
CMT-161	* 16.5
CMT-162	3/4
CMT-163	3/4
CMT-164	3/4
CMW-001	5/8
CMW-002	5/8
CMW-003	5/8
CMW-004	5/8
CMW-005	
CMW-006	5/8
CMW-007	
CMW-008	5/8

* : Unit is a millimeter

AISIN No.	Cylindr Bore Dia. (Unit : inch)
CRD-001	13/ 16
CRD-002	
CRD-003	13/ 16
CRD-004	3/ 4
CRD-005	13/ 16
CRD-006	13/ 16
CRM-001	3/ 4
CRM-002	* 17. 46
CRM-003	3/ 4
CRM-004	13/ 16
CRM-005	3/ 4
CRM-006	13/ 16
CRM-007	
CRM-008	3/ 4
CRM-009	3/ 4
CRM-010	
CRM-011	
CRM-012	13/ 16
CRM-013	3/ 4
CRM-014	3/ 4
CRM-015	3/ 4
CRM-016	13/ 16
CRM-017	13/ 16
CRM-018	3/ 4
CRM-019	3/ 4
CRM-020	13/ 16
CRM-021	3/ 4
CRM-022	3/ 4
CRM-023	13/ 16
CRM-024	13/ 16
CRM-025	13/ 16
CRM-026	3/ 4
CRM-027	13/ 16
CRM-029	13/ 16
CRM-031	3/ 4

AISIN No.	Cylindr Bore Dia. (Unit : inch)
CRM-032	15/ 16
CRM-033	3/ 4
CRM-034	15/ 16
CRM-035	3/ 4
CRM-036	3/ 4
CRM-037	3/ 4
CRM-038	15/ 16
CRM-039	13/ 16
CRM-040	15/ 16
CRT-001	13/ 16
CRT-002	13/ 16
CRT-003	13/ 16
CRT-004	13/ 16
CRT-005	13/ 16
CRT-006	3/ 4
CRT-007	13/ 16
CRT-008	13/ 16
CRT-009	13/ 16
CRT-010	13/ 16
CRT-011	13/ 16
CRT-012	13/ 16
CRT-013	13/ 16
CRT-014	13/ 16
CRT-015	7/ 8
CRT-016	13/ 16
CRT-017	13/ 16
CRT-018	13/ 16
CRT-019	13/ 16
CRT-020	13/ 16
CRT-021	13/ 16
CRT-022	15/ 16
CRT-023	13/ 16
CRT-024	7/ 8
CRT-025	7/ 8
CRT-026	13/ 16

* : Unit is a millimeter

AISIN No.	Cylindr Bore Dia. (Unit : inch)
CRT-027	7/8
CRT-028	13/16
CRT-029	13/16
CRT-030	15/16
CRT-031	7/8
CRT-032	13/16
CRT-033	13/16
CRT-034	7/8
CRT-035	3/4
CRT-036	* 15.0
CRT-037	7/8
CRT-038	* 15.0
CRT-039	13/16
CRT-040	13/16
CRT-041	13/16
CRT-042	13/16
CRT-043	13/16
CRT-044	3/4
CRT-045	13/16
CRT-046	3/4
CRT-047	7/8
CRT-049	13/16
CRT-050	7/8
CRT-051	3/4
CRT-052	3/4
CRT-053	13/16
CRT-054	
CRT-055	13/16
CRT-056	3/4
CRT-057	13/16
CRT-058	
CRT-059	
CRT-060	3/4
CRT-061	
CRT-062	

AISIN No.	Cylindr Bore Dia. (Unit : inch)
CRT-063	
CRT-064	
CRT-065	3/4
CRT-066	13/16
CRT-067	
CRT-068	15/16
CRT-069	* 22.2
CRT-070	* 22.2
CRT-071	3/4
CRT-072	3/4
CRT-073	* 22.2
CRT-074	
CRT-075	
CRT-077	13/16
CRT-078	
CRT-079	13/16
CRT-080	
CRT-081	* 22.2
CRT-082	13/16
CRT-083	13/16
CRT-084	* 22.2
CRT-085	13/16
CRT-086	* 22.2
CRT-087	* 22.2
CRT-088	* 22.2
CRT-089	13/16
CRT-090	13/16
CRT-091	13/16
CRT-092	13/16
CRT-093	13/16
CRT-094	3/4
CRT-095	* 22.2
CRT-096	* 22.2
CRT-097	13/16
CRT-098	13/16

* : Unit is a millimeter

AISIN No.	Cylindr Bore Dia. (Unit : inch)
CRT-099	13/ 16
CRT-100	3/ 4
CRT-101	3/ 4
CRT-102	3/ 4
CRT-103	
CRT-104	* 22. 2
CRT-105	13/ 16
CRT-106	15/ 16
CRT-107	3/ 4
CRT-108	13/ 16
CRT-109	15/ 16
CRT-110	15/ 16
CRT-111	15/ 16
CRT-112	13/ 16
CRT-113	3/ 4
CRT-114	3/ 4
CRT-115	13/ 16
CRT-116	15/ 16
CRT-117	13/ 16
CRT-118	15/ 16
CRT-119	13/ 16
CRT-120	3/ 4
CRT-121	3/ 4
CRT-122	13/ 16
CRT-123	3/ 4
CRT-124	3/ 4
CRT-125	15/ 16
CRW-001	13/ 16
CRW-002	* 22. 2
CRW-003	13/ 16

Reference List / Concentric Slave Cylinder

Genuine No.	AISIN No.	Model	Year	Body Type
31400-39005	SCT-001	CAMRY	09.04 ~ 10.03	ASV40 6F
		AVENSIS	08.11 ~ 10.03	ZRT272 6F
		RAV4	08.12 ~ 10.03	ZSA3# 6F
31400-39006	SCT-001	SCION TC	10.08 ~	AGT20 6F
		CAMRY	10.04 ~ 11.09	ASV40 6F
		CAMRY	11.10 ~ 12.11	ASV50 6F
		AVENSIS	10.04 ~ 15.05	ZRT272 6F
		RAV4	10.04 ~ 12.12	ZSA3# 6F
		RAV4	12.12 ~	ZSA4# 6F, ASA4# 6F
		COROLLA	10.10 ~ 14.01	ZRE153 6F
		COROLLA	13.10 ~	ZRE173 6F
		ZELAS	10.08 ~ 13.04	AGT20 6F
31400-59005	SCT-002	VERSO-S	10.11 ~ 14.05	NLP121 6FS
		AURIS	09.02 ~ 09.12	ZRE151 6FS
		AURIS	08.12 ~ 09.10	NDE150, ZRE151, 6FS
		AURIS HYBRID	09.02 ~ 10.01	NDE150, ZRE151, 6FS
		AURIS HYBRID	09.12 ~	NDE150, ZRE151 6FS
		AURIS HYBRID	12.10 ~ 15.05	NDE180 6FS
		COROLLA	08.12 ~ 10.04	NDE150, ZRE151, 6FS
		COROLLA	10.04 ~ 13.04	NDE150 6FS
		COROLLA	09.02 ~ 13.06	NDE150, ZRE151 6FS
		COROLLA	09.02 ~ 12.08	NDE150 6FS
		COROLLA	13.06 ~	NDE180 6FS
		YARIS	09.02 ~ 11.07	NLP90, NSP90 6FS
YARIS HYBRID	11.07 ~ 14.07	NLP130 6FS		
31400-59015	SCT-003	VERSO-S	10.11 ~ 15.04	NLP121, NSP120 6FS
		VERSO	10.07 ~ 13.07	ZGR2# 6F
		AURIS HYBRID	10.04 ~	NDE150, ZRE15# 6F
		AURIS	10.04 ~	NDE150, ZRE151
		AURIS	10.04 ~	NRE150, ZRE151
		AURIS	12.08 ~	NRE180, ZRE18# 6F
		AVENSIS	10.04 ~ 13.06	ZRT270,271 6F
		COROLLA	10.04 ~ 13.06	NDE150, NRE150, ZRE151 6F
		COROLLA	11.03 ~ 14.03	ZRE142, MTM
COROLLA	10.07 ~	ZRE14# 6F		

Genuine No.	AISIN No.	Model	Year	Body Type
		COROLLA	10.06 ~ 11.05	NDE140
		COROLLA	10.08 ~	NDE140, ZRE141,142 6F
		COROLLA	10.06 ~ 13.06	NDE150 6F
		COROLLA	10.04 ~	ZRE152 6F
		COROLLA	10.06 ~ 14.01	NRE150, ZRE151,152
		COROLLA	10.06 ~ 14.04	ZRE151
		COROLLA	13.08 ~	ZRE172 6F
		COROLLA	13.10 ~	NDE170, ZRE171,172
		COROLLA	14.06 ~	ZRE182 6F
		LEVIN HYBRID	14.08 ~	ZRE182 6F
		SCION TM	15.06 ~	ZRE186 6F
		URBAN CRUISER	10.04 ~	NLP11#, NSP110
		YARIS	10.04 ~ 11.07	NLP90. NSP90 6F
		YARIS	10.04 ~ 10.06	ZSP90
		YARIS	11.08 ~ 12.08	NSP130 6F
		YARIS HYBRID	11.07 ~ 14.07	NLP130, NSP130 6F
		ETIOS	11.08 ~ 15.09	NUK1#
		EZ	11.06 ~	ZGR20,21 6F
31400-79015	SCT-004	IQ	10.05 ~ 14.05	KGJ10, NGJ10, NUJ10 MTM
*31400-79005	SCT-004 *31482-74040 is necessary for replacement with SCT-004.	IQ	08.11 ~ 10.05	KGJ10, NGJ10, NUJ10 MTM

Reference List / Free Wheel Hub

Genuine No.	AISIN No.	Make	Model	Body Type	Year
43508-39015	FHT-018	TOYOTA	HI-LUX	LN167/ 172	
43508-39016	FHT-018	TOYOTA	HI-LUX	LN167/ 172	
43509-35030	FHT-018	TOYOTA	HI-LUX	LN6#, RN6#, RN6#, VZN6#	'85. 08- '89. 03
			HIACE VAN	LH56, 66 YH56, 66	'86. 08- '89. 08
			HIACE VAN	LH108, 118, RZH109, 119	'89. 08- '95. 08
			MODEL-F, VAN	YR31, 32	'86. 08- '90. 01
43530-35012	FHT-005	TOYOTA	HI-LUX	RN Series	
43530-35020	FHT-006	TOYOTA	HI-LUX	RN Series	
43530-39025	FHT-006	TOYOTA	HI-LUX	RN Series	
43530-39028	FHT-006	TOYOTA	HI-LUX	RN Series	
43530-35021	FHT-007	TOYOTA	HI-LUX	RN Series	
43530-39026	FHT-007	TOYOTA	HI-LUX	RN Series	
43530-39029	FHT-007	TOYOTA	HI-LUX	RN Series	
43530-35023	FHT-008	TOYOTA	HI-LUX	LN100, 106, YN100, 105	'88. 09- '97. 08
43530-60013	FHT-011	TOYOTA	LAND CRUISER	FJ	
43530-69015	FHT-011	TOYOTA	LAND CRUISER	BJ4#, FJ4#, 55, HJ45	'79. 01- '80. 07
43530-69018	FHT-011	TOYOTA	LAND CRUISER	BJ4#, FJ4#, 55, HJ45	'79. 01- '80. 07
43530-69016	FHT-012	TOYOTA	LAND CRUISER	BJ60, 4# FJ60, 4#, HJ60, 47	'80. 08- '81. 10
43530-69019	FHT-012	TOYOTA	LAND CRUISER	BJ60, 4# FJ60, 4#, HJ60, 47	'80. 08- '81. 10
43530-60016	FHT-013	TOYOTA	LAND CRUISER	LJ71, BJ7#, FJ62, HJ6#	'84. 11- '90. 01
43530-60030	FHT-015	TOYOTA	LAND CRUISER	BJ41, BJ44	'81. 02- '81. 10
43530-60031	FHT-016	TOYOTA	LAND CRUISER	BJ4#	'81. 10- '84. 10
43530-60040	FHT-002	TOYOTA	LAND CRUISER	HZJ7#, FZJ7#, KZJ7#, FZJ80, HZJ80	'90. 01- '93. 05
43530-60041	FHT-002	TOYOTA	LAND CRUISER	HZJ7#, FZJ7#, KZJ7#, FZJ80, HZJ80	'93. 05- '95. 07
43530-60042	FHT-002	TOYOTA	LAND CRUISER	HZJ7#, FZJ7#, KZJ7#, FZJ80, HZJ80	'95. 07- '99. 08
43530-60130	FHT-001	TOYOTA	LAND CRUISER	FZJ, HZJ7#	'99. 08-
			LAND CRUISER	VDJ, GRJ7#	'07. 01-
			LAND CRUISER100	FZJ, HZJ10#	'98. 01-
MB160940	FHM-002	MITSUBISHI	DELICA	L03, L06 Series	
			MONTERO, SHOGUN, PAJERO	V10, 20, 30, 40 Series	

Genuine No.	AISIN No.	Make	Model	Body Type	Year
MB886389	FHM-003	MITSUBISHI	CANTER	FD, FG300, 400 Series, FB, FD, FE, FG500, 600 Series	
MC865325	FHM-001	MITSUBISHI			
8-94368-363-0	FHG-002	ISUZU	TROOPER, BIG HORN MU	UBS25DW, UBS25GW, UBS69DW, UBS69GW UCS69DWM, UCS55DW, UCS55DWN, UCS17DH	
8-97062-018-0	FHG-001	ISUZU	TROOPER, BIG HORN MU	UBS25DW, UBS25GW, UBS69DW, UBS69GW UCS69DWM	
8-97113-446-1	FHG-005	ISUZU	ELF	NKS60, 70 Series, NKS81 Series	
8-97118-415-0	FHG-003	ISUZU	ESCUDO, VITARA, JIMNY SAMURAI		
43810-60A00	FHS-005	SUZUKI	JIMNY		
43810-80011	FHS-002	SUZUKI	JIMNY		

Reference List / Flywheel Damper

Genuine No.	AISIN No.	Make	Model	Body Type	Year
13450-70010 13450-70011	FDT-001	TOYOTA	IS200/300	GXE10	'99. 01- '02. 03 '02. 03- '02. 08
13450-27010 13450-27011 13450-27012 13450-27013	FDT-002	TOYOTA	AVENSIS	CDT220	'99. 08- '00. 08 '00. 08- '02. 03 '02. 03- '02. 10 '02. 10- '03. 01
13450-27020 13450-27021 13450-27022	FDT-002	TOYOTA	RAV4	CLA2#	'01. 05- '02. 03 '02. 03- '03. 11 '03. 11-
13450-18010 13450-18011	FDT-003	TOYOTA	Land Cruiser	PZJ7#	'90. 01- '93. 01 '93. 01- '95. 01

Free Wheel Hub

Flywheel Damper

HEIGHT CONTROL SENSOR

Model	Year	Body Type	AISIN No.	Genuine No.
4RUNNER	02.08-	UZN21#	AST-029	89408-60011
	02.11-	UZN21#	AST-027	89407-60022
AURIS	08.12-09.01	ZRE154	AST-052	89407-12050
	12.08-	RE186	AST-051	89407-12040
AURIS HYBRID	07.02-	ADE157	AST-051	89407-12040
	07.02-09.02	ZRE151	AST-032	89407-12030
	07.02-09.03	ADE150	AST-032	89407-12030
	09.02-10.01	ZRE15#,ADE150	AST-032	89407-12030
	09.12-	ZWE150,ADE150,ZRE15#	AST-032	89407-12030
	12.10-	ZRE185,NRE185,WWE185,ZWE186	AST-051	89407-12040
	12.10-15.05	ADE186,ZRE185,ZWE186	AST-051	89407-12040
	12.10-15.05	NDE180,NRE180	AST-032	89407-12030
15.05-	NDE180	AST-032	89407-12030	
AURIS/COROLLA	06.10-09.10	ADE150,ZRE15#	AST-032	89407-12030
AVALON	05.01-	GSX30	AST-024	89407-41010
	12.10-	AVX40,GSX40	AST-031	89407-06010
AVENSIS	03.01-	AZT250,ZZT251,ADT25#,CDT250	AST-023	89407-20020
	03.01-05.03	AZT250,ZZT251	AST-023	89407-20020
	03.01-06.04	AZT250,ZZT251,ADT251,AZT251,CDT250,ZZT250	AST-023	89407-20020
	06.04-	AZT250,ZZT251,ADT25#,AZT251,ZZT250	AST-023	89407-20020
	08.11-11.11	ADT270,ZRT272,ADT271,ZRT27#	AST-051	89407-12040
	08.11-13.04	ZRT272	AST-051	89407-12040
	11.07-	ZRT272	AST-051	89407-12040
15.05-	WWT27#,ZRT27#	AST-051	89407-12040	
CAMRY	06.01-09.03	ACV40,GSV40	AST-024	89407-41010
	06.01-11.08	ACV40	AST-024	89407-41010
	09.01-11.09	ACV40,GSV40	AST-024	89407-41010
CAMRY HV	11.09-13.03	ASV50,GSV50,AVV50	AST-031	89407-06010
CAMRY HYBRID	11.08-	ASV50	AST-024	89407-41010
	11.08-14.09	AVV50,GSV50	AST-024	89407-41010
COROLLA	06.11-10.02	ADE150	AST-032	89407-12030
	06.11-10.02	ZRE151	AST-032	89407-12030
	08.02-13.06	ADE150,ZRE151	AST-032	89407-12030
	08.03-11.03	ZRE14#,ZZE142	AST-049	89407-12010
	08.03-11.05	ZZE142	AST-049	89407-12010
	08.12-13.04	ZRE151	AST-032	89407-12030
COROLLA AXIO/ FIELDER	12.04-13.04	NZE161	AST-053	89407-12110
	12.04-13.04	NZE164	AST-054	89407-12120
COROLLA RUMION	07.01-13.01	ZRE154	AST-052	89407-12050
COROLLA/ FIELDER	04.04-06.09	NZE124,ZZE124	AST-050	89407-12020
HARRIER	03.02-	ACU35,MCU35	AST-025	89407-48030
	03.02-06.01	MCU31	AST-036	89407-48020
	06.01-08.12	GSU31	AST-036	89407-48020
LAND CRUISER	98.01-	HDJ101,UZJ100	AST-026	89407-60010
	02.09-	GRJ121,VDJ121,VZJ121	AST-029	89408-60011
	06.07-	HDJ101,UZJ100	AST-020	89405-60012
	06.07-	UZJ100	AST-021	89406-60012
	06.07-	UZJ100,HDJ100	AST-020	89405-60012
	07.09-12.01	UZJ200,VDJ200	AST-030	89405-60020

HEIGHT CONTROL SENSOR

Model	Year	Body Type	AISIN No.	Genuine No.
LAND CRUISER	07.09-12.01	UZJ200,VDJ200	AST-022	89406-60030
	07.09-12.01	UZJ200,VDJ200	AST-040	89408-60020
	08.06-12.01	UZJ200,VDJ200	AST-037	89407-60031
	09.05-	URJ202	AST-030	89405-60020
	09.05-	URJ202	AST-022	89406-60030
	09.05-	URJ202	AST-037	89407-60031
	09.05-12.01	URJ202	AST-040	89408-60020
	12.01-	URJ202,VDJ200	AST-037	89407-60031
	12.01-	URJ202,VDJ200	AST-041	89408-60040
	12.01-15.08	URJ202,VDJ200	AST-030	89405-60020
	12.01-15.08	URJ202,VDJ200	AST-022	89406-60030
	12.01-15.08	VDJ200	AST-030	89405-60020
	12.01-15.08	VDJ200	AST-022	89406-60030
	12.01-15.08	VDJ200	AST-037	89407-60031
	15.08-	URJ200	AST-041	89408-60040
LAND CRUISER 100	98.01-	HDJ101,UZJ100	AST-026	89407-60010
	06.07-	HDJ100,UZJ100	AST-020	89405-60012
	06.07-	UZJ100	AST-021	89406-60012
	06.08-	UZJ100	AST-020	89405-60012
LAND CRUISER PRADO	02.09-	GRJ120,KDJ120	AST-029	89408-60011
	02.11-	GRJ120,KDJ120	AST-027	89407-60022
	02.11-	GRJ121,KDJ121,VZJ121	AST-027	89407-60022
	09.08-	GRJ151	AST-063	89407-60040
	09.08-	GRJ151	AST-073	89408-60030
	09.08-11.10	GRJ150	AST-073	89408-60030
	09.08-11.10	GRJ150,KDJ150	AST-063	89407-60040
	09.08-13.08	KDJ150,GRJ150	AST-073	89408-60030
	11.11-13.08	GRJ150,KDJ150	AST-063	89407-60040
	11.11-13.08	KDJ150	AST-073	89408-60030
	13.08-15.06	GRJ150,KDJ150	AST-063	89407-60040
	13.08-15.06	GRJ150,KDJ150	AST-073	89408-60030
	15.06-	KDJ150,GDJ150,GRJ150	AST-073	89408-60030
LEXUS 450D/ 570	07.11-15.09	URJ201	AST-030	89405-60020
	15.09-	URJ201,VDJ201	AST-030	89405-60020
LEXUS CT200H	10.12-	ZWA10	AST-065	89407-76010
LEXUS ES300	99.08-	MCV20	AST-033	89407-33010
LEXUS ES300/330	01.07-	MCV3#	AST-035	89407-48010
LEXUS ES350	06.03-	GSV40	AST-024	89407-41010
	15.10-	GSV60	AST-031	89407-06010
LEXUS GS/GS HYBRID	12.01-15.10	AWL10,GRL1#,GWL10	AST-069	89408-30150
	15.10-	ARL10,AWL10,GRL16,GWL10	AST-069	89408-30150
LEXUS GS2##/ 350/ 450H	11.12-13.09	GRL10	AST-069	89408-30150
	11.12-15.10	GRL10,11,15,GWL10	AST-069	89408-30150
	11.12-15.10	GRL10,GRL11,15	AST-069	89408-30150
	15.10-	APL10,GRL1#,GWL10	AST-069	89408-30150
LEXUS GS250/ 350/ 450H	11.02-	GRL11,15,GWL10	AST-069	89408-30150
LEXUS GS30/ 35/ 43/ 460	05.01-07.09	GRS190,UZS190	AST-068	89408-30130
	07.09-	GRS19#,URS190,UZS190	AST-068	89408-30130
LEXUS GS450H	06.02-	GWS191	AST-068	89408-30130

Height Control Sensor

HEIGHT CONTROL SENSOR

Model	Year	Body Type	AISIN No.	Genuine No.
LEXUS GX460	09.11-	URJ150	AST-063	89407-60040
	09.11-	URJ150	AST-073	89408-60030
LEXUS GX470	02.11-	UZJ120	AST-027	89407-60022
	02.11-	UZN120	AST-029	89408-60011
LEXUS HS250H	10.07-12.01	ANF10	AST-065	89407-76010
LEXUS IS F	07.12-	USE20	AST-068	89408-30130
LEXUS IS2###/3###	13.04-15.08	GSE3#	AST-069	89408-30150
	15.08-	ASE30,GSE3#	AST-069	89408-30150
LEXUS IS2###/300H	13.04-15.08	AVE30,GSE30	AST-069	89408-30150
	15.08-	ASE30,AVE30	AST-069	89408-30150
LEXUS IS250/350	05.08-	GSE20,21	AST-068	89408-30130
	08.08-	GSE20,21	AST-045	89405-30140
	13.04-	GSE3#	AST-069	89408-30150
LEXUS IS250/350/2##D	05.08-12.02	AEL20,GSE20	AST-068	89408-30130
	06.02-08.08	AEL20	AST-068	89408-30130
	12.03-	GSE20,21	AST-068	89408-30130
LEXUS IS250C	09.04-	GSE20	AST-068	89408-30130
LEXUS LS460/460L	06.08-	USF40	AST-072	89408-50070
	06.08-	USF40,41	AST-043	89405-50070
	06.08-	USF40,41	AST-047	89406-50100
	06.08-	USF40,USF4#	AST-072	89408-50070
	06.08-	USF41	AST-057	89407-50070
	06.08-	USF41	AST-072	89408-50070
	06.08-08.09	USF4#	AST-072	89408-50070
	06.08-09.09	USF40,41	AST-057	89407-50070
	06.08-09.09	USF40,45,46	AST-057	89407-50070
	08.09-	USF4#	AST-057	89407-50070
	08.09-	USF45,46,UVF46	AST-047	89406-50100
	08.09-09.09	USF40,41	AST-057	89407-50070
	08.09-09.09	USF40,41	AST-072	89408-50070
	08.09-09.09	USF45,46	AST-072	89408-50070
	08.09-10.09	USF45,46	AST-057	89407-50070
	09.09-	USF45,46	AST-044	89405-50100
	09.09-	USF45,46	AST-048	89406-50130
	09.09-10.09	USF40,41	AST-072	89408-50070
	12.09-	USF4#	AST-057	89407-50070
	12.09-	USF4#	AST-072	89408-50070
12.09-	USF40,45	AST-072	89408-50070	
LEXUS LS600H/600HL	07.04-	UVF4#,46	AST-057	89407-50070
	07.04-	UVF4#,46	AST-072	89408-50070
	09.11-	UVF4#	AST-044	89405-50100
	09.11-	UVF4#	AST-048	89406-50130
	09.11-	UVF46	AST-044	89405-50100
	09.11-	UVF46	AST-048	89406-50130
LEXUS LX450D/570	07.11-12.01	URJ201	AST-040	89408-60020
	07.11-15.09	URJ201	AST-022	89406-60030
	08.06-15.09	URJ201	AST-037	89407-60031
LEXUS LX450D/570	12.01-15.09	URJ201	AST-041	89408-60040
	15.09-	URJ201,VDJ201	AST-022	89406-60030

HEIGHT CONTROL SENSOR

Model	Year	Body Type	AISIN No.	Genuine No.
	15.09-	URJ201,VDJ201	AST-037	89407-60031
	15.09-	URJ201,VDJ201	AST-041	89408-60040
LEXUS LX470	98.01-	UZJ100	AST-026	89407-60010
	06.07-	UZJ100	AST-020	89405-60012
	06.07-	UZJ100	AST-021	89406-60012
LEXUS LX570	07.11-12.01	UZN201	AST-040	89408-60020
	07.11-15.09	URJ201	AST-030	89405-60020
	07.11-15.09	URJ201	AST-022	89406-60030
	08.06-	URJ201	AST-037	89407-60031
	12.01-	URJ201	AST-041	89408-60040
LEXUS NX200T/ 300H	14.10-	AGZ15,AGZ1#	AST-070	89408-42010
LEXUS RC350/ 300/ 200T	14.09-15.10	GSC1#	AST-069	89408-30150
	15.10-	ASC10,GSC1#	AST-069	89408-30150
LEXUS RC350/ 300H/ 200T	14.09-15.10	GSC10	AST-069	89408-30150
	15.08-	ASC10,AVC10,GSC1#	AST-069	89408-30150
LEXUS RX200T/ 350/ 450H	15.09-	AGL2#,GGL25,GYL25	AST-056	89407-48060
LEXUS RX270/ 350/ 450H	08.12-	AGL10,GGL1#,GYL10,15	AST-056	89407-48060
	08.12-	GYL15,GGL15	AST-042	89405-48010
	08.12-	GYL16	AST-046	89406-48010
	08.12-10.08	GGL15	AST-042	89405-48010
	08.12-10.08	GGL15	AST-046	89406-48010
	08.12-10.08	GGL15	AST-071	89408-48030
	08.12-12.03	AGL10,GGL15,GYL1#	AST-056	89407-48060
	08.12-12.03	GYL15,GGL15	AST-042	89405-48010
	08.12-12.03	GYL15,GGL15	AST-046	89406-48010
	08.12-12.03	GYL15,GGL15	AST-071	89408-48030
	08.12-12.03	GYL15,GGL16,GYL16	AST-071	89408-48030
	08.12-12.03	GYL16	AST-042	89405-48010
	12.03-	AGL10,GYL1#,GGL15,GYL15	AST-056	89407-48060
	12.03-	GYL15	AST-042	89405-48010
	12.03-	GYL15,GGL15	AST-042	89405-48010
	12.03-	GYL15,GGL15	AST-046	89406-48010
	12.03-	GYL15,GGL15	AST-071	89408-48030
LEXUS RX300/ 330/ 350	03.02-06.01	MCU3#,35	AST-025	89407-48030
	06.01-08.12	GSU35	AST-025	89407-48030
LEXUS RX330/ 350	03.02-06.01	MCU33	AST-036	89407-48020
	03.02-06.01	MCU38	AST-025	89407-48030
	06.01-08.12	GSU30	AST-036	89407-48020
	06.01-08.12	GSU35	AST-025	89407-48030
LEXUS RX350/ 450H	08.12-10.08	GGL15	AST-071	89408-48030
	08.12-11.12	GYL15	AST-056	89407-48060
	08.12-12.03	GGL10	AST-056	89407-48060
	08.12-12.03	GGL15	AST-056	89407-48060
	08.12-12.03	GYL15	AST-042	89405-48010
	08.12-12.03	GYL15	AST-071	89408-48030
	09.03-12.03	GYL15	AST-056	89407-48060
	12.03-	GGL15,GYL15	AST-056	89407-48060
LEXUS RX350/ 450H	15.09-	GGL25,GYL25	AST-056	89407-48060
LEXUS RX400H	05.03-08.12	MHU33	AST-036	89407-48020

Height Control
Sensor

HEIGHT CONTROL SENSOR

Model	Year	Body Type	AISIN No.	Genuine No.
	05.03-08.12	MHU33	AST-025	89407-48030
NOAH/ VOXY	01.04-	ZRR7#	AST-055	89407-44010
PRIUS	03.05-	NHW20	AST-028	89408-47010
	03.08-09.03	NHW20	AST-028	89408-47010
	09.04-	ZVW30	AST-032	89407-12030
	09.04-11.12	ZVW30	AST-032	89407-12030
	11.12-	ZVW30	AST-032	89407-12030
	12.01-15.06	ZVW35(PLUG IN HV)	AST-032	89407-12030
	12.03-	ZVW40	AST-032	89407-12030
	12.05-15.06	ZVW35	AST-032	89407-12030
PRIUS V	11.09-14.11	ZVW41	AST-032	89407-12030
RAV4	12.12-15.10	ALA40,41,49,ZSA44	AST-070	89408-42010
	13.11-15.10	ALA49	AST-070	89408-42010
	15.10-	ALA49,ASA44,WWA42,ZSA4#	AST-070	89408-42010
	15.10-	ASA4#	AST-070	89408-42010
RAV4/ VANGUARD	05.11-	ACA31,36/ ACA33,38,GSA33	AST-070	89408-42010
SAI	10.07-	AZK10	AST-065	89407-76010
SEQUOIA	04.08-	UCK35,45	AST-038	89408-34010
	07.11-09.11	UCK6#,UPK6#,USK6#	AST-034	89407-34020
	07.11-09.11	UCK6#,UPK6#,USK6#	AST-039	89408-34030
VITZ	05.12-10.12	NCP95	AST-058	89407-52060
WINDOM	99.08-	MCV2#	AST-033	89407-33010
	01.07-04.06	MCV30	AST-035	89407-48010

Reference List / Genuine No. → AISIN No.

Genuine No.	AISIN No.	Make
89405-30140	AST-045	TOYOTA
89405-48010	AST-042	TOYOTA
89405-50070	AST-043	TOYOTA
89405-50100	AST-044	TOYOTA
89405-60012	AST-020	TOYOTA
89405-60020	AST-030	TOYOTA
89406-48010	AST-046	TOYOTA
89406-50100	AST-047	TOYOTA
89406-50130	AST-048	TOYOTA
89406-60012	AST-021	TOYOTA
89406-60030	AST-022	TOYOTA
89407-06010	AST-031	TOYOTA
89407-12010	AST-049	TOYOTA
89407-12020	AST-050	TOYOTA
89407-12030	AST-032	TOYOTA
89407-12040	AST-051	TOYOTA
89407-12050	AST-052	TOYOTA
89407-12110	AST-053	TOYOTA
89407-12120	AST-054	TOYOTA
89407-20020	AST-023	TOYOTA
89407-33010	AST-033	TOYOTA
89407-34020	AST-034	TOYOTA
89407-41010	AST-024	TOYOTA
89407-44010	AST-055	TOYOTA
89407-48010	AST-035	TOYOTA
89407-48020	AST-036	TOYOTA
89407-48030	AST-025	TOYOTA
89407-48060	AST-056	TOYOTA
89407-50070	AST-057	TOYOTA
89407-52060	AST-058	TOYOTA
89407-60010	AST-026	TOYOTA
89407-60022	AST-027	TOYOTA
89407-60031	AST-037	TOYOTA
89407-60040	AST-063	TOYOTA
89407-76010	AST-065	TOYOTA

Genuine No.	AISIN No.	Make
89408-30130	AST-068	TOYOTA
89408-30150	AST-069	TOYOTA
89408-34010	AST-038	TOYOTA
89408-34030	AST-039	TOYOTA
89408-42010	AST-070	TOYOTA
89408-47010	AST-028	TOYOTA
89408-48030	AST-071	TOYOTA
89408-50070	AST-072	TOYOTA
89408-60011	AST-029	TOYOTA
89408-60020	AST-040	TOYOTA
89408-60030	AST-073	TOYOTA
89408-60040	AST-041	TOYOTA
33136-STX-A01	ASH-003	HONDA
33136-SZT-J01	ASH-001	HONDA
33146-STX-A01	ASH-005	HONDA
33146-TM8-J01	ASH-002	HONDA
33186-STX-A01	ASH-004	HONDA
33196-STX-A01	ASH-006	HONDA
KD54-5122Y	ASZ-001	MAZDA
8651A047	ASM-001	MINATSUBISHI
8651A058	ASM-002	MINATSUBISHI
8651A095	ASM-003	MINATSUBISHI
84031-FG000	ASF-001	SUBARU
84031-SG000	ASF-002	SUBARU

Height Control
Sensor

MOTOR TRANSFER SHIFT ACTUATOR

Model	Year	Body Type	Reference	AISIN No.	Genuine No.
4RUNNER	09.08-	GRN285		AAT-003	36410-60093
	11.12-	GRN285		AAT-010	41400-35033
FJ CRUISER	11.12-14.07	GSJ15		AAT-010	41400-35033
HILUX	11.12-	GGN25,KUN25,TGN25		AAT-010	41400-35033
LAND CRUISER	99.08-01.08	HZJ71,79		AAT-001	41450-60042
	92.08-98.01	FZJ80		AAT-002	41450-60060
LEXUS GX460	09.11-	URJ150		AAT-003	36410-60093
LEXUS LX450	95.11-98.01	FZJ80		AAT-001	41450-60042
	95.11-98.01	FZJ80		AAT-002	41450-60060
SEQUOIA	07.11-	UCK65,UPK65,USK65		AAT-011	41400-34020
TACOMA	11.12-	GRN245,250,TRN24#		AAT-010	41400-35033
TUNDRA	06.11-	UCK55,56,57		AAT-011	41400-34020

Reference List / Genuine No.→ AISIN No.

Genuine No.	AISIN No.	Make
36410-60093	AAT-003	TOYOTA
41400-34020	AAT-011	TOYOTA
41400-35033	AAT-010	TOYOTA
41450-60042	AAT-001	TOYOTA
41450-60060	AAT-002	TOYOTA

Reference List / Genuine No.→ AISIN No.

Genuine No.	AISIN No.	Make
13025-1KA0C	VCN-001	NISSAN
13025-1KA0D	VCN-001	NISSAN
13025-1KA0E	VCN-001	NISSAN
13025-1KC0A	VCN-002	NISSAN
13025-1KC1A	VCN-002	NISSAN
13025-1KC2C	VCN-003	NISSAN
13025-EN20A	VCN-004	NISSAN
13025-EN21A	VCN-004	NISSAN
13025-ET00A	VCN-004	NISSAN
13025-CK80A	VCN-005	NISSAN
13025-CK81A	VCN-005	NISSAN
13025-JA01B	VCN-007	NISSAN
13025-JA02B	VCN-007	NISSAN
13025-JA04B	VCN-007	NISSAN
13025-JA05B	VCN-007	NISSAN
13025-3TA0A	VCN-010	NISSAN
13025-JG31B	VCN-011	NISSAN
13025-JG32B	VCN-011	NISSAN
13025-JG34B	VCN-011	NISSAN

Reference List / Genuine No.→ AISIN No.

Genuine No.	AISIN No.	Make
23796-EN200	OCV-001	NISSAN
23796-EN20A	OCV-002	NISSAN
23796-JA00A	OCV-003	NISSAN
23796-3JV0A	OCV-004	NISSAN
23796-3TA1A	OCV-005	NISSAN
23796-3HD0A	OCV-006	NISSAN

Variave Valve
Timing

Oil Control
Valve

Reference List / Manual Transmission(ASSY)

Model	Year	Body Type	Mission Model	AI SI No.	Productin Name	Genuine No.	Note
COASTER	97.05-99.07	BB42	M152	MTAT-00009	TRANSMISSION ASSY, MANUAL	33120-3E561	
		HZB50	M155	MTAT-00034	TRANSMISSION ASSY, MANUAL	33110-3J431	
	99.07-01.08	BB42	M152	MTAT-00009	TRANSMISSION ASSY, MANUAL	33120-3E561	
	99.07-04.08	BB42	M152	MTAT-00009	TRANSMISSION ASSY, MANUAL	33120-3E561	
		HZB50	M155	MTAT-00034	TRANSMISSION ASSY, MANUAL	33110-3J431	
	01.08-04.08	BZB40	M155	MTAT-00015	TRANSMISSION ASSY, MANUAL	33110-3J660	
	04.08-11.08	BB42	M152	MTAT-00009	TRANSMISSION ASSY, MANUAL	33120-3E561	
	04.08-15.01	BB42	M152	MTAT-00009	TRANSMISSION ASSY, MANUAL	33120-3E561	
		BZB40	M155	MTAT-00015	TRANSMISSION ASSY, MANUAL	33110-3J660	
		HZB50	M155	MTAT-00034	TRANSMISSION ASSY, MANUAL	33110-3J431	
	06.08-08.03	XZB50	M551	MTAT-00014	TRANSMISSION ASSY, MANUAL	33110-36A21	
	06.08-09.08	XZB50	M551	MTAT-00014	TRANSMISSION ASSY, MANUAL	33110-36A21	
	06.08-11.08	XZB40,50,59	M551	MTAT-00014	TRANSMISSION ASSY, MANUAL	33110-36A21	
	11.08-15.01	BZB50	M155	MTAT-00015	TRANSMISSION ASSY, MANUAL	33110-3J660	
	15.01-	BB42	M152	MTAT-00009	TRANSMISSION ASSY, MANUAL	33120-3E561	
	BZB40,50	M155	MTAT-00015	TRANSMISSION ASSY, MANUAL	33110-3J660		
	HZB50	M155	MTAT-00034	TRANSMISSION ASSY, MANUAL	33110-3J431		
COROLLA (ASIA/INDIA)	07.06-08.01	ZZE121	C52	MTAT-00030	TRANSAXLE ASSY, MANUAL	30300-1A832	
	07.06-08.02	ZZE121	C52	MTAT-00030	TRANSAXLE ASSY, MANUAL	30300-1A832	
COROLLA/ALTIS SED/WG	07.06-07.08	ZZE121	C52	MTAT-00030	TRANSAXLE ASSY, MANUAL	30300-1A832	
DYNA	03.04-08.02	XZU420,430		MTAT-00024	TRANSMISSION ASSY, MANUAL	33120-37670	
	10.11-11.06	WU300,340	M153	MTAT-00022	TRANSMISSION ASSY, MANUAL	33120-37591	
				MTAT-00023	TRANSMISSION ASSY, MANUAL	33120-37601	
		WU340	M153	MTAT-00023	TRANSMISSION ASSY, MANUAL	33120-37601	
		WU410	M153	MTAT-00022	TRANSMISSION ASSY, MANUAL	33120-37591	
			MTAT-00023	TRANSMISSION ASSY, MANUAL	33120-37601		
HIACE	11.08-13.05	KDH200,220,222	R351	MTAT-00011	TRANSMISSION UNIT ASSY, MANUAL	33030-26A01	
		KDH202,212	R351	MTAT-00026	TRANSMISSION UNIT ASSY, MANUAL	33030-26A42	
	13.09-14.02	TRH201,203,213,22#	R351	MTAT-00012	TRANSMISSION UNIT ASSY, MANUAL	33030-26A24	
	13.12-16.05	TRH223	R351	MTAT-00012	TRANSMISSION UNIT ASSY, MANUAL	33030-26A24	
	13.12-	TRH201,203,213,221,223	R351	MTAT-00012	TRANSMISSION UNIT ASSY, MANUAL	33030-26A24	
HILUX	08.08-08.10	KUN15	G50	MTAT-00036	TRANSMISSION UNIT ASSY, MANUAL	33030-71200	
	08.10-11.08	KUN15	G50	MTAT-00036	TRANSMISSION UNIT ASSY, MANUAL	33030-71200	
	09.05-11.08	LAN15,35	G58	MTAT-00046	TRANSMISSION UNIT ASSY, MANUAL	33030-71221	
	11.03-11.08	KUN10,15	G50	MTAT-00036	TRANSMISSION UNIT ASSY, MANUAL	33030-71200	
	11.07-15.08	KUN10,15	G50	MTAT-00036	TRANSMISSION UNIT ASSY, MANUAL	33030-71200	
	11.07-	KUN15	G50	MTAT-00036	TRANSMISSION UNIT ASSY, MANUAL	33030-71200	
	11.08-	LAN15,35	G58	MTAT-00046	TRANSMISSION UNIT ASSY, MANUAL	33030-71221	
LAND CRUISER	90.01-93.05	FJ7#,HJ75,HZJ7#	T/F	MTAT-00002	TRANSFER ASSY	36110-6C070	
		HZJ7#		MTAT-00003	TRANSMISSION UNIT ASSY, MANUAL	33030-60850	
	93.05-95.01	HZJ70	H55	MTAT-00003	TRANSMISSION UNIT ASSY, MANUAL	33030-60850	
			T/F	MTAT-00002	TRANSFER ASSY	36110-6C070	
	93.05-99.08	HZJ7#,75	H55	MTAT-00003	TRANSMISSION UNIT ASSY, MANUAL	33030-60850	
			T/F	MTAT-00002	TRANSFER ASSY	36110-6C070	
	93.05-99.09	HZJ75	H55	MTAT-00003	TRANSMISSION UNIT ASSY, MANUAL	33030-60850	
			T/F	MTAT-00002	TRANSFER ASSY	36110-6C070	
	93.05-00.07	HZJ70,75	H55	MTAT-00003	TRANSMISSION UNIT ASSY, MANUAL	33030-60850	
			T/F	MTAT-00002	TRANSFER ASSY	36110-6C070	

Reference List / Manual Transmission(ASSY)

Model	Year	Body Type	Mission Model	AISI No.	Productin Name	Genuine No.	Note
LAND CRUISER	98.01-99.01	HDJ80	T/F	MTAT-00032	TRANSMISSION UNIT ASSY, MANUAL	33030-6A261	
	01.04-06.05	FZJ78,79	T/F	MTAT-00025	TRANSFER ASSY	36120-60351	
	01.04-07.01	HDJ7#	T/F	MTAT-00025	TRANSFER ASSY	36120-60351	
	06.12-07.01	HZJ7#	T/F	MTAT-00010	TRANSFER ASSY	36110-6E181	
	07.01-09.07	VDJ7#	H150	MTAT-00020	TRANSMISSION UNIT ASSY, MANUAL	33030-60A70	
	07.01-10.12	FZJ71,76,VDJ76	T/F	MTAT-00021	TRANSFER ASSY	36120-60441	
		FZJ78,79,VDJ78,79	T/F	MTAT-00019	TRANSFER ASSY	36120-60420	
	07.01-13.10-	HZJ7#	T/F	MTAT-00010	TRANSFER ASSY	36110-6E181	
	HZJ7#	R151F	MTAT-00006	TRANSMISSION UNIT ASSY, MANUAL	33030-6A414		
LAND CRUISER 100	98.01-02.08	HZJ105	R151F	MTAT-00004	TRANSMISSION UNIT ASSY, MANUAL	33030-6A380	BENCH SEAT TYPE
				MTAT-00005	TRANSMISSION UNIT ASSY, MANUAL	33030-6A390	SEPARATE SEAT TYPE
	00.08-02.08	HDJ100	H151	MTAT-00033	TRANSMISSION UNIT ASSY, MANUAL	33030-6A550	
			H151	MTAT-00033	TRANSMISSION UNIT ASSY, MANUAL	33030-6A550	
	02.08-05.05	HZJ105	R151F	MTAT-00004	TRANSMISSION UNIT ASSY, MANUAL	33030-6A380	BENCH SEAT TYPE
				MTAT-00005	TRANSMISSION UNIT ASSY, MANUAL	33030-6A390	SEPARATE SEAT TYPE
		UZJ100	T/F	MTAT-00031	TRANSFER ASSY	36130-6A470	
	03.09-05.06	UZJ100	T/F	MTAT-00031	TRANSFER ASSY	36130-6A470	
	05.05-07.08	UZJ100	T/F	MTAT-00031	TRANSFER ASSY	36130-6A470	
	05.05-	HDJ100	H151	MTAT-00033	TRANSMISSION UNIT ASSY, MANUAL	33030-6A550	
			R151F	MTAT-00004	TRANSMISSION UNIT ASSY, MANUAL	33030-6A380	BENCH SEAT TYPE
		HZJ105		MTAT-00005	TRANSMISSION UNIT ASSY, MANUAL	33030-6A390	SEPARATE SEAT TYPE
	05.06-	UZJ100	T/F	MTAT-00031	TRANSFER ASSY	36130-6A470	
LEXUS LX470	02.08-05.05	UZJ100	T/F	MTAT-00031	TRANSFER ASSY	36130-6A470	
	05.05-07.08	UZJ100	T/F	MTAT-00031	TRANSFER ASSY	36130-6A470	

Reference List / Genuine No.→ AISIN No.

Genuine No.	AISIN No.	Make
30300-1A832	MTAT-00030	TOYOTA
33030-26A01	MTAT-00011	TOYOTA
33030-26A24	MTAT-00012	TOYOTA
33030-26A24	MTAT-00026	TOYOTA
33030-60850	MTAT-00003	TOYOTA
33030-60A70	MTAT-00020	TOYOTA
33030-6A261	MTAT-00032	TOYOTA
33030-6A380	MTAT-00004	TOYOTA
33030-6A390	MTAT-00005	TOYOTA
33030-6A414	MTAT-00006	TOYOTA
33030-6A550	MTAT-00033	TOYOTA
33030-71200	MTAT-00036	TOYOTA
33030-71221	MTAT-00046	TOYOTA
33110-36A21	MTAT-00014	TOYOTA
33110-3J431	MTAT-00034	TOYOTA
33110-3J660	MTAT-00015	TOYOTA
33120-37591	MTAT-00022	TOYOTA
33120-37601	MTAT-00023	TOYOTA
33120-37670	MTAT-00024	TOYOTA
33120-3E561	MTAT-00009	TOYOTA
36110-6C070	MTAT-00002	TOYOTA
36110-6E181	MTAT-00010	TOYOTA
36120-60351	MTAT-00025	TOYOTA
36120-60420	MTAT-00019	TOYOTA
36120-60441	MTAT-00021	TOYOTA
36130-6A470	MTAT-00031	TOYOTA

Reference List / Manual Transmission(Parts)

Model	Year	Body Type	Engine Type	AISIN No.	Productin Name	Genuine No.			
4RUNNER	95.11-96.08	KZN185	1KZT	MTPT-00256	RETAINER SUB-ASSY, CONTROL SHIFT LEVER (FOR FLOOR SHIFT)	33506-35110			
	95.11-00.08	RZN18#	3RZFE	MTPT-00023	GEAR, 2ND	33033-28011			
		VZN185	5VZFE	MTPT-00024	GEAR, 3RD	33034-30011			
				MTPT-00012	FORK, GEAR SHIFT, NO.1	33212-35032			
				MTPT-00111	FORK, GEAR SHIFT, NO.2	33213-35040			
	95.11-02.11	KZN185	1KZT,1KZTE	MTPT-00317	BEARING, INPUT SHAFT	90364-25012			
				MTPT-00010	RING, SYNCHRONIZER, NO.2	33368-35030			
				MTPT-00075	PIECE, GEAR SPLINE, NO.5	33318-35040			
				MTPT-00080	SLEEVE, TRANSMISSION HUB, NO.2	33364-35050			
				MTPT-00083	RING, SYNCHRONIZER, NO.1	33367-35080			
				MTPT-00084	RING, SYNCHRONIZER, NO.2	33368-35040			
				MTPT-00087	SLEEVE, TRANSMISSION HUB, NO.3	33395-35031			
				MTPT-00143	RETAINER, OUTPUT SHAFT REAR BEARING (MTM)	33151-35020			
				MTPT-00147	KEY, SYNCHROMESH SHIFTING, NO.2	33366-35030			
				MTPT-00174	PIN (FOR 5TH GEAR THRUST WASHER)	90250-05026			
				95.11-	KZN185,RZN185	1KZT,1KZTE,3RZFE	MTPT-00313	PIN OR BALL (FOR 1ST GEAR THRUST WASHER)	90250-05026
							MTPT-00176	WASHER, 1ST GEAR THRUST	33348-35010
	KZN185,RZN185,VZN185	1KZT,1KZTE,3RZFE,5VZFE	MTPT-00176		SPRING, COMPRESSION	90501-07104			
			MTPT-00140		RING SET, SYNCHRONIZER, NO.1	33037-30011			
			MTPT-00150		RING, SYNCHRONIZER, NO.2	33368-30120			
96.10-02.11	RZN18#	3RZFE	MTPT-00028	RING, SYNCHRONIZER (FOR TRANSFER FRONT DRIVE CLUTCH)	33367-14010				
	KZN185,RZN185,VZN185	1KZT,1KZTE,3RZFE,5VZFE	MTPT-00170	NUT (FOR TRANSFER OUTPUT SHAFT)	90179-22016				
98.01-02.11	RZN18#	3RZFE	MTPT-00141	RING SET, SYNCHRONIZER, NO.2	33038-30012				
01.07-02.11	KZN185	1KZT,1KZTE	MTPT-00008	RING SET, SYNCHRONIZER, NO.1	33037-60040				
02.02-02.11	RZN18#	3RZFE	MTPT-00149	RING, SYNCHRONIZER, NO.1	33367-53030				
02.02-02.11	KZN185	1KZTE	MTPT-00001	SHAFT, INPUT	33301-60050 (33301-26050)				
02.11-05.08	GRN215,KZN215	1GRFE,1KZTE	MTPT-00170	NUT (FOR TRANSFER OUTPUT SHAFT)	90179-22016				
05.08-	GRN215	1GRFE	MTPT-00170	NUT (FOR TRANSFER OUTPUT SHAFT)	90179-22016				
09.08-	GRN285	1GRFE	MTPT-00170	NUT (FOR TRANSFER OUTPUT SHAFT)	90179-22016				
AURIS (UKP)	07.06-08.11	ZZE150	4ZZFE	MTPT-00168	NUT (FOR MANUAL TRANSMISSION OUTPUT SHAFT REAR SET)	90179-18005			
	07.06-09.02	ZRE151	1ZRFE	MTPT-00168	NUT (FOR MANUAL TRANSMISSION OUTPUT SHAFT REAR SET)	90179-18005			
AVENSIS	03.01-	AZT250	1AZFE	MTPT-00115	SPRING, SYNCHROMESH SHIFTING KEY, NO.3	33392-12010			
				MTPT-00116	SPRING, SYNCHROMESH SHIFTING KEY, NO.3	33392-12020			
				MTPT-00117	HUB, TRANSMISSION CLUTCH, NO.3	33393-42010			
				MTPT-00120	RING, SHAFT SNAP (FOR TRANSMISSION CLUTCH HUB NO.3)	90520-27067			
				MTPT-00121	RING, SHAFT SNAP (FOR TRANSMISSION CLUTCH HUB NO.3)	90520-27069			
	MTPT-00169	NUT (FOR MANUAL TRANSMISSION OUTPUT SHAFT REAR SET)	90179-20012						
	06.06-	AZT250	1AZFE	MTPT-00122	RING SET, SYNCHRONIER, NO.5	33048-28010			
07.06-	AZT250	1AZFE	MTPT-00118	SLEEVE, TRANSMISSION HUB, NO.3	33395-42012				
CAMRY	02.05-03.07	ACV30	2AZFE	MTPT-00122	RING SET, SYNCHRONIER, NO.5	33048-28010			

Reference List / Manual Transmission(Parts)

Model	Year	Body Type	Engine Type	AISIN No.	Productin Name	Genuine No.
CAMRY	03.07-	ACV30	2AZFE	MTPT-00115	SPRING, SYNCHROMESH SHIFTING KEY, NO.3	33392-12010
				MTPT-00116	SPRING, SYNCHROMESH SHIFTING KEY, NO.3	33392-12020
				MTPT-00117	HUB, TRANSMISSION CLUTCH, NO.3	33393-42010
				MTPT-00120	RING, SHAFT SNAP (FOR TRANSMISSION CLUTCH HUB NO.3)	90520-27067
				MTPT-00121	RING, SHAFT SNAP (FOR TRANSMISSION CLUTCH HUB NO.3)	90520-27069
				MTPT-00169	NUT (FOR MANUAL TRANSMISSION OUTPUT SHAFT REAR SET)	90179-20012
	05.03-06.11	ACV30	2AZFE	MTPT-00122	RING SET, SYNCHRONIER, NO.5	33048-28010
CAMRY (AUSTRALIA)	02.08-03.07	ACV36	2AZFE	MTPT-00122	RING SET, SYNCHRONIER, NO.5	33048-28010
	02.08-	ACV36,MCV36	2AZFE,1MZFE	MTPT-00115	SPRING, SYNCHROMESH SHIFTING KEY, NO.3	33392-12010
				MTPT-00116	SPRING, SYNCHROMESH SHIFTING KEY, NO.3	33392-12020
				MTPT-00120	RING, SHAFT SNAP (FOR TRANSMISSION CLUTCH HUB NO.3)	90520-27067
				MTPT-00121	RING, SHAFT SNAP (FOR TRANSMISSION CLUTCH HUB NO.3)	90520-27069
				MTPT-00169	NUT (FOR MANUAL TRANSMISSION OUTPUT SHAFT REAR SET)	90179-20012
	MCV36	1MZFE	MTPT-00117	HUB, TRANSMISSION CLUTCH, NO.3	33393-42010	
			MTPT-00122	RING SET, SYNCHRONIER, NO.5	33048-28010	
	03.07-04.08	ACV36	2AZFE	MTPT-00117	HUB, TRANSMISSION CLUTCH, NO.3	33393-42010
	05.03-06.06	ACV36	2AZFE	MTPT-00122	RING SET, SYNCHRONIER, NO.5	33048-28010
CAMRY (JPP/SED)	92.08-96.08	VCV10	3VZFE	MTPT-00122	RING SET, SYNCHRONIER, NO.5	33048-28010
	92.08-97.08	VCV10	3VZFE	MTPT-00115	SPRING, SYNCHROMESH SHIFTING KEY, NO.3	33392-12010
				MTPT-00116	SPRING, SYNCHROMESH SHIFTING KEY, NO.3	33392-12020
				MTPT-00169	NUT (FOR MANUAL TRANSMISSION OUTPUT SHAFT REAR SET)	90179-20012
			MTPT-00120	RING, SHAFT SNAP (FOR TRANSMISSION CLUTCH HUB NO.3)	90520-27067	
			MTPT-00121	RING, SHAFT SNAP (FOR TRANSMISSION CLUTCH HUB NO.3)	90520-27069	
CAMRY/AURION/HV(ARL)	06.06-11.10	ACV40	2AZFE	MTPT-00122	RING SET, SYNCHRONIER, NO.5	33048-28010
	06.06-	ACV40	2AZFE	MTPT-00115	SPRING, SYNCHROMESH SHIFTING KEY, NO.3	33392-12010
				MTPT-00116	SPRING, SYNCHROMESH SHIFTING KEY, NO.3	33392-12020
				MTPT-00117	HUB, TRANSMISSION CLUTCH, NO.3	33393-42010
				MTPT-00120	RING, SHAFT SNAP (FOR TRANSMISSION CLUTCH HUB NO.3)	90520-27067
			MTPT-00121	RING, SHAFT SNAP (FOR TRANSMISSION CLUTCH HUB NO.3)	90520-27069	
			MTPT-00169	NUT (FOR MANUAL TRANSMISSION OUTPUT SHAFT REAR SET)	90179-20012	
	07.06-	ACV40	2AZFE	MTPT-00118	SLEEVE, TRANSMISSION HUB, NO.3	33395-42012
CARINA	70.12-77.07	TA1#	T,2T,2TB	MTPT-00020	RING, SYNCHRONIZER, NO.1	33368-20012
				MTPT-00028	RING, SYNCHRONIZER, NO.2	33367-14010
	77.08-81.07	TA40 TA4#	2T,2TB,2TC	MTPT-00020	RING, SYNCHRONIZER, NO.1	33368-20012
				MTPT-00028	RING, SYNCHRONIZER, NO.3	33367-14010
	79.03-81.07	TA40	2T,2TB,2TC	MTPT-00334	SPRING, SYNCHROMESH SHIFTING KEY, NO.1	33371-14031
	79.08-81.07	TA47	3T,3TC	MTPT-00020	RING, SYNCHRONIZER, NO.1	33368-20012
				MTPT-00028	RING, SYNCHRONIZER, NO.2	33367-14010
				MTPT-00334	SPRING, SYNCHROMESH SHIFTING KEY, NO.1	33371-14031
81.08-83.09	CA60,TA6#	1C,2T,3T,3TC	MTPT-00020	RING, SYNCHRONIZER, NO.1	33368-20012	
			MTPT-00028	RING, SYNCHRONIZER, NO.3	33367-14010	
			MTPT-00334	SPRING, SYNCHROMESH SHIFTING KEY, NO.1	33371-14031	

Reference List / Manual Transmission(Parts)

Model	Year	Body Type	Engine Type	AISIN No.	Productin Name	Genuine No.
CARINA		TA6#	2T,3T,3TC	MTPT-00028	RING, SYNCHRONIZER, NO.2	33367-14010
CELICA	77.08-81.07	RA40	18R,18RC,18RG	MTPT-00020	RING, SYNCHRONIZER, NO.1	33368-20012
					RING, SYNCHRONIZER, NO.2	33368-20012
				MTPT-00028	RING, SYNCHRONIZER, NO.3	33367-14010
				MTPT-00020	RING, SYNCHRONIZER, NO.1	33368-20012
				MTPT-00028	RING, SYNCHRONIZER, NO.2	33367-14010
		RING, SYNCHRONIZER, NO.3	33367-14010			
	79.03-81.07	TA40	2T,2TB,2TG	MTPT-00334	SPRING, SYNCHROMESH SHIFTING KEY, NO.1	33371-14031
	79.08-81.07	RA40	18R,18RC,18RG	MTPT-00020	RING, SYNCHRONIZER, NO.1	33368-20012
					RING, SYNCHRONIZER, NO.2	33368-20012
				MTPT-00334	SPRING, SYNCHROMESH SHIFTING KEY, NO.1	33371-14031
		RA40,TA40	18R,18RC,18RG,2T,2TB,2TG	MTPT-00028	RING, SYNCHRONIZER, NO.3	33367-14010
	81.08-83.07	MA61,RA6#	5MGE,21R,21RC,18RG	MTPT-00020	RING, SYNCHRONIZER, NO.2	33368-20012
				MTPT-00334	SPRING, SYNCHROMESH SHIFTING KEY, NO.1	33371-14031
	81.08-85.07	AA63,TA60	4AGE,2T,2TB	MTPT-00020	RING, SYNCHRONIZER, NO.1	33368-20012
				MTPT-00028	RING, SYNCHRONIZER, NO.2	33367-14010
				MTPT-00334	SPRING, SYNCHROMESH SHIFTING KEY, NO.1	33371-14031
	81.08-85.12	AA63,MA61,RA6#,SA63,TA60	4AGE,5ME,5MGE,21R,21RC,22REC,18RG,2SC,2T,2TB	MTPT-00028	RING, SYNCHRONIZER, NO.3	33367-14010
	85.08-89.08	AT160	4AGEL,4AL	MTPT-00168	NUT (FOR MANUAL TRANSMISSION OUTPUT SHAFT REAR SET)	90179-18005
	89.10-93.11	ST185	3SGTE	MTPT-00169	NUT (FOR MANUAL TRANSMISSION OUTPUT SHAFT REAR SET)	90179-20012
	89.11-93.08	AT180	4AFE	MTPT-00168	NUT (FOR MANUAL TRANSMISSION OUTPUT SHAFT REAR SET)	90179-18005
91.08-92.02	ST185	3SGTE	MTPT-00122	RING SET, SYNCHRONIER, NO.5	33048-28010	
91.08-93.11	ST185	3SGTE	MTPT-00115	SPRING, SYNCHROMESH SHIFTING KEY, NO.3	33392-12010	
			MTPT-00116	SPRING, SYNCHROMESH SHIFTING KEY, NO.3	33392-12020	
93.08-93.11	ST185	3SGTE	MTPT-00120	RING, SHAFT SNAP (FOR TRANSMISSION CLUTCH HUB NO.3)	90520-27067	
			MTPT-00121	RING, SHAFT SNAP (FOR TRANSMISSION CLUTCH HUB NO.3)	90520-27069	
94.02-	ST205	3SGTE	MTPT-00115	SPRING, SYNCHROMESH SHIFTING KEY, NO.3	33392-12010	
			MTPT-00116	SPRING, SYNCHROMESH SHIFTING KEY, NO.3	33392-12020	
			MTPT-00120	RING, SHAFT SNAP (FOR TRANSMISSION CLUTCH HUB NO.3)	90520-27067	
			MTPT-00121	RING, SHAFT SNAP (FOR TRANSMISSION CLUTCH HUB NO.3)	90520-27069	
			MTPT-00122	RING SET, SYNCHRONIER, NO.5	33048-28010	
			MTPT-00169	NUT (FOR MANUAL TRANSMISSION OUTPUT SHAFT REAR SET)	90179-20012	
99.08-05.07	ZZT23#	2ZZGE	MTPT-00228	BEARING (FOR OUTPUT SHAFT FRONT)	90365-33006	
COASTER	77.08-82.04	BB10,RB1#	2B,5R,20R	MTPT-00020	RING, SYNCHRONIZER, NO.2	33368-20012
				MTPT-00032	HUB, TRANSMISSION CLUTCH, NO.2	33362-36021
				MTPT-00148	KEY, SYNCHROMESH SHIFTING, NO.2	33366-36020
				MTPT-00028	RING, SYNCHRONIZER, NO.3	33367-14010
	79.06-82.04	BB10,RB11,13	2B,20R,22R	MTPT-00183	NUT (FOR COUNTER GEAR SHAFT)	90179-26002
	82.05-85.09	BB20,30,RB20	3B,22R	MTPT-00020	RING, SYNCHRONIZER, NO.2	33368-20012
	82.05-85.10	BB20,30,RB20	3B,22R	MTPT-00028	RING, SYNCHRONIZER, NO.3	33367-14010
				MTPT-00032	HUB, TRANSMISSION CLUTCH, NO.2	33362-36021
			MTPT-00148	KEY, SYNCHROMESH SHIFTING, NO.2	33366-36020	

Reference List / Manual Transmission(Parts)

Model	Year	Body Type	Engine Type	AISIN No.	Productin Name	Genuine No.	
COASTER				MTPT-00183	NUT (FOR COUNTER GEAR SHAFT)	90179-26002	
	85.10-90.01	BB2#,3#,FB30,HB3#,RB20	3B,13B,3F,2H,12HT,22R	MTPT-00236	BEARING, INPUT SHAFT	90361-08004	
	85.10-93.01	BB2#,3#,FB30,HB3#,HDB30,HZB30,RB20	3B,13B,14B,3F,1HDT, 1HZ,2H,12HT,22R	MTPT-00020	RING, SYNCHRONIZER, NO.3	33368-20012	
				MTPT-00173	PIN, STRAIGHT (FOR GEAR THRUST WASHER)	90250-04056	
		BB2#,3#,FB30,HB3#,RB20	3B,13B,14B,3F,2H,12HT,22R	MTPT-00173	PIN, STRAIGHT (FOR REVERSE GEAR THRUST WASHER)	90250-04056	
	88.06-90.06	BB2#,3#,FB30,HB3#,HDB30,HZB30,RB20	3B,13B,14B,3F, 1HDT,1HZ,12HT,2H,22R	MTPT-00231	RING, SYNCHRONIZER, NO.2	33368-36042	
	90.01-93.01	BB2#,32,HDB30,HZB30,RB20	3B,13B,14B,1HDT,1HZ,22R	MTPT-00172	NUT (FOR MANUAL TRANSMISSION OUTPUT SHAFT REAR SET)	90179-24008	
	93.01-99.07	BB4#,5#,HZB50 BB4#,5#,HZB50,RZB40,50	3B,14B,1HZ 14B,15BFT,1HZ,3RZFE,3RZF	MTPT-00219	RING SET, SYNCHRONIZER, NO.3	33039-36010	
				MTPT-00156	KEY, SYNCHROMESH SHIFTING, NO.3	33394-36020	
					MTPT-00158	WASHER, REVERSE IDLER THRUST	33462-60020
					MTPT-00159	WASHER, REVERSE IDLER THRUST, No.2	33464-60010
					MTPT-00172	NUT (FOR MANUAL TRANSMISSION OUTPUT SHAFT REAR SET)	90179-24008
					MTPT-00173	PIN, STRAIGHT (FOR GEAR THRUST WASHER)	90250-04056
					MTPT-00212	HUB, TRANSMISSION CLUTCH, NO.3	33393-36060
					MTPT-00217	RING, SYNCHRONIZER, NO.3	33369-36010
					MTPT-00218	SLEEVE, TRANSMISSION HUB, NO.3	33395-36030
			BB40,42	14B	MTPT-00214	GEAR, 2ND	33033-36090
	93.12-99.07	RZB40,50	3RZF	MTPT-00152	RING, SYNCHRONIZER, NO.2	33368-36051	
	95.05-99.07	BB4#,5#,HZB50,RZB40,50	14B,15BFT,1HZ,3RZF	MTPT-00221	SLEEVE, TRANSMISSION HUB, NO.1	33363-37020	
		BB40,42,RZB40,50	14B,3RZF	MTPT-00216	GEAR, 5TH	33036-37010	
	97.05-99.07	BB43,5#	15BFT	MTPT-00232	RETAINER, BEARING, FRONT (MTM)	33018-37010	
	99.07-01.08	BB42 BB42,4#,50,HZB50 BB42,4#,50,HZB50,RZB40	14B 14B,15BFT,15BFTE,1HZ 14B,15BFT,15BFTE,1HZ,3RZF	MTPT-00214	GEAR, 2ND	33033-36090	
				MTPT-00219	RING SET, SYNCHRONIZER, NO.3	33039-36010	
					MTPT-00156	KEY, SYNCHROMESH SHIFTING, NO.3	33394-36020
					MTPT-00158	WASHER, REVERSE IDLER THRUST	33462-60020
					MTPT-00159	WASHER, REVERSE IDLER THRUST, No.2	33464-60010
					MTPT-00172	NUT (FOR MANUAL TRANSMISSION OUTPUT SHAFT REAR SET)	90179-24008
					MTPT-00173	PIN, STRAIGHT (FOR GEAR THRUST WASHER)	90250-04056
				MTPT-00212	HUB, TRANSMISSION CLUTCH, NO.3	33393-36060	
				MTPT-00217	RING, SYNCHRONIZER, NO.3	33369-36010	
				MTPT-00218	SLEEVE, TRANSMISSION HUB, NO.3	33395-36030	
				MTPT-00221	SLEEVE, TRANSMISSION HUB, NO.1	33363-37020	
				MTPT-00216	GEAR, 5TH	33036-37010	
				MTPT-00232	RETAINER, BEARING, FRONT (MTM)	33018-37010	
		BB42,RZB40	14B,3RZFE	MTPT-00020	RING, SYNCHRONIZER, NO.2	33368-20012	
		BB43,50	15BFT,15BFTE	MTPT-00063	RING, SYNCHRONIZER, NO.3	33369-60010	
		BB50	15BFT,15BFTE	MTPT-00158	WASHER, REVERSE IDLER THRUST	33462-60020	
				MTPT-00196	SHAFT, OUTPUT	33321-37070	
			MTPT-00197	GEAR SUB-ASSY, 6TH	33037-37010		
			MTPT-00199	GEAR, COUNTER, 6TH	33429-37010		
			MTPT-00209	HUB, TRANSMISSION CLUTCH, NO.1	33361-37040		

Reference List / Manual Transmission(Parts)

Model	Year	Body Type	Engine Type	AISIN No.	Productin Name	Genuine No.	
COASTER				MTPT-00213	SLEEVE, TRANSMISSION HUB, NO.3	33395-60040	
				MTPT-00234	HUB, TRANSMISSION CLUTCH, NO.4	33352-37030	
				MTPT-00235	HUB, TRANSMISSION CLUTCH, NO.2	33362-37020	
				MTPT-00236	BEARING, INPUT SHAFT	90361-08004	
				MTPT-00237	BEARING, RADIAL BALL	90363-32038	
				MTPT-00238	BEARING, COUNTER SHAFT CENTER	90365-36004	
				MTPT-00319	SLEEVE, TRANSMISSION HUB, NO.4	33327-37010	
				MTPT-00320	WASHER, REVERSE GEAR THRUST	33354-37010	
				MTPT-00321	GEAR, REVERSE	33331-37060	
				MTPT-00322	GEAR, 5TH	33036-37030	
				MTPT-00323	RING SET, SYNCHRONIZER, NO.2	33038-37011	
				MTPT-00338	RING SET, SYNCHRONIZER, NO.1	33037-37021	
				MTPT-00339	HUB, TRANSMISSION CLUTCH, NO.3	33393-37010	
				MTPT-00340	BEARING OR ROLLER (FOR COUNTER GEAR FRONT)	90365-30030	
				MTPT-00341	KEY, SYNCHROMESH SHIFTING, NO.2	33366-37030	
				MTPT-00342	BEARING (FOR OUTPUT SHAFT REAR)	90363-38007	
				MTPT-00343	BEARING (FOR OUTPUT SHAFT CENTER)	90363-45019	
				MTPT-00344	BEARING (FOR REVERSE GEAR)	90364-47008	
				MTPT-00345	FORK, GEAR SHIFT, NO.4	33215-37021	
				MTPT-00346	RETAINER, BEARING, CENTER	33147-37011	
				MTPT-00347	BEARING, NEEDLE ROLLER (FOR 6TH GEAR)	90364-39015	
				MTPT-00348	GEAR, 2ND	33033-37020	
				MTPT-00349	BEARING, NEEDLE ROLLER (FOR 3RD GEAR)	90364-38017	
				MTPT-00350	BEARING, NEEDLE ROLLER (FOR 2ND GEAR)	90364-58006	
				MTPT-00351	GEAR, 1ST	33335-37090	
			RZB40	3RZFE	MTPT-00152	RING, SYNCHRONIZER, NO.2	33368-36051
		99.07-02.11	BB50	15BFT	MTPT-00232	RETAINER, BEARING, FRONT (MTM)	33018-37010
		BB50,HZB50	15BFT,1HZ	MTPT-00219	RING SET, SYNCHRONIZER, NO.3	33039-36010	
		BB50,HZB50,RZB40,50	15BFT,1HZ,3RZFE	MTPT-00156	KEY, SYNCHROMESH SHIFTING, NO.3	33394-36020	
				MTPT-00158	WASHER, REVERSE IDLER THRUST	33462-60020	
				MTPT-00159	WASHER, REVERSE IDLER THRUST, No.2	33464-60010	
				MTPT-00172	NUT (FOR MANUAL TRANSMISSION OUTPUT SHAFT REAR SET)	90179-24008	
				MTPT-00173	PIN, STRAIGHT (FOR GEAR THRUST WASHER)	90250-04056	
				MTPT-00212	HUB, TRANSMISSION CLUTCH, NO.3	33393-36060	
				MTPT-00217	RING, SYNCHRONIZER, NO.3	33369-36010	
				MTPT-00218	SLEEVE, TRANSMISSION HUB, NO.3	33395-36030	
				MTPT-00221	SLEEVE, TRANSMISSION HUB, NO.1	33363-37020	
		RZB40,50	3RZFE	MTPT-00152	RING, SYNCHRONIZER, NO.2	33368-36051	
				MTPT-00216	GEAR, 5TH	33036-37010	
	99.07-03.04	BB50,58	15BFT	MTPT-00323	RING SET, SYNCHRONIZER, NO.2	33038-37011	
				MTPT-00338	RING SET, SYNCHRONIZER, NO.1	33037-37021	
	99.07-04.08	BB40,42,50,59,BZB40,50,HZB50,RZB40,50	14B,15BFT,15BFTE,1BZPPE,1HZ,3RZFE	MTPT-00156	KEY, SYNCHROMESH SHIFTING, NO.3	33394-36020	
		BB42	14B	MTPT-00214	GEAR, 2ND	33033-36090	

Reference List / Manual Transmission(Parts)

Model	Year	Body Type	Engine Type	AISIN No.	Productin Name	Genuine No.		
COASTER		BB42,50,58,59,BZB40,50,HZB50,RZB40,50	14B,15BFTE,15BFT,1BZFPE,1HZ,3RZFE	MTPT-00172	NUT (FOR MANUAL TRANSMISSION OUTPUT SHAFT REAR SET)	90179-24008		
		BB42,50,59,BZB40,50,HZB50	14B,15BFT,15BFTE,1BZFPE,1HZ	MTPT-00219	RING SET, SYNCHRONIZER, NO.3	33039-36010		
		BB42,50,59,BZB40,50,HZB50,RZB40,50	14B,15BFT,15BFTE,1BZFPE,1HZ,3RZFE	MTPT-00173	PIN, STRAIGHT (FOR GEAR THRUST WASHER)	90250-04056		
				MTPT-00217	RING, SYNCHRONIZER, NO.3	33369-36010		
				MTPT-00218	SLEEVE, TRANSMISSION HUB, NO.3	33395-36030		
				MTPT-00221	SLEEVE, TRANSMISSION HUB, NO.1	33363-37020		
		BB42,50,59,BZB40,50,RZB40,50,HZB50	1BZFPE,14B,15BFT,15BFTE,1HZ,3RZFE	MTPT-00159	WASHER, REVERSE IDLER THRUST, No.2	33464-60010		
		BB42,50,59,HZB50,RZB40,50	14B,15BFT,15BFTE,3RZFE	MTPT-00212	HUB, TRANSMISSION CLUTCH, NO.3	33393-36060		
		BB42,50,59,BZB40,50,RZB40,50	1BZFPE,14B,15BFT,3RZFE	MTPT-00158	WASHER, REVERSE IDLER THRUST	33462-60020		
		BB42,RZB40,50	14B,3RZFE	MTPT-00216	GEAR, 5TH	33036-37010		
		BB50,59,RZB40,50	1BZFPE,15BFT,15BFTE	MTPT-00232	RETAINER, BEARING, FRONT (MTM)	33018-37010		
		RZB40,50	3RZFE	MTPT-00152	RING, SYNCHRONIZER, NO.2	33368-36051		
		99.07-06.08	BB50,58		15BFT,15BFTE	MTPT-00020	RING, SYNCHRONIZER, NO.2	33368-20012
						MTPT-00063	RING, SYNCHRONIZER, NO.3	33369-60010
		MTPT-00158				WASHER, REVERSE IDLER THRUST	33462-60020	
		MTPT-00196				SHAFT, OUTPUT	33321-37070	
		MTPT-00197				GEAR SUB-ASSY, 6TH	33037-37010	
		MTPT-00199				GEAR, COUNTER, 6TH	33429-37010	
		MTPT-00209				HUB, TRANSMISSION CLUTCH, NO.1	33361-37040	
		MTPT-00213				SLEEVE, TRANSMISSION HUB, NO.3	33395-60040	
		MTPT-00234				HUB, TRANSMISSION CLUTCH, NO.4	33352-37030	
		MTPT-00235				HUB, TRANSMISSION CLUTCH, NO.2	33362-37020	
		MTPT-00236				BEARING, INPUT SHAFT	90361-08004	
		MTPT-00237				BEARING, RADIAL BALL	90363-32038	
		MTPT-00238				BEARING, COUNTER SHAFT CENTER	90365-36004	
		MTPT-00319				SLEEVE, TRANSMISSION HUB, NO.4	33327-37010	
		MTPT-00320				WASHER, REVERSE GEAR THRUST	33354-37010	
	MTPT-00321	GEAR, REVERSE				33331-37060		
	MTPT-00322	GEAR, 5TH				33036-37030		
	MTPT-00339	HUB, TRANSMISSION CLUTCH, NO.3				33393-37010		
	MTPT-00340	BEARING OR ROLLER (FOR COUNTER GEAR FRONT)				90365-30030		
	MTPT-00341	KEY, SYNCHROMESH SHIFTING, NO.2				33366-37030		
	MTPT-00342	BEARING (FOR OUTPUT SHAFT REAR)				90363-38007		
	MTPT-00343	BEARING (FOR OUTPUT SHAFT CENTER)				90363-45019		
	MTPT-00344	BEARING (FOR REVERSE GEAR)				90364-47008		
	MTPT-00345	FORK, GEAR SHIFT, NO.4	33215-37021					
	MTPT-00346	RETAINER, BEARING, CENTER	33147-37011					
	MTPT-00347	BEARING, NEEDLE ROLLER (FOR 6TH GEAR)	90364-39015					
	MTPT-00348	GEAR, 2ND	33033-37020					
	MTPT-00349	BEARING, NEEDLE ROLLER (FOR 3RD GEAR)	90364-38017					
	MTPT-00350	BEARING, NEEDLE ROLLER (FOR 2ND GEAR)	90364-58006					
	MTPT-00351	GEAR, 1ST	33335-37090					
03.03-04.08	BB50,58		15BFT,15BFTE	MTPT-00210	SLEEVE, TRANSMISSION HUB, NO.1	33363-60052		

Reference List / Manual Transmission(Parts)

Model	Year	Body Type	Engine Type	AISIN No.	Productin Name	Genuine No.			
COASTER				MTPT-00318	SLEEVE, TRANSMISSION HUB, NO.2	33364-37021			
	03.04-04.08	BB50,58	15BFT,15BFTE	MTPT-00104	RING SET, SYNCHRONIZER, NO.2	33038-37012			
				MTPT-00136	RING SET, SYNCHRONIZER, NO.1	33037-37022			
				MTPT-00194	RING SET, SYNCHRONIZER, NO.3	33039-37011			
	04.08-06.02	RZB40	3RZFE	MTPT-00156	KEY, SYNCHROMESH SHIFTING, NO.3	33394-36020			
				MTPT-00158	WASHER, REVERSE IDLER THRUST	33462-60020			
				MTPT-00159	WASHER, REVERSE IDLER THRUST, No.2	33464-60010			
				MTPT-00172	NUT (FOR MANUAL TRANSMISSION OUTPUT SHAFT REAR SET)	90179-24008			
				MTPT-00173	PIN, STRAIGHT (FOR GEAR THRUST WASHER)	90250-04056			
				MTPT-00212	HUB, TRANSMISSION CLUTCH, NO.3	33393-36060			
				MTPT-00216	GEAR, 5TH	33036-37010			
				MTPT-00217	RING, SYNCHRONIZER, NO.3	33369-36010			
				MTPT-00218	SLEEVE, TRANSMISSION HUB, NO.3	33395-36030			
				MTPT-00221	SLEEVE, TRANSMISSION HUB, NO.1	33363-37020			
	04.08-06.08	BB5#,BZB50	15BFT,15BFTE,15BZFPE	MTPT-00172	NUT (FOR MANUAL TRANSMISSION OUTPUT SHAFT REAR SET)	90179-24008			
		BB50,58	15BFT,15BFTE	MTPT-00104	RING SET, SYNCHRONIZER, NO.2	33038-37012			
				MTPT-00136	RING SET, SYNCHRONIZER, NO.1	33037-37022			
				MTPT-00194	RING SET, SYNCHRONIZER, NO.3	33039-37011			
		BB50,59,BZB50	15BFT,15BFTE,1BZFPE	MTPT-00210	SLEEVE, TRANSMISSION HUB, NO.1	33363-60052			
				MTPT-00318	SLEEVE, TRANSMISSION HUB, NO.2	33364-37021			
				MTPT-00156	KEY, SYNCHROMESH SHIFTING, NO.3	33394-36020			
				MTPT-00158	WASHER, REVERSE IDLER THRUST	33462-60020			
				MTPT-00159	WASHER, REVERSE IDLER THRUST, No.2	33464-60010			
				MTPT-00173	PIN, STRAIGHT (FOR GEAR THRUST WASHER)	90250-04056			
				MTPT-00212	HUB, TRANSMISSION CLUTCH, NO.3	33393-36060			
				MTPT-00217	RING, SYNCHRONIZER, NO.3	33369-36010			
				MTPT-00218	SLEEVE, TRANSMISSION HUB, NO.3	33395-36030			
				MTPT-00219	RING SET, SYNCHRONIZER, NO.3	33039-36010			
				MTPT-00221	SLEEVE, TRANSMISSION HUB, NO.1	33363-37020			
				MTPT-00232	RETAINER, BEARING, FRONT (MTM)	33018-37010			
				04.08-07.08	RZB40,50	3RZFE	MTPT-00152	RING, SYNCHRONIZER, NO.2	33368-36051
							MTPT-00156	KEY, SYNCHROMESH SHIFTING, NO.3	33394-36020
		MTPT-00158	WASHER, REVERSE IDLER THRUST				33462-60020		
MTPT-00159		WASHER, REVERSE IDLER THRUST, No.2	33464-60010						
MTPT-00172	NUT (FOR MANUAL TRANSMISSION OUTPUT SHAFT REAR SET)	90179-24008							
MTPT-00173	PIN, STRAIGHT (FOR GEAR THRUST WASHER)	90250-04056							
MTPT-00212	HUB, TRANSMISSION CLUTCH, NO.3	33393-36060							
MTPT-00216	GEAR, 5TH	33036-37010							
MTPT-00217	RING, SYNCHRONIZER, NO.3	33369-36010							
MTPT-00218	SLEEVE, TRANSMISSION HUB, NO.3	33395-36030							
04.08-11.08	BB42	14B	MTPT-00156	KEY, SYNCHROMESH SHIFTING, NO.3	33394-36020				
			MTPT-00158	WASHER, REVERSE IDLER THRUST	33462-60020				
			MTPT-00159	WASHER, REVERSE IDLER THRUST, No.2	33464-60010				

Reference List / Manual Transmission(Parts)

Model	Year	Body Type	Engine Type	AISIN No.	Productin Name	Genuine No.	
COASTER				MTPT-00172	NUT (FOR MANUAL TRANSMISSION OUTPUT SHAFT REAR SET)	90179-24008	
				MTPT-00173	PIN, STRAIGHT (FOR GEAR THRUST WASHER)	90250-04056	
				MTPT-00212	HUB, TRANSMISSION CLUTCH, NO.3	33393-36060	
				MTPT-00216	GEAR, 5TH	33036-37010	
				MTPT-00217	RING, SYNCHRONIZER, NO.3	33369-36010	
				MTPT-00218	SLEEVE, TRANSMISSION HUB, NO.3	33395-36030	
				MTPT-00219	RING SET, SYNCHRONIZER, NO.3	33039-36010	
				MTPT-00221	SLEEVE, TRANSMISSION HUB, NO.1	33363-37020	
	04.08-11.10	TRB40,50		2TRFE	MTPT-00152	RING, SYNCHRONIZER, NO.2	33368-36051
	04.08-15.01	BB42		14B	MTPT-00214	GEAR, 2ND	33033-36090
		BB42,50,BZB40,50,HZB50		14B,15BFT,15BFTE,1HZ	MTPT-00219	RING SET, SYNCHRONIZER, NO.3	33039-36010
		BB42,50,BZB40,50,HZB50,TRB40,50		14B,15BFT,15BFTE,1HZ,2TRFE	MTPT-00156	KEY, SYNCHROMESH SHIFTING, NO.3	33394-36020
					MTPT-00158	WASHER, REVERSE IDLER THRUST	33462-60020
					MTPT-00159	WASHER, REVERSE IDLER THRUST, No.2	33464-60010
					MTPT-00173	PIN, STRAIGHT (FOR GEAR THRUST WASHER)	90250-04056
					MTPT-00212	HUB, TRANSMISSION CLUTCH, NO.3	33393-36060
					MTPT-00217	RING, SYNCHRONIZER, NO.3	33369-36010
					MTPT-00218	SLEEVE, TRANSMISSION HUB, NO.3	33395-36030
					MTPT-00221	SLEEVE, TRANSMISSION HUB, NO.1	33363-37020
					MTPT-00172	NUT (FOR MANUAL TRANSMISSION OUTPUT SHAFT REAR SET)	90179-24008
					MTPT-00216	GEAR, 5TH	33036-37010
					MTPT-00232	RETAINER, BEARING, FRONT (MTM)	33018-37010
	06.08-15.01	XZB40,50,59		N04C	MTPT-00173	PIN, STRAIGHT (FOR GEAR THRUST WASHER)	90250-04056
	11.10-	TRB40,50		2TRFE	MTPT-00152	RING, SYNCHRONIZER, NO.2	33368-36051
	15.01-	BB42		14B	MTPT-00214	GEAR, 2ND	33033-36090
		BB42,BZB40,50,HZB50		1BZFPE,14B,1HZ	MTPT-00219	RING SET, SYNCHRONIZER, NO.3	33039-36010
		BB42,BZB40,50,HZB50,TRB40,50		1BZFPE,14B,1HZ,2TRFE	MTPT-00156	KEY, SYNCHROMESH SHIFTING, NO.3	33394-36020
				MTPT-00158	WASHER, REVERSE IDLER THRUST	33462-60020	
				MTPT-00159	WASHER, REVERSE IDLER THRUST, No.2	33464-60010	
				MTPT-00173	PIN, STRAIGHT (FOR GEAR THRUST WASHER)	90250-04056	
				MTPT-00212	HUB, TRANSMISSION CLUTCH, NO.3	33393-36060	
				MTPT-00217	RING, SYNCHRONIZER, NO.3	33369-36010	
				MTPT-00218	SLEEVE, TRANSMISSION HUB, NO.3	33395-36030	
				MTPT-00221	SLEEVE, TRANSMISSION HUB, NO.1	33363-37020	
				MTPT-00172	NUT (FOR MANUAL TRANSMISSION OUTPUT SHAFT REAR SET)	90179-24008	
				MTPT-00216	GEAR, 5TH	33036-37010	
				MTPT-00232	RETAINER, BEARING, FRONT (MTM)	33018-37010	
			MTPT-00173	PIN, STRAIGHT (FOR GEAR THRUST WASHER)	90250-04056		
COASTER (CHINA)	00.12-03.10	BB5#	15BF	MTPT-00219	RING SET, SYNCHRONIZER, NO.3	33039-36010	
		BB5#,RZB5#	15BF,3RZFE	MTPT-00156	KEY, SYNCHROMESH SHIFTING, NO.3	33394-36020	
				MTPT-00158	WASHER, REVERSE IDLER THRUST	33462-60020	
				MTPT-00159	WASHER, REVERSE IDLER THRUST, No.2	33464-60010	
				MTPT-00172	NUT (FOR MANUAL TRANSMISSION OUTPUT SHAFT REAR SET)	90179-24008	

Reference List / Manual Transmission(Parts)

Model	Year	Body Type	Engine Type	AISIN No.	Productin Name	Genuine No.
COASTER (CHINA)		RZB5#	3RZFE	MTPT-00173	PIN, STRAIGHT (FOR GEAR THRUST WASHER)	90250-04056
				MTPT-00217	RING, SYNCHRONIZER, NO.3	33369-36010
				MTPT-00152	RING, SYNCHRONIZER, NO.2	33368-36051
	03.10-07.01	BB54,5#	15BFT	MTPT-00219	RING SET, SYNCHRONIZER, NO.3	33039-36010
	03.10-	BB5#,RZB5#,TRB53,XZB53	15BFT,3RZFE,2TRFE,N041	MTPT-00156	KEY, SYNCHROMESH SHIFTING, NO.3	33394-36020
				MTPT-00158	WASHER, REVERSE IDLER THRUST	33462-60020
				MTPT-00159	WASHER, REVERSE IDLER THRUST, No.2	33464-60010
				MTPT-00172	NUT (FOR MANUAL TRANSMISSION OUTPUT SHAFT REAR SET)	90179-24008
				MTPT-00173	PIN, STRAIGHT (FOR GEAR THRUST WASHER)	90250-04056
				MTPT-00217	RING, SYNCHRONIZER, NO.3	33369-36010
	13.01-15.07	RZB5#,TRB53 XZB53	3RZFE,3TRFE N041	MTPT-00152	RING, SYNCHRONIZER, NO.2	33368-36051
				MTPT-00219	RING SET, SYNCHRONIZER, NO.3	33039-36010
				MTPT-00156	KEY, SYNCHROMESH SHIFTING, NO.3	33394-36020
				MTPT-00158	WASHER, REVERSE IDLER THRUST	33462-60020
				MTPT-00159	WASHER, REVERSE IDLER THRUST, No.2	33464-60010
MTPT-00172				NUT (FOR MANUAL TRANSMISSION OUTPUT SHAFT REAR SET)	90179-24008	
13.01-15.07	GRB53,TRB53,XZB53	6GRFE,2TRFE,N04C,N041	MTPT-00173	PIN, STRAIGHT (FOR GEAR THRUST WASHER)	90250-04056	
			MTPT-00217	RING, SYNCHRONIZER, NO.3	33369-36010	
			MTPT-00152	RING, SYNCHRONIZER, NO.2	33368-36051	
			MTPT-00219	RING SET, SYNCHRONIZER, NO.3	33039-36010	
			MTPT-00156	KEY, SYNCHROMESH SHIFTING, NO.3	33394-36020	
			MTPT-00158	WASHER, REVERSE IDLER THRUST	33462-60020	
13.01-15.07	GRB53,TRB53,XZB53	6GRFE,N04C,N041	MTPT-00159	WASHER, REVERSE IDLER THRUST, No.2	33464-60010	
			MTPT-00172	NUT (FOR MANUAL TRANSMISSION OUTPUT SHAFT REAR SET)	90179-24008	
			MTPT-00173	PIN, STRAIGHT (FOR GEAR THRUST WASHER)	90250-04056	
			MTPT-00217	RING, SYNCHRONIZER, NO.3	33369-36010	
			MTPT-00219	RING SET, SYNCHRONIZER, NO.3	33039-36010	
			MTPT-00156	KEY, SYNCHROMESH SHIFTING, NO.3	33394-36020	
13.01-15.07	GRB53,TRB53	6GRFE,3TRFE	MTPT-00219	RING SET, SYNCHRONIZER, NO.3	33039-36010	
			MTPT-00156	KEY, SYNCHROMESH SHIFTING, NO.3	33394-36020	
			MTPT-00158	WASHER, REVERSE IDLER THRUST	33462-60020	
			MTPT-00159	WASHER, REVERSE IDLER THRUST, No.2	33464-60010	
			MTPT-00172	NUT (FOR MANUAL TRANSMISSION OUTPUT SHAFT REAR SET)	90179-24008	
			MTPT-00173	PIN, STRAIGHT (FOR GEAR THRUST WASHER)	90250-04056	
13.01-15.07	GRB53,TRB53	6GRFE,3TRFE	MTPT-00217	RING, SYNCHRONIZER, NO.3	33369-36010	
			MTPT-00152	RING, SYNCHRONIZER, NO.2	33368-36051	
			MTPT-00219	RING SET, SYNCHRONIZER, NO.3	33039-36010	
			MTPT-00156	KEY, SYNCHROMESH SHIFTING, NO.3	33394-36020	
			MTPT-00158	WASHER, REVERSE IDLER THRUST	33462-60020	
			MTPT-00159	WASHER, REVERSE IDLER THRUST, No.2	33464-60010	
COROLLA	79.08-85.08	AE71,CE70,TE7#	4A,4AC,1C,2T,2TB,2TG,3TC	MTPT-00020	RING, SYNCHRONIZER, NO.1	33368-20012
	79.08-87.07	AE71,CE70,TE7#	4A,4AC,1C,2T,2TB,2TG,3TC	MTPT-00334	SPRING, SYNCHROMESH SHIFTING KEY, NO.1	33371-14031
COROLLA (ASIA/INDIA)	01.05-05.08	NZE 120,ZZE12#	1NZFE,1ZZFE,3ZZFE	MTPT-00168	NUT (FOR MANUAL TRANSMISSION OUTPUT SHAFT REAR SET)	90179-18005
	03.11-08.02	ZZE121	3ZZFE	MTPT-00168	NUT (FOR MANUAL TRANSMISSION OUTPUT SHAFT REAR SET)	90179-18005
	03.11-	ZZE122	1ZZFE	MTPT-00168	NUT (FOR MANUAL TRANSMISSION OUTPUT SHAFT REAR SET)	90179-18005
COROLLA (CHINA)	05.02-07.05	ZZE122	1ZZFE	MTPT-00168	NUT (FOR MANUAL TRANSMISSION OUTPUT SHAFT REAR SET)	90179-18005
	07.05-08.02	ZRE120	1ZRFE	MTPT-00168	NUT (FOR MANUAL TRANSMISSION OUTPUT SHAFT REAR SET)	90179-18005
		ZRE151	1ZRFE	MTPT-00168	NUT (FOR MANUAL TRANSMISSION OUTPUT SHAFT REAR SET)	90179-18005
COROLLA (S.AFRICA)	02.08-07.07	ZZE 120,121,122	1ZZFE,3ZZFE,4ZZFE	MTPT-00168	NUT (FOR MANUAL TRANSMISSION OUTPUT SHAFT REAR SET)	90179-18005
	07.07-09.02	NDE150,ZRE151,ZZE150	1NDTV,1ZRFE,4ZZFE	MTPT-00168	NUT (FOR MANUAL TRANSMISSION OUTPUT SHAFT REAR SET)	90179-18005
COROLLA (S.AMERICA)	02.05-08.03	CDE120	1CDFTV	MTPT-00115	SPRING, SYNCHROMESH SHIFTING KEY, NO.3	33392-12010
				MTPT-00116	SPRING, SYNCHROMESH SHIFTING KEY, NO.3	33392-12020

Reference List / Manual Transmission(Parts)

Model	Year	Body Type	Engine Type	AISIN No.	Productin Name	Genuine No.
COROLLA (S.AMERICA)				MTPT-00117	HUB, TRANSMISSION CLUTCH, NO.3	33393-42010
				MTPT-00120	RING, SHAFT SNAP (FOR TRANSMISSION CLUTCH HUB NO.3)	90520-27067
				MTPT-00121	RING, SHAFT SNAP (FOR TRANSMISSION CLUTCH HUB NO.3)	90520-27069
				MTPT-00169	NUT (FOR MANUAL TRANSMISSION OUTPUT SHAFT REAR SET)	90179-20012
	02.05-	ZZE12#	1ZZFE,3ZZFE	MTPT-00168	NUT (FOR MANUAL TRANSMISSION OUTPUT SHAFT REAR SET)	90179-18005
05.03-08.03	CDE120	1CDFTV	MTPT-00122	RING SET, SYNCHRONIER, NO.5	33048-28010	
07.06-08.03	CDE120	1CDFTV	MTPT-00118	SLEEVE, TRANSMISSION HUB, NO.3	33395-42012	
08.03-	ZZE14# ZZE141,142	1ZZFE,1ZZFBE,3ZZFE 1ZZFE,1ZZFBE,3ZZFE	MTPT-00168	NUT (FOR MANUAL TRANSMISSION OUTPUT SHAFT REAR SET)	90179-18005	
			MTPT-00206	GEAR, 3RD	33034-12150	
			MTPT-00029	GEAR, 5TH DRIVEN	33428-12110	
			MTPT-00207	GEAR, 5TH	33036-12130	
COROLLA 5D	01.10-07.02	ZZE122	1ZZFE	MTPT-00168	NUT (FOR MANUAL TRANSMISSION OUTPUT SHAFT REAR SET)	90179-18005
COROLLA COUPE	83.05-87.07	AE86	4A,4AC,4AGE,4AGEC	MTPT-00020	RING, SYNCHRONIZER, NO.1	33368-20012
				MTPT-00028	RING, SYNCHRONIZER, NO.2	33367-14010
					RING, SYNCHRONIZER, NO.3	33367-14010
				MTPT-00334	SPRING, SYNCHROMESH SHIFTING KEY, NO.1	33371-14031
COROLLA CP/HB	87.05-93.08	AE92,EE90	4AF,4AGE,2E	MTPT-00168	NUT (FOR MANUAL TRANSMISSION OUTPUT SHAFT REAR SET)	90179-18005
COROLLA HB/LB	92.05-97.10	AE10#,EE100	4AF,4AFE,7AFE,2E	MTPT-00168	NUT (FOR MANUAL TRANSMISSION OUTPUT SHAFT REAR SET)	90179-18005
COROLLA LB	97.04-01.09	AE111,112,11#,EE110	4AF,4AFE,7AFE,2E	MTPT-00168	NUT (FOR MANUAL TRANSMISSION OUTPUT SHAFT REAR SET)	90179-18005
COROLLA SED/CP/WG	91.08-01.10	AE100,101,EE10#	5AFE,4AF,4AFE,4AGE,2E,4EFE,2E,3E	MTPT-00168	NUT (FOR MANUAL TRANSMISSION OUTPUT SHAFT REAR SET)	90179-18005
COROLLA SED/LB	83.05-88.07	AE8#,EE80	2AL,2ALC,4AGEL,4AGELC,4AL,4ALC,2EL,2ELC	MTPT-00168	NUT (FOR MANUAL TRANSMISSION OUTPUT SHAFT REAR SET)	90179-18005
COROLLA SED/LB/WG	87.05-93.08	AE92,EE9#	4AF,4AGE,2E	MTPT-00168	NUT (FOR MANUAL TRANSMISSION OUTPUT SHAFT REAR SET)	90179-18005
	87.10-90.08	AE95	4AF,4AFE	MTPT-00169	NUT (FOR MANUAL TRANSMISSION OUTPUT SHAFT REAR SET)	90179-20012
COROLLA SED/WG	95.05-01.12	AE110,111,112,EE110,111	5AFE,4AF,4AFE,7AFE,2E,4EFE	MTPT-00168	NUT (FOR MANUAL TRANSMISSION OUTPUT SHAFT REAR SET)	90179-18005
	01.12-	AE111,112,EE11#,ZZE11#	4AFE,7AFE,2E,3ZZFE,4ZZFE	MTPT-00168	NUT (FOR MANUAL TRANSMISSION OUTPUT SHAFT REAR SET)	90179-18005
	07.04-	NZE141	1NZFE	MTPT-00168	NUT (FOR MANUAL TRANSMISSION OUTPUT SHAFT REAR SET)	90179-18005
	07.08-	ZZE141,142 CE140	2C	MTPT-00168	NUT (FOR MANUAL TRANSMISSION OUTPUT SHAFT REAR SET)	90179-18005
MTPT-00115				SPRING, SYNCHROMESH SHIFTING KEY, NO.3	33392-12010	
MTPT-00116				SPRING, SYNCHROMESH SHIFTING KEY, NO.3	33392-12020	
MTPT-00117				HUB, TRANSMISSION CLUTCH, NO.3	33393-42010	
MTPT-00118				SLEEVE, TRANSMISSION HUB, NO.3	33395-42012	
MTPT-00120				RING, SHAFT SNAP (FOR TRANSMISSION CLUTCH HUB NO.3)	90520-27067	
MTPT-00121				RING, SHAFT SNAP (FOR TRANSMISSION CLUTCH HUB NO.3)	90520-27069	
MTPT-00122				RING SET, SYNCHRONIER, NO.5	33048-28010	
MTPT-00169				NUT (FOR MANUAL TRANSMISSION OUTPUT SHAFT REAR SET)	90179-20012	
COROLLA SPRINTER	94.02-96.05	AE102	4AF,4AFE	MTPT-00168	NUT (FOR MANUAL TRANSMISSION OUTPUT SHAFT REAR SET)	90179-18005

Reference List / Manual Transmission(Parts)

Model	Year	Body Type	Engine Type	AISIN No.	Productin Name	Genuine No.
COROLLA WAGON	90.09-95.08	AE95	4AF,4AFE	MTPT-00169	NUT (FOR MANUAL TRANSMISSION OUTPUT SHAFT REAR SET)	90179-20012
	91.09-95.08	AE95	4AF,4AFE	MTPT-00115	SPRING, SYNCHROMESH SHIFTING KEY, NO.3	33392-12010
				MTPT-00116	SPRING, SYNCHROMESH SHIFTING KEY, NO.3	33392-12020
				MTPT-00122	RING SET, SYNCHRONIER, NO.5	33048-28010
93.08-95.08	AE95	4AF,4AFE	MTPT-00120	RING, SHAFT SNAP (FOR TRANSMISSION CLUTCH HUB NO.3)	90520-27067	
			MTPT-00121	RING, SHAFT SNAP (FOR TRANSMISSION CLUTCH HUB NO.3)	90520-27069	
COROLLA/ALTIS	08.01-	NZE140,ZZE141,142	2NZFE,1ZZFE,3ZZFE	MTPT-00168	NUT (FOR MANUAL TRANSMISSION OUTPUT SHAFT REAR SET)	90179-18005
	08.08-	CE140	2C	MTPT-00115	SPRING, SYNCHROMESH SHIFTING KEY, NO.3	33392-12010
				MTPT-00116	SPRING, SYNCHROMESH SHIFTING KEY, NO.3	33392-12020
				MTPT-00117	HUB, TRANSMISSION CLUTCH, NO.3	33393-42010
				MTPT-00118	SLEEVE, TRANSMISSION HUB, NO.3	33395-42012
				MTPT-00120	RING, SHAFT SNAP (FOR TRANSMISSION CLUTCH HUB NO.3)	90520-27067
MTPT-00121	RING, SHAFT SNAP (FOR TRANSMISSION CLUTCH HUB NO.3)	90520-27069				
MTPT-00122	RING SET, SYNCHRONIER, NO.5	33048-28010				
MTPT-00169	NUT (FOR MANUAL TRANSMISSION OUTPUT SHAFT REAR SET)	90179-20012				
13.10-14.09	ZZE172	1ZZFE	MTPT-00168	NUT (FOR MANUAL TRANSMISSION OUTPUT SHAFT REAR SET)	90179-18005	
13.10-	NZE170	2NZFE	MTPT-00168	NUT (FOR MANUAL TRANSMISSION OUTPUT SHAFT REAR SET)	90179-18005	
COROLLA/ALTIS SED/WG	00.08-02.09	ZZE121,122,NZE121	1ZZFE,3ZZFE,1NZFZ	MTPT-00168	NUT (FOR MANUAL TRANSMISSION OUTPUT SHAFT REAR SET)	90179-18005
	00.08-05.07	NZE120	2NZFE	MTPT-00168	NUT (FOR MANUAL TRANSMISSION OUTPUT SHAFT REAR SET)	90179-18005
	00.08-07.02	ZZE122	1ZZFE	MTPT-00168	NUT (FOR MANUAL TRANSMISSION OUTPUT SHAFT REAR SET)	90179-18005
	01.10-	CE120	2C	MTPT-00115	SPRING, SYNCHROMESH SHIFTING KEY, NO.3	33392-12010
				MTPT-00116	SPRING, SYNCHROMESH SHIFTING KEY, NO.3	33392-12020
				MTPT-00117	HUB, TRANSMISSION CLUTCH, NO.3	33393-42010
				MTPT-00120	RING, SHAFT SNAP (FOR TRANSMISSION CLUTCH HUB NO.3)	90520-27067
	MTPT-00121	RING, SHAFT SNAP (FOR TRANSMISSION CLUTCH HUB NO.3)	90520-27069			
	MTPT-00169	NUT (FOR MANUAL TRANSMISSION OUTPUT SHAFT REAR SET)	90179-20012			
	02.02-05.07	ZZE121	3ZZFE	MTPT-00168	NUT (FOR MANUAL TRANSMISSION OUTPUT SHAFT REAR SET)	90179-18005
02.09-04.04	NZE12#,ZZE12#	1NZFE,2NZFE	MTPT-00168	NUT (FOR MANUAL TRANSMISSION OUTPUT SHAFT REAR SET)	90179-18005	
04.04-	NZE12#,ZZE122,12#	1NZFE,2NZFE,1ZZFE,3ZZFE	MTPT-00168	NUT (FOR MANUAL TRANSMISSION OUTPUT SHAFT REAR SET)	90179-18005	
05.03-07.08	CE120	2C	MTPT-00122	RING SET, SYNCHRONIER, NO.5	33048-28010	
07.06-	CE120	2C	MTPT-00118	SLEEVE, TRANSMISSION HUB, NO.3	33395-42012	
COROLLA/AXIO	12.04-	NZE161	1NZFE	MTPT-00168	NUT (FOR MANUAL TRANSMISSION OUTPUT SHAFT REAR SET)	90179-18005
	COROLLA/TRUENO	74.08-76.06	KE35	3KB,3KC,3KH	MTPT-00020	RING, SYNCHRONIZER, NO.1
KE35,TE37,47,51			3KB,3KC,3KH,2T,2TB,2TG	MTPT-00028	RING, SYNCHRONIZER, NO.3	33367-14010
74.08-80.04		TE3#,47,51	2T,2TB,2TG	MTPT-00020	RING, SYNCHRONIZER, NO.1	33368-20012
MTPT-00028	RING, SYNCHRONIZER, NO.2	33367-14010				
CORONA	73.08-77.11	RT10#,11#	12R,12RM,16R,18R,18RC	MTPT-00020	RING, SYNCHRONIZER, NO.1	33368-20012
	73.08-78.08	RT102,104	16R,18R,18RC	MTPT-00028	RING, SYNCHRONIZER, NO.3	33367-14010

Reference List / Manual Transmission(Parts)

Model	Year	Body Type	Engine Type	AISIN No.	Productin Name	Genuine No.
CORONA	78.09-81.08	RT13#,TT132	12R,12RM,18R,18RC,3T	MTPT-00020	RING, SYNCHRONIZER, NO.2	33368-20012
		RT132,TT13#	18R,18RC,2T,3T	MTPT-00028	RING, SYNCHRONIZER, NO.3	33367-14010
	79.03-81.08	RT13#,TT13#	12R,12RM,18R,18RC,2T,3T	MTPT-00334	SPRING, SYNCHROMESH SHIFTING KEY, NO.1	33371-14031
	81.08-81.12	TT132,133	2T,3T	MTPT-00028	RING, SYNCHRONIZER, NO.2	33367-14010
		TT132,133,RT130,132	2T,3T,12RM,18R	MTPT-00020	RING, SYNCHRONIZER, NO.1	33368-20012
	81.08-82.05	RT130,132,TT132,133	12RM,18R,18RC,2T,3T	MTPT-00334	SPRING, SYNCHROMESH SHIFTING KEY, NO.1	33371-14031
	81.08-83.01	RT13#	TT132,133,RT133	12RM,18RC	MTPT-00020	RING, SYNCHRONIZER, NO.2
2T,3T,21RC				MTPT-00334	SPRING, SYNCHROMESH SHIFTING KEY, NO.1	33371-14031
96.01-98.10	AT210	4AFE	MTPT-00168	NUT (FOR MANUAL TRANSMISSION OUTPUT SHAFT REAR SET)	90179-18005	
97.10-00.07	AT220	4AFE	MTPT-00168	NUT (FOR MANUAL TRANSMISSION OUTPUT SHAFT REAR SET)	90179-18005	
CORONA (SED/LB)	92.03-97.11	AT190	4AFE	MTPT-00168	NUT (FOR MANUAL TRANSMISSION OUTPUT SHAFT REAR SET)	90179-18005
CORONA FR	82.01-85.08	CT140,RT140,TT14#	1C,12RM,2T,3T	MTPT-00020	RING, SYNCHRONIZER, NO.1	33368-20012
			1C,2C,22REC,2T,3T	MTPT-00334	SPRING, SYNCHROMESH SHIFTING KEY, NO.1	33371-14031
	82.01-99.07	CT14#,RT142,TT14#	1C,2C,22REC,2T,3T	MTPT-00028	RING, SYNCHRONIZER, NO.3	33367-14010
	84.08-85.08	RT142	22REC	MTPT-00020	RING, SYNCHRONIZER, NO.2	33368-20012
	85.08-86.12	ST141	2S,2SC	MTPT-00028	RING, SYNCHRONIZER, NO.3	33367-14010
91.10-99.07	CT141,YT140	2C,2Y	MTPT-00150	RING, SYNCHRONIZER, NO.2	33368-30120	
CORONA SED (UKP)	96.01-97.10	AT190	4AFE	MTPT-00168	NUT (FOR MANUAL TRANSMISSION OUTPUT SHAFT REAR SET)	90179-18005
CORONA/ CARINA 2	83.10-87.11	AT151	4AL,4ALC	MTPT-00168	NUT (FOR MANUAL TRANSMISSION OUTPUT SHAFT REAR SET)	90179-18005
	87.12-92.11	AT17#	4AF	MTPT-00168	NUT (FOR MANUAL TRANSMISSION OUTPUT SHAFT REAR SET)	90179-18005
CRESSIDA	76.12-80.08	MX3#,RX3#,TX30	4M,18R,18RC,3T	MTPT-00020	RING, SYNCHRONIZER, NO.2	33368-20012
		RX3#	18R,18RC	MTPT-00028	RING, SYNCHRONIZER, NO.3	33367-14010
	79.03-80.08	MX3#,RX3#,TX30	4M,18R,18RC,3T	MTPT-00334	SPRING, SYNCHROMESH SHIFTING KEY, NO.1	33371-14031
	80.09-82.08	RX60	21R,21RC	MTPT-00334	SPRING, SYNCHROMESH SHIFTING KEY, NO.1	33371-14031
		GX6#,LX60,RX6#,TX62	1GE,1GGE,L,21R,21RC,3T	MTPT-00020	RING, SYNCHRONIZER, NO.2	33368-20012
	80.09-83.07	GX6#,LX60,RX60,6#,TX62	1GE,L,21R,21RC,3T	MTPT-00334	SPRING, SYNCHROMESH SHIFTING KEY, NO.1	33371-14031
		GX6#,LX60,RX6#,TX62	1GE,L,21R,21RC,3T	MTPT-00028	RING, SYNCHRONIZER, NO.3	33367-14010
	84.08-88.08	GX71,LX7#,MX73,RX7#,YX70	1GE,1GGE,5ME,5MGE,2L,2LT,21R,2Y	MTPT-00028	RING, SYNCHRONIZER, NO.3	33367-14010
	88.08-91.11	GX81,LX80,MX81,RX8#	1GFE,2L,5ME,22R	MTPT-00028	RING, SYNCHRONIZER, NO.3	33367-14010
91.11-96.08	GX81,LX80,MX81,RX8#	1GFE,2L,5ME,22R	MTPT-00150	RING, SYNCHRONIZER, NO.2	33368-30120	
			MTPT-00176	SPRING, COMPRESSION	90501-07104	
94.03-96.08	RX81	22R	MTPT-00140	RING SET, SYNCHRONIZER, NO.1	33037-30011	
CRESSIDA WAGON	88.10-91.11	GX71,MX75,RX7#,YX72	1GFE,7MGE,22R,3Y	MTPT-00028	RING, SYNCHRONIZER, NO.3	33367-14010
	91.11-92.05	GX71,MX75,RX7#,YX72	1GFE,7MGE,22R,3Y	MTPT-00150	RING, SYNCHRONIZER, NO.2	33368-30120
				MTPT-00176	SPRING, COMPRESSION	90501-07104
92.05-93.02	RX72	22R	MTPT-00150	RING, SYNCHRONIZER, NO.2	33368-30120	
				MTPT-00176	SPRING, COMPRESSION	90501-07104
CROWN	74.10-79.08	MS8#,95,RS80	4M,5R	MTPT-00020	RING, SYNCHRONIZER, NO.1	33368-20012
	79.03-80.08	MS8#,95,RS80	4M,5R	MTPT-00334	SPRING, SYNCHROMESH SHIFTING KEY, NO.1	33371-14031
	79.09-83.07	LS110,MS11#,RS110	L,4M,5M,5ME,5R	MTPT-00020	RING, SYNCHRONIZER, NO.2	33368-20012
		LS110,MS112	L,5ME	MTPT-00028	RING, SYNCHRONIZER, NO.3	33367-14010
	79.11-83.07	LS110,MS11#,RS110	L,4M,5M,5ME,5R	MTPT-00334	SPRING, SYNCHROMESH SHIFTING KEY, NO.1	33371-14031
	83.08-84.02	LS120	2L	MTPT-00334	SPRING, SYNCHROMESH SHIFTING KEY, NO.1	33371-14031
	83.08-87.08	LS120	2L	MTPT-00020	RING, SYNCHRONIZER, NO.2	33368-20012
LS120,MS122,123,YS120		2L,5M,5ME,5MGE,3Y	MTPT-00028	RING, SYNCHRONIZER, NO.3	33367-14010	

Reference List / Manual Transmission(Parts)

Model	Year	Body Type	Engine Type	AISIN No.	Productin Name	Genuine No.
CROWN	87.09-91.10	GS131,LS130,MS132,133	1GFE,2L,5M,5ME	MTPT-00028	RING, SYNCHRONIZER, NO.3	33367-14010
	87.09-92.11	LS130	2L	MTPT-00020	RING, SYNCHRONIZER, NO.2	33368-20012
	88.07-91.10	LS130	2L	MTPT-00112	WASHER, 4TH GEAR	33349-35010
	91.10-95.12	LS130	2L	MTPT-00028	RING, SYNCHRONIZER, NO.3	33367-14010
				MTPT-00112	WASHER, 4TH GEAR	33349-35010
	91.10-01.04	GS131,JZS133	1GFE,2JZGE	MTPT-00176	SPRING, COMPRESSION	90501-07104
		GS131,JZS133,LS130,YS132	1GFE,2JZGE,2L,4Y	MTPT-00150	RING, SYNCHRONIZER, NO.2	33368-30120
	94.03-01.04	GS131,JZS133,LS130,YS132	1GFE,2JZGE,2L,4Y	MTPT-00140	RING SET, SYNCHRONIZER, NO.1	33037-30011
	95.12-99.09	JZS155	2JZGE	MTPT-00140	RING SET, SYNCHRONIZER, NO.1	33037-30011
				MTPT-00150	RING, SYNCHRONIZER, NO.2	33368-30120
MTPT-00176				SPRING, COMPRESSION	90501-07104	
96.10-99.09	JZS155	2JZGE	MTPT-00141	RING SET, SYNCHRONIZER, NO.2	33038-30012	
96.10-01.04	JZS133	2JZGE	MTPT-00141	RING SET, SYNCHRONIZER, NO.2	33038-30012	
CROWN COMFORT	96.01-01.08	LXS1# LXS1#,YXS10	2L,5L 2L,5L,3YPE	MTPT-00140	RING SET, SYNCHRONIZER, NO.1	33037-30011
				MTPT-00150	RING, SYNCHRONIZER, NO.2	33368-30120
				MTPT-00176	SPRING, COMPRESSION	90501-07104
				MTPT-00028	RING, SYNCHRONIZER, NO.3	33367-14010
				MTPT-00112	WASHER, 4TH GEAR	33349-35010
	96.10-01.08	LXS1#	2L,5L	MTPT-00141	RING SET, SYNCHRONIZER, NO.2	33038-30012
	01.08-03.12	YXS10	3YPE	MTPT-00028	RING, SYNCHRONIZER, NO.3	33367-14010
				MTPT-00112	WASHER, 4TH GEAR	33349-35010
	01.08-06.07	LXS12	5L	MTPT-00140	RING SET, SYNCHRONIZER, NO.1	33037-30011
				MTPT-00141	RING SET, SYNCHRONIZER, NO.2	33038-30012
MTPT-00149				RING, SYNCHRONIZER, NO.1	33367-53030	
MTPT-00150				RING, SYNCHRONIZER, NO.2	33368-30120	
MTPT-00176				SPRING, COMPRESSION	90501-07104	
DYNA	77.08-82.04	BU2#,3#,HU30,JU20,RU2#,30	B,3B,H,2J,5R	MTPT-00028	RING, SYNCHRONIZER, NO.3	33367-14010
	77.08-84.11	BU2#,3#,40,HU30,40,50,JU20,RU2#,30,WU40,50	B,3B,H,2H,2J,5R,1W	MTPT-00020	RING, SYNCHRONIZER, NO.2	33368-20012
				MTPT-00032	HUB, TRANSMISSION CLUTCH, NO.2	33362-36021
				MTPT-00148	KEY, SYNCHROMESH SHIFTING, NO.2	33366-36020
	79.06-84.11	BU20,30,RU20,30	B,5R	MTPT-00183	NUT (FOR COUNTER GEAR SHAFT)	90179-26002
	82.04-84.08	BU20,23,25,31,32,36,40,HU40,50,WU40,50	B,2B,3B,2H,1W	MTPT-00020	RING, SYNCHRONIZER, NO.3	33368-20012
				MTPT-00142	PIPE, OIL RECEIVER, NO.1 (MTM)	33124-36010
				MTPT-00155	KEY, SYNCHROMESH SHIFTING (FOR NO.3 CLUTCH HUB)	33394-36011
				MTPT-00183	NUT (FOR COUNTER GEAR SHAFT)	90179-26002
				MTPT-00187	NUT (FOR MANUAL TRANSMISSION OUTPUT SHAFT REAR SET)	90179-22005
				MTPT-00189	WASHER (FOR MANUAL TRANSMISSION OUTPUT SHAFT SET)	90201-22005
	82.04-84.11	BU20,30,RU2#,30	B,5R	MTPT-00028	RING, SYNCHRONIZER, NO.3	33367-14010
	84.09-85.08	BU6#,7#,8# RU75,85,WU9#,YU6#,70,80	B,11B,13B 22R,1W,3Y,4Y	MTPT-00020	RING, SYNCHRONIZER, NO.2	33368-20012
MTPT-00028				RING, SYNCHRONIZER, NO.3	33367-14010	
MTPT-00032				HUB, TRANSMISSION CLUTCH, NO.2	33362-36021	
MTPT-00148				KEY, SYNCHROMESH SHIFTING, NO.2	33366-36020	
MTPT-00183				NUT (FOR COUNTER GEAR SHAFT)	90179-26002	
MTPT-00020				RING, SYNCHRONIZER, NO.2	33368-20012	
MTPT-00032				HUB, TRANSMISSION CLUTCH, NO.2	33362-36021	

Reference List / Manual Transmission(Parts)

Model	Year	Body Type	Engine Type	AISIN No.	Productin Name	Genuine No.					
DYNA		RU75,85,YU6#,70,80	22R,3Y,4Y	MTPT-00148	KEY, SYNCHROMESH SHIFTING, NO.2	33366-36020					
				MTPT-00183	NUT (FOR COUNTER GEAR SHAFT)	90179-26002					
				MTPT-00028	RING, SYNCHRONIZER, NO.3	33367-14010					
	84.09-87.08	WU9#		1W	MTPT-00020	RING, SYNCHRONIZER, NO.2	33368-20012				
						RING, SYNCHRONIZER, NO.3	33368-20012				
					MTPT-00032	HUB, TRANSMISSION CLUTCH, NO.2	33362-36021				
					MTPT-00142	PIPE, OIL RECEIVER, NO.1 (MTM)	33124-36010				
					MTPT-00148	KEY, SYNCHROMESH SHIFTING, NO.2	33366-36020				
					MTPT-00155	KEY, SYNCHROMESH SHIFTING (FOR NO.3 CLUTCH HUB)	33394-36011				
					MTPT-00173	PIN OR BALL (FOR 1ST GEAR THRUST WASHER)	90250-04056				
						PIN, STRAIGHT (FOR REVERSE GEAR THRUST WASHER)	90250-04056				
					MTPT-00183	NUT (FOR COUNTER GEAR SHAFT)	90179-26002				
					MTPT-00187	NUT (FOR MANUAL TRANSMISSION OUTPUT SHAFT REAR SET)	90179-22005				
					MTPT-00189	WASHER (FOR MANUAL TRANSMISSION OUTPUT SHAFT SET)	90201-22005				
					MTPT-00236	BEARING, INPUT SHAFT	90361-08004				
					MTPT-00028	RING, SYNCHRONIZER (FOR TRANSFER FRONT DRIVE CLUTCH)	33367-14010				
					85.08-87.08	BU60,61,62,63,65,7#,8#		B,11B,13B	MTPT-00020	RING, SYNCHRONIZER, NO.3	33368-20012
									MTPT-00173	PIN, STRAIGHT (FOR GEAR THRUST WASHER)	90250-04056
		PIN, STRAIGHT (FOR REVERSE GEAR THRUST WASHER)	90250-04056								
	MTPT-00236	BEARING, INPUT SHAFT	90361-08004								
	MTPT-00028	RING, SYNCHRONIZER, NO.3	33367-14010								
	MTPT-00032	HUB, TRANSMISSION CLUTCH, NO.2	33362-36021								
	BU65		11B			MTPT-00148	KEY, SYNCHROMESH SHIFTING, NO.2	33366-36020			
						MTPT-00183	NUT (FOR COUNTER GEAR SHAFT)	90179-26002			
						MTPT-00187	NUT (FOR MANUAL TRANSMISSION OUTPUT SHAFT REAR SET)	90179-22005			
						MTPT-00189	WASHER (FOR MANUAL TRANSMISSION OUTPUT SHAFT SET)	90201-22005			
						MTPT-00020	RING, SYNCHRONIZER, NO.3	33368-20012			
						MTPT-00173	PIN OR BALL (FOR 1ST GEAR THRUST WASHER)	90250-04056			
							PIN, STRAIGHT (FOR REVERSE GEAR THRUST WASHER)	90250-04056			
						MTPT-00236	BEARING, INPUT SHAFT	90361-08004			
						RU75,85,YU6#,7#,8#		22R,3Y,4Y		MTPT-00020	RING, SYNCHRONIZER, NO.3
	MTPT-00173	PIN OR BALL (FOR 1ST GEAR THRUST WASHER)	90250-04056								
		PIN, STRAIGHT (FOR REVERSE GEAR THRUST WASHER)	90250-04056								
99.07-02.12	XZU30#,320,330,34#		15BFTE	MTPT-00172	NUT (FOR MANUAL TRANSMISSION OUTPUT SHAFT REAR SET)	90179-24008					
				MTPT-00061	RING, SYNCHRONIZER, NO.2	33368-60022					
	XZU300,320,330,34#		15BFTE		MTPT-00158	WASHER, REVERSE IDLER THRUST	33462-60020				
					MTPT-00209	HUB, TRANSMISSION CLUTCH, NO.2	33361-37040				
					MTPT-00237	BEARING, RADIAL BALL	90363-32038				
					MTPT-00238	BEARING, COUNTER SHAFT CENTER	90365-36004				
					MTPT-00320	RACE, REVERSE GEAR BEARING, INNER	33354-37010				
					MTPT-00323	RING SET, SYNCHRONIZER, NO.3	33038-37011				
					MTPT-00338	RING SET, SYNCHRONIZER, NO.2	33037-37021				

Reference List / Manual Transmission(Parts)

Model	Year	Body Type	Engine Type	AISIN No.	Productin Name	Genuine No.	
DYNA				MTPT-00340	BEARING OR ROLLER (FOR COUNTER GEAR FRONT)	90365-30030	
				MTPT-00342	BEARING (FOR OUTPUT SHAFT REAR)	90363-38007	
				MTPT-00343	BEARING (FOR OUTPUT SHAFT CENTER)	90363-45019	
				MTPT-00344	BEARING (FOR REVERSE GEAR)	90364-47008	
				MTPT-00346	RETAINER, BEARING, CENTER	33147-37011	
		00.10-02.06	XZU302,307	S05C	MTPT-00156	KEY, SYNCHROMESH SHIFTING, NO.3	33394-36020
					MTPT-00158	WASHER, REVERSE IDLER THRUST	33462-60020
					MTPT-00159	WASHER, REVERSE IDLER THRUST, No.2	33464-60010
					MTPT-00173	PIN OR BALL (FOR 1ST GEAR THRUST WASHER)	90250-04056
					MTPT-00212	HUB, TRANSMISSION CLUTCH, NO.3	33393-36060
					MTPT-00217	RING, SYNCHRONIZER, NO.3	33369-36010
					MTPT-00218	SLEEVE, TRANSMISSION HUB, NO.3	33395-36030
					MTPT-00219	RING SET, SYNCHRONIZER, NO.3	33039-36010
					MTPT-00221	SLEEVE, TRANSMISSION HUB, NO.1	33363-37020
			XZU402	S05C	MTPT-00061	RING, SYNCHRONIZER, NO.2	33368-60022
					MTPT-00209	HUB, TRANSMISSION CLUTCH, NO.2	33361-37040
					MTPT-00323	RING SET, SYNCHRONIZER, NO.3	33038-37011
					MTPT-00338	RING SET, SYNCHRONIZER, NO.2	33037-37021
			XZU402,41#,420,430	S05C,S05D,J05C,J05D	MTPT-00158	WASHER, REVERSE IDLER THRUST	33462-60020
					MTPT-00172	NUT (FOR MANUAL TRANSMISSION OUTPUT SHAFT REAR SET)	90179-24008
					MTPT-00237	BEARING, RADIAL BALL	90363-32038
					MTPT-00238	BEARING, COUNTER SHAFT CENTER	90365-36004
					MTPT-00320	RACE, REVERSE GEAR BEARING, INNER	33354-37010
					MTPT-00340	BEARING OR ROLLER (FOR COUNTER GEAR FRONT)	90365-30030
					MTPT-00342	BEARING (FOR OUTPUT SHAFT REAR)	90363-38007
					MTPT-00343	BEARING (FOR OUTPUT SHAFT CENTER)	90363-45019
					MTPT-00344	BEARING (FOR REVERSE GEAR)	90364-47008
					MTPT-00346	RETAINER, BEARING, CENTER	33147-37011
			XZU41#,420,430	S05C,S05D,J05CJ05D	MTPT-00196	SHAFT, OUTPUT	33321-37070
					MTPT-00323	RING SET, SYNCHRONIZER, NO.2	33038-37011
					MTPT-00338	RING SET, SYNCHRONIZER, NO.1	33037-37021
					MTPT-00341	KEY, SYNCHROMESH SHIFTING, NO.2	33366-37030
		01.07-03.12	KDY220,230,LY22#	2KDFTV,5L	MTPT-00333	KEY, SYNCHROMESH SHIFTING, NO.2	33366-35040 (33366-35041)
		01.07-04.12	LY220	5L	MTPT-00334	SPRING, SYNCHROMESH SHIFTING KEY, NO.1	33371-14031
		01.07-06.09	KDY220	2KDFTV	MTPT-00020	RING, SYNCHRONIZER, NO.2	33368-20012
					MTPT-00028	RING, SYNCHRONIZER, NO.1	33367-14010
						RING, SYNCHRONIZER, NO.3	33367-14010
					MTPT-00095	HUB, TRANSMISSION CLUTCH, NO.2	33362-35040
					MTPT-00100	SLEEVE, TRANSMISSION HUB, NO.2	33364-26020
					MTPT-00112	WASHER, 5TH GEAR THRUST	33349-35010
					MTPT-00142	PIPE, OIL RECEIVER, NO.2 (FOR EXTENSION HOUSING)	33124-36010
					MTPT-00328	SHAFT, OUTPUT	33321-26050

Reference List / Manual Transmission(Parts)

Model	Year	Body Type	Engine Type	AISIN No.	Productin Name	Genuine No.
DYNA		KDY220,230	2KDFTV	MTPT-00332	SHAFT, INPUT	33301-35071
				MTPT-00334	SPRING, SYNCHROMESH SHIFTING KEY, NO.1	33371-14031
	01.07-06.10	LY235	5L	MTPT-00170	NUT (FOR DRIVE PINION COMPANION FLANGE REAR)	90179-22016
	01.07-09.05	KDY221,231	1KDFTV	MTPT-00080	SLEEVE, TRANSMISSION HUB, NO.2	33364-35050
		KDY221,231,251,261	1KDFTV	MTPT-00147	KEY, SYNCHROMESH SHIFTING, NO.2	33366-35030
				MTPT-00083	RING, SYNCHRONIZER, NO.1	33367-35080
	01.07-12.04	KDY221,23#,25#,26#,LY230,235	1KDFTV,2KDFTV,5L	MTPT-00080	SLEEVE, TRANSMISSION HUB, NO.2	33364-35050
				MTPT-00147	KEY, SYNCHROMESH SHIFTING, NO.2	33366-35030
		KDY221,230,231,25#,26#,LY23#	1KDFTV,2KDFTV,5L	MTPT-00010	RING, SYNCHRONIZER, NO.2	33368-35030
				MTPT-00084	RING, SYNCHRONIZER, NO.2	33368-35040
	01.07-13.10	KDY221,231	1KDFTV	MTPT-00083	RING, SYNCHRONIZER, NO.1	33367-35080
	01.07-	KDY220,230,LY22#	2KDFTV,5L	MTPT-00020	RING, SYNCHRONIZER, NO.2	33368-20012
				MTPT-00028	RING, SYNCHRONIZER, NO.1	33367-14010
					RING, SYNCHRONIZER, NO.3	33367-14010
				MTPT-00095	HUB, TRANSMISSION CLUTCH, NO.2	33362-35040
				MTPT-00100	SLEEVE, TRANSMISSION HUB, NO.2	33364-26020
				MTPT-00112	WASHER, 5TH GEAR THRUST	33349-35010
				MTPT-00142	PIPE, OIL RECEIVER, NO.2 (FOR EXTENSION HOUSING)	33124-36010
				MTPT-00328	SHAFT, OUTPUT	33321-26050
				MTPT-00332	SHAFT, INPUT	33301-35071
		KDY221,23#,25#,26#,LY230,235	1KDFTV,2KDFTV,5L	MTPT-00170	NUT (FOR MANUAL TRANSMISSION OUTPUT SHAFT REAR SET)	90179-22016
		KDY221,230,231,25#,26#,LY23#	1KDFTV,2KDFTV,5L	MTPT-00143	RETAINER, OUTPUT SHAFT REAR BEARING (MTM)	33151-35020
				MTPT-00174	PIN (FOR 5TH GEAR THRUST WASHER)	90250-05026
					PIN OR BALL (FOR 1ST GEAR THRUST WASHER)	90250-05026
				MTPT-00313	WASHER, 1ST GEAR THRUST	33348-35010
		KDY230,250,260,LY23#	2KDFTV,5L	MTPT-00083	RING, SYNCHRONIZER, NO.1	33367-35080
		LY225	5L	MTPT-00334	SPRING, SYNCHROMESH SHIFTING KEY, NO.1	33371-14031
	01.10-03.04	XZU404,41#,42#,434	S05C,,J05C	MTPT-00323	RING SET, SYNCHRONIZER, NO.3	33038-37011
				MTPT-00338	RING SET, SYNCHRONIZER, NO.2	33037-37021
	01.10-06.08	XZU414,424,434	S05C	MTPT-00158	WASHER, REVERSE IDLER THRUST	33462-60020
				MTPT-00172	NUT (FOR MANUAL TRANSMISSION OUTPUT SHAFT REAR SET)	90179-24008
				MTPT-00197	GEAR SUB-ASSY, 6TH	33037-37010
				MTPT-00199	GEAR, COUNTER, 6TH	33429-37010
				MTPT-00345	FORK, GEAR SHIFT, NO.4	33215-37021
	01.10-06.10	WU410,XZU404,412,414,422,424,434	W04D,S05C	MTPT-00172	NUT (FOR MANUAL TRANSMISSION OUTPUT SHAFT REAR SET)	90179-24008
		XZU404,412,414,422,424	S05C	MTPT-00061	RING, SYNCHRONIZER, NO.2	33368-60022
				MTPT-00209	HUB, TRANSMISSION CLUTCH, NO.2	33361-37040
				MTPT-00346	RETAINER, BEARING, CENTER	33147-37011
		XZU404,412,414,422,424,434	S05C	MTPT-00158	WASHER, REVERSE IDLER THRUST	33462-60020
				MTPT-00237	BEARING, RADIAL BALL	90363-32038
			MTPT-00238	BEARING, COUNTER SHAFT CENTER	90365-36004	
			MTPT-00320	RACE, REVERSE GEAR BEARING, INNER	33354-37010	
			MTPT-00340	BEARING OR ROLLER (FOR COUNTER GEAR FRONT)	90365-30030	

Reference List / Manual Transmission(Parts)

Model	Year	Body Type	Engine Type	AISIN No.	Productin Name	Genuine No.	
DYNA		XZU414,424,434	S05C	MTPT-00342	BEARING (FOR OUTPUT SHAFT REAR)	90363-38007	
				MTPT-00343	BEARING (FOR OUTPUT SHAFT CENTER)	90363-45019	
				MTPT-00344	BEARING (FOR REVERSE GEAR)	90364-47008	
				MTPT-00020	RING, SYNCHRONIZER, NO.2	33368-20012	
				MTPT-00063	RING, SYNCHRONIZER, NO.3	33369-60010	
				MTPT-00197	GEAR SUB-ASSY, 6TH	33037-37010	
				MTPT-00199	GEAR, COUNTER, 6TH	33429-37010	
				MTPT-00209	HUB, TRANSMISSION CLUTCH, NO.1	33361-37040	
				MTPT-00213	SLEEVE, TRANSMISSION HUB, NO.3	33395-60040	
				MTPT-00234	HUB, TRANSMISSION CLUTCH, NO.4	33352-37030	
				MTPT-00235	HUB, TRANSMISSION CLUTCH, NO.2	33362-37020	
				MTPT-00236	BEARING, INPUT SHAFT	90361-08004	
				MTPT-00319	SLEEVE, TRANSMISSION HUB, NO.4	33327-37010	
				MTPT-00321	GEAR, REVERSE	33331-37060	
				MTPT-00322	GEAR, 5TH	33036-37030	
		MTPT-00339	HUB, TRANSMISSION CLUTCH, NO.3	33393-37010			
		MTPT-00347	BEARING, NEEDLE ROLLER (FOR 6TH GEAR)	90364-39015			
		MTPT-00348	GEAR, 2ND	33033-37020			
		MTPT-00349	BEARING, NEEDLE ROLLER (FOR 3RD GEAR)	90364-38017			
		MTPT-00350	BEARING, NEEDLE ROLLER (FOR 2ND GEAR)	90364-58006			
		MTPT-00351	GEAR, 1ST	33335-37090			
		MTPT-00345	FORK, GEAR SHIFT, NO.4	33215-37021			
		01.10-07.01	BU410,420	15BFTE	MTPT-00020	RING, SYNCHRONIZER, NO.2	33368-20012
					MTPT-00063	RING, SYNCHRONIZER, NO.3	33369-60010
					MTPT-00158	WASHER, REVERSE IDLER THRUST	33462-60020
					MTPT-00172	NUT (FOR MANUAL TRANSMISSION OUTPUT SHAFT REAR SET)	90179-24008
					MTPT-00197	GEAR SUB-ASSY, 6TH	33037-37010
MTPT-00199	GEAR, COUNTER, 6TH				33429-37010		
MTPT-00209	HUB, TRANSMISSION CLUTCH, NO.1				33361-37040		
MTPT-00213	SLEEVE, TRANSMISSION HUB, NO.3				33395-60040		
MTPT-00234	HUB, TRANSMISSION CLUTCH, NO.4				33352-37030		
MTPT-00235	HUB, TRANSMISSION CLUTCH, NO.2				33362-37020		
MTPT-00236	BEARING, INPUT SHAFT				90361-08004		
MTPT-00237	BEARING, RADIAL BALL				90363-32038		
MTPT-00238	BEARING, COUNTER SHAFT CENTER				90365-36004		
MTPT-00319	SLEEVE, TRANSMISSION HUB, NO.4				33327-37010		
MTPT-00320	RACE, REVERSE GEAR BEARING, INNER				33354-37010		
MTPT-00321	GEAR, REVERSE				33331-37060		
MTPT-00322	GEAR, 5TH				33036-37030		
MTPT-00339	HUB, TRANSMISSION CLUTCH, NO.3				33393-37010		
MTPT-00340	BEARING OR ROLLER (FOR COUNTER GEAR FRONT)				90365-30030		
MTPT-00342	BEARING (FOR OUTPUT SHAFT REAR)				90363-38007		
MTPT-00343	BEARING (FOR OUTPUT SHAFT CENTER)	90363-45019					

Reference List / Manual Transmission(Parts)

Model	Year	Body Type	Engine Type	AISIN No.	Productin Name	Genuine No.	
DYNA				MTPT-00344	BEARING (FOR REVERSE GEAR)	90364-47008	
				MTPT-00345	FORK, GEAR SHIFT, NO.4	33215-37021	
				MTPT-00346	RETAINER, BEARING, CENTER	33147-37011	
				MTPT-00347	BEARING, NEEDLE ROLLER (FOR 6TH GEAR)	90364-39015	
				MTPT-00348	GEAR, 2ND	33033-37020	
				MTPT-00349	BEARING, NEEDLE ROLLER (FOR 3RD GEAR)	90364-38017	
				MTPT-00350	BEARING, NEEDLE ROLLER (FOR 2ND GEAR)	90364-58006	
				MTPT-00351	GEAR, 1ST	33335-37090	
		01.10-08.02	WU410,420,XZU412,420,422,430	J05C,S05C,W04D	MTPT-00172	NUT (FOR MANUAL TRANSMISSION OUTPUT SHAFT REAR SET)	90179-24008
			XZU412,420,422,430	J05C,S05C	MTPT-00020	RING, SYNCHRONIZER, NO.2	33368-20012
					MTPT-00063	RING, SYNCHRONIZER, NO.3	33369-60010
					MTPT-00197	GEAR SUB-ASSY, 6TH	33037-37010
					MTPT-00199	GEAR, COUNTER, 6TH	33429-37010
					MTPT-00209	HUB, TRANSMISSION CLUTCH, NO.1	33361-37040
					MTPT-00213	SLEEVE, TRANSMISSION HUB, NO.3	33395-60040
					MTPT-00234	HUB, TRANSMISSION CLUTCH, NO.4	33352-37030
					MTPT-00235	HUB, TRANSMISSION CLUTCH, NO.2	33362-37020
					MTPT-00236	BEARING, INPUT SHAFT	90361-08004
					MTPT-00237	BEARING, RADIAL BALL	90363-32038
					MTPT-00238	BEARING, COUNTER SHAFT CENTER	90365-36004
					MTPT-00319	SLEEVE, TRANSMISSION HUB, NO.4	33327-37010
					MTPT-00320	RACE, REVERSE GEAR BEARING, INNER	33354-37010
					MTPT-00321	GEAR, REVERSE	33331-37060
					MTPT-00322	GEAR, 5TH	33036-37030
					MTPT-00339	HUB, TRANSMISSION CLUTCH, NO.3	33393-37010
					MTPT-00340	BEARING OR ROLLER (FOR COUNTER GEAR FRONT)	90365-30030
					MTPT-00342	BEARING (FOR OUTPUT SHAFT REAR)	90363-38007
					MTPT-00343	BEARING (FOR OUTPUT SHAFT CENTER)	90363-45019
					MTPT-00344	BEARING (FOR REVERSE GEAR)	90364-47008
					MTPT-00345	FORK, GEAR SHIFT, NO.4	33215-37021
					MTPT-00347	BEARING, NEEDLE ROLLER (FOR 6TH GEAR)	90364-39015
					MTPT-00348	GEAR, 2ND	33033-37020
					MTPT-00349	BEARING, NEEDLE ROLLER (FOR 3RD GEAR)	90364-38017
					MTPT-00350	BEARING, NEEDLE ROLLER (FOR 2ND GEAR)	90364-58006
					MTPT-00351	GEAR, 1ST	33335-37090
			XZU420,430	J05C	MTPT-00158	WASHER, REVERSE IDLER THRUST	33462-60020
					MTPT-00346	RETAINER, BEARING, CENTER	33147-37011
		02.02-14.04	KDY221,230,231,25#,26#	1KDFTV,2KDFTV	MTPT-00001	SHAFT, INPUT	33301-60050 (33301-26050)
		02.07-08.02	BU410,420,XZU412,414,420,422,424,430,434	15BFTE,J05C,S05C	MTPT-00196	SHAFT, OUTPUT	33321-37070
					MTPT-00341	KEY, SYNCHROMESH SHIFTING, NO.2	33366-37030
		02.09-03.05	WU340	W04D	MTPT-00172	NUT (FOR MANUAL TRANSMISSION OUTPUT SHAFT REAR SET)	90179-24008

Reference List / Manual Transmission(Parts)

Model	Year	Body Type	Engine Type	AISIN No.	Productin Name	Genuine No.			
DYNA	02.09-06.12	BU303,343,WU300,340	14B,W04D	MTPT-00125	GEAR, COUNTER	33421-37040			
				MTPT-00214	GEAR, 2ND	33033-36090			
				MTPT-00215	GEAR, 3RD	33034-36090			
	02.09-08.02	BU30#,34#,WU300,340,XZU300,305,345 BU300,303,340,343 BU303,343,WU300,340 WU300,340	14B,15BFTE,N04C,N04D 14B,15BFTE 14B,W04D W04D	MTPT-00172	NUT (FOR MANUAL TRANSMISSION OUTPUT SHAFT REAR SET)	90179-24008			
				MTPT-00159	WASHER, REVERSE IDLER THRUST, No.2	33464-60010			
				MTPT-00156	KEY, SYNCHROMESH SHIFTING, NO.3	33394-36020			
				MTPT-00158	WASHER, REVERSE IDLER THRUST	33462-60020			
				MTPT-00173	PIN OR BALL (FOR 1ST GEAR THRUST WASHER)	90250-04056			
				MTPT-00212	HUB, TRANSMISSION CLUTCH, NO.3	33393-36060			
				MTPT-00216	GEAR, 5TH	33036-37010			
				MTPT-00217	RING, SYNCHRONIZER, NO.3	33369-36010			
				MTPT-00218	SLEEVE, TRANSMISSION HUB, NO.3	33395-36030			
				MTPT-00219	RING SET, SYNCHRONIZER, NO.3	33039-36010			
				MTPT-00221	SLEEVE, TRANSMISSION HUB, NO.1	33363-37020			
				MTPT-00126	SHAFT, INPUT	33301-37170			
				MTPT-00232	RETAINER, BEARING, FRONT (MTM)	33018-37010			
				02.12-03.03	BU300,340,XZU300,320,330,340	15BFTE	MTPT-00323	RING SET, SYNCHRONIZER, NO.3	33038-37011
							MTPT-00338	RING SET, SYNCHRONIZER, NO.2	33037-37021
	02.12-06.10	BU300,340,XZU300,320,330,340 XZU414,424 XZU414,424,434	15BFTE S05C S05C	MTPT-00061	RING, SYNCHRONIZER, NO.2	33368-60022			
				MTPT-00158	WASHER, REVERSE IDLER THRUST	33462-60020			
				MTPT-00209	HUB, TRANSMISSION CLUTCH, NO.2	33361-37040			
				MTPT-00237	BEARING, RADIAL BALL	90363-32038			
				MTPT-00238	BEARING, COUNTER SHAFT CENTER	90365-36004			
				MTPT-00320	RACE, REVERSE GEAR BEARING, INNER	33354-37010			
				MTPT-00340	BEARING OR ROLLER (FOR COUNTER GEAR FRONT)	90365-30030			
				MTPT-00342	BEARING (FOR OUTPUT SHAFT REAR)	90363-38007			
				MTPT-00343	BEARING (FOR OUTPUT SHAFT CENTER)	90363-45019			
				MTPT-00344	BEARING (FOR REVERSE GEAR)	90364-47008			
				MTPT-00346	RETAINER, BEARING, CENTER	33147-37011			
				MTPT-00345	FORK, GEAR SHIFT, NO.4	33215-37021			
	MTPT-00346	RETAINER, BEARING, CENTER	33147-37011						
	02.12-08.02	BU303,343,WU300,340 WU410	14B,W04D W04D	MTPT-00125	GEAR, COUNTER	33421-37040			
				MTPT-00214	GEAR, 2ND	33033-36090			
MTPT-00215				GEAR, 3RD	33034-36090				
MTPT-00232				RETAINER, BEARING, FRONT (MTM)	33018-37010				
02.12-11.06	WU410,420	W04D	MTPT-00125	GEAR, COUNTER	33421-37040				
			MTPT-00126	SHAFT, INPUT	33301-37170				
			MTPT-00156	KEY, SYNCHROMESH SHIFTING, NO.3	33394-36020				
			MTPT-00158	WASHER, REVERSE IDLER THRUST	33462-60020				
			MTPT-00159	WASHER, REVERSE IDLER THRUST, No.2	33464-60010				
			MTPT-00173	PIN, STRAIGHT (FOR GEAR THRUST WASHER)	90250-04056				
			MTPT-00212	HUB, TRANSMISSION CLUTCH, NO.3	33393-36060				
			MTPT-00214	GEAR, 2ND	33033-36090				
			MTPT-00215	GEAR, 3RD	33034-36090				

Reference List / Manual Transmission(Parts)

Model	Year	Body Type	Engine Type	AISIN No.	Productin Name	Genuine No.	
DYNA				MTPT-00216	GEAR, 5TH	33036-37010	
				MTPT-00217	RING, SYNCHRONIZER, NO.3	33369-36010	
				MTPT-00218	SLEEVE, TRANSMISSION HUB, NO.3	33395-36030	
				MTPT-00219	RING SET, SYNCHRONIZER, NO.3	33039-36010	
				MTPT-00221	SLEEVE, TRANSMISSION HUB, NO.1	33363-37020	
	03.03-06.10	BU300,340		15BFTE	MTPT-00104	RING SET, SYNCHRONIZER, NO.3	33038-37012
					MTPT-00136	RING SET, SYNCHRONIZER, NO.2	33037-37022
	03.03-07.01	BU410,420		15BFTE	MTPT-00210	SLEEVE, TRANSMISSION HUB, NO.1	33363-60052
					MTPT-00318	SLEEVE, TRANSMISSION HUB, NO.2	33364-37021
	03.03-08.02	XZU412,420,422,430		J05C,S05C	MTPT-00210	SLEEVE, TRANSMISSION HUB, NO.1	33363-60052
					MTPT-00318	SLEEVE, TRANSMISSION HUB, NO.2	33364-37021
	03.04-06.10	XZU300,320,330,340		15BFTE	MTPT-00104	RING SET, SYNCHRONIZER, NO.3	33038-37012
		XZU404,412,414,422,424		S05C	MTPT-00136	RING SET, SYNCHRONIZER, NO.2	33037-37022
					MTPT-00104	RING SET, SYNCHRONIZER, NO.3	33038-37012
					MTPT-00136	RING SET, SYNCHRONIZER, NO.2	33037-37022
		XZU414,424,434		S05C	MTPT-00104	RING SET, SYNCHRONIZER, NO.2	33038-37012
					MTPT-00136	RING SET, SYNCHRONIZER, NO.1	33037-37022
					MTPT-00194	RING SET, SYNCHRONIZER, NO.3	33039-37011
	03.04-07.01	BU410,420		15BFTE	MTPT-00104	RING SET, SYNCHRONIZER, NO.2	33038-37012
					MTPT-00136	RING SET, SYNCHRONIZER, NO.1	33037-37022
					MTPT-00194	RING SET, SYNCHRONIZER, NO.3	33039-37011
	03.04-08.02	XZU412,420,422,430		J05C,S05C	MTPT-00104	RING SET, SYNCHRONIZER, NO.2	33038-37012
					MTPT-00136	RING SET, SYNCHRONIZER, NO.1	33037-37022
					MTPT-00194	RING SET, SYNCHRONIZER, NO.3	33039-37011
					MTPT-00195	SHAFT, INPUT	33301-37190
					MTPT-00200	GEAR, COUNTER	33421-37110
					MTPT-00233	GEAR, 3RD	33034-37040
	03.06-08.02	WU340		W04D	MTPT-00172	NUT (FOR MANUAL TRANSMISSION OUTPUT SHAFT REAR SET)	90179-24008
	03.08-08.02	XZU320,330,340		15BFTE	MTPT-00172	NUT (FOR MANUAL TRANSMISSION OUTPUT SHAFT REAR SET)	90179-24008
	03.12-06.10	XZU305,345		N04C	MTPT-00173	PIN OR BALL (FOR 1ST GEAR THRUST WASHER)	90250-04056
	04.08-	KDY221,230,231,25#,26#,LY23#		1KDFTV,2KDFTV,5L	MTPT-00146	KEY, SYNCHROMESH SHIFTING, NO.1	33365-35060
	04.12-06.10	XZU414,424,434		S05C	MTPT-00198	RING, SYNCHRONIZER, NO.2	33368-37040
	04.12-07.01	BU410,420		15BFTE	MTPT-00198	RING, SYNCHRONIZER, NO.2	33368-37040
	04.12-08.02	XZU412,420,422,430		J05C,S05C	MTPT-00198	RING, SYNCHRONIZER, NO.2	33368-37040
	06.10-11.06	WU300,302,340,342		W04D	MTPT-00125	GEAR, COUNTER	33421-37040
					MTPT-00126	SHAFT, INPUT	33301-37170
					MTPT-00156	KEY, SYNCHROMESH SHIFTING, NO.3	33394-36020
					MTPT-00158	WASHER, REVERSE IDLER THRUST	33462-60020
					MTPT-00159	WASHER, REVERSE IDLER THRUST, No.2	33464-60010
					MTPT-00173	PIN OR BALL (FOR 1ST GEAR THRUST WASHER)	90250-04056
					MTPT-00212	HUB, TRANSMISSION CLUTCH, NO.3	33393-36060
					MTPT-00214	GEAR, 2ND	33033-36090
					MTPT-00215	GEAR, 3RD	33034-36090
					MTPT-00216	GEAR, 5TH	33036-37010
					MTPT-00217	RING, SYNCHRONIZER, NO.3	33369-36010
					MTPT-00218	SLEEVE, TRANSMISSION HUB, NO.3	33395-36030
					MTPT-00219	RING SET, SYNCHRONIZER, NO.3	33039-36010

Reference List / Manual Transmission(Parts)

Model	Year	Body Type	Engine Type	AISIN No.	Productin Name	Genuine No.	
DYNA				MTPT-00221	SLEEVE, TRANSMISSION HUB, NO.1	33363-37020	
				MTPT-00232	RETAINER, BEARING, FRONT (MTM)	33018-37010	
		WU300,302,340,342,XZU307,337	N04C,W04D	MTPT-00172	NUT (FOR MANUAL TRANSMISSION OUTPUT SHAFT REAR SET)	90179-24008	
		WU302,342,XZU307,337	N04C,W04D	MTPT-00173	PIN OR BALL (FOR 1ST GEAR THRUST WASHER)	90250-04056	
		WU410,412,42#,XZU413,423	N04C,W04D	MTPT-00172	NUT (FOR MANUAL TRANSMISSION OUTPUT SHAFT REAR SET)	90179-24008	
		WU410,420	W04D	MTPT-00232	RETAINER, BEARING, FRONT (MTM)	33018-37010	
		WU412,422,XZU413,423	N04C,S05C,W04D	MTPT-00173	PIN, STRAIGHT (FOR GEAR THRUST WASHER)	90250-04056	
	07.12-	KDY221,231,251,261,LY23#		1KDFTV,5L	MTPT-00145	WASHER, 5TH GEAR THRUST	33346-71010
	09.05-12.01	KDY221,231,251,261		1KDFTV	MTPT-00153	SPRING, SYNCHROMESH SHIFTING KEY, NO.3	33392-60020
					MTPT-00154	SPRING, SYNCHROMESH SHIFTING KEY, NO.3	33392-60030
	09.05-12.04	KDY221,231		1KDFTV	MTPT-00080	SLEEVE, TRANSMISSION HUB, NO.2	33364-35050
					MTPT-00147	KEY, SYNCHROMESH SHIFTING, NO.2	33366-35030
	09.05-	KDY221,231,251,261		1KDFTV	MTPT-00008	RING SET, SYNCHRONIZER, NO.1	33037-60040
					MTPT-00071	RING SET, SYNCHRONIZER, NO.1	33037-60050
					MTPT-00076	PIECE, GEAR SPLINE, NO.5	33318-60030
					MTPT-00086	RING, SYNCHRONIZER, OUTER NO.3	33384-60090
					MTPT-00157	KEY, SYNCHROMESH SHIFTING, NO.3	33394-60020
	09.12-	WU302,342		W04D	MTPT-00125	GEAR, COUNTER	33421-37040
					MTPT-00126	SHAFT, INPUT	33301-37170
					MTPT-00156	KEY, SYNCHROMESH SHIFTING, NO.3	33394-36020
					MTPT-00158	WASHER, REVERSE IDLER THRUST	33462-60020
					MTPT-00159	WASHER, REVERSE IDLER THRUST, No.2	33464-60010
					MTPT-00172	NUT (FOR MANUAL TRANSMISSION OUTPUT SHAFT REAR SET)	90179-24008
					MTPT-00173	PIN OR BALL (FOR 1ST GEAR THRUST WASHER)	90250-04056
					MTPT-00212	HUB, TRANSMISSION CLUTCH, NO.3	33393-36060
					MTPT-00214	GEAR, 2ND	33033-36090
					MTPT-00215	GEAR, 3RD	33034-36090
		MTPT-00216	GEAR, 5TH	33036-37010			
		MTPT-00217	RING, SYNCHRONIZER, NO.3	33369-36010			
		MTPT-00218	SLEEVE, TRANSMISSION HUB, NO.3	33395-36030			
		MTPT-00219	RING SET, SYNCHRONIZER, NO.3	33039-36010			
		MTPT-00221	SLEEVE, TRANSMISSION HUB, NO.1	33363-37020			
		MTPT-00232	RETAINER, BEARING, FRONT (MTM)	33018-37010			
09.12-		WU342		W04D	MTPT-00172	NUT (FOR MANUAL TRANSMISSION OUTPUT SHAFT REAR SET)	90179-24008
	MTPT-00173				PIN OR BALL (FOR 1ST GEAR THRUST WASHER)	90250-04056	
11.06-	KDY221,231		1KDFTV	MTPT-00003	GEAR, 1ST	33032-60111	
11.07-15.05	WU700,720		W04D	MTPT-00125	GEAR, COUNTER	33421-37040	
				MTPT-00126	SHAFT, INPUT	33301-37170	
				MTPT-00156	KEY, SYNCHROMESH SHIFTING, NO.3	33394-36020	
				MTPT-00158	WASHER, REVERSE IDLER THRUST	33462-60020	
				MTPT-00159	WASHER, REVERSE IDLER THRUST, No.2	33464-60010	
				MTPT-00172	NUT (FOR MANUAL TRANSMISSION OUTPUT SHAFT REAR SET)	90179-24008	

Reference List / Manual Transmission(Parts)

Model	Year	Body Type	Engine Type	AISIN No.	Productin Name	Genuine No.	
DYNA				MTPT-00173	PIN, STRAIGHT (FOR GEAR THRUST WASHER)	90250-04056	
				MTPT-00212	HUB, TRANSMISSION CLUTCH, NO.3	33393-36060	
				MTPT-00214	GEAR, 2ND	33033-36090	
				MTPT-00215	GEAR, 3RD	33034-36090	
				MTPT-00216	GEAR, 5TH	33036-37010	
				MTPT-00217	RING, SYNCHRONIZER, NO.3	33369-36010	
				MTPT-00218	SLEEVE, TRANSMISSION HUB, NO.3	33395-36030	
				MTPT-00219	RING SET, SYNCHRONIZER, NO.3	33039-36010	
				MTPT-00221	SLEEVE, TRANSMISSION HUB, NO.1	33363-37020	
				MTPT-00232	RETAINER, BEARING, FRONT (MTM)	33018-37010	
		11.07-	WU600,650	W04D	MTPT-00125	GEAR, COUNTER	33421-37040
					MTPT-00126	SHAFT, INPUT	33301-37170
					MTPT-00156	KEY, SYNCHROMESH SHIFTING, NO.3	33394-36020
					MTPT-00158	WASHER, REVERSE IDLER THRUST	33462-60020
					MTPT-00159	WASHER, REVERSE IDLER THRUST, No.2	33464-60010
					MTPT-00172	NUT (FOR MANUAL TRANSMISSION OUTPUT SHAFT REAR SET)	90179-24008
					MTPT-00173	PIN OR BALL (FOR 1ST GEAR THRUST WASHER)	90250-04056
					MTPT-00212	HUB, TRANSMISSION CLUTCH, NO.3	33393-36060
					MTPT-00214	GEAR, 2ND	33033-36090
					MTPT-00215	GEAR, 3RD	33034-36090
					MTPT-00216	GEAR, 5TH	33036-37010
					MTPT-00217	RING, SYNCHRONIZER, NO.3	33369-36010
					MTPT-00218	SLEEVE, TRANSMISSION HUB, NO.3	33395-36030
					MTPT-00219	RING SET, SYNCHRONIZER, NO.3	33039-36010
					MTPT-00221	SLEEVE, TRANSMISSION HUB, NO.1	33363-37020
					MTPT-00232	RETAINER, BEARING, FRONT (MTM)	33018-37010
			WU710	W04D	MTPT-00125	GEAR, COUNTER	33421-37040
					MTPT-00126	SHAFT, INPUT	33301-37170
					MTPT-00156	KEY, SYNCHROMESH SHIFTING, NO.3	33394-36020
					MTPT-00158	WASHER, REVERSE IDLER THRUST	33462-60020
					MTPT-00159	WASHER, REVERSE IDLER THRUST, No.2	33464-60010
					MTPT-00173	PIN, STRAIGHT (FOR GEAR THRUST WASHER)	90250-04056
					MTPT-00212	HUB, TRANSMISSION CLUTCH, NO.3	33393-36060
				MTPT-00214	GEAR, 2ND	33033-36090	
				MTPT-00215	GEAR, 3RD	33034-36090	
				MTPT-00216	GEAR, 5TH	33036-37010	
				MTPT-00217	RING, SYNCHRONIZER, NO.3	33369-36010	
				MTPT-00218	SLEEVE, TRANSMISSION HUB, NO.3	33395-36030	
				MTPT-00219	RING SET, SYNCHRONIZER, NO.3	33039-36010	
				MTPT-00221	SLEEVE, TRANSMISSION HUB, NO.1	33363-37020	
				MTPT-00232	RETAINER, BEARING, FRONT (MTM)	33018-37010	
		WU710,720,XZU710	N04C,W04D	MTPT-00172	NUT (FOR MANUAL TRANSMISSION OUTPUT SHAFT REAR SET)	90179-24008	
	11.09-	KDY231,251,261	1KDFTV	MTPT-00003	GEAR, 1ST	33032-60111	
	12.03-	KDY221,231,251,261,LY23#	1KDFTV,5L	MTPT-00144	GEAR, REVERSE	33331-60041	

Reference List / Manual Transmission(Parts)

Model	Year	Body Type	Engine Type	AISIN No.	Productin Name	Genuine No.	
DYNA	12.04-14.04	KDY221,231,251,261,LY230,235	1KDFTV,5L	MTPT-00079	HUB, TRANSMISSION CLUTCH, NO.2	33362-60030 (33362-60031)	
	12.04-	KDY221,231,251,261,LY23# KDY221,231,251,261,LY230,235	1KDFTV,5L	MTPT-00009	RING, SYNCHRONIZER, NO.2	33368-35050	
				MTPT-00151	RING, SYNCHRONIZER, NO.2	33368-35070	
				MTPT-00081	SLEEVE, TRANSMISSION HUB, NO.2	33364-60070	
				MTPT-00315	KEY, SYNCHROMESH SHIFTING, NO.2	33366-35050	
	12.05-	KDY231,251,261	1KDFTV	MTPT-00078	HUB, TRANSMISSION CLUTCH, NO.1	33361-71020	
13.10-	KDY221,231	1KDFTV	MTPT-00003	GEAR, 1ST	33032-60111		
			MTPT-00008	RING SET, SYNCHRONIZER, NO.1	33037-60040		
			MTPT-00071	RING SET, SYNCHRONIZER, NO.1	33037-60050		
13.12-15.02	KDY221,231	1KDFTV	MTPT-00327	SHAFT, OUTPUT	33321-35191		
DYNA 100	95.05-	LY100,YY100	2L,2Y	MTPT-00020	RING, SYNCHRONIZER, NO.2	33368-20012	
				MTPT-00095	HUB, TRANSMISSION CLUTCH, NO.2	33362-35040	
				MTPT-00100	SLEEVE, TRANSMISSION HUB, NO.2	33364-26020	
				MTPT-00112	WASHER, 5TH GEAR THRUST	33349-35010	
				MTPT-00142	PIPE, OIL RECEIVER, NO.2 (FOR EXTENSION HOUSING)	33124-36010	
				MTPT-00328	SHAFT, OUTPUT	33321-26050	
				MTPT-00332	SHAFT, INPUT	33301-35071	
				MTPT-00333	KEY, SYNCHROMESH SHIFTING, NO.2	33366-35040 (33366-35041)	
				MTPT-00334	SPRING, SYNCHROMESH SHIFTING KEY, NO.1	33371-14031	
DYNA 150	95.05-96.04	LY211,YY211	3L,3Y	MTPT-00083	RING, SYNCHRONIZER, NO.1	33367-35080	
	95.05-01.10	LY21#,YY211	3L,5L,3Y	MTPT-00010	RING, SYNCHRONIZER, NO.2	33368-35030	
				MTPT-00080	SLEEVE, TRANSMISSION HUB, NO.2	33364-35050	
				MTPT-00084	RING, SYNCHRONIZER, NO.2	33368-35040	
				MTPT-00143	RETAINER, OUTPUT SHAFT REAR BEARING (MTM)	33151-35020	
				MTPT-00147	KEY, SYNCHROMESH SHIFTING, NO.2	33366-35030	
				MTPT-00170	NUT (FOR MANUAL TRANSMISSION OUTPUT SHAFT REAR SET)	90179-22016	
				MTPT-00174	PIN (FOR 5TH GEAR THRUST WASHER)	90250-05026	
				MTPT-00313	PIN OR BALL (FOR 1ST GEAR THRUST WASHER) WASHER, 1ST GEAR THRUST	90250-05026 33348-35010	
	96.04-01.10	LY21#,YY211	3L,5L,3Y	MTPT-00083	RING, SYNCHRONIZER, NO.1	33367-35080	
	97.11-	LY21#,YY211	3L,5L,3Y	MTPT-00170	NUT (FOR REAR DRIVE PINION)	90179-22016	
	DYNA 200	87.08-88.08	BU6#,70,8#	B,11B,13B	MTPT-00020	RING, SYNCHRONIZER, NO.3	33368-20012
					MTPT-00173	PIN OR BALL (FOR 1ST GEAR THRUST WASHER)	90250-04056
MTPT-00236					BEARING, INPUT SHAFT	90361-08004	
MTPT-00020					RING, SYNCHRONIZER, NO.2	33368-20012	
					RING, SYNCHRONIZER, NO.3	33368-20012	
MTPT-00028					RING, SYNCHRONIZER, NO.1	33367-14010	
WU90			1W	MTPT-00032	HUB, TRANSMISSION CLUTCH, NO.2	33362-36021	
				MTPT-00036	RING SUB-ASSY, SYNCHRONIZER,NO.1	33306-60010	
				MTPT-00041	SLEEVE, TRANSMISSION HUB, NO.3	33395-60010	
				MTPT-00142	PIPE, OIL RECEIVER, NO.1 (MTM)	33124-36010	
				MTPT-00148	KEY, SYNCHROMESH SHIFTING, NO.2	33366-36020	
				MTPT-00155	KEY, SYNCHROMESH SHIFTING (FOR NO.3 CLUTCH HUB)	33394-36011	

Reference List / Manual Transmission(Parts)

Model	Year	Body Type	Engine Type	AISIN No.	Productin Name	Genuine No.
DYNA 200				MTPT-00183	NUT (FOR COUNTER GEAR SHAFT)	90179-26002
				MTPT-00187	NUT (FOR MANUAL TRANSMISSION OUTPUT SHAFT REAR SET)	90179-22005
				MTPT-00189	WASHER (FOR MANUAL TRANSMISSION OUTPUT SHAFT SET)	90201-22005
	87.08-90.01	BU6#,70,8#,91,94,96	B,11B,13B,14B,14BT	MTPT-00236	BEARING, INPUT SHAFT	90361-08004
	87.08-92.10	RU85,WU9#,YU6#,71,82	22R,1W,4Y	MTPT-00020 MTPT-00173	RING, SYNCHRONIZER, NO.3 PIN OR BALL (FOR 1ST GEAR THRUST WASHER)	33368-20012 90250-04056
	88.08-90.01	RU85,WU9#,YU6#,71,82	22R,1W,4Y	MTPT-00236	BEARING, INPUT SHAFT	90361-08004
	88.08-90.08	BU6#,70,8#,91,94,96	B,11B,13B,14B	MTPT-00231	RING, SYNCHRONIZER, NO.2	33368-36042
		RU85,WU9#,YU6#,71,82	22R,1W,4Y	MTPT-00231	RING, SYNCHRONIZER, NO.2	33368-36042
	88.08-92.10	BU6#,70,8#,91,94,96	B,11B,14B,14BT	MTPT-00020 MTPT-00173	RING, SYNCHRONIZER, NO.3 PIN OR BALL (FOR 1ST GEAR THRUST WASHER)	33368-20012 90250-04056
	88.08-95.05	BU91	14B,14BT	MTPT-00020 MTPT-00028 MTPT-00032 MTPT-00036 MTPT-00041 MTPT-00142 MTPT-00148 MTPT-00155 MTPT-00183 MTPT-00187 MTPT-00189	RING, SYNCHRONIZER, NO.2 RING, SYNCHRONIZER, NO.3 RING, SYNCHRONIZER, NO.1 HUB, TRANSMISSION CLUTCH, NO.2 RING SUB-ASSY, SYNCHRONIZER,NO.1 SLEEVE, TRANSMISSION HUB, NO.3 PIPE, OIL RECEIVER, NO.1 (MTM) KEY, SYNCHROMESH SHIFTING, NO.2 KEY, SYNCHROMESH SHIFTING (FOR NO.3 CLUTCH HUB) NUT (FOR COUNTER GEAR SHAFT) NUT (FOR MANUAL TRANSMISSION OUTPUT SHAFT REAR SET) WASHER (FOR MANUAL TRANSMISSION OUTPUT SHAFT SET)	33368-20012 33368-20012 33367-14010 33362-36021 33306-60010 33395-60010 33124-36010 33366-36020 33394-36011 90179-26002 90179-22005 90201-22005
	90.01-95.05	BU6#,70,8#,91,94,96	B,11B,14B,14BT	MTPT-00172	NUT (FOR MANUAL TRANSMISSION OUTPUT SHAFT REAR SET)	90179-24008
		RU85,WU9#,YU6#,71,8#	22R,1W,4Y	MTPT-00172	NUT (FOR MANUAL TRANSMISSION OUTPUT SHAFT REAR SET)	90179-24008
	91.09-95.05	BU91	14B,14BT	MTPT-00033	SLEEVE, TRANSMISSION HUB, NO.2	33364-36071
	92.10-93.05	WU9#	1W	MTPT-00219	RING SET, SYNCHRONIZER, NO.3	33039-36010
	92.10-95.05	BU6#,70,8#,91,94,96	B,11B,14B	MTPT-00156 MTPT-00158 MTPT-00159 MTPT-00173 MTPT-00212 MTPT-00217 MTPT-00218 MTPT-00219 MTPT-00214 MTPT-00215 MTPT-00156 MTPT-00158 MTPT-00159 MTPT-00173	KEY, SYNCHROMESH SHIFTING, NO.3 WASHER, REVERSE IDLER THRUST WASHER, REVERSE IDLER THRUST, No.2 PIN OR BALL (FOR 1ST GEAR THRUST WASHER) HUB, TRANSMISSION CLUTCH, NO.3 RING, SYNCHRONIZER, NO.3 SLEEVE, TRANSMISSION HUB, NO.3 RING SET, SYNCHRONIZER, NO.3 GEAR, 2ND GEAR, 3RD KEY, SYNCHROMESH SHIFTING, NO.3 WASHER, REVERSE IDLER THRUST WASHER, REVERSE IDLER THRUST, No.2 PIN OR BALL (FOR 1ST GEAR THRUST WASHER)	33394-36020 33462-60020 33464-60010 90250-04056 33393-36060 33369-36010 33395-36030 33039-36010 33033-36090 33034-36090 33394-36020 33462-60020 33464-60010 90250-04056
		BU66,88,91,96	14B,14BT			
		RU85,WU9#,YU6#,71,8#	22R,1W,4Y			

Reference List / Manual Transmission(Parts)

Model	Year	Body Type	Engine Type	AISIN No.	Productin Name	Genuine No.	
DYNA 200				MTPT-00212	HUB, TRANSMISSION CLUTCH, NO.3	33393-36060	
				MTPT-00217	RING, SYNCHRONIZER, NO.3	33369-36010	
				MTPT-00218	SLEEVE, TRANSMISSION HUB, NO.3	33395-36030	
	93.12-95.05	RU85,YU6#,8#	22R,4Y	MTPT-00152	RING, SYNCHRONIZER, NO.2	33368-36051	
	95.05-97.03	BU88,94	14B	MTPT-00156	KEY, SYNCHROMESH SHIFTING, NO.3	33394-36020	
				MTPT-00158	WASHER, REVERSE IDLER THRUST	33462-60020	
				MTPT-00159	WASHER, REVERSE IDLER THRUST, No.2	33464-60010	
				MTPT-00172	NUT (FOR MANUAL TRANSMISSION OUTPUT SHAFT REAR SET)	90179-24008	
				MTPT-00173	PIN OR BALL (FOR 1ST GEAR THRUST WASHER)	90250-04056	
				MTPT-00212	HUB, TRANSMISSION CLUTCH, NO.3	33393-36060	
				MTPT-00217	RING, SYNCHRONIZER, NO.3	33369-36010	
				MTPT-00218	SLEEVE, TRANSMISSION HUB, NO.3	33395-36030	
				MTPT-00219	RING SET, SYNCHRONIZER, NO.3	33039-36010	
DYNA100				85.08-87.08	LH80,YH8#	2L,1Y,2Y	MTPT-00020
	MTPT-00142	PIPE, OIL RECEIVER, NO.1 (FOR EXTENSION HOUSING)	33124-36010				
	MTPT-00328	SHAFT, OUTPUT	33321-26050				
	MTPT-00334	SPRING, SYNCHROMESH SHIFTING KEY, NO.1	33371-14031				
	87.08-95.05	LH80,YH81	2L,2Y	MTPT-00020	RING, SYNCHRONIZER, NO.1	33368-20012	
				MTPT-00142	PIPE, OIL RECEIVER, NO.1 (FOR EXTENSION HOUSING)	33124-36010	
				MTPT-00328	SHAFT, OUTPUT	33321-26050	
				MTPT-00334	SPRING, SYNCHROMESH SHIFTING KEY, NO.1	33371-14031	
	88.08-95.05	LH80,YH81	2L,2Y	MTPT-00095	HUB, TRANSMISSION CLUTCH, NO.2	33362-35040	
				MTPT-00112	WASHER, 5TH GEAR THRUST	33349-35010	
				MTPT-00333	KEY, SYNCHROMESH SHIFTING, NO.2	33366-35040 (33366-35041)	
	89.06-95.05	YH81	2Y	MTPT-00331	GEAR, COUNTER	33421-26100	
	92.09-95.05	LH80,YH81	2L,2Y	MTPT-00100	SLEEVE, TRANSMISSION HUB, NO.2	33364-26020	
	93.09-93.11	LH80,YH81	2L,2Y	MTPT-00098	GEAR, REVERSE	33331-28011 (33331-35061)	
	DYNA150	85.08-95.05	LY60,YY5#,6#	2L,2Y,3Y	MTPT-00082	RING, SYNCHRONIZER, NO.1	33367-35010
					MTPT-00142	PIPE, OIL RECEIVER, NO.2 (FOR EXTENSION HOUSING)	33124-36010
					MTPT-00143	RETAINER, OUTPUT SHAFT REAR BEARING (MTM)	33151-35020
					MTPT-00147	KEY, SYNCHROMESH SHIFTING, NO.2	33366-35030
					MTPT-00174	PIN OR BALL (FOR 1ST GEAR THRUST WASHER)	90250-05026
					MTPT-00187	NUT (FOR COUNTER GEAR SHAFT)	90179-22005
					MTPT-00313	WASHER, 1ST GEAR THRUST	33348-35010
92.03-95.05					LY61,YY52,61	3L,3Y	MTPT-00170
94.03-95.05		LY61,YY52,61	3L,3Y	MTPT-00010	RING, SYNCHRONIZER, NO.2	33368-35030	
				MTPT-00080	SLEEVE, TRANSMISSION HUB, NO.2	33364-35050	
94.04-95.05	LY61,YY52,61	3L,3Y	MTPT-00084	RING, SYNCHRONIZER, NO.2	33368-35040		
			MTPT-00083	RING, SYNCHRONIZER, NO.1	33367-35080		
DYNA200	95.05-01.08	BU10#,11#,14#,21#,22#,RZU100,YU210	3B,14B,15BF,15BFT,3RZFE,4Y	MTPT-00172	NUT (FOR MANUAL TRANSMISSION OUTPUT SHAFT REAR SET)	90179-24008	
		BU10#,11#,14#,211,212,221,222	3B,14B,15BF,15BFT	MTPT-00219	RING SET, SYNCHRONIZER, NO.3	33039-36010	
		BU10#,11#,14#,211,212,221,222,RZU100,YU210	3B,14B,15BF,15BFT,3RZFE,4Y	MTPT-00156	KEY, SYNCHROMESH SHIFTING, NO.3	33394-36020	

Reference List / Manual Transmission(Parts)

Model	Year	Body Type	Engine Type	AISIN No.	Productin Name	Genuine No.
DYNA200		BU102,112,142,212,222	15BF,15BFT	MTPT-00158	WASHER, REVERSE IDLER THRUST	33462-60020
	MTPT-00159			WASHER, REVERSE IDLER THRUST, NO.2	33464-60010	
	MTPT-00173			PIN OR BALL (FOR 1ST GEAR THRUST WASHER)	90250-04056	
	MTPT-00212			HUB, TRANSMISSION CLUTCH, NO.3	33393-36060	
	MTPT-00217			RING, SYNCHRONIZER, NO.3	33369-36010	
	MTPT-00218			SLEEVE, TRANSMISSION HUB, NO.3	33395-36030	
	MTPT-00221			SLEEVE, TRANSMISSION HUB, NO.1	33363-37020	
	MTPT-00232			RETAINER, BEARING, FRONT (MTM)	33018-37010	
	95.05-	BU10#,11#,140,141,211,212,221,222,RZU100,YU210 RZU100,YU210 BU100,101,102,110,140,141,211,221 BU100,101,102,110,140,141,221	3B,14B,15BF,15BFT,3RZFE,4Y 3RZFE,4Y 3B,14B 3B,14B	MTPT-00216 MTPT-00152 MTPT-00214 MTPT-00215 MTPT-00125	GEAR, 5TH RING, SYNCHRONIZER, NO.2 GEAR, 2ND GEAR, 3RD GEAR, COUNTER	33036-37010 33368-36051 33033-36090 33034-36090 33421-37040
	99.08-	BU213,223	15BFTE	MTPT-00020 MTPT-00063 MTPT-00158 MTPT-00196 MTPT-00197 MTPT-00199 MTPT-00209 MTPT-00213 MTPT-00234 MTPT-00235 MTPT-00236 MTPT-00237 MTPT-00238 MTPT-00319 MTPT-00320 MTPT-00321 MTPT-00322 MTPT-00339 MTPT-00340 MTPT-00341 MTPT-00342 MTPT-00343 MTPT-00344 MTPT-00345 MTPT-00346 MTPT-00347 MTPT-00348 MTPT-00349 MTPT-00350 MTPT-00351	RING, SYNCHRONIZER, NO.2 RING, SYNCHRONIZER, NO.3 WASHER, REVERSE IDLER THRUST SHAFT, OUTPUT GEAR SUB-ASSY, 6TH GEAR, COUNTER, 6TH HUB, TRANSMISSION CLUTCH, NO.1 SLEEVE, TRANSMISSION HUB, NO.3 HUB, TRANSMISSION CLUTCH, NO.4 HUB, TRANSMISSION CLUTCH, NO.2 BEARING, INPUT SHAFT BEARING, RADIAL BALL BEARING, COUNTER SHAFT CENTER SLEEVE, TRANSMISSION HUB, NO.4 RACE, REVERSE GEAR BEARING, INNER GEAR, REVERSE GEAR, 5TH HUB, TRANSMISSION CLUTCH, NO.3 BEARING OR ROLLER (FOR COUNTER GEAR FRONT) KEY, SYNCHROMESH SHIFTING, NO.2 BEARING (FOR OUTPUT SHAFT REAR) BEARING (FOR OUTPUT SHAFT CENTER) BEARING (FOR REVERSE GEAR) FORK, GEAR SHIFT, NO.4 RETAINER, BEARING, CENTER BEARING, NEEDLE ROLLER (FOR 6TH GEAR) GEAR, 2ND BEARING, NEEDLE ROLLER (FOR 3RD GEAR) BEARING, NEEDLE ROLLER (FOR 2ND GEAR) GEAR, 1ST	33368-20012 33369-60010 33462-60020 33321-37070 33037-37010 33429-37010 33361-37040 33395-60040 33352-37030 33362-37020 90361-08004 90363-32038 90365-36004 33327-37010 33354-37010 33331-37060 33036-37030 33393-37010 90365-30030 33366-37030 90363-38007 90363-45019 90364-47008 33215-37021 33147-37011 90364-39015 33033-37020 90364-38017 90364-58006 33335-37090
	99.08-03.04	BU213,223	15BFTE	MTPT-00323	RING SET, SYNCHRONIZER, NO.2	33038-37011

Reference List / Manual Transmission(Parts)

Model	Year	Body Type	Engine Type	AISIN No.	Productin Name	Genuine No.
DYNA200				MTPT-00338	RING SET, SYNCHRONIZER, NO.1	33037-37021
	01.08-	BU10#,111,14#,21#,22#,RZU100,YU210 BU10#,111,14#,211,212,221,222 BU10#,111,14#,211,212,221,222,RZU100,YU210	14B,15BF,15BFT,3RZFE,4Y	MTPT-00172	NUT <small>(FOR MANUAL TRANSMISSION OUTPUT SHAFT REAR SET)</small>	90179-24008
				MTPT-00219	RING SET, SYNCHRONIZER, NO.3	33039-36010
				MTPT-00156	KEY, SYNCHROMESH SHIFTING, NO.3	33394-36020
				MTPT-00158	WASHER, REVERSE IDLER THRUST	33462-60020
				MTPT-00159	WASHER, REVERSE IDLER THRUST, No.2	33464-60010
				MTPT-00173	PIN OR BALL <small>(FOR 1ST GEAR THRUST WASHER)</small>	90250-04056
				MTPT-00212	HUB, TRANSMISSION CLUTCH, NO.3	33393-36060
				MTPT-00217	RING, SYNCHRONIZER, NO.3	33369-36010
				MTPT-00218	SLEEVE, TRANSMISSION HUB, NO.3	33395-36030
				MTPT-00221	SLEEVE, TRANSMISSION HUB, NO.1	33363-37020
		BU102,142,212,222	15BF,15BFT	MTPT-00232	RETAINER, BEARING, FRONT <small>(MTM)</small>	33018-37010
	03.03-	BU213,223		MTPT-00210	SLEEVE, TRANSMISSION HUB, NO.1	33363-60052
				MTPT-00318	SLEEVE, TRANSMISSION HUB, NO.2	33364-37021
	03.04-	BU213,223		MTPT-00104	RING SET, SYNCHRONIZER, NO.2	33038-37012
MTPT-00136				RING SET, SYNCHRONIZER, NO.1	33037-37022	
MTPT-00194				RING SET, SYNCHRONIZER, NO.3	33039-37011	
FJ CRUISER	06.01-14.07	GSJ15	1GRFE	MTPT-00130	BEARING <small>(FOR OUTPUT SHAFT CENTER)</small>	90364-33012
				MTPT-00201	BEARING, NEEDLE ROLLER <small>(FOR 1ST GEAR)</small>	90364-48002
				MTPT-00202	BEARING, NEEDLE ROLLER <small>(FOR 2ND GEAR)</small>	90364-54007
	07.07-	GSJ15	1GRFE	MTPT-00170	NUT <small>(FOR TRANSFER OUTPUT SHAFT)</small>	90179-22016
				MTPT-00173	PIN OR BALL <small>(FOR 1ST GEAR THRUST WASHER)</small>	90250-04056
FORTUNER	05.01-08.08	GGN50,KUN5# GGN50,KUN5#,61	1GRFE,1KDFTV,2KDFTV 1GRFE,1KDFTV,2KDFTV	MTPT-00157	KEY, SYNCHROMESH SHIFTING, NO.3	33394-60020
				MTPT-00086	RING, SYNCHRONIZER, OUTER NO.3	33384-60090
				MTPT-00146	KEY, SYNCHROMESH SHIFTING, NO.1	33365-35060
				MTPT-00153	SPRING, SYNCHROMESH SHIFTING KEY, NO.3	33392-60020
				MTPT-00154	SPRING, SYNCHROMESH SHIFTING KEY, NO.3	33392-60030
				MTPT-00174	PIN <small>(FOR 5TH GEAR THRUST WASHER)</small>	90250-05026
					PIN OR BALL <small>(FOR 1ST GEAR THRUST WASHER)</small>	90250-05026
		MTPT-00313	WASHER, 1ST GEAR THRUST	33348-35010		
		MTPT-00315	KEY, SYNCHROMESH SHIFTING, NO.2	33366-35050		
		GGN50,KUN51,TGN51	1GRFE,1KDFTV,2KDFTV,2TRFE	MTPT-00170	NUT <small>(FOR TRANSFER OUTPUT SHAFT)</small>	90179-22016
	05.01-08.10	GGN50,KUN51,LAN50,TGN51	1GRFE,1KDFTV,5LE,2TRFE	MTPT-00170	NUT <small>(FOR TRANSFER OUTPUT SHAFT)</small>	90179-22016
	05.01-09.03	GGN50	1GRFE	MTPT-00170	NUT <small>(FOR TRANSFER OUTPUT SHAFT)</small>	90179-22016
	05.04-05.05	KUN60	2KDFTV	MTPT-00001	SHAFT, INPUT	33301-60050 <small>(33301-26050)</small>
				MTPT-00008	RING SET, SYNCHRONIZER, NO.1	33037-60040
				MTPT-00009	RING, SYNCHRONIZER, NO.2	33368-35050
MTPT-00071				RING SET, SYNCHRONIZER, NO.1	33037-60050	
MTPT-00076				PIECE, GEAR SPLINE, NO.5	33318-60030	
MTPT-00079				HUB, TRANSMISSION CLUTCH, NO.2	33362-60030 <small>(33362-60031)</small>	

Reference List / Manual Transmission(Parts)

Model	Year	Body Type	Engine Type	AISIN No.	Productin Name	Genuine No.	
FORTUNER				MTPT-00081	SLEEVE, TRANSMISSION HUB, NO.2	33364-60070	
				MTPT-00086	RING, SYNCHRONIZER, OUTER NO.3	33384-60090	
				MTPT-00143	RETAINER, OUTPUT SHAFT REAR BEARING (MTM)	33151-35020	
				MTPT-00146	KEY, SYNCHROMESH SHIFTING, NO.1	33365-35060	
				MTPT-00151	RING, SYNCHRONIZER, NO.2	33368-35070	
				MTPT-00153	SPRING, SYNCHROMESH SHIFTING KEY, NO.3	33392-60020	
				MTPT-00154	SPRING, SYNCHROMESH SHIFTING KEY, NO.3	33392-60030	
				MTPT-00157	KEY, SYNCHROMESH SHIFTING, NO.3	33394-60020	
				MTPT-00174	PIN (FOR 5TH GEAR THRUST WASHER) PIN OR BALL (FOR 1ST GEAR THRUST WASHER)	90250-05026 90250-05026	
				MTPT-00313	WASHER, 1ST GEAR THRUST	33348-35010	
				MTPT-00315	KEY, SYNCHROMESH SHIFTING, NO.2	33366-35050	
		05.05-08.08	GGN50,KUN51,60 GGN50,KUN51,60,TGN51	1GRFE,1KDFTV,2KDFTV 1GRFE,1KDFTV,2KDFTV,2TRFE	MTPT-00071	RING SET, SYNCHRONIZER, NO.1	33037-60050
					MTPT-00008	RING SET, SYNCHRONIZER, NO.1	33037-60040
					MTPT-00009	RING, SYNCHRONIZER, NO.2	33368-35050
					MTPT-00086	RING, SYNCHRONIZER, OUTER NO.3	33384-60090
					MTPT-00151	RING, SYNCHRONIZER, NO.2	33368-35070
					MTPT-00153	SPRING, SYNCHROMESH SHIFTING KEY, NO.3	33392-60020
					MTPT-00154	SPRING, SYNCHROMESH SHIFTING KEY, NO.3	33392-60030
					MTPT-00157	KEY, SYNCHROMESH SHIFTING, NO.3	33394-60020
					MTPT-00174	PIN (FOR 5TH GEAR THRUST WASHER) PIN OR BALL (FOR 1ST GEAR THRUST WASHER)	90250-05026 90250-05026
		05.07-08.08	TGN51	2TRFE	MTPT-00083	RING SET, SYNCHRONIZER, NO.1	33367-35080
		05.09-09.03	GGN60,TGN51,61	1GRFE,2TRFE	MTPT-00086	RING, SYNCHRONIZER, OUTER NO.3	33384-60090
					MTPT-00146	KEY, SYNCHROMESH SHIFTING, NO.1	33365-35060
					MTPT-00153	SPRING, SYNCHROMESH SHIFTING KEY, NO.3	33392-60020
					MTPT-00154	SPRING, SYNCHROMESH SHIFTING KEY, NO.3	33392-60030
					MTPT-00157	KEY, SYNCHROMESH SHIFTING, NO.3	33394-60020
					MTPT-00174	PIN (FOR 5TH GEAR THRUST WASHER) PIN OR BALL (FOR 1ST GEAR THRUST WASHER)	90250-05026 90250-05026
					MTPT-00313	WASHER, 1ST GEAR THRUST	33348-35010
					MTPT-00315	KEY, SYNCHROMESH SHIFTING, NO.2	33366-35050
		06.05-	LAN50	5LE	MTPT-00015	SHAFT, INPUT	33301-35080
					MTPT-00020	RING, SYNCHRONIZER, NO.1	33368-20012
					MTPT-00028	RING, SYNCHRONIZER, NO.2	33367-14010
					MTPT-00095	HUB, TRANSMISSION CLUTCH, NO.2	33362-35040
				MTPT-00097	SHAFT, OUTPUT	33321-60090	
				MTPT-00100	SLEEVE, TRANSMISSION HUB, NO.2	33364-26020	
				MTPT-00112	WASHER, 4TH GEAR	33349-35010	
				MTPT-00139	SLEEVE, TRANSMISSION HUB, NO.3	33395-71010	
				MTPT-00142	PIPE, OIL RECEIVER (FOR TRANSFER)	33124-36010	
				MTPT-00334	SPRING, SYNCHROMESH SHIFTING KEY, NO.1	33371-14031	
	06.08-08.08	KUN51	1KDFTV	MTPT-00001	SHAFT, INPUT	33301-60050 (33301-26050)	
				MTPT-00071	RING SET, SYNCHRONIZER, NO.1	33037-60050	

Reference List / Manual Transmission(Parts)

Model	Year	Body Type	Engine Type	AISIN No.	Productin Name	Genuine No.
FORTUNER				MTPT-00076	PIECE, GEAR SPLINE, NO.5	33318-60030
				MTPT-00079	HUB, TRANSMISSION CLUTCH, NO.2	33362-60030 (33362-60031)
				MTPT-00081	SLEEVE, TRANSMISSION HUB, NO.2	33364-60070
				MTPT-00143	RETAINER, OUTPUT SHAFT REAR BEARING (MTM)	33151-35020
				MTPT-00146	KEY, SYNCHROMESH SHIFTING, NO.1	33365-35060
				MTPT-00313	WASHER, 1ST GEAR THRUST	33348-35010
				MTPT-00315	KEY, SYNCHROMESH SHIFTING, NO.2	33366-35050
	07.08-08.08	GGN50,KUN50,5#,61 TGN61	1GRFE,1KDFTV,2KDFTV 2TRFE	MTPT-00145	WASHER, 5TH GEAR THRUST	33346-71010
				MTPT-00008	RING SET, SYNCHRONIZER, NO.1	33037-60040
				MTPT-00009	RING, SYNCHRONIZER, NO.2	33368-35050
				MTPT-00083	RING SET, SYNCHRONIZER, NO.1	33367-35080
				MTPT-00151	RING, SYNCHRONIZER, NO.2	33368-35070
	07.08-09.03	GGN60,TGN51,61	1GRFE,2TRFE	MTPT-00145	WASHER, 5TH GEAR THRUST	33346-71010
	07.12-09.01	GGN50,KUN51,60,TGN51	1GRFE,1KDFTV,2KDFTV,2TRFE	MTPT-00145	WASHER, 5TH GEAR THRUST	33346-71010
	08.08-08.11	GGN50,KUN51,60	1GRFE,1KDFTV,2KDFTV	MTPT-00071	RING SET, SYNCHRONIZER, NO.1	33037-60050
	08.08-09.01	GGN50,KUN51,6#,TGN51,61 KUN51,6# TGN51,61	1GRFE,1KDFTV,2KDFTV,2TRFE 1KDFTV,2KDFTV 2TRFE	MTPT-00008	RING SET, SYNCHRONIZER, NO.1	33037-60040
				MTPT-00009	RING, SYNCHRONIZER, NO.2	33368-35050
				MTPT-00151	RING, SYNCHRONIZER, NO.2	33368-35070
				MTPT-00071	RING SET, SYNCHRONIZER, NO.1	33037-60050
				MTPT-00083	RING SET, SYNCHRONIZER, NO.1	33367-35080
				MTPT-00146	KEY, SYNCHROMESH SHIFTING, NO.1	33365-35060
				MTPT-00315	KEY, SYNCHROMESH SHIFTING, NO.2	33366-35050
	08.08-09.03	GGN50,KUN5#,61	1GRFE,1KDFTV,2KDFTV	MTPT-00313	WASHER, 1ST GEAR THRUST	33348-35010
				MTPT-00315	KEY, SYNCHROMESH SHIFTING, NO.2	33366-35050
	08.08-09.08	KUN51,60,6#	1KDFTV,2KDFTV	MTPT-00146	KEY, SYNCHROMESH SHIFTING, NO.1	33365-35060
				MTPT-00315	KEY, SYNCHROMESH SHIFTING, NO.2	33366-35050
	08.08-10.07	GGN50,KUN51,6#,TGN51,61	1GRFE,1KDFTV,2KDFTV,2TRFE	MTPT-00145	WASHER, 5TH GEAR THRUST	33346-71010
	08.08-10.11	KUN51,60,6#	1KDFTV,2KDFTV	MTPT-00313	WASHER, 1ST GEAR THRUST	33348-35010
	08.08-11.07	GGN50,KUN51,60,TGN51,61	1GRFE,1KDFTV,2KDFTV,2TRFE	MTPT-00086	RING, SYNCHRONIZER, OUTER NO.3	33384-60090
				MTPT-00153	SPRING, SYNCHROMESH SHIFTING KEY, NO.3	33392-60020
				MTPT-00154	SPRING, SYNCHROMESH SHIFTING KEY, NO.3	33392-60030
				MTPT-00157	KEY, SYNCHROMESH SHIFTING, NO.3	33394-60020
				MTPT-00174	PIN (FOR 5TH GEAR THRUST WASHER)	90250-05026
	08.08-11.10	KUN61,TGN61	1KDFTV,2TRFE	MTPT-00086	RING, SYNCHRONIZER, OUTER NO.3	33384-60090
				MTPT-00146	KEY, SYNCHROMESH SHIFTING, NO.1	33365-35060
				MTPT-00157	KEY, SYNCHROMESH SHIFTING, NO.3	33394-60020
				MTPT-00174	PIN (FOR 5TH GEAR THRUST WASHER) PIN OR BALL (FOR 1ST GEAR THRUST WASHER)	90250-05026 90250-05026
				MTPT-00315	KEY, SYNCHROMESH SHIFTING, NO.2	33366-35050
	08.08-12.04	GGN50 GGN50,KUN50,51,LAN50,TGN51 GGN50,KUN51,6#,TGN51,61	1GRFE 1GRFE,1KDFTV,2KDFTV,5LE,2TRFE 1GRFE,1KDFTV,2KDFTV,2TRFE	MTPT-00146	KEY, SYNCHROMESH SHIFTING, NO.1	33365-35060
				MTPT-00315	KEY, SYNCHROMESH SHIFTING, NO.2	33366-35050
				MTPT-00170	NUT (FOR TRANSFER OUTPUT SHAFT)	90179-22016
				MTPT-00086	RING, SYNCHRONIZER, OUTER NO.3	33384-60090
MTPT-00153				SPRING, SYNCHROMESH SHIFTING KEY, NO.3	33392-60020	
MTPT-00154				SPRING, SYNCHROMESH SHIFTING KEY, NO.3	33392-60030	
MTPT-00157				KEY, SYNCHROMESH SHIFTING, NO.3	33394-60020	

Reference List / Manual Transmission(Parts)

Model	Year	Body Type	Engine Type	AISIN No.	Productin Name	Genuine No.
FORTUNER		KUN51,6#,TGN51,61	1KDFTV,2KDFTV,2TRFE	MTPT-00174	PIN (FOR 5TH GEAR THRUST WASHER)	90250-05026
				MTPT-00146	KEY, SYNCHROMESH SHIFTING, NO.1	33365-35060
				MTPT-00315	KEY, SYNCHROMESH SHIFTING, NO.2	33366-35050
	08.08-	KUN51,60	1KDFTV,2KDFTV	MTPT-00001	SHAFT, INPUT	33301-60050 (33301-26050)
				MTPT-00008	RING SET, SYNCHRONIZER, NO.1	33037-60040
				MTPT-00009	RING, SYNCHRONIZER, NO.2	33368-35050
				MTPT-00071	RING SET, SYNCHRONIZER, NO.1	33037-60050
				MTPT-00076	PIECE, GEAR SPLINE, NO.5	33318-60030
				MTPT-00079	HUB, TRANSMISSION CLUTCH, NO.2	33362-60030 (33362-60031)
				MTPT-00081	SLEEVE, TRANSMISSION HUB, NO.2	33364-60070
				MTPT-00086	RING, SYNCHRONIZER, OUTER NO.3	33384-60090
				MTPT-00143	RETAINER, OUTPUT SHAFT REAR BEARING (MTM)	33151-35020
				MTPT-00145	WASHER, 5TH GEAR THRUST	33346-71010
				MTPT-00146	KEY, SYNCHROMESH SHIFTING, NO.1	33365-35060
				MTPT-00151	RING, SYNCHRONIZER, NO.2	33368-35070
				MTPT-00153	SPRING, SYNCHROMESH SHIFTING KEY, NO.3	33392-60020
				MTPT-00154	SPRING, SYNCHROMESH SHIFTING KEY, NO.3	33392-60030
				MTPT-00157	KEY, SYNCHROMESH SHIFTING, NO.3	33394-60020
				MTPT-00174	PIN (FOR 5TH GEAR THRUST WASHER)	90250-05026
					PIN OR BALL (FOR 1ST GEAR THRUST WASHER)	90250-05026
				MTPT-00313	WASHER, 1ST GEAR THRUST	33348-35010
				MTPT-00315	KEY, SYNCHROMESH SHIFTING, NO.2	33366-35050
	09.02-10.07	KUN51,60	1KDFTV,2KDFTV	MTPT-00145	WASHER, 5TH GEAR THRUST	33346-71010
	09.02-10.11	KUN51,60	1KDFTV,2KDFTV	MTPT-00313	WASHER, 1ST GEAR THRUST	33348-35010
	09.11-	GGN50,KUN51,60,TGN51,61	1GRFE,1KDFTV,2KDFTV,2TRFE	MTPT-00145	WASHER, 5TH GEAR THRUST	33346-71010
	11.07-12.06	GGN50,KUN51,6#,TGN51,61	1GRFE,1KDFTV,2KDFTV,2TRFE	MTPT-00153	SPRING, SYNCHROMESH SHIFTING KEY, NO.3	33392-60020
				MTPT-00154	SPRING, SYNCHROMESH SHIFTING KEY, NO.3	33392-60030
	11.07-13.10	KUN60	2KDFTV	MTPT-00001	SHAFT, INPUT	33301-60050 (33301-26050)
	11.07-14.04	KUN51,60,TGN51	1KDFTV,2KDFTV,2TRFE	MTPT-00079	HUB, TRANSMISSION CLUTCH, NO.2	33362-60030 (33362-60031)
		KUN51,TGN51	1KDFTV,2TRFE	MTPT-00001	SHAFT, INPUT	33301-60050 (33301-26050)
	11.07-15.03	GGN50,KUN51,6#,TGN51,61	1GRFE,1KDFTV,2KDFTV,2TRFE	MTPT-00086	RING, SYNCHRONIZER, OUTER NO.3	33384-60090
				MTPT-00315	KEY, SYNCHROMESH SHIFTING, NO.2	33366-35050
11.07-	GGN50	1GRFE	MTPT-00073	RETAINER, BEARING, FRONT	33131-60080	
	GGN50,KUN5#,51,LAN50,TGN51	1GRFE,1KDFTV,5LE,2TRFE	MTPT-00170	NUT (FOR TRANSFER OUTPUT SHAFT)	90179-22016	
	GGN50,KUN51,6#,TGN51,61	1GRFE,1KDFTV,2KDFTV,2TRFE	MTPT-00146	KEY, SYNCHROMESH SHIFTING, NO.1	33365-35060	
			MTPT-00157	KEY, SYNCHROMESH SHIFTING, NO.3	33394-60020	
			MTPT-00174	PIN (FOR 5TH GEAR THRUST WASHER)	90250-05026	
				PIN OR BALL (FOR 1ST GEAR THRUST WASHER)	90250-05026	
	KUN51,60	1KDFTV,2KDFTV	MTPT-00003	GEAR, 1ST	33032-60111	
	TGN51	2TRFE	MTPT-00009	RING, SYNCHRONIZER, NO.2	33368-35050	
			MTPT-00076	PIECE, GEAR SPLINE, NO.5	33318-60030	
			MTPT-00081	SLEEVE, TRANSMISSION HUB, NO.2	33364-60070	

Reference List / Manual Transmission(Parts)

Model	Year	Body Type	Engine Type	AISIN No.	Productin Name	Genuine No.	
FORTUNER				MTPT-00086	RING, SYNCHRONIZER, OUTER NO.3	33384-60090	
				MTPT-00143	RETAINER, OUTPUT SHAFT REAR BEARING (MTM)	33151-35020	
				MTPT-00144	GEAR, REVERSE	33331-60041	
				MTPT-00145	WASHER, 5TH GEAR THRUST	33346-71010	
				MTPT-00151	RING, SYNCHRONIZER, NO.2	33368-35070	
				MTPT-00313	WASHER, 1ST GEAR THRUST	33348-35010	
				MTPT-00315	KEY, SYNCHROMESH SHIFTING, NO.2	33366-35050	
	12.03-	KUN51,60		1KDFTV,2KDFTV	MTPT-00144	GEAR, REVERSE	33331-60041
	12.04-14.04	TGN51,61		2TRFE	MTPT-00001	SHAFT, INPUT	33301-60050 (33301-26050)
					MTPT-00079	HUB, TRANSMISSION CLUTCH, NO.2	33362-60030 (33362-60031)
	12.04-14.10	TGN51,61		2TRFE	MTPT-00008	RING SET, SYNCHRONIZER, NO.1	33037-60040
					MTPT-00009	RING, SYNCHRONIZER, NO.2	33368-35050
					MTPT-00076	PIECE, GEAR SPLINE, NO.5	33318-60030
					MTPT-00081	SLEEVE, TRANSMISSION HUB, NO.2	33364-60070
					MTPT-00083	RING SET, SYNCHRONIZER, NO.1	33367-35080
					MTPT-00086	RING, SYNCHRONIZER, OUTER NO.3	33384-60090
					MTPT-00143	RETAINER, OUTPUT SHAFT REAR BEARING (MTM)	33151-35020
					MTPT-00145	WASHER, 5TH GEAR THRUST	33346-71010
					MTPT-00146	KEY, SYNCHROMESH SHIFTING, NO.1	33365-35060
					MTPT-00151	RING, SYNCHRONIZER, NO.2	33368-35070
					MTPT-00157	KEY, SYNCHROMESH SHIFTING, NO.3	33394-60020
					MTPT-00174	PIN (FOR 5TH GEAR THRUST WASHER) PIN OR BALL (FOR 1ST GEAR THRUST WASHER)	90250-05026 90250-05026
					MTPT-00313	WASHER, 1ST GEAR THRUST	33348-35010
MTPT-00315	KEY, SYNCHROMESH SHIFTING, NO.2	33366-35050					
12.04-15.03	TGN51		2TRFE	MTPT-00008	RING SET, SYNCHRONIZER, NO.1	33037-60040	
				MTPT-00083	RING SET, SYNCHRONIZER, NO.1	33367-35080	
12.05-	KUN51,60		1KDFTV,2KDFTV	MTPT-00078	HUB, TRANSMISSION CLUTCH, NO.1	33361-71020	
13.10-14.04	KUN60		2KDFTV	MTPT-00001	SHAFT, INPUT	33301-60050 (33301-26050)	
13.12-14.10	TGN61		2TRFE	MTPT-00327	SHAFT, OUTPUT	33321-35191	
13.12-15.03	TGN51		2TRFE	MTPT-00002	SHAFT, OUTPUT	33321-35141	
13.12-	KUN60		2KDFTV	MTPT-00327	SHAFT, OUTPUT	33321-35191	
15.07-	GUN156		1GDFTV	MTPT-00170	NUT (FOR TRANSFER OUTPUT SHAFT)	90179-22016	
	GUN156,165		1GDFTV,2GDFTV	MTPT-00174	PIN, STRAIGHT (FOR GEAR THRUST WASHER)	90250-05026	
HIACE	79.12-82.11	LH11,20,30	L	MTPT-00020	RING, SYNCHRONIZER, NO.1	33368-20012	
				MTPT-00334	SPRING, SYNCHROMESH SHIFTING KEY, NO.1	33371-14031	
	82.11-85.07	LH11	L		MTPT-00020	RING, SYNCHRONIZER, NO.1	33368-20012
					MTPT-00334	SPRING, SYNCHROMESH SHIFTING KEY, NO.1	33371-14031
	84.01-85.07	LH11	L		MTPT-00142	PIPE, OIL RECEIVER (MTM)	33124-36010
					MTPT-00328	SHAFT, OUTPUT	33321-26050
	05.01-12.01	KDH200,201,202,203,212,22#,TRH20#,213,22#		1KDFTV,2KDFTV,1TRFE,2TRFE	MTPT-00153	SPRING, SYNCHROMESH SHIFTING KEY, NO.3	33392-60020
					MTPT-00154	SPRING, SYNCHROMESH SHIFTING KEY, NO.3	33392-60030
	05.01-13.05	KDH200,201,202,203,212,22#,TRH20#,213,22#		1KDFTV,2KDFTV,1TRFE,2TRFE	MTPT-00007	GEAR, COUNTERSHAFT 5TH	33428-60040 (33428-60041)

Reference List / Manual Transmission(Parts)

Model	Year	Body Type	Engine Type	AISIN No.	Productin Name	Genuine No.		
HIACE	05.01-13.12	LH20#,212,222	5LE	MTPT-00020	RING, SYNCHRONIZER, NO.2	33368-20012		
				MTPT-00028	RING, SYNCHRONIZER, NO.1	33367-14010		
				MTPT-00142	PIPE, OIL RECEIVER, NO.1 (FOR EXTENSION HOUSING)	33124-36010		
	05.01-14.02	KDH20#,212,22#	1KDFTV,2KDFTV	MTPT-00008	RING SET, SYNCHRONIZER, NO.1	33037-60040		
				MTPT-00071	RING SET, SYNCHRONIZER, NO.1	33037-60050		
				KDH20#,212,22#,TRH201,203,213,22#	1KDFTV,2KDFTV,2TRFE	MTPT-00001	SHAFT, INPUT	33301-60050 (33301-26050)
						MTPT-00009	RING, SYNCHRONIZER, NO.2	33368-35050
						MTPT-00011	FORK, GEAR SHIFT, NO.1	33212-25011
						MTPT-00068	GEAR, 2ND	33033-60050
						MTPT-00069	GEAR, 3RD	33034-60030
						MTPT-00076	PIECE, GEAR SPLINE, NO.5	33318-60030
						MTPT-00079	HUB, TRANSMISSION CLUTCH, NO.2	33362-60030 (33362-60031)
						MTPT-00081	SLEEVE, TRANSMISSION HUB, NO.2	33364-60070
		MTPT-00086	RING, SYNCHRONIZER, OUTER NO.3	33384-60090				
		MTPT-00143	RETAINER, OUTPUT SHAFT REAR BEARING (MTM)	33151-35020				
		MTPT-00146	KEY, SYNCHROMESH SHIFTING, NO.1	33365-35060				
		MTPT-00151	RING, SYNCHRONIZER, NO.2	33368-35070				
		MTPT-00313	WASHER, 1ST GEAR THRUST	33348-35010				
		MTPT-00315	KEY, SYNCHROMESH SHIFTING, NO.2	33366-35050				
		MTPT-00317	BEARING, INPUT SHAFT	90364-25012				
		TRH201,203,213,22#	2TRFE	MTPT-00008	RING SET, SYNCHRONIZER, NO.1	33037-60040		
				MTPT-00083	RING, SYNCHRONIZER, NO.1	33367-35080		
		05.01-	LH20#,212,222	5LE	MTPT-00334	SPRING, SYNCHROMESH SHIFTING KEY, NO.1	33371-14031	
	07.12-14.02	KDH20#,212,22#,TRH201,203,213,22#	1KDFTV,2KDFTV,2TRFE	MTPT-00145	WASHER, 5TH GEAR THRUST	33346-71010		
	11.06-14.02	KDH20#,212,22# TRH201,203,213,22#	1KDFTV,2KDFTV 2TRFE	MTPT-00003	GEAR, 1ST	33032-60111		
				MTPT-00004	GEAR, 1ST	33032-60081		
	12.03-14.02	KDH200,201,202,203,212,22#,TRH201,203,213	1KDFTV,2KDFTV,2TRFE	MTPT-00144	GEAR, REVERSE	33331-60041		
	12.05-14.02	KDH200,201,202,203,212,22#	1KDFTV,2KDFTV	MTPT-00078	HUB, TRANSMISSION CLUTCH, NO.1	33361-71020		
	13.05-13.09	KDH202,212,TRH201,203,213,221,223	2KDFTV,2TRFE	MTPT-00014	FORK, GEAR SHIFT, NO.2	33213-25021		
	13.05-13.10	KDH200,201,202,203,22#	1KDFTV,2KDFTV	MTPT-00014	FORK, GEAR SHIFT, NO.2	33213-25021		
	13.05-14.02	KDH20#,212,22#,TRH201,203,213,22#	1KDFTV,2KDFTV,2TRFE	MTPT-00005	GEAR, COUNTER	33421-71011 (33421-26110)		
	13.09-14.02	KDH202,212,TRH201,203,213,22#	2KDFTV,2TRFE	MTPT-00014	FORK, GEAR SHIFT, NO.2	33213-25021		
	13.10-14.02	KDH200,201,203,22#	1KDFTV,2KDFTV	MTPT-00014	FORK, GEAR SHIFT, NO.2	33213-25021		
13.12-14.04	KDH20#,212,22#,TRH201,203,213,22#	1KDFTV,2KDFTV,2TRFE	MTPT-00001	SHAFT, INPUT	33301-60050 (33301-26050)			
			MTPT-00079	HUB, TRANSMISSION CLUTCH, NO.2	33362-60030 (33362-60031)			
13.12-15.08	KDH20#,21#,22#,TRH201,203,213,22# LH20#,212,222	1KDFTV,2KDFTV,2TRFE 5LE	MTPT-00008	RING SET, SYNCHRONIZER, NO.1	33037-60040			
			MTPT-00028	RING, SYNCHRONIZER, NO.1	33367-14010			
13.12-15.09	KDH20#,21#,22#,TRH201,203,213,22#	1KDFTV,2KDFTV,2TRFE	MTPT-00009	RING, SYNCHRONIZER, NO.2	33368-35050			
			MTPT-00151	RING, SYNCHRONIZER, NO.2	33368-35070			
13.12-	KDH20#,21#,212,22#,TRH201,203,213,221,223 KDH20#,212,21#,22# KDH20#,212,21#,22#,TRH201,203,213,221,223	1KDFTV,2KDFTV,2TRFE 1KDFTV,2KDFTV 1KDFTV,2KDFTV,2TRFE	MTPT-00146	KEY, SYNCHROMESH SHIFTING, NO.1	33365-35060			
			MTPT-00157	KEY, SYNCHROMESH SHIFTING, NO.3	33394-60020			
			MTPT-00315	KEY, SYNCHROMESH SHIFTING, NO.2	33366-35050			
			MTPT-00071	RING SET, SYNCHRONIZER, NO.1	33037-60050			
			MTPT-00078	HUB, TRANSMISSION CLUTCH, NO.1	33361-71020			
MTPT-00076	PIECE, GEAR SPLINE, NO.5	33318-60030						

Reference List / Manual Transmission(Parts)

Model	Year	Body Type	Engine Type	AISIN No.	Productin Name	Genuine No.
HIACE		KDH20#,212,21#,22# KDH20#,212,21#,22#,TRH201,203,213,221,223 LH20#,212,222 TRH201,203,213,221,223	1KDFTV,2KDFTV 1KDFTV,2KDFTV,2TRFE 5LE 2TRFE	MTPT-00081	SLEEVE, TRANSMISSION HUB, NO.2	33364-60070
				MTPT-00086	RING, SYNCHRONIZER, OUTER NO.3	33384-60090
				MTPT-00143	RETAINER, OUTPUT SHAFT REAR BEARING (MTM)	33151-35020
				MTPT-00145	WASHER, 5TH GEAR THRUST	33346-71010
				MTPT-00313	WASHER, 1ST GEAR THRUST	33348-35010
				MTPT-00327	SHAFT, OUTPUT	33321-35191
				MTPT-00003	GEAR, 1ST	33032-60111
				MTPT-00144	GEAR, REVERSE	33331-60041
				MTPT-00020	RING, SYNCHRONIZER, NO.2	33368-20012
	MTPT-00142	PIPE, OIL RECEIVER, NO.1 (FOR EXTENSION HOUSING)	33124-36010			
	MTPT-00083	RING, SYNCHRONIZER, NO.1	33367-35080			
	15.08-	LH20#,212,222	5LE	MTPT-00095	HUB, TRANSMISSION CLUTCH, NO.2	33362-35040
				MTPT-00100	SLEEVE, TRANSMISSION HUB, NO.2	33364-26020
				MTPT-00112	WASHER, 4TH GEAR	33349-35010
				MTPT-00137	GEAR, COUNTERSHAFT 5TH	33428-71020
				MTPT-00139	SLEEVE, TRANSMISSION HUB, NO.3	33395-71010
				MTPT-00328	SHAFT, OUTPUT	33321-26050
	MTPT-00332	SHAFT, INPUT	33301-35071			
	HIACE VAN,COMMUTER	82.12-88.07	LH50,51,60,61,7#,YH50,51,53,60,61,63,7#	L,2L,2Y,3Y,4Y	MTPT-00020	RING, SYNCHRONIZER, NO.1
MTPT-00334					SPRING, SYNCHROMESH SHIFTING KEY, NO.1	33371-14031
84.01-88.07		LH5#,6#,71,YH5#,61,63,66,7# LH51,61,71,YH50,51,53,60,61,63,7#	L,2L,2Y,3Y,4Y L,2L,2Y,3Y,4Y	MTPT-00142	PIPE, OIL RECEIVER (MTM)	33124-36010
				MTPT-00328	SHAFT, OUTPUT	33321-26050
86.08-87.08		LH56,66,YH56,66	2L,4Y	MTPT-00020	RING, SYNCHRONIZER (FOR TRANSFER FRONT DRIVE CLUTCH)	33368-20012
				MTPT-00082	RING, SYNCHRONIZER, NO.1	33367-35010
				MTPT-00143	RETAINER, OUTPUT SHAFT REAR BEARING (MTM)	33151-35020
				MTPT-00147	KEY, SYNCHROMESH SHIFTING, NO.2	33366-35030
				MTPT-00187	NUT (FOR COUNTER GEAR SHAFT)	90179-22005
				MTPT-00313	WASHER, 1ST GEAR THRUST	33348-35010
MTPT-00334		SPRING, SYNCHROMESH SHIFTING KEY, NO.1	33371-14031			
87.08-88.08		LH51,61,71,YH5#,61	2L,2Y,3Y	MTPT-00020	RING, SYNCHRONIZER, NO.1	33368-20012
				MTPT-00328	SHAFT, OUTPUT	33321-26050
MTPT-00334		SPRING, SYNCHROMESH SHIFTING KEY, NO.1	33371-14031			
87.08-97.12		YH53	4Y	MTPT-00142	PIPE, OIL RECEIVER, NO.1 (FOR EXTENSION HOUSING)	33124-36010
87.08-98.03		LH51,61,71,YH73	2L,3Y,4Y	MTPT-00142	PIPE, OIL RECEIVER, NO.1 (FOR EXTENSION HOUSING)	33124-36010
87.08-		YH63	4Y	MTPT-00142	PIPE, OIL RECEIVER, NO.1 (FOR EXTENSION HOUSING)	33124-36010
88.08-89.10	LH51,61,71,YH5#,6#,73	2L,2Y,3Y,4Y	MTPT-00020	RING, SYNCHRONIZER, NO.1	33368-20012	
			MTPT-00095	HUB, TRANSMISSION CLUTCH, NO.2	33362-35040	
			MTPT-00328	SHAFT, OUTPUT	33321-26050	
			MTPT-00333	KEY, SYNCHROMESH SHIFTING, NO.2	33366-35040 (33366-35041)	
MTPT-00334	SPRING, SYNCHROMESH SHIFTING KEY, NO.1	33371-14031				
88.08-97.12	YH53	4Y	MTPT-00112	WASHER, 4TH GEAR	33349-35010	
88.08-	YH63	4Y	MTPT-00112	WASHER, 4TH GEAR	33349-35010	
89.06-98.03	LH51,61,71,YH5#,60,61,63,73	2L,2Y,3Y,4Y	MTPT-00331	GEAR, COUNTER	33421-26100	

Reference List / Manual Transmission(Parts)

Model	Year	Body Type	Engine Type	AISIN No.	Productin Name	Genuine No.
HIACE VAN,COMMUTER	89.08-99.07	LH10#,11#,125,166,17#,184,RZH10#,11#,125,135,153	2L,3L,5L,5LE,1RZ,1RZE,2RZ,2RZE	MTPT-00142	PIPE, OIL RECEIVER, NO.1 (FOR EXTENSION HOUSING)	33124-36010
	89.08-01.08	LH10#, 11#, 125,166,172,174,176,184, RZH10#,102,103,104,105,112,113,114,125,135,153	2L,3L,5L,5LE,1RZ,1RZE,2RZ,2RZE	MTPT-00095	HUB, TRANSMISSION CLUTCH, NO.2	33362-35040
		LH10#, 11#, 125,172,174,184, RZH102,103,104,105,112,113,114,115,125,135,153	2L,3L,5L,5LE,1RZ,1RZE,2RZ,2RZE	MTPT-00328	SHAFT, OUTPUT	33321-26050
				MTPT-00331	GEAR, COUNTER	33421-26100
	89.08-03.12	LH10#,11#,125,166,172,174,176,184, RZH102,103,104,105,112,113,114,115,125,135,153	2L,3L,5L,5LE,1RZ,1RZE,2RZ,2RZE	MTPT-00333	KEY, SYNCHROMESH SHIFTING, NO.2	33366-35040 (33366-35041)
	89.08-	LH10#,11#,125,166,172,174,176,184, RZH102,103,104,105,112,113,114,115,125,135,153	2L,3L,5L,5LE,1RZ,1RZE,2RZ,2RZE	MTPT-00020	RING, SYNCHRONIZER, NO.1	33368-20012
				MTPT-00112	WASHER, 4TH GEAR	33349-35010
		LH10#,11#,125,166,172,174,176,186, RZH102,103,104,105,112,113,114,115,125,135,153	2L,3L,5L,5LE,1RZ,1RZE,2RZ,2RZE	MTPT-00334	SPRING, SYNCHROMESH SHIFTING KEY, NO.1	33371-14031
				MTPT-00028	RING, SYNCHRONIZER, NO.3	33367-14010
	89.10-98.03	YH53,6#	3Y,4Y	MTPT-00095	HUB, TRANSMISSION CLUTCH, NO.2	33362-35040
				MTPT-00328	SHAFT, OUTPUT	33321-26050
	89.10-03.12	YH53,6#	3Y,4Y	MTPT-00333	KEY, SYNCHROMESH SHIFTING, NO.2	33366-35040 (33366-35041)
	89.10-	YH53,6#	3Y,4Y	MTPT-00020	RING, SYNCHRONIZER, NO.1	33368-20012
				MTPT-00334	SPRING, SYNCHROMESH SHIFTING KEY, NO.1	33371-14031
	92.09-98.03	YH53,63	3Y,4Y	MTPT-00100	SLEEVE, TRANSMISSION HUB, NO.2	33364-26020
	92.09-01.08	LH10#, 11#, 125,166,172,174,176,184, RZH102,103,104,105,112,113,114,115,125,135,153	2L,3L,5L,5LE,1RZ,1RZE,2RZ,2RZE	MTPT-00100	SLEEVE, TRANSMISSION HUB, NO.2	33364-26020
	98.03-	YH63	4Y	MTPT-00331	GEAR, COUNTER	33421-26100
	98.06-01.08	LH10#, 11#, 125,172,174,184, RZH102,103,104,105,112,113,114,115,125,135,153	2L,3L,5L,5LE,1RZ,1RZE,2RZ,2RZE	MTPT-00332	SHAFT, INPUT	33301-35071
	98.08-04.08	LH166,176	5L	MTPT-00015	SHAFT, INPUT	33301-35080
99.07-03.12	LH10#,112,113,114,115,125,154,16#,172,174,176,184, RZH10#,112,113,114,115,125,135,15#	2L,3L,5L,5LE,1RZ,1RZE,2RZ,2RZE	MTPT-00333	KEY, SYNCHROMESH SHIFTING, NO.2	33366-35040 (33366-35041)	
99.07-	LH10#, 11#, 125,154,16#,17#,184, RZH10#, 112,113,114,115,125,135,15#	2L,3L,5L,5LE,1RZ,1RZE,2RZ,2RZE	MTPT-00020	RING, SYNCHRONIZER, NO.1	33368-20012	
			MTPT-00028	RING, SYNCHRONIZER, NO.2	33367-14010	
				RING, SYNCHRONIZER, NO.3	33367-14010	
	LH10#,11#,125,154,16#,172,174,176,184, RZH10#,112,113,114,115,125,135,15#	2L,3L,5L,5LE,1RZ,1RZE,2RZ,2RZE	MTPT-00112	WASHER, 4TH GEAR	33349-35010	
			MTPT-00334	SPRING, SYNCHROMESH SHIFTING KEY, NO.1	33371-14031	
			MTPT-00095	HUB, TRANSMISSION CLUTCH, NO.2	33362-35040	
	LH10#,11#,125,154,162,164,172,174,184, RZH10#,112,113,114,115,125,135,15#	2L,3L,5L,5LE,1RZ,1RZE,2RZ,2RZE	MTPT-00100	SLEEVE, TRANSMISSION HUB, NO.2	33364-26020	
			MTPT-00142	PIPE, OIL RECEIVER, NO.1 (FOR EXTENSION HOUSING)	33124-36010	
			MTPT-00328	SHAFT, OUTPUT	33321-26050	
			MTPT-00331	GEAR, COUNTER	33421-26100	
			MTPT-00332	SHAFT, INPUT	33301-35071	
01.11-	RZH114	1RZ	MTPT-00020	RING, SYNCHRONIZER, NO.1	33368-20012	
			MTPT-00028	RING, SYNCHRONIZER, NO.2	33367-14010	
				RING, SYNCHRONIZER, NO.3	33367-14010	
			MTPT-00095	HUB, TRANSMISSION CLUTCH, NO.2	33362-35040	
			MTPT-00100	SLEEVE, TRANSMISSION HUB, NO.2	33364-26020	
			MTPT-00112	WASHER, 4TH GEAR	33349-35010	
			MTPT-00142	PIPE, OIL RECEIVER, NO.1 (FOR EXTENSION HOUSING)	33124-36010	
			MTPT-00328	SHAFT, OUTPUT	33321-26050	
			MTPT-00331	GEAR, COUNTER	33421-26100	
			MTPT-00332	SHAFT, INPUT	33301-35071	

Reference List / Manual Transmission(Parts)

Model	Year	Body Type	Engine Type	AISIN No.	Productin Name	Genuine No.
HIACE VAN,COMMUTER				MTPT-00334	SPRING, SYNCHROMESH SHIFTING KEY, NO.1	33371-14031
	04.03-	YH63	4Y	MTPT-00100	SLEEVE, TRANSMISSION HUB, NO.2	33364-26020
				MTPT-00328	SHAFT, OUTPUT	33321-26050
				MTPT-00332	SHAFT, INPUT	33301-35071
HIACE/HIACE S.B.V	95.08-98.04	RCH12,22	2RZE	MTPT-00015	SHAFT, INPUT	33301-35080
	95.08-99.07	LXH1#,2#,RCH19,29	2L,2LT,2RZE,3RZFE	MTPT-00010	RING, SYNCHRONIZER, NO.2	33368-35030
				MTPT-00075	PIECE, GEAR SPLINE, NO.5	33318-35040
				MTPT-00080	SLEEVE, TRANSMISSION HUB, NO.2	33364-35050
				MTPT-00083	RING, SYNCHRONIZER, NO.1	33367-35080
				MTPT-00084	RING, SYNCHRONIZER, NO.2	33368-35040
				MTPT-00087	SLEEVE, TRANSMISSION HUB, NO.3	33395-35031
				MTPT-00143	RETAINER, OUTPUT SHAFT REAR BEARING (MTM)	33151-35020
				MTPT-00147	KEY, SYNCHROMESH SHIFTING, NO.2	33366-35030
				MTPT-00174	PIN (FOR 5TH GEAR THRUST WASHER)	90250-05026
				MTPT-00313	WASHER, 1ST GEAR THRUST	33348-35010
				MTPT-00020	RING, SYNCHRONIZER, NO.2	33368-20012
				MTPT-00028	RING, SYNCHRONIZER, NO.1	33367-14010
					RING, SYNCHRONIZER, NO.3	33367-14010
				MTPT-00095	HUB, TRANSMISSION CLUTCH, NO.2	33362-35040
				MTPT-00100	SLEEVE, TRANSMISSION HUB, NO.2	33364-26020
	MTPT-00112	WASHER, 5TH GEAR THRUST	33349-35010			
	MTPT-00142	PIPE, OIL RECEIVER, NO.1 (FOR EXTENSION HOUSING)	33124-36010			
	MTPT-00333	KEY, SYNCHROMESH SHIFTING, NO.2	33366-35040 (33366-35041)			
	MTPT-00334	SPRING, SYNCHROMESH SHIFTING KEY, NO.1	33371-14031			
	MTPT-00337	SHAFT, OUTPUT	33321-35092			
	MTPT-00331	GEAR, COUNTER	33421-26100			
		LXH12,22,RCH12,22	2L,2LT,2RZE			
		RCH12,LXH12,22	2RZE,2L,2LT			
	95.08-99.10	LXH1#,2#,RCH13,19,23,29	2L,2LT,2RZE,3RZFE	MTPT-00176	SPRING, COMPRESSION	90501-07104
	96.08-97.04	RCH18,28	2RZE	MTPT-00096	SHAFT, OUTPUT	33321-35111
	98.01-99.07	LXH1#,2#,RCH19,29	2L,2LT,3RZFE	MTPT-00008	RING SET, SYNCHRONIZER, NO.1	33037-60040
	98.04-06.05	RCH13,23	3RZFE	MTPT-00140	RING SET, SYNCHRONIZER, NO.1	33037-30011
				MTPT-00141	RING SET, SYNCHRONIZER, NO.2	33038-30012
				MTPT-00150	RING, SYNCHRONIZER, NO.2	33368-30120
	98.06-99.07	LXH12,22,RCH12	2L,2LT,2RZE	MTPT-00332	SHAFT, INPUT	33301-35071
	99.07-01.08	LXH1#,2#	2L,2LT	MTPT-00008	RING SET, SYNCHRONIZER, NO.1	33037-60040
				MTPT-00010	RING, SYNCHRONIZER, NO.2	33368-35030
MTPT-00075				PIECE, GEAR SPLINE, NO.5	33318-35040	
MTPT-00080				SLEEVE, TRANSMISSION HUB, NO.2	33364-35050	
MTPT-00083				RING, SYNCHRONIZER, NO.1	33367-35080	
MTPT-00084				RING, SYNCHRONIZER, NO.2	33368-35040	
MTPT-00087				SLEEVE, TRANSMISSION HUB, NO.3	33395-35031	
MTPT-00143				RETAINER, OUTPUT SHAFT REAR BEARING (MTM)	33151-35020	
MTPT-00147				KEY, SYNCHROMESH SHIFTING, NO.2	33366-35030	
MTPT-00176				SPRING, COMPRESSION	90501-07104	
MTPT-00313				WASHER, 1ST GEAR THRUST	33348-35010	
				LXH12,22	2L,2LT	MTPT-00020
			MTPT-00028	RING, SYNCHRONIZER, NO.1	33367-14010	

Reference List / Manual Transmission(Parts)

Model	Year	Body Type	Engine Type	AISIN No.	Productin Name	Genuine No.				
HIACE/HIACE S.B.V					RING, SYNCHRONIZER, NO.3	33367-14010				
				MTPT-00095	HUB, TRANSMISSION CLUTCH, NO.2	33362-35040				
				MTPT-00100	SLEEVE, TRANSMISSION HUB, NO.2	33364-26020				
				MTPT-00112	WASHER, 5TH GEAR THRUST	33349-35010				
				MTPT-00142	PIPE, OIL RECEIVER, NO.1 (FOR EXTENSION HOUSING)	33124-36010				
				MTPT-00331	GEAR, COUNTER	33421-26100				
				MTPT-00332	SHAFT, INPUT	33301-35071				
				MTPT-00333	KEY, SYNCHROMESH SHIFTING, NO.2	33366-35040 (33366-35041)				
				MTPT-00334	SPRING, SYNCHROMESH SHIFTING KEY, NO.1	33371-14031				
				MTPT-00337	SHAFT, OUTPUT	33321-35092				
99.07-02.02	KLH12,22		2KDFTV	MTPT-00334	SPRING, SYNCHROMESH SHIFTING KEY, NO.1	33371-14031				
99.07-03.11	RCH12,22		2RZE	MTPT-00020	RING, SYNCHRONIZER, NO.2	33368-20012				
				MTPT-00028	RING, SYNCHRONIZER, NO.1	33367-14010				
					RING, SYNCHRONIZER, NO.3	33367-14010				
				MTPT-00095	HUB, TRANSMISSION CLUTCH, NO.2	33362-35040				
				MTPT-00100	SLEEVE, TRANSMISSION HUB, NO.2	33364-26020				
				MTPT-00112	WASHER, 5TH GEAR THRUST	33349-35010				
				MTPT-00142	PIPE, OIL RECEIVER, NO.1 (FOR EXTENSION HOUSING)	33124-36010				
				MTPT-00331	GEAR, COUNTER	33421-26100				
				MTPT-00332	SHAFT, INPUT	33301-35071				
				MTPT-00333	KEY, SYNCHROMESH SHIFTING, NO.2	33366-35040 (33366-35041)				
MTPT-00334	SPRING, SYNCHROMESH SHIFTING KEY, NO.1	33371-14031								
MTPT-00337	SHAFT, OUTPUT	33321-35092								
99.07-03.12	KLH12,22		2KDFTV	MTPT-00333	KEY, SYNCHROMESH SHIFTING, NO.2	33366-35040 (33366-35041)				
99.07-06.05	RCH13,23 RCH19,29		3RZFE 3RZFE	MTPT-00176	SPRING, COMPRESSION	90501-07104				
				MTPT-00008	RING SET, SYNCHRONIZER, NO.1	33037-60040				
				MTPT-00010	RING, SYNCHRONIZER, NO.2	33368-35030				
				MTPT-00075	PIECE, GEAR SPLINE, NO.5	33318-35040				
				MTPT-00080	SLEEVE, TRANSMISSION HUB, NO.2	33364-35050				
				MTPT-00083	RING, SYNCHRONIZER, NO.1	33367-35080				
				MTPT-00084	RING, SYNCHRONIZER, NO.2	33368-35040				
				MTPT-00087	SLEEVE, TRANSMISSION HUB, NO.3	33395-35031				
				MTPT-00143	RETAINER, OUTPUT SHAFT REAR BEARING (MTM)	33151-35020				
				MTPT-00147	KEY, SYNCHROMESH SHIFTING, NO.2	33366-35030				
MTPT-00176	SPRING, COMPRESSION	90501-07104								
MTPT-00313	WASHER, 1ST GEAR THRUST	33348-35010								
99.07-06.08	KLH1#,2#		2KDFTV	MTPT-00010	RING, SYNCHRONIZER, NO.2	33368-35030				
				MTPT-00075	PIECE, GEAR SPLINE, NO.5	33318-35040				
				MTPT-00080	SLEEVE, TRANSMISSION HUB, NO.2	33364-35050				
				MTPT-00084	RING, SYNCHRONIZER, NO.2	33368-35040				
				MTPT-00087	SLEEVE, TRANSMISSION HUB, NO.3	33395-35031				
				MTPT-00143	RETAINER, OUTPUT SHAFT REAR BEARING (MTM)	33151-35020				
				MTPT-00147	KEY, SYNCHROMESH SHIFTING, NO.2	33366-35030				
				MTPT-00313	WASHER, 1ST GEAR THRUST	33348-35010				
								MTPT-00020	RING, SYNCHRONIZER, NO.2	33368-20012
					KLH12,22		2KDFTV			

Reference List / Manual Transmission(Parts)

Model	Year	Body Type	Engine Type	AISIN No.	Productin Name	Genuine No.	
HIACE/HIACE S.B.V				MTPT-00028	RING, SYNCHRONIZER, NO.1	33367-14010	
				MTPT-00095	RING, SYNCHRONIZER, NO.3	33367-14010	
				MTPT-00100	HUB, TRANSMISSION CLUTCH, NO.2	33362-35040	
				MTPT-00112	SLEEVE, TRANSMISSION HUB, NO.2	33364-26020	
				MTPT-00142	WASHER, 5TH GEAR THRUST	33349-35010	
				MTPT-00176	PIPE, OIL RECEIVER, NO.1 (FOR EXTENSION HOUSING)	33124-36010	
				MTPT-00332	SPRING, COMPRESSION	90501-07104	
				MTPT-00337	SHAFT, INPUT	33301-35071	
				MTPT-00176	SHAFT, OUTPUT	33321-35092	
			KLH18,28	2KDFTV	MTPT-00176	SPRING, COMPRESSION	90501-07104
	01.07-06.05		RCH13,23	3RZFE	MTPT-00149	RING, SYNCHRONIZER, NO.1	33367-53030
	01.08-06.08		KLH1#,2#	2KDFTV	MTPT-00008	RING SET, SYNCHRONIZER, NO.1	33037-60040
					MTPT-00071	RING SET, SYNCHRONIZER, NO.1	33037-60050
	02.02-06.05		RCH19,29	3RZFE	MTPT-00001	SHAFT, INPUT	33301-60050 (33301-26050)
	02.02-06.08		KLH1#,2#	2KDFTV	MTPT-00001	SHAFT, INPUT	33301-60050 (33301-26050)
	03.07-06.05		RCH13,23	3RZFE	MTPT-00022	SHAFT, INPUT	33301-30081 (33301-30082)
	04.08-06.05		RCH19,29	3RZFE	MTPT-00146	KEY, SYNCHROMESH SHIFTING, NO.1	33365-35060
	04.08-06.08		KLH1#,2#	2KDFTV	MTPT-00146	KEY, SYNCHROMESH SHIFTING, NO.1	33365-35060
	06.08-10.05		KLH1#,2#	2KDFTV	MTPT-00075	PIECE, GEAR SPLINE, NO.5	33318-35040
					MTPT-00087	SLEEVE, TRANSMISSION HUB, NO.3	33395-35031
					MTPT-00176	SPRING, COMPRESSION	90501-07104
	06.08-		KLH1#,2#	2KDFTV	MTPT-00001	SHAFT, INPUT	33301-60050 (33301-26050)
					MTPT-00008	RING SET, SYNCHRONIZER, NO.1	33037-60040
					MTPT-00010	RING, SYNCHRONIZER, NO.2	33368-35030
					MTPT-00071	RING SET, SYNCHRONIZER, NO.1	33037-60050
					MTPT-00080	SLEEVE, TRANSMISSION HUB, NO.2	33364-35050
					MTPT-00084	RING, SYNCHRONIZER, NO.2	33368-35040
				MTPT-00143	RETAINER, OUTPUT SHAFT REAR BEARING (MTM)	33151-35020	
				MTPT-00146	KEY, SYNCHROMESH SHIFTING, NO.1	33365-35060	
				MTPT-00147	KEY, SYNCHROMESH SHIFTING, NO.2	33366-35030	
				MTPT-00313	WASHER, 1ST GEAR THRUST	33348-35010	
07.12-		KLH1#,2#	2KDFTV	MTPT-00145	WASHER, 5TH GEAR THRUST	33346-71010	
10.05-11.11		KLH1#,2#	2KDFTV	MTPT-00153	SPRING, SYNCHROMESH SHIFTING KEY, NO.3	33392-60020	
				MTPT-00154	SPRING, SYNCHROMESH SHIFTING KEY, NO.3	33392-60030	
10.05-		KLH1#,2#	2KDFTV	MTPT-00076	PIECE, GEAR SPLINE, NO.5	33318-60030	
				MTPT-00086	RING, SYNCHRONIZER, OUTER NO.3	33384-60090	
				MTPT-00157	KEY, SYNCHROMESH SHIFTING, NO.3	33394-60020	
HILUX	77.02-78.07	RN22	18R	MTPT-00020	RING, SYNCHRONIZER, NO.1	33368-20012	
				MTPT-00028	RING, SYNCHRONIZER, NO.2	33368-20012	
				MTPT-00028	RING, SYNCHRONIZER, NO.3	33367-14010	
	78.08-83.12	LN30,36,40,RN31,41	L,18R	MTPT-00028	RING, SYNCHRONIZER, NO.3	33367-14010	
	78.08-84.03	LN30,36,40,46,RN31,41,46	L,18R	MTPT-00020	RING, SYNCHRONIZER, NO.1	33368-20012	
	79.03-84.03	LN30,36,40,46,RN31,41,46	L,18R	MTPT-00334	SPRING, SYNCHROMESH SHIFTING KEY, NO.1	33371-14031	
	79.11-84.03	LN30,36,40,46,RN46	L,18R	MTPT-00028	RING, SYNCHRONIZER, NO.2	33367-14010	
	83.08-85.08	LN5#,6#,YN56,57,6#	L,2L,2Y,3Y,3YC	MTPT-00020	RING, SYNCHRONIZER, NO.1	33368-20012	
			MTPT-00334	SPRING, SYNCHROMESH SHIFTING KEY, NO.1	33371-14031		

Reference List / Manual Transmission(Parts)

Model	Year	Body Type	Engine Type	AISIN No.	Productin Name	Genuine No.
HILUX		LN5#,6#,YN56,6#	L,2L,2Y,3Y	MTPT-00028	RING, SYNCHRONIZER, NO.2	33367-14010
		LN5#,YN56	L,2L	MTPT-00142	PIPE, OIL RECEIVER (MTM)	33124-36010
		LN51,56,6#,YN52,57,6#	2L,3Y,3YC	MTPT-00020	RING, SYNCHRONIZER, NO.1	33368-20012
				MTPT-00028	RING, SYNCHRONIZER, NO.2	33367-14010
				MTPT-00334	SPRING, SYNCHROMESH SHIFTING KEY, NO.1	33371-14031
	83.08-98.07	LN50,51,55,56,60,61,65,RN50,55,58,6#, YN51,52,56,57,58,6#	L,2L,22R,22REC,1Y,2Y,2YC,3Y,3YC	MTPT-00028	RING, SYNCHRONIZER, NO.3	33367-14010
	83.10-84.03	LN30,40	L	MTPT-00142	PIPE, OIL RECEIVER (MTM)	33124-36010
	83.12-84.03	LN30,40	L	MTPT-00337	SHAFT, OUTPUT	33321-35092
	84.01-85.08	LN5#,YN56	L,2L,2Y	MTPT-00337	SHAFT, OUTPUT	33321-35092
		LN51,56,YN52,57	2L,3Y,3YC	MTPT-00337	SHAFT, OUTPUT	33321-35092
	84.01-98.07	LN6#,RN67,YN6#	2L,22R,3Y,3YC,4Y,4YC,4YE	MTPT-00096	SHAFT, OUTPUT	33321-35111
	85.08-98.07	LN5#,RN5#,YN51,52,56,57,58	L,2L,3L,22R,1Y,2Y,2YC,3Y,4Y,4YC	MTPT-00142	PIPE, OIL RECEIVER (MTM)	33124-36010
		LN51,56,61,65,RN50,55,58,67, YN51,52,56,57,58,6#	2L,22R,2Y,2YC,3Y,3YC,4Y,4YC,4YE	MTPT-00020	RING, SYNCHRONIZER, NO.1	33368-20012
				MTPT-00028	RING, SYNCHRONIZER, NO.2	33367-14010
				MTPT-00334	SPRING, SYNCHROMESH SHIFTING KEY, NO.1	33371-14031
		LN51,56,RN50,55,YN51,52,56,57,58	2L,22R,2Y,2YC,3Y,3YC,4Y,4YC	MTPT-00337	SHAFT, OUTPUT	33321-35092
	88.08-95.08	LN5#,6#,RN58,67,YN51,57,58,6#	L,2L,22R,2Y,3Y,3YC,4Y,4YC,4YE	MTPT-00336	SHAFT, INPUT	33301-35060 (33301-26030)
	88.08-98.07	LN5#,6#,RN58,67,YN51,56,57,58,6#	L,2L,22R,2Y,3Y,3YC,4Y,4YC,4YE	MTPT-00095	HUB, TRANSMISSION CLUTCH, NO.2	33362-35040
				MTPT-00112	WASHER, 5TH GEAR THRUST	33349-35010
				MTPT-00333	KEY, SYNCHROMESH SHIFTING, NO.2	33366-35040 (33366-35041)
	91.08-95.08	LN5#,65,RN58,67,YN57,58,67	2L,22R,3Y,4Y	MTPT-00098	GEAR, REVERSE	33331-28011 (33331-35061)
	91.08-98.07	YN51,56	2Y	MTPT-00098	GEAR, REVERSE	33331-28011 (33331-35061)
	92.09-98.07	LN51,56,65,RN58,67,YN5#,67	2L,22R,1Y,2Y,4Y	MTPT-00100	SLEEVE, TRANSMISSION HUB, NO.2	33364-26020
	95.08-98.07	LN51,56,RN58,67,YN51,58	2L,22R,2Y,4Y	MTPT-00098	GEAR, REVERSE	33331-28011 (33331-35061)
				MTPT-00336	SHAFT, INPUT	33301-35060 (33301-26030)
		LN57,67	3L	MTPT-00015	SHAFT, INPUT	33301-35080
	97.08-01.06	LN16#,17#,RZN16#,174	3L,5L,5LE,2RZFE,3RZF,3RZFE	MTPT-00226	RETAINER SUB-ASSY, CONTROL SHIFT LEVER (FOR FLOOR SHIFT)	33506-35100
	97.08-01.08	LN166	3L	MTPT-00142	PIPE, OIL RECEIVER (FOR TRANSFER)	33124-36010
	97.08-01.09	LN167,172	5L,5LE	MTPT-00142	PIPE, OIL RECEIVER (FOR TRANSFER)	33124-36010
	97.08-02.03	LN166,167,172	3L,5L,5LE	MTPT-00097	SHAFT, OUTPUT	33321-60090
		LN167	5L,5LE	MTPT-00142	PIPE, OIL RECEIVER (FOR TRANSFER)	33124-36010
	RZN149,154,169,174,194	3RZF,3RZFE	MTPT-00140	RING SET, SYNCHRONIZER, NO.1	33037-30011	
			MTPT-00141	RING SET, SYNCHRONIZER, NO.2	33038-30012	
			MTPT-00150	RING, SYNCHRONIZER, NO.2	33368-30120	
97.08-02.06	RZN144,148,149,154,168,193	2RZFE,3RZF,3RZFE	MTPT-00150	RING, SYNCHRONIZER, NO.2	33368-30120	
97.08-03.12	LN140,141,145,146,147,150,152,155,157, 166,167,17#,191,192,RZN142,147,YN140	2L,3L,5L,5LE,1RZ,1RZE,2Y	MTPT-00333	KEY, SYNCHROMESH SHIFTING, NO.2	33366-35040 (33366-35041)	
97.08-04.02	KZN165,190,RZN144,148,149,154,168,169,174,193,194	1KZTE,2RZFE,3RZ,3RZFE	MTPT-00176	SPRING, COMPRESSION	90501-07104	
97.08-06.03	LN140,141,145,146,147,150,152,155,157, 166,167,17#,191,192,RZN142,147,YN140	2L,3L,5L,5LE,1RZ,1RZE,2Y	MTPT-00020	RING, SYNCHRONIZER, NO.1	33368-20012	
			MTPT-00028	RING, SYNCHRONIZER, NO.2	33367-14010	
				RING, SYNCHRONIZER, NO.3	33367-14010	

Reference List / Manual Transmission(Parts)

Model	Year	Body Type	Engine Type	AISIN No.	Productin Name	Genuine No.
HILUX		LN140,141,145,146,147,150,152,155,157, 166,167,17#,191,192,YN140 LN140,141,145,146,147,150,152,155,157,191, 192,RZN142,147,YN140 LN166,171	2L,3L,5L,5LE,2Y 2L,3L,5L,5LE,1RZ,1RZE,22Y 3L	MTPT-00095 MTPT-00100 MTPT-00112 MTPT-00334 MTPT-00015 MTPT-00142 MTPT-00337 MTPT-00096	HUB, TRANSMISSION CLUTCH, NO.2 SLEEVE, TRANSMISSION HUB, NO.2 WASHER, 4TH GEAR SPRING, SYNCHROMESH SHIFTING KEY, NO.1 SHAFT, INPUT PIPE, OIL RECEIVER, NO.2 (FOR EXTENSION HOUSING) SHAFT, OUTPUT SHAFT, OUTPUT	33362-35040 33364-26020 33349-35010 33371-14031 33301-35080 33124-36010 33321-35092 33321-35111
	97.08-	KZN165, LN166, 167, 172, RZN168, 169, 174	1KZTE, 3L, 5L, 5LE, 2RZFE, 3RZ, 3RZFE	MTPT-00028 MTPT-00170	RING, SYNCHRONIZER (FOR TRANSFER FRONT DRIVE CLUTCH) NUT (FOR TRANSFER OUTPUT SHAFT)	33367-14010 90179-22016
	98.06-98.07	YN51,56	2Y	MTPT-00332	SHAFT, INPUT	33301-35071
	98.06-06.03	RZN142, 147	1RZ, 1RZE	MTPT-00332	SHAFT, INPUT	33301-35071
	99.09-02.03	KZN165, 190	1KZTE	MTPT-00008 MTPT-00010 MTPT-00075 MTPT-00080 MTPT-00083 MTPT-00084 MTPT-00087 MTPT-00143 MTPT-00147 MTPT-00174 MTPT-00313	RING SET, SYNCHRONIZER, NO.1 RING, SYNCHRONIZER, NO.2 PIECE, GEAR SPLINE, NO.5 SLEEVE, TRANSMISSION HUB, NO.2 RING, SYNCHRONIZER, NO.1 RING, SYNCHRONIZER, NO.2 SLEEVE, TRANSMISSION HUB, NO.3 RETAINER, OUTPUT SHAFT REAR BEARING (MTM) KEY, SYNCHROMESH SHIFTING, NO.2 PIN (FOR 5TH GEAR THRUST WASHER) PIN OR BALL (FOR 1ST GEAR THRUST WASHER) WASHER, 1ST GEAR THRUST	33037-60040 33368-35030 33318-35040 33364-35050 33367-35080 33368-35040 33395-35031 33151-35020 33366-35030 90250-05026 90250-05026 33348-35010
	00.07-02.03	KZN165	1KZTE	MTPT-00090	GEAR,COUNTER SHAFT,5TH	33428-60031
	01.07-02.03	RZN144, 149, 154, 169, 174, 194	3RZF, 3RZFE	MTPT-00149	RING, SYNCHRONIZER, NO.1	33367-53030
	01.07-02.06	RZN148, 168, 193	2RZFE	MTPT-00149	RING, SYNCHRONIZER, NO.1	33367-53030
	01.08-03.11	KDN145, 150, 155, LN145, 150 KDN145, 150, 155, LN145, 150, 155 KDN145, 150, 155, LN150, 155	2KDFTV, 2L 2KDFTV, 2L 2KDFTV, 2L	MTPT-00095 MTPT-00015 MTPT-00100 MTPT-00337 MTPT-00028	HUB, TRANSMISSION CLUTCH, NO.2 SHAFT, INPUT SLEEVE, TRANSMISSION HUB, NO.2 SHAFT, OUTPUT RING, SYNCHRONIZER, NO.2	33362-35040 33301-35080 33364-26020 33321-35092 33367-14010
	01.08-03.12	KDN145, 150, 155, LN140, 141, 145, 146, 147, 150, 152, 155, 166, 167, 17#, 191, 192, RZN142, 147	2KDFTV, 2L, 3L, 5L, 5LE, 1RZ, 1RZE	MTPT-00333	KEY, SYNCHROMESH SHIFTING, NO.2	33366-35040 (33366-35041)
	01.08-04.02	LN147, 152 LN147, 152, 167, 172 LN167, 172	5LE 5LE 5LE	MTPT-00337 MTPT-00095 MTPT-00100 MTPT-00097	SHAFT, OUTPUT HUB, TRANSMISSION CLUTCH, NO.2 SLEEVE, TRANSMISSION HUB, NO.2 SHAFT, OUTPUT	33321-35092 33362-35040 33364-26020 33321-60090
	01.08-05.01	KZN165, LN167, 172, VZN167, 172 KZN165, RZN149, 154, VZN167, 172 LN147, 152	1KZTE, 5LE, 5VZFE 1KZTE, 3RZFE, 5VZFE 5LE	MTPT-00028 MTPT-00170 MTPT-00176 MTPT-00015 MTPT-00095 MTPT-00100	RING, SYNCHRONIZER (FOR TRANSFER FRONT DRIVE CLUTCH) NUT (FOR TRANSFER OUTPUT SHAFT) SPRING, COMPRESSION SHAFT, INPUT HUB, TRANSMISSION CLUTCH, NO.2 SLEEVE, TRANSMISSION HUB, NO.2	33367-14010 90179-22016 90501-07104 33301-35080 33362-35040 33364-26020

Reference List / Manual Transmission(Parts)

Model	Year	Body Type	Engine Type	AISIN No.	Productin Name	Genuine No.
HILUX		RZN149, 154	3RZFE	MTPT-00337	SHAFT, OUTPUT	33321-35092
				MTPT-00140	RING SET, SYNCHRONIZER, NO.1	33037-30011
				MTPT-00150	RING, SYNCHRONIZER, NO.2	33368-30120
	01.08-05.02	RZN194	3RZFE	MTPT-00140	RING SET, SYNCHRONIZER, NO.1	33037-30011
				MTPT-00141	RING SET, SYNCHRONIZER, NO.2	33038-30012
				MTPT-00149	RING, SYNCHRONIZER, NO.1	33367-53030
				MTPT-00150	RING, SYNCHRONIZER, NO.2	33368-30120
				MTPT-00176	SPRING, COMPRESSION	90501-07104
	01.08-05.06	LN166, 171	3L	MTPT-00096	SHAFT, OUTPUT	33321-35111
	01.08-05.08	KDN145,150,155,LN140,141,145,146,147,150,152,155,166,167,17#,191,192,RZN142,147 KDN145,150,155,LN140,141,145,146,147,155,166,167,17#,191,192,RZN142,147 KDN145,150,155,LN140,141,145,146,147,150,152,155,166,167,17#,191,192,RZN142,147 KDN16#,KZN165,LN166,167,RZN16#,174 KDN165,16#,KZN165,LN166,167,RZN16#,174 KDN145,150,155,LN140,141,145,146,147,150,152,155,166,167,17#,191,192,RZN142,147 LN140,141,145,146,147,152,16#,17#,19#,RZN142,147 LN140,141,145,146,166,167,17#,19#,RZN142,147 LN140,141,145,146,167,16#,17#,19# LN140,141,145,146,19#,RZN142,147 LN16#,172 LN167,16#,172 RZN142,147 RZN144,149,154,169,174	2KDFTV,2L,3L,5LE,1RZE	MTPT-00112	WASHER, 4TH GEAR	33349-35010
			2KDFTV,2L,3L,5LE,1RZE	MTPT-00334	SPRING, SYNCHROMESH SHIFTING KEY, NO.1	33371-14031
			2KDFTV,2L,3L,5LE,1RZE	MTPT-00020	RING, SYNCHRONIZER, NO.1	33368-20012
			2KDFTV,2L,3L,5LE,1RZE	MTPT-00028	RING, SYNCHRONIZER, NO.3	33367-14010
			1KDFTV,2KDFTV,1KZTE,	MTPT-00170	NUT (FOR TRANSFER OUTPUT SHAFT)	90179-22016
			3L,5LE,2RZFE,3RZF,3RZFE	MTPT-00028	RING, SYNCHRONIZER (FOR TRANSFER FRONT DRIVE CLUTCH)	33367-14010
			3L,5LE,2RZFE,3RZF,3RZFE	MTPT-00142	PIPE, OIL RECEIVER, NO.2 (FOR EXTENSION HOUSING)	33124-36010
			2L,3L,5LE,1RZE	MTPT-00028	RING, SYNCHRONIZER, NO.2	33367-14010
			2L,3L,5LE,1RZE	MTPT-00095	HUB, TRANSMISSION CLUTCH, NO.2	33362-35040
				MTPT-00100	SLEEVE, TRANSMISSION HUB, NO.2	33364-26020
			2L,3L,5LE	MTPT-00015	SHAFT, INPUT	33301-35080
			2L,3L,5LE,1RZE	MTPT-00337	SHAFT, OUTPUT	33321-35092
			3L,5LE	MTPT-00142	PIPE, OIL RECEIVER (FOR TRANSFER)	33124-36010
			5LE	MTPT-00097	SHAFT, OUTPUT	33321-60090
			1RZ,1RZE	MTPT-00332	SHAFT, INPUT	33301-35071
			3RZFE	MTPT-00140	RING SET, SYNCHRONIZER, NO.1	33037-30011
				MTPT-00141	RING SET, SYNCHRONIZER, NO.2	33038-30012
				MTPT-00149	RING, SYNCHRONIZER, NO.1	33367-53030
				MTPT-00150	RING, SYNCHRONIZER, NO.2	33368-30120
			01.08-05.11	KDN151,KZN165,190, RZN144,148,149,154,169,174,193 RZN148,168,193	1KDFTV,1KZFTV,2RZFE,3RZFE 2RZFE	MTPT-00176 MTPT-00149 MTPT-00150
	01.09-02.08	KDN165,KZN165	1KZTE,2KDFTV	MTPT-00174	PIN (FOR 5TH GEAR THRUST WASHER) PIN OR BALL (FOR 1ST GEAR THRUST WASHER)	90250-05026 90250-05026
				MTPT-00313	WASHER, 1ST GEAR THRUST	33348-35010
	01.09-04.08	KDN151,16#	1KDFTV,2KDFTV	MTPT-00174	PIN (FOR 5TH GEAR THRUST WASHER) PIN OR BALL (FOR 1ST GEAR THRUST WASHER)	90250-05026 90250-05026
				MTPT-00313	WASHER, 1ST GEAR THRUST	33348-35010
	01.09-05.01	KZN165	1KZTE	MTPT-00090	GEAR,COUNTER SHAFT,5TH	33428-60031

Reference List / Manual Transmission(Parts)

Model	Year	Body Type	Engine Type	AISIN No.	Productin Name	Genuine No.	
HILUX		KZN165,VZN167,172	1KZTE,5VZFE	MTPT-00008	RING SET, SYNCHRONIZER, NO.1	33037-60040	
				MTPT-00010	RING, SYNCHRONIZER, NO.2	33368-35030	
				MTPT-00075	PIECE, GEAR SPLINE, NO.5	33318-35040	
				MTPT-00080	SLEEVE, TRANSMISSION HUB, NO.2	33364-35050	
				MTPT-00083	RING, SYNCHRONIZER, NO.1	33367-35080	
				MTPT-00087	SLEEVE, TRANSMISSION HUB, NO.3	33395-35031	
				MTPT-00143	RETAINER, OUTPUT SHAFT REAR BEARING (MTM)	33151-35020	
				MTPT-00147	KEY, SYNCHROMESH SHIFTING, NO.2	33366-35030	
				MTPT-00174	PIN (FOR 5TH GEAR THRUST WASHER)	90250-05026	
					PIN OR BALL (FOR 1ST GEAR THRUST WASHER)	90250-05026	
				MTPT-00313	WASHER, 1ST GEAR THRUST	33348-35010	
			VZN167,172	5VZFE	MTPT-00084	RING, SYNCHRONIZER, NO.2	33368-35040
	01.09-05.03	KDN165		1KZFE	MTPT-00174	PIN (FOR 5TH GEAR THRUST WASHER)	90250-05026
						PIN OR BALL (FOR 1ST GEAR THRUST WASHER)	90250-05026
					MTPT-00313	WASHER, 1ST GEAR THRUST	33348-35010
	01.09-05.04	KDN151,16#,KZN165,190		1KDFTV,2KDFTV,1KZTE	MTPT-00008	RING SET, SYNCHRONIZER, NO.1	33037-60040
					MTPT-00075	PIECE, GEAR SPLINE, NO.5	33318-35040
					MTPT-00080	SLEEVE, TRANSMISSION HUB, NO.2	33364-35050
					MTPT-00083	RING, SYNCHRONIZER, NO.1	33367-35080
					MTPT-00087	SLEEVE, TRANSMISSION HUB, NO.3	33395-35031
					MTPT-00143	RETAINER, OUTPUT SHAFT REAR BEARING (MTM)	33151-35020
					MTPT-00147	KEY, SYNCHROMESH SHIFTING, NO.2	33366-35030
			KZN165	1KZTE	MTPT-00090	GEAR,COUNTER SHAFT,5TH	33428-60031
			KZN165,190	1KZTE	MTPT-00010	RING, SYNCHRONIZER, NO.2	33368-35030
					MTPT-00084	RING, SYNCHRONIZER, NO.2	33368-35040
					MTPT-00174	PIN (FOR 5TH GEAR THRUST WASHER)	90250-05026
				MTPT-00313	WASHER, 1ST GEAR THRUST	33348-35010	
01.10-05.03	KDN151,16#		1KDFTV,2KDFTV	MTPT-00010	RING, SYNCHRONIZER, NO.2	33368-35030	
				MTPT-00084	RING, SYNCHRONIZER, NO.2	33368-35040	
	KDN16#		1KDFTV,2KDFTV	MTPT-00176	SPRING, COMPRESSION	90501-07104	
02.02-05.04	KDN151,16#,KZN165,190		1KDFTV,2KDFTV,1KZTE	MTPT-00001	SHAFT, INPUT	33301-60050 (33301-26050)	
02.08-05.01	VZN167,172		5VZFE	MTPT-00074	SHAFT, INPUT	33301-35090 (33301-60120)	
03.07-05.02	RZN194		3RZFE	MTPT-00022	SHAFT, INPUT	33301-30081 (33301-30082)	
03.07-05.11	RZN144,148,149,154,16#,193		2RZFE,3RZFE	MTPT-00022	SHAFT, INPUT	33301-30081 (33301-30082)	
03.11-04.09	KDN145,150,155,LN145,150,155		2KDFTV,2L	MTPT-00028	RING, SYNCHRONIZER, NO.2	33367-14010	
04.08-05.03	KDN165		2KDFTV	MTPT-00146	KEY, SYNCHROMESH SHIFTING, NO.1	33365-35060	
04.08-05.05	GGN15		1GRFE	MTPT-00012	FORK, GEAR SHIFT, NO.1	33212-35032	
				MTPT-00111	FORK, GEAR SHIFT, NO.2	33213-35040	
		GGN15,25	1GRFE	MTPT-00086	RING, SYNCHRONIZER, OUTER NO.3	33384-60090	
				MTPT-00146	KEY, SYNCHROMESH SHIFTING, NO.1	33365-35060	
				MTPT-00157	KEY, SYNCHROMESH SHIFTING, NO.3	33394-60020	
				MTPT-00174	PIN (FOR 5TH GEAR THRUST WASHER)	90250-05026	

Reference List / Manual Transmission(Parts)

Model	Year	Body Type	Engine Type	AISIN No.	Productin Name	Genuine No.			
HILUX		KUN16,2#	1KDFTV,2KDFTV	MTPT-00313	PIN OR BALL (FOR 1ST GEAR THRUST WASHER)	90250-05026			
				MTPT-00315	WASHER, 1ST GEAR THRUST	33348-35010			
				MTPT-00317	KEY, SYNCHROMESH SHIFTING, NO.2	33366-35050			
				MTPT-00068	BEARING, INPUT SHAFT	90364-25012			
				MTPT-00069	GEAR, 2ND	33033-60050			
				MTPT-00071	GEAR, 3RD	33034-60030			
				MTPT-00071	RING SET, SYNCHRONIZER, NO.1	33037-60050			
				MTPT-00086	RING, SYNCHRONIZER, OUTER NO.3	33384-60090			
				MTPT-00001	SHAFT, INPUT	33301-60050 (33301-26050)			
				MTPT-00007	GEAR, COUNTERSHAFT 5TH	33428-60040 (33428-60041)			
				MTPT-00008	RING SET, SYNCHRONIZER, NO.1	33037-60040			
				MTPT-00009	RING, SYNCHRONIZER, NO.2	33368-35050			
				MTPT-00012	FORK, GEAR SHIFT, NO.1	33212-35032			
				MTPT-00076	PIECE, GEAR SPLINE, NO.5	33318-60030			
				MTPT-00079	HUB, TRANSMISSION CLUTCH, NO.2	33362-60030 (33362-60031)			
		MTPT-00081	SLEEVE, TRANSMISSION HUB, NO.2	33364-60070					
		MTPT-00111	FORK, GEAR SHIFT, NO.2	33213-35040					
		MTPT-00143	RETAINER, OUTPUT SHAFT REAR BEARING (MTM)	33151-35020					
		MTPT-00146	KEY, SYNCHROMESH SHIFTING, NO.1	33365-35060					
		MTPT-00151	RING, SYNCHRONIZER, NO.2	33368-35070					
		MTPT-00153	SPRING, SYNCHROMESH SHIFTING KEY, NO.3	33392-60020					
		MTPT-00154	SPRING, SYNCHROMESH SHIFTING KEY, NO.3	33392-60030					
		MTPT-00157	KEY, SYNCHROMESH SHIFTING, NO.3	33394-60020					
		MTPT-00174	PIN (FOR 5TH GEAR THRUST WASHER)	90250-05026					
			PIN OR BALL (FOR 1ST GEAR THRUST WASHER)	90250-05026					
		MTPT-00313	WASHER, 1ST GEAR THRUST	33348-35010					
		MTPT-00315	KEY, SYNCHROMESH SHIFTING, NO.2	33366-35050					
		MTPT-00317	BEARING, INPUT SHAFT	90364-25012					
			04.08-05.10	GGN25,KUN15,16,25,26,35,36	1GRFE,1KDFTV,2KDFTV	MTPT-00317	BEARING, INPUT SHAFT	90364-25012	
			04.08-08.08	GGN25,KUN15,16,2#,35,36	1GRFE,1KDFTV,2KDFTV	MTPT-00086	RING, SYNCHRONIZER, OUTER NO.3	33384-60090	
		MTPT-00146				KEY, SYNCHROMESH SHIFTING, NO.1	33365-35060		
		MTPT-00153				SPRING, SYNCHROMESH SHIFTING KEY, NO.3	33392-60020		
		MTPT-00154				SPRING, SYNCHROMESH SHIFTING KEY, NO.3	33392-60030		
MTPT-00157	KEY, SYNCHROMESH SHIFTING, NO.3	33394-60020							
MTPT-00174	PIN (FOR 5TH GEAR THRUST WASHER)	90250-05026							
	PIN OR BALL (FOR 1ST GEAR THRUST WASHER)	90250-05026							
MTPT-00313	WASHER, 1ST GEAR THRUST	33348-35010							
MTPT-00315	KEY, SYNCHROMESH SHIFTING, NO.2	33366-35050							
MTPT-00028	RING, SYNCHRONIZER (FOR TRANSFER FRONT DRIVE CLUTCH)	33367-14010							
MTPT-00170	NUT (FOR TRANSFER OUTPUT SHAFT)	90179-22016							
MTPT-00001	SHAFT, INPUT	33301-60050 (33301-26050)							
		GGN25,KUN2#,LH10#,11#,125,166,176, RZH104,114,125,135,153,TGN26				1GRFE,1KDFTV,2KDFTV,2TRFE			
		GGN25,KUN2#,TGN26				1GRFE,1KDFTV,2KDFTV,2TRFE			
		KUN15				2KDFTV			

Reference List / Manual Transmission(Parts)

Model	Year	Body Type	Engine Type	AISIN No.	Productin Name	Genuine No.
HILUX		KUN15,16,2#,35,36 LAN15	1KDFTV,2KDFTV 5LE	MTPT-00007	GEAR, COUNTERSHAFT 5TH	33428-60040 (33428-60041)
				MTPT-00008	RING SET, SYNCHRONIZER, NO.1	33037-60040
				MTPT-00009	RING, SYNCHRONIZER, NO.2	33368-35050
				MTPT-00068	GEAR, 2ND	33033-60050
				MTPT-00069	GEAR, 3RD	33034-60030
				MTPT-00071	RING SET, SYNCHRONIZER, NO.1	33037-60050
				MTPT-00076	PIECE, GEAR SPLINE, NO.5	33318-60030
				MTPT-00079	HUB, TRANSMISSION CLUTCH, NO.2 (33362-60031)	33362-60030 (33362-60031)
				MTPT-00081	SLEEVE, TRANSMISSION HUB, NO.2	33364-60070
				MTPT-00143	RETAINER, OUTPUT SHAFT REAR BEARING (MTM)	33151-35020
				MTPT-00151	RING, SYNCHRONIZER, NO.2	33368-35070
				MTPT-00317	BEARING, INPUT SHAFT	90364-25012
				MTPT-00012	FORK, GEAR SHIFT, NO.1	33212-35032
	MTPT-00111	FORK, GEAR SHIFT, NO.2	33213-35040			
	MTPT-00020	RING, SYNCHRONIZER, NO.1	33368-20012			
	MTPT-00334	SPRING, SYNCHROMESH SHIFTING KEY, NO.1	33371-14031			
	04.08-08.12	GGN25,KUN25,TGN26 KUN25,TGN26	1GRFE,2KDFTV,2TRFE 2KDFTV,2TRFE	MTPT-00170 MTPT-00028	NUT (FOR TRANSFER OUTPUT SHAFT) RING, SYNCHRONIZER (FOR TRANSFER FRONT DRIVE CLUTCH)	90179-22016 33367-14010
	04.08-12.02	KUN10,15,LAN15,25,35,TGN10,15 KUN10,15,LAN15,35,TGN10,15	2KDFTV,5LE,1TRFE 2KDFTV,5LE,1TRFE	MTPT-00020 MTPT-00028 MTPT-00334 MTPT-00142	RING, SYNCHRONIZER, NO.1 RING, SYNCHRONIZER, NO.2 SPRING, SYNCHROMESH SHIFTING KEY, NO.1 PIPE, OIL RECEIVER, NO.2 (FOR EXTENSION HOUSING)	33368-20012 33367-14010 33371-14031 33124-36010
	05.02-05.05	GGN15 KUN16 TGN16,26	1GRFE 1KDFTV 2TRFE	MTPT-00153 MTPT-00154 MTPT-00143 MTPT-00067 MTPT-00083	SPRING, SYNCHROMESH SHIFTING KEY, NO.3 SPRING, SYNCHROMESH SHIFTING KEY, NO.3 RETAINER, OUTPUT SHAFT REAR BEARING (MTM) GEAR, 2ND RING SET, SYNCHRONIZER, NO.1	33392-60020 33392-60030 33151-35020 33033-60040 33367-35080
	05.02-08.12	GGN25,TGN16,26,36 TGN16,26,36	1GRFE,2TRFE 2TRFE	MTPT-00012 MTPT-00111 MTPT-00086 MTPT-00153 MTPT-00154	FORK, GEAR SHIFT, NO.1 FORK, GEAR SHIFT, NO.2 RING, SYNCHRONIZER, OUTER NO.3 SPRING, SYNCHROMESH SHIFTING KEY, NO.3 SPRING, SYNCHROMESH SHIFTING KEY, NO.3	33212-35032 33213-35040 33384-60090 33392-60020 33392-60030
05.04-05.10	TGN16,26,36	2TRFE	MTPT-00317	BEARING, INPUT SHAFT	90364-25012	
05.04-08.10	KUN15 KUN15,LAN15,25,35 KUN15,LAN15,25,35,TGN15 KUN15,LAN15,35,TGN15 TGN15	2KDFTV 2KDFTV,5LE 2KDFTV,5LE,1TRFE 2KDFTV,5LE,1TRFE 1TRFE	MTPT-00016 MTPT-00094 MTPT-00128 MTPT-00015 MTPT-00093 MTPT-00095 MTPT-00099 MTPT-00100 MTPT-00112 MTPT-00139 MTPT-00337 MTPT-00137	GEAR, 2ND GEAR, 3RD GEAR, COUNTER SHAFT, INPUT GEAR, 1ST HUB, TRANSMISSION CLUTCH, NO.2 FORK, GEAR SHIFT, NO.1 SLEEVE, TRANSMISSION HUB, NO.2 WASHER, 4TH GEAR SLEEVE, TRANSMISSION HUB, NO.3 SHAFT, OUTPUT GEAR, COUNTERSHAFT 5TH	33033-35011 33034-35100 33421-71050 33301-35080 33032-26020 33362-35040 33212-35023 33364-26020 33349-35010 33395-71010 33321-35092 33428-71020	

Reference List / Manual Transmission(Parts)

Model	Year	Body Type	Engine Type	AISIN No.	Productin Name	Genuine No.			
HILUX				MTPT-00138	GEAR, 5TH	33336-26010			
				MTPT-00332	SHAFT, INPUT	33301-35071			
	05.04-08.12	TGN16,26,36	2TRFE	MTPT-00146	KEY, SYNCHROMESH SHIFTING, NO.1	33365-35060			
				MTPT-00174	PIN (FOR 5TH GEAR THRUST WASHER)	90250-05026			
					PIN OR BALL (FOR 1ST GEAR THRUST WASHER)	90250-05026			
				MTPT-00313	WASHER, 1ST GEAR THRUST	33348-35010			
				MTPT-00315	KEY, SYNCHROMESH SHIFTING, NO.2	33366-35050			
	05.05-05.10	KUN16,2#	1KDFTV,2KDFTV	MTPT-00317	BEARING, INPUT SHAFT	90364-25012			
	05.05-08.08	GGN15,25,KUN15,16,2#,35 GGN15,25,KUN15,16,2#,35,TGN11,16,26	1GRFE,1KDFTV,2KDFTV 1GRFE,1KDFTV,2KDFTV	MTPT-00071	RING SET, SYNCHRONIZER, NO.1	33037-60050			
				MTPT-00008	RING SET, SYNCHRONIZER, NO.1	33037-60040			
				MTPT-00009	RING, SYNCHRONIZER, NO.2	33368-35050			
				MTPT-00086	RING, SYNCHRONIZER, OUTER NO.3	33384-60090			
				MTPT-00111	FORK, GEAR SHIFT, NO.2	33213-35040			
				MTPT-00151	RING, SYNCHRONIZER, NO.2	33368-35070			
				MTPT-00153	SPRING, SYNCHROMESH SHIFTING KEY, NO.3	33392-60020			
				MTPT-00154	SPRING, SYNCHROMESH SHIFTING KEY, NO.3	33392-60030			
				MTPT-00157	KEY, SYNCHROMESH SHIFTING, NO.3	33394-60020			
				MTPT-00174	PIN (FOR 5TH GEAR THRUST WASHER)	90250-05026			
					PIN OR BALL (FOR 1ST GEAR THRUST WASHER)	90250-05026			
					FORK, GEAR SHIFT, NO.1	33212-35032			
					FORK, GEAR SHIFT, NO.1	33212-35032			
					RING, SYNCHRONIZER, OUTER NO.3	33384-60090			
					FORK, GEAR SHIFT, NO.2	33213-35040			
					KEY, SYNCHROMESH SHIFTING, NO.1	33365-35060			
					SPRING, SYNCHROMESH SHIFTING KEY, NO.3	33392-60020			
					SPRING, SYNCHROMESH SHIFTING KEY, NO.3	33392-60030			
					KEY, SYNCHROMESH SHIFTING, NO.3	33394-60020			
					PIN (FOR 5TH GEAR THRUST WASHER)	90250-05026			
					PIN OR BALL (FOR 1ST GEAR THRUST WASHER)	90250-05026			
					WASHER, 1ST GEAR THRUST	33348-35010			
					KEY, SYNCHROMESH SHIFTING, NO.2	33366-35050			
					RING SET, SYNCHRONIZER, NO.1	33367-35080			
				05.07-08.10	LAN15,25,35 LAN25	5LE 5LE	MTPT-00018	GEAR, 5TH	33336-28020
							MTPT-00097	SHAFT, OUTPUT	33321-60090
							MTPT-00142	PIPE, OIL RECEIVER (FOR TRANSFER)	33124-36010
	06.08-08.08	KUN15 KUN15,16,2#,36	2KDFTV 1KDFTV,2KDFTV	MTPT-00076	PIECE, GEAR SPLINE, NO.5	33318-60030			
				MTPT-00317	BEARING, INPUT SHAFT	90364-25012			
				MTPT-00001	SHAFT, INPUT	33301-60050 (33301-26050)			
				MTPT-00007	GEAR, COUNTERSHAFT 5TH	33428-60040 (33428-60041)			
				MTPT-00008	RING SET, SYNCHRONIZER, NO.1	33037-60040			
MTPT-00009				RING, SYNCHRONIZER, NO.2	33368-35050				
MTPT-00012				FORK, GEAR SHIFT, NO.1	33212-35032				
MTPT-00068				GEAR, 2ND	33033-60050				
MTPT-00069				GEAR, 3RD	33034-60030				

Reference List / Manual Transmission(Parts)

Model	Year	Body Type	Engine Type	AISIN No.	Productin Name	Genuine No.	
HILUX				MTPT-00071	RING SET, SYNCHRONIZER, NO.1	33037-60050	
				MTPT-00079	HUB, TRANSMISSION CLUTCH, NO.2	33362-60030 (33362-60031)	
				MTPT-00081	SLEEVE, TRANSMISSION HUB, NO.2	33364-60070	
				MTPT-00086	RING, SYNCHRONIZER, OUTER NO.3	33384-60090	
				MTPT-00111	FORK, GEAR SHIFT, NO.2	33213-35040	
				MTPT-00143	RETAINER, OUTPUT SHAFT REAR BEARING (MTM)	33151-35020	
				MTPT-00146	KEY, SYNCHROMESH SHIFTING, NO.1	33365-35060	
				MTPT-00151	RING, SYNCHRONIZER, NO.2	33368-35070	
				MTPT-00153	SPRING, SYNCHROMESH SHIFTING KEY, NO.3	33392-60020	
				MTPT-00154	SPRING, SYNCHROMESH SHIFTING KEY, NO.3	33392-60030	
				MTPT-00174	PIN (FOR 5TH GEAR THRUST WASHER)	90250-05026	
					PIN OR BALL (FOR 1ST GEAR THRUST WASHER)	90250-05026	
				MTPT-00313	WASHER, 1ST GEAR THRUST	33348-35010	
				MTPT-00315	KEY, SYNCHROMESH SHIFTING, NO.2	33366-35050	
				MTPT-00012	FORK, GEAR SHIFT, NO.1	33212-35032	
		KUN15,16,25,26,36		1KDFTV,2KDFTV			
	07.08-08.10	KUN25		2KDFTV	MTPT-00028	RING, SYNCHRONIZER (FOR TRANSFER FRONT DRIVE CLUTCH)	33367-14010
					MTPT-00170	NUT (FOR TRANSFER OUTPUT SHAFT)	90179-22016
	07.12-08.08	GGN15,25,KUN15,16,25,26,35,36,TGN11,16,26		1GRFE,1KDFTV,2KDFTV,2TRFE	MTPT-00145	WASHER, 5TH GEAR THRUST	33346-71010
08.08-08.11	GGN15,25,KUN15,16,25,26,35,36 GGN15,25,KUN15,16,25,26,35,36,TGN11,16,26		1GRFE,1KDFTV,2KDFTV 1GRFE,1KDFTV,2KDFTV,2TRFE	MTPT-00071	RING SET, SYNCHRONIZER, NO.1	33037-60050	
				MTPT-00008	RING SET, SYNCHRONIZER, NO.1	33037-60040	
				MTPT-00009	RING, SYNCHRONIZER, NO.2	33368-35050	
				MTPT-00151	RING, SYNCHRONIZER, NO.2	33368-35070	
08.08-08.12	GGN25,KUN25,26,35,36		1GRFE,1KDFTV,2KDFTV	MTPT-00153	SPRING, SYNCHROMESH SHIFTING KEY, NO.3	33392-60020	
				MTPT-00154	SPRING, SYNCHROMESH SHIFTING KEY, NO.3	33392-60030	
				MTPT-00313	WASHER, 1ST GEAR THRUST	33348-35010	
	GGN25,KUN25,26,35,36		1GRFE,1KDFTV,2KDFTV	MTPT-00145	WASHER, 5TH GEAR THRUST	33346-71010	
	KUN25,26,35,36		1KDFTV,2KDFTV	MTPT-00012	FORK, GEAR SHIFT, NO.1	33212-35032	
	KUN25,26,36		1KDFTV,2KDFTV	MTPT-00111	FORK, GEAR SHIFT, NO.2	33213-35040	
08.08-09.01	GGN15,25,KUN15,16,25,26,35,36 GGN15,25,KUN15,16,25,26,35,36,TGN11,16,26 GGN15,25,KUN15,16,25,26,35,36,TGN11,16,26,36		1GRFE,1KDFTV,2KDFTV 1GRFE,1KDFTV,2KDFTV,2TRFE 1GRFE,1KDFTV,2KDFTV,2TRFE	MTPT-00071	RING SET, SYNCHRONIZER, NO.1	33037-60050	
				MTPT-00145	WASHER, 5TH GEAR THRUST	33346-71010	
				MTPT-00008	RING SET, SYNCHRONIZER, NO.1	33037-60040	
				MTPT-00009	RING, SYNCHRONIZER, NO.2	33368-35050	
				MTPT-00012	FORK, GEAR SHIFT, NO.1	33212-35032	
				MTPT-00151	RING, SYNCHRONIZER, NO.2	33368-35070	
	TGN11,16,26,36		1TRFE,2TRFE	MTPT-00083	RING SET, SYNCHRONIZER, NO.1	33367-35080	
	TGN16,26,36		2TRFE	MTPT-00157	KEY, SYNCHROMESH SHIFTING, NO.3	33394-60020	
	TGN26		2TRFE	MTPT-00153	SPRING, SYNCHROMESH SHIFTING KEY, NO.3	33392-60020	
				MTPT-00154	SPRING, SYNCHROMESH SHIFTING KEY, NO.3	33392-60030	
08.08-09.02	GGN15,25,KUN15,16,25,26,35,36,TGN11,16,26		1GRFE,1KDFTV,2KDFTV,1TRFE,2TRFE	MTPT-00174	PIN OR BALL (FOR 1ST GEAR THRUST WASHER)	90250-05026	
08.08-10.07	GGN15,25,KUN15,16,25,26,35,36,TGN11,16,26,36		1GRFE,1KDFTV,2KDFTV,1TRFE,2TRFE	MTPT-00145	WASHER, 5TH GEAR THRUST	33346-71010	
08.08-10.11	KUN15,16,25,26,35,36		1KDFTV,2KDFTV	MTPT-00313	WASHER, 1ST GEAR THRUST	33348-35010	
08.08-11.07	GGN15,25,KUN16,26,TGN16		1GRFE,1KDFTV,2TRFE	MTPT-00086	RING, SYNCHRONIZER, OUTER NO.3	33384-60090	
				MTPT-00157	KEY, SYNCHROMESH SHIFTING, NO.3	33394-60020	
				MTPT-00174	PIN (FOR 5TH GEAR THRUST WASHER)	90250-05026	

Reference List / Manual Transmission(Parts)

Model	Year	Body Type	Engine Type	AISIN No.	Productin Name	Genuine No.				
HILUX		GGN15,KUN16,26	1GRFE,1KDFTV	MTPT-00315	PIN OR BALL (FOR 1ST GEAR THRUST WASHER)	90250-05026				
		GGN15,KUN16,26,TGN16	1GRFE,1KDFTV,2TRFE	MTPT-00146	KEY, SYNCHROMESH SHIFTING, NO.2	33366-35050				
		GGN25	1GRFE	MTPT-00146	KEY, SYNCHROMESH SHIFTING, NO.1	33365-35060				
		KUN15,16,25,26,35,36	1KDFTV,2KDFTV		MTPT-00315	KEY, SYNCHROMESH SHIFTING, NO.1	33365-35060			
					MTPT-00001	KEY, SYNCHROMESH SHIFTING, NO.2	33366-35050			
					MTPT-00007	SHAFT, INPUT	33301-60050 (33301-26050)			
					MTPT-00008	GEAR, COUNTERSHAFT 5TH	33428-60040 (33428-60041)			
					MTPT-00009	RING SET, SYNCHRONIZER, NO.1	33037-60040			
					MTPT-00068	RING, SYNCHRONIZER, NO.2	33368-35050			
					MTPT-00069	GEAR, 2ND	33033-60050			
					MTPT-00071	GEAR, 3RD	33034-60030			
					MTPT-00076	RING SET, SYNCHRONIZER, NO.1	33037-60050			
					MTPT-00079	PIECE, GEAR SPLINE, NO.5	33318-60030			
		TGN11,16	2TRFE		MTPT-00081	HUB, TRANSMISSION CLUTCH, NO.2	33362-60030 (33362-60031)			
					MTPT-00111	SLEEVE, TRANSMISSION HUB, NO.2	33364-60070			
					MTPT-00143	FORK, GEAR SHIFT, NO.2	33213-35040			
					MTPT-00145	RETAINER, OUTPUT SHAFT REAR BEARING (MTM)	33151-35020			
					MTPT-00151	WASHER, 5TH GEAR THRUST	33346-71010			
	MTPT-00153				RING, SYNCHRONIZER, NO.2	33368-35070				
	MTPT-00154				SPRING, SYNCHROMESH SHIFTING KEY, NO.3	33392-60020				
	MTPT-00313				SPRING, SYNCHROMESH SHIFTING KEY, NO.3	33392-60030				
	MTPT-00317				WASHER, 1ST GEAR THRUST	33348-35010				
	MTPT-00153				BEARING, INPUT SHAFT	90364-25012				
	08.08-11.08	GGN15,25,KUN15,16,25,26,35,36, TGN11,16,26	GGN15,25,KUN15,16,25,26,35,36,TGN11,16 GGN15,25,KUN15,16,25,26,35,36,TGN26 KUN10,15,LAN15,25,35,TGN10,15	1GRFE,1KDFTV,2KDFTV,2TRFE 1GRFE,1KDFTV,2KDFTV,2TRFE 2KDFTV,5LE,1TRFE	MTPT-00111	FORK, GEAR SHIFT, NO.2	33213-35040			
					MTPT-00154	SPRING, SYNCHROMESH SHIFTING KEY, NO.3	33392-60030			
					MTPT-00157	KEY, SYNCHROMESH SHIFTING, NO.3	33394-60020			
					MTPT-00174	PIN (FOR 5TH GEAR THRUST WASHER)	90250-05026			
					MTPT-00086	RING, SYNCHRONIZER, OUTER NO.3	33384-60090			
					MTPT-00153	SPRING, SYNCHROMESH SHIFTING KEY, NO.3	33392-60020			
					MTPT-00020	RING, SYNCHRONIZER, NO.1	33368-20012			
					MTPT-00028	RING, SYNCHRONIZER, NO.2	33367-14010			
					MTPT-00334	SPRING, SYNCHROMESH SHIFTING KEY, NO.1	33371-14031			
					MTPT-00142	PIPE, OIL RECEIVER, NO.2 (FOR EXTENSION HOUSING)	33124-36010			
08.08-12.04					GGN15,25,KUN15,16,25,26,35,36,TGN11,16,26,36 GGN15,25,KUN15,16,25,26,35,36,TGN11,16,36 GGN25,KUN2#,LAN25,TGN26	GGN15,25,KUN15,16,25,26,35,36,TGN11,16 GGN15,25,KUN15,16,25,26,35,36,TGN26 KUN10,15,LAN15,25,35,TGN10,15	1GRFE,1KDFTV,2KDFTV,2TRFE 1GRFE,1KDFTV,2KDFTV,2TRFE 1GRFE,2KDFTV,5LE,2TRFE	MTPT-00153	SPRING, SYNCHROMESH SHIFTING KEY, NO.3	33392-60020
								MTPT-00154	SPRING, SYNCHROMESH SHIFTING KEY, NO.3	33392-60030
	MTPT-00111	FORK, GEAR SHIFT, NO.2	33213-35040							
	MTPT-00028	RING, SYNCHRONIZER (FOR TRANSFER FRONT DRIVE CLUTCH)	33367-14010							
	MTPT-00170	NUT (FOR TRANSFER OUTPUT SHAFT)	90179-22016							
	MTPT-00012	FORK, GEAR SHIFT, NO.1	33212-35032							
	MTPT-00086	RING, SYNCHRONIZER, OUTER NO.3	33384-60090							
	MTPT-00157	KEY, SYNCHROMESH SHIFTING, NO.3	33394-60020							
	MTPT-00174	PIN (FOR 5TH GEAR THRUST WASHER)	90250-05026							

Reference List / Manual Transmission(Parts)

Model	Year	Body Type	Engine Type	AISIN No.	Productin Name	Genuine No.						
HILUX		KUN25	2KDFTV	MTPT-00146	PIN OR BALL (FOR 1ST GEAR THRUST WASHER)	90250-05026						
					MTPT-00174	KEY, SYNCHROMESH SHIFTING, NO.1	33365-35060					
				MTPT-00315	PIN (FOR 5TH GEAR THRUST WASHER)	90250-05026						
					PIN OR BALL (FOR 1ST GEAR THRUST WASHER)	90250-05026						
					KEY, SYNCHROMESH SHIFTING, NO.2	33366-35050						
					FORK, GEAR SHIFT, NO.1	33212-35032						
					RING, SYNCHRONIZER, OUTER NO.3	33384-60090						
		TGN16,26,36	2TRFE	MTPT-00012	FORK, GEAR SHIFT, NO.2	33213-35040						
				MTPT-00086	WASHER, 5TH GEAR THRUST	33346-71010						
				MTPT-00111	KEY, SYNCHROMESH SHIFTING, NO.1	33365-35060						
		08.08-	GGN15,25,KUN15,16,25,26,35,36,TGN11,16,26,36	1GRFE,1KDFTV,2KDFTV,2TRFE	MTPT-00174	PIN (FOR 5TH GEAR THRUST WASHER)	90250-05026					
						MTPT-00086	RING, SYNCHRONIZER, OUTER NO.3	33384-60090				
						MTPT-00157	KEY, SYNCHROMESH SHIFTING, NO.3	33394-60020				
						MTPT-00315	KEY, SYNCHROMESH SHIFTING, NO.2	33366-35050				
	MTPT-00146					KEY, SYNCHROMESH SHIFTING, NO.1	33365-35060					
	08.10-11.08					KUN15	2KDFTV	MTPT-00016	GEAR, 2ND	33033-35011		
								MTPT-00094	GEAR, 3RD	33034-35100		
								MTPT-00128	GEAR, COUNTER	33421-71050		
								MTPT-00015	SHAFT, INPUT	33301-35080		
									GEAR, 1ST	33032-26020		
								KUN15,LAN15,25,35	2KDFTV,5LE	MTPT-00095	HUB, TRANSMISSION CLUTCH, NO.2	33362-35040
										MTPT-00099	FORK, GEAR SHIFT, NO.1	33212-35023
										MTPT-00100	SLEEVE, TRANSMISSION HUB, NO.2	33364-26020
										MTPT-00112	WASHER, 4TH GEAR	33349-35010
								KUN15,LAN15,25,35,TGN15	2KDFTV,5LE,1TRFE	MTPT-00139	SLEEVE, TRANSMISSION HUB, NO.3	33395-71010
										MTPT-00337	SHAFT, OUTPUT	33321-35092
										MTPT-00018	GEAR, 5TH	33336-28020
								KUN15,LAN15,35,TGN15	2KDFTV,5LE,1TRFE	MTPT-00097	SHAFT, OUTPUT	33321-60090
										MTPT-00142	PIPE, OIL RECEIVER (FOR TRANSFER)	33124-36010
	MTPT-00137	GEAR, COUNTERSHAFT 5TH	33428-71020									
	LAN15,25,35	5LE	MTPT-00138	GEAR, 5TH	33336-26010							
			MTPT-00332	SHAFT, INPUT	33301-35071							
			LAN25	5LE	MTPT-00146	KEY, SYNCHROMESH SHIFTING, NO.1	33365-35060					
MTPT-00315	KEY, SYNCHROMESH SHIFTING, NO.2	33366-35050										
TGN15	1TRFE	MTPT-00137	GEAR, COUNTERSHAFT 5TH	33428-71020								
		MTPT-00138	GEAR, 5TH	33336-26010								
09.02-09.08	KUN16,2#,35	1KDFTV,2KDFTV	MTPT-00146	KEY, SYNCHROMESH SHIFTING, NO.1	33365-35060							
			MTPT-00315	KEY, SYNCHROMESH SHIFTING, NO.2	33366-35050							
09.02-10.11	KUN16,25,26,35	1KDFTV,2KDFTV	MTPT-00313	WASHER, 1ST GEAR THRUST	33348-35010							
09.11-11.08	GGN15,25,KUN15,16,25,26,35,36,TGN11,16,26	1GRFE,1KDFTV,2TRFE	MTPT-00145	WASHER, 5TH GEAR THRUST	33346-71010							
11.03-11.08	KUN10,15	2KDFTV	MTPT-00015	SHAFT, INPUT	33301-35080							
			MTPT-00016	GEAR, 2ND	33033-35011							
			MTPT-00093	GEAR, 1ST	33032-26020							
			MTPT-00094	GEAR, 3RD	33034-35100							
			MTPT-00095	HUB, TRANSMISSION CLUTCH, NO.2	33362-35040							

Reference List / Manual Transmission(Parts)

Model	Year	Body Type	Engine Type	AISIN No.	Productin Name	Genuine No.	
HILUX				MTPT-00100	SLEEVE, TRANSMISSION HUB, NO.2	33364-26020	
				MTPT-00112	WASHER, 4TH GEAR	33349-35010	
				MTPT-00128	GEAR, COUNTER	33421-71050	
				MTPT-00139	SLEEVE, TRANSMISSION HUB, NO.3	33395-71010	
				MTPT-00337	SHAFT, OUTPUT	33321-35092	
	11.03-	KUN10,15		2KDFTV	MTPT-00099	FORK, GEAR SHIFT, NO.1	33212-35023
	11.05-11.08	TGN10,15		1TRFE	MTPT-00112	WASHER, 4TH GEAR	33349-35010
					MTPT-00332	SHAFT, INPUT	33301-35071
					MTPT-00337	SHAFT, OUTPUT	33321-35092
	11.05-	TGN10,15		1TRFE	MTPT-00095	HUB, TRANSMISSION CLUTCH, NO.2	33362-35040
					MTPT-00099	FORK, GEAR SHIFT, NO.1	33212-35023
					MTPT-00100	SLEEVE, TRANSMISSION HUB, NO.2	33364-26020
					MTPT-00137	GEAR, COUNTERSHAFT 5TH	33428-71020
					MTPT-00138	GEAR, 5TH	33336-26010
					MTPT-00139	SLEEVE, TRANSMISSION HUB, NO.3	33395-71010
	11.06-11.07	KUN15,16,25,26,35,36		1KDFTV,2KDFTV	MTPT-00003	GEAR, 1ST	33032-60111
	11.07-12.01	GGN15,25,KUN15,16,2#,3#		1GRFE,1KDFTV,2KDFTV	MTPT-00153	SPRING, SYNCHROMESH SHIFTING KEY, NO.3	33392-60020
					MTPT-00154	SPRING, SYNCHROMESH SHIFTING KEY, NO.3	33392-60030
		KUN15,16,25,26,35,36,TGN11,36		1KDFTV,2KDFTV,2TRFE	MTPT-00153	SPRING, SYNCHROMESH SHIFTING KEY, NO.3	33392-60020
	11.07-12.06	GGN15,25,KUN15,16,25,26,35,36,TGN11,16,26,36		1GRFE,1KDFTV,2KDFTV,2TRFE	MTPT-00154	SPRING, SYNCHROMESH SHIFTING KEY, NO.3	33392-60030
					MTPT-00153	SPRING, SYNCHROMESH SHIFTING KEY, NO.3	33392-60020
		GGN15,25,KUN15,25,35,TGN11,16,26,36		1GRFE,2KDFTV,2TRFE	MTPT-00153	SPRING, SYNCHROMESH SHIFTING KEY, NO.3	33392-60020
	11.07-12.08	KUN15		2KDFTV	MTPT-00020	RING, SYNCHRONIZER, NO.1	33368-20012
	11.07-12.10	TGN36		2TRFE	MTPT-00111	FORK, GEAR SHIFT, NO.2	33213-35040
					MTPT-00146	KEY, SYNCHROMESH SHIFTING, NO.1	33365-35060
	11.07-13.05	KUN16,36,TGN16,26,36		1KDFTV,2TRFE	MTPT-00007	GEAR, COUNTERSHAFT 5TH	33428-60040 (33428-60041)
	11.07-13.10	GGN25		1GRFE	MTPT-00170	NUT (FOR TRANSFER OUTPUT SHAFT)	90179-22016
		KUN15,35,3#		2KDFTV	MTPT-00001	SHAFT, INPUT	33301-60050 (33301-26050)
	11.07-13.11	GGN15,25		1GRFE	MTPT-00073	RETAINER, BEARING, FRONT	33131-60080
	11.07-14.04	KUN15,25,35,TGN16,26,36		2KDFTV,2TRFE	MTPT-00079	HUB, TRANSMISSION CLUTCH, NO.2	33362-60030 (33362-60031)
		KUN16,2#,3#,TGN16,26,36		1KDFTV,2TRFE	MTPT-00001	SHAFT, INPUT	33301-60050 (33301-26050)
	11.07-14.05	GGN15,25,KUN15,16,2#,3#,TGN11,16,26,36		1GRFE,1KDFTV,2KDFTV,2TRFE	MTPT-00086	RING, SYNCHRONIZER, OUTER NO.3	33384-60090
					MTPT-00111	FORK, GEAR SHIFT, NO.2	33213-35040
					MTPT-00012	FORK, GEAR SHIFT, NO.1	33212-35032
	11.07-14.06	KUN15,16,25,26,35,36		1KDFTV,2KDFTV	MTPT-00012	FORK, GEAR SHIFT, NO.1	33212-35032
	11.07-14.07	GGN15,25,KUN15,16,2#,3#,TGN11,16,26,36		1GRFE,1KDFTV,2KDFTV,2TRFE	MTPT-00111	FORK, GEAR SHIFT, NO.2	33213-35040
		KUN16,25,26,TGN15,25		1KDFTV,2KDFTV,1TRFE	MTPT-00111	FORK, GEAR SHIFT, NO.2	33213-35040
	11.07-14.10	TGN26,36		2TRFE	MTPT-00009	RING, SYNCHRONIZER, NO.2	33368-35050
					MTPT-00012	FORK, GEAR SHIFT, NO.1	33212-35032
					MTPT-00076	PIECE, GEAR SPLINE, NO.5	33318-60030
					MTPT-00081	SLEEVE, TRANSMISSION HUB, NO.2	33364-60070
MTPT-00111					FORK, GEAR SHIFT, NO.2	33213-35040	
MTPT-00143					RETAINER, OUTPUT SHAFT REAR BEARING (MTM)	33151-35020	
MTPT-00145					WASHER, 5TH GEAR THRUST	33346-71010	
MTPT-00146					KEY, SYNCHROMESH SHIFTING, NO.1	33365-35060	
MTPT-00151					RING, SYNCHRONIZER, NO.2	33368-35070	

Reference List / Manual Transmission(Parts)

Model	Year	Body Type	Engine Type	AISIN No.	Productin Name	Genuine No.
HILUX				MTPT-00174	PIN (FOR 5TH GEAR THRUST WASHER) PIN OR BALL (FOR 1ST GEAR THRUST WASHER)	90250-05026 90250-05026
				MTPT-00313	WASHER, 1ST GEAR THRUST	33348-35010
	11.07-15.03	GGN15,25,KUN15,16,25,26,35,36,TGN11,16,26,36	1GRFE,1KDFTV,2KDFTV,2TRFE	MTPT-00086 MTPT-00315	RING, SYNCHRONIZER, OUTER NO.3 KEY, SYNCHROMESH SHIFTING, NO.2	33384-60090 33366-35050
	11.07-15.04	KUN15,16,25,26,35,36 TGN26	1KDFTV,2KDFTV 2TRFE	MTPT-00068 MTPT-00009 MTPT-00012 MTPT-00076 MTPT-00081 MTPT-00086 MTPT-00111 MTPT-00143 MTPT-00145 MTPT-00146 MTPT-00151 MTPT-00174	GEAR, 2ND RING, SYNCHRONIZER, NO.2 FORK, GEAR SHIFT, NO.1 PIECE, GEAR SPLINE, NO.5 SLEEVE, TRANSMISSION HUB, NO.2 RING, SYNCHRONIZER, OUTER NO.3 FORK, GEAR SHIFT, NO.2 RETAINER, OUTPUT SHAFT REAR BEARING (MTM) WASHER, 5TH GEAR THRUST KEY, SYNCHROMESH SHIFTING, NO.1 RING, SYNCHRONIZER, NO.2 PIN (FOR 5TH GEAR THRUST WASHER) PIN OR BALL (FOR 1ST GEAR THRUST WASHER)	33033-60050 33368-35050 33212-35032 33318-60030 33364-60070 33384-60090 33213-35040 33151-35020 33346-71010 33365-35060 33368-35070 90250-05026 90250-05026
		TGN26,36	2TRFE	MTPT-00313 MTPT-00315 MTPT-00008 MTPT-00069 MTPT-00317	WASHER, 1ST GEAR THRUST KEY, SYNCHROMESH SHIFTING, NO.2 RING SET, SYNCHRONIZER, NO.1 GEAR, 3RD BEARING, INPUT SHAFT	33348-35010 33366-35050 33037-60040 33034-60030 90364-25012
	11.07-15.08	KUN15,16,25,26,35,36 KUN15,16,25,26,35,36,TGN16,26 KUN15,16,25,26,35,36,TGN16,26,36 KUN16,25,26,35,36,TGN16,26 TGN10,15	1KDFTV,2KDFTV 1KDFTV,2KDFTV,2TRFE 1KDFTV,2KDFTV,2TRFE 1KDFTV,2KDFTV,2TRFE 1TRFE	MTPT-00069 MTPT-00317 MTPT-00111 MTPT-00012 MTPT-00142	GEAR, 3RD BEARING, INPUT SHAFT FORK, GEAR SHIFT, NO.2 FORK, GEAR SHIFT, NO.1 PIPE, OIL RECEIVER, NO.2 (FOR EXTENSION HOUSING)	33034-60030 90364-25012 33213-35040 33212-35032 33124-36010
	11.07-	GGN15,25,KUN15,16,2#,3#,TGN11,16,26,36 GGN15,25,KUN15,16,25,26,35,36, TGN11,16,26,36 GGN25,KUN2#,LAN25,TGN26 KUN10,15 KUN10,15,LAN15,25,35,TGN10,15 KUN10,15,TGN10,15	1GRFE,1KDFTV,2KDFTV,2TRFE 1GRFE,1KDFTV,2KDFTV,2TRFE 1GRFE,1KDFTV,2KDFTV,5LE,2TRFE 2KDFTV 2KDFTV,5LE,1TRFE 2KDFTV,2TRFE	MTPT-00145 MTPT-00174 MTPT-00146 MTPT-00170 MTPT-00015 MTPT-00016 MTPT-00093 MTPT-00094 MTPT-00128 MTPT-00142 MTPT-00099 MTPT-00020 MTPT-00095 MTPT-00100 MTPT-00112	WASHER, 5TH GEAR THRUST PIN (FOR 5TH GEAR THRUST WASHER) KEY, SYNCHROMESH SHIFTING, NO.1 NUT (FOR TRANSFER OUTPUT SHAFT) SHAFT, INPUT GEAR, 2ND GEAR, 1ST GEAR, 3RD GEAR, COUNTER PIPE, OIL RECEIVER, NO.2 (FOR EXTENSION HOUSING) FORK, GEAR SHIFT, NO.1 RING, SYNCHRONIZER, NO.1 HUB, TRANSMISSION CLUTCH, NO.2 SLEEVE, TRANSMISSION HUB, NO.2 WASHER, 4TH GEAR	33346-71010 90250-05026 33365-35060 90179-22016 33301-35080 33033-35011 33032-26020 33034-35100 33421-71050 33124-36010 33212-35023 33368-20012 33362-35040 33364-26020 33349-35010

Reference List / Manual Transmission(Parts)

Model	Year	Body Type	Engine Type	AISIN No.	Productin Name	Genuine No.	
HILUX		KUN15,16,25,26,35,36 KUN15,16,25,26,35,36,TGN16,26 KUN15,16,25,26,35,36,TGN16,26,36	1KDFTV,2KDFTV 1KDFTV,2KDFTV,2TRFE 1KDFTV,2KDFTV,2TRFE	MTPT-00139	SLEEVE, TRANSMISSION HUB, NO.3	33395-71010	
				MTPT-00334	SPRING, SYNCHROMESH SHIFTING KEY, NO.1	33371-14031	
				MTPT-00337	SHAFT, OUTPUT	33321-35092	
				MTPT-00003	GEAR, 1ST	33032-60111	
				MTPT-00146	KEY, SYNCHROMESH SHIFTING, NO.1	33365-35060	
				MTPT-00009	RING, SYNCHRONIZER, NO.2	33368-35050	
				MTPT-00076	PIECE, GEAR SPLINE, NO.5	33318-60030	
				MTPT-00086	RING, SYNCHRONIZER, OUTER NO.3	33384-60090	
				MTPT-00143	RETAINER, OUTPUT SHAFT REAR BEARING (MTM)	33151-35020	
				MTPT-00151	RING, SYNCHRONIZER, NO.2	33368-35070	
		MTPT-00174	PIN (FOR 5TH GEAR THRUST WASHER)	90250-05026			
		MTPT-00313	WASHER, 1ST GEAR THRUST	33348-35010			
		MTPT-00174	PIN OR BALL (FOR 1ST GEAR THRUST WASHER)	90250-05026			
		MTPT-00315	KEY, SYNCHROMESH SHIFTING, NO.2	33366-35050			
		MTPT-00174	PIN (FOR 5TH GEAR THRUST WASHER)	90250-05026			
		MTPT-00071	RING SET, SYNCHRONIZER, NO.1	33037-60050			
		MTPT-00008	RING SET, SYNCHRONIZER, NO.1	33037-60040			
		MTPT-00081	SLEEVE, TRANSMISSION HUB, NO.2	33364-60070			
		MTPT-00008	RING SET, SYNCHRONIZER, NO.1	33037-60040			
		MTPT-00071	RING SET, SYNCHRONIZER, NO.1	33037-60050			
		MTPT-00008	RING SET, SYNCHRONIZER, NO.1	33037-60040			
		MTPT-00071	RING SET, SYNCHRONIZER, NO.1	33037-60050			
		MTPT-00142	PIPE, OIL RECEIVER, NO.2 (FOR EXTENSION HOUSING)	33124-36010			
		MTPT-00137	GEAR, COUNTERSHAFT 5TH	33428-71020			
		MTPT-00138	GEAR, 5TH	33336-26010			
		MTPT-00142	PIPE, OIL RECEIVER, NO.2 (FOR EXTENSION HOUSING)	33124-36010			
		MTPT-00332	SHAFT, INPUT	33301-35071			
		11.08-	LAN15,25 LAN15,25,35	5LE 5LE	MTPT-00020	RING, SYNCHRONIZER, NO.1	33368-20012
					MTPT-00015	SHAFT, INPUT	33301-35080
					MTPT-00018	GEAR, 5TH	33336-28020
					MTPT-00093	GEAR, 1ST	33032-26020
					MTPT-00095	HUB, TRANSMISSION CLUTCH, NO.2	33362-35040
					MTPT-00100	SLEEVE, TRANSMISSION HUB, NO.2	33364-26020
					MTPT-00112	WASHER, 4TH GEAR	33349-35010
					MTPT-00139	SLEEVE, TRANSMISSION HUB, NO.3	33395-71010
					MTPT-00334	SPRING, SYNCHROMESH SHIFTING KEY, NO.1	33371-14031
					MTPT-00337	SHAFT, OUTPUT	33321-35092
		LAN15,35 LAN25	5LE 5LE	MTPT-00097	SHAFT, OUTPUT	33321-60090	
				MTPT-00142	PIPE, OIL RECEIVER (FOR TRANSFER)	33124-36010	
		12.03-	KUN15,16,25,26,35,36	1KDFTV,2KDFTV	MTPT-00144	GEAR, REVERSE	33331-60041
		12.04-13.05	TGN11,16,26,36	2TRFE	MTPT-00007	GEAR, COUNTERSHAFT 5TH	33428-60040 (33428-60041)
		12.04-14.04	TGN11,16,26,36	2TRFE	MTPT-00001	SHAFT, INPUT	33301-60050 (33301-26050)
					MTPT-00079	HUB, TRANSMISSION CLUTCH, NO.2	33362-60030 (33362-60031)

Reference List / Manual Transmission(Parts)

Model	Year	Body Type	Engine Type	AISIN No.	Productin Name	Genuine No.
HILUX	12.04-14.10	TGN16,26,36	2TRFE	MTPT-00012	FORK, GEAR SHIFT, NO.1	33212-35032
				MTPT-00065	GEAR, 1ST	33032-60051
				MTPT-00111	FORK, GEAR SHIFT, NO.2	33213-35040
	12.04-15.04	TGN11,16,26,36	2TRFE	MTPT-00012	FORK, GEAR SHIFT, NO.1	33212-35032
				MTPT-00111	FORK, GEAR SHIFT, NO.2	33213-35040
	12.04-15.08	TGN11,16,26,36	2TRFE	MTPT-00065	GEAR, 1ST	33032-60051
				MTPT-00067	GEAR, 2ND	33033-60040
				MTPT-00069	GEAR, 3RD	33034-60030
				MTPT-00317	BEARING, INPUT SHAFT	90364-25012
	12.04-	TGN11,16,26,36	2TRFE	MTPT-00008	RING SET, SYNCHRONIZER, NO.1	33037-60040
				MTPT-00009	RING, SYNCHRONIZER, NO.2	33368-35050
				MTPT-00076	PIECE, GEAR SPLINE, NO.5	33318-60030
				MTPT-00081	SLEEVE, TRANSMISSION HUB, NO.2	33364-60070
				MTPT-00083	RING SET, SYNCHRONIZER, NO.1	33367-35080
				MTPT-00086	RING, SYNCHRONIZER, OUTER NO.3	33384-60090
				MTPT-00143	RETAINER, OUTPUT SHAFT REAR BEARING (MTM)	33151-35020
				MTPT-00144	GEAR, REVERSE	33331-60041
				MTPT-00145	WASHER, 5TH GEAR THRUST	33346-71010
				MTPT-00146	KEY, SYNCHROMESH SHIFTING, NO.1	33365-35060
				MTPT-00151	RING, SYNCHRONIZER, NO.2	33368-35070
				MTPT-00174	PIN (FOR 5TH GEAR THRUST WASHER)	90250-05026
				MTPT-00313	PIN OR BALL (FOR 1ST GEAR THRUST WASHER)	90250-05026
				MTPT-00315	WASHER, 1ST GEAR THRUST	33348-35010
	12.05-	KUN15,16,25,26,35,36	1KDFTV,2KDFTV	MTPT-00078	HUB, TRANSMISSION CLUTCH, NO.1	33361-71020
	12.11-	KUN10,15,LAN15,25,35,TGN10,15	2KDFTV,5LE,1TRFE	MTPT-00021	FORK, GEAR SHIFT, NO.2	33213-35034
	13.05-14.04	KUN15,2#,3#	2KDFTV	MTPT-00005	GEAR, COUNTER	33421-71011 (33421-26110)
		TGN11,16,26,36	2TRFE	MTPT-00088	GEAR, COUNTER	33421-60181 (33421-60220)
13.10-13.11	GGN25	1GRFE	MTPT-00170	NUT (FOR TRANSFER OUTPUT SHAFT)	90179-22016	
13.10-14.04	KUN15,35,3#	2KDFTV	MTPT-00001	SHAFT, INPUT	33301-60050 (33301-26050)	
13.12-14.10	TGN16,36	2TRFE	MTPT-00327	SHAFT, OUTPUT	33321-35191	
13.12-	KUN15,35,36,TGN11,16,36	2KDFTV,2TRFE	MTPT-00327	SHAFT, OUTPUT	33321-35191	
	KUN2#,TGN26	2KDFTV,2TRFE	MTPT-00002	SHAFT, OUTPUT	33321-35141	
14.04-15.08	KUN26,36,TGN11,16,26,36	1KDFTV,2TRFE	MTPT-00007	GEAR, COUNTERSHAFT 5TH	33428-26020	
	KUN26,36,TGN11,16,36	1KDFTV,2TRFE	MTPT-00006	GEAR, 5TH	33336-26020	
15.05-	GGN125,126,KUN125,126,TGN126	1KDFTV,2KDFTV,1TRFE,2TRFE	MTPT-00170	NUT (FOR TRANSFER OUTPUT SHAFT)	90179-22016	
			MTPT-00145	WASHER, 5TH GEAR THRUST	33346-71010	
	GUN112,122,123,KUN112,122,TGN11#,12#,136	2GDFTV,2KDFTV,1TRFE,2TRFE	MTPT-00146	KEY, SYNCHROMESH SHIFTING, NO.1	33365-35060	
			MTPT-00174	PIN (FOR 5TH GEAR THRUST WASHER)	90250-05026	
	GUN125,126,13#,KUN125,126,13#	1GDFTV,2GDFTV,2KDFTV	MTPT-00174	PIN OR BALL (FOR 1ST GEAR THRUST WASHER)	90250-05026	
MTPT-00174	PIN, STRAIGHT (FOR GEAR THRUST WASHER)	90250-05026				
HILUX 2WD	88.08-90.08	RN8#,YN81,86	22R,3Y	MTPT-00093	GEAR, 1ST	33032-26020

Reference List / Manual Transmission(Parts)

Model	Year	Body Type	Engine Type	AISIN No.	Productin Name	Genuine No.
HILUX 2WD	88.08-91.03	LN80,85,90,RN8#,90,125,YN81,86,87,92	2L,3L,22R,2Y,3Y,4Y	MTPT-00336	SHAFT, INPUT	33301-35060 (33301-26030)
		LN80,85,RN8#,90,125,YN81,86,87,92	2L,3L,22R,2Y,3Y,4Y	MTPT-00335	GEAR, COUNTER	33421-35140 (33421-26120)
	88.08-91.08	LN8#,90,RN125,8#,90,YN81,86,87,92	2L,3L,22R,2Y,3Y,4Y	MTPT-00016	GEAR, 2ND	33033-35011
		LN8#,90,RN8#,90,125,YN81,85,86,87,92	2L,3L,22R,2Y,3Y,4Y	MTPT-00018	GEAR, 5TH	33336-28020
	88.08-93.05	LN8#,90,RN125,8#,90,YN81,85,86,87,92	2L,3L,22R,2Y,3Y,4Y	MTPT-00020	RING, SYNCHRONIZER, NO.1	33368-20012
				MTPT-00028	RING, SYNCHRONIZER, NO.2	33367-14010
				MTPT-00095	HUB, TRANSMISSION CLUTCH, NO.2	33362-35040
				MTPT-00099	FORK, GEAR SHIFT, NO.1	33212-35023
				MTPT-00112	WASHER, 4TH GEAR	33349-35010
				MTPT-00142	PIPE, OIL RECEIVER, NO.2 (FOR EXTENSION HOUSING)	33124-36010
				MTPT-00333	KEY, SYNCHROMESH SHIFTING, NO.2	33366-35040 (33366-35041)
	MTPT-00334	SPRING, SYNCHROMESH SHIFTING KEY, NO.1	33371-14031			
	MTPT-00337	SHAFT, OUTPUT	33321-35092			
	91.02-91.08	LN80,85,90,RN125,8#,90,YN81,85,86,87,92	2L,22R,2Y,3Y,4Y	MTPT-00098	GEAR, REVERSE	33331-28011 (33331-35061)
	91.08-94.01	LN81,85,86,RN85,90,125,YN81,86,92	2L,3L,22R,2Y,3Y	MTPT-00093	GEAR, 1ST	33032-26020
	91.10-97.08	RN8#,90	22R,22RE	MTPT-00025	GEAR, 5TH	33336-30030
				MTPT-00150	RING, SYNCHRONIZER, NO.2	33368-30120
	92.08-93.05	LN8#,90,RN85,90,125,YN81,85,86,92	2L,3L,22R,22R,2Y,3Y,4Y	MTPT-00028	RING, SYNCHRONIZER, NO.3	33367-14010
	92.08-97.08	RN8#,90	22R,22RE	MTPT-00026	GEAR, COUNTERSHAFT 5TH	33428-30040
				MTPT-00176	SPRING, COMPRESSION	90501-07104
	92.09-93.05	LN8#,90,RN85,90,125,YN81,85,86,92	2L,3L,22R,2Y,3Y,4Y	MTPT-00100	SLEEVE, TRANSMISSION HUB, NO.2	33364-26020
	93.05-94.01	LN80,85,90,YN80,85	2L,2Y	MTPT-00098	GEAR, REVERSE	33331-28011 (33331-35061)
				MTPT-00335	GEAR, COUNTER	33421-35140 (33421-26120)
				MTPT-00336	SHAFT, INPUT	33301-35060 (33301-26030)
93.05-94.08	LN8#,90,RN80,90,125,YN80,81,85,86,9#	2L,3L,22R,22RE,2Y,3Y,4Y	MTPT-00016	GEAR, 2ND	33033-35011	
			MTPT-00095	HUB, TRANSMISSION CLUTCH, NO.2	33362-35040	
	LN8#,90,RN85,90,125,YN80,81,85,86,9#	2L,3L,22R,22RE,2Y,3Y,4Y	MTPT-00020	RING, SYNCHRONIZER, NO.1	33368-20012	
			MTPT-00028	RING, SYNCHRONIZER, NO.2	33367-14010	
			MTPT-00099	FORK, GEAR SHIFT, NO.1	33212-35023	
	LN8#,90,RN85,90,125,YN80,81,85,88,9#	2L,3L,22R,22RE,2Y,3Y,4Y	MTPT-00334	SPRING, SYNCHROMESH SHIFTING KEY, NO.1	33371-14031	
			MTPT-00333	KEY, SYNCHROMESH SHIFTING, NO.2	33366-35040 (33366-35041)	
LN8#,90,RN85,90,125,YN81,85,86,9#	2L,3L,22R,22RE,2Y,3Y,4Y	MTPT-00100	SLEEVE, TRANSMISSION HUB, NO.2	33364-26020		
LN85,8#,90,RN125,YN80,81,85,86,9#	2L,3L,22R,22RE,2Y,3Y,4Y	MTPT-00337	SHAFT, OUTPUT	33321-35092		
93.05-99.08	LN8#,9#,RN85,90,125,YN8#,9#	2L,3L,22R,22RE,2Y,3Y,4Y	MTPT-00018	GEAR, 5TH	33336-28020	
			MTPT-00019	GEAR, COUNTERSHAFT 5TH	33046-35062	
			MTPT-00028	RING, SYNCHRONIZER, NO.3	33367-14010	
			MTPT-00112	WASHER, 4TH GEAR	33349-35010	
RN85,90,125,LN8#,9#,YN8#,9#	2L,3L,22R,22RE,2Y,3Y,4Y	MTPT-00142	PIPE, OIL RECEIVER, NO.2 (FOR EXTENSION HOUSING)	33124-36010		
94.01-94.08	LN81,85,86,YN85,RN85,90,YN80,81,86,9#	2L,3L,22R,22RE,2Y,3Y,4Y	MTPT-00093	GEAR, 1ST	33032-26020	
94.01-99.09	LN80,85,90	2L	MTPT-00098	GEAR, REVERSE	33331-28011 (33331-35061)	
			MTPT-00335	GEAR, COUNTER	33421-35140 (33421-26120)	

Reference List / Manual Transmission(Parts)

Model	Year	Body Type	Engine Type	AISIN No.	Productin Name	Genuine No.
HILUX 2WD				MTPT-00336	SHAFT, INPUT	33301-35060 (33301-26030)
	94.08-97.05	LN81,85,86,91,RN85,90,YN80,81,85,86,9#	2L,3L,22R,22RE,2Y,3Y,4Y	MTPT-00093	GEAR, 1ST	33032-26020
	94.08-99.08	LN8#,9#,RN85,90,YN8#,9#	2L,3L,22R,22RE,2Y,3Y,4Y	MTPT-00020	RING, SYNCHRONIZER, NO.1	33368-20012
				MTPT-00028	RING, SYNCHRONIZER, NO.2	33367-14010
				MTPT-00095	HUB, TRANSMISSION CLUTCH, NO.2	33362-35040
				MTPT-00099	FORK, GEAR SHIFT, NO.1	33212-35023
				MTPT-00100	SLEEVE, TRANSMISSION HUB, NO.2	33364-26020
				MTPT-00333	KEY, SYNCHROMESH SHIFTING, NO.2 (33366-35041)	33366-35040
				MTPT-00334	SPRING, SYNCHROMESH SHIFTING KEY, NO.1	33371-14031
				MTPT-00337	SHAFT, OUTPUT	33321-35092
	97.05-99.08	LN81,85,86,RN85,90,YN80,81,85,86,92	2L,3L,22R,22RE,2Y,3Y,4Y	MTPT-00093	GEAR, 1ST	33032-26020
	99.08-01.06	LN86	3L	MTPT-00016	GEAR, 2ND	33033-35011
				MTPT-00018	GEAR, 5TH	33336-28020
				MTPT-00019	GEAR, COUNTERSHAFT 5TH	33046-35062
				MTPT-00020	RING, SYNCHRONIZER, NO.1	33368-20012
				MTPT-00028	RING, SYNCHRONIZER, NO.2	33367-14010
					RING, SYNCHRONIZER, NO.3	33367-14010
				MTPT-00093	GEAR, 1ST	33032-26020
				MTPT-00095	HUB, TRANSMISSION CLUTCH, NO.2	33362-35040
				MTPT-00099	FORK, GEAR SHIFT, NO.1	33212-35023
				MTPT-00100	SLEEVE, TRANSMISSION HUB, NO.2	33364-26020
				MTPT-00112	WASHER, 4TH GEAR	33349-35010
				MTPT-00142	PIPE, OIL RECEIVER, NO.2 (FOR EXTENSION HOUSING)	33124-36010
				MTPT-00333	KEY, SYNCHROMESH SHIFTING, NO.2 (33366-35041)	33366-35040
				MTPT-00334	SPRING, SYNCHROMESH SHIFTING KEY, NO.1	33371-14031
				MTPT-00337	SHAFT, OUTPUT	33321-35092
01.05-01.06				LN86	3L	MTPT-00015
			MTPT-00017	GEAR, COUNTER	33421-35170	
01.06-03.12	LN200	5L	MTPT-00333	KEY, SYNCHROMESH SHIFTING, NO.2 (33366-35041)	33366-35040	
01.06-04.12	LN200	5L	MTPT-00015	SHAFT, INPUT	33301-35080	
			MTPT-00016	GEAR, 2ND	33033-35011	
			MTPT-00017	GEAR, COUNTER	33421-35170	
			MTPT-00018	GEAR, 5TH	33336-28020	
			MTPT-00019	GEAR, COUNTERSHAFT 5TH	33046-35062	
			MTPT-00020	RING, SYNCHRONIZER, NO.2	33368-20012	
			MTPT-00028	RING, SYNCHRONIZER, NO.1	33367-14010	
				RING, SYNCHRONIZER, NO.3	33367-14010	
			MTPT-00093	GEAR, 1ST	33032-26020	
			MTPT-00095	HUB, TRANSMISSION CLUTCH, NO.2	33362-35040	
			MTPT-00099	FORK, GEAR SHIFT, NO.1	33212-35023	
			MTPT-00100	SLEEVE, TRANSMISSION HUB, NO.2	33364-26020	
			MTPT-00112	WASHER, 5TH GEAR THRUST	33349-35010	
			MTPT-00142	PIPE, OIL RECEIVER, NO.2 (FOR EXTENSION HOUSING)	33124-36010	
MTPT-00334	SPRING, SYNCHROMESH SHIFTING KEY, NO.1	33371-14031				
MTPT-00337	SHAFT, OUTPUT	33321-35092				

Reference List / Manual Transmission(Parts)

Model	Year	Body Type	Engine Type	AISIN No.	Productin Name	Genuine No.
HILUX 2WD		RZN200	3RZFE	MTPT-00023	GEAR, 2ND	33033-28011
				MTPT-00024	GEAR, 3RD	33034-30011
				MTPT-00025	GEAR, 5TH	33336-30030
				MTPT-00026	GEAR, COUNTERSHAFT 5TH	33428-30040
				MTPT-00140	RING SET, SYNCHRONIZER, NO.1	33037-30011
	01.07-04.12	RZN200	3RZFE	MTPT-00140	RING SET, SYNCHRONIZER, NO.2	33038-30012
				MTPT-00141	RING, SYNCHRONIZER, NO.2	33368-30120
				MTPT-00150	SPRING, COMPRESSION	90501-07104
				MTPT-00149	RING, SYNCHRONIZER, NO.1	33367-53030
				MTPT-00022	SHAFT, INPUT	33301-30081
	03.07-04.12	RZN200	3RZFE	MTPT-00027	GEAR, COUNTER	(33301-30082) 33421-28053 (33421-28054)
HILUX/4RUNNER (4WD)	88.08-89.01	LN106,111,RN105,110,YN106	3L,22R,4Y	MTPT-00336	SHAFT, INPUT	33301-35060 (33301-26030)
	88.08-90.08	LN111,130,135,RN110,13#,YN135	3L,22R,4Y	MTPT-00170	NUT (FOR TRANSFER OUTPUT SHAFT)	90179-22016
		LN135,YN135	3L,4Y	MTPT-00028	RING, SYNCHRONIZER (FOR TRANSFER FRONT DRIVE CLUTCH)	33367-14010
	88.08-98.12	LN107,111,13#,RN106,110,13#,YN135	3L,22R,22RE,4Y	MTPT-00097	SHAFT, OUTPUT	33321-60090
	88.08-99.08	LN10#,111,13#,RN10#,110,13#,YN106,135	3L,22R,22RE,4Y	MTPT-00142	PIPE, OIL RECEIVER (FOR TRANSFER)	33124-36010
				MTPT-00020	RING, SYNCHRONIZER, NO.1	33368-20012
				MTPT-00028	RING, SYNCHRONIZER, NO.2	33367-14010
				MTPT-00095	RING, SYNCHRONIZER, NO.3	33367-14010
				MTPT-00095	HUB, TRANSMISSION CLUTCH, NO.2	33362-35040
				MTPT-00112	WASHER, 4TH GEAR	33349-35010
				MTPT-00333	KEY, SYNCHROMESH SHIFTING, NO.2	33366-35040 (33366-35041)
	88.08-99.08	LN106,107,111,RN105,106,YN106	3L,22R,22RE,4Y	MTPT-00334	SPRING, SYNCHROMESH SHIFTING KEY, NO.1	33371-14031
				MTPT-00096	SHAFT, OUTPUT	33321-35111
	89.01-91.08	RN105,110,13#,YN106,135	22R,4Y	MTPT-00336	SHAFT, INPUT	33301-35060 (33301-26030)
	89.01-99.08	LN10#,111,13#	3L	MTPT-00015	SHAFT, INPUT	33301-35080
	90.08-94.04	VZN130	3VZE	MTPT-00082	RING, SYNCHRONIZER, NO.1	33367-35010
	90.08-94.05	VZN130	3VZE	MTPT-00142	PIPE, OIL RECEIVER (FOR TRANSFER)	33124-36010
MTPT-00187				NUT (FOR COUNTER GEAR SHAFT)	90179-22005	
90.08-95.11	VZN130	3VZE	MTPT-00143	RETAINER, OUTPUT SHAFT REAR BEARING (MTM)	33151-35020	
			MTPT-00147	KEY, SYNCHROMESH SHIFTING, NO.2	33366-35030	
			MTPT-00174	PIN OR BALL (FOR 1ST GEAR THRUST WASHER)	90250-05026	
			MTPT-00313	WASHER, 1ST GEAR THRUST	33348-35010	
90.08-97.08	LN107,111,13#,RN106,110,13#,YN135,VZN130	3L,22R,22RE,4Y,3VZE	MTPT-00028	RING, SYNCHRONIZER (FOR TRANSFER FRONT DRIVE CLUTCH)	33367-14010	
			MTPT-00170	NUT (FOR TRANSFER OUTPUT SHAFT)	90179-22016	
91.02-91.08	RN105,110,13#,YN106,135	22R,4Y	MTPT-00098	GEAR, REVERSE	33331-28011 (33331-35061)	
92.09-99.08	LN10#,111,13#,RN10#,110,13#,YN106	3L,22R,22RE,4Y	MTPT-00100	SLEEVE, TRANSMISSION HUB, NO.2	33364-26020	
94.03-95.11	VZN130	3VZE	MTPT-00010	RING, SYNCHRONIZER, NO.2	33368-35030	
			MTPT-00080	SLEEVE, TRANSMISSION HUB, NO.2	33364-35050	
			MTPT-00084	RING, SYNCHRONIZER, NO.2	33368-35040	

Reference List / Manual Transmission(Parts)

Model	Year	Body Type	Engine Type	AISIN No.	Productin Name	Genuine No.
HILUX/4RUNNER (4WD)	94.04-95.11	VZN130	3VZE	MTPT-00083	RING, SYNCHRONIZER, NO.1	33367-35080
	99.08-01.06	LN107	3L	MTPT-00015	SHAFT, INPUT	33301-35080
				MTPT-00020	RING, SYNCHRONIZER, NO.1	33368-20012
				MTPT-00028	RING, SYNCHRONIZER, NO.2	33367-14010
					RING, SYNCHRONIZER, NO.3	33367-14010
				MTPT-00095	HUB, TRANSMISSION CLUTCH, NO.2	33362-35040
				MTPT-00096	SHAFT, OUTPUT	33321-35111
				MTPT-00100	SLEEVE, TRANSMISSION HUB, NO.2	33364-26020
				MTPT-00112	WASHER, 4TH GEAR	33349-35010
				MTPT-00333	KEY, SYNCHROMESH SHIFTING, NO.2	33366-35040 (33366-35041)
		MTPT-00334	SPRING, SYNCHROMESH SHIFTING KEY, NO.1	33371-14031		
	01.06-03.12	LN205	5L	MTPT-00333	KEY, SYNCHROMESH SHIFTING, NO.2	33366-35040 (33366-35041)
	01.06-04.12	LN205	5L	MTPT-00015	SHAFT, INPUT	33301-35080
				MTPT-00020	RING, SYNCHRONIZER, NO.2	33368-20012
				MTPT-00028	RING, SYNCHRONIZER, NO.1	33367-14010
					RING, SYNCHRONIZER, NO.3	33367-14010
				MTPT-00095	HUB, TRANSMISSION CLUTCH, NO.2	33362-35040
				MTPT-00096	SHAFT, OUTPUT	33321-35111
				MTPT-00100	SLEEVE, TRANSMISSION HUB, NO.2	33364-26020
				MTPT-00112	WASHER, 5TH GEAR THRUST	33349-35010
				MTPT-00334	SPRING, SYNCHROMESH SHIFTING KEY, NO.1	33371-14031
	01.08-04.12	KZN205	1KZTE	MTPT-00008	RING SET, SYNCHRONIZER, NO.1	33037-60040
				MTPT-00010	RING, SYNCHRONIZER, NO.2	33368-35030
				MTPT-00028	RING, SYNCHRONIZER (FOR TRANSFER FRONT DRIVE CLUTCH)	33367-14010
				MTPT-00075	PIECE, GEAR SPLINE, NO.5	33318-35040
				MTPT-00080	SLEEVE, TRANSMISSION HUB, NO.2	33364-35050
				MTPT-00083	RING, SYNCHRONIZER, NO.1	33367-35080
MTPT-00084				RING, SYNCHRONIZER, NO.2	33368-35040	
MTPT-00087				SLEEVE, TRANSMISSION HUB, NO.3	33395-35031	
MTPT-00090				GEAR,COUNTER SHAFT,5TH	33428-60031	
MTPT-00143				RETAINER, OUTPUT SHAFT REAR BEARING (MTM)	33151-35020	
MTPT-00147				KEY, SYNCHROMESH SHIFTING, NO.2	33366-35030	
MTPT-00174				PIN (FOR 5TH GEAR THRUST WASHER)	90250-05026	
				PIN OR BALL (FOR 1ST GEAR THRUST WASHER)	90250-05026	
MTPT-00176				SPRING, COMPRESSION	90501-07104	
MTPT-00313	WASHER, 1ST GEAR THRUST	33348-35010				
01.11-04.12	KZN205	1KZTE	MTPT-00170	NUT (FOR TRANSFER OUTPUT SHAFT)	90179-22016	
02.02-04.12	KZN205	1KZTE	MTPT-00001	SHAFT, INPUT	33301-60050 (33301-26050)	
			MTPT-00097	SHAFT, OUTPUT	33321-60090	
			MTPT-00142	PIPE, OIL RECEIVER (FOR TRANSFER)	33124-36010	
	MTPT-00170	NUT (FOR TRANSFER OUTPUT SHAFT)	90179-22016			
04.08-04.12	KZN205	1KZTE	MTPT-00146	KEY, SYNCHROMESH SHIFTING, NO.1	33365-35060	
INNOVA	15.11-	GUN142,TGN14#	2GDFTV,1TRFE,2TRFE	MTPT-00145	WASHER, 5TH GEAR THRUST	33346-71010

Reference List / Manual Transmission(Parts)

Model	Year	Body Type	Engine Type	AISIN No.	Productin Name	Genuine No.			
INNOVA				MTPT-00146	KEY, SYNCHROMESH SHIFTING, NO.1	33365-35060			
				MTPT-00174	PIN (FOR 5TH GEAR THRUST WASHER)	90250-05026			
					PIN OR BALL (FOR 1ST GEAR THRUST WASHER)	90250-05026			
INNOVA/KIJANG	11.07-15.03	TGN41	2TRFE	MTPT-00086	RING, SYNCHRONIZER, OUTER NO.3	33384-60090			
				MTPT-00315	KEY, SYNCHROMESH SHIFTING, NO.2	33366-35050			
	11.07-	KUN40,TGN40	2KDFTV,1TRFE	MTPT-00020	RING, SYNCHRONIZER, NO.1	33368-20012			
				MTPT-00028	RING, SYNCHRONIZER, NO.2	33367-14010			
				MTPT-00142	PIPE, OIL RECEIVER, NO.2 (FOR EXTENSION HOUSING)	33124-36010			
				MTPT-00334	SPRING, SYNCHROMESH SHIFTING KEY, NO.1	33371-14031			
				MTPT-00146	KEY, SYNCHROMESH SHIFTING, NO.1	33365-35060			
				MTPT-00157	KEY, SYNCHROMESH SHIFTING, NO.3	33394-60020			
	12.04-14.04	TGN41	2TRFE	MTPT-00174	PIN (FOR 5TH GEAR THRUST WASHER)	90250-05026			
					PIN OR BALL (FOR 1ST GEAR THRUST WASHER)	90250-05026			
				MTPT-00001	SHAFT, INPUT	33301-60050 (33301-26050)			
				MTPT-00079	HUB, TRANSMISSION CLUTCH, NO.2	33362-60030 (33362-60031)			
				12.04-14.08	TGN41	2TRFE	MTPT-00008	RING SET, SYNCHRONIZER, NO.1	33037-60040
							MTPT-00009	RING, SYNCHRONIZER, NO.2	33368-35050
	MTPT-00076	PIECE, GEAR SPLINE, NO.5	33318-60030						
MTPT-00081	SLEEVE, TRANSMISSION HUB, NO.2	33364-60070							
MTPT-00083	RING, SYNCHRONIZER, NO.1	33367-35080							
MTPT-00143	RETAINER, OUTPUT SHAFT REAR BEARING (MTM)	33151-35020							
13.12-14.08	TGN41	2TRFE	MTPT-00144	GEAR, REVERSE	33331-60041				
			MTPT-00145	WASHER, 5TH GEAR THRUST	33346-71010				
			MTPT-00151	RING, SYNCHRONIZER, NO.2	33368-35070				
			MTPT-00313	WASHER, 1ST GEAR THRUST	33348-35010				
INNOVA/KIJANG INNOVA	04.08-	KUN40,TGN40	1TRFE,2KDFTV	MTPT-00020	RING, SYNCHRONIZER, NO.1	33368-20012			
				MTPT-00028	RING, SYNCHRONIZER, NO.2	33367-14010			
				MTPT-00142	PIPE, OIL RECEIVER, NO.2 (FOR EXTENSION HOUSING)	33124-36010			
				MTPT-00334	SPRING, SYNCHROMESH SHIFTING KEY, NO.1	33371-14031			
	05.02-06.07	KUN40,TGN40	1TRFE,2KDFTV	MTPT-00015	SHAFT, INPUT	33301-35080			
				MTPT-00095	HUB, TRANSMISSION CLUTCH, NO.2	33362-35040			
				MTPT-00100	SLEEVE, TRANSMISSION HUB, NO.2	33364-26020			
				MTPT-00112	WASHER, 4TH GEAR	33349-35010			
				MTPT-00139	SLEEVE, TRANSMISSION HUB, NO.3	33395-71010			
	05.07-10.11	TGN41	2TRFE	MTPT-00337	SHAFT, OUTPUT	33321-35092			
				MTPT-00313	WASHER, 1ST GEAR THRUST	33348-35010			
	05.07-11.11	TGN41	2TRFE	MTPT-00086	RING, SYNCHRONIZER, OUTER NO.3	33384-60090			
				MTPT-00146	KEY, SYNCHROMESH SHIFTING, NO.1	33365-35060			
				MTPT-00153	SPRING, SYNCHROMESH SHIFTING KEY, NO.3	33392-60020			
				MTPT-00154	SPRING, SYNCHROMESH SHIFTING KEY, NO.3	33392-60030			
MTPT-00157				KEY, SYNCHROMESH SHIFTING, NO.3	33394-60020				
			MTPT-00174	PIN (FOR 5TH GEAR THRUST WASHER)	90250-05026				

Reference List / Manual Transmission(Parts)

Model	Year	Body Type	Engine Type	AISIN No.	Productin Name	Genuine No.
INNOVA/KIJANG INNOVA				MTPT-00315	PIN OR BALL (FOR 1ST GEAR THRUST WASHER) KEY, SYNCHROMESH SHIFTING, NO.2	90250-05026 33366-35050
	07.08-10.07	TGN41	2TRFE	MTPT-00145	WASHER, 5TH GEAR THRUST	33346-71010
	08.08-09.01	TGN41	2TRFE	MTPT-00008	RING SET, SYNCHRONIZER, NO.1	33037-60040
				MTPT-00009	RING, SYNCHRONIZER, NO.2	33368-35050
				MTPT-00083	RING SET, SYNCHRONIZER, NO.1	33367-35080
MTPT-00151				RING, SYNCHRONIZER, NO.2	33368-35070	
LAND CRUISER	73.09-75.01	BJ4#,FJ4#,55,HJ45	B,F,H	MTPT-00020 MTPT-00148	RING, SYNCHRONIZER, NO.2 KEY, SYNCHROMESH SHIFTING, NO.2	33368-20012 33366-36020
	75.01-80.07	BJ4#,FJ4#,55,HJ45	B,F,2F,H	MTPT-00032 MTPT-00148	HUB, TRANSMISSION CLUTCH, NO.2 KEY, SYNCHROMESH SHIFTING, NO.2	33362-36021 33366-36020
	75.10-80.07	BJ4#,FJ4#,55,HJ45	B,F,2F,H	MTPT-00020	RING, SYNCHRONIZER, NO.2	33368-20012
	80.08-84.10	BJ40,42,43,46,FJ40,43 BJ42,FJ40	B,3B,2F 3B,2F	MTPT-00048	SHAFT, TRANSFER OUTPUT, REAR	36231-60021
				MTPT-00051	FORK, TRANSFER GEAR SHIFT, NO.2	36312-60030
				MTPT-00167	BOOT, TRANSFER FRONT DRIVE SHIFT	36318-60020
				MTPT-00181	BEARING (FOR TRANSFER OUTPUTFRONT SHAFT) BEARING, RADIAL BALL (FOR TRANSFER INPUT SHAFT REAR)	90363-35013 90363-35013
	80.08-85.10	BJ60,FJ6#,HJ60	3B,2F,3F,2H	MTPT-00164	SHAFT, TRANSFER IDLER GEAR	36225-60030
	80.08-85.11	BJ4#,FJ4#,HJ47	B,3B,2F,2H	MTPT-00164	SHAFT, TRANSFER IDLER GEAR	36225-60030
	80.08-86.03	BJ60,FJ6#,HJ6#	3B,2F,3F,2H,12HT	MTPT-00183	NUT (FOR MANUAL TRANSMISSION OUTPUT SHAFT REAR SET)	90179-26002
	80.08-86.04	BJ4#,FJ4#,HJ47	B,3B,2F,2H	MTPT-00179	SPACER, TRANSFER INPUT SHAFT	36251-60030
	80.08-87.08	BJ60,FJ6#,HJ6# BJ60,FJ60,HJ60	3B,2F,3F,2H,12HT 3B,2F,3F,2H	MTPT-00020	RING, SYNCHRONIZER, NO.2	33368-20012
				MTPT-00032	HUB, TRANSMISSION CLUTCH, NO.2	33362-36021
				MTPT-00046	HUB, TRANSFER CLUTCH	36237-60020
				MTPT-00048	SHAFT, TRANSFER OUTPUT, REAR	36231-60021
				MTPT-00049	SLEEVE, FRONT DRIVE CLUTCH	36235-60020
				MTPT-00148	KEY, SYNCHROMESH SHIFTING, NO.2	33366-36020
				MTPT-00178	GEAR, POWER TAKE-OFF DRIVE	36215-60030
				MTPT-00187	NUT (FOR MANUAL TRANSMISSION OUTPUT SHAFT REAR SET)	90179-22005
				MTPT-00189	WASHER, PLATE (FOR TRANSFER OUTPUT SHAFT)	90201-22005
				MTPT-00051	FORK, TRANSFER GEAR SHIFT, NO.2	36312-60030
				MTPT-00167	BOOT, TRANSFER FRONT DRIVE SHIFT	36318-60020
				MTPT-00181	BEARING (FOR TRANSFER OUTPUTFRONT SHAFT) BEARING, RADIAL BALL (FOR TRANSFER INPUT SHAFT REAR)	90363-35013 90363-35013
				MTPT-00190	BOLT (FOR TRANSFER CASE)	91651-61040
				82.10-84.10	BJ42 BJ42,46,FJ40,43	3B 3B,2F
	MTPT-00035	GEAR, 2ND	33332-60020			
	MTPT-00037	GEAR, 1ST	33335-60020			
MTPT-00038	GEAR, 5TH	33336-60010				
MTPT-00110	FORK, 5TH SHIFT	33214-60021				
MTPT-00020	RING, SYNCHRONIZER, NO.3	33368-20012				
MTPT-00142	PIPE, OIL RECEIVER	33124-36010				
MTPT-00155	KEY, SYNCHROMESH SHIFTING (FOR NO.3 CLUTCH HUB)	33394-36011				

Reference List / Manual Transmission(Parts)

Model	Year	Body Type	Engine Type	AISIN No.	Productin Name	Genuine No.
LAND CRUISER				MTPT-00183	NUT (FOR COUNTER GEAR SHAFT)	90179-26002
	82.10-85.06	FJ45,HJ47	2F,2H	MTPT-00048	SHAFT, TRANSFER OUTPUT, REAR	36231-60021
	82.10-87.08	BJ60,FJ6#,HJ6#	3B,2F,3F,2H,12HT	MTPT-00142	PIPE, OIL RECEIVER	33124-36010
				MTPT-00155	KEY, SYNCHROMESH SHIFTING (FOR NO.3 CLUTCH HUB)	33394-36011
				MTPT-00183	NUT (FOR COUNTER GEAR SHAFT)	90179-26002
				MTPT-00034	GEAR, 3RD	33333-60030
				MTPT-00035	GEAR, 2ND	33332-60020
				MTPT-00037	GEAR, 1ST	33335-60020
				MTPT-00038	GEAR, 5TH	33336-60010
				MTPT-00110	FORK, 5TH SHIFT	33214-60021
	84.11-85.02	BJ7#,FJ7#,HJ75,LJ70,RJ70	3B,13BT,3F,2H,2L,22R	MTPT-00179	SPACER, TRANSFER INPUT SHAFT	36251-60030
		BJ7#,FJ7#,LJ70,RJ70	3B,13BT,3F,2L,22R	MTPT-00178	GEAR, POWER TAKE-OFF DRIVE	36215-60030
	84.11-85.10	BJ7#,FJ7#,HJ75,LJ70,RJ70	3B,13BT,3F,2H,2L,22R	MTPT-00164	SHAFT, TRANSFER IDLER GEAR	36225-60030
	84.11-86.03	LJ70,RJ70	2L,2LT,22R	MTPT-00183	NUT (FOR TRANSFER INPUT SHAFT)	90179-26002
	84.11-87.07	BJ70	3B	MTPT-00034	GEAR, 3RD	33333-60030
				MTPT-00035	GEAR, 2ND	33332-60020
				MTPT-00037	GEAR, 1ST	33335-60020
				MTPT-00038	GEAR, 5TH	33336-60010
				MTPT-00051	FORK, TRANSFER GEAR SHIFT, NO.2	36312-60030
				MTPT-00110	FORK, 5TH SHIFT	33214-60021
				MTPT-00167	BOOT, TRANSFER FRONT DRIVE SHIFT	36318-60020
				MTPT-00181	BEARING (FOR TRANSFER OUTPUTFRONT SHAFT)	90363-35013
	84.11-87.08	FJ62,HJ6#	3F,2H,12HT	MTPT-00180	RING, O (FOR TRANSFER INPUT GEAR)	90301-34005
				MTPT-00190	BOLT (FOR TRANSFER CASE)	91651-61040
	84.11-90.01	BJ7#,FJ7#,HJ75	3B,3BT,3F,2H	MTPT-00020	RING, SYNCHRONIZER, NO.2	33368-20012
				MTPT-00032	RING, SYNCHRONIZER, NO.3	33368-20012
				MTPT-00142	HUB, TRANSMISSION CLUTCH, NO.2	33362-36021
MTPT-00148				PIPE, OIL RECEIVER	33124-36010	
MTPT-00155				KEY, SYNCHROMESH SHIFTING, NO.2	33366-36020	
MTPT-00155				KEY, SYNCHROMESH SHIFTING (FOR NO.3 CLUTCH HUB)	33394-36011	
MTPT-00183				NUT (FOR COUNTER GEAR SHAFT)	90179-26002	
MTPT-00046				HUB, TRANSFER CLUTCH	36237-60020	
MTPT-00048				SHAFT, TRANSFER OUTPUT, REAR	36231-60021	
MTPT-00049				SLEEVE, FRONT DRIVE CLUTCH	36235-60020	
MTPT-00187				NUT (FOR MANUAL TRANSMISSION OUTPUT SHAFT REAR SET)	90179-22005	
MTPT-00189				WASHER, PLATE (FOR TRANSFER OUTPUT SHAFT)	90201-22005	
MTPT-00180				RING, O (FOR TRANSFER INPUT GEAR)	90301-34005	
MTPT-00020				RING, SYNCHRONIZER, NO.1	33368-20012	
MTPT-00028	LJ70,RJ70	2L,2LT,22R	RING, SYNCHRONIZER, NO.2	33367-14010		
			RING, SYNCHRONIZER, NO.3	33367-14010		
84.11-90.01	BJ74,FJ70,73	13BT,3F	MTPT-00180	RING, O (FOR TRANSFER INPUT GEAR)	90301-34005	
	LJ70,RJ70	2L,2LT,22R	MTPT-00020	RING, SYNCHRONIZER, NO.1	33368-20012	
			MTPT-00028	RING, SYNCHRONIZER, NO.2	33367-14010	
			MTPT-00028	RING, SYNCHRONIZER, NO.3	33367-14010	

Reference List / Manual Transmission(Parts)

Model	Year	Body Type	Engine Type	AISIN No.	Productin Name	Genuine No.
LAND CRUISER				MTPT-00097	SHAFT, OUTPUT	33321-60090
				MTPT-00142	PIPE, OIL RECEIVER, NO.1 (MTM)	33124-36010
				MTPT-00334	SPRING, SYNCHROMESH SHIFTING KEY, NO.1	33371-14031
	85.01-87.08	BJ60,FJ62,HJ60	3B,3F,2H	MTPT-00179	SPACER, TRANSFER INPUT SHAFT	36251-60030
		HJ6#	2H,12HT	MTPT-00179	SPACER, TRANSFER INPUT SHAFT	36251-60030
	85.02-85.10	BJ7#,FJ7#,HJ75,LJ70,RJ70	3B,3F,2L,22R	MTPT-00179	SPACER, TRANSFER INPUT SHAFT	36251-60030
		BJ70,75,FJ7#,LJ70,RJ70	3B,3F,2L,22R	MTPT-00178	GEAR, POWER TAKE-OFF DRIVE	36215-60030
	85.10-87.07	BJ70	3B	MTPT-00039	GEAR, COUNTER	33421-60060
	85.10-87.08	BJ60,FJ62,HJ6#	3B,3F,2H,12HT	MTPT-00043	GEAR, TRANSFER IDLER	36221-60080
				MTPT-00160	SEAT, TRANSMISSION SHIFT LEVER BALL	33505-60011
				MTPT-00165	SHAFT, TRANSFER IDLER GEAR	36225-60050
		BJ7#,FJ7#,HJ75	3B,3BT,3F,2H	MTPT-00043	GEAR, TRANSFER IDLER	36221-60080
		HJ60	2H	MTPT-00039	GEAR, COUNTER	33421-60060
				MTPT-00040	GEAR SUB-ASSY,COUNTER SHAFT,5TH	36046-60010
	85.10-88.02	HJ75	2H	MTPT-00040	GEAR SUB-ASSY,COUNTER SHAFT,5TH	36046-60010
	85.10-90.01	BJ7#,FJ7#,HJ75	3B,13BT,3F,2H	MTPT-00160	SEAT, TRANSMISSION SHIFT LEVER BALL	33505-60011
		BJ7#,FJ7#,HJ75,LJ70,RJ70	3B,13BT,3F,2H,2L,2LT,22R	MTPT-00165	SHAFT, TRANSFER IDLER GEAR	36225-60050
				MTPT-00178	GEAR, POWER TAKE-OFF DRIVE	36215-60030
				MTPT-00179	SPACER, TRANSFER INPUT SHAFT	36251-60030
		LJ70	3F	MTPT-00082	RING, SYNCHRONIZER, NO.1	33367-35010
				MTPT-00143	RETAINER, OUTPUT SHAFT REAR BEARING (MTM)	33151-35020
				MTPT-00147	KEY, SYNCHROMESH SHIFTING, NO.2	33366-35030
				MTPT-00174	PIN OR BALL (FOR 1ST GEAR THRUST WASHER)	90250-05026
				MTPT-00187	NUT (FOR COUNTER GEAR SHAFT)	90179-22005
				MTPT-00313	WASHER, 1ST GEAR THRUST	33348-35010
		LJ70,RJ70	3F,22R	MTPT-00091	GEAR, TRANSFER IDLER	36221-60090
	85.11-86.04	FJ45	2F	MTPT-00165	SHAFT, TRANSFER IDLER GEAR	36225-60050
	86.03-87.08	BJ60,FJ62,HJ6#	3B,3F,2H,2HT	MTPT-00188	NUT (FOR MANUAL TRANSMISSION OUTPUT SHAFT REAR SET)	90179-26004
	86.03-90.01	BJ7#,FJ7#,HJ75	3B,13BT,3F,2H	MTPT-00188	NUT (FOR MANUAL TRANSMISSION OUTPUT SHAFT REAR SET)	90179-26004
		LJ70,RJ70	2L,2LT,22R	MTPT-00188	NUT (FOR TRANSFER INPUT SHAFT)	90179-26004
	86.08-87.08	BJ60,FJ62,HJ6#	3B,3F,2H,12HT	MTPT-00036	RING SUB-ASSY, SYNCHRONIZER,NO.1	33306-60010
86.08-90.01	BJ7#,FJ7#,HJ75	3B,13BT,3F,2H	MTPT-00036	RING SUB-ASSY, SYNCHRONIZER,NO.1	33306-60010	
87.03-87.07	BJ70	3B	MTPT-00109	FORK, 3RD & 4TH SHIFT	33213-60051	
87.03-87.08	BJ60,FJ62,HJ6#	3B,3F,2H,12HT	MTPT-00041	SLEEVE, TRANSMISSION HUB, NO.3	33395-60010	
			MTPT-00042	PIECE, GEAR SPLINE, NO.5	33318-60010	
	HJ60	2H	MTPT-00109	FORK, 3RD & 4TH SHIFT	33213-60051	
87.03-90.01	BJ7#,FJ7#,HJ75	3B,13BT,3F,2H	MTPT-00041	SLEEVE, TRANSMISSION HUB, NO.3	33395-60010	
			MTPT-00042	PIECE, GEAR SPLINE, NO.5	33318-60010	
87.04-87.07	BJ70	3B	MTPT-00191	FLANGE, COMPANION (FOR TRANSFER OUTPUT SHAFT)	33309-60041	
87.04-87.08	FJ60,HJ60	2F,2H	MTPT-00191	FLANGE, COMPANION (FOR TRANSFER OUTPUT SHAFT)	33309-60041	
87.08-88.01	FJ62,HJ61	3F,12HT	MTPT-00180	RING, O (FOR TRANSFER INPUT GEAR)	90301-34005	
	HJ60	2H	MTPT-00040	GEAR SUB-ASSY,COUNTER SHAFT,5TH	36046-60010	
87.08-89.12	BJ60,FJ62,HJ6#	3B,3F,2H,12HT	MTPT-00160	SEAT SUB-ASSY, SHIFT LEVER	33505-60011	

Reference List / Manual Transmission(Parts)

Model	Year	Body Type	Engine Type	AISIN No.	Productin Name	Genuine No.	
LAND CRUISER	87.08-90.01	BJ7#,FJ7#,HJ75	3B,13BT,3F,2H	MTPT-00043	GEAR, TRANSFER IDLER	36221-60080	
		BJ74,FJ70,73	13BT,3F	MTPT-00091	GEAR, TRANSFER IDLER	36221-60090	
		FJ62	3F	MTPT-00181	BEARING (FOR TRANSFER OUTPUTFRONT SHAFT)	90363-35013	
					BEARING, RADIAL BALL (FOR TRANSFER INPUT SHAFT REAR)	90363-35013	
					MTPT-00190	BOLT (FOR TRANSFER CASE)	91651-61040
					MTPT-00191	FLANGE SUB-ASSY, OUTPUT SHAFT	33309-60041
	87.08-92.03	BJ60,FJ62,HJ6#	3B,3F,2H,12HT	MTPT-00020	RING, SYNCHRONIZER, NO.2	33368-20012	
					RING, SYNCHRONIZER, NO.3	33368-20012	
				MTPT-00032	HUB, TRANSMISSION CLUTCH, NO.2	33362-36021	
				MTPT-00036	RING SUB-ASSY, SYNCHRONIZER,NO.1	33306-60010	
				MTPT-00041	SLEEVE, TRANSMISSION HUB, NO.3	33395-60010	
				MTPT-00042	PIECE, GEAR SPLINE, NO.5	33318-60010	
				MTPT-00043	GEAR, TRANSFER IDLER	36221-60080	
				MTPT-00046	HUB, TRANSFER CLUTCH	36237-60020	
				MTPT-00048	SHAFT, TRANSFER OUTPUT, REAR	36231-60021	
				MTPT-00049	SLEEVE, TRANSFER HIGH & LOW CLUTCH	36235-60020	
				MTPT-00142	PIPE, OIL RECEIVER	33124-36010	
				MTPT-00148	KEY, SYNCHROMESH SHIFTING, NO.2	33366-36020	
				MTPT-00155	KEY, SYNCHROMESH SHIFTING (FOR NO.3 CLUTCH HUB)	33394-36011	
				MTPT-00165	SHAFT, TRANSFER IDLER GEAR	36225-60050	
				MTPT-00178	GEAR, POWER TAKE-OFF DRIVE	36215-60030	
				MTPT-00179	SPACER, TRANSFER INPUT SHAFT	36251-60030	
				MTPT-00183	NUT (FOR COUNTER GEAR SHAFT)	90179-26002	
				MTPT-00187	NUT (FOR MANUAL TRANSMISSION OUTPUT SHAFT REAR SET)	90179-22005	
	MTPT-00188	NUT (FOR MANUAL TRANSMISSION OUTPUT SHAFT REAR SET)	90179-26004				
	MTPT-00189	WASHER, PLATE (FOR TRANSFER OUTPUT SHAFT)	90201-22005				
		FJ62,HJ61	3F,12HT	MTPT-00091	GEAR, TRANSFER IDLER	36221-60090	
88.01-92.03	BJ60,FJ62,HJ6#	3B,3F,2H,12HT	MTPT-00180	RING, O (FOR TRANSFER INPUT GEAR)	90301-34005		
88.02-90.01	BJ7#,FJ7#,HJ75,LJ70,RJ70	3B,13T,3F,2L,2LT,22R	MTPT-00180	RING, O (FOR TRANSFER INPUT GEAR)	90301-34005		
88.04-90.01	LJ70	2L,2LT	MTPT-00184	SHAFT, TRANSFER INPUT	36211-60021		
88.08-90.01	LJ70,RJ70	2L,2LT,22R	MTPT-00095	HUB, TRANSMISSION CLUTCH, NO.2	33362-35040		
			MTPT-00112	WASHER, 5TH GEAR THRUST	33349-35010		
			MTPT-00333	KEY, SYNCHROMESH SHIFTING, NO.2	33366-35040 (33366-35041)		
	RJ70	22R	MTPT-00336	SHAFT, INPUT	33301-35060 (33301-26030)		
88.08-92.03	BJ60,FJ62,HJ6#	3B,3F,2H,2HT	MTPT-00177	GEAR, TRANSFER INPUT	36212-60081		
89.01-90.01	BJ7#,FJ7#,HJ75,LJ70,RJ70	3B,3F,2H,2L,2LT,22R	MTPT-00045	SHAFT, TRANSFER OUTPUT, FRONT	36234-60040		
89.01-	BJ7#,FJ7#,HJ75,LJ70,RJ70	3B,3F,2H,2L,2LT,22R	MTPT-00049	SLEEVE, TRANSFER HIGH & LOW CLUTCH	36235-60020		
89.06-92.03	BJ60	3B	MTPT-00045	SHAFT, TRANSFER OUTPUT, FRONT	36234-60040		
	FJ62,HJ61	3F,12HT	MTPT-00045	SHAFT, TRANSFER OUTPUT, FRONT	36234-60040		
	HJ60	2H	MTPT-00045	SHAFT, TRANSFER OUTPUT, FRONT	36234-60040		
89.09-92.03	BJ60,FJ62,HJ60,61	3B,3F,2H,12HT	MTPT-00049	SLEEVE, FRONT DRIVE CLUTCH	36235-60020		
90.01-90.04	RJ70	22R	MTPT-00099	FORK, 1ST & 2ND SHIFT	33212-35023		

Reference List / Manual Transmission(Parts)

Model	Year	Body Type	Engine Type	AISIN No.	Productin Name	Genuine No.
LAND CRUISER	90.01-91.01	FJ7#,HJ75,HZJ7#,LJ7#,PZJ7#,RJ7#	3F,2H,1HZ,2LT,1PZ,22R	MTPT-00190	BOLT (FOR TRANSFER CASE)	91651-61040
	90.01-91.04	FJ7#,HJ75,HZJ7#,LJ7#,PZJ7#,RJ7#	3F,2H,1HZ,2LT,1PZ,22R	MTPT-00177	GEAR, TRANSFER INPUT	36212-60081
	90.01-92.01	FJ70,73,HZJ73	3F,1HZ	MTPT-00188	NUT (FOR OUTPUT SHAFT)	90179-26004
				MTPT-00050	GEAR SUB-ASSY,TRANSFER,LOW SPEED	36204-60110
		MTPT-00193	BEARING,RADIAL BALL	90363-35012		
	90.01-92.08	FJ80,FZJ80,HDJ80,HZJ80	3F,3FE,1FZF,1FZFE,1HDFT,1HDT,1HZ	MTPT-00063	RING, SYNCHRONIZER, NO.3	33369-60010
				MTPT-00064	RING, 2ND SYNCHRONIZER OUTER	33381-60010
				MTPT-00158	WASHER, REVERSE IDLER THRUST	33462-60020
				MTPT-00159	WASHER, REVERSE IDLER THRUST, No.2	33464-60010
				MTPT-00160	SEAT SUB-ASSY, SHIFT LEVER	33505-60011
				MTPT-00162	SHAFT, TRANSFER INPUT	36211-60040
				MTPT-00163	GEAR, TRANSFER INPUT	36212-60100
				MTPT-00166	SLEEVE, TRANSFER HIGH & LOW CLUTCH	36235-60040
				MTPT-00173	PIN OR BALL (FOR 1ST GEAR THRUST WASHER)	90250-04056
					PIN, STRAIGHT (FOR OIL PUMP DRIVE ROTOR)	90250-04056
				MTPT-00175	RING, O, NO.2 (FOR MANUAL TRANSMISSION OIL PUMP COVER)	90301-91001
				MTPT-00224	SLEEVE, TRANSMISSION HUB, NO.4	33327-60010
				MTPT-00236	BEARING, INPUT SHAFT	90361-08004
				MTPT-00349	BEARING, NEEDLE ROLLER (FOR 3RD GEAR)	90364-38017
					RING, SYNCHRONIZER, NO.1	33367-60020
					RING, SYNCHRONIZER, NO.1	33367-60030
					RING, SYNCHRONIZER, NO.2	33368-60020
					RING, SYNCHRONIZER, NO.2	33368-60020
		FJ80,HZJ80	3F,3FE,1HZ	MTPT-00058	RING, SYNCHRONIZER, NO.1	33367-60020
				MTPT-00059	RING, SYNCHRONIZER, NO.1	33367-60030
				MTPT-00060	RING, SYNCHRONIZER, NO.2	33368-60020
		FZJ80,HDJ80	1FZF,1FZFE,1HDT	MTPT-00060	RING, SYNCHRONIZER, NO.2	33368-60020
	90.01-93.05	FJ7#,HJ75,HZJ7#	3F,2H,1HZ	MTPT-00020	RING, SYNCHRONIZER, NO.2	33368-20012
				MTPT-00032	HUB, TRANSMISSION CLUTCH, NO.2	33362-36021
				MTPT-00034	GEAR, 3RD	33333-60030
				MTPT-00035	GEAR, 2ND	33332-60020
				MTPT-00036	RING SUB-ASSY, SYNCHRONIZER,NO.1	33306-60010
MTPT-00037				GEAR, 1ST	33335-60020	
MTPT-00142				PIPE, OIL RECEIVER	33124-36010	
MTPT-00148				KEY, SYNCHROMESH SHIFTING, NO.2	33366-36020	
MTPT-00183				NUT (FOR TRANSFER INPUT SHAFT)	90179-26002	
MTPT-00043				GEAR, TRANSFER IDLER	36221-60080	
MTPT-00038				GEAR, 5TH	33336-60010	
MTPT-00039				GEAR, COUNTER	33421-60060	
MTPT-00041				SLEEVE, TRANSMISSION HUB, NO.3	33395-60010	
MTPT-00042				PIECE, GEAR SPLINE, NO.5	33318-60010	
MTPT-00109				FORK, 3RD & 4TH SHIFT	33213-60051	
MTPT-00155				KEY, SYNCHROMESH SHIFTING (FOR NO.3 CLUTCH HUB)	33394-36011	
MTPT-00050				GEAR SUB-ASSY,TRANSFER,LOW SPEED	36204-60110	
MTPT-00110				FORK, 5TH SHIFT	33214-60021	
MTPT-00193				BEARING,RADIAL BALL	90363-35012	
MTPT-00091				GEAR, TRANSFER IDLER	36221-60090	
MTPT-00031				SHAFT, INPUT	33311-60170	
	FJ7#,HJ75,HZJ7#,LJ7#,PZJ7#,RJ7#	3F,2H,1HZ,2LT,3L,1PZ,22R				
	FJ7#,HJ75,HZJ7#,PZJ7#	3F,2H,1HZ,1PZ				
	FJ7#,HZJ7#	3F,1HZ				
	FJ7#,HZJ70,73,75	3F,1HZ				
	FJ70,73,HZJ73,LJ7#,RJ7#	3F,1HZ,3L,22R				
	HZJ7#	1HZ				

Reference List / Manual Transmission(Parts)

Model	Year	Body Type	Engine Type	AISIN No.	Productin Name	Genuine No.
LAND CRUISER		LJ7#,PZJ7#,RJ7#	2LT,3L,1PZ,22R	MTPT-00040	GEAR SUB-ASSY,COUNTER SHAFT,5TH	36046-60010
				MTPT-00142	PIPE, OIL RECEIVER, NO.1 (MTM)	33124-36010
				MTPT-00182	BEARING, RADIAL BALL (FOR TRANSFER INPUT SHAFT FRONT)	90363-35020
				MTPT-00012	FORK, 1ST & 2ND SHIFT	33212-35032
				MTPT-00082	RING, SYNCHRONIZER, NO.1	33367-35010
				MTPT-00111	FORK, 3RD & 4TH SHIFT	33213-35040
		LJ70,77,PZJ7#	2LT,3L,1PZ	MTPT-00143	RETAINER, OUTPUT SHAFT REAR BEARING (MTM)	33151-35020
				MTPT-00147	KEY, SYNCHROMESH SHIFTING, NO.2	33366-35030
				MTPT-00174	PIN OR BALL (FOR 1ST GEAR THRUST WASHER)	90250-05026
				MTPT-00187	NUT (FOR COUNTER GEAR SHAFT)	90179-22005
				MTPT-00313	WASHER, 1ST GEAR THRUST	33348-35010
				MTPT-00016	GEAR, 2ND	33033-35011
		LJ72,79,RJ7#	3L,22R	MTPT-00018	GEAR, 5TH	33336-28020
				MTPT-00020	RING, SYNCHRONIZER, NO.1	33368-20012
				MTPT-00028	RING, SYNCHRONIZER, NO.2	33367-14010
					RING, SYNCHRONIZER, NO.3	33367-14010
				MTPT-00095	HUB, TRANSMISSION CLUTCH, NO.2	33362-35040
				MTPT-00097	SHAFT, OUTPUT	33321-60090
	MTPT-00112			WASHER, 5TH GEAR THRUST	33349-35010	
	MTPT-00333			KEY, SYNCHROMESH SHIFTING, NO.2	33366-35040 (33366-35041)	
	MTPT-00334			SPRING, SYNCHROMESH SHIFTING KEY, NO.1	33371-14031	
	MTPT-00050			GEAR SUB-ASSY,TRANSFER,LOW SPEED	36204-60110	
	MTPT-00073			RETAINER, BEARING, FRONT (MTM)	33131-60080	
	PZJ7#			1PZ	MTPT-00050	GEAR SUB-ASSY,TRANSFER,LOW SPEED
		MTPT-00073	RETAINER, BEARING, FRONT (MTM)		33131-60080	
		MTPT-00050	GEAR SUB-ASSY,TRANSFER,LOW SPEED		36204-60110	
		MTPT-00336	SHAFT, INPUT		33301-35060 (33301-26030)	
	90.01-96.04	LJ70,77,PZJ7#	2LT,3L,1PZ	MTPT-00317	BEARING, INPUT SHAFT	90364-25012
	90.01-99.09	FJ7#,HJ75,HZJ70,71,73,75,78,79,LJ7#,PZJ7#,RJ7#	3F,2H,1HZ,2LT,3L,1PZ,22R	MTPT-00045	SHAFT, TRANSFER OUTPUT, FRONT	36234-60040
				MTPT-00046	HUB, TRANSFER CLUTCH	36237-60020
				MTPT-00048	SHAFT, TRANSFER OUTPUT, REAR	36231-60021
				MTPT-00049	SLEEVE, TRANSFER HIGH & LOW CLUTCH	36235-60020
				MTPT-00165	SHAFT, TRANSFER IDLER GEAR	36225-60050
				MTPT-00178	GEAR, POWER TAKE-OFF DRIVE	36215-60030
				MTPT-00179	SPACER, TRANSFER INPUT SHAFT	36251-60030
				MTPT-00180	RING, O (FOR TRANSFER INPUT GEAR)	90301-34005
				MTPT-00181	BEARING (FOR TRANSFER OUTPUTFRONT SHAFT)	90363-35013
					BEARING, RADIAL BALL (FOR TRANSFER INPUT SHAFT REAR)	90363-35013
				MTPT-00187	NUT (FOR MANUAL TRANSMISSION OUTPUT SHAFT REAR SET)	90179-22005
				MTPT-00189	WASHER, PLATE (FOR TRANSFER OUTPUT SHAFT)	90201-22005
FJ7#,HZJ70,71,73,75,78,79,LJ7#,PZJ7#,RJ7#		3F,1HZ,2LT,3L,1PZ,22R	MTPT-00051	FORK, TRANSFER GEAR SHIFT, NO.2	36312-60030	
			MTPT-00167	BOOT, TRANSFER FRONT DRIVE SHIFT	36318-60020	
			MTPT-00185	FLANGE, COMPANION (FOR TRANSFER OUTPUT SHAFT)	33309-60060	

Reference List / Manual Transmission(Parts)

Model	Year	Body Type	Engine Type	AISIN No.	Productin Name	Genuine No.
LAND CRUISER		FJ7#,HZJ70,71,73,75,78,79,PZJ7#	3F,1HZ,1PZ	MTPT-00191	FLANGE, COMPANION (FOR TRANSFER OUTPUT SHAFT)	33309-60041
	90.01-03.08	HZJ71,78,79,UJ70,77,PZJ7#	1HZ,2LT,1PZ	MTPT-00184	SHAFT, TRANSFER INPUT	36211-60021
	90.04-93.05	LJ72,79	3L	MTPT-00015	SHAFT, INPUT	33301-35080
		LJ72,79,RJ7#	3L,22R	MTPT-00099	FORK, 1ST & 2ND SHIFT	33212-35023
	91.01-93.05	FJ70,73,HZJ73,UJ7#,PZJ7#,RJ7#	3F,1HZ,2LT,3L,1PZ,22R	MTPT-00186	BOLT (FOR TRANSFER CASE & ADAPTER SETTING)	90119-12234
	91.02-93.05	RJ7#	22R	MTPT-00098	GEAR, REVERSE	33331-28011 (33331-35061)
	91.03-93.05	LJ72,79,RJ7#	3L,22R	MTPT-00019	GEAR, COUNTERSHAFT 5TH	33046-35062
	91.04-93.05	LJ7#,PZJ7#,RJ7#	2LT,3L,22R	MTPT-00177	GEAR, TRANSFER INPUT	36212-60081
	91.06-92.03	FJ62	3F	MTPT-00123	SHAFT, OUTPUT	33321-60072
	91.06-93.05	FJ7#,HZJ7#	3F,1HZ	MTPT-00123	SHAFT, OUTPUT	33321-60072
	91.09-92.03	FJ62	3F	MTPT-00033	SLEEVE, TRANSMISSION HUB, NO.2	33364-36071
	91.09-93.05	FJ7#,HZJ7#	3F,1HZ	MTPT-00033	SLEEVE, TRANSMISSION HUB, NO.2	33364-36071
	92.01-92.08	FJ73	3F	MTPT-00050	GEAR SUB-ASSY,TRANSFER,LOW SPEED	36204-60110
				MTPT-00193	BEARING,RADIAL BALL	90363-35012
				MTPT-00059	RING, SYNCHRONIZER, NO.1	33367-60030
	92.01-92.12	PZJ70,73	1PZ	MTPT-00045	SHAFT, TRANSFER OUTPUT, FRONT	36234-60040
	92.01-93.05	FZJ7#	1FZF,1ZFZE	MTPT-00058	RING, SYNCHRONIZER, NO.1	33367-60020
				MTPT-00060	RING, SYNCHRONIZER, NO.2	33368-60020
				MTPT-00064	RING SET, REVERSE SYNCHRONIZER	33381-60010
				MTPT-00173	PIN OR BALL (FOR 1ST GEAR THRUST WASHER)	90250-04056
				MTPT-00224	SLEEVE, TRANSMISSION HUB, NO.4	33327-60010
	92.01-99.09	FZJ70,71,73,74,75,78,79	1FZF,1FZFE	MTPT-00166	SLEEVE, TRANSFER HIGH & LOW CLUTCH	36235-60040
	92.01-99.10	FZJ70,71,73,74,75,78,79	1FZF,1FZFE	MTPT-00063	RING, SYNCHRONIZER, NO.3	33369-60010
				MTPT-00107	FORK, GEAR SHIFT, NO.2	33213-60060
				MTPT-00158	WASHER, REVERSE IDLER THRUST	33462-60020
				MTPT-00159	WASHER, REVERSE IDLER THRUST, No.2	33464-60010
				MTPT-00160	SEAT SUB-ASSY, SHIFT LEVER	33505-60011
				MTPT-00175	RING, O, NO.2 (FOR MANUAL TRANSMISSION OIL PUMP COVER)	90301-91001
				MTPT-00225	GEAR, 5TH	33036-60010
				MTPT-00236	BEARING, INPUT SHAFT	90361-08004
				MTPT-00349	BEARING, NEEDLE ROLLER (FOR 3RD GEAR)	90364-38017
				MTPT-00173	PIN, STRAIGHT (FOR OIL PUMP DRIVE ROTOR)	90250-04056
	92.01-07.01	FZJ70,73,75,78,79,HDJ7#	1FZF,1FZFE,1HZ	MTPT-00163	GEAR, TRANSFER INPUT	36212-60100
92.08-93.05	FZJ7#	1FZF,1FZFE	MTPT-00054	RING, SYNCHRONIZER, NO.1	33038-60011	
			MTPT-00062	RING, SYNCHRONIZER, NO.2	33368-60041	
92.08-95.01	FZJ80,HDJ80,HZJ80	1FZF,1FZFE,1HDT,1HZ	MTPT-00162	SHAFT, TRANSFER INPUT	36211-60040	
92.08-96.08	FZJ80,HDJ80	1FZF,1FZFE,1HZ	MTPT-00052	RING SET, SYNCHRONIZER, NO.1	33037-60011	
			MTPT-00056	RING SET, SYNCHRONIZER, NO.3	33039-60011	
			MTPT-00054	RING SET, SYNCHRONIZER, NO.2	33038-60011	
92.08-98.01	FZJ80,HDJ80	1FZF,1FFE,1HDT	MTPT-00162	SHAFT, TRANSFER INPUT	36211-60040	
			MTPT-00060	RING, SYNCHRONIZER, NO.2	33368-60020	
	FZJ80,HDJ80,HZJ80	1FZF,1FZFE,1HDT,1HZ	MTPT-00163	GEAR, TRANSFER INPUT	36212-60100	
			MTPT-00058	RING, SYNCHRONIZER, NO.1	33367-60020	
92.08-99.09	FZJ80,HDJ80,HZJ80	1FZF,1FZFE,1HDT,1HZ	MTPT-00062	RING, SYNCHRONIZER, NO.2	33368-60041	
			MTPT-00064	RING, 2ND SYNCHRONIZER OUTER	33381-60010	

Reference List / Manual Transmission(Parts)

Model	Year	Body Type	Engine Type	AISIN No.	Productin Name	Genuine No.
LAND CRUISER				MTPT-00224	SLEEVE, TRANSMISSION HUB, NO.4	33327-60010
	92.08-	FZJ80,HDJ80,HZJ80	1FZF,1FZFE,1HZ	MTPT-00063	RING, SYNCHRONIZER, NO.3	33369-60010
				MTPT-00158	WASHER, REVERSE IDLER THRUST	33462-60020
				MTPT-00159	WASHER, REVERSE IDLER THRUST, No.2	33464-60010
				MTPT-00160	SEAT SUB-ASSY, SHIFT LEVER	33505-60011
				MTPT-00166	SLEEVE, TRANSFER HIGH & LOW CLUTCH	36235-60040
				MTPT-00173	PIN, STRAIGHT (FOR OIL PUMP DRIVE ROTOR)	90250-04056
				MTPT-00175	RING, O, NO.2 (FOR MANUAL TRANSMISSION OIL PUMP COVER)	90301-91001
				MTPT-00236	BEARING, INPUT SHAFT	90361-08004
				MTPT-00349	BEARING, NEEDLE ROLLER (FOR 3RD GEAR)	90364-38017
	92.09-93.05	LJ72,79,RJ7#	3L,22R	MTPT-00100	SLEEVE, TRANSMISSION HUB, NO.2	33364-26020
	92.12-93.05	FZJ70,75	1FZF,1FZFE	MTPT-00162	SHAFT, TRANSFER INPUT	36211-60040
		PZJ70,73	1PZ	MTPT-00045	SHAFT, TRANSFER OUTPUT, FRONT	36234-60040
	93.05-94.01	PZJ70	1PZ	MTPT-00142	PIPE, OIL RECEIVER, NO.1 (MTM)	33124-36010
		PZJ70,73	1PZ	MTPT-00050	GEAR SUB-ASSY,TRANSFER,LOW SPEED	36204-60110
		PZJ70,73,75	1PZ	MTPT-00012	FORK, 1ST & 2ND SHIFT	33212-35032
				MTPT-00043	GEAR, TRANSFER IDLER	36221-60080
				MTPT-00046	HUB, TRANSFER CLUTCH	36237-60020
				MTPT-00073	RETAINER, BEARING, FRONT (MTM)	33131-60080
				MTPT-00082	RING, SYNCHRONIZER, NO.1	33367-35010
				MTPT-00111	FORK, 3RD & 4TH SHIFT	33213-35040
				MTPT-00143	RETAINER, OUTPUT SHAFT REAR BEARING (MTM)	33151-35020
				MTPT-00147	KEY, SYNCHROMESH SHIFTING, NO.2	33366-35030
				MTPT-00174	PIN OR BALL (FOR 1ST GEAR THRUST WASHER)	90250-05026
				MTPT-00184	SHAFT, TRANSFER INPUT	36211-60021
				MTPT-00191	FLANGE, COMPANION (FOR TRANSFER OUTPUT SHAFT)	33309-60041
				MTPT-00313	WASHER, 1ST GEAR THRUST	33348-35010
				MTPT-00317	BEARING, INPUT SHAFT	90364-25012
				MTPT-00045	SHAFT, TRANSFER OUTPUT, FRONT	36234-60040
				MTPT-00048	SHAFT, TRANSFER OUTPUT, REAR	36231-60021
				MTPT-00049	SLEEVE, TRANSFER HIGH & LOW CLUTCH	36235-60020
				MTPT-00051	FORK, TRANSFER GEAR SHIFT, NO.2	36312-60030
				MTPT-00165	SHAFT, TRANSFER IDLER GEAR	36225-60050
MTPT-00167	BOOT, TRANSFER FRONT DRIVE SHIFT	36318-60020				
MTPT-00177	GEAR, TRANSFER INPUT	36212-60081				
MTPT-00178	GEAR, POWER TAKE-OFF DRIVE	36215-60030				
MTPT-00179	SPACER, TRANSFER INPUT SHAFT	36251-60030				
MTPT-00180	RING, O (FOR TRANSFER INPUT GEAR)	90301-34005				
MTPT-00181	BEARING (FOR TRANSFER OUTPUTFRONT SHAFT)	90363-35013				
MTPT-00182	BEARING, RADIAL BALL (FOR TRANSFER INPUT SHAFT REAR) BEARING, RADIAL BALL (FOR TRANSFER INPUT SHAFT FRONT)	90363-35013 90363-35020				

Reference List / Manual Transmission(Parts)

Model	Year	Body Type	Engine Type	AISIN No.	Productin Name	Genuine No.			
LAND CRUISER		PZJ75 RJ70	1PZ	MTPT-00183	NUT (FOR TRANSFER INPUT SHAFT)	90179-26002			
				MTPT-00185	FLANGE, COMPANION (FOR TRANSFER OUTPUT SHAFT)	33309-60060			
				MTPT-00186	BOLT (FOR TRANSFER CASE & ADAPTER SETTING)	90119-12234			
				MTPT-00187	NUT (FOR MANUAL TRANSMISSION OUTPUT SHAFT REAR SET)	90179-22005			
				MTPT-00189	WASHER, PLATE (FOR TRANSFER OUTPUT SHAFT)	90201-22005			
				MTPT-00050	GEAR SUB-ASSY,TRANSFER,LOW SPEED	36204-60110			
				MTPT-00015	SHAFT, INPUT	33301-35080			
				MTPT-00016	GEAR, 2ND	33033-35011			
				MTPT-00020	RING, SYNCHRONIZER, NO.1	33368-20012			
				MTPT-00028	RING, SYNCHRONIZER, NO.2	33367-14010			
			22R	MTPT-00091	GEAR, TRANSFER IDLER	36221-60090			
				MTPT-00093	GEAR, 1ST	33032-26020			
				MTPT-00095	HUB, TRANSMISSION CLUTCH, NO.2	33362-35040			
				MTPT-00097	SHAFT, OUTPUT	33321-60090			
				MTPT-00099	FORK, 1ST & 2ND SHIFT	33212-35023			
				MTPT-00100	SLEEVE, TRANSMISSION HUB, NO.2	33364-26020			
				MTPT-00334	SPRING, SYNCHROMESH SHIFTING KEY, NO.1	33371-14031			
				MTPT-00333	KEY, SYNCHROMESH SHIFTING, NO.2	33366-35040 (33366-35041)			
				93.05-95.01	FZJ70 FZJ70,75	1FZF,1FZFE	MTPT-00162	SHAFT, TRANSFER INPUT	36211-60040
							MTPT-00054	RING, SYNCHRONIZER, NO.1	33038-60011
MTPT-00058	RING, SYNCHRONIZER, NO.1	33367-60020							
MTPT-00060	RING, SYNCHRONIZER, NO.2	33368-60020							
MTPT-00062	RING, SYNCHRONIZER, NO.2	33368-60041							
MTPT-00063	RING, SYNCHRONIZER, NO.3	33369-60010							
MTPT-00107	FORK, GEAR SHIFT, NO.2	33213-60060							
MTPT-00158	WASHER, REVERSE IDLER THRUST	33462-60020							
MTPT-00159	WASHER, REVERSE IDLER THRUST, No.2	33464-60010							
MTPT-00160	SEAT SUB-ASSY, SHIFT LEVER	33505-60011							
HZJ70	1FZF,1FZFE	MTPT-00163	GEAR, TRANSFER INPUT		36212-60100				
		MTPT-00166	SLEEVE, TRANSFER HIGH & LOW CLUTCH		36235-60040				
		MTPT-00173	PIN OR BALL (FOR 1ST GEAR THRUST WASHER)		90250-04056				
			PIN, STRAIGHT (FOR OIL PUMP DRIVE ROTOR)		90250-04056				
		MTPT-00175	RING, O, NO.2 (FOR MANUAL TRANSMISSION OIL PUMP COVER)		90301-91001				
		MTPT-00224	SLEEVE, TRANSMISSION HUB, NO.4		33327-60010				
		MTPT-00225	GEAR, 5TH		33036-60010				
		MTPT-00236	BEARING, INPUT SHAFT		90361-08004				
		MTPT-00349	BEARING, NEEDLE ROLLER (FOR 3RD GEAR)		90364-38017				
		MTPT-00020	RING, SYNCHRONIZER, NO.2		33368-20012				
	RING, SYNCHRONIZER, NO.3	33368-20012							
MTPT-00031	SHAFT, INPUT	33311-60170							
MTPT-00032	HUB, TRANSMISSION CLUTCH, NO.2	33362-36021							
MTPT-00033	SLEEVE, TRANSMISSION HUB, NO.2	33364-36071							
MTPT-00034	GEAR, 3RD	33333-60030							

Reference List / Manual Transmission(Parts)

Model	Year	Body Type	Engine Type	AISIN No.	Productin Name	Genuine No.		
LAND CRUISER		HZJ70,75	1HZ	MTPT-00035	GEAR, 2ND	33332-60020		
				MTPT-00036	RING SUB-ASSY, SYNCHRONIZER,NO.1	33306-60010		
				MTPT-00037	GEAR, 1ST	33335-60020		
				MTPT-00038	GEAR, 5TH	33336-60010		
				MTPT-00039	GEAR, COUNTER	33421-60060		
				MTPT-00040	GEAR SUB-ASSY,COUNTER SHAFT,5TH	36046-60010		
				MTPT-00041	SLEEVE, TRANSMISSION HUB, NO.3	33395-60010		
				MTPT-00042	PIECE, GEAR SPLINE, NO.5	33318-60010		
				MTPT-00109	FORK, 3RD & 4TH SHIFT	33213-60051		
				MTPT-00110	FORK, 5TH SHIFT	33214-60021		
				MTPT-00123	SHAFT, OUTPUT	33321-60072		
				MTPT-00142	PIPE, OIL RECEIVER	33124-36010		
				MTPT-00148	KEY, SYNCHROMESH SHIFTING, NO.2	33366-36020		
				MTPT-00155	KEY, SYNCHROMESH SHIFTING (FOR NO.3 CLUTCH HUB)	33394-36011		
				MTPT-00050	GEAR SUB-ASSY,TRANSFER,LOW SPEED	36204-60110		
				MTPT-00193	BEARING,RADIAL BALL	90363-35012		
				HZJ70,PZJ75	1HZ,1PZ	MTPT-00043	GEAR, TRANSFER IDLER	36221-60080
						MTPT-00045	SHAFT, TRANSFER OUTPUT, FRONT	36234-60040
		MTPT-00046	HUB, TRANSFER CLUTCH			36237-60020		
		MTPT-00048	SHAFT, TRANSFER OUTPUT, REAR			36231-60021		
		MTPT-00049	SLEEVE, TRANSFER HIGH & LOW CLUTCH			36235-60020		
		MTPT-00051	FORK, TRANSFER GEAR SHIFT, NO.2			36312-60030		
		MTPT-00165	SHAFT, TRANSFER IDLER GEAR			36225-60050		
		MTPT-00167	BOOT, TRANSFER FRONT DRIVE SHIFT			36318-60020		
		MTPT-00178	GEAR, POWER TAKE-OFF DRIVE			36215-60030		
		MTPT-00179	SPACER, TRANSFER INPUT SHAFT			36251-60030		
		MTPT-00180	RING, O (FOR TRANSFER INPUT GEAR)			90301-34005		
		MTPT-00181	BEARING (FOR TRANSFER OUTPUTFRONT SHAFT)			90363-35013		
			BEARING, RADIAL BALL (FOR TRANSFER INPUT SHAFT REAR)			90363-35013		
		MTPT-00183	NUT (FOR TRANSFER INPUT SHAFT)			90179-26002		
		MTPT-00185	FLANGE, COMPANION (FOR TRANSFER OUTPUT SHAFT)			33309-60060		
		MTPT-00187	NUT (FOR MANUAL TRANSMISSION OUTPUT SHAFT REAR SET)			90179-22005		
		MTPT-00191	FLANGE, COMPANION (FOR TRANSFER OUTPUT SHAFT)	33309-60041				
		PZJ70,75	1PZ	MTPT-00189	WASHER, PLATE (FOR TRANSFER OUTPUT SHAFT)	90201-22005		
MTPT-00012	FORK, 1ST & 2ND SHIFT			33212-35032				
PZJ75	1PZ	MTPT-00073	RETAINER, BEARING, FRONT (MTM)	33131-60080				
		MTPT-00082	RING, SYNCHRONIZER, NO.1	33367-35010				
		MTPT-00111	FORK, 3RD & 4TH SHIFT	33213-35040				
		MTPT-00142	PIPE, OIL RECEIVER, NO.1 (MTM)	33124-36010				
		MTPT-00143	RETAINER, OUTPUT SHAFT REAR BEARING (MTM)	33151-35020				
		MTPT-00147	KEY, SYNCHROMESH SHIFTING, NO.2	33366-35030				

Reference List / Manual Transmission(Parts)

Model	Year	Body Type	Engine Type	AISIN No.	Productin Name	Genuine No.	
LAND CRUISER				MTPT-00174	PIN OR BALL (FOR 1ST GEAR THRUST WASHER)	90250-05026	
				MTPT-00177	GEAR, TRANSFER INPUT	36212-60081	
				MTPT-00182	BEARING, RADIAL BALL (FOR TRANSFER INPUT SHAFT FRONT)	90363-35020	
				MTPT-00184	SHAFT, TRANSFER INPUT	36211-60021	
				MTPT-00186	BOLT (FOR TRANSFER CASE & ADAPTER SETTING)	90119-12234	
				MTPT-00187	NUT (FOR COUNTER GEAR SHAFT)	90179-22005	
				MTPT-00313	WASHER, 1ST GEAR THRUST	33348-35010	
				MTPT-00317	BEARING, INPUT SHAFT	90364-25012	
	93.05-95.04	KZJ7#		1KZT	MTPT-00187	NUT (FOR COUNTER GEAR SHAFT)	90179-22005
	93.05-96.04	KZJ7#		1KZT	MTPT-00012	FORK, 1ST & 2ND SHIFT	33212-35032
					MTPT-00082	RING, SYNCHRONIZER, NO.1	33367-35010
					MTPT-00111	FORK, 3RD & 4TH SHIFT	33213-35040
					MTPT-00143	RETAINER, OUTPUT SHAFT REAR BEARING (MTM)	33151-35020
					MTPT-00147	KEY, SYNCHROMESH SHIFTING, NO.2	33366-35030
					MTPT-00174	PIN OR BALL (FOR 1ST GEAR THRUST WASHER)	90250-05026
					MTPT-00184	SHAFT, TRANSFER INPUT	36211-60021
					MTPT-00313	WASHER, 1ST GEAR THRUST	33348-35010
					MTPT-00317	BEARING, INPUT SHAFT	90364-25012
					KZJ7#,LJ7#,RJ7#	1KZT,3L,22R	MTPT-00045
		MTPT-00046	HUB, TRANSFER CLUTCH	36237-60020			
		MTPT-00048	SHAFT, TRANSFER OUTPUT, REAR	36231-60021			
		MTPT-00049	SLEEVE, TRANSFER HIGH & LOW CLUTCH	36235-60020			
		MTPT-00051	FORK, TRANSFER GEAR SHIFT, NO.2	36312-60030			
		MTPT-00091	GEAR, TRANSFER IDLER	36221-60090			
		MTPT-00165	SHAFT, TRANSFER IDLER GEAR	36225-60050			
		MTPT-00167	BOOT, TRANSFER FRONT DRIVE SHIFT	36318-60020			
		MTPT-00177	GEAR, TRANSFER INPUT	36212-60081			
		MTPT-00178	GEAR, POWER TAKE-OFF DRIVE	36215-60030			
					MTPT-00179	SPACER, TRANSFER INPUT SHAFT	36251-60030
	MTPT-00180				RING, O (FOR TRANSFER INPUT GEAR)	90301-34005	
	MTPT-00181				BEARING (FOR TRANSFER OUTPUTFRONT SHAFT)	90363-35013	
					BEARING, RADIAL BALL (FOR TRANSFER INPUT SHAFT REAR)	90363-35013	
	MTPT-00182				BEARING, RADIAL BALL (FOR TRANSFER INPUT SHAFT FRONT)	90363-35020	
	MTPT-00183				NUT (FOR TRANSFER INPUT SHAFT)	90179-26002	
	MTPT-00185				FLANGE, COMPANION (FOR TRANSFER OUTPUT SHAFT)	33309-60060	
	MTPT-00186				BOLT (FOR TRANSFER CASE & ADAPTER SETTING)	90119-12234	
	MTPT-00187				NUT (FOR MANUAL TRANSMISSION OUTPUT SHAFT REAR SET)	90179-22005	
	MTPT-00189				WASHER, PLATE (FOR TRANSFER OUTPUT SHAFT)	90201-22005	
	KZJ7#,LJ79,RJ7#		1KZT,3L,22R	MTPT-00142	PIPE, OIL RECEIVER, NO.1 (MTM)	33124-36010	

Reference List / Manual Transmission(Parts)

Model	Year	Body Type	Engine Type	AISIN No.	Productin Name	Genuine No.
LAND CRUISER		LJ7#,RJ7#	3L,22R	MTPT-00015	SHAFT, INPUT	33301-35080
				MTPT-00016	GEAR, 2ND	33033-35011
				MTPT-00020	RING, SYNCHRONIZER, NO.1	33368-20012
				MTPT-00028	RING, SYNCHRONIZER, NO.2	33367-14010
				MTPT-00093	GEAR, 1ST	33032-26020
				MTPT-00095	HUB, TRANSMISSION CLUTCH, NO.2	33362-35040
				MTPT-00097	SHAFT, OUTPUT	33321-60090
				MTPT-00099	FORK, 1ST & 2ND SHIFT	33212-35023
				MTPT-00100	SLEEVE, TRANSMISSION HUB, NO.2	33364-26020
				MTPT-00333	KEY, SYNCHROMESH SHIFTING, NO.2	33366-35040 (33366-35041)
				MTPT-00334	SPRING, SYNCHROMESH SHIFTING KEY, NO.1	33371-14031
				MTPT-00018	GEAR, 5TH	33336-28020
	MTPT-00019	GEAR, COUNTERSHAFT 5TH	33046-35062			
	MTPT-00112	WASHER, 5TH GEAR THRUST	33349-35010			
	93.05-96.08	FZJ70,73,75	3F	MTPT-00054	RING, SYNCHRONIZER, NO.1	33038-60011
	93.05-98.01	FZJ7# FZJ70,73,75	3F 3F	MTPT-00064	RING SET, REVERSE SYNCHRONIZER	33381-60010
				MTPT-00058	RING, SYNCHRONIZER, NO.1	33367-60020
				MTPT-00060	RING, SYNCHRONIZER, NO.2	33368-60020
				MTPT-00062	RING, SYNCHRONIZER, NO.2	33368-60041
	MTPT-00224	SLEEVE, TRANSMISSION HUB, NO.4	33327-60010			
	93.05-99.08	FZJ70,73,75	3F	MTPT-00063	RING, SYNCHRONIZER, NO.3	33369-60010
				MTPT-00107	FORK, GEAR SHIFT, NO.2	33213-60060
				MTPT-00158	WASHER, REVERSE IDLER THRUST	33462-60020
				MTPT-00159	WASHER, REVERSE IDLER THRUST, No.2	33464-60010
				MTPT-00160	SEAT SUB-ASSY, SHIFT LEVER	33505-60011
				MTPT-00166	SLEEVE, TRANSFER HIGH & LOW CLUTCH	36235-60040
				MTPT-00173	PIN, STRAIGHT (FOR OIL PUMP DRIVE ROTOR)	90250-04056
				MTPT-00175	RING, O, NO.2 (FOR MANUAL TRANSMISSION OIL PUMP COVER)	90301-91001
				MTPT-00225	GEAR, 5TH	33036-60010
				MTPT-00236	BEARING, INPUT SHAFT	90361-08004
				MTPT-00349	BEARING, NEEDLE ROLLER (FOR 3RD GEAR)	90364-38017
				MTPT-00162	SHAFT, TRANSFER INPUT	36211-60040
		MTPT-00163	GEAR, TRANSFER INPUT	36212-60100		
HZJ75,7#		1HZ	MTPT-00032	HUB, TRANSMISSION CLUTCH, NO.2	33362-36021	
			MTPT-00034	GEAR, 3RD	33333-60030	
			MTPT-00035	GEAR, 2ND	33332-60020	
			MTPT-00037	GEAR, 1ST	33335-60020	
			MTPT-00038	GEAR, 5TH	33336-60010	
			MTPT-00142	PIPE, OIL RECEIVER	33124-36010	
			MTPT-00148	KEY, SYNCHROMESH SHIFTING, NO.2	33366-36020	
			MTPT-00185	FLANGE, COMPANION (FOR TRANSFER OUTPUT SHAFT)	33309-60060	
			MTPT-00187	NUT (FOR MANUAL TRANSMISSION OUTPUT SHAFT REAR SET)	90179-22005	
			MTPT-00183	NUT (FOR TRANSFER INPUT SHAFT)	90179-26002	
HZJ70,75 HZJ75,7#		1HZ 1HZ	MTPT-00020	RING, SYNCHRONIZER, NO.2	33368-20012	
				RING, SYNCHRONIZER, NO.3	33368-20012	

Reference List / Manual Transmission(Parts)

Model	Year	Body Type	Engine Type	AISIN No.	Productin Name	Genuine No.		
LAND CRUISER				MTPT-00031	SHAFT, INPUT	33311-60170		
				MTPT-00033	SLEEVE, TRANSMISSION HUB, NO.2	33364-36071		
				MTPT-00039	GEAR, COUNTER	33421-60060		
				MTPT-00040	GEAR SUB-ASSY,COUNTER SHAFT,5TH	36046-60010		
				MTPT-00041	SLEEVE, TRANSMISSION HUB, NO.3	33395-60010		
				MTPT-00043	GEAR, TRANSFER IDLER	36221-60080		
				MTPT-00045	SHAFT, TRANSFER OUTPUT, FRONT	36234-60040		
				MTPT-00046	HUB, TRANSFER CLUTCH	36237-60020		
				MTPT-00048	SHAFT, TRANSFER OUTPUT, REAR	36231-60021		
				MTPT-00049	SLEEVE, TRANSFER HIGH & LOW CLUTCH	36235-60020		
				MTPT-00050	GEAR SUB-ASSY,TRANSFER,LOW SPEED	36204-60110		
				MTPT-00123	SHAFT, OUTPUT	33321-60072		
				MTPT-00155	KEY, SYNCHROMESH SHIFTING (FOR NO.3 CLUTCH HUB)	33394-36011		
				MTPT-00165	SHAFT, TRANSFER IDLER GEAR	36225-60050		
				MTPT-00179	SPACER, TRANSFER INPUT SHAFT	36251-60030		
				MTPT-00180	RING, O (FOR TRANSFER INPUT GEAR)	90301-34005		
				MTPT-00189	WASHER, PLATE (FOR TRANSFER OUTPUT SHAFT)	90201-22005		
				MTPT-00191	FLANGE, COMPANION (FOR TRANSFER OUTPUT SHAFT)	33309-60041		
				MTPT-00193	BEARING,RADIAL BALL	90363-35012		
93.05-99.09	FZJ75 HZJ70,75	1FZF,1FZFE 1HZ	MTPT-00166	SLEEVE, TRANSFER HIGH & LOW CLUTCH	36235-60040			
			MTPT-00033	SLEEVE, TRANSMISSION HUB, NO.2	33364-36071			
			MTPT-00036	RING SUB-ASSY, SYNCHRONIZER,NO.1	33306-60010			
			MTPT-00042	PIECE, GEAR SPLINE, NO.5	33318-60010			
			MTPT-00045	SHAFT, TRANSFER OUTPUT, FRONT	36234-60040			
			MTPT-00048	SHAFT, TRANSFER OUTPUT, REAR	36231-60021			
			MTPT-00051	FORK, TRANSFER GEAR SHIFT, NO.2	36312-60030			
			MTPT-00109	FORK, 3RD & 4TH SHIFT	33213-60051			
			MTPT-00110	FORK, 5TH SHIFT	33214-60021			
			MTPT-00155	KEY, SYNCHROMESH SHIFTING (FOR NO.3 CLUTCH HUB)	33394-36011			
			MTPT-00165	SHAFT, TRANSFER IDLER GEAR	36225-60050			
			MTPT-00167	BOOT, TRANSFER FRONT DRIVE SHIFT	36318-60020			
			MTPT-00178	GEAR, POWER TAKE-OFF DRIVE	36215-60030			
			MTPT-00179	SPACER, TRANSFER INPUT SHAFT	36251-60030			
			MTPT-00180	RING, O (FOR TRANSFER INPUT GEAR)	90301-34005			
			MTPT-00181	BEARING (FOR TRANSFER OUTPUTFRONT SHAFT)	90363-35013			
				BEARING, RADIAL BALL (FOR TRANSFER INPUT SHAFT REAR)	90363-35013			
			93.05-00.07	HZJ70,75	1HZ	MTPT-00020	RING, SYNCHRONIZER, NO.2	33368-20012
							RING, SYNCHRONIZER, NO.3	33368-20012
MTPT-00031	SHAFT, INPUT	33311-60170						
MTPT-00032	HUB, TRANSMISSION CLUTCH, NO.2	33362-36021						
MTPT-00034	GEAR, 3RD	33333-60030						
MTPT-00035	GEAR, 2ND	33332-60020						
MTPT-00037	GEAR, 1ST	33335-60020						
MTPT-00038	GEAR, 5TH	33336-60010						

Reference List / Manual Transmission(Parts)

Model	Year	Body Type	Engine Type	AISIN No.	Productin Name	Genuine No.
LAND CRUISER				MTPT-00039	GEAR, COUNTER	33421-60060
				MTPT-00040	GEAR SUB-ASSY,COUNTER SHAFT,5TH	36046-60010
				MTPT-00041	SLEEVE, TRANSMISSION HUB, NO.3	33395-60010
				MTPT-00043	GEAR, TRANSFER IDLER	36221-60080
				MTPT-00046	HUB, TRANSFER CLUTCH	36237-60020
				MTPT-00049	SLEEVE, TRANSFER HIGH & LOW CLUTCH	36235-60020
				MTPT-00050	GEAR SUB-ASSY,TRANSFER,LOW SPEED	36204-60110
				MTPT-00123	SHAFT, OUTPUT	33321-60072
				MTPT-00142	PIPE, OIL RECEIVER	33124-36010
				MTPT-00148	KEY, SYNCHROMESH SHIFTING, NO.2	33366-36020
				MTPT-00185	FLANGE, COMPANION (FOR TRANSFER OUTPUT SHAFT)	33309-60060
				MTPT-00187	NUT (FOR MANUAL TRANSMISSION OUTPUT SHAFT REAR SET)	90179-22005
				MTPT-00189	WASHER, PLATE (FOR TRANSFER OUTPUT SHAFT)	90201-22005
				MTPT-00191	FLANGE, COMPANION (FOR TRANSFER OUTPUT SHAFT)	33309-60041
				MTPT-00193	BEARING,RADIAL BALL	90363-35012
	93.05-01.06	FZJ70,75	1FZF,1FZFE	MTPT-00063	RING, SYNCHRONIZER, NO.3	33369-60010
				MTPT-00107	FORK, GEAR SHIFT, NO.2	33213-60060
				MTPT-00158	WASHER, REVERSE IDLER THRUST	33462-60020
				MTPT-00159	WASHER, REVERSE IDLER THRUST, No.2	33464-60010
				MTPT-00160	SEAT SUB-ASSY, SHIFT LEVER	33505-60011
				MTPT-00166	SLEEVE, TRANSFER HIGH & LOW CLUTCH	36235-60040
				MTPT-00173	PIN, STRAIGHT (FOR OIL PUMP DRIVE ROTOR)	90250-04056
				MTPT-00175	RING, O, NO.2 (FOR MANUAL TRANSMISSION OIL PUMP COVER)	90301-91001
				MTPT-00225	GEAR, 5TH	33036-60010
				MTPT-00236	BEARING, INPUT SHAFT	90361-08004
				MTPT-00349	BEARING, NEEDLE ROLLER (FOR 3RD GEAR)	90364-38017
	93.05-04.03	FZJ73,75	1FZF,1FZFE	MTPT-00159	WASHER, REVERSE IDLER THRUST, No.2	33464-60010
				MTPT-00166	SLEEVE, TRANSFER HIGH & LOW CLUTCH	36235-60040
	93.05-04.05	FZJ73,75	1FZF,1FZFE	MTPT-00063	RING, SYNCHRONIZER, NO.3	33369-60010
				MTPT-00107	FORK, GEAR SHIFT, NO.2	33213-60060
				MTPT-00158	WASHER, REVERSE IDLER THRUST	33462-60020
				MTPT-00225	GEAR, 5TH	33036-60010
				MTPT-00236	BEARING, INPUT SHAFT	90361-08004
				MTPT-00349	BEARING, NEEDLE ROLLER (FOR 3RD GEAR)	90364-38017
		FZJ75	1FZF,1FZFE	MTPT-00160	SEAT SUB-ASSY, SHIFT LEVER	33505-60011
	95.01-98.01	FZJ80,HDJ80	1FZF,1FZFE,1HDFT,1HDT	MTPT-00162	SHAFT, TRANSFER INPUT	36211-60040
	96.08-98.01	FZJ7# FZJ80,HDJ80	1FZF,1FZFE 1FZF,1FZFE,1HDFT,1HDT	MTPT-00055	RING, SYNCHRONIZER, NO.1	33038-60020
				MTPT-00053	RING SET, SYNCHRONIZER, NO.1	33037-60030
				MTPT-00057	RING SET, SYNCHRONIZER, NO.3	33039-60020
		FZJ80,HDJ80,HZJ80	1FZF,1FZFE,1HDFT,1HDT,1HZ	MTPT-00055	RING SET, SYNCHRONIZER, NO.2	33038-60020
	96.08-99.08	FZJ70,73	1FZF,1FZFE	MTPT-00104	RING SET, SYNCHRONIZER, NO.2	33038-37012
	96.08-01.06	FZJ70,75	1FZF,1FZFE	MTPT-00106	FORK, GEAR SHIFT, NO.1	33212-60050
	96.08-04.05	FZJ73,75	1FZF,1FZFE	MTPT-00106	FORK, GEAR SHIFT, NO.1	33212-60050
	97.06-04.05	FZJ73,75	1FZF,1FZFE	MTPT-00339	HUB, TRANSMISSION CLUTCH, NO.3	33393-37010

Reference List / Manual Transmission(Parts)

Model	Year	Body Type	Engine Type	AISIN No.	Productin Name	Genuine No.	
LAND CRUISER	97.06-	FZJ80,HDJ80,HZJ80	1FZF,1FZFE,1HDFT,1HDT,1HZ	MTPT-00339	HUB, TRANSMISSION CLUTCH, NO.3	33393-37010	
	97.11-00.07	HZJ70,75	1HZ	MTPT-00170	NUT (FOR DRIVE PINION COMPANION FLANGE REAR)	90179-22016	
	97.11-01.06	FZJ70,75	1FZF,1FZFE	MTPT-00170	NUT (FOR DRIVE PINION COMPANION FLANGE REAR)	90179-22016	
	97.11-04.05	FZJ73,75	1FZF,1FZFE	MTPT-00170	NUT (FOR DRIVE PINION COMPANION FLANGE REAR)	90179-22016	
	97.11-06.09	FZJ80,HDJ80,HZJ80	1FZF,1FZFE,1HDFT,1HDT,1HZ	MTPT-00170	NUT (FOR REAR DRIVE PINION)	90179-22016	
	98.01-	FZJ80,HDJ80 FZJ80,HDJ80,HZJ80		1FZF,1FZFE,1HDFT,1HDT 1FZF,1FZFE,1HDT,1HZ	MTPT-00222	SHAFT, INPUT	33301-60060
					MTPT-00105	RING SET, REVERSE SYNCHRONIZER	33049-60010
					MTPT-00213	SLEEVE, TRANSMISSION HUB, NO.3	33395-60040
					MTPT-00223	SHAFT, OUTPUT	33321-60140
					MTPT-00343	BEARING (FOR OUTPUT SHAFT REAR)	90363-45019
	MTPT-00345	FORK, REVERSE SHIFT	33215-37021				
	98.01-99.01	HZJ80	1HZ	MTPT-00339	HUB, TRANSMISSION CLUTCH, NO.3	33393-37010	
	98.01-99.08	FZJ70,73	1FZF,1FZFE	MTPT-00061	RING, SYNCHRONIZER, NO.2	33368-60022	
		FZJ75,7#	1FZF,1FZFE	MTPT-00103 MTPT-00222	RING, SYNCHRONIZER, NO.1 SHAFT, INPUT	33367-60023 33301-60060	
	98.01-01.06	FZJ70,75		1FZF,1FZFE	MTPT-00061	RING, SYNCHRONIZER, NO.2	33368-60022
					MTPT-00213	SLEEVE, TRANSMISSION HUB, NO.3	33395-60040
					MTPT-00222	SHAFT, INPUT	33301-60060
					MTPT-00223	SHAFT, OUTPUT	33321-60140
					MTPT-00343	BEARING (FOR OUTPUT SHAFT REAR)	90363-45019
	MTPT-00345	FORK, REVERSE SHIFT	33215-37021				
	98.01-04.03	FZJ73,75	1FZF,1FZFE	MTPT-00061	RING, SYNCHRONIZER, NO.2	33368-60022	
	98.01-04.05	FZJ70,73,75 FZJ73 FZJ73,75		1FZF,1FZFE 1FZF,1FZFE 1FZF,1FZFE	MTPT-00105	RING SET, REVERSE SYNCHRONIZER	33049-60010
					MTPT-00160	SEAT SUB-ASSY, SHIFT LEVER	33505-60011
					MTPT-00173	PIN, STRAIGHT (FOR OIL PUMP DRIVE ROTOR)	90250-04056
		MTPT-00175	RING, O, NO.2 (FOR MANUAL TRANSMISSION OIL PUMP COVER)	90301-91001			
		MTPT-00213	SLEEVE, TRANSMISSION HUB, NO.3	33395-60040			
		MTPT-00223	SHAFT, OUTPUT	33321-60140			
		MTPT-00343	BEARING (FOR OUTPUT SHAFT REAR)	90363-45019			
MTPT-00345		FORK, REVERSE SHIFT	33215-37021				
MTPT-00101		GEAR, 1ST	33335-60170				
MTPT-00222		SHAFT, INPUT	33301-60060				
98.03-04.05	FZJ70,73,75,7#	1FZF,1FZFE	MTPT-00108	FORK, GEAR SHIFT, NO.3	33230-60011		
98.09-99.10	FZJ70,73,75	1FZF,1FZFE	MTPT-00323	RING SET, SYNCHRONIZER, NO.2	33038-37011		
98.09-03.04	FZJ80,HDJ80	1FZF,1FZFE,1HDT	MTPT-00338	RING SET, SYNCHRONIZER, NO.1	33037-37021		
	FZJ80,HDJ80,HZJ80	1FZF,1FZFE,1HDT,1HZ	MTPT-00323	RING SET, SYNCHRONIZER, NO.2	33038-37011		
99.04-	FZJ80,HDJ80	1FZF,1FZFE,1HDT	MTPT-00209	HUB, TRANSMISSION CLUTCH, NO.1	33361-37040		
99.05-99.08	FZJ70,73,75	1FZF,1FZFE,1HDT	MTPT-00061	RING, SYNCHRONIZER, NO.2	33368-60022		
99.05-	FZJ80,HDJ80,HZJ80	1FZF,1FZFE,1HZ	MTPT-00061	RING, SYNCHRONIZER, NO.2	33368-60022		
99.08-99.10	FZJ71,74,78,79		1FZFE	MTPT-00106	FORK, GEAR SHIFT, NO.1	33212-60050	
				MTPT-00108	FORK, GEAR SHIFT, NO.3	33230-60011	
				MTPT-00222	SHAFT, INPUT	33301-60060	
				MTPT-00345	FORK, REVERSE SHIFT	33215-37021	

Reference List / Manual Transmission(Parts)

Model	Year	Body Type	Engine Type	AISIN No.	Productin Name	Genuine No.	
LAND CRUISER	99.08-00.07	HZJ70,75	1HZ	MTPT-00183	NUT (FOR TRANSFER INPUT SHAFT)	90179-26002	
	99.08-02.02	FZJ71,74,78,79,HDJ7#,HZJ71,78,79	1FZFE,1HDFTE,1HZ	MTPT-00170	NUT (FOR DRIVE PINION COMPANION FLANGE REAR)	90179-22016	
	99.08-03.04	FZJ71,74,78,79,HDJ7#	1FZFE,1HDFTE	MTPT-00323	RING SET, SYNCHRONIZER, NO.2	33038-37011	
	99.08-03.08	HZJ71,78,79	1HZ	MTPT-00184	SHAFT, TRANSFER INPUT	36211-60021	
	99.08-06.05	FZJ78,79		1FZFE	MTPT-00101	GEAR, 1ST	33335-60170
					MTPT-00162	SHAFT, TRANSFER INPUT	36211-60040
					MTPT-00163	GEAR, TRANSFER INPUT	36212-60100
					MTPT-00345	FORK, REVERSE SHIFT	33215-37021
	99.08-06.12	HZJ71,78,79		1HZ	MTPT-00050	GEAR SUB-ASSY,TRANSFER,LOW SPEED	36204-60110
					MTPT-00193	BEARING,RADIAL BALL	90363-35012
	99.08-07.01	FZJ71,74,78,79,HDJ78,79		1FZFE,1HDFTE	MTPT-00061	RING, SYNCHRONIZER, NO.2	33368-60022
					MTPT-00063	RING, SYNCHRONIZER, NO.3	33369-60010
					MTPT-00106	FORK, GEAR SHIFT, NO.1	33212-60050
					MTPT-00107	FORK, GEAR SHIFT, NO.2	33213-60060
					MTPT-00108	FORK, GEAR SHIFT, NO.3	33230-60011
					MTPT-00158	WASHER, REVERSE IDLER THRUST	33462-60020
					MTPT-00159	WASHER, REVERSE IDLER THRUST, No.2	33464-60010
					MTPT-00160	SEAT SUB-ASSY, SHIFT LEVER	33505-60011
					MTPT-00166	SLEEVE, TRANSFER HIGH & LOW CLUTCH	36235-60040
					MTPT-00173	PIN, STRAIGHT (FOR OIL PUMP DRIVE ROTOR)	90250-04056
					MTPT-00175	RING, O, NO.2 (FOR MANUAL TRANSMISSION OIL PUMP COVER)	90301-91001
					MTPT-00213	SLEEVE, TRANSMISSION HUB, NO.3	33395-60040
					MTPT-00222	SHAFT, INPUT	33301-60060
					MTPT-00223	SHAFT, OUTPUT	33321-60140
					MTPT-00225	GEAR, 5TH	33036-60010
					MTPT-00236	BEARING, INPUT SHAFT	90361-08004
					MTPT-00339	HUB, TRANSMISSION CLUTCH, NO.3	33393-37010
					MTPT-00343	BEARING (FOR OUTPUT SHAFT REAR)	90363-45019
					MTPT-00349	BEARING, NEEDLE ROLLER (FOR 3RD GEAR)	90364-38017
	99.08-08.08	FZJ71,74,78,79,HDJ7# FZJ71,78,79		1FZFE,1HDFTE 1FZFE	MTPT-00101	GEAR, 1ST	33335-60170
					MTPT-00162	SHAFT, TRANSFER INPUT	36211-60040
					MTPT-00163	GEAR, TRANSFER INPUT	36212-60100
	99.08-08.08	FZJ71,74,78,79,HDJ7# FZJ71,78,79		1FZFE,1HDFTE 1FZFE	MTPT-00105	RING SET, REVERSE SYNCHRONIZER	33049-60010
MTPT-00061					RING, SYNCHRONIZER, NO.2	33368-60022	
MTPT-00063					RING, SYNCHRONIZER, NO.3	33369-60010	
MTPT-00106					FORK, GEAR SHIFT, NO.1	33212-60050	
MTPT-00107					FORK, GEAR SHIFT, NO.2	33213-60060	
MTPT-00108					FORK, GEAR SHIFT, NO.3	33230-60011	
MTPT-00158					WASHER, REVERSE IDLER THRUST	33462-60020	
MTPT-00159					WASHER, REVERSE IDLER THRUST, No.2	33464-60010	
MTPT-00160					SEAT SUB-ASSY, SHIFT LEVER	33505-60011	
MTPT-00166					SLEEVE, TRANSFER HIGH & LOW CLUTCH	36235-60040	
MTPT-00173					PIN, STRAIGHT (FOR OIL PUMP DRIVE ROTOR)	90250-04056	
MTPT-00175					RING, O, NO.2 (FOR MANUAL TRANSMISSION OIL PUMP COVER)	90301-91001	

Reference List / Manual Transmission(Parts)

Model	Year	Body Type	Engine Type	AISIN No.	Productin Name	Genuine No.
LAND CRUISER				MTPT-00213	SLEEVE, TRANSMISSION HUB, NO.3	33395-60040
				MTPT-00222	SHAFT, INPUT	33301-60060
				MTPT-00223	SHAFT, OUTPUT	33321-60140
				MTPT-00225	GEAR, 5TH	33036-60010
				MTPT-00236	BEARING, INPUT SHAFT	90361-08004
				MTPT-00339	HUB, TRANSMISSION CLUTCH, NO.3	33393-37010
				MTPT-00343	BEARING (FOR OUTPUT SHAFT REAR)	90363-45019
				MTPT-00345	FORK, REVERSE SHIFT	33215-37021
				MTPT-00349	BEARING, NEEDLE ROLLER (FOR 3RD GEAR)	90364-38017
		FZJ78,79	1FZFE	MTPT-00101	GEAR, 1ST	33335-60170
	99.08-	HZJ71,78,79	1HZ	MTPT-00008	RING SET, SYNCHRONIZER, NO.1	33037-60040
				MTPT-00010	RING, SYNCHRONIZER, NO.2	33368-35030
				MTPT-00012	FORK, GEAR SHIFT, NO.1	33212-35032
				MTPT-00045	SHAFT, TRANSFER OUTPUT, FRONT	36234-60040
				MTPT-00046	HUB, TRANSFER CLUTCH	36237-60020
				MTPT-00048	SHAFT, TRANSFER OUTPUT, REAR	36231-60021
				MTPT-00049	SLEEVE, TRANSFER HIGH & LOW CLUTCH	36235-60020
				MTPT-00051	FORK, TRANSFER GEAR SHIFT, NO.2	36312-60030
				MTPT-00068	GEAR, 2ND	33033-60050
				MTPT-00069	GEAR, 3RD	33034-60030
				MTPT-00071	RING SET, SYNCHRONIZER, NO.1	33037-60050
				MTPT-00073	RETAINER, BEARING, FRONT (MTM)	33131-60080
				MTPT-00074	SHAFT, INPUT	33301-35090 (33301-60120)
				MTPT-00075	PIECE, GEAR SPLINE, NO.5	33318-35040
				MTPT-00080	SLEEVE, TRANSMISSION HUB, NO.2	33364-35050
				MTPT-00084	RING, SYNCHRONIZER, NO.2	33368-35040
				MTPT-00087	SLEEVE, TRANSMISSION HUB, NO.3	33395-35031
				MTPT-00091	GEAR, TRANSFER IDLER	36221-60090
				MTPT-00111	FORK, GEAR SHIFT, NO.2	33213-35040
				MTPT-00127	ADAPTER, TRANSFER	36107-60040
				MTPT-00143	RETAINER, OUTPUT SHAFT REAR BEARING (MTM)	33151-35020
				MTPT-00147	KEY, SYNCHROMESH SHIFTING, NO.2	33366-35030
				MTPT-00165	SHAFT, TRANSFER IDLER GEAR	36225-60050
				MTPT-00167	BOOT, TRANSFER FRONT DRIVE SHIFT	36318-60020
				MTPT-00174	PIN (FOR 5TH GEAR THRUST WASHER)	90250-05026
					PIN OR BALL (FOR 1ST GEAR THRUST WASHER)	90250-05026
				MTPT-00176	SPRING, COMPRESSION	90501-07104
				MTPT-00177	GEAR, TRANSFER INPUT	36212-60081
				MTPT-00178	GEAR, POWER TAKE-OFF DRIVE	36215-60030
				MTPT-00179	SPACER, TRANSFER INPUT SHAFT	36251-60030
				MTPT-00180	RING, O (FOR TRANSFER INPUT GEAR)	90301-34005
				MTPT-00181	BEARING (FOR TRANSFER OUTPUTFRONT SHAFT)	90363-35013
					BEARING, RADIAL BALL (FOR TRANSFER INPUT SHAFT REAR)	90363-35013

Reference List / Manual Transmission(Parts)

Model	Year	Body Type	Engine Type	AISIN No.	Productin Name	Genuine No.				
LAND CRUISER				MTPT-00182	BEARING, RADIAL BALL (FOR TRANSFER INPUT SHAFT FRONT)	90363-35020				
				MTPT-00185	FLANGE, COMPANION (FOR TRANSFER OUTPUT SHAFT)	33309-60060				
				MTPT-00186	BOLT (FOR TRANSFER CASE & ADAPTER SETTING)	90119-12234				
				MTPT-00187	NUT (FOR MANUAL TRANSMISSION OUTPUT SHAFT REAR SET)	90179-22005				
				MTPT-00188	NUT (FOR TRANSFER INPUT SHAFT)	90179-26004				
				MTPT-00189	WASHER, PLATE (FOR TRANSFER OUTPUT SHAFT)	90201-22005				
				MTPT-00190	BOLT (FOR TRANSFER CASE & ADAPTER SETTING)	91651-61040				
				MTPT-00191	FLANGE, COMPANION (FOR TRANSFER OUTPUT SHAFT)	33309-60041				
				MTPT-00256	RETAINER SUB-ASSY, CONTROL SHIFT LEVER (FOR FLOOR SHIFT)	33506-35110				
				MTPT-00313	WASHER, 1ST GEAR THRUST	33348-35010				
				MTPT-00317	BEARING, INPUT SHAFT	90364-25012				
				99.09-00.07	HZJ70,75		1HZ	MTPT-00033	SLEEVE, TRANSMISSION HUB, NO.2	33364-36071
								MTPT-00036	RING SUB-ASSY, SYNCHRONIZER,NO.1	33306-60010
								MTPT-00042	PIECE, GEAR SPLINE, NO.5	33318-60010
								MTPT-00045	SHAFT, TRANSFER OUTPUT, FRONT	36234-60040
MTPT-00048	SHAFT, TRANSFER OUTPUT, REAR	36231-60021								
MTPT-00051	FORK, TRANSFER GEAR SHIFT, NO.2	36312-60030								
MTPT-00109	FORK, 3RD & 4TH SHIFT	33213-60051								
MTPT-00110	FORK, 5TH SHIFT	33214-60021								
MTPT-00155	KEY, SYNCHROMESH SHIFTING (FOR NO.3 CLUTCH HUB)	33394-36011								
MTPT-00165	SHAFT, TRANSFER IDLER GEAR	36225-60050								
MTPT-00167	BOOT, TRANSFER FRONT DRIVE SHIFT	36318-60020								
MTPT-00178	GEAR, POWER TAKE-OFF DRIVE	36215-60030								
MTPT-00179	SPACER, TRANSFER INPUT SHAFT	36251-60030								
MTPT-00180	RING, O (FOR TRANSFER INPUT GEAR)	90301-34005								
MTPT-00181	BEARING (FOR TRANSFER OUTPUTFRONT SHAFT)	90363-35013								
					BEARING, RADIAL BALL (FOR TRANSFER INPUT SHAFT REAR)	90363-35013				
99.09-01.06	FZJ70,75		1FZF,1FZFE	MTPT-00339	HUB, TRANSMISSION CLUTCH, NO.3	33393-37010				
99.10-04.03	FZJ73,75		1FZF,1FZFE	MTPT-00104	RING SET, SYNCHRONIZER, NO.2	33038-37012				
99.10-04.05	FZJ73,75		1FZF,1FZFE	MTPT-00103	RING, SYNCHRONIZER, NO.1	33367-60023				
03.03-	FZJ80		1FZFE	MTPT-00210	SLEEVE, TRANSMISSION HUB, NO.1	33363-60052				
03.04-07.01	FZJ71,74,78,79,HDJ78,79		1FZFE,1HDFTE	MTPT-00103	RING, SYNCHRONIZER, NO.1	33367-60023				
				MTPT-00104	RING SET, SYNCHRONIZER, NO.2	33038-37012				
03.04-08.08	FZJ71,78,79		1FZFE	MTPT-00103	RING, SYNCHRONIZER, NO.1	33367-60023				
				MTPT-00104	RING SET, SYNCHRONIZER, NO.2	33038-37012				
03.04-	FZJ80		1FZFE	MTPT-00104	RING SET, SYNCHRONIZER, NO.2	33038-37012				
				MTPT-00136	RING SET, SYNCHRONIZER, NO.1	33037-37022				
03.08-	HZJ7#		1HZ	MTPT-00030	SHAFT, TRANSFER INPUT	36211-60090				
04.08-	HZJ7#		1HZ	MTPT-00146	KEY, SYNCHROMESH SHIFTING, NO.1	33365-35060				
07.01-09.05	FZJ7#,VDJ7#		1FZFE,1VDFTV	MTPT-00061	RING, SYNCHRONIZER, NO.2	33368-60022				
07.01-09.07	FZJ7#		1FZFE	MTPT-00222	SHAFT, INPUT	33301-60060				

Reference List / Manual Transmission(Parts)

Model	Year	Body Type	Engine Type	AISIN No.	Productin Name	Genuine No.
LAND CRUISER	07.01-10.05	HZJ7#	1HZ	MTPT-00075	PIECE, GEAR SPLINE, NO.5	33318-35040
				MTPT-00087	SLEEVE, TRANSMISSION HUB, NO.3	33395-35031
				MTPT-00176	SPRING, COMPRESSION	90501-07104
	07.01-11.09	FZJ7#,GRJ7#,VDJ7#	1FZFE,1GRFE,1VDFTV	MTPT-00104	RING SET, SYNCHRONIZER, NO.2	33038-37012
				MTPT-00105	RING SET, REVERSE SYNCHRONIZER	33049-60010
	07.01-12.04	HZJ7#	1HZ	MTPT-00010	RING, SYNCHRONIZER, NO.2	33368-35030
				MTPT-00080	SLEEVE, TRANSMISSION HUB, NO.2	33364-35050
				MTPT-00084	RING, SYNCHRONIZER, NO.2	33368-35040
				MTPT-00147	KEY, SYNCHROMESH SHIFTING, NO.2	33366-35030
	07.01-14.04	HZJ7#	1HZ	MTPT-00074	SHAFT, INPUT	33301-35090 (33301-60120)
	07.01-	FZJ7#,GRJ7#,VDJ7#	1FZFE,1GRFE,1VDFTV	MTPT-00063	RING, SYNCHRONIZER, NO.3	33369-60010
				MTPT-00103	RING, SYNCHRONIZER, NO.1	33367-60023
				MTPT-00106	FORK, GEAR SHIFT, NO.1	33212-60050
				MTPT-00107	FORK, GEAR SHIFT, NO.2	33213-60060
				MTPT-00108	FORK, GEAR SHIFT, NO.3	33230-60011
				MTPT-00158	WASHER, REVERSE IDLER THRUST	33462-60020
				MTPT-00159	WASHER, REVERSE IDLER THRUST, No.2	33464-60010
				MTPT-00160	SEAT SUB-ASSY, SHIFT LEVER	33505-60011
				MTPT-00166	SLEEVE, TRANSFER HIGH & LOW CLUTCH	36235-60040
				MTPT-00173	PIN, STRAIGHT (FOR OIL PUMP DRIVE ROTOR)	90250-04056
				MTPT-00175	RING, O, NO.2 (FOR MANUAL TRANSMISSION OIL PUMP COVER)	90301-91001
				MTPT-00213	SLEEVE, TRANSMISSION HUB, NO.3	33395-60040
				MTPT-00223	SHAFT, OUTPUT	33321-60140
				MTPT-00225	GEAR, 5TH	33036-60010
				MTPT-00236	BEARING, INPUT SHAFT	90361-08004
				MTPT-00339	HUB, TRANSMISSION CLUTCH, NO.3	33393-37010
				MTPT-00343	BEARING (FOR OUTPUT SHAFT REAR)	90363-45019
MTPT-00345	FORK, REVERSE SHIFT	33215-37021				
MTPT-00349	BEARING, NEEDLE ROLLER (FOR 3RD GEAR)	90364-38017				
	FZJ78,79,GRJ7#,VDJ7#	1FZFE,1GRFE,1VDFTV	MTPT-00101	GEAR, 1ST	33335-60170	
	VDJ7#	1VDFTV	MTPT-00230	SHAFT, INPUT	33301-60080	
07.09-09.01	VDJ200	1VDFTV	MTPT-00104	RING SET, SYNCHRONIZER, NO.2	33038-37012	
07.09-09.05	GRJ200,VDJ200	1GRFE,1VDFTV	MTPT-00061	RING, SYNCHRONIZER, NO.2	33368-60022	
07.09-	GRJ200,VDJ200	1GRFE,1VDFTV	MTPT-00063	RING, SYNCHRONIZER, NO.3	33369-60010	
			MTPT-00136	RING SET, SYNCHRONIZER, NO.1	33037-37022	
			MTPT-00158	WASHER, REVERSE IDLER THRUST	33462-60020	
			MTPT-00159	WASHER, REVERSE IDLER THRUST, No.2	33464-60010	
			MTPT-00160	SEAT SUB-ASSY, SHIFT LEVER	33505-60011	
			MTPT-00173	PIN, STRAIGHT (FOR OIL PUMP DRIVE ROTOR)	90250-04056	
			MTPT-00175	RING, O, NO.2 (FOR MANUAL TRANSMISSION OIL PUMP COVER)	90301-91001	
			MTPT-00209	HUB, TRANSMISSION CLUTCH, NO.1	33361-37040	
			MTPT-00210	SLEEVE, TRANSMISSION HUB, NO.1	33363-60052	
			MTPT-00213	SLEEVE, TRANSMISSION HUB, NO.3	33395-60040	
			MTPT-00236	BEARING, INPUT SHAFT	90361-08004	
MTPT-00339	HUB, TRANSMISSION CLUTCH, NO.3	33393-37010				

Reference List / Manual Transmission(Parts)

Model	Year	Body Type	Engine Type	AISIN No.	Productin Name	Genuine No.
LAND CRUISER				MTPT-00343	BEARING (FOR OUTPUT SHAFT REAR)	90363-45019
				MTPT-00345	FORK, REVERSE SHIFT	33215-37021
				MTPT-00349	BEARING, NEEDLE ROLLER (FOR 3RD GEAR)	90364-38017
	07.12-	HZJ7#	1HZ	MTPT-00044	WASHER, TRANSFER IDLER GEAR SIDE THRUST	36222-60021
				MTPT-00047	GEAR SUB-ASSY, TRANSFER HIGH SPEED OUTPUT	36203-60051
				MTPT-00145	WASHER, 5TH GEAR THRUST	33346-71010
	09.01-11.09	VDJ200	1VDFTV	MTPT-00104	RING SET, SYNCHRONIZER, NO.2	33038-37012
	10.05-12.01	HZJ7#	1HZ	MTPT-00153	SPRING, SYNCHROMESH SHIFTING KEY, NO.3	33392-60020
				MTPT-00154	SPRING, SYNCHROMESH SHIFTING KEY, NO.3	33392-60030
	10.05-13.05	HZJ7#	1HZ	MTPT-00007	GEAR, COUNTERSHAFT 5TH	33428-60040 (33428-60041)
	10.05-	HZJ7#	1HZ	MTPT-00076	PIECE, GEAR SPLINE, NO.5	33318-60030
				MTPT-00086	RING, SYNCHRONIZER, OUTER NO.3	33384-60090
				MTPT-00157	KEY, SYNCHROMESH SHIFTING, NO.3	33394-60020
	11.06-	HZJ7#	1HZ	MTPT-00003	GEAR, 1ST	33032-60111
	12.03-	HZJ7#	1HZ	MTPT-00144	GEAR, REVERSE	33331-60041
	12.04-14.03	HZJ7#	1HZ	MTPT-00079	HUB, TRANSMISSION CLUTCH, NO.2	33362-60030 (33362-60031)
	12.04-	HZJ7#	1HZ	MTPT-00009	RING, SYNCHRONIZER, NO.2	33368-35050
			MTPT-00078	HUB, TRANSMISSION CLUTCH, NO.1	33361-71020	
			MTPT-00081	SLEEVE, TRANSMISSION HUB, NO.2	33364-60070	
			MTPT-00151	RING, SYNCHRONIZER, NO.2	33368-35070	
			MTPT-00315	KEY, SYNCHROMESH SHIFTING, NO.2	33366-35050	
12.08-	HZJ7#	1HZ	MTPT-00193	BEARING,RADIAL BALL	90363-35012	
13.05-14.04	HZJ7#	1HZ	MTPT-00005	GEAR, COUNTER	33421-71011 (33421-26110)	
13.12-	GRJ7#,VDJ7#	1GRFE,1VDFTV	MTPT-00102	GEAR, COUNTER	33421-60122	
	HZJ7#	1HZ	MTPT-00002	SHAFT, OUTPUT	33321-35141	
14.04-	HZJ7#	1HZ	MTPT-00006	GEAR, 5TH	33336-26020	
			MTPT-00007	GEAR, COUNTERSHAFT 5TH	33428-26020	
LAND CRUISER 100	98.01-02.08	FZJ10#,HDJ100,UZJ100	1FZFE,1HDT,2UZFE	MTPT-00160	SEAT SUB-ASSY, SHIFT LEVER	33505-60011
		FZJ100,105,HDJ100,HZJ105,UZJ100	1FZFE,1HDT,1HZ,2UZFE	MTPT-00166	SLEEVE, TRANSFER HIGH & LOW CLUTCH	36235-60040
				MTPT-00170	NUT (FOR DRIVE PINION COMPANION FLANGE REAR)	90179-22016
	98.01-	FZJ10#,HDJ100	1FZFE,1HZ	MTPT-00222	SHAFT, INPUT	33301-60060
		FZJ10#,HDJ100,UZJ100	1FZE,1HDT,2UZFE	MTPT-00063	RING, SYNCHRONIZER, NO.3	33369-60010
				MTPT-00105	RING SET, REVERSE SYNCHRONIZER	33049-60010
				MTPT-00158	WASHER, REVERSE IDLER THRUST	33462-60020
				MTPT-00159	WASHER, REVERSE IDLER THRUST, No.2	33464-60010
				MTPT-00173	PIN, STRAIGHT (FOR OIL PUMP DRIVE ROTOR)	90250-04056
				MTPT-00175	RING, O, NO.2 (FOR MANUAL TRANSMISSION OIL PUMP COVER)	90301-91001
				MTPT-00213	SLEEVE, TRANSMISSION HUB, NO.3	33395-60040
				MTPT-00223	SHAFT, OUTPUT	33321-60140
				MTPT-00236	BEARING, INPUT SHAFT	90361-08004
				MTPT-00339	HUB, TRANSMISSION CLUTCH, NO.3	33393-37010
				MTPT-00343	BEARING (FOR OUTPUT SHAFT REAR)	90363-45019
				MTPT-00345	FORK, REVERSE SHIFT	33215-37021

Reference List / Manual Transmission(Parts)

Model	Year	Body Type	Engine Type	AISIN No.	Productin Name	Genuine No.
LAND CRUISER 100		HZJ105	1HZ	MTPT-00349	BEARING, NEEDLE ROLLER (FOR 3RD GEAR)	90364-38017
				MTPT-00008	RING SET, SYNCHRONIZER, NO.1	33037-60040
				MTPT-00070	GEAR, 3RD	33034-60060
				MTPT-00071	RING SET, SYNCHRONIZER, NO.1	33037-60050
				MTPT-00072	RING SET, SYNCHRONIZER, NO.2	33038-60030
				MTPT-00073	RETAINER, BEARING, FRONT (MTM)	33131-60080
				MTPT-00074	SHAFT, INPUT	33301-35090 (33301-60120)
				MTPT-00075	PIECE, GEAR SPLINE, NO.5	33318-35040
				MTPT-00077	SHAFT,OUTPUT	33321-60131
				MTPT-00079	HUB, TRANSMISSION CLUTCH, NO.2	33362-60030 (33362-60031)
				MTPT-00081	SLEEVE, TRANSMISSION HUB, NO.2	33364-60070
				MTPT-00085	RING, SYNCHRONIZER, NO.2	33368-60100
				MTPT-00087	SLEEVE, TRANSMISSION HUB, NO.3	33395-35031
				MTPT-00090	GEAR,COUNTER SHAFT,5TH	33428-60031
				MTPT-00143	RETAINER, OUTPUT SHAFT REAR BEARING (MTM)	33151-35020
				MTPT-00174	PIN (FOR 5TH GEAR THRUST WASHER)	90250-05026
					PIN OR BALL (FOR 1ST GEAR THRUST WASHER)	90250-05026
		SPRING, COMPRESSION	90501-07104			
		WASHER, 1ST GEAR THRUST	33348-35010			
	98.09-03.04	FZJ10#,HDJ100,UZJ100	1FZFE,1HDT,2UZFE	MTPT-00323	RING SET, SYNCHRONIZER, NO.2	33038-37011
				MTPT-00338	RING SET, SYNCHRONIZER, NO.1	33037-37021
	99.04-	FZJ10#,HDJ100,UZJ100	1FZFE,1HDT,1HDFTE,2UZFE	MTPT-00209	HUB, TRANSMISSION CLUTCH, NO.1	33361-37040
	99.05-	FZJ10#,HDJ100,UZJ100	1FZFE,1HDT,1HDFTE,2UZFE	MTPT-00061	RING, SYNCHRONIZER, NO.2	33368-60022
	02.08-05.05	FZJ10#,HDJ100,HZJ105,UZJ100	1FZFE,1HDFTE,1HZ,2UZFE	MTPT-00166	SLEEVE, TRANSFER HIGH & LOW CLUTCH	36235-60040
		FZJ10#,HDJ100,UZJ100	1FZFE,1HDFTE,2UZFE	MTPT-00160	SEAT SUB-ASSY, SHIFT LEVER	33505-60011
				MTPT-00209	HUB, TRANSMISSION CLUTCH, NO.1	33361-37040
	03.03-05.05	FZJ10#,HDJ100,UZJ100	1FZFE,1HDFTE,2UZFE	MTPT-00210	SLEEVE, TRANSMISSION HUB, NO.1	33363-60052
03.04-05.05	FZJ10#,HDJ100,UZJ100	1FZFE,1HDFTE,2UZFE	MTPT-00104	RING SET, SYNCHRONIZER, NO.2	33038-37012	
			MTPT-00136	RING SET, SYNCHRONIZER, NO.1	33037-37022	
03.09-05.06	FZJ100	1FZFE	MTPT-00160	SEAT SUB-ASSY, SHIFT LEVER	33505-60011	
			MTPT-00166	SLEEVE, TRANSFER HIGH & LOW CLUTCH	36235-60040	
			MTPT-00222	SHAFT, INPUT	33301-60060	
04.08-	HZJ105	1HZ	MTPT-00146	KEY, SYNCHROMESH SHIFTING, NO.1	33365-35060	
05.06-	FZJ100,UZJ100	1FZFE,2UZFE	MTPT-00104	RING SET, SYNCHRONIZER, NO.2	33038-37012	
			MTPT-00136	RING SET, SYNCHRONIZER, NO.1	33037-37022	
			MTPT-00210	SLEEVE, TRANSMISSION HUB, NO.1	33363-60052	
07.12-	HZJ105	1HZ	MTPT-00145	WASHER, 5TH GEAR THRUST	33346-71010	
LAND CRUISER 90	96.04-99.06	KZJ9#	1KZT	MTPT-00001	SHAFT, INPUT	33301-60050 (33301-26050)
				MTPT-00090	GEAR,COUNTER SHAFT,5TH	33428-60031
	96.04-99.10	KZJ9#,VZJ9#	1KZT,5VZFE	MTPT-00010	RING, SYNCHRONIZER, NO.2	33368-35030
				MTPT-00075	PIECE, GEAR SPLINE, NO.5	33318-35040
				MTPT-00080	SLEEVE, TRANSMISSION HUB, NO.2	33364-35050
				MTPT-00083	RING, SYNCHRONIZER, NO.1	33367-35080
			MTPT-00084	RING, SYNCHRONIZER, NO.2	33368-35040	

Reference List / Manual Transmission(Parts)

Model	Year	Body Type	Engine Type	AISIN No.	Productin Name	Genuine No.
LAND CRUISER 90		VZJ9#	5VZFE	MTPT-00087	SLEEVE, TRANSMISSION HUB, NO.3	33395-35031
				MTPT-00143	RETAINER, OUTPUT SHAFT REAR BEARING (MTM)	33151-35020
				MTPT-00147	KEY, SYNCHROMESH SHIFTING, NO.2	33366-35030
				MTPT-00174	PIN (FOR 5TH GEAR THRUST WASHER)	90250-05026
					PIN OR BALL (FOR 1ST GEAR THRUST WASHER)	90250-05026
				MTPT-00313	WASHER, 1ST GEAR THRUST	33348-35010
				MTPT-00074	SHAFT, INPUT	33301-35090 (33301-60120)
	96.04-02.09	KZJ9#,LJ9#,RZJ90,95,9#,VZJ9#	1KZT,1KZTE,3L,3RZF,3RZFE,5VZFE	MTPT-00028	RING, SYNCHRONIZER (FOR TRANSFER FRONT DRIVE CLUTCH)	33367-14010
				MTPT-00170	NUT (FOR TRANSFER OUTPUT SHAFT)	90179-22016
		KZJ9#,RZJ90,95,9#,VZJ9#	1KZT,1KZTE,3L,3RZF,3RZFE,5VZFE	MTPT-00176	SPRING, COMPRESSION	90501-07104
		RZJ90,95,9#	3RZF,3RZFE	MTPT-00140	RING SET, SYNCHRONIZER, NO.1	33037-30011
				MTPT-00150	RING, SYNCHRONIZER, NO.2	33368-30120
	96.10-02.09	RZJ90,95,9#	3RZF,3RZFE	MTPT-00141	RING SET, SYNCHRONIZER, NO.2	33038-30012
	98.01-99.10	KZJ9#,VZJ9#	1KZT,1KZTE,5VZFE	MTPT-00008	RING SET, SYNCHRONIZER, NO.1	33037-60040
	99.06-00.08	KZJ9#	1KZT,1KZTE	MTPT-00001	SHAFT, INPUT	33301-60050 (33301-26050)
				MTPT-00010	RING, SYNCHRONIZER, NO.2	33368-35030
				MTPT-00080	SLEEVE, TRANSMISSION HUB, NO.2	33364-35050
				MTPT-00084	RING, SYNCHRONIZER, NO.2	33368-35040
				MTPT-00087	SLEEVE, TRANSMISSION HUB, NO.3	33395-35031
				MTPT-00090	GEAR,COUNTER SHAFT,5TH	33428-60031
				MTPT-00143	RETAINER, OUTPUT SHAFT REAR BEARING (MTM)	33151-35020
		KZJ9#,VZJ9#	1KZT,1KZTE,5VZFE	MTPT-00008	RING SET, SYNCHRONIZER, NO.1	33037-60040
				MTPT-00083	RING, SYNCHRONIZER, NO.1	33367-35080
	99.06-02.08	LJ9#	3L	MTPT-00142	PIPE, OIL RECEIVER (FOR TRANSFER)	33124-36010
	99.06-02.09	KZJ95	1KZT,1KZTE	MTPT-00001	SHAFT, INPUT	33301-60050 (33301-26050)
				MTPT-00008	RING SET, SYNCHRONIZER, NO.1	33037-60040
		KZJ95,VZJ9#	1KZT,1KZTE,5VZFE	MTPT-00087	SLEEVE, TRANSMISSION HUB, NO.3	33395-35031
			MTPT-00143	RETAINER, OUTPUT SHAFT REAR BEARING (MTM)	33151-35020	
	KZJ95,VZJ90,95	1KZT,1KZTE,5VZFE	MTPT-00010	RING, SYNCHRONIZER, NO.2	33368-35030	
			MTPT-00080	SLEEVE, TRANSMISSION HUB, NO.2	33364-35050	
			MTPT-00084	RING, SYNCHRONIZER, NO.2	33368-35040	
	LJ9#	3L	MTPT-00015	SHAFT, INPUT	33301-35080	
			MTPT-00020	RING, SYNCHRONIZER, NO.1	33368-20012	
			MTPT-00095	HUB, TRANSMISSION CLUTCH, NO.2	33362-35040	
			MTPT-00097	SHAFT, OUTPUT	33321-60090	
			MTPT-00100	SLEEVE, TRANSMISSION HUB, NO.2	33364-26020	
			MTPT-00112	WASHER, 5TH GEAR THRUST	33349-35010	
			MTPT-00142	PIPE, OIL RECEIVER (FOR TRANSFER)	33124-36010	
			MTPT-00333	KEY, SYNCHROMESH SHIFTING, NO.2	33366-35040 (33366-35041)	
			MTPT-00334	SPRING, SYNCHROMESH SHIFTING KEY, NO.1	33371-14031	
99.06-	KZJ9#,LJ9#,RZJ9#,VZJ9#	1KZT,1KZTE,3L,3RZF,3RZFE,5VZFE	MTPT-00028	RING, SYNCHRONIZER (FOR TRANSFER FRONT DRIVE CLUTCH)	33367-14010	

Reference List / Manual Transmission(Parts)

Model	Year	Body Type	Engine Type	AISIN No.	Productin Name	Genuine No.
LAND CRUISER 90		KZJ9#,RZJ9#,VZJ9# KZJ9#,VZJ9#	1KZT,1KZTE,3RZF,3RZFE,5VZFE 1KZT,1KZTE,5VZFE	MTPT-00170	NUT (FOR TRANSFER OUTPUT SHAFT)	90179-22016
				MTPT-00176	SPRING, COMPRESSION	90501-07104
				MTPT-00075	PIECE, GEAR SPLINE, NO.5	33318-35040
				MTPT-00174	PIN (FOR 5TH GEAR THRUST WASHER)	90250-05026
					PIN OR BALL (FOR 1ST GEAR THRUST WASHER)	90250-05026
			WASHER, 1ST GEAR THRUST	33348-35010		
			KEY, SYNCHROMESH SHIFTING, NO.2	33366-35030		
			RING SET, SYNCHRONIZER, NO.1	33037-30011		
			RING SET, SYNCHRONIZER, NO.2	33038-30012		
			RING, SYNCHRONIZER, NO.2	33368-30120		
		RING, SYNCHRONIZER, NO.2	33368-35030			
		SLEEVE, TRANSMISSION HUB, NO.2	33364-35050			
		RING, SYNCHRONIZER, NO.2	33368-35040			
		SLEEVE, TRANSMISSION HUB, NO.3	33395-35031			
		RETAINER, OUTPUT SHAFT REAR BEARING (MTM)	33151-35020			
		SHAFT, INPUT	33301-35090 (33301-60120)			
	00.01-02.09	KZJ95	1KZT,1KZTE	MTPT-00070	GEAR, 3RD	33034-60060
				MTPT-00072	RING SET, SYNCHRONIZER, NO.2	33038-60030
				MTPT-00079	HUB, TRANSMISSION CLUTCH, NO.2	33362-60030 (33362-60031)
				MTPT-00081	SLEEVE, TRANSMISSION HUB, NO.2	33364-60070
			MTPT-00085	RING, SYNCHRONIZER, NO.2	33368-60100	
00.01-	KZJ95	1KZT,1KZTE	MTPT-00071	RING SET, SYNCHRONIZER, NO.1	33037-60050	
00.08-	VZJ95	5VZFE	MTPT-00008	RING SET, SYNCHRONIZER, NO.1	33037-60040	
			MTPT-00066	GEAR SUB-ASSY,1ST	33032-60121	
			MTPT-00071	RING SET, SYNCHRONIZER, NO.1	33037-60050	
			MTPT-00090	GEAR,COUNTER SHAFT,5TH	33428-60031	
01.07-	RZJ9#	3RZFE	MTPT-00149	RING, SYNCHRONIZER, NO.1	33367-53030	
03.07-	RZJ9#	3RZFE	MTPT-00022	SHAFT, INPUT	33301-30081 (33301-30082)	
04.09-	VZJ95	5VZFE	MTPT-00146	KEY, SYNCHROMESH SHIFTING, NO.1	33365-35060	
07.12-	VZJ95	5VZFE	MTPT-00145	WASHER, 5TH GEAR THRUST	33346-71010	
LAND CRUISER PRADO	02.09-03.12	LJ12#	5LE	MTPT-00333	KEY, SYNCHROMESH SHIFTING, NO.2	33366-35040 (33366-35041)
	02.09-04.08	GRJ120	1GRFE	MTPT-00086	RING, SYNCHRONIZER, OUTER NO.3	33384-60090
				MTPT-00157	KEY, SYNCHROMESH SHIFTING, NO.3	33394-60020
		RZJ12#	3RZFE	MTPT-00028	RING, SYNCHRONIZER (FOR TRANSFER FRONT DRIVE CLUTCH)	33367-14010
				MTPT-00140	RING SET, SYNCHRONIZER, NO.1	33037-30011
				MTPT-00141	RING SET, SYNCHRONIZER, NO.2	33038-30012
				MTPT-00149	RING, SYNCHRONIZER, NO.1	33367-53030
				MTPT-00150	RING, SYNCHRONIZER, NO.2	33368-30120
				MTPT-00176	SPRING, COMPRESSION	90501-07104
	02.09-09.08	KZJ120	1KZTE	MTPT-00066	GEAR SUB-ASSY,1ST	33032-60121
			MTPT-00089	GEAR,COUNTER	33421-60201	
02.09-	GRJ12#,KDJ120,KZJ120,LJ12#,RZJ12#,TRJ12#	1GRFE,1KDFTV,1KZTE,5LE,3RZFE,2TRFE	MTPT-00170	NUT (FOR TRANSFER OUTPUT SHAFT)	90179-22016	
	GRJ120,KZJ120	1GRFE,1KZTE	MTPT-00008	RING SET, SYNCHRONIZER, NO.1	33037-60040	

Reference List / Manual Transmission(Parts)

Model	Year	Body Type	Engine Type	AISIN No.	Productin Name	Genuine No.		
LAND CRUISER PRADO		GRJ120,KZJ120,TRJ12#	1GRFE,1KZTE,2TRFE	MTPT-00010	RING, SYNCHRONIZER, NO.2	33368-35030		
				MTPT-00071	RING SET, SYNCHRONIZER, NO.1	33037-60050		
				MTPT-00080	SLEEVE, TRANSMISSION HUB, NO.2	33364-35050		
				MTPT-00084	RING, SYNCHRONIZER, NO.2	33368-35040		
				MTPT-00147	KEY, SYNCHROMESH SHIFTING, NO.2	33366-35030		
				MTPT-00076	PIECE, GEAR SPLINE, NO.5	33318-60030		
				MTPT-00143	RETAINER, OUTPUT SHAFT REAR BEARING (MTM)	33151-35020		
				MTPT-00153	SPRING, SYNCHROMESH SHIFTING KEY, NO.3	33392-60020		
				MTPT-00154	SPRING, SYNCHROMESH SHIFTING KEY, NO.3	33392-60030		
		MTPT-00174	PIN OR BALL (FOR 1ST GEAR THRUST WASHER)	90250-05026				
		KZJ120	1KZTE	MTPT-00086	RING, SYNCHRONIZER, OUTER NO.3	33384-60090		
				MTPT-00157	KEY, SYNCHROMESH SHIFTING, NO.3	33394-60020		
				MTPT-00313	WASHER, 1ST GEAR THRUST	33348-35010		
		KZJ120,TRJ12#	1KZTE,2TRFE	MTPT-00001	SHAFT, INPUT	33301-60050 (33301-26050)		
				MTPT-00015	SHAFT, INPUT	33301-35080		
		LJ12#	5LE	MTPT-00020	RING, SYNCHRONIZER, NO.1	33368-20012		
				MTPT-00028	RING, SYNCHRONIZER (FOR TRANSFER FRONT DRIVE CLUTCH)	33367-14010		
					RING, SYNCHRONIZER, NO.2	33367-14010		
					RING, SYNCHRONIZER, NO.3	33367-14010		
				MTPT-00095	HUB, TRANSMISSION CLUTCH, NO.2	33362-35040		
				MTPT-00097	SHAFT, OUTPUT	33321-60090		
	MTPT-00100			SLEEVE, TRANSMISSION HUB, NO.2	33364-26020			
	MTPT-00112			WASHER, 5TH GEAR THRUST	33349-35010			
	MTPT-00142			PIPE, OIL RECEIVER (FOR TRANSFER)	33124-36010			
	MTPT-00334			SPRING, SYNCHROMESH SHIFTING KEY, NO.1	33371-14031			
	03.01-04.08			GRJ120	1GRFE	MTPT-00073	RETAINER, BEARING, FRONT (MTM)	33131-60080
						MTPT-00074	SHAFT, INPUT	33301-35090 (33301-60120)
	03.07-04.08	RZJ12#	3RZFE	MTPT-00022	SHAFT, INPUT	33301-30081 (33301-30082)		
	04.08-	GRJ120 KZJ120,TRJ12# TRJ12#	1GRFE	MTPT-00173	PIN OR BALL (FOR 1ST GEAR THRUST WASHER)	90250-04056		
				MTPT-00146	KEY, SYNCHROMESH SHIFTING, NO.1	33365-35060		
				MTPT-00008	RING SET, SYNCHRONIZER, NO.1	33037-60040		
				MTPT-00009	RING, SYNCHRONIZER, NO.2	33368-35050		
				MTPT-00081	SLEEVE, TRANSMISSION HUB, NO.2	33364-60070		
MTPT-00083				RING, SYNCHRONIZER, NO.1	33367-35080			
1KZTE,2TRFE 2TRFE			MTPT-00086	RING, SYNCHRONIZER, OUTER NO.3	33384-60090			
			MTPT-00151	RING, SYNCHRONIZER, NO.2	33368-35070			
			MTPT-00157	KEY, SYNCHROMESH SHIFTING, NO.3	33394-60020			
			MTPT-00174	PIN (FOR 5TH GEAR THRUST WASHER)	90250-05026			
			MTPT-00313	WASHER, 1ST GEAR THRUST	33348-35010			
			MTPT-00315	KEY, SYNCHROMESH SHIFTING, NO.2	33366-35050			
06.08-	KDJ120	1KDFTV	MTPT-00173	PIN OR BALL (FOR 1ST GEAR THRUST WASHER)	90250-04056			

Reference List / Manual Transmission(Parts)

Model	Year	Body Type	Engine Type	AISIN No.	Productin Name	Genuine No.	
LAND CRUISER PRADO	07.12-	KZJ120,TRJ12#	1KZTE,2TRFE	MTPT-00145	WASHER, 5TH GEAR THRUST	33346-71010	
	09.08-11.10	KDJ150	1KDFTV	MTPT-00173	PIN OR BALL (FOR 1ST GEAR THRUST WASHER)	90250-04056	
	09.08-12.01	TRJ150	2TRFE	MTPT-00153 MTPT-00154	SPRING, SYNCHROMESH SHIFTING KEY, NO.3 SPRING, SYNCHROMESH SHIFTING KEY, NO.3	33392-60020 33392-60030	
	09.08-	GRJ150,KDJ150	GRJ150,KDJ150,LJ150,TRJ150,155	1GRFE,1KDFTV	MTPT-00173	PIN OR BALL (FOR 1ST GEAR THRUST WASHER)	90250-04056
					MTPT-00170	NUT (FOR TRANSFER OUTPUT SHAFT)	90179-22016
		LJ150	LJ150	5LE	MTPT-00015	SHAFT, INPUT	33301-35080
					MTPT-00020	RING, SYNCHRONIZER, NO.1	33368-20012
					MTPT-00028	RING, SYNCHRONIZER, NO.2	33367-14010
						RING, SYNCHRONIZER, NO.3	33367-14010
					MTPT-00095	HUB, TRANSMISSION CLUTCH, NO.2	33362-35040
					MTPT-00097	SHAFT, OUTPUT	33321-60090
					MTPT-00100	SLEEVE, TRANSMISSION HUB, NO.2	33364-26020
					MTPT-00112	WASHER, 5TH GEAR THRUST	33349-35010
					MTPT-00142	PIPE, OIL RECEIVER (FOR TRANSFER)	33124-36010
					MTPT-00334	SPRING, SYNCHROMESH SHIFTING KEY, NO.1	33371-14031
					MTPT-00001	SHAFT, INPUT	33301-60050 (33301-26050)
		MTPT-00008	RING SET, SYNCHRONIZER, NO.1	33037-60040			
		MTPT-00009	RING, SYNCHRONIZER, NO.2	33368-35050			
		MTPT-00076	PIECE, GEAR SPLINE, NO.5	33318-60030			
		MTPT-00079	HUB, TRANSMISSION CLUTCH, NO.2	33362-60030 (33362-60031)			
		MTPT-00081	SLEEVE, TRANSMISSION HUB, NO.2	33364-60070			
		MTPT-00083	RING, SYNCHRONIZER, NO.1	33367-35080			
		MTPT-00086	RING, SYNCHRONIZER, OUTER NO.3	33384-60090			
		MTPT-00143	RETAINER, OUTPUT SHAFT REAR BEARING (MTM)	33151-35020			
		MTPT-00145	WASHER, 5TH GEAR THRUST	33346-71010			
		MTPT-00146	KEY, SYNCHROMESH SHIFTING, NO.1	33365-35060			
	MTPT-00151	RING, SYNCHRONIZER, NO.2	33368-35070				
	MTPT-00157	KEY, SYNCHROMESH SHIFTING, NO.3	33394-60020				
	MTPT-00174	PIN (FOR 5TH GEAR THRUST WASHER)	90250-05026				
		PIN OR BALL (FOR 1ST GEAR THRUST WASHER)	90250-05026				
	MTPT-00313	WASHER, 1ST GEAR THRUST	33348-35010				
	MTPT-00315	KEY, SYNCHROMESH SHIFTING, NO.2	33366-35050				
12.03-	TRJ150	2TRFE	MTPT-00144	GEAR, REVERSE	33331-60041		
13.08-14.04	TRJ150	2TRFE	MTPT-00079	HUB, TRANSMISSION CLUTCH, NO.2	33362-60030 (33362-60031)		
13.12-	TRJ150	2TRFE	MTPT-00002	SHAFT, OUTPUT	33321-35141		
15.03-	TRJ152	2TRFE	MTPT-00002	SHAFT, OUTPUT	33321-35141		
			MTPT-00076	PIECE, GEAR SPLINE, NO.5	33318-60030		
			MTPT-00081	SLEEVE, TRANSMISSION HUB, NO.2	33364-60070		
			MTPT-00083	RING, SYNCHRONIZER, NO.1	33367-35080		
			MTPT-00086	RING, SYNCHRONIZER, OUTER NO.3	33384-60090		
			MTPT-00143	RETAINER, OUTPUT SHAFT REAR BEARING (MTM)	33151-35020		
			MTPT-00144	GEAR, REVERSE	33331-60041		

Reference List / Manual Transmission(Parts)

Model	Year	Body Type	Engine Type	AISIN No.	Productin Name	Genuine No.
LAND CRUISER PRADO				MTPT-00145	WASHER, 5TH GEAR THRUST	33346-71010
				MTPT-00146	KEY, SYNCHROMESH SHIFTING, NO.1	33365-35060
				MTPT-00157	KEY, SYNCHROMESH SHIFTING, NO.3	33394-60020
				MTPT-00174	PIN (FOR 5TH GEAR THRUST WASHER)	90250-05026
					PIN OR BALL (FOR 1ST GEAR THRUST WASHER)	90250-05026
				MTPT-00313	WASHER, 1ST GEAR THRUST	33348-35010
				MTPT-00315	KEY, SYNCHROMESH SHIFTING, NO.2	33366-35050
LAND CRUISER(CHINA)	07.12-08.11	GRJ200	1GRFE	MTPT-00061	RING, SYNCHRONIZER, NO.2	33368-60022
				MTPT-00063	RING, SYNCHRONIZER, NO.3	33369-60010
				MTPT-00104	RING SET, SYNCHRONIZER, NO.2	33038-37012
				MTPT-00105	RING SET, REVERSE SYNCHRONIZER	33049-60010
				MTPT-00136	RING SET, SYNCHRONIZER, NO.1	33037-37022
				MTPT-00158	WASHER, REVERSE IDLER THRUST	33462-60020
				MTPT-00159	WASHER, REVERSE IDLER THRUST, No.2	33464-60010
				MTPT-00160	SEAT SUB-ASSY, SHIFT LEVER	33505-60011
				MTPT-00173	PIN, STRAIGHT (FOR OIL PUMP DRIVE ROTOR)	90250-04056
				MTPT-00175	RING, O, NO.2 (FOR MANUAL TRANSMISSION OIL PUMP COVER)	90301-91001
				MTPT-00209	HUB, TRANSMISSION CLUTCH, NO.1	33361-37040
				MTPT-00210	SLEEVE, TRANSMISSION HUB, NO.1	33363-60052
				MTPT-00213	SLEEVE, TRANSMISSION HUB, NO.3	33395-60040
				MTPT-00236	BEARING, INPUT SHAFT	90361-08004
				MTPT-00339	HUB, TRANSMISSION CLUTCH, NO.3	33393-37010
				MTPT-00343	BEARING (FOR OUTPUT SHAFT REAR)	90363-45019
				MTPT-00345	FORK, REVERSE SHIFT	33215-37021
MTPT-00349	BEARING, NEEDLE ROLLER (FOR 3RD GEAR)	90364-38017				
LEXUS GX400/ 460	09.11-	GRJ158,URJ150	1GRFE,1URFE	MTPT-00170	NUT (FOR TRANSFER OUTPUT SHAFT)	90179-22016
LEXUS IS200/ 300	99.01-05.07	GXE10	1GFE	MTPT-00174	PIN, STRAIGHT (FOR GEAR THRUST WASHER)	90250-05026
LEXUS IS250/ 350	05.09-12.08	GSE20	4GRFSE	MTPT-00130	BEARING (FOR OUTPUT SHAFT CENTER)	90364-33012
				MTPT-00201	BEARING, NEEDLE ROLLER (FOR 1ST GEAR)	90364-48002
				MTPT-00202	BEARING, NEEDLE ROLLER (FOR 2ND GEAR)	90364-54007
LEXUS IS250/ 350/ 2##D	05.09-12.08	ALE20,GSE20	2ADFHV,4GRFSE	MTPT-00173	PIN OR BALL (FOR 1ST GEAR THRUST WASHER)	90250-04056
	05.11-12.08	ALE20	2ADFHV	MTPT-00171	NUT (FOR MANUAL TRANSMISSION OUTPUT SHAFT REAR SET)	90179-22019
	08.12-12.08	ALE20	2ADFHV	MTPT-00135	BEARING,TAPERED ROLLER,NO.2	90366-35138
LEXUS IS250C/ 350C	09.04-12.08	GSE20	4GRFSE	MTPT-00130	BEARING (FOR OUTPUT SHAFT CENTER)	90364-33012
				MTPT-00201	BEARING, NEEDLE ROLLER (FOR 1ST GEAR)	90364-48002
				MTPT-00202	BEARING, NEEDLE ROLLER (FOR 2ND GEAR)	90364-54007
LEXUS LX470	98.01-02.08	UZJ100	2UZFE	MTPT-00170	NUT (FOR DRIVE PINION COMPANION FLANGE REAR)	90179-22016
	02.08-	UZJ100	2UZFE	MTPT-00166	SLEEVE, TRANSFER HIGH & LOW CLUTCH	36235-60040
LITEACE	82.10-85.08	CM20,YM2#	1C,1Y,2YC	MTPT-00020	RING, SYNCHRONIZER, NO.1	33368-20012

Reference List / Manual Transmission(Parts)

Model	Year	Body Type	Engine Type	AISIN No.	Productin Name	Genuine No.	
LITEACE				MTPT-00028	RING, SYNCHRONIZER, NO.2	33367-14010	
				MTPT-00142	PIPE, OIL RECEIVER (MTM)	33124-36010	
				MTPT-00334	SPRING, SYNCHROMESH SHIFTING KEY, NO.1	33371-14031	
	85.09-88.08	CM3#,YM3#	1C,2C,2Y,2YC	MTPT-00142	PIPE, OIL RECEIVER (MTM)	33124-36010	
		CM3#,YM3#,4#	1C,2C,2Y,2YC,3YC	MTPT-00328	SHAFT, OUTPUT	33321-26050	
				MTPT-00020	RING, SYNCHRONIZER, NO.1	33368-20012	
				MTPT-00028	RING, SYNCHRONIZER, NO.2	33367-14010	
				MTPT-00028	RING, SYNCHRONIZER, NO.3	33367-14010	
				MTPT-00334	SPRING, SYNCHROMESH SHIFTING KEY, NO.1	33371-14031	
				MTPT-00020	RING, SYNCHRONIZER, NO.1	33368-20012	
	88.08-98.04	CM36,KM30,36,YM3#	2C,5K,5KC,2Y,2YC	MTPT-00028	RING, SYNCHRONIZER, NO.2	33367-14010	
				MTPT-00095	HUB, TRANSMISSION CLUTCH, NO.2	33362-35040	
				MTPT-00112	WASHER, 4TH GEAR	33349-35010	
				MTPT-00142	PIPE, OIL RECEIVER, NO.1 (FOR EXTENSION HOUSING)	33124-36010	
				MTPT-00328	SHAFT, OUTPUT	33321-26050	
				MTPT-00333	KEY, SYNCHROMESH SHIFTING, NO.2	33366-35040 (33366-35041)	
				MTPT-00334	SPRING, SYNCHROMESH SHIFTING KEY, NO.1	33371-14031	
				92.09-93.11	KM36	5K	MTPT-00336
KM36,YM35	5K,2Y	MTPT-00098	GEAR, REVERSE		33331-28011 (33331-35061)		
92.09-98.04	CM36,KM36,YM3#	2C,5K,2Y	MTPT-00095	HUB, TRANSMISSION CLUTCH, NO.2	33362-35040		
	CM36,KM3#,YM3#	2C,5K,2Y	MTPT-00328	SHAFT, OUTPUT	33321-26050		
	CM36,KM36	2C,5K	MTPT-00100	SLEEVE, TRANSMISSION HUB, NO.2	33364-26020		
	CM36,KM36,YM31	2C,5K,2Y	MTPT-00336	SHAFT, INPUT	33301-35060 (33301-26030)		
LITEACE VAN WAGON	92.01-00.07	CR27,KR2#,YR2#,39	2C,5K,3Y,3YC,4YEC	MTPT-00020	RING, SYNCHRONIZER, NO.1	33368-20012	
				MTPT-00028	RING, SYNCHRONIZER, NO.2	33367-14010	
				MTPT-00095	HUB, TRANSMISSION CLUTCH, NO.2	33362-35040	
					MTPT-00112	WASHER, 4TH GEAR	33349-35010
					MTPT-00142	PIPE, OIL RECEIVER, NO.2 (FOR EXTENSION HOUSING)	33124-36010
					MTPT-00328	SHAFT, OUTPUT	33321-26050
					MTPT-00333	KEY, SYNCHROMESH SHIFTING, NO.2	33366-35040 (33366-35041)
					MTPT-00334	SPRING, SYNCHROMESH SHIFTING KEY, NO.1	33371-14031
					MTPT-00100	SLEEVE, TRANSMISSION HUB, NO.2	33364-26020
	92.09-00.07	CR27,KR2#,YR2#,39	2C,5K,3Y,3YC,4YEC	MTPT-00100	SLEEVE, TRANSMISSION HUB, NO.2	33364-26020	
	98.06-00.07	YR21	3Y	MTPT-00332	SHAFT, INPUT	33301-35071	
	MEGA CRUISER	96.10-98.01	BXD20	15BFT	MTPT-00163	GEAR, TRANSFER INPUT	36212-60100
96.10-		BXD20	15BFT	MTPT-00166	SLEEVE, TRANSFER HIGH & LOW CLUTCH	36235-60040	
MODEL-F	82.11-90.01	CR21,YR2#	2C,2Y,2YC,3Y,3YC	MTPT-00142	PIPE, OIL RECEIVER (MTM)	33124-36010	
		CR21,YR2#,31	2C,2Y,2YC,3Y,3YC,4YEC	MTPT-00020	RING, SYNCHRONIZER, NO.1	33368-20012	
					MTPT-00028	RING, SYNCHRONIZER, NO.2	33367-14010
					MTPT-00334	SPRING, SYNCHROMESH SHIFTING KEY, NO.1	33371-14031

Reference List / Manual Transmission(Parts)

Model	Year	Body Type	Engine Type	AISIN No.	Productin Name	Genuine No.
MODEL-F	84.01-90.01	CR21,YR2#	2C,2Y,3Y,3YC,4YEC	MTPT-00328	SHAFT, OUTPUT	33321-26050
	88.08-90.01	YR2#,31	3Y,3YC,4YEC	MTPT-00095	HUB, TRANSMISSION CLUTCH, NO.2	33362-35040
				MTPT-00112	WASHER, 4TH GEAR	33349-35010
				MTPT-00333	KEY, SYNCHROMESH SHIFTING, NO.2	33366-35040 (33366-35041)
MR2	84.11-89.12	AW11	4AGEL,4AGELC	MTPT-00168	NUT (FOR MANUAL TRANSMISSION OUTPUT SHAFT REAR SET)	90179-18005
	99.12-02.08	ZZW30	1ZZFE	MTPT-00168	NUT (FOR MANUAL TRANSMISSION OUTPUT SHAFT REAR SET)	90179-18005
	99.12-05.09	ZZW30	1ZZFE	MTPT-00228	BEARING (FOR OUTPUT SHAFT FRONT)	90365-33006
PASEO	91.04-95.08	EL44	5EFE	MTPT-00168	NUT (FOR MANUAL TRANSMISSION OUTPUT SHAFT REAR SET)	90179-18005
	95.08-	EL54	5EFE	MTPT-00168	NUT (FOR MANUAL TRANSMISSION OUTPUT SHAFT REAR SET)	90179-18005
PICNIC/AVENSIS VERSO	01.05-05.07	ACM20,CLM20	1AZFE,1CDFTV	MTPT-00115	SPRING, SYNCHROMESH SHIFTING KEY, NO.3	33392-12010
				MTPT-00116	SPRING, SYNCHROMESH SHIFTING KEY, NO.3	33392-12020
				MTPT-00117	HUB, TRANSMISSION CLUTCH, NO.3	33393-42010
				MTPT-00120	RING, SHAFT SNAP (FOR TRANSMISSION CLUTCH HUB NO.3)	90520-27067
				MTPT-00121	RING, SHAFT SNAP (FOR TRANSMISSION CLUTCH HUB NO.3)	90520-27069
	MTPT-00169	NUT (FOR MANUAL TRANSMISSION OUTPUT SHAFT REAR SET)	90179-20012			
05.04-05.07	CLM20	1CDFTV	MTPT-00122	RING SET, SYNCHRONIER, NO.5	33048-28010	
PREVIA	90.01-92.08	TCR20	2TZFE	MTPT-00093	GEAR, 1ST	33032-26020
				MTPT-00330	GEAR, COUNTER	33421-28040
	90.01-93.08	TCR10,20	2TZFE	MTPT-00138	GEAR, 5TH	33336-26010
	90.05-99.12	TCR1# TCR1#,2#	2TZFE 2TZFE	MTPT-00142	PIPE, OIL RECEIVER, NO.1 (FOR EXTENSION HOUSING)	33124-36010
				MTPT-00328	SHAFT, OUTPUT	33321-26050
				MTPT-00020	RING, SYNCHRONIZER, NO.1	33368-20012
				MTPT-00028	RING, SYNCHRONIZER, NO.2	33367-14010
					RING, SYNCHRONIZER, NO.3	33367-14010
				MTPT-00095	HUB, TRANSMISSION CLUTCH, NO.2	33362-35040
MTPT-00112				WASHER, 4TH GEAR	33349-35010	
MTPT-00333	KEY, SYNCHROMESH SHIFTING, NO.2	33366-35040 (33366-35041)				
			MTPT-00334	SPRING, SYNCHROMESH SHIFTING KEY, NO.1	33371-14031	
92.09-99.12	TCR1#,2#	2TZFE	MTPT-00100	SLEEVE, TRANSMISSION HUB, NO.2	33364-26020	
98.06-99.12	TCR1#,2#	2TZFE	MTPT-00332	SHAFT, INPUT	33301-35071	
PREVIA/TARAGO	00.02-	ACR30,CLR30	2AZFE,1CDFTV	MTPT-00115	SPRING, SYNCHROMESH SHIFTING KEY, NO.3	33392-12010
				MTPT-00116	SPRING, SYNCHROMESH SHIFTING KEY, NO.3	33392-12020
				MTPT-00117	HUB, TRANSMISSION CLUTCH, NO.3	33393-42010
				MTPT-00120	RING, SHAFT SNAP (FOR TRANSMISSION CLUTCH HUB NO.3)	90520-27067
				MTPT-00121	RING, SHAFT SNAP (FOR TRANSMISSION CLUTCH HUB NO.3)	90520-27069
				MTPT-00169	NUT (FOR MANUAL TRANSMISSION OUTPUT SHAFT REAR SET)	90179-20012
	05.03-06.01	ACR30 CLR30	2AZFE 2AZFE	MTPT-00122	RING SET, SYNCHRONIER, NO.5	33048-28010
				MTPT-00122	RING SET, SYNCHRONIER, NO.5	33048-28010
QUALIS	99.12-00.06	LF50	2L	MTPT-00015	SHAFT, INPUT	33301-35080
				MTPT-00095	HUB, TRANSMISSION CLUTCH, NO.2	33362-35040
				MTPT-00100	SLEEVE, TRANSMISSION HUB, NO.2	33364-26020

Reference List / Manual Transmission(Parts)

Model	Year	Body Type	Engine Type	AISIN No.	Productin Name	Genuine No.
QUALIS				MTPT-00337	SHAFT, OUTPUT	33321-35092
	99.12-03.12	LF50	2L	MTPT-00333	KEY, SYNCHROMESH SHIFTING, NO.2	33366-35040 (33366-35041)
	99.12-04.12	LF50,RZF50	2L,1RZE	MTPT-00020	RING, SYNCHRONIZER, NO.1	33368-20012
				MTPT-00028	RING, SYNCHRONIZER, NO.2	33367-14010
					RING, SYNCHRONIZER, NO.3	33367-14010
				MTPT-00112	WASHER, 5TH GEAR THRUST	33349-35010
			MTPT-00142	PIPE, OIL RECEIVER, NO.2 (FOR EXTENSION HOUSING)	33124-36010	
			MTPT-00334	SPRING, SYNCHROMESH SHIFTING KEY, NO.1	33371-14031	
	02.01-03.12	RZF50	1RZE	MTPT-00333	KEY, SYNCHROMESH SHIFTING, NO.2	33366-35040 (33366-35041)
RAV4	94.04-00.08	SXA1#	3SFE	MTPT-00115	SPRING, SYNCHROMESH SHIFTING KEY, NO.3	33392-12010
				MTPT-00116	SPRING, SYNCHROMESH SHIFTING KEY, NO.3	33392-12020
				MTPT-00120	RING, SHAFT SNAP (FOR TRANSMISSION CLUTCH HUB NO.3)	90520-27067
				MTPT-00121	RING, SHAFT SNAP (FOR TRANSMISSION CLUTCH HUB NO.3)	90520-27069
				MTPT-00169	NUT (FOR MANUAL TRANSMISSION OUTPUT SHAFT REAR SET)	90179-20012
	96.08-00.08	SXA1#	3SFE	MTPT-00122	RING SET, SYNCHRONIER, NO.5	33048-28010
	00.01-00.08	SXA1#	3SFE	MTPT-00119	BEARING, NEEDLE ROLLER (FOR 5TH GEAR)	90364-28023
	00.05-05.11	ACA2#,CLA2#	1AZFE,1CDFTV	MTPT-00115	SPRING, SYNCHROMESH SHIFTING KEY, NO.3	33392-12010
				MTPT-00116	SPRING, SYNCHROMESH SHIFTING KEY, NO.3	33392-12020
				MTPT-00120	RING, SHAFT SNAP (FOR TRANSMISSION CLUTCH HUB NO.3)	90520-27067
				MTPT-00121	RING, SHAFT SNAP (FOR TRANSMISSION CLUTCH HUB NO.3)	90520-27069
				MTPT-00169	NUT (FOR MANUAL TRANSMISSION OUTPUT SHAFT REAR SET)	90179-20012
		ZCA2#	1ZZFE	MTPT-00168	NUT (FOR MANUAL TRANSMISSION OUTPUT SHAFT REAR SET)	90179-18005
	00.08-05.11	ACA2#	1AZFE	MTPT-00119	BEARING, NEEDLE ROLLER (FOR 5TH GEAR)	90364-28023
	02.08-03.07	ACA21	1AZFE	MTPT-00113	GEAR, 5TH	33336-42030
	02.08-05.11	ACA2#,CLA2#	1AZFE,1CDFTV	MTPT-00117	HUB, TRANSMISSION CLUTCH, NO.3	33393-42010
	05.03-05.11	ACA20,21 ACA22,23	1AZFE	MTPT-00122	RING SET, SYNCHRONIER, NO.5	33048-28010
				MTPT-00117	HUB, TRANSMISSION CLUTCH, NO.3	33393-42010
		ACA23 ACA38 CLA2#	2AZFE	MTPT-00122	RING SET, SYNCHRONIER, NO.5	33048-28010
				MTPT-00114	GEAR, 5TH	33336-42040
MTPT-00113				GEAR, 5TH	33336-42030	
	1CDFTV	MTPT-00122	RING SET, SYNCHRONIER, NO.5	33048-28010		
05.11-12.12	ACA30,33,38	1AZFE,2AZFE	MTPT-00115	SPRING, SYNCHROMESH SHIFTING KEY, NO.3	33392-12010	
			MTPT-00116	SPRING, SYNCHROMESH SHIFTING KEY, NO.3	33392-12020	
			MTPT-00117	HUB, TRANSMISSION CLUTCH, NO.3	33393-42010	
			MTPT-00118	SLEEVE, TRANSMISSION HUB, NO.3	33395-42012	
			MTPT-00120	RING, SHAFT SNAP (FOR TRANSMISSION CLUTCH HUB NO.3)	90520-27067	
			MTPT-00121	RING, SHAFT SNAP (FOR TRANSMISSION CLUTCH HUB NO.3)	90520-27069	
			MTPT-00122	RING SET, SYNCHRONIER, NO.5	33048-28010	
			MTPT-00169	NUT (FOR MANUAL TRANSMISSION OUTPUT SHAFT REAR SET)	90179-20012	
RAV4 (CHINA)	09.03-	ACA3#	1AZFE,2AZFE	MTPT-00115	SPRING, SYNCHROMESH SHIFTING KEY, NO.3	33392-12010

Reference List / Manual Transmission(Parts)

Model	Year	Body Type	Engine Type	AISIN No.	Productin Name	Genuine No.
RAV4 (CHINA)				MTPT-00116	SPRING, SYNCHROMESH SHIFTING KEY, NO.3	33392-12020
				MTPT-00117	HUB, TRANSMISSION CLUTCH, NO.3	33393-42010
				MTPT-00118	SLEEVE, TRANSMISSION HUB, NO.3	33395-42012
				MTPT-00120	RING, SHAFT SNAP (FOR TRANSMISSION CLUTCH HUB NO.3)	90520-27067
				MTPT-00121	RING, SHAFT SNAP (FOR TRANSMISSION CLUTCH HUB NO.3)	90520-27069
				MTPT-00169	NUT (FOR MANUAL TRANSMISSION OUTPUT SHAFT REAR SET)	90179-20012
				MTPT-00122	RING SET, SYNCHRONIER, NO.5	33048-28010
		ACA33	2AZFE			
		ACA37	1AZFE	MTPT-00122	RING SET, SYNCHRONIER, NO.5	33048-28010
	11.08-13.07	ACA32	1AZFE	MTPT-00122	RING SET, SYNCHRONIER, NO.5	33048-28010
SOLUNA	96.12-03.07	AL50	5FE	MTPT-00168	NUT (FOR MANUAL TRANSMISSION OUTPUT SHAFT REAR SET)	90179-18005
STARLET	84.10-89.12	EP7#	1EL,2EL	MTPT-00168	NUT (FOR MANUAL TRANSMISSION OUTPUT SHAFT REAR SET)	90179-18005
	89.12-	EP8#	1E,2E	MTPT-00168	NUT (FOR MANUAL TRANSMISSION OUTPUT SHAFT REAR SET)	90179-18005
	96.01-	EP9#	2E,4EFE	MTPT-00168	NUT (FOR MANUAL TRANSMISSION OUTPUT SHAFT REAR SET)	90179-18005
STOUT	79.03-86.09	RK110	5R	MTPT-00020	RING, SYNCHRONIZER, NO.1	33368-20012
	86.09-00.02	YK110	4Y	MTPT-00143	RETAINER, OUTPUT SHAFT REAR BEARING (MTM)	33151-35020
				MTPT-00147	KEY, SYNCHROMESH SHIFTING, NO.2	33366-35030
				MTPT-00313	WASHER, 1ST GEAR THRUST	33348-35010
	88.04-93.08	YK110	4Y	MTPT-00082	RING, SYNCHRONIZER, NO.1	33367-35010
				MTPT-00187	NUT (FOR COUNTER GEAR SHAFT)	90179-22005
	92.03-00.02	YK110	4Y	MTPT-00170	NUT (FOR MANUAL TRANSMISSION OUTPUT SHAFT REAR SET)	90179-22016
	93.08-94.04	YK110	4Y	MTPT-00082	RING, SYNCHRONIZER, NO.1	33367-35010
	93.08-95.12	YK110	4Y	MTPT-00187	NUT (FOR COUNTER GEAR SHAFT)	90179-22005
	93.08-96.03	YK110	4Y	MTPT-00142	PIPE, OIL RECEIVER, NO.2 (FOR EXTENSION HOUSING)	33124-36010
94.03-00.02	YK110	4Y	MTPT-00010	RING, SYNCHRONIZER, NO.2	33368-35030	
			MTPT-00080	SLEEVE, TRANSMISSION HUB, NO.2	33364-35050	
			MTPT-00084	RING, SYNCHRONIZER, NO.2	33368-35040	
			MTPT-00083	RING, SYNCHRONIZER, NO.1	33367-35080	
SUPRA	86.01-91.10	MA70	7MGE,7MGTE	MTPT-00028	RING, SYNCHRONIZER, NO.3	33367-14010
	86.08-93.05	MA70	7MGE,7MGTE	MTPT-00111	FORK, 3RD & 4TH SHIFT	33213-35040
	87.01-93.05	MA70	7MGE,7MGTE	MTPT-00012	FORK, 1ST & 2ND SHIFT	33212-35032
				MTPT-00082	RING, SYNCHRONIZER, NO.1	33367-35010
				MTPT-00142	PIPE, OIL RECEIVER (MTM)	33124-36010
				MTPT-00143	RETAINER, OUTPUT SHAFT REAR BEARING (MTM)	33151-35020
				MTPT-00147	KEY, SYNCHROMESH SHIFTING, NO.2	33366-35030
				MTPT-00174	PIN OR BALL (FOR 1ST GEAR THRUST WASHER)	90250-05026
				MTPT-00187	NUT (FOR COUNTER GEAR SHAFT)	90179-22005
	MTPT-00313	WASHER, 1ST GEAR THRUST	33348-35010			
91.10-93.05	MA70	7MGE,7MGTE	MTPT-00025	GEAR, 5TH	33336-30030	
			MTPT-00026	GEAR, COUNTERSHAFT 5TH	33428-30040	
			MTPT-00150	RING, SYNCHRONIZER, NO.2	33368-30120	

Reference List / Manual Transmission(Parts)

Model	Year	Body Type	Engine Type	AISIN No.	Productin Name	Genuine No.	
SUPRA				MTPT-00176	SPRING, COMPRESSION	90501-07104	
	93.05-96.05	JZA80	2JZGE,2JZGTE	MTPT-00150 MTPT-00176	RING, SYNCHRONIZER, NO.2 SPRING, COMPRESSION	33368-30120 90501-07104	
	93.05-97.09	JZA80	2JZGE,2JZGTE	MTPT-00025 MTPT-00026	GEAR, 5TH GEAR, COUNTERSHAFT 5TH	33336-30030 33428-30040	
	94.03-96.05	JZA80	2JZGE,2JZGTE	MTPT-00140	RING SET, SYNCHRONIZER, NO.1	33037-30011	
	94.03-97.09	JZA80	2JZGE,2JZGTE	MTPT-00024	GEAR, 3RD	33034-30011	
T.U.V	96.12-03.06	KF60,7#,80,82,LF6#,7#,80,81,82,85, RZF71,80,81,85,YF60,80	7K,7KE,2L,5L,1RZE,2RZE,2Y	MTPT-00020 MTPT-00028 MTPT-00112 MTPT-00333 MTPT-00334 MTPT-00142 MTPT-00028	RING, SYNCHRONIZER, NO.1 RING, SYNCHRONIZER, NO.3 WASHER, 4TH GEAR KEY, SYNCHROMESH SHIFTING, NO.2 SPRING, SYNCHROMESH SHIFTING KEY, NO.1 PIPE, OIL RECEIVER, NO.2 (FOR EXTENSION HOUSING) RING, SYNCHRONIZER, NO.2	33368-20012 33367-14010 33349-35010 33366-35040 (33366-35041) 33371-14031 33124-36010 33367-14010	
	99.11-03.06	LF85,RZF85	5L,2RZE	MTPT-00097	SHAFT, OUTPUT	33321-60090	
	99.11-06.12	LF85,RZF85	5L,2RZE	MTPT-00028 MTPT-00142 MTPT-00170	RING, SYNCHRONIZER (FOR TRANSFER FRONT DRIVE CLUTCH) PIPE, OIL RECEIVER (FOR TRANSFER) NUT (FOR TRANSFER OUTPUT SHAFT)	33367-14010 33124-36010 90179-22016	
	00.10-03.06	LF61,81,85,RZF80,85,YF60,80	5L,2RZE,2Y	MTPT-00015 MTPT-00095 MTPT-00100 MTPT-00337	SHAFT, INPUT HUB, TRANSMISSION CLUTCH, NO.2 SLEEVE, TRANSMISSION HUB, NO.2 SHAFT, OUTPUT	33301-35080 33362-35040 33364-26020 33321-35092	
	02.08-03.09	KF60,7#,8#,LF60,80,82,RZF81,82,85	7K,7KE,2L,5L,1RZE,2RZE	MTPT-00333	KEY, SYNCHROMESH SHIFTING, NO.2	33366-35040 (33366-35041)	
	02.08-03.12	KF60,80,82,LF61,81,82,85,RZF61,80,81,85	7K,7KE,5L,2L,1RZE,2RZE	MTPT-00333	KEY, SYNCHROMESH SHIFTING, NO.2	33366-35040 (33366-35041)	
	02.08-06.07	KF60,80	7K,7KE	MTPT-00112	WASHER, 4TH GEAR	33349-35010	
	02.08-06.12	KF7#,80,82,LF6#,80,81,82,85, RZF61,80,81,82,85	7K,7KE,2L,5L,1RZE,2RZE	MTPT-00112	WASHER, 4TH GEAR	33349-35010	
	02.08-07.07	KF60,7#,80,82,LF60,61,80,81,82,85, RZF61,80,81,82,85	7K,7KE,2L,5L,1RZE,2RZE	MTPT-00020 MTPT-00028 MTPT-00334 MTPT-00142	RING, SYNCHRONIZER, NO.1 RING, SYNCHRONIZER, NO.2 RING, SYNCHRONIZER, NO.3 SPRING, SYNCHROMESH SHIFTING KEY, NO.1 PIPE, OIL RECEIVER, NO.2 (FOR EXTENSION HOUSING)	33368-20012 33367-14010 33367-14010 33371-14031 33124-36010	
	03.06-05.03	LF61,81,85,RZF61,80,81,85	5L,1RZE,2RZE	MTPT-00015 MTPT-00095 MTPT-00100 MTPT-00337	SHAFT, INPUT HUB, TRANSMISSION CLUTCH, NO.2 SLEEVE, TRANSMISSION HUB, NO.2 SHAFT, OUTPUT	33301-35080 33362-35040 33364-26020 33321-35092	
	03.06-06.12	LF85,RZF85	5L,2RZE	MTPT-00097	SHAFT, OUTPUT	33321-60090	
	T100	93.09-96.08	RCK10	3RZF	MTPT-00150 MTPT-00176	RING, SYNCHRONIZER, NO.2 SPRING, COMPRESSION	33368-30120 90501-07104
		93.10-95.08	RCK10	3RZF	MTPT-00025 MTPT-00026	GEAR, 5TH GEAR, COUNTERSHAFT 5TH	33336-30030 33428-30040
		94.03-96.08	RCK10	3RZF	MTPT-00140	RING SET, SYNCHRONIZER, NO.1	33037-30011
		94.03-98.07	RCK10	3RZF	MTPT-00024	GEAR, 3RD	33034-30011

Reference List / Manual Transmission(Parts)

Model	Year	Body Type	Engine Type	AISIN No.	Productin Name	Genuine No.
T100	94.03-	RCK10	3RZF	MTPT-00023	GEAR, 2ND	33033-28011
TERCEL	90.09-94.09	EL40	2E	MTPT-00168	NUT (FOR MANUAL TRANSMISSION OUTPUT SHAFT REAR SET)	90179-18005
	94.09-	EL5#	5EFE	MTPT-00168	NUT (FOR MANUAL TRANSMISSION OUTPUT SHAFT REAR SET)	90179-18005
TOWNACE/LITEACE	96.11-03.10	CR41,KR4#,SR40	2C,5K,3SFE	MTPT-00020	RING, SYNCHRONIZER, NO.2	33368-20012
				MTPT-00028	RING, SYNCHRONIZER, NO.1	33367-14010
					RING, SYNCHRONIZER, NO.3	33367-14010
				MTPT-00095	HUB, TRANSMISSION CLUTCH, NO.2	33362-35040
				MTPT-00100	SLEEVE, TRANSMISSION HUB, NO.2	33364-26020
				MTPT-00112	WASHER, 4TH GEAR	33349-35010
				MTPT-00142	PIPE, OIL RECEIVER, NO.1 (FOR EXTENSION HOUSING)	33124-36010
				MTPT-00333	KEY, SYNCHROMESH SHIFTING, NO.2	33366-35040 (33366-35041)
	MTPT-00334	SPRING, SYNCHROMESH SHIFTING KEY, NO.1	33371-14031			
	MTPT-00337	SHAFT, OUTPUT	33321-35092			
	98.06-01.11	SR40	3SFE	MTPT-00332	SHAFT, INPUT	33301-35071
	98.12-01.12	CR41	2C	MTPT-00098	GEAR, REVERSE	33331-28011 (33331-35061)
				MTPT-00336	SHAFT, INPUT	33301-35060 (33301-26030)
	98.12-03.10	KR42	7KE	MTPT-00015	SHAFT, INPUT	33301-35080
98.12-04.12	CR42	3CE	MTPT-00020	RING, SYNCHRONIZER, NO.2	33368-20012	
			MTPT-00028	RING, SYNCHRONIZER, NO.1	33367-14010	
				RING, SYNCHRONIZER, NO.3	33367-14010	
			MTPT-00095	HUB, TRANSMISSION CLUTCH, NO.2	33362-35040	
			MTPT-00098	GEAR, REVERSE	33331-28011 (33331-35061)	
			MTPT-00100	SLEEVE, TRANSMISSION HUB, NO.2	33364-26020	
			MTPT-00112	WASHER, 4TH GEAR	33349-35010	
			MTPT-00142	PIPE, OIL RECEIVER, NO.1 (FOR EXTENSION HOUSING)	33124-36010	
MTPT-00334	SPRING, SYNCHROMESH SHIFTING KEY, NO.1	33371-14031				
MTPT-00336	SHAFT, INPUT	33301-35060 (33301-26030)				
MTPT-00337	SHAFT, OUTPUT	33321-35092				
TOYOACE	72.07-79.02	JY16	2J	MTPT-00020	RING, SYNCHRONIZER, NO.2	33368-20012
				MTPT-00148	KEY, SYNCHROMESH SHIFTING, NO.2	33366-36020
	75.01-79.02	JY16	2J	MTPT-00032	HUB, TRANSMISSION CLUTCH, NO.2	33362-36021
	79.03-83.08	JY30	2J	MTPT-00020	RING, SYNCHRONIZER, NO.2	33368-20012
				MTPT-00032	HUB, TRANSMISSION CLUTCH, NO.2	33362-36021
	MTPT-00148	KEY, SYNCHROMESH SHIFTING, NO.2	33366-36020			
79.03-85.07	JY30,LY20,3# LY20,3#,RY20,3#	2J,L L,5R,12R	MTPT-00028	RING, SYNCHRONIZER, NO.3	33367-14010	
			MTPT-00020	RING, SYNCHRONIZER, NO.1	33368-20012	
MTPT-00028	RING, SYNCHRONIZER, NO.2	33367-14010				
79.06-83.08	JY30	2J	MTPT-00183	NUT (FOR COUNTER GEAR SHAFT)	90179-26002	
TOYOTA XA	03.08-	NCP61	1NZFE	MTPT-00168	NUT (FOR MANUAL TRANSMISSION OUTPUT SHAFT REAR SET)	90179-18005
VIOS	07.02-14.03	NCP93,NCP9#	1NZFE,2NZFE	MTPT-00168	NUT (FOR MANUAL TRANSMISSION OUTPUT SHAFT REAR SET)	90179-18005
VIOS/SOLUNA VIOS	02.12-07.09	NCP4#	1NZFE,2NZFE	MTPT-00168	NUT (FOR MANUAL TRANSMISSION OUTPUT SHAFT REAR SET)	90179-18005

Reference List / Manual Transmission(Parts)

Model	Year	Body Type	Engine Type	AISIN No.	Productin Name	Genuine No.
YARIS	05.08-	NCP9#	1NZFE,2NZFE	MTPT-00168	NUT (FOR MANUAL TRANSMISSION OUTPUT SHAFT REAR SET)	90179-18005
	08.11-	NCP91,93	1NZFE	MTPT-00029	GEAR, 5TH DRIVEN	33428-12110
				MTPT-00206	GEAR, 3RD	33034-12150
				MTPT-00207	GEAR, 5TH	33036-12130
			MTPT-00208	GEAR, 2ND	33332-12140	
	11.08-	NCP13#	1NZFE,2NZFE	MTPT-00168	NUT (FOR MANUAL TRANSMISSION OUTPUT SHAFT REAR SET)	90179-18005
	14.03-	NCP15#	1NZFE	MTPT-00168	NUT (FOR MANUAL TRANSMISSION OUTPUT SHAFT REAR SET)	90179-18005
YARIS (ASIA)	06.01-13.07	NCP91	1NZFE	MTPT-00168	NUT (FOR MANUAL TRANSMISSION OUTPUT SHAFT REAR SET)	90179-18005
YARIS/ECHO (3D,5D)	99.08-	NCP1#	1NZFE,2NZFE	MTPT-00168	NUT (FOR MANUAL TRANSMISSION OUTPUT SHAFT REAR SET)	90179-18005
YARIS/ECHO 4D	99.08-	NCP1#	1NZFE,2NZFE	MTPT-00168	NUT (FOR MANUAL TRANSMISSION OUTPUT SHAFT REAR SET)	90179-18005
YARIS/VIOS/LIMO	13.04-	NCP15#	1NZFE,2NZFE	MTPT-00168	NUT (FOR MANUAL TRANSMISSION OUTPUT SHAFT REAR SET)	90179-18005

Reference List / Genuine No. → AISIN No.

Genuine No.	AISIN No.	Make
33018-37010	MTPT-00232	TOYOTA
33032-26020	MTPT-00093	TOYOTA
33032-60051	MTPT-00065	TOYOTA
33032-60081	MTPT-00004	TOYOTA
33032-60111	MTPT-00003	TOYOTA
33032-60121	MTPT-00066	TOYOTA
33033-28011	MTPT-00023	TOYOTA
33033-35011	MTPT-00016	TOYOTA
33033-36090	MTPT-00214	TOYOTA
33033-37020	MTPT-00348	TOYOTA
33033-60040	MTPT-00067	TOYOTA
33033-60050	MTPT-00068	TOYOTA
33034-12150	MTPT-00206	TOYOTA
33034-30011	MTPT-00024	TOYOTA
33034-35100	MTPT-00094	TOYOTA
33034-36090	MTPT-00215	TOYOTA
33034-37040	MTPT-00233	TOYOTA
33034-60030	MTPT-00069	TOYOTA
33034-60060	MTPT-00070	TOYOTA
33036-12130	MTPT-00207	TOYOTA
33036-37010	MTPT-00216	TOYOTA
33036-37030	MTPT-00322	TOYOTA
33036-60010	MTPT-00225	TOYOTA
33037-30011	MTPT-00140	TOYOTA
33037-37010	MTPT-00197	TOYOTA
33037-37021	MTPT-00338	TOYOTA
33037-37022	MTPT-00136	TOYOTA
33037-60011	MTPT-00052	TOYOTA
33037-60030	MTPT-00053	TOYOTA
33037-60040	MTPT-00008	TOYOTA
33037-60050	MTPT-00071	TOYOTA
33038-30012	MTPT-00141	TOYOTA

Genuine No.	AISIN No.	Make
33038-37011	MTPT-00323	TOYOTA
33038-37012	MTPT-00104	TOYOTA
33038-60011	MTPT-00054	TOYOTA
33038-60020	MTPT-00055	TOYOTA
33038-60030	MTPT-00072	TOYOTA
33039-36010	MTPT-00219	TOYOTA
33039-37011	MTPT-00194	TOYOTA
33039-60011	MTPT-00056	TOYOTA
33039-60020	MTPT-00057	TOYOTA
33046-35062	MTPT-00019	TOYOTA
33048-28010	MTPT-00122	TOYOTA
33049-60010	MTPT-00105	TOYOTA
33124-36010	MTPT-00142	TOYOTA
33131-60080	MTPT-00073	TOYOTA
33147-37011	MTPT-00346	TOYOTA
33151-35020	MTPT-00143	TOYOTA
33212-25011	MTPT-00011	TOYOTA
33212-35023	MTPT-00099	TOYOTA
33212-35032	MTPT-00012	TOYOTA
33212-60050	MTPT-00106	TOYOTA
33213-25021	MTPT-00014	TOYOTA
33213-35034	MTPT-00021	TOYOTA
33213-35040	MTPT-00111	TOYOTA
33213-60051	MTPT-00109	TOYOTA
33213-60060	MTPT-00107	TOYOTA
33214-60021	MTPT-00110	TOYOTA
33215-37021	MTPT-00345	TOYOTA
33230-60011	MTPT-00108	TOYOTA
33301-30081 (33301-30082)	MTPT-00022	TOYOTA
33301-35060 (33301-26030)	MTPT-00336	TOYOTA
33301-35071	MTPT-00332	TOYOTA
33301-35080	MTPT-00015	TOYOTA

Genuine No.	AISIN No.	Make
33301-35090 (33301-60120)	MTPT-00074	TOYOTA
33301-37170	MTPT-00126	TOYOTA
33301-37190	MTPT-00195	TOYOTA
33301-60050 (33301-26050)	MTPT-00001	TOYOTA
33301-60060	MTPT-00222	TOYOTA
33301-60080	MTPT-00230	TOYOTA
33306-60010	MTPT-00036	TOYOTA
33309-60041	MTPT-00191	TOYOTA
33309-60060	MTPT-00185	TOYOTA
33311-60170	MTPT-00031	TOYOTA
33318-35040	MTPT-00075	TOYOTA
33318-60010	MTPT-00042	TOYOTA
33318-60030	MTPT-00076	TOYOTA
33321-26050	MTPT-00328	TOYOTA
33321-35092	MTPT-00337	TOYOTA
33321-35111	MTPT-00096	TOYOTA
33321-35141	MTPT-00002	TOYOTA
33321-35191	MTPT-00327	TOYOTA
33321-37070	MTPT-00196	TOYOTA
33321-60072	MTPT-00123	TOYOTA
33321-60090	MTPT-00097	TOYOTA
33321-60131	MTPT-00077	TOYOTA
33321-60140	MTPT-00223	TOYOTA
33327-37010	MTPT-00319	TOYOTA
33327-60010	MTPT-00224	TOYOTA
33331-28011 (33331-35061)	MTPT-00098	TOYOTA
33331-37060	MTPT-00321	TOYOTA
33331-60041	MTPT-00144	TOYOTA
33332-12140	MTPT-00208	TOYOTA
33332-60020	MTPT-00035	TOYOTA
33333-60030	MTPT-00034	TOYOTA
33335-37090	MTPT-00351	TOYOTA

Genuine No.	AISIN No.	Make
33335-60020	MTPT-00037	TOYOTA
33335-60170	MTPT-00101	TOYOTA
33336-26010	MTPT-00138	TOYOTA
33336-26020	MTPT-00006	TOYOTA
33336-28020	MTPT-00018	TOYOTA
33336-30030	MTPT-00025	TOYOTA
33336-42030	MTPT-00113	TOYOTA
33336-42040	MTPT-00114	TOYOTA
33336-60010	MTPT-00038	TOYOTA
33346-71010	MTPT-00145	TOYOTA
33348-35010	MTPT-00313	TOYOTA
33349-35010	MTPT-00112	TOYOTA
33352-37030	MTPT-00234	TOYOTA
33354-37010	MTPT-00320	TOYOTA
33361-37040	MTPT-00209	TOYOTA
33361-71020	MTPT-00078	TOYOTA
33362-35040	MTPT-00095	TOYOTA
33362-36021	MTPT-00032	TOYOTA
33362-37020	MTPT-00235	TOYOTA
33362-60030 (33362-60031)	MTPT-00079	TOYOTA
33363-37020	MTPT-00221	TOYOTA
33363-60052	MTPT-00210	TOYOTA
33364-26020	MTPT-00100	TOYOTA
33364-35050	MTPT-00080	TOYOTA
33364-36071	MTPT-00033	TOYOTA
33364-37021	MTPT-00318	TOYOTA
33364-60070	MTPT-00081	TOYOTA
33365-35060	MTPT-00146	TOYOTA
33366-35030	MTPT-00147	TOYOTA
33366-35040 (33366-35041)	MTPT-00333	TOYOTA
33366-35050	MTPT-00315	TOYOTA
33366-36020	MTPT-00148	TOYOTA

Genuine No.	AISIN No.	Make
33366-37030	MTPT-00341	TOYOTA
33367-14010	MTPT-00028	TOYOTA
33367-35010	MTPT-00082	TOYOTA
33367-35080	MTPT-00083	TOYOTA
33367-53030	MTPT-00149	TOYOTA
33367-60020	MTPT-00058	TOYOTA
33367-60023	MTPT-00103	TOYOTA
33367-60030	MTPT-00059	TOYOTA
33368-20012	MTPT-00020	TOYOTA
33368-30120	MTPT-00150	TOYOTA
33368-35030	MTPT-00010	TOYOTA
33368-35040	MTPT-00084	TOYOTA
33368-35050	MTPT-00009	TOYOTA
33368-35070	MTPT-00151	TOYOTA
33368-36042	MTPT-00231	TOYOTA
33368-36051	MTPT-00152	TOYOTA
33368-37040	MTPT-00198	TOYOTA
33368-60020	MTPT-00060	TOYOTA
33368-60022	MTPT-00061	TOYOTA
33368-60041	MTPT-00062	TOYOTA
33368-60100	MTPT-00085	TOYOTA
33369-36010	MTPT-00217	TOYOTA
33369-60010	MTPT-00063	TOYOTA
33371-14031	MTPT-00334	TOYOTA
33381-60010	MTPT-00064	TOYOTA
33384-60090	MTPT-00086	TOYOTA
33392-12010	MTPT-00115	TOYOTA
33392-12020	MTPT-00116	TOYOTA
33392-60020	MTPT-00153	TOYOTA
33392-60030	MTPT-00154	TOYOTA
33393-36060	MTPT-00212	TOYOTA
33393-37010	MTPT-00339	TOYOTA

Genuine No.	AISIN No.	Make
33393-42010	MTPT-00117	TOYOTA
33394-36011	MTPT-00155	TOYOTA
33394-36020	MTPT-00156	TOYOTA
33394-60020	MTPT-00157	TOYOTA
33395-35031	MTPT-00087	TOYOTA
33395-36030	MTPT-00218	TOYOTA
33395-42012	MTPT-00118	TOYOTA
33395-60010	MTPT-00041	TOYOTA
33395-60040	MTPT-00213	TOYOTA
33395-71010	MTPT-00139	TOYOTA
33421-26100	MTPT-00331	TOYOTA
33421-28040	MTPT-00330	TOYOTA
33421-28053 (33421-28054)	MTPT-00027	TOYOTA
33421-35140 (33421-26120)	MTPT-00335	TOYOTA
33421-35150	MTPT-00329	TOYOTA
33421-35170	MTPT-00017	TOYOTA
33421-37040	MTPT-00125	TOYOTA
33421-37110	MTPT-00200	TOYOTA
33421-60060	MTPT-00039	TOYOTA
33421-60122	MTPT-00102	TOYOTA
33421-60181 (33421-60220)	MTPT-00088	TOYOTA
33421-60201	MTPT-00089	TOYOTA
33421-71011 (33421-26110)	MTPT-00005	TOYOTA
33421-71050	MTPT-00128	TOYOTA
33428-12110	MTPT-00029	TOYOTA
33428-26020	MTPT-00007	TOYOTA
33428-60040 (33428-60041)	MTPT-00007	TOYOTA
33428-30040	MTPT-00026	TOYOTA
33428-60031	MTPT-00090	TOYOTA
33428-71020	MTPT-00137	TOYOTA
33429-37010	MTPT-00199	TOYOTA
33462-60020	MTPT-00158	TOYOTA

Genuine No.	AISIN No.	Make
33464-60010	MTPT-00159	TOYOTA
33505-60011	MTPT-00160	TOYOTA
33506-35100	MTPT-00226	TOYOTA
33506-35110	MTPT-00256	TOYOTA
36046-60010	MTPT-00040	TOYOTA
36107-60040	MTPT-00127	TOYOTA
36203-60051	MTPT-00047	TOYOTA
36204-60110	MTPT-00050	TOYOTA
36211-60021	MTPT-00184	TOYOTA
36211-60040	MTPT-00162	TOYOTA
36211-60090	MTPT-00030	TOYOTA
36212-60081	MTPT-00177	TOYOTA
36212-60100	MTPT-00163	TOYOTA
36215-60030	MTPT-00178	TOYOTA
36221-60080	MTPT-00043	TOYOTA
36221-60090	MTPT-00091	TOYOTA
36222-60021	MTPT-00044	TOYOTA
36225-60030	MTPT-00164	TOYOTA
36225-60050	MTPT-00165	TOYOTA
36231-60021	MTPT-00048	TOYOTA
36234-60040	MTPT-00045	TOYOTA
36235-60020	MTPT-00049	TOYOTA
36235-60040	MTPT-00166	TOYOTA
36237-60020	MTPT-00046	TOYOTA
36251-60030	MTPT-00179	TOYOTA
36312-60030	MTPT-00051	TOYOTA
36318-60020	MTPT-00167	TOYOTA
90119-12234	MTPT-00186	TOYOTA
90179-18005	MTPT-00168	TOYOTA
90179-20012	MTPT-00169	TOYOTA
90179-22005	MTPT-00187	TOYOTA
90179-22016	MTPT-00170	TOYOTA

Genuine No.	AISIN No.	Make
90179-22019	MTPT-00171	TOYOTA
90179-24008	MTPT-00172	TOYOTA
90179-26002	MTPT-00183	TOYOTA
90179-26004	MTPT-00188	TOYOTA
90201-22005	MTPT-00189	TOYOTA
90250-04056	MTPT-00173	TOYOTA
90250-05026	MTPT-00174	TOYOTA
90301-34005	MTPT-00180	TOYOTA
90301-91001	MTPT-00175	TOYOTA
90361-08004	MTPT-00236	TOYOTA
90363-32038	MTPT-00237	TOYOTA
90363-35012	MTPT-00193	TOYOTA
90363-35013	MTPT-00181	TOYOTA
90363-35020	MTPT-00182	TOYOTA
90363-38007	MTPT-00342	TOYOTA
90363-45019	MTPT-00343	TOYOTA
90364-25012	MTPT-00317	TOYOTA
90364-28023	MTPT-00119	TOYOTA
90364-33012	MTPT-00130	TOYOTA
90364-38017	MTPT-00349	TOYOTA
90364-39015	MTPT-00347	TOYOTA
90364-47008	MTPT-00344	TOYOTA
90364-48002	MTPT-00201	TOYOTA
90364-54007	MTPT-00202	TOYOTA
90364-58006	MTPT-00350	TOYOTA
90365-30030	MTPT-00340	TOYOTA
90365-33006	MTPT-00228	TOYOTA
90365-36004	MTPT-00238	TOYOTA
90366-35138	MTPT-00135	TOYOTA
90501-07104	MTPT-00176	TOYOTA
90520-27067	MTPT-00120	TOYOTA
90520-27069	MTPT-00121	TOYOTA

Genuine No.	AISIN No.	Make
91651-61040	MTPT-00190	TOYOTA

Published on February 28, 2016

Edited and Published by

AISIN SEIKI Co.,Ltd.

Aftermarket Dept.

Sales & Marketing Sector,

Automotive Systems

2-1, Asahi-machi, Kariya, Aichi, JAPAN

Printed in Japan

AISIN

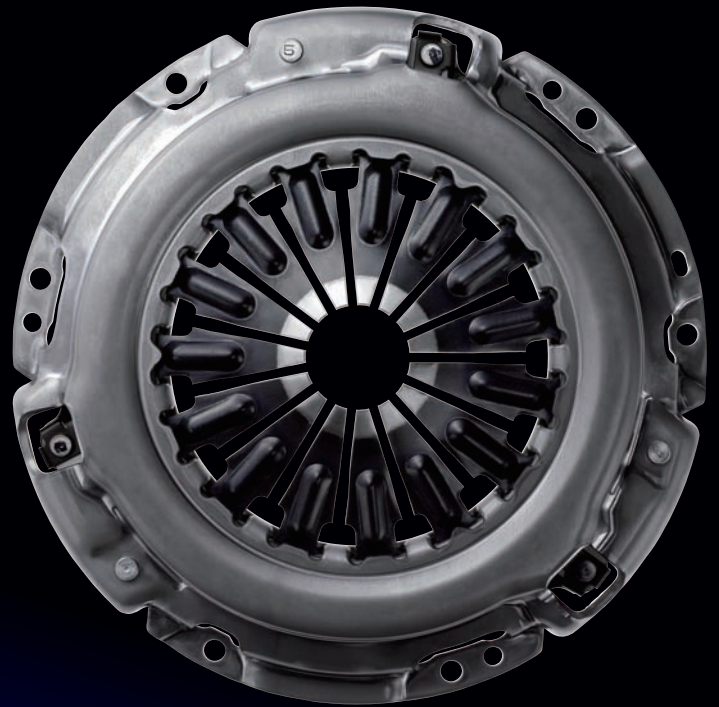

Meet the AISIN Family

Offering a wide selection
of quality products

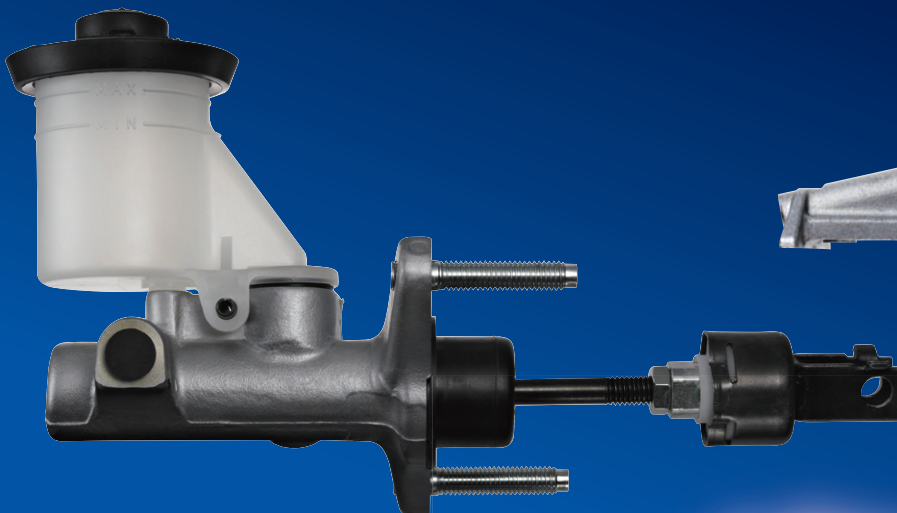

AISIN

AISIN

AISIN SEIKI Co.,Ltd.

AICHI, JAPAN

<http://www.aisinaftermarket.jp>



AL160201HQ

