



15 NOV -5 P3:02

ADMINISTRATION
STATE PROCUREMENT OFFICE
STATE OF HAWAII

November 3, 2015

State of Hawaii
Stanton Mato, State Procurement Office
P.O. Box 119
Honolulu, HI 96810

Subject: Contract CF-06-007-SW, SPO Pricelist No. 09-10
Telephone Services for Hawaii State Government
Manufacture Discontinued Phones on Pricelist and Addition of
MiVoice 9116 Analog Phone

Dear Stanton Mato,

The following expansion module and expansion module stand on HATS Contract CF-06-007-SW, SPO Pricelist No. 09-10 is manufacture discontinued with no replacements. The expansion module and expansion module stand are additions to the list of discontinued telephone instruments that was forwarded to the State Procurement Office on August 25, 2015. Attached is a copy of the letter dated August 25, 2015.

<u>Description of Discontinued Equipment</u>	<u>Reference No.</u>	<u>Mfg. Model No.</u>
M522 Meridian Mate Expansion Mod. Black (Expansion Module)	TI-10	B0240410
M522 Expansion Module Double Stand, Black	TI-10	P0780203

The following new telephone will be added to the HATS Contract CF-06-007-SW, SPO Pricelist No. 09-10.

<u>Description of New Equipment</u>	<u>Reference No.</u>	<u>Mfg. Model No.</u>
MiVoice 9116 Analog Phone	TI-13	A1265-0000-1005

The entire Telephone Instrument Pricing Sheets (Offer Pages OF-27 & OF-28) have been revised. The entire Telephone Instrument Reference Sheets have been revised.

Please update HATS Contract CF-06-007-SW, SPO Pricelist No. 09-10 to reflect the changes.

Regards,



Susan Chun

HATS Program Manager

Phone: (808)546-1725

cc: Christopher Lai, State ICSD

Attachments: Copy of Letter to State Procurement Office August 25, 2015
Telephone Instrument Pricing Sheets (Offer Pages OF-27 & OF-28) – Entire
Section
Telephone Instrument Reference Sheets – Entire Section



DUPLICATE

August 25, 2015

State of Hawaii
Stanton Mato, State Procurement Office
P.O. Box 119
Honolulu, HI 96810

Subject: Contract CF-06-007-SW, SPO Pricelist No. 09-10
Telephone Services for Hawaii State Government
Manufacture Discontinued Phones on Pricelist

Dear Stanton Mato,

Hawaiian Telcom has been notified by Mitel/Aastra the following phones on HATS Contract CF-06-007-SW, SPO Pricelist No. 09-10 is manufacture discontinued with no replacements.

<u>Description</u>	<u>Reference No.</u>	<u>Mfg. Model No.</u>
Analog Single Line Telephones		
Aastra 8004 Platinum (Basic, Model)	TI-1	A0780804
Aastra 9316CW Ash (Hands free/Display Model)	TI-3	A0674338
Aastra 9316CW Black (Hands free/Display Model)	TI-3	A0659641
Analog Two Line Telephones		
Aastra 9417CW Ash (Hands free/Display Model)	TI-4	A0674967
Aastra 9417CW Black (Hands free/Display Model)	TI-4	A0652243
Multiline Telephones		
Meridian 5008 Ash (Basic Model)	TI-6	B0240399
Meridian 5008 Black (Basic Model)	TI-6	B0240401
Meridian 5208 Ash (Display Model)	TI-7	B0240402
Meridian 5316 Ash (Hands free/Display Model)	TI-8	B0240405
Meridian 5216 Ash (Hands free/Display Headset Compatible)	TI-9	B0240411
M522 Meridian Mate Expansion Mod Ash (Expansion Module)	TI-10	B0240408
M522 Expansion Module Single Stand Ash	TI-10	P0780135
M522 Expansion Module Single Stand Black	TI-10	P0780103
M522 Expansion Module Double Stand Ash	TI-10	P0780235

Please update HATS Contract CF-06-007-SW, SPO Pricelist No. 09-10 to reflect the manufacture discontinued telephones and stands. Unfortunately, substitutes for these materials are not available.

Regards,

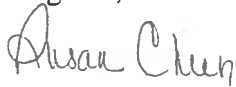

Susan Chun

HATS Program Manager

Phone: (808)546-1725

cc: Christopher Lai, State ICSD

The 8004 offers affordable quality, with added features that simplify and streamline your everyday business communications.



Model 8004 Telephone

Key Features:

- Flash key — for transferring calls or using custom calling features without worry of disconnect*
- Redial key — for easy repeat dialing
- Mute key
- Voltage Message Waiting indicator — shows when a Voice Mail message is waiting*
- High/medium/low ringer positions
- Compatible with Centrex, PBX, or standard telephone service

expandable

proven

powerful

Building success with the business telephone leader

The 8004 Business Set is designed to fit any place you need a high-quality, basic telephone. It's well suited for hotels, hospitals, and universities, as well as many business or commercial settings.

As a member of the 8000-series of analog business telephones, the 8004 is familiar and easy to use. While its cost remains attractively low, the 8004 meets the highest Aastra Telecoms standards — making it perfect for those who demand quality in their workplace.

The 8004 goes beyond the basics to offer added convenience features. The Flash key makes it easy to transfer calls and use custom calling features such as Call Forwarding, Call Waiting, and Three-Way Calling*. The Redial key saves time when you need to dial a number repeatedly. And, you'll find the Mute key is a great idea

whenever you need a moment's privacy from others on the line.

The 8004 also offers message waiting and visual ringing indicators, making it the ideal in-room telephone for universities, hotels, and hospitals*. The 8004 also works well by itself — in a lobby, reception area, or busy shipping department.

This flexibility is a valuable asset for the 8004. The telephone adapts to any home or office setting. It works with a PBX or with Centrex services, as well as with standard telephone service. Plus, the ringer and receiver volumes are both adjustable — so you can be sure the advantages of the 8004 come through loud and clear in any environment.

VIEW AASTRA TELECOM'S PHONES ON THE INTERNET AT WWW.AASTRA.COM

8004 Feature Highlights

- Flash key
- Redial key
- Mute key
- Voltage Message Waiting indicator*
- High/medium/low ringer positions
- Adjustable receiver volume
- Compatible with Centrex, PBX, or standard telephone services
- Line powered
- Provides basic telephone service in the event of a power failure
- Desk or wall mount
- Hearing aid compatible
- Scratch-resistant matte finish
- One-year warranty

Specifications

- Dial: Tone
- Power: Line
- Weight: .56 kg lbs.
- Dimensions: 17.15 cm L x 12.7 cm W x 2.54 cm H

* Functionality of some features assumes availability and customer subscription to service provider offerings.



AASTRA
Telecom

For more information, contact your Aastra Telecom representative, or call (905) 760-4200.

COPYRIGHT (C) 2003 AASTRA TELECOM. ALL RIGHTS RESERVED. INFORMATION IN THIS DOCUMENT IS SUBJECT TO CHANGE WITHOUT NOTICE. AASTRA TELECOM ASSUMES NO RESPONSIBILITY FOR ANY ERRORS THAT MAY APPEAR IN THIS DOCUMENT. PRODUCT CAPABILITIES DESCRIBED IN THIS DOCUMENT PERTAIN SOLELY TO AASTRA TELECOM'S MARKETING ACTIVITIES IN THE U.S AND CANADA. AVAILABILITY IN OTHER MARKETS MAY VARY.

DISCONTINUED

The 8009 helps you work smarter, not harder, without costing a small fortune.



Model 8009 Telephone

Key Features:

- Six programmable memory keys — for access to features* or frequently called numbers
- Visual Message Waiting indicator — shows when a Voice Mail message is waiting*
- LINK key — makes it easy to transfer a call or activate a special feature
- Line Release key
- Last-number redial
- Hold key
- Compatible with Centrex, PBX, or standard telephone service

expandable

proven

powerful

Building success with the business telephone leader

The 8009 gives you simple one-touch access to a variety of convenient communication features. Use the six programmable memory keys to store frequently used numbers — customers, suppliers, family members, and others. Or, you can store the code for features like Call Forwarding or Call Return.

Customize your phone by programming the combination of features and numbers that best fits your needs. Either way, you'll reach the service or person you need with a single keystroke.

An indicator light makes the 8009 especially easy to use. If you have Voice Mail services from your telephone company, the indicator light lets you know when messages are waiting*. The same indicator flashes to remind you

when a call is on hold or when your phone is ringing — something you'll appreciate in a hectic or noisy office.

Worried about accidentally disconnecting an important customer when transferring a call or activating a special feature? Just use the LINK key on the 8009 and you won't make a mistake. You can use the Hold key to place a caller on hold, and pick up from any extension. And, if you're tired of repeatedly trying to reach a busy number, make your life easier by using the Redial key.

Whether you're part of a professional firm, a small business, or operating an office at home, the affordable 8009 has the features and flexibility to help you stay competitive.

VIEW AASTRA TELECOM'S PHONES ON THE INTERNET AT WWW.AASTRA.COM

8009 Feature Highlights

- Six programmable memory keys
- Visual Message Waiting indicator*
- LINK key
- Line Release key
- Redial key
- Hold key
- Extension-in-use/visual ringing indicator
- Compatible with Centrex, PBX, or standard telephone service
- Line powered
- Provides basic telephone service in the event of a power failure
- Desk or wall mount
- Parallel line jack for extension, fax, or modem
- Adjustable receiver volume
- Scratch-resistant matte finish
- One-year warranty

Specifications

- Dial: Tone
- Power: Line
- Weight: 1.1 kg
- Dimensions: 19.1 cm L x 19.1 cm W x 8.9 cm H
- Colours: Black, Ash, Light Gray

* Functionality of some features assumes availability and customer subscription to service provider offerings.



AASTRA
Telecom

For more information, contact your Aastra Telecom representative, or call (905) 760-4200.

COPYRIGHT (C) 2003 AASTRA TELECOM. ALL RIGHTS RESERVED. INFORMATION IN THIS DOCUMENT IS SUBJECT TO CHANGE WITHOUT NOTICE. AASTRA TELECOM ASSUMES NO RESPONSIBILITY FOR ANY ERRORS THAT MAY APPEAR IN THIS DOCUMENT. PRODUCT CAPABILITIES DESCRIBED IN THIS DOCUMENT PERTAIN SOLELY TO AASTRA TELECOM'S MARKETING ACTIVITIES IN THE U.S AND CANADA. AVAILABILITY IN OTHER MARKETS MAY VARY.

DISCONTINUED

The 9316CW combines the convenience of Call Waiting with the control of Caller ID, making it the ideal telephone for people who want to better manage their phone calls and their time.



Model 9316CW Telephone

Key Features:

- Caller ID and Call Waiting Display — show you who's calling, even when you're on another call*
- Speakerphone with mute
- 50-name and number Call Log*
- Three-line backlit display — for easy viewing, day or night
- Secure Numbers — for privacy in entering personal codes
- 50-name and number Directory
- Eight programmable memory keys
- Five-number redial
- Hearing aid compatible

expandable

proven

powerful

Building success with the business telephone leader

The 9316CW takes the mystery out of who's calling. Equipped for Caller ID and Call Waiting Display, the 9316CW shows you who's calling, even when you're on another call*. The adjustable three line, backlit display provides all caller information on one screen for "at a glance" viewing. The LINK key lets you switch between calls without worry of accidentally disconnecting a caller. And the 50 name and number Call Log keeps a record of all your incoming calls*.

Outgoing calls are easy, too, with the 9316CW. On-hook dialing and a high quality speakerphone mean you can make calls without ever picking up the receiver. Program the memory keys with frequently called numbers or feature

codes, like your Voice Mail access number. The Secure Numbers feature protects your privacy by letting you enter passwords or personal codes without revealing them on the display.

You can even create your own Directory, so the numbers of business contacts and family members stay right at your fingertips, for fast and easy dialing.

The 9316CW offers a host of convenient features that meet the needs of today's busy families and businesses. When it comes to saving time, it's no mystery that the 9316CW is the right phone for the job.

VIEW AASTRA TELECOM'S PHONES ON THE INTERNET AT WWW.AASTRA.COM

9316CW Feature Highlights

- » Caller ID and Call Waiting Display*
- » 50-name and number Call Log*
- » Speakerphone with Mute
- » Eight programmable memory keys
- » 50-name and number Directory
- » Alphanumeric entry of name into memory keys or Directory
- » Preferred Name Match*
- » Adjustable three-line backlit display
- » Secure Numbers feature
- » CLASS/Voltage Message Waiting indicator*
- » Five-number redial
- » LINK/Release/Hold keys
- » Four ringing cadences
- » Adjustable receiver volume
- » Parallel line jack for extension, fax, or modem
- » Visual ringing/extension-in-use indicator
- » On-hook dialing
- » English/French/Spanish language prompts option
- » Provides basic telephone service in the event of a power failure
- » Desk or wall mount
- » Hearing aid compatible
- » One-year warranty

Specifications

- » Dial: Tone
- » Power: 16 Vac transformer
- » Weight: 2.3 lbs.
- » Dimensions: 7.5" L x 7.5" W x 3.5" H
- » Colors available: Black, Ash, Light Gray

* Functionality of some features assumes availability and customer subscription to service provider offerings.

AASTRA
Telecom

For more information, contact your Aastra Telecom representative, or call (905) 760-4200.

COPYRIGHT (C) 2003 AASTRA TELECOM. ALL RIGHTS RESERVED. INFORMATION IN THIS DOCUMENT IS SUBJECT TO CHANGE WITHOUT NOTICE. AASTRA TELECOM ASSUMES NO RESPONSIBILITY FOR ANY ERRORS THAT MAY APPEAR IN THIS DOCUMENT. PRODUCT CAPABILITIES DESCRIBED IN THIS DOCUMENT PERTAIN SOLELY TO AASTRA TELECOM'S MARKETING ACTIVITIES IN THE U.S AND CANADA. AVAILABILITY IN OTHER MARKETS MAY VARY.

DISCONTINUED

With two separate lines, the 9417CW is ideal for professionals who get work-related calls at home and those who need to be accessible while working on-line.



Model 9417CW Telephone

Key Features:

- Two lines with Conference key
- Caller ID and Call Waiting Display — show you who's calling, even when you're on another call*
- Speakerphone with Mute
- 100-name and number Call Log*
- Three-line backlit display — for easy viewing, day or night
- Secure Numbers — for privacy in entering personal codes
- 100-name and number Directory
- Six programmable memory keys
- 10-number redial

expandable

proven

powerful

Building success with the business telephone leader

When you're looking for convenience, the 9417CW gives you twice as much. Two separate lines are ideal for people who work at home, share lines with an associate, or who need to be accessible while working on-line.

The 9417CW's Call Director/Fax Switch, combined with Distinctive Ringing service from your service provider*, lets you know if the incoming call is business, personal, or a fax — and routes the call for you. With a Conference key to link the two lines, three-way calls are fast and simple. In addition to two lines, the 9417CW has a large three-line

backlit display so you can easily see who's calling, even at night. If you're on another call, Call Waiting Display gives you the information you need to decide which call is more important — the one you're on, or the one that's waiting.

The 9417CW offers all the convenient features you'd expect in a high quality business phone, and then some. Like handsfree, memory keys, a Directory, 10-number redial and a Call Log that can track calls to each line*. What more could you ask for?

VIEW AASTRA TELECOM'S PHONES ON THE INTERNET AT WWW.AASTRA.COM

9417CW Feature Highlights

- » Two lines with station conferencing of Line 1 and Line 2
- » Caller ID and Call Waiting Display*
- » 100-name and number Call Log*
- » Speakerphone with Mute
- » Six programmable memory keys
- » 100-name and number downloadable Directory
- » Alphanumeric entry of name into memory keys or Directory
- » Preferred Name Match*
- » Adjustable three-line backlit display
- » Call Director/Fax Switch
- » Secure Numbers feature
- » CLASS/Voltage Message Waiting indicator*
- » 10-number redial
- » Call Duration Timer
- » LINK/Release/Hold keys
- » Four ringing cadences
- » Adjustable receiver volume
- » Parallel line jack for extension, fax, or modem
- » Visual ringing/extension-in-use indicator
- » On-hook dialing
- » English/French/Spanish language prompts option
- » Provides basic telephone service in the event of a power failure
- » Desk or wall mount
- » Headset and hearing aid compatible
- » One-year warranty

Specifications

- » Dial: Tone
- » Power: 16 Vac transformer
- » Weight: 2.3 lbs.
- » Dimensions: 7.5" L x 7.5" W x 3.5" H
- » Colors: Black, Ash, Light Gray

* Functionality of some features assumes availability and customer subscription to service provider offerings.

AASTRA
Telecom

For more information, contact your Aastra Telecom representative, or call (905) 760-4200.

COPYRIGHT (C) 2003 AASTRA TELECOM. ALL RIGHTS RESERVED. INFORMATION IN THIS DOCUMENT IS SUBJECT TO CHANGE WITHOUT NOTICE. AASTRA TELECOM ASSUMES NO RESPONSIBILITY FOR ANY ERRORS THAT MAY APPEAR IN THIS DOCUMENT. PRODUCT CAPABILITIES DESCRIBED IN THIS DOCUMENT PERTAIN SOLELY TO AASTRA TELECOM'S MARKETING ACTIVITIES IN THE U.S AND CANADA. AVAILABILITY IN OTHER MARKETS MAY VARY.

EPIC™

PLUG & PLAY PHONE SYSTEM

ET4300

4 Line Intercom Speakerphone

with Caller ID and Jumbo Pivoting Display

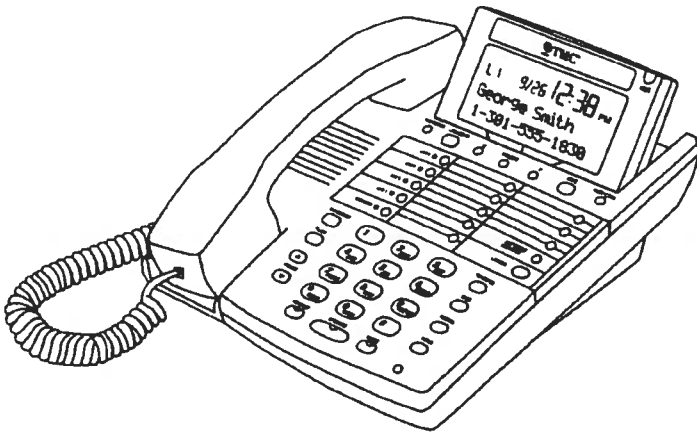

SYSTEM FEATURES

EXPANDABLE UP TO 16 STATIONS

All Epic telephones are compatible with each other and can accommodate up to 4 lines and 16 stations.

Combine Up To 16 Epic Phones & Feature Modules...



To Create Your Own Fully Featured Phone System!

FULL-FEATURED INTERCOM

Call any other station in your Epic system with ease. You can even answer intercom calls "hands-free" via speakerphone.

OFF-HOOK VOICE ANNOUNCE

Allows discrete intercom announcements to others even if they are on an outside call, without interrupting their call in progress.

PAGING

Make a voice announcement through the speaker of a particular station, or through all the stations at once.

TRANSFER

Answer a call and transfer it to any station in the system.

STATION STATUS INDICATION

See at a glance which stations are in use.

SHARED DIRECTORY DIALING

Store up to 40 names and numbers at station #11 and dial them from any phone in the system.

PHONE FEATURES

UP TO 4 LINES

Access up to four separate phone lines at the touch of a button. You can place any call on hold and switch to another line.

HANDS FREE SPEAKERPHONE

Allows you to talk hands free on both outside and intercom calls.

3-WAY CALL CONFERENCE

Allows you to have a 3-way conversation between you and persons on two outside lines.

JUMBO BACKLIT LIQUID CRYSTAL DISPLAY

Super large backlit LCD which pivots for easy viewing, even in the dark. Shows number dialed, clock, calendar, station in use indication. Also displays full caller ID information.

CALL TIMER

Every call is automatically timed in minutes and seconds. Great for account billing and controlling long distance usage.

NETWORK SERVICES BUTTON

Press this button to access a preprogrammed list of Telephone Company services, for easy one touch access.

HEADSET JACK

A dedicated 2.5mm headset jack with a dedicated headset button and a built-in headset amplifier make adding a headset easy and convenient.

DATA/FAX JACK

Easily connect a fax or computer modem to any of your Epic phones.

REDIAL LIST

Redial any of the 5 most recent calls, or just view the date and time they were made, along with their duration.

DO NOT DISTURB

Prevents interruption by silencing the ringers, and preventing intercom calls and pages to your phone.

TOLL RESTRICTION

Allows you to restrict specific numbers and prevent unauthorized calls.

CALL PRIVACY ON/OFF

Prevents others from joining or listening to your call, unless you release call privacy.

AUTOMATIC LINE SELECTION

Allows you to choose which line is automatically selected when making an outside call.

MEMORY DIAL

In addition to the shared directory dial numbers, you may store up to 16 memory dial numbers and 10 personal directory names and numbers in each Epic phone.

STATIC MEMORY

All memory dial numbers and feature settings are stored in a static memory which retains its contents even with no electrical power and no battery, so they can never be accidentally lost.

ADJUSTABLE VOLUME CONTROLS

You may adjust the volume of the handset, speakerphone and headset separately.

LINE RESERVE

Enables you to reserve a line that is currently in use. This spares you the trouble of constantly monitoring your telephone while waiting for a free line.

FEATURE MODULES AVAILABLE

Each of these optional accessories plugs easily into your Epic system and adds a unique capability:

- Music On Hold Adapter Allows you to connect a radio or tape player to the system.
- Door Intercom Adapter Allows the addition of a door intercom speaker and/or magnetic door strike.
- External Paging Adapter Allows connection of an external amplifier and speaker for paging from any Epic phone.

ADDITIONAL FEATURES

Battery Backup, Dual Color Line Status Indicators, Flash, Hold, Mute, Individual Ringer Control, Display Contrast Control, Predialing, Wall Mountable and Hearing Aid Compatible.

TWO YEAR WARRANTY

CALLER ID FEATURES

CALLER ID CAPABILITY ON ALL 4 LINES

Phone has caller ID capability for all 4 lines. You must subscribe separately for each line on which you want this service.

CALLER ID ON CALL WAITING

For each line subscribed to this service, you may view the caller ID information for all incoming calls, including Call Waiting calls.

50 NAME AND NUMBER CALLER ID LIST

Phone automatically stores the name, number, date and time of the 50 most recent calls.

CALLER ID DISPLAY DIAL

Any number in the caller ID list can be dialed at the touch of a button.

NEW CALL LAMP/ VISUAL MESSAGE WAITING INDICATOR

See at a glance whether you have received any new calls since you last viewed your caller list. Lamp also indicates any new messages in your Telephone Company voice mailbox.

CENTREX FEATURES

The Epic phones have features that make them great for Centrex, including...

CENTREX CODE STORE

Allows you to store your Centrex feature codes, including flashes, into memory dial locations, for easy one touch dialing.

PRIVATE LINE COMPATIBILITY

Allows you to set up private Centrex lines at your telephone.

DISTINCTIVE RINGING

You may assign a unique distinctive ring to your Centrex line to easily distinguish your ringing telephone from other nearby phones.

CENTREX CONSOLE

You may set an Epic phone as a Centrex console, which will enable you to easily answer other telephones' ringing Centrex lines.

SPECIFICATIONS

COLOR	GRAPHITE
DIMENSIONS	9.25"H X 9"W X 2.75"D
GIFT BOX DIMENSIONS	9.75"H X 11.8"W X 4.75"D
UNIT WEIGHT	4.7 LBS
MASTER CARTON	4 UNITS
MASTER CARTON DIMENSIONS	12.2"H X 19.7"W X 10.6"D
MASTER CARTON WEIGHT	20.2 LBS
POWER	AC ADAPTER INCLUDED, OUTPUT 12V DC 500MA

* Requires subscription to Caller ID, Call Waiting, and Call Waiting Caller ID combined service from local telephone company

** Requires subscription to Voice Mail service from local telephone company



TMC Corporation, 2540 Route 130, #117, Cranbury, NJ 08512
Tel: 609.860.1830, Fax: 609.860.8980, Toll Free 800.862.1638

www.tmccorporation.com

©2004 TMC Corporation. Specifications are subject to change without notice.



The ET4300 Plug and Play Phone System



System Features

EXPANDABLE UP TO 16 STATIONS

All Epic telephones are compatible with each other and can accommodate up to 4 lines and 16 stations.

FULL-FEATURED INTERCOM

Call any other station in your Epic system with ease. You can even answer intercom calls "hands-free" via speakerphone.

OFF-HOOK VOICE ANNOUNCE

Allows discrete intercom announcements to others even if they are on an outside call, without interrupting their call in progress.

PAGING

Make a voice announcement through the speaker of a particular station, or through all the stations at once.

TRANSFER

Answer a call and transfer it to any station in the system.

STATION STATUS INDICATION

See at a glance which

Phone Features

UP TO 4 LINES

Access up to four separate phone lines at the touch of a button. You can place any call on hold and switch to another line.

HANDS FREE SPEAKERPHONE

Allows you to talk hands free on both outside and intercom calls.

3-WAY CALL CONFERENCE

Allows you to have a 3-way conversation between you and persons on two outside lines.

JUMBO BACKLIT LIQUID CRYSTAL DISPLAY

Super large backlit LCD which pivots for easy viewing, even in the dark. Shows number dialed, clock, calendar, station in use indication. Also displays full caller ID information.

CALL TIMER

Every call is automatically timed in minutes and seconds. Great for account billing and controlling long distance usage.

NETWORK SERVICES BUTTON

Press this button to access a preprogrammed list of Telephone Company

CALL PRIVACY ON/OFF
Prevents others from joining or listening to your call, unless you release call privacy.

AUTOMATIC LINE SELECTION

Allows you to choose which line is automatically selected when making an outside call.

MEMORY DIAL

In addition to the shared directory dial numbers, you may store up to 28 memory dial numbers and 10 personal directory names and numbers in each Epic phone.

STATIC MEMORY

All memory dial numbers and feature settings are stored in a static memory which retains its contents even with no electrical power and no battery, so they can never be accidentally lost.

ADJUSTABLE VOLUME CONTROLS

You may adjust the volume of the handset, speakerphone and headset separately.

LINE RESERVE

Enables you to reserve a line that is currently in use. This spares you the trouble of constantly monitoring your telephone while waiting for a free line.

FEATURE MODULES AVAILABLE

Each of these optional accessories plugs easily into your Epic system and adds a unique capability:

- **Music On Hold Adapter** Allows you to connect a radio or tape player to the system.
- **Door Intercom Adapter** Allows the addition of a

Caller ID Features

CALLER ID CAPABILITY ON ALL 4 LINES

Phone has caller ID capability for all 4 lines. You must subscribe separately for each line on which you want this service.

CALLER ID ON CALL WAITING

For each line subscribed to this service, you may view the caller ID information for all incoming calls, including Call Waiting calls.

50 NAME AND NUMBER CALLER ID LIST

Phone automatically stores the name, number, date and time of the 50 most recent calls.

CALLER ID DISPLAY DIAL

Any number in the caller ID list can be dialed at the touch of a button.

NEW CALL LAMP/ VISUAL MESSAGE WAITING INDICATOR

See at a glance whether you have received any new calls since you last viewed your caller list. Lamp also indicates any new messages in your Telephone Company voice mailbox.

Centrex Features

The Epic phones have features that make them great for Centrex, including...

CENTREX CODE STORE

Allows you to store your Centrex feature codes, including flashes, into memory dial locations, for easy one touch dialing.

stations are in use.

SHARED DIRECTORY DIALING
Store up to 40 names and numbers at station #11 and dial them from any phone in the system.

Specifications

Color: Graphite

Dimension: 9.25"H X 9"W X 2.75"D

Gift Box Dimensions: 9.75"H X 11.8"W X 4.75"D

Unit Weight: 4.7 lbs.

Master Carton: 4 units

Master Carton Dimensions: 12.2"H X 19.7"W X 10.6"D

Master Carton Weight: 20.2 lbs.

Power: AC Adaptor included 12V DC 500 mA

services, for easy one touch access.

HEADSET JACK
A dedicated 2.5mm headset jack with a dedicated headset button and a built-in headset amplifier make adding a headset easy and convenient.

DATA/FAX JACK
Easily connect a fax or computer modem to any of your Epic phones.

REDIAL LIST
Redial any of the 5 most recent calls, or just view the date and time they were made, along with their duration.

DO NOT DISTURB
Prevents interruption by silencing the ringers, and preventing intercom calls and pages to your phone.

door intercom speaker and/or magnetic door strike.

• **External Paging Adapter** Allows connection of an external amplifier and speaker for paging from any Epic phone.

Additional Features

Battery Backup, Dual Color Line Status Indicators, Flash, Hold, Mute, Individual Ringer Control, Display Contrast Control, Predialing, Wall Mountable and Hearing Aid Compatible.

PRIVATE LINE COMPATIBILITY
Allows you to set up private Centrex lines at your telephone.

DISTINCTIVE RINGING
You may assign a unique distinctive ring to your Centrex line to easily distinguish your ringing telephone from other nearby phones.

CENTREX CONSOLE
You may set an Epic phone as a Centrex console, which will enable you to easily answer other telephones' ringing Centrex lines.

Acrobat Cut Sheet (PDF 295K)

ET4000 INTERACTIVE PRESENTATION

HOME

TMC Corporation
2540 Route 130, Unit 117
Cranbury, NJ 08512

Tel: 609.860.1830
Fax: 609.860.8980
Toll Free: 800.862.1638

Copyright © 2001- TMC Corporation, All Rights Reserved.
Specifications are subject to change without notice.

DISCONTINUED

The M5008 combines time-saving and convenience features with ease of operation. This phone is designed to maximize use of Meridian® Digital Centrex (MDC) features.



Meridian® 5008 Business Set

Key Features:

- Single-line set with multi-line functionality
- Line powered (no local power required)
- Larger keypad buttons
- Eight system programmable keys for feature access or directory numbers

expandable

proven

powerful



Building success with the business telephone leader

The M5008 combines time-saving and convenience features with ease of operation. This phone is designed to maximize use of Meridian® Digital Centrex (MDC) features. Select the M5008 when display capabilities are not required. Ease of use and reliability make the M5008 an excellent choice for a reception area, factory floor, construction site, or as a secondary departmental phone.

Convenience Features for Increased Productivity:

- On-hook dialing for convenient call setup or access to voice mail
- Feature/line indicator to let you know at a glance if a feature or line is in use
- Primary Directory Number (PDN) that is automatically selected for outgoing calls when you lift the handset
- Hold and Release keys for better call processing
- Last Number Redial to automatically store the last number you dialed, making it easier to reach busy numbers

VIEW AASTRA TELECOM'S PHONES ON THE INTERNET AT WWW.AASTRA.COM

Enhanced Design for Improved Functionality

- Sleek, low-profile styling that requires minimum space
- Enlarged keypad and control bar for easy dialing and volume adjustment
- Color-coded, conveniently-placed Hold and Release keys
- Colors available: Ash, Black, Gray
- Designation labels and key caps included (English, French, and Spanish)
- Desk or wall mountable (integrated wall mount kit included)
- Provides basic telephone service in the event of a power failure

Technical Specifications

- Length: 8.375 in. (209 mm)
- Width: 8.375 in. (209 mm)
- Height (front): .728 in. (18mm)
- Height (rear): 3.645 in. (92 mm)
- Weight: 2.1 lbs. (.95 Kg)
- Power requirements: Line powered

* Functionality of some features assumes availability and customer subscription to service provider offerings.

MERIDIAN® is a trademark of Nortel Networks, used under license by Aastra Technologies Limited.

AASTRA
Telecom

For more information, contact your Aastra Telecom representative, or call (905) 760-4200.

COPYRIGHT (C) 2003 AASTRA TELECOM. ALL RIGHTS RESERVED. INFORMATION IN THIS DOCUMENT IS SUBJECT TO CHANGE WITHOUT NOTICE. AASTRA TELECOM ASSUMES NO RESPONSIBILITY FOR ANY ERRORS THAT MAY APPEAR IN THIS DOCUMENT. PRODUCT CAPABILITIES DESCRIBED IN THIS DOCUMENT PERTAIN SOLELY TO AASTRA TELECOM'S MARKETING ACTIVITIES IN THE U.S AND CANADA. AVAILABILITY IN OTHER MARKETS MAY VARY.

Equipped with a Liquid Crystal Display (LCD), the M5208 combines time-saving and convenience features with ease of operation. This phone is designed to maximize use of Meridian® Digital Centrex (MDC) features.



Meridian® 5208 Business Set with Display

Key Features:

- Single-line set with multi-line functionality
- Extra wide, 2-line X 24-character display
- Reason Display to give users additional call information, such as whether a call has been forwarded
- Capability for Calling Name and Number Delivery
- Line powered (no local power required)
- Visual ringing indication
- Larger keypad buttons
- Eight system programmable keys for feature access or directory numbers

expandable

proven

powerful

Building success with the business telephone leader

Equipped with a Liquid Crystal Display (LCD), the M5208 combines time-saving and convenience features with ease of operation. This phone is designed to maximize use of Meridian® Digital Centrex (MDC) features. Select the M5208 for arrangements or other applications where occasional call coverage and exceptional reliability are important. Terminate one or multiple lines, or use Multiple Appearance Directory Number (MADN) to maximize call coverage.

Convenience Features for Increased Productivity:

- On-hook dialing for convenient call setup or access to voice mail
- Feature/line indicator to let you know at a glance if a feature or line is in use
- Visual message waiting indicator that works in combination with a message center application or your voice mail system to let you know when you have a voice mail message
- Primary Directory Number (PDN) that is automatically selected for outgoing calls when you lift the handset
- Hold and Release keys for better call processing
- Last Number Redial to automatically store the last number you dialed, making it easier to reach busy numbers

VIEW AASTRA TELECOM'S PHONES ON THE INTERNET AT WWW.AASTRA.COM

Power Features for Increased User Control

- Power Feature key (optional) to let users add, delete, or change MDC features on their sets
- Inspect key (optional) to give users access to information about the set's assigned features and about incoming calls

New Design for Enhanced Functionality

- Sleek, low-profile styling that requires minimum space
- Enlarged keypad and control bar for easy dialing and volume adjustment
- Color-coded, conveniently-placed Hold and Release keys
- Colors available: Ash, Black, Gray
- Designation labels and key caps included (English, French, and Spanish)
- Desk or wall mountable (integrated wall mount kit included)
- Provides basic telephone service in the event of a power failure

Technical Specifications

- Length: 8.375 in. (209 mm)
- Width: 8.375 in. (209 mm)
- Height (front): .728 in. (18mm)
- Height (rear): 3.645 in. (92 mm)
- Weight: 2.1 lbs. (.95 Kg)
- Power requirements: Line powered

* Functionality of some features assumes availability and customer subscription to service provider offerings.

MERIDIAN® is a trademark of Nortel Networks, used under license by Aastra Technologies Limited.

AASTRA
Telecom

For more information, contact your Aastra Telecom representative, or call (905) 760-4200.

COPYRIGHT (C) 2003 AASTRA TELECOM. ALL RIGHTS RESERVED. INFORMATION IN THIS DOCUMENT IS SUBJECT TO CHANGE WITHOUT NOTICE. AASTRA TELECOM ASSUMES NO RESPONSIBILITY FOR ANY ERRORS THAT MAY APPEAR IN THIS DOCUMENT. PRODUCT CAPABILITIES DESCRIBED IN THIS DOCUMENT PERTAIN SOLELY TO AASTRA TELECOM'S MARKETING ACTIVITIES IN THE U.S AND CANADA. AVAILABILITY IN OTHER MARKETS MAY VARY.

With LCD and third generation handsfree capability, the M5316 offers powerful time-saving and productivity features. This phone is designed to maximize use of Meridian® Digital Centrex features and recommended for busy professionals who conduct much of their business by phone.



Meridian® 5316 Business Set with Display and Hands- free Capability

Key Features:

- Single-line set with multi-line functionality
- Extra wide, 2-line X 24-character display
- Capability for Calling Name and Number Delivery
- Reason Display to give users additional call information, such as whether a call has been forwarded
- Handsfree capability, using third generation technology
- Visual ringing indication
- Larger keypad buttons
- Thirteen system programmable keys for feature access or directory numbers
- Hearing aid compatible

expandable

proven

powerful

Building success with the business telephone leader

With Liquid Crystal Display and third generation handsfree capability, the M5316 offers powerful time-saving and productivity features. This phone is designed to maximize use of Meridian® Digital Centrex features and recommended for busy professionals who conduct much of their business by phone.

Combined with the M522 Meridian® Mate Expansion Module, the M5316 can also be used as a mini-console.

Convenience Features for Increased Productivity:

- On-hook dialing for convenient call setup or access to voice mail
- Feature/line indicator to let you know at a glance if a feature or line is in use
- Visual message waiting indicator that works in combination with a message center application or your voice mail system to let you know when you have a voice mail message
- Primary Directory Number (PDN) that is automatically selected for outgoing calls when you lift the handset
- Hold and Release keys for better call processing
- Last Number Redial to automatically store the last number you dialed, making it easier to reach busy numbers

VIEW AASTRA TELECOM'S PHONES ON THE INTERNET AT WWW.AASTRA.COM

Power Features for Increased User Control

- Power Feature key (optional) to let users add, delete, or change MDC features on their sets
- Inspect key (optional) to give users access to information about the set's assigned features and about incoming calls
- Program key to let users enter the programming mode to set up local features, such as time and date and the call timer
- Mute key to turn off the microphone when you want to conduct a private conversation in your office

Expansion Capabilities for Improved Call Coverage

- Supports the M522 Meridian Mate Expansion Module, a 22-button add-on unit (add up to two expansion modules for a total of 44 additional buttons with associated LCD indicators for feature access or directory numbers)
- Mini-console capabilities such as Direct Station Select (DSS), Busy Lamp Field (BLF), and Camp-on that let you handle calls quickly and efficiently

New Design for Enhanced Functionality

- Sleek, low-profile styling that requires minimum space
- Enlarged keypad and control bar for easy dialing and volume adjustment
- Color-coded, conveniently-placed Hold and Release keys
- Colors available: Ash, Black, Gray
- Designation labels and key caps included
- Desk or wall mountable (integrated wall mount kit included)
- Provides basic telephone service in the event of a power failure

Technical Specifications

- Length: 9.48 in. (237mm)
- Width: 10.40 in. (261mm)
- Height (front): .728 in. (18mm)
- Height (rear): 3.645 in. (92.6 mm)
- Weight: 2.5 lbs. (1.14 Kg)
- Power requirements: AC/110 Volts

* Functionality of some features assumes availability and customer subscription to service provider offerings.

MERIDIAN® is a trademark of Nortel Networks, used under license by Aastra Technologies Limited.

AASTRA
Telecom

For more information, contact your Aastra Telecom representative, or call (905) 760-4200.

COPYRIGHT (C) 2003 AASTRA TELECOM. ALL RIGHTS RESERVED. INFORMATION IN THIS DOCUMENT IS SUBJECT TO CHANGE WITHOUT NOTICE. AASTRA TELECOM ASSUMES NO RESPONSIBILITY FOR ANY ERRORS THAT MAY APPEAR IN THIS DOCUMENT. PRODUCT CAPABILITIES DESCRIBED IN THIS DOCUMENT PERTAIN SOLELY TO AASTRA TELECOM'S MARKETING ACTIVITIES IN THE U.S AND CANADA. AVAILABILITY IN OTHER MARKETS MAY VARY.

With Liquid Crystal Display and headset compatibility, the M5216 offers powerful call coverage and call handling capabilities.

The M5216 is recommended when you need a central answering position or ACD support.



Meridian® 5216 Business Set with Display and Headset Capability

Key Features:

- Single-line set with multi-line functionality
- Extra wide, 2-line X 24-character display
- Reason Display to give users additional call information, such as whether a call has been forwarded
- Capability for Calling Name and Number Delivery
- Headset capability
- Visual ringing indication
- Larger keypad buttons
- Fourteen system programmable keys for feature access or directory numbers

expandable

proven

powerful

Building success with the business telephone leader

With Liquid Crystal Display and headset compatibility, the M5216 offers powerful call coverage and call handling capabilities. The M5216 is recommended when you need a central answering position or ACD support. This set offers unique functionality, making it the perfect solution for call centers and other high-volume calling applications. Combined with the M522 Meridian® Mate Expansion Module, the M5216 is also recommended as a mini-console.

Convenience Features for Increased Productivity:

- On-hook dialing for convenient call setup or access to voice mail
- Feature/line indicator to let you know at a glance if a feature or line is in use
- Visual message waiting indicator that works in combination with a message center application or your voice mail system to let you know when you have a voice mail message
- Primary Directory Number (PDN) that is automatically selected for outgoing calls when you lift the handset
- Hold and Release keys for better call processing
- Last Number Redial to automatically store the last number you dialed, making it easier to reach busy numbers

VIEW AASTRA TELECOM'S PHONES ON THE INTERNET AT WWW.AASTRA.COM

Power Features for Increased User Control

- Power Feature key (optional) to let users add, delete, or change MDC features on their sets
- Inspect key (optional) to give users access to information about the set's assigned features and about incoming calls
- Program key to let users enter the programming mode to set up local features, such as time and date and the call timer
- Mute key to turn off the microphone (invoke automatically when the headset is plugged in)

Call Handling Capabilities for Improved Call Coverage

- Headset capable
- Supervisor ACD features that let you monitor and manage individual agents and groups
- Supports the M522 Meridian Mate Expansion Module, a 22-button add-on unit (add up to two expansion modules for a total of 44 additional buttons with associated LCD indicators for feature access or directory numbers)
- Mini-console capabilities such as Direct Station Select (DSS), Busy Lamp Field (BLF), and Camp-on that let you handle calls quickly and efficiently

New Design for Enhanced Functionality

- Sleek, low-profile styling that requires minimum space
- Enlarged keypad and control bar for easy dialing and volume adjustment
- Color-coded, conveniently-placed Hold and Release keys
- Colors available: Ash, Black, Gray
- Designation labels and key caps included
- Desk or wall mountable (integrated wall mount kit included)
- Provides basic telephone service in the event of a power failure

Technical Specifications

- Length: 9.48 in. (237mm)
- Width: 10.40 in. (261mm)
- Height (front): .728 in. (18mm)
- Height (rear): 3.645 in. (92.6 mm)
- Weight: 2.5 lbs. (1.14 Kg)
- Power requirements: AC/110 Volts

* Functionality of some features assumes availability and customer subscription to service provider offerings.

MERIDIAN® is a trademark of Nortel Networks, used under license by Aastra Technologies Limited.

AASTRA
Telecom

For more information, contact your Aastra Telecom representative, or call (905) 760-4200.

COPYRIGHT (C) 2003 AASTRA TELECOM. ALL RIGHTS RESERVED. INFORMATION IN THIS DOCUMENT IS SUBJECT TO CHANGE WITHOUT NOTICE. AASTRA TELECOM ASSUMES NO RESPONSIBILITY FOR ANY ERRORS THAT MAY APPEAR IN THIS DOCUMENT. PRODUCT CAPABILITIES DESCRIBED IN THIS DOCUMENT PERTAIN SOLELY TO AASTRA TELECOM'S MARKETING ACTIVITIES IN THE U.S AND CANADA. AVAILABILITY IN OTHER MARKETS MAY VARY.

DISCONTINUED

The M522 Meridian® Mate Expansion Module is compatible with both the M5216 and M5316.

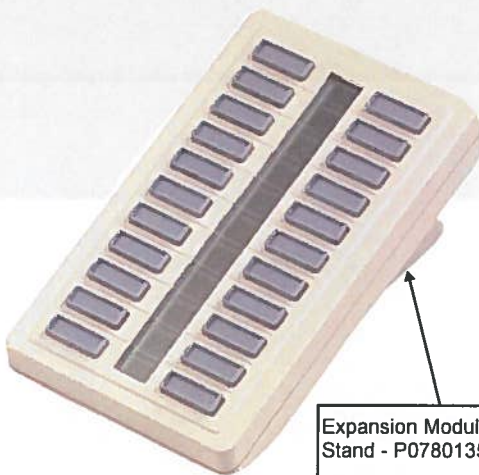

Expansion Module Single Stand - P0780135

Expansion Module Double Stand - P0780235

DISCONTINUED

M522 Meridian® Mate Expansion Module

Key Features:

- 22-button expansion unit, with associated LCD indicators, providing additional keys for lines or features.
- Up to two expansions can be used, for a total of 44 extra programmable buttons.
- Combined with Meridian® Digital Centrex, the M522 offers effective mini-console capabilities.

expandable

proven

powerful

Building success with the business telephone leader

The M522 Meridian® Mate Expansion Module is compatible with both the M5216 and M5316.

VIEW AASTRA TELECOM'S PHONES ON THE INTERNET AT WWW.AASTRA.COM

M522 Feature Highlights

- 22-button expansion unit, with associated LCD indicators, providing additional keys for lines or features.
- Up to two expansions can be used, for a total of 44 extra programmable buttons.
- Combined with Meridian® Digital Centrex, the M522 offers effective miniconsole capabilities.
- Colors available: Ash, Black, Gray



AASTRA
Telecom

For more information, contact your Aastra Telecom representative, or call (905) 760-4200.

COPYRIGHT (C) 2003 AASTRA TELECOM. ALL RIGHTS RESERVED. INFORMATION IN THIS DOCUMENT IS SUBJECT TO CHANGE WITHOUT NOTICE. AASTRA TELECOM ASSUMES NO RESPONSIBILITY FOR ANY ERRORS THAT MAY APPEAR IN THIS DOCUMENT. PRODUCT CAPABILITIES DESCRIBED IN THIS DOCUMENT PERTAIN SOLELY TO AASTRA TELECOM'S MARKETING ACTIVITIES IN THE U.S AND CANADA. AVAILABILITY IN OTHER MARKETS MAY VARY.

TI-11a, TI-11b, TI-11c, TI-11d, TI-11e, TI-11f, TI-11g, TI-11h, TI-11i, TI-11j

PHONE
COMMANDER

MODEL 6210 / 6220
ISDN TELEPHONE



The Affordable
ISDN Telephone
Solution.

The Power of ISDN at Every Desktop.

Now you can afford the advanced technology of ISDN (Integrated Services Digital Network) at every desktop. Tone Commander 6210 and 6220 ISDN phones set new standards for high quality and full-featured performance at an exceptional price.

These 10 and 20 button telephones are expandable to 40 or 50 buttons with the addition of a 6030X Button Expansion Module. Available in either S/T or U line configurations, they are loaded with all the advanced features you'd expect to find in a top-of-the-line set.

SIMPLE INSTALLATION.

The 6210 and 6220 support automatic switch detection, Auto-SPID and Parameter Downloading for true Plug & Play operation. These telephones are quick to install because they automatically configure themselves to your service. The reversible base and tilt display allow convenient desktop or wall mount installation. A free Windows-based Setup Wizard is available to simplify planning and ordering of your ISDN service and print labels for the phones.

EASY ACCESS TO ADVANCED ISDN FEATURES.

Tone Commander ISDN phones have intuitive user menus, making the phones easy to setup and use. You'll enjoy exceptional sound quality, quick connections, and sophisticated electronic key system features available from ISDN service.

Our products are designed to provide uniform operation over all ISDN switch types, eliminating the need for special user instruction or cross training programs.

With an optional 6001TA RS-232 Interface Adapter, you can get Caller ID screen pops and remote-control phone dialing from your Windows applications.



6030X
30 Line
Expansion Module

TI-11e 6220T Model No. 1010280001 Black

TI-11f 6220T Model No. 1010280003 White

TI-11g 6220U Model No. 1010282001 Black

TI-11h 6220U Model No. 1010282003 White

The phones utilize the latest flash memory technology, making it easy to install new features and enhancements without ever removing the phone from service. With Tone Commander products and ISDN technology, your telephone system can always be kept up to date; with Centrex service, you'll never have to worry about outgrowing your phone system.

TI-11a 6210T
Model No. 1010280
Black

TI-11b 6210T
Model No. 1010280
White

6210
10 Line
ISDN Telephone

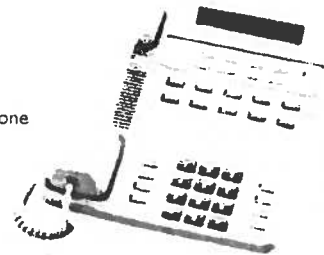

TI-11c 6210U
Model No. 10102820
Black

TI-11d 6210U
Model No. 10102820
White

MORE THAN JUST PHONES.

Tone Commander makes a complete family of ISDN and VoIP telephones, attendant consoles, and NT1 network terminations to fit any application, from a single telecommuter to large Centrex installations. We have been making products to meet the stringent requirements of telephone companies for over 30 years. Our products are designed and manufactured in the USA.

6210 / 6220 Features

Plug & Play Installation

Automatic switch type detection, automated SPID entry, and National ISDN parameter downloading are supported for simplified Plug & Play installation. The user can manually enter setup parameters if network parameter downloading is not available.

Works with All ISDN Versions

Each model supports all versions of National ISDN and Lucent 5ESS Custom ISDN without firmware or hardware modifications. Compatible with Lucent 5ESS, Nortel DMS-100, Siemens EWSD, and AG Communication Systems GTD-5 networks, and Lucent Definity PBXs. User operation is the same on all network platforms.

Call Identification

The call display indicates call state, caller ID information and elapsed time during calls. The identity of any call can be previewed at any time (even while on another call) to identify a call before it is answered or retrieved from hold.

Message Waiting Indication

A dedicated, easy-to-see message waiting lamp lights when you have new voicemail messages.

Multi-function Keys

Ten (6210) or twenty (6220) keys with indicators can be assigned for call appearances, feature activation, or one-touch speed dialing. Feature keys can be remapped to match any network configuration. Local and remote status is clearly indicated on highly visible multicolor LEDs.

Optional 30-Button Expansion Module

The 6030X Button Expansion Module adds 30 multifunction keys to a 6210 or 6220 for secretarial answering applications.

Special Function Keys

Dedicated keys are provided for Conference, Transfer, Drop, Hold, Speakerphone, Mute, and Volume functions. Four dedicated menu control keys and four softkeys are provided to conveniently navigate display-oriented menus and select context-based options.

Last Number Redial

A soft key redials the last number dialed on the dial pad or with a speed dial key.

Call Log

A call log maintains a running list of the last 100 answered, unanswered, and outbound calls, with the caller ID, called line ID, time, date, and duration of each call. Softkey autodialing allows easy callbacks. Entry into the call log can be password protected.

Call Preference Options

You can specify whether a ringing or idle line appearance is automatically selected when the handset is taken off-hook or the speakerphone is activated. Off-hook call preference may be set to Ringing, Idle, or None.

Flexible Ringing Options

One of eight distinct ringing tones can be selected for each terminal, to uniquely identify a ringing station in an environment with multiple terminals. Distinctive ringing cadences based upon network alerting patterns are supported. When off hook, ringing is muted, with selectable continuous or single burst ringing.

Ringling Control for Shared Lines

Shared call appearances can be individually programmed on the phone for normal ringing, delayed ringing, or no ringing for workgroup environments. No special network setup is required for this feature.

Call Directory

A 36-entry softkey-based speed dialing directory stores frequently dialed names and numbers.

Speed Dial

Spare keys can be programmed with up to 24 digits for quick one-key dialing. Network feature activators and "smart" pauses can be used for easy access to voice mail, directed call pickups, and call forwarding.

Direct Station Selection

Call appearance keys can be programmed to show busy line status on shared call appearances and provide one-key direct station selection for secretarial answering. No special network setup is required.

Voice Announce

Provides hands-free voice announcing of screened calls or station-level paging when the phone is on-hook.

Integrated Speakerphone

All models include a built-in speakerphone with volume controls and a microphone Mute key. The speakerphone allows two-way hands-free conversation and on-hook dialing.

Headset Operation

When a headset is used, hook switch operation can be disabled. Audio characteristics can be customized to match any headset.

Date and Time Display

Time and date are displayed when the phone is idle. A call timer shows the elapsed time for calls in progress.

U or S/T Interface

U interface models have a built-in ISDN Network Termination (NT1) and provide a powered S/T output to connect to other ISDN equipment. S/T interface models connect to an external NT1, such as the Tone Commander NT1U-220TC, for multipoint applications.

Desktop or Wall Mounting

A reversible base allows easy wall mounting without an adapter kit. A tilt display provides optimal viewing for any application.

Support for Computer Telephony Applications

The optional 6001TA RS-232 Interface Adapter provides remote control of the phone for Caller ID screen pops and phone dialing from Windows TAPI-compliant applications.

Advanced Troubleshooting Capabilities

Built-in Q 931 network protocol logging and analysis provide sophisticated tools to pinpoint network problems.

Local Inspect

Call appearances, network feature keys, and directory numbers can be inspected to verify the phone configuration after a network parameter download or user setup.

Easy Firmware Updates

Software can be easily updated to the latest version with a plug-in loader module or toll-free data call to Tone Commander's download server (requires circuit-switched data service).

Windows-based Setup Wizard

A question-and-answer interface guides you through the process of planning an installation, ordering service, and labeling the set.

Typical Installation

Call Appearance Capacities

6210T, U: 10 call appearances
 6220T, U: 20 call appearances
 6030X: 30 call appearances

Cabling

6210, 6220T: 2 pairs (S/T), 1 pair (power),
 8 position modular jack
 6210, 6220U: 1 pair (U), 1 pair (power),
 8 position modular jack (RJ-49C)

Standards Compliance

ANSI T1.601-1992 and T1.605-1991
 National ISDN, Lucent 5ESS Custom ISDN, Lucent Definity PBX
 FCC Part 15
 FCC Part 68
 Hearing Aid Compatible
 FCC Part 68 Volume Control Requirements
 UL, cUL Listed

Power Requirements

PS1 or PS2
 24 to 56.5 VDC @ 1 W idle, 2 W max. (excluding wiring losses)

Physical Dimensions

6210T/U, 6220T/U: 8.25" W x 8.5" D x 4.75" H, including handset
 6030X: 3.5" W x 8.5" D x 3.5" H

Weight

6210T/U, 6220T/U: 2.5 lbs
 6030X: 0.9 lbs, including base

Colors

Black, Off-White

Environmental

Operating temperature: 32° to 104° F (0° to 40°C)
 Storage temperature: 32° to 122° F (0° to 50°C)
 Humidity: 5% to 95% non-condensing

Made in USA

Typical Installation

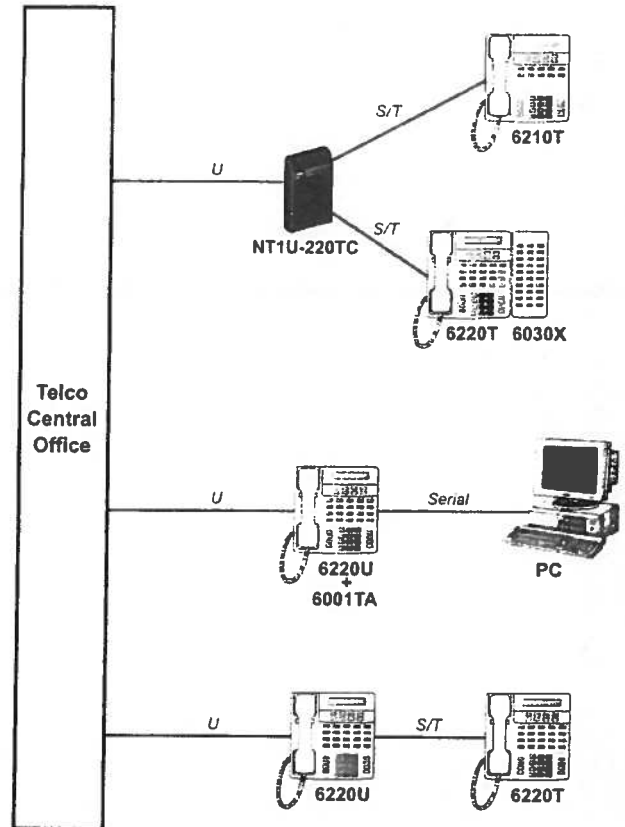

Ordering Information

Model #	Description
6210T-B	10 Line Telephone, S/T Interface, black (-W white version also available).
6210U-B	10 Line Telephone, U Interface, Built-in NT1, black (-W white version also available)
6220T-B	20 Line Telephone, S/T Interface, black (-W white version also available).
6220U-B	20 Line Telephone, U Interface, Built-in NT1, black (-W white version also available)
901042	Standalone Power Supply for U Interface phones.
6030X-B	30 button Expansion Module, compatible with all 6210 & 6220 phones, black (-W white version also available)
6001TA-B	Terminal Adapter for TAPI, RS-232 DB-25 female connector, black (-W white version also available).

Recommended support equipment:

NT1U-220TC	Desktop or Rack-mount ISDN Network Termination; supports one or two phones.
901034	Stand-alone Power Supply for one NT1U-220TC.
NT1-220 Rack	Rack with Power Supply for 12 NT1U-220TC units; supports up to 24 phones
NT1U-223TC	Triple NT1 circuit card for NT1-296 Rack.
NT1-296 Rack	High-density rack with power supply for 16 NT1U-223TC cards; supports up to 96 phones.
NT1-200 Battery Backup	Uninterruptible Battery Backup for NT1-220 or NT1-296 Rack.
NT1-200 Add-on Battery	Additional Battery to double the capacity of NT1-200 Battery Backup

tone commander.

Tone Commander Systems, Inc.
 11609 49th Place West
 Mukilteo, WA 98275-3255
 (800) 524-0024, (425) 449-1000, Fax (425) 449-1010
www.tonecommander.com

© 1998 rev D
 1998, Tone Commander Systems, Inc.
 Specifications subject to change without notice.

**STONE
COMMANDER®**6030X Expansion Module for
ISDN/VoIP Telephones

Add 30 Keys to Any 6210, 6220, 7210, or 7220 Telephone!

The new 6030X Expansion Module adds 30 multifunction keys to any Tone Commander 6210 / 6220 ISDN Telephone or 7210 / 7220 VoIP Telephone.

These additional multifunction keys can be set up as Call Appearance keys, speed dial keys, Direct Station Select keys, or Feature Activator keys. All multifunction keys have both red and green lamp indicators for easy status viewing.

This module is ideal for answering positions and high-density key applications.

The 6030X includes a replacement phone base that is compatible with desktop use and wall mounting; available in white or black.

TI-11i 6030X
Model No. 1010286601
Black

TI-11j 6030X
Model No. 1010286602
White



Fax: (425) 349-1010

Web: www.tonecommander.com

(800) 524-0024

TI-11k TI-11l

**ONE
COMMANDER**

NT1-200 and -300 SERIES
ISDN NETWORK TERMINATIONS

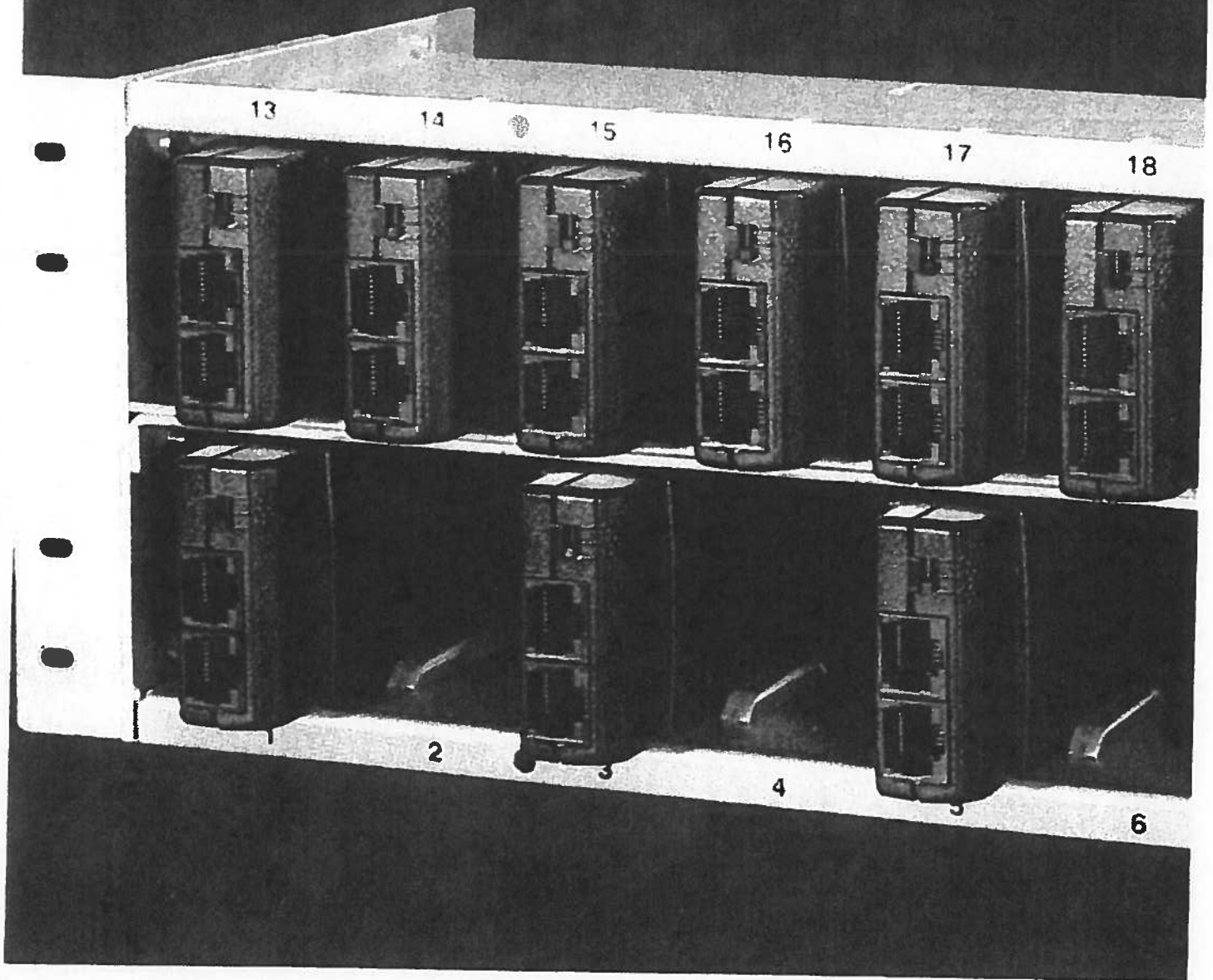

NT1 Solutions for
Every ISDN Application.

Choose the NT1 that Works the Best.

Tone Commander's ISDN Network Termination (NT1) units convert the ISDN network U-interface to an S/T interface for connection to local customer terminal equipment. These NT1 products are compatible with all Central Offices that support the ANSI standard 2B1Q U-interface and they have been used with virtually all ISDN terminal equipment and applications, in every Central Office environment. With Tone Commander, you can expect high quality products, excellent customer support, and economical pricing.

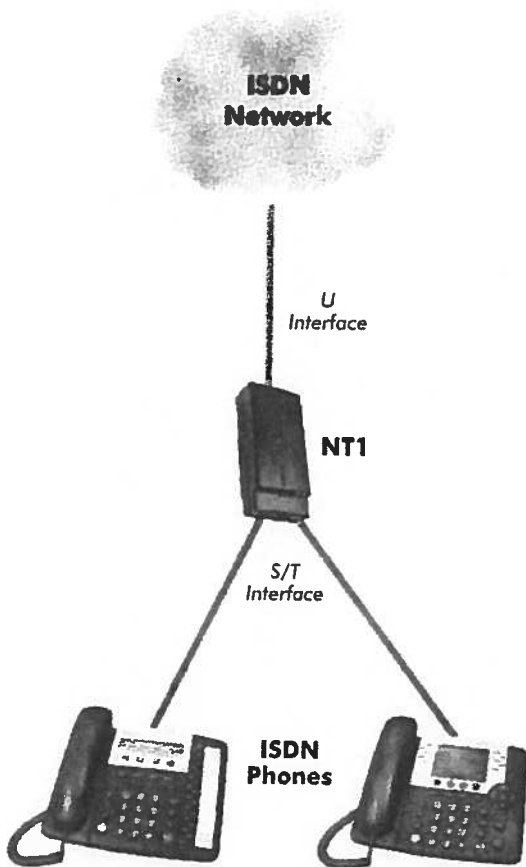

Typical Application

	NT1B-300TC	NT1U-223TC
NT1s per 5.2" (3U) high rack	24	48
Phones supported per rack (multipoint config.)	48	96
NT1 circuits per unit	1	3
Replacement for Lucent NT1B-300	✓	
Replacement for SEI PowerRack series	✓	
Standalone NT1 applications	✓	
19" or 23" rack or wall mount	✓	✓
NT1 status indicator LED	✓	✓
Power indicator LED	✓	✓
Switch-selectable S/T termination	✓	✓
Rack-accessible S/T termination switch	✓	
Front access S/T patch panel applications	✓	✓
U and S/T 50-pin ribbon connectors on rack	✓	✓
Local power jack for standalone applications	✓	
Rack power (watts)	240	300
Available terminal power per NT1 (watts)	8	5
Self-resetting short circuit power protection	✓	✓
Hot swappable in rack	✓	✓
Battery backup options	✓	✓
MLT (Mechanized Loop Testing) support	✓	✓
Made in USA	✓	✓

NT1 ISDN Network Terminations



TI-11k NT1B-300TC
Desktop/Rack Mount NT1
Model No. 1010293101

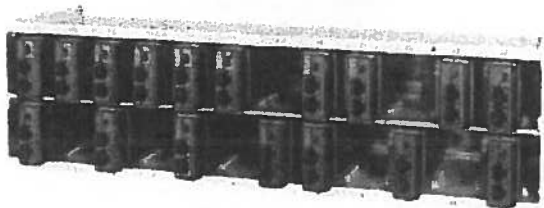

NT1B-300TC
NT1B-300 Rack

Standalone and rack mount solutions for industry-standard NT1B-300 applications.

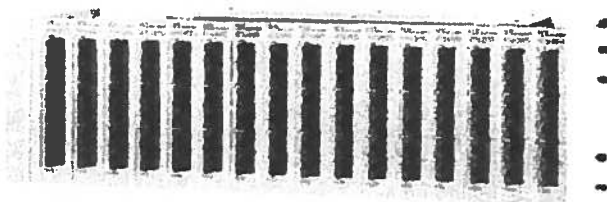

NT1U-223TC
NT1-296 Rack

The industry's highest density, lowest cost rack mount solution.

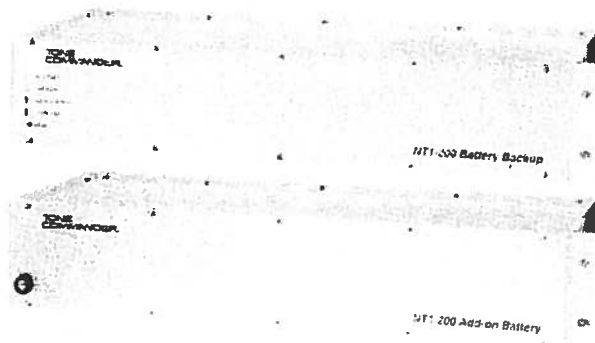

NT1-200 Battery Backup

Reserve power to maintain continuous telephone operation during a power failure.

NT1-200 Add-on Battery

Doubles the battery capacity of the NT1-200 Battery Backup.

NT1U-220TC, NT1U-100TC These models are discontinued.
 The NT1B-300TC is a replacement for the NT1U-220TC and NT1U-100TC.

Specifications & Ordering Information

Signaling Method

U Interface: ANSI Bellcore standard 2B1Q
 S/T Interface: ANSI Bellcore standard 4-wire passive bus,
 Point-to-Point or Multipoint

Standards Compliance

ANSI T1.601-1992 and T1.605-1991, including MLT
 (Mechanized Loop Testing) requirements
 Bellcore National ISDN-1 and National ISDN-2
 FCC Part 15, Part 68
 UL, cUL Listed

Selectable Options

S/T Line Termination — None, 50Ω, or 100Ω
 Timing — manual setting not required

Connectors

NT1B-300TC: Two 8-pin modular jacks — S/T interface
 One 8-pin modular jack — U interface
 8-pin connector — rack mount connection
 One barrel jack — optional local power
 NT1B-300 Rack: Four 50-pin ribbon connectors — S/T interface
 Two front panel 8-pin modular jacks per NT1 circuit
 — alternate S/T
 One 50-pin ribbon connector — U interface
 NT1U-296 Rack: Eight 50-pin ribbon connectors — S/T interface
 Two front panel 8-pin modular jacks per NT1 circuit
 — alternate S/T
 Two 50-pin ribbon connectors — U interface

Terminal Power Arrangement

PS1 and PS2 as defined in ANSI T1.605-1991

Status LEDs

NT1B-300TC: Power, Status
 NT1U-223TC: Power, Status for each NT1 circuit

Maximum Power Consumption

NT1B-300TC: 0.65 watts
 NT1U-223TC: 1.8 watts
 NT1B-300 Rack: 380 watts (fully loaded)
 NT1-296 Rack: 180 watts (fully loaded)

Power Available for Terminal Equipment, Fully Loaded

901034-01 Power Supply: 16 watts
 NT1B-300 Rack: 8 watts average per NT1
 NT1-296 Rack: 5 watts average per NT1 circuit

NT1-200 Battery Backup, NT1-200 Add-on Battery

Type and Voltage: Sealed Lead/Acid, 48V Nominal
 Capacity: 7 Amp Hour

Dimensions (Weight)

NT1B-300TC: 1.1" H x 2.1" W x 4.5" D (0.7 lbs.)
 NT1B-300 Rack: 5.2" H x 17.3" W x 7" D (7 lbs.)
 NT1-296 Rack: 5.2" H x 17.3" W x 12.3" D (7.5 lbs.)
 NT1-200 Battery Backup,
 NT1-200/296 Battery Backup: 3.5" H x 17.3" W x 6.25" D (28 lbs.)
 NT1-200 Add-on Battery: 3.5" H x 17.3" W x 6.25" (28 lbs.)
 901034-01 Power Supply: 1.3" H x 1.8" W x 3.3" D (0.4 lbs.)

Made in USA

Ordering Information

Model #	Description
NT1B-300TC	Desktop or Rack-mount ISDN Network Termination
NT1B-300 Rack	Rack with Power Supply for 24 NT1B-300TC Units
NT1U-223TC	ISDN Network Termination Rack-mount Circuit Card, 3 NT1 Circuits per card
NT1-296 Rack	Rack with Power Supply for 16 NT1U-223TC Cards
NT1-200 Battery Backup	Uninterruptible Battery Backup for NT1B-300 Rack
NT1-200/296 Battery Backup	Uninterruptible Battery Backup for NT1-296 Rack
NT1-200 Add-on Battery	Additional Battery to double the capacity of NT1-200 Battery Backup
901034-01	12 Watt Standalone Power Supply for NT1B-300TC and ISDN Terminals

TOPE COMMANDER

Tone Commander Systems, Inc.
 11609 19th Place West
 Mukilteo, WA 98275-1255
 (800) 524-0024, (425) 349-1000, Fax: (425) 339-0110
www.tonecommander.com

© 1997 Tone Commander Systems, Inc.
 Specifications are subject to change without notice.

-PWR1 Power Supply Option (901034-01)

TI-111

**TI-111 PWR1 Power Supply
Model No. 901034-01
Desktop Power Supply**

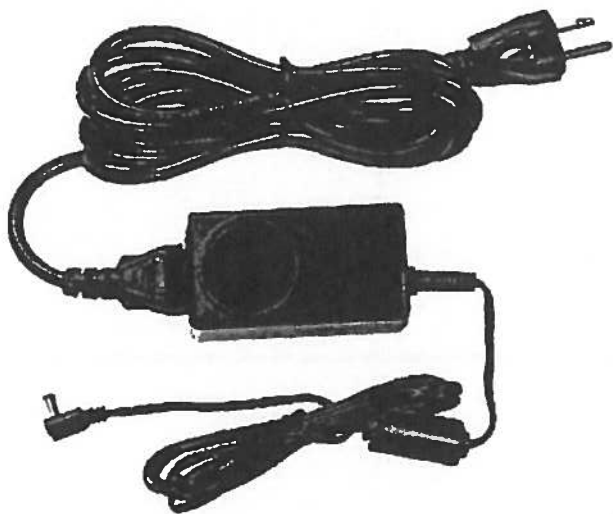

The -PWR1 Desktop Power Supply option provides filtered operating power for 8810U, 8610U/8620U, 6210U/6220U ISDN Telephones, 7310/7320 VoIP telephones, and NT1B-300TC, NT1U-220TC ISDN Network Terminations.

Older 6210U/6220U phones without an integrated power jack require the -PWR2 or -PWR3 Power Supply option when locally powered.

Input: 100-240 VAC, 50-60 Hz, 0.3 A; 7.5 ft. cord

Output: 48 VDC, 0.25 A; 6 ft. cord

UL Listed

 [Click for larger image](#)

STONE COMMANDER[®]

NT1B-300 Rack Installation Instructions

The NT1B-300 Rack houses 24 Tone Commander NT1B-300TC ISDN Network Terminations in a 19" rack, 23" rack, or wall mount configuration. The rack is also compatible with Lucent NT1B-300 NT1s.

The rack supplies power to the NT1 units and terminal equipment connected to the NT1s from an integral power supply. An optional NT1-200 Battery Backup Power Supply can be added to the NT1B-300 Rack to provide uninterrupted NT1 and ISDN terminal power during a power failure.

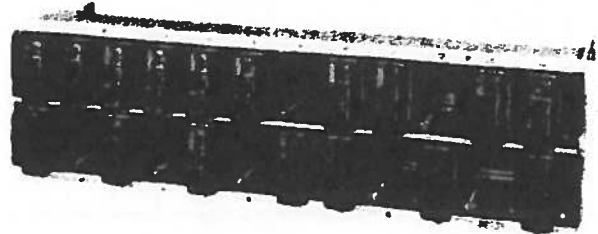

Specifications

NT1B-300 Rack with Power Supply

Capacity	24 NT1s (48 ISDN BRI terminals)
Physical Dimensions	5.22" H x 17.25" W x 7" D (fits 19" or 23" rack, 3U rack height)
Weight	7 lbs. without NT1s; 12 lbs. with 24 NT1s
Operating Temperature	0° - 40° C (32° - 104° F)
Humidity	5% to 95%, non-condensing
Short Circuit Protection	Individual self-resetting current limiting for each NT1; 20 W max. per NT1
Standards Compliance	UL, cUL 60950
Input Power Requirements	120 VAC, 60 Hz, 5 A max.
Output Power	48-55 VDC, 240 W max.

TI-11m NT1B-300
Rack with Power Supply
Model No. 1010293201

Contents of Shipping Box

- NT1B-300 Rack with Power Supply
- 19"/23" mounting brackets (2 each)
- 10-24 x 1/4" mounting bracket screws (4 each)
- Installation Instructions (this document)

Optional NT1B-300 Rack Locking Kit (Model 102933)



Important Safety Instructions

- This equipment is intended for installation in a restricted access location (dedicated equipment rooms, equipment closets, or the like) in accordance with Articles 110-16, 110-17, and 110-18 of the National Electrical Code, ANSI/NFPA No. 70.
- Never install telephone wiring during a lightning storm.
- Never install telephone jacks in wet locations unless the jack is specifically designed for wet locations
- Never touch uninsulated telephone wires or terminals unless the telephone line has been disconnected at the network interface.
- Use caution when installing or modifying telephone wires.
- Do not mount the NT1B-300 Rack within 12" of a heat source.
- The socket-outlet shall be installed near the equipment and shall be easily accessible.

Tone Commander NT1B-300 Rack Installation Instructions

Rack Mounting

1. The NT1B-300 Rack can be mounted in an EIA standard 19" commercial or 23" telco rack.
2. Attach the mounting brackets to the rack in a 19" or 23" mounting position as needed, using the supplied mounting bracket screws.
3. Mount the rack to the 19" or 23" rack standards using suitable fasteners.

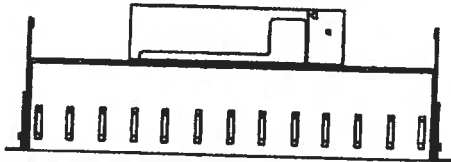

Bracket Positions – 19" Rack

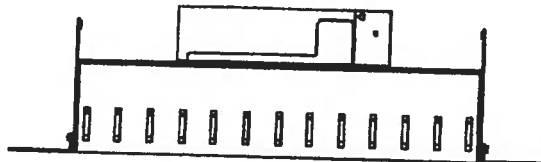

Bracket Positions – 23" Rack

Wall Mounting

Note – When mounting the NT1B-300 Rack in conjunction with a Battery Backup unit, refer to the NT1-200 Battery Backup/NT1-200 Add-on Battery Installation Instructions (doc. #13-102688) for proper mounting positions.

1. Remove all NT1 units from the rack. Unplug the power supply from the wall outlet.
2. Attach the mounting brackets to the rack in the wall mounting position, using the supplied mounting bracket screws.
3. Fasten a 3/4" plywood sheet to the wall.
4. Hold the rack up to the wall to mark the hole locations, then pre-drill the mounting holes for the rack.

When locating the rack make sure:

- the power supply fan and vents are not obstructed and there is good air flow around the rack.
 - there is enough room to tilt the rack forward to access the cables on the back and enough room to route cables. When mounted with NT1s installed, the rack extends 9.25" from the wall.
 - the power cord can reach a local 120 VAC, 60 Hz, single phase grounded power outlet.
5. Attach the rack to the plywood using four suitable fasteners (such as #10x3/4" pan head self-tapping screws). A fully loaded NT1B-300 Rack weighs 12 lbs.
 6. With no NT1s installed in rack, remove the top bracket mounting screw on each side of the rack and carefully tilt the rack forward to connect ribbon cable connectors. Leave enough slack in the ribbon cables to allow the rack to properly tilt forward for access after installation. After all cables are connected, replace and tighten mounting screws and install the NT1s.

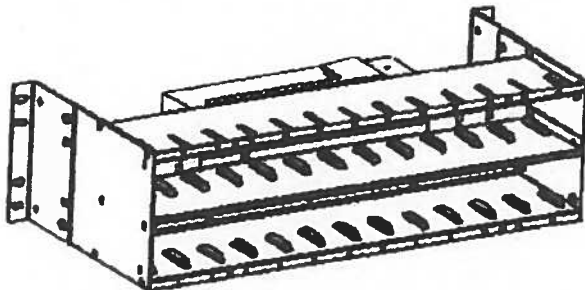

Wall Mount Bracket Positions

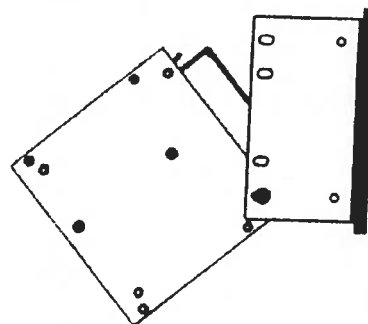

Tilting Rack for Cable Access

NT1B-300TC Installation

Carefully insert each NT1B-300TC into the appropriate slot in the NT1B-300 rack, with the indicator lights oriented at the top left. The rack connectors are offset to prevent incorrect installation. Slot numbers on the front of the rack correspond to 50-pin connector pinouts listed in Table 2. NT1s may be inserted or removed from an operational rack without affecting the performance of other NT1 units. Make sure all NT1s are oriented properly and fully seated in their rack connectors and verify that the termination switch settings are correct. Refer to the NT1B-300TC installation manual (doc. # 13-280111).

To prevent unintentional removal of NT1 units, install optional locking brackets (Tone Commander Model 102933) after all NT1s are installed. Align the brackets with the mounting holes on the front of the rack and push in the plunger on each panel fastener to secure them.

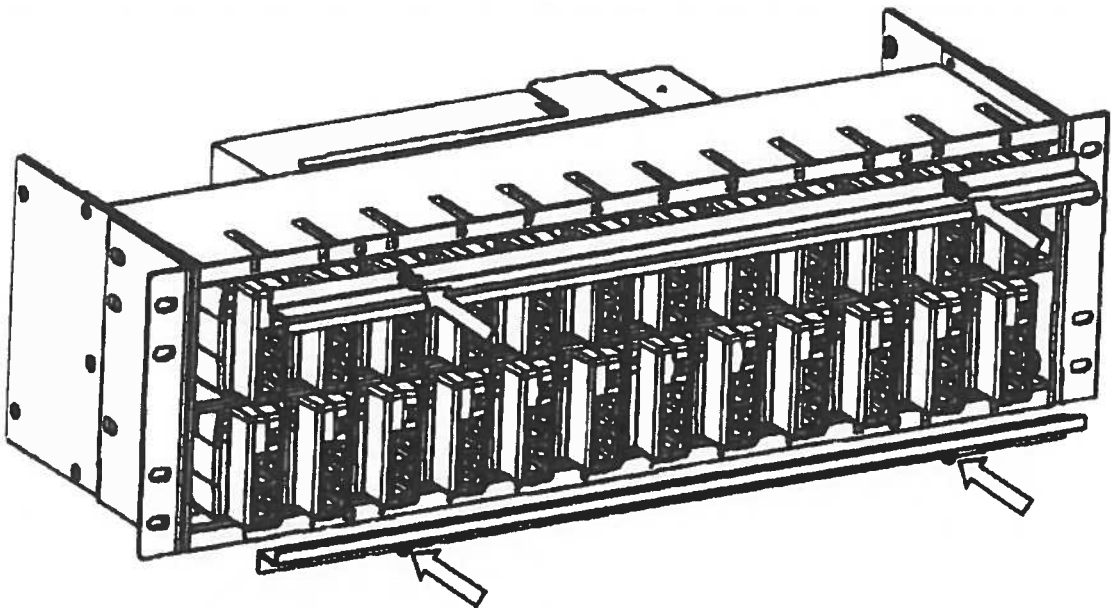

Rack with NT1B-300TCs Installed – Locking Bracket Installation

**TI-11n 102933
Rack Locking Unit
Model No. 1010293301**

Tone Commander NT1B-300 Rack Installation Instructions

Cable Connections

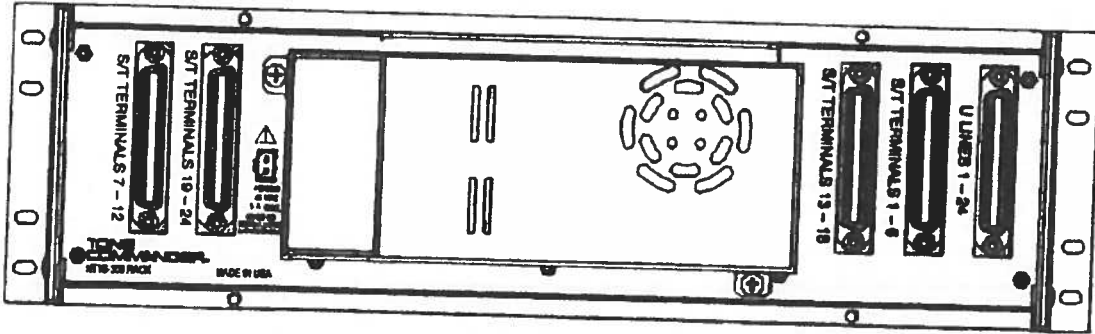

Back Panel Connectors

All rack S/T and U ribbon connectors are female; male connectors are required on the cable ends.

U Interface

Connect each U interface pair from the network interface block into the appropriate position on the 50-pin U interface connector on the rack rear panel. See Table 2 for connector pinouts. The rack uses self-locking connectors; to remove a cable, use a small tool to press in the tabs on the ends of the connector.

S/T Interface

The S/T interface for each terminal can be connected one of two ways:

1. Modular jacks on the front of the NT1B-300TC units – for terminal equipment or patch panel connection via an 8-position modular phone cord. Connecting cords must be Category 3 or higher with T568 A or T568 B wiring. See Table 1 and the figure below for jack pinout.

Two parallel-wired jacks are provided on each NT1, for two terminals connected in a multipoint arrangement.

2. 50-pin ribbon connectors on the rack back panel – for terminal equipment connection via a punch-down block. See Table 2 for connector pinouts.

Connect the terminal wall jacks to 4-pair cables as shown in Table 1. Punch down the cables to the cross-connect blocks in the order shown in Table 1. Note that pairs 1-2 and 3-6 for T568A jacks are reversed from T568B jacks.

Pin #	Signal	Wire Color	
		T568 A	T568 B * (AT&T)
5	Tx-	WHT-BLU	WHT-BLU
4	Tx+	BLU	BLU
1	unused	WHT-GRN	WHT-ORN
2	unused	GRN	ORN
3	Rx+	WHT-ORN	WHT-GRN
6	Rx-	ORN	GRN
7	-48V	WHT-BRN	WHT-BRN
8	-48VRTN	BRN	BRN

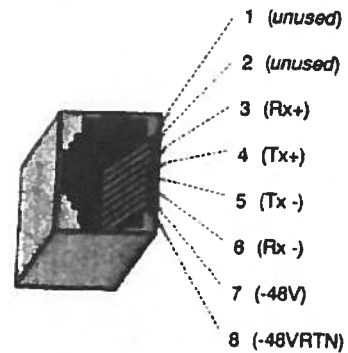

Table 1 – Modular Jack Pinout

Pin No.	Wire Color	U Lines 1-24	S/T Ports 1-6	S/T Ports 7-12	S/T Ports 13-18	S/T Ports 19-24
26	WHT-BLU	TIP 1	Tx1-	Tx7-	Tx13-	Tx19-
1	BLU-WHT	RING 1	Tx1+	Tx7+	Tx13+	Tx19+
27	WHT-ORN	TIP 2	-	-	-	-
2	ORN-WHT	RING 2	-	-	-	-
28	WHT-GRN	TIP 3	Rx1-	Rx7-	Rx13-	Rx19-
3	GRN-WHT	RING 3	Rx1+	Rx7+	Rx13+	Rx19+
29	WHT-BRN	TIP 4	-48V	-48V	-48V	-48V
4	BRN-WHT	RING 4	-48VRTN	-48VRTN	-48VRTN	-48VRTN
30	WHT-SLT	TIP 5	Tx2-	Tx8-	Tx14-	Tx20-
5	SLT-WHT	RING 5	Tx2+	Tx8+	Tx14+	Tx20+
31	RED-BLU	TIP 6	-	-	-	-
6	BLU-RED	RING 6	-	-	-	-
32	RED-ORN	TIP 7	Rx2-	Rx8-	Rx14-	Rx20-
7	ORN-RED	RING 7	Rx2+	Rx8+	Rx14+	Rx20+
33	RED-GRN	TIP 8	-48V	-48V	-48V	-48V
8	GRN-RED	RING 8	-48VRTN	-48VRTN	-48VRTN	-48VRTN
34	RED-BRN	TIP 9	Tx3-	Tx9-	Tx15-	Tx21-
9	BRN-RED	RING 9	Tx3+	Tx9+	Tx15+	Tx21+
35	RED-SLT	TIP 10	-	-	-	-
10	SLT-RED	RING 10	-	-	-	-
36	BLK-BLU	TIP 11	Rx3-	Rx9-	Rx15-	Rx21-
11	BLU-BLK	RING 11	Rx3+	Rx9+	Rx15+	Rx21+
37	BLK-ORN	TIP 12	-48V	-48V	-48V	-48V
12	ORN-BLK	RING 12	-48VRTN	-48VRTN	-48VRTN	-48VRTN
38	BLK-GRN	TIP 13	Tx4-	Tx10-	Tx16-	Tx22-
13	GRN-BLK	RING 13	Tx4+	Tx10+	Tx16+	Tx22+
39	BLK-BRN	TIP 14	-	-	-	-
14	BRN-BLK	RING 14	-	-	-	-
40	BLK-SLT	TIP 15	Rx4-	Rx10-	Rx16-	Rx22-
15	SLT-BLK	RING 15	Rx4+	Rx10+	Rx16+	Rx22+
41	YEL-BLU	TIP 16	-48V	-48V	-48V	-48V
16	BLU-YEL	RING 16	-48VRTN	-48VRTN	-48VRTN	-48VRTN
42	YEL-ORN	TIP 17	Tx5-	Tx11-	Tx17-	Tx23-
17	ORN-YEL	RING 17	Tx5+	Tx11+	Tx17+	Tx23+
43	YEL-GRN	TIP 18	-	-	-	-
18	GRN-YEL	RING 18	-	-	-	-
44	YEL-BRN	TIP 19	Rx5-	Rx11-	Rx17-	Rx23-
19	BRN-YEL	RING 19	Rx5+	Rx11+	Rx17+	Rx23+
45	YEL-SLT	TIP 20	-48V	-48V	-48V	-48V
20	SLT-YEL	RING 20	-48VRTN	-48VRTN	-48VRTN	-48VRTN
46	VIO-BLU	TIP 21	Tx6-	Tx12-	Tx18-	Tx24-
21	BLU-VIO	RING 21	Tx6+	Tx12+	Tx18+	Tx24+
47	VIO-ORN	TIP 22	-	-	-	-
22	ORN-VIO	RING 22	-	-	-	-
48	VIO-GRN	TIP 23	Rx6-	Rx12-	Rx18-	Rx24-
23	GRN-VIO	RING 23	Rx6+	Rx12+	Rx18+	Rx24+
49	VIO-BRN	TIP 24	-48V	-48V	-48V	-48V
24	BRN-VIO	RING 24	-48VRTN	-48VRTN	-48VRTN	-48VRTN
50	VIO-SLT	-	-	-	-	-
25	SLT-VIO	-	-	-	-	-

Table 2 – 50-pin Ribbon Connector Pinouts

Tone Commander NT1B-300 Rack Installation Instructions

Power

Rack Power Supply

1. Verify that the power output cable (red and black wires) is plugged into the rack's POWER connector.
2. Plug the power cord into a local 120 VAC, 60 Hz, single phase power outlet.

Battery Backup Power Supply

Refer to the NT1-200 Battery Backup Installation Instructions (doc. #13-102688) for Backup Battery power supply installation.

ISDN Terminal Power

ISDN terminals connected to the NT1s installed in the rack are powered from the NT1B-300 Rack power supply. Terminal power can be provided by either of the following methods:

PS-2 – Direct power feed on Terminal jack pin 7 (-) and pin 8 (+), approximately 4.5 watts average per terminal for a fully loaded rack (240 watts maximum per rack).

PS-1 – Phantom power feed over the transmission pairs, Terminal jack pins 3/6 (+) and pins 4/5 (-), 4 watts maximum per NT1 circuit.

Power connections to each NT1 are individually short circuit protected.

Power Up Test

Refer to the NT1B-300TC installation manual (doc. # 13-280111) for power up test information.

Service

Repair of the NT1B-300 Rack and NT1B-300TC must be done by Tone Commander. Prior to equipment removal, call Tone Commander Customer Technical Support for assistance in determining the source of the problem. This critical action can often prevent needless removal of equipment and subsequent customer inconvenience.

Tone Commander
Customer Technical Support Department
11609 49th Place West
Mukilteo, WA 98275-4255 USA

Phone: (425) 349-1000
(800) 524-0024

Fax: (425) 349-1010

E-mail: tech@tonecommander.com

Web: www.tonecommander.com

Tone Commander is committed to meeting the product needs of our customers. Please write or call us with any suggestions for improvement.

FCC Requirements

The Tone Commander Models NT1B-300 Rack and NT1B-300TC comply with Part 68 of the FCC Rules. The label affixed to this equipment contains, among other information, the FCC Registration for this equipment. You must, upon request, provide this information to your telephone company.

The following jacks must be ordered from the telephone company in order to interconnect this product with the public communication network: RJ21X.

If your NT1B-300 Rack or NT1B-300TC causes harm to the telephone network, the Telephone Company may discontinue your service temporarily. If possible, they will notify you in advance. But if advance notice is not practical you will be notified as soon as possible. You will be informed of your right to file a complaint with the FCC.

Your telephone company may make changes in its facilities, equipment, operations or procedures that could affect the proper functioning of your equipment. If they do, you will be notified in advance to give you an opportunity to maintain uninterrupted telephone service.

If you have trouble with the NT1B-300 Rack and NT1B-300TC, contact us at the address listed on page 6 of this manual for information on obtaining service or repairs. The telephone company may ask that you disconnect the telephone from the network until the problem has been corrected or until you are sure that the equipment is not malfunctioning.

The Tone Commander NT1B-300 Rack and NT1B-300TC have been tested and found to comply with the limits for a Class B digital device, pursuant to Part 15 of the FCC Rules. These limits are designed to provide reasonable protection against harmful interference when the equipment is operated in a residential environment. This equipment generates, uses, and can radiate radio frequency energy and, if not installed and used in accordance with the instruction manual, may cause harmful interference to radio communications. However, there is no guaranty that interference will not occur in a particular installation. If this equipment does cause harmful interference to radio or television reception, which can be determined by turning the equipment off and on, the user is encouraged to try to correct the interference by one of the following measures:

- Where it can be done safely, re-orient the receiving television or radio antenna.
- To the extent possible, increase the separation between the telephone equipment and the television, radio, or other equipment.
- If your telephone equipment runs on AC power, plug your product into an AC outlet that is not on the same circuit as the one used by your radio or television receiver.

Tone Commander NT1B-300 Rack Installation Instructions

Tone Commander Product Warranty

For a period of one year from date of dealer purchase, but not to exceed 16 months from date of manufacture, Tone Commander Systems, Inc. (Tone Commander) warrants its products to be free from defects in material and workmanship under conditions of normal use and service. Tone Commander shall, at its option, repair or replace any defective product which, in its opinion, has not been misused, damaged, or improperly installed.

Repair or replacement under this warranty will be performed at Tone Commander's factory. Authorization must be obtained from Tone Commander prior to returning a product for repair. Freight must be prepaid for all units returned to Tone Commander. Units repaired under warranty will be shipped UPS Ground (or equivalent), freight prepaid by Tone Commander.

Products that are older than the warranty period, but less than 7 years old, or still manufactured by Tone Commander may be repaired at the factory for a flat rate charge. Repaired out-of-warranty units are warranted for 90 days from the date of repair.

The repair or replacement of a product under this warranty represents the entire obligation of Tone Commander; Tone Commander shall not be liable for any special or consequential damages resulting from or caused by any defect, failure, incapacity or malfunction of any of its products.

The foregoing express warranty is in lieu of all other warranties, express or implied, including, but not limited to any implied warranty of merchantability, fitness, or adequacy for any purpose or use, quality, productiveness or capacity; Tone Commander, to the extent permitted by law, hereby disclaims all such other warranties.

**TONE
COMMANDER**

**NT1-200, NT1-200/296
Battery Backup
NT1-200 Add-on Battery
Installation Instructions**

The Battery Backup units for Tone Commander NT1 Racks and ISDN Power Supplies provide backup NT1 and terminal power (PS1 and PS2) during a power failure. The NT1-200 Battery Backup is used with the NT1B-300 Rack, NT1-220 Rack, and PS-50 ISDN Power Supply; the NT1-200/296 version is used with the NT1-296 Rack. An optional Add-on Battery is available to increase the duration of backup power.

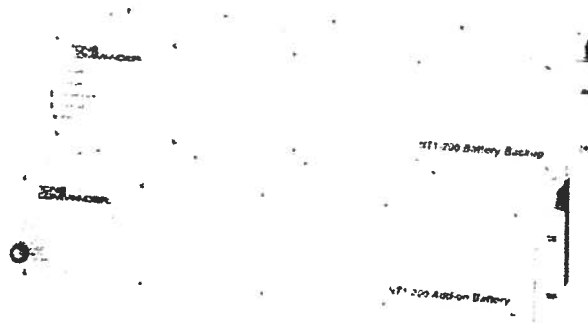

Specifications

NT1-200, NT1-200/296 Battery Backup

Built-in management circuit (protection, charging, and monitor display).

Output Voltage	42 - 55 VDC
Charging Current	700 mA max. (shared with the NT1-200 Add-on Battery if present)
Battery Capacity	7 AH
Overcurrent Protection	6.25 A, 250 V Slow Blow fuse
Physical Dimensions	3.5" H x 17.3" W x 6.2" D
Weight	27 lbs.
Operating Temperature	0° - 40° C (32° - 104° F) <i>Note: Battery life decreases above 20° C (68° F)</i>
Humidity	5% to 95%, non-condensing
Alarm Contacts	48 VDC @ 0.5A max. (resistance load)
Battery Type	Sealed lead-acid, maintenance-free
In-service Battery Life	3 - 6 years @ 20° C (68° F)

NT1-200 Add-on Battery

Output Voltage	42 - 55 VDC
Charging Current	shared with NT1-200(/296) Battery Backup
Battery Capacity	7 AH
Overcurrent Protection	6.25 A, 250 V Slow Blow fuse
Physical Dimensions	3.5" H x 17.3" W x 6.2" D
Weight	27 lbs.
Operating Temperature	0° - 40° C (32° - 104° F) <i>Note: Battery life decreases above 20° C (68° F)</i>
Humidity	5% to 95%, non-condensing
Battery Type	Sealed lead-acid, maintenance-free
In-service Battery Life	3 - 6 years @ 20° C (68° F)

TI-11o

**NT1-200 Battery Backup for
NT1B-300 Rack
Model No. 1010270001**

TI-11p

**NT1-200 Add-on Battery for
NT1-200
Model No. 1010269601**



Important Safety Instructions

- To be installed only in restricted access areas (dedicated equipment rooms, equipment closets, or the like) in accordance with Articles 110-16, 110-17, and 110-18 of the National Electrical Code, ANSI/NFPA No. 70.
- Never install telephone wiring during a lightning storm.
- Never install telephone jacks in wet locations unless the jack is specifically designed for wet locations.
- Never touch uninsulated telephone wires or terminals unless the telephone line has been disconnected at the network interface.
- Use caution when installing or modifying telephone wires.
- Do not mount the NT1-200(/296) Battery Backup or the NT1-200 Add-on Battery within 12" of a heat source.

Contents of Shipping Box

NT1-200, NT1-200/296 Battery Backup

- (1) Battery Backup
- (1) Interconnecting "Y" Cable
- (2) Mounting brackets
- (4) Mounting bracket screws
- (1) Fuse cap and fuse

NT1-200 Add-on Battery

- (1) NT1-200 Add-on Battery
- (2) Mounting brackets
- (4) Mounting bracket screws
- (1) Fuse cap and fuse

Installation

Rack Mounting

The NT1-200(/296) Battery Backup and the NT1-200 Add-on Battery can be mounted in an EIA standard 19" commercial or 23" Telco rack.

1. Attach the mounting brackets to the Battery Backup and/or Add-on Battery in the 19" or 23" mounting position as needed, using the supplied mounting bracket screws (see Figure 1).
2. Mount the battery units to the 19" or 23" rack using suitable fasteners. Refer to Figures 2-5 for mounting positions and required clearances.



Bracket Positions – 19" Rack

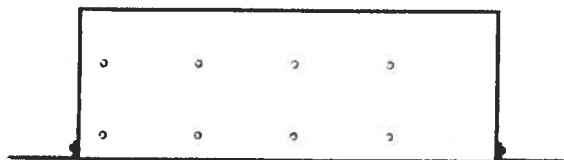

Bracket Positions – 23" Rack

Figure 1 – Rack Mount Bracket Positions

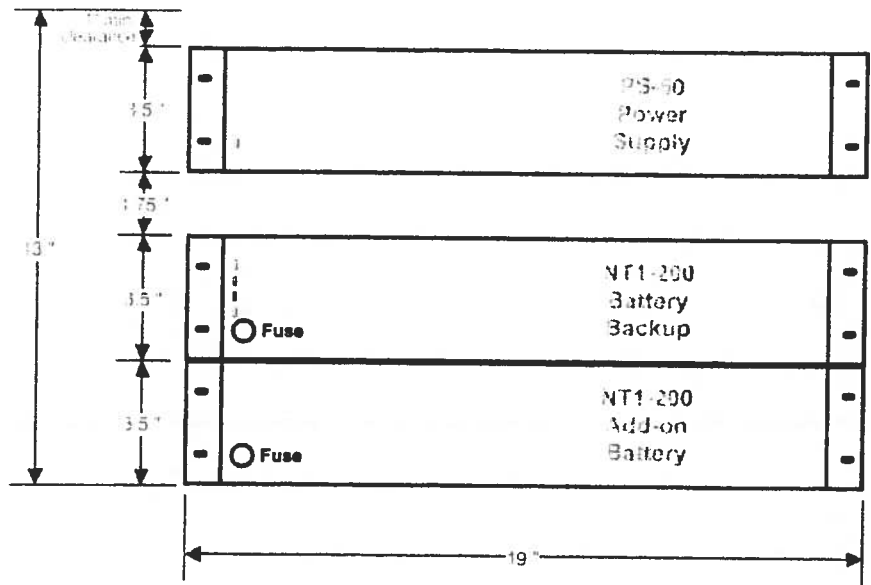

Figure 2 – Rack Mounting with PS-50

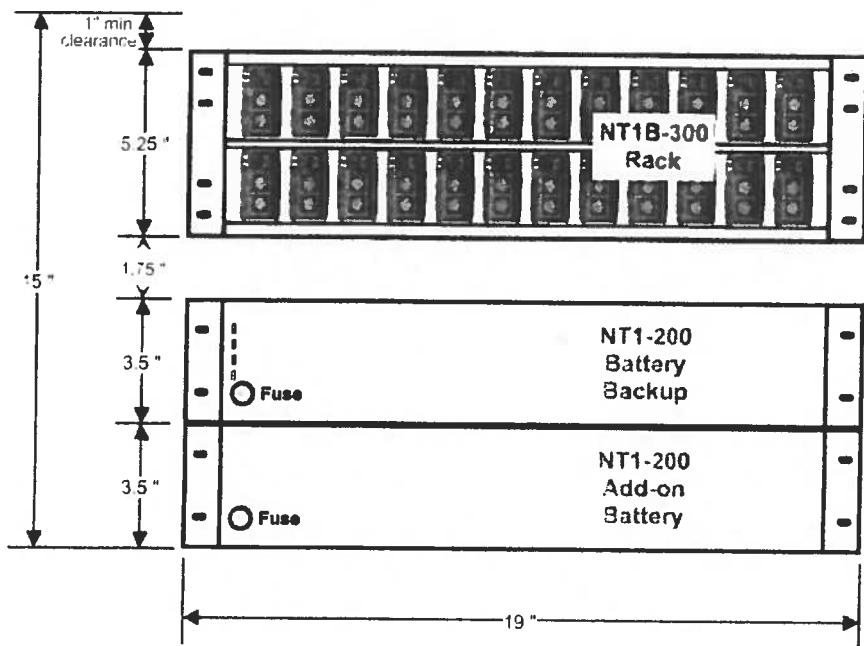

Figure 3 – Rack Mounting with NT1B-300 Rack

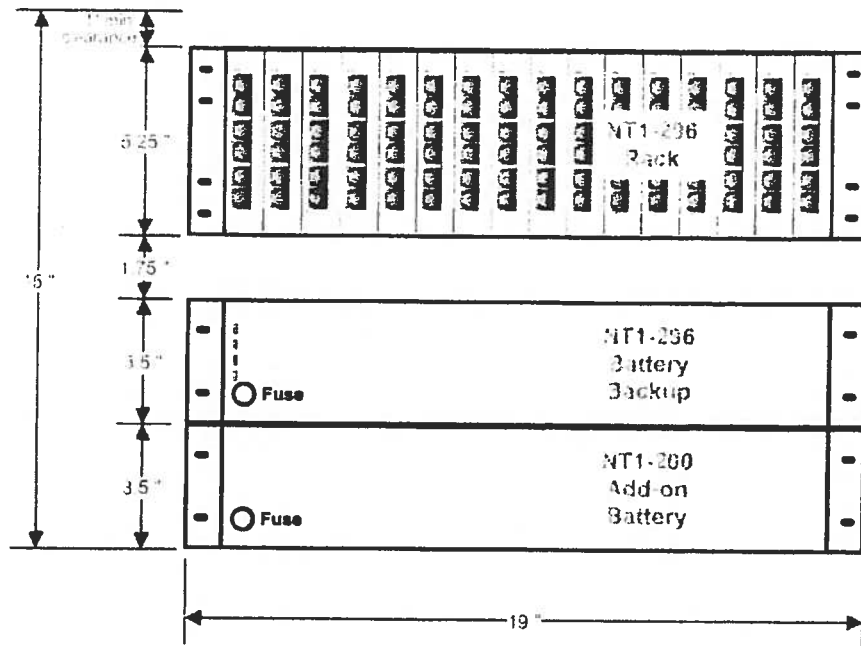

Figure 4 – Rack Mounting with NT1-296 Rack

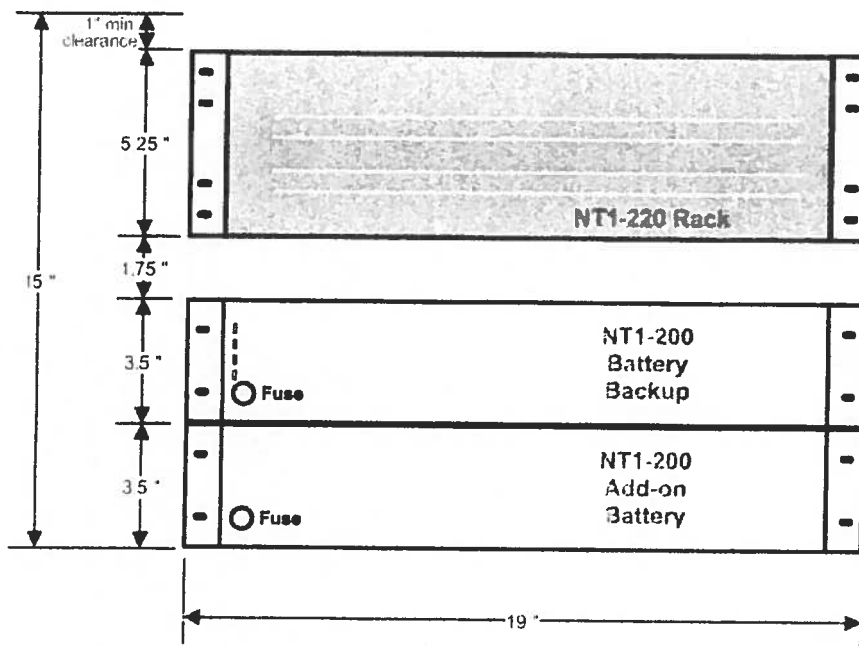

Figure 5 – Rack Mounting with NT1-220 Rack

Wall Mounting

1. Attach mounting brackets to the Battery Backup and/or Add-on Battery in the wall mounting position using the supplied mounting bracket screws (see Figure 6).
2. Fasten a plywood sheet to the wall, $\frac{3}{4}$ " minimum thickness. **Do not mount the rack or battery units directly to drywall material.**
3. Mark and pre-drill the mounting holes for the battery backup and/or add-on battery. Refer to Figures 7–10 for hole locations and required clearances.
4. Attach the battery backup and/or add-on battery to the plywood using four suitable fasteners.



The Battery Backup and Add-on Battery must be fastened securely; these units weigh 27 lbs. each!

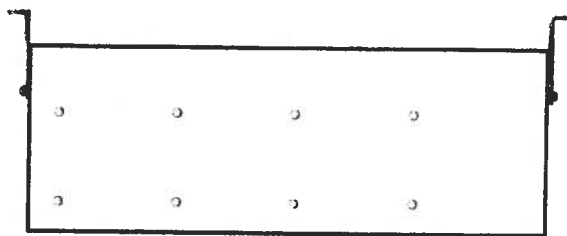

Figure 6 – Wall Mount Bracket Positions

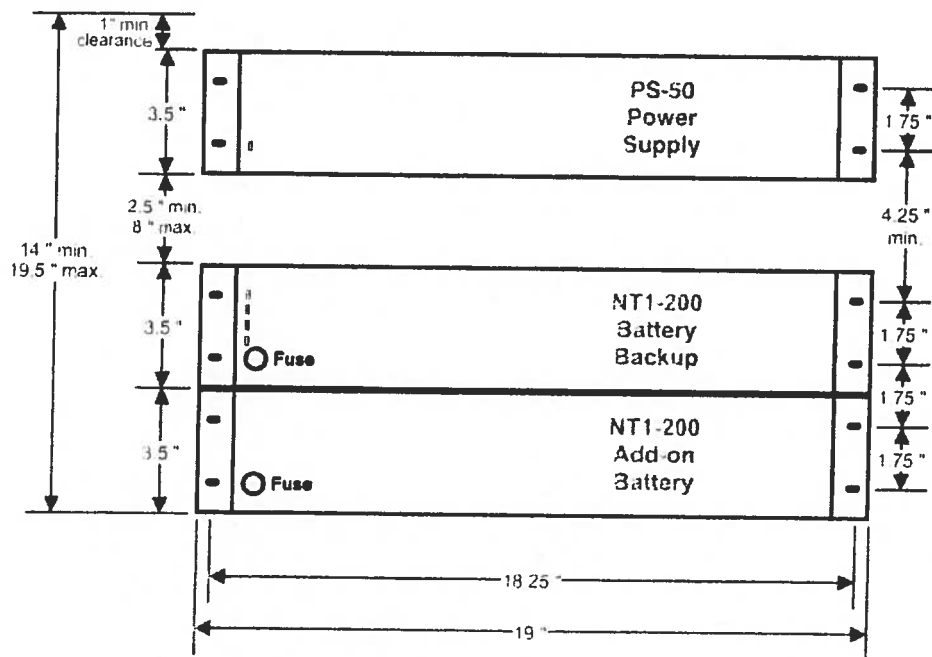

Figure 7 – Wall Mounting with PS-50

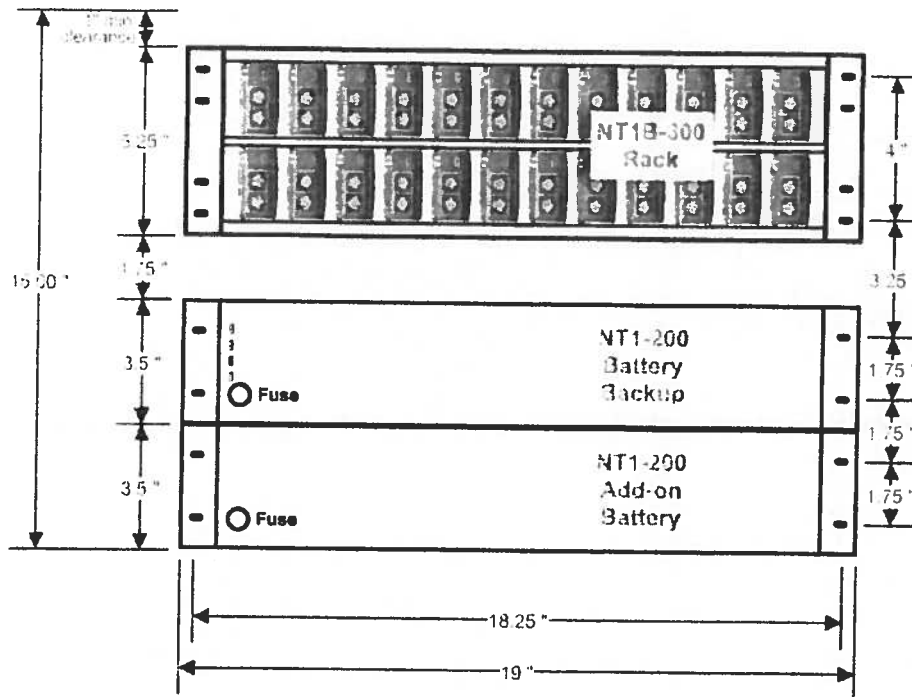

Figure 8 – Wall Mounting with NT1B-300 Rack

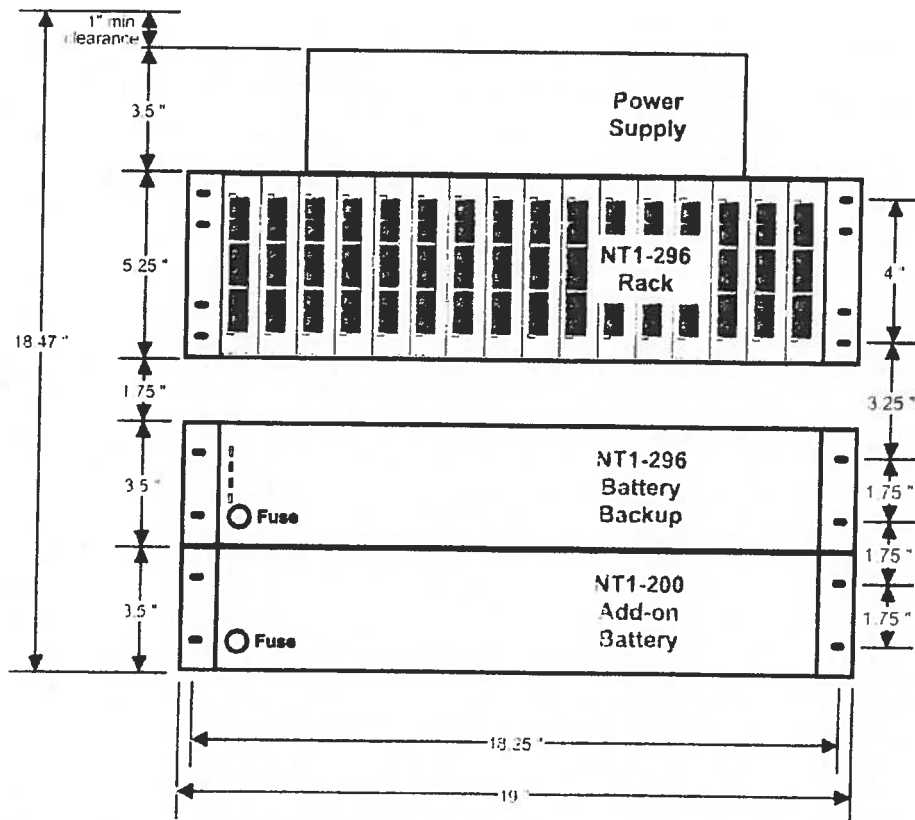

Figure 9 – Wall Mounting with NT1-296 Rack

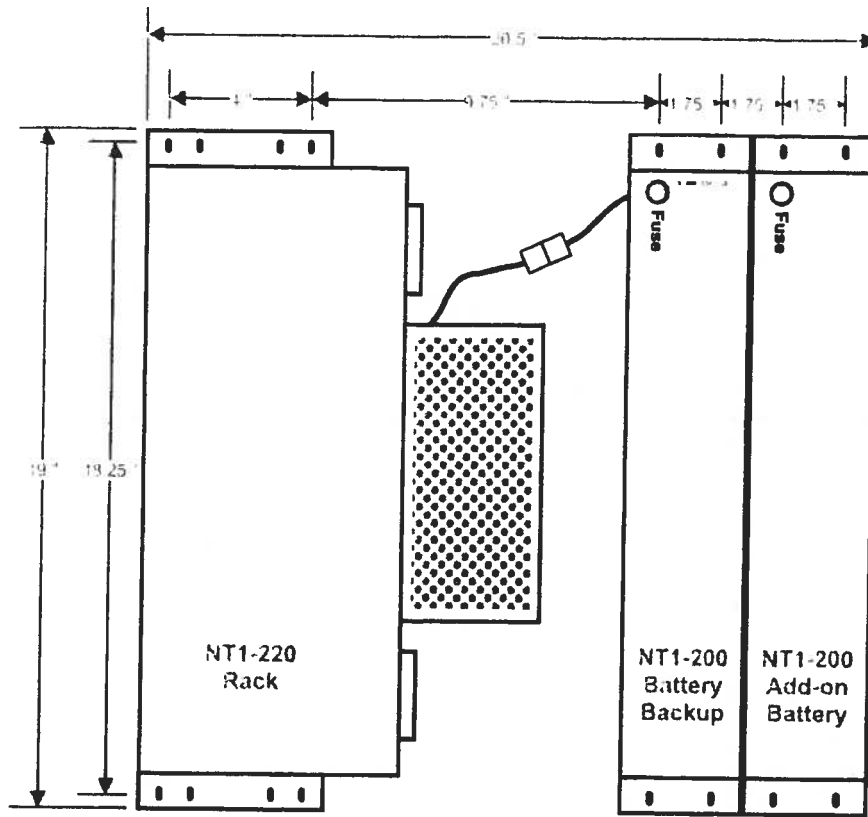

Figure 10 – Wall Mounting with NT1-220 Rack

Cable Connection

To avoid power supply connector damage due to load inrush currents, make sure all NT1s are removed from the rack before cable connections are made.

Refer to Figure 11.

1. Make sure that no NT1s are inserted in the rack.
2. Unplug the power supply output cable from the NT1 rack or PS-50.
3. Plug the 4-pin connector on the "Y" cable into the upper connector on the back panel of the Battery Backup.
4. Connect the short wires on the "Y" cable to the power supply output cable female connector.
5. Plug the long wires on the "Y" cable into the NT1B-300 Rack, NT1-296 Rack, NT1-220 Rack, or PS-50 "POWER" connector.
6. Insert the fuse into the fuse holder on the Battery Backup front panel and secure with the supplied fuse cap. The Backup Power indicator will light.
7. Connect AC power to the power supply.
8. Install NT1s in the rack.

Add-on Battery

Refer to Figure 11.

1. Insert the fuse into the fuse holder on the Add-on Battery front panel and secure with the supplied fuse cap.
2. Plug the Add-on Battery wires into the center connector on the back panel of the Battery Backup (AC power may be connected).

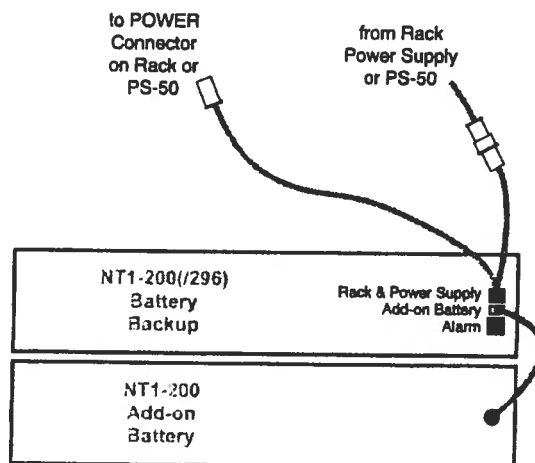

Figure 11 – Battery Connections

Alarm

The alarm modular jack provides two relay contact circuits for alarm monitoring. Make sure that you do not exceed the relay contact rating of 48 VDC @ 0.5 A (resistive). During AC power loss, pins 2 and 5 are shorted and pins 3 and 4 are open as shown in Figure 12.

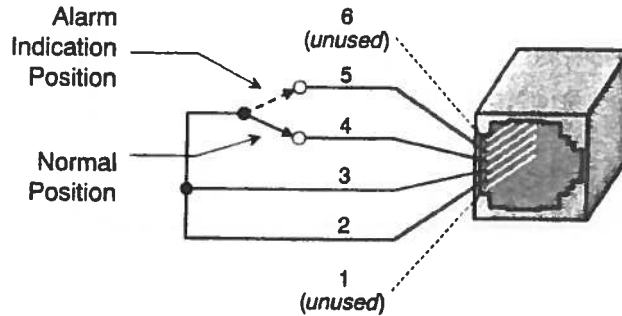

Figure 12 – Alarm (6 Position Modular Jack)

Status Indicators

The Battery Backup has four status indicator LEDs on the front panel.

Status Indicator LED	Description
AC Power (green)	Battery Backup is connected to the rack and the rack is currently being fed from the power supply.
Charging (Yellow)	The Battery Backup (and the Add-on Battery, if present) are currently being charged. Does not light when the rack is on backup power.
Backup Power (Red)	The rack is currently being powered by the Battery Backup (and the Add-on Battery, if present).
Overload (Red)	Too much power is being drawn from the Backup Battery and/or the Add-on Battery. Investigate and remove the fault condition.
all LEDs off	Batteries are fully discharged, or a fuse is blown.

Service

Repair of the NT1-200 or NT1-200/296 Battery Backup and the NT1-200 Add-on Battery must be done by Tone Commander. Prior to equipment removal, call Tone Commander Customer Service for assistance in determining the source of the problem. This critical action can often prevent needless removal of equipment and subsequent customer inconvenience.

Tone Commander
Technical Support Department
11609 49th Place West
Mukilteo, WA 98275-4255 USA

Phone: (425) 349-1000
(800) 524-0024

Fax: (425) 349-1010

E-mail: tech@tonecommander.com

Web: www.tonecommander.com

Tone Commander is committed to meeting the product needs of our customers. Please write or call us with any suggestions for improvement.

Tone Commander Product Warranty

For a period of one year from date of dealer purchase, but not to exceed 16 months from date of manufacture, Tone Commander Systems, Inc. (Tone Commander) warrants its products to be free from defects in material and workmanship under conditions of normal use and service. Tone Commander shall, at its option, repair or replace any defective product which, in its opinion, has not been misused, damaged, or improperly installed.

Repair or replacement under this warranty will be performed at Tone Commander's factory. Authorization must be obtained from Tone Commander prior to returning a product for repair. Freight must be prepaid for all units returned to Tone Commander. Units repaired under warranty will be shipped UPS Ground (or equivalent), freight prepaid by Tone Commander.

Products that are older than the warranty period, but less than 7 years old, or still manufactured by Tone Commander may be repaired at the factory for a flat rate charge. Repaired out-of-warranty units are warranted for 90 days from the date of repair.

The repair or replacement of a product under this warranty represents the entire obligation of Tone Commander; Tone Commander shall not be liable for any special or consequential damages resulting from or caused by any defect, failure, incapacity or malfunction of any of its products.

The foregoing express warranty is in lieu of all other warranties, express or implied, including but not limited to any implied warranty of merchantability, fitness, or adequacy for any purpose or use, quality, productiveness or capacity; Tone Commander, to the extent permitted by law, hereby disclaims all such other warranties.

**ONE
COMMANDER**

MODEL PS-50
ISDN POWER SUPPLY

Model No. 1010291501

Bulk Power for up to 50 ISDN Telephones.



The PS-50 is a rack- or wall-mountable bulk power supply for powering ISDN telephones and NT1 Network Terminations.

Fifty -48 VDC output connections are provided. Each output has self-resetting current limiting protection at 250 mA. The total available output current is 2.8 A, which is suitable to power up to 50 Tone Commander ISDN telephones.

Optional NT1-200 Battery Backup Power Supply and NT1-200 Add-on Battery units can be added to the PS-50 to enable uninterrupted ISDN power during a power failure.

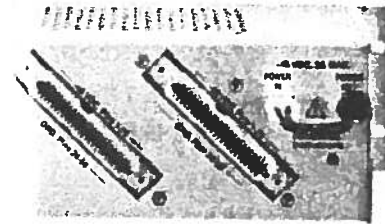

Power Requirements

120 VAC, 60 Hz, single phase, 2 A maximum

Output

Voltage -48 VDC nominal, -56 VDC maximum
 Current 2.8 A total (50 pairs),
 current limited at 250 mA per output
 Total Power 150 watts

Available Power for Terminals

2.5 watts average per output circuit with 50 loads
 10 watts maximum per output circuit
 150 watts total maximum

Output Connectors

(2) 50-position ribbon cable connectors (Amphenol type)

Short Circuit Protection

Individual self-resetting current limiting for each output

Physical

Dimensions 3.5" H x 17.25" W x 4.6" D
 Weight 4.3 lbs.

Environmental

Operating Temperature 32° to 122° F (0° to 50° C)
 Humidity 5% to 95%, non-condensing

Fax: (425) 349-1010

Web: www.tonecommander.com

(800) 524-0024

TI - 12



Reference No. TI - 12

Aastra M9110 Speakphone with Mute

Manufacturer Part No. A1264-0000-10-05

Color: Charcoal

**AASTRA**

Model 9110 Telephone

Building success with the business telephone leader

Finding the "right" business tool is an important element of success in today's competitive world. The "right" tool, with the "right" features at the "right" price, can improve efficiency while decreasing costs.

Introducing the Model 9110 telephone from Aastra Telecom. With a unique combination of features, it may just be the "right" communication tool for your business. Ideal for small or large offices, this non-display, value priced telephone is a model of efficiency and simplicity.

The Model 9110 offers a built in speakerphone with mute capability. While on a call your hands are free to take notes, enter data or perform other tasks. The Mute option allows you to discuss something privately within the office without the caller hearing you. Unlike many other telephones, this feature does not require an external power source, making handsfree capability available even in offices with limited power outlets.

For quick, one touch calling, the Model 9110 provides 7 programmable memory keys. Use the keys to store frequently called numbers or telephone feature codes. In addition, the last number redial feature improves efficiency by redialing a busy number.

The multifunction indicator light will notify you when you have a message waiting (voltage) and flash when there is an incoming call or when a call is on hold. To provide even more flexibility, the Flash key can be used with network features such as Call Waiting and Three Way Calling.

The Model 9110 offers even more by including a dataport on the side of the phone. This port can be connected to a fax or modem device that can be used when the phone is not in use. Compatible with most telephone systems, this telephone is a valuable asset for almost any business.

The Model 9110 — a smart solution for today's complex business environment.

Features & Benefits

- * Speakerphone with Mute
- * Seven programmable memory keys
- * Voltage Message Waiting indication (90V)
- * Last Number Redial
- * Hold, Flash and Mute keys
- * Dataport
- * Line powered
- * Receiver and Speakerphone volume control
- * Multifunction indicator light — incoming call, hold and voltage message waiting
- * Provides basic telephone service in the event of a power failure
- * Desk or wall mount
- * Hearing aid compatible
- * One year warranty
- * Color — Charcoal

Specifications

- * Dial: Tone
- * Power: Loop
- * Weight: 1.1 kg
- * Dimensions: 19 cm L x 16 cm W x 7.3 cm H

Aastra Technologies
155 Snow Blvd.
Concord, Ont., L4K 4N9 - Canada
T 1 905 760 4200
F 1 905 760 4233
www.aastra.com

Rev. 05.03.13



Copyright © 2013 Aastra Technologies Ltd. All rights reserved. Information in this document is subject to change without notice. Aastra Telecom assumes no responsibility for any errors that may appear in this document. Product capabilities described in this document pertain solely to Aastra Telecom's marketing activities in Canada. Availability in other markets may vary.

AASTRA

MiVoice 9116 Analog Phone

The sleek and compact MiVoice 9116 Analog Phone offers great value in a basic PBX line or DC powered business telephone.



Features

- Call Display with Visual Call Waiting — lets you see who's calling before you answer*
- PBX Line or DC powered
- Can enable or disable Speakerphone with mute
- 8 programmable memory keys — for quick access to features* or frequently called numbers
- Three line adjustable display with Contrast control — shows the number dialed and other helpful information
- Callers List — stores name, number, date, and time of 80 caller

- 20-name and number scroll style Directory
- On-hook dialing — lets you dial and listen without picking up the handset
- Compatible with Centrex, PBX or standard telephone service
- CLASS and Voltage Message Waiting indication
- Programmable Feature On and Off keys with indication
- Adjustable receiver volume
- English/French/Spanish prompts
- Call timer
- Desk or wall mount
- Hearing aid compatible

*Note: Functionality of some features assumes availability and customer subscription to service provider offerings.