

PRIMERGY RX1330 M3  
Rack server



4x 3.5"



4x 2.5" (exp. to 8x2.5")



10x 2.5"



Chapter	Folder	Content
	Cover	List of content, Instructions for usage of this configurator, abbreviations
	Description	System Description for easier understanding
1	Base	describes base unit of RX1330 M3
2		describes rack mount kits and services
3	CPU	Order code and Infos of Xeon E3-1200 v6 etc (Kaby Lake-E) processors
4	RAM	DDR4 System memory (RAM)
5	GFX	Graphics-cards
6	HD_cage	HDD cage kits
7	RAID	SAS / RAID Controller and components
8	ODD	optical disk drives (DVD, DVD-rw, Blu ray)
9	Backup	none
10	HD_SSD	Storage drives - PCIe SSD - SAS/SATA SSD & HDD
11	LAN_FC_IB	LAN Components
12		Fibre Channel Controller
13		
14	PSU	Power supply units, power cables, country specific opt.
15	USB_devices	none
16	others	System Management, ATD, RS232 port, TPM module, FH-Riser

## Instructions

This document contains basic product and configuration information that supports you in more complicated configurations.

In any case we recommend to use the PC-/SystemArchitect to make sure, that you configure a valid system.

This System configurator is divided into several chapters. They are identical to the current price list and PC-/SystemArchitect.

Please follow this document step by step from the top to the bottom.

### Chapter xx - description of chapter

Text fields with grey color offer extra information for related topics (e.g prerequisites, technical back ground, configuration rules, limitations, ...)

<b>S26361-F4610-E2</b>
<b>S26361-F4610-L3</b>
PLAN 2x1Gb Ethern. Controller
i350-T2 chip (based on Intel Powerville) offers 2x1Gb RJ45 connectors
PCIe Gen2 x4 full height card
max. 6x per system

<-- order code E-part (bold) --

<-- order code L-part (bold)

<-- "name" of this part

<--description of this part, in same cases as well description of content

<--requires a free PCIe slot --> means total amount of PCIe slots reduced

<--indicates how often this part can be configured in the related Server

**For further information see:**

Link to datasheet:

http:// xxx

[http://ts.fujitsu.com/products/standard\\_servers/index.html](http://ts.fujitsu.com/products/standard_servers/index.html)

(internet)

[https://partners.ts.fujitsu.com/com/order-supply/configurators/primergy\\_config/Pages/default.aspx](https://partners.ts.fujitsu.com/com/order-supply/configurators/primergy_config/Pages/default.aspx)

(extranet)

Fujitsu is providing the content of this document with very high accuracy. In case you identify a mistake, we would kindly encourage you to inform us. We kindly ask for understanding, that errors still may occur and that Fujitsu may change this document without notice

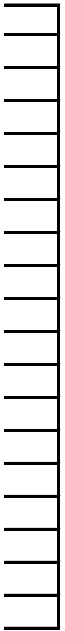



**PRIMERGY RX1330 M3 schematics of the System board and fans**

S26361-F1600-E/L8: L-shape Backplane to upgrade from 4x to 8x 2.5" HDD

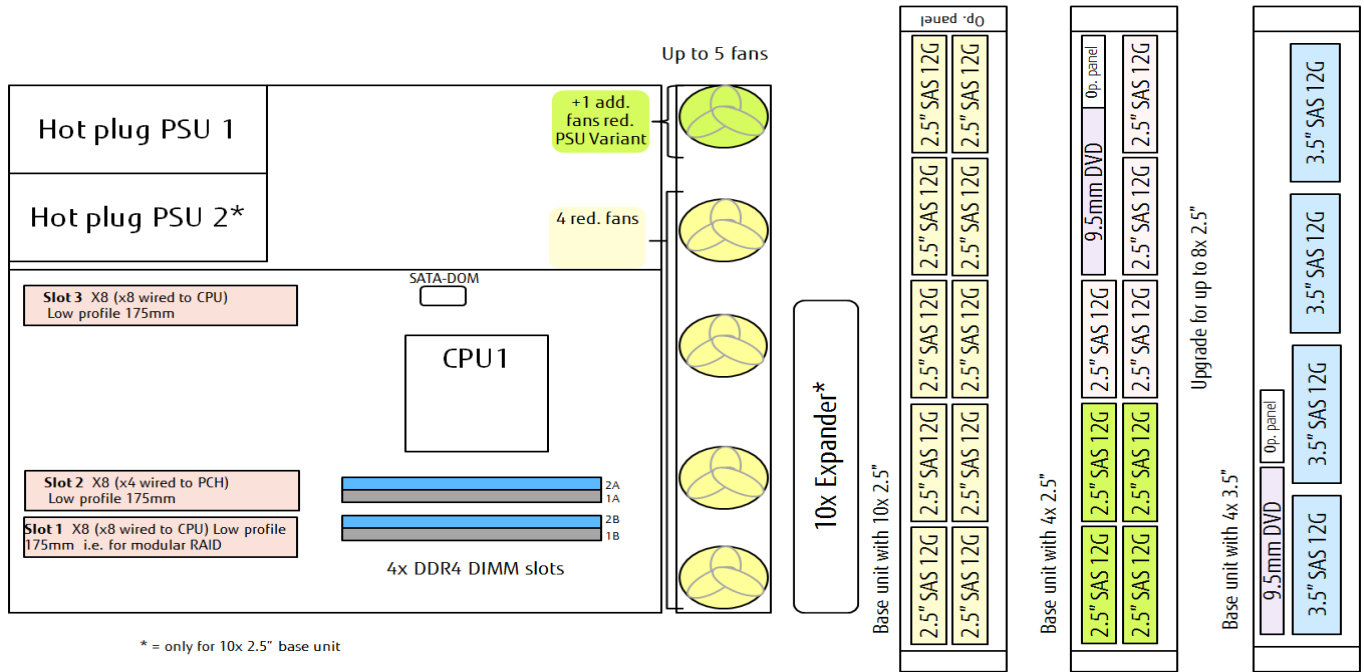

**PRIMERGY RX1330 M3 rear view with PSU and PCIe slots**

Standard: RX1330 - Rear view

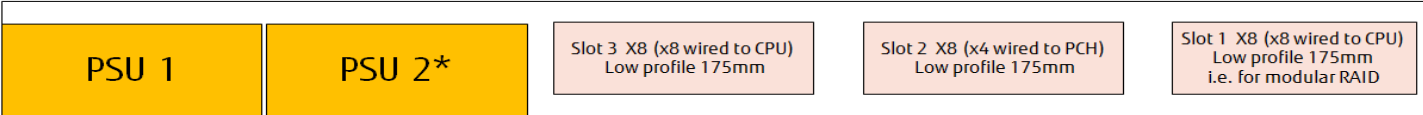

Option: Full height riser

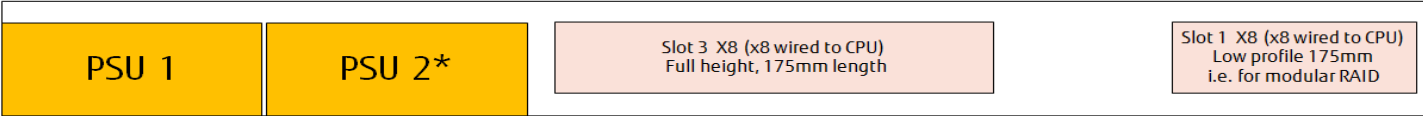

\* = option

**PRIMERGY RX1330 M3 front view**

**RX1330 4x3.5" - Front view**

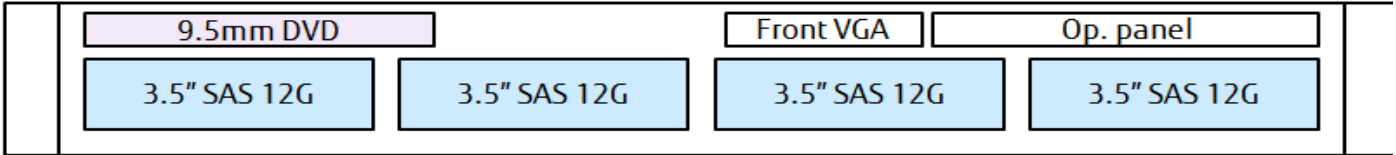

**RX1330 4x2.5" - Front view**

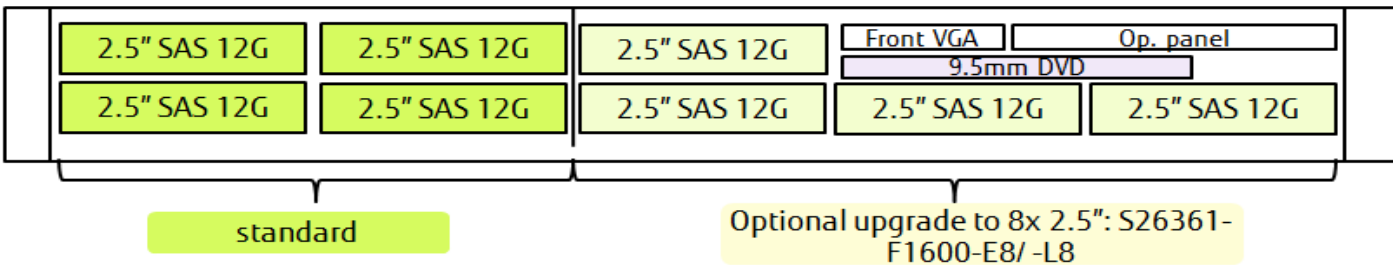

**RX1330 10x2.5" - Front view**

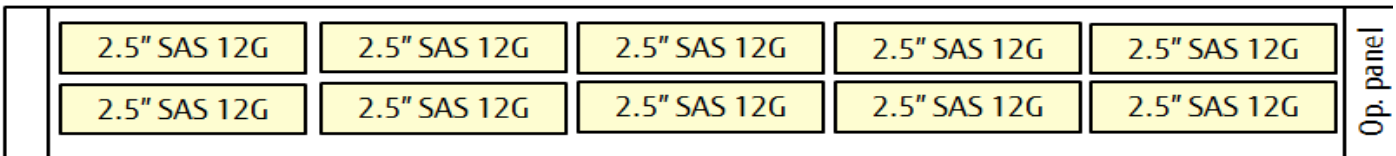

]

]

]

]

]



**Chapter 1 - base unit**

Start

**Power supply units & cooling**

The PRIMERGY RX1330 M3 offer bays for 1x or 2x hot plug (opt. redundant) power supply units of 450W with up to 94% efficiency. The PRIMERGY RX1330 M3 is equipped service friendly plug fans (4+1 for redundant PSU).

**Server Management**

iRMC S4 (integrated Remote Management Controller) on-board with dedicated (or shared) 10/100/1000 Service LAN-port and integrated graphics controller. With the integrated onboard indicators and controls You can highlight easily failed components via LEDs. The LEDs can be displayed during service even without mains connection by simply pressing the "indicate CSS" button.

**Platform**

Fujitsu Systemboard D3375 "designed and made in Germany" based on Chipset Intel® C236

> Xeon E3-1200 v6 series CPUs

**Slots:** as standard 3 PCIe slots are on Board - please see schematics in "description"

> 3 PCIe slots low profile, 175 mm length, all are mechanically x8

Slot 1 **PCIe-Gen3 x8** - supports modular RAID functions, routed to CPU

Slot 2 **PCIe-Gen3 x4**, routed to PCH

Slot 3 **PCIe-Gen3 x8**, routed to CPU

The required riser cards for the above configuration are part of the standard delivery.

Slot 3 can also be upgraded to PCIe Gen3 x8 full height, 175mm length (!Slot 2 and it's riser is not available in this case!)

**Onboard RAID** 0/1 6Gbit/s

available for up to 4x 3.5" SATA drives

**System RAM** up to DDR4-2400 MHz

2x2 memory slots for max. 64GB\* DDR4 RAM available, Please see folder "CPU" and "RAM" for further details.

**Software**

\* ServerView Suite Software incl. ServerStart, ServerBooks, Management Software and Updates

Interfaces at rear side

- 1 service LAN RJ45 (1 Gbit)
- 1x VGA (15 pins)
- 4x USB 3.0
- 2x 1GbE LAN
- 1x serial RS-232-C

Interfaces at front

- for base units with up to 8 HDD: 2x USB 3.0
- for base units with 10HDD: 1x USB2.0 (on "ear")

Interfaces internal

- 2x SATA DOM
- 4x SATA 6G

**S26361-K1600-V101**  
RX1330 M3 4x 3.5" Rack Server  
up to 4x 3.5" drives.  
D3375 system-board Standard powersupply

**S26361-K1600-V201**  
RX1330 M3 4x 3.5" Rack Server  
up to 4x 3.5" drives.  
D3375 system-board Redundant powersupply

**S26361-K1600-V301**  
RX1330 M3 4/ 8x 2.5" Rack  
up to 8x 2.5" drives.  
D3375 system-board Standard powersupply

**S26361-K1600-V401**  
RX1330 M3 4/8x 2.5" Rack  
up to 8x 2.5" drives.  
D3375 system-board Redundant powersupply

**S26361-K1600-V501**  
RX1330 M3 10x 2.5" Rack  
up to 10x 2.5" drives.  
D3375 system-board Redundant powersupply

**S26361-F1600-E8**  
**S26361-F1600-L8**  
Upgrade Kit 4x 2.5" to 8x 2.5"  
Including HDD cage, backplane and SAS 3.0 cables

PRIMECENTER Rack

**Chapter 2 - Rack architecture**

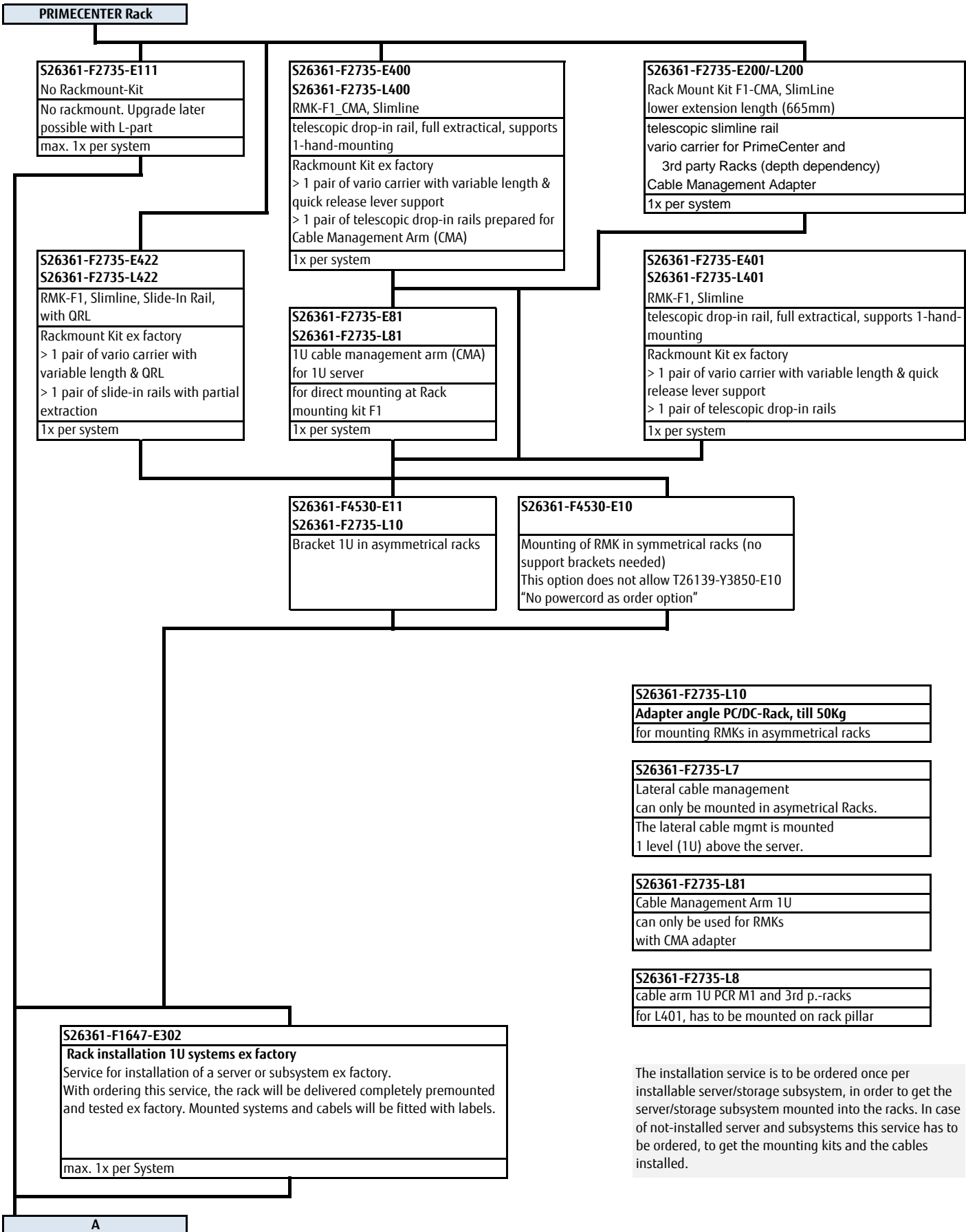

The installation service is to be ordered once per installable server/storage subsystem, in order to get the server/storage subsystem mounted into the racks. In case of not-installed server and subsystems this service has to be ordered, to get the mounting kits and the cables installed.

**Chapter 3 - CPU**

**B**

One of following CPU´s has to be selected  
for an orderable basic unit

<b>Celeron (Kaby Lake-E)</b>	
64-bit Intel Celeron processor supporting DDR4 @ 2.133MHz	
Celeron G3930 2.9GHz 2C/2T 2MB 2133MHz (51W)	S26361-F4029-E103
<b>Pentium (Kaby Lake-E)</b>	
64-bit Intel Pentium processor supporting DDR4 @ 2.400MHz	
Pentium G4560 3.5GHz 2C/4T 3MB 2400MHz (54W)	S26361-F4029-E104
<b>Core i3 (Kaby Lake-E)</b>	
64-bit Intel Core i3 processor supporting DDR4 @ 2.400MHz	
Core i3-7100 3.9GHz 2C/4T 3MB 2400MHz (51W)	S26361-F4029-E107
<b>Xeon E3-12xx v6 (Kaby Lake-E)</b>	
64-bit Intel Xeon processor supporting DDR4 @ 2.400MHz	
Xeon E3-1220v6 3.0GHz 4C/4T 8MB 2400MHz Turbo (72W)	S26361-F4029-E120
Xeon E3-1225v6 3.3GHz 4C/4T 8MB 2400MHz Turbo (73W)	S26361-F4029-E125
Xeon E3-1230v6 3.5GHz 4C/8T 8MB 2400MHz Turbo (72W)	S26361-F4029-E130
Xeon E3-1240v6 3.7GHz 4C/8T 8MB 2400MHz Turbo (72W)	S26361-F4029-E140
Xeon E3-1270v6 3.8GHz 4C/8T 8MB 2400MHz Turbo (72W)	S26361-F4029-E170
Xeon E3-1280v6 3.9GHz 4C/8T 8MB 2400MHz Turbo (72W)	S26361-F4029-E180

On special release request only

On special release request only

**C**

**Chapter 4 - DDR4 System memory**

R  
D

There are 2 memory banks with 2 DIMM slots each.

**Single channel memory configuration allow maximum flexibility:**  
Additional memory can be configured as single memory modules.

**Dual channel memory configurations for maximum performance:**  
For optimum performance memory has to be configured in pairs of memory modules with identical size.

max. 64GB unbuffered DDR4 RAM for UDIMMs with 16GB moduls @ 2.400 MT/s

**Note\*\*:** Memory is not included in the base unit and has to be configured separately, min 1x.

Unbuffered Memory (UDIMM) with ECC support			
4GB (1x4GB) 1Rx8 DDR4-2400 U ECC	Single rank	S26361-F3909-E614	S26361-F3909-L614
8GB (1x8GB) 1Rx8 DDR4-2400 U ECC	Single rank	S26361-F3909-E615	S26361-F3909-L615
16GB (1x16GB) 2Rx8 DDR4-2400 U ECC	Dual rank	S26361-F3909-E616	S26361-F3909-L616

E



**Chapter 5 - Graphics cards**

E

<b>S26361-F2748-E638</b>
<b>S26361-F2748-L638</b>
PGRA CP NVS 1GB VGA PCIe x16
NVIDIA NVS315
1024 MB PCIe-x16
Connectors: 1x LFH 59
cable kit for 2x DVI or 2x VGA
cable kits included
Dual head + professional 2-D + 3-D
supported for Windows OS
native driver support for Linux OS
Low profile bracket
max. 1x per system

The high end optional NVIDIA NVS315 graphic card offers dual head operation and fully 3D video support.  
The cables for either two times DVI-I or VGA connections are part of the delivery.  
**Remote Video direction via iRMC must be disabled.**  
This PCIe-x16 card can also be installed in split PCIe-x4, x8 or standard x16 slot.  
Only one card per server is allowed.

<b>S26361-F4066-E401</b>
<b>S26361-F4066-L401</b>
PGRA CP NVIDIA Quadro P400
NVIDIA Quadro
2GB PCIe 3.0 x16
Connectors: 3x Mini-DP
no cable kits included
cables must be ordered separately
Triple head + professional 2-D + 3-D
supported for Windows OS
native driver support for Linux OS
Low profile bracket
max. 1x per system

The high end optional NVIDIA Quadro graphic card offers triple head operation and fully 3D video support.  
**Remote Video direction via iRMC must be disabled.**  
Only one card per server is allowed.

<b>S26361-F4066-E11</b>
<b>S26361-F4066-L11</b>
MiniDP-DP ADAPTER
max. 3x per card

<b>S26361-F4066-E12</b>
<b>S26361-F4066-L12</b>
DP-VGA ADAPTER
max. 3x per card

<b>S26361-F4066-E13</b>
<b>S26361-F4066-L13</b>
DP-DVI ADAPTER
max. 3x per card

<b>S26361-F1420-E130</b>
<b>S26361-F1420-L130</b>
Front VGA connector (15-pin)
Front VGA connector (15-pin) including cable and front connector
not for base unit S26361-K1600-V501
max. 1x per system

F

**Chapter 7 - SAS / RAID Controller**

F

onboard SATA controller with SW-RAID

onboard controller for SATA HDD or SSD drives

4 ports 3, 6Gb/s SATA HDD/SSD	based on Intel chipset	No Cache	SW-RAID 0, 1, 10	1x	onboard
-------------------------------	------------------------	----------	------------------	----	---------

internal HBA and RAID controller, no 2nd Level cache

internal drive RAID / HBA controllers for SAS, SATA HDD or SSD drives

8 ports 3, 6 & 12Gb/s SAS/SATA HDD/ SSD, supports up to 8 devices without expander requires 1x LP PCIe 3.0 x8 (int.) slot, based on LSI SAS3008

PRAID CP400i RAID Contr.	No Cache	RAID 0, 1, 1E, 10, 5, 50	1x	S26361-F3842-E1	S26361-F3842-L501
PSAS CP400i HBA SAS Contr.	No Cache	HBA + RAID 0, 1	1x	S26361-F3842-E2	S26361-F3842-L502

internal RAID controller with 2nd Level cache 1GB, 2GB

internal drive RAID / SAS, SATA controllers with Cache and opt. TFM module + Flash Backup Unit and opt. Advanced SW Options

PRAID EP400i RAID Contr.	1GB Cache	RAID 0,1,1E,10,5,50,6,60	1x	S26361-F5243-E1	S26361-F5243-L1
--------------------------	-----------	--------------------------	----	-----------------	-----------------

8 ports 3, 6 & 12Gb/s SAS/SATA HDD/ SSD, supports up to 8 devices without expander requires 1x LP PCIe 3.0 x8 (int.) slot, based on LSI SAS3108

optional Licence Activation Key, a free of charge test licence is available at PRIMERGY-PM, FastPath is included in Controller FW

RAID Advanced SW Option CacheCade	1x	S26361-F5243-E670	S26361-F5243-L670
-----------------------------------	----	-------------------	-------------------

optional Transportable Flash module (TFM) and Flash Backup Unit (FBU), both components required

TFM module for 1GB Cache	NV-RAM & FBU control logic	1x	S26361-F5243-E100	S26361-F5243-L100
--------------------------	----------------------------	----	-------------------	-------------------

FBU Option for PRAID EP4xx: Supercap securing the power supply of the RAID controller in case of power failure including cable with 70cm length	1x	S26361-F5243-E170	S26361-F5243-L110
-------------------------------------------------------------------------------------------------------------------------------------------------	----	-------------------	-------------------

PRAID EP420i RAID Contr.	2GB Cache	RAID 0,1,1E,10,5,50,6,60	1x	S26361-F5243-E2	S26361-F5243-L2
--------------------------	-----------	--------------------------	----	-----------------	-----------------

PRAID EP420i for SafeStore R. Contr.	2GB Cache	RAID 0,1,1E,10,5,50,6,60	1x	S26361-F5243-E4**	S26361-F5243-L4**
--------------------------------------	-----------	--------------------------	----	-------------------	-------------------

8 ports 3, 6 & 12Gb/s SAS/SATA HDD/ SSD, supports up to 8 devices without expander requires 1x LP PCIe 3.0 x8 (int.) slot, based on LSI SAS3108

optional Licence Activation Key, a free of charge test licence is available at PRIMERGY-PM, FastPath is included in Controller FW

RAID Advanced SW Option CacheCade	1x	S26361-F5243-E670	S26361-F5243-L670
-----------------------------------	----	-------------------	-------------------

optional TFM module and Flash Backup Unit (FBU), both components required

TFM module for 2GB Cache	NV-RAM & FBU control logic	1x	S26361-F5243-E200	S26361-F5243-L200
--------------------------	----------------------------	----	-------------------	-------------------

FBU Option for PRAID EP4xx: Supercap securing the power supply of the RAID controller in case of power failure including cable with 70cm length	1x	S26361-F5243-E170	S26361-F5243-L110
-------------------------------------------------------------------------------------------------------------------------------------------------	----	-------------------	-------------------

internal NVMe, SAS, SATA RAID controller with 2nd Level cache 4GB, 8GB

as soon as available, used for high cache size, no NVMe support

internal drive RAID / SAS controllers for E91 and SAS, SATA HDD or SSD drives

PRAID EP540i RAID Contr. LP	4GB Cache	RAID 0,1,1E,10,5,50,6,60	1x	S26361-F4042-E204	S26361-F4042-L504
-----------------------------	-----------	--------------------------	----	-------------------	-------------------

PRAID EP580i RAID Contr. LP	8GB Cache	RAID 0,1,1E,10,5,50,6,60	1x	S26361-F4042-E208	S26361-F4042-L508
-----------------------------	-----------	--------------------------	----	-------------------	-------------------

16 ports 3, 6 & 12Gb/s SAS/SATA HDD/ SSD, based on LSI SAS3516, supports up to 16 devices without expander or

16 ports 8Gb/s NVMe PCIe, supports up to 4 x4 NVMe devices without expander

includes Fastpath and SafeStore Advanced SW-Licence

requires 1x LP PCIe 3.0 x8 (int.) slot, based on LSI SAS3516

optional Flash Backup Unit (FBU), Transportable Flash module (TFM) is already included

FBU Option for PRAID EP5xx: Supercap securing the power supply of the RAID controller in case of power failure including cable with 83cm length	1x	S26361-F4042-E183	S26361-F4042-L110
-------------------------------------------------------------------------------------------------------------------------------------------------	----	-------------------	-------------------

For Expander configurations PRAID EPxxi are optimal for performance, PRAID CP400i is not released for expander configurations, max. 8 drives supported

Check: the FBU can / cannot be combined with Advanced Thermal design.  
Check: how many FBU can be integrated per System

CacheCade + FastPath is supported  
SafeStore + FastPath is supported

G

external SAS controller

\*\* SafeStore (SED) RAID controller require SED HDD or SSD devices

HBA controller for ext. drives SAS, SATA HDD or SSD drives

8 ports 3, 6 & 12Gb/s SAS/SATA HDD/ SSD, 2x SFF8644 (external Mini-SAS HD) requires 1x LP PCIe 3.0 x8 (int.) slot, based on LSI SAS3008

PSAS CP400e HBA SAS Contr. LP	No Cache	HBA, no RAID	2x	S26361-F3845-E201	S26361-F3845-L501
-------------------------------	----------	--------------	----	-------------------	-------------------

H

! The SAS 3.0 cable kit (S26361-F1537-L180) is only required for later upgrades and just if the onboard SATA 6G RAID Controller (which has a SAS2.0 connector) was originally selected.  
! Orders ex factory always come with the right cable

S26361-F1537-L180
SAS3.0 cable upgrade kit for RX1330
T26139-Y4040-V15, 530mm for 4x 3.5" backplane ..
T26139-Y4040-V20, 540mm for 4x 2.5" L-shaped backplane ..
T26139-Y4040-V9, 385mm for 4x 2.5" rectangular backplane ..
.. to SAS3.0 controller in Slot1
required for later upgrade from onboard SATA 6G controller to dedicated SAS 3.0 Controller

**Chapter 8 - ODD optical disk drives**

The base units with up to 8x HDD offer 1x 9.5mm optical drive bay



No ODD, if 2x SATA-DOM selected  
No ODD for 10x 2,5" HDD variant

I  
Config with 1x 9.5mm bay

<p>S26361-F3778-E1 S26361-F3778-L1</p> <p>DVD-RW supermulti ultra slim</p> <p>all formats, DUAL/DL, DVD-RAM only W2K, W3K and Linux</p> <p>9.5mm, black bezel</p> <p>max. 1x per system</p>	<p>S26361-F3641-E6 S26361-F3641-L6</p> <p>Blu-ray Triple Writer ultra slim</p> <p>6x BD-RW, 8x DVD, 24x CD, BD DL and all CD/DVD formats</p> <p>9.5mm, black bezel</p> <p>max. 1x per system</p>	<p>S26361-F3718-E2 S26361-F3718-L2</p> <p>DVD-ROM</p> <p>16x DVD; 48x CD-ROM</p> <p>9.5mm black bezel</p> <p>max. 1x per system</p>
-----------------------------------------------------------------------------------------------------------------------------------------------------------------------------------------------------	----------------------------------------------------------------------------------------------------------------------------------------------------------------------------------------------------------	-----------------------------------------------------------------------------------------------------------------------------------------

J



**Chapter 10 - storage drives**

SAS drives and SATA drives can be mixed, but cannot be used in one logical RAID volume.  
 SAS drives require a dedicated SAS / RAID Controller  
 Hard Disk Sector Format Information  
 512n HDD: 512 byte sectors on the drive media.  
 512e (e-emulation) HDD: 4K physical sectors on the drive media with 512 byte logical configuration.  
 512e HDD Disk Drives: VMware 6.0 or earlier is not supported.  
 512n & 512e HDDs can be mixed, but cannot be used in one logical RAID volume.  
 When using SSDs with VMware ESXi, select the SSDs that meet the endurance requirement described in KB2145210 below.  
<https://kb.vmware.com/kb/2145210>  
 DDPD: Drive Writes Per Day over 5 years.  
 SED (=Self Encrypting Drives) require either a RAID controller with \*SafeStore (SED) support or an HBA and in addition a software instance, supporting SED Key Management.  
 It is strongly recommended to order SafeStore (SED) RAID controller with SED HDD or SSD devices for SafeStore (SED) functionality.  
 HDD Classes:  
 Economic (ECO) -SATA- Entry Class Drives.  
 Business-Critical (BC) -SATA-Nearline SATA Enterprise Drives / 7.2Krpm, SATA 6G.  
 Business-Critical (BC) -SATA-Nearline SAS Enterprise Drives / 7.2Krpm, SAS 12G .  
 Mission-Critical (MC)=SAS 10K and SAS 15K Enterprise Drives with max. performance and reliability.  
 Warranty:  
 SSD and SATA DOM have a built-in Wear-Out indicator. In this case the warranty for such a component, as an exception to the system warranty, is restricted to the time period until the indicator reaches the exhaust level.

L

**2.5" (SFF) SATA SSD**

SSD SATA 2.5" Mixed Use (SFF) Enterprise with hot plug/hot replace tray							
Capacity	Formfactor	Interface	Endurance	DWPD		order code E-part	order code L-part
240GB	2.5" (SFF)	SATA 6Gb/s	Mixed Use	3.6		S26361-F5675-E240	S26361-F5675-L240
480GB	2.5" (SFF)	SATA 6Gb/s	Mixed Use	3.6		S26361-F5675-E480	S26361-F5675-L480
960GB	2.5" (SFF)	SATA 6Gb/s	Mixed Use	3		S26361-F5588-E960	S26361-F5588-L960
1.92TB	2.5" (SFF)	SATA 6Gb/s	Mixed Use	3		S26361-F5588-E192	S26361-F5588-L192

max. 4x, 8, or 10x - depending on base unit & configuration

SSD SATA 2.5" Mixed Use S4600 (SFF) Enterprise with hot plug/hot replace tray							
Capacity	Formfactor	Interface	Endurance	DWPD		order code E-part	order code L-part
240GB	2.5" (SFF)	SATA 6Gb/s	Mixed Use	3.1	as soon as available	S26361-F5694-E240	S26361-F5694-L240
480GB	2.5" (SFF)	SATA 6Gb/s	Mixed Use	3.3	as soon as available	S26361-F5694-E480	S26361-F5694-L480
960GB	2.5" (SFF)	SATA 6Gb/s	Mixed Use	3.0	as soon as available	S26361-F5694-E960	S26361-F5694-L960
1.92TB	2.5" (SFF)	SATA 6Gb/s	Mixed Use	3.0	as soon as available	S26361-F5694-E192	S26361-F5694-L192

max. 4x, 8, or 10x - depending on base unit & configuration

SSD SATA 2.5" Read Intensive (SFF) Enterprise with hot plug/hot replace tray							
Capacity	Formfactor	Interface	Endurance	DWPD		order code E-part	order code L-part
240GB	2.5" (SFF)	SATA 6Gb/s	Read Intensive	1		S26361-F5632-E240	S26361-F5632-L240
480GB	2.5" (SFF)	SATA 6Gb/s	Read Intensive	1		S26361-F5632-E480	S26361-F5632-L480
800GB	2.5" (SFF)	SATA 6Gb/s	Read Intensive	1		S26361-F5632-E800	S26361-F5632-L800
960GB	2.5" (SFF)	SATA 6Gb/s	Read Intensive	1		S26361-F5632-E960	S26361-F5632-L960
1.2TB	2.5" (SFF)	SATA 6Gb/s	Read Intensive	1		S26361-F5632-E120	S26361-F5632-L120
1.6TB	2.5" (SFF)	SATA 6Gb/s	Read Intensive	1		S26361-F5632-E160	S26361-F5632-L160

max. 4x, 8, or 10x - depending on base unit & configuration

SSD SATA 2.5" Read Intensive (SFF) Enterprise with hot plug/hot replace tray							
Capacity	Formfactor	Interface	Endurance	DWPD		order code E-part	order code L-part
240GB	2.5" (SFF)	SATA 6Gb/s	Read Intensive	1.4	as soon as available	S26361-F5701-E240	S26361-F5701-L240
480GB	2.5" (SFF)	SATA 6Gb/s	Read Intensive	0.9	as soon as available	S26361-F5701-E480	S26361-F5701-L480
960GB	2.5" (SFF)	SATA 6Gb/s	Read Intensive	0.9	as soon as available	S26361-F5701-E960	S26361-F5701-L960
1.92TB	2.5" (SFF)	SATA 6Gb/s	Read Intensive	0.9	as soon as available	S26361-F5701-E192	S26361-F5701-L192
3.84TB	2.5" (SFF)	SATA 6Gb/s	Read Intensive	1.0	as soon as available	S26361-F5701-E384	S26361-F5701-L384
7.68TB	2.5" (SFF)	SATA 6Gb/s	Read Intensive	0.5	as soon as available	S26361-F5701-E768	S26361-F5701-L768

max. 4x, 8, or 10x - depending on base unit & configuration

**2.5" (SFF) Hard drives**

HDD SAS 2.5" 15K (SFF) Enterprise Mission Critical with hot plug/hot replace tray							
Capacity	RPM	Interface	Sector			order code E-part	order code L-part
300GB	15 000	SAS 12Gb/s	512n			S26361-F5531-E530	S26361-F5531-L530
450GB	15 000	SAS 12Gb/s	512n			S26361-F5531-E545	S26361-F5531-L545
600GB	15 000	SAS 12Gb/s	512n			S26361-F5531-E560	S26361-F5531-L560
900GB	15 000	SAS 12Gb/s	512n			S26361-F5531-E590	S26361-F5531-L590

max. 4x, 8, or 10x - depending on base unit & configuration

HDD SAS 2.5" 10K 512n (SFF) Enterprise Mission Critical with hot plug/hot replace tray							
Capacity	RPM	Interface	Sector			order code E-part	order code L-part
300GB	10 000	SAS 12Gb/s	512n			S26361-F5550-E130	S26361-F5550-L130
600GB	10 000	SAS 12Gb/s	512n			S26361-F5550-E160	S26361-F5550-L160
900GB	10 000	SAS 12Gb/s	512n			S26361-F5550-E190	S26361-F5550-L190
1.2TB	10 000	SAS 12Gb/s	512n			S26361-F5550-E112	S26361-F5550-L112
300GB	10 000	SAS 12Gb/s	512n	SED		S26361-F5581-E130	S26361-F5581-L130
600GB	10 000	SAS 12Gb/s	512n	SED		S26361-F5581-E160	S26361-F5581-L160
1.2TB	10 000	SAS 12Gb/s	512n	SED		S26361-F5581-E112	S26361-F5581-L112

max. 4x, 8, or 10x - depending on base unit & configuration

L1

L1

**HDD SAS 2.5" 10K 512e (SFF) Enterprise Mission Critical with hot plug/hot replace tray**

Capacity	RPM	Interface	Sector		order code E-part	order code L-part
600GB	10 000	SAS 12Gb/s	512e		S26361-F5543-E160	S26361-F5543-L160
900GB	10 000	SAS 12Gb/s	512e		S26361-F5543-E190	S26361-F5543-L190
1.2TB	10 000	SAS 12Gb/s	512e		S26361-F5543-E112	S26361-F5543-L112
1.8TB	10 000	SAS 12Gb/s	512e		S26361-F5543-E118	S26361-F5543-L118
2.4TB	10 000	SAS 12Gb/s	512e	as soon as available	S26361-F5543-E124	S26361-F5543-L124
1.8TB	10 000	SAS 12Gb/s	512e	SED	S26361-F5582-E118	S26361-F5582-L118
2.4TB	10 000	SAS 12Gb/s	512e	SED as soon as available	S26361-F5582-E124	S26361-F5582-L124

max. 4x, 8, or 10x - depending on base unit & configuration

**HDD SAS 2.5" 7.2K 512e (SFF) Enterprise Business Critical with hot plug/hot replace tray**

Capacity	RPM	Interface	Sector		order code E-part	order code L-part
1TB	7 200	SAS 12Gb/s	512e		S26361-F5573-E100	S26361-F5573-L100
2TB	7 200	SAS 12Gb/s	512e		S26361-F5573-E200	S26361-F5573-L200

max. 4x, 8, or 10x - depending on base unit & configuration

**HDD SATA 2.5" 7.2K 512n (SFF) Enterprise Business Critical with hot plug/hot replace tray**

Capacity	RPM	Interface	Sector		order code E-part	order code L-part
1TB	7 200	SATA 6Gb/s	512n		S26361-F3956-E100	S26361-F3956-L100
2TB	7 200	SATA 6Gb/s	512n		S26361-F3956-E200	S26361-F3956-L200

max. 4x, 8, or 10x - depending on base unit & configuration

**HDD SATA 2.5" 7.2K 512e (SFF) Enterprise Business Critical with hot plug/hot replace tray**

Capacity	RPM	Interface	Sector		order code E-part	order code L-part
1TB	7 200	SATA 6Gb/s	512e		S26361-F3907-E100	S26361-F3907-L100
2TB	7 200	SATA 6Gb/s	512e		S26361-F3907-E200	S26361-F3907-L200

max. 4x, 8, or 10x - depending on base unit & configuration

3.5" (LFF) SATA SSD

**SSD SATA 3.5" Mixed Use (LFF) 2.5" SSD Enterprise with 3.5" hot plug/hot replace tray**

Capacity	Formfactor	Interface	Endurance	DWPD		order code E-part	order code L-part
240GB	3.5" (LFF)	SATA 6Gb/s	Mixed Use	3.6		S26361-F5673-E240	S26361-F5673-L240
480GB	3.5" (LFF)	SATA 6Gb/s	Mixed Use	3.6		S26361-F5673-E480	S26361-F5673-L480
960GB	3.5" (LFF)	SATA 6Gb/s	Mixed Use	3		S26361-F5589-E960	S26361-F5589-L960
1.92TB	3.5" (LFF)	SATA 6Gb/s	Mixed Use	3		S26361-F5589-E192	S26361-F5589-L192

max. 4x - depending on base unit & configuration

**SSD SATA 3.5" Mixed Use S4600 (LFF) 2.5" SSD Enterprise with 3.5" hot plug/hot replace tray**

Capacity	Formfactor	Interface	Endurance	DWPD		order code E-part	order code L-part
240GB	3.5" (LFF)	SATA 6Gb/s	Mixed Use	3.1	as soon as available	S26361-F5692-E240	S26361-F5692-L240
480GB	3.5" (LFF)	SATA 6Gb/s	Mixed Use	3.3	as soon as available	S26361-F5692-E480	S26361-F5692-L480
960GB	3.5" (LFF)	SATA 6Gb/s	Mixed Use	3.0	as soon as available	S26361-F5692-E960	S26361-F5692-L960
1.92TB	3.5" (LFF)	SATA 6Gb/s	Mixed Use	3.0	as soon as available	S26361-F5692-E192	S26361-F5692-L192

max. 4x - depending on base unit & configuration

**SSD SATA 3.5" Read Intensive (LFF) 2.5" SSD Enterprise with 3.5" hot plug/hot replace tray**

Capacity	Formfactor	Interface	Endurance	DWPD		order code E-part	order code L-part
240GB	3.5" (LFF)	SATA 6Gb/s	Read Intensive	1		S26361-F5630-E240	S26361-F5630-L240
480GB	3.5" (LFF)	SATA 6Gb/s	Read Intensive	1		S26361-F5630-E480	S26361-F5630-L480
800GB	3.5" (LFF)	SATA 6Gb/s	Read Intensive	1		S26361-F5630-E800	S26361-F5630-L800
960GB	3.5" (LFF)	SATA 6Gb/s	Read Intensive	1		S26361-F5630-E960	S26361-F5630-L960
1.2TB	3.5" (LFF)	SATA 6Gb/s	Read Intensive	1		S26361-F5630-E120	S26361-F5630-L120
1.6TB	3.5" (LFF)	SATA 6Gb/s	Read Intensive	1		S26361-F5630-E160	S26361-F5630-L160

max. 4x - depending on base unit & configuration

**SSD SATA 3.5" Read Intensive (LFF) 2.5" SSD Enterprise with 3.5" hot plug/hot replace tray**

Capacity	Formfactor	Interface	Endurance	DWPD		order code E-part	order code L-part
240GB	3.5" (LFF)	SATA 6Gb/s	Read Intensive	1.4	as soon as available	S26361-F5700-E240	S26361-F5700-L240
480GB	3.5" (LFF)	SATA 6Gb/s	Read Intensive	0.9	as soon as available	S26361-F5700-E480	S26361-F5700-L480
960GB	3.5" (LFF)	SATA 6Gb/s	Read Intensive	0.9	as soon as available	S26361-F5700-E960	S26361-F5700-L960
1.92TB	3.5" (LFF)	SATA 6Gb/s	Read Intensive	0.9	as soon as available	S26361-F5700-E192	S26361-F5700-L192
3.84TB	3.5" (LFF)	SATA 6Gb/s	Read Intensive	1.0	as soon as available	S26361-F5700-E384	S26361-F5700-L384
7.68TB	3.5" (LFF)	SATA 6Gb/s	Read Intensive	0.5	as soon as available	S26361-F5700-E768	S26361-F5700-L768

max. 4x - depending on base unit & configuration

L2

L2

3.5" (LFF) Hard drives

**HDD SAS 3.5" 15K (LFF) 2.5" HDD Enterprise Mission Critical with 3.5" hot plug/hot replace tray**

Capacity	RPM	Interface	Sector	order code E-part	order code L-part
300GB	15 000	SAS 12Gb/s	512n	S26361-F5532-E530	S26361-F5532-L530
450GB	15 000	SAS 12Gb/s	512n	S26361-F5532-E545	S26361-F5532-L545
600GB	15 000	SAS 12Gb/s	512n	S26361-F5532-E560	S26361-F5532-L560
900GB	15 000	SAS 12Gb/s	512n	S26361-F5532-E590	S26361-F5532-L590

max. 4x - depending on base unit & configuration

**HDD SAS 3.5" 10K 512n (LFF) 2.5" HDD Enterprise Mission Critical with 3.5" hot plug/hot replace tray**

Capacity	RPM	Interface	Sector	order code E-part	order code L-part
300GB	10 000	SAS 12Gb/s	512n	S26361-F5568-E130	S26361-F5568-L130
600GB	10 000	SAS 12Gb/s	512n	S26361-F5568-E160	S26361-F5568-L160
1.2TB	10 000	SAS 12Gb/s	512n	S26361-F5568-E112	S26361-F5568-L112

max. 4x - depending on base unit & configuration

**HDD SAS 3.5" 10K 512e (LFF) 2.5" HDD Enterprise Mission Critical with 3.5" hot plug/hot replace tray**

Capacity	RPM	Interface	Sector	order code E-part	order code L-part
1.8TB	10 000	SAS 12Gb/s	512e	S26361-F5569-E118	S26361-F5569-L118
2.4TB	10 000	SAS 12Gb/s	512e	as soon as available	S26361-F5569-E124

max. 4x - depending on base unit & configuration

**HDD SAS 3.5" 7.2K 512e (LFF) Enterprise Business Critical with hot plug/hot replace tray**

Capacity	RPM	Interface	Sector	order code E-part	order code L-part
2TB	7 200	SAS 12Gb/s	512e	S26361-F5635-E200	S26361-F5635-L200
4TB	7 200	SAS 12Gb/s	512e	S26361-F5635-E400	S26361-F5635-L400
6TB	7 200	SAS 12Gb/s	512e	S26361-F5635-E600	S26361-F5635-L600
8TB	7 200	SAS 12Gb/s	512e	S26361-F5571-E800	S26361-F5571-L800
10TB	7 200	SAS 12Gb/s	512e	S26361-F5571-E100	S26361-F5571-L100
12TB	7 200	SAS 12Gb/s	512e	as soon as available	S26361-F5571-E120
6TB	7 200	SAS 12Gb/s	512e	SED	S26361-F5584-E600
10TB	7 200	SAS 12Gb/s	512e	SED	S26361-F5624-E100
12TB	7 200	SAS 12Gb/s	512e	SED	as soon as available

max. 4x - depending on base unit & configuration

**HDD SATA 3.5" 7.2K 512n (LFF) Enterprise Business Critical with hot plug/hot replace tray**

Capacity	RPM	Interface	Sector	order code E-part	order code L-part
1TB	7 200	SATA 6Gb/s	512n	S26361-F5636-E100	S26361-F5636-L100
2TB	7 200	SATA 6Gb/s	512n	S26361-F5636-E200	S26361-F5636-L200
4TB	7 200	SATA 6Gb/s	512n	S26361-F5636-E400	S26361-F5636-L400

max. 4x - depending on base unit & configuration

**HDD SATA 3.5" 7.2K 512e (LFF) Enterprise Business Critical with hot plug/hot replace tray**

Capacity	RPM	Interface	Sector	order code E-part	order code L-part
6TB	7 200	SATA 6Gb/s	512e	S26361-F5638-E600	S26361-F5638-L600
8TB	7 200	SATA 6Gb/s	512e	S26361-F3904-E800	S26361-F3904-L800
10TB	7 200	SATA 6Gb/s	512e	S26361-F3904-E100	S26361-F3904-L100
12TB	7 200	SATA 6Gb/s	512e	as soon as available	S26361-F3904-E120

max. 4x - depending on base unit & configuration

**HDD SATA 3.5" 7.2K (LFF) ECO with hot plug/hot replace tray**

Capacity	RPM	Interface	Sector	order code E-part	order code L-part
500GB	7 200	SATA 6Gb/s	512e	S26361-F5640-E500	S26361-F5640-L500
1TB	7 200	SATA 6Gb/s	512e	S26361-F3951-E100	S26361-F3951-L100

max. 4x - depending on base unit & configuration

SATA DOM

no 2x SATA DOM if ODD selected

**SATA DOM Non volatile storage drive for booting, non hot-plug**

Capacity	Formfactor	Interface	DWPD	Category	order code E-part	order code L-part
64GB	DOM	SATA 6Gb/s	0.14	Boot	S26361-F5618-E64	S26361-F5618-L64
128GB	DOM	SATA 6Gb/s	0.13	Boot	S26361-F5618-E128	S26361-F5618-L128

SATA DOM is designed for use as a boot drive with the Endurance Spec. above.

max. 2x per Server; via On-board SATA connector (please see folder "description"). VMware is not supported.

M

**Chapter 11 - LAN Components**

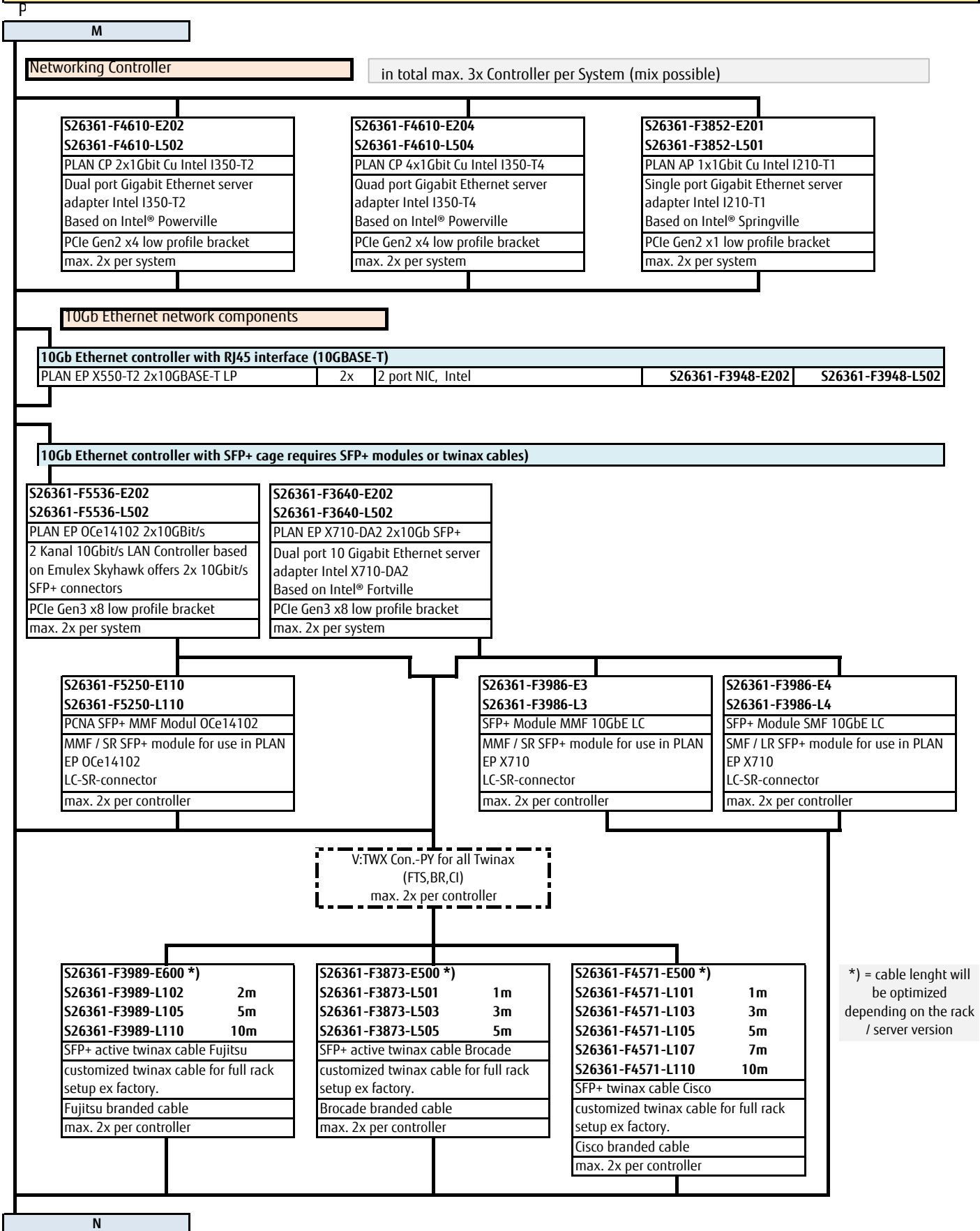



**Chapter 12 - Fibre Channel Controller**

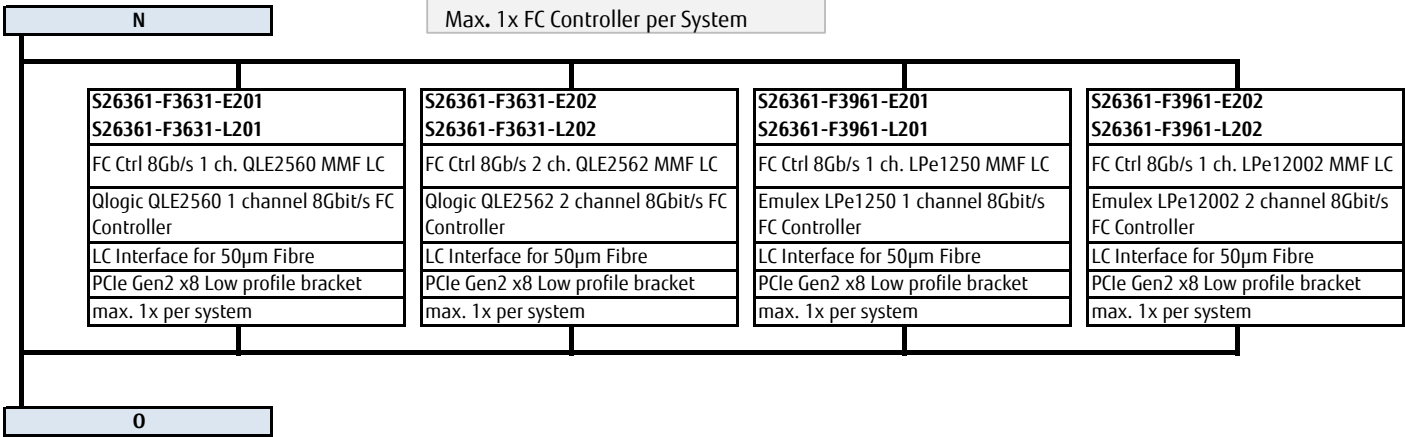

**Chapter 14 - Power supply unit, power cable, country specific options**

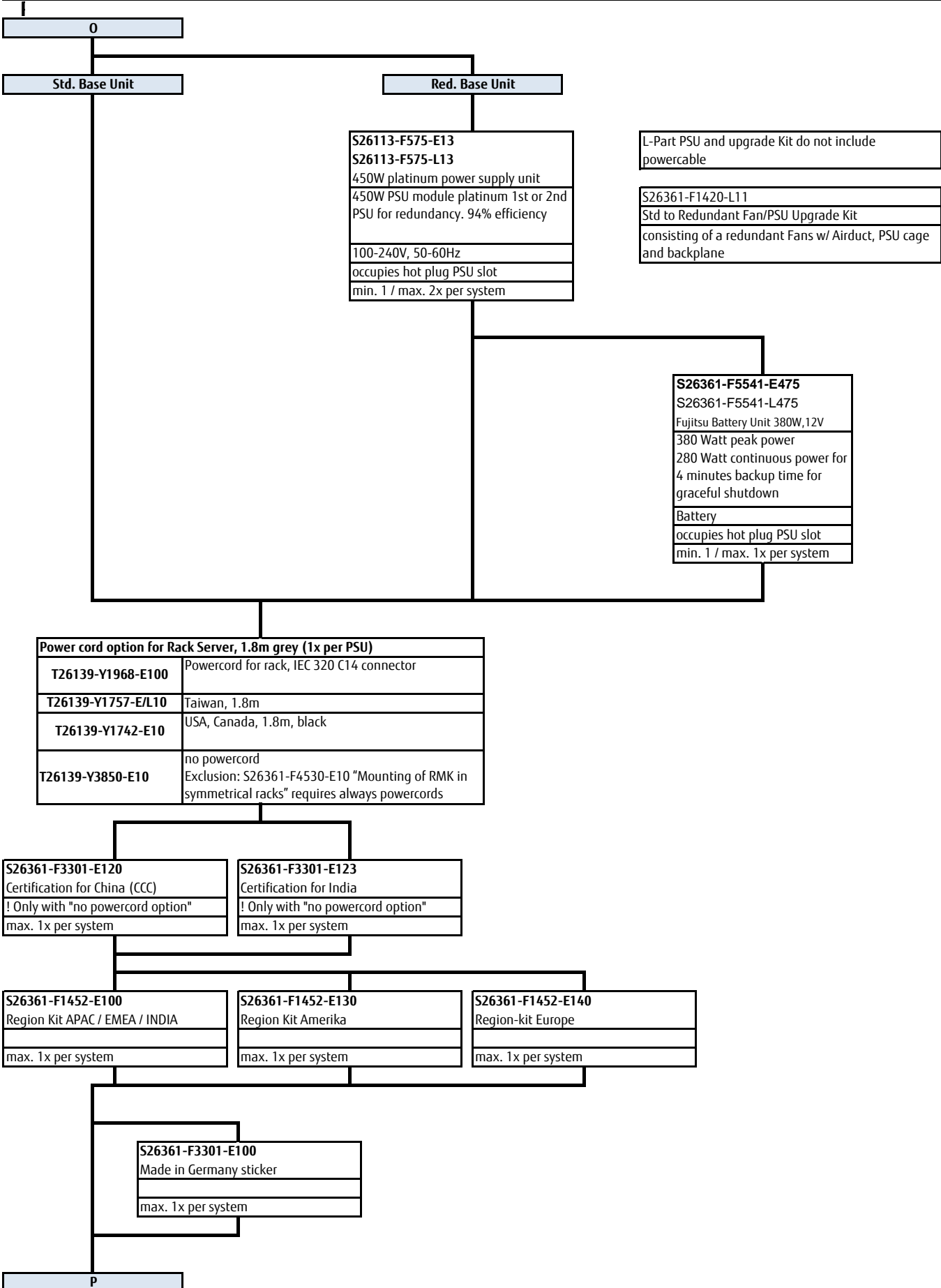

**Chapter 15 - Accessories**

N

<http://www.fujitsu.com/fts/products/computing/peripheral/accessories/index-facts.html>

**USB sticks (FOR PROJECTS ONLY) - no standard release**

ADATA USB 3.0 Flash Stick UE700 – 32GB		<b>S26391-F6048-L332</b>
ADATA USB 3.0 Flash Stick UE700 – 64GB		<b>S26391-F6048-L364</b>



**External USB Optical Disc Drive**

Ultra Slim Portable DVD Writer (Hitachi-LG)	<b>S26341-F103-L142</b>
---------------------------------------------	-------------------------



0



**Chapter 16 - others**

P

<b>S26361-F3301-E118</b>
RX1330 Mx E-Star Fam1 Certification
RX1330 Mx E-Star Fam1
Limits configuration in accordance with Energy Star requirements
max. 1x per system

Today there are no limitations for E-Star Fam1 certification.

Q

**Chapter 16 - others**

**Q**

<b>S26361-F1790-E243</b>
<b>S26361-F1790-L244</b>
iRMC S4 advanced pack
integrated remote Management controller activation key for graphical console redirection and remote media redirection
max. 1x per system

iRMC S4 (integrated Remote Management Controller) onboard server mgmt with dedicated 10/100/1000 LAN-port and integrated graphics controller.

<b>S26361-F1790-E310</b>
<b>embedded Lifecycle Management (eLCM)</b>
Server Online Update
OS driver Update
Hardware firmware update
Server Offline Update
Hardware update via Update Manager Express
PrimeCollect
Autonomous creation of Primecollect archives
Creation and use of PrimeCollect archives over AIS connect
Custom Image (Jukebox function)
Automatic and manual download of CD and DVD Images
Automatic and manual start of CD and DVD Images
max. 1x per system

Executing system updates, controlling the hardware setup or running diagnostic tests on components are frequent tasks of IT administrators to ensure a continuous 24x7 server operation. ServerView embedded Lifecycle Management (eLCM) for Fujitsu PRIMERGY servers greatly supports such routine tasks by consolidating and enhancing management functions directly available ("embedded") within the server.

Loose delivery
eLCM Activation Pack (Node Locked License)
<b>BDL:ELCM-PACK</b>
<b>options contains:</b>
- 16GB SD card
- Paper with TAN for Licensekey

only if S26361-K1600-V201 or -V401 is chosen

<b>S26361-F3776-E101</b>
Cool-safe <sup>®</sup> Advanced Thermal design see right side
enables the PRIMERGY Server to cope with temperatures from 5-40° in operating mode due to extended Fan settings
this setting can be activated ex factory only
max. 1x per system

<b>exclusion for all chassis variants</b>	
S26361-F5243-E100	TFM
S26361-F5243-E200	TFM
S26361-F4042-E204	PRAID EP540i
S26361-F4042-E208	PRAID EP580i
S26361-F4042-E183	FBU
S26361-F5243-E170	FBU
<b>add. exclusion for all 10x 2,5" and for all variants with Std. PSU:</b>	
S26361-K1600-V101	does not support ATD
S26361-K1600-V301	does not support ATD
S26361-K1600-V501	does not support ATD

<b>S26361-F3552-E6</b>
TPM Module
TPM module
max. 1x per system

<b>S26361-F3552-E10</b>
TPM 2.0 Module
TPM 2.0 module
max. 1x per system

<b>S26361-F1420-E210 FH KIT</b>
<b>S26361-F1420-L210</b>
Full height riser card kit
Offers 1x FH Gen 3 PCIe slots: 1* x8 for full height PCIe cards with max. 175mm length
will be inserted instead of Slot 2 and Slot 3
will be inserted into Slot 3 PCIe 3.0 x8
max. 1x per system

<b>S26361-F3552-L10</b>
TPM Module add-on kit
for later integration (loose delivery)
Trusted Platform Module on Motherboard
Use according to import restrictions
max. 1x per system

TPM 2.0 Module supported with Windows Server 2012 and successor. Currently not confirmed for SLES12 SP2 / RHEL 7.2 / ESXi 2016 / XenServer 7.

You would like to add some customer specific solutions?

**made4you**

With our made4you service we fulfill any individual requirement and wish of our customers perfectly - e.g.

- > special hardware configurations,
- > staging services ex factory,
- > extended lifecycle management,
- > customer specific logos, component,
- > BIOS fixes and many more.

For further information please contact us



#### Fujitsu Portfolio

Build on industry standards, Fujitsu offers a full portfolio of IT hardware and software products, services, solutions and cloud offering, ranging from clients to datacenter solutions and includes the broad stack of Business Solutions, as well as the full stack of Cloud offering. This allows customers to leverage from alternative sourcing and delivery models to increase their business agility and to improve their IT operation's reliability.

Your Server is ready





Date of change	Folder / order code / description	What has been changed / comment
24.08.2016	S26361-F4029-E105	CPU removed
24.08.2016		draft version
30.08.2016		CPU & Memory section updated
13.09.2016		CPU portfolio update
29.09.2016	S26361-F3909-E/L614/615/616	added order codes
11.10.2016		CPU power corrected
27.10.2016	HD_SSD	updated
27.10.2016	S26361-F3752-E202/S26361-F3752-L502	cleared
27.10.2016	S26361-F3629-E202/S26361-F3629-L502	cleared
03.11.2016	S26341-F103-L140	changed to new USB Optical Disc Drive
17.11.2016		order codes added for CPUs
21.11.2016	S26361-F1600-E8/L8	add backplane upgrade from x4 to x8 2,5" HDD
01.12.2016	S26361-F4029-E103/E104/E107	added
01.12.2016	ODD, HDD folder	add comment: ether 2x SATA-DOM and no ODD, or 1x SATA-DOM and ODD
01.12.2016	Base, Upgrade Kit 4x 2.5" to 8x 2.5"	wrong number S26361-F1537-L8 changed to S26361-F1600-L8
05.12.2016	HD_SSD / S26361-F5630/F5632-*	added
14.12.2016	HD_SSD / S26361-F5635/5636/5638/5640-*	added
26.12.2016	HD_SSD / SED	added
06.01.2017	HD_SSD / S26361-F5592/F5593-*	removed
06.01.2017	HD_SSD / S26361-F5588/F5589-E120/L120	removed
10.01.2017	others, S26361-F3552-L10	changed from -L12 to -L10
10.01.2017	TPM	S26361-F3552-L6 removed
12.01.2017	FC	No change required
12.01.2017	LAN	PLAN EP X550-T2 added
13.01.2017	eLCM	eLCM S26361-F1790-E310 / BDL:ELCM-PACK added
18.01.2017	S26361-F1452-E140	added Region-kit Europe
18.01.2017	S26361-F3301-E100	added Made in Germany sticker
19.01.2017	Cable Mangement Arm	Support RMK for S26361-F2735-L8 revised
31.01.2017	Rack installation	Replaced Rack installation ex works from old one
31.01.2017	USB devices	updated
31.01.2017	added EP540, 580i, EP420i SafeStore	added
07.02.2017	HD_SSD / SED	note for SED updated
09.02.2017	S26361-F5243-E4/L4	comment added
22.03.2017	HD_SSD / Note / F5618-*/ F5583-*	updated / Endurance updated / removed
28.03.2017	RAID	added RAID 10 for onboard, removed CacheCade for EP5x0i
28.03.2017	RAID	changed comment for SED RAID controller
28.03.2017	others	40 degree exclusions added
18.04.2017	base	info-text changed
27.04.2017	T26139-Y1757-E/L10	powercord for Taiwan added
27.04.2017	USB Devices	New ext. ODD added
28.04.2017	RAID	info-text added
06.06.2017	HD_SSD / Note	updated
13.06.2017	RAID	descriptions of FBU options changed
23.06.2017	S26361-E4042-E175	new number for FBU
29.06.2017	S26361-F4042-E175	changed from 70cm to 75cm
07.07.2017	S26361-F4042-E183	FBU: changed from 75cm to 83cm
12.07.2017	RAID	info-text changed
24.07.2017	HD_SSD / F5673/F5675-*/ F5531/F5532-E590	added
05.09.2017	HD_SSD / Note for 2.5" 7.2K/15K HDD	removed
11.10.2017	S26361-F4530-E10, T26139-Y3850-E10	added a comment for the following two partnumbers with the target to exclude from each other. Background: factory rackmount always requires power cable: S26361-F4530-E10 "Mounting of RMK in symmetrical racks" T26139-Y3850-E10 "No powercord as order option"
25.10.2017	RAID	note in BB58 changed
23.11.2017	CPU / S26361-F4029-E105	Xeon E3-1205v6 added
15.01.2018	HD_SSD / F5588/F5589-E240/E480	removed
15.01.2018	HD_SSD / F5694/F5692-*	/ F5543/F5582/F5569-E124 / F5571/F5624/F3904-E120 added
15.01.2018	HD_SSD / exclusions for 8/10TB HDDs and PSAS	removed
18.01.2018	HD_SSD / exclusions for 8/10TB HDDs and PRAID	added
02.03.2018	HD_SSD / S26361-F5701/F5700-*	added
04.05.2018	PLAN EP X550-T2	Max = 1 --> Max = 2.
04.05.2018	PLAN EP X710-DA2	Max = 1 --> Max = 2.
06.07.2018	ATD	implement latest ATD restrictions
11.07.2018	GFX	Update Graphic card information.
18.09.2018	GFX	Modify Graphic Card - Options in "GFX" tab. - add "DP- DVI/D" adapter
26.10.2018	HD_SSD / exclusions for 8/10TB HDDs and PRAID	removed