

PRIMERGY CX400 M4  
Multi Node Server



Chapter	Folder	Content
	Cover	List of content, Instructions for usage of this configurator, abbreviations
	Description	System Description for easier understanding
1	Base	describes base unit of CX400 M4
2		describes rack mount kits and services
3		Power supply units, power cables, country specific opt.
4	CPU	Order code and Infos of E5-26xxv5 series processors
5	RAM	DDR4 System memory (RAM) and memory modes
6	GFX	Graphics-, Grid-cards, GPU and Xeon Co processors and other graphics options
7	HD cage	Drive cage and PCIe riser options
8	RAID	SAS / RAID Controller and components
9	ODD	optical disk drives (DVD, DVD-rw, Blu ray)
10	Backup	LTO drives & RDX drive
11	HD SSD	Storage drives - PCIe SSD - SAS/SATA SSD & HDD
12		LAN Components
13	LAN_FC_IB	Fibre Channel Controller
14		Infiniband Controller
15	USB devices	Keyboards, Mice, USB devices
16	others	System Management, ATD, RS232 port, TPM module

# Instructions

This document contains basic product and configuration information supporting you in more complicated configurations.

In any case we recommend to use the PC-/SystemArchitect to make sure, that you configure a valid system.

This System configurator is divided into several chapters. They are identical to the current price list and PC-/SystemArchitect.

Please follow this document step by step from the top to the bottom.

## Chapter xx - description of chapter

Text fields with grey color offer extra information for related topics (e.g prerequisites, technical background, configuration rules, limitations, ...)

<b>S26361-F4610-E2</b>
<b>S26361-F4610-L3</b>
PLAN 2x1Gb Ethern. Controller
i350-T2 chip (based on Intel Powerville) offers 2x1Gb RJ45 connectors
PCIe Gen2 x4 full height card
max. 6x per system

<-- order code E-part (bold) --

<-- order code L-part (bold)

<-- "name" of this part

<--description of this part, in same cases as well description of content

<--requires a free PCIe slot --> means total amount of PCIe slots reduced

<--indicates how often this part can be configured in the related Server

### For further information see:

[http://ts.fujitsu.com/products/standard\\_servers/index.html](http://ts.fujitsu.com/products/standard_servers/index.html)

(internet)

[https://partners.ts.fujitsu.com/com/order-supply/configurators/primergy\\_config/Pages/default.aspx](https://partners.ts.fujitsu.com/com/order-supply/configurators/primergy_config/Pages/default.aspx)

(extranet)

Fujitsu is providing the content of this document with very high accuracy. In case you identify a mistake, we would kindly encourage you to inform us. We kindly ask for understanding, that errors still may occur and that Fujitsu may change this document without notice



**CX400 M4 Front view**

HDD less configuration for Node CX2550/CX2560/CX2570 M5



Front HDD bay option enabled configuration for Node CX2560 M5

Each CX2560 M5 use up to 6 drives (respective Slot 1-4)

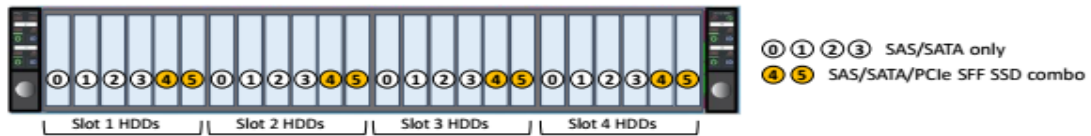

Front HDD bay option enabled configuration for Node CX2550 M5

Each CX2550 M5 use up to 2 drives (respective Slot 1-4)

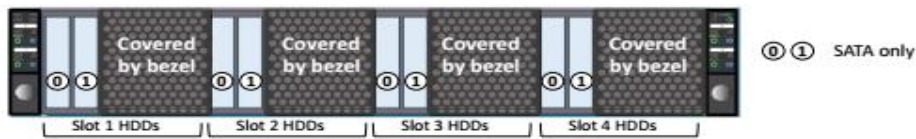

Front HDD bay option enabled configuration for Node CX2570 M5

Each CX2570 M5 use up to 6 drives (respective Slot 1, Slot 3)

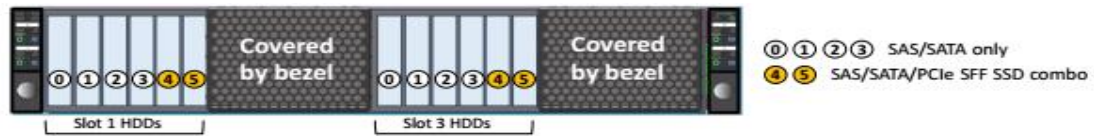

**CX400 M4 Rear View**

Node CX2550 / CX2560 M5

PSU	Slot 4	Slot 2
PSU	Slot 3	Slot 1

Node CX2570 M5

PSU	(GPU tray)	(GPU tray)
PSU	Slot 3	Slot 1

No mixture with different type of server nodes are not supported.

**Chapter 1 - Base unit**

Start

**Power supply units & cooling**

The PRIMERGY CX400 M4 offers bays for 1x or 2x direct attached hot plug (opt. redundant) power supply units of 1,600W, 2400W with up to 94% efficiency. The PRIMERGY CX400 M4 supports high performance hot plug fans (N+1 redundant).

**Server Management**

iRMC S5 (integrated Remote Management Controller) on-board with dedicated (or shared) 10/100/1000 Service LAN-port and integrated graphics controller. With the integrated onboard indicators and controls you can easily highlight failed components via LEDs. The LEDs can be displayed during service even without mains connection by simply pressing the "indicate CSS" button.

**Platform**

\* ServerView Suite Software incl. ServerStart, ServerBooks, Management Software and Updates

item	CX2560 M5	CX2550 M5	CX2570 M5
Use Case	Allround (cloud)	HPC	HPC
Form Factor (Height x Width)	Single x Half (4N)	Single x Half (4N)	Double x Half (2N)
# of CPU/Node	2	2	2
# of UPI	3	3	3
Liquid Cooling	-	Yes (option)	Yes (option)
CPU (W)	150W	165W (205W: liquid cooling)	205W
# of DIMM	16	16	16
# of 2.5"/3.5" HDDs (/chassis)	24/0	8/0	12/0
# of 2.5" HDDs (/Node)	6/6/6/6	2/2/2/2	6/6
# of HDD /Type (included)	6x SAS/SATA (2x PCIe4)	2x SATA	6x SAS/SATA (2x PCIe4)
# of 3.5" HDDs (/Node)	-	-	-
PCIe slot (type)	2 (Gen3 x16, 25W)	2 (Gen3 x16, 25W)	1 (Gen3 x16, 25W)
GPU slot	-	-	2x (Gen3 x16)
TPM slot / MicroSD for BMC	1 / 1	1 / 1	1 / 1
Internal boot device	USB mirrored device	-	-
	# of M.2 slot	2	2
	Form Factor	2242	2242
BMC (IPMI) LAN	M.2 I/F type	SAS / PCIe (Gen3)x2	SAS / PCIe (Gen3)x2
	Onboard NIC	1x 1000 Base -T	1x 1000 Base -T
1x OCP Mezz slot	PHY (selectable NIC option)	4x 1000Base -T 2x 10G Base -T	4x 1000Base -T 2x 10G Base -T
		2x 10G SFP+ 4x 10G SFP+	2x 10G SFP+ 4x 10G SFP+
		PCIe Gen3 x16	PCIe Gen3 x16
		PCIe Gen3 x16	PCIe Gen3 x16

**Note: Node population rules**

CX25y0M5 node population rules is defined by TPS (Technical Product Specification). CX25y0M5 must be installed by below order.

Chassis configuration			
PSU2	4 2		
PSU1	3 1		
(Rear View)			
Server Nodes			
Slot	Slot	Slot	Slot
1	2	3	4
#CX2550			
#CX2560			
1	1	2	3
2	1	2	3
3	1	3	2
4	1	3	2

Empty Slots must be filled with Dummy Nodes

Chassis configuration			
PSU2	4 2		
PSU1	3 1		
(Rear View)			
Server Nodes			
Slot	Slot	Slot	Slot
1	2	3	4
#CX2570			
1	1	2	3
2	1	1	2

Empty Slots must be filled with Dummy Nodes

Rack version for 19" racks with 2 height units  
 No PSU included in base unit  
 Basic unit is without node  
**Basic units for CX2550/CX2560/CX2570 M5 LC**  
 0-24x 2.5" HDD bays  
 For EMEA market S26361-K1614-V500  
 For APAC/US market S26361-K1614-V500  
 Up to 4 x CX2550/CX2560 M5, Up to 2x CX2570 M5 LC



Front HDD cage kit must be ordered under node config  
 Please refer to "HD\_cage" sheet

In case of HDD less

In case of front HDD is used

Bridge board for HDD configuration  
 S26361-F5651-E180  
 1x per CX400 M4

Loose delivery  
 Bridge board for HDD  
 S26361-F5651-L180

VGA/USB Dongle  
 Y-cable

Loose delivery  
 VGA/USB Y-Dongle cable



Liquid cooling requires PCR M2 Rack (800mm wide / 1200mm depth / 42U)  
**For RackCDU, please select below rack**  
 S26361-K828-V942



All type nodes have no support mixed node configuration

S26361-F5651-E310  
\*

S26361-F5651-L310  
\* At least 1x dongle cable is required per customer site

**In case of liquid cooling**

**For RackCDU**

**For Internal RackCDU**

**LC Tube for CX2550 M5**  
 S26361-F5651-E200/L200  
 1x per CX400 M4

**LC Tube for CX2570 M5**  
 S26361-F5651-E220/L220  
 1x per CX400 M4

**LC Tube for CX2560 M5**  
 S26361-F5651-E200/L200  
 1x per CX400 M4

**LC Tube for CX2550 M5**  
 S26361-F5651-E210/L210  
 1x per CX400 M4

**LC Tube for CX2570 M5**  
 S26361-F5651-E230/L230  
 1x per CX400 M4

**LC Tube for CX2560 M5**  
 S26361-F5651-E210/L210  
 1x per CX400 M4

Special release for CX2560 M5

Special release for CX2560 M5

<b>Basic units for CX2560 M5</b>	
0-6x 2.5" HDD bays	S26361-K1687-V100
Up to 4x per CX400 M4	
<b>Basic units for CX2550 M5</b>	
0-2x 2.5" HDD bays	S26361-K1688-V100
Up to 4x per CX400 M4	
<b>Dummy node (Half wide, 1U)</b>	
	S26361-F5651-E670/L670
Up to 3x per CX400 M4	

<b>Basic units for CX2550 M5 LC</b>	
0-2x 2.5" HDD bays	S26361-K1688-V200
Up to 4x per CX400 M4	
<b>Basic units for CX2570 M5 LC (SXM2)</b>	
0-6x 2.5" HDD bays	S26361-K1686-V200
Up to 2x per CX400 M4	
<b>Dummy node (Half wide, 1U)</b>	
	S26361-F5651-E670/L670
Up to 3x per CX400 M4	



Empty slots must be filled by the dummy nodes.



Basic unit for CX2570M5 (SXM2) always 4x SXM2 required

S26361-F4575-E11  
 Service for CX-Server nodes installation in the CX400  
 HDD cage standard  
 max. 4x per system unit

S26361-F4575-E21  
 CX-Server nodes individually packed/delivered for CX400  
 HDD cage standard  
 max. 1x per CX-Server node

**B**

**Chapter 2 - Rack architecture**

**PRIMECENTER Rack**

Rack Architecture		Remark			
Rack Cable Arm 2U	1x	Cable mgmt. arm for 2U	S26361-F5651-E100	S26361-F5651-L100	Required in case of hotplug FAN operation

- i** Rack Cable Arm 2U can be an installation on 19-inch rack by max. 16 chassis.
- Rack Cable Arm 2U cannot be installed in 39-42U, 22-24U, and 1-2U area.
- Rack Cable Arm 2U is not available in the following cable.
  - Infiniband cable - OPA passive copper cable w/QSFP28
  - OPA active optical cable w/QSFP28
  - Multimode Fibre Channel cable

**Chapter 3 - Power supply unit, power cable, country specific options**

<b>S26113-F617-E50</b> <b>S26113-F617-L50</b> 1600W platinum power supply unit  1600W PSU module platinum 1st or 2nd PSU for redundancy. 94% efficiency  100-240V, 50-60Hz occupies hot plug PSU slot min. 2 / max. 2x per system	<b>S26113-F620-E30</b> <b>S26113-F620-L30</b> 2400W platinum power supply unit  2400W PSU module platinum 1st or 2nd PSU for redundancy. 94% efficiency  100-240V, 50-60Hz occupies hot plug PSU slot min. 1 / max. 2x per system
---	---

Installing condition\* by configuration of Power Supply Unit  
 \*PSU redundancy (1+1) support depends on the configuration of server, please check the total power consumption in SystemArchtect for making PSU redundant configuration

<b>S26361-F5651-E190</b> <b>S26361-F5651-L190</b> Dummy module instead PSU  Dummy module for closing the 2nd PSU hole, in case only 1 PSU is equipped  closes hot plug PSU slot max. 1x per system
---

**i** 2400W (S26113-F620-E30) must use Power Cord 16A (S26361-F3151-E301)

	1600W PSU	2400W PSU
S26361-F3151-E351	200-240V	Not supported
S26361-F3151-E301	100-120V / 200-240V	100-120V / 200-240V

for CX400 M4 within rack please choose only 1 of this 2 cables

<b>S26361-F3151-E351</b> Power Cord 10A IEC 320 C19 -> C14  default within rack 1x per PSU	<b>S26361-F3151-E301</b> Power Cord 16A IEC 320 C19 -> C20 (for 100V-115V only*) 1x per PSU
---	---

<b>S26361-F3151-E500</b> Power Cord IEC320 C19 -> US NEMA L6-20p without rack only 1x per PSU	<b>T26139-Y3850-E10</b> No Power Cord  without rack only 1x per PSU
---	---

**i** \*) in System architect please change the default 16A connection to a 10A connection for all PSU

S26361-F4530-E12

S26361-F4530-E10

**i** S26361-F2735-L10

Mounting 2U server in asymmetrical racks with 2U support bracket

Mounting in symmetrical & 3rd party racks (no support bracket needed)

Adapter angle PC/DC-Rack, till 50Kg necessary for mounting RMKS in asymmetrical racks

**SNP:SY-F1647E301-P**  
**Installation ex works for one server or subsystem.**  
**Hereby the rack will be delivered completely pre-mounted and all wired connections are tested.**  
 With PCR M1 16U, 24U, 42U:  
 Systems and components will be delivered installed in the rack

To be ordered only together with a PRIMECENTER rack  
 refer PCR S2 or M1 rack configurator for air cooling  
 refer to M2 rack configurator for liquid cooling  
 max. 1x per System

**"Rack-mounting ex factory"**  
 This service is to be ordered once per installable server/storage subsystem, in order to get the server/storage subsystem mounted into the racks. In case of not-installed server and subsystems this service has to be ordered, to get the mounting kits and the cables installed.

Region Kits, <b>required to order one of them, 1x per System</b>	build-in order code	loose delivery order code
Region Kit APAC/EMEA/India, Contains warranty sheet and safety instructions for APAC, EMEA and India	S26361-F1452-E100	-
Region Kit America, Contains warranty sheet, registration hints and safety instructions for America	S26361-F1452-E130	-
Region Kit Europe, Contains warranty sheet and safety instructions in German, English, French, Spanish, Italian, Polish, Russian and Welsh language, <b>need to be included always into the order from EU and EFTA</b>	S26361-F1452-E140	-
Region Kit China for CCC option not required systems (N/A CCC systems for more than 1300W PSU or, systems printing CCC mark always), Contains warranty sheet and safety instructions for China, <b>need to be included always into the order from China country</b>	S26361-F1452-E102	-

(Sales region for EMEA only)

(Sales region for APAC only)

Certifications, optional 1x per system	build-in order code	loose delivery order code
Certification for India, (BIS), Reduced component selection possible, only with no power cord option	S26361-F3301-E123	-

A



Chapter 3 - CPU (CX2560 M5)

B			Base Units
<p>There are 2 processor sockets available. Please configure 1 or 2 Processors.                      &gt;&gt; All processors have to be the same type.                      &gt;&gt; With one processor LOM, iRMC and 8x DIMM slots are available                      &gt;&gt; With two processors all 16x DIMM slots are available.                      &gt;&gt; To configure 2nd CPU an additional cooler kit is required.                      &gt;&gt; Empty CPU slot have to be filled up with a CPU Dummy!</p> <p style="text-align: right;">* HT = Hyper Threading</p> <p><b>Restriction for CPUs above 150W TDP:</b>                      Ambient temperature requirement for CPUs between 150W is 30°C</p> <p><b>Restriction for ErP Lot9:</b></p> <p>&gt;&gt; Xeon Bronze 3204 is not orderable.                      &gt;&gt; 1 DIMM configuration is not orderable.</p> <p>These configuration is not allowed to ship in EU/EFTA countries to comply with ErP Lot 9 regulation.</p>			Standard (S26361-K1687-V100)
<b>Xeon Bronze 3200 - Basic</b>			
64-bit Intel Xeon processor supporting DDR4 @ 2133MHz & UPI Bus @ 9.6 GT/s			
Xeon Bronze 3204 6C 2.1GHz 85W	S26361-F4082-E104	S26361-F4082-L104	Not Orderable
Xeon Bronze 3206R 8C nHT 1.9GHz 85W	S26361-F4082-E806	S26361-F4082-L806	X
<b>Xeon Silver 4200 - Standard</b>			
64-bit Intel Xeon processor supporting HT*, DDR4 @ 2400 MHz & UPI Bus 9.6 GT/s			
Xeon Silver 4208 8C 2.1GHz 85W	S26361-F4082-E108	S26361-F4082-L108	X
Xeon Silver 4210 10C 2.2GHz 85W	S26361-F4082-E110	S26361-F4082-L110	X
Xeon Silver 4210R 10C 2.4GHz 100W	S26361-F4082-E811	S26361-F4082-L811	X
Xeon Silver 4214 12C 2.2GHz 85W	S26361-F4082-E114	S26361-F4082-L114	X
Xeon Silver 4214R 12C 2.4GHz 100W	S26361-F4082-E814	S26361-F4082-L814	X
Xeon Silver 4216 16C 2.2GHz 100W	S26361-F4082-E116	S26361-F4082-L116	X
<b>Xeon Silver 4200 - Frequency Optimized</b>			
64-bit Intel Xeon processor supporting HT*, DDR4 @ 2400 MHz & UPI Bus @ 9.6 GT/s			
Xeon Silver 4215 8C 2.5GHz 85W	S26361-F4082-E115	S26361-F4082-L115	X
Xeon Silver 4215R 8C 3.2GHz 130W	S26361-F4082-E815	S26361-F4082-L815	X
<b>Xeon Gold 5200 - Advanced AEP enabled</b>			
64-bit Intel Xeon processor supporting HT*, DDR4 @ 2666 MHz & UPI Bus @ 10.4 GT/s			
Xeon Gold 5215 10C 2.5GHz 85W	S26361-F4082-E215	S26361-F4082-L215	X
Xeon Gold 5217 8C 3.0GHz 115W	S26361-F4082-E217	S26361-F4082-L217	X
Xeon Gold 5218 16C 2.3GHz 125W	S26361-F4082-E218	S26361-F4082-L218	X
Xeon Gold 5218R 20C 2.1GHz 125W	S26361-F4082-E818	S26361-F4082-L818	X
Xeon Gold 5220 18C 2.2GHz 125W	S26361-F4082-E220	S26361-F4082-L220	X
Xeon Gold 5220R 24C 2.2GHz 150W	S26361-F4082-E820	S26361-F4082-L820	X
<b>Xeon Gold 5200 - Advanced AEP enabled</b>			
64-bit Intel Xeon processor supporting HT*, DDR4 @ 2933 MHz & UPI Bus @ 10.4 GT/s			
Xeon Gold 5222 4C 3.8GHz 105W	S26361-F4082-E222	S26361-F4082-L222	X
<b>Xeon Gold 6200 - Advanced AEP enabled</b>			
64-bit Intel Xeon processor supporting HT*, DDR4 @ 2933 MHz & UPI Bus @ 10.4 GT/s			
Xeon Gold 6226 12C 2.7GHz 125W	S26361-F4082-E326	S26361-F4082-L326	X
Xeon Gold 6226R 16C 2.9GHz 150W	S26361-F4082-E826	S26361-F4082-L826	X
Xeon Gold 6230 20C 2.1GHz 125W	S26361-F4082-E330	S26361-F4082-L330	X
Xeon Gold 6230R 26C 2.1GHz 150W	S26361-F4082-E830	S26361-F4082-L830	X
Xeon Gold 6234 8C 3.4GHz 130W	S26361-F4082-E334	S26361-F4082-L334	X
Xeon Gold 6238 22C 2.1GHz 140W	S26361-F4082-E338	S26361-F4082-L338	X
Xeon Gold 6240 18C 2.6GHz 150W	S26361-F4082-E340	S26361-F4082-L340	X
Xeon Gold 6242 16C 2.8GHz 150W	S26361-F4082-E342	S26361-F4082-L342	X
Xeon Gold 6248 20C 2.5GHz 150W	S26361-F4082-E348	S26361-F4082-L348	X
Xeon Gold 6252 24C 2.1GHz 150W	S26361-F4082-E352	S26361-F4082-L352	X
<b>Xeon Gold 5200M - Advanced (Shelf 3; 2.0TB p. Socket)</b>			
64-bit Intel Xeon processor supporting HT*, DDR4 @ 2666 MHz & UPI Bus @ 10.4 GT/s			
Xeon Gold 5215M 10C 2.5GHz 85W	S26361-F4082-E415	S26361-F4082-L415	X
<b>Xeon Gold 6200M - Advanced (Shelf 3; 2.0TB p. Socket)</b>			
64-bit Intel Xeon processor supporting HT*, DDR4 @ 2933 MHz & UPI Bus @ 10.4 GT/s			
Xeon Gold 6238M 22C 2.1GHz 140W	S26361-F4082-E438	S26361-F4082-L438	X
Xeon Gold 6240M 18C 2.6GHz 150W	S26361-F4082-E440	S26361-F4082-L440	X
<b>Xeon Silver 4200Y- Speed Select</b>			
64-bit Intel Xeon processor supporting HT*, DDR4 @ 2400 MHz & UPI Bus @ 9.6 GT/s			
Xeon Silver 4214Y 8/10/12C 2.2GHz 85W	S26361-F4082-E614	S26361-F4082-L614	X
<b>Xeon Gold 5200S - Serched Optimized</b>			
64-bit Intel Xeon processor supporting HT*, DDR4 @ 2666 MHz & UPI Bus @ 10.4 GT/s			
Xeon Gold 5220S 18C 2.6GHz 125W	S26361-F4082-E221	S26361-F4082-L221	X
<b>Xeon Gold 6200V - VM Optimized</b>			
64-bit Intel Xeon processor supporting HT*, DDR4 @ 2933 MHz & UPI Bus @ 10.4 GT/s			
Xeon Gold 6222V 20C 1.8GHz 115W	S26361-F4082-E322	S26361-F4082-L322	X
Xeon Gold 6262V 24C 1.9GHz 135W	S26361-F4082-E362	S26361-F4082-L362	X

Cooler Kit (see comment above; for upgrade please use according kit to the selected CPU)			
Cooling Kit 2nd CPU	S26361-F3849-E100		X
Cooling Kit for 2nd CPU (upgrade option for Standard BU)		S26361-F4051-L950	X

C

**Chapter 3 - CPU (CX2570 M5)**

**B**

There are 2 processor sockets available. Please configure 1 or 2 Processors.  
 >> All processors have to be the same type.  
 >> With one processor LOM, iRMC and 8x DIMM slots are available  
 >> With two processors all 16x DIMM slots are available.  
 >> Empty CPU slot have to be filled up with a CPU Dummy! \* HT = Hyper Threading

**Note: CX2570M5 supports only liquid cooling model**  
**Liquid cooling base unit requires always 2 CPUs**

**Restriction for ErP Lot9:**

>> Xeon Bronze 3204 is not orderable.  
 >> 1 DIMM configuration is not orderable.

These configuration is not allowed to ship in EU/EFTA countries to comply with ErP Lot 9 regulation.  
 For APAC and US region, please contact Fujitsu Marketing team, if you require those configuration.

**Base Units**

Liquid Cooled (S26361-K1686-V200)

<b>Xeon Bronze 3200 - Basic</b>			
64-bit Intel Xeon processor supporting DDR4 @ 2133MHz & UPI Bus @ 9.6 GT/s			
Xeon Bronze 3204 6C nHT 1.9 GHz 85W	S26361-F4082-E104		Not Orderable
Xeon Bronze 3206R 8C nHT 1.9GHz 85W	S26361-F4082-E806		
<b>Xeon Silver 4200 - Standard</b>			
64-bit Intel Xeon processor supporting HT*, DDR4 @ 2400 MHz & UPI Bus 9.6 GT/s			
Xeon Silver 4208 8C 2.1GHz 85W	S26361-F4082-E108		X
Xeon Silver 4210 10C 2.2GHz 85W	S26361-F4082-E110		X
Xeon Silver 4210R 10C 2.4GHz 100W	S26361-F4082-E811		X
Xeon Silver 4214 12C 2.2GHz 85W	S26361-F4082-E114		X
Xeon Silver 4214R 12C 2.4GHz 100W	S26361-F4082-E814		X
Xeon Silver 4216 16C 2.1GHz 100W	S26361-F4082-E116		X
<b>Xeon Silver 4200 - Frequency Optimized</b>			
64-bit Intel Xeon processor supporting HT*, DDR4 @ 2400 MHz & UPI Bus @ 9.6 GT/s			
Xeon Silver 4215 8C 2.5GHz 85W	S26361-F4082-E115		X
Xeon Silver 4215R 8C 3.2GHz 130W	S26361-F4082-E815		X
<b>Xeon Gold 5200 - Advanced AEP enabled</b>			
64-bit Intel Xeon processor supporting HT*, DDR4 @ 2666 MHz & UPI Bus @ 10.4 GT/s			
Xeon Gold 5215 10C 2.5GHz 85W	S26361-F4082-E215		X
Xeon Gold 5217 8C 3.0GHz 115W	S26361-F4082-E217		X
Xeon Gold 5218 16C 2.3GHz 125W	S26361-F4082-E218		X
Xeon Gold 5218R 20C 2.1GHz 125W	S26361-F4082-E818		X
Xeon Gold 5220 18C 2.2GHz 125W	S26361-F4082-E220		X
Xeon Gold 5220R 24C 2.2GHz 150W	S26361-F4082-E820		X
<b>Xeon Gold 5200 - Advanced AEP enabled</b>			
64-bit Intel Xeon processor supporting HT*, DDR4 @ 2933 MHz & UPI Bus @ 10.4 GT/s			
Xeon Gold 5222 4C 3.8GHz 105W	S26361-F4082-E222		X
<b>Xeon Gold 6200 - Advanced AEP enabled</b>			
64-bit Intel Xeon processor supporting HT*, DDR4 @ 2933 MHz & UPI Bus @ 10.4 GT/s			
Xeon Gold 6226 12C 2.7GHz 125W	S26361-F4082-E326		X
Xeon Gold 6226R 16C 2.9GHz 150W	S26361-F4082-E826		X
Xeon Gold 6230 20C 2.1GHz 125W	S26361-F4082-E330		X
Xeon Gold 6230R 26C 2.1GHz 150W	S26361-F4082-E830		X
Xeon Gold 6234 8C 3.4GHz 130W	S26361-F4082-E334		X
Xeon Gold 6238 22C 2.1GHz 140W	S26361-F4082-E338		X
Xeon Gold 6238R 28C 2.2GHz 165W	S26361-F4082-E838		X
Xeon Gold 6240 18C 2.6GHz 150W	S26361-F4082-E340		X
Xeon Gold 6240R 24C 2.4GHz 165W	S26361-F4082-E840		X
Xeon Gold 6242 16C 2.8GHz 150W	S26361-F4082-E342		X
Xeon Gold 6242R 20C 3.1GHz 205W	S26361-F4082-E842		X
Xeon Gold 6244 8C 3.6GHz 150W	S26361-F4082-E344		X
Xeon Gold 6246 12C 3.3GHz 165W	S26361-F4082-E346		X
Xeon Gold 6246R 16C 3.4GHz 205W	S26361-F4082-E846		X
Xeon Gold 6248 20C 2.5GHz 150W	S26361-F4082-E348		X
Xeon Gold 6248R 24C 3.0GHz 205W	S26361-F4082-E848		X
Xeon Gold 6250 8C 3.9GHz 185W	S26361-F4082-E850		X
Xeon Gold 6252 24C 2.1GHz 150W	S26361-F4082-E352		X
Xeon Gold 6254 18C 3.1GHz 200W	S26361-F4082-E354		X
Xeon Gold 6256 12C 3.6GHz 205W	S26361-F4082-E856		X
Xeon Gold 6258R 28C 2.7GHz 205W	S26361-F4082-E858		X
<b>Xeon Platinum 8200 Advanced AEP enabled</b>			
64-bit Intel Xeon processor supporting HT*, DDR4 @ 2933 MHz & UPI Bus @ 10.4 GT/s			
Xeon Platinum 8260 24C 2.4GHz 165W	S26361-F4082-E360		X
Xeon Platinum 8268 24C 2.9GHz 205W	S26361-F4082-E368		X
Xeon Platinum 8270 26C 2.7GHz 205W	S26361-F4082-E370		X
Xeon Platinum 8276 28C 2.2GHz 165W	S26361-F4082-E376		X
Xeon Platinum 8280 28C 2.7GHz 205W	S26361-F4082-E380		X
<b>Xeon Gold 5200M - Advanced (Shelf 3; 2.0TB p. Socket)</b>			

64-bit Intel Xeon processor supporting HT*, DDR4 @ 2666 MHz & UPI Bus @ 10.4 GT/s			
Xeon Gold 5215M 10C 2.5GHz 85W	S26361-F4082-E415		X
<b>Xeon Gold 6200M - Advanced (Shelf 3; 2.0TB p. Socket)</b>			
64-bit Intel Xeon processor supporting HT*, DDR4 @ 2933 MHz & UPI Bus @ 10.4 GT/s			
Xeon Gold 6238M 22C 2.1GHz 140W	S26361-F4082-E438		X
Xeon Gold 6240M 18C 2.6GHz 150W	S26361-F4082-E440		X
<b>Xeon Platinum 8200M - Advanced (2.0 TB p. Socket)</b>			
64-bit Intel Xeon processor supporting HT*, DDR4 @ 2933 MHz & UPI Bus @ 10.4 GT/s			
Xeon Platinum 8260M 24C 2.4GHz 165W	S26361-F4082-E460		X
Xeon Platinum 8276M 28C 2.2GHz 165W	S26361-F4082-E476		X
Xeon Platinum 8280M 28C 2.7GHz 205W	S26361-F4082-E480		X

**B1**

**B1**

<b>Xeon Silver 4200 - Speed Select</b>			
64-bit Intel Xeon processor supporting HT*, DDR4 @ 2666 MHz & QPI Bus @ 10.4 GT/s			
Xeon Silver 4214Y 8/10/12C 2.2GHz 85W	<b>S26361-F4082-E614</b>		X
<b>Xeon Gold 6200 - Speed Select AEP enabled</b>			
64-bit Intel Xeon processor supporting HT*, DDR4 @ 2666 MHz & QPI Bus @ 10.4 GT/s			
Xeon Gold 6240Y 8/14/18C 2.6GHz 150W	<b>S26361-F4082-E640</b>		X
<b>Xeon Platinum 8200 - Speed Select AEP enabled</b>			
64-bit Intel Xeon processor supporting HT*, DDR4 @ 2400 MHz & QPI Bus @ 9.6 GT/s			
Xeon Platinum 8260Y 16/20/24C 2.4GHz 165W	<b>S26361-F4082-E660</b>		X
<b>Xeon Gold 5200S - Serched Optimized</b>			
64-bit Intel Xeon processor supporting HT*, DDR4 @ 2666 MHz & UPI Bus @ 10.4 GT/s			
Xeon Gold 5220S 18C 2.6GHz 125W	<b>S26361-F4082-E221</b>		X
<b>Xeon Gold 6200V - VM Optimized</b>			
64-bit Intel Xeon processor supporting HT*, DDR4 @ 2933 MHz & UPI Bus @ 10.4 GT/s			
Xeon Gold 6222V 20C 1.8GHz 115W	<b>S26361-F4082-E322</b>		X
Xeon Gold 6262V 24C 1.9GHz 135W	<b>S26361-F4082-E362</b>		X

**C**

Chapter 3 - CPU (CX2550 M5)

**B**

There are 2 processor sockets available. Please configure 1 or 2 Processors.  
 >> All processors have to be the same type.  
 >> With one processor LOM, iRMC and 8x DIMM slots are available  
 >> With two processors all 16x DIMM slots are available.  
 >> To configure 2nd CPU an additional cooler kit is required.  
 >> Empty CPU slot have to be filled up with a CPU Dummy! \* HT = Hyper Threading

**Restriction for CPUs above 150W TDP:**  
 Ambient temperature requirement for CPUs between 150W and 165W TDP is 30°C  
 CPUs above 165W TDP require a liquid cooled base unit

Liquid cooling base unit requires always 2 CPUs

**Restriction for ErP Lot9:**

>> Xeon Bronze 3204 is not orderable.  
 >> 1 DIMM configuration is not orderable.

These configuration is not allowed to ship in EU/EFTA countries to comply with ErP Lot 9 regulation.  
 For APAC and US region, please contact Fujitsu Marketing team, if you require those configuration.

**Base Units**

Standard (S26361-K1688-V100)  
 Liquid Cooled (S26361-K1688-V200)

<b>Xeon Gold 5200 - Advanced AEP enabled</b>			
64-bit Intel Xeon processor supporting HT*, DDR4 @ 2666 MHz & UPI Bus @ 10.4 GT/s			
Xeon Gold 5215 10C 2.6GHz 85W	S26361-F4082-E215	S26361-F4082-L215	X X
Xeon Gold 5217 8C 3.0GHz 115W	S26361-F4082-E217	S26361-F4082-L217	X X
Xeon Gold 5218 16C 2.3GHz 125W	S26361-F4082-E218	S26361-F4082-L218	X X
Xeon Gold 5218R 20C 2.1GHz 125W	S26361-F4082-E818	S26361-F4082-L818	X X
Xeon Gold 5220 18C 2.2GHz 125W	S26361-F4082-E220	S26361-F4082-L220	X X
Xeon Gold 5220R 24C 2.2GHz 150W	S26361-F4082-E820	S26361-F4082-L820	X X
<b>Xeon Gold 5200 - Advanced AEP enabled</b>			
64-bit Intel Xeon processor supporting HT*, DDR4 @ 2933 MHz & UPI Bus @ 10.4 GT/s			
Xeon Gold 5222 4C 3.8GHz 105W	S26361-F4082-E222	S26361-F4082-L222	X X
<b>Xeon Gold 6200 - Advanced AEP enabled</b>			
64-bit Intel Xeon processor supporting HT*, DDR4 @ 2933 MHz & UPI Bus @ 10.4 GT/s			
Xeon Gold 6226 12C 2.7GHz 125W	S26361-F4082-E326	S26361-F4082-L326	X X
Xeon Gold 6226R 16C 2.9GHz 150W	S26361-F4082-E826	S26361-F4082-L826	X X
Xeon Gold 6230 20C 2.1GHz 125W	S26361-F4082-E330	S26361-F4082-L330	X X
Xeon Gold 6230R 26C 2.1GHz 150W	S26361-F4082-E830	S26361-F4082-L830	X X
Xeon Gold 6234 8C 3.4GHz 130W	S26361-F4082-E334	S26361-F4082-L334	X X
Xeon Gold 6238 22C 2.1GHz 140W	S26361-F4082-E338	S26361-F4082-L338	X X
Xeon Gold 6238R 28C 2.2GHz 165W	S26361-F4082-E838	S26361-F4082-L838	X X
Xeon Gold 6240 18C 2.6GHz 150W	S26361-F4082-E340	S26361-F4082-L340	X X
Xeon Gold 6240R 24C 2.4GHz 165W	S26361-F4082-E840	S26361-F4082-L840	X X
Xeon Gold 6242 16C 2.8GHz 150W	S26361-F4082-E342	S26361-F4082-L342	X X
Xeon Gold 6242R 20C 3.1GHz 205W	S26361-F4082-E842		X
Xeon Gold 6244 8C 3.6GHz 150W	S26361-F4082-E344		X
Xeon Gold 6246 12C 3.3GHz 165W	S26361-F4082-E346	S26361-F4082-L346	X
Xeon Gold 6246R 16C 3.4GHz 205W	S26361-F4082-E846		X
Xeon Gold 6248 20C 2.5GHz 150W	S26361-F4082-E348	S26361-F4082-L348	X X
Xeon Gold 6248R 24C 3.0GHz 205W	S26361-F4082-E848		X
Xeon Gold 6250 8C 3.9GHz 185W	S26361-F4082-E850		X
Xeon Gold 6252 24C 2.1GHz 150W	S26361-F4082-E352	S26361-F4082-L352	X X
Xeon Gold 6254 18C 3.1GHz 200W	S26361-F4082-E354		X
Xeon Gold 6256 12C 3.6GHz 205W	S26361-F4082-E856		X
Xeon Gold 6258R 28C 2.7GHz 205W	S26361-F4082-E858		X
<b>Xeon Platinum 8200 Advanced AEP enabled</b>			
64-bit Intel Xeon processor supporting HT*, DDR4 @ 2933 MHz & UPI Bus @ 10.4 GT/s			
Xeon Platinum 8260 24C 2.4GHz 165W	S26361-F4082-E360	S26361-F4082-L360	X X
Xeon Platinum 8268 24C 2.9GHz 205W	S26361-F4082-E368		X
Xeon Platinum 8270 26C 2.7GHz 205W	S26361-F4082-E370		X
Xeon Platinum 8276 28C 2.2GHz 165W	S26361-F4082-E376	S26361-F4082-L376	X X
Xeon Platinum 8280 28C 2.7GHz 205W	S26361-F4082-E380		X
<b>Xeon Gold 5200M - Advanced (Shelf 3; 2.0TB p. Socket)</b>			
64-bit Intel Xeon processor supporting HT*, DDR4 @ 2666 MHz & UPI Bus @ 10.4 GT/s			
Xeon Gold 5215M 10C 2.5GHz 85W	S26361-F4082-E415	S26361-F4082-L415	X X
<b>Xeon Gold 6200M - Advanced (Shelf 3; 2.0TB p. Socket)</b>			
64-bit Intel Xeon processor supporting HT*, DDR4 @ 2933 MHz & UPI Bus @ 10.4 GT/s			
Xeon Gold 6238M 22C 2.1GHz 140W	S26361-F4082-E438	S26361-F4082-L438	X X
Xeon Gold 6240M 18C 2.6GHz 150W	S26361-F4082-E440	S26361-F4082-L440	X X

<b>Xeon Platinum 8200M - Advanced (2.0 TB p. Socket)</b>				
64-bit Intel Xeon processor supporting HT*, DDR4 @ 2933 MHz & UPI Bus @ 10.4 GT/s				
Xeon Platinum 8260M 24C 2.4GHz 165W	S26361-F4082-E460	S26361-F4082-L460	X	X
Xeon Platinum 8276M 28C 2.2GHz 165W	S26361-F4082-E476	S26361-F4082-L476	X	X
Xeon Platinum 8280M 28C 2.7GHz 205W	S26361-F4082-E480			X
<b>B1</b>				

**B1**

<b>Xeon Gold 6200Y - Speed Select</b>			
64-bit Intel Xeon processor supporting HT*, DDR4 @ 2933 MHz & UPI Bus @ 10.4 GT/s			
Xeon Gold 6240Y 8/14/18C 2.6GHz 150W	S26361-F4082-E640		X

<b>Xeon Platinum 8200Y - Speed Select</b>			
64-bit Intel Xeon processor supporting HT*, DDR4 @ 2933 MHz & UPI Bus @ 10.4 GT/s			
Xeon Platinum 8260Y 16/20/24C 2.4GHz 165W	S26361-F4082-E660	S26361-F4082-L660	X X

<b>Xeon Gold 5200S - Serched Optimized</b>			
64-bit Intel Xeon processor supporting HT*, DDR4 @ 2666 MHz & UPI Bus @ 10.4 GT/s			
Xeon Gold 5220S 18C 2.6GHz 125W	S26361-F4082-E221	S26361-F4082-E221	X X

<b>Xeon Gold 6200V - VM Optimized</b>			
64-bit Intel Xeon processor supporting HT*, DDR4 @ 2933 MHz & UPI Bus @ 10.4 GT/s			
Xeon Gold 6222V 20C 1.8GHz 115W	S26361-F4082-E322	S26361-F4082-L322	X X
Xeon Gold 6262V 24C 1.9GHz 135W	S26361-F4082-E362	S26361-F4082-L362	X X

<b>Cooler Kit (see comment above; for upgrade please use according kit to the selected CPU)</b>			
Cooling Kit 2nd CPU	S26361-F3849-E100		X
Cooling Kit for 2nd CPU (upgrade option for Standard BU)		S26361-F4051-L950	X

**C**





**Chapter 4 - DDR4 System memory**

C

**Node CX2550 / CX2560 / CX2570 M5**

16x DIMM configuration (Mix configuration for 1DPC / 2DPC)

There are different kinds of DDR4 Memory Modules available: RDIMM x4, RDIMM x8, LRDIMM. Mix of these different kind of memories is not allowed.

In addition DCPMM (Data Center Persistent Memory) is available and can be mixed with all kind of memory modules.

Supported memory capacities per CPU:

- 256 GB DDR4 RDIMM (8x 32GB 2Rx4)
- 1.024 GB DDR4 LRDIMM (8x 128GB 4Rx4)
- 1.792 GB with 6x DDR4 128GB & 2x DCPMM 512 GB (CPU type with "M" at the end is required)

**Max memory capacity is 1.024GB/CPU. If > 1.024GB/CPU is required, please take CPU type with "M" at the end.**

Supported memory capacities per System:

- 512 GB using RDIMM
- 2.048 GB using LRDIMM technology with 128GB per module
- 3.584 GB using LRDIMM technology with 128GB per module and 512 GB DCPMM

The memory speed is independent from the configuration (1DPC or 2DPC) but restricted by the CPU SKU (max. 2.933 MT/s). DDR4 memory is operated at 1.2V



**CX2550 M5/CX2550 M5 LC does not support Rank Sparing Mode / Mirrored Channel Mode**

<b>S26361-F3694-E10</b>	Independent Mode Installation
Independent Channel Mode allows all channels to be populated in any order. No specific Memory RAS features are defined	
Requires minimum 1 memory Module per CPU	
<b>S26361-F3694-E1</b>	Rank Sparing Mode Installation
BIOS Setup factory preinstalled to this mode. One Rank is spare of other ranks on the same channel. Spare Rank is not shown in System Memory. For effective capacity within a channel, please have a look below.	
<b>Not supported with DCPMM modules!</b>	
Requires minimum 2x 1R/2R or 1x 4R/8R modules per CPU	
<b>S26361-F3694-E2</b>	Performance Mode Installation
BIOS Setup factory preinstalled for maximum Performance, six identical memory modules will be equipped in one memory bank to achieve highest memory performance. All six modules are active and full capacity can be used.	
<b>Not supported with DCPMM modules!</b>	
Multiple of 6 identical modules to be configured per CPU	
<b>S26361-F3694-E3</b>	Mirrored Channel Mode Installation
BIOS Setup factory preinstalled to this mode. Six identical memory modules are always equipped in one memory bank to use the Mirrored channel Mode. Only three modules contain active data, the remain three modules contain mirrored data.	
<b>Not supported with DCPMM modules!</b>	
Multiple of 6 identical modules to be configured per CPU	



**Resulting memory capacity / Rank Sparing Mode, 1 Channel populated**

	RDIMM						LRDIMM					
	16GB	1R	16GB	2R	32GB	2R	64GB	4R	128GB	4R	128GB	8R
1DPC	8GB		16GB		48GB		96GB		64GB			

**Restriction for ErP Lot9:**

- >> Xeon Bronze 3204 is not orderable.
- >> 1 DIMM configuration is not orderable.

These configuration is not allowed to ship in EU/EFTA countries to comply with ErP Lot 9 regulation.

<b>DDR4 rg 2933 x8x8</b>		
8GB (1x8GB) 1Rx8 DDR4-2933 R ECC	S26361-F4083-E608	S26361-F4083-L608
16GB (1x16GB) 2Rx8 DDR4-2933 R ECC	S26361-F4083-E616	S26361-F4083-L616

<b>DDR4 rg 2933 x4x4</b>		
16GB (1x16GB) 1Rx4 DDR4-2933 R ECC	S26361-F4083-E816	S26361-F4083-L816
32GB (1x32GB) 2Rx4 DDR4-2933 R ECC	S26361-F4083-E832	S26361-F4083-L832
64GB (1x64GB) 2Rx4 DDR4-2933 R ECC	S26361-F4083-E864	S26361-F4083-L864

<b>DDR4 lr 2933</b>		
64GB (1x64GB) 4Rx4 DDR4-2933 LR ECC	S26361-F4083-E964	S26361-F4083-L964
128GB (1x128GB) 4Rx4 DDR4-2933 LR ECC	S26361-F4083-E928	S26361-F4083-L928

As soon as available

<b>DDR4 lr 2933 3DS</b>		
128GB (1x128GB) 8Rx4 DDR4-2933 LR ECC	S26361-F4083-E929	S26361-F4083-L929

**DCPMM configuration section**



Only one type of DCPMM is allowed per system!  
 Only one DCPMM package and one Memory package is allowed per CPU!  
 Every CPU has to have the same DCPMM & Memory configuration!  
 Liquid cooling base unit does not support DCPMM

DCPMM 128GB 2666 (Apache Pass)		
128GB (1x128GB) DCPMM-2666	S26361-F4083-E501	S26361-F4083-L501

Available Memory Packages		
96GB (6x16GB) 1Rx4 DDR4-2933 R ECC	S26361-F4083-E817	
192GB (6x32GB) 2Rx4 DDR4-2933 R ECC	S26361-F4083-E833	
384GB (6x64GB) 4Rx4 DDR4-2933 LR ECC	S26361-F4083-E965	

DCPMM 256GB 2666 (Apache Pass)		
256GB (2x128GB) DCPMM-2666	S26361-F4083-E521	

Available Memory Packages		
96GB (6x16GB) 1Rx4 DDR4-2933 R ECC	S26361-F4083-E817	
192GB (6x32GB) 2Rx4 DDR4-2933 R ECC	S26361-F4083-E833	
384GB (6x64GB) 4Rx4 DDR4-2933 LR ECC	S26361-F4083-E965	
64GB (4x16GB) 1Rx4 DDR4-2933 R ECC	S26361-F4083-E818	
128GB (4x32GB) 2Rx4 DDR4-2933 R ECC	S26361-F4083-E834	
256GB (4x64GB) 4Rx4 DDR4-2933 LR ECC	S26361-F4083-E966	

DCPMM 256GB 2666 (Apache Pass)		
256GB (1x256GB) DCPMM-2666	S26361-F4083-E502	S26361-F4083-L502

Available Memory Packages		
96GB (6x16GB) 1Rx4 DDR4-2933 R ECC	S26361-F4083-E817	
192GB (6x32GB) 2Rx4 DDR4-2933 R ECC	S26361-F4083-E833	
384GB (6x64GB) 4Rx4 DDR4-2933 LR ECC	S26361-F4083-E965	

DCPMM 256GB 2666 (Apache Pass)		
512GB (2x256GB) DCPMM-2666	S26361-F4083-E522	

Available Memory Packages		
96GB (6x16GB) 1Rx4 DDR4-2933 R ECC	S26361-F4083-E817	
192GB (6x32GB) 2Rx4 DDR4-2933 R ECC	S26361-F4083-E833	
384GB (6x64GB) 4Rx4 DDR4-2933 LR ECC	S26361-F4083-E965	
64GB (4x16GB) 1Rx4 DDR4-2933 R ECC	S26361-F4083-E818	
128GB (4x32GB) 2Rx4 DDR4-2933 R ECC	S26361-F4083-E834	
256GB (4x64GB) 4Rx4 DDR4-2933 LR ECC	S26361-F4083-E966	

DCPMM 512GB 2666 (Apache Pass)		
512GB (1x512GB) DCPMM-2666	S26361-F4083-E503	S26361-F4083-L503

Available Memory Packages		
384GB (6x64GB) 4Rx4 DDR4-2933 LR ECC	S26361-F4083-E965	

DCPMM 512GB 2666 (Apache Pass)		
1024GB (2x512GB) DCPMM-2666	S26361-F4083-E523	

Available Memory Packages		
96GB (6x16GB) 1Rx4 DDR4-2933 R ECC	S26361-F4083-E817	
192GB (6x32GB) 2Rx4 DDR4-2933 R ECC	S26361-F4083-E833	
384GB (6x64GB) 4Rx4 DDR4-2933 LR ECC	S26361-F4083-E965	
768GB (6x128GB) 8Rx4 DDR4-2933 LR ECC	S26361-F4083-E931	
64GB (4x16GB) 1Rx4 DDR4-2933 R ECC	S26361-F4083-E818	
128GB (4x32GB) 2Rx4 DDR4-2933 R ECC	S26361-F4083-E834	
256GB (4x64GB) 4Rx4 DDR4-2933 LR ECC	S26361-F4083-E966	

D

**Detailed information**

Mode	Configuration	RDIMM		Use case, advantage
		x8	x4	
SDDC (chipkill) support	any	no	yes	supports detecting multi-bit errors
Independent channel mode	1 or 2 Modules per Bank	yes	yes	offers max. flexibility, upgradeability, capacity
Mirrored channel mode *)	6 identical Modules / Bank	no	yes	offers maximum security
Performance mode	6 identical Modules / Bank	yes	yes	offers maximum performance and capacity
Rank sparing mode *)	min. 2 Ranks / Channel	no	yes	balances performance and capacity

\*) For the delivery ex factory the system will be prepared with dedicated BIOS setting.

**For CX2550 M5 / CX2550 M5 LC / CX2560 M5 / CX2570 M5 LC**

Capacity	Configuration	RDIMM	LRDIMM	Notes
Min. Memory per CPU	1 Module / CPU	1x8GB	1x64GB	with one CPU
Max. Memory per CPU	8 Modules / CPU	8x32GB	8x128GB	with one CPU
Max. Memory per System	16 Modules / System	512GB	2,048GB	if second CPU is configured

The memory sockets on the Systemboards are color coded

<b>Bank I</b>	black sockets	<b>Bank II</b>	blue sockets
---------------	---------------	----------------	--------------

**Independent channel mode**

**For Node CX2550/CX2560/CX2570 M5**

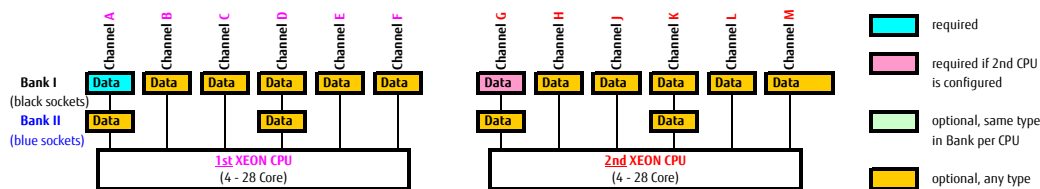

**Rank sparing mode --- 1-Rank Memory modules (RDIMM)**

No support for 1 RANK Memory module

**For Node CX2560/CX2570 M5 (only supported on 1DPC)**

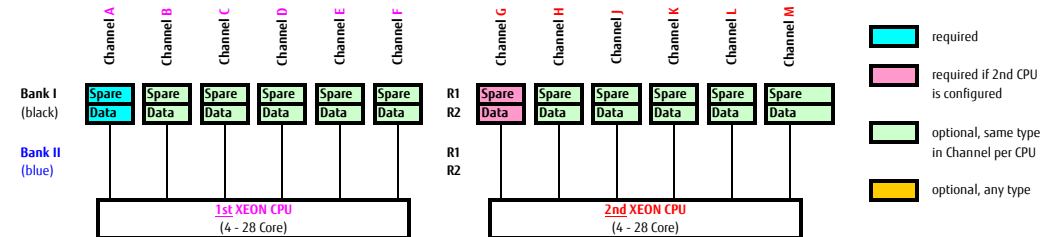

**Rank sparing mode --- 4-Rank Memory modules (LRDIMM)**

**For Node CX2560/CX2570 M5 (only supported on 1DPC)**

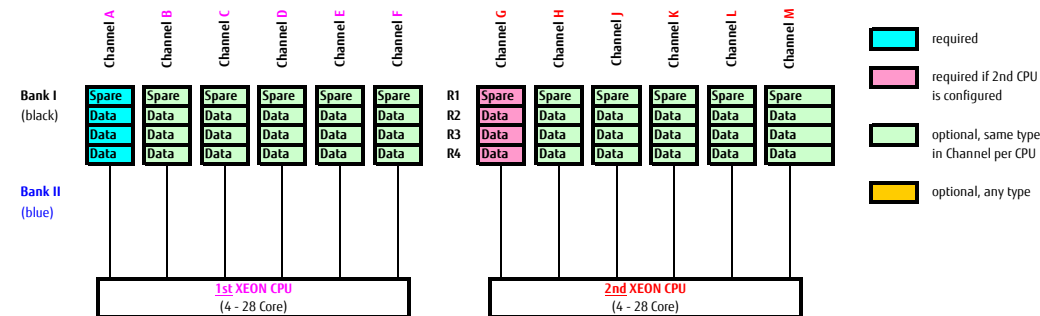

**Performance Channel Mode**

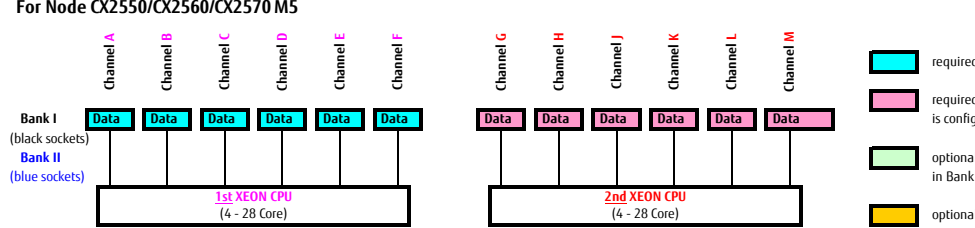

**Mirror Channel Mode (2 DIMMS per CPU) For Node CX2560/CX2570 M5 (only supported on 1DPC)**

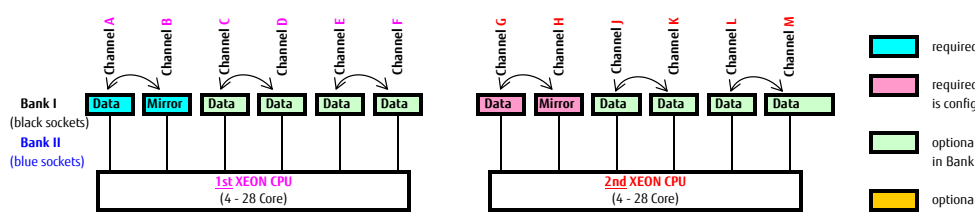

Mirrored Channel Mode (2 DIMMS per CPU) requires identical modules on channel A & B (1st CPU) or channel G & H (2nd CPU) 50% of the capacity is used for the mirror => the available memory for applications is only half of the installed memory. If this mode is used, a multiple of 2 identical modules has to be ordered.

**Mirror Channel Mode (3 DIMMS per CPU) For Node CX2560/CX2570 M5 (only supported on 1DPC)**

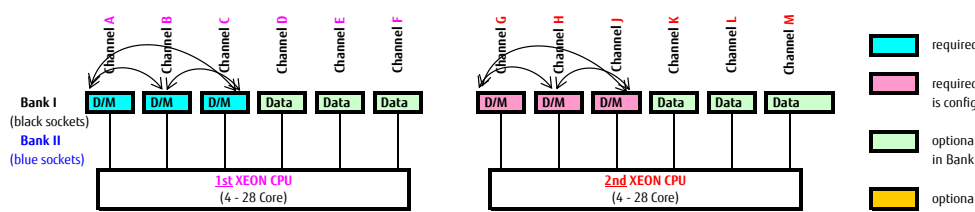

Mirrored Channel Mode (3 DIMMS per CPU) requires identical modules on channel A, B & C (1st CPU) or channel G, H & I (2nd CPU) 50% of the capacity is used for the mirror => the available memory for applications is only half of the installed memory. If this mode is used, a multiple of 3 identical modules has to be ordered.

**Mirror Channel Mode (4 DIMMS per CPU) For Node CX2560/CX2570 M5 (only supported on 1DPC)**

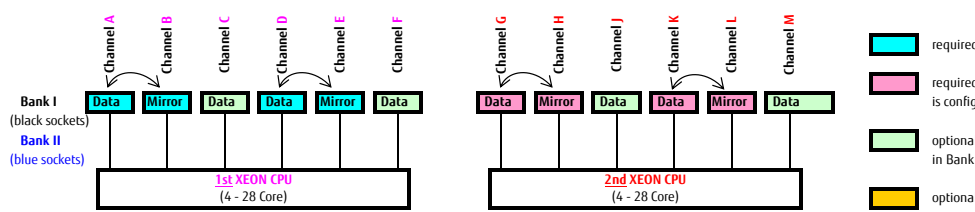

Mirrored Channel Mode (4 DIMMS per CPU) requires identical modules on channel A, B, D & E (1st CPU) or channel G, H, K & L (2nd CPU) 50% of the capacity is used for the mirror => the available memory for applications is only half of the installed memory. If this mode is used, a multiple of 4 identical modules has to be ordered.

**Mirror Channel Mode (6 DIMMS per CPU) For Node CX2560/CX2570 M5 (only supported on 1DPC)**

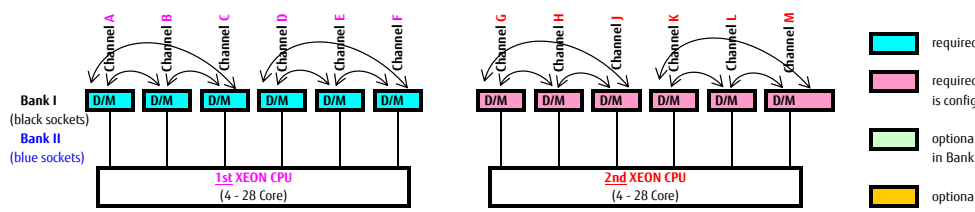

Mirrored Channel Mode requires identical modules on channel A, B, C, D, E, F (1st CPU) or channel G, H, I, J, K, L and M (2nd CPU) 50% of the capacity is used for the mirror => the available memory for applications is only half of the installed memory. If this mode is used, a multiple of 6 identical modules has to be ordered.

Released configurations with DCPMM modules per CPU

Modes	iMC1						iMC0						
	Channel 5		Channel 4		Channel 3		Channel 2		Channel 1		Channel 0		
	Bank II	Bank I	Bank II	Bank I	Bank II	Bank I	Bank II	Bank I	Bank II	Bank I	Bank II	Bank I	
AD		16		16	128	16		16		16	128	16	2-1-1
AD		32		32	128	32		32		32	128	32	2-1-1
AD		64		64	128	64		64		64	128	64	2-1-1
AD + MM		16		16	256	16		16		16	256	16	2-1-1
AD		32		32	256	32		32		32	256	32	2-1-1
AD		64		64	256	64		64		64	256	64	2-1-1
AD + MM		16		16	512	16		16		16	512	16	2-1-1
AD + MM		32		32	512	32		32		32	512	32	2-1-1
AD		64		64	512	64		64		64	512	64	2-1-1
AD		128		128	512	128		128		128	512	128	2-1-1
AD + MM		128		16		16		128		16		16	1-1-1
AD		128		32		32		128		32		32	1-1-1
AD		128		64		64		128		64		64	1-1-1
AD + MM		256		16		16		256		16		16	1-1-1
AD + MM		256		32		32		256		32		32	1-1-1
AD		256		64		64		256		64		64	1-1-1
AD + MM		512		16		16		512		16		16	1-1-1
AD + MM		512		32		32		512		32		32	1-1-1
AD + MM		512		64		64		512		64		64	1-1-1
AD		16		16		16		16		16	128	16	2/1-1-1
AD		32		32		32		32		32	128	32	2/1-1-1
AD		64		64		64		64		64	128	64	2/1-1-1
AD		16		16		16		16		16	256	16	2/1-1-1
AD		32		32		32		32		32	256	32	2/1-1-1
AD		64		64		64		64		64	256	64	2/1-1-1
AD		64		64		64		64		64	512	64	2/1-1-1

**Chapter 5 - Graphics options**

D

**NVIDIA Tesla V100 for SXM2**

Liquid cooling

S26361-F4025-E202/L202  
PY NVIDIA Tesla V100 for SXM2  
NVIDIA Tesla V100 with 5120 graphic cores & 32GB HBM2  
memory. NVLink  
power cables from PSU need to be ordered separately. 2400  
PSU is recommended  
PCIe \*16 (Gen3) - mezz type  
**Support OS is only RHEL7**  
min./max. 4x per CX2570 M5 LC (SXM2)



Basic unit for CX2570M5 (SXM2)  
Always 4x SXM2 required

E

**Chapter 6 - Drive cage and PCIe riser options**

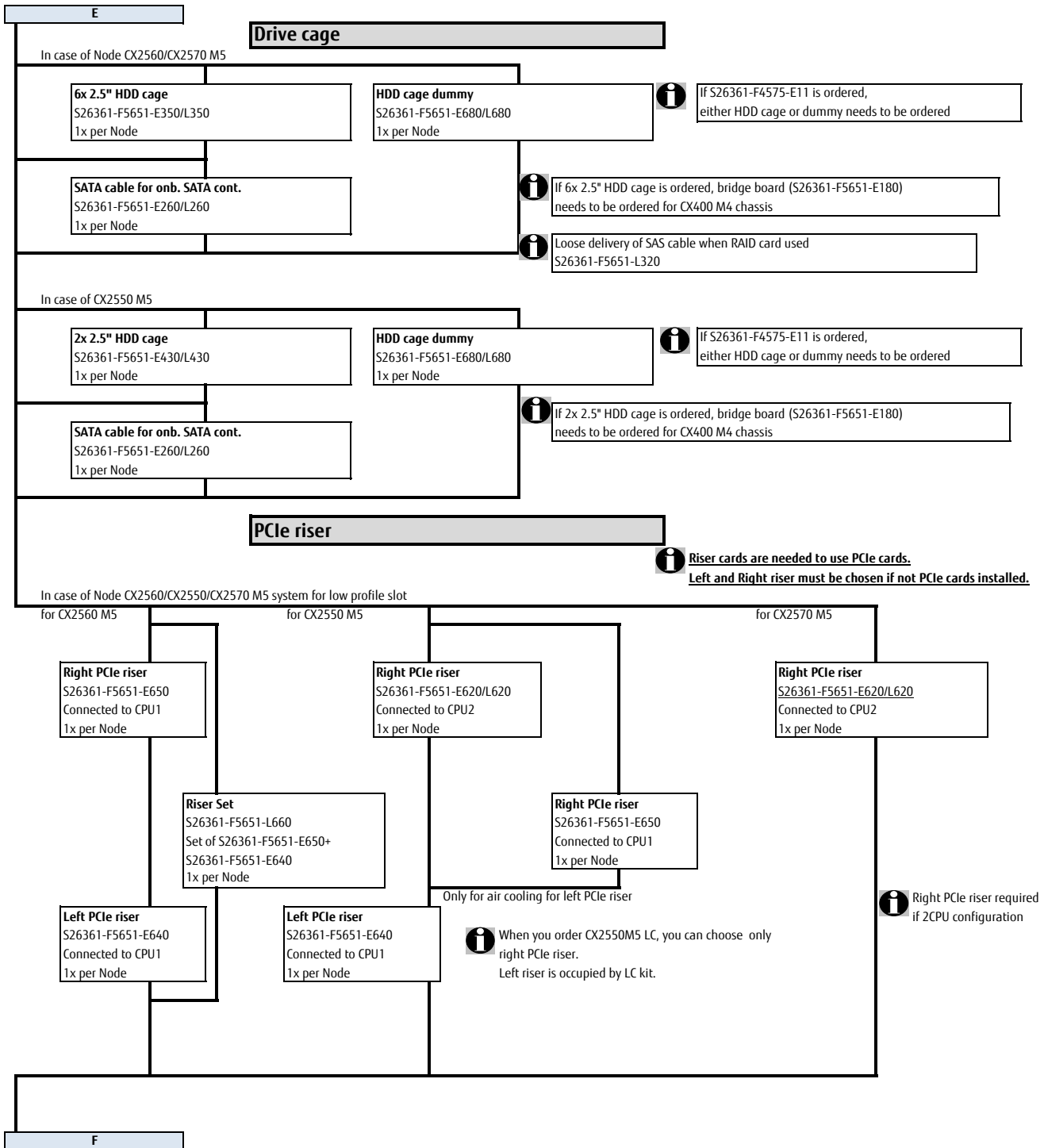

**Chapter 7 - SAS / RAID Controller**

**G**

onboard SATA controller with SW-RAID [for all CX2550 / CX2560 / CX2570 M5](#)

onboard controller for SATA HDD or SSD drives					
6Gb/s SATA HDD/SSD	based on Intel chipset	No Cache	SW-RAID 0, 1	1x	onboard, included

**Note: Not possible to use Software RAID with RHEL 7.6!**

internal HBA and RAID controller, no 2nd Level cache [Support for CX2550 / CX2560 Air cooling](#)

**Note: Not possible to connect HSGT Bear Cover Plus!**

internal drive RAID / HBA controllers for SAS, SATA HDD or SSD drives					
<b>PRAID CP400i RAID Contr.</b>	No Cache	RAID 0, 1, 1E, 10, 5, 50	1x	S26361-F3842-E1	S26361-F3842-L501
<b>PSAS CP400i HBA SAS Contr.</b>	No Cache	HBA + RAID 0, 1	1x	S26361-F3842-E2	S26361-F3842-L502
8 ports 3, 6 & 12Gb/s SAS/SATA HDD/SSD, supports up to 8 devices without expander requires 1x LP PCIe 3.0 x8 (int.) slot, based on LSI SAS3008					
<b>PSAS CP403i HBA SAS Contr.</b>	No Cache	HBA	1x	S26361-F3842-E3	S26361-F3842-L503
8 ports 3, 6 & 12Gb/s SAS/SATA HDD/SSD, supports up to 8 devices without expander requires 1x LP PCIe 3.0 x8 (int.) slot, based on LSI SAS3008; IT FW stack without RAID functionality; released for VMWare vSAN / vSphere					
internal drive HBA controllers for SAS, SATA HDD or SSD drives					
<b>PSAS CP503i HBA SAS Contr. for vSAN</b>	No Cache	HBA, no RAID	1x	S26361-F5792-E254	S26361-F5792-L554
8 ports 3, 6 & 12Gb/s SAS/SATA HDD/SSD, supports up to 8 devices without expander requires 1x LP PCIe 3.0 x8 (int.) slot, based on LSI SAS3408; IT FW stack without RAID functionality; released for VMWare vSAN / vSphere in CX2560					

**PSAS CP503i and PSAS CP400i / CP403i / CP400e cannot be mixed**

internal RAID controller with 2nd Level cache 1GB, 2GB [Support for CX2550 / CX2560 cooling](#)

[FBU is supported only for CX2560.](#)

internal drive RAID / SAS, SATA controllers with Cache and opt. TFM module + Flash Backup Unit and opt. Advanced SW Options					
<b>PRAID EP400i RAID Contr.</b>	1GB Cache	RAID 0, 1, 1E, 10, 5, 50, 6, 60	1x	S26361-F5243-E11	S26361-F5243-L11
8 ports 3, 6 & 12Gb/s SAS/SATA HDD/SSD, supports up to 8 devices without expander requires 1x LP PCIe 3.0 x8 (int.) slot, based on LSI SAS3108					
optional Licence Activation Key, a free of charge test licence is available at PRIMERGY-PM, FastPath is included in Controller FW					
RAID Advanced SW Option CacheCade ®Broadcom: SSD-cache-based HDD acceleration			1x	S26361-F5243-E670	S26361-F5243-L670
optional Transportable Flash module (TFM) and Flash Backup Unit (FBU), both components required					
<b>TFM module for 1GB Cache</b>	NV-RAM & FBU control logic		1x	S26361-F5243-E100	S26361-F5243-L100
<b>FBU Option for PRAID EP4xx</b> : Supercap securing the power supply of the RAID controller in case of power failure including cable with 55cm length			1x	S26361-F5243-E156	S26361-F5243-L112
<b>PRAID EP420i RAID Contr.</b>	2GB Cache	RAID 0, 1, 1E, 10, 5, 50, 6, 60	1x	S26361-F5243-E12	S26361-F5243-L12
<b>PRAID EP420i for SafeStore R. Contr.</b>	2GB Cache	RAID 0, 1, 1E, 10, 5, 50, 6, 60	1x	S26361-F5243-E14**	S26361-F5243-L14**
8 ports 3, 6 & 12Gb/s SAS/SATA HDD/SSD, supports up to 8 devices without expander requires 1x LP PCIe 3.0 x8 (int.) slot, based on LSI SAS3108					
optional Licence Activation Key, a free of charge test licence is available at PRIMERGY-PM, FastPath is included in Controller FW					
RAID Advanced SW Option CacheCade ®Broadcom: SSD-cache-based HDD acceleration			1x	S26361-F5243-E670	S26361-F5243-L670
optional TFM module and Flash Backup Unit (FBU), both components required					
<b>TFM module for 2GB Cache</b>	NV-RAM & FBU control logic		1x	S26361-F5243-E200	S26361-F5243-L200
<b>FBU Option for PRAID EP4xx</b> : Supercap securing the power supply of the RAID controller in case of power failure including cable with 55cm length			1x	S26361-F5243-E156	S26361-F5243-L112

**Note: If you would like to order FBU option, 2nd CPU must be installed to Node.**

**Check:** the FBU can / cannot be combined with Advanced Thermal design.  
**Check:** how many FBU can be integrated per System

CacheCade + FastPath is supported  
 SafeStore + FastPath is supported  
 SafeStore + CacheCade is not supported



G

external SAS controller

**\*\*It is strongly recommended to order SafeStore (SED) RAID controller with SED HDD or SSD devices for SafeStore (SED) functionality**

Support for CX2550 / CX2560 Air cooling

**HBA controller for ext. drives SAS, SATA HDD or SSD drives**

<b>PSAS CP400e HBA SAS Contr. LP</b>	No Cache	HBA, no RAID	2x	S26361-F3845-E201	S26361-F3845-L501
8 ports 3, 6 & 12Gb/s SAS/SATA HDD/ SSD, 2x SFF8644 (external Mini-SAS HD) requires 1x LP PCIe 3.0 x8 (int.) slot, based on LSI SAS3008					

**RAID / SAS, SATA controllers for external drives with Cache and opt. Flash Backup Unit**

<b>PRAID EP540e RAID Contr. LP</b>	4GB Cache	RAID 0,1,1E,10,5,50,6,60	1x	S26361-F4063-E204	S26361-F4063-L504
8 ports 3, 6 & 12Gb/s SAS/SATA HDD/ SSD, 2x SFF8644 (external Mini-SAS HD) includes Fastpath and SafeStore Advanced SW-Licence requires 1x LP PCIe 3.0 x8 (int.) slot, based on LSI SAS3516					
optional Flash Backup Unit (FBU), Transportable Flash module (TFM) is already included					
<b>FBU Option for PRAID EP5xx for base V101: Supercap securing the power supply of the RAID controller in case of power failure including cable with 25cm length</b>			1x	S26361-F4042-E125	S26361-F4042-L110
<b>FBU Option for PRAID EP5xx for base V301,V501: Supercap securing the power supply of the RAID contr. in case of power failure including cable with 70cm length</b>			1x	S26361-F4042-E170	S26361-F4042-L110

**Note:If you would like to order FBU option, 2nd CPU must be installed to Node.**

H

## Chapter 8 - ODD optical disk drives

No internal ODD support

I

**Chapter 9 - backup drives**

No internal backup drive support

L

**Chapter 10 - storage drives**

H

SAS drives and SATA drives can be mixed, but cannot be used in one logical RAID volume.  
 SATA drives can be connected to the onboard Controller (max. 8x).  
 SAS drives require a dedicated SAS / RAID Controller  
 Hard Disk Sector Format Information:  
 512n HDD: 512 byte sectors on the drive media.  
 512e (=emulation) HDD: 4K physical sectors on the drive media with 512 byte logical configuration.  
 512e HDD Disk Drives: VMware is not supported.  
 512n & 512e HDDs can be mixed, but cannot be used in one logical RAID volume.  
 When using SSDs with VMware ESXi, select the SSDs that meet the endurance requirement described in KB2145210 below.  
<https://kb.vmware.com/kb/2145210>  
 DDPD (5y): Drive Writes Per Day over 5 years.  
 SED (=Self Encrypting Drives) require either a RAID controller with \*SafeStore (SED) support or an HBA and in addition a software instance, supporting SED Key Management.  
 It is strongly recommended to order SafeStore (SED) RAID controller with SED HDD or SSD devices for SafeStore (SED) functionality.  
**HDD Classes:**  
 Business-Critical (BC) -SATA-Nearline SATA Enterprise Drives / 7.2Krpm, SATA 6G.  
 Business-Critical (BC) -SAS-Nearline SAS Enterprise Drives / 7.2Krpm, SAS 6G or SAS 12G .  
 Mission-Critical (MC)=SAS 10K and SAS 15K Enterprise Drives with max. performance and reliability.  
**Warranty:**  
 SSD and SATA DOM have a built-in Wear-Out indicator. In this case the warranty for such a component, as an exception to the system warranty, is restricted to the time period until the indicator reaches the exhaust level.

**2.5" (SFF) SAS and SATA SSD**

SSD SAS 2.5" Write Intensive (SFF) Enterprise with hot plug/hot replace tray							Toshiba Phoenix-M5	
Capacity	Formfactor	Interface	Endurance	DWPD		order code E-part	order code L-part	
400GB	2.5" (SFF)	SAS 12Gb/s	Write Intensive	10		S26361-F5710-E400	S26361-F5710-L400	
800GB	2.5" (SFF)	SAS 12Gb/s	Write Intensive	10		S26361-F5710-E800	S26361-F5710-L800	
1.6TB	2.5" (SFF)	SAS 12Gb/s	Write Intensive	10		S26361-F5710-E1600	S26361-F5710-L1600	
400GB	2.5" (SFF)	SAS 12Gb/s	Write Intensive	10	SED	S26361-F5711-E400	S26361-F5711-L400	
800GB	2.5" (SFF)	SAS 12Gb/s	Write Intensive	10	SED	S26361-F5711-E800	S26361-F5711-L800	
1.6TB	2.5" (SFF)	SAS 12Gb/s	Write Intensive	10	SED	S26361-F5711-E1600	S26361-F5711-L1600	

max. 4x - CX2560 M5 / CX2570 M5 with air cooling, **Mixing with other HDD/SSD is not possible**

SSD SAS 2.5" Mixed Use (SFF) Enterprise with hot plug/hot replace tray							HGST Bear Cove Plus	
Capacity	Formfactor	Interface	Endurance	DWPD		order code E-part	order code L-part	
400GB	2.5" (SFF)	SAS 12Gb/s	Mixed Use	3		S26361-F5713-E400	S26361-F5713-L400	
800GB	2.5" (SFF)	SAS 12Gb/s	Mixed Use	3		S26361-F5713-E800	S26361-F5713-L800	
1.6TB	2.5" (SFF)	SAS 12Gb/s	Mixed Use	3		S26361-F5713-E1600	S26361-F5713-L1600	
3.2TB	2.5" (SFF)	SAS 12Gb/s	Mixed Use	3		S26361-F5713-E3200	S26361-F5713-L3200	
6.4TB	2.5" (SFF)	SAS 12Gb/s	Mixed Use	3		S26361-F5713-E6400	S26361-F5713-L6400	

max. 6x - CX2560 M5 / CX2570 M5 with air cooling

SSD SAS 2.5" Read Intensive (SFF) Enterprise with hot plug/hot replace tray							HGST Bear Cove Plus	
Capacity	Formfactor	Interface	Endurance	DWPD		order code E-part	order code L-part	
480GB	2.5" (SFF)	SAS 12Gb/s	Read Intensive	1		S26361-F5715-E480	S26361-F5715-L480	
960GB	2.5" (SFF)	SAS 12Gb/s	Read Intensive	1		S26361-F5715-E960	S26361-F5715-L960	
1.92TB	2.5" (SFF)	SAS 12Gb/s	Read Intensive	1		S26361-F5715-E1920	S26361-F5715-L1920	
3.84TB	2.5" (SFF)	SAS 12Gb/s	Read Intensive	1		S26361-F5715-E3840	S26361-F5715-L3840	
7.68TB	2.5" (SFF)	SAS 12Gb/s	Read Intensive	1		S26361-F5715-E7680	S26361-F5715-L7680	
15.36TB	2.5" (SFF)	SAS 12Gb/s	Read Intensive	1		S26361-F5715-E15360	S26361-F5715-L15360	

max. 6x - CX2560 M5 / CX2570 M5 with air cooling

SSD SATA 2.5" Mixed Use (SFF) Enterprise with hot plug/hot replace tray							Samsung SM883	
Capacity	Formfactor	Interface	Endurance	DWPD		order code E-part	order code L-part	
240GB	2.5" (SFF)	SATA 6Gb/s	Mixed Use	3,6		S26361-F5675-E240	S26361-F5675-L240	
480GB	2.5" (SFF)	SATA 6Gb/s	Mixed Use	3,6		S26361-F5675-E480	S26361-F5675-L480	
960GB	2.5" (SFF)	SATA 6Gb/s	Mixed Use	3		S26361-F5588-E960	S26361-F5588-L960	
1.92TB	2.5" (SFF)	SATA 6Gb/s	Mixed Use	3		S26361-F5588-E1920	S26361-F5588-L1920	
3.84TB	2.5" (SFF)	SATA 6Gb/s	Mixed Use	3,6		S26361-F5588-E3840	S26361-F5588-L3840	

max. 6x - CX2560 M5 / CX2570 M5, max. 2x - CX2550 M5

SSD SATA 2.5" Read Intensive (SFF) Enterprise with hot plug/hot replace tray							Micron 5100/S200	
Capacity	Formfactor	Interface	Endurance	DWPD		order code E-part	order code L-part	
240GB	2.5" (SFF)	SATA 6Gb/s	Read Intensive	1,4		S26361-F5701-E240	S26361-F5701-L240	
480GB	2.5" (SFF)	SATA 6Gb/s	Read Intensive	0,9		S26361-F5701-E480	S26361-F5701-L480	
960GB	2.5" (SFF)	SATA 6Gb/s	Read Intensive	0,9		S26361-F5701-E960	S26361-F5701-L960	
1.92TB	2.5" (SFF)	SATA 6Gb/s	Read Intensive	0,9		S26361-F5701-E1920	S26361-F5701-L1920	
3.84TB	2.5" (SFF)	SATA 6Gb/s	Read Intensive	1,0		S26361-F5701-E3840	S26361-F5701-L3840	
7.68TB	2.5" (SFF)	SATA 6Gb/s	Read Intensive	0,5		S26361-F5701-E7680	S26361-F5701-L7680	

max. 6x - CX2560 M5 / CX2570 M5, max. 2x - CX2550 M5

I

<b>2.5" (SFF) Hard drives</b>						
<b>Note: If HDD selected, CPU must be below 140W and Ambient temperature is below 30 deg-C.</b>						
<b>HDD SAS 2.5" 15K (SFF) Enterprise Mission Critical with hot plug/hot replace tray</b>						
Capacity	RPM	Interface	Sector		order code E-part	order code L-part
300GB	15 000	SAS 12Gb/s	512n		S26361-F5531-E530	S26361-F5531-L530
600GB	15 000	SAS 12Gb/s	512n		S26361-F5531-E560	S26361-F5531-L560
900GB	15 000	SAS 12Gb/s	512n		S26361-F5531-E590	S26361-F5531-L590
max. 6x - CX2560 M5						
<b>Note: If HDD selected, CPU must be below 140W and Ambient temperature is below 30 deg-C.</b>						
<b>HDD SAS 2.5" 10K 512n (SFF) Enterprise Mission Critical with hot plug/hot replace tray</b>						
Capacity	RPM	Interface	Sector		order code E-part	order code L-part
600GB	10 000	SAS 12Gb/s	512n		S26361-F5720-E160	S26361-F5720-L160
900GB	10 000	SAS 12Gb/s	512n		S26361-F5550-E190	S26361-F5550-L190
1.2TB	10 000	SAS 12Gb/s	512n		S26361-F5550-E112	S26361-F5550-L112
300GB	10 000	SAS 12Gb/s	512n	SED	S26361-F5581-E130	S26361-F5581-L130
max. 6x - CX2560 M5						
<b>Note: If HDD selected, CPU must be below 140W and Ambient temperature is below 30 deg-C.</b>						
<b>HDD SAS 2.5" 10K 512e (SFF) Enterprise Mission Critical with hot plug/hot replace tray</b>						
Capacity	RPM	Interface	Sector		order code E-part	order code L-part
900GB	10 000	SAS 12Gb/s	512e		S26361-F5543-E190	S26361-F5543-L190
1.2TB	10 000	SAS 12Gb/s	512e		S26361-F5543-E112	S26361-F5543-L112
1.8TB	10 000	SAS 12Gb/s	512e		S26361-F5543-E118	S26361-F5543-L118
max. 6x - CX2560 M5						
<b>Note: If HDD selected, CPU must be below 140W and Ambient temperature is below 30 deg-C.</b>						
<b>HDD SAS 2.5" 7.2K 512n (SFF) Enterprise Business Critical with hot plug/hot replace tray</b>						
Capacity	RPM	Interface	Sector		order code E-part	order code L-part
1TB	7 200	SAS 12Gb/s	512n		S26361-F5600-E100	S26361-F5600-L100
max. 6x - CX2560 M5						
<b>Note: If HDD selected, CPU must be below 140W and Ambient temperature is below 30 deg-C.</b>						
<b>HDD SATA 2.5" 7.2K 512n (SFF) Enterprise Business Critical with hot plug/hot replace tray</b>						
Capacity	RPM	Interface	Sector		order code E-part	order code L-part
1TB	7 200	SATA 6Gb/s	512n		S26361-F3956-E100	S26361-F3956-L100
max. 6x - CX2560 M5 / CX2570 M5, max. 2x - CX2550 M5						
<b>Note: If HDD selected, CPU must be below 140W and Ambient temperature is below 30 deg-C.</b>						
<b>HDD SATA 2.5" 7.2K 512e (SFF) Enterprise Business Critical with hot plug/hot replace tray</b>						
Capacity	RPM	Interface	Sector		order code E-part	order code L-part
1TB	7 200	SATA 6Gb/s	512e		S26361-F3907-E100	S26361-F3907-L100
2TB	7 200	SATA 6Gb/s	512e		S26361-F3907-E200	S26361-F3907-L200
max. 6x - CX2560 M5 / CX2570 M5, max. 2x - CX2550 M5						

J

M.2 SATA SSD

**SSD SATA M.2 drive for booting, non hot-plug, for VMware ESXi**

Capacity	Formfactor	Interface	DWPD	Category	order code E-part	order code L-part
32GB	M.2	SATA 6Gbit/s		Boot	S26361-F5657-E32	S26361-F5657-L32

M.2 drive is designed for use as a VMware ESXi boot drive.  
 2x M.2 drive for any Hypervisor by the onboard chipset Software RAID is not supported.  
 max. 1x - CX2560 M5; connector located on Motherboard. VMware ESXi is only supported.

M.2 drive for VMware ESXi and for other OSs cannot be mixed

**SSD SATA M.2 drive for booting, non hot-plug**

Capacity	Formfactor	Interface	DWPD	Category	order code E-part	order code L-part
128GB	M.2	SATA 6Gbit/s	0,13	Boot	S26361-F5658-E128	S26361-F5658-L128

M.2 drive is designed for use as a boot drive with the Endurance Spec. above.  
 2x M.2 drive for any Hypervisor by the onboard chipset Software RAID is not supported.  
 max. 2x - CX2550 M5 / CX2560 M5 / CX2570 M5; connector located on Motherboard. VMware is not supported.

**SSD SATA M.2 drive for booting, non hot-plug**

Capacity	Formfactor	Interface	DWPD	Category	order code E-part	order code L-part
256GB	M.2	SATA 6Gbit/s	0,13	Boot	S26361-F5658-E256	S26361-F5658-L256

M.2 drive is designed for use as a boot drive with the Endurance Spec. above.  
 2x M.2 drive for any Hypervisor by the onboard chipset Software RAID is not supported.  
 max. 2x - CX2550 M5 / CX2560 M5 / CX2570 M5; connector located on Motherboard. VMware is not supported.

Dual microSD

Dual microSD and M.2 drive cannot be mixed

**Dual microSD Enterprise for booting, non hot-plug, for VMware ESXi**

Capacity	Formfactor	Interface	DWPD	Category	order code E-part	order code L-part
64GB	microSD	USB		Boot	TBD	TBD

Dual microSD is designed for use as a VMware ESXi boot drive. Only the standardly equipped microSD are supported.  
 Dual microSD offers Hardware-mirrored (RAID1) flash boot device for VMware ESXi, which cannot be supported by M.2.  
 vSAN can be booted in case ESXi host has 512 GB of memory or less. Even in case 512 GB or more, if vSAN is 6.5 or later, it can be booted by resizing the coredump partition on ESXi hosts. For more information, see the VMware knowledge base article at <http://kb.vmware.com/kb/2147881>.  
 max. 1x - CX2560 M5 / CX2570 M5; connector located on Motherboard. VMware ESXi is only supported.

2.5" (SFF) PCIe-SSD

Intel P4600

**PCIe-SSD 2.5" Mixed Use (SFF) Enterprise with hot plug/hot replace tray**

Capacity	Formfactor	Interface	Endurance	DWPD	order code E-part	order code L-part
1.6TB	2.5" (SFF)	PCIe3.0 x4	Mixed Use	3,0	S26361-F5648-E160	S26361-F5648-L160
3.2TB	2.5" (SFF)	PCIe3.0 x4	Mixed Use	3,1	S26361-F5648-E320	S26361-F5648-L320
6.4TB	2.5" (SFF)	PCIe3.0 x4	Mixed Use	3,2	S26361-F5648-E640	S26361-F5648-L640

max. 2x - CX2560 M5 / CX2570 M5 with air and liquid cooling

Intel P4610

**PCIe-SSD 2.5" Mixed Use (SFF) Enterprise with hot plug/hot replace tray**

Capacity	Formfactor	Interface	Endurance	DWPD	order code E-part	order code L-part
1.6TB	2.5" (SFF)	PCIe3.0 x4	Mixed Use	4,1	S26361-F5737-E160	S26361-F5737-L160
3.2TB	2.5" (SFF)	PCIe3.0 x4	Mixed Use	3,7	S26361-F5737-E320	S26361-F5737-L320
6.4TB	2.5" (SFF)	PCIe3.0 x4	Mixed Use	3,1	S26361-F5737-E640	S26361-F5737-L640

max. 2x - CX2560 M5 / CX2570 M5 with air and liquid cooling

Intel P4510

**PCIe-SSD 2.5" Mixed Use (SFF) Enterprise with hot plug/hot replace tray**

Capacity	Formfactor	Interface	Endurance	DWPD	order code E-part	order code L-part
1.0TB	2.5" (SFF)	PCIe3.0 x4	Mixed Use	1,0	S26361-F5738-E100	S26361-F5738-L100
2.0TB	2.5" (SFF)	PCIe3.0 x4	Mixed Use	0,7	S26361-F5738-E200	S26361-F5738-L200
4.0TB	2.5" (SFF)	PCIe3.0 x4	Mixed Use	0,8	S26361-F5738-E400	S26361-F5738-L400

max. 2x - CX2560 M5 / CX2570 M5 with air and liquid cooling

K

**Chapter 11 - LAN Components**

Default: 1x RJ45 1GbE ports on systemboard

x1 Dynamic LoM OCP PHY/PCIe interface cards

For CX2560/CX2570

Interface card to provide the external connectors for on-board LAN

PLAN EM 4x 1Gb T OCP interface Intel	4x RJ45 plug for 1000BASE-T	S26361-F5651-E530	S26361-F5651-L530
PLAN EM 2x 10Gb T OCP interface Intel	2x RJ45 plug for 10GBASE-T	S26361-F5651-E540	S26361-F5651-L540

For CX2560/CX2570

PLAN EM 2x 10GB SFP+ OCP interface Intel	2x SFP+ cages for SFP+ optical transceivers or twinax cables	S26361-F5651-E510	S26361-F5651-L510
PLAN EM 4x 10GB SFP+ OCP interface Intel	4x SFP+ cages for SFP+ optical transceivers or twinax cables	S26361-F5651-E550	S26361-F5651-L550

Optional for products with SFP+ cages: SFP+ optical transceiver modules or twinax cables

SFP+ Optical Transceiver 10G/1G Dual Rate SR	2x .. 4x	LC, MMF / SR SFP+ module, up to 400m, Intel	S26361-F3986-E5	S26361-F3986-L5
SFP+ Optical Transceiver 10G/1G Dual Rate LR	2x .. 4x	LC, SMF / LR SFP+ module, up to 10km, Intel	S26361-F3986-E6	S26361-F3986-L6
SFP+ Optical Transceiver 10G Single Rate SR	2x .. 4x	LC, MMF / SR SFP+ module, up to 400m, Finisar	S26361-F3986-E3	S26361-F3986-L3
SFP+ Optical Transceiver 10G Single Rate LR	2x .. 4x	LC, SMF / LR SFP+ module, up to 10km, Finisar	S26361-F3986-E4	S26361-F3986-L4
Twinax Anschlussplatz Primergy	2x .. 4x	virtual connector for twinax cables	V:TWX CONNECTOR-PY	
SFP+ active Twinax Cable Fujitsu	2x .. 4x	customized cable length	S26361-F3989-E600	see table at the bottom of this page
SFP+ active Twinax Cable Brocade	2x .. 4x	(best fitting cable length is defined during rack installation at the factory)	S26361-F3873-E500	

max. 1x per cage

For CX2550/CX2560/CX2570

PLAN EP MCX4-LX 25Gb 2p SFP28 OCP	Dual Port NIC, RoCE RDMA, Mellanox	S26361-F4054-E302	S26361-F4054-L302
-----------------------------------	------------------------------------	-------------------	-------------------

Optional, 25Gb SFP28 Optical Transceiver module with LC connector or 25G DAC or 25G AOC for PLAN EP MCX4-LX 25Gb 2p SFP28 OCP

SFP28 Optical Transceiver 25G SR MMA2P00-AS LC	2x	MMF / SR SFP28 module, Mellanox. Max reach supported 100m	S26361-F4054-E701	S26361-F4054-L701
SFP28 Optical Transceiver 25G SR E25GSFP28SR LC	2x	MMF / SR SFP28 module, Intel. Max reach supported 30m	S26361-F4055-E701	S26361-F4055-L701
"Virtual Connector" for DAC/AOC cables	2x	Enablement for System Architect	V:DAC/AOC-CONNECTOR-25	
25G DAC - Brocade	2x	DAC are not in Fujitsu's portfolio yet. Thus, test only and purchase from switch vendors.		
25G DAC - Cisco	2x			
25G DAC - Intel	2x			
25G AOC - Brocade	2x	AOC are not in Fujitsu's portfolio yet. Thus, test only and purchase from switch vendors.		
25G AOC - Cisco	2x			
25G AOC - Intel	2x			

Max. 2x SFP28 or DAC/AOC Cable per PLAN EP MCX4-LX 25Gb 2p SFP28 OCP

For CX2550/CX2560/CX2570

PLAN EP XXV710-DA2 2x25Gb OCP Type 1	Dual Port NIC, Intel	S26361-F4055-E302	S26361-F4055-L302
--------------------------------------	----------------------	-------------------	-------------------

Optional, 25G DAC or 25G AOC for PLAN EP XXV710-DA2

SFP28 Optical Transceiver 25G SR MMA2P00-AS LC	2x	MMF / SR SFP28 module, Mellanox. Max reach supported 100m	S26361-F4054-E701	S26361-F4054-L701
SFP28 Optical Transceiver 25G SR E25GSFP28SR LC	2x	MMF / SR SFP28 module, Intel. Max reach supported 30m	S26361-F4055-E701	S26361-F4055-L701
"Virtual Connector" for DAC/AOC cables	2x	Enablement for System Architect	V:DAC/AOC-CONNECTOR-25	
25G DAC - Brocade	2x	DAC are not in Fujitsu's portfolio yet. Thus, test only and purchase from switch vendors.		
25G DAC - Cisco	2x			
25G DAC - Intel	2x			
25G AOC - Brocade	2x	AOC are not in Fujitsu's portfolio yet. Thus, test only and purchase from switch vendors.		
25G AOC - Cisco	2x			
25G AOC - Intel	2x			

Max. 2x 25G DAC or 25G AOC Cable per PLAN EP XXV710-DA2 2x25Gb OCP Type 1. Use of SFP28 optical transceivers not allowed.

1Gb Ethernet network components

1Gb Ethernet controller with RJ45 interface (1000BASE-T)

PLAN CP 2x1Gbit Cu Intel I350-T2 LP	Up to 2	2 port, Intel	S26361-F4610-E202	S26361-F4610-L502
PLAN CP 4x1Gbit Cu Intel I350-T4 LP	Up to 2	4 port, Intel	S26361-F4610-E204	S26361-F4610-L504

\*max. 1 for CX2570 M5, max. 2 for CX2550/CX2560 M5

**10Gb Ethernet network components**

10Gb Ethernet controller with RJ45 interface (10GBASE-T)				
PLAN EP X550-T2 2x10GBASE-T LP	*	2 port 10 Gbit Intel X550-T2 (Sageville)	S26361-F3948-E202	S26361-F3948-L502
PLAN EP X710-T4 4x10GBASE-T LP	*	4 port 10 Gbit Intel X710-T4 (Fortville)	S26361-F3948-E204	S26361-F3948-L504
10/1Gb Ethernet controller with SFP+ cage requires SFP+ modules or twinax cables, Fujitsu / Intel based)				
Dual rate 10G/1G support requires 10G/1G Dual Rate SFP+ Optical Transceiver Modules				
PLAN EP X710-DA2 2x10Gb SFP+ LP	*	2 port NIC, Intel X710-DA2 (Fortville)	S26361-F3640-E202	S26361-F3640-L502
PLAN EP X710-DA4 4x10Gb SFP+ LP	*	4 port NIC, Intel X710-DA4 (Fortville)	S26361-F3640-E204	S26361-F3640-L504
optional 10Gb SFP+ module with LC connector for Fujitsu / Intel based controller				
SFP+ Optical Transceiver 10G/1G Dual Rate SR	**	LC, MMF / SR SFP+ module, up to 400m, Intel	S26361-F3986-E5	S26361-F3986-L5
SFP+ Optical Transceiver 10G/1G Dual Rate LR	**	LC, SMF / LR SFP+ module, up to 10km, Intel	S26361-F3986-E6	S26361-F3986-L6
SFP+ Optical Transceiver 10G Single Rate SR	**	LC, MMF / SR SFP+ module, up to 400m, Finisar	S26361-F3986-E3	S26361-F3986-L3
SFP+ Optical Transceiver 10G Single Rate LR	**	LC, SMF / LR SFP+ module, up to 10km, Finisar	S26361-F3986-E4	S26361-F3986-L4
Twinax Anschlussplatz Primergy	**	virtual connector for twinax cables	V:TWX CONNECTOR-PY	
SFP+ active Twinax Cable Fujitsu	**	customized cable length	S26361-F3989-E600	see table at the bottom of this page
SFP+ active Twinax Cable Brocade	**	(best fitting cable length is defined during rack	S26361-F3873-E500	
**max. 4x (OCF PHY, DA4), and 2x SFP+ or Twinax Cable per controller				
*max. 1 for CX2570 M5, max. 2 for CX2550/CX2560 M5				

**25/10Gb Ethernet network components**

25/10Gb Ethernet controller with 2x SFP28 cages (requires twinax cables or optical transceiver SFP28 or SFP+ modules)				
Dual speed support, auto-sense - supports 25Gbps and 10Gbps line rate per-port				
PLAN EP QL41212 25Gb 2p SFP28 LP	*)	Dual Port NIC, iWARP & RoCE RDMA, Cavium	S26361-F4056-E202	S26361-F4056-L502
Optional, 25Gb SFP28 Optical Transceiver module with LC connector for PLAN EP QL41212 25Gb 2p SFP28				
SFP28 Optical Transceiver 25G SR MMA2P00-AS LC	2x	MMF / SR SFP28 module, Mellanox. Max reach supported 100m	S26361-F4054-E701	S26361-F4054-L701
"Virtual Connector" for DAC/AOC cables	2x	Enablement for System Architect	V:DAC/AOC-CONNECTOR-25	
25G DAC - Cisco	2x	DAC are not in Fujitsu's portfolio yet. Thus, test only and purchase from switch vendors.		
25G DAC - Mellanox	2x			
25G AOC - Cisco	2x	AOC are not in Fujitsu's portfolio yet. Thus, test only and purchase from switch vendors.		
25G AOC - Mellanox	2x			
Max. 2x SFP28 or DAC/AOC Cable per PLAN EP QL41212 25Gb 2p SFP28				
Optional, 10Gb SFP+ Optical Transceiver module with LC connector for PLAN EP QL41212 25Gb 2p SFP28				
SFP+ Optical Transceiver 10G Single Rate SR	2x	LC, MMF / SR SFP+ module, up to 400m	S26361-F3986-E3	S26361-F3986-L3
SFP+ Optical Transceiver 10G Single Rate LR	2x	LC, SMF / LR SFP+ module, up to 10km	S26361-F3986-E4	S26361-F3986-L4
"Virtual Connector" for Twinax cables	2x	Enablement for System Architect	V:TWX CONNECTOR-10	
SFP+ active Twinax Cable - Fujitsu	2x	customized cable length	S26361-F3989-E600	see table at the bottom of this page
SFP+ active Twinax Cable - Brocade	2x	(best fitting cable length is defined during rack installation at the factory)	S26361-F3873-E500	
SFP+ active Twinax Cable Brocade	2x			
max. 2x SFP+ or Twinax Cable per PLAN EP QL41212 25Gb 2p SFP28				
*) max. 2x PLAN EP QL41212 25Gb 2p SFP28 for CX2550 M5, max 2x for CX2560 M5, max 1x for CX2570 M5.				

25/10Gb Ethernet controller with 2x SFP28 cages (requires twinax cables or optical transceiver SFP28 or SFP+ modules)				
Multiple speed support, auto-sense - supports 25Gbps, 10Gbps and 1Gbps line rate per-port				
PLAN EP XXV710-DA2 2x25Gb LP	*)	Dual Port NIC, Intel	S26361-F4055-E202	S26361-F4055-L502
Optional, 25Gb SFP28 Optical Transceiver module with LC connector for PLAN EP XXV710-DA2				
SFP28 Optical Transceiver 25G SR E25GFP28SR LC	2x	MMF / SR SFP28 module, Intel. Max reach supported 30m	S26361-F4055-E701	S26361-F4055-L701
SFP28 Optical Transceiver 25G SR MMA2P00-AS LC	2x	MMF / SR SFP28 module, Mellanox. Max reach supported 100m	S26361-F4054-E701	S26361-F4054-L701
"Virtual Connector" for DAC/AOC cables	2x	Enablement for System Architect	V:DAC/AOC-CONNECTOR-25	
25G DAC - Brocade	2x	DAC are not in Fujitsu's portfolio yet. Thus, test only and purchase from switch vendors.		
25G DAC - Cisco	2x			
25G DAC - Intel	2x			
25G AOC - Brocade	2x			
25G AOC - Cisco	2x	AOC are not in Fujitsu's portfolio yet. Thus, test only and purchase from switch vendors.		
25G AOC - Intel	2x			
Max. 2x SFP28 or DAC/AOC Cable per PLAN EP XXV710-DA2. No SFP28 for OCP Type 1 allowed.				
Optional, 10Gb SFP+ Optical Transceiver module with LC connector for PLAN EP XXV710-DA2				



SFP+ Optical Transceiver 10G/1G Dual Rate SR	2x	LC, MMF / SR SFP+ module, up to 400m	S26361-F3986-E5	S26361-F3986-L5
SFP+ Optical Transceiver 10G/1G Dual Rate LR	2x	LC, SMF / LR SFP+ module, up to 10km	S26361-F3986-E6	S26361-F3986-L6
SFP+ Optical Transceiver 10G Single Rate SR	2x	LC, MMF / SR SFP+ module, up to 400m	S26361-F3986-E3	S26361-F3986-L3
SFP+ Optical Transceiver 10G Single Rate LR	2x	LC, SMF / LR SFP+ module, up to 10km	S26361-F3986-E4	S26361-F3986-L4
"Virtual Connector" for Twinax cables	2x	Enablement for System Architect	V:TWX CONNECTOR-10	
SFP+ active Twinax Cable - Fujitsu	2x	customized cable length	S26361-F3989-E600	see table at the bottom of this page
SFP+ active Twinax Cable - Brocade	2x	(best fitting cable length is defined during rack installation at the factory)	S26361-F3873-E500	
SFP+ active Twinax Cable Brocade	2x			
<i>max. 2x SFP+ or Twinax Cable per controller</i>				
*) max. 2 controllers per CX2550 M5; max. 2 controllers per CX2560 M5; max. 1 controller for CX2570 M5.				

<b>25/10Gb Ethernet controller with 2x SFP28 cages (requires twinax cables or optical transceiver SFP28 or SFP+ modules)</b>				
Dual speed support, auto-sense - supports 25Gbps and 10Gbps line rate per-port				
PLAN EP MCX4-LX 25Gb 2p SFP28 LP	*)	Dual Port NIC, RoCE RDMA, Mellanox	S26361-F4054-E202	S26361-F4054-L502
<b>Optional, 25Gb SFP28 Optical Transceiver module with LC connector for PLAN EP MCX4-LX 25Gb 2p SFP28</b>				
SFP28 Optical Transceiver 25G SR MMA2P00-AS LC	2x	MMF / SR SFP28 module, Mellanox. Max reach supported 100m	S26361-F4054-E701	S26361-F4054-L701
"Virtual Connector" for DAC/AOC cables	2x	Enablement for System Architect	V:DAC/AOC-CONNECTOR-25	
25G DAC - Cisco	2x	DAC are not in Fujitsu's portfolio yet. Thus, test only and purchase from switch vendors.		
25G DAC - Mellanox	2x	AOC are not in Fujitsu's portfolio yet. Thus, test only and purchase from switch vendors.		
25G AOC - Cisco	2x			
25G AOC - Mellanox	2x			
<i>Max. 2x SFP28 or DAC/AOC Cable per PLAN EP MCX4-LX 25Gb 2p SFP28</i>				
<b>Optional, 10Gb SFP+ Optical Transceiver module with LC connector for PLAN EP MCX4-LX 25Gb 2p SFP28</b>				
SFP+ Optical Transceiver 10G/1G Dual Rate SR	2x	LC, MMF / SR SFP+ module, up to 400m	S26361-F3986-E5	S26361-F3986-L5
SFP+ Optical Transceiver 10G/1G Dual Rate LR	2x	LC, SMF / LR SFP+ module, up to 10km	S26361-F3986-E6	S26361-F3986-L6
SFP+ Optical Transceiver 10G Single Rate SR	2x	LC, MMF / SR SFP+ module, up to 400m	S26361-F3986-E3	S26361-F3986-L3
SFP+ Optical Transceiver 10G Single Rate LR	2x	LC, SMF / LR SFP+ module, up to 10km	S26361-F3986-E4	S26361-F3986-L4
"Virtual Connector" for Twinax cables	2x	Enablement for System Architect	V:TWX CONNECTOR-10	
SFP+ active Twinax Cable - Fujitsu	2x	customized cable length	S26361-F3989-E600	see table at the bottom of this page
SFP+ active Twinax Cable - Brocade	2x	(best fitting cable length is defined during rack installation at the factory)	S26361-F3873-E500	
SFP+ active Twinax Cable Brocade	2x			
<i>max. 2x SFP+ or Twinax Cable per controller</i>				
*) max. 2x PLAN EP MCX4-LX 25Gb 2p SFP28 for CX2550 M5, max 2x for CX2560 M5, max 1x for CX2570 M5.				

40Gb Ethernet network components

<b>40Gb Ethernet controller with QSFP cage (requires DAC, AOC cables or optical transceiver QSFP modules)</b>				
Supports 40Gbps line rate per-port				
PLAN EP MCX4-EN 40Gb 2p QSFP LP	*)	Dual Port NIC, RoCE RDMA, Mellanox	S26361-F4053-E202	S26361-F4053-L502
<b>Optional, 40Gb QSFP Optical Transceiver module with MPO connector for PLAN EP MCX4-EN 40Gb 2p QSFP</b>				
QSFP 40G SR4L MPO 850nm 30m MC2210411-SR4L	2x	MMF / SR4L QSFP module, Mellanox. Max reach supported 30m	S26361-F4053-E701	S26361-F4053-L701
QSFP 40G SR4 MPO 850nm 150m MC2210411-SR4	2x	MMF / SR4 QSFP module, Mellanox. Max reach supported 150m	S26361-F4053-E702	S26361-F4053-L702
"Virtual Connector" for DAC/AOC cables	2x	Enablement for System Architect	V:DAC/AOC-CONNECTOR-40	
40G DAC - Cisco	2x	DAC are not in Fujitsu's portfolio yet. Thus, test only and purchase from switch vendors.		
40G DAC - Mellanox	2x	AOC are not in Fujitsu's portfolio yet. Thus, test only and purchase from switch vendors.		
40G AOC - Cisco	2x			
40G AOC - Mellanox	2x			
<i>max. 2x QSFP or DAC, AOC per PLAN EP MCX4-EN 40Gb 2p QSFP</i>				
*) max. 2x PLAN EP MCX4 EN 40Gb 2p QSFP for CX2550 M5, max 2x for CX2560 M5, max 1x for CX2570 M5.				

100Gb Ethernet network components

<b>100Gb Ethernet controller with 1x QSFP28 cage (requires twinax cables or optical transceiver QSFP28 modules)</b>				
Supports 100Gbps line rate				
PLAN EP QL45611 100Gb 1p QSFP28 LP	*	Single Port NIC, RoCE RDMA, Cavium	S26361-F4057-E201	S26361-F4057-L501
<b>Optional, 100Gb QSFP28 Optical Transceiver module with MPO connector for PLAN EP QL45611 100Gb 1p QSFP28</b>				
QSFP28 100G SR4 MPO 850nm 100m MMA1B00-C100D	1x	MMF / SR4 QSFP28 module, Mellanox. Max reach supported 100m	S26361-F4052-E701	S26361-F4052-L701
QSFP28 100G PSM4 1310nm 500m MMS1C10-CM	1x	MMF / SR QSFP28 module, Mellanox. Max reach supported 500m	S26361-F4052-E801	S26361-F4052-L801
"Virtual Connector" for DAC/AOC cables	1x	Enablement for System Architect	<b>V:DAC/AOC-CONNECTOR-100</b>	
100G DAC - Cisco	1x	DAC are not in Fujitsu's portfolio yet. Thus, test only and purchase from switch vendors.		
100G DAC - Mellanox	1x	DAC are not in Fujitsu's portfolio yet. Thus, test only and purchase from switch vendors.		
100G AOC - Cisco	1x	AOC are not in Fujitsu's portfolio yet. Thus, test only and purchase from switch vendors.		
100G AOC - Mellanox	1x	AOC are not in Fujitsu's portfolio yet. Thus, test only and purchase from switch vendors.		
<i>Max. 1x QSFP28 or DAC/AOC Cable per PLAN EP QL45611 100Gb 1p QSFP28</i>				
*) max. 2x PLAN EP QL45611 100Gb 1p QSFP28 for CX2550 M5, max 2x for CX2560 M5, max 1x for CX2570 M5.				

<b>100Gb Ethernet controller with 1x QSFP28 cage (requires twinax cables or optical transceiver QSFP28 modules)</b>				
Supports 100Gbps line rate				
PLAN EP MCX4-EN 100Gb 1p QSFP28 LP	*	Single Port NIC, RoCE RDMA, Mellanox	S26361-F4052-E201	S26361-F4052-L501
<b>Optional, 100Gb QSFP28 Optical Transceiver module with MPO connector for PLAN EP MCX4-EN 100Gb 1p QSFP28</b>				
QSFP28 100G SR4 MPO 850nm 100m MMA1B00-C100D	1x	MMF / SR4 QSFP28 module, Mellanox. Max reach supported 100m	S26361-F4052-E701	S26361-F4052-L701
QSFP28 100G PSM4 1310nm 500m MMS1C10-CM	1x	MMF / SR QSFP28 module, Mellanox. Max reach supported 500m	S26361-F4052-E801	S26361-F4052-L801
"Virtual Connector" for DAC/AOC cables	1x	Enablement for System Architect	<b>V:DAC/AOC-CONNECTOR-100</b>	
100G DAC - Cisco	1x	DAC are not in Fujitsu's portfolio yet. Thus, test only and purchase from switch vendors.		
100G DAC - Mellanox	1x	DAC are not in Fujitsu's portfolio yet. Thus, test only and purchase from switch vendors.		
100G AOC - Cisco	1x	AOC are not in Fujitsu's portfolio yet. Thus, test only and purchase from switch vendors.		
100G AOC - Mellanox	1x	AOC are not in Fujitsu's portfolio yet. Thus, test only and purchase from switch vendors.		
<i>Max. 1x QSFP28 or DAC/AOC Cable per PLAN EP MCX4-EN 100Gb 1p QSFP28</i>				
*) max. 2x PLAN EP MCX4 EN 100Gb 1p QSFP28 for CX2550 M5, max 2x for CX2560 M5, max 1x for CX2570 M5.				

I
J

**Network cables for later upgrade**

<b>Fujitsu active SFP+ Twinax 10Gb cable</b>	
SFP+ active Twinax Cable Fujitsu 2m	S26361-F3989-L102
SFP+ active Twinax Cable Fujitsu 5m	S26361-F3989-L105
SFP+ active Twinax Cable Fujitsu 10m	S26361-F3989-L110
<b>Brocade active SFP+ Twinax 10Gb cable</b>	
SFP+ active Twinax Cable Brocade 1m	S26361-F3873-L501
SFP+ active Twinax Cable Brocade 3m	S26361-F3873-L503
SFP+ active Twinax Cable Brocade 5m	S26361-F3873-L505

K
---

**Chapter 12 - Fibre Channel Controller**

K
---



**Liquid cooling base unit / CX2550 M5 does not support FC controller**

<b>32Gb Fibre Channel controller generation 6 with LC interface for 50µm optical cables (OM3 or OM4)</b>
Dual speed support - supports 32Gb and 16Gb

PFC EP LPe32000 1x 32Gb LP	*****	1 port, low profile, Broadcom/Emulex	S26361-F4044-E201	S26361-F4044-L501
PFC EP LPe32002 2x 32Gb LP	*****	2 port, low profile, Broadcom/Emulex	S26361-F4044-E202	S26361-F4044-L502
PFC EP QLE2740 1x 32Gb LP	*****	1 port, low profile, Cavium/Qlogic	S26361-F4043-E201	S26361-F4043-L501
PFC EP QLE2742 2x 32Gb LP	*****	2 port, low profile, Cavium/Qlogic	S26361-F4043-E202	S26361-F4043-L502
<b>16Gb Fibre Channel controller generation 6 with LC interface for 50µm optical cables (OM3 or OM4)</b>				
Dual speed support - supports 16Gb and 8Gb				
PFC EP LPe31000 1x 16Gb LP	*****	1 port, low profile, Broadcom/Emulex	S26361-F5596-E201	S26361-F5596-L501
PFC EP LPe31002 2x 16Gb LP	*****	2 port, low profile, Broadcom/Emulex	S26361-F5596-E202	S26361-F5596-L502
PFC EP QLE2690 1x 16Gb LP	*****	1 port, low profile, Cavium/Qlogic	S26361-F5580-E201	S26361-F5580-L501
PFC EP QLE2692 2x 16Gb LP	*****	2 port, low profile, Cavium/Qlogic	S26361-F5580-E202	S26361-F5580-L502
***** max. 2 for CX2560 M5 (No FC card support for CX2550 M5/CX2570M5)				

**Chapter 13 - Infiniband Controllers**

configuration of different Controllers NOT supported

<b>S26361-F5717-E102/E202</b> <b>S26361-F5717-L102/L202</b> IB HCA 100Gb 1 / 2channel EDR 100Gbit 1 / 2channel Infiniband Controller EDR technology (8.0GT/s) 1x / 2x Q-SFP+ connector PCIe Gen3 x16, 170mm max. 1x per CX2570, 2 for the other	<b>S26361-F5724-E102/E202</b> <b>S26361-F5724-L102/L202</b> IB HCA 100Gb 1 / 2channel HDR 100Gbit 1 / 2channel Infiniband Controller HDR technology (8.0GT/s) 1x / 2x Q-SFP+ connector PCIe Gen3 x16, 170mm max. 1x per CX25x0, only liquid server	<b>S26361-F5562-E10</b> POP EP 100Gb 1port Omni Path 100Gbit 1channel HFI Card Q-SFP+ connector PCIe x16 max. 1x per CX2570, 2 for the other Supported only with Linux
---	--	--

The following card can not be mixed Infiniband card(S26361-F5717-E102/E202)  
 S26361-F4054-E302/S26361-F4052-E201/S26361-F4052-E1/S26361-F4053-E2/S26361-F4053-E202  
 S26361-F4054-E2/S26361-F4054-E202

The following card can not be mixed Infiniband card(S26361-F5724-E102/E202)  
 S26361-F4054-E302/S26361-F4052-E201/S26361-F4052-E1/S26361-F4053-E2/S26361-F4053-E202

The following card can not be mixed with Infiniband card(S26361-F5562-E10)  
 S26361-F4054-E302/S26361-F4052-E201/S26361-F4052-E1/S26361-F4053-E2/S26361-F4053-E202  
 S26361-F4054-E2/S26361-F4054-E202

**Network Components, Controller and cables for later upgrade**

S26361-F5717-E102/E202	
QSFP, IB 100Gb, 1m	S26361-F5549-L561
QSFP, IB 100Gb, 3m	S26361-F5549-L563
S26361-F5724-L102/L202/E102/E202	
QSFP, IB 100Gb, 1m (Y-cable) (To HDR SW)	S26361-F5748-E571
<b>Omni Path</b>	
100Gbit/s 1ch Omni Path HFI Card	S26361-F5562-L10
100Gbit/s 1 port Omni Path PHY Card	S26361-F5651-L460
QSFP, Omni 100Gb, 1.5m	S26361-F5563-L150
QSFP, Omni 100Gb, 2m	S26361-F5563-L200
QSFP, Omni 100Gb, 3m	S26361-F5563-L300

L

**Chapter 15 - Accessories**

Q

<http://www.fujitsu.com/fts/products/computing/peripheral/accessories/index-facts.html>

USB Mouse:		
Mouse M520 Black	n/a	S26381-K467-L100
Mouse M520 Grey	n/a	S26381-K467-L101
Mouse M530 Black	n/a	S26381-K468-L100
Mouse M530 Grey	n/a	S26381-K468-L101

USB Memory Sticks - Available until August 2020. No successor planned.		
ADATA UC350 USB3.1 Type C OTG Flash Drive 64GB		S26391-F6048-L464

USB Optical Disc Drive	
Fujitsu External Super Multi Drive	S26341-F103-L142

R

Please find the layout of all Fujitsu keyboards here:  
<http://abg0355a.abg.fsc.net/>

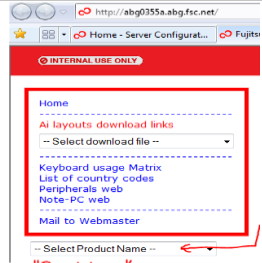

**Chapter 16 - others**

0

<b>S26361-F1790-E243</b>
<b>S26361-F1790-L244</b>
iRMC S4 advanced pack / S5 alternatively
integrated remote Management controller activation key for graphical console redirection and remote media redirection
max. 1x per system

Advanced Thermal design cannot be combined with the Flash backup unit of the RAID controllers

<b>S26361-F3552-E100</b>
<b>S26361-F3552-L100</b>
TPM Module 2.0
max. 1x per system

<b>S26361-F3552-E301</b>
<b>S26361-F3552-L301</b>
TPM 2.0 Module SPI for WS2022
required for Microsoft Windows Server 2022
max. 1x per system

<b>S26361-F1790-E311</b>
<b>embedded Lifecycle Management (eLCM)</b>
Server Online Update
OS driver Update
Hardware firmware update
Server Offline Update
Hardware update via Update Manager Express
PrimeCollect
Autonomous creation of Primecollect archives
Creation and use of PrimeCollect archives over AIS connect
Custom Image (Jukebox function)
Automatic and manual download of CD and DVD Images
Automatic and manual start of CD and DVD Images
max. 1x per system

Loose delivery
eLCM Activation Pack (Node Locked License)
<b>BDL:ELCM-PACK</b>
<b>options contains:</b>
- 16GB SD card
- Paper with TAN for Licensekey

Your Server is ready

**Legend**

GR: General Release

NR: No release



	Model Name	CX2550 M5		CX2560 M5	CX2570 M5
		Air	Liquid	Air	Liquid
Cooling					
Target market		HPC	HPC	Cloud	V100 32G
<b>Microsoft Windows</b>					
<b>Windows Server 2019</b>					
Microsoft Hyper-V Server 2019		NR	NR	NR	NR
Windows Server 2019 Datacenter		GR	NR	GR	NR
Windows Server 2019 Standard		GR	NR	GR	NR
Windows Server 2019 Essentials		NR	NR	GR	NR
<b>Windows Server 2016</b>					
Microsoft Hyper-V Server 2016		NR	NR	NR	NR
Windows Server 2016 Datacenter		GR	NR	GR	NR
Windows Server 2016 Standard		GR	NR	GR	NR
Windows Server 2016 Essentials		NR	NR	GR	NR
Windows Storage Server 2016 Standard		NR	NR	NR	NR
<b>Windows Server 2012R2</b>					
Microsoft Hyper-V Server 2012R2		NR	NR	NR	NR
Windows Server 2012R2 Datacenter		NR	NR	NR	NR
Windows Server 2012R2 Standard		NR	NR	NR	NR
Windows Server 2012R2 Essentials		NR	NR	NR	NR
Windows Server 2012R2 Foundation		NR	NR	NR	NR
Windows Storage Server 2012R2 Standard		NR	NR	NR	NR
<b>RedHat Linux</b>					
Red Hat Enterprise Linux 64-bit	6.10	NR	NR	NR	NR
Red Hat Enterprise Linux 64-bit	7.5	NR	NR	NR	NR
Red Hat Enterprise Linux 64-bit	7.6	GR	GR	GR	GR
Red Hat Enterprise Linux 64-bit	8.0	Planned	Planned	Planned	Planned
<b>Suse Linux</b>					
SUSE Linux Enterprise Server 12 64-bit	SP3	NR	NR	NR	NR
SUSE Linux Enterprise Server 12 64-bit	SP4	Planned	Planned	Planned	SR
SUSE Linux Enterprise Server 15 64-bit		Planned	Planned	Planned	SR
Open Enterprise Server 2 32-bit		NR	NR	NR	NR
Open Enterprise Server 2 64-bit		NR	NR	NR	NR
<b>VMware ESX Server</b>					
ESXi 6.5 U1		NR	NR	NR	NR
ESXi 6.5 U2		NR	NR	NR	NR
ESXi 6.7		NR	NR	NR	NR
ESXi 6.7U1		NR	NR	GR	NR
<b>Oracle</b>					
Oracle Linux 6 (RHEL & UEK kernel) 64-bit	6.10	NR	NR	NR	NR
Oracle Linux 7 (RHEL & UEK kernel) 64-bit	7.6	NR	NR	GR	NR
Oracle Linux 7 (RHEL & UEK kernel) 64-bit	8.0	NR	NR	Planned	NR
Oracle Virtual Manager 3	3.4	NR	NR	GR	NR
Solaris 11 64-bit		NR	NR	NR	NR
<b>Citrix</b>					
XenServer	7.1	NR	NR	GR	NR
XenServer	8.0	NR	NR	GR	NR
<b>Other</b>					
WinPE		NR	NR	NR	NR
CentOS	7.6	NR	NR	NR	NR

Date of change [dd.mm.yyyy]	Folder / order code / description	Name	What has been changed / comment
13.09.2021	others / S26361-F3552-E301/L301	Tatsuya Sudou	added TPM2.0 for WS2022
15.06.2021	LAN	Yuya Ikuta	update the SFP linup for S26361-F4055-E302.
01.04.2021	RAID / S26361-F5792-*	Tatsuya Sudou	added PSAS CP503i
17.03.2021	LAN	Yuya Ikuta	Changed the LOM SFP condition.
21.12.2020		Hiroyuki Homma	Fixed description added riser description
22.10.2020	HD_Cage	Hiroyuki Homma	added information regarding riser
30.06.2020	Base	Hiroyuki Homma	removed some accessories. (only BTO P/N)
29.05.2020	Base	Yuri Okubo	removed Made in Germany sticker
29.04.2020	CPU/RAM	Atsushi Iwata	Added CPUs (Bronze 32xxR, Silver 42xxR, Gold 52xxR and 62xxR)
26.03.2020	Base	Atsushi Iwata	Added Region kit china
19.03.2020	CPU/RAM	Atsushi Iwata	Added Restriction for ErP Lot9 (Bronze 3204, 1 DIMM configuration are not orderable)
19.03.2020	Other	Hiroyuki Homma	Update description
18.02.2020	IB	Takaoka masanori	Change the cable
10.01.2019	HD_Cage	Hiroyuki Homma	Added riser descriptopn
20.12.2019	RAM	Klaus-Dieter Ruf	Added new released 64GB 2Rx4 module
07.11.2019	Accessories	Y.Narita	USB memory sticks section updated. No longer 32GB.
31.10.2019	RAM	Klaus-Dieter Ruf	DCPMM section updated
17.10.2019	Base	Hiroyuki Homma	Fixed CX2570M5 description
17.10.2019	SSD	Hiroyuki Homma	Added P4610 and P4510
25.09.2019	Base	Hiroyuki Homma	Added Node popuration rules
27.08.2019	RAM	Klaus-Dieter Ruf	Added 768GB memory packages
26.06.2019	LAN_FC_IB	Takaoka masanori	Add ConnectX6(Infiniband card)
24.06.2019	RAM	Klaus-Dieter Ruf	Added missing memory module
19.06.2019	CPU	Hiroyuki Homma	Added some CPU
06.06.2019	RAID	Sven Pilz	Added PSAS CP403i
15.04.2019	RAM	Klaus-Dieter Ruf	Updated order codes for Memory Packages
01.04.2019		S.Ichihashi	Update
28.03.2019		S.Ichihashi	Update
15.03.2019		S.Ichihashi	Update
13.03.2019		S.Ichihashi	Update
08.03.2019	RAM	Klaus-Dieter Ruf	Updated order codes for Memory Packages
06.03.2019	RAM	Klaus-Dieter Ruf	Added Memory Packages for easy AEP configuration
04.03.2019		S.Ichihashi	Update
26.02.2019		S.Ichihashi	Update
12.02.2019		S.Ichihashi	Update
08.02.2019	LAN_FC_IB	Takaoka masanori	change EDR card parts number
08.02.2019		S.Ichihashi	Update
05.12.2018		xx	First Draft