



**Intel® Server Board S2600WT Family**

**Intel® Server Chassis R1000WT & R2000WT Family**

**Intel® Server System R1000WT & R2000WT Family**

## **Product Family Configuration Guide**

*A Reference document used to assist with ordering parts and accessories available to configure an Intel server system based on the Intel® Server S2600WT product family.*

Revision 2.06

Jan. 2016

Intel® Server Boards and Systems

## Document Revision History

Date Published	Revision	Revision Change Description
September 2014	1.0	First Public Release
November 2014	1.16	Updates to product illustrations and MM# for Intel® RAID Modules
March 2015	1.17	Content updates: <ul style="list-style-type: none"> <li>• DC Power Supply option target availability date</li> <li>• New Rail kit options target availability date</li> <li>• Removed I/O Module AXX10GBTWLIOM – Not supported</li> <li>• Added I/O Module AXX10GBTWLIOM3 with target availability date</li> </ul>
April 2015	2.0	<b>Document Upgrade</b> <ul style="list-style-type: none"> <li>• New document format</li> <li>• New product definition/data tables</li> <li>• New graphics</li> <li>• Improved guidance for configuration requirements</li> <li>• Improved descriptions for product family definition</li> <li>• Updated SAS/SATA data cable guide</li> <li>• Updated Disclaimer Statements</li> </ul>
May 2015	2.01	Document changes: <ul style="list-style-type: none"> <li>• Added “Server” reference to product family naming</li> <li>• Corrected 1U riser part number in 1U L6 BOM Lists</li> <li>• Updated Server Board, Chassis only and L6 product weight information</li> </ul>
July 2015	2.02	Document Upgrade <ul style="list-style-type: none"> <li>• Updated AXX750DCCRPS target availability date</li> <li>• Updated A1USHRTRAIL Order Information</li> <li>• Updated A1UFULLRAIL Order Information</li> <li>• Updated AXXFULLRAIL Order Information</li> <li>• Updated AXXCMA2 Order Information</li> </ul>
August 2015	2.03	Document changes <ul style="list-style-type: none"> <li>• Added Intel® Integrated RAID Module RMS25CB080</li> </ul>
September 2015	2.04	Document changes <ul style="list-style-type: none"> <li>• Added McAfee® Antivirus as an accessory</li> </ul>
November 2015	2.05	Document changes <ul style="list-style-type: none"> <li>• Removed the Ethernet modules AXX1P40FRTIOM and AXX2P40FRTIOM that are based on XL710-AM2.</li> </ul>
November 2015	2.06	Document Upgrade <ul style="list-style-type: none"> <li>• SKU code names, board names, updated with “R”. Updated MM#, UPC, EAM.</li> </ul>

## ***Disclaimer***

Intel technologies' features and benefits depend on system configuration and may require enabled hardware, software or service activation. Learn more at Intel.com, or from the OEM or retailer.

You may not use or facilitate the use of this document in connection with any infringement or other legal analysis concerning Intel products described herein. You agree to grant Intel a non-exclusive, royalty-free license to any patent claim thereafter drafted which includes subject matter disclosed herein.

No license (express or implied, by estoppel or otherwise) to any intellectual property rights is granted by this document.

The products described may contain design defects or errors known as errata which may cause the product to deviate from published specifications. Current characterized errata are available on request.

Intel disclaims all express and implied warranties, including without limitation, the implied warranties of merchantability, fitness for a particular purpose, and non-infringement, as well as any warranty arising from course of performance, course of dealing, or usage in trade.

Intel, the Intel logo, Xeon, and Xeon Phi are trademarks of Intel Corporation in the U.S. and/or other countries.

\*Other names and brands may be claimed as the property of others.

Copyright © 2015 Intel Corporation. All Rights Reserved.

# Table of Contents

<b>1</b>	<b>INTEL SERVER FAMILY OVERVIEW.....</b>	<b>1</b>
1.1	INTEL® SERVER S2600WT PRODUCT FAMILY NAMING CONVENTION.....	3
1.2	PRODUCT FAMILY SUMMARY CHART.....	6
1.3	INTEL® S2600GZ/GL PRODUCT FAMILY TO INTEL® SERVER S2600WT PRODUCT FAMILY TRANSITION GUIDE.....	8
<b>2</b>	<b>SERVER BUILDING BLOCK CONFIGURATION.....</b>	<b>9</b>
2.1	BUILDING BLOCK RECIPE SUMMARY.....	10
2.2	INTEL® SERVER BOARD S2600WT PRODUCT FAMILY SKUs.....	11
	<i>iPC – S2600WT2R</i> .....	11
	<i>iPC – S2600WTTR</i> .....	11
2.3	INTEL® SERVER CHASSIS R1000WT PRODUCT FAMILY SKUs – (1U RACK MOUNT CHASSIS).....	12
	<i>R1304WTXXX</i> .....	13
	<i>R1208WTXXX</i> .....	14
2.4	INTEL® SERVER CHASSIS R2000WT PRODUCT FAMILY SKUs – (2U RACK MOUNT CHASSIS).....	15
	<i>R2312WTXXX</i> .....	16
	<i>R2000WTXXX</i> .....	17
<b>3</b>	<b>SERVER SYSTEM CONFIGURATION.....</b>	<b>18</b>
3.1	INTEL® SERVER SYSTEM R1000WT PRODUCT FAMILY SKUs – (1U RACK MOUNT SYSTEM).....	19
	<i>R1304WTTGSR</i> .....	20
	<i>R1304WT2GSR</i> .....	21
	<i>R1208WTTGSR</i> .....	22
	<i>R1208WT2GSR</i> .....	23
3.2	INTEL® SERVER SYSTEM R2000WT PRODUCT FAMILY SKUs – (2U RACK MOUNT SYSTEM).....	24
	<i>R2208WT2YSR</i> .....	25
	<i>R2208WTTYSR</i> .....	26
	<i>R2208WTTYC1R</i> .....	27
	<i>R2308WTTYSR</i> .....	28
	<i>R2312WTTYSR</i> .....	29
	<i>R2224WTTYSR</i> .....	30
<b>4</b>	<b>SAS / SATA DATA CABLE GUIDE.....</b>	<b>31</b>
4.1	SAS / SATA DATA CABLE CONNECTOR TYPES.....	31
4.2	1U / 2U SERVER SYSTEM SAS / SATA CABLE GUIDE.....	32
4.2.1	1U 4 x 3.5" – <i>R1304WTxxx SAS / SATA Data Cable Guide</i> .....	34
4.2.2	1U 8 x 2.5" – <i>R1208WTxxx SAS / SATA Data Cable Guide</i> .....	35
4.2.3	2U 8 x 3.5" – <i>R2308WTxxx Cable Guide</i> .....	36
4.2.4	2U 12 x 3.5 – <i>R2312WTxxx Cable Guide</i> .....	37

4.2.5	2U 2.5" Front Mount Drive Bay Cable Guide .....	41
4.3	INTEL SAS / SATA DATA CABLE KITS.....	48
<b>5</b>	<b>INTEL 1U / 2U SYSTEM CONFIGURATION OPTIONS.....</b>	<b>52</b>
5.1	1U 8x2.5" COMBO PCI-E* SFF (NVME) SSD / SAS BACKPLANE – INTEL® ACCESSORY KIT A1U44X25NVMEDK.....	52
5.1.1	1U 8x2.5" – Intel® Accessory Kit A1U44X25NVMEDK Cable Guide .....	53
5.2	2U 8x2.5" COMBO PCI-E* SFF (NVME) SSD / SAS BACKPLANE – INTEL® ACCESSORY KIT A2U44X25NVMEDK .....	55
5.2.1	2U 8x2.5" – Intel® Accessory Kit A2U44X25NVMEDK SAS/SATA Cable Guide.....	57
5.2.2	2U 16x2.5" / 24x2.5" — Intel® Accessory Kit A2U44X25NVMEDK SAS / SATA Cable Guide .....	58
5.3	2U REAR MOUNT HOT SWAP DRIVE BAY ACCESSORY KIT – IPC A2UREARHSDK.....	59
	iPC - A2UCBLSSD .....	59
5.4	2U 8x3.5" FRONT MOUNT HOT SWAP BACKPLANE ASSEMBLY - IPC A2U8X35S3HSDK .....	60
	iPC – A2U8X35S3HSDK .....	60
5.5	2U 8x2.5" DRIVE BAY MODULE OPTIONS .....	61
	iPC – A2U8X25S3HSDK .....	62
	iPC – A2U8X25S3DPDK.....	62
	iPC – A2UHANDLKIT.....	63
5.6	LOCKING FRONT BEZEL ACCESSORY KITS .....	64
5.6.1	2U Front Bezel Accessory Kit – iPC A2UBEZEL .....	64
5.6.2	1U Front Bezel Accessory Kit – iPC A1UBEZEL .....	65
5.7	1U / 2U PCI-E* RISER CARD ACCESSORY/SPARE FRU OPTIONS .....	66
5.7.1	1U Riser Card Options.....	66
5.7.2	2U Riser Card Options.....	67
5.8	INTEL® I/O EXPANSION MODULES .....	68
	Intel Product Code .....	69
	iPC – AXX10GBNIAIOM.....	69
	iPC – AXX10GBTWLIOM3.....	69
	iPC – AXX1FDRIBIOM .....	69
	iPC – AXX2FDRIBIOM .....	70
	iPC – AXX4P1GBPWL IOM.....	70
5.9	INTEL® SAS RAID ADD-IN CARDS, MODULES, AND ACCESSORIES.....	71
5.9.1	Intel® Integrated RAID Module RMS3 Product Family – SAS 3.0 (12 Gb/s).....	71
5.9.2	Intel® RAID Controller Add-in Cards - SAS 3.0 (12Gb/s).....	74
5.9.3	Intel® RAID Accessory Options.....	77
5.10	INTEL POWER SUPPLY MODULES AND POWER CORDS .....	80
5.11	1U / 2U RACK MOUNT KITS.....	81
	iPC - AXXPRAIL .....	81
	iPC – AXXELVRAIL.....	81
	iPC – AXX1U2UCMA .....	81
	iPC - AXX2POSTBRCKT.....	82
5.12	INTEL® XEON PHI™ COPROCESSOR CARD AND NON-INTEL GPGPU SUPPORT.....	83

<i>iPC – AWTCOPRODUCT</i> .....	84
<i>iPC – A2UL16RISER2</i> .....	85
<b>6 1U / 2U MISCELLANEOUS ACCESSORY OPTIONS</b> .....	<b>86</b>
<i>iPC – A1U2ULCP</i> .....	86
<i>iPC – AXXSATADVDRAM</i> .....	86
<i>iPC – AXXSATADVDRWROM</i> .....	86
<i>iPC – AXXSSDODDKIT</i> .....	87
<i>iPC – AXXRJ45DB93</i> .....	87
<i>iPC – AXXRMM4LITE</i> .....	88
<i>iPC – AXXTPME5</i> .....	88
<b>7 1U / 2U SPARE AND REPLACEMENT PARTS (FRUS)</b> .....	<b>89</b>
<b>8 SOFTWARE SECURITY - MCAFEE® ANTIVIRUS FOR INTEL® SERVER SYSTEMS*</b> .....	<b>93</b>
8.1 HOW TO ORDER IT? .....	93
8.2 MCAFEE® ANTIVIRUS FOR INTEL® SERVER SYSTEMS SKUS .....	93
<b>9 EXTENDED WARRANTY</b> .....	<b>94</b>

# List of Tables

Table 1. Product Family Reference Collaterals .....	2
Table 2. Server Board Product Family Summary .....	6
Table 3. Server Chassis & Server System Product Family Summary.....	6
Table 4. 1U / 2U Server System Product Family Generation to Generation Transition Guide .....	8
Table 5. 1U / 2U Building Block to Integrated System Recipe Guide.....	10
Table 6. 2U 12 x 3.5" – R2312WTxxx SAS / SATA Data Cable Guide (with SAS Expander).....	39
Table 7. 2U 8 x 2.5" (Drive Bay #1) - SAS/SATA Data Cable Guid (with no SAS Expander).....	42
Table 8. 2U 8 x 2.5" (Drive Bay #2) – SAS / SATA Data Cable Guide (with no SAS Expander).....	43
Table 9. 2U 8 x 2.5" (Drive Bay #3) – SAS / SATA Data Cable Guide (with no SAS Expander).....	44
Table 10. 2U 2.5" Front Mount Drive Configurations with SAS Expander – SAS Data Cable Guide.....	46
Table 11. Storage Data Cable Kit Description and Order Information .....	49
Table 12. 1U 8x2.5" Combo Backplane SAS/SATA Cable Guide.....	54

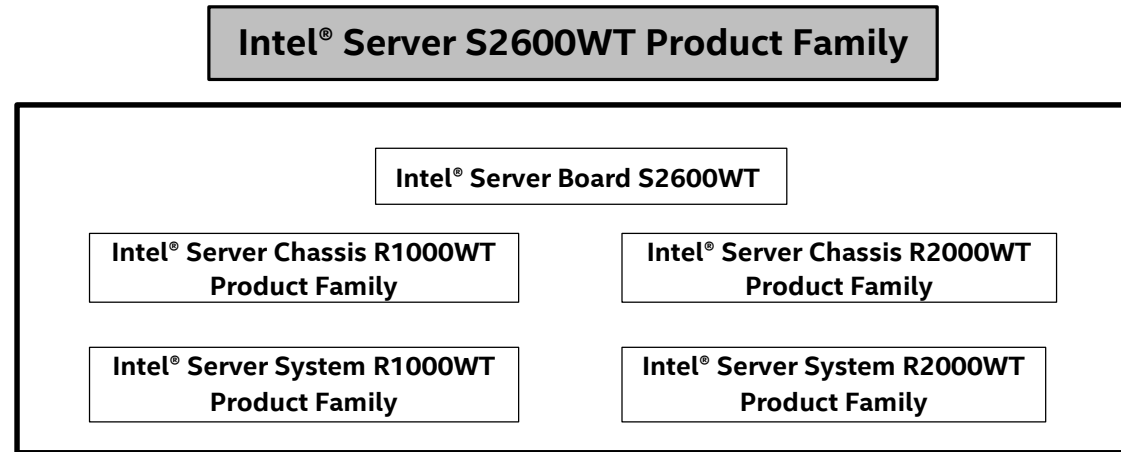




# 1 Intel Server Family Overview

This document is provided to assist Intel customers with identifying the right Intel server system and available accessories to create a unique server platform that meet their unique server requirements.

The Intel® S2600WT product family is offered as both building block options and integrated systems. The product family consists of the following:



## Server Building Blocks:

- **Intel® Server Board S2600WT** – Server Board only (Building block option and spare FRU)
- **Intel® Server Chassis R1000WT product family** – 1U Rack Mount Server Chassis only
- **Intel® Server Chassis R2000WT product family** – 2U Rack Mount Server Chassis only

## Integrated Server Systems:

- **Intel® Server System R1000WT product family** – 1U Rack Mount Server System integrated with an Intel® Server Board S2600WT
- **Intel® Server System R2000WT product family** – 2U Rack Mount Server System integrated with an Intel® Server Board S2600WT

The Intel® S2600WT product family supports the following processors and memory:

- **Note: Previous generation Intel® Xeon® processors are not supported.**
- DDR4 ECC RDIMM 1600, 1866, 2133
- DDR4 ECC LRDIMM 1600, 1866, 2133

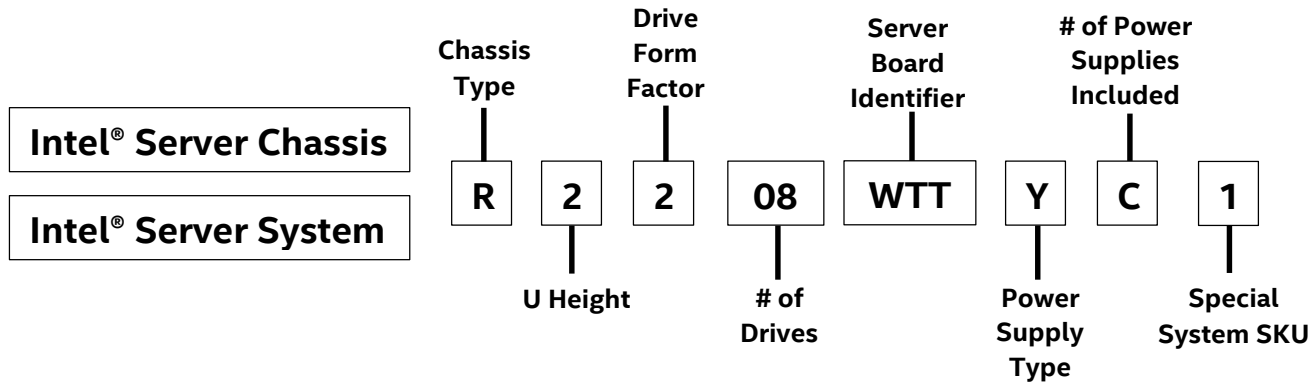
## Additional Information and Software

For additional information about this family of products or any of their supported accessories, refer to the following resources available at <http://www.intel.com/support>.

**Table 1. Product Family Reference Collaterals**

For this information or software	Use this Document or Software
For in-depth technical information about this product family	<ul style="list-style-type: none"> <li>• <i>Intel® Server Board S2600WT Technical Product Specification</i></li> <li>• <i>Intel® Server System R1000WT Product Family Technical Product Specification</i></li> <li>• <i>Intel® Server System R2000WT Product Family Technical Product Specification</i></li> <li>• <i>Intel® Remote Management Module 4 (Intel® RMM4) and Integrated BMC User Guide</i></li> <li>• <i>Intel® Remote Management Module 4 Technical Product Specification</i></li> <li>• <i>Intel® I/O Expansion Modules Hardware Specification</i></li> <li>• <i>Intel® Server System BIOS Setup Utility Guide</i></li> <li>• <i>Intel® Server Platform Firmware Specification Update</i></li> <li>• <i>Product Safety and Regulatory Compliance - Intel® Xeon® Processor E5-2600 v3</i></li> </ul> <p style="text-align: center;"><a href="http://www.intel.com/p/en_US/support/highlights/server/s2600wt?wapkw=s2600wt+family">http://www.intel.com/p/en_US/support/highlights/server/s2600wt?wapkw=s2600wt+family</a></p>
For system integration instructions and service guidance	<ul style="list-style-type: none"> <li>• Intel® Server System R1000WT product family System Integration and Service Guide</li> <li>• Intel® Server System R2000WT product family System Integration and Service Guide</li> </ul> <p style="text-align: center;"><a href="http://www.intel.com/p/en_US/support/highlights/server/s2600wt?wapkw=s2600wt+family">http://www.intel.com/p/en_US/support/highlights/server/s2600wt?wapkw=s2600wt+family</a></p>
For server configuration guidance and compatibility	<p>Intel® Server Configurator tool</p> <p style="text-align: center;"><a href="http://serverconfigurator.intel.com">http://serverconfigurator.intel.com</a></p>
For system power budget guidance	<p><i>Intel® Server Board S2600WT Product Family Power Budget Tool and Thermal Configuration Guide</i></p> <p style="text-align: center;"><a href="https://downloadcenter.intel.com/product/78562/Intel-Server-Board-S2600WT-Family">https://downloadcenter.intel.com/product/78562/Intel-Server-Board-S2600WT-Family</a></p>
For system firmware updates, onboard device drivers, and software to manage your Intel® Server System.	<p style="text-align: center;"><a href="https://downloadcenter.intel.com/product/78562/Intel-Server-Board-S2600WT-Family">https://downloadcenter.intel.com/product/78562/Intel-Server-Board-S2600WT-Family</a></p>
For a complete list of supported processors, memory, add-in cards, and peripherals:	<p style="text-align: center;"><a href="http://www.intel.com/p/en_US/support/category/server/s2600wt/doc_guide#">http://www.intel.com/p/en_US/support/category/server/s2600wt/doc_guide#</a></p>

## 1.1 Intel® Server S2600WT Product Family Naming Convention



<p><b>Chassis Type</b></p> <p>R = RACK MOUNT</p>	<p><b>Server Board Identifier</b></p> <p>WT = Intel® Server Board S2600WT product family supported                  WT2 = Intel® Server Board S2600WT w/1 GbE LOM – iPC <b>S2600WT2</b>                  WTT = Intel® Server Board S2600WT w/10 GbE LOM – iPC <b>S2600WTT</b></p>
<p><b>U Height</b></p> <p>1 = 1U                  2 = 2U</p>	<p><b>Power Supply Type Included</b></p> <p>X = None Included                  G = 750W                  Y = 1100W</p>
<p><b>Drive Form Factor</b>                  (Specific to front drive bays)</p> <p>0 = No drives supported                  2 = 2.5"                  3 = 3.5"</p>	<p><b># of Power Supplies Included</b></p> <p>X = None                  S = 1 (Non-redundant)                  C = 2 (Redundant)</p>
<p><b># of Drives Supported</b>                  (Specific to front drive bays)</p> <p>00 12                  04 16                  08 24</p> <p>Note: 00 product codes have no front mount drive bays. Hot swap drive support can be added with the addition of available drive bay accessory options.</p>	<p><b>Special System SKU</b></p> <p># = a sequential number starting with 1 within the product family, identifying a special system SKU that adds a non-standard feature from other offered system SKUs. This last digit may or may not be present on all offered system SKUs.</p>

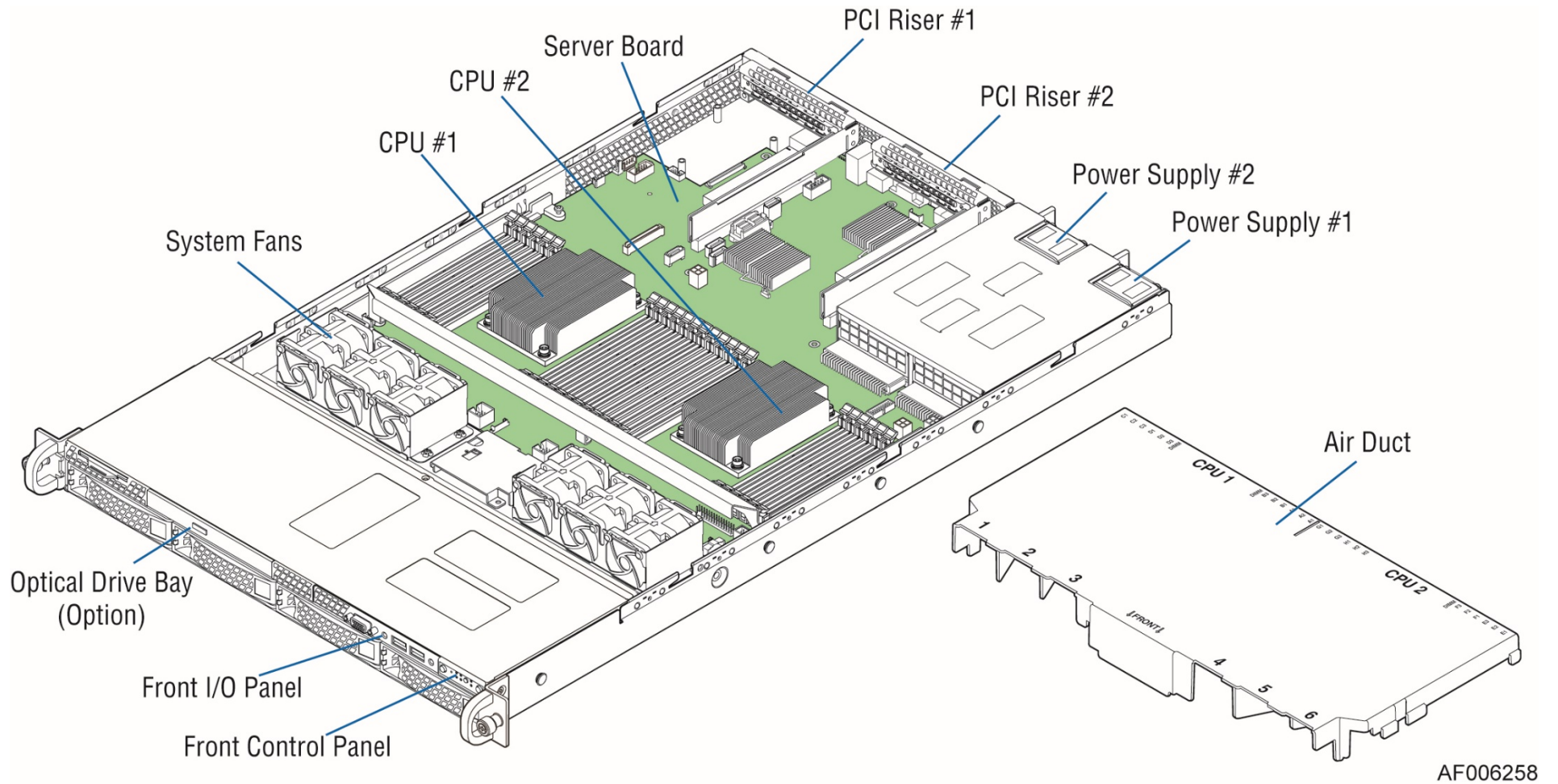


Figure 1. Intel® Server System R1000WT Feature Set Identification

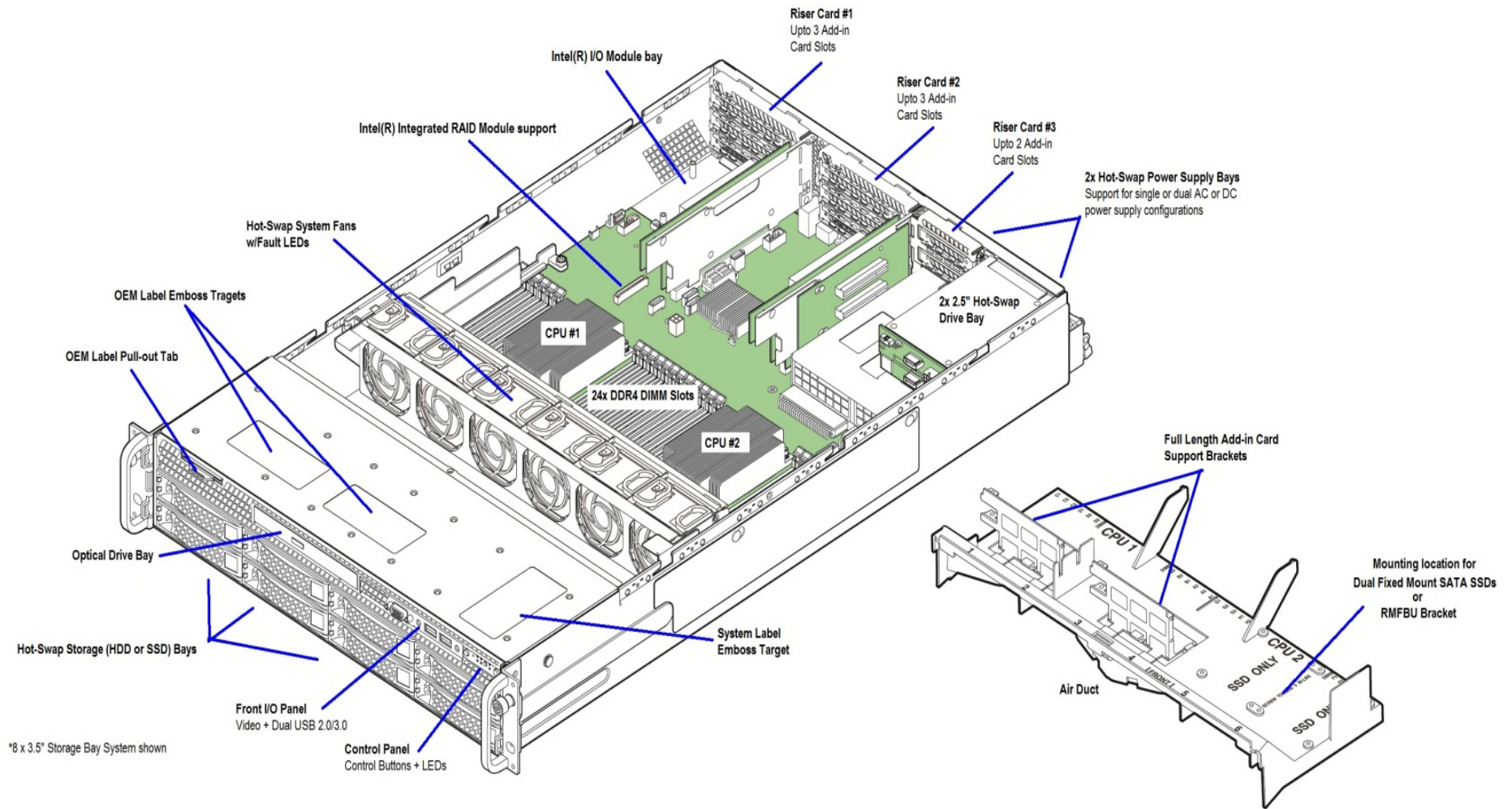


Figure 2. Intel® Server System R2000WT Feature Set Identification

## 1.2 Product Family Summary Chart

The Intel® S2600WT product family is built around either of two Intel® Server Board S2600WT options: S2600WTT and S2600WT2. The feature set of each server board option is identical except for the onboard LAN controller.

The **S2600WTTTR** SKU offers a LAN on Motherboard (LOM) option supporting dual RJ45 10Gb Base-T LAN ports.

The **S2600WT2R** SKU offers a LAN on Motherboard (LOM) option supporting dual RJ45 1Gb Base-T LAN ports.

The following tables provides an overview of available Intel product codes for building blocks and systems within the Intel® S2600WT product family. Each line item identifies key features supported in the shipping Intel SKU. Additional order code information and full product descriptions for each option are provided in later sections.

**Table 2. Server Board Product Family Summary**

Intel Product Code	# of CPU sockets	# of DIMM Slots	# of Riser Slots	Onboard RJ45 LAN ports	# of SATA ports (6 Gb)	SATA SW RAID Support	Intel® I/O Module Support	Intel® SAS RAID Module support
<b>Server Board only</b>								
S2600WT2R	2	24	3	2 (1 Gb)	10	Yes	Yes	Yes
S2600WTTTR	2	24	3	2 (10 Gb)	10	Yes	Yes	Yes

**Table 3. Server Chassis & Server System Product Family Summary**

Intel Product Code	Chassis Form Factor	Drive Form Factor	# of Drives (front) <sup>1</sup>	# of Drives (rear)	# of PCIe* Add-in Card Slots	3 <sup>rd</sup> Riser	Power Supply Modules	Rails	SAS RAID	SAS Expander
<b>Chassis Only (KDK)</b>										
R1304WTXXX	1U	3.5"	4	na	opt	na	opt	opt	opt	na
R1208WTXXX	1U	2.5"	8	na	opt	na	opt	opt	opt	na
R2312WTXXX	2U	3.5"	12	opt	opt	opt	opt	opt	opt	opt
R2000WTXXX <sup>2</sup>	2U	opt	opt	opt	opt	opt	opt	opt	opt	opt
<b>2x 10G LOM System (L6 BIK)</b>										
R1304WTTGSR	1U	3.5"	4	na	2	na	1x 750W AC	opt	opt	na
R1208WTTGSR	1U	2.5"	8	na	2	na	1x 750W AC	opt	opt	na
R2208WTTYSR	2U	2.5"	8	opt	8	yes	1x 1100W AC	opt	opt	na
R2308WTTYSR	2U	3.5"	8	opt	8	yes	1x 1100W AC	opt	opt	na
R2312WTTYSR	2U	3.5"	12	2	6	opt	1x 1100W AC	opt	opt	opt
R2224WTTYSR	2U	2.5"	24	2	6	opt	1x 1100W AC	opt	opt	opt
R2208WTTYC1 <sup>3</sup> R	2U	2.5"	8	opt	6	yes	2x 1100W AC	opt	opt	na

**Intel® Server S2600WT Product Family Configuration Guide and Spares/Accessories List**

Intel Product Code	Chassis Form Factor	Drive Form Factor	# of Drives (front) <sup>1</sup>	# of Drives (rear)	# of PCIe* Add-in Card Slots	3 <sup>rd</sup> Riser	Power Supply Modules	Rails	SAS RAID	SAS Expander
<b>2x 1G LOM System (L6 BIK)</b>										
<b>R1304WT2GSR</b>	1U	3.5"	4	na	2	na	1x 750W AC	opt	opt	na
<b>R1208WT2GSR</b>	1U	2.5"	8	na	2	na	1x 750W AC	opt	opt	na
<b>R2208WT2YSR</b>	2U	2.5"	8	opt	8	yes	1x 1100W AC	opt	opt	na

Table Notes:

1 – All front drive bays are 12Gb SAS capable

2 – R2000WTXXXXR Chassis can support all 8x2.5" drive bay accessory options or 8x3.5" drive bay accessory option

3 – System SKU with included system features to support Intel® Xeon Phi™ Coprocessor cards with **passive** (no fan) heat sink solutions. High power add-in cards with **active** cooling solutions are NOT supported in this SKU.

Terms used in the table:

**na** – Not Applicable

**opt** – Accessory option sold separately

**yes** – Option included

**KDK** – Knock Down Kit – Intel PCSD term for chassis only product

**BIK** – Server Board in KDK – Intel PCSD term for integrated (L6) system product

**L6** – Integrated system with no processors, memory, or storage devices

### 1.3 Intel® S2600GZ/GL Product Family to Intel® Server S2600WT Product Family Transition Guide

If transitioning from the previous generation Intel® S2600GZ/GL product family, the following table can be used to identify an equivalent system within the Intel® S2600WT product family.

**Table 4. 1U / 2U Server System Product Family Generation to Generation Transition Guide**

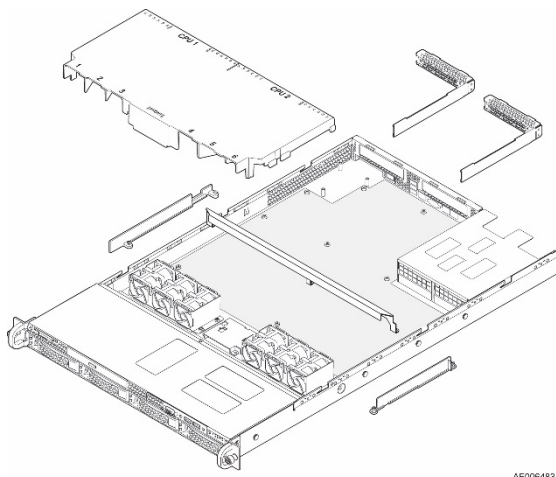
Prior Generation Product Code	New Generation 1G LOM SKU Product Code	New Generation 10G LOM SKU Product Code	Required accessories to match configuration			Advantages included in current generation
			AXXELVRAIL	AXXRMM4LITE	FXX750PCRPS	
R1208GL4DS	R1208WT2GSR	R1208WTTGSR	AXXELVRAIL	AXXRMM4LITE		750 vs460 PSU, 24 vs16DIMM
R1208GZ4GC	R1208WT2GSR	R1208WTTGSR	AXXELVRAIL	AXXRMM4LITE	FXX750PCRPS	
R1208GZ4GS9	R1208WT2GSR	R1208WTTGSR				
R1304GL4DS9	R1304WT2GSR	R1304WTTGSR				750 vs460 PSU, 24vs16DIMM
R1304GZ4GC	R1304WT2GSR	R1304WTTGSR	AXXELVRAIL	AXXRMM4LITE	FXX750PCRPS	
R1304GZ4GS9	R1304WT2GSR	R1304WTTGSR				
R2208GL4DS9	R2208WT2YSR	R2208WTTYSR				Rear drives option, 1100W vs 460W PSU, 3rd riser, 24vs16 dimms
R2208GL4GS	R2208WT2YSR	R2208WTTYSR	AXXELVRAIL	AXXRMM4LITE		Rear drives option, 1100W vs 750W PSU, 3rd riser, 24vs16 dimms
R2208GZ4GC	R2208WT2YSR	R2208WTTYSR	AXXELVRAIL	AXXRMM4LITE	AXX1100PCRPS	Rear drives option, 1100W vs 750W PSU, 3rd riser
R2208GZ4GS9	R2208WT2YSR	R2208WTTYSR				Rear drives option, 1100W vs 750W PSU, 3rd riser
R2224GZ4GC4		R2224WTTYSR	AXXELVRAIL	AXXRMM4LITE		Rear drives included, 1100W vs 750W PSU, 3rd riser optional
R2308GL4GS		R2308WTTYSR	AXXELVRAIL	AXXRMM4LITE		Rear drives option, 1100W vs 750W PSU, 3rd riser, 24vs16 dimms
R2308GZ4GC		R2308WTTYSR	AXXELVRAIL	AXXRMM4LITE	AXX1100PCRPS	Rear drives option, 1100W vs 750W PSU, 3rd riser
R2308GZ4GS9		R2308WTTYSR				Rear drives option, 1100W vs 750W PSU, 3rd riser
R2312GL4GS		R2312WTTYSR	AXXELVRAIL	AXXRMM4LITE		Rear drives included, 1100W vs 750W PSU, 3rd riser optional, 24vs16 dimms
R2312GZ4GC4		R2312WTTYSR	AXXELVRAIL	AXXRMM4LITE	AXX1100PCRPS	Rear drives included, 1100W vs 750W PSU, 3rd riser optional
R2312GZ4GS9		R2312WTTYSR				Rear drives included, 1100W vs 750W PSU, 3rd riser optional



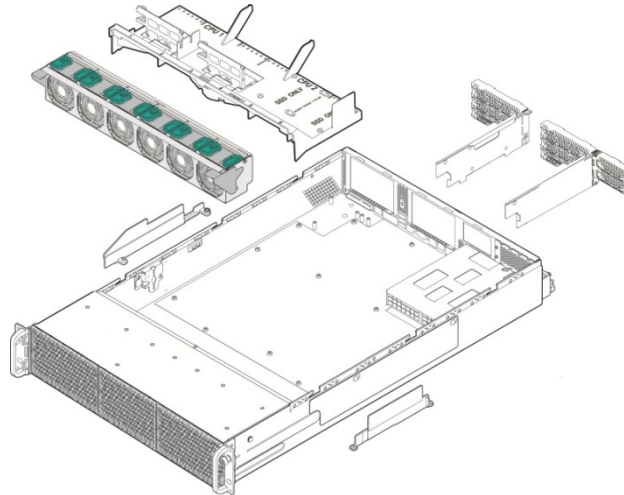
## 2 Server Building Block Configuration

Server building blocks are offered to give Intel customers the option to configure and assemble a unique server system from the bare chassis up. Each building block component and optional accessory is purchased separately. At a minimum, building up a functional server system using building blocks will require the following:

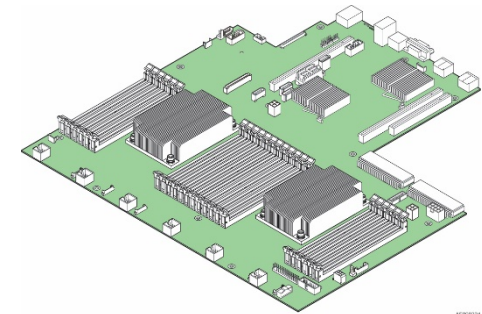
- 1U or 2U Intel Server Chassis – Intel® Server Chassis R1000WT or R2000WT
- Intel® Server Board S2600WT– S2600WT2R or S2600WTTR
- SAS / SATA Data cables
- Power Supply module(s)
- Power cord(s)
- Rack mount kit – Rails or fixed mount
- Processor
- Memory
- Storage Drives



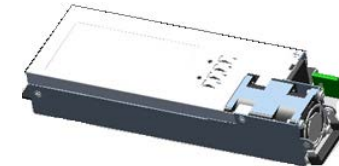
**1U – Intel® Server Chassis R1000WT**



**2U – Intel® Server Chassis R2000WT**



**Intel® Server Board S2600WT**



**750W or 1100W Power Supply Module**

Optional Intel accessories that can be added include the following: See chapter 5 for available options.

- Riser cards options
- SAS / SAS RAID support – PCIe\* add-in card or module + Appropriate SAS Data cable(s)
- Intel® I/O Module
- Intel® Remote Management Module 4 Lite

## 2.1 Building Block Recipe Summary



The following table is used to identify the building block options required to assemble an equivalent server system SKU offered within the Intel® Server System R1000WT or R2000WT product families.

The first column in the table identifies the available integrated system SKUs. The columns to the right of a specified system SKU identify the Intel building block kits required to assemble the equivalent system.

**Table 5. 1U / 2U Building Block to Integrated System Recipe Guide**

Intel L6 System Product Code	Building blocks needed to assemble an equivalent system							
	Intel Chassis Product Code	Server Board	Front Drive Bay assembly	Power Supply Modules	Riser Slot 1 and 2 Riser Cards	Riser Slot 3 Riser Card	Rear Drive Bay Assembly	SAS cables for 12Gb
R1304WTTGSR	R1304WTXXX	S2600WTTR	included	(1x) FXX750PCRPS	(2x) F1UL16RISER2	NA	NA	800mm cable AXXCBL1UHRHD
R1304WT2GSR	R1304WTXXX	S2600WT2R	included	(1x) FXX750PCRPS	(2x) F1UL16RISER2	NA	NA	800mm cable AXXCBL1UHRHD
R1208WTTGSR	R1208WTXXX	S2600WTTR	included	(1x) FXX750PCRPS	(2x) F1UL16RISER2	NA	NA	AXXCBL1UHRHD
R1208WT2GSR	R1208WTXXX	S2600WT2R	included	(1x) FXX750PCRPS	(2x) F1UL16RISER2	NA	NA	AXXCBL1UHRHD
R2208WTTYSR	R2000WTXXX	S2600WTTR	A2U8X25S3HS DK	(1x) AXX1100PCRPS	(2x) A2UL8RISER2	A2UX8X4RISER	optional	AXXCBL730HDHD
R2208WTTYC1R	R2000WTXXX + AWTCOPRODU CT	S2600WTTR	A2U8X25S3HS DK	(2x) AXX1100PCRPS	(2x) A2UL16RISER2	A2UX8X4RISER	optional	AXXCBL730HDHD
R2208WT2YSR	R2000WTXXX	S2600WT2R	A2U8X25S3HS DK	(1x) AXX1100PCRPS	(2x) A2UL8RISER2	A2UX8X4RISER	optional	AXXCBL730HDHD
R2224WTTYSR	R2000WTXXX + A2UHANDLKIT	S2600WTTR	(3x) A2U8X25S3HS DK	(1x) AXX1100PCRPS	(2x) A2UL8RISER2	optional	A2UREARHSDK	AXXCBL730HDHD + (2) AXXCBL875HDHD
R2308WTTYSR	R2000WTXXX	S2600WTTR	A2U8X35S3HS DK	(1x) AXX1100PCRPS	(2x) A2UL8RISER2	A2UX8X4RISER	optional	1/2 kit of: AXXCBL800HDHD & AXXCBL950HDHD
R2312WTTYSR	R2312WTXXX	S2600WTTR	included	(1x) AXX1100PCRPS	(2x) A2UL8RISER2	optional	A2UREARHSDK	AXXCBL800HDHD AXXCBL875HDHD AXXCBL950HDHD

## 2.2 Intel® Server Board S2600WT Product Family SKUs

Intel Product Code (iPC)	Order Information	Product Description	Product Type
<p>iPC – <b>S2600WT2R</b></p> 	<p>MM# - 943786                      UPC - 00735858308618                      EAN - 5032037081375                      MOQ - 1</p> <p>Packaged Gross Weight  <b>3.1 Kgs, 6.8 Lbs</b></p> <p>Un-packaged Net Weight  <b>1.7 Kgs, 3.8 Lbs</b></p>	<p align="center"><b><u>Intel® Server Board S2600WT2R</u></b></p> <ul style="list-style-type: none"> <li>• Support for dual Intel® Xeon E5-2600 v3, families</li> <li>• Maximum supported TDP for board 145W (not available in all chassis configurations)</li> <li>• Intel® C612 chipset</li> <li>• 24 DDR4 DIMM Slots</li> <li>• 8 AHCI SATA 6Gb ports thru two 4-port SFF-8643 connectors</li> <li>• 2 AHCI SATA 6Gb ports for ODD, DOM, SSD thru two 7-pin SATA connectors</li> <li>• <b>2 Integrated 1Gb ports (Intel® Ethernet Controller I350)</b></li> <li>• Integrated Baseboard Management controller with IPMI 2.0 support</li> <li>• Optional advanced management features activated by <b>AXXRMM4LITE</b> key</li> <li>• Dedicated 1Gb management port onboard</li> <li>• Support for up to 3 riser cards with multiple Intel riser card options                             <ul style="list-style-type: none"> <li>◦ NOTE – 2 CPUs required for riser #2 and riser #3 support</li> </ul> </li> <li>• Support for Intel® I/O expansion module option</li> <li>• Support for Intel® SAS module option</li> </ul> <p><b>Box includes:</b> one server board                      Note: All necessary mounting hardware, cabling, and shielding will ship with the Intel chassis and optional accessory kits.</p>	<p align="center"><b>Server Board only</b></p> <ul style="list-style-type: none"> <li>• Building block option</li> <li>• Spare FRU</li> </ul>
<p>iPC – <b>S2600WTTR</b></p> 	<p>MM# - 943785                      UPC - 00735858308601                      EAN - 5032037081368                      MOQ - 1</p> <p>Packaged Gross Weight  <b>3.1 Kgs, 6.8 Lbs</b></p> <p>Un-packaged Net Weight  <b>1.7 Kgs, 3.8 Lbs</b></p>	<p align="center"><b><u>Intel® Server Board S2600WTTR</u></b></p> <ul style="list-style-type: none"> <li>• Support for dual Intel® Xeon E5-2600 v3, families</li> <li>• Maximum supported TDP for board 145W (not available in all chassis configurations)</li> <li>• Intel® C612 chipset</li> <li>• 24 DDR4 DIMM Slots</li> <li>• 8 AHCI SATA 6Gb ports thru two 4-port SFF-8643 connectors</li> <li>• 2 AHCI SATA 6Gb ports for ODD, DOM, SSD thru two 7-pin SATA connectors</li> <li>• <b>2 Integrated 10Gb ports (Intel® Ethernet Controller X-540)</b></li> <li>• Integrated Baseboard Management controller with IPMI 2.0 support</li> <li>• Optional advanced management features activated by <b>AXXRMM4LITE</b> key</li> <li>• Dedicated 1Gb management port</li> <li>• Support for up to 3 riser cards with multiple Intel riser card options                             <ul style="list-style-type: none"> <li>◦ NOTE – 2 CPUs required for riser #2 and riser #3 support</li> </ul> </li> <li>• Support for Intel® I/O expansion module option</li> <li>• Support for Intel® SAS module option</li> </ul> <p><b>Box includes:</b> one server board                      Note: All necessary mounting hardware, cabling, and shielding will ship with the Intel chassis and optional accessory kits.</p>	<p align="center"><b>Server Board Only</b></p> <ul style="list-style-type: none"> <li>• Building block option</li> <li>• Spare FRU</li> </ul>

## 2.3 Intel® Server Chassis R1000WT Product Family SKUs – (1U Rack Mount Chassis)

The product tables found in this section provide order code information and detailed descriptions for each available 1U Intel server chassis building block option. The lower sections of each table identify:

- The ship along components of the specified chassis product code – (product BOM)
- **Required Items** – Hardware required to be installed to the base system to achieve basic functionality using the default system feature set.
- **Optional Accessories** – Some of the available accessories which can be installed to enhance the basic feature set of the server board / chassis. Additional accessories can be found in Chapter 5.

### NOTES:

- Each **required item** and **optional accessory** is sold separately from the specified Intel server building block.
- Items identified as **iPC** (Intel Product Code), are an orderable building block option, accessory or spare FRU.
- In an effort to provide the complete product bill of materials, the ship along components list in each product table will include items identified by description and by **iPN** (Intel Part Number). The iPN information is provided for reference only. These components are **not** orderable as a spare or accessory.

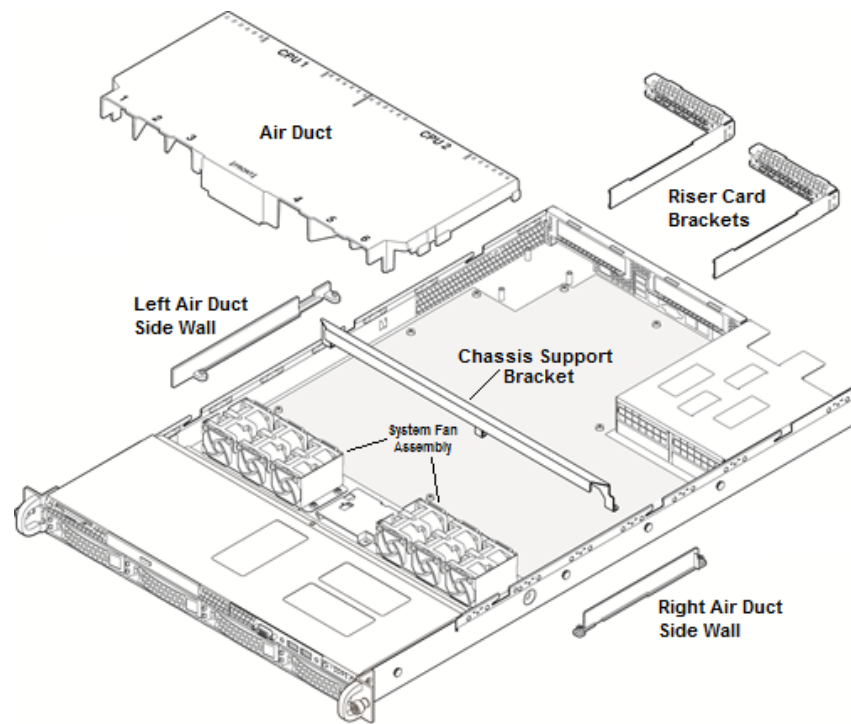
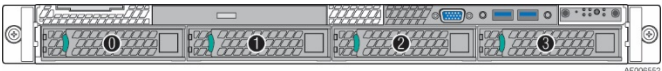
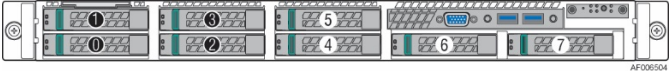


Figure 3. Intel® Server Chassis R1000WT – 1U Chassis only Building Block (KDK)

<p><b>Intel Product Code (iPC):</b></p> <p style="text-align: center;"><b>R1304WTXXX</b></p>  <p style="text-align: center;"><b>1U – 4 x 3.5" HDD or 4 x 2.5" SSD front mount drives</b></p>	<p><b>Order Code Information:</b></p> <p>MM# - 936121                  UPC - 00735858287944                  EAN - 5032037067492                  MOQ - 1</p>	<p>Product Type: <b>Chassis Only</b>                  Chassis Form Factor: <b>1U rack mount</b>                  Chassis dimensions: <b>L=712mm, W=439mm, H=43.2mm</b>                  Packaged Gross Weight: <b>19 Kgs, 41.9 Lbs</b>                  Un-packaged Net Weight: <b>10.3 Kgs, 22.7 Lbs</b>                  Outer Box Dimensions: <b>L=983mm, W=577mm, H=260mm</b></p>
---	---	---

**Product Definition and Configuration Requirements**

<p>Intel product code <b>R1304WTXXX</b> includes the following components:</p> <ul style="list-style-type: none"> <li>(1) – 1U Chassis with Quick Reference Label affixed to top cover</li> <li>(1) – Air duct</li> <li>(6) – Dual rotor system fans – iPC <b>FR1UFAN10PW</b></li> <li>(1) – Pre-installed Standard Control Panel assembly (board only – iPC <b>FXXFPANEL</b>)</li> <li>(1) – Pre-installed Front I/O Panel assembly (1 x VGA and 2 x USB) (w/internal attach cables)</li> <li>(1) – SATA Optical drive bay with filler panel                         <ul style="list-style-type: none"> <li>• Includes optical drive mounting latch kit – iPN H19168-00x</li> <li>• Includes optical drive power cable – iPN G95880-00x</li> </ul> </li> <li>(4) – 3.5" Hot-swap drive bays with drive carriers and drive blanks                         <ul style="list-style-type: none"> <li>• includes (1) 12 Gb SAS backplane – iPC <b>FR1304S3HSBP</b></li> <li>• includes (4) 3.5" hot swap drive carriers – iPC <b>FXX35HSCAR</b></li> </ul> </li> <li>(1) – Server board to backplane power cable – iPN H38458-00x</li> <li>(1) – Server board to backplane I2C cable – iPN H39941-00x</li> <li>(2) – CPU heatsinks – iPC <b>FXXCA84X106HS</b></li> <li>(2) – CPU heat sink Mylar Spacer inserts – iPN H28618-00x</li> <li>(2) – Riser card mounting brackets – (riser cards sold separately. See chapter 5.7.1)</li> <li>(1) – Power Supply Bay blank insert</li> <li>(8) – DIMM slot blanks – iPN H43597-00x</li> <li>(2) – Chassis handles (1 set) installed – iPN H19171-00x</li> <li>(2) – AC Power Cord retention strap assembly – iPN H23961-00x</li> </ul> <p>Server board and riser card mounting screws                  Spares for each screw type included</p>	<p style="text-align: center;"><b><u>Required Items – Sold Separately:</u></b></p> <ul style="list-style-type: none"> <li>• Intel® Server Board S2600WT (choose one)                         <ul style="list-style-type: none"> <li>○ iPC <b>S2600WT2R</b> – with 1G LOM</li> <li>○ iPC <b>S2600WTTR</b> – with 10G LOM</li> </ul> </li> <li>• Power supply module(s) – (Choose one type) two common modules required for redundancy                         <ul style="list-style-type: none"> <li>○ iPC <b>FXX750PCRPS</b> – 750 W AC Power Supply Module</li> <li>○ iPC <b>AXX750DCCRPS</b> – 750 W DC Power Supply Module (<b>Available Late Q2 2015</b>)</li> </ul> </li> <li>• Power Cord(s) – See chapter 5.10</li> <li>• Rack Mount Kit – See chapter 5.11</li> <li>• 1 or 2 Intel® Xeon® Processor E5-2600 v3 product family</li> <li>• ECC DDR4 memory (RDIMM or LRDIMM)</li> </ul>	<p style="text-align: center;"><b><u>Optional Intel Accessories – Sold Separately:</u></b></p> <ul style="list-style-type: none"> <li>• iPC <b>F1UL16RISER2</b> – One x16 PCIe* 3.0 slot Riser Card – (1 for each riser slot)</li> <li>• Intel® I/O Module – See chapter 0 for options</li> <li>• Intel® SAS RAID Card / Module – See section 5.9 for options</li> <li>• SAS/SATA Data cables – Cable selection is dependant on desired storage option. See Chapter 4.2.1 for available cable options</li> <li>• iPC <b>A1UBEZEL</b> – Lockable front system bezel</li> <li>• iPC <b>AXXRMM4LITE</b> – Intel® Remote Management Module Lite key. For advanced management features</li> <li>• Storage Drives</li> </ul> <p>See Chapter 5 for all available accessory options.</p>
--	---	--

<p><b>Intel Product Code (iPC):</b></p> <p style="text-align: center;"><b>R1208WTXXX</b></p>  <p style="text-align: center;"><b>1U – 8 x 2.5" front mount drives</b></p>	<p><b>Order Code Information:</b></p> <p>MM# - <b>936187</b>          UPC - <b>00735858287951</b>          EAN - <b>5032037067508</b>          MOQ - <b>1</b></p>	<p>Product Type: <b>Chassis Only</b>          Chassis Form Factor: <b>1U rack mount</b>          Chassis dimensions: <b>L=712mm, W=439mm, H=43.2mm</b>          Packaged Gross Weight: <b>19 Kgs, 41.9 Lbs</b>          Un-packaged Net Weight: <b>10.3 Kgs, 22.7 Lbs</b>          Outer Box Dimensions: <b>L=983mm, W=577mm, H=260mm</b></p>
<p><b>Product Definition and Configuration Requirements</b></p>		
<p>Intel product code <b>R1208WTXXX</b> includes the following components:</p> <ul style="list-style-type: none"> <li>(1) – 1U Chassis with Quick Reference Label affixed to top cover</li> <li>(1) – Air duct</li> <li>(6) – Dual rotor system fans – iPC <b>FR1UFAN10PW</b></li> <li>(1) – Pre-installed Standard control panel assembly (board only iPC <b>FXXFPANEL</b>)</li> <li>(1) – Pre-installed Front I/O Panel assembly (1 x VGA and 2 x USB) (w/internal attach cables)             <ul style="list-style-type: none"> <li>• If removed, can be used as an optical drive bay.</li> <li>• Includes optical drive mounting latch kit – iPN H19168-00x</li> <li>• Includes optical drive power cable – iPN H23851-00x</li> </ul> </li> <li>(8) – 2.5" Hot-swap drive bays with drive carriers and drive blanks             <ul style="list-style-type: none"> <li>• Includes (1) 12 Gb SAS backplane – iPC <b>F1U8X25S3HSBP</b></li> <li>• Includes (8) 2.5" hot swap drive carriers – iPC <b>FXX25HSCAR2</b></li> </ul> </li> <li>(1) – Server board to backplane power cable – iPN H38457-00x</li> <li>(1) – Server board to backplane I2C cable – iPN H39941-00x</li> <li>(2) – CPU heatsinks – iPC <b>FXXCA84X106HS</b></li> <li>(2) – CPU heat sink Mylar Spacer inserts – iPN H28618-00x</li> <li>(2) – Riser card mounting brackets – (riser cards sold separately. See chapter 5.7.1)</li> <li>(1) – Power Supply Bay blank insert</li> <li>(8) – DIMM slot blanks – iPN H43597-00x</li> <li>(2) – Chassis handles (1 set) installed – iPN H19171-00x</li> <li>(2) – AC Power Cord retention strap assembly – iPN H23961-00x</li> </ul> <p>Server board and riser card mounting screws          Spares for each screw type included</p>	<p style="text-align: center;"><b>Required Items – Sold Separately:</b></p> <ul style="list-style-type: none"> <li>• Intel® Server Board S2600WT (choose one)             <ul style="list-style-type: none"> <li>○ iPC <b>S2600WT2R</b> – with 1G LOM</li> <li>○ iPC <b>S2600WTTR</b> – with 10G LOM</li> </ul> </li> <li>• Power supply module(s) – (Choose one type) two common modules required for redundancy             <ul style="list-style-type: none"> <li>○ iPC <b>FXX750PCRPS</b> – 750 W AC Power Supply Module</li> <li>○ iPC <b>AXX750DCCRPS</b> – 750 W DC Power Supply Module (<b>Available Late Q2 2015</b>)</li> </ul> </li> <li>• Power Cord(s) – See chapter 5.10</li> <li>• Rack Mount Kit – See chapter 5.11</li> <li>• 1 or 2 Intel® Xeon® Processor E5-2600 v3 product family</li> <li>• ECC DDR4 memory (RDIMM or LRDIMM)</li> </ul>	<p style="text-align: center;"><b>Optional Intel Accessories – Sold Separately:</b></p> <ul style="list-style-type: none"> <li>• iPC <b>F1UL16RISER2</b> – One x16 PCIe* 3.0 slot Riser Card – (1 for each riser slot)</li> <li>• Intel® I/O Module – See chapter 0 for options</li> <li>• Intel® SAS RAID Card / Module – See section 5.9 for options</li> <li>• SAS/SATA Data cables – Cable selection is dependant on desired storage option. See Chapter 4.2.2 for available cable options</li> <li>• iPC <b>A1UBEZEL</b> – Lockable front system bezel</li> <li>• iPC <b>AXXRMM4LITE</b> – Intel® Remote Management Module Lite key. For advanced management features</li> <li>• iPC <b>A1U44X25NVMEDK</b> – (4) PCIe* SSD SFF (NVMe*) + (4) SAS support – replaces existing backplane and requires use of one PCIe* slot. See system accessories table or System TPS for details</li> <li>• Storage Drives</li> </ul> <p>See Chapter 5 for all available accessory options.</p>

## 2.4 Intel® Server Chassis R2000WT Product Family SKUs – (2U Rack Mount Chassis)

The product tables found in this section provide order code information and detailed descriptions for each available 2U Intel server chassis building block option. The lower sections of each table identify:

- The ship along components of the specified chassis product code – (product BOM)
- **Required Items** – Hardware required to be installed to the base system to achieve basic functionality using the default system feature set
- **Optional Accessories** – Some of the available accessories which can be installed to enhance the basic feature set of the server board / chassis. Additional accessories can be found in Chapter 5

### NOTES:

- Each **required item** and **optional accessory** is sold separately from the specified Intel server building block
- Items identified as **iPC** (Intel Product Code), are an orderable building block option, accessory or spare FRU
- In an effort to provide the complete product bill of materials, the ship along components list in each product table will include items identified by description and by **iPN** (Intel Part Number). The iPN information is provided for reference only. These components are **not** orderable as a spare or accessory.

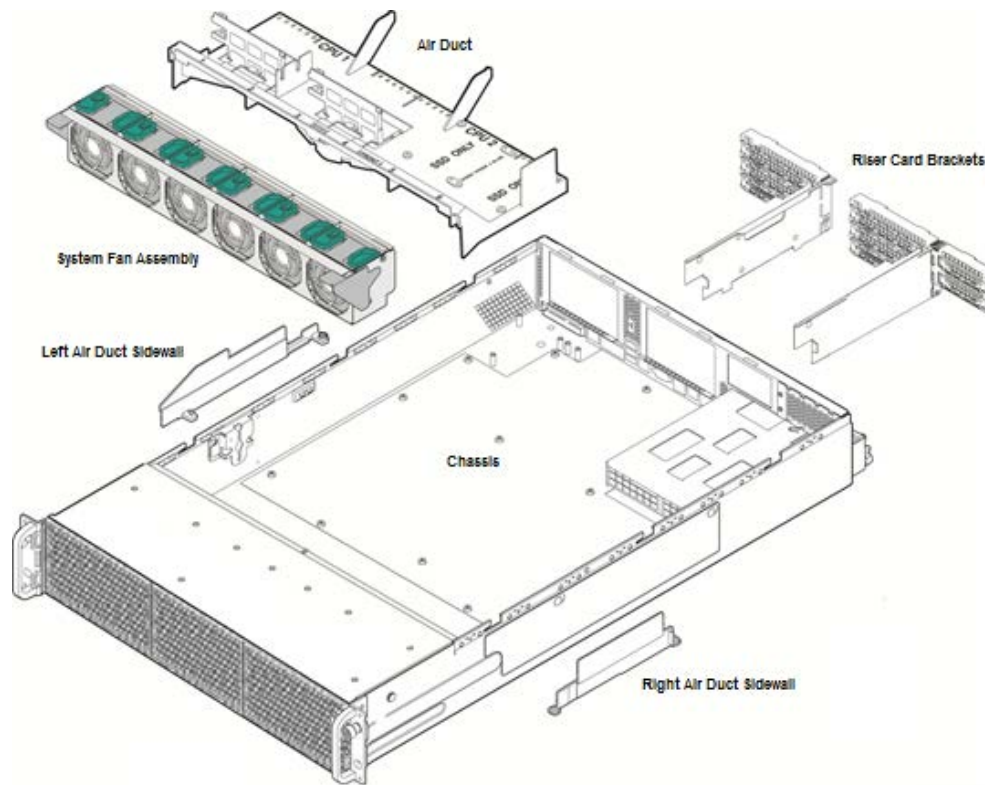
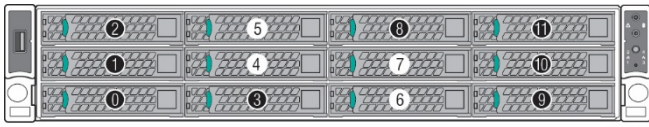
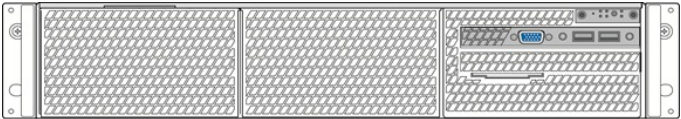


Figure 4. Intel® Server Chassis R2000WT – 2U Chassis only Building Block (KDK)

<p><b>Intel Product Code (iPC):</b></p> <p style="text-align: center;"><b>R2312WTXXX</b></p>  <p style="text-align: center;"><b>2U – 12 x 3.5" HDD or 12 x 2.5" SSD front mount drives</b></p>	<p><b>Order Code Information:</b></p> <p>MM# - <b>936022</b>          UPC - <b>00735858288729</b>          EAN - <b>5032037068000</b>          MOQ - <b>1</b></p>	<p>Product Type: <b>Chassis only</b>          Chassis Form Factor: <b>2U rack mount</b>          Chassis dimensions: <b>L=712mm, W=439mm, H=89mm</b>          Packaged Gross Weight: <b>21.2 Kgs, 46.7 Lbs</b>          Un-packaged Net Weight: <b>14.4 Kgs, 32.0 Lbs</b>          Outer Box Dimensions: <b>L=983mm, W=577mm, H=260mm</b></p>
<p><b>Product Definition and Configuration Requirements</b></p>		
<p>Intel product code <b>R2312WTXXX</b> includes the following components:</p> <ul style="list-style-type: none"> <li>(1) – 2U Chassis with Quick Reference Label affixed to top cover</li> <li>(1) – Air duct</li> <li>(6) – Hot swap system fans – iPC <b>FR2UFAN60HSW</b></li> <li>(2) – Chassis Handles (1 set) installed, with Integrated control panel &amp; USB Port - iPC <b>A2UHANDLKIT</b></li> <li>(12) – 3.5" Hot-swap drive bays with drive carriers and drive blanks             <ul style="list-style-type: none"> <li>• Includes (1) 12 Gb SAS backplane – iPC <b>F2U12X35S3HSBP</b> – (SAS Data cables sold separately)</li> <li>• Includes (12) 3.5" hot swap drive carriers – iPC <b>FXX35HSCAR</b></li> </ul> </li> <li>(1) – Backplane I2C cable – iPN G92510-00x</li> <li>(1) – Backplane power cable – iPN G92685-00x</li> <li>(1) – Internal fixed mount SSD power cable – iPN H23901-00x</li> <li>(2) – CPU heatsinks – iPC <b>FXXCA84X106HS</b></li> <li>(2) – CPU heat sink Mylar Spacer inserts – iPN H28618-00x</li> <li>(2) – Riser Card mouting brackets supporting up to 3 riser cards – (risers cards sold separately – See chapter 5.7.2)</li> <li>(1) – Power Supply Bay blank insert</li> <li>(16) – DIMM slot blanks - iPN H43597-00x</li> <li>(1) – 3x RMFBU Mounting Bracket – iPN H18238-00x</li> <li>(2) – AC Power Cord retention strap assembly – iPN H23961-00x</li> </ul> <p>Server Board and Riser Card mounting screws          Spares for each screw type included</p>	<p><b><u>Required Items – Sold Separately:</u></b></p> <ul style="list-style-type: none"> <li>• Intel® Server Board S2600WT (choose one)             <ul style="list-style-type: none"> <li>○ iPC <b>S2600WT2R</b> – with 1G LOM</li> <li>○ iPC <b>S2600WTTR</b> – with 10G LOM</li> </ul> </li> <li>• Power supply module(s) – (Choose one type) two common modules required for redundancy             <ul style="list-style-type: none"> <li>○ iPC <b>AXX1100PCRPS</b> – 1100W AC Power Supply Module</li> <li>○ iPC <b>FXX750PCRPS</b> – 750 W AC Power Supply Module</li> <li>○ iPC <b>AXX750DCCRPS</b> – 750 W DC Power Supply Module (<b>Available Late Q2 2015</b>)</li> </ul> </li> <li>• Power Cord(s) – See chapter 5.10</li> <li>• Rack Mount Kit – See chapter 5.11</li> <li>• 1 or 2 Intel® Xeon® Processor E5-2600 v3 product family</li> <li>• ECC DDR4 memory (RDIMM or LRDIMM)</li> </ul>	<p><b><u>Optional Intel Accessories – Sold Separately:</u></b></p> <ul style="list-style-type: none"> <li>• <b>Riser Cards</b> – Up to three riser cards can be installed concurrently – See chapter 5.7             <ul style="list-style-type: none"> <li>○ Risers Slots #1 and #2 – Available riser cards include:                 <ul style="list-style-type: none"> <li>- iPC <b>A2UL8RISER2</b> – (3) x8 PCIe* 3.0 slots</li> <li>- iPC <b>A2UL16RISER2</b> – (1) x16 PCIe* 3.0 slot + (1) x8 PCIe* 3.0 slot</li> </ul> </li> <li>○ Riser Slot #3 – Available riser cards include:                 <ul style="list-style-type: none"> <li>- iPC <b>A2UX8X4RISER</b> – (1) Low profile x8 PCIe* 3.0 slot + (1) LP x8 PCIe* 2.0 slot</li> </ul> </li> </ul> </li> <li>• <b>Rear Storage Bay Option</b> – See chapter 5.3             <ul style="list-style-type: none"> <li>○ iPC <b>A2UREARHSDK</b> – Up to (2) hot swap SATA SSDs</li> </ul> </li> <li>• Intel® I/O Module – See chapter 0 for options</li> <li>• Intel® SAS RAID Card / Module – See section 5.9 for options</li> <li>• SAS/SATA Data cables – Cable selection is dependant on desired storage option. See Chapter 4.2.4 for available cable options</li> <li>• iPC <b>A2UBEZEL</b> – Lockable front system bezel</li> <li>• iPC <b>AXXRMM4LITE</b> – Intel® Remote Management Module Lite key. For advanced management features</li> <li>• Storage Drives</li> </ul> <p>See Chapter 5 for all available accessory options.</p>



<p><b>Intel Product Code (iPC):</b></p> <p style="text-align: center;"><b>R2000WTXXX</b></p>  <p style="text-align: center;"><b>2U – No front mount drives</b></p>	<p><b>Order Code Information:</b></p> <p>MM# - 936021                  UPC - 00735858287968                  EAN - 5032037067515                  MOQ - 1</p>	<p>Product Type: <b>Chassis only</b>                  Chassis Form Factor: <b>2U rack mount</b>                  Chassis dimensions: <b>L=712mm, W=439mm, H=89mm</b>                  Packaged Gross Weight: <b>19 Kgs, 41.9 Lbs</b>                  Un-packaged Net Weight: <b>13.3 Kgs, 29.3 Lbs</b>                  Outer Box Dimensions: <b>L=983mm, W=577mm, H=260mm</b></p>
---	---	---

**Product Definition and Configuration Requirements**

<p>Intel product code <b>R2000WTXXX</b> includes the following components:</p> <ul style="list-style-type: none"> <li>(1) – 2U Chassis with Quick Reference Label affixed to top cover</li> <li>(1) – Air duct</li> <li>(6) – Hot swap system fans – iPC <b>FR2UFAN60HSW</b></li> <li>(1) – Pre-installed Standard control panel assembly – (board only iPC <b>FXXFPANEL</b>)</li> <li>(1) – Pre-installed Front I/O Panel assembly (1 x VGA and 2 x USB) (w/internal attach cables)</li> <li>(1) – SATA Optical drive bay with filler panel and optical drive mounting latch</li> <li>(1) – I2C cable - server board to backplane – iPN G41809-00x (backplane sold separately)</li> <li>(1) – Internal fixed mount SSD / optical drive power cable - iPN H23901-xxx</li> <li>(2) – Riser Card mounting brackets supporting up to 3 riser cards (riser cards sold separately – see chapter 5.7.2)</li> <li>(2) – CPU heatsinks – iPC <b>FXXCA84X106HS</b></li> <li>(2) – CPU heat sink Mylar Spacer inserts – iPN H28618-00x</li> <li>(1) – Power supply bay blank insert</li> <li>(16) – DIMM slot blanks – iPN H43597-00x</li> <li>(2) – Rack chassis handles (1 set) installed – iPN H18229-xxx</li> <li>(1) – 3x RMFBU Mounting Bracket – iPN H18238-00x</li> <li>(2) – AC Power Cord retention strap assembly – iPN H23961-00x</li> </ul> <p>Server Board and Riser Card mounting screws                  Spares for each screw type included</p>	<p><b>Required Items – Sold Separately:</b></p> <ul style="list-style-type: none"> <li>• Intel® Server Board S2600WT (choose one)                         <ul style="list-style-type: none"> <li>○ iPC <b>S2600WT2R</b> – with 1G LOM</li> <li>○ iPC <b>S2600WTTR</b> – with 10G LOM</li> </ul> </li> <li>• Power supply module(s) – (Choose one type) two common modules required for redundancy                         <ul style="list-style-type: none"> <li>○ iPC <b>AXX1100PCRPS</b> – 1100W AC Power Supply Module</li> <li>○ iPC <b>FXX750PCRPS</b> – 750 W AC Power Supply Module</li> <li>○ iPC <b>AXX750DCCRPS</b> – 750 W DC Power Supply Module (<b>Available Late Q2 2015</b>)</li> </ul> </li> <li>• Power Cord(s) – See chapter 5.10</li> <li>• Rack Mount Kit – See chapter 5.11</li> <li>• 1 or 2 Intel® Xeon® Processor E5-2600 v3 product family</li> <li>• ECC DDR4 memory (RDIMM or LRDIMM)</li> </ul>	<p><b>Optional Intel Accessories – Sold Separately</b></p> <ul style="list-style-type: none"> <li>• <b>Front storage bay option</b> <ul style="list-style-type: none"> <li>○ Upto (3) 8 x 2.5" drive bay modules can be installed:                             <ul style="list-style-type: none"> <li>▪ iPC <b>A2U8X25S3HSDK</b> – SAS/SATA</li> <li>▪ iPC <b>A2U8X25S3DPDK</b> – Dual port SAS</li> <li>▪ iPC <b>A2U44X25NVMDK</b> – PCIe* SSD SFF (NVMe) + SAS</li> <li>▪ <b>(Note)</b> for a 24 x 2.5" drive configuration, system will lose front video and optical drive support, and system must include the 2U storage front panel in Storage handle kit iPC <b>A2UHANDLKIT</b></li> </ul> </li> <li>○ iPC <b>A2U8X35S3HSDK</b> – 8 x 3.5" drive + Optical drive bay                             <ul style="list-style-type: none"> <li>▪ Re-uses control panel and front I/O panel. Includes SAS/SATA data cables and peripheral power cable</li> </ul> </li> </ul> </li> <li>• <b>Rear Storage Bay Option</b> <ul style="list-style-type: none"> <li>○ iPC <b>A2UREARHSDK</b> – Up to (2) hot swap SATA SSDs</li> </ul> </li> <li>• <b>Riser Cards</b> – Up to three riser cards can be installed concurrently                         <ul style="list-style-type: none"> <li>○ Riser Slots #1 and #2 – Available riser cards include:                                 <ul style="list-style-type: none"> <li>- iPC <b>A2UL8RISER2</b> – (3) x8 PCIe* 3.0 slots</li> <li>- iPC <b>A2UL16RISER2</b> – (1) x16 PCIe* slot + (1) x8 PCIe* slot</li> </ul> </li> <li>○ Riser Slot #3 – Available riser cards include:                                 <ul style="list-style-type: none"> <li>- iPC <b>A2UX8X4RISER</b> – (1) Low profile x8 PCIe* 3.0 slot + (1) LP x8 PCIe* 2.0 slot</li> </ul> </li> </ul> </li> <li>• SAS/SATA Data cables – Cable selection is dependant on desired storage option. See Chapter 4 for available cable options</li> <li>• Intel® SAS RAID Card / Module – See section 5.9 for options</li> <li>• Intel® I/O Module – See chapter 0 for options</li> <li>• iPC <b>A2UBEZEL</b> – Lockable front system bezel</li> <li>• iPC <b>AXXRMM4LITE</b> – Intel® Remote Management Module Lite key. For advanced management features</li> </ul> <p>See Chapter 5 for all available accessory options.</p>
--	--	---

### 3 Server System Configuration

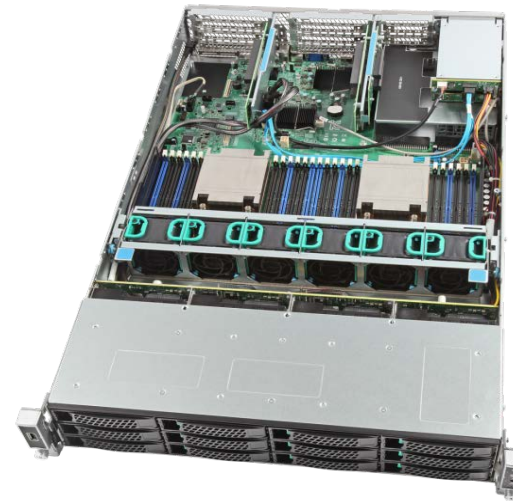
Intel makes available L6 integrated server systems that include a specific server board, power supply module, and hot swap drive bays options. At a minimum, building up a functional L6 server system will require the following:

- Rack mount kit option – Rails or fixed mount
- Power Cord(s)
- Processor(s)
- Memory
- Storage Drives



**Intel® Server System  
R1000WT Product Family**

\*R1208WT configuration shown



**Intel® Server System  
R2000WT Product Family**

\*R2312WT configuration shown

Optional Intel accessories that can be added include the following: See chapter 5 for available options.

- 2<sup>nd</sup> power supply module to add power redundancy
- SAS / SAS RAID support – PCIe\* add-in card or module + Appropriate SAS Data cable(s)
- Intel® I/O Module
- Intel® Remote Management Module Lite

### 3.1 Intel® Server System R1000WT Product Family SKUs – (1U Rack Mount System)

The product tables found in this section provide order code information and detailed descriptions for the specified L6 integrated 1U Intel server system. The lower sections of each table identify:

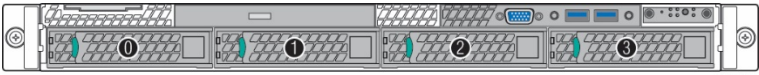
- The ship along components of the specified chassis product code – (product BOM)
- **Required Items** – Hardware required to be installed to the base system to achieve basic functionality using the default system feature set
- **Optional Accessories** – Some of the available accessories which can be installed to enhance the basic feature set of the server board / chassis. Additional accessories can be found in Chapter 5

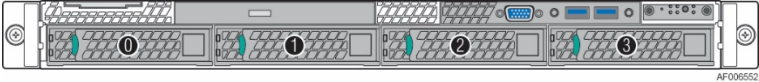
#### NOTES:

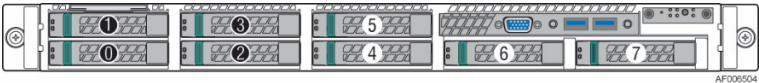
- Each **required item** and **optional accessory** is sold separately from the specified Intel L6 server system
- Items identified as **iPC** (Intel Product Code), are an orderable building block option, accessory or spare FRU
- In an effort to provide the complete product bill of materials, the ship along components list in each product table will include items identified by description and by **iPN** (Intel Part Number). The iPN information is provided for reference only. These components are **not** orderable as a spare or accessory.

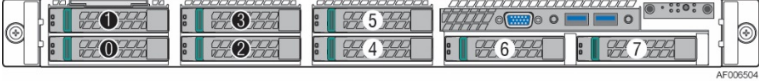


Figure 5. Intel® Server System R1000WT – L6 Integrated 1U System \*R1208WTxxx shown

<p><b>Intel Product Code (iPC):</b></p> <p style="text-align: center;"><b>R1304WTTGSR</b></p>  <p style="text-align: center;"><b>1U – 4 x 3.5" HDD or 4 x 2.5" SSD front mount drives</b></p>	<p><b>Order Code Information:</b></p> <p>MM# - 943891          UPC – 00735858300865          EAN – 5032037075954          MOQ – 1</p>	<p>Product Type: <b>L6 Integrated System</b>          Chassis Form Factor: <b>1U rack mount</b>          Chassis dimensions: <b>L=712mm, W=439mm, H=43.2mm</b>          Packaged Gross Weight: <b>21.3 Kgs, 47.0 Lbs</b>          Un-packaged Net Weight: <b>12.3 Kgs, 27.1 Lbs</b>          Outer Box Dimensions: <b>L=983mm, W=577mm, H=260mm</b></p>
<p><b>Product Definition and Configuration Requirements/Options</b></p>		
<p><u>Intel product code R1304WTTGSR includes the following components:</u></p> <p>(1) –1U Chassis with Quick Reference Label affixed to top cover          (1) – Intel® Server Board S2600WT w/ Dual <b>10GbE</b> – iPC <b>S2600WTTR</b>          (2) – Riser card assembly with single x16 PCIe* slot riser card – iPC <b>F1UL16RISER2</b>          (1) – 750W power supply module - iPC <b>FXX750PCRPS</b>          (1) – Power supply bay blank insert          (2) – AC Power Cord retention strap assembly – iPN H23961-00x          (4) – 3.5" Hot-swap drive bays with drive carriers and drive blanks              • Includes (1) 12 Gb SAS backplane – iPC <b>FR1304S3HSBP</b>              • Includes (4) 3.5" hot swap drive trays – iPC <b>FXX35HSCAR</b>          (1) – 800mm SAS/SATA Multiport data cable – iPC <b>AXXCBL1UHRHD</b>          (1) – 350mm Backplane power cable – iPN H38458-00x          (1) – 150mm Backplane I2C cable – iPN H39941-00x          (1) – Air duct          (6) – Dual rotor system fans – iPC <b>FR1UFAN10PW</b>          (1) – Standard control panel assembly (board only – iPC <b>FXXFPANEL</b>)          (1) – Front I/O Panel assembly (1 x VGA and 2 x USB)          (1) – SATA Optical drive bay with filler panel – (optical drive sold separately)              • Includes optical drive mounting latch kit – iPN H19168-00x              • Includes 550mm optical drive power cable – iPN G95880-00x          (2) – CPU heatsinks – iPC <b>FXXCA84X106HS</b>          (2) – CPU heat sink Mylar Spacer inserts – iPN H28618-00x          (8) – DIMM slot blanks – iPN G75158-00x          (2) – Chassis handle (1 set) installed – iPN H19171-00x          Spares for each screw type included</p>	<p style="text-align: center;"><b>Required Items – Sold Separately:</b></p> <ul style="list-style-type: none"> <li>• Rack Mount Kit – See chapter 5.11 for available options</li> <li>• 1 or 2 Intel® Xeon® Processor E5-2600 v3 product family</li> <li>• ECC DDR4 memory (RDIMM or LRDIMM)</li> <li>• Power Cord(s) – See chapter 5.10</li> </ul> <p>NOTE: L6 Systems shipping from Intel to North America will include (1) AC power cord</p>	<p style="text-align: center;"><b>Optional Intel Accessories – Sold Separately</b></p> <ul style="list-style-type: none"> <li>• iPC <b>FXX750PCRPS</b> – 2nd 750W AC Power supply module – to support power redundancy</li> <li>• Intel® 12G SAS RAID module + RMFBU - See chapter 5.9 for available options</li> <li>• SAS Data cable – Depending on the location of the SAS Data controller, a new data cable may be necessary. See chapter 4.2.1</li> <li>• Intel® I/O Module - See chapter 0 for available options</li> <li>• iPC <b>A1UBEZEL</b> – Lockable front system bezel</li> <li>• iPC <b>AXXRMM4LITE</b> - Intel® Remote Management Module 4 Lite key – For advanced management features</li> <li>• iPC <b>RKSATA4R5</b> – Embedded SATA ESRT2 SW RAID 5 support key</li> <li>• Storage Drives</li> </ul> <p>See Chapter 5 for all available accessory options.</p>

<p><b>Product Code (iPC):</b></p> <p style="text-align: center;"><b>R1304WT2GSR</b></p>  <p style="text-align: center;"><b>1U – 4 x 3.5" HDD or 4 x 2.5" SSD front mount drives</b></p>	<p><b>Order Code Information:</b></p> <p>MM# – 943892</p> <p>UPC – 00735858300872</p> <p>EAN – 5032037075961</p> <p>MOQ – 1</p>	<p>Product Type: <b>L6 Integrated System</b></p> <p>Chassis Form Factor: <b>1U rack mount</b></p> <p>Chassis dimensions: <b>L=712mm, W=439mm, H=43.2mm</b></p> <p>Packaged Gross Weight: <b>21.3 Kgs, 47.0 Lbs</b></p> <p>Un-packaged Net Weight: <b>12.3 Kgs, 27.1 Lbs</b></p> <p>Outer Box Dimensions: <b>L=983mm, W=577mm, H=260mm</b></p>
<p><b>Product Definition and Configuration Requirements/Options</b></p>		
<p><u>Intel product code <b>R1304WT2GSR</b> includes the following components:</u></p> <p>(1) – 1U Chassis with Quick Reference Label affixed to top cover</p> <p>(1) – Intel® Server Board S2600WT w/ Dual <b>1GbE</b> – iPC <b>S2600WT2R</b></p> <p>(2) – Riser card assembly with single x16 PCIe* slot riser card – iPC <b>F1UL16RISER2</b></p> <p>(1) – 750W power supply module - iPC <b>FXX750PCRPS</b></p> <p>(1) – Power supply bay blank insert</p> <p>(2) – AC Power Cord retention strap assembly – iPN H23961-00x</p> <p>(4) – 3.5" Hot-swap drive bays with drive carriers and drive blanks</p> <ul style="list-style-type: none"> <li>• Includes (1) 12 Gb SAS backplane – iPC <b>FR1304S3HSBP</b></li> <li>• Includes (4) 3.5" hot swap drive trays – iPC <b>FXX35HSCAR</b></li> </ul> <p>(1) – 800mm SAS/SATA Multiport data cable – iPC <b>AXXCBL1UHRHD</b></p> <p>(1) – 350mm Backplane power cable – iPN H38458-00x</p> <p>(1) – 150mm Backplane I2C cable – iPN H39941-00x</p> <p>(1) – Air duct</p> <p>(6) – Dual rotor system fans – iPC <b>FR1UFAN10PW</b></p> <p>(1) – Standard control panel assembly (board only – iPC <b>FXXFPANEL</b>)</p> <p>(1) – Front I/O Panel assembly (1 x VGA and 2 x USB)</p> <p>(1) – SATA Optical drive bay with filler panel – (optical drive sold separately)</p> <ul style="list-style-type: none"> <li>• Includes optical drive mounting latch kit – iPN H19168-00x</li> <li>• Includes 550mm optical drive power cable – iPN G95880-00x</li> </ul> <p>(2) – CPU heatsinks – iPC <b>FXXCA84X106HS</b></p> <p>(2) – CPU heat sink Mylar Spacer inserts – iPN H28618-00x</p> <p>(8) – DIMM slot blanks – iPN G75158-00x</p> <p>(2) – Chassis handle installed (1 set) – iPN H19171-00x</p> <p>Spares for each screw type included</p>	<p><b>Required Items – Sold Separately:</b></p> <ul style="list-style-type: none"> <li>• Rack Mount Kit – See chapter 5.11 for available options</li> <li>• 1 or 2 Intel® Xeon® Processor E5-2600 v3 product family</li> <li>• ECC DDR4 memory (RDIMM or LRDIMM)</li> <li>• Power Cord(s) – See chapter 5.10</li> </ul> <p>NOTE: L6 Systems shipping from Intel to North America will include (1) AC power cord</p>	<p><b>Optional Intel Accessories – Sold Separately</b></p> <ul style="list-style-type: none"> <li>• iPC <b>FXX750PCRPS</b> – 2nd 750W AC Power supply module – to support power redundancy</li> <li>• Intel® 12G SAS RAID module + RMFBU - See chapter 5.9 for available options</li> <li>• SAS Data cable – Depending on the location of the SAS Data controller, a new data cable may be necessary. See chapter 4.2.1</li> <li>• Intel® I/O Module - See chapter 0 for available options</li> <li>• iPC <b>A1UBEZEL</b> – Lockable front system bezel</li> <li>• iPC <b>AXXRMM4LITE</b> - Intel® Remote Management Module 4 Lite key – For advanced management features</li> <li>• iPC <b>RKSATA4R5</b> – Embedded SATA ESRT2 SW RAID 5 support key</li> <li>• Storage Drives</li> </ul> <p>See Chapter 5 for all available accessory options.</p>

<p><b>Product Code (iPC):</b></p> <p style="text-align: center;"><b>R1208WTTGSR</b></p>  <p style="text-align: center;"><b>1U – 8 x 2.5" front mount drives</b></p>	<p><b>Order Code Information:</b></p> <p>MM# – 943893</p> <p>UPC – 00735858300889</p> <p>EAN – 5032037075978</p> <p>MOQ – 1</p>	<p>Product Type: <b>L6 Integrated System</b></p> <p>Chassis Form Factor: <b>1U rack mount</b></p> <p>Chassis dimensions: <b>L=712mm, W=439mm, H=43.2mm</b></p> <p>Packaged Gross Weight: <b>21.1 Kgs, 46.5 Lbs</b></p> <p>Un-packaged Net Weight: <b>12.9 Kgs, 28.4 Lbs</b></p> <p>Outer Box Dimensions: <b>L=983mm, W=577mm, H=260mm</b></p>
<p><b>Product Definition and Configuration Requirements/Options</b></p>		
<p><u>Intel product code <b>R1208WTTGSR</b> includes the following components:</u></p> <p>(1) –1U Chassis with Quick Reference Label affixed to top cover</p> <p>(1) – Intel® Server Board S2600WT w/ Dual 10GbE – iPC <b>S2600WTTR</b></p> <p>(2) – Riser card assembly with single x16 PCIe* 3.0 slot riser card - <b>F1UL16RISER2</b></p> <p>(1) – 750W power supply module - iPC <b>FXX750PCRPS</b></p> <p>(1) – Power supply bay blank insert</p> <p>(2) – AC Power Cord retention strap assembly – iPN H23961-00x</p> <p>(1) – Air duct</p> <p>(6) – Dual rotor system fans – iPC <b>FR1UFAN10PW</b></p> <p>(1) – Standard control panel assembly (board only – iPC <b>FXXFPANEL</b>)</p> <p>(1) – Front I/O Panel assembly (1 x VGA and 2 x USB)</p> <ul style="list-style-type: none"> <li>• If removed, can be used as an optical drive bay.</li> <li>• Includes optical drive mounting latch kit – iPN H19168-00x</li> <li>• Includes optical drive power cable – iPN H23851-00x</li> </ul> <p>(8) – 2.5" Hot-swap drive bays with drive carriers and drive blanks</p> <ul style="list-style-type: none"> <li>• Includes (1) 12 Gb SAS backplane – iPC <b>F1U8X25S3HSBP</b></li> <li>• Includes (8) 2.5" hot swap drive trays – iPC <b>FXX25HSCAR2</b></li> </ul> <p>(1) – 730mm SAS/SATA Multiport data cable – iPC <b>AXXCBL730HRHD</b></p> <p>(1) – 800mm SAS/SATA Multiport data cable – iPC <b>AXXCBL800HRHD</b></p> <p>(1) – Backplane power cable – iPN H38458-00x</p> <p>(1) – 200mm Backplane I2C cable – iPN H23846-00x</p> <p>(2) – CPU heatsink – iPC <b>FXXCA84X106HS</b></p> <p>(8) – DIMM slot blanks – iPN G75158-00x</p> <p>(2) – Chassis handle (1 set) installed - iPN H19171-00x</p> <p>Spares for each screw type included</p>	<p><b>Required Items – Sold Separately:</b></p> <ul style="list-style-type: none"> <li>• Rack Mount Kit – See chapter 5.11 for available options</li> <li>• 1 or 2 Intel® Xeon® Processor E5-2600 v3 product family</li> <li>• ECC DDR4 memory (RDIMM or LRDIMM)</li> <li>• Power Cord(s) – See chapter 5.10</li> </ul> <p>NOTE: L6 Systems shipping from Intel to North America will include (1) AC power cord</p>	<p><b>Optional Intel Accessories – Sold Separately</b></p> <ul style="list-style-type: none"> <li>• iPC <b>FXX750PCRPS</b> – 2nd 750W AC Power supply module – to support power redundancy</li> <li>• Intel® 12G SAS RAID module + RMFBU - See chapter 5.9 for available options</li> <li>• SAS Data cables – Depending on the location of the SAS Data controller, new data cables may be necessary. See chapter 4.2.2</li> <li>• Intel® I/O Module - See chapter 0 for available options</li> <li>• iPC <b>A1U44X25NVMEDK</b> – (4) PCIe* SSD SFF (NVMe*) + (4) SAS support – replaces existing backplane and requires use of one PCIe* slot. See chapter 5.1 and/or System TPS for details</li> <li>• iPC <b>A1UBEZEL</b> – Lockable front system bezel</li> <li>• iPC <b>AXXRM4LITE</b> - Intel® Remote Management Module Lite key – For advanced management features</li> <li>• iPC <b>RKSATA4R5</b> – Embedded SATA ESRT2 SW RAID 5 support key</li> <li>• Storage Drives</li> </ul> <p>See Chapter 5 for all available accessory options.</p>

<p><b>Product Code (iPC):</b></p> <p style="text-align: center;"><b>R1208WT2GSR</b></p>  <p style="text-align: center;"><b>1U – 8 x 2.5" front mount drives</b></p>	<p><b>Order Code Information:</b></p> <p>MM# - 943894</p> <p>UPC – 00735858300896</p> <p>EAN – 5032037075985</p> <p>MOQ – 1</p>	<p>Product Type: <b>L6 Integrated System</b></p> <p>Chassis Form Factor: <b>1U rack mount</b></p> <p>Chassis dimensions: <b>L=712mm, W=439mm, H=43.2mm</b></p> <p>Packaged Gross Weight: <b>21.1 Kgs, 46.5 Lbs</b></p> <p>Un-packaged Net Weight: <b>12.9 Kgs, 28.4 Lbs</b></p> <p>Outer Box Dimensions: <b>L=983mm, W=577mm, H=260</b></p>
<p><b>Product Definition and Configuration Requirements/Options</b></p>		
<p>Intel product code <b>R1208WT2GSR</b> includes the following components:</p> <ul style="list-style-type: none"> <li>(1) – 1U Chassis with Quick Reference Label affixed to top cover</li> <li>(1) – Intel® Server Board S2600WT w/ Dual 1GbE – iPC <b>S2600WT2R</b></li> <li>(2) – Riser card assembly with single x16 PCIe* 3.0 slot riser card - <b>F1UL16RISER2</b></li> <li>(1) – 750W power supply module - iPC <b>FXX750PCRPS</b></li> <li>(1) – Power supply bay blank insert</li> <li>(2) – AC Power Cord retention strap assembly – iPN H23961-00x</li> <li>(1) – Air duct</li> <li>(6) – Dual rotor system fan – iPC <b>FR1UFAN10PW</b></li> <li>(1) – Standard control panel assembly (board only – iPC <b>FXXFPANEL</b>)</li> <li>(1) – Front I/O Panel assembly (1 x VGA and 2 x USB) <ul style="list-style-type: none"> <li>• If removed, can be used as an optical drive bay.</li> <li>• Includes optical drive mounting latch kit – iPN H19168-00x</li> <li>• Includes optical drive power cable – iPN H23851-00x</li> </ul> </li> <li>(8) – 2.5" Hot-swap drive bays with drive carriers and drive blanks <ul style="list-style-type: none"> <li>• Includes (1) 12 Gb SAS backplane – iPC <b>F1U8X25S3HSBP</b></li> <li>• Includes (8) 2.5" hot swap drive trays – iPC <b>FXX25HSCAR2</b></li> </ul> </li> <li>(1) – 730mm SAS/SATA Multiport data cable – iPC <b>AXXCBL730HRHD</b></li> <li>(1) – 800mm SAS/SATA Multiport data cable – iPC <b>AXXCBL800HRHD</b></li> <li>(1) – Server board to backplane power cable – iPN H38458-00x</li> <li>(1) – Server board to backplane I2C cable – iPN H39941-00x</li> <li>(2) – CPU heatsink – iPC <b>FXXCA84X106HS</b></li> <li>(8) – DIMM slot blanks – iPN G75158-00x</li> <li>(2) – Chassis handle (1 set) installed – iPN H19171-00x</li> </ul> <p>Spares for each screw type included</p>	<p><b>Required Items – Sold Separately:</b></p> <ul style="list-style-type: none"> <li>• Rack Mount Kit – See chapter 5.11 for available options</li> <li>• 1 or 2 Intel® Xeon® Processor E5-2600 v3 product family</li> <li>• ECC DDR4 memory (RDIMM or LRDIMM)</li> <li>• Power Cord(s) – See chapter 5.10</li> </ul> <p>NOTE: L6 Systems shipping from Intel to North America will include (1) AC power cord</p>	<p><b>Optional Intel Accessories – Sold Separately</b></p> <ul style="list-style-type: none"> <li>• iPC <b>FXX750PCRPS</b> – 2nd 750W AC Power supply module – to support power redundancy</li> <li>• Intel® 12G SAS RAID module + RMFBU - See chapter 5.9 for available options</li> <li>• SAS Data cables – Depending on the location of the SAS Data controller, new data cables may be necessary. See chapter 4.2.2</li> <li>• Intel® I/O Module - See chapter 0 for available options</li> <li>• iPC <b>A1U44X25NVMEDK</b> – (4) PCIe* SSD SFF (NVMe*) + (4) SAS support – replaces existing backplane and requires use of one PCIe* slot. See chapter 5.1 and/or System TPS for details</li> <li>• iPC <b>A1UBEZEL</b> – Lockable front system bezel</li> <li>• iPC <b>AXXRMM4LITE</b> - Intel® Remote Management Module Lite key – For advanced management features</li> <li>• iPC <b>RKSATA4R5</b> – Embedded SATA ESRT2 SW RAID 5 support key</li> <li>• Storage Drives</li> </ul> <p>See Chapter 5 for all available accessory options.</p>

## 3.2 Intel® Server System R2000WT Product Family SKUs – (2U Rack Mount System)

The product tables found in this section provide order code information and detailed descriptions for the specified L6 integrated 2U Intel server system. The lower sections of each table identify:

- The ship along components of the specified chassis product code – (product BOM)
- **Required Items** – The options required to be installed to the base system to achieve basic functionality using the default system feature set
- **Optional Accessories** – Some of the available accessories which can be installed to enhance the basic feature set of the server board / chassis. Additional accessories can be found in Chapter 5

### NOTES:

- Each **required item** and **optional accessory** is sold separately from the specified Intel L6 server system
- Items identified as **iPC** (Intel Product Code), are an orderable building block option, accessory or spare FRU
- In an effort to provide the complete product bill of materials, the ship along components list in each product table will include items identified by description and by **iPN** (Intel Part Number). The iPN information is provided for reference only. These components are **not** orderable as a spare or accessory.

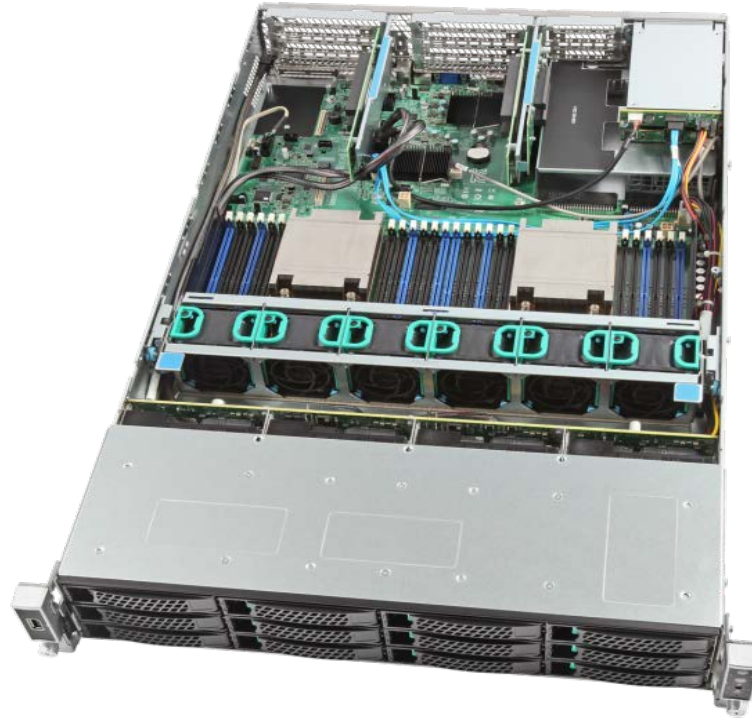
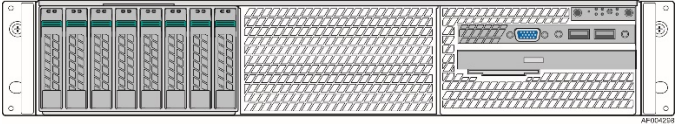
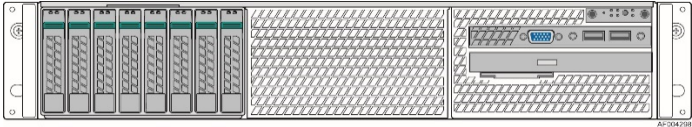
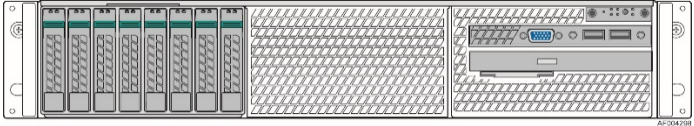


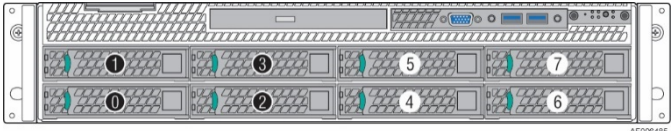
Figure 6. Intel® Server System R2000WT – L6 Integrated 2U System \*R2312WTxxx shown

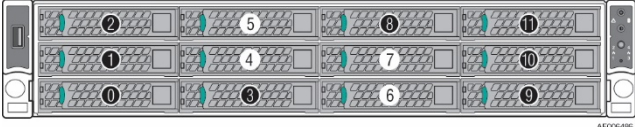


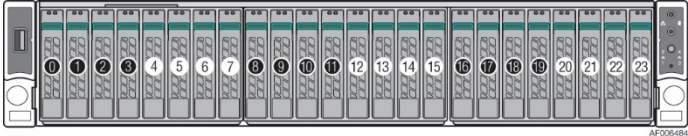
<p><b>Product Code (iPC):</b></p> <p style="text-align: center;"><b>R2208WT2YSR</b></p>  <p style="text-align: center;"><b>2U – 8 x 2.5" front mount drives</b></p>	<p><b>Order Code Information:</b></p> <p>MM# – 943827</p> <p>UPC – 00735858300919</p> <p>EAN – 5032037076005</p> <p>MOQ – 1</p>	<p>Product Type: <b>L6 Integrated System</b></p> <p>Chassis Form Factor: <b>2U rack mount</b></p> <p>Chassis dimensions: <b>L=712mm, W=439mm, H=89mm</b></p> <p>Packaged Gross Weight: <b>22.9 Kgs, 50.5 Lbs</b></p> <p>Un-packaged Net Weight: <b>16.2 Kgs, 35.7 Lbs</b></p> <p>Outer Box Dimensions: <b>L=983mm, W=577mm, H=260mm</b></p>
<p><b>Product Definition and Configuration Requirements/Options</b></p>		
<p><u>Intel product code <b>R2208WT2YSR</b> includes the following:</u></p> <ul style="list-style-type: none"> <li>(1) – 2U Chassis with Quick Reference Label affixed to top cover</li> <li>(1) – Intel® Server Board S2600WT w/ Dual <b>1GbE</b> – iPC <b>S2600WT2R</b></li> <li>(1) – 1100W AC Power Supply Module – iPC <b>AXX1100PCRPS</b></li> <li>(1) – Power supply bay blank insert</li> <li>(2) – AC Power Cord retention strap assembly – iPN H23961-00x</li> <li>(2) – PCIe Riser card brackets             <ul style="list-style-type: none"> <li>o Includes (2) 3-slot PCIe* riser cards – iPC <b>A2UL8RISER2</b></li> <li>o Includes (1) 2-slot low profile PCIe* riser card – iPC <b>A2UX8X4RISER</b></li> </ul> </li> <li>(1) – Air duct</li> <li>(6) – Hot swap system fans – iPC <b>FR2UFAN60HSW</b></li> <li>(1) – Standard control panel assembly (board only – iPC <b>FXXFPANEL</b>)</li> <li>(1) – Front I/O Panel assembly (1 x VGA and 2 x USB)</li> <li>(1) – SATA Optical drive bay with filler panel – (optical drive sold separately)             <ul style="list-style-type: none"> <li>• Includes optical drive mounting latch kit – iPN H19168-00x</li> <li>• Includes 300mm optical drive / internal mount SSD power cable – iPN H23901-00x</li> </ul> </li> <li>(8) – 2.5" Hot-swap drive bays with drive carriers and drive blanks             <ul style="list-style-type: none"> <li>• Includes (1) 12Gb SAS backplane – iPC <b>A2U8X25S3HSDK</b></li> <li>• Includes (8) 2.5" hot swap drive trays – iPC <b>FXX25HSCAR2</b></li> </ul> </li> <li>(2) – Multiport 730mm SAS/SATA data cables – iPC <b>AXXCBL730HDHD</b></li> <li>(1) – Backplane 250mm I2C cable – iPN G41809-00x</li> <li>(1) – Backplane power cable – iPN H23927-00x</li> <li>(2) – CPU heatsinks – iPC <b>FXXCA84X106HS</b></li> <li>(2) – CPU heat sink Mylar Spacer inserts – iPN H28618-00x</li> <li>(8) – DIMM slot blanks – iPN G75158-00x</li> <li>(2) – Chassis handle (1 set) installed – iPN H18229-xxx</li> <li>(1) – 3x RMFBU Mounting Bracket – iPN H18238-00x</li> </ul> <p>Spares for each screw type included</p>	<p><u>Required Items – Sold Separately:</u></p> <ul style="list-style-type: none"> <li>• Rack Mount Kit – See chapter 5.11 for available options</li> <li>• 1 or 2 Intel® Xeon® Processor E5-2600 v3 product family</li> <li>• ECC DDR4 memory (RDIMM or LRDIMM)</li> <li>• Power Cord(s) – See chapter 5.10</li> </ul> <p>NOTE: L6 Systems shipping from Intel to North America will include (1) AC power cord</p>	<p><u>Optional Intel Accessories – Sold Separately</u></p> <ul style="list-style-type: none"> <li>• iPC <b>AXX1100PCRPS</b> – 1100W AC Power Supply Module – to support power redundancy</li> <li>• Intel® I/O Module - See chapter 0 for available options</li> <li>• Intel® 12G SAS RAID module + RMFBU - See chapter 5.9 for available options</li> <li>• SAS Data cables – Depending on the location of the SAS Data controller, new data cables may be necessary. See chapter 4.2.5</li> <li>• iPC <b>A2U44X25NVMEDK</b> – (4) PCIe* SSD SFF (NVMe*) + (4) SAS support – requires use of one PCIe* slot. See chapter 5.2 and/or System TPS for details</li> <li>• 8x2.5" Drive Bay Module upgrade kit. See chapter 5.5 for available options.</li> <li>• iPC <b>A2UBEZEL</b> – Lockable front system bezel</li> <li>• iPC <b>AXXRMM4LITE</b> - Intel® Remote Management Module Lite key – For advanced management features</li> <li>• iPC <b>RKSATA4R5</b> – Embedded SATA ESRT2 SW RAID-5 support key</li> <li>• Storage Drives</li> </ul> <p>See Chapter 5 for all available accessory options.</p>

<p><b>Product Code (iPC):</b></p> <p style="text-align: center;"><b>R2208WTTYSR</b></p>  <p style="text-align: center;"><b>2U – 8 x 2.5" front mount drives</b></p>	<p><b>Order Code Information:</b></p> <p>MM# – 943826                  UPC – 00735858300902                  EAN – 5032037075992                  MOQ – 1</p>	<p>Product Type: <b>L6 Integrated System</b>                  Chassis Form Factor: <b>2U rack mount</b>                  Chassis dimensions: <b>L=712mm, W=439mm, H=89mm</b>                  Packaged Gross Weight: <b>22.9 Kgs, 50.5 Lbs</b>                  Un-packaged Net Weight: <b>16.2 Kgs, 35.7 Lbs</b>                  Outer Box Dimensions: <b>L=983mm, W=577mm, H=260mm</b></p>
Product Definition and Configuration Requirements/Options		
<p>Intel product code <b>R2208WTTYSR</b> includes the following:</p> <ul style="list-style-type: none"> <li>(1) – 2U Chassis with Quick Reference Label affixed to top cover</li> <li>(1) – Intel® Server Board S2600WT w/ Dual <b>10GbE</b> – iPC <b>S2600WTR</b></li> <li>(1) – 1100W AC Power Supply Module – iPC <b>AXX1100PCRPS</b></li> <li>(1) – Power supply bay blank insert</li> <li>(2) – AC Power Cord retention strap assembly – iPN H23961-00x</li> <li>(2) – PCIe Riser card brackets                         <ul style="list-style-type: none"> <li>o Includes (2) 3-slot PCIe* riser cards – iPC <b>A2UL8RISER2</b></li> <li>o Includes (1) 2-slot low profile PCIe* riser card – iPC <b>A2UX8X4RISER</b></li> </ul> </li> <li>(1) – Air duct</li> <li>(6) – Hot swap system fans – iPC <b>FR2UFAN60HSW</b></li> <li>(1) – Standard control panel assembly (board only – iPC <b>FXXFPANEL</b>)</li> <li>(1) – Front I/O Panel assembly (1 x VGA and 2 x USB)</li> <li>(1) – SATA Optical drive bay with filler panel – (optical drive sold separately)                         <ul style="list-style-type: none"> <li>• Includes optical drive mounting latch kit – iPN H19168-00x</li> <li>• Includes 300mm optical drive / internal mount SSD power cable – iPN H23901-00x</li> </ul> </li> <li>(8) – 2.5" Hot-swap drive bays with drive carriers and drive blanks                         <ul style="list-style-type: none"> <li>• Includes (1) 12Gb SAS backplane – iPC <b>A2U8X25S3HSDK</b></li> <li>• Includes (8) 2.5" hot swap drive trays – iPC <b>FXX25HSCAR2</b></li> </ul> </li> <li>(2) – Multiport 730mm SAS/SATA data cables – iPC <b>AXXCBL730HDHD</b></li> <li>(1) – Backplane 250mm I2C cable – iPN G41809-00x</li> <li>(1) – Backplane power cable – iPN H23927-00x</li> <li>(2) – CPU heatsinks – iPC <b>FXXCA84X106HS</b></li> <li>(2) – CPU heat sink Mylar Spacer inserts – iPN H28618-00x</li> <li>(8) – DIMM slot blanks – iPN G75158-00x</li> <li>(2) – Chassis handle (1 set) installed – iPN H18229-xxx</li> <li>(1) – 3x RMFBU Mounting Bracket – iPN H18238-00x</li> </ul> <p>Spares for each screw type included</p>	<p><b>Required Items – Sold Separately:</b></p> <ul style="list-style-type: none"> <li>• Rack Mount Kit – See chapter 5.11 for available options</li> <li>• 1 or 2 Intel® Xeon® Processor E5-2600 v3 product family</li> <li>• ECC DDR4 memory (RDIMM or LRDIMM)</li> <li>• Power Cord(s) – See chapter 5.10</li> </ul> <p>NOTE: L6 Systems shipping from Intel to North America will include (1) AC power cord</p>	<p><b>Optional Intel Accessories – Sold Separately</b></p> <ul style="list-style-type: none"> <li>• iPC <b>AXX1100PCRPS</b> – 1100W AC Power Supply Module – to support power redundancy</li> <li>• Intel® I/O Module - See chapter 0 for available options</li> <li>• Intel® 12G SAS RAID module + RMFBU - See chapter 5.9 for available options</li> <li>• SAS Data cables – Depending on the location of the SAS Data controller, new data cables may be necessary. See chapter 4.2.5</li> <li>• iPC <b>A2U44X25NVMEDK</b> – (4) PCIe* SSD SFF (NVMe*) + (4) SAS support – requires use of one PCIe* slot. See chapter 5.2 and/or System TPS for details</li> <li>• 8x2.5" Drive Bay Module upgrade kit. See chapter 5.5 for available options.</li> <li>• iPC <b>A2UBEZEL</b> – Lockable front system bezel</li> <li>• iPC <b>AXXRMM4LITE</b> - Intel® Remote Management Module Lite key – For advanced management features</li> <li>• iPC <b>RKSATA4R5</b> – Embedded SATA ESRT2 SW RAID-5 support key</li> <li>• Storage Drives</li> </ul> <p>See Chapter 5 for all available accessory options.</p>

<p><b>Product Code (iPC):</b></p> <p style="text-align: center;"><b>R2208WTTYC1R</b></p>  <p style="text-align: center;"><b>2U – 8 x 2.5" front mount drives</b></p>	<p><b>Order Code Information:</b></p> <p>MM# – 943828          UPC – 00735858300926          EAN – 5032037076012          MOQ – 1</p>	<p>Product Type: <b>L6 Integrated System</b>          Special - <b>Features to support passive Intel® Xeon Phi™ coprocessor</b>          NOTE: Intel® Xeon Phi™ cards with Active heat sinks are NOT supported in this SKU.          Chassis Form Factor: <b>2U</b>          Chassis dimensions: <b>L=712mm, W=439mm, H=89mm</b>          Packaged Gross Weight: <b>22.9 Kgs, 50.5 Lbs</b>          Un-packaged Net Weight: <b>16.2 Kgs, 35.7 Lbs</b>          Outer Box Dimensions: <b>L=983mm, W=577mm, H=260mm</b></p>
<p style="text-align: center;"><b>Product Definition and Configuration Requirements/Options</b></p>		
<p>Intel product code <b>R2208WTTYC1R</b> includes the following:</p> <ul style="list-style-type: none"> <li>(1) – 2U Chassis with Quick Reference Label affixed to top cover</li> <li>(1) – Intel® Server Board S2600WT w/ Dual <b>10GbE</b> – iPC <b>S2600WTTR</b></li> <li>(2) – 1100W AC Power Supply Module – iPC <b>AXX1100PCRPS</b></li> <li>(2) – AC Power Cord retention strap assembly – iPN H23961-00x</li> <li>(2) – PCIe Riser card brackets             <ul style="list-style-type: none"> <li>o Includes (2) 2-slot PCIe* riser cards – iPC <b>A2UL16RISER2</b></li> <li>o Includes (1) 2-slot low profile PCIe* riser card – iPC <b>A2UX8X4RISER</b></li> </ul> </li> <li>(1) – High air flow air duct (iPC <b>AWTCOPRODUCT</b>)</li> <li>(1) – Intel® Xeon Phi™ / GPGPU Secure Mount Adapter Bracket kit</li> <li>(2) – 12V-Auxiliary Power Cables – iPC <b>AXXGPGPUCABLE</b></li> <li>(6) – Hot swap system fans – iPC <b>FR2UFAN60HSW</b></li> <li>(1) – Standard control panel assembly (board only – iPC <b>FXXFPANEL</b>)</li> <li>(1) – Front I/O Panel assembly (1 x VGA and 2 x USB)</li> <li>(1) – SATA Optical drive bay with filler panel – (optical drive sold separately)             <ul style="list-style-type: none"> <li>• Includes optical drive mounting latch kit – iPN H19168-00x</li> <li>• Includes 300mm optical drive / internal mount SSD power cable – iPN H23901-00x</li> </ul> </li> <li>(8) – 2.5" Hot-swap drive bays with drive carriers and drive blanks             <ul style="list-style-type: none"> <li>• Includes (1) 12 Gb SAS backplane – iPC <b>A2U8X25S3HSDK</b></li> <li>• Includes (8) 2.5" hot swap drive trays – iPC <b>FXX25HSCAR2</b></li> </ul> </li> <li>(2) – Multiport 730mm SAS/SATA data cables – iPC <b>AXXCBL730HDHD</b></li> <li>(1) – Backplane 250mm I2C cable – iPN G41809-00x</li> <li>(1) – Backplane power cable – iPN H23927-00x</li> <li>(2) – CPU heatsinks – iPC <b>FXXCA84X106HS</b></li> <li>(2) – CPU heat sink Mylar Spacer inserts – iPN H28618-00x</li> <li>(8) – DIMM slot blanks – iPN G75158-00x</li> <li>(2) – Chassis handle (1 set) installed – iPN H18229-xxx</li> <li>(1) – 3x RMFBU Mounting Bracket – iPN H18238-00x</li> </ul> <p>Spares for each screw type included</p>	<p><b><u>Required Items – Sold Separately:</u></b></p> <ul style="list-style-type: none"> <li>• Rack Mount Kit – See chapter 5.11 for available options</li> <li>• 1 or 2 Intel® Xeon® Processor E5-2600 v3 product family</li> <li>• ECC DDR4 memory (RDIMM or LRDIMM)</li> <li>• Power Cord(s) – See chapter 5.10</li> </ul> <p>NOTE: L6 Systems shipping from Intel to North America will include (2) AC power cords</p>	<p><b><u>Optional Intel Accessories – Sold Separately</u></b></p> <ul style="list-style-type: none"> <li>• Intel® I/O Module - See chapter 0 for available options</li> <li>• Intel® 12G SAS RAID module + RMFBU - See chapter 5.9 for available options</li> <li>• SAS Data cables – Depending on the location of the SAS Data controller, new data cables may be necessary. See chapter 4.2.5</li> <li>• iPC <b>A2U44X25NVMEDK</b> – (4) PCIe* SSD SFF (NVMe*) + (4) SAS support – requires use of one PCIe* slot. See chapter 5.2 and/or System TPS for details</li> <li>• 8x2.5" Drive Bay Module upgrade kit. See chapter 5.5 for available options.</li> <li>• iPC <b>A2UBEZEL</b> – Lockable front system bezel</li> <li>• iPC <b>AXXRMM4LITE</b> - Intel® Remote Management Module Lite key – For advanced management features</li> <li>• iPC <b>RKSATA4R5</b> – Embedded SATA ESRT2 SW RAID-5 support key</li> <li>• Storage Drives</li> </ul> <p>See Chapter 5 for all available accessory options.</p>

<p><b>Product Code (iPC):</b></p> <p style="text-align: center;"><b>R2308WTTYSR</b></p>  <p style="text-align: center;"><b>2U – 8 x 3.5" HDD or 8 x 2.5" SSD front mount drives</b></p>	<p><b>Order Code Information:</b></p> <p>MM# – 943829  UPC – 00735858300933  EAN – 5032037076029  MOQ – 1</p>	<p>Product Type: <b>L6 Integrated System</b>  Chassis Form Factor: <b>2U rack mount</b>  Chassis dimensions: <b>L=712mm, W=439mm, H=89mm</b>  Packaged Gross Weight: <b>23.5 Kgs, 51.8 Lbs</b>  Un-packaged Net Weight: <b>16.1 Kgs, 35.5 Lbs</b>  Outer Box Dimensions: <b>L=983mm, W=577mm, H=260mm</b></p>
<p><b>Product Definition and Configuration Requirements/Options</b></p>		
<p>Intel product code <b>R2308WTTYSR</b> includes the following:</p> <ul style="list-style-type: none"> <li>(1) – 2U Chassis with Quick Reference Label affixed to top cover</li> <li>(1) – Intel® Server Board S2600WT w/ Dual <b>10GbE</b> – iPC <b>S2600WTTR</b></li> <li>(1) – 1100W AC Power Supply Module – iPC <b>AXX1100PCRPS</b></li> <li>(1) – Power supply bay blank insert</li> <li>(2) – AC Power Cord retention strap assembly – iPN H23961-00x</li> <li>(2) – PCIe Riser card brackets <ul style="list-style-type: none"> <li>o Includes (2) 3-slot PCIe* riser cards – iPC <b>A2UL8RISER2</b></li> <li>o Includes (1) 2-slot low profile PCIe* riser card – iPC <b>A2UX8X4RISER</b></li> </ul> </li> <li>(1) – Air duct</li> <li>(6) – Hot swap system fans – iPC <b>FR2UFAN60HSW</b></li> <li>(1) – Standard control panel assembly (board only – iPC <b>FXXFPANEL</b>)</li> <li>(1) – Front I/O Panel assembly (1 x VGA and 2 x USB)</li> <li>(1) – SATA Optical drive bay with filler panel – (optical drive sold separately) <ul style="list-style-type: none"> <li>• Includes optical drive mounting latch kit – iPN H19168-00x</li> <li>• Includes 500mm optical drive / internal mount SSD power cable – iPN G95878-00x</li> </ul> </li> <li>(8) – 3.5" Hot-swap drive bays with drive carriers and drive blanks <ul style="list-style-type: none"> <li>• Includes (1) 12 Gb SAS backplane – iPC <b>F2U8X35S3HSBP</b></li> <li>• Includes (8) 3.5" hot swap drive carriers – iPC <b>FXX35HSCAR</b></li> </ul> </li> <li>(1) – Backplane power cable – iPN H38457-00x</li> <li>(1) – Multiport 800mm SAS/SATA data cables – iPC <b>AXXCBL800HDHD</b></li> <li>(1) – Multiport 950mm SAS/SATA data cables – iPC <b>AXXCBL950HDHD</b></li> <li>(1) – Backplane I2C cable – iPN G92510-00x</li> <li>(2) – CPU heatsinks – iPC <b>FXXCA84X106HS</b></li> <li>(2) – CPU heat sink Mylar Spacer inserts – iPN H28618-00x</li> <li>(8) – DIMM slot blanks – iPN G75158-00x</li> <li>(2) – Chassis handle (1 set) installed – iPN H18229-xxx</li> <li>(1) – 3x RMFBU Mounting Bracket – iPN H18238-00x</li> </ul> <p>Spares for each screw type included</p>	<p><b>Required Items – Sold Separately:</b></p> <ul style="list-style-type: none"> <li>• Rack Mount Kit – See chapter 5.11 for available options</li> <li>• 1 or 2 Intel® Xeon® Processor E5-2600 v3 product family</li> <li>• ECC DDR4 memory (RDIMM or LRDIMM)</li> <li>• Power Cord(s) – See chapter 5.10</li> </ul> <p>NOTE: L6 Systems shipping from Intel to North America will include (1) AC power cord</p>	<p><b>Optional Intel Accessories – Sold Separately</b></p> <ul style="list-style-type: none"> <li>• iPC <b>AXX1100PCRPS</b> – 1100W AC Power Supply Module – to support power redundancy</li> <li>• Intel® I/O Module - See chapter 0 for available options</li> <li>• Intel® 12G SAS RAID module + RMFBU - See chapter 5.9 for available options</li> <li>• SAS Data cables – Depending on the location of the SAS Data controller, new data cables may be necessary. See chapter 4.2.3</li> <li>• iPC <b>A2UBEZEL</b> – Lockable front system bezel</li> <li>• iPC <b>AXXRMM4LITE</b> - Intel® Remote Management Module Lite key – For advanced management features</li> <li>• iPC <b>RKSATA4R5</b> – Embedded SATA ESRT2 SW RAID-5 support key</li> <li>• Storage Drives</li> </ul> <p>See Chapter 5 for all available accessory options.</p>

<p><b>Product Code (iPC):</b></p> <p style="text-align: center;"><b>R2312WTTYSR</b></p>  <p style="text-align: center;"><b>2U – 12 x 3.5" HDD or 12 x 2.5" SSD front mount drives</b></p>	<p><b>Order Code Information:</b></p> <p>MM# – 943830          UPC – 00735858300940          EAN – 5032037076036          MOQ – 1</p>	<p>Product Type: <b>L6 Integrated System</b>          Chassis Form Factor: <b>2U rack mount</b>          Chassis dimensions: <b>L=712mm, W=439mm, H=89mm</b>          Packaged Gross Weight: <b>24.4 Kgs, 53.8 Lbs</b>          Un-packaged Net Weight: <b>17.0 Kgs, 37.5 Lbs</b>          Outer Box Dimensions: <b>L=983mm, W=577mm, H=260mm</b></p>
<p><b>Product Definition and Configuration Requirements/Options</b></p>		
<p>Intel product code <b>R2312WTTYSR</b> includes the following:</p> <ul style="list-style-type: none"> <li>(1) – 2U Chassis with Quick Reference Label affixed to top cover</li> <li>(1) – Intel® Server Board S2600WT w/ Dual 10GbE – iPC <b>S2600WTTR</b></li> <li>(1) – 1100W AC Power Supply Module – iPC <b>AXX1100PCRPS</b></li> <li>(1) – Power supply bay blank insert</li> <li>(2) – AC Power Cord retention strap assembly – iPN H23961-00x</li> <li>(2) – PCIe Riser card brackets             <ul style="list-style-type: none"> <li>o Includes (2) 3-slot PCIe* riser cards – iPC <b>A2UL8RISER2</b></li> </ul> </li> <li>(1) – Air duct</li> <li>(6) – Hot swap system fans – iPC <b>FR2UFAN60HSW</b></li> <li>(2) – Chassis Handles (1 set) installed – includes Integrated control panel &amp; USB Port - iPC <b>A2UHANDLKIT</b></li> <li>(1) – 500mm internal mount SSD power cable – iPN G95878-00x</li> <li>(12) – 3.5" Hot-swap drive bays with drive carriers and drive blanks             <ul style="list-style-type: none"> <li>• Includes (1) 12 Gb SAS backplane – iPC <b>F2U12X35S3HSBP</b></li> <li>• Includes (12) 3.5" hot swap drive carriers – iPC <b>FXX35HSCAR</b></li> </ul> </li> <li>(1) – Multiport 800mm SAS/SATA data cable – iPC <b>AXXCBL800HDHD</b></li> <li>(1) – Multiport 875mm SAS/SATA data cable – iPC <b>AXXCBL875HDHD</b></li> <li>(1) – Multiport 950mm SAS/SATA data cable – iPC <b>AXXCBL950HDHD</b></li> <li>(1) – Backplane I2C cable – iPN G92510-00x</li> <li>(1) – Backplane power cable – iPN G92685-00x</li> <li>(2) – 2.5" Rear Mount Hot Swap Drive Bays with drive carriers, drive blanks, SATA data/SGPIO cable harness, and I2C cable (Intel Accessory Kit – iPC <b>A2UREARHSDK</b>)</li> <li>(2) – CPU heatsinks – iPC <b>FXXCA84X106HS</b></li> <li>(2) – CPU heat sink Mylar Spacer inserts – iPN H28618-00x</li> <li>(16) – DIMM slot blanks – iPN G75158-00x</li> <li>(1) – 3x RMFBU Mounting Bracket – iPN H18238-00x</li> </ul> <p>Spares for each screw type included</p>	<p><b>Required Items – Sold Separately:</b></p> <ul style="list-style-type: none"> <li>• Rack Mount Kit – See chapter 5.11 for available options</li> <li>• 1 or 2 Intel® Xeon® Processor E5-2600 v3 product family</li> <li>• ECC DDR4 memory (RDIMM or LRDIMM)</li> <li>• Power Cord(s) – See chapter 5.10</li> </ul> <p>NOTE: L6 Systems shipping from Intel to North America will include (1) AC power cord</p>	<p><b>Optional Intel Accessories – Sold Separately</b></p> <ul style="list-style-type: none"> <li>• iPC <b>AXX1100PCRPS</b> – 1100W AC Power Supply Module – to support power redundancy</li> <li>• Intel® I/O Module - See chapter 0 for available options</li> <li>• Intel® 12G SAS RAID module + RMFBU - See chapter 5.9 for available options</li> <li>• Intel® SAS Expander – See Chapter 0 for available options</li> <li>• SAS Data cables – Depending on the location of the SAS Data controller, new data cables may be necessary. See chapter 4.2.44.2.3</li> <li>• iPC <b>A2UBEZEL</b> – Lockable front system bezel</li> <li>• iPC <b>AXXRMM4LITE</b> - Intel® Remote Management Module Lite key – For advanced management features</li> <li>• Storage Drives</li> </ul> <p>See Chapter 5 for all available accessory options.</p>

<p><b>Product Code (iPC):</b></p> <p style="text-align: center;"><b>R2224WTTYSR</b></p>  <p style="text-align: center;"><b>2U – 24 x 2.5" front mount drives</b></p>	<p><b>Order Code Information:</b></p> <p>MM# – 943831</p> <p>UPC – 00735858300957</p> <p>EAN – 5032037076043</p> <p>MOQ – 1</p>	<p>Product Type: <b>L6 Integrated System</b></p> <p>Chassis Form Factor: <b>2U</b></p> <p>Chassis dimensions: <b>L=712mm, W=439mm, H=89mm</b></p> <p>Packaged Gross Weight: <b>25.0 Kgs, 55.1 Lbs</b></p> <p>Un-packaged Net Weight: <b>18.3 Kgs, 40.3 Lbs</b></p> <p>Outer Box Dimensions: <b>L=983mm, W=577mm, H=260mm</b></p>
<p><b>Product Definition and Configuration Requirements/Options</b></p>		
<p>Intel product code <b>R2224WTTYSR</b> includes the following:</p> <ul style="list-style-type: none"> <li>(1) – 2U Chassis with Quick Reference Label affixed to top cover</li> <li>(1) – Intel® Server Board S2600WT w/ Dual <b>10GbE</b> – iPC <b>S2600WTTR</b></li> <li>(1) – 1100W AC Power Supply Module – iPC <b>AXX1100PCRPS</b></li> <li>(1) – Power supply bay blank insert</li> <li>(2) – AC Power Cord retention strap assembly – iPN H23961-00x</li> <li>(2) – PCIe Riser card brackets             <ul style="list-style-type: none"> <li>o Includes (2) 3-slot PCIe* riser cards – iPC <b>A2UL8RISER2</b></li> </ul> </li> <li>(1) – Air duct</li> <li>(6) – Hot swap system fans – iPC <b>FR2UFAN60HSW</b></li> <li>(2) – Chassis Handles (1 set) installed – includes Integrated control panel &amp; USB Port - iPC <b>A2UHANDLKIT</b></li> <li>(24) – 2.5" Hot-swap drive bays with drive carriers and drive blanks             <ul style="list-style-type: none"> <li>• Includes (3) 12 Gb SAS backplanes – iPC <b>A2U8X25S3HSDK</b></li> <li>• Includes (24) 2.5" hot swap drive trays – iPC <b>FXX25HSCAR2</b></li> <li>• Includes (2) backplane to backplane I2C jumper cables – iPN G17347-00x</li> </ul> </li> <li>(1) – Backplane power cable – iPN H23927-00x</li> <li>(2) – 2.5" Rear Mount Hot Swap Drive Bays with drive carriers, drive blanks, SATA data/SGPIO cable harness, and I2C cable (Intel Accessory Kit – iPC <b>A2UREARHSDK</b>)</li> <li>(2) – Multiport 730mm SAS/SATA data cables – iPC <b>AXXCBL730HDHD</b></li> <li>(4) – Multiport 875mm SAS/SATA data cables – iPC <b>AXXCBL875HDHD</b></li> <li>(1) – Backplane 250mm I2C cable – iPN G41809-00x</li> <li>(1) – Rear Backplane power cable – iPN H24615-00x</li> <li>(2) – CPU heatsinks – iPC <b>FXXCA84X106HS</b></li> <li>(2) – CPU heat sink Mylar Spacer inserts – iPN H28618-00x</li> <li>(16) – DIMM slot blanks – iPN G75158-00x</li> <li>(2) – Chassis handle (1 set) – iPN H18229-xxx</li> <li>(1) – 3x RMFBU Mounting Bracket – iPN H18238-00x</li> </ul> <p>Spares for each screw type included</p>	<p><b>Required Items – Sold Separately:</b></p> <ul style="list-style-type: none"> <li>• Rack Mount Kit – See chapter 5.11 for available options</li> <li>• 1 or 2 Intel® Xeon® Processor E5-2600 v3 product family</li> <li>• ECC DDR4 memory (RDIMM or LRDIMM)</li> <li>• Power Cord(s) – See chapter 5.10</li> </ul> <p>NOTE: L6 Systems shipping from Intel to North America will include (1) AC power cord</p>	<p><b>Optional Intel Accessories – Sold Separately</b></p> <ul style="list-style-type: none"> <li>• iPC <b>AXX1100PCRPS</b> – 1100W AC Power Supply Module – to support power redundancy</li> <li>• Intel® I/O Module - See chapter 0 for available options</li> <li>• Intel® 12G SAS RAID module + RMFBU - See chapter 5.9 for available options</li> <li>• Intel® SAS Expander – See Chapter 0 for available options</li> <li>• SAS Data cables – Depending on the location of the SAS Data controller, new data cables may be necessary. See chapter 4.2.54.2.3</li> <li>• iPC <b>A2UBEZEL</b> – Lockable front system bezel</li> <li>• iPC <b>AXXRMM4LITE</b> - Intel® Remote Management Module Lite key – For advanced management features</li> <li>• Storage Drives</li> </ul> <p>See Chapter 5 for all available accessory options.</p>

## 4 SAS / SATA Data Cable Guide

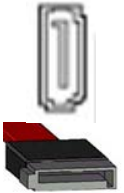
By default, all L6 integrated system will include SAS / SATA data cables routed from the front hot swap backplane to the on-board SATA controller connectors. SAS data cables may need to be ordered separately when adding a SAS RAID module or SAS RAID PCIe\* add-in card to an integrated system SKU.

SAS / SATA data cables are NOT included with any of the chassis only building block SKUs. They must be ordered separately to match the desired system configuration.

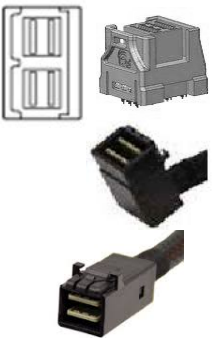
### 4.1 SAS / SATA Data Cable Connector Types

There are three storage interface connector types used within this product family:


#### Single Port SATA Connector

Image	Description
	<p>7-pin Single Port SATA Support for up to 6 GB/sec SATA devices</p> <p>Where used:</p> <ul style="list-style-type: none"> <li>- On the server board – (2) single port SATA connectors (SATA 4, SATA 5)</li> <li>- 2U Rear Mount Hot-Swap Backplane (iPC A2UREARHSDK)</li> <li>- SATA Optical Drive – CD/DVD</li> <li>- SATA DOM</li> </ul>

#### Multiport MiniSAS HD Connectors

Image	Description
	<p>SFF-8643</p> <ul style="list-style-type: none"> <li>• Support for up to 12 Gb/Sec SAS and 6 Gb/sec SATA devices</li> <li>• PCIe* (NVMe) SFF support associated with Intel Accessory Kits A1U44X25NVMEDK &amp; A2U44X25NVMEDK</li> </ul> <p>Where used:</p> <ul style="list-style-type: none"> <li>- On the server board – (2) 4-port SATA connectors (SATA 0-3, sSATA 0-3)</li> <li>- All 12 Gb/sec SAS capable hot swap backplanes</li> <li>- All 12 Gb/sec SAS RAID Controllers</li> <li>- All 12 Gb/sec SAS Expander Cards</li> </ul>




**Multiport MiniSAS Connector**

Image	Description
	<p>SFF-8087 Support for up to 6 Gb/Sec SAS / SATA devices</p> <p>Where used:</p> <ul style="list-style-type: none"> <li>- All 6 Gb/sec SAS RAID Controllers</li> <li>- All 6 Gb/sec SAS Expander Cards</li> </ul>

When connecting a 6Gb/sec SAS Controller or SAS Expander to a 12 Gb/sec capable hot swap backplane, the data cables used will need a SFF-8643 connector on one end of the cable and a SFF-8087 connector on the other. See Table 11. Storage Data Cable Kit Description and Order Information for appropriate cable kits.

**4.2 1U / 2U Server System SAS / SATA Cable Guide**

Product tables in this section will reference SAS/SATA cables using different connector types to meet the connection and routing requirements for the specified system configuration. Each cable reference and product code will identify the connector type at each end of the cable using the following identifiers: **HR**, **HD**, and **MS**. The following table identifies the three cable connector types and their identifiers.

	<p><b>HR = Right Angle SFF-8643 Mini SAS HD Connector</b></p>
	<p><b>HD = Straight SFF-8643 Mini SAS HD Connector</b></p>
	<p><b>MS = Straight SFF-8087 Mini SAS Connector</b> (compatible with 6Gb/sec SAS controllers and expanders)</p>

Cable Kit Product Code Example - **AXXCBL950HDMS**

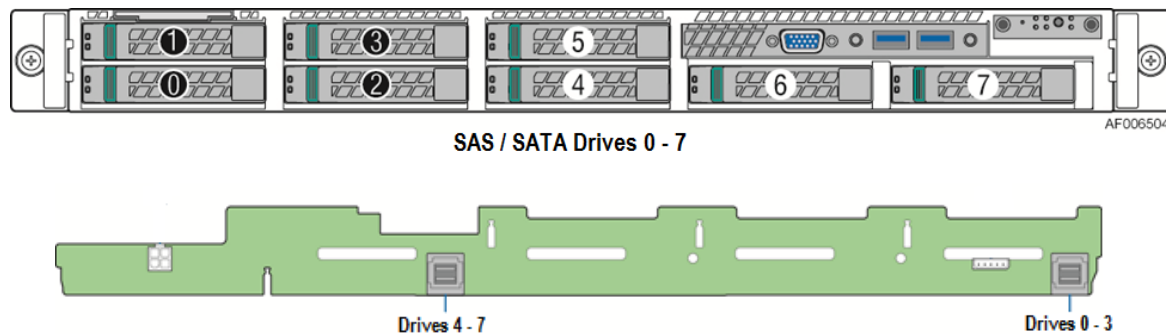
**AXXCBL** – Identifies an accessory cable kit

**950** – identifies the length of the cable

**HD** – identifies that one end of cable connector supports SFF-8643 connector



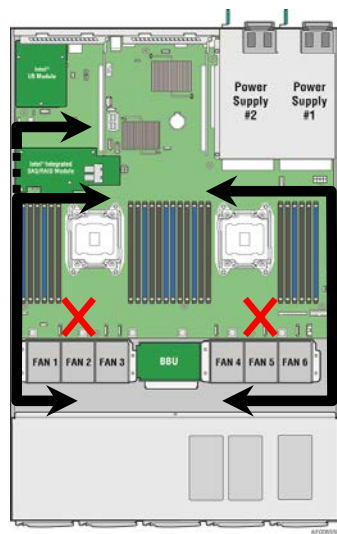
System illustrations in each of the following sections will denote drive numbering as shown below:



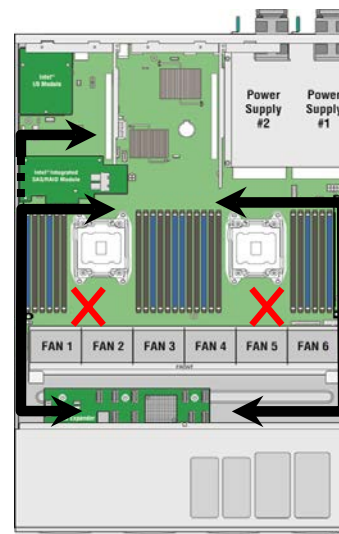
Drive numbering in the system illustrations is for general reference only. Actual drive numbering will be dependant on SAS / SATA controller configuration and how they are cabled to the backplane. Each installed backplane will include a multi-port data connector for each set of four drives. Example for an 8 drive configuration (as shown above), the backplane will include 2 four-port data connectors. In the illustration, drives showing a common color for the Drive ID label will share a common data connector on the backside of the bacplane.

Each table in the following sections identify the cable connections and recommended cable lengths for each supported storage controller option in the specified system. Each “recommended” cable length for a given connector pair provides enough cable to attach the two devices and provides the least amount of access cable, providing the cleanest cable routing.

In the given server system, no cables should be routed in front of the system fans or in between the processors and memory slots. All cables that require routing from the front of the system to the back, are routed within the cable channels along the chassis sidewalls.

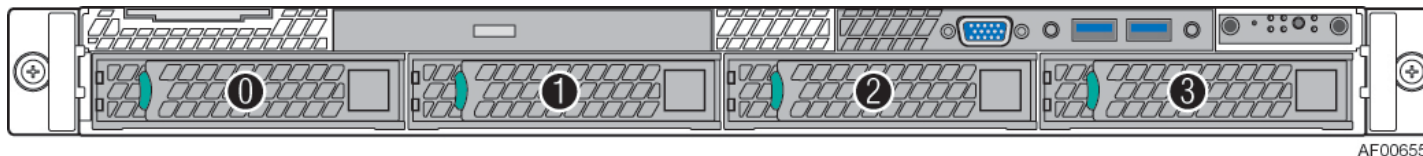


Intel® Server System R1000WT product family cable routing



Intel® Server System R2000WT product family cable routing

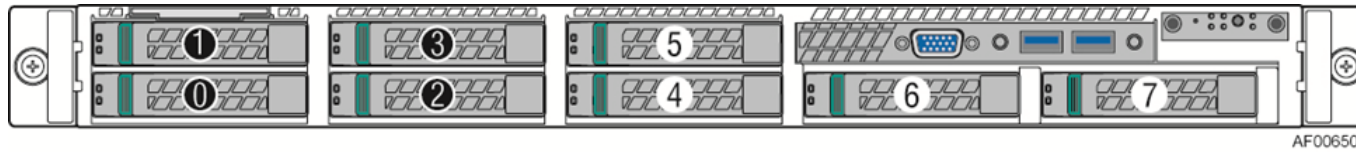
4.2.1 1U 4 x 3.5" – R1304WTxxx SAS / SATA Data Cable Guide



System Configuration	Drive Support	Cables for On-board Multi-port SATA Ports to Backplane	Cables for Mezzanine 12 Gb SAS ROC Module to Backplane	Cables for Mezzanine 6 Gb SAS RAID module to Backplane	Cables for 12 Gb SAS RAID PCIe* add-in card to Backplane	Cables for 6 Gb SAS RAID PCIe* add-in card to Backplane
<p><b>R1304WTxxx</b>  <b>R1304WTTGSR</b>  <b>R1304WT2GSR</b></p>	<p><b>4 x 3.5"</b>                      12 Gb SAS capable</p>	<p><b>Cable Connections:</b></p> <p><b>SATA -&gt; BP 0-3</b>                      800 mm HR --- HD</p> <p>From data above, select appropriate cable kit from list below:</p> <p><b>AXXCBL1UHRHD</b></p> <p><b>Cable included with L6 Integrated systems</b></p>	<p><b>Cable Connections:</b></p> <p><b>SAS Mezz -&gt; BP 0-3</b>                      800 mm HD --- HD</p> <p>From data above, select appropriate cable kit from list below:</p> <p><b>AXXCBL800HDHD</b></p>	<p><b>Cable Connections:</b></p> <p><b>SAS Mezz -&gt; BP 0-3</b>                      800 mm HD --- MS</p> <p>From data above, select appropriate cable kit from list below:</p> <p><b>AXXCBL800HDMS</b></p>	<p><b>From Riser #1</b>  <b>Cable Connections:</b>  <b>SAS PCIe -&gt; BP 0-3 **</b>                      875 or 950 mm HD --- HD</p> <p><b>From Riser #2</b>  <b>Cable Connections:</b>  <b>SAS PCIe -&gt; BP 0-3 **</b>                      730 or 875 mm HD --- HD</p> <p>From data above, select appropriate cable kits from list below:                      See ** note below</p> <p><b>AXXCBL730HDHD</b>  <b>AXXCBL875HDHD</b>  <b>AXXCBL950HDHD</b></p>	<p><b>From Riser #1</b>  <b>Cable Connections:</b>  <b>SAS PCIe -&gt; BP 0-3 **</b>                      875 or 950 mm HD --- MS</p> <p><b>From Riser #2</b>  <b>Cable Connections:</b>  <b>SAS PCIe -&gt; BP 0-3 **</b>                      730 or 875 mm HD --- MS</p> <p>From data above, select appropriate cable kits from list below:                      See ** note below</p> <p><b>AXXCBL730HDMS</b>  <b>AXXCBL875HDMS</b>  <b>AXXCBL950HDMS</b></p>

\*\* 1 or 2 cable lengths may be specified for a PCIe add-in card. Generally, if the cable connector of the add-in card is located on the back edge of the card, a shorter cable is specified. Cable connectors on the top edge or near the front of the add-in card will require the longer cable length.

4.2.2 1U 8 x 2.5" – R1208WTxxx SAS / SATA Data Cable Guide



SAS / SATA Drives 0 - 7

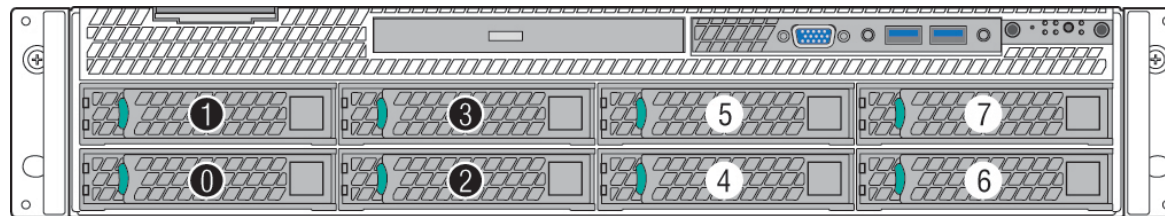
AF006504

Note: For data cable information associated with Intel® Accessory Kit A2U44X25NVMEDK, see section 5.1.1

System Configuration	Drive Support	Cables for On-board Multi-port SATA Ports to Backplane	Cables for Mezzanine 12 Gb SAS ROC Module to Backplane	Cables for Mezzanine 6 Gb SAS RAID module to Backplane	Cables for 12 Gb SAS RAID PCIe* add-in card to Backplane	Cables for 6 Gb SAS RAID PCIe* add-in card to Backplane
<p><b>R1208WTxxx</b>  <b>R1208WTTGSR</b>  <b>R1208WT2GSR</b></p>	<p><b>8 x 2.5"</b>                      12 Gb SAS capable</p>	<p><b>Cable Connections:</b>                      SATA -&gt; BP 0-3                      730 mm HR --- HD</p> <p>sSATA -&gt; BP 4-7                      800 mm HR --- HD</p> <p>From data above, select appropriate cable kits from list below:</p> <p><b>AXXCBL1UHRHD</b></p> <p><b>1 of each cable included with L6 Integrated systems</b></p>	<p><b>Cable Connections:</b>                      SAS Mezz -&gt; BP 0-3                      650 mm HD --- HD</p> <p>SAS Mezz -&gt; BP 4-7                      800 mm HD --- HD</p> <p>From data above, select appropriate cable kits from list below:</p> <p><b>AXXCBL650HDHD</b>  <b>AXXCBL800HDHD</b></p>	<p><b>Cable Connections:</b>                      SAS Mezz -&gt; BP 0-3                      650 mm HD --- MS</p> <p>SAS Mezz -&gt; BP 4-7                      800 mm HD --- MS</p> <p>From data above, select appropriate cable kits from list below:</p> <p><b>AXXCBL650HDMS</b>  <b>AXXCBL800HDMS</b></p>	<p><b>From Riser #1</b>  <b>Cable Connections:</b>                      SAS PCIe -&gt; BP 0-3                      650 mm HD --- HD                      SAS PCIe -&gt; BP 4-7 **                      730 or 800 mm HD --- HD</p> <p><b>From Riser #2</b>  <b>Cable Connections:</b>                      SAS PCIe -&gt; BP 0-3 **                      650 or 730mm HD --- HD                      SAS PCIe - BP 4-7 **                      800 or 875 mm HD --- HD</p> <p>From data above, select appropriate cable kits from list below:                      See ** notes below</p> <p><b>AXXCBL650HDHD</b>  <b>AXXCBL730HDHD</b>  <b>AXXCBL800HDHD</b>  <b>AXXCBL875HDHD</b></p>	<p><b>From Riser #1</b>  <b>Cable Connections:</b>                      SAS PCIe -&gt; BP 0-3                      650 mm HD --- MS                      SAS PCIe -&gt; BP 4-7 **                      730 or 800 mm HD --- MS</p> <p><b>From Riser #2</b>  <b>Cable Connections:</b>                      SAS PCIe -&gt; BP 0-3 **                      650 or 730mm HD --- MS                      SAS PCIe - BP 4-7 **                      800 or 875 mm HD --- MS</p> <p>From data above, select appropriate cable kits from list below:                      See ** notes below</p> <p><b>AXXCBL650HDMS</b>  <b>AXXCBL730HDMS</b>  <b>AXXCBL800HDMS</b>  <b>AXXCBL875HDMS</b></p>

\*\* 1 or 2 cable lengths may be specified for a PCIe add-in card. Generally, if the cable connector of the add-in card is located on the back edge of the card, a shorter cable is specified. Cable connectors on the top edge or near the front of the add-in card will require the longer cable length.

4.2.3 2U 8 x 3.5" – R2308WTxxx Cable Guide

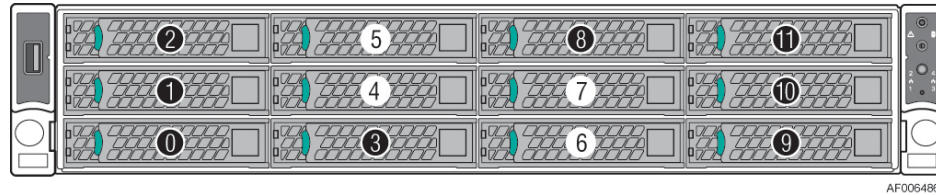


AF006485

System Configuration	Drive Support	Cables for On-board Multi-port SATA Ports to Backplane	Cables for Mezzanine 12 Gb SAS ROC Module to Backplane	Cables for Mezzanine 6 Gb SAS RAID module to Backplane	Cables for 12 Gb SAS RAID PCIe* add-in card to Backplane	Cables for 6 Gb SAS RAID PCIe* add-in card to Backplane
<b>R2308WTTYSR</b>	<b>8 x 3.5"</b> 12 Gb SAS Capable	<p><b>Cable Connections:</b> SATA -&gt; BP 0-3 800 mm HD --- HD</p> <p>sSATA -&gt; BP 4-7 950 mm HD --- HD</p> <p>From data above, select appropriate cable kits from list below:</p> <p><b>AXXCBL800HDHD</b> <b>AXXCBL950HDHD</b></p> <p><b>1 of each cable included with L6 Integrated systems</b></p>	<p><b>Cable Connections:</b> SAS Mezz -&gt; BP 0-3 800 mm HD --- HD</p> <p>SAS Mezz -&gt; BP 4-7 950 mm HD --- HD</p> <p>From data above, select appropriate cable kits from list below:</p> <p><b>AXXCBL800HDHD</b> <b>AXXCBL950HDHD</b></p> <p><b>1 of each cable included with L6 Integrated systems</b></p>	<p><b>Cable Connections:</b> SAS Mezz -&gt; BP 0-3 800 mm HD --- MS</p> <p>SAS Mezz -&gt; BP 4-7 950 mm HD --- MS</p> <p>From data above, select appropriate cable kits from list below:</p> <p><b>AXXCBL800HDMS</b> <b>AXXCBL950HDMS</b></p>	<p><b>From Riser #1:</b> <b>Cable Connections:</b> SAS PCIe -&gt; BP 0-3 ** 650 or 730 mm HD --- HD SAS PCIe -&gt; BP 4-7 ** 800 or 950 mm HD --- HD</p> <p><b>From Riser #2:</b> <b>Cable Connections:</b> SAS PCIe -&gt; BP 0-3 ** 730 or 800 mm HD --- HD SAS PCIe -&gt; BP 4-7 ** 730 or 800 mm HD --- HD</p> <p>From data above, select appropriate cable kits from list below: See ** Notes below</p> <p><b>AXXCBL650HDHD</b> <b>AXXCBL730HDHD</b> <b>AXXCBL800HDHD</b> (1) 800mm Included in L6 <b>AXXCBL950HDHD</b> (1) 950mm Included in L6</p>	<p><b>From Riser #1:</b> <b>Cable Connections:</b> SAS PCIe -&gt; BP 0-3 ** 650 or 730 mm HD --- MS SAS PCIe -&gt; BP 4-7 ** 800 or 950 mm HD --- MS</p> <p><b>From Riser #2:</b> <b>Cable Connections:</b> SAS PCIe -&gt; BP 0-3 ** 730 or 800 mm HD --- MS SAS PCIe -&gt; BP 4-7 ** 730 or 800 mm HD --- MS</p> <p>From data above, select appropriate cable kits from list below: See ** Notes below</p> <p><b>AXXCBL650HDMS</b> <b>AXXCBL730HDMS</b> <b>AXXCBL800HDMS</b> <b>AXXCBL950HDMS</b></p>

\*\* 1 or 2 cable lengths may be specified for a PCIe add-in card. Generally, if the cable connector of the add-in card is located on the back edge of the card, a shorter cable is specified. Cable connectors on the top edge or near the front of the add-in card will require the longer cable length.

### 4.2.4 2U 12 x 3.5 – R2312WTxxx Cable Guide



AF006486




#### 4.2.4.1 2U 12 x 3.5” - R2312WTxxx SAS / SATA Data Cable Guide (with No SAS Expander)

System Configuration	Drive Support	Cables for On-board Multi-port SATA Ports to Backplane	Cables for Onboard SATA controller + Mezzanine 12 Gb SAS ROC Module to Backplane	Cables for Onboard SATA Controller + Mezzanine 6 Gb SAS RAID module to Backplane	Cables for Onboard SATA controller + 12 Gb SAS RAID PCIe* add-in card to Backplane	Cables for Onboard SATA controller + 6 Gb SAS RAID PCIe* add-in card to Backplane
<b>R2312WTxxx</b> <b>R2312WTTYSR</b>	12 x 3.5" 12 Gb SAS Capable	<p><b>Cable Connections:</b> SATA -&gt; BP 0-3 800mm HD --- HD</p> <p>sSATA Cntrl -&gt; BP 4-7 875 mm HD --- HD</p> <p>From data above, select appropriate cable kits from list below:</p> <p><b>AXXCBL800HDHD</b> <b>AXXCBL875HDHD</b></p> <p><b>1 of each cable included with L6 Integrated systems</b></p>	<p><b>Cable Connections:</b> SATA -&gt; BP 0-3 800mm HD --- HD</p> <p><b>SAS Mezz -&gt; BP 4-7</b> 875 mm HD --- HD</p> <p><b>SAS Mezz -&gt; BP 8-11</b> 950 mm HD ---HD</p> <p>From data above, select appropriate cable kits from list below:</p> <p><b>AXXCBL800HDHD</b> <b>AXXCBL875HDHD</b> <b>AXXCBL950HDHD</b></p> <p><b>1 of each cable included with L6 Integrated systems</b></p>	<p><b>Cable Connections:</b> SATA -&gt; BP 0-3 800mm HD --- HD</p> <p><b>SAS Mezz -&gt; BP 4-7</b> 875 mm HD --- MS</p> <p><b>SAS Mezz -&gt; BP 8-11</b> 950 mm HD ---MS</p> <p>From data above, select appropriate cable kits from list below:</p> <p><b>AXXCBL800HDHD</b> <b>AXXCBL875HDMS</b> <b>AXXCBL950HDMS</b></p>	<p><b>Cable Connections:</b> SATA -&gt; BP 0-3 800mm HD --- HD</p> <p><b>From Riser #1</b> <b>SAS PCIe -&gt; BP 4-7 **</b> 800 or 875 mm HD --- HD <b>SAS PCIe -&gt; BP 8-11</b> 875 mm HD ---HD</p> <p><b>From Riser #2</b> <b>SAS PCIe -&gt; BP 4-7 **</b> 730 or 875 mm HD --- HD <b>SAS PCIe -&gt; BP 8-11 **</b> 650 or 800 mm HD --- HD</p> <p>From data above, select appropriate cable kits: See ** Notes below <b>AXXCBL650HDHD</b> <b>AXXCBL730HDHD</b> <b>AXXCBL800HDHD</b> (1) 800mm Included in L6 <b>AXXCBL875HDHD</b> (1) 875mm Included in L6 <b>AXXCBL950HDHD</b> (1) 950mm included in L6)</p>	<p><b>Cable Connections:</b> SATA -&gt; BP 0-3 800mm HD --- HD</p> <p><b>From Riser #1</b> <b>SAS PCIe -&gt; BP 4-7 **</b> 800 or 875 mm HD --- MS <b>SAS PCIe -&gt; BP 8-11</b> 875 mm HD ---MS</p> <p><b>From Riser #2</b> <b>SAS PCIe -&gt; BP 4-7 **</b> 730 or 875 mm HD --- MS <b>SAS PCIe -&gt; BP 8-11 **</b> 650 or 800 mm HD --- MS</p> <p>From data above, select appropriate cable kits from list below: See ** Notes below</p> <p><b>AXXCBL650HDMS</b> <b>AXXCBL730HDMS</b> <b>AXXCBL800HDMS</b> <b>AXXCBL875HDMS</b> <b>AXXCBL950HDMS</b></p>

\*\* 1 or 2 cable lengths may be specified for a PCIe add-in card. Generally, if the cable connector of the add-in card is located on the back edge of the card, a shorter cable is specified. Cable connectors on the top edge or near the front of the add-in card will require the longer cable length.

#### 4.2.4.2 2U 12 x 3.5" - R2312WTxxx SAS / SATA Data Cable Guide (with SAS Expander)

SAS drive configurations consisting of more than 8 drives may require the addition of a SAS Expander card. In the 2U 12x3.5" system configuration, the SAS expander must be installed in any available PCIe add-in slot. Intel provides two SAS expander options to support this drive configuration:

Intel Product Code	Order Information	Product Description	Product Type
 <p>Intel® RAID Expander RES3FV288</p>	<p>MM# – 932895 UPC – 00735858287548 EAN – 5032037067287 MOQ = 5</p>	<p><b>SAS 3.0 12 Gb/s expander</b></p> <ul style="list-style-type: none"> <li>Featuring 6Gbps data aggregation for 12Gbps data transfer with 6Gb/s devices</li> <li>Low Profile MD2 PCIe* add-in card form factor</li> <li>28 internal ports and 8 external ports</li> <li>Redundant dual-port capable for HA and high performance systems</li> <li>Power from PCIe x1</li> <li>HD Mini-SAS 8643 Connectors</li> </ul> <p>Kit includes: (1) SAS Expander card, (2) HD-HD 250mm Expander-to-RAID card cables, PCI brackets for Low profile and Full height</p> <p>Required (sold separately): HD-HD SAS DATA Cables – Expander to backplane – See Table 6</p>	<ul style="list-style-type: none"> <li>2U Accessory Kit</li> </ul>
 <p>Intel® RAID Expander RES2SV240</p>	<p>MM# – 908137 UPC – 00735858216289 EAN – 5032037017053 MOQ - 5</p>	<p><b>SAS 2.0 6 Gb/s expander</b></p> <ul style="list-style-type: none"> <li>Low Profile MD2 PCIe* add-in card form factor</li> <li>24 Port 6Gb expander card with ports configurable for input or output</li> <li>Power from PCIe x1 or 4-pin connector</li> <li>Mini-SAS 8087 connectors</li> </ul> <p>Kit includes: (1) 6 Gb/s SAS Expander card, (2) MS-MS 300mm Expander-to-6Gb/s RAID card cables, PCI brackets for Low profile and Full height , (4) MS-MS 650mm Expander-to-Backplane cables (<b>cables not compatible in R2312WTxxx system</b>)</p> <p>Required (sold separately): MS-HD SAS Data Cables – See Table 6</p>	<ul style="list-style-type: none"> <li>2U Accessory Kit</li> </ul>
 <p>Intel® RAID Expander RES2SV240NC</p>	<p>MM# – 915431 UPC – 00735858221375 MOQ - 5</p>	<p><b>SAS 2.0 6 Gb/s expander</b></p> <ul style="list-style-type: none"> <li>Low Profile MD2 PCIe* add-in card form factor</li> <li>24 Port 6Gb expander card with ports configurable for input or output</li> <li>Power from PCIe x1 or 4-pin connector</li> <li>Mini-SAS 8087 connectors</li> </ul> <p>Kit includes: (1) 6 Gb/s SAS Expander card (<b>with no cables</b>), PCI brackets for Low profile and Full height</p> <p>Required (sold separately): MS-HD SAS Data Cables – See Table 6</p>	<ul style="list-style-type: none"> <li>2U Accessory Kit</li> </ul>

**Note:** The onboard SATA ports are not compatible with SAS Expander cards. The onboard SATA ports can only be cabled directly to a specified backplane.

Table 6. 2U 12 x 3.5" – R2312WTxxx SAS / SATA Data Cable Guide (with SAS Expander)

System Configuration	Drive Support	On-board Multi-port SATA Ports	Mezzanine 12Gb SAS ROC Module + 12 Gb SAS Expander to Backplane	Mezzanine 6 Gb SAS ROC module + 6 Gb SAS Expander to Backplane	12Gb SAS RAID PCIe* add-in card + 12 Gb SAS Expander to Backplane	6Gb SAS RAID PCIe* add-in card + 6 Gb SAS Expander to Backplane
<b>R2312WTxxx</b> <b>R2312WTTYSR</b>	<b>12 x 3.5"</b> 12 Gb SAS Capable	<p>Onboard SATA controllers do not support SAS expanders.</p> <p>If attaching the onboard SATA controller to the Backplane, then use cables that are included in the System SKUs.</p> <p>For building block integration use cable kits: <b>AXXCBL800HDHD</b> <b>AXXCBL875HDHD</b></p>	<p>With 12 Gb SAS Expander <b>RES3FV288</b> installed in Riser #1:</p> <ul style="list-style-type: none"> <li>- Use cables in Expander Kit to attach SAS ROC to Expander Card</li> <li>- Use the following cables to attach Expander to Backplane:</li> </ul> <p><b>Expander -&gt; BP 0-3</b> 800 mm HD --- HD</p> <p><b>Expander -&gt; BP 4-7</b> 875 mm HD --- HD</p> <p><b>Expander -&gt; BP 8-11</b> 950 mm HD ---HD</p> <p><b>1 of each cable included with L6 Integrated systems</b></p> <p>From data above, select appropriate cable kits from list below:</p> <p><b>AXXCBL800HDHD</b> <b>AXXCBL875HDHD</b> <b>AXXCBL950HDHD</b></p>	<p>With 6 Gb SAS Expander <b>RES2SV240</b> installed in Riser #1:</p> <ul style="list-style-type: none"> <li>- Use cables in Expander Kit to attach SAS ROC to Expander Card</li> <li>- Use the following cables to attach Expander to Backplane:</li> </ul> <p><b>Expander -&gt; BP 0-3</b> 800 mm HD --- MS</p> <p><b>Expander -&gt; BP 4-7</b> 875 mm HD --- MS</p> <p><b>Expander -&gt; BP 8-11</b> 950 mm HD ---MS</p> <p>From data above, select appropriate cable kits from list below:</p> <p><b>AXXCBL800HDMS</b> <b>AXXCBL875HDMS</b> <b>AXXCBL950HDMS</b></p>	<p>With 12 Gb PCIe RAID and 12 Gb SAS Expander <b>RES3FV288</b> installed in <b>riser #1:</b></p> <ul style="list-style-type: none"> <li>- Use cables in Expander Kit to attach PCIe SAS card to Expander Card</li> <li>- Use the following cables to attach Expander to Backplane:</li> </ul> <p><b>Expander -&gt; BP 0-3</b> 800 mm HD --- HD</p> <p><b>Expander -&gt; BP 4-7</b> 875 mm HD --- HD</p> <p><b>Expander -&gt; BP 8-11</b> 950 mm HD ---HD</p> <p>From data above, select appropriate cable kits from list below:</p> <p><b>AXXCBL800HDHD</b> <b>AXXCBL875HDHD</b> <b>AXXCBL950HDHD</b></p>	<p>With 6 Gb PCIe RAID and 6 Gb SAS Expander <b>RES2SV240</b> installed in <b>riser #1:</b></p> <ul style="list-style-type: none"> <li>- Use cables in Expander Kit to attach PCIe SAS card to Expander Card</li> <li>- Use the following cables to attach Expander to Backplane:</li> </ul> <p><b>Expander -&gt; BP 0-3</b> 800 mm HD --- MS</p> <p><b>Expander -&gt; BP 4-7</b> 875 mm HD --- MS</p> <p><b>Expander -&gt; BP 8-11</b> 950 mm HD ---MS</p> <p>From data above, select appropriate cable kits from list below:</p> <p><b>AXXCBL800HDMS</b> <b>AXXCBL875HDMS</b> <b>AXXCBL950HDMS</b></p>

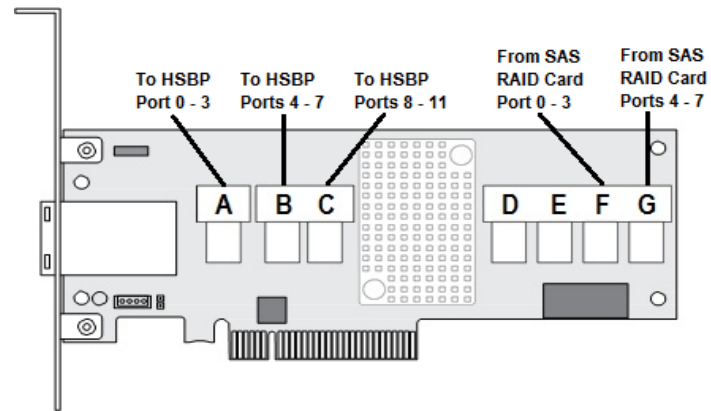


Figure 7. Intel® RAID Expander RES3FV288 Connector Identification

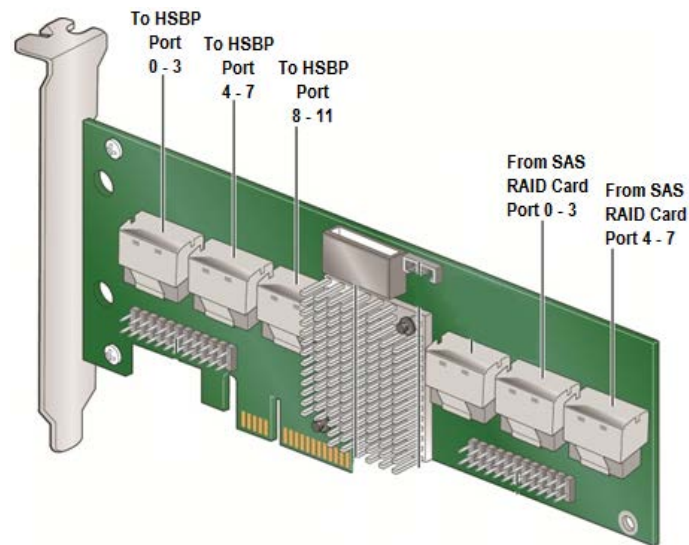
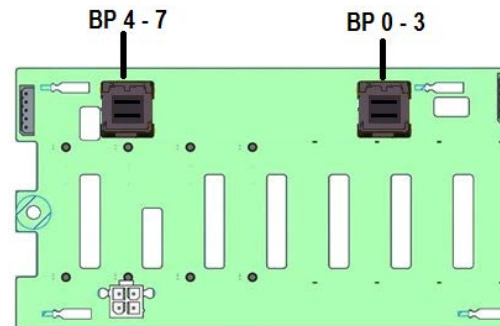
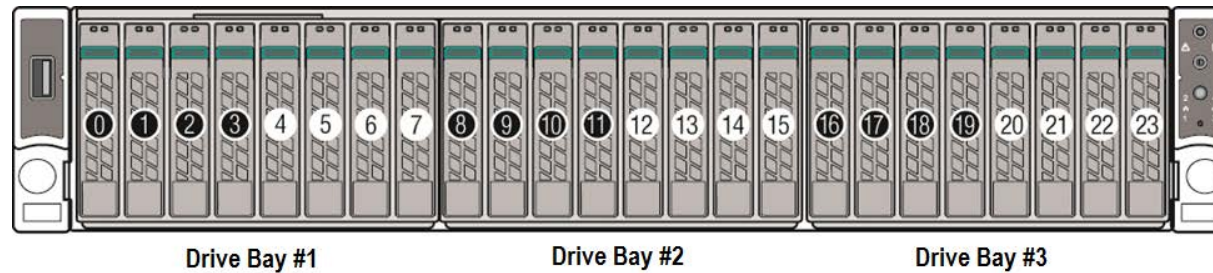
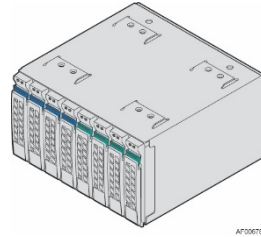


Figure 8. Intel® RAID Expander RES2SV240 Connector Identification



## 4.2.5 2U 2.5" Front Mount Drive Bay Cable Guide

The front drive bay of the 2U system can support up to three 8x2.5" drive bay modules capable of supporting system configurations of 8 (R2208), 16 (R2216), or 24 (R2224) drives. Each 8x2.5" drive bay is numbered in sequence from 1 to 3, as shown below. Each installed 8x2.5" backplane will include at least two multi-port 8643 data connectors, each supporting a set of four drives. Note that some 8x2.5" backplane options include more than two 8643 connectors in order to support features available to the specific backplane.



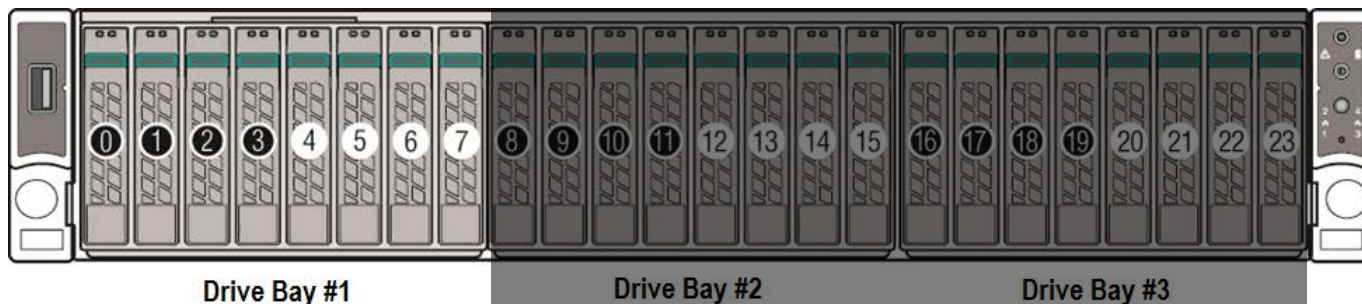
Intel makes available several different 8x2.5" drive bay module options, each supporting a different feature set (see chapter 5). The system tables in this section define the SAS/SATA data cables required to support the specified drive bay location regardless of the backplane option installed.

Reference each table as appropriate to determine the cable requirements relevant to your specific drive bay configuration.

Note: For data cable information associated with Intel® Accessory Kit A2U44X25NVMEDK, see sections 5.2.1 and 5.2.2

4.2.5.1 2U 2.5" Front Mount Drive Configurations – SAS Data Cable Guide (with no SAS Expander)

Table 7. 2U 8 x 2.5" (Drive Bay #1) - SAS/SATA Data Cable Guid (with no SAS Expander)

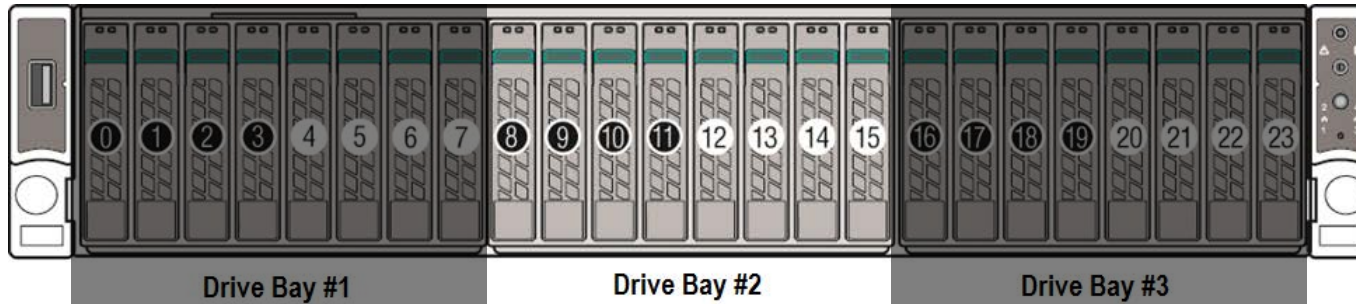


System Configuration	Drive Support	Cables for On-board Multi-port SATA Ports to Drive Bay #1	Cables for Mezzanine 12 Gb SAS ROC Module to Drive Bay #1	Cables for Mezzanine 6 Gb SAS RAID module to Drive Bay #1	Cables for 12 Gb SAS RAID PCIe* add-in card to Drive Bay #1	Cables for 6 Gb SAS RAID PCIe* add-in card to Drive Bay #1
<p><b>Drive Bay #1</b></p> <p>R2208... R2216... R2224...</p>	<p>8 x 2.5"</p>	<p><b>Cable Connections:</b> SATA Cntrl -&gt; BP 0-3 730mm HD --- HD</p> <p>sSATA Cntrl -&gt; BP 4-7 730 mm HD --- HD</p> <p>From data above, select appropriate cable kits from list below:</p> <p><b>AXXCBL730HDHD</b></p> <p><b>(2) 730mm Cables included with all 2.5" L6 Integrated systems</b></p>	<p><b>Cable Connections:</b> SAS Mezz -&gt; BP 0-3 730 mm HD --- HD</p> <p><b>SAS Mezz -&gt; BP 4-7</b> 730 mm HD --- HD</p> <p>From data above, select appropriate cable kits from list below:</p> <p><b>AXXCBL730HDHD</b></p> <p><b>(2) 730mm Cables included with all 2.5" L6 Integrated systems</b></p>	<p><b>Cable Connections:</b> SAS Mezz -&gt; BP 0-3 730 mm HD --- MS</p> <p><b>SAS Mezz -&gt; BP 4-7</b> 730 mm HD --- MS</p> <p>From data above, select appropriate cable kits from list below:</p> <p><b>AXXCBL730HDMS</b></p>	<p><b>From Riser #1:</b> <b>Cable Connections:</b></p> <p><b>SAS PCIe -&gt; BP 0-3</b> 730 mm HD --- HD</p> <p><b>SAS PCIe -&gt; BP 4-7</b> 730 mm HD --- HD</p> <p><b>From Riser #2</b> <b>SAS PCIe -&gt; BP 0-3</b> 730 mm HD --- HD</p> <p><b>SAS PCIe -&gt; BP 4-7</b> 730 mm HD --- HD</p> <p>From data above, select appropriate cable kits from list below:</p> <p><b>AXXCBL730HDHD</b></p> <p><b>(2) 730mm Cables included with all 2.5" L6 Integrated systems</b></p>	<p><b>From Riser #1:</b> <b>Cable Connections:</b></p> <p><b>SAS PCIe -&gt; BP 0-3</b> 730 mm HD --- MS</p> <p><b>SAS PCIe -&gt; BP 4-7</b> 730 mm HD --- MS</p> <p><b>From Riser #2</b> <b>SAS PCIe -&gt; BP 0-3</b> 730 mm HD --- MS</p> <p><b>SAS PCIe -&gt; BP 4-7</b> 730 mm HD --- MS</p> <p>From data above, select appropriate cable kits from list below:</p> <p><b>AXXCBL730HDMS</b></p>

\*\* 1 or 2 cable lengths may be specified for a PCIe add-in card. Generally, if the cable connector of the add-in card is located on the back edge of the card, a shorter cable is specified. Cable connectors on the top edge or near the front of the add-in card will require the longer cable length.

For R2216WTxxx System configurations with no SAS Expander, reference Tables 7 and 8 for cabling guidance

**Table 8. 2U 8 x 2.5" (Drive Bay #2) – SAS / SATA Data Cable Guide (with no SAS Expander)**

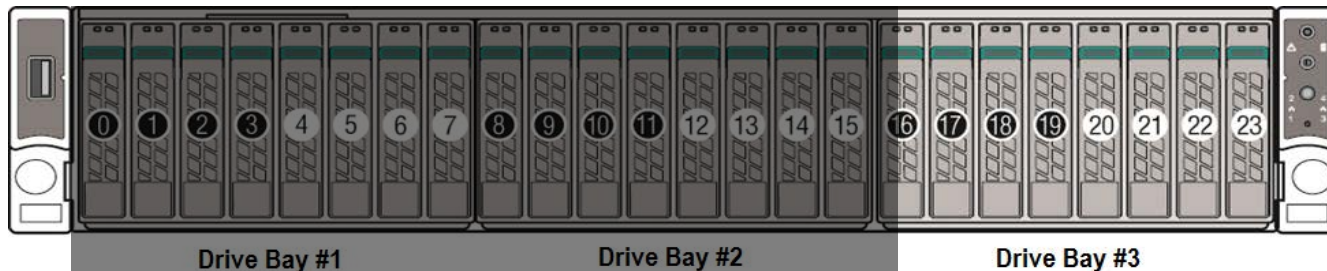


System Configuration	Drive Support	Cables for On-board Multi-port SATA Ports to Drive Bay #2	Cables for Mezzanine 12 Gb SAS ROC Module to Drive Bay #2	Cables for Mezzanine 6 Gb SAS ROC module to Drive Bay #2	Cables for 12 Gb SAS RAID PCIe* add-in card to Drive Bay #2	Cables for 6 Gb SAS RAID PCIe* add-in card to Drive Bay #2
<p><b>Drive Bay #2</b> (no SAS Expander)</p> <p>R2216... R2224...</p>	<p><b>8 x 2.5"</b></p>	<p><b>Cable Connections:</b></p> <p><b>SATA Cntrl -&gt; BP 0-3</b> 730mm HD -- HD</p> <p><b>sSATA Cntrl -&gt; BP 4-7</b> 875mm HD -- HD</p> <p>From data above, select appropriate cable kits from <a href="#">list below</a>:</p> <p><b>AXXCBL730HDHD</b> (730mm Included in all 2.5" L6) <b>AXXCBL875HDHD</b> (875mm Included in R2224 L6)</p>	<p><b>Cable Connections:</b></p> <p><b>SAS Mezz -&gt; BP 0-3</b> 730mm HD -- HD</p> <p><b>SAS Mezz -&gt; BP 4-7</b> 875mm HD -- HD</p> <p>From data above, select appropriate cable kits from <a href="#">list below</a>:</p> <p><b>AXXCBL730HDHD</b> (730mm Included in all 2.5" L6) <b>AXXCBL875HDHD</b> (875mm Included in R2224 L6)</p>	<p><b>Cable Connections:</b></p> <p><b>SAS Mezz -&gt; BP 0-3</b> 730mm HD -- MS</p> <p><b>SAS Mezz -&gt; BP 4-7</b> 875mm HD -- MS</p> <p>From data above, select appropriate cable kits from <a href="#">list below</a>:</p> <p><b>AXXCBL730HDMS</b> <b>AXXCBL875HDMS</b></p>	<p><b>From Riser #1:</b></p> <p><b>SAS PCIe -&gt; BP 0-3 **</b> 650 or 730mm HD -- HD</p> <p><b>SAS PCIe -&gt; BP 4-7 **</b> 730 or 800mm HD -- HD</p> <p><b>From Riser #2:</b></p> <p><b>SAS PCIe -&gt; BP 0-3 **</b> 800 or 875mm HD -- HD</p> <p><b>SAS PCIe -&gt; BP 4-7 **</b> 730 or 875mm HD -- HD</p> <p>From data above, select appropriate cable kits from <a href="#">list below</a>:</p> <p><b>AXXCBL650HDHD</b> <b>AXXCBL730HDHD</b> (2) 730mm Included in all 2.5" L6 <b>AXXCBL800HDHD</b> <b>AXXCBL875HDHD</b> (4) 875mm Included in R2224 L6)</p>	<p><b>From Riser #1:</b></p> <p><b>SAS PCIe -&gt; BP 0-3 **</b> 650 or 730mm HD -- MS</p> <p><b>SAS PCIe -&gt; BP 4-7 **</b> 730 or 800mm HD -- MS</p> <p><b>From Riser #2:</b></p> <p><b>SAS PCIe -&gt; BP 0-3 **</b> 800 or 875mm HD -- MS</p> <p><b>SAS PCIe -&gt; BP 4-7 **</b> 730 or 875mm HD -- MS</p> <p>From data above, select appropriate cable kits from <a href="#">list below</a>:</p> <p><b>AXXCBL650HDMS</b> <b>AXXCBL730HDMS</b> <b>AXXCBL800HDMS</b> <b>AXXCBL875HDMS</b></p>

\*\* 1 or 2 cable lengths may be specified for a PCIe add-in card. Generally, if the cable connector of the add-in card is located on the back edge of the card, a shorter cable is specified. Cable connectors on the top edge or near the front of the add-in card will require the longer cable length.

For R2224WTxxx System configurations with no SAS Expander, reference Tables 7, 8, and 9 for cable guidance for all three drive bay modules.

**Table 9. 2U 8 x 2.5" (Drive Bay #3) – SAS / SATA Data Cable Guide (with no SAS Expander)**


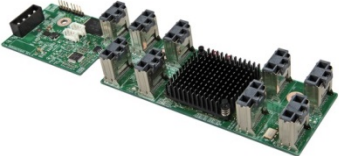


System Configuration	Drive Support	Cables for On-board Multi-port SATA Ports to Drive Bay #3	Cables for Mezzanine 12 Gb SAS ROC Module to Drive Bay #3	Cables for Mezzanine 6 Gb SAS ROC module to Drive Bay #3	Cables for 12 Gb SAS RAID PCIe* add-in card to Drive Bay #3	Cables for 6 Gb SAS RAID PCIe* add-in card to Drive Bay #3
<b>Drive Bay #3</b> (no SAS Expander)  R2224...	<b>8 x 2.5"</b>	<p><b>Cable Connections:</b></p> <p><b>SATA Cntrl -&gt; BP 0-3</b> 800mm HD -- HD</p> <p><b>sSATA Cntrl -&gt; BP 4-7</b> 730mm HD -- HD</p> <p>From data above, select appropriate cable kits from <a href="#">list below</a>:</p> <p><b>AXXCBL730HDHD</b> (2) 730mm cables Included in all 2.5" L6)</p> <p><b>AXXCBL800HDHD</b></p>	<p><b>Cable Connections:</b></p> <p><b>SAS Mezz -&gt; BP 0-3</b> 730mm HD -- HD</p> <p><b>SAS Mezz -&gt; BP 4-7</b> 730mm HD -- HD</p> <p>From data above, select appropriate cable kits from <a href="#">list below</a>:</p> <p><b>AXXCBL730HDHD</b> (2) 730mm cables Included in all 2.5" L6)</p>	<p><b>Cable Connections:</b></p> <p><b>SAS Mezz -&gt; BP 0-3</b> 730mm HD -- MS</p> <p><b>SAS Mezz -&gt; BP 4-7</b> 730mm HD -- MS</p> <p>From data above, select appropriate cable kits from <a href="#">list below</a>:</p> <p><b>AXXCBL730HDMS</b></p>	<p><b>From Riser #1:</b></p> <p><b>SAS PCIe -&gt; BP 0-3 **</b> 730 or 875mm HD -- HD</p> <p><b>SAS PCIe -&gt; BP 4-7 **</b> 800 or 950mm HD -- HD</p> <p><b>From Riser #2:</b></p> <p><b>SAS PCIe -&gt; BP 0-3 **</b> 730 or 875mm HD -- HD</p> <p><b>SAS PCIe -&gt; BP 4-7 **</b> 650 or 800mm HD -- HD</p> <p>From data above, select appropriate cable kits from <a href="#">list below</a>:</p> <p><b>AXXCBL650HDHD</b> <b>AXXCBL730HDHD</b> (2) 730mm Included in all 2.5" L6 <b>AXXCBL800HDHD</b> <b>AXXCBL875HDHD</b> (4) 875mm Included in R2224 L6 <b>AXXCBL950HDHD</b></p>	<p><b>From Riser #1:</b></p> <p><b>SAS PCIe -&gt; BP 0-3 **</b> 730 or 875mm HD -- MS</p> <p><b>SAS PCIe -&gt; BP 4-7 **</b> 800 or 950mm HD -- MS</p> <p><b>From Riser #2:</b></p> <p><b>SAS PCIe -&gt; BP 0-3 **</b> 800 or 875mm HD -- MS</p> <p><b>SAS PCIe -&gt; BP 4-7 **</b> 650 or 800mm HD -- MS</p> <p>From data above, select appropriate cable kits from <a href="#">list below</a>:</p> <p><b>AXXCBL650HDMS</b> <b>AXXCBL730HDMS</b> <b>AXXCBL800HDMS</b> <b>AXXCBL875HDMS</b> <b>AXXCBL950HDMS</b></p>

\*\* 1 or 2 cable lengths may be specified for a PCIe add-in card. Generally, if the cable connector of the add-in card is located on the back edge of the card, a shorter cable is specified. Cable connectors on the top edge or near the front of the add-in card will require the longer cable length.

#### 4.2.5.2 2U 2.5" Front Mount Drive Configurations – SAS Data Cable Guide (with SAS Expander)

SAS drive configurations consisting of more than 8 drives may require the addition of a SAS Expander card. In the 2U 16x2.5" or 24x2.5" system configurations, a SAS expander can be mounted in the area directly behind the drive bays. Intel provides two SAS expander options to support these drive configurations:

Intel Product Code	Order Information	Product Description	Product Type
<p><b>iPC – RES3TV360</b></p>  <p>Intel® RAID Expander RES3TV360</p>	<p>MM# – 932894 UPC – 00735858287364 EAN – 5032037067102 MOQ - 5</p>	<ul style="list-style-type: none"> <li>• <b>SAS 3.0 12 Gb/s expander</b> featuring 6Gbps data aggregation for 12Gbps data transfer with 6Gb/s devices</li> <li>• Internal mount mid-plane form factor</li> <li>• 36 internal ports supporting point-to-point 12, 6, and 3 Gb/s data transfer rates</li> <li>• RA 4-pin power connector</li> <li>• HD Mini-SAS 8643 Connectors</li> </ul> <p><b>Kit includes:</b> (1) SAS expander card; (1) 130mm Power cable; (1 set) Expander-to-backplane cables: (4) HD-HD 165mm, (1) HD-HD 300mm, (1) HD-HD 250mm; (3) Rubber Pads; mounting screws</p> <p><b>Required (sold separately)</b></p> <ul style="list-style-type: none"> <li>• HD-HD 12 Gb/sec RAID Controller-to-Expander cables – See table section 0</li> <li>• HD-MS 6 Gb/s RAID Controller-to-Expander cables – See table section 0</li> </ul>	<ul style="list-style-type: none"> <li>• 2U Accessory Kit</li> </ul>
<p><b>iPC – RES2CV360</b></p>  <p>Intel® RAID Expander RES2CV360</p>	<p>MM# – 918935 UPC – 00735858241168 EAN – 5032037035897 MOQ - 1</p>	<ul style="list-style-type: none"> <li>• <b>SAS 2.0 6 Gb/s expander</b></li> <li>• Internal mount mid-plane form factor</li> <li>• 36 Port 6Gb expander card with ports configurable for input or output</li> <li>• Power from 4-pin connector</li> <li>• Mini-SAS 8087 connectors</li> </ul> <p><b>Kit includes:</b> (1) 6 Gb/s SAS Expander card; (1) 130mm power cable; (3) rubber mounting pads; (1 set) 6 Gb Expander to 6 Gb backplane cables: (3) MS-MS 165mm, (2) MS-MS 185mm, (1) MS-MS 245mm (<b>NOTE: included data cables not compatible in R2312WT... system</b>)</p> <p><b>Required (sold separately):</b> iPC – <b>AXXCBLEXPDMMS</b> - MS-HD 6Gb Expander to 12 Gb Backplane Data Cable kit, SAS Data Cables from 6 Gb SAS RAID PCIe/Mezz Card to expander. See Table 10.</p>	<ul style="list-style-type: none"> <li>• 2U Accessory Kit</li> </ul>

**Note:** The onboard SATA ports are not compatible with SAS Expander cards. The onboard SATA ports can only be cabled directly to a specified backplane.

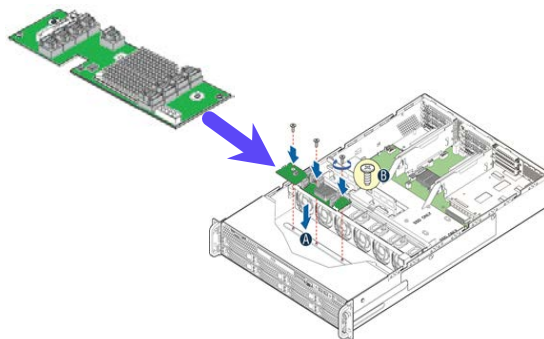


Table 10. 2U 2.5" Front Mount Drive Configurations with SAS Expander – SAS Data Cable Guide

Mezzanine 12Gb SAS ROC Module to 12 Gb SAS Expander	12Gb SAS RAID PCIe* add-in card to 12 Gb SAS Expander	Mezzanine 6 Gb SAS ROC Module to 12 Gb SAS Expander	6Gb SAS RAID PCIe* add-in card to 12 Gb SAS Expander	Mezzanine 6 Gb SAS ROC Module to 6 Gb SAS Expander	6Gb SAS RAID PCIe* add-in card to 6 Gb SAS Expander
<p>12 Gb SAS Expander RES3TV360 installed:</p> <p><b>SAS Mezz -&gt; Exp 0-3 (G)</b> 730mm HD -- HD</p> <p><b>SAS Mezz -&gt; Exp 4-7 (H)</b> 730mm HD -- HD</p> <p>From data above, select appropriate cable kits from <a href="#">list below</a>:</p> <p><b>AXXCBL730HDHD</b> (2) 730mm cables Included in all 2.5" L6)</p>	<p>12 Gb SAS Expander RES3TV360 installed:</p> <p><b>From Riser #1:</b> <b>SAS PCIe -&gt; Exp 0-3 (G)</b> 650mm HD -- HD <b>SAS PCIe -&gt; Exp 4-7 (H)</b> 650mm HD -- HD</p> <p><b>From Riser #2:</b> <b>SAS PCIe -&gt; Exp 0-3 (G)</b> 730mm HD -- HD <b>SAS PCIe -&gt; Exp 4-7 (H)</b> 730mm HD -- HD</p> <p>From data above, select appropriate cable kits from <a href="#">list below</a>:</p> <p><b>AXXCBL650HDHD</b> <b>AXXCBL730HDHD</b> (2) 730mm cables Included in all 2.5" L6)</p>	<p>12 Gb SAS Expander RES3TV360 installed:</p> <p><b>SAS Mezz -&gt; Exp 0-3 (G)</b> 730mm HD -- MS</p> <p><b>SAS Mezz -&gt; Exp 4-7 (H)</b> 730mm HD -- MS</p> <p>From data above, select appropriate cable kits from <a href="#">list below</a>:</p> <p><b>AXXCBL730HDMS</b></p>	<p>12 Gb SAS Expander RES3TV360 installed:</p> <p><b>From Riser #1:</b> <b>SAS PCIe -&gt; Exp 0-3 (G)</b> 650mm HD --MS <b>SAS PCIe -&gt; Exp 4-7 (H)</b> 650mm HD --MS</p> <p><b>From Riser #2:</b> <b>SAS PCIe -&gt; Exp 0-3 (G)</b> 730mm HD --MS <b>SAS PCIe -&gt; Exp 4-7 (H)</b> 730mm HD -- MS</p> <p>From data above, select appropriate cable kits from <a href="#">list below</a>:</p> <p><b>AXXCBL650HDMS</b> <b>AXXCBL730HDMS</b></p>	<p>6 Gb SAS Expander RES2CV360 installed:</p> <p><b>SAS Mezz -&gt; Exp 0-3 (A)</b> 730mm MS -- MS</p> <p><b>SAS Mezz -&gt; Exp 4-7 (B)</b> 730mm MS -- MS</p> <p>From data above, select appropriate cable kits from <a href="#">list below</a>:</p> <p><b>AXXCBL730MSMS</b></p>	<p>6 Gb SAS Expander RES2CV360 installed:</p> <p><b>From Riser #1:</b> <b>SAS PCIe -&gt; Exp 0-3 (G)</b> 650mm MS --MS <b>SAS PCIe -&gt; Exp 4-7 (H)</b> 650mm MS --MS</p> <p><b>From Riser #2:</b> <b>SAS PCIe -&gt; Exp 0-3 (G)</b> 730mm MS --MS <b>SAS PCIe -&gt; Exp 4-7 (H)</b> 730mm MS -- MS</p> <p>From data above, select appropriate cable kits from <a href="#">list below</a>:</p> <p><b>AXXCBL650MSMS</b> <b>AXXCBL730MSMS</b></p>
<b>12 Gb SAS Expander to drive bays</b>	<b>12 Gb SAS Expander to drive bays</b>	<b>12 Gb SAS Expander to drive bays</b>	<b>12 Gb SAS Expander to drive bays</b>	<b>6 Gb SAS Expander to drive bays</b>	<b>6 Gb SAS Expander to drive bays</b>
Use cables included in SAS Expander Kit	Use cables included in SAS Expander Kit	Use cables included in SAS Expander Kit	Use cables included in SAS Expander Kit	Cable Kit Required: iPC – <b>AXXCBLEXPHDMS</b>	Cable Kit Required: iPC – <b>AXXCBLEXPHDMS</b>

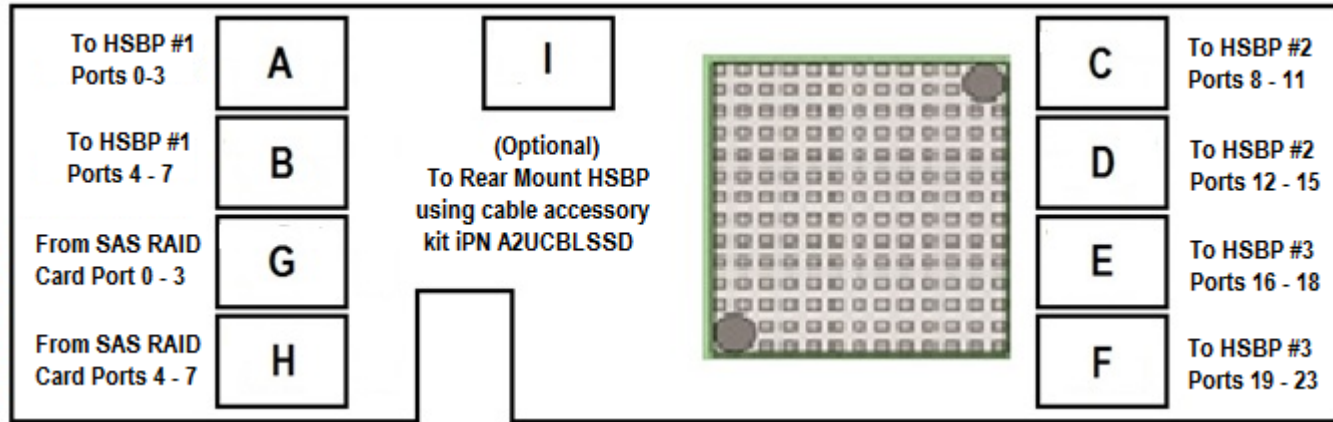


Figure 9. – 12Gb Internal 36-Port Intel® RAID Expander Card RES3TV360 - Connector Identification Block Diagram

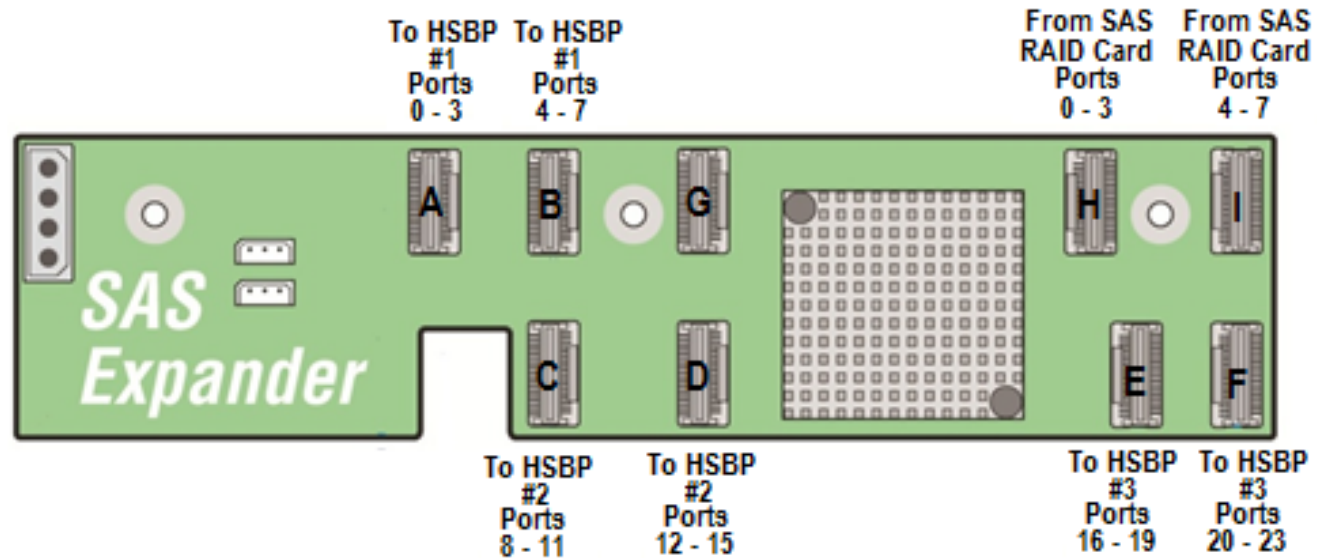





Figure 10. – 6 Gb Internal 36-Port Intel® RAID Expander Card RES2CV360 - Connector Identification Block Diagram

### 4.3 Intel SAS / SATA Data Cable Kits

Each cable accessory kit referenced in this section will identify the connector type at each end of the cable using the following identifiers: **HR**, **HD**, and **MS**. The following table identifies the three cable connector types and their identifiers.

	<b>HR = Right Angle SFF-8643 Mini SAS HD Connector</b>
	<b>HD = Straight SFF-8643 Mini SAS HD Connector</b>
	<b>MS = Straight SFF-8087 Mini SAS Connector</b> (compatible with 6Gb/sec SAS controllers and expanders)

#### Cable Kit Product Code Decoder

Example – iPC **AXXCBL950HDMS**

**AXXCBL** – Identifies an accessory cable kit

**950** – identifies the length of the cable

**HD** – identifies that one cable connector supports an SFF-8643 type connector

**MS** – identifies that one cable connector supports an SFF-8087 type connector



Table 11. Storage Data Cable Kit Description and Order Information







Image	Order Information	Description
	iPC – <b>AXXCBL950HDHD</b> MM – 936122 UPC – 00735858286596 EAN – 5032037066495 MOQ – 1	<b>950 mm</b> long, cable kit (2 cables included) straight SFF8643 to straight SFF8643  Used in multiple systems as spare and/or accessory (1304, 2308, 2312)
	iPC – <b>AXXCBL875HDHD</b> MM – 936123 UPC – 00735858284769 EAN – 5032037065054 MOQ – 1	<b>875 mm</b> long, cable kit (2 cables included) straight SFF8643 to straight SFF8643  Used in multiple systems as spare and/or accessory (1304, 1208 2208, 2312)
	iPC – <b>AXXCBL800HDHD</b> MM – 937312 UPC – 00735858286015 EAN – 5032037066006 MOQ – 1	<b>800 mm</b> long, cable kit (2 cables included) straight SFF8643 to straight SFF8643  Used in multiple systems as spare and/or accessory (1203, 1208, 2308, 2312)
	iPC – <b>AXXCBL730HDHD</b> MM – 936178 UPC – 00735858284745 EAN – 5032037065030 MOQ – 1	<b>730 mm</b> long, cable kit (2 cables included) straight SFF8643 to straight SFF8643  Used in multiple systems as spare and/or accessory (1208, 2208)
	iPC – <b>AXXCBL650HDHD</b> MM – 937129 UPC – 00735858284752 EAN – 5032037065047 MOQ – 1	<b>650 mm</b> long, cable kit (2 cables included) straight SFF8643 to straight SFF8643  Used as accessory when installing 12G ROC module in 1208 for optimal cabling. (longer cable may be used)
	iPC – <b>AXXCBL1UHRHD</b> MM – 937311 UPC – 00735858287401 EAN – 5032037067140 MOQ – 1	Combo cable kit, contains 2 cables. One of each of the following: <b>730mm</b> (AXXCBL800HRHD), <b>800mm</b> right angle SFF8643 to straight SFF8643, Spare cables used in 1U WT systems to connect to onboard SATA ports.






Image	Order Information	Description
	iPC – <b>AXXCBL950HDMS</b> MM – 937131 UPC – 00735858286633 EAN – 5032037066532 MOQ – 1	<p><b>950 mm</b> long, cable kit (2 cables included) straight SFF8643to straight SFF8087</p> <p>Required in WT 2U systems with 6G SAS ROC module or 6G SAS RAID cards. (1304 with HBA, 2308 and 2312 HBA/module)</p>
	iPC – <b>AXXCBL875HDMS</b> MM – 937130 UPC – 00735858286626 EAN – 5032037066525 MOQ – 1	<p><b>875 mm</b> long, cable kit (2 cables included) straight SFF8643 to straight SFF8087</p> <p>Required in WT 2U systems with 6G SAS ROC module or 6G SAS RAID cards. (1304 and 1208 with HBA, 2216,2224,2312 with HBA/module)</p>
	iPC – <b>AXXCBL800HDMS</b> MM – 937309 UPC – 00735858286084 EAN – 5032037066075 MOQ – 1	<p><b>800 mm</b> long, cable kit (2 cables included) straight SFF8643 to straight SFF8087</p> <p>Required in WT 2U systems with 6G SAS ROC module or 6G SAS RAID cards. (1304 and 1208 with module, 2308 and 2312 HBA/module)</p>
	iPC – <b>AXXCBL730HDMS</b> MM – 927238 UPC – 00735858266970 EAN – 5032037053648 MOQ – 5	<p><b>730 mm</b> long, cable kit (2 cables included) straight SFF8643 to straight SFF8087</p> <p>Required in WT 2U systems with 6G SAS ROC module or 6G SAS HBA cards. (1208 with HBA, 2208 with HBA/module)</p>
	iPC – <b>AXXCBL650HDMS</b> MM – 927237 UPC – 00735858266963 EAN – 5032037053631 MOQ – 5	<p><b>650 mm</b> long, cable kit (2 cables included) straight SFF8643 to straight SFF8087</p> <p>Used as accessory when installing 6Gb ROC module in 1208 for optimal cabling. (longer cable may be used)</p>

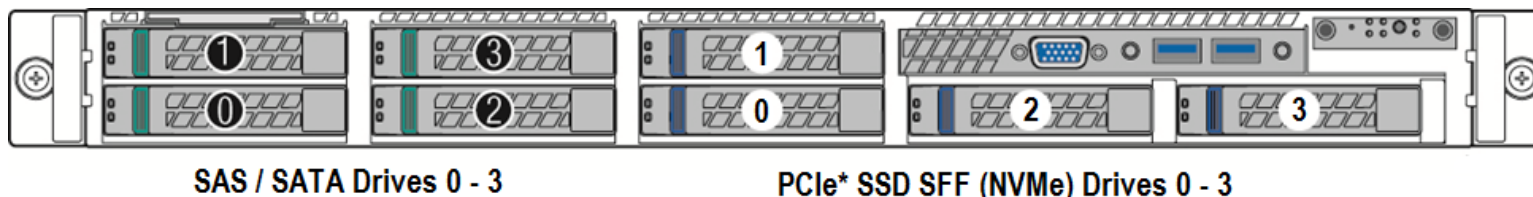
Image	Order Information	Description
	<p>iPC – <b>AXXCBLEXPDM5</b>                      MM – 937127                      UPC – 00735858284776                      EAN – 5032037065061                      MOQ – 1</p>	<p>6 Gb Expander to 12 Gb Backplane cable kit                      6Gb MS – to – 12Gb HD</p> <p>(3) <b>165 mm</b>, (1) <b>185 mm</b>, (1) <b>245 mm</b>, (1) <b>300 mm</b> straight SFF8643 to straight SFF8087</p>
	<p>iPC – <b>AXXCBL650MSMS</b>                      MM – 918376                      UPC – 00735858224444                      EAN – 5032037019910                      MOQ – 5</p>	<p><b>650 mm</b> long, cable kit (2 cables included) straight SFF8087 to straight SFF8087</p> <p>Required in WT 2U systems with 6Gb SAS ROC module or 6Gb SAS HBA cards. (1208 with HBA, 2208 with HBA/module) and 6 Gb Expander card</p>
	<p>iPC – <b>AXXCBL730MSMS</b>                      MM – 921049                      UPC – 00735858245340                      EAN – 5032037039864                      MOQ – 1</p>	<p><b>730 mm</b> long, cable kit (2 cables included) straight SFF8087 to straight SFF8087</p> <p>Required in WT 2U systems with 6Gb SAS ROC module or 6Gb SAS HBA cards. (1208 with HBA, 2208 with HBA/module) and 6 Gb Expander card</p>
	<p>iPC – <b>AXXCBL880SATA</b>                      MM – 922988                      UPC – 00735858250290                      EAN – 5032037044806                      MOQ – 10</p>	<p>Spare SATA ODD Data cable for rack chassis family – 880mm long                      Included with ODD accessories</p>
	<p>iPC - <b>A2UCBLSSD</b>                      MM# – 937328                      UPC – 00735858287005                      EAN – 5032037066747                      MOQ - 1</p>	<p>2U Cable kit accessory                      This kit includes cables necessary to provide simultaneous support for up to two internal air duct mounted SATA SSDs + rear drive bay (iPC – <b>A2UREARHSDK</b>)                      Kit includes:                      (1) Power Cable – Connectors to support rear drive bay and 2 internal mount SSDs (No CD/DVD Drive support)                      (1) fan out multiport SATA Data cable – Cable connectors include (1) HD mini-SAS SFF8643 + (4) 7-pin SATA + (1) SGPIO</p>

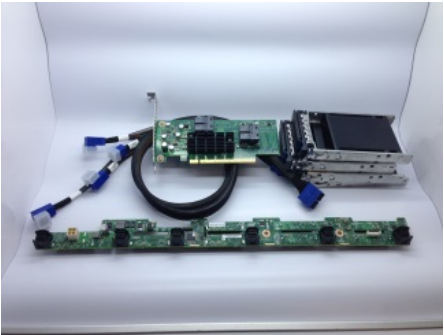
## 5 Intel 1U / 2U System Configuration Options

The following sections identify available accessory kits supported within the Intel® S2600WT product family.

### 5.1 1U 8x2.5" Combo PCIe\* SFF (NVMe) SSD / SAS Backplane – Intel® Accessory Kit A1U44X25NVMEDK

- The 8x2.5" combo backplane kit is capable of supporting a combination of both SAS devices and up to four PCIe\* SFF (Small Form Factor) (NVMe) SSD drives
- All eight drive connectors are capable of supporting a SAS device, but only four include SFF8639 connectors that can support PCIe\* SFF (NVMe) SSDs
- This kit is only supported in dual processor configurations



Intel Product Code	Order Information	Product Description	Product Type
<p><b>iPC – A1U44X25NVMEDK</b></p> 	<p>MM# – 936251                      UPC – 00735858288873                      EAN – 5032037068154                      MOQ – 1</p>	<p><b>1U 8x2.5" Combo PCIe* SFF (NVMe) SSD / SAS Backplane Kit</b>                      Kit IncludesL                      (1) Combo Hot Swap Backplane PCBA                      (4) SAS / SATA Hot Swap Drive Carriers (Green Latch)                      (4) PCIe* SFF SSD (NVMe) Hot Swap Drive Carriers (Blue Latch)                      (2) Dual PCIe* Port Cables                      (1) PCIe x16 Add-in card                      (1) Installation Guide</p> <p>Required (Sold Separately):                      SAS / SATA Data cables - See section 5.1.1</p>	<ul style="list-style-type: none"> <li>• 1U Accessory Kit</li> </ul>

See the Intel® Server System R1000WT Technical Product Specification for additional information

5.1.1 1U 8x2.5" – Intel® Accessory Kit A1U44X25NVMEDK Cable Guide

Figure 11. 1U Combo Backplane (iPC – A1U44X25NVMEDK) Cable Routing

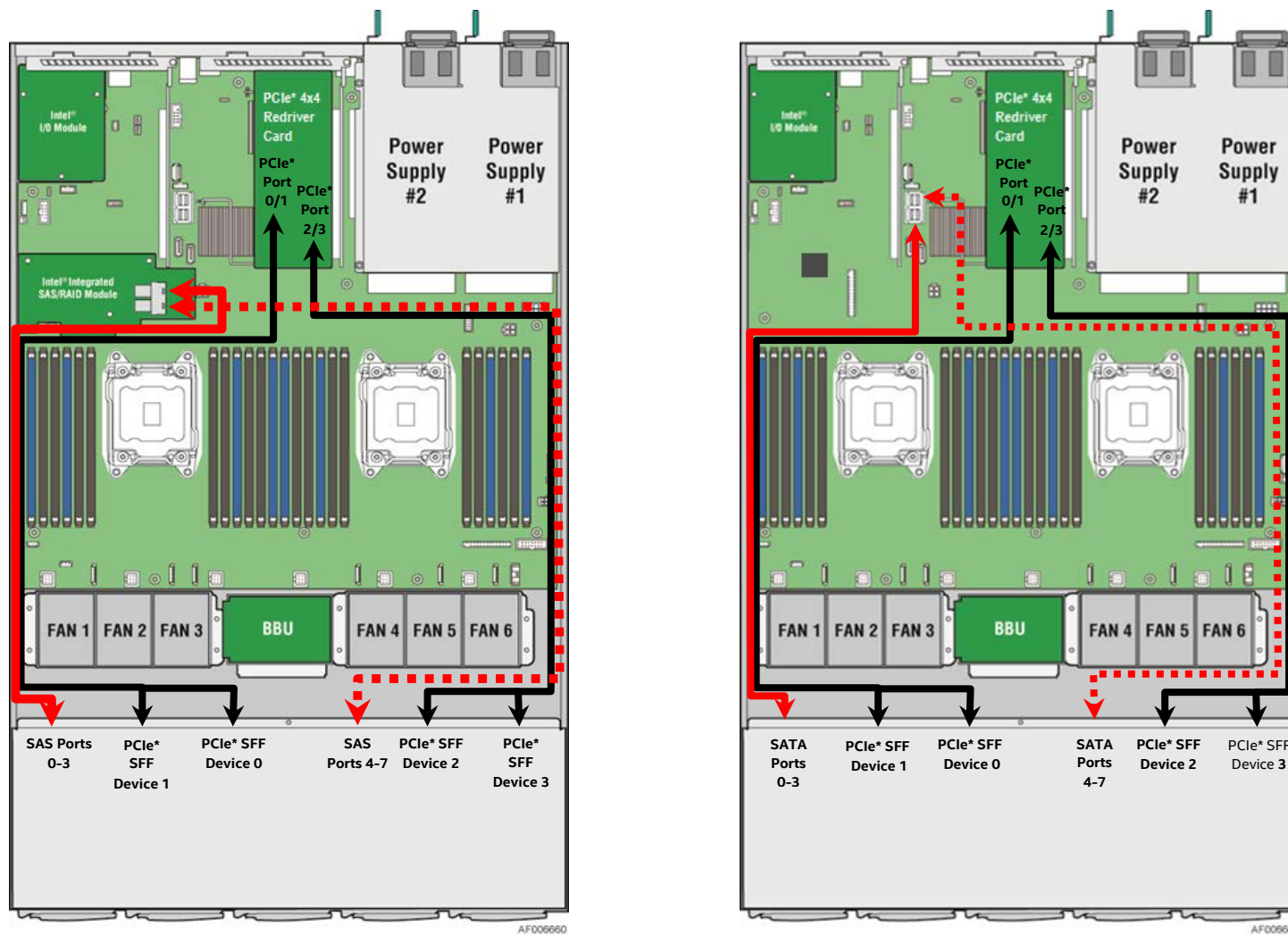
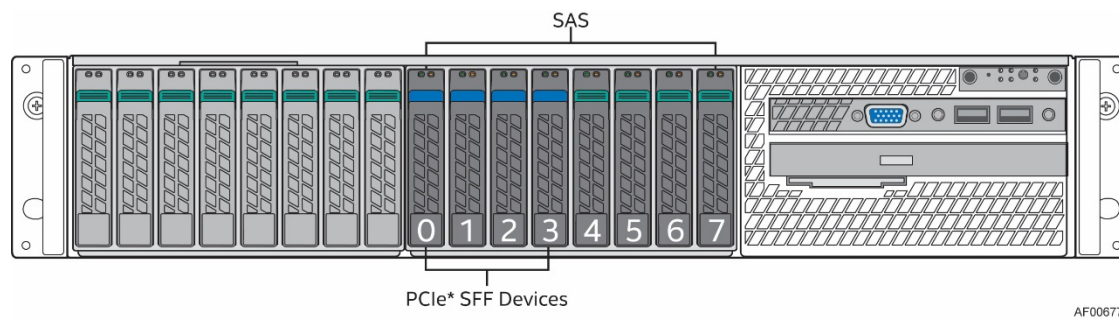



Table 12. 1U 8x2.5" Combo Backplane SAS/SATA Cable Guide

System Configuration	Drive Support	Cables for On-board Multi-port SATA Ports to Backplane	Cables for Mezzanine 12 Gb SAS ROC Module to Backplane	Cables for Mezzanine 6 Gb SAS RAID module to Backplane	Cables for 12 Gb SAS RAID PCIe* add-in card to Backplane	Cables for 6 Gb SAS RAID PCIe* add-in card to Backplane
<p><b>R1208WTxxx</b>  <b>R1208WTTGSR</b>  <b>R1208WT2GSR</b></p> <p><b>with</b>  <b>A1U44X25NVMEDK</b></p>	<p><b>A1U44X25NVMEDK</b>  <b>Accessory kit</b>  <b>Option</b></p> <p><b>8 x 2.5" Combo</b>  <b>SAS / SATA + PCIe*</b>  <b>SSD SFF (NVMe)</b>  12 Gb SAS capable</p> <p>PCIe* cables included in accessory kit. For SAS/SATA support see the following options</p>	<p>730 mm HR --- HD  Connect cable to:  SATA -&gt; BP 0-3</p> <p>and / or</p> <p>800 mm HR --- HD  Connect cable to:  sSATA -&gt; BP 4-7</p> <p><b>Cables Included with system SKUs.</b></p> <p>Cable kit required for building block integration:  <b>AXXCBL1UHRHD</b></p> <p>Use PCIe* cables included with Combo backplane kit for PCIe* SSD / NVMe drive support</p>	<p>650 mm HD --- HD  Connect cable to:  SAS Mezz -&gt; BP 0-3</p> <p>and/or</p> <p>800 mm HD --- HD  Connect cable to:  SAS Mezz -&gt; BP 4-7</p> <p>Cable Kits Required:  <b>AXXCBL650HDHD</b>  and / or  <b>AXXCBL800HDHD</b></p> <p>Use PCIe* cables included with Combo backplane kit for PCIe* SSD / NVMe drive support</p>	<p>650 mm HD --- MS  Connect cable to:  SAS Mezz -&gt; BP 0-3</p> <p>and/or</p> <p>800 mm HD --- MS  Connect cable to:  SAS Mezz -&gt; BP 4-7</p> <p>Cable Kits Required:  <b>AXXCBL650HDMS</b>  and / or  <b>AXXCBL800HDMS</b></p> <p>Use PCIe* cables included with Combo backplane kit for PCIe* SSD / NVMe drive support</p>	<p>From Riser #1</p> <p>730 mm HD --- HD  Connect cable to:  SAS PCIe -&gt; BP 0-3</p> <p>and/or</p> <p>875 mm HD --- HD  Connect cable to:  SAS PCIe -&gt; BP 4-7</p> <p>Cable Kits Required:  <b>AXXCBL730HDHD</b>  and / or  <b>AXXCBL875HDHD</b></p> <p>Use PCIe* cables included with Combo backplane kit for PCIe* SSD / NVMe drive support</p>	<p>From Riser #1</p> <p>730 mm HD --- MS  Connect cable to:  SAS PCIe -&gt; BP 0-3</p> <p>and/or</p> <p>875 mm HD --- MS  Connect cable to:  SAS PCIe -&gt; BP 4-7</p> <p>Cable Kits Required:  <b>AXXCBL730HDMS</b>  and / or  <b>AXXCBL875HDMS</b></p> <p>Use PCIe* cables included with Combo backplane kit for PCIe* SSD / NVMe drive support</p>

## 5.2 2U 8x2.5" Combo PCIe\* SFF (NVMe) SSD / SAS Backplane – Intel® Accessory Kit A2U44X25NVMEDK

- The 8x2.5" combo backplane kit is capable of supporting a combination of both SAS devices and up to four PCIe\* SFF (Small Form Factor) (NVMe) SSD drives
- All eight drive connectors are capable of supporting a SAS device, but only four include SFF8639 connectors that can support PCIe\* SFF (NVMe) SSDs
- The PCIe\* x16 interface add-in card **MUST** be installed in a x16 riser card (included), and is only supported in the Riser #2 slot of the server board.
- This kit is only supported in dual processor configurations
- The 2U system is limited to supporting only one combo backplane kit in addition to one or two other backplane options
- The combo backplane module can only be supported in the first (left) drive bay when no other backplane module is installed
- Due to thermal and power limits associated with 16 x 2.5" and 24 x 2.5" front drive configurations, the combo backplane module can only be supported in the second (middle) drive bay



Intel Product Code	Order Information	Product Description	Product Type
<p><b>iPC – A2U44X25NVMEDK</b></p> 	<p>MM# – 936253                      UPC – 00735858288880                      EAN – 5032037068161                      MOQ – 1</p>	<p><b>2U 8x2.5" Combo PCIe* SFF (NVMe) SSD / SAS Backplane Kit</b></p> <p>Kit Includes:</p> <ul style="list-style-type: none"> <li>(1) 8x2.5" Drive Bay Assembly with backplane</li> <li>(4) SAS / SATA Hot Swap Drive Carriers (Green Latch)</li> <li>(4) PCIe* SFF SSD (NVMe) Hot Swap Drive Carriers (Blue Latch)</li> <li>(2) Dual PCIe* Port Cables</li> <li>(1) PCIe x16 Add-in card</li> <li>(1) 2-slot PCIe Riser card PCBA and mounting screws</li> <li>(1) I2C jumper cable (used in dual backplane configurations)</li> <li>(1) Installation Guide</li> </ul> <p>Required (Sold Separately):</p> <p>SAS / SATA Data cables - See sections 5.2.1&amp; 5.2.2</p>	<ul style="list-style-type: none"> <li>• 2U Accessory Kit</li> </ul>

See the Intel® Server System R2000WT Technical Product Specification for additional information.

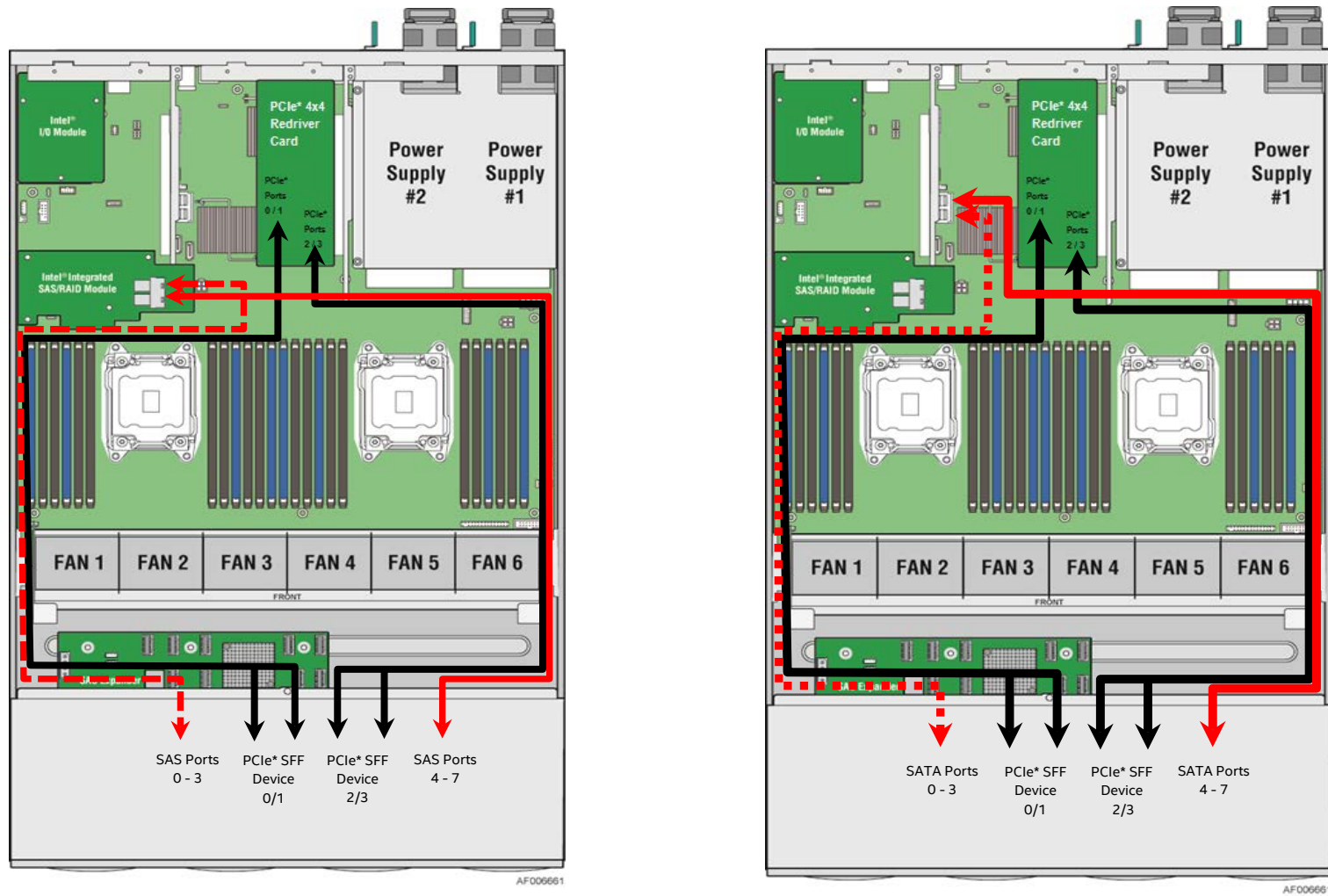


Figure 12. 2U Combo Backplane (iPC - A2U44X25NVMEDK) Cable Routing



5.2.1 2U 8x2.5" – Intel® Accessory Kit A2U44X25NVMEDK SAS/SATA Cable Guide

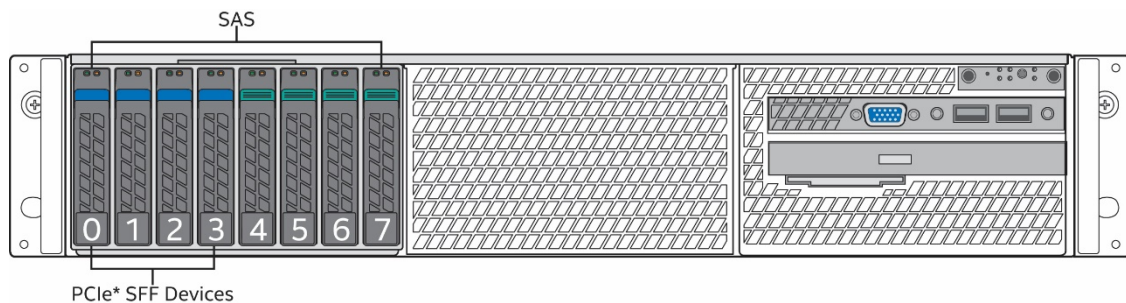
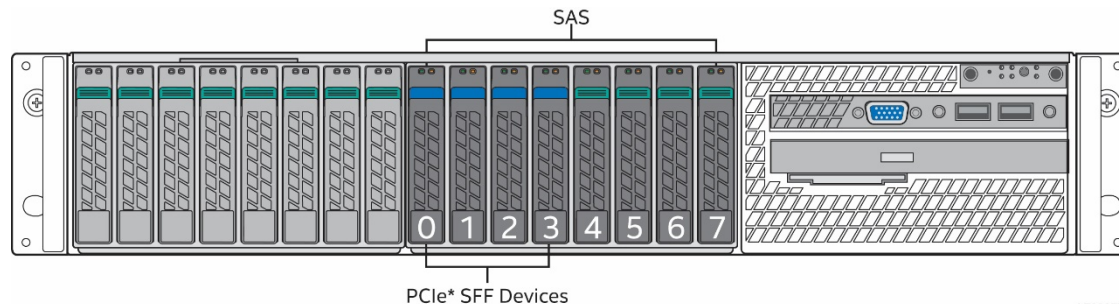


Figure 13. Combo Backplane Module Placement – 8 x 2.5" front drive configurations

System Configuration	Drive Bay #1	Cables for On-board Multi-port SATA Ports to Backplane	Cables for Mezzanine 12 Gb SAS ROC Module to Backplane	Cables for Mezzanine 6 Gb SAS RAID module to Backplane	Cables for 12 Gb SAS RAID PCIe* add-in card to Backplane	Cables for 6 Gb SAS RAID PCIe* add-in card to Backplane
<p><b>R2208WT...</b></p> <p>Drive Bay #1 populated</p>	<p>8 x 2.5" Combo SAS / SATA + PCIe* SSD SFF (NVMe) iPC <b>A2U44X25NVMEDK</b></p> <p>PCIe* cables included in accessory kit. For SAS/SATA support see the following options</p>	<p>730 mm HD --- HD Connect cable to: SATA -&gt; BP 0-3 <b>Included w/system SKUs</b></p> <p>and / or</p> <p>730 mm HR --- HD Connect cable to: sSATA -&gt; BP 4-7 Included w/system SKUs</p> <p>Cable kit required for building block integration: (2) <b>AXXCBL730HDHD</b></p> <p>Use PCIe* cables included with Combo backplane kit for PCIe* SSD SFF / NVMe drive support</p>	<p>730 mm HD --- HD Connect cable to: SAS Mezz -&gt; BP 0-3 <b>Included w/system SKUs</b></p> <p>and/or</p> <p>730 mm HD --- HD Connect cable to: SAS Mezz -&gt; BP 4-7 Included w/system SKUs</p> <p>Cable kit required for building block integration: (2) <b>AXXCBL730HDHD</b></p> <p>Use PCIe* cables included with Combo backplane kit for PCIe* SSD SFF / NVMe drive support</p>	<p>730 mm HD --- MS Connect cable to: SAS Mezz -&gt; BP 0-3</p> <p>and/or</p> <p>730 mm HD --- MS Connect cable to: SAS Mezz -&gt; BP 4-7</p> <p>Cable Kits Required: (1 or 2) <b>AXXCBL730HDMS</b></p> <p>Use PCIe* cables included with Combo backplane kit for PCIe* SSD SFF / NVMe drive support</p>	<p>From Riser #1</p> <p>730 mm HD --- HD Connect cable to: SAS PCIe -&gt; BP 0-3</p> <p>and/or</p> <p>730 mm HD --- HD Connect cable to: SAS PCIe -&gt; BP 4-7</p> <p>Cable Kits Required: (1 or 2) <b>AXXCBL730HDHD</b></p> <p>Use PCIe* cables included with Combo backplane kit for PCIe* SSD SFF / NVMe drive support</p>	<p>From Riser #1</p> <p>730 mm HD --- MS Connect cable to: SAS PCIe -&gt; BP 0-3</p> <p>and/or</p> <p>730 mm HD --- MS Connect cable to: SAS PCIe -&gt; BP 4-7</p> <p>Cable Kits Required: (1 or 2) <b>AXXCBL730HDMS</b></p> <p>Use PCIe* cables included with Combo backplane kit for PCIe* SSD SFF / NVMe drive support</p>

5.2.2 2U 16x2.5" / 24x2.5" — Intel® Accessory Kit A2U44X25NVMEDK SAS / SATA Cable Guide

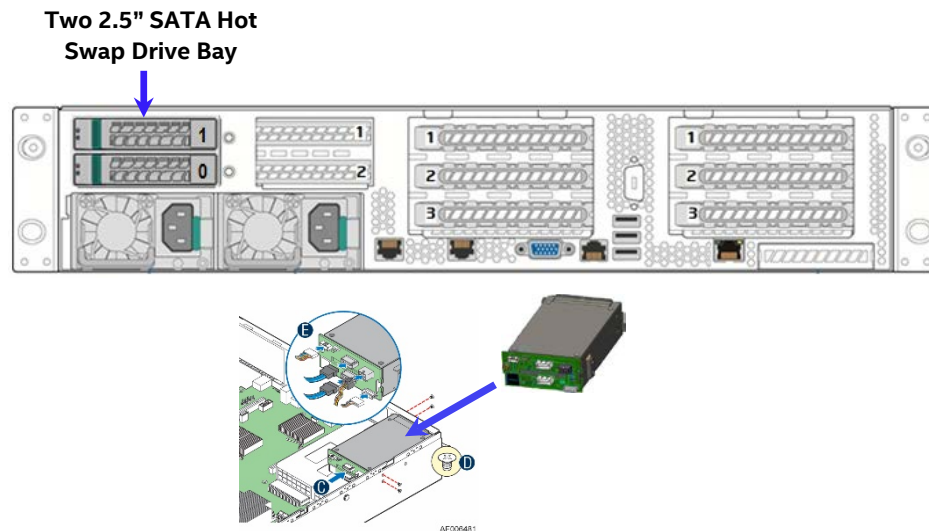
Figure 14. Combo Backplane Module Placement - 16 x 2.5" and 24 x 2.5" front drive configurations

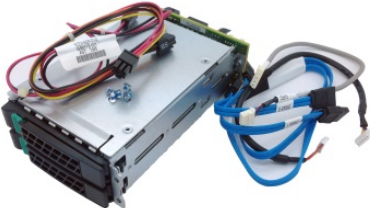
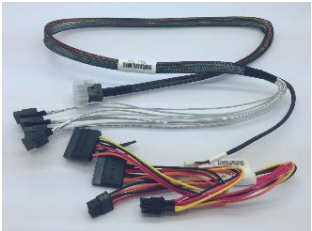


System Configuration	Cables for Drive Bay #1	Drive Bay #2 Backplane Type	Cables for Mezzanine 12 Gb SAS ROC Module to Drive Bay #2	Cables for Mezzanine 6 Gb SAS RAID module to Drive Bay #2	Cables for 12 Gb SAS RAID PCIe* add-in card to Drive Bay #2	Cables for 6 Gb SAS RAID PCIe* add-in card to Drive Bay #2
<b>R2216WT...</b> <b>R2224WT...</b>	See section 5.2.1	8 x 2.5" Combo SAS / SATA + PCIe* SSD SFF (NVMe) iPC <b>A2U44X25NVMEDK</b>  PCIe* cables included in accessory kit. For SAS/SATA support see the following options	730mm HD --- HD Connect cable to: SAS Mezz -> BP 0-3  and/or  800mm HD --- HD Connect cable to: SAS Mezz -> BP 4-7  One or both cable kits for building block integration: <b>(1) AXXCBL730HDHD</b> <b>(1) AXXCBL800HDHD</b>  Use PCIe* cables included with Combo backplane kit for PCIe* SSD / NVMe drive support	730mm HD --- MS Connect cable to: SAS Mezz -> BP 0-3  and/or  800mm HD --- MS Connect cable to: SAS Mezz -> BP 4-7  One or both cable kits for building block integration: <b>(1) AXXCBL730HDMS</b> <b>(1) AXXCBL800HDMS</b>  Use PCIe* cables included with Combo backplane kit for PCIe* SSD / NVMe drive support	From Riser #1  730 mm HD --- HD Connect cable to: SAS PCIe -> BP 0-3  and/or  800 mm HD --- HD Connect cable to: SAS PCIe -> BP 4-7  One or both cable kits for building block integration: <b>(1) AXXCBL730HDHD</b> <b>(1) AXXCBL800HDHD</b>  Use PCIe* cables included with Combo backplane kit for PCIe* SSD SFF / NVMe drive support	From Riser #1  730 mm HD --- MS Connect cable to: SAS PCIe -> BP 0-3  and/or  800 mm HD --- MS Connect cable to: SAS PCIe -> BP 4-7  One or both cable kits for building block integration: <b>(1) AXXCBL730HDMS</b> <b>(1) AXXCBL800HDMS</b>  Use PCIe* cables included with Combo backplane kit for PCIe* SSD SFF / NVMe drive support

### 5.3 2U Rear Mount Hot Swap Drive Bay Accessory Kit – iPC A2UREARHSDK

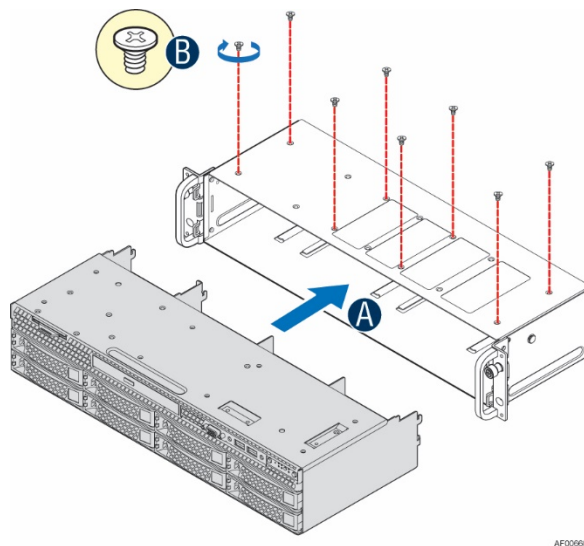
The 2U product family provides the option to support two 2.5" 6 Gb/sec hot swap SSDs installed to a modular drive bay mounted in the back of the system




Intel Product Code	Order Information	Product Description	Product Type
<p><b>iPC – A2UREARHSDK</b></p> 	<p>MM – 934976                      UPC – 735858283298                      EAN – 5032037064354                      MOQ – 1</p>	<p><b>2U Rear Mount Hot Swap Drive Bay Accessory Kit</b></p> <p>Kit Includes:</p> <ul style="list-style-type: none"> <li>(1) Drive Bay Assembly and mounting hardware</li> <li>(2) 2.5" Hot Swap Drive Carriers</li> <li>(2) SATA Data Cables</li> <li>(1) Power Cable</li> <li>(1) I2C Cable</li> <li>(1) SGPIO cable</li> </ul>	<ul style="list-style-type: none"> <li>• 2U Accessory Kit System and Building Block</li> </ul>
<p><b>iPC - A2UCBLSSD</b></p> 	<p>MM# – 937328                      UPC – 735858287005                      EAN – 5032037066747                      MOQ - 1</p>	<p><b>2U Fixed Mount SSD + Rear Drive Bay Cable Kit</b></p> <p>This kit includes cables to provide simultaneous support for up to two internal fixed mount SATA SSDs + rear drive bay</p> <p>Kit includes:</p> <ul style="list-style-type: none"> <li>(1) Power Cable – Connectors to support rear drive bay and 2 internal mount SSDs (No CD/DVD Drive support)</li> <li>(1) Fan out multiport SATA Data cable – Cable connectors include (1) HD mini-SAS SFF8643 + (4) 7-pin SATA + (1) SGPIO</li> </ul>	<ul style="list-style-type: none"> <li>• 2U Cable kit accessory</li> </ul>

## 5.4 2U 8x3.5" Front Mount Hot Swap Backplane Assembly - iPC A2U8X35S3HSDK

8x3.5" SAS/SATA Front Mount Hot-Swap Drive Bay Module option for 2U Building Block Chassis iPC – R2000WTxxx.



Intel Product Code	Order Information	Product Description	Product Type
<p><b>iPC – A2U8X35S3HSDK</b></p> 	<p>MM# – 936191                      UPC – 00735858288781                      EAN – 5032037068062                      MOQ – 5</p>	<p><b>2U 8x3.5" Front Mount Hot Swap Backplane Assembly</b></p> <p>Kit Includes:</p> <ul style="list-style-type: none"> <li>(1) Drive Bay Assembly Module</li> <li>(1) 8x3.5" hot swap backplane</li> <li>(8) 3.5" drive carriers + drive blanks</li> <li>(1) 175mm I2C Cable</li> <li>(1) 500mm ODD/SSD Power Cable</li> <li>(1) Chassis mounting clip</li> <li>(1 set) mounting hardware</li> </ul> <p>Required (Sold Separately):                      SAS / SATA Data Cables. See section 4.2.3</p>	<ul style="list-style-type: none"> <li>• 2U Building Block Accessory Kit</li> </ul>

See the *Intel® Server System R2000WT product family System Integration and Service Guide* for complete kit installation instructions.

## 5.5 2U 8x2.5" Drive Bay Module Options

2U system configurations that include support for 2.5" front mount storage devices can support up to three 8x2.5" drive bay modules. Intel makes available different types of 8x2.5" drive bay modules and can support from 1 to 3 of the same module or a mix of different modules. Only the PCIe\* SSD (NVMe) compatible module (iPC – A2U44X25NVMEDK) has the limitation of only supporting one of these modules in combination with other backplane modules in the system.

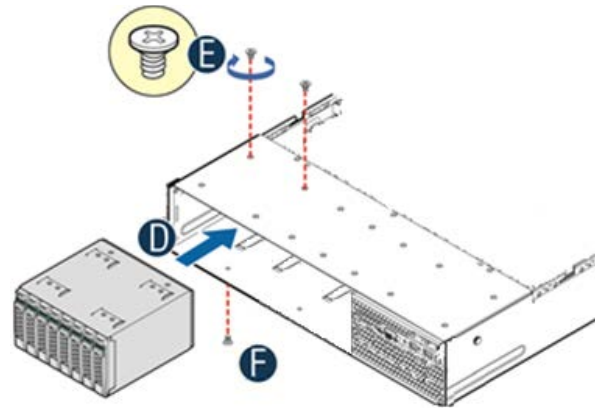


Figure 15. R2208WT and R2216WT based system with Front I/O Module Bay Assembly

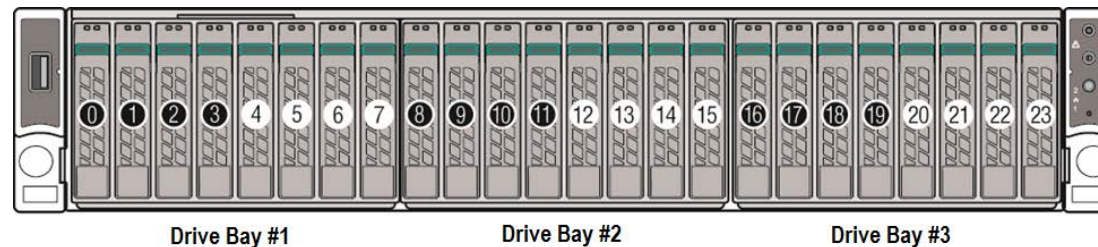
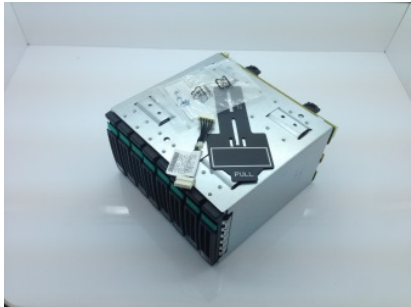



Figure 16. 2U 2.5" Drive Bay Numbering


Drive numbering in the illustrations above is for general reference only. Actual drive numbering will be dependant on SAS / SATA controller configuration and how they are cabled to the backplane. Each drive bay will include a single backplane. Each backplane will include a multi-port data connector for each set of four drives. Ex) for an 8 drive configuration, the backplane will include 2 four port data connectors. In the illustration above, drives showing a common Drive ID label color share a common data connector on the backside of the given backplane.

**R2208WT** (8x2.5" – 1 drive bay) and **R2216WT** (16x2.5" – 2 drive bays) system configurations utilize the same front I/O module bay assembly containing the System Control Panel and Front I/O Panel (as shown in Figure 9). When upgrading a R2208WT based system to an R2216WT based system, all that is needed is the removal of the Bay #2 face plate to insert the new drive bay, and adding the required data cables. No other chassis changes or additions are required.

Available SAS / SATA 8x25" accessory kits include the following.

Intel Product Code	Order Information	Product Description	Product Type
<p><b>iPC – A2U8X25S3HSDK</b></p> 	<p>MM# – 935066                      UPC – 00735858288767                      EAN – 5032037068048                      MOQ – 1</p>	<p><b>8x2.5" SAS/SATA Front Mount Hot Swap Drive Bay Module for all 2U 2.5" systems</b></p> <p>Kit Includes:</p> <ul style="list-style-type: none"> <li>(1) Drive Bay Assembly Module</li> <li>(1) 8x2.5" hot swap backplane</li> <li>(8) 2.5" drive carriers + drive blanks</li> <li>(1) 75mm I2C Backplane-to-Backplane jumper cable</li> <li>(1 set) mounting hardware</li> </ul> <p>Required (Sold Separately):                      SAS / SATA Data Cables. See section 4.2.5</p>	<ul style="list-style-type: none"> <li>• 2U 2.5" Drive Upgrade Kit</li> <li>• 2U Building Block Accessory Kit</li> </ul>
<p><b>iPC – A2U8X25S3DPDK</b></p> 	<p>MM# – 935067                      UPC – 00735858288774                      EAN – 5032037068055                      MOQ – 1</p>	<p><b>8x2.5" Dual Port SAS Front Mount Hot Swap Drive Bay Module for all 2U 2.5" systems</b></p> <p>Kit Includes:</p> <ul style="list-style-type: none"> <li>(1) Drive Bay Assembly Module</li> <li>(1) 8x2.5" hot swap backplane</li> <li>(8) 2.5" drive carriers + drive blanks</li> <li>(1) 75mm I2C Backplane-to-Backplane jumper cable</li> <li>(1 set) mounting hardware</li> </ul> <p>Required (Sold Separately):                      SAS / SATA Data Cables. See section 4.2.5</p>	<ul style="list-style-type: none"> <li>• 2U 2.5" Drive Upgrade Kit</li> <li>• 2U Building Block Accessory Kit</li> <li>• </li> </ul>

For a 2U building block configuration consisting of 24x2.5" drives (3 drive bays – See Figure 10) or when upgrading a R2208WT or R2216WT system to a 24 drive R2224WT system, the 2U storage front panel option of Intel Accessory Kit A2UHANDLKIT must be installed.


Intel Product Code	Order Information	Product Description	Product Type
<p><b>iPC – A2UHANDLKIT</b></p> 	<p>MM# – 936038                      UPC – 00735858288866                      EAN – 5032037068147                      MOQ – 1</p>	<p><b>1U / 2U Rack Handle Kit</b></p> <p>This kit includes <b>3 different rack handles</b>, including:</p> <p>(1) Set of 2U storage rack handles with control panel and USB support                      (R2312WT &amp; R2224WT)</p> <p>(1) Set of 2U non –storage rack handles                      (R2208WT &amp; R2216WT)</p> <p>(1) Set of 1U rack handles                      (R1304WT &amp; R1208WT)</p>	<ul style="list-style-type: none"> <li>• 2U – 24 2.5" Drive Upgrade Kit</li> <li>• 1U / 2U Spares Kit</li> </ul>

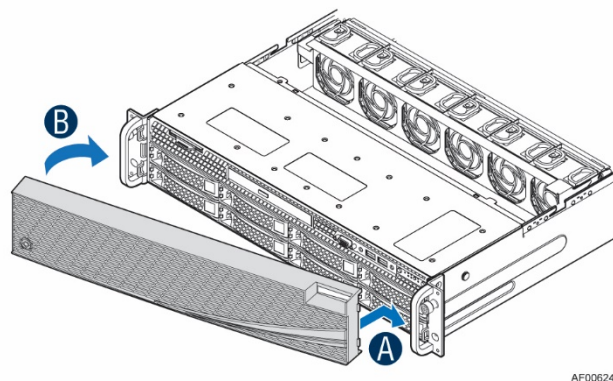
See the *Intel Server System R2000WT Product Family System Integration and Service Guide* for complete system integration and upgrade instructions.

## 5.6 Locking Front Bezel Accessory Kits

The optional front bezel is made of Black molded plastic and uses a snap-on design. When installed, its design allows for maximum airflow to maintain system cooling requirements. The front bezel includes a keyed locking mechanism which can be used to prevent unauthorized access to installed storage devices and front I/O ports.

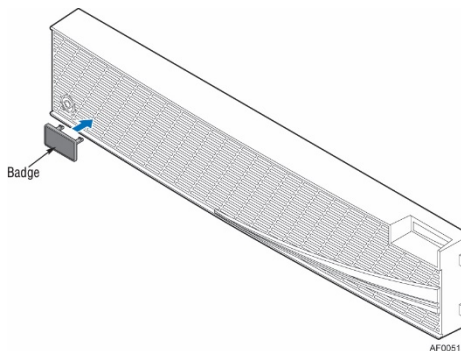
### 5.6.1 2U Front Bezel Accessory Kit – iPC A2UBEZEL

Intel Product Code	Order Information	Product Description	Product Type
<p><b>iPC – A2UBEZEL</b></p> 	<p>MM# – 918086                      UPC – 735858241137                      EAN – 5032037035880                      MOQ – 1</p>	<p><b>2U Front Bezel Accessory Kit</b></p> <p>Kit Includes:</p> <ul style="list-style-type: none"> <li>(1) 2U locking bezel</li> <li>(1) Front Panel Window Insert</li> <li>(1 Set) Bezel branding inserts – two ID badges, one wave</li> <li>(1 Set) Keys</li> </ul>	<ul style="list-style-type: none"> <li>• 2U Accessory Kit</li> </ul>



AF006243


The face of the bezel assembly includes snap-in identification badge options and a wave feature option to allow for customization.

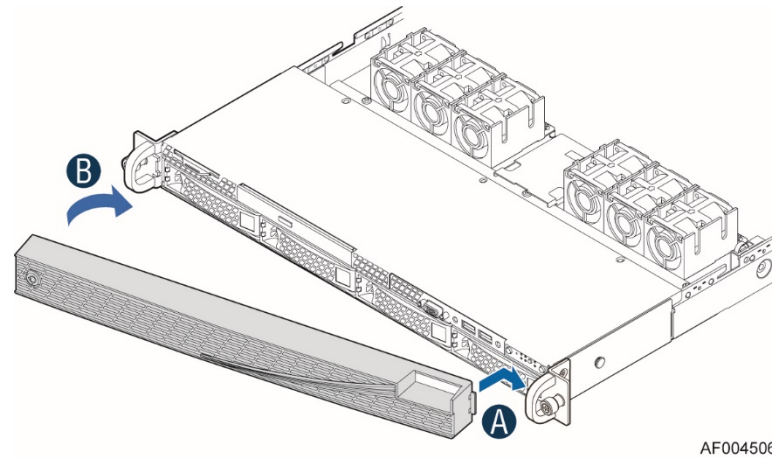


AF005159

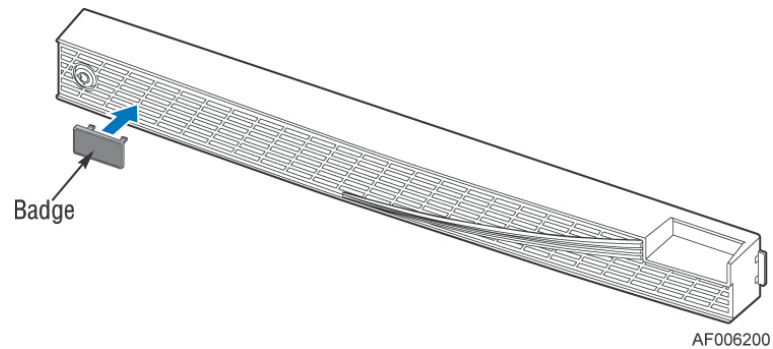


### 5.6.2 1U Front Bezel Accessory Kit – iPC A1UBEZEL

Intel Product Code	Order Information	Product Description	Product Type
<p><b>iPC – A1UBEZEL</b></p> 	<p>MM# – 917983                      UPC – 735858241120                      EAN – 5032037035873                      MOQ – 1</p>	<p><b>1U Front Bezel Accessory Kit</b></p> <p>Kit Includes:</p> <ul style="list-style-type: none"> <li>(1) 1U locking bezel</li> <li>(1) Front Panel Window Insert</li> <li>(1 Set) Bezel branding inserts – two ID badges, one wave</li> <li>(1 Set) Keys</li> </ul>	<ul style="list-style-type: none"> <li>• 1U Accessory Kit</li> </ul>



The face of the bezel assembly includes snap-in identification badge options and a wave feature option to allow for customization.




## 5.7 1U / 2U PCIe\* Riser Card Accessory/Spare FRU Options

The Intel® Server Board S2600WT provides three riser slots. Riser slots 1 and 2 are capable of supporting different riser card options to meet needs of specific system configurations. Riser card options for riser slots 1 and 2 are common. Riser slot 3 is only supported in 2U system configurations and can only support a riser capable of supporting low profile PCIe\* add-in cards.

All PCIe\* bus lanes to the riser slots are routed from the processors. Riser slot 1 has a total of 24 PCIe\* 3.0 bus lanes routed from both processors; 16 lanes from processor #1 and 8 lanes from processor #2. Riser slot 2 has a total of 24 PCIe\* 3.0 bus lanes routed from CPU 2. For riser slot 3, all PCIe\* bus lanes are routed from CPU 2; 8 PCIe\* bus lanes are PCIe\* 3.0 compatible and 4 PCIe\* lanes are PCIe\* 2.0 compatible. See the product Technical Product Specification (TPS) for additional information.

Riser slots 1 and 2 are capable of supporting up to 100W maximum power each. Available power to each add-in card slot on a given riser card is defined by the PCIe\* specification. The server board provides two Auxiliary 12V power connectors that when cabled (iPC **AXXGPGPUCABLE**), can provide additional power to high power PCIe\* add-in cards.


### 5.7.1 1U Riser Card Options

Intel Product Code	Order Information	Product Description	Product Type
<b>iPC – F1UL16RISER2</b> 	MM# – 934884 UPC – 00735858288682 EAN – 5032037067966 MOQ – 1	<b>1U 1-slot PCIe riser card option</b>  One PCIe* add-in card slot – PCIe* x16, x16 mechanical  Kit includes: (1) Riser card PCBA	<ul style="list-style-type: none"> <li>• 1U Building Block Accessory Kit</li> <li>• 1U Spare FRU</li> </ul>


Each riser card assembly has support for a single full height, ½ length PCIe\* add-in card. However, riser card #2 may be limited to ½ length, ½ height add-in cards if either of the two mini-SAS HD connectors on the server board are used.

**Note:** Add-in cards that exceed the PCI specification for ½ length PCI add-in cards (167.65mm or 6.6in) may interfere with other installed devices on the server board.

### 5.7.2 2U Riser Card Options

Intel Product Code	Order Information	Product Description	Product Type					
<b>iPC – A2UL8RISER2</b> 	MM# – 934885 UPC – 00735858288675 EAN – 5032037067959 MOQ – 1	<b>2U 3-slot PCIe* riser card option</b>  Riser Slots <b>#1 &amp; #2</b> Riser Card Option	<ul style="list-style-type: none"> <li>2U Building Block Accessory Kit</li> <li>2U Spare FRU</li> </ul>					
		<table border="1"> <thead> <tr> <th>Slot #</th> <th>Description</th> </tr> </thead> <tbody> <tr> <td>Slot-1 (Top)</td> <td>PCIe* x8 elec, x16 mechanical</td> </tr> <tr> <td>Slot-2 (Middle)</td> <td>PCIe* x8 elec, x16 mechanical</td> </tr> <tr> <td>Slot-3 (Bottom)</td> <td>PCIe* x8 elec, x8 mechanical</td> </tr> </tbody> </table> Kit includes: (1) riser card PCBA		Slot #	Description	Slot-1 (Top)	PCIe* x8 elec, x16 mechanical	Slot-2 (Middle)
Slot #	Description							
Slot-1 (Top)	PCIe* x8 elec, x16 mechanical							
Slot-2 (Middle)	PCIe* x8 elec, x16 mechanical							
Slot-3 (Bottom)	PCIe* x8 elec, x8 mechanical							


Each 3-slot riser card assembly has support for up to two full height full length add-in cards (top and middle slots) and one full height ½ length add-in card (bottom slot).

Intel Product Code	Order Information	Product Description	Product Type			
<b>iPC – A2UL16RISER2</b> 	MM# – 934886 UPC – 00735858288668 EAN – 5032037067942 MOQ – 1	<b>2U 2-slot PCIe* Riser card option</b>  Riser Slots <b>#1 &amp; #2</b> Riser Card Option	<ul style="list-style-type: none"> <li>2U Building Block Accessory Kit</li> <li>2U Spare FRU</li> </ul> <p>* Required Kit for Intel® Xeon Phi™ or high power PCIe* add-in card support</p>			
		<table border="1"> <thead> <tr> <th>Slot #</th> <th>Description</th> </tr> </thead> <tbody> <tr> <td>Slot-1 (Top)</td> <td>PCIe* x16 elec, x16 mechanical</td> </tr> <tr> <td>Slot-2 (Bottom)</td> <td>PCIe* x8 elec, x8 mechanical</td> </tr> </tbody> </table> Kit includes: (1) Riser card PCBA (1) 12V-AUX Power Cable		Slot #	Description	Slot-1 (Top)
Slot #	Description					
Slot-1 (Top)	PCIe* x16 elec, x16 mechanical					
Slot-2 (Bottom)	PCIe* x8 elec, x8 mechanical					

Each 2-slot riser card assembly has support for one full height full length add-in card (top slot) and one full height ½ length add-in card (bottom slot).

Note: The **A2UL16RISER2** accessory kit includes a 12V Auxiliary Power cable which can be used to provide additional 12V power for high power PCIe\* add-in cards that require it.

Note: The x16 2-slot riser card is included in Intel Accessory Kit A2U44X25NVMEDK. Systems configured with the A2U44X25NVMEDK accessory kit cannot support dual Intel® Xeon Phi™ coprocessor cards or dual non-Intel GPGPU cards.

Intel Product Code	Order Information	Product Description	Product Type						
<p><b>iPC – A2UX8X4RISER</b></p> 	<p>MM# – 934883                      UPC – 00735858283311                      EAN – 5032037064378                      MOQ – 1</p>	<p><b>2U 2-slot riser card option</b></p> <p>Riser Slot #3 (only) Riser Card Option</p> <table border="1" data-bbox="852 368 1514 550"> <thead> <tr> <th>Slot #</th> <th>Description</th> </tr> </thead> <tbody> <tr> <td>Slot-1 (Top)</td> <td>PCIe* x4 elec, x8 mechanical (PCIe* 2.0 support only)</td> </tr> <tr> <td>Slot-2 (Bottom)</td> <td>PCIe* x8 elec, x8 mechanical</td> </tr> </tbody> </table> <p>Kit includes:                      (1) Riser card PCBA</p>	Slot #	Description	Slot-1 (Top)	PCIe* x4 elec, x8 mechanical (PCIe* 2.0 support only)	Slot-2 (Bottom)	PCIe* x8 elec, x8 mechanical	<ul style="list-style-type: none"> <li>• 2U Building Block Accessory Kit</li> <li>• 2U Spare FRU</li> </ul>
Slot #	Description								
Slot-1 (Top)	PCIe* x4 elec, x8 mechanical (PCIe* 2.0 support only)								
Slot-2 (Bottom)	PCIe* x8 elec, x8 mechanical								

Riser Slot #3 is provided to support up to two additional PCIe\* add-in card slots for 2U server configurations. The available riser card option is designed to support low profile add-in cards only.

### 5.8 Intel® I/O Expansion Modules

The Intel® S2600WT product family includes support for a number of optional Intel® I/O modules that install onto proprietary connectors on the server board leaving all available PCIe\* add-in cards slots available for other add-in card options. The onboard high density interface connector has x8 PCIe\* 3.0 bus lanes routed to it from CPU 1.

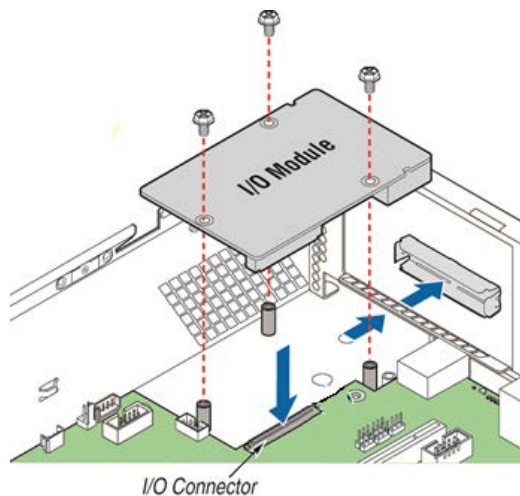







Figure 17. Intel® I/O Module Installation

Intel Product Code	Order Information	Product Description	Product Type
<p><b>iPC – AXX10GBNIAIOM</b></p> 	<p>MM# – 917905 UPC – 00735858241090 EAN – 5032037035842 MOQ – 1</p>	<p><b>Intel® I/O Module AXX10GBNIAIOM</b></p> <p>Dual SFP+ port 10GbE IO module based on Intel® 82599ES 10 Gigabit Ethernet Controller</p> <p>Kit Includes: (1) I/O module (1) EMI shield (1) Port Labeling Sticker (1 set) Mounting screws</p>	<ul style="list-style-type: none"> <li>• 1U / 2U Accessory Kit</li> </ul>
<p><b>iPC – AXX10GBTWLIOM3</b></p> 	<p>MM – 941869 UPC – 00735858296656 EAN – 5032037072472 MOQ – 1</p>	<p><b>Intel® I/O Module AXX10GBTWLIOM3</b></p> <p>Dual RJ-45 port 10GBASE-T IO module, based on Intel® Ethernet Controller X540</p> <p>Kit Includes: (1) I/O module (1) EMI shield (1) Port Labeling Sticker (1 set) Mounting screws</p>	<ul style="list-style-type: none"> <li>• 1U / 2U Accessory Kit</li> </ul>
<p><b>iPC – AXX1FDRIBIOM</b></p> 	<p>MM – 918607 UPC – 00735858241106 EAN – 5032037035859 MOQ – 1</p>	<p><b>Intel® I/O Module AXX1FDRIBIOM</b></p> <p>Single port, FDR 56GT/S speed Intel® I/O Expansion Infiniband* module</p> <p>Kit Includes: (1) I/O module (1) EMI shield (1) Port Labeling Sticker (1 set) Mounting screws</p>	<ul style="list-style-type: none"> <li>• 1U / 2U Accessory Kit</li> </ul>

Intel Product Code	Order Information	Product Description	Product Type
<p><b>iPC – AXX2FDRIBIOM</b></p> 	<p>MM – 920627                      UPC – 00735858245722                      EAN – 5032037040235                      MOQ – 1</p>	<p><b>Intel® I/O Module AXX2FDRIBIOM</b>                      Dual port, FDR 56GT/S (per port capable) speed Infiniband* module</p> <p>Kit Includes:                      (1) I/O module                      (1) EMI shield                      (1) Port Labeling Sticker                      (1 set) Mounting screws</p>	<ul style="list-style-type: none"> <li>• 1U / 2U Accessory Kit</li> </ul>
<p><b>iPC – AXX4P1GBPWL IOM</b></p> 	<p>MM – 917911                      UPC – 00735858241083                      EAN – 5032037035835                      MOQ – 1</p>	<p><b>Intel® I/O Module AXX4P1GBPWL IOM</b>                      Quad port 1GbE IO Module based on Intel® Ethernet Controller I350</p> <p>Kit Includes:                      (1) I/O module                      (1) EMI shield                      (1) Port Labeling Sticker                      (1 set) Mounting screws</p>	<ul style="list-style-type: none"> <li>• 1U / 2U Accessory Kit</li> </ul>

## 5.9 Intel® SAS RAID Add-in Cards, Modules, and Accessories

Intel® RAID offers a broad portfolio of RAID solutions designed to address the storage-related challenges of the modern day datacenter as well as the small business. The Intel® S2600WT product family includes support for the latest generation of 12 Gb/s SAS Intel® RAID add-in cards, modules, expanders, and accessories. Previous generation 6Gb/s Intel RAID cards can also be supported. See the published Tested Hardware and OS List for a full list of validated Intel RAID cards.



Additional information for Intel RAID products can be found at the following Intel web sites:




[http://www.intelraid.com/files/Intel\\_RMS3\\_Brief\\_Final.pdf](http://www.intelraid.com/files/Intel_RMS3_Brief_Final.pdf)

[http://www.intelraid.com/files/Intel-1106-RAID-Brochure\\_New2014102.pdf](http://www.intelraid.com/files/Intel-1106-RAID-Brochure_New2014102.pdf)


[http://www.intelraid.com/files/RAID\\_Matrix\\_20142.pdf](http://www.intelraid.com/files/RAID_Matrix_20142.pdf)

### 5.9.1 Intel® Integrated RAID Module RMS3 Product Family – SAS 3.0 (12 Gb/s)




Intel Product Code	Order Information	Product Description	Product Type
<b>iPC – RMS3CC080</b> 	MM# – 932474 UPC – 00735858276832 EAN – 5032037060448 MOQ - 5	<b>Intel® Integrated RAID Module RMS3CC080</b> Mezzanine Form Factor HW RAID Module 8 internal SAS / SATA ports Mini-SAS HD SFF8643 connectors LSI* SAS3108 ROC with 1GB DDR3 RAID Levels 0, 1, 5, 6, 10, 50, 60 Embedded 1GB DDR3 Cache Memory Supports Maintenance Free Backup Unit – iPC <b>AXXRMFBU5</b>  SAS Data cables not included . Must be purchased separately	<ul style="list-style-type: none"> <li>• 1U / 2U Accessory Kit</li> </ul>
<b>iPC – RMS3CC040</b> 	MM# –932473 UPC – 00735858276849 EAN – 5032037060455 MOQ – 5	<b>Intel® Integrated RAID Module RMS3CC040</b> Mezzanine Form Factor HW RAID Module 4 internal SAS / SATA ports Mini-SAS HD SFF8643 connectors LSI* SAS3108 ROC with 1GB DDR3 RAID Levels 0, 1, 5, 6, 10, 50, 60 Embedded 1GB DDR3 Cache Memory Supports Maintenance Free Backup Unit – iPC <b>AXXRMFBU5</b>  SAS Data cables not included . Must be purchased separately	<ul style="list-style-type: none"> <li>• 1U / 2U Accessory Kit</li> </ul>




Intel Product Code	Order Information	Product Description	Product Type
<p><b>iPC – RMS3HC080</b></p> 	<p>MM – 932469                      UPC – 00735858276818                      EAN – 5032037060424                      MOQ – 5</p>	<p><b>Intel® Integrated RAID Module RMS3HC080</b>                      Mezzanine Form Factor Entry-RAID Module                      8 internal SAS / SATA ports                      Mini-SAS HD SFF8643 connectors                      LSI* SAS3008 SAS IOC with Advanced Management                      Entry HW RAID levels – JBOD, RAID 0,1,10 &amp; Hybrid 5,50                      128MB server board memory utilized as cache memory for RAID 5/50</p> <p>SAS Data cables not included . Must be purchased separately</p>	<ul style="list-style-type: none"> <li>• 1U / 2U Accessory Kit</li> </ul>
<p><b>iPC – RMS3JC080</b></p> 	<p>MM – 932472                      UPC – 00735858276825                      EAN – 5032037060431                      MOQ – 5</p>	<p><b>Intel® Integrated RAID Module RMS3JC080</b>                      Mezzanine Form Factor Entry-RAID Module                      8 internal SAS / SATA ports                      Mini-SAS HD SFF8643 connectors                      LSI* SAS3008 IOC with Basic Firmware                      Entry HW RAID levels – JBOD, RAID 0, 1, 1E, 10</p> <p>SAS Data cables not included . Must be purchased separately</p>	<ul style="list-style-type: none"> <li>• 1U / 2U Accessory Kit</li> </ul>
<p><b>iPC – RMS25CB080</b></p> 	<p>MM# – 924871                      UPC – 00735858238977                      EAN – 5032037033756                      MOQ – 5</p>	<p><b>Intel® Integrated RAID Module RMS25CB080</b>  <b>*NOT RMS3 Product Family</b>                      Intel® Integrated RAID Module RMS25CB080, SIOM Connector, LSI2208 ROC, 8P Internal SAS, MegaRAID SWStack, 1GB DDR3, R0,1,10,5,50,6,60.</p> <p>Data Transfer rate 6 Gb/s                      8 Internal ports                      Entry Level SAS/SATA                      RAID Levels - 0, 1, 10, 5, 50, 6, 60. NO JBOD mode.</p> <p>Note: Cables sold separately</p>	<ul style="list-style-type: none"> <li>•</li> </ul>





Intel Product Code	Order Information	Product Description	Product Type
<p><b>iPC – AXRMFBU5</b></p> 	<p>MM# – 933907                      UPC – 00735858276801                      EAN – 5032037060417                      MOQ – 5</p>	<p><b>Intel® RAID Maintenance Free Backup Unit AXRMFBU5</b></p> <p>A super-capacitor module and flash memory card designed to help protect data in dynamic memory during a power failure or system crash event.</p> <p>The AXRMFBU5 kit is used with the 12 Gb/s Intel® Integrated RAID Modules</p> <p>Compatible with:</p> <ul style="list-style-type: none"> <li>• Intel® Integrated RAID Module RMS3CC080</li> <li>• Intel® Integrated RAID Module RMS3CC040</li> </ul>	<ul style="list-style-type: none"> <li>• 1U / 2U Accessory Kit</li> </ul>





5.9.2 Intel® RAID Controller Add-in Cards - SAS 3.0 (12Gb/s)



Intel Product Code	Order Information	Product Description	Product Type
<p><b>iPC – RS3DC080</b></p> 	<p>MM# – 934643 UPC – 00735858265355 MOQ – 5</p>	<p><b>Intel® RAID Controller RS3DC080</b> Low Profile, half length, (MD2 Compliant) PCIe* add-in card 8 internal SAS / SATA ports LSI* SAS3108 ROC RAID Levels – 0, 1, 5, 6, 10, 50, and 60 Embedded 1GB DDR3 Cache Memory Supports Maintenance Free Backup Unit – iPC <b>AXXRMFBU4</b></p> <p>SAS Data cables not included . Must be purchased separately</p>	<ul style="list-style-type: none"> <li>• 1U / 2U Accessory Kit</li> </ul>
<p><b>iPC – RS3DC040</b></p> 	<p>MM# – 934644 UPC – 00735858265362 MOQ – 5</p>	<p><b>Intel® RAID Controller RS3DC040</b> Low Profile, half length, (MD2 Compliant) PCIe* add-in card 4 internal SAS / SATA ports LSI* SAS3108 ROC RAID Levels – 0, 1, 5, 6, 10, 50, and 60 Embedded 1GB DDR3 Cache Memory Supports Maintenance Free Backup Unit – iPC <b>AXXRMFBU4</b></p> <p>SAS Data cables not included . Must be purchased separately</p>	<ul style="list-style-type: none"> <li>• 1U / 2U Accessory Kit</li> </ul>
<p><b>iPC – RS3SC008</b></p> 	<p>MM# – 928223 UPC – 00735858266956 EAN – 5032037068567 MOQ – 5</p>	<p><b>Intel® RAID Controller RS3SC008</b> Low Profile, half length, (MD2 Compliant) PCIe* add-in card 8 external SAS / SATA ports LSI* SAS3108 ROC RAID Levels – 0, 1, 5, 6, 10, 50, and 60 Embedded 1GB DDR3 Cache Memory Supports Maintenance Free Backup Unit – iPC <b>AXXRMFBU4</b></p> <p>SAS Data cables not included . Must be purchased separately</p>	<ul style="list-style-type: none"> <li>• 1U / 2U Accessory Kit</li> </ul>

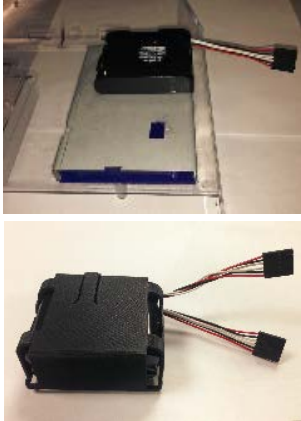
Intel Product Code	Order Information	Product Description	Product Type
<p><b>iPC – RS3MC044</b></p> 	<p>MM# – 928244 UPC – 00735858266987 EAN – 5032037068574 MOQ – 5</p>	<p><b>Intel® RAID Controller RS3MC044</b> Low Profile, half length, (MD2 Compliant) PCIe* add-in card 4 internal SAS / SATA ports + 4 external SAS / SATA ports LSI* SAS3108 ROC RAID Levels – 0, 1, 5, 6, 10, 50, and 60 Embedded 1GB DDR3 Cache Memory Supports Maintenance Free Backup Unit – iPC <b>AXXRMFBU4</b></p> <p>SAS Data cables not included . Must be purchased separately</p>	<ul style="list-style-type: none"> <li>• 1U / 2U Accessory Kit</li> </ul>
<p><b>iPC – RS3GC008</b></p> 	<p>MM# – 928220 UPC – 00735858267175 EAN – 5032037053839 MOQ – 5</p>	<p><b>Intel® RAID Controller RS3GC008</b> Low Profile, half length, (MD2 Compliant) PCIe* add-in card Entry Level SAS Card 8 external SAS / SATA ports LSI* SAS3008 IOC RAID Levels – JBOD (SAS Connectivity)</p> <p>SAS Data cables not included. Must be purchased separately</p>	<ul style="list-style-type: none"> <li>• 1U / 2U Accessory Kit</li> </ul>
<p><b>iPC – RS3UC080</b></p> 	<p>MM# – 928218 UPC – 00735858267649 EAN – 5032037053938 MOQ – 5</p>	<p><b>Intel® RAID Controller RS3UC080</b> Low Profile, half length, (MD2 Compliant) PCIe* add-in card Entry Level SAS RAID Card 8 internal SAS / SATA ports LSI* SAS3008 IOC RAID Levels – 0, 1, 1E, 10, and JBOD</p> <p>SAS Data cables not included. Must be purchased separately</p>	<ul style="list-style-type: none"> <li>• 1U / 2U Accessory Kit</li> </ul>

Intel Product Code	Order Information	Product Description	Product Type
<p><b>iPC – RS3FC044</b></p> 	<p>MM# – 928219                      UPC – 00735858267267                      EAN – 5032037053921                      MOQ – 5</p>	<p><b>Intel® RAID Controller RS3FC044</b>                      Low Profile, half length, (MD2 Compliant) PCIe* add-in card                      Entry Level SAS RAID Card                      4 internal + 4 external SAS / SATA ports                      LSI* SAS3008 IOC                      RAID Levels – 0, 1, 1E, 10, and JBOD</p> <p>SAS Data cables not included. Must be purchased separately</p>	<ul style="list-style-type: none"> <li>• 1U / 2U Accessory Kit</li> </ul>
<p><b>iPC – AXRMFBU4</b></p> 	<p>MM# – 937318                      UPC – 00735858273787                      EAN – 5032037058544                      MOQ – 5</p>	<p><b>Intel® RAID Maintenance Free Backup Unit AXRMFBU4</b>                      A super-capacitor module and flash memory card designed to help protect data in dynamic memory during a power failure or system crash event.</p> <p>The AXRMFBU4 kit is used with the 12 Gb/s Intel® RAID Controller PCIe* Add-in Cards</p> <p>Compatible with:</p> <ul style="list-style-type: none"> <li>• Intel® RAID Controller RS3DC080</li> <li>• Intel® RAID Controller RS3DC040</li> <li>• Intel® RAID Controller RS3SC008</li> <li>• Intel® RAID Controller RS3MC044</li> </ul>	<ul style="list-style-type: none"> <li>• 1U / 2U Accessory Kit</li> </ul>




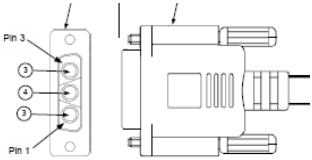

### 5.9.3 Intel® RAID Accessory Options

Intel Product Code	Order Information	Product Description	Product Type
<p><b>iPC – AXRPFKSSD2</b></p> 	<p>MM# – 919499 UPC – 00735858221467 EAN - 5032037051699 MOQ – 5</p>	<p><b>Intel® RAID SSD Cache with Fast Path I/O</b></p> <p>Upgrade Key to enable SSD Cache with Fastpath I/O for Intel®'s RAID RS25 and RS3 (based on LSI 3108) families of ROC products.</p>	<ul style="list-style-type: none"> <li>• 1U / 2U Accessory Kit</li> </ul>
<p><b>iPC – AXRPFKDE2</b></p> 	<p>MM# – 915317 UPC – 00735858221474 EAN - 5032037051705 MOQ – 5</p>	<p><b>Intel® RAID Drive Encryption Management</b></p> <p>Upgrade Key to enable Drive Encryption Management for Intel®'s RAID RS25 and RS3 (based on LSI 3108) families of ROC products.</p>	<ul style="list-style-type: none"> <li>• 1U / 2U Accessory Kit</li> </ul>
<p><b>iPC – AXRPFKSNSH2</b></p> 	<p>MM# – 915318 UPC – 00735858221481 EAN - 5032037051712 MOQ – 5</p>	<p><b>Intel® RAID Rapid Recovery Snapshot</b></p> <p>Upgrade Key to enable Rapid Recovery Snapshot for Intel®'s RAID RS25 and RS3 (based on LSI 3108) families of ROC products.</p>	<ul style="list-style-type: none"> <li>• 1U / 2U Accessory Kit</li> </ul>
<p><b>iPC – RKSATA4R5</b></p> 	<p>MM# – 916346 UPC – 00735858238861 EAN – 5032037033640 MOQ - 5</p>	<p><b>ESRT2 SATA SW RAID activation key</b></p> <p>Used to enable onboard SATA controllers to support embedded ESRT2 SW RAID 5</p>	<ul style="list-style-type: none"> <li>• 1U / 2U Accessory Kit</li> </ul>
			<ul style="list-style-type: none"> <li>•</li> </ul>

Intel Product Code	Order Information	Product Description	Product Type
<p><b>iPC – AXXRMFBU5</b></p> 	<p>MM# – 933907                      UPC – 00735858276801                      EAN – 5032037060417                      MOQ – 5</p>	<p><b>Intel® RAID Maintenance Free Backup Unit AXXRMFBU5</b>                      A super-capacitor module and flash memory card designed to help protect data in dynamic memory during a power failure or system crash event.</p> <p>The AXXRMFBU5 kit is used with the 12 Gb/s Intel® <b>Integrated RAID Modules</b></p> <p>Compatible with:</p> <ul style="list-style-type: none"> <li>• Intel® Integrated RAID Module RMS3CC080</li> <li>• Intel® Integrated RAID Module RMS3CC040</li> </ul>	<ul style="list-style-type: none"> <li>• 1U / 2U Accessory Kit</li> </ul>
<p><b>iPC – AXXRMFBU4</b></p> 	<p>MM# – 937318                      UPC – 00735858273787                      EAN – 5032037058544                      MOQ – 5</p>	<p><b>Intel® RAID Maintenance Free Backup Unit AXXRMFBU4</b>                      A super-capacitor module and flash memory card designed to help protect data in dynamic memory during a power failure or system crash event.</p> <p>The AXXRMFBU4 kit is used with the 12 Gb/s Intel® RAID Controller <b>PCIe* Add-in Cards</b></p> <p>Compatible with:</p> <ul style="list-style-type: none"> <li>• Intel® RAID Controller RS3DC080</li> <li>• Intel® RAID Controller RS3DC040</li> <li>• Intel® RAID Controller RS3SC008</li> </ul> <p>Intel® RAID Controller RS3MC044</p>	<ul style="list-style-type: none"> <li>• 1U / 2U Accessory Kit</li> </ul>

Intel Product Code	Order Information	Product Description	Product Type
<p><b>iPC - AWTAUXBBUBKT</b></p> 	<p>MM# – 937082                      UPC – 00735858289344                      EAN – 5032037068321                      MOQ – 1</p>	<p><b>1U / 2U RMFBU Mounting Option Kit</b></p> <p>Kit includes:</p> <p>(1) – 2U RMFBU Mounting plate. The mounting plate installs in one of two possible mounting locations in front of either riser slot on the 2U air duct and can support up to two AXXRMFBU5 or AXXRSBBU9 units. Full length PCIe cards cannot be supported when this mounting plate is installed behind the given riser slot.</p> <p>(1) – RMFBU plastic housing bracket to support two stacked AXXRMFBU5 units in a 1U chassis</p>	<ul style="list-style-type: none"> <li>• 1U / 2U Accessory Kit</li> </ul>



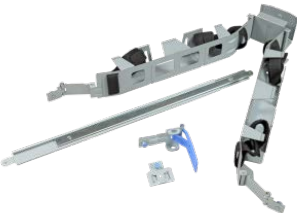
## 5.10 Intel Power Supply Modules and Power Cords


Intel Product Code	Order Information	Product Description	Product Type
<b>iPC – AXX1100PCRPS</b> 	MM# – 936183 UPC – 00735858287920 EAN – 5032037067478 MOQ - 1	<b>1100W AC CRPS 80+ Platinum efficiency power supply module</b>  Power cord sold separately	<ul style="list-style-type: none"> <li>• 2U Building Block Option</li> <li>• 2U Accessory Kit</li> <li>• 2U Spare FRU</li> </ul>
<b>iPC – FXX750PCRPS</b> 	MM# – 915604 UPC – 00735858234979 EAN – 5032037030601 MOQ - 1	<b>750W AC CRPS 80+ Platinum efficiency power supply module</b>  Power cord sold separately	<ul style="list-style-type: none"> <li>• 1U / 2U Building Block Option</li> <li>• 1U / 2U Accessory Kit</li> <li>• 1U / 2U Spare FRU</li> </ul>
<b>iPC – AXX750DCCRPS</b> 	MM# – 927253 UPC – 00735858260862 EAN – 5032037051354 MOQ - 1	<b>750W -48v DC (Direct current) CRPS 80+ Gold efficiency power supply module</b>  Kit Includes: (1) power supply (1) O-ring terminal adapter. Power cable sold separately	<ul style="list-style-type: none"> <li>• 1U / 2U Building Block Option</li> <li>• 1U / 2U Accessory Kit</li> <li>• 1U / 2U Spare FRU</li> </ul>
<b>iPC – AXXDCCRPS CBL</b> 	MM – 922062 UPC – 00735858247993 EAN – 5032037042871 MOQ – 1	<b>4000mm (13ft) DC power cable.</b> Connects directly to power supply instead of O-ring terminals adapter	<ul style="list-style-type: none"> <li>• 1U / 2U Accessory Kit</li> <li>• 1U / 2U Spare FRU</li> </ul>
<b>iPC – FPWRCABLENA</b> 	MM# – 879287 UPC – 00735858181129 EAN – 5032037015738 MOQ – 1	<b>1500mm (59in) North American Power Cord</b>	<ul style="list-style-type: none"> <li>• 1U / 2U Accessory Kit</li> <li>• 1U / 2U Spare FRU</li> </ul>



## 5.111U / 2U Rack Mount Kits

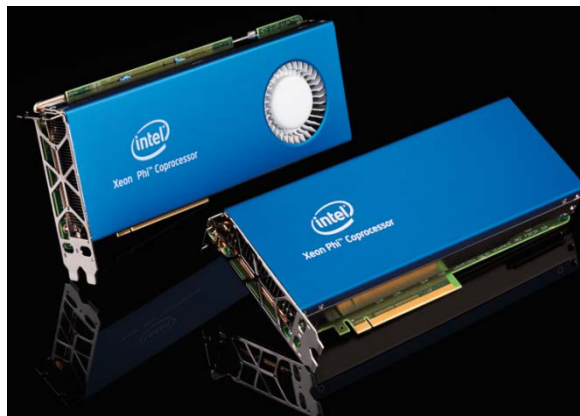
**Caution:** Exceeding the rail kit's specified maximum weight limit or misalignment of the server in the rack may result in failure of the rack rails, resulting in damage to the system or personal injury. Using two people or the use of a mechanical assist tool to install and align the server into the rack is highly recommended.

Intel Product Code	Order Information	Product Description	Product Type
<p><b>iPC - AXXPRAIL</b></p> 	<p>MM# – 924417 UPC – 00735858219686 EAN – 5032037014823 MOQ – 1</p>	<p><b>1U / 2U Premium Rail Kit</b></p> <ul style="list-style-type: none"> <li>• 1U and 2U compatible</li> <li>• Adjustment within 609.6mm~762mm to fit difference depth rack</li> <li>• 800mm maximum travel length</li> <li>• Full extension from rack</li> <li>• 54 lbs (24 kgs) max support weight</li> <li>• Tool-less installation</li> <li>• Drop in system install</li> <li>• For Cable Management arm support – order iPC <b>AXX1U2UCMA</b></li> </ul>	<ul style="list-style-type: none"> <li>• 1U / 2U Accessory Kit</li> </ul>
<p><b>iPC – AXXELVRAIL</b></p> 	<p>MM# – 920970 UPC – 00735858244367 EAN – 5032037038980 MOQ - 1</p>	<p><b>1U / 2U Enhanced Value Rail Kit</b></p> <ul style="list-style-type: none"> <li>• Works for all 438mm wide Intel® Rack Chassis 1U, 2U, 4U</li> <li>• Adjustment within 609.6mm~765mm to fit difference depth rack</li> <li>• 424.2mm maximum travel length</li> <li>• 2/3 extension from rack</li> <li>• 130 lbs (59 kgs) max support weight</li> <li>• Tool-less chassis attach</li> <li>• Tools required to attach to rails to rack</li> </ul> <p>Note: No Cable Management Arm support.</p>	<ul style="list-style-type: none"> <li>• 1U / 2U Accessory Kit</li> </ul>
<p><b>iPC – AXX1U2UCMA</b></p> 	<p>MM# – 913117 UPC – 00735858224604 EAN – 5032037019972 MOQ – 1</p>	<p><b>1U / 2U Cable Management Arm (CMA)</b></p> <ul style="list-style-type: none"> <li>• 1U / 2U compatible</li> <li>• Support for Premium 1U/2U <b>AXXPRAIL</b> and 1U <b>A1UFULLRAIL</b> rail kit options only</li> </ul>	<ul style="list-style-type: none"> <li>• 1U / 2U Accessory Kit</li> </ul>

Intel Product Code	Order Information	Product Description	Product Type
<p><b>iPC - AXX2POSTBRCKT</b></p> 	<p>MM# – 918808 UPC – 00735858245319 EAN – 5032037039833 MOQ – 1</p>	<p><b>1U / 2U 2-Post fixed mount bracket kit</b></p> <ul style="list-style-type: none"> <li>• 1U and 2U compatible</li> <li>• Tools required to attach components to rack</li> </ul> <p>NOTE: Not compatible with 24x2.5" drive or 12x3.5" drive system configurations</p>	<ul style="list-style-type: none"> <li>• 1U / 2U Accessory Kit</li> </ul>
<p><b>iPC – A1USHRTRAIL</b></p>	<p>MM# – 939208 UPC –00735858289931 EAN –5032037068772 MOQ – 1</p>	<p><b>1U Premium quality rails with no CMA support</b></p> <ul style="list-style-type: none"> <li>• Travel distance 780mm</li> <li>• Full extension from rack</li> <li>• Kit includes: Rails, screws, installation manual</li> </ul>	<ul style="list-style-type: none"> <li>• 1U Accessory Kit</li> </ul>
<p><b>iPC – A1UFULLRAIL</b></p>	<p>MM# –939207 UPC –00735858291972 EAN –5032037070539 MOQ – 1</p>	<p><b>1U Premium quality rails with CMA support.</b></p> <ul style="list-style-type: none"> <li>• Travel distance 780mm</li> <li>• Full extension from rack</li> <li>• Kit includes: Rails, screws, installation manual</li> <li>• For Cable Management arm support – order iPC <b>AXX1U2UCMA</b></li> </ul>	<ul style="list-style-type: none"> <li>• 1U Accessory Kit</li> </ul>
<p><b>iPC – AXXFULLRAIL</b></p>	<p>MM# –939209 UPC –00735858291989 EAN –5032037070546 MOQ – 1</p>	<p><b>2U+ Premium quality rails with CMA support.</b></p> <ul style="list-style-type: none"> <li>• Travel distance 780mm</li> <li>• Full extension from rack</li> <li>• Kit includes: Rails, screws, installation manual</li> <li>• For Cable Management arm – order iPC <b>AXXCMA2</b></li> </ul>	<ul style="list-style-type: none"> <li>• 2U Accessory Kit</li> </ul>
<p><b>iPC – AXXCMA2</b></p>	<p>MM# – 939211 UPC –00735858292009 EAN –5032037070560 MOQ – 1</p>	<p><b>Cable management arm</b></p> <ul style="list-style-type: none"> <li>• Compatible with AXXFULLRAIL only</li> </ul>	<ul style="list-style-type: none"> <li>• 2U Accessory Kit</li> </ul>

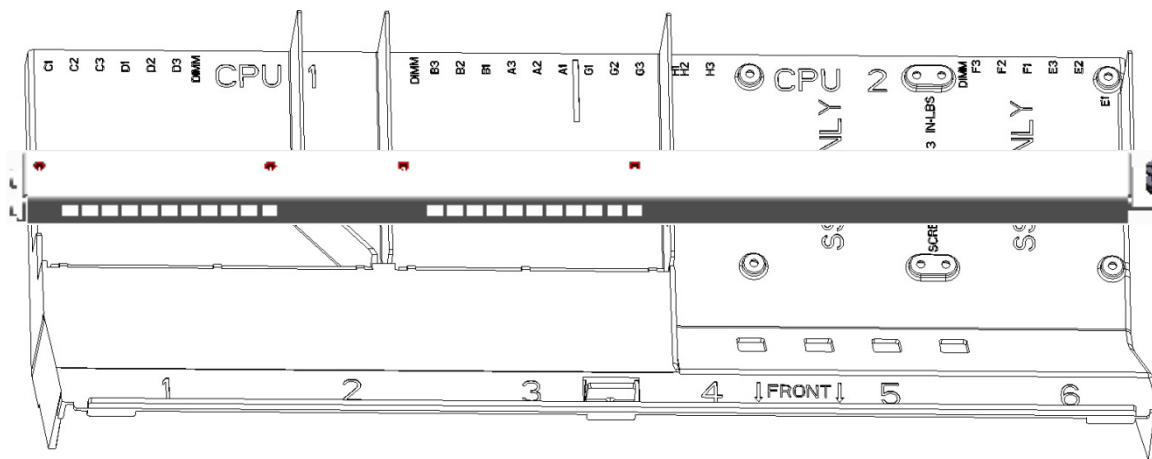
## 5.12 Intel® Xeon Phi™ Coprocessor Card and Non-Intel GPGPU Support

Intel® Xeon Phi™ Coprocessor cards and non-Intel GPGPU cards are supported in the following 2U system configurations only: **R2208WT, R2308WT, and R2216WT**. Because of mechanical and thermal limits, the **1U product family** and the **R2312WT... and R2224WT...** system configurations do NOT have support for Intel® Xeon Phi™ coprocessor cards or non-Intel GPGPU cards.



**Figure 18. Intel® Xeon Phi™ Coprocessor Cards With Active and Passive Cooling**

- Supported 2U systems configured with the standard (default) air duct, can only support high power add-in cards (>75W) with active (with fan) heat sinks.
- In supported 2U system, high power add-in cards (>75W) with passive (no fan) heat sinks can only be supported in systems configured with a high air flow air duct available in Intel Accessory Kit – iPC **AWTCOPRODUCT**
  - NOTE: Intel® Server System **R2208WTTYC1R** is a special system SKU that includes the necessary components to support passive high power (>75W) add-in cards like the Intel® Xeon Phi™ coprocessor card or non-Intel GPGPU cards.




See the *Intel® Server System R2000WT product family Technical Product Specification* for more information.

**Non-Intel GPGPU Support Disclaimer:**


Intel incorporates necessary features and conducts appropriate thermal testing of its server systems to ensure the thermal requirements of Intel® Xeon Phi™ coprocessor cards can be supported when the documented support criteria are met.

Intel can make support recommendations for non-Intel GPGPU cards listed on its Tested Hardware and Support List, based on the same support criteria. However, Intel cannot guarantee its server systems can meet the thermal requirements of these non-Intel high power add-in cards. System integrators should verify non-Intel GPGPU add-in card air flow and thermal requirements from vendor specifications before integrating them into the system. It is the responsibility of the system integrator to conduct appropriate system testing on server systems configured with a non-Intel GPGPU card to ensure reliable operation.



For non-Intel GPGPU cards listed on Intel’s tested hardware and OS list, Intel will provide best internal support efforts to duplicate and understand reported issues. However, Intel cannot guarantee an issue will be root caused nor that a fix can be made available to correct it.

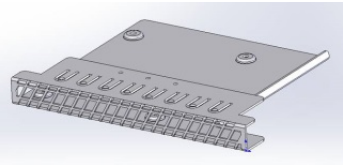

Intel Product Code	Order Information	Product Description	Product Type
<p><b>iPC – AWT COPRODUCT</b></p> 	<p>MM# – 934988                      UPC – 00735858283328                      EAN – 5032037064385                      MOQ – 1</p>	<p><b>2U High Air flow Air Duct Kit</b></p> <p>Required 2U accessory kit when installing an Intel® Xeon Phi™ coprocessor card with passive heat sink (heat sink only, no fan)</p> <p>Kit Includes:</p> <ul style="list-style-type: none"> <li>(1) High air flow air duct</li> <li>(1) Metal shipping bracket</li> <li>(2) Non-intel GPGPU secure mounting adapters</li> </ul> <p>Note: Intel Xeon Phi cards with active heat sinks are NOT supported in systems configured with the high air flow air duct.</p> <p>Note: Systems configured with any type of Intel® Xeon Phi™ card and/or non-Intel GPGPU card must have the shipping bracket installed before the system is exposed to any level of shock or vibration or is shipped to the end user location. Failure to install the shipping bracket has the potential to cause serious damage to various components within the system.</p>	<ul style="list-style-type: none"> <li>• 2U Accessory Kit</li> </ul>



- Each Intel® Xeon Phi™ coprocessor card and non-Intel GPGPU card must be installed into the top x16 slot of a 2-Slot PCIe\* Riser card. With a 2-slot riser card installed, the embedded fan speed control will operate system fans at a higher speed. 3-slot riser cards (as shipped in the standard platform configuration) cannot be used due to air flow and thermal limitations.

Intel Product Code	Order Information	Product Description	Product Type						
<p><b>iPC – A2UL16RISER2</b></p> 	<p>MM# – 934886                      UPC – 00735858288668                      EAN – 5032037067942                      MOQ – 1</p>	<p><b>2U 2-slot riser card</b></p> <p>Required 2U accessory kit when installing an Intel® Xeon Phi™ coprocessor or other Non-Intel GPGPU card</p> <table border="1" data-bbox="863 326 1421 427"> <thead> <tr> <th>Slot #</th> <th>Description</th> </tr> </thead> <tbody> <tr> <td>Slot-1 (Top)</td> <td>PCIe* x16 elec, x16 mechanical</td> </tr> <tr> <td>Slot-2 (Bottom)</td> <td>PCIe* x8 elec, x8 mechanical</td> </tr> </tbody> </table> <p>Kit includes:                      (1) Riser card PCBA                      (1) 12V-AUX Power Cable</p>	Slot #	Description	Slot-1 (Top)	PCIe* x16 elec, x16 mechanical	Slot-2 (Bottom)	PCIe* x8 elec, x8 mechanical	<ul style="list-style-type: none"> <li>• 2U Building Block Accessory Kit</li> <li>• 2U Spare FRU</li> </ul>
Slot #	Description								
Slot-1 (Top)	PCIe* x16 elec, x16 mechanical								
Slot-2 (Bottom)	PCIe* x8 elec, x8 mechanical								

## 6 1U / 2U Miscellaneous Accessory Options

Intel Product Code	Order Information	Product Description	Product Type
<p><b>iPC – A1U2ULCP</b></p> 	<p>MM# – 921028 UPC – 00735858245302 EAN – 5032037039826 MOQ – 1</p>	<p><b>Intel® Local Control Panel</b></p> <p>A 1U / 2U front panel module which supports the following features:</p> <ul style="list-style-type: none"> <li>• 2 line LCD screen</li> <li>• Customized messaging</li> <li>• Able to display critical system errors</li> </ul> <p>When installed this module replaces the front I/O port module on R1304, R1208, R2308, R2208, and R2216 based systems. The LCP module re-uses the existing front USB port assembly from these systems. It does NOT support a front video connector.</p> <p>This Kit is NOT compatible with R2224 and R2312 based systems.</p> <p>See the <i>Intel® Local Control Panel Technical Product Specification</i> for more information</p>	<ul style="list-style-type: none"> <li>• 1U / 2U Accessory Kit</li> </ul>
<p><b>iPC – AXXSATADVDRM</b></p> 	<p>MM# – 937569 UPC – 00735858197663 EAN – 5032037015127 MOQ – 1</p>	<p><b>Slimline SATA DVDROM Drive</b></p> <p>Includes 880mm SATA cable</p> <p>A peripheral power cable is included with the systems that have support for optical drives</p> <p>Optical drives are not supported in R2312WT &amp; R2224WT based systems</p>	<ul style="list-style-type: none"> <li>• 1U / 2U Accessory Kit</li> </ul>
<p><b>iPC – AXXSATADVDRWROM</b></p> 	<p>MM# – 937575 UPC – 00735858197670 EAN – 5032037015134 MOQ – 1</p>	<p><b>Slimline SATA DVD+/-RW ROM Drive</b></p> <p>Includes 880mm SATA cable</p> <p>A peripheral power cable is included with the systems that have support for optical drives</p> <p>Optical drives are not supported in R2312WT &amp; R2224WT based systems</p>	<ul style="list-style-type: none"> <li>• 1U / 2U Accessory Kit</li> </ul>



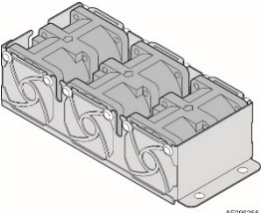
Intel Product Code	Order Information	Product Description	Product Type
<p><b>iPC - AXSSDODDKIT</b></p> 	<p>MM# – 935065                      UPC – 00735858288750                      EAN – 5032037068031                      MOQ – 1</p>	<p><b>1U fixed mount SSD mounting Kit</b></p> <p>Tray is installed in the optical drive bay of 1U systems.</p> <p>Kit includes:</p> <ul style="list-style-type: none"> <li>(1) – Metal SSD mounting tray accomodates one 2.5" SATA SSD</li> <li>(1) – 800mm SATA data cable</li> <li>(1) – SSD peripheral power cable</li> </ul> <p>Note: Maximum SSD thickness supported = 7mm                      Note: Systems configured with this kit cannot support an additional optical drive</p>	<ul style="list-style-type: none"> <li>• 1U Accessory Kit</li> </ul>
<p><b>iPC - AXJRJ45DB93</b></p> 	<p>MM# – 920430                      UPC – 00735858242820                      EAN – 5032037037525                      MOQ – 1</p>	<p><b>Serial Port Cable Kit</b></p> <p>This kit provides serial port cables for use with systems that include a back panel cut out to support a DB9 Serial 'B' port as routed from the server board and for systems that include an external RJ45 Serial 'A' port that need to convert the connector to a DB9 style connector.</p> <p>Kit includes:</p> <ul style="list-style-type: none"> <li>(1) - 1040mm Internal Serial 'B' port cable – Onboard DH10 header- to- External Mount DB9 – for 2U systems</li> <li>(1) - 520mm Internal Serial 'B' port cable – Onboard DH10 header- to- External mount DB9 – for 2U systems</li> <li>(1) – 100mm DCD RJ45 to DB9 Dongle</li> <li>(1) – 100mm DSR RJ45 to DB9 Dongle</li> </ul>	<ul style="list-style-type: none"> <li>• 1U / 2U Accessory Kit</li> </ul>

Intel Product Code	Order Information	Product Description	Product Type
<p><b>iPC - AXXRMM4LITE</b></p> 	<p>MM# – 911660                      UPC – 00735858219297                      EAN – 5032037014946                      MOQ – 1</p>	<p><b>Intel® Remote Management Module 4 Lite Activation key</b></p> <p>Installation of this activation key on to the server board enables support for the following advanced server management features:</p> <ul style="list-style-type: none"> <li>• Integrated KVM</li> <li>• Media Redirection</li> </ul> <p>See the <i>Intel Remote Management Module 4 and Integrated Web Console Users Guide</i> for more information.</p>	<ul style="list-style-type: none"> <li>• 1U / 2U Accessory Kit</li> </ul>
<p><b>iPC - AXXTPME5</b></p> 	<p>MM# – 919737                      UPC – 00735858240352                      EAN – 5032037035088                      MOQ – 1</p>	<p><b>Intel® Trusted Platform Module (TPM)</b></p> <p>A TPM is a hardware-based security device that addresses the growing concern on boot process integrity and offers better data protection. TPM protects the system start-up process by ensuring it is tamper-free before releasing system control to the operating system. A TPM device provides secured storage to store data, such as security keys and passwords. In addition, a TPM device has encryption and hash functions.</p> <p>AXXTPME5 implements TPM as per TPM PC Client specifications revision 1.2 by the Trusted Computing Group (TCG)</p>	<ul style="list-style-type: none"> <li>• 1U / 2U Accessory Kit</li> </ul>


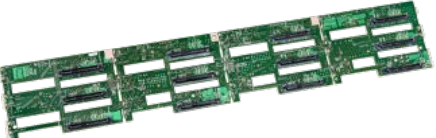





## 7 1U / 2U Spare and Replacement Parts (FRUs)

System integrators and distributors may choose to hold additional stock of individual system components. Intel makes available the following Spare and Replacement Parts (FRUs) compatible with the specified Intel server family.

Intel Product Code	Order Information	Product Description	Product Type
<p><b>iPC – FXXFPANEL2</b></p> 	<p>MM# – 937543 UPC – 00735858288712 EAN – 5032037067997 MOQ – 1</p>	<p>Front Panel board spare for use on 1U/2U rack systems (R1000, R2000 except R2224 and R2312) Rack chassis and P4000 Pedestal Chassis. Different from FXXFPANEL by 0.6mm offset of reset and power buttons.</p>	<ul style="list-style-type: none"> <li>• 1U / 2U Spare FRU</li> </ul>
<p><b>iPC – FXXCA84X106HS</b></p> 	<p>MM# – 918318 UPC – 00735858236676 EAN - 5032037031448 MOQ – 2</p>	<p>1U Heat Sink FXXCA84X106HS (Cu/Al 84mmx106mm)</p>	<ul style="list-style-type: none"> <li>• 1U / 2U Spare FRU</li> </ul>
<p><b>iPC - FR1UFAN10PW</b></p> 	<p>MM# – 935064 UPC – 00735858283342 EAN – 5032037064408 MOQ – 1</p>	<p>Three spare fans for 1U R1000WT system. 40x56mm dual rotor with 10p connector.  Includes 3 fans in the bracket, with grommets preinstalled.</p>	<ul style="list-style-type: none"> <li>• 1U Spare FRU</li> </ul>

Intel Product Code	Order Information	Product Description	Product Type
<p><b>iPC - FR2UFAN60HSW</b></p> 	<p>MM# – 934990                      UPC – 00735858283359                      EAN – 5032037064415                      MOQ – 1</p>	<p>Two spare fans for 2U R2000WT system. 60x38mm, with hot swap connector.</p> <p>Includes 2 fans with finger guards and housing.</p>	<ul style="list-style-type: none"> <li>• 2U Spare FRU</li> </ul>
<p><b>iPC – FR1304S3HSBP</b></p> 	<p>MM# – 934887                      UPC – 00735858288835                      EAN – 5032037068116                      MOQ – 1</p>	<p>Hot swap backplane board spare for 1U 4x3.5" chassis (R1304 family).</p>	<ul style="list-style-type: none"> <li>• 1U Spare FRU</li> </ul>
<p><b>iPC – F1U8X25S3HSBP</b></p> 	<p>MM# – 934888                      UPC – 00735858288798                      EAN – 5032037068079                      MOQ – 1</p>	<p>Hot swap backplane board spare for 1U 8x2.5" chassis (R1208 family).</p>	<ul style="list-style-type: none"> <li>• 1U Spare FRU</li> </ul>
<p><b>iPC – FXX8X25S3HSBP</b></p> 	<p>MM# – 934890                      UPC – 00735858288804                      EAN – 5032037068086                      MOQ – 1</p>	<p>Single port hot swap backplane board spare for 2U 8x2.5" cage (R2200 and P4000 families).</p> <p>Includes one backplane board.</p>	<ul style="list-style-type: none"> <li>• 2U Spare FRU</li> </ul>

Intel Product Code	Order Information	Product Description	Product Type
<p><b>iPC – F2U8X35S3HSBP</b></p> 	<p>MM# – 934892                      UPC – 00735858288811                      EAN – 5032037068093                      MOQ – 1</p>	<p>Hot swap backplane board spare for 2U 8x3.5" chassis (R2308 family).</p> <p>Includes one backplane board.</p>	<ul style="list-style-type: none"> <li>• 2U Spare FRU</li> </ul>
<p><b>iPC – F2U12X35S3HSBP</b></p> 	<p>MM# – 934893                      UPC – 00735858288828                      EAN – 5032037068109                      MOQ – 1</p>	<p>Hot swap backplane board spare for 2U 12x3.5" chassis (R2312 family).</p> <p>Includes one backplane board.</p>	<ul style="list-style-type: none"> <li>• 2U Spare FRU</li> </ul>
<p><b>iPC – A2UHANDLKIT</b></p> 	<p>MM# – 936038                      UPC – 00735858288866                      EAN – 5032037068147                      MOQ – 1</p>	<p style="text-align: center;"><b>1U / 2U Rack Handle Kit</b></p> <p>This kit includes <b>3 different rack handles</b>, including:</p> <p>(1) Set of 2U storage rack handles with control panel and USB support (R2312WT &amp; R2224WT)</p> <p>(1) Set of 2U non-storage rack handles (R2208WT &amp; R2216WT)</p> <p>(1) Set of 1U rack handles (R1304WT &amp; R1208WT)</p>	<ul style="list-style-type: none"> <li>• 2U – 24 2.5" Drive Upgrade Kit</li> <li>• 1U / 2U Spares Kit</li> </ul>

Intel Product Code	Order Information	Product Description	Product Type
<p><b>iPC – FXX25HSCAR2</b></p> 	<p>MM# – 937542                      UPC – 00735858289405                      EAN – 5032037068383                      MOQ – 8</p>	<p>Spare 2.5" HDD hot swap carriers.</p>	<ul style="list-style-type: none"> <li>• 1U / 2U Spare FRU</li> </ul>
<p><b>iPC – FXX35HSCAR</b></p> 	<p>MM# – 936192                      UPC – 00735858289412                      EAN – 5032037068390                      MOQ – 8</p>	<p>Spare 3.5" hot swap drive carriers.                      Includes mounting screws for mounting 2.5" SSDs.</p>	<ul style="list-style-type: none"> <li>• 1U / 2U Spare FRU</li> </ul>

## 8 Software Security - McAfee® Antivirus for Intel® Server Systems\*

McAfee® Antivirus for Intel® Server Systems Accessory is a software accessory offered with the Intel® Server Systems S2600WT SKUs Product family as orderable SKU. McAfee® Antivirus for Enterprise provides world class malware detection with proactive protection against attacks.

The McAfee® Antivirus for Intel® Server Systems Accessory consists of the latest version of either McAfee® VirusScan Enterprise (Windows) or McAfee® VirusScan Enterprise for Linux and consists of one downloadable 1- or 3-year license with 1- 3-year renewals at the end of the licensing term.

### 8.1 How to order it?

Customers have the opportunity to purchase McAfee® Antivirus Intel® Server Systems from an Intel authorized distributor. Upon placing an order for one or more McAfee® Antivirus Intel® Server Systems SKU(s) and registering their purchase, they will receive a certificate from McAfee, asking them to register the software. Once Registered, they will receive a grant letter from McAfee that includes download instructions. See <http://www.intelserveredge/mcafeeaccessory> for more information.




**\*Note:** This accessory will only be offered from the Intel site with a qualifying Intel® Server System purchase. Learn more at <http://www.intelserveredge/mcafeeaccessory>.

### 8.2 McAfee® Antivirus for Intel® Server Systems SKUs

SKU Name	Description	Supported Operating Systems
<b>SWMAVSE1YR</b>	<b>1 year license</b> (30-day grace period at end of the term), Two download options: McAfee® VirusScan Enterprise or McAfee® VirusScan Enterprise for Linux*. <b>*Renewal option available for 1- and 3- year terms.</b>	Supported Operating systems can be located on the Server compatibility list on (THOL) or external web <a href="http://www.intel.com/support/motherboards/server/sb/CS-034855.htm">http://www.intel.com/support/motherboards/server/sb/CS-034855.htm</a>
<b>SWMAVSE3YR</b>	<b>3 year license</b> (30-day grace period at end of the term), Two download options: McAfee® VirusScan Enterprise or McAfee® VirusScan Enterprise for Linux*. <b>*Renewal option available for 1- and 3- year terms.</b>	
<b>SWMAVSERN1YR</b>	<b>1 year renewal</b> of existing license. Renewal option available.	
<b>SWMAVSERN3YR</b>	<b>3 year renewal</b> of existing license. Renewal option available.	

Support link <http://support.intel.com/support/motherboards/server/sb/CS-035755.htm>

## 9 Extended Warranty

Image	Order Information	Description
 <p>Intel Server Component Extended Warranty Key  <small>Component Order Guide</small></p> <p>Expiration: 365 Days</p> <p>Instructions to enable Intel® Server Component Extended Warranty</p> <ol style="list-style-type: none"> <li>1. Register the component number with the Intel Server System, Intel Server Board, Intel RAID Controller or Intel RAID Controller only by going to the online registration page.</li> <li>2. Log on to <a href="http://www.intel.com/go/Server/ExtendedWarranty">www.intel.com/go/Server/ExtendedWarranty</a> with a valid Intel account and create a new account if you do not have one. You will be prompted to create a new account if you do not have one. The registration process will be completed automatically for you. After the registration is complete, you will be able to view the extended warranty details.</li> <li>3. For more information, visit: <a href="http://www.intel.com/go/Server/ExtendedWarranty">http://www.intel.com/go/Server/ExtendedWarranty</a></li> </ol>	<p>iPC – <b>SVCEWDPSP</b>                      MM# – 911295                      MOQ – 1</p>	<p>Two year extended warranty for Intel® Server Systems or Intel® Server Knock Down Kits + Intel® Server Boards that support two processors. Intel® RAID controller extended warranty is purchased separately.</p>
 <p>Intel Server Component Extended Warranty Key  <small>Component Order Guide</small></p> <p>Expiration: 365 Days</p> <p>Instructions to enable Intel® Server Component Extended Warranty</p> <ol style="list-style-type: none"> <li>1. Register the component number with the Intel Server System, Intel Server Board, Intel RAID Controller or Intel RAID Controller only by going to the online registration page.</li> <li>2. Log on to <a href="http://www.intel.com/go/Server/ExtendedWarranty">www.intel.com/go/Server/ExtendedWarranty</a> with a valid Intel account and create a new account if you do not have one. You will be prompted to create a new account if you do not have one. The registration process will be completed automatically for you. After the registration is complete, you will be able to view the extended warranty details.</li> <li>3. For more information, visit: <a href="http://www.intel.com/go/Server/ExtendedWarranty">http://www.intel.com/go/Server/ExtendedWarranty</a></li> </ol>	<p>iPC - <b>SVCEWDPBD</b>                      MM# – 911294                      MOQ – 1</p>	<p>Two year extended warranty for Intel® Server Boards that support two processors.</p>
 <p>Intel Server Component Extended Warranty Key  <small>Component Order Guide</small></p> <p>Expiration: 365 Days</p> <p>Instructions to enable Intel® Server Component Extended Warranty</p> <ol style="list-style-type: none"> <li>1. Register the component number with the Intel Server System, Intel Server Board, Intel RAID Controller or Intel RAID Controller only by going to the online registration page.</li> <li>2. Log on to <a href="http://www.intel.com/go/Server/ExtendedWarranty">www.intel.com/go/Server/ExtendedWarranty</a> with a valid Intel account and create a new account if you do not have one. You will be prompted to create a new account if you do not have one. The registration process will be completed automatically for you. After the registration is complete, you will be able to view the extended warranty details.</li> <li>3. For more information, visit: <a href="http://www.intel.com/go/Server/ExtendedWarranty">http://www.intel.com/go/Server/ExtendedWarranty</a></li> </ol>	<p>iPC - <b>SVCEWRAID</b>                      MM# – 911298                      MOQ – 1</p>	<p>Two year extended warranty for Intel® RAID controllers. Batteries are not included in the Extended Warranty. RAID expanders are included as part of the system SKU</p>

## Glossary of Terms

A list of Acronyms and Terms used throughout this document

Acronym or Term	Definition	Acronym or Term	Definition
BIK	Baseboard In Knock-Down-Kit – Integrated System	QSFP	Quad Small Form factor Pluggable
CRPS	Common Redundant Power Supply	RAID	Redundant Array of Independent Drives
EAN	International Article Number (Barcode)	Required Option	Hardware that must be added to the shipping configuration for the system to operate
EMI	Electromagnetic Interference	RMFBU	RAID Maintenance Free Backup Unit
ESRT2	Intel® Embedded Server RAID Technology 2	RMM4 Lite	Intel® Remote Management Module 4 Lite Activation key
FDR Infiniband	Fourteen Data Rate Infiniband	ROC	RAID on Chip
FRU	Field Replaceable Unit	RSTe	Intel® Rapid Storage Technology
GPGPU	General Purpose computing on Graphics Processing Unit	SAS	Serial Attached SCSI
iPC	Intel Product Code	SATA	Serial ATA
iPN	Intel Product Number	SFP	Small Form factor Pluggable
LCP	Intel® Local Control Panel		
JBOD	Just a bunch of drives		
KDK	Knock-Down-Kit – (Chassis only product)	SKU	Stock Keeping Unit
KVM	Keyboard / Video / Mouse	SSD	Solid State Drive
MM#	Master Material order number	UPC	Universal Product Code ( Barcode)
MOQ	Mimimum Order Quantity		
NVMe	NVM Express – based on Non-Volatile Memory Host Controller Interface Specification (NVMHCI)		
Optional Accessory	Hardware that can be added to the system to enhance the default feature set of the shipping configuration		
PCBA	Printed Cricuit Board Assembly		