

SAFETY SUPPLEMENT

TECHNICAL MANUAL

AEROSPACE EMERGENCY RESCUE AND MISHAP RESPONSE INFORMATION (EMERGENCY SERVICES)

THIS PUBLICATION SUPPLEMENTS TO 00-105E-9 REVISION 10, DATED 1 MAY 2005, LOCATED AT WEB SITE:
<http://www.robins.af.mil/logistics/LGEDA/Documents/to00-105e-9.htm>.

DISTRIBUTION STATEMENT - Approved for public release; distribution unlimited.

**COMMANDERS ARE RESPONSIBLE FOR BRINGING THIS SUPPLEMENT
TO THE ATTENTION OF ALL AFFECTED AIR FORCE PERSONNEL.**

PUBLISHED UNDER AUTHORITY OF THE SECRETARY OF THE AIR FORCE

19 MAY 2005

1. PURPOSE.

This supplement provides instructions for update of TO 00-105E-9 Revision 10, dated 1 May 2005, affecting Chapter 8, Fighter Aircraft. This supplement is an updated file for the latest information regarding the F-117A aircraft procedures.

2. INSTRUCTIONS.

- a. This information, formatted in PDF, can be downloaded and printed from this web site by the end user. Use the most current Adobe Reader for this function, available free from Adobe.com.
- b. This supplement to Chapter 8 updates information based on newly researched source data information regarding this aircraft. The new file update should be added to Chapter 8 in TO 00-105E-9 Revision 10. The end user should save this file and print the affected pages, if applicable to the user's operation. File a copy of this Safety Supplement with the main Technical Order according to current regulations.

NOTE

This information should also be included in mobility boxes where applicable. If your unit or a part of your unit is serving elsewhere, they should be informed of this Safety Supplement and how to obtain it. See TO 00-5-2 paragraphs 1-1.4, 1-1.4.1, and 1-1.6 for Local Reproduction of TOs and Digital Media guidance.

THE END



AIRCRAFT PAINT SCHEME

F-117A

F-117A1

T.O. 00-105E-9

AIRCRAFT DIMENSIONS

F-117A

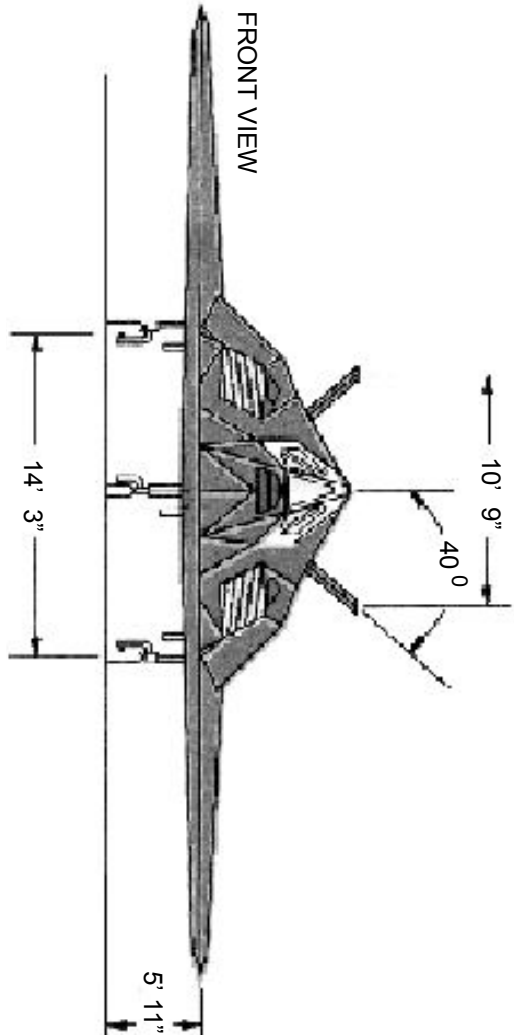

NOTE:
 Dimension shown (side view) is for nose and main gear struts inflated to 3 inch extension.

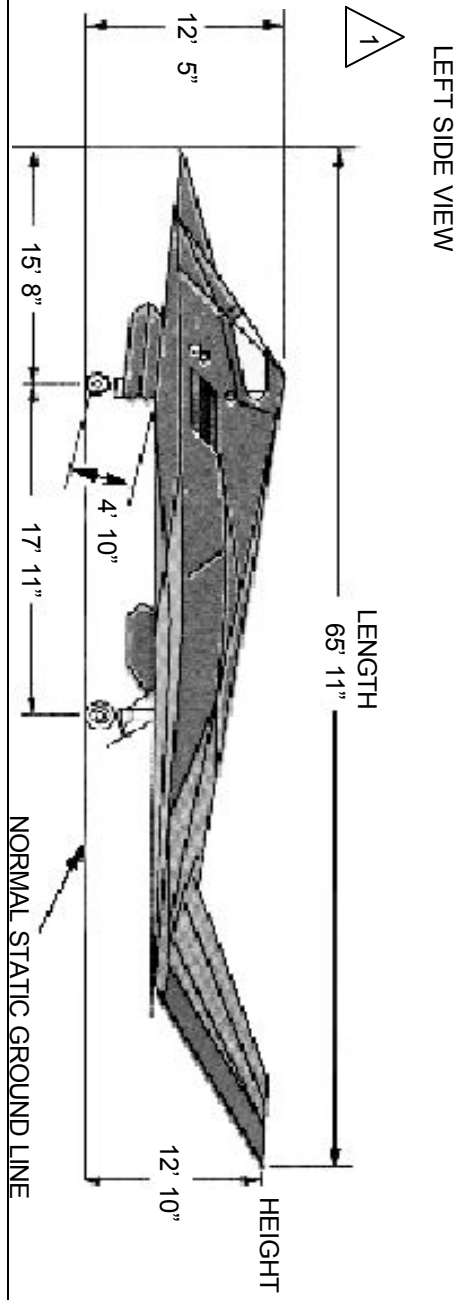
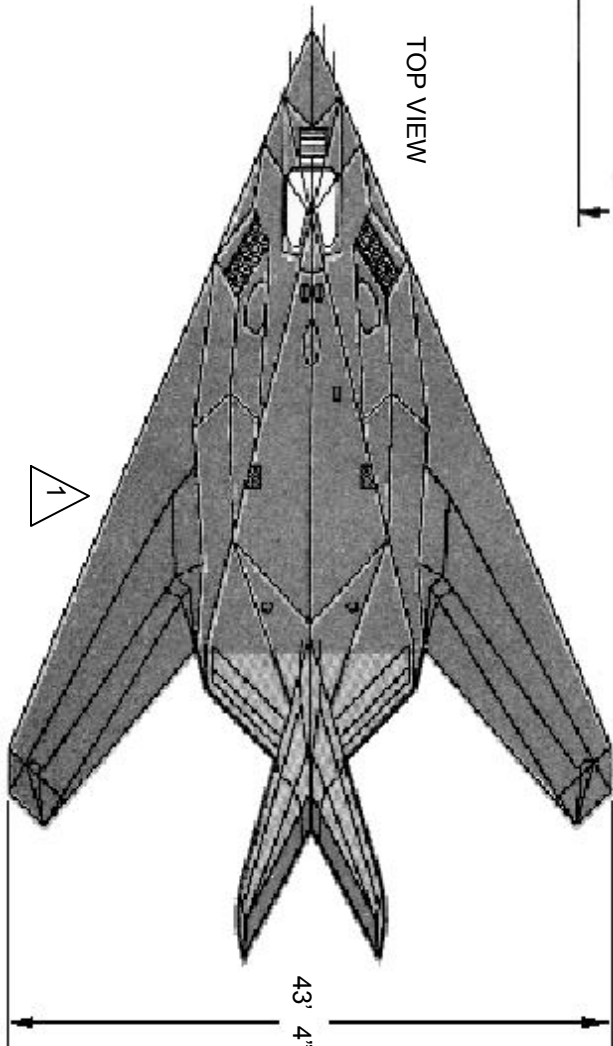

AIRCRAFT HAZARDS

TOP VIEW

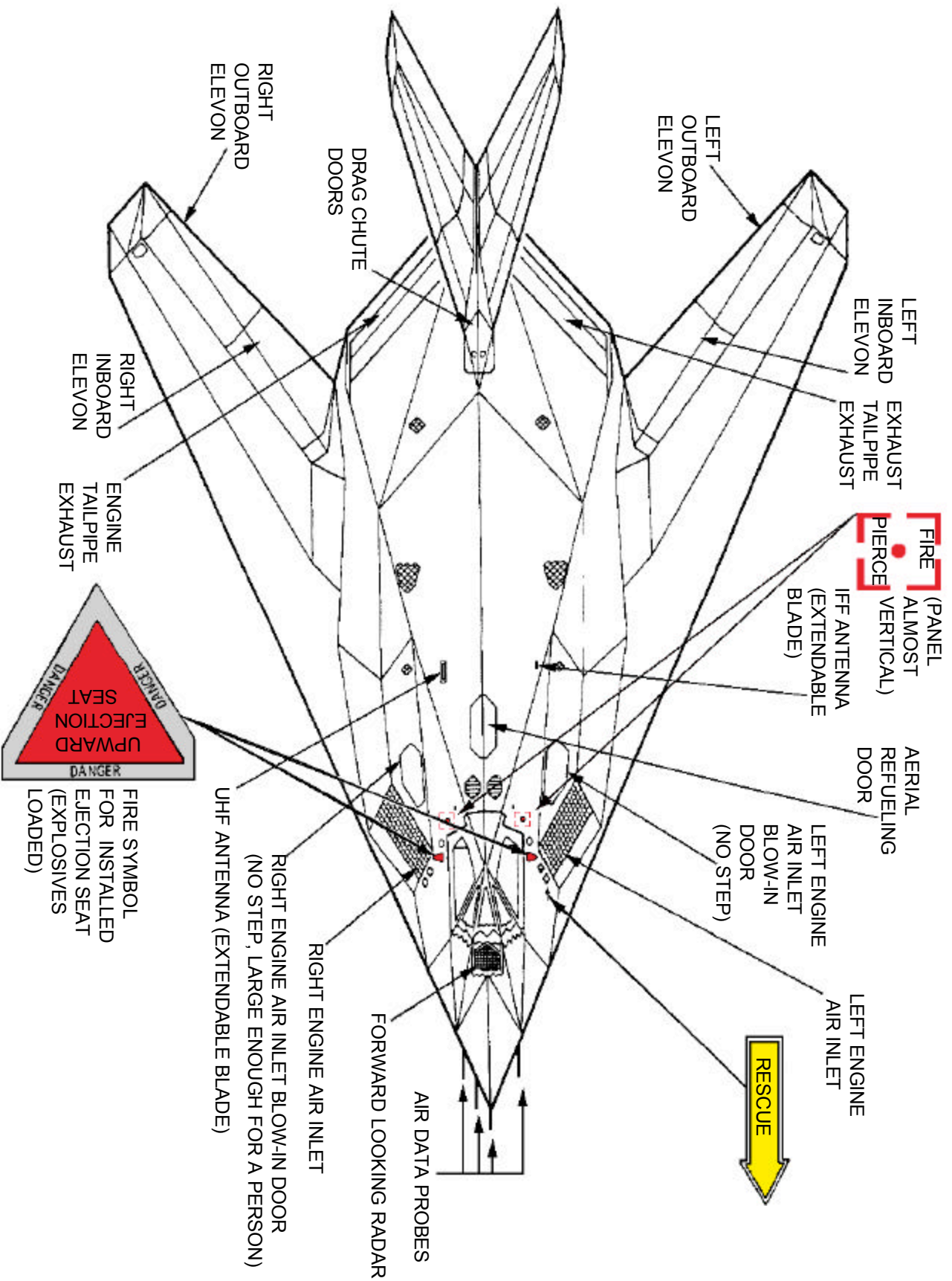

AIRCRAFT HAZARDS-Continued

BOTTOM VIEW

RIGHT SIDE

F-117A

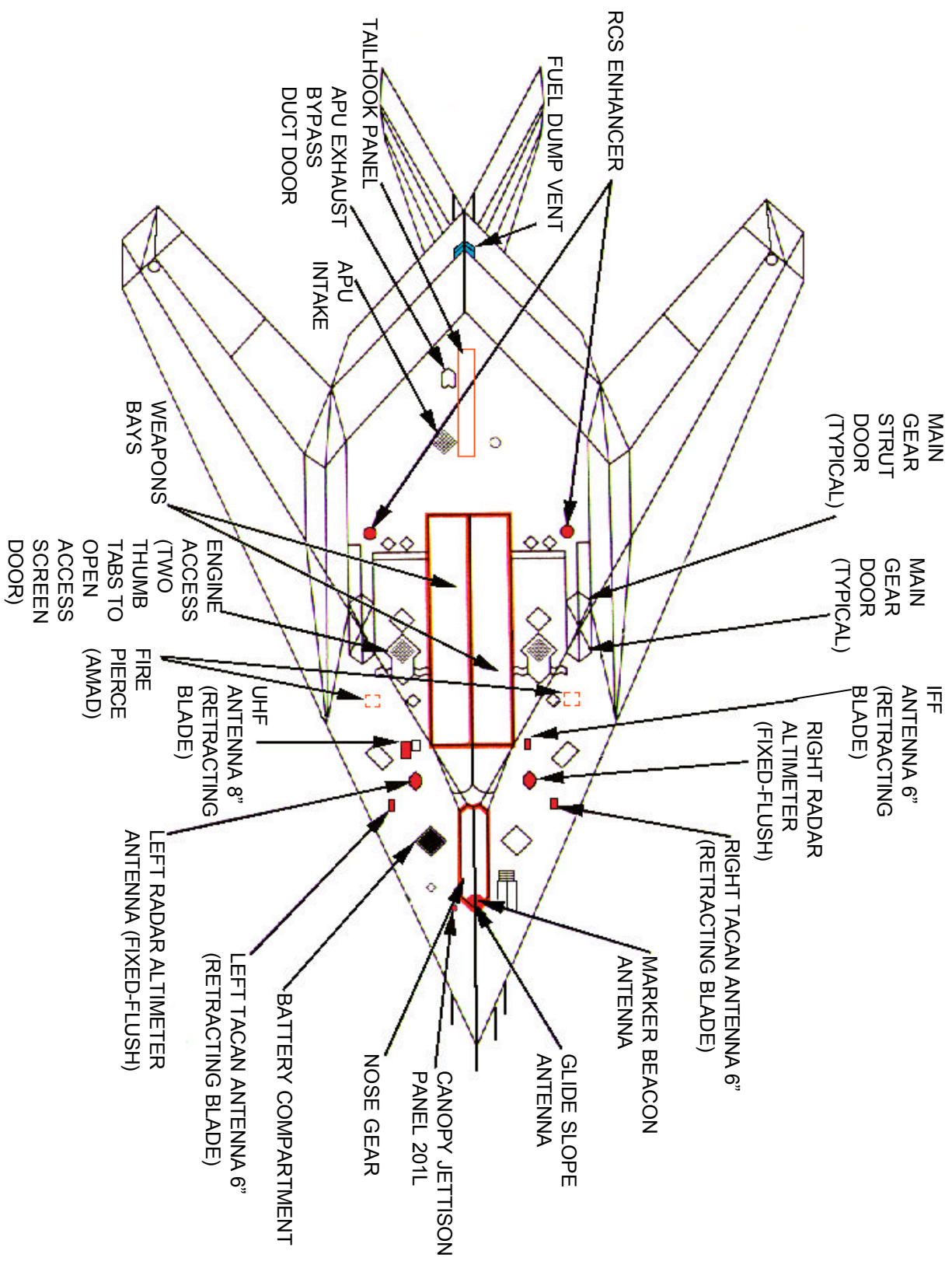

LEFT SIDE

AIRCRAFT HAZARDS-Continued

LEFT AND RIGHT SIDE VIEWS

NOTE:
5 Gallons of Alcohol are located behind the Environmental Control Unit (ECU) (Served in the bomb bay. These areas are fire sources.

NOTE:
No Step Areas are Engine Intakes, Engine Exhaust and Inlet Blow In Doors.

NOTE:
The aircraft can have 2,000 pounds of munitions/weapons on each side.

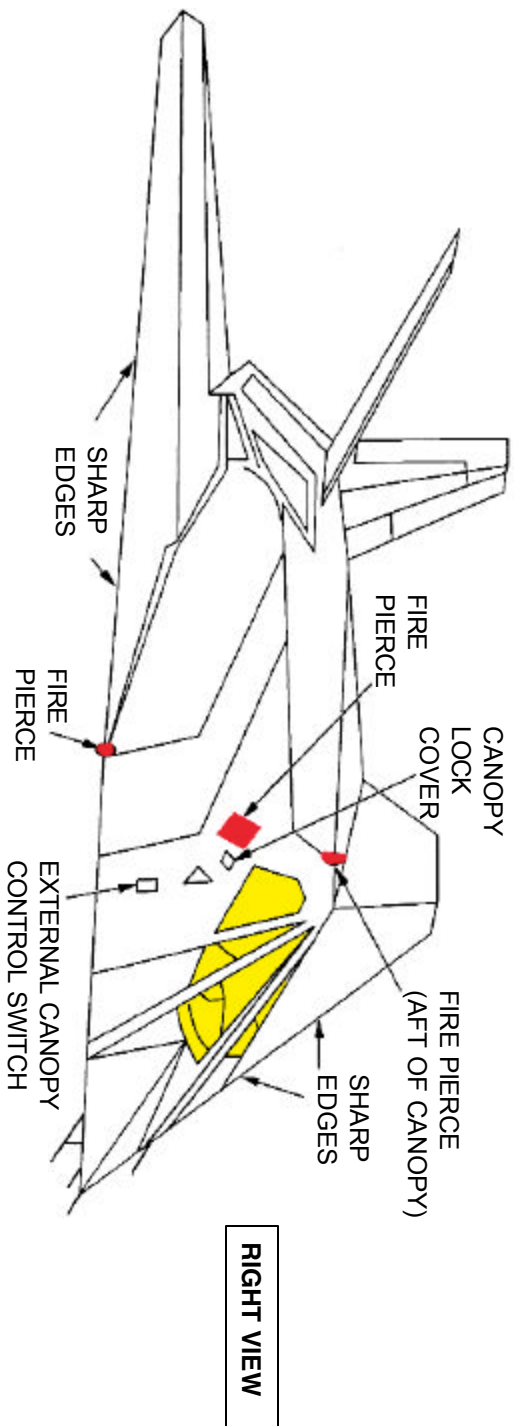
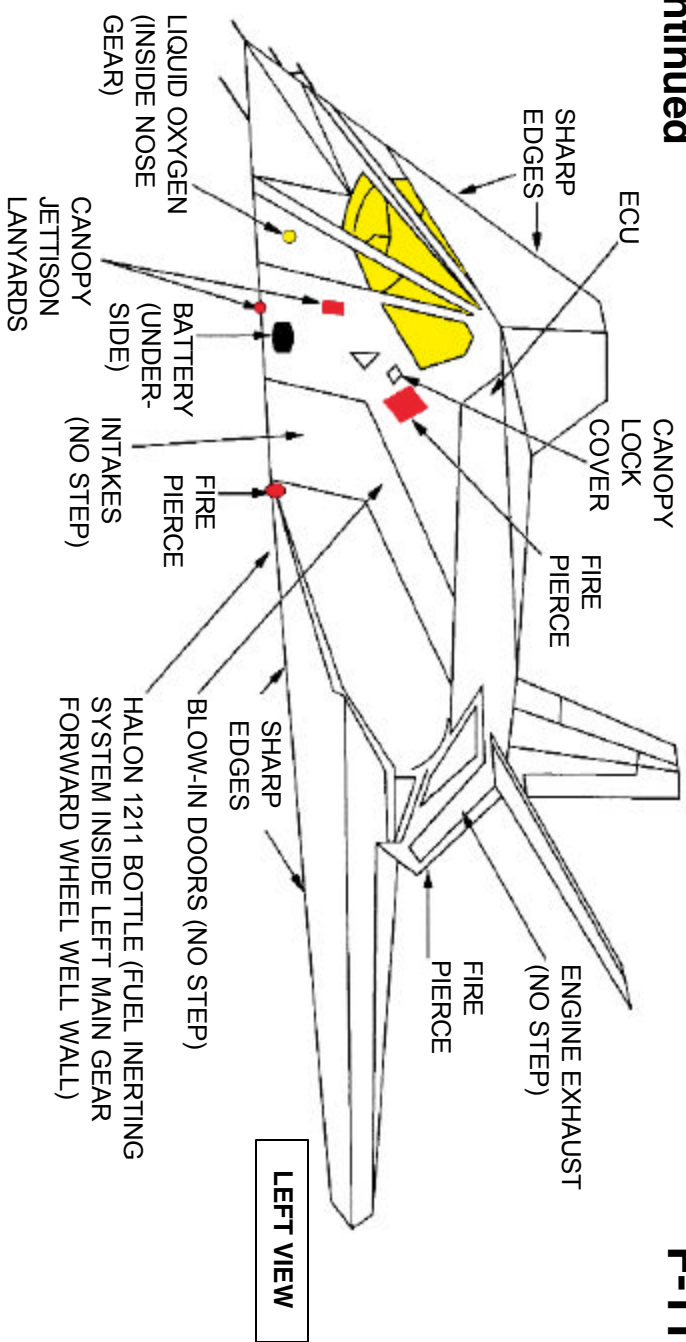

AIRCRAFT HAZARDS-Continued





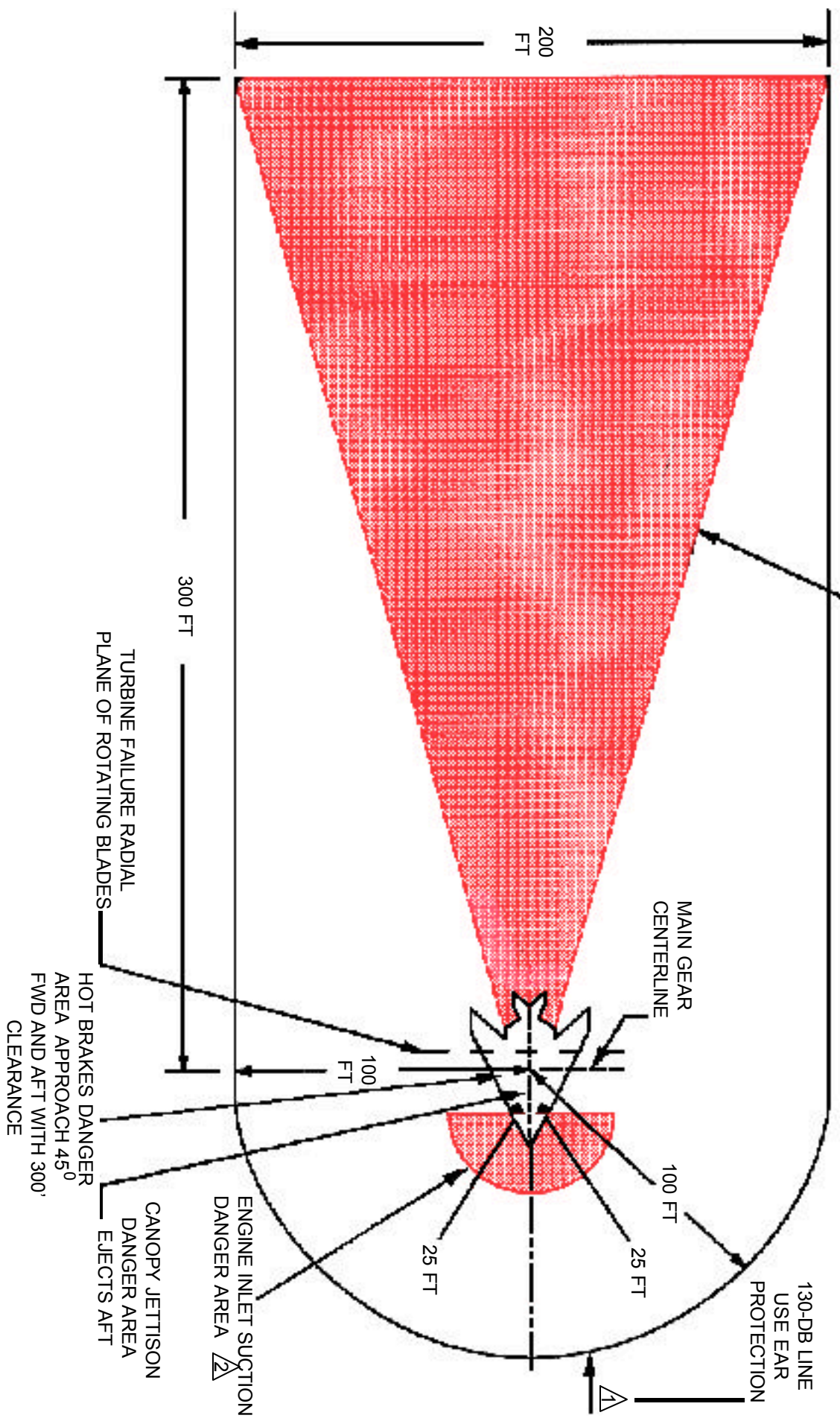

- NOTE:
- 1 When engine is running above idle power, area inside this line will have noise level generally above 130 decibels (db).
 - 2 This area shall be clear of all foreign objects.
 - 3 Area of severe turbulence when engine is running above idle power.

NOTE:
Emergency lighting needed at night.
There is no RF emission radiation.



AIRFRAME MATERIALS

LEGEND

-  a. ALUMINUM - MAIN BODY
-  b. ALUMINUM - TITANIUM - AFT OF WING ROOTS
-  c. EPOXY FIBERGLASS - EDGES
-  d. GRAPHITE POLYETHERETHERKETONE (PEEK)
- RUDDER, A PLASTIC THAT BURNS @ 600 DEGREES WITH TOXIC SMOKE
-  e. GRAPHITE EPOXY - WEAPONS BAY DOOR
-  f. POLYIMID - AFT TRAILING EDGE - BURNS AT A HIGHER TEMPERATURE; > 600 DEGREES

NOTE:

Composites comprise 5% or less of total structure and polyurethane plastic is paint coating.

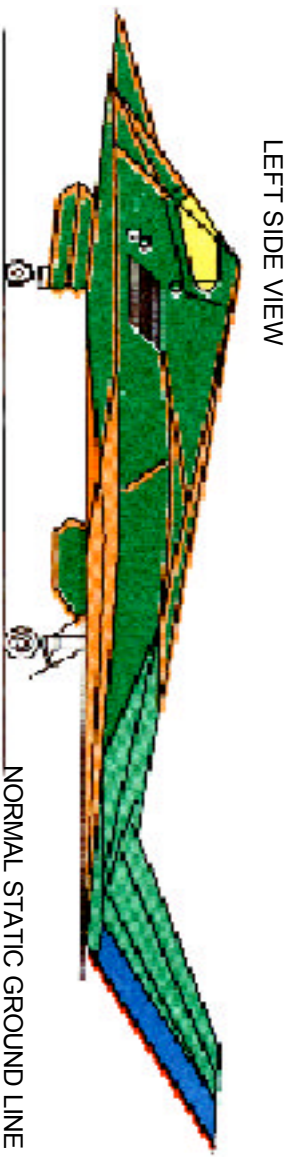
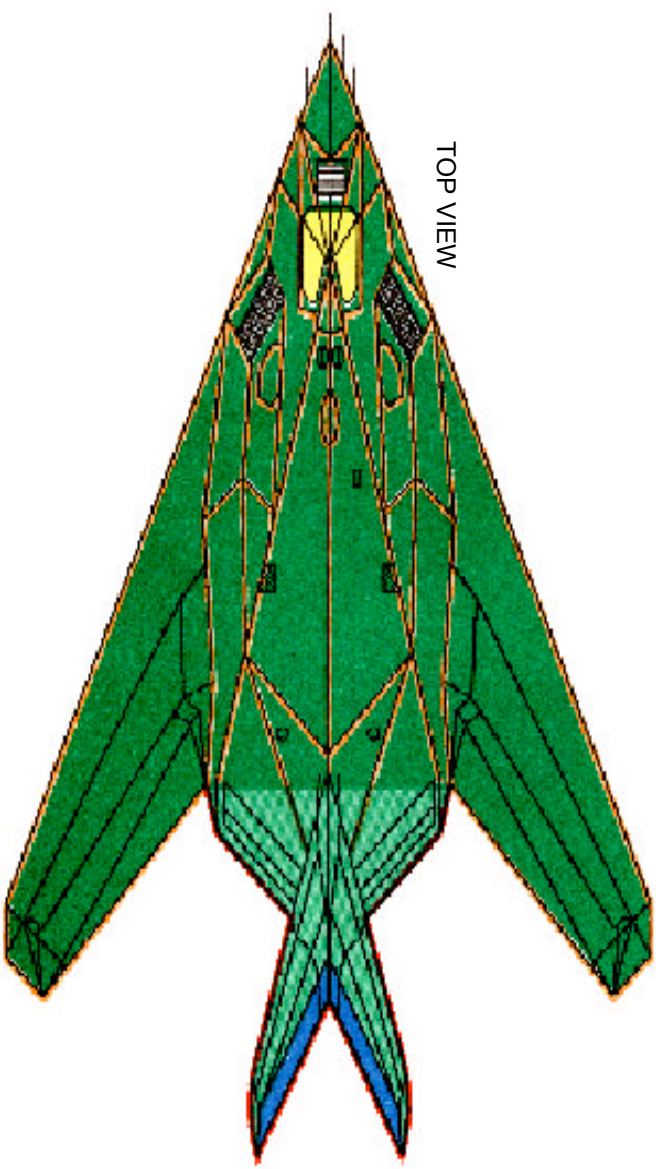
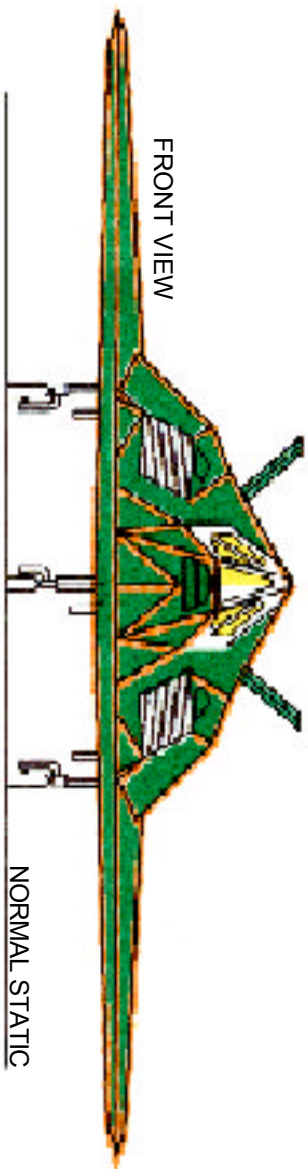

HAZARDOUS BYPRODUCTS OF BURNING WRECKAGE

NOTE:
Aircraft areas identified by numbers 1 through 8.

F-117A

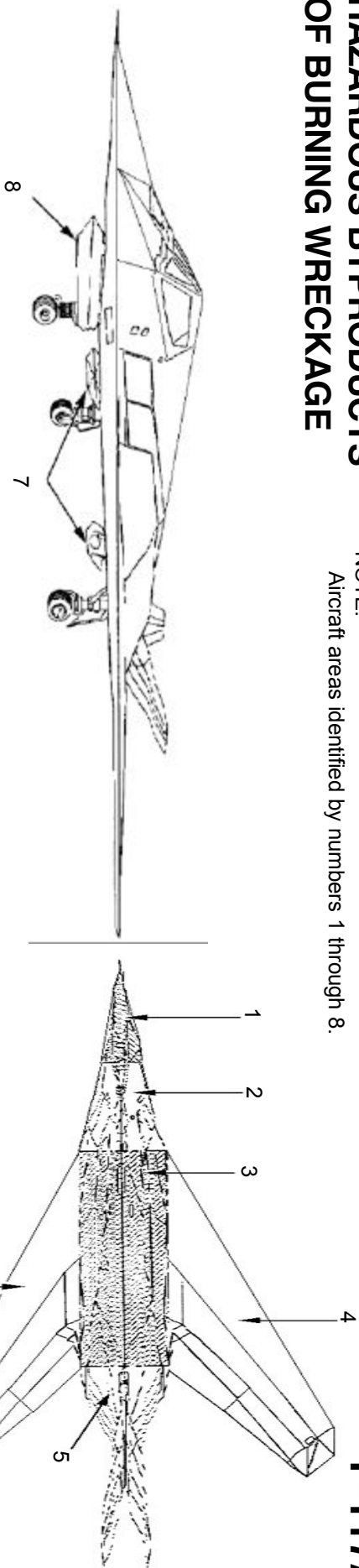

GENERAL MATERIAL	SPECIFIC MATERIAL	AREA USED ON AIRCRAFT	BYPRODUCT
Fuel Hydraulic fluids Lubricants	Fuel, JP8 Oil, low temperature Oil, synthetic Molybdenum disulfide Grease, various types Fluid, hydraulic, various types	3,4,5,6,7,8	Carbon monoxide Carbon dioxide Sulfur oxides Polynuclear aromatic hydrocarbons Phosphorus oxides
Rubber (gaskets and tires) Honey comb core Plastics (gaskets, sleeving, electrical and thermal insulations, tubing, canopy, sheets, and parts	Neoprene Chloroprene Silicones Fluorosilicones Nitriles Polyvinyl chloride Nylons Polyolefins Teflons Polyurethanes Acrylic - polycarbonate Viton, Phenolics, Bismaleimides, Epoxies, and Polysulfide	Throughout aircraft	Carbon monoxide Carbon dioxide Polynuclear aromatic hydrocarbons Hydrochloric acid Hydrofluoric acid Nitrogen oxides Hydrogen cyanide Phosgene Formaldehyde Sulfur oxides

HAZARDOUS BYPRODUCTS OF BURNING WRECKAGE-Continued

GENERAL MATERIAL	SPECIFIC MATERIAL	AREA USED ON AIRCRAFT	BYPRODUCT
Fabrics and fibers, natural and synthetic	Wool Kevlar Carbon fibers - epoxy coated Glass fibers - aramid, epoxy, teflon, and polyester coated Polyetherether ketone Polysulfide Cellulose	1,2,3,4,5,6	Hydrogen cyanide Nitrogen oxides Sulfur oxides Carbon monoxide Carbon dioxide Polynuclear aromatic hydrocarbons Hydrochloric acid Hydrofluoric acid Phosgene Formaldehyde
Metal alloys - structural, fillers, bonding, and welding	Aluminum, Chrome, Copper, Gold, Iron, Steel, Lead, Silver, Tin, Titanium, Zinc, and Trace metals	Throughout aircraft	All may melt and resolidify. No hazardous emissions.
Blanket insulation and other ceramics	Fibrefrax, Fused ceramic powders	1,3,5	None
Adhesives Sealants Paint Coatings	Polysulfides Silicones Fluorosilicones Epoxy Polyurethane Buena - N Iron Silver Silicon dioxide Strontium chromate Lead chromate	Throughout aircraft	Hydrogen cyanide Nitrogen oxides Sulfur oxides Carbon monoxide Carbon dioxide Polynuclear aromatic hydrocarbons Hydrochloric acid Hydrofluoric acid Phosgene Formaldehyde

SPECIAL TOOLS/EQUIPMENT
 Power Rescue Saw or equivalent
 Rescue Ladder for left side
 Rescue Ladder for right side
 1/2 In. Dr. Speed Handle with 1/2 In. Socket
 6 In. X 1/2 In. Extension
 Canopy Unlock Tool
 Extraction Kit
 Hydraulic Power Rescue Tool
 Ballistic Hose Dearing Cutter
 AT501C or equivalent
 Modified Bayonet Nozzle
 Fire Drill II

AIRCRAFT ENTRY

NOTE:
 Electric drills or pneumatic tools will not be used to manually raise the canopy.
 This unauthorized procedure will damage the canopy raising/lowering mechanism.

NOTE:
 Primary communication hook-up is made by using the connection located in the nose gear compartment. However, the main gear compartments also have hook-ups.

NOTE:
 The F-117A does not use a canopy strut or prop support for the aircraft canopy. A temporary prop may be used as an aid during rescue and extraction procedures.

NOTE:
 The special tools (Canopy Unlock Tool and Modified Bayonet Tool) illustrated at the right are locally manufactured. All dimensions are measured in inches.

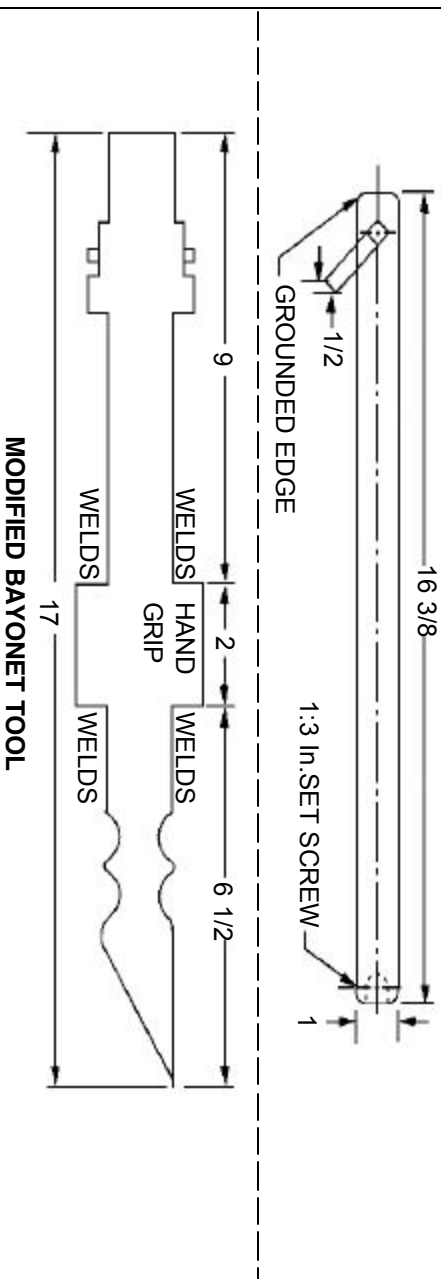
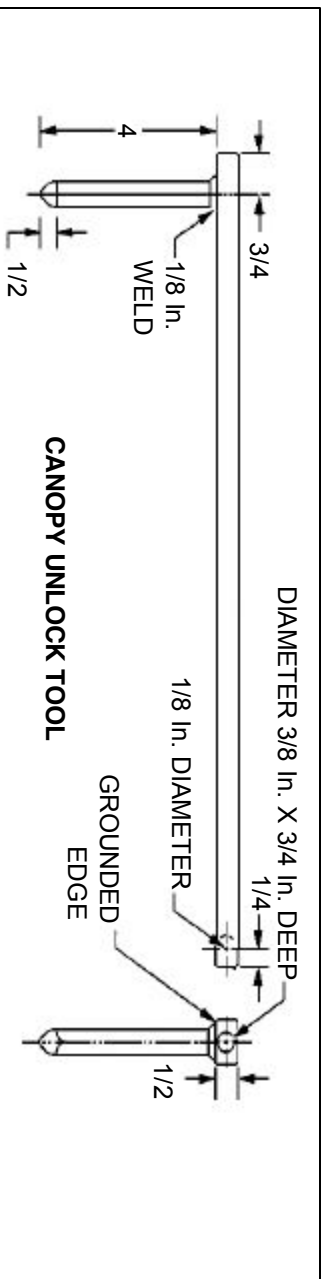
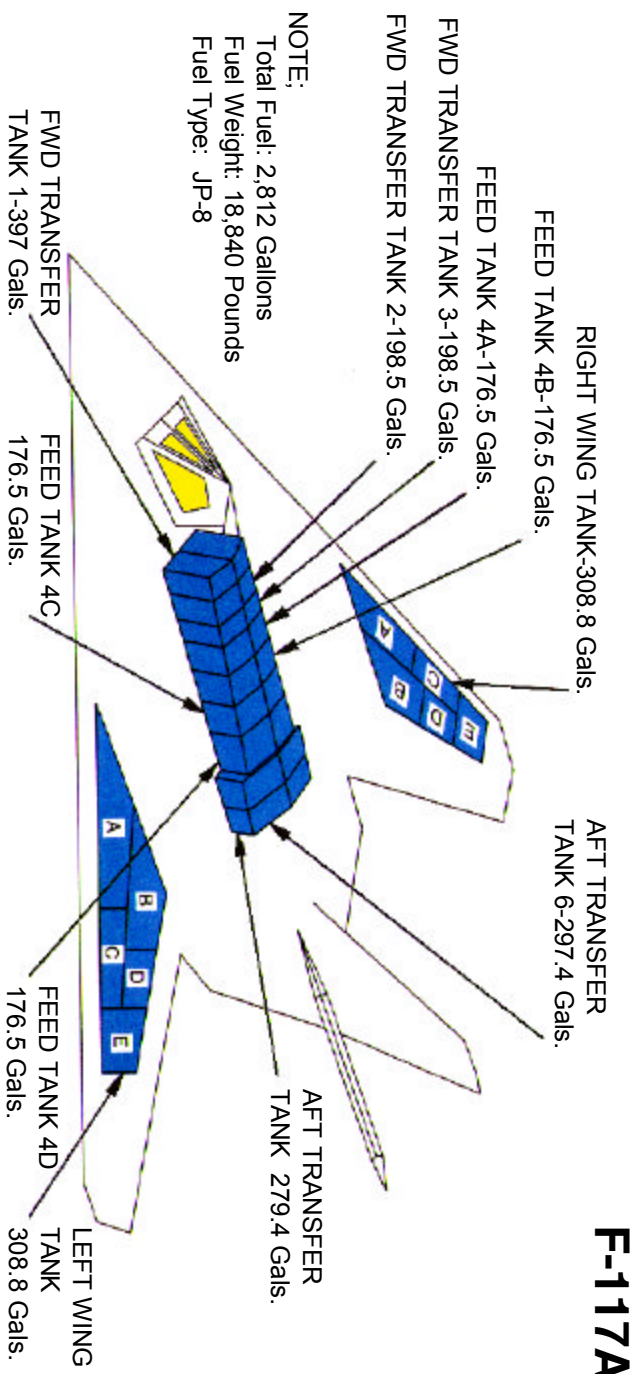

AIRCRAFT ENTRY-Continued

1. MANUAL ENTRY

- a. Punch through 104R canopy latch access panel with canopy unlocking tool. Rotate tool 90 degrees counterclockwise to unlock canopy. (Canopy may be unlocked from left side in the same manner by rotating handle 90 degrees clockwise.)
- b. Press latch to open 103R hinged service panel.
- c. Insert speed handle with socket attached (extension necessary when working from ladder) and place on 1/2 inch hex drive link located in center of opening.
- d. Crank speed handle 322 turns counterclockwise to raise canopy.

NOTE:

If canopy actuator motor crank fails, canopy can be opened if pilot is conscious by performing the following:

- 1) Unlock canopy with canopy unlocking tool.
- 2) Have pilot remove left and right canopy actuator pins.
- 3) Pry open canopy with pry bar to gain hand hold.
- 4) Lift canopy to full-open position.
- 5) Canopy may either be raised to shear hinges and pushed over side or locked open with canopy props depending upon situation. (At least two people are required for lifting canopy.)

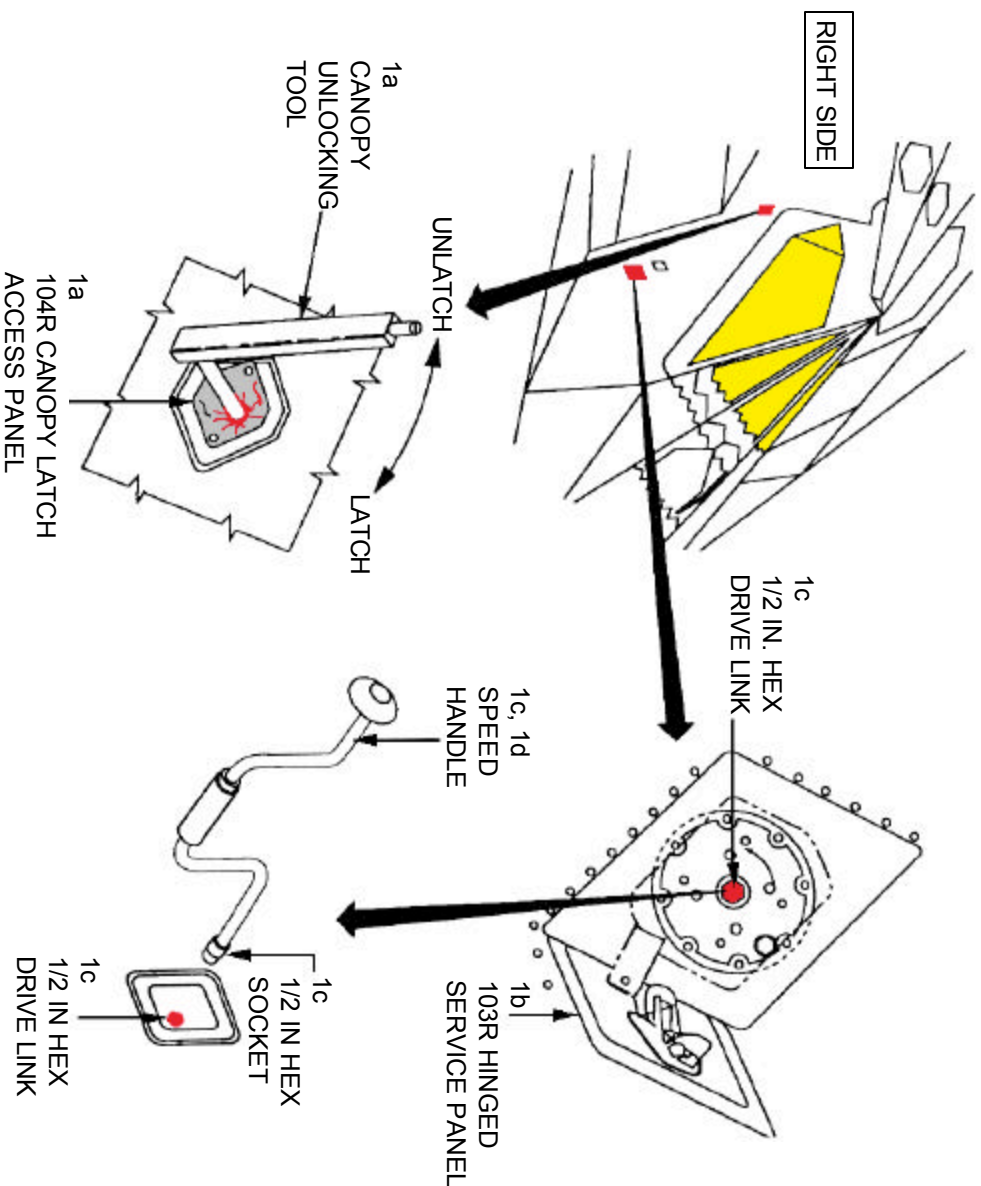

AIRCRAFT ENTRY-Continued

2. NORMAL ENTRY

- a. Access from right side is illustrated for these procedures. Punch through canopy lock cover, located right or left side of fuselage below aft portion of canopy, with canopy unlocking tool. Rotate tool 90 degrees counterclockwise to unlock canopy. (Canopy may be unlocked from left side in same manner, by rotating handle 90 degrees clockwise.)

NOTE:

If the canopy external unlocking latch is damaged on both sides of aircraft from impact, electrical and manual methods of raising canopy will not be possible. Under these conditions, cut-in method should be used.

- b. Press latch to open 103R hinged service panel.
- c. Turn and hold external canopy control switch in OPEN position to raise canopy.

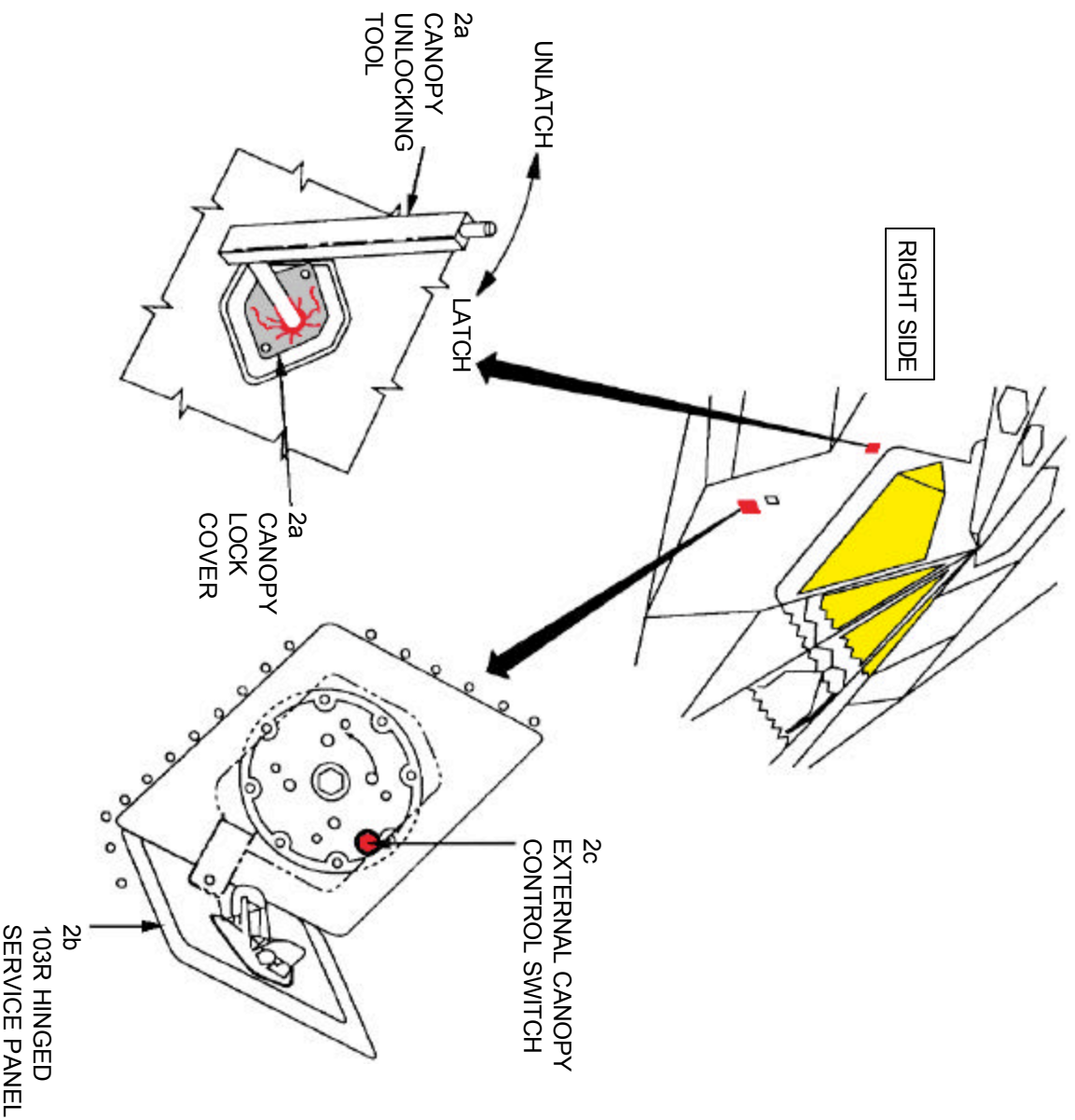

AIRCRAFT ENTRY-Continued

3. EMERGENCY ENTRY

WHEELS UP

WARNING

Canopy will not eject if open over eight inches. Do not jettison canopy if canopy and cockpit have been damaged from impact. If canopy is jettisoned under these conditions, pilot may suffer severe injury and/or death.

- a. Press latch to open 103L hinged service panel. Remove T-handle and lanyard.

CAUTION

Ensure area is clear to side and aft of cockpit before jettisoning canopy.

- b. Extend lanyard and T-handle to full length and pull hard to jettison canopy.

WHEELS DOWN

- a. Press latch to open 103L or 201L hinged service panel. Remove T-handle and lanyard.

CAUTION

Ensure area is clear to side and aft of cockpit before jettisoning canopy.

- b. Extend lanyard and T-handle to full length and pull hard to jettison canopy.

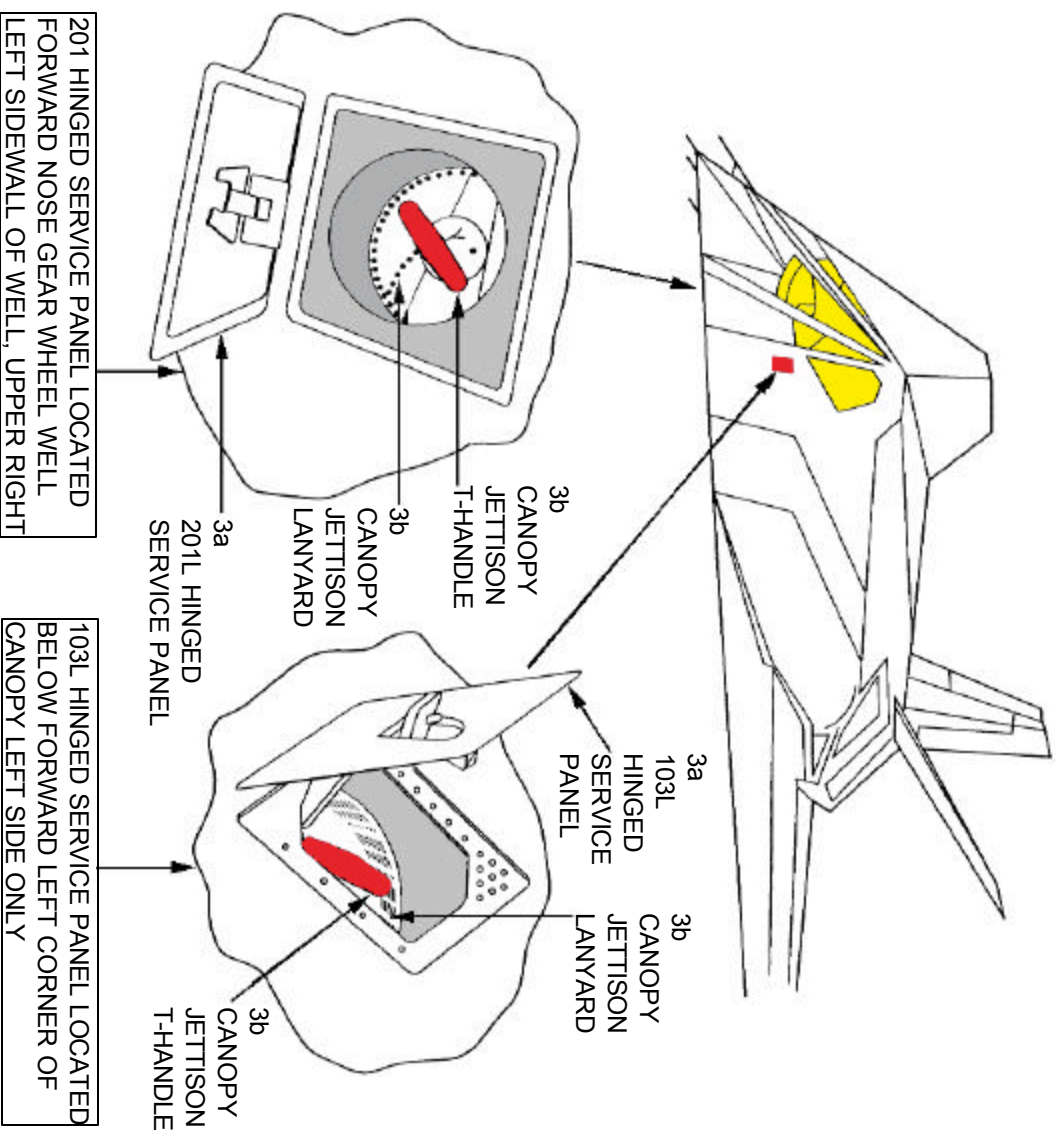

AIRCRAFT ENTRY-Continued

4. CUT-IN

WARNING

Do not use portable gas rescue saw in an explosive atmosphere. This may cause an explosive and/or fire resulting in injury or death to pilot and rescue personnel.

- a. Using portable gas rescue saw, cut out left or right side panel by cutting along inside edge of canopy frame on all four sides of panel.
- b. Lift out panel.

NOTE:

Use 12 inch diameter metal blade with carbide tip, 3 and 1/8 inch pitch.

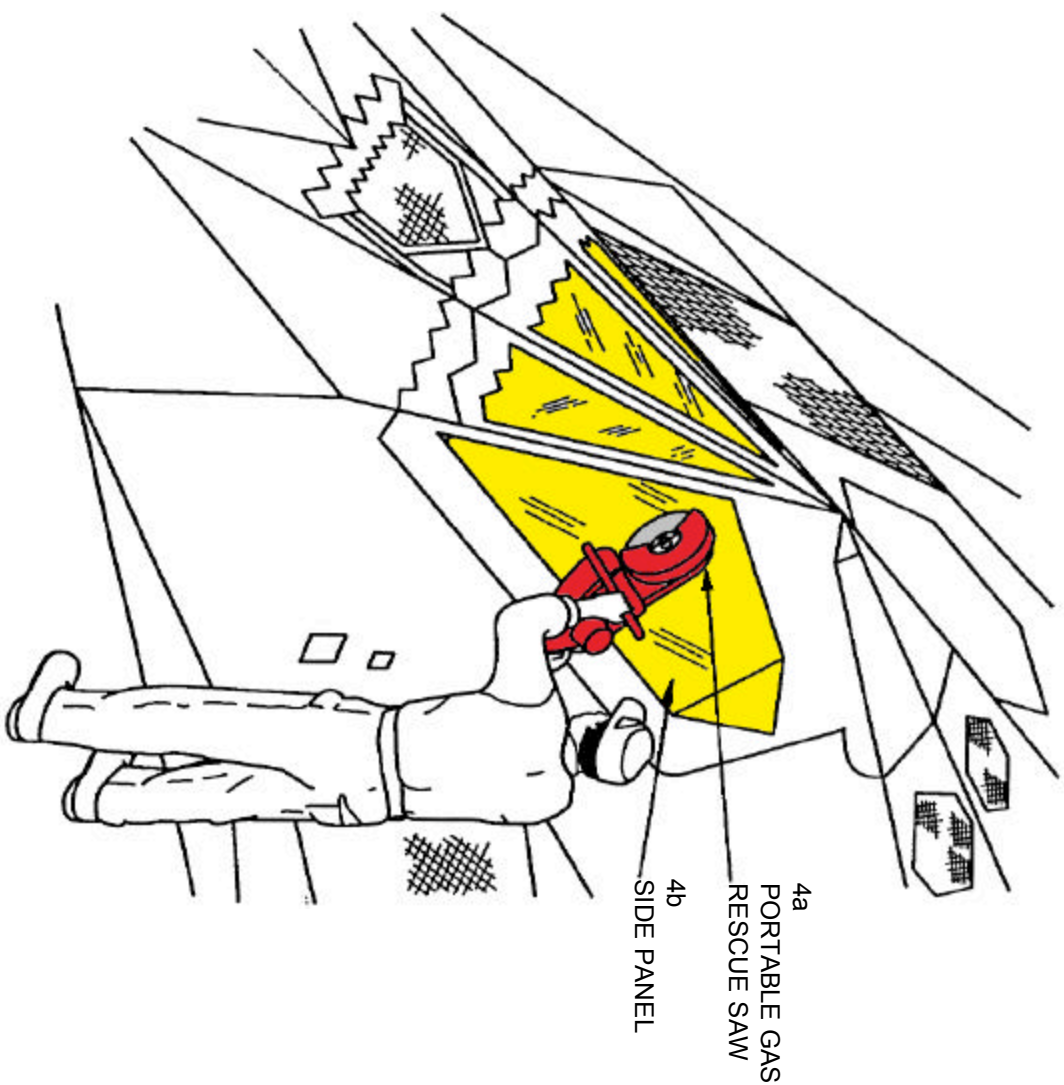

ENGINE SHUTDOWN

1. ENGINE SHUTDOWN

NOTE:

Throttles cannot be retarded simultaneously. Throttles must be retarded one at a time.

- a. Raise finger lifts, raise throttles located on left console and move aft to OFF position.

NOTE:

The INERT switch is used to make the fuel system inert by using Halon 1211. Halon 1211 is not used to extinguish fire.

- b. Set INERT switch on left console forward of throttles to ON.

NOTE:

Ensure that the engine and APU switches are touched only once. Subsequent touching will cause firewall shutoff valves to reopen.

- c. Touch left engine, right engine and APU switches to ensure that fuel flow is shutoff.

NOTE:

If fuel fails to stop, manual fuel shutoff valves are located in the forward section of the main landing gear well.

BATTERY switch must be turned off last. Wait one or two seconds after step c. is performed before setting BATTERY switch to OFF to allow time for firewall shutoff valves to close electrically.

- d. Set BATTERY switch on right console to OFF.

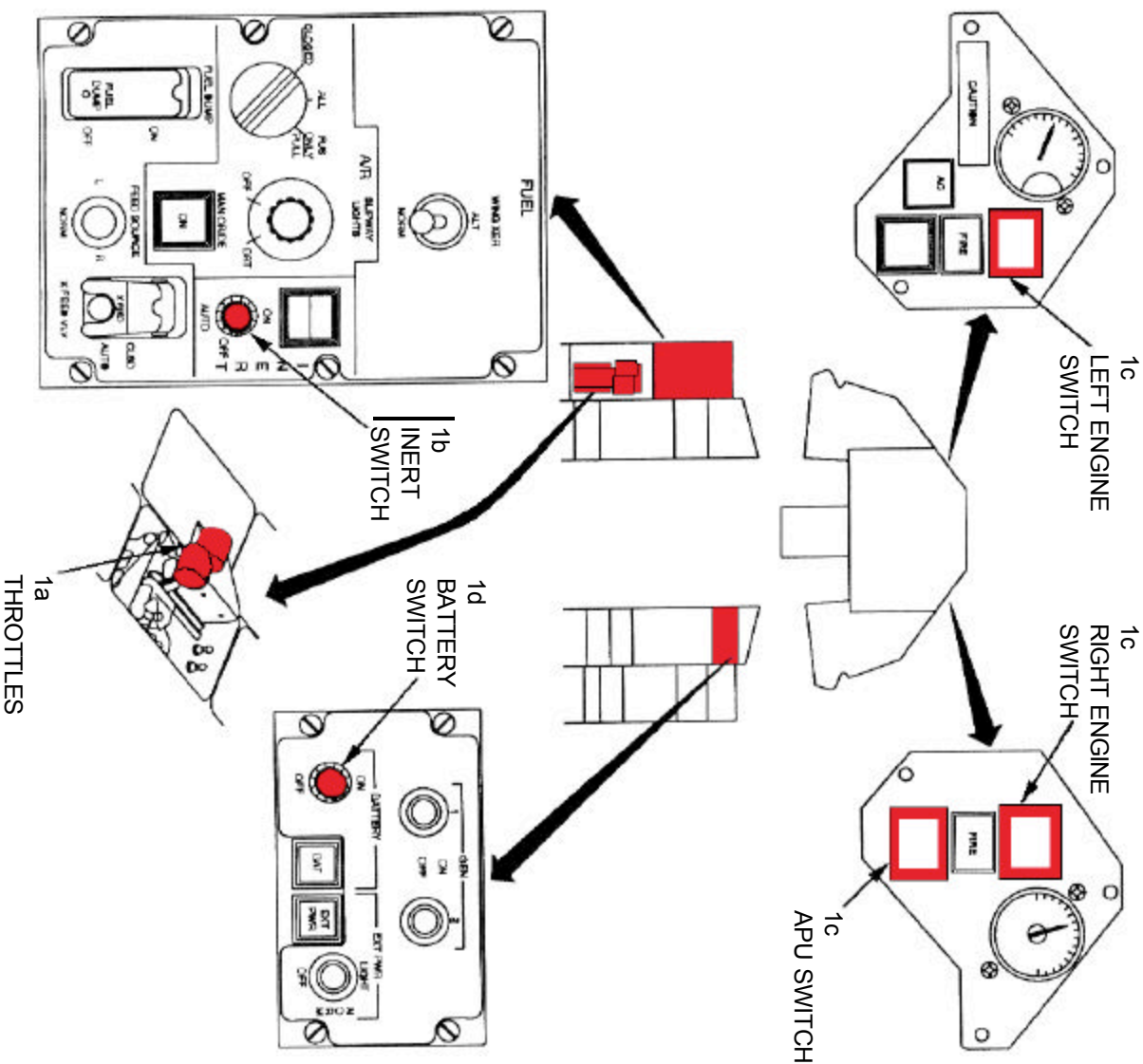

INTERNAL CANOPY CONTROLS

1. INTERNAL CANOPY CONTROLS

- a. Canopy Unsafe indicator is located on the forward instrument panel right corner. This indicator will illuminate when the canopy is unlatched (unlocked) or ajar.
- b. Canopy Open/Close switch is located on the right side panel. Move switch up for open, down for close.
- c. Canopy Manual Control is located on the right side panel. Handle must be pulled out of the stowed position to operate. This handle must be rotated clockwise to manually open the canopy and counterclockwise to manually close the canopy.
- d. Canopy Latch Handle is located on the canopy sill above the right console. Handle must be moved forward to latch (lock) the canopy and moved aft to unlatch (unlock) the canopy.
- e. Canopy/Seat T-Handle is located on the left console. This handle provides the pilot with the capability of jettisoning only the canopy without firing the ejection seat. When the T-handle is pulled straight up, the canopy will jettison. The T-handle requires an approximate 12 to 15 pound pull for the first 3/8 inch of travel to take up slack present in the lines. The handle then requires a 50 pound pull over one inch of travel to actuate the canopy jettison initiator. If the T-handle is turned 90 degrees counterclockwise after the canopy is jettisoned and pulled up further, **seat ejection will occur**. The T-handle will separate in the pilot's hand to prevent injury during the ejection.

WARNING

The seat will eject even if the Ground Safety Lock is rotated forward in the Safe Position if the Canopy/Seat T-handle is pulled!

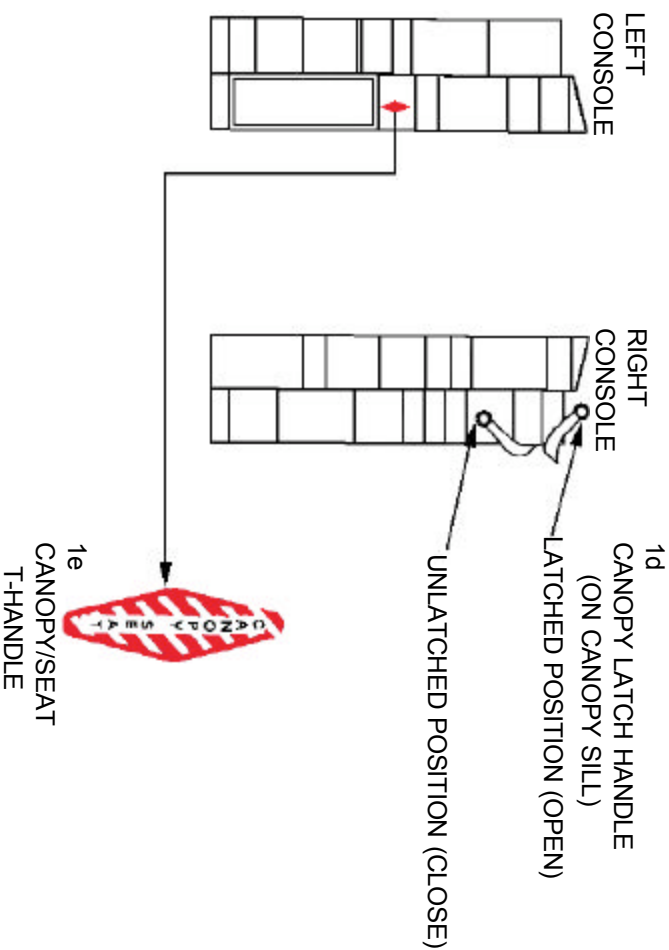
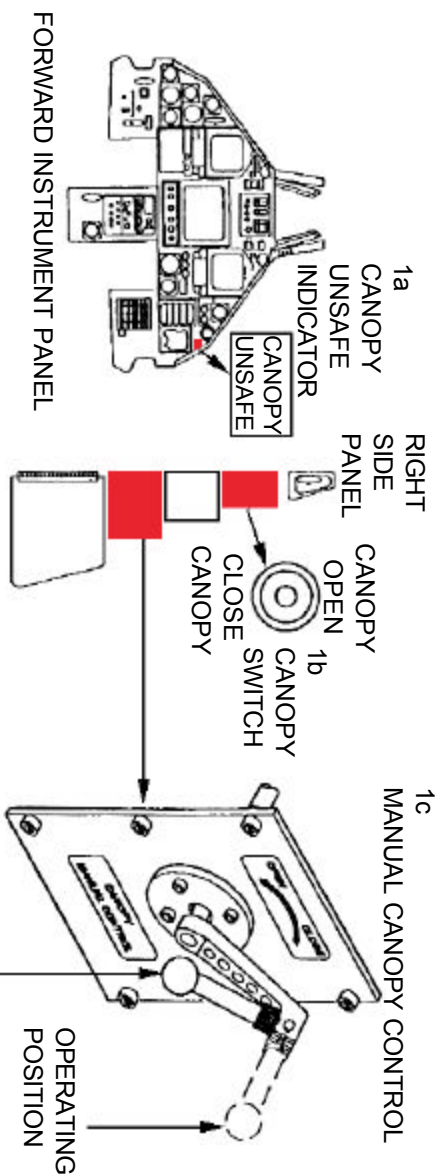

SAFETYING EJECTION SYSTEM AND AIRCREW EXTRACTION

1. EJECTION SYSTEM

NOTE:

The Advanced Concept Ejection System (ACES II) can be identified by pitot airspeed sensing inlet tubes at top of seat and two ejection control handles. **DO NOT USE PITOTS AS A HAND HOLD FOR GAINING COCKPIT ENTRY.**

- Rotate Ground Safety Lever, located left side of seat directly aft of the Ejection Control Handle, UP and FORWARD.
- Install Safety Pin inboard in left Ejection Control Handle.
- Install Safety Pin in the Canopy/Seat T-Handle. See item 1e on page F-15.16.

NOTE:

Do not use Emergency Manual Chute Handle. Actuation of this handle will cause pilot chute to deploy only after ejection. It does not release restraints.

- Install Safety Pin (if time allows) in Emergency Manual Chute Handle. **BWARE OF INTANGLING.**

2. AIRCREW EXTRACTION

NOTE:

If seat has been damaged by fire or impact, ballistic hoses must be cut with disarming tool. If aircraft lands with all wheels up, or nose wheel up, pilot may have suffered severe back and/or neck injuries. In these situations, Kendrick Extraction Kit must be used to avoid causing further injuries that could be fatal or kill pilot. If possible, rescue should not be effected until pilot is secured in Kendrick device.

- Release lap belt buckle. Insert thumb into fitting, push cover up and roll serration bar downward with thumb to release.
- Release left and right survival kit buckles.
- Release left and right shoulder harness fittings. Insert thumb into fitting, push cover up and roll serration bar downward with thumb to release.
- Disconnect personnel leads: communication, oxygen hose, and "G" suit hose, if applicable. (Not illustrated.)

NOTE:

Do not touch indicator sealant when checking condition. Frequent touching wears off sealant exposing tip of red pin indicating a false ARMED ARS condition.

ARS INDICATOR

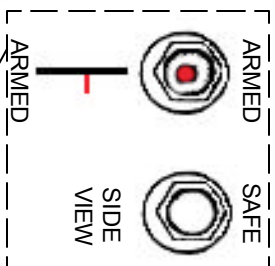

F-117A

