

### Overview

#### HPE ProLiant ML110 Gen10 Server

The HPE ProLiant ML110 Gen10 delivers a performance that meets the growing needs of the SMB. The server is a single processor, 4.5U Tower Server that is designed to provide enterprise class features such as redundancy, reliability, and manageability. The server delivers the right size Tower with performance and expandability that covers a wide range of applications and workloads and addresses our customers from SMB to enterprise class server ROBO environments. Accelerate your business with this right-sized compute.

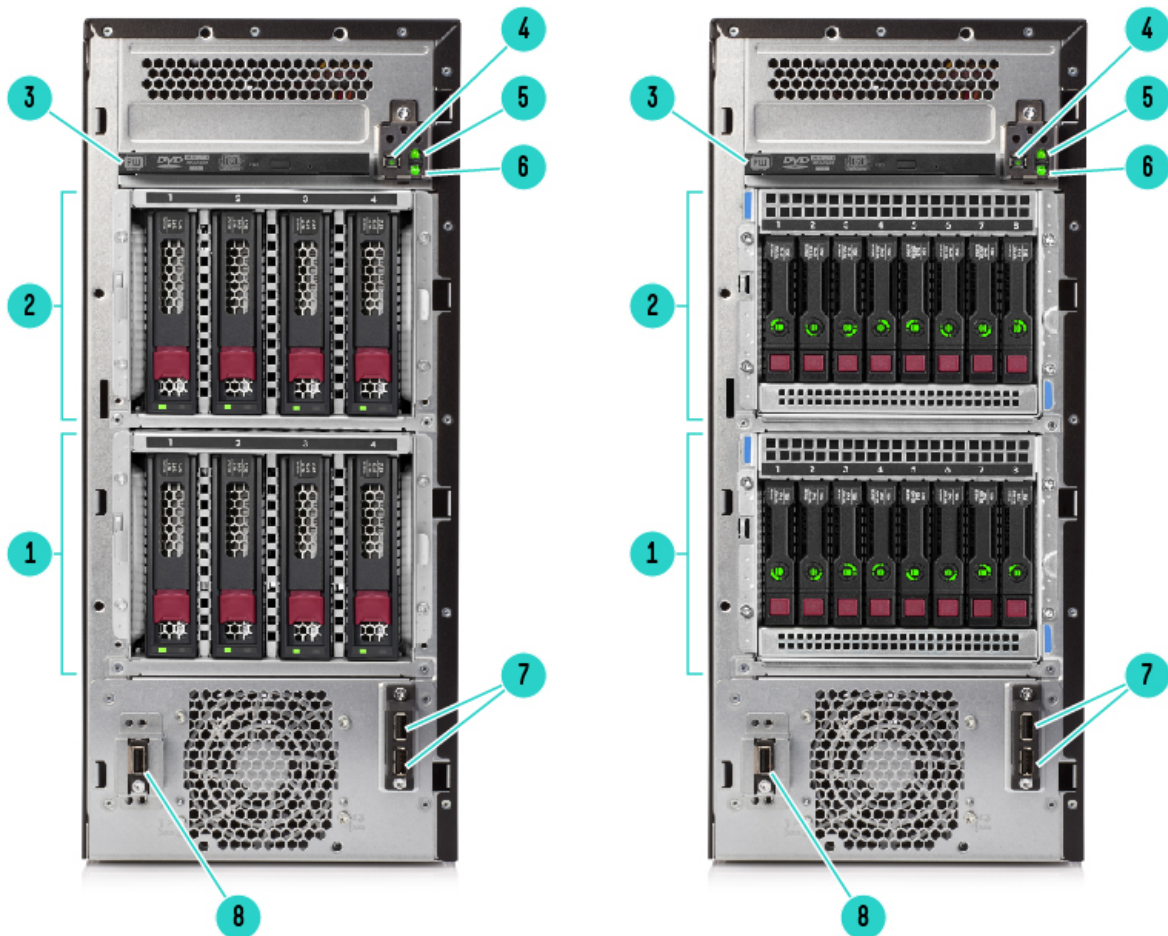

#### Front View (details for 8LFF and 16SFF)

- |                             |                            |
|-----------------------------|----------------------------|
| 1. Drive Cage 1             | 2. Drive Cage 2 (optional) |
| 3. Optical drive (optional) | 4. Power button/ LED       |
| 5. Health LED               | 6. NIC status LED          |
| 7. USB 3.0 (2) connectors   | 8. iLO Service Port        |

## Overview

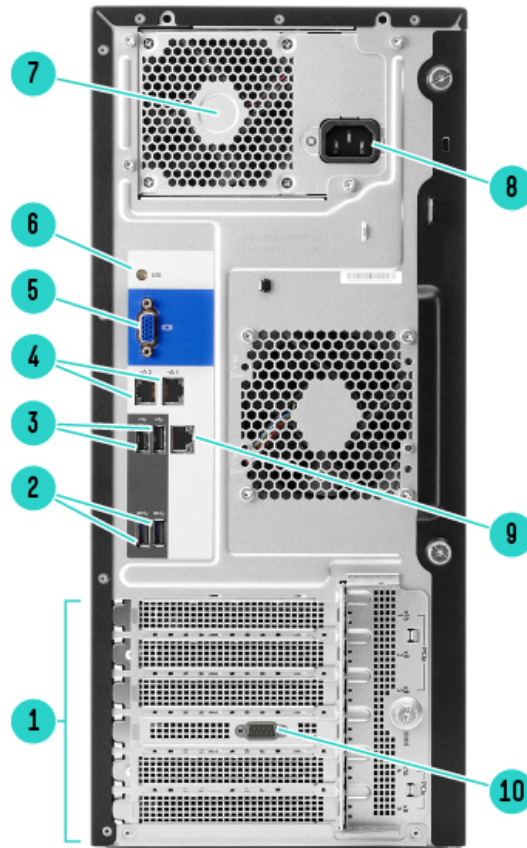

### Rear View

- |                              |                                  |
|------------------------------|----------------------------------|
| 1. PCIe3.0 Slots (Slots 1-5) | 2. USB 3.0 (2) connectors        |
| 3. USB 2.0 (2) connectors    | 4. Network RJ-45 ports (2)       |
| 5. Video connector           | 6. UID button/LED                |
| 7. Power supply bay          | 8. Power supply power connection |
| 9. iLO management port       | 10. Serial port (optional)       |

## Overview

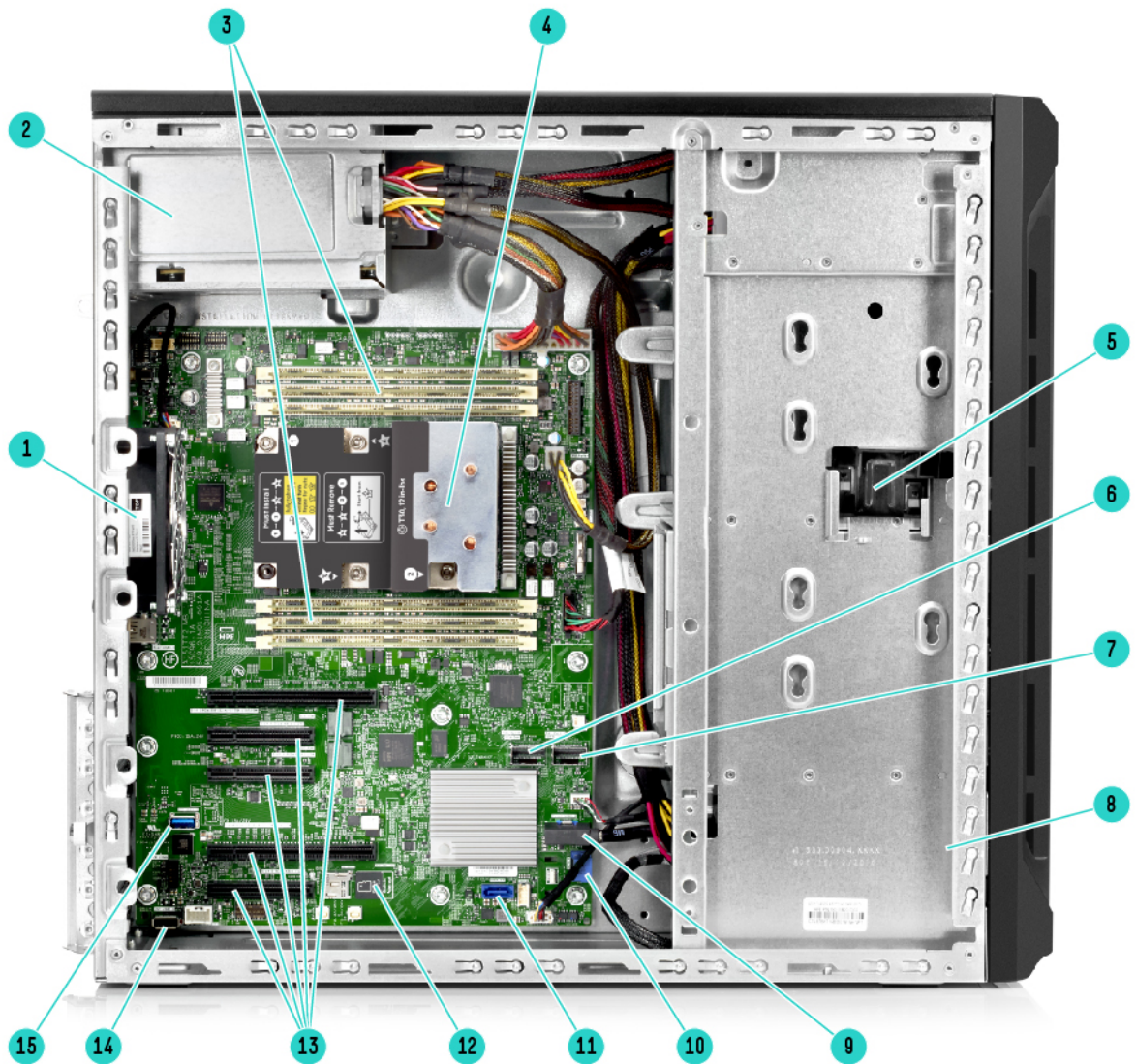

## Internal View

- |                                      |                                   |
|--------------------------------------|-----------------------------------|
| 1. System Fan (92x32mm default)      | 2. Power Supply                   |
| 3. Six (6) DDR4 DIMM slots           | 4. One (1) processor and heatsink |
| 5. Front Bezel Lock                  | 6. X4 SATA Port 2 (5-8)           |
| 7. X4 SATA Port 1 (1-4)              | 8. PCIe fan (92x32mm default)     |
| 9. Front USB 3.0 connector           | 10. SATA Port 9                   |
| 11. SATA Port 10                     | 12. MicroSD slot                  |
| 13. Five (5) PCIe3.0 expansion slots | 14. Internal USB 2.0 connector    |
| 15. Internal USB 3.0 connector       |                                   |

## Overview

### What's New:

- New SMB SKU Offerings
- NVIDIA Quadro P2000 GPU Module (optional)
- HPE 12TB SAS/ SATA 7.2K LFF HDD
- Intel® Xeon® Scalable processors , up to 14 cores, up to 105W
- Redundant Fan Kit (optional)
- Support up to 8 LFF NHP SATA HDDs
- HPE DDR4 SmartMemory up to 2666 MT/s
- Security features: iLO 5 (Security Root of Trust)

## Platform Information

### Platform Information

**Form Factor**

Tower (4.5U)

**NOTE:** Sliding Shelf - 874578-B21 is optional to support rack form factor.**System Fans**

1 Default system fan module (92 x 32 mm)

1 Default PCIe fan module (92 X 32 mm)

**NOTE:** When one of the following scenarios occurs, the server requires a Redundant Fan with a 800W Redundant Power Supply to be installed.

1. When a second HDD cage is installed and the SAS HDDs are running at 15K RPM.
2. When a SAS SSD is installed.
3. If one fan fails, the system will be required to continue operating with a Redundant Fan. This condition is indicated by a flashing amber Health LED.
4. When the system requirements are to meet the A3 extended operating environment.

## Standard Features

### Standard Features

Processors – One of the following depending on model.

**NOTE:** For more information regarding Intel Xeon processors, please see the following <http://www.intel.com/xeon>.

Intel Xeon Models	CPU Frequency	Cores	L3 Cache	Power	UPI	DDR4	Memory per socket
<b>Gold Processors</b>							
Gold 5122 Processor	3.6 GHz	4	16.50 MB	105W	2 @ 10.4 GT/s	2666 MT/s	192 GB
Gold 5120 Processor	2.2 GHz	14	19.25 MB	105W	2 @ 10.4 GT/s	2400 MT/s	192 GB
<b>Silver Processors</b>							
Silver 4112 Processor	2.6 GHz	4	8.25 MB	85W	2 @ 9.6 GT/s	2400 MT/s	192 GB
Silver 4110 Processor	2.1 GHz	8	11.00 MB	85W	2 @ 9.6 GT/s	2400 MT/s	192 GB
Silver 4108 Processor	1.8 GHz	8	11.00 MB	85W	2 @ 9.6 GT/s	2400 MT/s	192 GB
<b>Bronze Processors</b>							
Bronze 3106 Processor	1.7 GHz	8	11.00 MB	85W	2 @ 9.6 GT/s	2133 MT/s	192 GB
Bronze 3104 Processor	1.7 GHz	6	11.00 MB	85W	2 @ 9.6 GT/s	2133 MT/s	192 GB

**NOTE:** Gold – 5100 Series - Supports 6-Channel DDR4 @ 2400 MT/s of SKU 5120 and @2666 MT/s of SKU 5122 providing up to 192 GB memory capacity. Intel Turbo Boost Technology, Intel Hyper-Threading Technology, Intel AVX-512(1x 512-bit FMA) (SKU 5122 supports 2x 512 bit FMA), 48 lanes PCIe 3.0, advanced RAS supported.

**NOTE:** Silver – 4100 Series -6-Channel DDR4 @ 2400 MT/s providing up to 192 GB memory capacity. Intel Turbo Boost Technology, Intel Hyper-Threading Technology, Intel AVX-512(1x 512-bit FMA), 48 lanes PCIe 3.0, standard RAS supported.

**NOTE:** Bronze – 3100 Series - Supports 6-Channel DDR4 @ 2133 MT/s providing up to 192GB memory capacity. Intel AVX-512(1x 512-bit FMA), 48 lanes PCIe 3.0, standard RAS supported.

### Chipset

Intel C621 Chipset

**NOTE:** For more information regarding Intel® chipsets, please see the following URL: <http://www.intel.com/products/server/chipsets/>

### On System Management Chipset

HPE iLO 5 ASIC

**NOTE:** Read and learn more in the [iLO QuickSpecs](#).

### Memory

Type: HPE SmartMemory and Standard Memory  
DDR4 Registered (RDIMM)

DIMM Slots Available 6 6 DIMM slots per processor, 6 channels per processor, 1 DIMM per channel

Maximum capacity (RDIMM) 192 GB 6 x 32 GB RDIMM @ 2666 MT/s

**NOTE:** LRDIMM is not qualified by this server. This server does not support mixing LRDIMMs and RDIMMs. Attempting to mix any combination of these DIMMs can cause the server to halt during BIOS installation. All memory installed in the server must be of the same type.

**NOTE:** The maximum memory speed is a function of the memory type, memory configuration, and processor model.

### Memory Protection

For details on the HPE Server Memory Options RAS feature, visit: <http://www.hpe.com/docs/memory-ras-feature>.

## Standard Features

### Expansion Slots

Slots #	Technology	Bus Width	Connector Width	Slot Form Factor	Notes
5	PCIe 3.0	X4	X8	Full-height, half-length slot	PCH
4	PCIe 3.0	X16	X16	Full-height, full-length slot	Proc 1
3	PCIe 3.0	X8	X8	Full-height, half-length slot	Proc 1
2	PCIe 3.0	X4	X8	Full-height, half-length slot	Proc 1
1	PCIe 3.0	X16	X16	Full-height, $\frac{3}{4}$ length (up to 9.5") Slot	Proc 1

**NOTE:** Bus Width Indicates the number of physical electrical lanes running to the connector.

**NOTE:** Although the Speed of slot is designed for 32Gb/s, the actual running speed will be lower than it was designed. Hence Slot 2 and Slot 5 will be least recommended for usage.

### Storage Controllers

The Gen10 controller naming framework has been updated to simplify identification as depicted below. For a more detailed breakout of the available Gen10 Smart Array controllers visit the [HPE Smart Array Gen10 Controllers Data Sheet](#).

One of the following depending on model

**Software RAID** HPE Smart Array S100i SR Gen10 SW RAID

**NOTE:** HPE Smart Array S100i SR Gen10 SW RAID will operate in UEFI mode only. For legacy support an additional controller will be needed, and for CTO orders please also select the Legacy mode settings part, 758959-B22.

**NOTE:** HPE Smart Array S100i SR Gen10 SW RAID is off by default and must be enabled. For enabling please select HPE FIO Enable Smart Array SW RAID (784308-B21).

**NOTE:** The S100i supports 10 ports as 2 additional ports are leveraged to support the M.2 option.

**NOTE:** For Linux users, HPE offers a solution that uses in-distro open-source software to create a two-disk RAID 1 boot volume. For more information visit: <https://downloads.linux.hpe.com/SDR/project/lsrrb/>

**Essential RAID Controller** HPE Smart Array E208i-p SR Gen10 Controller  
HPE Smart Array E208e-p SR Gen10 Controller

**Performance RAID Controller** HPE Smart Array P408i-p SR Gen10 Controller  
HPE Smart Array P408e-p SR Gen10 Controller

**NOTE:** Performance RAID Controllers require the HPE Smart Storage Battery (P01367-B21-B21) which is sold separately.

### Internal Storage Devices

One of the following depending on model

Optical Drive Optional SATA 9.5mm DVD-ROM Optical Drive  
Optional SATA 9.5mm DVD RW Optical Drive  
**NOTE:** Optical is optional in BTO models.

Hard Drives None ship standard

Hard Drive Bays Up to 8 Non-hot plug SATA 3.5-inch drives  
**NOTE:** Mixing drive cage types is not allowed.  
**NOTE:** All Pre-configured Models come populated with hard drive blanks installed. The 4LFF configurations includes 3 blanks and 8SFF includes 7 blanks. Additional hard drive blanks can be ordered using either P/N 807878-B21 for the HPE LFF HDD Blank Kit or P/N 666987-B21 for

## Standard Features

the HPE SFF HDD Blank Kit. These part numbers for single HDD blanks below are also provided should you require replacement HDD blanks for your server.

**NOTE:** NHP SATA is limited to S100i controller.

4 Hot plug LFF SAS/SATA HDD bays; upgradable to 8

8 Hot plug SFF SAS/SATA HDD bays; upgradable to 16

### Maximum Internal Storage

	CAPACITY	CONFIGURATION
Hot Plug LFF SAS	96 TB	8 x 12 TB
Hot Plug LFF SATA	96 TB	8 x 12 TB
Hot Plug SFF SAS	38.4 TB	16 x 2.4 TB
Hot Plug SFF SATA	32 TB	16 x 2 TB
Non Hot Plug LFF SATA	32 TB	8 x 4 TB
Hot Plug LFF SATA SSD	30.72 TB	8 x 3.84 TB
Hot Plug SFF SAS SSD	61.44 TB	16 x 3.84 TB
Hot Plug SFF SATA SSD	61.44 TB	16 x 3.84 TB

### Power Supply

HPE ML110 Gen10 350W ATX Power Supply Kit

HPE ML110 Gen10 550W ATX Power Supply Kit

**NOTE:** ATX power supply will not support redundant fan option.

HPE Entry-Level Power Supplies provide lower-cost options for customers trying to balance their need for enterprise class efficiency and reliability while maintaining lowest possible hardware costs. All Entry-Level power supply options have been designed specifically for HPE ProLiant Gen10 Essential Series servers.

The HPE 550W ATX Power Supply is the standard, non-redundant AC power supply option for most HPE ProLiant Gen10 Essential servers. It features Silver-level (88%) certified power efficiency with a set of features optimized for the Gen10 Essential-series rack and tower servers.

HPE 800W Flex Slot Platinum Hot Plug Low Halogen Power Supply Kit

**NOTE:** Flex Slot Platinum power supplies support power efficiency of up to 94% and include a standard C-14 power inlet connector.

**NOTE:** The 800W Flex Slot Platinum Hot Plug Low Halogen Power Supply Kit requires the RPS Enablement Kit.

**NOTE:** The RPS Enablement kit will support two power supplies.

HPE Flexible Slot (Flex Slot) Power Supplies share a common electrical and physical design that allows for hot plug, tool-less installation into HPE ProLiant Gen10 Performance Servers. Flex Slot power supplies are certified for high-efficiency operation and offer multiple power output options, allowing users to "right-size" a power supply for specific server configurations. This flexibility helps to reduce power waste, lower overall energy costs, and avoid "trapped" power capacity in the data center.

This jumper cord is also included with each standard AC power supply option kit. If a different power cord is required, please check the [ProLiant Power Cables](#) web page.

To review the power requirements for your selected system, please use the [HPE Power Advisor Tool](#).

For information on power specifications and technical content visit [HPE Server power supplies](#).

### Interfaces

Video	1 standard ( at system rear)
Network RJ-45 (Ethernet)	2 standard ( at system rear)
Serial	1 optional ( at system rear)



## Standard Features

iLO Management Port	1 standard (at system rear)
iLO Service Port	1 standard (at system front)
MicroSD Slot	1 standard (at system internal)
USB 3.0	5 (2 front, 2 rear, 1 internal)
USB 2.0	3 (2 rear, 1 internal)

**NOTE:** The MicroSD slot is not hot-pluggable, please power down server before installation or removal.

## Operating Systems and Virtualization Software Support for ProLiant Servers

### Microsoft Windows Serve

### Red Hat Enterprise Linux (RHEL)

### SUSE Linux Enterprise Server (SLES)

### VMware

### ClearOS

HPE and ClearCenter will help you lower the cost of building on-premise solutions without sacrificing security and ease of use. HPE ProLiant servers with ClearOS give you a simple, secure, and affordable operating system with an intuitive web-based graphical user interface that provides a cloud-like experience on-premise, and an Application Marketplace with over 100 apps and growing. Whether you're starting out or scaling, you decide what applications you need and pay as you grow.

**NOTE:** ClearOS allows you to build a fully functional server that is just right for you at no upfront cost.

For more information on ClearOS, please visit <http://www.hpe.com/servers/clearos>.

### CentOS

**NOTE:** CentOS not directly supported / Community Supported (Based on RHEL so RHEL testing and enablement applicable to CentOS) CentOS 6.9 / CentOS 7.3, 7.4.

**NOTE:** For more information on Hewlett Packard Enterprise Certified and Supported ProLiant Servers for OS and Virtualization Software and latest listing of software drivers available for your server. <http://h20566.www2.hpe.com/portal/site/hpsc/public/psi/home?sp4ts.oid=1010026818>.

## Industry Standard Compliance

ACPI 6.1 Compliant  
 PCIe 3.0 Compliant  
 WOL Support  
 Microsoft® Logo certifications  
 Novell Certified  
 PXE Support  
 VGA Port  
 USB 3.0 Compliant  
 USB 2.0 Compliant  
 Energy Star 2.1  
 SMBIOS 3.1  
 UEFI 2.6  
 ASHRAE A3

**NOTE:** For additional technical thermal details regarding ambient temperatures, humidity and features support please visit: <http://www.hpe.com/servers/ashrae>.

UEFI (Unified Extensible Firmware Interface Forum)

**NOTE:** UEFI is the default for the ML110 Gen10. Legacy mode can be selected in the field or as a CTO option (758959-B22).

## Standard Features

### Graphics

Integrated Video Standard

- Video modes up to 1920 x 1200 @60Hz (32 bpp)
- 16MB Video Memory

HPE iLO 5 on system management memory

- 32 MB Flash
- 4 Gbit DDR 3 with ECC protection

### HPE Server UEFI/Legacy ROM

Unified Extensible Firmware Interface (UEFI) is an industry standard that provides better manageability and more secured configuration than the legacy ROM while interacting with your server at boot time. HPE ProLiant Gen10 servers have a UEFI Class 2 implementation and support both UEFI Mode (default) and Legacy BIOS Mode.

**NOTE:** The UEFI System Utilities tool is analogous to the HPE ROM-Based Setup Utility (RBSU) of legacy BIOS. For more information, please visit <http://www.hpe.com/servers/uefi>.

UEFI enables numerous new capabilities specific to HPE ProLiant servers such as:

- Secure Boot and Secure Start enable for enhanced security
- Operating system specific functionality
- Support for > 2.2 TB (using GPT) boot drives
- USB 3.0 Stack
- Embedded UEFI Shell
- Mass Configuration Deployment Tool using iLO RESTful API that is Redfish API Conformant
- PXE boot support for IPv6 networks
- Workload Profiles for simple performance optimization

UEFI Boot Mode only:

- TPM 2.0 Support
- iSCSI Software Initiator Support.
- HTTP/HTTPS Boot support as a PXE alternative.
- Boot support for option cards that only support a UEFI option ROM

**NOTE:** For UEFI Boot Mode, boot environment and OS image installations should be configured properly to support UEFI.

**NOTE:** UEFI FIO Setting (758959-B22) can be selected to configure the system in Legacy mode in the factory for your HPE ProLiant Gen10 Server.

### Embedded Management

#### HPE Integrated Lights-Out (HPE iLO)

Monitor your servers for ongoing management, service alerting, reporting and remote management with HPE iLO. Learn more at <http://www.hpe.com/info/ilo>.

#### UEFI

Configure and boot your servers securely with industry standard Unified Extensible Firmware Interface (UEFI). Learn more at <http://www.hpe.com/servers/uefi>.

#### Intelligent Provisioning

Hassle free server and OS provisioning for 1 or more servers with Intelligent Provisioning. Learn more at <http://www.hpe.com/servers/intelligentprovisioning>.

#### iLO RESTful API

iLO RESTful API is Redfish API conformance and offers simplified server management automation such as configuration and maintenance tasks based on modern industry standards. Learn more at <http://www.hpe.com/info/restfulapi>.

## Standard Features

### Server Utilities

#### Active Health System

The HPE Active Health System (AHS) is an essential component of the iLO management portfolio that provides continuous, proactive health monitoring of HPE servers. Learn more at <http://www.hpe.com/servers/ahs>.

#### Active Health System Viewer

Use the Active Health System Viewer, a web-based portal, to easily read AHS logs and speed problem resolution with HPE self-repair recommendations, to learn more visit: <http://www.hpe.com/servers/ahsv>.

#### Smart Update

Keep your servers up to date with the HPE Smart Update solution by using Smart Update Manager (SUM) to optimize the firmware and driver updates of the Service Pack for ProLiant (SPP). Learn more at <http://www.hpe.com/info/smartupdate>.

#### iLO Amplifier Pack

Designed for large enterprise and service provider environments with hundreds of HPE servers, the iLO Amplifier Pack is a free, downloadable open virtual application (OVA) that delivers the power to discover, inventory and update Gen8, Gen9 and Gen10 HPE servers at unmatched speed and scale. Use with an iLO Advanced License to unlock full capabilities. Learn more at <http://www.hpe.com/servers/iLOamplifierpack>.

#### HPE iLO Mobile Application

Enables the ability to access, deploy, and manage your server anytime from anywhere from select smartphones and mobile devices. For additional information please visit: <http://www.hpe.com/info/ilo/mobileapp>.

#### RESTful Interface Tool

RESTful Interface tool (iLOREST) is a single scripting tool to provision using iLO RESTful API to discover and deploy servers at scale. Learn more at <http://www.hpe.com/info/resttool>.

#### Scripting Tools

Provision one to many servers using your own scripts to discover and deploy with Scripting Tool (STK) for Windows and Linux or Scripting Tools for Windows PowerShell. Learn more at <http://www.hpe.com/servers/stk> or <http://www.hpe.com/servers/powershell>.

#### HPE OneView Standard

HPE OneView Standard can be used for inventory, health monitoring, alerting, and reporting without additional fees. It can monitor multiple HPE server generations. The user interface is similar to the HPE OneView Advanced version, but the software-defined functionality is not available. Learn more at <http://www.hpe.com/info/oneview>.

#### HPE Systems Insight Manager (HPE SIM)

Ideal for environments already using HPE SIM, it allows you to monitor the health of your HPE ProLiant Servers and HPE Integrity Servers. Also provides you with basic support for non-HPE servers. HPE SIM also integrates with Smart Update Manager to provide quick and seamless firmware updates. Learn more at <http://www.hpe.com/info/hpesim>.

---

### Security

UEFI Secure Boot and Secure Start support

Immutable Silicon Root of Trust

FIPS 140-2 validation (iLO 5 certification in progress)

Common Criteria certification (iLO 5 certification in progress)

Configurable for PCI DSS compliance

Ability to rollback firmware

Secure erase of NAND/User data

TPM (Trusted Platform Module) 1.2 option

## Standard Features

---

TPM (Trusted Platform Module) 2.0 option

---

### Warranty

This product is covered by a global limited warranty and supported by HPE Services and a worldwide network of HPE Authorized Channel Partners resellers. Hardware diagnostic support and repair is available for three years from date of purchase. Support for software and initial setup is available for 90 days from date of purchase. Enhancements to warranty services are available through HPE Pointnext operational services or customized service agreements. Hard drives have either a one year or three year warranty; refer to the specific hard drive QuickSpecs for details.

**NOTE:** Server Warranty includes 3-Year Parts, 3-Year Labor, 3-Year Onsite support with next business day response.

Exceptions may apply to certain regions or countries. Warranty repairs may be accomplished through the use of Customer Self Repair (CSR) parts. These parts fall into two categories: 1) Mandatory CSR parts are designed for easy replacement. A travel and labor charge will result when customers decline to replace a Mandatory CSR part; 2) Optional CSR parts are also designed for easy replacement but may involve added complexity; 3) Non CSR parts must be serviced by a trained authorized service engineer. Customers may choose to have Hewlett Packard Enterprise replace Optional CSR parts at no charge. Additional information regarding worldwide limited warranty and technical support is available

at: <http://h17007.www1.hpe.com/us/en/enterprise/servers/warranty/>.

## Optional Features

### Server Management

#### HPE iLO Advanced

HPE iLO Advanced licenses offer smart remote functionality without compromise, for all HPE ProLiant servers. The license includes the full integrated remote console, virtual keyboard, video, and mouse (KVM), multi-user collaboration, console record and replay, and GUI-based and scripted virtual media and virtual folders. You can also activate the enhanced security and power management functionality. Learn more about HPE iLO Advanced at <http://www.hpe.com/servers/iloadvanced>.

#### HPE iLO Advanced Premium Security Edition

HPE iLO Advanced Premium Security Edition for iLO 5 includes iLO Advanced License plus high-end security modes, unique security capabilities, like Automatic FW recovery; Runtime FW verification, and Secure erase. Learn more about HPE iLO Advanced Premium Security Edition at: <http://www.hpe.com/servers/ilopremium>.

---

### One Config Simple (SCE)

SCE is a guided self-service tool to help sales and non-technical people provide customers with initial configurations in 3 to 5 minutes. You may then send the configuration on for configuration help, or use in your existing ordering processes. If you require "custom" rack configuration or configuration for products not available in SCE, please contact Hewlett Packard Enterprise Customer Business Center or an Authorized Partner for assistance. <https://h22174.www2.hpe.com/SimplifiedConfig/Welcome#>

## Service and Support

### HPE Pointnext - Service and Support

#### Protect your business beyond warranty with HPE Pointnext Operational Service

HPE Pointnext provides a comprehensive portfolio including Advisory and Transformational, Professional, and Operational Services to help accelerate your digital transformation. From the onset of your transformation journey, Advisory and Transformational Services focus on designing the transformation and creating a solution roadmap. Professional Services specializes in creative configurations with flawless and on-time implementation, and on-budget execution. Finally, operational services provides innovative new approaches like Flexible Capacity and Datacenter Care, to keep your business at peak performance. HPE is ready to bring together all the pieces of the puzzle for you, with an eye on the future, and make the complex simple.

#### Connect your devices:

Unlock all of the benefits of your technology investment by connecting your products to Hewlett Packard Enterprise. Achieve up to 77%<sup>1</sup> reduction in down time, near 100%<sup>2</sup> diagnostic accuracy and a single consolidated view of your environment. By connecting, you will receive 24x7 monitoring, pre-failure alerts, automatic call logging, and automatic parts dispatch. HPE Proactive Care Service and HPE Datacenter Care Service customers will also benefit from proactive activities to help prevent issues and increase optimization. All of these benefits are already available to you with your server storage and networking products, securely connected to HPE support.

1- IDC 2 - HP CSC reports 2014 - 2015

Learn more about getting connected at <http://www.hpe.com/services/getconnected>.

### Recommended Services

#### HPE Proactive Care\* with 6 hour call-to-repair commitment, three year Support Service

HPE Proactive Care gives customers an enhanced call experience. When your products are connected to HPE, Proactive Care helps prevent problems and maintains IT stability by utilizing personalized proactive reports with recommendations and advice. This Service combines three years' proactive reporting and advice with our highest level of hardware support - HPE's 24x7, six hour hardware call-to-repair. HPE is the only leading manufacturer who makes this level of coverage available as a standard service offering for your most valuable servers. This service also includes collaborative software support for Independent Software Vendors (ISVs), (Red Hat, VMWare, Microsoft, etc.) running on your HPE servers.

<https://www.hpe.com/h20195/v2/GetPDF.aspx/4AA3-8855ENW.pdf>

#### HPE Proactive Care\* with 24x7 coverage, three year Support Service

HPE Proactive Care gives customers an enhanced call experience. When your products are connected to HPE, Proactive Care helps prevent problems and maintains IT stability by utilizing personalized proactive reports with recommendations and advice. This Service combines three years proactive reporting and advice with our 24x7 coverage, four hour hardware response time when there is a problem. This service also includes collaborative software support for Independent Software Vendors (ISVs), (Red Hat, VMWare, Microsoft, etc.) running on your HPE servers.

<https://www.hpe.com/h20195/v2/GetPDF.aspx/4AA3-8855ENW.pdf>

#### HPE Proactive Care\* - Next Business Day service, three year Support Service

HPE Proactive Care gives customers an enhanced call experience. When your products are connected to HPE, Proactive Care helps prevent problems and maintains IT stability by utilizing personalized proactive reports with recommendations and advice. This service combines three years of Hardware Support where an HPE authorized representative will arrive at the Customer's site during the onsite coverage window to begin hardware maintenance service the next coverage day after the service request has been logged. This service also includes collaborative software support for Independent Software Vendors (ISVs), (Red Hat, VMWare, Microsoft, etc.) running on your HPE servers.

## Service and Support

<https://www.hpe.com/h20195/v2/GetPDF.aspx/4AA3-8855ENW.pdf>

\*HPE Proactive Care and HPE Proactive Care Advanced require that the customer connect their devices to make the most of these services and receive all the deliverables.

### HPE Foundation Care CTR, three-year Support Service

HPE Foundation Care Call-To-Repair Service connects you to HPE 24 hours a day, seven days a week for assistance on resolving issues -this includes our highest level commitment to repair hardware within six hours after opening your case and respond to software questions within two hours. HPE is the only leading manufacturer who makes this level of coverage available as a standard service offering for your most valuable servers. In addition, Collaborative software support is included and provides troubleshooting assistance on industry leading software running on your server. Simplify your support experience and make HPE your first call to help resolve hardware or software problems.

<https://www.hpe.com/h20195/V2/GetDocument.aspx?docname=4AA4-8876ENW&cc=us&lc=en>

### HPE Foundation Care 24x7, three-year Support Service

HPE Foundation Care 24x7 gives you access to HPE 24 hours a day, seven days a week for assistance on resolving issues. This service includes need based Hardware onsite response within four hours. In addition, collaborative software support is included in this service that provides troubleshooting assistance on industry leading software running on your HPE server. Simplify your support experience and make HPE your first call to help resolve hardware or software problems.

<https://www.hpe.com/h20195/V2/GetDocument.aspx?docname=4AA4-8876ENW&cc=us&lc=en>

### HPE Foundation Care NBD, three-year Support Service

HPE Foundation Care Next Business Day connects you to HPE during business hours for assistance on resolving issues – This service features need based next business day hardware onsite response and software call back within two hours. In addition, Collaborative software support and provides troubleshooting assistance on industry leading software running on your HPE server. Simplify your support experience and make HPE your first call to help resolve hardware or software problems.

<https://www.hpe.com/h20195/V2/GetDocument.aspx?docname=4AA4-8876ENW&cc=us&lc=en>

---

## Parts and Materials

HPE will provide HPE-supported replacement parts and materials necessary to maintain the covered hardware product in operating condition, including parts and materials for available and recommended engineering improvements.

Parts and components that have reached their maximum supported lifetime and/or the maximum usage limitations as set forth in the manufacturer's operating manual, product QuickSpecs, or the technical product data sheet will not be provided, repaired, or replaced as part of these services.

The defective media retention service feature option applies only to Disk or eligible SSD/Flash Drives replaced by HPE due to malfunction.

---

## Other related Services

### HPE Server Hardware Installation

Provides for the basic hardware installation of HPE branded servers, storage devices and networking options to assist you in bringing your new hardware into operation in a timely and professional manner.

<https://www.hpe.com/h20195/V2/GetPDF.aspx/5981-9356EN.pdf>

## Service and Support

### HPE Installation and Startup Service

Provides for the installation of your HPE hardware according to product specifications including options. The HPE service delivery technician will connect the product to a LAN as appropriate and enable remote support to allow for automatic case creation for hardware failures. Installation and start up services also includes the installation of one supported operating system type (Windows® or Linux).

---

### HPE Datacenter Care service

HPE Datacenter Care helps improve IT stability and security, increase the value of IT, and enable agility and innovation. It is a structured framework of repeatable, tested, and globally available services “building blocks.” You can deploy, operate, and evolve your datacenter wherever you are on your IT journey. With HPE Datacenter Care, you benefit from a personalized relationship with HPE via a single point of accountability for HPE and others’ products. For more information, visit <http://www.hpe.com/services/datacentercare>

---

### HPE GreenLake Flex Capacity

With HPE GreenLake Flex Capacity, you get the speed, scalability, and economics of the public cloud in the privacy of your data center. Gain the advantages of the public cloud—consumption-based payment, rapid scalability without worrying about capacity constraints. Reduce the “heavy lifting” needed to operate a data center. And retain the advantages that IT provides the business (i.e., control, security). Deliver the right user experience, choose the right technology for the business, manage privacy and compliance, and manage the cost of IT. And, you have the option to use the public cloud when needed.

---

### DC for Hyperscale

Datacenter Care for Hyperscale is available for Service Providers and HPC customers who use a scale out approach to computing with a high volume homogenous infrastructure and resilient architecture can take advantage of this environment support tailored to their operating model.

### HPE Factory Express for Servers and storage

HPE Factory Express offers configuration, customization, integration and deployment services for HPE servers and storage products. Customers can choose how their factory solutions are built, tested, integrated, shipped and deployed. Factory Express offers service packages for simple configuration, racking, installation, complex configuration and design services as well as individual factory services, such as image loading, asset tagging, and custom packaging. HPE products supported through Factory Express include a wide array of servers and storage: HPE Integrity, HPE ProLiant, HPE Apollo, HPE ProLiant Server Blades, HPE BladeSystem, HPE 9000 servers as well as the MSAxxxx3PAR suite, XP, rackable tape libraries and configurable network switches.

### HPE Service Credits

HPE Service Credits offers flexible services and technical skills to meet your changing IT demands. With a menu of service that is tailored to suit your needs, you get additional resources and specialist skills to help you maintain peak performance of your IT. Offered as annual credits, you can plan your budgets while proactively responding to your dynamic business.

---

### HPE Education Services

Keep your IT staff trained making sure they have the right skills to deliver on your business outcomes. Book on a class today and learn how to get the most from your technology investment.

<http://www.hpe.com/ww/learn>

---

### HPE Support Center

The HPE Support Center is a personalized online support portal with access to information, tools and experts to support HPE business products. Submit support cases online, chat with HPE experts, access support resources or collaborate with peers.

Learn more <http://www.hpe.com/support/hpesc>.



## Service and Support

HPE's Support Center Mobile App\* allows you to resolve issues yourself or quickly connect to an agent for live support. Now, you can get access to personalized IT support anywhere, anytime.

HPE Insight Remote Support and HPE Support Center are available at no additional cost with a HPE warranty, HPE Support Service or HPE contractual support agreement.

\*HPE Support Center Mobile App is subject to local availability.

For more information: <http://www.hpe.com/services>.

---

**NOTE:** HPE ProLiant ML110 Gen10 Server is covered under the HPE Service Contract applied to the HPE ProLiant Server. No separate HPE support services need to be purchased.

Warranty and Support Services will extend to include HPE options configured with your server or storage device. The price of support service is not impacted by configuration details. HPE sourced options that are compatible with your product will be covered under your server support at the same level of coverage allowing you to upgrade freely. Installation for HPE options is available as needed. To keep support costs low for everyone, some high value options will require additional support. Additional support is only required on select high value workload accelerators, fibre switches, InfiniBand and UPS batteries over 12KVA. See the specific high value options that require additional support [HERE](#).

## Pre-configured Models

	Entry Models	Performance Models
<b>[SKU Number]</b>	878450-xx1	878452-xx1
<b>Model Name</b>	HPE ProLiant ML110 Gen10 3104 8GB-R S100i 4LFF NHP SATA 350W PS Entry Server	HPE ProLiant ML110 Gen10 4110 16GB-R S100i 4LFF SATA 550W PS Perf Server
<b>Processor</b>	3104 (6-Core, 1.7 GHz, 85W)	4110 (8-Core, 2.1 GHz, 85W)
<b>Number of Processors</b>	One processor	
<b>Memory</b>	8 GB RDIMM DDR4 2666 MT/s (1x 8 GB) <b>NOTE: The maximum memory speed for Intel 3104 processor is 2133 MT/s.</b>	16 GB RDIMM DDR4 2666 MT/s (1x 16 GB) <b>NOTE: The maximum memory speed for Intel 4110 processor is 2400 MT/s.</b>
<b>Network Controller</b>	Embedded 2-Port 1GbE HPE Ethernet 1Gb 2-port 332i Adapter	
<b>Storage Controller</b>	Embedded SW RAID with 10 SATA ports	
<b>Hard Drive</b>	None ship as standard	
<b>Internal Storage</b>	4 LFF HDD Bays (Non Hot Plug)	4 LFF HDD Bays (Hot Plug)
<b>Optical Drive Bay</b>	1; (Optional: DVD-ROM, DVD-RW)	
<b>Optical Drive</b>	None ship as standard	
<b>PCI-Express Slots</b>	5 PCIe 3.0 slots	
<b>Power Supply</b>	(1) 350W ATX Power Supply	(1) 550W ATX Power Supply
<b>Fans</b>	2 non-hot plug, non-redundant	
<b>Management</b>	HPE iLO Standard with Intelligent Provisioning (embedded), HPE OneView Standard (requires download); HPE iLO Advanced(optional), HPE iLO Advanced Premium Security Edition (optional)	
<b>Energy Star</b>	2.1 certified	
<b>Form Factor</b>	Tower (4.5U)	
<b>Warranty</b>	3-year parts, 3-year labor, 3-year onsite support with next business day response.	

<b>Country Code Key</b>	xx1 = B21	Worldwide
	xx1 = 001	US
	xx1 = 031	UK
	xx1 = 291	Japan
	xx1 = 371	AP
	xx1 = 421	EU
	xx1 = AA1	PRC

**NOTE: The -B21 WW SKU is to be ordered in all countries other than Japan.**

## SMB Models

	Entry Models	Performance Models	Performance Models
<b>[SKU Number]</b>	P03684-xxx	P03685-xxx	P03686-xxx
<b>Model Name</b>	HPE ProLiant ML110 Gen10 3104 1.7GHz 6-core 1P 8GB-R S100i 4LFF NHP SATA 350W PS Entry Server	HPE ProLiant ML110 Gen10 3106 1.7GHz 8-core 1P 16GB-R S100i 4LFF Hot Plug 550W PS Perf Server	HPE ProLiant ML110 Gen10 4108 1.8GHz 8-core 1P 16GB-R S100i 4LFF Hot Plug 550W PS Perf Server
<b>Processor</b>	3104 (6-Core, 1.7 GHz, 85W)	3106 (8-Core, 1.7 GHz, 85W)	4108 (8-Core, 1.8 GHz, 85W)
<b>Number of Processors</b>	One processor		
<b>Memory</b>	8 GB RDIMM DDR4 2666 MT/s (1x 8 GB) <b>NOTE: The maximum memory speed for Intel 3104 processor is 2133 MT/s.</b>	16 GB RDIMM DDR4 2666 MT/s (1x 16 GB) <b>NOTE: The maximum memory speed for Intel 3106 processor is 2133 MT/s.</b>	16 GB RDIMM DDR4 2666 MT/s (1x 16 GB) <b>NOTE: The maximum memory speed for Intel 4108 processor is 2400 MT/s.</b>
<b>Network Controller</b>	Embedded 2-Port 1GbE HPE Ethernet 1Gb 2-port 332i Adapter		
<b>Storage Controller</b>	Embedded SW RAID with 10 SATA ports		
<b>Hard Drive</b>	None ship as standard		
<b>Internal Storage</b>	4 LFF HDD Bays (Non Hot Plug)	4 LFF HDD Bays (Hot Plug)	4 LFF HDD Bays (Hot Plug)
<b>Optical Drive Bay</b>	1; (Optional: DVD-ROM, DVD-RW)		
<b>Optical Drive</b>	1 DVD-RW	None ship as standard	
<b>PCI-Express Slots</b>	5 PCIe 3.0 slots		
<b>Power Supply</b>	(1) 350W ATX Power Supply	(1) 550W ATX Power Supply	(1) 550W ATX Power Supply
<b>Fans</b>	2 non-hot plug, non-redundant		
<b>Management</b>	HPE iLO Standard with Intelligent Provisioning (embedded), HPE OneView Standard (requires download); HPE iLO Advanced(optional), HPE iLO Advanced Premium Security Edition (optional)		
<b>Energy Star</b>	2.1 certified		
<b>Form Factor</b>	Tower (4.5U)		
<b>Warranty</b>	3-year parts, 3-year labor, 3-year onsite support with next business day response.		

## SMB Models

	Solution Models	
<b>[SKU Number]</b>	P03687-xxx	
<b>Model Name</b>	ProLiant ML110 Gen10 / 8 SFF Hot Plug / 4.5U Tower / 4110 Xeon-S / 16Gb (1 x 16GB) / Smart Array S100i SATA / 2 x 1GB NIC / 800W Power Supply / 3-3-3	
<b>Processor</b>	4110 (8-Core, 2.1 GHz, 85W)	
<b>Number of Processors</b>	One processor	
<b>Memory</b>	16 GB RDIMM DDR4 2666 MT/s (1x 16 GB) <b>NOTE: The maximum memory speed for Intel 4108 processor is 2400 MT/s.</b>	
<b>Network Controller</b>	Embedded 2-Port 1GbE HPE Ethernet 1Gb 2-port 332i Adapter	
<b>Storage Controller</b>	Embedded SW RAID with 10 SATA ports	
<b>Hard Drive</b>	None ship as standard	
<b>Internal Storage</b>	8 SFF HDD Bays (Hot Plug)	
<b>Optical Drive Bay</b>	1; (Optional: DVD-ROM, DVD-RW)	
<b>Optical Drive</b>	Non ship as standard	None ship as standard
<b>PCI-Express Slots</b>	5 PCIe 3.0 slots	
<b>Power Supply</b>	(1) 800W RPS	
<b>Fans</b>	2 non-hot plug, non-redundant	
<b>Management</b>	HPE iLO Standard with Intelligent Provisioning (embedded), HPE OneView Standard (requires download); HPE iLO Advanced/HPE iLO Advanced Premium Security Edition (optional)	
<b>Energy Star</b>	2.1 certified	
<b>Form Factor</b>	Tower (4.5U)	
<b>Operation System</b>	ClearOS/VM Installer ( USB) <b>NOTE: ClearOS, an easy to use OS with an application marketplace, allows you to build a fully functional server that is just right for you at no upfront cost. To learn more on what you can do, please visit <a href="http://www.hpe.com/servers/clearos">http://www.hpe.com/servers/clearos</a>.</b>	
<b>Warranty</b>	3-year parts, 3-year labor, 3-year onsite support with next business day response.	

<b>Country Code Key</b>	xxx = S01	NA and LAC
	xxx = 425	EU and UK
	xxx = 375	AP
	xxx = 291	Japan

## Configuration Information - Factory Integrated Models

### Recommended Options

Offering the best combination of performance, value and availability, Recommended Options have been selected by HPE experts to provide the right technology for a range of workloads and market segments. Fully integrated into the HPE management and security experience, Recommended Options provide the best fit with timely availability.

### Extended Options

Extended Options provide an extended catalog of products tailored for customers in specific markets or with specific workloads, requiring the utmost in performance or value. Fully integrated into the HPE management and security experience, Extended Options represent great value and performance but typically have a longer lead-time.

This section lists some of the steps required to configure a Factory Integrated Model. To ensure only valid configurations are ordered, Hewlett Packard Enterprise recommends the use of an HPE approved configurator. Contact your local sales representative for information on configurable product offerings and requirements.

1. Factory Integrated Models must start with a CTO Server.
2. FIO indicates that this option is only available as a factory installable option.
3. All Factory Integrated Models will be populated with sufficient hard drive blanks based on the number of initial hard drives ordered with the server.
4. Some options may not be integrated at the factory. Contact your local sales representative for additional information.

### Step 1: Base Configuration (choose one of the following configurable models)

<b>CTO Server</b>	HPE ProLiant ML110 Gen10 4LFF Non Hot Plug Configure-to-order Server	HPE ProLiant ML110 Gen10 4LFF Configure-to-order Server	HPE ProLiant ML110 Gen10 8SFF Configure-to-order Server
<b>SKU Number</b>	872305-B21	872307-B21	872309-B21
<b>Processor</b>	Not included as standard		
<b>DIMM Slots</b>	6 DIMM slots for RDIMM DDR4 Memory		
<b>Storage Controller</b>	Embedded SW RAID with 10 SATA ports, or choice of HPE PCIe Smart Array controller		
<b>PCIe</b>	5 PCIe 3.0 Slots		
<b>Drive Cage - included</b>	4 LFF Non Hot Plug	4 LFF Hot Plug	8 SFF Hot Plug
<b>Network Controller</b>	Embedded 2-Port 1GbE HPE Ethernet 1Gb 2-port 332i Adapter		
<b>Fans</b>	2 non-hot plug, non-redundant		
<b>Management</b>	HPE iLO Standard with Intelligent Provisioning (embedded), HPE OneView Standard (requires download); HPE iLO Advanced(optional), HPE iLO Advanced Premium Security Edition (optional)		
<b>USB</b>	2 front, 2 internal, 4 rear		

### Step 2a: Choose Required Options - Processors

(only one of the following from each list unless otherwise noted)

#### Processor Option Kits - Recommended

	<b>Required Processor</b>
HPE ML110 Gen10 Intel® Xeon-Gold 5122 (3.6GHz/4-core/105W) FIO Processor Kit (Recommended)	872308-L21
HPE ML110 Gen10 Intel® Xeon-Gold 5120 (2.2GHz/14-core/105W) FIO Processor Kit (Recommended)	872306-L21
HPE ML110 Gen10 Intel® Xeon-Silver 4112 (2.6GHz/4-core/85W) FIO Processor Kit (Recommended)	872296-L21
HPE ML110 Gen10 Intel® Xeon-Silver 4110 (2.1GHz/8-core/85W) FIO Processor Kit (Recommended)	876918-L21
HPE ML110 Gen10 Intel® Xeon-Silver 4108 (1.8GHz/8-core/85W) FIO Processor Kit (Recommended)	876917-L21

## Configuration Information - Factory Integrated Models

HPE ML110 Gen10 Intel® Xeon-Bronze 3106 (1.7GHz/8-core/85W) FIO Processor Kit (Recommended)	876916-L21
HPE ML110 Gen10 Intel® Xeon-Bronze 3104 (1.7GHz/6-core/85W) FIO Processor Kit (Recommended)	876915-L21

### Step 2b: Choose Memory Options

#### Recommended Options

Offering the best combination of performance, value and availability, Recommended Options have been selected by HPE experts to provide the right technology for a range of workloads and market segments. Fully integrated into the HPE management and security experience, Recommended Options provide the best fit with timely availability.

#### Extended Options

Extended Options provide an extended catalog of products tailored for customers in specific markets or with specific workloads, requiring the utmost in performance or value. Fully integrated into the HPE management and security experience, Extended Options represent great value and performance but typically have a longer lead-time.

Please select one or more memory from below.

For new Gen10 memory population rule whitepaper and optimal memory performance guidelines, please go to: <https://www.hpe.com/docs/memory-population-rules>

For Gen10 memory speed table, please go to: <https://www.hpe.com/docs/memory-speed-table>

For memory Reliability, Accessibility, Serviceability (RAS) features whitepaper like Gen10 Fast Fault Tolerance and legacy mirrored memory feature etc. please go to: <http://www.hpe.com/docs/memory-ras-feature>

**NOTE:** Memory DIMM availability with a server platform is dependent upon completion of certification testing.

**NOTE:** The maximum memory speed is a function of the memory type, memory configuration, and processor model.

#### Memory - Recommended

HPE 16GB (1x16GB) Single Rank x4 DDR4-2666 CAS-19-19-19 Registered Smart Memory Kit (Recommended)	815098-B21
HPE 32GB (1x32GB) Dual Rank x4 DDR4-2666 CAS-19-19-19 Registered Smart Memory Kit (Recommended)	815100-B21

#### Memory - Extended

HPE 8GB (1x8GB) Single Rank x8 DDR4-2666 CAS-19-19-19 Registered Smart Memory Kit (Extended)	815097-B21
--	------------

### Step 2c: Choose Power Supplies

Select one or two power supplies from below.

**NOTE:** Prior to selecting a power supply option, it is highly recommended that you review your server configuration in the HPE Power Advisor tool to determine the right size power supply for your server configuration. The HPE Power Advisor is located at: <http://www.hpe.com/info/hppoweradvisor>.

**NOTE:** By RPS Enablement Kit power options, mixing of power supplies in the same RPS enablement kit is not supported. All power supplies must be of the same input voltage, output rating, and efficiency rating. If non-matching power supplies are installed, you may receive an error message and/or experience operational issues with your server.

HPE ProLiant Special Power Supply	867876-B21
HPE ML110 Gen10 550W ATX Power Supply Kit	874009-B21
HPE ML110 Gen10 Redundant Power Supply Enablement Kit	867875-B21

#### Power Supplies - Recommended

HPE 800W Flex Slot Platinum Hot Plug Low Halogen Power Supply Kit (Recommended)	865414-B21
---	------------

### Step 3: Choose Additional Factory Integratable Options

One of the following from each list may be selected if desired at time of factory integration

HPE Legacy FIO Mode Setting	758959-B22
-----------------------------	------------

**NOTE:** UEFI is the default, this FIO part can be used for CTO to enable Legacy mode.

## Core Options

### Recommended Options

Offering the best combination of performance, value and availability, Recommended Options have been selected by HPE experts to provide the right technology for a range of workloads and market segments. Fully integrated into the HPE management and security experience, Recommended Options provide the best fit with timely availability.

### Extended Options

Extended Options provide an extended catalog of products tailored for customers in specific markets or with specific workloads, requiring the utmost in performance or value. Fully integrated into the HPE management and security experience, Extended Options represent great value and performance but typically have a longer lead-time.

**NOTE:** Some options may not be integrated at the factory. To ensure only valid configurations are ordered, Hewlett Packard Enterprise recommends the use of an HPE approved configurator. Contact your local sales representative for additional information. Note the **Cabling Matrix** can help to explain the cable routing for each option:

### HPE Unique Options

HPE ML110 Gen10 4LFF Drive Backplane Cage Kit 869491-B21

**NOTE:** The 4 LFF hot-plug drive cage can be installed in both box 1 and box 2. Follow the same installation procedure.

HPE ML110 Gen10 4LFF Non Hot Plug Drive Cage Kit 874008-B21

**NOTE:** The 4 LFF Non hot-plug drive cage can be installed in both box 1 and box 2. Follow the same installation procedure.

HPE ML110 Gen10 8SFF Drive Backplane Cage Kit 874007-B21

**NOTE:** The 8SFF hot-plug drive cage can be installed in both box 1 and box 2. Follow the same installation procedure.

HPE ML110 Gen10 Redundant Power Supply Enablement Kit 867875-B21

**NOTE:** This kit is also required to support an optional redundant fan kit.

HPE ML110 Gen10 Redundant Fan with 4 Fans Kit 869489-B21

**NOTE:** When one of the following scenarios occurs, the server requires a Redundant Fan with a 800W Redundant Power Supply to be installed.

1. When a second HDD cage is installed and the SAS HDDs are running at 15K RPM.
2. When a SAS SSD is installed.
3. If one fan fails, the system will be required to continue operating with a Redundant Fan. This condition is indicated by a flashing amber Health LED.
4. When the system requirements are to meet the A3 extended operating environment.

HPE ML110 Gen10 Serial Port Kit 874010-B21

HPE ML110 Gen10 550W ATX Power Supply Kit 874009-B21

**NOTE:** Prior to selecting a power supply option, it is highly recommended that you review your server configuration in the HPE Power Advisor tool to determine the right size power supply for your server configuration. The HPE Power Advisor is located at: <http://www.hpe.com/info/hppoweradvisor>

### Memory Selection

To streamline the configuration process for HPE ProLiant Gen10 servers and to provide the best product availability, HPE recommends memory from the list located here: <http://www.hpe.com/servers/servermemoryconfigurator>. Best product availability is limited to US, Canada, and Latin America at this time.

### HPE DDR4 SmartMemory

#### SmartMemory – Recommended

HPE 16GB (1x16GB) Single Rank x4 DDR4-2666 CAS-19-19-19 Registered Smart Memory Kit (Recommended) 815098-B21

HPE 32GB (1x32GB) Dual Rank x4 DDR4-2666 CAS-19-19-19 Registered Smart Memory Kit (Recommended) 815100-B21

## Core Options

### SmartMemory - Extended

HPE 8GB (1x8GB) Single Rank x8 DDR4-2666 CAS-19-19-19 Registered Smart Memory Kit (Extended) 815097-B21

**NOTE:** Memory DIMM availability with a server platform is dependent upon completion of certification testing.

**NOTE:** The maximum memory speed is a function of the memory type, memory configuration, and processor model.

### HPE Optical Drives

#### Optical Drives - Recommended

HPE 9.5mm SATA DVD-ROM Optical Drive (Recommended) 726536-B21

HPE 9.5mm SATA DVD-RW Optical Drive (Recommended) 726537-B21

### HPE Drives

#### Enterprise - 12G SAS - SFF Drives - Recommended

HPE 300GB SAS 12G Enterprise 15K SFF (2.5in) SC 3yr Wty Digitally Signed Firmware HDD (Recommended) 870753-B21

HPE 300GB SAS 12G Enterprise 10K SFF (2.5in) SC 3yr Wty Digitally Signed Firmware HDD (Recommended) 872475-B21

HPE 600GB SAS 12G Enterprise 15K SFF (2.5in) SC 3yr Wty Digitally Signed Firmware HDD (Recommended) 870757-B21

HPE 600GB SAS 12G Enterprise 10K SFF (2.5in) SC 3yr Wty Digitally Signed Firmware HDD (Recommended) 872477-B21

HPE 900GB SAS 12G Enterprise 15K LFF (3.5in) LPC 3yr Wty Digitally Signed Firmware HDD (Extended) 870761-B21

HPE 900GB SAS 12G Enterprise 15K SFF (2.5in) SC 3yr Wty Digitally Signed Firmware HDD (Recommended) 870759-B21

HPE 900GB SAS 12G Enterprise 15K SFF (2.5in) SC 3yr Wty 512e Digitally Signed Firmware HDD (Extended) 870765-B21

HPE 1.2TB SAS 12G Enterprise 10K SFF (2.5in) SC 3yr Wty Digitally Signed Firmware HDD (Recommended) 872479-B21

HPE 1.8TB SAS 12G Enterprise 10K SFF (2.5in) SC 3yr Wty 512e Digitally Signed Firmware HDD (Recommended) 872481-B21

HPE 2.4TB SAS 12G Enterprise 10K SFF (2.5in) SC 3yr Wty 512e Digitally Signed Firmware HDD (Recommended) 881457-B21

#### Enterprise - 12G SAS - LFF Drives - Extended

HPE 300GB SAS 12G Enterprise 15K LFF (3.5in) LPC 3yr Wty Digitally Signed Firmware HDD (Extended) 870755-B21

#### Midline - 12G SAS - SFF Drives - Recommended

HPE 1TB SAS 12G Midline 7.2K SFF (2.5in) SC 1yr Wty Digitally Signed Firmware HDD (Recommended) 832514-B21

HPE 2TB SAS 12G Midline 7.2K SFF (2.5in) SC 1yr Wty 512e HDD (Recommended) 765466-B21

#### Midline - 12G SAS - SFF Drives - Extended

HPE 1TB SAS 12G Midline 7.2K SFF (2.5in) SC 1yr Wty 512e Digitally Signed Firmware HDD (Extended) 765464-B21

#### Midline - 12G SAS - LFF Drives - Recommended

HPE 2TB SAS 12G Midline 7.2K LFF (3.5in) LP 1yr Wty Digitally Signed Firmware HDD (Recommended) 833926-B21

HPE 4TB SAS 12G Midline 7.2K LFF (3.5in) LP 1yr Wty Digitally Signed Firmware HDD (Recommended) 833928-B21

HPE 8TB SAS 12G Midline 7.2K LFF (3.5in) LP 1yr Wty 512e Digitally Signed Firmware HDD (Recommended) 834031-B21

HPE 10TB SAS 12G Midline 7.2K LFF (3.5in) LP 1yr Wty Helium 512e Digitally Signed Firmware HDD (Recommended) 857646-B21

HPE 12TB SAS 12G Midline 7.2K LFF (3.5in) LP 1yr Wty Helium 512e Digitally Signed Firmware HDD (Recommended) 881781-B21



## Core Options

### Midline - 6G SATA - SFF Drives - Recommended

HPE 1TB SATA 6G Midline 7.2K SFF (2.5in) SC 1yr Wty Digitally Signed Firmware HDD (Recommended)	655710-B21
HPE 2TB SATA 6G Midline 7.2K SFF (2.5in) SC 1yr Wty 512e Digitally Signed Firmware HDD (Recommended)	765455-B21

### Midline - 6G SATA - LFF Drives - Recommended

HPE 1TB SATA 6G Midline 7.2K LFF (3.5in) LP 1yr Wty Digitally Signed Firmware HDD (Recommended)	861686-B21
HPE 1TB SATA 6G Midline 7.2K LFF (3.5in) RW 1yr Wty HDD (Recommended)	801882-B21
HPE 4TB SATA 6G Midline 7.2K LFF (3.5in) LP 1yr Wty Digitally Signed Firmware HDD (Recommended)	861683-B21
HPE 6TB SATA 6G Midline 7.2K LFF (3.5in) LP 1yr Wty 512e HDD (Recommended)	861742-B21
HPE 8TB SATA 6G Midline 7.2K LFF (3.5in) LP 1yr Wty 512e Digitally Signed Firmware HDD (Recommended)	834028-B21
HPE 10TB SATA 6G Midline 7.2K LFF (3.5in) LP 1yr Wty Helium 512e Digitally Signed Firmware HDD (Recommended)	857650-B21
HPE 12TB SATA 6G Midline 7.2K LFF (3.5in) LP 1yr Wty Helium 512e Digitally Signed Firmware HDD (Recommended)	881787-B21

### Midline - 6G SATA - LFF Drives - Extended

HPE 2TB SATA 6G Midline 7.2K LFF (3.5in) LP 1yr Wty Digitally Signed Firmware HDD (Extended)	861681-B21
HPE 4TB SATA 6G Midline 7.2K LFF (3.5in) RW 1yr Wty HDD (Extended)	801888-B21
HPE 4TB SATA 6G Midline 7.2K LFF (3.5in) LP 1yr Wty 512e HDD (Extended)	861744-B21
HPE 8TB SATA 6G Midline 7.2K LFF (3.5in) LP 1yr Wty Helium 512e Digitally Signed Firmware HDD (Extended)	861596-B21

### SSD Selection

To streamline the configuration process for HPE ProLiant Gen10 servers and to provide the best product availability, HPE recommends SSDs from the list located here: <http://www.hpe.com/products/recommend>.

### Write Intensive - 12G SAS - SFF - Solid State Drives - Recommended

HPE 400GB SAS 12G Write Intensive SFF (2.5in) SC 3yr Wty Digitally Signed Firmware SSD (Recommended)	873351-B21
HPE 800GB SAS 12G Write Intensive SFF (2.5in) SC 3yr Wty Digitally Signed Firmware SSD (Recommended)	873355-B21
HPE 1.6TB SAS 12G Write Intensive SFF (2.5in) SC 3yr Wty Digitally Signed Firmware SSD (Recommended)	873357-B21

### Read Intensive - 6G SATA - SFF - Solid State Drives - Recommended

HPE 240GB SATA 6G Read Intensive SFF (2.5in) SC 3yr Wty Digitally Signed Firmware SSD (Recommended)	875503-B21
HPE 480GB SATA 6G Read Intensive SFF (2.5in) SC 3yr Wty Digitally Signed Firmware SSD (Recommended)	877746-B21
HPE 480GB SATA 6G Read Intensive SFF (2.5in) SC 3yr Wty Digitally Signed Firmware SSD (Recommended)	875509-B21
HPE 960GB SATA 6G Read Intensive SFF (2.5in) SC 3yr Wty Digitally Signed Firmware SSD (Recommended)	877752-B21
HPE 960GB SATA 6G Read Intensive SFF (2.5in) SC 3yr Wty Digitally Signed Firmware SSD (Recommended)	875511-B21
HPE 1.92TB SATA 6G Read Intensive SFF (2.5in) SC 3yr Wty Digitally Signed Firmware SSD (Recommended)	877758-B21
HPE 1.92TB SATA 6G Read Intensive SFF (2.5in) SC 3yr Wty Digitally Signed Firmware SSD (Recommended)	875513-B21
HPE 3.84TB SATA 6G Read Intensive SFF (2.5in) SC 3yr Wty Digitally Signed Firmware SSD (Recommended)	877764-B21

### Read Intensive - 6G SATA - SFF - Solid State Drives - Extended

HPE 240GB SATA 6G RI SFF SC DS SSD (Extended)	868814-B21
HPE 240GB SATA 6G Read Intensive SFF (2.5in) SC 3yr Wty Digitally Signed Firmware SSD (Extended)	P04556-B21
HPE 480GB SATA 6G Read Intensive SFF (2.5in) SC 3yr Wty Digitally Signed Firmware SSD (Extended)	P04560-B21
HPE 960GB SATA 6G Read Intensive SFF (2.5in) SC 3yr Wty Digitally Signed Firmware SSD (Extended)	P04564-B21
HPE 1.92TB SATA 6G Read Intensive SFF (2.5in) SC 3yr Wty Digitally Signed Firmware SSD (Extended)	P04566-B21
HPE 3.84TB SATA 6G Read Intensive SFF (2.5in) SC 3yr Wty Digitally Signed Firmware SSD (Extended)	P04570-B21

## Core Options

### Read Intensive - 6G SATA - LFF - Solid State Drives - Extended

HPE 960GB SATA 6G Read Intensive LFF (3.5in) LPC 3yr Wty Digitally Signed Firmware SSD (Extended)	877756-B21
HPE 1.92TB SATA 6G Read Intensive LFF (3.5in) LPC 3yr Wty Digitally Signed Firmware SSD (Extended)	877762-B21

### Read Intensive - 6G SAS - SFF - Solid State Drives - Recommended

HPE 960GB SAS 12G Read Intensive SFF (2.5in) SC 3yr Wty Digitally Signed Firmware SSD (Recommended)	872390-B21
HPE 1.92TB SAS 12G Read Intensive SFF (2.5in) SC 3yr Wty Digitally Signed Firmware SSD (Recommended)	872392-B21
HPE 3.84TB SAS 12G Read Intensive SFF (2.5in) SC 3yr Wty Digitally Signed Firmware SSD (Recommended)	872394-B21

### Read Intensive - 6G SAS - SFF - Solid State Drives - Extended

HPE 7.68TB SAS 12G Read Intensive SFF (2.5in) SC 3yr Wty Digitally Signed Firmware SSD (Extended)	870144-B21
---	------------

### Mixed Use - 12G SAS - SFF - Solid State Drives - Recommended

HPE 400GB SAS 12G Mixed Use SFF (2.5in) SC 3yr Wty Digitally Signed Firmware SSD (Recommended)	872374-B21
HPE 400GB SAS 12G Mixed Use SFF (2.5in) SC 3yr Wty Digitally Signed Firmware SSD (Recommended)	873359-B21
HPE 800GB SAS 12G Mixed Use SFF (2.5in) SC 3yr Wty Digitally Signed Firmware SSD (Recommended)	872376-B21
HPE 800GB SAS 12G Mixed Use SFF (2.5in) SC 3yr Wty Digitally Signed Firmware SSD (Recommended)	873363-B21
HPE 1.6TB SAS 12G Mixed Use SFF (2.5in) SC 3yr Wty Digitally Signed Firmware SSD (Recommended)	872382-B21
HPE 1.6TB SAS 12G Mixed Use SFF (2.5in) SC 3yr Wty Digitally Signed Firmware SSD (Recommended)	873365-B21
HPE 3.2TB SAS 12G Mixed Use SFF (2.5in) SC 3yr Wty Digitally Signed Firmware SSD (Recommended)	873367-B21

### Mixed Use - 12G SAS - SFF - Solid State Drives - Extended

HPE 3.2TB SAS 12G Mixed Use SFF (2.5in) SC 3yr Wty Digitally Signed Firmware SSD (Extended)	872386-B21
---	------------

### Mixed Use - 6G SATA - SFF - Solid State Drives - Recommended

HPE 240GB SATA 6G Mixed Use SFF (2.5in) SC 3yr Wty Digitally Signed Firmware SSD (Recommended)	880295-B21
HPE 240GB SATA 6G Mixed Use SFF (2.5in) SC 3yr Wty Digitally Signed Firmware SSD (Recommended)	875483-B21
HPE 480GB SATA 6G Mixed Use SFF (2.5in) SC 3yr Wty Digitally Signed Firmware SSD (Recommended)	877776-B21
HPE 480GB SATA 6G Mixed Use SFF (2.5in) SC 3yr Wty Digitally Signed Firmware SSD (Recommended)	875470-B21
HPE 960GB SATA 6G Mixed Use SFF (2.5in) SC 3yr Wty Digitally Signed Firmware SSD (Recommended)	877782-B21
HPE 960GB SATA 6G Mixed Use SFF (2.5in) SC 3yr Wty Digitally Signed Firmware SSD (Recommended)	875474-B21
HPE 1.92TB SATA 6G Mixed Use SFF (2.5in) SC 3yr Wty Digitally Signed Firmware SSD (Recommended)	877788-B21
HPE 1.92TB SATA 6G Mixed Use SFF (2.5in) SC 3yr Wty Digitally Signed Firmware SSD (Recommended)	875478-B21

**NOTE:** HPE Universal SATA HHHL 3yr Wty M.2 Kit (Recommended).

**NOTE:** Requires the M.2 universal enablement card kit (878783-B21) and use S100i SATA controller only.

**NOTE:** Installation of the M.2 universal enablement card kit is limited to PCIe slot 1, 2, 3 or 4. Max. in ML350 Gen10 is one M.2 enablement card kit.

**NOTE:** M.2 supports Software RAID only.

### Mixed Use - SATA – M.2 - Solid State Drives - Recommended

HPE 240GB SATA 6G Mixed Use M.2 2280 3yr Wty Digitally Signed Firmware SSD (Recommended)	875488-B21
--	------------

**NOTE:** HPE Universal SATA HHHL 3yr Wty M.2 Kit (Recommended) (878783-B21) and use S100i SATA controller only.

**NOTE:** M.2 supports Software RAID only.

### Mixed Use - SATA – M.2 - Solid State Drives - Extended

HPE 480GB SATA 6G Mixed Use M.2 2280 3yr Wty Digitally Signed Firmware SSD (Extended)	875490-B21
---	------------

**NOTE:** HPE Universal SATA HHHL 3yr Wty M.2 Kit (Recommended) (878783-B21) and use S100i SATA controller only.

**NOTE:** M.2 supports Software RAID only.

### Hard Drive Blank Kits

HPE Gen9 LFF HDD Spade Blank Kit	807878-B21
HPE Small Form Factor Hard Drive Blank Kit	666987-B21

## Core Options

GPGPU Information					ML110 configuration			
Part number	Card	Qty support	Processor support	PCIe speed	8SFF	4LFF	16 SFF	8 LFF
Q0V77A	NVIDIA Quadro P2000 GPU Module	2	All	Gen3	35C	35C	35C	35C

**NOTE:** Please see the HPE Power Advisor for estimated power consumption of your individual system configuration prior to installing GPUs. The HPE Power Advisor is located at: <http://www.hpe.com/info/hppoweradvisor>.

**NOTE:** Only the above listed Graphics cards are HPE standard supported options in this server.

### HPE Computation and Graphics Accelerators

HPE NVIDIA Quadro P2000 Graphics Accelerator Q0V77A

### Hard Drive Kits - Recommended

HPE Universal SATA HHHHL 3yr Wty M.2 Kit (Recommended) 878783-B21

### HPE Networking

#### 1 Gigabit Ethernet adapters - Recommended

HPE Ethernet 1Gb 4-port 331T Adapter (Recommended) 647594-B21

HPE Ethernet 1Gb 4-port 366T Adapter (Recommended) 811546-B21

#### 1 Gigabit Ethernet adapters - Extended

HPE Ethernet 1Gb 2-port 361T Adapter (Extended) 652497-B21

HPE Ethernet 1Gb 2-port 332T Adapter (Extended) 615732-B21

#### 10 Gigabit Ethernet adapters - Recommended

HPE Ethernet 10Gb 2-port 530SFP Adapter (Recommended) 652503-B21

HPE Ethernet 10Gb 2-port 530T Adapter (Recommended) 656596-B21

HPE Ethernet 10Gb 2-port 535T Adapter (Recommended) 813661-B21

HPE Ethernet 10Gb 2-port 562T Adapter (Extended) 817738-B21

**NOTE:** The ML110 Gen10 ships with 2x 1 Gb Embedded.

**NOTE:** A minimum of two Gigabytes (2 GB) of server memory is required per each adapter.

**NOTE:** Direct Attach Cable (DAC) for copper environments or fiber transceivers and cables for fiber-optic environments must be purchased separately. Please see the related NIC QuickSpecs for Technical Specifications and additional information:

<http://www.hpe.com/us/en/product-catalog/servers/server-adapters.hits-12.html>

#### 10 Gigabit Ethernet adapters - Extended

HPE Ethernet 10Gb 2-port 562SFP+ Adapter (Extended) 727055-B21

**NOTE:** The ML110 Gen10 ships with 2x 1 Gb Embedded.

**NOTE:** A minimum of two Gigabytes (2 GB) of server memory is required per each adapter.

**NOTE:** Direct Attach Cable (DAC) for copper environments or fiber transceivers and cables for fiber-optic environments must be purchased separately. Please see the related NIC QuickSpecs for Technical Specifications and additional information:

<http://www.hpe.com/us/en/product-catalog/servers/server-adapters.hits-12.html>

## Core Options

### HPE Power Supplies

HPE ML110 Gen10 550W ATX Power Supply Kit	874009-B21
HPE ML110 Gen10 Redundant Power Supply Enablement Kit	867875-B21

#### Power Supplies - Recommended

HPE 800W Flex Slot Platinum Hot Plug Low Halogen Power Supply Kit (Recommended)	865414-B21
---	------------

**NOTE:** Flex Slot Platinum power supplies support power efficiency of up to 94% and include a standard C-14 power inlet connector.

---

### HPE Cooling Options

HPE ML110 Gen10 Redundant Fan with 4 Fans Kit	869489-B21
---	------------

**NOTE:** When one of the following scenarios occurs, the server requires a Redundant Fan with a 800W Redundant Power Supply to be installed.

1. When a second HDD cage is installed and the SAS HDDs are running at 15K RPM.
2. When a SAS SSD is installed.
3. If one fan fails, the system will be required to continue operating with a Redundant Fan. This condition is indicated by a flashing amber Health LED.
4. When the system requirements are to meet the A3 extended operating environment.

## Additional Options

### Recommended Options

Offering the best combination of performance, value and availability, Recommended Options have been selected by HPE experts to provide the right technology for a range of workloads and market segments. Fully integrated into the HPE management and security experience, Recommended Options provide the best fit with timely availability.

### Extended Options

Extended Options provide an extended catalog of products tailored for customers in specific markets or with specific workloads, requiring the utmost in performance or value. Fully integrated into the HPE management and security experience, Extended Options represent great value and performance but typically have a longer lead-time.

### Embedded Management

#### HPE iLO Advanced

HPE iLO Advanced Electronic License with 1yr Support on iLO Licensed Features	E6U59ABE
HPE iLO Advanced 1-server License with 1yr Support on iLO Licensed Features	512485-B21
HPE iLO Advanced Flexible Quantity License with 1yr Support on iLO Licensed Features	512486-B21
HPE iLO Advanced AKA Tracking License with 1yr Support on iLO Licensed Features	512487-B21
HPE iLO Advanced Electronic License with 3yr Support on iLO Licensed Features	E6U64ABE
HPE iLO Advanced 1-server License with 3yr Support on iLO Licensed Features	BD505A
HPE iLO Advanced Flexible Quantity License with 3yr Support on iLO Licensed Features	BD506A
HPE iLO Advanced AKA Tracking License with 3yr Support on iLO Licensed Features	BD507A

#### HPE iLO Essentials

HPE iLO Essentials License with 1yr Support on iLO Licensed Features	BD775A
HPE iLO Essentials Electronic License with 1yr Support on iLO Licensed Features	E6U62ABE
HPE iLO Essentials License with 3yr Support on iLO Licensed Features	BD774A
HPE iLO Essentials Electronic License with 3yr Support on iLO Licensed Features	E6U61ABE

### HPE Security

HPE Trusted Platform Module 2.0 Gen10 Option	864279-B21
--	------------

**NOTE:** HPE Trusted Platform Module 2.0 option works with Gen10 servers with UEFI Mode not Legacy Mode. It is

not compatible with HPE ProLiant Gen8 servers or earlier generation variants.

**NOTE:** HPE server systems can have a TPM module (of any type) installed only once. It cannot be replaced with

any other TPM module.

**NOTE:** There is a FIO setting to allow this TPM module to operate in a TPM 1.2 mode (872108-B21).

### HPE Smart Array Controllers

The Gen10 controller naming framework has been updated to simplify identification as depicted below. For a more detailed breakout of the available Gen10 Smart Array controllers visit the [HPE Smart Array Gen10 Controllers Data Sheet](#).

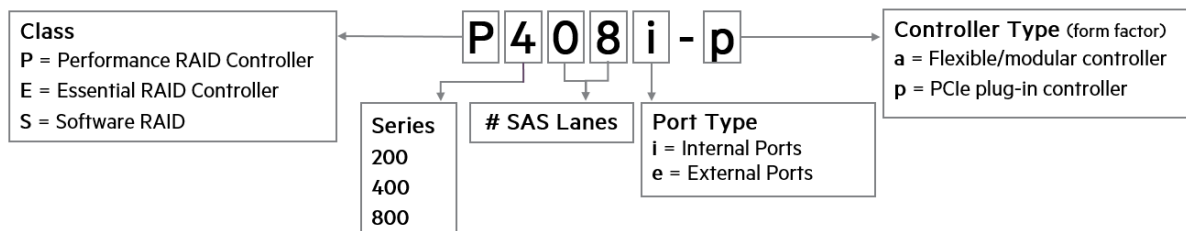

## Additional Options

**NOTE:** HPE 96W Smart Storage Battery (up to 20 Devices) with 145mm Cable Kit (Extended).

**NOTE:** All performance RAID controllers are supported by the HPE Smart Storage Battery (875241-B21), which supports multiple devices and is sold separately.

### Performance RAID Controllers - Recommended

HPE Smart Array P408i-p SR Gen10 (8 Internal Lanes/2GB Cache) 12G SAS PCIe Plug-in Controller (Recommended) 830824-B21

### Performance RAID Controllers - Extended

HPE Smart Array P408e-p SR Gen10 (8 External Lanes/4GB Cache) 12G SAS PCIe Plug-in Controller (Extended) 804405-B21

### Essential RAID Controllers

#### RAID Controller - Recommended

HPE Smart Array E208e-p SR Gen10 (8 External Lanes/No Cache) 12G SAS PCIe Plug-in Controller (Recommended) 804398-B21

#### RAID Controller - Extended

HPE Smart Array E208i-p SR Gen10 (8 Internal Lanes/No Cache) 12G SAS PCIe Plug-in Controller (Extended) 804394-B21

### Optional Software

HPE Smart Array SR Secure Encryption (Data at Rest Encryption/per Server Entitlement) E-LTU Q2F26AAE

HPE Smart Array SR SmartCache (Single Key/Single Server) LTU D7S26A

HPE Smart Array SR SmartCache (Single Key/Multiple Servers) LTU D7S27A

HPE Smart Array SR SmartCache (Single Key/Multiple Servers) E-LTU D7S27AAE

**NOTE:** SmartCache is offered on HPE Smart Array performance RAID controllers.

### Optional Upgrades - Recommended

HPE 96W Smart Storage Battery (up to 20 Devices) with 145mm Cable Kit (Extended) 875241-B21

HPE 96W Smart Storage Battery (up to 20 Devices) with 260mm Cable Kit (Recommended) P01367-B21

**NOTE:** Provides backup power for multiple HPE Smart Array controllers or other devices. Is required with performance RAID controllers. This product replaces 875242-B21.

**NOTE:** A Battery holder is required: HPE Gen9 Smart Storage Battery Holder Kit 786710-B21.

### HPE Tape Backup

**NOTE:** For the complete range of tape drives, autoloaders, libraries and media see:

<https://www.hpe.com/us/en/storage/storeever-tape-storage.html>. For hardware and software compatibility of Hewlett Packard Enterprise tape backup products <http://www.hpe.com/storage/BURACompatibility>.

### HPE USB and SD Options

#### HPE Enterprise Mainstream Flash Media Kits for Memory Cards - Recommended

HPE 32GB microSD Flash Memory Card (Recommended) 700139-B21

HPE 8GB microSD Flash Memory Card (Recommended) 726116-B21

HPE 8GB microSD Flash USB Drive (Recommended) 737953-B21

HPE 8GB Dual microSD Flash USB Drive (Recommended) 741279-B21

#### Rail Kits

HPE ML Gen10 Tower to Rack Conversion Kit with Sliding Rail Rack Shelf and Cable Management Arm 874578-B21

**NOTE:** Easy install rack rail tray which takes up 1U height in a standard rack facility. This kit is supported in both ML350 and ML110 Gen10 for tower to rack conversion.

### HPE Support Services

HPE 3 Year Foundation Care 24x7 ML110 Gen10 Service H9CH9E

HPE 3 Year Foundation Care 24x7 with DMR ML110 Gen10 Service H9CJOE

## Additional Options

HPE 3 Year Foundation Care 24x7 with CDMR ML110 Gen10 Service	H9CJ1E
HPE 3 Year Proactive Care 24x7 ML110 Gen10 Service	H9CJ2E
HPE 3 Year Proactive Care 24x7 with DMR ML110 Gen10 Service	H9CJ3E
HPE 3 Year Proactive Care 24x7 with CDMR ML110 Gen10 Service	H9CJ4E
HPE Installation ML310e/ML110 Service	U6G21E
HPE Installation and Startup ML310e Service	U6G23E

**NOTE:** For a full listing of support services available for this server, please visit <https://ssc.hpe.com/>

## Memory

### Memory Population guidelines

### HPE ML110 Gen10 server

1 Slot per Channel

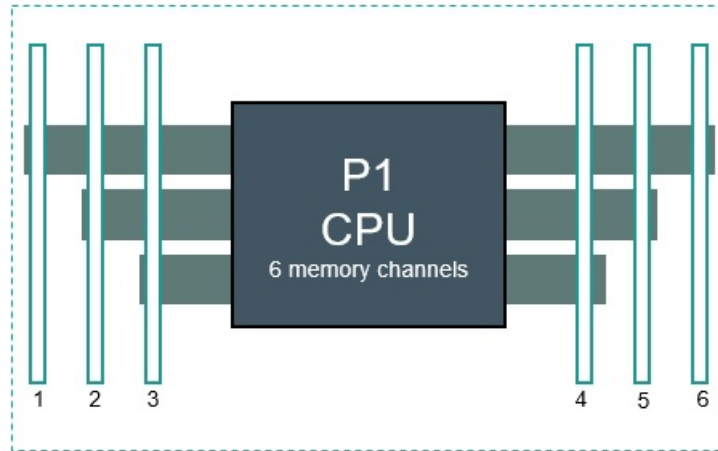

Front of server

HPE ProLiant Gen10 6 slot per CPU DIMM population order						
1 DIMM				4		
2 DIMMs				4	5	
3 DIMMs				4	5	6
4 DIMMs		2	3	4	5	
5 DIMMs*		2	3	4	5	6
6 DIMMs	1	2	3	4	5	6
* Unbalanced, not recommended						

#### General Memory Population Rules and Guidelines:

- . Install DIMMs only if the corresponding processor is installed.
- . White DIMM slots denote the first slot to be populated in a channel.
- . Mixing of DIMM types (UDIMM, RDIMM, and LRDIMM) is not supported.
- . The maximum memory speed is a function of the memory type, memory configuration, and processor model.
- . The maximum memory capacity is a function of the number of DIMM slots on the platform, the largest DIMM capacity qualified on the platform, the number and model of installed processors qualified on the platform.
- . For details on the HPE Server Memory Options Population Rules, visit:  
<http://www.hpe.com/docs/memory-population-rules>.
- . To realize the performance memory capabilities listed in this document, HPE DDR4 SmartMemory is required. For additional information, please see the [HPE DDR4 SmartMemory QuickSpecs](#).



## Memory

DIMM Type	Register DIMM (RDIMM)		
HPE SKU P/N	815097-B21	815098-B21	815100-B21
SKU Description	HPE 8GB (1x8GB) Single Rank x8 DDR4-2666 CAS-19-19-19 Registered Smart Memory Kit (Extended)	HPE 16GB (1x16GB) Single Rank x4 DDR4-2666 CAS-19-19-19 Registered Smart Memory Kit (Recommended)	HPE 32GB (1x32GB) Dual Rank x4 DDR4-2666 CAS-19-19-19 Registered Smart Memory Kit (Recommended)
DIMM Rank ->	Single Rank (1R)	Single Rank (1R)	Dual Rank (2R)
DIMM Capacity ->	8GB	16GB	32GB
Voltage	1.2V	1.2V	1.2V
DRAM depth [bit]	1Gb	2Gb	2Gb
DRAM Width [bit]	x8	x4	x4
DRAM Density	8Gb	8Gb	8Gb
CAS Latency	19-19-19	19-19-19	19-19-19
DIMM Native Speed (MT/s)	2666 MT/s	2666 MT/s	2666 MT/s
<b>HPE Server Memory Speed (MT/s): Intel Xeon® Gold 51xx Processors *</b>			
1 DIMM Per Channel	2400 MT/s	2400MT/s	2400MT/s
<b>HPE Server Memory Speed (MT/s): Intel Xeon® Silver 41xx Processors *</b>			
1 DIMM Per Channel	2400 MT/s	2400 MT/s	2400 MT/s
<b>HPE Server Memory Speed (MT/s): Intel Xeon® Bronze 31xx Processors *</b>			
1 DIMM Per Channel	2133 MT/s	2133 MT/s	2133 MT/s

**NOTE:** Intel Xeon® Gold Processor #5122 supports 2666MT/s.

**NOTE:** The maximum memory speed is a function of the memory type, memory configuration, and processor model.

For details on the HPE Server Memory speed, visit: <https://www.hpe.com/docs/memory-speed-table>

### Standard and Maximum Memory Capacity (Pre-configured Models)

Pre Configured Models	Standard Memory	Maximum Memory Plus Optional Memory	Standard Memory Replaced with Optional Memory
3104	8 GB (1x8 GB RDIMM )	168 GB (8GB + 5x32GB)	192 GB (6x32 GB)
4110	16 GB (1x16 GB RDIMM)	176 GB (16GB + 5x32 GB)	192 GB (6x32 GB)

### DDR4 memory options part number decoder

**NOTE:** Capacity references are rounded to the common gigabyte (GB) values.

- 8GB = 8,192 MB
- 16GB = 16,384 MB
- 32GB = 32,768 MB

For more information on memory, please see the Memory QuickSpecs: [HPE DDR4 SmartMemory](#)

## Storage

### 4-bay LFF non-hot-plug / hot-plug drive model

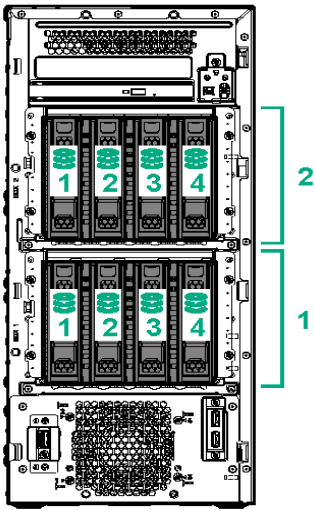

1 x 1-4

2 x 1-4

4 x LFF SATA Non-hot-plug / SAS,SATA Hot Pluggable Hard Drive Bays

4 x LFF SATA Non-hot-plug / SAS,SATA Hot Pluggable Hard Drive Bays (optional)

### 8-bay SFF hot-plug drive model

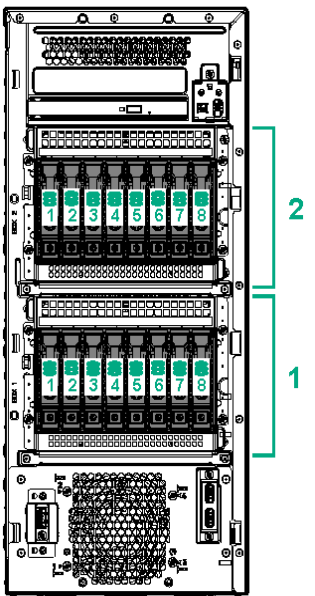

1 x 1-8

2 x 1-8

8 x SFF SATA/SSD Hot Pluggable Hard Drive Bays

8 x SFF SATA/SSD Hot Pluggable Hard Drive Bays (optional)

## Technical Specifications

### System Unit

<b>Tower Dimensions</b>	17.32 (H)x 7.68.(W) x 18.92. (D) in (44 x 19.5 x 48.05 cm)
<b>Tower Weight (approximate)</b>	Minimum: 29.82 lbs (13.5 kg) Maximum: 55.0 lbs (25.0 kg)
<b>Input Requirements (per power supply)</b>	Rated Line Voltage 100 to 120 VAC Rated Input Frequency For 350W & 550W Power Supply:8A (at 100~240 VAC) 50 to 60 Hz Rated Input Power For 550 W Power Supply:< 639 W (at 100 VAC),< 605 W (at 200 VAC) For 350 W Power Supply:< 427 W (at 100 VAC),< 427 W (at 200 VAC)
<b>BTU Rating</b>	Maximum For 550 W Power Supply:2204 BTU/hr (at 100 VAC),2113 BTU/hr (at 200 VAC) For 350 W Power Supply:1452 BTU/hr (at 100 VAC),1544 BTU/hr (at 200 VAC)
<b>Power Supply Output (per power supply)</b>	Rated Steady-State Power For 550 W Power Supply:550 W (at 100 VAC),550 W (at 200 VAC), Maximum Peak Power For 350 W Power Supply:350 W (at 100 VAC),350 W (at 200VAC),
<b>System Inlet Temperature</b>	Standard Operating Temperature 10° to 35°C (50° to 95°F) at sea level with an altitude derating of 1.0°C per every 305 m (1.8°F per every 1000 ft) above sea level to a maximum of 3050 m (10,000 ft), no direct sustained sunlight. Maximum rate of change is 20°C/hr (36°F/hr). The upper limit and rate of change may be limited by the type and number of options installed.  System performance during standard operating support may be reduced if operating with a fan fault or above 30°C (86°F).  Extended Ambient Operating Support For approved hardware configurations, the supported system inlet range is extended to be: 5° to 10°C (41° to 50°F) and 35° to 40°C (95° to 104°F) at sea level with an altitude derating of 1.0°C per every 175 m (1.8°F per every 574 ft) above 900 m (2953 ft) to a maximum of 3048m (10,000 ft). The approved hardware configurations for this system are listed at the URL: <a href="http://www.hpe.com/servers/ashrae">http://www.hpe.com/servers/ashrae</a> .  System performance may be reduced if operating in the extended ambient operating range or with a fan fault.
<b>Relative Humidity (non-condensing)</b>	Non-operating -30° to 60°C (-22° to 140°F). Maximum rate of change is 20°C/hr (36°F/hr). Operating 8% to 90% - Relative humidity (Rh), 28°C maximum wet bulb temperature, non-condensing. Non-operating 5 to 95% relative humidity (Rh), 38.7°C (101.7°F) maximum wet bulb temperature, non-condensing..
<b>Altitude</b>	Operating 3050 m (10,000 ft). This value may be limited by the type and number of options installed. Maximum allowable altitude change rate is 457 m/min (1500 ft/min). Non-operating 9144 m (30,000 ft). Maximum allowable altitude change rate is 457 m/min (1500 ft/min).
<b>Acoustic Noise</b>	Listed are the declared A-Weighted sound power levels ( $L_{WA,d}$ ) and declared average bystander position A-Weighted sound pressure levels ( $L_{pAm}$ ) when the product is operating in a 23°C ambient environment. Noise emissions were measured in accordance with ISO 7779 (ECMA 74) and declared in accordance with ISO 9296 (ECMA 109). The listed sound levels apply to standard shipping configurations. Additional options may result in increased sound levels. Please have your HPE representative provide information from the HPE EMESC website for further technical details regarding the configurations listed below.

## Technical Specifications

### Idle

LWAd	4.0 Bels Entry 4.0 Bels Perf
LpAm	24.8 dBA Entry 24.1 dBA Perf

### Operating

LWAd	4.0 Bels Entry 4.0 Bels Perf
LpAm	25.1 dBA Entry 24.1 dBA Perf

**NOTE:** Acoustics levels presented here are generated by the test configuration only. Acoustics levels will vary depending on system configuration. Values are subject to change without notification and are for reference only.

### Emissions Classification (EMC) – Regulatory Information

To view the regulatory information for your product, view the Safety and Compliance Information for Server, Storage, Power, Networking, and Rack Products, available at the Hewlett Packard Enterprise Support Center:

<http://www.hpe.com/support/Safety-Compliance-EnterpriseProducts>

For information on the HPE Smart Array E208i-p SR Gen10 Controller please refer to their [QuickSpecs](#).

For information on the HPE Smart Array E208e-p SR Gen10 Controller please refer to their [QuickSpecs](#).

For information on the HPE Smart Array P408i-p SR Gen10 Controller please refer to their [QuickSpecs](#).

For information on the HPE Smart Array P408e-p SR Gen10 Controller please refer to their [QuickSpecs](#).

### Environment-friendly Products and Approach

### End-of-life Management and Recycling

Hewlett Packard Enterprise offers **end-of-life product return, trade-in, and recycling programs**, in many geographic areas, for our products. Products returned to Hewlett Packard Enterprise will be recycled, recovered or disposed of in a responsible manner.

The EU WEEE directive (2002/95/EC) requires manufacturers to provide treatment information for each product type for use by treatment facilities. This information (product disassembly instructions) is posted on the Hewlett Packard Enterprise web site. These instructions may be used by recyclers and other WEEE treatment facilities as well as Hewlett Packard Enterprise OEM customers who integrate and re-sell Hewlett Packard Enterprise equipment.

## Summary of Changes

Date	Version History	Action	Description of Change
11-Jun-2018	Version 8	Changed	Smart Buy Models section for the NA version was revised.
04-Jun-2018	Version 7	Added	Added Support up to 8 LFF NHP SATA HDDs. Added HPE DDR4 SmartMemory up to 2666 MT/s. Added Security features: iLO 5 (Security Root of Trust).
		Changed	Service and Support, Configuration Information – Factory Integrated Models, Core Options, Additional Options, and Memory section were revised.
		Removed	Obsolete SKUs were removed from the QuickSpecs.
02-Apr-2018	Version 6	Changed	SKU descriptions were updated.
05-Mar-2018	Version 5	Added	Added new Solution Model.
		Changed	SMB Models section was revised.
		Removed	Obsolete SKUs were removed from the QuickSpecs.
05-Feb-2018	Version 4	Added	Added new SMB offerings. Added GPGPU information.
04-Dec-2017	Version 3	Added	Added new HPE 12TB SATA 6G LFF Hard Disk Drive.
		Changed	Standard Features, Pre-Configured Models, Additional Options, and Memory were revised.
16-Oct-2017	Version 2	Added	Added HPE Support Services.
		Changed	Standard Features, Configuration Information – Factory Integrated Models, Core Options, Additional Options, and Memory section were revised.
25-Sep-2017	Version 1	New	New QuickSpecs.



**Sign up for updates**

© Copyright 2018 Hewlett Packard Enterprise Development LP. The information contained herein is subject to change without notice. The only warranties for Hewlett Packard Enterprise products and services are set forth in the express warranty statements accompanying such products and services. Nothing herein should be construed as constituting an additional warranty. Hewlett Packard Enterprise shall not be liable for technical or editorial errors or omissions contained herein.

Intel® and Xeon® are registered trademarks of Intel Corporation in the U.S. and other countries.

Microsoft®, Windows®, and Windows Server® are U.S. registered trademarks of the Microsoft group of companies.

For hard drives, 1GB = 1 billion bytes. Actual formatted capacity is less

a00021851enw - 16054 - Worldwide - V8 - 11-June-2018

