

Sensormatic Product Catalog



Sensormatic®
50 YEARS OF INNOVATION

The Sensormatic Difference

High-Performance Loss Prevention Solutions Trusted by Retailers Worldwide



Tyco Retail Solutions is a leading global provider of retail security and store performance systems with nearly 50 years of experience serving customers ranging from store boutiques to global retail enterprises. Today, over 80 percent of the world's top 200 retailers that use EAS rely on Tyco Retail Solutions to keep their assets protected and customers satisfied.

Backed by over 1,500 patents, the genuine Sensormatic portfolio offers comprehensive merchandise protection for nearly every high-theft, high-velocity category. Our suite of EAS labels, hard tags, detection systems, detachers, deactivators and more are engineered to enable open merchandising and reduce theft in virtually any retail environment. Beyond traditional EAS, Sensormatic also offers Traffic Counting Devices and RFID Antennas and readers that allow retailers to gain new insights at the store or enterprise level to help not only reduce shrink, but also improve store operations in an increasingly demanding industry.

- // Introduction 3**
- // EAS 4**
- // Traffic Counting Devices..... 171**
- // RFID Antennas & Readers..... 176**
- // Accessories 186**



All genuine Sensormatic offerings come with Tyco Retail Solutions' guarantee of quality, service, expertise and innovation retailers have come to trust. And all Sensormatic products feature high-performance technology designed to optimize merchandise protection, drive down shrink and preserve your bottom-line profits. Our technologies include:

// Acousto-Magnetic (AM) Technology:

High-performance Sensormatic acousto-magnetic (AM) technology provides industry-leading EAS detection rates to promote open merchandising for increased sales and a better customer experience.

// Radio Frequency Identification Technology (RFID):

With Tyco Retail Solutions' RFID technology, retailers get access to near real-time inventory data. Armed with this information, retailers can identify high-risk locations to reduce out-of-stocks and achieve greater inventory accuracy.

// Acousto-Magnetic/Radio Frequency Identification (AM/RFID) Technology:

Our dual AM/RFID option lets retailers enjoy AM shrink deterrence with RFID item-level inventory visibility to optimize product availability and improve operations throughout the entire retail enterprise.

// Acousto-Magnetic (AM) Technology:

From hard goods to soft goods, Tyco Retail Solutions can provide a higher degree of security specific to your business goals. For more information on our solutions or to purchase any of our applications, visit www.tycoretailsolutions.com and find a sales representative near you.

“ The Sensormatic Magnetic 9kG Hard Tag has given us the freedom to display products openly to customers, standardize product displays and reduce losses while increasing sales. Our employees have recognized the benefits of easy application and removal, enhanced productivity and greater security that the Magnetic 9kG Hard Tag offers.”

~ Almacenes Éxito

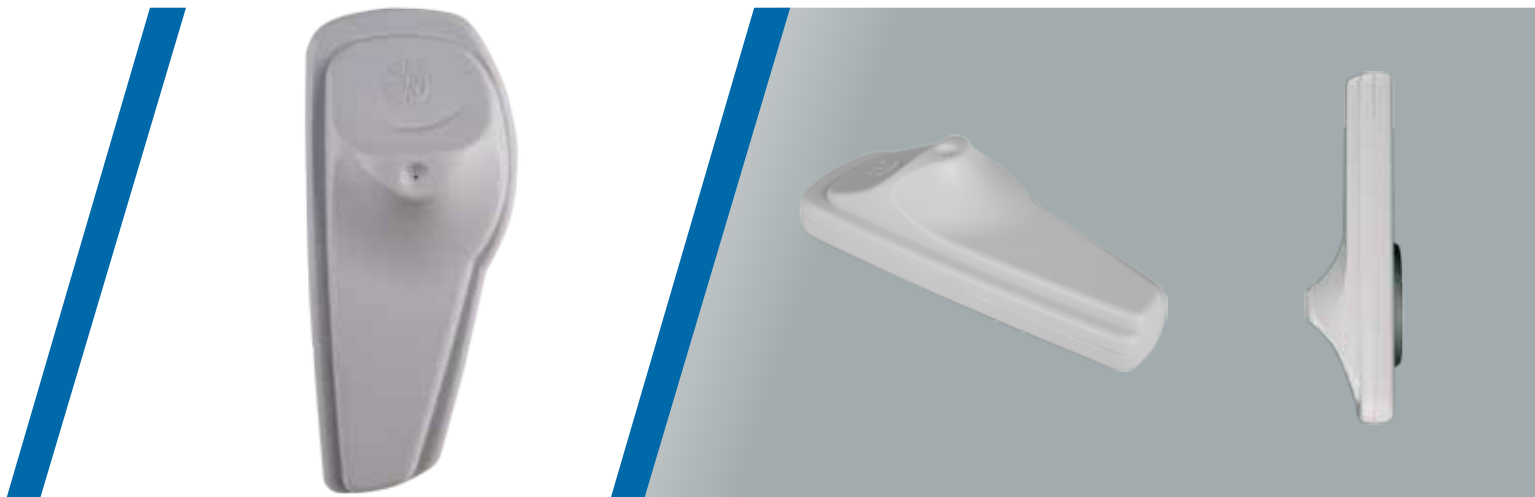

SuperTag III

This SuperTag provides top-of-the-line theft protection for everything from heavy outerwear to delicate intimate garments. The sleek shape provides a strong visual deterrent without detracting from high-end merchandise, letting retailers open merchandise with confidence.

Retailer Values

- // SuperTag, the gold standard in asset protection, features a patented clamp design for superior defeat resistance
- // Sleek, aesthetic design helps minimize impact to merchandise on display
- // Promotes open merchandising for increased sales

Solution Application

Apparel, General Merchandise

Product Codes

- Tag (Black): ZL303-B
- Tack (Black): MJ200-B
- Tag (Gray): ZL303-G
- Tack (Gray): MJ200-G

Product Compatibility

- MJ200L-W: Long Tack
- ST13564: Flat Metal Tack
- MJVT-2: Versa Tack
- MXSTL: Lanyard-21cm (8.27in)
- MXGL: Lanyard-19cm (7.5in)
- MJ200-G: Tack
- MJ200-B: Tack
- MJVT-3: Versa Tack
- MJVT-4: Versa Tack
- MXVT15: Versatie

Detachers

- SuperTag Detacher
- SuperTag Manual Handheld Detacher

Detacher Type

SuperTag

Environmental Constraints

Temperature

Maximum storage temperature not to exceed 60°C (140°F) for 96 hours at 80% RH.

Humidity

Unaffected by 80% humidity at 60°C (140°F), up to 96 hours.

Specifications

- Color** Gray, Black
- Length** 69.0mm (2.72in)
- Width** 30.5mm (1.20in)
- Depth** 18.8mm (0.74in)
- Weight** 9.7g (0.32oz)
- Pullout Force** 63.50kg (140lbs)

CE This product is in conformity with RoHS II Directive 2011/65/EU and REACH Substances of Very High Concern as defined in Regulation (EC) No 1907/2006 and subsequent amendments to both.

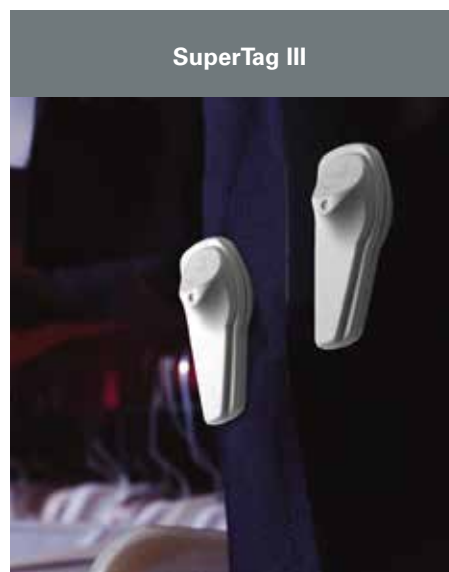



SuperTag III Lanyard

This SuperTag provides top-of-the-line protection for high-risk items unable to be secured with a pin-style hard tag. The integrated lanyard cable contains a stainless-steel pin for superior defeat resistance in a light, easy-to-use format. The sleek shape does not detract from high-end products, yet provides a strong visual deterrent, letting retailers open-merchandise with confidence.

Retailer Values

- // Allows application to a wider assortment of hard-to-tag, high-risk merchandise
- // SuperTag, the gold standard in asset protection, features a patented clamp design for superior defeat resistance
- // Sleek, aesthetic design helps minimize impact to merchandise on display

Solution Application

Shoes, Handbags, Backpacks, Luxury Apparel, Sporting Goods

Product Codes

Tag (Gray): ZL303L-4G
Tag (Black): ZL303L-4B

Product Compatibility

Detachers

SuperTag Detacher
SuperTag Manual Handheld Detacher

Detacher Type

SuperTag

Environmental Constraints

Temperature

Maximum storage temperature not to exceed 60°C (140°F) for 96 hours at 80% RH.

Humidity

Unaffected by 80% humidity at 60°C (140°F), up to 96 hours.

Specifications

| | |
|----------------------------|--|
| Color | Gray, Black |
| Length | 69.0mm (2.72in) |
| Cable Length | 10.1cm (4in) |
| Width | 30.5mm (1.20in) |
| Depth | 18.8mm (0.74in) |
| Weight | 11.9g (0.42oz) (weight includes tack) |
| Pullout Force | 63.50kg (140lbs) |

CE This product is in conformity with RoHS II Directive 2011/65/EU and REACH Substances of Very High Concern as defined in Regulation (EC) No 1907/2006 and subsequent amendments to both.

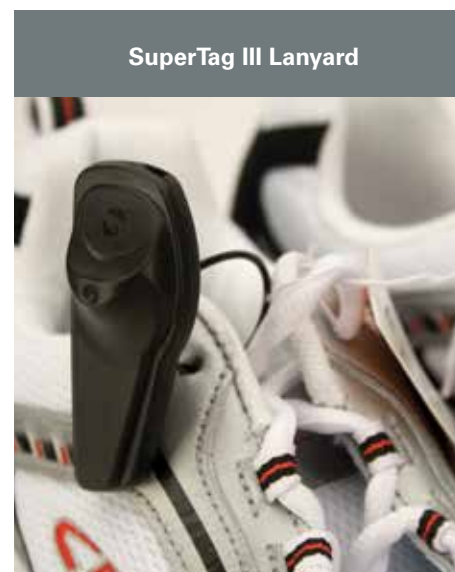



SuperTag Alarming 2-Tone Pin

Add an extra level of security to your high-value, high-risk merchandise—anywhere in the store. This alarming 2-tone SuperTag provides top-of-the-line protection for everything from heavy outerwear to delicate intimate garments. It's sleek shape does not detract from high-end items, yet provides a strong visual deterrent. The alarming feature reduces risk of theft when protected merchandise is out of staff's view. The tag will emit an audible alarm if defeat is attempted and will alarm the AM pedestal system if protected products pass through the detection zone. The tag alarm will stop once the battery is depleted or tag is reset.

Retailer Values

- // 2-tone alarming feature adds an extra layer of security to high-value, high-risk merchandise
- // Supertag, the gold standard in asset protection, features a patented clamp design for superior defeat resistance
- // Sleek, aesthetic design helps minimize impact to merchandise on display
- // Backed by a multi-year battery life warranty to reduce operational and replacement costs

Solution Application

Electronics, Leather, Luxury Goods, Handbags, Sporting Goods, Power Tools

Product Codes

Tag: ZLAMT-3100A2P
Tack: MJ200-B

Product Compatibility

MXVT15: Versa Tie
MJ200L-W: Long Tack
MJVT-2: Versa Tack
MJVT-3: Versa Tack
MJVT-4: Versa Tack
MXVT15: Versatie
MXSTL: Lanyard-21cm (8.27in)
MXGL: Lanyard-19cm (7.5in)

Detachers

SuperTag Detacher
SuperTag Manual Handheld Detacher

Detacher Type

SuperTag

Environmental Constraints

Temperature

Maximum storage temperature not to exceed 66°C (150°F) for 96 hours at 80% RH.

Humidity

Unaffected by 80% humidity at 66°C (150°F), up to 96 hours.

Specifications

| | |
|----------------------------|------------------|
| Color | Black |
| Length | 88mm (3.46in) |
| Width | 31mm (1.22in) |
| Depth | 21mm (0.83in) |
| Weight | 22g (0.77oz) |
| Pullout Force | 63.50kg (140lbs) |

CE This product is in conformity with RoHS II Directive 2011/65/EU and REACH Substances of Very High Concern as defined in Regulation (EC) No 1907/2006 and subsequent amendments to both.



SuperTag Alarming 2-Tone Lanyard

Add an extra level of security to hard-to-tag, high-value, high-risk merchandise—anywhere in the store. This alarming 2-tone SuperTag features an integrated lanyard cable with a stainless-steel pin for superior defeat resistance in an easy-to-use format. It is ideal for protecting items unable to be secured with a pin-style tag including shoes, handbags, luggage, sporting goods and more. The sleek shape does not detract from high-end items, yet provides a strong visual deterrent. The alarming feature reduces risk of theft when protected merchandise is out of staff's view. The tag will emit an audible alarm if defeat is attempted and will alarm the AM pedestal system if a protected products pass through the detection zone. The tag alarm will stop once the battery is depleted or the tag is reset.

Retailer Values

- // 2-tone alarming feature adds an extra layer of security to hard-to-tag high-value, high-risk merchandise
- // SuperTag, the gold standard in asset protection, features a patented clamp design for superior defeat resistance
- // Sleek, aesthetic design helps minimize impact to merchandise on display

- // Promotes open merchandising for increased sales
- // Backed by a multi-year battery life warranty to reduce operational and replacement costs

Solution Application

Electronics, Footwear, Leather, Luggage, Luxury Goods, Handbags, Sporting Goods, Power Tools

Product Codes

ZLAMT-3100A2L (15cm)
ZLAMT-3100A2L15 (152cm)

Product Compatibility

Detachers

SuperTag Detacher
SuperTag Manual Handheld Detacher

Detacher Type

SuperTag

Environmental Constraints

Temperature

Maximum storage temperature not to exceed 66°C (150°F) for 96 hours at 80% RH.

Humidity

Unaffected by 80% humidity at 66°C (150°F), up to 96 hours.

Specifications

| | |
|----------------------------|--|
| Color | Black |
| Length | 88mm (3.46in) |
| Cable Length | 15cm (6in) 152cm (60in) |
| Width | 31mm (1.22in) |
| Depth | 24mm (0.94in) |
| Weight | 15cm: 24.9g (0.88oz) 152cm: 39.6g (1.4oz) |
| Pullout Force | 63.50kg (140lbs) |

CE This product is in conformity with RoHS II Directive 2011/65/EU and REACH Substances of Very High Concern as defined in Regulation (EC) No 1907/2006 and subsequent amendments to both.

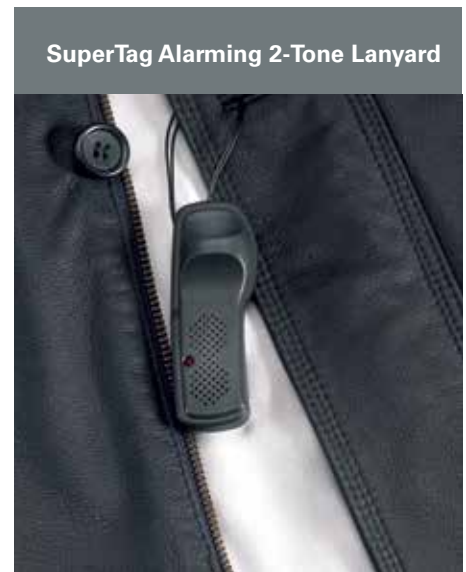



SuperTag Alarming 3-Tone Pin

Get the highest level of security for high-value, high-risk merchandise—anywhere in the store. This alarming 3-tone SuperTag provides the trusted protection of Sensormatic SuperTags with additional audible alarms. The alarming feature reduces risk of theft when protected merchandise is out of staff's view. The tag will emit an audible alarm if defeat is attempted and alarm the AM pedestal system if protected products pass through the detection zone. For additional security, the tag itself will also alarm if removed from the store. The tag alarm will stop once the battery is depleted or the tag is reset.

Retailer Values

- // 3-tone alarming feature provides the highest level of security to high-value, high-risk merchandise
- // SuperTag, the gold standard in asset protection, features a patented clamp design for superior defeat resistance
- // Sleek, aesthetic design helps minimize impact to merchandise on display
- // Backed by a multi-year battery life warranty to reduce operational and replacement costs

Solution Application

Electronics, Leather, Luxury Goods, Handbags, Sporting Goods, Power Tools

Product Codes

Tag: ZLAMT-3100A3P
Tack: MJ200-B

Product Compatibility

MXVT15: Versa Tie
MJ200L-W: Long Tack
MJVT-2: Versa Tack
MJVT-3: Versa Tack
MJVT-4: Versa Tack
MXVT15: Versatie
MXSTL: Lanyard-21cm (8.27in)
MXGL: Lanyard-19cm (7.5in)

Detachers

SuperTag Detacher
SuperTag Manual Handheld Detacher

Detacher Type

SuperTag

Environmental Constraints

Temperature

Maximum storage temperature not to exceed 66°C (150°F) for 96 hours at 80% RH.

Humidity

Unaffected by 80% humidity at 66°C (150°F), up to 96 hours.

Specifications

| | |
|----------------------------|------------------|
| Color | Black |
| Length | 88mm (3.46in) |
| Width | 31mm (1.22in) |
| Depth | 21mm (0.83in) |
| Weight | 22.1g (0.78oz) |
| Pullout Force | 63.50kg (140lbs) |

CE This product is in conformity with RoHS II Directive 2011/65/EU and REACH Substances of Very High Concern as defined in Regulation (EC) No 1907/2006 and subsequent amendments to both.



SuperTag Alarming 3-Tone Lanyard

Get the highest level of security for hard-to-tag high-value, high-risk merchandise—anywhere in the store. This alarming 3-tone lanyard SuperTag features an integrated lanyard cable with a stainless-steel pin for superior defeat resistance in an easy-to-use format. It is ideal for protecting items unable to be secured with a pin-style tag including shoes, handbags, luggage, sporting goods and more. The sleek shape does not detract from high-end items, yet provides a strong visual deterrent. The alarming feature reduces risk of theft when protected merchandise is out of staff's view. The tag will emit an audible alarm if defeat is attempted and will alarm the AM pedestal system if protected products pass through the detection zone. For additional security, the tag itself will also alarm if removed from the store. The tag alarm will stop once the battery is depleted or the tag is reset.

Retailer Values

- // 3-tone alarming feature provides the highest level of security hard-to-tag, high-value, high-risk merchandise
- // SuperTag, the gold standard in asset protection, features a patented clamp design for superior defeat resistance

- // Sleek, aesthetic design helps minimize impact to merchandise on display
- // Promotes open merchandising for increased sales
- // Backed by a multi-year battery life warranty to reduce operational and replacement costs

Solution Application

Electronics, Footwear, Leather, Luggage, Luxury Goods, Handbags, Sporting Goods, Power Tools

Product Codes

ZLAMT-3100A3L (15cm)
ZLAMT-3100A3L15 (152cm)

Product Compatibility

Detachers

SuperTag Detacher
SuperTag Manual Handheld Detacher

Detacher Type

SuperTag

Environmental Constraints

Temperature

Maximum storage temperature not to exceed 66°C (150°F) for 96 hours at 80% RH.

Humidity

Unaffected by 80% humidity at 66°C (150°F), up to 96 hours.

Specifications

| | |
|----------------------------|---|
| Color | Black |
| Length | 88mm (3.46in) 152cm (60in) |
| Cable Length | 15cm (6in) 152cm (60in) |
| Width | 31mm (1.22in) |
| Depth | 24mm (0.94in) |
| Weight | 15cm: 26g (0.92oz) 152cm: 40.7g (1.44oz) |
| Pullout Force | 63.50kg (140lbs) |

CE This product is in conformity with RoHS II Directive 2011/65/EU and REACH Substances of Very High Concern as defined in Regulation (EC) No 1907/2006 and subsequent amendments to both.



Deactivatable SuperTag VST-R

The Deactivatable SuperTag VST-R is a Sensormatic visible source tag that is part of a low-cost-per-use recirculation program. This hard tag is applied to soft goods at the point of manufacturing to help reduce operational costs and eliminate in-store tagging labor. This tag also features a robust locking mechanism with 80lbs of pull-out force.

Retailer Values

- // SuperTag, the gold standard in asset protection, features a patented clamp design for superior defeat resistance
- // Merchandise arrives sales-floor ready for immediate product availability
- // Reduces lost sales and eliminates labor costs associated with in-store tagging, allowing store associates to better serve customers
- // Improves tagging compliance with tagging at the point of manufacturing
- // Substantiates/endorsees green initiatives by reducing waste through recycling used tags for reapplication

Solution Application

Apparel, General Merchandise

Product Codes

Tag: ZLAMT7200R-B

Metal Tack: MJ70-H

Product Compatibility

Detachers

SuperTag Detacher

SuperTag Manual Handheld Detacher

Detacher Type

SuperTag

Environmental Constraints

Temperature

Maximum storage temperature not to exceed 60°C (140°F) for 96 hours at 80% RH.

Humidity

Unaffected by 80% humidity at 60°C (140°F), up to 96 hours.

Materials of Construction

Tag Housing

High-Impact ABS

Label Housing

Low Density Polyethylene/Polyester/
Polyethylene 0.127mm (0.0050in)

Tack

ABS Tack Head/Stainless-Steel Pin

Specifications

| | |
|----------------------------|----------------------------|
| Color | Charcoal |
| Length | 62mm (2.44in) |
| Width | 31mm (1.22in) |
| Depth | 19mm (0.75in) |
| Weight | With Tack: 8.67g (0.306oz) |
| Pullout Force | 36.29kg (80lbs) |

Order multiple..... Tag: 1,000
Tack: 1,000

Carton Weight Tag: 7.5kg (16.5lbs)
Tack: 1.17kg (2.57lbs)

Ext. Carton Dims.....
Tag: 368 x 368 x 268mm
(14.5 x 14.5 x 10.6in)
Tack: 140 x 75 x 75mm
(5.5 x 3 x 3in)

Ext. Carton Vol.....
Tag: 0.0363m³ (1.28ft³)
Tack: 0.0008m³ (0.028ft³)

Cartons Per Pallet Tag: 42

CE This product is in conformity with RoHS II Directive 2011/65/EU and REACH Substances of Very High Concern as defined in Regulation (EC) No 1907/2006 and subsequent amendments to both.



* Visit sensormatic.com to download usage guidelines



Non-Deactivatable SuperTag VST-R

The Non-Deactivatable SuperTag VST-R is a Sensormatic visible source tag that is part of a low-cost-per-use recirculation program. This hard tag is applied to soft goods at the point of manufacturing to help reduce operational costs and eliminate in-store tagging labor. This tag also features a robust locking mechanism with 80lbs of pull-out force.

Retailer Values

- // Merchandise arrives sales-floor ready for immediate product availability
- // Reduces lost sales and eliminates labor costs associated with in-store tagging, allowing store associates to better serve customers
- // Improves tagging compliance with tagging at the point of manufacturing
- // Substantiates/endorsees green initiatives by reducing waste through recycling used tags for reapplication

Solution Application

Apparel, General Merchandise

Product Codes

Tag: ZLAMT7100R-G,
Metal Tack: MJ70-H

Product Compatibility

Detachers

SuperTag Detacher
SuperTag Manual Handheld Detacher

Detacher Type

SuperTag

Environmental Constraints

Temperature

Maximum storage temperature not to exceed 60°C (140°F) for 96 hours at 80% RH.

Humidity

Unaffected by 80% humidity at 60°C (140°F), up to 96 hours.

Materials of Construction

Tag Housing

High-Impact ABS

Label Housing

Low Density Polyethylene/Polyester/
Polyethylene 0.127mm (0.0050in)

Tack

ABS Tack Head/Stainless-Steel Pin

Specifications

| | |
|----------------------------|----------------------------|
| Color | Gray |
| Length | 62mm (2.44in) |
| Width | 31mm (1.22in) |
| Depth | 19mm (0.75in) |
| Weight | With Tack: 8.67g (0.306oz) |
| Pullout Force | 36.29kg (80lbs) |

Order multiple..... Tag: 1,000
Tack: 1,000

Carton Weight Tag: 7.5kg (16.5lbs)
Tack: 1.17kg (2.57lbs)

Ext. Carton Dims.....
Tag: 368 x 368 x 268mm
(14.5 x 14.5 x 10.6in)
Tack: 140 x 75 x 75mm
(5.5 x 3 x 3in)

Ext. Carton Vol.....
Tag: 0.0363m³ (1.28ft³)
Tack: 0.0008m³ (0.028ft³)

Cartons Per Pallet Tag: 42

CE This product is in conformity with RoHS II Directive 2011/65/EU and REACH Substances of Very High Concern as defined in Regulation (EC) No 1907/2006 and subsequent amendments to both.



* Visit sensormatic.com to download usage guidelines



MVST-R Tag

The Magnetic VST-R is a visible source tag that is part of a low-cost-per-use recirculation program. This hard tag is applied to soft goods at the point of manufacturing to help reduce operational costs and eliminate in-store tagging labor. This multi-use tag also features a robust locking mechanism with 106lbs of pull-out force.

Retailer Values

- // Merchandise arrives sales-floor ready for immediate product availability
- // Reduces lost sales and eliminates labor costs associated with in-store tagging, allowing store associates to better serve customers
- // Improves tagging compliance with tagging at the point of manufacturing
- // Easy application and removal to help improve store operations
- // Fulfills green initiatives by reducing waste through recycling used tags for reapplication

Solution Application

Apparel, General Merchandise

Product Codes

New Tag: ZLAMT7400

New Tack: MJ7400 (Gray)
 Re-Circulated Tag: ZLAMT7400R
 Re-Circulated Tack: MJ400R (Gray)

Product Compatibility

Detachers

Magnetic 9kG Detachers
 Magnetic 5kG Detacher
 Magnetic 5 and 9kG Detacher

Detacher Type

Magnetic

Environmental Constraints

Temperature

Maximum storage temperature not to exceed 60°C (140° F) for 96 hours at 80% RH.

Humidity

Unaffected by 80% humidity at 60°C (140°F), up to 96 hours.

Materials of Construction

Tag Housing

High-Impact ABS

Tack

Nylon/Stainless-Steel Pin

Specifications

Color Gray

| | |
|-------------------------------------|--|
| Length | 56mm (2.2in) |
| Width | 16mm (0.65in) |
| Depth | 18mm (0.71in) |
| Weight | Tag: 7.12g (0.251oz) Tack: 0.57g (0.020oz) |
| Pullout Force | 45.36kg (100lbs) |
| Lock Magnetic Strength | 5kG |
| Order multiple | Tag: 1,000 Tack: 1,000 |
| Carton Weight | Tag: 7.8kg (17.16lbs) Tack: 0.68kg (1.50lbs) |
| Ext. Carton Dims | Tag: 370 x 370 x 155mm (14.56 x 14.56 x 6.1in) Tack: 175 x 110 x 100mm (6.09 x 4.3 x 3.94in) |
| Ext. Carton Vol | Tag: 0.0212m ³ (0.75ft ³) Tack: 0.0019m ³ (0.068ft ³) |
| Cartons Per Pallet | Tag: Atlanta DC: No Pallet |

CE This product is in conformity with RoHS II Directive 2011/65/EU and REACH Substances of Very High Concern as defined in Regulation (EC) No 1907/2006 and subsequent amendments to both.

* Visit sensormatic.com to download usage guidelines

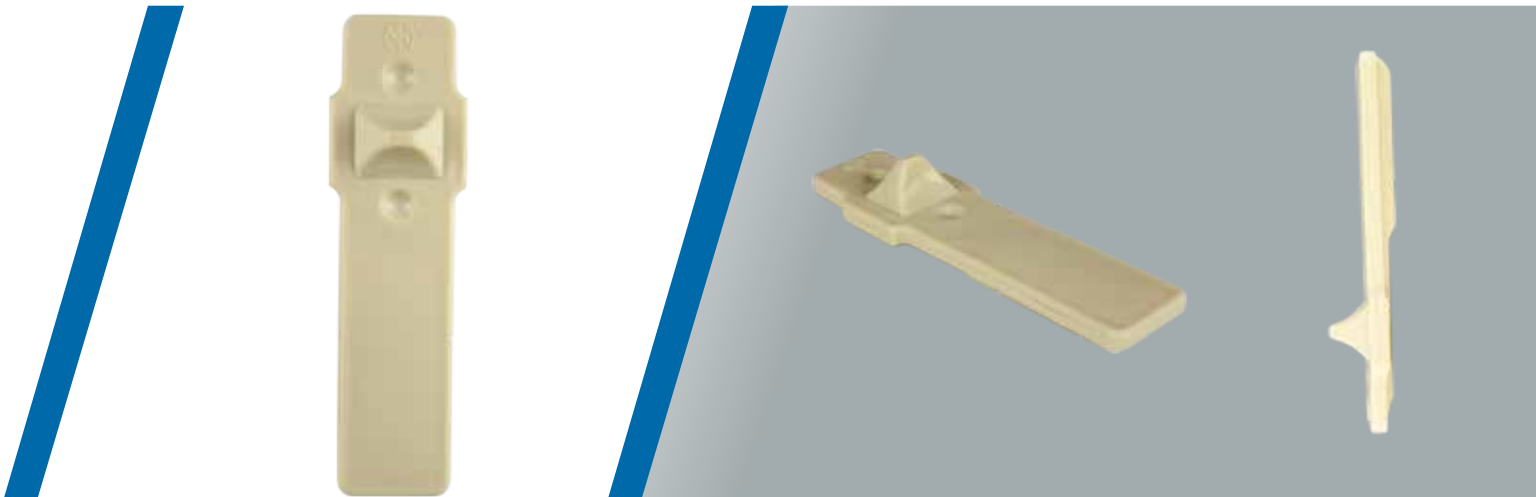

Ultra-Gator Tag

This all-purpose hard tag is a highly visible shoplifting deterrent. The traditional lock design provides moderate defeat resistance for a wide range of merchandise. It can be attached via tack, lanyard, Versatie or VersaTack.

Retailer Values

- // Standard EAS asset protection at an affordable price
- // Lightweight design ideal for protecting small or sensitive merchandise
- // Promotes open merchandising for increased sales

Solution Application

Apparel, General Merchandise

Product Codes

Tag: ZL92BXP
 Tack: MJ25-2P
 Tack: MJ31L-W
 (use with thick apparel only)

Product Compatibility

MXVT15: Versatie
 MJVT-2: Versa Tack
 MJVT-3: Versa Tack
 MJVT-4: Versa Tack
 MXGL: Lanyard-19cm (7.5in)

Detachers

Power: Ultra-Gator Detacher
 Handheld: Ultra-Gator Manual Handheld Detacher

Detacher Type

Ultra-Gator

Environmental Constraints

Temperature

Maximum storage temperature not to exceed 60°C (140° F) for 96 hours at 80% RH.

Humidity

Unaffected by 80% humidity at 60°C (140°F), up to 96 hours.

Specifications

Color Tan
Length 95mm (3.7in)
Width 29mm (1.1in)
Depth 16.4mm (0.25in)
Weight 13.2g (0.46oz)
Pullout Force 54.43kg (120lbs)

CE This product is in conformity with RoHS II Directive 2011/65/EU and REACH Substances of Very High Concern as defined in Regulation (EC) No 1907/2006 and subsequent amendments to both.



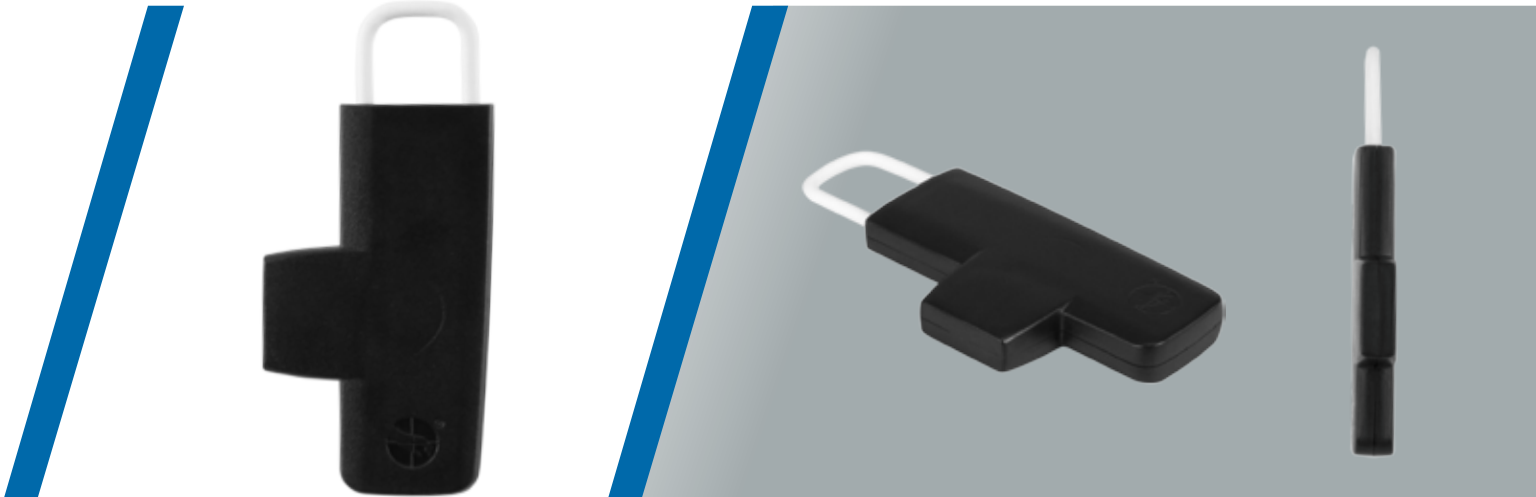

Magnetic Accessory Tag

This hard tag provides versatile protection for jewelry, optical and small accessories. Four distinct clasp lengths and a 360-degree pivot provide a variety of application opportunities, helping protect more items without affecting aesthetics. The coated stainless steel clasp prevents abrasion and won't rust, stain or damage merchandise. Available in AM or RF technology.

Retailer Values

- // Flexible application to a wide variety of jewelry, optical and small accessories
- // Will not rust, stain or damage merchandise
- // Promotes open merchandising for increased sales

Solution Application

Belts, Handbags, Watches, Jewelry, Optical

Product Codes

AM Technology

ZLAMT3210-B (Black)
ZLAMT3210-G (Gray)

RF Technology

RFT3210-B (Black)
RFT3210-G (Gray)

Product Compatibility

Detachers

Magnetic 9kG Detachers
Magnetic 5kG Detacher
Magnetic 5 and 9kG Detacher

Detacher Type

Magnetic

Environmental Constraints

Temperature

Maximum storage temperature not to exceed 60°C (140° F) for 96 hours at 80% RH.

Humidity

Unaffected by 80% humidity at 60°C (140°F), up to 96 hours.

Specifications

| | |
|-------------------------------------|------------------|
| Color | Gray, Black |
| Length | 46.6mm (1.83in) |
| Width | 18.5mm (0.73in) |
| Depth | 6.0mm (0.24in) |
| Weight | 5.9g (0.21oz) |
| Pullout Force | 45.35kg (100lbs) |
| Lock Magnetic Strength | 5kG |

CE This product is in conformity with RoHS II Directive 2011/65/EU and REACH Substances of Very High Concern as defined in Regulation (EC) No 1907/2006 and subsequent amendments to both.

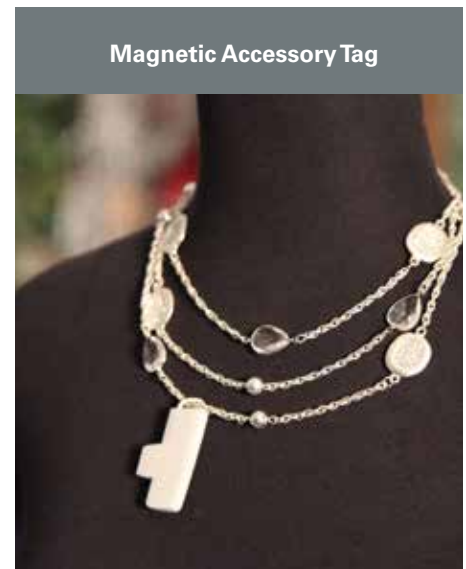



Magnetic RF MVST-R Tag

The RF Magnetic VST-R is a visible source tag that is part of the Sensormatic recirculation program. This hard tag is applied to soft goods at the point of manufacturing to help reduce operational costs and eliminate in-store tagging labor. This multi-use tag also features a robust locking mechanism with 90 lbs of pull-out force.

Retailer Values

- // Conical shape maximizes defeat resistance
- // Small form factor minimizes impact on product merchandising, brand promotion and shopper experience
- // Merchandise arrives sales-floor ready for immediate product availability
- // Reduces lost sales and eliminates labor costs associated with in-store tagging, allowing store associates to better serve customers
- // Improves tagging compliance with tagging at the point of manufacturing
- // Fulfills green initiatives by reducing waste through recycling used tags for reapplication

Solution Application

Apparel, General Merchandise

Product Codes

New Tag: RFT7000B
 Re-circulated Tag: RFT7000R-B

Product Compatibility

Tacks

MJ7000
 MJ7000R

Detachers

Magnetic 9kG Detachers
 Magnetic 5kG Detacher
 Magnetic 5 and 9kG Detacher

Detacher Type

Magnetic

Environmental Constraints

Temperature

Storage temperature range:
 0-40°C (32-104°F)

Humidity

Unaffected by 20-85% humidity

Specifications

Color Black
Length 35mm (1.38in)
Width 23mm (0.91in)
Weight 8.25g (0.29oz includes pin)
Pullout Force ≥45kg (99Lb)
Lock Magnetic Strength 5kG

CE This product is in conformity with RoHS II Directive 2011/65/EU and REACH Substances of Very High Concern as defined in Regulation (EC) No 1907/2006 and subsequent amendments to both.



* Visit sensormatic.com to download usage guidelines

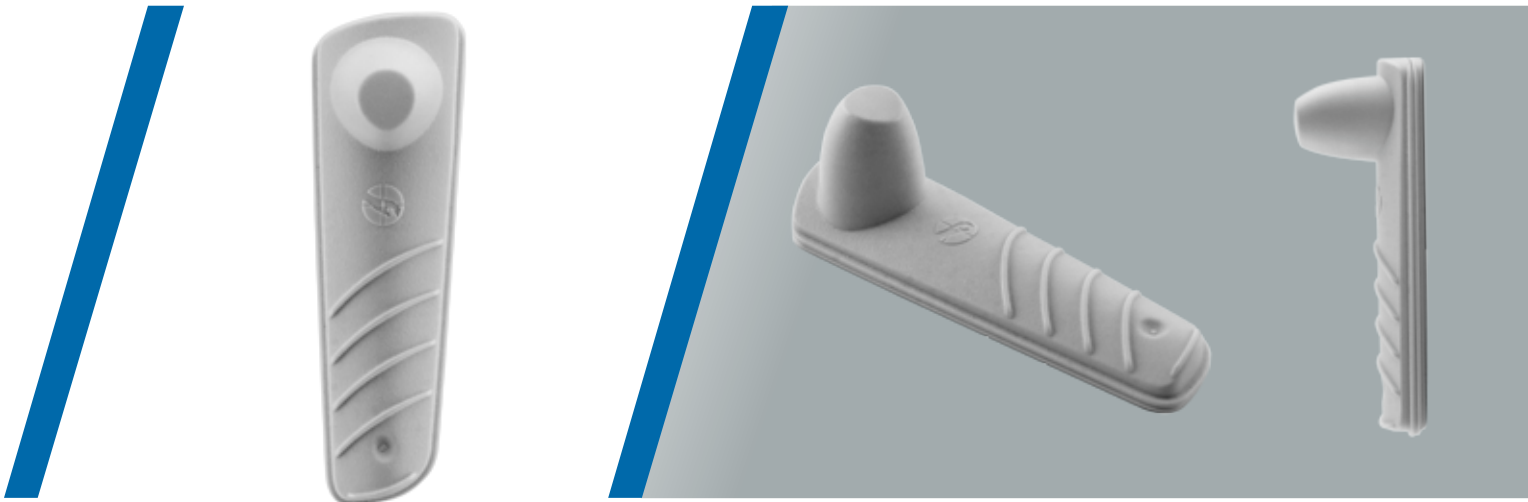

Magnetic 5kG Tack Tag

This hard tag provides application versatility for garments and most soft goods. Highly resistant to theft, this tag withstands slamming, crushing, bending and pulling defeat efforts. It is compatible with the Sensor-Ink Mini tag.

Product Features

- // A versatile solution for garments and soft goods
- // Tag is resistant to slamming, crushing, bending and pulling defeat efforts
- // Promotes open merchandising for increased sales

Solution Application

Specialty Apparel, General Merchandise, Sporting Goods, DIY

Product Code

ZLAMT42-G

Product Compatibility

Sensor Ink Mini
 MJAMT3200-G
 MJAMT3200-S
 MJAMT3200-B
 MJLT-1 (CE only)
 MJRMIN-G
 MJ31LW
 Smooth Tacks/Pins

Detachers

Magnetic 5kG Detacher
 Magnetic 5 and 9kG Detacher

Detacher Type

Magnetic

Environmental Constraints

Temperature

Maximum storage temperature not to exceed 60°C (140°F) for 96 hours at 80% RH.

Humidity

Unaffected by 80% humidity at 60°C (140°F), up to 96 hours.

Specifications

| | |
|-------------------------------------|------------------|
| Color | Gray |
| Length | 60.54mm (2.38in) |
| Width | 18.84mm (0.74in) |
| Depth | 20.49mm (0.81in) |
| Weight | 6.4g (0.23oz) |
| Pullout Force | >45.4kg (100lbs) |
| Lock Magnetic Strength | 5kG |

CE This product is in conformity with RoHS II Directive 2011/65/EU and REACH Substances of Very High Concern as defined in Regulation (EC) No 1907/2006 and subsequent amendments to both.

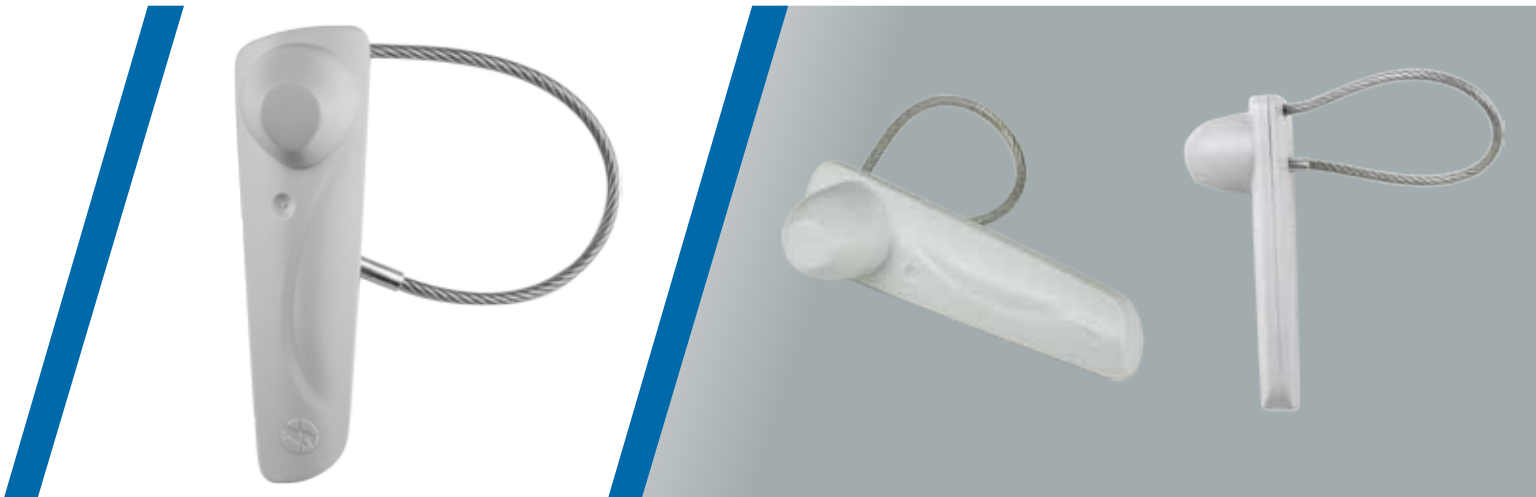

Magnetic 5kG Lanyard

This non-deactivatable hard tag features a sleek, lightweight design to minimize theft while preserving aesthetics. The small footprint and four-inch cable permits attachment to a wide variety of merchandise. With proven high-performance AM technology, this defeat-resistant tag is compatible with the Sensormatic suite of detachers.

Retailer Values

- // Small footprint and cable allow secure attachment to a wide variety of merchandise
- // Promotes open merchandising for increased sales

Solution Application

Belts, Shoes, Handbags, Watches, etc.

Product Codes

ZLAMT3200L-G (Lanyard; 100mm)
 ZLAMT3200PL-G (Plastic Lanyard; 155mm)

Product Compatibility

Detachers

Magnetic 5kG Detacher
 Magnetic 5 and 9kG Detacher

Detacher Type

Magnetic

Environmental Constraints

Temperature

Maximum storage temperature not to exceed 60°C (140° F) for 96 hours at 80% RH.

Humidity

Unaffected by 80% humidity at 60°C (140°F), up to 96 hours.

Specifications

| | |
|-------------------------------------|-----------------|
| Color | Gray |
| Length | 59.7mm (2.3in) |
| Cable Length | 100mm (4in) |
| Width | 19.5mm (0.76in) |
| Depth | 17.3mm (0.68in) |
| Weight | 6.4g (0.23oz) |
| Pullout Force | 45.4kg (100lbs) |
| Lock Magnetic Strength | 5kG |

CE This product is in conformity with RoHS II Directive 2011/65/EU and REACH Substances of Very High Concern as defined in Regulation (EC) No 1907/2006 and subsequent amendments to both.

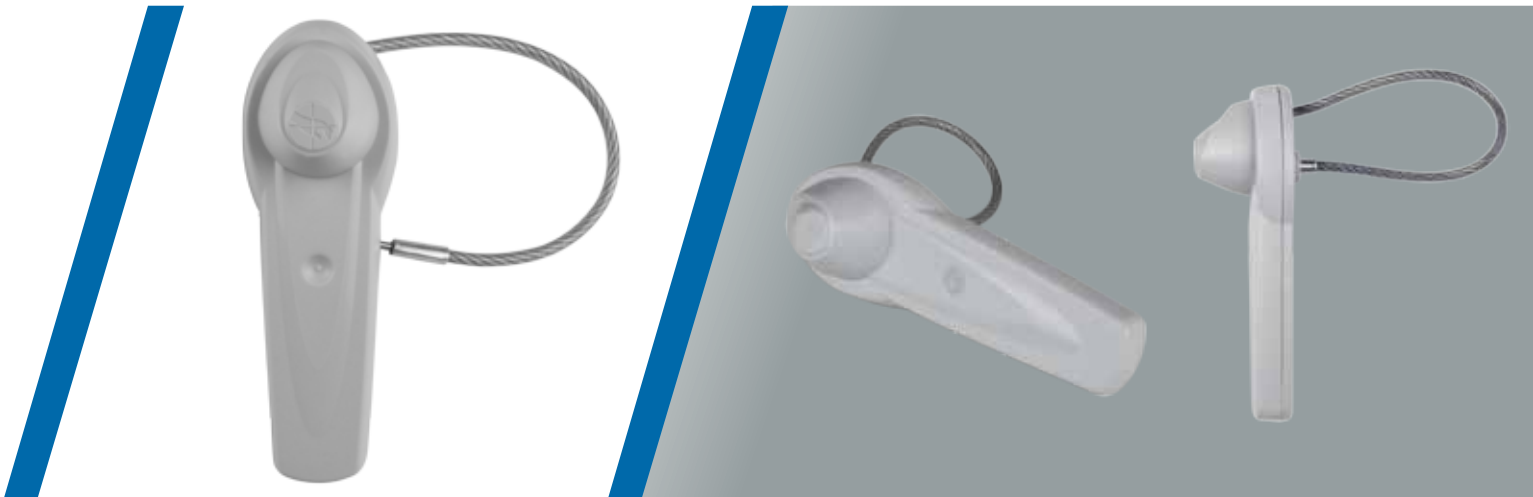

Magnetic 9kG Steel Lanyard

This one-piece, hard tag has a four-inch multi-strand stainless-steel cable to protect high-theft footwear, handbags and high-end apparel. The flexible lanyard cable combined with a sleek, discreet look makes this tag a reliable solution for merchandise of all shapes and sizes.

Retailer Values

- // Flexible lanyard attaches to merchandise of all shapes and sizes
- // High magnetic strength for superior protection
- // Protects several merchandise categories
- // Promotes open merchandising for increased sales

Solution Application

Shoes, Handbags, Belts, Apparel

Product Codes

ZL400AL-4G

Product Compatibility

Detachers

Magnetic 9kG Detachers
Magnetic 5 and 9kG Detacher

Detacher Type

Magnetic

Environmental Constraints

Temperature

Maximum storage temperature not to exceed 60°C (140° F) for 96 hours at 80% RH.

Humidity

Unaffected by 80% humidity at 60°C (140°F), up to 96 hours.

Specifications

| | |
|-------------------------------------|------------------|
| Color | Gray |
| Length | 60.8mm (2.4in) |
| Cable Length | 100mm (4in) |
| Width | 21.47mm (0.85in) |
| Depth | 18.0mm (0.71in) |
| Weight | 7g (0.24oz) |
| Pullout Force | 63.5kg (140lbs) |
| Lock Magnetic Strength | 9kG |

CE This product is in conformity with RoHS II Directive 2011/65/EU and REACH Substances of Very High Concern as defined in Regulation (EC) No 1907/2006 and subsequent amendments to both.

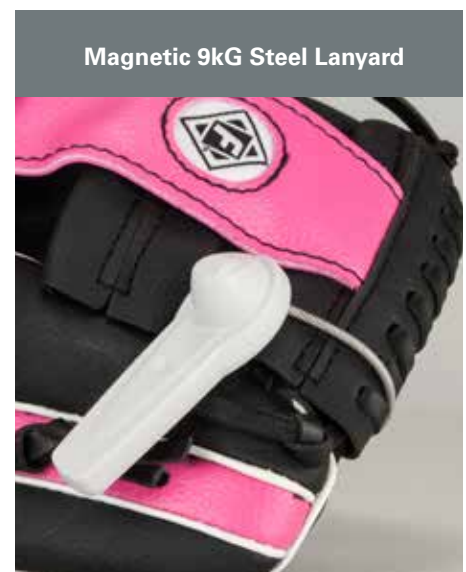

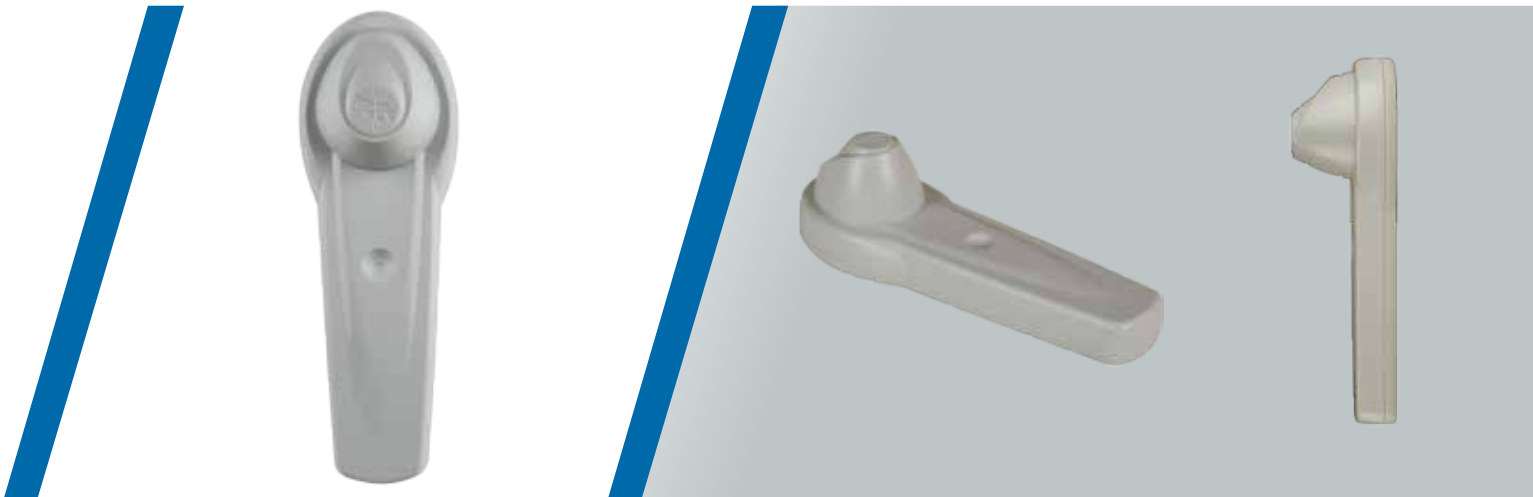

Magnetic 9kG Tack Tag

This hard tag is designed to protect everything from heavy denim to the lightest intimate apparel. The high-strength magnetic clamp prevents removal using common magnets by would-be shoplifters. The highly aesthetic design minimizes impact to merchandise on display.

Retailer Values

- // Multi-purpose tag protects several merchandise categories
- // High magnetic strength for superior protection
- // Promotes open merchandising for increased sales

Solution Application

Apparel, Delicates, Accessories

Product Codes

Tag: ZL400A-G

Tack: MJ400-G

Product Compatibility

Detachers

Magnetic 9kG Detachers
Magnetic 5 and 9kG Detacher

Detacher Type

Magnetic

Environmental Constraints

Temperature

Maximum storage temperature not to exceed 60°C (140° F) for 96 hours at 80% RH.

Humidity

Unaffected by 80% humidity at 60°C (140°F), up to 96 hours.

Specifications

| | |
|-------------------------------------|------------------|
| Color | Gray |
| Length | 60.8mm (2.4in) |
| Width | 21.47mm (0.85in) |
| Depth | 18.0mm (0.71in) |
| Weight | 5.4g (0.19oz) |
| Pullout Force | 63.50kg (140lbs) |
| Lock Magnetic Strength | 9kG |

CE This product is in conformity with RoHS II Directive 2011/65/EU and REACH Substances of Very High Concern as defined in Regulation (EC) No 1907/2006 and subsequent amendments to both.



Magnetic 9kG Pinless Tag

This pinless, hard tag with adjustable clip provides exceptional protection for a variety of apparel and sporting goods. A versatile, one-piece solution, this tag attaches securely without damaging merchandise.

Retailer Values

- // Adjustable spring-loaded metal clip for secure attachment without damaging merchandise
- // Robust ABS plastic housing combined with a fortified metal clip keeps merchandise secure
- // Small size provides the ideal visual deterrent without interfering with the shopper experience
- // High magnetic strength for superior protection

Solution Application

Department Store, Specialty Apparel, Discount, General Merchandise, Sporting Goods, DIY

Product Codes

ZLAMT4100P-G

Product Compatibility

Detachers

Magnetic 9kG Detachers
Magnetic 5 and 9kG Detacher

Detacher Type

Magnetic

Environmental Constraints

Temperature

Maximum storage temperature not to exceed 60°C (140° F) for 96 hours at 80% RH.

Humidity

Unaffected by 80% humidity at 60°C (140°F), up to 96 hours.

Specifications

| | |
|-------------------------------------|-------------------------------|
| Color | Gray |
| Length Closed position: | 63.5mm (2.5in) |
| | Open position: 76.0mm (3.0in) |
| Depth | 14.5mm (0.57in) |
| Weight | 23.8g (0.83oz) |
| Pullout Force | 45.35kg (100lbs) |
| Lock Magnetic Strength | 9kG |

CE This product is in conformity with RoHS II Directive 2011/65/EU and REACH Substances of Very High Concern as defined in Regulation (EC) No 1907/2006 and subsequent amendments to both.



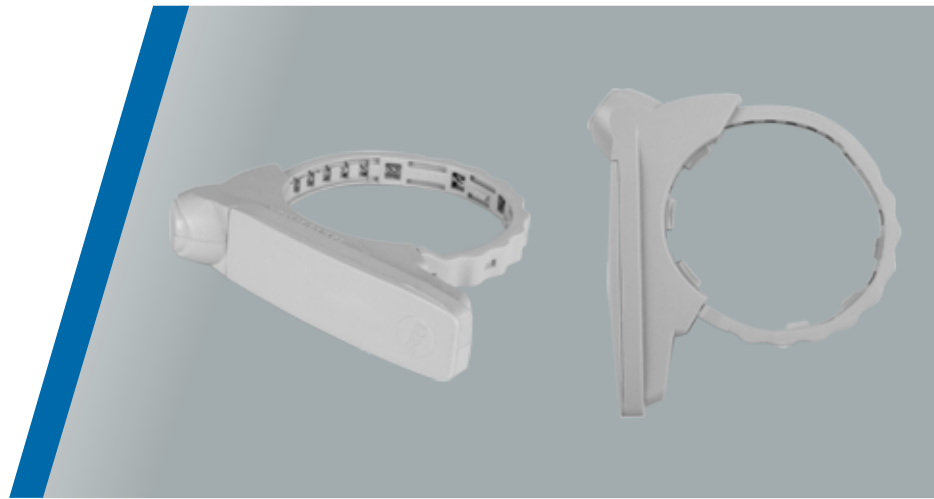

Magnetic 9kG- Multi-Purpose Tag

This multi-purpose hard tag secures products ranging from bottled wines and spirits to sporting goods and apparel. Featuring a multi-strand steel cable and nylon clamp, this versatile solution provides superior protection while minimizing impact on product merchandising.

Retailer Values

- // Multi-purpose tag secures hard goods, soft goods and everything in between
- // High magnetic strength for superior protection
- // Promotes open merchandising for increased sales

Solution Application

Bottled Wines, Spirits, Sporting Goods, Luggage, Power Tools

Product Codes

ZL410B-G

Product Compatibility

Detachers

Magnetic 9kG Detachers
Magnetic 5 and 9kG Detacher

Detacher Type

Magnetic

Environmental Constraints

Temperature

Maximum storage temperature not to exceed 60°C (140° F) for 96 hours at 80% RH.

Humidity

Unaffected by 80% humidity at 60°C (140°F), up to 96 hours.

Specifications

| | |
|-------------------------------------|-----------------|
| Color | Gray |
| Length | 54mm (2.1in) |
| Width | 13mm (0.51in) |
| Weight | 9g (0.31oz) |
| Pullout Force | 40.82kg (90lbs) |
| Lock Magnetic Strength | 9kG |

CE This product is in conformity with RoHS II Directive 2011/65/EU and REACH Substances of Very High Concern as defined in Regulation (EC) No 1907/2006 and subsequent amendments to both.

Magnetic 9kG Multi-Purpose Tag





Magnetic Mini Alarming 2-Tone Lanyard

The 2-Tone Mini Alarming Tag provides audible anti-theft protection for merchandise that cannot be protected with a pin-style tag. The integrated lanyard cable with a stainless-steel pin provides superior defeat resistance for items such as shoes, handbags, luggage and sporting goods. Its small size does not detract from high-end items, yet provides a strong visual deterrent. The alarming feature reduces risk of theft when protected merchandise is out of staff's view. Available with AM or RF technology, the tag will emit an audible alarm if defeat is attempted and will alarm the AM or RF pedestal system if a protected products pass through the detection zone. The tag alarm will stop once the battery is depleted or the tag is reset.

Retailer Values

- // 2-tone alarming feature provides a high level of security to high-risk merchandise
- // Small footprint does not interfere with the shopper experience
- // Integrated lanyard allows application to items that cannot be protected with pin-style tags
- // Promotes open merchandising for increased sales

// Battery life warranty reduces operational and replacement costs

Solution Application

Outerwear, Suits, Denim, Leather Goods, Footwear, Accessories, Handbags

Product Codes

AM Technology:

- ZLAMT2TL (10.16cm)
- ZLAMT2TL12 (120cm)
- ZLAMT2TL15 (150cm)

RF Technology:

- RFT2TL (10.16cm)
- RFT2TL12 (120cm)
- RFT2TL15 (150cm)

Product Compatibility

Detachers

- Magnetic 9kG Detachers
- Magnetic 5kG Detacher
- Magnetic 5 and 9kG Detacher

Detacher Type

Magnetic

Environmental Constraints

Temperature

Maximum storage temperature not to exceed 66°C (150°F) for 96 hours at 80% RH.

Humidity

Unaffected by 80% humidity at 66°C (150°F), up to 96 hours

Specifications

| | |
|-------------------------------------|------------------|
| Color | Black |
| Length | 65mm (2.56in) |
| Cable Length | 10.16cm (4in) |
| | 120cm (47.24in) |
| | 150cm (60in) |
| Width | 33.2mm (1.3in) |
| Depth | 18.2mm (0.72in) |
| Weight | 30.39g (1.07oz) |
| Pullout Force | >36.28kg (80lbs) |
| Lock Magnetic Strength | 5kG |

CE This product is in conformity with RoHS II Directive 2011/65/EU and REACH Substances of Very High Concern as defined in Regulation (EC) No 1907/2006 and subsequent amendments to both.

Magnetic Mini Alarming 2-Tone Lanyard





Magnetic Mini Alarming 3-Tone Lanyard

The 3-Tone Mini Alarming Lanyard provides audible anti-theft protection for merchandise that cannot be protected with a pin-style tag. The integrated lanyard cable with a stainless-steel pin provides superior defeat resistance for items such as shoes, handbags, luggage and sporting goods. Its small size does not detract from high-end items, yet provides a strong visual deterrent. The alarming feature reduces risk of theft when protected merchandise is out of staff's view. The tag will emit an audible alarm if defeat is attempted and will alarm the AM pedestal system if protected products pass through the detection zone. For additional security, the tag itself will alarm if removed from the store. The tag alarm will stop once the battery is depleted or the tag is reset.

Retailer Values

- // 3-tone alarming feature provides the highest level of security for high-risk merchandise
- // Small footprint does not interfere with the shopper experience
- // Integrated lanyard secures items unable to be protected with pin-style tags

- // Promotes open merchandising for increased sales
- // Battery life warranty reduces operational and replacement costs

Solution Application

Outerwear, Suits, Denim, Leather Goods, Footwear, Accessories, Handbags

Product Codes

AM Technology:

- ZLAMT3TL (10.16cm)
- ZLAMT3TL12 (120cm)
- ZLAMT3TL15 (150cm)

Product Compatibility

Detachers

- Magnetic 9kG Detachers
- Magnetic 5kG Detacher
- Magnetic 5 and 9kG Detacher

Detacher Type

Magnetic

Environmental Constraints

Temperature

Maximum storage temperature not to exceed 66°C (150°F) for 96 hours at 80% RH.

Humidity

Unaffected by 80% humidity at 66°C (150°F), up to 96 hours

Specifications

| | |
|-------------------------------------|------------------|
| Color | Black |
| Length | 65mm (2.56in) |
| Cable Length | 10.16cm (4in) |
| | 120cm (47.24in) |
| | 150cm (60in) |
| Width | 33.2mm (1.3in) |
| Depth | 18.2mm (0.72in) |
| Weight | 30.39g (1.07oz) |
| Pullout Force | >36.28kg (80lbs) |
| Lock Magnetic Strength | 5kG |

CE This product is in conformity with RoHS II Directive 2011/65/EU and REACH Substances of Very High Concern as defined in Regulation (EC) No 1907/2006 and subsequent amendments to both.





Magnetic Optical Tag

This optical tag offers maximum protection for eyewear without impacting the shopper experience. The tag is placed on the side arm of eyewear with the tag body on the outside, allowing customers to try on glasses without interference. Available in both AM and RF technology.

Retailer Values

- // Protects eyewear without impacting the shopper "try-on" experience
- // Small footprint minimizes impact to displayed merchandise
- // Promotes open merchandising for increased sales
- // Maximum security for high-theft eyewear

Solution Application

Optical, Sunglasses, Sporting Goods

Product Codes

AM Technology:

- ZLAMT6008-5 (5kG, Black)
- ZLAMT6008-9 (9kG, Black)
- ZLAMT6008W-5 (5kG, White)
- ZLAMT6008W-9 (9kG, White)

RF Technology:

- RFT6008-5 (5kG, Black)
- RFT6008-9 (9kG, Black)

Product Compatibility

Detachers

- Magnetic 9kG Detachers
- Magnetic 5kG Detacher
- Magnetic 5 and 9kG Detacher

Detacher Type

Magnetic

Environmental Constraints

Temperature

Maximum storage temperature not to exceed 60°C (140°F) for 96 hours at 80% RH.

Humidity

Unaffected by 80% humidity at 60°C (140°F), up to 96 hours

Specifications

| | |
|-------------------------------------|---------------|
| Color | White, Black |
| Length | 50mm (1.97in) |
| Width | 25mm (0.98in) |
| Depth | 20mm (0.79in) |
| Weight | 8.5g (0.30oz) |
| Pullout Force | >45kg (99lbs) |
| Lock Magnetic Strength | 5kG, 9kG |

CE This product is in conformity with RoHS II Directive 2011/65/EU and REACH Substances of Very High Concern as defined in Regulation (EC) No 1907/2006 and subsequent amendments to both.





Magnetic Mini Square Tag

The Magnetic Mini Square Tag is a versatile shoplifting deterrent for a wide range of products. Its small form factor and simple design secures items without interfering with the shopper experience, merchandising or brand promotion. Compatible with magnetic detachers, this hard tag is a desirable addition to any existing RF EAS system.

Retailer Values

- // Versatile shoplifting deterrent for a wide range of products
- // Small form factor does not interfere with shopper experience or brand promotion
- // Promotes open merchandising for increased sales

Solution Application

Apparel, Accessories, Hats
Sportswear, Home Fashions

Product Codes

RFT6018-5 (5kG) Tack Included
RFT6018-9 (9kG) Tack Included

Product Compatibility

Detachers

Magnetic 9kG Detachers
Magnetic 5kG Detacher
Magnetic 5 and 9kG Detacher

Detacher Type

Magnetic

Environmental Constraints

Temperature

Storage temperature range:
0-40°C (32-104°F)

Humidity

Unaffected by 20-85% humidity

Specifications

Color Black
Length 48mm (1.89in)
Width 42mm (1.65in)
Weight 11g (0.024oz) includes pin
Pullout Force ≥45kg (99lbs)
Lock Magnetic Strength 5kG, 9kG

CE This product is in conformity with RoHS II Directive 2011/65/EU and REACH Substances of Very High Concern as defined in Regulation (EC) No 1907/2006 and subsequent amendments to both.



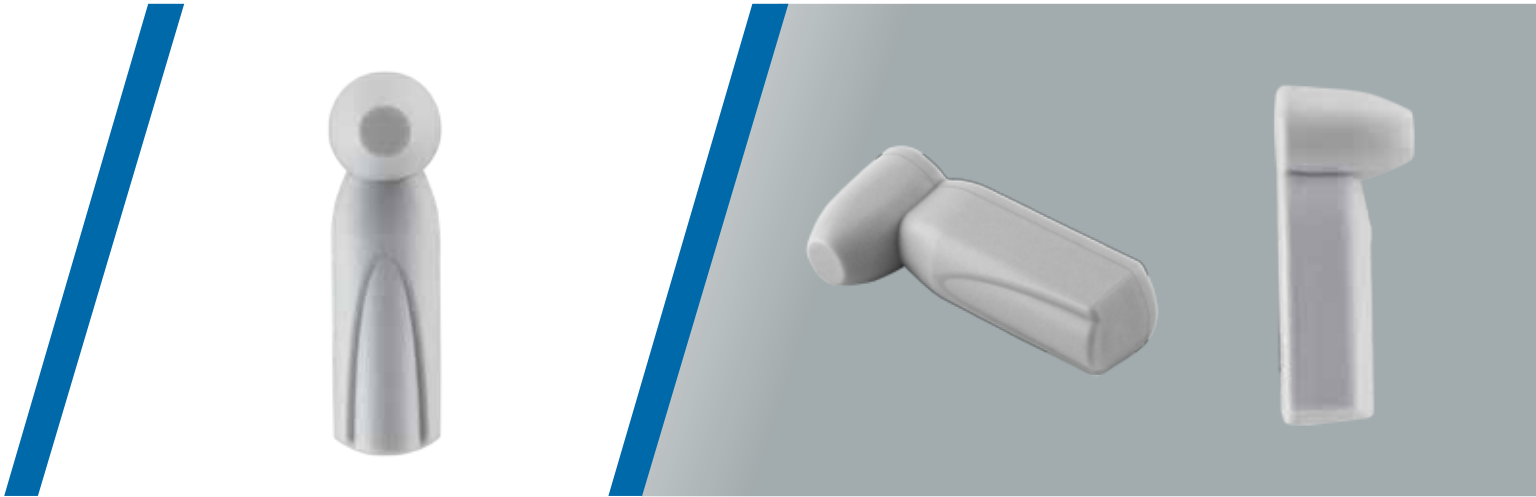

Magnetic Pencil Tag

This Pencil hard tag protects everything from heavy denim to delicate intimate apparel. Featuring a modern, defeat-resistant design and easy application/removal at the point-of-sale, this ferrite hard tag is ideal for protecting a wide variety of merchandise. This unobtrusive, visible deterrent is a desirable addition to any existing AM, EAS or RF system.

Retailer Values

- // Small aesthetic design minimizes impact to merchandise on display
- // Promotes open merchandising for increased sales

Solution Application

Apparel, Delicates/Intimates, Outerwear, Denim, Sportswear

Product Codes

AM/Ferrite Technology:

ZLAMT6016-5 (5kG) - Tack included
ZLAMT6016-9 (9kG) - Tack included

RF Technology:

RFT6016-5 (5kG) - Tack included
RFT6016-9 (9kG) - Tack included

Product Compatibility

Detachers

Magnetic 9kG Detachers
Magnetic 5kG Detacher
Magnetic 5 and 9kG Detacher

Detacher Type

Magnetic

Environmental Constraints

Temperature

Storage temperature range:
0-40°C (32-104°F)

Humidity

Unaffected by 20-85% humidity

Specifications

Color Grey
Length 45mm (1.77in)
Width 19mm (0.748in)
Depth 12mm (0.472in)
Weight 7.5g (0.264oz)
Pullout Force ≥ 45kg (99.2lbs)
Lock Magnetic Strength 5kG, 9kG

CE This product is in conformity with RoHS II Directive 2011/65/EU and REACH Substances of Very High Concern as defined in Regulation (EC) No 1907/2006 and subsequent amendments to both.



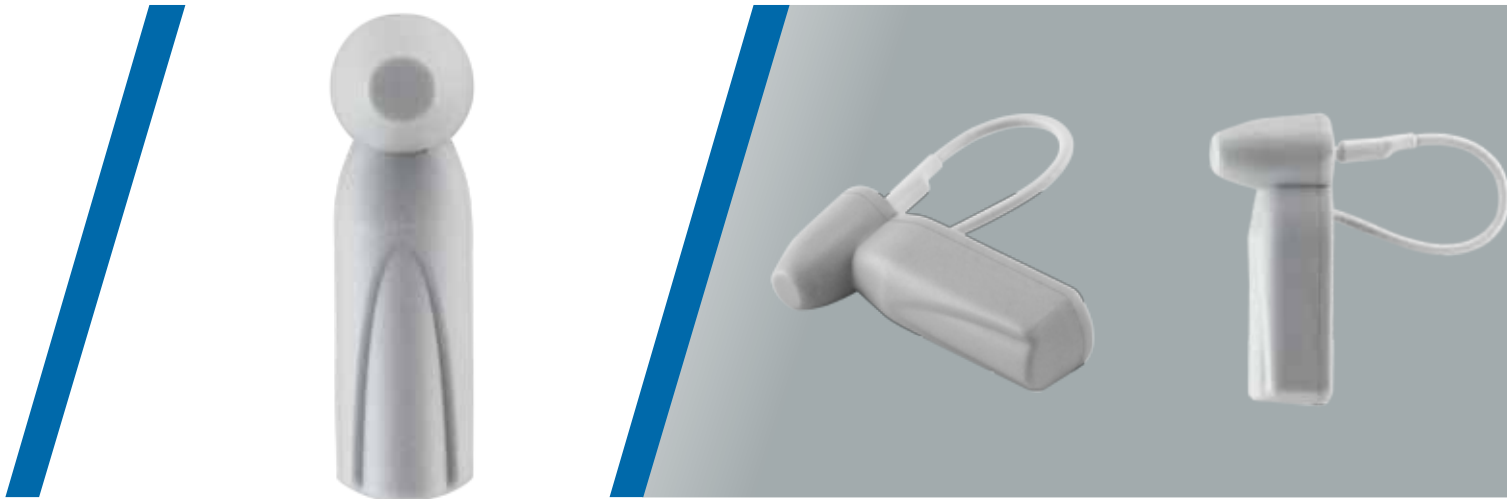

Magnetic Pencil Lanyard

This hard tag protects everything from accessories to sportswear. It features a modern, defeat-resistant design, and is easily applied and removed at the point-of-sale. The integrated lanyard allows application to a wide variety of hard-to-tag merchandise. This ferrite tag is an unobtrusive, yet visible deterrent and a desirable addition to any existing AM, EAS or RF system.

Retailer Values

- // Small, aesthetic design minimizes impact to merchandise on display
- // Integrated lanyard allows application to items that cannot be protected with pin-style tags
- // Promotes open merchandising for increased sales

Solution Application

Accessories, Footwear, Handbags, Hats, Luggage, Belts, Watches, Sportswear

Product Codes

AM/Ferrite Technology:

ZLAMT6016L-5 (5kG)
ZLAMT6016L-9 (9kG)

RF Technology:

RFT6016L-5 (5kG)
RFT6016L-9 (9kG)

Product Compatibility

Detachers

Magnetic 9kG Detachers
Magnetic 5kG Detacher
Magnetic 5 and 9kG Detacher

Detacher Type

Magnetic

Environmental Constraints

Temperature

Storage temperature range:
0-40°C (32-104°F)

Humidity

Unaffected by 20-85% humidity

Specifications

| | |
|-------------------------------------|------------------|
| Color | Gray |
| Length | 45mm (1.77in) |
| Width | 19mm (0.748in) |
| Depth | 12mm (0.472in) |
| Weight | 9g (0.32oz) |
| Pullout Force | ≥ 45kg (99.2lbs) |
| Lock Magnetic Strength | 5kG, 9kG |

CE This product is in conformity with RoHS II Directive 2011/65/EU and REACH Substances of Very High Concern as defined in Regulation (EC) No 1907/2006 and subsequent amendments to both.





Magnetic Super Pencil Tag

Thin and sleek, the Super Pencil tag adds a modern look to the traditional AM Ferrite EAS solution. Offering robust engineering, easy in-store application and removal at the point-of-sale, this hard tag provides a strong visual deterrent with reliable detection for optimal merchandise protection. Ideal for wide exit coverage areas, it is a seamless addition to any existing AM EAS detection environment.

Retailer Values

- // Thin and sleek design adds a modern look to traditional AM Ferrite EAS protection
- // Ideal for wide exit coverage areas
- // Promotes open merchandising for increased sales

Solution Application

Outerwear, Suits, Denim, Footwear, Apparel

Product Codes

ZLAMT6011-5 (5kG) - Tack included
ZLAMT6011-9 (9kG) - Tack included

Product Compatibility

Detachers

Magnetic 9kG Detachers
Magnetic 5kG Detacher
Magnetic 5 and 9kG Detacher

Detacher Type

Magnetic

Environmental Constraints

Temperature

Maximum storage temperature not to exceed 60°C (140°F) for 96 hours at 80% RH.

Humidity

Unaffected by 80% humidity at 60°C (140°F), up to 96 hours

Specifications

Color Dark Gray
Length 61.6mm (2.43in)
Width 15.4mm (0.61in)
Depth 19.8mm (0.78in)
Weight 9.07g (0.32oz)
Pullout Force >45kg (99lbs)
Lock Magnetic Strength 5kG, 9kG

CE This product is in conformity with RoHS II Directive 2011/65/EU and REACH Substances of Very High Concern as defined in Regulation (EC) No 1907/2006 and subsequent amendments to both.





Soft Tag

The Soft Tag provides premier performance and merchandise protection. The reusable soft tag is sealed inside a flexible, clear plastic pouch for easy reuse without having to deactivate. It is attached to merchandise via a plastic cord typically supplied by the retailer or via a standard Ultra-Gator pin or micro clamp.

Retailer Values

- // Sealed inside clear pouch for easy reuse without deactivating
- // Small label footprint minimizes impact on brand promotion and important product information
- // Robust construction provides optimal merchandise protection

Solution Application

General Merchandise, Apparel

Product Codes

ZL60-2

Product Compatibility

Sensormatic AM detection and deactivation devices.

Environmental Constraints

Temperature

Maximum storage temperature not to exceed 60°C (140°F) for 96 hours at 80% RH.

Humidity

Unaffected by 80% humidity at 60°C (140°F), up to 96 hours

Specifications

ColorBarcode

Length..... 28.7mm (1.13in)

Width 61.72mm (2.43in)

CE This product is in conformity with RoHS II Directive 2011/65/EU and REACH Substances of Very High Concern as defined in Regulation (EC) No 1907/2006 and subsequent amendments to both.



Bottle Cap Tag

The Bottle Cap Tag provides maximum anti-theft protection for wine and spirits. This innovative hard tag fits most bottle-neck sizes to prevent theft, in-store consumption or bottle content transfer. Its slim, transparent design provides a strong visual deterrent without interfering with merchandising or brand promotion. Containing both an AM non-deactivateable label and RF ferrite technology, this hard tag will alarm any EAS pedestal system if protected product passes through the detection zone.

Retailer Values

- // Strong visual deterrent for high-theft, high-value wine and spirits
- // Fits most bottle neck sizes
- // Form factor minimizes impact on store merchandising and brand promotion
- // Promotes open merchandising for increased sales

Solution Application

Spirits, Wine, Bottled Products

Product Codes

AM & RF Technology

Standard Bottle Cap

ZLAMT6017-5 (5kG)

ZLAMT6017-9 (9kG)

Large Bottle Cap

ZLAMT6017L-5 (5kG)

ZLAMT6017L-9 (9kG)

Product Compatibility

Detachers

Magnetic 9kG Detachers

Magnetic 5kG Detacher

Magnetic 5 and 9kG Detacher

Detacher Type

Magnetic

Environmental Constraints

Temperature

Storage temperature range:

0-40°C (32-104°F)

Humidity

Unaffected by 20-85% humidity

Specifications

Color Black

Length..... Standard: 47.5mm (1.87in)
Large: 78.2mm (3.07in)

Width Standard: 41.5mm (1.63in)
Large: 49.0mm (1.93in)

Depth Standard: 18mm (0.71in)
Large: 72.2mm (2.84in)

Weight Standard: 65g (0.144lbs)
Large: 81g (0.18lbs)

Pullout Force 45kg (99.20lbs)

Lock Magnetic Strength.....5kG, 9kG

CE This product is in conformity with RoHS II Directive 2011/65/EU and REACH Substances of Very High Concern as defined in Regulation (EC) No 1907/2006 and subsequent amendments to both.



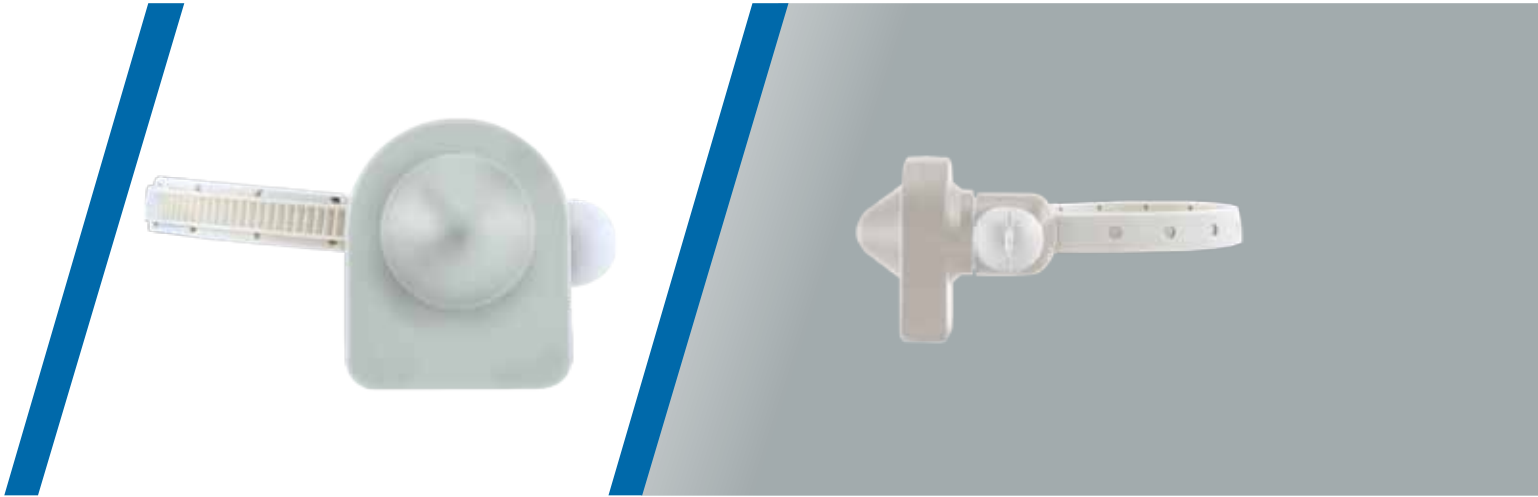

Magnetic RF Bottle Tag

The Magnetic RF Bottle Tag provides secure anti-theft protection for a wide variety of bottled wine and spirits. This versatile hard tag features an adjustable multi-strand stainless-steel reinforced strap that attaches to assorted bottle neck sizes for a strong visual deterrent. Its small form factor does not interfere with brand promotion or product merchandising, while its intuitive design is quickly and easily applied and removed, helping improve in-store operations.

Retailer Values

- // Strong visual deterrent protects bottled wines and spirits without damage
- // Minimizes impact on store merchandising and brand promotion
- // Easy application and removal ensure ease of use at POS
- // Promotes open merchandising for increased sales

Solution Application

Bottled Wines and Spirits

Product Codes

- RFT6019-5 (5kG)
- RFT6019-9 (9kG)

Product Compatibility

Detachers

- Magnetic 9kG Detachers
- Magnetic 5kG Detacher
- Magnetic 5 and 9kG Detacher

Detacher Type

Magnetic

Environmental Constraints

Temperature

Storage temperature range:
0-40°C (32-104°F)

Humidity

Unaffected by 20-85% humidity

Specifications

Color

- Tag Light Gray
- Lanyard Off-White

Length

- Tag 36mm (1.41in)
- Lanyard 167 ± 5mm (6.57 ± .20in)

Width

..... 30mm (1.18in)

Depth

..... 18mm (0.71in)

Weight

..... 19.05g (0.144lbs)

Pullout Force

..... >30kg (65lbs)

Lock Magnetic Strength

..... 5kG, 9kG

CE This product is in conformity with RoHS II Directive 2011/65/EU and REACH Substances of Very High Concern as defined in Regulation (EC) No 1907/2006 and subsequent amendments to both.





Magnetic Golf Tag

This sleek, lightweight design provides exceptional protection for high-value golf equipment. With placement on the shaft of the club and a modern look, this tag promotes a pleasant “try-out” experience with a strong visual deterrent to would-be shoplifters.

Retailer Values

- // Secures high-value golf equipment with ease
- // Promotes open merchandising for increased sales
- // Visually appealing; does not affect shopper experience

Solution Application

Golf Clubs, Fishing Rods

Product Codes

- ZLAMT6009-5 (5kG)
- ZLAMT6009-9 (9kG)

Product Compatibility

Detachers

- Magnetic 9kG Detachers
- Magnetic 5kG Detacher
- Magnetic 5 and 9kG Detacher

Detacher Type

Magnetic

Environmental Constraints

Temperature

Maximum storage temperature not to exceed 60°C (140°F) for 96 hours at 80% RH.

Humidity

Unaffected by 80% humidity at 60°C (140°F), up to 96 hours

Specifications

- Color** Black
- Length**..... 63.2mm (2.48in)
- Width** 20mm (0.79in)
- Depth** 43.7mm (1.72in)
- Weight**36.28g (1.28oz)
- Pullout Force** >45kg (99lbs)
- Lock Magnetic Strength**.....5kG, 9kG

CE This product is in conformity with RoHS II Directive 2011/65/EU and REACH Substances of Very High Concern as defined in Regulation (EC) No 1907/2006 and subsequent amendments to both.

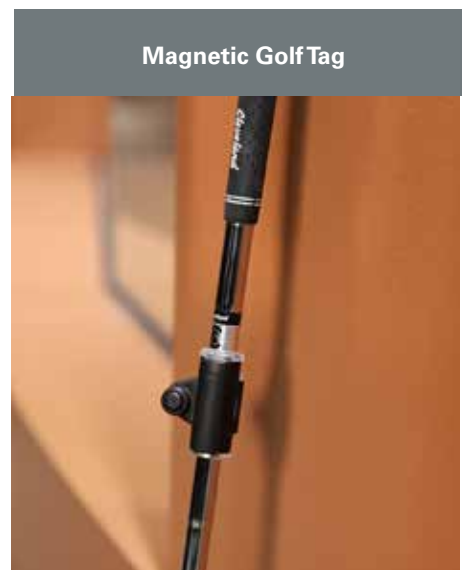



Magnetic Bat Tag

This unique, hard tag provides maximum protection for hard-to-tag sporting equipment including baseball bats, fishing rods and tennis rackets. With placement on the shaft of the merchandise, the tag does not interfere with customers' handling of equipment.

Retailer Values

- // Provides maximum protection for hard-to-tag sporting equipment
- // Reusable; the long shelf life helps reduce shrink and decrease operational costs
- // Promotes open merchandising for increased sales
- // Visually appealing, does not affect shopper experience

Solution Application

Baseball Bats, Fishing Rods, Tennis Rackets

Product Codes

ZLAMT6010-5 (5kG)
ZLAMT6010-9 (9kG)

Product Compatibility

Detachers

Magnetic 9kG Detachers
Magnetic 5kG Detacher
Magnetic 5 and 9kG Detacher

Detacher Type

Magnetic

Environmental Constraints

Temperature

Maximum storage temperature not to exceed 60°C (140°F) for 96 hours at 80% RH.

Humidity

Unaffected by 80% humidity at 60°C (140°F), up to 96 hours

Specifications

Color Black
Length..... 63.2mm (2.48in)
Width 20mm (0.79in)
Depth 43.7mm (1.72in)
Weight36.28g (1.28oz)
Pullout Force >35kg (77lbs)
Lock Magnetic Strength.....5kG, 9kG

CE This Product is in conformity with RoHS II Directive 2011/65/EU and REACH Substances of Very High Concern as defined in Regulation (EC) No 1907/2006 and subsequent amendments to both.





Magnetic High-Heel Footwear Tag

This innovative, hard tag for high-heel pumps fastens to the back of the shoe with a lanyard cable and adjustable knob for protection without damage. Easy-to-remove with compatible Sensormatic detachers, the aesthetic tag design allows open merchandising with a strong visual deterrent that doesn't detract from the customer "try-on" experience. Available in AM or RF technology.

Retailer Values

- // The first of its kind, this unique tag protects hard-to-tag high-heel pumps without causing cosmetic damage
- // High magnetic strength for superior detection
- // Reusable; the long shelf life helps reduce shrink and decrease operational costs
- // Does not interfere with customer "trying-on" experience

Solution Application

High-Heel Pumps

Product Codes

AM Technology

ZLAMT4300

RF Technology

RFT4300

Product Compatibility

Detachers

Magnetic 9kG Detachers
Magnetic 5 and 9kG Detacher

Detacher Type

Magnetic

Environmental Constraints

Temperature

Maximum storage temperature not to exceed 60°C (140°F) for 96 hours at 80% RH.

Humidity

Unaffected by 80% humidity at 60°C (140°F), up to 96 hours

Specifications

| | |
|-------------------------------------|----------------|
| Color | Gray |
| Length | 99mm (3.89in) |
| Width | 69mm (2.71in) |
| Depth | 70mm (2.75in) |
| Weight | 37.7g (1.32oz) |
| Lock Magnetic Strength | 9kG |

CE This product is in conformity with RoHS II Directive 2011/65/EU and REACH Substances of Very High Concern as defined in Regulation (EC) No 1907/2006 and subsequent amendments to both.



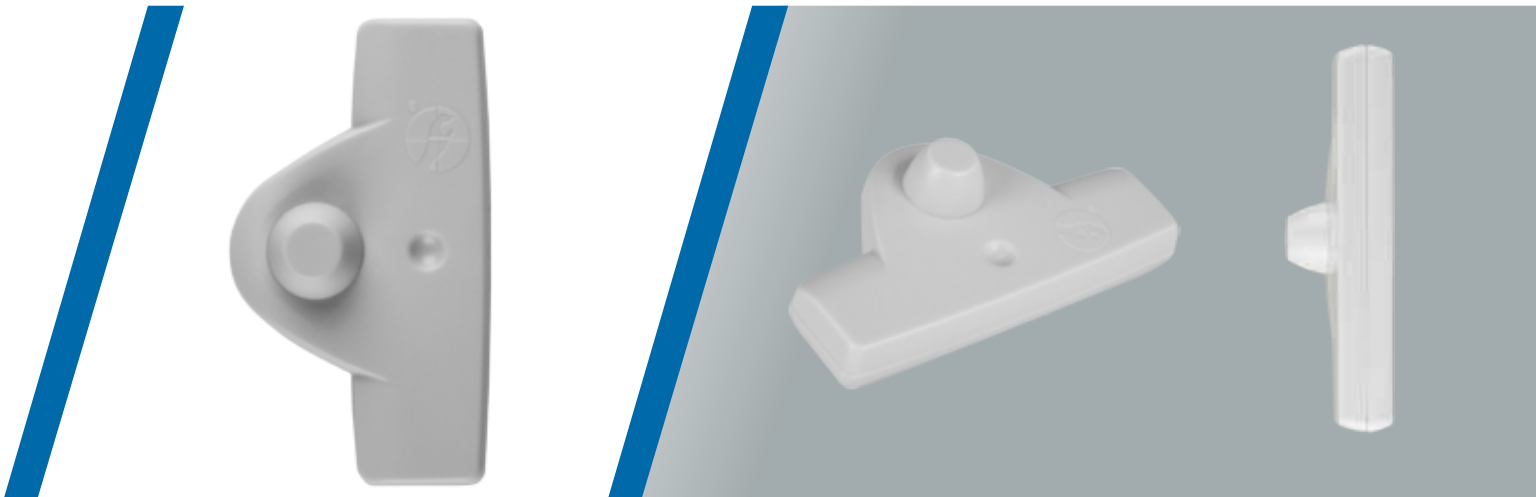

Magnetic Delicate Tag

The Delicate Tag protects easily damaged apparel and fine garments, without fear of rips or stretching from heavy tags with large pinholes. A strong visual deterrent, this tag delivers optimal merchandise protection to scarves, blouses, sarees, lingerie, bathing suits and other high-value, high-theft apparel. Available in AM or RF technology.

Retailer Values

- // Protects delicate fine merchandise with reduced risk of snags, rips or tears
- // Small tag form allows easy stacking of garments for maximum merchandising flexibility
- // Small size and neutral color for low impact to merchandise
- // Promotes open merchandising for increased sales

Solution Application

Specialty Apparel, Delicate Apparel

Product Codes

AM Technology

Tag (Gray): ZLAMT3220-G

Tack (Gray): MJ3220-G

Tag (Black): ZLAMT3220-B

Tack (Black): MJ3220-B

RF Technology

Tag (Gray): RFT3220-G

Tack (Gray): MJ3220-G

Tag (Black): RFT3220-B

Tack (Black): MJ3220-B

Product Compatibility

Detachers

Magnetic 9kG Detachers

Magnetic 5kG Detacher

Magnetic 5 and 9kG Detacher

Detacher Type

Magnetic

Environmental Constraints

Temperature

Maximum storage temperature not to exceed 60°C (140°F) for 96 hours at 80% RH.

Humidity

Unaffected by 80% humidity at 60°C (140°F), up to 96 hours

Specifications

Color Gray, Black

Length 45mm (1.77in)

Width 25mm (0.98in)

Weight 4.0g (0.14oz) with tack

Lock Magnetic Strength 5kG

Pullout Force 31.75kg (70lbs)

Material Thickness 0.1mm-0.3mm
(0.0039in-0.012in)

CE This product is in conformity with RoHS II Directive 2011/65/EU and REACH Substances of Very High Concern as defined in Regulation (EC) No 1907/2006 and subsequent amendments to both.





Magnetic Alarming 3-Tone Wrap

The 3-tone alarming wrap features adjustable cables that secure around merchandise of all shapes and sizes. The robust design offers a strong visual deterrent, while the low-profile footprint minimizes impact on brand promotion. When secured, the 3-tone wrap tag emits an audible alarm if defeat is attempted and alarms the pedestal system if protected products pass through the detection zone. For additional security, the wrap itself will alarm when tagged merchandise is removed from the retail store. The tag alarm will stop once the battery is depleted or the tag is reset.

Retailer Values

- // Wraps securely around merchandise of all shapes and sizes
- // 3-tone alarming feature provides the highest level of security to high-value, high-risk merchandise
- // Promotes open merchandising for increased sales

Solution Application

Medium: Electronics, Laptops, Software, Power Tools, Video Games, Toys, Games

Large: Plasma TVs, Computers, Printers/ Monitors, Ceiling Fans

Product Codes

3-Tone Medium:

- ZLAMT6003-5 (5kG)
- ZLAMT6003-9 (9kG)

Product Compatibility

Detachers

- Magnetic 9kG Detachers
- Magnetic 5kG Detacher
- Magnetic 5 and 9kG Detacher

Detacher Type

Magnetic

Environmental Constraints

Temperature

Maximum storage temperature not to exceed 66°C (150°F) for 96 hours at 80% RH.

Humidity

Unaffected by 80% humidity at 66°C (150°F), up to 96 hours

Specifications

- Color** Black
- Length**..... Medium: 57mm (2.24in)
Large: 72mm (2.83in)

- Cable Length**... Medium: 720mm (28.3in)
Large: 1800mm (70.1in)
- Width**Medium: 47mm (1.85in)
Large: 55mm (2.16in)
- Weight** Medium: 113.40g (4oz)
Large: 113.40g (4oz)
- Lock Magnetic Strength**.....5kG, 9kG

CE This product is in conformity with RoHS II Directive 2011/65/EU and REACH Substances of Very High Concern as defined in Regulation (EC) No 1907/2006 and subsequent amendments to both.

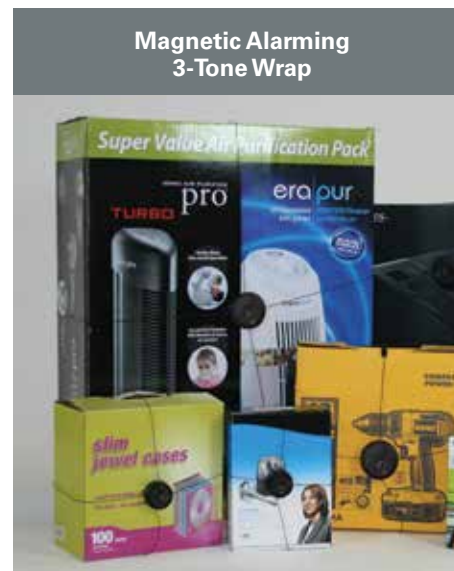



Magnetic Infant Formula Tag

This unique Sensormatic hard tag is designed to protect high-value, high-risk infant formula cans, while promoting open merchandising on the sales floor. The robust tag attaches to the base of a formula can, or other similarly shaped item, for a strong visual deterrent. Its slim form factor minimizes impact to brand promotion and product instructions, and allows shoppers to access and purchase with ease. When secured, the tag will alarm an AM or RF detection system if a protected product passes through the detection zone.

Retailer Values

- // Maximum security for high-value, high-risk infant formula
- // Promotes open merchandising by allowing shoppers to easily access and purchase products
- // Attractive design minimizes impact to product merchandising and allows stacking
- // Robust tag is easy to attach and remove from merchandise

Solution Application

Infant formula, coffee cans

*Diameter size of merchandise to protect
128–132mm (5.03–5.19in)

Product Codes

ZLAMT6020-5 (5kG, Black)
ZLAMT6020-9 (9kG, Black)

Product Compatibility

Magnetic 9kG Detachers
Magnetic 5 and 9kG Detacher
Magnetic 5kG Detacher

Detacher Type

Magnetic

Environmental Constraints

Temperature

Storage temperature range
0°C - 40°C (32°F - 104°F)

Humidity

Unaffected by 20–85% humidity

Specifications

| | |
|-------------------------------------|------------------|
| Color | Black |
| Max Diameter | 165mm (6.49in) |
| Height | 32mm (1.25in) |
| Weight | 108.86g (3.84oz) |
| Pullout Force | 40kg (88lbs) |
| Lock Magnetic Strength | 9kG, 5kG |

CE This product is in conformity with RoHS II Directive 2011/65/EU and REACH Substances of Very High Concern as defined in Regulation (EC) No 1907/2006 and subsequent amendments to both.

Magnetic Infant Formula Tag





Magnetic Alarming 2-Tone Wrap

This 2-tone alarming wrap provides product security for a broad range of popular, high-valued merchandise. The adjustable cables secure packaging of all shapes and sizes, but still keep items accessible. When secured, the 2-tone wrap tag emits an audible alarm if defeat is attempted and alarms AM or RF pedestal systems if protected products pass through the detection field. The wrap alarm will stop when the battery is depleted or when properly detached. The robust design provides a strong visual deterrent while the small form factor minimizes impact on brand promotion.

Retailer Values

- // Wraps securely around merchandise of all shapes and sizes
- // 2-tone alarming feature adds an extra layer of security to high-value, high-risk merchandise
- // Small form factor minimizes impact on brand promotion

Solution Application

Small Wrap: Video Games, Small Electronics, Hand Tools, Gift Box Sets, CD/DVD Collections, Software, E-Readers, Digital Cameras

Medium Wrap: Electronics, Laptops, Software, Power Tools, Video Games, Toys, Games

Large Wrap: Plasma TVs, Computers, Printers/Monitors, Ceiling Fans

Product Codes

Small Wrap:

ZLAMT6001-5 (5kG)
ZLAMT6001-9 (9kG)

Medium Wrap:

ZLAMT6002-5 (5kG)
ZLAMT6002-9 (9kG)

Product Compatibility

Detachers

Magnetic 9kG Detachers
Magnetic 5kG Detacher
Magnetic 5 and 9kG Detacher

Detacher Type

Magnetic

Environmental Constraints

Temperature

Maximum storage temperature not to exceed 66°C (150°F) for 96 hours at 80% RH.

Humidity

Unaffected by 80% humidity at 66°C

(150°F), up to 96 hours

Specifications

| | |
|-------------------------------------|---|
| Color | Black |
| Length | Small: 45mm (1.77in) Medium: 47mm (1.85in) Large: 55mm (2.16in) |
| Cable Length | Small: 360mm (14.1in) Medium: 720mm (28.3in) Large: 1800mm (70.1in) |
| Width | Small: 45mm (1.77in) Medium: 47mm (1.85in) Large: 55mm (2.16in) |
| Weight | Small: 58.96g (2.08oz) Medium: 90.71g (3.2oz) Large: 113.40g (4oz) |
| Lock Magnetic Strength | 5kG, 9kG |

CE This product is in conformity with RoHS II Directive 2011/65/EU and REACH Substances of Very High Concern as defined in Regulation (EC) No 1907/2006 and subsequent amendments to both.



Clutch Retainer II

The Clutch Retainer II is a reusable magnetic locking device designed to hold Sensor-Ink or other benefit denial magnetic tags. This product must be used with a benefit denial tag to provide asset protection value.

Retailer Values

- // Designed to hold Sensormatic benefit denial tags
- // Protects ink tags if they are not installed through an active hard tag

Solution Application

Apparel

Product Codes

ST14594

Product Compatibility

Detachers

- Magnetic 9kG Detachers
- Magnetic 5kG Detacher
- Magnetic 5 and 9kG Detacher

Detacher Type

Magnetic

Specifications

- Color** Gray
- Depth** 16.8mm (0.66in)
- Diameter** 28.6mm (1.12in)
- Weight** 5.67g (0.2oz)
- Pullout Force** 54.43kg (120lbs)



SuperTag Ink

The SuperTag Ink combines the superior defeat resistance of the SuperTag with the added deterrence of ink. The small, lightweight design provides a visual warning that complements other Sensormatic tagging solutions. If defeat is attempted, the non-freezable, non-toxic, non-flammable aggressive ink permanently stains garments, denying the benefit of shoplifting.

Retailer Values

- // Features permanent, non-toxic, non-flammable, non-freezable ink
- // SuperTag, the gold standard in asset protection, features a patented clamp design for superior defeat resistance
- // Enhances existing SuperTag security platform without changing detachers
- // Protects high-risk, high-value merchandise with an additional layer of security for the existing SuperTag platform

Solution Application

Apparel

Product Codes

Tag (Gray with Yellow Ink and Universal Warning): ZL310Y-G
Tack (Gray): MJ200-G

Product Compatibility

Detachers

SuperTag Detacher
SuperTag Manual Handheld Detacher

Detacher Type

SuperTag

Environmental Constraints

Temperature

Maximum storage temperature not to exceed 60°C (140°F) for 96 hours at 80% RH.

Humidity

Unaffected by 80% humidity at 60°C (140°F), up to 96 hours

Specifications

| | |
|----------------------------|-----------------|
| Color | Gray |
| Length | 79mm (3.1in) |
| Width | 30.5mm (1.2in) |
| Depth | 18.8mm (0.74in) |
| Weight | 16.8g (0.59oz) |
| Pullout Force | 63.5kG (140lbs) |

CE This product is in conformity with RoHS II Directive 2011/65/EU and REACH Substances of Very High Concern as defined in Regulation (EC) No 1907/2006 and subsequent amendments to both.

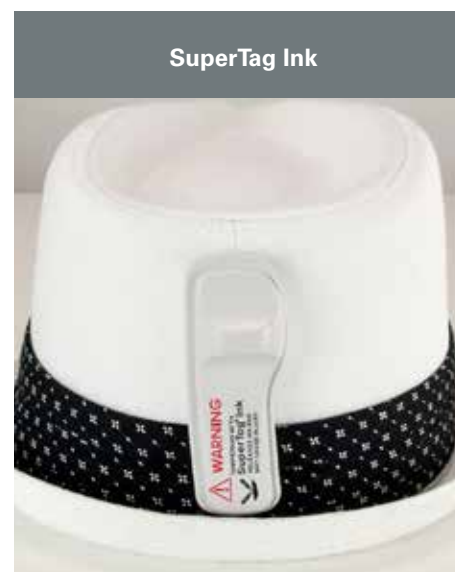

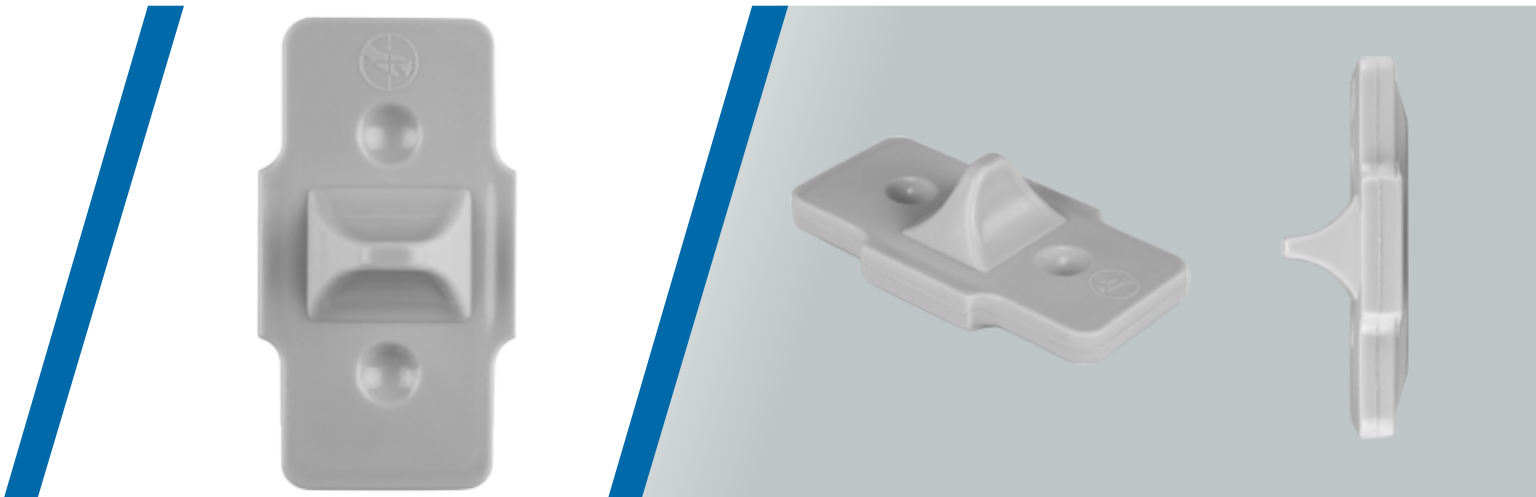

MicroClamp

The MicroClamp is designed to hold Ultra•Ink, InkTag III or Sensor-Ink for a reusable benefit denial solution. This reusable clamp detaches via Ultra-Gator hand or power detachers for an added benefit to customers who use Ultra-Gator hard tags. This product must be used with a benefit denial tag to provide asset protection value.

Retailer Values

// Protects ink tags if not installed through an active hard tag

Solution Application

Apparel

Product Codes

MX90

Product Compatibility

Detachers

Ultra-Gator Detacher
Ultra-Gator Manual Handheld Detacher

Detacher Type

Ultra-Gator

Specifications

Color Gray
Length 51mm (2.0in)
Width 28.5mm (1.12in)
Depth 16mm (0.63in)
Weight 8.45g (0.3oz)
Pullout Force 54.43kg (120lbs)



SuperClamp

The SuperClamp is designed to hold Ultra•Ink or Sensor-Ink to soft goods. This reusable clamp detaches via SuperTag detachers for an added benefit to customers who use SuperTag hard tags. This product must be used with a benefit denial tag to provide asset protection value.

Retailer Values

// Locking device holds either Ultra•Ink or Sensor-Ink to soft goods

Solution Application

Apparel

Product Codes

ML50-G

Product Compatibility

Detachers

SuperTag Detacher
SuperTag Manual Handheld Detacher

Detacher Type

SuperTag

Specifications

Color Gray
Length 51mm (2.0in)
Width 30mm (1.18in)
Depth 18.75mm (0.73in)
Weight 9g (0.32oz)
Pullout Force 63.5kG (140lbs)





Sensor-Ink Mini Tag

The Sensor-Ink Mini is the perfect benefit denial solution for protecting everything from heavy denims to delicate intimates. Small, lightweight and durable, the reusable non-EAS Sensor-Ink Mini meets the retailer demand for a high-integrity, cost-effective solution. It features a visible ink vial with a universal warning, providing a strong visual deterrent for would-be thieves. If defeat is attempted, the non-freezable, non-toxic, non-flammable aggressive ink permanently stains garments, denying the benefit of shoplifting. When paired with any SuperTag hard tag, the Sensor-Ink Mini provides both benefit denial and AM EAS protection.

Retailer Values

- // Small design minimizes impact to displayed merchandise
- // Features permanent, non-toxic, non-flammable, non-freezable ink
- // Provides a visual deterrent against shoplifting
- // Stainless-steel tack will not snag or tear garments and will not rust

Solution Application

General Merchandise, Apparel, Specialty Apparel

Product Codes

MJRMIN-G

Product Compatibility

Detachers

- SuperTag Detacher
- SuperTag Manual Handheld Detacher
- Ultra-Gator Detacher
- Ultra-Gator Manual Handheld Detacher
- Magnetic 5kG Detacher

Detacher Type

SuperClamp, all SuperTags, MicroClamp and Ultra-Gator

Specifications

| | |
|----------------------------|-----------------|
| Color | White |
| Length | 36.9mm (1.5in) |
| Width | 23.9mm (0.9in) |
| Depth | 12.9mm (0.5in) |
| Weight | 5g (0.16oz) |
| Pullout Force | 11.34kg (25lbs) |

CE This product is in conformity with RoHS II Directive 2011/65/EU and REACH Substances of Very High Concern as defined in Regulation (EC) No 1907/2006 and subsequent amendments to both.





Magnetic Saucer Ink Tag

The Saucer Ink tag provides double protection: dual ink vials for visual deterrence and a choice of AM Ferrite or RF technology. The slim design with visible ink vials provides maximum theft prevention. The tag secures a wide variety of high-risk merchandise, while allowing retailers to open merchandise with confidence.

Retailer Values

- // Works with both AM Ferrite or RF technology
- // Flat profile does not interfere with the shopper experience
- // Visible ink vials for maximum theft deterrence

Solution Application

Denim, Designer Apparel, Footwear, Sportswear, Swimsuits, Home Fashions, Backpacks

Product Codes:

AM Technology:

ZLAMT6015-5 (5kG) - Tack Included
ZLAMT6015-9 (9kG) - Tack Included
MJ6015 - Metal Tack

RF Technology:

RFT6015-5 (5kG) - Tack Included
RFT6015-9 (9kG) - Tack Included
MJ6015 - Metal Tack

Product Compatibility

Detachers

Magnetic 9kG Detacher's
Magnetic 5 and 9kG Detacher
Magnetic 5kG Detacher

Detacher Type

Magnetic

Environmental Constraints

Temperature

Maximum storage temperature not to exceed 60°C (140°F) for 96 hours at 80% RH.

Humidity

Unaffected by 80% humidity at 60°C (140°F), up to 96 hours

Specifications

| | |
|-------------------------------------|---|
| Color | White |
| Depth | 18.5mm (0.73in) |
| Diameter | Tag: 50mm (1.97in) Pin: 1.2mm (0.05in) |
| Weight | 17g (0.6oz) includes pin |
| Pullout Force | 58.96kg (130lbs) |
| Lock Magnetic Strength | 5kG, 9kG |

CE This product is in conformity with RoHS II Directive 2011/65/EU and REACH Substances of Very High Concern as defined in Regulation (EC) No 1907/2006 and subsequent amendments to both.



AM/RFID Hard Tag

This hard tag features a highly sensitive Radio Frequency Identification (RFID) inlay for item-level visibility and inventory management and an AM EAS element for asset protection. The RFID component stores information specific to the protected merchandise for item-level and near real-time merchandise visibility. Source Tagging is available so retailers can receive floor-ready merchandise with consistent tag placement—expediting receiving and selling floor fulfillment.

Retailer Values

- // Enables near real-time merchandise visibility
- // RFID element offers an efficient way to track inventory, while the AM EAS element provides product protection
- // Tagging at the point of manufacturing (Source Tagging) helps improve tag compliance and ensures consistent application
- // Source Tagged merchandise arrives floor-ready, enabling faster speed to sales floor

Solution Application

General Merchandise, Department Store, Specialty Apparel

Product Codes

New Dual Tag: IDTM2200 - Medium Gray
Re-Circulated Dual Tag: IDTM2200R -

Medium Gray

In-Store Use: IDTM2200N - Light Gray

Tack: MJ211B

Product Compatibility

Detachers

AM/RFID Detachers:
AM/RFID SuperTag Detacher

For AM Detaching Only:
SuperTag Detacher

For AM Hand-Held Detaching Only:
SuperTag Manual Handheld Detacher

Detacher Type

SuperTag

Environmental Constraints

Temperature

Maximum storage temperature not to exceed 60°C (140°F) for 96 hours at 80% RH.

Humidity

Unaffected by 80% humidity at 60°C (140°F), up to 96 hours

Materials of Construction

Tag Housing

High-Impact ABS

Label Housing

Low Density Polyethylene/Polyester/
Polyethylene 0.127mm (0.0050in)

RFID inlay

Copper, Mylar, Silicon

Tack

ABS Tack Head/Stainless-Steel Pin

Specifications

Color Charcoal Gray

Length 61mm (2.4in)

Width 30.5mm (1.20in)

Depth 24.6mm (0.97in)

Weight 8.8g (0.31oz)

Pullout Force 36.29kg (80lbs)

EPC Memory 96 bits up to 128 bits

Operating Frequencies 860-928MHz

Order multiple Tag: 1,000
Tack: 1,000

Carton Weight Tag: 8.48kg (18.72lbs)
Tack: 1.17kg (2.57lbs)

Ext. Carton Dims
Tag: 476 x 292 x 219mm
(18.75 x 11.5 x 8.6in)
Tack: 140 x 75 x 75mm
(5.5 x 3 x 3in)

Ext. Carton Vol
Tag: 0.031m³ (1.07ft³)
Tack: 0.0008m³ (0.028ft³)

Cartons Per Pallet Tag: Atlanta DC: 32
Echt DC: 48

CE This product is in conformity with RoHS II Directive 2011/65/EU and REACH Substances of Very High Concern as defined in Regulation (EC) No 1907/2006 and subsequent amendments to both.

* Visit sensormatic.com to download usage guidelines



Magnetic AM/RFID Tag

The Magnetic AM/RFID hard tag features a highly sensitive Radio Frequency Identification (RFID) inlay for item-level visibility and inventory management, and an AM EAS element for asset protection. The RFID component stores information specific to the protected merchandise for item-level and near real-time merchandise visibility. Source Tagging is available so retailers can receive floor-ready merchandise with consistent tag placement — expediting receiving and selling floor fulfillment.

Retailer Values

- // Enables near real-time merchandise visibility and improves inventory accuracy
- // RFID element offers an efficient way to track inventory, while the AM EAS element protects products from theft
- // Tagging at the point of manufacturing (Source Tagging) helps improve tag compliance
- // Source Tagged merchandise arrives floor-ready, enabling faster speed to sales floor

Solution Application

Apparel, General Merchandise

Product Codes

- 9kG New Tag: IDTM2220 (Medium Gray)
- 9kG Re-Circulated Tag: IDTM2220R (Medium Gray)
- 9kG In-Store Use Tag: IDTM2220N (Light Gray)
- 5kG New Tag: IDTM2225 (Charcoal)
- 5kG Re-Circulated Tag: IDTM2225R (Charcoal)
- 5kG In-Store Use Tag: IDTM2225N (Light Gray)

Tacks:

- MJ200-MG** (use with IDTM2220, IDTM2220R)
- MJ200-G** (use with IDTM2220N, IDTM2225N)
- MJ200-B** (use with IDTM2225, IDTM2225R)

Product Compatibility

Detachers

- Sensormatic Magnetic 9kG Detachers
- Sensormatic Magnetic 5kG Detachers

Readers

Sensormatic Multipurpose RFID Readers

Detacher Type

Magnetic

Environmental Constraints

Temperature

Maximum storage temperature not to exceed 60°C (140°F) for 96 hours at 80% RH.

Humidity

Unaffected by 80% humidity at 60°C (140°F), up to 96 hours.

Materials of Construction

- Tag Housing** High-Impact ABS
- Label Housing**.....
- Low Density Polyethylene/Polyester/
Polyethylene 0.127mm (0.0050in)
- RFID Inlay** Aluminum, Mylar, Silicon
- Tack**ABS Tack Head with Stainless-Steel Pin

Specifications

Color

- 9kG Medium Gray, Light Gray
- 5kGCharcoal, Light Gray

Length..... 61.0mm (2.4in)

Width 30.5mm (1.20in)

Depth 19.9mm (0.78in)

Weight (With Tack):8.8g (0.019lbs)

Pullout Force56.8kg (125lbs)

* Visit sensormatic.com to download usage guidelines

EPC Memory96 bits
Up to 128 bits

Operating Frequencies 860-960MHz

Lock Magnetic Strength.....9kG, 5kG

Carton Weight

IDTM2220, IDTM2220R, IDTM2225,
IDTM2225R.....9.65kg (21.23lbs)

IDTM2220N,
IDTM2225N.....10.00kg (22lbs)

Tack: 5.82kg (12.80lbs) (5000/box)

Ext. Carton Dims.

Tag: 370 x 370 x 280mm
(14.57 x 14.57 x 3.15in)

Tack: 370 x 370 x 195mm
(14.57 x 14.57 x 7.68in)

Cartons per Pallet

Tag: Atlanta DC: 32
Tag: Echt DC: 48

CE This product is in conformity with RoHS II Directive 2011/65/EU and REACH Substances of Very High Concern as defined in Regulation (EC) No 1907/2006 and subsequent amendments to both.



IDTM2225 5kG - New Tag
Charcoal



IDTM2220 9kG - New Tag
Medium Gray



IDTM2220N 9kG - In-Store Use Tag
Light Gray
IDTM2225N 5kG - In-Store Use Tag
Light Gray

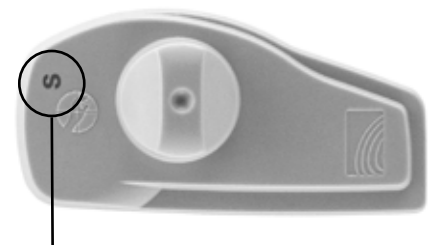

NOTE: IDTM2220 9kG - In-Store Use Tag marked with **S** on top of tag.



Magnetic AM/RFID 2D Barcode Tag

This Magnetic AM/RFID 2D hard tag combines trusted EAS protection with the item-level visibility and inventory management only RFID can provide. The tag's RFID component stores item-specific information directly on the tag – delivering near real-time item-level visibility while the AM EAS component delivers asset protection.

This durable tag features a laser-etched 2D barcode that allows retailers to program item-specific information directly onto the tag using a compatible mobile reader. The barcode is especially helpful when a swing ticket is missing from tagged merchandise, allowing store associates to quickly scan and retrieve point-of-sale (POS) data necessary to complete the checkout process.

With this tag retailers can continue using non-RFID barcode readers at POS to process transactions. This hard tag is intended for in-store application.

Retailer Values

- // RFID component offers an efficient way to track inventory, while AM EAS component protects products from theft
- // Item-specific information can be programmed directly on tag with compatible mobile reader, without investing in additional RFID hardware and infrastructure
- // RFID element enables near real-time merchandise visibility and improves inventory accuracy
- // Supports global frequencies and provides reliable RFID performance

Solution Application

Apparel, General Merchandise

Product Codes

9kG - IDTM2220N2D (Numeric)

5kG - IDTM2225N2D (Numeric)

Tack:

MJ200-G

Product Compatibility

Detachers

Magnetic 9kG Detacher

Magnetic 5kG and 9kG Detachers

Magnetic 5kG Detacher

Readers

Multipurpose RFID Reader

Compatible to industry EPC Gen2 Reader

Detacher Type

Magnetic

Environmental Constraints

Temperature

Maximum storage temperature not to exceed 60°C (140°F) for 96 hours at 80% RH

Humidity

Unaffected by 80% humidity at 60°C (140°F), up to 96 hours

Materials of Construction

Tag Housing

High-Impact ABS

Label Housing

Low Density Polyethylene/Polyester/
Polyethylene 0.127mm (0.0050in)

RFID Inlay

Aluminum, Mylar, Silicon

Tack

ABS Tack Head/Stainless-Steel Pin

Specifications

Color Light Gray
Length 61.0mm (2.4in)
Width 30.5mm (1.20in)
Depth 19.9mm (0.78in)
Weight with Tack: 8.8g (0.019lbs)
EPC Memory 96 bits
 Up to 128 bits

Operating

RFID Frequencies 860-928MHz
Pullout Force 56.8kg (125lbs)
Lock Magnetic Strength 5kG, 9kG
Order Multiple Tag: 1,000
 Tack: 5,000

Carton Weight

Tags 10kg (22lbs)
Tack 5.82kg (12.80lbs)
 (5,000/box)

Ext. Carton Dims.

Tag 370 x 370 x 280mm
 (14.57 x 14.57 x 3.15in)
Tack 370 x 370 x 195mm
 (14.57 x 14.57 x 7.68in)

Cartons Per Pallet

Tag Atlanta DC: 32
Tag Echt DC: 48

CE The radio frequency (RF) label is in conformity with RoHS II Directive 2011/65/EU and REACH Substances of Very High Concern as defined in Regulation (EC) No 1907/2006 and subsequent amendments to both.

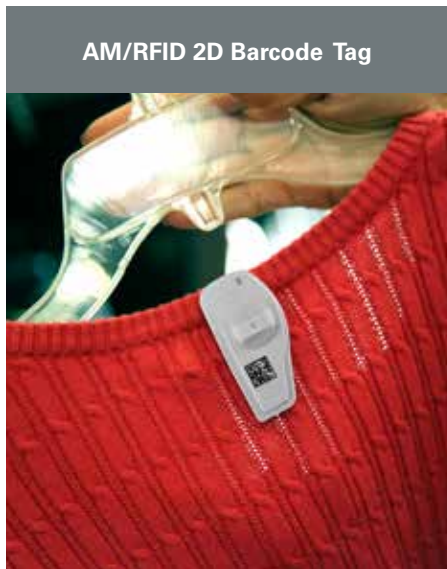

IDTM2225 - 5kG



NOTE: IDTM2220 - 9kG - In-Store Use Tag marked with **S** on top of tag.

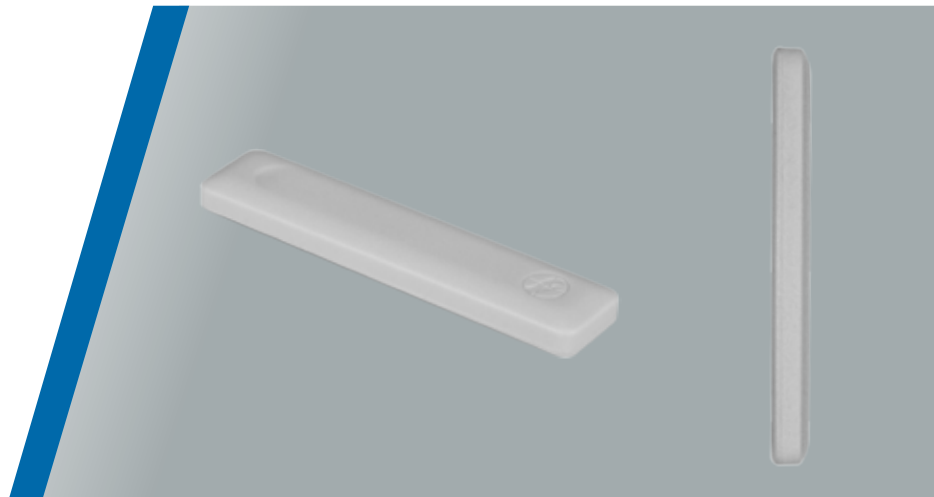

Non-Adhesive Hard Tag

The non-deactivatable, reusable Non-Adhesive Hard Tag delivers high-performance AM EAS technology in a small hard tag design. Ideal for drop in applications, such as handbags or wallets, this lightweight, compact tag provides a strong visual deterrent with low impact to merchandise display.

Retailer Values

- // Non-adhesive for drop in applications such as handbags or wallets
- // Non-deactivatable and reusable to help preserve the bottom line
- // Lightweight design and small footprint provide the right visual deterrent for small or delicate merchandise
- // Rigid ABS housing helps minimize tampering by would-be shoplifters

Solution Application

Apparel, General Merchandise, Specialty Apparel, Sporting Goods, DIY, Jewelry

Product Codes

ZLAMT5000-G

Product Compatibility

Sensormatic AM EAS detection systems

Environmental Constraints

Temperature

Maximum storage temperature not to exceed 60°C (140°F) for 96 hours at 80% RH.

Humidity

Unaffected by 80% humidity at 60°C (140°F), up to 96 hours.

Specifications

| | |
|---------------------|---------------|
| Color | Gray |
| Length | 42mm (1.65in) |
| Width | 9mm (0.35in) |
| Height | 4mm (0.16in) |
| Weight | 1.4g (0.04oz) |

CE This product is in conformity with RoHS II Directive 2011/65/EU and REACH Substances of Very High Concern as defined in Regulation (EC) No 1907/2006 and subsequent amendments to both.

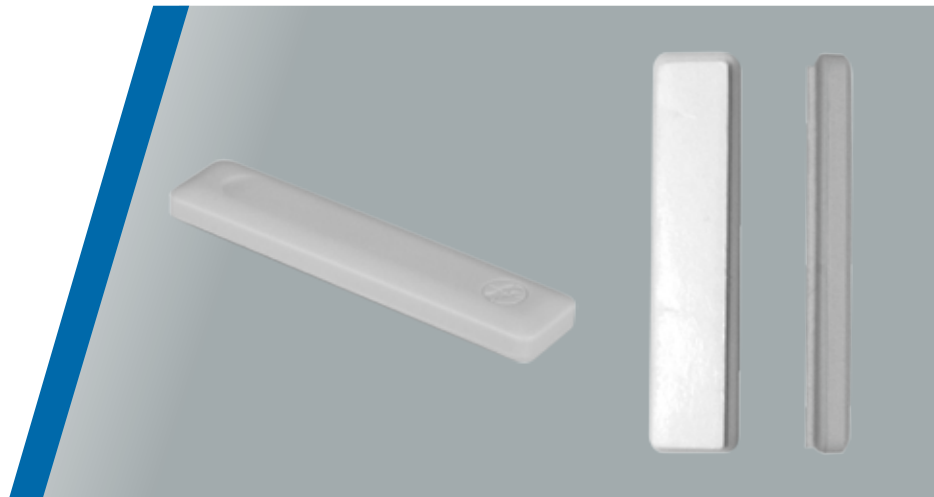

Adhesive Hard Tag

The non-deactivatable, reusable Adhesive Hard Tag delivers high-performance AM EAS technology in a small hard-tag design. The high-bond adhesive quickly attaches to any flat surface, making this tag ideal for protecting display items and assets that should not be removed from the store. The lightweight, compact tag provides a strong visual deterrent with low impact to merchandise on display.

Retailer Values

- // Non-deactivatable tag is ideal for protecting display items and store assets that should not be removed from the store
- // High-bond adhesive attaches quickly to any flat surface
- // Rigid ABS housing helps minimize tampering by would-be shoplifters

Solution Application

Display Items, General Merchandise

Product Codes

ZLAMT5000A-G

Product Compatibility

Sensormatic AM EAS detection systems

Environmental Constraints

Temperature

Maximum storage temperature not to exceed 60°C (140°F) for 96 hours at 80% RH.

Humidity

Unaffected by 80% humidity at 60°C (140°F), up to 96 hours.

Specifications

Color Gray

Length 42mm (1.65in)

Width 9mm (0.35in)

Height 5mm (0.20in)

Weight 1.5g (0.05oz)

CE This product is in conformity with RoHS II Directive 2011/65/EU and REACH Substances of Very High Concern as defined in Regulation (EC) No 1907/2006 and subsequent amendments to both.



Eyelet Hard Tag

The non-deactivatable, reusable Eyelet Hard Tag delivers high-performance AM EAS technology in a small hard-tag design. It easily attaches to small, delicate merchandise, such as jewelry and accessories, with a cable tie or lanyard. Lightweight and compact, this tag provides a strong visual deterrent with low impact to merchandise on display.

Retailer Values

- // Easily attaches to merchandise with a cable tie or lanyard
- // Lightweight design and small footprint provide the right visual deterrent for small or delicate merchandise
- // Rigid ABS housing helps minimize tampering by would-be shoplifters

Solution Application

Apparel, General Merchandise, Specialty Apparel, Sporting Goods, DIY, Jewelry

Product Codes

ZLAMT5000T-G

Product Compatibility

Sensormatic AM EAS detection systems

Environmental Constraints

Temperature

Maximum storage temperature not to exceed 66°C (150°F) for 96 hours at 80% RH.

Humidity

Unaffected by 80% humidity at 66°C (150°F), up to 96 hours.

Specifications

| | |
|---------------------|--------------------------------|
| Color | Gray |
| Length | 52mm (2.0in) |
| Width | 10mm (0.39in) |
| Height | 4mm (0.16in) |
| Weight | 1.7g (0.06oz) |
| Hole 1 | 2 x 2.5mm (0.08 x 0.10in) |
| Hole 2 | 2.7 x 4.2mm (0.11 x 0.17in) |

CE This product is in conformity with RoHS II Directive 2011/65/EU and REACH Substances of Very High Concern as defined in Regulation (EC) No 1907/2006 and subsequent amendments to both.



APX Sheet Label

The premier choice in label performance and merchandise protection.

The Advanced Performance Xtreme (APX) Sheet Label delivers top-of-the-line performance and superior merchandise protection using proven Sensormatic technology. The APX Label provides exceptional range, sensitivity, tamper-resistance, detection and consistent deactivation at the point-of-sale (POS) with virtually no nuisance alarms. This robust and stable AM EAS label operates efficiently after exposure to environmental stresses, including shipping and handling. Available for in-store hand application, this label can also be applied to merchandise at the point of manufacturing so retailers can receive floor-ready merchandise with consistent label placement-expediting receiving and selling floor fulfillment.

Retailer Values

- // Utilizes proven Sensormatic AM technology and manufacturing process to provide reliable detection performance
- // Quality materials and precision manufacturing help deliver consistent deactivation at the POS
- // Small label footprint minimizes impact on brand promotion and important product information

- // Robust construction provides optimal merchandise protection
- // Works well on liquids, foils and in metal shopping carts
- // Reactivatable for unlimited reuse

Product Codes

- ZLAPXS1: White
- ZLAPXS2: Mock Barcode
- ZLAPXS5: Black

Technology

AM

Product Compatibility

Sensormatic AM detection and deactivation devices.

Environmental Constraints

Temperature

Maximum storage temperature not to exceed 50°C (122°F) for 96 hours at 80% RH.

Humidity

Unaffected by 80% humidity at 50°C (122°F), up to 96 hours.

Shelf Life

Two years from date of manufacture when labels are stored between 15°C-32°C (60°F-90°F), 30-80% RH.

Mode of Application

Hand

Materials of Construction

Plastic Substrate

Polystyrene/Polyethylene 0.254mm (0.010in) thickness

Magnetic Acoustic Resonator

Proprietary resonant magnetic material Amorphous alloy based on iron, containing nickel, cobalt, boron and silicon

Laminate

Low Density Polyethylene/Polyester 0.101mm (0.004in)

Bias

Proprietary semi-hard magnetic material containing iron and nickel

Adhesive

Double-coated, rubber-based adhesive:

- // 2.4 mil thick each side
- // Minimum peel strength of 2.27kg/5lbs/in.

Release Liner

Double-sided, silicon-coated 80lb. bleached Kraft liner 0.114mm (0.0045in) thick.

Dimensions

Color White, Mock Barcode, Black

Length.....45.21mm ± 0.5mm
(1.78in ± 0.020in)

Width 10.67mm ± 0.5mm
(0.420in ± 0.020in)

Label Thickness

(excluding liner)..... Maximum
1.89mm (0.074in)

(including liner)..... Maximum
2.00mm (0.079in)

Labels Per Sheet 108

Note: Warranty terms and conditions are as specified in the applicable Sales Agreement.

CE The acousto-magnetic (AM) label is in conformity with RoHS II Directive 2011/65/EU and REACH Substances of Very High Concern as defined in Regulation (EC) No 1907/2006 and subsequent amendments to both.

See Sensormatic.com for Usage Instructions



| SHEET SPECS | |
|-----------------------------|--------------------------------------|
| | Sheet |
| PRODUCT CODE | ZLAPXS1,ZLAPXS2 ZLAPXS5 |
| Case Weight | 2.486kg (5.48lbs) |
| External Carton Dimensions | 27.9 x 20 x 11cm (11 x 8 x 4.5in) |
| External Cubic Ft. Per Case | 0.23 |
| Cases Per Pallet | 160 |
| Order Multiple | 5,000-unit case |



Ultra•Strip III Roll Label

The Ultra•Strip III Roll Label provides premier performance and merchandise protection. Available in two sizes; the small rolls are designed for hand and tabletop application and the large rolls are designed for automatic application.

Retailer Values

- // Fast application in-store or at the source
- // Utilizes proven Sensormatic AM technology and manufacturing process to provide the highest in detection performance
- // Small label footprint minimizes impact on brand promotion and important product information
- // Reactivable for unlimited reuse
- // Works well on liquids, foils and in metal shopping carts
- // Robust construction provides optimal merchandise protection

Product Codes

- ZLDR1K71: Small, White
- ZLDR1K75: Small, Black
- ZLDR7K51: Large, White
- ZLDR7K55: Large, Black

Technology

AM

Environmental Constraints

Temperature

Maximum storage temperature not to exceed 50°C (122°F) for 96 hours at 80% RH.

Humidity

Unaffected by 80% humidity at 50°C (122°F), up to 96 hours.

Shelf Life

ZLDR1K71, ZLDR1K75: 2 years from date of manufacture when labels are stored between 15°C-32°C (60°F-90°F), 30-80% RH.

ZLDR7K51, ZLDR7K55: 1 year from date of manufacture when labels are stored between 15°C-32°C (60°F-90°F), 30-80% RH.

Product Compatibility

Sensormatic AM detection and deactivation devices.

Mode of Application

- ZLDR1K71 and ZLDR1K75: Hand or Tabletop
- ZLDR7K51 and ZLDR7K55: Automatic

Materials of Construction

Plastic Substrate

Polystyrene/polyethylene 0.3mm (0.012in) thickness

Magnetic Acoustic Resonator

Proprietary resonant magnetic material. Amorphous alloy based on iron, containing nickel, cobalt, boron and silicon

Laminate

Low Density Polyethylene/Polyester 0.119mm (0.0047in)

Bias

Proprietary semi-hard magnetic material containing iron, nickel and chromium

Adhesive

Double-coated, rubber-based adhesive:

- // 2.4 mil thick each side
- // Minimum peel strength of 2.27kg/5lbs

Release Liner

Double-sided, silicon-coated 2 mil polyester

Dimensions

- Color**White, Black
- Length**.....44.6mm ± 0.15mm
(1.76in ± 0.006in)
- Width** 10.16mm ± 0.15mm
(0.40in ± 0.006in)
- Label Thickness**
(excluding liner)..... Maximum
1.73mm (0.068in)
(including liner)..... Maximum
1.78mm (0.070in)
- Liner Width**48.64mm ± 0.75mm
(1.915in ± 0.030in)
- Label Repeat**14.73mm ± 0.75mm
(0.580in ± 0.030in)
- Label to Liner Spacing**2.02mm ±
0.75mm Large; ± 2.0mm
Small (0.080in ± 0.030in)

Note: Warranty terms and conditions are as specified in the applicable Sales Agreement.

CE The acousto-magnetic (AM) label is in conformity with RoHS II Directive 2011/65/EU and REACH Substances of Very High Concern as defined in Regulation (EC) No 1907/2006 and subsequent amendments to both.

See Sensormatic.com for Usage Instructions

| ROLL SPECIFICATIONS | | | | | |
|---------------------|---------------------------------|---------------------------------|-----------------------------|---|--|
| | Small Roll | Large Roll | | Small Roll | Large Roll |
| PRODUCT CODE | ZLDR1K71, ZLDR1K75 1700-unit | ZLDR7K51, ZLDR7K55 7500-unit | PRODUCT CODE | ZLDR1K71, ZLDR1K75 1700-unit | ZLDR7K51, ZLDR7K55 7500-unit |
| Diameter Of Core | 76.2mm (3in) core | 152.4mm (6in) core* | External Carton Dimensions | 27.6 x 24.5 x 30.5cm (10.88 x 9.63 x 12in) | 51.8 x 51.8 x 25.4cm (20.38 x 20.38 x 10in) |
| Max Roll Diameter | 232mm (9.14in) | 508mm (20in) | External Cubic Ft. Per Case | 0.73 | 2.4 |
| Number Splices | 4 splices, 1 leader splice | 6 splices, 1 leader splice | Rolls Per Case | 5 | 4 |
| Roll Weight | 0.90kg (1.99lbs) | 4.09kg (9.02lbs) | Cases Per Pallet | 64 | 16 |
| Case Weight | 4.767kg (10.50lbs) | 16.15kg (35.60lbs) | Order Multiple | 1700-unit roll | 7500-unit roll |

*Includes 3in core adapter



Ultra•Strip III Low Profile Roll Label

The Ultra•Strip III Low Profile Label provides premier performance and protection for CDs, DVDs and other slim merchandise. Designed for automatic application.

Retailer Values

- // Protects CDs, DVDs and other applications with height restrictions
- // Utilizes proven Sensormatic AM technology and manufacturing process to provide the highest in detection performance
- // Small label footprint minimizes impact on brand promotion and important product information
- // Reactivatable for unlimited reuse
- // Works well on liquids, foils and in metal shopping carts
- // Robust construction provides optimal merchandise protection

Product Codes

ZLDR9K1

Technology

AM

Environmental Constraints

Temperature

Maximum storage temperature not to exceed 50°C (122°F) for 96 hours at 80% RH.

Humidity

Unaffected by 80% humidity at 50°C (122°F), up to 96 hours.

Shelf Life

One year from date of manufacture when labels are stored between 15°C-32°C (60°F-90°F), 30-80%.

Product Compatibility

Sensormatic AM detection and deactivation devices.

Mode of Application

Automatic

Materials of Construction

Plastic Substrate

Polystyrene/Polyethylene 0.3mm (0.012in) thickness

Magnetic Acoustic Resonator

Resonant magnetic material. Amorphous alloy based on iron, containing nickel, cobalt, boron, and silicon

Laminate

Low Density Polyethylene/Polyester
0.119mm (0.0047in)

Bias

Proprietary semi-hard magnetic material containing iron, nickel and chromium

Adhesive

Double-coated, rubber-based adhesive:

// 2.4 mil thick each side

// Minimum peel strength of 2.27kg/5lbs

Release Liner

Double-sided, silicon-coated liner:
2 mil polyester

Dimensions

Color White

Length.....44.6mm ± 0.15mm
(1.76in ± 0.006in)

Width 10.16mm ± 0.15mm
(0.4in ± 0.006in)

Label Thickness

(excluding liner)..... 1.20mm ± 0.13mm
(0.047in ± 0.005in)

Liner Width48.64mm ± 0.75mm
(1.915in ± 0.030in)

Label Repeat14.73mm ± 0.75mm
(0.58in ± 0.03in)

Label to Liner Spacing2.02mm ±
0.75mm

Note: Warranty terms and conditions are as specified in the applicable Sales Agreement.

CE The acousto-magnetic (AM) label is in conformity with RoHS II Directive 2011/65/EU and REACH Substances of Very High Concern as defined in Regulation (EC) No 1907/2006 and subsequent amendments to both.

See Sensormatic.com for Usage Instructions

Additional Consideration:
Must be applied to a rigid substrate

ROLL SPECIFICATIONS

| | Roll | | Roll |
|-------------------|-------------------------------|-----------------------------|-----------------|
| PRODUCT CODE | ZLDR9K1 | PRODUCT CODE | ZLDR9K1 |
| Diameter Of Core | 152.4mm (6in) core* | External Carton Dimensions | N/A |
| Max Roll Diameter | 508mm (20in) | External Cubic Ft. Per Case | 2.4 |
| Number Splices | 6 splices, 1 leader splice | Rolls Per Case | 4 |
| Roll Weight | 4.09kg (9.02lbs) | Cases Per Pallet | 16 |
| Case Weight | 18.87kg (41.60lbs) | Order Multiple | 9,000-unit roll |

*Includes 3in core adapter



Ultra•Strip III Microwavable Roll Label

The Ultra•Strip III Microwavable Label provides premier protection for meat products. This label is designed to be source tagged in meat soaker pads for inconspicuous protection.

Retailer Values

- // Designed for meat products that will be microwaved
- // Utilizes proven Sensormatic AM technology and manufacturing process to provide the highest in detection performance
- // Works well on liquids, foils and in metal shopping carts
- // Robust construction provides optimal merchandise protection

Product Codes

ZLDRM7K3

Technology

AM

Environmental Constraints

Temperature

Maximum storage temperature not to exceed 50°C (122°F) for 96 hours at 80% RH.

Humidity

Unaffected by 80% humidity at 50°C (122°F), up to 96 hours.

Shelf Life

One year from date of manufacture when labels are stored between 15°C-32°C (60°F-90°F), 30-80% RH.

Product Compatibility

Sensormatic AM detection and deactivation devices.

Mode of Application

Automatic

Materials of Construction

Plastic Substrate

Polystyrene 0.3mm (0.012in) 178.2010 and 178.3860

Magnetic Acoustic Resonator

Resonant magnetic material. Amorphous alloy based on iron, containing nickel, cobalt, boron and silicon

Laminate

Low Density Polyethylene/Polyester
0.119mm (0.0047in)

Bias

Proprietary semi-hard magnetic material containing iron, nickel and chromium

Adhesive

Double-coated, rubber-based adhesive:

- // 2.4 mil thick per side
- // Minimum peel strength of 2.27kg/5lbs

Aluminum

99.45% pure aluminum 0.038mm (0.0015in thick), 12.7mm (0.5in wide)

Release Liner

Double-sided, silicon-coated liner:
2 mil polyester

Dimensions

Color White

Length.....44.60mm ± 0.15mm
(1.76in ± 0.006in)

Width 10.16mm ± 0.15mm
(0.400in ± 0.006in)

Label Thickness

(excluding liner)..... Maximum
1.83mm (0.072in)

Liner Width Maximum
4mm (0.157in)

Label Repeat Maximum
4mm (0.157in)

Label to Liner

Spacing2.02mm ± 0.762mm
(0.08in ± 0.03in)

Note: Warranty terms and conditions are as specified in the applicable Sales Agreement.

CE The acousto-magnetic (AM) label is in conformity with RoHS II Directive 2011/65/EU and REACH Substances of Very High Concern as defined in Regulation (EC) No 1907/2006 and subsequent amendments to both.

See Sensormatic.com for Usage Instructions

Additional Consideration:
The label must be applied to packaging containing meat weighing at least 227 grams (0.5lbs) or greater to be microwavable

ROLL SPECIFICATIONS

| | Roll | | Roll |
|-------------------|----------------------------|-----------------------------|---|
| PRODUCT CODE | ZLDRM7K3 | PRODUCT CODE | ZLDRM7K3 |
| Diameter Of Core | 152.4mm (6in)* | External Carton Dimensions | 51.8 x 51.8 x 25.4cm (20.38 x 20.38 x 10in) |
| Max Roll Diameter | 7000 unit roll | External Cubic Ft. Per Case | 2.4 |
| Number Splices | 6 splices, 1 leader splice | Rolls Per Case | 4 |
| Roll Weight | 4.09kg (9.02lbs) | Cases Per Pallet | 16 |
| Case Weight | 17.77kg (39.18lbs) | Order Multiple | 7,000-unit roll |

*Including 3in core adapter

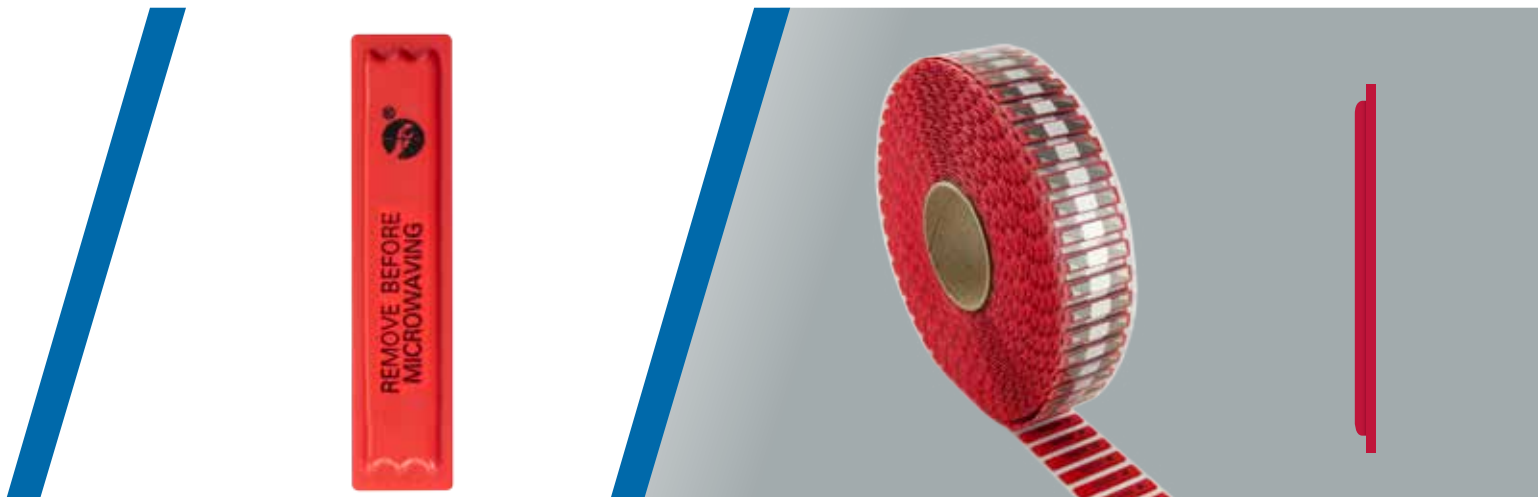

Ultra•Strip III Microwavable Roll Label

The Ultra•Strip III Microwavable Label provides premier protection for meat products. This label features a precautionary warning text and is designed for external hand application to meat packaging.

Retailer Values

- // Designed for meat products that could be microwaved
- // Utilizes proven Sensormatic AM technology and manufacturing process to provide the highest in detection performance
- // Works well on liquids, foils and in metal shopping carts
- // Robust construction provides optimal merchandise protection

Product Codes

ZLDRM1K43

Technology

AM

Environmental Constraints

Temperature

Maximum storage temperature not to exceed 50°C (122°F) for 96 hours at 80% RH.

Humidity

Unaffected by 80% humidity at 50°C (122°F), up to 96 hours.

Shelf Life

Two years from date of manufacture when labels are stored between 15°C-32°C (60°F-90°F), 30-80% RH.

Product Compatibility

Sensormatic AM detection and deactivation devices.

Mode of Application

Hand

Materials of Construction

Plastic Substrate

Polystyrene 0.3mm (0.012in) 178.2010 and 178.3860

Magnetic Acoustic Resonator

Resonant magnetic material. Amorphous alloy based on iron, containing nickel, cobalt, boron and silicon

Laminate

Low Density Polyethylene/Polyester
0.119mm (0.0047in)

Bias

Proprietary semi-hard magnetic material containing iron, nickel and chromium

Adhesive

Double-coated, rubber-based adhesive:

- // 2.4 mil thick per side
- // Minimum peel strength of 2.27kg/5lbs

Aluminum

99.45% pure aluminum 0.038mm (0.0015in thick), 12.7mm (0.5in wide)

Release Liner

Double-sided, silicon-coated liner:
2 mil polyester

Dimensions

| | |
|--|---|
| Color | Red |
| Length | 44.60mm ± 0.15mm (1.76in ± 0.006in) |
| Width | 10.16mm ± 0.15mm (0.400in ± 0.006in) |
| Label Thickness (excluding liner)..... | Maximum 1.83mm (0.072in) |
| Liner Width | Maximum 4mm (0.157in) |
| Label Repeat | Maximum 4mm (0.157in) |
| Label to Liner Spacing | 2.0mm ± 0.762mm (0.080in ± 0.030in) |

Note: Warranty terms and conditions are as specified in the applicable Sales Agreement.

CE The acousto-magnetic (AM) label is in conformity with RoHS II Directive 2011/65/EU and REACH Substances of Very High Concern as defined in Regulation (EC) No 1907/2006 and subsequent amendments to both.

See Sensormatic.com for Usage Instructions

Additional Consideration:

The label must be applied to packaging containing meat weighing at least 227 grams (0.5lbs) or greater to be microwavable

ROLL SPECIFICATIONS

| | Roll | | Roll |
|-------------------|----------------------------|-----------------------------|--|
| PRODUCT CODE | ZLDRM1K43 | PRODUCT CODE | ZLDRM1K43 |
| Diameter Of Core | 76.2mm (3in) | External Carton Dimensions | 27.4 x 24.5 x 30.5cm (10.88 x 9.63 x 12in) |
| Max Roll Diameter | 232mm (9.14in) | External Cubic Ft. Per Case | 0.73 |
| Number Splices | 4 splices, 1 leader splice | Rolls Per Case | 5 |
| Roll Weight | 0.73kg (1.61lbs) | Cases Per Pallet | 68 |
| Case Weight | 17.77kg (39.18lbs) | Order Multiple | 1,400-unit roll |



Ultra•Strip III Hang Tag (Bag)

The Ultra•Strip III Hang Tag provides premier protection for accessory items such as costume jewelry, watches and sunglasses. The tag attaches to merchandise via a plastic or string lanyard supplied by the retailer or manufacturer. It can be used once or multiple times. The tag format is intended for source tagging accessory items.

Retailer Values

- // Designed to protect high-theft accessories
- // Utilizes proven Sensormatic AM technology and manufacturing process to provide the highest in detection performance
- // Small label footprint minimizes impact on brand promotion and important product information
- // Reactivable for unlimited reuse
- // Works well on liquids, foils and in metal shopping carts
- // Robust construction provides optimal merchandise protection

Product Codes

ZLDRHT1

Technology

AM

Environmental Constraints

Temperature

Maximum storage temperature not to exceed 50°C (122°F) for 96 hours at 80% RH.

Humidity

Unaffected by 80% humidity at 50°C (122°F), up to 96 hours.

Shelf Life

Two years from date of manufacture when labels are stored between 15°C-32°C (60°F-90°F), 30-80% RH.

Product Compatibility

Sensormatic AM detection and deactivation devices.

Mode of Application

Hand

Materials of Construction

Plastic Substrate

Polystyrene/Polyethylene 0.3mm (0.012in) thick magnetic.

Magnetic Acoustic Resonator

Resonant magnetic material. Amorphous alloy based on iron, containing nickel, cobalt, boron and silicon

Laminate

Low Density Polyethylene/Polyester/ Polyethylene 0.127mm (0.0050in)

Bias

Proprietary semi-hard magnetic material containing iron, nickel and chromium

Adhesive

Adhesive=Acrylic. Facestock=80 pound densified bleached Kraft, silicone coated one side

Dimensions

Color White

Length.....58mm ± 0.5mm
(2.28in ± 0.020in)

Width 10mm ± 0.5mm
(0.394in ± 0.020in)

Label Thickness

(including liner)..... Maximum
2.0mm (0.078in)

Labels Per Bag 100

Note: Warranty terms and conditions are as specified in the applicable Sales Agreement.

CE The acousto-magnetic (AM) label is in conformity with RoHS II Directive 2011/65/EU and REACH Substances of Very High Concern as defined in Regulation (EC) No 1907/2006 and subsequent amendments to both.

See Sensormatic.com for Usage Instructions

| BAG SPECS | |
|-----------------------------|--|
| | Label Tag |
| PRODUCT CODE | ZLDRHT1 |
| Case Weight | 0.86kg (1.90lbs) |
| External Carton Dimensions | 27.9 x 20 x 11cm (11 x 8 x 4.5in) |
| External Cubic Ft. Per Case | 0.23 |
| Cases Per Pallet | 140 |
| Order Multiple | 1,000-unit case (10 bags of 100 labels each) |

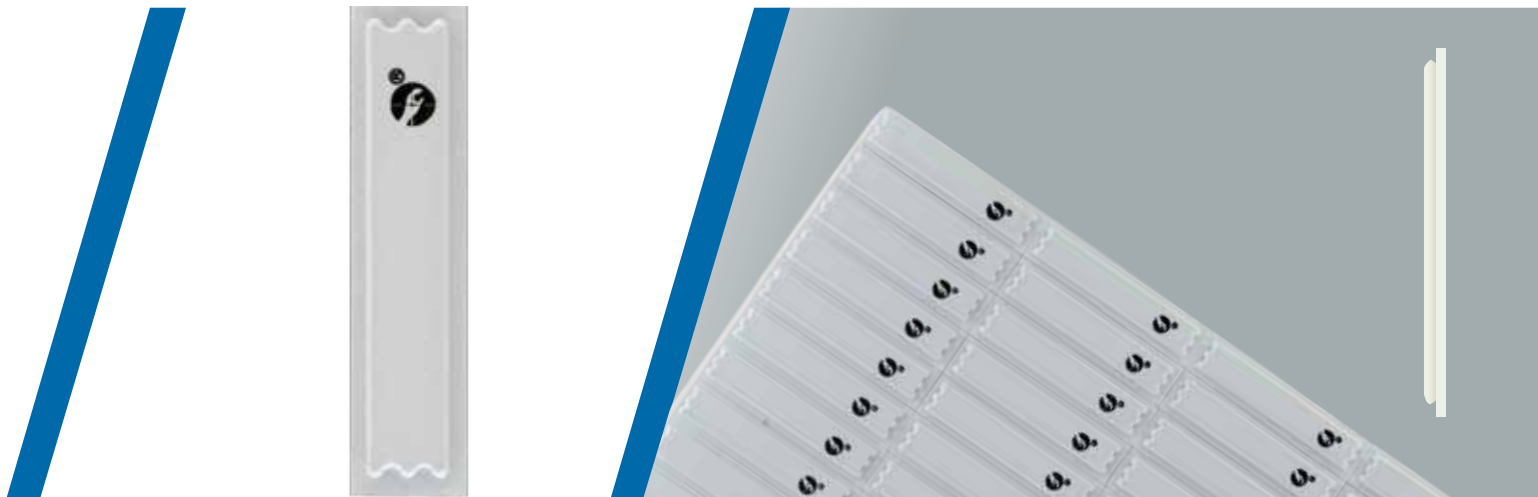

Ultra•Strip III Individual Sheet Label

This permanent source tagged Ultra•Strip III Individual Label is intended for manual application directly to the product or product packaging. This label is not designed to be “dropped” into product or product packaging.

Retailer Values

- // Permanent source tag label is manually applied to product/product packaging
- // Utilizes proven Sensormatic AM technology and manufacturing process to provide the highest in detection performance
- // Reactivable for unlimited reuse
- // Works well on liquids, foils and in metal shopping carts
- // Robust construction provides optimal merchandise protection

Product Codes

ZLDRSING1

Technology

AM

Environmental Constraints

Temperature

Maximum storage temperature not to exceed 50°C (122°F) for 96 hours at 80% RH.

Humidity

Unaffected by 80% humidity at 50°C (122°F), up to 96 hours.

Shelf Life

One year from date of manufacture when labels are stored between 15°C-32°C (60°F-90°F), 30-80% RH.

Product Compatibility

Sensormatic AM detection and deactivation devices.

Mode of Application

Hand

Materials of Construction

Plastic Substrate

Polystyrene/Polyethylene 0.3mm (0.012in) thick

Magnetic Acoustic Resonator

Proprietary resonant magnetic material. Amorphous alloy based on iron, containing nickel, cobalt, boron and silicon.

Laminate

Low Density Polyethylene/Polyester/ Polyethylene 0.127mm (0.0050in)

Bias

Proprietary semi-hard magnetic material containing iron, nickel and chromium

Adhesive

Self-wound tape with removable adhesive

Dimensions

Color White

Length.....45.21mm ± 0.5mm
(1.78in ± 0.020in)

Width 10.67mm ± 0.5mm
(0.420in ± 0.020in)

Label Thickness

(excluding liner)..... Maximum
1.89mm (0.074in)

Labels Per Sheet54

Note: Warranty terms and conditions are as specified in the applicable Sales Agreement.

CE The acousto-magnetic (AM) label is in conformity with RoHS II Directive 2011/65/EU and REACH Substances of Very High Concern as defined in Regulation (EC) No 1907/2006 and subsequent amendments to both.

See Sensormatic.com for Usage Instructions

Additional Consideration:

Cannot be sold into an uncontrolled environment.

Cannot be used in any type of bowl feeding operation due to decreased performance issues:

// **Magnetic:** causes deactivation-
Vibrator: causes frequency shifts

// **Centrifugal/Gravity:** label is too light and will not feed. Due to usage, contact deactivation is not recommended.

| SHEET SPECS | |
|-----------------------------|--------------------------------------|
| | Sheet |
| PRODUCT CODE | ZLDRSING1 |
| Case Weight | 2.52kg (5.55lbs) |
| External Carton Dimensions | 27.9 x 20 x 11cm (11 x 8 x 4.5in) |
| External Cubic Ft. Per Case | 0.23 |
| Cases Per Pallet | 140 |
| Order Multiple | 5,000-unit case |



Ultra•Strip III Insertable Label

The Ultra•Strip III Insertable Label is designed to be inserted into plastic shrink wrapped packaging such as CD cases and perfume boxes. It should not be inserted into products intended for children's use. The bag format is intended for hand application.

Retailer Values

- // Ideal for CDs, perfume products or other plastic shrink wrapped boxes
- // Utilizes proven Sensormatic AM technology and manufacturing process to provide the highest in detection performance
- // Reactivable for unlimited reuse
- // Works well on liquids, foils and in metal shopping carts
- // Robust construction provides optimal merchandise protection

Product Codes

ZLDRCI5K2

Technology

AM

Environmental Constraints

Temperature

Maximum storage temperature for up to 96 hours=65°C (150°F).

Humidity

Unaffected by 80% humidity at 65°C (150°F), up to 96 hours.

Shelf Life

Two years from date of manufacture when labels are stored between 15°C-32°C (60°F-90°F), 50-70% RH.

Product Compatibility

Sensormatic AM detection and deactivation devices.

Mode of Application

Hand

Materials of Construction

Plastic Substrait

Polystyrene–Maximum thickness 0.51 mm (0.02in)

Plastic Substrate

Polystyrene/Polyethylene 0.3mm (0.015in) thickness

Magnetic Acoustic Resonator

Proprietary resonant magnetic material. Amorphous alloy based on iron, and containing nickel, cobalt, boron and silicon

Laminate

Low Density Polyethylene/Polyester/ Polyethylene-0.127mm (0.0050in)

Bias

Proprietary semi-hard magnetic material containing iron, nickel and chromium

Adhesive

Double-coated, rubber-based adhesive:

- // 2.4mil thick per side
- // Minimum peel strength of 2.27kg/5lbs

Dimensions

| | |
|---------------------|---------------------------------------|
| Color | Barcode |
| Length | 50mm ± 1mm (1.968in ± 0.039in) |
| Width | 9.25mm ± 0.5mm (0.364in ± 0.020in) |

Label Thickness

(excluding liner)... 2.1mm (0.082in) typical

Labels Per Bag1,000

Note: Warranty terms and conditions are as specified in the applicable Sales Agreement.

CE The acousto-magnetic (AM) label is in conformity with RoHS II Directive 2011/65/EU and REACH Substances of Very High Concern as defined in Regulation (EC) No 1907/2006 and subsequent amendments to both.

See Sensormatic.com for Usage Instructions

Additional Consideration:

- // Product is for the European market only. Not for use in the USA
- // Placement of labels is to be in accordance with the Product Usage Guidelines located in each box
- // Due to usage, contact deactivation is not recommended

| SHEET SPECS | |
|-----------------------------|--|
| | Sheet |
| PRODUCT CODE | ZLDRCI5K2 |
| Case Weight | 3.56kg (7.85lbs) |
| External Carton Dimensions | 300 x 250 x 200mm (11.81 x 9.84 x 7.84in) |
| External Cubic Ft. Per Case | 0.53 |
| Order multiple | 5,000-unit case (5 bags of 1,000 labels per case) |

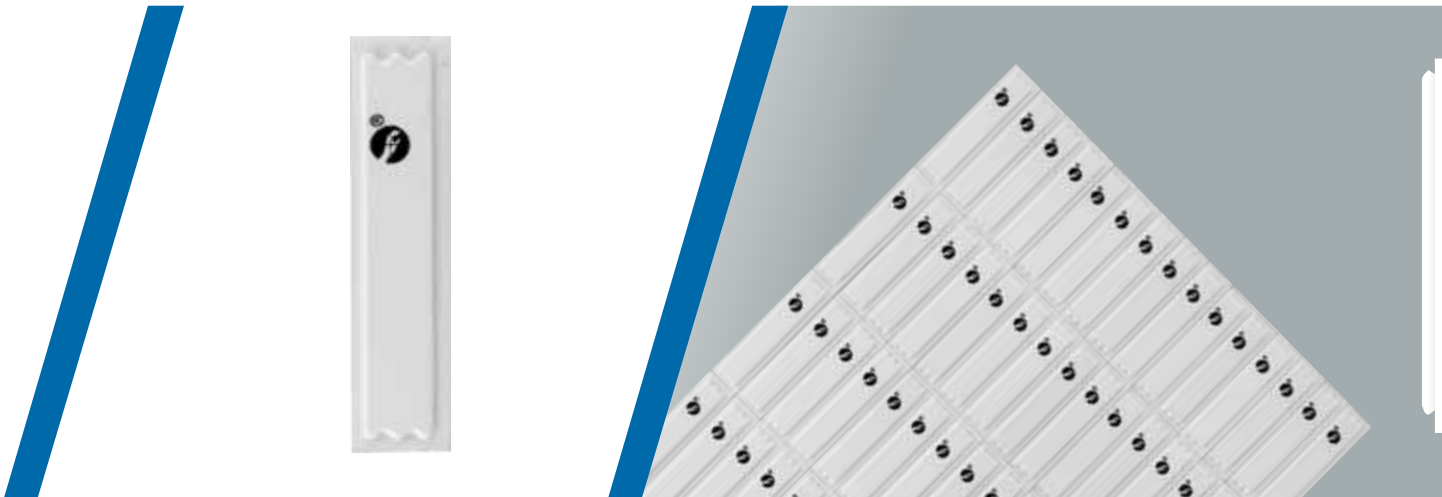

Ultra•Strip III Non-Reactivatable Sheet Label

The Ultra•Strip III Non-Reactivatable Sheet Label provides premier performance and merchandise protection. Applied at the point of manufacturing, this label remains with the product after purchase. The non-reactivatable design prevents inadvertent reactivation after customer purchase.

Retailer Values

- // Utilizes proven Sensormatic AM technology and manufacturing process to provide the highest detection performance
- // Non-reactivatable format helps prevent inadvertent reactivation, reducing nuisance EAS alarms at the store entrance
- // Merchandise arrives sales-floor ready, enabling immediate product availability

Solution Application

Footwear

Product Codes

ZLAML-DRDBS6

Technology

AM

Environmental Constraints

Temperature

Maximum storage temperature not to exceed 50°C (122°F) for 96 hours at 80% RH

Humidity

Unaffected by 80% humidity at 50°C (122°F), up to 96 hours.

Shelf Life

Two years from date of manufacture when labels are stored between 15°C-32°C (60°F-90°F), 30-80% RH.

Product Compatibility

Sensormatic AM detection and deactivation devices

Mode of Application

Hand

Materials of Construction

Plastic Substrate

Polystyrene/Polyethylene 0.3mm (0.012in) thick

Magnetic Acoustic Resonator

Proprietary resonant magnetic material. Amorphous alloy based on iron, containing nickel, cobalt, boron and silicon

Laminate

Low Density Polyethylene/Polyester 0.101mm (0.004in)

Bias

Proprietary semi-hard magnetic material containing iron, nickel and chromium

Adhesive

Double-coated, rubber-based adhesive:

// 2.4 mil thick per side

// Minimum peel strength of 80oz/in

Release Liner

Double-sided, silicon-coated 80lb bleached kraft liner 0.114mm (0.0045in) thick

Dimensions

Color White

Length 45.21mm + 0.5mm
(1.78 + 0.020in)

Width 10.67mm + 0.5mm
(0.420in + 0.020in)

Label Thickness

(excluding liner) Maximum
1.89mm (0.074in)

(including liner) Maximum
2.00mm (0.079in)

Labels Per Sheet 108

Note: Warranty terms and conditions are as specified in the applicable Sales Agreement.

CE The acousto-magnetic (AM) label is in conformity with RoHS II Directive 2011/65/EU and REACH Substances of Very High Concern as defined in Regulation (EC) No 1907/2006 and subsequent amendments to both.

See Sensormatic.com for Usage Instructions

| SHEET SPECS | |
|-----------------------------|--------------------------------------|
| | Sheet |
| PRODUCT CODE | ZLAML-DRDBS6 |
| Case Weight | 3.69kg (8.12lbs) |
| External Carton Dimensions | 27.9 x 20 x 11cm (11 x 8 x 4.5in) |
| External Cubic Ft. Per Case | 0.23 |
| Labels per sheet | 108 |
| Order Multiple | 5,000-unit case |



AP Sheet Label

The Advanced Performance (AP) Sheet Label delivers reliable performance and merchandise protection using proven Sensormatic technology. This AM EAS label features a robust design for consistent deactivation at the point-of-sale (POS) and reliable performance, even when exposed to environmental stressers including shipping and handling. Available for in-stozxzdfrre hand application, this label can also be applied to merchandise at the point of manufacturing so retailers can receive floor-ready merchandise with consistent label placement-expediting receiving and selling floor fulfillment.

Retailer Values

- // Utilizes proven Sensormatic AM technology and manufacturing process to provide reliable detection performance
- // Quality materials and precision manufacturing help deliver consistent deactivation at the POS
- // Small label footprint minimizes impact on brand promotion and important product information
- // Robust construction provides optimal merchandise protection
- // Works well on liquids, foils and in metal shopping carts
- // Reactivable for unlimited reuse

Product Codes

ZLAPS1: White
ZLAPS2: Mock Barcode

Technology

AM

Product Compatibility

Sensormatic AM detection and deactivation devices.

Environmental Constraints

Temperature

Maximum storage temperature not to exceed 50°C (122° F) for 96 hours at 80% RH.

Humidity

Unaffected by 80% humidity at 50°C (122°F), up to 96 hours.

Shelf Life

Two years from date of manufacture when labels are stored between 15°C -32°C (60°F-90°F), 30-80% RH.

Mode of Application

Hand

Materials of Construction

Plastic Substrate

Polystyrene/Polyethylene 0.254mm (0.010in) thick.

Magnetic Acoustic Resonator

Proprietary resonant magnetic material. Amorphous alloy based on iron, containing nickel, cobalt, boron and silicon

Laminate

Low Density Polyethylene/Polyester Polyethylene 0.101mm (0.0040in)

Bias

Proprietary semi-hard magnetic material containing iron and nickel

Adhesive

Double-coated, rubber-based adhesive:

- // 2.4mil thick per side
- // Minimum peel strength of 2.27kg/5lbs

Release Liner

Double-sided, silicon-coated 80 lb. bleached Kraft liner 0.114mm

Dimensions

Color White, Mock Barcode

Length 45.21mm ± 0.5mm
(1.78in ± 0.020in)

Width 10.67mm ± 0.5mm
(0.420in ± 0.020in)

Label Thickness

(excluding liner)..... Maximum
1.89mm (0.074in)

(including liner)..... Maximum
2.00mm (0.079in)

Labels Per Sheet 108

Note: Warranty terms and conditions are as specified in the applicable Sales Agreement.

CE The acousto-magnetic (AM) label is in conformity with RoHS II Directive 2011/65/EU and REACH Substances of Very High Concern as defined in Regulation (EC) No 1907/2006 and subsequent amendments to both.

See Sensormatic.com for Usage Instructions

Additional Consideration:
This label is not recommended for use with the Sensormatic Contact Pad deactivator.

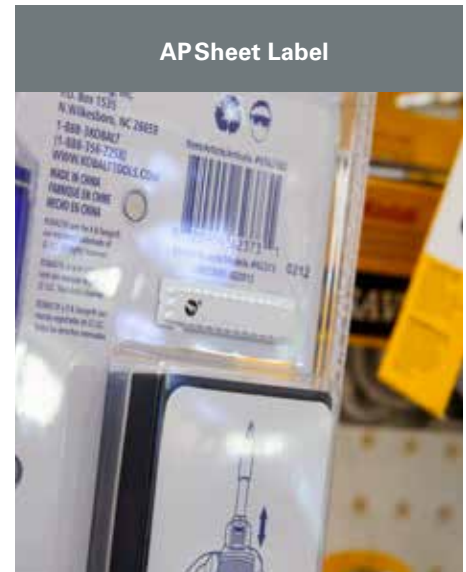

| SHEET SPECS | |
|-----------------------------|--------------------------------------|
| | Sheet |
| PRODUCT CODE | ZLAPS1, ZLAPS2 |
| Case Weight | 2.205kg (4.86lbs) |
| External Carton Dimensions | 27.9 x 20 x 11cm (11 x 8 x 4.5in) |
| External Cubic Ft. Per Case | 0.23 |
| Cases Per Pallet | 160 |
| Order Multiple | 5,000-unit case |

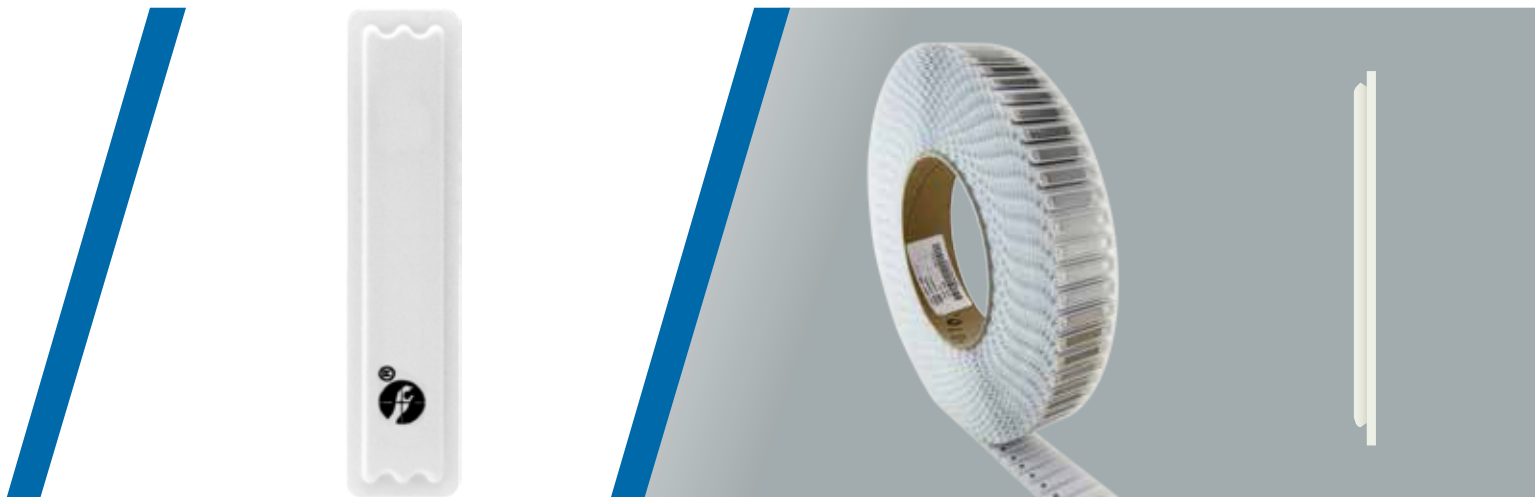

Ultra•Strip II Roll Label

The Ultra•Strip II Label delivers proven Sensormatic technology and high deactivation performance. Available in two sizes, the small format is designed for hand and tabletop application and the large roll is designed for automatic application.

Retailer Values

- // Utilizes proven Sensormatic AM technology and manufacturing process to provide the highest in detection performance
- // Small label footprint minimizes impact on brand promotion and important product information
- // Reactivable for unlimited reuse
- // Works well on liquids, foils and in metal shopping carts
- // Robust construction provides optimal merchandise protection

Product Codes

Small Roll:

ZLNRLE2K1: White
ZLNRLE2K5: Black

Large Roll:

ZLNRLE85K1: White

Technology

AM

Environmental Constraints

Temperature

Maximum storage temperature not to exceed 50°C (122° F) for 96 hours at 80% RH

Humidity

Unaffected by 80% humidity at 50°C (122°F), up to 96 hours

Shelf Life

ZLNRLE2K1, ZLNRLE2K5: two years from date of manufacture when labels are stored between 15°C-32°C (60°F-90°F), 30-80% RH.

ZLNRLE85K1: one year from date of manufacture when labels are stored between 15°C-32°C (60°F-90°F), 30-80% RH.

Product Compatibility

Sensormatic AM detection and deactivation devices.

Mode of Application

ZLNRLE2K1 and ZLNRLE2K5: Hand or Tabletop
ZLNRLE85K1: Automatic

Materials of Construction

Plastic Substrate

Polystyrene/Polyethylene 0.3mm (0.012in) thickness

Magnetic Acoustic Resonator

Proprietary resonant magnetic material. Amorphous alloy based on iron, containing nickel, cobalt, boron and silicon

Laminate

Low Density Polyethylene/Polyester 0.119mm (0.0047in)

Bias

Proprietary semi-hard magnetic material containing iron and nickel

Adhesive

Double-coated, rubber-based adhesive:

- // 2.4mil thick per side
- // Minimum peel strength of 2.27kg/5lbs

Release Liner

Double-sided, silicon-coated 2 mil polyester

Dimensions

- Color**White, Black
- Length**.....44.6mm ± 0.15mm
(1.76in ± 0.006in)
- Width** 10.16mm ± 0.15mm
(0.40in ± 0.006in)
- Label Thickness**
(excluding liner)..... Maximum
1.32mm (0.052in)
(including liner)..... Maximum
1.37mm (0.054in)
- Liner Width**48.64mm ± 0.75mm
(1.915in ± 0.030in)
- Label Repeat** 14. 73mm ± 0.75mm
(0.580in ± 0.030in)
- Label to Liner Spacing**.....
2.02mm ± 0.75mm Large;
± 2.0mm Small (0.080in ± 0.030in)

Note: Warranty terms and conditions are as specified in the applicable Sales Agreement.

CE The acousto-magnetic (AM) label is in conformity with RoHS II Directive 2011/65/EU and REACH Substances of Very High Concern as defined in Regulation (EC) No 1907/2006 and subsequent amendments to both.

See Sensormatic.com for Usage Instructions

Additional Consideration:
This label is not recommended for use with the Sensormatic Contact Pad deactivator.

| ROLL SPECIFICATIONS | | | | | |
|---------------------|-------------------------------|-------------------------------|-----------------------------|---|--|
| | Small Roll | Large Roll | | Small Roll | Large Roll |
| PRODUCT CODE | ZLNRLE2K1, ZLNRLE2K5 | ZLNRLE85K1 | PRODUCT CODE | ZLNRLE2K1, ZLNRLE2K5 | ZLNRLE85K1 |
| Diameter Of Core | 76.2mm (3in) core | 152.4mm (6in) core* | External Carton Dimensions | 27.6 x 24.5 x 30.5cm (10.88 x 9.63 x 12in) | 51.8 x 51.8 x 25.4cm (20.38 x 20.38 x 10in) |
| Max Roll Diameter | 232mm (9.14in) | 508mm (20in) | External Cubic Ft. Per Case | 0.73 | 2.4 |
| Number Splices | 4 splices, 1 leader splice | 6 splices, 1 leader splice | Rolls Per Case | 5 | 4 |
| Roll Weight | 0.90kg (1.99lbs) | 4.09kg (9.02lbs) | Cases Per Pallet | 68 | 16 |
| Case Weight | 5.37kg (11.82lbs) | 17.77kg (39.18lbs) | Order Multiple | 2,000-unit roll | 8,500-unit roll |

*Includes 3in core adapter



Ultra•Strip III Non-Deactivatable Sheet Label (NDL)

The Ultra•Strip III Non-Deactivatable Label delivers the stability and resistance to deactivation similar to a Sensormatic hard tag. This reusable anti-shoplifting label provides the highest anti-theft protection option for safers and asset protection solutions. The label remains active in a typical point-of-sale environment where it may come in close proximity to deactivators and magnetic detachers.

Retailer Values

- // Non-deactivatable format designed to protect safers and other asset protection solutions
- // Utilizes the proven Sensormatic AM technology to provide the highest detection performance available
- // Works well on liquids, foils and in metal shopping carts
- // Robust construction provides optimal merchandise protection

Product Codes

ZLAML-NDLS4

Technology

AM

Environmental Constraints

Temperature

Maximum storage temperature not to exceed 50°C (122°F) for 96 hours at 80% RH.

Humidity

Unaffected by 80% humidity at 50°C (122°F), up to 96 hours.

Shelf Life

Two years from date of manufacture when labels are stored between 15°C-32°C (60°F-90°F), 30-80% RH.

Product Compatibility

Sensormatic AM detection and deactivation devices.

Mode of Application

Hand

Dimensions

Color Red

Length 45.21mm ± 0.15mm
(1.786in ± 0.006in)

Width 10.67mm ± 0.15mm
(0.420in ± 0.006in)

Label Thickness

(excluding liner) Maximum
2.37mm (0.093in)

(including liner) Maximum
2.48mm (0.098in)

Labels Per Sheet 108

Note: Warranty terms and conditions are as specified in the applicable Sales Agreement.

CE The acousto-magnetic (AM) label is in conformity with RoHS II Directive 2011/65/EU and REACH Substances of Very High Concern as defined in Regulation (EC) No 1907/2006 and subsequent amendments to both.

See Sensormatic.com for Usage Instructions

| SHEET SPECS | |
|----------------------------|-------------------------------------|
| | Sheet |
| PRODUCT CODE | ZLAML-NDLS4 |
| Case Weight | 3kg (6.499lbs) |
| External Carton Dimensions | 279 x 20 x 11cm (11 x 8 x 4.5in) |
| Cases Per Pallet | 140 |
| Order Multiple | 4000-unit case |



Adjustable Multi-Purpose Safers

The Sensormatic AM or RF EAS Adjustable Multi-Purpose Safers are the ideal solution for open merchandising high-theft products such as perfumes, cosmetics, iPods, MP3 players, razor blades and ink cartridges. The reusable safers protect products in secure housing, integrated with Sensormatic Non-Deactivatable EAS labels, providing the highest anti-theft protection. These transparent, height-adjustable locking devices keep high-value, high-theft items secure and accessible, letting retailers' open-merchandise products with confidence. The safers alarm the Sensormatic AM pedestal system if protected products pass through the detection zone.

Retailer Values

- // Promotes open merchandising for perfume, cosmetics, iPods, MP3 players, ink cartridges, razor blades and more for increased sales
- // Provides superior protection and optimal merchandising, allowing shoppers to easily view and purchase items
- // Easy application and removal helps improve store operations

- // Constructed of clear high-grade polycarbonate, the material is scratch-resistant and will not become cloudy or yellow over time, ensuring attractive product displays
- // Built from recyclable materials

Application

Perfume, MP3 Players, Memory Sticks, Computer Hardware, Digital Cameras, iPods, Ink Cartridges, Cosmetics, Batteries, Small Electronics, Razor Blades

RF Technology

See sales associates for details.

Product Compatibility

EAS Detection Systems

Detachers:

- Magnetic 9kG Detachers
- Magnetic 5kG Detacher
- Magnetic 5 and 9kG Detacher

Specifications

- Color** Clear
- Magnetic Strength** 5kG, 9kG
- Blister Hooks** Included

Note: Sensormatic safers are sold by the carton. Cartons can not be split. Quantities per carton vary by safer model.

| | 1 | 2 | 3 | 4 |
|---------------------------|---|--|---|---|
| PRODUCT SPECIFICATIONS | MSAMT-5100-PRFL: 5kG | MSAMT-5100-PRFS: 5kG | MSAMT-5100-PRFA: 5kG | MSAMT-5100-PRFC: 5kG |
| | MSAMT-9100-PRFL: 9kG | MSAMT-9100-PRFS: 9kG | MSAMT-9100-PRFA: 9kG | MSAMT-9100-PRFC: 9kG |
| Internal Dimensions HxWxD | 115-175 x 100 x 60mm (4.53-6.9 x 3.94 x 2.36in) | 115-165 x 66 x 51mm (4.53 - 6.5 x 2.6 x 2.01in) | 100-145 x 120 x 90mm (4-5.75 x 4.75 x 3.50in) | 140-230 x 65 x 60mm (5.50-9 x 2.50 x 2.37in) |
| External Dimensions HxWxD | 133-200 x 113 x 80mm (5.24-7.87 x 4.45 x 3.15in) | 125-200 x 79 x 70mm (4.92-7.87 x 3.11 x 2.76in) | 125-175 x 132 x 111mm (5-6.87 x 5.25 x 4.37in) | 162-268 x 78.5 x 80mm (6.37-10.5 x 3 x 3.12in) |
| Per Carton | 48 | 72 | 25 | 50 |
| Carton Weight | 6.528kg (14.392lbs) | 8.165kg (18.001lbs) | 25/Case @ .35lb/ea. = 8.75lbs/carton | 50/Case @ .25lb/ea. = 12.50lbs/carton |



Sensormatic Synergy 2.5 ABS Pedestal

Delivering next-generation store performance.

The Sensormatic Synergy 2.5 Pedestal combines the power of AM and RFID technology to enable comprehensive store performance. Its thin, narrow, open-frame design is constructed of high-impact ABS, preserving aesthetics and delivering the right look for virtually any retail setting. This detection system features Sensormatic AM EAS technology for the highest level of theft detection with up to 2.5m (8ft 2in) coverage for wide or multiple exits. The integrated audio and visual alarms notify store personnel if protected merchandise passes through the detection zone. The multiple audio and visual alarms can be customized for different event types, mapping the audio and ambient lighting options to reflect the source of the alert, such as foil-lined bags and jammer devices.

The pedestal features embedded, multiple-beam people-counting sensors designed for optimal accuracy. With the Synergy network card, these sensors

enable Traffic Intelligence reports that provide visibility into shopper traffic to enhance store performance and increase conversion rates. Integrating directional traffic information with EAS alarm events allows the sensors to discern between inbound and outbound traffic, virtually eliminating unintended alarms triggered by shoppers carrying protected merchandise near the pedestals. People-counting sensors also enable a “power-on-demand” feature that puts the system into low-power standby mode during periods of low or no traffic activity to reduce power consumption up to 90%.

Compatible with the Sensormatic Synergy RFID Retrofit Panel, this pedestal provides a cost-effective migration to advanced Radio Frequency Identification (RFID) functionality. The easy-to-install upgrade panel delivers an optimal combination of proven Sensormatic AM loss prevention technology with RFID-enabled inventory and shrink visibility. When leveraging RFID technology, these flexible and modular pedestals can integrate with surveillance cameras for video verification of EAS alarm events.

To effectively combat Organized Retail Crime, the AMS9060 Controller — part of this flexible and modular system — can be enhanced with the optional integrated Metal-Foil Detection plug-in card.

The network plug-in card, standard with this pedestal system, delivers remote management, EAS and Traffic Intelligence.

Through system configuration, “tags-too-close” is an offered feature developed to help retailers maximize valuable selling floor space near the pedestals. This feature helps reduce unnecessary and costly service calls and decreases nuisance alarms to enhance the shopper experience. Another system-configured feature is Jammer Detection which triggers a pedestal alarm as soon as an electronic signal from a jammer device is detected, helping eliminate the threat of would-be thieves using this method.

The optional Advertising Upgrade Kit leverages valuable pedestal real estate at the store entrance to reach a large number of shoppers on-the-move. The easy-to-install poster helps draw shoppers with advertisements, modern designs or simple, low-cost printed graphics. This add-on also provides an opportunity to generate additional marketing co-op profit by bidding out this valuable advertising space to vendors.

Retailer Values

- // Compatible RFID Retrofit Panel provides an easy, cost-effective migration path to advanced RFID functionality to provide inventory and shrink visibility
- // Consistent 2.5m (8ft 2in) global detection performance protects critical assets
- // Embedded people-counting sensors provide Traffic Intelligence and directionality to calculate conversion rates and maximize store performance
- // Optional Metal-Foil Detection alerts staff when foil-lined bags or clothing enter the store environment, helping combat shrink and ORC
- // Standard network plug-in card delivers store-front alarm event and Traffic Intelligence to enhance loss prevention efforts and increase shopper visibility
- // "Tags-too-close" feature helps reduce unnecessary and costly service calls and maximizes valuable selling floor space near the pedestals
- // Jammer detection helps reduce shrink by notifying staff of attempts to disable the EAS system using a separate audible alarm
- // Add-on surveillance cameras provide video verification of EAS alarm events for enhanced shrink visibility
- // Optional Advertising Upgrade Kit offers a flexible medium to reach a large number of shoppers where most purchasing decisions are made
- // Customizable alarm tones and LED alarm light identify unique events to help reduce shrink
- // Remote alarm option alerts staff of alarm events anywhere in store
- // Service connection port allows full system software control at any antenna, helping reduce in-store service time

Required Choices

Base Covers

ZSSB-E1180CG

Cool Gray (Qty. 1=1 pair)

ZSSB-E1180CH

Charcoal (Qty. 1=1 pair) (Qty. 1=1 pair)

ZSSB-E1180-SS

Stainless Steel (Qty 1 = 1 pair)

ZSSB-E1180-SB

Stainless Steel Black (Qty 1 = 1 pair)

Base Cover Accent Plate

ZPS-ACCENT-1 With Sensormatic Logo

ZPS-ACCENT-4 No Logo

Product Compatibility

- Sensormatic AM Sensors
- Ranger Antenna
- Satellite Antenna
- Amorphous Core Antenna
- Stereo Overhead Traffic Sensor
- Mono Overhead Traffic Sensor
- Local Device Manager II (LDM II)
- UltraLink
- Metal Foil Detection Plug-In Card
- Digital Remote Alarm
- Sensormatic Synergy Upgrade Advertising Kit
- Sensormatic Synergy RFID Retrofit Panel

Specifications

- Height** 165cm (65in)
- Width** 41.9cm (16.5in)
- Depth** 8.6cm (3.4in)
(at base w/o covers)
- Weight** 7.1kg (15.85lbs)
(w/o cover)
- Base cover** 1.7kg (2.6lbs)
- Accent band** 3.4kg (7.6lbs)

Electrical

Power Supply

- Primary input.....100-120Vac or
220-240Vac@50-60Hz
- Primary power fuse.....3.15A, 25OV
slo-blow, hi-breaking
- (One pedestal only)
- Current draw (120V).....<0.75Arms
- Current draw (240V).....<0.37Arms
- Input power (120V).....<57W
- Input power (240V).....<57W

Transmitter

- Operating Frequency.....58kHz +/-200Hz
(sync pulse) 56kHz
- Transmit Burst Duration.....1.6ms
- Transmit Current mx.....20A peak

Burst Repetition Rate

- Based on 50Hz ac.....75Hz or 37.5Hz
- Based on 60Hz ac.....90Hz or 45Hz

Receiver

Center Frequency 58kHz

Environmental Constraints

Ambient Temperature

0°C to 50°C (32°F to 122°F)

Relative Humidity

0 to 90%, non-condensing

Enclosure Rating

IPX0

Evaluated for altitudes less than 3000m (9800ft)

Declarations

EMC

- 47 CFR, Part 15
- EN 300 330-2
- EN 301 489-3
- EN 301 489-1
- EN55022
- EN55024
- ICES-003
- RSS-210

Safety

- UL 60950-1 (second edition)
- CSA C22.2.60950-1
- EN 60950-1

Consumer Awareness

Although this anti-theft system complies with all applicable safety standards, advertising inserts must be designed to avoid creating any delay in customer movement through the system. Medical implant wearers are instructed by their physicians not to linger near, or lean on, anti-theft pedestals. Inserts should not encourage them to linger or lean.

CE This product is in conformity with RoHS II Directive 2011/65/EU and REACH Substances of Very High Concern as defined in Regulation (EC) No 1907/2006 and subsequent amendments to both.1

Configurations

Measurements - meters (feet)

Single

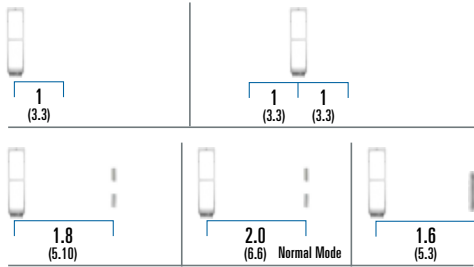

Dual

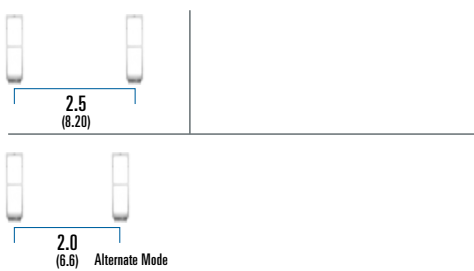

Split

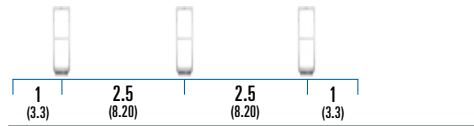

Quad

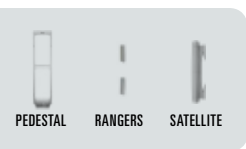
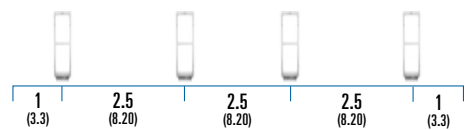

| Product Codes | Primary 2.5 Antenna | Single 2.5 Antenna | Dual 2.5 Antennas | Split 2.5 Antennas | Quad 2.5 Antennas | AMS9060 Controller | Cool Gray | Charcoal |
|--------------------------------------|---------------------|--------------------|-------------------|--------------------|-------------------|--------------------|-----------|----------|
| ZS1180-CG | ● | | | | | | ● | |
| ZASE-E25G1-12M (12M interconnect) | | ● | | | | ● | ● | |
| ZASE-E25G2-12M (12M interconnect) | | | ● | | | ● | ● | |
| ZASE-E25G3-12M (12M interconnect) | | | | ● | | ● | ● | |
| ZASE-E25G4-12M (12M interconnect) | | | | | ● | ● | ● | |
| ZS1180-CH | ● | | | | | | | ● |
| ZASE-E25B1-12M (12M interconnect) | | ● | | | | ● | | ● |
| ZASE-E25B2-12M (12M interconnect) | | | ● | | | ● | | ● |
| ZASE-E25B3-12M (12M interconnect) | | | | ● | | ● | | ● |
| ZASE-E25B4-12M (12M interconnect) | | | | | ● | ● | | ● |

Please see hardware add-on options in the Accessory section

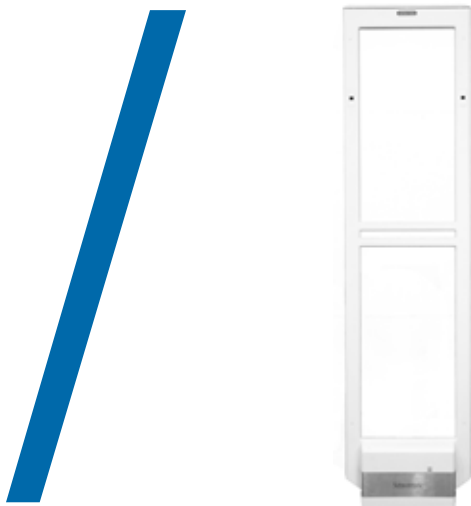

Sensormatic Synergy 2.0 ABS Pedestal

Delivering next-generation store performance.

The Sensormatic Synergy 2.0 Pedestal combines the power of AM and RFID technology to enable comprehensive store performance. Its thin, narrow, open-frame design is constructed of high-impact ABS, preserving aesthetics and delivering the right look for virtually any retail setting. This detection system features Sensormatic AM EAS technology for the highest level of theft detection with up to 2m (6ft 6in) coverage for wide or multiple exits. The integrated audio and visual alarms notify store personnel if protected merchandise passes through the detection zone. The multiple audio and visual alarms can be customized for different event types, mapping the audio and ambient lighting options to reflect the source of the alert, such as foil-lined bags and jammer devices.

The pedestal features embedded, multiple-beam people-counting sensors designed for optimal accuracy. With the Synergy network card, these sensors enable Traffic Intelligence reports that provide visibility into shopper traffic to

enhance store performance and increase conversion rates. Integrating directional traffic information with EAS alarm events allows the sensors to discern between inbound and outbound traffic, virtually eliminating unintended alarms triggered by shoppers carrying protected merchandise near the pedestals. People-counting sensors also enable a “power-on-demand” feature that puts the system into low-power standby mode during periods of low or no traffic activity to reduce power consumption up to 90%.

Compatible with the Sensormatic Synergy RFID Retrofit Panel, this pedestal provides a cost-effective migration to advanced Radio Frequency Identification (RFID) functionality. The easy-to-install upgrade panel delivers an optimal combination of proven Sensormatic AM loss prevention technology with RFID-enabled inventory and shrink visibility. When leveraging RFID technology, these flexible and modular pedestals can integrate with surveillance cameras for video verification of EAS alarm events.

To effectively combat Organized Retail Crime, the AMS9060 Controller — part of this flexible and modular system — can be enhanced with the optional integrated Metal-Foil Detection plug-in card. The network plug-in card, standard with this pedestal system, delivers remote

management, EAS and traffic intelligence.

Through system configuration, “tags-too-close” is an offered feature developed to help retailers maximize valuable selling floor space near pedestals.

This feature helps reduce unnecessary and costly service calls and decreases nuisance alarms to enhance the shopper experience. Another system-configured feature is Jammer Detection which triggers a pedestal alarm as soon as an electronic signal from a jammer device is detected, helping eliminate the threat of would-be thieves using this method.

The optional Advertising Upgrade Kit leverages valuable pedestal real estate at the store entrance to reach a large number of shoppers on-the-move. The easy-to-install poster helps draw shoppers with advertisements, modern designs or simple, low-cost printed graphics. This add-on also provides an opportunity to generate additional marketing co-op profit by bidding out this valuable advertising space to vendors.

Retailer Values

// Compatible RFID Retrofit Panel provides an easy, cost-effective migration path to advanced RFID functionality to provide inventory and shrink visibility

- // Consistent 2m (6ft 6in) global detection performance protects critical assets
- // Embedded people-counting sensors provide Traffic Intelligence and directionality to calculate conversion rates and maximize store performance
- // Optional Metal-Foil Detection alerts staff when foil-lined bags or clothing enter the store environment, helping combat shrink and ORC
- // Standard network plug-in card delivers store-front alarm event and traffic intelligence to enhance loss prevention efforts and increase shopper visibility
- // "Tags-too-close" feature helps reduce unnecessary and costly service calls and maximizes valuable selling floor space near the pedestals
- // Jammer Detection helps reduce shrink by notifying staff of attempts to disable the EAS system using a separate audible alarm
- // Add-on surveillance cameras provide video verification of EAS alarm events for enhanced shrink visibility
- // Optional Advertising Upgrade Kit offers a flexible medium to reach a large number of shoppers where most purchasing decisions are made
- // Customizable alarm tones and LED alarm light identify unique events to help reduce shrink
- // Remote alarm option alerts staff of alarm events anywhere in store
- // Service connection port allows full system software control at any antenna, reducing in-store service time

Required Choices

Base Covers

ZSSB-E1180CG

Cool Gray (Qty. 1=1 pair)

ZSSB-E1180CH

Charcoal (Qty. 1=1 pair) (Qty. 1=1 pair)

ZSSB-E1180-SS

Stainless Steel (Qty 1=1 pair)

ZSSB-E1180-SB

Stainless Steel Black (Qty 1=1 pair)

Base Cover Accent Band

ZPS-ACCENT-1 With Sensormatic Logo

ZPS-ACCENT-4 No Logo

Product Compatibility

Sensormatic AM Sensors

Ranger Antenna

Satellite Antenna

Amorphous Core Antenna

Stereo Overhead Traffic Sensor

Mono Overhead Traffic Sensor

Local Device Manager II (LDM II)

UltraLink

Metal Foil Detection Plug-In Card

Digital Remote Alarm

Sensormatic Synergy Upgrade

Advertising Kit

Sensormatic Synergy RFID Retrofit Panel

Specifications

Height 165cm (65in)

Width41.9cm (16.5in)

Depth8.6cm (3.38in)
(at base w/o covers)

Weight 7.1kg (15.85lbs)
(w/o cover)

Base cover 1.7kg (2.6lbs)

Accent band 3.4kg (7.6lbs)

Electrical

Power Supply

Primary input.....100-120Vac or
220-240Vac@50-60Hz

Primary power fuse.....3.15A, 25OV
slo-blow, hi-breaking

(One pedestal only)

Current draw (120V).....<0.75Arms

Current draw (240V).....0.37Arms

Input power (120V).....<57W

Input power (240V).....<57W

Transmitter

Operating Frequency.....58kHz +/-200Hz
(sync pulse) 56kHz

Transmit Burst Duration.....1.6ms

Transmit Current mzx.....16A peak

Burst Repetition Rate

Based on 50Hz ac.....75Hz or 37.5Hz

Based on 60Hz ac.....90Hz or 45Hz

Receiver

Center Frequency 58kHz

Environmental Constraints

Ambient Temperature

0°C to 50°C (32°F to 122°F)

Relative Humidity

0 to 90%, non-condensing

Enclosure Rating

IPX0

Evaluated for altitudes less than 3000m
(9800ft)

Declarations

EMC

47 CFR, Part 15

EN 300 330-2

EN 301 489-3

EN 301 489-1

EN55022

EN55024

ICES-003

RSS-210

Safety

UL 60950-1 (second edition)

CSA C22.2.60950-1

EN 60950-1

Consumer Awareness

Although this anti-theft system complies with all applicable safety standards, advertising inserts must be designed to avoid creating any delay in customer movement through the system. Medical implant wearers are instructed by their physicians not to linger near, or lean on, anti-theft pedestals. Inserts should not encourage them to linger or lean.

CE This product is in conformity with RoHS II Directive 2011/65/EU and REACH Substances of Very High Concern as defined in Regulation (EC) No 1907/2006 and subsequent amendments to both.1

Configurations

Measurements - meters (feet)

Single

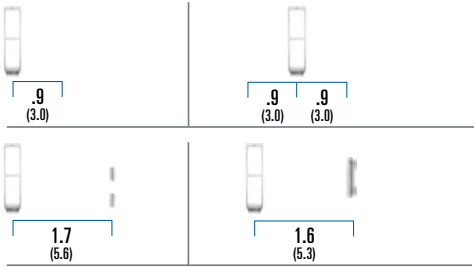

Dual

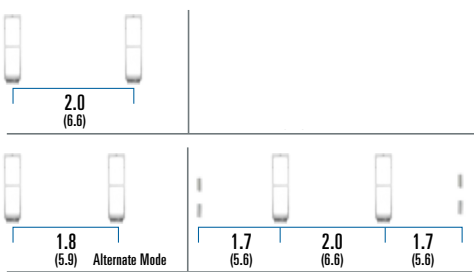

Split

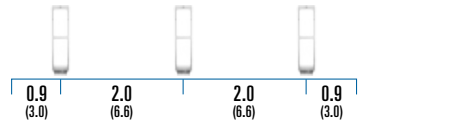

Quad

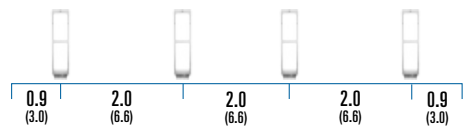

| Product Codes | Primary 2.0 Antenna | Single 2.0 Antenna | Dual 2.0 Antennas | Split 2.0 Antennas | Quad 2.0 Antennas | AMS9060 Controller | Cool Gray | Charcoal |
|--------------------------------------|---------------------|--------------------|-------------------|--------------------|-------------------|--------------------|-----------|----------|
| ZS1175-CG | ● | | | | | | ● | |
| ZASE-E20G1-12M (12M interconnect) | | ● | | | | ● | ● | |
| ZASE-E20G2-12M (12M interconnect) | | | ● | | | ● | ● | |
| ZASE-E20G3-12M (12M interconnect) | | | | ● | | ● | ● | |
| ZASE-E20G4-12M (12M interconnect) | | | | | ● | ● | ● | |
| ZS1175-CH | ● | | | | | | | ● |
| ZASE-E20B1-12M (12M interconnect) | | ● | | | | ● | | ● |
| ZASE-E20B2-12M (12M interconnect) | | | ● | | | ● | | ● |
| ZASE-E20B3-12M (12M interconnect) | | | | ● | | ● | | ● |
| ZASE-E20B4-12M (12M interconnect) | | | | | ● | ● | | ● |

Please see hardware add-on options in the Accessory section





Sensormatic Synergy 2.5 Self-Contained Pedestal

Delivering next-generation store performance.

The Sensormatic Synergy 2.5 Self-Contained Pedestal provides superior Sensormatic AM EAS anti-theft protection with up to 2.5m (8.2ft) of coverage between pedestals. The on-board electronics are mounted in the primary pedestal, eliminating the need for an external controller. The integrated audio and visual alarms notify store personnel if protected merchandise passes through the detection zone. The multiple audio and visual alarms can be customized for different event types, mapping the audio and ambient lighting options to reflect the source of the alert such as foil-lined bags and jammer devices.

The pedestal features embedded, multiple-beam people-counting sensors designed for optimal accuracy. With the Synergy network card, these sensors enable Traffic Intelligence reports that provide visibility into shopper traffic to enhance store performance and increase

conversion rates. Integrating directional traffic information with EAS alarm events allows the sensors to discern between inbound and outbound traffic, virtually eliminating unintended alarms triggered by shoppers carrying protected merchandise near the pedestals. People-counting sensors also enable a “power-on-demand” feature that puts the system into low-power standby mode during periods of low or no traffic activity to reduce power consumption up to 90%.

The onboard controller can be enhanced with the optional integrated Metal-Foil Detection plug-in card to effectively combat Organized Retail Crime, or the network plug-in card to deliver remote management, EAS and Traffic Intelligence.

Through system configuration, “tags-too-close” is an offered feature developed to help retailers maximize valuable selling floor space near the pedestals. This feature decreases nuisance alarms to enhance the shopper experience and reduce unnecessary and costly service calls. Another system-configured feature is Jammer Detection, which triggers a pedestal alarm as soon as an electronic signal from a jammer device is detected, helping eliminate the threat of would-be thieves using this method.

The optional Advertising Upgrade Kit

leverages valuable pedestal real estate at the store entrance to reach a large number of shoppers on-the-move. The easy-to-install poster helps draw shoppers into the retail environment with advertisements, modern designs or simple, low-cost printed graphics. This add-on also provides an opportunity to generate additional marketing co-op profit by bidding out this valuable advertising space to vendors.

Retailer Values

- // Consistent 2.5m (8.2ft) global detection performance protects critical assets
- // Embedded people-counting sensors provide Traffic Intelligence and directionality to calculate conversion rates and maximize store performance
- // Optional Metal-Foil Detection alerts staff when foil-lined bags or clothing enter the store environment, helping combat shrink and ORC
- // Optional network plug-in card delivers store-front alarm event and Traffic Intelligence to enhance loss prevention efforts and increase shopper visibility
- // “Tags-too-close” feature helps reduce unnecessary and costly service calls and maximizes valuable selling floor space near the pedestals

Retailer Values (con't)

- // Jammer Detection helps reduce shrink by notifying staff of attempts to disable the EAS system using a separate audible alarm
- // Optional Advertising Upgrade Kit offers a flexible medium to reach a large number of shoppers where most purchasing decisions are made
- // Customizable alarm tones and LED alarm light identify unique events to help reduce shrink
- // Remote alarm option alerts staff of alarm events anywhere in store
- // Service connection port allows full system software control at any antenna, helping reduce in-store service time

Required Choices

Base Covers

ZSSB-E1170CG

Cool Gray (Qty. 1=1 pair)

ZSSB-E1170CH

Charcoal (Qty. 1=1 pair)

Base Cover Accent Band

ZPS-ACCENT-1 With Sensormatic Logo

ZPS-ACCENT-4 No Logo

Product Compatibility

- Sensormatic AM Sensors
- Ranger Antenna
- Satellite Antenna
- Amorphous Core Antenna
- Stereo Overhead Traffic Sensor
- Mono Overhead Traffic Sensor
- Local Device Manager II (LDM II)
- Metal Foil Detection Plug-In Card
- Network Plug-In Card
- UltraLink
- Digital Remote Alarmt
- Sensormatic Synergy Upgrade Advertising Kit

Specifications (without covers)

- Height** 165cm (65in)
- Width**41.9cm (16.5in)
- Thickness/Depth**..... 8.6cm (3.4in)
(w/o base covers)
- Weight** 7.18kg (15.85lbs)
(w/o base covers)
- Base cover** 4.3kg (9.5lbs)
- 2C Controller Board** 1.2kg (2.75lbs)
- 4C Controller Board** 1.4kg (3.25lbs)
- Accent Band** 3.4kg (7.6lbs)

Electrical

Power Supply

- Primary input.....100-120Vac or
220-240Vac@50-60Hz
- Primary power fuse.....3.15A, 250V
slo-blow, hi-breaking
- Current draw (120V).....<0.6Arms
- Current draw (240V).....<0.3Arms
- Input power (120V).....<45W
- Input power (240V).....<45W

Transmitter

- Operating Frequency..... 58kHz +/-200Hz
(sync pulse) 56kHz
- Transmit Burst Duration.....1.6ms
- Transmit Current mzx.....20A peak
- Burst Repetition Rate:
Based on 50Hz ac..... 75Hz or 37.5Hz
Based on 60HZ zc.....90Hz or 45Hz

Receiver

- Center Frequency 58kHz

Environmental Constraints

Ambient Temperature

0°C to 50°C (32°F to 122°F)

Relative Humidity

0 to 90%, non-condensing

Enclosure Rating

- IPX0
- Evaluated for altitudes less than
3000m (9800ft)

Declarations

EMC

- 47 CFR, Part 15
- EN 300 330-2
- EN 301 489-3
- EN 301 489-1
- EN55022
- EN55024
- ICES-003
- RSS-210

Safety

- UL 60950-1 (second edition)
- CSA C22.2.60950-1
- EN 60950-1

Consumer Awareness

Although this anti-theft system complies with all applicable safety standards, advertising inserts must be designed to avoid creating any delay in customer movement through the system. Medical implant wearers are instructed by their physicians not to linger near, or lean on, anti-theft pedestals. Inserts should not encourage them to linger or lean.

CE This product is in conformity with RoHS II Directive 2011/65/EU and REACH Substances of Very High Concern as defined in Regulation (EC) No 1907/2006 and subsequent amendments to both.1

Configurations

Measurements - meters (feet)

Single

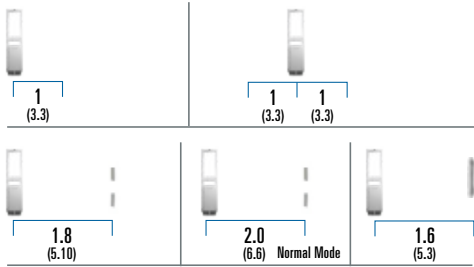

Dual

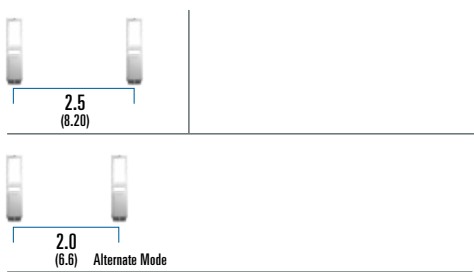

Split

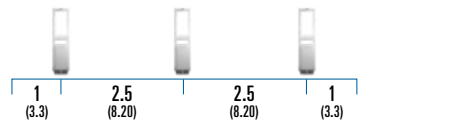

| Product Codes | Primary 2.5 Antenna 2-channel stand alone | Primary 2.5 Antenna 4-channel stand alone | Single 2.5 Antennas | Dual 2.5 Antennas | Split 2.5 Antennas | Cool Gray | Charcoal |
|--------------------------------------|--|--|---------------------|-------------------|--------------------|-----------|----------|
| AMS1170-2C | ● | | | | | | |
| AMS1170-4C | | ● | | | | | |
| ZASI-E25G1 (no interconnect) | | | ● | | | ● | |
| ZASI-E25G2-4M (4M interconnect) | | | | ● | | ● | |
| ZASI-E25G3-4M (4M interconnect) | | | | | ● | ● | |
| ZASI-E25G2-12M (12M interconnect) | | | | ● | | ● | |
| ZASI-E25G3-12M (12M interconnect) | | | | | ● | ● | |
| ZASI-E25B1 (no interconnect) | | | ● | | | | ● |
| ZASI-E25B2-4M (4M interconnect) | | | | ● | | | ● |
| ZASI-E25B3-4M (4M interconnect) | | | | | ● | | ● |
| ZASI-E25B2-12M (12M interconnect) | | | | ● | | | ● |
| ZASI-E25B3-12M (12M interconnect) | | | | | ● | | ● |

Please see hardware add-on options in the Accessory section



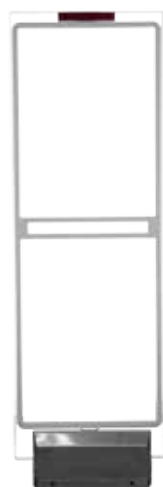

Ultra•Exit 2.4 Acrylic Pedestal

Superior shoplifting protection for wide or multiple exits in a sleek, transparent design.

The Ultra•Exit 2.4 Acrylic Pedestal is a key element of the Sensormatic Enhanced Detection suite. Its open-frame design preserves store aesthetics, while its sleek, high-quality acrylic construction has the right look for virtually any retail setting. Ideal for wide or multiple exits, this detection system uses Sensormatic AM EAS technology to provide the highest level of theft detection with up to 2.4m (7ft 10in) of coverage between pedestals to maximize customer flow. Audio and visual alarms are incorporated into the pedestal to notify staff if protected merchandise passes through the detection zone.

As business needs change, this system's open architecture can be enhanced with Sensormatic's upgradable, integrated add-on devices, Metal-Foil Detection and Traffic Counting, to combat Organized Retail Crime (ORC) and increase labor productivity. The front-end pedestal remains simple and streamlined to maintain the visual appeal of store entrances.

Through system configuration, "Tags-too-Close" is an offered feature developed to help store associates better manage merchandising of tagged goods at the front of the store. This feature helps reduce unnecessary and costly service calls and decreases nuisance alarms to enhance the shopper experience.

Another system-configured feature is Jammer Detection. This software triggers a pedestal alarm as soon as an electronic signal from a Jammer device is detected; helping eliminate the threat of would-be thieves using this method.

The Ultra•Exit 2.4 Acrylic Pedestal provides in-store EAS and Traffic Intelligence when connected to a compatible data management device to help better manage store operations.

Retailer Values

- // Straight acrylic form factor preserves store aesthetics
- // Sensormatic AM EAS technology delivers superior shoplifting protection for wider or multiple exits, maximizing customer flow
- // Integrated traffic counting option provides Traffic Intelligence and directionality to calculate conversion rates and maximize store performance
- // EAS Intelligence option allows delivery of in-store operational information to better manage loss prevention and store operation efforts
- // Integrated Metal-Foil Detection alerts staff when foil-lined bags or clothing enter the store environment, helping combat shrink and ORC
- // "Tags-too-Close" feature helps reduce unnecessary and costly service calls and helps manage merchandising of tagged products at the store front
- // Jammer Detection helps reduce shrink by notifying staff of attempts to disable the EAS system using a separate audible alarm
- // Remote Alarm option alerts staff of alarm events anywhere in store
- // Service connection port allows full system software control at any antenna, helping reduce in-store service time

Required Choices

ZPUE-PLBASE

Ultra•Exit Base Cover: Dark Gray
(Qty. 1=1 pair)

ZPUE-PLBASE-MS

Ultra•Exit Base Cover: Silver Gray
(Qty. 1=1 pair)

ZPUE-SSBASE4

Ultra•Exit Base Cover Standard:
Stainless Steel (Qty. 1=1 pair)

Product Compatibility

- Sensormatic AM Sensors
- 9.75m Concealed Floor System
- 8.5m Concealed Floor System
- 7.5m Concealed Floor System
- Floor-Max Concealed Floor System
- Ranger Receivers
- Satellite Receivers
- Amorphous Core Receiver
- Integrated Traffic Counter
- Stereo Overhead Traffic Sensor
- Mono Overhead Traffic Sensor
- Local Device Manager II (LDM II)
- UltraLink
- Digital Remote Alarm
- Metal-Foil Detection

Specifications

- Height** 155cm (61in)
- Width** 49.2cm (19.4in)
- Thickness/Depth** 12.5cm (4.9in)
- Weight** 25.7kg (56.7lbs)

Electrical

Receiver

- Center Frequency 58kHz
- Receiver Coil Resistance 1.6 ohms
(±5%)

Alarm

- Audio Level 83dB(A)

Environmental Constraints

Ambient Temperature

0°C to 50°C (32°F to 122°F)

Relative Humidity

0 to 90%, non-condensing

Declarations

EMC

- 47 CFR, Part 15
- EN 300 330
- EN 301 489
- RSS-210

Safety

- IEC 60950-1

CE This product is in conformity with RoHS II Directive 2011/65/EU and REACH Substances of Very High Concern as defined in Regulation (EC) No 1907/2006 and subsequent amendments to both.

Configurations

Measurements - meters (feet)

Single

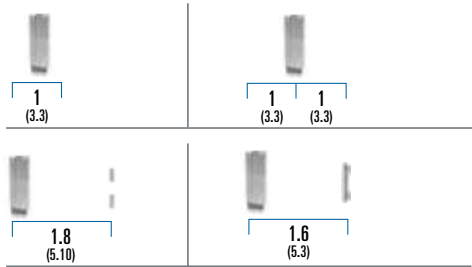

Dual

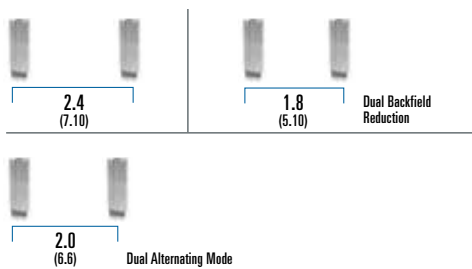

Split

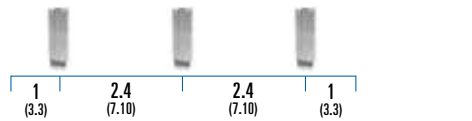

Quad

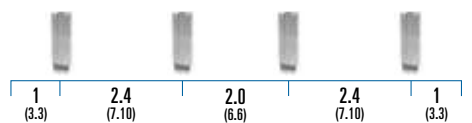

| Product Codes | Single 2.4 Acrylic Antenna | Dual 2.4 Acrylic Antennas | Split 2.4 Acrylic Antennas | Quad 2.4 Acrylic Antennas | AMS9050 Controller | AMS9060 Controller | Base Counter Kit | NA and EU | Rest of World (ROW) |
|---|----------------------------|---------------------------|----------------------------|---------------------------|--------------------|--------------------|------------------|-----------|---------------------|
| ZS1121A | ● | | | | | | | ● | |
| ZAUESAW-1 | ● | | | | | ● | | ● | |
| ZAUESAW-2 | | ● | | | | ● | | ● | |
| ZAUESAW-3 | | | ● | | | ● | | ● | |
| ZAUESAW-4 Traffic ready, excludes base cover | | | | ● | | ● | | ● | |
| ZS1121 | ● | | | | | | | | ● |
| ZAUEAW-1 | ● | | | | ● | | | | ● |
| ZAUEAW-2 | | ● | | | ● | | | | ● |
| ZAUEAW-3 | | | ● | | ● | | | | ● |
| ZAUEAW-4 Traffic ready, excludes base cover | | | | ● | ● | | | | ● |

Please see hardware add-on options in the Accessory section





Pro-Max

Not approved for sale in European Countries

A durable, all-weather anti-theft solution ideal for outdoor retail settings.

The high-impact construction and attractive design of the Pro-Max provides all-weather durability and performance; making it an ideal solution for DIY outdoor patios. This detection system features Sensormatic AM EAS technology for the highest level of theft detection and protection for wide exits up to 10.7m (35ft) with a minimum 1.2m (4ft) of coverage between pedestals. Multiple pedestal systems can be set up for zone detection and only activate alarms on the pedestal closest to where a live tag or label is detected. Each pedestal is equipped with integrated visual and audible alarms to notify store associates if protected merchandise passes through the detection zone.

Through system configuration, "Tags-too-Close" is an offered feature developed to help store associates better manage merchandising of tagged goods at the front of the store. This feature helps reduce unnecessary and costly service calls and decreases nuisance alarms to enhance the shopper experience.

Another system-configured feature is Jammer Detection. This software triggers a pedestal alarm as soon as an electronic signal from a Jammer device is detected; helping eliminate the threat of would-be thieves using this method.

Pro-Max provides in-store EAS and Traffic Intelligence when connected to a compatible data management device to help better manage store operations.

Retailer Values

- // All-weather design can be installed outdoors without an additional cover
- // Zone detection helps associates quickly pinpoint detection event location
- // Built-in visual and audible indicators immediately notify staff of alarm events
- // When connected to a compatible data management device, this system provides in-store EAS and Traffic Intelligence to better manage store operations
- // "Tags-too-Close" feature helps reduce unnecessary and costly service calls and helps manage merchandising of tagged products at the store front
- // Jammer Detection helps reduce shrink by notifying staff of attempts to disable the EAS system using a separate audible alarm

Product Compatibility

- Sensormatic AM Sensors
- Local Device Manager II (LDM II)
- UltraLink
- Stereo Overhead Traffic Sensor
- Mono Overhead Traffic Sensor
- Digital Remote Alarm

Specifications

Height 159cm (62.5in)

Width

Pedestal Width 68cm (26.75in)

Base Shroud Width 72cm (28.5in)

Thickness/Depth

Base Shroud Depth 10cm (4in)

Weight 14kg (31lbs)

Electrical

Transmitter

Operating Frequency 58 kHz (±200Hz)

Transmit Burst Duration 1.6ms

Transmit Current 20A peak

Burst Repetition Rate

Based on 50Hz ac 75Hz or 37.5Hz

Based on 60Hz ac 90Hz or 45Hz

Receiver

Center Frequency 58kHz

Receiver Coil Resistance 1.6 ohms
(±5%)

Alarm

Alarm Relay Output DPDT contacts

Contact Switching Current 1.0A max

Contact Switching Voltage 28V max

Environmental Constraints

Ambient Temperature

0°C to 50°C (32°F to 122°F)

Relative Humidity

0 to 90%, non-condensing

Declarations

EMC

47 CFR, Part 15

RSS 210

ICES-003

Safety (second edition)

IEC 60950-1

ZSPM4-OD only

NEMA 3R, IP43

This product is in conformity with RoHS II Directive 2011/65/EU and REACH Substances of Very High Concern as defined in Regulation (EC) No 1907/2006 and subsequent amendments to both.

Configurations for countries in the EU/EFTA and those using similar rules and standards.

Measurements - meters (feet)

Single

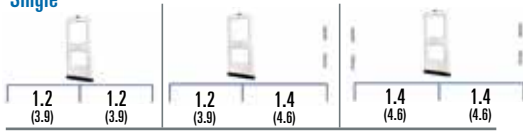

Dual

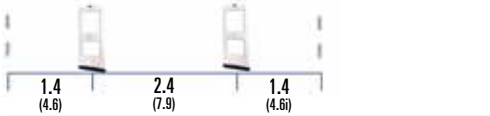
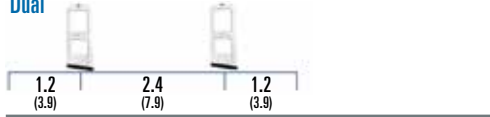

Split

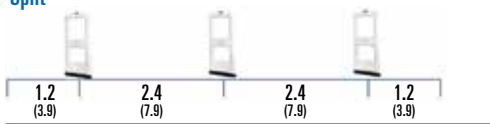

Quad



Configurations for the Rest of the World (ROW)

Single (ROW)

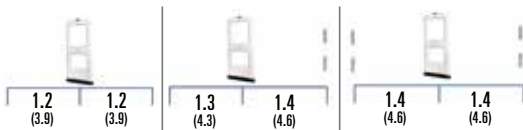

Dual (ROW)

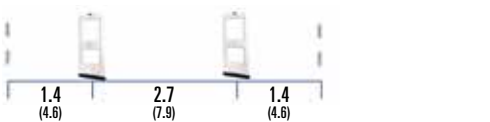
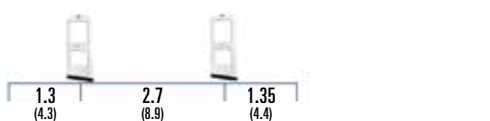

Split (ROW)

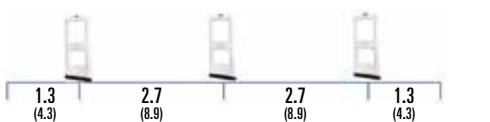

Quad (ROW)

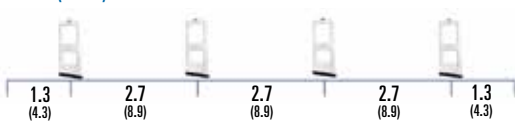

| Product Codes | Antenna Configurations | | | | | | | | | | | AMS9060 Controller | Dual Digital Antenna(s) w/2 satellite receivers | NA | Rest of World (ROW) | |
|---------------|---------------------------|-------------------------|--------------------------|-------------------------|-----------------------------------|---------------------------------|----------------------------------|---------------------------------|--------------------|---|----|--------------------|---|----|---------------------|---------------------|
| | Single Digital Antenna(s) | Dual Digital Antenna(s) | Split Digital Antenna(s) | Quad Digital Antenna(s) | Single Outdoor Digital Antenna(s) | Dual Outdoor Digital Antenna(s) | Split Outdoor Digital Antenna(s) | Quad Outdoor Digital Antenna(s) | AMS9060 Controller | Dual Digital Antenna(s) w/2 satellite receivers | NA | | | | | Rest of World (ROW) |
| ZSPM5 | ● | | | | | | | | | | | | | | ● | |
| ZAPM5-1 | ● | | | | | | | | | | | | ● | | ● | |
| ZAPM5-2 | | ● | | | | | | | | | | | ● | | ● | |
| ZAPM5-3 | | | ● | | | | | | | | | | ● | | ● | |
| ZAPM5-4 | | | | ● | | | | | | | | | ● | | ● | |
| ZAPM5-OD1 | | | | | ● | | | | | | | | ● | | ● | |
| ZAPM5-OD2 | | | | | | ● | | | | | | | ● | | ● | |
| ZAPM5-OD3 | | | | | | | ● | | | | | | ● | | ● | |
| ZAPM5-OD4 | | | | | | | | ● | | | | | ● | | ● | |

Please see hardware add-on options in the Accessory section

Configurations for countries in the EU/EFTA and those using similar rules and standards.

Measurements - meters (feet)

Single

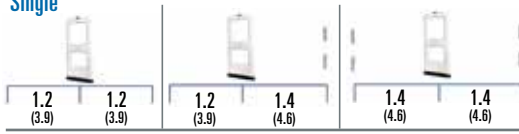

Dual

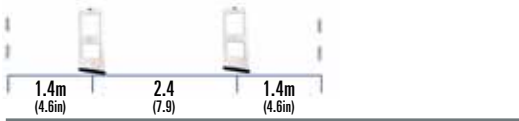
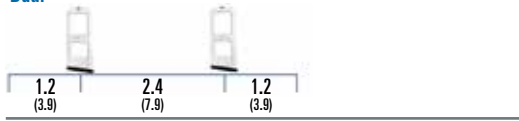

Split

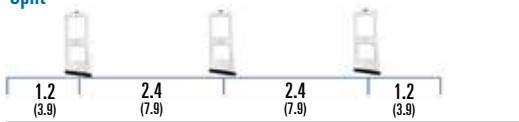

Quad

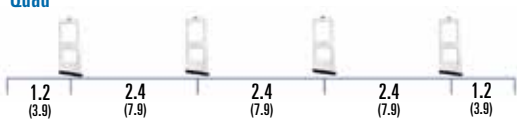

Configurations for the Rest of the World (ROW)

Single (ROW)

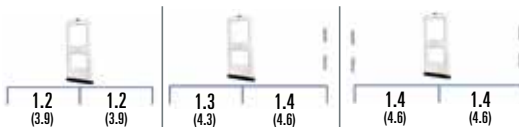

Dual (ROW)

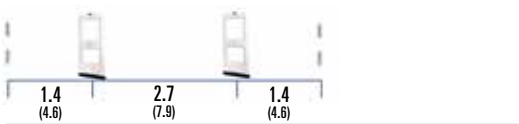
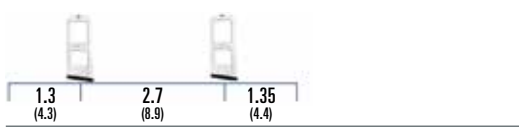

Split (ROW)

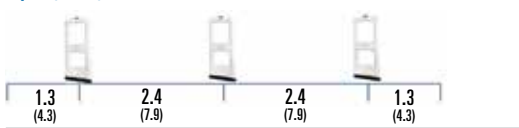

Quad (ROW)

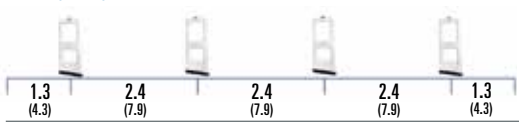

| Product Codes | Digital Antenna(s) with Counter in Face | Single Digital Antenna(s) | Dual Digital Antenna(s) | Split Digital Antenna(s) | Quad Digital Antenna(s) | Single Outdoor Digital Antenna(s) | Dual Outdoor Digital Antenna(s) | Split Outdoor Digital Antenna(s) | Quad Outdoor Digital Antenna(s) | AMS9040 Controller | Dual Digital Antenna(s) w/2 satellite receivers | NA | Rest of World (ROW) |
|---------------|---|---------------------------|-------------------------|--------------------------|-------------------------|-----------------------------------|---------------------------------|----------------------------------|---------------------------------|--------------------|---|----|---------------------|
| ZAPM4 | | ● | | | | | | | | | | | ● |
| ZAPM4-1 | | ● | | | | | | | | ● | | | ● |
| ZAPM4-2 | | | ● | | | | | | | ● | | | ● |
| ZAPM4-2SR2 | | | | | | | | | | ● | ● | | ● |
| ZAPM4-3 | | | | ● | | | | | | ● | | | ● |
| ZAPM4-4 | | | | | ● | | | | | ● | | | ● |
| ZAPM4-OD1 | | | | | | ● | | | | ● | | | ● |
| ZAPM4-OD2 | | | | | | | ● | | | ● | | | ● |
| ZAPM4-OD3 | | | | | | | | ● | | ● | | | ● |
| ZAPM4-OD4 | | | | | | | | | ● | ● | | | ● |
| ZAPM4-FC1 | ● | ● | | | | | | | | ● | | | ● |
| ZAPM4-FC2 | ● | | ● | | | | | | | ● | | | ● |
| ZAPM4-FC3 | ● | | | ● | | | | | | ● | | | ● |
| ZAPM4-FC4 | ● | | | | ● | | | | | ● | | | ● |

Please see hardware add-on options in the Accessory section



Ultra•Post Self-Contained Pedestal

Energy-efficient pedestal saves on power without sacrificing performance.

The energy-efficient Ultra•Post provides superior Sensormatic AM EAS anti-theft protection with up to 1.8m (6ft) of coverage between pedestals. The on-board electronics are contained within the base cover of the primary pedestal, eliminating the need for an external controller, and reducing installation and maintenance costs. The integrated audio and visual alarms notify store personnel if protected merchandise passes through the detection zone.

The optional integrated Traffic Counter add-on device provides visibility into shopper traffic patterns and directional traffic information that is customizable to control alarm events. This add-on also provides visibility into shopper directionality by discerning between inbound and outbound traffic and helps virtually eliminate unintended EAS alarms triggered by shoppers carrying tagged goods near EAS detectors. The integrated Traffic Counter also provides the "power-on-demand" feature that places this dual detection system into low-power standby mode during periods of low or no traffic

activity to reduce power consumption up to 86% when in this mode.

Through system configuration, "Tags-too-Close" is an offered feature developed to help store associates better manage merchandising of tagged goods at the front of the store. This feature helps reduce unnecessary and costly service calls and decreases nuisance alarms to enhance the shopper experience. Another system-configured feature is Jammer Detection. This software triggers a pedestal alarm as soon as an electronic signal from a Jammer device is detected; helping eliminate the threat of would-be thieves using this method.

The optional Advertising Upgrade Kit leverages valuable pedestal real estate at the store entrance to reach a large number of shoppers on-the-move. The easy-to-install poster helps draw shoppers into the retail environment with advertisements, modern designs or simple low-cost printed graphics. This add-on also provides an opportunity to generate additional marketing co-op profit by bidding out this valuable advertising space to vendors.

Retailer Values

- // Consumes up to 40% less power out-of-the-box than previous Ultra•Post systems, without sacrificing performance
- // Consistent 1.8m (6ft) global detection performance protects critical assets
- // Integrated traffic counting option provides Traffic Intelligence and directionality to calculate conversion rates and maximize store performance
- // EAS Intelligence option allows delivery of in-store operational information to better manage loss prevention and store operation efforts
- // "Tags-too-Close" feature helps reduce unnecessary and costly service calls and helps manage merchandising of tagged products at the store front
- // Jammer Detection helps reduce shrink by notifying staff of attempts to disable the EAS system using a separate audible alarm
- // Advertising Upgrade Kit offers a flexible medium to reach a large number of shoppers on the move

Product Compatibility

- Sensormatic AM Sensors
- 9.75m Concealed Floor System
- 8.5m Concealed Floor System
- 7.5m Concealed Floor System
- Floor-Max Concealed Floor System
- Ranger Receivers
- Satellite Receivers
- Amorphous Core Receiver
- Integrated Traffic Counter
- Stereo Overhead Traffic Sensor
- Mono Overhead Traffic Sensor
- Local Device Manager II (LDM II)
- UltraLink
- Digital Remote Alarm

Specifications

- Height** 145cm (57in)
- Width** 41cm (16.1in)
- Thickness/Depth**..... 11.5cm (4.5in) (base)
- Weight**
- Primary Pedestal.....15.1kg (33.3lbs)
- Secondary Pedestal14kg (30.9lbs)

Electrical

Transmitter

- Outputs..... 1 port
(two antennas, multiplexed)
- Operating Frequency 58kHz (±200Hz)
- Transmit Burst Duration..... 1.6ms
- Transmit Current (nominal)37A peak

Burst Repetition Rate

- Based on 50Hz ac..... 37.5Hz/75Hz
- Based on 60Hz ac..... 45Hz/90Hz
- Transmit Coil Resistance 0.11 ohms
(±2%)

Receiver

- Inputs..... 8 ports
- Center Frequency58kHz
- Receive Coil Resistance 0.11 ohms
(±2%)

Alarm

- Alarm Relay Output DPDT contacts
- Contact Switching Current.....1.0A max.
- Contact Switching Voltage 28V max.
- Lamp/Audio Duration..... 1–30 sec.
(1 sec. increments)
- Audio Level 89dB(A)

Environmental Constraints

Ambient Temperature

0°C to 50°C (32°F to 122°F)

Relative Humidity

0 to 90%, non-condensing

Declarations

EMC

- 47 CFR, Part 15
- EN 300 330
- EN 301 489
- RSS-210

Safety

IEC 60950-1

Consumer Awareness:

Although this anti-theft system complies with all applicable safety standards, poster inserts must be designed to avoid creating any delay in customer movement through the system. Medical implant wearers are instructed by their physicians not to linger near, or lean on, anti-theft system pedestals. Graphic inserts should not encourage them to linger or lean.

CE This product is in conformity with RoHS II Directive 2011/65/EU and REACH Substances of Very High Concern as defined in Regulation (EC) No 1907/2006 and subsequent amendments to both.

Configurations

Measurements - meters (feet)

Single

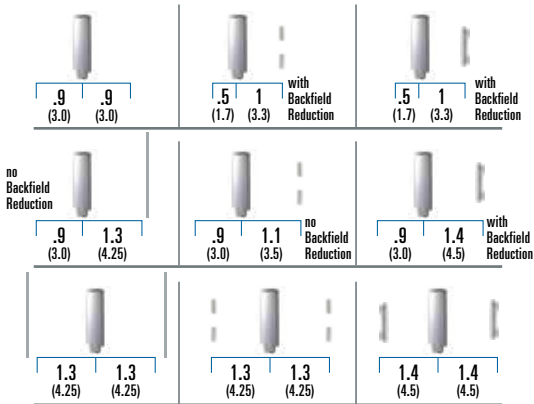

Dual

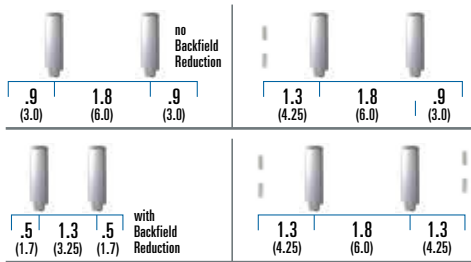

Dual Install w/one side secondary

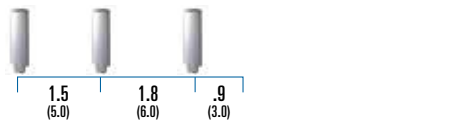

Dual Install w/two side secondary

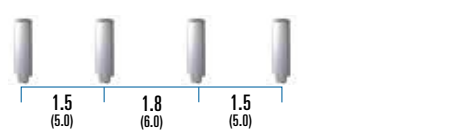

Split

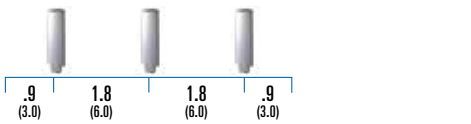

| Product Codes | Primary Antenna(s) | Secondary Antenna(s) | Single Antenna(s) | Dual Antenna(s) | 4m (13ft) Cable | 12m (40ft) Cable | 15m (50ft) Cable |
|---------------|--------------------|----------------------|-------------------|-----------------|-----------------|------------------|------------------|
| ZS1014-P | ● | | | | | | |
| ZS1014-S | | ● | | | | | |
| ZA1014-1 | | | ● | | | | |
| ZA1014-2-4M | | | | ● | ● | | |
| ZA1014-2-12M | | | | ● | | ● | |
| ZA1014-2-15M | | | | ● | | | ● |

Please see hardware add-on options in the Accessory section



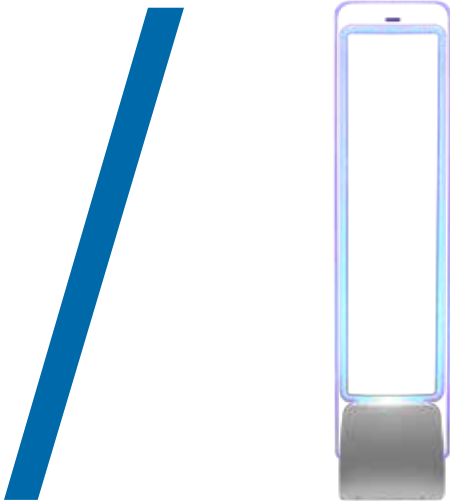

Essentials 3.6m Acrylic Self-Contained Pedestal

Combines simplicity and reliability for a attractive, affordable anti-theft solution.

The Essentials 3.6m Self-Contained Pedestal combines simplicity with reliable performance to deliver an affordable, attractive anti-shoplifting solution. Constructed from high-grade, durable acrylic, this pedestal provides a transparent, sophisticated look at store entrances. The on-board electronics are contained within the base cover of the primary pedestal, eliminating the need for an external controller, and reducing installation and maintenance costs. To support green initiatives, this system uses less than 50W of energy per hour to help lower energy costs while supplying EAS protection for wider exits up to 3.6m (11.81ft). The integrated alarm located in the base of the primary pedestal uses a distinguished audible alarm to notify store personnel if protected merchandise passes through the detection zone. Each pedestal also fully illuminates with a blue (standard) or red (optional) illumination scheme for visual notification and deterrence during an alarm event.

Through system configuration, "Tags-too-Close" is an offered feature developed

to help store associates better manage merchandising of tagged goods at the front of the store. This feature helps reduce unnecessary and costly service calls and decreases nuisance alarms to enhance the shopper experience.

This pedestal provides in-store EAS and Traffic Intelligence when connected to a compatible data management device to better manage store operations.

Retailer Values

- // Ideal for protecting wider exits up to 3.6m (11.81ft), maximizing customer flow
- // Modern, transparent design compliments any store setting
- // Each pedestal provides a unique blue (standard) or red (optional) illumination scheme for visual notification of alarm events
- // Integrated audible alarm notifies store associates of alarm events
- // EAS Intelligence option allows delivery of in-store operational information to better manage loss prevention and store operation efforts
- // "Tags-too-Close" feature helps reduce unnecessary and costly service calls and helps manage merchandising of tagged products at the store front
- // Service connection port allows full system software control at any antenna, helping reduce in-store service time

Product Compatibility

- Sensormatic AM Sensors
- Ranger Receivers
- Digital Remote Alarm
- Local Device Manager II (LDM II)
- UltraLink

Specifications

- Height** 145cm (4.75ft)
- Width** 35.6mm (1.4in)
- Thickness/Depth** 2.1cm (0.83in)
- Base Thickness 10.9cm (4.3in)

Electrical

Transmitter

- Operating Frequency 58kHz (+200Hz)
- Transmit Burst Duration 1.6ms
- Transmit Current 34.4A (in Tx coil) peak
- Transmit Current 15.2A peak (in Interconnect cable)

Burst Repetition Rate

- Based on 50Hz ac 37.5Hz
- Based on 60Hz ac 45Hz
- Antenna Coil Resistance 0.1 ohms (@58kHz)

Receiver

- Center Frequency 58kHz

Alarm

- Audio Level 83dB(A)

Environmental Constraints

Ambient Temperature

0°C to 40°C (32°F to 104°F)

Relative Humidity

0 to 90%, non-condensing

Enclosure

IPX0

Evaluated for altitudes less than

2000m (6500ft)

Declarations

EMC

47 CFR, Part 15

EN 300 330

EN 301 489

RSS-210

Safety

IEC 60950-1

CE This product is in conformity with RoHS II Directive 2011/65/EU and REACH Substances of Very High Concern as defined in Regulation (EC) No 1907/2006 and subsequent amendments to both.

Configuration

Measurements - meters (feet)

Dual

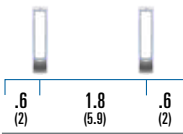

| Product Codes | Single-Level Primary Antenna(s) | Single-Level Secondary Antenna(s) | Dual Pedestal Antenna(s) (CFG) | Split Pedestal Antenna(s) (CFG) | Optional LED Kit, Red |
|---|---------------------------------|-----------------------------------|--------------------------------|---------------------------------|-----------------------|
| ZS1150-P2 Secondary antenna required | ● | | | | |
| ZS1150-S2 Primary antenna required | | ● | | | |
| ZA1150-2 | | | ● | | |
| ZA1150-3 | | | | ● | |
| 0352-0507-01 | | | | | ● |



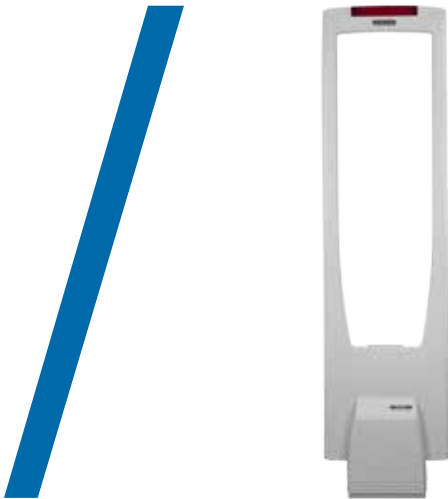

Essentials 1.8m ABS Self-Contained Pedestal

Energy-efficient, affordable anti-theft protection in a modern, durable design.

The Essentials 1.8m ABS Self-Contained Pedestal is a reliable, affordable anti-theft solution. Its modern, durable design blends seamlessly into any retail setting, yet provides a strong visual deterrent against theft. The on-board electronics are contained within the base cover of the primary pedestal, eliminating the need for an external controller and reducing installation and maintenance costs. To support green initiatives, this system uses less than 50W of energy per hour to help lower energy costs while supplying EAS protection up to 1.8m (6ft) between pedestals. The integrated alarm located in the base of the primary pedestal uses a distinguished audible alarm to notify store personnel if protected merchandise passes through the detection zone. Each pedestal also fully illuminates with a blue (standard) or red (optional) illumination scheme for visual notification and deterrence during an alarm event.

Through system configuration, "Tags-too-Close" is an offered feature developed to help store associates better manage

merchandising of tagged goods at the front of the store. This feature helps reduce unnecessary and costly service calls and decreases nuisance alarms to enhance the shopper experience.

This pedestal provides in-store EAS and Traffic Intelligence when connected to a compatible data management device to better manage store operations.

Retailer Values

- // Provides shoplifting coverage up to 1.8m (6ft) between pedestals to protect critical assets
- // The high-impact ABS construction provides long term durability for virtually any retail setting
- // Integrated audible and visual indicators immediately notify store associates of alarm events
- // EAS Intelligence option allows delivery of in-store operational information to better manage loss prevention and store operation efforts
- // "Tags-too-Close" feature helps reduce unnecessary and costly service calls and helps manage merchandising of tagged products at the store front
- // Electronics are located in the primary pedestal to help reduce install and maintenance costs

Product Code

ZA1140-D: Dual Antenna

Product Compatibility

- Sensormatic AM Sensors
- Ranger Receivers
- Digital Remote Alarm
- Local Device Manager II (LDM II)
- UltraLink

Specifications

- Height** 137.1cm (4.5ft)
- Width** 35.8mm (1.4in)
- Thickness/Depth**
- Pedestal Thickness..... 26mm (1in)
- Base Thickness 8.6cm (3.4in)
- Weight** 9.16kg (20.2lbs)

Electrical

Transmitter

- Operating Frequency 58kHz (+200Hz)
- Transmit Burst Duration..... 1.6ms
- Transmit Current 36A peak
(in Tx coil) (nominal)
- Transmit Current 16A peak
(in Interconnect cable)

Burst Repetition Rate

- Based on 50Hz ac..... 37.5Hz
- Based on 60Hz ac..... 45Hz
- Antenna Coil Resistance..... 0.25 ohms
(±5%)

Receiver

- Center Frequency 58kHz

Alarm

- Audio Level 83dB(A)

Environmental Constraints

Ambient Temperature

0°C to 40°C (32°F to 104°F)

Relative Humidity

0 to 90%, non-condensing

Enclosure

IPX0

Evaluated for altitudes less than 2000m (6500ft)

Declarations

EMC

47 CFR, Part 15

EN 300 330

EN 301 489

RSS-210

Safety

IEC 60950-1

CE This product is in conformity with RoHS II Directive 2011/65/EU and REACH Substances of Very High Concern as defined in Regulation (EC) No 1907/2006 and subsequent amendments to both.

Configuration

Measurements - meters (feet)

Dual

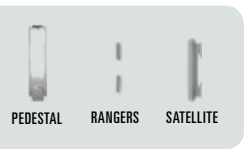
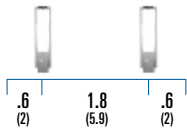



Door-Max

Attractive, slender design compliments any store environment.

The Door-Max features Sensormatic AM EAS technology in an attractive, slender antenna to protect exits up to 1.8m (6ft) wide. Attached to door frames, glass and other surfaces, this detection system compliments any store decor whether in a shopping mall or a stylish boutique. The Door-Max is compatible with Sensormatic auxiliary receivers for a cost-effective alternative with comparable detection performance. The integrated audio and visual alarms notify store personnel if protected merchandise passes through the detection zone.

Through system configuration, "Tags-too-Close" is an offered feature developed to help store associates better manage merchandising of tagged goods at the front of the store. This feature helps reduce unnecessary and costly service calls and decreases nuisance alarms to enhance the shopper experience. Another system-configured feature is Jammer Detection. This software triggers a pedestal alarm as soon as an electronic signal from a Jammer device is detected; helping eliminate the threat of would-be thieves using this method.

Door-Max provides in-store EAS and Traffic Intelligence when connected to a compatible data management device to better manage store operations.

Retailer Values

- // Sleek, modern antenna compliments any store entrance
- // Built-in visual and audible indicators immediately notify store associates of alarm events
- // When connected to a compatible data management device, this system provides in-store EAS and Traffic Intelligence to better manage store operations
- // "Tags-too-Close" feature helps reduce unnecessary and costly service calls and helps manage merchandising of tagged products at the store front
- // Jammer Detection helps reduce shrink by notifying staff of attempts to disable the EAS system using a separate audible alarm

Product Compatibility

- Sensormatic AM Sensors
- Ranger Receivers
- Satellite Receivers
- Amorphous Core Receiver
- Stereo Overhead Traffic Sensor
- Mono Overhead Traffic Sensor
- Local Device Manager II (LDM II)
- UltraLink
- Digital Remote Alarm

Specifications

- Height** 183.9cm (72.4in)
- Width** 24cm (9.4in)
- Thickness/Depth**..... 4.4cm (1.7in)
- Weight** 11.6kg (25.5lbs)

Electrical

Receiver

- Center Frequency 58kHz
- Receive Coil Resistance 1.6 ohms (±5%)

Alarm

- Audio Level 109dBA

Environmental Constraints

Ambient Temperature

0°C to 50°C (32°F to 122°F)

Relative Humidity

0 to 90%, non-condensing

Enclosure

IPx0
Evaluated for altitudes less than 3200m (10,500ft)

Declarations

EMC

47 CFR, Part 15
 EN 300 330
 EN 301 489
 RSS 210

Safety

EN 60950-1

CE This product is in conformity with RoHS II Directive 2011/65/EU and REACH Substances of Very High Concern as defined in Regulation (EC) No 1907/2006 and subsequent amendments to both.

Configurations for the AMS9060 (NA and EU) and AMS9040 (ROW).

Measurements - meters (feet)

Single

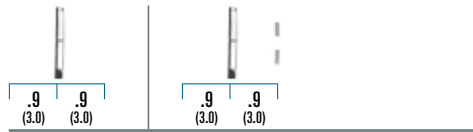

Dual



Split

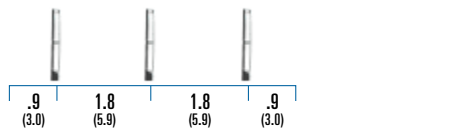

Quad

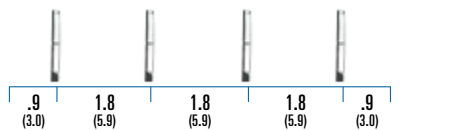

| Product Codes | Digital Antenna | Single Antenna(s) | Dual Antenna(s) | Split Antenna(s) | Quad Antenna(s) | AMB9040 Controller | AMB9060 Controller | NA and EU | Rest of World (ROW) |
|---------------|-----------------|-------------------|-----------------|------------------|-----------------|--------------------|--------------------|-----------|---------------------|
| ZSDM4 | ● | | | | | | | | ● |
| ZADM4-1 | | ● | | | | ● | | | ● |
| ZADM4-2 | | | ● | | | ● | | | ● |
| ZADM4-3 | | | | ● | | ● | | | ● |
| ZADM4-4 | | | | | ● | ● | | | ● |
| ZSDM4A | ● | | | | | | | ● | |
| ZSDM4A-1 | | ● | | | | | ● | ● | |
| ZSDM4A-2 | | | ● | | | | ● | ● | |
| ZSDM4A-3 | | | | ● | | | ● | ● | |
| ZSDM4A-4 | | | | | ● | | ● | ● | |





Ultra•Lane Pedestal

Ideal anti-theft protection for grocery store checkout aisles or narrow doorways.

The Ultra•Lane Pedestal — specifically developed for grocery store checkout aisles or narrow doorways — features Sensormatic AM EAS technology to provide up to 1.8m (5ft 10in) of protection between pedestals. Each pedestal is equipped with integrated visual and audible alarms to notify store associates if protected merchandise passes through the detection zone. Multiple install options include installation to either side of a checkout counter, a railing post, or directly on to the door frame. Utilizing a Sensormatic Ranger Receivers, this system can also be mounted to the side of an opposing counter.

An optional system-configured feature is Jammer Detection. This software triggers a pedestal alarm as soon as an electronic signal from a Jammer device is detected; helping eliminate the threat of would-be thieves using this method.

Retailer Values

- // Slim antenna is ideal for checkout lanes and narrow doorways
- // High-impact construction protects against damage in high-traffic zones
- // Built-in visual and audible indicators immediately notify store associates of alarm events
- // When connected to a compatible data management device, this system provides in-store EAS and Traffic Intelligence to better manage store operations
- // Jammer Detection helps reduce shrink by notifying staff of attempts to disable the EAS system using a separate audible alarm

Product Compatibility

- Sensormatic AM Sensors
- Ranger Receivers
- Stereo Overhead Traffic Sensor
- Mono Overhead Traffic Sensor
- Local Device Manager II (LDM II)
- UltraLink
- Digital Remote Alarm

Specifications

- Height** 121.3cm (47.8in)
- Width** 36.4cm (14.3in)
- Thickness/Depth**..... 3.6cm (1.4in)
- Weight** 5.2kg (11.5lbs)

Electrical

Transmitter

- Operating Frequency 58 kHz (±200Hz)
- Transmit Burst Duration..... 1.6ms
- Transmit Current Maximum..... 15A peak

Burst Repetition Rate

- Based on 50Hz ac..... 75Hz or 37.5Hz
- Based on 60Hz ac..... 90Hz or 45Hz

Receiver

- Center Frequency 58kHz

Alarm

- Audio Level 83dB(A) (maximum)

Environmental Constraints

Ambient Temperature

- 0°C to 50°C (32°F to 122°F)

Relative Humidity

- 0 to 90%, non-condensing

Declarations

EMC

- 47 CFR, Part 15
- EN 300 330
- EN 301 489
- RSS-210

Safety

- IEC 60950-1

CE This product is in conformity with RoHS II Directive 2011/65/EU and REACH Substances of Very High Concern as defined in Regulation (EC) No 1907/2006 and subsequent amendments to both.

Configurations

Measurements - meters (feet)

Single

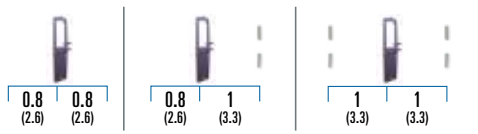

Dual

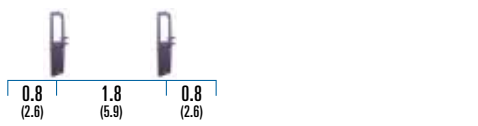

Split

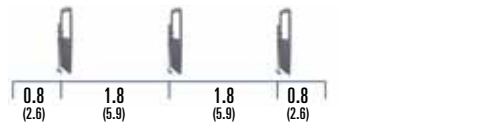

Quad

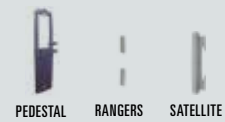
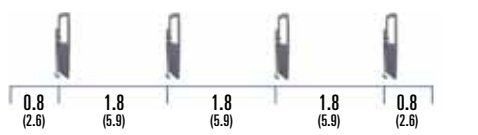

| Product Codes | Single Antenna(s) | Dual Antenna(s) | Split Antenna(s) | Quad Antenna(s) | AMS9050 Controller | AMS9060 Controller | AMS1080 Controller | Ranger Antenna(s) | Dark Gray Mullion Mounts | Checkstand Mounts | Pole Mounts | NA and EU | Rest of World (ROW) |
|---------------|-------------------|-----------------|------------------|-----------------|--------------------|--------------------|--------------------|-------------------|--------------------------|-------------------|-------------|-----------|---------------------|
| ZASE-EAG1-R1C | ● | | | | ● | | ● | | | | | ● | |
| ZASE-EAG2-R2C | | ● | | | ● | | ● | | | | | ● | |
| ZASE-EAG1-R2P | | | ● | | ● | | ● | | | | | ● | |
| ZASE-EAG1-C | ● | | | | ● | | | | | ● | | ● | |
| ZASE-EAG2-C | | ● | | | ● | | | | | ● | | ● | |
| ZASE-EAG3-C | | | ● | | ● | | | | | ● | | ● | |
| ZASE-EAG4-C | | | | ● | ● | | | | | ● | | ● | |
| ZASE-EAG1-P | ● | | | | ● | | | | | | ● | ● | |
| ZASE-EAG2-P | | ● | | | ● | | | | | | ● | ● | |
| ZASE-EAG3-P | | | ● | | ● | | | | | | ● | ● | |
| ZASE-EAG4-P | | | | ● | ● | | | | | | ● | ● | |
| ZASE-EEG1-M | ● | | | | ● | | | | ● | | | ● | |
| ZASE-EEG1-R1M | ● | | | | ● | | ● | ● | | | | ● | |
| ZASE-EEG2-M | | ● | | | ● | | ● | ● | | | | ● | |
| ZAAISLE-1C | ● | | | | | | ● | | | ● | | | ● |
| ZAAISLE-2C | | ● | | | | | ● | | | ● | | | ● |
| ZAAISLE-1P | ● | | | | | | ● | | | | ● | | ● |
| ZAAISLE-2P | | ● | | | | | ● | | | | ● | | ● |
| ZAUL9050-1C | ● | | | | ● | | | | | ● | | | ● |
| ZAUL9050-2C | | ● | | | ● | | | | | ● | | | ● |
| ZAUL9050-3C | | | ● | | ● | | | | | ● | | | ● |
| ZAUL9050-4C | | | | ● | ● | | | | | ● | | | ● |
| ZAUL9050-1P | ● | | | | ● | | | | | | ● | | ● |
| ZAUL9050-2P | | ● | | | ● | | | | | | ● | | ● |
| ZAUL9050-3P | | | ● | | ● | | | | | | ● | | ● |
| ZAUL9050-4P | | | | ● | ● | | | | | | ● | | ● |
| ZAUL9050-1M | ● | | | | ● | | | | ● | | | | ● |
| ZAUL950-IMR | ● | | | | ● | | ● | ● | | | | | ● |
| ZAUL9050-2M | | ● | | | ● | | | | ● | | | | ● |



9.6m Concealed Floor System

Not approved for sale in the EU

Hidden antennas provide invisible anti-theft protection for wide store exits.

The discrete 9.6m Concealed Floor System delivers merchandise protection for wide exits or open architecture requirements. The system emits an audible alert to notify store associates if protected merchandise passes through the detection zone. Providing up to 9.6m (31.5ft) of coverage with a detection height of up to 1.2m (4ft) to maximize customer flow, the installation of this concealed system minimally impacts store operations by eliminating the need for sub-floor excavation. Its thin, flat antenna simplifies the installation process even further by allowing the antenna to mount directly onto the concrete floor, then covering the antenna with flooring material. It is the ideal detection system for locations where pedestal systems or floor excavation is unwanted or prohibited.

Through system configuration, "Tags-too-Close" is an offered feature developed to help store associates better manage merchandising of tagged goods at the front of the store. This feature helps

reduce unnecessary and costly service calls and decreases nuisance alarms to enhance the shopper experience. Another system-configured feature is Jammer Detection. This software triggers a pedestal alarm as soon as an electronic signal from a Jammer device is detected; helping eliminate the threat of would-be thieves using this method.

This system provides in-store EAS and Traffic Intelligence when connected to a compatible data management device to better manage store operations.

Retailer Values

- // Delivers superior shoplifting protection for wider exits to help maximize customer flow and optimize merchandising floor space
- // Flooring material is installed directly over thin antenna to eliminate costly excavations
- // Provides an invisible, yet effective, AM EAS solution where pedestal systems are unwanted or prohibited
- // "Tags-too-Close" feature helps reduce unnecessary and costly service calls and helps manage merchandising of tagged products at the store front
- // Electronics are located in the primary pedestal to help reduce install and maintenance costs

- // When connected to a compatible data management device, this system provides in-store EAS and Traffic Intelligence to better manage store operations

Product Compatibility

- Sensormatic AM Sensor
- Ultra-Exit Pedestals
- Ultra-Post Self-Contained Pedestals
- Pro-Max
- Ranger Receivers
- Satellite Receivers
- Amorphous Core Receiver
- Stereo Overhead Traffic Sensor
- Mono Overhead Traffic Sensor
- Local Device Manager II (LDM II)
- UltraLink
- Digital Remote Alarm

Power Supply

Primary Input

100-120VAC, 200-240VAC
50-60Hz

Primary Power Fuse

5A slo-blow

Current Draw

5.0A@120VAC
3.1A@230VAC

Power Supply (con't)

Input Power

440W@120VAC with 2 or 4 ants.
440W@230VAC with 2 or 4 ants.

Electrical

Transmitter

Operating Frequency 50-60Hz
Transmit Burst Duration..... 1.6ms
Transmit Current.....8-16Ao-p

Burst Repetition Rate

..... 90Hz (1 or 2 ants.)
..... 45Hz (3 or 4 ants.)
..... 45Hz (1 floor ant. and 2 pedestals)
..... 45Hz (2 floor ants. and 2 pedestals)

Receiver

Center Frequency 58kHz±200Hz
Floor Antenna (Tx/Rx) Cable .. 4-conductor,
shielded, burial-rated
Cap Board Tx/Rx Cable 13m (40ft),
4-conductor, shielded, plenum-rated
Cap Board Comm Cable 13m (40ft),
9-conductor, shielded, plenum-rated

Environmental Constraints

Operating Temperature

0°C to 50°C (32° to 122°F)

Relative Humidity

0 to 90%, non-condensing

Enclosure

IPX0
This product is ONLY approved for use at elevations up to 3,200m (10,500ft)

Declarations

EMC

47 CFR, Part 15
RSS 210

Safety (second edition)

IEC 60950-1

This product is in conformity with RoHS

II Directive 2011/65/EU and REACH

Substances of Very High Concern as defined in Regulation (EC) No 1907/2006 and subsequent amendments to both.

Configurations

Measurements - meters (feet)

Single

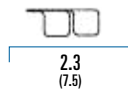

Dual

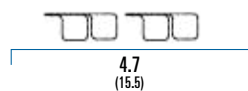

Split



Quad

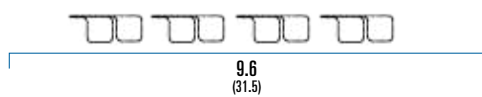

| Product Codes | Single Flat Floor Antenna(s) | Dual Flat Floor Antenna(s) | Split Flat Floor Antenna(s) | Quad Flat Floor Antenna(s) | AMS9040 Controller | # Cosmetic Cap Boxes | Flat Floor Loop Coil Set | Digital Remote Alarm | Flat Floor Stencil | Single Cap Board Enclosure |
|----------------|------------------------------|----------------------------|-----------------------------|----------------------------|--------------------|----------------------|--------------------------|----------------------|--------------------|----------------------------|
| ZA2020-1 | ● | | | | | | | | | |
| ZA2020-2 | | ● | | | ● | | | ● | | |
| ZA2020-3 | | | ● | | ● | | | ● | | |
| ZA2020-4 | | | | ● | ● | | | ● | | |
| ZA2020-1SC | ● | | | | | 1 | | | | |
| ZA2020-2SC | | ● | | | | 2 | | | | |
| ZA2020-3SC | | | ● | | | 3 | | | | |
| ZA2020-4SC | | | | ● | | 4 | | | | |
| ZS2020 | | | | | | 4 | ● | | | |
| ZP2020-STENCIL | | | | | | | | | ● | |
| ZPENCL-CAP-S | | | | | | | | | | ● |



8.4m Concealed Floor System

Not approved for sale in the EU

Invisible Sensormatic anti-theft protection for virtually any retail environment.

The discrete AM EAS 8.4m Concealed Floor System offers up to 8.4m (27.5ft) of merchandise protection with a detection height of up to 1.2m (4ft). The system emits an audible alert to notify store associates if protected merchandise passes through the detection zone. For existing retail environments, the AMS3030's thin, flat antenna is a perfect solution. Installation simply requires thin floor cuts in concrete where the antenna cabling is placed. Once secured, flooring material (ex. tile or marble — not carpet) is then applied over the antenna. The AMS3031 is intended for pre-construction installation. Its setup protects detection antennas against possible interference when metal or rebar is discovered below the subfloor. The antennas, routed through conduit, are placed on shielded tiles to eliminate possible metal interference for consistent system reliability. Both install options deliver EAS detection for wide exits or open

architecture requirements.

Through system configuration, "Tags-too-Close" is an offered feature developed to help store associates better manage merchandising of tagged goods at the front of the store. This feature helps reduce unnecessary and costly service calls and decreases nuisance alarms to enhance the shopper experience. Another system-configured feature is Jammer Detection. This software triggers a pedestal alarm as soon as an electronic signal from a Jammer device is detected; helping eliminate the threat of would-be thieves using this method.

This system provides in-store EAS and Traffic Intelligence when connected to a compatible data management device to better manage store operations.

Retailer Values

- // Delivers superior shoplifting protection for wider exits to maximize customer flow and optimize merchandising floor space
- // AMS3030 antenna install eliminates costly, large scale excavations for minimal impact on store operations
- // For pre-construction installs, the AMS3031 helps protect detection antennas against possible interference when metal or rebar are discovered for consistent system performance
- // Provides an invisible, yet effective, AM EAS solution where pedestal systems are unwanted or prohibited
- // "Tags-too-Close" feature helps reduce unnecessary and costly service calls and helps manage merchandising of tagged products at the store front
- // Jammer Detection helps reduce shrink by notifying staff of attempts to disable the EAS system using a separate audible alarm
- // When connected to a compatible data management device, this system provides in-store EAS and Traffic Intelligence to better manage store operations

Product Compatibility

- Sensormatic AM Sensor
- Ultra•Exit Pedestals
- Ultra•Post Self-Contained Pedestals
- Pro-Max
- Ranger Receivers
- Satellite Receivers
- Amorphous Core Receiver
- Stereo Overhead Traffic Sensor
- Mono Overhead Traffic Sensor
- Local Device Manager II (LDM II)
- UltraLink
- Digital Remote Alarm

Power Supply

Primary Input

100-120VAC, 200-240VAC
50-60Hz

Primary Power Fuse

5A slo-blow

Current Draw

5.0A@120VAC
3.1A@230VAC

Input Power

440W@120VAC with 2 or 4 ants.
440W@230VAC with 2 or 4 ants.

Electrical

Transmitter

Operating Frequency 50-60Hz
Transmit Burst Duration..... 1.6ms
Transmit Current.....8-16Ao-p

Burst Repetition Rate

..... 90Hz (1 or 2 ants.)
..... 45Hz (3 or 4 ants.)
..... 45Hz (1 floor ant. and 2 pedestals)
..... 45Hz (2 floor ants. and 2 pedestals)

Receiver

Center Frequency58kHz±200Hz
Floor Antenna (Tx/Rx) Cable ..4-conductor, shielded, burial-rated
Cap Board Tx/Rx Cable 13m (40ft), 4-conductor, shielded, plenum-rated
Cap Board Comm Cable 13m (40ft), 9-conductor, shielded, plenum-rated

Environmental Constraints

Operating Temperature

0°C to 50°C (32°F to 122°F)

Relative Humidity

0 to 90% non-condensing

Enclosure

IPX0
This product is ONLY approved for use at elevations up to 3,200m (10,500ft).

Declarations

EMC

47 CFR Part 15
RSS 210

Safety (second edition)

IEC 60950-1

This product is in conformity with RoHS II Directive 2011/65/EU and REACH Substances of Very High Concern as defined in Regulation (EC) No 1907/2006 and subsequent amendments to both.

Configurations

Measurements - meters (feet)

Single



Dual



Split

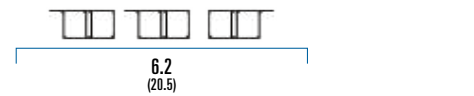

Quad

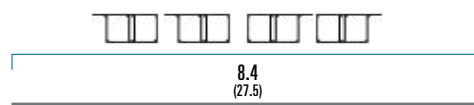

| Product Codes | Single Antenna 2.1m (7ft) | Dual Antennas 4.2m (14ft) | Split Antennas 6.4m (21ft) | Quad Antennas 8.5m (28ft) | AMS9040 Controller | Surface Mount (Float on Floor Kit) | Digital Remote Alarm | Shielding Tray and Tiles |
|---------------|---------------------------|---------------------------|----------------------------|---------------------------|--------------------|------------------------------------|----------------------|--------------------------|
| ZA3030-1 | ● | | | | ● | | ● | |
| ZA3030-2 | | ● | | | ● | | ● | |
| ZA3030-3 | | | ● | | ● | | ● | |
| ZA3030-4 | | | | ● | ● | | ● | |
| ZPLOOP-SM | | | | | | ● | | |
| ZA3031-1 | ● | | | | ● | | ● | |
| ZA3031-2 | | ● | | | ● | | ● | |
| ZA3031-3 | | | ● | | ● | | ● | |
| ZA3031-4 | | | | ● | ● | | ● | |
| ZP3031-SHIELD | | | | | | | | ● |





Floor-Max Concealed System

Invisible, dependable anti-theft protection for a wide-range of environmental conditions.

The Floor-Max AM system is an ideal EAS detection solution for wide exits or open architecture requirements. This system provides up to 8.0m (26ft) of discrete merchandise protection with a detection height up to 1.4m (4.59ft), and emits an audible alert to notify store associates if protected merchandise passes through the detection zone. Additional Sensormatic Ranger or Satellite Antennas can be installed to expand the detection field width, but the detection height will remain the same. The Floor-Max detection antenna is suitable for most floor types and is outdoor-rated to help ensure dependable performance under a wide range of environmental conditions. For second floor or other elevated locations, the antennas are placed on insulation to eliminate interference that is possible when metal or rebar are present, ensuring consistent system reliability.

Through system configuration, “Tags-too-Close” is an offered feature developed to help store associates better manage merchandising of tagged goods at the

front of the store. This feature helps reduce unnecessary and costly service calls and decreases nuisance alarms to enhance the shopper experience.

Another system-configured feature is Jammer Detection. This software triggers a pedestal alarm as soon as an electronic signal from a Jammer device is detected; helping eliminate the threat of would-be thieves using this method.

The Floor-Max system provides in-store EAS and Traffic Intelligence when connected to a compatible data management device to better manage store operations.

Retailer Values

- // Suitable for most floor types and is outdoor-rated for dependable performance under a wide range of environmental conditions
- // Delivers superior shoplifting protection for wider exits to help maximize customer flow and optimize merchandising floor space
- // When connected to a compatible data management device, this system provides in-store EAS and Traffic Intelligence to better manage store operations
- // “Tags-too-Close” feature helps reduce unnecessary and costly service calls and helps manage merchandising of tagged products at the store front

- // Jammer Detection helps reduce shrink by notifying staff of attempts to disable the EAS system using a separate audible alarm

Product Compatibility

- Sensormatic AM Sensors
- Ultra-Exit Pedestals
- Ultra-Post Self-Contained Pedestals
- Pro-Max Pedestals
- Ranger Receivers
- Satellite Receivers
- Amorphous Core Receiver
- Stereo Overhead Traffic Sensor
- Mono Overhead Traffic Sensor
- Digital Remote Alarm
- Local Device Manager II (LDM II)
- UltraLink

Specifications

- Height** 148.4cm (58.4in)
- Width** 72cm (28.3in)
- Thickness/Depth**..... 1.85cm (0.7in)
- Weight** 21.1kg (46.52lbs) (w/cable)
10.4kg (23lbs) (w/out cable)

Power Supply

- Primary Input**
100-120VAC
200-240VAC @ 50-60Hz
- Primary Power Fuse**
5A, 250V, slo-blow
hi-breaking

Power Supply (con't)

Current Draw

5.0Arms@120VAC

Input Power

<440W

Electrical

Transmitter

Outputs..... 4 ports

Operating Frequency 58kHz (±200Hz)

Transmission Burst Duration..... 1.6m

Transmit Current..... 16.A

Burst Repetition Rate

Based on 50Hz ac..... 75Hz or 37.5Hz

Based on 60Hz ac..... 90Hz or 45Hz

Receiver

Center Frequency58kHz

Receiver Coil Resistance 1.6 ohms
(±5%)

Alarm

Alarm Relay OutputDPDT contacts

Contact Switching Current..... 1.0A max.

Contact Switching Voltage28V max.

Lamp/Audio Duration..... 1–30 sec.
(1 sec. increments)

Maximum Audio Level..... 105dB(A)

Evaluated for altitudes less than

3,200m (10,500ft)

Environmental Constraints

Operating Temperature

0°C to 50°C (32° to 122°F)

Relative Humidity

0 to 90%, non-condensing

Declarations

EMC

47 CFR, Part 15

EN 300 330

EN 301 489

RSS-210

Safety

IEC 60950-1

CE This product is in conformity with RoHS II Directive 2011/65/EU and REACH Substances of Very High Concern as defined in Regulation (EC) No 1907/2006 and subsequent amendments to both.

Configurations for countries in the EU/EFTA and those using similar rules and standards.

Measurements - meters (feet)

Single



Dual



Split



Quad

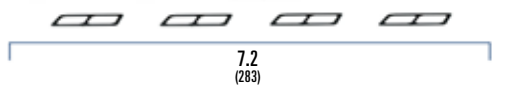

| Product Codes | Floor-Max Single Antenna (s) | Floor-Max Dual Antenna(s) | Floor-Max Triple Antenna(s) | Floor-Max Quad Antenna(s) | AMS9040 Controller | Dual Receiver | Digital Remote Alarm |
|---------------|------------------------------|---------------------------|-----------------------------|---------------------------|--------------------|---------------|----------------------|
| ZAFM4-1 | ● | | | | ● | | ● |
| ZAFM4-1SR2 | ● | | | | | ● | |
| ZAFM4-2 | | ● | | | ● | | ● |
| ZAFM4-2SR2 | | ● | | | | ● | |
| ZAFM4-3 | | | ● | | ● | | ● |
| ZAFM4-4 | | | | ● | ● | | ● |

Configurations for ROW

Single



Dual



Split



Quad

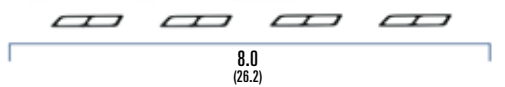



2.4m Concealed Door or Wall System

Not approved for sale in the EU

Superior, invisible Sensormatic protection for wide store exits.

The 2.4m Concealed Detection System delivers superior, yet discrete, AM EAS protection for wide exits to maximize customer flow and optimize merchandising floor space. This system secures exit widths up to 2.4m (7ft 10in) with a detection height up 1.8m (6ft), and delivers an audible alert to notify store associates if protected merchandise passes through the detection zone. The receiver antennas mount to the door in a self-adhesive cable channel or inside the wall of the doorway. The transmitter cable is installed under the floor for high-detection performance at lower operating costs.

Through system configuration, "Tags-too-Close" is an offered feature developed to help store associates better manage merchandising of tagged goods at the front of the store. This feature helps reduce unnecessary and costly service calls and decreases nuisance alarms to enhance the shopper experience. Another system-configured feature is

Jammer Detection. This software triggers a pedestal alarm as soon as an electronic signal from a Jammer device is detected; helping eliminate the threat of would-be thieves using this method.

This system provides in-store EAS and Traffic Intelligence when connected to a compatible data management device to better manage store operations.

Retailer Values

- // Delivers superior shoplifting protection for wider exits to help maximize customer flow and optimize merchandising floor space
- // Quick, simple installation helps lower cost of ownership
- // When connected to a compatible data management device, this system provides in-store EAS and Traffic Intelligence to better manage store operations
- // "Tags-too-Close" feature helps reduce unnecessary and costly service calls and helps manage merchandising of tagged products at the store front
- // Jammer Detection helps reduce shrink by notifying staff of attempts to disable the EAS system using a separate audible alarm

Product Compatibility

- Sensormatic AM Sensor
- Ultra-Exit Pedestals
- Ultra-Post Self-Contained Pedestals
- Pro-Max
- Stereo Overhead Traffic Sensor
- Mono Overhead Traffic Sensor
- Local Device Manager II (LDM II)
- UltraLink
- Digital Remote Alarm

Power Supply

Primary Input

- 100-120Vac
- 200-240Vac
- 50-60Hz

Primary Power Fuse

5A, 250V, slo-blow, hi-breaking

Current Draw

4.0Arms@120Vac

Input Power

<400W

Electrical

Transmitter

- Operating Frequency 58kHz (±200Hz)
- Transmission Burst Duration..... 1.6m
- Transmit Current..... 16.A

Burst Repetition Rate

- Based on 50Hz ac..... 75Hz or 37.5Hz
- Based on 60Hz ac..... 90Hz or 45Hz

Receiver

Center Frequency58kHz
 Receiver Coil Resistance 1.6 ohms
 (±5%)

Environmental Constraints

Operating Temperature

0°C to 50°C (32°F to 122°F)

Relative Humidity

0 to 90%, non-condensing

Declarations

EMC

47 CFR, Part 15
 RSS 210

Safety

IEC 60950-1

This product is in conformity with RoHS II Directive 2011/65/EU and REACH Substances of Very High Concern as defined in Regulation (EC) No 1907/2006 and subsequent amendments to both.

Configurations

Measurements - meters (feet)

Single

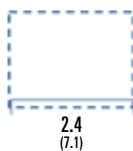

Dual

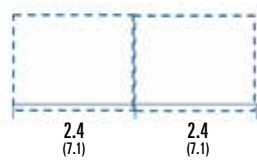

| Product Codes | Single Loop Antenna(s) 0.9m (3ft) | Dual Loop Antenna(s) 0.9m (3ft) | Single Loop Antenna(s) 1.8m (6ft) | Dual Loop Antenna(s) 1.8m (6ft) | Single Loop Antenna(s) 2.4m (7.1ft) | Dual Loop Antenna(s) 2.4m (7.1ft) | AMS9040 Controller | Conduit Kit |
|----------------|--------------------------------------|------------------------------------|--------------------------------------|------------------------------------|--|--------------------------------------|--------------------|-------------|
| ZAL4-3004-1 | ● | | | | | | | |
| ZAL4-3004-2 | | | ● | | | | ● | |
| ZAL4-3004-24 | | | | | ● | | ● | |
| ZAL4-3004D-1 | | ● | | | | | ● | |
| ZAL4-3004D-2 | | | | ● | | | ● | |
| ZAL4-3004D-24 | | | | | | ● | ● | |
| ZP3004 CONDUIT | | | | | | | | ● |





2.0m Concealed Door or Wall System

Approved for EMEA only

Invisible, high-performance Sensormatic protection at a lower operating cost.

The 2.0m Concealed Detection System provides high-detection performance and discrete AM EAS protection at a lower operating cost. This system secures exit widths up to 2.0m (6ft 6in), maximizing customer flow. The less costly, easy-to-install receiver antennas mount directly to the door in a self-adhesive cable channel or inside the wall of the doorway. The transmitter cable is installed directly into the floor. The system's Remote Alarm delivers an audible alert to notify store associates if protected merchandise passes through the detection zone.

Retailer Values

- // Delivers superior shoplifting protection for wider exits to maximize customer flow and optimize merchandising floor space
- // Preserves store aesthetics while maximizing customer flow
- // Quick, simple installation helps lower cost of ownership

Product Compatibility

Sensormatic AM Sensors
Digital Remote Alarm

Power Supply

Primary Input
100-120Vac or
200-240Vac @ 50-60Hz

Primary Power Fuse

2.5A, 250V

Current Draw

1.2A peak (120Vac)
0.8A peak (230Vac)

Input Power

<150W

Electrical

Transmitter

Outputs.....2 ports (two multiplexed antennas)
Operating Frequency 58kHz (±200Hz)
Transmission Burst Duration..... 1.6ms
Transmission Current.....8A peak

Burst Repetition Rate

Based on 50Hz ac..... 37.5Hz (normal)
75Hz (validation)
Based on 60Hz ac..... 45Hz (normal)
90Hz (validation)

Receiver

Inputs..... 2 ports
(two antennas, multiplexed)
Center Frequency58kHz

Environmental Constraints

Operating Temperature

0°C to 50°C (32°F to 122°F)

Non-Operating Temperature

-40°C to 70°C (-40°F to 158°F)

Relative Humidity

0 to 90%, non-condensing

Declarations

EMC

47 CFR, Part 15
EN 300 330
EN 301 489
RSS-210

Safety

IEC 60950-1

CE This product is in conformity with RoHS II Directive 2011/65/EU and REACH Substances of Very High Concern as defined in Regulation (EC) No 1907/2006 and subsequent amendments to both.

Configurations

Measurements - meters (feet)

Single

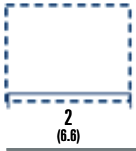

Dual

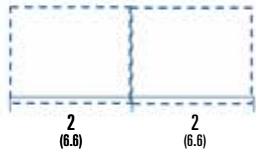

| Product Codes | Single Loop Antenna(s) | Dual Loop Antenna(s) | AMS9033 Controller | Glass mount set for installation of channels on glass doors |
|---------------|------------------------|----------------------|--------------------|---|
| ZAL33-3005-2 | ● | | ● | |
| ZAL33-3005D-2 | | ● | ● | |
| 0352-0072-01 | | | | ● |





Metal-Foil Detection

Identify foil-lined “booster” objects as they enter the store.

The upgradeable Metal-Foil Detection device identifies foil-lined bags or clothing commonly used in Organized Retail Crime (ORC) to circumvent EAS systems. Integrated onto a compatible detection system controller, this device helps identify foil-lined objects, or “boosters,” entering and/or exiting the store when paired with the optional people-counting device. When a “booster” is detected, store personnel are alerted via an audible or visual alarm. This device features multiple alarm methods that can be tailored to accommodate any store environment. These alarm methods include a visual alarm at the pedestal, an audio alarm at the pedestal, a digital remote alarm or triggering a relay that connects to another device, such as a paging system. Unlike competitive offerings, Metal-Foil Detection does not require additional antennas to operate — optimizing retail floor space and preserving store aesthetics.

Retailer Values

- // Protects merchandise from the most sophisticated shoplifter by identifying foil-lined bags or clothing as they enter or exit the store
- // Easily integrates onto a compatible EAS detection controller for a system upgrade
- // No additional antennas required to help provide optimal retail floor space for shopper traffic and merchandise displays
- // Provides full directional alarm flexibility when used with optional traffic counting

Product Codes

ZPMETAL-CFG3

Dual Metal Foil Detection Controller, Filter Board & Test Kit

ZPMETAL-CT3-7010

Split Metal Foil Detection Controller, Filter Board & Test Kit

ZPMETAL-CT4-7010

Quad Metal Foil Detection Controller, Filter Board & Test Kit

Product Compatibility

- Sensormatic AM Sensors
- Ultra-Exit Pedestals
- Stereo Overhead Traffic Sensor
- Mono Overhead Traffic Sensor
- Digital Remote Alarm
- Remote Visual Indicator
- Local Device Manager II (LDM II)
- UltraLink
- Integrated Traffic Counter

Specifications

- Height** 9.2cm (3.6in)
- Width** 33.5cm (13.2in)
- Length** 44.6cm (17.6in)
- Weight** 5.9kg (13lbs)
7.9kg (17.5lbs) (w/hat bracket)

Power Supply

Primary Input

100-120Vac or
200-240Vac @ 50–60Hz

Primary Power Fuse

2.5A, 250V, slo-blow, hi-breaking

Current Draw

(120V) +G26: 0.7Arms

Current Draw

(240V): 0.4Arms

Input Power

(120/240V): <60W

Electrical

Transmitter

Operating Frequency56kHz
 Transmit Burst Duration..... 1.6ms
 Transmit Current Maximum..... 16A peak

Burst Repetition Rate (based on 60Hz ac)
 58kHz signal only..... 90Hz
 Combined 56/58kHz >90Hz

Burst Repetition Rate (based on 50Hz ac)
 58kHz signal only..... 75Hz
 Combined 56/58kHz >75Hz

Receiver

Center Frequency 56kHz

Environmental Constraints

Ambient Temperature

0°C to 50°C (32°F to 122°F)

Relative Humidity

0 to 90%, non-condensing

Enclosure

IPx0
 Evaluated for altitudes less than 3200m
 (10,500ft).

Declarations

EMC

47 CFR, Part 15
 EN 300 330
 EN 301 489
 RSS-210

Safety

IEC 60950-1

CE This product is in conformity with
 RoHS II Directive 2011/65/EU and REACH
 Substances of Very High Concern as
 defined in Regulation (EC) No 1907/2006
 and subsequent amendments to both.

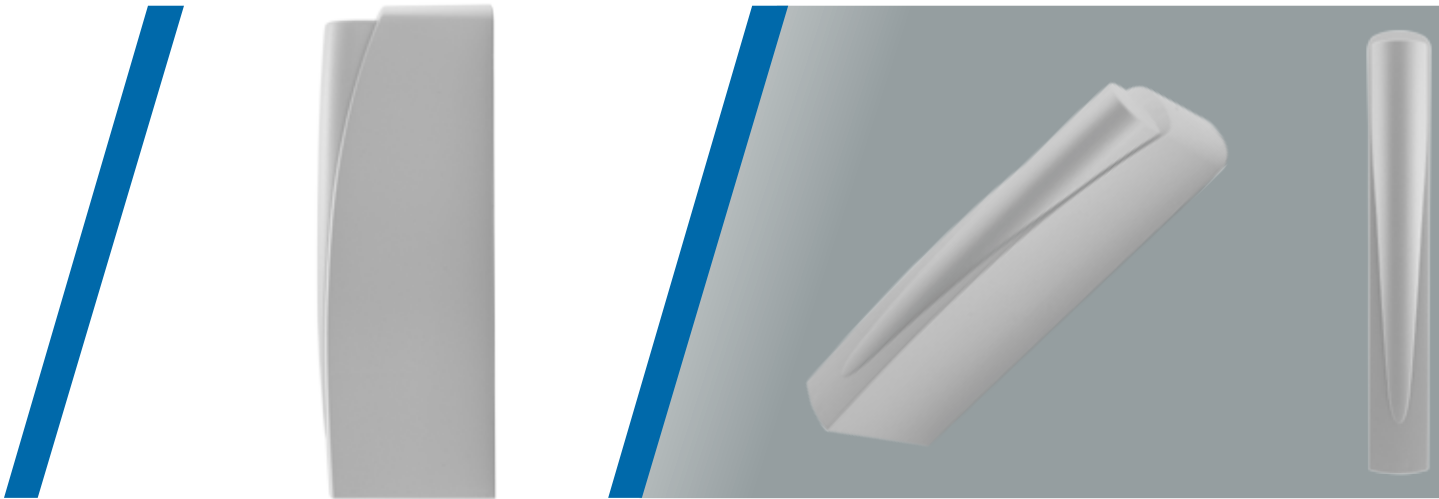

Ranger Antenna

A cost-effective, discrete way to extend Sensormatic EAS detection performance.

The Ranger Antenna is a small AM receiver installed on walls, doorframes, glass or metal surfaces. Compatible with all Sensormatic AM EAS detection systems, this antenna can be installed in place of an additional detection antenna, or used to extend the EAS detection performance of a compatible system. Its small size has minimal impact at the store entrance, is easy to conceal and can be a cost-effective alternative compared to the addition of another pedestal.

Retailer Values

- // Extends the detection field which may eliminate the need for a secondary pedestal
- // Lower cost of ownership and simple installation
- // Small size has minimal impact on store aesthetics

Product Codes

- ZKRANGER-1:** Single Configuration
- ZKRANGER-2:** Dual Configuration
- ZKRANGER-3:** Split Configuration
- ZKRANGER-DG:** Install Kit

Product Compatibility

- Sensormatic AM Sensors
- Ultra-Exit Pedestals
- Ultra-Post Self-Contained Pedestals
- Pro-Max
- 9.75m Concealed Floor System
- 8.4m Concealed Floor System
- Floor-Max Concealed System

Specifications

- Height** 24cm (9.5in)
- Width** 3.8cm (1.5in)
- Thickness/Depth**..... 8cm (3in)
- Weight** 0.5kg (1lb)

Environmental Constraints

Operating Temperature

0°C to 50°C (32°F to 122°F)

Relative Humidity

0 to 90%, non-condensing
Evaluated for altitudes less than 3200m (10500ft)

Declarations

EMC

47 CFR, Part 15
EN 300 330
EN 301 489
RSS-210

Safety (second edition)

IEC 60950-1

CE This product is in conformity with RoHS II Directive 2011/65/EU and REACH Substances of Very High Concern as defined in Regulation (EC) No 1907/2006 and subsequent amendments to both.

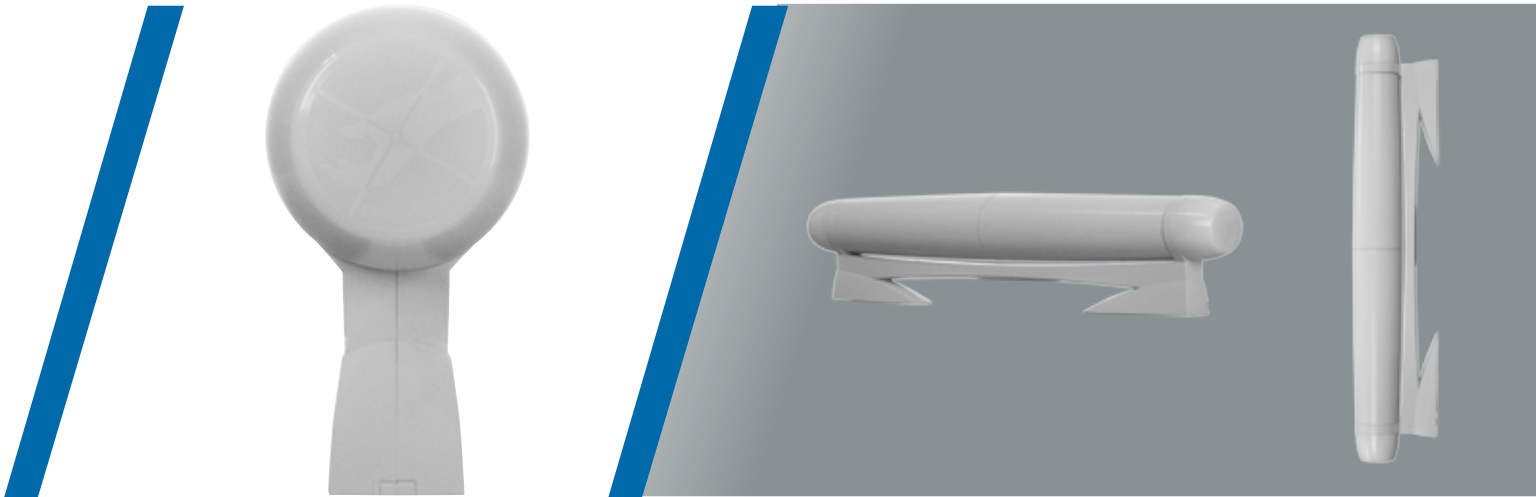

Satellite Antenna

An unobtrusive, highly-aesthetic solution for indoor retail environments.

Designed for indoor use only, the Satellite Antenna is an AM receiver that delivers maximum EAS protection with minimal visual impact on store entrances. This unobtrusive receiver can eliminate the need for one or more pedestals, making it a highly aesthetic solution for wide exits. With minimal backfield of approximately 0.5m (1.5ft), this device allows tagged merchandise close to the exit. The antenna mounts to walls or door frames and is compatible with all AM EAS detection systems.

Retailer Values

- // Open architecture solution provides wide exit coverage with minimal visual impact on store aesthetics
- // Minimal backfield allows tagged merchandise close to the exit
- // Mounts easily to walls or doorframes, to help maximize customer flow

Product Code

ZKRXMULLMT

Mullion Mount Satellite Receiver

Product Compatibility

- Sensormatic AM Sensors
- Ultra•Exit Pedestals
- Ultra•Post Self-Contained Pedestals
- Pro-Max
- 9.75m Concealed Floor System
- 8.4m Concealed Floor System
- Floor-Max Concealed System

Specifications

- Length**..... 72.5cm (28.5in)
- Diameter**..... 8.7cm (3.4in)
- Thickness/Depth**..... 14.3cm (5.6in)
(w/bracket)
- Weight** 4.5kg (10lbs)

Receiver

- Operating Frequency 58-68kHz
- Receiver Coil Resistance 14 ohms
(±5%)

Alarm

- Audio Level Less than 70dB(A)
- Evaluated for altitudes less than 3200m (10500ft)

Environmental Constraints

Operating Temperature

0°C to 50°C (32°F to 122°F)

Relative Humidity

0 to 90%, non-condensing

Declarations

Regulatory

(M4000 CE/Ultra•Post – non-European)

EMC

47 CFR Part 15

Regulatory

(M2000/Ultra•Post – European)

EMC

- 47 CFR, Part 15
- EN 300 330
- EN 301 489
- RSS-210

Safety

Regulatory

(M4000 CE/Ultra•Post–non-European)
IEC 60950-1

Regulatory

(M2000/Ultra•Post–European)
IEC 60950-1

CE This product is in conformity with RoHS II Directive 2011/65/EU and REACH Substances of Very High Concern as defined in Regulation (EC) No 1907/2006 and subsequent amendments to both.



Amorphous Core Antenna

Hidden antenna provides an open-architecture solution for wide store exits.

The Amorphous Core Antenna delivers maximum EAS protection with minimal visual impact on store entrances, giving retailers with wide exits an open architecture solution. The unobtrusive antenna is hidden in a raceway installed on or inside the walls on one side of a pedestal, eliminates the need for one or more pedestals in a traditional EAS system. This antenna is compatible with all AM EAS detection systems.

Retailer Values

- // Open architecture solution provides wide exit coverage with minimal visual impact on store aesthetics
- // Mounts easily to walls for simple installation and lower cost of ownership
- // Small size has minimal impact on store aesthetics

Product Codes

ZPAMRX-S

Single Amorphous Core Receiver with Raceway

ZPAMRX-D

Dual Amorphous Core Receiver with Raceway

Product Compatibility

- Sensormatic AM Sensors
- Ultra•Exit Pedestals
- Ultra•Post Self-Contained Pedestals
- Pro-Max
- 9.75m Concealed Floor System
- 8.4m Concealed Floor System
- Floor-Max Concealed System

Specifications

- Height** 6.75mm (0.266in)
- Width** 25.5mm (1.0in)
- Length**..... 1.74m (5ft 8.5in)
- Weight** 0.88kg (1.95lbs) (antenna only)

Receiver

- Operating Frequency55-70kHz
- Rx Antenna Resistance @DC..... 1.8 ohms (+20%)
- Rx Antenna Resistance @58kHz..75 ohms (+20%)
- Receiver Cable.....12m (40ft), 2-conductor, shielded, burial-rated, plenum-rated

Environmental Constraints

Operating Temperature

0°C to 50°C (32°F to 122°F)

Relative Humidity

0 to 90%, non-condensing

Declarations

EMC

- 47 CFR, Part 15
- EN 300 330
- EN 301 489
- RSS-210

Safety

IEC 60950-1

CE This product is in conformity with RoHS II Directive 2011/65/EU and REACH Substances of Very High Concern as defined in Regulation (EC) No 1907/2006 and subsequent amendments to both.



AMS9040 Controller

Powers up to eight compatible antennas and pedestals for superior wide-exit protection.

The AMS9040 Controller powers Sensormatic’s concealed detection systems, Door-Max and Pro-Max, to provide maximum AM EAS detection performance with efficient management of power consumption. Its Digital Signal Processing (DSP) algorithms and filter technologies ensure superior performance in high-noise environments, automatically adjusting to account for changing surroundings. Dependent on the configuration, this controller supports up to eight antennas and external alarm interfaces for the integration of additional audio alarms, video connections or enhanced detection features. The latest software automatically detects the type of antenna being used. It also provides set-up options including backfield reduction and a spectrum analyzer function that applies the most accurate filters for optimal performance, while providing the “Tags-Too-Close” and Jammer Detection features.

The AMS9040 collects EAS alarm and

traffic counting data from connected compatible devices and delivers this data to connected data management devices to help better manage store operations.

Retailer Values

- // Supports up to eight antennas and detection while providing wide exit coverage
- // Features up to eight optional independent alarm counters for superior merchandise protection
- // Independent current controls allow each antenna to be individually tuned to a specific environment
- // Alarm mapping allows retailers to set custom preferences

Product Code

ZE9040: AMS9040 Controller

Product Compatibility

- Sensormatic AM Sensors
- Pro-Max
- 9.6m Concealed Floor System
- 8.4m Concealed Floor System
- Floor-Max Concealed System
- 2.4m Concealed Floor System
- Door-Max
- Ranger Receivers
- Satellite Receivers
- Amorphous Core Receive
- Digital Remote Alarm

Specifications

- Height** 15cm (5.9in)
- Width** 43.4cm (17.1in) (w/bracket)
32.2cm (14.3in) (w/out bracket)
- Length**..... 50.8cm (20in)
- Weight** 7.3kg (16.15lbs)

Power Supply

- Primary Input**
100-120Vac or 220-240Vac @ 50–60Hz
- Primary Power Fuse**
5A, 250V, sloblow, hi-breaking
- Current Draw**
4.0Arms @ 120Vac
- Input Power**
<400W

Electrical

- Transmitter**
Operating Frequency 58kHz (±200Hz)
Transmit Burst Duration..... 1.6ms
- Transmit Current**
European 12A peak
Non-European..... 16A peak
- Burst Repetition Rate**
Based on 50Hz ac..... 75Hz or 37.5Hz
Based on 60Hz ac..... 90Hz or 45Hz
- Receiver**
Center Frequency 58kHz
Receiver Coil Resistance 1.6 ohms (±5%)



This controller uses Digital Signal Processing (DSP) and filter technologies to remove disruptions from electronic devices for a high detection rate in difficult store environments.

Alarm

Alarm Relay OutputDPDT contacts
 Contact Switching Current..... 1.0A max.
 Contact Switching Voltage28V max.
 Lamp/Audio Duration..... 1–30 sec.
 (1 sec. increments)

Environmental Constraints

Ambient Temperature

0°C to 50°C (32°F to 122°F)

Relative Humidity

0 to 90%, non-condensing

Declarations

EMC

47 CFR, Part 15
 EN 300 330
 EN 301 489
 RSS-210

Safety

IEC 60950-1

CE This product is in conformity with RoHS II Directive 2011/65/EU and REACH Substances of Very High Concern as defined in Regulation (EC) No 1907/2006 and subsequent amendments to both.

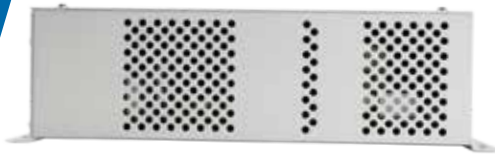

AMS9050 Controller

Powers up to four compatible pedestals for maximum, energy-efficient detection performance.

The AMS9050 Controller provides power to Sensormatic's Ultra•Exit and Ultra•Lane pedestals, as well as the Metal-Foil Detection device for maximum AM EAS detection performance with efficient management of power consumption. Its Digital Signal Processing (DSP) algorithms and filter technologies ensure superior performance in high-noise environments, automatically adjusting to account for changing surroundings.

Delivering up to 2.4m (7ft 10in) of coverage between pedestals, the AMS9050 supports wide or multiple exits to drive up to four pedestals in any combination. The controller processes signal inputs received from connected detection systems to determine if an active AM EAS tag or label has been detected. If protected merchandise passes through the detection zone, the controller activates an integrated alarm within the detection system to notify store associates of the theft attempt. The on-board intelligence allows flexible system configurations,

monitors operation and adjusts for continuous, high-level performance. The latest software automatically detects the type of antenna being used. It also provides set-up options including backfield reduction and a spectrum analyzer function that applies the most accurate filters for optimal performance, while providing the "Tags-Too-Close" and Jammer Detection features.

The AMS9050 collects EAS alarm and traffic counting data from connected compatible devices and delivers this data to connected data management devices to help better manage store operations.

Retailer Values

- // Provides up to 2.4m (7ft 10in) of coverage between pedestals for one of the highest levels of AM technology theft deterrence
- // Innovative DSP and filter technologies help ensure performance under harsh electronic noise conditions
- // On-board self diagnostics, EAS metrics and traffic counting data provide important and timely loss prevention and operational information

Product Code

ZE9050: AMS9050 Controller

Product Compatibility

- Sensormatic AM Sensors
- Ultra•Exit Pedestals
- Ultra•Lane Pedestals
- Metal-Foil Detection
- Ranger Receivers
- Satellite Receivers
- Amorphous Core Receive
- Digital Remote Alarm

Specifications

- Height** 9.2cm (3.6in)
- Width** 33.5cm (13.2in)
- Length** 44.6cm (17.6in)
- Weight** 6.4kg (14.1lbs)

Power Supply

Primary Input

100-120Vac or 200-240Vac @ 50–60Hz

Primary Power Fuse

2.5A, 250V, slo-blow, hi-breaking

Current Draw

- 120V: < 1.5Arms
- 240V: < 1Arms

Input Power

- 120V: < 130W
- 240V: < 123W



This controller identifies active AM EAS hard tags and disposable labels as they pass through compatible detection systems for superior merchandise protection.

Electrical

Transmitter

Operating Frequency 58kHz (±200Hz)
 Transmit Burst Duration..... 1.6ms
 Transmit Current Maximum..... 16A peak

Burst Repetition Rate

Based on 50Hz ac..... 75Hz or 37.5Hz
 Based on 60Hz ac..... 90Hz or 45Hz

Receiver

Center Frequency58kHz

Environmental Constraints

Ambient Temperature

0°C to 50°C (32°F to 122°F)

Relative Humidity

0 to 90%, non-condensing

Declarations

EMC

47 CFR, Part 15
 EN 300 330
 EN 301 489
 RSS-210

Safety

IEC 60950-1

CE This product is in conformity with RoHS II Directive 2011/65/EU and REACH Substances of Very High Concern as defined in Regulation (EC) No 1907/2006 and subsequent amendments to both.



AMS9060 Controller

Available in NA and EU only

Compact, energy efficient controller maximizes performance for compatible detection systems.

The AMS9060 Controller provides considerable cost savings, while significantly improving the performance of compatible detection systems. This controller processes signal inputs received from connected detection systems to determine if an active AM EAS tag or label has been detected. If protected merchandise passes through the detection zone, the controller activates an integrated alarm within the detection system to notify store personnel of the theft attempt. Its Digital Signal Processing (DSP) algorithms and filter technologies ensure superior performance in high-noise environments, automatically adjusting to account for changing surroundings. Focusing on the enhancement of EAS systems and the fulfillment of evolving retailers' needs, Tyco Retail Solutions engineered this advanced, lightweight controller to minimize total cost of ownership and enhance overall detection system's performance.

Retailer Values

- // 10% smaller and over 50% lighter than prior Sensormatic controllers
- // Uses 25% less power than prior Sensormatic controllers without sacrificing performance
- // Built-in 4kV surge protection minimizes service and maintenance costs
- // Improved synchronization reduces install time and false alarms caused by interferences
- // Output supports intelligent Sensormatic antennas for faster, more reliable install and service
- // Eliminates noise and minimizes power waste
- // Innovative DSP and filter technologies help ensure performance under harsh electronic noise conditions
- // Controls up to four pedestals to protect wide or multiple exits
- // Improved backfield reduction and "tags-too-close" feature maximize space and reduce nuisance alarms
- // Jammer and Metal-Foil Detection notifies staff of potential organized retail crime activity
- // Auto-save function prevents count data loss in case of power interruption
- // Compatible with AM EAS pedestal RFID upgrades

Product Codes

ZE9060
AMS9060 Controller

Product Compatibility

- Sensormatic AM Sensors
- Ultra•Exit Pedestals
- Pro-Max
- Ranger Antennas
- Satellite Antennas
- Local Device Manager II (LDM II)
- UltraLink
- Metal-Foil Detection
- Digital Remote Alarm

Specifications

| | |
|---------------------|-------------------|
| Length | 46.1cm (18.15in) |
| Width | 29.82cm (11.74in) |
| Height | 8.87cm (3.5in) |
| Weight | 2.95kg (6.5lbs) |

Electrical

Transmitter

| | |
|------------------------------|------------------------------|
| Operating Frequency..... | 58kHz (±200Hz) |
| Transmit Burst Duration..... | 1.6ms |
| Max. Transmit Current..... | 20A peak (2.4m pedestals) |
| Max. Transmit Current..... | 16A peak (2m pedestals) |

Burst Repetition Rate

| | |
|-----------------------|----------------|
| Based on 50Hz ac..... | 75Hz or 37.5Hz |
| Based on 60Hz ac..... | 90Hz or 45Hz |



This controller improves the performance of compatible detections systems at considerable cost savings.

Electric (con't)

Receiver

Center Frequency58kHz

Environmental Constraints

Ambient Temperature

0°C to 50°C (32°F to 122°F)

Relative Humidity

0 to 90%, non-condensing

Enclosure

IPXO
Evaluated for altitudes
<2000m (6500ft)

Power Supply

Primary Input

100-120VAC
200-240VAC @ 50/60 Hz

Primary Power Fuse

3.15A, 250V, slo-blow, hi-breaking

Current Draw

(120V): <2.1Arms

Current Draw

(240V): < 0.9Arms

Input Power

(120V) <165W

Input Power

(240V): <165W

Declarations

EMC

47 CFR, Part 15
EN 300 330
EN 301 489
RSS-210

Safety

IEC 60950-1

CE This product is in conformity with RoHS II Directive 2011/65/EU and REACH Substances of Very High Concern as defined in Regulation (EC) No 1907/2006 and subsequent amendments to both.

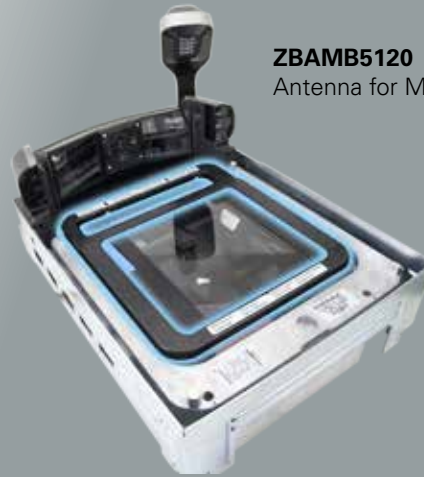

ZBAMB5120
Antenna for Magellan 9800i Model

Integrated Deactivators for Compatible Datalogic Scanners

These high-performance Sensormatic deactivators are comprised of antennas designed specifically to integrate with compatible Datalogic scanners. After products are scanned and information verified at the point-of-sale, the antennas automatically deactivate attached AM EAS labels for a fast and accurate checkout — even in high-traffic, high-volume locations. The antennas deactivate 2.5 active labels per second, regardless of label orientation, and the optional remote module provides audible and visual confirmations when active labels are detected and deactivated. These true integrated deactivation solutions help prevent sweethearting, scan avoidance and merchandise switching.

When connected to a compatible EAS data management device, real-time deactivation counts can be generated into user-friendly customizable reports to provide business-critical data.

Retailer Values

- // Accelerates checkout by simultaneously scanning and deactivating protected merchandise when connected to compatible scanners
- // Only deactivates merchandise that has been scanned and purchased to help prevent sweethearting, scan avoidance and merchandise switching
- // Built-in audible and visual indicators provide immediate feedback when active labels are detected and deactivated, enhancing front-end productivity
- // EAS connectivity option allows generation of operational information to help quickly identify and correct performance issues

Product Compatibility

- All Sensormatic AM EAS Labels
- Local Device Manager II (LDM II)
- Remote Alarm Module

Product Codes

NA, APAC, LATAM and EMEA:

Antenna for Magellan 9800i Model

Note: Must be retrofitted in the field.

ZBAMB5120

Deactivator Coil Antenna, AMB9010-IPS Controller, Install Kit, Power Cord

ZBAMB9010-IPS

AMB9010-IPS Controller

ZBAMB5120A

Deactivator Coil Antenna, Install Kit

EMEA:

Antenna for Magellan 8500 Model

Note: Must be retrofitted in the field.

An industrial cover is required, minor check-stand modifications are necessary.

ZBAMB5185R

Deactivator coil antenna, AMB9010-IPS controller, Remote alarm unit, Power cord

ZBAMB5185A

Deactivator coil antenna

ZBAMB9010-IPS

AMB9010 controller

NA, APAC and LATAM:

Antenna for Magellan 8500Xt Model

Note: Cannot be retrofitted in the field or into non-EAS ready scanners.

Retailer: When placing scanner order, Datalogic must be informed that the purchase will include a Sensormatic EAS deactivation antenna.

Product Codes (con't)

ZBAMB5190

Deactivator Coil Antenna, AMB9010-IPS Controller, Install Kit, Power Cord

ZBAMB9010-IPS

AMB9010-IPS Controller

ZBAMB5190A

Deactivator Coil Antenna

0352-0412-01

Install Kit

NA, APAC, LATAM and EMEA:

Antenna for Magellan 8300/8400

Model:

Note: Must be retrofitted in the field.

ZBAMB5184A

Deactivator Coil Antenna

ZBAM9010-IPS

AMB9010-IPS Controller

0352-0395-01

Install Kit

ZBAMB5184

Antenna for new and short platter installs

ZBAMB5184VB

Coil Antenna Vertical Bezel

0352-0411-01

AMB9010 Ferrite Kit with Remote Alarm

ZBAMB5184M

Antenna configuration for medium platter installs

ZBAMB5185MS

Antenna configuration for medium sapphire platter installs

ZBAMB5185L

Antenna configuration for long platter installs

0352-0394-01

Short length platter for PSC Magellan 8300/8400

0352-0397-01

Short length sapphire platter for PSC Magellan 8300/8400

0352-0394-02

Medium length platter for PSC Magellan 8300/8400

0352-0397-02

Medium length sapphire platter for PSC Magellan 8300/8400

0352-0394-03

Long length platter for PSC Magellan 8300/8400

0352-0397-03

Long length sapphire platter for PSC Magellan 8300/8400

ZPSTP-RA

Remote Alarm Module (optional)

Additional Antenna Options

Sensormatic deactivation antenna integrates around a single plane vertical scanner housing. Compatible with Datalogic single plane vertical scanners 2200vs and 3200vs.

ZBAMB5010

AMB5010 Vertical Antenna, AMB9010-IPS Controller, Install Kit, Power Cord

ZBAMB5010A2

AMB5010 Vertical Antenna, Install Kit

ZBAMB9010-IPS

AMB9010-IPS Controller

ZPSTP-RA

Remote Alarm Module (required)

Electrical

Requires Universal Controller: ZBAMB9010-IPS

CE This product is in conformity with RoHS II Directive 2011/65/EU and REACH Substances of Very High Concern as defined in Regulation (EC) No 1907/2006 and subsequent amendments to both.

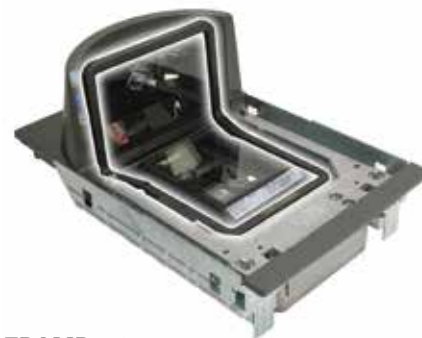

ZBAMB5184

Antenna for Magellan 8300/8400 Model



ZBAMB5185

Antenna for Magellan 8500 Model



ZBAMB5190

Antenna for Magellan 8500Xt Model



ZBAMB5010

Antenna for Magellan 2200VS and 3200VS



ZBAMB5279
AMB5279 Horizontal Antenna

Integrated Deactivators for Compatible NCR Scanners/Scales

These high-performance Sensormatic deactivators are comprised of antennas designed specifically to integrate with compatible NCR RealScan scanner/scales. After products are scanned and information verified at the point-of-sale, the antennas automatically deactivate attached AM EAS labels for a fast and accurate checkout — even in high-traffic, high-volume locations. The antennas deactivate 2.5 active labels per second, regardless of label orientation. The optional Remote Alarm Module provides audible and visual confirmations when active labels are detected and deactivated.

The antennas' design and geometry are unique to compatible NCR RealScan scanners/scales and must be retrofitted in the field. The antenna is located inside the scanner housing to eliminate the need for modifications to the checkstand, helping reduce overall installation costs. These true integrated deactivation solutions help prevent sweethearting, scan avoidance and merchandise switching.

When connected to a compatible EAS data management device, real-time deactivation counts can be generated into user-friendly customizable reports to provide business critical data.

Retailer Values

- // Accelerates checkout by simultaneously scanning and deactivating protected merchandise to alleviate unnecessary shopper delays
- // Only deactivates merchandise that has been scanned and purchased to help prevent sweethearting, scan avoidance and merchandise switching
- // Reduces overall installation costs by eliminating the need to modify checkstand
- // Audible and visual indicators provide immediate feedback when active labels are detected and deactivated, enhancing front-end productivity
- // EAS connectivity option allows generation of operational information to help quickly identify and correct performance issues

Product Codes

Antenna for NCR RealScan 740 OFX Bi-Optic Scanner/Scale

ZBAMB5274
AMB5274 Horizontal and Vertical Antenna, AMB9010-IPS Controller, Install Kit, Power Cord

ZBAMB5274H
AMB5274 Horizontal Antenna

ZBAMB5274V

AMB5274 Vertical Antenna

ZBAMB9010-IPS

AMB9010-IPS Controller

0352-0400-01

AMB5274 Install Kit

ZPSTP-RA

Remote Alarm Module (optional)

Antenna for NCR RealScan 780 OFX Bi-Optic Scanner/Scale

ZBAMB5278

AMB5278 Antenna, AMB9010-IPS Controller, Install Kit, Power Cord

ZBAM9010-IPS

AMB9010-IPS Controller

ZBAM5278A

AMB5278 Antenna

0352-0337-01

Install Kit

ZPSTP-RA

Remote Alarm Module (optional)

Additional Antenna Option

Sensormatic deactivation antenna integrates around the vertical scanner housing.

ZBAMB5010

AMB5010 Vertical Antenna, AMB9010-IPS Controller, Install Kit, Power Cord

Product Codes (con't)

ZBAMB5010A2

AMB5010 Vertical Antenna, Install Kit

ZBAMB9010-IPS

AMB9010-IPS Controller

ZPSTP-RA

Remote Alarm Module (required)

Antenna for NCR FastLane 7812 Single Window Scanner/Scale

ZBAMB5212

AMB5212 Horizontal Antenna, AMB9010-IPS Controller, Install Kit, Power Cord

ZBAMB5212H

AMB5212 Horizontal Antenna

ZBAMB9010-IPS

AMB9010-IPS Controller

0352-0618-01

AMB5212 Install Kit

ZPSTP-RA

Remote Alarm Module (optional)

Antenna for NCR RealScan 79 Bi-Optic Imager/Scale

ZBAMB5279

AMB5279 Horizontal Antenna, AMB9010-IPS Controller, Install Kit, Power Cord

ZBAMB5279H

AMB5279 Horizontal Antenna

ZBAMB9010-IPS

AMB9010-IPS Controller

0352-0627-01

AMB5279 Install Kit

ZPSTP-RA

Remote Alarm Module (optional)

Product Compatibility

All Sensormatic AM EAS Labels

Local Device Manager II (LDM II)

Remote Alarm Module

Electrical

Requires Universal Controller (ZBAMB9010-IPS)

CE This product is in conformity with RoHS II Directive 2011/65/EU and REACH Substances of Very High Concern as defined in Regulation (EC) No 1907/2006 and subsequent amendments to both.



ZBAMB5278

Scan 780 OFX Bi-Optic Scanner/Scale



ZBAMB5212

AMB5212 Horizontal Antenna

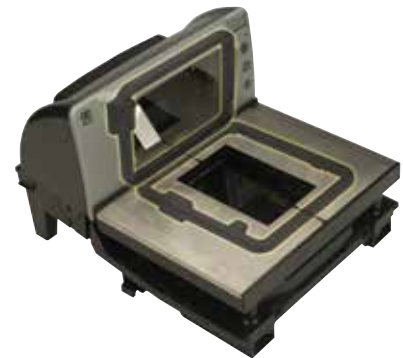

ZBAMB5274

Horizontal and Vertical Antenna



ZBAMB5010

AMB5010 Vertical Antenna

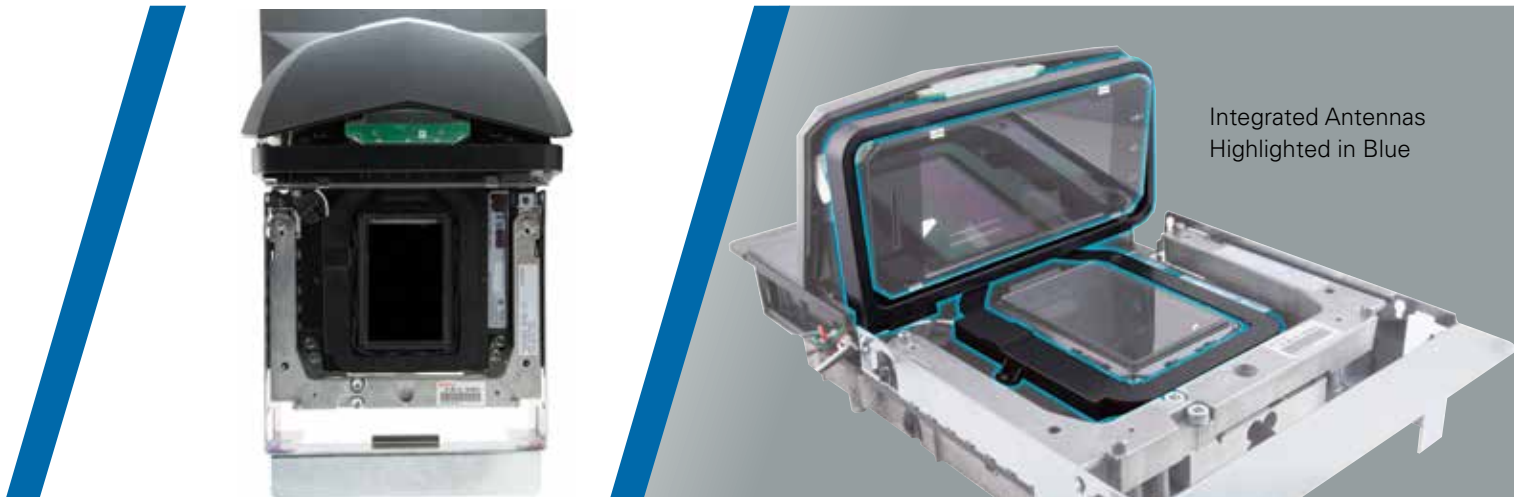

Integrated Deactivator for Motorola Scanners

The Sensormatic AMB5410 Deactivator is part of a true integrated scan/deactivation solution. This deactivator was specifically designed to attach to Motorola's Odyssey MP6000 scanner so cashiers can simultaneously scan and deactivate AM EAS labeled merchandise for a more streamlined checkout experience.

The AMB5410 enables fast, accurate checkout service, even in high-traffic, high-volume locations. Once protected merchandise is scanned and information is verified at the point-of-sale, the integrated antenna deactivates AM EAS anti-theft security labels. By only deactivating merchandise that has been scanned, this solution helps prevent sweethearting, scan avoidance and merchandise switching to drive revenue and increase shopper throughput.

When connected to a compatible data management device, real-time deactivation counts can be generated into a user-friendly customizable reports to provide business critical data.

The AMB5410's antenna coil design and geometry are unique to the Motorola Odyssey MP6000 scanner and must be retrofitted in the store environment.

Retailer Values

- // Helps prevent sweethearting by only deactivating merchandise that has been scanned and purchased, driving revenue
- // Accelerates check-out process to alleviate unnecessary shopper delays
- // EAS connectivity allows for delivery of operational information
- // Audible and visual indicators provide immediate feedback when label is detected and deactivated, enhancing front-end productivity

Product Codes

Antenna for Motorola Odyssey MP6000 Scanner

ZBAMB5410

AMB5410 Vertical and Horizontal Antennas, AMB9010-IPS Controller, Install Kit

ZBAMB5410A

AMB5410 Vertical and Horizontal Antennas, Install Kit

Additional Antenna Options

Sensormatic deactivation antenna integrates around a single plane vertical scanner housing.

ZBAMB5010

AMB5010 Vertical Antenna, AMB9010-IPS Controller, Install Kit, Power Cord

ZBAMB5010A2

AMB5010 Vertical Antenna, Install Kit

ZBAMB9010-IPS

AMB9010-IPS Controller

ZPSTP-RA

Remote Alarm Module (required)

Product Compatibility

- All Sensormatic AM EAS Labels
- Local Device Manager II (LDM II)
- Remote Alarm Module

Specifications

Weight

| | |
|---------------------|-----------------|
| ZBAMB5410 | 5.2kg (11.5lbs) |
| ZBAMB5410A | 1.8kg (4.0lbs) |
| ZBAMB9010-IPS | 2.5kg (5.5lbs) |

Electrical

Requires Universal Controller:
ZBAMB9010-IPS

CE This product is in conformity with RoHS II Directive 2011/65/EU and REACH Substances of Very High Concern as defined in Regulation (EC) No 1907/2006 and subsequent amendments to both.

**ZBAMB5010**

AMB5010 Vertical Antenna



Mobile Handheld Deactivator

The Sensormatic Mobile Handheld Deactivator is designed to attach to Motorola’s MT2070 or DS6878 scanners for an all-in-one mobile scanner/ deactivation solution. After scanning merchandise, the deactivator emits a visual and an audible signal to confirm successful AM EAS label deactivation. When lit, the indicator light alerts cashiers that an active label is still in the deactivator’s range. This level of intelligence and control helps prevent sweethearting, scan avoidance and merchandise switching.

The mobility feature allows cashiers to scan and deactivate heavy, bulky merchandise in the shopping cart to help improve checkout throughput, reduce nuisance EAS alarms at the door, and minimize heavy-lifting related injuries. As a result, the deactivator contributes to greater flexibility and safety for store associates, as well as faster checkout and increased customer satisfaction.

The required Wireless Sync Access Point provides synchronization of the Mobile Handheld Deactivator with the EAS functionality of the detection pedestals to avoid interferences.

Retailer Values

- // Reduces nuisance EAS alarms at the door
- // Speeds throughput at the point-of-sale (POS) to help improve the customer experience
- // Frees up counter space; device does not need to be installed in/under POS counter
- // Scans heavy, bulky items right in the cart, helping prevent lifting related injuries
- // Color LEDs and audible alerts let associates know the device is working properly
- // Rugged design for reliable operation

Product Codes

Integration onto Motorola MT2070

- ZBAMB4410**
Deactivation Module
- ZBAMB4415**
Cradle Adapter for the MT2070 (required order)
- ZBAMB4310**
Wireless Sync Access Point (required order)

Integration onto Motorola DS6878

- ZBAMB4400**
Deactivation Module
- ZBAMB4420**
Module Adapter (required order)
- ZBAMB4425**
Cradle Adapter Required for DS6878 (required order)
- ZBAMB4310**
Wireless Sync Access Point (required order)

Product Compatibility

- All Sensormatic AM EAS Labels
- Motorola MT2070 Scanner (sold separately)
- Motorola DS6878 Scanner (sold separately)

Specifications

- ZBAMB4410 Deactivation Module with MT2070**
- Length** 13.33cm (5.25in)
- Width** 11.43cm (4.5in)
- Height** 20.32.cm (8.0in)
- Weight (with battery)** 0.88kg (1.93lbs)

Specifications (con't)

ZBAMB4400 Deactivation Module with DS6878

Length..... 13.34cm (5.25in)
Width 11.43cm (4.5in)
Height 18.90cm (7.44in)
Weight (with battery) 0.75kg (1.654lbs)

ZBAMB4310 Wireless Sync Access Point (Required order)

Length..... 13cm (5.5in)
Width 11.5cm (4.5in)
Depth 4.3cm (1.7in)
Weight 0.24kg (0.536lbs)

Electrical

AC Input
 100–240V @ 47-63Hz

DC Input
 12Vdc @ 2.5A

Communications

Power On Indicator..... Blue LED

DisplayScanner has LCD

Data Communication:

Wireless 802.15.4

Data Rate 250Kbps

Frequency Range 2.4GHz ISM band
 2405MHz–2480MHz

Output Power..... 5mW, +7dBm Max.
 (boost mode)

Spreading Technique

..... Direct Sequence Spread

..... Spectrum (DSSS)

EAS Synchronization

..... Wireless EAS

..... Sync-AP Transceiver

Declarations

EMC

47 CFR, Part 15
 ICES-003
 RSS-Gen
 RSS-210

Safety (second edition)

UL 60950-1
 CSA C22.2.60950-1
 EN 60950-1

CE This product is in conformity with RoHS II Directive 2011/65/EU and REACH Substances of Very High Concern as defined in Regulation (EC) No 1907/2006 and subsequent amendments to both.



Base Charging Station
 with Cradle Adapters



Wireless Sync Access Point



FreeStyle Handheld Deactivator

The Sensormatic FreeStyle Handheld Deactivator is a battery-operated deactivator and verifier for AM EAS labels. Combining three accessories into one, this device detects active labels up to 15cm (6in), deactivates them up to 7.6cm (3in) above the surface of the unit, and when in "Search Only Mode," it verifies source tagged labels on protected merchandise. While in this mode, the handheld will not deactivate an active label.

The mobility feature allows cashiers to deactivate labels on merchandise too heavy or bulky to life onto the point-of-sale counter. This feature can also be used to address incoming/outgoing alarms at the entrance to ensure a valid purchase, and eliminate customer wait time and embarrassment.

The FreeStyle Handheld Deactivator features integrated status indicators that provide visual and audible notifications when live labels are successfully detected and deactivated. This self-contained unit utilizes internal batteries that automatically recharge when placed in charging cradle. Security passcode and time out features help prevent unauthorized use.

Retailer Values

- // Portable device detects and deactivates active AM EAS labels anywhere in the store for enhanced customer service and employee productivity
- // Automatically recharges in charging cradle to ensure device is always ready for use
- // Built-in audible and visual indicators provide immediate feedback when labels are detected and deactivated, enhancing front-end productivity
- // Security passcode and time out features help prevent authorized use

Product Codes

ZBHHCW

Handheld Deactivator, Base Charging Station (Customer Install-US Only)

ZBHHCW-I

Handheld Deactivator, Base Charging Station (Sensormatic Installed)

ZEHHDW

Handheld Unit

ZEHHBCS

Base Charging Station

Product Compatibility

All Sensormatic AM EAS Labels

Specifications

Color Dark Gray

Length

Handheld 28cm (11in)

Docking Station 20cm (8in)

Width

Handheld 11.4cm (4.5in)

Docking Station 14cm (5.5in)

Height

Handheld 3.2cm (1.25in)

Docking Station 7.6cm (3.0in)

Weight 0.8kg (28oz)

Power Supply Weight 0.8kg (28oz)

Electrical

Base Charging Station

AC Power (N. America) 120Vac, 0.5A
(60Hz) Class 2

AC Power (Europe) 230Vac, 0.3A
(50Hz) LPS

Environmental Constraints

Operating Temperature

0°C to 40°C (32°F to 104°F)

Declarations

Deactivator and Charger

EMC

47 CFR, FCC Part 15

Subpart C

EN55022

ETS 300 330

ETS 300 683

RS 210

Safety (second edition)

Power Supply

Certified Class 2

EN60950 LPS

UL 1950

Handheld

EN60950

UL 1950

CSA C22.2 No. 950

Charger

UL 1950

EN60950

CE This product is in conformity with RoHS II Directive 2011/65/EU and REACH Substances of Very High Concern as defined in Regulation (EC) No 1907/2006 and subsequent amendments to both.



Hand Stamp Deactivator

The Sensormatic Hand Stamp Deactivator conveniently deactivates AM EAS labels without removing merchandise from the shopping cart. This device is especially useful for deactivating heavy, bulky products that are difficult to lift onto the register — helping reduce nuisance alarms and prevent lifting-related injuries. The spring-loaded feature returns the stamp to its normal position after deactivation. The hand stamp includes a durable lanyard to fasten to the counter to prevent removal from the store environment.

Retailer Values

- // Conveniently deactivates labels without removing merchandise from the shopping cart to reduce nuisance alarms and improve employee productivity
- // Integrated lanyard fastens to the counter to prevent unauthorized use or removal from the store

Product Code ZK20-1

Product Compatibility

All Sensormatic AM EAS Labels

Specifications

Length.....7.0cm (2.75in)

Width 3.6cm (1.4in)

CE This product is in conformity with RoHS II Directive 2011/65/EU and REACH Substances of Very High Concern as defined in Regulation (EC) No 1907/2006 and subsequent amendments to both.

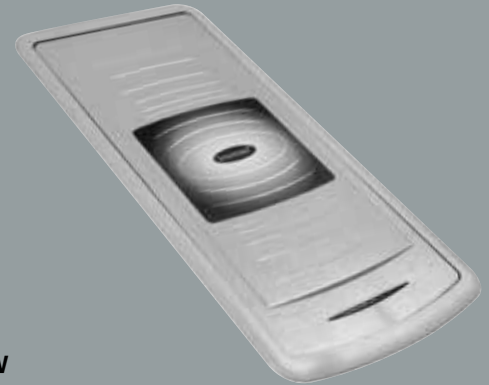

ZBSMP-PW
PowerPad Deactivator

PowerPad Deactivator

The Sensormatic PowerPad Deactivator offers superior deactivation reliability at impressive throughput speeds. The PowerPad deactivates active AM EAS labels up to 17.5cm (7in) above its surface at a throughput speed of up to 200cm/sec (80in/sec) — allowing deactivation of both source-tagged and retailer-tagged merchandise.

Designed to accommodate various checkstand configurations, the PowerPad can be installed on or below the counter, or at the counter's edge with brackets. The optional Remote Alarm Module can be mounted almost anywhere on the checkstand. The alarm module provides audible and visual confirmations when active labels are detected and deactivated. The locking key feature within the alarm module, prevents unauthorized use of the PowerPad when point-of-sale is unattended.

When connected to a compatible EAS data management device, real-time deactivation counts can be generated into user-friendly customizable reports to provide business-critical data.

Retailer Values

- // Flexible installation options accommodate a variety of checkstand configurations
- // Fast deactivation accelerates check-out and alleviates unnecessary shopper delays
- // EAS connectivity option allows generation of operational information to help quickly identify and correct performance issues
- // Built-in audible and visual indicators provide immediate feedback when active labels are detected and deactivated, enhancing front end productivity

Product Codes

- ZBSMP-PW**
PowerPad Deactivator, AMB9010-IPS Controller, Remote Alarm Module, Power Cord
- ZBAMB9010-IPS**
Controller with Cord
- ZBSMPPP**
PowerPad Deactivator Only
- ZBSTP-PP-B1**
Flush Mount Tray
- ZBSTP-PP-B2**
Under-the-Counter Bracket
- ZBSTP-PP-B3**
Cantilever Mounting Bracket

ZBSTP-PP-B4

Flip Mount Bracket

Product Compatibility

All Sensormatic AM EAS Labels
Local Device Manager II (LDM II)
Remote Alarm Module

Specifications

Length..... 39.3cm (15.5in)
Width 17cm (6.7in)
Height 5.7cm (2.2in)
Weight 9.6kg (21lbs)
Pad Cable Length.....3m (10ft)

Electrical

Requires Universal Controller (ZBAMB9010-IPS)

Environmental Constraints

Operating Frequency

58 kHz

Operating Temperature

0°C to 40°C (32°F to 104°F)

CE This product is in conformity with RoHS II Directive 2011/65/EU and REACH Substances of Very High Concern as defined in Regulation (EC) No 1907/2006 and subsequent amendments to both.



SlimPad Deactivator

The Sensormatic SlimPad Deactivator offers reliable deactivation for checkstands with limited space. The SlimPad automatically deactivates active AM EAS labels up to 15cm (6in) above its surface at a throughput speed of up to 200cm/sec (80in/sec). It's narrow design allows installation on either side of the scanner to help maintain the proper flow of products: first over the scanner, then over the deactivator. The optional Remote Alarm Module can be mounted almost anywhere on the checkstand. The alarm module provides audible and visual confirmations when active labels are detected and deactivated. The locking key feature within the alarm module prevents unauthorized use of the SlimPad when point-of-sale is unattended.

When connected to a compatible EAS data management device, real-time deactivation counts can be generated into user-friendly customizable reports to provide business-critical data.

Retailer Values

- // Narrow design allows installation on either side of the scanner to maintain proper "scan-deactivation" product flow

- // Fast deactivation accelerates check-out and alleviates unnecessary shopper delays
- // EAS connectivity option allows generation of operational information to help quickly identify and correct performance issues
- // Built-in audible and visual indicators provide immediate feedback when active labels are detected and deactivated, enhancing front-end productivity

Product Codes

ZBSMP-SL
SlimPad Deactivator, AMB9010-IPS Controller, Remote Alarm Module, Power Cord

ZESMPRO
Controller with Cord

ZBAMB9010-IPS
AMB9010-IPS Controller Only

ZBSMPSP
SlimPad Deactivator Only

ZPSTP-RA
Remote Alarm Module

ZPSL-B2
Under-the-Counter Mounting Bracket

ZPSL-B3
End-of-the-Counter Cantilever Bracket

Product Compatibility

All Sensormatic AM EAS Labels
Local Device Manager II (LDM II)
Remote Alarm Module

Specifications

Length..... 35.7cm (14.0in)
Width 11.4cm (4.5in)
Height 7.0cm (2.8in)
Weight 6.5kg (14.3lbs)
Pad Cable Length.....3m (10ft)

Electrical

Requires Universal Controller (ZBAMB9010-IPS)

Environmental Constraints

Operating Frequency
58 kHz

Operating Temperature
0°C to 40°C (32°F to 104°F)

CE This product is in conformity with RoHS II Directive 2011/65/EU and REACH Substances of Very High Concern as defined in Regulation (EC) No 1907/2006 and subsequent amendments to both.



ZBSMP-CM
Tabletop System

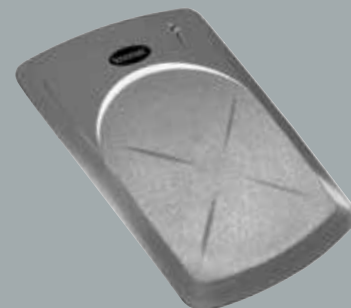

ZBSMP-CM-F
Flush Mount System

CompactPad Deactivator

The Sensormatic CompactPad Deactivator provides convenient and simple deactivation for even the smallest checkstand areas. Designed in front-end applications where high-speed throughput is not a priority, this unit deactivates active AM EAS labels up to 15cm (6in) above the surface of the pad at a throughput speed of up to 152 cm/sec. (60in/sec). An LED light on the deactivator provides visual deactivation notification. Optional Remote Alarm Module provides visual and audible confirmations when active labels are detected and deactivated. The locking key feature within the remote alarm module prevents unauthorized use of the CompactPad when point-of-sale is unattended. The alarm module can be mounted almost anywhere on the checkstand.

When connected to a compatible EAS data management device, real-time deactivation counts can be generated into user-friendly customizable reports to provide business-critical data.

Retailer Values

- // Designed for even the smallest checkstand areas to allow maximum use of counter space
- // Reliable deactivation for increased customer service and fewer nuisance alarms
- // EAS connectivity option allows generation of operational information to help quickly identify and correct performance issues
- // Built-in audible and visual indicators provide immediate feedback when active labels are detected and deactivated, enhancing front-end productivity

Product Codes

ZBSMP-CM

Tabletop System: CompactPad Pro, AMB9010-IPS Controller, Remote Alarm Module, Power Cord

ZBSMP-CM-F

Flush Mount System: CompactPad Pro, AMB9010-IPS Controller, Remote Alarm Module, Power Cord

Product Compatibility

All Sensormatic AM EAS Labels
Local Device Manager II (LDM II)
Remote Alarm Module

Specifications

Length

Tabletop 20.8cm (8.2in)
Flush Mount 24.2cm (9.5in)

Width

Tabletop 16.2cm
Flush Mount 19.1cm (7.5in)

Height

Tabletop 4.9cm (1.9in)
Flush Mount 4.9cm (1.9in)

Weight 3.1kg (6.9lbs)

Electrical

Requires Universal Controller (ZBAMB9010-IPS)

Environmental Constraints

Operating Frequency

58 kHz

Operating Temperature

0°C to 40°C (32°F to 104°F)

CE This product is in conformity with RoHS II Directive 2011/65/EU and REACH Substances of Very High Concern as defined in Regulation (EC) No 1907/2006 and subsequent amendments to both.

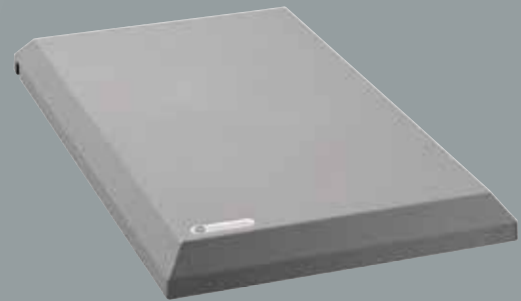

Low Profile Pad Deactivator

The Sensormatic Low Profile Pad Deactivator features high-speed throughput for grocery, DIY and general merchandise retail stores. Accommodating a variety of checkstand configurations, this deactivator can be installed under the counter or conveyor. The unit deactivates AM EAS labels up to 20cm (8in) above the surface of the pad at a throughput speed of up to 254 cm/sec (100 in/sec). The optional Remote Alarm Module provides visual and audible confirmations when active labels are detected and deactivated. The locking key feature within the alarm module, prevents unauthorized use of the Low Profile Pad when point-of-sale is unattended. The alarm module can be mounted almost anywhere on the checkstand.

When connected to a compatible EAS data management device, real-time deactivation counts can be generated into user-friendly customizable reports to provide business-critical data.

Retailer Values

- // Flexible installation options accommodate a variety of checkstand configurations in high throughput environments
- // Fast deactivation rates expedite checkout for increased customer service and efficiency
- // EAS connectivity option allows generation of operational information to help quickly identify and correct performance issues
- // Built-in audible and visual indicators provide immediate feedback when active labels are detected and deactivated, enhancing front-end productivity

Product Codes

ZBSMP-LW

Low Profile Pad Deactivator, AMB9010-IPS Controller, Remote Alarm Module, Power Cord

ZBAMB5011

Low Profile Pad Deactivator

Product Compatibility

All Sensormatic AM EAS Labels
Local Device Manager II (LDM II)
Remote Alarm Module

Specifications

Length..... 35.6cm (14in)
Width 22.9cm (9in)
Height 2.9cm (1.1in)
Weight 5.4kg (12lbs)
Pad Cable Length.....3m (10ft)

Electrical

Requires Universal Controller (ZBAMB9010-IPS)

Environmental Constraints

Operating Frequency

58 kHz

Operating Temperature

0°C to 40°C (32°F to 104°F)

CE This product is in conformity with RoHS II Directive 2011/65/EU and REACH Substances of Very High Concern as defined in Regulation (EC) No 1907/2006 and subsequent amendments to both.

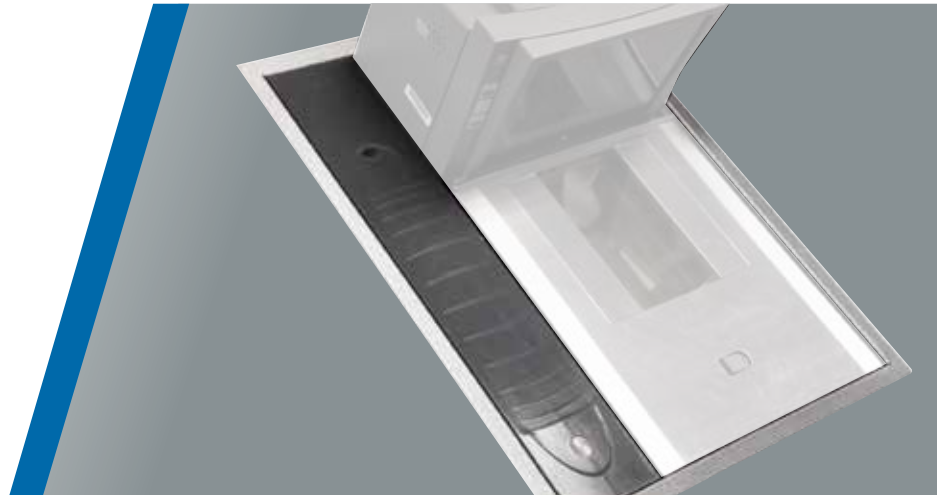
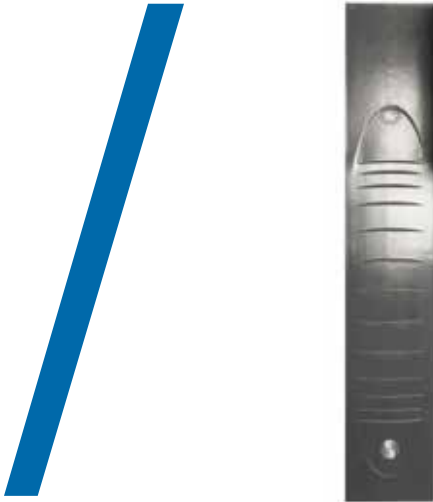

Integrated Pad Pro Deactivator

The Sensormatic Integrated Pad (IP) Pro deactivates AM EAS labels several inches above the surface of the unit to deliver a reliable and virtually seamless scan-deactivate process. This deactivator is only 9.2cm (3.6in) wide, it's installed flush against any 51cm (20in) long bar code scanner for seamless scan-deactivation of AM EAS labels. The optional stainless steel trim ring can be installed around both devices for complete a one-unit appearance. Since the scanner and deactivator are not connected physically or operationally, the service warranty or other device issues will not be affected.

Retailer Values

- // Mounts flush to scanner for seamless scan-deactivation of AM EAS labels
- // Small, narrow footprint allows maximum use of point-of-sale space
- // Deactivates active AM EAS labels up to 15cm (6in) above the pad to help expedite throughput
- // Provides visual confirmation of label deactivation

Product Codes

ZBSMP-IN

IP Pro Antenna, AMB-9010-IPS Controller, Remote Alarm Module, Power Cord

ZBSMPIPE

IP Pro Antenna

Product Compatibility

All Sensormatic AM EAS Labels

Remote Alarm Module

Magellan Scanner SL 383

Magellan Scanner/Scale 384

NCR Scanners

7870-1000, 7872-1000 and 7875-1000

NCR Scanner/Scale

7870-2000, 7872-2000, 7875-2000

ICL / Fujitsu

Orion 9500 and Model 9900 Scanner/Scale

Specifications

Length..... 51cm (20in)

Width 9.2cm (3.6in)

Height 12.7cm (5in)

Weight 7.25kg (16lbs)

Electrical

Requires Universal Controller (ZBAMB9010-IPS)

Environmental Constraints

Operating Frequency

58 kHz

Operating Temperature

0°C to 40°C (32°F to 104°F)

CE This product is in conformity with RoHS II Directive 2011/65/EU and REACH Substances of Very High Concern as defined in Regulation (EC) No 1907/2006 and subsequent amendments to both.



ZBAMB2011T
Deactivator Antenna,
Countertop



ZBAMB2011F
Deactivator Antenna,
Flushmount

Value Pad Deactivator

The Sensormatic Value Pad Deactivator deactivates active AM EAS labels up to four inches above the surface of the pad for a reliable and virtually seamless process while expediting throughput at the point-of-sale (POS). This unit uses a two-step detect and deactivate process. The integrated status indicators provide visual and audible notifications when live labels are successfully detected and deactivated.

In addition, the deactivator acts as a double-checking device if an associate is ever uncertain whether the label was deactivated. The integrated keypad allows associates to control the volume and tone of the deactivator to distinguish it from other POS equipment. The keypad also initiates the "power-save" mode to help prevent theft by turning the unit off.

With a variety of installation options available – countertop, vertical and flush mount – the sleek design and small footprint maximizes POS counter space. The Value Pad operates off an ordinary electrical outlet and does not require a separate controller.

When connected to a compatible EAS data management device, real-time deactivation counts can be generated into user-friendly customizable reports to provide business-critical data.

Retailer Values

- // Scan-enable functionality only deactivates labels with a valid barcode
- // Slim design allows maximum use of POS space
- // EAS connectivity option allows for generation of operational information to help quickly identify and correct performance
- // Built-in audible and visual indicators provide immediate feedback when active labels are detected and deactivated

Product Codes

ZBAMB2011T
Deactivator Antenna, Countertop Mounting Hardware, Power Cord

ZBAMB2011F
Deactivator Antenna, Flushmount Bracket, Power Cord

ZBAMB2011
Deactivator Antenna

5606-0079-01
Power Supply

ZBAMB1101
Deactivator Antenna (without keypad)

Product Compatibility

- All Sensormatic AM EAS Labels
- Local Device Manager II (LDM II)
- Remote Alarm Module

Specifications

- Length** 21cm (8.3in)
- Width** 16cm (6.3in)
- Height** 4cm (1.6in)
- Weight** 0.95kg (2.1lbs)
- Power Cord Length** 170cm (5.5ft)
- Power Supply Weight** 0.28kg (0.6lbs)

Electrical

Deactivator

Input Voltage 18Vdc, 1.7A

Separate Power Supply

Input Voltage 100–240Vac, 50/60Hz
 AC Line Current 1Arms (max.)
 Output Voltage 18Vdc,
 1.7A Listed Class 2

Certified Limited Power Source

Environmental Constraints

Operating Temperature

0°C to 35°C (32°F to 95°F)

Enclosure

0 to 90%, non-condensing

Declarations**EMC**

47 CFR Part 15
RSS 210
EN 300330
EN 301489

Safety (second edition)

UL 60950-1
CSA C22.2.60950-1
EN 60950-1

EMF

EN 50364

CE This product is in conformity with
RoHS II Directive 2011/65/EU and REACH
Substances of Very High Concern as
defined in Regulation (EC) No 1907/2006
and subsequent amendments to both.



AMB1200
Antenna and AMB1200C
Controller

Essentials Deactivator

The ultra-thin Sensormatic Essentials Deactivator features a large pad target area to help provide reliable performance in a single pass. Regardless of label orientation, this unit deactivates active AM EAS labels up to 10cm (4in) above the surface of the pad and detects labels 15.2cm (6in) above its surface for consistent and effective operation. The pad features integrated status indicators that provide visual and audible notifications when live labels are successfully detected and deactivated.

The AMB1200AM model is designed specifically for metal countertop installation. This model offers a seamless installation without cutting into the point-of-sale (POS) counter in an effort to maintain store aesthetics. The AMB1200 model is installed on top of the counter. The Essentials Controller powers either deactivator. For flexible installation options, the controller is attached to a flat surface and can be positioned vertically or horizontally.

When connected to a compatible EAS data management device, real-time deactivation counts can be generated into user-friendly customizable reports to provide business-critical data.

Retailer Values

- // Deactivates protected merchandise in a single pass, regardless of label orientation, to accelerate check-out and alleviate unnecessary shopper delays
- // Built-in audible and visual indicators provide immediate feedback when active labels are detected and deactivated
- // EAS connectivity option allows for generation of operational information to help quickly identify and correct performance issues

Product Codes

ZBAMB1200
AMB1200 Antenna (for countertop),
AMB1200C Controller

ZBAMB1200A
AMB1200 Deactivation Pad
(for countertop)

ZBAMB1200M
AMB1200AM Antenna
(for metal countertop),
AMB1200C Controller

ZBAMB1200AM
AMB1200AM Deactivation Pad
(for metal countertop)

ZBAMB1200C
Essentials Controller

Product Compatibility

- All Sensormatic AM EAS Labels
- Local Device Manager II (LDM II)
- Remote Alarm Module

Specifications

Length

- ZBAMB1200 31cm (12in)
- ZBAMB1200AM 30.2cm (11.9in)

Width

- ZBAMB1200 18cm (7in)
- ZBAMB1200AM 19.8cm (7.8in)

Height

- ZBAMB1200 1.17cm (0.5in)
- ZBAMB1200AM 2.01cm (0.79in)

Weight

- ZBAMB1200 0.85kg (1.9lbs)
- ZBAMB1200AM 2.62kg (5.78lbs)

Electrical

Requires Essential Controller

Declarations**EMC**

47 CFR, Part 15

RSS 210

EN 300 330

EN 301 489

Safety (second edition)

UL 60950-1

CSA-C22.2.60950-1

EN 60950-1

Environmental rating

IP20

CE This product is in conformity with RoHS II Directive 2011/65/EU and REACH Substances of Very High Concern as defined in Regulation (EC) No 1907/2006 and subsequent amendments to both.

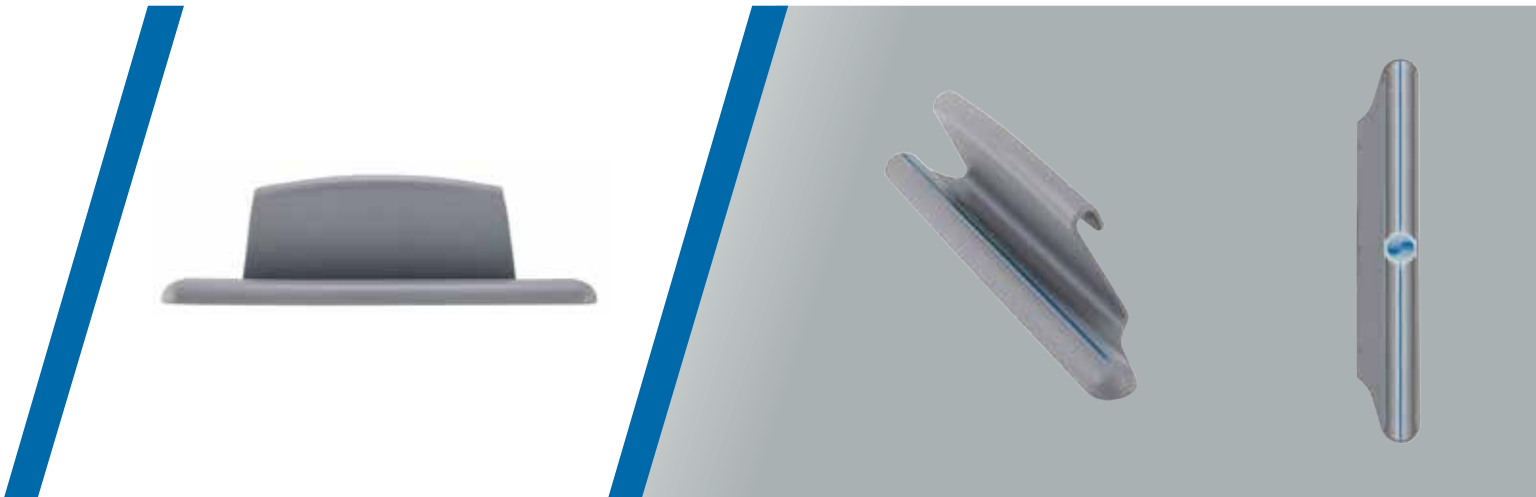

Hand Wand Activator

The Sensormatic Hand Wand Activator reactivates AM EAS labels so returned merchandise can be securely placed back on the sales floor. By sliding the wand lengthwise over the deactivated label, the label is reactivated and the returned product is ready to be remerchandised. The device is especially useful for large and/or bulky items.

Retailer Values

- // Quickly reactivates AM EAS labels on returned merchandise to ensure theft protection when put back on the sales floor
- // Not multimedia safe
- // Portable device is ideal for reactivating labels on heavy and/or bulky merchandise

Product Code

ZKWACT

Product Compatibility

All Sensormatic AM EAS Labels

Specifications

Width 19.7cm (7.75in)
Height 5.72cm (2.25in)
Depth 3.2cm (1.25in)

CE This product is in conformity with RoHS II Directive 2011/65/EU and REACH Substances of Very High Concern as defined in Regulation (EC) No 1907/2006 and subsequent amendments to both.



MKAMK-1000
SuperTag Detacher Countertop Mount

MKAMK-1010
SuperTag Detacher Flush Mount

SuperTag Detacher

The Sensormatic SuperTag Detacher removes SuperTag hard tags from protected merchandise at the point-of-sale for quick and efficient operation while enhancing throughput. Operating off an ordinary electrical outlet, the detacher is offered as a countertop or flush-mount install to allow maximum use of checkout space. Integrated with a unique programmable keypad, this unit can be customized to help prevent unauthorized use.

When connected to a compatible EAS data management device, real-time deactivation counts can be generated into user-friendly customizable reports to provide business-critical data.

Retailer Values

- // Quickly and efficiently removes all SuperTags to accelerate checkout and alleviate unnecessary shopper delays
- // Compact design and flexible installation options allow maximum use of checkout space
- // EAS connectivity option allows for generation of operational information to help quickly identify and correct performance issues
- // Unique programmable keypad prevent unauthorized use when check stand is unattended

Product Codes

MKAMK-1000
SuperTag Detacher Countertop Mount

MKAMK-1010
SuperTag Detacher Flush Mount

Product Compatibility

SuperTag Portfolio
Local Device Manager II (LDM II)

Specifications

Length

Countertop..... 15cm (5.9in)
Flush Mount 22cm (8.7in)

Width

Countertop..... 10.2cm (4in)
Flush Mount 18cm (7.1in)

Depth

Countertop..... 6.3cm (2.5in)
Flush Mount 6.3cm (2.5in)

Weight

Countertop..... 1.015g (2.2lbs)
Flush Mount 1.12kg (2.5lbs)

Electrical

Detacher Input.... 24 Vdc/2,0A (2.0A) max.
Power Supply Input (based on Sensormatic part # 5606-0083-01)
..... 100-240 Vac (50/60Hz)/1,8A (1.8A)
Power Supply Output... 24 Vdc/2,0A (2.0A)

Environmental Constraints

Operating Temperature

0°C to 40°C (32°F to 104°F) Ambient

Enclosure

0 to 90%, non-condensing

Storage Temperature

–40°C to 70°C (–40°F to 158°F)

Evaluated for altitudes less than 3200m
(10,500ft)

Declarations**EMC**

47 CFR Part 15

EN55022

EN55024

EN61000-3-2

EN61000-3-3

ICES 003

EN55014-1

EN55014-2

Safety (second edition)

UL 60950-1

CSA C22.2.60950-1

EN 60950-1

CE This product is in conformity with
RoHS II Directive 2011/65/EU and REACH
Substances of Very High Concern as
defined in Regulation (EC) No 1907/2006
and subsequent amendments to both.



Ultra-Gator Detacher

The Sensormatic Ultra-Gator Detacher easily removes Ultra-Gator hard tags at the point-of-sale (POS) for quick and efficient operation while enhancing checkout productivity. Operating off an ordinary electrical outlet, the detacher is offered as a countertop or flush-mount install to allow maximum use of checkout space. Equipped with a key lock to prevent unauthorized use, the detacher also features an internal EAS element that alarms detection systems if an attempt is made to remove it from the store.

Retailer Values

- // Quickly and easily removes all Ultra-Gator hard tags to accelerate checkout and alleviate unnecessary shopper delays
- // Compact design and flexible installation options allow maximum use of checkout space
- // Security lock prevents unauthorized use when checkstand is unattended
- // Internal EAS element alarms the detection system if attempt is made to remove from the store

Product Codes

MK91-XP
Power Detacher, Beige

MK91B-XP
Power Detacher, Black

Product Compatibility

Ultra-Gator Portfolio

Specifications

- Color** MK91-XP: Beige
MK91B-XP: Black
- Length** 19cm (7.5in)
- Width** 10.15cm (4in)
- Height** 11.4cm (4.5in)
- Weight** 2.05kg (4.5lbs)

Electrical

- Detacher Input 24Vac (50/60Hz), 1.0A max.
- Requires NEC Class 2, Certified Limited, Power Source, Power supply
- Input 100–240Vac @ 50-60Hz
- Output 24Vac 50/60Hz, 1.0A min
- NEC Class 2
- Certified Limited Power Source

Environmental Constraints

- Operating Temperature**
0°C to 40°C (32°F to 104°F) Ambient
- Relative Humidity**
IPX0
- Enclosure**
0 to 90%, non-condensing
- Storage Temperature**
–40°C to 70°C (–40°F to 158°F)
- Highest Sound Pressure Level**
83dB(A)

Declarations**EMC**

47 CFR, Part 15

EN 55014

EN 61000-3-2+R19

EN 61000-3-3

Safety (second edition)

UL 60950-1

CSA C22.2.60950-1

EN 60950-1

IEC 60950-1

CE This product is in conformity with RoHS II Directive 2011/65/EU and REACH Substances of Very High Concern as defined in Regulation (EC) No 1907/2006 and subsequent amendments to both.



IDKM-1000DT
Desktop Detacher



IDKM-1010FM
Flush Mount Detacher

AM/RFID SuperTag Detacher

IDKM-1000

IDKM-1010

The Sensormatic AM/RFID SuperTag Detacher combines performance with real-time visibility into inventory and assets to help improve operations, optimize profitability and create memorable shopper experiences. Fitted with an ultra-high frequency (UHF) RFID antenna, this detacher solution supports the AM SuperTag portfolio and RFID-enabled dual-technology tags, preparing for transition to RFID solutions in the future.

When connected to the Sensormatic IDX Multipurpose RFID reader, the RFID item-level data stored in dual-technology hard tags is read when the tag is detached. Through proper integration with the point-of-sale (POS) via the reader, this item-level data can be seamlessly captured, analyzed and acted upon. For instance, one function requires the tag's RFID information to match the scanned merchandise barcode prior to completing the transaction and releasing the tag. This level of intelligence helps greatly reduce sweethearting, scan avoidance and merchandise switching.

A detacher and RFID reader work together to send item-level and AM detach data to TrueVUE™ management

software. This information drives reporting and dashboards to support decision making in near real-time. Reporting data points include item detail, inventory by location, detacher counts and more.

Retailer Values

- // Access item-level data from AM/RFID hard tags to ensure inventory accuracy and improve replenishment time
- // Combats theft techniques such as scan avoidance, merchandise switching and sweethearting when connected to an IDX Multipurpose RFID Reader
- // Removes all SuperTags quickly and easily to accelerate check-out and improve the customer experience
- // Works with a connected RFID reader to send item-level and detach data to TrueVUE management software for near real-time reporting and analysis
- // Increases detaching security with password-protected lock and reset
- // Provides ergonomic flexibility with desktop and flush mount options
- // Gives feedback for correct operation via LEDs and the insertion switch

Product Codes

IDKM-1000DT

AM/RFID Desktop Detacher with Power Supply and Power Cord

IDKM-1010FM

AM/RFID Flush Mount Detacher with Power Supply and Power Cord

IDKM-1000

AM/RFID Desktop Detacher Only

IDKM-1010

AM/RFID Flush Mount Detacher Only

Product Compatibility

Sensormatic SuperTag Portfolio, AM and AM/RFID Dual Tech Tags

Sensormatic IDX-2000 2-Port Multipurpose RFID Reader

Sensormatic IDX-8000 8-Port Multipurpose RFID Reader

TrueVUE™ Software

EPC Gen2 standard RFID Tags

Specifications

Desk Mount

Length 15.0cm (5.9in)
 Width 10.2cm (4.0in)
 Height 6.3cm (2.5in)
 Weight 1.035kg (2.31lbs)

Flush Mount

Length 22.0cm (8.7in)
 Width 18.0cm (7.1in)
 Height 6.3cm (2.5in)
 Weight 1.140kg (2.35lbs)

Electrical

Detacher Input 24 Vdc / 2.5A max.
 Power Consumption 48W max.

Recommended Power Supply
 Sensormatic part #5606-0083-01)

Power Input 100-240 Vac (50/60Hz)
 1.8A max.

Power Output 24 Vdc / 2.0A

RF Characteristics

Detacher is fitted with embedded wideband RFID antenna. Requires external RFID Reader to operate.
 Detacher Antenna Gain -13.0dBil

Can be used with readers operating in NA (902–928MHz) or EU (865–868MHz) frequencies (or subsets).

Choice of reader and settings limit operation to match country specific RF requirements.

Negative gain of antenna limits detacher output to less than 100mW, even when reader is set to 2W (33dBm).

Environmental Constraints

Temperature Range

Operating 0°C to +40° C (32°F to +104°F)

Storage 0°C to +70° C (32°F to +158° F)

Evaluated for altitudes less than 3200m (10,500ft)

Humidity

0 to 90%, non-condensing

Regulatory

Declarations

EMC
 47 CFR Part 15
 EN55022
 EN55024
 EN61000-3-2
 EN61000-3-3
 ICES 003
 EN55014-1
 EN55014-2

Safety (second edition)

UL 60950-1
 CSA C22.2.60950-1
 EN 60950-1

CE This product is in conformity with RoHS II Directive 2011/65/EU and REACH Substances of Very High Concern as defined in regulation (EC) No 1907/2006 and subsequent amendments to both.





SuperTag Manual Handheld Detacher

The Sensormatic SuperTag Manual Handheld Detacher is ergonomically designed to comfortably and easily remove SuperTags at the point-of-sale. At only 0.36kg (12.77oz), this detacher provides a lightweight and portable detacher solution. It features a symmetrical handle/trigger design that accommodates both left- and right-handed users and includes a top-mounted tag “nest” that allows easy operation with either hand. Associates simply insert any SuperTag into the nest beneath the thumbnail tab, press the tag down flush in the nest, then squeeze the trigger to release the tack.

The tough, molded construction makes it rugged and user-friendly — without sacrificing durability. For added security, this detacher has an internal EAS element to alarm detection systems if an attempt is made to remove it from the retail environment.

Retailer Values

- // Ambidextrous design allows for quick and easy operation with either hand
- // Rugged construction helps ensure reliable operation in spite of everyday drops and bumps
- // No electric power or batteries needed for operation in any environment
- // Integrated lanyard helps prevent unauthorized use and prevents removal from the store

Product Code

MK225-1

Product Compatibility

SuperTag Portfolio

Specifications

| | |
|---------------------|-----------------|
| Length | 19.56cm (7.7in) |
| Width | 7.43cm (2.9in) |
| Depth | 10.86cm (4.2in) |
| Weight | 0.36kg (12.7oz) |

CE This product is in conformity with RoHS II Directive 2011/65/EU and REACH Substances of Very High Concern as defined in Regulation (EC) No 1907/2006 and subsequent amendments to both.



Ultra-Gator Manual Handheld Detacher

The Sensormatic Ultra-Gator Manual Handheld Detacher is designed for comfort and easy tag removal at the point-of-sale (POS). At only 0.41kg (14.4oz), this device provides a lightweight, portable detacher solution that is an excellent backup to the Ultra-Gator Detacher. The tough, molded construction makes it rugged and user-friendly — without sacrificing durability. The optional AM EAS label deactivator attaches to the top of the detacher for a combined deactivation and detaching solution. The integrated cable attaches the detacher to the POS to prevent removal from the register. For additional security, this detacher features an internal EAS element to alarm detection systems if an attempt is made to remove it from the store.

Retailer Values

- // Lightweight and portable to comfortably and easily remove Ultra Gator-Tags at the point-of-sale
- // Rugged construction helps ensure reliable operation in spite of everyday drops and bumps
- // No electric power or batteries needed for operation in any environment
- // Integrated lanyard helps prevent unauthorized use and prevents removal from the store

Product Codes

MK751

Ultra-Gator Manual Hand Detacher

MKD751ZA

Ultra-Gator Manual Hand Detacher with Label Deactivator

Product Compatibility

Ultra-Gator Tag Portfolio

Specifications

Length

Detacher with Boot Deactivator (Boot Deactivator only) ... 69.80mm (2.7in)

Width

Detacher with Boot Deactivator (Boot Deactivator only) 30.10mm (1.2in)

Height

Hand Detacher..... 18cm (7in)

Detacher with Boot Deactivator (Boot Deactivator only) ..21.40mm (0.84in)

Weight 0.41kg (0.90lbs)

CE This product is in conformity with RoHS II Directive 2011/65/EU and REACH Substances of Very High Concern as defined in Regulation (EC) No 1907/2006 and subsequent amendments to both.



MKD400-BL
Countertop or Recessed Detacher

Magnetic 9kG Detachers

Designed for quick and efficient removal of magnetic 9kG security tags from merchandise at the point-of-sale (POS), this high-strength detaching platform provides security for a full line of products. These detachers are easy to use and can be secured directly to, or recessed into, the POS countertop to maximize space while maintaining high standards of security.

The mobility feature of the coiled cable handheld detacher (MKDAMK4100-CBL) allows cashiers to remove magnetic 9kG security tags from heavy, bulky merchandise in the shopping cart and at the POS counter. It attaches to the countertop via the integrated coiled cable and features a locking key to prevent unauthorized use. For added security, the detacher has an internal EAS element that will alarm detection systems if attempt is made to remove it from the store.

The countertop detacher (MKD400-BL) maximizes space at the POS and expedites throughput with one-handed detaching of magnetic 9kG hard tags. It fastens directly on, or recesses into, any POS countertop to prevent removal from the store and features a locking key to prevent unauthorized use.

The optional Retrofit Kit (MKDAMK421) combines superior unlocking magnetic

strength with the detaching capabilities of the flush mount industry-standard SuperTag Power Detacher for a total detaching solution. This solution eliminates the need for multiple detaching devices at the POS in a SuperTag and magnetic 9kG hard tag environment.

Retailer Values

- // One-handed detaching accelerates checkout and alleviates unnecessary shopper delays
- // Extendable coiled cable allows cashiers to detach hard tags on merchandise unable to be placed on the counter
- // Compact design and flexible installation options allow maximum use of POS space
- // Security lock prevents unauthorized use when POS is unattended
- // Seamlessly combines high magnetic detaching strength with SuperTag power detaching to eliminate the need for multiple detaching devices at the POS
- // Internal EAS element within the coiled cable detacher alarms the detection system if attempt is made to remove from the store

Product Codes

MKD400-BL
Countertop or Recessed Detacher

MKDAMK4100-CBL
Coiled Cable Handheld Detacher

MKDAMK4100-CL
Coiled Cable Replacement Kit

MKDAMK4210-BL
Retrofit flush mount Kit (not a standalone, must attach to the SuperTag flush mount power detacher)

MKDAMK4300-BL
Retrofit Countertop Mount (not a standalone, must attach to the SuperTag Countertop power detacher)

Product Compatibility

Sensormatic 9kG Magnetic Strength Hard Tags

Magnetic Alarming 2-Tone Tag

Magnetic Mini Alarming 2 and 3-Tone Lanyard Tags

Specifications

MKD400-BL
Countertop or Recessed Detacher

Base Diameter 102mm (4.016in)

Height 44mm (1.73in)

Weight 0.35kg (0.77lbs)

Specifications (con't)

MKDAMK4100-CBL

Coiled Cable Handheld Detacher

Height 73mm (2.9in)
Diameter 86mm (3.4in)
Weight 0.60k (1.32lbs)
Maximum coiled cable range .. 1.8m (6ft)



Coiled Cable Handheld Detacher

MKDAMK4210-BL

Retrofit Flush Mount Kit

Length 287mm (11.3in)
Width 164mm (6.5in)
Depth 45mm (1.8in)
Weight 0.38kg (13.4oz)



Retrofit Flush Mount Kit

MKDAMK4300-BL

Retrofit Countertop Mount Kit

Length 287mm (11.3in)
Width 45mm (1.8in)
Depth 164mm (6.5in)
Weight 0.39kg (.86lbs)



Retrofit Countertop Mount Kit

Environmental Constraints

Operating Temperature

0°C to 40°C (32°F to 104°F)

Enclosure

Retrofit Kit 0 to 90%,
 non-condensing
 Coiled Cable Detacher 30% to 95%,
 non-condensing

CE This product is in conformity with RoHS II Directive 2011/65/EU and REACH Substances of Very High Concern as defined in Regulation (EC) No 1907/2006 and subsequent amendments to both.





Magnetic 5 and 9kG Detacher

The Sensormatic Magnetic 5 and 9kG Detacher supports the Sensormatic magnetic portfolio and most standard magnetic hard tags for increased sensor compatibility. The detacher's small profile allows for one-handed detaching to expedite throughput. Attached to the base with an integrated cable, the detacher can be positioned two ways within the base – detacher side up or down. When facing up, the detacher will remove magnetic sensors from protected merchandise. When facing down, the device can be locked to protect against unauthorized use. In either orientation, the detacher can be locked so it cannot be removed from the base.

Retailer Values

- // One-handed detaching accelerates checkout and alleviates unnecessary shopper delays
- // Compact design and flexible installation options allow maximum use of point-of-sale (POS) space
- // Security lock prevents unauthorized use to reduce theft when check stand is unattended

Product Code

MKD600

Specifications

- Length** 100mm (3.39in)
- Width** 75mm (2.95in)
- Depth** 47mm (1.82in)
- Weight** 0.41 kg (0.90lbs)
- Lock Magnetic Strength**..... 5kG and 9kG

CE This product is in conformity with RoHS II Directive 2011/65/EU and REACH Substances of Very High Concern as defined in Regulation (EC) No 1907/2006 and subsequent amendments to both.



Magnetic 5kG Detacher

This easy-to-use, small-profile detacher supports the Sensormatic magnetic 5kG hard tag portfolio, expediting throughput with one-handed detaching. The detacher can be secured directly to or recessed into any point-of-sale (POS) countertop to maximize counter space. The detacher features a T-bar type lock to prevent unauthorized use and reduce theft when POS is unattended.

Retailer Values

- // One-handed detaching accelerates checkout and alleviates unnecessary shopper delays
- // Compact design and flexible installation options allow maximum use of POS space
- // Security lock prevents unauthorized use to reduce theft when POS is unattended

CE This product is in conformity with RoHS II Directive 2011/65/EU and REACH Substances of Very High Concern as defined in Regulation (EC) No 1907/2006 and subsequent amendments to both.

Product Codes

MKD31-BL

5kG Magnetic Detacher with Lock

MKD31-B

5kG Magnetic Detacher without Lock

MKDLOCK

T-Bar Lock

Product Compatibility

Sensormatic 5kG Magnetic Strength
Hard Tags

Specifications

- Height** 41.9mm (1.65in)
- Base Diameter** 80.0mm (3.15in)
- Weight** 0.18kg (0.40lbs)
- Lock Magnetic Strength** 5kG



Universal Deactivation Controller

The Sensormatic Universal Deactivation Controller provides the power to efficiently operate compatible EAS deactivation antennas within the store environment, deactivating active AM EAS anti-theft security labels at 2.5 labels per second. Regardless of label orientation, this controller offers fast, accurate checkout service even in high-traffic, high-volume retail locations to help drive revenue while enhancing shopper throughput. Providing the power to drive two deactivation antennas, this controller allows each to independently detect and deactivate AM EAS security labels. Additionally, this controller complies with international safety requirements to ensure global safety and quality standards are met.

Retailer Values

- // Fast deactivation rates expedite checkout for increased customer satisfaction and employee efficiency
- // Compact design and internal power supply allow flexible installation options including vertical, surface, and under-counter for maximum use of space

- // EAS connectivity option allows generation of operational information to help quickly identify and correct performance issues
- // Status LED lights show "power on," communication activity, and basic diagnostics to help reduce service calls
- // Cable management helps prevent accidental unplugging and unintended increases in "nuisance" alarms

Product Code ZBAMB9010-IPS

Product Compatibility

- Sensormatic Integrated Label Deactivators
- Sensormatic Countertop/Recessed Deactivators

ZPSTP-RA Remote Alarm Module

Specifications

- Width** 26.2cm (10.3in)
- Height** 10.1cm (4in)
- Depth** 22.1cm (8.7in)
- Weight** 2.5kg (5.5lbs)
- Power Cord Length**..... 18.3m (6ft)

Electrical

Primary Input
100-120/200-240Vac 50/60Hz (±5%)

AC Line Current
1Arms max.

Scanner Port

Maximum Input Voltage..... +25Vdc (±5%)
Input 1+ and Input 2+
Input Voltage..... ±5-12Vdc typical greater than 12V observing the 32mA maximum
Input Current 10mA Source Minimum
Minimum Pulse Duration..... 100ms
Detect Out.....Open-Collector Side of an opto-isolator

Maximum Pull-Up Voltage..... +25Vdc
This output remains in the open state until label detection occurs. It then shorts to the Detect Common for a minimum of 39ms based on label vicinity to the antenna plus 7 detection windows (5.555 x 7 = 39mS).

Detect common..... Emitter side of the Detect Out opto-isolator. It normally should be tied to D Ground (J8, Pin 6).
Maximum current limit: 6.3mA @ Vce < 10V 2mA @ Vce < 0.4V

Environmental Constraints

Operating Frequency

58kHz (+200Hz)

Operating Temperature

0°C to 40°C (32°F to 104°F)

Non-Operating Temperature

-40°C to 70°C (-40°F to 158°F)

Relative Humidity

0 to 90%, non-condensing

Declarations

EMC

47 CFR, Part 15

EN300 330-2

EN301 489

EN 55022

EN 55024

ICES-003

RSS-210

Safety (second edition)

UL 60950-1

CSA C22.2.60950-1

EN 60950-1

Environmental Rating

IPXO

CE This product is in conformity with RoHS II Directive 2011/65/EU and REACH Substances of Very High Concern as defined in Regulation (EC) No 1907/2006 and subsequent amendments to both.



Essentials Deactivation Controller

The compact Sensormatic Essentials Deactivation Controller offers fast, accurate checkout service to drive revenue and increase shopper throughput. This device powers Essentials deactivation antennas to effectively deactivate active AM EAS labels, regardless of orientation. Its small footprint allows vertical or horizontal installation to meet individual retailers' needs.

Retailer Values

- // Reliable deactivation, regardless of label orientation, for fewer nuisance alarms and a better customer experience
- // Compact design allows flexible installation options to fit virtually any retailer's needs

Product Code

ZBAMB1200C

Product Compatibility

Essentials Deactivators
Remote Alarm Module

Specifications

Length.....29.4cm (11.6in)
Width 18.7cm (7.4in)
Height 8.15cm (3.2in)
Weight 1.43kg (3.15lbs)
Power Cord Length.....Approx. 1.8–2.5m (6–8.2ft)

Electrical

Voltage Input
100–240Vac (±10%)
50/60Hz (±5%)
AC Line Current
1.5Arms max.

Environmental Constraints

Operating Temperature
0°C to 40°C (32°F to 104°F)
Non-Operating Temperature
–40°C to 70°C (–40°F to 158°F)
Relative Humidity
0 to 90%, non-condensing

Declarations

EMC

47 CFR, Part 15
RSS 210
EN 300 330
EN 301 489

Safety (second edition)

UL 60950-1
CSA-C22.2.60950-1
EN 60950-1

Environmental Rating

IP20

CE This product is in conformity with RoHS II Directive 2011/65/EU and REACH Substances of Very High Concern as defined in Regulation (EC) No 1907/2006 and subsequent amendments to both.



Local Device Manager II

The Local Device Manager II (LDM II) is a powerful tool used to drive store-front EAS compliance. This device controls up to 124 (31 per port) connected Sensormatic EAS and Traffic hardware devices within the store environment. It aggregates alarm and traffic counts, and Metal-Foil Detection and Jammer events for insight into equipment issues to help ensure all systems are working properly. Collected information may be stored in the device up to 30 days and can be securely transmitted over any TCP/IP network at scheduled intervals. The LDM II ensures Sensormatic EAS and Traffic Intelligence investments are optimized by monitoring equipment functionality and use, and by helping manage ongoing equipment maintenance and service. Authorized parties can remotely configure, diagnose and correct EAS equipment challenges from virtually anywhere. EAS Reporting Analytics process the data from the LDM II into a user-friendly, customizable report format. This EAS reporting makes it simple for retailers to analyze and address abnormal alarm and event trends to reduce shrink, monitor device health and help increase store efficiency and profitability.

Retailer Values

- // Identifies and tracks shrink and failure-to-deactivate challenges
- // Helps optimize staffing based on customer traffic
- // Determines store conversion rates by comparing traffic volume to actual sales
- // Assists in analyzing promotion and marketing campaign effectiveness
- // Reduces power consumption of EAS system components when leveraging the Power-on-Demand feature
- // Provides remote set-up, firmware updates and problem diagnosis of connected EAS systems

Product Code

CBC-4055-1ULDMII
(includes install kit & power supply)

Product Compatibility

- Sensormatic Detection Systems
- Sensormatic Deactivators and Detachers
- Sensormatic Integrated Deactivators
- UltraLink
- Metal-Foil Detection
- Overhead Traffic Sensors
- Integrated Traffic Counters

Specifications

Length 21.59cm (8.5in)
Width 11.18cm (4.4in)
Height 3.56cm (1.4in)
Weight0.45kg (1lb)

Electrical

DC Input

12–14.5Vdc (this product is intended to be supplied by a Listed Direct Plug-In Power Unit marked Class 2 and rated from 12 to 14.5 Vdc, 1.5 to 2.0A)

Service Replaceable Parts

Fuse F1 4A, 250V, fast-acting
 Littelfuse..... 217004P or recognized equivalent

CAUTION: For continued protection against risk of fire, replace fuse only with same type and rating.

Battery B1.....3V, 190mAh
 Panasonic BR2032

CAUTION: Risk of explosion if battery is replaced with an incorrect type. Dispose of used batteries according to manufacturer’s instructions.

Current Draw

12Vdc..... 0.65A max.
 14.5Vdc..... 0.54A max.

Cabling..... CAT5,CAT5e, CAT6
 required for input, output and RS-485 ports

Network

Cabling..... Category 5e
Ethernet..... Single Channel
10/100Mb Ethernet
Addressing..... DHCP or Static IP
Protocols..... TCP/IP, DHCP
Time Synchronization..... SNTP, Daytime
Protocol, Proprietary
Data Delivery..... HTTP, SMTP, FTP
Serial RS485 Connector

Environmental Constraints

Operating Temperature

0° to 50°C (32° to 122°F)

Relative Humidity

0 to 95%, non-condensing

Declarations

EMC

47 CFR, Part 15
EN 55022
EN 55024
ICES-003

Safety

UL 60950-1
EN 60950-1
IEC 60950-1
CSA C22.2.60950-1-03

CE This product is in conformity with
RoHS II Directive 2011/65/EU and REACH
Substances of Very High Concern as
defined in Regulation (EC) No 1907/2006
and subsequent amendments to both.



UltraLink

The UltraLink alarm management device is a powerful tool used to drive store-front EAS compliance. This device collects and analyzes real-time EAS alarm activity and provides traffic counts on shoppers entering and exiting the store. When an EAS alarm event occurs at the exit, an authorized employee uses the system's keypad or optional barcode scanner to enter information from the customer's receipt. By capturing the reason for an alarm, the item causing it, the point-of-sale lane, and/or the cashier's name, retailers can quickly identify equipment issues, assess source tagging compliance and more opportunities to improve store operations. Retailers can also access associate response times, trends in alarm occurrences, reasons for alarms, and items and SKUs that cause alarms. When connected with compatible traffic hardware devices, retailers can see the number of people who entered and exited through a monitored doorway. UltraLink delivers this EAS alarm and traffic data to a central location, then EAS and Traffic Intelligence reporting software processes comprehensive analytics detailing or summarizing alarm and traffic activities.

Retailer Values

- // Enables structured response procedures to help increase EAS effectiveness and reduce shrink
- // Provides traffic counts to increase operation efficiencies
- // Combines captured alarm data with receipt information keyed in by staff
- // Provides visibility into unintended EAS alarms to improve the shopping experience
- // Eliminates manual data logging, sorting and reporting
- // Connects directly to store or enterprise network to reduce implementation cost
- // Can connect to video surveillance devices to enhance visibility of alarm events
- // Supplies data to help develop staff training programs for tagging merchandise

Product Code

2025-0410-06

Product Compatibility

- Sensormatic Detection Systems
- Sensormatic Deactivators and Detachers

- Sensormatic Integrated Deactivators
- Local Device Manager II
- Metal-Foil Detection
- Overhead Traffic Sensors
- Integrated Traffic Counters

Specifications

| | |
|---------------------|------------------|
| Length | 27.3cm (10.75in) |
| Width | 10.2cm (4.0in) |
| Height | 16.5cm (6.5in) |
| Weight | 2.4kg (5.3lbs) |

Power Supply

| | |
|-----------------|----------------------|
| AC Input..... | 100-250Vac @ 50-60Hz |
| DC Output | 12V, 1A min. |

Electrical

DC Input

10–15Vdc (class 2 power source required)

Current Draw

| | |
|--------------|------------|
| 12Vdc..... | 0.65A max |
| 14.5Vdc..... | 0.54A max. |

Network

Cabling..... Category 5e

Ethernet.....Single Channel 10/100Mb

Addressing..... DHCP or Static IP

Protocols..... TCP/IP, DHCP

Time Synchronization..... SNTP, Daytime Protocol, Proprietary

Data Delivery HTTP, SMTP, FTP

Serial RS485 Connector

Environmental Constraints

Operating Temperature

10° to 40°C (50° to 104°F)

Non-Operating Temperature

-40° to 70°C (-40° to 158°F)

Relative Humidity

0 to 90%, non-condensing

Declarations

EMC

47 CFR Part 15

ICES-003

EN 55022

EN 55024

EN 61000-3-2

EN 61000-3-33

Safety

UL 60950

CSA C22.2 No. 60950

EN 60950

CE This product is in conformity with RoHS II Directive 2011/65/EU and REACH Substances of Very High Concern as defined in Regulation (EC) No 1907/2006 and subsequent amendments to both.

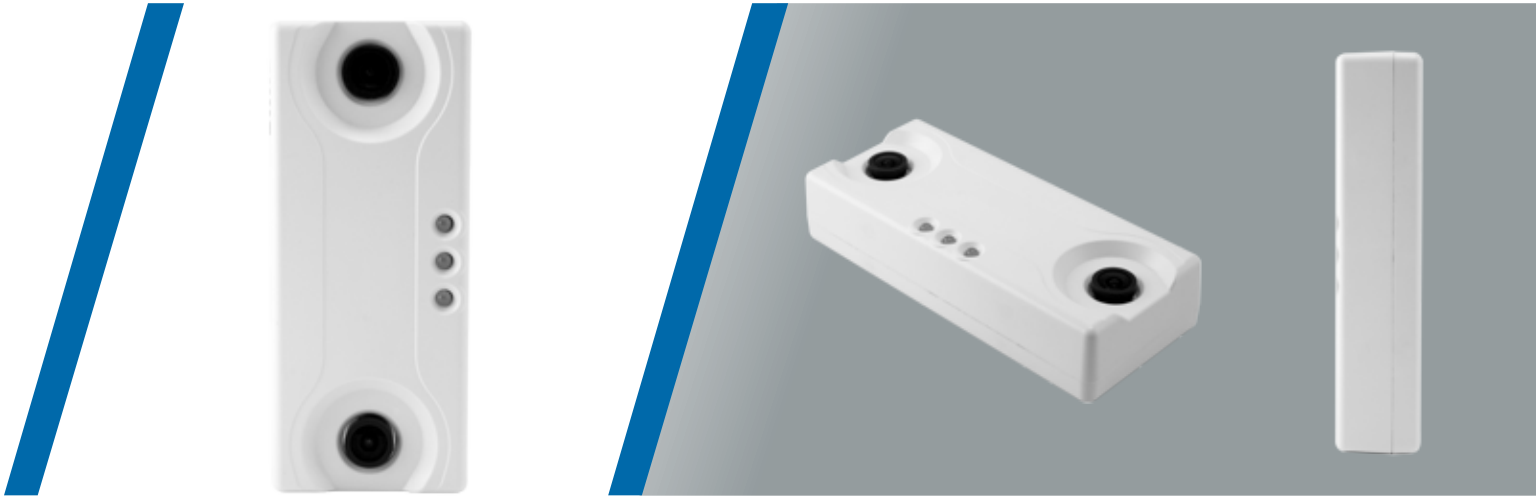

Stereo Overhead Traffic Sensor

Sensormatic's premier Stereo Overhead (3-D) Traffic Sensor mounts to the ceiling to provide a holistic traffic view with enhanced activity analysis and video validation abilities. Advanced capabilities allow the sensor to count side-by-side traffic, track multiple people simultaneously, differentiate between adults and children, and avoid counting carts and strollers. As shoppers pass through the sensor's field of view, they leave a unique trail or path. Each path is tagged with a unique ID that can then be converted into numerous metric opportunities within the sensor. Integrated with intelligent software, this sensor collects this real-time shopper data to enable timely operational decision-making for improved sales and shopper satisfaction. This sensor also provides accurate data under a broad set of indoor and outdoor environmental conditions such as high traffic and dynamic lighting. By connecting directly to existing data networks, the need for additional collection components is eliminated — reducing implementation costs.

Retailer Values

- // Drives improved conversion rates by identifying shopper opportunity and best operational practices
- // Helps optimize staffing based on customer traffic
- // Assists in analyzing effectiveness of promotions and marketing campaigns
- // Connects directly to existing store networks
- // Minimizes nuisance alarms to improve the shopper experience
- // Reduces power consumption of EAS system components when leveraging the Power-On-Demand feature
- // Decreases service costs with remote monitoring of EAS equipment

Product Code

BIC-2300-25SP

BIC2300, 2.5 lens, surface mount, Mid Span Power Injector (power supply), 15' patch cable, 2.5 install guide, sheet of labels, power cord – selectable by region

BIC-2300-25SN

BIC-2300, 2.5 lens, surface mount, 15' patch cable, 2.5 install guide, sheet of labels

BIC-2300-25RP

BIC-2300, 2.5 lens, recess tilt mount, Mid Span Power Injector (power supply), 15' patch cable, 2.5 install guide, sheet of labels, power cord – selectable by region

BIC-2300-25RN

BIC-2300, 2.5 lens, recess tilt mount, 15' patch cable, 2.5 install guide, sheet of labels

BIC-2300-29SP

BIC2300, 2.9 lens, surface mount, Mid Span Power Injector (power supply), 15' patch cable, 2.5 install guide, sheet of labels, power cord – selectable by region

BIC-2300-29SN

BIC-2300, 2.9 lens, surface mount, 15' patch cable, 2.5 install guide, sheet of labels

BIC-2300-29RP

BIC-2300, 2.9 lens, recess tilt mount, Mid Span Power Injector (power supply), 15' patch cable, 2.5 install guide, sheet of labels, power cord – selectable by region

BIC-2300-29RN

BIC-2300, 2.9 lens, recess tilt mount, 15' patch cable, 2.5 install guide, sheet of labels

BIC-2300-38SP

BIC2300, 3.8 lens, surface mount, Mid Span Power Injector (power supply), 15' patch cable, 2.5 install guide, sheet of labels, power cord – selectable by region

Product Codes (con't)

BIC-2300-38SN

BIC-2300, 3.8 lens, surface mount, 15' patch cable, 2.5 install guide, sheet of labels

BIC-2300-38RP

BIC-2300, 3.8 lens, recess tilt mount, Mid Span Power Injector (power supply), 15' patch cable, 2.5 install guide, sheet of labels, power cord – selectable by region

BIC-2300-38RN

BIC-2300, 3.8 lens, recess tilt mount, 15' patch cable, 2.5 install guide, sheet of labels

BIC-2300-60SP

BIC2300, 6.0 lens, surface mount, Mid Span Power Injector (power supply), 15' patch cable, 2.5 install guide, sheet of labels, power cord – selectable by region

BIC-2300-60SN

BIC-2300, 6.0 lens, surface mount, 15' patch cable, 2.5 install guide, sheet of labels

BIC-2300-60RP

BIC-2300, 6.0 lens, recess tilt mount, Mid Span Power Injector (power supply), 15' patch cable, 2.5 install guide, sheet of labels, power cord – selectable by region

BIC-2300-60RN

BIC-2300, 6.0 lens, recess tilt mount, 15' patch cable, 2.5 install guide, sheet of labels

CBC-40SW-VAL (Required)

Accuracy Validation (must place order for each sensor/zone purchased)

Product Compatibility

- Sensormatic Detection Systems
- Metal-Foil Detection
- SuperTag Power Detachers
- AM/RFID SuperTag Power Detacher

Lens Options

Ranges from 2.5mm to 6mm supporting mounting heights from 2.4m (8ft) to 10m (33ft)

Specifications

| | |
|---------------------|---------------|
| Length | 66mm (2.6in) |
| Width | 155mm (6.1in) |
| Height | 33mm (1.3in) |
| Weight | 0.2kg (7oz) |

Power Supply

Primary Input (barrel connector)
0.24Vdc, 0.2A

Certified Limited Power Source

Electrical

PoE (Power over Ethernet)..... 48Vdc, 0.1A
Power Consumption 4.5W
GPIO Connector (RS-485)... 3 Alarm Input/
Outputs (configurable)

Network

Cabling..... Category 5e
Ethernet..... Single Channel 10/100Mb
Ethernet
Power IEEE 802.3af Power
over Ethernet Class 2
Addressing..... DHCP or Static IP
Protocols..... TCP/IP, DHCP
Time Synchronization..... SNTP,
Daytime Protocol, Proprietary
Data Delivery HTTP, SMTP, FTP
Secure Data Delivery..... HTTPS, FTPS
Software Upgrade..... TFTP

Environmental Constraints

Operating Temperature

0° to 45°C (32° to 113°F)

Enclosure

IP20 Nema 1

Declarations

EMC

47 CFR, Part 15
EN 55022
EN 55024
ICES-003

Safety

UL 60950-1 (second edition)
CSA C22.2.60950-1
EN 60950-1

CE This product is in conformity with RoHS II Directive 2011/65/EU and REACH Substances of Very High Concern as defined in Regulation (EC) No 1907/2006 and subsequent amendments to both.



Mono Overhead Traffic Sensor

The entry level Mono Overhead Traffic Sensor is a ceiling-mounted, single lens camera that gathers accurate shopper counts in low to medium traffic environments with consistent lighting. As shoppers pass through the sensor's field of view, they leave a unique trail or path. Each path is tagged with a unique ID that can be converted into numerous metric opportunities within the sensor. Integrated with intelligent software, this sensor collects this real-time shopper data to enable timely operational decision-making for improved sales and shopper satisfaction. This overhead sensor connects to existing data networks, eliminating the need for additional data collection components to help reduce implementation costs.

Retailer Values

- // Drives improved conversion rates by identifying shopper opportunity and best operational practices
- // Helps optimize staffing based on customer traffic
- // Assists in analyzing effectiveness of promotions and marketing campaigns
- // Connects directly to existing store networks
- // Minimizes nuisance alarms to improve the shopper experience
- // Reduces power consumption of EAS system components when leveraging the Power-On-Demand feature
- // Decreases service costs with remote monitoring of EAS equipment

Product Codes

BIC-1100-20SP

BIC-1100, 2.0 lens, Mid Span Power Injector (power supply), surface mount with cover, 15' patch cable, 2.0 install guide, sheet of labels, power cord – selectable by region

BIC-1100-20SN

BIC-1100, 2.0 lens, surface mount with cover, 15' patch cable, 2.0 install guide, sheet of labels

BIC-1100-20RP

BIC-1100, 2.0 lens, recess fixed mount, Mid Span Power Injector (power supply), 15' patch cable, 2.0 install guide, sheet of labels, power cord – selectable by region

BIC-1100-20RN

BIC-1100, 2.0 lens, recess fixed mount, 15' patch cable, 2.0 install guide, sheet of labels

Product Compatibility

- Ultra•Exit Pedestals
- Ultra•Post Pedestals
- Essentials Pedestals
- Door-Max
- Pro-Max Pedestals
- Ultra•Lane
- 2.4m Concealed Door or Wall System
- 9.6m Concealed Floor System
- 8.4m Concealed Floor System
- Floor-Max Concealed Floor System
- Metal-Foil Detector
- SuperTag Power Detachers
- AM/RFID SuperTag Power Detacher

Lens Options

Ranges from 2.5mm to 6mm
 Supporting mounting heights from 2.4m (8ft) to 10m (33ft)

Specifications

Length..... 71mm (2.8in)
Width 88mm (3.5in)
Height 45mm (1.75in)
Weight 0.1kg (7oz)

Power Supply

Primary Input (barrel connector)
 0.24Vdc, 0.2A
 Certified Limited Power Source

Electrical

PoE (Power over Ethernet)..... 48Vdc, 0.1A
 Power consumption..... 3.8W
 GPIO connector (RS-485) 3 alarm input/outputs (configurable)

Network

Cabling..... Category 5e
 Ethernet..... Single Channel 10/100Mb Ethernet
 Power IEEE 802.3af Power over Ethernet Class 2
 Addressing..... DHCP or Static IP
 Protocols..... TCP/IP, DHCP
 Time Synchronization..... SNTP, Daytime Protocol, Proprietary
 Data delivery..... HTTP, SMTP, FTP
 Secure Data Delivery.....HTTPS, FTPS
 Software Upgrade..... TFTP

Environmental Constraints

Operating Temperature
 0° to 45°C (32° to 113°F)

Enclosure

IP20 Nema 1

Declarations

EMC
 47 CFR, Part 15
 EN 55022
 EN 55024
 ICES-003

Safety
 UL 60950-1 (second edition)
 CSA C22.2.60950-1
 EN 60950-1

CE This product is in conformity with RoHS II Directive 2011/65/EU and REACH Substances of Very High Concern as defined in Regulation (EC) No 1907/2006 and subsequent amendments to both.



Ultra•Exit Pedestal

Integrated EAS Traffic Counter

The Integrated EAS Traffic Counter integrates into the lens of compatible EAS pedestals to provide accurate customer traffic information. This sensor's dual beam-break detects shopper presence by tracking interruptions in horizontal infrared beams between pedestals; keeping separate counts for inbound and outbound shoppers. Armed with this valuable data, investments can be directed outside to boost traffic or inside to maximize conversion and average sales. The information provided by the traffic counter gives unparalleled visibility into business intelligence that can be used to streamline processes and improve profitability, such as optimizing critical shopper-to-associate staffing ratios and measuring the impact promotions have on traffic and conversion. This device does not replace or interfere with existing EAS detection systems and is not affected by common environmental interference like shadows or moving masses of warm or cold air near entrances.

Retailer Values

- // Provides data comparing people counting information to sales transaction data to determine conversion rates and effectiveness of marketing campaigns
- // Helps optimize staffing based on customer traffic
- // Provides visibility to directionality of potential shoplifting events
- // Helps to deliver accurate alarm management

Product Code

ZPUE-PCNTR2
People Counting Sensor

ZPUE-PC2-PCBKIT
Ultra•Exit Hardware Kit

ZPUP-PC2-CBLKIT
Ultra•Post Hardware Kit

Product Compatibility

- Ultra•Exit Pedestals
- Ultra•Post Pedestals
- Local Device Manager II (LDM II)
- UltraLink
- Digital Remote Alarm
- Metal-Foil Detection

Declarations

EMC

- 47 CFR, Part 15
- EN 55022
- EN 55024
- ICES-0033

Safety

- UL 60950-1 (second edition)
- CSA C22.2.60950-1
- EN 60950-1

Certified as part of the Ultra•Exit and Ultra•Post antenna series

CE This product is in conformity with RoHS II Directive 2011/65/EU and REACH Substances of Very High Concern as defined in Regulation (EC) No 1907/2006 and subsequent amendments to both.



Ultra•Post Pedestal



UHF RFID Handheld Reader TSL1128

Tyco Retail Solutions provides retailers with real-time visibility to their inventory and assets to help improve operations, optimize profitability and create memorable shopper experiences.

The TSL1128 from Technology Solutions UK Ltd. is a lightweight, hardware independent, high-power portable UHF RFID handheld reader. It allows retailers flexibility in choosing compatible mobile devices to create a cost-effective, high-performance RFID handheld platform supporting inventory intelligence use cases.

Designed to read and write EPC Class 1 Gen 2 UHF RFID tags, it communicates with mobile devices via Bluetooth® wireless technology and is available with an integrated 1D/2D barcode imager.

The TSL1128 features an RFID tag read range of up to 4.5m (14.5 ft.) in a rugged but lightweight form designed for retail environments. It has been drop and tumble tested and is IP54 rated for resistance to dust and fluids.

Custom integrated mounts are available for most popular mobile devices and a universal mount option allows use with off-the-shelf protective cases.

The user replaceable battery has a typical life of 6+ hours and may be augmented with spares for heavy usage. An optional

4-slot external battery charger is available to support multiple units in high volume operations.

When paired with an iOS mobile device, the TSL1128 reader can use Tyco's TrueVUE™ Retail Platform to drive inventory accuracy, the key fundamental for omni-channel excellence and the basis for optimized merchandise planning and allocation.

When paired with TrueVUE software, TSL1128 devices can be used for:

- Rapid inventory cycle counting
- Reading and writing RFID tags
- Locating products using Geiger counter mode with audible feedback
- Receiving and transferring merchandise

Retailer Values

- // Leverages TrueVUE's Inventory Intelligence solution to drive increased revenue, employee productivity and customer satisfaction
- // Protects your investment in Bluetooth® enabled mobile devices deployed for other retail tasks
- // Its retail tested rugged design is competitively priced when compared with similarly featured devices
- // Mobile device user interface is familiar to store associates, reducing training requirements

Product Codes

TSL1128-EU

1128 Bluetooth UHF RFID Reader (ETSI)

TSL1128-NA

1128 Bluetooth UHF RFID Reader (FCC)

TSL1128-2D-EU

1128 Bluetooth UHF RFID Reader (ETSI) with 1D/2D imager

TSL1128-2D-NA

1128 Bluetooth UHF RFID Reader (FCC) with 1D/2D imager

Options

Mobile Device Mounts

- iPhone 4th gen.
- iPhone 5th gen.
- iPod 4th gen.
- iPod 5th gen.
- iPhone 6
- iPhone 6 Plus
- Universal Connection

TSL1136-4CHG

4-Slot Easy Pack Battery Charger

Product Compatibility

TrueVUE Software
EPC Gen2 standard RFID Tag
Sensormatic AM/RFID 2D Barcode Tag

Specifications

Length

Trigger Handle..... 16.0 x 7.7 x 16.9cm
(6.3 x 3.03 x 6.6in)

Weight 380g (13.4oz)
(including battery & trigger handle)

Power Removable, Rechargeable
4.2 volt Lithium Polymer
2200 mAh battery pack,
8.4 watt hrs

Input Power

MicroUSB connector5V / 1A

Environmental Constraints

Operating Temperature

-20°C to 60°C (-4°F to 140°F)

Charging Temperature

5°C to 40°C (41°F to 104°F)

Storage Temperature

-40°C to 70°C (-40°F to 158°F)

Humidity

5% to 95% non-condensing

Performance Characteristics

RFID engine

TSL custom module with embedded
Impinj R2000

Communication protocols

TSL ABC (Parameterized ASCII command
set) and Impinj binary

Memory

Supports up to 32 GB Micro SD/SDHD
Card

Compatible Host devices (Bluetooth®)

Host device must have Bluetooth®
wireless technology functionality.

Bluetooth Wireless Technology

Bluetooth

Bluetooth Version 2.1
Apple iAP

Bluetooth Class

Class 2 - 10m (32.8ft) range

RFID Performance

Standards supported

EPC Class 1 Gen 2

Nominal read range

Up to 4m (13ft)

Nominal write range

Up to 1.22m (4ft)

Antenna

Detachable, Circularly Polarized with
optional 2D scanner

Frequency Range

EU: 865-868MHz
US: 902-928MHz

Output Power

10mW to 800mW

Barcode Scanning

Imager:

SE4500 2D imager

Sensor Resolution

752 x 480 pixels

Field of View

Horizontal: 40°, Vertical: 25°

Focal Distance

SR: 203.2mm (8in)
DL: 134.62mm (5.3in)
HD: 73.66mm (2.9in)

Symbologies Supported

1D: All major codes
2D: PDF417, MicroPDF417, Composite,
RSS, TLC-39, Datamatrix, QR code,
Micro QR code, Aztec, MaxiCode Postal
Codes: US PostNet, US Planet, UK Postal,
Australian Postal, Japan Postal Dutch
Postal (KIX)

Charging

External interface

MicroUSB connector for battery charging
and USB connectivity

Optional desktop charger

TSL 1136 4-Slot battery charger

Regulatory

Country Availability

Approved for use in the US, Canada,
Europe

Electrical Safety

Certified to UL60950-1, CSA C22.2
No.60950-1, IEC 60950-1, EN 60950-1

EMI/RFI

USA: FCC Part 15

Canada: ICES 003 Class B

EU: EN 301 489-3, EN 301 489-1, EN 301
489-17, EN 302-208, EN55022 Class B,
EN55024

Laser Safety

IEC Class2/FDA Class II in accordance
with IEC60825-1/EN60825-1,
21CFR1040.10

The Bluetooth® word mark and logos are registered trademarks owned by Bluetooth SIG, Inc. and any use of such marks by Technology Solutions (UK) Ltd. is under license. Other trademarks and trade names are those of their respective owners. I-PHONE and I-POD are trademarks of Apple Inc. TSL is a mark of Technology Solutions Ltd.

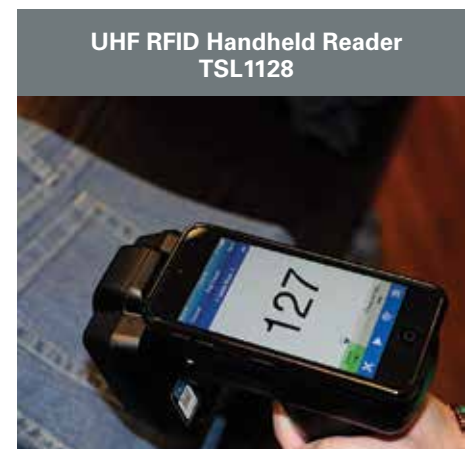



IDX-2000
RFID Reader

Multipurpose RFID Reader IDX-2000 IDX-8000

The Sensormatic IDX-2000 and IDX-8000 Multipurpose RFID Readers help retailers gain real-time visibility into inventory and assets to improve operations, optimize profitability and create a memorable shopper experience. Available in 2- and 8-port models, both with integrated remote device management capabilities, these devices deliver enterprise-class RFID performance and dependability when reading and writing RFID tags.

The IDX readers ensure high read rates and reliable data capture with dense reader mode and noise-cancellation features proven in retail deployments worldwide. The devices also conform to the EPC Low Level Reader Protocol (LLRP) standard and can be used with any compatible control system.

Using Power over Ethernet (PoE), a technology that passes electrical power and data safely over Ethernet cabling, reduces the cost and complexity of installation compared to dedicated power wiring, and minimizes space needed in existing conduits.

In the fitting room - IDX-2000 can power up to two individual antennas and IDX-8000 can power up to eight individual

antennas (wall or ceiling mounted) so retailers can monitor the presence of RFID-tagged items, improving loss prevention and capturing actionable data for this valuable conversion zone.

In transition areas - Multiple antennas can be connected to create a portal to monitor items at passing through a chokepoint or at impact doors to update inventory location.

At the POS and kiosks - Readers can speed checkout by integrating with existing POS systems, while providing item-level transaction visibility using the Sensormatic IDKM AM/RFID detacher or IDA-1000 Work Surface Antenna.

In the stockroom - as components of a workstation, a reader and antenna enable tagging received, transferred or returned merchandise, and transitioning items between zones for improved inventory accuracy.

Retailer Values

- // Drive consistent inventory accuracy with enterprise-class quality and reliability
- // Reduce installation costs and simplify wiring requirements with Power over Ethernet
- // Manage remotely over the network or locally using an Ethernet over USB connection, allowing for device health monitoring and maintenance
- // Supports industry-standard LLRP, enabling inbound and outbound Web

Service interfaces to accommodate new applications and use cases

- // Deployed in thousands of installations worldwide
- // Withstands dirt and electrical noise found in retail stores

Product Codes

IDX-2000-N1
2-port RFID Reader

IDX-8000-N1
8-port RFID Reader
North America 902-928MHz, FCC

IDX-2000-E1
2-port RFID Reader

IDX-8000-E1
8-port RFID Reader
Europe 865-868MHz, ETSI

IDX-2000-W1
2-port RFID Reader

IDX-8000-W1
8-port RFID Reader
Sub-band of 902-928MHz for China, Korea, Japan and more*

IDX-2000-W2
2-port RFID Reader

IDX-8000-W2
8-port RFID Reader
Sub-band of 902-928MHz for Australia, Singapore, Hong Kong, Taiwan, Brazil and others*

* Refer to IDX-2000/8000 Quick Start Guide for current list of approved countries

Product Compatibility

Sensormatic IDA-1000
RFID Work Surface Antenna (4dBiL)

Sensormatic IDA-3100
Beam Steerable RFID Antenna (6dBiL)
(except Korea)

Sensormatic IDKM-1000/1010
RFID SuperTag detacher (<-13dBiL)

Motorola AN480-CL66100WR RFID
Antenna (6dBiL)

EPC Gen2 Std. RFID Antennas and Tags

Specifications

Dimensions

Length 18.4cm (7.25in)
Width 19.0cm (7.5in)
Height 2.5cm (1.0in)
Weight 544g (1.2lbs)

Electrical

Powering Options: 24V DC, 1.7A ext.
power supply (included)
Power over Ethernet (PoE) IEEE 802.3at
(802.3af limits power to 27dBm)

Power Consumption

24 W max Air Interface Protocol

Air Interface Protocol

EPCglobal UHF Class 1 Gen 2/
ISO 18000-6C

Transmit Power

+10.0 to +30.0 dBm

Receive Sensitivity

-82.0 dBm

IP Configuration

DHCP or Static IP configuration

Management Options

LLRP, embedded web GUI, telnet

Firmware Upgrade Options

Embedded web GUI
USB storage device
TrueVUE and Web GUI

On Board Storage

4Gb SD card slot

Connectivity

2/8 monostatic RP-SMA ports
1 USB Device (Type B) port
1 USB Host (Type A) port
2 RS-485 ports (RJ45)
GPIO 4 in ports/ 4 outputs (DE15)
1 x 10/100base-T (RJ45)
1 x 10/100base-T Ethernet switch (RJ45)

Environmental Constraints

Temperature Range

Operating -20°C to +50°C (-4°F to +122°F)
Storage -20°C to +85°C (-4° to +185°F)

Humidity

5% to 95%, non-condensing

Rating

Plenum-rated, UL-listed and complies with
UL-2043

Regulatory

North America (-N1)

EMC 47 CFR, Part 15
ICES-003
RSS-210
UL 60950-1
CSA-C22.2.60950-1

Europe (-E1)

EN 302 208
EN 301 489
EN 60950-1

Other (-W1 or -W2)

Refer to IDX-2000/8000 Quick Start Guide
at Sensormatic.com for current list of
approved countries.

CE This product is in conformity
with the following Directives: RTTE
(1999/5/EC), RoHS II (2011/65/EU),
and amendments. It also meets the
Substances of Very High Concern
requirements of the REACH Regulation
(1907/2006 and amendments).





RFID Work Surface Antenna IDA-1000

The RFID Work Surface Antenna is a key element of Tyco's TrueVUE™ Inventory Intelligence solution suite. With a compact, low-profile design and focused read range, this antenna adds cost-effective RFID read points to point-of-sale (POS) cash wraps, kiosks and stockrooms. With additional RFID read points, retailers can improve labor efficiency and enhance customer convenience, while providing the precise inventory accuracy needed to succeed in omni-channel retailing.

Compatible with EPC Gen2 standard RFID tags, the IDA-1000 antenna reads accurately across a wide variety of product types including apparel, footwear, books, electronics and more.

In the stockroom - the antenna supports numerous RFID workflow tasks including receiving small shipments of merchandise, transferring items to another location and writing new RFID tags with precision.

At kiosks - the antenna provides more accurate product lookups and enables self-checkout to provide improved customer service.

At the POS - the antenna provides near real-time visibility into what products are selling — dramatically improving restocking efforts and on-floor availability. Checkout is expedited by instantaneously reading information on merchandise placed on or near the antenna, instead of scanning barcodes by hand, to efficiently reduce costs and increase customer satisfaction.

Retailer Values

- // Aesthetic design and small form factor allow use in multiple areas throughout the store
- // Ideal for use at the POS, kiosks and stock rooms with RFID tag reading distances from several inches to over two feet
- // Multiple installation options for a variety of environments: under counter, above counter or mounted on a wall
- // Uniquely identifiable when used with IDX-family RFID reader, allowing remote management and easy diagnosis and troubleshooting
- // Integrated LED Indicators provide visual confirmation of successful operation
- // Expedites checkout to decrease costs while improving customer satisfaction

Product Codes

IDA-1000-US-RS
Desktop Antenna
(North America), RP-SMA

IDA-1000-EU-RS
Desktop Antenna
(European), RP-SMA

Product Compatibility

Sensormatic IDX-2000 2-port
Multipurpose RFID Reader

Sensormatic IDX-8000 8-port
Multipurpose RFID Reader

TrueVUE™ Software

EPC Gen2 standard RFID Tag

Specifications

Length..... 21.6cm (8.5in)

Width 21.6cm (8.5in)

Depth 1.5cm (0.6in)

Cable

Length 2.43m (8.0ft)

Connector..... RP-SMA

SMA-TNC cable adapter included

Mounting Weight 0.4kg (0.9lb)

Mounting 2 slotted holes

Housing High-impact plastic

LED Indicators..... 1 red, 1 green

Controlled by software when connected to IDX RFID Multipurpose Reader

Frequency Bands

US 902 – 928 MHz (FCC Band)

EU 865 – 868 MHz (ETSI Band)

Gain..... 3.3 dBiL

Beam Pattern..... 3dB width < =60°
(horizontal and vertical)

Polarization RHCP

Max VSWR (free space)..... < 2.0

Impedance (nominal)50 Ohm

Max Conducted Input Power..... 2W*

*Maximum legal input power determined by in-country regulatory requirements

DC Resistance 10K Ohm

Environmental Constraints

Operating Temperature

0°C to 50°C (32°F to 122°F)

Storage Temperature

0°C to 70°C (32°F to 158°F)

Regulatory Compliance

Safety

UL 60950-1

CSA-C22.2.60950-1

EN 60950-11

CE This product is in conformity with RoHS II Directive 2011/65/EU and REACH Substances of Very High Concern as defined in Regulation (EC) No 1907/2006 and subsequent amendments to both.

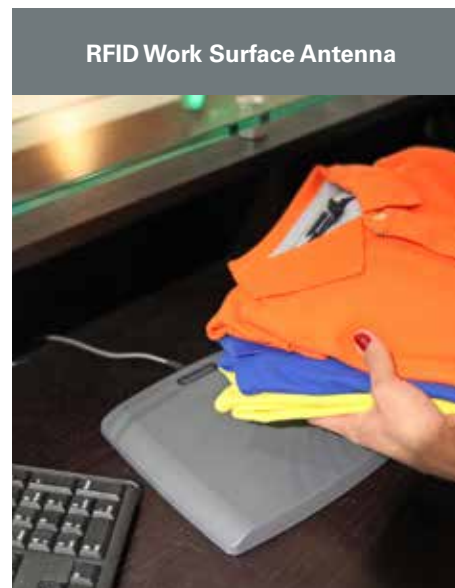



Beam Steerable RFID Antenna IDA-3100

Tyco Retail Solutions provides retailers with real-time visibility to their inventory and assets to help improve operations, optimize profitability and create memorable shopper experiences.

The Sensormatic IDA-3100 RFID antenna was designed with retail environments in mind. The low-profile form factor blends easily with store interiors and withstands harsh retail environments.

Software controlled beam steering delivers true directional read capability with a single antenna, enabling real-time capture of RFID tag movement. Beam steering customization allows the antenna to be configured to perform optimally in a range of installations; creating superior read zones in fitting rooms, transition areas and stockrooms.

The antenna mounts to flat surfaces including walls and ceilings with four concealed screws. A single cable connects the antenna to a Sensormatic IDX-2000 or 8000 Multipurpose RFID reader and can be fully concealed. Beam steering enables optimal tag reading from its flat position.

Compatible with standard UHF EPC Gen2 standard RFID tags, the IDA-3100 antenna reads tags accurately across a wide variety of product types including apparel, footwear, books, electronics and more.

In the fitting room - retailers can capture actionable data in real-time to monitor item location for visibility into shrink and on-floor availability. Additionally, visibility of tags in a fitting room provides opportunities for interaction with store associates as well as advanced merchandizing and loyalty applications.

In transition areas - beam steering technology enables visibility to the direction a tag is moving without needing multiple antennas; enabling true item location, faster receiving and transfers and improved item location accuracy with lower hardware cost.

In the stock room – this antenna supports numerous RFID workflows, from receiving small shipments, transferring merchandise items to another location and writing new RFID tags with precision.

Retailer Values

- // Low-profile, retail-friendly design with discreet hidden mounting features for fitting rooms, transition areas and stockrooms
- // Beam steering technology allows true sensing of tag directional movement with a single antenna
- // Software control allows beam customization for various wall or ceiling reading challenges
- // Compatible with EPC Gen2 standard RFID tags
- // Durable construction withstands demanding retail environments
- // Automatically recognized by Sensormatic IDX Multi-purpose RFID readers for built-in compatibility and ease of operation

Product Codes

IDA-3100-NA-RS

(North America)
902-928MHz, RP-SMA

IDA-3100-EU-RS

(Europe)
865-868MHz, RP-SMA

Product Compatibility

Sensormatic IDX-2000 2-port
RFID Reader

Sensormatic IDX-8000 8-port
RFID Reader

TrueVUE™ Software

EPC Gen2 standard RFID Tags

Specifications

Height 33.8cm (13.32in)

Width 37.2cm (14.63in)

Depth 1.9cm (0.75in)

Weight 1.2kg (2.6lbs)

Housing White, high-impact ABS
UV Stabilized

Cable

Length 1.22m (4ft)

Connector RP-SMA

Mounting

4 x #8 sheet metal screws included

Snap-on screw covers

Functionality

Frequency Bands

FCC band (NA) 902-928 MHz

ETSI band (EU) 865-868 MHz

Gain 6 dBiL Center Beam

4 dBiL Left and Right Beams

Beam Pattern 30dBm width <=50°

Polarization RHCP

Max VSWR (free space) <2.0

Impedance (nominal) 50 Ohm

Max Conducted Input Power 2W*

*Maximum legal input power determined by
in-country regulatory requirements

DC Resistance 10K Ohm

Environmental Constraints

Operating Temperature

-20° to +50°C (-4° to 122°F)

Storage

-20° to +70°C (-4° to 158°F)

Environmental Rating IP54

CE This product is in conformity with
RoHS II Directive 2011/65/EU and REACH
Substances of Very High Concern as
defined in Regulation (EC) No 1907/2006
and subsequent amendments to both.

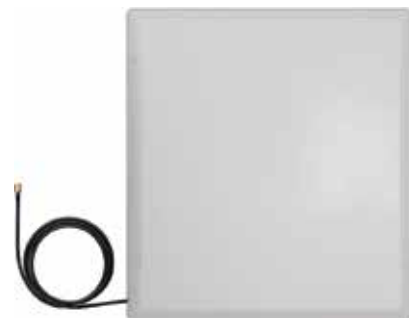

IDA-3100 with cable

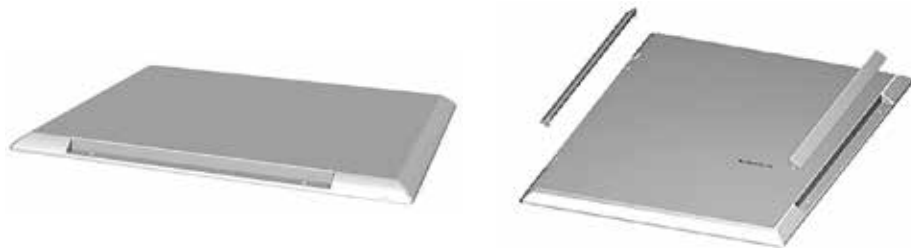

snap-on screw covers



cable routing options





Ultra•Exit RFID Retrofit Kit IDSM-1000

Tyco Retail Solutions provides retailers with real-time visibility to their inventory and assets to help improve operations, optimize profitability and create memorable shopper experiences.

The Ultra•Exit RFID Retrofit Kit is a simple, cost-effective upgrade to existing Ultra•Exit 2.4 ABS pedestals. This protects your investment in EAS infrastructure and provides a migration path to advanced RFID functionality.

This easy to install upgrade delivers an optimal combination of proven Acousto Magnetic (AM) EAS technology from Sensormatic along with the increased shrink and inventory visibility enabled by RFID technology.

At exits and transition areas, upgraded pedestals use software-controlled beam steering technology for true directional reading of RFID tags. For EAS and Inventory applications, this means pedestals are alerted and aware of tagged items moving from one area of the store to another, while static merchandise is ignored.

Deployment options:

The Ultra•Exit RFID Retrofit Kit is designed for in-place upgrading, with no need to remove or replace existing pedestals.

When combined with TrueVUE™ software, the Ultra•Exit RFID Retrofit Kit delivers advanced RFID functionality to increase inventory visibility, minimize markdowns, and replenish out-of-stocks, helping to maximize sales and increase customer satisfaction. With enhanced RFID theft detection at the exit, EAS and Traffic sensors provide detailed reporting of what, when and how specific items go missing.

The Ultra•Exit RFID Retrofit Kit can be deployed as an unmanaged stand-alone system using RFID to provide EAS.

For maximum value, it can be deployed as a managed system using TrueVUE™ software to deliver advanced reporting and analytics for increased inventory accuracy, selective alarming, and real-time visibility into loss events.

Retailer Values

- // A simple, cost-effective upgrade to existing AM pedestals that protects your EAS infrastructure investment and provides a migration path to advanced RFID functionality
- // Augments proven, reliable AM EAS technology with advanced RFID capabilities for item-level intelligence
- // Provides true directional sensing of RFID tag movement using beam steering technology at store exits, transition areas, or a specific zone within a store
- // Installs on single, double, split and quad pedestal configurations
- // Compatible with Sensormatic AM/RFID Dual Tech tags or any other EPC Gen2 standard RFID tags
- // Deploy as a stand-alone system, or integrate with TrueVUE™ software for advanced RFID functionality with real-time visibility into shrink and inventory accuracy

Product Codes

IDSM10-NA-RR1U
RFID Retrofit Kit NA Unidirectional

IDSM10-EU-RR1U
RFID Retrofit Kit EU Unidirectional

IDSM10-NA-RR1B
RFID Retrofit Kit NA Bidirectional

IDSM10-EU-RR1B
RFID Retrofit Kit EU Bidirectional

Above kits include: antenna, antenna cover, base cover and mounting hardware for one pedestal.

Ultra-Exit 2.4m ABS Pedestal sold separately

Options

ZPUE-PCNTR2
I/K, UE-UP People Counting 2 sensor kit

ZPUE-PC2-PCBKIT
I/K, UE People Counting 2 PCB kit

Required Hardware

IDX-2000
2-port Multipurpose RFID Reader

IDX-8000
8-port Multipurpose RFID Reader

Refer to IDX Multipurpose Reader User Guide for specific model and country compatibility

Product Compatibility

Sensormatic Ultra•Exit 2.4 ABS Pedestal

Sensormatic AM/RFID hard tags

AM hard tags and labels

EPC Gen2 Class I RFID tags

Specifications (with pedestal and base)

Height 155cm (61in)

Width 49cm (19.4in)

Depth 12.5cm (4.9in)

Install Weight 9.7kg (21.3lbs)

Environmental Constraints

Operating Temperature

0° to +50°C (32° to 122°F)

Storage

0° to +70°C (32° to 158°F)

RFID Functionality

Frequency Bands

US 902-928MHz (FCC Band)

EU 865-868MHz (ETSI Band)

Other Countries

W1 915 – 926 MHz

W2 902 – 928 MHz

Gain..... 6 dBiL center beam
4 dBiL left & right beams

Beam Pattern..... 3dB Beam Width <=50°
Polarization RHCP

Max VSWR (free space) < 2.0
Impedance (nominal) - 50 Ohms

Max Conducted Input Power 2W*

*Maximum legal input power determined by in-country regulatory requirements

DC Resistance 10K Ohm

CE This product is in conformity with RoHS II Directive 2011/65/EU and REACH Substances of Very High Concern as defined in Regulation (EC) No 1907/ 2006 and subsequent amendments to both.





Digital Remote Alarm

The Digital Remote Alarm facilitates response to alarm events at the store front, extending the benefits of Sensormatic’s Enhanced Detection suite. This aesthetically pleasing, feature-rich device enhances existing Ultra•Exit or Ultra•Post detection systems by allowing retailers to customize alerts for alarm events.

The remote alarm can be used to extend the detection system’s internal audible alarm by playing a tone or standard voice message. It also features the option to record personalized messages so retailers can inform customers and/or staff on how to respond to EAS alarms and avoid customer embarrassment.

The easy-to-see visual alarm counter logs the number of alarm events, identifying increases or decreases that may indicate staff training issues or increased shoplifting activity. Unique alarm patterns are available to differentiate events including “Tags-too-Close” and Jammer Detection.

The easy-to-use, optional remote control adjusts the Digital Remote Alarm’s functions from a distance while remaining as discreet as possible. The remote is passcode-protected and will disable in two minutes if no key is pressed.

The Digital Remote Alarm provides easy management of in-store EAS programs when connected to compatible data management device.

Retailer Values

- // The high-volume audible alarm makes it easier for store personnel to hear over ambient noise
- // Traffic-counting option helps identify shopping peaks, gauge marketing effectiveness and more
- // Unique alarm sequence for the “Tags-too-Close” feature aids in merchandising products near store entrance/exits
- // Jammer Device indicator includes visual and audible feedback for quicker response and more effective event management
- // Remote alarm housing can be custom painted to fit any store decor
- // The alarm displays counts from 0–999 and features a larger LED display for better visibility in low-light conditions

Product Code

- ZP1060-W:** Digital Remote Alarm, White
- ZP1060-G:** Digital Remote Alarm, Gray
- ZP1060-BRKT:** J-Box Mounting Bracket (attaches digital remote alarm to a J-Box mounted in or on a wall)

ZP1060-T: AC Adapter (plugs into wall outlet when power from controller is not available)

ZP1060-RCTF: Infrared Remote Control (allows user to control remote alarm from a distance)

Product Compatibility

- AMS9060 Controller
- AMS9050 Controller
- Local Device Manager II
- UltraLink
- Integrated Traffic Counting
- Tags-too-Close
- Jammer Detection
- Metal-Foil Detection

Specifications

| | |
|-----------------------------|------------------|
| Length | 202mm (8in) |
| Width | 148mm (5.8in) |
| Height | 52.7mm (2in) |
| Weight | |
| Digital Remote Alarm | 0.64kg (1.40lbs) |
| J-Box Mounting Bracket | 0.09kg (0.2lbs) |
| AC Adapter..... | 0.03kg (0.06lbs) |
| Infrared Remote Control... | 0.07kg (0.15lbs) |

Electrical

DC Input 12-15Vdc, 1A
Limited power source required
Contact Switching Current (max) 1.0A
Contact Switching Voltage (max) 28V

AC Adapter

AC Input 100-250Vac @ 50/60Hz
DC Output 12V, 1A min.
UL Listed Class 2
Certified Limited Power Source

Alarm

Visual Alarm

Tag Detect Alarm Rep Rate 3Hz
Jammer Detect Alarm Rep Rate 6Hz
Tags-too-Close Alarm Pattern 2 Blinks/
Pause

Audible Alarm

Maximum Alarm Volume
(measured at 1m) 105dB
Tone Alarm Duration (max) 15 sec
Voice Message Duration (max) 17 sec
Voice Message File Type WAV
Voice Message Sampling Rate 14kHz
Voice Message Bits 8 or 16
Voice Message Type Mono

Environmental Constraints

Operating Temperature

0°C to 50°C (32°F to 122°F)

Non-Operating Temperature

-40°C to 70°C (-40°F to 158°F)

Relative Humidity

0 to 90% non-condensing

Enclosure

IPX0

Evaluated for altitudes less than
3200m (10500ft)

Declarations

EMC

47 CFR, Part 15
ICES-003
EN 61000-6-1
EN 61000-6-3
EN 61000-3-2
EN 61000-3-3

Safety (second edition)

UL 60950-1
CSA-C22.2.60950-1
EN 60950-1

CE This product is in conformity with
RoHS II Directive 2011/65/EU and REACH
Substances of Very High Concern as
defined in Regulation (EC) No 1907/2006
and subsequent amendments to both.



Base Alarm Counter

This discreet device integrates into the base of the Ultra•Exit detection pedestal to deliver real-time alarm counts. The easy-to-read LCD display shows alarm counts to enhance compatible Sensormatic detection systems. When leveraging the optional Integrated EAS Traffic Counter, the display also provides visibility into directional traffic counts.

Retailer Values

- // Delivers real-time counts to better manage alarm events
- // Provides visibility and directionality of potential shoplifting events when paired with the Integrated Traffic Counter

Product Code

ZPUE-ALMCNTR

Product Compatibility

Ultra•Exit Pedestals



Advertising Upgrade Kit

The optional Advertising Upgrade Kit is designed to display poster inserts on compatible Sensormatic pedestals. By leveraging valuable real estate at the store entrance for advertisements, modern designs or simple low-cost printed graphics, this easy-to-install kit offers a flexible medium to reach a great number of potential customers on-the-move. It can also be used to generate additional marketing co-op profit by bidding out this valuable advertising space to vendors.

Consumer Awareness: Although this anti-theft system complies with all applicable safety standards, poster inserts must be designed to avoid creating any delay in the movement of customers through the system. Medical implant wearers are instructed by their physicians not to linger near, or lean on, anti-theft pedestals. Graphic inserts should not encourage them to linger or lean.

Retailer Values

- // Reach a large number of shoppers on-the-move where most purchasing decisions are made
- // Generate additional marketing co-op profit by bidding out advertising space to vendors
- // Change out poster inserts easily with slide-release clamps

Product Code

Synergy Series Pedestals

ZPS-AD1180-CL

Advertising Kit for Sensormatic Synergy 2.0 and 2.5 ABS Pedestals

ZPS-AD1170-CL

Advertising Kit for Sensormatic Synergy Self-Contained Pedestal

ZPS-ADRFID-CL

Advertising Kit for Sensormatic Synergy RFID Retrofit Panel

Ultra•Post Pedestal

ZPUP-PSTPANEL

Advertising Kit for Ultra•Post Pedestals

Note: One kit supports one antenna each side

Product Compatibility

- Sensormatic Synergy 2.0 ABS Pedestal
- Sensormatic Synergy 2.5 ABS Pedestal
- Sensormatic Synergy Self-Contained Pedestal
- Sensormatic Synergy RFID Retrofit Panel
- Ultra•Post Self-Contained Pedestal

Specifications

ZPS-AD1180-CL

Weight0.82kg (1.8lbs)

ZPS-AD1170-CL

Weight0.41kg (0.9lbs)

ZPS-ADRFID-CL

Weight1.04kg (2.3lbs)

ZPUP-PSTPANEL

Weight.....2.60kg (5.75lbs)



Outdoor Enclosure

This enclosure is designed to protect the required electronic components for compatible AM EAS detection systems in virtually any outdoor retail environment. Welded hardware creates a weather-tight aluminum housing that holds a thermostat control to manage internal temperatures. The thermostat prevents condensation from forming on installed equipment and ensures evenly-distributed interior air temperature.

Retailer Values

- // Weather-tight construction allows EAS detection in any retail outdoor environment
- // Thermostat control manages internal temperatures to prevent condensation that can damage the system's electronic components

Product Code

ZPUODPP-ENC

Product Compatibility

- AMS9040 Controller
- AMS9050 Controller
- AMS9060 Controller

Specifications

- Width** 61cm (24in)
- Height** 168cm (66in)
- Depth** 33cm (13in)
- Weight** 33.5kg (74lbs)

Electrical

DC Input

- Primary Input 120Vac, 50/60Hz or
230Vac, 50/60Hz
- Input Current 15A max.

Environmental Constraints

Operating Temperature

-30°C to 50°C (-22°F to 122°F)

Relative Humidity

0 to 100% condensing

Declarations

Regulatory ID

UM HB2A Outdoor Enclosure

Regulatory Compliance

Safety UL1950
Can/CSA C22.2 No. 950-95
NEMA 3R/IP43



Side-Impact Bumpers

The optional Side-Impact Bumpers prevent damage and preserve the look of the Sensormatic Ultra•Exit 2.0 ABS Pedestal. The bumpers are designed to withstand high-traffic, tough retail environments including supermarkets, DIY stores and garden centers.

Retailer Values

- // Help prevent damage and maintain the integrity of Sensormatic Ultra•Exit 2.0 ABS Pedestal
- // Ideal for tough retail environments including supermarkets, DIY stores and garden centers

Product Code **ZPUE-BUMPER**

Product Compatibility
Ultra•Exit 2.0 ABS Pedestal

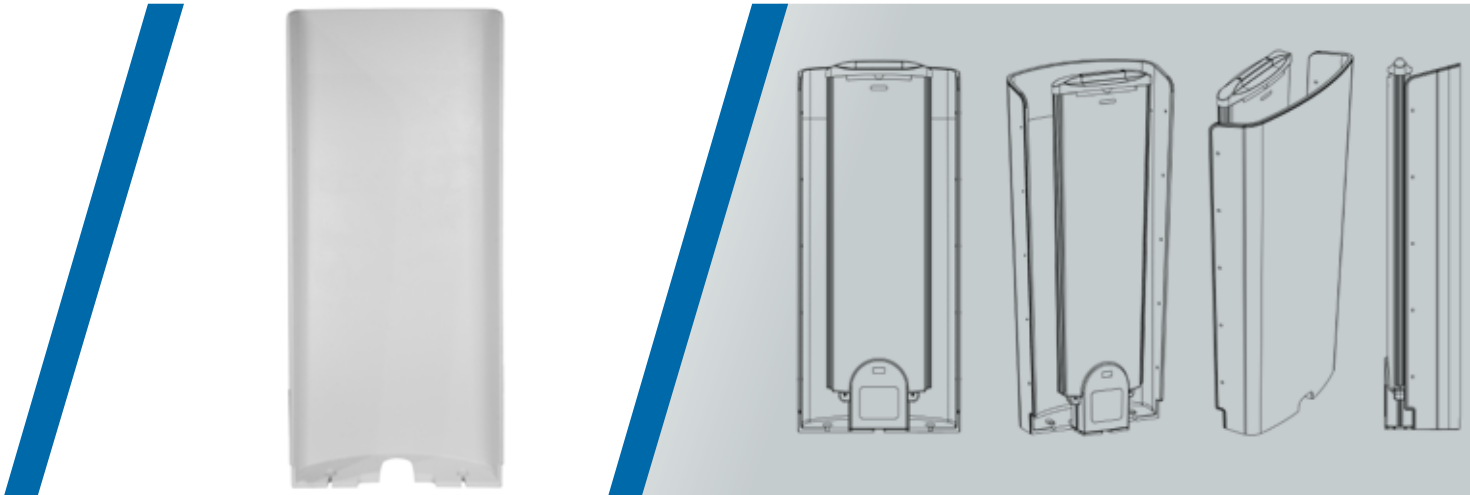

Ultra•Post Shield

The Ultra•Post Shield minimizes the detection field behind the Sensormatic Ultra•Post pedestal. The shield is installed behind the primary or secondary pedestal to allow store associates to better manage merchandising of tagged goods at the front of the store.

Retailer Values

- // Reduces detection field behind the Ultra•Post pedestal
- // Enables store associates to better manage merchandising of tagged goods at the front of the store

Product Code ZPUSHLD

Product Compatibility

Ultra•Post Self-Contained Pedestal

Specifications

| | |
|-------------------------|----------------|
| Width Base | 61cm (24in) |
| Height | 142cm (56in) |
| Depth Base | 21cm (8.5in) |
| Weight | 24.9kg (55lbs) |

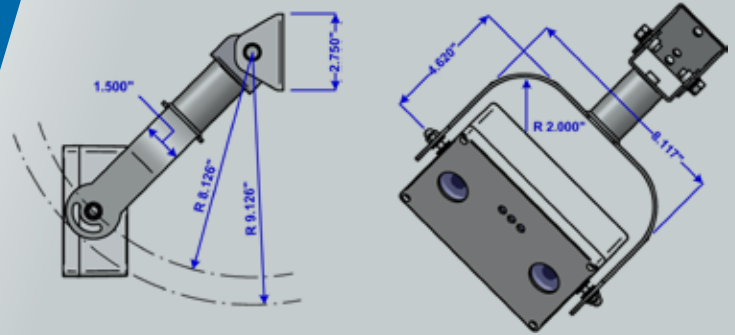

Outdoor Tilting Mount for Stereo Overhead Traffic Sensor

This tilting housing helps easily mount the Sensormatic Stereo Overhead Traffic Sensor in outdoor retail environments. The mount's main housing swivels freely on the attached metal U-bracket's arms that rotate at the base for both X- and Y-axis tilt—for a more accurate traffic count. The sensor is attached to a bracket inside the main housing.

Retailer Values

- // Ideal for installation of Sensormatic Stereo Overhead Traffic Sensors in outdoor retail settings
- // Swivels freely for a more accurate traffic count

Product Code 2025-0686-01

Product Compatibility

Stereo Overhead Traffic Sensor

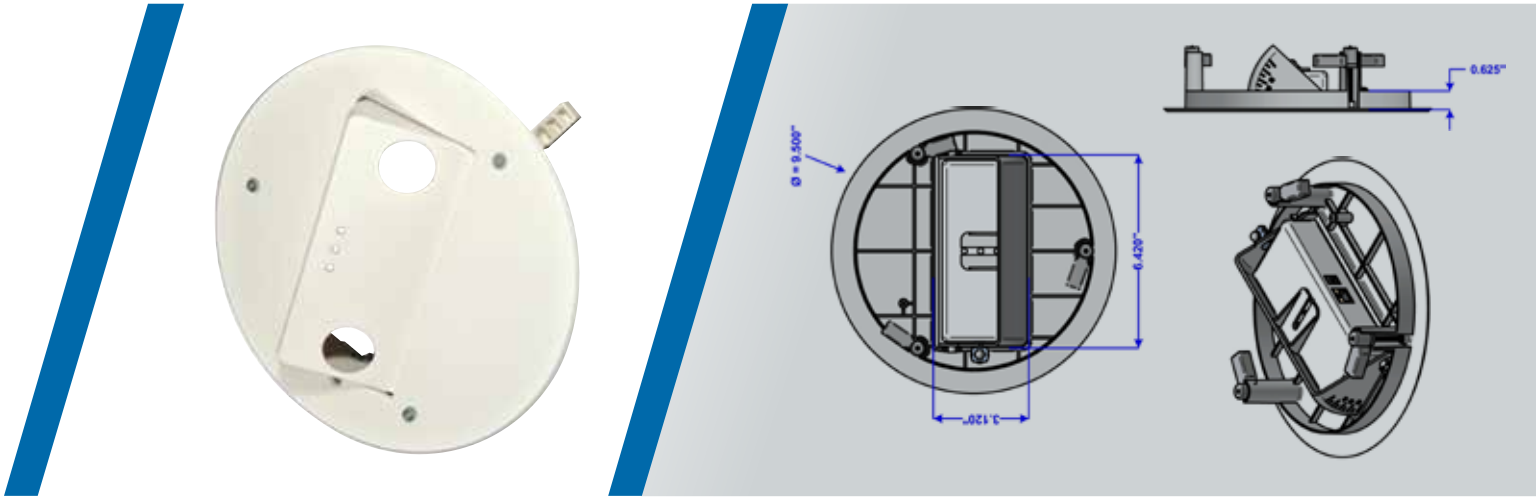

Recessed Tilting Mount for Stereo Overhead Traffic Sensor

This one-piece tilting housing is intended for recess mounting of the Sensormatic Stereo Overhead Traffic Sensor into ceilings. Used for installations that require X-axis tilt and/or discreet profile, the sensor is inserted into the tilt housing and secured. The mount grips the unexposed portion of the ceiling panel and the tilt angle is controlled by adjusting an embedded screw. Angle markings are laser-engraved in 5° increments for accurate tilt control.

Retailer Values

- // Intended for recess mounting of the Sensormatic Stereo Overhead Traffic Sensor into ceilings
- // Provides accurate tilt control

Product Code 2025-0685-01

Product Compatibility Stereo Overhead Traffic Sensor

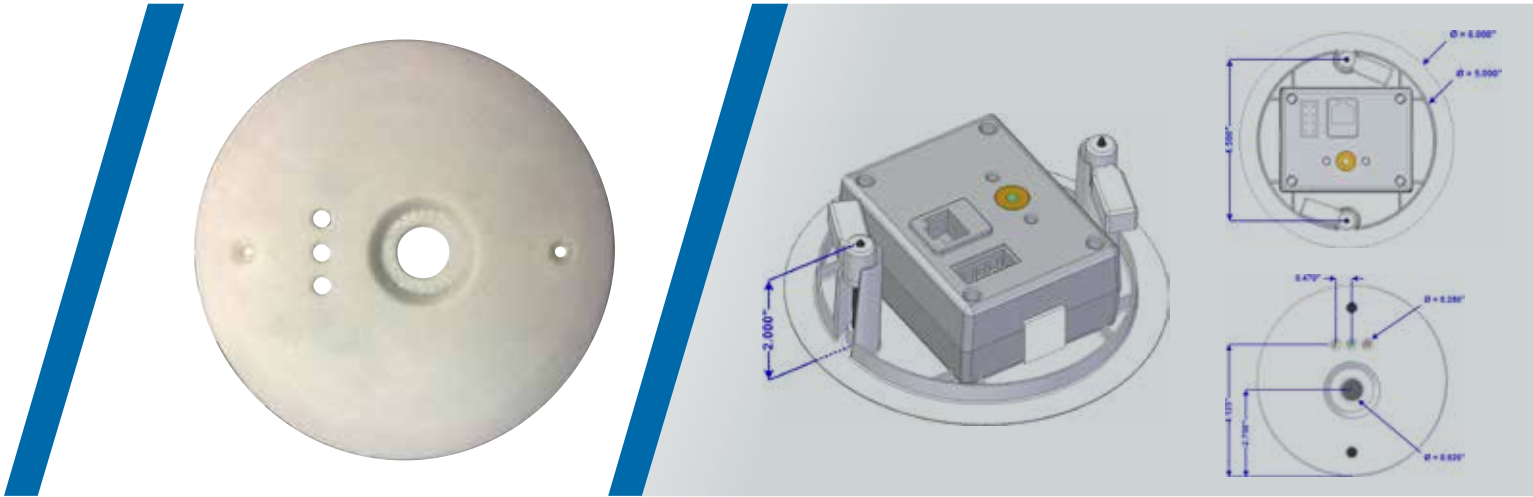

Recessed Mount for Mono Overhead Traffic Sensor

The one-piece housing is intended for recess mounting of the Sensormatic Mono Overhead Traffic Sensor into ceilings with an unexposed open void. Used for installations that require a discreet profile, the sensor is inserted into the housing and secured. The mount grips the unexposed portion of the ceiling panel with two swiveling clamps.

Retailer Values

// Intended for recess mounting of the Sensormatic Mono Overhead Traffic Sensor into ceilings

Product Code
2025-0687-01

Product Compatibility

Mono Overhead Traffic Sensor



Remote Alarm Module

The Remote Alarm Module provides visual and audible notifications when an AM EAS label is successfully deactivated. This device can be mounted almost anywhere on the check stand and features a key switch for turning the compatible deactivator on or off. The ZPSTP-RA1 model provides “on” or “standby” status only, while the ZPSTP-RA model provides audio and visual detection, deactivation and status.

Retailer Values

- // Provides visual and/or audible notification of successful AM EAS label deactivation
- // Features a key switch for turning the compatible deactivator on or off

Product Code

ZPSTP-RA1

Remote Alarm Kit (4-pin connector)

ZPSTP-RA

Remote Alarm Kit (6-pin connector)





Product Compatibility

- Value Pad
- Universal Deactivation Controller
- Essentials Controller
- Integrated Pad (IP) Pro
- Low Profile Pad Deactivator
- Compact Pad Deactivator
- SlimPad Deactivator
- PowerPad Deactivator



Grooved Tacks

Secure compatible hard tags to soft goods of various thickness for a strong, tamper-resistant fit.

| | | |
|--|--|--|
|  <p>Product Compatibility SuperTag Portfolio Magnetic AM/RFID Tag AM/RFID Hard Tag SuperTag Lanyard Versatie</p> | <p>Product Codes MJ200-G: Gray Tack MJ200-B: Black Tack MJ200L-W: White Long Tack MJ200-MG: Gray Tack for AM/RFID Magnetic Tag</p> | <p>Specifications MJ200-G and MJ200-B Tack Length..... 15mm (0.59in) MJ200L-W Tack Length..... 17mm (0.66in) MJ200-MG Tack Length..... 15mm (0.59in)</p> |
|  <p>Product Compatibility Deactivatable SuperTag VST-R Non-Deactivatable SuperTag VST-R</p> | <p>Product Codes M70-H: Metal Tack</p> | <p>Specifications Tack Length..... 14.5mm (0.57in)</p> |
|  <p>Product Compatibility Ultra-Gator Tag Verstie Lanyard for Ultra-Gator Tag</p> | <p>Product Codes MJ25-2P: Beige Tack</p> | <p>Specifications Tack Length..... 14mm (0.54in)</p> |
|  <p>Product Compatibility Magnetic 9kG Tack Tag</p> | <p>Product Codes MJ400-G: Gray Tack MJ400-B: Black Tack</p> | <p>Specifications Tack Length..... 15mm (0.60in)</p> |



Product Compatibility
MVST-R Tag

Product Codes
MJ7400: New Gray Tack
MJ7400R: Re-circulated Gray Tack

Specifications
Tack Length..... 17.1mm (0.67in)



Product Compatibility
Magnetic 5kG Tack Tag

Product Codes
MJAMT3200-G: Gray Tack
MJAMT3200-S: Steel Tack
MJAMT3200-B: Black Tack

Specifications
MJAMT3200-G
Tack Length..... 17.9mm (0.70in)
MJAMT3200-S
Tack Length..... 17.9mm (0.70in)
MJAMT3200-B
Tack Length..... 17.9mm (0.70in)



Product Compatibility
Magnetic 5kG Tack Tag
Ultra-Gator Tag

Product Codes
MJ31L-W: Long White Tack

Specifications
Tack Length..... 19mm (0.74in)



Product Compatibility
SuperTag Portfolio
Ultra-Gator Portfolio
Magnetic 9kG Tack Tag

Product Codes
Tack Only
MJVT-2: Beige
MJVT-3B: Beige
MJVT-4B: Beige
Clip Only
MXVC-1: Metal

Specifications
Tacks:
MJVT-2
Tack Length..... 12.3mm (0.48in)
MJVT-3B
Tack Length..... 12.3mm (0.48in)
MJVT-4B
Tack Length..... 12.3mm (0.48in)
Clip:
MXVC-1
0.30 x 0.20 x 2.4mm (1.18 x 0.79 x 1in)



Smooth Tacks



Unique, ultra-thin tack design minimizes risk of damage to delicate fabrics.

| | | | |
|--|--|--|--|
|  | <p>Product Compatibility Magnetic 5kG Tack Tag MVST-R Tag</p> | <p>Product Codes MJLT-1 (CE only): White Tack</p> | <p>Specifications Tack Length.....13mm (0.51in)</p> |
|  | <p>Product Compatibility Magnetic Delicate Tag</p> | <p>Product Codes MJ3220-G: Gray Tack MJ3220-B: Black Tack</p> | <p>Specifications Tack Length.....0.318mm (0.012in)</p> |
|  | <p>Product Compatibility Magnetic RF MVST-R Tag</p> | <p>Product Codes MJ7000: New Black Tack MJ7000R: Re-circulated Black Tack</p> | <p>Specifications Tack Length.....18.37mm (0.72in)</p> |
|  | <p>Product Compatibility Magnetic Saucer Ink Tag</p> | <p>Product Codes MJ6015: Metal Tack</p> | <p>Specifications Tack Length.....12.7mm (0.5in)</p> |



Lanyards

A flexible and secure way to attach compatible hard tags to a variety of merchandise, including hard-to-tag product categories.

| | | |
|---|---|--|
|  <p>Product Compatibility Magnetic 5kG Tack Tag</p> | <p>Product Codes MXETL: Loop on one end and unique eye on other end</p> | <p>Specifications Length21cm (8.26in)</p> |
|  <p>Product Compatibility Ultra-Gator Tag Portfolio</p> | <p>Product Codes MXGL: Loops on both ends</p> | <p>Specifications Length19cm (7.5in)</p> |
|  <p>Product Compatibility SuperTag Portfolio</p> | <p>Product Codes MXSTL: Stainless-steel cable with loop on one end and eye on other end</p> | <p>Specifications Length21cm (8.26in)</p> |



Versatie

Adjustable, reusable plastic strap attaches compatible hard tags to a variety of merchandise.

Product Compatibility

SuperTag Portfolio
Ultra-Gator Portfolio
Magnetic 9KG Tack Tag



Product Codes

MXVT15: Gray

Specifications

Length 15.5cm (6.1in)



Global strength. Local expertise. At your service.

North America Headquarters

4700 Exchange Court
Suite 300
Boca Raton, FL 33431
United States
Phone: +1 877 258 6424

Latin America Headquarters

6600 Congress Ave.
Boca Raton, FL 33487
United States
Phone: +1 561 912 6000

United Kingdom/Ireland Regional Headquarters

Security House, The Summit
Hanworth Road
Sunbury-on-Thames
Middlesex. TW16 5DB
United Kingdom
Phone: +44 1932 743 432

Continental Europe Headquarters

Am Schimmersfeld 5-7
40880 Ratingen
Germany
Phone: +49 2102 7141 0

Asia-Pacific Headquarters

31 International Business Park,
Creative Resource Building #03-02
Singapore 609921
Phone: +65 63898000

South Africa Headquarters

1 Charles Crescent
Eastgate Ext 4, Sandton
South Africa
Phone: +086 12 12 910a

Leverage our strength and experience

Tyco Retail Solutions is a leading global provider of integrated retail performance and security solutions, deployed today at more than 80 percent of the world's top 200 retailers. Customers range from single-store boutiques to global retail enterprises. Operating in more than 70 countries worldwide, Tyco Retail Solutions provides retailers with real-time visibility to their inventory and assets to improve operations, optimize profitability and create memorable shopper experiences.

The Tyco Retail Solutions portfolio for retailers is sold direct and through authorized business partners around the world.

www.tycoretailsolutions.com

© 2015 Tyco Retail Solutions

All rights reserved. TYCO RETAIL SOLUTIONS, SENSORMATIC and TrueVUE are marks and/or registered marks. Unauthorized use is strictly prohibited.

tyco
Retail Solutions

Safer. Smarter. Tyco.™