



**SAMSUNG SDI**

ELSR362-00002

# RES 3.6 kWh All In One

User Manual

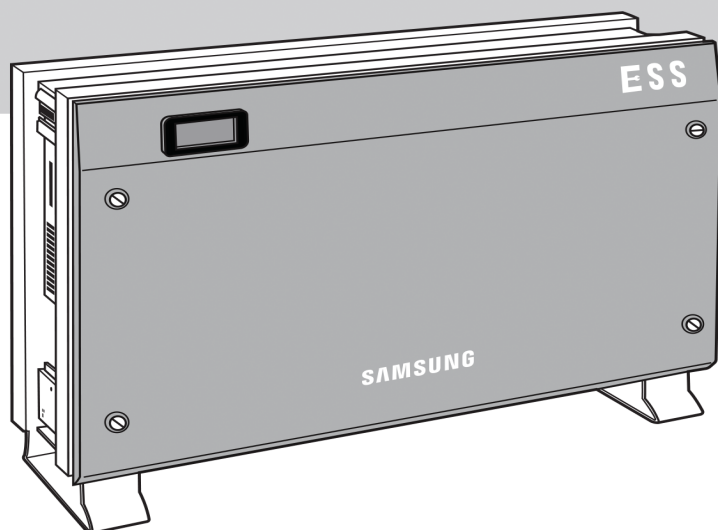

	<b>CAUTION</b>
	<ul style="list-style-type: none"><li>▪ Do not operate with other components not approved by the ESS systems. (Connecting other products in parallel to Samsung SDI's products may result in abnormal operation.)</li><li>▪ The internet connection is required to use all functions of the ESS system.</li><li>▪ If you have a problem, please contact the installer.</li><li>▪ The Specifications of the product may be modified without prior notice to improve product quality.</li></ul>

# Table of Contents

<b>Table of Contents .....</b>	<b>i</b>
<b>Table of Tables.....</b>	<b>iii</b>
<b>Table of Figures .....</b>	<b>iv</b>
<b>1. Information in this Manual.....</b>	<b>1</b>
1.1 About this Manual.....	1
1.2 Target Group .....	1
1.3 Additional Information .....	1
1.4 Symbols Used .....	1
<b>2. Safety.....</b>	<b>5</b>
2.1 Intended Use.....	5
2.1.1 Installation Application Suitable for Safety .....	7
2.1.2 Technical Specifications.....	9
2.2 Safety Guidelines .....	13
2.3 Symbol Indication .....	14
<b>3. Product Overview .....</b>	<b>15</b>
<b>4. Operating Modes .....</b>	<b>16</b>
4.1 Descriptions of Operation Mode .....	16
4.1.1 PV-Auto Mode.....	16
4.1.2 PV-Only Mode .....	17
4.1.3 Battery-Discharge Mode.....	18
4.1.4 Standby Mode.....	18
4.1.5 Forced-Charge Mode (Maintenance mode) .....	19
4.1.6 Stand-Alone Mode .....	19
4.1.7 Event Check Mode.....	20
4.1.8 Application Download Mode.....	24
4.2 Starting the System.....	25
4.2.1 Turning off the System .....	25
<b>5. Communication .....</b>	<b>26</b>
5.1 Overview .....	26
5.2 Components and LAN Connection .....	26
5.2.1 Essential Components.....	26
5.2.2 LAN Connection .....	26
5.3 Homepage.....	27

5.3.1	Service Terms.....	27
5.3.2	Membership .....	27
5.3.3	Membership Withdrawal .....	29
5.3.4	Log-In.....	29
5.3.5	Password Initialization.....	30
5.3.6	Types of Service Offered .....	30
5.3.7	Mobile Service .....	33
<b>6.</b>	<b>Maintenance for Problem Solving .....</b>	<b>34</b>
6.1	Fan Exchange.....	34
6.2	Cleaning .....	35
6.2.1	Cleaning the Side Cover.....	35
6.3	Checking the Event Logs.....	36
6.4	Checking the Terminals .....	36
<b>7.</b>	<b>Message Description .....</b>	<b>37</b>
7.1	Messages in Normal Operation.....	37
7.2	General Events.....	38
7.2.1	INVERTER General Events (Warnings).....	38
7.2.2	INVERTER General Events (Protection) .....	39
7.2.3	Battery Discharge General Events .....	41
7.2.4	PV General Events (Protection).....	43
7.2.5	System General Events (Protection).....	44
7.2.6	BMS General Events .....	45
7.2.7	EMS/Communication Events.....	47
7.2.8	Single Fault Events.....	47
7.3	Significant Events .....	48
<b>8.</b>	<b>Arrangement of Terms .....</b>	<b>50</b>
<b>9.</b>	<b>Contact .....</b>	<b>51</b>

---

# Table of Tables

[Table 1-1: Symbol Description] .....	4
[Table 2-1: Technical Specifications] .....	10
[Table 2-2: Inverter symbols] .....	14
[Table 3-1: Part Description] .....	15
[Table 7-1: Message List] .....	37
[Table 7-2: Inverter general events warning list] .....	39
[Table 7-3: Inverter protection list] .....	41
[Table 7-4: Battery operation general events list] .....	43
[Table 7-5: PV general events protection list] .....	44
[Table 7-6: System general events protection list] .....	45
[Table 7-7: BMS general events list] .....	47
[Table 7-8: EMS/communication events list] .....	47
[Table 7-9: Single fault events list] .....	48
[Table 7-10: Significant events list] .....	49

# Table of Figures

[Figure 2-1: Electrical connections] .....	5
[Figure 2-2: Name Plate] .....	7
[Figure 2-3: PV connections].....	8
[Figure 2-4: Distribution box connection diagram].....	8
[Figure 2-5: Derating Curve] .....	11
[Figure 2-6: Power efficiency curve of System].....	11
[Figure 2-7: Power efficiency curve of PV Generation] .....	12
[Figure 3-1: Part View of Samsung All in One] .....	15
[Figure 4-1: Front status indication screen] .....	16
[Figure 4-2: PV generation, battery charge, Load use, sell remaining amount] .....	17
[Figure 4-3: PV generation, battery discharge, Load use, buy shortage amount] .....	17
[Figure 4-4: PV generation, Battery standby, Load use, sell remaining amount].....	17
[Figure 4-5: PV generation, Sell remaining amount].....	17
[Figure 4-6: PV generation, Buy shortage amount].....	18
[Figure 4-7: Battery discharge, Load use] .....	18
[Figure 4-8: Battery discharge, Load use, Buy shortage amount] .....	18
[Figure 4-9: Indication screen on Standby Mode].....	19
[Figure 4-10: Indication screen on Forced charged Mode].....	19
[Figure 4-11: Indication screen on stand-alone mode] .....	19
[Figure 4-12: Event occurrence, Grid RMS over current protection] .....	20
[Figure 4-13: Event occurrence, DC link over voltage protection].....	20
[Figure 4-14: Event occurrence, PV string1 reverse connection protection].....	20
[Figure 4-15: Event occurrence, PV string2 reverse connection protection].....	20
[Figure 4-16: Event occurrence, PV string1 over voltage protection].....	21
[Figure 4-17: Event occurrence, PV string1 over current protection] .....	21
[Figure 4-18: Event occurrence, PV string2 over voltage protection].....	21
[Figure 4-19: Event occurrence, PV string2 over current protection] .....	21
[Figure 4-20: Event occurrence, Battery over voltage protection] .....	21
[Figure 4-21: Event occurrence, Battery over current protection].....	22
[Figure 4-22: Event occurrence, On sequence Inverter DC link event].....	22
[Figure 4-23: Event occurrence, On sequence Battery V/I event] .....	22
[Figure 4-24: Event occurrence, Normal Inverter DC link event].....	22
[Figure 4-25: Event occurrence, Normal Battery V/I & BDC DC link event].....	22
[Figure 4-26: Event occurrence, On sequence Inverter DC link event].....	23
[Figure 4-27: Event occurrence, Normal Inverter DC link & PV I event].....	23
[Figure 4-28: Event occurrence, Temperature protection] .....	23
[Figure 4-29: Event occurrence, Over Current TZ Fault].....	23
[Figure 4-30: Events occurrence, temperature sensor connection error] .....	23
[Figure 4-31: Event occurrence, PV mis-wiring].....	24
[Figure 4-32: Event occurrence, SPI communication event] .....	24
[Figure 4-33: Event occurrence, Single fault event] .....	24
[Figure 4-34: Event occurrence, Continuously 3 times Inverter fault] .....	24
[Figure 4-35: Indication screen on Application Download Mode] .....	24
[Figure 4-36: Initial indication screen on power on] .....	25
[Figure 4-37: Standby state indication screen before the EMS command] .....	25
[Figure 5-1: Communication terminal].....	26
[Figure 5-2: Connecting to the website].....	28

[Figure 5-3: Entering the information to sign up for a membership] .....	28
[Figure 5-4: Log-in page] .....	29
[Figure 5-5: Password initialization page] .....	30
[Figure 5-6: Monitoring page] .....	31
[Figure 5-7: Consumption report page] .....	31
[Figure 5-8: Forecast page] .....	32
[Figure 5-9: Mobile service page] .....	33
[Figure 6-1: Side cover removal] .....	34
[Figure 6-2: Fan removal] .....	34
[Figure 6-3: Side cover removal] .....	35



# 1. Information in this Manual

## 1.1 About this Manual

This is the user's manual for the Samsung 3.6 kWh All in One. This user manual is specially designed to detail the device's functions and features. Please read this manual before using the device to ensure safe and proper use.

## 1.2 Target Group



This user manual applies only to the Samsung 3.6 kWh All in One.

## 1.3 Additional Information





The user manual and installation manual can be downloaded from the product download section at "<https://myess.samsungsdi.com>". The specifications of the product can be changed for improvement without notice.





Also, the software can be updated automatically without notice over the Internet.















## 1.4 Symbols Used





Symbols	Meaning
	<b>CAUTION</b> This symbol indicates a hazardous situation which could result in a light injury, if not avoided.
	<b>NOTICE</b> This symbol indicates a hazardous situation which could result in damage to the property, if not avoided.
	Information This symbol indicates valuable tips for optimum installation and operation of the product.



Symbols	Meaning
	Beware dangerous voltage. The inverter operates at high voltage. All works related to the inverter can only be performed by an electrical technician.
	Beware of hot surface. The inverter can become hot during operation. Avoid contact during operation.
	Follow the guidelines in all relevant documents enclosed along with the inverter.
	Do not dispose of the inverter with household wastes. For further information on disposal, refer to the installation manual provided.
	The CE Indication: The relevant equipment complies with the requirements in the EC guidelines.

Number	Symbol	Description
1		Direct current
2		Alternating current
3		Both direct and alternating current
4		Three-phase alternating current

Number	Symbol	Description
5		Three-phase alternating current with neutral conductor
6		Earth terminal
7		Protective conductor terminal
8		Frame or chassis terminal
9		Refer to the operating instructions
10		On (supply)
11		Off (supply)
12		Equipment protected throughout by double insulation or reinforced insulation
13		Caution: Risk of Electric Shock
14		Caution: Hot Surface
15		Caution: Risk of Danger
16		In position of a bi-stable push control
17		Out position of a bi-stable push control
18		Input terminal or rating

Number	Symbol	Description
19		Output terminal or rating
20		Bidirectional terminal rating
21		Caution: Risk of Electric Shock and Energy Storage Timed Discharge
22		Caution: Risk of Hearing Damage and Wear Hearing Protection

[Table 1-1: Symbol Description]

## 2. Safety

### 2.1 Intended Use

	<b>NOTICE</b>
	<p><b>The 3.6 kWh All in One system is intended for residential use only.</b></p> <p><b>The 3.6 kWh All in One system should not be used for commercial or building.</b></p>

The original usage purpose of this device is for household single-phase system link solar energy generation and Li-Ion Battery charge and discharge. The basic operations are as follows.

Samsung 3.6 kWh All In One uses solar energy power connected to the input/output terminal installed on the side of the device to charge the Li-Ion Battery installed inside, and converts the direct current electricity of the battery to alternating current to discharge as household single-phase load or electric system, or uses the electric system of electric energy to charge the battery.

This device should not be used for any purpose other than the purpose described in this User manual. Any substitute use of this device, random change in any of its parts, and use of components other than sold or recommended by Samsung SDI will nullify the product's guarantee. For further information on proper use of this device, contact the Samsung SDI Service line or visit at "www.samsungsdi.com".

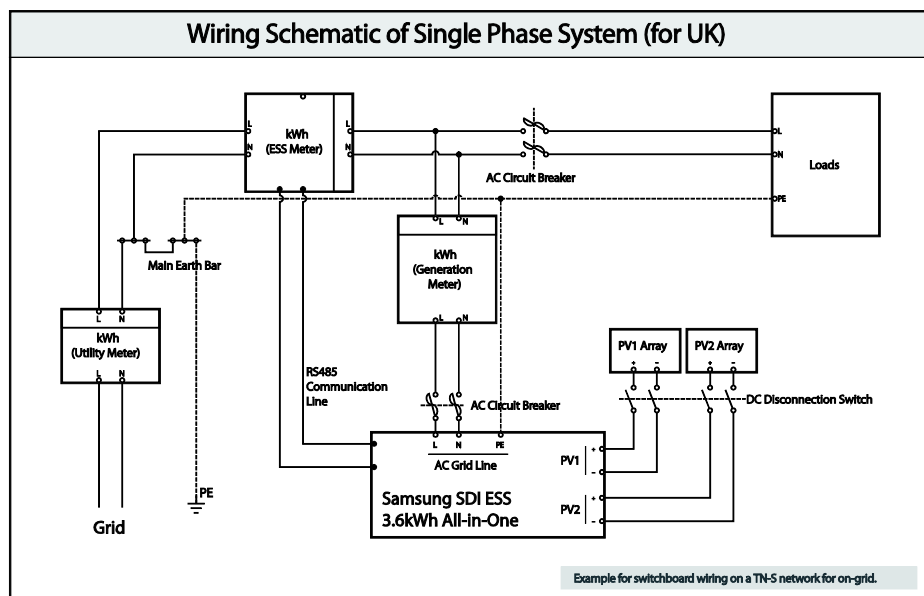

[Figure 2-1: Electrical connections]

### ■ Identifying the Product

Attached on the enclosure of this product is the Type Label where the identity of this product is described. For safe usage, make sure that the following product information is indicated on the Type Label.

- Product Name
- Device Type (Model)
- Serial Number (Serial No.)
- Device-specific characteristics
- Certification Lists
- Warnings and Notification













The model No. of 3.6 kWh All In One system is defined as below.

- ELSR362-00002
  - ELSR: Residential application
  - 36: Battery capacity (x0.1kWh)
  - 2: Battery capacity group (Less than 10kW)
  - 00002: product line number

The model No. of INVERTER (power conditioning system) is defined as below.

- SJ94-00108B
  - SJ: battery for ESS
  - 94: Ass'y
  - 00108: product number
  - B: National Code (UK)

The Type Label is shown in the **[Figure 2-2]**.

<b>SAMSUNG SDI</b>  System No. ELSR362-00002 Inverter No. SJ94-00108B    Serial No. <div style="border: 1px solid black; width: 100px; height: 20px; margin-top: 5px;"></div>		<table border="1"> <tr> <td rowspan="3">             DC            Photovoltaic            Module Input         </td> <td>Max. Voltage</td> <td>550V</td> </tr> <tr> <td>MPPT Range</td> <td>125V ~ 500V</td> </tr> <tr> <td>Max. PV Current Per String / I<sub>sc</sub> pv</td> <td>15A / 20A</td> </tr> <tr> <td rowspan="4">             AC            (Output)         </td> <td>AC Nominal Power</td> <td>4600W</td> </tr> <tr> <td>AC Nominal Voltage / Frequency</td> <td>230V / 50Hz</td> </tr> <tr> <td>AC Nominal Current</td> <td>20A</td> </tr> <tr> <td>Power Factor</td> <td>0.95~1~0.95</td> </tr> <tr> <td rowspan="3">             Battery            (Input/            Output)         </td> <td>Battery Type</td> <td>Li-Ion</td> </tr> <tr> <td>Battery Capacity</td> <td>3.6kWh</td> </tr> <tr> <td>Max. Current</td> <td>46.3A</td> </tr> <tr> <td colspan="2">Nominal Voltage</td> <td>60V</td> </tr> <tr> <td colspan="2">Protection Degree / Class</td> <td>IP21 / I</td> </tr> <tr> <td colspan="3">IEC 62109-1/-2, ER-G83/2, ER-G59/3</td> </tr> <tr> <td colspan="3">MADE IN KOREA</td> </tr> </table>	 DC Photovoltaic Module Input	Max. Voltage	550V	MPPT Range	125V ~ 500V	Max. PV Current Per String / I <sub>sc</sub> pv	15A / 20A	 AC (Output)	AC Nominal Power	4600W	AC Nominal Voltage / Frequency	230V / 50Hz	AC Nominal Current	20A	Power Factor	0.95~1~0.95	 Battery (Input/ Output)	Battery Type	Li-Ion	Battery Capacity	3.6kWh	Max. Current	46.3A	Nominal Voltage		60V	Protection Degree / Class		IP21 / I	IEC 62109-1/-2, ER-G83/2, ER-G59/3			MADE IN KOREA		
 DC Photovoltaic Module Input	Max. Voltage	550V																																			
	MPPT Range	125V ~ 500V																																			
	Max. PV Current Per String / I <sub>sc</sub> pv	15A / 20A																																			
 AC (Output)	AC Nominal Power	4600W																																			
	AC Nominal Voltage / Frequency	230V / 50Hz																																			
	AC Nominal Current	20A																																			
	Power Factor	0.95~1~0.95																																			
 Battery (Input/ Output)	Battery Type	Li-Ion																																			
	Battery Capacity	3.6kWh																																			
	Max. Current	46.3A																																			
Nominal Voltage		60V																																			
Protection Degree / Class		IP21 / I																																			
IEC 62109-1/-2, ER-G83/2, ER-G59/3																																					
MADE IN KOREA																																					

[Figure 2-2: Name Plate]

### 2.1.1 Installation Application Suitable for Safety

This device, Samsung RES 3.6 kWh All in One, is designed to be suitable for household purposes. The PV Input terminal is composed of two Strings. One PV String input must install 3.3 kW or less PV panel capacity, and the maximum input voltage of the PV String must be limited to 550V or less.

As shown in the [Figure 2-3], the 3.6 kWh All In One uses the two independent channels of the PV Input ({PV1+, PV1-}, {PV2+, PV2-}). They are used independently for running the maximum power from the sources of PV1 and PV2. Two channels are recommended for independent use for the two PV Inputs. Make sure not to connect one PV string in parallel with the two independent PV inputs (PV1, PV2). (Refer to 3.6 kWh All In One Solar energy input connection in the [Figure 2-3]). PV common mode is not allowed.

※ **PV modules shall have an IEC61730 Application Class A rating or equivalent.**

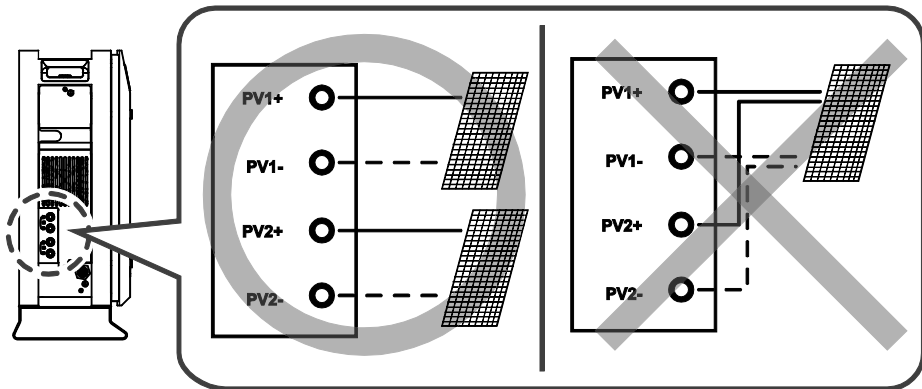

[Figure 2-3: PV connections]

To connect 3.6 kWh All In One with the Public Grid, make sure to install the watt-hour meter recommended by Samsung SDI (refer to the installation manual) and to install the distribution box between 3.6 kWh All In One and the Grid watt-hour meter. Before installing the distribution box, select a suitable location complying with the IP21 and use the equipment recommended by the installation company. Please note that failure to do so may cause malfunction and the product will not be guaranteed for any accident or damage. Refer to the installation manual for further information. The [Figure 2-4] shows the complete connection line as described so far.

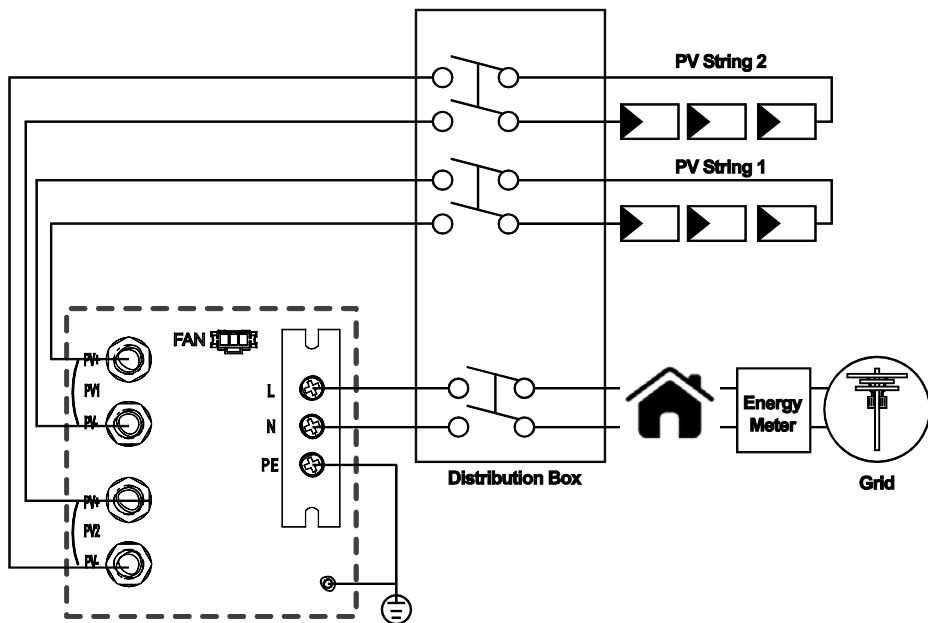

[Figure 2-4: Distribution box connection diagram]

## 2.1.2 Technical Specifications

Item	3600-UK	4600-UK
<b>PV Data (DC)</b>		
Max. input total power	6.6 kWp	
Max. input power per string	3.3 kWp	
Max. input voltage	550 V	
Min. input voltage/Initial input voltage	125 V/150 V	
MPPT voltage range	125 V~500 V	
Max. input current per string	15 A	
Max. input short circuit current for each MPPT	20 A	
Max. inverter backfeed current to the array	Negligible	
Number of independent MPPT trackers	2	
Number of DC inputs pairs for each MPPT	2	
Connection type	MC4	
<b>Battery Data (DC)</b>		
Battery capacity	3.6 kWh	
Battery voltage range/nominal voltage	48.0 V~65.9 V/60 V	
Battery Max. current	46.3 A	
Battery nominal current	33.3 A	
Discharge of depth	90% (6000 cycles)	
Battery technology	Li-Ion	
Nominal DC/DC power	2.0 kW	
DC/DC converter technology	Isolated	
<b>Grid Data (AC)</b>		
Rated power (at 230V, 50 Hz)	3.6kW(*)	4.6 kW(*)
Max. apparent power	5 kVA	
Nominal voltage/range	230 V/184 V~264 V	
Rated power frequency/range	50 Hz/47.5 Hz~51.5 Hz	
Max. current	16A	20A
Max. over-current protection	30 A	
Max. allowed current for fuse protection	32 A	
Inrush current	68.6 A (peak), 100 $\mu$ s	
Max. output fault current	420 A (peak), 4 ms	
Adjustable power factor range	0.95~1~0.95	



Feed-in phases/connection phases	1/1
Total Harmonic Distortion. (Total harmonic factor of the output current with total harmonic factor of the AC voltage < 2%, and AC power > 50% of the rated power)	5%
<b>Efficiency (PV to Grid)</b>	
European efficiency	95 % (when power is 4600W)
Max. efficiency	95.5 %
Protective Device	
DC disconnection device for PV	No
Ground-fault monitoring/grid monitoring	Yes/Yes
<b>General Data</b>	
Dimensions (W/H/D)	1000/680/267 mm
Weight	95 kg
Protective class (I, II, III)	Class I
Degree of protection	IP21
Max. permissible value for relative humidity	95 % (non-condensing)
Operating temperature	-10~40°C
Storage temperature	-20~60°C
Noise emission	≤ 50dB(A) @ 1m
Over voltage category	III
<b>Features</b>	
Display	Custom LCD
Communication	LAN, RS485
Energy management system	Integrated
Certificates and approvals	IEC 62109-1, IEC 62109-2 ER-G83/2, ER-G59/3

(\*) : It can be set 3600W or 4600W by software when installing.

[Table 2-1: Technical Specifications]

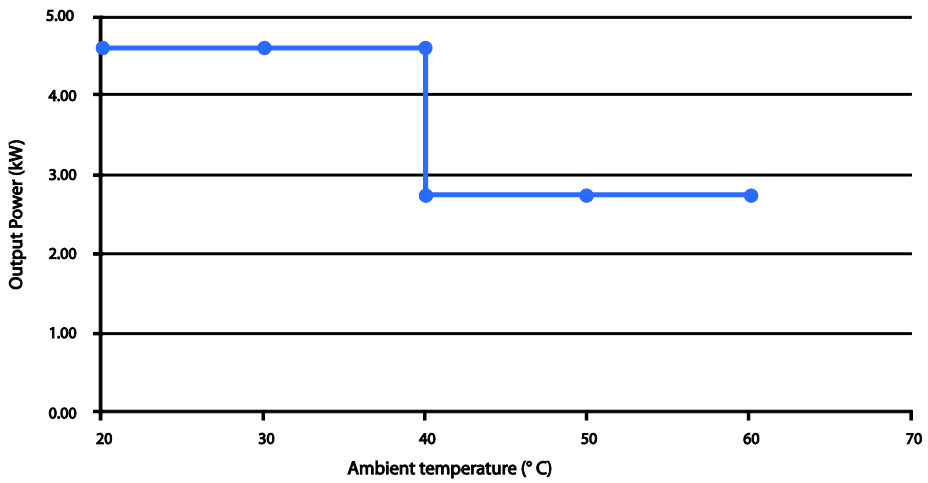

[Figure 2-5: Derating Curve]

### System Efficiency Curve (poly 250wp, mono 270wp)

System Efficiency @Battery SOC 60%  
(Solar → Battery → Grid)

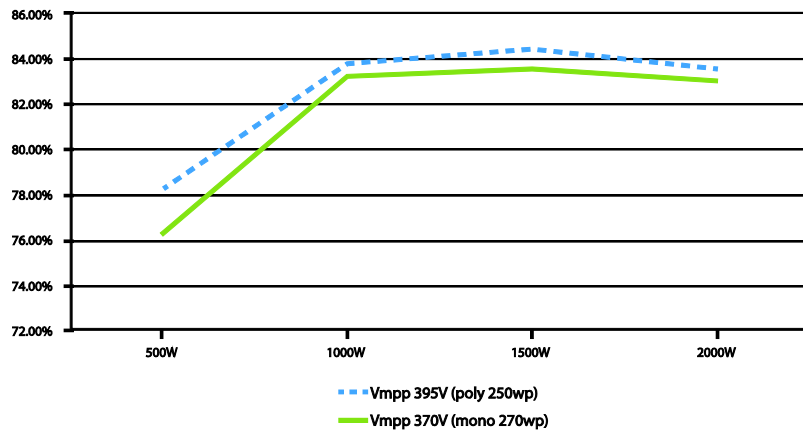



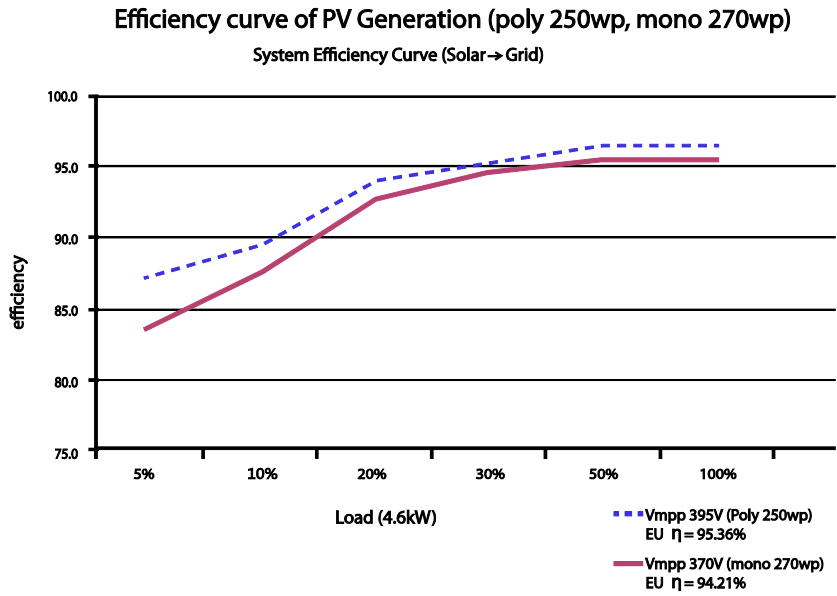

[Figure 2-6: Power efficiency curve of System]



[Figure 2-7: Power efficiency curve of PV Generation]



## 2.2 Safety Guidelines

	<b>DANGER</b>
	<p>High voltages in power conditioning circuits. Lethal hazard of electric shock or serious burns.</p> <p>The following work on the inverter must be carried out by qualified personnel only.</p> <ul style="list-style-type: none"> <li>▪ Electrical insulation</li> <li>▪ Repairs</li> <li>▪ Modification</li> </ul> <p>Except when under supervision by qualified personnel, children or people lacking physical, mental, or intellectual capabilities should not work on this system.</p> <p>The system should be installed out of the reach of children.</p> <p>Even when no external voltage is applied to the system, it may have internal high voltage in the device, which can cause lethal damage to the human body. High voltage can cause lethal damage to the human body.</p>
	<b>CAUTION</b>
	<p>Photovoltaic array supplies DC voltage to the 3.6 kWh All In One system. Do not touch the PV cable when it PV cable is connected to the PV arrays.</p>
	<b>CAUTION</b>
	<p>Li-Ion battery energy storage system (ESS) inside. When assembling the system, do not intentionally short the positive (+) and negative (-) terminals with metallic object.</p> <p>All work on the ESS and electrical connections must be carried out by qualified personnel only. The ESS within 3.6 kWh All In One provides a safe source of electrical energy when operated as intended and as designed.</p> <p>A potentially hazardous circumstance such as excessive heat or electrolyte mist may occur due to improper operating conditions, damage, misuse and/or abuse. The following safety precautions and the warning messages described in this section must be observed. If any of the following precautions are not fully understood, or if you have any questions, contact Customer Support for guidance. The safety section may not include all regulations for your locale; personnel working with 3.6 kWh All In One must review applicable federal, state and local regulations as well as the industry standards regarding this product.</p>
	<b>CAUTION</b>
	<p>When transporting the All In One system with packaged type units, remove the battery tray from the All In One system and transport them separately.</p>

<b>NOTICE</b>	
	<ol style="list-style-type: none"> <li>1. Over voltages in the power conditioning circuits. Any damage to the All In One system will result in voiding of warranty claims.  Danger to life from electric shock due to damaged 3.6 kWh All in One. Inadvertent operation of damaged 3.6 kWh All In One can lead to a hazardous situation that may result in death or serious injury due to electrical shock. Only operate 3.6 kWh All In One when it is technically faultless and in an operationally safe stat. Regularly check the All In One system for visible damage. Make sure that all safety equipment is freely accessible at all times. If the 3.6 kWh All In One is damaged, do not touch it. Please immediately contact your installer or Samsung SDI for arrange for a repair.</li> <li>2. Please contact your installer or Samsung SDI if a significant event message is shown on the LCD screen or if the All In One system reports an event. Refer to the table of event messages for different significant/general events.</li> </ol>

## 2.3 Symbol Indication

### ■ INVERTER Symbols

Symbol	Description
	Inverter
	dc/dc converter

[Table 2-2: Inverter symbols]

## 3. Product Overview

The All In One system includes the PV inverter, battery charger/discharger, Li-Ion battery, and EMS. When compared to previously released products, it is much simpler to install, thus making it an optimized solution for increasing self-consumption rate at a low cost.

The basic operating modes consist of PV generation mode, PV generation + charge/discharge mode. The operation mode of this product is automatically determined by the EMS algorithm.

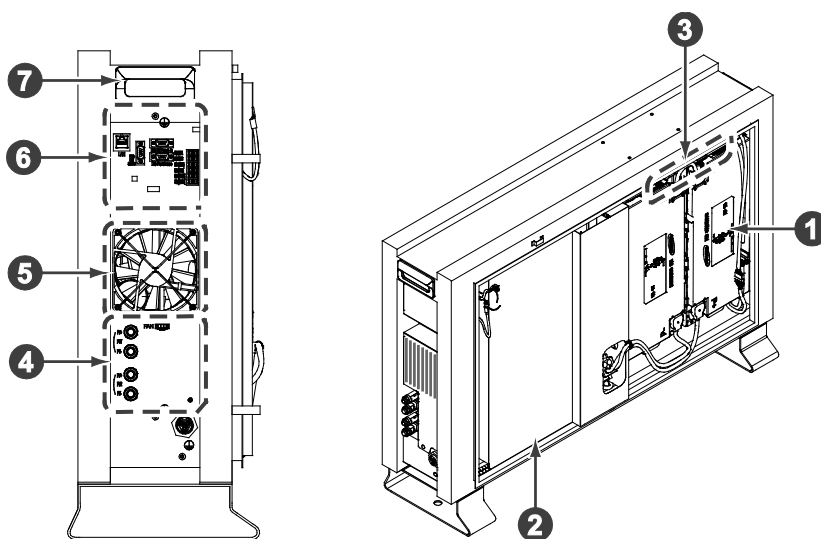

[Figure 3-1: Part View of Samsung All in One]

-	Description
1	Li-Ion battery
2	INVERTER (PV inverter and battery charger / discharger)
3	Tray BMS
4	Input / Output terminal (MC4-2set and Grid connection terminal -L/N/PE)
5	Cooling Fan
6	Communication terminal block
7	Carrying handle

[Table 3-1: Part Description]

## 4. Operating Modes

As shown in the [Figure 4-1], the status of this system is displayed in real-time on the indication screen (LCD screen). This status indication screen extends to 4-digit numbers. The icons are defined for each state and the details are described in the ensuing subsections.

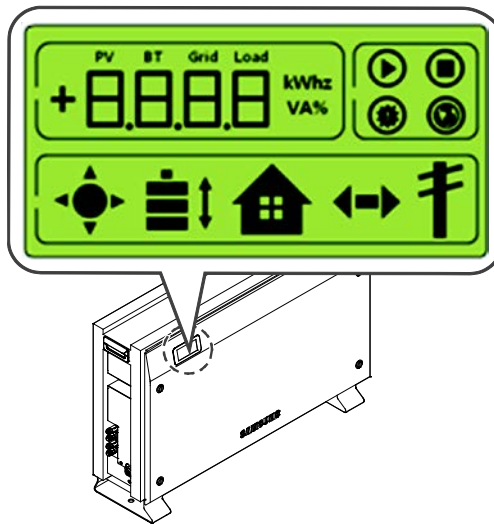

[Figure 4-1: Front status indication screen]

### 4.1 Descriptions of Operation Mode

This system is composed of six modes: PV Auto, PV Only, Battery discharge, Standby, Maintenance (forced charge), and Stand-alone. The event check status should not be considered as any specific mode.

#### 4.1.1 PV-Auto Mode

1. Both solar energy generation and battery charge-discharge are available.
2. The solar-generated power is charged or discharged to the battery based on the EMS decision.
3. A maximum of 4.6kW or less can be sent to the LOAD and the electric power system.



[Figure 4-2: PV generation, battery charge, Load use, sell remaining amount]

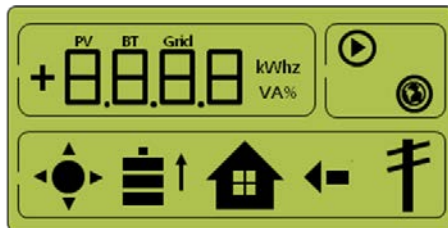

[Figure 4-3: PV generation, battery discharge, Load use, buy shortage amount]

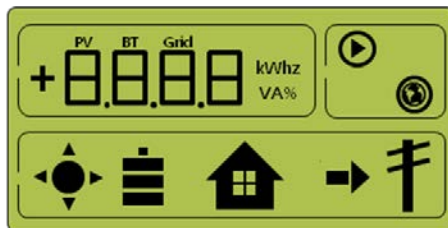

[Figure 4-4: PV generation, Battery standby, Load use, sell remaining amount]

#### 4.1.2 PV-Only Mode

1. This mode enables the solar energy to be generated. However, the battery charge-discharge does not operate.
2. A maximum of 4.6 kW or less of solar energy generation power can be sent to the LOAD and the system based on the EMS decision.



[Figure 4-5: PV generation, Sell remaining amount]



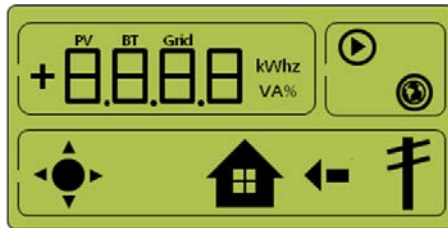

[Figure 4-6: PV generation, Buy shortage amount]

#### 4.1.3 Battery-Discharge Mode

1. This mode permits of no solar energy generation. Battery discharge is only available on this mode.
2. Based on the EMS decision, the battery discharge power can be sent maximum 2kW or less only to the LOAD.

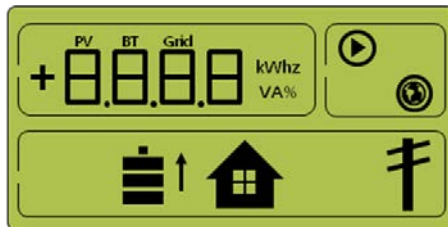

[Figure 4-7: Battery discharge, Load use]

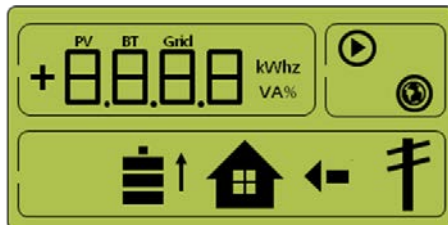

[Figure 4-8: Battery discharge, Load use, Buy shortage amount]

#### 4.1.4 Standby Mode

1. This is the standby mode before converting to operation mode (PV Auto, PV Only, Battery discharge mode).
2. Conversion to the operation mode (PV Auto, PV Only, Battery discharge mode) is made by the EMS decision.

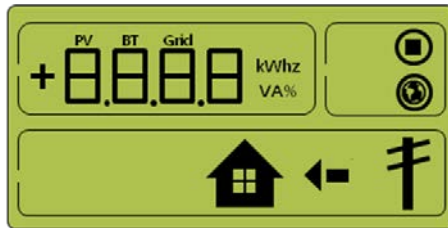

[Figure 4-9: Indication screen on Standby Mode]

#### 4.1.5 Forced-Charge Mode (Maintenance mode)

(1) In this mode, solar energy generation is not used, but the power continuously flows from the electric power system to the battery.



[Figure 4-10: Indication screen on Forced charged Mode]

#### 4.1.6 Stand-Alone Mode

When the All In One is disconnected from the energy meter, or the power conversion system is disconnected from the energy management system (EMS), the All In One system enters into the Stand-Alone Mode. The system operates in a PV- only mode.



[Figure 4-11: Indication screen on stand-alone mode]

### 4.1.7 Event Check Mode

This mode stops solar energy generation and put it in standby mode as an event occurs.



[Figure 4-12: Event occurrence, Grid RMS over current protection]



[Figure 4-13: Event occurrence, DC link over voltage protection]



[Figure 4-14: Event occurrence, PV string1 reverse connection protection]



[Figure 4-15: Event occurrence, PV string2 reverse connection protection]



[Figure 4-16: Event occurrence, PV string1 over voltage protection]



[Figure 4-17: Event occurrence, PV string1 over current protection]



[Figure 4-18: Event occurrence, PV string2 over voltage protection]



[Figure 4-19: Event occurrence, PV string2 over current protection]



[Figure 4-20: Event occurrence, Battery over voltage protection]



[Figure 4-21: Event occurrence, Battery over current protection]



[Figure 4-22: Event occurrence, On sequence Inverter DC link event]



[Figure 4-23: Event occurrence, On sequence Battery V/I event]



[Figure 4-24: Event occurrence, Normal Inverter DC link event]



[Figure 4-25: Event occurrence, Normal Battery V/I & BDC DC link event]



[Figure 4-26: Event occurrence, On sequence Inverter DC link event]

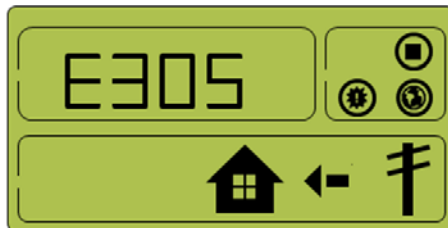

[Figure 4-27: Event occurrence, Normal Inverter DC link &amp; PV I event]



[Figure 4-28: Event occurrence, Temperature protection]



[Figure 4-29: Event occurrence, Over Current TZ Fault]



[Figure 4-30: Events occurrence, temperature sensor connection error]



[Figure 4-31: Event occurrence, PV mis-wiring]

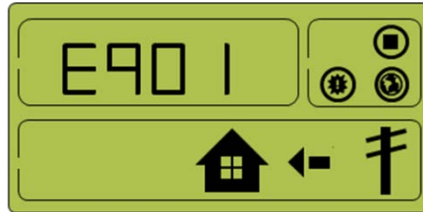

[Figure 4-32: Event occurrence, SPI communication event]

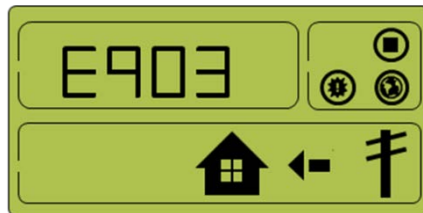

[Figure 4-33: Event occurrence, Single fault event]



[Figure 4-34: Event occurrence, Continuously 3 times Inverter fault]

#### 4.1.8 Application Download Mode



[Figure 4-35: Indication screen on Application Download Mode]

## 4.2 Starting the System

1. After completing the installation, turn on the AC circuit breaker and the DC disconnect switch installed in the distribution box (distribution board). (see the Section 5.7 in the installation guide)
2. Check the system check message on the front LCD screen.

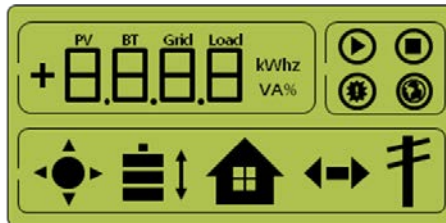

[Figure 4-36: Initial indication screen on power on]

3. After finishing the system check, check the system, the PV, and the battery status.

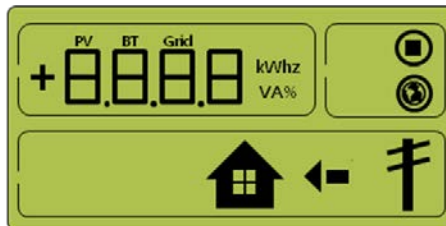

[Figure 4-37: Standby state indication screen before the EMS command]

4. You will receive the command from the EMS to convert to operation mode. For individual operation mode screen, refer to 4.1.1~4.1.6.
5. If there is an event message received, refer to 4.1.7 and 7.2.

### 4.2.1 Turning off the System

To turn-off the system, push down the manual AC circuit breaker and DC disconnect switch in the distribution board (panel board).



# 5. Communication

## 5.1 Overview

When the Internet connection is properly completed, you can monitor the system operation status on the computer.

## 5.2 Components and LAN Connection

### 5.2.1 Essential Components

- Internet service line
- Wired Router
- RJ45 LAN connection cable

### 5.2.2 LAN Connection

- LAN terminal

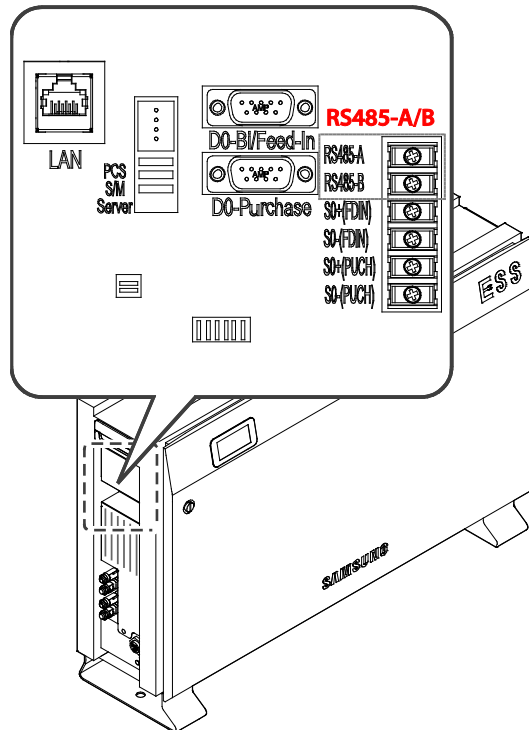

[Figure 5-1: Communication terminal]

### ■ Check Internet connection status

You can use the information on the LED lighting status to check the Internet connection status.

- Function per LED

Upper LED: Turns on automatically when connected to the Internet line (Connection).

Lower LED: Blinks when there is data. (Rx, Tx)

- LED status on normal connection

The upper LED is On and the lower LED is blinking.

- LED status on abnormal connection

Both the upper and lower LEDs are turned Off.

### ■ On abnormal connection

- Connect the LAN cable again, then check the LED status.
- Check whether the Router is Off.
- Contact the installation company for repair and maintenance.

## 5.3 Homepage

Any customer who has purchased this device can use a web browser (<https://myess.samsungsdi.com>) or a smart phone to check its current operation status and receive various statistical information on operation in the house or remotely.

### 5.3.1 Service Terms

This service is provided only when the device is connected to the Internet, and specific services may require additional information only after approval from the customer.

### 5.3.2 Membership

To use this service, you must register for membership through our homepage. During membership registration, the member's information such as ID, password, name and the address are collected, and additional data may also be collected to provide statistical information upon customer's approval.

#### 5.3.2.1 Signing up for a membership

1. Open the browser on an internet-connected device such as PC, notebook or smart phone
2. Enter "https://myess.samsungsdi.com" in the address field of the browser.
3. When you connect to the website successfully, the screen shown in [Figure 5-2] will appear.

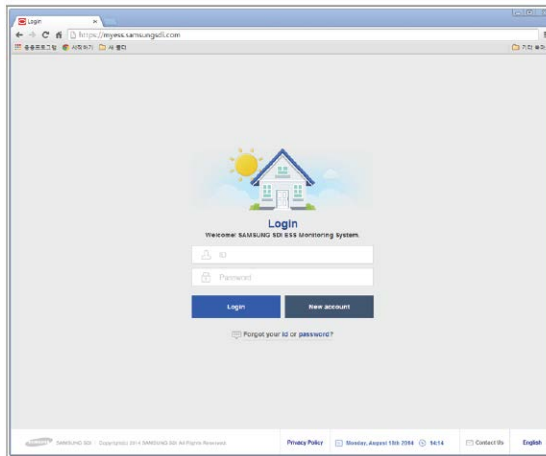

[Figure 5-2: Connecting to the website]

4. Press the "New Account" button to register as a new member.
5. First time users of the service must sign up for membership.
6. Enter the required information and additional information to sign up for membership.
7. Lastly, agree to the service subscription terms and conditions, and then press the "Submit" button.

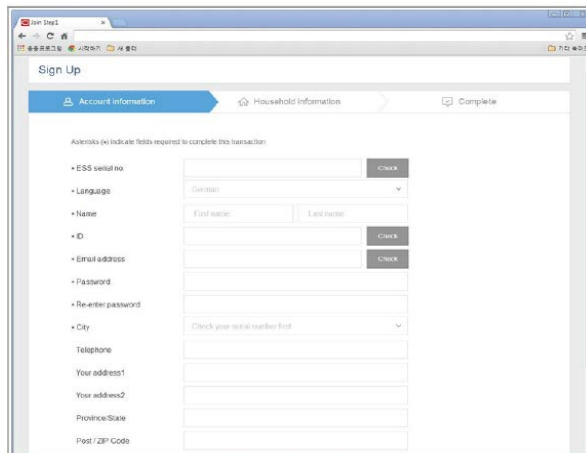

[Figure 5-3: Entering the information to sign up for a membership]

<b>CAUTION</b>	
	<ul style="list-style-type: none"> <li>▪ Items marked with (*) are required.</li> <li>▪ Family information is optional. If you agree to provide this additional information, you can receive a variety of analysis information.</li> <li>▪ If you do not wish to provide additional information later, you can cancel it from the setting page.</li> </ul>

### 5.3.3 Membership Withdrawal

For a customer who does not want to use this service, membership withdrawal is available through the personal information modification menu on the homepage.

### 5.3.4 Log-In

Log in to the homepage through the ID and the password generated through membership registration. You can monitor the product online only when you are logged in.

Also, if a log-in ID error or a password error occurs five consecutive times, access is blocked for 10 minutes for security reasons, and access is permitted after this waiting period of time.

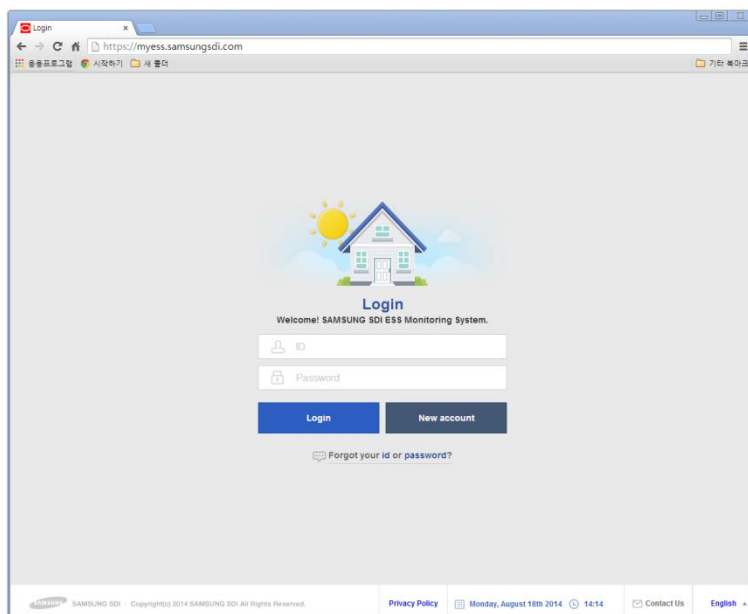

[Figure 5-4: Log-in page]

### 5.3.5 Password Initialization

A customer who forgets the password during use can initialize the password by using the password initialization menu on the homepage. On the log-in page, select the “Forgot your id or password?” menu, and when the customer confirms the ID and the e-mail address created during membership registration, the initialized password is sent to the registered e-mail address.

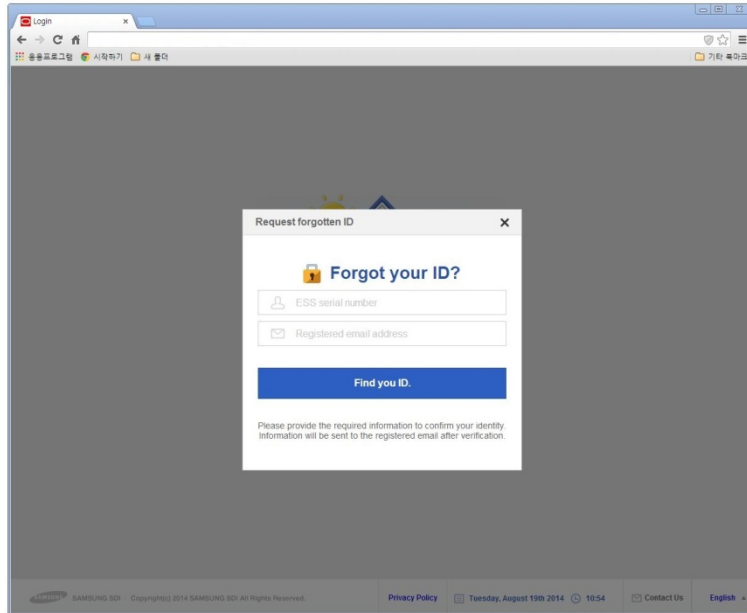

[Figure 5-5: Password initialization page]

### 5.3.6 Types of Service Offered

After completing log-in, normal service is available. This service currently provides such menu items as monitoring, consumption reports, ESS reports, ESS forecasts, and notices. (Enabled to modify after further update.)

#### 5.3.6.1 Monitoring

The operational status of the product is indicated. You can check the current status of operation, the customer's power consumption information, and power generation amount information in real-time. You can also check event codes generated during run time on the monitoring page. You can check the details of the event codes by clicking the exclamation marks which appear on the ESS icon. If the Internet is not available, the event codes cannot be checked.

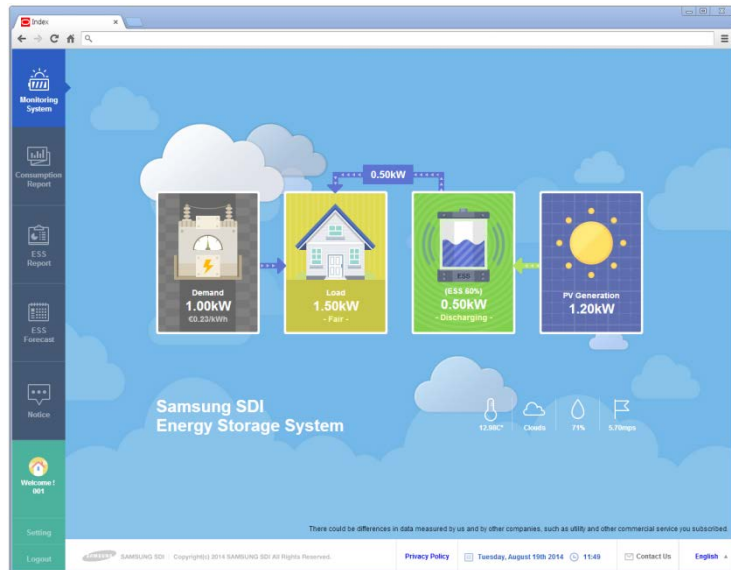

[Figure 5-6: Monitoring page]

### 5.3.6.2 Consumption Report

The household power consumption information collected during energy meter linkage is provided. In particular, such information on as the household type, the size, and the number of family residents is collected according to the customer's approval. You can use these data to identify various types of statistics and comparative analysis data.

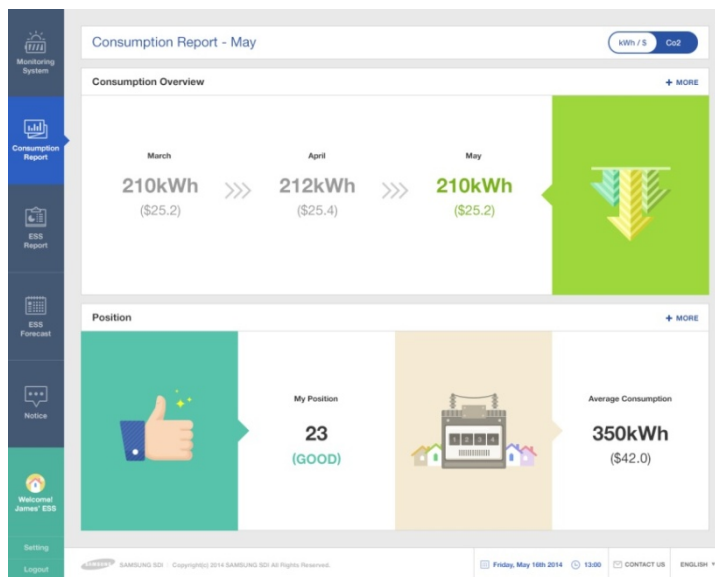

[Figure 5-7: Consumption report page]

### 5.3.6.3 ESS Report

On the ESS Report page, you can check various types of data generated through ESS operation. You can also use the ESS Report to check the amount of energy charged or discharged and other data comparisons with the solar energy production amount or the power sales amount.

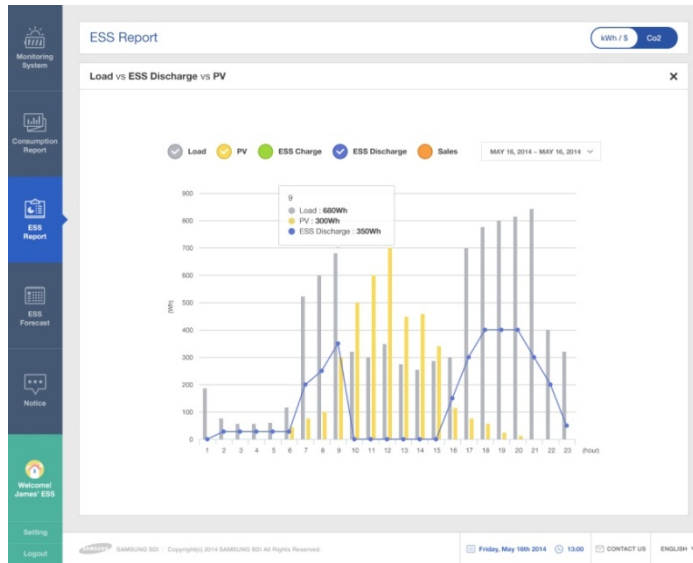

[Figure 5-8: Forecast page]

### 5.3.6.4 ESS Forecast

In the ESS Forecast menu, the generation amount forecast information and the guide for optimized operation can be checked through the algorithm mounted on the product.

### 5.3.6.5 Notices

You can check the notice message whenever there is an update or any other change in the service.

### 5.3.7 Mobile Service

Customers who use Android or I-Phone can use a smart phone to easily check the product status anytime, anywhere. To use the mobile service, the customer must first register the membership through the webpage and use the ID and the password to log-in.

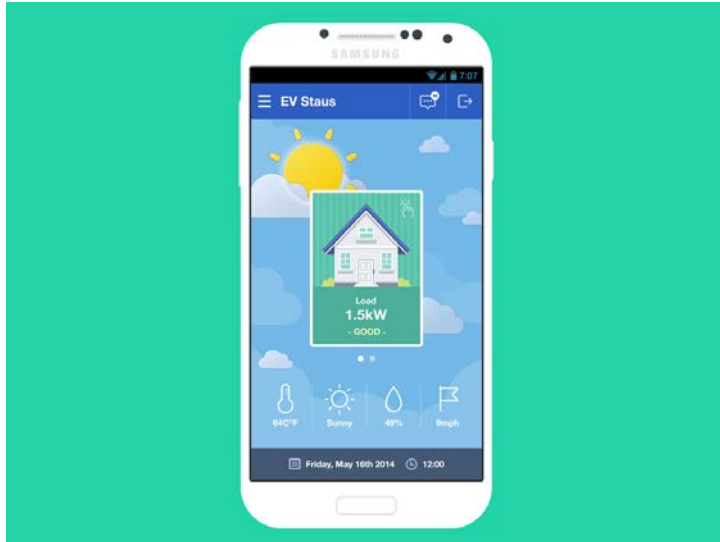

[Figure 5-9: Mobile service page]



## 6. Maintenance for Problem Solving

	<b>WARNING</b>
	<p>Do not disassemble the parts in operation for cleaning purposes. High voltage can cause lethal damage to the human body. Please make sure that the AC and DC switch relay in the distribution box is disconnected before disassembling the system.</p>

### 6.1 Fan Exchange

Change the fan according to the following procedures.

1. Turn off the AC circuit breaker and the DC disconnect switch.
2. Remove the side cover. Make sure not to remove the front case cover.

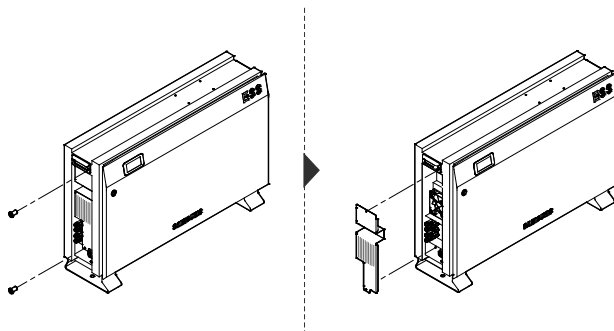

[Figure 6-1: Side cover removal]

3. Remove the fan connector.
4. Separate the fan.

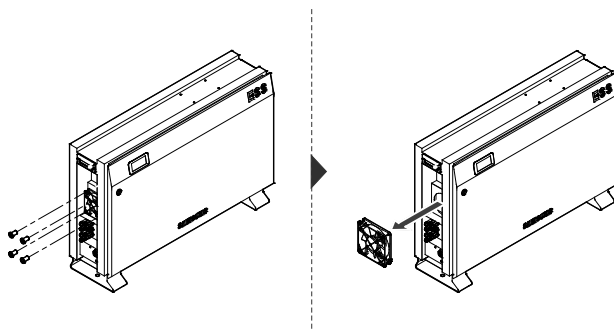

[Figure 6-2: Fan removal]

5. Exchange the fan.

6. Once the fan has been exchanged, follow the stages from 1 to 4 in reverse order to install a new fan. Use 1.3~1.6N·m torque to tighten and fix the screw.
7. Check the fan state.
8. Once a new fan has been installed, perform a test operation to check whether there is a fan event message.

## 6.2 Cleaning

You should clean the enclosure if it is in a dirty condition, please use a soft brush or a vacuum to remove the dirt.

Do not use liquids, such as solvents, abrasives, or liquid corrosives in the enclosures.

### 6.2.1 Cleaning the Side Cover

If the inside of the side cover needs to be cleaned, contact a qualified person (technician) so that they can clean according to the following steps:

Clean the side cover according to the follow procedures.

1. Turn off the DC disconnect switch and the AC circuit breaker on the panel board, then separate the MC connector.
2. Remove the side cover. Make sure not to remove the front case cover.

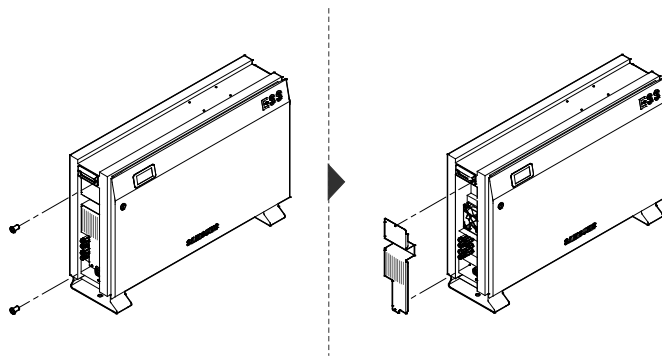

[Figure 6-3: Side cover removal]

3. Clean the side cover with a vacuum cleaner.

<b>NOTICE</b>	
	<p>Using compressed air may damage the fan.</p> <ul style="list-style-type: none"> <li>▪ When cleaning the fan, do not use compressed air. It may damage the fan.</li> </ul>

4. Use a torque screwdriver of 1.3-1.6 Nm and tighten the screws to attach the side cover.

## 6.3 Checking the Event Logs





You can check the event messages on the website (<https://myess.samsungsdi.com>) and identify various causes of the event message described in the following chapter (Chapter 7) to perform a correct measure. Regarding a significant message, contact the designated installer or the maintenance company for customer service.

## 6.4 Checking the Terminals

<b>WARNING</b>	
	<p>High voltages during operation can cause lethal damage to the human body if the terminals are touched. Please disconnect the product from the voltage sources (PV, AC grids).</p> <p>Ensure that PV connection cables on the PV1+, PV1- and PV2+, PV2- are fastened.</p> <p>Check for corrosion on the terminals. If corrosion is seen, please contact the installer.</p> <p>Ensure that AC cables in AC1 and AC2 are fastened.</p>

## 7. Message Description

### 7.1 Messages in Normal Operation

Status message	Description	Remark
	Operation mode under progress	
	NOP State	
	Warning and fault state	When this icon is displayed, check the event list.
	Normal communication state	
kW	Indicating PV, BATT, GRID value	
kWh	Indicating the integrating power value of each mode	
Hz	Indicating the frequency under operation	
V	Indicating PV, BATT, GRID voltage	
A	Indicating PV, BATT, GRID current	
%	Indicating BATT SOC	

[Table 7-1: Message List]

## 7.2 General Events

The general events contain warnings and protection.

The warning level events does not stop the generating process. A displayed warning message automatically disappears as soon as the issue is resolved.

When protection level events occur, the product stop the generating process. The process may automatically resume as long as the issue is resolved.

Checking event codes is available on the website (<https://myess.samsungsdi.com>). If the Internet is not available, the event codes cannot be checked.

### 7.2.1 INVERTER General Events (Warnings)

Type	Code	Description	Measures
WARNING	E001	GRID UNDER VOLTAGE	When the system voltage drops below standard level. This is the overall voltage-current warning message, with no special change in the sequence. The warning message disappears on reversion to the normal state.
	E002	GRID OVER VOLTAGE	When the system voltage rises above standard level. This is the overall voltage-current warning message, with no special change in the sequence. The warning message disappears on reversion to the normal state.
	E003	BATT UNDER VOLTAGE	When the battery energy voltage drops below standard level. This is the overall voltage-current warning message, with no special change in the sequence. The warning message disappears on reversion to the normal state.
	E004	BATT OVER VOLTAGE	When the battery energy voltage drops above standard level. This is the overall voltage-current warning message, with no special change in the sequence. The warning message disappears on reversion to the normal state.
	E005	FAN WARNING	When the Fan operation is abnormal. This is the overall Fan warning

			<p>message, with no special change in the sequence.</p> <p>The warning message disappears on reversion to the normal state.</p>
	E006	BATT CONNECTION WARNING	<p>When the battery connection is abnormal.</p> <p>This is the connection warning message, with no special change in the sequence.</p> <p>The warning message disappears on reversion to the normal state.</p>

[Table 7-2: Inverter general events warning list]

### 7.2.2 INVERTER General Events (Protection)

Type	Code	Description	Measures
PROTECTION	E101	GRID RMS OVER CURRENT PROTECTION	<p>The product stops the generating process because a significant PROTECTION event has occurred.</p> <p>Wait until the event message disappears. After the event message is removed, it automatically returns to normal.</p> <p>If it is not removed until the time limit is reached, it is converted to a significant event.</p>
	E102	DC LINK OVER VOLTAGE PROTECTION	<p>The product stops the generating process because a significant PROTECTION event has occurred.</p> <p>Wait until the event message disappears. After the event message is removed, it automatically returns to normal.</p> <p>If it is not removed until the time limit is reached, it is converted to a significant event.</p>
	E103	PV STRING1 REVERSE CONNECTION PROTECTION	<p>The product stops the generating process because a significant PROTECTION event has occurred.</p> <p>Wait until the event message disappears. After the event message is removed, it automatically returns to normal.</p> <p>If it is not removed until the time limit is reached, it is converted to a significant event.</p>
	E104	PV STRING2 REVERSE	The product stops the generating

## 7. Message Description

Type	Code	Description	Measures
		CONNECTION PROTECTION	<p>process because a significant PROTECTION event has occurred.</p> <p>Wait until the event message disappears. After the event message is removed, it automatically returns to normal.</p> <p>If it is not removed until the time limit is reached, it is converted to a significant event.</p>
	E105	PV STRING1 OVER VOLTAGE PROTECTION	<p>The product stops the generating process because a significant PROTECTION event has occurred.</p> <p>Wait until the event message disappears. After the event message is removed, it automatically returns to normal.</p> <p>If it is not removed until the time limit is reached, it is converted to a significant event.</p>
	E106	PV STRING1 OVER CURRENT PROTECTION	<p>The product stops the generating process because a significant PROTECTION event has occurred.</p> <p>Wait until the event message disappears. After the event message is removed, it automatically returns to normal.</p> <p>If it is not removed until the time limit is reached, it is converted to a significant event.</p>
	E107	PV STRING2 OVER VOLTAGE PROTECTION	<p>The product stops the generating process because a significant PROTECTION event has occurred.</p> <p>Wait until the event message disappears. After the event message is removed, it automatically returns to normal.</p> <p>If it is not removed until the time limit is reached, it is converted to a significant event.</p>
	E108	PV STRING2 OVER CURRENT PROTECTION	<p>The product stops the generating process because a significant PROTECTION event has occurred.</p> <p>Wait until the event message disappears. After the event message is removed, it automatically returns to normal.</p> <p>If it is not removed until the time</p>

Type	Code	Description	Measures
			limit is reached, it is converted to a significant event.
	E109	BATT OVER VOLTAGE PROTECTION	The product stops the generating process because a significant PROTECTION event has occurred. Wait until the event message disappears. After the event message is removed, it automatically returns to normal. If it is not removed until the time limit is reached, it is converted to a significant event.
	E110	BATT OVER CURRENT PROTECTION	The product stops the generating process because a significant PROTECTION event has occurred. Wait until the event message disappears. After the event message is removed, it automatically returns to normal. If it is not removed until the time limit is reached, it is converted to a significant event.

[Table 7-3: Inverter protection list]

### 7.2.3 Battery Discharge General Events

Type	Code	Description	Measures
PROTECTION	E201	ON SEQUENCE GRID OFF	While in progress, battery discharged/charged operation is terminated through the protection function. Wait until the event message disappears. After the event message is removed, it automatically returns to normal. If it is not removed until the time limit is reached, it is converted to a significant event.
PROTECTION	E202	ON SEQUENCE BATT STATUS EVENT	While in progress, battery discharged/charged operation is terminated through the protection function. Wait until the event message disappears. After the event message is removed, it automatically returns to normal.



## 7. Message Description

Type	Code	Description	Measures
			If it is not removed until the time limit is reached, it is converted to a significant event.
PROTECTION	E203	ON SEQUENCE INV DC LINK EVENT	<p>While in progress, battery discharged/charged operation is terminated through the protection function.</p> <p>Wait until the event message disappears. After the event message is removed, it automatically returns to normal.</p> <p>If it is not removed until the time limit is reached, it is converted to a significant event.</p>
PROTECTION	E204	ON SEQUENCE BATT V & BATT I EVENT	<p>While in progress, battery discharged/charged operation is terminated through the protection function.</p> <p>Wait until the event message disappears. After the event message is removed, it automatically returns to normal.</p> <p>If it is not removed until the time limit is reached, it is converted to a significant event.</p>
PROTECTION	E0205	NORMAL GRID OFF	<p>While in progress, battery discharged/charged operation is terminated through the protection function.</p> <p>Wait until the event message disappears. After the event message is removed, it automatically returns to normal.</p> <p>If it is not removed until the time limit is reached, it is converted to a significant event.</p>
PROTECTION	E206	NORMAL BATT STATUS EVENT	<p>While in progress, battery discharged/charged operation is terminated through the protection function.</p> <p>Wait until the event message disappears. After the event message is removed, it automatically returns to normal.</p> <p>If it is not removed until the time limit is reached, it is converted to a significant event.</p>

Type	Code	Description	Measures
PROTECTION	E207	NORMAL INV DC LINK EVENT	<p>While in progress, battery discharged/charged operation is terminated through the protection function.</p> <p>Wait until the event message disappears. After the event message is removed, it automatically returns to normal.</p> <p>If it is not removed until the time limit is reached, it is converted to a significant event.</p>
PROTECTION	E208	NORMAL BATT V & BATT I & BDC DC LINK EVENT	<p>While in progress, battery discharged/charged operation is terminated through the protection function.</p> <p>Wait until the event message disappears. After the event message is removed, it automatically returns to normal.</p> <p>If it is not removed until the time limit is reached, it is converted to a significant event.</p>

[Table 7-4: Battery operation general events list

#### 7.2.4 PV General Events (Protection)

Type	Code	Description	Measures
PROTECTION	E301	ON SEQUENCE GRID OFF	<p>PV generation mode is stopped by the protection event.</p> <p>Wait until the event message disappears. After the event message is removed, it automatically returns to normal.</p> <p>If it is not removed until the time limit is reached, it is converted to a significant event.</p>
PROTECTION	E302	ON SEQUENCE INV DC LINK EVENT	<p>PV generation mode is stopped by the protection event.</p> <p>Wait until the event message disappears. After the event message is removed, it automatically returns to normal.</p> <p>If it is not removed until the time limit is reached, it is converted to a significant event.</p>
PROTECTION	E303	ON SEQUENCE PV V	<p>PV generation mode is stopped by</p>

Type	Code	Description	Measures
		EVENT	<p>the protection event.</p> <p>Wait until the event message disappears. After the event message is removed, it automatically returns to normal.</p> <p>If it is not removed until the time limit is reached, it is converted to a significant event.</p>
PROTECTION	E304	NORMAL GRID OFF	<p>PV generation mode is stopped by the protection event.</p> <p>Wait until the event message disappears. After the event message is removed, it automatically returns to normal.</p> <p>If it is not removed until the time limit is reached, it is converted to a significant event.</p>
PROTECTION	E305	NORMAL INV DC LINK & PV I EVENT	<p>PV generation mode is stopped by the protection event.</p> <p>Wait until the event message disappears. After the event message is removed, it automatically returns to normal.</p> <p>If it is not removed until the time limit is reached, it is converted to a significant event.</p>
PROTECTION	E306	NORMAL PV V EVENT	<p>PV generation mode is stopped by the protection event.</p> <p>Wait until the event message disappears. After the event message is removed, it automatically returns to normal.</p> <p>If it is not removed until the time limit is reached, it is converted to a significant event.</p>

[Table 7-5: PV general events protection list]

### 7.2.5 System General Events (Protection)

Type	Code	Description	Measures
PROTECTION	E401	TEMPERATURE Protection	<p>When the switch temperature is high.</p> <p>Wait until the event message disappears. After the event message is removed, it automatically returns to normal.</p>

Type	Code	Description	Measures
			If it is not removed until the time limit is reached, it is converted to a significant event.
PROTECTION	E402	OVER CURRENT TZ FAULT	Occurs on INVERTER hardware protection. Wait until the event message disappears. After the event message is removed, it automatically returns to normal. If it is not removed until the time limit is reached, it is converted to a significant event.
PROTECTION	E403	TEMPERATURE SENSOR	When the temperature sensor connection is abnormal. Wait until the event message disappears. After the event message is removed, it automatically returns to normal.
PROTECTION	E404	PV MIS-WIRING	When the PV mis-wiring states is abnormal. Wait until the event message disappears. After the event message is removed, it automatically returns to normal.

[Table 7-6: System general events protection list]

### 7.2.6 BMS General Events

Type	Code	Description	Measures
WARNING	E501	OVER VOLTAGE PROTECTION-CELL	When the maximum cell voltage is above Warning level. Automatically returns to normal when the maximum cell voltage goes below the limit value.
PROTECTION	E502	OVER VOLTAGE PROTECTION-CELL	When the maximum cell voltage is above Protection level, thus terminating the system. Automatically returns to normal when the maximum cell voltage goes below the limit value.
WARNING	E503	UNDER VOLTAGE PROTECTION-CELL	When the minimum cell voltage is below Warning level. Automatically returns to normal when the minimum cell voltage goes above the limit value.

Type	Code	Description	Measures
PROTECTION	E504	UNDER VOLTAGE PROTECTION-CELL	When the minimum cell voltage is below Protection level, thus terminating the system. Automatically returns to normal when the minimum cell voltage goes above the limit value.
WARNING	E505	OVER TEMPERATURE. PROTECTION-CELL	When the maximum cell temperature is above Warning level. Automatically returns to normal when the maximum cell temperature goes below the limit value.
PROTECTION	E506	OVER TEMPERATURE. PROTECTION-CELL	When the maximum cell temperature is above Protection level, thus terminating the system. Automatically returns to normal when the maximum cell temperature goes below the limit value.
WARNING	E507	UNDER TEMPERATURE. PROTECTION-CELL	When the minimum cell temperature is below Warning level. Automatically returns to normal when the minimum cell temperature goes above the limit value.
PROTECTION	E508	UNDER TEMPERATURE. PROTECTION-CELL	When the minimum cell temperature is below Protection level, thus terminating the system. Automatically returns to normal when the minimum cell temperature goes above the limit value.
WARNING	E509	CELL VOLTAGE IMBALANCE PROTECTION	When the imbalance of the Cell voltage is above the limit value. Returns to normal when the imbalance of the Cell voltage is below the limit value.
PROTECTION	E510	CELL VOLTAGE IMBALANCE PROTECTION	When the imbalance of the Cell voltage is above the limit value. Returns to normal when the imbalance of the Cell voltage is below the limit value.
WARNING	E511	AFE INITIALIZATION	AFE initialization failure Restored to normal mode on AFE initialization success
PROTECTION	E512	AFE INITIALIZATION	AFE communication failure

Type	Code	Description	Measures
WARNING	E513	CELL TEMPERATURE SENSOR 1EA	Occurs above the standard battery cell temperature.
PROTECTION	E514	CELL TEMPERATURE SENSOR 2EA	Occurs above the standard battery cell temperature.

[Table 7-7: BMS general events list]

### 7.2.7 EMS/Communication Events

Type	Code	Description	Measures
WARNING	E601	INVERTER COMMUNICATION EVENT	Turn off and restart the system. Reconnect the communication line between the EMS board and the DSP board.
WARNING	E602	ETHERNET EVENT	Disconnect and reconnect the LAN. Turn off and restart the Router. Make sure that the DHCP server function of Router is activated. Turn off and restart the system.
WARNING	E603	ENERGY METER EVENT	Make sure that the Meter device is properly selected. Disconnect and reconnect the D0 cable. Turn off and restart the system.
WARNING	C128	Ethernet Error	Make sure that the Ethernet communication port and wire connected properly.

[Table 7-8: EMS/communication events list]

### 7.2.8 Single Fault Events

Type	Code	Description	Measures
WARNING	E701	GRID UNDER VOLTAGE FAULT	The operation mode is terminated when a power system event occurs. Restart 1 minute after the electric power system event is settled.
	E702	GRID OVER VOLTAGE FAULT	The operation mode is terminated when a power system event occurs. Restart 1 minute after the electric power system event is settled.
	E703	GRID UNDER FREQUENCY FAULT	The operation mode is terminated when a power system event occurs. Restart 1 minute after the electric power system event is settled.

Type	Code	Description	Measures
	E704	GRID OVER FREQUENCY FAULT	The operation mode is terminated when a power system event occurs. Restart 1 minute after the electric power system event is settled.
	E705	GRID TEN MINUTE AVERAGE FAULT	The operation mode is terminated when a power system event occurs. Restart 1 minute after the electric power system event is settled.
	E706	RCMU (Residual Current Monitoring Unit) FAULT	Turn off system power when the leakage current level is above standard level. Check the leakage current level, then restart or turn off to get back to the below standard level.
	E708	PV INSULATION FAULT	OFF Turn off system power if PV INSULATION RESISTANCE is at the standard level. Restart after 3 minutes.
	E709	ANTI ISLANDING FAULT	If the electric power system blacks out, it automatically detects the state and turns off the All in One. Restart after 3 minutes.
	E710	FUNCTIONAL SAFETY FAULT	When the two MCU measuring values are mismatched. Restart after 3 minutes if no problem is found.

[Table 7-9: Single fault events list]

## 7.3 Significant Events

If a significant event is notified, the system is set to stop operation. If that is the case, contact your installer to restore the system to normal operation.

Checking event codes is available on the website (<https://myess.samsungsdi.com>). If the Internet is not available, the event codes cannot be checked.

Type	Code	Description	Measures
Significant	E901	SPI COMMUNICATION EVENT	Occurs on internal non-communication between the INVERTER. Contact the installer immediately.
	E902	CAN (Controller Area Network) COMMUNICATION	Occurs on non-communication with the EMS. When in operation, the All In One

		EVENT	System is converted to the Stand Alone mode. Contact the installer immediately.
	E903	SINGLE FAULT EVENT	The protection device against hazards has a defect or a fault that can cause a hazard has occurred. Contact the installer immediately.
	E904	CONTINUOUSLY 3 TIMES INVERTER FAULT	When INVERTER FAULT occurs three consecutive times, INVERTER HARD FAIL is considered to be occurred to stop the operation. Contact the installer immediately.
	E905	PV CROSS CONNECTION Permanent Fail	PV mis-wiring, for example (P1+/P2-) or (P2+/P1-). Contact the installer immediately.
	E906	Cell Over Voltage Permanent Fail	When exceeding Cell Max voltage. Contact the installer immediately.
	E907	Cell Under Voltage Permanent Fail	When an abnormal decrease in Cell Min voltage is reported. Contact the installer immediately.

[Table 7-10: Significant events list]



## 8. Arrangement of Terms

### ■ Chapter 1

RES	Residential Energy Storage
-----	----------------------------

### ■ Chapter 2

Li-Ion Battery	Li-Ion Battery
SDI	Abbreviation of Samsung Display and Interface
PV	Photo voltaic
Single phase	A type of phase in electricity
Distribution Box	A box containing AC, DC ON-OFF switches for electricity distribution
AC	Alternating Current
DC	Direct Current
LCD	Liquid Crystal Display
Inverter	An electric circuit that converts DC to AC and vice versa.
Converter	An electric circuit that converts DC to DC

### ■ Chapter 3

INVERTER	Power conversion system which contains inverters and converters
Tray BMS	Tray battery management system
EMS	Energy management system

### ■ Chapter 4

Load	Power load
Power grid	Electricity grid which connects to power system

### ■ Chapter 7

SOC	State of Charge (battery charging state)
PV String	Describes series connected photovoltaic modules
SPI	Serial port interface
CAN	Controller Area Network
CELL	Battery individual cell

## 9. Contact

For technical problems or inquiries for use, please contact the installation company.

To receive customer support, the following information is required.

1. Product type: ELSR362-00002
2. Serial Number: AR00460036Z1\*\*\*\*\*A
3. PV module type and configuration
4. Option equipment: Energy Meter Model Name

■ Address: Oskar-Messter-Str. 29  
85737 Ismaning (München)  
Germany

■ E-Mail: [esseuservice@samsung.com](mailto:esseuservice@samsung.com)

[www.samsungsdi.com](http://www.samsungsdi.com)



**SAMSUNG SDI**