

MULTILEVEL INSTALLATION TERMINAL

For Building Installations and Industrial Applications

Multilevel Installation Terminal Blocks with N-Disconnect Slide Links for Mounting with N-busbar

- Configure larger circuit groups
- Automatically and permanently connect to the N-busbar by simply sliding the screwless N-disconnect link

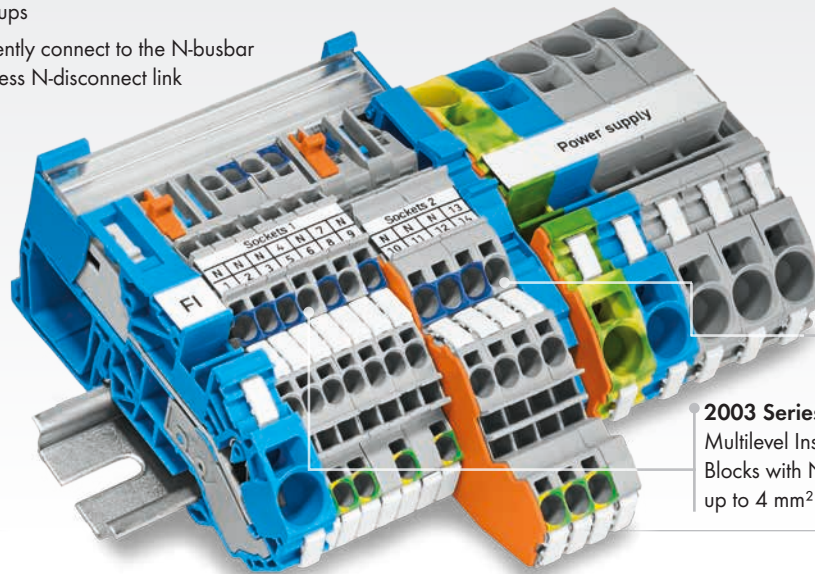

2005 Series
Multilevel Installation Terminal Blocks with N-Disconnect Slide Link up to 6 mm² (8 AWG), 36 A

2003 Series
Multilevel Installation Terminal Blocks with N-Disconnect Slide Link up to 4 mm² (12 AWG), 32 A

Maximum Touch-Proof Safety

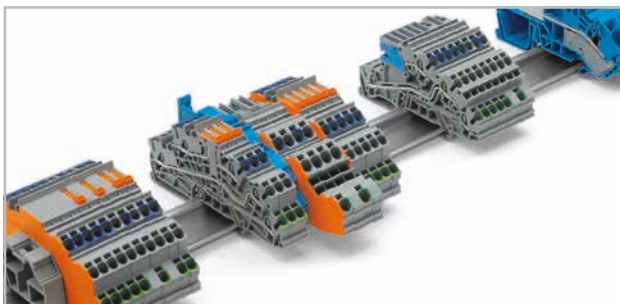

- Transparent busbar cover provides touch protection for the busbar.
- Cover enables user to see if N-disconnect slide links are connected to the N-busbar.

Maximum Wiring Space



- 2003 and 2005 Series Multilevel Installation Terminal Blocks feature extremely compact dimensions while providing all of the functionality of a 4 mm² or 6 mm² terminal block.
- Maximize wiring space in standard distribution boxes.

BLOCKS

Multilevel Installation Terminal Blocks with Internal N-Disconnection for Mounting without N-busbar

- Configure smaller circuit groups, e.g., in installations with multiple RCD potentials.
- Internal N-knife disconnect enables continuously wired N-potential disconnection.

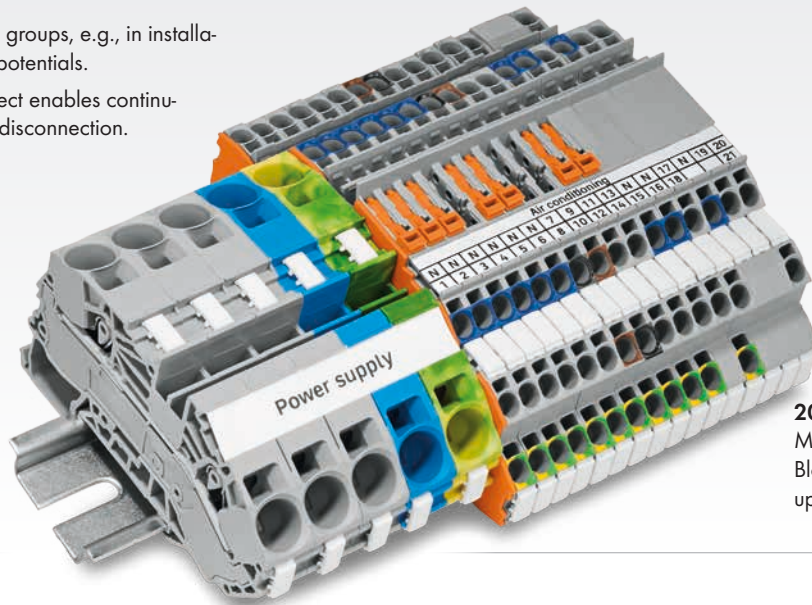

Supply Terminal
Blocks up to 16 mm²
(4 AWG), 76 A

2003 Series
Multilevel Installation Terminal
Blocks with internal N-disconnection
up to 4 mm² (12 AWG), 28 A

Insulation Resistance Measurement – Fast and Safe

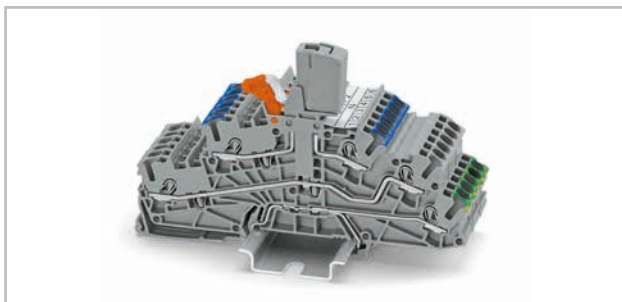

- Disconnect N-potential via movable knife disconnect
- Plug N/L test adapter into the free shaft to link N and L conductors
- Halve testing times and protect devices against high test voltage

Multilevel Installation Terminal Blocks as Fuse Terminal Block

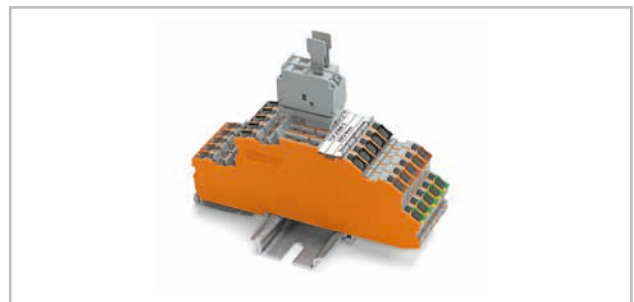

- Multilevel installation terminal blocks integrate a DIN rail-centered slot allowing them to be used with TOPJOB® S Fuse Plugs for microfuses
- In combination with a 1 mm thick end plate, the carrier terminal blocks can be used as fuse terminal blocks in the standard recess of a distribution board

TOPJOB® S

Multilevel Installation Terminal Blocks with N-Disconnect Slide Link 2.5 (4) mm² 2003 Series

0.25 ... 2.5 (4) mm² ① | AWG 22 ... 12
 250 V/4 kV/3; 32 A (32 A) ② ③
 400 V/6 kV/3; 32 A (32 A) ② ④
 Terminal block width 5.2 mm / 0.205 in.
 10 ... 12 mm / 0.43 in.⑤

0.25 ... 2.5 (4) mm² ① | AWG 22 ... 12
 400 V/6 kV/3 ②
 I_N 32 A
 Terminal block width 5.2 mm / 0.205 in.
 10 ... 12 mm / 0.43 in.⑤

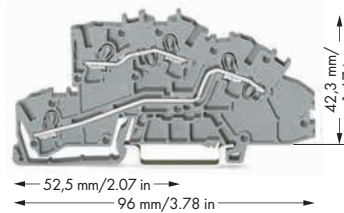
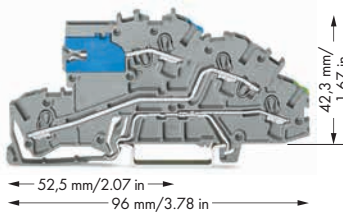



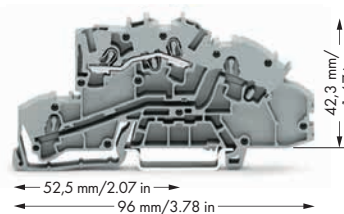
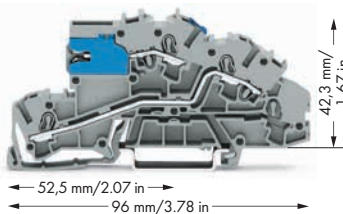



Item No.	Pack. Unit	Item No.	Pack. Unit	Accessories
Multilevel installation terminal block, with N-disconnect slide link, gray		Multilevel installation terminal block, gray		
○ NT/L/PE 2003-7641	50	○ L/L 2003-7642	50	Busbar, tin-plated, Cu 10 x 3 mm, 1000 mm long I _N 140 A 210-133 1
		○ N/L 2003-7649	50	











Item No.	Pack. Unit	Item No.	Pack. Unit	Accessories
Multilevel installation terminal block, with N-disconnect slide link, gray		Multilevel installation terminal block, gray		Connector, for N-busbar, with blue cover, 2.5 ... 16 mm ² blue 210-281 100 (2x50)
○ NT/L 2003-7640	50	○ L 2003-7650	50	
○ LT/L 2003-7659	50	○ N 2003-7651	50	Connector, for N-busbar, 2.5 ... 35 mm ² unplated 209-105 50
Multilevel installation terminal block, gray				
○ N/L/PE 2003-7646	50			Lock-out, snap-on type, prevents reclosing of slide link orange 2003-7300 100 (4x25)
○ L/L/PE 2003-7645	50			
				Insulation stop, 5 pcs/strip, 0.25 ... 0.5 mm ² light gray 2002-171 200 (8x25)

2003 Series Accessories

Appropriate marking systems: WMB/WMB Inline/Marking strips

Busbar carrier,  not suitable as end stop, for DIN 35 rail, 1.5 mm thick blue 2009-304 100 (4x25)	Busbar carrier,  can replace end bracket, with detachable separator plate, for DIN 35 rail, 7.5 mm thick blue 2009-305 25	Test plug,  with 500 mm cable, 2 mm Ø red 210-136 50
End and intermediate plate, 0.8 mm thick  orange 2003-7692 100 (4x25)	Cover for N-busbar,  transparent, 1000 mm long 777-303 1	Test plug,  with 500 mm cable, 2.3 mm Ø yellow 210-137 50

- 1 Conductor sizes: 0.25 mm² ... 4 mm² "s + f-st";
Push-in conductor sizes: 0.75 mm² ... 4 mm² "s"
and 0.75 mm² ... 2.5 mm²
"insulated ferrules, 12 mm"
- 2 250 V/
400 V = rated voltage
4 kV/
6 kV = rated surge voltage
3 = pollution degree
(see Full Line Catalog, Volume 1, Section 14)
- 3 250 V/4 kV potential-ground
- 4 400 V/6 kV potential-potential
- 5 Strip length, see packaging or instructions.
- 6 See application notes for:
Colored push-in type jumper bars, page 163
Staggered jumper, page 166
Adjacent jumper for continuous commoning,
page 163
Push-in type wire jumper, page 164

Accessories Multilevel Installation Terminal Block				
Push-in type jumper bars and staggered jumpers, see 2002 Series				
 <p>Push-in type jumper bar, insulated, I_N 25 A, light gray</p>	2-way	2002-402	200 (8x25)	
	3-way	2002-403	200 (8x25)	
	4-way	2002-404	200 (8x25)	
	5-way	2002-405	100 (4x25)	
	6-way	2002-406	100 (4x25)	
	7-way	2002-407	100 (4x25)	
	8-way	2002-408	100 (4x25)	
	9-way	2002-409	100 (4x25)	
	10-way	2002-410	100 (4x25)	
	 <p>Staggered jumper, insulated, I_N 25 A, light gray</p>	2-way	2002-472	100 (4x25)
3-way		2002-473	100 (4x25)	
4-way		2002-474	100 (4x25)	
5-way		2002-475	50 (2x25)	
6-way		2002-476	50 (2x25)	
7-way		2002-477	50 (2x25)	
8-way		2002-478	50 (2x25)	
9-way		2002-479	50 (2x25)	
10-way		2002-480	50 (2x25)	
11-way		2002-481	50 (2x25)	
 <p>Push-in type jumper bar, insulated, I_N 25 A, light gray</p>	from 1 to 3	2002-433	200 (8x25)	
	from 1 to 4	2002-434	200 (8x25)	
	from 1 to 5	2002-435	100 (4x25)	
	from 1 to 6	2002-436	100 (4x25)	
	from 1 to 7	2002-437	100 (4x25)	
	from 1 to 8	2002-438	100 (4x25)	
	from 1 to 9	2002-439	100 (4x25)	
	from 1 to 10	2002-440	100 (4x25)	
	 <p>Push-in type wire jumper, insulated, I_N 16 A, wire size 1.5 mm²</p>	L = 60 mm	2009-412	100 (10x10)
		L = 110 mm	2009-414	100 (10x10)
L = 250 mm		2009-416	100 (10x10)	
Customized staggered jumper, insulated, I _N 25 A, light gray				
1-3		2002-473/011-000	100 (4x25)	
1-3-5	2002-475/011-000			
1-3-5-7	2002-477/011-000			
1-3-5-7-9	2002-479/011-000			
1-3-5-7-9-11	2002-481/011-000	50 (2x25)		
 <p>Adjacent jumper for continuous commoning, insulated, I_N 25 A, light gray</p>	2-way	2002-400	100 (4x25)	
	WMB Multi marking system, 10 strips with 10 markers per card, stretchable 5 ... 5.2 mm plain			
 <p>Test plug adapter, for 4 mm Ø test plug gray</p>	793-5501 5			
	WMB Inline, plain, stretchable 5 ... 5.2 mm, 1,500 WMB markers, 5 mm, on roll white			
 <p>Banana plug, for socket 4 mm Ø, color mixed</p>	2009-115 1			
	Marking strip, plain, 11 mm wide, 50 m roll white			
 <p>Testing tap, for max. 2.5 mm² gray</p>	2009-110 1			
	Operating tool, 3.5 mm and 5.5 mm blade, for TOPJOB® S installation terminal blocks			
 <p>Operating tool, 3.5 mm and 2.5 mm blade, for TOPJOB® S installation terminal blocks</p>	2009-310 1			
	Operating tool, 3.5 mm and 2.5 mm blade, for TOPJOB® S installation terminal blocks			
			2009-309 1	

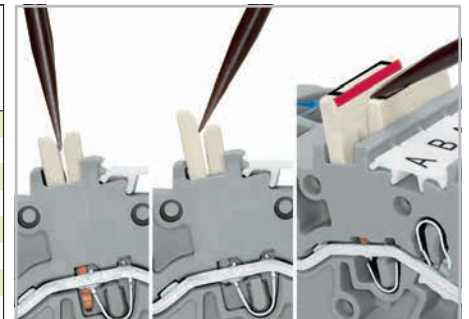

Commoning is performed via a staggered jumper system in one single jumper slot. This allows two potentials to be lead parallel past each other in the jumper slot of the 2003 Series Multilevel Installation Terminal Blocks in confined spaces.

Staggered jumper removal

Insert the operating tool between the jumpers and lift up the jumper.

For additional application notes, see page 166.

Application note:

N-disconnect slide links, used in installation terminal blocks, consist of switch contacts that are opened and then closed as part of regular circuit testing. To guarantee a reliable connection, a corrosion-resistant contact area is required on the N-busbar.



Historically, uninsulated copper busbars that have been cleaned/stripped of any possible corrosion prior to install can be used in dry, pollution-free locations.

According to DIN VDE 0100-520 (VDE 0100 Part 520), installation equipment exposed to contamination or corrosive substances (e.g., water) that promote corrosion or deterioration, must be protected or made of a corrosion- or wear extra space resistant material. In these cases, tinned copper busbars guarantee a reliable connection.



WAGO only offers tinned copper busbars.

TOPJOB® S

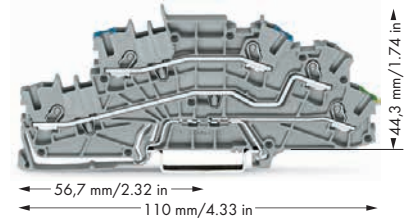
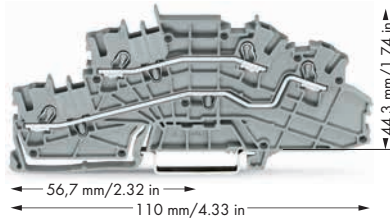
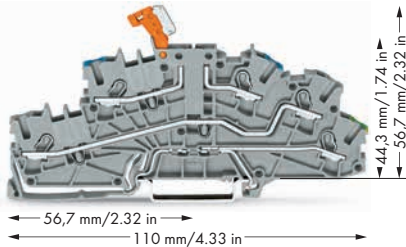

Multilevel Installation Terminal Blocks with Movable Knife Disconnect 2.5 (4) mm², 2003 Series

<p>0.25 ... 2.5 (4) mm² ① AWG 22 ... 12 250 V/4 kV/3; 20 A (25 A) ② ③ 400 V/6 kV/3; 20 A (25 A) ② ④</p> <p>Terminal block width 5.2 mm / 0.205 in.  10 ... 12 mm / 0.43 in.⑤</p>	<p>0.25 ... 2.5 (4) mm² ① AWG 22 ... 12 400 V/6 kV/3 ② I_N 24 A (28 A)</p> <p>Terminal block width 5.2 mm / 0.205 in.  10 ... 12 mm / 0.43 in.⑤</p>	<p>0.25 ... 2.5 (4) mm² ① AWG 22 ... 12 250 V/4 kV/3; 24 A (28 A) ② ③ 400 V/6 kV/3; 24 A (28 A) ② ④</p> <p>Terminal block width 5.2 mm / 0.205 in.  10 ... 12 mm / 0.43 in.⑤</p>
--	--	---

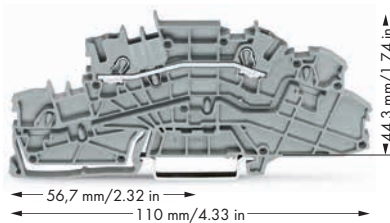
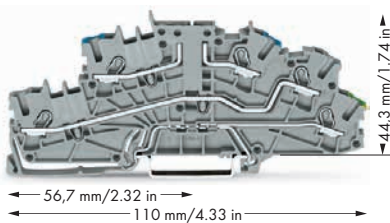

Item No.	Pack. Unit	Item No.	Pack. Unit	Item No.	Pack. Unit
Multilevel installation terminal block, with movable knife disconnect, gray		Multilevel installation terminal block, gray		Multilevel installation terminal block, gray	
○ NTi/L/PE	2003-6641	50	○ L/L	2003-6642	50
○ LTi/L/PE	2003-6644	50	○ N/L	2003-6649	50
Item-Specific Accessories					
Test plug adapter N/L, for vertical test slot, gray					
	2-pole	2003-499	100 (4x25)		
Test plug adapter N, for vertical test slot, gray					
	1-pole	2003-500	100 (4x25)		



Item No.	Pack. Unit	Item No.	Pack. Unit		
Multilevel installation terminal block, I_N 10 A, carrier terminal block without knife disconnect, gray		Multilevel installation terminal block, gray			
Maximum current depends on accessories used.					
○ N/L/PE	2003-6640	50	○ L	2003-6650	50
Black upper-deck, brown middle-deck, green-yellow lower-deck printing			○ N	2003-6651	50
○ P2/P1/PE	2003-6643	50			
Brown upper-deck, black middle-deck, green-yellow lower-deck printing					
○ P1/P2/PE	2003-6660	50			
Item-Specific Accessories					
Fuse plug with pull-tab, for miniature fuses 5 x 20 mm, nominal voltage and current are given by the fuse					
	gray	2004-911	50		
End and intermediate plate, only for use with fuse plugs, 1 mm thick					
	orange	2003-6693	100 (4x25)		

Approvals see www.wago.com

Accessories for Multilevel Installation Terminal Blocks

PUSH-IN CAGE CLAMP®

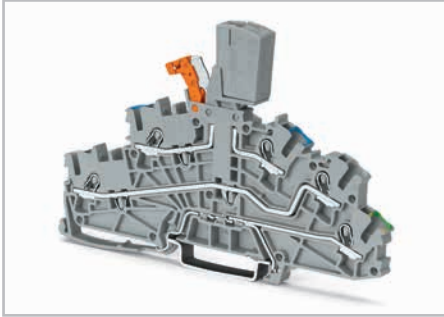

Multilevel installation terminal block (2003-6641) with N/L test plug adapter (2003-499) for insulation resistance measurement with connected N and L potentials

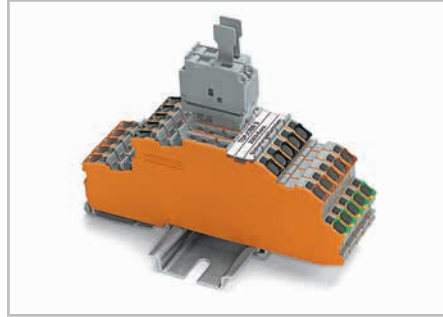

In combination with the 1 mm thick end and intermediate plate (2003-6693), the fuse plug (2004-911) can also be used with the carrier terminal blocks (2003-6640 and 2003-6643).

- ❶ Conductor sizes: 0.25 mm² ... 4 mm² "s + f-st";
Push-in conductor sizes: 0.75 mm² ... 4 mm² "s"
and 0.75 mm² ... 2.5 mm²
"insulated ferrules, 12 mm"
- ❷ 250 V/
400 V = rated voltage
4 kV/
6 kV = rated surge voltage
3 = pollution degree
(see Full Line Catalog, Volume 1, Section 14)
- ❸ 250 V/4 kV potential-ground
- ❹ 400 V/6 kV potential-potential
- ❺ Strip length, see packaging or instructions.
- ❻ See application notes for:
Colored push-in type jumper bars, page 163
Staggered jumper, page 166
Adjacent jumper for continuous commoning,
page 163
Push-in type wire jumper, page 164

Accessories Multilevel Installation Terminal Block

Push-in type jumper bars and staggered jumpers, see 2002 Series

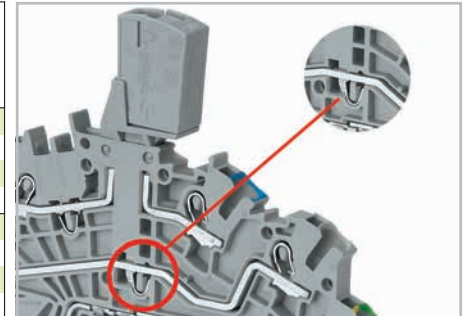

Multilevel installation terminal block (2003-6640) with N/L test plug adapter (2003-499) for insulation resistance measurement with connected N and L potentials

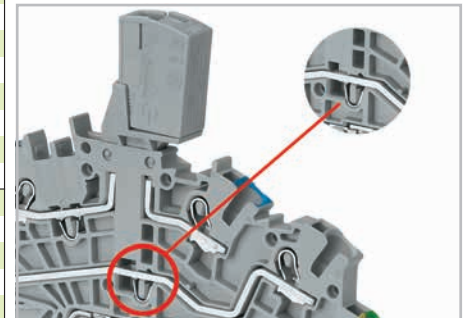

Multilevel installation terminal block (2003-6640) with N test plug adapter (2003-500) for insulation resistance measurement of N potential

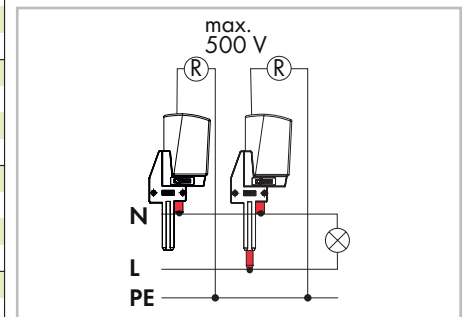

End and intermediate plate, for use without fuse plug, 0.8 mm thick orange 2003-6692 100 (4x25)	Insulation stop, 5 pcs/strip, 0.25 ... 0.5 mm ² light gray 2002-171 200 (8x25)
Adjacent jumper for continuous commoning, insulated, ❶ I _N 25 A, light gray 2-way 2002-400 100 (4x25)	Insulation stop, 5 pcs/strip, 0.75 ... 1 mm ² dark gray 2002-172 200 (8x25)
Busbar carrier, not suitable as end stop, for DIN 35 rail, 1.5 mm thick blue 2009-304 100 (4x25)	Staggered jumper, ❶ insulated, I _N 25 A, light gray 2-way 2002-472 100 (4x25) 3-way 2002-473 100 (4x25) 4-way 2002-474 100 (4x25) 5-way 2002-475 50 (2x25) 6-way 2002-476 50 (2x25) 7-way 2002-477 50 (2x25) 8-way 2002-478 50 (2x25) 9-way 2002-479 50 (2x25) 10-way 2002-480 50 (2x25) 11-way 2002-481 50 (2x25) 12-way 2002-482 50 (2x25)
Busbar carrier, can replace end bracket, with detachable separator plate, for DIN 35 rail, 7.5 mm thick blue 2009-305 25	Push-in type wire jumper, ❶ insulated, I _N 16 A, wire size 1.5 mm ² L = 60 mm 2009-412 100 (10x10) L = 110 mm 2009-414 100 (10x10) L = 250 mm 2009-416 100 (10x10)
Push-in type jumper bar, insulated, ❶ I _N 25 A, light gray 2-way 2002-402 200 (8x25) 3-way 2002-403 200 (8x25) 4-way 2002-404 200 (8x25) 5-way 2002-405 100 (4x25) 6-way 2002-406 100 (4x25) 7-way 2002-407 100 (4x25) 8-way 2002-408 100 (4x25) 9-way 2002-409 100 (4x25) 10-way 2002-410 100 (4x25)	WMB Multi marking system, 10 strips with 10 markers per card, stretchable 5 ... 5.2 mm plain 793-5501 5
Push-in type jumper bar, insulated, I _N 25 A, light gray from 1 to 3 2002-433 200 (8x25) from 1 to 4 2002-434 200 (8x25) from 1 to 5 2002-435 100 (4x25) from 1 to 6 2002-436 100 (4x25) from 1 to 7 2002-437 100 (4x25) from 1 to 8 2002-438 100 (4x25) from 1 to 9 2002-439 100 (4x25) from 1 to 10 2002-440 100 (4x25)	WMB Inline, plain, stretchable 5 ... 5.2 mm, 1,500 WMB markers, 5 mm, on roll white 2009-115 1
Operating tool, 3.5 mm and 2.5 mm blade, for TOPJOB® S installation terminal blocks 2009-309 1	Marking strip, plain, 11 mm wide, 50 m roll white 2009-110 1
Operating tool, 3.5 mm and 5.5 mm blade, for TOPJOB® S installation terminal blocks 2009-310 1	

TOPJOB® S

2003 Series Double Fuse Plugs

on 2002 and 2003 Series Carrier Terminal Blocks

Double fuse plug for miniature fuses 5 x 20 mm 250 V / I _N 6.3 A Plug width 10.4 mm / 0.409 in.	Double fuse plug for miniature fuses 5 x 20 mm 250 V / I _N 6.3 A Plug width 10.4 mm / 0.409 in.
--	--

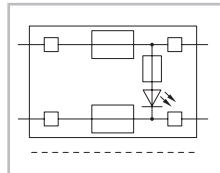
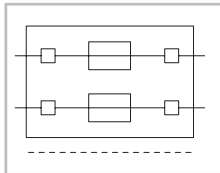

- ① Length of 2002-1661: 66.5 mm / 2.62 in.
2-conductor carrier terminal block
- ② Length of 2002-1761: 76.8 mm / 3.02 in.
3-conductor carrier terminal block
- ③ Length of 2002-1861: 87.5 mm / 3.45 in.
4-conductor carrier terminal block
- ④ Length of 2002-1961: 72.9 mm / 2.87 in.
2-conductor carrier terminal block with additional jumper position
- ⑤ Length of 2002-2961: - 108 mm / 4.25 in.
Double-deck carrier terminal block
- ⑥ Length of 2003-6640: - 110 mm / 4.33 in.
Multilevel installation terminal block

Item No.	Pack. Unit	Item No.	Pack. Unit
Double fuse plug, for miniature fuses 5 x 20 mm Both nominal voltage and current are given by the fuse.		Double fuse plug, for miniature fuses 5 x 20 mm, with indicator lamp, gray Both nominal voltage and current are given by the fuse. LED 0.25mA	
● gray	2003-911	● 230 V	2003-911/1000-923
	25		25

Accessories

Appropriate marking systems: WMB/Marking strips

2-conductor carrier terminal block, ① 0.25 ... 2.5 (4) mm ² / AWG 22 ... 12 Terminal block width 5.2 mm / 0.205 in. gray 2002-1661 50	2-conductor carrier terminal block, ④ 0.25 ... 2.5 (4) mm ² / AWG 22 ... 12 Terminal block width 5.2 mm / 0.205 in. gray 2002-1961 50
End and intermediate plate, 1 mm thick orange 2002-1692 100 (4x25) gray 2002-1691 100 (4x25)	End and intermediate plate, 1 mm thick orange 2002-1992 100 (4x25) gray 2002-1991 100 (4x25)
3-conductor carrier terminal block, ② 0.25 ... 2.5 (4) mm ² / AWG 22 ... 12 Terminal block width 5.2 mm / 0.205 in. gray 2002-1761 50	Double-deck carrier terminal block, ⑤ 0.25 ... 2.5 (4) mm ² / AWG 22 ... 12 Terminal block width 5.2 mm / 0.205 in. L/L 2002-2961 50
End and intermediate plate, 1 mm thick orange 2002-1792 100 (4x25) gray 2002-1791 100 (4x25)	Double-deck carrier terminal block, 0.25 ... 2.5 (4) mm ² / AWG 22 ... 12 Terminal block width 5.2 mm / 0.205 in. L/N 2002-2963 50
4-conductor carrier terminal block, ③ 0.25 ... 2.5 (4) mm ² / AWG 22 ... 12 Terminal block width 5.2 mm / 0.205 in. gray 2002-1861 50	Double-deck carrier terminal block, 0.25 ... 2.5 (4) mm ² / AWG 22 ... 12 Terminal block width 5.2 mm / 0.205 in. L/L 2002-2941 50
End and intermediate plate, 1 mm thick orange 2002-1892 100 (4x25) gray 2002-1891 100 (4x25)	End and intermediate plate, 1 mm thick orange 2002-2992 100 (4x25) gray 2002-2991 100 (4x25)

Accessories



Multilevel installation terminal block, gray ⑥ 0.25 ... 2.5 (4) mm ² / AWG 22 ... 12 Terminal block width 5.2 mm / 0.205 in. N/L/PE 2003-6640 50
Multilevel installation terminal block, gray 0.25 ... 2.5 (4) mm ² / AWG 22 ... 12 Terminal block width 5.2 mm / 0.205 in. P2/P1/PE 2003-6643 50
Multilevel installation terminal block, gray 0.25 ... 2.5 (4) mm ² / AWG 22 ... 12 Terminal block width 5.2 mm / 0.205 in. P1/P2/PE 2003-6660 50
End and intermediate plate, 1 mm thick orange 2003-6692 100 (4x25)
End plate for fuse terminal blocks, 2 mm thick orange 2002-992 100 (4x25) gray 2002-991 100 (4x25)
Shorting link, 5 x 20 mm, if the fuse plug is used as disconnect plug I _N 6.3 A 281-503 250 (10x25)
WMB Multi marking system, 10 strips with 10 markers per card, stretchable 5 ... 5.2 mm plain 793-5501 5
WMB Multi marking system, plain, 10 strips with 10 markers per card, stretchable 5 ... 5.2 mm yellow 793-5501/000-002 red 793-5501/000-005 blue 793-5501/000-006 gray 793-5501/000-007 orange 793-5501/000-012 light green 793-5501/000-017 green 793-5501/000-023 violet 793-5501/000-024 5

Miniature metric fuses 5 x 20









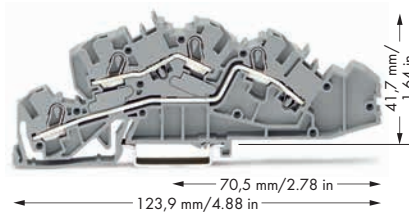
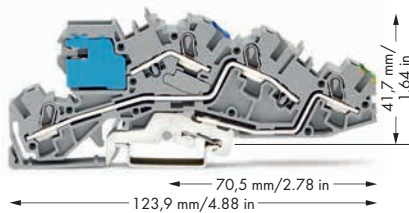

Series Item No.	Overload and short circuit protection		Short circuit protection only	
	Individual argmt.	Group argmt.	Individual argmt.	Group argmt.
Fuse terminal blocks				
2003-911 2003-911/.....	1.6 W	1.6 W	2.5 W	2.5 W

TOPJOB® S

Multilevel Installation Terminal Blocks with N-Disconnect Slide Link 4 (6) mm² 2005 Series

0.5 ... 4 (6) mm ² ① AWG 20 ... 10 250 V/4 kV/3; 36 A (36 A) ② ③ 400 V/6 kV/3; 36 A (36 A) ② ④ Terminal block width 6.2 mm / 0.244 in.  11 ... 13 mm / 0.47 in.⑤	0.5 ... 4 (6) mm ² ① AWG 20 ... 10 400 V/6 kV/3 ② I _N 36 A Terminal block width 6.2 mm / 0.244 in.  11 ... 13 mm / 0.47 in.⑤
---	---



Item No.	Pack. Unit	Item No.	Pack. Unit	Accessories
Multilevel installation terminal block, with N-disconnect slide link, gray ○ NT/L/PE 2005-7641	50	Multilevel installation terminal block, gray ○ L/L 2005-7642	50	N-supply terminal block, I_N 76 A, 16 mm ² , 12 mm wide blue 2016-7714 20
		○ N/L 2005-7649	50	
				Ground supply terminal block, 16 mm ² , 12 mm wide green-yellow 2016-7607 20
				Connector,  for N-busbar, with blue cover, 2.5 ... 16 mm ² blue 210-281 100 (2x50)
				Connector,  for N-busbar, 2.5 ... 35 mm ² unplated 209-105 50
				Lock-out, snap-on type,  prevents reclosing of slide link orange 2005-7300 100 (4x25)
				Insulation stop,  5 pcs/strip, 0.25 ... 0.5 mm ² light gray 2004-171 200 (8x25)
				Insulation stop,  5 pcs/strip, 0.75 ... 1 mm ² dark gray 2004-172 200 (8x25)
				Push-in type jumper bar, insulated, I _N 32 A, light gray 2-way 2004-402 200 (8x25) 3-way 2004-403 200 (8x25) 4-way 2004-404 100 (4x25) 5-way 2004-405 100 (4x25) 6-way 2004-406 100 (4x25) 7-way 2004-407 100 (4x25) 8-way 2004-408 100 (4x25) 9-way 2004-409 100 (4x25) 10-way 2004-410 100 (4x25)
End and intermediate plate, 1 mm thick orange 2005-7692 100 (4x25) 		Busbar carrier, not suitable as end stop, for DIN 35 rail, 1.5 mm thick blue 2009-304 100 (4x25) 		
Busbar, tin-plated, Cu 10 x 3 mm, 1000 mm long I _N 140 A 210-133 1 		Busbar carrier, can replace end bracket, with detachable separator plate, for DIN 35 rail, 7.5 mm thick blue 2009-305 25 		
Cover for N-busbar, transparent, 1000 mm long 777-303 1 				

Approvals see www.wago.com

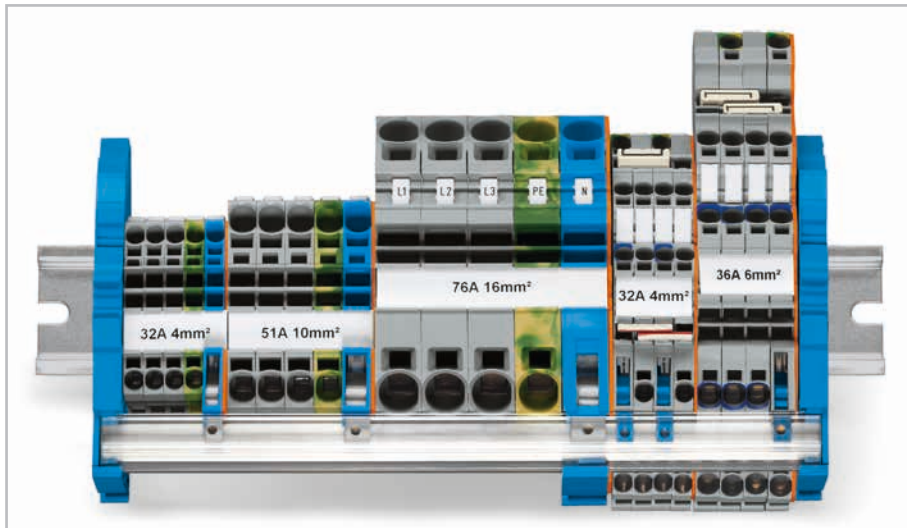

- ❶ Conductor sizes: 0.5 mm² ... 6 mm² "s + f-st";
Push-in conductor sizes: 1 mm² ... 6 mm² "s"
and 0.75 mm² ... 4 mm²
"insulated ferrules, 12 mm"
- ❷ 250 V/
400 V = rated voltage
4 kV/
6 kV = rated surge voltage
3 = pollution degree
(see Full Line Catalog, Volume 1, Section 14)
- ❸ 250 V/4 kV potential-ground
- ❹ 400 V/6 kV potential-potential
- ❺ Strip length, see packaging or instructions.

Accessories

Appropriate marking systems: WMB/Marking strips









Application note:

N-disconnect slide links, used in installation terminal blocks, consist of switch contacts that are opened and then closed again as part of the regular circuit testing. To guarantee a reliable connection, a corrosion-resistant contact area is required on the N-busbar.

Historically, uninsulated copper busbars, that have been cleaned/stripped of any possible corrosion prior to install, can be used in dry, pollution-free locations.



According to DIN VDE 0100-520 (VDE 0100 Part 520), installation equipment exposed to contamination or corrosive substances (e.g., water) that promote corrosion or deterioration, must be protected or made of a corrosion- or wear-resistant material. In these cases, tinned copper busbars guarantee a reliable connection.

WAGO only offers tinned copper busbars.

Push-in type jumper bar, insulated,  I _N 32 A, light gray from 1 to 3 2004-433 200 (8x25) from 1 to 4 2004-434 200 (8x25) from 1 to 5 2004-435 100 (4x25) from 1 to 6 2004-437 100 (4x25) from 1 to 8 2004-438 100 (4x25) from 1 to 9 2004-439 100 (4x25) from 1 to 10 2004-440 100 (4x25)	TOPJOB® S group marker carrier, snap-on type for jumper slot, 5 mm wide gray 2009-191 50 (2x25)
	Screwless end stop, for DIN 35 rail, 6 mm wide gray 249-116 100 (4x25)
	Screwless end stop, for DIN 35 rail, 10 mm wide gray 249-117 50 (2x25)
Push-in type wire jumper, insulated,  I _N 18 A, wire size 1.5 mm ² L = 60 mm 2009-412 100 (10x10) L = 110 mm 2009-414 100 (10x10) L = 250 mm 2009-416 100 (10x10)	Operating tool, 3.5 mm and 5.5 mm blade, for TOPJOB® S installation terminal blocks 2009-310 1
	Operating tool, 3.5 mm and 2.5 mm blade, for TOPJOB® S installation terminal blocks 2009-309 1
Test plug adapter,  for 4 mm Ø test plug gray 2009-174 100 (4x25)	
Banana plug,  for socket 4 mm Ø, color mixed 215-111 50	
Testing tap,  for max. 2.5 mm ² gray 2009-182 100 (4x25)	
Test plug,  with 500 mm cable, 2 mm Ø red 210-136 50	
Test plug,  with 500 mm cable, 2.3 mm Ø yellow 210-137 50	
WMB Multi marking system,  10 strips with 10 markers per card, stretchable 5 ... 5.2 mm plain 793-5501 5	
Marking strip, plain,  11 mm wide, 50 m roll white 2009-110 1	

TOPJOB® S

N-Conductor Disconnect and Power Distribution Disconnect Terminal Blocks 2002 / 2006 / 2016 Series

<p>0.25 ... 2.5 (4) mm² ① AWG 22 ... 12 250 V/4 kV/3 ④ I_N 32 A</p> <p>Terminal block width 5.2 mm / 0.205 in.  10 ... 12 mm / 0.43 in. ⑤</p>	<p>0.5 ... 6 (10) mm² ② AWG 20 ... 8 250 V/4 kV/3 ④ I_N 51 A</p> <p>Terminal block width 7.5 mm / 0.295 in.  13 ... 15 mm / 0.55 in. ⑤</p>	<p>0.5 ... 16 (25 "f-st") mm² ③ AWG 20 ... 4 250 V/4 kV/3 ④ I_N 76 A</p> <p>Terminal block width 12 mm / 0.472 in.  18 ... 20 mm / 0.75 in. ⑤</p>
---	---	--

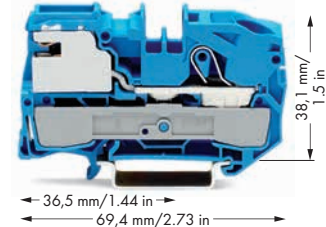
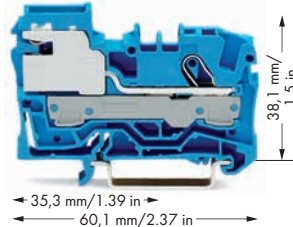
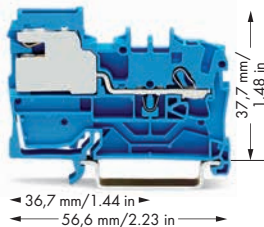

Item No.	Pack. Unit	Item No.	Pack. Unit	Item No.	Pack. Unit
1-conductor N-disconnect terminal block ● blue 2002-7114 ⑥	50	1-conductor N-disconnect terminal block ● blue 2006-7114 ⑥	50	1-conductor N-disconnect terminal block ● blue 2016-7114 ⑥	25
1-conductor power distribution disconnect terminal block ● gray 2002-7111 ⑦	50	1-conductor power distribution disconnect terminal block ● gray 2006-7111 ⑦	50	1-conductor power distribution disconnect terminal block ● gray 2016-7111 ⑦	25
Appropriate through and ground conductor terminal blocks, see page 14		Appropriate through and ground conductor terminal blocks, see page 20		Appropriate through and ground conductor terminal blocks, see page 22	
Item-Specific Accessories		Item-Specific Accessories		Item-Specific Accessories	
End and intermediate plate, 0.8 mm thick orange 2002-7192	100 (4x25)	End and intermediate plate, 1 mm thick orange 2006-7192	100 (4x25)	End and intermediate plate, 1 mm thick orange 2016-7192	100 (4x25)
Lock-out, snap-on type, prevents reclosing of slide link orange 2005-7300	100 (4x25)	Lock-out, snap-on type, prevents reclosing of slide link orange 2006-7300	100 (4x25)	Lock-out, snap-on type, prevents reclosing of slide link orange 2006-7300	100 (4x25)

Accessories for N-Conductor and Power Distribution Disconnect Terminal Blocks

Appropriate marking systems: WMB/Marking strips

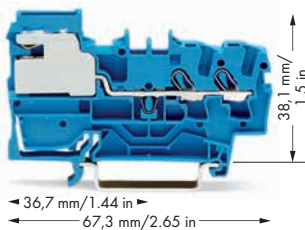

2-conductor N-disconnect terminal block ● blue 2002-7214 ⑥	50	Busbar carrier, not suitable as end stop, for DIN 35 rail, 1.5 mm thick blue 2009-304	100 (4x25)	Connector, for N-busbar, 2.5 ... 35 mm ² unplated 209-105	50
2-conductor power distribution disconnect terminal block ● gray 2002-7211 ⑦	50	Busbar carrier, can replace end bracket, with detachable separator plate, for DIN 35 rail, 7.5 mm thick blue 2009-305	25	Connector, for N-busbar, with blue cover, 2.5 ... 16 mm ² blue 210-281	100 (2x50)
Item-Specific Accessories		Busbar, tin-plated, Cu 10 x 3 mm, 1000 mm long I _N 140 A 210-133	1	Test plug, with 500 mm cable, 2 mm Ø red 210-136	50
End and intermediate plate, 0.8 mm thick orange 2002-7292	100 (4x25)	Cover for N-busbar, transparent, 1000 mm long 777-303	1	Test plug, with 500 mm cable, 2.3 mm Ø yellow 210-137	50
				WMB Multi marking system, 10 strips with 10 markers per card, stretchable 5 ... 5.2 mm plain 793-5501	5

- Handling - N-Disconnect Slide Link and Busbar Carrier

PUSH-IN CAGE CLAMP®

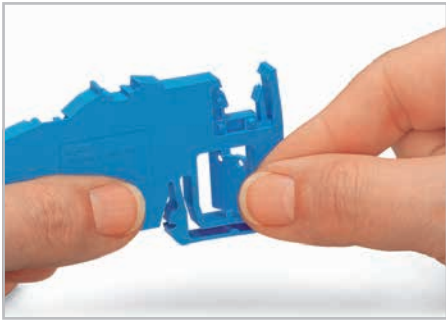

Removing the separator plate from the busbar carrier.

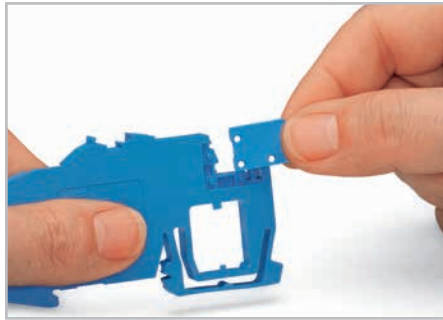

Inserting the separator plate to protect the N-busbar against accidental contact.

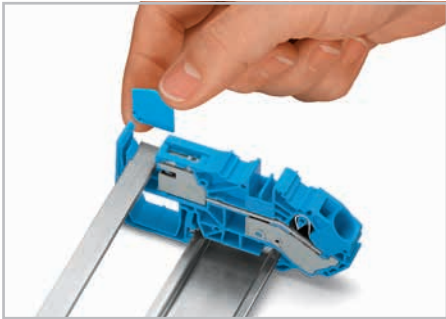

Inserting the separator plate.

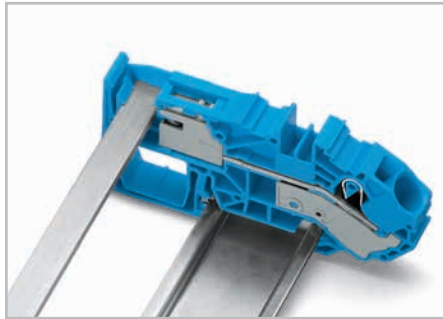

Separator plate is inserted.

- ❶ Conductor sizes: 0.25 mm² ... 4 mm² "s + f-st";
Push-in conductor sizes: 0.75 mm² ... 4 mm² "s"
and 0.75 mm² ... 2.5 mm²
"insulated ferrule, 12 mm"
- ❷ Conductor sizes: 0.5 mm² ... 10 mm² "s + f-st";
Push-in conductor sizes: 1.5 mm² ... 10 mm² "s"
and 1.5 mm² ... 6 mm²
"insulated ferrule, 12 mm"
- ❸ Conductor sizes: 0.5 mm² ... 16 mm² "s + f-st",
25 mm² "f-st";
Push-in conductor sizes: 2.5 mm² ... 16 mm² "s"
and 2.5 mm² ... 16 mm²
"insulated ferrule, 18 mm"
- ❹ 250 V = rated voltage
4 kV = rated surge voltage
3 = pollution degree
(see Full Line Catalog, Volume 1, Section 14)
- ❺ Strip length, see packaging or instructions.
- ❻ See column 4
- ❼ See column 5

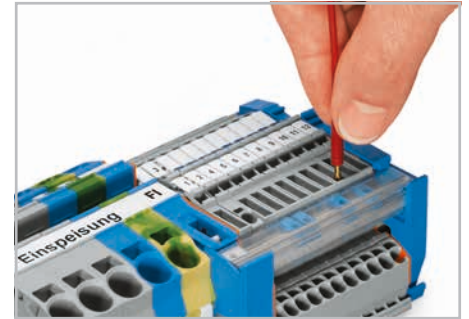

Testing with test plug 2 mm Ø
(max. test voltage: 42 V)

❹ For the construction and operation of power installations in fire hazardous locations or public buildings – such as conference centers, stores, hospitals, schools, theaters, hotels. – the DIN VDE 0100-710 or DIN VDE 0100-718 standards shall be observed. DIN VDE 0100-482 shall be observed for fire hazardous locations. These VDE mandate determine that every neutral conductor must be provided with a disconnection device so, e.g., insulation testing is possible for every circuit without disconnecting the N-conductor.

WAGO N-disconnect terminal blocks meet this requirement.

❼ According to DIN VDE 0100-710 "Requirements for operating facilities, rooms and special installations = medical facilities", equipotential bonding conductors shall be run on a potential equalization busbar. The potential equalization busbar and the protective ground conductor busbar must be accommodated in a common housing and be connected by means of a disconnectable connection using a copper conductor with a minimum cross section of 16 mm²/AWG 6. Furthermore, all equipotential bonding conductors must be connected to the potential equalization busbar and clearly arranged so they can be disconnected individually and accessed at any time. Depending on their function, they must be provided with captive marking.

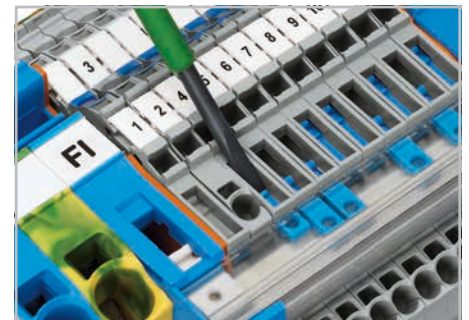

WAGO power distribution disconnect terminal blocks meet these requirements.



Tool-operated N-disconnect slide link

TOPJOB® S

Supply Terminal Blocks for Distribution Boxes, N-Conductor Disconnect and Power Distribution Disconnect Terminal Blocks 16 (25 "f-st") mm², 2016 Series

0.5 ... 16 (25 "f-st") mm ² ① AWG 20 ... 4 800 V/8 kV/3 ② I _N 76 A Terminal block width 12 mm / 0.472 in.  18 ... 20 mm / 0.75 in. ④	0.5 ... 16 (25 "f-st") mm ² ① AWG 20 ... 4 250 V/4 kV/3 ③ I _N 76 A Terminal block width 12 mm / 0.472 in.  18 ... 20 mm / 0.75 in. ④
--	---

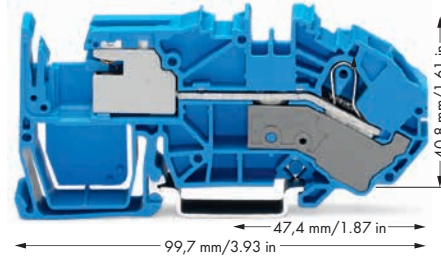
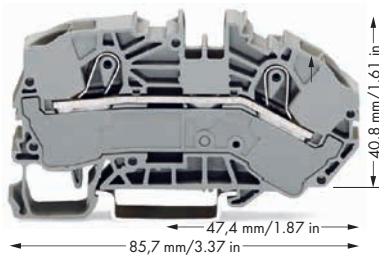

- ① Conductor sizes: 0.5 mm² ... 16 mm² "s + f-st", 25 mm² "f-st"; Push-in conductor sizes: 2.5 mm² ... 16 mm² "s" and 0.25 mm² ... 16 mm² "insulated ferrule, 18 mm"
- ② 800 V = rated voltage
8 kV = rated surge voltage
3 = pollution degree
(see Full Line Catalog, Volume 1, Section 14)
- ③ 250 V = rated voltage
4 kV = rated surge voltage
3 = pollution degree
(see Full Line Catalog, Volume 1, Section 14)
- ④ Strip length, see packaging or instructions.

Item No.	Pack. Unit	Item No.	Pack. Unit	Accessories
2-conductor supply terminal blocks for distribution boxes		1-conductor N-disconnect terminal block		
gray	2016-7601 20	blue	2016-7714 20	
blue	2016-7604 20			Banana plug, for socket 4 mm Ø, color mixed 215-111 50
2-conductor ground conductor terminal block, 15mm-high DIN 35 rails shall be used for a current load higher than 76A!		1-conductor power distribution disconnect terminal block		
green-yellow	2016-7607 20	gray	2016-7711 20	WMB Multi marking system, 10 strips with 10 markers per card, stretchable 5 ... 5.2 mm plain 793-5501 5
Item-Specific Accessories		Item-Specific Accessories		Marking strip, plain, 11 mm wide, 50 m roll white 2009-110 1
End and intermediate plate, 1 mm thick orange 2016-7692 100 (4x25)		End and intermediate plate, 1 mm thick orange 2016-7792 100 (4x25)		
		Lock-out, snap-on type, prevents reclosing of slide link orange 2006-7300 100 (4x25)		
2016 Series Accessories Appropriate marking systems: WMB/Marking strips				
Push-in type jumper bar, insulated, I _N 76 A, light gray 2-way 2016-402 50 (2x25) 3-way 2016-403 50 (2x25) 4-way 2016-404 50 (2x25) 5-way 2016-405 50 (2x25)		Busbar, tin-plated, Cu 10 x 3 mm, 1000 mm long I _N 140 A 210-133 1		
		Cover for N-busbar, transparent, 1000 mm long 777-303 1		
Push-in type jumper bar, insulated, I _N 76 A, light gray from 1 to 3 2016-433 50 (2x25) from 1 to 4 2016-434 50 (2x25) from 1 to 5 2016-435 50 (2x25)		Testing tap, for max. 2.5 mm ² gray 2009-182 100 (4x25)		
		Test plug, with 500 mm cable, 2 mm Ø red 210-136 50		
Protective warning marker, with high-voltage symbol, black, for 5 terminal blocks yellow 2016-115 50 (2x25)		Test plug, with 500 mm cable, 2.3 mm Ø yellow 210-137 50		
Finger guard, touchproof cover protects unused conductor entries yellow 2016-100 100 (4x25)		Test plug adapter, for 4 mm Ø test plug gray 2009-174 100 (4x25)		

Approvals see www.wago.com

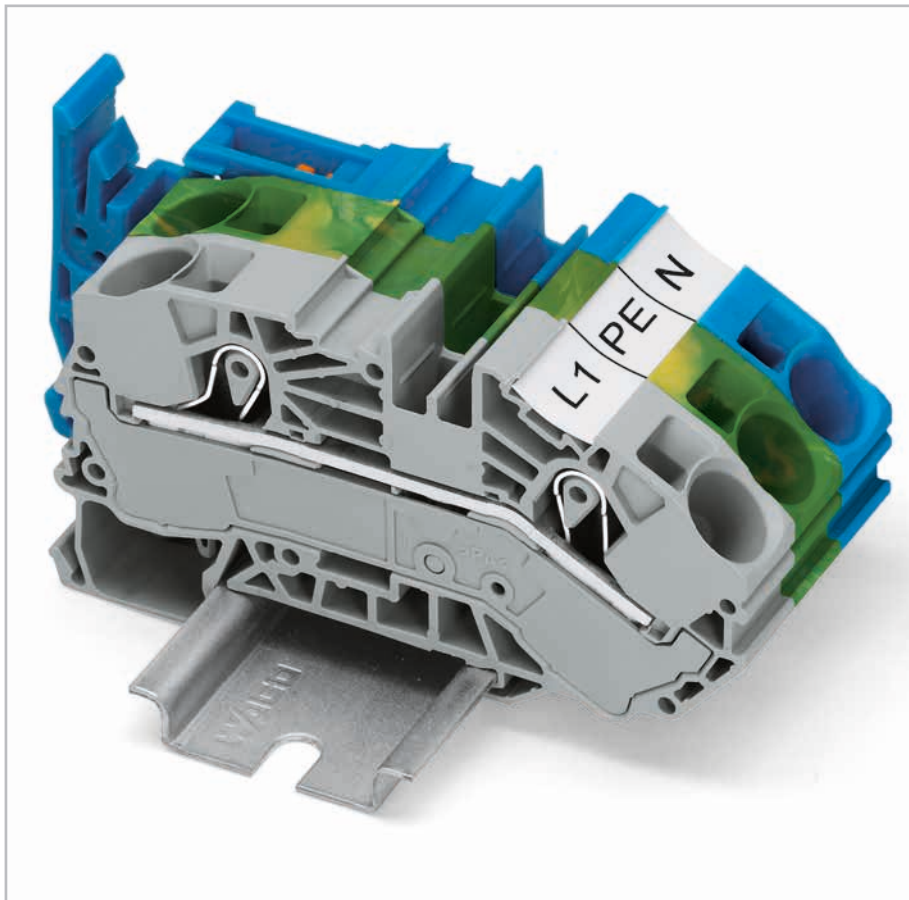

With an angled conductor entry, the 2016 Series supply terminal blocks simplify the wiring of solid conductors in distribution boxes. Solid conductors of the largest cross section can be connected easily, enabling the cover of the distribution box to fit without interfering with the conductors.

TOPJOB® S

Connectors and Connector Strips





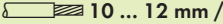

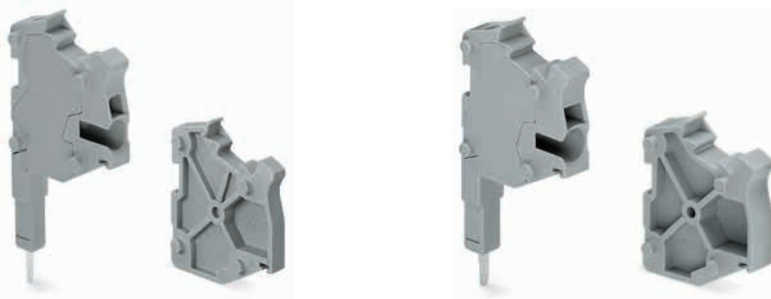





2001/2002 Series

PUSH-IN CAGE CLAMP®

0.25 ... 1.5 (2.5) mm ² ① AWG 22 ... 14 500 V/6 kV/3 ③ I _N 18 A Terminal block width 4.2 mm / 0.165 in.  9 ... 11 mm / 0.39 in. ④	0.25 ... 2.5 (4) mm ² ② AWG 22 ... 12 500 V/6 kV/3 ③ I _N 24 A Terminal block width 5.2 mm / 0.205 in.  10 ... 12 mm / 0.43 in. ④
--	--



- ① Conductor sizes: 0.25 mm² ... 2.5 mm² "s + f-st"; Push-in conductor sizes: 0.5 mm² ... 2.5 mm² "s" and 0.75 mm² ... 1.5 mm² "insulated ferrule, 12 mm"
- ② Conductor sizes: 0.25 mm² ... 4 mm² "s + f-st"; Push-in conductor sizes: 0.75 mm² ... 4 mm² "s" and 0.75 mm² ... 2.5 mm² "insulated ferrule, 12 mm"
- ③ 500 V = rated voltage
6 kV = rated surge voltage
3 = pollution degree
(see Full Line Catalog, Volume 1, Section 14)
- ④ Strip length, see packaging or instructions.

Item No.	Pack. Unit	Item No.	Pack. Unit	Accessories
Modular TOPJOB® S connector, for jumper contact slot, can be snapped together, gray ● 1-pole 2001-511 100 (4x25)		Modular TOPJOB® S connector, for jumper contact slot, can be snapped together, gray ● 1-pole 2002-511 100 (4x25)		Appropriate marking systems: WMB/Marking
Spacer module, can be snapped together, e.g., for bridging commoned terminal blocks ● gray 2001-549 100 (4x25)		Spacer module, can be snapped together, e.g., for bridging commoned terminal blocks ● gray 2002-549 100 (4x25)		Test plug,  with 500 mm cable, 2.3 mm Ø yellow 210-137 50
TOPJOB® S connector strip, for jumper contact slot, gray ● 2-pole 2001-552 25 ● 3-pole 2001-553 25 ● 4-pole 2001-554 25 ● 5-pole 2001-555 10 ● 6-pole 2001-556 10 ● 7-pole 2001-557 10 ● 8-pole 2001-558 10 ● 9-pole 2001-559 10 ● 10-pole 2001-560 10		TOPJOB® S connector strip, for jumper contact slot, gray ● 2-pole 2002-552 25 ● 3-pole 2002-553 25 ● 4-pole 2002-554 25 ● 5-pole 2002-555 10 ● 6-pole 2002-556 10 ● 7-pole 2002-557 10 ● 8-pole 2002-558 10 ● 9-pole 2002-559 10 ● 10-pole 2002-560 10		Test plug,  with 500 mm cable, 2 mm Ø red 210-136 50
Item-Specific Accessories		Item-Specific Accessories		Strain relief plate, gray  35 mm width 734-326 100 (4x25) 6 mm wide 734-327 100 (4x25) 12.5 mm width 734-328 100 (4x25) 25 mm wide 734-329 100 (4x25)
End plate,  for modular TOPJOB® S connectors, 1.5 mm thick gray 2002-541 100 (4x25)		End plate,  for modular TOPJOB® S connectors, 1.5 mm thick gray 2002-541 100 (4x25)		Marking strip, plain,  11 mm wide, 50 m roll white 2009-110 1
WMB Inline, plain,  stretchable 4 ... 4.2 mm, 2,000 WMB markers, 4 mm, on roll white 2009-114 1		WMB Inline, plain,  stretchable 5 ... 5.2 mm, 1,500 WMB markers, 5 mm, on roll white 2009-115 1		
WMB Multi marking system,  10 strips with 10 markers per card, stretchable 4 ... 4.2 mm plain 793-4501 5		WMB Multi marking system,  10 strips with 10 markers per card, stretchable 5 ... 5.2 mm plain 793-5501 5		
WMB Multi marking system, plain,  10 strips with 10 markers per card, stretchable 4 ... 4.2 mm yellow 793-4501/000-002 red 793-4501/000-005 blue 793-4501/000-006 gray 793-4501/000-007 orange 793-4501/000-012 light green 793-4501/000-017 green 793-4501/000-023 violet 793-4501/000-024 5		WMB Multi marking system, plain,  10 strips with 10 markers per card, stretchable 5 ... 5.2 mm yellow 793-5501/000-002 red 793-5501/000-005 blue 793-5501/000-006 gray 793-5501/000-007 orange 793-5501/000-012 light green 793-5501/000-017 green 793-5501/000-023 violet 793-5501/000-024 5		
		Miniature WSB Quick marking system,  10 strips with 10 markers per card, 5 mm wide markers plain 248-501 5		

MODULAR CONNECTORS

For Even More Applications

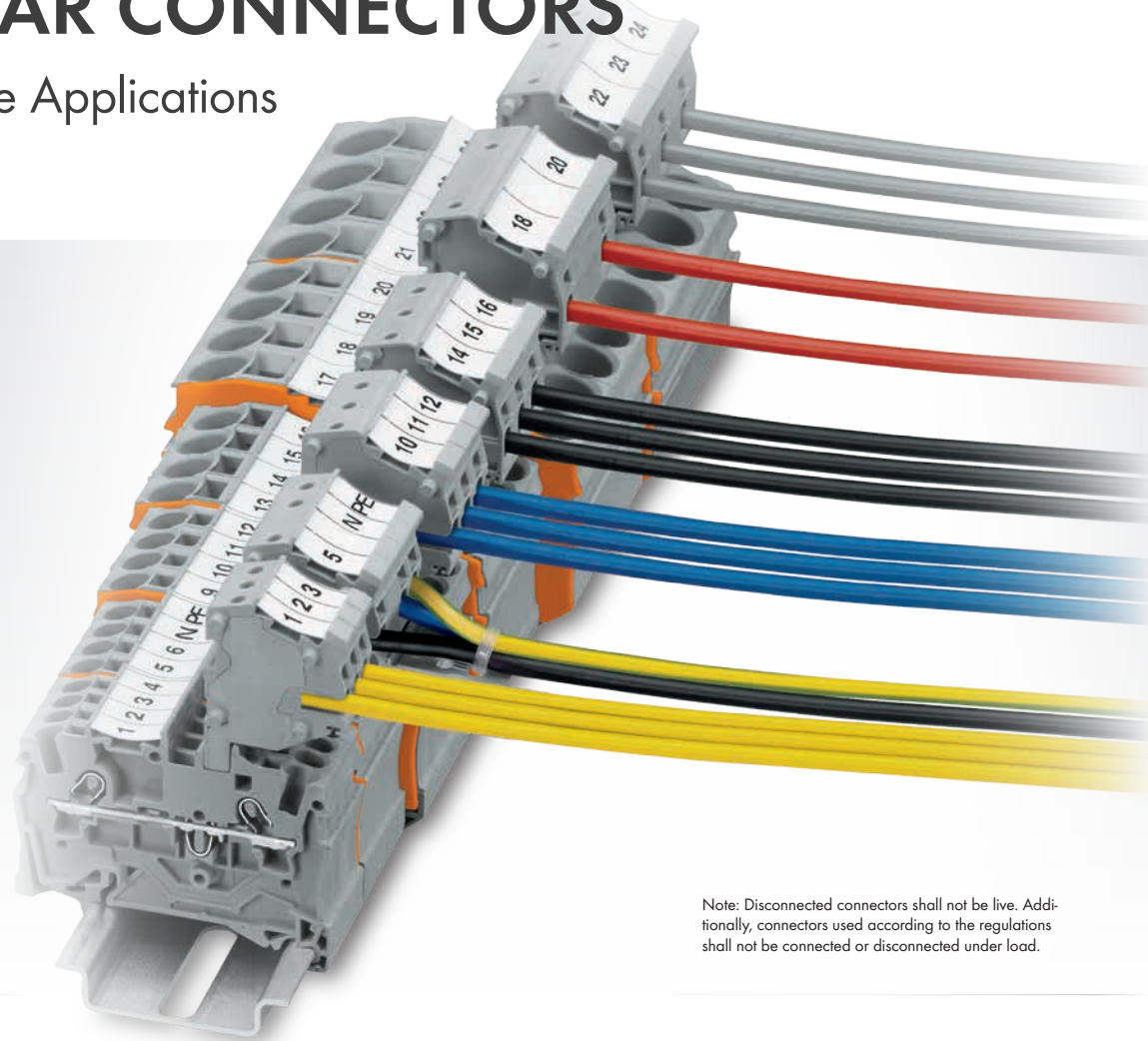

Note: Disconnected connectors shall not be live. Additionally, connectors used according to the regulations shall not be connected or disconnected under load.

Modular Connectors



Modular connectors with Push-in CAGE CLAMP® technology offer an additional connection option for conductors of the same size as the terminal block being used (up to 23 A). They can also double as test plugs.

Connector Strips



Additionally, 2- to 10-pole connector strips for the 2001 and 2002 Series, as well as 2- to 5-pole connector strips for the 2004 Series are available.

Testing

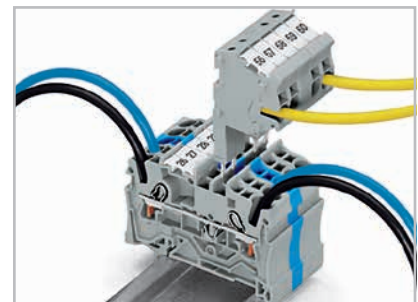

Modular connectors for 2001, 2002, 2004, 2006, 2010 and 2016 Series have a test socket for 2 mm or 2.3 mm Ø test plugs (max. test voltage: 42 V).

TOPJOB® S

Connectors 4 (6) mm²

2004/2006/2010/2016 Series

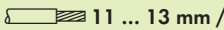
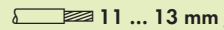
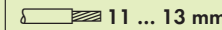

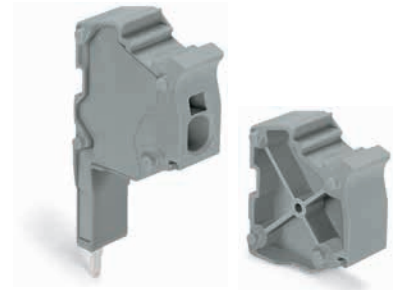
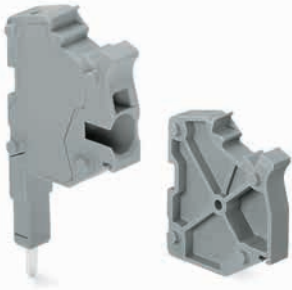

0.5 ... 4 (6) mm² ① AWG 20 ... 10 500 V/6 kV/3 ② 300 V, 30 A ③ I_N 32 A Terminal block width 6.2 mm / 0.244 in.  11 ... 13 mm / 0.47 in. ③	0.5 ... 4 (6) mm² ① AWG 20 ... 10 500 V/6 kV/3 ② I_N 32 A Terminal block width 7.5 mm / 0.295 in.  11 ... 13 mm / 0.47 in. ③	0.5 ... 4 (6) mm² ① AWG 20 ... 10 500 V/6 kV/3 ② I_N 32 A Terminal block width 10 mm / 0.394 in.  11 ... 13 mm / 0.47 in. ③
--	---	--



Item No.	Pack. Unit	Item No.	Pack. Unit	Item No.	Pack. Unit
Modular TOPJOB® S connector, for jumper contact slot, can be snapped together, gray ● 1-pole 2004-511 100 (4x25)		Modular TOPJOB® S connector, for jumper contact slot, can be snapped together, gray ● 1-pole 2006-511 50 (2x25)		Modular TOPJOB® S connector, for jumper contact slot, can be snapped together, gray ● 1-pole 2010-511 50 (2x25)	
Spacer module, can be snapped together, e.g., for bridging commoned terminal blocks ● gray 2004-549 100 (4x25)		Spacer module, can be snapped together, e.g., for bridging commoned terminal blocks ● gray 2006-549 50 (2x25)		Spacer module, can be snapped together, e.g., for bridging commoned terminal blocks ● gray 2010-549 50 (2x25)	
TOPJOB® S connector strip, for jumper contact slot, gray ● 2-pole 2004-552 25 ● 3-pole 2004-553 25 ● 4-pole 2004-554 25 ● 5-pole 2004-555 10					
Item-Specific Accessories					
Test plug,  with 500 mm cable, 2.3 mm Ø yellow 210-137 50					

Accessories

Appropriate marking systems: WMB/Marking strips

End plate,  for modular TOPJOB® S connectors, 1.5 mm thick gray 2004-541 100 (4x25)	Strain relief plate, gray  35 mm width 734-326 100 (4x25) 6 mm wide 734-327 100 (4x25) 12.5 mm width 734-328 100 (4x25) 25 mm wide 734-329 100 (4x25)	Marking strip, plain,  11 mm wide, 50 m roll white 2009-110 1
Test plug,  with 500 mm cable, 2 mm Ø red 210-136 50		WMB Multi marking system,  10 strips with 10 markers per card, stretchable 5 ... 5.2 mm plain 793-5501 5

0.5 ... 4 (6) mm² ¹ | AWG 20 ... 10
 500 V/6 kV/3 ²
 I_N 32 A
 Terminal block width 12 mm / 0.472 in.
 11 ... 13 mm / 0.47 in. ³

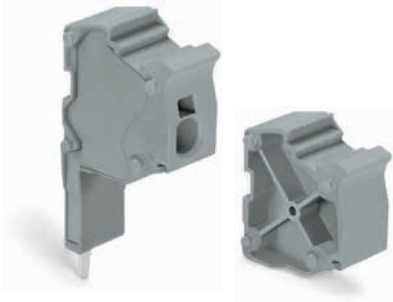

- ❶ Conductor sizes: 0.5 mm² ... 6 mm² "s + f-st";
 Push-in conductor sizes: 1 mm² ... 6 mm² "s"
 and 0.75 mm² ... 4 mm²
 "insulated ferrule, 1.2 mm"
- ❷ 500 V = rated voltage
 6 kV = rated surge voltage
 3 = pollution degree
 (see Full Line Catalog, Volume 1, Section 14)
- ❸ Strip length, see packaging or instructions.

	Item No.	Pack. Unit
Modular TOPJOB® S connector,		
for jumper contact slot,		
can be snapped together, gray		
○ 1-pole	2016-511	50 (2x25)
Spacer module, can be snapped together,		
e.g., for bridging commoned terminal blocks		
○ gray	2016-549	50 (2x25)

TOPJOB® S

PUSH-IN CAGE CLAMP®

L-Type Test Plug Modules for Testing Rail-Mounted Terminal Blocks Terminal Block Width 5.2 mm via Conductor Wire Opening, 2002 Series

0.25 ... 2.5 (4) mm² ① | AWG 22 ... 12
 500 V/6 kV/3 ②
 I_N 18 A
 Terminal block width 5.2 mm / 0.205 in.
 ③ 10 ... 12 mm / 0.43 in. ③

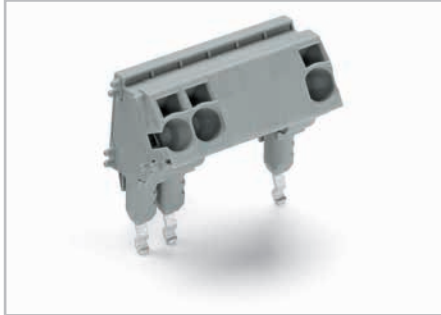

TOPJOB® S L-type test plug assembly consisting of: L-test plug modules and spacer modules

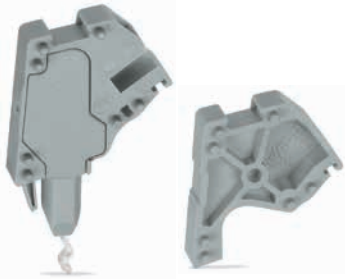

- ① Conductor sizes: 0.25 mm² ... 4 mm² "s + fst"; Push-in conductor sizes: 0.75 mm² ... 4 mm² "s" and 0.75 mm² ... 2.5 mm² "insulated ferrule, 12 mm"
- ② 500 V = rated voltage
 6 kV = rated surge voltage
 3 = pollution degree
 (see Full Line Catalog, Volume 1, Section 14)
- ③ Strip length, see packaging or instructions.

Item No.	Pack. Unit
TOPJOB® S L-test plug module , can be snapped together, gray	
According to EN 61984, connectors without current interrupting capacity shall not be mated and unmated when live or under load.	
○ 1-pole 2002-611	100 (4x25)
TOPJOB® S L-type spacer module , can be snapped together, e.g., for bridging commoned terminal blocks	
○ gray 2002-649	100 (4x25)



L-type test plug modules fitted in a triple-deck terminal block



Accessories L-Type Test Plug Modules

Appropriate marking systems:
 WMB/Marking strips/WMB Inline

End plate , for modular TOPJOB® S test plugs, 1.5 mm thick	
gray 2002-641	100 (4x25)
Test plug , with 500 mm cable, 2 mm Ø	
red 210-136	50
Test plug , with 500 mm cable, 2.3 mm Ø	
yellow 210-137	50
Strain relief plate , gray	
35 mm width 734-326	100 (4x25)
6 mm wide 734-327	100 (4x25)
12.5 mm width 734-328	100 (4x25)
25 mm wide 734-329	100 (4x25)

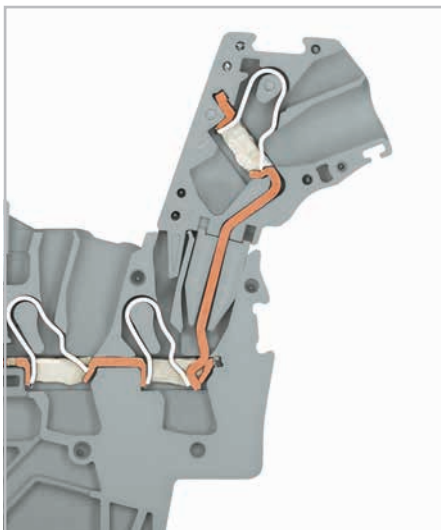

L-type test plug module, cross-sectional view of contact

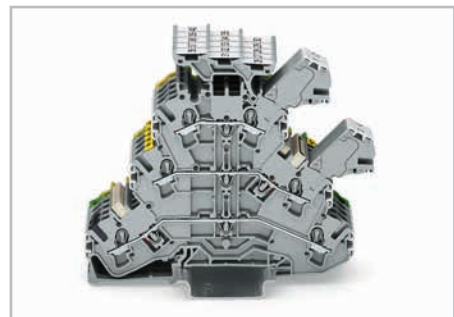

WMB Inline , plain, stretchable 5 ... 5.2 mm, 1,500 WMB markers, 5 mm, on roll white 2009-115		1
WMB Multi marking system , 10 strips with 10 markers per card, stretchable 5 ... 5.2 mm plain 793-5501		5

TOPJOB® S

Adjacent Jumpers for Continuous Commoning and Colored Push-In Type Jumper Bars, 2002 Series

Adjacent jumper for continuous commoning	Push-in type jumper bar	Push-in type jumper bar
--	-------------------------	-------------------------



Item No.	Pack. Unit	Item No.	Pack. Unit	Item No.	Pack. Unit
Adjacent jumper for continuous commoning, insulated,		Push-in type jumper bar, insulated,		Push-in type jumper bar, insulated,	
I _N 25 A, light gray		I _N 25 A,		I _N 25 A,	
○ 2-way		red		blue	
2002-400	100 (4x25)	● 2-way	2002-402/000-005	● 2-way	2002-402/000-006
		● 3-way	2002-403/000-005	● 3-way	2002-403/000-006
		● 4-way	2002-404/000-005	● 4-way	2002-404/000-006
			200 (8x25)		200 (8x25)
		● 5-way	2002-405/000-005	● 5-way	2002-405/000-006
		● 6-way	2002-406/000-005	● 6-way	2002-406/000-006
		● 7-way	2002-407/000-005	● 7-way	2002-407/000-006
		● 8-way	2002-408/000-005	● 8-way	2002-408/000-006
		● 9-way	2002-409/000-005	● 9-way	2002-409/000-006
		● 10-way	2002-410/000-005	● 10-way	2002-410/000-006
			100 (4x25)		100 (4x25)
		Push-in type jumper bar, insulated,		Push-in type jumper bar, insulated,	
		I _N 14 A,		I _N 14 A,	
		red		blue	
		● 2-way	2000-402/000-005	● 2-way	2000-402/000-006
		● 3-way	2000-403/000-005	● 3-way	2000-403/000-006
		● 4-way	2000-404/000-005	● 4-way	2000-404/000-006
			200 (8x25)		200 (8x25)
		● 5-way	2000-405/000-005	● 5-way	2000-405/000-006
		● 6-way	2000-406/000-005	● 6-way	2000-406/000-006
		● 7-way	2000-407/000-005	● 7-way	2000-407/000-006
		● 8-way	2000-408/000-005	● 8-way	2000-408/000-006
		● 9-way	2000-409/000-005	● 9-way	2000-409/000-006
		● 10-way	2000-410/000-005	● 10-way	2000-410/000-006
			100 (4x25)		100 (4x25)

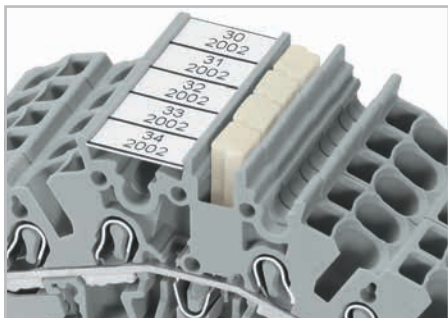

Adjacent jumpers for continuous commoning

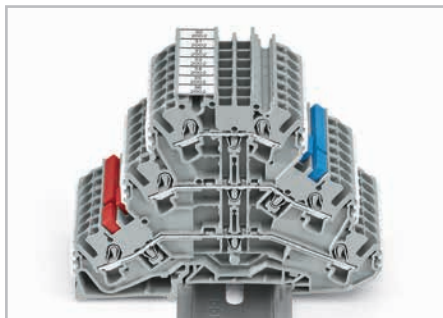

Colored push-in type jumper bars are used with sensor terminal blocks.

TOPJOB[®] S Push-In Type Wire Jumpers

Push-in type wire jumper I_N 9 A Conductor size 0.75 mm²	Push-in type wire jumper I_N 18 A Conductor size 1.5 mm²
--	--



Item No.	Pack. Unit	Item No.	Pack. Unit
Push-in type wire jumper, insulated, conductor cross section 0.75 mm ² , suitable for 2000 and 2020 Series rail-mounted terminal blocks		Push-in type wire jumper, insulated, conductor cross section 1.5 mm ² , suitable for 2001, 2002, 2003 and 2022 Series rail-mounted terminal blocks	
L = 60 mm 2009-402	100 (10x10)	L = 60 mm 2009-412	100 (10x10)
L = 110 mm 2009-404	100 (10x10)	L = 110 mm 2009-414	100 (10x10)
L = 250 mm 2009-406	100 (10x10)	L = 250 mm 2009-416	100 (10x10)

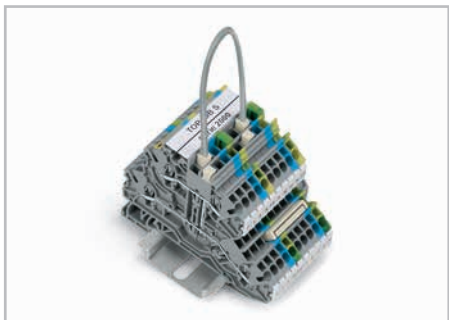

Push down the wire jumper until fully inserted.
Lift the jumper with an operating tool for rewiring.

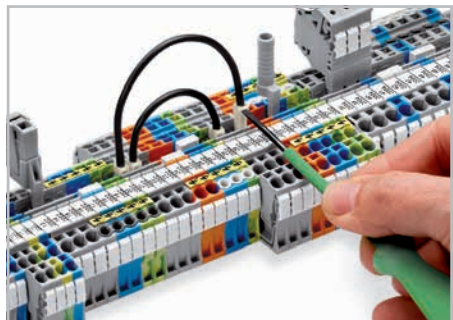

Push down the wire jumper until fully inserted.
Lift the jumper with an operating tool for rewiring.

TOPJOB® S

Star Point Jumpers and Delta Jumpers

Star point jumper 800 V/8 kV/3 $I_N = I_N$ terminal block	Delta jumper 800 V/8 kV/3 $I_N = I_N$ terminal block
--	---



Item No.	Pack. Unit	Item No.	Pack. Unit
Star point jumper, insulated, 1-3-5, light gray		Delta jumper, insulated, 1-2 3-4 5-6, light gray	
<input type="radio"/>	2000-405/011-000	<input type="radio"/>	2000-406/020-000
<input type="radio"/>	2001-405/011-000	<input type="radio"/>	2001-406/020-000
<input type="radio"/>	2002-405/011-000	<input type="radio"/>	2002-406/020-000
<input type="radio"/>	2004-405/011-000	<input type="radio"/>	2004-406/020-000
	100 (4x25)		100 (4x25)
<input type="radio"/>	2006-405/011-000		
<input type="radio"/>	2010-405/011-000		
<input type="radio"/>	2016-405/011-000		
	50 (2x25)		

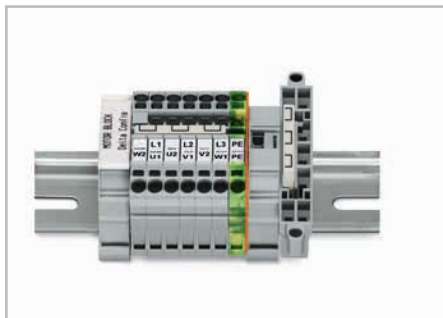
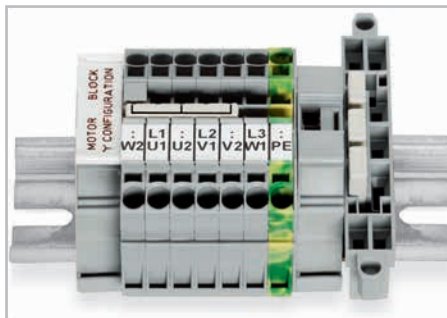

This jumper has been specially developed to create a "star point" and is used on motor terminal boards equipped with TOPJOB® S rail-mount terminal blocks.

This jumper has been specially developed to create a "delta" configuration and is used on motor terminal boards equipped with TOPJOB® S rail-mounted terminal blocks.

TOPJOB® S

Staggered Jumpers

2002 Series

Staggered jumper
400 V/6 kV/3
I_N 25 A

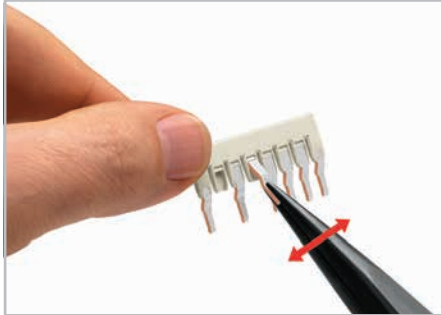

Staggered jumper with 7 contacts
Breaking off contact lugs - Individual jumper contacts can be broken off by bending them. The remaining piece of insulation will meet requirements for clearances and creepage distances.

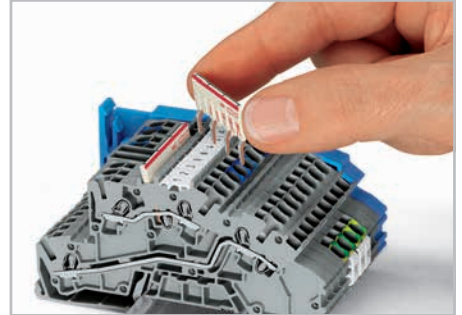

Insert staggered jumper
Push staggered jumper down until fully inserted.

Item No.	Pack. Unit
Staggered jumper, insulated, suitable for 2002, 2003 and 2022 Series rail-mounted terminal blocks, light gray	
○ 2-way	2002-472 100 (4x25)
○ 3-way	2002-473 100 (4x25)
○ 4-way	2002-474 100 (4x25)
○ 5-way	2002-475 50 (2x25)
○ 6-way	2002-476 50 (2x25)
○ 7-way	2002-477 50 (2x25)
○ 8-way	2002-478 50 (2x25)
○ 9-way	2002-479 50 (2x25)
○ 10-way	2002-480 50 (2x25)
○ 11-way	2002-481 50 (2x25)
○ 12-way	2002-482 50 (2x25)

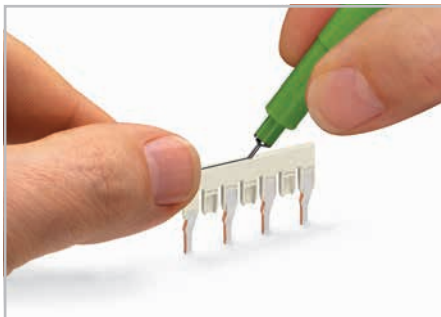

Staggered jumper 1 - 3 - 5 - 7
Marking with a felt-tip pen.

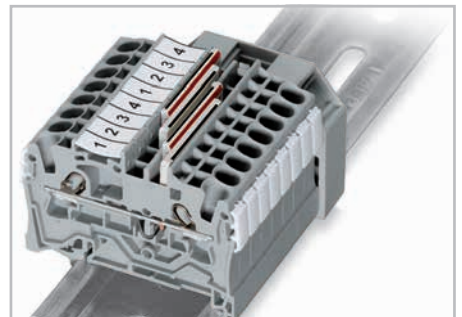

Locate red stripes of the staggered jumpers on the inside

Commoning using staggered jumpers

Individual jumper contacts can be broken off by bending them. The remaining piece of insulation will meet the requirements for clearances and creepage distances. This makes it possible to create custom staggered jumpers, e.g. for bridging over a terminal block with a different potential. When creating the jumpers, ensure only one contact lug is in contact with the terminal block. The contact lugs of the customized staggered jumpers contact the terminal blocks via the gaps created in the second jumper. Insert and press jumper into the jumper slot until it hits the backstop.

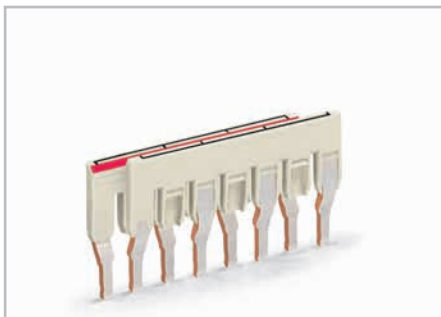

Jumpers staggered in a jumper slot
Custom staggered jumpers can be created, e.g., for bridging over a terminal block with a different potential. Make sure only one contact lug is in contact with the terminal block.

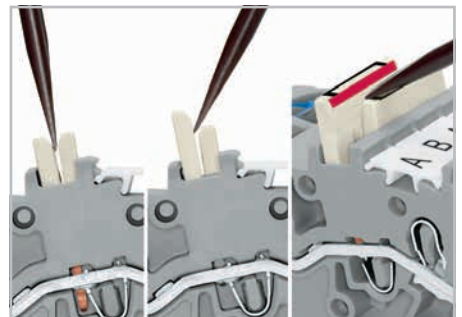

Staggered jumper removal
Insert the operating tool between the jumpers and lift up the jumper.

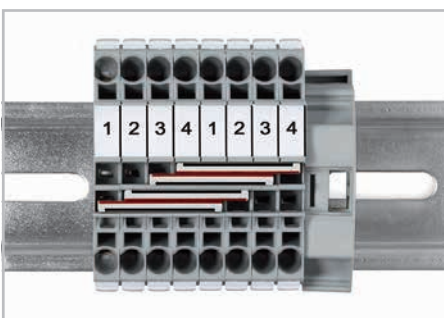

Staggered jumpers for sophisticated circuit requirements.

That way, staggered jumpers are created with contact lugs that will make contact to the terminal block in the gaps of the second jumper. Insert the ready-made jumper assembly into the jumper slot until it hits the stop.

TOPJOB® S

Vertical Jumpers

2000 and 2002 Series

<p>Double-deck vertical jumper 500 V/6 kV/3 I_N 13.5 A</p>	<p>Double-deck vertical jumper 500 V/6 kV/3 I_N 24 A</p>	<p>Triple-deck vertical jumper 500 V/6 kV/3 I_N 24 A</p>
---	---	---



Item No.	Pack. Unit	Item No.	Pack. Unit	Item No.	Pack. Unit
Double-deck vertical jumper, insulated		Double-deck vertical jumper, insulated		Triple-deck vertical jumper, insulated	
○ light gray	2000-492	100 (4x25)	○ light gray	2002-492	100 (4x25)
			● orange	2002-492/000-012	100 (4x25)

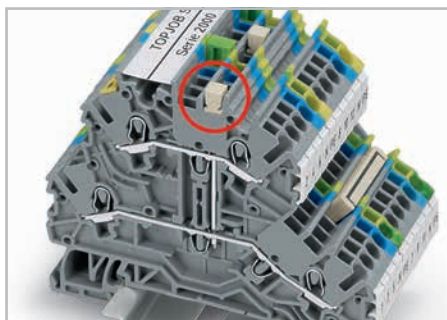

Double-deck vertical jumper (2000-492), inserted.

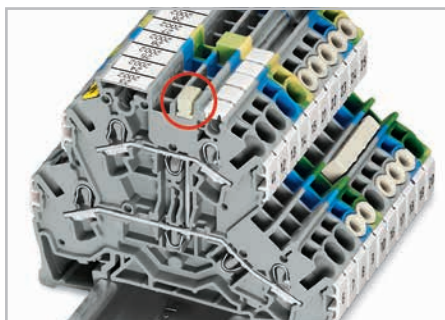

Double-deck vertical jumper (2002-492), inserted.



Triple-deck vertical jumper, inserted.

TOPJOB® S

Disconnect Plugs for Carrier Terminal Blocks

Disconnect plug for carrier terminal blocks 400 V/6 kV/3 I _N 10 A	Disconnect plug for carrier terminal blocks 800 V/8 kV/3 I _N 30 A
--	--



Item No.	Pack. Unit	Item No.	Pack. Unit
Disconnect plug for carrier terminal blocks, suited when using a carrier terminal block as disconnect terminal block		Disconnect plug for carrier terminal blocks, suited when using a carrier terminal block as disconnect terminal block	
orange	2002-401	100 (4x25)	orange
2006-401	100 (4x25)		

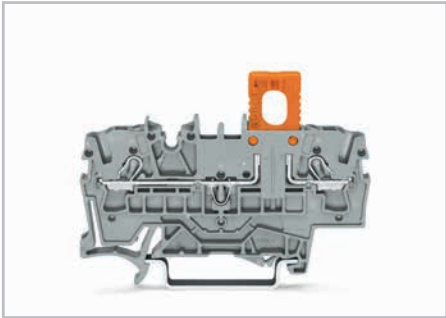

Carrier terminal block with disconnect plug in operating position.

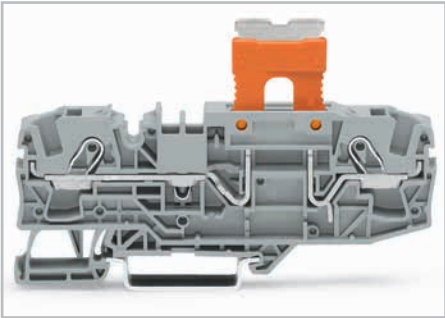

Carrier terminal block with disconnect plug in parked position.

TOPJOB® S Lockout Caps

Lockout cap

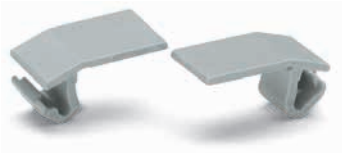

Item No.	Pack. Unit
Lockout cap, for conductor entry hole and operating slot	
<input type="radio"/> gray	2006-191 25

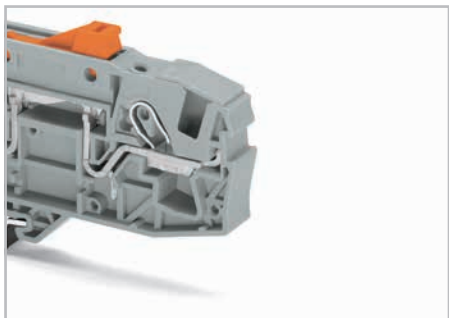

Lockout cap for covering unused clamping units of 2006 Series TOPJOB® S terminal blocks.

OUR POWER TEAM

Terminate Conductors up to 185 mm² (350 kcmil) with Just One Turn

Assembly

- Firmly snap a ground conductor terminal block onto DIN-rail.
- The contact foot is secured, providing the appropriate power grounding connection. Use a 2.3 mm copper carrier rail.

Marking

- WMB markers are suitable for all high-current terminal blocks.
- Marking strips must be applied directly to both 35 mm² (2 AWG) and 185 mm² (350 kcmil) terminal blocks.
- Marking strip adapters are used for 35 ... 95 mm² (2 ... 4/0 AWG) terminal blocks.

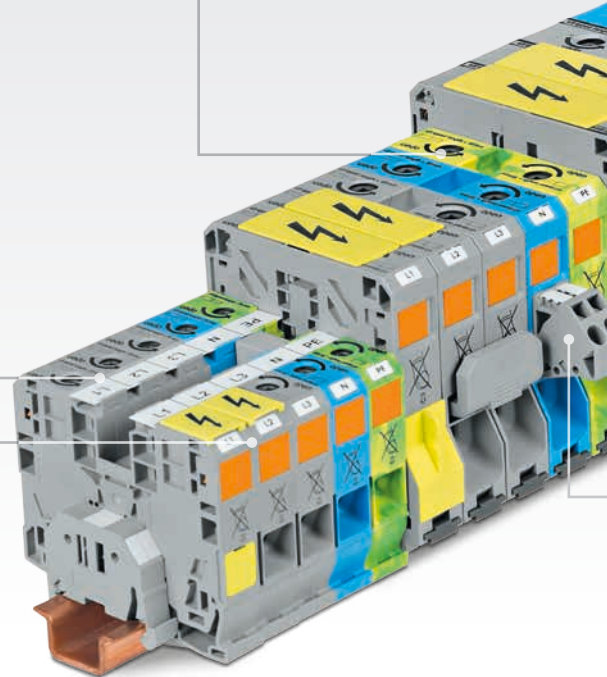

Connection



Rotate the T-wrench or screwdriver counter-clockwise to the stop ①. Next, push in the orange locking tab. The clamp is locked open for hands-free wiring.

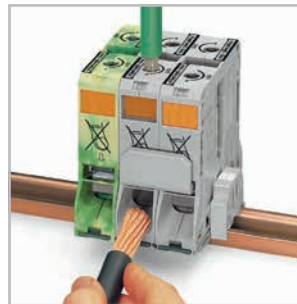

Insert a stripped conductor into the clamping unit until it hits backstop. Hold in this position.



A short counter-clockwise rotation ② releases the tab. When unlocked, the T-wrench rotates clockwise, securely clamping the conductor.



1. Bend conductor
2. Cut conductor to length (Conductor end must be straight!)
3. Strip conductor (Observe strip length printed on terminal block!)

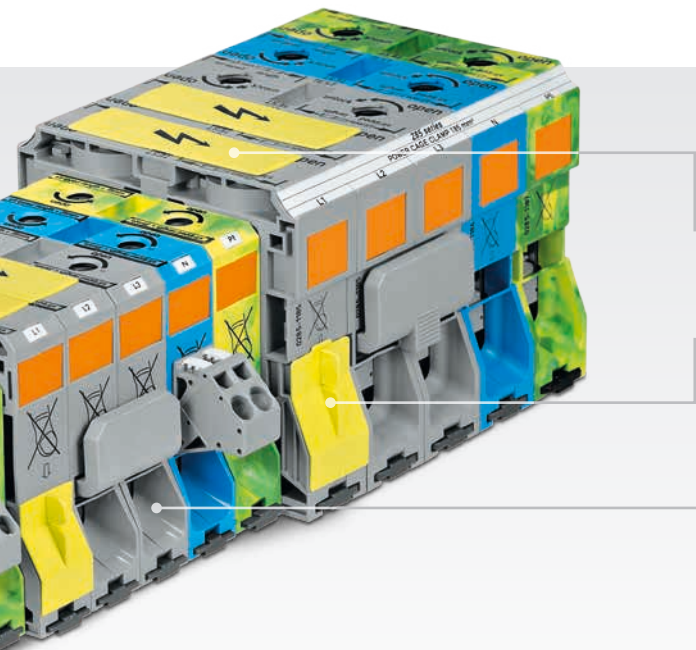

Safety

- **Warning covers** visually indicate high-voltage applications
E.g.,: NOTICE: Power is still on even after switching off the main switch!
- **Yellow, detachable covers** shield the jumper slots and/or unused conductor entries, making them touch-proof.
- **Risk of injury!**
Keep fingers out of the conductor entry hole!

Power Tap (50 ... 185 mm² / 2/0 AWG ... 350 kcmil)

- Power tap provides safe and easy power distribution to additional loads.
- Insert the unwired tap before actuating the spring.
- Also insert the power tap into the jumper slot of 35 mm² (2 AWG) terminal blocks.

Commoning

... for 35 mm² (2 AWG)



Commoning adjacent terminal blocks using a centrally positioned push-in jumper. Use an operating tool to remove the jumper.

... for 50, 95 and 185 mm²
(2/0, 4/0 AWG and 350 kcmil)

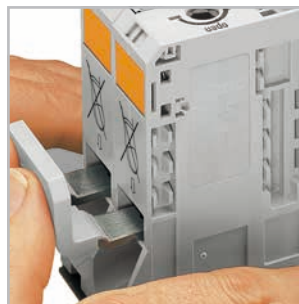

Commoning with an adjacent jumper: Inserting the jumper above the conductor entry hole - prior to conductor termination. The nominal cross-section remains unchanged.

Commoning

... via step-down jumpers with TOPJOB® S

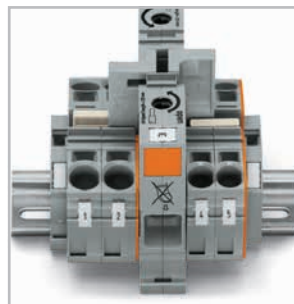

Commoning 35 mm² (2 AWG) high-current terminal blocks with 10/16 mm² (8/6 AWG) TOPJOB® S Terminal Blocks using step-down jumpers.



Testing



Easy troubleshooting via 4 mm Ø touch-proof test plug. A test plug adapter (283-404) is used for 35 mm² (2 AWG) terminal blocks. (Test plugs are not available from WAGO, but are offered by industry suppliers such as Multi-Contact Deutschland GmbH.)



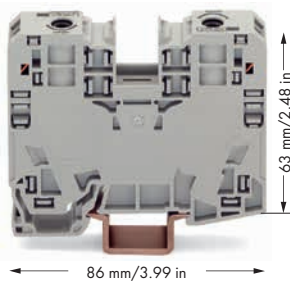

High-Current, Through and Ground Conductor Terminal Blocks 35 mm² 285 Series

POWER
CAGE CLAMP®

6 ... 35 mm² 1000 V/8 kV/3 ① I_N 125 A Terminal block width 16 mm / 0.63 in.  25 mm / 0.98 in. ③	AWG 10 ... 2 600 V, 115 A^② 600 V, 115 A^③	0.2 ... 6 mm² 800 V/8 kV/3 ② I_N 32 A Module width 8 mm / 0.315 in.  12 ... 13 mm / 0.49 in. ③	AWG 24 ... 10 600 V, 30 A^② 600 V, 32 A^③
--	---	---	--



- ① 1000 V = rated voltage
8 kV = rated surge voltage
3 = pollution degree
(see Full Line Catalog, Volume 1, Section 14)
- ② 800 V = rated voltage
8 kV = rated surge voltage
3 = pollution degree
(see Full Line Catalog, Volume 1, Section 14)
- ③ Strip length, see packaging or instructions.
- ④ See application notes for:
Step-down jumper, page 171

Item No.	Pack. Unit	Item No.	Pack. Unit
2-conductor through terminal block , to be used exclusively on DIN 35 x 15 rail		Voltage tap , for 35 mm ² high-current terminal blocks	
 gray	285-135 15	 gray	285-427 5
 blue	285-134 15		
2-conductor ground terminal block , to be used exclusively on DIN 35 x 15 rail; 2.3 mm thick			
 green-yellow	285-137 15		
Item-Specific Accessories		Item-Specific Accessories	
 Adjacent jumper , insulated, I _N 85 A	gray 285-435 50 (2x25)	 Strain relief plate , gray	1-pole 769-410 100 (4x25)
 Step-down jumper , insulated, I _N 90 A	gray 285-430 50 (2x25)	 Test plug , with 500 mm cable, 2 mm Ø	red 210-136 50
 Protective warning marker , with high-voltage symbol, black	yellow 285-420 100 (4x25)	WMB Multi marking system , 10 strips with 10 markers per card, for terminal widths 5 ... 17.5 mm	
 Finger guard , touchproof cover protects unused conductor entries	yellow 285-421 100 (4x25)	 plain	793-501 5
 Test plug adapter , 11.6 mm wide, for 1.5 ... 16 mm ² terminal blocks, for 4 mm Ø test plug	gray 283-404 25	 stretchable 5 ... 5.2 mm	plain 793-5501 5
 Operating tool with partially insulated shaft , type 3, (5.5 x 0.8) mm blade	210-721 1		
 Three-phase set , with 35mm ² high-current terminal blocks	285-139 1		
 Voltage tap , I _N 24 A, with 500 mm cable, for terminal blocks 16 mm ² (283/783 Series) and 35 mm ² (285/785 Series)	gray 283-407 25		
 Marking strip , plain, 11 mm wide, 50 m roll	white 2009-110 1		
 Copper carrier rail , acc. to EN 60715, 35 x 15 mm, 2.3 mm, 2 m/6'6" long	unslotted 210-198 10		



Always push voltage tap (283-407) down into the terminal block until fully inserted!

High-Current, Through and Ground Conductor Terminal Blocks 50 (70 "f-st") mm² 285 Series

POWER CAGE CLAMP®

10 ... 50 (70 "f-st") mm ² 1000 V/8 kV/3 ① I _N 150 A	AWG 8 ... 1/0 600 V, 150 A ② 600 V, 150 A ③	0.2 ... 6 mm ² 1000 V/8 kV/3 ① I _N 41 A	AWG 24 ... 10 600 V, 30 A ② 600 V, 41 A ③
Terminal block width 20 mm / 0.787 in. 30 mm / 1.18 in. ②		Module width 16 mm / 0.63 in. 12 ... 13 mm / 0.49 in. ②	

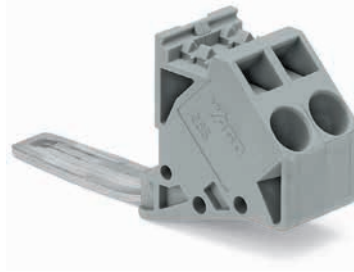
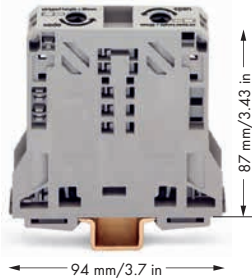

- ① 1000 V = rated voltage
8 kV = rated surge voltage
3 = pollution degree
(see Full Line Catalog, Volume 1, Section 14)
- ② Strip length, see packaging or instructions.
- ③ Jumper can only be removed or inserted when the clamp is in closed position.

Item No.	Pack. Unit	Item No.	Pack. Unit
2-conductor through terminal block , to be used exclusively on DIN 35 x 15 rail		Voltage tap , for 50 mm ² high-current terminal blocks	
gray 285-150	5	gray 285-447	5
blue 285-154	5		
2-conductor ground terminal block , to be used exclusively on DIN 35 x 15 rail; 2.3 mm thick, copper			
green-yellow 285-157	5		
Item-Specific Accessories		Item-Specific Accessories	
Adjacent jumper , insulated, ③ I _N 150 A for 1 jumper, I _N 130 A for 2 ... 4 jumpers		Protective warning marker , with high-voltage symbol, black, for 5 terminal blocks	
gray 285-450	100 (4x25)	yellow 282-415	50 (2x25)
Protective warning marker , with high-voltage symbol, black		WMB Multi marking system , 10 strips with 10 markers per card, for terminal widths 5 ... 17.5 mm	
yellow 285-440	50 (2x25)	plain 793-501	5
Finger guard , touchproof cover protects unused conductor entries and jumper slots		WMB Multi marking system , 10 strips with 10 markers per card, stretchable 5 ... 5.2 mm	
yellow 285-441	100 (4x25)	plain 793-5501	5
Allen wrench with partially insulated shaft			
	285-172	1	
Three-phase set , with 50 mm ² high-current terminal blocks			
	285-159	1	
WMB Multi marking system , 10 strips with 10 markers per card, for terminal widths 5 ... 17.5 mm			
	793-501	5	
WMB Multi marking system , 10 strips with 10 markers per card, stretchable 5 ... 5.2 mm			
	793-5501	5	
Marking strip , plain, 11 mm wide, 50 m roll			
	2009-110	1	
Marker carrier , for POWER CAGE CLAMP 35/50/95 mm ² , 10.4 mm wide			
	285-442	25	
Copper carrier rail , acc. to EN 60715, 35 x 15 mm, 2.3 mm, 2 m/6'6" long			
	210-198	10	

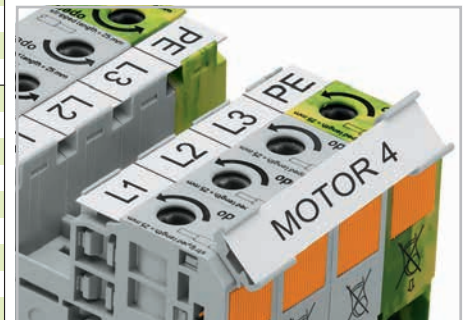

Adapter for marking strips or 2 x WMB

High-Current Through/Ground Conductor and Ex Terminal Blocks

95 mm²

285 Series

**POWER
CAGE CLAMP®**

25 ... 95 mm ² 1000 V/8 kV/3 ② I _N 232 A	AWG 4 ... 4/0 600 V, 200 A ④ 600 V, 210 A ④	0.2 ... 10 (16) mm ² ① 1000 V/8 kV/3 ② I _N 57 A	AWG 24 ... 8 600 V, 50 A ④
Terminal block width 25 mm / 0.984 in. 35 mm / 1.38 in. ③		Module width 20 mm / 0.787 in. 12 ... 13 mm / 0.49 in. ③	

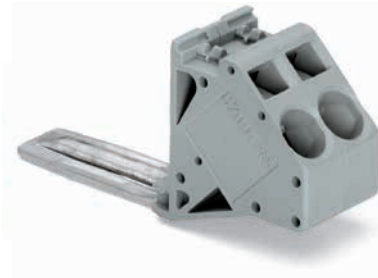
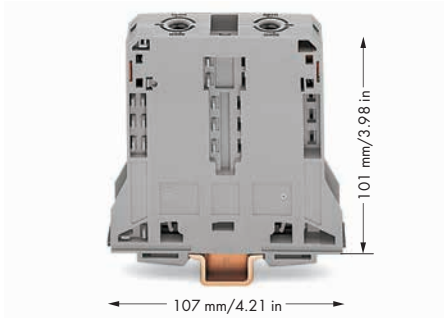

- ① Max. connector size: 16 mm²
- ② 1000 V = rated voltage
8 kV = rated surge voltage
3 = pollution degree
(see Full Line Catalog, Volume 1, Section 14)
- ③ Strip length, see packaging or instructions.
- ④ Suitable for Ex e II applications
25 ... 95 mm²/AWG 4 ... 4/0
880 V, 211 A
1 jumper 211 A
2 ... 4 jumpers 175 A
35 ... 70 mm²/AWG 2 ... 2/0
for ground conductor terminal blocks
(see Full Line Catalog, Volume 1, Section 14)

Item No.	Pack. Unit	Item No.	Pack. Unit		
2-conductor through terminal block, to be used exclusively on DIN 35 x 15 rail		Voltage tap, for 95 mm ² high-current terminal blocks			
● gray	285-195	5	● gray	285-407	5
● blue	285-194	5			
● light gray ④	285-995	5			
2-conductor ground terminal block, to be used exclusively on DIN 35 x 15 rail; 2.3 mm thick, copper					
● green-yellow	285-197	5			
● green-yellow ④	285-197/999-950	5			
Item-Specific Accessories		Item-Specific Accessories			
Adjacent jumper, insulated, I _N 232 A for 1 jumper, I _N 130 A for 2 ... 4 jumpers		Protective warning marker, with high-voltage symbol, black, for 5 terminal blocks			
● gray	285-495	25	● yellow	284-415	50 (2x25)
Protective warning marker, with high-voltage symbol, black		WMB Multi marking system, 10 strips with 10 markers per card, for terminal widths 5 ... 17.5 mm			
● yellow	285-170	50 (2x25)	● plain	793-501	5
Finger guard, touchproof cover protects unused conductor entries and jumper slots		WMB Multi marking system, 10 strips with 10 markers per card, stretchable 5 ... 5.2 mm			
● yellow	285-169	25	● plain	793-5501	5
Allen wrench with partially insulated shaft					
● green	285-172	1			
Three-phase set, with 95 mm ² high-current terminal blocks					
● blue	285-199	1			
Steel carrier rail, acc. to EN 60715, 35 x 15 mm, 2.3 mm, 2 m/6'6" long					
● unslotted	210-118	10			
Copper carrier rail, acc. to EN 60715, 35 x 15 mm, 2.3 mm, 2 m/6'6" long					
● unslotted	210-198	10			
WMB Multi marking system, 10 strips with 10 markers per card, for terminal widths 5 ... 17.5 mm					
● plain	793-501	5			
Marker carrier, for POWER CAGE CLAMP 35/50/95 mm ² , 10.4 mm wide					
● gray	285-442	25			

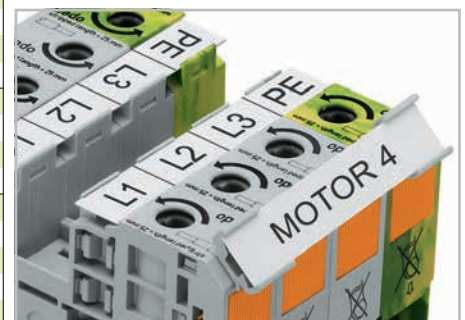

Adapter for marking strips or 2 x WMB

High-Current Through and Ground Conductor Terminal Blocks

185 mm² 285 Series

**POWER
CAGE CLAMP®**

50 ... 185 mm ² 1000 V AC/DC/1500 VDC/12 kV/3 ① I _N 353 A Terminal block width 32 mm / 1.26 in. 45 ... 47 mm / 1.77 ... 1.85 in. ②	AWG 1/0 ... 350 kcmil	50 ... 120 mm ² Terminal block width 32 mm / 1.26 in. 45 ... 47 mm / 1.77 ... 1.85 in. ②	AWG 1/0 ... 250 kcmil
--	-----------------------	---	-----------------------

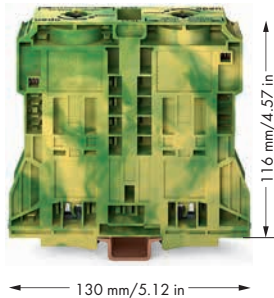
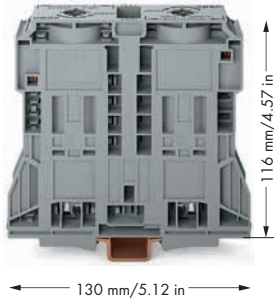

- ① AC/DC up to 1000 V = rated voltage
DC up to 1500 V
12 kV = rated surge voltage
3 = pollution degree
(see Full Line Catalog, Volume 1, Section 14)
- ② Strip length, see packaging or instructions.

Item No.	Pack. Unit	Item No.	Pack. Unit
2-conductor through terminal block, to be used exclusively on DIN 35 x 15 rail		2-conductor ground terminal block, to be used exclusively on DIN 35 x 15 rail; 2.3 mm thick, copper	
gray 285-1185	5	green-yellow 285-1187	5
blue 285-1184	5		
Item-Specific Accessories		Item-Specific Accessories	
Steel carrier rail, acc. to EN 60715, 35 x 15 mm, 2.3 mm, 2 m/6'6" long unslotted 210-118 10		Copper carrier rail, acc. to EN 60715, 35 x 15 mm, 2.3 mm, 2 m/6'6" long unslotted 210-198 10	
Copper carrier rail, acc. to EN 60715, 35 x 15 mm, 2.3 mm, 2 m/6'6" long unslotted 210-198 10			
Accessories Appropriate marking systems: WMB/WMB Inline/Marking strips			
Adjacent jumper, insulated, I _N 309 A for 1 jumper gray 285-1171 25		WMB Inline, plain, stretchable 5 ... 5.2 mm, 1,500 WMB markers, 5 mm, on roll white 2009-115 1	
Protective warning marker, with high-voltage symbol, black yellow 285-1177 50 (2x25)		Marking strip, plain, 11 mm wide, 50 m roll white 2009-110 1	
Finger guard, touchproof cover protects unused conductor entries and jumper slots yellow 285-1178 25		WMB Multi marking system, 10 strips with 10 markers per card, for terminal widths 5 ... 17.5 mm plain 793-501 5	
Allen wrench with partially insulated shaft 285-172 1		WMB Multi marking system, 10 strips with 10 markers per card, stretchable 5 ... 5.2 mm plain 793-501 5	
Three-phase set, with 35mm ² high-current terminal blocks 285-1169 1			
Screwless end stop, for DIN 35 rail, 14 mm wide gray 249-197 10			

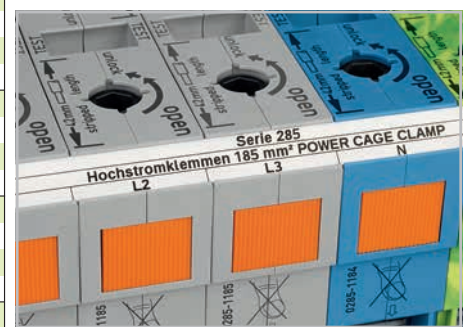

Besides WMB markers, marking strips can also be directly accommodated on the 185 mm² (350 MCM) terminal block.

smartPRINTER

Fast – Clear – Cost-Effective

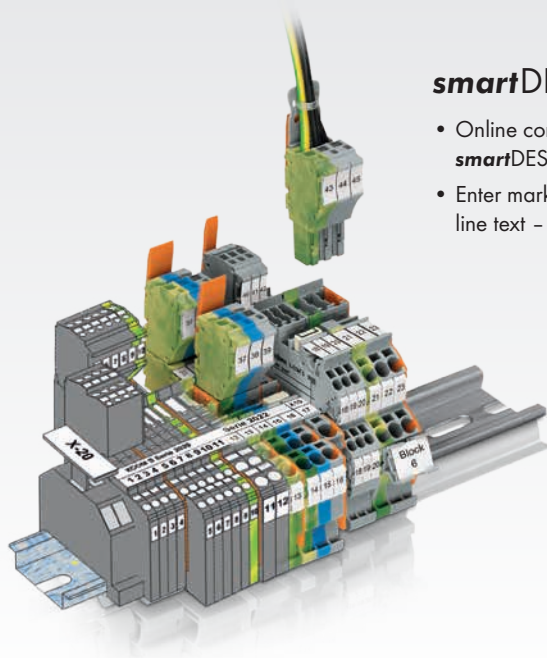

smartDESIGNER

- Online configuration via **smartDESIGNER**
- Enter marking data – including multi-line text – and print

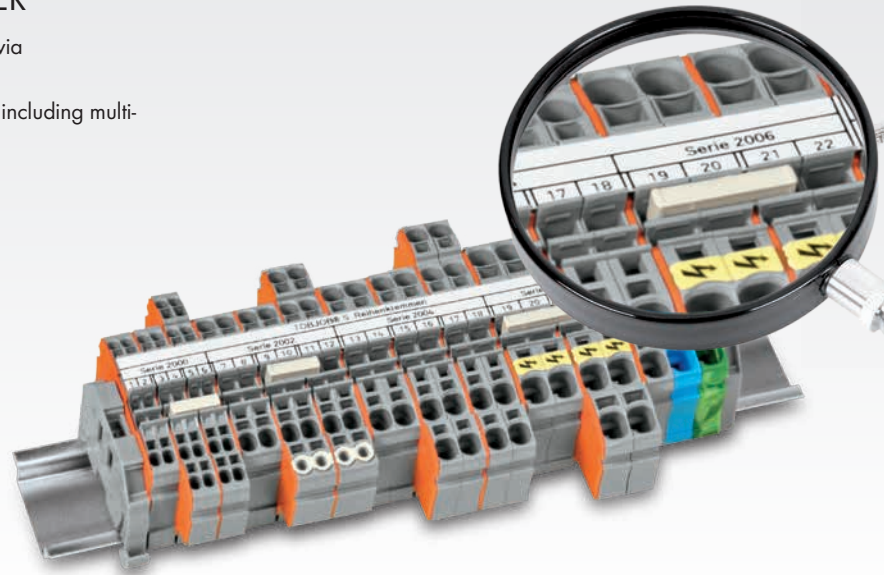

Marking Strips



- Fast printing
- Quick and easy mounting
- Suitable for all TOPJOB® S, POWER CAGE CLAMP Rail-Mounted Terminal Blocks and more

WMB Inline Markers



- Custom printing
- Snapping marker strips
- For rail-mounted terminal blocks



smartPRINTER

- Compact and easy-to-use
- Quickly print and install marking strips
- Cost-effective marking from beginning to end

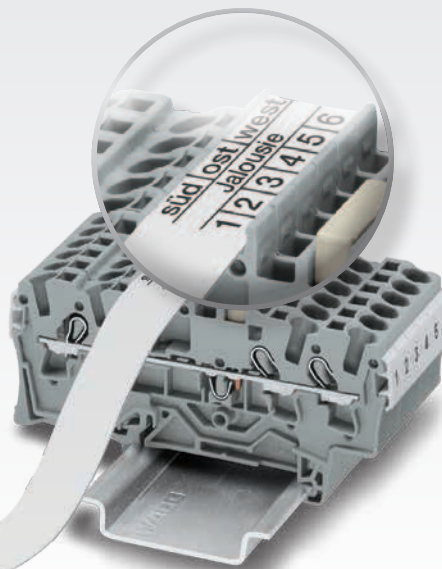

Three-Line Printing

- Provides clear labeling
- Immediately identify which function corresponds with each terminal block

Type Plates



Wire Markers



Push-Button Markers



TOPJOB® S WMB Inline, Mini-WSB Inline and Marking Strips

WMB Inline	Mini-WSB Inline	Marking strip
------------	-----------------	---------------



Similar to picture

Item No.	Pack. Unit	Item No.	Pack. Unit	Item No.	Pack. Unit
WMB Inline, plain, stretchable 5 ... 5.2 mm, 1,500 WMB markers, 5 mm, on roll ○ white 2009-115	1	Mini-WSB Inline, plain, stretchable 5 ... 5.2 mm, 1,700 WMB markers, 5 mm, on roll ○ white 2009-145	1	Marking strip, plain, 11 mm wide, white ○ 50 m roll 2009-110	1
WMB Inline, plain, stretchable 4 ... 4.2 mm, 2,000 WMB markers, 4 mm, on roll ○ white 2009-114	1				

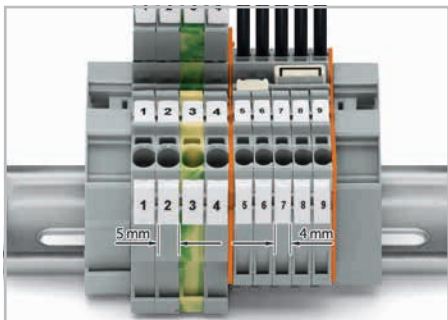

WMB Inline
2009-115 markers for 5 ... 5.2 mm wide terminal blocks compared to 2009-114 markers for 4 ... 4.2 mm wide terminal blocks



WMB Inline
WMB markers on roll

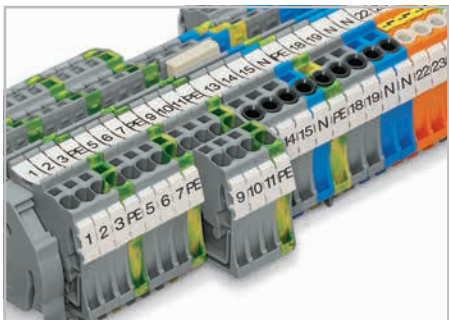

Marker strips for center marking

TOPJOB® S

Group Marker Carriers and Marker Carriers

Group marker carrier	Marker carrier
----------------------	----------------

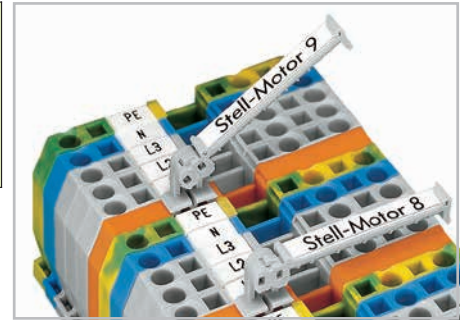

This pivoting group marker carrier has been developed for group marking of rail-mount terminal blocks to satisfy several customer requirements:

- Can be used in all multiprofile marker slots for rail-mount terminal blocks from 5 mm on or in spacer housings as shown above.
- Improves marking visibility due to difficult mounting conditions by pivoting into one of seven stable positions.

Item No.	Pack. Unit	Item No.	Pack. Unit
TOPJOB® S group marker carrier, snap-on type for jumper slot, gray		Marker carrier, for jumper slots 2002 Series, 5 mm wide	
○ 5 mm wide 2009-191	50 (2x25)	○ gray 2002-161	100 (4x25)
○ 10 mm wide 2009-192	50 (2x25)		
○ 15 mm wide 2009-193	50 (2x25)		
TOPJOB® S group marker carrier, snap-on type for jumper slot, gray			
○ 10 mm wide 2009-196	50 (2x25)		

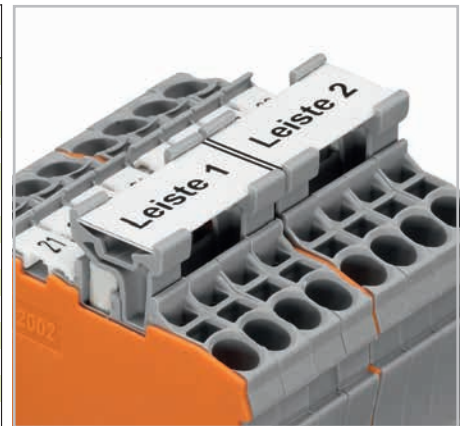

Marking strip carriers
for use in jumper slots

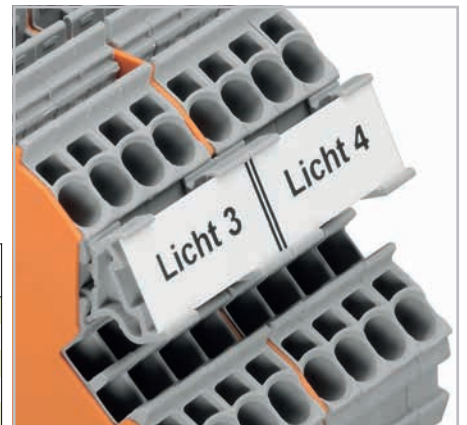
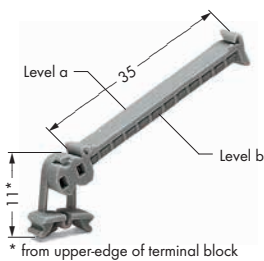





Marking strip carriers
for use in lateral marker slots

Item No.	Pack. Unit	Item No.	Pack. Unit
Pivoting group marker carrier		Marker carrier, for lateral marker receptacle, 5 mm wide	
○ gray 249-105	50 (2x25)	○ gray 2009-198	200 (8x25)
Marker card, 4 x 30 markers per sheet			
○ white 209-183	1		
Protection cover			
transparent 209-184	50		

Thermal Transfer Printer

smartPRINTER



Description	Item No.	Pack. Unit
smartPRINTER		
includes:		
- Power supply unit and cable		
- USB cable		
- 1 x marking strip roll and WMB Inline markers		
- 2 x rollers		
- 1 x roll holder		
- 1 x ink ribbon		
	258-5000	1
Accessories		
Ink ribbon for smartPRINTER		
	258-5005	1
Roller for markingSTRIP		
	258-5006	1
Roller for WMB Inline		
	258-5007	1
Roller for Mini-WSB Inline		
	258-5008	1
Carrying case for smartPRINTER		
light gray, with foam padding for printer		
Dimensions (W x H x D): 50 x 26 x 33 cm		
	258-5015	1

Technical Data	
Printing method	Thermal transfer
Print head	Glass layer, spring-mounted
Print speed	max. 127 mm/s
	(WAGO recommends 50.8 mm/s)
Print width (max.)	47 mm
Print length (max.)	762 mm
Print resolution	300 dpi (12 pixels/mm)
Transmissive/Reflective sensor	yes, centrally fixed
Operating display	Color TFT LCD with navigation button
Memory	8 MB Flash, 16 MB SDRAM
Interfaces	USB, RS-232, ETHERNET 10/100 Mbps
Operating voltage	100 ... 240 VAC, 50 ... 60 Hz
	(automatic adjustment)
Dimensions (W x H x D)	135 x 175 x 245 mm
Weight	2,000 g (without printing material)
Operating temperature	5 °C ... 40 °C (41 °F ... 104 °F)
Storage temperature	-20 °C ... 50 °C (-4 °F ... 122 °F)
Safety approvals	CE (EMC)
Ink ribbon	External roll diameter: 40 mm;
	Internal core diameter: 0.5" (12.7 mm);
	Max. length: 110 m; Max. width: 58 mm

Mounting Accessories

Carrier Rails, Rail End Cap, Angled Support Brackets and Collective Carriers

Carrier rail acc. to EN 60715	Carrier rail acc. to EN 60715	Carrier rail acc. to EN 60715
----------------------------------	----------------------------------	----------------------------------

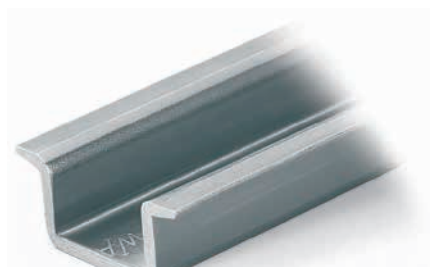
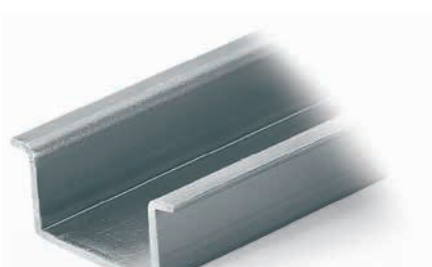

Item No.	Pack. Unit	Item No.	Pack. Unit	Item No.	Pack. Unit
Steel carrier rail, I_N 76 A (reference length of 1m/3'3"), 35 x 7.5 mm, 1 mm, 2 m/6'6" long		Steel carrier rail, I_N 125 A (reference length of 1m/3'3"), 35 x 15 mm, 1.5 mm, 2 m/6'6" long		Steel carrier rail, I_N 125 A (reference length of 1m/3'3"), 35 x 15 mm, 2.3 mm, 2 m/6'6" long	
unslotted	210-113	10	unslotted	210-114	10
Hole width 25 mm; hole spacing 36 mm		slotted		210-112	10 (10x1)
Hole width 18 mm; hole spacing 25 mm		slotted		210-115	1
slotted		slotted		210-197	10

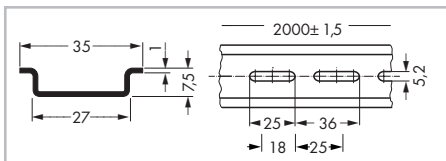

Dimensions in mm

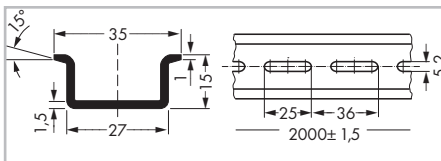

Dimensions in mm

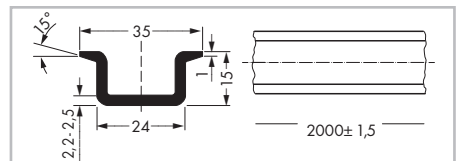

Dimensions in mm



Item No.	Pack. Unit	Item No.	Pack. Unit	Item No.	Pack. Unit
Copper carrier rail, I_N 309 A (reference length of 1m/3'3"), 35 x 15 mm, 2.3 mm, 2 m/6'6" long		Aluminum carrier rail, I_N 76 A (reference length of 1m/3'3"), 35 x 8.2 mm, 1.6 mm, 2 m/6'6" long		Rail end cap, for DIN 35 rail (7.5 mm high)	
unslotted	210-198	10	unslotted	210-196	10
				● gray	209-109
					50 (2x25)

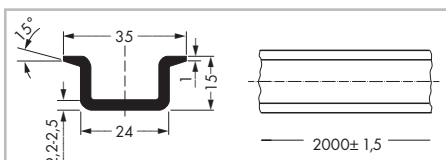

Dimensions in mm

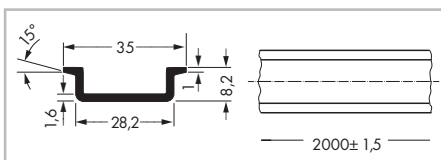

Dimensions in mm

Carrier rail acc. to EN 60715	Angled support bracket	Collective carrier for jumpers
---	-------------------------------	---------------------------------------

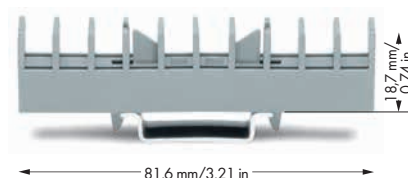

Item No.	Pack. Unit	Item No.	Pack. Unit	Item No.	Pack. Unit
Steel carrier rail, I_N 76 A (reference length of 1 m/3'3"), 35 x 7.5 mm, 1 mm, 2 m/6'6" long		Angled support bracket, without screw		Collective carrier for jumpers, for DIN 35 rail, for jumpers for transverse switching terminal block (282-811) and longitudinal switching disconnect terminal block (282-821)	
unslotted 210-505	1	210-148	10	● gray 282-369	25
slotted 210-504	1	Screw M 5 x 8		The collective carrier can be snapped onto DIN 35 rails. It holds jumpers, e. g., during maintenance.	
		210-149	100 (5x20)		

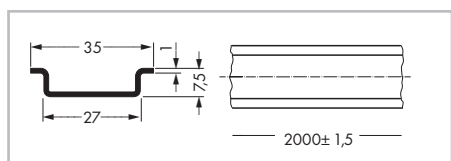

Dimensions in mm

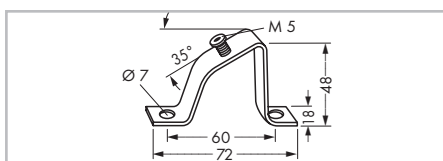

Dimensions in mm

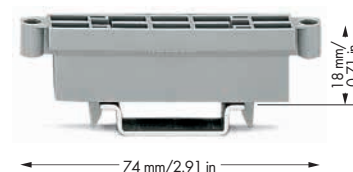
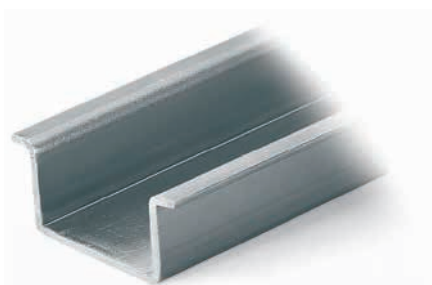

Item No.	Pack. Unit	Item No.	Pack. Unit	Item No.	Pack. Unit
Steel carrier rail, I_N 125 A (reference length of 1 m/3'3"), 35 x 15 mm, 1.5 mm, 2 m/6'6" long				Collective carrier for adjacent jumpers, for DIN 35 rail, for 279, 280, 281, 282 and 284 Series adjacent jumpers, as well as 215 Series banana plugs	
unslotted 210-506	1			● gray 209-100	50 (2x25)
slotted 210-508	1			The collective carrier can be snapped onto DIN 35 rails. It holds adjacent jumpers and banana plugs, e. g., during maintenance.	

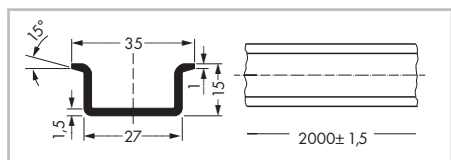

Dimensions in mm

Transparent Covers for Rail-Mounted Terminal Blocks, Usable with Lead Seals – Description and Handling –

Assembly

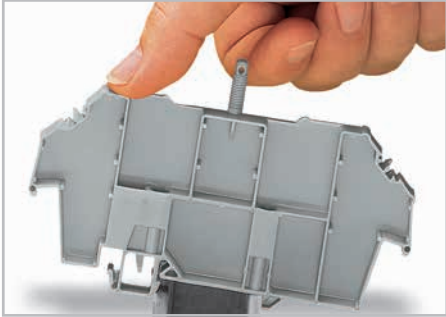

Snapping a cover carrier onto the carrier rail.

Application

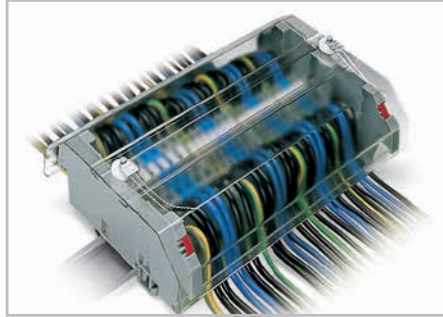

Application examples:
cover (Type 1) without safety warning and lead seals.



Cover with safety warning and lead seals.

Assembly

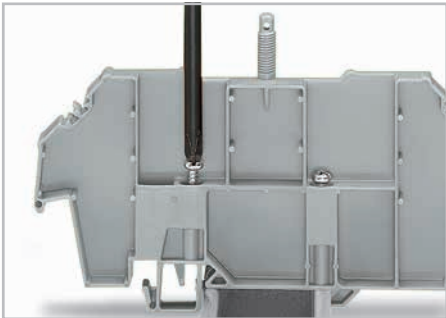

Tightening both securing screw (left) and mounting screw (right).

Assembly

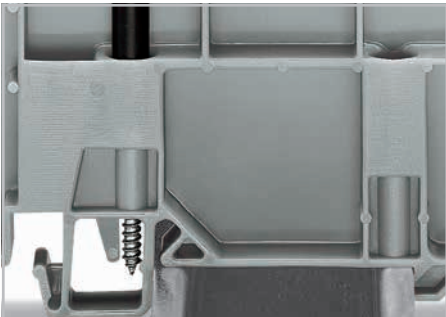

Securing screw – prevents lifting off from rail.
Mounting screw – prevents the cover carrier from being moved on the rail.



Removal

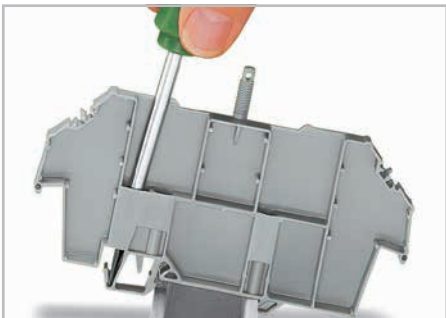

Removing a cover carrier from the carrier rail.

Marking



Inserting a marking strip into the cover.

Lead seal



Cover with lead seals.
Using covers without lead seals, the thread dome-head can be broken off.

Transparent Covers for Rail-Mounted Terminal Blocks, Usable with Lead Seals 709 Series

Cover and cover carrier, type 1

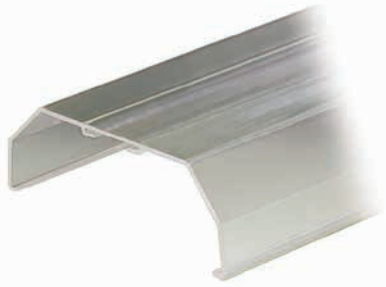

Item No.	Pack. Unit
Cover, type 1, suitable for cover carrier, type 1, 1 m/3'3" long transparent	709-153 10



Item No.	Pack. Unit
Cover carrier, type 1, incl. mounting/securing screws and knurled nut, for 279 ... 282 Series and 880 Series rail-mount terminal blocks, for 264 Series miniature terminal blocks, for 270 Series sensor and acuator blocks	
● gray	709-167 10

Accessories

Marking card with 6 marking strips,

for group marking or safety instructions

plain	709-183	1
-------	----------------	---

Spare mounting/securing screw,

for cover

	209-196	200 (8x25)
---	----------------	------------

Spare knurled nut,

for cover

	210-549	100 (4x25)
---	----------------	------------

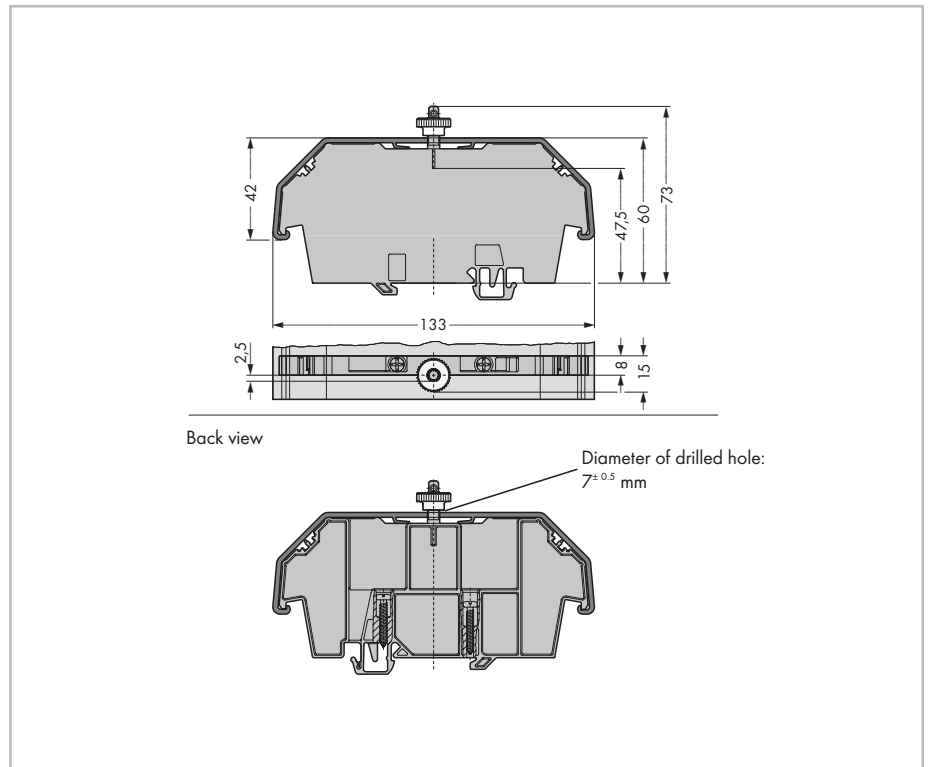

Dimensions in mm

Transparent Covers for Rail-Mounted Terminal Blocks, Usable with Lead Seals 709 Series

Cover and cover carrier, type 2



Item No.	Pack. Unit
Cover, type 2, suitable for cover carrier, type 2, 1 m/3'3" long transparent	709-154 1



Item No.	Pack. Unit
Cover carrier, type 2, incl. mounting/securing screws and knurled nut, for 283 ... 285 Series rail-mount terminal blocks, for 279 ... 281 Series double- and triple-deck blocks, for 780 ... 785, 775, 776 and 777 Series TOPJOB® terminals, for 280 Series sensor and actuator blocks, for 282 Series disconnect terminals for test and measurement for transformer circuits	
● gray	709-168 10

Accessories

Marking card with 6 marking strips,

for group marking or safety instructions



plain **709-183** 1

Spare mounting/securing screw,

for cover



209-196 200 (8x25)

Spare knurled nut,

for cover



210-549 100 (4x25)

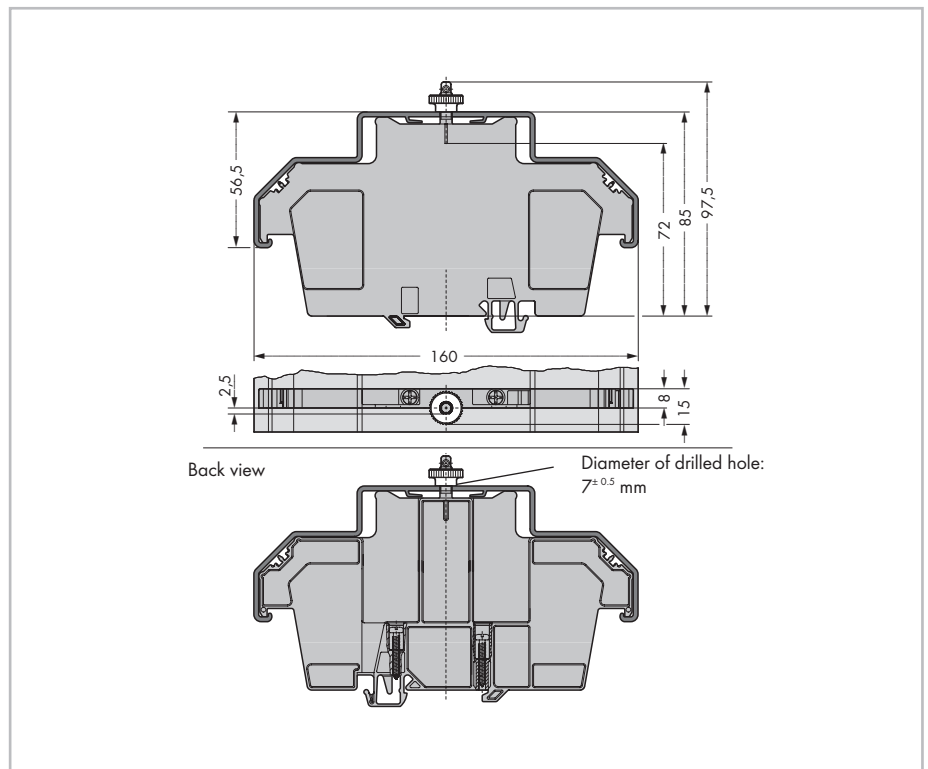

Dimensions in mm

Operating Tools

Operating tool with a partially insulated shaft	Operating tool	Allen wrench with a partially insulated shaft
---	----------------	---



Item No.	Pack. Unit	Item No.	Pack. Unit	Item No.	Pack. Unit
Operating tool with a partially insulated shaft, type 1, (2.5 x 0.4) mm blade, for 279, 726, 727, 2000, 2001 and 2020 Series	1	Operating tool, 3.5 mm and 2.5 mm blade, for TOPJOB® S installation terminal blocks	50	Allen wrench with a partially insulated shaft	1
210-719		2009-309		285-172	
Operating tool with a partially insulated shaft, type 2, (3.5 x 0.5) mm blade, for 260, 261, 262, 264, 270, 280, 281, 290, 775, 776, 777, 769, 780, 781, 869, 870, 880, 2002, 2003, 2004, 2005 and 2022 Series	1	Operating tool, 3.5 mm and 5.5 mm blade, for TOPJOB® S installation terminal blocks	50		
210-720		2009-310			
Operating tool with a partially insulated shaft, type 3, (5.5 x 0.8) mm blade, for 282, 283, 284, 285, 782, 783, 784, 785, 2006, 2010 and 2016 Series	1				
210-721					

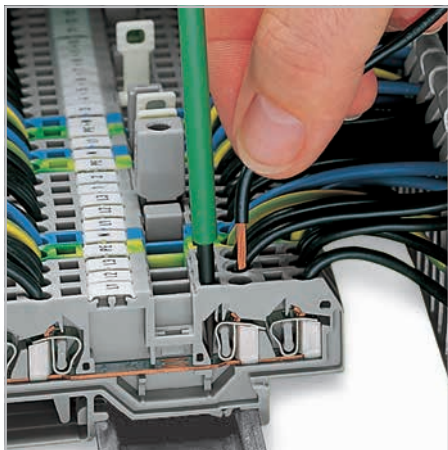

The blade dimensions of the above-listed operating tools with a partially insulated shaft are ideal for easy operation of front-entry terminal blocks.



Open the clamping unit using an operating tool.

Cable Strippers

Cable stripper
for round cables with an outer Ø
from 2.5 mm ... 11 mm

Cable stripper
for round cables with an outer Ø
from 4.5 mm ... 45 mm



Item No.	Pack. Unit	Item No.	Pack. Unit
Cable stripper, for round cables with an outer Ø from 2.5 mm ... 11 mm		Cable stripper, for round cables with an outer Ø from 4.5 mm ... 45 mm	
206-171	1	206-174	1
Item-Specific Accessories		Item-Specific Accessories	
Replacement blade, from 2.5 mm ... 11 mm		Replacement blade, from 4.5 mm ... 45 mm	
	206-170 1		206-173 1



206-171 Cable Stripper

- 10-position adjustment wheel ensures repeatable stripping results
- Fine adjustability via 10-position blade cutting depth adjustment
- Strips the sheath from multi-core and fiber optic cables up to 11 mm diameter
- Safe and easy to use through closed stripping cavity

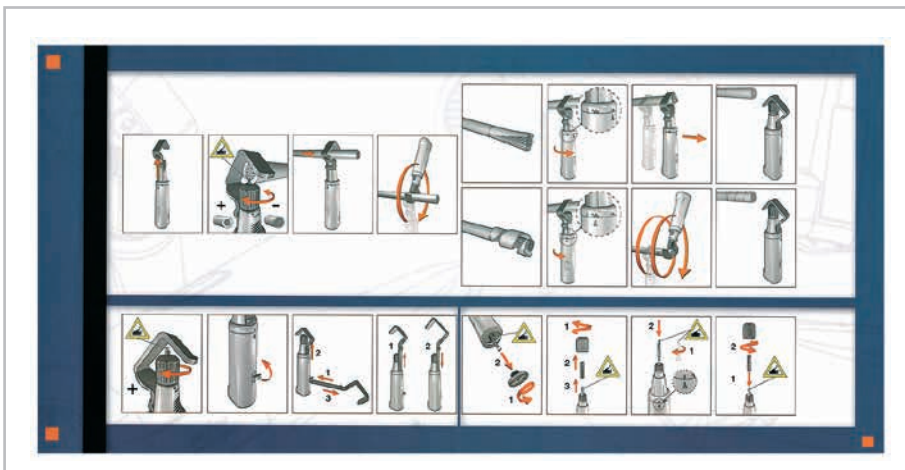

206-174 Cable Stripper



- Safe and easy to use: Three locking positions for circular, longitudinal and spiral cuts
- High cable stripping capacity of up to 40 mm diameter
- Well balanced, ergonomic design features rests for thumb, index and pinky fingers to ease raising of the cable retention hook.
- Spare blades can be stored within the tool body

Operating instructions for 206-171 cable stripper (top) and 206-174 cable stripper (bottom)

Stripping Tools

<p>"Quickstrip 10" wire stripper 0.02 mm² ... 10 mm² "f-st" (6 mm² "s") Cutter for conductors up to 10 mm² "f-st" (1.5 mm² "s")</p>	<p>"Quickstrip 16" wire stripper 4 mm² ... 16 mm² Cutter for conductors up to 10 mm² "f-st" (1.5 mm² "s")</p>	
---	--	--



Item No.	Pack. Unit	Item No.	Pack. Unit
"Quickstrip 10" wire stripper 206-124	1	"Quickstrip 16" wire stripper 206-125	1
Item-Specific Accessories		Item-Specific Accessories	
<p>"Standard" blade cassette, 0.02 mm² ... 10 mm²  206-126</p>	1	<p>"Standard" blade cassette, 4 mm² ... 16 mm²  206-128</p>	1
<p>"V" blade cassette, 0.1 mm² ... 4 mm² for PTFE  206-127</p>	1		



Cutting



Stripping

- Automatically adjusts to conductor size.
- No damage to conductor strands.
- Gripping pressure of jaws automatically adjusts to conductor insulation diameter.
- Clamping jaws and stripping blades automatically open once the stripping process is completed, ensuring no damage to the conductor strands.
- Exact strip length may be set by sliding red setting stop.
- Stripping blades can be replaced.
- Self-sharpening, fully protected cutter, also replaceable.*
- The complete body is made of glass fiber-reinforced polyamide.

* applies for Microstrip

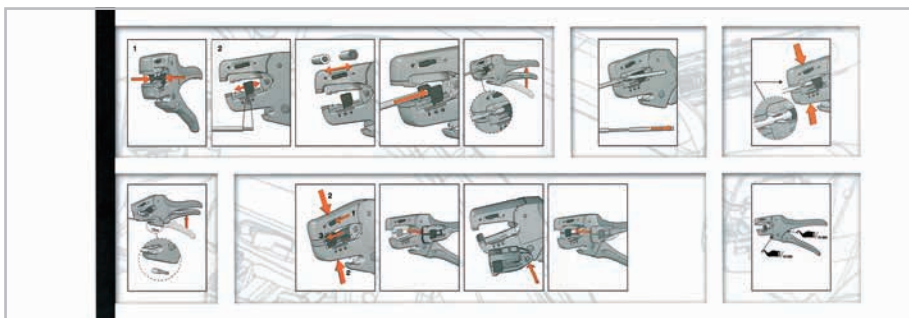

Handling description included

TOPJOB® S

Ferrules for Rail-Mounted Terminal Blocks and Crimping Tools



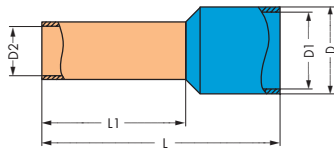





Ferrule, insulated, tin-plated, electrolytic copper, gastight crimped	Variocrimp 4 crimping tool for insulated and uninsulated ferrules 0.25 mm² ... 4 mm²/AWG 24 ... 12	Variocrimp 16 crimping tool for insulated and uninsulated ferrules 6 mm² ... 16 mm²/AWG 10 ... 6
---	--	--



Item No.	Pack. Unit	Item No.	Pack. Unit	Item No.	Pack. Unit
Ferrule, insulated, according to DIN 46228, part 4/09.90		Variocrimp 4 crimping tool, 0.25 mm² ... 4 mm²/AWG 24 ... 12		Variocrimp 16 crimping tool, 6 mm² ... 16 mm²/AWG 10 ... 6	
○ white	216-241	1000	206-204	1	206-216
○ gray	216-242	1000			
○ gray	216-262	1000			
● red	216-243	1000			
● red	216-263	1000			
● black	216-244	1000			
● black	216-264	1000			
● black	216-284	1000			
● blue	216-246	1000			
● blue	216-266	1000			
● blue	216-286	1000			
○ gray	216-267	1000			
○ gray	216-287	500			
● yellow	216-208	100			
● yellow	216-288	500			
● blue	216-289	500			
● blue	216-210	100			

Ferrules

Technical Data

Ferrule, insulated,	Ferrule, insulated,	Ferrule, insulated,
 sleeve for 0.5 mm²/AWG 22, 12 mm strip length, L: 16 mm, L1: 10 mm, D: 3.1 mm, D1: 2.6 mm, D2: 1 mm white 216-241	 sleeve for 1 mm²/AWG 18, 12 mm strip length, L: 16 mm, L1: 10 mm, D: 3.5 mm, D1: 3 mm, D2: 1.4 mm red 216-243	 sleeve for 1.5 mm²/AWG 16, 14 mm strip length, L: 18 mm, L1: 12 mm, D: 4 mm, D1: 3.5 mm, D2: 1.7 mm black 216-264
 sleeve for 0.75 mm²/AWG 20, 12 mm strip length, L: 16 mm, L1: 10 mm, D: 3.3 mm, D1: 2.8 mm, D2: 1.2 mm gray 216-242	 sleeve for 1 mm²/AWG 18, 14 mm strip length, L: 18 mm, L1: 12 mm, D: 3.5 mm, D1: 3 mm, D2: 1.4 mm red 216-263	 sleeve for 1.5 mm²/AWG 16, 20 mm strip length, L: 24 mm, L1: 18 mm, D: 4 mm, D1: 3.5 mm, D2: 1.7 mm black 216-284
 sleeve for 0.75 mm²/AWG 20, 14 mm strip length, L: 18 mm, L1: 12 mm, D: 3.3 mm, D1: 2.8 mm, D2: 1.2 mm gray 216-262	 sleeve for 1.5 mm²/AWG 16, 12 mm strip length, L: 16 mm, L1: 10 mm, D: 4 mm, D1: 3.5 mm, D2: 1.7 mm black 216-244	 sleeve for 2.5 mm²/AWG 14, 12 mm strip length, L: 17 mm, L1: 10 mm, D: 4.7 mm, D1: 4.2 mm, D2: 2.2 mm blue 216-246







Insert ferruled conductor into crimping station.



Squeeze handles until ratchet mechanism is released.

Application notes:

- With "Variocrimp 4," the built-in crimping pressure control automatically adjusts force to the conductor cross section used. With "Variocrimp 16," it is necessary to select the wire gauge on the tool before crimping.
- Only one crimping station is needed to handle the specified conductor size range.
- Uniform compact crimping from all four sides for high conductor retention.
- No need to center the conductor into the ferrule.
- Conductor and ferrule insertion possible from both sides (for left- and right-handers).
- Built-in ratchet mechanism ensures gastight crimp connection.
- Crimping tools open automatically after crimping operation is complete.
- Comfortable handles for operator.

Ferrules	
Technical Data	
Ferrule, insulated,  Sleeve for 2.5 mm ² / AWG 14, 14 mm strip length, L: 19 mm, L1: 12 mm, D: 4.7 mm, D1: 4.2 mm, D2: 2.2 mm blue 216-266	Ferrule, insulated,  Sleeve for 10 mm ² / AWG 8, 20 mm strip length, L: 28 mm, L1: 18 mm, D: 8.4 mm, D1: 7.6 mm, D2: 4.5 mm blue 216-289
Ferrule, insulated,  Sleeve for 2.5 mm ² / AWG 14, 20 mm strip length, L: 25 mm, L1: 18 mm, D: 4.7 mm, D1: 4.2 mm, D2: 2.2 mm blue 216-286	Ferrule, insulated,  Sleeve for 16 mm ² / AWG 6, 23 mm strip length, L: 29 mm, L1: 18 mm, D: 9.6 mm, D1: 8.8 mm, D2: 5.8 mm blue 216-210
Ferrule, insulated,  Sleeve for 4 mm ² / AWG 12, 14 mm strip length, L: 20 mm, L1: 12 mm, D: 5.4 mm, D1: 4.8 mm, D2: 2.8 mm gray 216-267	
Ferrule, insulated,  Sleeve for 4 mm ² / AWG 12, 20 mm strip length, L: 26 mm, L1: 18 mm, D: 5.4 mm, D1: 4.8 mm, D2: 2.8 mm gray 216-287	
Ferrule, insulated,  Sleeve for 6 mm ² / AWG 10, 14 mm strip length, L: 20 mm, L1: 12 mm, D: 6.8 mm, D1: 6.2 mm, D2: 3.5 mm yellow 216-208	
Ferrule, insulated,  Sleeve for 6 mm ² / AWG 10, 20 mm strip length, L: 26 mm, L1: 18 mm, D: 6.9 mm, D1: 6.3 mm, D2: 3.5 mm yellow 216-288	

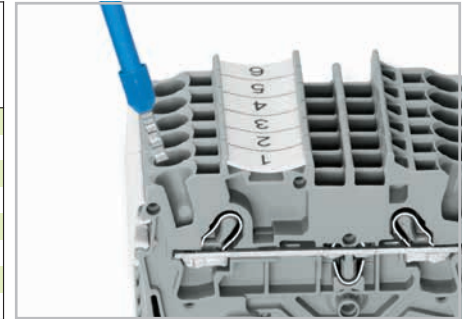

Stranded conductors with ferrules

from at least two sizes below the rated cross section up to the rated cross section can be simply pushed in - without tools.

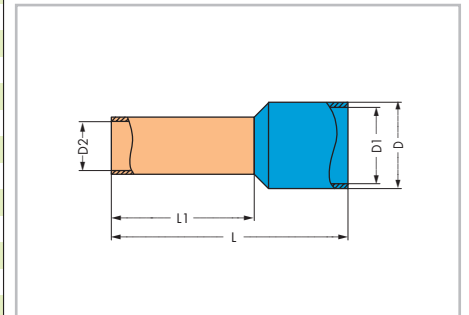

For dimensions of insulated ferrules, see technical data.

Crimping Tools

Crimping tool 25
for insulated and uninsulated ferrules
crimping range: 10 mm²/AWG 8, 16 mm²/
AWG 6 and 25 mm²/AWG 4

Crimping tool 50
for insulated and uninsulated ferrules
crimping range: 35 mm²/AWG 2 and
50 mm²/AWG 1/0

Application notes

- Improved crimping for higher conductor retention
- The crimping can be done from either side (for left- or right-handed users)
- Built-in ratchet mechanism ensures gastight crimp connection
- The crimping tool automatically opens once the crimping process is completed
- Ergonomically designed handles



Item No.	Pack. Unit	Item No.	Pack. Unit
Crimping tool 25, crimping range: 10 mm ² /AWG 8, 16 mm ² /AWG 6 and 25 mm ² /AWG 4		Crimping tool 50, crimping range: 35 mm ² /AWG 2 and 50 mm ² /AWG 1/0	
206-225	1	206-250	1



Insert ferruled conductor into crimping station.



Squeeze handles until ratchet mechanism is released.





What is "gas-tight?"
In a gas-tight connection, the conductor and the ferrule are compressed together, eliminating all spaces. Under normal atmospheric conditions, neither a liquid nor a gaseous medium can penetrate into the crimped connection. Oxidation between crimped single conductors is prevented, ruling out nearly any increase in the crimped connection resistance. In some exceptional cases, minute, isolated spaces may be present. These instances can be considered as closed off due to twisted wires, however. Inadequate crimping can allow the conductor to be pulled out of the connection. Hollow spaces also remain in which oxidation can form and lead to an increase in contact resistance.

Elevated resistance is detrimental for signal transmission, as the signal flow is damped (weakened), and for power transmission, as power loss and, hence a temperature increase due to contact (risk of fire) can result. Crimping tools with built-in ratchets are recommended, such as the WAGO Variocrimp tools. These tools only open after the crimping process has been fully completed. Space-saving crimping from all four sides is ideal for spring clamp termination. Cross section data for ferruled conductors indicated for WAGO products is based on this crimping method.

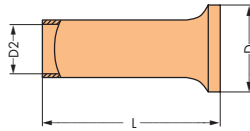
Cable Cutter and Uninsulated Ferrules

Cable cutter	Ferrule, uninsulated, tin plated, electrolytic copper, gastight crimped
--------------	---



Item No.	Pack. Unit	Item No.	Pack. Unit	Ferrules
Cable cutter, cutting Cu and Al conductors up to 35 mm ²		Ferrule, uninsulated		Technical Data
206-118	1	216-413	50	Ferrule, uninsulated,  sleeve for 25 mm ² /AWG 4, 25 mm strip length, L: 25 mm, D: 9.5 mm, D2: 7.3 mm 216-413
		216-414	50	
		216-424	50	
		216-425	50	
		216-435	50	
				Ferrule, uninsulated,  sleeve for 35 mm ² /AWG 2, 25 mm strip length, L: 25 mm, D: 11 mm, D2: 8.3 mm 216-414
				Ferrule, uninsulated,  sleeve for 35 mm ² /AWG 2, 30 mm strip length, L: 30 mm, D: 11 mm, D2: 8.3 mm 216-424
				Ferrule, uninsulated,  sleeve for 50 mm ² /AWG 1, 30 mm strip length, L: 30 mm, D: 13 mm, D2: 10.3 mm 216-425



Cutting a conductor.



A perfect gastight crimp, both electrically and mechanically reliable.

				Ferrule, uninsulated,  sleeve for 50 mm ² /AWG 1, 35 mm strip length, L: 35 mm, D: 13 mm, D2: 10.3 mm 216-435

Test and Measurement Tools

Profi LCD+	Profi LED+
------------	------------

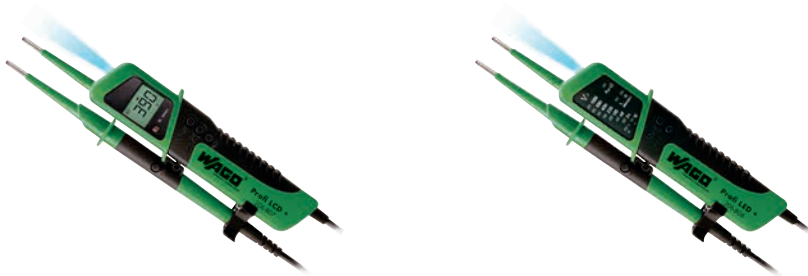

Item No.	Pack. Unit	Item No.	Pack. Unit
Profi LCD+, 2-pole voltage tester with LCD display, removable test probes, 4 mm Ø Measuring range: 6 V ... 1000 V AC/DC Degree of protection: IP65 Resistance measurement: up to 2000 Ω		Profi LED+, 2-pole voltage tester with LED display, removable test probes, 4 mm Ø Measuring range: 6 V ... 1000 V AC/DC Degree of protection: IP65 Resistance measurement: up to 2000 Ω	
206-807	1	206-806	1
Item-Specific Accessories		Item-Specific Accessories	
Spare test probes, 4 mm Ø (2 pieces)		Spare test probes, 4 mm Ø (2 pieces)	
206-808	25	206-808	25

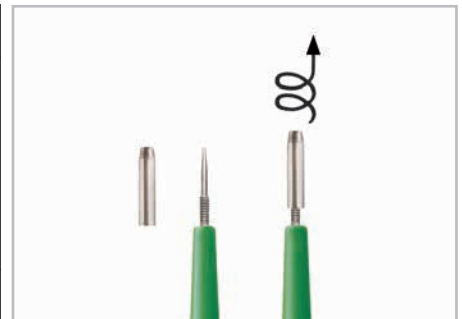

Profi LCD+ and Profi LED+

- Improved socket contact via 4 mm Ø test probes
- Removable test probes for small test ports (suitable for all WAGO terminal blocks)



Additional product features for Profi LCD+:

- Automatic measurement range selection
- Single-pole phase testing AC >100 V
- Two-pole sequence testing (R and L)
- Continuity testing
- FI/RCD testing (30 mA) via buttons
- One-hand operation for SCHUKO and CEE sockets
- LED torch lamp function
- Automatic backlight
- Auto power-Off function
- CAT IV 1000 V
- IEC/EN 61243-3 (DIN VDE 0682-401)



Additional product features for Profi LED+:

- Automatic measurement range selection
- Single-pole phase testing AC >100 V
- Two-pole sequence testing (R and L)
- Continuity testing
- FI/RCD testing (30 mA) via buttons
- One-hand operation for SCHUKO and CEE sockets
- LED torch lamp function
- CAT IV 1000 V
- TÜV/GS tested and approved
- IEC/EN 61243-3 (DIN VDE 0682-401)

Test and Measurement Tools and Testboy

Multi-Tester	Clamp-Multi-Tester	Testboy
--------------	--------------------	---------



Item No.	Pack. Unit	Item No.	Pack. Unit	Item No.	Pack. Unit
Multi-Tester, Digital multimeter with contact-less voltage tester, Includes: carrying case Measuring range: AC/DC 600 V AC/DC 10 A Resistance measurement: up to 20 MΩ		Clamp-Multi-Tester, digital clamp meter DC and AC current up to 600 A - True RMS and min./max. value measurement - DC and AC voltage up to 600 V - Manual or automatic selection of measurement range - Resistance up to 60 MΩ, Capacitance measurement - Acoustical continuity test - Diode test, Data hold function - Large LCD with backlight, LED measuring point lighting - CAT III 600 V overvoltage protection, IEC/EN 61010-1 (DIN VDE 0411) - Including batteries - measurement leads and carrying bag		Testboy, with integrated flashlight Voltage range: 12 ... 1000 V AC	
206-810	1	206-816	1	206-804	1
Item-Specific Accessories					
Replacement test leads, red/black					
 206-811	1				



Additional product features for Multi Tester:

- Contact-less voltage test AC >100 V (optical and acoustical)
- Resistance measurement up to 20 MΩ
- Acoustical continuity test
- Diode test
- Data hold function
- Auto power-off function
- LED torch lamp function
- CAT IV 600 V
- TÜV/GS tested and approved
- IEC/EN 61010-1 (DIN VDE 0411)

Voltage testing in switchgear cabinet



Current measurement in switchgear cabinet

A device that will reliably detect AC voltage in cables, sockets, fuses, switches, outlets, etc.

Testboy can detect the following:

- live conductors
- cable breaks
- blown fuses (in cartridge or holder)
- defective switches
- defective lamps

Item Number Index

Item No.	Page	Item No.	Page	Item No.	Page	Item No.	Page
206 Series		216 Series		285 Series		793 Series	
206-118	193	216-262	190	285-159	173	793-5501	23
206-124	189	216-263	190	285-169	174	793-5501/000-002	25
206-125	189	216-264	190	285-170	174	793-5501/000-005	25
206-126	189	216-266	190	285-172	173	793-5501/000-006	25
206-127	189	216-267	190	285-194	174	793-5501/000-007	25
206-128	189	216-284	190	285-195	174	793-5501/000-012	25
206-170	188	216-286	190	285-197	174	793-5501/000-017	25
206-173	188	216-287	190	285-197/999-950	174	793-5501/000-023	25
206-174	188	216-288	190	285-199	174	793-5501/000-024	25
		216-289	190				
206-204	190			285-407	174		
206-216	190	216-413	193	285-420	172	794 Series	
206-225	192	216-414	193	285-421	172	794-5553/000-002	85
206-250	192	216-424	193	285-427	172	794-5554/000-006	85
		216-425	193	285-430	172		
206-804	195	216-435	193	285-435	172	859 Series	
206-806	194			285-440	173	859-500	110
206-807	194	248 Series		285-441	173		
206-808	194	248-501	158	285-442	173		
206-808	194			285-447	173		
206-810	195	249 Series		285-450	173	2000 Series	
206-811	195	249-105	179	285-495	174	2000-115	18
206-816	195	249-116	21			2000-121	33
		249-117	21	285-1169	175		
209 Series		249-197	175	285-1171	175	2000-402	18
209-100	183			285-1177	175		
209-105	146	258 Series		285-1178	175	2000-410	
209-109	182	258-5000	180	285-1184	175	2000-402/000-005	163
209-170	83	258-5005	180	285-1185	175		
209-183	179	258-5006	180	285-1187	175	2000-410/000-005	
209-184	179	258-5007	180			2000-402/000-006	163
209-190	18	258-5008	180	709 Series			
209-191	18	258-5015	180	709-153	185	2000-410/000-006	
209-192	37			709-154	186	2000-405/011-000	165
209-196	185			709-167	185	2000-406/020-000	165
		281 Series		709-168	186	2000-433	18
210 Series		281-503	88	709-183	185		
210-103	97					2000-440	
210-112	182	282 Series		734 Series		2000-492	33
210-113	182	282-369	183	734-326	116		
210-114	182			734-327	116	2000-1201	18
210-115	182	282-415	173	734-328	116	2000-1202	18
210-118	174	282-432	84	734-329	116	2000-1203	18
210-123	97			734-430	129	2000-1204	18
210-133	146	282-440		734-431	129	2000-1205	18
210-136	18	282-432/100-000	84			2000-1206	18
210-137	18	282-433/100-000	84	769 Series		2000-1207	18
210-148	183	282-434/100-000	84	769-410	172	2000-1291	18
210-149	183	282-435/011-000	84			2000-1292	18
210-196	182	282-436/301-000	84	777 Series			
210-197	182	282-437/011-000	84	777-303	146	2000-1301	18
210-198	172	282-437/012-000	84			2000-1302	18
		282-438/300-000	84	793 Series		2000-1303	18
210-254	84	282-438/301-000	84	793-3501	18	2000-1304	18
210-281	146	282-439/011-000	84			2000-1305	18
						2000-1306	18
210-504	183	282-881	84			2000-1307	18
210-505	183					2000-1391	18
210-506	183	282-888				2000-1392	18
210-508	183						
210-549	185	283 Series				2000-1401	18
		283-404	172			2000-1402	18
210-719	187	283-407	172			2000-1403	18
210-720	187					2000-1404	18
210-721	172	284 Series				2000-1405	18
210-721	187	284-415	174			2000-1406	18
						2000-1407	18
215 Series		285 Series				2000-1491	18
215-111	18	285-134	172			2000-1492	18
		285-135	172				
216 Series		285-137	172			2000-2141	19
216-208	190	285-139	172			2000-2195	19
216-210	190	285-150	173			2000-2196	19
216-241	190	285-154	173			2000-2201	32
216-242	190	285-157	173			2000-2201/099-000	34
216-243	190					2000-2202	32
216-244	190					2000-2202/099-000	34
216-246	190					2000-2203	32
						2000-2203/099-000	34
						2000-2204	32
						2000-2204/099-000	34
						2000-2207	32

Item Number Index

Item No.	Page	Item No.	Page	Item No.	Page	Item No.	Page
2002 Series		2002 Series		2003 Series		2004 Series	
2002-2227	36	2002-2961	55	2003-911/1000-923	150	2004-1392	26
2002-2227/099-000	38	2002-2961	88			2004-1393	26
2002-2228	37	2002-2963	88	2003-6640	148	2004-1394	26
2002-2228/099-000	39	2002-2971	54	2003-6641	148		
2002-2231	36	2002-2972	54	2003-6642	148	2004-1401	26
2002-2231/099-000	38	2002-2974	54	2003-6643	148	2004-1402	26
2002-2232	36	2002-2991	54	2003-6644	148	2004-1403	26
2002-2232/099-000	38	2002-2992	54	2003-6645	148	2004-1404	26
2002-2233	36			2003-6646	148	2004-1405	26
2002-2233/099-000	38	2002-3201	46	2003-6649	148	2004-1406	26
2002-2234	36	2002-3203	46	2003-6650	148	2004-1407	26
2002-2234/099-000	38	2002-3204	46	2003-6651	148	2004-1408	26
2002-2237	36	2002-3207	46	2003-6660	148	2004-1411/1000-400	96
2002-2237/099-000	38	2002-3208	46	2003-6692	149	2004-1411/1000-401	96
2002-2238	36	2002-3209	46	2003-6693	148	2004-1491	26
2002-2238/099-000	38	2002-3211/1000-410	100			2004-1492	26
2002-2239	36	2002-3211/1000-411	100	2003-7300	146	2004-1493	26
2002-2239/099-000	38	2002-3211/1000-675	100			2004-1494	26
2002-2247	36	2002-3211/1000-676	100	2003-7640	146		
2002-2247/099-000	38	2002-3212/1000-673	100	2003-7641	146		
2002-2248	37	2002-3212/1000-674	100	2003-7642	146		
2002-2248/099-000	39	2002-3217	46	2003-7645	146		
2002-2257	36	2002-3218	47	2003-7646	146		
2002-2257/099-000	38	2002-3221/1000-413	100	2003-7649	146	2005 Series	
2002-2258	37	2002-3221/1000-434	100	2003-7650	146	2005-7300	152
2002-2258/099-000	39	2002-3227	46	2003-7651	146		
2002-2291	37	2002-3228	47	2003-7659	146	2005-7641	152
2002-2292	37	2002-3231	46	2003-7692	146	2005-7642	152
		2002-3233	46			2005-7645	152
		2002-3234	46			2005-7646	152
		2002-3237	46	2004 Series		2005-7649	152
		2002-3238	46	2004-115	26	2005-7692	152
		2002-3239	46	2004-171	26		
		2002-3247	46	2004-172	26	2006 Series	
		2002-3248	47			2006-115	28
		2002-3257	46	2004-402	26	2006-191	169
		2002-3258	47			2006-401	168
		2002-3291	47	2004-410		2006-402	28
		2002-3292	47	2004-405/011-000	165		
				2004-406/020-000	165	2006-405	
		2002-4101	48	2004-433	26	2006-405/011-000	165
		2002-4111	48			2006-433	28
		2002-4127	48	2004-440		2006-434	28
		2002-4131	48			2006-435	28
		2002-4141	48	2004-511	160	2006-499	17
		2002-4157	48	2004-541	160		
		2002-4191	48	2004-549	160	2006-511	160
		2002-4192	48	2004-552	160	2006-549	160
				2004-553	160		
		2002-6301	24	2004-554	160	2006-911	90
		2002-6302	24	2004-555	160	2006-911/1000-541	90
		2002-6303	24			2006-911/1000-542	90
		2002-6304	24	2004-911	88	2006-911/1000-836	90
		2002-6305	24	2004-911/1000-541	88	2006-911/1000-867	90
		2002-6306	24	2004-911/1000-542	88	2006-921	90
		2002-6307	24	2004-911/1000-836	88	2006-921/1000-541	90
		2002-6308	24	2004-911/1000-867	88	2006-921/1000-542	90
		2002-6391	24			2006-921/1000-836	90
		2002-6392	24	2004-1201	26	2006-921/1000-859	90
				2004-1202	26	2006-921/1000-867	90
		2002-6401	25	2004-1203	26	2006-931	90
		2002-6402	25	2004-1204	26	2006-931/099-000	90
		2002-6403	25	2004-1205	26	2006-931/1000-541	90
		2002-6404	25	2004-1206	26	2006-931/1000-542	90
		2002-6405	25	2004-1207	26	2006-931/1000-836	90
		2002-6406	25	2004-1211/1000-400	96	2006-931/1000-859	90
		2002-6407	25	2004-1211/1000-401	96	2006-931/1000-867	90
				2004-1291	26	2006-931/1099-541	91
		2002-7111	154	2004-1292	26	2006-931/1099-542	91
		2002-7114	154	2004-1293	26	2006-931/1099-836	91
		2002-7192	154	2004-1294	26	2006-931/1099-859	91
		2002-7211	154			2006-931/1099-867	91
		2002-7214	154	2004-1301	26	2006-991	76
		2002-7292	154	2004-1302	26	2006-992	76
				2004-1303	26		
				2004-1304	26	2006-1201	28
2002-2941	150	2003 Series		2004-1305	26	2006-1202	28
2002-2951	54	2003-499	148	2004-1306	26	2006-1204	28
2002-2952	54			2004-1307	26	2006-1207	28
2002-2954	54	2003-500	148	2004-1311/1000-400	96	2006-1208	28
2002-2958	54			2004-1311/1000-401	96	2006-1291	28
2002-2959	54	2003-911	150	2004-1391	26	2006-1292	28
						2006-1293	28

Item No.	Page	Item No.	Page	Item No.	Page	Item No.	Page
2022 Series							
2022-2204	130						
2022-2207	130						
2022-2207/999-953	140						
2022-2208	130						
2022-2209	130						
2022-2217	130						
2022-2227	130						
2022-2231	130						
2022-2232	130						
2022-2233	130						
2022-2234	130						
2022-2234/999-953	140						
2022-2237	130						
2022-2238	130						
2022-2239	130						
2022-2247	130						
2022-2257	130						
2022-2291	131						
2022-2291	141						
2022-2292	131						
2022-2292	141						

Algeria
please contact WAGO France

Argentina
Bruno Schillig S.A.
Arenales 4030, B1604CFD
Florida, PBA
Phone +54 11 4730 1100
Fax +54 11 4761 7244
wago@schillig.com.ar

Australia
WAGO Pty. Ltd.
2-4 Overseas Drive
Noble Park, Victoria, 3174
Tel. +61 03 8791 6300
Fax +61 03 9701 0177
sales@wago.com.au

NHP ELECTRICAL ENGINEERING PRODUCTS PTY LTD
43-67 River Street
Richmond, Victoria, 3121, P.O. Box 199
Phone +61 3 9429 2999
Fax +61 3 9429 1075
export@wago.com

Austria
WAGO Kontakttechnik Ges.m.b.H.
Campus 21, Europaring F15 602
2345 Brunn am Gebirge
Phone +43 1 6150780
Fax +43 1 6150775
info.at@wago.com

Azerbaijan
AZ Technics LTD
Zulfi V. Alizade
Y.Safarov str.33 , AZ1025,
Baku
Republic of Azerbaijan
Tel. +994 12 4968335
Fax +994 12 4968334
info@AZtechnics.az

Bangladesh
please contact WAGO India

Belarus
OOO FEK
prt Pushkina 29-B
220015 Minsk
Phone +375 17 2102189
Fax +375 17 2102189
wago@fek.by

UE ATAVA
ul. Denisovskaya, 47, office 1
220006 Minsk
Phone +375 17 2054015
Fax +375 17 2851759

Belgium
WAGO BeLux nv
Excelsiorlaan 11
1930 Zaventem
Tel. +32 2 717 9090
Fax +32 2 717 9099
info-be@wago.com

Bolivia
ISOTEK S.R.L.
Zona Casco Viejo
Calle Isso #578, B/San Roque
Santa Cruz
Tel. +591 721 000 27

Bosnia and Herzegovina
please contact WAGO Bulgaria

Brazil
WAGO Eletroeletrônicos Ltda
Rua Américo Simões 1470
São Roque da Chave
Itupeva SP Brasil 13295-000
Phone +55 11 4591 0199
Fax +55 11 4591 0190
info.br@wago.com

Bulgaria
WAGO Kontakttechnik GmbH & Co. KG/
Representative Office Sofia
Business Center Serdika
2E Akad. Ivan Geshov Blvd.
Building 1, Floor 4, Office 417
1330 Sofia
Tel. +359 2 489 46 09
Fax +359 2 928 28 50
info-BG@wago.com

Canada
please contact WAGO USA

Chile
Desimat Chile
Av Puerto Vespuccio 9670
Pudahuel Santiago
Phone +56 2 7470152
Fax +56 2 7470153
ventaschile@desimat.cl

China
WAGO ELECTRONIC (TIANJIN) Co. LTD
No.5, Quan Hui Road
Wuqing Development Area
Tianjin 301700
Phone +86 22 59617688
Fax +86 22 59617668
info-cn@wago.com

Columbia
T.H.L. Ltda.
Cra. 49 B # 91-33
Bogotá
Phone +57 1 621 85 50
Fax +57 1 621 60 28
ventas.thl@thltda.com

Croatia
M.B.A. d.o.o.
Frana Supila 5
51211 Matulji
Tel. +385 51 275-736
Fax +385 51 275-066
mba@ri.hinet.hr

MICROSTAR d.o.o.
Siget 18 b
10020 Zagreb
Tel. +385 1 3647 849
Fax +385 1 3636 662
wago@microstar.hr

Czech Republic
WAGO Elektro spol. sr. o.
Rozvodova 1116/36
143 00 Praha 4 - Modřany
Phone +420 261 090 143
Fax +420 261 090 144
info.cz@wago.com
wago-cz@wago.com

Denmark
WAGO Danmark A/S
Filial of WAGO Kontakttechnik GmbH & Co. KG
Lejrvej 17
3500 Værløse
Tel. +45 44 357 777
info.dk@wago.com

Ecuador
ECUAINSETEC CIA LTDA
El Zurriago E9-32 y el Vengador
Quito
Tel. +593 2 2 26 91 48
Fax +593 2 2 46 18 33
g.castro@ecuainsetec.com.ec

Egypt
IBN Engineering Instrumentation & Control
71 a El-Shaheed Ahmed Hamdi St.
King Faisal, Giza
Phone +20 2 7214350
Fax +20 2 7221709
sales@ibnengineering.com

Estonia
Eltarko OÜ
Laki 14 - 502
10621 Tallinn
Phone +372 651 7731
Fax +372 651 7786
andres@eltarko.ee

Finland
WAGO Finland Oy
Vellamankatu 30 B
00550 Helsinki
Tel. +358 9 7744 060
Fax +358 9 7744 0660
tilaus@wago.fi

France
WAGO CONTACT SAS
Paris Nord 2
83 Rue des Chardonnerets
B.P. 55065 - Tremblay en France
95947 - ROISSY CDG CEDEX
Phone +33 1 48172590
Fax +33 1 48632520
info-fr@wago.com

Germany
WAGO Kontakttechnik GmbH & Co. KG
Postfach 28 80, 32385 Minden
Hansastraße 27
32423 Minden
Phone +49 571 887-0
Fax +49 571 887-169
info@wago.com

WAGO Kontakttechnik GmbH & Co. KG
Waldstraße 1
99706 Sondershausen
Phone +49 3632 659-0
Fax +49 3632 659-100
info@wago.com

Great Britain
WAGO Limited
Triton Park, Swift Valley Industrial Estate
RUGBY
Warwickshire, CV21 1SG
Phone +44 1788 568008
Fax +44 1788 568050
uksales@wago.com

Greece
PANAGIOTIS SP. DIMOULAS - BIOMAT
DIMOULAS AUTOMATIONS
Kritis Str. 26
10439 Aithen
Tel. +30 210 883 3337
Fax +30 210 883 4436
wago.info@dimoulas.com.gr

Honduras
CILASAS S.A. de C.V.
Barrio Los Andes
7 Calle entre 14 y 15 Ave. N.O.
P.O. Box. 1061
San Pedro Sula
Tel. +504 25571146/7
Fax +504 25571149

Hong Kong
National Concord Eng., Ltd.
Unit A-B, 5/F,
Southeast Industrial Building
611-619 Castle Peak Road
Tsuen Wan, N.T.
Phone +852 24292611
Fax +852 24292164
sales@nce.com.hk

Hungary
WAGO Hungária KFT
Ipari Park, Gyár u. 2
2040 Budapest
Phone +36 23 502-170
Fax +36 23 502-166
info.hu@wago.com

Iceland
S. Gudjonsson ehf.
Audbrekkur 9-11
202 Kopavogur
Phone +354 520-4500
Fax +354 520-4501
export@wago.com

India
WAGO Private Limited
C-27, Sector-58, Phase-III
Noida-201 301
Gautam Budh Nagar (U.P.)
Tel. +91 120 438 8700
Fax +91 120 438 8799
info.india@wago.com

Indonesia
please contact WAGO Singapore

Iraq
please contact WAGO Middle East

Ireland
Drives & Controls
Unit F4, Riverview Business Park
Nangor Road
Dublin 12
Phone +353 1 4604474
Fax +353 1 4604507
wago@drivesandcontrols.ie

Israel
Comtel Israel Electronic Solutions Ltd.
Bet Hapaamon
20 Hataas Street
P.O. Box 66
44425 Kfar-Saba
Phone +972 9 76 77 240
Fax +972 9 76 77 243
sales@comtel.co.il

Italy
WAGO ELETTRONICA SRL a Socio Unico
Via Parini 1
40033 Casalecchio di Reno (BO)
Tel. +39 051 6132112
Fax +39 051 6272174
info-ita@wago.com

Japan
WAGO Co. of JAPAN Ltd.
Kinsicho Prime Tower
5-7, Kameido, Koto-Ku
Tokyo 136-0071
Tel. +81 3 5627 2059
Fax +81 3 5627 2055
info-jp@wago.com

Jordan
please contact WAGO Middle East

Kazakhstan
TOO INTANT
232/2, Ryskulov avenue
050061 Almaty
Tel. +7 727 356 52 91/92/93
Fax +7 727 327 14 92/93
ee@intant.net
ees_sm1@intant.net

TOO Technik-Trade
ul. i. A. Protosanova, 81
070004 Ust-Kamenogorsk
Tel. +7 7232 254 054
Fax +7 7232 253 251
info@technik.kz

Korea
WAGO Korea Co., Ltd.
Room205 AnyangMegaValley,
268, Hagui-ro, Dongan-gu, Anyang-si,
Gyeonggi-do, 14056, South Korea
Tel. +82 31 420 2470
info.korea@wago.com

Kosovo
please contact WAGO Bulgaria

Latvia
INSTABALT LATVIA SIA
Vestienas iela 6
Riga, LV-1035
Phone +371 790 1188
Fax +371 790 1180
info@instabalt.lv

Lebanon
Gemayel Trading & Contracting
Antoninis Project
P.O. BOX 70-1096
Antelias
Lebanon
Tel. +961 4 521 029
Fax +961 4 521 029
indo@uae.com

Lithuania
INSTABALT LIT UAB
Savanoriu 187
Vilnius, 2053
Phone +370 52 322 295
Fax +370 52 322 247
info@instabalt.lt

Luxembourg
please contact WAGO Belgium

Notes

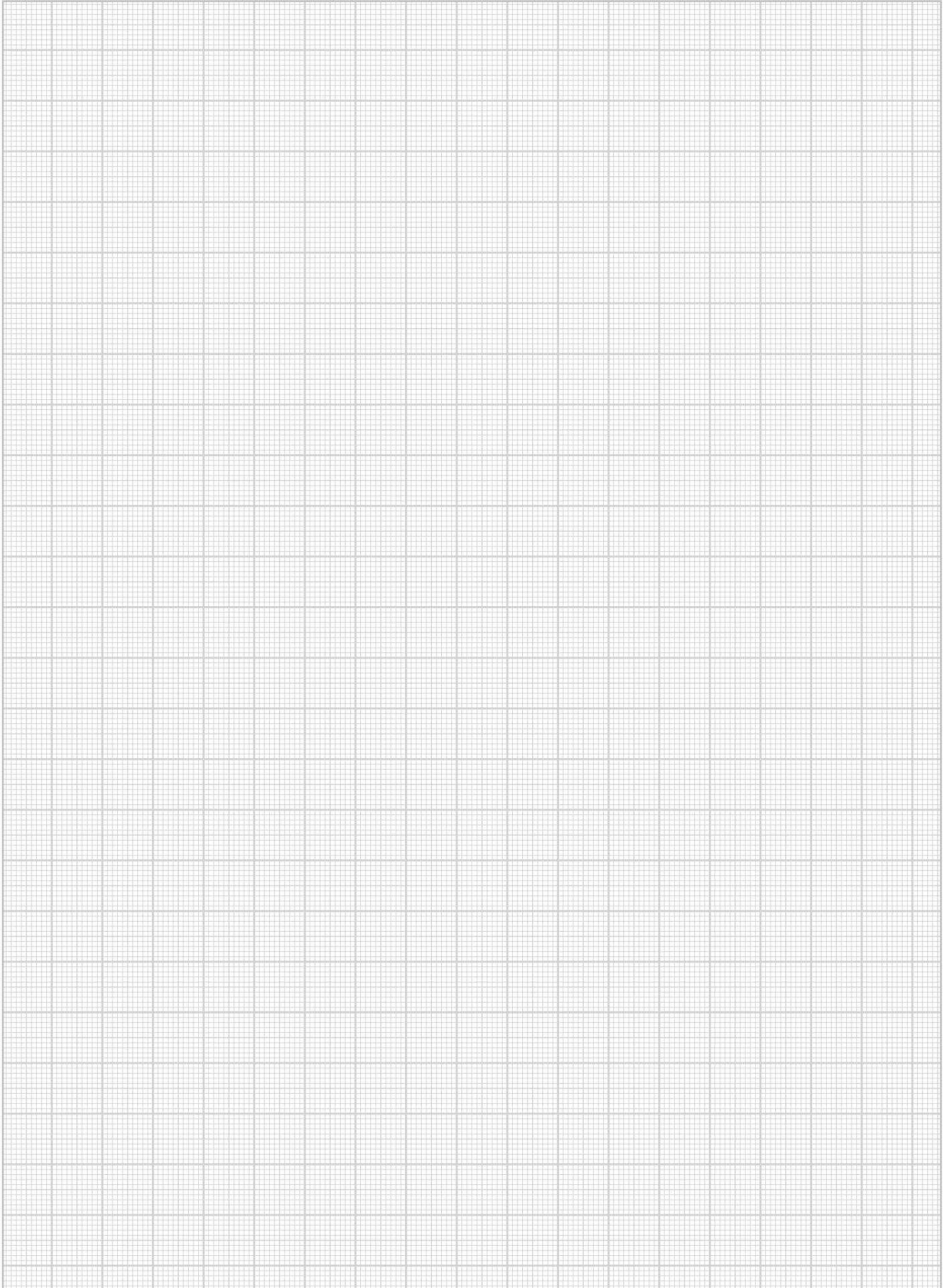

Notes

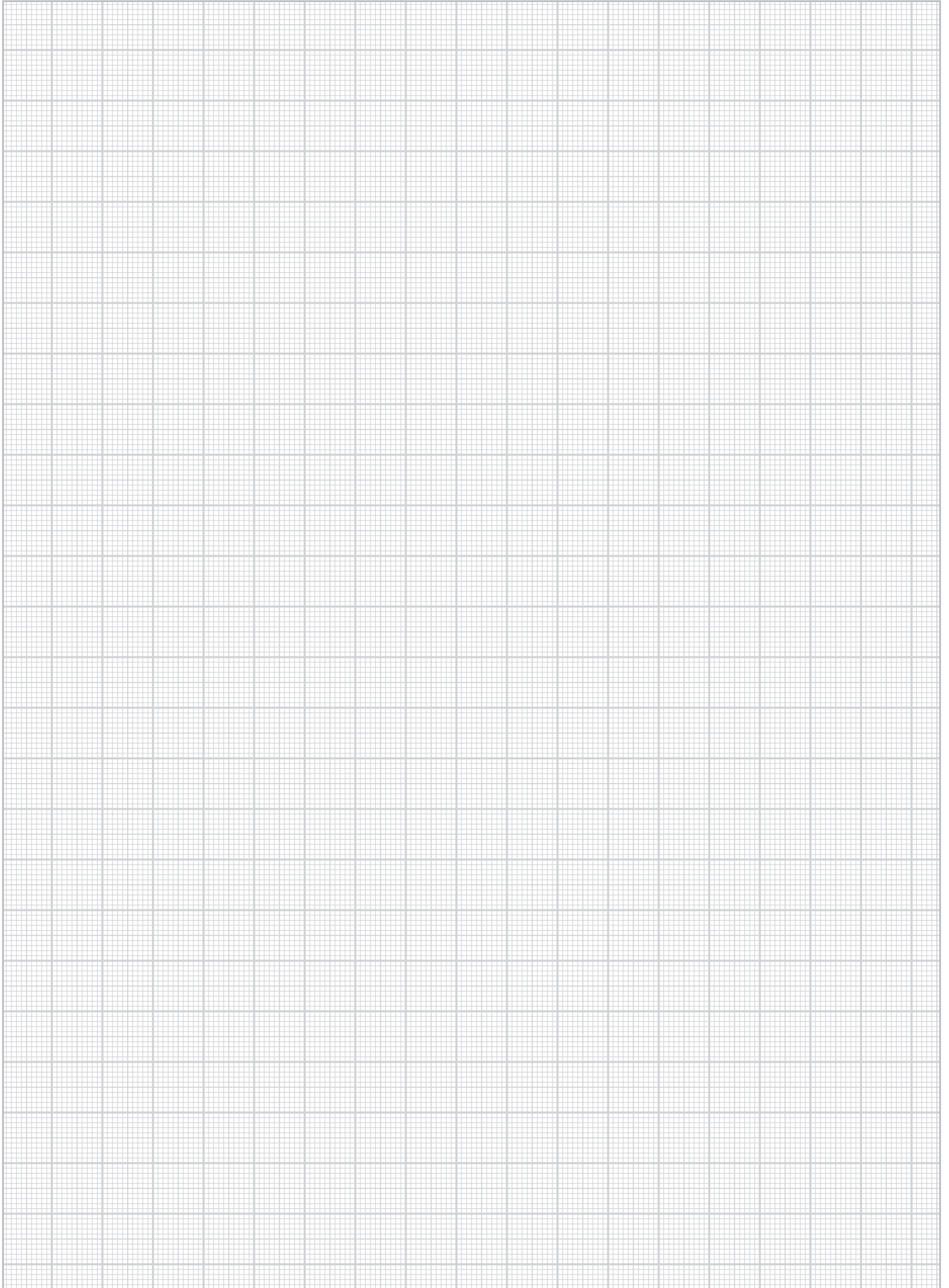

Notes

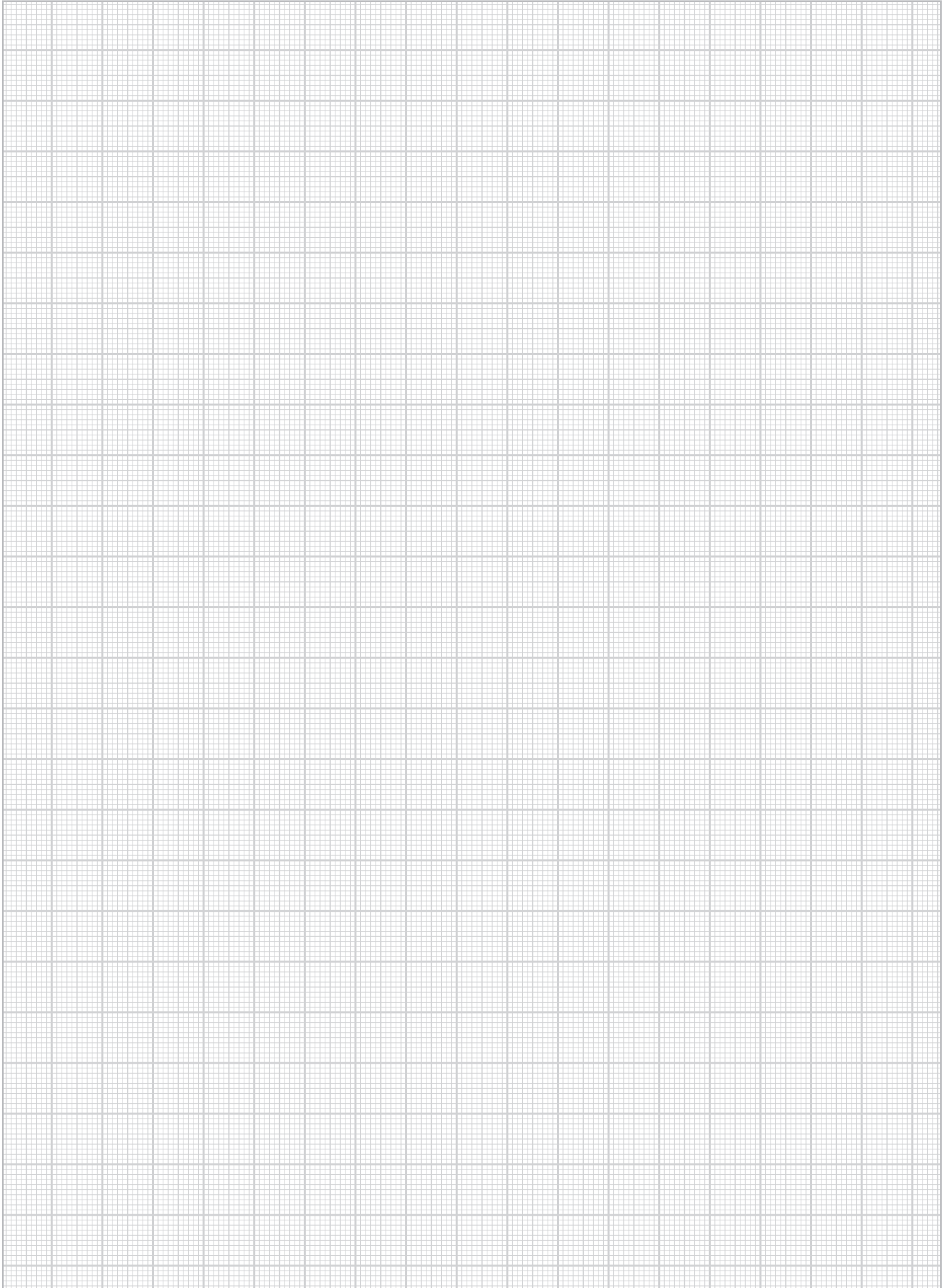

Notes

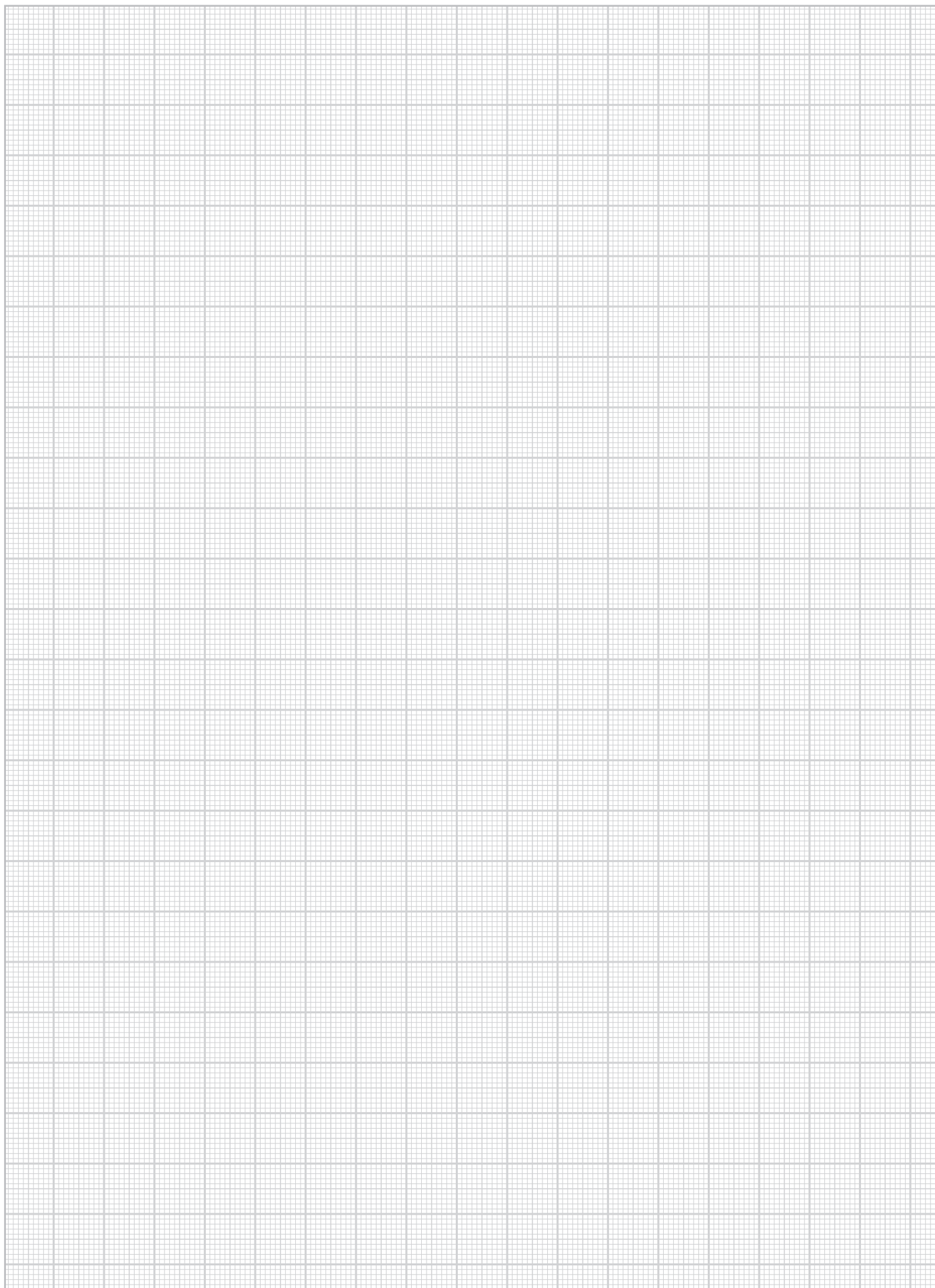

WAGO Kontakttechnik GmbH & Co. KG
Postfach 2880 · D · 32385 Minden
Hansastraße 27 · D · 32423 Minden
info@wago.com
www.wago.com

Headquarters	+49 571 887 - 0
Sales	+49 571 887 - 222
Order Service	+49 571 887 - 333
Fax	+49 571 887 - 169