



454
502
7.4 MPI
PARTS
MANUAL

17506 Marine Power Industrial Park
Ponchatoula, LA 70454
Parts Direct Line: (504) 386-3571 or (877) 388-9555
Parts Direct Fax: (504) 386-0076

TL454-10.00

HOW TO USE THIS BOOK

This 454, 502, 7.4 multi-port Parts Book has been designed to assist our distributors, dealers and customers in locating the correct replacement part for their Marine Power engine. This manual is sorted in specific groups for easy reference. Please refer to the Table of Contents, Alphabetical or Numerical Index to locate a particular Marine Power part.

This manual also contains many commonly used parts for these engine CID's. Most parts are common among the three engines.

If the part you are looking for is not listed, please contact your nearest Marine Power distributor or dealer for further assistance.

Thank you for purchasing Marine Power products.

Happy and Safe Boating !

Marine Power Engine Descriptions:

Base	Base Engine or Long Block
ParPac	Partial Engine With Additional Equipment
SportPac	Complete Inboard Engine
EnPac	Complete Inboard/Outboard Engine
JetPac	Complete Inboard Jet Engine

/// MARINEPOWER

The Force Behind The Fun.™



TABLE OF CONTENTS

BASIC ENGINE BLOCK - INTERNAL / LOWER END 454/502.....	1-2
BASIC ENGINE BLOCK - INTERNAL / UPPER END 454/502.....	3-4
BASIC ENGINE BLOCK - INTERNAL / UPPER END 7.4.....	5-6
BASIC ENGINE BLOCK - INTERNAL / LOWER 7.4.....	7-8
FLYWHEEL, STARTER & DRIVE GROUP.....	9
- FLYWHEELS	
- STARTERS	
- BELLHOUSINGS	
- COUPLERS, DAMPER PLATES	
- DUST COVERS, DRIVE LINE	
LUBRICATION GROUP	10-11
- OIL PANS	
- DIPSTICK TUBES, DIPSTICKS, ETC.	
- OIL FILTERS	
- COOLERS, COOLER BRACKETS	
- OIL LINES & OIL BYPASS	
- DUAL OIL BASE, OIL BASE BRACKETS	
COOLING GROUP	11-18
- HOSES	
- THERMOSTAT HOUSINGS	
- FRESH WATER TANKS, BRACKETS	
- THERMOSTATS, RECOVERY BOTTLE	
- GASKETS, BLOCK-OFF PLATES	
- COOLERS, FRESH WATER TEES	
- WATER PUMPS, BRACKETS, ACCESSORIES	
- LIFT BRACKETS, PULLEYS	
- SEAWATER PUMP & ACCESSORIES	
- RAW WATER & FRESH WATER FLOW DIAGRAMS	
ELECTRICAL GROUP	19-24
- ALTERNATOR, BRACKETS, BELTS	
- DISTRIBUTOR, COIL, ELECTRICAL REPLACEMENT PARTS	
- SENDERS, SWITCHES, RELAYS	
- IGNITION WIRES, WIRE LEADS	
- HARNESSSES	
- INSTRUMENT PANEL, GAUGES	
- WIRING DIAGRAMS	
EXHAUST GROUP	25
- MARINE POWER MANIFOLD, RISER, GASKETS	
- MERC STYLE MANIFOLD, RISER, GASKETS	
- MARINE POWER 2000 ALUMINUM MANIFOLD, RISER, GASKET	

TABLE OF CONTENTS

CARBURETION	26
<ul style="list-style-type: none"> - ROCHESTER CARBURETOR, FUEL LINES, ETC. - FUEL PUMPS, BRACKETS, FUEL/WATER SEPARATOR - HOLLEY CARBURETORS, FUEL LINES - INTAKE MANIFOLDS - GASKETS, BRACKETS - FLAME ARRESTORS, WEATHER COVER - CONTROL CABLE CLIPS, MISCELLANEOUS - ELECTRIC FUEL PUMP KITS 	
EFI - THROTTLE BODY INJECTION	27-28
<ul style="list-style-type: none"> - THROTTLE BODY DIAGRAM, INTAKE MANIFOLDS - FUEL LINES - GASKETS - BRACKETS - HARNESSSES - FUEL PUMPS - SENSORS, SENDERS, ECM MODULES - FLAME ARRESTORS, WEATHER COVERS, FITTINGS, ETC. 	
EFI - MULTIPOINT FUEL INJECTION	29-31
<ul style="list-style-type: none"> - FUEL LINES - GASKETS - BRACKETS - HARNESSSES - FUEL PUMPS - SENSORS, SENDERS, ECM MODULES - HOSES - FUEL RAIL, FILTERS, FUEL INJECTOR, FUEL PRESSURE REGULATOR - FITTINGS, PLUGS, ETC. - WIRING DIAGRAMS 	
MOUNTING GROUP.....	32
<ul style="list-style-type: none"> - ENGINE MOUNTS - GEAR MOUNTS - ISOLATOR MOUNT, TRUNION PINS 	
POWER STEERING GROUP	32-34
<ul style="list-style-type: none"> - PUMPS & ACCESSORIES - POWER STEERING DIAGRAM 	
TRANSMISSIONS	35-36
<ul style="list-style-type: none"> - VELVET DRIVE & HURTH TRANSMISSIONS - GEAR LINES, COOLERS, SHIFT BRACKETS 	
CATALOG NUMERICAL INDEX	37-45
CATALOG ALPHABETICAL INDEX	46-54

**MARINE POWER
PARTS DEPARTMENT**

**Direct Phone: 504 - 386 - 3571 or 877 - 388 - 9555
Direct Fax: 504 - 386 - 0076**

REF	STANDARD	PREMIUM	PERFORMANCE	DESCRIPTION
1	0025-266	0025-266	0025-266	BOLT: CAMSHAFT SPROCKET
2	*WFO0-005	*WFO0-005	*WFO0-005	WASHER: FLAT 5/16" CAMSHAFT
3	0053-081	0005-081		GEAR: CAMSHAFT NORMAL ROTATION
3	0004-081	0004-081		GEAR: CAMSHAFT REVERSE ROTATION
4	0053-084	0055-084	0055-084	CHAIN: TIMING NORMAL ROTATION
5	PART OF 8	PART OF 8	PART OF 8	PIN: CAMSHAFT SPROCKET
6	PART OF 8	PART OF 8	PART OF 8	KEY: CAMSHAFT
7	0053-189F8	0053-189F8	0053-189F8	BEARING: CAMSHAFT #1
7	0053-190F8	0053-190F8	0053-190F8	BEARING: CAMSHAFT #2, #5
7	0053-191F8	0053-191F8	0053-191F8	BEARING: CAMSHAFT #3, #4
8	0053-089	0053-089	0053-089	CAMSHAFT: 454/502 NORMAL ROTATION
8	0054-089	0006-089	0006-089	CAMSHAFT: 454/502 REVERSE ROTATION
9	0009-877	0009-877	0009-877	PLUG: KNOCK SENSOR HOLE
10	0053-205F8	0053-205F8	0053-205F8	PLUG: OIL GALLEY
11	0053-840	0053-840	0053-840	PLUG: ENGINE BLOCK OIL GALLEY
12	0003-036	0003-036	0003-036	CONNECTING ROD: 454/502
13	0053-037F8	0055-037F8	0055-037F8	PISTON: 454 GEN V
13		0066-037F8	0066-037F8	PISTON: 502 GEN V
14	0053-348F8	0053-348F8	0053-348F8	RING KIT: 454 GEN V
14		0066-348F8	0066-348F8	RING KIT: 502 GEN V
15	PART OF 12	PART OF 12	PART OF 12	BOLT: CONNECTING ROD
16	0053-038F8	0053-038F8	0053-038F8	BEARING KIT: CONNECTING ROD
17	PART OF 12	PART OF 12	PART OF 12	CAP: CONNECTING ROD
18	PART OF 12	PART OF 12	PART OF 12	NUT: CONNECTING ROD
19	0053-001	0053-001	0053-001	CASE: ENGINE 454 GEN V
19		0066-001	0066-001	CASE: ENGINE 502 GEN V
20	0009-877	0009-877	0009-877	PLUG: DRAIN
21	0003-208	0003-208	0003-208	PLUG: CAMSHAFT REAR
22	0009-877	0009-877	0009-877	PLUG: DRAIN
23	0025-815	0025-815	0025-815	PLUG: DRAIN
24	0053-840	0053-840	0053-840	PLUG: ENGINE BLOCK OIL GALLEY
25	0009-830	0009-830	0009-830	PLUG: OIL PRESSURE
26	0053-210F8	0053-210F8	0053-210F8	PLUG: WATER JACKET FREEZE
27	0009-830	0009-830	0009-830	PLUG: OIL PRESSURE
28	0053-033F8	0053-033F8	0053-033F8	SEAL: CRANKSHAFT OIL REAR NORMAL ROTATION
28	0054-033F8	0054-033F8	0053-033F8	SEAL: CRANKSHAFT OIL REAR REVERSE ROTATION
29	0053-009F8	0053-009F8	0053-009F8	BEARING KIT: CRANKSHAFT #5
30	0053-440F8	0053-440F8	0053-440F8	BEARING: KIT CRANKSHAFT #1, #2, #3, #4
31	0053-209	0053-209	0053-209	KEY: CRANKSHAFT BALANCER
32	0053-061F8	0053-061F8	0053-061F8	GASKET: TIMING COVER
33	PART OF 8	PART OF 8	PART OF 8	PIN: TIMING COVER
34	0053-059F8	0053-059F8	0053-059F8	BOLT: TIMING COVER
35	0054-260	0054-260	0054-260	INDICATOR: TIMING REVERSE ROTATION
36	0053-906	0053-906	0053-906	PIN: CRANKSHAFT
37	0053-002F3	0053-002F3	0053-002F3	BOLT: CRANKSHAFT
38	0003-003	0003-003	0003-003	WASHER: CRANKSHAFT DAMPER
39	0053-004F8	0053-004F8	0053-004F8	DAMPER: TORSIONAL 454 NORMAL ROTATION
39		0055-004F8	0055-004F8	DAMPER: TORSIONAL 502 NORMAL ROTATION
40	0053-058F8	0053-058F8	0053-058F8	COVER: TIMING GEN V NORMAL ROTATION
40	0054-058F3	0054-058F3	0054-058F3	COVER: TIMING GEN V REVERSE ROTATION
41	0053-005	0053-005	0053-005	SEAL: CRANKSHAFT OIL FRONT
42	0053-810	0053-810	0053-810	CAP: CRANKSHAFT BEARING
43	0053-082	0053-082	0053-082	GEAR: CRANKSHAFT NORMAL ROTATION
43	0004-082			GEAR: CRANKSHAFT REVERSE ROTATION
43		0005-082	0005-082	GEAR: CRANKSHAFT NORMAL ROTATION
44	0053-018F8	0055-018F8	0055-018F8	CRANKSHAFT: 454 GEN V NORMAL ROTATION
44	0054-018F8	0067-018F8	0067-018F8	CRANKSHAFT: 454 GEN V REVERSE ROTATION
44		0066-018F8	0066-018F8	CRANKSHAFT: 502 GEN V NORMAL ROTATION
44		0067-018F8	0067-018F8	CRANKSHAFT: 502 GEN V REVERSE ROTATION
45				NOT APPLICABLE
46	PART OF 44	PART OF 44	PART OF 44	PIN: FLYWHEEL
47	0053-601	0053-601	0053-601	SEAL: CRANKSHAFT BEARING CAP #5
48	0053-815	0053-815	0053-815	CAP: CRANKSHAFT BEARING #5
49	0053-151F8	0053-151F8	0053-151F8	BOLT: CRANKSHAFT BEARING CAP
50	0053-153F8	0053-153F8	0053-153F8	STUD: CRANKSHAFT BEARING CAP

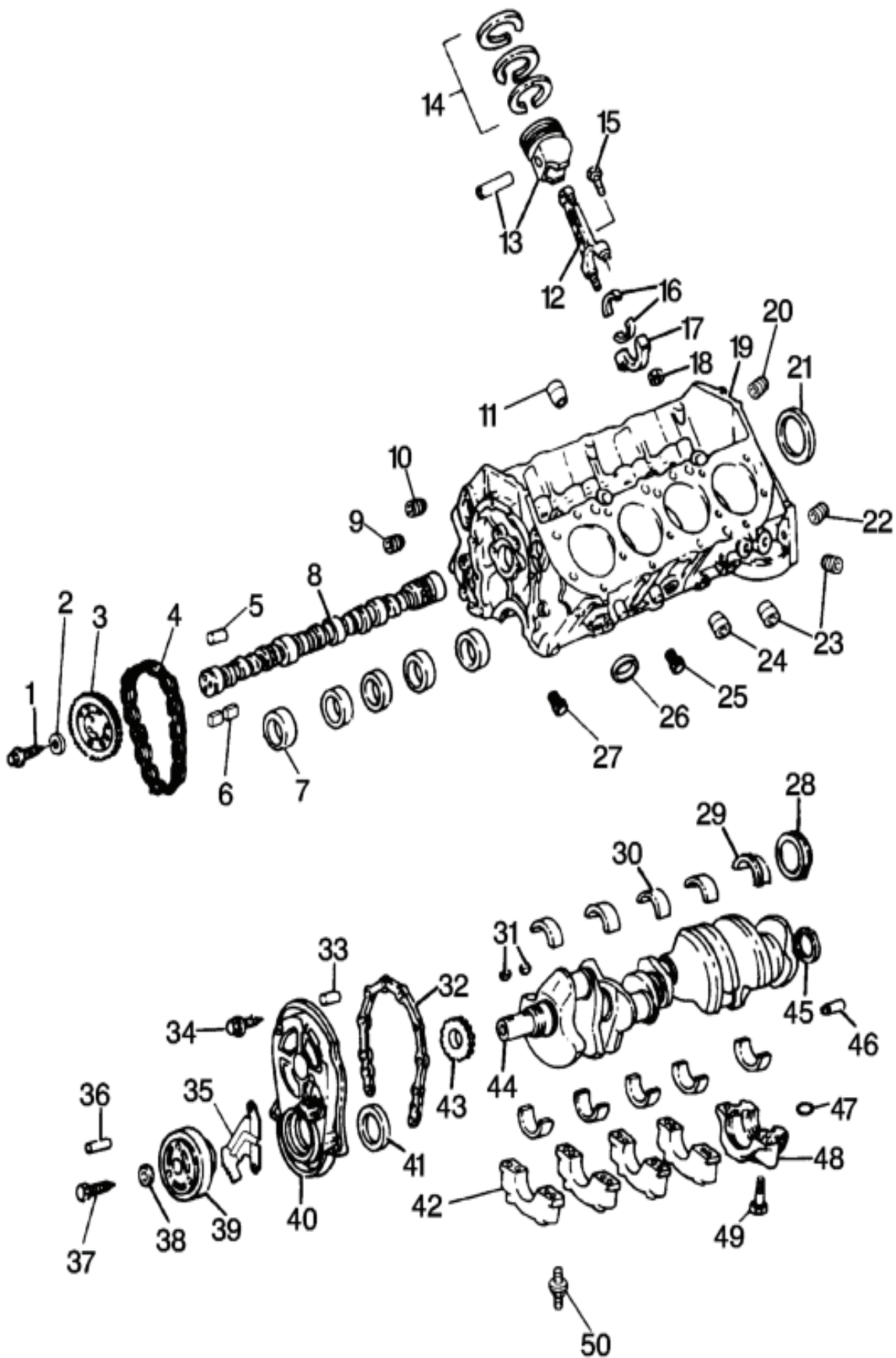

REF	STANDARD	PREMIUM	PERFORMANCE	DESCRIPTION
1	0053-102F8	0053-102F8	0053-102F8	CAP: OIL FILL
2	0303-006	0303-006	0303-006	GROMMET: VALVE COVER
3				NOT APPLICABLE
4	0053-100F3	0053-100F3	0053-100F3	VALVE COVER: 454/502
5	0053-101F8	0053-101F8	0053-101F8	GASKET: VALVE COVER 454/502
6	0025-107	0025-107	0025-107	BOLT: VALVE COVER
7	0003-380	0003-380	0003-380	KEY: VALVE STEM
8	0003-379			ROTATOR: VALVE 454 GEN V
9	0003-378	0055-378F8	0055-378F8	CAP: VALVE SPRING
10	0053-178F8	0053-178F8	0053-178F8	SEAL: VALVE STEM OIL
11	0003-176	0055-176F8	0055-176F8	SPRING: VALVE
12		0005-122	0005-122	SHIM: VALVE SPRING
13	0003-027	0003-027	0003-027	BOLT: CYLINDER HEAD LONG
14	0053-902	0053-902	0053-902	BOLT: ENGINE LIFT FRONT
15	0053-203	0053-203	0053-203	BRACKET: ENGINE LIFT REAR
16	0053-903	0053-903	0053-903	STUD: ENGINE LIFT RING BRACKET
17	0003-015	0003-015	0003-015	SPARK PLUG: V8
18	0003-029	0003-029	0003-029	BOLT: CYLINDER HEAD SHORT
19	0003-206	0003-206	0003-206	PIN: CYLINDER HEAD LOC
20	0053-030F8	0053-030F8	0053-030F8	PLUG: ENGINE COOLANT SENSOR
21	0053-174	0055-174	0055-174	VALVE: INTAKE GEN V
22	0003-175	0005-175	0005-175	VALVE: EXHAUST GEN V
23	0053-097	0055-097F8	0055-097F8	LIFTER: VALVE
24	0003-127	0005-127	0005-127	PUSH ROD: INTAKE VALVE
24	0003-128	0005-128	0005-128	PUSH ROD: EXHAUST VALVE
25	0053-025F8	0053-025F8	0053-025F8	GASKET: CYLINDER HEAD GEN V
26	0053-965	0053-965	0053-965	STUD: INTAKE MANIFOLD
27	0053-276	0055-276	0055-276	SHIELD: INTAKE MANIFOLD
28	0053-024F8	0055-024F8		HEAD: CYLINDER BARE
28	0053-024Z	0055-024Z		HEAD: CYLINDER COMPLETE
29	0053-119F8	0055-119F8	0055-119F8	GUIDE: PUSH ROD
30	0053-120F8	0055-120F8	0055-120F8	ARM: ROCKER
31	0053-121F8	0053-121F8	00053-121F8	BALL: ROCKER ARM
32	0053-920	0053-920	0053-920	BOLT: ROCKER ARM
33	0053-921	0053-921	0053-921	STUD: ROCKER ARM
34	0053-975	0730-928	0730-928	BOLT: NTAKE MANIFOLD GEN V
35	0053-030F8	0053-030F8	0053-030F8	PLUG: CYLINDER HEAD
36	0053-204	0053-204	0053-204	BRACKET: ENGINE LIFT FRONT
37	0053-903	0053-903	0053-903	STUD: ENGINE LIFT BRACKET
38	0053-450	0053-450	0053-450	HOSE: BYPASS (RAW WATER ONLY)
39	0053-750	0053-750	0053-750	CLAMP: GEAR (RAW WATER ONLY)
40	0000-809	0000-809	0000-809	FITTING: BYPASS T-STAT (RAW WATER ONLY)
41	0003-275	0005-275	0005-275	MANIFOLD: INTAKE GEN V
42	0053-275F8	0055-275F8	0055-275F8	GASKET: INTAKE MANIFOLD GEN V

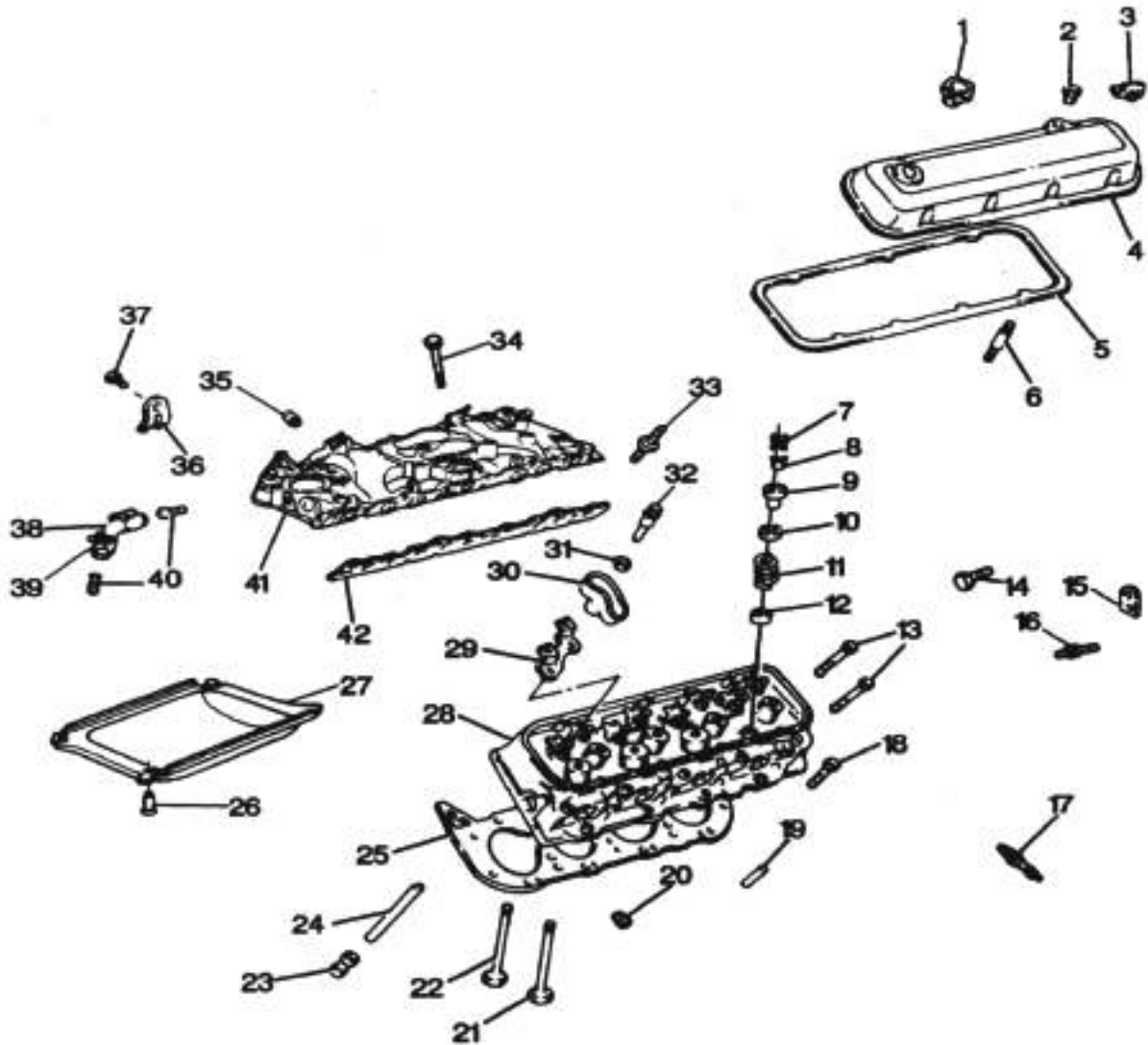

Note: Engine Serial Number or GM Engine Block Number is required to assure correct parts.

To locate block number:

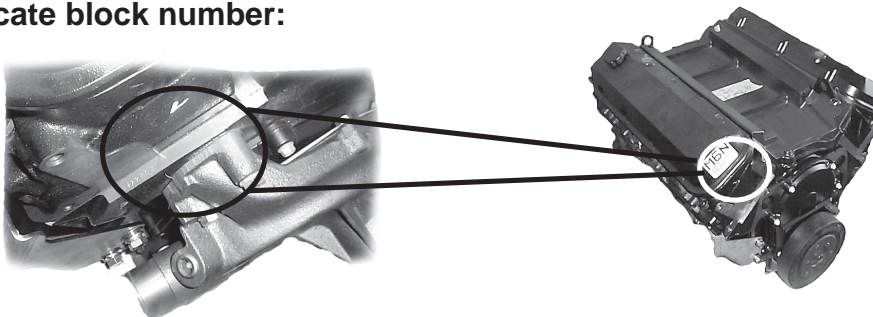

REF	PART NUMBER	DESCRIPTION
1	0730-270	MANIFOLD: UPPER
2	0730-261	COVER: EGR
3	0730-262	BOLT: EGR
4	0730-677	GASKET: INTAKE SET
5	0730-930	BOLT: INJECTION RAIL
6	0730-272	MANIFOLD: LOWER
7	0053-030F8	PLUG: INTAKE MANIFOLD
8	0053-102F8	CAP: OIL FILL
9	0025-107	BOLT: VALVE COVER
10	0003-380	KEY: VALVE COVER
11	0005-378	CAP: VALVE SPRING
12	0055-178I8	SEAL: VALVE STEM OIL
13	0053-178K8	SPRING: VALVE
14	0005-120	SHIM: VALVE SPRING
15	0003-927	BOLT: CYLINDER HEAD
16	0053-101F8	GASKET: VALVE COVER
17	0003-029	BOLT: CYLINDER HEAD
18	0003-206	PIN: CYLINDER HEAD
19	0053-030F8	PLUG: COOLANT
120	0055-174F8	VALVE: INTAKE
21	0003-175	VALVE: EXHAUST
22	0053-097K8	LIFTER: HYDRAULIC
23	0060-128	ROD: INTAKE VALVE PUSH
24	0053-025L-29	GASKET: HEAD
25	0053-119F8	GUIDE: VALVE
26	0053-920	BOLT: VALVE ROCKER ARM
27	0053-921	STUD: ROCKER ARM
28	0003-003	BOLT: VALVE
29	0053-277	SHIELD: INTAKE MANIFOLD

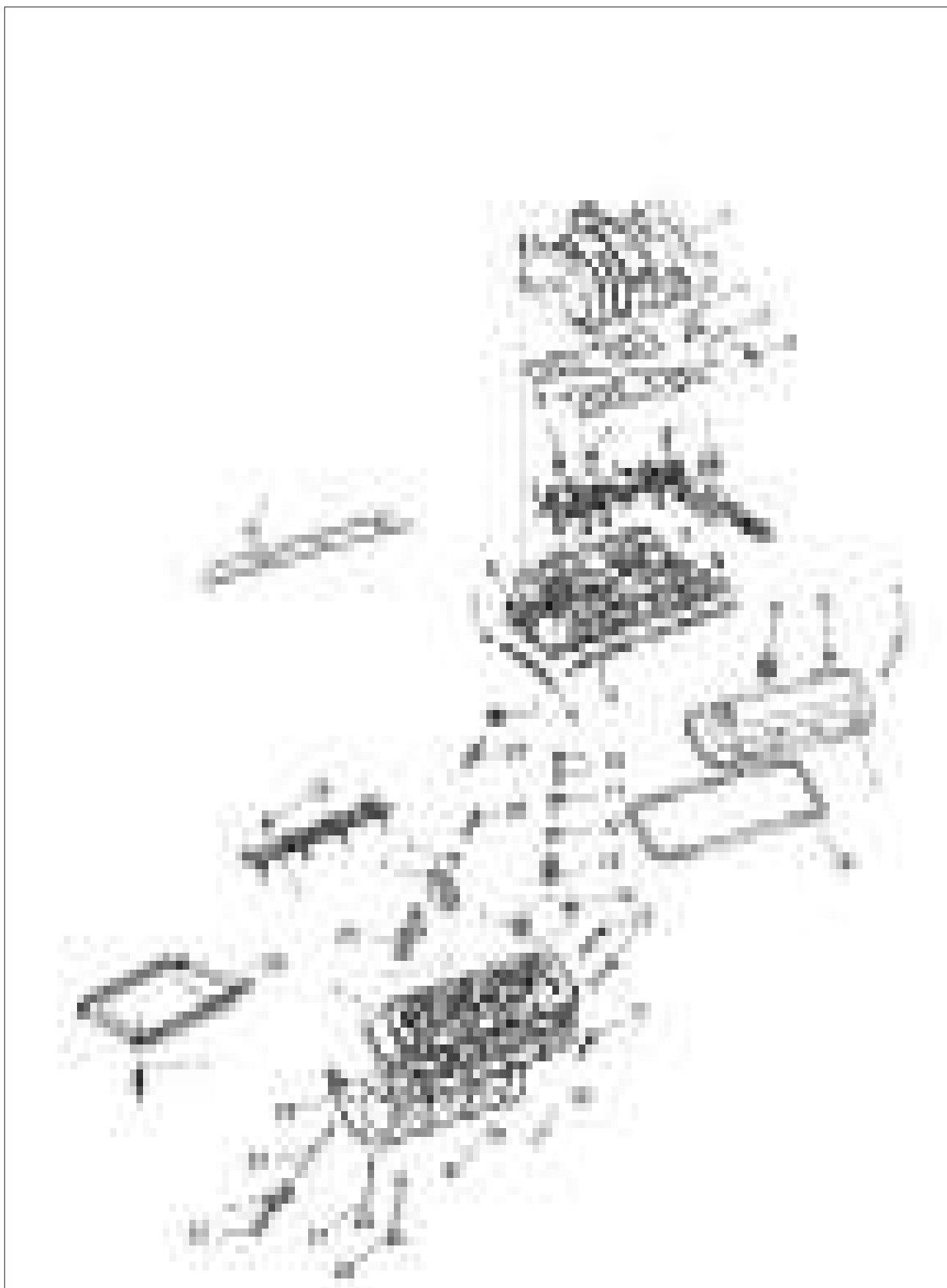



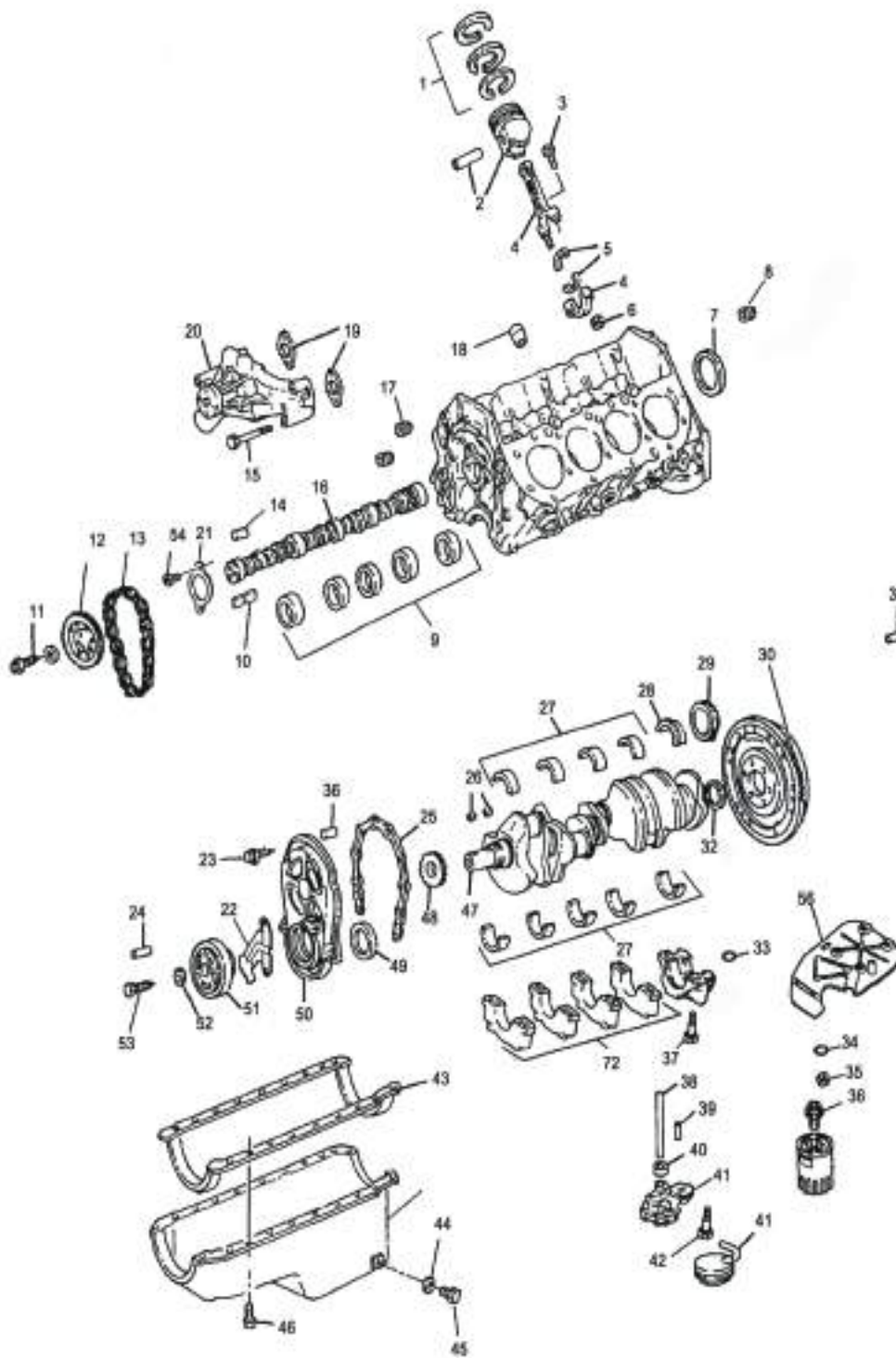

BASIC ENGINE BLOCK - INTERNAL / LOWER END**7.4 LITER MULTI-PORT**

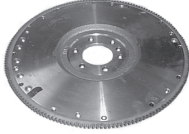

1	0053-348I8	RING: KIT
2	0055-037F8	PISTON
3	0003-026	BOLT: CONNECTING ROD
4	0003-036	ROD: CONNECTING
5	0053-038F8	BEARING
6	0060-067	NUT: CONNECTING ROD
7	0003-208	PLUG
8	0025-815	PLUG: DRAIN
9	0053-189F8	BEARING: CAMSHAFT
10	0004-094	KEY: CAMSHAFT
11	0025-266	BOLT: CAM SHAFT
12	0066-081	SPROCKET: CAMSHAFT
13	0053-084	CHAIN: TIMING
14	0007-090	PIN: ENGINE
15	0730-928	BOLT: WATER PUMP
16	0055-089	CAMSHAFT
17	0053-205F8	PLUG: ENGINE BLOCK
18	0025-815	PLUG: ENGINE BLOCK
19	0303-050	GASKET: WATER PUMP
20	0003-064	PUMP KIT: WATER
21	0023-096	RETAINER: CAMSHAFT
22	0054-260	INDICATOR: TIMING
23	0053-059K8	BOLT: ENGINE FRONT COVER
24	0007-090	PIN: ENGINE FRONT
25	0053-061K8	GASKET: FRONT COVER
26	0053-209	KEY: CRANKSHAFT
27	0053-440F8	BEARING: CRANKSHAFT
28	0053-009F8	BEARING: CRANKSHAFT #5
29	0053-033	SEAL: CRANKSHAFT
30	0055-140F8	FLYWHEEL
31	0025-143F5	PIN: FLYWHEEL
32	0065-198	BEARING: PILOT
33	0053-601	SEAL: CRANKSHAFT
34	0053-915	NUT
35	0065-994	WASHER
36	0000-820	FITTING: OIL FILTER
37	0053-151F8	BOLT: CRANKSHAFT
38	0003-258	SHAFT: OIL PUMP
39	0007-090	PIN: OIL PUMP
40	0007-259	RETAINER
41	0055-255F8	PUMP : OIL W/ SCREEN
42	0053-257	BOLT: OIL PUMP
43	0053-245F7	GASKET: OIL PAN
44	0065-245	GASKET: OIL PAN DRAIN PLUG
45	0065-945	PLUG: OIL PAN DRAIN
46	0003-303	BOLT: OIL PAN
47	0053-018F8	CRANKSHAFT
48	0053-082	SPROCKET: CRANKSHAFT
49	0053-005	SEAL: CRANKSHAFT
50	0053-058K8	COVER: ENGINE FRONT
51	0055-004F8	BALANCER
52	0003-003	WASHER
53	0053-002F3	BOLT: CRANKSHAFT
54	0053-093	BOLT: CAMSHAFT







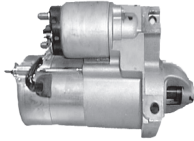
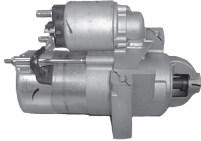





FLYWHEELS

 <p>0053-140F8 FLYWHEEL: SPORTPAC REAR RING GEAR GEN V STANDARD 454</p>	 <p>0053-141 FLYWHEEL: ENPAC BM FORWARD GEAR GEN V REAR MOUNT STD 454</p>	 <p>0055-141 FLYWHEEL: W/ FORWARD RING GEAR GEN V PREMIUM 454 / 502</p>	 <p>0055-140F8 FLYWHEEL: TOP MOUNT SPORTPAC454 / 502 REAR MOUNT PREMIUM</p>
---	---	--	---

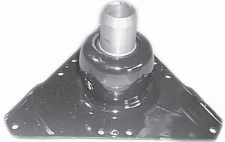

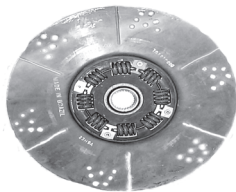

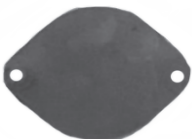





STARTERS

 <p>0172-000 STARTER: BOTTOM MOUNT 12 3/4" FLYWHEEL NORMAL ROTATION (Bolts: 0180-001 Short 0181-001 Long)</p>	 <p>0174-000 STARTER: BOTTOM MOUNT 14" FLYWHEEL NORMAL ROTATION (Bolts (2) 0181-001)</p>	 <p>0170-000 STARTER: TOP MOUNT 14" FLYWHEEL NORMAL ROTATION</p>	 <p>0171-000 STARTER: TOP MOUNT 14" FLYWHEEL REVERSE ROTATION</p>
---	--	---	---



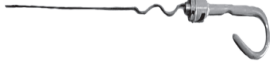













BELLHOUSING & COUPLERS

 <p>0100-000 BELLHOUSING: INBOARD</p>	 <p>0102-538 BELLHOUSING CAL JET 14" TM</p>	 <p>0102-537 PLATE: ACCESS CAL JET BELLHOUSING</p>	 <p>0150-000 DUST COVER: REAR ENTRY</p>
 <p>0007-990F7 FLEXPLATE: COUPLER 14"</p>	 <p>0055-143 FLEXPLATE: AUTO JET PREMIUM 454/502 0053-143G2 FLEXPLATE: AUTO JET 454 STANDARD</p>	 <p>0003-999 ADAPTER: FLYWHEEL THIN USE W/ SOLID 0053-999 ADAPTER: FLYWHEEL THICK USE W/ FLEXPLATE</p>	 <p>0077-000 DAMPER PLATE 14"</p>
 <p>0151-538 COVER: DUST 14" CAL JET</p>	 <p>0151-010 PLATE: STARTER BELLHOUSING</p>	 <p>7909-005 SHAFT: JET DRIVE</p>	 <p>0105-000 ADAPTER: JET CONE</p>

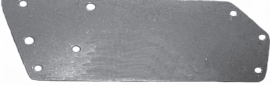
OIL PANS & DIPSTICKS

 <p>0053-248 OIL PAN: 8 QT PLASTISOL</p>	 <p>0053-242 OILPAN: 10 QT IRIDITED</p>	 <p>0053-002P3 TUBE: DIPSTICK ENPAC</p>	 <p>0407-002 TUBE: DIPSTICK SPORTPAC</p>
 <p>1460-000 EZ OIL DRAIN (STANDARD)</p> <p>1460-001 EZ OIL DRAIN (METRIC)</p>	 <p>0403-200 BRACKET: DIPSTICK TUBE SPORTPAC</p>	 <p>0307-001 DIPSTICK: SPORTPAC</p>	 <p>0400-800 FITTINGS: BANJO ASSY STANDARD</p> <p>0400-801 FITTINGS: BANJO ASSY METRIC</p>
 <p>0053-245F7 GASKET: OIL PAN</p>	 <p>0017-002P3 DIPSTICK: ENPAC, JETPAC</p>		

FILTERS - COOLER - MISCELLANEOUS

 <p>0904-000 FILTER: OIL SPORTPAC (2 REQUIRED)</p>	 <p>0905-000 FILTER: OIL ENPAC</p>	 <p>0442-001 COOLER: OIL 180 DEGREE 5 X 1 1/4</p>	 <p>0440-001 COOLER: OIL 5 X 1 1/4 0 DEGREE</p>
 <p>0440-549G3 COOLER: OIL 5 X 9 X 1 1/4</p>	 <p>1255-002 OIL LINE: ENPAC 5"</p>	 <p>1255-001 OIL LINE: ENPAC 9"</p>	 <p>1256-003E3 OIL LINE: SPORTPAC 19"</p>
 <p>1250-002E3 OIL LINE: SPORTPAC 30"</p>	 <p>1256-051F8 OIL LINE: SPORTPAC 51"</p>	 <p>0901-350 BRACKET: DUAL OIL</p>	 <p>0901-538 BRACKET: DUAL OIL CAL JET LONG</p>
 <p>0900-100 BASE: DUAL OIL FILTER</p>	 <p>0520-001 COVER: OIL BYPASS</p> <p>0520-000 COVER: OIL BYPASS ASSY INCLUDES (2) 0000-871</p>	 <p>0000-871 FITTING: REMOTE OIL SYSTEM</p>	 <p>0053-042 FITTING: OIL BYPASS</p>

FILTERS - COOLERS - MISCELLANEOUS



0525-000
ADAPTER: OIL COOLER
ENPAC



0790-000
CLAMP: SEAPUMP
HOSE 1 1/2

0791-000
CLAMP: OIL COOLER 2"



0000-895
PLUG: PIPE 1/2 BRASS



PARTS DEPT
877-388-9555

FAX
504-386-0076



0900-400
KIT: OIL EXCHANGE
(Includes Pump, Mounting
Bracket, EZ Oil Drain)



0791-006
BRACKET: OIL COOLER



1005-000
CLAMP: DIPSTICK
3/8 X 3/8



1440-001
BRACKET: GEAR COOLER
TWIST

HOSES



1451-000F12
HOSE CIRC PUMP
RAW WATER



1458-004
HOSE: RISER-TANK FWS



1458-001
HOSE: MANIFOLD-TSTAT



1456-000
HOSE: SEAPUMP-TSTAT HSG
RAW WATER



1458-003
HOSE: SEAPUMP-FW TANK



1452-000F11
HOSE CIRC PUMP
FRESHWATER



1458-005
HOSE: SEAWATER PUMP-
COOLER



HPWS-010
HOSE: COOLING CALJET
5/8"



1458-101P10
HOSE: TSTAT-MANIFOLD
MERC-STBD



1458-002
HOSE: TSTAT



1458-102P10
HOSE: TSTAT-MANIFOLD
MERC-PORT



1455-017G8
HOSE: UNIVERSAL



1455-003
HOSE: FRESHWATER
CIRC PUMP TO TANK



HPWS-006
HOSE: POWER STEERING
RESERVOIR TO COOLER



HWRF-016
HOSE: SEAFLEX 1"

HWRF-020
1 1/4" SEA FLEX

HWRF-024
HOSE: SEAFLEX 1 1/2"



1450-100
HOSE: VENT TUBE

HOUSINGS & THERMOSTATS



0506-009F4
HOUSING: T-STAT
FRESH WATER TANK

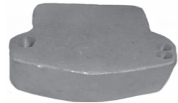

0509-004N11
HOUSING: FRESHWATER
OUTLET



0553-002
HOUSING: WATER OUTLET
CAL JET



0553-100
PLATE: INLET WATER
CAL JET



0500-009
HOUSING: T-STAT BASE
FRESHWATER
REAR MOUNT



0500-002
HOUSING: T-STAT CAP
REAR MOUNT FRESHWATER



0212-001
HOUSING: T-STAT
RAW WATER



0210-002
THERMOSTAT
RAW WATER 142D



0500-007
THERMOSTAT
FRESH WATER
REAR MOUNT



0212-007
THERMOSTAT
RAW WATER
MERC STYLE



0500-007F6
THERMOSTAT:
FRESHWATER V8-160D



0505-008
SPACER: THERMOSTAT
FRESH WATER
REAR MOUNT COPPER

PULLEYS AND BELTS



0303-028
PULLEY: CRANKSHAFT



0310-001
PULLEY: POWER
STEERING PUMP



0307-007
PULLEY: CIRC PUMP



1210-002
PULLEY: DUAL
ALTERNATOR
FOR PRESTOLITE



0539-350
BELT: ALTERNATOR
CAL-JET
0547-350
BELT: ALTERNATOR



0538-350
BELT: POWER STEERING

TANKS & BRACKETS



0509-103H7
TANK: FRESH WATER 5"
FRONT MOUNT

0500-011
ANODE: ZINC PLUG



0500-003
TANK: FRESH WATER 5"
REAR MOUNT

0500-011
ANODE: ZINC PLUG



0505-114
BRACKET: RIGHT



0515-115
BRACKET: LEFT



0500-005G7
CAP: TANK 7 PSI
DUAL SEAL



0500-014
BRACKET: REAR MOUNT
LEFT



0500-015
BRACKET: REAR MOUNT
RIGHT



0505-013
GASKET: END PLATE 5"
FRESH WATER TANK

0500-013
GASKET: END PLATE 4"
FRESH WATER TANK



0500-008
END PLATE 4"
0500-018
END PLATE 5"
0500-011
ANODE: ZINC PLUG



0515-734
BRACKET: MPI
FRESHWATER STBD



0515-735
BRACKET: MPI
FRESHWATER PORT

GASKETS & BLOCK-OFF PLATES



0992-301G5
GASKET: RISER C-R
FRESHWATER
MP MANIFOLD



0500-001
PLATE: BLOCK-OFF
SB/BB MARINEPOWER



0992-205P5
GASKET: RISER C-R
V6/V8 MARINEPOWER



0992-300G5
GASKET: RISER C-R V8
RAW WATER MP MANIFOLD



0501-001N4
GASKET: BLOCK-OFF
MERC SB/BB
FRESH WATER



0992-310N4
GASKET: RISER
MERC RAW WATER

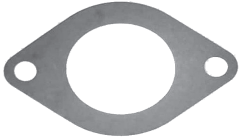

0303-009
GASKET: T-STAT
V6/V8

COOLERS



0440-549G3
COOLER: DUAL 5 X 9



0440-001
COOLER: ENGINE 5" X 1 1/4"



0442-001
COOLER: 5 X 1 1/4
180 DEGREE

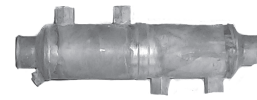

0440-505P1
COOLER: 5 X 5
180 DEGREE

T'S & ADAPTERS



0000-850
TEE: FRESH WATER
REAR MOUNT



0441-103
TUBE: COPPER INLET
NORTHWEST JET



0000-852
TEE: HEATER ADAPTER
5/8" 90 D

REAR MOUNT FRESH WATER COOLING

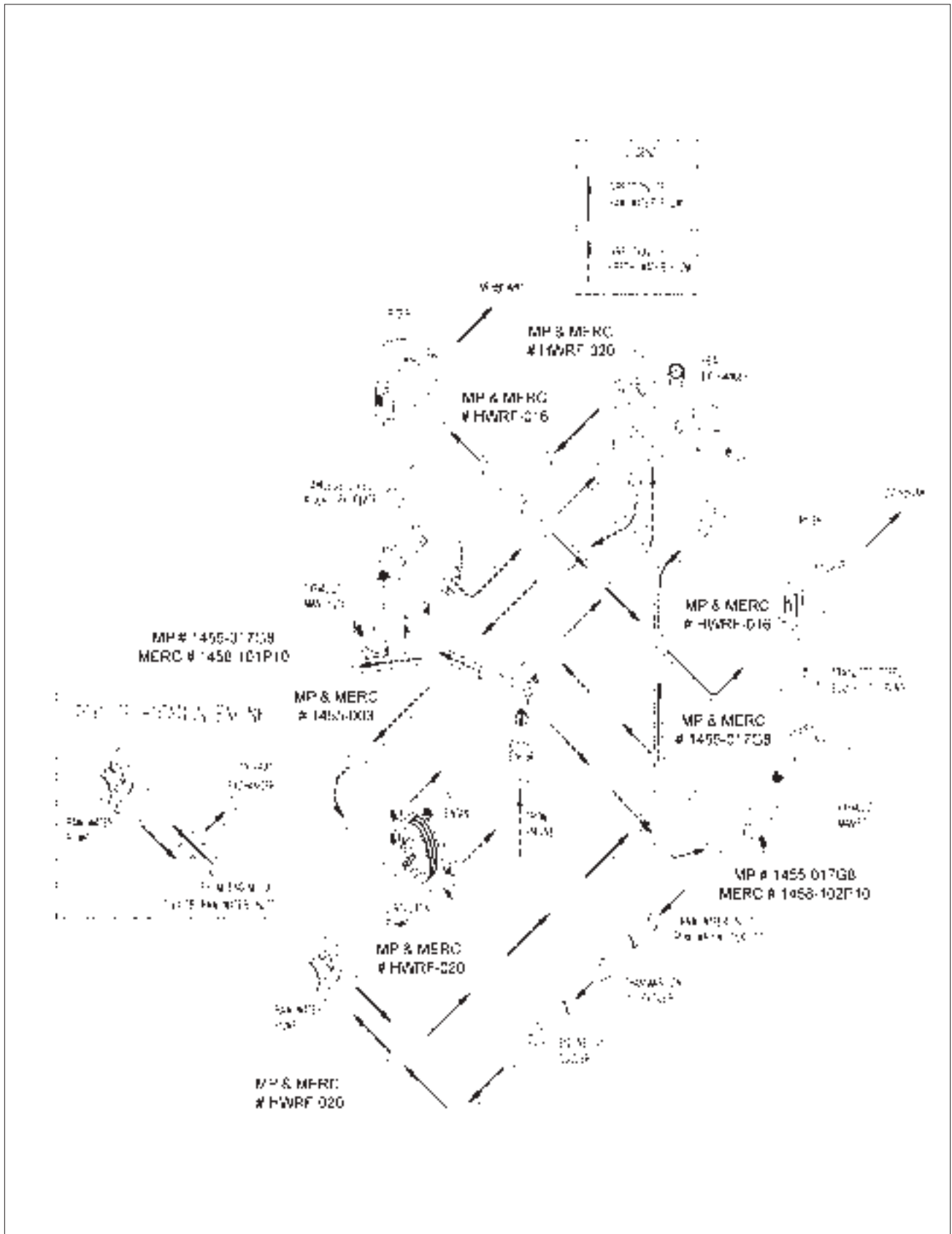

WATER PUMPS & ACCESSORIES



0003-065
PUMP: CIRCULATING



0303-050
GASKET: CIRC PUMP
(Req. 2)



0307-007
PULLEY: CIRC PUMP



0566-000P8
PUMP: SEA WATER
JABSCO



0572-000
BRACKET: SEA PUMP



0790-000
CLAMP: SEAWATER
PUMP HOSE
1 1/2 PREFORM



0509-102
BRACKET: MOUNTING
RECOVERY BOTTLE



0572-001
BUSHING, SEAWATER
PUMP



0509-101F4
BOTTLE: RECOVERY
WITH HOLDING BASKET

JOHNSON PUMP

JABSCO PUMP

0563-020
IMPELLER KIT: JOHNSON
F6B KIT INCLUDES:

- (1) 0562-001 IMPELLER
- (1) 0563-009 BEARING
- (1) 0563-010 O-RING
- (1) 0563-012 SCREW
- (1) 0563-013 WASHER
- (1) 0562-002 GASKET
- (1) 0562-003 CAM
- (1) 0563-003 COVER
- (1) 0563-008 LIPSEAL

0566-000ZBB
IMPELLER KIT: JABSCO
KIT INCLUDES

- (1) 0566-002P8 GASKET
- (1) 0566-003P8 COVER
- (1) 0566-004P8 CAM
- (1) 0566-005P8 SCREW
- (1) 0566-006P8 SEAL
- (1) 0566-008P8 LIPSEAL
- (6) 0566-011P8 SCREW

FITTINGS



0000-800H7
FITTING: BRASS
3/4" NPT X 1"



0720-851
FITTING: BRASS 1/4 X 3/8" 90D

0000-845
FITTING: BRASS 3/4" PIPE X 5/8"
HOSE 90D

0000-815H7
FITTING: BRASS 90D 3/4" X 1"

0730-851
FITTING: BRASS 90D 1/4 x 1/2

JOHNSON F6B SEA WATER PUMP

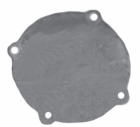

0563-006
COVER

0563-001
SCREW: COVER



0562-002
GASKET



0562-003
CAM

0563-012
SCREW: CAM



0562-001
IMPELLER



0563-008
LIPSEAL



0563-009
BEARING



0563-013
WASHER

JABSCO SEA WATER PUMP



0566-003P8
COVER

0566-011P8
SCREW: COVER
(6 REQUIRED)



0566-002P8
GASKET



0566-008P8
LIPSEAL



0566-004P8
CAM: FULL

0566-005P8
SCREW



0566-001P8
IMPELLER



0566-006P8
SEAL: SPACER

ALTERNATOR & ACCESSORIES

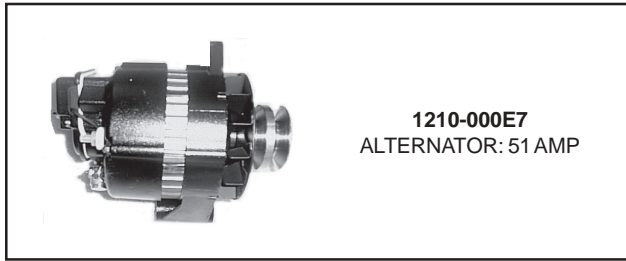

1210-000E7
ALTERNATOR: 51 AMP

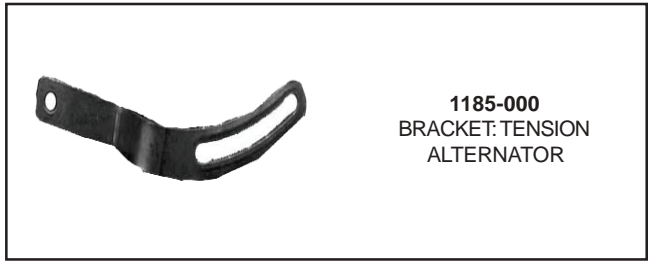

1185-000
BRACKET: TENSION
ALTERNATOR



0547-350
BELT: ALTERNATOR
0539-350
BELT: ALTERNATOR (JETPAC)

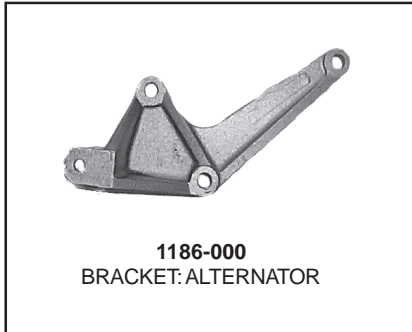

1186-000
BRACKET: ALTERNATOR

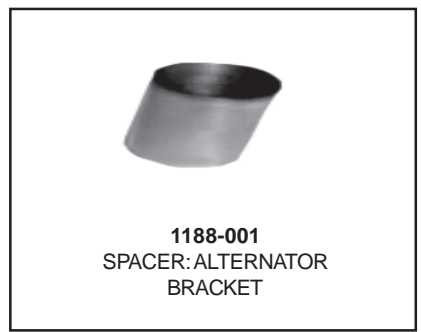

1188-001
SPACER: ALTERNATOR
BRACKET

DISTRIBUTOR - COIL - ETC

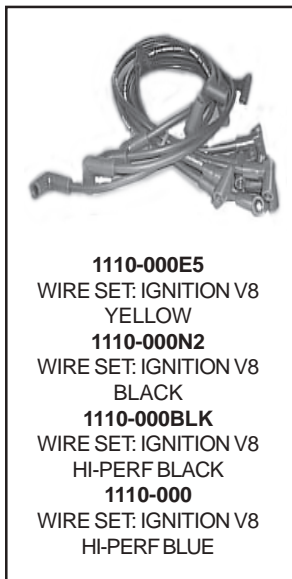

1110-000E5
WIRE SET: IGNITION V8
YELLOW
1110-000N2
WIRE SET: IGNITION V8
BLACK
1110-000BLK
WIRE SET: IGNITION V8
HI-PERF BLACK
1110-000
WIRE SET: IGNITION V8
HI-PERF BLUE



0807-000M5
DISTRIBUTOR: NORMAL
ROTATION
0808-000P9
DISTRIBUTOR: OPPOSITE
ROTATION



0805-001E5
CAP: DISTRIBUTOR V8
0807-001M5
CAP: DISTRIBUTOR V8
>99

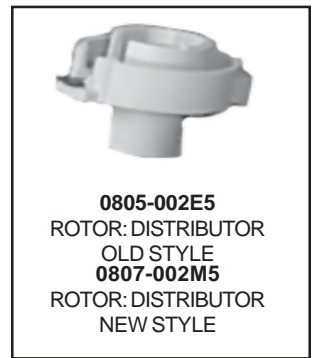

0805-002E5
ROTOR: DISTRIBUTOR
OLD STYLE
0807-002M5
ROTOR: DISTRIBUTOR
NEW STYLE



0303-043
GASKET: DISTRIBUTOR



0807-006M5
MODULE: DISTRIBUTOR



0805-100E5
COIL: STANDARD
0805-101H3
COIL: HIGH PERFORMANCE



0003-015
SPARK PLUG: 454 / 502
0007-015
7.4 MULTI PORT



0303-042
CLAMP: DISTRIBUTOR

SWITCHES - SENDERS - RELAYS

WIRE LEADS



0940-001
SENDER: WATER
SINGLE 1/2"

0940-011
SENDER: WATER
SINGLE 3/8"

0940-111
SENDER: WATER
DUAL 3/8"



0940-201
SWITCH: WATER TEMP 3/8"



0940-002
SENDER: OIL SINGLE

0940-102
SENDER: OIL DUAL



0940-202
SWITCH: OIL PRESSURE
1/8" 7 PSI



0303-017F3
SWITCH: HOBBS
OIL/FUEL PUMP CUTOFF



1140-006
RELAY: STARTER
OLD STYLE
(< MARCH 99)



1140-011N4
RELAY: STARTER
70 AMP (>APR 99)



6754-850N4
RELAY: ELEC FUEL PUMP
NEW STYLE



1140-004
BREAKER: CIRCUIT
IGNITION



1140-102F5
RELAY: HARNESS
40 AMP OLD STYLE



1140-240N7
HARNESS: CARBURETED
3.0 - 8.2L

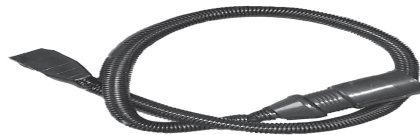

0947-003 HARNESS: 03 FT EXTENSION
0947-010 HARNESS: 10 FT EXTENSION
0947-016 HARNESS: 16 FT EXTENSION
0947-025 HARNESS: 25 FT EXTENSION
0947-035 HARNESS: 35 FT EXTENSION

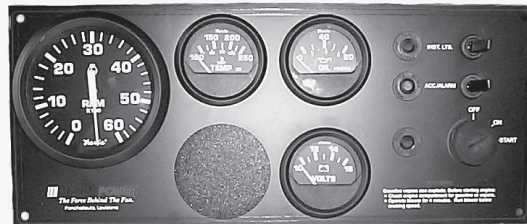

0945-000 PANEL: INSTRUMENT WITH GAUGES
0945-002* GAUGE: WATER TEMP
0945-003* GAUGE: VOLTMETER
0945-004* GAUGE: TACHOMETER
0945-005* GAUGE: OIL PRESSURE
0945-015 GAUGE: FUEL
0945-476 GAUGE: HOUR METER
* Gauge Included with Panel



0811-020F8
WIRE LEAD: HOBBS OIL
SWITCH

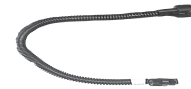

0811-018
WIRE LEAD: COIL TO DIST
+ FILTER



0811-016
WIRE LEAD: COIL TO HAR-
NESS
(PURPLE & GREY WIRES)



9000-001
TOOL: TIMING



0811-019
WIRE LEAD: IGNITION SHIFT
INTERRUPT



0811-027
WIRE LEAD SET:
ELECTRIC FUEL PUMP



1110-001
CLIP: IGNITION WIRE

PRIMARY ENGINE HARNESS DIAGRAM

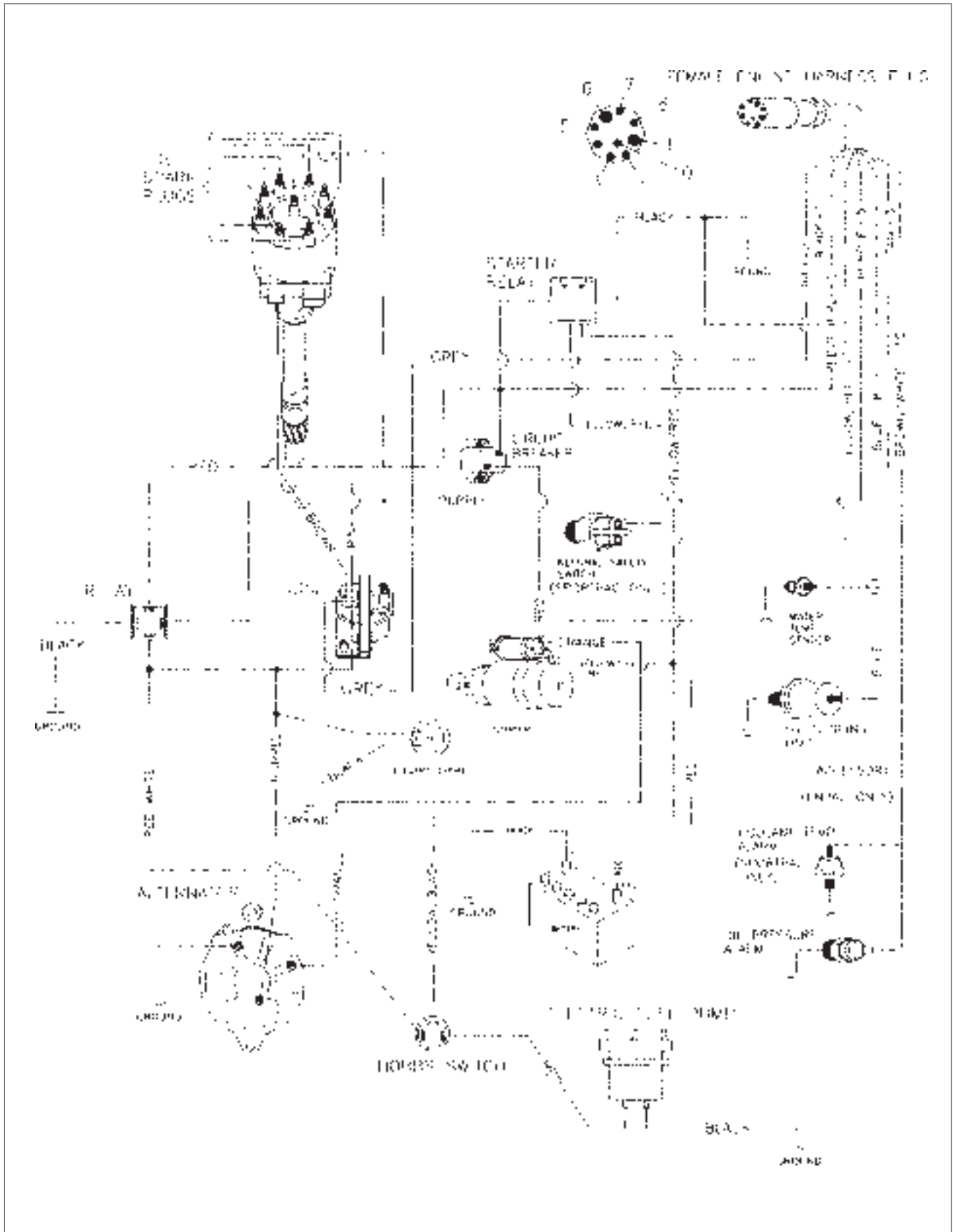

PANEL WIRING DIAGRAM

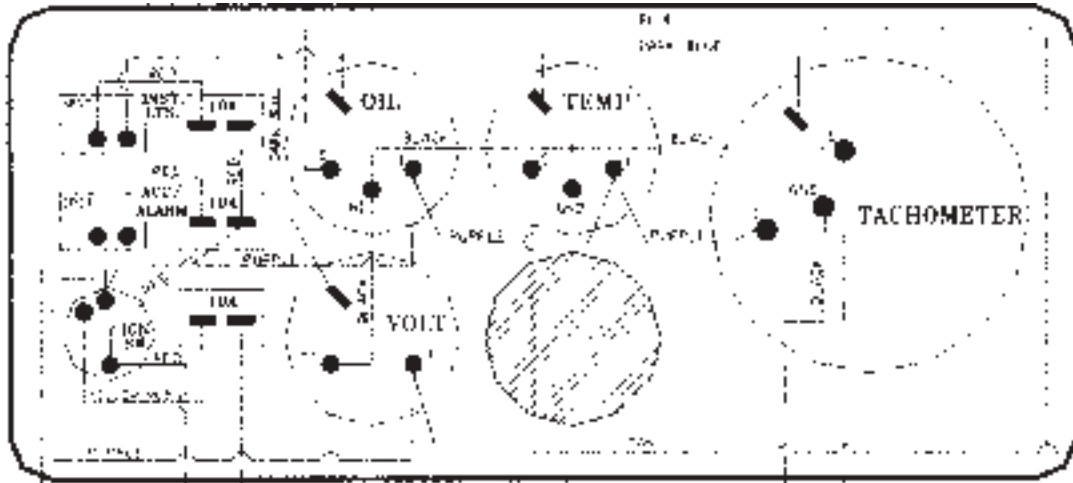

- NO1 - 10 GA. BLACK
- NO2 - 12 GA. BLUE
- NO3 - 14 GA. RED W/WHITE
- NO4 - 16 GA. RED/WHITE

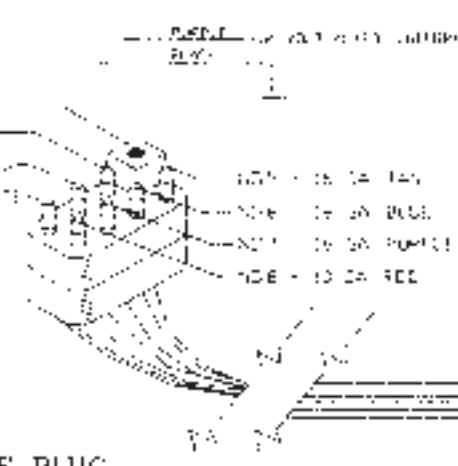

8X MOULDED MALE PLUG
PART NO. 100-10000

- NO5 - 16 GA. TAN
- NO6 - 16 GA. BLUE
- NO7 - 16 GA. PURPLE
- NO8 - 16 GA. RED

- 10 GA. BLACK
- 12 GA. BLUE
- 14 GA. RED W/WHITE
- 16 GA. RED
- 16 GA. TAN
- 16 GA. BLUE
- 16 GA. PURPLE
- 16 GA. RED

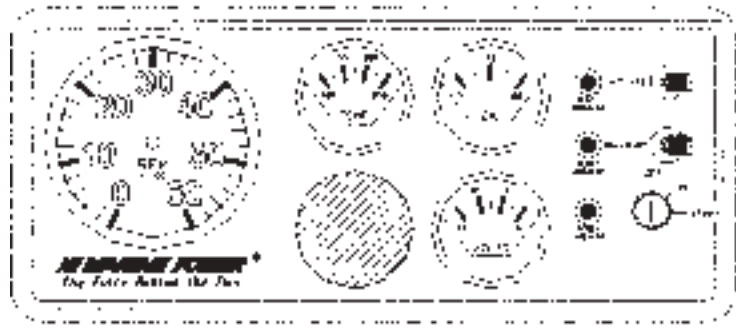

- 10 GA. BLACK - ENGINE OIL PRESS.
- 12 GA. BLUE - OIL SERVICE
- 14 GA. RED W/WHITE - IGNITION
- 16 GA. RED - 12V BATTERY POSITIVE
- 16 GA. RED - GROUND
- 16 GA. TAN - TACHOMETER CENTER
- 16 GA. BLUE - TACHOMETER POSITIVE
- 16 GA. PURPLE - TACHOMETER
- 16 GA. RED - BATTERY

INITIAL TIMING JUMPER WIRING DIAGRAM

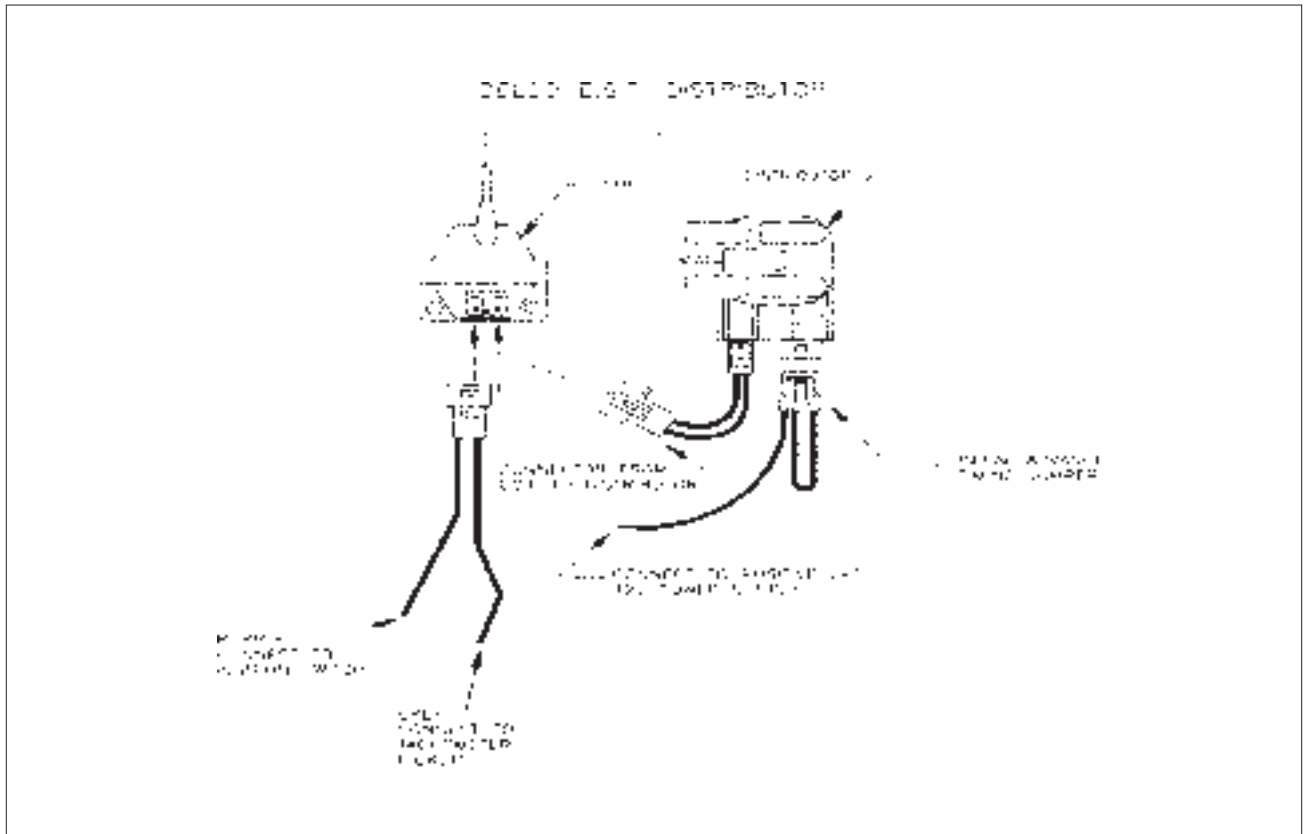

SHIFT ASSIST WIRING DIAGRAM

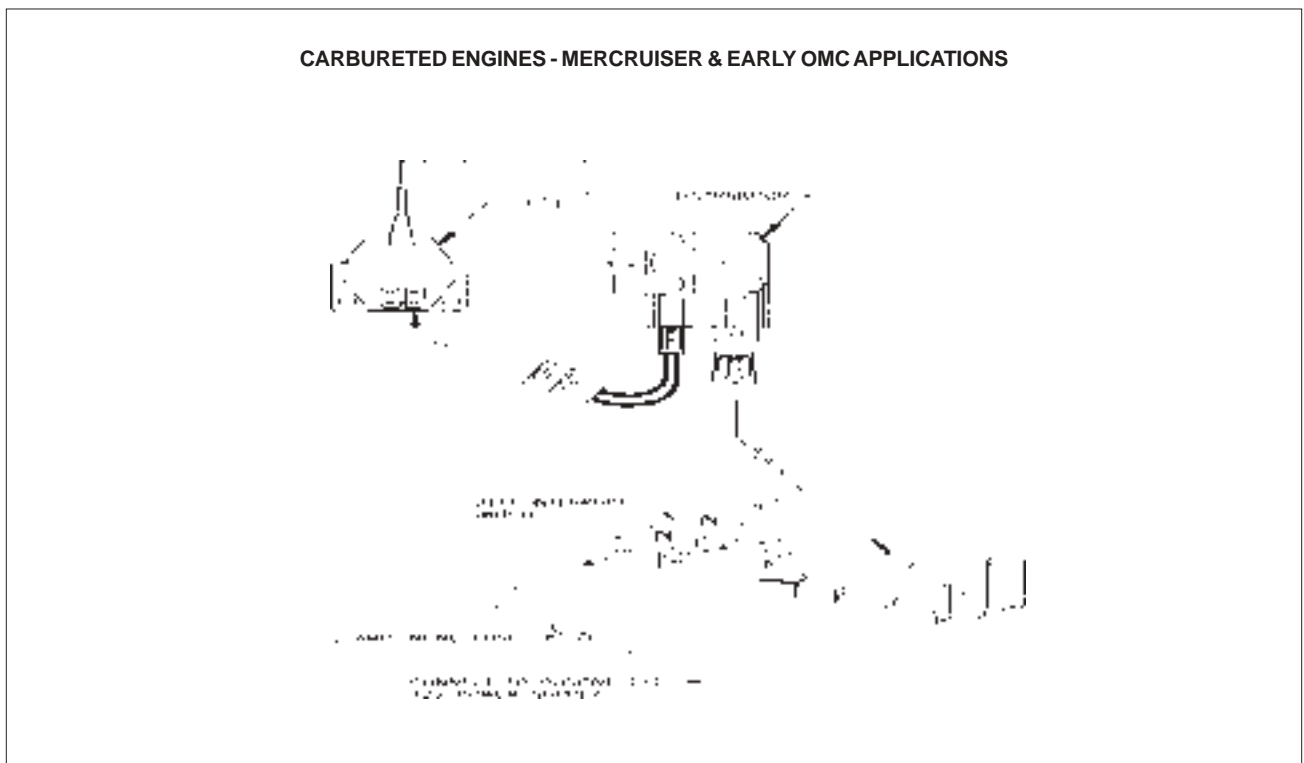

OMC SHIFT INTERRUPT DIAGRAM

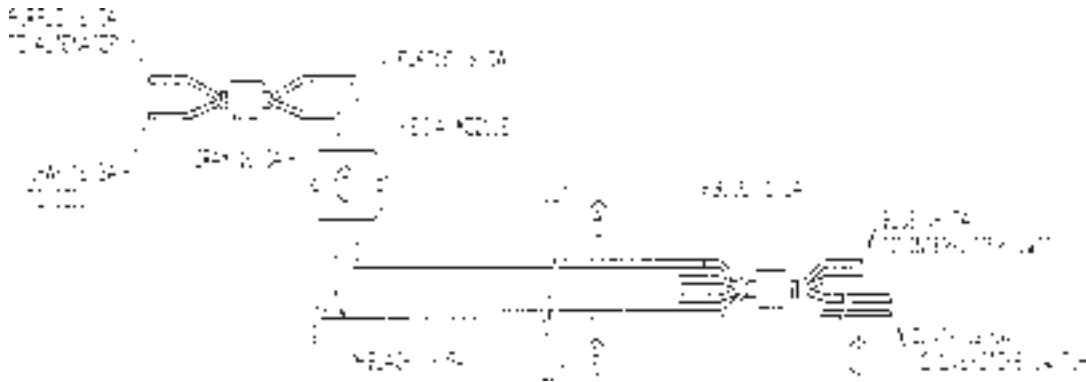

Installation Instructions:

1. Cut the blue 16 gauge wire (A) and connect to 12V positive supply when ignition switch is in the "ON" position with 2 amp in-line fuse.
2. Cut the black 16 gauge wire (B) and connect the shift interrupt wire on the engine. (Refer to Shift Cutout Wiring Diagram.)
3. Cut the black 16 gauge wire (C). The overstroke switch and the E.S.A. module are no longer used.

MARINE POWER MANIFOLDS & RISER GROUP



0992-635
SPACER: MERC 3"
0992-660
SPACER: MERC 6"



0992-310N4
GASKET: RISER
MERC RAW WATER



0992-000
RISER: MP 3" IRON
0992-040
RISER: MP 4" IRON
0992-003
RISER: MP 3" ALUM
0992-004
RISER: MP 4" ALUM
0992-005
RISER" MP 4"
POLISHED ALUMINUM



0053-275F8
GASKET: INTAKE MANIFOLD
GEN V



0991-200P5
MANIFOLD: EXHAUST
MP2K ALUMINUM
FRESHWATER
0994-210P5
MANIFOLD: EXHAUST
MP2K ALUMINUM
RAW WATER



0500-001
PLATE: BLOCK OFF MP C-R



0055-275F8
GASKET: INTAKE MANIFOLD
454/502 PREMIUM



0501-001N4
GASKET: RISER
MERC FRESH WATER

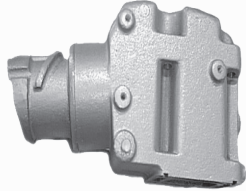

0992-400
RISER: MERC



0003-275
INTAKE: STANDARD
IRON GEN V - VI



0991-100
MANIFOLD: EXHAUST
MERC



0992-205P5
GASKET: RISER
RAW WATER MP2K



0055-275
MANIFOLD: INTAKE
PREMIUM
WITHOUT BRASS
INSERT



0991-000
MANIFOLD: EXHAUST
MP IRON



0992-300G5
GASKET: RISER C-R
RAW WATER MP



0992-200P5
RISER: MP2K
ALUMINUM FRESHWATER
0992-210P5
RISER: MP2K
ALUMINUM RAW WATER



0053-274
MANIFOLD: INTAKE
STANDARD ALUMINUM
WITHOUT
BRASS INSERT
0005-275
MANIFOLD: PREMIUM
ALUMINUM
WITH BRASS INSERT



0992-110P5
O-RING: MP2K RISER
RAW WATER SYSTEM



FUEL SYSTEMS



0303-016F1
PUMP: FUEL
ELECTRIC 7.5 PSI

FUEL PUMP KIT

0430-018
ROCHESTER CARB
FRONT MOUNT

0430-021
HOLLEY 750 CFM
PREMIUM



0700-200
LINKAGE: THROTTLE
MERC

**ELECTRIC CHOKE
KITS**

0702-224
KIT: ELECTRIC CHOKE
800 CFM



0303-013
COVER: THERMOCHOKE



0400-003P12
FUEL LINE: PUMP - CARB
454 STANDARD
ROCHESTER CARB
FRONT MOUNT



0416-100N2
FUEL LINE: HOLLEY
DUAL PUMPER PREMIUM
0415-100N2
FUEL LINE: HOLLEY
DUAL PUMPER 800 CFM



0303-011
ROD: THERMOCHOKE
454 STANDARD

0305-011
454-502 PREMIUM



0430-004
FUELLINE: SEPERATOR -
LP FUEL PUMP



0432-049
FILTER: FUELWATER
SEPERATOR



0432-048
BASE: FUEL / WATER
SEPERATOR



0303-999
THERMOCHOKE

0303-010
**THERMOCHOKE
ASSEMBLY**



0730-278N2
BRACKET: LOW PRESS
FUEL PUMP



0730-282N2
BRACKET: FUEL / WATER
SEPERATOR



0952-001
ARRESTOR: FLAME

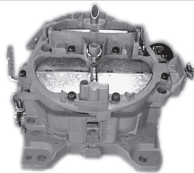

0702-280
CARBURETOR:
ROCHESTER
QUADRAJET 280

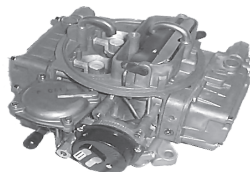

0702-416
CARBURETOR:
HOLLEY 4160
454 PREMIUM / 502



0705-004
GASKET: CARB
HOLLEY 1/8"



0700-002
GASKET: CARB
QUADRAJET

THROTTLE BODY

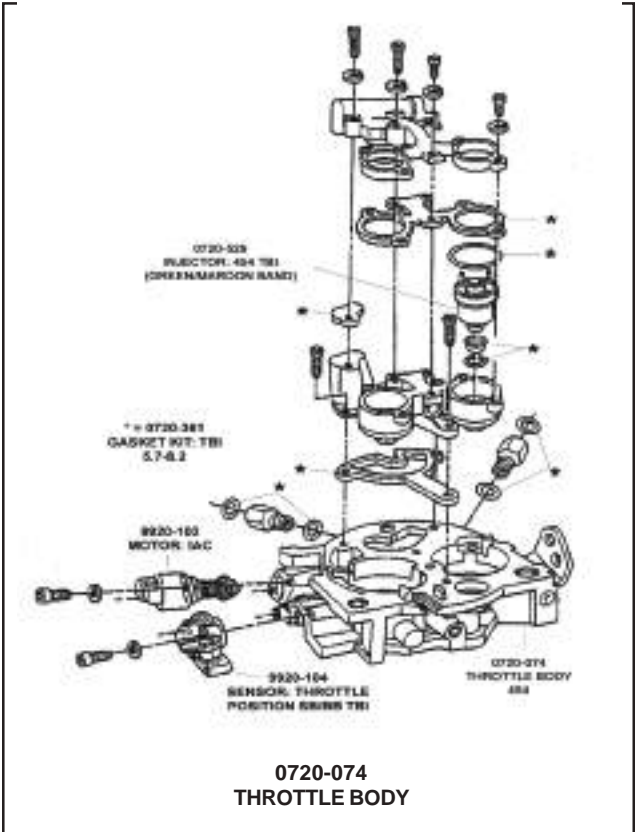

GASKETS

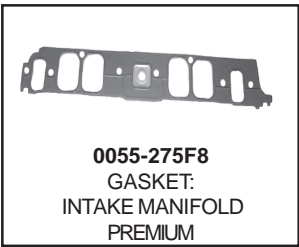

ADAPTER



INTAKE MANIFOLD



FUEL LINES

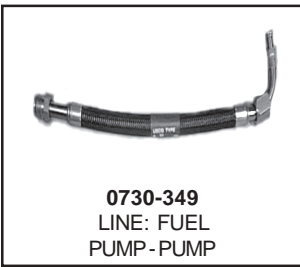
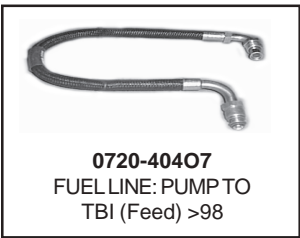

FUEL FITTINGS

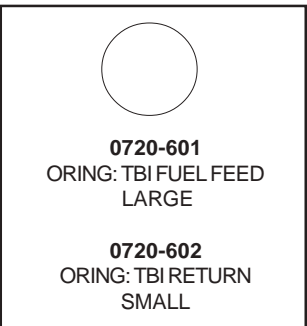
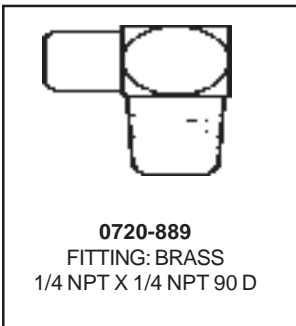
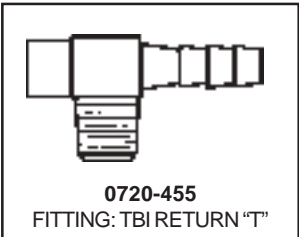
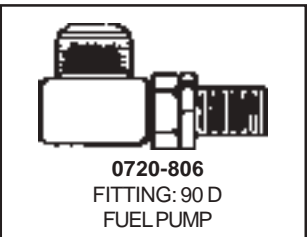
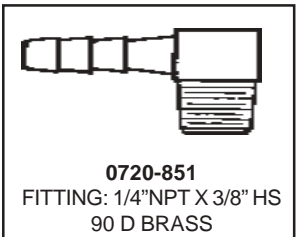
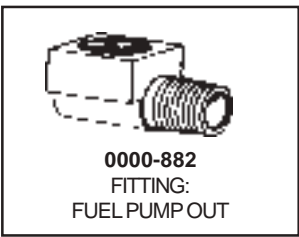
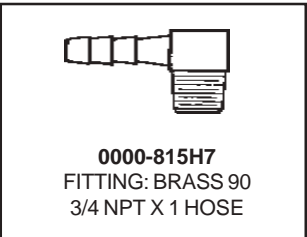
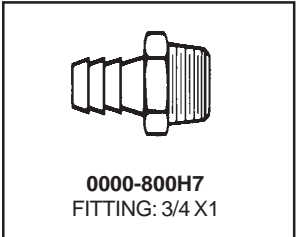

HARNESSES





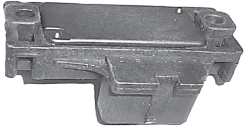

0806-017
SENSOR: KNOCK TBI-MPI

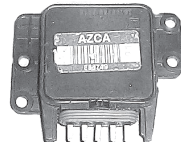

0806-020F12
SENSOR: MAP TBI-MPI



0806-017
MODULE: KNOCK



0806-010F12
SENDER: TEMPERATURE
TBI - MPI



0806-599
MODULE: ECM EFI #2
MEFI 1

Order this ECM to replace the following
ECM: Model#: 16220371 or
Model#: 16189069
The #16189069 ECM has an offset hole
pattern. It will require drilling an additional
hole to fit the replacement ECM bolt pattern.



0806-596
MODULE: ECM EFI #3
MEFI 2

this ECM to replace ECM Model #
16210729



0806-600
MODULE: ECM >98 #4
MEFI 3/ MEFI 4

Order this ECM to replace ECM Model #
16237009

NOTE: BEFORE ORDERING ECM MODULE, THE PROGRAM NUMBERS THAT ARE RECORDED ON THE BACK OF THE ECM WILL BE REQUIRED TO CORRECTLY PROGRAM THE REPLACEMENT MODULE.

FUEL PUMPS



0303-016F1
PUMP: ELEC FUEL PUMP
7 PSI

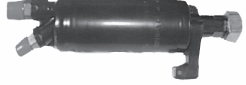

0730-016
PUMP: FUEL EFI
5.7 - 8.2



0080-650
GROMMET:
HIGH PRESS PUMP

BRACKETS

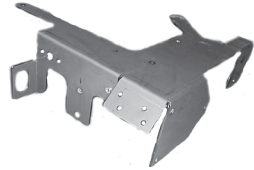

0730-286N4
BRACKET: COMPONENT
7.4V MEFI 3 ECM

BRACKETS



0720-289N4
BRACKET: ECM
TBI 5.7 - 7.4L



0720-220
BRACKET: MAP SENSOR
TBI / PFI



0730-103N2
BRACKET: HI PRESS PUMP
5.7 - 8.2L



0720-288
BRACKET: INTAKE "Z"
ELECT COMPONENT



0720-279I9
BRACKET: THROTTLE
TBI 5.7 - 7.4



1150-100F11
BRACKET: ELECT COMP
V-8

BRACKETS

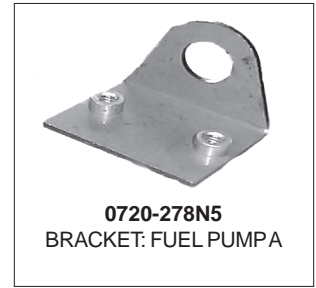
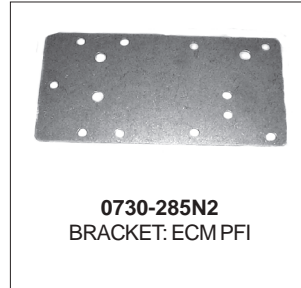
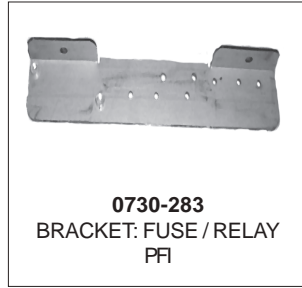
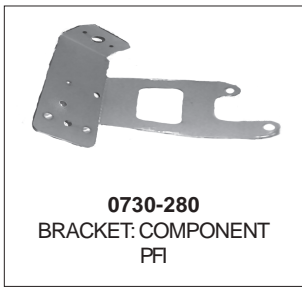

COMPONENTS

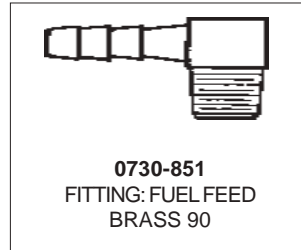
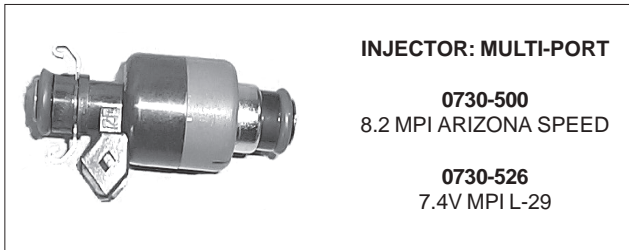
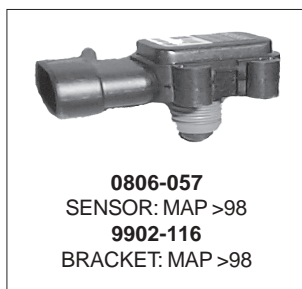
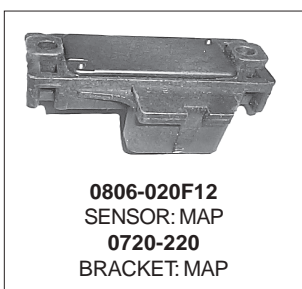
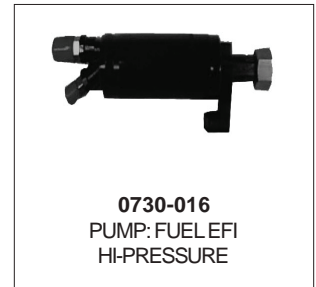
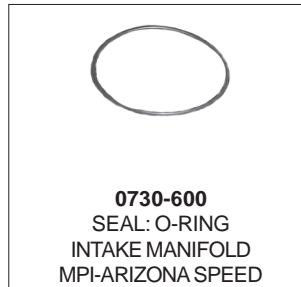
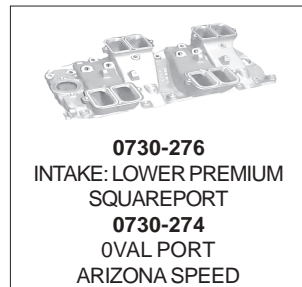

EFI SECONDARY WIRING HARNESS

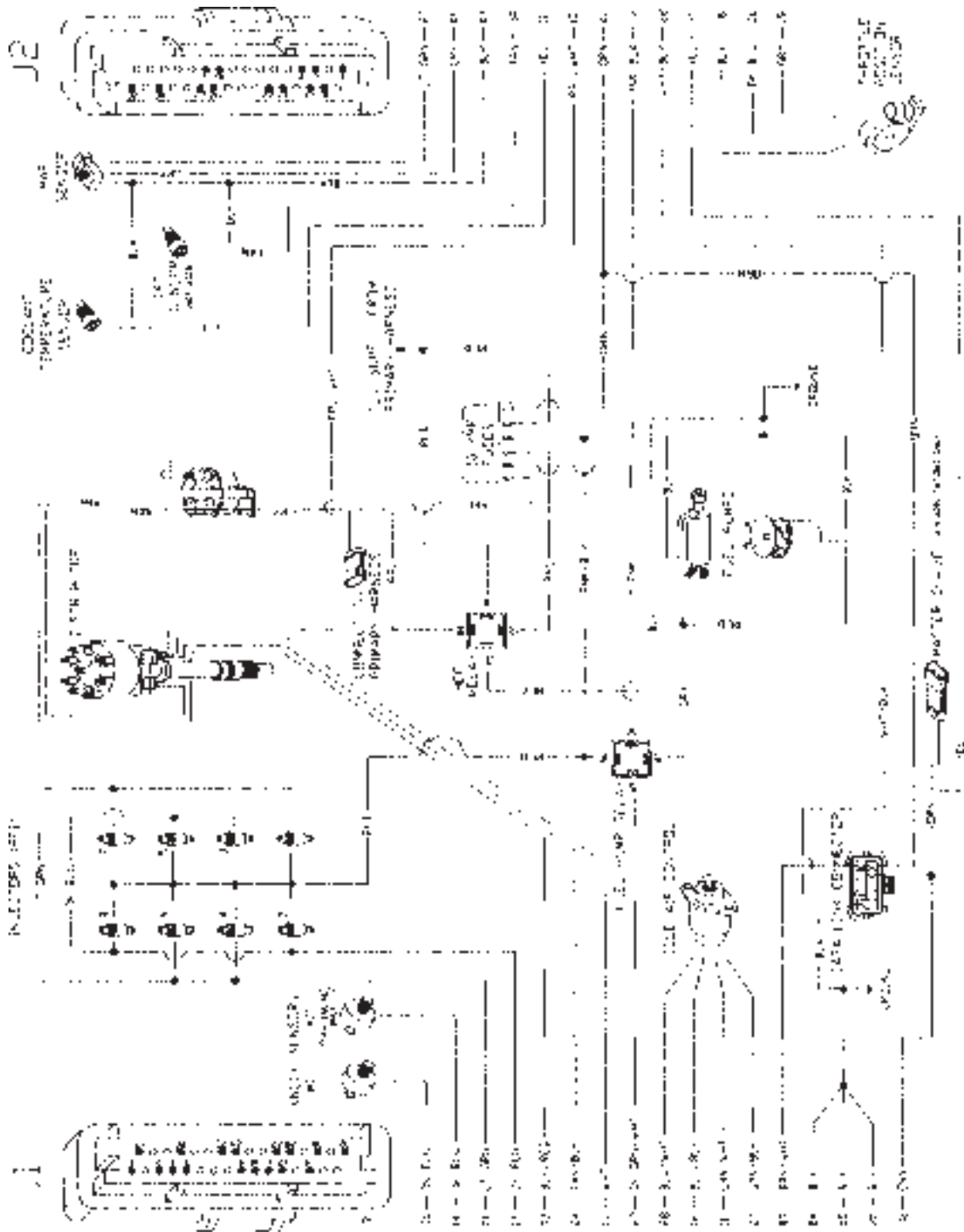

NOTE: This schematic shows two knock sensos. These are used on the SportPac and Enpac 7.4 Model only all other EFI engines utilize one knock sensor.
 This schematic is a drawing of a multi-port fuel system. The only change to the TBI wiring schematic is the reduction of the eight fuel injector connectors to two and the elimination of the MAT Sensor.

SHIFT INTERRUPT DIAGRAM

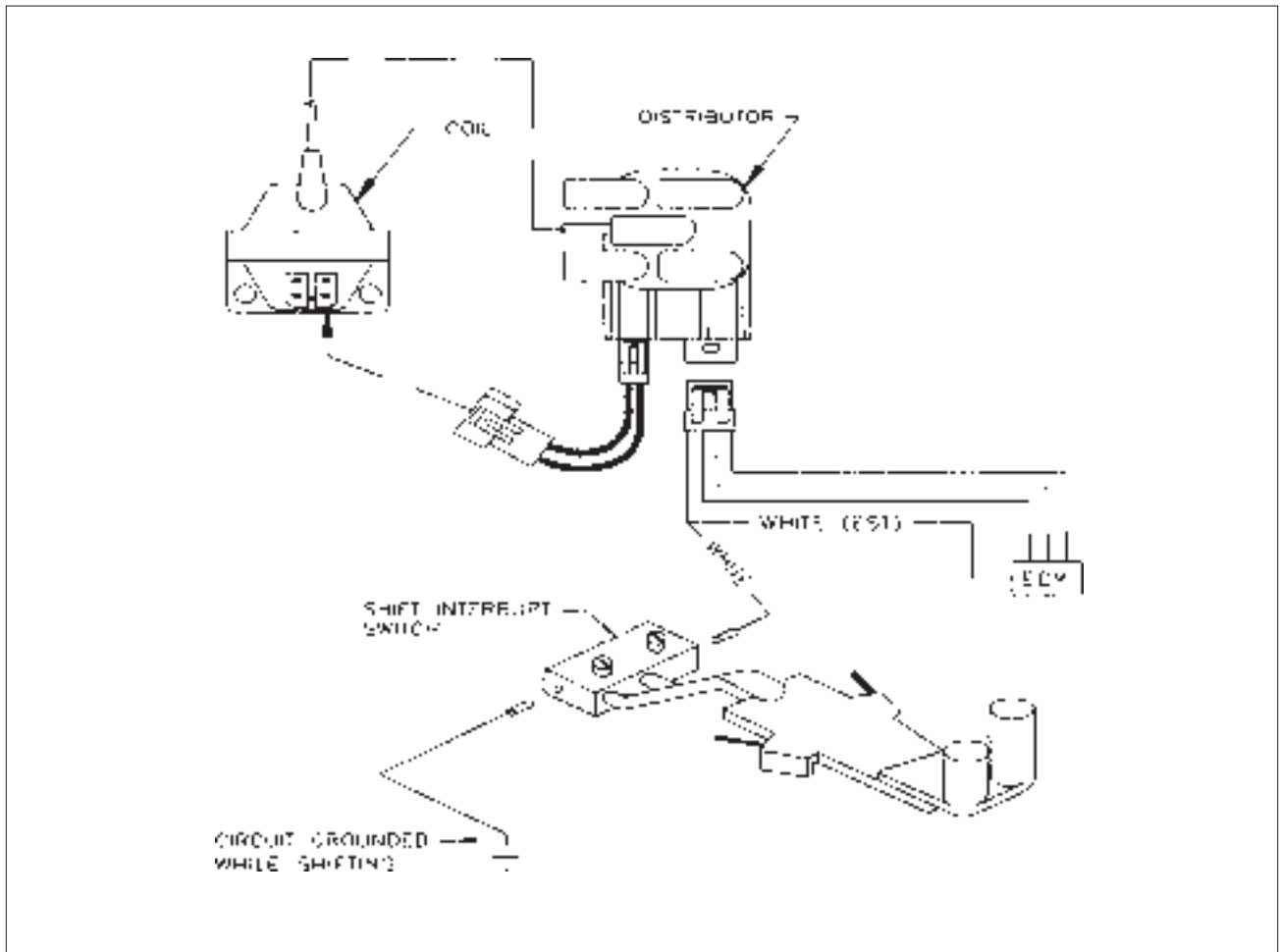

ENGINE | GEAR MOUNTS



0032-00116*
MOUNT: SHORT TRUNION
KIT



0032-001*
MOUNT: TRUNION MEDIUM
KIT



0032-001F12*
MOUNT: TRUNION TALL
KIT



1435-000
MOUNT: ISOLATOR 3/4



0034-210
MOUNT: GEAR UNIVERSAL
BW 5000C & HURTH
STARBOARD



0034-215
MOUNT: GEAR UNIVERSAL
BW 5000C & HURTH
PORT



0032-002
MOUNT: ENGINE ENPAC

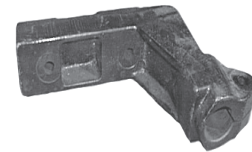

0034-100
MOUNT: GEAR
BW 71C / 72C



0032-00316
PIN: ENGINE / GEAR 4.75"
0032-004
PIN: ENGINE / GEAR 6"

* KIT INCLUDES
ALL MOUNTING
HARDWARE



PARTS LINE
1-877-388-9555

POWER STEERING

0310-454
KIT: POWER
STEERING
RAW WATER

0311-454
KIT: POWER
STEERING
FRESH
WATER



0310-108F7
BRACKET: R/W POWER
STEERING RESEVOIR



0310-007N3
BRACKET:
POWER STEERING ARM

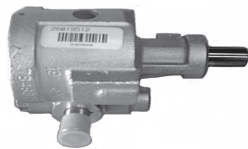

0310-104F7
PUMP: POWER STEERING
NEW



0310-105F7
RESERVOIR:
POWER STEERING



0310-255
BRACKET: FWS POWER
STEERING RESEVOIR



0310-110
HOSE:
POWER STEERING
PRESSURE



0310-111
HOSE:
POWER STEERING
RETURN



0310-200
BRACKET:
POWER STEERING
MOUNTING



0310-800
FITTING:
POWER STEERING

POWER STEERING KIT			
REF	QTY	DESCRIPTION	454 / 502
1	1	BRACKET: OIL COOLER 6"	0791-006
2	1	NUT: 3/8" NYLON LOCK	*NSLD-006
3	1	BOLT: 3/8" X 3/4"	*BS00-612
4	1	CLAMP: OIL COOLER	0791-000
5	1	COOLER: OIL 5" X 1-1/4"	0440-001
6	2	FITTING: P/S COOLER → HOSE	0310-800
7	2	CLAMP: HOSE #10	HC00-010
8	3	CLAMP: HOSE #8	HC00-008
9	1	BOLT: M10 X 1.5 X 30	*B0M0-1030
10	1	SPACER: ALTERNATOR	1188-001
11	2	WASHER: LOCK 1/4" SS	*WSL0-004
12	2	BOLT: 1/4" X 1/2" NC SS	*BS00-408
13	1	BRACKET: P/S-SEAWATER PUMP	0740-000
14	3	WASHER: LOCK M10	*W0L0-010
15	2	BOLT: M10 X 20	*B000-1020
16	1	BOLT: 3/8" X 1-1/4" NC (SB) / 7/16" X 1-1/4" NC (BB)	*B000-772
17	1	BOLT: 3/8" X 4-1/2" NC (SB) / 7/16" X 4-1/2" NC (BB)	*B000-972
18	1	BRACKET: POWER STEERING PUMP MOUNTING	0310-200
19	1	SPACER: POWER STEERING	0000-310
20	1	BRACKET: P/S TENSION	0310-007N3
21	1	PUMP: POWER STEERING	0310-104F7
22	1	PULLEY: POWER STEERING	0310-001
23	4	WASHER: LOCK 3/8" (SB) / 7/16" (BB)	*W0L0-007
24	1	HOSE: 5/8" POWER STEERING (2 FT)	HPWS-010
25	1	HOSE: 3/8" P/S RESERVOIR → COOLER (3 FT)	HPWS-006
26	1	HOSE: P/S PRESSURE	0310-110
27	1	HOSE: P/S RETURN	0310-111
28	2	SCREW: 10-32 X 1/2"	*SS10-3208
29	1	RESERVOIR: POWER STEERING	0310-105F7
30	1	BRACKET: RESERVOIR RAW WATER	0310-108F7
30	1	BRACKET: RESERVOIR FRESH WATER	0310-255
31	2	BOLT: 3/8" X 2" NC (SB) / 7/16" X 2" NC (BB)	*B000-732
32	2	BUSHING: P/S BRACKET SPACER	0431-057

POWER STEERING

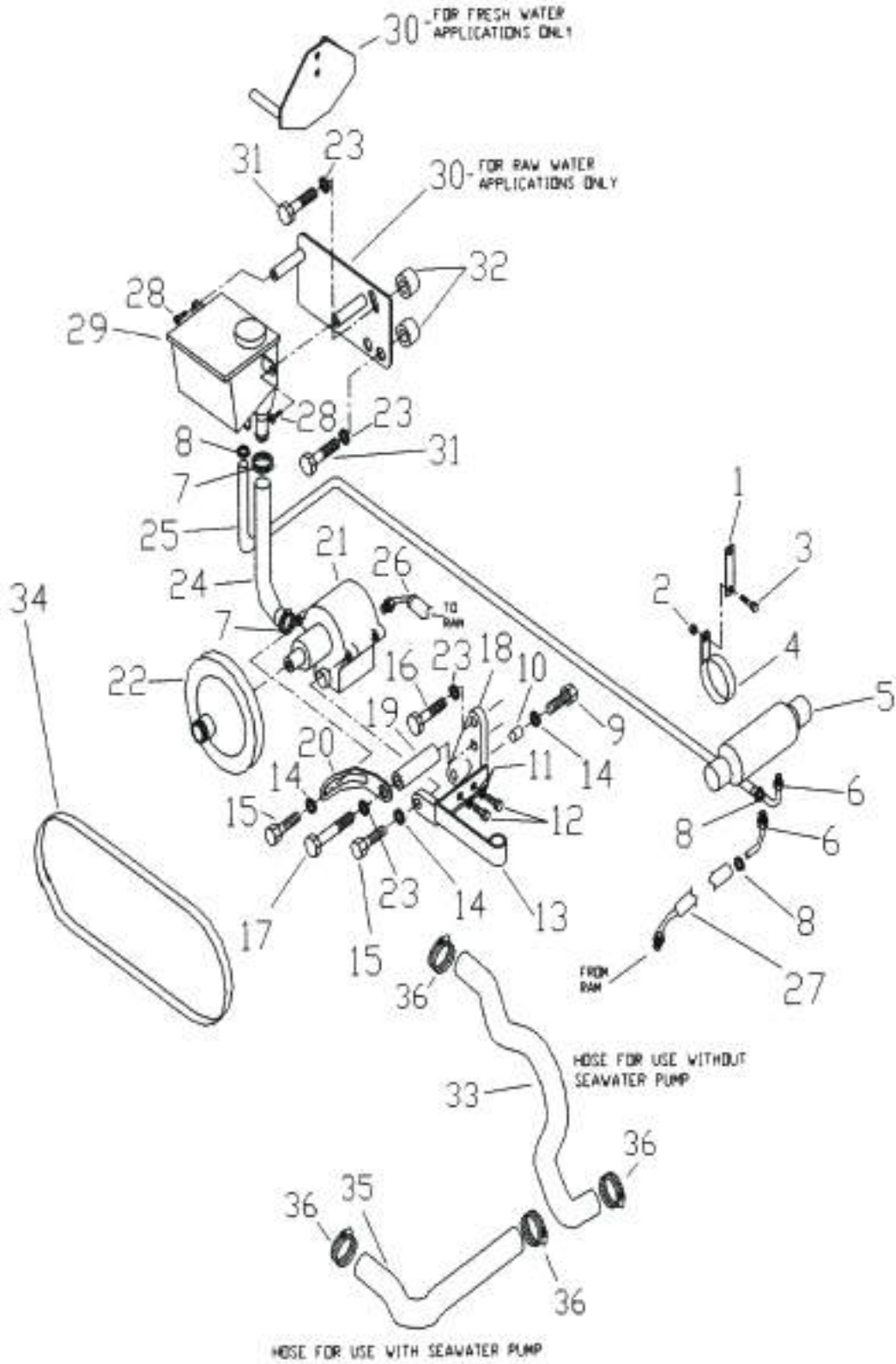

TRANSMISSIONS

VELVET DRIVE DIRECT DRIVE



6017-004
GEAR: 71C 1:1
6018-002
GEAR: 72C 1:1

VELVET DRIVE 72C SERIES



6018-004
GEAR: 72C 1.5:1
6018-106
GEAR: 72C 1.88:1
6018-210
GEAR: 72C 2.1:1
6018-010
GEAR: 72C 2.5:1
6018-012
GEAR: 72C 2.9:1

VELVET DRIVE 5000V V-DRIVE SERIES



6002-002
GEAR: 5000V 1.25:1
6002-003
GEAR: 5000V 1.5:1
6002-004
GEAR: 5000V 2.0:1
6022-005
GEAR: 5000V 2.5:1

VELVET DRIVE 5000C SERIES



6020-001
GEAR: 5000C 1:1
6020-002
GEAR: 5000C 1.25:1
6020-003
GEAR: 5000C 1.5:1
6020-004
GEAR: 5000C 2.0:1
6020-005
GEAR: 5000C 2.5:1
6020-006
GEAR: 5000C 2.8:1

VELVET DRIVE 72C V-DRIVE SERIES



6005-012
GEAR: 72C V-DRIVE 1.2:1
GEAR DRIVEN
6005-013
GEAR: 72C V-DRIVE 1.2:1
CHAIN DRIVEN
6005-010
GEAR: 72C V-DRIVE 1.5:1
CHAIN DRIVEN
6005-011
GEAR: 72C V-DRIVE 1.5:1
GEAR DRIVEN
6005-002
GEAR: 72C V-DRIVE 1.9:1
GEAR DRIVEN
6005-003
GEAR: 72C V-DRIVE 1.9:1
CHAIN DRIVEN
6005-004
GEAR: 72C V-DRIVE 2.5:1
CHAIN DRIVEN
6005-005
GEAR: 72C V-DRIVE 2.5:1
GEAR DRIVEN

HURTH DIRECT DRIVE

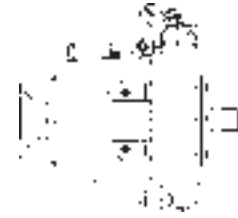

6450-100
GEAR: 450D 1:1

HURTH



6450-125
GEAR: 450A 1.25:1
6450-150
GEAR: 450A 1.5:1
6450-200
GEAR: 450A 2.0:1

HURTH V-DRIVE



6635-130
GEAR: 630V 1.3:1
6635-150
GEAR: 630V 1.6:1
6635-210
GEAR: 630V 2.0:1
6635-250
GEAR: 630V 2.5:1

NOTE:
SOME TRANSMISSIONS LISTED MAY NOT BE AN IN-STOCK ITEM. LEAD TIMES MAY APPLY TO CERTAIN TRANSMISSIONS. CALL FOR AVAILABILITY.

GEAR LINES, COOLER, SWITCHES & FITTING



1256-037F8
GEAR LINE: 37" SPORTPAC
1256-042F8
GEAR LINE: 42" SPORTPAC
1250-003E3
GEAR LINE: 45" SPORTPAC



0440-549G3
COOLER: DUAL 5 X 9 GEAR



0000-899
FITTING: OIL / GEAR
COOLER



6640-005
SWITCH: NEUTRAL SAFETY



6450-204
SWITCH: GEAR ALARM
HI-TEMP OIL

SHIFT BRACKETS



1194-630
BRACKET: SHIFT HURTH 630A



1194-500J12
BRACKET: SHIFT BW5000



1194-000
BRACKET: SHIFT GEAR
BW 71C/72C

///MARINEPOWER®
The Force Behind The Fun.™

MARINE POWER 454, 502, 7.4 PARTS BOOK NUMERICAL LISTING

PART #	DESCRIPTION	PAGE NUMBER(S)
*WOFO-005	WASHER: FLAT 5/16" CAMSHAFT	1
0000-809	FITTING: BYPASS T-STAT (RAW WATER ONLY)	3
0000-800H7	FITTING: BRASS 3/4 X 1	18,27
0000-815H7	FITTING: BRASS 90 DEGREE 3/4 X 1	18, 27
0000-820	FITTING: OIL FILTER	7
0000-850	TEE: FRESHWATER REAR MOUNT	14
0000-852	TEE: ADAPTER 5/8" 90 DEGREE	14
0000-871	FITTING: REMOTE OIL	10
0000-882	FITTING: FUEL PUMP OUT	27
0000-895	FITTING: PIPE 1/2" BRASS	11
0003-003	WASHER: CRANKSHAFT DAMPER	1, 5
0003-003	WASHER	7
0003-015	SPARK PLUG: V8	3,19
0003-026	BOLT: CONNECTING ROD	7
0003-027	BOLT: CYLINDER HEAD LONG	3
0003-029	BOLT: CYLINDER HEAD SHORT 454/502/7.4 MPI	3, 5
0003-036	ROD: CONNECTING 454 / 502	1, 7
0003-064	PUMP KIT: WATER	7
0003-065	PUMP: CIRCULATING	18
0003-127	PUSH ROD: INTAKE VALVE	3
0003-128	PUSH ROD: EXHAUST VALVE	3
0003-175	VALVE: EXHAUST GEN V 454/502/ 7.4 MPI	3, 5
0003-178	SPRING: VALVE	3
0003-206	PIN: CYLINDER HEAD LOC 454/502/7.4 MPI	3,5
0003-208	PLUG: CAMSHAFT REAR	1,7
0003-258	SHAFT: OIL PUMP	7
0003-275	MANIFOLD: INTAKE STANDARD IRON GEN V - VI	3,25
0003-303	BOLT: OIL PAN	7
0003-378	CAP: VALVE SPRING STANDARD	3
0003-379	ROTOR: VALVE 454 GEN V	3
0003-380	KEY: VALVE STEM 454/502/ 7.4 MPI	3, 5
0003-927	BOLT: CYLINDER HEAD 7.4 MPI	5
0003-999	ADAPTER: FLYWHEEL	9
0004-081	GEAR: CAMSHAFT REAR ROTATION	1
0004-082	GEAR: CRANKSHAFT REVERSE ROTATION	1
0004-094	KEY: CAMSHAFT	7
0005-082	GEAR: CRANKSHAFT NORMAL ROTATION PREMIUM / PERFORMANCE	1
0005-120	SHIM: VALVE SPRING 7.4 MPI	5
0005-122	SHIM: VALVE SPRING	3
0005-127	PUSH ROD: INTAKE VALVE PREMIUM / PERFORMANCE	3
0005-128	PUSH ROD: EXHAUST VALVE PREMIUM / PERFORMANCE	3
0005-175	VALVE: EXHAUST GEN V PREMIUM / PERFORMANCE	3
0005-275	MANIFOLD: INTAKE PREMIUM RAW WATER WITH BRASS INSERT	25
0005-378	CAP: VALVE SPRING 7.4 MPI	5
0006-089	CAMSHAFT: 454 / 502 REVERSE ROTATION	1
0007-015	PLUG: SPARK 7.4 MULTIPOINT	19
0007-090	PIN: OIL PUMP	7
0007-259	RETAINER	7
0007-990F7	FLEXPLATE: COUPLER 14"	9
0009-830	PLUG: OIL PRESSURE	1
0009-877	PLUG: DRAIN / KNOCK SENSOR PORT	1
0017-001P3	DIPSTICK: ENPAC, JETPAC	10
0025-107	BOLT: VALVE COVER 454/502/ 7.4 MPI	3,5
0025-143F5	PIN: FLYWHEEL	7
0025-266	BOLT: CRANKSHAFT SPROCKET	1, 7
0025-815	PLUG: DRAIN	1,7

MARINE POWER 454, 502, 7.4 PARTS BOOK NUMERICAL LISTING

PART #	DESCRIPTION	PAGE NUMBER(S)
0032-001	MOUNT: TRUNION MEDIUM	32
0032-001F12	MOUNT: TRUNION TALL	32
0032-001I6	MOUNT: TRUNION SHORT	32
0032-002	MOUNT: ENGINE ENPAC	32
0032-003I6	PIN: ENGINE / GEAR 4.75"	32
0032-004	PIN: ENGINE / GEAR 6"	32
0034-100	MOUNT: GEAR BW 71C /72C	32
0034-210	MOUNT: GEAR UNIVERSAL STARBOARD	32
0034-215	MOUNT: GEAR UNIVERSAL PORT	32
0053-001	CASE: ENGINE 454 GEN V	1
0053-002F3	BOLT: CRANKSHAFT	1,7
0053-002P3	TUBE: DIPSTICK ENPAC	10
0053-004F8	DAMPER: TORSIONAL 454 NORMAL ROTATION	1
0053-005	SEAL: CRANKSHAFT	7
0053-009F8	BEARING KIT: CRANKSHAFT #5	1,7
0053-018F8	CRANKSHAFT: 454 GEN V NORMAL ROTATION	1,7
0053-024F8	HEAD: CYLINDER BARE	3
0053-024Z	HEAD: CYLINDER COMPLETE	3
0053-025F8	GASKET: CYLINDER HEAD GEN V	3
0053-025L-29	GASKET: HEAD 7.4 MPI	5
0053-030F8	PLUG: CYLINDER HEAD 454/502/7.4MPI	3,5
0053-033	SEAL: CRANKSHAFT	7
0053-033F8	SEAL: CRANKSHAFT OIL REAR NORMAL ROTATION	1
0053-037F8	PISTON: 454 GEN V STANDARD	1
0053-038F8	BEARING KIT: CONNECTING ROD	1,7
0053-042	FITTING: OIL BYPASS	10
0053-058F8	COVER: TIMING COVER GEN V NORMAL ROTATION	1
0053-058K8	COVER: ENGINE FRONT	7
0053-059F8	BOLT: TIMING COVER	1
0053-059K8	BOLT: ENGINE FRONT COVER	7
0053-061F8	GASKET: TIMING COVER	1
0053-061K8	GASKET: FRONT COVER	7
0053-081	GEAR: CAMSHAFT NORMAL ROTATION	1
0053-082	GEAR: CRANKSHAFT NORMAL ROTATION	1,7
0053-084	CHAIN: TIMING NORMAL ROTATION	1,7
0053-089	CAMSHAFT: 454 / 502 NORMAL ROTATION	1
0053-093	BOLT: CAMSHAFT	7
0053-097	LIFTER: VALVE	3
0053-097K8	LIFTER: HYDRAULIC 7.4 MPI	5
0053-100F3	COVER: VALVE 454 / 502	3
0053-101F8	GASKET: VALVE COVER 454/502/7.4	3,5
0053-102F8	CAP: OIL FILL	3,5
0053-119F8	GUIDE: PUSH ROD 454/502/7.4 MPI	3,5
0053-120F8	ARM: ROCKER	3
0053-121F8	BALL: ROCKER ARM	3
0053-140F8	FLYWHEEL: REAR RING GEN V STANDARD 454	9
0053-141	FLYWHEEL: BOTTOM MOUNT FORWARD GEAR GEN V STANDARD 454	9
0053-143G2	FLEXPLATE: AUTOMATIC JET STANDARD 454 / 502	9
0053-151F8	BOLT: CRANKSHAFT BEARING CAP	1,7
0053-153F8	STUD: CRANKSHAFT BEARING CAP	1
0053-174	VALVE: INTAKE GEN V	3
0053-178F8	SEAL: VALVE STEM OIL	3
0053-178K8	SPRING: VALVE 7.4 MPI	5
0053-189F8	BEARING: CAMSHAFT #1	1,7
0053-190F8	BEARING: CAMSHAFT #2 #5	1
0053-191F8	BEARING: CAMSHAFT #3 #4	1

MARINE POWER 454, 502, 7.4 PARTS BOOK NUMERICAL LISTING

PART #	DESCRIPTION	PAGE NUMBER(S)
0053-203	BRACKET: ENGINE LIFT REAR	3
0053-204	BRACKET: ENGINE LIFT FRONT	3
0053-205F8	PLUG: OIL GALLEY	1,7
0053-209	KEY: CRANKSHAFT BALANCER	1,7
0053-210F8	PLUG: WATER JACKET FREEZE	1
0053-242	PAN: OIL IRIDITED 10 QT	10
0053-245F7	GASKET: OIL PAN	7,10
0053-248	PAN: OIL PLASTISOL 8 QT	10
0053-257	BOLT: OIL PUMP	7
0053-274	MANIFOLD: INTAKE STANDARD ALUMINUM FRESHWATER	25
0053-275F8	GASKET: INTAKE MANIFOLD GEN V	3,25
0053-276	SHIELD: INTAKE MANIFOLD	3
0053-277	SHIELD: INTAKE MANIFOLD 7.4 MPI	5
0053-348F8	RING KIT: 454 GEN V	1
0053-348I8	RING: KIT	7
0053-440F8	BEARING KIT: CRANKSHAFT #1, #2, #3, #4	1,7
0053-450	HOSE: BYPASS (RAW WATER ONLY)	3
0053-601	SEAL: CRANKSHAFT BEARING CAP #5	1,7
0053-750	CLAMP: GEAR (RAW WATER ONLY)	3
0053-810	CAP: CRANKSHAFT BEARING	1
0053-815	CAP: CRANKSHAFT BEARING #5	1
0053-840	PLUG: ENGINE BLOCK OIL GALLEY	1
0053-902	BOLT: ENGINE LIFT FRONT	3
0053-903	STUD: ENGINE LIFT BRACKET	3
0053-906	PIN: CRANKSHAFT	1
0053-915	WEIGHT: FLYWHEEL	7
0053-920	BOLT: ROCKER ARM	3,5
0053-921	STUD: ROCKER ARM 454/502/7.4 MPI	3
0053-965	STUD: INTAKE MANIFOLD	3
0053-975	BOLT: INTAKE MANIFOLD GEN V	3
0053-999	ADAPTER: FLYWHEEL	9
0054-018F8	CRANKSHAFT: 454 GEN V REVERSE ROTATION	1
0054-033F8	SEAL: CRANKSHAFT OIL REAR REVERSE ROTATION	1
0054-058F3	COVER: TIMING COVER GEN V REVERSE ROTATION	1
0054-089	CAMSHAFT: 454 / 502 REVERSE ROTATION	1
0054-260	INDICATOR: TIMING COVER REVERSE ROTATION	17
0055-004F8	BALANCER	7
0055-018F8	CRANKSHAFT: 454 GEN V NORMAL ROTATION PREM / PERFORMANCE	1
0055-024F8	HEAD: CYLINDER BARE PREMIUM	3
0055-024Z	HEAD: CYLINDER COMPLETE PREMIUM	3
0055-037F8	PISTON: 454 GEN V PREMIUM / PERFORMANCE	1,7
0055-084	CHAIN: TIMING NORMAL ROTATION	1
0055-089	CAMSHAFT	7
0055-097F8	LIFTER: VALVE PREMIUM / PERFORMANCE	3
0055-119F8	GUIDE: PUSH ROD PREMIUM / PERFORMANCE	3
0055-120F8	ARM: ROCKER PREMIUM / PERFORMANCE	3
0055-140F8	FLYWHEEL: TOP MOUNT REAR MOUNT PREMIUM	7,9
0055-141	FLYWHEEL: FORWARD RING GEAR GEN V PREMIUM	9
0055-143	FLEXPLATE: AUTOMATIC JET PREMIUM 454 / 502	9
0055-174	VALVE: INTAKE GEN V PREMIUM / PERFORMANCE	3
0055-174F8	VALVE: INTAKE 7.4 MPI	5
0055-176F8	SPRING: VALVE	3
0055-178I8	SEAL: VALVE STEM OIL 7.4 MPI	5
0055-255F8	PUMP : OIL W/ SCREEN	7
0055-275	MANIFOLD: INTAKE PREMIUM FRESHWATER	25,27
0055-275F8	GASKET: INTAKE MANIFOLD GEN V PREMIUM	25,27
0055-276	SHIELD: INTAKE MANIFOLD PREMIUM / PERFORMANCE	3

MARINE POWER 454, 502, 7.4 PARTS BOOK NUMERICAL LISTING

PART #	DESCRIPTION	PAGE NUMBER(S)
0055-378F8	CAP: VALVE SPRING PREMIUM / PERFORMANCE	3
0060-067	NUT: CONNECTING ROD	7
0060-128	ROD: INTAKE VALVE PUSH 7.4 MPI	5
0065-198	BEARING: PILOT	7
0065-245	GASKET: OIL PAN DRAIN PLUG	7
0065-945	PLUG: OIL PAN DRAIN	7
0065-994	WASHER	7
0066-001	CASE: ENGINE 502 GEN V	1
0066-004F8	DAMPER: TORSIONAL 502 NORMAL ROTATION	1
0066-018F8	CRANKSHAFT: 502 GEN V NORMAL ROTATION	1
0066-037F8	PISTON: 502 GEN V	1
0066-081	SPROCKET: CAMSHAFT	7
0066-348F8	RING KIT: 502 GEN V	1
0067-018F8	CRANKSHAFT: 454 / 502 GEN V REVERSE ROTATION	1
0077-000	PLATE: DAMPER 14"	9
0080-650	GROMMET: HI PRESSURE PUMP	28
0100-000	BELLHOUSING: INBOARD	9
0102-537	PLATE: ACCESS CAL JET BELLHOUSING	9
0102-538	BELLHOUSING: CAL JET 14" TOP MOUNT	9
0105-000	ADAPTER: JET CONE	9
0150-000	COVER: DUST REAR ENTRY	9
0151-010	PLACE: STARTER BELLHOUSING	9
0151-538	COVER: DUST 14" CAL JET	9
0170-000	STARTER: TOP MOUNT 14" NORMAL ROTATION	9
0171-000	STARTER: TOP MOUNT 14" REVERSE ROTATION	9
0172-000	STARTER: BOTTOM MOUNT 12 3/4 NORMAL ROTATION	9
0174-000	STARTER: BOTTOM MOUNT 14 NORMAL ROTATION	9
0210-001	HOUSING: T-STAT RAW WATER	12
0210-002	THERMOSTAT: RAW WATER 142D	12
0212-007	THERMOSTAT: RAW WATER MERC STYLE	12
0303-008	GROMMET: VALVE COVER	3
0303-009	GASKET: T-STAT	13
0303-011	THERMOCHOKE: ROD	26
0303-013	THERMOCHOKE: COVER	26
0303-016F1	PUMP: ELECTRIC FUEL	26,28
0303-017F3	SWITCH: HOBBS OIL / FUEL PUMP CUTOFF	20
0303-028	PULLEY: CRANKSHAFT	12
0303-042	CLAMP: DISTRIBUTOR	19
0303-043	GASKET: DISTRIBUTOR	19
0303-050	GASKET: WATER CIRC PUMP	7,18
0303-999	THERMOCHOKE	26
0307-001	DIPSTICK: SPORTPAC	10
0307-007	PULLEY: CIRC PUMP	12,18
0310-001	PULLEY: POWER STEERING PUMP	12
0310-007N3	BRACKET: POWER STEERING ARM	32
0310-104F7	PUMP: POWER STEERING NEW	32
0310-105F7	RESERVOIR: POWER STEERING	32
0310-108F7	BRACKET: RAW WATER POWER STEERING	32
0310-110	HOSE: POWER STEERING PRESSURE	32
0310-111	HOSE: POWER STEERING RETURN	32
0310-200	BRACKET: POWER STEERING MOUNTING	32
0310-255	BRACKET: FRESH WATER POWER STEERING RESERVOIR	32
0310-454	KIT: POWER STEERING RAW WATER	33
0310-800	FITTING: POWER STEERING	32
0311-454	KIT: POWER STEERING FRESH WATER	33
0400-003P12	LINE: FUEL PUMP - CARB STANDARD ROCHESTER	26
0400-800	FITTING: BANJO ASSY STANDARD	10

MARINE POWER 454, 502, 7.4 PARTS BOOK NUMERICAL LISTING

PART #	DESCRIPTION	PAGE NUMBER(S)
0400-801	FITTING: BANJO ASSY METRIC	10
0403-200	BRACKET: DIPSTICK TUBE SPORTPAC	10
0407-002	TUBE: DIPSTICK SPORTPAC	10
0415-100N2	LINE: FUEL HOLLEY DUAL PUMPER 800 CFM	26
0416-100N2	LINE: FUEL HOLLEY DUAL PUMPER PREMIUM	26
0430-004	LINE: FUEL SEP TO LOW PRESSURE FUEL PUMP	26,27
0432-048	BASE: FUEL / WATER SEP	26
0432-049	FILTER: FUEL WATER SEP	26
0440-001	COOLER: OIL	10, 14
0440-505P1	COOLER: OIL 5 X 5 180 DEGREE	14
0440-549G3	COOLER, OIL	10, 14
0441-103	TEE: COPPER NW-JET	14
0442-001	COOLER: OIL 180 DEGREE	10,14
0500-001	PLATE: BLOCK OFF	13, 25
0500-002	HOUSING: T-STAT CAP REAR MOUNT	12
0500-003	TANK: FRESHWATER 5" REARMOUNT	13
0500-005G7	CAP: TANK 7 PSI DUAL SEAL	13
0500-007	THERMOSTAT: FRESHWATER REAR MOUNT	12
0500-007F6	THERMOSTAT: FRESHWATER 160 DEGREE	12
0500-008	PLATE: TANK END 4"	13
0500-009	HOUSING: T-STAT REAR MOUNT	12
0500-011	ANODE: ZINC PLUG	13
0500-013	GASKET: END PLATE 4" TANK	13
0500-014	BRACKET: TANK REAR MOUNT LEFT	13
0500-015	BRACKET: TANK REAR MOUNT RIGHT	13
0500-018	PLATE: TANK END 5"	13
0501-001N4	PLATE: BLOCKOFF	13, 25
0505-008	SPACER: THERMOSTAT	12
0505-013	GASKET: END PLATE 5" TANK	13
0505-114	BRACKET: TANK RIGHT	13
0506-009F4	HOUSING:T-STAT	12
0509-004N11	HOUSING: FRESHWATER OUTLET	12
0509-101F4	BOTTLE: RECOVERY	18
0509-102	BRACKET: MOUNTING RECOVERY BOTTLE	18
0509-103H7	TANK: FRESHWATER 5" FRONT MOUNT	13
0514-115	BRACKET: TANK LEFT	13
0515-734	BRACKET: MPI FRESHWATER RIGHT	13
0515-735	BRACKET: MPI FRESHWATER LEFT	13
0520-000	COVER: OIL BYPASS ASSY	10
0520-001	COVER: OIL BYPASS	10
0525-000	ADAPTER: OIL COOLER ENPAC	11
0538-250	BELT: POWER STEERING	12
0538-350	BELT: ALTERNATOR ENPAC	12
0539-350	BELT: ALTERNATOR CAL-JET	12, 19
0547-350	BELT: ALTERNATOR NW-JET SPORTPAC	12, 19
0553-002	HOUSING: WATER OUTLET CAL JET	12
0553-100	PLATE: WATER INLET CAL JET	12
0562-001	IMPELLER: SEA WATER JOHNSON	18
0562-002	GASKET: SEA WATER JOHNSON	18
0562-003	CAM: SEA WATER JOHNSON	18
0562-020	KIT: IMPELLER JOHNSON	18
0563-001	SCREW: COVER JOHNSON	18
0563-006	COVER: SEA WATER JOHNSON	18
0563-008	LIPSEAL: SEA WATER JOHNSON	18
0563-009	BEARING: SEA WATER JOHNSON	18
0563-013	WASHER: SEA WATER JOHNSON	18
0566-000P8	PUMP: SEAWATER JABSCO	18

MARINE POWER 454, 502, 7.4 PARTS BOOK NUMERICAL LISTING

PART #	DESCRIPTION	PAGE NUMBER(S)
0566-000ZBB	KIT: IMPELLER JABSCO	18
0566-001P8	IMPELLER: SEA WATER JABSCO	18
0566-002P8	GASKET: SEA WATER JABSCO	18
0566-003P8	COVER: SEA WATER JABSCO	18
0566-004P8	CAM: SEA WATER JABSCO	18
0566-005P8	SCREW: CAM SEA WATER JABSCO	18
0566-006P8	SEAL: SPACER SEA WATER JABSCO	18
0566-008P8	LIPSEAL: SEA WATER JABSCO	18
0566-011P8	SCREW: COVER JABSCO	18
0572-000	BRACKET: SEAPUMP	18
0572-001	BUSHING: SEAWATER PUMP	18
0700-002	GASKET: CARB QUADRAJET	26
0700-200	LINKAGE: THROTTLE MERC	26
0702-280	CARBURETOR: ROCHESTER QUADRAJET 280	26
0702-416	CARBURETOR: HOLLEY 4160 PREMIUM	26
0705-004	GASKET: CARB HOLLEY 1/8"	26
0720-000	ARRESTOR: FLAME TBI 8"	26
0720-074	THROTTLE BODY: TBI	27
0720-220	BRACKET: MAP SENSOR	28,29
0720-278N5	BRACKET: FUEL PUMP "A"	29
0720-279I9	BRACKET: THROTTLE TBI	28
0720-285	PLATE: ADAPTER TBI	27
0720-288	BRACKET: INTAKE "Z" ELECTRICAL COMPONENT	28
0720-289N4	BRACKET: ECM TBI 7.4V	28
0720-361	KIT: GASKET TBI	27
0720-404O7	LINE: FUEL PUMP - TBI	27
0720-455	FITTING: TBI RETURN T	27
0720-529	INJECTOR: TBI GREEN / MAROON BAND	27
0720-601	ORING: FUEL FEED LARGE TBI	27
0720-602	ORING: RETURN TBI SMALL	27
0720-651	GASKET: THROTTLEBODY	27
0720-700N4	HARNES: MPI 7.4V	29
0720-851	FITTING: BRASS 3/4 PIPE X 5/8 HOSE 90 DEGREE	18,27
0730-016	PUMP: ELECTRIC FUEL HI PRESSURE	28, 29
0730-193N2	BRACKET: HI PRESSURE PUMP	28
0730-261	COVER: EGR 7.4 MPI	5
0730-262	BOLT: EGR 7.4 MPI	5
0730-270	MANIFOLD: UPPER 7.4 MPI	5
0730-272	MANIFOLD: LOWER 7.4 MPI	5
0730-274	MANIFOLD: LOWER OVAL PORT	29
0730-275	MANIFOLD: INTAKE UPPER	29
0730-276	MANIFOLD: LOWER PREMIUM SQUAREPORT	29
0730-278N2	BRACKET: LOW PRESSURE FUEL PUMP	26
0730-280	BRACKET: COMPONENT MPI	29
0730-282N2	BRACKET: FUEL / WATER SEP	26
0730-283	BRACKET: FUSE / RELAY MPI	29
0730-285N2	BRACKET: ECM MPI	29
0730-286N4	BRACKET: COMPONENT 7.4V MEFI 3 ECM	28
0730-349	LINE: FUEL PUMP - PUMP	27
0730-361	LINE: FUEL REGULATOR TO HI PRESSURE PUMP	29
0730-362	LINE: FUEL RETURN	27
0730-500	INJECTOR: MPI 8.2	29
0730-510	REGULATOR: PRESSURE FUEL	29
0730-526	INJECTOR: MPI 7.4V	29
0730-550	THROTTLE BODY: MPI	29
0730-600	ORING: INTAKE MANIFOLD ARIZONA SPEED	29
0730-651	ORING: FUEL PRESSURE REGULATOR	29

MARINE POWER 454, 502, 7.4 PARTS BOOK NUMERICAL LISTING

PART #	DESCRIPTION	PAGE NUMBER(S)
0730-655	GASKET: THROTTLE BODY	29
0730-677	GASKET: INTAKE SET 7.4 MPI	5
0730-700	FITTING: FUEL RAIL AZ SPEED	29
0730-851	FITTING: BRASS 90 DEGREE	18,29
0730-928	BOLT: INTAKE MANIFOLD GEN V PREMIUM / PERFORMANCE	3,7
0730-930	BOLT: INJECTION RAIL 7.4 MPI	5
0774-550	FILTER: AIR	29
0790-000	CLAMP: SEAPUMP HOSE	11,18
0791-006	BRACKET: OIL COOLER	11
0805-001E5	CAP: DISTRIBUTOR	19
0805-002E5	ROTOR: DISTRIBUTOR OLD STYLE	19
0805-100E5	COIL: STANDARD	19
0805-101H3	COIL: HI PERFORMANCE	19
0806-007	SENSOR: KNOCK	29
0806-010F12	SENSOR: TEMPERATURE TBI-MPI	28
0806-017	MODULE: KNOCK MODULE TBI-MPI	28
0806-020F12	SENSOR: MAP TBI - MPI	28,29
0806-030	SENSOR: MANIFOLD AIR TEMP	29
0806-057	SENSOR: MAP >98	29
0806-596	MODULE: ECM EFI #3 MEFI 2	28
0806-599	MODULE: ECM EFI #2 MEFI 1	28
0806-600	MODULE: ECM EFI #4 MEFI 3 AND 4	28
0806-620	SEAL: MAP SENSOR	29
0806-735N3	HARNESS: MPI MEFI 3	29
0806-824N5	HARNESS: TBI	27
0807-000M5	DISTRIBUTOR: NORMAL LEFT ROTATION	19
0807-001M5	CAP: DISTRIBUTOR >99	19
0807-002M5	ROTOR: DISTRIBUTOR NEW STYLE	19
0807-006M5	MODULE: DISTRIBUTOR	19
0808-000P9	DISTRIBUTOR: OPPOSITE RIGHT ROTATION	19
0811-016	LEAD: WIRE COIL TO HARNESS	20
0811-018	LEAD: WIRE COIL TO DISTRIBUTOR	20
0811-019	LEAD: WIRE IGNITION SHIFT INTERRUPT	20
0811-020F8	LEAD: WIRE HOBBS OIL SWITCH	20
0811-027	LEAD: ELECTRIC FUEL PUMP	20
0900-100	BASE: DUAL OIL FILTER	10
0900-400	KIT: OIL EXCHANGE	11
0901-350	BRACKET: DUAL OIL	10
0901-538	BRACKET: DUAL OIL CAL JET LONG	10
0904-000	FILTER: OIL SPORTPAC	10
0905-000	FILTER: OIL ENPAC	10
0940-001	SENDER: WATER SINGLE 1/2	20
0940-002	SENDER: OIL SINGLE	20
0940-011	SENDER: WATER SINGLE 3/8	20
0940-102	SENDER: OIL DUAL	20
0940-111	SENDER: WATER DUAL 3/8	20
0940-201	SWITCH: WATER TEMP 3/8	20
0940-202	SWITCH: OIL PRESSURE 1/8 7 PSI	20
0945-000	PANEL: INSTRUMENT WITH GAUGES	20
0945-002	GAUGE: WATER TEMP	20
0945-003	GAUGE: VOLTMETER	20
0945-004	GAUGE: TACHOMETER	20
0945-005	GAUGE: OIL PRESSURE	20
0945-015	GAUGE: FUEL	20
0945-476	GAUGE: HOUR METER	20
0947-003	HARNESS: EXTENSION 3 FT	20
0947-010	HARNESS: EXTENSION 10 FT	20

MARINE POWER 454, 502, 7.4 PARTS BOOK NUMERICAL LISTING

PART #	DESCRIPTION	PAGE NUMBER(S)
0947-016	HARNESS: EXTENSION 16 FT	20
0947-025	HARNESS: EXTENSION 25 FT	20
0947-035	HARNESS: EXTENSION 35 FT	20
0991-000	MANIFOLD: EXHAUST MARINE POWER IRON	25
0991-100	MANIFOLD: EXHAUST MERC	25
0991-200P5	MANIFOLD: EXHAUST ALUMINUM MP2K	25
0992-000	RISER: MP 3" IRON	25
0992-003	RISER: MP 3" ALUMINUM	25
0992-004	RISER: MP 4" ALUMINUM	25
0992-005	RISER: MP 4" POLISHED ALUMINUM	25
0992-040	RISER: MP 4" IRON	25
0992-110P5	ORING: RISER RAW WATER SYSTEM MP2K	25
0992-200P5	RISER: MP2K ALUMINUM	25
0992-205P5	GASKET: RISER CENTER RISE FRESHWATER MP2K	13,25
0992-300G5	GASKET: RISER RAW WATER	13,25
0992-301G5	GASKET: RISER CENTER RISE FRESHWATER	13
0992-310N4	GASKET: RISER RAW WATER	13,25
0992-400	RISER: MERC	25
0992-635	SPACER: MERC RISER 3"	25
0992-660	SPACER: MERC RISER 6"	25
1005-000	CLAMP: DIPSTICK	11
1110-000	WIRE SET: IGNITION BLUE HI PERFORMANCE	19
1110-000BLK	WIRE SET: IGNITION BLACK HI PERFORMANCE	19
1110-000E5	WIRE SET: IGNITION YELLOW	19
1110-000N2	WIRE SET: IGNITION BLACK	19
1110-001	CLIP: IGNITION WIRE	20
1140-004	BREAKER: CIRCUIT IGNITION	20
1140-006	RELAY: STARTER OLD STYLE	20
1140-011N4	RELAY: STARTER 70 AMP >APR 99	20
1140-102F5	RELAY: HARNESS 40 AMP OLD STYLE	20
1140-240N7	HARNESS: CARBURETED	20
1140-334P8	HARNESS: PRIMARY EFI TB1 >8/99	27
1150-100F11	BRACKET: ELECTRICAL COMPONENT	28
1185-000	BRACKET: ALTERNATOR TENSION	19
1186-000	BRACKET: ALTERNATOR	19
1188-001	SPACER: ALTERNATOR BRACKET	19
1210-000E7	ALTERNATOR: 51 AMP	19
1210-002	PULLEY: DUAL ALTERNATOR	12
1250-002E3	LINE: OIL SPORTPAC 30"	10
1255-001	LINE: OIL ENPAC 9"	10
1255-002	LINE: OIL ENPAC 5"	10
1256-003E3	LINE: OIL SPORTPAC 19.5"	10
1256-051F8	LINE: OIL SPORTPAC 51"	10
1435-000	MOUNT: ISOLATOR 3/4	32
1440-001	BRACKET: GEAR COOLER	11
1450-100	HOSE: VENT TUBE	11
1451-000F12	HOSE: CIRC PUMP RAW WATER	11
1452-000F11	HOSE: CIRC PUMP FRESHWATER	11
1455-003	HOSE: FRESHWATER CIRC PUMP	11
1455-017G8	HOSE: UNIVERSAL	11
1456-000	HOSE: SEAPUMP - T-STAT	11
1458-001	HOSE: MANIFOLD	11
1458-002	HOSE: T-STAT	11
1458-003	HOSE: SEAPUMP	11
1458-004	HOSE" RISER - TANK FRESHWATER	11
1458-005	HOSE: SEAWATER PUMP - COOLER	11

MARINE POWER 454, 502, 7.4 PARTS BOOK NUMERICAL LISTING

PART #	DESCRIPTION	PAGE NUMBER(S)
1458-101P10	HOSE: T-STAT STBD	11
1458-102P10	HOSE: T-STAT PORT	11
1460-000	DRAIN: EZ OIL STANDARD	10
1460-001	DRAIN: EZ OIL METRIC	10
6754-850N4	RELAY: ELECTRIC FUEL PUMP NEW STYLE	20
7909-005	SHAFT: JET DRIVE	9
9000-001	TOOL: TIMING	20
9902-116	BRACKET: MAP >98	29
9920-102	MOTOR: IAC	27
9920-104	SENSOR: THROTTLE POSITION	27
HPWS-006	HOSE: POWER STEERING RESERVOIR TO COOLER	11
HPWS-010	HOSE: COOLING CALJET / POWER STEERING	11
HWRF-016	HOSE: SEA FLEX 1"	11
HWRF-020	HOSE: SEA FLEX 1 1/4"	11
HWRF-024	HOSE: SEA FLEX 1 1/2"	11

MARINE POWER 454, 502, 7.4 PARTS BOOK ALPHABETICAL LISTING

PART #	DESCRIPTION	PAGE NUMBER(S)
0003-999	ADAPTER: FLYWHEEL	9
0053-999	ADAPTER: FLYWHEEL	9
0105-000	ADAPTER: JET CONE	9
0525-000	ADAPTER: OIL COOLER ENPAC	11
1210-000E7	ALTERNATOR: 51 AMP	19
0500-011	ANODE: ZINC PLUG	13
0053-120F8	ARM: ROCKER	3
0055-120F8	ARM: ROCKER PREMIUM / PERFORMANCE	3
0720-000	ARRESTOR: FLAME TBI 8"	26
0055-004F8	BALANCER	7
0053-121F8	BALL: ROCKER ARM	3
0900-100	BASE: DUAL OIL FILTER	10
0432-048	BASE: FUEL / WATER SEP	26
0053-038F8	BEARING KIT: CONNECTING ROD	1,7
0053-440F8	BEARING KIT: CRANKSHAFT #1, #2, #3, #4	1,7
0053-009F8	BEARING KIT: CRANKSHAFT #5	1,7
0053-189F8	BEARING: CAMSHAFT #1	1,7
0053-190F8	BEARING: CAMSHAFT #2 #5	1
0053-191F8	BEARING: CAMSHAFT #3 #4	1
0065-198	BEARING: PILOT	7
0563-009	BEARING: SEA WATER JOHNSON	18
0102-538	BELLHOUSING: CAL JET 14" TOP MOUNT	9
0100-000	BELLHOUSING: INBOARD	9
0539-350	BELT: ALTERNATOR CAL-JET	12, 19
0538-350	BELT: ALTERNATOR ENPAC	12
0547-350	BELT: ALTERNATOR NW-JET SPORTPAC	12, 19
0538-250	BELT: POWER STEERING	12
0053-093	BOLT: CAMSHAFT	7
0003-026	BOLT: CONNECTING ROD	7
0053-002F3	BOLT: CRANKSHAFT	1,7
0053-151F8	BOLT: CRANKSHAFT BEARING CAP	1,7
0025-266	BOLT: CRANKSHAFT SPROCKET	1,7
0003-927	BOLT: CYLINDER HEAD 7.4 MPI	5
0003-027	BOLT: CYLINDER HEAD LONG	3
0003-029	BOLT: CYLINDER HEAD SHORT 454/502/7.4 MPI	3, 5
0730-262	BOLT: EGR 7.4 MPI	5
0053-059K8	BOLT: ENGINE FRONT COVER	7
0053-902	BOLT: ENGINE LIFT FRONT	3
0730-930	BOLT: INJECTION RAIL 7.4 MPI	5
0053-975	BOLT: INTAKE MANIFOLD GEN V	3
0730-928	BOLT: INTAKE MANIFOLD GEN V PREMIUM / PERFORMANCE	3,7
0003-303	BOLT: OIL PAN	7
0053-257	BOLT: OIL PUMP	7
0053-920	BOLT: ROCKER ARM	3,5
0053-059F8	BOLT: TIMING COVER	1
0025-107	BOLT: VALVE COVER 454/502/ 7.4 MPI	3,5
0509-101F4	BOTTLE: RECOVERY	18
1186-000	BRACKET: ALTERNATOR	19
1185-000	BRACKET: ALTERNATOR TENSION	19
0730-286N4	BRACKET: COMPONENT 7.4V MEFI 3 ECM	28
0730-280	BRACKET: COMPONENT MPI	29
0403-200	BRACKET: DIPSTICK TUBE SPORTPAC	10
0901-350	BRACKET: DUAL OIL	10
0901-538	BRACKET: DUAL OIL CAL JET LONG	10
0730-285N2	BRACKET: ECM MPI	29
0720-289N4	BRACKET: ECM TBI 7.4V	28

MARINE POWER 454, 502, 7.4 PARTS BOOK ALPHABETICAL LISTING

PART #	DESCRIPTION	PAGE NUMBER(S)
0500-011	ANODE: ZINC PLUG	13
1150-100F11	BRACKET: ELECTRICAL COMPONENT	28
0053-204	BRACKET: ENGINE LIFT FRONT	3
0053-203	BRACKET: ENGINE LIFT REAR	3
0310-255	BRACKET: FRESH WATER POWER STEERING RESERVOIR	32
0730-282N2	BRACKET: FUEL / WATER SEP	26
0720-278N5	BRACKET: FUEL PUMP "A"	29
0730-283	BRACKET: FUSE / RELAY MPI	29
1440-001	BRACKET: GEAR COOLER	11
0730-193N2	BRACKET: HI PRESSURE PUMP	28
0720-288	BRACKET: INTAKE "Z" ELECTRICAL COMPONENT	28
0730-278N2	BRACKET: LOW PRESSURE FUEL PUMP	26
9902-116	BRACKET: MAP >98	29
0720-220	BRACKET: MAP SENSOR	28,29
0509-102	BRACKET: MOUNTING RECOVERY BOTTLE	18
0515-735	BRACKET: MPI FRESHWATER LEFT	13
0515-734	BRACKET: MPI FRESHWATER RIGHT	13
0791-006	BRACKET: OIL COOLER	11
0310-007N3	BRACKET: POWER STEERING ARM	32
0310-200	BRACKET: POWER STEERING MOUNTING	32
0310-108F7	BRACKET: RAW WATER POWER STEERING	32
0572-000	BRACKET: SEAPUMP	18
0514-115	BRACKET: TANK LEFT	13
0500-014	BRACKET: TANK REAR MOUNT LEFT	13
0500-015	BRACKET: TANK REAR MOUNT RIGHT	13
0505-114	BRACKET: TANK RIGHT	13
0720-279I9	BRACKET: THROTTLE TBI	28
1140-004	BREAKER: CIRCUIT IGNITION	20
0572-001	BUSHING: SEAWATER PUMP	18
0566-004P8	CAM: SEA WATER JABSCO	18
0562-003	CAM: SEA WATER JOHNSON	18
0055-089	CAMSHAFT	7
0053-089	CAMSHAFT: 454 / 502 NORMAL ROTATION	1
0006-089	CAMSHAFT: 454 / 502 REVERSE ROTATION	1
0054-089	CAMSHAFT: 454 / 502 REVERSE ROTATION	1
0053-815	CAP: CRANKSHAFT BEARING #5	1
0053-810	CAP: CRANKSHAFT BEARING	1
0805-001E5	CAP: DISTRIBUTOR	19
0807-001M5	CAP: DISTRIBUTOR >99	19
0053-102F8	CAP: OIL FILL	3,5
0500-005G7	CAP: TANK 7 PSI DUAL SEAL	13
0005-378	CAP: VALVE SPRING 7.4 MPI	5
0055-378F8	CAP: VALVE SPRING PREMIUM / PERFORMANCE	3
0003-378	CAP: VALVE SPRING STANDARD	3
0702-416	CARBURETOR: HOLLEY 4160 PREMIUM	26
0702-280	CARBURETOR: ROCHESTER QUADRAJET 280	26
0053-001	CASE: ENGINE 454 GEN V	1
0066-001	CASE: ENGINE 502 GEN V	1
0053-084	CHAIN: TIMING NORMAL ROTATION	1,7
0055-084	CHAIN: TIMING NORMAL ROTATION	1
1005-000	CLAMP: DIPSTICK	11
0303-042	CLAMP: DISTRIBUTOR	19
0053-750	CLAMP: GEAR (RAW WATER ONLY)	3
0790-000	CLAMP: SEAPUMP HOSE	11,18
1110-001	CLIP: IGNITION WIRE	20
0805-101H3	COIL: HI PERFORMANCE	19

MARINE POWER 454, 502, 7.4 PARTS BOOK ALPHABETICAL LISTING

PART #	DESCRIPTION	PAGE NUMBER(S)
0805-100E5	COIL: STANDARD	19
0440-549G3	COOLER, OIL	10,14
0440-001	COOLER: OIL	10,14
0442-001	COOLER: OIL 180 DEGREE	10,14
0440-505P1	COOLER: OIL 5 X 5 180 DEGREE	14
0150-000	COVER: DUST REAR ENTRY	9
0151-538	COVER: DUST 14" CAL JET	9
0730-261	COVER: EGR 7.4 MPI	5
0053-058K8	COVER: ENGINE FRONT	7
0520-001	COVER: OIL BYPASS	10
0520-000	COVER: OIL BYPASS ASSY	10
0566-003P8	COVER: SEA WATER JABSCO	18
0563-006	COVER: SEA WATER JOHNSON	18
0054-058F3	COVER: TIMING COVER GEN V REVERSE ROTATION	1
0053-058F8	COVER: TIMING COVER GEN V NORMAL ROTATION	1
0053-100F3	COVER: VALVE 454 / 502	3
0053-018F8	CRANKSHAFT: 454 GEN V NORMAL ROTATION	1,7
0067-018F8	CRANKSHAFT: 454 / 502 GEN V REVERSE ROTATION	1
0055-018F8	CRANKSHAFT: 454 GEN V NORMAL ROTATION PREMIUM / PERFORMANCE	1
0054-018F8	CRANKSHAFT: 454 GEN V REVERSE ROTATION	1
0066-018F8	CRANKSHAFT: 502 GEN V NORMAL ROTATION	1
0053-004F8	DAMPER: TORSIONAL 454 NORMAL ROTATION	1
0066-004F8	DAMPER: TORSIONAL 502 NORMAL ROTATION	1
0017-001P3	DIPSTICK: ENPAC, JETPAC	10
0307-001	DIPSTICK: SPORTPAC	10
0807-000M5	DISTRIBUTOR: NORMAL LEFT ROTATION	19
0808-000P9	DISTRIBUTOR: OPPOSITE RIGHT ROTATION	19
1460-001	DRAIN: EZ OIL METRIC	10
1460-000	DRAIN: EZ OIL STANDARD	10
0774-550	FILTER: AIR	29
0432-049	FILTER: FUEL WATER SEP	26
0905-000	FILTER: OIL ENPAC	10
0904-000	FILTER: OIL SPORTPAC	10
0400-801	FITTING: BANJO ASSY METRIC	10
0400-800	FITTING: BANJO ASSY STANDARD	10
0720-851	FITTING: BRASS 3/4 PIPE X 5/8 HOSE 90 DEGREE	18,27
0000-800H7	FITTING: BRASS 3/4 X 1	18,27
0730-851	FITTING: BRASS 90 DEGREE	18,29
0000-815H7	FITTING: BRASS 90 DEGREE 3/4 X 1	18,27
0000-809	FITTING: BYPASS T-STAT (RAW WATER ONLY)	3
0000-882	FITTING: FUEL PUMP OUT	27
0730-700	FITTING: FUEL RAIL AZ SPEED	29
0053-042	FITTING: OIL BYPASS	10
0000-820	FITTING: OIL FILTER	7
0000-895	FITTING: PIPE 1/2" BRASS	11
0310-800	FITTING: POWER STEERING	32
0000-871	FITTING: REMOTE OIL	10
0720-455	FITTING: TBI RETURN T	27
0055-143	FLEXPLATE: AUTOMATIC JET PREMIUM 454 / 502	9
0053-143G2	FLEXPLATE: AUTOMATIC JET STANDARD 454 / 502	9
0007-990F7	FLEXPLATE: COUPLER 14"	9
0053-141	FLYWHEEL: BOTTOM MOUNT FORWARD GEAR GEN V STANDARD 454	9
0055-141	FLYWHEEL: FORWARD RING GEAR GEN V PREMIUM	9
0053-140F8	FLYWHEEL: REAR RING GEN V STANDARD 454	9
0055-140F8	FLYWHEEL: TOP MOUNT REAR MOUNT PREMIUM	7,9
0705-004	GASKET: CARB HOLLEY 1/8"	26
0700-002	GASKET: CARB QUADRAJET	26

MARINE POWER 454, 502, 7.4 PARTS BOOK ALPHABETICAL LISTING

PART #	DESCRIPTION	PAGE NUMBER(S)
0053-025F8	GASKET: CYLINDER HEAD GEN V	3
0303-043	GASKET: DISTRIBUTOR	19
0500-013	GASKET: END PLATE 4" TANK	13
0505-013	GASKET: END PLATE 5" TANK	13
0053-061K8	GASKET: FRONT COVER	7
0053-025L-29	GASKET: HEAD 7.4 MPI	5
0053-275F8	GASKET: INTAKE MANIFOLD GEN V	3,25
0055-275F8	GASKET: INTAKE MANIFOLD GEN V PREMIUM	25,27
0730-677	GASKET: INTAKE SET 7.4 MPI	5
0053-245F7	GASKET: OIL PAN	7,10
0065-245	GASKET: OIL PAN DRAIN PLUG	7
0992-301G5	GASKET: RISER CENTER RISE FRESHWATER	13
0992-205P5	GASKET: RISER CENTER RISE FRESHWATER MP2K	13,25
0992-300G5	GASKET: RISER RAW WATER	13,25
0992-310N4	GASKET: RISER RAW WATER	13,25
0566-002P8	GASKET: SEA WATER JABSCO	18
0562-002	GASKET: SEA WATER JOHNSON	18
0730-655	GASKET: THROTTLE BODY	29
0720-651	GASKET: THROTTLEBODY	27
0053-061F8	GASKET: TIMING COVER	1
0303-009	GASKET: T-STAT	13
0053-101F8	GASKET: VALVE COVER 454/502/7.4	3,5
0303-050	GASKET: WATER CIRC PUMP	7,18
0945-015	GAUGE: FUEL	20
0945-476	GAUGE: HOUR METER	20
0945-005	GAUGE: OIL PRESSURE	20
0945-004	GAUGE: TACHOMETER	20
0945-003	GAUGE: VOLTMETER	20
0945-002	GAUGE: WATER TEMP	20
0053-081	GEAR: CAMSHAFT NORMAL ROTATION	1
0004-081	GEAR: CAMSHAFT REAR ROTATION	1
0053-082	GEAR: CRANKSHAFT NORMAL ROTATION	1,7
0005-082	GEAR: CRANKSHAFT NORMAL ROTATION PREMIUM / PERFORMANCE	1
0004-082	GEAR: CRANKSHAFT REVERSE ROTATION	1
0080-650	GROMMET: HI PRESSURE PUMP	28
0303-008	GROMMET: VALVE COVER	3
0053-119F8	GUIDE: PUSH ROD 454/502/7.4 MPI	3,5
0055-119F8	GUIDE: PUSH ROD PREMIUM / PERFORMANCE	3
1140-240N7	HARNESS: CARBURETED	20
0947-010	HARNESS: EXTENSION 10 FT	20
0947-016	HARNESS: EXTENSION 16 FT	20
0947-025	HARNESS: EXTENSION 25 FT	20
0947-003	HARNESS: EXTENSION 3 FT	20
0947-035	HARNESS: EXTENSION 35 FT	20
0720-700N4	HARNESS: MPI 7.4V	29
0806-735N3	HARNESS: MPI MEFI 3	29
1140-334P8	HARNESS: PRIMARY EFI TB1 >8/99	27
0806-824N5	HARNESS: TBI	27
0055-024F8	HEAD: CYLINDER BARE PREMIUM	3
0053-024Z	HEAD: CYLINDER COMPLETE	3
0053-024F8	HEAD: CYLINDER BARE	3
0055-024Z	HEAD: CYLINDER COMPLETE PREMIUM	3
1458-004	HOSE" RISER - TANK FRESHWATER	11
0053-450	HOSE: BYPASS (RAW WATER ONLY)	3
1451-000F12	HOSE: CIRC PUMP RAW WATER	11
1452-000F11	HOSE: CIRC PUMP FRESHWATER	11

MARINE POWER 454, 502, 7.4 PARTS BOOK ALPHABETICAL LISTING

PART #	DESCRIPTION	PAGE NUMBER(S)
HPWS-010	HOSE: COOLING CALJET / POWER STEERING	11
1455-003	HOSE: FRESHWATER CIRC PUMP	11
1458-001	HOSE: MANIFOLD	11
0310-110	HOSE: POWER STEERING PRESSURE	32
HPWS-006	HOSE: POWER STEERING RESERVOIR TO COOLER	11
0310-111	HOSE: POWER STEERING RETURN	32
HWRP-024	HOSE: SEA FLEX 1 1/2"	11
HWRP-020	HOSE: SEA FLEX 1 1/4"	11
HWRP-016	HOSE: SEA FLEX 1"	11
1458-003	HOSE: SEAPUMP	11
1456-000	HOSE: SEAPUMP - T-STAT	11
1458-005	HOSE: SEAWATER PUMP - COOLER	11
1458-002	HOSE: T-STAT	11
1458-102P10	HOSE: T-STAT PORT	11
1458-101P10	HOSE: T-STAT STBD	11
1455-017G8	HOSE: UNIVERSAL	11
1450-100	HOSE: VENT TUBE	11
0509-004N11	HOUSING: FRESHWATER OUTLET	12
0500-002	HOUSING: T-STAT CAP REAR MOUNT	12
0210-001	HOUSING: T-STAT RAW WATER	12
0500-009	HOUSING: T-STAT REAR MOUNT	12
0553-002	HOUSING: WATER OUTLET CAL JET	12
0506-009F4	HOUSING:T-STAT	12
0566-001P8	IMPELLER: SEA WATER JABSCO	18
0562-001	IMPELLER: SEA WATER JOHNSON	18
0054-260	INDICATOR: TIMING COVER REVERSE ROTATION	17
0730-526	INJECTOR: MPI 7.4V	29
0730-500	INJECTOR: MPI 8.2	29
0720-529	INJECTOR: TBI GREEN / MAROON BAND	27
0004-094	KEY: CAMSHAFT	7
0053-209	KEY: CRANKSHAFT BALANCER	1,7
0003-380	KEY: VALVE STEM 454/502/ 7.4 MPI	3, 5
0720-361	KIT: GASKET TBI	27
0566-000ZBB	KIT: IMPELLER JABSCO	18
0562-020	KIT: IMPELLER JOHNSON	18
0900-400	KIT: OIL EXCHANGE	11
0311-454	KIT: POWER STEERING FRESH WATER	33
0310-454	KIT: POWER STEERING RAW WATER	33
0811-027	LEAD: ELECTRIC FUEL PUMP	20
0811-018	LEAD: WIRE COIL TO DISTRIBUTOR	20
0811-016	LEAD: WIRE COIL TO HARNESS	20
0811-020F8	LEAD: WIRE HOBBS OIL SWITCH	20
0811-019	LEAD: WIRE IGNITION SHIFT INTERRUPT	20
0053-097K8	LIFTER: HYDRAULIC 7.4 MPI	5
0053-097	LIFTER: VALVE	3
0055-097F8	LIFTER: VALVE PREMIUM / PERFORMANCE	3
0415-100N2	LINE: FUEL HOLLEY DUAL PUMPER 800 CFM	26
0416-100N2	LINE: FUEL HOLLEY DUAL PUMPER PREMIUM	26
0400-003P12	LINE: FUEL PUMP - CARB STANDARD ROCHESTER	26
0730-349	LINE: FUEL PUMP - PUMP	27
0720-404O7	LINE: FUEL PUMP - TBI	27
0730-361	LINE: FUEL REGULATOR TO HI PRESSURE PUMP	29
0730-362	LINE: FUEL RETURN	27
0430-004	LINE: FUEL SEP TO LOW PRESSURE FUEL PUMP	26,27
1255-002	LINE: OIL ENPAC 5"	10
1255-001	LINE: OIL ENPAC 9"	10

MARINE POWER 454, 502, 7.4 PARTS BOOK ALPHABETICAL LISTING

PART #	DESCRIPTION	PAGE NUMBER(S)
1256-003E3	LINE: OIL SPORTPAC 19.5"	10
1250-002E3	LINE: OIL SPORTPAC 30"	10
1256-051F8	LINE: OIL SPORTPAC 51"	10
0700-200	LINKAGE: THROTTLE MERC	26
0566-008P8	LIPSEAL: SEA WATER JABSCO	18
0563-008	LIPSEAL: SEA WATER JOHNSON	18
0991-200P5	MANIFOLD: EXHAUST ALUMINUM MP2K	25
0991-000	MANIFOLD: EXHAUST MARINE POWER IRON	25
0991-100	MANIFOLD: EXHAUST MERC	25
0055-275	MANIFOLD: INTAKE PREMIUM FRESHWATER	25,27
0005-275	MANIFOLD: INTAKE PREMIUM RAW WATER WITH BRASS INSERT	25
0053-274	MANIFOLD: INTAKE STANDARD ALUMINUM FRESHWATER	25
0003-275	MANIFOLD: INTAKE STANDARD IRON GEN V - VI	3,25
0730-275	MANIFOLD: INTAKE UPPER	29
0730-272	MANIFOLD: LOWER 7.4 MPI	5
0730-274	MANIFOLD: LOWER OVAL PORT	29
0730-276	MANIFOLD: LOWER PREMIUM SQUAREPORT	29
0730-270	MANIFOLD: UPPER 7.4 MPI	5
0807-006M5	MODULE: DISTRIBUTOR	19
0806-599	MODULE: ECM EFI #2 MEFI 1	28
0806-596	MODULE: ECM EFI #3 MEFI 2	28
0806-600	MODULE: ECM EFI #4 MEFI 3 AND 4	28
0806-017	MODULE: KNOCK MODULE TBI-MPI	28
9920-102	MOTOR: IAC	27
0032-002	MOUNT: ENGINE ENPAC	32
0034-100	MOUNT: GEAR BW 71C /72C	32
0034-215	MOUNT: GEAR UNIVERSAL PORT	32
0034-210	MOUNT: GEAR UNIVERSAL STARBOARD	32
1435-000	MOUNT: ISOLATOR 3/4	32
0032-001	MOUNT: TRUNION MEDIUM	32
0032-001I6	MOUNT: TRUNION SHORT	32
0032-001F12	MOUNT: TRUNION TALL	32
0060-067	NUT: CONNECTING ROD	7
0720-601	ORING: FUEL FEED LARGE TBI	27
0730-651	ORING: FUEL PRESSURE REGULATOR	29
0730-600	ORING: INTAKE MANIFOLD ARIZONA SPEED	29
0720-602	ORING: RETURN TBI SMALL	27
0992-110P5	ORING: RISER RAW WATER SYSTEM MP2K	25
0053-242	PAN: OIL IRIDITED 10 QT	10
0053-248	PAN: OIL PLASTISOL 8 QT	10
0945-000	PANEL: INSTRUMENT WITH GAUGES	20
0053-906	PIN: CRANKSHAFT	1
0003-206	PIN: CYLINDER HEAD LOC 454/502/7.4 MPI	3,5
0032-003I6	PIN: ENGINE / GEAR 4.75"	32
0032-004	PIN: ENGINE / GEAR 6"	32
0025-143F5	PIN: FLYWHEEL	7
0007-090	PIN: OIL PUMP	7
0055-037F8	PISTON: 454 GEN V PREMIUM / PERFORMANCE	1,7
0053-037F8	PISTON: 454 GEN V STANDARD	1
0066-037F8	PISTON: 502 GEN V	1
0151-010	PLACE: STARTER BELLHOUSING	9
0102-537	PLATE: ACCESS CAL JET BELLHOUSING	9
0720-285	PLATE: ADAPTER TBI	27
0500-001	PLATE: BLOCK OFF	13,25
0501-001N4	PLATE: BLOCK OFF	13, 25
0077-000	PLATE: DAMPER 14"	9

MARINE POWER 454, 502, 7.4 PARTS BOOK ALPHABETICAL LISTING

PART #	DESCRIPTION	PAGE NUMBER(S)
0500-008	PLATE: TANK END 4"	13
0500-018	PLATE: TANK END 5"	13
0553-100	PLATE: WATER INLET CAL JET	12
0003-208	PLUG: CAMSHAFT REAR	1,7
0053-030F8	PLUG: CYLINDER HEAD 454/502/7.4MPI	3,5
0025-815	PLUG: DRAIN	1
0009-877	PLUG: DRAIN / KNOCK SENSOR PORT	1
0025-815	PLUG: ENGINE BLOCK	7
0053-840	PLUG: ENGINE BLOCK OIL GALLEY	1
0053-205F8	PLUG: OIL GALLEY	1,7
0065-945	PLUG: OIL PAN DRAIN	7
0009-830	PLUG: OIL PRESSURE	1
0007-015	PLUG: SPARK 7.4 MULTIPOINT	19
0053-210F8	PLUG: WATER JACKET FREEZE	1
0307-007	PULLEY: CIRC PUMP	12,18
0303-028	PULLEY: CRANKSHAFT	12
1210-002	PULLEY: DUAL ALTERNATOR	12
0310-001	PULLEY: POWER STEERING PUMP	12
0055-255F8	PUMP : OIL W/ SCREEN	7
0003-064	PUMP KIT: WATER	7
0003-065	PUMP: CIRCULATING	18
0303-016F1	PUMP: ELECTRIC FUEL	26,28
0730-016	PUMP: ELECTRIC FUEL HI PRESSURE	28,29
0310-104F7	PUMP: POWER STEERING NEW	32
0566-000P8	PUMP: SEAWATER JABSCO	18
0003-128	PUSH ROD: EXHAUST VALVE	3
0005-128	PUSH ROD: EXHAUST VALVE PREMIUM / PERFORMANCE	3
0003-127	PUSH ROD: INTAKE VALVE	3
0005-127	PUSH ROD: INTAKE VALVE PREMIUM / PERFORMANCE	3
0730-510	REGULATOR: PRESSURE FUEL	29
6754-850N4	RELAY: ELECTRIC FUEL PUMP NEW STYLE	20
1140-102F5	RELAY: HARNESS 40 AMP OLD STYLE	20
1140-011N4	RELAY: STARTER 70 AMP >APR 99	20
1140-006	RELAY: STARTER OLD STYLE	20
0310-105F7	RESERVOIR: POWER STEERING	32
0007-259	RETAINER	7
0053-348F8	RING KIT: 454 GEN V	1
0066-348F8	RING KIT: 502 GEN V	1
0053-348I8	RING: KIT	7
0992-400	RISER: MERC	25
0992-003	RISER: MP 3" ALUMINUM	25
0992-000	RISER: MP 3" IRON	25
0992-004	RISER: MP 4" ALUMINUM	25
0992-040	RISER: MP 4" IRON	25
0992-005	RISER: MP 4" POLISHED ALUMINUM	25
0992-200P5	RISER: MP2K ALUMINUM	25
0003-036	ROD: CONNECTING 454 / 502	1, 7
0060-128	ROD: INTAKE VALVE PUSH 7.4 MPI	5
0807-002M5	ROTOR: DISTRIBUTOR NEW STYLE	19
0805-002E5	ROTOR: DISTRIBUTOR OLD STYLE	19
0003-379	ROTOR: VALVE 454 GEN V	3
0566-005P8	SCREW: CAM SEA WATER JABSCO	18
0566-011P8	SCREW: COVER JABSCO	18
0563-001	SCREW: COVER JOHNSON	18
0053-005	SEAL: CRANKSHAFT	7
0053-033	SEAL: CRANKSHAFT	7

MARINE POWER 454, 502, 7.4 PARTS BOOK ALPHABETICAL LISTING

PART #	DESCRIPTION	PAGE NUMBER(S)
0053-601	SEAL: CRANKSHAFT BEARING CAP #5	1,7
0053-033F8	SEAL: CRANKSHAFT OIL REAR NORMAL ROTATION	1
0054-033F8	SEAL: CRANKSHAFT OIL REAR REVERSE ROTATION	1
0806-620	SEAL: MAP SENSOR	29
0566-006P8	SEAL: SPACER SEA WATER JABSCO	18
0053-178F8	SEAL: VALVE STEM OIL	3
0055-178I8	SEAL: VALVE STEM OIL 7.4 MPI	5
0940-102	SENDER: OIL DUAL	20
0940-002	SENDER: OIL SINGLE	20
0940-111	SENDER: WATER DUAL 3/8	20
0940-001	SENDER: WATER SINGLE 1/2	20
0940-011	SENDER: WATER SINGLE 3/8	20
0806-007	SENSOR: KNOCK	29
0806-030	SENSOR: MANIFOLD AIR TEMP	29
0806-057	SENSOR: MAP >98	29
0806-020F12	SENSOR: MAP TBI - MPI	28,29
0806-010F12	SENSOR: TEMPERATURE TBI-MPI	28
9920-104	SENSOR: THROTTLE POSITION	27
7909-005	SHAFT: JET DRIVE	9
0003-258	SHAFT: OIL PUMP	7
0053-276	SHIELD: INTAKE MANIFOLD	3
0053-277	SHIELD: INTAKE MANIFOLD 7.4 MPI	5
0055-276	SHIELD: INTAKE MANIFOLD PREMIUM / PERFORMANCE	3
0005-122	SHIM: VALVE SPRING	3
0005-120	SHIM: VALVE SPRING 7.4 MPI	5
1188-001	SPACER: ALTERNATOR BRACKET	19
0992-635	SPACER: MERC RISER 3"	25
0992-660	SPACER: MERC RISER 6"	25
0505-008	SPACER: THERMOSTAT	12
0003-015	SPARK PLUG: V8	3,19
0003-178	SPRING: VALVE	3
0055-176F8	SPRING: VALVE	3
0053-178K8	SPRING: VALVE 7.4 MPI	5
0066-081	SPROCKET: CAMSHAFT	7
0172-000	STARTER: BOTTOM MOUNT 12 3/4 NORMAL ROTATION	9
0174-000	STARTER: BOTTOM MOUNT 14 NORMAL ROTATION	9
0170-000	STARTER: TOP MOUNT 14" NORMAL ROTATION	9
0171-000	STARTER: TOP MOUNT 14" REVERSE ROTATION	9
0053-153F8	STUD: CRANKSHAFT BEARING CAP	1
0053-903	STUD: ENGINE LIFT BRACKET	3
0053-965	STUD: INTAKE MANIFOLD	3
0053-921	STUD: ROCKER ARM 454/502/7.4 MPI	3
0303-017F3	SWITCH: HOBB OIL / FUEL PUMP CUTOFF	20
0940-202	SWITCH: OIL PRESSURE 1/8 7 PSI	20
0940-201	SWITCH: WATER TEMP 3/8	20
0509-103H7	TANK: FRESHWATER 5" FRONT MOUNT	13
0500-003	TANK: FRESHWATER 5" REARMOUNT	13
0000-852	TEE: ADAPTER 5/8" 90 DEGREE	14
0441-103	TEE: COPPER NW-JET	14
0000-850	TEE: FRESHWATER REAR MOUNT	14
0303-999	THERMOCHOKE	26
0303-013	THERMOCHOKE: COVER	26
0303-011	THERMOCHOKE: ROD	26
0500-007F6	THERMOSTAT: FRESHWATER 160 DEGREE	12
0500-007	THERMOSTAT: FRESHWATER REAR MOUNT	12
0212-007	THERMOSTAT: RAW WATER MERC STYLE	12

MARINE POWER 454, 502, 7.4 PARTS BOOK ALPHABETICAL LISTING

PART #	DESCRIPTION	PAGE NUMBER(S)
0210-002	THERMOSTAT: RAW WATER 142D	12
0730-550	THROTTLE BODY: MPI	29
0720-074	THROTTLE BODY: TBI	27
9000-001	TOOL: TIMING	20
0053-002P3	TUBE: DIPSTICK ENPAC	10
0407-002	TUBE: DIPSTICK SPORTPAC	10
0003-175	VALVE: EXHAUST GEN V 454/502/ 7.4 MPI	3, 5
0005-175	VALVE: EXHAUST GEN V PREMIUM / PERFORMANCE	3
0055-174F8	VALVE: INTAKE 7.4 MPI	5
0053-174	VALVE: INTAKE GEN V	3
0055-174	VALVE: INTAKE GEN V PREMIUM / PERFORMANCE	3
0003-003	WASHER	7
0065-994	WASHER	7
0003-003	WASHER: CRANKSHAFT DAMPER 454/502/ 7.4 MPI	1, 5
*WOFO-005	WASHER: FLAT 5/16" CAMSHAFT	1
0563-013	WASHER: SEA WATER JOHNSON	18
0053-915	WEIGHT: FLYWHEEL	7
1110-000N2	WIRE SET: IGNITION BLACK	19
1110-000BLK	WIRE SET: IGNITION BLACK HI PERFORMANCE	19
1110-000	WIRE SET: IGNITION BLUE HI PERFORMANCE	19
1110-000E5	WIRE SET: IGNITION YELLOW	19