



Southeastern EMERGENCY EQUIPMENT

Led by...dedicated to...we are EMS and Fire.



EMS and Fire Catalog

Volume 24

(800) 334-6656 ■ www.SEEquip.com ■ info@SEEquip.com



***A message from Carla J. Baker, NRP
President, Southeastern Emergency Equipment***

*Welcome and thank you for taking time to review the 24th edition of our EMS and Fire Catalog. We at Southeastern Emergency Equipment are honored by your interest in our company. Recognizing your time is precious, I will be brief and not elaborate on the areas of our company we believe every distribution company must have to function in today's ever-changing environment. **What's key is how we are different . . .***

■ **Led by...Dedicated to...We are EMS and Fire.**

At Southeastern Emergency Equipment, our connection to the EMS and Fire brotherhood is not just about transacting business; it's a way of life. You will never have to question our dedication and loyalty to the profession we hold so dear in our hearts. The majority of our front-line staff, including me, is a current or former EMS/Fire professional. As a result, we have experienced the unpredictable and ever-changing climate in which you work and relate to the unique physical, mental and emotional environment you face. We've been where you are and understand.

■ **Acceleration of Education and Clinical Services**

Like many of you, we have watched some EMS/Fire distributors shift toward an "order taking" mindset—at a time when respected industry leaders advocate the need for distributors to increase their footprint in areas related to training, education, and clinical services. We are gratified that our long-standing commitment to helping you choose the best products and being there to help you learn to use them is now considered cutting-edge. In fact, we have taken steps to increase our commitment to this vital service.

■ **Increased Commitment to Technology and Operational Efficiencies**

Our commitment to better serve you includes investing in a new company-wide operating system that helps us be more efficient and effective. We also are improving our operational processes. One immediate example is that every in-stock order placed is shipped same day. This means your orders arrive more quickly and helps you be more efficient.

■ **We are an Independent Company**

We've been serving our customers as an independent company since 1979. We're fully committed to remaining independent and to continuing our long-standing tradition of remarkable customer service. Our business decisions are based on doing what is right for our customers and our employees—both short- and long-term. This part of our "DNA" reflects our belief that business success extends far beyond the profit/loss statement.

■ **We are a Family of Companies**

Our sister company, Southeastern Specialty Vehicles (SSV), offers new and pre-owned ambulances, remounts and specialty vehicles such as QRVs. A second sister company, EMS American LLC, designs portable structures that can serve as temporary housing, food service facilities, mortuary units, etc. With the family of companies, Southeastern Emergency Equipment can be your one-stop shop.

To our current customers, THANK YOU for your business and your friendship – we truly value both. To those of you that haven't yet worked with us, we hope you will give us the opportunity to show you the "Southeastern Emergency Equipment difference."

Sincerely,

Carla J. Baker, NRP
President



**Led by...
Dedicated to...
We are EMS and Fire.**

We are an independent full-line specialty distributor providing equipment, supplies and educational services to EMS and Fire communities since 1979.



- **Customer Service**
(800) 334-6656 — 8:00 am - 5:00 pm (EST)
- **Fax (Toll Free)**
(888) 556-1048
- **Website**
www.SEEquip.com
- **eMail**
info@SEEquip.com
- **Mailing Address**
PO Box 1097 ■ Youngsville, NC 27596
- **Shipping Address**
5760 Hwy 96W ■ Youngsville, NC 27596

Prices in the Southeastern EMS and Fire Catalog, Volume 24 are current at time of printing. Due to manufacturer price increases, prices are subject to change without notice. We will make every attempt to notify you prior to shipment of any price changes so that you can make a determination.

© Southeastern Emergency Equipment, 2016

EMS and Fire Catalog

Volume 24

AEDs.....	2-27
Defibrillators and Monitors	28-59
Diagnostic Instruments.....	60-89
Training and Education	90-125
Respiratory Care	126-173
Infection Control	174-199
IV Products	200-229
Pharmaceuticals	230-245
Immobilization	246-269
Patient Moving and Handling	270-283
Wound and Burn Care	284-299
First Aid and Personal Items	300-317
Equipment Bags and Cases.....	318-353
5.11 Tactical	354-395
Tactical Products	369-407
Triage, WMD and MCI	408-421
Lights and Flashlights	422-433
Southeastern Specialty Vehicles	434-445
Vehicle Accessories.....	446-455
Medical Trailers.....	456-463
Portable Module Buildings.....	464-467
Indexes and Business Information	468-496



- Download FREE Layar App (from your App Store)
- Scan this page
- View custom product info

Bring catalog pages to life

View additional content about selected products throughout our catalog by using your mobile device to scan pages that display the AR graphic (left). To get started, simply download the free "Layar" app from your device's App store.

PHILIPS

HeartStart® family of AEDs



HeartStart Onsite

HeartStart FR3

HeartStart FRx

AEDs

HeartStart FR3



pages 4-8

HeartStart FRx



pages 9-11

HeartStart OnSite



pages 12-14

HeartStart FR2+



pages 15-17

HeartStream Forerunner



page 18

AED Cabinets



pages 19-23

Data Management



pages 24-25

AED Supplies



pages 25-26

**BILINGUAL
OPTION**



**5-YEAR
WARRANTY**



FR3 Rigid System Case
Item 989803149971



FR3 Soft System Case
Item 989803179161



FR3 Small Soft Case
Item 989803179181

HeartStart FR3 Defibrillator (Philips)

Our best professional-grade AED yet, the HeartStart FR3 is designed to make lifesaving faster, easier, and better.

Faster – helping you do your job faster as it significantly reduces deployment. It eliminates steps to help you start the right therapy – CPR or defibrillation.

Easier – helping make your job easier with the smallest and lightest professional-grade AED among leading global manufacturers. It is designed to be rugged, reliable, and ready to use.

Better – helping you improve your response by supporting a culture of continuous improvement, including optimizing training and fine-tuning SCA response.

- Automatically powers on by opening the FR3 carrying case so you can focus on pad placement from the start (rigid carrying case only).
- Peel and place SMART Pads III. There's no foil pouch to open when the pads are pre-connected.
- Receive patient-specific guidance with Philips SMART CPR for the most appropriate initial therapy –CPR or defibrillation – even for shockable rhythms.
- Minimize CPR interruptions and speed shock delivery with Philips Quick Shock.
- No need to change pads during pediatric cardiac arrest. Just use the same SMART Pads III for adults and children.
- Insert the Infant/Child Key to automatically decrease the defibrillation therapy and implement the configured infant/child CPR protocols..

**3-LEAD
CABLE AND
Q-CPR NOW
AVAILABLE**



- Download **FREE Layar App** (from your App Store)
- Scan this page
- View custom product info

861388	HeartStart FR3 Text bundle includes standard battery, SMART Pads III and user documentation	each	2,799.00
861389	HeartStart FR3 ECG bundle includes standard battery, SMART Pads III and user documentation	each	3,320.00

FR3 Carrying Cases (Philips)

There are three cases available for the FR3 defibrillator.

- **Rigid System Case** is designed for environments like Fire, EMS, military and heavy industry, or anywhere aggressive use is expected. It's made of very durable plastic, and will protect FR3 and its accessories in demanding applications. A Pads Sentry is included. 13.2" w x 10.3" h x 5.2" d.
- **Soft System Case** is lightweight and medium-sized, and allows room for a spare battery, spare pads, and an optional Infant/Child Key. This case is intended for environments where the defibrillator is protected from excessive moisture and harsh treatment. Includes a Pads Sentry. 10.15" w x 9.1" h x 4.86" d.
- **Small Soft Case** is for when ultimate portability is essential. Its small, lightweight design makes it ideal where size and weight are among top criteria for decision makers. This case is intended for environments where the defibrillator is protected from excessive moisture and harsh treatment. Pads Sentry included.

989803149971	FR3 rigid system case	each	243.00
989803179161	FR3 soft system case	each	164.00
989803179181	FR3 small soft case	each	160.00

SMART Pads III (Philips)

SMART Pads III have been streamlined for fast deployment. The time-consuming steps of removing the pads' packaging during the initial stages of the response have been eliminated. Also, they can be used on both adults and children (with optional Infant/Child Key) so there's no time wasted changing pad sets. Offset tabs enable a peel-and-place workflow that is easier and faster to use. The multifunction SMART Pads III connector is compatible with HeartStart manual defibrillators, and can be used for ECG monitoring, external pacing, and synchronized cardioversion as well as defibrillation.



989803149981	SMART Pads III	pair	46.00
989803149991	SMART Pads III	5 pairs/case	208.00

FR3 Infant/Child Key (Philips)

The FR3 Infant/Child Key with tether is designed for use with the HeartStart FR3 Defibrillator when treating an infant or child who is under 55 lbs. Once the Infant/Child Key is inserted, the FR3 automatically reduces the defibrillation therapy to an appropriate level for children.



989803150031	FR3 Infant/Child Key	each	97.00
--------------	----------------------	------	-------

FR3 Primary Disposable Battery (Philips)

FR3 primary battery is a lithium manganese dioxide disposable battery. 5 year shelf life. Typically 300 shocks, or 12 hours of monitoring time.



989803150161	FR3 Primary Disposable Battery	each	270.00
989803150171	FR3 FAA-Compliant Battery	each	261.00

FR3 Rechargeable Clinical Battery (Philips)

This rechargeable battery is intended for organizations that frequently use the FR3. It is often used with the 3-Lead Cable (989803150041) to keep per-use costs low.

- Provides ~100 shocks
- Provides up to 3.5 hours of operating time (3 hours with CPR meter)
- Fuel gauge on the FR3 shutdown display
- Long battery life cycle ~300 charge/discharge cycles
- Charger shared with the FR3 Training Pack



989803150241	FR3 Rechargeable Clinical Battery	each	500.00
861394	FR3 Rechargeable Battery Charger	each	310.00

FR3 Fast Response Kit (Philips)

The FR3 Fast Response Kit includes two pairs of gloves, an adult pocket mask, paramedic scissors, prep razor, and a large paper towel. These items are enclosed in a durable plastic housing that's been designed to fit conveniently inside the lid of the Philips Rigid System Case (989803150111).



989803150111	FR3 Fast Response Kit	each	51.00
--------------	-----------------------	------	-------

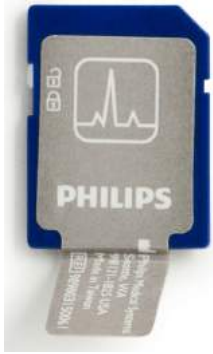

FR3 Data Card (Philips)

Stores 8 hours of ECG, patient event data, and 8 hours of voice recording (if desired) for download and retrospective review.

989803150061	FR3 data card	each	92.00
--------------	---------------	------	-------



FR3 Pads Sentry Replacement (Philips)

The Pads Sentry is designed for use in the Philips FR3 carrying cases, and provides support for the fast response features available on the Philips SMART Pads III. Once the pouch has been removed from SMART Pads III, they can be inserted into the Pads Sentry making them ready for fast deployment. The Pads Sentry also enables SMART Pads III to be tested when FR3 does its routine self-tests.

989803150011	FR3 pads sentry replacement	each	39.00
--------------	-----------------------------	------	-------

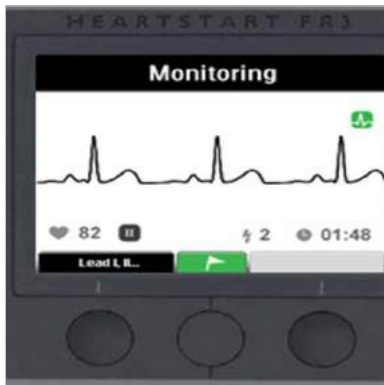

FR3 3-Lead ECG Cable (Philips)

The FR3 3-Lead ECG Cable gives trained responders the following features and benefits:

- Selectable Lead I, II, III for optimized view
- ECG trace using standard monitoring electrodes
- Event Marker to capture noteworthy events
- Heart Rate to evaluate patient stability
- No battery in ECG cable to limit life
- Includes storage bag

A software upgrade may be required. Please see "FR3 Software Upgrade Kit" on page 7.



989803150041	3-Lead ECG Cable	each	305.00
--------------	------------------	------	--------

CPRmeter Upgrade Kit for FR3 (Philips)

Q-CPR™ is a CPR measurement and feedback tool that has been demonstrated to improve CPR delivery and patient outcomes.



Why Philips added QCPR to the FR3

- AHA and ERC 2015 Guidelines compliant
- Provides visual targets where you want it—on the patient’s chest
 - Compression depth
 - Compression release
 - Compression rate
 - Compression inactivity
- Corrective feedback when targets are missed
- Compression counter
- Detects and alerts when hyperventilation occurs



NOTE: The CPR Meter Upgrade Kit for FR3 (989803149941) runs on software version PR2.1 or higher. For software versions below PR2.1, the FR3 Software Upgrade Kit (989803184831) is also needed.

989803149941	CPR Meter Upgrade Kit for FR3 includes CPR meter, cable link, CPR meter cradle (for rigid case), user documentation and 10 patient adhesives	each	1,295.00
--------------	----------------------------------------------------------------------------------------------------------------------------------------------	------	----------

FR3 Software Upgrade Kit (Philips)

An FR3 Software Upgrade Kit is required (in addition to hardware) for FR3 customers who want to add QCPR, 3-Lead and rechargeable battery functionality to their existing FR3 whose **software version is below PR2.1**. A software upgrade is not required to add the FAA-compliant battery functionality to an existing FR3.



NOTE: One upgrade kit can upgrade any number of FR3 units.

989803184831	FR3 Software upgrade kit to add Q-CPR, 3-Lead and Rechargeable Battery functionality to existing FR3	each	122.00
--------------	------------------------------------------------------------------------------------------------------	------	--------

FR3 CPRmeter Replacement Accessories (Philips)

989803162401	Replacement CPRmeter (does not include cable link, CPR meter cradle or adhesive pads)	each	1,200.00
989803149951	CPRmeter cable link for FR3	each	155.00
989803162231	CPRmeter cradle for FR3	each	23.00
989803163291	CPRmeter patient adhesive pads	10/pkg	50.00



AED Trainer 3
Item 861467-OPTA01



HeartStart FR3 Training Pack
Item 989803150191

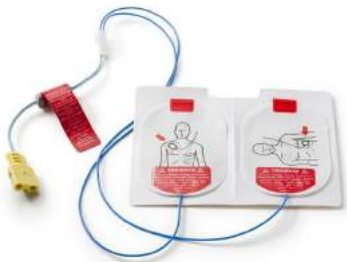

AED Trainer 3 Replacement Training Pads III and Interconnect Cable
Items 989803150181 (Pads III) and 989803150201 (Cable)



HeartStart FR3 Battery Charger
Item 861394



AED Trainer 3 Remote Control
Item 989803171631

AED Trainer 3 (Philips)

Designed to help prepare emergency responders to use the HeartStart FR3 and other AEDs. Together with appropriate manikins and other training tools, the AED Trainer 3 is intended to help provide realistic training on delivering correct treatment, including shock delivery and CPR, to a cardiac arrest victim.

The AED Trainer 3 guides you through each step of the training scenario with the same voice prompts as the FR3 AED. Like the FR3 AED, the AED Trainer 3 configuration can be customized and its operation easily updated.

- Provides 8 training scenarios that simulate realistic episodes of SCA and help responders become familiar with use of the FR3.
- Like the HeartStart FR3 AED, the AED Trainer 3 can be prepared with its training pads pre-connected and out of their packaging, ready for fast deployment.
- Includes Training Pads III and a reusable interconnect cable. There's no need to change the pads for children. The AED Trainer 3 comes with a Training Infant/Child Key to replicate the infant/child mode of the FR3 AED.

861467-OPTA01	AED Trainer 3	each	451.00
989803150191	FR3 Training Pack provides 4 simulation scenarios and includes training battery, set of Replacement Training Pads III, interconnect cable for Replacement Training Pads III and an external manikin adapter	each	305.00
989803150181	Replacement Training Pads III (requires Interconnect cable 989803150201 and typically provides 100 uses)	pair	26.00
989803150201	Interconnect cable for Training Pads III	each	19.00
861394	FR3 training battery charger	each	310.00
989803171631	Remote control for AED Trainer 3	each	48.00



HeartStart FRx Defibrillator (Philips)

The Philips FRx Defibrillator features technological advancements to help in treating the most common cause of SCA. It's designed to be easy to set up and use, as well as rugged and reliable for those who get there first.

Proven therapy

At the core of all HeartStart Defibrillators is SMART Biphasic technology. The Philips SMART Biphasic waveform is highly effective, yet minimizes harmful side effects. Its effectiveness is backed by over 40 published, peer-reviewed studies. SMART Analysis automatically assesses the victim's heart rhythm and is designed not to deliver therapy unless the rhythm is determined to be shockable – even if the Shock button is pressed. And the FRx is among the fastest in class at delivering a shock after CPR.

Designed for real world use

The Philips HeartStart FRx Defibrillator is exceptionally rugged. Designed to surpass rigorous testing requirements, the FRx withstands jetting water, loads up to 500 pounds, and a one-meter drop onto concrete.

Preconnected SMART Pads II

SMART Pads II can be used for both adults and children. They eliminate the expense of having to purchase different sets of pads for different patient types. SMART Pads II enable the FRx to keep pace with responders by adjusting to their actions.

Infant/Child key

Simply insert the Infant/Child key into the FRx to signal to the device that you're treating an infant or a child. The defibrillator adjusts to provide special pads placement and CPR instructions. The pads icons also flash to show you the optimized pads placement, and the device reduces the shock energy to a level more appropriate for an infant or a child.

Wireless Data Transfer

Infrared data port for easy transmission to a Smartphone or PC running Event Review software, without cables or hardware compatibility issues.

Built on a platform of proven ease-of-use

Small and lightweight – just 3.5 lbs – the FRx is equipped to direct you through the resuscitation of a SCA victim. The HeartStart FRx guides you through every step with clear, calm voice commands and descriptive visual icons.

861304-OPTC01	HeartStart FRx defibrillator with standard carrying case	each	2,099.00
861304-C03	HeartStart FRx defibrillator with hard-shell carrying case	each	2,179.00
861304-OPTR01	HeartStart FRx defibrillator Ready-Pack (includes standard carrying case, spare SMART Pads II)	each	2,127.00
861304-OPTA01	HeartStart FRx defibrillator, aviation bundle	each	2,122.00

FRx Infant/Child Key (Philips)

The infant/child key turns the HeartStart FRx into a pediatric defibrillator by adjusting the voice instructions and decreasing defibrillation therapy to treat infants and children. The same pad set works for adults, children, and infants.

989803139311	HeartStart FRx infant/child key	each	105.00
--------------	---------------------------------	------	--------



The HeartStart FRx

Defibrillator includes an Owner Manual, Quick Set-up guide, maintenance booklet, pre-installed battery, one set pre-installed SMART Pads II and a Quick Reference Guide and choice of carrying case.

The FRx Aviation Bundle

(861304-OPTA01) replaces the standard M5070A battery with the 989803139301 Aviation battery and includes aviation carrying case (zippered).

The FRx Ready-Pack has the device and spare pads pre-installed in carrying case.

The HeartStart FRx Defibrillator device includes an 8-year manufacturer's warranty at no charge. Battery includes 4-year warranty; pads are warranted until expiration date. Other accessories include a one-year warranty.





FRx Standard Carrying Case
Item 989803139251



FRx Hard-Shell Carrying Case
Item YC



Adapter for Zoll 1200, 1400, 1600 and M-series
Item 05-10100



Adapter for Medtronic Physio-Control Quick Combo LP9, 10C, 11, 12, 15, 20 and 500 defibrillators
Item 05-10000



FRx Replacement Carrying Cases (Philips)

Two carrying cases are available for the FRx defib illator:

- **FRx Standard Carrying Case** (item 989803139251) is constructed with easy-to-clean urethane. This case is durable enough to withstand bumps and drops, and provides easy access with a VELCRO® closure. The FRx case holds and protects your FRx Defib illator and optional accessories, including a spare battery, two pads sets, the Infant/Child Key and Quick Reference Guide. Includes strap. Dimensions: 9.5" w x 8.0" h x 5.0" d.
- **FRx Hard-Shell Carrying Case** (item YC) is a waterproof carrying case made of hardshell plastic suited for more rigorous use, particularly in wet outdoor settings. It can also accommodate a spare battery, spare pads cartridge, and the contents of the Fast Response Kit. Dimensions: 13.5" w x 12" h x 6" d.

989803139251	FRx standard carrying case, urethane	each	147.00
YC	FRx hard-shell carrying case, waterproof	each	227.00

SMART Pads II (Philips)

Save valuable time in an emergency with pads that can be used on adults, children and infants. SMART Pads II eliminate the expense of having to purchase a different pads set for different patient types. These pre-connected pads are packaged in a semi-rigid pads case for added protection, and are equipped with a HeartStart-compatible plug for easy hand-off o Philips ALS defib illators and to competitive defib illators with adapters. For patients less than 55 lbs. Use with the Infant/Child Key.

989803139261	SMART Pads II	each	56.00
--------------	---------------	------	-------

HeartStart Pads Adapters (Philips)

Smart Pads II can also be used with defib illators from other manufacturers, when equipped with Philips Heart Start Adapters.

05-10100	Removable adapter for Zoll 1200, 1400, 1600, M and X-series	each	42.00
05-10000	Removable adapter for Medtronic Physio-Control Quick Combo LP9, 10C, 11, 12, 15 and 500 defib illators LP9, LP10C, 11, 12, 15 and 500 defib illators	each	42.00
05-10200	Pads Adapter, adapts plug style pads into Hewlett Packard barrel style connector	each	42.00

Fast Response Kit (Philips)

The Fast Response Kit contains tools and supplies typically needed for patient care and personal protection: 2 pairs of hypoallergenic nitrile gloves, a pocket breathing mask, paramedic scissors, a chest hair razor and a large extra-absorbent paper towel. These items are housed in a zippered pouch which attaches securely to the handle of either the semi-rigid or vinyl carrying case.

68-PCHAT	HeartStart Fast Response Kit	each	38.92
----------	------------------------------	------	-------

FRx Long-Life Batteries (Philips)

The FRx Defibrillator uses a disposable, lithium manganese dioxide, long-life battery with a five-year shelf life plus a (typical) four-year installed life. A spare battery should be stored with the defibrillator. Additional batteries should be purchased for defibrillators used frequently for training and/or demonstrations. This battery is also compatible with HeartStart Onsite Defibrillators.

M5070A	HeartStart FRx lithium manganese dioxide battery	each	143.00
989803139301	HeartStart FRx aviation battery	each	176.00



HeartStart FRx Trainer (Philips)

Empower your students by teaching them how to use the HeartStart FRx Defibrillator to help save lives. The HeartStart FRx Trainer simulates how the HeartStart FRx Defibrillator will operate during a real-life cardiac arrest event. Clear, confident voice instructions and pre-configured rescue scenarios make training students easier and more rewarding. Voice instructions match those of the HeartStart FRx Defibrillator.

- Works with internal and external pads adapters, allowing the instructor to provide some or no clues toward pad placement, resulting in the most realistic training scenario.
- Resembles the HeartStart FRx Defibrillator, yet is sufficiently different to avoid inadvertent use in an actual emergency.
- Accepts Infant/Child Key for pediatric defibrillation training.
- CPR coaching helps train students in adult and infant/child CPR.
- Uses four standard "AA" batteries (not included), allowing you to manage training costs.



HeartStart FRx Trainer
Item 861306

861306	HeartStart FRx Trainer includes nylon carrying case, one set of reusable adult training pads and one external manikin adapter strip	each	369.00
989803139271	HeartStart FRx training pads, complete (pads case and pads)	each	84.00
M5090A	HeartStart adult pads placement guide ("Flat Man")	each	29.00
989803139281	HeartStart infant/child pads placement guide ("Flat Kid")	each	29.00
989803139291	HeartStart FRx replacement training pads (pads only, no pads case)	each	28.77
989803139321	HeartStart FRx training toolkit includes CD and DVD with PowerPoint Presentation and video on how to operate and maintain the HeartStart FRx	each	34.00
M5088A	Internal manikin adapter	each	34.00
M5089A	External manikin adapters	5/pkg	58.00
T1950	"AA" battery	each	0.52



HeartStart FRx Training Pads
Item 989803139271



HeartStart Adult Pads Placement Guide ("Flat Man")
Item M5090A



HeartStart FRx Training Toolkit
Item 989803139321



HeartStart OnSite (HS1) Defibrillator (Philips)

Philips, the leader in portable defibrillation technology, designed the HeartStart OnSite Defibrillator for the ordinary person in the extraordinary moment. The first commercial defibrillator available without a prescription, the OnSite is designed to be the easiest to use and most reliable defibrillator available.

Innovative technology, based on extensive research and user feedback, has produced a defibrillator so easy to use that you can potentially save the life of a coworker, friend, or anyone else stricken with sudden cardiac arrest.

The HeartStart OnSite Defibrillator includes one pre-installed battery, one pre-installed SMART Pads Cartridge, Quick Set-up Guide, Maintenance Booklet, Quick Reference Guide, and Owners' Manual plus the user-selected carrying case.

The HeartStart OnSite Ready-Pack configuration has the AED and spare pads cartridge pre-installed in the standard carrying case.

The HeartStart OnSite Defibrillator device includes an 8-year manufacturer's warranty while the battery includes a 4-year warranty from time of installation. SMART Pads Cartridge warranty extends to the expiration date. Other accessories include a 1-year warranty.

- **Voice instructions.** Clear, natural voice instructions are paced to your actions, guiding you through the entire process; from assessing the patient and placing pads, to delivering a shock and performing CPR.
- **Low maintenance.** Battery powered by a simple, safe, long-life (four-year) battery.
- **Pads placement.** Guides the user to place pads on the patient. Best in class based on two studies.
- **Easy to carry.** Treats infants, children and adults with special cartridges.
- **Daily self-tests** check electrical components, subsystems and battery.
- **CPR coaching.** Simply follow the voice instructions on rescue breathing and hand placement, and listen to the metronome to coach you on the frequency of compressions.
- **A self-test** also verifies that the pads cartridge is installed and in working order.
- **A blinking green "Ready" light** means the OnSite has passed its last self-test, so you can be confident the defibrillator is ready for use.
- **Automatic self-tests** help ensure continued readiness.



M5066A-OPTC01	HeartStart OnSite defibrillator with standard carrying case	each	1,455.00
M5066A-OPTC02	HeartStart OnSite defibrillator with slim carrying case	each	1,389.00
M5066A-OPTC03	HeartStart OnSite defibrillator with hard-shell carrying case	each	1,581.00
M5066A-OPTR01	HeartStart OnSite defibrillator Ready-Pack (includes standard carrying case, spare adult SMART pads cartridge. Device and spare pads are pre-installed in carrying case.)	each	1,512.00

HeartStart OnSite Replacement Cases (Philips)

There are three carrying cases available for the HeartStart OnSite Defib illator:

- **Standard Carrying Case** (item M5075A) can accommodate one spare pads cartridge and a spare battery, in addition to the OnSite Defib illator. It also comes equipped with a pair of paramedic scissors. 9.5" w x 8.5" h x 4.8" d
- **Slim Carrying Case** (item M5076A) holds the OnSite Defib illator and a pair of paramedic scissors. 9.5" w x 8.5" h x 3.5" d
- **Hard-Shell Carrying Case** (item YC) is made of hardshell plastic suited for more rigorous use, particularly in wet outdoor settings. It can also accommodate a spare battery, spare pads cartridge, and the contents of the Fast Response Kit. 13.5" w x 12" h x 6" d

The Standard and Slim cases are constructed with semi-rigid materials and covered in durable red Cordura.® A window pocket inside both cases, the Standard and Slim, holds the OnSite Quick Reference Guide.

M5075A	OnSite standard carrying case	each	133.00
M5076A	Onsite slim carrying case	each	95.00
YC	OnSite hard-shell carrying case, waterproof	each	227.00



Standard Carrying Case
Item M5075A



Slim Carrying Case
Item M5076A



Hard-Shell Carrying Case
Item YC

OnSite Adult SMART Pads Cartridge (Philips)

Appropriate for cardiac arrest victims weighing 55 pounds or more. Defib illation pads should be replaced after each use or once every two years.

M5071A	OnSite adult SMART pads cartridge	each	73.70
--------	-----------------------------------	------	-------



OnSite Infant/Child SMART Pads Cartridge (Philips)

Children weighing less than 55 pounds, including infants, should be treated using HeartStart Infant/Child SMART Pads. These pads instruct the defib illator to reduce the energy of its shock from 150 to 50 Joules (J), a more appropriate dosage. The Infant/Child Pads cartridge is marked with an indication of patient weight and with a teddy bear icon for easy identification. Defib illation pads should be replaced after each use or once every two years.

M5072A	OnSite infant/child SMART pads cartridge	each	118.80
--------	------------------------------------------	------	--------





OnSite Long Life Battery (Philips)

The OnSite Defib illator uses a disposable, lithium manganese dioxide, long-life battery with a five-year shelf life plus a (typical) four-year installed life. A spare battery should be stored with the defib illator. Additional batteries should be purchased for defib illators used frequently for training and/or demonstrations. This battery is also compatible with HeartStart FRx Defib illators.

M5070A	OnSite long life battery	each	143.00
--------	--------------------------	------	--------



Fast Response Kit (Philips)

The Fast Response Kit contains tools and supplies typically needed for patient care and personal protection: 2 pairs of hypoallergenic nitrile gloves, a pocket breathing mask, paramedic scissors, a chest hair razor and a large extra-absorbent paper towel. These items are housed in a zippered pouch which attaches securely to the handle of either the semi-rigid or vinyl carrying case.

68-PCHAT	HeartStart Fast Response Kit	each	38.92
----------	------------------------------	------	-------



HeartStart OnSite Trainer
Item M5085A

HeartStart OnSite (HS1) Trainer (Philips)

The HeartStart OnSite Trainer simulates how the HeartStart OnSite Defib illator will operate during a real-life cardiac arrest event.

- Clear, confident voice instructions and preconfigured scenarios make training students easier and more rewarding.
- Voice instructions match those of the HeartStart OnSite Defib illator.
- Works with internal and external pads adapters, allowing the instructor to provide some or no clues toward pad placement.
- Resembles the HeartStart OnSite Defib illator, yet is sufficiently different to avoid inadvertent use in an actual emergency.
- Uses four standard "AA" batteries (not included).



HeartStart OnSite Adult Pads Placement Guide
Item M5090A

M5085A	HeartStart OnSite trainer includes nylon carrying case, one set of reusable adult training pads and one external manikin adaptor strip	each	358.00
M5073A	HeartStart OnSite adult training pads with cartridge	each	84.00
M5093A	HeartStart OnSite adult training pads, no cartridge	each	34.00
M5090A	HeartStart OnSite adult pads placement guide ("Flat Man")	each	29.00
M5074A	HeartStart OnSite infant/child training pads with cartridge	each	91.00
M5094A	HeartStart-OnSite infant/child training pads, no cartridge	each	34.00
989803139281	HeartStart OnSite infant/child pads placement guide ("Flat Kid")	each	29.00
M5066-89100	HeartStart OnSite training toolkit includes CD and DVD with PowerPoint presentation and video	each	34.00
M5088A	Internal manikin adapter	each	34.00
M5089A	External manikin adapters	5/pkg	58.00
T1950	"AA" battery	each	0.52



External Manikin Adaptor
Item M5089A

HeartStart FR2+ Defibrillator

After nine years on the market, the **Philips FR2+ was discontinued** in 2009.

Supplies and training accessories **are currently** still available.

If you should have questions or need assistance with selecting another Philips AED to meet your needs, please call your Southeastern Emergency Equipment District Sales Manager or customer service representative for more information and assistance.



FR2 Carrying Cases (Philips)

There are four carrying cases available for the HeartStart FR2-Series Defibrillator.

- **Standard Carrying Case**, either semi-rigid Cordura® (item M3868A) or vinyl (M3869A) are intended for use in environments where the defibrillator is protected from excessive moisture and harsh treatment. Both hold the device as well as its main accessories and supplies. 9.5" w x 8.5" h x 4.8" d.
- **Temperature Control Carrying Case** (item 9898-3133171) allows you to safely store your FR2 in the trunk or storage compartment of a vehicle during extreme winter and summer temperatures. 9.5" w x 8.5" h x 3.5" d.
- **Hard-Shell Carrying Case** (item YC) is made of hard-shell plastic and is suited for more rigorous use, particularly in wet outdoor settings. It can also accommodate a spare battery, spare pads cartridge, and the contents of the Fast Response Kit. 13.5" w x 12" h x 6" d.



FR2+ Standard Carrying Case
Item M3868A



FR2+ Temperature-Control Carrying Case
Item 9898-3133171



FR2+ Hard-Shell Carrying Case
Item YC

M3868A	HeartStart FR2 standard carrying case, red cordura	each	150.00
M3869A	HeartStart FR2 vinyl carrying case	each	150.00
989803133171	HeartStart FR2 temperature control carrying case	each	439.00
YC	Hard-shell carrying case, waterproof	each	220.00

FR2+ Adult Pads (Philips)

Soft, flexible and oval shaped, HeartStart Adult Defibrillator Pads conform to the body contours for ample surface contact and adhesion. The robust lead wire connector is ergonomically designed, enabling fast and easy insertion. These pads are the same as DP2/DP6. Philips changed part numbers and packaging.

- Includes rugged defibrillation pads connector.
- Recommended for patients 8 years and older, or above 55 lbs.
- Constructed of a thin flexible conductor sandwiched between a protective non-conductive backing and a hydro-gel adhesive.
- May be used for ECG monitoring, external pacing, synchronized cardioversion and defibrillation.



989803158211	Adult defibrillator pads for FR2-series defibrillators (same as DP2/DP6)	pair	34.60
989803158221	Adult defibrillator pads for FR2-series defibrillators (same as DP2/DP6)	5 pair	173.00



FR2 Infant/Child Reduced-Energy Defibrillator Pads (Philips)

HeartStart FR2 Infant/Child Defibrillator Pads are for treating infants and children under 55 lbs. with an FR2-series defibrillator. These special infant/child pads contain electronics that attenuate, or reduce, the energy of the defibrillator's shock from 150 to 50 joules, a more appropriate dosage of SMART Biphasic therapy for infants and small children.

The pads' design was carefully thought out to ensure that even for the most inexperienced user under the most stressful circumstances, it is instantly obvious that these pads are for children and infants only. This helps ensure the correct pads are chosen when you need to be prepared to treat both adults and children. The packaging, graphics and pink teddy bear-shaped connector clearly communicate pediatric use.

M3870A	FR2 infant/child reduced-energy defibrillator pads	pair	93.08
--------	----------------------------------------------------	------	-------



FR2+ Data Card and Tray (Philips)

The data card holds approximately 8 hours of incident and ECG information, or one hour with voice recording. One card can hold data from multiple cases. A flash data card reader enables data transfer from the card to a personal computer for use with HeartStart Event Review data management software.

M3854A	FR2+ data card and tray	each	103.00
--------	-------------------------	------	--------



FR2+ Rechargeable Battery (Philips)

This lithium-ion battery fully charges using the Charger (item M3849A) in just three hours to provide 100 shocks (typical) or five hours (typical) of ECG display time. The "fuel gauge" on the FR2 displays the battery's remaining power. Under normal conditions, the FR2 rechargeable battery withstands 300 charge-discharge cycles or 2.5 years of use.

M3848A	FR2+ rechargeable battery	each	307.00
--------	---------------------------	------	--------



FR2+-Series Disposable Batteries (Philips)

FR2+-series defibrillators come with a disposable lithium manganese dioxide battery which has a shelf life of 5 years, plus typical standby life of 5 years (4 years minimum).

M3863A	FR2+-series standard battery	each	233.54
989803136291	FR2+-series aviation battery	each	277.00



Fast Response Kit (Philips)

The Fast Response Kit contains tools and supplies typically needed for patient care and personal protection: two pairs of hypoallergenic nitrile gloves, a pocket breathing mask, paramedic scissors, a chest hair razor and a large extra-absorbent paper towel. These items are housed in a zippered pouch which attaches securely to the handle of either the semi-rigid or vinyl carrying case.

68-PCHAT	HeartStart Fast Response Kit	each	38.92
----------	------------------------------	------	-------

HeartStart Pads Adapters (Philips)

Smart Pads II can also be used with defibrillators from other manufacturers, when equipped with Philips Heart Start Adapters.

05-10100	Removable adapter for Zoll 1200, 1400, 1600, M and X-series	each	42.00
05-10000	Removable adapter for Medtronic Physio-Control Quick Combo LP9, 10C, 11, 12, 15 and 500 defibrillators	each	42.00
05-10200	Pads Adapter, adapts plug style pads into Hewlett Packard barrel style connector	each	42.00



Adapter for Zoll 1200, 1400, 1600 and M-series
Item 05-10100



Adapter for Medtronic Physio-Control Quick Combo LP9, 10C, 11, 12, 15, 20 and 500 defibrillators
Item 05-10000

HeartStart AED Trainer 2 (Philips)

For training many responders simultaneously, Philips HeartStart AED Trainer 2 is a more flexible and economical solution. AED Trainer 2 helps your responders learn to use FR2-series defibrillators in simulated sudden cardiac arrest episodes for an extremely realistic training experience. AED Trainer 2 looks and behaves like the FR2-series defibrillators, but cannot deliver an actual defibrillation shock.

It is pre-configured with 10 realistic training scenarios, developed in accordance with internationally recognized emergency responder training programs. Voice prompts in various languages and additional custom scenarios can be configured using the optional programming kit.

The AED Trainer 2 comes equipped with one set of adult-size reusable training pads, a quick reference instruction card, a user guide, and a carrying case. Also available is the all-in-one AED Little Anne Training System, for added realism. Uses 6 standard "C" batteries (not included).



AED Trainer 2
Item M3752A



Little Anne Training System
Item M3756A

M3752A	AED Trainer 2 includes nylon carrying case, one set of reusable adult training pads and user guide.	each	341.00
M3756A	AED Little Anne training system consists of HeartStart AED Trainer 2, Laerdal Little Anne manikin, special pads and carrying case	each	670.00
07-10900	AED Trainer 2 adult pads	each	31.00
M3871A	AED Trainer 2 infant/child pads	each	51.00
M3753A	AED Trainer 2 remote control	each	48.23
M3754A	AED Trainer 2 programming kit	each	35.00
989803150291	HeartStart FR2+ Training Toolkit Includes: CD and DVD with PowerPoint presentations and video on how to operate and maintain the Philips HeartStart FR2+ AED.	each	35.00
T1951	"C" battery	each	0.97



AED Trainer 2 Adult Pads
Item 07-10900

HeartStart ForeRunner (FR) Defibrillator

Although **Philips' Forerunner (FR) defibrillator has been discontinued**, the supplies below are available.

If you should have questions or need assistance with this or another Philips AED, please call your Southeastern Emergency Equipment District Sales Manager or customer service representative for more information and assistance.



HeartStream ForeRunner (FR) Defibrillator Pads (Philips)

Soft, flexible and oval shaped, HeartStart Adult Defibrillator Pads conform to the body contours for ample surface contact and adhesion. The robust lead wire connector is ergonomically designed, enabling fast and easy insertion. These pads are the same as DP2/DP6. Philips changed part numbers and packaging.

- Includes rugged defibrillation pads connector.
- Recommended for patients 8 years and older, or above 55 lbs.
- Constructed of a thin flexible conductor sandwiched between a protective non-conductive backing and a hydro-gel adhesive.
- May be used for ECG monitoring, external pacing, synchronized cardioversion and defibrillation.

989803158211	Adult defibrillator pads (same as DP2/DP6)	pair	34.60
989803158221	Adult defibrillator pads (same as DP2/DP6)	5 pair	173.00



HeartStream Forerunner (FR) Battery Pack (Philips)

This disposable lithium manganese dioxide battery pack has a typical shelf life of five years and a typical standby life of one year.

PHIBT1	Disposable battery pack for FR AED	each	162.00
--------	------------------------------------	------	--------

NOTE: The Philips battery pack (item BT1) was discontinued in December 2016. PHIBT1 is an aftermarket replacement battery.

HeartStart AED Cabinets (Philips)

To mobilize an emergency medical response or deter AED theft, Philips offers three different battery-operated, alarmed wall cabinets. Basic Surface-Mounted Cabinet has a simple audible alarm. Two premium cabinets feature combination audible and flashing light alarms. They are made of sturdy heavy-gauge steel, and are large enough to accommodate additional medical supplies. You can also connect the premium cabinets' alarms to your internal security or facility's monitoring system so that a more coordinated emergency response can be mobilized centrally. Each cabinet requires two 9-volt batteries (not included).

- **Basic Surface-Mounted Cabinet** mounts on the wall. 16.5" w x 15" h x 6" d.
- **Premium Semi-Recessed Cabinet** is inserted into a wall cut-out. It's perfect where ADA regulations are a consideration. 16.5" w x 24.5" h x 2.5" d.
- **Premium Surface-Mounted Cabinet** provides easy installation without cutting into walls. 16" w x 22.5" h x 6" d.

989803136531	Basic surface-mounted cabinet	each	253.00
PFE7023D	Premium semi-recessed cabinet	each	469.00
PFE7024D	Premium surface-mounted cabinet	each	440.00
T1954	9 volt battery	each	1.78



Premium Semi-Recessed
Item PFE7023D



Basic Surface-Mounted
Item 989803136531



Premium Surface-Mounted
Item PFE7024D

Wall Mount Bracket (Philips)

The Wall Mount Bracket is designed specifically for housing a Philips HeartStart Defibrillator and its accessories. The defibrillator's carrying case can be tethered to the Wall Mount Bracket with a breakaway Secure-Pull Seal (item M3859A), to discourage tampering. A broken seal indicates that the defibrillator has been removed from the Wall Mount and accessories may need to be replenished. The Fast Response Kit (68-PCHAT) tucks neatly behind the defibrillator case.

989803170891	AED wall mount bracket	each	98.00
--------------	------------------------	------	-------



SOME CABINETS AVAILABLE IN STAINLESS STEEL.

Call Customer Service at (800) 334-6656 for information.





Window Cling

Let your guests and everyone on your premises know that you've secured your facility with a Philips HeartStart AED. These clings can be placed on glass in doors, windows, etc. and can be easily removed without residue or damage.

DPCLING	Philips AED window cling	each	2.95
---------	--------------------------	------	------



AED Wall Sign (Philips)

An AED wall sign hanging above a wall mount bracket or defibrillator cabinet gives even greater visibility to the defibrillator. Can be mounted three different ways to maximize visibility: T-mount, V-mount or corner mount.

989803170921	AED wall sign	each	36.00
--------------	---------------	------	-------



AED Awareness Poster Pack (Philips)

Place this poster away from the AED, in break areas, copy rooms or locker rooms—anywhere employees or members of the public can take a moment to raise their awareness about AEDs. Includes space for the AED coordinator to write-in the location of the nearest AED. Pack of four posters.

861476-ABA	AED awareness poster pack	4/pkg	22.00
------------	---------------------------	-------	-------



AED Signage Bundle (Philips)

This AED Signage Bundle includes an AED wall sign (989803170921), AED awareness placard (989803170901) and four AED posters (861476-ABA).

861478-ABA	AED signage bundle	each	66.00
------------	--------------------	------	-------



AED Awareness Placard (Philips)

Raise AED awareness by putting an AED Awareness Placard above every AED located in a public area. Easy-to-understand graphics raise awareness of passers-by about how to use an AED in an emergency.

989803170901	AED awareness placard	each	27.00
--------------	-----------------------	------	-------



Secure Pull Seal (Philips)

M3859A	Secure pull seal	10/pkg	11.00
--------	------------------	--------	-------

AED Inspection/Maintenance Tag

These tags, like those commonly found with fire extinguishers, allow you to record each time the AED is inspected. Printed on both sides. Includes cable tie.

AMP3737	AED inspection/maintenance tag	5/pkg	4.62
---------	--------------------------------	-------	------



TL1 AED Cabinet (HeartStation)

- Traditional HeartStation quality and value
- Accommodates EVERY major AED on the market
- Molded side handle is flush, preventing accidental openings and damage
- KEYLESS ALARM can be controlled from outside or inside the cabinet
- Alarm is ultra small so it doesn't waste cabinet space yet produces 90 decibels
- Magnetic door latch provides solid closure and trouble-free opening
- Entire cabinet front swings open to allow easy access
- Powder coat finish provides durable protection
- Welded 20 gauge steel throughout (20% thicker than 22 gauge)
- Impact-resistant acrylic window – 9 1/4" w x 10 5/8" h
- 15" h x 14" w x 6 3/4" d; weighs 10 lbs
- Uses three 1.5 Volt LR44 or AG13 batteries (batteries included)
- Shipped fully assembled in protective foam packaging
- One year limited warranty



Note: "FOR USE BY TRAINED RESPONDERS" is no longer printed on cabinet. Decal is included if required in your area.

HSTL1	TL1 AED cabinet	each	183.69
T1955	1.5 volt replacement battery	each	3.06

RC5300 AED Cabinet (HeartStation)

- Rugged 16 gauge welded steel (58% thicker than standard 20 gauge)
- Large 3/16" impact resistant acrylic window
- Distinctive slant top design indicates AED station (also eliminates clutter)
- 100 decibel high output alarm
- High intensity strobe light alarm
- System powered by 9 volt battery (battery included)
- Multiple cabinets can be keyed alike
- Flush, industrial strength hardware
- Powder coat finish with UV protection
- Shipped fully assembled
- One year warranty
- 17" w x 16" d x 6.25" h; weighs 18 lbs



HSRC5300	RC5300 AED cabinet with alarm	each	235.32
T1954	9 volt battery	each	1.78



RC2000 AED Cabinet (HeartStation)

Large cabinet allows for oxygen cylinder, first aid kit, and supplies.

- Multiple cabinets can be keyed alike
- Shipped fully assembled
- One year warranty
- AED bracket included
- Powder coat finish with UV protection
- Flush, industrial strength hardware
- Alarms powered by 12 volt lithium battery pack for higher output and longer life (battery included)
- Theft deterrent system
- High intensity strobe light alarm
- 120 decibel high output alarm (30 seconds) followed by intermittent service tone
- Rugged 14 gauge welded steel (97% thicker than standard 20 gauge)
- Large 3/16" impact resistant acrylic window
- Continual self-monitoring circuitry (9 volt battery included)
- 22" h x 16" w x 6.25" d; weighs 30 lbs

HSRC2000	HeartStart 2000 AED cabinet with alarm and AED bracket	each	508.40
HSRC2000S	HeartStart 2000 AED cabinet with alarm, security tie-in and AED bracket	each	508.40
HSRC2000SL	HeartStart 2000 AED cabinet with alarm, security tie-in, locking door handle and AED bracket	each	508.40
HSRC2000RSB	HeartStart 2000 AED recessed cabinet with alarm, security tie-in and AED bracket	each	553.69
T1956	12 volt replacement battery pack	each	36.15
T1954	9 volt battery	each	1.78



FRx is versatile for use in just about any environment

RC5000 AED Cabinet (HeartStation)

Provide secure, easy AED access in an easily identifiable cabinet. HeartStation is the original, patented AED cabinet unsurpassed in quality, features, and value.

- Rugged 16 gauge welded steel (58% thicker than standard 20 gauge)
- Large 3/16" impact resistant acrylic window
- Distinctive slant top design indicates AED station (also eliminates clutter)
- 120 decibel high output alarm (30 seconds), followed by intermittent service tone
- High intensity strobe light alarm
- Theft deterrent system
- Alarms powered by 12 volt lithium battery pack (included) for higher output and longer life
- Continual self-monitoring circuitry using 9 volt battery (included)
- Multiple cabinets can be keyed alike, specific key numbers available upon request
- Flush, industrial strength hardware
- Powder coat finish with UV protection
- Shipped fully assembled
- One year warranty
- 17" h x 16" w x 6.25" d, weighs 19 lbs (recessed model 21 lbs)



Recessed AED Cabinet
Item HSRC5000R



Wall Mount AED Cabinet
Item HSRC5000W

HSRC5000WS	RC5000 wall mount AED cabinet with alarm and security tie-in	each	340.55
HSRC5000W	RC5000 wall mount AED cabinet with alarm	each	294.39
HSRC5000RS	RC5000 recessed AED cabinet with alarm and security tie-in	each	333.78
HSRC5000R	RC5000 recessed AED cabinet with alarm	each	333.69
T1956	12 volt replacement battery pack	each	36.15
T1954	9 volt battery	each	1.78

SOME CABINETS AVAILABLE IN STAINLESS STEEL.
Call Customer Service for information.



HeartStart Data Messenger (Philips)

Data Messenger software lets you download, view, report, store and send Philips defibrillator data where it needs to go. You can forward patient data for retrospective analysis by your medical director or data administrator. Forward the event report as a PDF, or forward the case to any electronic patient care reporting system enabled with Philips Data Software Developer’s Kit.

- Compatible with Philips Onsite, FRx, FR3 and MRx defibrillators.

861451-A01	HeartStart Data Messenger software, single PC	each	215.00
861451-A03	HeartStart Data Messenger software, site-wide license	each	4,100.00

HeartStart Event Review (Philips)

With Event Review software you can download patient event data from your defibrillator or import events created in Data Messenger. Allows you to analyze defibrillator events and annotate them with your observations, then use Event Review reports to debrief responders to improve their next response.

- Compatible with Philips Onsite, FRx, FR2 and FR3 defibrillators.
- For Philips MRx or systems with both Philips AEDs and MRx’s, please see HeartStart Event Review Pro software below.

861489	HeartStart Event Review software, single PC	each	407.00
861489-A02	HeartStart Event Review software, site-wide license	each	1,025.00

HeartStart Event Review Pro (Philips)

Event Review Pro is Philips’ most comprehensive case management tool for the most demanding data managers and medical directors. It includes even more detailed data entry screens to record every aspect of the response, including detailed response times, interventions, and patient observations. In addition to the individual case reports, you get Utstein reporting and graphical summaries of your system’s overall response times to help you manage your service levels more efficiently.

- For Philips MRx or systems with both Philips AEDs and MRx’s.

861431-OPTA01	HeartStart Event Review Pro software, single PC	each	2,570.00
861431-OPTA06	HeartStart Event Review Pro software, multi-download license (20 downloads)	each	6,175.00

HeartStart Configure (Philips)

HeartStart Configure lets you review and change the configuration of your Philips OnSite, FRx and FR3 on a personal computer. With a few single-click commands, you can retrieve the current configuration from your defibrillator, reset the configuration to default values or revise individual settings according to your medical director’s preferred response protocol, and update your AED. You can save the configuration settings to a file within HeartStart Configure. This makes it easy to use the same configurations on all your AEDs and maintain a record of selected settings. For FR3, you can also set the language, including bilingual primary and secondary languages. You can set the device internal clock setting via FR3 Bluetooth module (item 989893150081).

- Compatible with Philips Onsite, FRx and FR3 defibrillators.

861487	HeartStart Configure software	each	67.00
--------	-------------------------------	------	-------

Infrared Data Cable/Adapter (Philips)

In addition to software, an Infrared Data Association (IrDA) adapter is required to transfer information to and from a HeartStart Onsite or HeartStart FRx defibrillator.

Configuration settings for HeartStart FR3 are changed via Bluetooth or data card.



ACT-IR	Infrared data cable/adapter	each	143.00
--------	-----------------------------	------	--------

Bluetooth Transceiver Module (Philips)

Enables the Philips FR3 to transmit event data to a computer equipped with HeartStart Data Messenger and HeartStart Event Review, Event Review Pro or HeartStart Configure. FR3 protocol configuration settings can be changed and FR3's internal clock can be synchronized with another clock.



989803150081	Bluetooth transceiver module to transmit event data	each	139.00
--------------	-----------------------------------------------------	------	--------

AEDs ■ AED Supplies

Supplies for HeartStart XLT/Laerdal 4000 (Philips)

Note: The Philips HeartStart XLT/Laerdal 4000 semi-automatic defibrillator has been discontinued. However, the following supplies are still available.



40457C	50 mm chemical thermal paper, gray grid	10/box	34.00
M3501A	XLT/Laerdal 4000 defibrillation pads, adult with white barrel-style connector	each	27.10
989803158211	Adult defibrillator pads (same as DP2/DP6)	pair	34.60
M3507A	XLT/Laerdal 4000 hands-free defibrillation cable with barrel-style connector	each	142.00
M3508A	XLT/Laerdal 4000 hands-free defibrillation cable with FR2 style/plug connector	each	132.00
M1191B	Reusable SpO ₂ finger sensor, adult	each	264.00
M1192A	Reusable SpO ₂ finger sensor, pediatric	each	264.00
M1943A	Nellcor SpO ₂ sensor adapter cable	each	180.00

Supplies for Cardiac Science AEDs

9131-001	Adult defibrillation pads for all Cardiac Science and Survivalink AEDs	each	48.68
9730-002	Pediatric defibrillation pads for Cardiac Science AEDs only	each	111.11
9146-101	PowerHeart AED G3 replacement battery	each	468.37
9145-101	PowerHeart AED G3 PRO replacement battery (PRO only)	each	608.88
9146-102	FirstSave AED G3 replacement battery (yellow)	each	468.37
9141R-001	Original Survivalink AED replacement battery	each	442.90

Supplies for LIFEPAK CR Plus and LIFEPAK Express

11403-000002	CR Plus Charge-Pak with one set defibrillation electrodes	set	120.77
11101-000016	Physio-Control infant/child electrode pads	each	134.05

Supplies for LIFEPAK 500 AED

11996-000017	Physio-Control Redi-Pak LIFEPAK electrode pads, adult	pair	51.18
11101-000016	Physio-Control infant/child electrode pads (use only with LP500 AED with pink connector)	each	134.05
KE1310P	MEDI-TRACE electrodes w/quick combo connector, adult (replaces 11996-000091)	pair	25.38
KE22550PC	Replaces Physio-Control Quick-Combo RediPack (11996-000017). For LP10C, LP12, LP500 and LP1000	pair	33.85
LP500B	LP500 battery, generic	each	258.00
11141-000013	LIFEPAK 500 replacement lithium battery	each	396.03

Supplies for LIFEPAK 1000 AED

11996-000017	Physio-Control Redi-Pak LIFEPAK electrode pads, adult	pair	51.18
KE22550PC	Medi-Track Cadence Pre-Connect adult Quick Combo defibrillation pads	pair	33.85
11101-000016	Physio-Control infant/child electrode pads	each	134.05
11141-000100	LP1000 non-rechargeable battery pack	each	447.69

Supplies for Zoll AED Plus and Zoll AED Pro

8900-0800-01	CPR-D Padz System - a one-piece (Z-shaped) pre-connected electrode with compression, depth and rate sensor. Comes with CPR barrier mask, pair of scissors, gloves, prep razor, towel and moist towelette.	each	195.00
8900-0810-01	Pedi-Padz II multifunction electrodes for AED Plus, AED Pro, E-Series and X-Series	each	109.62
8900-0802-01	Stat Pads II (There is no CPR feedback capability with these traditional 2-piece electrode pads.)	pair	47.98
8000-0807-01	Type 124 lithium batteries for Zoll AED Plus (includes 10 batteries with storage sleeve)	each	86.54
8000-0860-01	Non-rechargeable battery for Zoll AED PRO	each	184.62



Southeastern Emergency Equipment & ReNew Biomedical Partnership

Southeastern Emergency Equipment is pleased and excited to announce a partnership with ReNew Biomedical! We will now be able to service and maintain your medical equipment to prolong and extend the life of its use. We can service, maintain, and support defibrillators, ventilators, infusion pumps, AEDs, EKGs and vital signs monitors. Utilize and take advantage of this cost effective, hassle-free program to renew and maintain your equipment. This opportunity is made exclusively for the EMS and fire rescue market!

Together, we are able to offer the EMS and Fire Rescue market an affordable, low-cost, and effective way to preserve and maintain medical equipment, prolonging the life of your machines through use of ReNew's Preventative Maintenance programs and Service Contracts.

For more information on how you can save money on servicing and maintaining your equipment, contact your Southeastern District Sales Manager or call Customer Service at (800) 334-6656.



Defibrillators and Monitors

HeartStart MRx



pages 30-33

HeartStart MRx Supplies



pages 34-39

Intellivue MP2 Monitor



pages 40-41

Electrodes



pages 42-44

LifePak 12 Supplies



page 44-48

LifePak 15 Supplies



pages 49-54

Miscellaneous LifePak Supplies



page 54

Zoll X-Series Supplies



pages 56-57

Zoll ALS Supplies



page 57

Defibrillator Accessories



pages 58-59

HeartStart MRx Monitor/Defibrillator for EMS by Philips

BUILT TOUGH AND READY FOR ACTION



For whatever situation you face in a day, the HeartStart MRx is built to be tough and ready for action. It is designed to meet stringent test requirements including spraying water, military helicopter vibration, mechanical shock, one-meter drop, electro-magnetic compatibility, and extreme environmental conditions (temperature, humidity, and altitude).

Rugged and reliable

- **Active ready-for-use visual indicator** flashes to signal the device has power and is in good functioning order to monitor and deliver therapy.
- **18 hours of continuous ECG monitoring** with two fully charged batteries.
- **Automatic lead switching** to the next preferred lead when a lead falls off or is cut when in monitor or manual defibrillation mode, letting you focus on the patient, not the monitor.
- **Enhanced ECG performance** with improved connection points, more robust cables, and rugged lead sets. The EMS lead sets also have labels that can be seen in low light environments.
- **Seamless wireless data transmission** of 12-lead ECGs, periodic clinical data, and event summaries over Wi-Fi or cellular broadband improves speed, reduces workflow complexity, and helps increase reliability.
- **Choice of color** with the tactical gray color designed to show less dirt and wear and tear over time. Original white MRx is still available.

Intuitive and easy-to-use

- **Intuitive design** with therapy controls and connections on the right, monitoring on the left.
- **Easy-to-use interface** with contrasting colors for sync button, printer button, and menu and soft keys around the monitor face make it easier to find what you need fast. The tactical gray MRx provides even greater contrast.
- **Large color display** shows 4 waveforms and numerics, or view all 12 leads at once with the 12-lead acquisition option.
- **Comprehensive automated** hourly, daily, weekly self-test results are available on the display.
- **Flexible Event Summary print option** allows configuration of the desired clinical data, including EtCO₂ waveform, in the Event Summary report.
- **Enhanced event markers** offer the ability to enter the dose and unit of measure providing greater flexibility in patient care.



- Download **FREE Layar App** (from your App Store)
- Scan this page
- View custom product info

M3536A

HeartStart MRx monitor/defibrillator for EMS

Available in numerous configurations to meet your needs. Please call for more information and pricing.

Tough enough for the US Army

The same MRx model Philips ships to all EMS customers is tough enough to receive an Airworthiness Certification from the United States Army. The MRx was subjected to extensive testing for the most rigorous and demanding environments faced by military personnel.



CLINICAL DECISION SUPPORT THERAPIES

For Philips, clinical decision support means delivering actionable clinical intelligence that can have a real impact on patient care, workflow, and financial outcomes. The smart clinical decision support solutions analyze, interpret, and present data in meaningful ways that provide valuable information about changes in a patient's status.

Only Philips has the advanced DXL 12-lead ECG algorithm, which takes STEMI decision support to a new level by providing unique data views that enable confident decision-making to help speed triage.

- Pinpoints the **STEMI-Culprit Artery** most likely responsible for the acute symptoms, which can assist in directing care in the field and treatment in the Cath Lab.
- Generates **Critical Values** for four distinct life-threatening conditions – acute MI, acute ischemia, complete heart block, and very fast heart rate – that require immediate clinical attention. An enhancement of the DXL 12-lead ECG algorithm assists in detecting STEMI imposters, potentially reducing false positives.
- Provides **Gender-Specific Diagnostic Criteria** to enhance recognition and interpretation of cardiac symptoms in women.

The MRx also offers predictive instruments designed to help support confident decision-making.

- Acute Cardiac Ischemia – Time Insensitive Predictive Instrument (ACI-TIPI)** uses the 12-lead ECG to provide a percentage score for predictable probability that the patient is experiencing acute ischemia.
- Thrombolytic Predictive Instrument (TPI)** uses the 12-lead ECG and other demographic information to help predict patient outcome with and without thrombolytic therapy.

12-lead ECG strip

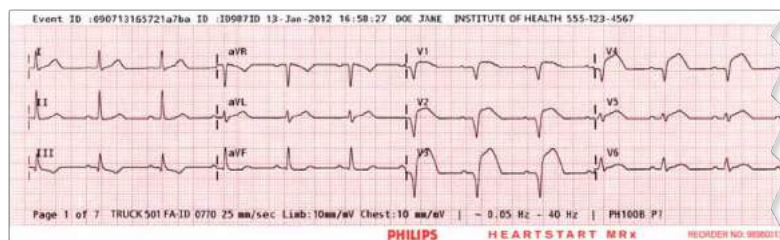

STEMI decision support data

Patient age and chest pain status

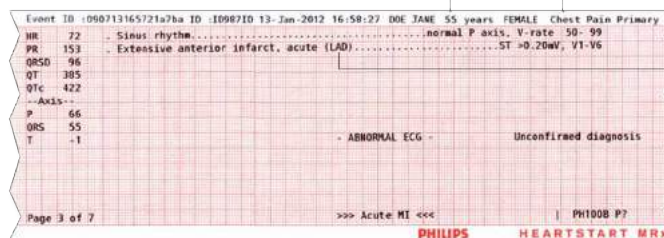

STEMI-Culprit Artery Identification (Left Anterior Descending)

Acute cardiac ischemia predictive probability data

Predicted probability of acute ischemia.

Explanation of clinical factors behind the predicted probability.



Pinpoint the STEMI-Culprit Artery most likely responsible for the patient's acute symptoms, which can assist in directing care in the field and treatment in the Cath Lab.

ENHANCED RESUSCITATION THERAPIES

Philips continues to be the leader in developing meaningful innovations in resuscitation therapy, including the first biphasic waveform for an external defibrillator. Philips' evidence-based, proven resuscitation therapies are designed to work together to help you give sudden cardiac arrest (SCA) patients the best chance of surviving and returning to active living.

- **SMART Biphasic** therapy has been rigorously studied and is supported by substantial peer-reviewed, published data. It has been clinically proven to deliver high first shock efficacy for long-downtime SCA patients, as well as to effectively defibrillate across the full spectrum of patients, including those considered "difficult-to-treat."
- **Q-CPR** measurements and feedback tool is supported by more published data than any other CPR quality improvement tool. It has been demonstrated to improve CPR delivery and patient outcomes.
- **Quick Shock** enables fast time to shock. Delivering a shock quickly after chest compressions is critical as benefits of CPR oxygenated blood delivered to the vital organs – dissipate in seconds.
- **Noninvasive Pacing** using either demand or fixed mode. Supports protocols for demand mode only or, if configured, switches to fixed mode in the event a lead is lost, which allows the patient to be continuously paced.

Q-CPR CPR QUALITY IMPROVEMENT TOOL

- **Philips Q-CPR** is supported by more published research than any other CPR quality improvement tool and is available as a fully integrated option with the HeartStart MRx.
- The Q-CPR meter delivers instant audiovisual feedback so that every compression meets depth and rate, complete chest recoil, hands-off time, and ventilation rate to help improve patient chance of survival and increase the opportunity for a complete neurological recovery.
- Q-CPR supports AHA/ERC 2015 CPR Guidelines. The HeartStart MRx can be configured to display either AHA or ERC protocol for depth and rate.



Good compressions



Release pressure between compressions



Compress deeper



Compress slower



CPR timer and compression counter
Ventilation guidance
Real-time feedback directly on monitor
Delivering accurate compression depth on a compliant surface.

Q-CPR offers protocol management and enhanced visual feedback in code view or AED mode.

Turn voice prompts ON or OFF depending on your system's protocol.

Q-CPR at a glance

Ventilation rate	Yes
Ventilation feedback from bag valve mask (BVM) or intubation	Philips exclusive
Displays 2-minute progress bar	Philips exclusive
Chest compression depth too-shallow	Yes
Chest compression rate high	Philips exclusive
Chest compression rate low	Yes
Complete chest recoil	Yes
"Hands off" time – provide audio feedback after 15 seconds if no compression activity	Yes
Complaint vs. non-complaint surface capability	Philips exclusive

DATA MANAGEMENT

Philips' goal is operational efficiency, allowing you to focus more on patient care and less on moving data during treatment and transport. Philips does this through an open data management approach, which means timely transmission of data, interoperability with virtually any ePCR software to streamline information flow, and quality debriefing to help you and your medics continuously improve your emergency responsive services.

With Philips, you have many options to help optimize your operation

- Whatever your workflow...print, display, fax, email, Wi-Fi, cellular broadband, Bluetooth, or Ethernet... the MRx can accommodate it.
- Flexible, fast, and reliable solutions provide data to the intended recipients.
- The Wireless Link transmits 12-lead ECGs, periodic clinical data, and event summaries via Wi-Fi or cellular broadband much faster than Bluetooth, with increased reliability and fewer buttons to push.
- Reliable and trackable automated download and delivery solutions mean no files or data are left behind and medic involvement in administrative tasks is reduced.
- Move data at LAN speed, which enables rapid downloads and faster device return-to-service times.
- Automatic time setting when all events are transferred ensures the HeartStart MRx is in sync with the system of record from "911 call" to "device on."
- Using the Wireless Link, transmit data seamlessly at fast speeds via Wi-Fi or cellular Broadband without any further user interaction so you can focus on your patients.
- Uses same low-cost infrastructure as 12-lead transmission.

Collaborate with hospital care teams by providing critical patient data en route using Periodic Clinical Data Transmission

- Communicate/collaborate on critical care patients – stroke, trauma, respiratory, pediatric, cardiac – to help hospital care teams better prepare for arrival.
- Press "start data transmit" to automatically document critical events and vitals en route.
- Using the Wireless Link, transmit data seamlessly at fast speeds via Wi-Fi or cellular Broadband without any further user interaction so you can focus on your patients.
- Uses same low-cost infrastructure as 12-lead transmission.

Capture and store the entire code, including Q-CPR data, with HeartStart Event Review Pro to help your team reach its full potential

- A breakthrough application for post-event review that provides a robust, insightful view of a resuscitation event.
- Built-in, easy-to-use navigation to pinpoint areas in specific patient's code event to reinforce effective techniques and motivate change where needed.

NEW DATA TRANSMISSION OPTION: WIRELESS LINK



Wireless Link lets you transmit 12-lead ECG's, periodic clinical data, and event summaries via Wi-Fi or cellular broadband (2G/3G). Powered by your MRx, this small, lightweight device stores easily in the back or side pouch of your carry case, and delivers a seamless data transmission experience that's faster than Bluetooth with fewer buttons to push.

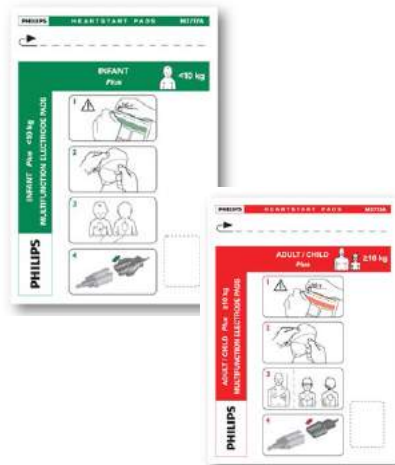

Multifunction Electrode Pads (Philips)

M3713A—Use these pads with your MRx when manually defibrillating anyone heavier than 22 lbs. Adult range is described as >25 kg (55 lbs). Child range is described as >10 kg to 25 kg (roughly 22 to 55 lbs).

M3717A—Use these pads with your MRx when manually defibrillating anyone weighing under 22 lbs. Infant range is described as <10 kg (roughly 22 lbs).

M3713A	Electrode pads, Adult/Child Plus, plug/FR2-style	each	29.00
989803166021	Electrode pads, Adult pre-connect pads, 10 sets, plug/FR2-style	10 sets	315.00
M3717A	Electrode pads, Pediatric Plus, 1 set, plug/FR2-style	1 set	37.20
M3501A	Electrode pads, Defibrillator, adult, 1 set, barrel-style	1 set	27.10
M3504A	Electrode pads, Defibrillator pediatric, 1 set, barrel-style	1 set	28.60



SMART Pads III (Philips)

SMART Pads III can be your total pad solution for MRx. SMART Pads III allow you to treat any patient (infant to adult) with one pad. This eliminates the need to carry separate infant/child pads, and will also reduce overall pad cost. Use of the MRx for defibrillation on infants/children is limited to the manual mode where the actual energy can be selected.**

989803149981	SMART Pads III	pair	46.00
989803149991	SMART Pads III	5 pairs	208.00

****NOTE: Use of the AED function on an MRx is for adults only. There is no mechanism (pad attenuator or key) that will allow a reduction in energy in AED mode. Please consult with Medical Control or established protocols before using the MRx in AED mode on patients <55 pounds.**



Barrel-Style cable
Item M3507A



Plug/FR2-style cable
Item M3508A

External Multifunction Cables and Test Loads (Philips)

M3508A	Hands-free defibrillator cable, plug/FR2-style	each	132.00
M3507A	Hands-free defibrillator cable, barrel-style	each	142.00
989803158661	Hands-free defibrillator cable, current Q-CPR connector only, plug/FR2-style	each	180.00
M4763A	Hands-free defibrillator cable, first-generation Q-CPR connector only, plug/FR2-style	each	192.00
M3725A	Test Load, plug/FR2-style (for use with M3508A defibrillation cable)	each	125.00
M1781A	Test Load, barrel-style (for use with M3507A defibrillation cable)	each	129.00

External Paddles (Philips)

M3543A	External paddles, water resistant	1 set	731.00
--------	-----------------------------------	-------	--------

ECG Monitoring Electrodes (Philips)

M2202A	Adult High-Tack foam ECG electrodes, wet gel/circular, 5 electrodes/pack (60 packs/case)	60/case	116.00
--------	------------------------------------------------------------------------------------------	---------	--------



12-Lead ECG Cables and Lead Sets (Philips)

M1663A	10-lead trunk cable, 12-pin connector (for 5-lead and 12-lead use), 2.0 meters long	each	268.00
989803176161	5-lead ruggedized EMS set, snap, shielded (AAMI), limb	each	120.00
989803176171	5-lead ruggedized EMS set , snap, shielded (AAMI), chest	each	140.00
989803144991	5-lead set, snap (AAMI) , limb (alternate part # M1644A)	each	104.00
989803144911	5-lead set, snap (AAMI), chest (alternate part # M1602A)	each	110.00
M3526A	3-lead set, snap (AAMI)	each	81.00
M3527A	7-lead set, snap (AAMI)	each	108.00
M5530A	Combiner plug for 3-lead set (connects to M3526A/M3527A)	each	12.00



3-Lead Cable Set (Philips)

M1500A	3-lead ECG trunk cable (AAMI)	each	136.00
M1605A	3-lead ECG lead set with snaps (AAMI)	each	105.00



5-Lead Cable Set (Philips)

M1520A	5-lead ECG trunk cable (AAMI)	each	180.00
M1625A	5-lead ECG lead set with snaps (AAMI)	each	115.00





M1191B, M1191BL, M1191T



M1196A, M1196T



M1194A



M1192A, M1192T



M1193A



M1195A



M1131A, M1132A



M1943A, M1943AL



M1941A

SpO₂ Sensors and Cables (Philips)

M1191B	Reusable SpO ₂ sensor, adult finger (1 m)	each	264.00
M1191BL	Reusable SpO ₂ sensor, adult finger (3 m)	each	276.00
M1191T	Reusable SpO ₂ sensor, adult finger (Nell or 9-pin D-sub connector)	each	225.00
M1196A	Reusable SpO ₂ sensor, adult finger	each	113.00
M1196T	Reusable SpO ₂ sensor, adult finger (Nell or 9-pin D-sub connector)	each	92.00
M1194A	Reusable SpO ₂ sensor, adult/pediatric ear clip	each	264.00
M1192A	Reusable SpO ₂ sensor, pediatric/small adult, finger (1 m)	each	264.00
M1192T	Reusable SpO ₂ sensor, pediatric, finger, (Nellcor 9-pin D-sub connector)	each	225.00
M1193A	Reusable SpO ₂ sensor, neonate, foot	each	264.00
M1195A	Reusable SpO ₂ sensor, infant, finger	each	264.00
M1131A	Disposable SpO ₂ sensor, adult/pediatric, finger	20/case	244.00
M1132A	Disposable SpO ₂ sensor, infant, finger	20/case	297.00
M1943A	Nellcor SpO ₂ sensor adapter cable (1 m) use with M1191T, M1192T, M1196T	each	180.00
M1943AL	Nellcor SpO ₂ sensor adapter cable (3 m) use with M1191T, M1192T, M1196T	each	210.00
M1941A	Philips SpO ₂ extension cable (2 m)	each	120.00



NIBP Interconnect Tubing (Philips)

M1598B	Adult pressure interconnect cable (1.5 m)	each	73.00
M1599B	Adult pressure interconnect cable (3 m)	each	69.00

Reusable Blood Pressure Cuffs (Philips)

With rounded edges for greater comfort, Easy Care Multi-Patient Cuffs are durable, come in a wide range of sizes, and are treated with an antimicrobial agent that prevents growth of fungal, bacterial and algal organisms on the cuff.

- Note: these cuffs are replacing the Traditional Multi-Patient Cuffs (the 404 series, navy). The 404 series will only be available for a limited time. Please call customer service at (800) 334-6656 to check availability.

M4552B	Easy Care Cuff, infant, orange	each	27.00
M4553B	Easy Care Cuff, pediatric, green	each	29.00
M4554B	Easy Care Cuff, small adult, light blue	each	34.00
M4555B	Easy Care Cuff, adult, navy	each	32.00
M4556B	Easy Care Cuff, adult, XL, navy	each	40.00
M4557B	Easy Care Cuff, large adult, burgundy	each	33.00
M4558B	Easy Care Cuff, large adult, XL, burgundy	each	45.00
M4559B	Easy Care Cuff, thigh, gray	each	52.00



Disposable Blood Pressure Cuffs (Philips)

M4572B	Soft single-patient disposable cuff, infant, 1 cuff	each	8.40
M4573B	Soft single-patient disposable cuff, pediatric, 1 cuff	each	6.50
M4574B	Soft single-patient disposable cuff, small adult, 1 cuff	each	6.70
M4575B	Soft single-patient disposable cuff, adult, 1 cuff	each	7.20
M4576B	Soft single-patient disposable cuff, adult, extra long, 1 cuff	each	8.80
M4577B	Soft single-patient disposable cuff, large adult, 1 cuff	each	7.20
M4578B	Soft single-patient disposable cuff, large adult, extra long, 1 cuff	each	98.00
M4579B	Soft single-patient disposable cuff, thigh, 1 cuff	each	8.50



ETCO₂ Intubated Circuits (Philips)

M1920A	Filter Line set, adult/pediatric (orange)	each	13.44
M1921A	Filter H set, adult/pediatric (yellow)	each	20.92
M1923A	Filter H set infant/neonatal (yellow)	each	26.92



Non-Intubated Single Purpose Circuits (CO₂) (Philips)

M2526A	Smart CapLine, adult	each	18.64
M2524A	Smart CapLine, pediatric	each	19.36





Non-Intubated Dual Purpose Circuits (CO₂/O₂) (Philips)

M2522A	Smart CapLine, adult	each	21.12
M2520A	Smart CapLine, pediatric	each	21.12



Disposable Temperature Supplies (Philips)

21090A	Esophageal/rectal temperature probe, 36"	20/case	161.00
21091A	Skin surface temperature probe, 28"	20/case	150.00
M1837A	Esophageal/rectal temperature probe, 9FR, 36"	20/case	161.00



Reusable Temperature Supplies (Philips)

21075A	Esophageal/rectal temperature probe, adult, 10'	each	98.00
21076A	Esophageal/rectal temperature probe, pediatric, 10'	each	136.00
21082B	1.5 m, 2-pin extension cable for mini phone plug	each	60.00



Batteries and Chargers (Philips)

M3538A	Lithium Ion battery for MRx	each	415.00
M3539A	AC power module for MRx	each	424.00
M5529A	DC power module for MRx	each	783.00
CE5260-010	AC power module cord extender for MRx (non-Philips product)	each	11.45
989803135301	2-bay battery charger for MRx	each	1,385.00
989803135331	4-bay battery charger for MRx	each	2,570.00



Q-CPR Supplies (Philips)

989803162401	Replacement Q-CPR compression meter (latest generation). Does not include hands-free cable or adhesive pads.	each	1,200.00
989803163291	Q-CPR compression meter (latest generation) adhesive pads	10/pack	50.00
M4761A	First-generation Q-CPR compression replacement sensor	each	1,586.00
M4762A	First-generation Q-CPR sensor adhesive pads	10/pack	54.00



First-generation Q-CPR sensor
Item M4716A

Latest-generation Q-CPR meter
Item 989803162401

Paper (Philips)

989803138171	75mm chemical thermal paper	10 rolls	62.00
989803138181	75mm chemical thermal paper	80 rolls	487.00
40457C	50mm chemical thermal paper, gray grid	10 rolls	34.00
40457D	50 mm chemical thermal paper, gray grid	80 rolls	185.00



Carrying Cases (Philips)

989803180871	Black carry case (detachable pouch) includes two side pouches, rear pouch, and carry strap	each	345.00
M3541A	Red carry case (detachable pouch) includes two side pouches, a rear pouch, and carry strap	each	355.00
989803172501	Soft black carry case	each	345.00



Miscellaneous Supplies (Philips)

M3544A	Data Card tray	each	9.00
989803146981	Data Card and tray	each	105.00
989803176411	MRx paddle tray kit, includes paddle tray and signage	each	174.26
M4737A	MRx display cover	each	88.00
M3549A	MRx wide metal bedrail hook	each	64.00
989803176541	Quick disconnect DC power cable	each	220.00



Calibration Kits and Supplies (Philips)

MRx NBP Calibration Kit includes:

- MRx calibration kit DVD (1)
- NBP/CO₂ calibration instructions (1)
- MRx PLAST tube assembly (1)
- MRx NBP aneroid gauge (1)
- Adult pressure interconnect cable, 1.5 m (1)
- Easy Care cuff (2)
- Hose, adult (1)
- Bulb and valve kit (1)
- Y cuff adapter for two-hose cuffs (1)

MRx etCO₂ Calibration Kit includes:

- MRx calibration kit DVD (1)
- NBP/CO₂ calibration instructions (1)
- Calibration tube assembly (1)
- Filter Line set adult/pedi (1)
- Calibration regulator (1)
- Additional equipment required for calibration: CO and O gas (not included in kit)

453564063841	MRx NBP calibration kit	each	558.00
453564063851	MRx EtCO ₂ calibration kit	each	734.00
15210-64010	5% gas	6/case	343.20

Intellivue MP2 Patient Monitor (Philips)

Philips IntelliVue MP2 patient monitor is intuitive, tough, and packed with features. It delivers IntelliVue monitoring power and functionality in a compact and rugged housing to match the demands of a wide range of out-of-hospital environments. The IntelliVue MP2 offers a long battery run time, along with best-in-class measurements and the ease of use necessary to let users keep their focus where it matters most: providing care to the patient.

Hospital-quality applications for use in the field

- The flexible touchscreen display is configurable to your environment and presents up to 3 waveforms on a crisp and colorful 3.5" QVGA display. A redesigned user interface improves visibility of patient data, makes it easier to use and enhances compatibility with standard software.
- Intellivue MP2 is available with a wide range of clinical measurements, including 12-lead ECG (both conventional and with the EASI method), multi-lead arrhythmia and ST segment analysis, mainstream or sidestream CO₂, FAST-SPO₂, invasive pressure and temperature.
- Each NBP measurement now generates a column in the vital signs trend table. Measurements for other values are added to provide comprehensive vital signs data offering a more complete picture.
- The Smart Alarm Delay algorithm helps reduce the number of pulse oximetry nuisance alarms, allowing you to focus your attention where needed.
- Within the hospital environment the MP2 connects to Philips IntelliVue Information Center.

World-class technology that fits anywhere

- Small in size and big in capability, it's a very simple way to monitor a patient during transport. A simple step allows you to unplug and go, helping you to evaluate, diagnose and treat patients in need in difficult environments.

Approved for aeromedical use

- The MP2 offers rugged performance that meets critical transport requirements in adverse circumstances.

Key Advantages

- *Small, light, and easy to use, with robust performance in tough conditions*
- *Clinical Decision Support tools help you to respond quickly in challenging circumstances*
- *Best-in-class measurements and flexible measurement configurations*



Built to perform under harsh conditions, the MP2 is compliant with out-of-hospital transport standards for both land and air transport.



Strong on performance and light in weight, the IntelliVue MP2 is an excellent choice for monitoring patients during transport.

CLEARER DECISIONS IN TOUGH SITUATIONS

Seamless wired and wireless performance with easy switching between modes.

Comfortable handle for easy transport.

Night Vision Goggle (NVG) Display Filter enables use of Night Vision Goggles for night time flying.³

Lightweight. The basic monitor weighs just 1.5 kg (3.3 lbs.) and is small enough to take anywhere.

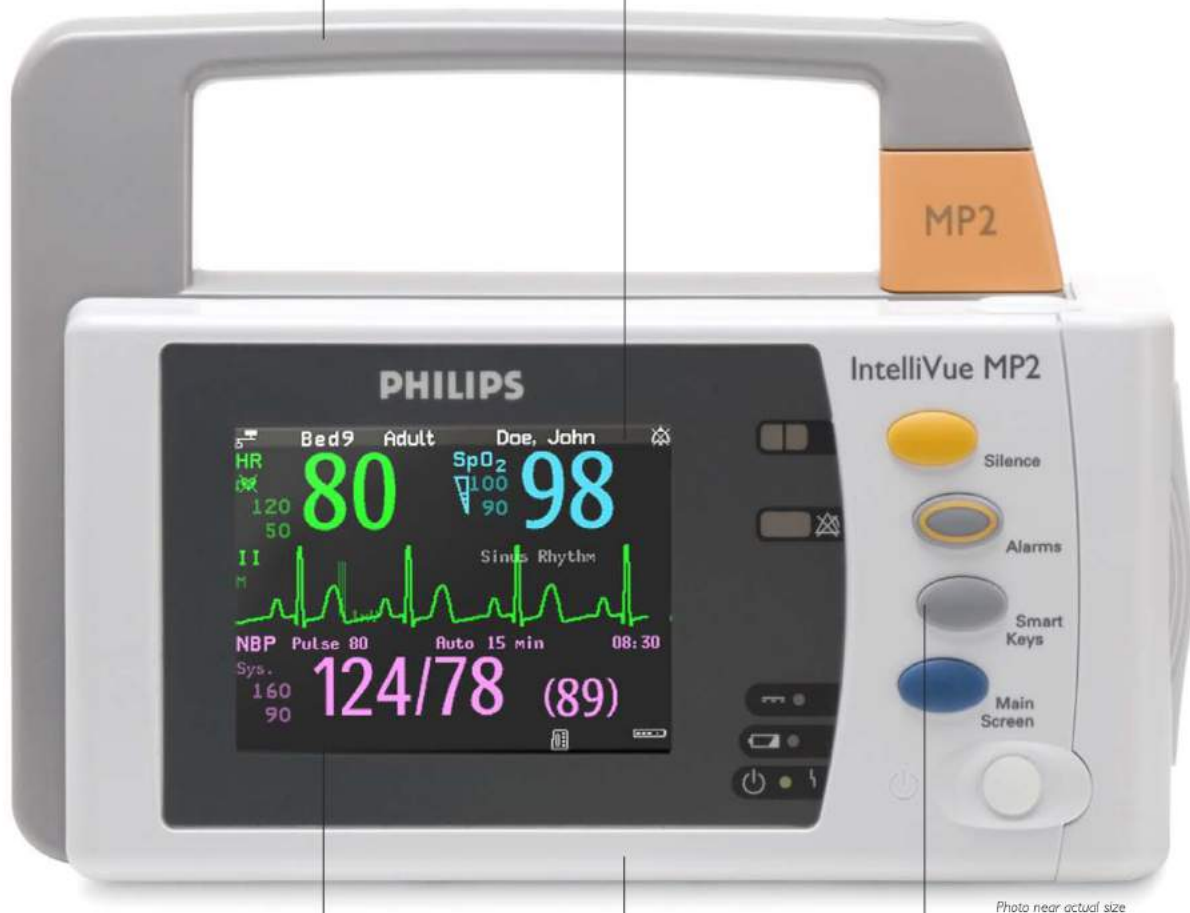

Photo near actual size.

Outdoor profile so the monitor can be used in bright sunlight and areas with higher ambient noise.

Crisp and colorful touchscreen display designed for easy information input and intuitive onscreen navigation.

Sturdy housing (Class 7M3) to withstand rough handling.

Long battery run time of up to 3 hours.⁴

Configurable Smart Keys

M8102A IntelliVue MP2 Patient Monitor

Available in numerous configurations to meet your needs. Please contact your District Sales Manager or call Customer Service at (800) 334-6656.

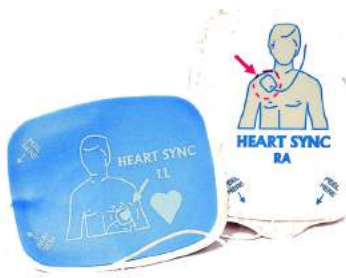

Defibrillation Electrodes (Heart Sync)

Heart Sync electrodes include direct connection to all major defibrillators.

- Remarkable 36-month shelf life
- Direct connection to all major defibrillators on the market.
- Heart Sync pads can be utilized to standardize most makes and models of defibrillators to one connection. This helps reduce confusion and waste, while increasing patient safety.

Item	Description	Replaces	Pkg	Price
HET100-Z	Defibrillation electrode, Zoll, radiolucent, adult	Zoll 8900-4003, 8900-2303, 8900-2100, 8900-2055	pair	22.00
HET100LO-Z	Defibrillation electrode, Zoll, radiolucent, lead out, adult	Zoll 8900-4003	pair	24.00
HE100PED-Z	Defibrillation electrode, Zoll, radiolucent, pediatric	Zoll 8900-2065, 8900-3000-01, 8900-1005-01	pair	22.00
HEC100-Z	Defibrillation electrode, Zoll, radio transparent, adult	Zoll 8900-4005, 8900-2105-01	pair	23.40
HET100-PC	Defibrillation electrode, Physio Control, radiolucent, adult	Physio 11996-000091	pair	22.00
HET100LO-PC	Defibrillation electrode, Physio Control, radiolucent, lead out, adult	Physio 11996-000017	pair	24.00
HE100PED-PC	Defibrillation electrode, Physio Control, radiolucent, pediatric	Physio 11996-000093	pair	22.00
HEC100-PC	Defibrillation electrode, Physio Control, radio transparent, adult	Physio 11996-000090	pair	23.40

NOTE: Pediatric pads are for manual defibrillation only; not AEDs



KE1010P



KE1210H



KE1410Z



KE1710H



KE1310P

Medi-Trace™ Defibrillation Electrodes

Medi-Trace Defibrillation Electrodes are value priced defibrillation electrodes appropriate for less clinically sensitive areas. They connect directly to your defibrillator without the use of adapters.

KE1010P	Replaces Physio-Control Fast Patch Adult Pads for LP5, LP7, LP8, LP10P, LP200 and LP300.	pair	17.69
KE1210H	Replaces adult HP pads with barrel connector for HP CodeMaster 100, Philips MRx with barrel connector and Philips XLT/Laerdal 4000 with barrel connector	pair	20.00
KE1410Z	Replaces adult defibrillation pads for Zoll 1400, 1600, M Series, E Series and CCT	pair	25.38
KE1710H	Replaces Philips HeartStart, Agilent HeartStream and Laerdal FR and FR2 Adult Pads For Philips, Agilent and Laerdal FR and FR2	pair	26.92
KE1310P	Replaces Physio-Control Quick-Combo Adult Pads for LP10C, LP11, LP12, LP15 and LP500	pair	25.38

NOTE: Pediatric pads are for manual defibrillation only; not AEDs

Medi-Trace™ Cadence Defibrillation Electrodes

Medi-Trace Cadence Defibrillation Electrodes employ a unique silver/silver chloride design resulting in a more uniform distribution of current during defibrillation, pacing and cardioversion. This uniform current distribution helps to reduce the risk of skin irritation. These electrodes incorporate radiotransparent wires to provide a clearer view of the patient during x-ray as well as long lead wires to facilitate easier patient positioning. There is no need for adapters or cable retrofitting since the Medi-Trace Cadence Electrodes come available with connectors for all the major defibrillators. In addition, a version with the leads sealed on the outside of the package to facilitate pre-connection to the defibrillator is also available.



Adult Quick-Combo, Zoll, HP/Philips Barrel (left to right)

■ Adult, Leads Out Electrodes

KE22550PC	Replaces Physio-Control Quick-Combo RediPack (11996-000017). For LP10C, LP12, LP15, LP500 and LP1000	pair	33.85
KE22770PC	Replaces Stat-Padz 8900-4003 for Zoll ALS monitors/defibrillators	pair	32.31
KE22661PC	Replaces HP/Philips barrel connector pad. For HP CodeMaster 100, Philips MRx with barrel connector and Philips XLT/Laerdal 4000 barrel connector	pair	32.31



KE22550P

■ Pediatric Electrodes

KE22550P	Replaces Physio-Control Quick-Combo for LP10C, LP11, LP12 and LP15 (not for AEDs)	pair	37.38
KE22770P	Replaces Pedi-Padz 8900-2065 for Zoll ALS monitors/defibrillators (not for AEDs)	pair	49.29
KE22661P	Replaces HP/Philips barrel connector pad. For HP Codemaster 100, MRx w/barrel connector (not for AEDs)	pair	54.77

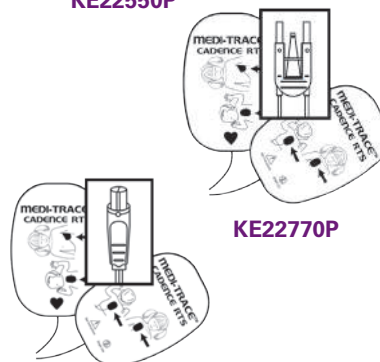

KE22770P

KE22661P

NOTE: Pediatric pads are for manual defibrillation only; not AEDs

ConMed Multifunction Electrodes

- Direct connect to defibrillators; no adapters needed
- 36" adult lead wire; 24" pediatric lead wire
- Defibrillation, synchronized cardioversion, external pacing and ECG monitoring
- Suitable for use with manufacturer's defibrillators that meet AAMI DF-2 and AAMI DF-39 performance requirements

KC3200-1715	ConMed electrode w/quick combo connector for Physio-Control, adult	pair	21.55
KC3200-1711	ConMed electrode w/quick combo connector for R2/MRL, pediatric	pair	24.62
BL3112-1730	ConMed electrode w/quick combo connector for Physio-Control, pediatric	pair	24.62
BL3111-1720	ConMed electrode w/quick combo connector for Zoll, pediatric	pair	24.62



NOTE: Pediatric pads are for manual defibrillation only; not AEDs



ConMed PadPro Multifunction Electrodes

CN2516M	ConMed PadPro Multifunction Electrodes for Physio-Control Quick Combo, adult	pair	26.92
CN2603M	ConMed PadPro Multifunction Electrodes with connector for Physio-Control Quick Combo, pediatric	pair	27.40
CN2516Z	ConMed PadPro Multifunction Electrodes, radiotranslucent pad, adult	pair	22.44
CN2603Z	ConMed PadPro Multifunction Electrodes, radiotranslucent pad, pediatric (manual defibrillators only)	pair	30.80
CN2516P	ConMed PadPro Multifunction Electrodes, radiotranslucent, HP/Philips w/ barrel connector, adult	pair	22.44
CN2603P	ConMed PadPro Multifunction Electrodes, radiotranslucent, HP/Philips w/ barrel connector, pediatric (manual defibrillators only)	pair	40.00

NOTE: Pediatric pads are for manual defibrillation only; not AEDs

Defibrillators and Monitors ■ LifePak 12 Supplies

■ Paper

N6064	100mm paper	3/box	14.44
-------	-------------	-------	-------

■ Pads

11996-000091	EDGE system electrodes w/quick combo connector, adult	pair	42.94
11996-000093	EDGE system electrodes w/quick combo connector, pediatric	pair	52.23
11996-000017	EDGE system electrodes w/quick combo connector and REDI-PAK pre-connect system, adult	pair	51.18
HET100PC	Defibrillation electrode, Physio-Control, radiolucent, adult (replaces 11996-000091)	pair	22.00
HET100LO-PC	Defibrillation electrode, Physio-Control, radiolucent, lead out, adult (replaces 11996-000017)	pair	24.00
HE100PED-PC	Defibrillation electrode, Physio-Control, radiolucent, pediatric (replaces 11996-000093)	pair	22.00
KE1310P	Medi-Trace electrodes w/quick combo connector, adult (replaces 11996-000091)	pair	25.38
KE22550PC	Medi-Trace Cadence electrodes w/quick combo connector and leads out, adult (replaces 11996-000017)	pair	33.85
BL3112-1731	ConMed electrodes w/quick combo connector, adult (replaces 11996-000091)	pair	24.62
BL3112-1730	ConMed electrodes w/quick combo connector, pediatric (replaces 11996-000093)	pair	24.62

■ Batteries

11141-000149	1.6 amp hr. capacity, rechargeable nickel-cadmium, with fuel gauge	each	371.55
11141-000106	7.2 amp hr. capacity, rechargeable Li-ion, with fuel gauge	each	395.00
N6082	Generic 1.2 amp hr. rechargeable nickel-cadmium, no fuel gauge	each	62.00

Medtronic/Physio Control LifePak 12 Supplies

■ Cables

11111-000018	12-lead trunk cable w/4-wire limb leads, 5'	each	382.89
11111-000020	12-lead trunk cable w/4-wire limb leads, 8'	each	387.68
11111-000022	12-lead ECG cable w/6-wire pre-cordial attachment	each	153.15
11110-000029	3-lead ECG cable w/right-angle connector	each	153.66
11110-000040	Quick combo therapy (defib) cable	each	420.67

■ NIBP Monitoring Accessories

Reusable Blood Pressure Cuffs

CASUS2635ML	Ultra-check blood pressure cuff, adult (PC# 11996-000024)	each	16.66
CASUS3242ML	Ultra-check blood pressure cuff, large adult (PC# 11996-000025)	each	18.76
CASUS4250ML	Ultra-check cuff, thigh (PC# 11996-000026)	each	23.39
CASUS1826ML	Ultra-check blood pressure cuff, small adult (PC# 11996-000023)	each	14.26
CASUS1320ML	Ultra-check blood pressure cuff, child (PC# 11996-000022)	each	9.27
CASUS0814ML	Ultra-check blood pressure cuff, infant (PC#11996-000020)	each	10.58

Disposable Blood Pressure Cuffs

CASVST2635ML	Soft-check blood pressure cuff, adult (PC#11996-000030)	each	5.38
CASVST3242ML	Soft-check blood pressure cuff, large adult (PC# 11996-000031)	each	6.14
CASVST4250ML	Soft-check blood pressure cuff, thigh	each	11.88
CASVST1826ML	Soft-check blood pressure cuff, small adult (PC# 11996-000029)	each	4.05
CASVST1320ML	Soft-check blood pressure cuff, child (PC# 11996-000028)	each	3.50
CASVST0814ML	Soft-check blood pressure cuff, infant (PC# 11996-000027)	each	2.98

Tubing

11996-000125	NIBP hose, coiled, 2-9'	each	50.00
--------------	-------------------------	------	-------

■ ETCO₂ Monitoring Accessories

The LP12 uses Oridion technology as does the Philips MRx monitor/defibrillator. Southeastern purchases these ETCO₂ monitoring accessories from Philips, so each will have a Philips part number. The Physio Control part number is noted in parentheses.

Intubated Filterlines

M1920A	Filterline SET, adult/pediatric (PC# 1196-000299/000081)	each	13.60
M1921A	Filterline H (high-humidity) SET, adult/pediatric (PC# 11996-000080)	each	20.92
M1923A	Filterline H (high-humidity) SET infant/neonatal (PC# 11996-000001)	each	26.92

Non-Intubated Filterlines

M2526A	Smart-Capnoline, adult (PC# 11996-0000297/000162/ 000166)	each	19.36
M2524A	Smart-Capnoline, pediatric (PC# 11996-000120)	each	19.36
M2522A	Smart-Capnoline dual purpose (CO ₂ /O ₂), adult (PC# 11996-000298/000163/000167)	each	21.36
M2520A	Smart-Capnoline dual purpose (CO/O ₂), pediatric (PC# 11996-000128)	each	21.36

LifePak 12 SpO₂ Monitoring Accessories

Nellcor Sensors and Cables

DuraSensor Reusable Clip Sensor Adult



Reusable clip sensor, adult
(PC# 11996-000060)
Item Number DS-100A
each 500.00

Oxiband Reusable Sensor Adult/Neonate



Reusable sensor, adult/neonate, includes 50
disposable adhesive bandage wraps (PC#
11996-000061)
Item Number NP-OXI-A/N
each 150.05

Oxiband Reusable Sensor Pedi/Infant



Reusable sensor, pedi/infant, includes 50
disposable adhesive bandage wraps
(PC# 11996-000062)
Item Number NP-OXI-P/I
each 150.05

Oxisensor II Disposable Sensor Adult



Disposable sensor, adult
(PC# 11996-000013)
Item Number D-25
each 20.37

Oxisensor II Disposable Sensor Pediatric



Disposable sensor, pediatric
(PC# 11996-000116)
Item Number D-20
each 20.37

Oxisensor II Disposable Sensor Infant



Disposable sensor, infant
(PC# 11996-000115)
Item Number I-20
each 34.42

Oxisensor II Disposable Sensor Neonatal/Adult



Neonatal sensor (PC# 11996-000117)
Item Number N-25
each 26.48

SpO₂ Cable Extensions Neonatal/Adult



DEC-4 cable extension, 4' (PC# 11996-000113)
Item Number NP-EC4
each 54.42
DEC-8 cable extension, 8' (PC# 11110-000176)
Item Number NP-EC8
each 68.02

LifePak 12 SpO₂ Monitoring Accessories

Masimo LNCS Sensors and Cables

LNCS Reusable Sensor
Adult/Pediatric



SET LNCS DCI adult reusable sensor (PC# 11171-000017)
Item Number MA1863
each 215.38

SET LNCS DCIP pediatric reusable sensor (PC# 11171-000018)
Item Number MA1864
each 275.00

LNCS Reusable Soft Sensor
Adult



SET LNCS adult reusable soft sensor
Item Number MA2653
each 253.85

LNCS Reusable Patient Cable



SET LNC-4 LNCS patient cable, 4'
(PC# 11171-000024)
Item Number MA2017
each 175.00

SET LNC-10 LNCS patient cable, 10'
(PC# 11171-000016)
Item Number MA1814
each 245.00

SET LNC-4 -EXT LNCS extension cable, 4'
(PC#11171-000027)
Item Number MA2021
each 225.00

LNCS Disposable Adhesive Sensor
Adult/Pediatric



SET LNCS Amtx adhesive disposable sensor, adult (PC# 11171-000019)
Item Number MA1859
20/box 16.14

LNCS Disposable Adhesive Sensor
Infant/Neonatal/Pre-Term



SET LNCS Inf-L adhesive disposable sensor, infant (PC# 11171-000031)
Item Number MA1861
20/box 19.23

SET LNCS NEO-L adhesive disposable sensor, neonatal (PC# 11171-000028)
Item Number MA2320
20/box 400.00

SET LNCS Neo-L adhesive disposable sensor, neonatal/pre-term (PC# 11171-000029)
Item Number MA2412
20/box 550.00



DON'T SEE WHAT YOU'RE LOOKING FOR?
Call Customer Service; we're here to help.
(800) 334-6656

LifePak 12 SpO₂ Monitoring Accessories

Masimo LNOP Sensors and Cables

LNOP Reusable Sensor Adult/Pediatric



SET LNOP DCI reusable sensor, adult
(PC#11171-000007)
Item Number MA1269
each 260.00

SET LNOP DCIP reusable sensor, pediatric
(PC# 11171-000010)
Item Number MA1276
each 275.00

LNOP Disposable Adhesive Sensor Adult



SET LNOP Adt adhesive disposable sensor,
adult (PC# 11171-000011)
Item Number 320.00MA1165
20/box 320.00

LNOP Disposable Adhesive Sensor Neonatal/Pediatric



SET LNOP NEO adhesive disposable sensor,
neonatal (PC# 11171-000013)
Item Number MA1798
20/box 430.00

SET LNOP NEO adhesive disposable sensor,
neonatal/pediatric (PC# 11171-000014)
Item Number MA1651
20/box 450.00

LNOP Reusable Patient Cables 4', 8' and 12'



SET PC-04 LNOP patient cable, 4'
(PC# 11171-000006)
Item Number MA1173
each 225.00

SET PC-08 LNOP patient cable, 8'
(PC# 11171-000008)
Item Number MA1005
each 250.00

SET PC-12 LNOP patient cable, 12'
(PC#11171-000009)
Item Number MA1006
each 275.00

Direct Connect Reusable Soft Sensor



SET adult reusable direct connect soft
sensor (PC# 11171-000051)
Item Number MA2652
each 746.15

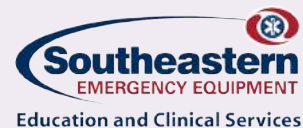

We offer BLS/ALS education, simulation and many specialty courses often not found in other educational facilities.

Our courses are taught by experienced EMTs, paramedics, nurses, physician assistants, physicians, and other healthcare providers involved in day-to-day emergency care.

Paramedic Refresher Course

To learn about our exceptional Paramedic Refresher Courses, go to www.seequip.com/paramedic-refresher-course.html. Or, call us at (800) 334-6656.

Medtronic/Physio Control LifePak15 Supplies

■ Paper

N6064	100 mm paper	3/box	14.44
-------	--------------	-------	-------

■ Pads

11996-000091	EDGE system electrodes w/quick combo connector, adult	pair	42.94
11996-000093	EDGE system electrodes w/quick combo connector, pediatric	pair	52.23
11996-000017	EDGE system electrodes w/quick combo connector and REDI-PAK pre-connect system, adult	pair	48.75
HET100PC	Defibrillation electrode, Physio-Control, radiolucent, adult (replaces 11996-000091)	pair	22.00
HET100LO-PC	Defibrillation electrode, Physio-Control, radiolucent, lead out, adult (replaces 11996-000017)	pair	24.00
HE100PED-PC	Defibrillation electrode, Physio-Control, radiolucent, pediatric (replaces 11996-000093)	pair	22.00
KE1310P	Medi-Trace electrodes w/quick combo connector, adult (replaces 11996-000091)	pair	25.38
KE22550PC	Medi-Trace Cadence electrodes w/quick combo connector and leads out, adult (replaces 11996-000017)	pair	33.85
BL3112-1731	ConMed electrodes w/quick combo connector, adult (replaces 11996-000091)	pair	45.23
BL3112-1730	ConMed electrodes w/quick combo connector, pediatric (replaces 11996-000093)	pair	24.62

■ Batteries

21330-001176	LifePak 15 battery, 5.7 amp hr. capacity, rechargeable, lithium-ion, with fuel gauge	each	531.78
--------------	--------------------------------------------------------------------------------------	------	--------

■ Cables

11111-000018	12-lead trunk cable w/4-wire limb leads, 5'	each	382.89
11111-000020	12-lead trunk cable w/4-wire limb leads, 8'	each	387.68
11113-000004	Quick-combo Therapy (defibrillator) cable with True Lock cable connector	each	445.40

■ NIBP Monitoring Accessories

Reusable Blood Pressure Cuffs

CASUS2635ML	Ultra-check blood pressure cuff, adult (PC# 11996-000024)	each	12.82
CASUS3242ML	Ultra-check blood pressure cuff, large adult (PC# 11996-000025)	each	14.43
CASUS4250ML	Ultra-check blood pressure cuff, thigh (PC# 11996-000026)	each	17.98
CASUS1826ML	Ultra-check blood pressure cuff, small adult (PC# 11996-000023)	each	10.97
CASUS1320ML	Ultra-check blood pressure cuff, child (PC# 11996-000022)	each	9.27
CASUS0814ML	Ultra-check blood pressure cuff, infant (PC#11996-000020)	each	8.14

Disposable Blood Pressure Cuffs

CASVST2635ML	Soft-check blood pressure cuff, adult (PC#11996-000030)	each	4.13
CASVST3242ML	Soft-check blood pressure cuff, large adult (PC# 11996-000031)	each	4.73
CASVST4250ML	Soft-check blood pressure cuff, thigh (PC# 11996-000032)	each	9.13
CASVST1826ML	Soft-check blood pressure cuff, small adult (PC# 11996-000029)	each	3.12
CASVST1320ML	Soft-check blood pressure cuff, child (PC# 11996-000028)	each	2.70
CASVST0814ML	Soft-check blood pressure cuff, infant (PC# 11996-00027)	each	2.29

Tubing

21300-007300	NIBP tubing, coiled, 9'	each	72.34
21300-007299	NIBP tubing, straight, 9'	each	72.34
21300-007298	NIBP tubing, straight, 12'	each	72.34

Medtronic/Physio Control LifePak15 Supplies

■ ETCO₂ Monitoring Accessories

The LP15 uses Oridion technology as does the Philips MRx monitor/defibrillator. Southeastern purchases these ETCO₂ monitoring accessories from Philips, so each will have a Philips part number. Physio Control part numbers are noted in parentheses)

Intubated Filterlines

M1920A	Filterline SET, adult/pediatric (PC# 1196-000299/000081)	each	13.44
M1921A	Filterline H (high-humidity) SET, adult/pediatric (PC# 11996-000080)	each	20.92
M1923A	Filterline H (high-humidity) SET infant/neonatal (PC# 11996-000001)	each	26.92

Non-Intubated Filterlines

M2526A	Smart-Capnoline, adult (PC# 11996-0000297 /000162/ 000166)	each	19.36
M2524A	Smart-Capnoline, pediatric (PC# 11996-000120)	each	19.36
M2522A	Smart-Capnoline dual purpose (CO ₂ /O ₂), adult (PC# 11996-000298 000163/000167)	each	21.12
M2520A	Smart-Capnoline dual purpose (CO/O ₂), pediatric (PC# 11996-000128)	each	21.12



Anywhere, anytime

Philips IntelliVue MP2 patient monitor

Learn more on pages 40-41

LifePak 15 SpO₂, SpCO and SpMet Monitoring Accessories
Masimo Rainbow® Sensors and Cables

Rainbow Reusable Sensor
Adult and Pediatric



Rainbow 3' adult reusable sensor for patients >30kg
Item Number MA2696
 each..... 884.62

Rainbow 3' pediatric reusable sensor for patients 10-50kg
Item Number MA2697
 each..... 1,038.46

Rainbow Disposable Adhesive Sensor
Adult and Neonatal/Adult



Rainbow R25 adult adhesive sensors for patients >30kg
Item Number MA2221
 10/pkg 889.23

Rainbow R25 neonatal/adult adhesive sensors for patients <3kg or >40kg
Item Number MA2219
 10box 889.23

Rainbow Disposable Adhesive Sensor
Pediatric and Infant



Rainbow R20 pediatric adhesive sensors for patients 10-50 kg
Item Number MA2222
 10/box 1,058.46

Rainbow R20-L infant adhesive sensors for patients 3-20 kg
Item Number MA2220
 10/box 1,058.46

Rainbow Direct Connect Reusable Sensor
Adult



SET Rainbow 3' adult reusable direct connector sensor for patients >30 kg (PC# 11996-000335)
Item Number MA2201
 each..... 663.32

SET Rainbow 8' adult reusable direct connector sensor for patients >30 kg (PC# 11171-000032)
Item Number MA2407
 each..... 820.00

SET Rainbow 12' adult reusable direct connector sensor for patients >30 kg (PC# 11996-000336)
Item Number MA2202
 each..... 720.00

Rainbow Direct Connect Reusable Sensor
Pediatric



SET Rainbow 3' pediatric reusable direct connector sensor for patients 10-50 kg (PC# 11996-000337)
Item Number MA2069
 each..... 992.90

SET Rainbow 8' pediatric reusable direct connector sensor for patients 10-50 kg (PC# 11171-000033)
Item Number MA2640
 each..... 970.00

SET Rainbow 12' pediatric reusable direct connector sensor for patients 10-50 kg (PC# 11996-000338)
Item Number MA2070
 each..... 845.00

Rainbow Patient Cable
4' and 12'



Rainbow RC-4 20-pin, 4' patient cable for use with Rainbow and M-LNCS sensors
Item Number MA2406
 each..... 115.38

Rainbow RC-12 20-pin; 12' patient cable for use with Rainbow and M-LNCS sensors
Item Number MA2404
 each..... 400.00

LifePak 15 SpO₂ Monitoring Accessories

Nellcor Sensors and Cables

DuraSensor Reusable Clip Sensor Adult



Reusable clip sensor, adult
(PC# 11996-000060)
Item Number DS-100A
each 500.00

Oxiband Reusable Sensor Adult/Neonate



Reusable sensor, adult/neonate, includes 50
disposable adhesive bandage wraps (PC#
11996-000061)
Item Number NP-OXI-A/N
each 150.05

Oxiband Reusable Sensor Pedi/Infant



Reusable sensor, pedi/infant, includes 50
disposable adhesive bandage wraps
(PC# 11996-000062)
Item Number NP-OXI-P/I
each 150.05

Oxisensor II Disposable Sensor Adult



Disposable sensor, adult
(PC# 11996-000013)
Item Number D-25
each 20.37

Oxisensor II Disposable Sensor Pediatric



Disposable sensor, pediatric
(PC# 11996-000116)
Item Number D-20
each 20.37

Oxisensor II Disposable Sensor Infant

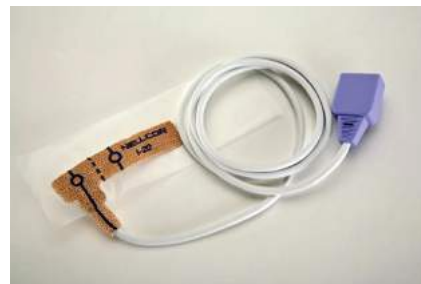

Disposable sensor, infant
(PC# 11996-000115)
Item Number I-20
each 34.42

Oxisensor II Disposable Sensor Neonatal/Adult



Neonatal sensor (PC# 11996-000117)
Item Number N-25
each 26.48

SpO₂ Cable Extension DEC-4 and DEC-8



DEC-4 cable, 4' (PC# 11996-000113)
Item Number NP-EC4
each 54.42

DEC-8 cable, 8' (PC# 11110-000176)
Item Number NP-EC8
each 54.42

LifePak 15 SpO₂ Monitoring Accessories

Masimo M-LNCS Sensors and Cables

M-LNCS Reusable Sensor

Adult and Pediatric



M-LNCS DCI adult reusable sensor, 3' for patients >30 kg
Item Number MA2501
 each 215.38
 M-LNCS DCI pediatric reusable sensor, 3' for patients 10-50 kg
Item Number MA2502
 each 230.77

M-LNCS Disposable Adhesive Sensor

Adult



M-LNCS Aadx adult disposable SpO₂ adhesive sensor, 18" for patients >30 kg
Item Number MA2508
 each 16.95

M-LNCS Disposable Adhesive Sensor

Pediatric



M-LNCS Ppdx pediatric disposable SpO₂ adhesive sensor, 18" for patients 10-50 kg
Item Number MA2510
 each 16.95

M-LNCS Disposable Adhesive Sensor

Infant



M-LNCS Inf infant disposable SpO₂ adhesive sensor, 18" for patients 3-20 kg
Item Number MA2512
 each 19.25

M-LNCS Disposable Adhesive Sensor

Neonatal/Adult



M-LNCS Neo neonatal/adult SpO₂ disposable adhesive sensor, 18" for patients <3 kg or >40 kg
Item Number MA2514
 each 19.25

M-LNCS Disposable Adhesive Sensor

Neonatal/Pre-Term



M-LNCS Neo neonatal/pre-term SpO₂ disposable adhesive sensor, 18" for patients <1 kg
Item Number MA2516
 20/box 19.25



DON'T SEE WHAT YOU'RE LOOKING FOR?
 Call Customer Service; we're here to help.
 (800) 334-6656

LifePak 15 SpO₂ Monitoring Accessories

Masimo Red Direct Connect Sensors

Red Direct Connect Reusable Sensor Adult



Red Direct Connect Reusable Sensor Pediatric



SET Red DCI-dc3 adult reusable direct connect sensor, 3' (PC# 11996-000331)
Item Number MA2053
 each 215.38

SET Red DCI-dc12 adult reusable direct connect sensor, 12' (PC# 11996-000332)
Item Number MA2054
 each 670.00

SET Red DCIP-dc3 pediatric reusable direct connect sensor, 3' (PC# 11996-000333)
Item Number MA2256
 each 230.77

SET Red DCIP-dc12 pediatric reusable direct connect sensor, 12' (PC# 11996-000334)
Item Number MA2257
 each 525.00

Defibrillators and Monitors ■ Miscellaneous LifePak Supplies

Lifepak Supplies

N6063	ECG paper for LP300, LP10, LP12 w/ 3-lead only	10 rolls/ box	20.39
N6082	12V, NICD battery for LP5, LP10, LP11	each	62.00

See our entire AED section beginning on page 2.





Southeastern Emergency Equipment & ReNew Biomedical Partnership

Southeastern Emergency Equipment is pleased and excited to announce a partnership with ReNew Biomedical! We will now be able to service and maintain your medical equipment to prolong and extend the life of its use. We can service, maintain, and support defibrillators, ventilators, infusion pumps, AEDs, EKGs and vital signs monitors. Utilize and take advantage of this cost effective, hassle-free program to renew and maintain your equipment. This opportunity is made exclusively for the EMS and fire rescue market!

Together, we are able to offer the EMS and Fire Rescue market an affordable, low-cost, and effective way to preserve and maintain medical equipment, prolonging the life of your machines through use of ReNew's Preventative Maintenance programs and Service Contracts.

For more information on how you can save money on servicing and maintaining your equipment, contact your Southeastern District Sales Manager or call Customer Service at (800) 334-6656.



Zoll X-Series Supplies

■ Paper

8000-00901	ECG plain white paper, 80mm	6 rolls/box	15.31
------------	-----------------------------	-------------	-------

■ Pads

8900-0402	CPR Stat Pads HVP multifunction electrodes (required CPR connector 8000-0370 for CPR feedback)	pair	86.71
8900-0810-01	Pedi-Padz II multifunction electrodes for AED Plus, AED Pro, E-Series and X-Series	each	109.62

■ Battery

8000-0580-01	Six-hour rechargeable SurePower Smart battery	each	840.00
--------------	-----------------------------------------------	------	--------

■ Cable

8000-000898-01	12-lead one-step ECG cable, AAMI, includes 4-lead trunk cable and removable precordial 6-lead set	each	720.00
----------------	---------------------------------------------------------------------------------------------------	------	--------

■ NIBP Monitoring Accessories

WAREUSE-07-2MQ	Reusable-07-2MQ cuff, infant, 2-tube, twist lock connector	each	26.08
WAREUSE-08-2MQ	Reusable-08-2MQ cuff, small child, 2-tube, twist lock connector	each	26.08
WAREUSE-09-2MQ	Reusable-09-2MQ cuff, child, 2-tube, twist lock connector	each	29.25
WAREUSE-10-2MQ	Reusable-10-2MQ cuff, small adult, 2-tube, twist lock connector	each	30.16
WAREUSE-11-2MQ	Reusable-11-2MQ cuff, adult, 2-tube, twist lock connector	each	31.25
WAREUSE-11L-2MQ	Reusable 11-2MQ cuff, adult long, 2-tube, twist lock connector	each	33.69
WAREUSE-12-2MQ	Reusable-12-2MQ cuff, large adult, 2-tube, twist lock connector	each	35.50
WAREUSE-12L-2MQ	Reusable-12-2MQ cuff, large adult long, 2-tube, twist lock connector	each	40.56
WAREUSE-13-2MQ	Reusable-13-2MQ cuff, thigh, 2-tube, twist lock connector	each	54.50
WASOFT-07-2MQ	Disposable cuff, soft infant, 2-tube, twist lock connector	20/box	101.00
WASOFT-08-2MQ	Disposable cuff, soft small child, 2-tube, twist lock connector	20/box	101.00
WASOFT-09-2MQ	Disposable cuff, soft child, 2-tube, twist lock connector	20/box	101.00
WASOFT-10-2MQ	Disposable cuff, soft small adult, 2-tube, twist lock connector	20/box	137.00
WASOFT-11-2MQ	Disposable cuff, soft adult, 2-tube, twist lock connector	20/box	137.00
WASOFT-11L-2MQ	Disposable cuff, soft adult long, 2-tube, twist lock connector		
WASOFT-12-2MQ	Disposable cuff, soft large adult, 2-tube, twist lock connector	20/box	137.00
WASOFT-12L-2MQ	Disposable cuff, soft large adult long, 2-tube, twist lock connector	20/box	156.00
WASOFT-13-2MQ	Disposable cuff, soft thigh, 2-tube, twist lock connector	20/box	182.00

■ ETCO₂ Monitoring Accessories

The Zoll X-Series uses Oridion technology as does the Philips MRx monitor/defibrillator. Southeastern purchases these items from (Philips), so each will have a Philips part number. Zoll part numbers are noted in parentheses.

M1920A	Filter Line SET, adult/pediatric (Zoll #8300-0520-01)	each	13.60
M2522A	Smart-Capnoline dual purpose (CO ₂ /O ₂), adult (Zoll #8300-0524-01)	each	21.36
M2520A	Smart-Capnoline dual purpose (CO ₂ /O ₂), pediatric (Zoll #8300-0525-01)	each	21.36

Zoll X-Series Supplies

■ SpO₂ Monitoring Accessories

MA2055	SET Red LNC-04 LNCS patient cable, 4', reusable connector cable (Zoll #8000-0330)	each	196.92
MA2056	SET Red LNC-10 LNCS patient cable, 10', reusable connector cable (Zoll #8000-0331)	each	275.00
MA2053	SET Red DCI-dc3 adult reusable direct connect sensor, 3' (Zoll #8000-0332)	each	215.38
MA2256	SET Red DCIP-dc3 pediatric reusable direct connect sensor, 3' (Zoll #8000-0333)	each	230.77
MA2054	SET Red DCI-dc12 adult reusable direct connect sensor, 12' (Zoll #8000-0334)	each	670.00
MA2257	SET Red DCIP-dc12 pediatric reusable direct connect sensor, 12' (Zoll #8000-0335)	each	525.00
MA2406	Rainbow RC-4 20-pin, 4' patient cable, for use with Rainbow and M-LNCS sensors (Zoll #8000-0341)	each	115.38
MA2404	Rainbow RC-12 20-pin; 12' patient cable for use with Rainbow and M-LNCS sensors (Zoll #8000-0342)	each	400.00
MA2407	SET Rainbow 8' adult reusable direct connector sensor for patients >30 kg (Zoll #8000-0343)	each	820.00
MA2202	SET Rainbow 12' adult reusable direct connector sensor for patients >30 kg (Zoll #8000-0344)	each	720.00
MA2069	SET Rainbow 3' pediatric reusable direct connector sensor for patients 10-50 kg (Zoll #8000-0345)	each	992.90
MA2070	SET Rainbow 12' pediatric reusable direct connector sensor for patients 10-50 kg (Zoll #8000-0346)	each	845.00
MA2696	Rainbow 3' adult reusable sensor for patients >30kg (Zoll #8000-000371)	each	884.62
MA2697	Rainbow 3' pediatric reusable sensor for patients 10-50kg (Zoll #8000-000372)	each	1,038.46
MA2221	Rainbow R25 adult adhesive sensors for patients >30kg (Zoll #8000-0336)	10/pkg	889.23
MA2219	Rainbow single-use sensor for patients >3kg, <30kg (Zoll #8000-0337)	10/pkg	889.23
MA2222	Rainbow R20 pediatric adhesive sensors for patients 10-50 kg (Zoll #8000-0339)	10/pkg	1,058.46
MA2220	Rainbow R20-L infant adhesive sensors for patients 3-20 kg (Zoll #8000-0340)	10/pkg	1,058.46

See photos of the above in the LifePak 15 section beginning on page 51

Defibrillators and Monitors ■ Zoll ALS Supplies

■ Paper and Pads

8000-0301	Zoll brand paper, 80mm pad, fan fold	20/case	86.54
8000-0302	Zoll brand paper, 80mm pad, fan fold	10/case	46.15
N6067	Paper for Zoll M Series	each	4.49
N6065	Paper for Zoll 1400, Zoll 1600, MRL with graph	3/box	8.13
8900-0802-01	Stat Pads II (There is no CPR feedback capability with these traditional 2-piece electrode pads.)	pair	47.98
8900-2061	Pedi-Padz	pair	69.23
8900-2065	Pedi-Padz	6/case	287.31

Additional pads can be found beginning on page 42

■ Batteries

8000-0299-01	M-Series, 1400, 1600 battery (not Smart)	each	161.54
MLA149GP	Generic battery for M-series, 1400, 1600, AED Pro (not Smart)	each	99.65
8004-0103-01	Smart rechargeable battery	each	257.69
8019-0535-01	E-Series - SurePower Battery Pack	each	538.25



DIH8000A



DIH7000



DIH7000A



DIH1800



DIH1801



DIH1805

Defibrillator Mounts (NCE)

An unsecured defibrillator in an emergency vehicle has the potential to seriously injure both patient and attendant when the vehicle goes around a corner or makes a sudden stop. Secure your equipment with a high-quality mount.

- One hand quick release
- Holds up to 12 G-Force
- 360 degree swivel
- Durable white-baked enamel
- Lifetime warranty
- Dimensions shown are L x W x H.

DIH8000A	Defibrillator mount for Philips MRx with red or black bag. 14.652" x 14.61" x 14.99"	each	700.00
DIH7000	Defibrillator mount for Lifepak 12 or Lifepak 15. 15.680" x 11.907" x 15.04"	each	660.00
DIH7000A	Defibrillator mount for Lifepak 12 with battery charger. 15.680" x 11.907" x 17.127"	each	700.00
DIH9000	Defibrillator mount for Zoll E-Series. 11.6" x 9.3" x 4.7"	each	700.00
DIX9000	Defibrillator mount for Zoll X-Series. 13.5" x 11.866" x 13.24"	each	838.00
DIH1800	Defibrillator mount for Zoll M-Series with Extreme Pack 2. 12.6" x 12" x 2.7"	each	660.00
DIH1801	Defibrillator mount for Zoll M-Series without Extreme Pack 2. 12.6" x 12" x 2.7"	each	640.00
DIH1805	Defibrillator mount for Zoll M-Series with Extreme Pack 2 and NIBP. 10.5" x 9.3" x 2.5"	each	670.00
DIWM1000	Universal wall mount. 13" x 17" x 14"	each	500.00



DIH9000



DIX9000



DIWM1000

Signigel Electrode Gel

A highly conductive multi-purpose gel that is bacteriostatic, water soluble, non-irritating, and non-staining. Recommended for ECG and defibrillation.



PKL15-60	Electrode gel, 60 gram tube	each	1.41
PKL15-25	Electrode gel, 250 gram tube	each	2.78

Surgical Clipper with Pivoting Head (3M)

This battery-powered precision clipper works with either a pushing or pulling motion by simply rotating the pivoting head. It will remove body hair or head hair and is effective in just one pass, even in body folds. Its lightweight and compact design allows it to glide easily across the skin without causing nicks or cuts. Single-use blades help reduce the possibility of cross-contamination and are easy to snap on and pop off. An 8-hour recharge provides approximately 60 minutes of run time. Starter Kit M9667 contains both surgical clipper and charger.



3M9667	Surgical clipper starter kit	each	136.86
3M9660	Surgical clipper blades	50/case	275.89

Prep Razors

DY4251	Gallant prep razor	50/box	22.77
DYND70837	Prep razor, 2-sided, fixed head	each	0.44



Red Dot® Skin Prep (3M)

Red Dot skin prep is a gentle, abrasive material used to remove the non-conductive skin layer to achieve a better quality trace. This product, when used properly, promotes better patient skin care, does not harm skin or hurt patient and helps to minimize the number of electrode changes due to poor or inadequate trace recognition. ¾" x 196" roll with dispenser.



3M2236	Red Dot trace prep	each	18.46
--------	--------------------	------	-------

EKG Caliper

Hardened steel arms and points for accurate measurement of tracing intervals. Point protector has built-in 40mm metric scale. Measures 4 ¾ inches

ADC395		each	8.11
--------	--	------	------

EKG Ruler

Seconds scale for PR, QRS, Cycle, Length, Coupling, Escape, and Parasystolic Intervals. Measures just 1 11/16" 3/8"; small enough to fit in a medical coat pocket. Complete with protective sleeve



ADC394	EKG ruler	each	6.71
--------	-----------	------	------



Diagnostic Equipment

Monitors and Dectors



pages 62-64

Electrodes



pages 64-66

Glucometry



pages 67-68

Blood Pressure



pages 68-75

Stethoscopes



page 76-81

Pulse Oximetry



pages 82-85

Thermometry



pages 85-88

Intellivue MP2 Patient Monitor (Philips)

World-class technology that fits anywhere

- Small in size and big in capability, it's a very simple way to monitor a patient during transport. A simple step allows you to unplug and go, helping you to evaluate, diagnose and treat patients in need in difficult environments.

Approved for aeromedical use

- The MP2 offers rugged performance that meets critical transport requirements in adverse circumstances.

Hospital-quality applications for use in the field

- The flexible touchscreen display is configurable to your environment and presents up to 3 waveforms on a crisp and colorful 3.5" QVGA display. A redesigned user interface improves visibility of patient data, makes it easier to use and to enhance compatibility.
- Intellivue MP2 is available with a wide range of clinical measurements, including 12-lead ECG (both conventional and with the EASI method), multi-lead arrhythmia and ST segment analysis, mainstream or sidestream CO₂, FAST-SPO₂, invasive pressure and temperature.
- The MP2 can transfer data seamlessly throughout the continuum of care.



Built to perform under harsh conditions, the MP2 is compliant with out-of-hospital transport standards for both land and air transport.

- The Smart Alarm Delay algorithm helps reduce the number of pulse oximetry nuisance alarms, allowing you to focus your attention where needed.
- Each NBP measurement now generates a column in the vital signs trend table. Measurements for other values are added to provide comprehensive vital signs data offering a more complete picture.
- Within the hospital environment the MP2 connects to Philips Intellivue Information Center for the wired or wireless networked central surveillance and clinical decision support.

For configuration options and pricing, please call Customer Service at (800) 334-6656.



740 Vital Signs Monitor (CasMed)

The 740 allows you to monitor blood pressure, SpO₂ and temperature for patients from neonates to adults, and provides leading-edge technology in a rugged, portable unit that weighs only 3 lbs. It features CasMed's proprietary Motion Artifact Extraction (MAXNIBP®) technology for fast and reliable blood pressure measurements. Oximetry choices include Masimo SET®, Nellcor® OxiMax® and Nonin®.

Four models offer various configurations:

- CAS 740-1 MAXNIBP
- CAS 740-2 MAXNIBP and SpO₂
- CAS 740-2T MAXNIBP and Temperature
- CAS 740-3 MAXNIBP, SpO₂ and Temperature

- Fast, accurate blood pressure readings for neonates through adults even in the most challenging situations such as high motion or low perfusion
- Monitor SpO₂ and temperature either continuously or in "spot-check" mode
- Accurate oral temperature in just 4 seconds
- Ideal for EMS applications

See page 74 for blood pressure cuffs for the 740 Monitor



For configuration options and pricing, please call Customer Service at (800) 334-6656.

Rad-57® Pulse CO-Oximeter (Masimo)

Protect against immediate and long-term health problems by quickly assessing and treating those exposed to carbon monoxide.

- Monitor for carboxyhemoglobin in firefighters on scene with the Rad-57.
- Recognition is the key to immediate on scene treatment. With early recognition, treatment for CO poisoning can begin immediately, which significantly reduces both immediate and long-term health risks.
- In emergency medical services, SpCO helps first responders assess both victims and other first responders for CO exposure.
- SpCO may help paramedics and emergency medical technicians facilitate earlier treatment and removal of those exposed to CO in homes, hotels, and places of work.
- SpCO may help firefighters reduce the risk of CO exposure that they frequently face. Chronic CO exposure may cause long-term cardiac and neurological damage.
- When even mild levels of CO are circulating in the blood, the heart and brain are deprived of critical oxygen.



MA3734	Rad 57 CO Monitor with SPO2, Rainbow sensor, cable and case	each	5,675.00
MA2208	Rad 57 case only, red	each	46.15

Rainbow® Sensors for Rad-57 (Masimo)

For use with the Masimo Rad-57, which helps first responders detect CO poisoning on the scene.

MA2696	Rainbow 3' reusable sensor for Rad-57, adult	each	884.62
MA2697	Rainbow 3' reusable sensor for Rad-57, pediatric	each	1,038.46
MA2405	Rainbow 1' RC cable, required for use with MA2696 and/or MA2697	each	376.00



MicroCO CO Analyzer (MicroDirect)

The MicroCO is an ideal tool for firefighter rehab and triage of suspected CO poisoning. Small, lightweight and powerful, it measures alveolar Carbon Monoxide in parts per million (ppm) concentrations and also calculates the percentage Carboxyhemoglobin (%COHb). Operating from a single 9 volt battery, the MicroCO combines accuracy and simplicity.

MDMC02	MicroCO CO2 analyzer	each	1,286.92
MDMC15	MicroCO CO2 analyzer calibration kit	each	190.38
MD3301	Cardboard mouthpieces	100/box	15.38



1200 Carbon Monoxide Monitor (Airspace Monitoring)

AGS with Snif technology, and now with a backlit LCD display, the 1200 monitor will accurately measure and display CO levels from 12 ppm to 250 ppm. It also includes alarms like the 1100 with a panel of flashing lights and 92 decibel audio that begins at 30 ppm and grows in intensity to 120 ppm. The Snif technology provides an update every 4 seconds when in alarm to help you find the source, see the trend and otherwise manage the CO event. When motion switch management is chosen, the monitor will turn itself on by any movement and if it doesn't sense CO or hasn't moved in 45 minutes, it will shut itself off. There is no routine bump testing or calibration required and the monitor is warranted for five years, even the sensor and its calibration is included in the warranty.



ASAI1200	1200 CO2 monitor	each	446.92
----------	------------------	------	--------

BW Clip CO Monitor (Airgas)

The BW Clip CO Monitor is your everyday companion for hazardous environments. It operates up to three years maintenance-free. Just turn on the device and it runs continuously - no need for calibration, sensor replacement, battery replacement or battery charging. That means great reliability and no downtime.

GA24XTM	BW Clip CO Monitor	each	150.00
---------	--------------------	------	--------



ToxiRAE 3 Gas Monitor (RAE Systems)

The ToxiRAE 3 is a full-featured single-gas monitor that offers unequalled cost of ownership value. The ToxiRAE 3 is compatible with the AutoRAE Lite bump and calibration station. The detector features a 2-year warranty.

- Large, easy-to-read display for gas concentration or days remaining (end-user adjustable)
- Event logging of up to 10 events

FRG01	ToxiRAE 3 gas monitor	each	239.09
-------	-----------------------	------	--------



Blue Sensor[®] Adult Electrodes (Ambu)

The large Ambu BlueSensor R features highly conductive wet gel, offset connector, superior adhesion, and a large measuring area to ensure an optimal signal during stress tests and monitoring applications. The medium-size Ambu BlueSensor SP features highly conductive wet gel, offset connector and superior adhesion to ensure optimal signal quality during stress test and monitoring.

- M electrodes feature highly conductive wet gel and superior adhesion to ensure optimal signal quality during short- to medium-term applications. Thanks to the special occlusive backing material, the electrode will not absorb liquids.
- R electrodes feature highly conductive wet gel, superior adhesion, and a large measuring area to ensure an optimal signal during stress tests and medium to long-term applications. Thanks to the comfortable foam backing, the electrode is gentle to the skin.
- SP features highly conductive wet gel and superior adhesion to ensure optimal signal quality during medium-term applications. Thanks to the foam backing, the electrode is gentle to the skin.



AUR-00-S/3	Blue Sensor R adult electrodes	3/pkg	1.71
AUR-00-S/4	Blue Sensor R adult electrodes	4/pkg	2.11
AUR-00-S/5	Blue Sensor R adult electrodes	5/pkg	2.52
AUR-00-S/10	Blue Sensor R adult electrodes	10/pkg	4.51
AUR-00-S/25	Blue Sensor R adult electrodes	25/pkg	11.26
AUM-00-S/50	Blue Sensor M adult electrodes	50/pkg	13.08
AUSP-00-S/4	Blue Sensor SP adult electrodes	4/pkg	1.54
AUSP-00-S/10	Blue Sensor SP adult electrodes	10/pkg	3.82
AUSP-00-S/50	Blue Sensor SP adult electrodes	50/pkg	16.11

Medi-Trace™ 200 Series Electrodes (Medtronic/Covidien)

Medi-Trace 200 series electrodes are a cost-effective general adult monitoring electrode. The foam substrate repels fluids and conforms to body contours. They have a smaller footprint for convenient lead placement and a teardrop shape for easy removal from the liner and patient. The patented conductive adhesive hydrogel is designed to stay fresh up to 45 days out of the package.

KE210	Medi-Trace 210 electrode, adult	10/pkg	1.33
KE230	Medi-Trace 230 electrode, adult	30/box	4.50
KE233	Medi-Trace 233 electrode, adult	3/pkg	0.56



Medi-Trace™ 450 Series Foam Electrodes (Medtronic/Covidien)

Medi-Trace 450 series electrodes are high performance adult electrodes ideal for EMS use. The thin foam substrate incorporates an aggressive adhesive, is fluid-resistant, flexible and conforms easily to patient skin. Medi-Trace 450 series electrodes have a lift tab located on one edge to facilitate easy removal from the release liner as well as the patient.

KE22450	Medi-Trace 450 foam electrode, adult	50/pkg	7.62
---------	--------------------------------------	--------	------



Medi-Trace™ 530 Series Foam Electrodes (Medtronic/Covidien)

Utilizing a highly aggressive adhesive, the Medi-Trace 530 electrode is appropriate for the most challenging of monitoring environments. The high quality foam substrate conforms easily to the skin to ensure electrical contact for consistent tracings.

KE530	Medi-Trace 530 foam electrode, adult	30/pkg	6.00
KE533	Medi-Trace 533 foam electrode, adult (3/pack, 20 packs/box)	60/box	13.38
KE535	Medi-Trace 535 foam electrode, adult (5/pack, 12 packs/box)	60/box	13.38



ECG Monitoring Electrodes (Philips)

M2202A	Adult High-Tack foam ECG electrodes, wet gel/circular, (5 electrodes/pack, 60 packs/case)	300/case	116.00
--------	-------------------------------------------------------------------------------------------	----------	--------



Red Dot® Foam Electrodes (3M)

Each electrode has a unique 3M solid gel conductive column and a 3M SureSeal moisture vapor barrier cap to ensure product freshness.

3M2237	Red Dot foam electrodes (50/pack, 20 packs/case)	1000/case	249.49
3M2259-50	Red Dot foam electrodes, 5.1 cm	50/box	17.37





Red Dot® Repositionable Electrodes (3M)

These electrodes are designed with a larger conductive area to improve trace quality by reducing ECG artifact. They're repositionable once upon initial application allowing the electrodes to be moved rather than replacing them with new ones.

3M2670-5	Red Dot repositionable electrodes (5/pack, 200 packs/case)	1000/case	288.70
----------	------------------------------------------------------------	-----------	--------



Red Dot® Electrode with Foam Tape (3M)

The Red Dot 2560 electrode with foam tape and sticky gel is great for applications requiring high adhesion. It measures 4cm x 3.5cm and does not have an abrader.

3M2560	Red Dot electrode with foam tape and sticky gel (5 strips of 10 electrodes/bag, 20 bags/case)	100/case	249.34
--------	-----------------------------------------------------------------------------------------------	----------	--------



Red Dot® Diaphoretic Foam Electrodes (3M)

A rectangular-shaped electrode that offers a high-tack adhesive and foam backing designed for diaphoretic clinical situations. Red Dot electrodes have a 3M solid gel conductive column and 3M SureSeal moisture vapor barrier cap to ensure product freshness. Each electrode also has a border adhesive that works well on moist skin conditions.

3M2230	Red Dot diaphoretic foam electrodes	50/pkg	17.48
--------	-------------------------------------	--------	-------



Huggables® Pediatric/Neonatal ECG Electrodes (ConMed)

- Clear NeoDerm™ tape allows visual monitoring of the baby's skin condition at all times
- Huggables hug the skin, minimizing motion artifact

CN1620-001	Huggables pediatric/neonatal ECG electrodes (1/pack, 30 packs/box, 20 boxes/case)	600/case	7.31
CN1620-003	Huggables pediatric/neonatal ECG electrodes (3/pack, 10 packs/box, 20 boxes/case)	600/case	15.00



Adult Foam Conductive Adhesive Gel Electrodes (ConMed)

Designed with a larger tear-drop shape and a more robust foam adhesive, Positrace and Positrace RTL electrodes provide a more aggressive adhesive for more challenging or diaphoretic applications.

CN1870-030	Positrace diaphoretic foam conductive adhesive gel electrode (30/pack)	600/case	111.54
CN1870C-003	Positrace RTL diaphoretic foam conductive adhesive gel electrode (3/pack, 10 packs/box, 20 boxes/case)	600/case	6.35
CN1870C-004	Positrace RTL diaphoretic foam conductive adhesive gel electrode (4/pack, 10 packs/box, 15 boxes/case)	600/case	8.46
CN1870C-050	Positrace RTL diaphoretic foam conductive adhesive gel electrode (50/pack, 20 packs/case)	1000/case	198.72

Microdot® EMS Blood Glucose Monitoring System (Cambridge Sensors)

Developed to provide quality patient care, the Microdot and Microdot Xtra Blood Glucose Monitoring Systems provide accurate results, convenience, speed and safety. Glucometer and all supplies are included in one zippered case.

- Requires only 0.6µL sample
- Test results in 10 seconds
- No code (Microdot Xtra); no code chip required (Microdot)
- Strip eject button provides safe disposal of used test strips
- Beeper to assist in testing
- Insulin data entry
- 4 programmable alarms
- 500 data memory (glucose and insulin)
- PC download



CS201-01	Microdot Xtra glucometer	each	0.00*
CS200-50	Microdot Xtra glucometer strips	50/bottle	20.92
CS100-01	Microdot glucometer	each	0.00*
CS169-50	Microdot glucometer strips	50/bottle	29.94
CS120-02	Microdot glucometer hi/lo control solution	each	19.00
CS921-21	Microdot lancet, 21G, blue	200/bottle	26.00
CS925-25	Microdot lancet, 25G, purple	200/bottle	26.00

* **Free Glucometer** when you purchase at least two bottles of CS200-50 or CS169-50 in the same transaction

Ascensia Contour™ Meter (Bayer)

The Ascensia Contour codes automatically the moment you put in the test strip so you don't have to worry about coding the meter each time you use a new bottle of strips. It takes a very small blood sample size (0.6 uL). It also has automatic control marking to eliminate the need to manually mark control tests. It produces results in 5 seconds and has a 480 test memory with time and date.

BY9556C	Ascensia Contour glucometer	each	0.00
BY7109	Control solution, normal, for Ascensia Contour meter	each	7.00
BY7110	Control solution, low, for Ascensia Contour meter	each	7.00
BY7111	Control solution, high, for Ascensia Contour meter	each	7.00
BY7099	Test strips for Ascensia Contour meter	50/box	26.00

* **Free Glucometer** when you purchase at least two boxes of BY7099 in the same transaction



Ascensia Contour® TS Test Strips (Bayer)

- Compatible with Contour, Contour USB and Contour Link meters
- Tiny 0.6 µL blood sample
- 5-second test time

BY1820	Contour TS test strips	50/box	21.54
--------	------------------------	--------	-------



One Touch Ultra Test Strips (LifeScan)

- Checks each blood sample twice, automatically
- Eliminates falsely elevated results from other sugars

OTU50I	One Touch Ultra test strips	50/box	89.00
OTU100I	One Touch Ultra test strips	100/box	153.77





Glucometry Accessories

J8089	Monolet lancet, plastic blade, blue	200/box	10.00
990350	Safe-T-Lance® lancet, normal fl w, 21G	150/box	54.57
170951	Safe-T-Pro lancet	200/box	93.00
SLB250100	Surgilance lancet, 2.3mm	100/box	14.65
J3001	Surgilance lancet, 1.8 mm	100/box	13.60
J3000	Surgilance lancet, 2.2 mm	100/box	17.68
SLN3001001501	Surgilance One Step Plus lancet, 2.8 mm, pink	100/box	13.60
J8081	UniStik 2 lancet, 2.4mm	50/box	11.38
J8084	UniStik 2 lancet, 2.4mm	100/box	20.77
J8083	UniStik 3 lancet, 1.8mm	50/box	11.38
CR2032	Battery, 3V for Elite glucometer	each	4.59

Diagnostic Equipment ■ Blood Pressure



Economy Aneroid Sphygmomanometer (Southeastern)

This basic sphygmomanometer is the most economical model offered. The gauge is backed by a five-year calibration warranty. Graduated to 300 mmHg with a no stop pin manometer, this reliable model features a standard bulb, standard air release valve and calibrated blue nylon cuff with hook and loop closure.

H6040	Economy aneroid blood pressure cuff, adult	black	each	7.54
H6015	Economy aneroid blood pressure cuff, large adult	black	each	11.00
H6014E	Economy aneroid blood pressure cuff, child	navy blue	each	8.69
H6013E	Economy aneroid blood pressure cuff, infant	navy blue	each	9.08
H6016E	Economy aneroid blood pressure cuff, thigh	navy blue	each	11.00



Diagnostix 776 Pocket Aneroid Blood Pressure Cuff (ADC)

- Chrome-plated precision-crafted 300mmHg no-pin stop manometer
- Adcuff nylon cuff
- ADC's proprietary Size Guide marking system

ADC776Z	Diagnostix 776 pocket aneroid blood pressure cuff	navy blue	each	10.87
---------	---------------------------------------------------	-----------	------	-------

Diagnostix™ 700 Series Blood Pressure Cuff (ADC)

Chrome-plated, precision-crafted 300mmHg manometer. Adcuff™ nylon cuff with ADC's proprietary Size Guide™ marking system prevents mis-cuffing. Adfl w™ chrome-plated brass air release valve with micro-threads for precise deflation control. Leatherette carrying case with durable nylon zipper.



ADC700XLF	Diagnostix 700 series blood pressure cuff, large adult	black	each	70.89
ADC700LF	Diagnostix 700 series blood pressure cuff, adult	maroon	each	62.81

Diagnostix™720 Series Blood Pressure Cuff (ADC)

Precision-crafted 300mmHg Japanese-engineered manometer with classic black baked enamel finish, exceeds industry performance standards. Adcuff™ nylon cuff with ADC's proprietary Size Guide™ marking system prevents mis-cuffing. Adfl w chrome-plated brass air release valve with micro-threads for precise deflation control. Leatherette carrying case with durable nylon zipper.



ADC720BKLF	Diagnostix 720 series blood pressure cuff	black	each	52.29
------------	-------------------------------------------	-------	------	-------

System 5 Blood Pressure System (ADC)

A multi-pocketed, heavy duty 600D nylon attaché style case that keeps each component securely in place, yet instantly accessible. Dual zipper closure permits rapid access and protects against the elements. Measures a compact 10" x 9" x 4" when closed, weighs just 2 1/2 lb. Includes child, small adult, adult, large adult and thigh Adcuff™ nylon cuffs featuring the Size Guide™ marking system. Meets or exceeds ANSI/AAMI/ISO 81060-1



ADC740LF	System 5 blood pressure system, latex free	navy blue	each	216.97
ADC746LF	System 5 blood pressure system, latex free	orange	each	216.97
ADC804	System 5 blood pressure system replacement palm aneroid		each	82.38

Multikuf™ Blood Pressure System (ADC)

Three-cuff model includes adult, small adult, and large adult Adcuffs™ with one-tube bladder with quick-release luer slip connector. Four-cuff model also includes child cuff. Black Nylon zipper case keeps each component in place, yet instantly accessible



ADC731BK	Multikuf blood pressure system	black	each	162.36
ADC731DB	Multikuf blood pressure system	navy blue	each	162.36
ADC731OR	Multikuf blood pressure system	orange	each	162.36

Trigger Aneroid Family Kit (Welch Allyn)

Gear free, shock resistant, jewel movement. Laser engraved dial. 15-year calibration warranty. Zipper case; Four-cuff kit: size 09 to size 12. FlexiPort reusable, 1-tube cuffs.



WA5098-30	Trigger aneroid family kit		each	325.00
-----------	----------------------------	--	------	--------



Diagnostix™ 750 Series Mobile Aneroid (ADC)

A large face aneroid that offers the superb precision, styling, and dependability synonymous with the ADC name.

- Large, easy-to-read, 6" luminescent dial for high visibility in virtually any light condition
- Adcuff™ inflation system includes latex-free Adcuff nylon cuff, Adfl w bulb and valve and eight-foot length (when extended) of coiled tubing
- Assembled, inspected and packaged in the U.S.A. from foreign components

ADC752M	Diagnostix 750 series mobile aneroid with rolling stand	each	273.52
---------	---------------------------------------------------------	------	--------



Prosphyg™ 760 Series Blood Pressure Cuff (ADC)

- Contemporary black enamel 300mmHg manometer
- Adcuff™ nylon cuff with ADC's proprietary Size Guide™ marking system
- Chrome-plated brass air release valve
- Leatherette carrying case with durable nylon zipper
- Assembled, inspected and packaged in the U.S.A. from foreign components

ADC760BKLF	Prosphyg 760 series blood pressure cuff, adult, latex free	black	each	35.25
ADC760BDLF	Prosphyg 760 series blood pressure cuff, adult, latex free	maroon	each	35.25
ADC760DBLF	Prosphyg 760 series blood pressure cuff, adult, latex free	navy blue	each	35.25
ADC760XLF	Prosphyg 760 series blood pressure cuff, large adult, latex free	black	each	42.84
ADC760CLF	Prosphyg 760 series blood pressure cuff, child, latex free	black	each	35.25
ADC760ILF	Prosphyg 760 series blood pressure cuff, infant, latex free	black	each	35.25
ADC760BK	Prosphyg 760 series blood pressure cuff, adult	black	each	34.90
ADC760DB	Prosphyg 760 series blood pressure cuff, adult	navy blue	each	34.90
ADC760OR	Prosphyg 760 series blood pressure cuff, adult	orange	each	35.25
ADC760DBX	Prosphyg 760 series blood pressure cuff, large adult	navy blue	each	42.84
ADC760XOR	Prosphyg 760 series blood pressure cuff, large adult	orange	each	42.84
ADC760C	Prosphyg 760 series blood pressure cuff, child	black	each	34.90
ADC760T	Prosphyg 760 series blood pressure cuff, thigh	black	each	48.30

Advantage™ Ultra Digital BP Monitor (ADC)



- Measures systolic, diastolic pressure, and pulse
- Automatic inflation and deflation control
- Averages 3 readings for superior reporting accuracy
- Irregular Heartbeat Detection
- Displays AM and PM readings separately to help detect morning hypertension.
- USB cable for easy PC hook-up
- AC adapter
- 4 "AA" batteries included
- Deluxe storage case
- 5-year warranty

ADC6017	Advantage Ultra digital blood pressure monitor, adult, blue	each	69.95
---------	-------------------------------------------------------------	------	-------

Aneroid Blood Pressure Cuffs, Classic Series (Barrington Ventures)

- Precision crafted 300mmHg no-pin stop, spring loaded, chrome-plated manometer
- Manometer face plate features bold luminescent numerals and extended graduation marks for easy reading in any light condition
- Double stitched nylon cuff includes unique marking system to prevent users applying the wrong size cuff on patients
- Chrome-plated brass air release valve with filter screen
- Vinyl carrying case with deluxe nylon zipper
- Inspected and packaged in the USA from foreign components
- Lifetime calibration warranty
- Two-year warranty on inflation system
- Navy blue color



BV20-202-184	Aneroid blood pressure cuff, Classic Series, adult, latex free	each	27.20
BV20-202-185	Aneroid blood pressure cuff, Classic Series, large adult, latex free	each	33.00
BV20-202-183	Aneroid blood pressure cuff, Classic Series, child, latex free	each	27.20
BV20-202-182	Aneroid blood pressure cuff, Classic Series, infant, latex free	each	27.20
BV20-202-186	Aneroid blood pressure cuff, thigh, latex free	each	39.00
BV20-201-184	Aneroid blood pressure cuff, Classic Series, adult	each	24.72
BV20-201-183	Aneroid blood pressure cuff, Classic Series, child	each	20.00
BV20-201-186	Aneroid blood pressure cuff, Classic Series, thigh	each	18.50

Lifesource Wrist Blood Pressure Monitor (Barrington Ventures)

The UB-521 wrist monitor is smaller, lighter, and less expensive than other wrist monitors. It measures blood pressure during cuff inflation for a faster, more comfortable reading. The automatic memory keeps your last 90 blood pressure measurements for effective tracking. The average reading feature automatically calculates the “average” of the total readings stored in memory. The UB-521 also has the Irregular Heartbeat feature. This feature provides blood pressure and pulse rate measurements even when an irregular heartbeat occurs and alerts the user. A rigid carrying case is included to protect the monitor when not in use.



BVUB-521	Lifesource wrist blood pressure monitor	each	55.00
----------	-----------------------------------------	------	-------

Caliber® Aneroid Sphygmomanometer (Mabis)

- Designed for many years of demanding service in the hospital and EMS
- Blue aneroid gauge and matching calibrated blue nylon cuff
- Deluxe air release valve
- Twenty-year calibration warranty
- Zippered carrying case
- Navy blue color



MA01-130-011	Caliber aneroid blood pressure cuff, adult	each	44.54
MA01-130-016	Caliber aneroid blood pressure cuff, large adult	each	35.97
MA01-130-015	Caliber aneroid blood pressure cuff, child	each	34.29
MA01-130-013	Caliber aneroid blood pressure cuff, infant	each	34.29
MA01-130-017	Caliber aneroid blood pressure cuff, thigh	each	49.14



Signature® Aneroid Sphygmomanometers (Mabis)

The Signature Series offers superior performance and unsurpassed quality.

The deluxe air release valve delivers a precise deflation rate. Range markings on the cuff assist in proper cuff placement and size selection. Includes deluxe air release valve, inflation bulb, blue nylon calibrated cuff and deluxe zippered carrying case.

Adult cuff measures 54/5Wide and 21" long; comfortably fits a m girth of 11" to 162/5.

MA01-100-011	Signature aneroid blood pressure cuff, adult	navy blue	each	48.10
--------------	----------------------------------------------	-----------	------	-------



Caliber® Adjustable Aneroid Sphygmomanometers (Mabis)

Specially designed so the user can easily set the gauge to zero if needed. Insert a mini-screwdriver (included) into the stem of the gauge and turn the screwdriver until the needle returns to zero.

- Blue aneroid gauge and matching calibrated blue nylon cuff
- Zippered carrying case
- Twenty-year calibration warranty
- Deluxe air release valve
- Navy blue color

MA01-133-011	Caliber adjustable aneroid blood pressure cuff, adult		each	37.97
MA01-133-016	Caliber adjustable aneroid blood pressure cuff, large adult		each	51.82
MA01-133-015	Caliber adjustable aneroid blood pressure cuff, child		each	43.02



Diagnostix™ 703 Series Blood Pressure Cuff (ADC)

- Palm style manometer with integral latex-free bulb and trigger-style air release valve
- Precision-crafted 300mmHg Japanese-engineered movement tested to 50,000 cycles
- Movement housed in a zinc cage that suspends within the polymer housing for enhanced shock resistance
- Adcuff™ nylon cuff with ADC's proprietary Size Guide™ marking system
- Complete with leatherette carrying case with self repairing nylon zipper
- Assembled, inspected and packaged in the U.S.A. from foreign components

ADC703	Diagnostix 703 series blood pressure cuff, adult	navy blue	each	95.46
ADC703BDLF	Diagnostix 703 series blood pressure cuff, adult, latex free	maroon	each	95.46

MatchMates® Dual Head Combination Kit (Mabis)

- MatchMates® aneroid sphygmomanometer with calibrated nylon cuff and dual head stethoscope
- Stethoscope includes: binaural, lightweight anodized aluminum chestpiece, 22" vinyl Y-tubing, spare diaphragm and a pair of mushroom eartips
- Lifetime replacement warranty on gauge
- Carrying case: 9" x 5" x 2"



MA01-260BK	MatchMates dual head combination kit	black	each	34.95
MA01-260BU	MatchMates dual head combination kit	maroon	each	34.95
MA01-260NV	MatchMates dual head combination kit	navy blue	each	34.95
MA01-260PU	MatchMates dual head combination kit	purple	each	34.95
MA01-260RE	MatchMates dual head combination kit	red	each	34.95
MA01-260RB	MatchMates dual head combination kit	royal blue	each	34.95
MA01-260TL	MatchMates dual head combination kit	teal	each	34.95

MatchMates® Sprague Rappaport-Type Combo Kit (Mabis)

- MatchMates® aneroid sphygmomanometer with calibrated nylon cuff and 31 sprague rappaport-type stethoscope
- Select colors available in latex-free and latex
- Stethoscope includes: (3) bells, (adult, medium, and infant), (2) diaphragms (small and large) and 3 types of eartips
- Oversized, matching carrying case
- Lifetime replacement warranty on gauge



MA09-361-211	MatchMates Sprague Rappaport-type combination kit, latex free	royal blue	each	48.92
MA01-360BK	MatchMates Sprague Rappaport-type combination kit	black	each	38.95
MA01-360BU	MatchMates Sprague Rappaport-type combination kit	burgundy	each	38.95
MA01-360HG	MatchMates Sprague Rappaport-type combination kit	green	each	38.95
MA01-360MA	MatchMates Sprague Rappaport-type combination kit	maroon	each	38.95
MA01-360NV	MatchMates Sprague Rappaport-type combination kit	navy blue	each	38.95
MA01-360OR	MatchMates Sprague Rappaport-type combination kit	orange	each	38.95
MA01-360PU	MatchMates Sprague Rappaport-type combination kit	purple	each	38.95
MA01-360-RE	MatchMates Sprague Rappaport-type combination kit	red	each	38.95
MA01-360RB	MatchMates Sprague Rappaport-type combination kit	royal blue	each	38.95
MA01-360TL	MatchMates Sprague Rappaport-type combination kit	teal	each	38.95



SAVE TIME BY ORDERING ONLINE
Store.Seequip.com



UltraCheck® Blood Pressure Cuffs (CasMed)

UltraCheck blood pressure cuffs are reusable, constructed from lightweight, soft nylon coated with antimicrobial protection. They are easy to disinfect and clean and have Velcro closures. Cuffs are stain and fluid resistant.

CASUS1826ML	UltraCheck blood pressure cuff, small adult for CAS 740 / 750	each	14.26
CASUS2635ML	UltraCheck blood pressure cuff, adult, for CAS 740 /750	each	16.66
CASUS3242ML	UltraCheck blood pressure cuff, large adult for CAS 740 /750	each	18.76
CASUS0814ML	UltraCheck blood pressure cuff, infant, for CAS 740 /750	each	10.58
CASUS2635MQ	UltraCheck blood pressure cuff, adult for MRL PIC/Propaq	each	16.66
CASUS3242MQ	UltraCheck blood pressure cuff, large adult for MRL PIC/Propaq	each	18.76
CASUS0814MQML	UltraCheck blood pressure cuff, infant, for Procyon and IPRO	each	12.78
CASUS2635HP-05	UltraCheck blood pressure cuff, adult with single tube HP fitting	each	15.82
CASUS3242HP-05	UltraCheck blood pressure cuff, large adult with single tube HP fitting	each	17.82
CASUS0814HP-05	UltraCheck blood pressure cuff, infant with single tube HP fitting	each	10.06
CASUS4250HP	UltraCheck blood pressure cuff, thigh, with single tube HP fitting	each	22.22
CASUS4250ML	UltraCheck blood pressure cuff, thigh, with single tube ML	each	23.39

Many other configurations are available. Please call customer service at (800) 334-6656.



SoftCheck® Blood Pressure Cuffs (CasMed)

SoftCheck Blood Pressure Cuff with a single tube has soft fabric which prevents perspiration under cuff.

CASVST1826ML	SoftCheck blood pressure cuff, small adult, for CAS 740 /750	each	4.05
CASVST2635ML	SoftCheck blood pressure cuff, adult, for CAS 740 /750	each	5.38
CASVST3242ML	SoftCheck blood pressure cuff, large adult, for CAS 740 /750	each	6.14
CASVST1320ML	SoftCheck blood pressure cuff, child, for CAS 740 /750	each	3.50
CASVST4250ML	Soft-check blood pressure cuff, thigh, for CAS 740 /750	each	11.88
CASVST0814ML	Soft-check blood pressure cuff, infant, for CAS 740 /750	each	2.98
CASVST2635HP	SoftCheck blood pressure cuff, adult, for HP Agilent, Philips	each	5.48
CASVST2635MQ	SoftCheck blood pressure cuff, adult, for MRL Pic/Propaq	each	5.48

Durashock Blood Pressure Cuffs (Welch Allyn)

- Gear free
- Shock resistant
- 5-year calibration warranty
- Inflation bulb and valve
- FlexiPort reusable 1-tube cuff



WADS44-11	Durashock blood pressure cuff, adult	each	62.50
WADS44-12	Durashock blood pressure cuff, large adult	each	68.00
WADS44-09	Durashock blood pressure cuff, child	each	62.50

Pro's Combo III™ Pocket Aneroid Kit (ADC)

A combination of ADC's finest pocket aneroid and one of its most popular acoustic scopes. Together they provide outstanding performance with rugged durability.

- Chrome-plated pocket aneroid (Diagnostix™ 700) with luminescent dial provides day-in, day-out dependability
- Adcuff™ nylon cuff with ADC's proprietary Size Guide™ marking system
- Color-coordinated matching professional Adscope™ 603 stethoscope
- Extra-large, color-matched dual-pocket nylon carry case
- Assembled, inspected and packaged in the U.S.A. from foreign components



ADC778-603BK	Pro's Combo III™ pocket aneroid with Adscope	black	each	116.75
ADC778-603DG	Pro's Combo III™ pocket aneroid with Adscope	green	each	116.75
ADC778-603NV	Pro's Combo III™ pocket aneroid with Adscope	navy blue	each	116.75
ADC778-603OR	Pro's Combo III™ pocket aneroid with Adscope	orange	each	116.75
ADC778-603RB	Pro's Combo III™ pocket aneroid with Adscope	royal blue	each	116.75
ADC778-603RE	Pro's Combo III™ pocket aneroid with Adscope	red	each	69.91

Medic-Kit3™ EMT Kit (Mabis)

- Includes three cuffs: adult, child, and large adult
- The easy access, fold-open carrying case is made of heavy-duty blue nylon for many years of rugged service
- Features a chrome-plated, German-crafted palm aneroid gauge
- Has additional pockets for infant and thigh cuffs



MA01-350-018	Medic-Kit3 EMT kit, navy blue		each	123.60
MA01-350-058	Medic-Kit3 EMT kit, orange		each	123.60

Medic-Kit5™ EMT Kit (Mabis)

Medic-Kit 5 was designed with the EMT/paramedic in mind.

- Includes five cuffs—adult, infant, child, large adult and thigh
- The easy access, fold-open carrying case is made of heavy-duty blue nylon for many years of rugged service
- Chrome-plated, German-crafted palm aneroid gauge
- Lifetime calibration warranty



MA01-550-018	Medic Kit 5	navy blue	each	147.97
MA01-550-058	Medic Kit 5	orange	each	151.97

Blood Pressure Accessories (ADC)

ADC804	Gauge for ADC 703, 705, 731, 732, 740, 788 series		each	82.38
ADC804C	Luer connector for ADC 804 gauge only		each	0.92
ADC804N	Gauge for ADC 760, 768, 769 series		each	82.38
ADC850DB	Adcuff™ and bladder replacement, 1 tube, adult, navy blue		each	20.91





e-sphyg™ Digital Pocket Aneroid Stethoscope (ADC)

The e-sphyg replaces your mechanical gauge and its fragile, vulnerable design with a digital instrument that can stand up to the toughest use.

- Systolic assist alerts practitioner to the onset of Korotkoff sound
- Extra large backlit LCD with 7/8" digits, is easy to read in virtually any light
- Lifetime calibration warranty
- Manometer works with virtually every cuff on the market
- 2 "AAA" batteries (included)
- Black color

ADC7002XLF	e-sphyg™ digital pocket aneroid stethoscope, large adult, latex free	each	85.34
ADC7002CLF	e-sphyg™ digital pocket aneroid stethoscope, child, latex free	each	77.25
ADC7002LF	e-sphyg™ digital pocket aneroid stethoscope, infant, latex free	each	77.25
ADC7002	e-sphyg™ digital pocket aneroid stethoscope, adult	each	77.25
ADC7002X	e-sphyg™ digital pocket aneroid stethoscope, large adult	each	84.75
ADC7002C	e-sphyg™ digital pocket aneroid stethoscope, child	each	77.25
ADC7002I	e-sphyg™ digital pocket aneroid stethoscope, infant	each	77.25



Adscope® 602 Traditional Cardiology Stethoscope (ADC)

- Combination chestpiece precisely machined from surgical stainless steel
- Extra deep bell for unsurpassed low frequency response
- Ultra-sensitive diaphragm for greater amplification and crisper transmission
- Cardiology headset with large bore stainless steel binaurals are fixed at 15° angle

ADC602BK	Adscope 602 traditional cardiology stethoscope.	black	each	109.23
----------	-------------------------------------------------	-------	------	--------



Adscope™ 603 Acoustic Stethoscope (ADC)

- Ultra-sensitive diaphragm (17/8" diameter) for greater amplification and crisper high frequency response
- Reinforcing yoke molded into flexible 22" PVC "Y" tubing
- Scope ID Tag and spare diaphragm included
- Adsoft® deluxe PVC eartips (in small and large)
- Color coordinated non-chill bell and diaphragm retaining rim for patient comfort
- Combination adult size chestpiece precisely machined to exacting tolerances from surgical stainless steel for outstanding performance and rugged durability
- Extra large bell (13/8" diameter) for unsurpassed low frequency response
- Stainless steel binaurals with double leaf internal spring fixed at 15 degree angle for greater comfort

ADC603BK	Adscope 603 acoustic stethoscope	black	each	54.99
ADC603BD	Adscope 603 acoustic stethoscope	burgundy	each	54.99
ADC603FG	Adscope 603 acoustic stethoscope	frosted glacier	each	54.99
ADC603LV	Adscope 603 acoustic stethoscope	lavender	each	54.99
ADC603NV	Adscope 603 acoustic stethoscope	navy blue	each	54.99
ADC603RB	Adscope 603 acoustic stethoscope	red	each	54.99
ADC603R	Adscope 603 acoustic stethoscope	royal blue	each	54.99
ADC603ST	Adscope 603 acoustic stethoscope, stainless steel	steel ninja	each	60.00

Adscope® 604 Pediatric Clinician Stethoscope (ADC)

- Combination pediatric chestpiece precisely machined to exacting tolerances from surgical stainless steel for outstanding performance and rugged durability
- Extra large bell (1 1/8" diameter) for unsurpassed low frequency response
- 1 3/8" diameter diaphragm for greater amplification and crisper transmission

ADC604BK	Adscope 604 pediatric clinician stethoscope	black	each	54.99
ADC604P	Adscope 604 pediatric clinician stethoscope	pink	each	54.99



Adscope™ 641 Sprague Stethoscope (ADC)

- Latex-free, double tube configuration
- Proprietary valve mechanism eliminates acoustic leakage
- Adjustable chrome-plated brass binaurals
- Complete with an accessory pouch containing the bell chestpieces, chestpiece key, two spare diaphragms, one pair of mushroom eartips and one pair of silicon eartips
- Overall length 30"; 5-year warranty



ADC641BK	Adscope 641 Sprague stethoscope	black	each	18.35
ADC641BD	Adscope 641 Sprague stethoscope	burgundy	each	18.35
ADC641FG	Adscope 641 Sprague stethoscope	frosted glacier	each	18.35
ADC641GR	Adscope 641 Sprague stethoscope	green	each	18.35
ADC641LV	Adscope 641 Sprague stethoscope	lavender	each	18.35
ADC641NO	Adscope 641 Sprague stethoscope	neon orange	each	18.35
ADC641NP	Adscope 641 Sprague stethoscope	neon pink	each	18.35
ADC641NY	Adscope 641 Sprague stethoscope	neon yellow	each	18.35
ADC641RB	Adscope 641 Sprague stethoscope	royal blue	each	18.35
ADC641TL	Adscope 641 Sprague stethoscope	teal	each	18.35

Adscope-lite™ Stethoscope (ADC)

The Adscope-lite™ is an affordably priced stethoscope that combines superior acoustic response with an ultra-lightweight design.

- Combination diaphragm/bell adult chestpiece precisely machined to exacting tolerances from lightweight aluminum
- Extra large 1 3/8" diameter bell
- Highly sensitive 1 3/4" diaphragm
- Non-chill bell and diaphragm retaining rim for patient comfort
- Clinician headset boasts reinforcing yoke molded into the flexible 22" PVC tubing
- Lightweight aluminum binaurals in matching satin finish
- Adsoft™ threaded PVC eartips for the ultimate in wearing comfort and acoustic seal
- Includes spare diaphragm and eartips
- Weighs 3.5 oz. Overall length 31"
- Assembled, inspected and packaged in the USA
- Five-year warranty covers all parts



ADC609BK	Adscope-lite stethoscope	black	each	24.63
ADC609G	Adscope-lite stethoscope	grey	each	24.63
ADC609R	Adscope-lite stethoscope	red	each	24.63
ADC609RB	Adscope-lite stethoscope	royal blue	each	24.63



Proscope™ Dual Head Stethoscope (ADC)

The Proscope™ Dual Head combines lightweight construction with truly affordable pricing.

- Combination diaphragm/bell chestpiece for wide frequency response
- Lightweight aluminum chestpiece construction
- Non-chill diaphragm rim for patient comfort
- Diaphragm diameter 1¾", bell diameter ¾"
- Proprietary diaphragm enhances acoustic response by 50% over traditional designs
- Flexible 22" PVC tubing
- Spare pair of black mushroom eartips included
- Inspected and packaged in the U.S.A.
- Weighs 3 oz. / Overall length 32.5"
- One-year warranty

H6430	Proscope dual head stethoscope	black	each	6.49
ADC670NO	Proscope dual head stethoscope	neon orange	each	6.49
H6431	Proscope dual head stethoscope	red	each	6.49
ADC670RB	Proscope dual head stethoscope	royal blue	each	6.49



Proscope™ Disposable Stethoscope (ADC)

- Nurse-style, diaphragm-only single patient use scope
- ABS construction throughout is super lightweight
- May be ETO sterilized and safely incinerated
- Ultra-sensitive diaphragm for outstanding acoustic performance
- Individually packaged in a sealed polybag
- Weighs 1.5 oz. / overall length 32"

ADC665-10RB	Proscope disposable stethoscope	royal blue	10/box	22.09
ADC665-10YL	Proscope disposable stethoscope	yellow	10/box	22.09



Proscope™ Pediatric and Infant Stethoscopes (ADC)

- Adjustable aluminum binaurals with PVC eartips
- Flexible 22" PVC tubing and spare pair of black mushroom eartips
- Pediatric dual-head features lightweight aluminum combination chestpiece with 1¼" diaphragm and ¾" non-chill bell and rim
- Infant dual-head features chrome-plated zinc combination chestpiece with 25mm diaphragm and bell and slip on gray non-chill bell ring for patient comfort

ADC675BK	Proscope pediatric stethoscope	black	each	7.49
ADC675DG	Proscope pediatric stethoscope	green	each	7.49
ADC675NY	Proscope pediatric stethoscope	neon yellow	each	7.49
ADC675P	Proscope pediatric stethoscope	pink	each	7.49
ADC675RB	Proscope pediatric stethoscope	royal blue	each	7.49
ADC676BK	Proscope infant stethoscope	black	each	8.99
ADC676DG	Proscope infant stethoscope	green	each	8.99
ADC676NY	Proscope infant stethoscope	neon yellow	each	8.99
ADC676P	Proscope infant stethoscope	pink	each	8.99

Proscope™ 670 Dual Head Stethoscope (ADC)

- Combination diaphragm/bell chestpiece for wide frequency response
- Lightweight aluminum chestpiece construction
- Non-chill bell and diaphragm rim for patient comfort
- Diaphragm diameter 1¾", bell diameter ¾"
- Proprietary diaphragm enhances acoustic response by 50% over traditional designs



ADC670N	Proscope 670 dual head stethoscope	navy blue	each	6.49
---------	------------------------------------	-----------	------	------

Proscope™ Dual Head Teaching Scope (ADC)

A training aid that allows student and instructor to listen simultaneously.

- Combination diaphragm/bell chestpiece
- Two sets of flexible aluminum binaurals
- Two sets of flexible 22" and one straight 10" length of black PVC tubing
- Two spare pairs of black mushroom eartips included
- Weighs 6.5 oz. / overall length 44.5"
- Inspected and packaged in the U.S.A.
- One-year warranty



ADC671	Proscope dual head teaching scope		each	18.67
--------	-----------------------------------	--	------	-------

Proscope™ Nurses Stethoscopes

- Nurse-style chestpiece diaphragm/bell chestpiece for wide frequency (1¾" diameter)
- Proprietary diaphragm enhances acoustic response by 50% over traditional designs
- Flexible 22" PVC tubing
- Spare pair of black mushroom eartips included
- Lightweight aluminum chestpiece construction
- Overall length 32"



H6420	Proscope nurses stethoscopes	black	each	4.15
H6423	Proscope nurses stethoscopes	green	each	5.49
H6421	Proscope nurses stethoscopes	red	each	5.14
H6422	Proscope nurses stethoscopes	royal blue	each	4.15

Littmann® Cardiology III Stethoscopes (3M)

The Littmann Cardiology III stethoscope offers two tunable diaphragms which allows the user to conveniently alternate between low- and high-frequency sounds without turning over the chestpiece. The large side can be used for adult patients, while the small side is especially useful for pediatric or thin patients, around bandages and for carotid assessment. The pediatric side of the chestpiece easily converts to a traditional bell by simply replacing the diaphragm with the nonchill bell sleeve included with each stethoscope.

3M3128	Littmann Cardiology III stethoscope, 27"	black	each	266.74
3M3131BE	Littmann Cardiology III stethoscope, 27"	black plated	each	294.20
3M3146	Littmann Cardiology III stethoscope, 27"	blue	each	266.74
3M3134	Littmann Cardiology III stethoscope, 27"	green	each	293.42
3M3130	Littmann Cardiology III stethoscope, 27"	navy blue	each	293.42
3M3127	Littmann Cardiology III stethoscope, 22"	black	each	266.74





Littmann® Master Classic II Stethoscope (3M)

The Littmann Master Classic II stethoscope features a tunable diaphragm, which allows the user to conveniently alternate between low- and high- frequency sounds without turning over the chestpiece.

3M2144L	Littmann Master Classic II stethoscope	black	each	183.38
3M2146	Littmann Master Classic II stethoscope	burgundy	each	183.38
3M2147	Littmann Master Classic II stethoscope	navy blue	each	183.38



Littmann® Classic II Pediatric and Infant Stethoscopes (3M)

The Littmann Classic II Pediatric stethoscope features a 1" traditional bell combined with a floating diaphragm. The Littmann Classic II Infant stethoscope features a 3/4-inch bell with a floating diaphragm.

3M2113	Littmann Classic II stethoscope, pediatric	black	each	109.54
3M2203	Littmann Classic II stethoscope, pediatric	raspberry	each	91.54
3M2113R	Littmann Classic II stethoscope, pediatric	red	each	109.54
3M2114	Littmann Classic II stethoscope, infant	black	each	109.15
3M2114R	Littmann Classic II stethoscope, infant	red	each	109.54



Littmann® Classic II S.E. Stethoscopes (3M)

Featuring a two-sided chestpiece, this classic stethoscope offers high acoustic sensitivity for superior performance.

3M2201	Littmann Classic II S.E. stethoscope	black	each	119.42
3M2813	Littmann Classic II S.E. stethoscope	blue	each	119.00
3M2211	Littmann Classic II S.E. stethoscope	burgundy	each	119.42
3M2208	Littmann Classic II S.E. stethoscope	hunter green	each	91.54
3M2205	Littmann Classic II S.E. stethoscope	navy blue	each	119.42
3M2812	Littmann Classic II S.E. stethoscope	orange	each	119.00
3M2817	Littmann Classic II S.E. stethoscope	pearl	each	119.00
3M2818	Littmann Classic II S.E. stethoscope	pine green	each	91.54
3M2815	Littmann Classic II S.E. stethoscope	pink	each	89.42
3M2209	Littmann Classic II S.E. stethoscope	purple	each	91.86
3M2210	Littmann Classic II S.E. stethoscope	raspberry	each	119.42



Littmann® Master Cardiology® Stethoscopes (3M)

Offers a handcrafted stainless steel chestpiece with the portable convenience of a single-sided stethoscope. The tunable diaphragm conveniently alternates between low- and high-frequency sounds with a simple pressure change on the chestpiece.

3M2160	Littmann Master Cardiology stethoscope	black	each	322.32
3M2163	Littmann Master Cardiology stethoscope	burgundy	each	332.00
3M2165	Littmann Master Cardiology stethoscope	green	each	322.32
3M2164	Littmann Master Cardiology stethoscope	navy blue	each	321.20

Littmann® Select Stethoscopes (3M)

Features a tunable diaphragm that allows the user to conveniently alternate between bell and diaphragm modes by applying simple pressure on the chestpiece.

3M2290	Littmann Select stethoscope	black	each	81.38
3M2298	Littmann Select stethoscope	royal blue	each	81.38



Littmann® Lightweight II S.E. Stethoscope (3M)

The Littmann Lightweight II S. E. Stethoscope is an entry-level stethoscope specially designed for basic blood pressure monitoring and physical assessment

3M2450	Littmann Lightweight II S.E. stethoscope	black	each	75.36
--------	------------------------------------------	-------	------	-------



Sprague Rappaport-Type Stethoscope (Barrington Ventures)

- Allows for the use of 5 interchangeable chestpiece fittings - adult and pediatric diaphragm, and 3 bells (1¼", 1", ¾").

BV30-416-014	Sprague Rappaport-type stethoscope	black	each	7.85
BV30-416-324	Sprague Rappaport-type stethoscope	neon orange	each	7.85
BV30-415-254	Sprague Rappaport-type stethoscope	royal blue	each	10.00



Sprague Rappaport Legacy Stethoscope (Mabis)

- Five interchangeable chestpieces - three bells (adult, medium and infant) and two diaphragms (small and large)

MA10-414-020	Sprague Rappaport Legacy stethoscope	black	each	14.75
MA10-414-010	Sprague Rappaport Legacy stethoscope	blue	each	14.75
MA10-414-120	Sprague Rappaport Legacy stethoscope	green	each	14.75
MA10-414-110	Sprague Rappaport Legacy stethoscope	lavender	each	14.75
MA10-414-150	Sprague Rappaport Legacy stethoscope	magenta	each	14.75
MA10-414-050	Sprague Rappaport Legacy stethoscope	neon orange	each	14.75
MA10-414-130	Sprague Rappaport Legacy stethoscope	neon yellow	each	14.75
MA10-414-080	Sprague Rappaport Legacy stethoscope	red	each	14.75
MA10-414-160	Sprague Rappaport Legacy stethoscope	teal	each	14.75



Stethoscope Accessories

ADC698BK	ID tag for ADC scopes	each	1.02
ADC600-06BK	Mushroom eartips for ADC scopes, latex free, black	pair	1.05
3M37812	Soft-sealing eartips for Littmann scopes	pair	8.91
ADC640-03	Diaphragm for Sprague-type stethoscope, large	each	0.90
ADC640-03S	Diaphragm for Sprague-type stethoscope, pediatric	each	0.90
ADC640-02	Retaining ring for Sprague-type stethoscope, large	each	2.04
ADC640-02S	Retaining ring for Sprague-type stethoscope, small	each	2.04





Fingertip Pulse Oximeter (Southeastern)

This inexpensive, accurate pulse oximeter allows it to be used for adult applications in many different areas such as hospital, homecare and EMS. Includes blue protective rubber case.

- Convenient, compact and portable
- Bright, 6-way OLED color display
- Displays SpO2, heart rate and waveform
- Auto-off function (after 8 seconds of no use)
- 30 hrs of use on two AAA-size batteries
- Adjustable 10 level brightness
- FDA-approved

MD300C2	Fingertip pulse oximeter	each	65.00
---------	--------------------------	------	-------



Onyx® Vantage Finger Pulse Oximeter (Nonin)

The Onyx Vantage 9590 provides a fast, accurate, cost-effective solution for spot-checking oxygen saturation and pulse rate in pediatric to adult patients.

- Units work on pediatric to larger adult patients and can be used on finger, thumbs or toes
- 4-year warranty and up to 6,000 spot checks on two AAA batteries

NO9590	Onyx Vantage finger pulse oximeter, black	each	179.00
NO9590RE	Onyx Vantage finger pulse oximeter, red	each	179.00
NOJM2-CC	Onyx Vantage finger pulse oximeter, hard protective case only, black	each	25.00
NO9500CC-B	Onyx Vantage finger pulse oximeter, soft case only, black	each	18.00



Digit Finger Pulse Oximeter (BCI)

- Displays SPO2, Pulse rate and pulse strength
- Large LED display
- Auto Shut-off
- Low battery indicator
- High Impact Polycarbonate shield
- 2 year warranty
- Comes w/ Lanyard, 2-AAA Batteries, operation manual

BCI3420Y	Digit pulse oximeter	each	206.00
BCI3427	Digit pulse oximeter carry case	each	32.10
BCI3426	Digit pulse oximeter lanyard	each	6.64

8500 Digital Handheld Pulse Oximeter (Nonin)

Provides an easy and accurate assessment of oxygen saturation and pulse rate from adults to neonates. With 100 hours of battery life, the 8500 provides a cost-effective, environmentally friendly solution for your monitoring needs.

NO8500C	8500 Digital Handheld Pulse Oximeter unit with black case	each	437.92
NO8500	8500 Digital Handheld Pulse Oximeter unit only	each	524.00
NO8500CC-B	8500 Digital Handheld Pulse Oximeter, old style carrying case only	each	49.50



3301 Handheld Pulse Oximeter (BCI)

- Includes, monitor, oximetry finger senso , three“C” size batteries and manual
- Displays SPO2, Pulse rate and Pulse strength
- Storage data for up to 99 patients; 2 year warranty

BCI3301	3301 handheld pulse oximeter	each	937.86
BCI3315	3301 handheld pulse oximeter carrying case, belt clip, shoulder strap	each	75.12
BCI3318	3301 handheld pulse oximeter protective rubber boot with strap	each	68.28
BCI3311	3301 handheld pulse oximeter 5' extension cable	each	75.12



Nellcor™ SpO₂ Sensors (Medtronic/Covidien)

- Sterile, single-patient use sensors for neonates, pediatrics and adults
- Tear-resistant bandages for durability
- Compatible with current Nellcor pulse oximeters with OxiMax™ technology and previous generations

D-25	Nellcor Oxisensor II SpO2 sensor, disposable adult	each	20.37
D-20	Nellcor Oxisensor II SpO2 sensor, disposable pediatric	each	20.37
I-20	Nellcor Oxisensor II SpO2 sensor, disposable infant	each	34.42
DS-100A	Nellcor Durasensor SpO2 finger clip senso , reusable, adult	each	500.00



Rainbow® Sensor (Masimo)

- Sensor is for use with Rainbow® devices with SpHb, SpMet and SpO2

MA2053	Red DCI-dc3 adult reusable direct connect SpO2 sensor, 3'	each	215.38
--------	-----------------------------------------------------------	------	--------



LNCS Sensors and Patient Cables (Masimo)

MA2320	LNCS NEO-L adhesive disposable sensors, neonatal, 3'	20/box	400.00
MA1860	LNCS Amtx pediatric SpO2 adhesive sensor, 18"	each	16.92
MA1861	LNCS Infant-L infant SPO2 adhesive sensor, 18"	each	19.23
MA2055	Red LNC-04 LNCS 20-pin SpO2 patient cable, 4'	each	196.92
MA2056	Red LNC-10 LNCS 20-pin SpO2 patient cable, 10'	each	275.00
MA2017	LNC-4 LNCS patient cable, 4'	each	175.00
MA1814	LNC-10 LNCS patient cable, 10'	each	245.00





Flexi-Form® III Disposable SpO₂ Sensors (Nonin)

Provides ultimate comfort and secure placement in extended monitoring situations. Provides patient comfort and is conformable to the application site.

- **7000A Adult Patient range** - > 30 kg 66 lbs ; preferred application - index, middle or ring fingers
- **7000P Pediatric Patient range** - > 10 kg 22 lbs ; preferred application - index, middle or ring fingers
- **7000I Infant Patient range** - 2 kg - 20 kg 4.4 lbs - 44

NO7000A	Flexi-Form III disposable SpO ₂ sensor, adult	24/box	360.00
NO7000A-EA	Flexi-Form III disposable SpO ₂ sensor, adult	each	17.70
NO7000P	Flexi-Form III disposable SpO ₂ sensor, pediatric	24/box	428.00
NO7000P-EACH	Flexi-Form III disposable SpO ₂ sensor, pediatric	each	17.85
NO7000I	Flexi-Form III disposable SpO ₂ sensor, infant	24/box	430.00
NO7000I-EACH	Flexi-Form III disposable SpO ₂ sensor, infant	each	19.50
NO7000N	Flexi-Form III disposable SpO ₂ sensor, neonate	24/box	360.00



Disposable SpO₂ Sensors (Sensoronics)

Compatible disposable SpO₂ sensors are suitable for single patient use. The ideal application site is the index finger, thumb or great toe.

SESFN-NCR-18P	Nellcor-compatible disposable SpO ₂ sensor, pediatric	24/case	223.08
SESFN-NON-18P	Nonin-compatible disposable SpO ₂ sensor, pediatric	24/case	223.08



Oximetry Sensors (BCI)

BCI1300	Oximetry sensor, disposable adult finger	10/box	25.58
BCI1301	Oximetry sensor, disposable pediatric finger	each	18.44
BCI1303	Oximetry sensor, disposable infant finger	10/box	18.44
BCI3025	Oximetry sensor, reusable infant wrap	each	236.84



PureLight® Reusable Finger Clip SpO₂ Sensors (Nonin)

- For spot-checking and short-term monitoring Comfortable, self-aligning grip Durable and easy to clean

NO8000AA-1	PureLight reusable finger clip SpO ₂ senso , adult, 1 meter	each	231.00
NO8000AA-2	PureLight reusable finger clip SpO ₂ senso , adult, 2 meter	each	272.00
NO8000AA-3	PureLight reusable finger clip SpO ₂ senso , adult, 3 meter	each	252.00
NO8000AP	PureLight reusable finger clip SpO ₂ senso , pediatric, 1 meter	each	231.00
NO8000AP-3	PureLight reusable finger clip SpO ₂ senso , pediatric, 3 meter	each	252.00

Reusable Oximetry Finger Sensors (Sensoronics)

These reusable SpO2 sensors are compatible with the following oximeters.

- BCI-3401, 3304, 3303, 3302, 3301, 3300; Spacelabs Burdick-PRO2; Dräger-Oxipac 2000
- Nellcor®-N100 (req. preamp cable), N180, N200 (req. preamp cable), N-20, NPB-40, NPB-75, NPB-290/ 5, N-390, N-395, N-3000, N-6000
- Nonin-8500, 8600, 8700, 8800



SESRP-BCI-3A	Reusable finger clip oximetry sensor, BCI, adult, 3'	each	84.62
SESRP-MALNC-3A	Reusable finger clip oximetry sensor, LNCS, adult, 3'	each	84.62
SESRP-NCR-3A	Reusable finger clip oximetry sensor, Nellcor, adult, 3'	each	84.62
SESRP-NCR-9A	Reusable finger clip oximetry sensor, Nellcor, adult, 9'	each	84.62
SESRP-NON-3A	Reusable finger clip oximetry sensor, Nonin, adult, 3'	each	84.62
SESB-BCI-3A	Reusable soft silicone oximetry sensor, BCI, adult, 3'	each	92.31
SESB-BCI-3P	Reusable soft silicone oximetry sensor, BCI, pediatric, 3'	each	92.31
SESB-NON-3P	Reusable soft silicone oximetry sensor, Nonin, pediatric, 3'	each	92.31

Diagnostic Equipment ■ Thermometry

Adtemp™ 419 Hypothermia Thermometer (ADC)

- Extended range 78.0°F - 111.9°F ±.2°F or 25.5°C - 44.3°C ±.1°C
- Replaceable 1.55v (LR41) type battery provides up to 1,500 measurements
- Clear two-piece plastic storage case
- Oral, rectal, ancillary



ADC419	Adtemp 419 hypothermia thermometer	each	9.99
ADC416-100	Adtemp digital disposable sheaths	100/box	4.63

Adtemp™ 421 Digital Ear Thermometer (ADC)

- Range 89.6°F-108°F ± .4°F or 32°C-42.2°C ± .2°C depending on scale selection
- Probe cover FREE design is less costly and more convenient to use
- Compact ergonomic design fits comfortably in operator's hand and patient's ear
- Audible fever alarm at 99.5°F (37.5°C)
- 12 reading memory
- Complete with lithium battery, storage/travel case and operating instructions



ADC421	Adtemp 421 digital ear thermometer	each	40.00
--------	------------------------------------	------	-------

Adtemp™ 10-Second Digital Thermometer (ADC)

- 18-second oral, 10-second rectal temperature measurement
- Range 90°F - 109.9°F ±.2°F or 32°C - 43.2°C ±.1°C depending upon scale selection
- Replaceable 1.55v (LR41) type battery provides up to 1,500 measurements
- Includes five probe sheaths
- Clear plastic scabbard storage case



ADC415	Adtemp IV 415 digital thermometer	each	8.33
ADC416-100	Adtemp digital disposable sheaths	100/box	4.63



Adtemp™ 413 30-40 Second Digital Thermometer (ADC)

- Compact size - under 5" long, weighs just 11 grams
- Range 90°F-109.9°F ±.2°F
- Reads in as little as 30 seconds (typical response time 30-40 seconds)
- Replaceable 1.55v (LR41) type battery provides up to 1,500 measurements
- Scabbard carry case keeps instrument sanitary

ADC413	Adtemp 413 30-40 second digital thermometer	each	6.48
--------	---------------------------------------------	------	------



Adtemp™ 424 Infrared Tympanic Ear Thermometer (ADC)

Easy to use Tympanic thermometer measures core temperature instantly. Convenient, economical probe covers make it the ideal instrument for use on all types of patients.

- Multiple use (wide range 89.6°F - 108°F +/- .4°F(32°C - 42.2°C +/- .2°C)
- °F/°C switchable display
- Fever alarm at 99.5°F (37.5°C)
- Last reading memory
- Compact design - 5½" long, weighs 1.6oz. including battery
- Powered by 1.55v (CR2032) Lithium battery (included)
- Includes 20 probe covers in convenient dispenser
- Desktop storage caddy

ADC424	Adtemp 424 infrared ear thermometer	each	41.75
ADC425-40	Adtemp tympanic sheaths	40/pkg	5.01



Adtemp™ 427 Temple Touch Thermometer (ADC)

- Non-invasive temple temperature measurement using patented conductive technology delivers clinically accurate readings in about six seconds
- Auto off function conserves battery life
- Last reading memory
- Dual scale (°F/°C)
- Water resistant
- Uses two "AAA" batteries (included)
- Temp range 95°F to 107.6°F +/- .2°F (35°C to 42°C +/- .1°C)**
- Compact design measures just 4.7" x 1.17" x 1"
- Weighs 1.3oz including batteries

ADC427	Adtemp 427 temple touch thermometer	each	14.41
--------	-------------------------------------	------	-------



Temporal Scanner (Exegen)

- Soft-Glow display
- Eight temperature memory
- Silent mode
- Fahrenheit or Celsius mode

124275	Temporal scanner	each	710.00
--------	------------------	------	--------

SureTemp® Plus 690 Electronic Thermometer (Welch Allyn)

- Prominent recall button for display of last temperature taken
- Battery life indicator
- Removable probe well for easy cleaning
- Convenient storage for 25 probe covers
- Mode selection button for selecting oral, pediatric axillary or adult axillary
- Interchangeable probe with push-button probe cover ejection

WA01690-200	SureTemp Plus 690 electronic thermometer, 4' cord and oral probe with oral probe well	each	297.00
WA01690-400	SureTemp Plus 690 electronic thermometer, wall mount, 4' cord and oral probe with oral probe well	each	311.00
WA02893-000	SureTemp Plus 690 thermometer probe and well kit, 4', oral	each	89.00
WA02892-000	SureTemp Plus 690 thermometer probe and well kit, 4', rectal	each	89.00
WA05031-750	SureTemp Plus 690 probe covers	250/box	12.83
WA21326-0000	SureTemp Plus 690 wall mount	each	41.50



Filac™ 3000EZ Electronic Thermometer (Medtronic/Covidien)

The Filac 3000EZ electronic thermometer features an easy-to-use, intuitive icon-based user interface, easy-to-read LCD display with backlight as well as a durable, robust design.

KE504000	Filac 3000EZ electronic thermometer	each	230.77
KE500036	Filac 3000EZ rectal probes, 4'	each	100.00
KE502000	Filac 3000EZ probe covers	25/box	24.00
KE5000038	Rilac 3000EZ rectal isolation chamber	each	19.69
KE500046	Filac 3000EZ wall mount base with lock	each	30.00



Deluxe Digital Thermometer (Mabis)

- Peak temperature tone
- Memory recall of last reading
- Auto shut-off
- Fast, 60-second readout
- Clinical accuracy to 2/10 th of a degree
- Waterproof for easy cleaning

S3606	Deluxe digital oral thermometer	each	6.14
S3607	Thermometer sheaths, disposable	100/box	4.18



Digital Pacifier Thermometer with Musical Fever Alarm (Mabis)

- Soothing "Twinkle, Twinkle, Little Star" lullaby fever alarm
- Waterproof
- Memory recall of last reading
- Non-replaceable battery sealed for safety
- Fast 90-second readout
- Orthodontic nipple
- Automatic shut-off

MA15-690-000	Digital pacifier the mometer with musical fever alarm	each	8.48
--------------	-------------------------------------------------------	------	------





RediScan™ Infrared Thermometer with Digital Readout (Mabis)

The RediScan is easy-to-use with a professionally accurate, one-second-readout and a Nite-Glo® feature that backlights the display. A fever alarm sounds instantly if the temperature is above normal, and a 10-reading memory recall allows the user to track the progress of the temperature. Includes a convenient storage bag, English and Spanish detailed guidebook, 2 AAA batteries and a 5-year limited warranty.

MA18-535-000	RediScan infrared thermometer with digital readout	each	93.98
--------------	----------------------------------------------------	------	-------



ZooTemps™ Digital 20-Second Thermometers (Mabis)

This 5-pack of thermometers includes a protective half storage case, replaceable LR41 battery and 5 probe covers

- Soft, flexible tip
- Large display
- Low battery indicator
- Automatic shut-off
- F/C switchable
- Peak temperature tone
- Memory recall of last reading
- Water resistant
- Fever alarm sounds at 99.5°F
- 5-year limited warranty

MA15-705-000	Zoo Temp digital thermometer	each	8.46
--------------	------------------------------	------	------



Temp Assure Disposable Forehead Thermometer (Medline)

DVPTA105	Temp Assure disposable forehead thermometer	100/box	117.16
----------	---------------------------------------------	---------	--------



Otoscope and Ophthalmoscope (ADC)

Available as otoscope/ophthalmoscope set (ADC5110) or otoscope (ADC5111). Includes hard carry case.

- Fiber optics for cool, obstruction-free light transmission
- 2.5v Xenon lamp for true tissue color
- Wide angle swivel 2.5x viewing lens permits instrumentation
- Insufflator port (fitting and insufflator sold separately) for pneumatic otoscopy

ADC5182	Otoscope specula, disposable, 2.75 mm	850/box	45.34
ADC5185	Otoscope specula, disposable, 4.25 mm	850/box	45.34
ADC5110	Otoscope/Ophthalmoscope set	each	283.23
ADC5111	Otoscope pocket set	each	140.58

Financing available to all qualified users.

Ambulances and Rescue Trucks



Remounts



Defibrillators and Monitors



EMS Equipment



MCI, Rehab and Mortuary Trailers



Portable Buildings, Shelters and Coolers



- Lower financed rates
- No down payment
- Deferred first payment available
- Terms from 1 to 7 years
- Monthly, quarterly, semi-annually and annually

For more information or to request a credit application, please call



(800) 334-6656



(866) 640-2028



Menu

ACS (Chest Pain)

STEMI

Nitroglycerin

Nitroglycerin 2nd

Morphine

Healthy

00:10

Current state (00:10)

100 %

Sinus



HR

80

SpO2

98

RR

12

BP

120/80
(93)

Temp.

37.2

Simulation started, theme...

END



Training and Education

AED Trainers



pages 92-95

SimPad Products



pages 96-100

Simulation (QCPR)



pages 100-103

Simulation (Manikins)



pages 104-108

Simulation (Moulage) Simulation Accessories



pages 109-110



page 110

Airway Training



pages 111-114

IV Training



pages 115-116

IO Training



page 117

Birth Training



page 118

CPR Training



page 118

Specialty Training



pages 119-120

Books and References



pages 121-123

Southeastern Emergency Training



pages 124-125



AED Trainer 3
Item 861467-OPTA01



HeartStart FR3 Training Pack
Item 989803150191

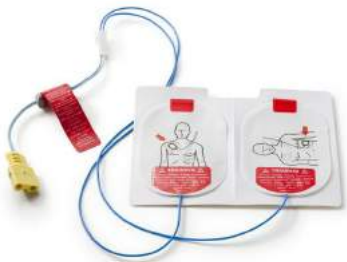

AED Trainer 3 Replacement Training Pads III and Interconnect Cable
Items 989803150181 (Pads III) and 989803150201 (Cable)



HeartStart FR3 Battery Charger
Item 861394



AED Trainer 3 Remote Control
Item 989803171631

AED Trainer 3 (Philips)

Designed to help prepare emergency responders to use the HeartStart FR3 and other AEDs. Together with appropriate manikins and other training tools, the AED Trainer 3 is intended to help provide realistic training on delivering correct treatment, including shock delivery and CPR, to a cardiac arrest victim.

The AED Trainer 3 guides you through each step of the training scenario with the same voice prompts as the FR3 AED. Like the FR3 AED, the AED Trainer 3 configuration can be customized and its operation easily updated.

- Provides 8 training scenarios that simulate realistic episodes of SCA and help responders become familiar with use of the FR3.
- Like the HeartStart FR3 AED, the AED Trainer 3 can be prepared with its training pads pre-connected and out of their packaging, ready for fast deployment.
- Includes Training Pads III and a reusable interconnect cable. There's no need to change the pads for children. The AED Trainer 3 comes with a Training Infant/Child Key to replicate the infant/child mode of the FR3 AED.

861467-OPTA01	AED Trainer 3	each	451.00
989803150191	FR3 Training Pack provides 4 simulation scenarios and includes training battery, set of Replacement Training Pads III, interconnect cable for Replacement Training Pads III and an external manikin adapter	each	305.00
989803150181	Replacement Training Pads III (requires Interconnect cable 989803150201 and typically provides 100 uses)	pair	26.00
989803150201	Interconnect cable for Training Pads III	each	19.00
861394	FR3 training battery charger	each	310.00
989803171631	Remote control for AED Trainer 3	each	48.00



HeartStart FRx Trainer (Philips)

Empower your students by teaching them how to use the HeartStart FRx Defibrillator to help save lives. The HeartStart FRx Trainer simulates how the HeartStart FRx Defibrillator will operate during a real-life cardiac arrest event. Clear, confident voice instructions and pre-configured rescue scenarios make training students easier and more rewarding. Voice instructions match those of the HeartStart FRx Defibrillator.

- Works with internal and external pads adapters, allowing the instructor to provide some or no clues toward pad placement, resulting in the most realistic training scenario.
- Resembles the HeartStart FRx Defibrillator, yet is sufficiently different to avoid inadvertent use in an actual emergency.
- Accepts Infant/Child Key for pediatric defibrillation training.
- CPR coaching helps train students in adult and infant/child CPR.
- Uses four standard "AA" batteries (not included), allowing you to manage training costs.

861306	HeartStart FRx Trainer includes nylon carrying case, one set of reusable adult training pads and one external manikin adapter strip	each	369.00
989803139271	HeartStart FRx training pads, complete (pads case and pads)	each	84.00
M5090A	HeartStart adult pads placement guide ("Flat Man")	each	29.00
989803139281	HeartStart infant/child pads placement guide ("Flat Kid")	each	29.00
989803139291	HeartStart FRx replacement training pads (pads only, no pads case)	each	28.77
989803139321	HeartStart FRx training toolkit includes CD and DVD with PowerPoint Presentation and video on how to operate and maintain the HeartStart FRx	each	34.00
M5088A	Internal manikin adapter	each	34.00
M5089A	External manikin adapters	5/pkg	58.00
T1950	"AA" battery	each	0.52



HeartStart FRx Trainer
Item 861306



HeartStart FRx Training Pads
Item 989803139271



HeartStart Adult Pads Placement Guide ("Flat Man")
Item M5090A



HeartStart FRx Training Toolkit
Item 989803139321



**Led by...Dedicated to...
We are EMS and Fire.**

HeartStart OnSite (HS1) Trainer (Philips)

The HeartStart OnSite Trainer simulates how the HeartStart OnSite Defibrillator will operate during a real-life cardiac arrest event.

- Clear, confident voice instructions and preconfigured scenarios make training students easier and more rewarding.
- Voice instructions match those of the HeartStart OnSite Defibrillator.
- Works with internal and external pads adapters, allowing the instructor to provide some or no clues toward pad placement.
- Resembles the HeartStart OnSite Defibrillator, yet is sufficiently different to avoid inadvertent use in an actual emergency.
- Uses four standard "AA" batteries (not included).



HeartStart OnSite Trainer
Item M5085A



HeartStart OnSite Adult Pads Placement Guide
Item M5090A



External Manikin Adaptor
Item M5089A

M5085A	HeartStart OnSite trainer includes nylon carrying case, one set of reusable adult training pads and one external manikin adaptor strip	each	358.00
M5073A	HeartStart OnSite adult training pads with cartridge	each	84.00
M5093A	HeartStart OnSite adult training pads, no cartridge	each	34.00
M5090A	HeartStart OnSite adult pads placement guide ("Flat Man")	each	29.00
M5074A	HeartStart OnSite infant/child training pads with cartridge	each	91.00
M5094A	HeartStart-OnSite infant/child training pads, no cartridge	each	34.00
989803139281	HeartStart OnSite infant/child pads placement guide ("Flat Kid")	each	29.00
M5066-89100	HeartStart OnSite training toolkit includes CD and DVD with PowerPoint presentation and video	each	34.00
M5088A	Internal manikin adapter	each	34.00
M5089A	External manikin adapters	5/pkg	58.00
T1950	"AA" battery	each	0.52

The Southeastern Emergency Medicine Training & Education Center

Our Training & Education Center is located on the same campus as our headquarters in Youngsville, NC (just north of Raleigh). It features the latest in AV technology to ensure courses are presented in a professional and academically sound environment.

The Center is equipped with a vast array of emergency supplies and equipment as well as cutting-edge patient simulators and support materials that ensure participants train in a real-world environment.

- Philips Healthcare MRx monitors/defibrillators
- Philips Healthcare AEDs
- Laerdal Patient Simulators
- Laerdal-supported CPR feedback devices
- Stryker stretchers
- Fully-stocked hospital-style crash carts
- Emergency responder bags and accessories
- Ambulances (if needed for training purposes)



Philips MRx



Laerdal SimPad

For more information on our full array of training and education services, see pages 124-125.



LA185-10050



LA198-80150

ShockLink™ (Laerdal)

ShockLink is a compact solution for standardized CPR-D training that enables users to adapt their own AED or advanced defibrillator for use as a training tool in a realistic and controlled environment. ShockLink allows you to use adhesive training pads on your manikins and simulates multiple shockable rhythms, but when used with Resusci Anne QCPR AED and SimPad SkillReporter, it becomes part of an integrated platform for high-performance CPR teams training. When used with Resusci Anne QCPR AED and SimPad SkillReporter, heart rhythms and shocks delivered are automatically captured in the screen for future analysis and debriefing.

- Adult defibrillation (up to 360 J)
- Child/infant defibrillation (from 10 J)
- Measure defibrillation energy and pacing
- ECG library when used with remote control
 - Sinus Rhythm -VF
 - VT Slow -PEA
 - VT Fast -Asystole
 - SVT -Bradycardia

LA185-10050	ShockLink system includes ShockLink device, defibrillator training pads for ShockLink, remote control, ShockLink pouch and user guide	each	795.00
LA198-80150	Defibrillator training pads for ShockLink	each	26.50



AED Practi-Trainer (WNL Products)

This AED training unit includes a replaceable scenario/language module. When ECC guidelines are updated, you only need to upgrade your plug-in module - no need to buy an entirely new unit or send it out for re-programming. Includes one complete unit with 8 English and Spanish pre-programmed scenarios, remote control, 1 set of child pads and connector, 1 set of adult pads and connector, manual and carry case.

- Uses 3 AA batteries (not included) or A/C adapter (you provide)
- 1 year warranty

WNLWL220E505	AED Practi-Trainer	each	149.94
WNLXFTAP	AED Practi-Trainer training pads	pair	7.95
T1950	"AA" battery	each	0.52



Basic Buddy® AED Training Package (Nasco)

Includes the LifePak™ CR Plus AED Trainer plus a Basic Buddy™ manikin. Only use AED training pads designed for foam body manikins.

LF03734U	Basic Buddy AED Training Package	each	575.00
----------	----------------------------------	------	--------



SimPad® Plus System (Laerdal)

SimPad PLUS is an operating device used to control Laerdal manikins and simulators and can be used with task trainers and standardised patients. It allows instructors, new or experienced, to deliver highly-effective simulation-based training.

The SimPad Plus system includes:

- SimPad PLUS device, link box and handheld remote control
- Lithium ion battery, AC adapter and power cord
- USB and Ethernet cables
- Wrist strap and protective sleeve
- Nametags, manikin strap, headset, microphone and quick start guide

NOTE: LLEAP for SimPad PLUS Software (LA204-50150) is required for use.

LA204-30001	SymPad Plus system	each	1,530.00
LA204-50150	LLEAP software for SimPad Plus license	each	2,550.00
LA200-30350	Lithium-ion battery for SimPad Plus	each	295.00
LA204-30001PP	SimPad Plus protection plan	each	864.00

SimPad Plus with SkillReporter (Laerdal)

The new SimPad Plus with SkillReporter includes the same easy setup and intuitive operation as the discontinued SimPad SkillReporter, plus faster startup time and Bluetooth connectivity.

SimPad Plus with SkillReporter facilitates real-time feedback, records data, and calculates overall performance for thorough training and debrief on CPR performance. Users can connect to multiple manikins (up to 6) with either the available Multi-Manikin Router or new Bluetooth connection. Includes:

- SimPad Plus device with activated SkillReporter software
- AC power supply (power and charger)
- Rechargeable lithium-ion battery
- SimPad Plus sleeve (protective case for SimPad Plus)
- USB cable – attaches SimPad Plus to PC for updates and downloads
- Wrist strap for SimPad Plus
- User guide

NOTE: SimPad SkillReporter (LA202-30001) has been discontinued. Service and software support for this product will be available until November 2021.

LA206-30001	SimPad Plus with SkillReporter	each	1,750.00
LA202-40050	Multi-manikin router for SimPad Plus with SkillReporter	each	231.00
LA202-40100	Stand for SimPad	each	42.00
LA30002PP	SimPad Protection Plan renewal, 2-year extension	each	912.00
LA204-30001PP	SimPad Plus Protection Plan	each	864.00



SimMan® ALS (SimPad Plus and SimPad Capable) (Laerdal)

SimMan ALS is a mobile, durable solution that will meet the training needs of pre-hospital and in-hospital emergency care providers. SimMan ALS can be used for the complete training of the American Heart Association (AHA) Advanced Cardiac Life Support (ACLS) Course as well as a wide range of skills from basic assessment to critical care. SimMan ALS can be operated via a LLEAP- Laerdal Learning Application PC or the SimPad PLUS remote along with a simulated patient monitor. SimMan ALS features:



- Wireless, rugged, and self-contained design with internal compressor allowing training to take place in clinically relevant environments
- QCPR measurement and scoring that complies with 2010 / 2015 CPR guidelines
- Accurate pad placement for defibrillation and cardioversion with live shock
- Difficult airway management including surgical and needle cricothyrotomy, airway resistance, and airway complications such as tongue edema. Airway allows for use of ET tube, Combitube, LMA, I-gel and other airway placement devices
- Breathing assessment with bilateral and unilateral chest rise as well as normal and abnormal breath sounds with anterior and posterior auscultation sites
- Fluid resuscitation via intraosseous access (tibia) and pre-ported IV access
- Optional diagnostic ultrasound training using the Laerdal- SonoSim Ultrasound solution

For more information on this product, please contact your Southeastern District Sales Manager or call (800) 334-6656.

MegaCode Kelly Advanced (SimPad Plus and SimPad Capable)

(Laerdal)

The advanced life support manikin for realistic training focusing on a wide variety of advanced lifesaving skills for pre-hospital emergencies from advanced airway scenarios to IV therapy. MegaCode Kelly with SimPad allows cardiac defibrillation, pacing and ECG interpretation of over 1400 rhythm variations. This flexible manikin platform, complete with scenario based simulation curriculum provides a wide range of multiple accessory modules to accommodate training, including CPR, ACLS, NBC, trauma, bleeding control and first aid. Integrate pre-programmed simulation content designed to provide students with realistic scenario-based clinical training focusing on specific learning objectives geared toward patient assessment, patient diagnosis, interventions and management of care to improve to student’s critical thinking and decision making skills.



- Airway/Intubation Trainer—obstructed airway, endotracheal, nasotracheal intubation, ventilation, surgical and needle cricothyrotomy, suctioning techniques, stomach auscultation
- Cardiac-Related Skills—cardiac rhythm variations, manual chest compressions, pacing, defibrillation and synchronized cardioversion
- Circulatory Skills and IV Drug Administration—bilateral carotid pulse, brachial and radial pulses, blood pressure, IV cannulation, venipuncture, subcutaneous and intramuscular injections, tension pneumothorax decompression
- Trauma module set—trauma head, avulsed ear, avulsed eye, lacerations, impaled object and face contusions. abdominal wound and clavicle fracture lay-on. Crushed foot with exposed bone and soft tissue amputation

LA200-05050	MegaCode Kelly Advanced	each	8,670.00
LA200-05050B	MegaCode Kelly Advanced, brown skin	each	8,500.00



MegaCode Kid Advanced (SimPad Plus and SimPad Capable)

(Laerdal)

MegaCode Kid is a realistic manikin for training in a wide range of pediatric advanced life saving skills in pre-hospital emergencies. MegaCode Kid operated via the SimPad System will improve your ability to deliver highly effective simulation based training and achieve your learning objectives. MegaCode Kid features:

- Realistic airway for insertion of standard airway devices
- Intravenous drug administration via IV bolus or drip using the multi-venous pediatric IV arm
- Realistic needle insertion and feel at the medial malleolus and tibial tuberosity for intraosseous infusion

LA231-05050	MegaCode Kid Advanced (SimPad Plus and SimPad capable)	each	5,550.00
LA231-15050	ECG Kid (SimPad ECG capabilities only)	each	3,200.00
LA231-01150	MegaCode Kid soft carry case	each	156.00



Nursing Kelly (SimPad Plus and SimPad Capable) (Laerdal)

A full-body adult manikin designed for scenario-based training for a wide variety of basic to advanced patient care and management skills. Coupled with the SimPad system, training can be delivered efficiently and effectively and for the best possible educational experience. Nursing Kelly is educationally effective for clinical training from basic to advanced patient care and management skills. This flexible manikin platform allows multiple accessory modules to be added including wound assessment and treatment and NBC module. Includes:

- Head with anatomical landmarks, trachea, and esophagus, along with simulated lungs and stomach, allowing the practice of trach care, NG tube insertion, and gastric lavage/gavage
- IV training arms allow peripheral intravenous therapy and site care as well as subcutaneous and intramuscular injection sites
- Practice of standard patient assessment techniques such blood pressure auscultation and palpation
- Interchangeable stoma sites depict colostomy, ileostomy and suprapubic cystostomy

LA30005050	Nursing Kelly (SimPad Plus and SimPad capable)	each	4,970.00
LA276-15001	Simulated NBC (nuclear, biological, chemical) module	each	1,420.00
LA381500	Trauma module set	each	2,250.00
LA381450	Nursing wound module set	each	2,250.00



SAVE TIME BY ORDERING ONLINE
Store.Seequip.com

Nursing Anne (SimPad Plus and SimPad Capable) (Laerdal)

Nursing Anne is a SimPad Plus-capable manikin designed for scenario-based training for the care and management of basic patient handling skills to advanced nursing skills. This flexible manikin platform allows multiple accessory modules to be added for practice of wound care, fundus skills and assessment, breast exam and mastectomy care. Nursing Anne operated via the SimPad Plus System will improve your ability to deliver highly effective simulation based training and achieve your learning objectives. Nursing Anne allows for:



- NG tube insertion care, medication administration and removal; gastric lavage and gavage.
- Articulating IV training arm allows peripheral intravenous therapy with IV bolus or push injection.
- Venipuncture possible in the antecubital fossa or dorsum of the hand.
- Interchangeable genitalia with connectors and urinary and colon reservoirs facilitate urologic care procedures and gastrointestinal procedures.

LA325-05050	Nursing Anne manikin	each	5,150.00
LA325-05050B	Nursing Anne manikin, brown skin	each	5,150.00
LA325-05050T	Nursing Anne manikin, tan skin	each	5,150.00
LA325-00750	Nursing Anne breast exam module	each	735.00
LA325-00450	Nursing Anne fundus skills and assessment module	each	529.00
LA325-00650	Nursing Anne mastectomy module	each	529.00
LA325-00550	Nursing Anne wound care assessment set	each	2,046.00

Nursing Kid (SimPad Plus and SimPad Capable) (Laerdal)

Realistically representing a six-year-old child, Nursing Kid is designed for skill and scenario-based training of the care and management of a variety of pediatric patients. This child is ideal for clinical training of common and uncommon in-hospital pediatric patients including wound assessment and care, first aid, and child abuse training. Nursing Kid operated via the SimPad Plus System provides training targeting key skills specific to pediatric care providers. Nursing Kid allows for:



- Auscultation and recognition of normal and abnormal heart and breath sounds
- Basic to advanced nursing techniques including intubation, venous cannulation, catheterization
- Realistic NG tube insertion, care, removal and medication administration

LA350-05050	Nursing Kid manikin	each	2,870.00
LA350-05050B	Nursing Kid manikin, brown skin	each	2,810.00

Nursing Baby (SimPad Plus and SimPad Capable) (Laerdal)

Nursing Baby is a full-size infant manikin that realistically simulates a 6-month old patient. It is specifically designed for training professionals in the practice of basic and advanced infant patient care procedures. Nursing Baby features:

- Patient care skills such as tracheostomy care and suctioning (oral and nasal), NG and OG tube insertion
- Intraosseous puncture and infusion as well as intramuscular injection site identification
- Variable fontanelles simulating normal, bulging and depressed



LA365-05050	Nursing Baby (SimPad Plus and SimPad capable)	each	2,805.00
-------------	-----------------------------------------------	------	----------



SimPad® Touchscreen Simulated Patient Monitor (Laerdal)

When used with the SimPad Plus or SimPad System, this 23" touchscreen panel simulates heart rate, SpO₂, blood pressure, respiratory rate, temperature, ECG and etCO₂. Use it with:

- ALS Simulator
- Nursing Kid
- Nursing Baby
- Resusci Anne Advanced SkillTrainer with SimPad
- MegaCode Kelly
- Nursing Anne
- Nursing Kelly
- MegaCode Kid
- Resusci Anne Simulator with SimPad
- SimMan ALS

LA400-29301	SimPad simulated touchscreen 23" patient monitor	each	3,155.00
LA200-11950	SimPad Patient Monitor software license	each	1,117.00



Resusci Anne® QCPR® (Laerdal)

The Resusci Anne QCPR is an adult CPR training manikin now improved for multiple feedback options that provide opportunity to focus on student competency. Measurement, assessment and quality feedback are key factors in developing competency. Resusci Anne QCPR works with SimPad® SkillReporter™, SkillGuide and Resusci Anne Wireless SkillReporter Software (PC) feedback devices (not included).

- Realistic anatomy including head tilt, chin lift, compression depth, compression force and chest rise
- Sensor indicates correct hand placement
- Ventilation system provides appropriate chest rise with BMV (Bag Valve Mask) and MTM (Mouth to Mouth)
- Enhanced measurement and feedback capabilities
- Wireless connectivity with SimPad SkillReporter or Resusci Anne Wireless SkillReporter software
- Wired connectivity with SkillGuide or SimPad SkillReporter
- Guidelines compliant

LA171-00150	Resusci Anne QCPR, torso with carry case	each	1,550.00
LA172-01250	Resusci Anne QCPR with airway head, full body with trolley suitcase	each	2,629.00
LA318003	Resusci Anne wireless skill reporter software only	each	1,090.00
LA170-30050	SkillGuide	each	63.00



Quality CPR Saves Lives

There are many factors that contribute to survival from a sudden cardiac arrest, but none as powerful as receiving quality CPR*. The Resusci Anne[®] QCPR manikin provides learners the ability to accurately assess their performance real-time or in debriefing to maximize their psychomotor skills for improved CPR competence. By incorporating a ShockLink[™] System for defibrillation training, learners can easily integrate most defibrillators into a realistic and controlled training environment.

To learn more about Laerdal's complete line of CPR training solutions, contact your Southeastern representative at (800) 334-6656 or visit store.seequip.com



Resusci Anne[®] QCPR

ShockLink[™]
Compatible AED

ShockLink[™] System



Resusci® Baby QCPR® (Laerdal)

The Resusci Baby QCPR is an infant CPR training manikin now improved for multiple feedback options that provide opportunity to focus on student competency. Measurement, assessment and quality feedback are key factors in developing competency. Resusci Baby with QCPR manikin provides thorough and realistic CPR training.

Enhanced measurement of compressions and ventilations allows for comprehensive and accurate guidance. Detailed feedback and debriefing functionalities enables students to learn and improve CPR performance better than ever before. Resusci Baby QCPR works with following feedback devices (sold separately).

- SimPad® SkillReporter™
- SkillGuide

Many other configurations of Resusci Baby QCPR are available. Contact your Southeastern District Sales Manager or call (800) 334-6656.

LA161-01250	Resusci Baby QCPR with suitcase	each	920.00
LA202-30001	SimPad SkillReporter	each	1,620.00
LA202-50050	SimPad SkillReporter software	each	1,040.00
LA170-30050	SkillGuide	each	63.00

SkillGuide(Laerdal)



The new SkillGuide for the QCPR manikins enhances the ability to measure, track and improve your CPR skills. Small, portable and light weight, **it is compatible with Resusci Anne with QCPR and Resusci Baby with QCPR.**

LA170-30050	SkillGuide	each	63.00
-------------	------------	------	-------

Resusci Anne Simulator with SimPad (Laerdal)

The Resusci Anne Simulator with SimPad has been designed for the unique training needs of emergency care in both pre-hospital and in-hospital environments. The SimPad System will work wirelessly via Wi-Fi with Resusci Anne Simulator transforming the simulation exercise into a mobile and dynamic learning experience enabling learning opportunities to evolve in real time. SimPad sold separately.

- High quality airway management with a BVM and supraglottic airways
- Spontaneous breathing
- ECG and live defibrillation
- IV
- Blood pressure
- Voice, lung and heart sounds for basic simulation training
- Quality QCPR feedback on the SimPad Plus or SimPad

LA150-20001	Resusci Anne Simulator with SimPad	each	11,875.00
LA200-30150	SimPad only	each	3,200.00



Resusci Anne Advanced SkillTrainer with SimPad (Laerdal)

By combining the functionality of the Resusci Anne Advanced SkillTrainer with the SimPad System, instructors and trainers have the ability to offer a more comprehensive, high quality, cost-effective simulation-based training program focusing on advanced skills practice. The anatomically realistic airway allows training in basic to intermediate airway management. With the SimPad remote control with Q-CPR feedback, instructors can monitor, assess and debrief students easily and efficiently. The touch screen remote control allows for flexibility in simulation based training to maximize overall learning objectives. SimPAD sold separately.



LA151-20089	Resusci Anne Advanced SkillTrainer	each	6,855.00
LA200-30150	SimPad only	each	3,200.00

Resusci Anne® Wireless SkillReporter™ Software (Laerdal)

The Wireless SkillReporter and its easy-to-use software, Multi-Manikin Overview options and realtime performance feedback will help you train multiple students in their actual working environment. Can control up to six manikins via bluetooth. Manikin not included. Please order separately. PC not included.

- Real-time performance feedback on CPR Skills
- Software is compatible with Resusci Anne and Resusci Baby Q CPR manikins and Resusci Anne SkillReporter manikins
- Operating System requirements: Windows XP, Vista or Windows 7, Windows 8 (except the W8 RT Light version)



LA318000	Resusci Anne Wireless SkillReporter Complete includes software, wireless kit and bluetooth adapter (for SkillReporter manikins only)	each	1,150.00
LA318003	Resusci Anne wireless skill reporter software only	each	1,090.00
LA318001	Resusci Anne wireless skill reporter USB antenna for laptop	each	182.00

CPRmeter™ (Laerdal)

Using Laerdal's latest generation of Q-CPR technology, the CPRmeter records and documents CPR performance. This opportunity to debrief events objectively is essential to facilitate team improvement and establish best practice to help improve patient outcomes.

The opportunity for trained responders to immediately self-evaluate their CPR performance is both an empowering and motivating feature of the CPRmeter. This can help reassure that optimal CPR has been delivered or highlight areas for improvement for discussion during the de-brief. The provided MicroSD card can capture comprehensive CPR event statistics for in-depth evaluation and debriefing. A quick download into the Q-CPR Review software enables the user to:

- Create a graphical view of a CPR case for debriefing
- Create and print an individual CPR Report Card
- Compile CPR event statistics for multiple cases



LA801-00149	CPRmeter	each	895.00
LA801-10550	CPRmeter carry case	each	62.00
LA801-10850	CPRmeter patient adhesives	10 sets of 3	65.00
LA801-10650	CPRmeter reusable silicone cover kit	each	40.00



Little Anne® AED Training System (Laerdal)

The Little Anne AED Training System combines Little Anne AED manikin and your choice of AED Trainer (3 or 2). The Little Anne AED Training System offers all the essential features necessary for learning adult CPR, defibrillation and defibrillator pad placement.

- Anatomically correct landmarks and sternal notch allow the student to practice identification of all anatomical landmarks relevant to adult CPR and defibrillation.
- Natural obstruction of the airway allows students to learn the important technique of opening the airway as in a real-life situation. This teaches how to effectively administer air to the patient. Abdominal thrusts can also be practiced.
- The realistic airway function means that the airway remains obstructed without proper head tilt/chin lift or jaw thrust manoeuvres. Chest rise is seen with correct ventilations.
- Oral and nasal passages allow realistic nose pinch required for mouth-to-mouth ventilation.

For complete system, order Little Anne AED and either AED Trainer 3 or 2.

LA020060	Little Anne AED (Laerdal part number 122-01050)	each	637.50
861467-OPTA01	AED Trainer 3	each	451.00
M3752A	AED Trainer 2	each	341.00



Little Anne® CPR Training Manikin (Laerdal)

The Little Anne CPR training manikin has been enhanced to provide more realistic adult CPR training without compromising quality or usability. It is durable and designed for convenience making hands-on practice possible for every student.

- Realistic airway construction means that the airway naturally remains obstructed without the use of proper head tilt, chin lift or jaw thrust
- Little Anne's anatomically correct torso and sternal notch allow the student to practice identification of all anatomical landmarks relevant to conducting adult CPR
- Realistic oral and nasal passages allow for mouth-to-mouth ventilation.
- **Feedback devices can be used to conduct Q CPR training.**
- Due to the highly realistic chest movement and compression resistance feedback devices, such as the CPRmeter, can be used to enhance training and ensure real time feedback and quality debriefing is provided.
- Audible feedback reinforces correct compression depth. An optional "clicker" feature signals when the correct compression depth is achieved.

LA020024	Little Anne Four Pack	each	885.00
LA020029	Little Anne Four Pack, dark skin	each	885.00
LA02002001	Little Anne with soft pack/training mat	each	239.00
LA02002501	Little Anne with soft pack/training mat, dark skin	each	229.00
LA121-03050	Little Anne with dark skin, carry case	each	850.00
LA020300	Little Anne manikin airways	24/pkg	57.20
LA020301	Little Anne manikin lungs	96/pkg	216.00
LA310210	Little Anne manikin faces	6/pkg	61.20
LA15120103	Little Anne face shields	6 rolls	66.00
LA021000	Little Anne chest cover	each	69.70
LA020111	Little Anne compression clicker	each	36.40
LA020113	Little Anne manikin clicker activator	each	8.40

Little Family Pack of Manikins (Laerdal)

Designed to reflect the realistic anatomical differences among an adult, a child and an infant, the new Family Pack comes complete with one Little Anne, one Little Junior and one Baby Anne, all in their individual cases.



Little Anne Manikin

- Manikin
- Soft Pack training mat (1)
- Resusci manikin faces (2)
- Little Anne airways (2)
- Manikin wipes (6)
- Directions for use

Little Junior Manikin

- Manikin (1)
- Soft Pack training mat (1)
- Faces (2)
- Airways (2)
- Manikin wipes (6)
- Directions for use

Baby Anne

- Manikin (1)
- Soft Pack (1)
- Airways (6)
- Foreign body practice objects (10)
- Directions for use

LA02008001	Little Family Pack, Light Skin	each	556.00
LA02008501	Little Family Pack, Dark Skin	each	556.00

CPR Prompt® Training Manikins (Nasco)

Comprehensive design allows for practice of Heimlich maneuver and abdominal thrusts, as well as CPR and mouth-to-mouth breathing. Realistic anatomical markings (Adams apple, carotid arteries, navel, rib cage, chest notch) make it easy to learn correct hand placement for checking pulse, performing chest compressions, and more.



CPR Prompt 7-pack includes five adult/child manikins, two infant manikins, 50 adult/child face shield/lung bags, 20 infant face shield/lung bags and nylon carry case.

CPR Prompt 5-pack includes five manikins with age selector dial that adjusts chest compression piston for learning adult or child techniques. Each set is packed in a rugged nylon carrying case with a supply of 50 face-shield lung bags and an insertion tool.

Only use AED pads designed for foam body manikins.

LF06700U	CPR Prompt 7-pack training and practice manikins, 5 adult/child, 2 infants, blue	each	525.00
LF06100U	CPR Prompt 5-pack training and practice manikins, adult/child, blue	each	430.00
LF06050U	CPR Prompt 5-pack training and practice manikins, infant, blue	each	295.00
LF06051U	CPR Prompt 5-pack training and practice manikins, infant, tan	each	295.00
LF06208U	CPR Prompt face shield lung bags with insertion tool, adult/child	100/pkg	55.75
LF06206U	CPR Prompt face shield lung bags no insertion tool, adult/child	10/pkg	9.94
LF06209U	CPR Prompt face shield lung bags with insertion tool, infant	100/pkg	49.95



DON'T SEE WHAT YOU'RE LOOKING FOR?
 Call Customer Service; we're here to help.
 (800) 334-6656



Basic Buddy® CPR Manikins (Nasco)

The Basic Buddy CPR Manikin is a dramatic, inexpensive, and state-of-the-art manikin designed for teaching individuals or large groups the life-saving techniques of CPR. This manikin offers a realistic and affordable way to provide each student with their own CPR manikin.

Basic Buddy 10-pack consists of 10 adult/child manikins, 100 lung/mouth protection bags, 10 lung insertion tools, two carrying cases, and two instruction manuals.

Basic Buddy 5-pack consists of five adult/child manikins, 50 lung/mouth protection bags, five lung insertion tools, one carrying case, and an instruction manual.

Baby Buddy 5-pack consists of five infant manikins, 50 lung/mouth protection bags, carrying bag, five lung insertion tools, and an instruction manual.

NOTE: Only use AED pads designed for foam body manikins.

LF03695U	Basic Buddy, 10-pack	each	775.00
LF03694U	Basic Buddy, 5-pack	each	430.00
LF03721U	Baby Buddy, 5-pack	each	430.00
LF03696U	Adult/child lung/mouth bags for Basic Buddy	100/box	41.50
LF03723U	Infant lung/mouth bags for Basic Buddy	100/box	39.25
LF03729U	Lung bag tool	4/pkg	11.50



Instructors' Economy Starter Package (Simulaid)

This package is intended to give instructors the opportunity to replace older equipment or purchase start-up needs in the most economical way possible. Includes:

- Economy Adult Sani-Manikin 4 pack with carry storage bag (1)
- Adult face shield lung systems (200)
- Sani-Baby Manikin 4 pack with carry storage bag (1)
- Baby face shield lung systems (200)

SI2151	Instructor's economy starter package	each	784.00
--------	--------------------------------------	------	--------



Economy Adult Sani-Manikin (Simulaid)

Manikin features realistic head tilt, single-use airway/lung/face shield system, simulated chest rise, palpable landmarks, and xiphoid process for reference in hand placement. The manikin is light in weight, yet durable for extended training life.

SI2145	Economy adult Sani-Manikin with carry bag	4/pkg	353.00
SI2144	Economy adult Sani-Manikin without carry bag	each	97.00
SI2135	Face shield lung system	100/case	40.00

Brad® CPR Manikin (Simulaids)

These economical CPR manikins are constructed of soft, realistic vinyl plastic over polyurethane foam. Also included are three disposable/lung airways.

SI2801	Brad CPR manikin with carry bag	each	217.00
SI2850	Brad CPR manikin with electronics and carry bag	each	626.00
SI2805	Brad CPR manikin airway system	24/pkg	64.00
SI2023	Brad CPR manikin channel design mouth/nosepiece	10/pkg	51.00



Little Junior® (Laerdal)

The Little Junior manikin meets your need for a low-cost, lifelike child CPR trainer and is the perfect supplement to the Resusci Junior manikin. This package of four Little Junior manikins makes hands-on practice affordable for every student.

- Educationally effective by offering all of the essential features necessary for learning child CPR
- Affordability through increased hands-on practice by allowing higher student-to-manikin ratios
- Realistic anatomical landmarks provide the essential features necessary to teach quality appropriate CPR techniques
- Logistically convenient lightweight design makes Little Junior easy to transport
- Durable construction allows unequalled long-term use

LA18002050	Little Junior with soft pack and training mat	each	206.00
LA18002250	Little Junior four pack	4/pkg	760.00
LA183211	Airways for Resusci Junior / Little Junior	100/case	200.00
LA184511	Manual clicker activator for Little Junior	each	5.85



Resusci® Junior Basic and SkillGuide® (Laerdal)

The high-quality child CPR and water rescue trainer. The Resusci Junior manikin offers realistic, high-quality child CPR education. It has full-body construction and use of an optional SkillGuide performance indicator. Students can quickly sharpen their skills in performing child CPR to high standards.

- Educationally effective by focusing on the performance level of key CPR skills and techniques for children
- Enhanced student motivation through use of the optional SkillGuide indicator that allows real-time CPR performance feedback during training
- Cost efficient through easy to use and maintain disposable airways
- Realistic anatomical body and landmarks provide the essential features necessary to learn realistic child handling and quality child CPR skills
- Logistically convenient transportation provided by a durable hard case

LA18001101	Resusci Junior with SkillGuide	each	1,342.00
LA18001201	Resusci Junior with water rescue	each	893.00
LA18001001	Resusci Junior manikin with hard case	each	832.00
LA18001301	Resusci Junior manikin without case	each	765.00





Baby Anne® (Laerdal)

This low-cost, lifelike infant CPR trainer is the perfect supplement to the Resusci Baby manikin. The Baby Anne manikin was developed to provide effective infant CPR training without compromising realism or quality. The convenient packaging of four Baby Anne manikins makes hands-on practice affordable for every student. Educationally effective by offering all the essential features necessary for learning infant CPR. Affordability allows increased hands-on practice. Realistic chest compressions and chest rise allow students to learn proper techniques. Logistically convenient, lightweight and portable. 4-pack weighs under 12.1 lb. making Baby Anne easy to transport. Practical because it is inexpensive and easy to maintain. Durable construction allows unequalled long-term use.

LA050000	Baby Anne manikin with soft pak	each	119.00
LA050002	Baby Anne manikin with soft pak (dark skin)	each	119.00
LA050010	Baby Anne manikin four pack with soft pak	each	435.00
LA050012	Baby Anne manikin four pack with soft pak (dark skin)	each	445.00
LA050100	Baby Anne airways	24/pkg	18.80
LA050200	Baby Anne faces	6/pkg	61.20
LA050400	Baby Anne jaw	each	8.40
LA050500	Baby Anne mask connector	each	7.20
LA152400	Manikin wipes	50/pkg	11.50
LA152401	Manikin wipes	1,200/box	200.00



Pediatric ALS Trainer (Simulaids)

This pediatric ALS trainer features include:

- Bag valve mask ventilation
- Intubation head
- Oral or nasal intubation
- Sellicks Maneuver
- Accepts NG tube
- Four lead monitoring
- Brachial pulse
- External chest compressions
- Jaw thrust
- IV sites in hand and arm,
- I/O legs for intraosseous needle insertion and aspiration of bone marrow (2)
- Scalp vein for palpation
- Cranial sutures
- Fontanels
- Soft carry bag

SI090	Pediatric ALS Trainer with carry bag	each	894.00
SI091	Pediatric ALS Trainer complete with arrhythmia simulator	each	1,614.00
SI092	I/O bone and blood capsule for Pediatric ALS trainer	12/pkg	107.00
SI093	Leg skins I/O for pediatric ALS trainer	4/pkg	53.00
SI094	Arm/hand skins for Pediatric ALS trainer	2/pkg	41.00
SI095	Arm/hand vein set for Pediatric ALS trainer	each	14.00
SI098	Replacement lung and stomach for Pediatric ALS trainer	4/pkg	19.00

Basic Casualty Simulation Kit (Simulaids)

The most economical way to get started in simulated injuries. Re-useable wounds and refillable accessories let you practice bandaging and splinting techniques repeatedly. Compound fracture Tibia

- 12 assorted stick-on lacerations and open fractures
- Rugged plastic case
- Assembled reservoir bag and pump on Tibia
- Atomizer mist sprayer
- Coagulant makeup blood
- Casualty simulation wax
- Blood powder to make 1 gallon simulated blood
- Broken Plexiglas™ (simulating glass imbedded wound) (1 pkg)
- Grease paint white, blue, brown and red (1 each)
- Adhesive stick (1)
- Spatulas (2)
- Wood tongue depressors (2)



SI815	Basic Casualty Simulation Kit	each	200.00
-------	-------------------------------	------	--------

Multiple Casualty Simulation Kit (Simulaids)

Multiple Casualty Simulation Kit is more versatile than the basic kit. This unit gives you more complex wounds for testing higher levels of skill in bandaging and patient care, while keeping initial expenditures low. The kit comes in a heavy duty plastic tool box with a lift out tray for your convenience. Kit contains:

- Bleeding strap on wounds complete with reservoir bags with pump assembly
- Open amputation (1)
- Compound fracture of tibia (1)
- Compound fracture of humerus (1)
- Sucking wound of chest (1)
- Gunshot wound of palm (1)
- Assorted lacerations and open fractures (24)
- Bottle coagulant makeup blood (1)
- Blood powder thickener (1 pkg)
- Blood powder (3 pkgs)
- Adhesive stick (1)
- Casualty simulation wax (1)
- Broken plexiglas™ (simulating glass imbedded wound) (1 pkg)
- Grease paint: white, blue, brown and red (1 of each)
- Spatulas (3)
- Wood tongue depressors (3)



SI816	Multiple Casualty Simulation Kit	each	376.00
-------	----------------------------------	------	--------

EMT Casualty Simulation Kit (Simulaids)

This complex kit uses components applied to human and manikin patients to get the widest variety of training situations possible. Kit includes:

- Bleeding strap on wounds with reservoir bags with pump assembly (1)
- Jaw wound (1)
- Abdominal wound with protruding intestines (1)
- Sucking wound of chest (1)
- Compound fracture of humerus (1)
- Upper arm (1)
- Compound fracture of femur (1)
- Upper leg (1)
- Laceration of the forehead (1)
- Leg amputation (1)
- Compound fracture of tibia (1)
- Lower leg (1)
- Gunshot wound of palm (1)
- Non-bleeding wounds (1)
- Phosphorous hand burn (1)
- Face in shock (1)
- 1st, 2nd and 3rd degree burn of the face, chest, back, hand and forearm (1 of each)
- Assorted stick-on lacerations and open fracture wounds (36)



SI818	EMT Casualty Simulation Kit	each	1,055.00
-------	-----------------------------	------	----------



Trauma Modules (Laerdal)

Trauma Module sets may be added to manikins for realism in trauma life support and lifesaving first aid scenarios.

- Trauma head cover features an avulsed ear, avulsed eye, lacerations of the lip, neck, and scalp, nasal bleeding, impaled object, and face contusions.
- Seat belt contusion with compound clavicle fracture (lay-on)
- Compound radius fracture (lay-on)
- 1st, 2nd, and 3rd degree burn arm
- Hand with open fracture of index finger, exposed tendons, and multiple lacerations
- Abdominal wound with exposed viscera (lay-on)
- Impaled object in thigh
- Compound femur fracture
- Crushed foot with exposed bone and soft tissue and amputation of the small toe (rt)
- Projectile entry / exit wounds (small and large caliber)

LA27610001	Trauma modules	each	1,360.00
------------	----------------	------	----------

Training and Education ■ Simulation Accessories



Cardiac Simulators (Symbio)

Connect directly to your defibrillator and external pacer for safe simulation of cardioversion and electrical capture. CS1201 generates fibrillations, tachycardias, and bradycardias, as well as ST segment and T wave abnormalities.

ECG waveforms – VF, VT-HI, VT-LO, T de P, AFIB, AFLTR, PSVT, STACH/anterior ST depression, NSR, ASYS, SINUS/AMI, SINUS/AMI/ PVC, SINUS/antero-septal ST elevation, 2nd I /lateral ST elevation, S BRDY/inferior ST elevation, S BRDY/IMI, 1st/RBBB, 2ND II/LBBB/PVC, 2nd II/LBBB,

Convert – simulate cardioversion by activating convert* feature.

Defibrillator discharge - indicator illuminates for two seconds when simulator is shocked by a defibrillator set to 50J, or more.

Pacer pulse - paced beat is displayed and indicator blinks off when simulator is paced by an external pacer. Use capture control* to vary the pacing capture level.

Connectors – V1, V2, V3, V4, V5, V6, RA, LA, LL, RL and PADS.

Battery – powered by four AA alkaline batteries. Low battery indicator illuminates when battery needs to be replaced. Battery saver feature powers off simulator automatically when not in use. Battery life is approximately 15 hours.

SYCS1201-006	ECG 12-lead simulator for Philips HeartStream Flat Plug Style	each	669.23
SYCS1201-001	ECG 12-lead simulator for Physio Quick-Combo	each	669.23
SYCS1201-000	ECG 12-lead simulator for Zoll	each	669.23



Practi-Mat Kneeling Pads (WNL Products)

Practi-Mat kneeling pad is a great solution for reducing knee pain and lower back stress when performing manikin training. Made of 1" thick closed-cell Nitrile blend foam. Built-in carrying handle, Conveniently packaged in a durable nylon carrying case.

WNLMAT	Practi-Mat kneeling pads with carry case	5/pkg	24.95
--------	------------------------------------------	-------	-------

Airway Management Trainer (Laerdal)

The Laerdal Airway Management Trainer's lifelike upper torso and head simulates real-world complications when practicing a variety of intubation, ventilation and suction techniques. Realistic representation of human anatomy, tissue and skin allows students to undertake training that is directly transferable to the clinical setting. Minimal maintenance and robust design delivers cost-effective training. Base plate mount allows stable practicing conditions. A hard carry case provides easy transportation and safe storage.



- Realistic anatomical features allow demonstration of Sellick Maneuver and laryngospasm
- Airway demonstration model is standard with each trainer
- Provides auscultation of breath sounds
- Provides visual inspection of lung expansion
- Bag-Valve-Mask ventilation can be practiced
- Correct tube placement can be checked by practical inflation test
- Practicing use of LMA (Laryngeal Mask Airway) and Combitube®
- Practicing of oral and nasal intubation
- Stomach inflation and vomiting situation can be simulated

LA25000033	Laerdal Airway Management Trainer	each	2,215.00
------------	-----------------------------------	------	----------

Deluxe Difficult Airway Trainer (Laerdal)

- Management of the obstructed airway
- Manually inflatable tongue to simulate obstructed airway or tongue edema
- Anatomically correct internal anatomy facilitates airway management skills using manual maneuvers and mechanical devices



LA261-10001	Deluxe Difficult Airway Trainer	each	2,480.00
-------------	---------------------------------	------	----------

Adult Airway Management Trainer Torso (Simulaids)

Features anatomical landmarks including sternum and ribcage plus substernal notch. The manikin contains teeth, uvula, vocal cords, glottis, epiglottis, larynx, arytenoid cartilage and trachea. Additional features include esophagus and inflatable lungs and stomach, NG tube placement and bag valve mask ventilation. Soft carry bag included. Accepts Combitube™, E.O.A., E.G.T.A., P.T.L., and L.M.A. Airway.



SI086	Adult Airway Management Trainer Torso with carry bag	each	1,226.00
SI072	Adult Airway Management Trainer Torso replacement lungs/stomach	3/pkg	16.00

Economy Adult Airway Management Trainer (Simulaids)

This detailed adult intubation head comes mounted for clinical teaching and practice of advanced airway management. Intubation procedures and skills, including anatomy knowledge and recognition, endotracheal intubation, nasotracheal intubation, use of field emergency airway adjunct tubes like LMAs and Combitube, securing and suctioning, and maintenance of the installation can all be practiced with this unit. Includes soft carry bag, lubricant and instructions for use.



SI500	Economy Adult Airway Management Trainer	each	894.00
-------	-----------------------------------------	------	--------



Adult Airway Management Trainer with Stand (Nasco)

Simulates a non-anesthetized patient for practicing intubation, ventilation, suction, and CPR techniques. Realistic anatomy and landmarks include teeth, tongue, oral and nasal pharynx, larynx, epiglottis, arytenoids, false cords, true vocal cords, trachea, lungs, esophagus and stomach. The trainer allows you to practice oral, digital and nasal intubation, as well as E.T., E.O.A., P.T.L., L.M.A., and Combitube® insertion. Features durable, rugged, one-piece construction and bifurcated lungs. The Adult Airway Management Trainer Head represents a small adult, making it ideal for practicing more difficult approaches and for training purposes. Includes training stand to mount head, pump spray lubricant, hard carry case, manual Carotid pulse and three-year warranty.

LF03601U	Adult Airway Management Trainer with stand	each	745.00
----------	--------------------------------------------	------	--------



Pediatric Airway Management Trainers (Simulaid)

Features landmarks including uvula, vocal cords, glottis, epiglottis, larynx, arytenoids cartilage, trachea, esophagus, and inflatable lungs and stomach. Perform nasal and oral intubation. Vocal cords are highlighted in white for easy laryngoscope viewing. Carry bag and lubricant included.

SI125	3-Year-Old Child Trainer with carry bag	each	679.00
SI115	Infant Trainer with carry bag	each	679.00
SI122	Child replacement lungs/stomach	3/pkg	24.00
SI121	Infant replacement lungs/stomach	3/pkg	24.00



Infant Airway Management Trainer (Laerdal)

The Laerdal Infant Airway Management Trainer provides the realistic anatomy of a three-month-old infant for teaching and practicing basic and advanced airway management skills. Realistic representation of human anatomy, tissue and skin material. Allows students to undertake training that is directly transferable to the clinical setting. Minimal maintenance and robust design enable cost-effective training. A base plate mount allows stable practicing conditions and easy transportation. The cover prevents dust from coming into contact with the head during storage.

- Stomach inflation
- Realistic tissue simulation
- Sellick Maneuver can be performed
- Bag-Valve-Mask ventilation can be practiced
- Practicing use of LMA (Laryngeal Mask Airway)
- Practicing of oral and nasal intubation
- Realistic anatomy of the tongue, oropharynx, epiglottis, larynx, vocal cords, and trachea
- Correct tube placement can be checked by practical inflation test

LA250-00250	Infant Airway Management Trainer	each	745.00
-------------	----------------------------------	------	--------

Pediatric Intubation Trainer (Laerdal)

Anatomically accurate reproduction of a pediatric torso designed for teaching the differences in pediatric and adult anatomy for airway management procedures. Anatomically accurate airway allows sizing and insertion of various airway adjuncts:



- Oropharyngeal and nasopharyngeal airway insertion
- Endotracheal tube insertion and securing
- Bag-Valve-Mask ventilation
- Tracheal suctioning
- Manually generated carotid pulse
- Closed chest compressions
- Pediatric Intubation Trainer includes: Trainer, Manikin Lubricant, Shorts, Carry Case, and Directions for use.

LA255-00001	Pediatric Intubation Trainer	each	1,435.00
-------------	------------------------------	------	----------

Neonatal Intubation Trainer (Laerdal)

Ideal for newborn intubation training Laerdal Neonatal Intubation Trainer allows teaching of intubation skills on the newborn baby. Robust and realistic, this model allows students to undertake training that is directly transferable to the clinical setting.



- Intubation (oral and nasal)
- Bag-Valve-Mask ventilation
- Correct tube placement can be checked by practical inflation test
- Realistic anatomy of a newborn baby

LA250-00101	Laerdal Neonatal Intubation Trainer	each	607.00
-------------	-------------------------------------	------	--------

Nita Newborn Infant Venous Access Simulator (Laerdal)

A unique, anatomically correct representation of a 4 lb., 16" female baby developed to teach and practice the vascular accessing of newborns and infants, including the availability of those veins uniquely used in this age group. There are barely discernable blue veins under the replaceable translucent "skins" on the head, right and left arms and the right leg. Veins are now made with latex-free Dermalike™ - with 50% less needle drag when accessing and improved tear resistance to permit a greater number of needle "sticks". The veins presented include the temporal, external jugular, post-auricular, basilic, cephalic, saphenous and popliteal. When accessing a "pop" is felt as the needle enters the vein followed by a realistic flashback of simulated blood confirming proper needle placement. The veins were specifically designed to have a small internal diameter, as you would find on a small baby, to make accessing more challenging, improving technique and confidence. You can practice accessing, securing, dressing, site care, and maintenance for standard IVs and PICC (Peripherally Inserted Central Catheter). A redesigned umbilicus and umbilical valve allows repeated catheterization with a 5FR umbilical catheter with proper placement verified by a blood return. Nasal and oral openings allow placement of nasal cannulas, as well as endotracheal, nasogastric, and feeding tubes to teach suctioning, securing, dressing, cleansing, and maintenance. A great tool for teaching, training, competency testing and skills assessment.



VT1800	Nita Newborn Infant Venous Access Simulator	each	653.00
--------	---------------------------------------------	------	--------



Cricothyrotomy Simulator (Nasco)

Designed for learning and practicing the technique necessary to perform an emergency cricothyrotomy. Palpable landmarks include the cricoid and thyroid cartilage. The prominentia laryngea is prominent on the hyperextended neck. All landmarks are accurately placed and allow for fast action. The “trachea” in this simulator is replaceable as the “airway” passes completely through from top to bottom. This allows checking the stylet and obturator placement once the “stab” has been made.

Complete with a full-size neck, ties can be used to hold the obturator in a secure position. Life/form™ Cricothyrotomy Simulator comes complete with five replacement skins and five cartilage inserts, REN cleaner, instruction guide, and a durable carrying case. Three-year warranty.

LF01082U	Cricothyrotomy simulator	each	685.00
LF01081U	Cricothyrotomy replacement kit (includes three skins and three inserts)	each	199.00
LF01075U	Cricothyrotomy replacement skin	3/pkg	185.00

Pneumothorax Trainer (Laerdal)



The Pneumothorax Trainer, with bilateral tension pneumothoraces and decompression portals in each axilla and subclavian region, is specifically designed for training professionals in the practice of chest decompression.

- Anatomical landmarks aid in site location
- Bilateral mid-axillary and mid-clavicular sites available for decompression
- Heimlich Abdominal Thrust Maneuver may be performed
- Includes: Torso manikin, bladder replacement kit, manikin lubricant, tank top, carry case and directions for use

LA26005001	Pneumothorax Trainer	each	1,235.00
------------	----------------------	------	----------

Tension Pneumothorax Simulator (Simulaids)



This model allows medical personnel to practice proper needle insertion which enables built-up air pressure to escape the thorax. The model accepts needle and thoracotomy in second intercostal space in the midclavical line or fifth intercostal space in the midaxillary line. Complete with foot pump, replacement 2-piece pleural chamber, ribcage and soft lifelike skin. Soft carry bag included. Procedural needle not included.

SI1800	Tension Pneumothorax Simulator	each	584.00
SI1801	Pneumothorax replacement skin	each	114.00
SI1805	Pneumothorax 2-piece pleural cavity	each	39.00

Multi-Venous IV Training Arm Kits (Laerdal)

This lifelike adult arm reproduction with multi-vein system is designed for peripheral intravenous therapy. Each kit contains one of the following:



- Arm reproduction
- Replacement skin and multi-vein system
- Bottle of red simulated blood
- Can of manikin lubricant
- Blood bag with tubing and connector
- Clamp and hook
- Set shoulder attachment hardware
- Carry case and directions for use

LA27000001	Multi-Venous IV Training Arm kit, adult male	each	701.00
LA27000001B	Multi-Venous IV Training Arm kit, adult male, dark skin	each	687.00
LA37550001	Multi-Venous IV Training Arm kit, adult female	each	687.00
LA312029	Multi-Venous IV Training Arm replacement skin vein set, male	each	211.00
LA325-00350	Multi-Venous IV Training Arm replacement skin vein set, female	each	204.00

Advanced Venipuncture and Injection Arm (Nasco)

This training arm provides complete venous access for IV therapy and phlebotomy, plus sites for intramuscular and intradermal injections. An extensive 8-line vascular system allows students to practice venipuncture at all primary and secondary locations, including starting IVs and introducing IV catheters. The replaceable skin rolls as the veins are palpated, and a discernable “pop” is felt when entering the veins. Includes:



- Simulated blood (2 quarts)
- 3 cc syringe (1)
- 12 cc syringe (1)
- Needle (1)
- Fluid bags (2)
- Instruction manual (1)
- Carrying case (1)

LF01121U	Advanced Venipuncture and injection arm	each	625.00
LF01122U	Advanced Venipuncture and injection arm skin and vein replacement	each	172.00
LF01022U	Advanced Venipuncture and injection arm fluid supply stan	each	47.50

Venipuncture and Injection Training Arm (Nasco)

Teach venipuncture and injection techniques including starting IVs and introducing over-the-needle IV catheters. The skin actually rolls as you palpate the vein and the characteristic “pop” can be felt as the needle penetrates the vein. Veins are accessible at the antecubital fossa, along the forearm, and at the back of the hand, making it possible to practice venipuncture at any of the common sites. Practice of intramuscular injection is equally realistic. A foam pad simulates muscle tissue, and the boundaries are identified by natural bonelike landmarks. Designed with replaceable skins and veins. Includes:



- Arm with skin (1)
- 22 gauge needle (1)
- Butterfly set (1)
- Infusion set (1)
- 3 cc syringe (1)
- 12 cc syringe (1)
- Arterial blood (1 pint)
- Fluid supply bags (fluid supply stand not included)
- Instruction manual (1)
- Hard carry case (1)

LF00698U	Venipuncture and Injection Training Arm	each	536.00
LF01022U	Venipuncture and injection arm fluid supply stan	each	47.50



Geriatric IV Arm (Simulaids)

Developed from a live cast, this arm is unique to the industry. Its properties include veins that roll away or disappear as you attempt to catheterize the vessel and a specially developed skin that is exceptionally thin. If your students work with the aged, this adjunct to your teaching lab will enable them to better serve in the future.

SI610	Geriatric IV Arm	each	584.00
-------	------------------	------	--------



IV Arm and Hand (Simulaids)

Detailed exercises in venipuncture can be mastered on a realistic model before administration to live patients. Demonstrate sterile technique, sharps injury protection, taping and securing techniques, and infusion or withdrawal procedures. Features include: lifelike vein roll-over, durable for repeated use, palpation of vein for location. Characteristic “pop” can be felt when needle penetrates vein. Carry tray and blood included.

SI140	IV arm and hand trainer	each	447.00
SI146	IV training arm only	each	259.00
SI147R	IV training hand only	each	259.00



Advanced IV Hand (Nasco)

The ideal simulator for advanced IV training. The dorsal surface of the incredibly realistic hand includes injectable metacarpal, digital, and thumb veins. Students have the opportunity to develop important manipulation skills provided by the flexion of the wrist. The skin rolls as you palpate the veins and you’ll feel the characteristic “pop” when the vein is entered. The simulated veins and skin are completely replaceable. Under normal use, hundreds of injections may be performed before the veins or skin need to be replaced. Comes in storage box. Includes:

- Arterial blood (1 pint) (stand not included)
- IV bags (2)
- Butterfly set (1)
- 3 cc syringe (1)
- 12 cc syringe (1)
- 22 gauge needle (1)

LF01139U	Advanced IV Hand, light	each	283.00
LF01146U	Advanced IV Hand, dark	each	283.00
LF01022U	Venipuncture and injection arm fluid supply stan	each	47.50



Infant IV Leg (Laerdal)

The Infant IV Leg is designed for training extremity venipuncture procedures and intravenous fluid administration in the superficial veins of the foot.

LA365000101	Infant IV leg	each	236.00
-------------	---------------	------	--------

FAST1® Trainer (Simulaids)

This small trainer provides critical anatomic landmarks for training care givers in the use of the FAST1.

SI204	FAST1 Trainer with FAST 1 Training Kit	each	264.00
SI201	FAST1 Trainer	each	114.00
SI202	FAST1 Trainer refill disk	4/pkg	30.00
SI203	FAST1 Trainer replacement skin	each	58.00



Single Intraosseous Infusion Leg (Nasco)

This simulator is a single leg with the ability to be placed on the Life/form® Infant CRi-Sis™ Manikin. The leg comes complete with 10 replaceable bones, two sets of replacement skins, and a fluid administration kit enabling you to actually visualize a flashback and infuse fluid into the leg. Intraosseous infusion needle included.

LF03622U	Single Intraosseous Infusion Leg	each	405.00
----------	----------------------------------	------	--------



Infant Intraosseous Infusion Simulator (Nasco)

The Intraosseous Infusion Simulator is designed to demonstrate and simulate the intraosseous infusion procedure. The bones used in the model have been designed with four sides, each side having the ability to be punctured several times. In addition, three palpable landmarks, including patella, tibia, and tibial tuberosity are located in both legs. Both legs have also been designed so that aspiration is possible. Life/form™ Intraosseous Infusion Simulator represents a six-month-old infant. Included with the simulator are:

- Replaceable bone inserts (10)
- Replacement leg skins (2 sets)
- White towelettes (2)
- Syringe with tubing (1)
- Blood powder (1)
- Sealing wax (1)
- Liquid lubricant (1/2 z)
- Mixing bottle (1)
- Needle (1)
- Hard carrying case. (1)

LF01108U	Infant Intraosseous Infusion Simulator	each	650.00
LF01109U	Infant Intraosseous Infusion Simulator bone replacement kit	10/pkg	130.00
LF01110U	Infant Intraosseous Infusion Simulator skin replacement kit	each	78.00
LF03619U	Infant Intraosseous Infusion Simulator leg skin replacement kit	each	81.95



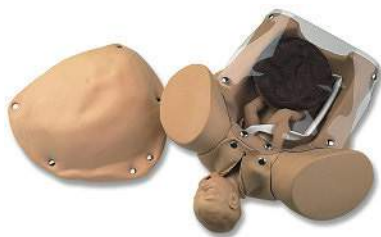

Obstetrical Manikin (Simulaids)

This is an anatomically correct pelvic model with full term newborn and placenta to give your trainees realistic practice in multiple techniques, and to learn the procedure for emergency childbirth. It comes with disposable umbilical cords, clamps, easily replaceable spare vulva, powder to make simulated blood, a modular pregnant belly overlay, and a clear abdominal overlay. The modular overlay has a self-contained fetus for practicing the Leopolds maneuver. A soft carry bag is included.

SI180	Obstetrical Manikin with Carry Bag	each	647.00
-------	------------------------------------	------	--------

Training and Education ■ CPR Training



CPR Micromask® (MDI)

The mask with the removable/disposable, filtered valve allows the professional rescuer to be prepared to give CPR efficiently. Features a cushion inflation tube allowing the rescuer to adjust the cushion to the desired shape and firmness. Includes zippered pouch with belt loop and a pair of nitrile gloves.

MDI73-500	CPR Micromask with O2 inlet	each	13.10
MDI73-402	CPR Micromask with valve	each	11.68
MDI73-200	CPR Micromask training mouthpiece only (mask not included)	each	1.43
MDI73-204V	CPR Micromask replacement valve only (mask not included)	each	3.74



CPR Practi-Shield (WNL Products)

Ideal for CPR training, offering cost-effective barrier protection for students sharing a manikin. Individually folded and packed in a dispenser box. For training purposes only.

WNL3136	CPR Practi-Shield	36/box	9.94
---------	-------------------	--------	------



CPR Practi-Valve (WNL Products)

This Practi-Valve will fit all CPR masks (15mm I.D. or 22mm O.D.) For training purposes only. Note: Blue mouthpieces with filter only - mask not included.

WNL5000-TV	CPR Practi-Valve	10/box	11.90
------------	------------------	--------	-------



Student CPR Training Kit (WNL Products)

This training kit is an economical, time saving product for classroom training of CPR. Contains one pair vinyl gloves and one CPR barrier.

WNL1100	Student CPR training kit	each	0.45
---------	--------------------------	------	------

ALS Baby® (Laerdal)

The Laerdal ALS Baby manikin is a three-month-old infant with an anatomy that offers exceptional realism for individual training. It offers the opportunity to practice advanced resuscitation skills, including airway management, professional rescuer CPR, vascular access and 4-lead ECG monitoring.

- 3-lead, 4 connectors ECG monitoring
- Realistic airway anatomy with tongue, oropharynx, epiglottis, larynx, vocal cords and trachea
- Sellick Maneuver can be performed
- Compatible with the HeartSim® 200 Rhythm Simulator (must be purchased separately)
- CPR can be performed
- Practicing of bag-valve-mask ventilation, oral and nasal intubation and use of LMA (Laryngeal Mask Airway)
- Intraosseous needle insertion with aspiration of bone marrow



LA08003140	ALS Baby with HeartSim® 200 Rhythm Simulator	each	3,135.00
LA08003040	ALS Baby (manikin only)	each	1,795.00
LA082025	ALS Baby lungs/stomachs	6/pkg	58.65
LA082305	ALS Baby leg replacement pads	5/pkg	237.00
LA252090	ALS Baby airway lubricant spray can (180ml)	each	29.75

Central Venous Cannulation Simulator (Nasco)

ACLS and ATLS participants will find this simulator to be the ideal trainer. Anatomically accurate, palpation is exactly the same as on a patient. The sternal notch, sternocleidomastoid, clavicle, and other supporting features make this simulator a pleasure to work with. Internal features include a replaceable muscle and bone section, subclavian, internal jugular, external jugular, and carotid. Includes replaceable skin, tubing sealant, needles, one quart of Life/form™ Blood, and instruction guide in a hard storage case.



LF01087U	Central Venous Cannulation Simulator	each	860.00
LF01093U	Central Venous Cannulation Simulator bone and muscle replacement kit	each	199.00
LF01112U	Central Venous Cannulation Simulator skin repair kit	each	33.00

Traction Splint Trainer (Simulaids)

The Traction Splint Trainer can be set to correspond to an individual's body weight. This allows the instructor to determine if the student is correctly applying the rule of thumb that states "10% of the body weight traction results in adequate relief for, but no further damage, to the patient." The Traction Splint Trainer can be adjusted for body weights ranging from 100 lbs to 300 lbs. The electrical, push-button panel makes simplified selection easy. This trainer comes completely assembled and requires attachment to a base to secure it during training sessions. After applying traction, the deformity of the thigh recedes and splint can be applied, including any standard ankle hitch.



SI031	Traction Splint Trainer	each	1,836.00
-------	-------------------------	------	----------



Chester Chest® with Advanced Arm (Laerdal)

Lifelike model of human torso with detachable right arm designed for the insertion care, and removal of common long-term vascular access routes. The basilic vein is slightly raised for easy identification. Posterior to the PICC insertion site is a recessed area for the placement of a peripheral port. The base of the recessed area is made of soft material that permits the port to “float” when accessed. This area is covered with a removable tissue-like flap which, when placed over the port, provides the realistic feel of palpating and accessing. An additional feature of the new arm is a pre-positioned 20g IV catheter in the forearm. The New Advanced Arm has a greater degree of rotation and extension than the previous arm, just as you would experience on a patient when accessing the PICC or catheter sites. Chester Chest can be used in either an upright or supine position.

VT2400	Chester Chest with Advanced Arm	each	753.00
--------	---------------------------------	------	--------



WMD/CBRNE/DECON Full-body Trainer (Simulaids)

This 5'5", full-body trainer combines our standard intubation head and IV arm with a non-electronic body. BLS services utilizing advanced skills, like airway maintenance and IV administration, will appreciate this unit. The addition of a casualty simulation kit to this manikin broadens its use for MCIs. Couple those options and a WMD (Weapons of Mass Destruction) or CBRNE (Chemical, Biological, Radiological, Nuclear, Explosive) scenario where DECON (decontamination) processes are scheduled and you have the perfect setup for use in processing through decontamination stations. Water won't hurt this trainer, and you can initialize advanced life support treatment as you are flushing contaminants. No ECG features.

SI088FB	WMD/CBRNE/DECON Full-Body Trainer	each	1,913.00
---------	-----------------------------------	------	----------



Crash Kelly (Laerdal)

Crash Kelly is a durable, rugged training manikin with an intubation head for advanced airway management training and realistic articulation allowing the manikin to be placed in various settings for extrication or rescue. Crash Kelly is the ideal manikin for training in airway management, extrication and rescue exercises.

LA20110001	Crash Kelly manikin	each	2,275.00
------------	---------------------	------	----------



Rescue Randy (Simulaids)

Rescue Randy was developed for lifelike adult or juvenile victim handling, transportation and extrication training. These manikins can be safely used in situations too hazardous or uncomfortable for human volunteers. Made of durable vinyl with 4,100 lb. test plastic-coated cables. Features include: articulated joints, weight distribution according to human weight distribution chart. Used by the U.S. military, fire and police departments, safety teams and emergency personnel for rescue and extrication from pole top, confined spaces, collapsed buildings, smoke rooms and ladder carry-down protocols worldwide.

SI1344	Rescue Randy 55", 145 lbs.	each	1,128.00
SI1345	Rescue Randy, 55", 165 lbs.	each	1,286.00
SI1475	I.A.F.F. Rescue Randy (with additional reinforcement) 61", 165 lbs.	each	1,349.00

Emergency & Critical Care Pocket Guide

The most popular pocket reference in emergency nursing - now in a new edition! The Emergency & Critical Care Pocket Guide has been an essential resource for physicians, paramedics, and nurses for over a decade. The Pocket Guide consolidates the critical information found in desk references into a convenient 3" x 5" pocket-size format that is handy enough to take with you anywhere. The newly updated Eighth Edition features:

- Updated poisons
- Emergency medications
- Common drugs sections
- Updated pediatric medications
- Revised Spanish section
- Clear ECG rhythm images
- Straightforward medical emergency treatments

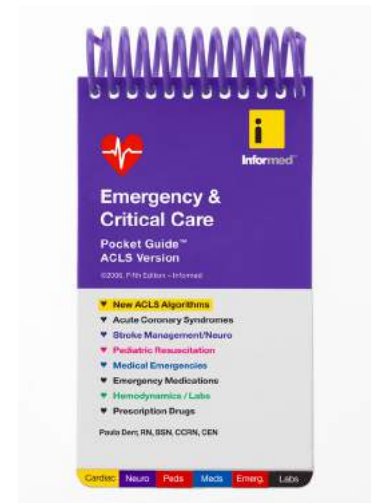

P7800EC	Emergency & Critical Care Pocket Guide	each	23.95
---------	----------------------------------------	------	-------

EMS Field Guide (ALS Version)

The original EMS field guide has grown into the most used reference guide in EMS history. This is the guide that EMS Magazine calls "The original and still the best." The Nineteenth Edition of the EMS Field Guide, ALS Version has been updated with the new 2010 CPR and ACLS algorithms from the AHA. This handy guide makes it easy for paramedics, nurses and physicians to look up their patients' medications, check drug doses, quickly interpret 12-Lead EKGs and much more. This field guide is 3 x 5", fits easily in our pocket, has color-coded tabs and is waterproof, alcohol-fast and durable.



P7800	EMS Field Guide (ALS Guide)	each	21.95
-------	-----------------------------	------	-------

EMS Field Guide (Basic & Intermediate Version)

Designed for both beginning and experienced EMTs, the EMS Field Guide, Basic & Intermediate Version is the ideal quick reference. Now in its Ninth Edition, this field guide has been an essential resource for EMS professionals for over a decade. Whether you're a student, or a 20-year veteran of emergency medical services, this guide gives you quick access to vital information needed to perform your job. This newly updated edition includes:

- EMS protocols
- Spell-checking
- EKGs
- Defibrillation
- Home medications



P7800BLS	EMS Field Guide (Basic & Intermediate Version)	each	23.95
----------	------------------------------------------------	------	-------

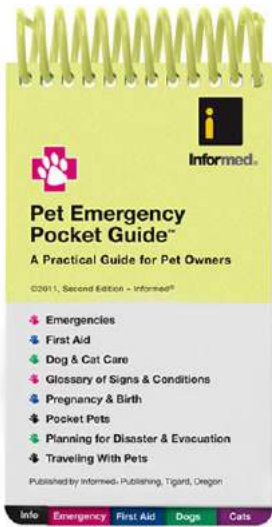

Pet Emergency Pocket Guide

The Pet Emergency Pocket Guide is a practical reference for pet owners that provides complete planning, response and survival guidelines for both common and uncommon pet emergencies, presented in an easy to use and convenient pocket-sized format. This compact tool delivers step-by-step instructions for daily care, first aid, illness and injury assessment, emergency planning, and natural disaster preparation and survival. It features tabbed, color-coded and illustrated sections that make it easy to use, with checklists and inventory lists for creating your own pet emergency, travel, and evacuation kits. This new Second Edition features the following:

- Updated content as suggested by emergency veterinarians
- Expanded Glossary of Signs & Conditions, including new entries and illustrations
- Reorganized content and tabs for ease-of-use
- Updated toxic food list and detailed reactions for dogs
- Information about preventing dog bites and scratches, as well as how to break up dog fights
- Common plants that are poisonous to cats
- New section for 'Pocket Pets', including basic information and signs and conditions for ferrets, guinea pigs, hamsters, gerbils, mice, rats, rabbits, birds, turtles and snakes
- New graphics, charts and an updated design

P7800PG Pet Emergency Pocket Guide each 14.95

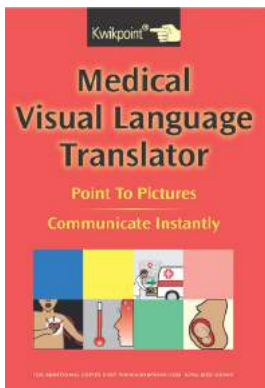

Medical Visual Language Translator

The Medical Visual Language Translator facilitates fast communication between medical personnel and patients and contains essential content for dealing with and treating medical needs and emergencies. Helps exchange information with patients about symptoms and conditions including falls, bites, wounds, allergic reactions, toxic ingestions, critical pain and illness identification, as well as medication dosage and treatment options. The new 24-panel version gives you four more panels of content, with additional food identification graphics and language identification panel to assist in finding an interpreter when necessary.

KP6L-MED-GEN09 Medical Visual Language Translator each 50.40



Pedi-Wheel

The Pedi-Wheel is a convenient pocket reference tool that puts vital pediatric data at your finger tips. This sturdy, full-color, water resistant device provides virtually all of the information you will need to successfully perform during a pediatric emergency. An incredibly valuable reference for medical professionals and students because we've compiled volumes of vital pediatric information into this slide chart that is only the size of a compact disc. The Pedi-Wheel is perfect for every day use or as a study aid. Turn the dial to your patient's age on one side and the following information appears in the window: average weight, blood pressure, heart rate, respiratory rate, suggested sizes for ET tubes and laryngoscope blades, as well as the average length of a properly inserted ET tube at the teeth or gum line. Age categories range from premie to 16 years-old.

P7803 Pedi-Wheel each 9.94

Pedi-Sleeve® Pediatric Dosing System (M.E.D.I.C.)

Currently, treating the pediatric patient and reading a length-based resuscitation tape has been difficult and sometimes awkward. Pedi-Sleeve is a three-page protected sleeve worn on the forearm of the healthcare professional that displays pediatric medication dosing and equipment sizes. This means the exact dose in milliliters is always just a glance away, making drug calculations—the number one source of pediatric medication dosing errors—unnecessary and obsolete. Inserts can be customized to reflect individual protocols as well as future guideline changes. Pedi-Sleeve Kit comes with nine color sleeves which reflect the colors of industry-standard length-based resuscitation tapes.



See page 241 for more information on Pedi-Sleeve, including part numbers and pricing.

Pediatric Drug Chart™

The Pediatric Drug Chart has been completely updated to include current AHA Guidelines. Includes new EMS and ACLS medications and the Laryngeal Mask Airway sizes. You can easily carry it in your trauma or pediatric drug kit, attach it to a wall, or the side of drug/crash cart to keep it handy when needed. This chart makes it easy for physicians, nurses and paramedics to look up correct pediatric drug doses, because the math is already done. All doses are shown in ml. The built-in length/weight ruler makes it easy for the provider to estimate patient weights. Includes:

- Current AHA Guidelines
- Updated Pediatric Emergency Medications
- New Emergency Drugs
- ET Tube, LMA, Suction Catheter and Nasogastric Tube Sizes
- Pediatric Cardiac Algorithms
- Vital Signs
- Infant Burn Charts
- APGAR Scale
- Infant and Child Glasgow Coma
- Length / Weight Ruler
- IV Drips
- Nebulized Pediatric Medications
- Temperature



P7801	Pediatric Drug Chart	each	11.95
-------	----------------------	------	-------

Cruiser-Mate Recycled Aluminum Portable Desktop

Made from durable recycled aluminum with at least 60% post-consumer waste. Two storage compartments offer a total of 1½" capacity. Top opening, self-locking latch keeps the compartments securely fastened. High capacity clip holds 1" paper securely and includes a built-in license/card holder. Made in USA



T1751	Cruiser-Mate portable desktop, letter size	each	45.94
T1753	Cruiser-Mate portable desktop, legal size	each	50.47

Redi-Rite Recycled Aluminum Portable Desktop

Made from durable recycled aluminum with at least 60% post-consumer waste. 1½" storage with divider keeps items organized. Self-locking latch keeps the compartment securely fastened. High capacity clip holds up to 1" paper and includes a built-in license/card holder.



T1750	Redi-Rite recycled aluminum portable desktop, letter size	each	40.84
T1754	Redi-Rite recycled aluminum portable desktop, letter size, legal size	each	44.70

EMS TRAINING ■ CPR/FIRST AID/AED COURSES AED IMPLEMENTATION PROGRAMS ■ HEALTHCARE PROVIDER COURSES

■ EMS TRAINING

Our EMS programs are accredited by the North Carolina Office of EMS and/or CAPCE*

Our primary objective is to provide quality training and education through our network of seasoned EMS educators—paramedics, emergency physicians, PAs and RNs—each of whom provide emergency care.

We offer BLS/ALS education, simulation and many specialty courses often not found in other educational facilities. Participants can be confident that educational programs provided by Southeastern will be accepted in most states.

Courses are offered throughout the year and online and at our Emergency Medicine Training & Education Center (see facing page). Course schedules and registration information can be found by visiting the Training & Education section of www.SEEquip.com or our Training & Education website, www.SEEtraining.com.

* Commission on Accreditation for Pre-Hospital Continuing Education

■ AMERICAN HEART ASSOCIATION (AHA)

As an AHA-approved training facility, we offer a variety of courses.

FOR HEALTHCARE PROFESSIONALS

- Basic Life Support (BLS) for Healthcare Providers
- BLS for Healthcare Providers Hybrid Renewal
- HeartCode™ ACLS, BLS and PALS (eLearning – requires in-person skills testing)
- Advanced Cardiovascular Life Support (ACLS)
- Pediatric Advanced Life Support (PALS)

WORKPLACE

- Heartsaver CPR & AED
- Heartsaver First Aid with CPR & AED
- Heartsaver Bloodborne Pathogens
- We also offer AED Implementation Programs that include AED sales and registration, site surveys, medical direction (if needed), Policies and Procedures, web-based tracking to prevent expiration of pads, batteries and training certifications, and post-event follow-up.
- Any Heartsaver course can be completed in a hybrid/eLearning format as well

FOR THE COMMUNITY

- Family & Friends CPR
- Family & Friends First Aid for Children
- Heartsaver CPR in Schools



Education and Clinical Services

Read what recent students have written in course evaluations

- I've been in EMS 30 years. This is one of the best classes I have ever had.
- Not your normal refresher...great to interact with medics from other states.
- Instructors did not read slides. The training room and amenities were great. They exceed the normal environment i.e. community college.
- I brought stuff home 'd forgotten or never knew. (That) equals success.
- Great snacks and drinks.
- Kept it interactive and pertinent. Even though the chairs were comfy, I didn't fall asleep.

■ ABOUT OUR COURSES

Our primary focus is to enhance the level of EMS and emergency care education so that all responders—from lay public to EMS to nurses and hospital physicians—can be better prepared to handle critical situations. Our motto is, and will continue to be, “Because Education Never Ends”.

ON-THE-STREET AND CLINICAL EXPERTISE

We offer courses taught by experienced EMTs, paramedics, nurses, physician assistants, physicians, and other healthcare providers involved in day-to-day emergency care. Our staff provides real-world experience and hands-on training in a classroom setting that will leave participants feeling confident they can handle emergency situations.

ONLINE AND ON-SITE

Courses are offered both online (hybrid) and at our Training & Education Center. Additional information and registration information can be found by visiting our website at www.SEEquip.com. All hybrid courses require in-person skill check.

YOUR LOCATION

As with AHA courses, we also offer the option of conducting classes at client locations, keeping staff from having to travel*. Thanks to our customized trailer, we can also bring the equipment to you.

CUSTOMIZED TRAINING

We also develop EMS-related courses to meet individual customer needs. If you would like to talk with us about a custom course, or if there is a “standard course” you would like to see offered, please contact us at 1-800-334-6656 or via e-mail to training@seequip.com.

*Note: Customized training may be limited to certain geographical areas.



We bring the equipment to you.

The Southeastern Emergency Medicine Training & Education Center

Our Training & Education Center is located on the same campus as our headquarters in Youngsville, NC (just north of Raleigh). It features the latest in AV technology to ensure courses are presented in a professional and academically sound environment.

The Center is equipped with a vast array of emergency supplies and equipment as well as cutting-edge patient simulators and support materials that ensure participants train in a real-world environment.

- Philips Healthcare MRx monitors/defibrillators
- Philips Healthcare AEDs
- Laerdal Patient Simulators
- Laerdal-supported CPR feedback devices
- Stryker stretchers
- Fully-stocked hospital-style crash carts
- Emergency responder bags and accessories
- Ambulances (if needed for training purposes)



Philips MRx



Laerdal SimPad

Since the Training & Education Center opened in 2008, we have provided numerous educational programs to all sectors of the healthcare spectrum as well as to the general public. Our courses have attracted participants from across the U.S. and other countries.



Respiratory Care

Endotracheal Tubes



pages 128-134

Laryngoscopy



pages 135-140

Advanced Airways



pages 141-142

Airways



pages 143-145

CPAP



pages 146-147

BVMs/Resuscitators



pages 147-150

Cricothyrotomy



page 151

Pneumothorax



page 152

Ventilators



pages 153-155

Masks



pages 155-156

Medication Delivery



pages 157-158

Oxygen Delivery



pages 159-164

Medical Fittings



page 165

CPR Protection



page 166

Suction



pages 167-173



Aircare® Uncuffed Endotracheal Tubes (Smiths Medical)

SM100101030	Aircare uncuffed oral/nasal ET tube, 3.0	each	1.25
SM100101035	Aircare uncuffed oral/nasal ET tube, 3.5	each	1.25
SM100101040	Aircare uncuffed oral/nasal ET tube, 4.0	each	1.25
SM100101045	Aircare uncuffed oral/nasal ET tube, 4.5	each	1.25
SM100101050	Aircare uncuffed oral/nasal ET tube, 5.0	each	1.25
SM100101055	Aircare uncuffed oral/nasal ET tube, 5.5	each	1.25
SM100101060	Aircare uncuffed oral/nasal ET tube, 6.0	each	1.25



Aircare® Cuffed Endotracheal Tubes (Smiths Medical)

SM100100030	Aircare cuffed ET tube, 3.0	each	1.50
SM100100035	Aircare cuffed ET tube, 3.5	each	1.50
SM100100040	Aircare cuffed ET tube, 4.0	each	1.50
SM100100045	Aircare cuffed ET tube, 4.5	each	1.50
SM100100050	Aircare cuffed ET tube, 5.0	each	1.50
SM100100055	Aircare cuffed ET tube, 5.5	each	1.50
SM100100060	Aircare cuffed ET tube, 6.0	each	1.50
SM100100065	Aircare cuffed ET tube, 6.5	each	1.50
SM100100070	Aircare cuffed ET tube, 7.0	each	1.50
SM100100075	Aircare cuffed ET tube, 7.5	each	1.50
SM100100080	Aircare cuffed ET tube, 8.0	each	1.50
SM100100085	Aircare cuffed ET tube, 8.5	each	1.50
SM100100090	Aircare cuffed ET tube, 9.0	each	1.50
SM100100010	Aircare cuffed ET tube, 10.0	each	1.50



Aircare® Uncuffed Endotracheal Tubes with Preloaded Stylet
(Smiths Medical)

SM100103030	Aircare uncuffed oral/nasal ET tube with stylet, 3.0	each	2.00
SM100103035	Aircare uncuffed oral/nasal ET tube with stylet, 3.5	each	2.00
SM100103040	Aircare uncuffed oral/nasal ET tube with stylet, 4.0	each	2.00
SM100103045	Aircare uncuffed oral/nasal ET tube with stylet, 4.5	each	2.00
SM100103050	Aircare uncuffed oral/nasal ET tube with stylet, 5.0	each	2.00

Aircare® Cuffed Endotracheal Tubes with Preloaded Stylet (Smiths Medical)

SM100102030	Aircare cuffed oral/nasal ET tube with stylet, 3.0	each	2.00
SM100102035	Aircare cuffed oral/nasal ET tube with stylet, 3.5	each	2.00
SM100102040	Aircare cuffed oral/nasal ET tube with stylet, 4.0	each	2.00
SM100102045	Aircare cuffed oral/nasal ET tube with stylet, 4.5	each	2.00
SM100102050	Aircare cuffed oral/nasal ET tube with stylet, 5.0	each	2.00
SM100102055	Aircare cuffed oral/nasal ET tube with stylet, 5.5	each	2.00
SM100102060	Aircare cuffed oral/nasal ET tube with stylet, 6.0	each	2.00
SM100102065	Aircare cuffed oral/nasal ET tube with stylet, 6.5	each	2.00
SM100102070	Aircare cuffed oral/nasal ET tube with stylet, 7.0	each	2.00
SM100102075	Aircare cuffed oral/nasal ET tube with stylet, 7.5	each	2.00
SM100102080	Aircare cuffed oral/nasal ET tube with stylet, 8.0	each	2.00
SM100102085	Aircare cuffed oral/nasal ET tube with stylet, 8.5	each	2.00
SM100102090	Aircare cuffed oral/nasal ET tube with stylet, 9.0	each	2.00
SM100102010	Aircare cuffed oral/nasal ET tube with stylet, 10.0	each	2.00



Murphy Uncuffed Endotracheal Tubes (SunMed)

SU1-7330-20	Murphy uncuffed endotracheal tube, 2.0	each	1.32
SU1-7330-25	Murphy uncuffed endotracheal tube, 2.5	each	1.32
SU1-7330-30	Murphy uncuffed endotracheal tube, 3.0	each	1.32
SU1-7330-35	Murphy uncuffed endotracheal tube, 3.5	each	1.32
SU1-7330-40	Murphy uncuffed endotracheal tube, 4.0	each	1.32
SU1-7330-45	Murphy uncuffed endotracheal tube, 4.5	each	1.32
SU1-7330-50	Murphy uncuffed endotracheal tube, 5.0	each	1.32
SU1-7330-55	Murphy uncuffed endotracheal tube, 5.5	each	1.32



Murphy Cuffed Endotracheal Tubes (SunMed)

SU1-7333-30	Murphy cuffed endotracheal tube, 3.0	each	1.80
SU1-7333-35	Murphy cuffed endotracheal tube, 3.5	each	1.80
SU1-7333-40	Murphy cuffed endotracheal tube, 4.0	each	1.80
SU1-7333-45	Murphy cuffed endotracheal tube, 4.5	each	1.80
SU1-7333-50	Murphy cuffed endotracheal tube, 5.0	each	1.80
SU1-7333-55	Murphy cuffed endotracheal tube, 5.5	each	1.80
SU1-7333-60	Murphy cuffed endotracheal tube, 6.0	each	1.80
SU1-7333-65	Murphy cuffed endotracheal tube, 6.5	each	1.80
SU1-7333-70	Murphy cuffed endotracheal tube, 7.0	each	1.80
SU1-7333-75	Murphy cuffed endotracheal tube, 7.5	each	1.80
SU1-7333-80	Murphy cuffed endotracheal tube, 8.0	each	1.80
SU1-7333-85	Murphy cuffed endotracheal tube, 8.5	each	1.80
SU1-7333-90	Murphy cuffed endotracheal tube, 9.0	each	1.80
SU1-7333-95	Murphy cuffed endotracheal tube, 9.5	each	1.80
SU1-7333-10	Murphy cuffed endotracheal tube, 10.0	each	1.80





Murphy Cuffed Endotracheal Tubes with Stylet (SunMed)

SU1-7343-30	Murphy cuffed endotracheal tube with stylet, 3.0	each	3.10
SU1-7343-35	Murphy cuffed endotracheal tube with stylet, 3.5	each	3.10
SU1-7343-40	Murphy cuffed endotracheal tube with stylet, 4.0	each	3.10
SU1-7343-45	Murphy cuffed endotracheal tube with stylet, 4.5	each	3.10
SU1-7343-50	Murphy cuffed endotracheal tube with stylet, 5.0	each	3.10
SU1-7343-55	Murphy cuffed endotracheal tube with stylet, 5.5	each	3.10
SU1-7343-60	Murphy cuffed endotracheal tube with stylet, 6.0	each	3.10
SU1-7343-65	Murphy cuffed endotracheal tube with stylet, 6.5	each	3.10
SU1-7343-70	Murphy cuffed endotracheal tube with stylet, 7.0	each	3.10
SU1-7343-75	Murphy cuffed endotracheal tube with stylet, 7.5	each	3.10
SU1-7343-80	Murphy cuffed endotracheal tube with stylet, 8.0	each	3.10
SU1-7343-85	Murphy cuffed endotracheal tube with stylet, 8.5	each	3.10
SU1-7343-90	Murphy cuffed endotracheal tube with stylet, 9.0	each	3.10



Uncuffed Endotracheal Tubes (Telefl x Medical)

RU100382025	Uncuffed endotracheal tube, 2.5	each	1.51
RU100382030	Uncuffed endotracheal tube, 3.0	each	1.51
RU100382035	Uncuffed endotracheal tube, 3.5	each	1.51
RU100382040	Uncuffed endotracheal tube, 4.0	each	1.51
RU100382045	Uncuffed endotracheal tube, 4.5	each	1.51
RU100382050	Uncuffed endotracheal tube, 5.0	each	1.51
RU100382055	Uncuffed endotracheal tube, 5.5	each	1.51
RU100382060	Uncuffed endotracheal tube, 6.0	each	1.51
RU100382065	Uncuffed endotracheal tube, 6.5	each	1.51



Cuffed Endotracheal Tubes (Telefl x Medical)

RU112480025	Cuffed endotracheal tube, 2.5	each	2.19
RU112480030	Cuffed endotracheal tube, 3.0	each	2.19
RU112480035	Cuffed endotracheal tube, 3.5	each	2.19
RU112480040	Cuffed endotracheal tube, 4.0	each	2.19
RU112480045	Cuffed endotracheal tube, 4.5	each	2.19
RU112082050	Cuffed endotracheal tube, 5.0	each	1.55
RU112082055	Cuffed endotracheal tube, 5.5	each	1.55
RU112082060	Cuffed endotracheal tube, 6.0	each	1.55
RU112082065	Cuffed endotracheal tube, 6.5	each	1.55
RU112082070	Cuffed endotracheal tube, 7.0	each	1.55
RU112082075	Cuffed endotracheal tube, 7.5	each	1.55
RU112082080	Cuffed endotracheal tube, 8.0	each	1.55
RU112082085	Cuffed endotracheal tube, 8.5	each	1.55
RU112082090	Cuffed endotracheal tube, 9.0	each	1.55
RU112082095	Cuffed endotracheal tube, 9.5	each	1.55
RU112082100	Cuffed endotracheal tube, 10.0	each	1.55

Flexi-Set™ Uncuffed Endotracheal Tubes with Stylet (Telefl x)

RU506525	Flexi-Set uncuffed endotracheal tube with stylet, 2.5	each	4.54
RU506530	Flexi-Set uncuffed endotracheal tube with stylet, 3.0	each	4.54
RU506535	Flexi-Set uncuffed endotracheal tube with stylet, 3.5	each	4.54
RU506540	Flexi-Set uncuffed endotracheal tube with stylet, 4.0	each	4.54
RU506545	Flexi-Set uncuffed endotracheal tube with stylet, 4.5	each	4.54
RU506550	Flexi-Set uncuffed endotracheal tube with stylet, 5.0	each	4.54



Flexi-Set™ Cuffed Endotracheal Tubes with Stylet (Telefl x)

RU504550	Flexi-Set cuffed endotracheal tube with stylet, 5.0	each	4.70
RU504555	Flexi-Set cuffed endotracheal tube with stylet, 5.5	each	4.70
RU504560	Flexi-Set cuffed endotracheal tube with stylet, 6.0	each	4.70
RU504565	Flexi-Set cuffed endotracheal tube with stylet, 6.5	each	4.70
RU504570	Flexi-Set cuffed endotracheal tube with stylet, 7.0	each	4.70
RU504575	Flexi-Set cuffed endotracheal tube with stylet, 7.5	each	4.70
RU504580	Flexi-Set cuffed endotracheal tube with stylet, 8.0	each	4.70
RU504585	Flexi-Set cuffed endotracheal tube with stylet, 8.5	each	4.70
RU504590	Flexi-Set cuffed endotracheal tube with stylet, 9.0	each	4.70



Slick Set® Preloaded Uncuffed Endotracheal Tubes with Stylet

(Telefl x)

RU150020	Slick Set preloaded uncuffed ET tube with stylet, 2.0	each	3.00
RU150025	Slick Set preloaded uncuffed ET tube with stylet, 2.5	each	3.00
RU150030	Slick Set preloaded uncuffed ET tube with stylet, 3.0	each	3.00
RU150035	Slick Set preloaded uncuffed ET tube with stylet, 3.5	each	3.00
RU150040	Slick Set preloaded uncuffed ET tube with stylet, 4.0	each	3.00
RU150045	Slick Set preloaded uncuffed ET tube with stylet, 4.5	each	3.00
RU150050	Slick Set preloaded uncuffed ET tube with stylet, 5.0	each	3.00
RU150055	Slick Set preloaded uncuffed ET tube with stylet, 5.5	each	3.00



Slick Set® Preloaded Cuffed Endotracheal Tubes with Stylet (Telefl x)

RU170075	Slick Set preloaded cuffed ET tube with stylet, 7.5	each	5.07
RU170085	Slick Set preloaded cuffed ET tube with stylet, 8.5	each	5.07
RU170055	Slick Set preloaded cuffed ET tube with stylet, 5.5	each	5.07
RU170060	Slick Set preloaded cuffed ET tube with stylet, 6.0	each	5.07
RU170065	Slick Set preloaded cuffed ET tube with stylet, 6.5	each	5.07
RU170070	Slick Set preloaded cuffed ET tube with stylet, 7.0	each	5.07
RU170080	Slick Set preloaded cuffed ET tube with stylet, 8.0	each	5.07
RU170090	Slick Set preloaded cuffed ET tube with stylet, 9.0	each	5.07





Endotrol Oral/Nasal Endotracheal Tube (Medtronic/Covidien)

The Endotrol oral/nasal endotracheal tube has a directional distal tip control designed for fast, easy intubation in emergency situations when the intubating pathway is abnormal. Often referred to as a “trigger tube,” it features a moveable tip that enables manipulation of the tube tip for easier placement within the trachea.

N7652	Endotrol oral/nasal endotracheal tube, 6.0	each	11.60
N7653	Endotrol oral/nasal endotracheal tube, 7.0	each	11.60
N7654	Endotrol oral/nasal endotracheal tube, 8.0	each	11.60
N7655	Endotrol oral/nasal endotracheal tube, 9.0	each	11.60



Bougie-to-Go™ Endotracheal Tube Introducer (SunMed)

- Innovative compact packaging is designed specifically for EMS professionals
- Low density polyethylene provides proper stiffness for ease of insertion
- Calibrated to ensure accurate distance insertion
- Adult size fits in 6mm to 11mm tubes
- Single use, sterile

SU9-0212-82	Bougie-to-Go endotracheal tube introducer	each	6.47
-------------	-------------------------------------------	------	------

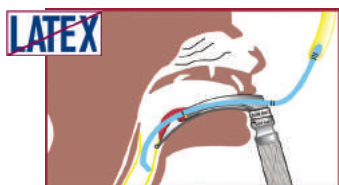

Bougie Endotracheal Tube Introducers (SunMed)

SU9-0212-70	Bougie ET tube introducer, adult, 15FR x 70cm with Coude tip	each	6.47
SU9-0211-70	Bougie ET tube introducer, 10FR x 70cm with Coude tip	each	6.47



Malleable Endotracheal Tube Introducers (SunMed)

- Combines benefits of an introducer and stylette into one unit
- Pediatric size features calibrated markings on both ends allowing it to be used as a straight or coudé tip
- Single use, sterile

SU9-0213-82	Malleable ET tube introducer, pediatric, 10FR x 70cm	each	6.47
SU9-0213-92	Malleable ET tube introducer, adult, 15FR x 70cm	each	6.47



Flexi-Slip Stylet (Teleflex)

RU502503	Flexi-Slip stylet, 10FR	each	2.46
RU502505	Flexi-Slip stylet, 12FR	each	2.46
RU502507	Flexi-Slip stylet, 14FR	each	2.46



Slick Stylet with Stopper (Teleflex)

RU500	Slick Stylet with stopper, 6FR	each	3.53
RU750	Slick Stylet with stopper, 8FR	each	3.53
RU1000	Slick Stylet with stopper, 10FR	each	5.04

Thomas® Select™ Tube Holder (Laerdal Medical)

Similar in shape to the Thomas Tube Holder, a larger opening allows the Thomas Select Tube Holder to accommodate a wider range of Supraglottic Airway Devices (SGAs), Laryngeal Masks (LMAs) and endotracheal (ET) tubes. Combined with a push-screw mechanism, tubes can be secured in a fast and efficient manner.

LA600-42500	Thomas Select tube holder	each	5.00
-------------	---------------------------	------	------



Thomas® Tube Holder (Laerdal)

The original Thomas Tube Holder is a tried and trusted tube holder, and an industry leader for the last two decades. Designed to secure a range of advanced airway devices, Thomas Tube Holders are easy to apply and provide a reliable hold over tape fastening methods.

LA500	Thomas tube holder, adult	each	4.00
LA400P	Thomas tube holder, pediatric	each	4.00



Endotracheal Tube Holder (Ambu)

Ambu's endotracheal tube holder allows the rescuer to apply holder with one hand in just seconds. It is easy to use and can be placed on patients needing a 3mm-9mm ET tube. Quick connect ratchet system for ease of use and one-hand operation. Rubber or soft Velcro strap. See- thru design. For adults and children.

AU320-264-040	ET tube holder with blue rubber strap	each	3.67
AU320-264-041	ET tube holder with white velcro strap	each	3.67



Endotracheal Tube Holder (Precision Medical)

This Endotracheal Tube Holder is fully padded to protect lips and teeth. It has a sturdy bite block to prevent tube occlusion. Available in adult size only.

PM1110	ET tube holder	10 /box	35.25
--------	----------------	---------	-------



Easy Cap II CO₂ Detectors (Medtronic/Covidien)

Reliable carbon dioxide detectors help verify endotracheal tube placement. Responds quickly to exhaled CO₂ with a simple color change from purple to yellow. Breath-to-breath response. Constant visual feedback for up to 2 hours.

N7697	Easy-Cap CO2 detector	each	12.23
N7698	Pedi-Cap CO2 detector	each	12.23

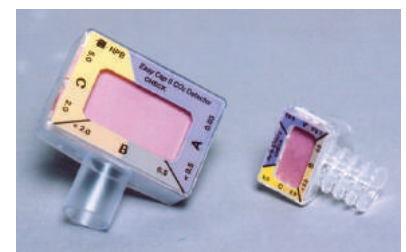



CO₂ Easy™ Carbon Dioxide Detector (Westmed)

Featuring the largest visual indicator available, the CO₂ Easy is ideally mounted up front where clinicians and first responders can effectively view critical carbon dioxide levels without looking away from the patient. The non-toxic, pH sensitive indicator uses familiar purple-to-yellow color conversion when CO₂ is exhaled.

WE562134	CO ₂ Easy detector, adult	each	10.00
WE562135	CO ₂ Easy detector, pediatric	each	10.00



TubeChek (Ambu)

The disposable Ambu TubeChek is a device that reliably confirms if endotracheal tube placement is correct. This tool uses the anatomical differences between the esophagus and trachea to confirm correct ET tube placement. If there is negative pressure, the esophagus has been intubated; if air can be aspirated, correct tracheal intubation has been achieved. Illuminates in the dark

N7696	TubeChek, bulb style	each	2.80
-------	----------------------	------	------



PosiTUBE (Para Products)

Inadequate light, loud noises and other factors can make successful intubation of a patient difficult in the field. Even in a more controlled setting, it's often a challenge to differentiate between the patient's trachea and esophagus. With PosiTUBE you can immediately verify proper placement of the endotracheal tube or double lumen airway. You can then oxygenate your patient with complete confidence.

N7580	PosiTUBE	each	3.99
-------	----------	------	------



Beck Airway Airflow Monitor (B.A.A.M.) (Great Plains)

The B.A.A.M. is attached to the endotracheal connector on either a nasal or oral intubated patient. If no whistle sound is elicited on exhalation and inhalation, then the tube is either not in the trachea or the airway is obstructed. Positive whistle sounds indicate patency of the airway.

N6050	B.A.A.M. airway airflow monitor	each	9.00
-------	---------------------------------	------	------



EID100 Esophageal Intubation Detector (Teleflex)

The EID100 esophageal intubation detection device gives immediate confirmation of endotracheal tube placement. It features a 90 degree elbow and a "pistol grip," which allows you to hold the handle while gripping the elbow and endotracheal tube with your finger. The "pistol grip" facilitates a horizontal pull preventing accidental extubation, thus eliminating any vertical movement of the endotracheal tube.

N7695	EID 100 esophageal intubation detector, syringe style	each	5.41
-------	-------------------------------------------------------	------	------



Nasal Intubation Spray

Constricts blood vessels in nose to help reduce bleeding during nasal intubations.

WH5711-35	Nasal spray, oxymetazoline, 0.05%, 15ml	each	3.95
-----------	-----------------------------------------	------	------

King Vision Portable Video Laryngoscope (Ambu)

The King Vision is an affordable, durable and portable video laryngoscope. It is designed for indirect laryngoscopy, difficult endotracheal intubations and routine intubations. It accommodates minimum mouth openings of 13mm for the standard blade and 18mm for the channeled blade making it effective for the majority of adult patients. The King Vision combines the best features of traditional laryngoscopes, fiber optic laryngoscopes and new cutting-edge visualization technology to offer clinicians an immediate and clear view of the vocal cords. This results in a more accurate intubation while minimizing soft tissue manipulation.

- Lightweight, self-contained, battery operated and water resistant. The reusable display comes packaged in a protective, foam case. Blades are individually packaged. The disposable blades allow economical use of the King Vision for all of your intubations



AUKVLKIT3	King Vision Kit (display head, 3 channel blades, standard blade, carry case for head only)	each	1,599.00
AUKVIS01	King Vision display head only with carry case	each	1,499.00
AUKVL03	King Vision standard blade	each	29.95
AUKVL03C	King Vision channel blade	each	29.95
AU900002116	King Vision pocket DVR recorder	each	338.95
AUKVCABL	King Vision video out cable	each	40.00



- Download **FREE Layar App** (from your App Store)
- Scan this page
- View custom product info

GreenLine®/D™ Disposable Fiber Optic Laryngoscope (SunMed)

- Disposable blade solves contamination problems and eliminates the cost and time spent cleaning blades and returning them for use
- Answers the professional's request for a non-plastic single-use blade suitable for everyday hospital use
- Polished acrylic stem produces exceptional illumination
- Compliant with ISO standard 7376
- Green System compatible
- Constructed of surgical stainless steel



SU5-5332-01	GreenLine/D disposable F/O blade, Macintosh, size 1, infant	each	4.73
SU5-5332-02	GreenLine/D disposable F/O blade, Macintosh, size 2, child	each	4.73
SU5-5332-03	GreenLine/D disposable F/O blade, Macintosh, size 3, medium adult	each	4.73
SU5-5332-04	GreenLine/D disposable F/O blade, Macintosh, size 4, large adult	each	4.73
SU5-5333-00	GreenLine/D disposable F/O blade, Miller, size 0, newborn	each	4.73
SU5-5333-01	GreenLine/D disposable F/O blade, Miller, size 1, infant	each	4.73
SU5-5333-02	GreenLine/D disposable F/O blade, Miller, size 2, child	each	4.73
SU5-5333-03	GreenLine/D disposable F/O blade, Miller, size 3, medium	each	4.73
SU5-5333-04	GreenLine/D disposable F/O blade, Miller, size 4, large adult	each	4.73
SU5-5333-57	GreenLine/D disposable F/O kit includes medium handle, Macintosh blades size 2, 3 and 4 and Miller blades size 0, 1, 2 and 3	each	114.29
SU5-0236-69	GreenLine/D disposable F/O handle	each	14.67



LED Disposable Standard/D™ Laryngoscope Blades (SunMed)

- Compatible with all conventional laryngoscope systems
- Surgical stainless steel single-use laryngoscope
- Helps prevent cross-contamination
- Patented safety heel inhibits blade tip from contacting handle
- Clean, cool, white LED illumination

SU5-5132-01	LED disposable standard/D™ laryngoscope blade, Macintosh, size 1	each	7.38
SU5-5132-02	LED disposable standard/D™ laryngoscope blade, Macintosh, size 2	each	7.38
SU5-5132-03	LED disposable standard/D™ laryngoscope blade, Macintosh, size 3	each	7.38
SU5-5132-04	LED disposable standard/D™ laryngoscope blade, Macintosh, size 4	each	7.38
SU5-5133-20	LED disposable standard/D™ laryngoscope blade, Miller, size 00	each	7.38
SU5-5133-00	LED disposable standard/D™ laryngoscope blade, Miller, size 0	each	7.38
SU5-5133-01	LED disposable standard/D™ laryngoscope blade, Miller, size 1	each	7.38
SU5-5133-02	LED disposable standard/D™ laryngoscope blade, Miller, size 2	each	7.38
SU5-5133-03	LED disposable standard/D™ laryngoscope blade, Miller, size 3	each	7.38
SU5-5133-04	LED disposable standard/D™ laryngoscope blade, Miller, size 4	each	7.38



GreenLine® Reusable Fiber Optic Handles (SunMed)

These reusable handles are for use with disposable blades.

- Chrome-plated brass
- Knurled finish or secure grip
- Batteries not included

SU5-0236-09	GreenLine F/O handles, medium, uses two "C" batteries (not included)	each	53.85
SU5-0236-10	GreenLine F/O handles, penlight, uses two "AA" batteries (not included)	each	53.85
SU5-0240-52	GreenLine F/O lamp with gold cartridge	each	18.54
SU5-0240-53	GreenLine F/O lamp without gold cartridge	each	20.72
T1950	"AA" battery	each	0.52
T1951	"C" battery	each	0.97



SunBrite™ LED Economical Laryngoscope Handles (SunMed)

These economical handles offer a lifetime warranty.

SU5-0236-90	SunBrite LED handle, penlight, uses 2 "AA" batteries (not included)	each	94.12
SU5-0236-99	SunBrite LED handle, medium, uses 2 "C" batteries (not included)	each	94.12
T1950	"AA" battery	each	0.52
T1951	"C" battery	each	0.97

Conventional Chrome-Plated Brass Laryngoscope Handles

(SunMed)

SU5-0237-01	Conventional laryngoscope handle, penlite (2 "AA" batteries not included)	each	26.91
SU5-0237-03	Conventional laryngoscope handle, medium (2 "C" batteries not included)	each	32.63
T1950	"AA" battery	each	0.52
T1951	"C" battery	each	0.97



Rusch TruLite Secure™ Disposable Laryngoscope Blade and Handle (Telefl x)

RU004671002	Rusch TruLite Secure laryngoscope, Macintosh, size 2	10/case	228.54
RU004671003	Rusch TruLite Secure laryngoscope, Macintosh, size 3	10/case	228.54
RU004671004	Rusch TruLite Secure laryngoscope, Macintosh, size 4	10/case	228.54
RU004670000	Rusch TruLite Secure laryngoscope, Miller, size 0	10/case	228.54
RU004670001	Rusch TruLite Secure laryngoscope, Miller, size 1	10/case	228.54
RU004670002	Rusch TruLite Secure laryngoscope, Miller, size 2	10/case	228.54
RU004670003	Rusch TruLite Secure laryngoscope, Miller, size 3	10/case	228.54
RU004670004	Rusch TruLite Secure laryngoscope, Miller, size 4	10/case	228.54



Rusch Lite Slim™ Disposable Laryngoscope Blade (Telefl x)

The Rusch Lite Slim disposable laryngoscope blade offers compatibility with your current standard handles. It features a bright xenon light.

RU004801100	Rusch Lite Slim disposable laryngoscope blade, Macintosh, size 1	each	6.10
RU004802200	Rusch Lite Slim disposable laryngoscope blade, Macintosh, size 2	each	6.10
RU004803300	Rusch Lite Slim disposable laryngoscope blade, Macintosh, size 3	each	6.10
RU004804400	Rusch Lite Slim disposable laryngoscope blade, Macintosh, size 4	each	6.10
RU004850050	Rusch Lite Slim disposable laryngoscope blade, Miller, size 0	each	6.10
RU004851100	Rusch Lite Slim disposable laryngoscope blade, Miller, size 1	each	6.10
RU004852200	Rusch Lite Slim disposable laryngoscope blade, Miller, size 2	each	6.10
RU004853300	Rusch Lite Slim disposable laryngoscope blade, Miller, size 3	each	6.10
RU0048	Rusch Lite Slim disposable laryngoscope blade kit includes Macintosh sizes 1, 2, 3 and 4 and Miller sizes 0, 1, 2 and 3, medium standard handle and storage case	each	93.95





Standard Reusable Laryngoscope Blades (Telefl x)

Rusch reusable laryngoscope blades are made of polished stainless steel - providing more durability than chrome-plated brass blades. The stain finish produces a glare-free blade which helps airway visualization. Features a halogen light.

RU8601100	Standard reusable laryngoscope blade, Macintosh, size 1	each	15.68
RU8602200	Standard reusable laryngoscope blade, Macintosh, size 2	each	15.68
RU8603300	Standard reusable laryngoscope blade, Macintosh, size 3	each	15.68
RU8604400	Standard reusable laryngoscope blade, Macintosh, size 4	each	15.68
RU8615050	Standard reusable laryngoscope blade, Miller, size 0	each	15.68
RU8616100	Standard reusable laryngoscope blade, Miller, size 1	each	15.68
RU8617200	Standard reusable laryngoscope blade, Miller, size 2	each	15.68
RU8618300	Standard reusable laryngoscope blade, Miller, size 3	each	15.68
RU8619400	Standard reusable laryngoscope blade, Miller, size 4	each	15.68



BriteView® Disposable Laryngoscope Blades (Hartwell Medical)

BriteView disposable laryngoscope blades are strong, crafted with a brilliant light source and color coded for instant size recognition in emergency situations.

HALB42MAC1DS	BriteView laryngoscope blade, Macintosh, size 1	pink	each	9.72
HALB42MAC2DS	BriteView laryngoscope blade, Macintosh, size 2	yellow	each	9.72
HALB42MAC3DS	BriteView laryngoscope blade, Macintosh, size 3	orange	each	9.72
HALB42MAC4DS	BriteView laryngoscope blade, Macintosh, size 4	lime green	each	9.72
HALB42MIL0DS	BriteView laryngoscope blade, Miller, size 0	white	each	9.72
HALB42MIL1DS	BriteView laryngoscope blade, Miller, size 1	pink	each	9.72
HALB42MIL2DS	BriteView laryngoscope blade, Miller, size 2	yellow	each	9.72
HALB42MIL3DS	BriteView laryngoscope blade, Miller, size 3	orange	each	9.72
HALB42MIL4DS	BriteView laryngoscope blade, Miller, size 4	lime green	each	9.72



Grandview® Laryngoscope Blades (Hartwell Medical)

The Grandview combines a brilliant light source with a wider field of view to improve direct visualization of the cords and helps you increase your intubation success rate. 80% wider blade surface keeps the tongue out of the way. Fits all standard handles.

HAGV2020A	Grandview laryngoscope blade, adult	each	86.31
HAGV2020C	Grandview laryngoscope blade, child	each	86.31
HAGV2020A-DS	Grandview disposable laryngoscope blade, adult	each	12.14
HAGV1008	Grandview lamp, fits adult and child blade	each	9.36

Disposable Laryngoscope Blades (IntuBrite)

IntuBrite manufactures its uniquely designed laryngoscope blades from surgical-grade, stainless steel. These are custom-fit ed with a proprietary array of UV and White LED bulbs (black light and white light) with wavelengths specifically “tuned” to deliver precisely the correct illumination, providing a unique, anatomy-differentiating and glareless view.



IB1021	Disposable laryngoscope blade, Macintosh, size 1	each	7.95
IB1022	Disposable laryngoscope blade, Macintosh, size 2	each	7.95
IB1023	Disposable laryngoscope blade, Macintosh, size 3	each	7.95
IB1024	Disposable laryngoscope blade, Macintosh, size 4	each	7.95
IB1039	Disposable laryngoscope blade, Miller size 00	each	7.95
IB1030	Disposable laryngoscope blade, Miller size 0	each	7.95
IB1031	Disposable laryngoscope blade, Miller size 1	each	7.95
IB1032	Disposable laryngoscope blade, Miller size 2	each	7.95
IB1033	Disposable laryngoscope blade, Miller size 3	each	7.95
IB1034	Disposable laryngoscope blade, Miller size 4	each	7.95

Reusable Laryngoscope Blades (Intubrite)

Patented combination White/UV LED lighting produces optimized high definition viewing area, causing airway structures to be clearly visible and vocal cords to stand out. Reflexivity from fluids and tissue in ai way is also dramatically reduced when compared to incandescent lighted blades, even fiber optic .



IB4021	Reusable laryngoscope blade, Macintosh, size 1	each	69.95
IB4022	Reusable laryngoscope blade, Macintosh, size 2	each	69.95
IB4023	Reusable laryngoscope blade, Macintosh, size 3	each	69.95
IB4024	Reusable laryngoscope blade, Macintosh, size 4	each	69.95
IB4039	Reusable laryngoscope blade, Miller, size 00	each	69.95
IB4030	Reusable laryngoscope blade, Miller, size 0	each	69.95
IB4031	Reusable laryngoscope blade, Miller, size 1	each	69.95
IB4032	Reusable laryngoscope blade, Miller, size 2	each	69.95
IB4033	Reusable laryngoscope blade, Miller, size 3	each	69.95
IB4034	Reusable laryngoscope blade, Miller, size 4	each	69.95

Laryngoscope Handles (Intubrite)

IntuBrite offers a complete line of laryngoscope handles to meet most organizations’ needs. All handles feature our unique power source which helps provide IntuBrite’s patented, dual-lighted view.

IB1000	Intubrite laryngoscope handle, E-Max	each	119.95
IB1010	Intubrite laryngoscope handle, E-Flex	each	119.95
IB1011	Intubrite laryngoscope handle, E-Classic	each	119.95
IB2155	Intubrite laryngoscope lithium battery, 3.6V	each	10.77





Standard Satin™ Reusable Laryngoscope Blades (ADC)

Made of high quality stainless steel and compatible with any standard handle. Satin finish reduces glare.

N7314	Standard reusable laryngoscope blade, Macintosh, size 0	each	13.85
N7315	Standard reusable laryngoscope blade, Macintosh, size 1	each	13.85
N7316	Standard reusable laryngoscope blade, Macintosh, size 2	each	13.85
N7317	Standard reusable laryngoscope blade, Macintosh, size 3	each	13.85
N7318	Standard reusable laryngoscope blade, Macintosh, size 4	each	13.85
N7319	Standard reusable laryngoscope blade, Miller, size 0	each	13.85
N7320	Standard reusable laryngoscope blade, Miller, size 1	each	13.85
N7321	Standard reusable laryngoscope blade, Miller, size 2	each	13.85
N7322	Standard reusable laryngoscope blade, Miller, size 3	each	13.85
N7323	Standard reusable laryngoscope blade, Miller, size 4	each	13.85



Laryngoscope Handles and Bulbs

RU77700	Laryngoscope handle, Rusch DispoLED disposable fiber opti	20/case	348.52
RU8620100	Laryngoscope handle, small/penlight, uses two "AA" batteries (not included)	each	17.43
RU8621000	Laryngoscope handle, medium, uses two "C" batteries (not included)	each	17.43
RU8628300	Laryngoscope handle bulb, large, frosted	each	1.88
RU8629100	Laryngoscope handle bulb, small, frosted	each	1.96
T1950	"AA" battery	each	0.52
T1951	"C" battery	each	0.97

The Southeastern Emergency Medicine Training & Education Center

Our Training & Education Center is located on the same campus as our headquarters in Youngsville, NC (just north of Raleigh). It features the latest in AV technology to ensure courses are presented in a professional and academically sound environment.

The Center is equipped with a vast array of emergency supplies and equipment as well as cutting-edge patient simulators and support materials that ensure participants train in a real-world environment.

- Philips Healthcare MRx monitors/defib illators
- Philips Healthcare AEDs
- Laerdal Patient Simulators
- Laerdal-supported CPR feedback devices
- Stryker stretchers
- Fully-stocked hospital-style crash carts
- Emergency responder bags and accessories
- Ambulances (if needed for training purposes)



Philips MRx



Laerdal SimPad

For more information on our full array of training and education services, see pages 124-125.

King Disposable Supraglottic Airway Kits (Ambu)

The King LTS-D kit contains one each of King LTS-D supraglottic airway, ET tube holder with bite block, luer lock syringe and 50-60cc lubricating jelly packet.

The King LTS-D mini-kit contains one each of King LTS-D supraglottic airway, luer lock syringe and 50-60cc lubricating jelly packet.

The King LT-D kit contains one each of King LT-D supraglottic airway, luer lock syringe and 50-60cc lubricating jelly packet.



KLTS403K	LTS-D supraglottic airway kit, size 3.0	each	55.00
KLTS404K	LTS-D supraglottic airway kit, size 4.0	each	55.00
KLTS405K	LTS-D supraglottic airway kit, size 5.0	each	55.00
KLTS403K-NG	LTS-D supraglottic airway kit with NG tube, size 3.0	each	53.50
KLTS404K-NG	LTS-D supraglottic airway kit with NG tube, size 4.0	each	53.00
KLTS405K-NG	LTS-D supraglottic airway kit with NG tube, size 5.0	each	53.00
KLTS413	LTS-D supraglottic airway mini-kit, size 3.0	each	42.00
KLTS414	LTS-D supraglottic airway mini-kit, size 4.0	each	42.00
KLTS415	LTS-D supraglottic airway mini-kit, size 5.0	each	42.00
KLTD202P	LT-D supraglottic airway kit, size 2.0	each	44.00
KLTD2025P	LT-D supraglottic airway kit, size 2.5	each	44.00
KLTD203	LT-D supraglottic airway kit, size 3.0	each	44.00
KLTD204	LT-D supraglottic airway kit, size 4.0	each	44.00
KLTD205	LT-D supraglottic airway kit, size 5.0	each	44.00

King LTS-D™ Disposable Supraglottic Airways (Ambu)

The King LTS-D is a simple-to-use airway tool that provides a patent airway and positive pressure ventilation with seal pressures. It offers the unique ability to easily pass a gastric tube through a second channel of the airway and into the esophagus and stomach. The distal tip and cuff assist in the airway's passage behind the larynx and into the normally collapsed esophagus. Suction with up to an 18FR suction catheter for gastric access.

KLTS403	LTS-D supraglottic airway, size 3.0	each	48.00
KLTS404	LTS-D supraglottic airway, size 4.0	each	48.00
KLTS405	LTS-D supraglottic airway, size 5.0	each	48.00
KLTS420	LTS-D supraglottic airway, pediatric, size 0	each	51.00
KLTS421	LTS-D supraglottic airway, pediatric, size 1	each	51.00
KLTS422	LTS-D supraglottic airway, pediatric, size 2	each	51.00
KLTS4225	LTS-D supraglottic airway, pediatric, size 2.5	each	51.00



King LT-D™ Disposable Supraglottic Airways (Ambu)

The King LT-D, is an alternative to tracheal intubation or mask ventilation. It is easy to insert and is strategically designed to minimize airway trauma. This sterile, single-use supraglottic airway provides a patent airway for superior patient ventilation.

KLTD202	LT-D supraglottic airway, size 2.0	each	44.00
KLTD2025	LT-D supraglottic airway, size 2.5	each	44.00



i-gel Supraglottic Airway (Intersurgical)

i-gel fits anatomically in unison with the airway, creating higher seal pressures without compression and trauma to the airway and surrounding structures. i-gel O2 Resus Pack includes an i-gel O2 with hook ring, sachet of lubricant, airway support strap and a 12FG suction tube.



IS8703030	i-gel O2 Resus Pack for small adults, size 3.0	each	30.00
IS8704030	i-gel O2 Resus Pack for medium adults, size 4.0	each	30.00
IS8705030	i-gel O2 Resus Pack for large adults, size 5.0	each	30.00
IS8201030	i-gel supraglottic airway for neonates, size 1.0	each	23.10
IS8215030	i-gel supraglottic airway for infants, size 1.5	each	23.10
IS8202030	i-gel supraglottic airway for small pediatrics, size 2.0	each	23.10
IS8225030	i-gel supraglottic airway for large pediatrics, size 2.5	each	23.10
IS8203030	i-gel supraglottic airway for small adults, size 3.0	each	23.10
IS8204030	i-gel supraglottic airway for medium adults, size 4.0	each	23.10
IS8205030	i-gel supraglottic airway for large adults, size 5.0	each	23.10

LMA Supreme® (LMA North America)

The LMA Supreme™ inspires confidence beyond any other laryngeal mask. The integrated drain tube is designed to channel fluid and gas safely away from the airway. Subtle refinements in the mask make correct placement easier. And, every LMA Supreme™ comes packaged sterile, new, and ready for one-time use when you need it.



LMA175010	LMA Supreme, size 1	each	30.77
LMA175015	LMA Supreme, size 1.5	each	30.77
LMA175020	LMA Supreme, size 2	each	30.77
LMA175025	LMA Supreme, size 2.5	each	30.77
LMA175030	LMA Supreme, size 3	each	30.77
LMA175040	LMA Supreme, size 4	each	30.77
LMA175050	LMA Supreme, size 5	each	30.77

Combitube® Esophageal/Tracheal Double-Lumen Airway

(Mallinckrodt)

- Unique design provides patient airway with either esophageal or tracheal placement
- Blind placement eliminates the need for a laryngoscope
- Reduces risk of aspiration of gastric contents
- Requires no restraining devices
- Single-patient use
- Kit includes two inflation syringes, elbow and a suction catheter



MA5-18437	Combitube roll-up kit, 37FR; for patients 4'-6' tall	each	55.46
MA5-18537	Combitube tray kit, 37FR; for patients 4'-6' tall	each	67.16
MA5-18441	Combitube roll-up kit, 41FR; for patients 5' tall and above	each	55.46
MA5-18541	Combitube tray kit, 41FR; for patients 5' tall and above	each	67.16
MA5-18141	Combitube trainer airway kit (for training only)	each	79.45

Color-Coded Berman Airways (Telefl x)

The dual channel Berman airway is constructed of semi-rigid, nontoxic polyethylene. Easily inserted. Allows for suction catheter insertion or withdrawal and ensures an unobstructed pathway for ventilation. Not individually wrapped.

SEEBAK-BX	Color-coded berman airway kit in plastic case (contains one each of eight airways, 40mm-110mm)		kit	4.75
SEEBAK	Color-coded berman airway kit in Ziplock bag (contains one each of eight airways sizes 40mm-110mm)		kit	3.00
RU121801	Color-coded berman airway, 40mm	pink	each	0.18
RU121850	Color-coded berman airway, 50mm	light blue	each	0.18
RU121802	Color-coded berman airway, 60mm	black	each	0.18
RU121870	Color-coded berman airway, 70mm	white	each	0.18
RU121803	Color-coded berman airway, 80mm	green	each	0.18
RU121804	Color-coded berman airway, 90mm	yellow	each	0.18
RU121805	Color-coded berman airway, 100mm	lavender	each	0.18
RU121806	Color-coded berman airway, 110mm	orange	each	0.18

**Color-Coded Berman Airways (individually wrapped)** (SunMed)

Color-coded for easy identification. Polyethylene plastic. Vented. Disposable and individually wrapped.

SEEAIR-1	Color-coded Berman airway kit (contains one each of eight airways, sizes 00 to 6)		each	2.80
SU1-1506-40	Color-coded Berman airway, size 00, 40mm, individually wrapped	pink	each	0.32
SU1-1506-50	Color-coded Berman airway, size 0, 50mm, individually wrapped	blue	each	0.32
SU1-1506-60	Color-coded Berman airway, size 1, 60mm, individually wrapped	black	each	0.32
SU1-1506-70	Color-coded Berman airway, size 2, 70mm, individually wrapped	white	each	0.32
SU1-1506-80	Color-coded Berman airway, size 3, 80mm, individually wrapped	green	each	0.32
SU1-1506-90	Color-coded Berman airway, size 4, 90mm, individually wrapped	yellow	each	0.32
SU1-1506-99	Color-coded Berman airway, size 5, 100mm, individually wrapped	red	each	0.32
SU1-1506-11	Color-coded Berman airway, Size 6, 110mm, individually wrapped	orange	each	0.32





Cath-Guide® Guedel Airways, Individually Wrapped (Telefl x)

HU1171	Cath-Guide guedel airway, size 0	each	1.09
HU1170	Cath-Guide guedel airway, size 1	each	1.09
HU1169	Cath-Guide guedel airway, size 2	each	1.09
HU1168	Cath-Guide guedel airway, size 3	each	1.09
HU1164	Cath-Guide guedel airway, size 4	each	1.09
HU1167	Cath-Guide guedel airway, size 5	each	1.09
HU1166	Cath-Guide guedel airway, size 6	each	1.09
HU1165	Cath-Guide guedel airway, size 7	each	1.09



Guedel Oral Airways, Individually Wrapped (Telefl x)

SEEGAK	Complete kit in Ziplock bag (contains one of sizes 0, 1, 2, 3, 4 and 5)	each	4.09
RU122950	Geudel oral airways, size 0	blue	each 0.62
RU122960	Geudel oral airways, size 1	black	each 0.62
RU122970	Geudel oral airways, size 2	white	each 0.62
RU122980	Geudel oral airways, size 3	green	each 0.62
RU122990	Geudel oral airways, size 4	yellow	each 0.62
RU1229100	Geudel oral airways, size 5	red	each 0.62



Color-Coded Guedel Airway Kit (Southeastern)

SEEAIR	Color-coded Guedel airway kit contains one each of size 50, 60, 70, 80, 90 and 99 airways	each	5.25
--------	-------------------------------------------------------------------------------------------	------	------



Soft PVC Nasopharyngeal Airways (Telefl x)

RU1233	PVC nasopharyngeal kit, contains one each of four sizes (12-18FR)	each	11.09
RU1234	PVC nasopharyngeal kit, contains one each of nine sizes (20-36FR)	each	24.97
RU123312	PVC nasopharyngeal airway, 12FR	each	2.86
RU123314	PVC nasopharyngeal airway, 14FR	each	2.86
RU123316	PVC nasopharyngeal airway, 16FR	each	2.86
RU123318	PVC nasopharyngeal airway, 18FR	each	2.86
RU123319	PVC nasopharyngeal airway, 19FR	each	2.86
RU123320	PVC nasopharyngeal airway, 20FR	each	2.86
RU123322	PVC nasopharyngeal airway, 22FR	each	2.86
RU123324	PVC nasopharyngeal airway, 24FR	each	2.86
RU123326	PVC nasopharyngeal airway, 26FR	each	2.86
RU123328	PVC nasopharyngeal airway, 28FR	each	2.86
RU123330	PVC nasopharyngeal airway, 30FR	each	2.86
RU123332	PVC nasopharyngeal airway, 32FR	each	2.86
RU123334	PVC nasopharyngeal airway, 34FR	each	2.86
RU123336	PVC nasopharyngeal airway, 36FR	each	2.86

Robertazzi Airways (Telefl x)

RU1231	Robertazzi airway kit contains one each of nine airways (22-32FR), 4 packets of lubricant	each	16.66
RU123120	Robertazzi airway, 20FR	each	2.78
RU123122	Robertazzi airway, 22FR	each	2.78
RU123124	Robertazzi airway, 24FR	each	2.78
RU123126	Robertazzi airway, 26FR	each	2.78
RU123128	Robertazzi airway, 28FR	each	2.78
RU123130	Robertazzi airway, 30FR	each	2.78
RU123132	Robertazzi airway, 32FR	each	2.78
RU123134	Robertazzi airway, 34FR	each	2.78
RU123136	Robertazzi airway, 36FR	each	2.78



Robertazzi Nasopharyngeal Airways, Individually Wrapped
(SunMed)

SU1-5075-20	Robertazzi nasopharyngeal airway, 20FR	each	4.15
SU1-5075-22	Robertazzi nasopharyngeal airway, 22FR	each	4.15
SU1-5075-24	Robertazzi nasopharyngeal airway, 24FR	each	4.15
SU1-5075-26	Robertazzi nasopharyngeal airway, 26FR	each	4.15
SU1-5075-28	Robertazzi nasopharyngeal airway, 28FR	each	4.15
SU1-5075-30	Robertazzi nasopharyngeal airway, 30FR	each	4.15
SU1-5075-32	Robertazzi nasopharyngeal airway, 32FR	each	4.15
SU1-5075-34	Robertazzi nasopharyngeal airway, 34FR	each	4.15
SU1-5075-36	Robertazzi nasopharyngeal airway, 36FR	each	4.15



Nasal Airway Kit (Southeastern)

SEENASK	Nasal airway kit contains one each of six airways (22-32FR), four packets of lubricant, all in poly bag	each	16.75
SEENSKIT	Nasal airway kit contains one each of eight airways (20-32FR), four packets of lubricant, all in ziplock bag	each	30.00
SEEPEDNA	Nasal airway kit contains one each of four airways (12-18FR), four packets of lubricant, all in ziplock bag	each	14.00



Bitestick (ADC)

Depresses tongue and provides airway for seizure patients. One piece, nontoxic, unbreakable and reusable.

ADC4010	Bitestick	each	6.18
---------	-----------	------	------





Rescuer® Emergency CPAP System (BLS Systems)

This award-winning disposable CPAP system allows you to produce 15cm of CPAP pressure at only 10Lpm. This means you can triple your oxygen tank life. Controlled airway pressure provides rapid relief for maximum patient benefit with minimal oxygen consumption.

- Low-cost and 100% disposable
- Begin CPAP therapy with only 5Lpm
- Provides filtration on inhalation and exhalation to reduce risk of transmitting airborne pathogens
- Multi-function medication port accommodates manometer
- Anti-suffocation valve
- Simple-to-operate adjustable PEEP
- Oxygen supplied by standard flowmeter
- High-quality CPAP mask with adjustable forehead pads (BLS-8700, BLS-8705)
- 360° swivel elbow



- Download FREE Layar App (from your App Store)
- Scan this page
- View custom product info

BLS-8700KIT	Rescuer CPAP device with premium adjustable large adult cushion mask and nebulizer tee	each	39.95
BLS-8700	Rescuer CPAP device with premium adjustable large adult mask	each	42.50
BLS-8705	Rescuer CPAP device with premium adjustable medium mask	each	42.50
BLS-8750	Rescuer CPAP device with economy large adult cushion mask	each	39.50
BLS-8755	Rescuer CPAP device with economy medium cushion mask	each	39.50
BLS-8700M	Rescuer CPAP premium mask only, adjustable large adult	each	29.35
BLS-8710M	Rescuer CPAP premium mask only, adjustable small adult	each	29.35
BLS-8705M	Rescuer CPAP premium mask only, adjustable medium	each	29.35
BLS-4000M	Rescuer CPAP manometer	each	5.00



Rescuer® II Compact CPAP System (BLS Systems)

The Rescuer II Compact CPAP System is smaller and simpler to operate than its companion product, the Rescuer Emergency CPAP System. The Rescuer II includes a calibrated pressure manometer that allows the user to read the pressure in the system during operation.

BLS-8805	Rescuer II CPAP device with medium adult mask	each	37.50
BLS-8800	Rescuer II CPAP device with large adult mask	each	37.50



PortO₂Vent™ Oxygen Delivery System (Emergent)

The PortO₂Vent Oxygen Delivery System is a gas-powered device that delivers non-invasive CPAP to spontaneously breathing patients who are awake and can maintain a patent airway. It delivers CPAP at operator adjustable levels throughout the breathing cycle, independent of the patient's inspiratory flow requirements.

1900-001	PortO ₂ Vent unit	each	1,000.00
1900-124	PortO ₂ Vent breathing circuit and mask	each	74.00
1900-222	PortO ₂ Vent Soft-Seal mask, small adult	each	17.50
1900-333	PortO ₂ Vent Soft-Seal mask, medium adult	each	16.46
1900-444	PortO ₂ Vent Soft-Seal mask, large adult	each	19.92
1900-654	PortO ₂ Vent black neoprene head harness for Soft-Seal mask	each	7.00

WhisperFlow® CPAP Procedure Packs (Philips)

989803164971	WHISPERPAK (includes large SealFlex ribbed cushion mask, "H" style head strap, bacterial filter, 7.5 cmH2O CPAP valve, 36" collapsible hose)	each	36.09
989803165031	WHISPERPAK (includes large SealFlex ribbed cushion mask, "H" style head strap, bacterial filter, 10.0 cmH2O CPAP valve, 36" collapsible hose)	each	37.10
989803165041	WHISPERPAK (includes large SealFlex ribbed cushion mask, 4-pt non-latex head strap, bacterial filter, 7.5 cmH2O CPAP valve, 80" smooth inner wall hose)	each	34.25
989803165281	WHISPERPAK (includes large SealFlex ribbed cushion mask, "H" head strap, 10.0 cmH2O CPAP valve, bacterial filter, 80" smooth inner wall hose)	each	35.00
989803165061	WHISPERPAK (includes large Performa Trak mask, 10.0 cmH2O CPAP valve, bacterial filter, 80" smooth inner wall hose)	each	48.50
989803165211	WHISPERPAK (includes medium SealFlex ribbed cushion mask, multi-strap "H" head strap pack, 7.5 cmH2O CPAP valve, bacterial filter, 80" smooth inner wall hose)	each	46.00



Respiratory Care ■ BVMs/Manual Resuscitators

Patriot™ Manual Resuscitator/BVM (Southeastern)

This competitively-priced, high-quality BVM Includes bacterial/viral filter, oxygen reservoir and mask. Single patient use helps prevent cross-contamination. No cleaning, disinfecting or reprocessing required. The Patriot is completely disposable. Attached bacterial/viral filter, oxygen reservoir and mask means The Patriot is ready for immediate use which reduces response times.

- Available in most commonly used sizes—adult (1500ml), child (550ml) and infant (300ml)
- Easy-to-read, colorful packaging ensures correct resuscitator size selection
- Drawstring bag can conveniently hang inside ambulances for immediate access
- Face mask appropriate to patient size is conveniently packaged with resuscitator
- Patient port swivel allows caregiver to move easily around patient while maintaining proper resuscitation
- Pliable bag body provides very good tactile feel of lung compliance to assess resuscitation effort
- Red fits-all oxygen tubing connector provides quick visualization of oxygen connection



- Download **FREE** Layar App (from your App Store)
- Scan this page
- View custom product info

SEE1000	Patriot disposable BVM, adult	each	10.25
SEE2000	Patriot disposable BVM, child	each	10.25
SEE3000	Patriot disposable BVM, infant	each	10.25



Med-Rescuer® Disposable Resuscitator (BLS Systems)

360 degree swivel connector. Medication port for use with MDI or syringe. Manometer port. Integrated PEEP connection, no adapter necessary. All models complete with reservoir.

BLS-4000	Rescuer BVM, adult w/handle	each	10.75
BLS-4010	Rescuer BVM, child w/handle	each	10.75
BLS-4025	Rescuer BVM, infant w/handle	each	10.75



SPUR® II Disposable Resuscitator (Ambu)

Ambu SPUR II is the only single use resuscitator that is made from a SEBS polymer instead of PVC. This classifies Ambu SPUR II as more environmentally safe and fully disposable, thus eliminating all risk of cross contamination. All SPUR II bags come in individual, resealable carrying bags, complete with one or more masks and special accessories.

- Unique single-shutter valve system for very low inspiratory and expiratory resistance
- Crystal clear valve housing provides an unimpeded view of the valve operation
- SafeGrip surface and integrated handle for user comfort

AU520211033	SPUR II, adult w/built-in meter dose inhaler w/CDC HEPA, medium mask	each	15.70
AU520-611-700	SPUR II, adult w/CO2 detector	each	25.09
N7064	SPUR II, adult w/medium adult mask and medication port	each	12.71
AU5220-211-000B	SPUR II, adult, w/medium adult mask w/oxygen reservoir bag (boxed)	each	12.71
AU530-215-000B	SPUR II, pediatric w/infant and toddler masks (boxed)	each	39.94
AU530-213-000B	SPUR II, pediatric, w/toddler mask and oxygen reservoir bag (boxed)	each	24.20
N7062	SPUR II, pediatric w/infant mask and medication port	each	16.85
N7061	SPUR II, pediatric w/neonatal, toddler, infant masks and medication port	each	20.04
N7063	SPUR II, pediatric w/toddler mask and medication port	each	16.85
AU544-211-000	SPUR II, infant w/neonatal mask	each	16.85
AU540-211-000	SPUR II, infant, w/neonatal mask, oxygen reservoir bag	each	16.85

PEEP Valves (Ambu)

The Ambu Disposable PEEP Valves have been designed to provide unique resistance characteristics when used with manual resuscitators, ventilators, anaesthesia machines and CPAP systems where specified by the manufacturer.

- adjustable between 1.5-20 H₂O cm
- 30 mm connector
- MR conditional

AU199-002-020	Disposable PEEP valve	each	5.66
AU199-003-020	Disposable PEEP valve with adapter	each	6.42



The BAG II® Disposable Resuscitator (Laerdal)

- Universal Star-Lumen oxygen tubing
- Closed system oxygen reservoir
- Adjustable hook and loop handle
- Swivel elbow - swivels a full 360 degrees
- Transparent PVC construction
- Reinforced non-kink oxygen tubing



LA845011	The BAG II BVM, adult, with #5 mask	each	16.00
LA845041	The BAG II BVM, adult, with #4 mask	each	16.00
LA845021	The BAG II BVM, child, with #3 mask	each	16.00
LA845031	The BAG II BVM, infant, with #1 mask	each	16.00

Smart Bag® MO Disposable Resuscitators (O-Two Systems)

The Smart Bag MO has been designed to allow the provision of consistent ventilations while almost completely eliminating the risks associated with conventional BVM ventilation. The unique actuating mechanism hidden inside the neck bushing actually responds to the rescuer and the patient. By responding to the rescuer’s squeeze and release of the BVM, the Smart Bag limits the excessive flow of gas into the patients airway, significantly reducing the risk of gastric insufflation by effectively lowering the airway pressure generated. In a normally compliant and resistant airway, the airway pressure is limited to below the esophageal sphincter opening pressure of 19 cmH₂O. The Smart Bag MO comes with a manual override to “disable the actuator”.



OT01BM3200	Smart Bag MO, adult w/universal mask	each	23.46
OT01BM3200W	Smart Bag MO, adult w/inflated cuff mas	each	23.46
OT01BM3210-MO	Smart Bag MO, child w/universal mask	each	24.88
OT01BM3210W	Smart Bag MO, child w/inflated cuff mas	each	24.88

Disposable Bag Valve Mask Resuscitator (LSP)

- Integrated swivel allows the caregiver to change position
- Comes complete with mask, reservoir bag and 7’ oxygen tubing
- Standard pressure relief valve on pediatric and infant bags
- The new positional exhalation port is easily adjusted to any desired position to avoid exhaled gases.



LSP670-040	Disposable BVM, adult	each	15.00
LSP670-101	Disposable BVM, child	each	15.00
LSP670-200	Disposable BVM, infant	each	15.00

Disposable Resuscitator (Teleflex)

The Rusch disposable BVM combines dependable performance at an economical price.

RU157100300	Disposable BVM, adult	each	15.23
RU157300100	Disposable BVM, child	each	15.23
RU157400100	Disposable BVM, infant	each	15.23



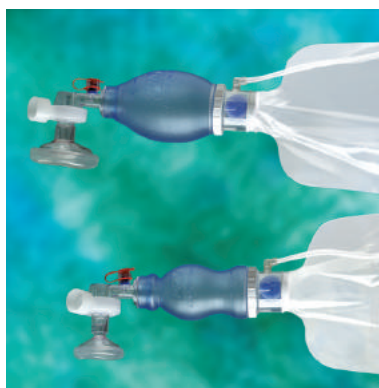

Lifesaver® Disposable BVM (Hudson)

Lifesaver disposable manual resuscitators combine quality, features and performance. Unique right-angled oxygen tubing connector swivels 360 degrees. Includes STAR-LUMEN tubing and universal oxygen connector. All configurations include swivel flow diverter for connection of PEEP valve. Individually packaged, in convenient, tamper-evident, drawstring bag.

HU5372	Lifesaver BVM, adult	each	14.60
HU5367	Lifesaver BVM, pediatric	each	15.80
HU5362	Lifesaver BVM, infant	each	16.35



Easy Grip® Disposable Bag Valve Mask Resuscitator (O-Two Medical Technologies)

Easy Grip™ Bag Valve Mask Resuscitators provide improved resiliency in performance that incorporates immediate lung condition feedback (“feel”) directly to the fingertips. The Easy Grip design improves grasp even with a wet or slippery bag, and the unequalled rapid recoil time allows for quick response to the patient’s respiratory needs. Child and infant resuscitators come complete with a pressure relief valve set at 40cm H₂O that can be overridden by the operator by manually holding the valve in a depressed position or locking it into the off position

OTBM3500	Easy Grip BVM, adult	each	15.25
OTBM3510	Easy Grip BVM, child	each	15.37
OTBM3520	Easy Grip BVM, infant	each	15.37



Pocket BVM (PerSys Medical)

This hand-held disposable device is used for manual resuscitation and emergency respiratory support.

PSPBVM-C	Pocket BVM, adult	each	43.75
PSPBVM-G	Pocket BVM, adult with 6’ oxygen tubing	each	49.50



BVM Assist Kit (Southeastern)

BVMASSIST	BVM Assist Kit includes ventilator adapter, nebulizer tee adapter (22 mm OD x 18 mm ID / 22 mm OD x 22mm OD) and 6” oxygen tubing	each	1.70
BVMASSISTDC	BVM Assist Kit includes ventilator adapter, nebulizer tee (22 mm OD x 18 mm ID x 22 mm ID) and 6” oxygen tubing	each	1.33

Basic Cricothyrotomy Kit (Southeastern)

This basic cricothyrotomy kit provides everything you need to establish a patent airway during certain life-threatening situations. It includes:

- Jelco IV catheter, 14 ga x 2" (1)
- Povidone iodine wipes (2)
- Sodium Chloride 0.9% 10ml needleless prefilled syringe (1)
- Gauze pads, sterile, 4" x 4" 8 ply, 2 per pack (1)
- Contents sheet
- Packed in poly bag



SEECRIC	Basic cricothyrotomy kit	each	3.80
---------	--------------------------	------	------

Melker Emergency Cricothyrotomy Catheter Set (Cook Medical)

Used for emergency airway access when conventional endotracheal intubation cannot be performed. Airway access is achieved by standard wire-guided (Seldinger) technique via the cricothyroid membrane. Subsequent dilation of the tract and tracheal entrance site permits passage of the emergency airway. Catheter is cuffed to protect and control airway once placed. Airway catheter is radiopaque. Special Operations Set is custom packaged in slip peel-pouch design for easy transportation. Dilator is pre-inserted into airway catheter. Includes two 18 gauge introducer needles, 5cm and 7cm.



CC175437	Melker cricothyrotomy kit, 3.5mm uncuffed catheter	each	223.42
CC175438	Melker cricothyrotomy kit, 4.0mm uncuffed catheter	each	223.42
CC144501	Melker cricothyrotomy kit, 6.0mm uncuffed catheter	each	225.62
CC274208	Melker cricothyrotomy special operations kit, 5.0mm uncuffed catheter in a slip peel-pouch package	each	343.78

QuickTrach® (Teleflex)

The Rusch QuickTrach allows quick and safe access for ventilation in the presence of acute respiratory distress with upper airway obstruction. The kit consists of a preassembled emergency cricothyrotomy unit with a 10ml syringe, padded neck strap and a flexible connecting tube.



RU120900040	QuickTrach, adult	each	171.38
RU120900020	QuickTrach, child	each	171.38



**Led by...Dedicated to...
We are EMS and Fire.**



Pneumothorax Kit (Southeastern)

Southeastern offers both multiple- and single-patient pneumothorax kits.

Multiple-Patient

- 14ga x 3.25" IV catheters (4)
- Sterile 4x4 gauze pads (6)
- PVP swabsticks (4)
- 20cc syringes (2)
- Stopcocks (2)
- Sterile gloves (2 pair)

Single-Patient

- 14ga x 3.25" IV catheter (1)
- Sterile 4x4 sterile gauze pads (2)
- PVP swabstick (1)
- 20cc syringe (1)
- 3-way stopcock with 20" tubing (1)

SEEPNEK	Pneumothorax kit, multiple-patient	each	51.75
SEEDEK	Pneumothorax kit, single-patient	each	29.90



ARS[®] for Needle Decompression (North American Rescue)

The new and improved ARS (Airs Release System) for needle decompression increases the likelihood of success in the management of casualties who present with the signs and symptoms of a tension pneumothorax.

- No-flash chamber ca
- Easy identification
- Textured twist top
- Rugged needle/catheter protective tube

NAZZ-0298	ARS for needle decompression, 10ga x 3.25"	each	17.97
NAZZ-0056	ARS for needle decompression, 14ga x 3.25"	each	10.78



Emergency Pneumothorax Set (Cook Medical)

Used to treat simple tension pneumothorax. Set contains reinforced FEP catheter needle, vinyl connecting tube, Cook Chest Drain Valve, Molnar disc with pull tie, syringe, alcohol prep, ChloroPrep One-Step and transport tape.

CC219184	Emergency pneumothorax set	each	169.29
----------	----------------------------	------	--------



Simple Pneumothorax Aspiration Accessory Set (Cook Medical)

Used in conjunction with pneumothorax aspiration catheters if incomplete expansion of the lung persists after mechanical aspiration of air. Connection of the one-way Cook Chest Drain Valve to the catheter permits continued re-expansion of the lung by natural forces, preventing inadvertent backflow of air into the pleural space.

CC155900	Pneumothorax aspiration accessory set	each	94.58
----------	---------------------------------------	------	-------

ParaPAC Transport Ventilator (Smiths Medical)

Designed specifically for use by respiratory therapists, paramedics, and trained emergency personnel, ParaPAC® enables greater control of breathing parameters. The dual controls allow easy selection of tidal volume and frequency to match your patient’s ventilatory requirements. Suitable for ventilation during emergency or controlled transportation of adults, children and infants. MRI compatibility gives maximum flexibility for transport within the hospital.



- Separate controls for tidal volume and frequency
- Unique CMV/Demand - Demand feature
- Patented mode of operation
- Adjustable pressure relief with audible alarm
- Air mix facility
- Optional PEEP facility
- Integrated pressure monitoring/alarm system
- Low gas supply indicator
- Pneumatically powered
- Lightweight and durable

SM120003	ParaPAC ventilator with alarms	each	11,600.00
SM120002	ParaPAC ventilator without alarms	each	9,600.00
SM122002	ParaPAC ventilator circuit with PEEP	10/case	290.00
SM122003	ParaPAC ventilator circuit	10/case	199.90

AHP300™ Transport Ventilator (Allied Healthcare)

The AHP300 Transport Ventilator offers invasive and non-invasive support for infant (5 kg and up) to adult patients, with a flexible array of ventilation options including Pressure Control/Volume Control ventilation, SIMV/Assist Control spontaneous breath support, and stand-alone CPAP/BiLevel support. The AHP300 offers value-added features for intra-hospital and inter-hospital transport.



- Quick Start Ventilation - Featuring programmable presets, the AHP300 allows trained caregivers to rapidly recall up to 5 saved ventilation protocols.
- Long Battery Life - Up to 7.5 hours on internal battery, with auxiliary battery capability for up to 21 hours of battery life.
- Oxygen Conserve Mode - Allows the use of low pressure sources (oxygen concentrator, liquid oxygen, etc.) to extend available oxygen.

AHP300	AHP300 transport ventilator, gray	each	6,475.00
AHP300-Y	AHP300 transport ventilator, yellow	each	6,475.00
LSPL599-600	AHP300 adult single limb ventilator circuit	each	130.77
AHP300-BAG	AHP300 transport ventilator circuit bag	each	65.20
AHP300-CASE	AHP300 transport ventilator wrap case	each	201.42
AHP300-WMSYS	AHP300 transport ventilator wall mount system	each	400.00
AHP300-HDLHOOK	AHP300 transport ventilator carrying handle with static hooks	each	126.09
AHP300-HASWHO	AHP300 transport ventilator carrying handle with swivel hooks	each	193.50



AutoVent™ 4000 Automatic Transport Ventilator (LSP)

The AutoVent 4000 Series Transport Ventilator offers the capabilities of ventilation and CPAP in one system.

- Pneumatically powered, durable and light with basic models weighing less than 5 lbs.
- Independent settings for breaths per minute, inspiratory time, tidal volume and airway pressure relief.
- Manual breath button and anti-breath stacking is standard on all models.
- Manometer gauge, along with a full set of alarms, ensures optimal performance and patient safety.

LSPL760	Autovent 4000 ventilator	each	3,587.50
LSPL760CPAP	Autovent 4000 ventilator with CPAP	each	4,791.88
LSPL761	AutoVent 4000 ventilator with air mix mode	each	4,458.75
LSPL761CPAP	Autovent 4000 ventilator with air mix mode and CPAP	each	5,663.13
LSPL762	AutoVent 4000 ventilator with air mix mode and electronic alarm package	each	5,125.00
LSPL762CPAP	Autovent 4000 ventilator with air mix mode, electronic alarm package and CPAP	each	6,329.38
LSPL763	AutoVent 4000 ventilator with electronic alarm package	each	4,253.75
LSPL763CPAP	Autovent 4000 ventilator with electronic alarm package and CPAP	each	5,458.13
LSP800148	Autovent 4000 ventilator circuit with CPAP	each	18.38
LSPL599-130	Autovent 4000 ventilator circuit without CPAP	each	10.15
LSPLPEEP	PEEP valve w/adapter for Autovent 3000	12/case	45.00

Control your patient's breathing parameters with ParaPAC®



Learn more about the ParaPAC ventilator on page 153

The ParaPAC® Ventilator enables greater control of breathing parameters. Dual controls allow easy selection of tidal volume and frequency to match your patient's ventilatory requirements. Suitable for ventilation during emergency or controlled transportation of adults, children and infants. MRI compatibility gives maximum flexibility for transport within the hospital.

- Separate controls for tidal volume and frequency
- Unique CMV/Demand - Demand feature
- Patented mode of operation
- Adjustable pressure relief with audible alarm
- Air mix facility
- Optional PEEP facility
- Integrated pressure monitoring/alarm system
- Low gas supply indicator
- Pneumatically powered
- Lightweight and durable

smiths medical
bringing technology to life

Ventilator Circuits, Miscellaneous

CF10822	Ventilator circuit for LTV-1200	10/case	163.08
CF10820	Ventilator circuit for LTV-1000	10/case	225.00
CD003762	Ventilator circuit for use with Philips PLV-100 and PLV-102 ventilators	15/case	134.54
CD003764	7' breathing circuit with cuttable cuffs, exhalation valve and tube hanger, 3' humidifier line with cuttable cuffs, exhalation valve, drive line (clear) with connectors and pressure line (blue) with connectors	15/case	135.46
KEBCD43811P	Newport "J" circuit	10/case	115.40
CD001851	Ventilator circuit filter	each	2.79



Respiratory Care ■ Masks

Disposable Cushion Face Mask (Teleflex)

- Extremely pliable bladder for excellent sealing
- "No-Valve" construction provides an extended shelf life without fear of deflation
- Crystal clear cone for easy assessment of patient condition

RU158600	Disposable cushion face mask, large adult, #5	each	2.02
RU158400	Disposable cushion face mask, medium adult, #4	each	2.02
RU158300	Disposable cushion face mask, small adult, #3	each	2.02
RU158200	Disposable cushion face mask, pediatric, #2	each	2.02
RU158100	Disposable cushion face mask, infant, #1	each	2.02
RU158000	Disposable cushion face mask, neonatal, #0	each	2.02



Disposable Face Masks (Ambu)

Ambu disposable face masks are designed for use with manual and automatic resuscitators and ventilators.

- Crystal clear dome for easy observation of the patient's condition
- Supplied with hook ring that can easily be removed if not needed
- Single patient

AU252-051	Disposable face mask, neonate	each	1.94
AU252-052	Disposable face mask, infant	each	1.94
AU252-053	Disposable face mask, toddler	each	1.94
AU252-054	Disposable face mask, small adult/child	each	1.94
AU252-055	Disposable face mask, medium adult	each	1.94
AU252-056	Disposable face mask, large adult	each	1.94





Tracheostomy Masks (Telefl x)

For use for tracheostomy and laryngectomy aerosol therapy. Tubing connector swivels 360 degrees and accepts 22mm I.D. corrugated tubing. Adult and pediatric sizes available.

HU1075	Tracheostomy masks, adult	each	1.07
HU1076	Tracheostomy masks, pediatric	each	1.30



Tracheostomy Mask Kit (Carefusion)

This adult tracheostomy under-the chin-style mask kit features

- 6" fl x tube
- Six diluter jets (24%, 28%, 31%, 35%, 40% and 50% oxygen concentrations)
- Humidification hood
- 7' crush resistant tubing

CD001248	Tracheostomy mask kit, adult with 6' fl x tube	each	5.69
----------	------------------------------------------------	------	------



Pet Oxygen Mask Kit

The Pet Oxygen Mask Kit is designed to provide supplemental oxygen to animals suffering from respiratory distress, smoke inhalation, or for general recovery from anesthesia. The masks are used on animals by general and specialty veterinary facilities, emergency referral clinics and fire and rescue departments.

SXV7148	Pet oxygen mask kit contains one each of small, medium and large pet oxygen masks	each	100.00
---------	-----------------------------------------------------------------------------------	------	--------



SMART TRIAGE

The most widely used system in the world, the SMART Incident Command System™ is a scalable approach to triage, working from the first responder on scene through the evacuation process to the receiving hospital.

Learn about the entire SMART Incident Command System beginning on page 410.



Micro Mist® Nebulizer

- Optimal particle size delivered at efficient nebulization rates (MMAD = 2.1 microns)
- 84" tubing
- Easy-seal, threaded cap and 8cc capacity anti-spill jar to prevent leakage
- Jet stays in place unless intentionally removed
- Consistent performance at angles up to 90 degrees allowing medication delivery to patients positioned horizontally or with special requirements

HU1884	Micro Mist nebulizer with tee, 7' tubing, mouthpiece, reservoir tube and connector	each	1.05
N7281R	Micro Mist nebulizer with tee, mouthpiece and reservoir tube	each	0.91
N7281M	Micro Mist nebulizer with elongated adult mask	each	1.34
N7281PM	Micro Mist nebulizer with elongated pediatric mask	each	1.96
N7281	Micro Mist nebulizer with tee and mouthpiece	each	0.84
HU1880	Micro Mist nebulizer only	each	0.50



Up-Draft II® Opti-Neb® Nebulizer (Telefl x)

The compact, high output Up-Draft II Opti-Neb nebulizer produces a concentrated mist at flow settings as low as 5 LPM with a minimal residual of medication.

- Jet stays in place unless intentionally removed
- Anti-spill design prevents loss of medication in any position
- Nebulizes at angles up to 45 degrees to accommodate special treatment requirements
- 84" tubing

HU1705	Nebulizer w/adult mask	50/case	95.08
HU1734	Nebulizer w/tee, mouthpiece, and reservoir tube	50/case	54.08



Neb-U-Mask® System (Telefl x)

The Neb-U-Mask is a combination device that allows for the concurrent delivery of aerosolized medications and high concentrations of oxygen or heliox. The system is composed of an innovative wye design featuring a nebulizer connection and MDI adapter, a high concentration mask and a 750ml gas reservoir bag. The nebulizer connection features a valved port, which maintains a closed system when the neb is not in use.

HU1895	Neb-U-Mask, adult	each	15.35
HU1896	Neb-U-Mask, pediatric	each	15.35



BVM Nebulizer Assist Kit (Southeastern)

Allows for supplying medication while "bagging." Comes with nebulizer kit with tee, tubing, "T" mouthpiece, neb tee connector, multi-adapter and elbow adapter.

SEENEBK	BVM nebulizer assist kit	each	6.27
---------	--------------------------	------	------





Aerosol Masks, Elongated

Clear, soft vinyl for patient comfort. Adjustable nose clip assures comfortable fit. Specifically designed for aerosol therapy. Connector accepts 22mm aerosol tubing.

N7281-ADULT	Aerosol mask, elongated, adult	each	0.49
N7281-PEDI	Aerosol mask, elongated, child	each	0.77



Dragon Pediatric Aerosol Mask (CareFusion)

The Asthmatic Dragon is a pediatric nebulizing mask that is more “toy-like” making children more apt to accept treatment without fear and resistance. When the child takes a deep breath and exhales, the exhaled air exits through the dragon's nostrils making the dragon appear to be huffing and puffing.

N7281NICKIT	Dragon mask, nebulizer and tubing	each	2.54
CD001266	Dragon mask only	each	1.69



MAD Nasal™ Intranasal Mucosal Atomization Device (LMA North America)

The MAD is used for delivery of atomized medication to the nasal, oral, laryngeal, tracheal and pulmonary mucosal surfaces. Reliable atomization of topical solution across the nasal and oropharyngeal mucous membranes.

- No needles
- Works in any position
- Complete control
- Consistent, reliable spray every time

WTMAD100	MAD with 3ml syringe	each	7.65
WTMAD300	MAD with no syringe	each	6.36

Adapters and Connectors

HU1641	Elbow adapter	50/case	26.32
HU1565	Mouthpiece, 15mm/22mm OD	50/case	8.61
HU1422	Multi-adapter cuff adapter, 15mm ID	50/case	18.35
HU1639	Nebulizer tee connector, 22mm OD x 18mm ID x 22mm ID	each	0.49
IS1931030	Straight mouthpiece, 22mm ID	each	0.61



HU1641



HU1565



HU1422



HU1639



IS1931030

Nonbreathing Masks

N7295	Nonbreathing mask, safety vent, adjustable nose clip, 750ml reservoir bag and 84" tubing, adult	each	2.72
HU1059	Nonbreathing mask, safety vent, adjustable nose clip, 750ml reservoir bag and 84" tubing, adult	each	1.28
N7284	Nonbreathing mask, safety vent, adjustable nose clip, 750ml reservoir bag and 84" tubing, pediatric	each	1.28
N7293	Nonbreathing mask, safety vent	each	1.05
RU395497	Nonbreathing mask, safety vent, adjustable nose clip, 750ml reservoir bag and 84" tubing, infant	each	4.63
N7298	Nonbreathing mask, NO safety vent, adjustable nose clip, 750ml reservoir bag and 84" tubing, adult	each	1.28
SU2201	Nonbreathing mask, pediatric with safety vent	each	1.25



High Concentration Masks, Elongated

Under the chin design, adjustable nose clip, swivel adapter, 750ml reservoir bag and 84" tubing.

N7286	High concentration mask, elongated, adult	each	2.22
N7288	High concentration mask, elongated, child	each	2.50
HU1011	High concentration mask, elongated, pediatric	each	1.58



Multi Vent Masks

Provides a safe, simple, reliable method of accurately administering oxygen concentrations of 24, 26, 28, 30, 35, 40, and 50 percent. Comes complete with low-oxygen concentration diluter, medium concentration diluter, locking ring, high humidity adapter, 7' oxygen tubing.

N7299	Multi vent mask, adult	each	1.73
N7300	Multi vent mask, pediatric	each	3.91



Medium Concentration Oxygen Masks

Soft vinyl for patient comfort, adjustable nose clip and 84" tubing.

N7285	Medium concentration mask, elongated, adult	each	1.50
N7287	Medium concentration mask, elongated, pediatric	each	1.63
N7280	Medium concentration mask, short, adult	each	1.41
N7283	Medium concentration mask, short, pediatric	each	1.01
RU396218	Medium concentration mask, short, infant (by Rusch)	each	1.14



Non Rebreather Masks (B&F Medical)

BF61075	Tracheotomy mask, adult, with elastic strap	each	2.52
BF64059	Non-rebreathing mask, adult, without safety vent	each	1.17





Three-In-One Mask (Telefl x)

Can be used as a medium concentration, high concentration or nonbreathing mask. Includes mask with latex-free flapper valve, nonbreathing bag assembly, 7-ft. oxygen supply tubing, and oxygen connector. Adjustable nose clip. 750ml reservoir bag.

N7301	Three-in-one mask	each	1.17
-------	-------------------	------	------



Airlife™ Oxygen Masks (Cardinal)

Made from soft, high-grade vinyl resins. Smooth, feathered edges are designed for patient comfort while reducing irritation points. Designed for anatomical compatibility

CD001211	High-concentration, nonbreather mask with safety vent and 7' tubing, adult	each	2.89
CD001269	High-concentration, nonbreather mask with safety vent and 7' tubing, pediatric	each	3.46



Nasal Cannulas

N7294	Sofflex nasal cannula, adult, over-the-ear, 7' tubing , non-fla ed (by Smiths Medical)	each	0.96
N7297	Nasal cannula, adult, with 7' sure fl w tubing (by Allied)	each	0.35
HU1103	Nasal cannula, adult, over-the-ear, 7' tubing, non-fla ed (by Telefl x)	each	0.41
N7296	Nasal cannula, adult, over-the-ear, fla ed nasal tip, 7' tubing (by Telefl x)	each	0.43
HU1820	Softech cannula, adult (by Telefl x)	50/case	31.06
SU8-3550-02	Nasal cannula, child (by SunMed)	each	1.35
N7292	Softech cannula, pedi, 7' Star-Lumen tubing, standard connector, curved (by Telefl x)	each	1.00
HU1101	Nasal cannula, pediatric, adjustable elastic band, 7' tubing, non-fla ed (by Telefl x)	each	1.72
SU8-3550-01	Nasal cannula, infant (by SunMed)	each	1.35
N7291	Nasal cannula, infant, straight tip, 7' oxygen tubing w/no-crush tubing and oxygen connector (by Hospitak)	each	1.96



Prefilled Humidifie (CareFusion)

Filled with sterile water for inhalation. This humidifier s stem features a dual-purpose reservoir with a snap-open trigger, which makes a round opening for secure attachment of a humidifier adap er. The oxygen pathway is designed to help prevent particulate from reaching oxygen delivery tubing.

N7157	Prefilled humidifi , 500ml with adapter	each	3.32
-------	-----------------------------------------	------	------



Disposable Humidifie (Telefl x)

Disposable, durable plastic with preset audible alarm at 4 psi pressure relief. Unique diffuser desi ned to provide patient with comfortable, therapeutic humidity and minimal noise. 500ml usable volume

HU3230	Disposable humidifie	each	1.65
--------	----------------------	------	------

Oxygen Hose (Southeastern)

All hoses have hand tight DISS fitting. Additional lengths available. Call customer service at (800) 334-6656 for personal assistance.

N2551	Oxygen hose, 3', hand tight DISS fitting	each	31.20
N2555	Oxygen hose, 6', hand tight DISS fitting	each	34.29
N2554	Oxygen hose, 7', hand tight DISS fitting	each	23.85
N2553	Oxygen hose, 10', hand tight DISS fitting	each	32.90



Oxygen Supply Tubing (Telefl x)

N7289	Oxygen tubing, 7'	each	0.48
N7289C	Oxygen tubing connector	each	0.14



Unibody All-Brass Regulators (Southeastern)

Uni-body all brass regulators are economically priced to meet your budget needs. Flowrate: 0.25, 0.5, 1, 2, 3, 4, 6, 8, 10, 15, 25 LPM.

N7013	Unibody all-brass regulators, constant flow with 1 DISS outlet	each	95.00
N7012	Unibody all-brass regulators, constant flow	each	79.50



Heavy Duty EMS Regulator (Inovo)

Two DISS outlets with check valves. FDA recommended brass- Viton sealer washer. Twelve position flow dial. Nickel plated for protection against elements. Solid all brass construction. UL listed impact resistant gauge

IN2925-R-2	Heavy duty EMS regulator, 0-25 LPM, with barb and two DISS outlets	each	128.46
------------	--------------------------------------------------------------------	------	--------



Oxygen Regulator

Anti-blowout design with no snap rings. Low profile gauge with impact resistant rubber boot. Sure-grip knob with 12 click stop positions. Flow rate: 0, 1/4, 1/2, 1, 2, 3, 4, 6, 8, 10, 15, 2 LPM. All metal construction, unibody window design

N6998	Oxygen regulator, aluminum/brass, constant flow, 2 DISS outlets	each	194.71
N6999	Oxygen regulator, aluminum/brass, constant flow	each	174.74



Oxygen Regulator with Quick Disconnect (Southeastern)

Allows you to connect your demand valve or ventilator to your small oxygen cylinder and disconnect quickly to your on-board oxygen system. Five-year warranty. Flow ranges of 0, 1/4, 1/2, 1, 2, 3, 4, 6, 8, 10, 15 and 25 LPM.

N6997	Oxygen regulator with quick disconnect	each	150.00
-------	----------------------------------------	------	--------





Rhino Brass Regulator (LSP)

Features a unique protective aluminum shroud that is integral to the regulator body and is designed to prevent gauge damage and contamination. Comes with a 10-year warranty against breakage and a replaceable shroud lens cover which prevents dirt and liquids from contaminating it. All brass construction. Flow Rates: 0, 1/2, 1, 2, 4, 6, 8, 10, 12, 15, 20 or 25LPM.

LSP370-220A	Rhino brass regulator, constant fl w with 2 DISS outlets	each	264.45
-------------	----------------------------------------------------------	------	--------

InGage™ Line Regulator

This medical gas regulator features a unique pressure gauge built into the body with a window to show the cylinder pressure. The InGage has a color-coded 0-3000 PSI operating range. The yoke connector has a special 10-micron sintered metal inlet filter and an all-brass construction in the high-pressure zones. The regulator has a single stage, piston type, backpressure compensated, pressure reducing cartridge with an internal relief valve. The “click style” flowmeter module offers 12 flow settings and, unlike the Thorpe tube style, will operate in any position or while moving.



N6986	InGage demand valve regulator w/2 DISS fitting	each	198.78
-------	------------------------------------------------	------	--------

N6991	InGage constant flow regulator	each	218.66
-------	--------------------------------	------	--------



Pressure Reducer Regulator

For the large “H” and “M” oxygen cylinders onboard the ambulance. Includes CGA-540 fitting. Reduces large cylinder pressure to a regulated 50 psi. Smaller, more rugged unibody design.

N7014F	Pressure reducer regulator	each	114.75
--------	----------------------------	------	--------

Flowmeter 0-25 LPM

Medical gas flowmeter is a calibrated, 12 positions, fixed orifice, non-gravity sensitive type. The flowmeter has a metal inlet filter and effectively functions as back pressure compensated device.

- All metal construction, unibody window design
- Large window, high visibility, night glow numbers
- Sure-grip knob with 12 click stop positions
- Flow range: 0, 1/4, 1/2, 1, 2, 3, 4, 6, 8, 10, 15, 25 LPM



N7324	Flowmeter 0-25 LPM with DISS outlet	each	42.25
-------	-------------------------------------	------	-------

Tube Flowmeter

The polycarbonate housings are extremely durable. They are impervious to chemical solutions normally used in a clinical setting preventing clouding and spidering. The polycarbonate flow tubes ensure durability. These flowmeters use black glass flow indicator balls. Their exceptional sphericity and uniform weight contribute to a more accurate flowmeter than those using plastic floats.



N7325	Tube flowmeter with Ohio adapter	each	49.72
-------	----------------------------------	------	-------

N7326	Tube flowmeter with Puritan Bennett adapter	each	40.88
-------	---------------------------------------------	------	-------

Portable Emergency Oxygen Manifold (Western Enterprises)

Flowmeters are individually controlled. Cannulas, breathing masks and compact carrying case included. Lightweight aluminum construction. Standard DISS 1240 inlet and a 100PSI relief valve safety feature. 8 easy-to-read click-style flowmeters from 0-25LPM. Used for mass casualty, EMS and triage situations. Pressure gauge on manifold



WEMD-8	Portable emergency oxygen manifold	each	848.30
--------	------------------------------------	------	--------

Oxygen Cylinders, Carts and Stands

N7457	"D" cylinder, aluminum, with built-in on/off toggle	each	64.54
LCLIFE-EMS-D	"D" cylinder, aluminum, with knurled valve	each	70.00
N7455	Jumbo "D" cylinder, aluminum with built-in on/off toggle	each	113.77
N7453	"E" cylinder, aluminum, with built in on/off toggle	each	73.77
N7456	"M" cylinder, steel	each	310.16
MM1402ED	"M9" cylinder, aluminum, with toggle valve	each	58.38
WEPX1025	Cylinder stand for "C", "D" and "E" cylinders	each	66.48
WEPX-1027	Cylinder rack for "C", "D" and "E" cylinders, 12 bottles	each	99.73



IT'S IN THE BAG

*CONTENTS NOT INCLUDED

IRON DUCK
BUILT FOR LIFE

The Breathsaver Series popular and versatile airway management bags efficiently organize tank, valve masks, airway adjuncts, hand-held suction and trauma supplies. Quality materials, exacting workmanship and task-specific design. It's in the bag. **See pg. 326 for details.**

Breathsaver ID34016D

Breathsaver Plus ID34016DP

Ultra Breathsaver ID34018



Floor-Mounted Cylinder Base (Cast Products)

Lightweight aluminum floor-mounted cylinder base provides secure retention of single or dual steel or aluminum oxygen cylinders. Threaded thumbscrew holds cylinder in place and prevents swaying, tipping or rattling. Holds either “D” or “E” size cylinders. Will not accept Jumbo “D” cylinders. Does not interfere with regulator controls.

CPC2050	Floor-mounted cylinder base, single	each	48.03
CPC2051	Floor-mounted cylinder base, dual	each	97.73



Wall-Mounted Cylinder Bracket (Cast Products)

These wall-mounted cylinder brackets can be used with either “D” or “E” size steel or aluminum cylinders. Features an aluminum ring that fits over the cylinder and slides into a wall-mounted bracket allowing the cylinder to be removed. Holds two cylinders side by side. The cylinders are held in place by a retaining plate that is secured with a threaded bolt and wing nut. Will not accept Jumbo “D” size cylinders.

CPOA0006-1	Wall-mounted cylinder bracket, single	each	58.18
CPOA0008-1	Wall-mounted cylinder bracket, dual	each	60.15



Universal Oxygen Cylinder Brackets

This oxygen cylinder bracket accommodates steel and aluminum cylinders including “D,” “E” and Jumbo “D” sizes. This bracket meets the KKK-1822-C specification. Constructed of stainless steel and aluminum alloy, Model 521 will not rust or corrode. Neck support bracket is changed with common tools to fit either “D” or “E” size cylinders. Heavy duty nylon strap and metal buckle keep cylinder in place.

FW521	Universal oxygen cylinder bracket	each	319.00
ZIQR-D-2	Strapless “D” cylinder bracket	each	283.50



Oxygen Cylinder Lift (Zico)

Zico Cylinder Lifts transport, raise, and lower “M” through “J” cylinders so you can easily remove the empty cylinder and replace it with a full one. Lifts keep heavy cylinders secured through the entire exchange process. Heavy-duty wheels allow you to service multiple ambulances with a single unit. Each unit operates off of a supplied 12v battery. A wall charger is provided.

ZIQR-CL	Oxygen bottle cart lift for M, G and J cylinders, with 110 volt charger	each	2,533.06
---------	-------------------------------------------------------------------------	------	----------



Cylinder Accessories

N7174	Wrench for “D” and “E” cylinders, metal	each	1.83
N7175	Wrench with metal chain for “D” and “E” cylinders, nylon	each	1.04
N7180	Wrench for “H” and “M” cylinders, metal	each	7.76
WEMPV-4027	Plastic clip dust cover–post valve seal	each	0.35
N2540	Cylinder gasket, nylon	each	0.07
N2545	Cylinder gasket, brass, with rubber center	each	0.92

Medical Gas Adapters (Precision Medical)

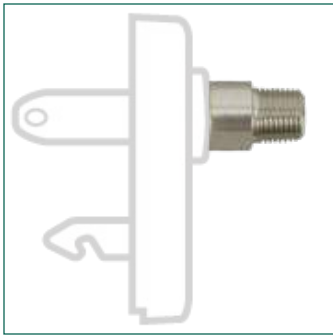

Chemetron-style, oxygen, quick connect x DISS male
PM3105 18.05

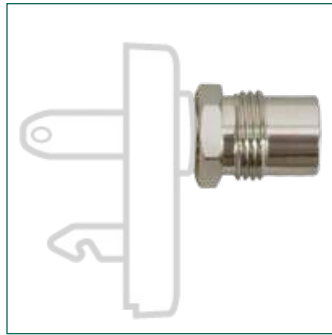

Chemetron-style, oxygen, quick connect x DISS male with check
PM311423.13



Ohmead style, oxygen, compact coupler x DISS male
PM216538.61



Ohmeda style, oxygen, compact coupler x DISS handtight
PM216850.21

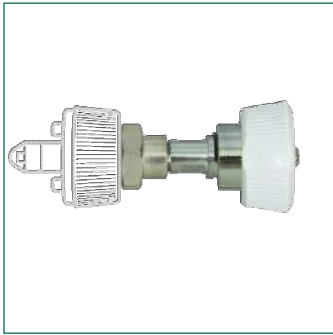

Ohmeda-style, oxygen, quick connect x DISS handtight
PM2108 24.09

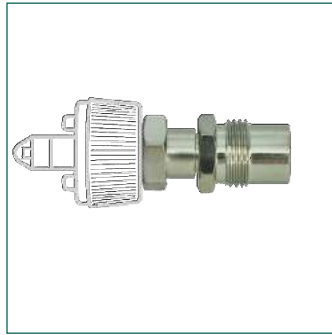

Ohmeda-style, oxygen, quick connect x DISS male
PM2105 20.93



Christmas tree nipple
N7178 0.59



Hex/nut tubing nipple
N7179 3.35



“Pigtail” Quick Connect Kit (Southeastern)

Sometimes called a “pigtail”, this kit will allow you to quickly disconnect from your portable O2 tank and quickly connect to your on-board O2 tank.

QDISSKIT	“Pigtail” quick connect kit	each	65.00
----------	-----------------------------	------	-------

DISS “Y” Assembly with Check Valves



PM7211	DISS “Y” assembly w/check valves	each	31.81
--------	----------------------------------	------	-------



Mouth to Mask Resuscitator (Southeastern)

The Mouth to Mask Resuscitator is designed for both adult and child applications. For ease of use, simplified graphic anatomical illustrations are printed on the case. The patented one way valve filtering system incorporates a highly effective bacterial filter to protect both the rescuer and the victim, thereby ensuring the safest emergency resuscitation environment.

N7491	Mouth to mask resuscitator with 1-way valve, filter, oxygen inlet, head strap, case	each	4.62
N7490	Mouth to mask resuscitator with 1-way valve, filter and case	each	6.34
N7492	Mouth to mask resuscitator replacement kit (contains 1-way valve and filter)	each	4.30



Laerdal Pocket Mask®

The Laerdal Pocket Mask offers superior protection for both rescuer and victim. The Laerdal Pocket Mask combines a low resistance one-way valve with a disposable hydrophobic filter to help prevent the passage of liquids and secretions. The distance to the patient allows the rescuer to check mouth color, secretions and chest movement. An optional oxygen inlet facilitates delivery of supplemental oxygen during ventilation of a non-breathing patient or for inhalation by a spontaneously breathing patient. Either residing in your pocket or in the new soft pack with belt loop, it can be carried with you at all times.

- Replaceable, disposable one-way valve and filter
- Can be used on adult, child and infant

LA830011	Pocket Mask with oxygen inlet, head strap, gloves and wipe in hard yellow case	each	21.00
LA820019	Pocket Mask in hard yellow case	each	14.00
LA820050	Pocket Mask with gloves in blue soft case, pediatric	each	15.00



CPR Resuscitator Masks (WNL Products)

The masks come completely assembled with the one-way valve and head strap already attached. Masks include gloves and an antiseptic wipe. Adult mask includes an oxygen inlet. The infant mask fits conveniently inside the adult mask.

WNLFAK5000SGI	CPR resuscitator with adult/child mask, gloves and wipe in soft red nylon case	each	9.28
---------------	--------------------------------------------------------------------------------	------	------



Laerdal Face Shields

Laerdal's most value-priced, convenient to carry single-use CPR barrier. Offering protection to both rescuer and victim when used by CPR-trained rescuers. Ideal for carrying every day, for inclusion with corporate CPR training courses and in first aid kits.

- Bi-directional filter
- Helps prevent direct contact with victims mouth, nose and face
- Fits into wallets, pockets, small handbags and first aid kits

LA4600001	Face Shields only	50/box	102.00
LA460000	Face Shields only	10/box	20.00

Laerdal Compact Suction Unit® (LCSU) 4

Laerdal's LCSU® 4 suction unit combines rugged design with lightweight portability, an essential tool for every first responder.

LA880051	Laerdal Compact Suction Unit (LCSU) 4, 800ml	each	649.00
LA880061	Laerdal Compact Suction Unit (LCSU) 4, 300ml	each	553.00
LA886108	LCSU4 wire stand, 800ml	each	30.90
LA886115	LCSU 4 wire stand, 300ml	each	30.90
LA886102	LCSU 4 suction canister, 800ml, tubing	each	28.90
BE8002004	LCSU 4 suction canister, 800mL, no tubing (by Bemis)	each	3.05
LA886100	LCSU 4 suction canister, 300ml, tubing	each	14.45
LA886110	LCSU 4 carry case for 800mL unit	each	65.43
LA886109	LCSU 4 carry case for 300ml unit	each	34.00
LA884904	LCSU 4 elbow connection for 800mL canister	each	7.35
LA884905	LCSU 4 connector tubing	6/pkg	13.40
LA886113	LCSU 4 rechargeable battery	each	106.10
LA884500	LCSU 4 12V DC power cord	each	42.30
LA886126	LCSU 4 AC power cord	each	27.90
LA886111	LCSU 4 adapter/charger, no power cord	each	136.00
LA886112	LCSU 4 external battery charger	each	97.90
LA884901	LCSU 4 bacteria filter	each	10.39
LA886106	LCSU 4 vacuum tube	each	10.19



Laerdal Suction Unit (LSU)

Raising the standard for EMS suction units, the LSU features industry-first device diagnostics, a "no-tools" replaceable battery, built-in charger and an integrated vacuum regulation/power control. All this in a rugged "bump-proof / splash-proof" design that is very quiet.

LA780020	Laerdal Suction Unit (LSU) with disposable canister and tubing	each	995.00
BE424410	800cc disposable suction canister (by Bemis)	each	3.15
BE484410	1200cc disposable suction canister (by Bemis)	each	4.15
LA782600	LSU wall bracket, DC power cord	each	348.20
LA782610	LSU wall bracket, AC power cord	each	348.20
LA780421	LSU vacuum connector tubing, 40cm	each	12.40
LA780400	LSU battery	each	112.30
LA782400	LSU side pouch	each	24.80
LA780210	LSU AC power cord	each	27.90





LA886110

LA886100



LA886113

Laerdal Compact Suction Unit Accessories (LCSU 3 and 2)

LA886100	LCSU 3 suction canister, 300ml, tubing	each	14.45
LA88005006	LCSU 3 wire canister bracket	each	30.90
LA886109	LCSU 3 carry case for 300ml unit	each	34.00
LA886110	LCSU 3 carry case for 800mL unit	each	65.43
LA886125	LCSU 3 shoulder strap for carry case	each	4.50
LA886113	LCSU 3 rechargeable battery	each	106.10
LA886112	LCSU 3 external battery charger, no power cord	each	97.90
LA884500	LCSU 3 12V DC power cord	each	42.30
LA886126	LCSU 3 and 2 AC power cord	each	27.90
LA886111	LCSU 3 and 2 AC adapter/charger, no power cord	each	136.00
LA886106	LCSU 3 and 2 vacuum tube	each	10.19
LA884301	LCSU 2 battery	each	122.60



DCell Suction Device (SSCOR)

The SSCOR DCell Suction device is the world's first and only full size portable suction device powered by 12 off-the-shelf alkaline batteries. This makes it ideal for emergencies when external power sources are not available. With "D" cell alkaline batteries that can run the device for 6-9 hours without the need to recharge, the SSCOR DCell Suction device ensures that medical vacuum is available when power sources fail.

- Intended for storage for extended periods in disaster preparedness equipment caches where it does not need to be maintained on charge.
- Can be used for most procedures generally performed with wall vacuum.
- Variable regulator allows the negative pressure to be adjusted quickly between -50mmHg to -525mmHg with a quarter turn of the knob.
- Accommodates most standard hospital suction canisters.
- Can operate indefinitely with replaceable, off the shelf alkaline batteries or be powered from an external power source using an AC power adapter or a DC power cord.

SSDM10-001	DCell suction device. Requires 12 "D" cell batteries (not included).	each	1,250.00
SS80529	DCell suction device AC power adapter	each	115.00
SS80665	DCell suction device DC power cord	each	15.00
T1952	"D" cell alkaline battery (12 required)	each	1.00



DON'T SEE WHAT YOU'RE LOOKING FOR?
 Call Customer Service; we're here to help.
 (800) 334-6656

Quickdraw® Suction Unit (SSCOR)

Quickdraw is the ideal battery-operated portable suction device to carry in your ‘first i ’ kit and have on hand every time you are with the patient. It weighs less than 3 pounds and is powered by either 10 “AAA” alkaline batteries (not included) or a sealed lead acid battery.



Quickdraw (Alkaline-powered)

- Suction unit
- Canister
- Alkaline battery pack
- “AAA” battery holder
- Batteries are not included

Quickdraw (Sealed lead acid rechargeable battery)

- Suction unit
- Canister
- Rechargeable sealed lead acid battery
- DC charging cable

SS2400	Quickdraw suction unit, rechargeable battery powered	each	607.00
SS2403	Quickdraw suction unit, alkaline battery powered (10 “AAA” batteries not included)	each	464.00
SS2480-20	Quickdraw suction canister, integral catheter	each	14.95
SS2488-20	Quickdraw suction canister, barbed fittin	each	14.95
SS2480-36	Quickdraw tubing and catheter combo	each	4.09
SS80636	Quickdraw replacement rechargeable battery	each	45.00
T1949	“AAA” battery	each	0.54

S-SCORT® III Suction Unit (SSCOR)

The S-SCORT III provides all of the power and versatility necessary to quickly and effectively clear an airway, weighs only 7 pounds and is economical to purchase and maintain. The components of the S-SCORT III are encased in protective foam for exceptional protection and durability. The S-SCORT III delivers >30 LPM clinical airfl w and vacuum is regulated by a two position regulator, allowing the operator to choose between full power (>525mmHg) and reduced power (120mmHg +/- 15%) for endotracheal and pediatric suction procedures. The device is powered by an internal sealed lead acid battery, which is maintained by an AC/DC charger or a DC power cord.



SS74000	S-SCORT III suction unit	each	607.00
SS80638	S-SCORT III suction unit battery	each	45.00
SS80665	S-SCORT III DC power cord	each	15.00

Tote-L-Vac Suction Unit (Aeros)

The Tote-L-Vac is a very compact battery powered aspirator designed for EMS and patient transport applications. Packaged in a compact durable soft case, it provides the high vacuum and fl w needed in emergency situations. A sealed lead acid battery powers the Tote-L-Vac and no tools are required for changing out the battery. Tote-L-Vac is one of the smallest battery powered aspirators available on the market today.



L5625	Tote-L-Vac suction unit	each	584.62
750150	Tote-L-Vac hydrophobic fil er, 5’ tubing	each	14.37
L5625B	Tote-L-Vac replacement battery	each	76.23
L5628	Tote-L-Vac AC charger	each	119.42
L5626	Tote-L-Vac DC charger adapter	each	13.95
AI749001	Tote-L-Vac gauge	each	44.29



BE424410



BE485410



BE8002004
with white top (not shown)



BE494410



BE484410

Suction Canisters and Accesories (Bemis)

Bemis offers a wide range of collection options with its suction canister line. A wide variety of accessories and hardware are available to allow the use of Bemis canisters in virtually any facility.

Other Bemis canisters are also available. To learn more, please contact your District Sales Manager or call Customer Service at (800) 334-6656.

BE424410	800cc disposable suction canister	each	3.15
BE8002004	800cc suction canister for LCSU4, white top	each	3.05
BE534510	800cc canister wire ring for wall plate	each	4.23
BE484410	1200cc disposable suction canister	each	4.15
BE485410	1200cc disposable suction canister with 18" and 6" tubing	each	7.11
BE532810	1200cc canister wire ring for wall plate	each	4.05
BE532710	1200cc, 2000cc and 3000cc canisters wire ring	each	3.15
BE494410	2000cc high-fl w canister	each	4.43



V-VAC Manual Suction Unit (Laerdal)

The V-VAC Suction Unit is a manual portable unit designed to provide quick and effective suction. Weighs less than 0.3 kg and can be adjusted to accommodate different hand sizes.

- Adjustable stroke distance - for high or low vacuum
- Suction range of 170 - 380 mmHg
- 70 suction liters per min (LMP)
- Catheter connection
- Disposable one-piece cartridge (canister) eliminates the need for cleaning contaminated parts
- Reusable handle - easy to clean for repeated use

LA985015	V-Vac suction unit includes handle, two cartridges, short catheter and adapter tip, double male connector	each	125.00
LA985001	V-Vac cartridge	each	23.60
LA985002	V-Vac adapter tips	4/pkg	29.05
LA985003	V-Vac double male connectors	10/pkg	6.25
LA985004	V-Vac catheters, 8", 18FR	4/pkg	14.00
LA985030	V-Vac replacement handle	each	101.00



RS-4X Aspirator (Rico)

The Rico RS-4X can be wall or shelf mounted and is designed to operate from the vacuum system of any ambulance or from an electric vacuum pump. Consists of a regulating valve, vacuum gauge (which connects via an adapter to the vacuum outlet) and disposable canister. A wall mount holds the disposable Guardian canister. Patient hose included.

RI1001B	RS-4X aspirator	each	114.72
RI1019	RX-4X Sani Liners	24/pkg	9.39
PM2301	RS-4X vacuum adapter, Ohio 1/8 NPT	each	18.75

Res-Q-Vac® Handheld Suction Device (Vortran)

RES-Q-VAC is a hand-operated advanced suction system which provides a full range of suction options for every medical requirement. It consists of a high-quality non-electric suction pump and disposable canisters with appropriate catheters. The system is totally portable and has a very long shelf life providing suction anywhere and anytime it is needed.

RPP1F1S110NLED	Res-Q-Vac First Responder Kit with LED Light contains pump, FSP canister, soft Yankauer, 3.5"/14" 10FR catheters and carry bag	each	106.61
RPP1N1S000S	Res-Q-Vac, adult, soft wide-bore	each	75.80
RPP1N00110S	Res-Q-Vac, neonatal/pediatric, 10FR catheter	each	75.95
RPR1F1R110N	Res-Q-Vac rigid replacement catheter, standard bore, Full Stop Protection	each	25.00
RPR1N00110S	Res-Q-Vac replacement canister, neonatal/pediatric, 10FR catheter	each	16.25
RPR1N1R000S	Res-Q-Vac replacement canister, adult, rigid Yankauer	each	17.64
RPR1N1S000S	Res-Q-Vac replacement canister, adult, soft wide-bore	each	16.10



Res-Cue Pump (Ambu)

Kit is a cost effective alternative to electrical and foot powered devices. The Res-Cue Pump is a portable, hand-operated emergency suction pump.

- Compact and light weight - small and handy unit takes up very little space
- Easy to squeeze - requires extremely little force
- Adjustable vacuum - 100%, adult or 50%, children
- Overfill protection prevents contamination inside the pump/handle
- Disposable collection container - no cleaning/sterilization required
- Replacement Canister Kit for the Ambu Res-Cue Pump. Contains one disposable canister, cap, disposal bag and two suction catheters.

AU276-000-001	Res-Cue Pump	each	53.31
AU276-000-010	Res-Cue Pump replacement canister kit	each	10.58



Rescuer® MVP Manual Vacuum Pump (BLS Systems)

GO7000-MVP	Rescuer MVP	each	60.00
GO7000-AD	Rescuer MVP replacement canister, adult and child canister	each	13.00



Big Yank™ Suction System (ConMed)

Big Yank™ suction system, standard bulb tip, 11/32" integral blister tube, canister connector pre-attached

CN0034910U	Big Yank suction system	each	15.00
------------	-------------------------	------	-------



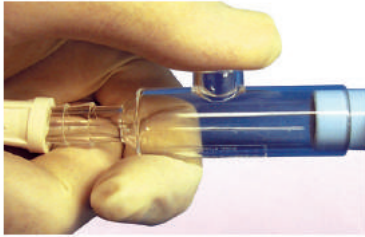

Meconium Aspirator

For removing deep tracheal meconium aspiration, the meconium aspirator allows gentle but firm suction.

L5190	Meconium aspirator	each	5.38
-------	--------------------	------	------



Syringe Bulbs

L5512	Syringe bulb, 2 oz, non-sterile	each	0.44
L5511	Syringe bulb, 2 oz, sterile	each	0.86



Suction Catheters (Dynarex)

This catheter is sterile, coil-packed and includes a control valve. Suction catheter kits contain pop-up solution cup, suction catheter with control valve and two sterile gloves.

DY4806	Suction catheter, 6FR	each	0.25
DY4808	Suction catheter, 8FR	each	0.25
DY4810	Suction catheter, 10FR	each	0.25
DY4812	Suction catheter, 12FR	each	0.25
DY4814	Suction catheter, 14FR	each	0.25
DY4816	Suction catheter, 16FR	each	0.25
DY4818	Suction catheter, 18FR	each	0.25
DY4826	Suction catheter kit (pop-up solution cup, 6FR suction catheter with control valve, 2 sterile vinyl gloves)	each	0.56
DY4828	Suction catheter kit (pop-up solution cup, 8FR suction catheter with control valve, 2 sterile vinyl gloves)	each	0.56
DY4834	Suction catheter kit (pop-up solution cup, 14FR suction catheter with control valve, 2 sterile vinyl gloves)	each	0.56



Argyle™ Suction Catheters (Kendall)

These suction catheters feature a chimney valve with a large opening on the control vent that minimizes residual suction.

KE30500	Argyle graduated suction catheter, 5FR, straight packed	each	0.54
KE30620	Argyle graduated suction catheter, 6FR, coil packed	each	0.56
KE30820	Argyle graduated suction catheter, 8FR, coil packed	each	0.56
KE31015	Argyle graduated suction catheter, 10FR, coil packed	each	0.56
KE31220	Argyle graduated suction catheter, 12FR, coil packed	each	0.56
KE31420	Argyle graduated suction catheter, 14FR, coil packed	each	0.56
KE31620	Argyle graduated suction catheter, 16FR, coil packed	each	0.56
KE31820	Argyle graduated suction catheter, 18FR, coil packed	each	0.56

HI-D® – The “Big Stick” Suction Tip (SSCOR)

The SSCOR HI-D suction tip has an inner diameter nearly twice as large as traditional surgical suction tips .25” and nearly as large as the inner diameter of the suction tubing. This larger diameter allows a patient’s airway to be cleared more efficiently with the HI-D than with the traditional surgical suction tip. The HI-D also has a thumb port so the caregiver can regulate the suction at the distal end of the suction tip as well as side eye holes to prevent soft tissue damage.



SS44241	Hi-D Big Stick suction tip	each	2.14
---------	----------------------------	------	------

Salem Sump Tubes (Kendall)

KE8888268060	Salem sump tube, 6FR	each	8.11
KE8888-268086	Salem sump tube, 8FR	each	8.11
KE8888-264911	Salem sump tube, 10FR	each	2.35
KE8888-264929	Salem sump tube, 12FR	each	2.35
KE8888-264945	Salem sump tube, 14FR	each	2.35
KE8888-264960	Salem sump tube, 16FR	each	2.35
KE8888-264986	Salem sump tube, 18FR	each	2.35

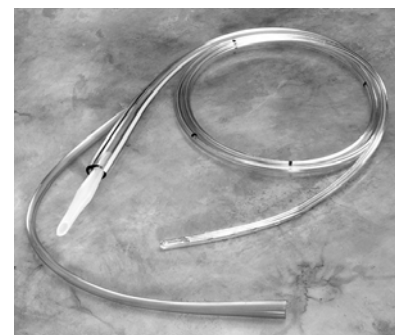

Gastric Sump Tubes

MV1217-10	Gastric sump pump, 10FR (by Medovations)	each	3.26
MV1217-12	Gastric sump pump, 12FR (by Medovations)	each	3.26
MV1217-14	Gastric sump pump, 14FR (by Medovations)	each	3.26
MV1217-16	Gastric sump pump, 16FR (by Medovations)	each	3.26
MV1217-18	Gastric sump pump, 18FR (by Medovations)	each	3.26

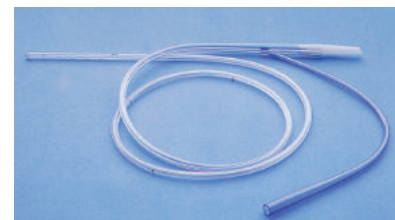

Yankauer Suction Tips

Features a bulb tip for patient comfort with a large lumen body for maximum suction performance. Features control vent with convenient one-handed operation.



CN0034920	Yankauer suction tip with 6’ tubing	each	4.08
KE42614	Yankauer suction tip with 6’ tubing	each	3.83
L5522	Yankauer suction tip, bulb, vented	each	0.48
L5524	Yankauer suction tip, sterile, bulb, non-vented	each	0.48



Infection Control

Latex Gloves



pages 176-178

Latex-Free Gloves



pages 179-185

Colored Gloves



pages 185-187

Glove Holders



pages 187

Protective Masks



pages 188-189

Contamination Control System



pages 190

Eye Protection



pages 190-191

Personal Protection



pages 192-193

Disinfection



pages 194-196

Hand Cleaners



pages 197-198

Clean-up



pages 199



Ultra One® Powder-Free Extended Cuff Latex Exam Gloves (Microflex)

Ultra One gloves are ideal if high-risk conditions require extended protection for your wrist and forearm. Strong, durable and comfortable, these latex gloves minimize risk through superior barrier protection. **11.8" cuff, 11.7 mil (0.30mm) finger thickness**

MXUL315-S	Ultra One latex gloves, small	50/box	13.77
MXUL315-M	Ultra One latex gloves, medium	50/box	13.77
MXUL315-L	Ultra One latex gloves, large	50/box	13.77
MXUL315-XL	Ultra One latex gloves, extra large	50/box	13.77



Diamond Grip™ Powder-Free Latex Exam Gloves (Microflex)

The benchmark in strength and durability in latex gloves. Thicker than typical latex gloves, Diamond Grip gloves provide enhanced protection, especially in the finger tips where protection is critical. **9.6" cuff, 7.8 mil (0.20mm) finger thickness**.

MXMF300-XS	Diamond Grip latex exam gloves, extra small	100/box	12.58
MXMF300-S	Diamond Grip latex exam gloves, small	100/box	12.58
MXMF300-M	Diamond Grip latex exam gloves, medium	100/box	12.58
MXMF300-L	Diamond Grip latex exam gloves, large	100/box	12.58
MXMF300-XL	Diamond Grip latex exam gloves, extra large	100/box	12.58



SafeGrip® Powder-Free Extended Cuff Latex Exam Gloves (Microflex)

SafeGrip provides ideal protection for high-risk or heavy-duty conditions. Four times thicker than standard latex gloves, SafeGrip provides unparalleled defense against many hazards in the work area. **11.6" cuff, 14 mil (0.36mm) finger thickness**.

MXSG375-S	SafeGrip latex exam gloves, extended cuff, small	50/box	15.11
MXSG375-M	SafeGrip latex exam gloves, extended cuff, medium	50/box	15.11
MXSG375-L	SafeGrip latex exam gloves, extended cuff, large	50/box	15.11
MXSG375-XL	SafeGrip latex exam gloves, extended cuff, extra large	50/box	15.11

CHOOSING THE RIGHT GLOVE IS BLACK & WHITE

TM



Learn more about APEX Pro gloves on page 179



Digitcare APEX Pro™
Nitrile Exam Gloves
2-Ply pH Balanced



Digitcare is a Registered Trademark of Digitcare Corporation. The COLORS BLACK and WHITE are a Trademark of Digitcare Corporation. Digitcare APEX Pro and CHOOSING THE RIGHT GLOVE IS BLACK AND WHITE are Trademarks of Digitcare Corporation.

©2015 Digitcare Corporation. www.digitcare.net



Led by...Dedicated to...We are EMS and Fire

(800) 334-6656
www.SEEquip.com

Reorder No:	Size:
DCAP12-1	Small
DCAP12-2	Medium
DCAP12-3	Large
DCAP12-4	X-Large
DCAP12-5	XX-Large
DCAP12-6	XXX-Large



Synetron® Powder-Free Extended Cuff Latex Exam Gloves (Microfl x)

Polymer-coated to slide on easily in wet or dry conditions, Synetron gloves are fully textured for a secure grip. Exceptional durability to handle tough tasks coupled with sensitivity for finding a pulse and starting an IV. **11.4" cuff, 11.7 mil (0.30mm) finger thickness.**

- Interior/exterior polymer system provides superior anti-sticking properties
- Extended length provides superior protection in high-risk conditions
- Meets or exceeds NFPA requirements.

MXSY911-S	Synetron latex exam gloves, extended cuff, small	50/box	13.77
MXSY911-M	Synetron latex exam gloves, extended cuff, medium	50/box	13.77
MXSY911-L	Synetron latex exam gloves, extended cuff, large	50/box	13.77
MXSY911-XL	Synetron latex exam gloves, extended cuff, extra large	50/box	13.77
MXSY911-XXL	Synetron latex exam gloves, extended cuff, 2XL	50/box	13.77



ICU911™ Powder-Free Latex Gloves (Digitcare)

ICU911 is Digitcare's class-leading glove that meets NFPA 1999-2013 Edition edition specifications. This glove meets an industry leading AQL of 0.65 and is one of the leading High-Risk EMS gloves used in the United States. Low drag textured finish is ideal for police and corrections applications as it allows for double gloving. **12" cuff, 10 mil finger thickness.**

DCER-1B	ICU911 latex glove, small	50/box	15.00
DCER-2B	ICU911 latex glove, medium	50/box	15.00
DCER-3B	ICU911 latex glove, large	50/box	15.00
DCER-4B	ICU911 latex glove, extra large	50/box	15.00
DCER-5B	ICU911 latex glove, 2XL	50/box	15.00
DCER-1T	ICU911 latex glove, small	100/bag	26.00
DCER-2T	ICU911 latex glove, medium	100/bag	26.00
DCER-3T	ICU911 latex glove, large	100/bag	26.00
DCER-4T	ICU911 latex glove, extra large	100/bag	26.00
DCER-5T	ICU911 latex glove, 2XL	100/bag	26.00



Sterile Exam Gloves (Dynarex)

- Individual peel packs
- Beaded cuff

S3707	Sterile exam gloves, small	pair	0.35
S3708	Sterile exam gloves, medium	pair	0.35
S3718	Sterile exam gloves, large	pair	0.35

APEX Pro™ 2-Ply Gloves (Digitcare)

APEX Pro 2-Ply Glove is a true innovation in an otherwise static glove market. Digitcare’s 2-ply technology white exterior and black interior increases strength, durability and puncture resistance. The glove’s exterior offers excellent contrast against infectious fluid and blood. The “game changer” is the pH value of the glove that has been formulated to match the pH of human skin. This keeps the skin in balance and reduces the likelihood of contact dermatitis. **12” cuff, 8.3 mil finger thick n ess.**

DCAP12-1	APEX Pro 2-ply glove, small	100/box	19.20
DCAP12-2	APEX Pro 2-ply glove, medium	100/box	19.20
DCAP12-3	APEX Pro 2-ply glove, large	100/box	19.20
DCAP12-4	APEX Pro 2-ply glove, extra large	100/box	19.20
DCAP12-5	APEX Pro 2-ply glove, 2XL	90/box	19.20
DCAP12-6	APEX Pro 2-ply glove, 3XL	90/box	19.20



See ad on page 177

Supreno® EC Powder-Free Extend Cuff Nitrile Exam Gloves (Microflex)

Supreno EC provides extended-cuff protection of the wrists and arms for high-risk applications. Designed to maintain a comfortable fit while providing reliable hazard protection, these gloves are also adhesive-resistant. Tested for use with chemotherapy drugs. **11.6” cuff, 7.8 mil (0.20mm) finger thick n ess.**

MXSEC375-S	Supreno EC nitrile exam gloves, extended cuff, small	50/box	9.32
MXSEC375-M	Supreno EC nitrile exam gloves, extended cuff, medium	50/box	9.32
MXSEC375-L	Supreno EC nitrile exam gloves, extended cuff, large	50/box	9.32
MXSEC375-XL	Supreno EC nitrile exam gloves, extended cuff, extra large	50/box	9.32
MXSEC375-XXL	Supreno EC nitrile exam gloves, extended cuff, 2XL	50/box	9.32



Supreno® SE Powder-Free Nitrile Exam Gloves (Microflex)

Supreno SE gloves provide the durability needed for demanding applications. Offering all the benefits of a nitrile glove, Supreno SE meets your requirement of strength and comfort. **9.6” cuff, 7 mil (0.18mm) finger thick n ess.**

MXSU690-XS	Supreno SE nitrile exam gloves, extra small	100/box	11.85
MXSU690-S	Supreno SE nitrile exam gloves, small	100/box	11.85
MXSU690-M	Supreno SE nitrile exam gloves, medium	100/box	11.85
MXSU690-L	Supreno SE nitrile exam gloves, large	100/box	11.85
MXSU690-XL	Supreno SE nitrile exam gloves, extra large	100/box	11.85



FreeForm® SE Powder-Free Nitrile Exam Gloves (Microflex)

If your light to mid-duty tasks demand reliable protection, FreeForm SE is the glove you need. The unique combination of strength and comfort makes FreeForm SE gloves a top choice for a variety of jobs. Best for light to mid-duty tasks that need reliable protection. **9.6” cuff, 7 mil (0.18) finger thick n ess.**

MXFFS700-XS	FreeForm SE nitrile exam gloves, extra small	100/box	11.71
MXFFS700-S	FreeForm SE nitrile exam gloves, small	100/box	11.71
MXFFS700-M	FreeForm SE nitrile exam gloves, medium	100/box	11.71
MXFFS700-L	FreeForm SE nitrile exam gloves, large	100/box	11.71
MXFFS700-XL	FreeForm SE nitrile exam gloves, extra large	100/box	11.71





FreeForm® EC Powder-Free Ext Cuff Nitrile Exam Gloves (Microflex)

These extra strong gloves meet or exceed NFPA standards for emergency medical equipment. The long cuff provides durable, extended coverage for high-risk conditions. **11.6" cuff, 7.8 mil (0.20mm) finger thickness.**

MXFFE775-S	FreeForm EC nitrile exam gloves, extended cuff, small	50/box	11.43
MXFFE775-M	FreeForm EC nitrile exam gloves, extended cuff, medium	50/box	11.43
MXFFE775-L	FreeForm EC nitrile exam gloves, extended cuff, large	50/box	11.43
MXFFE775-XL	FreeForm EC nitrile exam gloves, extended cuff, extra large	50/box	11.43
MXFFE775-XXL	FreeForm EC nitrile exam gloves, extended cuff, 2XL	50/box	11.43



UltraSense® Powder-Free Nitrile Exam Gloves (Microflex)

UltraSense gloves are designed to provide enhanced tactile sensitivity and comfort, even during extended use. Excellent sensitivity when handling small parts or instruments. Non-stick properties resist tape and adhesives. **9.6" cuff, 4.3 mil (0.11mm) finger thickness.**

MXUS220-XS	UltraSense nitrile exam gloves, extra small	100/box	9.91
MXUS220-S	UltraSense nitrile exam gloves, small	100/box	9.91
MXUS220-M	UltraSense nitrile exam gloves, medium	100/box	9.91
MXUS220-L	UltraSense nitrile exam gloves, large	100/box	9.91
MXUS220-XL	UltraSense nitrile exam gloves, extra large	100/box	9.91



UltraSense® EC Powder-Free Ext Cuff Nitrile Exam Gloves (Microflex)

UltraSense EC provides reliable barrier protection with enhanced tactile sensitivity, better grip and extended coverage of the wrist and forearm. UltraSense EC gloves have a non-stick surface that prevents tapes and adhesives from sticking. Thinner at the finger tip and palm, yet one of the strongest, most durable gloves available. Non-stick properties resist tape and adhesives. **11.4" cuff, 4.7 mil (0.12mm) finger thickness.**

MXUSE880-XS	UltraSense nitrile exam gloves, extended cuff, extra small	100/box	14.03
MXUSE880-S	UltraSense nitrile exam gloves, extended cuff, small	100/box	14.03
MXUSE880-M	UltraSense nitrile exam gloves, extended cuff, medium	100/box	14.03
MXUSE880-L	UltraSense nitrile exam gloves, extended cuff, large	100/box	14.03
MXUSE880-XL	UltraSense nitrile exam gloves, extended cuff, extra large	100/box	14.03
MXUSE880-2XL	UltraSense nitrile exam gloves, extended cuff, 2XL	100/box	14.03
MXUSE880-3XL	UltraSense nitrile exam gloves, extended cuff, 3XL	100/box	14.03



Ultraform® Powder-Free Nitrile Exam Gloves (Microflex)

Unique, soft formulation forms to your hands effortlessly, as if it is a second skin. In field tests, users wearing Ultraform gloves experienced an increase in fine motor task performance compared to a bare hand. **9.1" cuff, 3.1 mil (0.08mm) finger thickness.**

MXUF524-XS	Ultraform nitrile exam gloves, extra small	300/box	20.30
MXUF524-S	Ultraform nitrile exam gloves, small	300/box	20.30
MXUF524-M	Ultraform nitrile exam gloves, medium	300/box	20.30
MXUF524-L	Ultraform nitrile exam gloves, large	300/box	20.30
MXUF524-XL	Ultraform nitrile exam gloves, extra large	250/box	20.30

NeoPro® Powder-Free Chloroprene Exam Gloves (Microfl x)

NeoPro gloves' unique chloroprene blend provides secure protection against a variety of chemicals with excellent puncture resistance. The textured finger tips and soft, latex-like feel gives these gloves a secure grip in wet environments. **9.6" cuff, 6.6 mil (0.17mm) finger thickness.**



- Provides enhanced protection against a broad chemical array
- Chloroprene has better puncture resistance than latex
- Tested for use with chemotherapy drugs
- Ideal for use in wet environments

MXNPG888-XS	NeoPro chloroprene exam gloves, extra small	100/box	13.72
MXNPG888-SM	NeoPro chloroprene exam gloves, small	100/box	13.72
MXNPG888-M	NeoPro chloroprene exam gloves, medium	100/box	13.72
MXNPG888-L	NeoPro chloroprene exam gloves, large	100/box	13.72
MXNPG888-XL	NeoPro chloroprene exam gloves, extra large	100/box	13.72

NeoPro® EC Powder-Free Extended Cuff Chloroprene Exam Gloves

(Microfl x)

Featuring an extended cuff, NeoPro EC is Microfl x's longest and thickest glove. It uses a polychloroprene formulation to provide a secure grip and exceptional protection from biological and chemical hazards in wet or dry conditions. **11.4" cuff, 8.2 mil (0.21mm) finger thickness.**



MXNEC288-S	NeoPro EC chloroprene exam gloves, small	50/box	12.78
MXNEC288-M	NeoPro EC chloroprene exam gloves, medium	50/box	12.78
MXNEC288-L	NeoPro EC chloroprene exam gloves, large	50/box	12.78
MXNEC288-XL	NeoPro EC chloroprene exam gloves, extra large	50/box	12.78
MXNEC288-XXL	NeoPro EC chloroprene exam gloves, 2XL	50/box	12.78

Defender™ Powder Free Nitrile Exam Gloves (Digitcare)

Defender is designed specifically for the rigors of the EMS, Fire, Industrial and Safety environments. Defender is an effective barrier against blood borne agents that you may encounter in an unpredictable field response. **10" and 12" cuffs, 8.25 mil finger thickness.**



DCDFR10-1	Defender 10" nitrile exam gloves, small	100/box	16.39
DCDFR10-2	Defender 10" nitrile exam gloves, medium	100/box	16.39
DCDFR10-3	Defender 10" nitrile exam gloves, large	100/box	16.39
DCDFR10-4	Defender 10" nitrile exam gloves, extra large	100/box	16.39
DCDFR10-5	Defender 10" nitrile exam gloves, 2XL	100/box	16.39
DCDFR12-1	Defender 12" nitrile exam gloves, small	50/box	13.20
DCDFR12-2	Defender 12" nitrile exam gloves, medium	50/box	13.20
DCDFR12-3	Defender 12" nitrile exam gloves, large	50/box	13.20
DCDFR12-4	Defender 12" nitrile exam gloves, extra large	50/box	13.20
DCDFR12-5	Defender 12" nitrile exam gloves, 2XL	50/box	13.20



FrontLine™ Powder-Free Nitrile Exam Gloves (Digitcare)

FrontLine powder-free textured nitrile exam gloves are suitable for high-risk and patient care environments. FrontLine was developed for use with aldehydes and offers substantial puncture resistance and is free of latex proteins. Ideal for healthcare professionals who are sensitive to latex. Textured finish. NF A 1999, 2008 certified. **9.5 and 12” cuffs, 6 mil finger thickness.**

DCFL9-1	FrontLine nitrile exam gloves, 9.5” cuff, small	100/box	14.00
DCFL9-2	FrontLine nitrile exam gloves, 9.5” cuff, medium	100/box	14.00
DCFL9-3	FrontLine nitrile exam gloves, 9.5” cuff, large	100/box	14.00
DCFL9-4	FrontLine nitrile exam gloves, 9.5” cuff, extra large	100/box	14.00
DCFL9-5	FrontLine nitrile exam gloves, 9.5” cuff, 2XL	90/box	14.00
DCFL9-6	FrontLine nitrile exam gloves, 9.5” cuff, 3XL	90/box	14.00
DCFL12-1	FrontLine nitrile exam gloves, 12” cuff, small	100/box	18.00
DCFL12-2	FrontLine nitrile exam gloves, 12” cuff, medium	100/box	18.00
DCFL12-3	FrontLine powder-free nitrile exam gloves, 12” cuff, large	100/box	18.00
DCFL12-4	FrontLine powder-free nitrile exam gloves, 12” cuff, extra large	100/box	18.00
DCFL12-5	FrontLine powder-free nitrile exam gloves, 12” cuff, 2XL	90/box	18.00



FlexSense™ Powder-Free Nitrile Exam Gloves (Digitcare)

FlexSense offers UltraPure™ formulation – giving you a nitrile glove that is completely free of accelerators (chemicals such as Nitrosamines, Carbamates and Sulphur) most commonly used in the manufacture of nitrile exam gloves. Clinicians who field tested FlexSense unanimously indicated it improved touch sensitivity compared to the exam glove currently in use. **9.5” cuff, 4 mil finger thickness.**

DCFS9-1	FlexSense nitrile exam gloves, small	150/box	12.80
DCFS9-2	FlexSense nitrile exam gloves, medium	150/box	12.80
DCFS9-3	FlexSense nitrile exam gloves, large	150/box	12.80
DCFS9-4	FlexSense nitrile exam gloves, extra large	150/box	12.80
DCFS9-5	FlexSense nitrile exam gloves, 2XL	135/box	12.80



Black-Fire™ Nitrile Exam Gloves (Halyard Health)

With proprietary Quick Check breach detection technology, new Black Fire nitrile exam gloves offer the unique ability to detect rips and tears by revealing a high-visibility orange inner layer through the breach. These dual-purpose gloves can also be reversed and worn with the bright orange side out in situations that call for high-visibility. NFPA 1999-2013 Certified. Powder-free. **9.5” cuff, 5.5 mil finger thickness.**

KC44755	Black-Fire nitrile gloves extra small	150/box	25.00
KC44756	Black-Fire nitrile gloves, small	150/box	25.00
KC44757	Black-Fire nitrile gloves, medium	150/box	25.00
KC44758	Black-Fire nitrile gloves, large	150/box	25.00
KC44759	Black-Fire nitrile gloves, extra large	140/box	25.00

AS A FIRST RESPONDER, YOU DO MORE THAN ONE JOB. NOW YOUR GLOVES CAN, TOO!

With proprietary QUICK CHECK* breach detection technology, NEW BLACK-FIRE* Nitrile Exam Gloves offer the unique ability to detect rips and tears by revealing a high-visibility orange inner layer through the breach.



Introducing the BLACK-FIRE* Powder-Free Nitrile Exam Glove

BLACK-FIRE* Nitrile Exam Gloves

Item	Size	Packaging
KC44755	Extra small	150/box
KC44756	Small	150/box
KC44757	Medium	150/box
KC44758	Large	150/box
KC44759	Extra Large	140/box

BLACK-FIRE* NITRILE EXAM GLOVES ARE DESIGNED FOR SUPERIOR PROTECTION AND SAFETY.

- NFPA 1999-2013 Certified
- Patented nitrile formulation increases comfort and strength
- Not made with natural rubber latex
- Reversible



*Registered Trademark or Trademark of Halyard Health, Inc. or its affiliates. ©2016 HYH. All rights reserved.

Caution: These gloves do not protect against heat or fire. Do not use in applications involving exposure to fire, flames or other heat.





Sterling Powder-Free Nitrile Exam Gloves (Halyard Health)

Provides the protection of nitrile with the sensitivity of latex. Cleared for use in chemotherapy. **9" and 12" cuffs, 3.5 mil finger thickness.**

KC50705	Sterling nitrile exam gloves, 9" cuff, extra small	200/box	18.45
KC50706	Sterling nitrile exam gloves, 9" cuff, small	200/box	18.45
KC50707	Sterling nitrile exam gloves, 9" cuff, medium	200/box	18.45
KC50708	Sterling nitrile exam gloves, 9" cuff, large	200/box	18.45
KC50709	Sterling nitrile exam gloves, 9" cuff, extra large	170/box	18.45
KC53138	Sterling powder-free nitrile exam gloves, 12" cuff, small	100/box	19.75
KC53139	Sterling powder-free nitrile exam gloves, 12" cuff, medium	100/box	19.75
KC53140	Sterling powder-free nitrile exam gloves, 12" cuff, large	100/box	19.75
KC53141	Sterling powder-free nitrile exam gloves, 12" cuff, extra large	100/box	19.75



Purple Nitrile Powder-Free Exam Gloves (Halyard Health)

- Beaded cuff. Textured finger tips. Non-sterile. **9.5" cuff, 5.9 mil finger thickness.**

KC55080	Purple nitrile exam gloves, extra small (10 boxes of 100/box)	1000/case	116.92
KC55081	Purple nitrile exam gloves, small	100/box	11.69
KC55082	Purple nitrile exam gloves, medium	100/box	11.69
KC55083	Purple nitrile exam gloves, large	100/box	11.69
KC55084	Purple nitrile exam gloves, extra large	90/box	11.69



KC500 Purple Nitrile-Xtra Exam Gloves (Halyard Health)

- Proven barrier protection from bacteria, bloodborne viruses and chemicals during procedures where fluid exposure risk is moderate to high. NFPA 1999-2013 certified. **12" cuff, 5.9 mil finger thickness.**

KC39504	Purple Nitrile-Xtra exam gloves, extra small	50/box	13.20
KC39505	Purple Nitrile-Xtra exam gloves, small	50/box	13.20
KC39506	Purple Nitrile-Xtra exam gloves, medium	50/box	13.20
KC39507	Purple Nitrile-Xtra exam gloves, large	50/box	13.20
KC39508	Purple Nitrile-Xtra exam gloves, extra large	50/box	13.20



Safe-Touch Blue Nitrile Exam Gloves (Dynarex)

For all-around industrial and medical use. Resistant to many chemicals, Dynarex nitrile gloves are formulated to go on easy and provide consistent quality at a reasonable price. The nitrile material provides an added degree of durability. They also feature textured finger tips that provide enhanced grip and dexterity.

DY2511	Safe-Touch Blue nitrile exam gloves, small	100/box	6.96
DY2512	Safe-Touch Blue nitrile exam gloves, medium	100/box	6.96
DY2513	Safe-Touch Blue nitrile exam gloves, large	100/box	6.96

Tillotson True Advantage Nitrile Exam Gloves (Dynarex)

Manufactured using a patented non-sulfur based curing process which connects the polymer molecules when compared to the curing methods of other nitrile gloves. This allows the polymer more freedom of movement, allowing the glove to conform to the hand rather than constrict it. **5 mil finger thick ness.**

DY6502	True Advantage nitrile exam gloves, small	100/box	11.00
DY6503	True Advantage nitrile exam gloves, medium	100/box	11.00
DY6504	True Advantage nitrile exam gloves, large	100/box	11.00
DY6505	True Advantage nitrile exam gloves, extra large	100/box	11.00



Infection Control ■ Colored Gloves

Blaze® Powder-Free Nitrile Glove (Microfl x)

Blaze high-visibility orange glove provides protection you can see. Complete with textured finger tips for enhanced gripping power. **10.6" cuff, 8 mil (0.20mm) finger thick ness.**

MXN481	Blaze powder-free nitrile glove, small	100/box	12.15
MXN482	Blaze powder-free nitrile glove, medium	100/box	12.15
MXN483	Blaze powder-free nitrile glove, large	100/box	12.15
MXN484	Blaze powder-free nitrile glove, extra large	100/box	12.15



Cobalt® Powder-Free Nitrile Exam Gloves (Microfl x)

This soft and stretchy nitrile glove is the best-selling glove from High Five brand of products. Durable and puncture resistant with a fully textured surface for enhanced grip. Ideal for jobs requiring exceptional tactile sensitivity. Unique, cobalt blue coloring. **10.6" cuff, 8 mil (0.20mm) finger thick ness.**

MXN191	High Five Cobalt powder-free nitrile exam gloves, small	100/box	8.15
MXN192	High Five Cobalt powder-free nitrile exam gloves, medium	100/box	8.15
MXN193	High Five Cobalt powder-free nitrile exam gloves, large	100/box	8.15
MXN194	High Five Cobalt powder-free nitrile exam gloves, extra large	100/box	8.15



Cobalt® X Powder-Free Nitrile Exam Gloves (Microfl x)

This thicker version of our popular Cobalt glove provides extra durability and protection in more demanding tasks. Offers the same soft and stretchy nitrile formulation as our thinner gloves. **9.5" cuff, 4.3 mil (0.11mm) finger thick ness.**

MXN211	High Five Cobalt X powder-free nitrile exam gloves, small	100/box	9.63
MXN212	High Five Cobalt X powder-free nitrile exam gloves, medium	100/box	9.63
MXN213	High Five Cobalt X powder-free nitrile exam gloves, large	100/box	9.63
MXN214	High Five Cobalt X powder-free nitrile exam gloves, extra large	100/box	9.63





MidKnight® Powder-Free Nitrile Exam Gloves (Microfl x)

MidKnight gloves are designed with a distinct color that masks stains and provides improved framing effect. This is the glove of choice for individuals who demand both quality and protection against day-to-day hazards. **9.6" cuff, 5.5 mil (0.14mm) finger thic ness.**

MXMK296-XS	MidKnight nitrile exam gloves, extra small	100/box	11.62
MXMK296-S	MidKnight nitrile exam gloves, small	100/box	11.62
MXMK296-M	MidKnight nitrile exam gloves, medium	100/box	11.62
MXMK296-L	MidKnight nitrile exam gloves, large	100/box	11.62
MXMK296-XL	MidKnight nitrile exam gloves, extra large	100/box	11.62
MXMK296-XXL	MidKnight nitrile exam gloves, 2XL	100/box	11.62



The Pink Pearl Glove (Medline)

Soothing comfort of an organic aloe lining with the protection of nitrile. Superior chemical resistance and barrier protection. Pink, sheen color with full texture for better grip. Generation Pink® Gloves help support Medline's annual corporate commitment to the National Breast Cancer Foundation. Tested for use with chemotherapy drugs. **9.5" cuff , 5.9 mil finger thic ness.**

PINK5084	Generation Pink powder-free nitrile gloves with aloe, small	100/box	14.84
PINK5085	Generation Pink powder-free nitrile gloves with aloe, medium	100/box	14.84
PINK5086	Generation Pink powder-free nitrile gloves with aloe, large	100/box	14.84
PINK5087	Generation Pink powder-free nitrile gloves with aloe, extra large	90/box	14.84



ColorTouch® Pink Powder-Free Latex Exam Gloves (Microfl x)

ColorTouch Pink latex gloves deliver medical-grade barrier protection with consistent comfort and quality in every box. With relaxing all-day comfort and a wonderful cause attached to its sales, ColorTouch Pink latex gloves are a worthwhile change from ordinary hand protection. \$1 from each case sold donated to The Breast Cancer Research Foundation. **9.6" cuff, 6.6 mil (0.17mm) finger thic ness.**

MXCTP233-S	ColorTouch latex exam gloves, small	100/box	10.23
MXCTP233-M	ColorTouch latex exam gloves, medium	100/box	10.23
MXCTP233-L	ColorTouch latex exam gloves, large	100/box	10.23



NitriDerm® Ultra Orange Exam Gloves (Innovative Healthcare)

This medium weight nitrile glove is extremely elastic and comfortable while providing the tensile strength required for these demanding procedures. Polymer interior for rapid donning. Textured finish or an excellent grip even in the presence of moisture. **9.5" cuff, 4.3 mil finger thic ness.**

199100	NitriDerm nitrile exam gloves, small	100/box	8.64
199200	NitriDerm nitrile exam gloves, medium	100/box	8.64
199300	NitriDerm nitrile exam gloves, large	100/box	8.64
199350	NitriDerm nitrile exam gloves, extra large	100/box	8.64
199400	NitriDerm nitrile exam gloves, 2XL	10 boxes of 100	86.40

NitriDerm EP Orange Powder-Free Nitrile Gloves (Innovative Healthcare)

This powder-free nitrile synthetic glove has an extended cuff to provide extra protection in high risk situations. Excellent donning properties in a soft, low modulus formula. Textured, slightly tacky surface for a better grip. **12.0" cuff, 6.5 mil finger thickness.**



189100	NitriDerm powder-free textured nitrile gloves, small	100/box	15.78
189200	NitriDerm powder-free textured nitrile gloves, medium	100/box	15.78
189300	NitriDerm powder-free textured nitrile gloves, large	100/box	15.78
189350	NitriDerm powder-free textured nitrile gloves, extra large	100/box	15.78

Infection Control ■ Glove Holders

Glove Butler (Bowman)

The Glove Butler provides fast and easy accessibility for most any size glove. The spring-loaded dispenser holds most popular size glove boxes firmly in place. Can be mounted easily, virtually anywhere. Stainless steel option features 20 gauge brushed finish



BOGP-013	Glove Butler, single, plexiglass (5½" w x 10" h x 3¾" d)	each	22.00
BOGP-020	Glove Butler, single, plexiglass (6½" w x 10" h x 3¾" d)	each	28.00
BOGS-004	Glove Butler, single, stainless steel (5½" w x 10" h x 3¾" d)	each	41.00
BOGS-073	Glove Butler, single, stainless steel (6½" w x 10" h x 3¾" d)	each	52.00
BOGP-014	Glove Butler, double, plexiglass (10½" w x 10" h x 3¾" d)	each	30.00
BOGS-005	Glove Butler, double, stainless steel (10" w x 10" h x 3¾" d)	each	53.00
BOGP-015	Glove Butler, triple, plexiglass (18" w x 10" h x 3¾" d)	each	46.80
BOGS-006	Glove Butler, triple, stainless steel (18" w x 10" h x 3¾" d)	each	66.00
BOGP-061	Glove Butler, quad, plexiglass (24" w x 10" h x 3¾" d)	each	49.00
BOGS-060	Glove Butler, quad, stainless steel (24" w x 10" h x 3¾" d)	each	90.00

Glove Box Dispenser (Bowman)

- Two-way keyholes for vertical or horizontal wall mounting
- White powder coated steel

BOGB-001	Glove box dispenser, single	each	28.00
BOGB-002	Glove box dispenser, double	each	37.00
BOGB-003	Glove box dispenser, triple	each	46.00
BOGB-059	Glove box dispenser, quad	each	51.00





Aura™ N95 Particulate Respirator (3M)

The 3M™ Aura N95 Particulate Respirator is a breakthrough in comfort and convenience. This three-panel, flangeless, t-fold disposable respirator with its innovative design helps provide comfortable, reliable worker protection against non-oil based particles.

3M9210	Aura N95 particulate respirator	20//box	32.31
3M9211	Aura N95 particulate respirator	each	3.17



1860 N95 Particulate Respirator by (3M)

3M1860	1860 N95 particulate respirator, regular	20//box	23.16
3M1860EA	1860N95 particulate respirator, regular	each	1.50
3M1860S-BX	1860 N95 particulate respirator, small	20//box	23.16
3M1860S	1860 N95 particulate respirator, small	each	1.14



SaniFold® N95 Particulate Respirator (Gateway Safety)

Individually and hygienically sealed, SaniFold respirators ensure the sanitary condition of each mask when opened.

- Foldable design is ideal for easy carrying and storage
- Large, flexible shell creates an “air pocket” that makes breathing easier
- Ultra-soft polypropylene lining provides superior comfort
- NIOSH approved N95 level protection

GW80201	SaniFold N95 particulate respirator, unvented	each	0.57
GW80202V	SaniFold N95 particulate respirator, vented	each	1.12



PeakFit® N95 Particulate Respirator (Gateway Safety)

The peak of safety and comfort in NIOSH-approved, disposable respiratory protection, PeakFit offers the perfect fit. Large, contoured design makes breathing easy, reducing worker fatigue. Molded nose bridge with no metal nosepiece — no pinching required. Adjustable, one-piece cloth head strap is more durable and comfortable than conventional, stapled versions.

GW80101	PeakFit N95 particulate respirator, unvented	20//box	12.52
---------	----------------------------------------------	---------	-------



CriticalCover® PFL® N95 Particulate Respirator (Alpha Pro Tech)

This N95 particulate respirator meets the World Health Organization (WHO) and the Centers for Disease Control (CDC) recommended protection levels (where applicable) for many airborne contaminants. NIOSH-certified, the PFL N95 mask delivers the appropriate amount of filtration efficiency and when combined with a trio of patented and unique design features, also delivers the user a comfortable, custom-fitting face mask.

AL695	N95 particulate respirator	35//box	29.98
-------	----------------------------	---------	-------

N95 Particulate Filter Respirator and Surgical Mask (Kimberly-Clark)

N95 Particulate Filter Respirator and Surgical Mask is constructed with a fluid-resistant layer and a patented combination of materials to resist fluid penetration. Pouch-style, large breathing chamber for added comfort. Two polyurethane headbands secure the mask to the face to help ensure a tight facial seal and prevent leakage around the mask edges. Provides a minimum of 95% filtration efficiency of 0.3 micron particles.

X2400S	N95 respirator and mask, small	35/box	33.83
X2400	N95 respirator and mask, regular	35/box	33.83
X2401	Fit Test Kit includes 1 hood, 2 nebulizers and parts, Fit test solutions, stop watch, wall chart, video tape, cleaning tools and certificate of training. Perform approximately 200 Fit tests.	each	206.15



FluidShield Fog-Free Procedure Mask with Visor (Kimberly-Clark)

- Pleat-style with earloops

S3723	FluidShield mask with splashguard visor	25/box	36.75
S3724	FluidShield mask with wraparound splashguard visor	25/box	29.97



Critical Cover® Combo® Masks with Shield (Alpha Pro Tech)

The Combo facemask and face shield is hypoallergenic with an optically clear shield. The face shield is attached to the mask with snaps so that it can be easily removed where applicable. The face shield is 7 millimeters thick with an anti-fog coating, low glare and is distortion free.

AL5194E	Face shield/eye mask combo	25/box	47.58
---------	----------------------------	--------	-------



Molded Mask (Dynarex)

Over 99% filtration efficiency with molded contour shape to prevent moisture seepage. Flared soft edges to fit all facial contours.

S3727	Molded mask, blue	50/box	5.77
-------	-------------------	--------	------

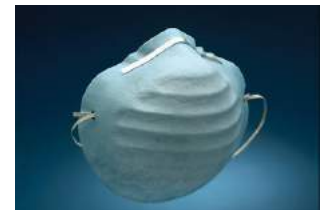

Humane Restraint Transport Hood

The TranZport Hood deters spitting and biting. No straps or ties for easy application and removal. Plastic sizing tab makes this item one-size-fits-all for juvenile to adult populations. Dark mesh allows for good visual observation of the subject

HRNIK7000	Humane restraint transport hood	each	10.00
-----------	---------------------------------	------	-------





Quantum Containment Unit™ (Quantum EMS)

The Quantum Containment Unit is for transporting a contaminated patient requiring en route monitoring. The 300 micron polyurethane chamber is at negative pressure with respect to the surrounding area to prevent pathogenic microorganisms from escaping. Negative pressure is maintained by a filter motor attached to the feet end. Its flat base allows for use with medical cots and other patient transport devices.

- Waterproof to prevent any BBP or bodily fluid exposure. Three input filters filter the outside air. Suction engine capacity is 160 liters. Military grade zipper creates tight seal of compartment. Battery life is eight hours.

Q-CONT	Quantum Containment Unit	each	7,999.00
--------	--------------------------	------	----------



Technician™ Impact Safety Goggles (Gateway Safety)

These goggles are designed to fit tightly, wear comfortably and shield the entire eye area. A durable, polycarbonate lens combines with a soft vinyl frame and hassle-free headband to create protection that workers will wear. Ventilation is incorporated into each design. Features four, patented indirect vents that construct a path of three 90° angles to prevent splash entry.

S3726	Technician impact safety goggles	each	1.77
-------	----------------------------------	------	------



Utility™ VS Eyewear (Gateway Safety)

- Classic style combines a panoramic view with durable impact protection
- Large, vented side shields help minimize fogging and provide extra coverage
- Uncoated lenses for cost-effective options
- Meets ANSI Z87.1+ and CSA Z94.3 standards

S3030	Utility VS protective eyewear, regular size, clear frame and lens	each	1.11
-------	-------------------------------------------------------------------	------	------



Nemesis Safety Eyewear (Halyard Health)

Sporty, flexible, lightweight design. Soft-touch temples for added comfort. Single-lens wraparound protection. Every pair includes a neck cord. Available in reader style lenses 99.9% UV protection. Meets ANSI Z87.1+ Impact Standard.

KC25679	V30 NEMESIS eyewear, clear anti-fog lens, black frame	pair	6.40
KC25676	V30 NEMESIS eyewear, clear lens, black frame	pair	5.32
KC22475	V30 NEMESIS eyewear, smoke anti-fog lens, black frame	pair	8.41

StarLite Squared Safety Glasses

- Indoors or outdoors
- Scratch-resistant, hard-coated 100% polycarbonate lens that lasts longer than non-treated lenses
- Snug and comfortable fit; helps minimize slippage and provides full brow protection
- Incredibly light eyewear - weighing less than an ounce - that provides superior impact protection
- Soft, pliable temples and a finger tip nose piece offer long-wearing comfort for end users



GW4480	StarLite Squared eyewear, clear temple, clear lens	each	1.66
--------	----------------------------------------------------	------	------

Scorpion Eyewear

- Free lanyard retainer helps prevent loss and damage
- Meets or exceeds ANSI Z83.1 standard
- Scratch- and impact-resistant, hard-coated lens blocks more than 99.9% of UV-A and UV-B light
- Four-point ratchet temple fits virtually any worker...better!
- Adjustable length temples and finger-tip nose piece offer custom, flexible fit
- Frame support behind lens provides added durability yet lightweight for extreme comfort



GW16GB0M	Scorpion eyewear, black frame, indoor-outdoor, clear mirror lens	each	3.83
GW16GB80	Scorpion eyewear, black frame, clear lens	each	2.80

Strobe Protective Eyewear

- Lightweight
- Resists fogging, scratching static and chemicals
- High impact polycarbonate lens

S3020	Strobe protective eyewear, blue frame, clear lens	each	1.49
-------	---------------------------------------------------	------	------



DON'T "SEE" WHAT YOU'RE LOOKING FOR?
 Call Customer Service; we're here to help.
 (800) 334-6656



MicroMax NS Coverall (Lakeland)

LICTL414-S	MicroMax coverall, zipper closure, attached hood, boots, elastic wrists, white, small	25/case	128.68
LICTL414-M	MicroMax coverall, zipper closure, attached hood, boots, elastic wrists, white, medium	25/case	128.68
LICTL414-L	MicroMax coverall, zipper closure, attached hood, boots, elastic wrists, white, large	25/case	128.68
LICTL414-XL	MicroMax coverall, zipper closure, attached hood, boots, elastic wrists, white, extra large	25/case	128.68
LICTL414-2X	MicroMax coverall, zipper closure, attached hood, boots, elastic wrists, white, 2XL	25/case	128.68
LICTL414-3X	MicroMax coverall, zipper closure, attached hood, boots, elastic wrists, white, 3XL	25/case	128.68
LICTL414-4X	MicroMax coverall, zipper closure, attached hood, boots, elastic wrists, white, 4XL	25/case	128.68



Coverall Kit (Protect Aide)

This coverall kit contains impervious jumpsuit with hood and attached boots, FluidShield Procedure Mask with wraparound SplashGuard visor, pair of high-risk, powder-free, 12" cuffed gloves, antimicrobial hand wipe, red biohazard waste bag, black waste bag.

G4395	Coverall kit, large	each	10.50
G4395XL	Coverall kit, extra large	each	10.50
G43952XL	Coverall kit, 2XL	each	12.25
G43953XL	Coverall kit, 3XL	each	13.00

Impervious Coverall with Attached Hood and Boots (Protect Aide)

X2322M	Coverall with attached hood and boots, impervious, medium	each	6.18
X2322	Coverall with attached hood and boots, impervious, large	each	6.18
X2322XL	Coverall with attached hood and boots, impervious, extra large	each	6.18
X2322-2XL	Coverall with attached hood and boots, impervious, 2XL	each	6.62
X2322-3XL	Coverall with attached hood and boots, impervious, 3XL	each	6.62



Isolation Gowns

Garrison style with adjustable ties. Full length for maximum coverage.

DY2145	Isolation gown, poly-coated barrier, impervious	white	50/case	33.08
S3721	Isolation gown, fluid- esistant, full-back	yellow	each	0.40

Isolation Gown

This gown is made of high quality spunbonded polypropylene. Elastic cuffs provide a more secure fit under gl ves, and waist and neck ties for closure.

X2315	Isolation gown	10/box	5.03
-------	----------------	--------	------



Thumbs Up® Polyethylene Isolation Gown (Medline)

Features a special design and an apron-style neck to enable gowns to be removed quickly.



X2320	Polyethylene isolation gown	each	1.10
-------	-----------------------------	------	------

Personal Protection Covers

DY2131	Shoe cover, non-conductive	blue	150 pr/case	18.07
DY2132	Shoe cover, non-conductive, non-skid	blue	150 pr/case	21.54
X2324	Shoe cover, 17"		pair	1.50
X2323	Bouffant head cover		each	0.33
X2325	Arm sleeve cover		50/case	65.11



SF™ SuperFit Premium Overboot (Servus)

Tested to the chemical resistance requirements of the Military spec Mil-O-43995C and CID A-A-59520. One-piece, seamless molded construction, molded buttons, tabbed grips and elastic loops. Slip-coated interior for improved donning and doffing, slip-resistant, self-cleaning outsole, packed 6 pairs per case.

NS11095S	SF™ SuperFit premium overboot, small, sizes 6-8	6/case	176.12
NS11095M	SF™ SuperFit premium overboot, medium, sizes 9-10	6/case	176.12
NS11095L	SF™ SuperFit premium overboot, large, sizes 11-13	6/case	176.12
NS11095XL	SF™ SuperFit premium overboot, XL, sizes 14-15	6/case	176.12



Personal Protection Kit #1 (Protect Aide)

This kit comes with one each of:

- Full-length impervious open-back gown
- FluidShield Procedure Mask with wraparound SplashGuard visor
- Pair of high-risk, powder-free, 12" cuffed gloves
- Antimicrobial alcohol gel wipe
- Red biohazard waste bag
- Black waste bag
- Pair impervious knee-high boot covers
- Packaged in a waterproof plastic sleeve

G4392	Personal protection kit , universal size	each	12.00
-------	------------------------------------------	------	-------



Personal Protection Kit #2 (Protect Aide)

This kit comes with one each of Personal Protection Kit #1 except boot covers:

- Full-length impervious open-back gown
- FluidShield Procedure Mask with wraparound SplashGuard visor
- Pair of high-risk, powder-free, 12" cuffed gloves
- Antimicrobial alcohol gel wipe
- Red biohazard waste bag
- Black waste bag
- Packaged in a waterproof plastic sleeve

G4391	Protectaide personal protection pack, ISO kit	each	8.50
-------	-----------------------------------------------	------	------





Total Release Sanitizing Fogger (SaniGuard)

Sanitize an entire ambulance in 15-20 minutes with one fogger. The world's first, and only, patented and extensively tested product that enables you to sanitize an ambulance or up to 12' x 12' area with the same kill-on-contact power of conventional SaniGuard sprays. This fogger dries on contact. Use it to sanitize ambulances and fire vehicles, transport vehicles, fire station living areas, eating/food prep areas and more.

Kills germs that cause MRSA, VRE, RSV, Staph, HIV-1, Herpes Simplex (1 and 2), Influenza A/Brazil and A(PR), Rubella, Hepatitis B, E coli, and more. **One 3.2 ounce fogger sanitizes an ambulance.**

DE55001	Total Release Fogger, 3.2 oz can (sanitizes an ambulance in 15-20 minutes)	each	8.67
---------	----------------------------------------------------------------------------	------	------



Insect Defense (SaniGuard)

Eliminate harmful insects including bed bugs, ants, bees, dust mites, flea, fly, lice, moths, mosquitoes, roaches, spiders, termites, ticks, wasps and more.

- Combines plant-based active ingredients and fragrances with other naturally occurring ingredients that also help to combat insect infestation.
- Kills both via dehydration (for crawling insects) as well as being toxic to all insects but not humans or animals.
- Includes naturally occurring ingredients to attract insects to the treated area so you can be sure you are not missing any that may hide or not be present when the initial application is applied.
- Keeps working after it is applied thanks to a proprietary process which bonds nanoparticles during production, ensuring Insect Defense remains on the treated surface longer!

DE42480	Insect Defense spray	each	9.50
---------	----------------------	------	------



Sani-Cloth® HB Germicidal Disposable Wipes (PDI)

Sani-Cloth HB Germicidal Disposable Wipes are alcohol-free and is effective against over 100 microorganisms. EPA registered; meets CDC and OSHA guidelines.

PDIQ08472	Sani-Cloth HB wipes, 6" x 6¾"	160/tub	7.69
PDIQ85484	Sani-Cloth HB wipes, 8" x 14"	65/tub	9.18
PDIP10901	Sani-Cloth universal bracket	each	28.46



Sani-Cloth® Plus Germicidal Disposable Wipes (PDI)

Sani-Cloth Plus Germicidal Disposable Wipes contains 14.85% alcohol. Cleans, disinfects and deodorizes hard, non-porous surfaces. Sani-Cloth Plus kills RSV in one minute; HBV and HIV-1 in 2 minutes; TB, MRSA, VRE, Staphylococcus aureus, Salmonella cholerasuis.

PDIQ89072	Sani-Cloth Plus wipes, 6" x 6¾"	160/tub	9.39
PDIQ85084	Sani-Cloth Plus wipes, 8" x 14"	65/tub	8.61

Super Sani-Cloth Germicidal Disposable Wipes (PDI)

Super Sani-Cloth Germicidal Wipes contain 55% alcohol to achieve faster kill times. Cleans, disinfects and deodorizes hard non-porous surfaces. Kills a broader range of bacteria and viruses including: RSV and TB in 1 minute; HBV and HIV-1 in 2 minutes. The only wipe proven effective against MRSA, VRE and E-Coli.

PDIH04082	Super Sani-Cloth wipes, individual packets, 5" x 8", 10/box, 50/case	50/case	88.62
PDIU87295	Super Sani-Cloth wipes, individual packets, 11½" X 11¾", 3/box, 50/case	50/case	27.29
PDIQ55172	Super Sani-Cloth wipes, 6" x 6¾"	160/tub	7.59



Cavicide® (Metrex)

CaviCide is a convenient, ready-to-use, intermediate-level disinfectant which is effective against TB, HBV, viruses, bacteria, and fungi. CaviCide does the job of three products, thus saving money by reducing repetitive inventory and time. Safe for non-porous surfaces. 3-in-1 cleaner, disinfectant and decontaminant. Non-toxic.

MX13-1024	Cavicide, 24 oz spray	each	9.96
MX13-1000	Cavicide, 1 gallon bottle	each	26.00
MX13-1100	Caviwipes™	160/tub	9.59



Microdot® Bleach Wipes (Cambridge Sensors)

This bleach wipe is a one-step cleaner and disinfectant that kills:

- C DIFF in one step in three minutes
- HBV in 30 seconds
- HCV in 30 seconds

CS600-12	Microdot bleach wipes	160/tub	13.95
----------	-----------------------	---------	-------



Envirocide® (Metrex)

Envirocide surface disinfectant and cleaner can also be used as an instrument cleaner or as a sterilization pre-soak. Effective against HIV-1, Polio virus types 1 & 2, Salmonella, Staph, Pseudomonas and more.

S3640	Envirocide, 24oz spray	each	15.00
S3641	Envirocide, 1 gallon refill	each	43.14





RED Z Absorbent Powder (Safetec)

Solidifier decontaminant and deodorizer.

SA41101	Red Z absorbent powder, 5 oz shaker top bottle	bottle	7.35
---------	------------------------------------------------	--------	------



EZ-Cleans Plus Spill Clean Up Kit (Safetec)

A responsible method for the clean up of potentially infectious and harmful blood and body fluid spill. Minimizes cross contamination. Safe, convenient, effective and inexpensive.

- Germicidal disinfectant with dry wipe
- Gloves
- Instructions - universal and easy to follow
- Disposable bag (red or white) with twist ties
- Pick-up scoop with scraper
- Red Z pouch
- Antimicrobial hand wipe

SA17121	EZ-Cleans Plus spill clean up kit	each	7.35
---------	-----------------------------------	------	------



Antiseptic Towelette (Dynarex)

Antiseptic towelette for general wash up. Cleans and refreshes hands, face and body without soap and water. Each antiseptic towelette provides effective antiseptic cleansing and is saturated with benzalkonium chloride solution and 5% alcohol. Made of high quality paper tissue.

S3709	Antiseptic towelette	100/box	2.10
-------	----------------------	---------	------



Lysol® I.C.™ Disinfectant Spray

95029	Lysol I.C. disinfectant spray, 19 oz	each	11.26
-------	--------------------------------------	------	-------

Alcare Plus® Antiseptic Handrub

Alcare Plus Antiseptic Handrub is a foamed, alcohol-based handrinse with broad spectrum antimicrobial action against pathogenic microorganisms that provides the same benefits as Alcare Antiseptic Handrub but is not a surgical scrub. The Alcare Plus formulation of 62% alcohol and enhanced emollients provides hand antiseptics and moisturizing at the same time. For use where immediate, waterless hand degerming compliance is needed.

GM6399-57	Alcare Plus handrub, 5.4 oz	24/case	174.75
S3665	Alcare Plus handrub, 9 oz	each	11.00
S3665D	Alcare Plus wall bracket for 9 oz container	each	12.25



Epi-Clenz Foaming Instant Hand Sanitizer

Contains ethyl alcohol and moisturizers to clean hands while killing most common germs, as well as aloe vera and vitamin E to soothe the skin.

MSC097030	Epi-Clenz hand sanitizer, 4 oz	bottle	1.92
MSC097042	Epi-Clenz hand sanitizer, 16 oz	12/case	117.50



Quik-Care® Aerosol Foam Hand Sanitizer (Ecolab)

Quik-Care is a waterless, foaming antimicrobial hand sanitizer formulated with 62.5% ethyl alcohol (by volume) as well as skin conditioners and emollients to help moisturize and improve skin health with continued use. Quik-Care is ideal for situations when there is simply no time or place to wash with soap and water. Kills germs on hands that can lead to infections, yet its emollients are gently soothing to the skin. Convenient no-rinse formula encourages frequent hand hygiene. Fragrance-free formula helps reduce the opportunity for irritation and allergic reactions. Dries within seconds, reducing the application time for staff.

EC68132100	Quik-Care waterless foam hand sanitizer, 1.5 oz	each	3.25
EC61032713	Quik-Care waterless foam hand sanitizer, 7 oz	12/case	59.00
EC61032729	Quik-Care waterless foam hand sanitizer, 15 oz	each	9.10
EC92022357	Quik-Care waterless foam hand sanitizer holder for 15 oz container	each	4.88



Instant Hand Sanitizer (Safetec)

Kills 99.9% of germs in 15 seconds. Evaporates completely. No rinsing. Contains aloe vera for prevention of drying out the skin.

SA17350	Instant hand sanitizer, 4 oz	bottle	2.08
SA17360	Instant hand sanitizer, 800ml (refill only)	each	8.82
SA27500	Instant hand sanitizer dispenser	each	10.50





Vionex Hand Hygiene Products (Metrex)

Metrex offers a wide range of hand hygiene products that provide the first line of defense from organisms that cause healthcare-related infections.

MX10-1624	Vionex no rinse hand gel, 4 oz flip-top	each	4.43
MX10-1628	Vionex no rinse hand gel, 18 oz pump bottle	each	10.92
MX10-1510	Vionex towelettes	50/box	11.01



p.a.w.s.® Antimicrobial Hand Wipes (Safetec)

p.a.w.s. Antimicrobial Hand Wipes kill 99.99% of germs on hands. Provides sanitizing and antimicrobial action with a pre-moistened towelette. Formulated with 66.5% ethyl alcohol to provide the most rapid and greatest reduction of microbial counts on the skin. Contains aloe vera to condition skin. Wipe size is 5" x 8".

SA34400	p.a.w.s. antimicrobial towelettes	100/box	7.06
---------	-----------------------------------	---------	------



Sani-Hands® Antimicrobial Handwipes (PDI)

Pre-moistened wipe delivery system. 65.9% ethyl alcohol. Proven more effective than alcohol gels alone. Friction of wipe removes soil and bacteria. Kills 99.99% of germs. Helps reduce the risk of cross-contamination and spread of infection. Contains moisturizing aloe and Vitamin E which helps retain moisture in skin with no gummy residue. Dries quickly so no need to "wave" hands to air dry. Fragrance-free and dye-free which minimizes allergic reactions and sensitivity. FDA food compliant. Convenient quick-pull canister and individual packet options.

PDID43600	Sani-Hands handwipes, individual packets, 5" x 8"	100/box	6.22
PDI13472	Sani-Hands handwipes	135/tub	6.37



Sani-Cloth® Bleach Germicidal Disposable Wipe (PDI)

Ideal for disinfecting high risk areas endemic with multidrug-resistant organisms, Clostridium difficile species and Norovirus. Effective against 50 microorganisms in 4 minutes.

PDIP28072	Sani-Cloth bleach wipes, 5" x 7", 75/tub, 12 tubs/case	12/case	126.95
PDIP25784	Sani-Cloth bleach wipes, 7½" x 15"	65/tub	19.64

Biohoop Bag (Hartwell Medical)

Largest opening of any collection bag. Semi-rigid rim keeps the bag open, providing a large target for the patient that will not collapse in use. Large 8" x 13¾" bag holds up to 3 liters. Cinchable strap allows instant closure with just a quick pull, eliminating spills and odor. Handy hook places the BioHoop within easy reach on ambulance cot rails, grab rails, hospital beds or wheelchairs.

S3507	Biohoop bag	12/pkg	24.22
-------	-------------	--------	-------



Convenience Bag (GKR Industries)

Disposable bag for vomit and urine disposal. Inner valve seals shut, prevents contents from leaking or spilling even if dropped. No strings, no ties, no odor, no mess, no cleanup.

S3703	Convenience bag	12/pkg	24.70
-------	-----------------	--------	-------



Bedpans and Basins

S3699	Fracture bedpan	each	1.35
S3700	Bedpan	each	1.55
S3701	Disposable emesis basin	each	0.22
S3702	Disposable male urinal	each	0.68
S3796	Disposable wash basin	each	0.80



Biohazard Infectious Waste Bags

X2332	Biohazard bags, Ziplock, 6" x 9"	20/pkg	1.26
X2334	Biohazard bags, Ziplock, 9" x 12"	20/pkg	2.80
X2344	Biohazard bags, 1-3 gallon, 11" x 14¼"	100/pkg	2.00
X2343	Biohazard bags, 7-10 gallon, 23" x 23"	10/pkg	1.37
X2340	Biohazard bags, 20 gallon, 25" x 34"	10/pkg	1.76
X2342	Biohazard bags, 30 gallon, 30½" x 41"	10/pkg	2.90
X4413	Biohazard bags, 40-45 gallon, 40" x 46"	10/pkg	2.85



Emesis Bags

DY4707	Emesis bag, blue, with plastic ring	24/box	16.62
NON80328	Clean Sack emesis bag	144/case	135.52
NON80328DH	Clean Sack emesis bag dispenser only	each	50.02
NON70600	Economy emesis bags with graduations	25/pkg	12.71



NON80328

DY4707



NON70600



NON80328DH



IV Products

IV Catheters



pages 201-207

IV Administration



pages 208-213

IV Dressings



page 214

IV Accessories



pages 214-218

Intraosseous Infusion



page 219

IV Modules



pages 220-222

Blood Collection



pages 222-223

Syringes and Needles



pages 224-226

Sharps Containment



page 227-229

ViaValve™ Safety IV Catheters (Smiths Medical)

ViaValve Safety IV Catheters provide blood control to help reduce the risk of blood exposure and contamination. A unique valve inside the catheter hub impedes blood flow from the patient's vein upon initial venipuncture. Maintaining a clean access site helps prevent the transfer of bloodborne pathogens from patient to caregiver on soiled gloves, clothing, bedding and dressings.

- Fully encased needle protection with proven safety, efficacy and control you want in a safety IV Catheter.
- V-Point needle for best-in-class sharpness, smoother vein insertion.
- Reassuring click of the locking tabs signal safety activation.

SM3268	ViaValve Safety IV catheter, 14ga x 1¼"	orange	50/box	221.40
SM3262	ViaValve Safety IV catheter, 16ga x 1¼"	grey	50/box	221.40
SM3265	ViaValve Safety IV catheter, 18ga x 1¼"	green	50/box	221.40
SM3266	ViaValve Safety IV catheter, 20ga x 1¼"	pink	50/box	221.40
SM3263	ViaValve Safety IV catheter, 24ga x 5/8"	yellow	50/box	221.40
SM3267	ViaValve Safety IV catheter, 20ga x 1", Flash-Vue	pink	50/box	221.40
SM3260	ViaValve Safety IV catheter, 22ga x 1", Flash-Vue	blue	50/box	221.40

End cap helps steady the needle to facilitate catheter threading

Push-off tab keeps fingers away from the catheter hub, reducing the potential of touch contamination

Ribbed catheter hub improves grip and securement

Ribbed finger pads enhance control during catheter insertion, threading and safety activation

Integral valve helps prevent blood exposure throughout the IV insertion

Ocrilon® polyurethane catheter softens in the vein and becomes more pliable allowing longer, less invasive in-dwell

FLASH-VUE™ window near the needle tip confirms venous access

V-Point reduces insertion force by 25% to 30% compared to leading competitor's J-Point needles, helping minimize pain and venous trauma during insertion!

Safety Features

- > Audible "click" of the needle guard when safety is activated signifies the needle is contained for handling and disposal
- > Safety guard surrounds the needle to help prevent unintended contact with the needle

Introducer and Needle Housing

- > Allows for one-handed or two-handed insertion, threading and disconnection

smiths medical
bringing technology to life

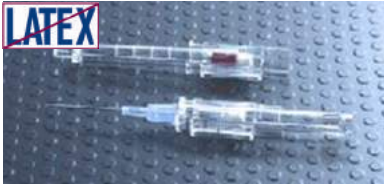

Protectiv® and Protectiv Plus Safety IV Catheters (Smiths Medical)

Protectiv and Protectiv Plus Safety IV Catheters offer distinct product safety features, with documented results in reducing accidental needlesticks.

- Protectiv Plus IV Safety Catheters come with Ocrilon Polyurethane Catheter material.
- Fully encased needle protection with proven safety, efficacy and control you want in a safety IV Catheter.
- Encased protection designed to cover the needle throughout use.
- V-Point needle for best-in-class sharpness, smoother vein insertion.
- Reassuring click of the locking tabs signal safety activation.
- Needle gasket design to minimize blood exposure.

■ **Non-Winged**

JJ3068	Protectiv Plus safety IV catheter, radiopaque, 14ga x 1 ¼"	orange	50/box	155.54
JJ3062	Protectiv Plus safety IV catheter, radiopaque, 16ga x 1 ¼"	grey	50/box	155.54
JJ3065	Protectiv Plus safety IV catheter, radiopaque, 18ga x 1 ¼"	green	50/box	155.54
JJ3067	Protectiv Plus safety IV catheter, radiopaque, 20ga x 1"	pink	50/box	155.54
JJ3066	Protectiv Plus safety IV catheter, radiopaque, 20ga x 1 ¼"	pink	50/box	155.54
JJ3060	Protectiv Plus safety IV catheter, radiopaque, 22ga x 1"	blue	50/box	155.54
JJ3063	Protectiv Plus safety IV catheter, radiopaque, 24ga x ¾"	yellow	50/box	155.54
JJ3048	Protectiv safety IV catheter, FEP polymer, 14ga x 1 ¼"	orange	50/box	147.80
JJ3042	Protectiv safety IV catheter, FEP polymer, 16ga x 1 ¼"	grey	50/box	147.80
JJ3055	Protectiv safety IV catheter, FEP polymer, 18ga x 1 ¼"	green	50/box	147.80
JJ3057	Protectiv safety IV catheter, FEP polymer, 20ga x 1"	pink	50/box	147.80
JJ3056	Protectiv safety IV catheter, FEP polymer, 20ga x 1 ¼"	pink	50/box	147.80
JJ3050	Protectiv safety IV catheter, FEP polymer, 22ga x 1"	blue	50/box	147.80
JJ3053	Protectiv safety IV catheter, FEP polymer, 24ga x ¾"	yellow	50/box	147.80

■ **Winged**

JJ3088	Protectiv Plus safety IV catheter, radiopaque, 14ga x 1 ¼"	orange	200/case	653.04
JJ3082	Protectiv Plus safety IV catheter, radiopaque, 16ga x 1 ¼"	grey	50/box	163.26
JJ3085	Protectiv Plus safety IV catheter, radiopaque, 18ga x 1 ¼"	green	50/box	163.26
JJ3086	Protectiv Plus safety IV catheter, radiopaque, 20ga x 1 ¼"	pink	50/box	163.26
JJ3080	Protectiv Plus safety IV catheter, radiopaque, 22ga x 1"	blue	50/box	163.26
JJ3083	Protectiv Plus safety IV catheter, radiopaque, 24ga x 5/8"	yellow	50/box	163.26
JJ3078	Protectiv safety IV catheter, FEP polymer, 14ga x 1 ¼"	orange	200/case	622.16
JJ3076	Protectiv safety IV catheter, FEP polymer, 20ga x 1 ¼"	pink	200/case	622.16



Acuvance® Plus Safety IV Catheters (Smiths Medical)

Acuvance Plus is available in a variety of catheter lengths, from 14- to 24-gauge sizes and feature Ocrilon polyurethane biomaterials. The Flash-Vue feature on the 24-gauge is designed to enhance flashback visualization.

- Acuvance Plus Safety IV Catheters come with a Ocrilon Polyurethane Catheter material.
- Passive safety device
- V-Point needle for best-in-class sharpness, smoother vein insertion.
- Safety device activates automatically when needle is removed from the vein.

JJ3358	Acuvance Plus safety IV catheter, 14ga x 2"	orange	50/box	160.00
JJ3342	Acuvance Plus safety IV catheter, 16ga x 1¼"	grey	50/box	160.00
JJ3355	Acuvance Plus safety IV catheter, 18ga x 1¼"	green	50/box	160.00
JJ3356	Acuvance Plus safety IV catheter, 20ga x 1¼"	pink	50/box	160.00
JJ3350	Acuvance Plus safety IV catheter, 22ga x 1"	blue	50/box	160.00
JJ3353	Acuvance Plus safety IV catheter, Flash-Vue, 24ga x 5/8"	yellow	50/box	160.00



Jelco® IV Catheters (Smiths Medical)

The FEP polymer construction and "J"-point needle design of Jelco IV Catheters allow clinicians to easily feel the vein entry.

- They have high flow rates and improved securement for most active patients.
- J point needle design allow the clinician to feel vein entry.

JJ4048	Jelco IV catheter, 14ga x 1¼", non-winged	orange	50/box	76.00
JJ4088	Jelco IV catheter, 14ga x 2", non-winged	orange	50/box	76.00
JJ4042	Jelco IV catheter, 16ga x 1¼", non-winged	grey	50/box	76.00
JJ4055	Jelco IV catheter, 18ga x 1¼", non-winged	green	50/box	76.00
JJ4057	Jelco IV catheter, 20ga x 1", non-winged	pink	50/box	76.00
JJ4056	Jelco IV catheter, 20ga x 1¼", non-winged	pink	50/box	76.00
JJ4050	Jelco IV catheter, 22ga x 1", non-winged	blue	50/box	76.00
JJ4053	Jelco IV catheter, 24ga x ¾", non-winged	yellow	50/box	76.00
JJ4075	Jelco IV catheter, 18ga x 1¼", winged	grey	50/box	80.00
JJ4073	Jelco IV catheter, 24ga x 5/8" winged	yellow	50/box	80.00



SAVE TIME BY ORDERING ONLINE
Store.Seequip.com

Insyte® Autoguard IV Catheters (BD)

BD Insyte Autoguard shielded IV catheters made of BD Vialon™ biomaterial means added safety for you. The unique, patented push-button shielding mechanism releases the spring and allows the needle and flash chamber to quickly retract into the safety barrel. The clinician maintains control of the process by deciding when to activate the push-button shielding mechanism.



■ **Winged**

BD381467	Insyte safety IV catheter, 14ga x 1¾"	orange	50/box	195.68
BD381454	Insyte safety IV catheter, 16ga x 1¼"	grey	50/box	195.68
BD381444	Insyte safety IV catheter, 18ga x 1¼"	green	50/box	185.66
BD381433	Insyte safety IV catheter, 20ga x 1"	pink	50/box	185.66
BD382534	Insyte safety IV catheter, 20ga x 11/8"	pink	50/box	185.66
BD381434	Insyte safety IV catheter, 20ga x 1¼"	pink	50/box	185.66
BD381423	Insyte safety IV catheter, 22ga x 1"	blue	50/box	185.66
BD381412	Insyte safety IV catheter, 24ga x ¾"	yellow	50/box	185.66

■ **Blood Control**

BD382554	Insyte safety IV catheter, blood control, 16ga x 11/8"	grey	50/box	195.68
BD382544	Insyte safety IV catheter, blood control, 18ga x 11/8"	green	50/box	185.66
BD382533	Insyte safety IV catheter, blood control, 20ga x 1"	pink	50/box	185.66
BD382523	Insyte safety IV catheter, blood control, 22ga x 1"	blue	50/box	185.66
BD382512	Insyte safety IV catheter, blood control, 24ga x ¾"	yellow	50/box	185.66

■ **Non-Winged**

BD381554	Insyte safety IV catheter, 16ga x 1¼"	grey	50/box	195.68
BD381544	Insyte safety IV catheter, 18ga x 1¼"	green	50/box	185.66
BD381534	Insyte safety IV catheter, 20ga x 1¼"	pink	50/box	185.66
BD381523	Insyte safety IV catheter, 22ga x 1"	blue	50/box	185.66
BD381512	Insyte safety IV catheter, 24ga x ¾"	yellow	50/box	185.66

See our AED section beginning on page 2.





Introcan® Safety IV Catheters (B. Braun)

Ergonomically designed to minimize accidental needlestick injuries without requiring user activation. Push-off plate on the hub ensures smooth insertion, allowing a single-handed technique.

■ Non-Winged

BB4251890	Introcan safety IV catheter, FEP, 14ga x 1¼"	orange	50/box	143.18
BB4252594	Introcan safety IV catheter, FEP, 14ga x 2"	orange	50/box	143.18
BB4252586	Introcan safety IV catheter, FEP, 16ga x 1¼"	grey	50/box	143.18
BB4252560	Introcan safety IV catheter, FEP, 18ga x 1¼"	green	50/box	143.18
BB4252543	Introcan safety IV catheter, FEP, 20ga x 1"	pink	50/box	143.18
BB4252535	Introcan safety IV catheter, FEP, 20ga x 1¼"	pink	50/box	143.18
BB4252519	Introcan safety IV catheter, FEP, 22ga x 1"	blue	50/box	143.18
BB4252500	Introcan safety IV catheter, FEP, 24ga x ¾"	yellow	50/box	143.18
BB4251709	Introcan safety IV catheter, PUR, 16ga x 1¼"	grey	50/box	143.18
BB4251695	Introcan safety IV catheter, PUR, 16ga x 2"	grey	50/box	143.18
BB4251687	Introcan safety IV catheter, PUR, 18ga x 1¼"	green	50/box	143.18
BB4251644	Introcan safety IV catheter, PUR, 20ga x 1¼"	pink	50/box	143.18
BB4251628	Introcan safety IV catheter, PUR, 22ga x 1"	blue	50/box	143.18
BB4251601	Introcan safety IV catheter, PUR, 24ga x ¾"	yellow	50/box	143.18

■ Winged

BB4254570	Introcan safety IV catheter, winged, FEP, 16ga x 2"	grey	50/box	143.18
BB4254538W	Introcan safety IV catheter, winged, FEP, 20ga x 1¼"	pink	50/box	148.13
BB4254511	Introcan safety IV catheter, winged, FEP, 22ga x 1"	blue	50/box	148.13
BB4254512	Introcan safety IV catheter, winged, FEP, 24ga x ½"	yellow	50/box	148.13
BB4253604	Introcan safety IV catheter, winged, PUR, 18ga x 1¼"	green	50/box	143.18

Angiocath™ IV Catheters (BD)

These longer-than-standard and large bore IV catheters are often used for needle decompression in cases of tension pneumothorax.



BD382287	Angiocath IV catheter, 10ga x 3"	10/box	278.42
BD382277	Angiocath IV catheter, 12ga x 3"	10/box	278.42
BD382268	Angiocath IV catheter, 14ga x ¾"	10/box	265.32

Surflo® Non-Protective ETFE IV Catheters (Terumo)

An ultra-sharp double-bevel introducer needle plus a medical grade lubricant allow for easier penetration and smoother travel through tissue. Preview chamber in clear sure-grip hub gives immediate indication of proper placement.

SROX1451	Surflo IV catheter, non-protective, 14ga x 2"	orange	50/box	106.67
SROX1832	Surflo IV catheter, non-protective, 18ga x 1¼"	green	50/box	106.67
SROX1851	Surflo IV catheter, non-protective, 18ga x 2"	green	50/box	106.67
SROX2032	Surflo IV catheter, non-protective, 20ga x 1¼"	pink	50/box	106.67
SROX2225	Surflo IV catheter, non-protective, 22ga x 1"	blue	50/box	106.67
SROX2419	Surflo IV catheter, non-protective, 24ga x ¾"	yellow	50/box	106.67



Nexiva™ Closed IV Catheter System (BD)

Made of BD Vialon™ catheter biomaterial, this catheter system is designed to reduce insertion attempts, increase protection against blood exposure and needlestick injuries, as well as simplify IV therapy process and enhance patient safety and satisfaction.

BD383519	Nexiva closed IV catheter system with single port, 18ga x 1¼"	20/box	176.62
BD383540	Nexiva closed IV catheter system with dual port, 18ga x 1¾"	20/box	220.78
BD383536	Nexiva closed IV catheter system with dual port, 20ga x 1"	20/box	210.74
BD383532	Nexiva closed IV catheter system with dual port, 22ga x 1"	20/box	210.74
BD383530	Nexiva closed IV catheter system with dual port, 24ga x ½"	20/box	220.78



The Southeastern Emergency Medicine Training & Education Center

Our Training & Education Center is located on the same campus as our headquarters in Youngsville, NC (just north of Raleigh). It features the latest in AV technology to ensure courses are presented in a professional and academically sound environment.

The Center is equipped with a vast array of emergency supplies and equipment as well as cutting-edge patient simulators and support materials that ensure participants train in a real-world environment.

- Philips Healthcare MRx monitors/defibrillators
- Philips Healthcare AEDs
- Laerdal Patient Simulators
- Laerdal-supported CPR feedback devices
- Stryker stretchers
- Fully-stocked hospital-style crash carts
- Emergency responder bags and accessories
- Ambulances (if needed for training purposes)



Philips MRx



Laerdal SimPad

For more information on our full array of training and education services, see pages 124-125.

Basic IV Sets (Amsino)

AM108301	Basic IV set, adult, 10 drops/ml, 83"; non-vented, roller clamp, 1 "Y" site, rotating male luer lock, PE poly pouch	each	1.00
----------	---------------------------------------------------------------------------------------------------------------------	------	------



AM108305	Basic IV set, adult, 10 drops/ml, 89"; non-vented, 1 pre-pierced "Y" Site, 1 AMSafe needle-free "Y" Site with pre-attached extension set, Roberts clamp, rotating male luer lock, PE poly pouch	each	2.93
----------	-------------------------------------------------------------------------------------------------------------------------------------------------------------------------------------------------	------	------



AM108306	Basic IV set, adult, 10 drops/ml, 83"; non-vented, roller clamp, 1 pre-pierced "Y" site, 1 AMSafe needle-free "Y" site, rotating male luer lock, PE poly pouch	each	2.43
----------	----------------------------------------------------------------------------------------------------------------------------------------------------------------	------	------



AM608305	Basic IV set, pediatric, 60 drops/ml, 89"; non-vented, roller clamp, 1 pre-pierced "Y" site, 1 AMSafe needle-free "Y" site, roller clamp with pre-attached extension set, Roberts clamp, rotating male luer lock, PE poly pouch	50/case	158.66
----------	---------------------------------------------------------------------------------------------------------------------------------------------------------------------------------------------------------------------------------	---------	--------



AM608306	Basic IV set, pediatric, 60 drops/ml, 83"; non-vented, roller clamp, 1 pre-pierced "Y" site, 1 AMSafe needle-free "Y" site, rotating male luer lock, PE poly pouch	each	2.56
----------	--------------------------------------------------------------------------------------------------------------------------------------------------------------------	------	------



IV Administration Sets (Kawasumi)

KAIV009Y	IV set, MacroDrip, 10 drop/ml, 72"; 1 "Y" site	each	1.23
----------	------------------------------------------------	------	------

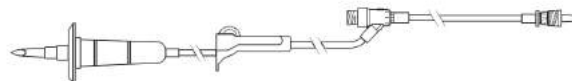

KAIV013Y	IV set, MicroDrip, 60 drop/ml, 72"; 1 "Y" site	each	1.38
----------	------------------------------------------------	------	------

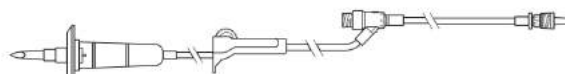

KAIV016Y	IV set, MacroDrip, 10 drop/ml, 96"; 2 "Y" sites	each	1.42
----------	-------------------------------------------------	------	------



IV Sets (B. Braun)

BB352239	EMS IV set, 10 drops/mL, 88", non-vented IV set with Safeline injection site 12" above and Safeday injection site 6" above distal end	each	2.22
----------	---------------------------------------------------------------------------------------------------------------------------------------	------	------



BB352379A	EMS IV set, 60 drops/mL, 86", universal spike, roller clamp, Ultrasite injection sites 8" and 3" above distal end, Spin-Lock connector	each	3.24
-----------	----------------------------------------------------------------------------------------------------------------------------------------	------	------



BBUS1150	EMS IV set, 15 drops/mL, 86", universal spike, roller clamp, Ultrasite injection sites 8" and 3" above distal end, Spin-Lock connector	each	8.31
----------	----------------------------------------------------------------------------------------------------------------------------------------	------	------



BBUS1160	EMS IV set, 15 drops/mL, 86", universal spike, roller clamp, Safeline injection site 8" and UltraSite injection site 3" above distal end, Spin-Lock connector	50/case	169.23
----------	---------------------------------------------------------------------------------------------------------------------------------------------------------------	---------	--------



BBUS1165	EMS IV set, 60 drops/mL, 86", universal spike, roller clamp, Safeline injection site 8" and UltraSite injection site 3" above distal end, Spin-Lock connector	each	2.29
----------	---------------------------------------------------------------------------------------------------------------------------------------------------------------	------	------

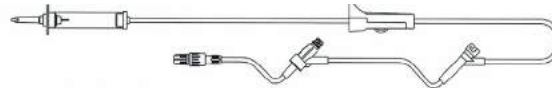

BB352242	IV set with extension, 1.6 drips/mL, 2-site needleless, split septum, 9"	each	2.25
----------	--------------------------------------------------------------------------	------	------

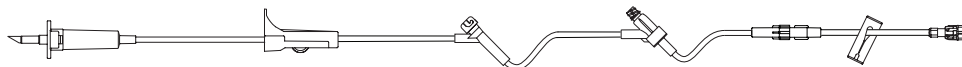

BB352241	IV set with extension, 10 drips/mL, 2-site needleless, split septum, 84"	each	5.66
----------	--------------------------------------------------------------------------	------	------

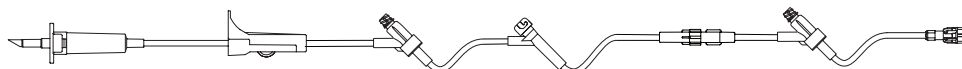

BB352243	IV set with extension, 10 drips/mL, 2-site needleless, split septum, 88"	each	3.30
----------	--------------------------------------------------------------------------	------	------

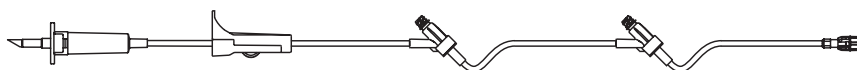

BB352240	IV set with extension, 15 drips/mL, 2-site needleless, split septum, 88"	each	3.08
----------	--------------------------------------------------------------------------	------	------

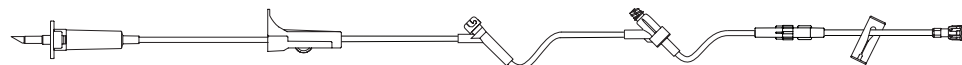

IV Solution Sets (Baxter)

BA2C6401	IV set, 10 drops/ml, Interlink injection site, lever lock cannula (detached), luer lock adapter, 76"	48/case	206.14
----------	------------------------------------------------------------------------------------------------------	---------	--------

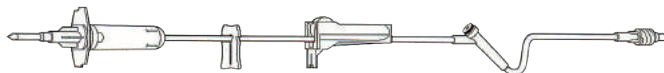

BA2C6425	IV set, 10 drops/ml, 2 Interlink injection sites, male luer lock adapter, 100"	48/case	234.18
BA2C6425-EA	IV set, 10 drops/ml, 2 Interlink injection sites, male luer lock adapter, 100"	each	5.05



BA2C8537	IV set, Continu-Flo, 10 drops/ml, 3 Clearlink luer activated valves, male luer lock adapter, retractable collar, 109"	48/case	314.68
----------	-----------------------------------------------------------------------------------------------------------------------	---------	--------



BAEMS3110	IV set, Clearlink and Interlink system, duo vent spike, male luer lock, 10 drops/ml	48/case	122.77
-----------	-------------------------------------------------------------------------------------	---------	--------

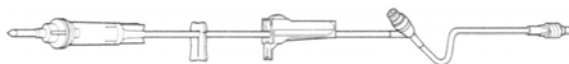

MiniDrip IV Sets (Baxter)

BA2C8402	IV set, 60 drops/ml, Clearlink luer activated valve, male luer lock adapter, 76"	each	7.70
----------	----------------------------------------------------------------------------------	------	------

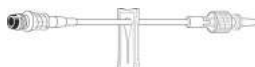

BA2C6402	IV set, 60 drops/ml, Interlink injection site, lever lock cannula (detached), male luer lock adapter, 76"	48/case	4.54
----------	-----------------------------------------------------------------------------------------------------------	---------	------



BA2C7564	Buretrol solution set, 60 drops/ml, 150mL Interlink burette, 2 Interlink injection "Y" sites, male luer lock adapter, retractable collar, 105"	each	12.71
----------	------------------------------------------------------------------------------------------------------------------------------------------------	------	-------



Specialty IV Administration Set (Baxter)

BA2C6714	"Y"-Type blood/solution set, large standard blood filter	each	9.14
----------	----------------------------------------------------------	------	------

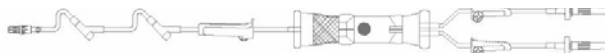

IV Catheter Extension Set (Baxter)

BA2N8378	IV catheter extension set, Clearlink luer activated valve, male luer lock adapter, retractable collar	50/case	242.06
----------	-------------------------------------------------------------------------------------------------------	---------	--------

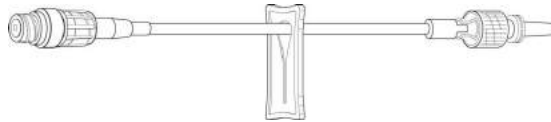

Standard Bore IV Extension Sets (Amsino)

AM000606	Standard bore extension set, 6", female luer lock, 1 pre-pierced "Y" site, 1 AMSafe needle-free "Y" Site, 1 slide clamp, rotating male luer lock, PE poly pouch	each	2.10
----------	-----------------------------------------------------------------------------------------------------------------------------------------------------------------	------	------



AMAE3107	Standard bore extension set, 7", 1 AMSafe needle-free connector, 1 slide clamp, rotating male luer lock, Tyvek poly pouch	50/case	145.51
----------	---------------------------------------------------------------------------------------------------------------------------	---------	--------



AMAF5107	Standard bore extension set, 20", female luer lock, flow controller, 1 slide clamp, 1 "Y" site, rotating male luer lock, PE poly pouch	48/case	191.03
----------	----------------------------------------------------------------------------------------------------------------------------------------	---------	--------



Primary Gravity IV Set (B.Braun)

BBV1415	IV set, universal spike (15 drops/mL), roller clamp, slide clamp, injection site 26" above distal end, spin-lock connector, DEHP-free, 93"	50/case	210.68
---------	--------------------------------------------------------------------------------------------------------------------------------------------	---------	--------



BBV1443	IV set, universal spike (15 drops/mL), backcheck valve, injection sites 60" and 6" above distal end, roller clamp, spin-lock connector, 84"	50/case	193.42
---------	---------------------------------------------------------------------------------------------------------------------------------------------	---------	--------



Extension Sets (B. Braun)

BB473447	Ultrasite extension set, standard bore, 6"	each	3.18
----------	--------------------------------------------	------	------

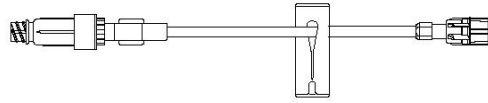

BBCE8SL	Ultrasite extension set, standard bore, 6.5"	100/case	318.27
---------	----------------------------------------------	----------	--------

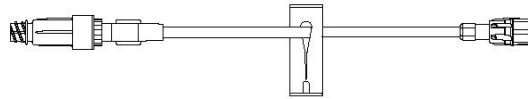

BB474921	Ultrasite extension set, small bore, 7"	50/case	181.66
----------	-----------------------------------------	---------	--------

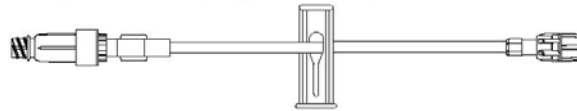

BBET04TS	T-port extension set, small bore	each	2.59
----------	----------------------------------	------	------

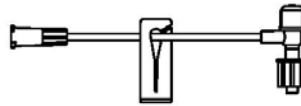

BB352244	Extension set, standard bore, with bonded SafeDAY valve, spin lock connector	each	2.74
----------	------------------------------------------------------------------------------	------	------



8" IV Extension Set (Codan)

PAT108-EM	Regular bore extension set with detachable swabable valve, red pinch clamp, sliding spin-lock. Components and tubing do not contain DEHP or natural rubber latex. Approximate priming volume: 1.1mL, Length: 8 in.	each	2.00
-----------	--------------------------------------------------------------------------------------------------------------------------------------------------------------------------------------------------------------------	------	------



8" Extension Set (Amsino)

AMAE3108	8" extension set for use without an IV bag	each	2.06
----------	--------------------------------------------	------	------



Selec-3® Multi-Drop IV Administration Sets (Biomedix)

The Selec-3 IV administration set is designed to save time, reduce storage space and minimize the risk of contamination by offering three different drop settings, all in the same system. By simply turning the patented selector top, you may choose between a 10, 15 or 60 drop/mL volume setting without breaking the line.



BMB10	Selec-3 IV set	each	9.08
BMB12-102	Selec-3 IV set, needleless	each	9.53
BMB30-102	Selec-3 IV set, one needleless "Y" site and one luer activated "Y" site, 81 3/4"	each	10.08
BMB32-102	Selec-3 IV set, one needleless "Y" site and one luer activated "Y" site, spin lock on extension set, 82"	each	10.19

STAT2 Extension Set (ConMed)

The STAT2 Extension Set offers an ideal gravity flow controlling solution. Unique design allows the rescuer to operate the STAT2 with one hand.



CNS2-12	STAT2 controller extension set, 12", "Y" site	10/pkg	67.00
---------	-----------------------------------------------	--------	-------

IV Start Kits (Southeastern)

J8023A	IV start kit includes tourniquet, gauze sponge, alcohol pre pad, PVP prep pad, VeniGard IV dressing	each	1.54
J8023V	IV start kit includes tourniquet, gauze sponge, alcohol pad, Choraprep FREPP applicator, tape roll, VeniGard IV dressing	each	2.82
J8023E	IV start kit includes latex-free tourniquet, gauze sponge, alcohol pad, tape roll, iodine swab, Clearsite IV dressing	each	1.26
J8023T	IV start kit with Tegaderm	50/box	95.97
BD386150	IV start kit includes sterile tourniquet, two gauze sponges, two alcohol pads, iodine swab, Transpore tape roll, Tegaderm IV dressing	each	2.02
MI69244	IV start kit with Chloraprep	100/case	174.92





Tegaderm IV Dressing (3M)

Tegaderm transparent IV dressing has a thin film backing with a hypoallergenic, water-resistant adhesive. The dressing is sterile and has good oxygen and moisture vapor permeability.

3M1624W	Tegaderm, 23/8x 2¾"	100/box	70.59
3M1626W	Tegaderm, 4" x 4¾"	50/box	70.86



VeniGard® (ConMed)

The safe, quick way to secure IV lines. A self-adhesive device with transparent membrane.

J8025	VeniGard	100/box	66.00
J8026	VeniGard Jr.	100/box	62.00



Transparent Film Dressing (Kendall)

Kendall transparent film dressings consist of a thin polymer film coated with a hypoallergenic adhesive. A simple, effective delivery system allows one-handed application. The dressings are ideal for I.V. sites, donor sites, burns, ulcers and sutures.

KE6640	Transparent film dressing, moisture vapor permeable, 2" x 2¾"	100/box	30.22
KE6641	Transparent film dressing, moisture vapor permeable, 4" x 4¾"	50/box	46.14
KE6640WF	Transparent film dressing, window film	100/box	27.04



View Guard Transparent Dressings (Dynarex)

Easy to apply. Conforms to difficult body contours. Provides a breathable barrier that lets air in while keeping moisture vapors and fluid out. Ideal for use around IV sites, for wound care and surgical site protection.

DY3642	View Guard transparent dressings, 23/8x 2¾"	100/box	40.50
--------	---------------------------------------------	---------	-------



Q-Syte Luer Access Split-Septum (BD)

BD385100	Q-Syte luer access split-septum	200/case	609.38
----------	---------------------------------	----------	--------

Interlink® Syringe Cannula (BD)

Attaches to a luer-lock or luer-slip syringe or Vacutainer holder. Allows needleless access to Interlink™ injection sites, “Y” sites or vial adapters for administering medications and drawing blood. Can also be used with Abbott Lifeshield or B.Braun SafeLine systems.

BD303345	Syringe blunt cannula	100/box	34.81
----------	-----------------------	---------	-------



Interlink® Leverlock Cannula (BD)

Female luer-lock with a blunt cannula and leverlock. Attaches to a standard luer-lock or luer-slip IV administration set and locks onto an Interlink injection site. Will also lock onto an Interlink “Y” site for setting up needleless “piggybacks.”

BD303370	Leverlock cannula	100/box	62.67
----------	-------------------	---------	-------



Interlink® Injection Site (Baxter)

Male luer-lock with a pre-slit Interlink injection site. Will fit on a standard IV catheter hub. With a blunt cannula on a syringe or Vacutainer holder, allows needleless access to administer medications or draw blood. Allows the use of an Interlink IV set with a leverlock cannula.

BA2N3399	Luer-lock injection site	200/case	516.46
----------	--------------------------	----------	--------

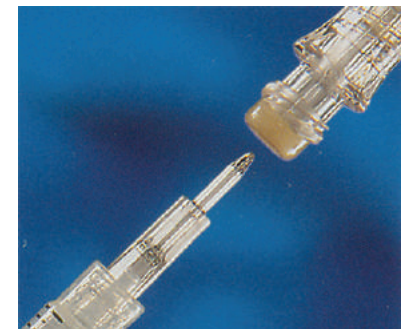

Twinpak® Dual Cannula Device (BD)

Universal device that simplifies needleless IV access. The Twinpak features two cannulas in one shield: one red hub steel cannula for syringe filling and one clear blue plastic cannula for safe access into a split septum. The BD Twinpak helps to streamline IV workflow practices by reducing the number of components required to perform IV push and flush protocols, thereby saving time and reducing costs.

BD303390	Twinpak dual cannula device, no syringe	100/box	54.61
BD303393	Twinpak dual cannula device, 10ml syringe	100/box	67.93



Clearlink Luer Activated Valve (Baxter)

BA2N8399	Clearlink luer activated valve, .25 mL, non-DEHP, non-PVC, sterile	200/case	700.95
----------	--------------------------------------------------------------------	----------	--------





BBBCSU100



BBNF9100



BBNF9210



BBNF9200



BBNF9280

B.Braun IV Accessories

BBBCSU100	Ultrasite valve	100/case	212.18
BBNF9100	Safeline injection site	100/box	193.85
BBNF9200	Safeline lever lock cannula	100/box	56.54
BBNF9210	Safeline syringe blunt cannula	100/box	38.88
BBNF9280	Universal vial adapter	100/case	298.85



AB11302-01



AB11301-01



AB11390-01

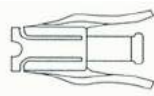

AB11952-01

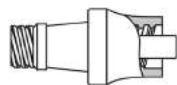

AB11956-01

LifeShield® IV Accessories by Hospira

AB11302-01	LifeShield blunt cannula, steel, 18ga	100/box	46.00
AB11301-01	LifeShield prepierced injection plug	120/case	129.22
AB11390-01	LifeShield prepierced reseal vial adapter, allows vial access (13-20mm) when using LifeShield blunt cannula	200/case	323.08
AB11952-01	LifeShield locking blunt cannula, prepierced "Y" site	50/case	26.15
AB11956-01	Clave port male adapter plug	100/case	250.00



AmSafe IV Accessories (Amsino)

- DEHP-free Sterile

AMAY0200	IV connector, AMSafe® needle-free PRN	100/case	926.35
----------	---------------------------------------	----------	--------



Stopcocks

MEMX412SL	3-way stopcock with 20" tubing	each	2.63
MX5311L	3-way stopcock with swivel, male luer lock	each	1.23



Disposable IV Armboards (Morrison Medical)

Padded boards with vinyl cover.

J8072	IV armboard, disposable, 2" x 6"	each	0.94
J8071	IV armboard, disposable, 3" x 9"	each	1.11
J8070	IV armboard, disposable, 3" x 18"	each	1.41

FloorMount IV Warmer (Smithworks)

The FloorMount IV Warmer is user-friendly, assures accurate warming of your IV solutions, and maintains a normal body temperature infusion for year-round rapid interventions of shock, burn patients, pediatric emergencies, geriatric care, and care of patients unable to maintain body temperatures. Utilizing existing cabinetry within your emergency vehicle, space allocation for this equipment is minimized or eliminated. Controlled to a temperature range of 99 to 101 degrees F (36 to 38 degrees C), the FloorMount IV Warmer delivers a thermal normal IV solution consistently. This helps to reduce the risk of induced or secondary hypothermia while providing greater patient comfort.



J7900	FloorMount IV warmer	each	497.71
-------	----------------------	------	--------

Soft Sack IV Fluid Warmer™ (Smithworks)

- 3-liter capacity
- Pouch for IV catheters, tubing and other accessories
- Insulated Cordura bag
- Mylar heat reflective inner lining

12VSS3L02	Soft Sack IV fluid warmer	each	587.03
12VRFE	AC adapter for Soft Sack IV fluid warmer	each	75.00



Disposable Pressure Infuser (Ethox)

Disposable, single patient use eliminates cross contamination and cleaning.

J8029	Disposable pressure infuser, 500 ml	each	18.50
J8030	Disposable pressure infuser, 1000 ml	each	18.50



Disposable Tourniquets

Latex or latex-free material.

J8046	Disposable tourniquet, 1" x 18", latex	10/pkg	1.42
J8047	Disposable tourniquet, 1" x 18", latex-free	10/pkg	1.14
BD367203	Disposable tourniquet, 1" x 18", latex-free	25/box	11.29



Reusable Tourniquets (ADC)

Reusable, rugged tourniquets feature gum rubber material with Velcro-type contact closure.

ADC340	Reusable tourniquet, adult	each	3.29
ADC341	Reusable tourniquet, child	each	3.29
ADC342	Reusable tourniquet, thigh	each	5.29



LATEX



BOA® Constricting Band (North American Rescue)

The patented BOA Constricting Band provides circumferential pressure to obtain venous access in the patient with little or no cardiac output. Once the device is applied, it is rolled downward on the extremity forcing blood into the veins.

NA30-0009	BOA constricting band	each	6.94
-----------	-----------------------	------	------



Chlorascrub (PDI)

3.15% Chlorhexidine Gluconate (w/v) and 70% Isopropyl Alcohol (v/v) solution guards against pathogens like most bacteria, fungi, yeast and viruses. Often recommended by infection control specialists for skin prep instead of alcohol or betadine.

PDIB10800	Chlorascrub	100/box	19.23
-----------	-------------	---------	-------



Alcohol Prep Pads

KES3511	Alcohol prep pads, medium	200/box	2.36
S3510	Alcohol prep pads, medium	100/box	1.46
B60307	Alcohol prep pads, medium	200/box	4.53
S3512	Alcohol prep pads, large	100/box	3.00

HeartStart MRx Monitor/Defibrillator for EMS by Philips
BUILT TOUGH AND READY FOR ACTION



For whatever situation you face in a day, the HeartStart MRx is built to be tough and ready for action. It is designed to meet stringent test requirements including spraying water, military helicopter vibration, mechanical shock, one-meter drop, electro-magnetic compatibility, and extreme environmental conditions (temperature, humidity, and altitude).

Tough enough for the US Army

The same MRx model Philips ships to all EMS customers is tough enough to receive an Airworthiness Certification from the United States Army. The MRx was subjected to extensive testing for the most rigorous and demanding environments faced by military personnel.



Bone Injection Gun™ (PerSys Medical)

The Bone Injection Gun (B.I.G.) offers a safe, reliable and cost-effective solution for Intraosseous (I.O.) access which allows the chance to save lives. The world's first automatic, user-friendly I.O. device brings you safe, rapid I.O. access for the delivery of fluids and medications at flow rates similar to peripheral IV infusion. With the help of B.I.G., I.O. infusion can be established in less than 60 seconds. B.I.G.'s spring-loaded needle mechanism delivers accurate and consistent results. The B.I.G. presents an easy and safe "position and press" mechanism. Typically used at the upper tibia plateau, the technique is simple to learn through brief training.



PSBIG-A	Bone Injection Gun, adult	each	92.40
PSBIG-P	Bone Injection Gun, pediatric	each	92.40

FAST1® Intraosseous Infusion System (Pyng)

Sternal IO delivers drugs to the heart two to three times faster and in higher therapeutic concentrations than tibial IO in cardiac arrest patients. Actual insertion is complete within 10 seconds. In various studies, the entire FAST1 procedure—from site prep to securing the protective dome—can easily be accomplished in under 60 seconds.



J8205	FAST1 IO System	each	176.80
-------	-----------------	------	--------

Illinois/Sternal Iliac Style Intraosseous Needle (Kendall)

The extra large, winged design of Illinois/Sternal Iliac is designed for extra control.



J8201	Illinois/Sternal Iliac style I/O, 16ga	each	15.16
-------	----------------------------------------	------	-------

Jamshidi® Style Intraosseous Needles (Carefusion)

Unique distal tip allows for quicker penetration and reduced patient trauma.



CDDIN1515	Jamshidi style I/O needle, 15ga x 3/8 17/8"	each	16.80
CDDIN1518	Jamshidi style I/O needle, 18ga x 9/16 1 1/2"	each	16.80



G3 Intravenous Cell (StatPacks)

For an EMS I.V. bag, this foam molded book style design helps keep IV therapies organized and at your finger tips. Drip sets, IV bags , catheters, needles and Start Kits are neatly arranged for fast access. It doubles as a pressure bag for rapid fluid infusion. This Intravenous Cell is considered to be one half cell in the StatPacks Third Generation Cellular System. Each Cell sets the stage for clear thinking and quick reaction. They are designed to reveal your supplies in a way unique to StatPacks: intuitively grouped and securely protected. G3 Cells unfold to expose all your vital supplies at once, and puts away just as quickly.

- Contents NOT included
- Unique foam molded design keeps all Emergency Medical Equipment inside protected from breakage or the elements
- Specifically designed to stack neatly in StatPacks Generation 2 Emergency Medical Services packs.
- Two handles with "INTRAVENOUS" written to identify the difference in EMT Gear
- Clear plastic window to identify IV bag solution
- An area to place a pressure gauge for rapid fluid infusion or high altitude fluid therapy
- Hot or cold packs pocket to warm or cool fluids
- Nicely fits in the Generation 3 Perfusion and Backup EMS Backpacks
- Accommodates a Sharps Shuttle
- Color-coded for easy identification from other EMS I.V. bags
- Fits into most EMT Jump Bags available in the market today
- A quick stash pocket for trash or extra supplies
- Capacity: 390 in; Weight: 0.6 lbs; Dimensions: 12" H x 6"W x 3"D

STPG31001BU	G3 Intravenous cell	blue	each	80.00
-------------	---------------------	------	------	-------



G3 First Aid Circulatory Kit (StatPacks)

For an EMS IV bag, this foam lined, roll style design helps keep IV therapies organized and at your finger tips. Drip sets, IV bags , catheters, needles and Start Kits are neatly arranged for fast access. It doubles as a pressure bag for rapid fluid infusion. Holds everything you need for a quick IV setup in one convenient kit. The IV Kit makes it easy to share on multi-victim accident scenes. This is a perfect accessory EMS IV bag for any StatPacks main packs.

- Contents NOT included
- Accommodates all IV bag sizes 1L, 500mL, 250mL
- Unique foam lined design keeps all Intravenous Emergency Medical Equipment inside protected from breakage or the elements
- Specifically designed to stow neatly in StatPacks Generation 3 Emergency Medical Services packs
- Hot or cold packs may be placed in to warm or cool fluids
- Front and inside pockets organize IV tubing and catheters together with the IV bag
- Transparent durable urethane window for quick IV bag solution identification
- Single-buckle closure securely holds contents in place and allows quick, one-handed access
- Top loop hangs the entire kit with the IV bag solution
- Capacity: 210", Weight: 6 oz. Dimensions: 10" H x 6"W x 3.5" D rolled

STPG36002RE	G3 First Aid Circulatory kit	red	each	38.00
-------------	------------------------------	-----	------	-------

EMS TRAINING ■ CPR/FIRST AID/AED COURSES AED IMPLEMENTATION PROGRAMS ■ HEALTHCARE PROVIDER COURSES

■ EMS TRAINING

Our EMS programs are accredited by the North Carolina Office of EMS and/or CAPCE*

Our primary objective is to provide quality training and education through our network of seasoned EMS educators—paramedics, emergency physicians, PAs and RNs—each of whom provide emergency care.

We offer BLS/ALS education, simulation and many specialty courses often not found in other educational facilities. Participants can be confident that educational programs provided by Southeastern will be accepted in most states.

Courses are offered throughout the year and online and at our Emergency Medicine Training & Education Center (see facing page). Course schedules and registration information can be found by visiting the Training & Education section of www.SEEquip.com or our Training & Education website, www.SEEtraining.com.

* Commission on Accreditation for Pre-Hospital Continuing Education

■ AMERICAN HEART ASSOCIATION (AHA)

As an AHA-approved training facility, we offer a variety of courses.

FOR HEALTHCARE PROFESSIONALS

- Basic Life Support (BLS) for Healthcare Providers
- BLS for Healthcare Providers Hybrid Renewal
- HeartCode™ ACLS, BLS and PALS (eLearning – requires in-person skills testing)
- Advanced Cardiovascular Life Support (ACLS)
- Pediatric Advanced Life Support (PALS)

WORKPLACE

- Heartsaver CPR & AED
- Heartsaver First Aid with CPR & AED
- Heartsaver Bloodborne Pathogens
- We also offer AED Implementation Programs that include AED sales and registration, site surveys, medical direction (if needed), Policies and Procedures, web-based tracking to prevent expiration of pads, batteries and training certifications, and post-event follow-up.
- Any Heartsaver course can be completed in a hybrid/eLearning format as well

FOR THE COMMUNITY

- Family & Friends CPR
- Family & Friends First Aid for Children
- Heartsaver CPR in Schools

Read what recent students have written in course evaluations

- I've been in EMS 30 years. This is one of the best classes I have ever had.
- Not your normal refresher...great to interact with medics from other states.
- Instructors did not read slides. The training room and amenities were great. They exceed the normal environment i.e. community college.
- I brought stuff home I'd forgotten or never knew. (That) equals success.
- Great snacks and drinks.
- Kept it interactive and pertinent. Even though the chairs were comfy, I didn't fall asleep.

Learn more about our Education and Clinical Services capabilities on pages 124-125.



S600X IV Module (R&B Fabrications)

It's a compact kit for your IV setup. Slot pockets and elastic loops secure your supplies. These keep everything needed convenient and organized. It is constructed of 1000 denier Cordura® nylon. #10 YKK heavy zipper with lockable zipper slides.

- Weight: 18 oz
- Dimensions: 2½" L x 8"W x 3"H

PAS600RE	S600X IV module	red	each	105.54
PAS600RB	S600X IV module	royal blue	each	105.54



IV Starter Pack (Iron Duck)

Designed by field professionals, this zippered unit holds all the necessary equipment for starting an IV. There is room for everything from catheters and tape, to blood draw tubes and 10cc syringes. Completely padded with ¼" closed cell foam. Fits into all Iron Duck oxygen and trauma cases. 11"L x 7"W x 11/2"

ID36015-OR	IV starter pack	orange	each	37.03
ID36015-RB	IV starter pack	royal blue	each	37.03



MI:01 IV Administration Module (Propak)

The MI:01 Pullout IV Administration Module organizes and displays all your IV supplies so everything you need to start an intravenous line is at your fingertips. This module works well in conjunction with the MD:02. Constructed of 500 denier cordura nylon, the MI:01 comes with sliders that have interlocking loops and a clear top pocket for identification and posting expiration dates for quick referral.

PRMI01-OR	MI:01 IV administration module, orange		each	37.78
PRMI01-RE	MI:01 IV administration module, red		each	37.78
PRMI01-RB	MI:01 IV administration module, royal blue		each	37.78



Vacutainer® Plus Plastic Blood Collection Tubes (BD)

- Plastic tubes reduce the risk of tube breakage and specimen spillage
- Disposal of plastic tubes is safe, simple and in accordance with EPS guidelines

BD363083	Vacutainer Plus blood collection tube, 2.7ml, Hemogard closure, blue		100/pkg	20.28
BD367861	Vacutainer Plus blood collection tube, 4ml, Hemogard closure, lavender		100/box	304.45
J8214	Vacutainer Plus blood collection tube, 5ml, red		100/box	38.32
J8215	Vacutainer Plus blood collection tube, 7ml, lavender		100/box	37.70
BD367886	Vacutainer Plus plasma tube, 6ml, Hemogard closure, green		100/box	469.60
BD367814	Vacutainer Plus serum tube, 5ml, Hemogard closure, red		100/box	23.65
BD367815	Vacutainer Plus serum tube, 6ml, Hemogard closure, red		100/box	23.65

Vacutainer® Safety-Lok™ Blood Collection Sets (BD)

These winged sets for both infusion and blood collection feature a translucent, integrated, protective shield. It allows for one-handed activation immediately after use to help minimize the risk of needlestick injuries as well as clear visibility of blood flashback .

BD367281	Vacutainer Safety-Lok winged blood collection set, 21ga x .75", 12" tubing, luer, green wing	50/box	74.59
BD367283	Vacutainer Safety-Lok winged blood collection set, 23ga x .75", 12" tubing, luer, light blue wing	50/box	74.59



Vacutainer® Blood Transfer Device (BD)

Transferring venous blood from a syringe and needle to a blood collection tube or blood culture bottle is both a dangerous procedure and an OSHA-prohibited practice. This single-use device reduces the risk of transfer-related injuries, while maintaining the specimen integrity required for accurate disease diagnosis.

BD364880	Vacutainer blood transfer device, female luer adapter	200/case	245.58
----------	-------------------------------------------------------	----------	--------



Vacutainer® Blood Collection Needle/Luer Adapter (Kendall)

For use with Vacutainer blood collection tubes, these multi-sample needles provide extra smooth vein entry. The multi-sample luer adapters allow for a direct connection to IV hub while the other end attaches to a Vacutainer holder for multiple sampling.

J8225	Multiple sample blood collection needle, 21ga x 1"	100/box	8.68
J8224	Multiple sample luer adapter	100/box	15.36



Vacutainer® Luer Adapters (BD)

Designed for sterile, secure and safer specimen sampling. This device provides the security of a threaded, locking luer connection—the patented male Luer-Lok™ that replaces a luer slip device. The product is also compatible with a female luer connection or needleless IV site designed for luer-lock access, and luer-locking Foley catheter sampling ports.

BD364902	BD Vacutainer Luer-Lok access device	200/case	231.58
----------	--------------------------------------	----------	--------



Saf-T Holder Blood Draw Devices (Smiths Medical)

Saf-T Holder devices come with the back-end needle and multi-sample luer permanently attached to the holder to eliminate potential exposures and holder re-use.

SM96000	Saf-T Holder blood draw device, male luer adapter	50/box	59.00
SM96002	Saf-T holder blood draw device, female luer adapter	50/box	59.00



Blood Collection Needle and Tube Holder

Transparent plastic holders for using blood collection needles with collection tubes. Fits 5ml to 20ml tubes.

J8220	Blood collection tube holder	10/pkg	0.62
-------	------------------------------	--------	------





Magellan™ Safety Needle and Syringe Combinations (Kendall)

KE8881811558	Magellan safety needle and syringe, 1ml, 25ga x 5/8"	50/box	23.65
KE8881833110	Magellan safety needle and syringe, 3ml, 21ga x 1"	50/box	24.20
KE8881833115	Magellan safety needle and syringe, 3ml, 21ga x 1½"	50/box	24.20



SafetyGlide™ Syringe and Needle (BD)

BD305903	SafetyGlide 1cc syringe, 25ga x 5/8" needle	50/box	31.40
BD305906	SafetyGlide 3cc syringe, 22ga x 1½" needle	50/box	29.26
BD305905	SafetyGlide 3cc syringe, 23ga x 1" needle	50/box	29.12
BD305904	SafetyGlide 3cc syringe, 25ga x 5/8" needle	50/box	29.26
BD305907	SafetyGlide 5cc syringe, 22ga x 1½" needle	50/box	34.70
BD305908	SafetyGlide 10cc syringe, 22ga x 1½" needle	50/box	35.63



Safety-Lok™ Syringe and Needle (BD)

BD305554	Safety-Lok 1cc syringe (TB), 25ga x 5/8" needle	100/box	65.79
BD309595	Safety-Lok 3cc syringe, 21ga x 1½" needle	100/box	37.80
BD309596	Safety-Lok 3cc syringe, 22ga x 5/8" needle	100/box	38.40
BD309594	Safety-Lok 3cc syringe, 23ga x 1" needle	100/box	38.40
BD309592	Safety-Lok 3cc syringe, 25ga x 5/8" needle	100/box	38.40
BD305561	Safety-Lok 5cc syringe, 21ga x 1½" needle	50/box	44.38



3cc Syringe/Needle Combination (Exel)

Positive plunger stop to prevent spillage when drawing. Sterile. Smooth plunger motion. Non-toxic polypropylene construction. Pyrogen free.

26105	Exel 3cc syringe/needle combination, luer lock tip, 21ga x 1"	100/box	10.10
26107	Exel 3cc syringe/needle combination, luer lock tip, 21ga x 1½"	100/box	10.10
26101	Exel 3cc syringe/needle combination, luer lock tip, 23ga x 1"	100/box	10.10
26100	Exel 3cc syringe/needle combination, luer lock tip, 25ga x 5/8"	100/box	10.10
26111	Exel 3cc syringe/needle combination, luer lock tip, 25ga x 1"	100/box	10.10



5cc Syringe/Needle Combination (Exel)

Positive plunger stop to prevent spillage when drawing. Sterile. Smooth plunger motion. Non-toxic. Polypropylene construction. Pyrogen free.

26214	Exel 5cc syringe/needle combination, luer lock tip, 20ga x 1"	yellow	100/box	23.26
26213	Exel 5cc syringe/needle combination, luer lock tip, 21ga x 1½"	green	100/box	23.26

Syringe and Needle Combination

J8128	Syringe and needle, 1cc (TB), 25ga x 5/8"	100/box	14.60
J8129	Syringe and needle, 1cc (TB), 27ga x 1/2"	100/box	14.60
J8132	Syringe and needle, 1cc (TB), 28ga x 1/2"	100/box	10.10
J8133	Syringe and needle, 3cc, 22ga x 1 1/2"	100/box	10.10
J8135	Syringe and needle, 5cc, 22ga x 1 1/2"	100/box	23.26
J8139	Syringe and needle, 10cc, 21ga x 1 1/2"	100/box	27.50



Interlink® System and Cannulas (BD)

Designed for use with Interlink, Abbott Lifeshield® and B.Braun Safeline® sites.

BD303346	Syringe with preattached blunt cannula, 3cc	100/box	52.99
BD303347	Syringe with preattached blunt cannula, 5cc	100/box	61.82
BD303348	Syringe with preattached blunt cannula, 10cc	100/box	66.23



Vanishpoint® Syringe and Needle (Retractable Technologies)

RT110151	Vanishpoint 1cc TB syringe, 25ga x 5/8" needle	100/box	84.00
RT110131	Vanishpoint 1cc TB syringe, 27ga x 1/2" needle	100/box	84.00
RT110381	Vanishpoint 3cc syringe, 20ga x 1 1/2" needle	100/box	74.00
RT110361	Vanishpoint 3cc syringe, 21ga x 1 1/2" needle	100/box	74.00
RT110311	Vanishpoint 3cc syringe, 23ga x 1" needle	100/box	74.00
RT110301	Vanishpoint 3cc syringe, 25ga x 5/8" needle	100/box	74.00
RT110391	Vanishpoint 3cc syringe, 25ga x 1" needle	100/box	74.00
RT110561	Vanishpoint 5cc syringe, 21ga x 1 1/2" needle	100/box	88.00
RT111061	Vanishpoint 10cc syringe, 21ga x 1 1/2" needle	100/box	92.00



Tuberculin Safety Syringes (Kendall)

26043	1cc TB syringe, 26ga x 1/2", w/detachable needle, luer slip	100/box	11.23
26048	1cc TB syringe only, slip tip w/cap	100/box	9.60
KE8881-511235	Monject tuberculin safety syringe, 1ml, 25ga x 5/8"	100/box	30.15



Syringes Only

26050	Syringe, 1cc luer lock	100/box	18.80
J8255	Syringe, 3cc luer lock	100/box	9.55
J8256	Syringe, 3cc luer slip	100/box	10.05
J8254BX	Syringe, 5cc luer lock	100/box	15.74
J8257	Syringe, 5cc luer slip	100/box	16.45
J8253BX	Syringe, 10cc luer lock	100/box	17.62
J8258	Syringe, 10cc luer slip	100/box	14.10
J8140BX	Syringe, 20cc luer lock	50/box	19.38
J8259	Syringe, 20cc luer slip	50/box	19.40
J8141BX	Syringe, 30cc luer lock	50/box	31.72
J8260	Syringe, 30cc luer slip	50/box	31.72
J8142BX	Syringe, 60cc luer lock	25/box	18.80
J8143	Syringe, 60cc luer slip, eccentric	25/box	18.80





Needles Only

J8156	Needle only, 18ga x 1"	100/box	4.47
J8157	Needle only, 18ga x 1½"	100/box	4.47
J8158	Needle only, 19ga x 1½"	100/box	4.47
J8154	Needle only, 20ga x 1"	100/box	4.47
J8155	Needle only, 20ga x 1½"	100/box	4.47
J8152	Needle only, 21ga x 1"	100/box	4.47
J8153	Needle only, 21ga x 1½"	100/box	4.47
J8150	Needle only, 22ga x 1"	100/box	4.47
J8151	Needle only, 22ga x 1½"	100/box	4.47
J8148	Needle only, 23ga x ¾"	100/box	4.47
J8149	Needle only, 23ga x 1"	100/box	4.47
J8145	Needle only, 25ga x 5/8"	100/box	4.47
J8146	Needle only, 25ga x 1"	100/box	4.47
J8147	Needle only, 25ga x 1½"	100/box	4.47
J8159	Needle only, 27ga x ½"	100/box	4.47



Magellan™ Safety Needles (Kendall)

KE8881850810	Magellan safety needle, 18ga x 1"	50/box	15.54
KE8881850815	Magellan safety needle, 18ga x 1½"	50/box	15.54
KE8881850010	Magellan safety needle, 20ga x 1"	50/box	15.54
KE8881850015	Magellan safety needle, 20ga x 1½"	50/box	15.54
KE8881850110	Magellan safety needle, 21ga x 1"	50/box	15.54
KE8881850115	Magellan safety needle, 21ga x 1½"	50/box	15.54
KE8881850310	Magellan safety needle, 23ga x 1"	50/box	15.54

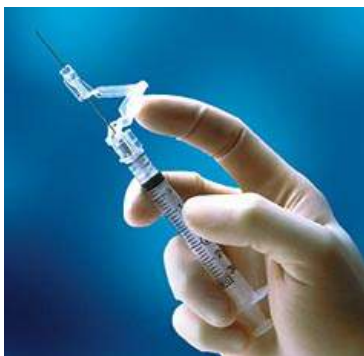

SafetyGlide™ Needles (BD)

BD305918	SafetyGlide needle, 18ga x 1½"	50/box	25.22
BD305915	SafetyGlide needle, 21ga x 1"	50/box	25.22
BD305917	SafetyGlide needle, 21ga x 1½"	50/box	25.22
BD305900	SafetyGlide needle, 22ga x 1½"	50/box	25.22
BD305902	SafetyGlide needle, 23ga x 1"	50/box	25.22
BD305916	SafetyGlide needle, 25ga x 1"	50/box	25.22
BD305901	SafetyGlide needle, 25ga x 5/8"	50/box	25.22



Butterfly™ Infusion Set

J8110	Butterfly winged infusion set, 19ga x ¾"	each	0.28
J8111	Butterfly winged infusion set, 21ga x ¾"	each	0.28
J8112	Butterfly winged infusion set, 23ga x ¾"	each	0.28
J8113	Butterfly winged infusion set, 25ga x ¾"	each	0.28

1 Quart, Nestable, Clear Lid



MI8702 red each 1.81
7 x 3.5 x 3.5 (H"x D"x W")

1 Quart, Phlebotomy
(by Covidien)



KE8900SA red each 2.20
6.25 x 4.25 x 4.5 (H"x D"x W")

1.5 Quart, Phlebotomy
(by BD)



BD305487 red each 3.93
9 x 4 x 4.75 (H"x D"x W")

2 Quart, Mailbox Style Lid
(by Covidien)



KE85021 clear 20/case 77.68
KE8503-1 transparent red each 5.16
6.25 x 4.75 x 10.75 (H"x D"x W")

2.2 Quart, Clear Lid
(by Covidien)



KE1522SA red each 3.07
6.25 x 4.5 x 6.75 (H"x D"x W")

3 Quart, Rotating Cylinder Lid
(by Bemis)



BE125020 beige 24/case 124.43
8 x 4.25 x 11 (H"x D"x W")

3.3 Quart, Funnel Entry
(by BD)



BD305488 red each 5.43
5.75 x 5 x 8.5 (H"x D"x W")

4.7 Quart
(by Winfield)



MI184R brown 12/case 98.71
9.5 x 7 x 10 (H"x D"x W")

5 Quart, Counterbalanced Lid
(by Covidien)



KE8506SA clear 20/case 113.08
KE8507SA red each 5.65
12.5 x 5.5 x 10.75 (H"x D"x W")

5 Quart, Mailbox Style Lid
(by Covidien)



J8550 clear each 5.19
KE8513-1 transparent red each 5.19
11 x 4.75 x 10.75 (H"x D"x W")

5 Quart, Rotating Cylinder Lid
(by Bemis)



BE150020 beige each 5.78
12 x 4.25 x 11 (H"x D"x W")

5.4 Quart, Counterbalanced Door
(by BD)



BD305517 red each 7.73
10.75 x 4.5 x 12 (H"x D"x W")

6.9 Quart, Funnel Entry
(by BD)



BD305489 red 12/case 97.92
11.5 x 5.5 x 8.75 (H"x D"x W")

8 Quart, Nestable, Square Funnel, Clear Top
(by BD)



BD305344 red each 7.16
10.07 in. x 7.09 in. x 9.84 in (H"x D"x W")

8.2 Quart, Funnel Entry
(by BD)



BD305490 red 12/case 103.66
13.5 x 5.5 x 8.75 (H"x D"x W")

2 Gallon, Horizontal-Drop Opening Lid
(by Covidien)



KE89671 transparent red 20/case 94.62
12.75 x 7.25 x 10.5 (H"x D"x W")

2 Gallon, Rotor Opening Lid
(by Covidien)



KEV8970 red each 4.26
10 x 7.25 x 10.5 (H"x D"x W")

2 Gallon, Sliding Lid
(by Covidien)



J8500 red each 4.00
10.25 x 7 x 10.5 (H"x D"x W")

2 Gallon, Stackable
(by Medical Action)



J8049 red each 4.12
10 x 9.5 x 7 (H"x D"x W")

5 Gallon, Open Top
(by BD)



BD305491 red each 17.52
18 x 7.5 x 10.5 (H"x D"x W")

Transportable sharps container, 1 quart



KE8303 red each 4.38

Interested in a different Sharps container than what is shown here?

Call Customer Service or your District Sales Manager at (800) 334-6656.

Sharps Container Brackets

KE8518X	Locking bracket for 2 and 5 quart Covidien containers	each	24.98
BD305447	Locking bracket for 5.4 quart BD containers	each	26.21
BE410020	Mounting bracket for Wallsafe sharps containers	10/case	50.15
BE415020	Key for #410 mounting bracket	10/case	17.85



Sharps-a-Gator™ Covidien

Flexible flap ensures hands never come into contact with contaminated waste. Container features a clear top. A positive lock secures opening and containers are autoclavable and incinerable.

J8501	Sharps-a-Gator, 5 quart, tortuous path	transparent red	each	3.51
J8053	Sharps-a-Gator, 1 gallon, slide lid	red	each	4.30
J8502	Sharps-a-Gator wall bracket, hidden bracket and key		each	6.31



Sharp-Trap Harbour Safety Products

The Sharp-Trap effectively encloses used IV catheters and smaller syringes at point of use. Its compact 7" x 2" x 2" design allows for the placement in trauma bags. Clear material allows for the monitoring of fill level and for the proper disbursement of contents.

ST100	Sharp-Trap, one half quart	each	2.58
-------	----------------------------	------	------



Sharps Shaft Dynarex

- Designed to hold syringes
- Temporary closure with final locking feature

DY4630	Sharps Shaft transportable sharps container	each	2.00
--------	---------------------------------------------	------	------



SGT Safety Tube

Disposable tube for contaminated syringes. Has biohazard label for sealing after use.

J8059	SGT safety tube, 1" diameter x 8¾" long	pearl	each	2.31
-------	-----------------------------------------	-------	------	------



Pharmaceuticals

Syringe Comparison Chart



page 232

Prescription Pharmaceuticals



pages 233-236

Schedule II Controlled Substances



page 236

Schedule IV and III Controlled Substances



page 237

Over-Counter Medications



page 237-238

Pharmaceutical Training



page 238

IV Fluids



page 239

Irrigation Solutions



page 240

Pediatric Medication Dosing



page 241

Narcotics Protection

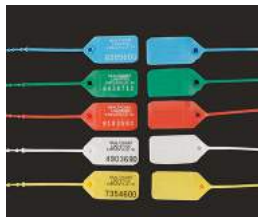

page 242







Pharmaceutical Forms

Sample DEA Form 222	
USERS:	No order form may be issued for Schedule I and II substances unless CONTAINED BACKPACKED form has been received. (21 CFR 1305.34)
STREET ADDRESS:	
Emergency Equipment	5760 NC HWY 36W
NC	TO BE FILLED IN BY SUPPLIER
DATE:	SUPPLIER DEA REGISTRATION No:
FILLED IN BY PURCHASER	
Name of Item:	National Drug Code:

pages 244-245

Syringe Comparison Chart

Use this chart to identify six commonly used syringes.

	Syringe Type	Description
	Hospira Ansyrr®	One-piece, plastic prefilled syringe with needleless luer-lock tip.
	Hospira Carpuject®	Needleless delivery system requiring the use of a separate Carpuject Injector for administration. Carpujects are packaged and sold in boxes of 10 units and feature a tamper-resistant design.
	Hospira iSECURE2™	Needleless delivery system similar to Carpujects except that it is a self-contained needleless delivery system, with no need for a separate injector. These are packaged and sold in boxes of 10 units and feature an advanced tamper-resistant design.
	Hospira LifeShield®	Two-piece, glass prefilled syringe with a safety covered-needle design which allows for a standard or luer connection.
	IMS Needleless	Two-piece, glass prefilled syringe with a needleless luer-lock tip.
	Sagent Needleless	One-piece, glass prefilled syringe with a needleless luer-lock tip.

Prescription Pharmaceuticals

Refrigerated Items

NOTE: Pharmaceutical name shown in **bold** indicates which drug type you are purchasing (brand or generic).

Item Number	Brand/Common Name	Generic Name	Strength	Container	Quantity
8234-12	ADENOCARD	adenosine	6mg/2ml	Ansy™ Syringe	each
SP301-67	ADENOCARD	adenosine	6mg/2ml	Needleless Syringe	each
WH6710	ADENOCARD	adenosine	6mg/2ml	Vial	each
8234-14	ADENOCARD	adenosine	12mg/4ml	Ansy™ Syringe	each
SP301-68	ADENOCARD	adenosine	12mg/4ml	Needleless Syringe	each
WH358-6807	ADENOCARD	adenosine	12mg/4ml	Vial	each
WH147-2273C	PROVENTIL	albuterol	2.5mg/3ml	Twist-Top Vial	25/Box
NP9501-01	PROVENTIL	albuterol	2.5mg/3ml	Twist-Top Vial	30 singles/Box
WH243-7010	PROVENTIL	albuterol	5mg/ml 20ml	Bottle w/dropper	each
WH516-9997	PRO AIR	albuterol	90mcg/spray (200 dose)	Inhaler	each
NP0201-01	DUONEB	albuterol-ipratropium	3mg-0.5mg/3ml	Twist-Top Vial	30 singles/Box
SP302-66	CORDARONE	amiodarone	150mg/3ml	Needleless Syringe	each
0057-10	CORDARONE	amiodarone	150mg/3ml	Vial	each
APP616-09	CORDARONE	amiodarone	450mg/9ml	Vial	each
BA2G3451	NEXTERONE	amiodarone	150mg/100ml	GALAXY IV Bag	each
4910-34	ATROPINE	atropine sulfate	0.5mg/5ml	LifeShield™ Syringe	each
4911-34	ATROPINE	atropine sulfate	1mg/10ml	LifeShield™ Syringe	each
IMS3339	ATROPINE	atropine sulfate	1mg/10ml	Needleless Syringe	each
AR1010-25	ATROPINE	atropine sulfate	1mg/1ml	Vial	each
WH131-9276	ATROPINE	atropine sulfate	8mg/20ml	Vial	each
AB1412-04C	BUMEX	bumetanide	1mg/4ml	Vial	10/Box
AB4928-34	CALCIUM CHLORIDE	calcium chloride	1gm/10ml	LifeShield™ Syringe	each
IMS3304	CALCIUM CHLORIDE	calcium chloride	1gm/10ml	Needleless Syringe	each
WH0311-19	CALCIUM GLUCONATE	calcium gluconate	1gm/10ml	Vial	each
4901-25	DECADRON	dexamethasone	4mg/1ml	Vial	each
AR4905-25	DECADRON	dexamethasone	20mg/5ml	Vial	each
2030	DECADRON	dexamethasone	100mg/10ml	Vial	each
AB1775-10	D25	dextrose	2.5gm/10ml (25%)	Ansy™ Syringe	each
AB7517-16	D50	dextrose	25gm/50ml (50%)	Ansy™ Syringe	each
AB4902-34	D50	dextrose	25gm/50ml (50%)	LifeShield™ Syringe	each
IMS3301	D50	dextrose	25gm/50ml (50%)	Needleless Syringe	each
AB6648-02	D50	dextrose	25gm/50ml (50%)	Vial	each
BA6013-10C	CARDIZEM	diltiazem	25gm/5ml	Vial	10/Box
AB4350-03C	CARDIZEM	diltiazem	100mg Powder	ADD-Vantage™ Vial	10/Box
WH102-0700	BENADRYL	diphenhydramine	50mg/1ml	Vial	each
AB2290-31C	BENADRYL	diphenhydramine	50mg/1ml	Carpujet™	10/Box
AB9104-20	INTROPIN	dopamine	400mg/10ml	Vial	each
BA2B0832	INTROPIN	dopamine	200mg/250ml (800mcg)	VIAFLEX® IV Bag	each
BA2B0833	INTROPIN	dopamine	400mg/500ml (800mcg)	VIAFLEX® IV Bag	each
BA2B0842	INTROPIN	dopamine	400mg/250ml (1600mcg)	VIAFLEX® IV Bag	each
BA2B0843	INTROPIN	dopamine	800mg/500ml (1600mcg)	VIAFLEX® IV Bag	each
AB2122-01	VASOTEC	enalaprilat	1.25mg/1ml	Vial	each
AB7241-01	ADRENALIN	epinephrine	1mg/1ml (1:1,000)	Ampule	each

Prescription Pharmaceuticals

Refrigerated Items

NOTE: Pharmaceutical name shown in **bold** indicates which drug you are purchasing (brand or generic).

Item Number	Brand/Common Name	Generic Name	Strength	Container	Quantity
WH0122-25	ADRENALIN	epinephrine	1mg/1ml (1:1,000)	Vial	each
AR113001	ADRENALIN	epinephrine	30mg/30ml (1:1,000)	Multi-Dose Vial	each
4921-34	ADRENALIN	epinephrine	1mg/10ml (1:10,000)	LifeShield™ Syringe	each
IMS3316	ADRENALIN	epinephrine	1mg/10ml (1:10,000)	Needleless Syringe	each
WH0501-02	EPI-PEN	epinephrine	0.15mg	Auto-Injector	2/Pack with trainer
WH0500-02	EPI-PEN	epinephrine	0.3mg	Auto-Injector	2/Pack with trainer
WH0101-02	ADRENACLICK	epinephrine	0.15mg	Auto-Injector	2/Pack
WH0102-02	ADRENACLICK	epinephrine	0.3mg	Auto-Injector	2/Pack
AB6695-01	AMIDATE	etomidate	20mg/10ml	Vial	each
AB6695-02	AMIDATE	etomidate	40mg/20ml	Vial	each
AB8060-29	AMIDATE	etomidate	40mg/20ml	LifeShield™ Syringe	each
BA6022-25C	PEPCID	famotidine	20mg/2ml	Vial	25/Box
WH141-1602	ROMAZICON	fluma enil	0.5mg/5ml	Vial	each
WH141-1636	ROMAZICON	fluma enil	1mg/10ml	Vial	each
AB9631-04	LASIX	furosemide	40mg/4ml	Ansyr™ Syringe	each
AB6102-04	LASIX	furosemide	40mg/4ml	Vial	each
AB1639-10	LASIX	furosemide	100mg/10ml	Ansyr™ Syringe	each
AB6102-10	LASIX	furosemide	100mg/10ml	Vial	each
WH0593-03	GLUCAGEN	glucagon	1mg/1ml Diagnostic Kit	Vial	each
WH132-4433	GLUCAGON	glucagon	1mg/1ml Emergency Kit	Syringe	each
WH153-1854	HALDOL	haloperidol	5mg/1ml	Vial	each
SP402-01C	HEPARIN	heparin sodium	5,000u/1ml	Vial	25/Box
WH137-7936	HEPARIN	heparin sodium	10,000u/1ml	Vial	each
WH0821-52	ENGERIX	hepatitis B vaccine	20mcg/1ml (adult)	Needleless Syringe	10/Box
0856-01	RECOMBIVAX	hepatitis B vaccine	10mcg/1ml (adult)	Vial	each
WH550-02	CYANOKIT	hydroxocobalamin	5gm/250ml	Kit	each
WH253-7918C	ATROVENT	ipratropium bromide	0.5mg/2.5ml	Twist-Top Vial	25/Box
NP9801-01	ATROVENT	ipratropium bromide	0.5mg/2.5ml	Twist-Top Vial	30 singles/Box
AB2287-31	TORADOL	ketorolac	30mg/1ml	Carpujet™	10/Box
AB3795-01	TORADOL	ketorolac	30mg/1ml	Vial	each
AB3796-01	TORADOL	ketorolac	60mg/2ml	Vial	25/Box
AB2339-34	NORMODYNE	labetalol	20mg/5ml	Carpujet™	each
AB2267-20	NORMODYNE	labetalol	100mg/20ml	Vial	each
WH2919-23	XOPENEX	levabuterol	0.63mg/3ml	Twist-Top Vial	24/Box
WH2920-23	XOPENEX	levabuterol	1.25mg/3ml	Twist-Top Vial	24/Box
AB9137-05	XYLOCAINE	lidocaine	50mg/5ml (1%)	Ansyr™ Syringe	each
AB1323-05	XYLOCAINE	lidocaine	100mg/5ml (2%)	Ansyr™ Syringe	each
4903-34	XYLOCAINE	lidocaine	100mg/5ml (2%)	LifeShield™ Syringe	each
IMS3390	XYLOCAINE	lidocaine	100mg/5ml (2%)	Needleless Syringe	each
BA2B0973	XYLOCAINE	lidocaine	2gm/500ml (0.4%)	VIAFLEX® IV Bag	each
BA2B0962	XYLOCAINE	lidocaine	2gm/250ml (0.8%)	VIAFLEX® IV Bag	each
AB4277-02	XYLOCAINE	lidocaine	1gm/50ml (2%)	Vial	each
WH106-2256	XYLOCAINE	lidocaine	2% Jelly 30gm	Tube	each

Prescription Pharmaceuticals

Refrigerated Items

NOTE: Pharmaceutical name shown in **bold** indicates which drug you are purchasing (brand or generic).

Item Number	Brand/Common Name	Generic Name	Strength	Container	Quantity
WH349-8359	XYLOCAINE	lidocaine	2% Jelly 5gm	Tube	10/Box
WH1394-47	XYLOCAINE	lidocaine	4% 50ml Topical Solution	Bottle	each
AR2602-25	MAG SULFATE	magnesium sulfate	1gm/2ml	Vial	each
AR2610-25	MAG SULFATE	magnesium sulfate	5gm/10ml	Vial	each
AB1754-10	MAG SULFATE	magnesium sulfate	5gm/10ml	Ansyr™ Syringe	each
WH148-5622	SOLU-MEDROL	methylprednisolone	125mg/2ml	Act-O-Vial®	each
WH184-7755	SOLU-MEDROL	methylprednisolone	1gm/8ml	Act-O-Vial®	each
AB3414-01	REGLAN	metoclopramide	10mg/2ml	Vial	each
WH350-7233	LOPRESSOR	metoprolol	5mg/5ml	Vial	each
IMS3369	NARCAN	naloxone	2mg/2ml	Needleless Syringe	each
IMS1469	NARCAN	naloxone	2mg/2ml	Syringe with Needle	each
AB1782-69C	NARCAN	naloxone	0.4mg/1ml	Carpject™	10/Box
AB1215-01	NARCAN	naloxone	0.4mg/1ml	Vial	each
WH294-2290	NITRO-BID	nitroglycerin	1gm Ointment (2%)	Unit Dose Packet	48/Box
WH129-4420	NITRO-BID	nitroglycerin	30gm Ointment (2%)	Tube	each
WH0410-04	NITROMIST	nitroglycerin	90 Dose (400mcg)	Pump Spray Bottle	each
WH0410-08	NITROMIST	nitroglycerin	230 Dose (400mcg)	Pump Spray Bottle	each
WH282-1494	NITROSTAT	nitroglycerin	0.4mg Tablets	Bottle	25/Bottle
WH120-4213	NITROSTAT	nitroglycerin	0.4mg Tablets	Bottle	100/Bottle
BA1A0692	NITROGLYCERIN	nitroglycerin	25mg/250ml (100mcg)	IV Bottle	each
BA1A0694	NITROGLYCERIN	nitroglycerin	50mg/250ml (200mcg)	IV Bottle	each
WH104-6218	LEVOPHED	norepinephrine	4mg/4ml	Ampule	each
AB4755-02	ZOFRAN	ondansetron	4mg/2ml	Vial	each
AB1120-12C	ZOFRAN	ondansetron	4mg/2ml	iSecure™ Syringe	10/Box
WH7732-93	ZOFRAN	ondansetron	4mg ODT	Tablets	30/Box
WH170-4261	PITOCIN	oxytocin	10u/1ml	Vial	each
AB1902-01	PRONESTYL	procainamide	1gm/10ml	Vial	each
AB1903-01	PRONESTYL	procainamide	1gm/2ml	Vial	each
WH129-8579	PHENERGAN	promethazine	25mg/1ml	Ampule	each
WH342-1104	PHENERGAN	promethazine	25mg/1ml	Vial	each
WH323-5652	ASTHMANEFRIN	racepinephrine	0.5mg/0.5ml Inhalation	Twist-Top Vial	each
WH0362-10C	ZANTAC	ranitidine	50mg/2ml	Vial	10/Box
WH2243-11	ZANTAC	ranitidine	150mg/6ml	Vial	each
AB9558-05C	ZEMURON	rocuronium bromide	50mg/5ml	Vial	10/Box
AB955-10C	ZEMURON	rocuronium bromide	100mg/10ml	Vial	10/Box
5534-34	SODIUM BICARB	sodium bicarbonate	4.2% 10ml (INFANT)	LifeShield™ Syringe	each
AB4900-33	SODIUM BICARB	sodium bicarbonate	8.4% 10ml (PEDIATRIC)	LifeShield™ Syringe	each
AB6637-33	SODIUM BICARB	sodium bicarbonate	8.4% 50ml (ADULT)	LifeShield™ Syringe	each
IMS3352	SODIUM BICARB	sodium bicarbonate	8.4% 50ml (ADULT)	Needleless Syringe	each
WH144-3308C	NORMAL SALINE	sodium chloride	0.9% 3ml Inhalation	Twist-Top Vial	100/Box
KE8881570125	NORMAL SALINE	sodium chloride	0.9% 5ml	Needleless Syringe	each
J8375	NORMAL SALINE	sodium chloride	0.9% 10ml	Needleless Syringe	each

Prescription Pharmaceuticals

Refrigerated Items

NOTE: Pharmaceutical name shown in **bold** indicates which drug you are purchasing (brand or generic).

Item Number	Brand/Common Name	Generic Name	Strength	Container	Quantity
AB4888-10	NORMAL SALINE	sodium chloride	0.9% 10ml	Vial	25/Box
AB4888-20C	NORMAL SALINE	sodium chloride	0.9% 20ml	Vial	25/Box
AB1966-07	NORMAL SALINE	sodium chloride	0.9% 30ml Bacteriostatic	Vial	each
AB6629-02	QUELICIN	succinylcholine	200mg/10ml	Vial	each
WH0400-15	ADACEL	TDAP Vaccine	0.5ml	Needless Syringe	5/Box
WH357-9810	BRETHINE	terbutaline	1mg/1ml	Vial	each
WH113-5458	PONTACAINE	tetracaine	0.5% Ophthalmic Solution	15ml Bottle	each
WH107-4939	PONTACAINE	tetracaine	0.5% Ophthalmic Solution	2ml Bottle	12/Box
WH1354	VITAMINE B1	thiamine	200mg/2ml	Vial	each
WH0605-01	TXA	tranexamic acid	1gm/10ml	Vial	each
0752-21	APLISOL	tuberculin	10 Test	Vial	each
WH101-3358	APLISOL	tuberculin	50 Test	Vial	each
WH0752-22	TUBERSOL	tuberculin	50 Test	Vial	each
AB1632-01	NORCURON	vecuronium	10mg Powder	Vial	each
AB1144-05	CALAN	verapamil	5mg/2ml	Vial	each
AB4887-10	WATER	water	Sterile 10ml	Vial	25/Box
AB4887-20C	WATER	water	Sterile 20ml	Vial	25/Box
AB3977-03C	WATER	water	Bacteriostatic 30ml	Vial	25/Box

Schedule II Controlled Substances
NOTE: Pharmaceutical name shown in **bold** indicates which drug you are purchasing (brand or generic).

Item Number	Brand/Common Name	Generic Name	Strength	Container	Quantity
AB9093-32C	SUBLIMAZE	fentanyl	100mcg/2ml	Ampule	10/Box
AB1276-32C	SUBLIMAZE	fentanyl	100mcg/2ml	Carpject™	10/Box
AB9094-22C	SUBLIMAZE	fentanyl	100mcg/2ml	Vial	25/Box
BA6028-25C	SUBLIMAZE	fentanyl	250mcg/5ml	Vial	25/Box
AB1312-30C	DILAUDID	hydromorphone	2mg/1ml	Carpject™	10/Box
BA0121-25C	DILAUDID	hydromorphone	2mg/1ml	Vial	25/Box
AB1176-30C	DEMEROL	meperidine	25mg/1ml	Carpject™	10/Box
AB1178-30C	DEMEROL	meperidine	50mg/1ml	Carpject™	10/Box
BA0160-01C	DEMEROL	meperidine	50mg/1ml	Vial	25/Box
AB1890-01C	DURAMORPH	morphine	2mg/1ml	Carpject™	10/Box
AB1891-01C	DURAMORPH	morphine	4mg/1ml	Carpject™	10/Box
BA6125-25C	DURAMORPH	morphine	4mg/1ml	Vial	25/Box
AB1893-01C	DURAMORPH	morphine	10mg/1ml	Carpject™	10/Box
BA6127-25C	DURAMORPH	morphine	10mg/1ml	Vial	25/Box

Schedule IV and III Controlled Substances

Refrigerated Items

NOTE: Pharmaceutical name shown in **bold** indicates which drug you are purchasing (brand or generic).

Item Number	Brand/Common Name	Generic Name	Strength	Container	Quantity
AB1273-32C	VALIUM	diazepam	10mg/2ml	Carpject™	10/Box
AB2051-05C	KETALAR	ketamine	500mg/5ml	Vial	10/Box
AB2053-10C	KETALAR	ketamine	500mg/10ml	Vial	10/Box
AB6778-02C	ATIVAN	lorazepam	2mg/1ml	Vial	10/Box
AB1985-30C	ATIVAN	lorazepam	2mg/1ml	Carpject™	10/Box
AB1539-31C	ATIVAN	lorazepam	4mg/1ml	Carpject™	10/Box
BA6057-10C	VERSED	midazolam	2mg/2ml	Vial	10/Box
BA6059-10C	VERSED	midazolam	5mg/5ml	Vial	10/Box
BA6061-10C	VERSED	midazolam	5mg/1ml	Vial	10/Box
AB2308-01C	VERSED	midazolam	5mg/1ml	Vial	10/Box
AB2307-60C	VERSED	midazolam	5mg/1ml	Carpject™	10/Box
BA6063-10C	VERSED	midazolam	10mg/2ml	Vial	10/Box
AB2308-02C	VERSED	midazolam	10mg/2ml	Vial	10/Box
BA6056-10C	VERSED	midazolam	10mg/10ml	Vial	10/Box

Over-Counter Medications

NOTE: Pharmaceutical name shown in **bold** indicates which drug you are purchasing (brand or generic).

Item Number	Brand/Common Name	Generic Name	Strength	Container	Quantity
WH3222-01	TYLENOL	acetaminophen	325mg	Tablets	100/Bottle
F233602	TYLENOL	acetaminophen	325mg Unit Dose 2/pack	Tablets	75pks/Box
PK20-450	TYLENOL	acetaminophen	500mg Unit Dose 2/pk	Tablets	50pks/Box
PK20-450TYL	TYLENOL	acetaminophen	500mg Unit Dose 2/pk	Tablets	50pks/Box
PK20-425	TYLENOL	acetaminophen	500mg Unit Dose 2/pk	Tablets	125pks/Box
WH218-1444	TYLENOL	acetaminophen	4oz Liquid (160mg/5ml)	Bottle	each
WH0657-05	TYLENOL	acetaminophen	5ml Liquid (160mg/5ml)	Unit Dose Cup	10/Pack
WH0657-11	TYLENOL	acetaminophen	10ml Liquid (325mg/10ml)	Unit Dose Cup	10/Pack
VP0202-04	INSTA-CHAR	activated charcoal	25gm Cherry Flavor	Bottle	each
VP0203-04	INSTA-CHAR	activated charcoal	25gm w/Sorbitol	Bottle	each
VP0202-08	INSTA-CHAR	activated charcoal	50gm Cherry Flavor	Bottle	each
VP0203-08	INSTA-CHAR	activated charcoal	50gm w/Sorbitol	Bottle	each
VP0201-08	INSTA-CHAR	activated charcoal	50gm Unfl vored	Bottle	each
S3504	SMELLING SALTS	ammonia	Inhalant	Amp	100/Box
PK20-365	EXCEDRIN	apap/aspirin/caffeine	250mg-250mg-65mg 2/pk	Tablets	125pks/Box
J8337	BABY ASPIRIN	aspirin	81mg Chewable	Tablets	36/Bottle
PK20-150	ECOTRIN	aspirin	325mg Unit Dose 2/pack	Tablets	50pks/Box
PK20-125	ECOTRIN	aspirin	325mg Unit Dose 2/pack	Tablets	125pks/Box
WH281-2444	ECOTRIN	aspirin	325mg	Tablets	100/Bottle

Over-Counter Medications

NOTE: Pharmaceutical name shown in **bold** indicates which drug you are purchasing (brand or generic).

Item Number	Brand/Common Name	Generic Name	Strength	Container	Quantity
PK20-750	TUMS	calcium carbonate	500mg Antacid 2/pack	Tablets	50pks/Box
PK20-725	TUMS	calcium carbonate	500mg Antacid 2/pack	Tablets	125pks/Box
18247	BENADRYL	diphenhydramine	25mg Unit Dose 1/pack	Tablets	200pks/Box
WH0479-62	BENADRYL	diphenhydramine	25mg Blister Pack	Tablets	24/Box
WH1228-20	BENADRYL	diphenhydramine	4oz Liquid (12.5mg/5ml)	Bottle	each
WH03013	MEDI-LYTE	electrolytes	Unit Dose 2/pk	Tablets	250pks/Box
WH0872-30	PEPCID AC	famotidine	10mg	Tablets	30/Bottle
LN6739	GLUCOSE	glucose	15gm Gel - Strawberry	Foil Pack	3/Pack
CS703-03	GLUCOSE	glucose	15gm Gel - Fruit	Tube	3/Pack
PD0070-30	GLUCOSE-15	glucose	15gm Gel - Grape	Tube	3/Pack
PD0069-30	GLUCOSE-15	glucose	15gm Gel - Lemon	Tube	3/Pack
ICN0746-31	INSTA-GLUCOSE	glucose	31gm Gel - Cherry	Tube	each
ICN0746-33	INSTA-GLUCOSE	glucose	31gm Gel - Cherry	Tube	3/Pack
S3520	LEMON GLYCERIN	glycerin	Lemon Flavor	Swab stick	25/Box
PK20-550ADV	ADVIL	ibuprofen	200mg Unit Dose 2/pack	Tablets	50pks/Box
PK20-525	MOTRIN	ibuprofen	200mg Unit Dose 2/pack	Tablets	125pks/Box
PK20-550	MOTRIN	ibuprofen	200mg Unit Dose 2/pack	Tablets	50pks/Box
WH0074-71	MOTRIN	ibuprofen	200mg	Tablets	50/Bottle
WH1255-94	MOTRIN	ibuprofen	4oz Liquid (100mg/5ml)	Bottle	each
WH5201-79	VICKS	medicated chest rub	3.5oz Ointment	Tub	each
7560-59	AFRIN	oxymetazoline	0.05% 15ml Nasal Spray	Bottle	each
WH5711-35	AFRIN	oxymetazoline	0.05% 15ml Nasal Spray	Bottle	each
WH109-4515	NEO-SYNEPHRINE	phenylephrine	0.5% 15ml Nasal Spray	Bottle	each
WH0351-50	ZANTAC	ranitidine	150mg	Tablets	50/Bottle

Pharmaceutical Training

Item Number	Description	Quantity
ME-FPAF	DuoDote Auto-Injector Trainer	25/Box
J8400T	Epi-Pen Trainer	each
WC619PI	Metered Dose Inhaler Trainer	5/Pack
WC1507N	Naloxone Needleless Syringe Trainer	each
WC730NP	Nitroglycerin Tablet Bottle Trainer	5/Pack

IV Fluids (Baxter)

BA2B0086	Dextrose, 5%, 50ml, Viafl x® IV bag	96/case	328.91
BA2B0082	Dextrose, 5%, 100ml, Viafl x IV bag	4/pkg	238.12
BA2B0062	Dextrose, 5%, 250ml, Viafl x IV bag	each	4.74
BA2B0063	Dextrose, 5%, 500ml, Viafl x IV bag	each	6.40
BA2B0064	Dextrose, 5%, 1000ml, Viafl x IV bag	each	1.95
BA2B0162-Q	Dextrose, 10%, 250ml, Viafl x IV bag	each	2.27
BA2B1306	Sodium Chloride, 0.9%, 50ml, Viafl x IV bag	96/case	159.44
BA2B1301	Sodium Chloride, 0.9%, 50ml (4/pack), Viafl x IV bag	24 packs/case	379.40
BA2B1322Q	Sodium Chloride, 0.9%, 250ml, Viafl x IV bag	36/case	74.88
BA2B1323	Sodium Chloride, 0.9%, 500ml, Viafl x IV bag	each	3.68
BA2B1324	Sodium Chloride, 0.9%, 1000ml, Viafl x IV bag	each	2.04
BA2B2323	Lactated Ringers, 500ml, Viafl x IV bag	each	1.85
BA2B2324	Lactated Ringers, 1000ml, , Viafl x IV bag	each	2.14



IV Fluids (Braun)

BBS51045384	Dextrose, 5%, 50ml, PAB® IV bag	each	1.97
BBS5104-5264	Dextrose, 5%, 100ml, PAB IV bag	each	1.97
BBL5102	Dextrose, 5%, 250ml, Excel® IV bag	24/case	72.00
BBL5101	Dextrose, 5%, 500ml, Excel IV bag	24/case	72.00
BBL5100	Dextrose, 5%, 1000ml, Excel IV bag	12/case	36.00
BBS8004-5384	Sodium Chloride, 0.9%, 50ml, PAB IV bag	84/case	173.17
BBS8004-5264	Sodium Chloride, 0.9%, 100ml, PAB IV bag	each	2.06
BBL8002	Sodium Chloride, 0.9%, 250ml, Excel IV bag	24/case	72.00
BBL8001	Sodium Chloride, 0.9%, 500ml, Excel IV bag	24/case	72.00
BBL8000	Sodium Chloride, 0.9%, 1000ml, Excel IV bag	12/case	46.80
BBL7501	Lactated Ringers, 500ml, Excel IV bag	24/case	72.00
BBL7500	Lactated Ringers, 1000ml, Excel IV bag	12/case	46.80
BBL8502	Sterile Water, 250 ml, Excel IV bag	24/case	72.00



IV Fluids (Hospira)

AB7100-67	Dextrose, 5%, 100ml, ADD-Vantage™ bag	5/pkg	18.75
AB7922-02	Dextrose, 5%, 250ml, IV bag	24/case	184.62
AB7922-03	Dextrose, 5%, 500 ml, IV bag	24/case	184.62
7930-02	Dextrose, 10%, 250ml, IV bag	each	7.25
AB3579-30	Dextrose, 10%, 500ml, IV bag	each	7.25
AB7984-36	Sodium Chloride, 0.9%, 50ml, IV bag	4 each	11.36
AB7101-66	Sodium Chloride, 0.9%, 50ml, ADD-Vantage bag	5/pkg	19.95
AB7101-67	Sodium Chloride, 0.9%, 100ml, ADD Vantage bag	5/pkg	13.85
AB7984-37	Sodium Chloride, 0.9%, 100ml (4/pack), IV bag	20 packs/case	288.00
AB7984-37-4	Sodium Chloride, 0.9%, 100ml, IV bag	4 packs	15.04
AB7983-02	Sodium Chloride, 0.9%, 250ml, IV bag	24/case	240.00
AB7983-03	Sodium Chloride, 0.9%, 500ml, IV bag	24/case	240.00
AB7983-09	Sodium Chloride, 0.9%, 1000ml, IV bag	12/case	120.00
AB7953-02	Lactated Ringers, 250ml, IV bag	24/case	240.00
AB7953-03	Lactated Ringers, 500ml, IV bag	24/case	240.00
AB7953-09	Lactated Ringers, 1000ml, IV bag	12/case	120.00





Irrigation Solutions (Baxter)

BA2F7122	Sodium Chloride, 0.9%, 250ml, bottle	each	3.58
BA2F7123	Sodium Chloride, 0.9%, 500ml, bottle	each	2.79
BA2F7124	Sodium Chloride, 0.9%, 1000ml, bottle	each	3.01
BA2F7112	Sterile Water, 250ml, bottle	each	2.87
BA2F7113	Sterile Water, 500ml, bottle	each	5.96
BA2F7114	Sterile Water, 1000ml, bottle	each	2.79



Irrigation Solutions (Braun)

BBR5201-01	Sodium Chloride, 0.9%, 500ml, bottle	16/case	34.46
BBR5200-01	Sodium Chloride, 0.9%, 1000ml, bottle	16/case	38.46
BBR5001-01	Sterile Water, 500ml, bottle	16/case	34.46
BBR5000-01	Sterile Water, 1000ml, bottle	16/case	48.12



Irrigation Solutions (Hospira)

AB6138-03	Sodium Chloride, 0.9%, 500ml, bottle	24/case	240.00
AB7138-09	Sodium Chloride, 0.9%, 1000ml, bottle	12/case	120.00
AB6139-03	Sterile Water, 500ml, bottle	24/case	240.00
AB7139-09	Sterile Water, 1000ml, bottle	12/case	120.00



Irrigation Solutions (Saljet)

SAL000909	Sodium Chloride, 0.9%, 30ml, twist-top vial	40/box	35.90
-----------	---------------------------------------------	--------	-------



- Download **FREE** Layar App (from your App Store)
- Scan this page
- View custom product info

Bring catalog pages to life

View additional content about selected products throughout our catalog by using your mobile device to scan pages that display the AR graphic (left). To get started, simply download the free "Layar" app from your device's App store.

Pedi-Sleeve® Pediatric Dosing System (M.E.D.I.C.)

Currently, treating the pediatric patient and reading a length-based resuscitation tape has been difficult and sometimes awkward. Pedi-Sleeve is a three-page protected sleeve worn on the forearm of the healthcare professional that displays pediatric medication dosing and equipment sizes. This means the exact dose in milliliters is always just a glance away, making drug calculations—the number one source of pediatric medication dosing errors—unnecessary and obsolete. Inserts can be customized to reflect individual protocols as well as future guideline changes. Pedi-Sleeve Kit comes with nine color sleeves which reflect the colors of industry-standard length-based resuscitation tapes.



MEDPQ10014	Pedi-Sleeve ALS kit with nine sleeves in soft, roll-up case	each	124.95
MEDPQR10014B	Pedi-Sleeve BLS kit with nine sleeves, in soft roll-up case	each	114.95
MEDPQR10015	Pedi-Sleeve ALS Response Bag with nine sleeves, measuring device and Pedi-Sleeve Pro Software access	each	168.58
MEDPQR10015B	Pedi-Sleeve BLS Response Bag with nine sleeves, measuring device and Pedi-Sleeve Pro Software access	each	148.47
MEDPQR10016	Pedi-Sleeve ALS kit in drawstring bag with nine sleeves, measuring device, and Ped-Sleeve Pro Software access	each	104.95
MEDPQR10016B	Pedi-Sleeve BLS kit in drawstring bag with nine sleeves, measuring device, and Ped-Sleeve Pro Software access	each	34.77
MEDPQR2007	Pedi-Sleeve replacement sleeve, blue	2/pkg	12.50
MEDPQR2001	Pedi-Sleeve replacement sleeve, gray	2/pkg	12.50
MEDPQR2009	Pedi-Sleeve replacement sleeve, green	2/pkg	12.50
MEDPQR2008	Pedi-Sleeve replacement sleeve, orange	2/pkg	12.50
MEDPQR2002	Pedi-Sleeve replacement sleeve, pink	2/pkg	12.50
MEDPQR2004	Pedi-Sleeve replacement sleeve, purple	2/pkg	12.50
MEDPQR2003	Pedi-Sleeve replacement sleeve, red	2/pkg	12.50
MEDPQR2005	Pedi-Sleeve replacement sleeve, yellow	2/pkg	12.50
MEDPQR2006	Pedi-Sleeve replacement sleeve, white	2/pkg	12.50
MEDPTR3001	Pediatape replacement for Pedi-Sleeve	each	8.00



- Download **FREE Layar App** (from your App Store)
- Scan this page
- View custom product info



MEDPQR10015



MEDPQR10016

Customize your Pedi-Sleeve inserts with Pedi-Sleeve Pro Software

- Pedi-Sleeve Pro is a software program designed to allow users of Pedi-Sleeve products to manage their own insertion cards.
- Each card can be edited and printed with an agency's custom information.
- All card information is kept on the installation computer in a password-protected database on the local machine.
- A registration key is required to run the software.

Equilok Pull-Tight Security Seal (Equilok)

The Equilok is a medium strength pull-tight, adjustable security seal designed to be used on any equipment requiring a highly tamper-resistant locking mechanism and reasonable degree of strength. This adjustable, pull-tight seal is manufactured out of high density polyethylene and acetal, which enables it to withstand great variances in temperature. Individually numbered or barcoded.

SO1021326	Equilok pull-tight security seal	blue	100/pkg	22.54
SO1029134	Equilok pull-tight security seal	red	100/pkg	22.54
SO1043643	Equilok pull-tight security seal	yellow	100/pkg	22.54
SO1046381	Equilok pull-tight security seal	green	100/pkg	22.54
SO1046645	Equilok pull-tight security seal	white	100/pkg	22.54



Drug Lock, Padlock Style (Healthcare Logistics)

These individually numbered plastic locks indicate previous use or tampering. Ideal for drug box or cabinet.

HL7906	Drug lock, padlock style	blue	100/pkg	18.00
HL7912	Drug lock, padlock style	green	100/pkg	18.00
HL7914	Drug lock, padlock style	purple	100/pkg	18.00
HL7901	Drug lock, padlock style	red	100/pkg	18.00
HL7910	Drug lock, padlock style	white	100/pkg	18.00
HL7903	Drug lock, padlock style	yellow	100/pkg	18.00



Pull-Tight Seals (Healthcare Logistics)

Excellent seal for code carts and emergency kits that need security with quick entry. Average breaking strength is 11-14 lbs. One side of the seal tab is textured to permit writing of verification information (e.g., date, time, initials).

HL7816	Pull-Tight seals, numbered	blue	100/pkg	19.50
HL7817	Pull-Tight seals, numbered	green	100/pkg	19.50
HL7820	Pull-Tight seals, numbered	red	100/pkg	19.50
HL7814	Pull-Tight seals, numbered	white	100/pkg	19.50
HL7813	Pull-Tight seals, numbered	yellow	100/pkg	19.50
HL7827	Pull-Tight seals, unnumbered	blue	100/pkg	13.35
HL7825	Pull-Tight seals, unnumbered	green	100/pkg	13.35
HL7823	Pull-Tight seals, unnumbered	yellow	100/pkg	13.35
HL7828	Pull-Tight seals, unnumbered	white	100/pkg	13.35

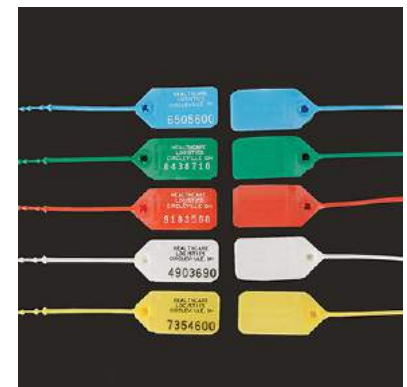

Two pediatric solutions for your two most common pediatric challenges

ACR4 Ambulance Child Restraint

- Transport pediatric patients safely and securely.
- Safely restrain all children from 4 to 99 pounds.



Learn more about ACR4 on page 282

Pedi-Sleeve Pediatric Dosing System

- Minimize pediatric dosing errors.
- Use as is or customize to your protocols.
- No calculation or reading a tape of book.



Learn more about Pedi-Sleeve on page 241

Download a PDF version of this form at www.seequip.com/pharmaceutical-forms.html



Schedule II Controlled Substance Ordering Information

Sample DEA Form 222

See Reverse of PURCHASER's Copy for Instructions		No order form may be issued for Schedule I and II substance unless completed application form has been received. (21 CFR 1305.04).		OMB APPROVAL NO. 1117-0010	
TO: Southeastern Emergency Equipment		STREET ADDRESS: 5760 NC HWY 96 W			
CITY and STATE: Youngsville, NC		DATE: _____			
TO BE FILLED IN BY PURCHASER			TO BE FILLED IN BY SUPPLIER		
			SUPPLIER DEA REGISTRATION No.		
No. of Packages	Size of Package	Name of Item	National Drug Code	Packaging Shipped	Date Shipped
1					
2					
3					
4					
5					
6					
7					
8					
9					
10					
LAST LINE COMPLETED (MUST BE 10 OR LESS)		SIGNATURE OF PURCHASER OR ATTORNEY OR AGENT			
Date Issued	DEA Registration No.	Name and Address of Registrant			
Schedules					
Registered as a	No. of this Order Form				
DEA Form -222 (Oct. 1992)		US OFFICIAL ORDER FORMS - SCHEDULES I & II DRUG ENFORCEMENT ADMINISTRATION SUPPLIER'S Copy 1			

Customer is required to complete all areas in yellow on this form. Incomplete forms will be returned for completion.

Customer should leave this area blank on the front (Brown) copy of 222 form. Upon receipt of product, customer should complete this section on the retained Blue copy of 222 form.

Due to DEA regulations, controlled substances will be shipped to the address preprinted here.

Information about DEA 222 Forms

- ▶ Please read back of 222 Form for information about proper completion
- ▶ Southeastern must have the physical Form before order can be filled
- ▶ Only Schedule 2 controlled substances can be ordered on this form
- ▶ Controlled Substances must be shipped to the address pre-printed on the Form
- ▶ Customer must submit Brown and Green Copies of Form with carbons attached
- ▶ Customer should keep back Blue copy of Form
- ▶ Forms with strikethroughs, corrections, or omissions cannot be accepted
- ▶ Form is only valid for 60 days after the date placed on the Form
- ▶ Completed Forms can be mailed to either:
 - PO Box 1097, Youngsville, NC 27596
 - 5760 NC HWY 96 W, Youngsville, NC 27596
- ▶ If Customer does not have 222 Forms they can be ordered from the DEA
 - <https://www.deadiversion.usdoj.gov/webforms/orderFormsRequest.jsp>
- ▶ Please feel free to call for help completing this Form: (800) 334-6656

Download a PDF version of this form at www.seequip.com/pharmaceutical-forms.html

Prescription Authorization Form

- Prior to shipping prescription products (pharmaceuticals and/or medical devices), we must have authorization from the physician (Medical Director) responsible for your department. Please fill in your customer information below, have your authorizing physician complete the box below, and send this completed form to us by email, fax or mail along with copies of all requested licenses. If your agency does not have a Medical Director, but is licensed to purchase prescription products, please send us a copy of all applicable licenses along with this form for review.
- To purchase controlled substances, we must also have a copy of your agency's Federal DEA license (Form 223) and State issued controlled substance license (if applicable). Please note that controlled substances can only ship to the address listed on the Federal DEA license submitted.
- Schedule II controlled substances require an original, completed, and signed Federal DEA Form 222 sent each time an order is placed and, the physical copy must be received before the order may be filled. Please call for information about completing this form properly.

Customer Number (if known): _____

Customer Name: _____

Contact Person: _____ E-Mail: _____

Telephone Number: _____ Fax Number: _____

Shipping Address: _____

City: _____ State: _____ Zip: _____

Additional Shipping Locations? _____ If allowing medications to be shipped to multiple addresses initial here & attach list of approved locations.

Customer License Information (MUST attach copies of all applicable licenses):

State EMS or Pharmacy License Number & Exp. Date: _____

State Controlled Substance License & Exp. Date (if applicable): _____

Federal DEA License & Expiration Date (if applicable): _____

*** THIS SECTION TO BE COMPLETED BY MEDICAL DIRECTOR***

Please check **one** of the four categories below denoting the approved level of authorization for the purchase of devices and medications for the above facility; include additional information and approvals where necessary.

Medical Device Authorization Only. *Absolutely No Medications!*

Limited Authorization for the following Medical Devices and Medications Only: *List below or attach sheet if necessary*

Unlimited Medical Devices and Medications Authorization. *Absolutely No Controlled Substances!*

Unlimited Medical Devices, Medications, and Controlled Substances: *Please initial all approved controlled substances*

Schedule III, IV, & V Controlled Substance Authorization of: **(please initial each approved medication)**

_____ ATIVAN/lorazepam _____ VALIUM/diazepam _____ VERSED/midazolam

_____ Ketamine (Schedule III) _____ Other(s) (list here): _____

Schedule II Controlled Substance Authorization of: **(please initial each approved medication)**

_____ DEMEROL/meperidine _____ DILAUIDID/hydromorphone _____ Fentanyl Citrate

_____ Morphine Sulfate _____ Other(s) (list here): _____

By signing below, I hereby authorize the internally-designated representative(s) of this facility to order the above approved devices and/or medications (please send copy of physician's license with this form).

Physician Name (please print): _____ Medical License# & Exp. Date: _____

Physician Signature: _____

Physician Phone#: _____ Date: _____

If any change occurs in the above information (including authorizations, license information, and/or authorizing physician) a new Prescription Drug Authorization Form must be submitted with applicable licenses before any additional shipments may be processed.

Southeastern Emergency Equipment
P.O. Box 1097
Youngsville, NC 27596



Email: eric@seequip.com
Phone: 800-334-6656
Fax: 888-556-1048



Immobilization

Traction and Splinting



pages 248-253

Collars



pages 254-255

Backboards



pages 256-258

Extrication



page 260

Head Immobilizers



page 260-261

Pediatric



pages 262-263

Limb Restraints



page 264

Straps and Systems



pages 265-268



SAM Pelvic Sling™ II (SAM Medical)

The first and only force-controlled circumferential pelvic belt. The patented Truforce buckle provides the safe and effective force every time, taking the guesswork out of tightening. The buckle is programmed to stop your pull once the correct compression force has been obtained. Two prongs are released from the buckle, which stops the belt from further tightening. The SAM Pelvic Sling II is simple, compact and quick to apply usually in less than one minute. The standard size fits 98% of the adult population without cutting or trimming.

- Front of SAM Sling is narrow and tapered to facilitate urinary catheterization, interventional radiology, external fixation and abdominal surgery
- Low friction posterior slider facilitates transfers
- Reusable, not a onetime use device. Can be cleaned for re-use with common detergents or anti-microbial solutions.
- MADE IN THE USA

SE556652-SM	SAM Pelvic Sling II, small, 27-47" hip circumference	each	85.00
SE556652	SAM Pelvic Sling II, standard, 32-50" hip circumference	each	85.00
SE556652-LG	SAM Pelvic Sling II, large, 36-60" hip circumference	each	85.00



SAM® Splint (SAM Medical)

The SAM Soft Shell Splint incorporates the revolutionary arc technology. The splint has "O" temper aluminum encased in soft foam. The aluminum core allows the splint to be molded in seconds into a variety of shapes. The splint is used for a wide range of splinting to include - arm, wrist, foot and finger. It comes either rolled or flattened versions. The SAM Splint can be bent into any of three simple curves, becoming extremely strong and supportive for any fractured or injured limb.

- Each SAM Splint contains inch and centimeter measurement graphics to document and communicate location and other information about wounds.

SE1005	SAM splint, 4.25" x 9", flat	each	5.95
SE1410	SAM splint, 4.25" x 18", flat	each	8.94
SE1121F	SAM splint, 4.25" x 36", flat	each	15.00
SE1121	SAM splint, 4.25" x 36", roll	each	15.00
SE1121-XL	SAM splint, 5.5" x 36", roll	each	15.00



Optimum Traction Device (OTD) (Rapid Deployment)

Unlike other traction devices, only the OTD allows the ability to work around any hip or groin trauma. And it's unnecessary to roll your patient or raise their leg when applying. Furthermore, there is no ischial bar to deal with, so any concerns of causing unnecessary pressure and additional pain are not an issue. A single person can properly apply the OTD in less than one minute. The traction pole instantly adjusts for adult or pediatric use! The OTD comes complete in a convenient 9.5" x 3.5" storage pouch with easy-to-follow instructions. It weighs less than 20 ounces. Designed to be carried in a trauma box, jump bag or first aid kit, this device is especially practical for wilderness rescue, ski patrols, SWAT medics and military field medicine.

EP-800	Optimum traction device with boot hitch	orange	each	88.75
EP-810	Optimum traction device with boot hitch	black	each	88.75

QD-4 and QD-3 Traction Splints (FareTec)

The QD-4 has become an industry standard for patients requiring Hare style traction splinting. The “Hex Lock” system allows the splint to be quickly adjusted to any length. Once it has been sized appropriately, the intuitive locking mechanism is engaged by turning the Hex Lock to either side. It’s fast, easy and reliable. This system helps eliminate problems with dirt or corrosion which cause other splints to malfunction. The QD-4 splint will adjust to accommodate pediatrics and adults. All units come as a complete kit with straps, ankle hitch and carrying case included. The QD-3 is a dedicated pediatric splint. In addition, all QD’s are available with either our anodized aluminum ratchet or our injection molded ratchet.

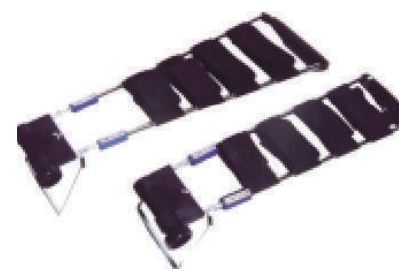

FA1126524	QD-4 adult traction splint with aluminum ratchet	each	253.85
FAQD4	QD-4 adult traction splint with molded ratchet	each	189.23
FA1126522	QD-3 pediatric traction splint with aluminum ratchet	each	253.85
FAQD3	QD-3 pediatric traction splint with molded ratchet	each	189.23
FA1126726	QD-4 and QD-3 combined traction splint with aluminum ratchet	each	486.00
FA1126716	QD-4 and QD-3 combined traction splint with molded ratchet	each	372.31
FA1124200	Q-D4 and QD-3 traction splint replacement ankle hitch	each	18.30
FA1125010	QD-4 carry case	each	21.06
FA11250088	QD-3 carry case	each	20.00

FernoTrac™ Traction Splints (Ferno)

The exclusive low contour design to the FernoTrac allows for perfect alignment of the lower limbs from the hip to the heel. The problem of forcing the ischium upward has been completely eliminated. The force applied by the FernoTrac on the ankle hitch is directly in line with the ankle, giving true traction alignment all the way back to the hip. Includes ankle hitch and carrying case.



FW444	FernoTrac traction splint with case, adult	each	456.92
FW443	FernoTrac traction splint with case, child	each	456.92
FW441	FernoTrac combo traction kit includes adult and child splints in one case	each	812.31
FW447	Pediatric replacement straps and ankle hitch for FernoTrac traction splint	each	57.69
FW446	Adult replacement straps and ankle hitch for FernoTrac traction splint	each	57.69

Sager® Splints (Minto R&D)

- Quantifiable, dynamic traction
- Simple, one-person application
- Compact

MNS301	Super Sager III, button latch operation	each	327.95
MNS304	Sager Form III bilateral	each	463.00
MNS300	Sager infant bilateral splint	each	390.00





Super Sager Combo Pacs (Minto)

Treat 99% of all patients and 93% of the most common fracture types with Super Sager Combo Pacs. Super Sager Combo Pac #2 enables you to treat bilateral fractures on infants, children and adults (six times the potential of all Ischial Pad type traction splints). The adult/child and infant splints are contained in one forest green Sager carry case (the infant model is stored in a specially designed inside pocket).

MNS300-1	Super Sager Combo Pac #1 includes one each of S301 Form III Single and the S300 Infant Bilateral	each	702.50
MNS300-4	Super Sager Combo Pac #2 includes one each of S304 Form III Bilateral and the S300 Infant Bilateral	each	820.00



EMS Econo-Vac™ Vacuum Splint (MDI)

Designed as a low cost, disposable splint, EMS Econo-Vac splints eliminate the concern of expensive products being lost or left at the hospital. The wrist/ankle, arm and leg splints feature T-Lock Velcro® straps providing a quick and easy method of securing the splints.

MDI82-E7700	EMS Econo-Vac vacuum splint, deluxe extremity set includes wrist/ankle splint, leg splint, arm splint, medium and large forearm splint, adapter, pump and case	each	185.08
MDI82-E2014	EMS Econo-Vac vacuum splint, arm	each	23.77
MDI82-E2215	EMS Econo-Vac vacuum splint, medium forearm	each	9.18
MDI82-E2222	EMS Econo-Vac vacuum splint, large forearm	each	10.49
MDI82-E2024	EMS Econo-Vac vacuum splint, leg	each	35.65
MDI82-E2010	EMS Econo-Vac vacuum splint, wrist/ankle	each	22.07
MDI82-E2580	EMS Econo-Vac hand-held vacuum pump	each	40.32



Evac-U-Splint® Extremity Splint and Vacuum Mattress (Hartwell Medical)

Whether the need is for a simple long bone fracture or a complicated Colles wrist fracture with a compound forearm fracture, the Evac-U-Splint will conform and support the injured area without applying unnecessary pressure which can cause tissue, nerve or vessel damage. X-ray and MRI safe. The quick-connect MaxiValve™ has no parts to lose and is guaranteed for the life of the product. Six large, well-padded handles are positioned along the sides of the mattress for easy lifting and moving of the patient. 3 year warranty on all EVAC-U-SPLINT vacuum splints, mattresses and pumps.

HAEV3000	Evac-U-Splint set includes small, medium and large splints, compact pump and carry case	each	580.62
HAEV101	Evac-U-Splint, extremity splint, small	each	89.97
HAEV102	Evac-U-Splint, extremity splint, medium	each	116.12
HAEV103	Evac-U-Splint, extremity splint, large	each	163.19
HAMT3075-6	Evac-U-Splint adult vacuum mattress set includes mattress, standard pump and carry case	each	868.31
HAPD3000	Evac-U-Splint pediatric vacuum mattress set includes mattress, standard pump and carry case	each	570.15
HAMT1075-6	Evac-U-Splint mattress only	each	601.54
HAMT13A	Evac-U-Splint mattress restraint with side buckles	each	41.32
HAEV14	Evac-U-Splint carrying case	each	47.08

Fasplint® Vacuum Splint (Hartwell Medical)

The Fasplint uses vacuum technology just like Evac-U-Splint extremity splints. From dislocated shoulders to angulated wrist fractures, simply grab your vacuum splint, place it around the injured area, evacuate the air and you're done!

- Molds to exact shape of injury site without applying circumferential pressure
- Reduces nerve, tissue and vessel damage
- Can be evacuated using the same Evac-U-Splint manual pump with a tapered adapter tip or a portable suction unit
- Evacuation time for any size extremity splint is less than 8 seconds



see ad on page 259

HAFSF3000	Fasplint Fullbody vacuum splint kit includes full body splint, case, and standard vacuum pump with foot stirrup	each	438.34
HAFS9000RC	Fasplint vacuum splint kit includes small, medium and large splints, compact pump with tapered tip, rectangular carry case	each	298.14
HAFSF1000	Fasplint vacuum splint only, full body	each	205.05
HAFS801	Fasplint vacuum splint only, small (19½" x 14")	each	20.87
HAFS802	Fasplint vacuum splint only, medium (27½" x 20")	each	28.19
HAFS803	Fasplint vacuum splint only, large (40" x 30")	each	38.65
HAFS12C	Fasplint vacuum splint pump	each	164.25
HAFS15TIP	Fasplint vacuum splint adapter converts existing Evac-U-Splint pump for use with Fasplint	each	13.55

Inflatable Air Splints (LSP)

Orally inflated clear vinyl emergency pressure splints for instant splinting and pressure bandaging.

F3162	Air splints kit includes one each of full arm, half arm, hand/wrist, full leg, half leg and foot ankle splints	each	83.95
F3165	Air splints, full arm	each	15.48
F3166	Air splints, half arm	each	13.53
F3167	Air splints, hand/wrist	each	12.20
F3168	Air splints, full leg	each	19.27
F3169	Air splints, half leg	each	15.89
F3170	Air splints, foot ankle	each	14.76

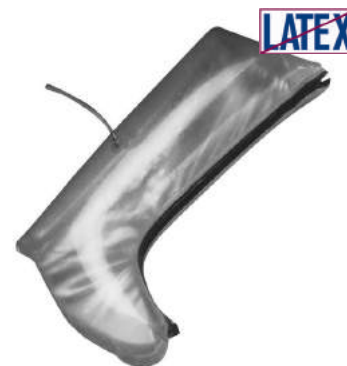

ActiSplint™ (Dynarex)

ActiSplint is comfortable and easy to mold, and can be cut with scissors. Adaptable and lightweight, it weighs only 180 grams. Not available for use in x-rays.

DY3528	ActiSplint, rolled, 4¼" x 36"	each	6.50
DY3533	ActiSplint, rolled, 4¼" x 36", with Sensiwrap	each	5.80





Prosplints (Medical Specialties)

Prosplints are designed to withstand all types of weather conditions without wear and are resistant to blood and liquids. They have no metal stays, eliminating any bending, saving time and giving a shadow free x-ray. They may be used on either left or right side limbs.

MS113919	Prosplint combo kit contains one each of combo (adult and pedi), leg (large, small and child), arm (large, small and child), wrist/forearm (adult and child) splints. Also includes a carry case.	each	281.00
MS113908	Prosplint extremity kit contains one each small leg, large leg, small arm, large arm, wrist/forearm, and combo splints. Also includes a carry case.	each	195.38
MS113899	Prosplint pediatric kit contains one each of combo, leg, arm and wrist splints and pediatric e-collar. Also includes a carry case.	each	90.00
MS113011	Prosplint replacement combo splint, child	each	16.00
MS113010	Prosplint replacement combo splint, adult	each	30.90
MS113031	Prosplint replacement leg splint, child	each	23.75
MS113032	Prosplint replacement leg splint, small	each	41.25
MS113034	Prosplint replacement leg splint, large	each	47.69
MS113051	Prosplint replacement arm splint, child	each	14.46
MS113052	Prosplint replacement arm splint, small	each	22.50
MS113054	Prosplint replacement arm splint, large	each	25.50
MS113071	Prosplint replacement wrist/forearm splint, child	each	6.38
MS113070	Prosplint replacement wrist/forearm splint, adult	each	11.86
MS113280	Prosplint replacement rib splint	each	25.77
MS113310	Prosplint carrying case with zipper, large	each	27.80
MS113315	Prosplint carrying case with zipper, small	each	37.50



FOX Xtremity Splint (Compliance Medical)

Self-contained extremity splint is made of cardboard and convoluted foam rubber. Includes hook and loop strap

CM504	FOX Xtremity splint, 12"	each	3.62
CM505	FOX Xtremity splint, 18"	each	4.88
CM506	FOX Xtremity splint, 24"	each	6.40

Fracture Splints

- In multiple injuries, the units are totally interchangeable (arm units can be used on the legs, left on right, etc.)

F3250	Adult fracture kit includes two adult arm splints, two adult leg splints, one arm/shoulder immobilizer, one extraction collar with neck pad and one waterproof nylon carry case	each	128.00
F3254	Fracture splint, full arm, adult	each	25.00
F3255	Fracture splint, full leg, adult	each	33.00
F3252	Fracture splint, full leg, child	each	65.90
F3253	Fracture splint, full arm, child	each	50.32



Cardboard Splints (Morrison Medical)

Splints feature 5/8" punch-out holes for tie downs. 24" and 34" lengths offer an extra center crease for firm support of thin limbs.

MO1500	Cardboard splint, no foam, 12"	each	1.06
MO1510	Cardboard splint, no foam, 18"	each	1.42
MO1520	Cardboard splint, no foam, 24"	each	1.91
MO1570	Cardboard splint, no foam, 34"	each	3.14
MO1504	Cardboard splint, center foam, 12"	each	2.06
MO1530	Cardboard splint, center foam, 18"	each	2.48
MO1540	Cardboard splint, center foam, 24"	each	3.49
MO1573	Cardboard splint, center foam, 34"	each	4.42
MO1507	Cardboard splint, full foam, 12"	each	2.17
MO1550	Cardboard splint, full foam, 18"	each	3.64
MO1560	Cardboard splint, full foam, 24"	each	3.53
MO1576	Cardboard splint, full foam, 34"	each	4.84



Wire Ladder Splint (FareTec)

Splinting device that can be used individually or in multiples to achieve desired rigidity. Pliability makes it possible to make 90 degree bends.

F3490	Wire ladder splint, 3½" x 32"	each	6.35
-------	-------------------------------	------	------

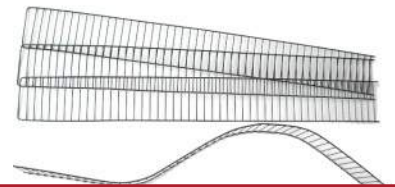



Stifneck® Select Collar (Laerdal)

As a single piece, that requires no assembly, the Stifneck Select collar is an easy choice for patients requiring spinal immobilization. Strong quality and molded directions on the back of the collar mean that providers will always be able to administer proper sizing and application. The locking mechanism ensures symmetrical adjustments and that the collar is locked safely into place. In 4 steps your patient is ready for further transport:

- Measure the patient (using finger sizing method)
- Adjust to correct size
- Lock
- Place on patient

LA980011	Stifneck Select collar, adult	each	14.00
LA980020	Stifneck Select collar, pediatric	each	14.00



Stifneck® Extrication Collar (Laerdal)

Preferred for over 20 years, the original Stifneck extrication collar remains the standard of care for suspected cervical spine injuries. Outstanding motion restriction without hyperextension or limiting access to the airway.

LA980100	Stifneck collar, baby no-neck	each	9.00
LA980200	Stifneck collar, pediatric	each	9.00
LA980300	Stifneck collar, adult no-neck	each	9.00
LA980400	Stifneck collar, adult short	each	9.00
LA980500	Stifneck collar, regular adult	each	9.00
LA980600	Stifneck collar, tall adult	each	9.00
LA980700	Stifneck collar carry case 26" x 12" x 4"	each	28.00



Perfit CE™ Extrication Collars (Ambu)

The Perfit CE Extrication Collar adjusts with 16 different settings from Neckless to Tall Adult. Latches allow the rescuer to size the collar according to the victim's exact neck size.

- Preshaped flip-chin piece to ensure they can be stored completely flat
- Flip-chin piece facilitates intubation and removal of vomit from a patient's mouth
- One-piece collar simplifies application and at the same time there are no extra pieces that can get lost
- All collars are radiotranslucent, CAT and MRI compatible, and fully disposable

AU281-000	Perfit CE collar	each	6.87
AU281-106	Mini Perfit CE collar	each	6.87
AU264-008	Collar carry case, red	each	33.61

Perfit E trication Collars (Ambu)

Perfit E trication Collar is designed to assist with the maintenance of neutral spine, prevention of lateral sway and anterior-posterior flexion and extension of the spine during transport and routine patient care movement.



AU264-501	Perfit xtrication collar, infant	each	4.75
AU264-502	Perfit xtrication collar, pediatric	each	4.75
AU264-503	Perfit xtrication collar, neckless adult	each	4.75
AU264-504	Perfit xtrication collar, short adult	each	4.75
AU264-505	Perfit xtrication collar, regular adult	each	4.75
AU264-506	Perfit xtrication collar, tall adult	each	4.75

Philadelphia Tracheostomy Collar (Ossur)

- Anterior and posterior rigid plastic reinforcement supports limited movement
- Latex-free, non-toxic and hypoallergenic, X-ray, CT and MRI lucent

F3444	Philadelphia tracheostomy collar, infant	each	13.85
F3443	Philadelphia tracheostomy collar, pediatric	each	13.85
F3447	Philadelphia tracheostomy collar, small, 3¼	each	13.85
PHPT3M	Philadelphia tracheostomy collar, medium, 3¼	each	13.85
F3449	Philadelphia tracheostomy collar, medium, 4¼	each	13.85
F3446	Philadelphia tracheostomy collar, large, 4¼	each	13.85
F3445	Philadelphia tracheostomy collar, extra large, 4¼	each	13.85



XCollar and XCollar Plus Cervical Spine (Emegear)

The XCollar and XCollar Plus are designed to splint the Cervical Spine by securing the head to the torso of the patient above C-1 and below C-7; on two points anterior and two points posterior. This splinting system utilizes bi-lateral and vertical adjustments to obtain a customized fit for both the desired circumference and height of large adult and small pediatric patients. An important feature of the XCollar Plus is the integrated head restraint system, which replaces the use of head blocks, towels or tape.

EGA-0100	XCollar cervical spine, adult/pediatric	clear	each	24.44
EGA-0120	XCollar cervical spine, adult/pediatric	orange	each	24.44
EGA-H0100	XCollar Plus cervical spine, adult/pediatric	clear	each	24.44
EGA-H0120	XCollar Plus cervical spine, adult/pediatric	orange	each	24.44



Patriot Cervical Collar (Ossur)

F3440	Patriot cervical collar, adult	each	7.85
F3441	Patriot cervical collar, pediatric	each	7.85



Collar Bag (Kemp)

Heavy duty stitching. Impervious base. Fits all C-Collars, CIDs, towel rolls and straps

KB10-102	Collar bag	each	26.92
----------	------------	------	-------





MCI Backboards (Southeastern)

- Measures 72" x 16" x 1 3/4"
- 450 lb capacity
- Weighs only 14 lbs.
- 100% X-Ray translucent

SEE500R	MCI backboard, adult, no pins, blue	each	125.00
SEE500P	MCI backboard, adult, pins, yellow	each	125.00
SEE501	MCI backboard, pediatric, call to discuss color	each	100.00

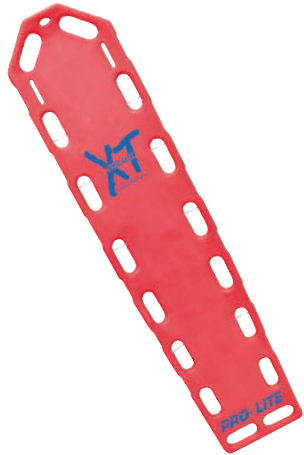

Pro-Lite® XT Spineboard (Rapid Deployment)

- Measures 72" x 16" x 2 1/4"
- Capacity of 1,000 lbs.
- Weighs 14 lbs.
- X-ray translucent

RD717P-BL	Pro-Lite XT spineboard, 16", with pins	blue	each	216.65
RD717P-OR	Pro-Lite XT spineboard, 16", with pins	orange	each	216.65
RD717NY	Pro-Lite XT spineboard, 16", no pins	neon yellow	each	203.39
RD717OR	Pro-Lite XT spineboard, 16", no pins	orange	each	213.39
RD717PK	Pro-Lite XT spineboard, 16", no pins	pink	each	203.39
RD718P-BL	Pro-Lite XT spineboard, 18", with pins	blue	each	248.27
RD718P-RD	Pro-Lite XT spineboard, 18", with pins	red	each	248.27
RD717PIL	Pillow for Pro-Lite XT spineboard		pair	54.25



Pro-Eco Spineboard (Rapid Deployment)

- Measures 72" x 16" x 2 1/4"
- Capacity of 500 lbs.
- Weighs 16 lbs.
- X-ray translucent

RD719BL	Pro-Lite Pro-Eco spineboard, no pins	blue	each	166.67
RD719BU	Pro-Lite Pro-Eco spineboard, no pins	burgundy	each	166.67
RD719LG	Pro-Lite Pro-Eco spineboard, no pins	lime green	each	166.67
RD719NY	Pro-Lite Pro-Eco spineboard, no pins	neon yellow	each	156.67
RD719RE	Pro-Lite Pro-Eco spineboard, no pins	red	each	166.67
RD719P-BL	Pro-Lite Pro-Eco spineboard, with pins	blue	each	178.61
RD719P-LG	Pro-Lite Pro-Eco spineboard, with pins	lime green	each	178.61
RD719P-NY	Pro-Lite Pro-Eco spineboard, with pins	neon yellow	each	168.61
RD719P-OR	Pro-Lite Pro-Eco spineboard, with pins	orange	each	178.61
RD719P-RE	Pro-Lite Pro-Eco spineboard, with pins	red	each	178.61

BaXstrap® Spineboard (Laerdal)

- Measures 16" x 72" x 2½"
- Capacity of 800 lbs.
- Weighs 13 1/2 l
- X-ray translucent

LA982600	BaXstrap spineboard	olive drab	each	231.00
LA982500	BaXstrap spineboard	yellow	each	219.00



Ultra Vue 18 Backboard (Iron Duck)

- Measures 72" x 18" x 1¾"
- Capacity of 1,000 lbs
- Weighs 22 lbs.
- X-ray translucent

ID35755BL	Ultra Vue 18" backboard, no pins	blue	each	195.43
ID35755LG	Ultra Vue 18" backboard, no pins	lime green	each	195.43
ID35755OD	Ultra Vue 18" backboard, no pins	olive drab	each	195.43
ID35755OR	Ultra Vue 18" backboard, no pins	orange	each	195.43
ID35755RD	Ultra Vue 18" backboard, no pins	red	each	195.43
ID35755PBL	Ultra Vue 18" backboard, with pins	blue	each	208.69
ID35755PLG	Ultra Vue 18" backboard, with pins	lime green	each	208.69
ID35755POD	Ultra Vue 18" backboard, with pins	olive drab	each	208.69
ID35755POR	Ultra Vue 18" backboard, with pins	orange	each	208.69
ID35755PRE	Ultra Vue 18" backboard, with pins	red	each	208.69



Patient Transfer Spine Board (Iron Duck)

- Measures 72" x 16" x 1¾"
- Capacity of 500 lbs.
- Weighs 16 lbs.
- X-ray translucent

ID35850BL	Patient transfer spine board, no pins	blue	each	166.67
ID35850LG	Patient transfer spine board, no pins	lime green	each	166.67
ID35850YE	Patient transfer spine board, no pins	yellow	each	156.67
ID35850P-BK	Patient transfer spine board, with 12 pins	black	each	178.61
ID35850PBL	Patient transfer spine board, with 12 pins	blue	each	178.61
ID35850PLG	Patient transfer spine board, with 12 pins	lime green	each	178.61





Ultra Short Board (Iron Duck)

Measures 31¼" x 15¾" x 1"; weighs 5 lbs.

ID35955BL	Ultra Short board, no pins	blue	each	73.17
ID35955LG	Ultra Short board, no pins	lime green	each	73.17
ID35955OR	Ultra Short board, no pins	orange	each	73.17
ID35955P-BL	Ultra Short board, with six pins	blue	each	86.43
ID35955P-LG	Ultra Short board, with six pins	lime green	each	86.43
ID35955P-OR	Ultra Short board, with six pins	orange	each	86.43
ID35955P-RE	Ultra Short board, with six pins	red	each	86.43



Ultra Space Save Backboard (Iron Duck)

Measures 72" x 16" x 2" (standing) ; 36" x 16" x 4" (folded); capacity of 500 lbs. weighs 19 lbs.

ID35940BL	Ultra Space Save backboard, no pins	blue	each	415.55
ID35940OR	Ultra Space Save backboard, no pins	orange	each	415.55
ID35940YE	Ultra Space Save backboard, no pins	yellow	each	415.55
ID35940PBK	Ultra Space Save backboard, with pins	black	each	429.17
ID35940PBL	Ultra Space Save backboard, with pins	blue	each	429.17
ID35940PYE	Ultra Space Save backboard, with pins	yellow	each	429.17
ID35940-CASE	Ultra Space Save carrying case		each	120.86

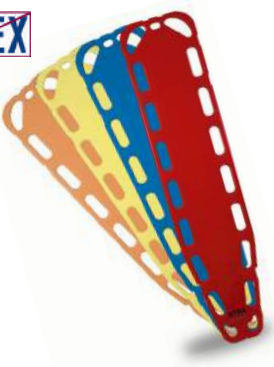

XTRA® Backboard (LSP)

Measures 72: x 16" x 1.85. Capacity of 1,000 lbs. Weighs 15¼ lbs. X-ray translucent.

LSP816000	XTRA backboard, no pins	blue	each	104.14
LSP818000	XTRA backboard, no pins	orange	each	104.14
LSP815000	XTRA backboard, no pins	red	each	104.14
LSP812000	XTRA backboard, no pins	hi-viz yellow	each	104.14
LSP816014	XTRA backboard, with 14 pins	blue	each	116.45
LSP818014	XTRA backboard, with 14 pins	orange	each	116.45
LSP815014	XTRA backboard, with 14 pins	red	each	116.45
LSP812014	XTRA backboard, with 14 pins	hi-viz yellow	each	116.45



CombiCarrierII (Hartwell Medical)

The 2 in 1 patient handling device that saves time, storage space and budget dollars is now the product of choice for many departments because it minimizes patient movement at the scene and is well-suited to meet the most recent EMS protocols. The CombiCarrierII retains the reliable heavy-duty latch system and is now thinner, lighter and stronger than the original product. Includes four 2-piece Speed Clip patient restraint straps. Measures 73.5" x 16.5" x 2.19"; weighs 15.5 lbs.; capacity of 450 lbs.; X-ray translucent.

HACC2200P	CombiCarrierII, green		each	940.49
HACC3200H	CombiCarrierII head immobilizer		each	120.31



IMPROVE THE PATIENT EXPERIENCE

Replace those patient complaints about a painful board with words of praise for comfort and security. For years we have been immobilizing our patient's head, neck and torso as separate elements. We have used all kinds of rigid collars, head blocks and strap configurations to try and restrict movement of our patient's body on a hard flat backboard. All our good intentions may not be providing the results we had hoped to achieve.

The **FASPLINT FULLBODY**[®] and **FASPLINT HALFBACK**[®] both provide "spinal splinting" in a comfortable and cost-effective vacuum splint device. The **FASPLINT FULLBODY** enables the patient's knees to be flexed for the utmost in comfort during transport. By conforming to the unique anatomy of each individual patient, the head, neck and torso are stabilized as one unit even for patients with kyphosis. Easy to clean, requires minimal storage space and it's reusable. Join the movement to provide stabilization and comfort at the same time.



FASPLINT[®]

Stabilize your patient in their position of comfort with or without a collar, depending on your protocols. Fast, effective and affordable.

See pg 251

CombiCarrier II[®]

Functions like a scoop stretcher and an extrication board, minimizing patient movement. Use in conjunction with the **FASPLINT FULLBODY** or **FASPLINT HALFBACK** for improved patient comfort.

See pg 258



K.E.D.® (Ferno)

The Original Ferno K.E.D. is ideal for extricating and immobilizing patients from auto accidents and other confined spaces. The K.E.D. immobilizes the torso, head and neck, enabling prompt extrication while minimizing risks of further injury. X-rays or advanced life support procedures can be performed with the K.E.D. in place. Includes wrap-around vest, Adjusta-Pad neck roll, two head straps and a carrying case.

FW125	The Original K.E.D.	each	148.85
039-0325	K.E.D. pillow pad	each	98.55
090-4118	K.E.D. buckles (three black, two white, male only)	each	29.57
039-0201	Replacement head/chin straps for KED devices (by Emsar)	2 pair	65.04



Optimum Rescue Vest (EP&R)

A time-proven versatile design, this is the best spinal fracture management tool for emergency medical personnel to fully immobilize a victim and remove them quickly. The wrap-around design provides horizontal flexibility for easy application and vertical rigidity for maximum support of the spine, neck and head during extraction.

EP705	Optimum rescue vest with case, red	each	110.95
EP706	Optimum rescue vest with case, black	each	110.95
EP717	Optimum rescue vest with case, green	each	110.95
EP700	Optimum rescue vest head and chin straps (replacement parts)	each	10.00
EP703	Optimum rescue vest carry case, red	each	10.00



SpeedBlocks® Head Immobilizer (Laerdal Medical)

SpeedBlocks with disposable foam pads and head straps are so effective that the inconvenience of taping the patient can be eliminated. SpeedBlocks offer a simple four-step process for application, a blocks system to accommodate all head shapes and injury positions, and direct access to patient's ears for better communication and inspection.

LA983090	SpeedBlocks head immobilizer starter pack includes 1 block set, 1 universal base, 1 strap and pad replacement set	each	55.00
LA983097	SpeedBlocks head immobilizer strap and pad replacement set includes 5 sets of block pads, head strap and base pads	each	21.00
LA983092	SpeedBlocks head immobilizer block set	each	29.00
LA983060	SpeedBlocks head immobilizer base	each	41.00



Sta-Blok™ Head Immobilizer (Laerdal Medical)

Sta-Blok Head Immobilizer is easy to use, compact and extremely effective. Constructed of soft, closed-cell foam "Sharks Fin" blocks with a padded strap that immobilizes the head comfortably and securely. Repositionable Velcro® fasteners allow the Sta-Blok to adapt to virtually any patient on any backboard.

STI975	Sta-Blok head immobilizer	each	5.83
--------	---------------------------	------	------

HeadBed® II (Laerdal)

The HeadBed II is easy and compact to store. Providing maximum immobilization, the HeadBed II is designed for adults, pediatrics and infants. Fits most types of backboards.

LA982001	HeadBed II immobilizer	each	6.00
----------	------------------------	------	------



Head Wedge™ (Ambu)

The Head Wedge is designed to immobilize the patient's head instantly and effectively when placed on a backboard. It is applied in just four simple steps. With its innovative construction it enables a perfect fit to the patient in one go.

- Disposable, waterproof, radiolucent and very durable
- Stores completely flat
- Fully adjustable to fit all sizes from children to adults
- Fits all known backboards
- Strong, self-adhesive head strap with medical grade glue ensures a secure hold

AU264-034	Ambu Head Wedge	each	4.49
-----------	-----------------	------	------



Head-On Head Immobilizers (Compliance Medical)

Lightweight, disposable blocks sealed in Dispos-O-Bags. Fits all standard backboards. Weatherproof.

CM401S	Head-On system includes two Dispos-O-Bags and two Head-On straps	each	10.58
CM401	Head-On system includes two Dispos-O-Bags and one occipital pad	each	5.23
CM402	Head-On body straps	3/pkg	6.40
CM403	Head-On straps	2/pkg	5.00



Multi-Grip® Head Immobilizers (i-Tec)

Disposable and inexpensive. Compatible with all backboards, c-collars and extrication devices. X-ray transparent. Packed in poly bags for long shelf life. One-piece construction. Buoyant for water rescue.

IT-IN	Multi-Grip head immobilizer, infant	each	7.00
IT-CH	Multi-Grip head immobilizer, child	each	7.00
IT-AD	Multi-Grip head immobilizer, adult	each	7.00



Head Blocks® (Morrison Medical)

Disposable Rectangular 4" x 5" x 10" foam blocks sealed in highly visible orange vinyl, complete with handle and writable surface. Uses tape or straps to secure patient. Use any place for firm but lightweight support. Blocks float, ideal for water rescue.

MO320	Head Blocks only	pair	7.06
MO322	Head Blocks with straps	each	12.27





See ad on page 269

Ambulance Child Restraint (Q-ACR4) (Quantum EMS)

The Quantum ACR (Ambulance Child Restraint) is an innovative, flexible and fully adjustable harnessing system for the safe and effective transport of infants in an ambulance, and is color-coded for easy selection in three sizes from 11 lbs to 99 lbs. Quick release clips dock with the ACR harness, holding the patient in place to prevent potentially dangerous movement during transportation.

- Allows for the safe, effective restraint of all children from 4-99 lbs.
- ACR-4 offers four sizes of restraints in a single device. XS: 4-11 lbs., SM: 10-26 lbs., MED: 22-55 lbs., LARGE: 44-99 lbs.
- Open channel design allows complete patient access from the airway to the waist without unrestraining the child
- The restraint tightens in the mattress of the stretcher, not into the child; thus preventing any additional injury to the patient
- Compact packaging allows the ACR-4 to fit into its own 10" x 10" custom bag, taking up less room in the back of an ambulance
- ACR-4 is universal and will work on any stretcher or backboard without a bracket
- ACR-4 replaces the need to carry multiple devices to accomplish the task of restraining all size pediatric patients
- ACR-4 has been fully crash-tested under the strictest of standards
- Color-coded for easy size identification
- Machine washable



- Download FREE Layer App (from your App Store)
- Scan this page
- View custom product info

Q-ACR4	Ambulance Child Restraint (Q-ACR4) 4-pack	each	799.00
Q-BABY/ADD	Ambulance Child Restraint Baby (add on for the existing Baby 3-pk only)	each	219.00
Q-STRAP	Ambulance Child Restraint (Q-ACR4) replacement straps	each	139.00

Pedi-Immobilizer (Quadmed)

Pedi-Immobilizer is an extrication and immobilization device designed for immobilizing infants and small children up to 60 lbs. who have suffered potential cervical spine injuries.

- Entire device weighs only 5 lbs. (case included)
- Unique shoulder pad assures proper spinal alignment and simultaneously enhances airway

QMPL1750	Pedi-Immobilizer extrication and immobilization device	each	275.00
----------	--------------------------------------------------------	------	--------

Pedi Lite Pediatric Backboard (Rapid Deployment)

The Pedi Lite Pediatric Backboard is constructed with a seamless design to prevent fluid from entering and eliminates cross-contamination. The board is foam-filled for flotation and patient insulation. 100% x-ray translucent. It comes with a 100% guarantee for the life of the spineboard under normal conditions.

RD721K-GR	Pedi Lite kit includes a carry case, disposable head blocks, head/chin tapes, 4 color-coded straps and a pediatric c-collar, neon green board	each	236.22
RD721K-BL	Pedi Lite kit includes a carry case, disposable head blocks, head/chin tapes, 4 color-coded straps and a pediatric c-collar, blue board	each	246.97
RD721	Pedi Lite backboard, neon green	each	143.16
RD721RS	Pedi Lite strap set	4 /set	21.55



Pedi-Mate® Restraint System (Ferno)

The Pedi Mate Pediatric Restraint System quickly adapts any ambulance cot for the safe transport of children ranging in size from 10-40 lbs. (4.5-18 kg).

- Fully adjustable, five-point harness system securely holds patients, providing safe restraint for transport
- Rolls compactly for convenient storage and easy deployment
- Vinyl construction is nontoxic and easy-to-clean
- Three restraint straps easily attach to any cot



FW678	Ped-Mate restraint system	each	368.08
-------	---------------------------	------	--------

Pedi Air Align Complete (Iron Duck)

The Pedi Air Align's patented dual plane head drop system allows for a patient to be completely immobilized while managing their airway and establishing neutral spinal alignments simultaneously. The board accommodates the larger occipital area of a child's head, allowing for neutral spinal alignment and an open, maintainable airway. The Pedi Air Align is the only pediatric immobilization board that is rotomolded from high density polyethylene (HDPE). This creates a one-piece seamless product that is completely impervious and easy to clean and disinfect. Board size: 48" x 12" x 1.75" Weighs 7.5 lbs. Lifetime warranty.



ID35840TE	Pedi Air Align complete system includes 1 board, 1 shoulder restraint, 1 chest strap, 4 body straps, 2 wrist restraints, 6 disposable head blocks and 1 carry case, teal	each	301.22
ID35840YE	Pedi Air Align complete system includes 1 board, 1 shoulder restraint, 1 chest strap, 4 body straps, 2 wrist restraints, 6 disposable head blocks and 1 carry case, yellow	each	301.22
ID35841YE	Pedi Air Align board only	each	212.85
ID35843	Pedi Air Align head block system includes three sets of 2 head blocks and 2 head straps	each	27.17

Pedi-Pac® (Ferno)

The Pedi-Pac provides stabilization of the pediatric trauma patient at the scene and during transport. Designed for the 2-10 year old age group, the Pedi-Pac's unique strap system allows easy access to child's body for monitoring vital cardiac and respiratory status, as well as intraosseous infusion sites. The Pedi-Pac can easily be stored under squad bench or in an exterior compartment.



FW78	Pedi-Pac immobilization system includes Pedi-Pac, integral head support, two head stabilization straps, two pedi pads and carrying case.	each	443.08
------	------------------------------------------------------------------------------------------------------------------------------------------	------	--------

Infant/Pediatric Immobilization Board (LSP)

The LSP Infant/Pediatric Immobilization Board is durable and perfectly scaled for children from infancy to 75 lbs. The frame features a split-leg design, elevated hand holds and versatile head harness. Case included.



LSP484040	Pedi-Board (includes case)	each	292.05
LSP484-075	Pedi-Board drug dosage and patient management sleeve	each	41.00



Limb Holders (Posey)

PO2631	Deluxe limb holder, cotton ankle and wrist restraint	each	12.54
PO2510	Foam limb holder, 3/8" thick, D-ring closure, single strap tie	1 pair	5.31
PO2528	Foam limb holder, 1/4" thick, D-ring closure, double strap tie	each	6.48
PO2532	Foam limb holder, 1/4" thick, quick release buckle closure	each	9.19
PO2526	Soft felt limb holder	each	9.51



Quick Check Limb Holder (Morrison Medical)

The Quick Check limb restraint has a large 3" x 12" long cuff made of soft, breathable foam held together with a hook and loop fastener and a 1" plastic side release buckle.

MO1130	Quick Check limb holder with buckle	1 pair	6.49
--------	-------------------------------------	--------	------

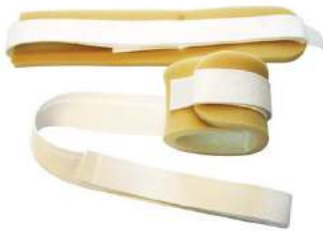

Economy Deluxe Limb Restraint (Morrison Medical)

Morrison Medical Limb Restraints prevent combative patients from interfering with administration of medical care and harming themselves or medical personnel. Constructed of soft breathable foam, strong polypropylene 1" strap, and hook and loop closure.

MO1103	Deluxe limb restraint, adult, tie down style	1 pair	4.75
--------	----------------------------------------------	--------	------



Hand-E Hand Hold Device (EP&R)

The Hand-E offers many advantages over traditional methods of securing the arms.

- Lightweight and compact
- Brightly colored and easy to spot when you need it
- Universally sized to accommodate most patients
- Allows for quick and easy removal of an arm for checking blood pressures or placing IVs
- Can be placed easily by one person and takes just seconds
- Reusable, making it a cost effective, multi-use tool

EP77	Hand-E hand hold device	each	21.95
EP78	Hand-E rubber band	each	5.95



Limb Lok (Morrison Medical)

Secures wrists of unconscious patients to backboard strap. Helps protect limbs during transport. Made with 1" black polypropylene webbing and 1" black plastic side release buckle. Adjusts to fit various size wrists.

MO1115	Limb Lok	each	10.58
--------	----------	------	-------

Metal Push Button Buckle David Dick Medical

Item Number	Webbing	Strap End	Pieces	Length	Color	Price
DD11091	Nylon	Loop lok	1	9'	specify	8.69
DD11091-BK	Nylon	Loop lok	1	9'	black	8.69
DD11091-OR	Nylon	Loop lok	1	9'	orange	8.69
DD11152-BK	Nylon	Loop lok	2	5'	black	8.69
DD11152-YL	Nylon	Loop lok	2	5'	yellow	8.69
DD11172-BK	Nylon	Loop lok	2	7'	black	9.08
DD11272-BK	Nylon	Metal swivel speed clip	2	7'	black	12.38
DD11272-YL	Nylon	Metal swivel speed clip	2	7'	yellow	12.38
DD11652-OR	Nylon	Metal loop	2	5'	orange	12.38
DD11672-OR	Nylon	Metal loop	2	5'	orange	12.77
DD21091-BK	Poly	Loop lok	1	9'	black	8.69
DD21152-BK	Poly	Loop lok	2	5'	black	8.69
DD21252-OR	Poly	Metal swivel speed clip	2	5'	orange	12.15
DD31091-OR	Impervious	Loop lok	1	9'	orange	8.69
DD31152-BL	Impervious	Loop lok	2	5'	blue	8.69
DD31252-OR	Impervious	Metal swivel speed clip	2	5'	orange	12.15
DD31672-BL	Impervious	Metal loop	2	7'	blue	12.77
DD31652-BK	Impervious	Metal loop	2	5'	black	12.38
DD31672-YL	Impervious	Metal loop	2	7'	yellow	12.77
DD31652-BL	Impervious	Metal loop	2	5'	black	12.38
DD31652-YL	Impervious	Metal loop	2	5'	yellow	12.77
DD31672-BK	Impervious	Metal loop	2	7'	black	12.77

Plastic Side Release Buckle David Dick Medical

Item Number	Webbing	Strap End	Pieces	Length	Color	Price
DD27152	Economy poly	Plastic side release	2	5'	orange	7.00
DD47091-OR	Economy poly	Loop lok	1	9'	orange	2.08
DD47091-WH	Economy poly	Loop lok	1	9'	white	2.08
DD47152	Economy poly	Loop lok	2	5'	orange	2.08
DD47152-BL	Economy poly	Loop lok	2	5'	blue	2.08
DD47152-WHM	Economy poly	Loop lok	2	5'	white	2.08
DM47552-OR	Economy poly	Plastic swivel speed clip	2	5'	orange	5.15

Metal Cam Buckle David Dick Medical

Item Number	Webbing	Strap End	Pieces	Length	Color	Price
DD12091-BK	Nylon	Loop lok	1	9'	black	17.10
DD12091-BL	Nylon	Loop lok	1	9'	blue	17.10
DD12091-GR	Nylon	Loop lok	1	9'	green	17.10

Buckles



Metal Push Button



Plastic Side Release



Metal Cam Buckle

Strap Ends



Loop Lok



Metal Loop



Metal Swivel Speed Clip



Plastic Swivel Speed Clip

Buckles



Metal Push Button



Plastic Side Release



Metal Cam Buckle

Strap Ends



Loop Lok



Metal Loop



Metal Swivel Speed Clip



Plastic Swivel Speed Clip

Metal Push-Button Buckle, Nylon Webbing (Morrison Medical)

Item Number	Webbing	Strap End	Pieces	Length	Color	Price
MO1200-BK	Nylon	Loop lok	2	5'	black	8.42
MO1200-BL	Nylon	Loop lok	2	5'	blue	8.42
MO1200-MA	Nylon	Loop lok	2	5'	maroon	8.42
MO1200-OR	Nylon	Loop lok	2	5'	orange	8.42
MO1200-RE	Nylon	Loop lok	2	5'	red	8.42
MO1200-YE	Nylon	Loop lok	2	5'	yellow	8.42
MO1201-BK	Nylon	Loop lok	2	7'	black	9.74
MO1201-MA	Nylon	Loop lok	2	7'	maroon	9.74
MO1209-BK	Nylon	Loop lok	1	9'	black	8.46
MO1209-OR	Nylon	Loop lok	1	9'	orange	8.46
MO1209-YE	Nylon	Loop lok	1	9'	yellow	8.46
MO1210-BK	Nylon	Metal swivel speed clip	2	5'	black	16.95
MO1210-BL	Nylon	Metal swivel speed clip	2	5'	blue	16.95
MO1210-MA	Nylon	Metal swivel speed clip	2	5'	maroon	16.95
MO1210-OR	Nylon	Metal swivel speed clip	2	5'	orange	16.95
MO1210-RE	Nylon	Metal swivel speed clip	2	5'	red	16.95
MO1210-YE	Nylon	Metal swivel speed clip	2	5'	yellow	16.95
MO1211OR-9	Nylon	Metal swivel speed clip	2	9'	orange	16.95
MO1211YL-9	Nylon	Metal swivel speed clip	2	9'	yellow	16.95
MO1217-1-BK	Nylon	Extension strap	1	1'	black	9.17
MO1217-2-BK	Nylon	Extension strap	1	2'	black	8.68

Metal Push-Button Buckle, Impervious Webbing (Morrison Medical)

Item Number	Webbing	Strap End	Pieces	Length	Color	Price
MO1300X-BK	Impervious	Loop lok	2	5'	black	9.58
MO1300X-BL	Impervious	Loop lok	2	5'	blue	9.58
MO1300X-OR	Impervious	Loop lok	2	5'	orange	9.58
MO1300X-YE	Impervious	Loop lok	2	5'	yellow	9.58
MO1301X-BK	Impervious	Loop lok	2	7'	black	9.94
MO1301X-BL	Impervious	Loop lok	2	7'	blue	13.89
MO1301X-YE	Impervious	Loop lok	2	7'	yellow	9.94
MO1309X-BK	Impervious	Loop lok	1	9'	black	9.18
MO1309X-BL	Impervious	Loop lok	1	9'	blue	9.18
MO1309X-OR	Impervious	Loop lok	1	9'	orange	9.18
MO1309X-YE	Impervious	Loop lok	1	9'	yellow	9.18
MO1310X-BK	Impervious	Swivel speed clip	2	5'	black	13.86
MO1310X-BL	Impervious	Swivel speed clip	2	5'	blue	13.86
MO1310X-OR	Impervious	Swivel speed clip	2	5'	orange	13.86
MO1310X-YE	Impervious	Swivel speed clip	2	5'	yellow	13.86

Plastic Side-Release Buckle (Morrison Medical)

Item Number	Webbing	Strap End	Pieces	Length	Color	Price
MO1250-BK	Nylon	Loop lok	2	5'	black	7.12
MO1250-OR	Nylon	Loop lok	2	5'	orange	7.12
MO1260-BK	Nylon	Swivel speed clip	2	5'	black	15.92
MO1260-OR	Nylon	Swivel speed clip	2	5'	orange	15.92
MO1261-BK	Nylon	Swivel speed clip	2	7'	black	16.28
MO1261-OR	Nylon	Swivel speed clip	2	7'	orange	16.28
MO1390-BK	Poly	Loop lok	2	5'	black	2.85
MO1390-BL	Poly	Loop lok	2	5'	blue	2.85
MO1390-OR	Poly	Loop lok	2	5'	orange	2.85
MO1390-RE	Poly	Loop lok	2	5'	red	2.85
MO1390-WH	Poly	Loop lok	2	5'	white	2.85
MO1390-YE	Poly	Loop lok	2	5'	yellow	2.85
MO1392-BK	Poly	Loop lok	1	9'	black	2.85
MO1392-OR	Poly	Loop lok	1	9'	orange	2.85
MO1392-RE	Poly	Loop lok	1	9'	red	2.85
MO1392-WH	Poly	Loop lok	1	9'	white	2.85
MO1394-OR	Poly	Plastic swivel speed clips	2	5'	orange	4.57
MO1394-WH	Poly	Plastic swivel speed clips	2	5'	white	4.57

Double-Adjusting Buckle (Morrison Medical)

Item Number	Webbing	Strap End	Pieces	Length	Color	Price
MO1396-OR	Poly	Loop lok	1	6'	orange	5.98
MO1396-WH	Poly	Loop lok	1	6'	white	5.98
MO1396-YE	Poly	Loop lok	1	6'	yellow	5.98
MO1396LOR	Poly	Loop lok	2	7'	orange	6.26

Biothane® Coated Webbing G1 Straps (Dick Medical Supply)

Item Number	Strap	Pieces	Length	Color	Price
DD51652-OR	Metal push button buckle, metal loop ends	2	5'	orange	23.34
DD51021-OR	Metal push button buckle	1	2'	orange	16.92
DD51021-YE	Metal push button buckle	1	2'	yellow	16.92
DD57652-OR	Plastic side release buckle, metal loop ends	2	5'	orange	19.69
DD57652-YE	Plastic side release buckle, metal loop ends	2	5'	yellow	19.69

BioSafe Coated Straps (BioPlastics)

Item Number	Strap	Pieces	Length	Color	Price
F06YY200OR415-E60C	Metal auto buckle, speed clip	2	5'	orange	21.50
F06YY200YE417-E60C	Metal auto buckle, speed clip	2	5'	yellow	21.50
F06YY200YE417-P60A	Metal speed clip, side release buckle	2	5'	yellow	13.90

Buckles



Metal Push Button



Plastic Side Release



Metal Cam Buckle

Strap Ends

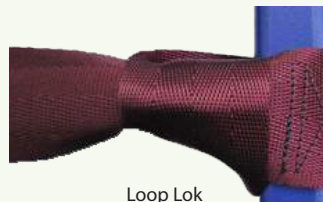

Loop Lok



Metal Loop



Metal Swivel Speed Clip



Plastic Swivel Speed Clip



Economy Best Strap™ System (Morrison Medical)

- Two “suspender” style over-the-shoulder straps
- Four adjustable torso/limb straps with adjustable center strap
- Black polypropylene webbing with hook and loop closures
- No choking “V” by patient’s neck

MO1381	Economy Best Strap with Velcro	each	23.08
--------	--------------------------------	------	-------



The Authentic Spider-Strap™ (EP&R)

The Spider Strap is known the world over as the best in patient immobilization. Its unique design comes with ten points of attachment and secures easily to the shoulder and foot area of the spineboard. Constructed of heavy grade polypropylene webbing and long-lasting hook and loop fasteners. Can be used on both 16” and 18” spineboards.

EP503	Spider Strap, polypropylene, multi-color	each	89.95
-------	------------------------------------------	------	-------



Shoulder Harness Strap System (Morrison Medical)

Designed to minimize patient movement, the Shoulder Harness Strap System incorporates two adjustable shoulder straps and a two-piece torso strap with a metal push button buckle. Loop Lok ends attach the system to the stretcher/cot at four different points. Each strap is fully adjustable for a custom fit. 2” straps are also available in nylon, polypropylene, impervious or plastic. Call (800) 334-6656 for more information.

MO1285-BK	Shoulder harness strap system, nylon, black	each	36.85
MO1385X-BK	Shoulder harness strap system, impervious, black	each	51.70
MO1286-7-BK	Bottom half of shoulder restraint, 7', for shoulder harness strap system, black	each	20.25
MO1286-BK	Bottom half of shoulder restraint, 5', for shoulder harness strap system, black	each	19.02



Original Best Strap™ System (Morrison Medical)

- Provides fast, firm total body immobilization
- Two “suspender” type over-the-shoulder straps
- Five adjustable torso/limb straps, with adjustable center strap
- Nylon webbing with hook and loop closures and EZ Peel ends
- All straps color-coded for easy application

MO1280	Best Strap System	each	46.08
--------	-------------------	------	-------

Two pediatric solutions for your two most common pediatric challenges

ACR4 Ambulance Child Restraint

- Transport pediatric patients safely and securely.
- Safely restrain all children from 4 to 99 pounds.



Learn more about ACR4 on page 262

Pedi-Sleeve® Pediatric Dosing System

- Minimize pediatric dosing errors.
- Use as is or customize to your protocols.
- No calculation or reading a tape of book.



Learn more about Pedi-Sleeve on page 241



Patient Moving and Handling

Stryker



pages 272-274

Evacuation



pages 275-279

Blankets and Linens



pages 280-282

Child Transport



page 282

Accessories



page 283



Power-Pro XT Powered Ambulance Cot (Stryker)

An innovative battery-powered hydraulic system raises and lowers the patient at the touch of a button. Utilizes an easy-to-use manual back-up system for all powered cot functions. The retractable head section reduces footprint, and allows the cot to navigate very tight spaces in any height position. A Stryker exclusive: automatic high-speed retracting feature saves precious seconds when loading and unloading. Reduces workers' compensation costs, injuries and lost and modified workdays, while improving recruitment and retention. 700-pound capacity and weighs 120 pounds.

Warranty

- Two-year parts, labor and travel
- One-year soft goods
- Three-year X-frame components
- Three-year limited powertrain
- Lifetime on all welds

SY6506	Power-Pro XT Powered Ambulance Cot	each	17,632.50
SY6506-170-000	Defibrillator platform for Power-Pro XT	each	571.58
SY6080-140-000	Removable O2 holder for Power-Pro XT	each	326.94
SY6500-240-000	Foot end O2 holder for Power-Pro XT	each	277.50
SY6500-316-000	3-stage IV pole (patient left) for Power-Pro XT	each	437.09
SY6500-315-000	3-stage IV pole (patient right) for Power-Pro XT	each	368.00
SY6500-147-000	Equipment hook for Power-Pro XT	each	64.00
SY6082-128-000	Head end storage fl t for Power-Pro XT	each	89.85
SY6500-130-000	Backrest storage pouch for Power-Pro XT	each	276.27



Performance Pro-XT Manual Ambulance Cot (Stryker)

The Performance-Pro XT is a tough, all-aluminum X-frame cot that sets the standard for manual cot operation. Lightest-in-class versatility, proven performance and increased stability put this cot in a class of its own. The retractable head section delivers 360 degrees of mobility in any height. And Its hand clearance around the litter frame allows for an increase in operator safety. 700-pound capacity

Warranty

- One-year parts, labor and travel or two-year parts-only
- One-year soft goods
- Three-year X-frame components
- Lifetime on all weld
- Extended warranties available
- 7-year service life

SY6086	Performance Pro-XT Manual Ambulance Cot	each	11,028.00
SY6506-170-000	Defibrillator platform for Performance Pro-XT	each	571.58
SY6080-140-000	Removable O2 holder for Performance Pro-XT	each	326.94
SY6500-240-000	Foot end O2 holder for for Performance Pro-XT	each	277.50
SY6500-316-000	3-stage IV pole (patient left) for Performance Pro-XT	each	437.09
SY6500-315-000	3-stage IV pole (patient right) for Performance Pro-XT	each	368.00
SY6500-147-000	Equipment hook for Performance Pro-XT	each	64.00
SY6085-035-000	Head end storage fl t for Performance Pro-XT	each	207.00
SY6500-130-000	Backrest storage pouch for Performance Pro-XT	each	276.27
SY6085-032-000	Knee-Gatch for Performance Pro-XT	each	1,056.03

MX-Pro R3 Manual Ambulance Cot (Stryker)

The light, durable and fast-handling MX-Pro R3 features a 650-pound weight capacity, yet it weighs only 81 pounds. You get a lightweight cot that's strong, durable and easy to handle. Warranty is one year parts, labor and travel or two years parts.



SY6082	MX-Pro R3 Manual Ambulance Cot	each	5,752.00
SY6082-170-000	Defibrillator tray for MX-Pro R3	each	595.41
SY6080-140-000	Removable O2 holder for MX-Pro R3	each	326.94
SY6500-147-000	Equipment hook for MX-Pro R3	each	64.00
SY6082-128-012	Head end storage fl t for MX-Pro R3	each	182.80
SY6082-128-000	Rigid head end storage tray for MX-Pro R3	each	89.85
SY6500-130-000	Backrest storage pouch for MX-Pro R3	each	276.27
SY6082-260-10	Strap set for MX-Pro 3	each	221.98

Stair-Pro Stair Chair (Stryker)

- High visibility powder-coated frame
- Color-coded controls
- Extendable foot end lift handles
- Locking rear lift handles
- Molded hand grips
- Lightweight, rugged aluminum construction

Model 6251 Standard Features

- 4-inch front caster wheels

Model 6252 Standard Features

- Innovative Stair-Tread™ system
- Extendable upper control handle
- 4-inch front caster wheel

SY6252	Stair-Pro stair chair, model 6252 (includes track)	each	3,556.00
SY6250-140-000	O2 bottle holder for Stair-Pro	each	184.62
SY6250-025-000	Lower lift handles, extended length for Stair-Pro	each	352.55
SY6250-160-000	Restraint set, poly, plastic buckle for Stair-Pro	each	62.37
SY6250-161-000	Restraint set, non-absorbent, metal buckle for Stair-Pro	each	146.25
SY6250-001-127	Ankle restraint for Stair-Pro	each	25.20
SY6250-001-089	Rubber grip for Stair-Pro	each	29.38



We also distribute Ferno Cots. For information, call Customer Service at (800) 334-6656.



SMRT Power System (Stryker)

The SMRT Power System will give your Power- Pro cot superior performance. This is a tough, professional-grade system designed for the high-pressure world of EMS. The SMRT Power System eliminates the time-consuming and elaborate charging protocols and “tuning” usually required for maintaining reliable, high performance battery-powered systems.

- A complete charge in approximately two hours
- SMRT Paks have zero memory
- Automatic Power Management extends battery life
- Sealed durable construction for all-weather toughness
- Charge SMRT Paks when and where needed
- Complete System includes two SMRT Paks, SMRT Charger, and power cord

SY6500-700-041	SMRT 120V AC option, one charger, two batteries, cord	each	1,226.41
SY6500-700-040	SMRT 120V DC option, one charger, two batteries, cord	each	1,509.43
SY6500-033-000	SMRT Pak 1 battery only	each	536.65
SY6500-201-000	SMRT charger	each	989.75
SY6500-034-000	Mounting bracket for SMRT power system	each	43.09
SY6500-035-000	12 volt DC cable for SMRT power system	each	43.05



Evacuation Slyde (Stryker)

- Folds flat and stacks 15 deep for easy storage
- Easy set-up and instruction pictograms on each unit
- Four strong web handles for multipoint control by two to seven operators
- Functions as post-evacuation surge capacity device
- Lightweight for easier transports
- Fastex buckle restraints are quick and easy to use
- Compatible with Stryker Stairwell Belay System for heavy patient evacuations
- Wall-mounted storage options are space-saving and convenient

SY6400-000-000	Evacuation Slyde, standard	each	438.74
SY6410-000-000	Evacuation Slyde, bariatric	each	582.37



Cot Fasteners (Stryker)

- Durable steel construction combined with an oversized rail clamp design maximize cot stability for heavy use conditions
- Innovative antler design minimizes effort while loading and unloading
- Recessed knobs prevent interference with cot mechanisms

SY6370-000-000	Floor mount fastener, model 6370, for Stryker cots	each	951.88
SY6371-000-000	Wall mount fastener, model 6371, for Stryker cots	each	588.00

Xtract² Extraction Device (Kingfisher)

Xtract2 is a lightweight, robust extraction device which can be carried or dragged from the point of injury. Extrication can be achieved by use of some or all of the nine handles which are located at measured intervals around the base layer of the stretcher. When low cube size and minimal weight are paramount, Xtract2 gives responders a viable solution for casualty extraction. Utilizing Duralite fabric, the Xtract2 stretcher has been designed for personnel who perform tactical rescues within an austere environment. The Xtract2 is designed to securely cocoon the casualty, ensuring limbs and exposed medical devices are held securely inside the stretcher, minimizing the chance of disruption.

- Length Unadjusted 6' 10"
- Length Adjusted 3' 8"
- Width (Max) 43
- Maximum Load 660lbs



KF72015	Xtract 2 extraction device with case	each	329.95
---------	--------------------------------------	------	--------

CombiCarrierII (Hartwell Medical)

The 2 in 1 patient handling device that saves time, storage space and budget dollars is now the product of choice for many departments because it minimizes patient movement at the scene and is well-suited to meet the most recent EMS protocols. The CombiCarrierII retains the reliable heavy-duty latch system and is now thinner, lighter and stronger than the original product.



HACC2200P	CombiCarrierII	each	940.49
HACC3200H	CombiCarrierII head immobilizer	each	120.31

Swiftlite Stair Chairs for EMS (Quantum EMS)

Swiftlite Stair Chairs for EMS are lightweight and easy-to-use devices which glide effortlessly down stairways to assist with the quick and safe removal of people with limited mobility in the event of an emergency evacuation. Five-year defective workmanship guarantee.

- Swiftlite Q-100 folds neatly in half and can be stored in the smallest of areas. The chair unfolds in one swift movement for immediate use. 440 lb capacity.
- Swiftlite Q-110 is a single person operation enhanced stairchair for use on steep stairs. Folds away ready to use in seconds. 400 lb capacity.
- Swiftlite Q-120 safely descends and ascends stairs without carrying or heavy lifting. Telescopic extendable handle. Ascending and descending capability (no power required). Adjustable brake. Compact storage. 350 lb capacity.



Q-100	Q-100 stairchair, 48" H x 16" W x 14" D	each	599.00
Q-110	Q-110 stairchair, 47" H x 21" W x 9" D	each	1,499.00
Q-120	Q-120 stairchair, 43" H x 18" (top) / 16" (bottom) W (folded) x 14" D	each	1,900.00

Evacuation Chairs (Junkin Safety)

Designed for use in confined areas. 2" standard automotive-style patient restraints straps included. Green vinyl covers are made of 18oz. antibacterial material and are fungus and rot resistant.

- 35 1/4" H x 18 7/8" W x 22 3/8" D; Weighs 15 1/2 lb



JSA-800	Evacuation chair	each	767.85
JSA-800W	Evacuation chair with 4 wheels	each	844.31



Plastic Scoop Stretcher (Quantum EMS)

Orthopedic stretcher with break-apart scissor action at either / both ends. Ergonomic design allows for ideal immobilization during patient transfer. Recessed head section and X-ray translucent. Complete with 3" seatbelt buckle style patient straps with loop ends.

- Height 92in, Width 18in, Depth 3in, Weight 16lb, Load Capacity 350lb

Q-6217C	Plastic scoop stretcher	each	1,075.38
---------	-------------------------	------	----------



Scoop 65 EXL Stretcher (Ferno)

Ferno's Scoop EXL Stretcher provides superior comfort and safety to patients who need spinal immobilization. The Scoop EXL eliminates the need for log-roll maneuvers, which significantly decreases movement to the cervical spine. Two hinged, interlocking pieces allow operators to bring the two halves together beneath the patient and gently scoop them up. Made from X-ray translucent composite material. Includes three burgundy restraints.

- Dimensions: 17" W x 3" H x 79" L
- Load limit: 350 lbs.
- Weight: 18 lbs.

FW65EXL	Scoop 65 EXL stretcher	each	1,153.84
---------	------------------------	------	----------



Scoop Stretcher (David Dick Medical)

- Adjustable length with automatic lock
- Folds in half for easy storage
- Effective hooking and unhooking device for the stretcher uncoupling can be put under the patient without removing the patient
- Open center permits patients to be X-rayed while still in the stretcher
- Two straps

DA-02859-3	Scoop stretcher	each	588.98
------------	-----------------	------	--------



Aluminum Break-Apart Stretcher (Junkin Safety)

Designed to gently maneuver stretcher under patient without rolling or lifting. Immobilization of the patient in the position found minimizes the risk of complicating the existing injuries. The center of the stretcher can be opened to allow the patient to be X-rayed while secured on the stretcher. Folds for easy storing and separates in half during application and removal.

- 66¼" L x 17½" W x 25/8" H
- Folded length: 49 1/2"; folded depth: 3 1/2"; adjustable to 80"
- Weighs 21 1/2 lb.
- Load capacity: 400 lbs.

JSA-400	Aluminum break-apart stretcher	each	645.08
---------	--------------------------------	------	--------



Basket Stretcher (Junkin Safety)

Made of steel, all-welded rigid construction which does not rely on injured person to attain form or rigidity. Light in weight and ample in size. Nylon web straps at chest, abdomen, thigh, and calf. Frame is 5/8" steel tubing; cross braces and runners 3/16" x 3/4" fl t steel. Basket is 18 gauge, 1" hexagon mesh netting.

JSA-300W	Basket stretcher, without leg divider	each	294.00
----------	---------------------------------------	------	--------

Confined Space Splint Rescue Stretcher (Junkin Safety)

The new 19" wide Confined Space Splint Rescue Stretcher has been designed for rescues where space is confined. Steel, all-welded rigid construction does not rely on the injured person to attain form or rigidity. Light in weight and ample in size. The basket is 18 gauge, 1" hexagon mesh netting. Nylon web straps for securing at chest, abdomen, thigh and calf. Supplemental accessories to facilitate special handling needs are available



JSA-300CS	Confined space stretcher	each	369.38
-----------	--------------------------	------	--------

Plastic Basket-Type Stretcher (Junkin Safety)

Yellow high-density polyethylene shell, supported by a stainless steel outer rail, permanently attached with stainless steel semi-tubular rivets. Features molded runners, fully exposed outer rail, non-absorbent foam pad secured to stretcher and four patient restraint straps. Ideal for unusually rugged rescue situations. Patent Pending.



- Dimensions: 84½" L x 24"W x 7½" H
- Weight: 31 lbs.
- Load capacity: 1200 lbs.

JSA-200	Plastic basket-type stretcher	each	739.85
---------	-------------------------------	------	--------

Stretcher Bridle Sling (Junkin Safety)

The JSA-300-X Stretcher Bridle Sling provides horizontal or vertical lifting capacity of up to 2,500 lbs. Made of 1" nylon webbing resistant to moisture and fungal rot with forged snap hooks and 3" ID forged steel suspension ring.



- Dimensions: 35¼"H x 187/8"W x 223/8"D; Folded: 8"
- Weight: 4 lbs.
- Load capacity: 2500 lbs.

JSA-300XSS	Stretcher bridle sling	each	269.23
------------	------------------------	------	--------

Easy-Fold Aluminum Pole Stretcher (Junkin Safety)

Easily set up and compact for storing. This Medical Corps type litter is light in weight with shaped nylon grips. Cover is durable 18 oz. vinyl coated nylon.



- Dimensions: Open: 87" L x 22"W x 4½" H; Folded: 43½" L x 3½"W x 7½" H
- Weight: Anodized aluminum pole - 14 lbs.

JSA-601NA	Easy-Fold aluminum pole stretcher	each	235.85
-----------	-----------------------------------	------	--------

EFS12 Folding Stretcher (Triple Inc)

Anodized aluminum frame and vinyl-coated nylon cover. Folds in half for easy storage.

- Unfolded size: 76¾ x 21¼ x 1¼ inches
- Folded size: 37¾ x 21¼ x 23/8 inches
- Load capacity 440 lbs.
- Weight: 10 lbs.

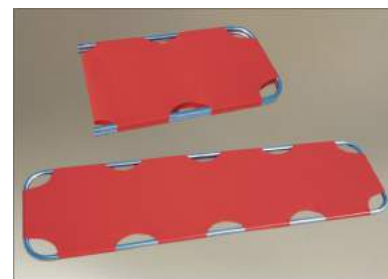

DA-02799	EFS 12 folding stretcher	each	182.22
----------	--------------------------	------	--------



Easy-Fold Aluminum Mesh Pole Stretcher (Junkin Safety)

Easy set up and compact for storing. This Medical Corps type litter is light in weight with shaped nylon handles. Cover is durable 18 oz. mesh vinyl coated nylon.

JSA-601NAM	Easy-fold aluminum mesh pole stretcher	each	254.15
------------	----------------------------------------	------	--------



MegaMover Portable Transport Unit (Graham Medical)

A compact, cost effective, portable transport unit used to transport, transfer or rescue patients from areas inaccessible to stretchers. The nonwoven, latex-free construction holds up to 1000 lbs. and has 14 handles for ergonomic lifting.

51926	Megamover portable transport unit	each	33.02
-------	-----------------------------------	------	-------



MegaMover Plus Portable Transport Unit (Graham Medical)

A durable, compact, cost effective, portable transport unit used to transport, transfer or rescue patients from areas inaccessible to stretchers. The Plus accepts standard backboards for immobilization. Dimensions: 40" x 80"

53376	MegaMover Plus portable transport unit	10/case	338.62
-------	----------------------------------------	---------	--------



MegaMover Transport Chair (Graham Medical)

Made of strong nonwoven material with 8 reinforced nylon yellow straps for ergonomic lifting. The chair weighs only 10 oz., rolls to the size of a water bottle and can transport up to 350 lbs. Ideal for carrying patients in areas of limited space, narrow hallways or down stairs.

56307	MegaMover Transport Chair	10/case	171.15
-------	---------------------------	---------	--------

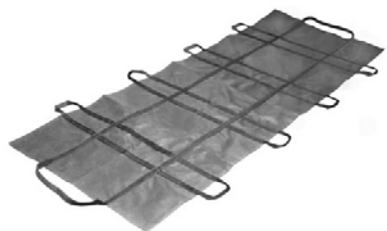

Disposable GO Stretcher (GO Manufacturing)

- Will hold over 500 lb
- Features 10 large hand holds
- Water-resistant coated woven polyethylene provides strength and durability
- Stretcher size with handles is 35" x 71"

GO100-DS	Disposable GO stretcher	each	14.62
----------	-------------------------	------	-------



Flexible Stretcher (Reeves EMS)

- Five removable hardwood slats positioned between two layers of 18oz. fabric
- Load capacity - 350 lbs; Weighs 15 lbs
- Three polypropylene web patient security straps for immobilization
- Handles constructed of polypropylene webbing with foam inserts
- Six handles ergonomically placed for ease of transport
- Compact and portable - opens to 78"L x 28"W; closes to 58"L x 6"W

RSS0003	Flexible stretcher	each	294.00
---------	--------------------	------	--------

Heavy-Duty Flexible Stretcher (Reeves EMS)

- Seven removable hardwood slats positioned between two layers of 18 oz. fabric
- Load capacity - 750 lbs
- Three reinforced polypropylene web patient security straps for immobilization
- Ten reinforced handles ergonomically placed for ease of transport
- Compact and portable - opens to 79”L x 38”W; closes to 64”L x 8”W
- Lightweight- 16 lbs.



RSS0004	Heavy-duty flexible stretcher	each	420.00
---------	-------------------------------	------	--------

Reeves Sleeve (Reeves EMS)

Designed for rapid immobilization of spinal and neck injuries in tight places. The Reeves Sleeve stretcher has a load capacity that has been independently tested to over 1,000 lbs. It is constructed of lightweight 18 oz. vinyl-coated polyester that is easily washed with soap and water, highly resistant to acids and alkali, and unable to be penetrated by liquids.



RSS0005	Reeves Sleeve, six padded carrying handles	each	594.00
---------	--------------------------------------------	------	--------

Soft Stretchers (Morrison Medical)

Soft Stretchers are specially designed for moving extra large people. Great for getting patients out of confined spaces. Eases moving large people in stairways. Allows you to move several children or more than one average adult

MO3010	Soft stretcher, regular, 30” x 70”	each	108.31
MO3020	Soft stretcher, large, 40” x 71”	each	143.44
MO3030	Soft stretcher, 3XL, 60” x 80”	each	246.95



Titan Reusable Bariatric Stretcher (Taylor Medical)

Designed to lift up to 1,500 lbs. Foldable and washable, the Titan is made of ultra strong nylon and nylon webbing. Handles allow for easy lifting. 40” x 80” with backboard pockets. Can be used with or without a backboard (backboard shown is not included).

TH44-TT4080	Titan reusable bariatric stretcher	each	62.20
-------------	------------------------------------	------	-------



The Perry Pouch (Morrison Medical)

The Perry Pouch soft stretcher cinches around patient when lifted

- Compact and lightweight, 1 lb., 4 oz.
- Made with orange vinyl and 1” black polypropylene webbing
- Black vinyl handles for “easy on your hands” lifting
- The Perry Pouch supports up to 500 pounds



MO3000	Perry Pouch, 28” x 31”	each	62.72
--------	------------------------	------	-------

Absorbent Products



BT100-10	Bath towel 20" x 40"	100/case	28.94
HT100-10EA	Hand towel, 14" x 21"	each	0.10
HT100-10	Hand towel, 14" x 21"	200/case	21.77
KE948	Maxicare disposable underpad, 30" x 30"	200/case	49.06
UP100-20	Underpad 24" x 36"	100/case	22.18
WC100-10	Washcloth 12½" x 13½"	200/case	12.22

Simplicity Basic Underpad (Medtronic/Covidien)



Featuring honeycomb technology, super absorbent polymer is encapsulated in every cell for improved fluid management resulting in drier skin, improved skin wellness and increased patient comfort. The backsheet channels moisture vapor away from the patient while keeping fluid from passing through to the bed sheet.

KE7136	Tendersorb underpad, 23" x 24"	10/bag	1.71
KE7134	Tendersorb underpad, 23" x 24"	50/bag	7.31

Fitted Sheet



B2052	Fitted sheet, non-woven, 30" x 84"	50/case	69.94
TH90-BSS3084	Fitted Sheet, fluid resistant, 30" x 84"	50/case	68.06
ES200-20	Fitted sheet, fluid resistant, no elastic, 30" x 72"	100/case	58.46
ES500-20	Fitted sheet, impervious, fluid resistant, 30" x 72", light blue	50/case	72.09
ES800-10	Fitted sheet, heavy duty fluid resistant, 30" x 72"	50/case	63.22

Flat Sheet



UF500-20	Flat sheet, 40" x 84", dark blue	50/case	49.65
B2053	Flat sheet, tissue/poly, 40" x 90", white	50/case	35.02
UF300-10	Flat sheet, 40" x 84", white	50/case	43.25

Fleece Blankets

A lightweight and a heavyweight blanket that are ideal for field use in ambulance or mass casualty scenarios. Measures 60" x 90" with rounded corners. Machine washable.



EB500-MA	Heavyweight fleece blanket, 60" x 90"	maroon	each	12.00
EB500-NV	Heavyweight fleece blanket, 60" x 90"	navy blue	each	12.00

Silver Swaddler

Conserves body heat in newborn infants by preventing loss due to radiation, conduction, convection and evaporation. Made from metalized polyester film one thousandth of an inch thick. Pack size 10" x 5" x 1/4" and weighs 1 oz.

D5326	Silver Swaddler foil baby bunting	each	6.68
-------	-----------------------------------	------	------



Isothermal Rescue Blanket

Designed to retain body heat of victims in shock. Windproof and waterproof. Warmer than wool, the blanket remains flexible at temperatures well below zero. The blanket is silver colored on one side for day or night reflection.

D5327	Isothermal rescue blanket	each	0.54
-------	---------------------------	------	------



Emergency "Yellow" Blanket

B5340	Economy disposable blanket, 54" x 80", yellow	each	4.84
B5340-G	Economy disposable blanket, 54" x 80", yellow	each	4.84
EB100-50	Heavy duty blanket, 60" x 90"	each	3.75



Wool Blanket (Kemp)

The Kemp 30% wool blanket is a great all around blanket.

KB10-604	30% wool blanket, 60" x 90"	each	7.69
----------	-----------------------------	------	------



Pillows and Cases

Pillows are hypoallergenic and fluid resistant.

PL100-20	Pillow, disposable, 16" x 14"	each	1.33
PM1824	Pillow, disposable, 18" x 14", medium weight	each	3.96
PL200-20	Pillow, disposable 21" x 17 1/2"	each	3.32
B2183	Pillow, reusable, 20" x 26"	each	7.31
B2050	Pillow case, disposable, plastic	100/case	33.90
UF400-10	Pillow case, disposable, fluid resistant, 20" x 30"	100/case	38.82
437	Pillow case, 21" x 30", Fabricel, blue	100/case	54.45





Ready Heat II

- First Responder 12-panel blanket; 34" x 48"
- 100 degrees F within 8-10 minutes

G12RH2	Ready Heat II 12-panel blanket	each	21.00
--------	--------------------------------	------	-------



Table Paper and Drape Sheets (ProAdvantage)

P751018	Exam table paper, absorbent crepe, 18" x 225 ft	12/case	22.11
P754048	Drape sheet, 2ply, 40" x 48", white	100/case	16.69



Ambulance Child Restraint (Q-ACR4) (Quantum EMS)

- Allows for the safe, effective restraint of all children from 4-99 lbs
- ACR-4 offers four sizes of restraints in a single device. XS: 4-11 lbs, SM: 10-26 lbs, MED: 22-55 lbs, LARGE: 44-99 lbs
- Open channel design allows complete patient access from the airway to the waist without unrestraining the child
- The restraint tightens in the mattress of the stretcher, not into the child; thus preventing any additional injury
- Compact packaging allows the ACR-4 to fit into its own 10" x 10" custom bag, taking up less room in the back of an ambulance
- ACR-4 is universal and will work on any stretcher or backboard without a bracket
- ACR-4 replaces the need to carry multiple devices to accomplish the task of restraining all size pediatric patients
- ACR-4 has been fully crash-tested under the strictest of standards
- Color-coded for easy size identification
- Machine washable



- Download **FREE Layer App** (from your App Store)
- Scan this page
- View custom product info

Q-ACR4	Ambulance Child Restraint (Q-ACR4) 4-pack	4/pkg	799.00
Q-BABY/ADD	Ambulance Child Restraint Baby (add on for the existing Baby 3-pk only)	each	219.00
Q-STRAP	Ambulance Child Restraint (Q-ACR4) replacement straps	each	139.00

Radian® Convertible+ Booster Car Seats (Diono)

- Full steel frame and aluminum reinforced sides for unmatched safety
- Comfortably seats rear-facing children from 5-45 lbs, forward-facing children from 20-80 lbs in a 5-point harness, then converts to a booster for children up to 120 lbs.
- Folds flat for travel and is FAA certified;
- Booster mode from 50 -120 lbs (40 to 57 inches)



SS16910	Radian RXT convertible + booster car seat, 12-position adjustable headrest, 5 shoulder and 3 buckle positions, plum color	each	339.99
SS16812	Radian 120 convertible + booster car seat, 5 shoulder and 3 buckle positions, storm color	each	304.62

Catch-All® (Hartwell Medical)

The Catch-All provides an easy and convenient storage area for small medical equipment used frequently on EMS calls.

- Attaches in less than 2 minutes
- Lightweight, durable mesh fabric
- Waterproof material will not absorb blood or body fluid
- Great for stethoscope, gloves, pocket masks, patient belongings, medicine vials. etc.



HACA3000	Catch-all for Ferno35A	each	93.11
HACA3600	Catch-all for Ferno Profll xx	each	93.11
HACA4000	Catch-all for Ferno 93 series	each	93.11
HACA6000	Catch-all for Stryker MX Pro	each	93.11

Lifesaver CPR Board (Kemp USA)

Anatomically contoured to position the patient for effective application of cardiopulmonary resuscitation (CPR). Can be stored under stretcher mattress.



KB10-518	Lifesaver CPR board	each	55.38
----------	---------------------	------	-------

Patient Belongings Bag

White bag with space to write patients name. 20" x 20" with drawstring



DNDSPB01	Patient belongings bag	250/case	48.00
----------	------------------------	----------	-------

Body Bags

Economy/disposable body bags

B2194	Body bag, extra heavy duty with curved zipper, 36" x 90", green	each	69.90
B2195	Body bag, heavy duty with curved zipper, six handles, 36" x 90", black	each	36.85
B2193	Body bag, vinyl with curved zipper, 36" x 90"	each	15.52
EMP550	Body bag, extra large, 92" x 54", weight capacity of 750 pounds	each	49.15
309220	Body bag, pediatric, 36" x 20"	each	5.31
300040	Body bag with handles, black	each	35.00
309020	Body bag, disposable, 8mL thick	each	11.92





Wound and Burn Care

Hemorrhage Control



pages 286-287

Gauze



pages 288-290

Bandages



pages 291-293

Dressings



page 294

Tape



page 295-296

Hemostatics



page 297

Burn Relief



pages 298-299



Combat Application Tourniquet® (C-A-T®) (North American Rescue)

The Combat Application Tourniquet (C-A-T) is a small and lightweight one-handed tourniquet that completely occludes arterial blood flow in an extremity. The C-A-T uses a Self-Adhering Band and a Friction Adaptor Buckle to fit a wide range of extremities combined with a one-handed windlass system. The windlass uses a free moving internal band to provide true circumferential pressure to an extremity. The windlass is then locked in place; this requires only one hand, with the Windlass Clip™. The C-A-T also has a Hook-and-Loop Windlass Strap™ for further securing of the windlass during patient transport.

NA30-0001	Combat Application Tourniquet (C-A-T), black	each	29.99
NA30-0023	Combat Application Tourniquet (C-A-T), orange	each	29.99
NA30-0033	C-A-T Trainer, blue	each	37.72



SOF® Tactical Tourniquet (Tactical Medical Solutions)

The SOF Tactical Tourniquet is one of the top performing tourniquets currently available. It is the tourniquet of choice for many of the world's most elite and experienced warriors who have selected it for its outstanding ability to control severe bleeding, high level of reliability and ease of application. The SOF tourniquet is applied the same to an arm or leg.

PSSOFTT-01	SOF Tactical Tourniquet, black	each	26.78
PSSOFTT-02	SOF Tactical Tourniquet, orange	each	26.78
PSSOFTT-W	SOF Tactical Tourniquet, wide, black	each	29.93
PSSOFTT-W-R	SOF Tactical Tourniquet, wide, orange	each	29.93



MAT® Tourniquet (Pyng)

The MAT Tourniquet is a versatile and efficient tourniquet, providing fast application, simple and effective one-handed operation. Stops blood loss with complete occlusion in about 30 seconds. Designed to be self-administered by individual military personnel or civilians—as well as used by medical personnel—it is the only tourniquet that meets all U.S. Department of Defense performance requirements.

CYMAT1	MAT Tourniquet	each	32.31
--------	----------------	------	-------



Racheting Medical Tourniquets (RMTs™) (RMT)

RMTs are self-locking tactical tools for hemorrhage control.

- Applies precise mechanical pressure
- Racheting sound when activated
- Simple, intuitive “gross motor” operation
- Proven technology since 2002

RMT-PARAMED	Racheting Medical Tourniquet (RMT), paramedic	each	36.95
RMT-TAC	Racheting Medical Tourniquet (RMT), tactical	each	35.95
RMT-CHILD	Racheting Medical Tourniquet (RMT), pediatric	each	35.95

SAM® Chest Seal (SAM Medical)

The SAM Chest Seal is an occlusive dressing designed to treat open chest wounds, a life-threatening situation that could lead to tension pneumothorax. This is the second-leading cause of preventable death on the battlefield .

It is available with or without valve. The valved version features a one-way valve when its cap is removed. This provides for low-resistance flow of air out of the chest cavity while preventing ingress. The dome design protects against occlusion from direct external pressure.

- Adheres despite the presence of blood, sweat, hair and sand
- The pouch, dressing backing, and tabs provide optimal contrast for visibility in normal light, low light, and night conditions (using a night vision device)
- Vacuum packed tear and peel pouch



SECS062013	SAM Chest Seal combo pack containing one each of with valve and without valve	2/pkg	1,464.00
SECS062010	SAM Chest Seal with valve, 9.2" x 7.6"	1/pkg	22.49
SECS062011	SAM Chest Seal without valve, 9.2" x 7.6"	2/pkg	27.99

HyFin® Vent Chest Seals (North American Rescue)

- Patented, new design with 3-channel pressure relief vents
- Advanced adhesive technology for a superior seal in the most adverse conditions, including sweaty or hairy casualties
- Easy-to-grip, large Red-Tip™ tab for single step, peel-and-apply application that allows for the burping of the wound if necessary

NA10-0029	HyFin chest seal, single	each	10.94
NA10-0031	HyFin chest seal, twin pack	2/pkg	15.23



Asherman Chest Seal (Teleflex)

Designed specifically for open chest wounds. Clear circular design for good visualization of wound dressing. Size 5.5" diameter.

RU849100	Asherman chest seal	each	11.73
----------	---------------------	------	-------

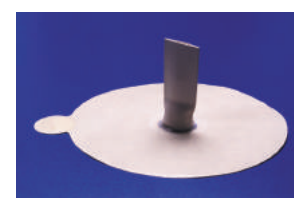

Halo and Fox Chest Seals (Tac Med)

The Halo Chest Seal is an ultra-sticky hydro-gel occlusive dressing for treatment of penetrating chest trauma. Each pack includes two seals, allowing for the treatment of entry and exit wounds. Fox Chest Seal has been tested in extreme conditions. It comes with two dressings in a compact package designed for IFAK-carry and is used for treating potentially lethal open chest wounds.

TMHALO	Chest seal, Halo	2/pkg	15.95
TMFCS	Chest seal, Fox	2/pkg	13.00





Economy Stretch Roller Gauze

D5300	Self adhesive conforming roller gauze, non-sterile, 2" x 4.1 yards	12/box	1.39
D5301	Self adhesive conforming roller gauze, non-sterile, 3" x 4.1 yards	12/box	1.63
D5302	Self adhesive conforming roller gauze, non-sterile, 4" x 4.1 yards	12/box	1.91
D5303	Self adhesive conforming roller gauze, non-sterile, 6" x 4.1 yards	6/box	1.73
D5400	Self adhesive conforming roller gauze, sterile, 2" x 4.1 yards	12/box	2.87
D5401	Self adhesive conforming roller gauze, sterile, 3" x 4.1 yards	12/box	3.37
D5402	Self adhesive conforming roller gauze, sterile, 4" x 4.1 yards	12/box	3.62
D5403	Self adhesive conforming roller gauze, sterile, 6" x 4.1 yards	6/box	3.65



Economy Gauze Fluff Rolls

D5198	Gauze fluff rolls, non-sterile, 4.5" x 4.1 yards, 6 ply	each	0.54
D5199	Gauze fluff rolls, sterile, 4.5" x 4.1 yards, 6 ply	each	0.72



Kerlix™ Gauze Bandage Rolls (Kendall)

This 6-ply 100% cotton gauze bandage conforms, absorbs and protects wounds. The roll provides fast-wicking action, superior aeration and excellent absorbency.

KE1892	Kerlix conforming bandage, non-sterile, 4.5" x 4.1 yards	each	1.57
KE6715	Kerlix conforming bandage, sterile, 4.5" x 4.1 yards	each	1.73
KE6720	Kerlix conforming bandage, sterile, 2.25" x 3 yards	12/box	9.94



Curity™ Stretch Bandages (Kendall)

Curity Stretch Bandages provide softness, low lint and high absorbency with moderate stretch for maximum clinical flexibility. Made from a cotton/polyester crocheted blend.

KE2239	Stretch conforming bandage, non-sterile, 1"	24/box	5.60
KE2242	Stretch conforming bandage, non-sterile, 2"	12/box	3.76
KE2244	Stretch conforming bandage, non-sterile, 3"	12/box	4.72
KE2247	Stretch conforming bandage, non-sterile, 4"	12/box	7.34
KE2249	Stretch conforming bandage, non-sterile, 6"	6/box	5.46
KE2231	Stretch conforming bandage, sterile, 2"	12/box	6.58
KE2232	Stretch conforming bandage, sterile, 3"	12/box	8.08
KE2236	Stretch conforming bandage, sterile, 4"	12/box	9.61
KE2238	Stretch conforming bandage, sterile, 6"	12/box	15.56

Triangular Bandage

D5210	Triangular bandage, non-sterile, with two safety pins	each	0.42
PK4-006	Triangular bandage, non-sterile (by Pac-Kit)	each	1.45



Economy Gauze Pads

D5430	Gauze pads, sterile, 2" x 2" 8 ply (2 per pack)	100/pkg	1.59
D5436	Gauze pads, sterile, 2" x 2" 12 ply (singles)	100/pkg	2.96
D5437	Gauze pads, sterile, 3" x 3" 12 ply (singles)	100/pkg	4.25
D5431	Gauze pads, sterile, 3" x 3" 12 ply (2 per pack)	50/pkg	1.51
D5432	Gauze pads, sterile, 4" x 4" 8 ply (2 per pack)	50/pkg	5.05
D5438	Gauze pads, sterile, 4" x 4" 12 ply (singles)	100/pkg	7.11
D5433	Gauze pads, non-sterile, 2" x 2" 12 ply	200/pkg	1.27
D5434	Gauze pads, non-sterile, 3" x 3" 12 ply	200/pkg	2.65
D5435	Gauze pads, non-sterile, 4" x 4" 12 ply	200/pkg	3.83



Gauze Pads

DK6124	Gauze pads, sterile, 4" x 4" 4 ply (24 boxes of 25 packs, 2 per pack)	1200/case	58.12
DY3342	Gauze pads, sterile, 4" x 4" 8 ply (2 per pack)	25/box	2.00
D5557	Gauze pads, sterile 4" x 4" 12 ply (2 per pack)	25/box	2.34
D5558	Gauze pad, sterile 4" x 4" 12 ply	10/pkg	0.41
DY3222	Gauze pads, non-sterile, 2" x 2", 8 ply	200/bag	1.18
D5552	Gauze pads, non-sterile, 4" x 4" 8 ply	200/bag	3.34



Curity™ Sterile Gauze Pads (Kendall)

KE3381	Gauze pads, sterile, 2" x 2" 12 ply (singles)	100/box	9.00
KE6132	Gauze pads, sterile 3" x 3" 12 ply (singles)	100/box	11.74
KE6309	Gauze pads, sterile, 4" x 4" 12 ply (singles)	100/box	19.73
KE3033	Gauze pads, sterile 4" x 4" 12 ply (2 per pack)	50/pkg	3.37
KE6939	Gauze pads, non-sterile 4" x 4" 12 ply (plastic tray)	10/pkg	1.25



Curity™ Sterile Gauze Sponges (Kendall)

KE1806	Gauze sponges, sterile, 2" x 2" 8 ply (2 per pack)	100/box	3.08
KE1903	Gauze sponges, sterile, 3" x 3" 2 ply (2 per pack)	50/box	2.50





Non-Woven All Purpose Sponges

Ideal for applying ointments, prepping wiping needles and more. Highly absorbent, cost-effective and virtually lint free.

D5508	Gauze sponges, non-woven, non-sterile, 2" x 2" 4 ply	200/pkg	3.25
D5509	Gauze sponges, non-woven, non-sterile, 3" x 3" 4 ply	200/pkg	4.54
D5510	Gauze sponges, non-woven, non-sterile, 4" x 4" 4 ply	200/pkg	10.00



Combine Pads

Designed as a secondary dressing over sponges or as primary dressing for heavy drainage. Individually packaged permitting aseptic delivery.

D5420	Combine pads, sterile, 5" x 9"	25/box	2.45
D5520	Combine pads, sterile, 5" x 9"	36/box	9.85
DY3501	Combine pads, sterile, 5" x 9"	20/box	2.97
D5521	Combine pads, sterile, 8" x 7.5"	18/box	5.47
D5422	Combine pads, sterile, 8" x 10"	20/box	7.50
D5522	Combine pads, sterile, 8" x 10"	18/box	10.16



Vaseline™ Petrolatum Gauze (Kendall)

Vaseline Petrolatum Gauze is a fine mesh, abso bent gauze impregnated with white petrolatum. This product remains moist, nontoxic and nonirritating. It is non-adherent and sterile.

KE8884413605	Vaseline gauze, 3" x 9"	each	0.81
KE8884415600	Vaseline gauze, 3" x 36"	each	1.41
KE8884433605	Vaseline gauze, 5" x 9"	50/box	57.69



DON'T SEE WHAT YOU'RE LOOKING FOR?
 Call Customer Service; we're here to help.
 (800) 334-6656

Adhesive Bandages

CRA5261	¾" crayon bandages	100/box	4.28
GAR5293	¾" Garfield bandag	100/box	3.61
D5123	¾" fl xible fabric bandages	100/box	1.99
D5114	¾" sheer plastic bandages	100/box	1.67
D5124	1" fl xible fabric bandages	100/box	2.47
D5115	1" sheer plastic bandages	100/box	1.87
D5116	2" x 4" sheer plastic bandages	50/box	3.29
D5117	Butterfly st ip, ½" x 2¾" fl xible fabric	100/box	2.61
D5118	Butterfly st ip, 3/8" x 1 13/16"	100/box	1.92
D5121	Fingertip bandage, 1¾" x 2"	100/box	4.51
D5122	Knuckle bandage, 1½" x 3" fl xible fabric	100/box	4.17



Band-Aid® Adhesive Bandages (J&J)

JJ4434	Band-Aids, ¾" fl xible fabric strip	100/box	6.57
JJ4444	Band-Aids, 1" fl xible fabric strip	100/box	5.74
JJ4430	Band-Aids, assorted fl xible fabric strips	30/box	3.74
JJ4634	Band-Aids, ¾" sheer strip	100/box	4.26
JJ5716	Band-Aids, 2" x 4½" sheer strip	50/box	8.02



Curity™ Adhesive Bandages (Medtronic/Covidien)

KE5024	Adhesive bandage, fl xible fabric, ¾"	50/box	1.54
D5504	Adhesive bandage, fl xible fabric, ¾" neon	50/box	1.71
KE44101	Adhesive bandage, fl xible fabric, 1"	50/box	1.72
KE44114	Adhesive bandage, plastic, 1"	50/box	1.45
KE44115	Adhesive bandage, plastic, 1"	50/box	1.34



Steri-Strip™ Reinforced Adhesive Skin Closures (3M)

3MR1541	Steri-Strip™ reinforced adhesive skin closures, ¼" x 3" (3 strips per envelope)	50/pkg	36.54
---------	------------------------------------------------------------------------------------	--------	-------





CoFlex® Med Cohesive Bandages, Latex (Andover)

CoFlex Med is a hand-tear, self-adhering, non-slip bandage. It is soft enough for use on the most sensitive skin, yet strong enough to provide consistent compression. Contains latex.

AC7100BK	CoFlex Med cohesive bandage, 1" x 5 yards	black	2/roll	2.69
AC7100BL	CoFlex Med cohesive bandage, 1" x 5 yards	blue	2/roll	2.69
AC7100GR	CoFlex Med cohesive bandage, 1" x 5 yards	green	2/roll	2.69
AC7100RE	CoFlex Med cohesive bandage, 1" x 5 yards	red	2/roll	2.69
AC7100TN	CoFlex Med cohesive bandage, 1" x 5 yards	tan	2/roll	2.69
AC7100WH	CoFlex Med cohesive bandage, 1" x 5 yards	white	2/roll	2.69
AC7100CP	CoFlex Med cohesive bandage, 1" x 5 yards	color pack	2/roll	40.40
AC7200BK	CoFlex Med cohesive bandage, 2" x 5 yards	black	each	2.12
AC7200BK-036	CoFlex Med cohesive bandage, 2" x 5 yards	black	36/case	76.38
AC7200BL	CoFlex Med cohesive bandage, 2" x 5 yards	blue	each	2.12
AC7200GR-036	CoFlex Med cohesive bandage, 2" x 5 yards	green	36/case	76.38
AC7200LB-036	CoFlex Med cohesive bandage, 2" x 5 yards	light blue	36/case	76.38
AC7200LG	CoFlex Med cohesive bandage, 2" x 5 yards	lime green	each	2.12
AC7200OR	CoFlex Med cohesive bandage, 2" x 5 yards	orange	36/case	76.38
AC7200P	CoFlex Med cohesive bandage, 2" x 5 yards	pink	each	2.12
AC7200PU	CoFlex Med cohesive bandage, 2" x 5 yards	purple	each	2.12
AC7200RD	CoFlex Med cohesive bandage, 2" x 5 yards	red	each	2.12
AC7200TN-036	CoFlex Med cohesive bandage, 2" x 5 yards	tan	each	2.12
AC7200WH	CoFlex Med cohesive bandage, 2" x 5 yards	white	each	2.12
AC7200-CP	CoFlex Med cohesive bandage, 2" x 5 yards	color pack	36/case	76.38
AC7200-KP	CoFlex Med cohesive bandage, 2" x 5 yards	kid pack	36/case	76.38
AC7200-SC	CoFlex Med cohesive bandage, 2" x 5 yards	smiley face	36/case	102.82
AC7300BL	CoFlex Med cohesive bandage, 3" x 5 yards	blue	each	2.82
AC7300RD	CoFlex Med cohesive bandage, 3" x 5 yards	red	each	2.82
AC7300TN	CoFlex Med cohesive bandage, 3" x 5 yards	tan	each	2.82
AC7300-CP	CoFlex Med cohesive bandage, 3" x 5 yards	color pack	24/case	67.56
AC7300-KP	CoFlex Med cohesive bandage, 3" x 5 yards	kid pack	24/case	67.56
AC7300NP	CoFlex Med cohesive bandage, 3" x 5 yards	pink	24/case	67.56
AC7300-SC	CoFlex Med cohesive bandage, 3" x 5 yards	smiley face	24/case	67.56
AC7300WH-024	CoFlex Med cohesive bandage, 3" x 5 yards	white	24/case	67.56
AC7400BL	CoFlex Med cohesive bandage, 4" x 5 yards	blue	each	3.57
AC7400TN	CoFlex Med cohesive bandage, 4" x 5 yards	tan	each	3.57
AC7600BL-012	CoFlex Med cohesive bandage, 6" x 5 yards	blue	12/case	67.31

Co-Flex® Med Cohesive Bandages, Latex-Free (Andover)

CoFlex Med is a hand-tear, self-adhering, non-slip bandage. It is soft enough for use on the most sensitive skin, yet strong enough to provide consistent compression. Latex-free.



AC9100BL	CoFlex Med cohesive bandage, 1" x 5 yards, latex free	blue	2/pkg	3.39
AC9100RD	CoFlex Med cohesive bandage, 1" x 5 yards, latex free	red	2/pkg	3.39
AC9100TN	CoFlex Med cohesive bandage, 1" x 5 yards, latex free	tan	2/pkg	3.39
AC9200BL	CoFlex Med cohesive bandage, 2" x 5 yards, latex free	blue	each	3.10
AC9200CP	CoFlex Med cohesive bandage, 2" x 5 yards, latex free	color pack	36/case	111.62
AC9200NG	CoFlex Med cohesive bandage, 2" x 5 yards, latex free	neon green	each	3.10
AC9200RD	CoFlex Med cohesive bandage, 2" x 5 yards, latex free	red	each	3.10
AC9200TN	CoFlex Med cohesive bandage, 2" x 5 yards, latex free	tan	each	3.10
AC9300BL	CoFlex Med cohesive bandage, 3" x 5 yards, latex free	blue	each	3.84
AC9300CP	CoFlex Med cohesive bandage, 3" x 5 yards, latex free	color pack	24/case	92.04
AC9300RD	CoFlex Med cohesive bandage, 3" x 5 yards, latex free	red	each	3.84
AC9300TN	CoFlex Med cohesive bandage, 3" x 5 yards, latex free	tan	each	3.84

Elastic Bandages

D5110	Elastic bandage, 2"	each	0.39
D5111	Elastic bandage, 3"	each	0.55
D5112	Elastic bandage, 4"	each	0.71
D5113	Elastic bandage, 6"	each	1.11



Cohesive Flex-Wrap (Medtronic/Covidien)

KE4582TN	Curity™ cohesive bandage, 2" x 5 yards	tan	each	0.99
KE4583C	Curity™ cohesive bandage, 3" x 5 yards	tan	each	1.51



Coban Self-Adherent Wrap (3M)

3M1582	Coban self-adherent wrap, tan, 2" x 5 yards	36/case	81.45
3M1583B	Coban self-adherent wrap, blue, 3" x 5 yards	24/case	68.00
3M1583N	Coban self-adherent wrap, bright color assortment	12/box	34.04



OLAES Modular Bandages

TMOAL-6C	OLAES modular bandage, 6"	each	7.95
TMOAL-4C	OLAES modular bandage, 4"	each	6.95



Oval Eye Pads (Dynarex)

D5320	Oval eye pad	50/box	5.42
KE2841	Curity oval eye pad, sterile, 15/8x 25/8"	50/box	9.42





Multi-Trauma Dressing

A sterile absorbent dressing that cushions and protects.

MD1030-1	Multi-trauma dressing, 10" x 30" (by Dynarex)	each	1.52
KE1967	Multi-trauma dressing, 10" x 30" (by Kendall)	each	3.14
D5220	Multi-trauma dressing, 12" x 30"	each	1.55



Adaptic® Non-Adhering Dressing (Systagenix)

Non-adhering cellulose acetate impregnated with specially formulated petrolatum emulsion permits flow of wound exudate to the absorbent dressing.

JJ2015	Adaptic dressing, 3" x 8"	24/box	37.97
--------	---------------------------	--------	-------



Telfa™ Ouchless Adhesive Dressings (Kendall)

An absorbent cotton pad integrated with unique Telfa "ouchless" dressing that won't stick to the wound.

KE6017	Telfa pads, 2" x 3"	100/box	13.21
KE7643	Telfa pads, 3" x 4"	100/box	24.89



CoFlex® AFD Absorbent Foam Dressing (Andover)

All-in-one foam pad dressing and latex-free cohesive bandage ideal for wound care and emergency care applications. Tan color.

AN9720S	CoFlex AFD absorbent foam dressing, 2" x 2.5 yards	each	7.40
AN9740S	CoFlex AFD absorbent foam dressing, 4" x 2.5 yards	each	12.84
AN9840S	CoFlex AFD absorbent foam dressing, 4" x 7.5 yards	each	12.03
AN9760S	CoFlex AFD absorbent foam dressing, 6" x 2.5 yards	each	9.53



Dyna-Stopper (Dynarex)

A multi-purpose wound and trauma dressing. Additional stretch gauze roll for use as a pressure bandage. Non-stick, expandable pad for wound or burn coverage. The Dyna-Stopper can also be used as an arm sling. Unfolds to 9" x 5½" for extra coverage.

D5225	Dyna-Stopper blood stopping trauma dressing	each	1.74
-------	---------------------------------------------	------	------

Clear Surgical Tape

Ideal for securing I.V. tubing and catheters, primary wound dressings, tubing and drainage lines. Micro perforation allows for bidirectional tearing. Water resistant and hypoallergenic.

D5045	Clear surgical tape, ½" x 10 yards	24/box	7.80
D5046	Clear surgical tape, 1" x 10 yards	12/box	7.80
D5047	Clear surgical tape, 2" x 10 yards	6/box	7.80
D5048	Clear surgical tape, 3" x 10 yards	4/box	7.80



Cloth Surgical Tape

Strong woven construction make this durable tape ideal for securing wound dressings, tubing and drainage lines. Tears easily for convenient application. Moderate stretching ability to accommodate movement and swelling. Breathable and hypoallergenic.

D5040	Cloth surgical tape, ½" x 10 yards	24/box	10.38
D5041	Cloth surgical tape, 1" x 10 yards	12/box	10.38
D5042	Cloth surgical tape, 2" x 10 yards	6/box	10.38
D5043	Cloth surgical tape, 3" x 10 yards	4/box	10.38



Paper Surgical Tape

Paper tape provides superior skin adhesion with minimal irritation. Hypoallergenic. It is highly porous to allow maximum breathability.

D5030	Paper surgical tape, ½" x 10 yards	24/box	4.83
D5031	Paper surgical tape, 1" x 10 yards	12/box	4.83
D5032	Paper surgical tape, 2" x 10 yards	6/box	4.83
D5033	Paper surgical tape, 3" x 10 yards	4/box	4.83



Standard Porous Tape

Provides high tensile strength, excellent adhesion and maximum breatheability.

D5055	Standard porous tape, ½"	24/box	10.61
D5056	Standard porous tape, 1"	12/box	10.61
D5057	Standard porous tape, 2"	6/box	10.61
D5058	Standard porous tape, 3"	4/box	10.61



Curasilk Tape (Kendall)

A strong, versatile silk tape for medium to heavy dressings. Hypoallergenic which reduces the chance of skin irritation and porous to allow the skin to breathe. Tears easily without shredding for speedy application.

KE7137C	Curasilk tape, ½" x 10 yards	24/box	20.14
KE7138C	Curasilk tape, 1" x 10 yards	12/box	19.57
KE7139C	Curasilk tape, 2" x 10 yards	6/box	19.57
KE7140C	Curasilk tape, 3" x 10 yards	4/box	24.40





Curity™ Clear Tape (Kendall)

Transparent tape adheres well to skin and IV tubing. Easily torn across or lengthwise.

KE8533	Curity clear tape, ½"	24/box	13.04
KE8534	Curity clear tape, 1"	12/box	11.40
KE8535	Curity clear tape, 2"	6/box	11.40
KE8536	Curity clear tape 3"	4/box	12.00



Curity™ Standard Porous Tape (Kendall)

Porous design allows ventilation and minimal skin irritation.

KE2304	Curity standard porous tape, ½"	24/box	15.64
KE2531	Curity standard porous tape, 1"	12/box	14.15
KE6613	Curity standard porous tape, 2"	6/box	13.72
KE7046	Curity standard porous tape, 3"	4/box	13.99



Durapore™ Cloth Surgical Tape (3M™)

"Silk-like" cloth tape allows skin to breathe. Hypoallergenic. Convenient bi-directional tear.

3M1538-0	Durapore tape, ½"	24/box	20.20
3M1538-1	Durapore tape, 1"	12/box	20.20
3M1538-2	Durapore tape, 2"	6/box	20.20
3M1538-3	Durapore tape, 3"	4/box	20.20



Micropore™ Paper Tape (3M™)

3M Micropore paper tapes are gentle, hypoallergenic and provides secure adhesion.

3M1530-0	Micropore paper tape, ½"	24/box	12.94
3M1530-1	Micropore paper tape, 1"	12/box	12.94
3M1530-2	Micropore paper tape, 2"	6/box	12.94
3M1530-3	Micropore paper tape, 3"	4/box	12.94



Transpore™ Tape (3M™)

3M Transpore plastic tape is transparent and hypoallergenic.

D5089	Transpore tape, ½"	24/box	18.77
D5090	Transpore tape, 1"	12/box	18.77
D5091	Transpore tape, 2"	6/box	18.77
D5092	Transpore tape, 3"	4/box	18.77



Adhesive Tape Remover Pads (Dynarex)

Aids in the removal of adhesive tapes.

DY1505	Adhesive tape remover pads	100/box	4.76
--------	----------------------------	---------	------

Celox™ Hemostatic Gauze

Celox is a high performance granular hemostatic designed to stop a lethal bleeding fast. It is easy to use, extremely effective (clots blood in 30 seconds), and safe (is a CE Marked Class III Medical Device). Celox does not generate heat and will not burn the casualty or care giver. Celox works independently of the body's normal clotting processes. Its clotting ability has been proven to work in hypothermic conditions and in the presence of common anticoagulants such as Coumadin. Proven to control arterial bleeding within minutes.



SEC42900-A	Celox hemostatic gauze, 6 gram via barrel and plunger (supplied)	each	29.00
SEC42859-15	Celox hemostatic gauze, 15 gram	each	16.14
SEC42859-35	Celox hemostatic gauze, 35 gram	each	26.00
SEC42859-35MIL	Celox hemostatic gauze, 35 gram (olive drab pack)	each	26.00
FG08839011	Celox hemostatic gauze, Z-fold, 5'	each	57.00
FG08838011	Celox hemostatic gauze, Z-fold, 10'	each	43.31

QuikClot® EMS Rolled Gauze (Z-Medica)

Soft, white, sterile 3" x 48" nonwoven rolled gauze impregnated with kaolin 4 foot length. Developed for rapid deployment. Easy-rip package designed for faster opening and rapid deployment. Roll format for easily packing and wrapping wounds.



ZMQC475	QuikClot EMS rolled gauze	each	19.98
---------	---------------------------	------	-------

QuikClot® EMS 4x4 Dressing (Z-Medica)

Soft, white, sterile 4" x 4", 4-ply nonwoven gauze impregnated with kaolin. Easy-rip package designed for faster opening and removal.



ZMQC473	QuikClot EMS 4x4 dressing	3/pk	29.99
---------	---------------------------	------	-------

QuikClot® 1st Response® (Z-Medica)

QuikClot 1st Response hemostatic agent stops bleeding fast with the power of zeolite, a natural mineral that accelerates the clotting process. The product is a self-contained clotting sponge made of hydrated beads of zeolite, which rapidly stop bleeding. Indicated for temporary external use to control traumatic bleeding. Simply open the package and apply clotting sponge to the wound and hold pressure.



ZMQC102	QuikClot 1st Response, 25g sponge	5/box	39.99
---------	-----------------------------------	-------	-------

QuikClot ACS+® (Z-Medica)

When time is critical, just rip open a packet of Quik Clot ACS+, pack the self-contained sponge into the wound, and the bleeding stops rapidly. The sponge can be packed to conform to the shape of the wound and is easily removed in the hospital setting.



ZMQC100	QuikClot ACS+	each	29.99
---------	---------------	------	-------



Fire Blanket Plus (Water-Jel)

A full-size blanket that adequately covers a patient and can be used to extinguish flames and smoldering clothes or dangerous white phosphorous. The durable, easily identifiable canister protects the blanket from outside elements. Directions for use clearly defined on canister label. Shelf life - 5 years from date of manufacture.

WJ7260C	6' x 5' in orange canister	each	186.84
WJ7260P	6' x 5' in foil pouch	each	186.84



Sterile Burn Sheet (Gam)

D5020	Sterile disposable burn sheet, 60" x 96", blue	each	3.22
-------	------------------------------------------------	------	------



Burn Sheet (Roehampton)

Roehampton sterile burn sheets are non-woven. The burn sheets are made of laminated tissue fibers that provide a sterile environment to protect the patient from infection.

D5021	Burn sheet, disposable, sterile, 60" x 90", blue	each	7.50
-------	--------------------------------------------------	------	------



Polypropylene Burn Sheet (Allcare)

A disposable sterile blanket that measures 60" x 96". Sheet is tear resistant.

BS100	Burn sheet, polypropylene, 60" x 96"	each	2.17
-------	--------------------------------------	------	------



Burn Dressings (Water-Jel)

Water-Jel Burn Dressings provide fast, one-step relief for emergency first aid when someone has been burned. The dressing stops burn progression and cools the skin, relieves pain and protects against airborne contamination.

WJ0206	Water-Jel burn dressing, 2" x 6"	each	6.83
WJ0404	Water-Jel burn dressing, 4" x 4"	each	8.27
WJ0416	Water-Jel burn dressing, 4" x 16"	each	16.89
WJ0818	Water-Jel burn dressing, 8" x 18"	each	24.70
WJ0820	Water-Jel burn dressing, 8" x 20", hand	each	32.29
WJ1216	Water-Jel burn dressing, 12" x 16", face	each	32.29

Trauma/Burn Towel Dressings (LSP)

LSP Trauma/Burn Towel Dressings are designed for wet or dry emergency first aid treatment of burns, abrasions and skin irritations.

LSP830-056	Burn sheet, 15" x 20"	6/box	50.05
LSP830-054	Burn towel, 12" x 12"	6/box	35.88
LSP830-058	Burn towel, 20" x 30"	6/box	68.68
LSP830-066	Burn dressing face mask	6/box	52.36



Burn Jel (Water-Jel)

Unlike petroleum products that can actually trap the heat in a burn, this water-based, water-soluble gel actually draws the heat away from the skin and dissipates it on contact. It relieves pain fast and cools and soothes the affected area. Contains active ingredient - 2% Lidocaine.

WJ100U	Burn Jel, 3.5g unit dose packs	6/box	8.14
WJ600U	Burn Jel, 3.5g unit dose packs	25/box	33.72
WJB4	Burn Jel, 4oz squeeze bottle	each	11.25



Burn Kits

Economy Kit (Southeastern)



- 15" x 20" burn sheets (2)
- 1" cloth tape (2 rolls)
- normal saline, 1000ml (2 bottles)
- bandage scissors (1)
- 60" x 96" burn sheets (2)
- burn face masks (2)
- 20" x 30" towels (2)
- 12" x 12" burn towels (2)
- rolls of gauze (2)
- heavy cordura nylon case with web handle

Item D5005, Burn care kit, each.....100.00

Item RB177YL, Burn care bag only, yellow, each.....\$28.92

Soft-Sided Kit (Water-Jel)



- 12" x 16" burn dressing (2)
- 4" x 16" burn dressing (2)
- 4" x 4" burn dressing (2)
- 3" rolls of gauze (2)
- scissors (1)
- instruction card (1)
- soft-sided, heavy-duty carry case (1)

Item WJEBK1, Soft-sided burn kit, small each119.15

Soft-Sided Kit w/Fire Blanket (Water-Jel)



- 4" x 4" burn dressing (3)
- 4" x 16" burn dressing (1)
- 8" x 18" burn dressing (1)
- 12" x 16" burn dressing with pre-cut holes for facial burns (1)
- 36" x 30" fire blanket/burn wrap (1)
- sterile gauze roll 3" x 4 yds (3)
- scissors (1)
- instruction card (1)
- soft-sided, heavy-duty carry case (1)

Item WJEBK2, Soft-sided burn kit with fire blanket, each\$232.37



First Aid and Personal Items

First Aid Kits



pages 302-303

Instruments



pages 304-305

Personal Items



pages 306-307

Cold and Hot Packs



pages 308-309

Solutions



page 309-310

Eye Care



pages 310-311

Sting and Bite



pages 312

Supplies



page 313-316



50-Person Weatherproof Plastic First Aid Kit (Pac-Kit)

This 50-person weatherproof first aid kit has a plastic case. Gasket seal keeps contents free of dust and moisture. Neat, orderly interior packaging makes contents easy to locate and use. OSHA-compliant box has easy carry handle or is wall mountable. Contains 207 pieces:

- 1" x 3" adhesive strips (100)
- fabric knuckle bandages (5)
- fabric finge tip bandages (5)
- fabric extra large strips (5)
- 3" x 3" gauze pads (4)
- 4" x 4" gauze pads (4)
- large wound pad (1)
- 2" gauze bandage (1)
- 4" gauze bandage (1)
- triangular bandage (1)
- adhesive tape (1)
- eye pads with strips (2)
- exam gloves (4)
- antiseptic wipes (30)
- first aid/bu n cream packets (6)
- triple antibiotic ointment packets (6)
- pain relief tablets (24)
- 4 oz. eyewash (1)
- cold packs (2)
- 2" elastic bandage (1)
- scissors (1)
- forceps (1)
- first aid guide (1)

S3851P 50-person first aid kit, weatherproof plastic case each 29.45



25-Person Weatherproof First Aid Kit (Pac-Kit)

This 25-person first aid kit keeps contents free from dust and moisture. OSHA-compliant box has easy carry handle or is wall mountable. Available in weatherproof stainless steel or plastic cases. Contains 143 pieces:

- 1" x 3" adhesive strips (60)
- fabric knuckle bandages (4)
- fabric finge tip bandages (5)
- 4" gauze pads (5)
- large wound pad (1)
- 4" gauze bandage (1)
- triangular bandage (1)
- adhesive tape (1)
- exam gloves (4)
- BZK antiseptic wipes (30)
- first aid/bu n cream packets (6)
- triple antibiotic ointment packets (6)
- 4 oz. eye wash (1)
- eye pads with strips (2)
- pain relief tablets (12)
- cold pack (1)
- scissors (1)
- forceps (1)
- first aid guide (1)

PK6100 25-person first aid kit, weatherproof stainless steel case each 26.83

S3852P 25-person first aid kit, weatherproof plastic case each 20.75

10-Person Plastic First Aid Kit (Pac-Kit)

This 10-person first aid kit features thermoformed interior tray to keep items neatly organized and accessible. It meets ANSI standards. It is wall mountable and includes a carrying handle. Contains 57 pieces:

- 1" x 3" adhesive strips (16)
- fabric finge tip bandages (2)
- fabric knuckle bandages (2)
- 3" gauze pads (4)
- large wound pad (1)
- 2" gauze bandage (1)
- triangular bandage (1)
- adhesive tape (1)
- exam gloves (4)
- BZK antiseptic wipes (10)
- first aid/bu n cream packets (6)
- triple antibiotic ointment packets (6)
- scissors (1)
- forceps (1)
- first aid instru tions (1)

PK90754 10-person first aid kit, plastic case each 22.50



Family First Aid Kit (WNL Products)

This innovative first aid kit is two kits in one. The complete kit features 5 zippered interior pockets, arranged by emergency category. Each pocket lists the contents on one side while the other side is clear to view pocket contents. Two of these zippered pockets can be removed to form its own compact first aid kit. The main kit is padded and includes a convenient webbed carry handle and a belt loop in back. This kit contains 108 pieces—enough for 8-10 people.



- combine pads 5" x 9" (2)
- pair scissors (1)
- pair tweezers (1)
- finger tip bandages (2)
- knuckle bandages (2)
- adhesive bandages 3/4" x 3" (25)
- adhesive bandage 2" x 4 1/2" (1)
- adhesive bandages 1" x 3" (5)
- adhesive bandages 3/8" x 1 1/2" (26)
- adhesive bandages 1.5" x 1 1/2" (5)
- wrapped rolled gauze 3" (1)
- wrapped rolled gauze 4" (1)
- first aid tape 1" x 10 yds. (1)
- sterile gauze pads 3" x 3" (5)
- sterile gauze pads 4" x 4" (5)
- triple antibiotic packets 0.9gm (5)
- BZK towelettes (5)
- hydrocortisone packs 0.9gm (2)
- hand sanitizer packs 0.9gm (4)
- emergency blanket (1)
- NexTemp thermometer (1)
- Patho-Shield Plus CPR barrier (1)
- triangular bandages (1)
- instant cold pack (1)
- vinyl gloves (pair)
- first aid instruction guide (1)

WNLFAK4100 Family first aid kit each 19.95



Raptor Medical Shears (Leatherman)



The Raptor combines six tools in one device in a polymer holster.

- **420HC stainless steeling folding medical shears**—Features serrations to help grip materials for a strong, fast cut. Shears also come apart for cleaning and maintenance.
- **Strap cutter**—An improved, high-carbon (HC) form of 420 stainless steel that works well with high production tooling.
- **Ring cutter**—The specially-designed cutter is placed under a ring made of soft metal, like gold, and used like scissors to remove it.
- **Ruler (5 cm)**—A precise measuring guide for determining length, up to 5 centimeters.
- **Oxygen tank wrench**—A rectangular cutout used to slot over an oxygen tanks to open; ideal for EMS, fire department or first responder use.
- **Carbide glass breaker**—A small, pointed tip made of carbide, a very hard material, which is ideal for shattering auto glass

LT831741	Raptor medical shears with MOLLE-compatible injection-molded polymer holster, black	each	80.00
LT832168	Raptor medical shears with utility holster, black	each	80.00

Para-Med Shears (Magnum Medical)



Designed to cut everything from sheet metal to gauze. Made of cold forged stainless steel.

A4515BK	Para-Med shears, 7 1/4" with carabiner	black	each	3.85
A4500	Para-Med shears, 7 1/4"	black	each	2.00
A4501	Para-Med shears, 7 1/4"	blue	each	2.00
A4506	Para-Med shears, 7 1/4"	green	each	2.00
A4503	Para-Med shears, 7 1/4"	orange	each	2.00
A4505	Para-Med shears, 7 1/4"	pink	each	2.00
A4507	Para-Med shears, 7 1/4"	purple	each	2.00
A4502	Para-Med shears, 7 1/4"	red	each	2.00
A4504	Para-Med shears, 7 1/4"	yellow	each	2.00
A4514	Para-Med shears, 5 1/2"	black	each	1.31
A4514BL	Para-Med shears, 5 1/2"	blue	each	1.31
A4514GR	Para-Med shears, 5 1/2"	green	each	1.31
A4514OR	Para-Med shears, 5 1/2"	orange	each	1.31
A4514RD	Para-Med shears, 5 1/2"	red	each	1.31

Medicut 7 1/4" Shears (ADC)



- Stainless steel safety bandage tip
- Razor sharp, super-hardened surgical stainless steel blades with one serrated edge to cut through the toughest materials
- Blades tempered to a Rockwell hardness of C56 for unsurpassed durability

ADC320BK	Medicut 7 1/4" shears, black	each	4.99
ADC320NP	Medicut 7 1/4" shears, neon pink	each	4.99

Bandage Scissors And Forceps (Magnum Medical)

A4521	Bandage scissors, 5 ½"	each	1.14
A4520	Bandage scissors, 7 ½"	each	2.12
A4522	Forceps, straight Kelly, 5 ½"	each	1.23
A4523	Forceps, curved Kelly, 5 ½"	each	1.23
A4530	Forceps, splinter sharp points	each	0.77



Umbilical Cord Scissors and Clamp (Magnum Medical)

G4353	Umbilical cord scissors	each	2.38
G4351	Umbilical cord clamp	each	0.54



Magill Forceps (Maco International)

N7131	Magill forceps, adult	each	4.62
N7132	Magill forceps, child	each	4.62



Splinter Forcep With Magnifie (Magnum Medical)

Enlarges view of splinter. Adjustable magnifier comes with protective case.

A4531	Splinter forcep with magnifie	each	1.52
-------	-------------------------------	------	------



Thumb Forceps (Magnum Medical)

Heavy duty stainless steel forceps, 5 ½"

A4524	Thumb forcep	each	0.80
-------	--------------	------	------



Disposable Scalpels (Dynarex)

Sterile, disposable, efficient and economical.

DY4110	Disposable scalpel, size 10	10/box	7.15
DY4111	Disposable scalpel, size 11	10/box	7.15
DY4112	Disposable scalpel, size 12	10/box	7.15
DY4115	Disposable scalpel, size 15	10/box	7.15



Safety Scalpels (BD)

Features locking retractable shield to minimize the risk of blade injuries.

BD372610	Safety scalpel, size 10	10/box	29.12
BD372611	Safety scalpel, size 11	10/box	29.12
BD372615	Safety scalpel, size 15	10/box	29.12

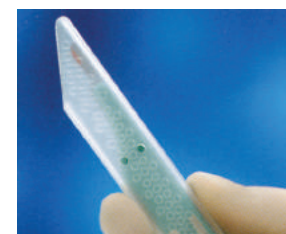



Adlite II® Penlight (ADC)

- Reusable penlight with attractive tapered barrel
- Measures 5" long, ½" diameter
- Activated by depressing pocket clip
- Uses two "AAA" batteries (included)

S3603	Adlite II penlight	each	3.39
-------	--------------------	------	------



Disposable Penlight (Southeastern)

High intensity penlight with pupil gauge

S3604	Disposable penlight with pupil gauge	each	1.10
ADC351P	Adlite disposable penlight with pupil gauge	6/pkg	9.99



Professional Rescue Kit and Holster (Southeastern)

Holster made of super tough nylon for unsurpassed durability. Items in holster:

- Kelly forceps, 5 ½"
- Paramedic scissors, 7"
- Penlight
- Bandage scissors, 5 ½"
- Knife
- Tourniquet

A4619	Professional rescue kit and holster	each	25.00
A4620	Holster only, blue	each	6.00
A4620B	Holster only, black	each	6.00



Responder Jr. Holster Only (ADC)

- Supertough water repellent 600D nylon lined with 8mm of cushioning foam
- Snap open belt loop reinforced with hook and loop adhesive
- 1 deep slide-in pocket in back; 2 half-width slide-in pockets in front
- Measures 7 ¼" x 2 ¾" x ½"
- One-year warranty

ADC205BK	Responder Jr. holster, vertical	each	6.70
ADC215BK	Responder Jr. holster, horizontal	each	6.70



Glove Pouch (R&B Fabrications)

- Holds four pair of gloves.
- Size 4" x 3"
- Conforms to the contour of your belt

A4750	Glove pouch, black	each	6.23
-------	--------------------	------	------

TRECK+ EMS Tool (Talon Rescue)

The TRECK+ is an alternative to trauma shears and seat belt cutters designed to simultaneously remove multiple layers of clothing without the use of trauma shears. TRECK+ works most effectively when drawn away from the patient using your wrist and arm. This gives access to wounds quickly, safely and easily.



- Slices multiple layers of clothing in one simple motion
- No blade changes (replace your TRECK+ about half as often as shears)
- Patented, corrosion-resistant, Teflon coated razor blade
- Five cutting surface layers, so it stays sharp longer than any other razor blade
- Safer and faster than shears

TRECK+HOLSTER	TRECK+ EMS tool with holster and sheath	orange	each	11.00
TRECK+	TRECK+ EMS tool	orange	each	11.50

Seat Belt Cutter (Magnum Medical)

A lightweight seat belt cutter. Will easily cut through webbing and cords with ease. Manufactured from high impact plastic with hardened stainless steel blade. 4.75" x 1.75".



M6503	Seat belt cutter		each	1.46
-------	------------------	--	------	------

Window Punches

- Specially hardened replaceable steel tip tempered to a Rockwell hardness of C60 resists dulling
- Force is adjustable by twisting rear cap for precise control
- Lightweight corrosion-resistant aluminum barrel has a knurled finish or positive grip
- Removable pen-type pocket clip

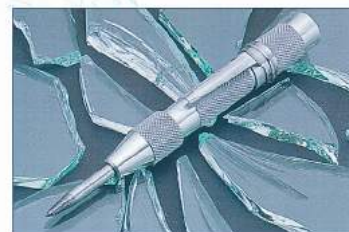

M6500	Window punch (by Magnum Medical)		each	3.08
ADC360	Window punch (by ADC)		each	11.24

Ring Cutter

A handy tool when a ring is difficult to remove. A lever slides a protective plate under the ring, and a thumb screw operates a miniature cutting wheel to saw through the ring band.



ADC380	Ring cutter (by ADC)		each	25.73
A4510	Ring cutter (by Magnum Medical)		each	5.94
A4511	Ring cutter blades (by Magnum Medical)		each	1.62



Rapid Heat and Cold Packs (Rapid Deployment)

Rapid Heat and Cold Packs' instant activation provides heat exceeding 130 degrees and cold below 32 degrees F. No more impact activation, leakage on patients or failures during storage. Features a convenient slip-off clip that activates the heat pack without impact. Zero percent failure guarantee ensures that Rapid Heat and Cold Packs will work every time.

S3545	Rapid Cold cold pack	24/case	29.40
S3546	Rapid Heat heat pack	24/case	32.51



Ice Kold (Duro-Med)

Soft, disposable cold packs provide instant relief. Operates at below 32 degrees F for approximately 30 minutes.

- Large bag measures 6"W x 8 1/4"H
- Remains cold approximately 30 minutes
- Easy to activate
- Useful for treatment of swelling, burns, nose bleeds, headaches and other injuries
- Has long shelf life

S3521	Ice Kold cold compress, 6" x 8 1/4"	24/case	14.76
S3522	Ice Kold cold compress, junior size	each	0.55



InstaKool™ Instant Cold Pack (Nortech Labs)

InstaKool Instant Cold Pack delivers immediate cold therapy for first aid, providing comfort and reducing swelling after an injury. This revolutionary formula is the first instant cold pack with National Security and Safety in mind. InstaKool is a urea-based formula that is ammonium nitrate-free and rivals the temperature ranges of previous cold packs. Exceeds American National Standard - Minimum Requirements for Workplace First Aid Kits (ANSI Z308.1-1998).

NLTKINST5748	InstaKool cold pack, 5" x 7"	each	0.80
NLTKINST6824	InstaKool cold pack, 6" x 8"	24/case	21.60



Kwik-Kold® Instant Cold Packs (Cardinal)

These single-use instant cold packs offer a convenient and cost-effective method of delivering localized cold therapy. Ready when you need them, the cold packs require no special preparation or refrigeration. Store them at room temperature and activate them in an instant with a firm squeeze and a gentle shake. Approximate peak temperature and therapeutic time duration: 33 degrees F, 30 minutes.

S3600	Kwik-Kold instant cold pack	16/case	8.83
S3601	Kwik-Kold instant cold pack	each	0.87

Instant Hot Pack (Dynarex)

- Provides soothing warmth
- Flexible material conforms to body contours
- Ideal for applications such as neck pain, arthritis, back injuries and shoulder injuries
- Treat muscle strains, aches, tension and cramps

S3527	Instant hot pack	24/case	13.85
-------	------------------	---------	-------



Kwik-Heat Instant Hot Pack (Cardinal)

This instant hot pack provides a safe, therapeutic temperature of 110 degrees F, with an approximate duration of 30 minutes.

S3602	Kwik-Heat instant hot pack	12/case	9.97
-------	----------------------------	---------	------



First Aid Spray (Pac-Kit)

Medicated spray to help relieve pain from minor burns. Also contains antiseptic to help prevent infection from burns, minor cuts and abrasions. Water soluble and non-staining.

S3715	First aid/burn spray, 4 oz pump	each	3.18
-------	---------------------------------	------	------



Alcohol Prep

Alcohol prep pads are absorbent non-woven cotton pads saturated with 70% isopropyl alcohol. Individually sealed in a foil packet.

KES3511	Alcohol prep pads, medium	200/box	2.36
S3510	Alcohol prep pads, medium	100/box	1.46
PK12-110	Alcohol prep pads, medium	100/box	2.46
S3512	Alcohol prep pads, large	100/box	3.00





Rubbing Alcohol

S3710	Rubbing alcohol, 70% ISO, 16 oz container	each	1.51
-------	-------------------------------------------	------	------



Hydrogen Peroxide

S3720	Hydrogen peroxide, 8 oz container	each	0.84
S3711	Hydrogen peroxide, 16 oz container	each	0.59
MDS098002	Hydrogen peroxide, gallon	4/case	37.44



Morgan® Lens (MorTan)

When an eye emergency happens, outdated lavage procedures can be catastrophic to the patient. The Morgan Lens is molded to fit the unique curvature of the eye and equipped with directional fin, attached tubing and an adapter. The Morgan Lens provides gentle, thorough, hands-free ocular irrigation and/or medication to the cornea and conjunctiva.

MT2000	Morgan lens	each	30.54
MT202	Morgan lens delivery set	each	8.08

Eye Magnet With Loop (Magnum Medical)



Strong magnet attracts loose metal particles when held 1/4" to 1" from the eye. Nylon loop picks up nonmetallic materials such as wood, aluminum, etc.

A4525	Eye magnet with loop	each	4.76
-------	----------------------	------	------

Eye Flush Solution



S3502	Eye flush solution, 1 z	each	2.23
S3508	Eye flush solution, 4 z	each	2.43
PK24-101	Eye flush solution, 16 z	each	6.77
PK24-201	Eye flush solution, 32 z	each	10.19
PK24-102	Eye flush station with wall mount. Includes two 16 oz bottles and eye cup.	each	20.95

Eye Care Kit (Pac-Kit)

- sterile eye pads (4)
- adhesive eye strips (4 sets)
- 4 oz eye flush bottle (1)
- sterile eye cup (1)

PK7-600	Eye care kit	each	5.12
---------	--------------	------	------



FOX EyeShield (Graham-Field)

- Lightweight 1060 aluminum
- Perforate convex eye shield with slots
- Autoclavable

13-1276	FOX EyeShield	12/box	13.00
---------	---------------	--------	-------



Sterile Eye Cups (Pac-Kit)

For use in eye irrigation treatment. Contains 10 individually wrapped sterile eye cups, capacity 0.75 fl z.

PK7-110	Sterile eye cups	10/box	7.65
---------	------------------	--------	------



- Download **FREE Layar App** (from your App Store)
- [Scan this page](#)
- [View custom product info](#)

Bring catalog pages to life

View additional content about selected products throughout our catalog by using your mobile device to scan pages that display the AR graphic (left). To get started, simply download the free “Layar” app from your device’s App store.



Bee Sting Swabs (Pac-Kit)

Provides immediate relief of stings caused by wasps, bees, hornets, mosquitoes, etc. Non-toxic formula reduces pain and contains a germicide to prevent secondary infection. Sterile package.

S3500	Bee sting swabs	10/box	3.80
S3501	Bee sting swabs	100/box	34.18



Sting Relief (Safetec)

Provides temporary relief from pain and itching caused by insect stings and bites. Simply apply to the affected area and feel relief fast; dries instantly. If you can stop the urge to itch, you can reduce your chance of a secondary infection. Also works great to cleanse and numb the skin to a needle stick.

S3499	Sting Relief, 2oz spray bottle	each	3.15
-------	--------------------------------	------	------



Splinter and Tick Removal Kit (Pac-Kit)

Portable splinter and tick removal kit fits easily i to pocket. Includes tick identific tion card to help protect against Lyme Disease.

S3816	Splinter and tick removal kit	each	13.54
-------	-------------------------------	------	-------



Snake Bite Kit (Pac-Kit)

This kit is packaged in plastic telescoping carrying case. It contains:

- venom extraction pump (1)
- tourniquet (1)
- antiseptic wipes (2)
- disposable scalpel (1)
- ammonia inhalants (2)
- adhesive strips (2)
- instructions (1)

S3815	Snake bite kit	each	23.36
-------	----------------	------	-------

Ointments and Gels

DY1171	Bacitracin zinc 0.9 gram foil packet	144/box	13.85
PK13-011	Burn Jel packets, 1/8oz	6/box	8.14
S3714	First aid cream, 1/8oz foil pack	6/box	1.95
PK18-125	Hydrocortisone, 0.9 gram	25/box	3.54
DY1137	Hydrocortisone 1%, 0.9 gram foil packet	144/box	14.04
S3716	Lubricating jelly, 3 gm, sterile	144/box	6.69
S3717	Lubricating jelly, 4 ¼ oz flip-top tube	tube	1.47
23769	Neosporin, 1/32oz foil pack	144/box	40.34
DY1129	Triple antibiotic ointment, 1 oz tube	each	2.68
PK12-001	Triple antibiotic ointment, 1/2 m packet	12/box	1.86
S3514	Triple antibiotic ointment, 1/2 m packet	144/box	12.60



Ammonia Inhalants (Pac-Kit)

Each ampule is encased in a knitted sleeve and securely fastened at both ends. Ammonia inhalants will perform instantly when needed.

S3503	Ammonia inhalant	10/box	2.86
S3504	Ammonia inhalant	100/box	23.37



Cotton Applicators

DY4303	Cotton-tipped applicator, 3", sterile, 2 per pack	100/box	3.60
DY4305	Cotton-tipped applicator, 6", sterile, 2 per pack	100/box	3.39
D5479	Cotton-tipped applicator, 6", non-sterile	100/bag	0.50



Facial Tissue (Kleenex)

21400	Facial tissue, Kleenex brand	100/box	1.77
-------	------------------------------	---------	------



Medicine Cups

115-CH	Medicine cup, paper, 5 oz, bubble design (by Medicom)	1000/case	52.00
P250500	Medicine cup, plastic, 1 oz (by Proadvantage)	100/pkg	0.98





Lemon-Glycerin Swabs (Dynarex)

Relieves dryness and cracking of patients with restricted oral intake. Saturated with 50% lemon juice and 50% glycerin. 3 per packet, 25 packets per box.

S3520	Lemon-glycerin swabs, 3 per packet	25/box	3.62
-------	------------------------------------	--------	------



Nail Polish Remover Pads

Aids in the removal of adhesive tapes. Leaves the skin free of tape residue. Non-irritating, reduces patient discomfort.

S3509	Nail polish remover pads	100/box	4.62
-------	--------------------------	---------	------



Adhesive Tape Remover Pads (Dynarex)

Aids in the removal of adhesive tapes. Leaves the skin free of tape residue. Non-irritating, reduces patient discomfort.

DY1505	Adhesive tape remover pads	100/box	4.76
--------	----------------------------	---------	------



Povidone Iodine (Dynarex)

This antiseptic is used to treat and prevent infection in wounds. It is commonly used in first aid for minor cuts, grazes, burns, abrasions and blisters.

S3719	Povidone Iodine swabsticks	50/box	6.38
S3900	Povidone Iodine wipes	100/box	4.61
S3902	Povidone Iodine, swab ampules	10/box	5.40
S3901	Povidone Iodine, 16oz bottle	bottle	3.22

Obstetrical Kits (Dynarex)

A complete disposable OB kit with all the necessary components for emergency use. Contains:

- alcohol preps, medium (2)
- disposable towels (4)
- drape sheet (1)
- nylon tie-offs (2)
- o.b. towelettes (2)
- sterile vinyl exam gloves (pair)
- plastic bag to hold placenta (1)
- receiving blanket (1)
- sterile bulb syringe (1)
- sterile disposable scalpel (1)
- sterile gauze sponges (6)
- sterile o.b. pad (1)
- sterile umbilical clamps (2)
- twist ties (2)
- underpad (1)



G4350	OB kit, hard pack	each	8.15
G4352	OB kit, soft pack	each	10.00

Prep Razor

- double sided fi ed-head razor
- precision stainless steel blade for smooth shaving
- contoured handle for comfortable grip
- non-sterile



DY4251	Gallant prep razor	50/box	22.77
DYND70837	Prep razor, 2-sided, fi ed head	each	0.44

Save-A-Tooth®

Without proper care, the roots of a knocked-out tooth will die in 15 minutes. Even when re-implanted quickly, a tooth that has been handled improperly may be rejected, leading to a lifetime of bridgework repairs. Both children and adults suffer. Saving a tooth in milk is not an effective solution. With its use, over 90 percent of knocked-out teeth can be retained for life.



SAV-A-TOOTH	Save-A-Tooth	each	15.38
-------------	--------------	------	-------

Tincture Of Benzoin (PDI)

Contains compound Benzoin Tincture U.S.P. Containing 77% alcohol, assures good adhesion for tapes. Protects against skin breakdown.

S3811	Tincture of Benzoin, 4.75oz. pump spray	each	26.87
S42450	Tincture of Benzoin, swabstick	50/box	12.59





Ear Plugs

S3040	Softplugz ear plugs with cord	pair	0.20
AOS3111114	3M E-A-R-Express ear plugs with cord	pair	1.03



Tweezers, Disposable (Magnum Medical)

MM052391	Tweezers, disposable, individually wrapped	100/pkg	14.06
----------	--------------------------------------------	---------	-------



Wooden Tongue Depressors (Dynarex)

- precision cut, polished smooth edges
- sturdy, uniform in size and color
- packed in convenient sterile peel-down pouches

DY4312	Wooden tongue depressors	500/box	4.58
S3706	Wooden tongue depressors	100/box	3.65



Batteries, Alkaline

ST65030	"AAAA" battery	each	1.31
T1949	"AAA" battery	each	0.54
T1950	"AA" battery	each	0.52
T1951	"C" battery	each	0.97
T1952	"D" battery	each	1.00

Financing available to all qualified buyers.

Ambulances and Rescue Trucks



Remounts



Defibrillators and Monitors



EMS Equipment



MCI, Rehab and Mortuary Trailers



Portable Buildings, Shelters and Coolers

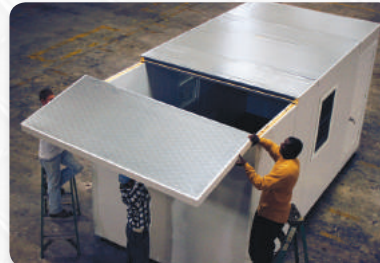

- Lower financed rates
- No down payment
- Deferred first payment available
- Terms from 1 to 7 years
- Monthly, quarterly, semi-annually and annually

For more information or to request a credit application, please call



(800) 334-6656



(866) 640-2028



Equipment Bags and Cases

Trauma



pages 320-324

Oxygen/Trauma



pages 326-327

Oxygen



pages 328-330

Bags and Packs



pages 332-341

Intubation Modules



pages 341-344

Medication Modules



pages 345-346

IV Modules



pages 346-347

Meret Bags



pages 348-350

Kits and Cases



pages 351-353



Premium Large Professional Trauma Bag (Kemp USA)

This popular bag featuring replaceable bottoms has been redesigned using 1680 Denier Ballistic Nylon to increase durability. High stress points have been reinforced with bartack and cross stitched. Also added are easy to access high visibility reflective zip pulls and a higher visibility reflective trim, while all of the standard features remain. It includes optimum organization, like a front pocket organized with elastic loops and pouches, an external, easy-access top pocket, and an internal pouch; suitable to accommodate the most modern supplies used by emergency professionals. This bag comes with all metal black nickel hardware, tuck-away padded backpack harness, as well as a gel foam padded shoulder strap. Dimensions: 17.5" x 13" x 10"; Weight: 5 lbs

KB10-104PRE-BL	Premium large professional trauma bag, navy	each	89.15
----------------	---------------------------------------------	------	-------



Large Professional Trauma Bag (Kemp USA)

Kemp's first and most popular bag features replaceable bottoms, dual-density structural foam and strong nylon construction. Optimum organization accommodates the most modern supplies used by emergency professionals. This bag contains a front pocket organized with elastic loops and pouches; an external, easy-access top pocket; and an internal pouch. Also comes with a tuck-away backpack harness and is compatible with mini-kits. This bag is made with 600D nylon. 22 1/2" L x 14 1/2" W x 14 1/2" H

KB10-104-RB	Large professional trauma bag, royal blue	each	70.77
KB10-104-032	Large professional trauma bag, red	each	70.77



Ultra EMS Bag (Kemp USA)

With eight compartments, extra pockets and strapping, everything stays in its place and organized. This bag even has an additional pocket on each end for extra storage. Two removable zippered pouches with transparent window are attached to the top flap with Velcro. This bag is made with 600D durable nylon with a reflective white stripe all the way around the bag for high visibility at night. The bottom has feet to protect from wear and tear, and it comes with padded nylon duffel handles and an adjustable shoulder strap. The water-resistant nylon is easy to clean. 17" L x 16" W x 25" H.

KB10-110-RD	Ultra EMS bag, red	each	84.62
-------------	--------------------	------	-------



Responder Bag (Kemp USA)

The Kemp Responder Bag comes with several movable dividers on the inside of the large compartment. It also has elastic loops to store supplies and a large storage pouch on the outside. This bag comes with molded feet on the bottom for extra protection and a shoulder strap. 15" L x 15" W x 7" H.

KB10-111-RB	Responder bag, royal blue	each	38.46
-------------	---------------------------	------	-------

Tuff ottom Trauma Bag (R&B Fabrications)

The Tuff ottom trauma bag offers ample storage and durability. The outside has two side storage compartments with double self healing zippers, a divider and elastic storage straps for small items. A glove storage pouch is on the top for easy access. The top of the case opens with double self healing zippers to open completely for access to internal storage. There are two zippered clear plastic compartments in the top with a semi-rigid nylon storage divide for ample trauma supplies. A molded handle on the end of the bag makes it easy to pull from storage compartments. The bottom is protected by a waterproof Tuff Bottom. 18”L x 9”D x 11.5”H. Contents not included.



RB929IM-OR	Tuff ottom trauma bag, orange	each	48.46
------------	-------------------------------	------	-------

Responder 84 ALS Backpack (5.11 Tactical)

Modeled after the legendary 5.11® RUSH Backpack series, the Responder 84 ALS™ EMS Backpack is designed to provide first responders with EMS-specific storage in a highly mobile, highly functional frame. The 84 ALS features removable color-coded Airway Kit and IV Kit packs for fast treatment, multiple internal mesh pockets for quick visual ID and fast access to your critical tools, and adaptable Tank-Trap system for secure storage of a full-sized O₂ tank.



511-56936-694-BAG	Responder 84 ALS backpack, alert blue	each	239.99
511-56936-328-BAG	Responder 84 ALS backpack, sandstone	each	239.99

Responder ALS 2900™ Bag (5.11 Tactical)

Engineered with feedback from EMS professionals in the field, the Responder ALS (Advanced Life Support) 2900 series provides first responders with a comprehensive and reliable storage solution that keeps everything you need within reach. The ALS 2900 features four removable color-coded EMS kit bags: an Airway Kit (blue), IV Kit (red), Advanced Drug Case, and Basic Drug Case, granting you access to the tools you need quickly and efficiently. A fold out front organizer with mesh pockets keeps smaller accessories in sight, multiple external pockets offer adjustable dividers for adaptable storage, and a removable heavy-duty garage secures a full sized oxygen tank. The adjustable shoulder strap/backpack system supports multiple carry options, and MOLLE/5.11 SlickStick® web platforms on both sides allow you to customize your loadout as you see fit.



511-56933-694-BAG	Responder ALS 2900 bag, alert blue	each	314.99
-------------------	------------------------------------	------	--------

Responder BLS 2000™ Bag (5.11 Tactical)

The Responder BLS (Basic Life Support) 2000 Bag is a sturdy and efficient first responder bag that keeps all your essential tools within easy reach. Designed for rugged use in demanding environments, the Responder BLS 2000 Bag offers significantly more space and customization than standard EMS trauma bags while remaining lightweight and easy to carry. A stadium-style fold out front features mesh pockets for easy organization and quick ID of critical gear, two tear-out front pockets can be used for second stage treatment or delegated triage, and a roomy side-access central pocket holds a full-sized oxygen tank. An adjustable shoulder strap/backpack system supports multiple carry options, and MOLLE/SlickStick web platforms on both sides allow you to customize your loadout as you see fit.



511-56934-694-BAG	Responder BLS 2000 bag, alert blue	each	209.99
-------------------	------------------------------------	------	--------



RED 8100 Duffel (5.11 Tactical)

5.11 RED (Responder’s Every Day) 8100 fi e bags are engineered to provide fi e profes- sionals with a durable, lightweight, and highly functional carryall that provides maximum utility and reliable resilience in harsh environments. The large main storage compartment features a light colored interior for quick visual recognition of your gear and an interior hanging pocket for accessories, while the durable grab-and-go handles and non-slip pad- ded shoulder strap offer multiple carry options. Robust YKK® zippers with oversized pulls are quick and reliable with or without gloves, and a water resistant coating keeps your gear safe and secure in any setting.

511-56878-474-BAG	RED 8100 Duffel, fi e red	each	79.98
-------------------	---------------------------	------	-------



Tapered pockets reduce wear and tear.

Ultra Sofbox Plus Trauma Bag (Iron Duck)

The Ultra Sofbox Plus has sleek tapered exterior pockets and impact-resistant runners on the UP-covered bottom. Front and rear full length pockets will help organize your day. Open the main compartment and you will see moveable dividers that you can configu e and a removable interior liner for easy cleaning. The top lid has a full length clear mesh reinforced pocket with different sizes of elastic tool holders. The large pockets on each end of this bag can hold sharps containers or anything of your choice. 23” L x 17”W x 12” H.

ID32325-GR	Ultra Sofbox Plus trauma bag, green	each	337.02
ID32325-OR	Ultra Sofbox Plus trauma bag, orange	each	337.02
ID32325-RD	Ultra Sofbox Plus trauma bag, red	each	337.02
ID32325-RB	Ultra Sofbox Plus trauma bag, royal blue	each	337.02



Pack Case Plus Trauma Bag (Iron Duck)

This rugged trauma bag is constructed from 1000 denier nylon and has an easy-to-clean, durable UP bottom. Zip open the main compartment to find great ways to organize your supplies. On the top lip is a fl t zippered UP pocket with strategically placed elastic tool holders. Look into the main compartment to find a emovable 400D liner with padded dividers to help you organize different supplies. 19” L x 12½”W x 8½” H.

ID32499A-NV	Pack Case Plus trauma bag, blue	each	150.29
ID32499A-OR	Pack Case Plus trauma bag, orange	each	150.29



Pack Case Triple Trauma Bag (Iron Duck)

The Pack Case Triple is constructed of rugged 1000D nylon with bright 3M refle tive safety tape and UP covered bottom. Zip open the main compartment to find great ways to orga- nize your supplies. On the top lip you will find a flat zippered UP pocket with strategically placed elastic tool holders. Look into the main compartment to find a emovable 400D liner with padded dividers to help organize different supplies. If you need more space for bulky supplies you can use any of the three exterior pockets to store any supplies you may need. Carry your Pack Case Triple with either two nylon web handles or with the removable sling-style shoulder strap. Dimensions: 19”L x 14.5”W x 8.5”H

ID32499AT-NB	Pack Case Triple trauma bag, blue	each	166.51
ID32499AT-OR	Pack Case Triple trauma bag, orange	each	166.51
ID32499AT-REUP	Pack Case Triple trauma bag, universal protection fabric, red	each	183.15

DE:01 Semi-Rigid Trauma Deployment System (Propak)

The DE:01 is a premium, semi-rigid deployment system that organizes your airway, trauma and diagnostic supplies into one space-efficient, user-friendly kit. The DE:01 is constructed from the highest quality fabrics and hardware. The thoughtfully laid out interior features many things including a clear windowed pocket on the lid, various elastic looping, and a generous amount of pockets/pouches and removable dividers. Contents not included.

PRDE01-OR	DE:01 semi-rigid trauma deployment system, orange	each	342.46
PRDE01-RE	DE:01 semi-rigid trauma deployment system, red	each	342.46
PRDE01-RB	DE:01 semi-rigid trauma deployment system, royal blue	each	342.46
PRDE01FR-RB	DE:01 semi-rigid trauma deployment system, fluid resistant, royal blue	each	342.46
PRDE01FR-RE	DE:01 semi-rigid trauma deployment system, fluid resistant, red	each	342.46



DE:01A Semi-Rigid Trauma Deployment System (ALS) (Propak)

The DE:01A is a premium, semi-rigid deployment system that organizes your airway, trauma, diagnostic, medications and IV administration supplies into one space-efficient, user-friendly kit. The DE:01A is constructed from the highest quality fabrics and hardware. The thoughtfully laid out interior features many things including a clear windowed pocket on the interior lid with a double elastics system that holds stacked boxes of preload meds. Contents not included.

PRDE01A-OR	DE:01 semi-rigid trauma deployment system (ALS), orange	each	542.38
PRDE01A-RE	DE:01 semi-rigid trauma deployment system (ALS), red	each	542.38
PRDE01A-RB	DE:01 semi-rigid trauma deployment system (ALS), royal blue	each	542.38
PRDE01AFR-RE	DE:01 semi-rigid trauma deployment system (ALS), fluid resistant, red	each	542.38
PRDE01AFR-RB	DE:01 semi-rigid trauma deployment system (ALS), fluid resistant, royal blue	each	542.38



FI:01 Multi-Purpose Kit (Propak)

The FI:01 is constructed of 1000 Denier cordura nylon with a 200 denier oxford liner, nylon webbing, nickel-plated steel hardware and large #10YKK self-repairing zippers. The FI:01 features a developed front pocket, an external lid pocket and an internal lid pocket. The shape is maintained with removable closed celled evazote foam.

PRFI01-OR	FI:01 multi-purpose trauma kit, orange	each	133.65
PRFI01-RE	FI:01 multi-purpose trauma kit, red	each	133.65
PRFI01-RB	FI:01 multi-purpose trauma kit, royal blue	each	133.65
PRFI01FR-RE	FI:01 multi-purpose trauma kit, fluid resistant, red	each	133.65
PRFI01FR-RB	FI:01 multi-purpose trauma kit, fluid resistant, royal blue	each	133.65





FI:04 Deluxe Multi-Purpose Trauma Kit (Propak)

The FI:04 adds two end pockets, a replaceable bottom and color coded sliders to the FI:01. The FI:01 is constructed of 1000 Denier cordura nylon with a 200 denier oxford liner, nylon webbing, nickel-plated steel hardware and large #10YKK self-repairing zippers. The FI:01 features a developed front pocket, an external lid pocket and an internal lid pocket. The shape is maintained with removable closed celled evazote foam.

PRFI04-OR	FI:04 deluxe multi-purpose kit, orange	each	263.83
PRFI04-RE	FI:04 deluxe multi-purpose kit, red	each	263.83
PRFI04-RB	FI:04 deluxe multi-purpose kit, royal blue	each	263.83
PRFI04FR-RE	FI:04 deluxe multi-purpose kit, red	each	263.83
PRFI04FR-RB	FI:04 deluxe multi-purpose kit, royal blue	each	263.83



Responder I Medic Bag (Conterra)

The Conterra Responder I bag carries all of your EMS supplies in one rugged compact unit. Made entirely out of ultra strong SI-TEX fluid proof fabric and high visibility reflective tape. The Responder I has a non-absorbent sure grip handle and opens via a huge #10 main zipper, making it the perfect choice for a vehicle response kit. The Responder I sports 10 internal pockets, 17 elastic loops and two removable dividers for your gear. The bag also has a full length zippered inside pocket and converts to a fanny pack for hands free use when climbing ladders or going over embankments. 14½" L x 8½" W x 7" H.

CTRB1	Responder I medic bag, blue	each	85.00
-------	-----------------------------	------	-------



Responder II Medic Bag (Conterra)

The Responder II is large enough to carry all your EMS gear but small enough to fit behind any car seat or in any storage compartment. The bag is made entirely out of ultra strong SI-TEX fluid proof fabric, and features a #10 coil zipper, high visibility reflective tape and a hideaway fanny pack suspension. Inside are 11 organizer pockets, 14 elastic loops, three removable dividers and an internal zippered pocket. The unique fold out front pocket is perfect for organizing ET tubes or storing assessment tools. The Responder II also has a new non-absorbent easy grip handle that can be carried even with turnout gloves on.

CTRB2	Responder II medic bag, blue	each	95.00
-------	------------------------------	------	-------



Aeromed Pack (Thomas EMS)

The Aeromed Pack is an extremely space efficient and durable pack most commonly used for ambulance, search and rescue, high rise rescue, helicopter or as a personal medical kit. In addition, it is an excellent specialty kit for trauma, pediatric, neonatal, burn, obstetrical, cardiac or respiratory patients. The placement and closure of the 13 pockets is specially designed to reduce the likelihood of equipment loss. The "D" rings on the back of the pack allow shoulder straps to be easily attached. The ladder frame of the pack can also serve as a splint when needed. 11" L x 12" W x 5" H.

TT894	Aeromed pack, black	each	150.00
TT892	Aeromed pack, blue	each	150.00
TT890	Aeromed pack, orange	each	150.00
TT896	Aeromed pack, red	each	150.00



www.kempusa.com

PREMIUM BLUE LINE OF BAGS NOW AVAILABLE

**1680 DENIER
BALLISTIC NYLON**



10-104-PRE
KEMP USA PREMIUM
LARGE PROFESSIONAL TRAUMA BAG



10-121-PRE
KEMP USA PREMIUM TOTAL EMS BAG



1680 DENIER



10-115-PRE
KEMP USA PREMIUM ULTIMATE BACKPACK



10-120-PRE
KEMP USA PREMIUM ULTIMATE SUITCASE



10-122-PRE
KEMP USA PREMIUM MINI BACKPACK

SEE OUR WEBSITE FOR MORE INFO: WWW.KEMPUSA.COM



Breathsaver Oxygen/Trauma Bag (Iron Duck)

The Breathsaver efficiently organizes valve masks, airway adjuncts, an oxygen tank, diagnostic tools and trauma supplies. The full-length front and back pockets feature strategically placed tacked elastic tool holders. The end pocket opens half-way. The main compartment contains double-tacked straps to secure a “D” or Jumbo “D” tank. One side has roomy mesh pouches and the other is lined with tacked elastic tool holders. The inside lid has a full length mesh pouch. Other colors available. 27”L x 13”W x 11”H.

ID34016D-GR	Breathsaver oxygen/trauma bag, nylon fabric, green	each	226.45
ID34016D-RE	Breathsaver oxygen/trauma bag, nylon fabric, red	each	226.45
ID34016D-RB	Breathsaver oxygen/trauma bag, nylon fabric, royal blue	each	226.45
ID34016DLF-GR	Breathsaver oxygen/trauma bag, nylon fabric latex free, green	each	231.00
ID34016DUP-RE	Breathsaver oxygen/trauma bag, universal precaution (UP) fabric, red	each	249.08



Breathsaver Plus Oxygen/Trauma Bag (Iron Duck)

The Breathsaver Plus offers additional organizational features. The fully-opening front pocket features multiple gussets and elastic tool holders. Carry hard collars in the full-length rear pocket lined with tool holders. The end pocket offers quick access to a “D” size tank, masks and tubing. The large main compartment offers a removable liner for easy cleaning, mesh pouches and tacked elastic, for easy organization of tools and modules. Contents of the interior lid pocket are easily seen through the clear vinyl window. Carry options: nylon carry handles, a sling-style shoulder strap with adjustable, non-slip fl t pad and a fl t rubber pull handle on the end. Other colors available. 27”L x 13”W x 11”H.

ID34016DP-GR	Breathsaver Plus oxygen/trauma bag, nylon fabric, green	each	322.18
ID34016DP-RE	Breathsaver Plus oxygen/trauma bag, nylon fabric, red	each	322.18
ID34016DP-UPRE	Breathsaver Plus oxygen/trauma bag, universal precaution (UP) fabric, red	each	354.42



Ultra Breathsaver Oxygen/Trauma Bag (Iron Duck)

The Ultra Breathsaver takes organization to a new level. Five exterior pockets with every combination of roomy pouches, zippered pockets and tacked elastic tool holders. Quick access to the regulator/shut off valve through the end pocket. The main compartment offers a removable shelf, padded dividers and a removable liner. A clear vinyl window in the lid pocket allows view of contents. Carry options include: nylon carry handles with snap closure, a deluxe, adjustable shoulder strap with padding and a molded rubber handle above the oxygen access pocket. Other colors available. 29”L x 13”W x 12”H

ID34018-GR	Ultra Breathsaver oxygen/trauma bag, nylon fabric, green	each	457.98
ID34018-RD	Ultra Breathsaver oxygen/trauma bag, nylon fabric, red	each	457.98
ID34018-RB	Ultra Breathsaver oxygen/trauma bag, nylon fabric, royal blue	each	457.98
ID34018UP-RD	Ultra Breathsaver oxygen/trauma bag, universal precaution (UP) fabric, red	each	503.78
ID34018UP-RB	Ultra Breathsaver oxygen/trauma bag, universal precaution (UP) fabric, royal blue	each	503.78

DC:01 Oxygen/Trauma Deployment Kit (Propak)

The DC:01 fits a “D” cylinder and has a hard collar back pocket with organized front pocket. This is a premium, semi-rigid deployment system that organizes your oxygen, airway, hard collars and trauma supplies into one space-efficient, user-friendly kit. The DC:01 is constructed from the highest quality fabrics and hardware. The thoughtfully laid out interior features many things including a clear windowed pocket on the lid and a supported shelf which will not drop down impeding the removal and replacement of the O2 cylinder.

PRDC01-OR	DC:01 oxygen/trauma semi-rigid deployment kit, orange	each	433.34
PRDC01-RE	DC:01 oxygen/trauma semi-rigid deployment kit, red	each	433.34
PRDC01-RB	DC:01 oxygen/trauma semi-rigid deployment kit, royal blue	each	433.34
PRDC01FR-RE	DC:01 oxygen/trauma semi-rigid deployment kit, fluid resistant, red	each	433.34
PRDC01FR-RB	DC:01 oxygen/trauma semi-rigid deployment kit, fluid resistant, royal blue	each	433.34



DC:03 Oxygen/Trauma Deployment Kit (Propak)

The DC:03 fits a “D” cylinder and has a pocket to fit an additional module on back and an organized front pocket. This premium, semi-rigid deployment system organizes your oxygen, airway and trauma supplies into one space-efficient, user-friendly kit. The DC:03 is constructed from the highest quality fabrics and hardware. The thoughtfully laid-out interior features many things including a clear windowed pocket on the lid and a supported shelf which will not drop down impeding the removal and replacement of the O2 cylinder.

PRDC03-OR	DC:03 oxygen/trauma semi-rigid deployment kit, orange	each	433.46
PRDC03-RE	DC:03 oxygen/trauma semi-rigid deployment kit, red	each	433.46
PRDC03-RB	DC:03 oxygen/trauma semi-rigid deployment kit, royal blue	each	433.46
PRDC03FR-RE	DC:03 oxygen/trauma semi-rigid deployment kit, fluid resistant, red	each	433.46
PRDC03FR-RB	DC:03 oxygen/trauma semi-rigid deployment kit fluid resistant, royal blue	each	433.46



Responder IV Medic Bag (Conterra)

The Responder IV is Conterra’s largest and most technically organized ambulance response bag. The main compartment is sized to work with any of Conterra’s modular kits, but is long enough to fit an O2 bottle, and will accept Conterra’s O2 Caddy insert. The Responder IV also sports twin side pockets (long enough to fit stiff neck type collars) and two end pockets. All pockets and top lid are built with rip and stick-compatible fabric. There are fluid proof handles on each end of the bag, a padded bottom, giant #10 coil tape reinforced zippers and super-tough SI-TEX fabric. 29”L x 9”H x 13”D.

CTRB41	Responder IV medic bag, blue	each	249.00
--------	------------------------------	------	--------





Oxygen Cylinder Bag (Kemp USA)

The Kemp USA Cylinder Oxygen Bag is a durable oxygen duffel bag with a side pocket, created to hold and protect a “D” tank and regulator. This bag is part of the Premium Blue Line of Bags and is constructed using 1680 Denier Ballistic Nylon. The bag is completely padded inside with closed cell foam. It features eight interior mesh pockets, one extended side pocket to hold supplies and accessories, and has two interior straps to secure the tank. The clamshell design with a full zipper and highly reflective pull tab gives quick access to the tank. It comes with both handheld duffel straps and a removable padded shoulder strap, and is made of tough water resistant nylon with reflective trim and all metal black nickel hardware. If you need to get the tank out in a hurry, the entire inner padded lining is removable. Dimensions: 22” L x 11” W x 8.5” H; Weighs 2 lbs.

KB10-109-RB	Oxygen cylinder bag, navy blue	each	35.38
-------------	--------------------------------	------	-------



G3 Oxygen Module (StatPacks)

An emergency oxygen tank holder, designed to accommodate most “D” and Jumbo “D” tanks. This Oxygen Module may be considered to be a double cell in the StatPacks Third Generation Cellular System. It also fits nicely into some of the StatPacks Generation 3 main pack to help with any EMS oxygen therapy. Contents not included

- This Oxygen Module makes for a quick, easy to use, EMS oxygen bag
- Foam-lined construction maintains rigidity to securely hold oxygen tanks in packs
- Two adjustable locking cam buckles with strong Hypalon material that friction hold the tank firmly to the aluminum frame
- Hook Velcro on back panel attaches securely in packs
- Fits in Responder, Clinician, Tidal Volume, Back Up and Breather main packs
- 16.5” H x 5” W x 1” D

STPG33004GN	G3 Oxygen module, green	each	51.00
-------------	-------------------------	------	-------

G3 Tidal Volume Oxygen Pack (StatPacks)

Securely holds a regular or Jumbo “D” size oxygen cylinder. Accommodates the Oxygen Module. Multiple pockets help to organize breathing equipment, tubes, masks, BVM’s, and extra regulators. Carry your oxygen on your back, or hook it to a cot. Contents not included.



- Unique foam lined design keeps all Emergency Medical Equipment inside protected from breakage or the elements
- Outside accessible urethane window to see regulator oxygen level and to access the tank
- Padded shoulder strap doubles as shoulder sling, offering hands-free comfort during transport
- O2 wrench lanyard is located on the inside of this emergency oxygen pack to help ensure you never forget
- Main fabric is Tarpaulin with a one ounce urethane coating for easier cleaning and protection from the elements and BBP’s
- ID window to label any way you want to identify between other emergency oxygen packs
- Weighs 3.5 lbs. Dimensions: 22” H x 8” W x 9” D

STPG35002GN	G3 Tidal Volume oxygen pack, BBP-resistant, green	each	160.00
STPG35002RE	G3 Tidal Volume oxygen pack, BBP-resistant, red	each	160.00

“D” Cylinder Sleeve with Pocket (R&B Fabrications)

Attaches to rail of cot and holds a “D” cylinder. Attaches with 2” hook and loop sewn to 2” webbing. There is a hook and loop tab sewn to the top where you can coil your demand valve or mask tubing and store it when not in use. A small side pocket holds extra masks. Weighs 8 oz.



RB475GR	“D” Cylinder sleeve with pocket, green	each	56.70
RB475OR	“D” Cylinder sleeve with pocket, orange	each	56.70

Oxygen Bag (Iron Duck)

This rugged oxygen bag is designed for you to be able to grab your “D” oxygen tank, regulator and accessories at a moment’s notice. Pull the heavy duty zippers the full length of the bag to find the main compartment fully lined with high impact foam and a removable liner for easy cleaning. The padded regular protector and adjustable tie downs secure the tank wherever the day takes you. On each side of the main compartment you will find multiple pockets to store masks, tubes and other accessories. There is also a line of elastic tool holders that can contain up to six tools. Carry with either the heavy duty handles or the ergonomically designed adjustable shoulder strap (included). 21”L x 8½”W x 81/2”



ID36002D-GR	Oxygen bag for “D” cylinder, green	each	142.75
ID36002DLF-GN	Oxygen bag for “D” cylinder, latex free, green	each	147.00
ID36002D-PK-GR	Oxygen bag for “D” cylinder, one pocket, green	each	166.71
ID36002D-2PK-GR	Oxygen bag for “D” cylinder, two pockets, green	each	178.91

A little banged up?

We'll stitch you up. StatPacks lifetime guarantee!



customerservice@statpacks.com
<http://statpacks.com/medic-bag-company/warranty/>
 PH: 435-627-2265
 G3 BACKUP SKU: G30608RE



SA:02 Oxygen Carry Bag, "D" Cylinder (Propak)

The SA:02 features a regulator access compartment with airway loops and an elasticized pocket. The removable pouch can carry airway accessories. The bag is padded to protect the cylinder and regulator.

PRSA02-GR	SA:02 oxygen bag for "D" cylinder, green	each	105.19
PRSA02-RE	SA:02 oxygen bag for "D" cylinder, red	each	105.19
PRSA02-RB	SA:02 oxygen bag for "D" cylinder, royal blue	each	105.19



Basic Oxygen Organizer (Conterra)

This basic kit can carry a steel "D", aluminum "D", or jumbo aluminum "D" bottle. The mesh pockets built into the lid can carry gloves and supply tubing. The generous outside pocket is large enough to fit a bag valve mask and V-Vac suction device, as well as oral or nasal airways, which can be organized in built-in elastic keepers. The outside of the kit is built with Cordura nylon for years of dependable service. Add a #10 coil zipper "quick open" top, fluid proof grab loops, and you've got a kit that will give you years of faithful service. Recommended for first response use only. Not for daily ambulance duty. O₂ tank shown not included.

CTBOK1	Basic oxygen organizer	each	98.00
--------	------------------------	------	-------



Thomas O₂ Lite Pack (Thomas EMS)

The Thomas O₂ Lite is a compact airway bag designed to accommodate all O₂ and airway supplies when storage space is tight and multiple carrying methods are required. The lid section has been engineered to open and remain upright during use to minimize supply loss and speed treatment time on scene.

TTF1250	Thomas O ₂ lite pack, black	each	269.23
---------	----------------------------------------	------	--------



- Download **FREE Layar App** (from your App Store)
- Scan this page
- View custom product info

Bring catalog pages to life

View additional content about selected products throughout our catalog by using your mobile device to scan pages that display the AR graphic (left). To get started, simply download the free "Layar" app from your device's App store.



www.kempusa.com

MORE BAGS AT KEMPUSA.COM

10-104
KEMP USA LARGE PROFESSIONAL
TRAUMA BAG

10-118
KEMP USA PEDIATRIC PACK



10-120
KEMP USA ULTIMATE SUITCASE

10-115
KEMP USA ULTIMATE BACKPACK

10-109
KEMP USA OXYGEN BAG





Premium Ultimate Backpack (Kemp USA)

The redesigned Premium Ultimate Backpack is built using 1680 Denier Ballistic Nylon. High stress points have been reinforced with bartack and cross stitched. The backpack has two large front pockets that measure 10" x 13" x 3" and a lower pocket that features elastic loops on the inside. The upper pocket comes with a zippered pouch on the outside. On the sides it features two pockets 19" x 7" x 4". The one on the right comes with dividers and the pocket on the left comes with 4 standard size removable pouches. All zippers have a high visibility reflective zip pull to ensure quick and easy access. Upon opening the large pocket of the bag you see three large utility pouches and one extra-large utility pouch. On the bottom of the bag is a strap to hold a D Tank Cylinder. This bag comes with highly visible reflective trim, all metal black nickel hardware, molded feet on the bottom for extra protection and handles if the person decides to carry it. Dimensions: 13" x 16" x 25". Weight: 9 lbs.

KB10-115PRE-BL	Premium ultimate backpack, blue	each	250.00
----------------	---------------------------------	------	--------



Premium Ultimate Suitcase (Kemp USA)

The Kemp USA Premium Ultimate Suitcase is offered in the new Premium Blue Line of Bags, by Kemp USA. The carry-on sized suitcase is constructed using 1680 Denier Ballistic Nylon for maximum durability. High stress points have been reinforced with bartack and cross stitched. The bag features six removable, color coded zippered pouches (Green, Blue, Red, Orange, White, and Yellow) with clear windows, 3 external pockets, and 6 internal pockets for additional storage. The suitcase is equipped with a periscoping handle, a top and side handle for carry, tuck-away padded shoulder straps for backpack carry, double wheels on each side for more floor contact and more control while pulling, and high visibility reflective trim and pull tabs on zippers. Dimensions: 15" x 7" x 20"; Weight: 8 lbs.

KB10-120PRE-BL	Premium ultimate suitcase, blue	each	185.00
----------------	---------------------------------	------	--------



Ultimate EMS Backpack (Kemp USA)

The Kemp USA Ultimate Backpack has two large front pockets that measure 10" x 13" x 3" and a lower pocket that features elastic loops on the inside. The upper pocket comes with a zippered pouch on the outside. On the sides it features two pockets 19" x 7" x 4"; the one on the right comes with dividers and the pocket on the left comes with 4 standard size removable pouches. Upon opening the large pocket of the bag you see three large utility pouches and one extra-large utility pouch. On the bottom of the bag is a strap to hold a D Tank Cylinder. High stress points have been reinforced with bartack and cross stitched. All zippers have a high visibility reflective zip pull to ensure quick and easy access. This bag comes with highly visible reflective trim, all metal black nickel hardware, molded feet on the bottom for extra protection, and handles if the person decides to carry it. Dimensions: 13" x 16" x 25"; Weight: 8 lbs.

KB10-115	Ultimate EMS backpack, red	each	101.54
----------	----------------------------	------	--------

G3 BackUp Backpacks (StatPacks)

The BackUp is a great medical backpack that works exceptionally well in urban or rural areas where “stay and play” medical protocol is used. Customizable shelving allows superior organization of virtually any combination of Emergency Medical Equipment and supplies. The advanced harness system helps you tackle daunting flights of stairs and hard-to-reach accident scenes safely and with free hands. Contents not included.

- Unique design allows access to the main compartment from the front of this medical backpack
- Designed to hold StatPacks Generation 3 Emergency Medical Services Kits; including all StatPacks First Aid QuickRoll intubation, Remedy and Circulatory kits
- QuickZip access to front compartment for quick access to Emergency Medical Equipment
- Tarpaulin bottom panel for protection from abrasion and the elements
- Added more durable reflective material that has a protective outer mesh cover which shields it from wear and tear
- Removable adjustable inside divider(s) for customized organization
- Capacity: 3800". Weight: 6.0 lbs.



STPG35006BU	G3 BackUp backpack, BBP-resistant, blue	each	290.00
STPG35006GN	G3 BackUp backpack, BBP-resistant, green	each	290.00
STPG35006RE	G3 BackUp backpack, BBP-resistant, red	each	290.00

G3 Universal Cell (StatPacks)

The unique foam molded design of the G3 Universal Cell helps keep inside contents organized, at your fingertips, and protected from the elements. Easy to open zipper position allows for quick access and ease. This Universal Cell is considered to be one full cell in the StatPacks' Third Generation Cellular System. They are designed to reveal your supplies intuitively grouped and securely protected. G3 Cells unfold to expose all your vital supplies at once, and put away just as quickly. Contents not included. Capacity: 470". Weighs 1.5 lbs. Dimensions: 12" H x 6" W x 6.5" D

STPG31002BK	G3 Universal cell, black	each	80.00
-------------	--------------------------	------	-------



G3 Clinician EMT Bag (StatPacks)

Designed as a quick first in EMT Jump bag for Medics who only need the basic Airway, Breathing and Circulation supplies. Accommodates the QuickRoll Intubation, Circulatory, and Remedy Kits, as well as the stackable Cellular System. Foam molded shoulder straps allow for comfortable transport of most emergency medical equipment. Up to 3 of the Generation 3 standard Cells will fit inside. Contents not included.

- Unique design allows access to the Cells from the top or front of the EMS Backpack
- Specifically designed for the StatPacks Cell System and accommodates all StatPacks Kits in many different configurations
- Tarpaulin bottom panel for protection from abrasion and the elements
- Main fabric is Tarpaulin with a one ounce urethane coating for easier cleaning and protection from the elements and BBPs
- Capacity: 3000". Weighs 3.0 lbs. Dimensions: 22"H x 19"W x 7" D



STPG35001RE	G3 Clinician EMT bag, red	each	220.00
-------------	---------------------------	------	--------



G3 Golden Hour EMT Backpack (StatPacks)

The Golden Hour is the perfect pack for use in close-quarter areas, such as helicopters. Compact and comfortable, built to organize and carry essential equipment. The unique wide-mouth main compartment opening allows easy access to contents and provides convenient, upright availability from the captain’s chair. Helicopter EMT’s appreciate the ergonomic shoulder straps and a breathable padded rear panel when hiking to patients.

- Contents NOT included
- Unique design allows access to the main compartment from the top or front of this EMT Backpack
- Specifically designed to hold StatPacks Generation 3 Emergency Medical Services Kits; including all StatPacks’ First Aid QuickRoll intubation, Remedy, and Circulatory kits
- Tarpaulin bottom panel for protection from abrasion and the elements
- Capacity: 2400”. Weighs 3.1 lbs. Dimensions: 18” H x 17” W x 8” D

STPG35003RE	G3 Golden Hour EMT backpack, BBP-resistant, red	each	180.00
-------------	-------------------------------------------------	------	--------



G3 Load N’ Go Medic Backpack (StatPacks)

The Load N’ Go is an ideal medic backpack for fixed wing and critical care transport, ambulance and fire engines. Contents not included.

- Unique design allows access to the main compartment from the top or front of this Transport Medic Backpack
- Designed to hold StatPacks Generation 3 Emergency Medical Services Kits; including all StatPacks® First Aid QuickRoll intubation, Remedy, and Circulatory kits
- Tarpaulin bottom panel for protection from abrasion and the elements
- Main fabric is Tarpaulin with a one ounce urethane coating for easier cleaning and protection from the elements and BBP’s
- Capacity: 2600”. Weighs 4.5 lbs. Dimensions: 7” H x 19” W x 20” D

STPG35004RE	G3 Load N’ Go medic backpack, BBP-resistant, red	each	250.00
-------------	--------------------------------------------------	------	--------



G3 Medslinger EMT Packs (StatPacks)

The Med Slinger is the original EMT pack that doubles as a sports medicine pack. For medics who do not like to wear double shoulder-strap packs. Still ergonomic, it slings quickly off and on for easy wearing. Contents not included.

- This cell makes for a quick, easy to use, EMS medication bag
- Unique foam molded design keeps all Emergency Medical Equipment inside protected from breakage or the elements
- Innovative fold-out design is compact, yet quickly reveals well-organized medication supplies and tools
- Specifically designed to stack neatly in StatPacks Generation 3 Emergency Medical Services packs.
- Two handles with “MEDICINE” written to identify the difference in EMT Gear
- 4 Vial Strands that holds multi dose vials securely in place
- Capacity: 470”. Weighs 1.5 lbs. Dimensions: 12” H x 6” H x 6.5” D

STPG35011BU	G3 Medslinger EMT pack, BBP-resistant, blue	each	100.00
-------------	---------------------------------------------	------	--------

STPG35011RE	G3 Medslinger EMT pack, BBP-resistant, red	each	100.00
-------------	--------------------------------------------	------	--------

G3 Perfusion Backpacks (StatPacks)

This EMS backpack is great for all EMS Clinicians. Two main compartments and three external pockets allow for superior organization of large amounts of BLS and ALS equipment. The hybrid design may be worn as a back pack, side sling, or carried by hand. The Perfusion doubles as a fine EMS shoulder bag. Contents not included.



- Unique design allows access to the main compartment from the front of this EMS Backpack
- Specifically designed to hold StatPacks Generation 3 Emergency Medical Services Kits; including all StatPacks First Aid QuickRoll intubation, Remedy, and Circulatory kits
- Tarpaulin bottom panel for protection from abrasion and the elements
- Added more durable reflective material that has a protective outer mesh cover which shields it from wear and tear
- Removable adjustable inside divider(s) for customized organization
- Side pockets for easy access to vital sign tools, bandages, and smaller ambulance equipment
- ID window to label any way you want to identify between other EMS Backpacks
- Main fabric is Tarpaulin with a one ounce urethane coating for easier cleaning and protection from the elements and BBP's
- Stow-away padded shoulder straps make for an EMS Backpack or EMS shoulder bag for side-carry option
- Capacity: 3000". Weighs: 5.7 lbs.

STPG35005BU	G1 Perfusion backpack, BBP-resistant, blue	each	270.00
STPG35005GN	G1 Perfusion backpack, BBP-resistant, green	each	270.00
STPG35005RE	G1 Perfusion backpack, BBP-resistant, red	each	270.00

G3 QuickLook AED Backpacks (StatPacks)

The QuickLook is built to accommodate most Automated External Defibrillators. It is perfect for use in public areas such as airports, coliseums, shopping malls or homes as an all-in-one first responder AED backpack. Uses a very simple design for the layperson as well as experienced clinicians. Contents not included.



- A stow away "Rain Fly" is included for bad weather
- Unique design allows access to the main compartment from the backside of this Medical Backpack
- Single-buckle AED pocket offers quick access to the Defibrillator
- Clear durable urethane window allows quick view of AED status
- Main compartment features three removable stick-in-place pouches that give visibility and organization to contents
- Specifically designed to hold StatPacks' Generation 3 Emergency Medical Services Kits; including all StatPacks' First Aid QuickRoll intubation, Remedy, and Circulatory kits
- Tarpaulin bottom panel for protection from abrasion and the elements
- Side pockets for easy access to vital sign tools, bandages, and smaller ambulance equipment
- Main fabric is Tarpaulin with a one ounce urethane coating for easier cleaning and protection from the elements and BBPs
- Capacity: 1800". Weighs 3.2 lbs. Dimensions: 18" H x 14" W x 7.5" D

STPG35007BU	G3 Quicklook AED backpack, BBP-resistant, blue	each	195.00
STPG35007RE	G3 Quicklook AED backpack, BBP-resistant, red	each	195.00



G3 Responder EMS Backpack (StatPacks)

A large-sized street pack whose design keeps your shoulder straps off the ground when you're accessing contents. Internal Cells stack neatly and securely in many different configurations. Accommodates the First Aid QuickRoll Intubation Kit, Circulatory Kit, and Remedy Kit, as well as the stackable Cellular System. The aluminum track creates a bomb proof secure point for the shoulder straps that allows for comfortable transport of most emergency medical equipment. Up to 4 of the Generation 3 standard Cells will fit inside as this is the large-sized of the EMS Backpacks included in the Cellular System. Contents not included.

- Skids protect high wear areas and lengthen the lifetime of the EMS bag
- Tarpaulin bottom panel for protection from abrasion and the elements
- Internal Velcro® lining strips to secure modules or other Velcro-compatible items to secure ambulance equipment
- Unique foam lined design keeps all Emergency Medical Equipment inside protected from breakage or the elements
- Specifically designed to hold StatPacks' Generation 3 Emergency Medical Services Cells
- Main fabric is Tarpaulin with a one ounce urethane coating for easier cleaning and protection from the elements
- Capacity: 3600". Weighs 6.0 lbs. Dimensions: 29" H x 18"W x 7" D

STPG35000RE	G3 Responder EMS backpack, red	each	285.00
-------------	--------------------------------	------	--------



G3 Universal Kit (StatPacks)

For a simple EMS Bag, the Universal Kit keeps your random supplies together and quickly accessible. The unique foam lined design helps keep inside contents organized, at your fingertips, and protected from the elements. Easy to open zipper position allows for quick access and ease. This is a perfect accessory EMS Bag for any StatPacks' main packs. Contents non included.

- Unique foam-lined design keeps all Emergency Medical Equipment inside protected from breakage or the elements
- Specifically designed to stack neatly in StatPacks' Generation 3 Emergency Medical Services packs.
- Inside liner fabric made of ANSI Lime Green fabric for easier view of contents inside this EMS bag
- Fits into most EMT Jump Bags available in the market today
- Capacity: 300". Weighs 7 oz. Dimensions: 6" H x 9.5"W x 5.5" D

STPG36004BK	G3 Universal kit, black	each	30.00
-------------	-------------------------	------	-------



Range Ready™ and Range Qualifie™ Bags (5.11 Tactical)

Constructed from durable, all-weather 600D nylon, the bag features separate padded storage for multiple pistols, a zip-down front organizer that effectively stores eight magazines, side pockets, a removable ammo tote to keep you topped off, and a removable brass tote for easy cleanup. Includes a padded shoulder strap, easy-grip handles, and an ID insert. The Range Qualifier is a medium-sized version of the Range Ready Bag. Imported.

511-59049-019	Range Ready bag, black	each	99.99
511-59049-328-BAG	Range Ready bag, sandstone	each	99.99
511-56947-019	Range Qualifier bag (medium sized version of Range Ready bag), black	each	84.99

RUSH LBD Duffels (5.11 Tactical)

Built to haul heavy loads like armor and equipment, the RUSH LBD (Load Bearing Duffel) is built from durable 1050D nylon, with webbing and heavy-duty bartacking reinforcements throughout. Featuring interior mesh pockets, lashing straps, compression straps and grab handles, the duffel can be shouldered or worn as a backpack. The RUSH LBD is MOLLE-compatible, allowing you customizable storage options. Imported. **LIMA dimensions:** 13.5" H x 24" L x 13.5" W. **Xray dimensions:** 15.5"H x 31"L x 15.5"W.



511-56294-019-BAG	RUSH LBD duffel, LIMA, black	each	134.99
511-56294-188-BAG	RUSH LBD duffel, LIMA, OD green	each	134.99
511-56294-328-BAG	RUSH LBD duffel, LIMA, sandstone	each	134.99
511-56295-019-BAG	RUSH LBD duffel, Xray, black	each	149.99
511-56295-188-BAG	RUSH LBD duffel, Xray, OD green	each	149.99
511-56295-328-BAG	RUSH LBD duffel, Xray, sandstone	each	149.99

RUSH Backpacks (5.11 Tactical)

The RUSH Backpack is a high-performance tactical pack suitable for active duty, hunting and recreation, or grab-and-go. The pack features unmatched storage capability, a wrap-around MOLLE- and SlickStick-compatible web platform, adjustable shoulder and sternum straps, a 60-oz. hydration pocket, and durable, water-resistant construction. Imported.



511-56892-019	RUSH 12 Backpack, black	each	109.99
511-56892-026	RUSH 12 Backpack, double tap	each	109.99
511-56892-328-BAG	RUSH 12 Backpack, sandstone	each	109.99
511-58601-019	RUSH 24 Backpack, black	each	139.99
511-58601-131	RUSH 24 Backpack, dark earth	each	139.99
511-58601-026	RUSH 24 Backpack, double tap	each	139.99
511-58601-328	RUSH 24 Backpack, sandstone	each	139.99
511-58601-188	RUSH 24 Backpack, TAC OD	each	139.99
511-58602-019	RUSH 72 Backpack, black	each	179.99
511-58602-131	RUSH 72 Backpack, dark earth	each	179.99
511-58602-026	RUSH 72 Backpack, double tap	each	179.99
511-58602-328-BAG	RUSH 72 Backpack, sandstone	each	179.99
511-58602-092	RUSH 72 Backpack, storm	each	179.99
511-58602-188	RUSH 72 Backpack, TAC OD	each	179.99

RUSH Delivery LIMA Messenger Bag (5.11 Tactical)

At 11" high, 17" long, and 4" deep, the Lima Class RUSH Delivery Bag is built from ruggedized Nylon for superior resilience in any climate or environment. Features a quick-draw compartment that provides accelerated access to a covert sidearm, a padded laptop sleeve, a quick-access admin panel that keeps your keys, business cards, and flashlight within easy reach, and a main storage area with ample space for documents or accessories.



511-56177-019-BAG	RUSH Delivery Messenger Bag, LIMA, black color	each	109.99
511-56177-026-BAG	RUSH Delivery Messenger Bag, LIMA, double tap color	each	109.99
511-56177-236-BAG	RUSH Delivery Messenger Bag, LIMA, OD trail color	each	109.99
511-56177-328-BAG	RUSH Delivery Messenger Bag, LIMA, sandstone color	each	109.99

RUSH Delivery MIKE Messenger Bag (5.11 Tactical)



At 9.5" high, 14" long, and 3.5" deep, the Mike Class RUSH Delivery Bag is a quick and efficient tactical carryall with a wide range of customizable options that allow you to sort and store as you see fit. Built from ruggedized Nylon for superior resilience in any climate or environment, the RUSH Delivery Mike features a quick-draw compartment that provides accelerated access to a covert sidearm, a padded laptop sleeve to protect sensitive electronics, a quick-access admin panel that keeps your keys, business cards, and flashlight within easy reach, and a main storage area with ample space for documents or accessories.

511-56176-019-BAG	RUSH Delivery Messenger Bag, MIKE, black	each	94.99
511-56176-026-BAG	RUSH Delivery Messenger Bag, MIKE, double tap	each	94.99
511-56176-236-BAG	RUSH Delivery Messenger Bag, MIKE, OD trail	each	94.99
511-56176-328-BAG	RUSH Delivery Messenger Bag, MIKE, sandstone	each	94.99

RUSH Delivery Xray Messenger Bag (5.11 Tactical)



At 12" high, 20" long, and 6.5" deep, the RUSH Delivery Xray Messenger Bag is the ultimate multipurpose carryall, offering expanded capacity and a wide range of customizable features designed to support travel, business, or tactical operations. Built from ruggedized Nylon for superior resilience in any climate or environment, the RUSH Delivery Xray features a quick-draw compartment that provides accelerated access to a covert sidearm, a padded laptop sleeve to protect sensitive electronics, a quick-access admin panel to keep your keys, business cards, and flashlight within easy reach, and a main storage area with ample space for documents or accessories.

511-56178-236-BAG	RUSH Delivery Messenger Bag, XRAY, OD trail	each	119.99
511-56178-328-BAG	RUSH Delivery Messenger Bag, XRAY, OD, sandstone	each	119.99

MOAB™ 6 and MOAB 10 Backpacks (5.11 Tactical)



MOAB 6

MOAB 6 is a small sling pack with modular storage expandability. It can act as a tactical pack, a grab-and-go bag, or a quick and easy shoulder pack for school or travel. The ambidextrous padded strap is fully adjustable, while a tech pocket at the shoulder holds a phone or iPod and provides pass-through access for headphones. A quick stash pocket at the rear offers covert storage, and an internal water bottle pocket helps you stay hydrated. Sturdy, lightweight 1050D nylon. 10.5" H x 9" L x 5" D.



MOAB 10

MOAB 10 is a high performance tactical go bag that gives you plenty of room for gear and accessories. The ambidextrous padded strap is fully adjustable, while a coms pocket at the shoulder provides pass-through access for headphones. A covert pocket at the rear is TacTec System™ compatible and large enough for a sidearm, while an internal water bottle pocket includes a pass-through port for easy hydration. Sturdy, lightweight 1050D nylon. 18.25" H x 9" L x 5.25" D.

511-56963-019-BAG	MOAB 6 Backpack, black	each	69.98
511-56963-026-BAG	MOAB 6 Backpack, double tap	each	69.98
511-56963-328-BAG	MOAB 6 Backpack, sandstone	each	69.98
511-56963-092-BAG	MOAB 6 Backpack, storm	each	69.98
511-56964-019-BAG	MOAB 10 Backpack, black	each	99.99
511-56964-026-BAG	MOAB 10 Backpack, double tap	each	109.99
511-56964-328	MOAB 10 Backpack, sandstone	each	99.99
511-56964-092-BAG	MOAB 10 Backpack, storm	each	109.99

COVRT18™ Backpack (5.11 Tactical)

Designed to appear subtle and inconspicuous, the COVRT18 is a full-sized pack that delivers superior utility and a low-vis appearance. Ideal for CCW use, the backpack features a TacTec System-compatible hidden pistol pocket, Roll-Down Assault Compartment (R.A.C.™) for MOLLE or web pouches, and a main compartment with a built-in padded laptop sleeve and roomy primary and secondary storage zones. Built from rugged 500D and 420D water-resistant nylon. Imported.

511-56961-021	COVRT18 Backpack, asphalt	each	129.99
511-56961-019-BAG	COVRT18 Backpack, black	each	129.99
511-56961-671-BAG	COVRT18 Backpack, blue depth/steel grey	each	129.99
511-56961-475	COVRT18 Backpack, code red/steel grey	each	129.99
511-56961-193-BAG	COVRT18 Backpack, mantis green	each	129.99
511-56961-726-BAG	COVRT18 Backpack, true navy/asphalt	each	129.99



PUSH™ Pack (5.11 Tactical)

The PUSH Pack features a main compartment, expandable side compartments, a covert TacTec-compatible pocket at the rear, and MOLLE- and SlickStick-compatible slots on the sides. Also features a hook-and-loop nametape and flag holders or quick ID. Imported.

511-56037-019	PUSH Pack, black	each	64.98
511-56037-131-BAG	PUSH Pack, fl t dark earth	each	64.98
511-56037-188	PUSH Pack, tac OD	each	64.98



Wingman Patrol Bag™ (5.11 Tactical)

An ideal patrol partner, the Wingman is designed to ride in the passenger seat with the upper panel fastened around the headrest, serving as an organizer, tool kit, and tactical bag. Featuring dual-fold open web platforms, a foldout organizer panel, adjustable main compartment divider, mesh pockets, and almost limitless storage options, the Wingman Patrol Bag will keep your gear stable, secure, and within easy reach. When it's time to disembark, the bag becomes a traditional patrol bag. Imported.

511-56003-019	Wingman Patrol Bag, black	each	99.99
---------------	---------------------------	------	-------



Patrol Ready™ Bag (5.11 Tactical)

Crafted from rugged, all-weather 600D polyester, the Patrol Ready Bag is an ideal storage solution for your trunk or cab. Featuring an adjustable, roomy main compartment, multiple pockets sized for common accessories, a transparent ID panel, sturdy grab-and-go handles, and a removable shoulder strap for easy carry, the Patrol Ready Bag keeps your gear safe, secure, and at the ready in the toughest spots. Imported.

511-59012-019	Patrol Ready Bag, black	each	49.99
---------------	-------------------------	------	-------





All Hazards Prime Bag (5.11 Tactical)

The All Hazards Prime main compartment can hold two Ammo Mules or other equipment, while the front panel unzips 180 degrees for full access to a MOLLE and SlickStick-compatible medical compartment. The bag features an internal laptop sleeve, dedicated hydration or armor compartment, and an all-purpose shove-it pocket for quick storage of a helmet or jacket. Also featuring a fleece-lined sunglasses pocket, side-mounted retention lanyards, and a quick-grip top handle. Imported.

511-56997-019	All Hazards Prime bag, black	each	219.99
511-56997-328-BAG	All Hazards Prime bag, sandstone	each	219.99
511-56997-188	All Hazards Prime bag, TAC OD	each	219.99



All Hazards Nitro Bag (5.11 Tactical)

The All Hazards Nitro Bag features dual main compartments, a 180 degree opening for easy access, pass-through slots for breaching tools or a baton, loop patches, and a three-surface MOLLE- and SlickStick-compatible web platform. An orange lining helps you identify your gear in low-light, and the all-purpose shove-it pocket holds your helmet or jacket. Imported.

511-56167-026	All Hazards Nitro bag, double tap	each	139.99
511-56167-328	All Hazards Nitro bag, sandstone	each	139.99



Pacific Coast Pedi Pack (R&B Fabrications)

This compact Pediatric Pack keeps all the equipment needed for pediatric emergencies organized without needless repetition of supplies. The outside front pocket has ample room for a child BVM and a 1000cc IV pack stored without crushing the equipment. Double self-healing zippers allow easy access to the interior storage which has an abundance of storage for advanced and basic supplies. Elastic straps hold the intubation equipment and a standing divider with nylon pockets for items ranging from pediatric size guides to oxygen equipment. Weight: 40 oz. 13”L X 6 1/2”D x 14”H. Made in the USA. Contents not included.

RB829	Pediatric pack, purple	each	172.46
-------	------------------------	------	--------



Ultra Backpack (Iron Duck)

The Ultra Backpack is Iron Duck’s largest backpack, designed to carry an AED, oxygen tank, ALS supplies and more with infinite customization options. Dimensions: 23” H x 19” W x 12” D.

ID32440BK	Ultra Backpack, black	each	617.77
ID32440GR	Ultra Backpack, green	each	617.77
ID32440RE	Ultra Backpack, red	each	617.77

First Aid Bag (Iron Duck)

This empty first aid bag carries all your basic first aid necessities in durable 1000D nylon. The exterior pocket is unlined and the main compartment is closed by a single zipper across the top.



ID36007RE	First aid bag only, red	each	50.49
-----------	-------------------------	------	-------

PK:08 and 09 Trauma Medical Packs (Propak)

The PK:08 and PK:09 are commercial grade backpacks that are versatile and able to be configured in several different ways. If you wish to carry oxygen, the pack is equipped with both vertical and horizontal mounting hardware. The PK:09 features extra side pockets and oxygen outlet through the side pocket. Both designs come with a very comfortable fully adjustable pack system which can be hidden away to keep the straps from interfering on calls where a pack is not required.



PRPK08-RE	PK:08 trauma medical pack, red	each	547.59
PRPK08-RB	PK:08 trauma medical pack, royal blue	each	547.59
PRPK09-RE	PK:09 trauma medical pack with side pockets, red	each	633.85
PRPK09-RB	PK:09 trauma medical pack with side pockets, royal blue	each	633.85

Equipment Bags and Cases ■ Intubation Modules

Intubation Bag (Kemp USA)

The KEMP Intubation Bag is designed specifically to help organize supplies required to do a successful intubation in the field. It has enough space to hold ET tubes, a full set of airways and laryngoscope with its blades. This EMS Intubation Bag is equipped with numerous elastic loops of varying sizes and lengths for tape storage with easy organization and quick access for all your supplies. The black nylon webbing handles are strong and durable; they have the ability to withstand large forces of pressure. This intubation bag is equipped with two large Velcro strips on the back to make attaching and transporting the Intubation Bag easy and convenient. 9" x 12" x 3.5"



KB10-116	Intubation bag, royal blue	each	30.00
----------	----------------------------	------	-------



DON'T SEE WHAT YOU'RE LOOKING FOR?
 Call Customer Service; we're here to help.
 (800) 334-6656

G3 Airway Cell (StatPacks)



This EMS Trauma Bag has a foam molded quad-fold design that helps keep basic and advanced airway adjuncts organized and at your finger tips. For EMT Intubation, Laryngoscope blades, Oral Pharyngeal Airways, and Nasal Pharyngeal Airways are neatly arranged for fast access. Endotracheal tubes, suction catheters, stylets, and ET_{CO}₂ meters may be stored in the middle section. The Airway Cell is considered to be one full cell in the StatPacks Third Generation Cellular System. Contents NOT included.

- Innovative fold-out design is compact, yet quickly reveals well-organized airway supplies and tools
- Fits into most EMT Jump Bags available in the market today
- ID window to label any way you want to identify between other Medic Bags
- Two handles with "AIRWAY" written to identify the difference in EMT Gear
- Capacity: 470". Weighs 1.5 lbs. Dimensions: 12" H x 6" W x 6.5

STPG31000GN	G3 Airway Cell, green	each	100.00
-------------	-----------------------	------	--------

G3 Breather Airway Backpacks (StatPacks)



The Breather is an all-inclusive EMS airway management pack for the O₂ module with a "D" or Jumbo "D" size tank. It fits many basic and advanced airway adjuncts and oxygen delivery devices. The Breather is a versatile EMS airway management pack that can be used in many different departments and settings, meeting local protocol for oxygen and airway requirements. Contents not included.

- Unique design allows access to the main compartment from the top or front of this EMS airway management backpack
- Side pockets for easy access to vital sign tools, bandages, and smaller ambulance equipment
- Main fabric is Tarpaulin with a one ounce urethane coating for easier cleaning and protection from the elements and BBPs
- Capacity: 2600". Weighs 4.5 lbs. Dimensions: 20" H x 19" W x 7" D

STPG35008BU	G3 Breather airway backpack, BBP-resistant, blue	each	250.00
STPG35008GN	G3 Breather airway backpack, BBP-resistant, green	each	250.00
STPG35008RE	G3 Breather airway backpack, BBP-resistant, red	each	250.00

G3 First Aid QuickRoll Intubation Module (StatPacks)



The Generation 3 First Aid QuickRoll intubation kit is designed to organize basic and advanced airway equipment for EMT intubation or basic airway adjunct procedures. The single-buckle closure allows fast, one-handed access. The fact it rolls up makes it very quick to access and stow. Contents not included.

- Innovative roll-out design is compact, yet quickly reveals well-organized airway supplies and tools
- Specifically designed to stow neatly in StatPacks' Generation 3 Emergency Medical Services packs
- ID window to label any way you want to identify between other Medic Bags
- Main fabric is 420 Denier Nylon with a one ounce urethane coating for easier cleaning and protection from the elements
- Separate Velcro closure that holds a 10 cc syringe
- Capacity: 400". Weighs 11 oz. Dimensions: 8" H x 10" W x 5" rolled.

STPG36000RE	G3 First Aid QuickRoll intubation module, red	each	52.00
-------------	-----------------------------------------------	------	-------

S400X Intubation Module (R&B Fabrications)

All of your intubation needs packaged in one convenient kit. Elastic loops and slot pockets hold your airways, ET tubes, blades and related items. It is constructed of 1000 denier Cordura nylon. #10 YKK heavy zipper with lockable zipper slides. Weighs 20 oz. Dimensions: 14" L x 9½"W x 3" H.

PAS400RE	S400X intubation module, red	each	124.85
RBS400XRB	S400X intubation module, royal blue	each	124.85



Airway-Pro™ Airway Kit (Conterra)

This rugged kit is built to withstand the everyday abuse of street EMS. It is built entirely of Conterra's exclusive SI TEX fabric, which is totally fluid proof and over five times stronger than the Cordura fabric used on other brands of airway kits. The fully padded Airway-Pro opens with a single huge #10 coil YKK® zipper to reveal a main compartment that is divided into three parts for organizing your O₂ equipment. It has the ability to carry a "D" or Jumbo "D" oxygen cylinder. The top flap is lined with Veltex fabric and can accept any of Conterra's MOS modular organizers. The kit itself comes with two detachable vinyl window pockets for organizing tubing and delivery devices and an elastic strap for your oral or nasal airways (you can add as many additional straps as you need). The top flap has a full length zippered compartment that can hold combi-tubes or several C-collars. The Airway-Pro also sports three fluid-proof handles and fold-away back pack straps. Contents not included.



CTAPK1	Airway-Pro airway kit	each	185.00
--------	-----------------------	------	--------

Intubation Organizer (Conterra)

This Intubation Organizer will allow access to all your ALS airway supplies with just one operation. It will hold a variety of ET tubes in "file folder style" for instant access. There are several pockets for scope handles, masks, gloves, lubricant, etc. There is also a zippered compartment for extra batteries, bulbs, etc. The Conterra intubation kit also has elasticized slots for up to eight blades and forceps. The kit is built entirely out of Cordura with a rip and stick closure, and will easily fit in the front pocket of the Airway Pro™ Kit (CTAPK1). Contents not included. Dimensions: 3" x 6" x 14"



CTITK1	Intubation organizer	each	69.00
--------	----------------------	------	-------

Tube Pro Deluxe Intubation Kit (Conterra)

Tube Pro will carry all of your adult and pediatric gear in Conterra's unique file folder style. It has slots for carrying up to 10 blades. An exciting feature of this bag is its ability to hang vertically while being used, freeing up space in rigs or aircraft. Made in USA and lifetime guaranteed. Contents not included. 4" x 9" x 14".



CTTP1	Tube Pro deluxe intubation kit	each	124.00
-------	--------------------------------	------	--------



Intubation Pouch (Thomas EMS)

This intubation pouch can hold all necessary intubation equipment required to perform a neonate, child or adult intubation. There are specific pockets or elastics for intubation: handle, tongue blades, bulb syringe, curved blades, straight blades, 10cc syringe, xylocaine jelly, umbilical tape, extra light bulbs and batteries. It also has a belt clip on the back. 8" x 4" x 2". Contents not included.

TT400	Intubation pouch	each	19.00
-------	------------------	------	-------



Pediatric Airway Pouch (Thomas EMS)

The color-coded pediatric airway pouch can hold intubation tubes, bulb syringe, masks, tubing and a pediatric-infant bag. 8" x 4" x 2". Contents not included.

TT102	Pediatric airway pouch	each	7.50
-------	------------------------	------	------



ME:01 Pullout Intubation Module (Propak)

The ME:01 Pullout Intubation Module organizes and displays all of your advanced airway management supplies. The removable center card dramatically increases display area, with a windowed pocket on one side and airway loops on the other. The ME:01 features individual pockets to hold your blades. There are also pockets for organizing ET tubes. The front of the case is padded for extra protection. Contents not included.

PRME01-OR	ME:01 pullout intubation module with pockets for blades, orange	each	94.08
PRME01-RE	ME:01 pullout intubation module with pockets for blades, red	each	94.08
PRME01-RB	ME:01 pullout intubation module with pockets for blades, royal blue	each	94.08



ME:03 Compact Intubation Module (Propak)

The ME:03 is a comprehensive module for the size and weight discerning. It is constructed with 500 denier cordura, nylon webbing, heavy woven elastic and YKK self repairing zipper. Contents not included.

PRME03-OR	ME:03 compact intubation module, orange	each	60.29
PRME03-RE	ME:03 compact intubation module, red	each	60.29
PRME03-RB	ME:03 compact intubation module, royal blue	each	60.29

G3 First Aid Remedy Kit (StatPacks)

The Generation 3 First Aid Remedy Kit is compact and organized. This EMS drug bag brings all your meds together while offering a quick way for central supply or pharmacies to restock. Lockable kiss-zippers help you keep track of used modules. Contents NOT included.

- Specifically designed to stow neatly in StatPacks Generation 3 Emergency Medical Services packs
- Nicely fits in the Generation 3 Perfusion and Backup EMS Backpacks
- External pocket window for medical drug listing or unit identification. May be used as a quick stash pocket for trash or extra supplies.
- Capacity: 240". Weighs 9 oz. Dimensions: 6" H x 8" W x 5" D



STPG36001RE	G3 First Aid Remedy kit, red	each	50.00
-------------	------------------------------	------	-------

G3 First Aid Pharmacy Kit (StatPacks)

For an EMS medication bag, this foam lined, quad-fold design helps keep medications organized and at your fingertips. IV catheters, needles and syringes are neatly arranged for simple identification. Prefilled doses may be organized in the middle section. Designed to stow neatly in StatPacks Generation 3 Emergency Medical Services packs. It unfolds to expose all your vital supplies at once, and puts away just as quickly.



STPG36005BK	G3 First Aid Pharmacy kit, black/red handle	each	80.00
-------------	---------------------------------------------	------	-------

G3 Medicine Cell (StatPacks)

This foam-molded quad-fold design helps keep medications organized and at your fingertips. IV catheters, needles, syringes are neatly arranged for simple identification. The Vial Strand holds multi-dose meds tightly in place with bright yellow pull tabs for easy removal. Prefilled doses can be organized in the middle section. This Medicine Cell is considered to be one full cell in the StatPacks Third Generation Cellular System. Contents not included.



- Specifically designed to stack neatly in StatPacks' Generation 3 Emergency Medical Services packs.
- Color-coded for easy identification from other EMS medication bags
- 4 Vial Strands hold multi-dose vials securely in place
- Capacity: 470". Weight: 1.5 lbs. Dimensions: 12" H x 6" W x 6.5" D

STPG31003RE	G3 Medicine cell, red	each	100.00
-------------	-----------------------	------	--------

G3 Bolus Medication Backpacks (StatPacks)

Not only does the Bolus hold first responder medical supplies, it works as a medication pack that may be used with the Breather. This EMT medical bag holds a large supply of oral and intravenous medication for basic and advanced life support. Medication vials and pre-filled syringes are easily organized as well as IV set-ups and fluids. Contents not included.

- Clear, durable urethane windows, mesh pockets, and elastic holsters keep contents in place and well-organized
- Removable center divider holds vials, syringes, and IV therapy equipment
- Designed to hold StatPacks' Generation 3 Emergency Medical Services Kits; including all StatPacks' First Aid QuickRoll intubation, Remedy, and Circulatory kits
- Capacity: 1800". Weighs 5.0 lbs. Dimensions: 16" H x 15.5" W x 7.5" D



STPG35010BU	G3 Bolus medication backpack (BBP-resistant), blue	each	250.00
-------------	----------------------------------------------------	------	--------

STPG35010RE	G3 Bolus medication backpack (BBP-resistant), red	each	250.00
-------------	---------------------------------------------------	------	--------



MD:01 Compact Medication Module (ProPak)

The MD:01 Compact Medication Module organizes and displays all of your injectable medications. The RX:01 and RX:02 medication cassettes add great protection to those fragile ampules and vials. The MD:01 has two sliders with loops for a lock or seal. Constructed of 500 denier cordura, it is designed for trouble free service. Supplied with two RX:01 and two RX:02 medication cassettes. Contents not included.

PRMD01-OR	MD:01 compact medication module, orange	each	59.87
PRMD01-RE	MD:01 compact medication module, red	each	59.87
PRMD01-RB	MD:01 compact medication module, royal blue	each	59.87



MD:02 Medication Module (Propak)

The MD:02 Pullout Medication Module organizes and displays all of your advanced medication supplies. The internal divider dramatically increases display area, while the left side has windows. It is made of 500 denier cordura and is supplied with two sliders with interlocking loops for an additional lock or seal. The MD:02 is supplied with four RX:01 and four RX:02 medication cassettes. Contents not included.

PRMD02-OR	MD:02 medication module, orange	each	88.52
PRMD02-RE	MD:02 medication module, red	each	88.52
PRMD02-RB	MD:02 medication module, royal blue	each	88.52



G3 Intravenous Cell (StatPacks)

For an EMS I.V. bag, this foam molded book style design helps keep IV therapies organized and at your finger tips. Drip sets, IV bags, catheters, needles and Start Kits are neatly arranged for fast access. It doubles as a pressure bag for rapid fluid infusion. This Intravenous Cell is considered to be one half cell in the StatPacks' Third Generation Cellular System. Each Cell sets the stage for clear thinking and quick reaction. They are designed to reveal your supplies intuitively grouped and securely protected. G3 Cells unfold to expose all your vital supplies at once, and puts away just as quickly. Contents not included.

- Unique foam molded design keeps all Emergency Medical Equipment inside protected from breakage or the elements
- Specifically designed to stack neatly in StatPacks Generation 2 Emergency Medical Services packs
- Clear plastic window to identify IV bag solution
- An area to place a pressure gauge for rapid fluid infusion or high altitude fluid therapy
- Hot or cold packs pocket to warm or cool fluids
- Nicely fits in the Generation 3 Perfusion and Backup EMS Backpacks
- Color-coded for easy identification from other EMS IV bags
- Fits into most EMT Jump Bags available in the market today
- A quick stash pocket for trash or extra supplies
- Capacity: 390"; Weight: 0.6 lbs; Dimensions: 12" H x 6" H x 3" zD

STPG31001BU	G3 Intravenous cell	blue	each	80.00
-------------	---------------------	------	------	-------

G3 First Aid Circulatory Kit (StatPacks)

For an EMS IV bag, this foam lined, roll style design helps keep IV therapies organized and at your finger tips. Drip sets, IV bags, catheters, needles and Start Kits are neatly arranged for fast access. It doubles as a pressure bag for rapid fluid infusion. Holds everything you need for a quick IV setup in one convenient kit. The IV Kit makes it easy to share on multi-victim accident scenes. This is a perfect accessory EMS IV bag for any StatPacks' main packs. Contents not included.

- Accommodates all IV bag sizes 1L, 500mL, 250mL
- Specifically designed to stow neatly in StatPacks' Generation 3 Emergency Medical Services packs
- Front and inside pockets organize IV tubing and catheters together with the IV bag
- Top loop hangs the entire kit with the IV bag solution
- A quick stash pocket for trash or extra supplies
- Capacity: 210"; Weight: 6 oz.; Dimensions: 10"H x 6"W x 3.5"D (rolled)



STPG36002RE	G3 First Aid Circulatory kit	red	each	38.00
-------------	------------------------------	-----	------	-------

S600X IV Module (R&B Fabrications)

It's a compact kit for your IV setup. Slot pockets and elastic loops secure your supplies. These keep everything needed convenient and organized. It is constructed of 1000 denier Cordura nylon. #10 YKK heavy zipper with lockable zipper slides.

- Wt. 18 oz. Overall dimensions - 12 1/2"L x 7"W x 3"H.

PAS600RE	S600X IV module	red	each	105.54
PAS600RB	S600X IV module	royal blue	each	105.54



IV Starter Pack (Iron Duck)

Designed by field professionals, this zippered unit holds all the necessary equipment for starting an IV. There is room for everything from catheters and tape, to blood draw tubes and 10cc syringes. Completely padded with 1/4" closed cell foam. Fits into all Iron Duck oxygen and trauma cases. 11"L x 7"W x 1.5"H.

ID36015-OR	IV starter pack	orange	each	37.03
ID36015-RB	IV starter pack	royal blue	each	37.03



MI:01 IV Administration Module (Propak)

The MI:01 Pullout IV Administration Module organizes and displays all your IV supplies so everything you need to start an intravenous line is at your finger tips. This module works well in conjunction with the MD:02. Constructed of 500 denier cordura nylon, the MI:01 comes with sliders that have interlocking loops and a clear top pocket for identification and posting expiration dates for quick referral.

PRMI01-OR	MI:01 IV administration module, orange		each	37.78
PRMI01-RE	MI:01 IV administration module, red		each	37.78
PRMI01-RB	MI:01 IV administration module, royal blue		each	37.78



Omni Pro™ BLS/ALS Total System (Meret)



The Omni Pro is the foundation for a system of TS2 Ready bags that are interchangeable, allowing you to attach additional TS2 Ready modules to the bag's sides depending on your requirements. The Omni Pro's internal main compartment can be completely customized for small and large items using the innovative SLIDER system. Overlapping panels secure internal contents and provide access to TS2 Ready Deep Stuff pockets and tickit Strips. The bag opens completely facing one direction, providing access to all compartments without moving the bag. The bag is ergonomically designed for use as a backpack, shoulder bag, can be carried briefcase style, or can be grabbed from any position using a system of light weight comfort-grip side handles. Dimensions: 15" x 22" x 9 1/2" Weight: 6lbs, 10oz standard, 7lbs 7oz infection control. M4L Lifetime Warranty.

MUM5001	Omni Pro BLS/ALS standard system, blue	each	299.95
MUM5001F	Omni Pro BLS/ALS standard system, red	each	299.95
MUM5001TB	Omni Pro BLS/ALS standard system, tactical black	each	299.95
MUM5101	Omni Pro BLS/ALS infection control system, black	each	399.95
MUM5101F	Omni Pro BLS/ALS infection control system, red	each	399.95

Recover™ Pro Oxygen Response Bag (Meret)



Similar to the Omni Pro, the Recover Pro is the foundation for a system of TS2 Ready bags that are interchangeable, enabling you to attach additional TS2 Ready modules to the bag's sides depending on your requirements. Using EZ-Grab pull bars, the two main panels quickly open to reveal your M9, "D", "Jumbo D", or 425/623 liter composite oxygen cylinder, along with a BVM and other airway equipment. Dimensions: 16.5" at bottom, 11" at top x 22.5" x 7.75" (standard and double cylinder), 16.5" at bottom, 11" at top x 26" x 7.75" (extended height). Weight: 4 lbs, 15oz (standard), 5 lbs, 11oz (infection control and double cylinder), 5 lbs, 15oz (extended length). M4L lifetime warranty.

MUM5008	Recover Pro oxygen response bag, blue	each	199.95
MUM5008F	Recover Pro oxygen response bag, red	each	199.95
MUM5108	Recover Pro infection control oxygen response bag, black	each	239.95
MUM5108F	Recover Pro infection control oxygen response bag, red	each	239.95
MUM5128F	Recover Pro dual cylinder infection control oxygen response bag, red	each	269.95

M.U.L.E.™ Pro Response System (Meret)



The M.U.L.E. Pro Multi-Use Large Equipment Response System is a field- tested roller bag, a harness style backpack, can be carried as a briefcase, can carry up to 4 TS2 Ready modules to expand its capacity by more than 50%, can be completely internally customized, and is backed by the Meret M4L lifetime warranty. Constructed from waterproof, durable, wipe-clean tarpaulin that's designed to easily clean and remove blood borne pathogens, this response system is the foundation for a system of TS2 Ready bags that are interchangeable, allowing you to attach additional TS2 Ready modules to the bag's sides depending on your requirements. The main internal compartment can be completely customized for small and large items using the innovative Slider system while 3 outer pockets offer quick access to equipment when you're on the move.

MUM5107	Mule Pro infection control response bag, black	each	339.95
---------	------------------------------------------------	------	--------

First-In™ Pro Sidepack System (Meret)

The First-In Pro is a hands-free solution, ergonomically designed for use as a sidepack or shoulder/cross-body bag. Using EZ-Grab pull bars, the two top panels quickly open to a main compartment that can be customized for small and large items using the innovative Slider system. Flip-out webbing straps allow you to attach tape rolls that can be rapidly deployed while they are still attached to the bag. Shears, pens, and pen lights can be inserted and secured into their respective pouches on the front of the bag for easy access. Reinforced side webbing offers dual radio and pager mounts. A stress reducing waist belt system uses wide webbing, a large easy-to-use buckle, and a padded lumbar pad to reduce pressure on the side or lower back. Using the included shoulder strap, the waist straps can be concealed into a rear compartment to convert the First-In Pro into a shoulder bag. The First-In Pro has interchangeable TS2 Ready components and offers the ability to attach an additional TS2 Ready module to the front of the bag depending on your requirements. Dimensions: 7.25" x 12.5" x 5". Weighs 1 lb, 12 oz. Standard M4L lifetime warranty.



MUM5010	First-In sidepack system, black	each	89.95
MUM5010F	First-In sidepack system, red	each	89.95
MUM5010TB	First-In sidepack system, tactical black	each	89.95

G2™ Pro Grab 2 Go Quick Aid System (Meret)

The G2 Pro Grab 2 Go Quick Aid System is the perfect BLS bag for the first responder who wants a small but very organized solution for their equipment. As a miniature version of the popular Omin Pro, the G2 Pro offers the same customizability but in a smaller briefcase style design. It is constructed from waterproof, durable, wipe-clean tarpaulin that's designed to easily clean and remove blood borne pathogens. The G2 Pro's internal main compartment can be completely customized for small and large items using the innovative mini-Slider system. Overlapping panels secure internal contents and provide access to TS2 Ready Deep Stuff sockets and Stickit strips. An outer zippered pocket provides organization for pens, phones, or any other smaller items you would typically carry in your personal briefcase. The bag opens completely facing one direction, providing access to all compartments without moving the bag. A system of grommet holes allows all compartments to be air dried while the bag is completely closed. The bag is ergonomically designed and can be grabbed from any position using a system of light weight handles. Dimensions: 15" x 12" x 6"; Weighs 4 lbs 3 oz. M4L lifetime warranty.



MUM5105	G2 Pro Grab 2 Go quick aid system, black	each	129.94
---------	------------------------------------------	------	--------

GO₂™ Pro O₂ Response Bag (Meret)

The GO₂ Pro can secure an MD 425 liters or an MJD 623 liters aluminum oxygen cylinder with the regulator installed and the high pressure hoses deployed and ready for action. The bag is reinforced with internal and external PVC lining and multiple external skid pads to prevent wear. A large outer zipper pocket provides ample storage for masks, tubing, and a demand valve. This bag can be carried from the top or side carry handles. Incredibly durable 1680/1200 Denier coated TPE, water- and stain-resistant. Dimensions: 21" x 5.5" x 8.5". Weighs 2 lbs. M4L Lifetime Warranty.



MUM5003	GO2 Pro oxygen response bag, blue	each	89.95
MUM5003F	GO2 Pro oxygen response bag, red	each	89.95



IV Med™ Pro (Meret)

The IV Med Pro was designed for advanced life support medics as both an IV start kit for adults/ pediatrics as well as a medications kit. It is designed to carry a variety of IV start needles, medications, tourniquets, vacutainers, alcohol prep swabs, tape, Tergaderm packages, up to 1000cc fluid bags or multiple smaller IV solution , catheters, syringes, and other IV start supplies. The infection control deluxe version is constructed from waterproof, durable, wipe-clean tarpaulin and is designed specifically o easily clean and remove blood borne pathogens. Machine washable, drip dry only. Dimensions: 8.5" x 16" x 1.5". Weight: 12.8 oz. M4L lifetime warranty.

MUM5001DP2-IV	IV Med Pro, black	each	52.95
---------------	-------------------	------	-------



Meret Bag Modules (Meret)

MUM5001A	Airway intubation tri-fold module, blue	each	79.95
MUM5001A-F	Airway intubation tri-fold module, red	each	79.95
MUM5001A-TB	Airway intubation tri-fold module, tactical black	each	79.95
MUM5101A	Airway intubation infection control tri-fold module, black	each	89.95
MUM5101A-F	Airway intubation infection control tri-fold module, red	each	89.95
MUM5001B	NARKIT drug module, blue	each	69.95
MUM5001B-F	NARKIT drug module, red	each	69.95
MUM5101B	NARKIT infection control drug module, black	each	79.95
MUM5101B-F	NARKIT infection control drug module, red	each	79.95
MUM5001C	Fill pad module, blue	each	56.95
MUM5001C-F	Fill pad module, red	each	56.95
MUM5001C-TB	Fill pad module, tactical black	each	56.95
MUM5101C	Fill pad infection control module, black	each	79.95
MUM5101C-F	Fill pad infection control module, red	each	79.95
MUM5001E	Multi-purpose fold out module, blue	each	59.95



Meret Bag Accessories (Meret)

MUM5001DP	Deep Stuff pocket or Meret bags	each	12.95
MUM5001X	Oxygen conversion kit for Meret bags	each	25.95
MUMS3601	Slider dividers for Meret bags	each	5.95
MUMLS1	Stick It strips for Meret bags	each	7.95

First Responder Trauma Kit (Southeastern)

This First Responder Trauma Kit contains everything needed to respond to a basic trauma situation. It starts with our popular Large Professional Trauma Bag from Kemp USA (item KB10-104-032), featuring replaceable bottoms, dual-density structural foam and strong 600D nylon construction. Contents include:



- Alcohol preps (1)
- Dual head stethoscope (1)
- 4" x 4" sterile guaze (1)
- Triangle bandages (1)
- 1" tape (1 roll)
- 2" tape (1 roll)
- 5" x 9" ABD pads (1 roll)
- Multi-trauma dressing (1)
- 500ml sterile water (1)
- Burn sheet (1)
- 3" ACE bandage (1)
- 6" ACE bandage (1)
- Eye wash (1)
- 5 ½" straight kelly forcep (1)
- 7 ½" bandage scissors (1)
- Penlight (1)
- Oval eye pads (2)
- Large bandaids (1)
- 1" bandaids (1)
- Non-sterile kerlix (1)
- Oral airway kit (1)
- Isothermal rescue blanket (1)
- Adult blood pressure cuff (1)
- OB kit (1)
- Pocket mask (1)
- Gloves (1 pair)
- Vaseline gauze (1)

SEEFRKIT	First responder trauma kit, red	each	155.85
----------	---------------------------------	------	--------

Maxi Trauma Bag/Kit (Southeastern)

The Maxi Trauma Bag features a padded interior compartment that is customizable for fit, regardless of what you're putting in it. This bag is made with 600D nylon. It comes with an adjustable shoulder strap for easier transport and has elastic loops on the top flap that can accommodate oral airways and small equipment. It has a removable fully adjustable padded center compartment and two large zippered end pockets with bright reflective trim. 20"L x 11"W x 12"H. Available as either bag only or a bag filled with the following:



- Gloves (2 pair)
- 500ml sterile water (1)
- Ammonia inhalant (1)
- Sterile burn sheet (1)
- 3" elastic bandage (1)
- Eye wash solution (1)
- Bulb syringe (1)
- Disposable penlights (2)
- Oval eye pads (2)
- 1" Bandaids (10)
- Extra large Bandaids (5)
- 5 ½" stainless Kelly forceps, straight (1)
- 7 ½" stainless bandage scissor (1)
- Vaseline gauze (2)
- 6" elastic bandage (1)
- Adult blood pressure cuff (1)
- 1" adhesive tape (1)
- 2" adhesive tape (1)
- Alcohol preps (20)
- Multi-trauma dressing (1)
- Dual head stethoscope (1)
- 4 x 4 sterile gauze (10)
- Triangular bandages (3)
- Kwik-Kold (2)
- Abdominal pads, 5" x 9" (2)
- Non-sterile Kerlix (1)
- OB kit soft pack (1)
- Pocket mask (1)
- Bitestick (1)
- Oral airway kit (1)
- Isothermal rescue blanket (1)

G4500BK	Maxi trauma bag kit with contents, blue	each	135.00
G4500OK	Maxi trauma bag kit with contents, orange	each	135.00
G4500B	Maxi trauma bag only, blue	each	39.22
G4500	Maxi trauma bag only, orange	each	39.22



First Responder Bag (Southeastern)

The First Responder Bag is geared for the first on the scene. Made of durable nylon material, this kit will stand up to the toughest applications. Numerous pockets and elastic loops hold a variety of first aid items. 8”L x 18”W x 8”H.

- Vaseline gauze (2)
- Bulb aspirator (1)
- 500ml sterile water (1)
- Ammonia inhalant (1)
- Sterile burn sheet (1)
- 3” elastic bandage (1)
- Eye wash solution (1)
- Disposable penlights (2)
- 6” elastic bandage (1)
- Oval eye pads (2)
- Gloves (2 pair)
- 5 ½” stainless Kelly forceps, straight (1)
- Large bandaids (5)
- Alcohol preps (20)
- 7 ½” stainless bandage scissor (1)
- Adult BP cuff (1)
- Multi-Trauma dressing (1)
- Dual head stethoscope (1)
- 4 x 4 sterile gauze (10)
- Triangular bandages (3)
- Kwik-Kold (2)
- Bite stick (1)
- Abdominal pads, 5” x 9” (2)
- 1” bandaids (10)
- Non-sterile Kerlix (1)
- 2” adhesive tape (1)
- OB kit soft pack (1)
- Pocket mask (1)
- 1” adhesive tape (1)
- Oral airway kit (1)
- Isothermal rescue blanket (1)

G4401BK	First responder bag with contents, blue	each	100.00
G4401OK	First responder bag with contents, orange	each	100.00
G4401B	First responder bag only, blue	each	23.08
G4401	First responder bag only, orange	each	23.08



Opioid Overdose Kit

This Opioid Overdose Kit is manufactured to suit the needs of police officers, first responders and public health outreach groups. Small, lightweight and portable, these bags are a necessary addition to your system. Contents include:

- Naloxone 1mg/ml 2ml needleless PFS (Narcan) (2)
- Nasal atomization device—without 3cc syringe (2)
- CPR Microshield (1)
- Nasal airway 28FR (1)
- Surgical lubricant packet (1)
- Purple Nitrile gloves, large (1 pair)

SEEOPK	Opioid overdose kit with contents	each	215.47
ID36010-BK	Opioid overdose bag only, black	each	46.42
ID36010-YE	Opioid overdose bag only, yellow	each	46.42



Trauma Drug Kit (Flambeau)

This trauma drug kit has a drop-front panel for easy access to the storage bin below, a positive cam-over latch and is lockable for protection of contents. ABS drawers are removable, interchangeable and can be sterilized. 17 3/8”L x 9 1/4”W x 5”D.

FMPM2272	Trauma drug kit	each	105.85
----------	-----------------	------	--------

747 Trauma Box (Plano)

Features a drop-front panel, three large trays, three pull-out drawers and an extra-deep bottom. Contents not included.

PL747M	747 trauma box	each	176.10
720053	Bottom latch for 747 trauma box	each	0.80
747057	Door latch for 747 trauma box	each	0.55
280714	Door pin for 747 trauma box	each	0.03
747046	Handle for 747 trauma box	each	1.08



Polycarbonate Waterproof Cases (Plano)

This waterproof case provides unparalleled protection for your important items. The strong poly-carbonate structure and Dri-Loc seal make the case tough and airtight. Contents not included. Dimensions: **PL144900**—6.5" L x 4.5" D x 2.125" H. **PL1450**—9" L x 4.875" D x 3" H.

PL144900	Polycarbonate waterproof case, extra small, red	each	12.03
PL1450	Polycarbonate waterproof case, small, orange	each	18.42



1550 EMS Case with EMS Organizer/Divider (Pelican)

Padded dividers with adjustable walls for customizing compartments to any size. Automatic pressure equalization valve. Lid organizer clear cover with Velcro® fasteners. Multi-layer lid organizer with numerous clean pockets. Watertight, crushproof, and dustproof. 18.43" L x 14.00 D" x 7.62" H. Stainless steel padlock protectors. Contents not included.

PE1550EMS	1550 EMS case with EMS organizer/divider, black	each	424.31
PE1550EMS-OR	1550 EMS case with EMS organizer/divider, orange	each	424.31



1120 Case (Pelican)

Ultra high-impact polycarbonate shell. Waterproof seal. Pick N Pluck™ with convoluted lid foam. Chemical-resistant, corrosion-resistant, airtight, dustproof, crushproof.

PE1120	1120 case with foam, black	each	46.15
PE1120BL	1120 case with foam, blue	each	46.15
PE1120OR	1120 case with foam, orange	each	46.15
PE1120YE	1120 case with foam, yellow	each	46.15



1010 Micro Case (Pelican)

Small valuables like your GPS, cell phone, MP3 player and other pocket-sized electronics need portable protection. The Pelican 1010 is the perfect fit. It's water resistant, crushproof and dustproof.

PE1010	1010 micro case with liner	each	18.48
PE1012	Pick and pluck foam insert for 1010 micro case	each	6.31





5.11 Tactical Clothing

Icon Key, Sizing Instructions

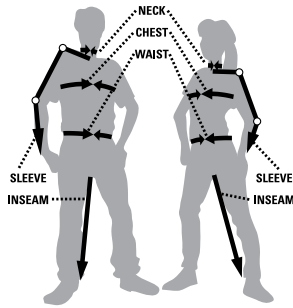

pages 356-357

Shirts



pages 358-365

Pants and Shorts



pages 366-373

Uniforms



pages 374-376

Belts



page 377

Outerwear



pages 378-389

Footwear



pages 390-395

Product Features and Benefits

Our product design teams are always on the prowl for problems to solve based on real-world feedback from our customers worldwide. As a result, 5.11 Tactical® products are loaded with features inspired by operator experience. To effectively communicate 5.11's arsenal of technical

features and situation-specific functionality, we have developed this icon key to help you discover and evaluate our products' features and benefits.

 **Air Flow** Constructed with mesh panels, vents, and/or a cape back for maximum airflow.

 **Adjustable Waistband** Made with a self-adjusting or elastic waistband for flexibility when carrying an inside the waistband (IWB) holster.

 **Antimicrobial** Antimicrobial technology inhibits the growth of bacteria.

 **CCW Ready** Designed and built to confidentially carry a concealed sidearm.

 **Comms Ready** With product features built to accommodate cable routing, radio equipment, and/or writing tools.

 **Device Ready** Designed for easy transportation of smart phones, MP3 players, or other similar handheld devices.

 **Document Ready** Document features like 5.11's patented chest utility pockets and windows on select bags.

 **Gear Ready** Designed and built to serve as a load-bearing platform.

 **High Bartack Count** Product is built with a large quantity of reinforcing bartacks.

 **Hydration Ready** Built to carry a hydration bladder.

 **ID Panels** Built with customizable ID panels that can be stowed away or shown for agency identification.

 **Inspection Ready** Fabric and construction features designed to promote a neat, clean, and professional appearance.

 **Kneepad Ready** Product is built to accommodate 5.11's neoprene knee pad (59008 available separately).

 **Laptop Ready** Built with a laptop-compatible compartment.

 **Load Ready** Created with construction features like flatlock that allow comfortable wear underneath load-bearing or ballistic equipment.

 **Moisture Wicking** A fabric function that helps transport moisture (sweat) away from your skin.

 **Performance Ready** Built with stretch fabric or articulation and/or gussets for range of motion.

 **Pocket Count** The number of pockets.

 **Polar Ready** A rating of 1-5 for cold weather performance. 5 is warmest.

 **Rain Ready** A rating of 1-5 for water resistance. 5 is fully seam-sealed waterproof.

 **RAPIDDraw** Designed and built with features to allow the fast presentation of a concealed sidearm.

 **Reinforced Zones** Features reinforced or double-layer fabric in high wear zones like the seat, knees, and elbows.

 **UV Protection** Ultraviolet protection factor.

 **Women's Fit** Products are designed and fitted specifically for women.

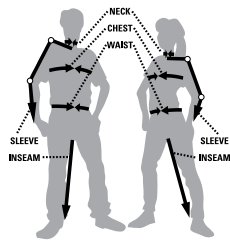

Sizing Instructions

Using measuring tape, measure your body (not over clothing) and refer to diagram as a guide. If you fall between sizes, order the smaller size for a tighter fit or the larger size for a looser fit.

Men: Utilize your chest, arm length, and neck measurements to determine the proper size for tops, outerwear, or jumpsuits; utilize your waist measurement (where you wear your pants) for bottoms.

Women: Utilize your chest measurement to determine the proper size for tops, outerwear, or jumpsuits; utilize your waist (smallest part) and hip measurements for bottoms; utilize your waist measurement (where you wear your pants) for belts.

Men's Body Measurements

Alpha Size	XS	S	M	L	XL	2XL	3XL	4XL	5XL	6XL
Neck	13-13 ½	14-14 ½	15-15 ½	16-16 ½	17-17 ½	18-18 ½	19-19 ½	20-20 ½	21-21 ½	22-22 ½
Chest	30-32	34-36	38-40	42-44	46-48	50-52	54-56	58-60	62-64	66-68
Arm Length*	32 ¼-32 ¾	33-33 ½	33 ¾-34 ¼	34 ½-35	35 ¼-35 ¾	36-36 ½	36 ¾-37 ¼	37 ½-38	38 ¾-39 ¼	39-39 ½
Waist	24-26	28-30	32-34	36-38	40-42	44-46	48-50	52-54	56-58	60-62

Short = 5'3"-5'7", Regular = 5'8"-6'1", Tall = 6'1"-6'3", Tall sizes have 2" added to body and sleeve length. *Arm length refers to your actual arm length, not the garment's sleeve length.

Women's Body Measurements

Alpha Size	X-Small	Small	Medium	Large	X-Large
Numeric Size	2	4	6	8	10
Chest	32 ½	33 ½	34 ½	35 ½	36 ½
Arm Length*	29 ¾	30 ¾	30 ¾	31	31 ¼
Waist	25	26	27	28	29
Hip	35 ½	36 ½	37 ½	38 ½	39 ½

Regular = 5'5"-5'7", Tall = 5'8"-5'11", Tall sizes have 2" added to body length and 1 ½" added to sleeve length.

*Arm length refers to your actual arm length, not the garment's sleeve length.

Men's Footwear Sizing

US Size	5	6	6 ½	7	7 ½	8	8 ½	9	9 ½	10	10 ½	11	11 ½	12	13	14	15
UK Size	4	5	5 ½	6	6 ½	7	7 ½	8	8 ½	9	9 ½	10	10 ½	11	12	13	14
EU Size	37 ½	38 ½	39	40	40 ½	41	42	42 ½	43	44	44 ½	45	45 ½	46	47 ½	48 ½	49 ½

Wide available in US Sizes 7-12, 13

Women's Footwear Sizing

US Size	5	6	6 ½	7	7 ½	8	8 ½	9	9 ½	10
UK Size	4	4 ½	5	5 ½	6	6 ½	7	7 ½	8	8 ½
EU Size	37	37 ½	38	38 ½	39	40	40 ½	41	42	42 ½

Glove Sizing

Unisex Size	S	M	L	XL	2XL
Men's	78mm	90mm	103mm	114mm	127mm
Women's	71mm	83mm	96mm		

Measure across the palm of your hand from where your thumb and index meet.

Hat Sizing

Hat Size	Measurement	A-Flex	One Size
7	22" / 55.8 cm	M/L	One Size Fits Most
7 1/8	22 3/8" / 56.8 cm		
7 1/4	22 3/4" / 57.7 cm		
7 3/8	23 1/8" / 58.7 cm		
7 1/2	23 1/2" / 59.6 cm		
7 5/8	23 7/8" / 60.6 cm	L/XL	
7 3/4	24 1/4" / 61.5 cm		
7 7/8	24 5/8" / 62.5 cm		

Trademarks: The following are trademarks of their respective owners: Teflon®, YKK®, Prym®, MultiCam®, VELCRO®, VTAC®, Viking Tactics®, Blade-Tech®, Ironclad®, Storm Cotton®, 3M®, Scotchlite®, Nomex®, Duraclad®, Kevlar®, Breathoprene®, Molle-Lok®, iPhone®, Apple®, Facebook®, YouTube®, OrthoLite®, NanoGLIDE®, TransDRY®, eVent®, HELCOR®, AustriAlpin®, Realtree®, Duraflex®, Wiley X®

PRODUCT DETAILS, PRICES, AND AVAILABILITY ARE SUBJECT TO CHANGE WITHOUT NOTICE.

5.11 Warranties: All of our products are backed by a limited warranty. Please visit <http://www.511tactical.com/customer-service/warranty> for details regarding our product warranties.

Returns and Exchanges: Please visit <http://www.511tactical.com/customer-service/return-policy/> for details regarding how to return products.

Bloodborne Pathogen Resistance: Certain 5.11 products feature resistance to bloodborne pathogens. Please visit <http://www.511tactical.com/customer-service/help-center/> for more details regarding the level of this resistance and other important information.

Notice Regarding Knives: The purchase, possession, and use of knives are subject to a variety of federal, state, and local laws. Please visit www.511tactical.com/disclaimers.html for more details prior to purchasing your knife. You should consult your local Law Enforcement official to identify restrictions in your area.

BE SEEN, BE SAFE

VELO PERFORMANCE



3M Scotchlite
Reflective Material

CLASSIC FIT

CLASSIC FIT

Hi-Vis Polo

When it's getting dark, you need a polo that works for you. Specially designed to provide a highly visible profile in our Hi-Vis Polo features 3M® Scotchlite® reflective material in jersey-knit 100% polyester fabric. It offers a moisture-wicking, antimicrobial finish, side vents for added breathability, integrated mic loops, and a pen pocket at the chest. The Hi-Vis Polo is ANSI 107-2010 Class II, Level II certified. Imported.

41007 Hi-Vis Polo | Hi-Vis Yellow 320 | XS-3XL (3XL \$64.99) | **\$59.99**

-  MOISTURE WICKING
-  AIR FLOW
-  COMMS READY
-  ANTIMICROBIAL

Bike Patrol Polo

Made for officers who work around and in-between traffic, the Bike Patrol Polo presents a professional, highly visible profile. Made of jersey-knit 100% polyester, the shirt offers a moisture-wicking, antimicrobial finish, a stay-flat, no-roll collar, gusseted sleeves for superior freedom of movement, and mic clips at the sternum. Plus, dual pen pockets on the chest, reflective tape at the sleeves, chest, and back, and a black epaulette kit. If Frogger had one of these, he would've made it out of the '80s. Imported.

71322 Bike Patrol Polo | Hi-Vis Yellow/Black 320, Royal Blue/Black 693 | S-3XL (3XL \$54.99) | **\$49.99**

- ROYAL BLUE/BLACK**
- HI-VIS YELLOW/BLACK**

-  MOISTURE WICKING
-  COMMS READY
-  ANTIMICROBIAL

**Anti-microbial technology inhibits the growth of bacteria*

COMFORTABLE JERSEY KNIT



CLASSIC FIT

Tactical Polos

Made of 100% cotton jersey, built to be shrink-, wrinkle-, and fade-resistant, 5.11's Tactical Polo is a clean, professional shirt useful for any situation. It features our stay-flat, no-roll collar, pen pockets on the sleeve, and mic-clips at the shoulders and sternum. The Tactical Polo is ready for custom embroidery or printing from the 5.11 Custom Shop. UPF 50. Imported.

71182 Men's Short-Sleeve Tactical Polo | White 010, Heather Grey 016, Black 019, Silver Tan 160, Dark Navy 724 | S-3XL (3XL \$44.99) | **\$39.99**

72360 Men's Long-Sleeve Tactical Polo | Black 019, Silver Tan 160, Dark Navy 724 | S-3XL (3XL \$49.99) | **\$44.99**

61164 Women's Short-Sleeve Tactical Polo | White 010, Heather Grey 016, Black 019, Silver Tan 160, Dark Navy 724 | S-XL | **\$39.99**

WHITE 010	HEATHER GREY 016	BLACK 019
SILVER TAN 160	DARK NAVY 724	COMMS READY

COTTON PIQUE KNIT



CLASSIC FIT

Professional Polos

5.11's Professional Polo is made of durable, soft 100% cotton pique knit that's treated to retain color. The Professional Polo features a stay-flat, no-roll collar, pen pockets on the sleeve, and shrink-, wrinkle-, and fade-resistance. It's also ready for custom embroidery or printing from the 5.11 Custom Shop. Imported.

41060 Men's Short-Sleeve Professional Polo | White 010, Heather Grey 016, Black 019, Silver Tan 160, Range Red 477, Academy Blue 692, Dark Navy 724, LE Green 860 | XS-3XL (3XL \$44.99) | **\$39.99**

41060T Tall Men's Short-Sleeve Professional Polo | Heather Grey 016, Silver Tan 160, Dark Navy 724 | L-5XL Tall | **\$44.99**

42056 Men's Long-Sleeve Professional Polo | White 010, Heather Grey 016, Black 019, Silver Tan 160, Range Red 477, Academy Blue 692, Dark Navy 724, LE Green 860 | XS-3XL (3XL \$49.99) | **\$44.99**

42056T Tall Men's Long-Sleeve Professional Polo | Heather Grey 016, Black 019, Silver Tan 160, Dark Navy 724 | L-5XL Tall | **\$54.99**

61166 Women's Short-Sleeve Professional Polo | White 010, Black 019, Silver Tan 160, Dark Navy 724 | S-XL | **\$39.99**

WHITE 010	HEATHER GREY 016	BLACK 019
SILVER TAN 160	RANGE RED 477	ACADEMY BLUE 692
DARK NAVY 724	LE GREEN 860	INSPECTION READY

POLY/COTTON BLEND



CLASSIC FIT

OUR LIGHTEST WEIGHT POLO



CLASSIC FIT

Utility Polos

5.11®'s Utility Polo is shrink-, wrinkle-, and fade-resistant. It features a stay-flat, no-roll collar, pen pockets on the sleeve, and a 60% cotton/40% polyester pique blend for superior comfort and flexibility. You can't build a better basic polo shirt, and you can't stock your wardrobe with a better value. It's a win-win. UPF 50. Imported.

41180 Men's Short-Sleeve Utility Polo | White 010, Heather Grey 016, Black 019, Silver Tan 160, Range Red 477, Academy Blue 692, Dark Navy 724, LE Green 860 | XS-3XL (3XL \$29.99) | **\$24.99**

41180T Men's Short-Sleeve Utility Polo | White 010, Heather Grey 016, Black 019, Silver Tan 160, Range Red 477, Academy Blue 692, Dark Navy 724, LE Green 860 | L-5XL Tall | **\$29.99**

72057 Long-Sleeve Utility Polo | White 010, Heather Grey 016, Black 019, Silver Tan 160, Range Red 477, Academy Blue 692, Dark Navy 724, LE Green 860 | XS-3XL (3XL \$34.99) | **\$29.99**

61173 Women's Short-Sleeve Utility Polo | Heather Grey 016, Black 019, Silver Tan 160, Dark Navy 724 | S-XL | **\$24.99**

WHITE 010	HEATHER GREY 016	BLACK 019
SILVER TAN 160	RANGE RED 477	ACADEMY BLUE 692
DARK NAVY 724	LE GREEN 860	INSPECTION READY

Helios Polo

Built from 4.5-oz. snag-resistant knit fabric, the Helios Polo is moisture-wicking, quick-drying, and antimicrobial; all of which means you'll stay nice and cool when the weather gets hot and sticky. With underarm gussets to provide full range of movement, front mic-clip pockets, shoulder mic loops, and a sunglasses loop, you'll be ready for anything life throws at you. Imported.

41192 Helios Polo | S-3XL (3XL \$54.99) | Heather Grey 016, Charcoal 018, Black 019, Silver Tan 160, Academy Blue 692, Dark Navy 724 | **\$49.99**

61305 Womens Helios Polo | S-XL | Charcoal 018, Black 019, Silver Tan 160, Dark Navy 724 | **\$49.99**

HEATHER GREY 016	CHARCOAL 018	BLACK 019
SILVER TAN 160	ACADEMY BLUE 692	DARK NAVY 724

MOISTURE WICKING	COMMS READY	ANTIMICROBIAL
------------------	-------------	---------------

SNAG AND FADE RESISTANT

LIGHTWEIGHT AND COLORFAST



CLASSIC FIT

REGULAR FIT

Performance Polos

TAA AVAILABLE

Made of jersey-knit 100% polyester fabric, the Performance Polo is wrinkle- and shrink-resistant, snag-resistant, antimicrobial, and has a stay-flat, no-roll collar. You could wad this thing up, stuff it in a cannon, and fire it down the range, and it would still look shiny and new. The Performance Polo also features collarbone and front mic-clip pockets, embellishment friendly pen pocket and it wicks moisture. Imported.

71049 Men's Short-Sleeve Performance Polo | White 010, Charcoal 018, Black 019, Silver Tan 160, TDU Green 190, Range Red 477, Dark Navy 724, LE Green 860 | XS-3XL (3XL \$44.99) | **\$39.99**

71049T Men's Short-Sleeve Performance Polo | Black 019, Silver Tan 160, Dark Navy 724 | L-5XL | **\$44.99**

72049 Men's Long-Sleeve Performance Polo | Black 019, Silver Tan 160, Dark Navy 724, LE Green 860 | XS-3XL (3XL \$49.99) | **\$44.99**

72049T Men's Long-Sleeve Performance Polo | Black 019, Silver Tan 160, Dark Navy 724 | L-5XL | **\$49.99**

61165 Women's Short-Sleeve Performance Polo | White 010, Black 019, Silver Tan 160, Range Red 477, Dark Navy 724 | S-XL | **\$39.99**

WHITE 010	CHARCOAL 018	BLACK 019
SILVER TAN 160	TDU GREEN 190	RANGE RED 477
DARK NAVY 724	LE GREEN 860	ANTIMICROBIAL
PERFORMANCE READY	MOISTURE WICKING	COMMS READY

Rapid Performance Polo

Bringing operator-oriented performance to everyday comfortable apparel, the Rapid Performance Polo features woven polyester sleeves and a polyester/spandex jersey body for outstanding colorfastness and comfort. Raglan shoulder construction and gusseted sleeves offer a full range of motion and comfortable wear. UPF 50. Imported.

41018 Rapid Performance Polo | XS-3XL (3XL \$59.99) | UPF 50 | Black 019, Silver Tan 160, TDU Green 190, Fire Medium Blue 696, Dark Navy 724 | **\$54.99**

BLACK 019	SILVER TAN 160	TDU GREEN 190
FIRE MEDIUM BLUE 696	DARK NAVY 724	ANTIMICROBIAL
MOISTURE WICKING	LOAD READY	PERFORMANCE READY

COMFORT AND LASTING PERFORMANCE



REGULAR FIT

Odyssey Polo



Built with a contemporary style and fit in mind, made of a snag- and fade-resistant polyester/spandex blend, the Odyssey Polo provides all-day comfort, ease of movement, and moisture wicking and antimicrobial properties. Add a patent pending pen pocket on the sleeve and a zippered chest pocket and you've got everything you need. Imported.

71032 Odyssey Polo | UPF 50 | S-2XL | Black 019, Pearl 087, Marina 754, Mosstone 861 | **\$49.99**

BLACK 019

PEARL 087

MARINA 754

MOSSTONE 861



PERFORMANCE READY



ANTIMICROBIAL



MOISTURE WICKING

FUNCTIONAL LOGOWEAR BY 5.11®



REGULAR FIT

Pinnacle Polo

Constructed from snag-resistant, antimicrobial, lightweight, 100% polyester fabric, the Pinnacle Polo features a sunglass loop at the placket base, a patent pending pen pocket on the sleeve, and moisture-wicking breathability. The Pinnacle Polo is also handsome and fade-resistant. Imported.

71036 Pinnacle Polo | S-2XL | Charcoal 018, Black 019, Fatigue 200, Range Red 477, Nautical 677, Dark Navy 724 | **\$44.99**

CHARCOAL 018

BLACK 019

FATIGUE 200

RANGE RED 477

NAUTICAL 677

DARK NAVY 724



MOISTURE WICKING



ANTIMICROBIAL



LOAD READY

**Anti-microbial technology inhibits the growth of bacteria*



NEW WOMEN'S STYLES

CLASSIC FIT

FIELD TESTED BY VAC

FITTED

TDU® Shirt

Available in several blends and colors, our TDU Shirt is an ideal choice for tactical duty use. Rugged and fade-resistant, Teflon® treated for stain- and soil-resistance, and featuring bi-swing shoulders, reinforced elbows, and bartacking at seams and stress points, the shirt is as comfortable as it is tough. And it's real tough. The TDU Shirt offers hidden utility pockets and elbow pockets. Patented document pockets. Imported.

71339 Taclite® Short-Sleeve TDU Shirt | Black 019, Storm 092, TDU Khaki 162, TDU Green 190, Dark Navy 724 | S-4XL (3XL-4XL \$54.99) | **\$49.99**

71339T Taclite® Short-Sleeve TDU Shirt - Tall | Black 019, Storm 092, TDU Khaki 162, TDU Green 190, Dark Navy 724 | L-5XL | **\$54.99**

72054 Taclite® Long-Sleeve TDU Shirt | Black 019, Storm 092, TDU Green 190, Dark Navy 724 | S-4XL (3XL-4XL \$54.99) | **\$49.99**

72054T Taclite® Long-Sleeve TDU Shirt - Tall | Black 019, Storm 092, TDU Green 190, Dark Navy 724 | L-5XL Tall | **\$54.99**

72013 MultiCam® TDU Long-Sleeve Shirt | MultiCam 169 | S-4XL (3XL-4XL \$89.99) | **\$79.99**

72002 Ripstop Long-Sleeve TDU Shirt | UPF 50 | Black 019, TDU Khaki 162, TDU Green 190, Dark Navy 724 | XS-4XL (3XL-4XL \$54.99) | **\$49.99**

61025 Women's Taclite SS TDU Shirt | Public Safety Only | S-XL | 019 Black, 162 TDU Khaki, 724 Dark Navy | **\$49.99**

62016 Women's Taclite LS TDU Shirt | Public Safety Only | S-XL | 019 Black, 162 TDU Khaki, 724 Dark Navy | **\$49.99**



Rapid Assault Shirt

TAA AVAILABLE

What happens when you combine two exceptional fabric blends into one rugged shirt? You get the ideal tactical base layer. The body of the Rapid Assault Shirt is built from moisture-wicking poly/cotton/spandex for durability, breathability, and stretch. The shoulders and sleeves are made of poly/cotton ripstop and feature angled sleeve pockets, just in case the shirt wasn't tough enough. With a zip-up collar, flat-lock seams for comfort, and saddle-shoulder design, you'll be ready for anything. Imported.

72194 Rapid Assault Shirt | UPF 50 (woven upper only) | Black 019, Storm 092, TDU Khaki 162, TDU Green 190, Dark Navy 724 | XS-3XL (3XL \$64.99) | **\$59.99**

72185 Rapid Assault Shirt MultiCam® | UPF 50 (woven upper only) | MultiCam 169 | S-3XL (3XL \$79.99) | **\$74.99**



MOISTURE WICKING



LOAD READY



UV PROTECTION

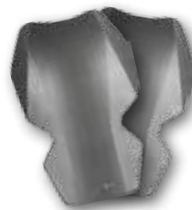

D30 is a patented technology featuring unique molecular properties. In standard conditions its molecules flow freely, but on impact, they lock together to absorb energy and reduce the force transmitted.

NEW

BLACK 019

BROWN 108

TDU KHAKI 162

TDU GREEN 190

DARK NAVY 724

MULTICAM 169

STORM 092



CLASSIC FIT

Taclite® Pro Shirt

The Taclite Pro Shirt is a tactical wardrobe staple, alongside shoes, pants, and mean-looking sunglasses. This shirt is rugged, lightweight, breathable, finished with Teflon®, and made of poly/cotton ripstop fabric. It has hidden utility pockets, pen pockets, and adjustable cuffs. Imported.

71175 Short-Sleeve Taclite Pro Shirt | White 010, Charcoal 018, Black 019, TDU Khaki 162, TDU Green 190, Dark Navy 724 | S-3XL (3XL \$54.99) | **\$49.99**

71175T Tall Short-Sleeve Taclite Pro Shirt | Charcoal 018, Black 019, TDU Khaki 162, Dark Navy 724 | L-5XL | **\$54.99**

72175 Long-Sleeve Taclite Pro Shirt | White 010, Charcoal 018, Black 019, Storm 092, Battle Brown 116, Coyote 120, TDU Khaki 162, TDU Green 190, Tundra 192, Dark Navy 724 | S-3XL (3XL \$59.99) | **\$54.99**

72175T Tall Long-Sleeve Taclite Pro Shirt | Charcoal 018, Black 019, TDU Khaki 162, Dark Navy 724 | L-5XL | **\$59.99**

62070 Women's Taclite Pro Long-Sleeve Shirt | Black 019, TDU Khaki 162, TDU Green 190, Dark Navy 724 | S-XL | **\$49.99**

WHITE 010	CHARCOAL 018	BLACK 019
STORM 092	BATTLE BROWN 116	COYOTE 120
TDU KHAKI 162	TDU GREEN 190	TUNDRA 192
DARK NAVY 724	DOCUMENT READY	HIGH BARTACK COUNT

AIR FLOW



CLASSIC FIT

TAA AVAILABLE

5.11® Tactical Shirt

Every once in a while, something great comes along that changes the way people think. The 5.11 Tactical Shirt, another time-tested industry standard, features triple-needle stitching, strategic bartacking, and 100% cotton canvas for enhanced durability. A cape-back with mesh lining guarantees comfort and breathability, and our 5.11's patented hidden utility pockets, pen pockets, and adjustable cuffs provide superior functionality. There's nothing to add. It's the original tactical shirt. Imported.

71152 Short-Sleeve 5.11 Tactical Shirt | Black 019, Grey 029, Khaki 055, Coyote 120, OD Green 182, Fire Navy 720, Sage 833 | XS-3XL (3XL \$54.99) | **\$49.99**

72157 Long-Sleeve 5.11 Tactical Shirt | Black 019, Grey 029, Khaki 055, Coyote 120, OD Green 182, Fire Navy 720, Sage 833 | XS-3XL (3XL \$59.99) | **\$54.99**

BLACK 019	GREY 029	KHAKI 055
COYOTE 120	OD GREEN 182	FIRE NAVY 720
SAGE 833	DOCUMENT READY	AIR FLOW



CLASSIC FIT

Job Shirt

Constructed from fade-, shrink-, and wrinkle-resistant 82% cotton/18% polyester fabric, the Job Shirt provides superior versatility and utility while remaining tough, comfortable, and professional. The shirt offers warmth and breathability, and our exclusive Chest BreakThrough pocket utilizes a hook-and-loop divider to keep your gear within reach. Also featuring a no-roll collar, mic loops, side-seam hand-warmer pockets, and sleeve pocket, the Job Shirt is available in four types, including a water-resistant version made with Storm Cotton®. Imported.

72321 Job Shirt with Canvas Collar | Fire Navy 720 | XS-3XL (3XL \$67.99) (72321T L-5XL Tall \$72.99) | **\$62.99**

72301 Job Shirt with Denim Collar | Fire Navy 720 | XS-3XL (3XL \$67.99) | **\$62.99**

72314 1/4-Zip Job Shirt | Heather Grey 016, Black 019, Fire Navy 720 | XS-3XL (3XL \$72.99) (72314T L-5XL Tall | Fire Navy 720 | \$67.99) | **\$62.99**

72363 Water-Repellent Storm Cotton® 1/4-Zip Job Shirt | Fire Navy 720 | XS-3XL (3XL \$77.99) | **\$72.99**

HEATHER GREY 016

BLACK 019

FIRE NAVY 720



COMMS READY



Storm Cotton® 1/4 Zip Job Shirt (72363) provides protection from light showers.





EMS Pant & EMS Short

Our popular EMS Pant and Short are engineered with features, comfort, and performance you won't find anywhere else. Available in a polyester/cotton twill or our Taclite ripstop, treated with Teflon® finish for stain and soil resistance, the EMS Pant and Short feature compartmentalized cargo pockets, secondary cargo pockets at the calf, and double-time belt loops for enhanced accessory anchorage. The reinforced knees accept kneepads, and a self-adjusting waist and gusseted crotch ensure comfort and mobility. It's an unbeatable setup. UPF 50. Imported.

74363 Men's Taclite EMS Pants | Black 019, Dark Navy 724 | 28-44 even, even inseams 30-36 or unhemmed in waist sizes 46-54 (74363L \$69.99) | **\$59.99**

74310 Men's EMS Pants | Black 019, Dark Navy 724 | 28-44 even, even inseams 30-36 or unhemmed in waist sizes 46-54 even (74310L \$69.99) | **\$59.99**

64369 Women's Taclite EMS Pants | Black 019, Dark Navy 724 | 2-20 even (Inseams: Regular = 30-32", Long = 34-36") | **\$59.99**

64301 Women's EMS Pants | Black 019, Dark Navy 724 | 2-20 even (Inseams: Regular = 30-32", Long = 34-36") | **\$59.99**

73309 Men's Taclite EMS Shorts | Dark Navy 724 | 28-54, 11" inseam (\$59.99) | **\$54.99**

BLACK 019

DARK NAVY 724

22 HIGH BARTACK COUNT

KNEEPAD READY

REINFORCED ZONES



Company Pant

Constructed from 100% cotton twill, the Company Pant is fade-, shrink-, and wrinkle-resistant. A self-adjusting tunnel waistband and gusseted crotch provide comfort and mobility, all in a clean, professional profile. Reinforced belt loops offer plenty of support for mission-critical gear. UPF 50. Imported.

74398 Company Pant | Fire Navy 720 | 28-44 even, inseams 30-36, 46-54 even unhemmed (74398L \$54.99) | **\$49.99**

74399 Company Cargo Pant | Fire Navy 720 | 28-44 even, inseams 30-36, 46-54 even unhemmed (74399L \$59.99) | **\$54.99**



INSPECTION READY



REINFORCED ZONES



CLASSIC FIT

Station Shirt

Built from 100% cotton, the 5.11® Station Shirt is available in A-Class or B-Class. Fade-, shrink-, and wrinkle-resistant, the shirt features permanent stitched creases and durable melamine buttons. The B-Class shirt includes patented document pockets at the chest. Imported.

46122 Men's A-Class Short-Sleeve Station Shirt | S-3XL | White 010, Med Blue 696, Fire Navy 720 (L-3XL Tall available in Fire Navy only for \$54.99) | **\$49.99**

46123 Men's A-Class Long-Sleeve Station Shirt | S-3XL, L-3XL Tall, Fire Navy 720 (\$54.99) | **\$49.99**

46124 Men's B-Class Short-Sleeve Station Shirt | S-3XL, L-3XL Tall, Fire Navy 720 (\$54.99) | **\$49.99**

46125 Men's B-Class Long-Sleeve Station Shirt | S-3XL, L-3XL Tall, Fire Navy 720 (\$54.99) | **\$49.99**

WHITE 010

MEDIUM BLUE 696

FIRE NAVY 720



INSPECTION READY



DOCUMENT READY

* B Class Only



5.11 Stryke™ Pant

The 5.11 Stryke Pant is what all other pants want to be. Made of our patent-pending two-way Flex-Tac® mechanical stretch fabric, finished with stain- and soil-resistant Teflon®, the 5.11 Stryke pant is exceptionally durable. With 12 pockets, reinforcements in strategic places, and a self-adjusting waistband (men's only), it's high-performance functionality at its finest. Imported.

74369 Men's Stryke Pant | Charcoal 018, Black 019, Khaki 055, Stone 070, Storm 092, Battle Brown 116, Coyote 120, TDU Green 190, Tundra 192, Dark Navy 724 | (46-54 unhemmed \$79.99) 28-44 even sizes, 30-36 even inseams | **\$69.99**

64386 Women's Stryke Pant | Black 019, Khaki 055, Storm 092, TDU Green 190, Tundra 192, Dark Navy 724 | 0-20 even Regular or Long Dims | **\$69.99**

Women's inseams: Regular = 30-32", Long = 34-36"

CHARCOAL 018	BLACK 019
KHAKI 055	STONE 070
STORM 092	BATTLE BROWN 116
COYOTE 120	TDU GREEN 190
TUNDRA 192	DARK NAVY 724



KNEEPAD READY



HIGH BARTACK COUNT



DEVICE READY

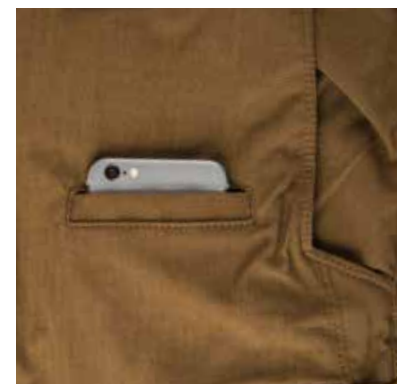



Now available with Flannel-lining in Black, TDU Khaki and Dark Navy

Taclite® Pro Pant

The Taclite Pro Pant features eight pockets, our durable ripstop fabric, and a Teflon® finish for stain- and soil-resistance. Double-reinforced at the seat and knees, these pants won't wear out, no matter how much sitting, hustling, and crawling through the brush you do. If you've ever wondered what it's like to wear comfortable, invincible pants, here's your opportunity. Imported.

74273 Taclite Pro Pant | Charcoal 018, Black 019, Stone 070, Storm 092, Battle Brown 116, Coyote 120, TDU Khaki 162, TDU Green 190, Tundra 192, Dark Navy 724 | 28-44 even sizes, 30-36 even inseams (select colors in sizes 46-54 unhemmed for \$59.99) | **\$49.99**

74437 Taclite Flannel Pant | Black 019, TDU Khaki 162, Dark Navy 724 | 28-44 even sizes, 30-36 even inseams | **\$69.99**

64360 Women's Taclite Pro Pant | Charcoal 018, Black 019, TDU Khaki 162, TDU Green 190, Dark Navy 724 | 2-20 even, Reg/Long inseams | **\$49.99**

CHARCOAL 018	BLACK 019	STONE 070
STORM 092	BATTLE BROWN 116	COYOTE 120
TDU KHAKI 162	TDU GREEN 190	TUNDRA 192
DARK NAVY 724	KNEEPAD READY	ADJUSTABLE WAISTBAND



CLASSIC FIT

Taclite® Pro Shirt

The Taclite Pro Shirt is a tactical wardrobe staple, alongside shoes, pants, and mean-looking sunglasses. This shirt is rugged, lightweight, breathable, finished with Teflon®, and made of poly/cotton ripstop fabric. It has hidden utility pockets, pen pockets, and adjustable cuffs. Imported.

62070 Women's Taclite Pro Long-Sleeve Shirt | Black 019, TDU Khaki 162, TDU Green 190, Dark Navy 724 | S-XL | **\$49.99**

BLACK 019
TDU KHAKI 162
TDU GREEN 190
DARK NAVY 724

DOCUMENT READY
 AIR FLOW
 HIGH BARTACK COUNT

Taclite® Pro Pant

The Taclite Pro Pant features eight pockets, our durable ripstop fabric, and a Teflon® finish for stain- and soil-resistance. Double-reinforced at the seat and knees, these pants won't wear out, no matter how much sitting, hustling, and crawling through the brush you do. If you've ever wondered what it's like to wear comfortable, invincible pants, here's your opportunity. Imported.

64360 Women's Taclite Pro Pant | Charcoal 018, Black 019, TDU Khaki 162, TDU Green 190, Dark Navy 724 | 2-20 even, Reg/Long inseams | **\$49.99**

CHARCOAL 018
BLACK 019
TDU KHAKI 162
TDU GREEN 190

DARK NAVY 724
 KNEEPAD READY
 HIGH BARTACK COUNT
 ADJUSTABLE WAISTBAND



1.25" Athena Belt

With a low-profile buckle and an interior channel made to store a flex cuff, the belt works for easy wear on the range or around town. Imported.

BLACK 019
STORM 092

BTL BRN 116

59528 1.25" Athena Belt | XS-XL | Black 019, Storm 092, Battle Brown 116 | **\$17.99**



Holster Belt Adapter

Adapts a 1.25" belt to work with holsters and other accessories with a 1.5" minimum belth width.

56302 Holster Belt Adapter | One Size | Black 019, Sandstone 328 | **\$9.99**



1.25" Kella Belt

Constructed from durable 840D nylon web, featuring a low-profile, non-metallic FRN buckle, the 1-1/4" Kella Belt is an ideal on- and off-duty belt. It's good for everything. Imported.

BLACK 019
BTL BRN 116

SWAMP 197

59529 1.25" Kella Belt | Women's S-XL | Black 019, Battle Brown 116, Swamp 197 | **\$17.99**

Women's Belt Sizing

Alpha Size	XS	S	M	L	XL
Numeric size	2-4	6-8	10-12	14-16	18-20



TDU® Pant

Available in twill, Taclite® and ripstop, 5.11®'s TDU Pant is rugged, durable, and high-performance. With a self-adjusting tunnel waistband, double-reinforced seat and knees, triple stitching and robust bartacking, these pants are made to last. And with a Teflon® finish, roomy cargo pockets, secure rear pockets, hidden kneepad pockets, and secondary mag pockets, you'll be more than satisfied. Imported.

74003 Men's Ripstop TDU Pant | UPF 50 | Black 019, Brown 108, TDU Khaki 162, TDU Green 190, Dark Navy 724 | XS-4XL (Short/Regular/Long) (3XL-4XL \$59.99) | **\$49.99**

74350 MultiCam® TDU Pant | UPF 50 | MultiCam 169 | S-3XL (3XL \$89.99) (Short/Regular/Long) | **\$79.99**

74004 Men's Twill TDU Pant | UPF 50 | Black 019, TDU Green 190, Dark Navy 724 | XS-4XL (Short/Regular/Long) (3XL-4XL \$59.99) | **\$49.99**

74280 Men's Taclite TDU Pant | UPF 50 | Black 019, Storm 092, TDU Green 190, Dark Navy 724 | XS-4XL (Short/Regular/Long)(3XL-4XL \$59.99) | **\$49.99**

64359 Women's Ripstop TDU Pant | UPF 50 | Black 019, TDU Green 190, Dark Navy 724 | 2-20 (Inseams: Regular = 30-32", Long = 34-36") | **\$49.99**

59008 Neoprene Kneepads | **\$14.99**



Cirrus Pant



Have you ever had a pair of pants that fit perfectly, pants you could wear casually or at the range? Pants that gave you great mobility, comfort, and durability? You have them now. The Cirrus Pant features our Flex-Tac mechanical stretch fabric, a running gusset for maximum movement, a Teflon® finish, and pockets made for magazines, a phone, and pretty much anything else. Comfortable and well-equipped. That's you. Imported.

64391 Women's Cirrus Pant | Black 019, Stone 070, Storm 092, Tundra 192 | 0 - 20 even sizes, Reg/Long inseams | **\$69.99**

BLACK 019

STONE 070

STORM 092

TUNDRA 192



PERFORMANCE READY



DEVICE READY

Women's inseams: Regular = 30-32", Long = 34-36"



NEW

BLACK 019

COYOTE 120

TUNDRA 192



PERFORMANCE READY



*Insulator Vest, 97 and
Glacier Half-Zip, 27*

Cirrus Pant

Patrol Duty Uniform® Pants are available in 7.3-oz. twill or 6.1-oz. Taclite® ripstop. All PDU® pants are made from 65% polyester/35% cotton and feature a Teflon® finish for stain- and soil-resistance. PDU pants feature a self-adjusting comfort waistband with an extra-wide gripper that cushions your duty belt and helps keep your shirt tucked in. Imported.



Self-adjusting waist



Epaulettes and badge tab



Secure covert pocket



Patented Cargo pockets (B-Class)



Patrol Duty Uniform®

In order to progress you must have an understanding of the past. Rooted in tradition, the uniform for peace officers is a symbol of authority and professionalism. We continue to honor the traditional uniform by creating a functional garment for the contemporary peace officer. That evolution of tradition leads to lighter and stronger fabrics, uniforms with enhanced functionality and comfort, and enhanced officer safety.

To this aim, we have introduced our innovative Taclite® fabric to the PDU® (Patrol Duty Uniform®) and created the Go Pant for the female officer. These innovations are the result of constant feedback we receive from operators in the field and Law Enforcement agencies around the globe. We are honored to be the brand of choice for such agencies, and we will continue to live up to their high standards. UPF 50.

PDU® Benefits:

- + Comfortable and breathable
- + Superior fade-resistance
- + Wash-and-wear fabric saves laundering costs
- + No dry cleaning

Patrol Duty Uniform® Shirts are available in 5.8-oz. twill or 4.4-oz. Taclite® ripstop. All PDU® shirts are made from 65% polyester 35% cotton and feature a Teflon® finish for stain- and soil- resistance. PDU shirts come with epaulettes, badge tabs, and a front zippered placket. PDU shirts also include armpit vents, a mic-cord pass-through, and adjustable cuffs.



Twill or Taclite® Ripstop?



Twill is a traditional uniform fabric and drapes well. Our PDU Twill is a blend of 65% polyester and 35% cotton for easy wear and care.

Fabric Weight:
Shirts - 5.8-oz (197 g/m²)
Pants - 7.3-oz (248 g/m²)



Taclite® Ripstop is a highly durable and breathable fabric with a subtle ripstop pattern built in. Taclite Ripstop is a blend of 65% polyester and 35% cotton for easy wear and care.

Fabric Weight:
Shirts - 4.4-oz (149 g/m²)
Pants - 6.1-oz (207 g/m²)



PDU® are finished with Teflon® fabric protector to repel soil and stains.



Front zipper placket



Mic wire pass-through



Hidden utility pocket (B-Class)



Bi-Swing shoulders

Men's Patrol Duty Uniform® Shirts

REGULAR FIT

Style #	Product	Fabric	Feature	Sizes	Dimensions	Colors	\$
71183	A-Class Shirt	PDU Twill	Short-Sleeve	S-6XL*	Short/Regular/Tall**	750, 019, 160, 010	\$51.99
72344	A-Class Shirt	PDU Twill	Long-Sleeve	S-6XL*	Short/Regular/Tall**	750, 019, 160, 010	\$51.99
71177	B-Class Shirt	PDU Twill	Short-Sleeve	S-6XL*	Short/Regular/Tall**	750, 019, 160, 010	\$51.99
72345	B-Class Shirt	PDU Twill	Long-Sleeve	S-6XL*	Short/Regular/Tall**	750, 019, 160, 010	\$51.99
71167	A-Class Shirt	Taclite® Ripstop	Short-Sleeve	S-6XL*	Short/Regular/Tall**	750, 850, 108	\$51.99
72365	A-Class Shirt	Taclite Ripstop	Long-Sleeve	S-6XL*	Short/Regular/Tall**	750, 850, 108	\$51.99
71168	B-Class Shirt	Taclite Ripstop	Short-Sleeve	S-6XL*	Short/Regular/Tall**	724, 750	\$51.99
72366	B-Class Shirt	Taclite Ripstop	Long-Sleeve	S-6XL*	Short/Regular/Tall**	724, 750	\$51.99
71332	PDU® Rapid Shirt	Twill/Knit	Short-Sleeve	S-6XL*	Short/Regular/Tall**	750, 019, 160	\$61.99
72197	PDU Rapid Shirt	Twill/Knit	Long-Sleeve	S-6XL*	Short/Regular/Tall**	750, 019, 160	\$61.99
71046	Taclite PDU Rapid Shirt	Taclite/Knit	Short-Sleeve	XS-6XL*	Short/Regular/Tall**	750	\$49.99
72093	Taclite PDU Rapid Shirt	Taclite/Knit	Long-Sleeve	XS-6XL*	Short/Regular/Tall**	750	\$49.99

* Sizes 3XL+ and Tall sizes add \$5.00, ** Shorts and Talls in select sizes and colors. Short: 5'3" - 5' 7 1/2", Regular: 5'8" - 6' 1/2", Tall: 6'1" - 6'3".

Men's PDU® Shirt Size Chart

Alpha Size	S	M	L	XL	2XL	3XL	4XL	5XL	6XL
Neck Size	14-14 1/2	15-15 1/2	16-16 1/2	17-17 1/2	18-18 1/2	19-19 1/2	20-20 1/2	21-21 1/2	22-22 1/2
Short-Sleeve Length	33	33	33	-	-	-	-	-	-
Regular Sleeve Length	35	35	35	35	35	-	-	-	-
Tall Sleeve Length	-	-	37	37	37	37	37	37	37

Short: 5'3" - 5' 7 1/2", Regular: 5'8" - 6' 1/2", Tall: 6'1" - 6'3".



Epaulette and pocket flap kits (Style 59571) are available in select colors. Contact customer service at 866.451.1726.



Women's Patrol Duty Uniform® Shirts

Style #	Product	Fabric	Feature	Sizes	Dimensions	Colors	\$
61158	A-Class Shirt	PDU Twill	Short-Sleeve	Missy Fit XS-XL*	Regular/Tall**	750, 019, 160, 010	\$51.99
62064	A-Class Shirt	PDU Twill	Long-Sleeve	Missy Fit XS-XL*	Regular/Tall**	750, 019, 160, 010	\$51.99
61159	B-Class Shirt	PDU Twill	Short-Sleeve	Missy Fit XS-XL*	Regular/Tall**	750, 160	\$51.99
62065	B-Class Shirt	PDU Twill	Long-Sleeve	Missy Fit XS-XL*	Regular/Tall**	750, 019, 160	\$51.99
61167	A-Class Shirt	Taclite Ripstop	Short-Sleeve	Missy Fit XS-XL	Regular/Tall**	750, 108	\$51.99
62365	A-Class Shirt	Taclite Ripstop	Long-Sleeve	Missy Fit XS-XL	Regular/Tall**	750, 108	\$51.99
61168	B-Class Shirt	Taclite Ripstop	Short-Sleeve	Missy Fit XS-XL	Regular/Tall**	750	\$51.99
62366	B-Class Shirt	Taclite Ripstop	Long-Sleeve	Missy Fit XS-XL	Regular/Tall**	750	\$51.99
61304	PDU Rapid Shirt	Twill/Knit	Short-Sleeve	XS-XL	Regular/Tall**	750, 019	\$61.99
62372	PDU Rapid Shirt	Twill/Knit	Long-Sleeve	XS-XL	Regular/Tall**	750, 019, 160	\$61.99
61025	Taclite TDU Shirt	Taclite/Knit	Short-Sleeve	S-XL	Regular/Tall**	019, 162, 724	\$49.99
62016	Taclite TDU Shirt	Taclite/Knit	Long-Sleeve	S-XL	Regular/Tall**	019, 162, 724	\$49.99

** Talls available in select sizes and colors.

Women's PDU® Shirt Size Chart

Alpha Size	Missy Fit					Women's Fit			
	XS	S	M	L	XL	1X	2X	3X	4X
Regular Sleeve Length	30 3/4	31 1/4	31 3/4	32 3/8	33 1/8	33 7/8	34 1/2	35 1/8	35 3/4
Tall Sleeve Length			33 1/8	33 3/4	34 1/2	35 7/8	36 1/2	37 1/8	37 3/4

Regular = 5'5 - 5'7, Tall = 5'8 - 5'11

Plus-Fit Size Chart

Alpha Size	1X	2X	3X	4X				
Numeric Size	16	18	20	22	24	26	28	30
Chest	42	44	46	48	50	52	54	56
Waist	36	38	40	42	44	46	48	50
Hip	44	46	48	50	52	54	56	58

Regular = 5'5 - 5'7, Tall = 5'8 - 5'11

010 WHITE	019 BLACK	160 SILVER TAN	162 TDU KHAKI	724 DARK NAVY	750 MIDNIGHT NAVY	850 SPRUCE GREEN
--------------	--------------	-------------------	------------------	------------------	----------------------	---------------------

Men's Patrol Duty Uniform® Pants

Style #	Product	Fabric	Feature	Sizes	Colors	\$
74338	A-Class Pant	PDU Twill	Hidden zip-side thigh pocket	30, 31, 32, 33, 34, 35, 36-60 even sizes*, unhemmed	750, 019, 890	\$51.99
74326	B-Class Pant	PDU Twill	Low Profile Cargo Pocket	30, 31, 32, 33, 34, 35, 36-60 even sizes*, unhemmed	750, 019, 890, 108	\$51.99
74370	A-Class Pant	Taclite Ripstop	Hidden side-zip thigh pocket	30, 31, 32, 33, 34, 35, 36-60 even sizes*, unhemmed	750, 108, 724	\$51.99
74371	B-Class Pant	Taclite Ripstop	Low Profile Cargo Pocket	30, 31, 32, 33, 34, 35, 36-60 even sizes*, unhemmed	750, 850, 108	\$51.99



Women's Patrol Duty Uniform® Pants

Style #	Product	Fabric	Feature	Sizes	Colors	\$
64304	A-Class Pant	PDU Twill	Hidden zip-side thigh pocket	Missy Fit 2-20 evens unhemmed	750, 019, 890	\$51.99
64308W	A-Class Pant	PDU Twill	Hidden side-zip thigh pocket	Women's Fit 16W-28W evens unhemmed	750	\$56.99
64306	B-Class Pant	PDU Twill	Low Profile Cargo Pocket	Missy Fit 2-20 evens unhemmed	750, 019, 890	\$51.99
64310W	B-Class Pant	PDU Twill	Low Profile Cargo Pocket	Women's Fit 16W-28W evens unhemmed	750	\$61.99
64370	A-Class Pant	Taclite Ripstop	Hidden side-zip thigh pocket	Missy Fit 2-20 evens unhemmed	750, 108	\$51.99
64371	B-Class Pant	Taclite Ripstop	Low Profile Cargo Pocket	Missy Fit 2-20 evens unhemmed	750, 108	\$51.99
64387	GO Pant	PDU Twill	Zippered Drop Tail	2-20 unhemmed	750	\$59.99

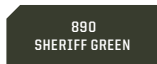
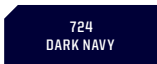
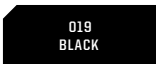

See Equipment Bags from 5.11 and others starting on page 318



Trainer and Operator Belts

Popular among law enforcement professionals, 5.11®'s Trainer and Operator belts are constructed from ultra-strong nylon mesh and features a stainless steel buckle with a 6,000 rating. Ideal for on- and off-duty wear, the Trainer Belt supports your holster and accessories without sagging, bending, or losing shape. With heavy, reinforced stitching, the Trainer Belt can also quickly convert into a secure tie-down, carry strap, or emergency harness. Now that's utility. Imported.

59409 Trainer Belt (1-1/2" (38mm) w/ matte stainless buckle) | Charcoal 018, Tundra 192, Sandstone 328 | S-4XL (2XL+ \$44.99) | **\$39.99**

59409 Trainer Belt (1-1/2" (38mm) w/ black buckle) | Black 019, Coyote 120, TDU Green 190 | S-4XL (2XL+ \$44.99) | **\$39.99**



59405 Operator Belt (1-3/4", visually similar to Trainer, but heavily stiffened (not pictured)). | Black 019, Coyote 120, TDU Green 190 | S-4XL (2XL+ \$44.99) | **\$39.99**



Traverse™ Double Buckle Belt

The Traverse Double-Buckle is a superior multi-purpose belt, featuring ribbed-weave 1-1/2" nylon webbing for enhanced strength and durability in a comfortable, low-profile design. The Traverse Double-Buckle resists rolling and supports your holster and sidearm. A belt that offers peace of mind. How about that. Imported.

59510 Traverse Double Buckle Belt | Black 019, Storm 092, Battle Brown 116, Sandstone 328 | S-2XL (2XL+ \$34.99) | **\$29.99**



TDU® Belt

A convenient tactical or patrol belt that excels in a wide range of environments, our 1-1/2" TDU Belt quickly converts into a secure tie-down or secondary carry strap. Crafted from tear-resistant nylon, the belt features a durable non-metallic buckle that won't set off metal detectors. Functional and affordable, it's a versatile addition to your wardrobe. Imported.

59551 TDU 1.5 Belt | Black 019, Coyote 120, TDU Green 190 | S-4XL (2XL+ \$19.99) | **\$17.99**

59552 TDU 1.75 Belt | Black 019, Coyote 120, TDU Green 190 | S-4XL (2XL+ \$19.99) | **\$17.99**



Double-Duty TDU® Belt

Featuring a dual-layer reversible design with two different color options, the 1-1/2" Double-Duty TDU Belt offers exceptional versatility and efficiency. Crafted from tear-resistant nylon, the belt incorporates a durable non-metallic buckle ideal for air travel and EOD. An easy thread belt tip ensures ease of use, and five-row stitching delivers stability. Two great belts in one. Imported.

59567 1.75" Double-Duty TDU Belt | Black/Coyote 120, Black/TDU Green 190 | S-4XL (2XL+ \$27.99) | **\$22.99**

59568 1.5" Double-Duty TDU Belt | Black/Coyote 120, Black/TDU Green 190 | S-4XL (2XL+ \$27.99) | **\$22.99**





REGULAR FIT

Packable Jacket



Have you ever looked at a cargo pocket and thought, "I need a jacket that fits in there." Thanks to 5.11, you've got one. The Packable Jacket consists of a durable 100% polyester shell, features mic loops, hidden utility pocket, and hand-warmer pockets, and best of all, it folds cleanly into its own pocket so that you can carry it anywhere, toss it in your truck, or keep it in your gear bag. Quick, easy protection from wind and rain. Imported.

48035 Packable Jacket | Black 019, Dark Navy 724, Sheriff Green 890 | XS-4XL (3XL+ \$34.99) | **\$29.99**

48052 Lined Packable Jacket | Black 019 | XS-3XL (3XL \$59.99) | **\$49.99**

BLACK 019

DARK NAVY 724

SHERIFF GREEN 890



All of our Packable Jackets conveniently stuff into their own pocket.

REGULAR FIT

Packable Operator Jacket



Featuring water-resistant, polyester, mic loops, hidden utility chest pocket, and a stowable hood, the Packable Operator Jacket folds neatly into its own pocket and stores easily. Imported.

48169 Packable Operator Jacket | Black 019, Dark Navy 724, Sheriff Green 890 | XS-4XL (3XL+ \$64.99) | **\$59.99**

BLACK 019

DARK NAVY 724

SHERIFF GREEN 890



CLASSIC FIT

Response Jacket™



If you've got 5.11's Response Jacket in your grab-and-go bag, changing weather is nothing to worry about. Built from high-performance for superior durability and all-weather comfort, the Response Jacket is lightweight and wind- and water-resistant. The jacket also features hidden utility pockets, zippered hand-warmer pockets, and hidden ID panels. Imported.

48016 Response Jacket | Black 019, Dark Navy 724 | XS-4XL (3XL+ \$69.99) | **\$59.99**

59094 POLICE ID Panel Set | 6" x 5" front, 12-1/2" x 9" back | Black 019 | **\$9.99**

48017BF Blank Back ID Panel | 12-1/2" x 9" | Black 019 | **\$5.99**

48017FF Blank Front ID Panel | 6" x 5" | Black 019 | **\$5.99**

BLACK 019

DARK NAVY 724



CLASSIC FIT

Big Horn Jacket



Our popular Big Horn Jacket is a multi-purpose mid-weight jacket ideally suited for on- and off-duty wear. The all-weather shell, anti-pilling fleece lining, and elastic waistband ensure comfort, durability, and weather-resistance. Side zippers provide quick access to a concealed firearm, hidden utility pockets and a zippered sleeve pocket give you smart storage options, and zippered hand-warmer pockets are there as well. Imported.

48026 Big Horn Jacket | Black 019, Dark Navy 724 | XS-4XL (3XL+ \$84.99) | **\$79.99**

BLACK 019

DARK NAVY 724





CLASSIC FIT

Sabre Jacket 2.0™



The Sabre Jacket 2.0 provides a covert appearance and a wealth of tactical features. A high-performance 3 layer shell and waterproof, seam-sealed membrane insulate you from wind and water. Adjustable cuffs, a drop tail, and a removable hood add comfort and functionality. Then there's our patented Quixip® System for immediate access to a concealed firearm, a secure lumbar pocket, hand-warmer and zippered utility pockets, and three zip-out ID panels. Stout and strong. Imported.

48112 Sabre Jacket 2.0 | Black 019, Coyote 120, Moss 191, Dark Navy 724 | XS-4XL (3XL-4XL \$259.99) | **\$249.99**

BLACK 019

COYOTE 120

MOSS 191

DARK NAVY 724



RAPIDRAW



ID PANELS



CLASSIC FIT

Chameleon Softshell Jacket



We designed the Chameleon Softshell to match today's outerwear styles, while retaining peak functionality. The jacket's 100% polyester bonded softshell fabric, lightweight mesh liner, adjustable cuffs, and drop tail give it superior water- and wind-resistance. Hidden ID panels let you identify as needed, three internal pockets provide additional storage, and zippered hand-warmer pockets do just that. Imported.

48099 Chameleon Softshell Jacket | Black 019, Flat Dark Earth/Mil. Brown 131, Moss/Black 191, Dark Navy 724 | XS-3XL (3XL \$129.99) | **\$119.99**

BLACK 019

FDE/MIL. BROWN 131

MOSS/BLACK 191

DARK NAVY 724



ID PANELS





Includes side zippers for access to a duty belt.

CLASSIC FIT

5-In-1 Jacket™



5.11®'s 5-in-1 Jacket offers five different configurations as a comprehensive all-weather duty solution. Breathable and waterproof, the outer-shell features mic loops, ID panels, hidden utility pockets, side zippers for CCW firearm access, and a detachable hood. The detachable inner fleece offers mic loops, hidden utility pockets, and TacTec System® compatibility. The fleece's sleeves zip off, converting the lining to a standalone vest. You've got five ways to wear this jacket. Imported.

48017 5-in-1 Jacket | Black 019, Dark Navy 724 | XS-4XL (3XL+ \$259.99) | **\$249.99**

BLACK 019
DARK NAVY 724
DOCUMENT READY

ID PANELS



Includes a fleece jacket with removable sleeves.



Hidden ID panels included and can be customized with your department ID.



Patrol Rain Pant features pass-through front pockets and abrasion-resistant knees and kick-panels on the inside bottom leg.

Patrol Rain Pant



The Patrol Rain Pant is designed to pull over your pants and is a perfect partner to any 5.11 jacket or parka. Featuring waterproof, breathable, seam-sealed construction, an elasticized waistband with our Keeper+™ belt loops, abrasion-resistant kick-panels, and hook-and-loop ankle closures, the Patrol Rain Pant will keep out the water. With pass-through pockets for direct access to your PDU®, cargo pockets, articulated knees, a gusseted crotch for superior movement, and 12" boot zippers, you'll be optimized for wet-weather duty. Imported.

48057 Patrol Rain Pant | Black 019 | S-3XL, regular (32.5") or long (35.5") length (3XL \$109.99) | **\$99.99**

BLACK 019
REINFORCED ZONES
ADJUSTABLE WAISTBAND

PERFORMANCE READY



*Visit <http://www.511tactical.com/customer-service/help-center/> for our full disclosure on bloodborne pathogen resistant items.



Includes a softshell liner.

CLASSIC FIT

Bristol Parka



5.11®'s Bristol Parka has a 100% nylon outer-shell that's breathable, waterproof, and bloodborne pathogen-resistant. The outer shell also features mic loops, hidden utility pockets, a hidden badge tab, hidden ID panels, and our Quixip System™ for rapid access to a concealed firearm. The removable inner-shell is 100% polyester bonded softshell, and offers hidden utility pocket and hand-warmer pockets. Bring on the weather. Imported.

48152 5.11 Bristol Parka | Black 019, Coyote 120, Tundra 192, Range Red 477, Dark Navy 724 | XS-4XL (3XL-4XL \$299.99) | **\$289.99**



CLASSIC FIT

3-In-1 Parka™



The 3-in-1 Parka is another versatile, all-weather solution. With a breathable, waterproof outer-shell and removable fleece liner that doubles as a standalone tactical jacket, you'll be in great shape no matter the elements. The outer-shell features mic loops, a detachable hood, hidden utility pockets, hidden ID panels, and side zippers for rapid firearm access and enhanced ventilation. The fleece liner offers mic loops, 4 tactical pockets, and side zippers. Both are TacTec-compatible. Imported.

48001 3-in-1 Parka | Black 019, Range Red 477, Dark Navy 724 | XS-4XL (3XL+ \$259.99) | **\$249.99**

NEW 48001TAA TAA Compliant 3 in 1 Parka | Black 019, Dark Navy 724 | XS-4XL | **\$289.99**

48032 3-in-1 Aggressor Parka™ | Tundra 192, Coyote 120 | XS-4XL (3XL+ \$259.99) | **\$249.99**



Includes a fleece liner, hidden ID panels, and CCW compatibility.



CLASSIC FIT

Signature Duty Jacket



5.11®'s Signature Duty Jacket will take care of the elements for you while you're on patrol. Featuring a waterproof, breathable nylon bloodborne pathogen-resistant shell, removable quilted liner, removable hood, and a bi-swing back for superior movement, the Signature Duty Jacket is an exceptional all-weather jacket. Side-seam zippers provide quick access to your firearm, while Tac-Tec-compatible pockets give you the storage you need. Other features include a back ID panel, badge tab kit, and hidden utility pockets. If you step in the ring with Mother Nature, make sure this jacket's got your back. Imported.

48103 Signature Duty Jacket | Black 019, Dark Navy 724 | XS-4XL Reg/Long (3XL+ \$209.99) | **\$199.99**

BLACK 019
DARK NAVY 724
DOCUMENT READY

CCW READY
ID PANELS



CLASSIC FIT

4-in-1 Jacket



The 4-in-1 Jacket offers an adaptable design popular with law enforcement professionals. Featuring a high-performance bloodborne pathogen-resistant rain shell and a removable liner, the 4-in-1 Jacket offers a wide range of weather-resistant options. Waterproof and breathable, the jacket features a removable hood, double storm flaps, side zippers for rapid access to a firearm and enhanced ventilation, TacTec-compatible pockets, a back ID panel, badge tabs, and hidden utility pockets. Imported.

48027 4-in-1 Jacket | Black 019, Dark Navy 724, Sheriff Green 890 | Short and Long sizes available in Black and Dark Navy | S-6XL (3XL+ \$259.99) | **\$249.99**

BLACK 019
DARK NAVY 724
SHERIFF GREEN 890

CCW READY
ID PANELS



CLASSIC FIT

Double-Duty Jacket™



An ideal patrol solution for a wide range of climates, the Double-Duty Jacket features a wind- and water-resistant nylon shell, removable liner, front-facing cargo pockets, hidden utility pockets, and hidden hand-warmer pockets. The jacket is TacTec compatible, too. Imported.

48096 Double-Duty Jacket™ | Black 019, Dark Navy 724 | XS-4XL (3XL+ \$139.99) | **\$129.99**

BLACK 019
DARK NAVY 724

CCW READY
DOCUMENT READY



CLASSIC FIT

Taclite® Reversible



A jacket as adaptable and practical as you are. Specially constructed with Teflon®-treated polyester/cotton Taclite ripstop fabric, layered over 87% cotton/13% polyester terry fabric, the Taclite Reversible Jacket is lightweight, durable, and offers unprecedented versatility. Featuring mic loops, a radio pocket, dual pen pockets, and hidden utility pockets, the jacket reverses from a comfortable company jacket to a sharp-looking job shirt. Imported.

48159 Taclite Reversible Jacket | Fire Navy 720 | XS-4XL (3XL-4XL \$109.99) | **\$99.99**

FIRE NAVY 720 **COMMS READY** **DOCUMENT READY**



CLASSIC FIT

Tactical Fleece



Compatible with 5.11®'s 3-in-1 Parka™ and Aggressor Parka™, the Tactical Fleece excels as a standalone jacket. Featuring wind-resistant fabric, abrasion-resistant chest and shoulder panels, mic loops, hidden utility pockets, internal chest pockets, zippered hand-warmer pockets, and side zippers for rapid firearm access, the Tactical Fleece is a solid addition to your cold-weather wardrobe. Imported.

48038 Tactical Fleece | Black 019, Dark Navy 724, Sheriff Green 890 | XS-4XL (3XL+ \$119.99) | **\$109.99**

BLACK 019 **DARK NAVY 724** **SHERIFF GREEN 890**
DOCUMENT READY **COMMS READY**



CLASSIC FIT

Tac Dry® Rain Shell



Our TacDry shell features a 100% nylon, seam-sealed construction, a storm flap, hook-and-loop storm cuffs, a removable hood, hidden ID panels, five smart pockets, and Quixip® rapid access to your firearm. Simple and sharp. Imported.

48098 Tac Dry Rain Shell | Black 019, Dark Navy 724 | XS-3XL (3XL \$139.99) | **\$129.99**

BLACK 019 **DARK NAVY 724**
RAPIDDRAW **ID PANELS**

Quixip side zippers for concealed carry.



CLASSIC FIT



Bike Patrol Jacket



Specially engineered for mounted officers, the Bike Patrol Jacket offers exceptional utility and comfort in a crisp, professional, high-visibility profile. Built from 96% polyester/4% spandex, with underarm zippers for ventilation and an elasticized waistband, the Bike Patrol Jacket is waterproof, breathable, and flexible. Featuring 3M® Scotchlite® reflective tape, dual-entry hand pockets, and a badge tab and epaulette kit, this jacket is made for high-speed duty. Time to ride. Imported.

45801 Bike Patrol Jacket | Hi-Vis Yellow 320, Royal Blue 693 | XS-3XL (3XL \$179.99) | \$169.99

HIGH VIS YELLOW 320

ROYAL BLUE 693





CLASSIC FIT

Valiant Softshell



The Valiant Softshell works as a standalone medium-weight jacket or as the inner lining for our Valiant Duty Jacket or Bristol Jacket™. Basically, the Valiant Softshell can play nice with others, or march to its own beat. Featuring lightweight, water resistant construction, a lined chin guard, an inner wire guide and pocket, and hand-warmer pockets, the jacket offers exceptional comfort and functionality. And with zip-off sleeves, the Valiant Softshell converts to a vest. Imported.

48167 Valiant Softshell | Wear on its own or compatible with 48152, 48153, 48073 and 48063 | Black 019, Storm 092, Brown 108, Range Red 477, Royal Blue 693, Dark Navy 724, Sheriff Green 890 | XS-4XL (3XL-4XL \$139.99) | **\$129.99**

BLACK 019	STORM 092	BROWN 108
RANGE RED 477	ROYAL BLUE 693	DARK NAVY 724
SHERIFF GREEN 890	RAPIDRAW	DOCUMENT READY

CLASSIC FIT

Valiant Duty Jacket



Built on a 5-in-1 platform, the Valiant Duty Jacket consists of a high-performance shell and a removable softshell liner that works as a standalone jacket or converts to a vest. The outer-shell is waterproof, bloodborne pathogen-resistant and features chest, forearm, internal, and hand-warmer pockets. The jacket also offers hidden mic loops and ID panels, a detachable hood, and our Quixip® System for rapid access to a concealed firearm. Imported.

48153 Valiant Duty Jacket | Black 019, Brown 108, Dark Navy 724, Sheriff Green 890 | XS-4XL (3XL-4XL \$299.99) | **\$289.99**

BLACK 019		
SHERIFF GREEN 890	DOCUMENT READY	ID PANELS
RAPIDRAW		



CLASSIC FIT

Responder Jacket



The Responder Parka™ and Responder Hi-Vis Parka are loaded to the hilt with performance and functionality. Responder Parkas feature blood-borne pathogen resistance. Built with waterproof breathable seam-sealed construction and has 3M reflective tape. Parkas also feature removable hoods, zippered armpit vents and a stretch drawcord waist. Imported

48063 Men's Responder Jacket | Black 019, Dark Navy 424 (KX available) | S-4XL (3XL + \$284.99) | \$269.99

BLACK 019

DARK NAVY 724



CLASSIC FIT

Hi-Vis Responder Parka



The high-visibility and high-performance solution for today's first responders, our Hi-Vis Responder Parka offers versatile warmth and dryness in the harshest of conditions. Responder Parkas feature blood-borne pathogen resistance. Built with waterproof breathable seam-sealed construction. The Hi-Vis version meets ANSI/ISEA 107-2010 Class II, Level II standards and has 3M® reflective tape. Parkas also feature removable hoods, zippered armpit vents and a stretch drawcord waist. Imported.

48073 Men's Hi-Vis Responder Parka | Range Red 477, Royal Blue 693, Dark Navy 724 (XS available) | S-4XL (3XL + \$304.99) | \$289.99

RANGE RED

ROYAL BLUE

DARK NAVY





CLASSIC FIT

First Responder™ Hi-Vis Jacket



Like the First Responder Jacket, to the right, the Hi-Vis version offers exceptional weather protection in a versatile design. Seam-sealed and waterproof, the jacket is bloodborne pathogen-resistant. Storm flaps, adjustable cuffs, a removable hood, and multiple pockets add utility, and the integrated Quixip® System allows you to access your sidearm or belt gear quickly, or add ventilation. The jacket includes a softshell liner that converts into a vest. With 3M® Scotchlite® tape and distinctive coloring, the jacket meets ANSI/ISEA 107-2010 Class III, Level II standards. Be ready, be visible. Imported.

48198 First Responder™ Hi-Vis Jacket | Range Red 477, Royal Blue 693, Dark Navy 724 | S-4XL (3XL+ \$344.99) | **\$329.99**



CLASSIC FIT

First Responder Jacket



Superior protection from the elements in a versatile, functional design. Fully seam-sealed and waterproof, the First Responder Jacket is bloodborne pathogen-resistant and features storm flaps, adjustable cuffs, and a removable hood. With our Quixip® System, you're able to reach your sidearm quickly, or add ventilation as needed. The jacket includes a softshell liner that easily converts into a vest. Multiple pockets add utility. Don't be caught without it. Imported.

48197 First Responder Jacket | Black 019, Dark Navy 724 | S-4XL (3XL+ \$344.99) | **\$329.99**

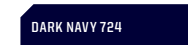
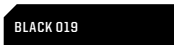

*Visit <http://www.511tactical.com/customer-service/help-center/> for our full disclosure on bloodborne pathogen resistant items.

REGULAR FIT

Reversible High Vis Softshell



5.11®'s Reversible Hi-Vis Softshell combines superior weather protection and safety in a lightweight, durable frame. One side of the jacket features a 100% polyester bonded softshell in high-visibility yellow, with 3M® Scotchlite® reflective tape. The other side is black 100% laminated nylon crafted for durability and comfort. Both sides are wind- and water-resistant. The jacket also has side zippers for unrestricted access to a sidearm, a badge tab and epaulette kit, and removable ID panels. The Reversible Hi-Vis Softshell meets ANSI/ISEA 107-2010 Class III Level II standards. From fluorescent to understated in seconds. Imported.

48171 Reversible High Vis Softshell | High Vis Yellow - reverses to black | XS-3XL (3XL \$189.99) | \$179.99

HIGH VIS YELLOW TO BLACK  ID PANELS



CLASSIC FIT

Reversible Duty Jacket



Modeled after our popular 4-in-1 Patrol Jacket™, the Reversible Hi-Vis Duty Jacket gives you two patrol jackets in one. The traditional duty-side is TacTec compatible, while the Hi-Vis side features 3M® Scotchlite® reflective tape and is ANSI/ISEA 107-2010 Class II Level II certified. The whole jacket is bloodborne pathogen-resistant, and it offers mic loops, hand-warmer pockets, and a badge tab kit. With an elasticized hem and cuffs and fleece lining, the Hi-Vis Duty Jacket is as comfortable and smart as it is warm. Imported.

48095 Reversible Duty Jacket | Black 019 - reverses to Hi-Vis Yellow, Dark Navy 724 - reverses to Hi-Vis Yellow | S-4XL (3XL+ \$139.99) | \$129.99

BLACK 019  DARK NAVY 724  COMMS READY



CLASSIC FIT

Reversible Long Hi-Vis Rain Coat



A configurable rain coat. The bottom of the Long Hi-Vis Rain Coat detaches for situations that only require parka-length. For situations that require high visibility, the coat reverses from standard patrol duty black to ANSI 107-2010 Class III Level II Certified, with 3M® Scotchlite® reflective tape. The coat's waterproof, breathable, seam-sealed nylon construction will keep you dry, and mic loops, badge tabs, and pass-through pockets will keep you ready. Sometimes, duty calls when it's pouring. You'll barely notice. Imported.

48125 Long Hi-Vis Rain Coat | Black 019 - reverses to Yellow | S-3XL (3XL \$149.99) | \$139.99

HIGH VIS YELLOW TO BLACK 



CLASSIC FIT

Reversible High-Vis 3-in-1 Parka™



The Reversible Hi-Vis 3-in-1 Parka offers superior weather protection and high-visibility performance. The reversible outer-shell has standard patrol duty black, with ANSI/ISEA 107-2010 Class III Level II Certified and 3M® Scotchlite® reflective tape on the other side. The parka features mic loops, badge tabs, a removable hood, TacTec compatibility, hidden utility pockets, side zippers for unrestricted access to a firearm, and hand-warmer pockets. A removable fleece liner works as a standalone jacket. Dry, warm, responsive. Imported.

48033 Reversible Hi-Vis 3-in-1 Parka™ | Includes Fleece Liner | High-Vis Yellow 320, reverses to black | XS-4XL (3XL+ \$259.99) | **\$249.99**

48014 Hi-Vis Parka | Shell Only | High-Vis Yellow 320, reverses to black | XS-4XL (3XL+ \$169.99) | **\$159.99**

HIGH VIS YELLOW TO BLACK

COMMS READY CCW READY ID PANELS



CLASSIC FIT

Reversible Hi-Vis Jacket



The Reversible Hi-Vis Jacket features waterproof, breathable, seam-sealed nylon for exceptional cold and wet weather performance. One side presents standard patrol duty black, and the other ANSI/ISEA 107-2010 Class III Level II certified with 3M® Scotchlite® reflective tape. Featuring mic loops, a removable hood, TacTec-compatible chest pockets, and zippered hand-warmer pockets, this jacket is built for bad weather. Imported.

48037 Reversible Hi-Vis Jacket | High-Vis Yellow 320 - reverses to black | M-4XL (3XL+ \$189.99) | **\$179.99**

HIGH VIS YELLOW TO BLACK

COMMS READY CCW READY ID PANELS



CLASSIC FIT

5-Point Breakaway Vest

Offering both superior visibility and functional safety, the 5-Point Breakaway Vest features 3M® Scotchlite® reflective tape, breaks harmlessly away in case of mechanical entanglement, and meets ANSI/ISEA 107-2010 Class II Level II and ANSI/ISEA 207/2011 standards. The vest also has mic loops, a badge tab, and front accessory pockets. Imported.

49022 5-Point Breakaway Vest | High-Vis Yellow 320 | Reg, 2XL | **\$39.99**

HIGH VIS YELLOW 320 COMMS READY



NEW

Speed 3.0 Jungle Boots



Who's afraid of a little water? Not you. Built to handle the harshest environments and Speed 3.0 RapidDry Boots feature innovative rapid-dry technology. Using our newly developed Speed cupsole platform for comfort and stability, forefoot lugs, a fence-climbing toe, and oil- and slip-resistant multi-terrain tread, this boot delivers the traction and support you'll need in wet conditions. An Agion antimicrobial treatment and OrthoLite insole enhance comfort and security, and a 14mm heel-to-toe drop ensures an accelerated stance. Imported.

12338 Speed 3.0 Jungle | Dark Coyote 106 | Regular 4, 5, 6-12, 13, 14, 15 | Wide 7-12, 13, 14 | **\$89.99**

12337 Speed 3.0 Desert Side Zip | Coyote 120 | Regular 4, 5, 6-12, 13, 14, 15 | Wide 7-12, 13, 14 | **\$89.99**



OrthoLite®

Skyweight Boots



Constructed from durable 1200D and rough out suede, Skyweight Boots are built to provide superior speed and agility in a lightweight, rugged, high-performance package. Featuring a full CMEVA midsole, board-lasting, and a nylon shank for torsional rigidity and stability, plus a broad forefoot, arch lugs, and integrated rear heel brake for balance and rope work, Skyweight Boots are field-ready. An OrthoLite® insole and an 8mm heel-to-toe drop mean they're comfortable and responsive, too. The Rapid Dry model features rapid-dry Clarino™ suede with medial and lateral drainage holes for fast drying. Built for duty, built for speed. Imported.

12320 Skyweight | Coyote 120 | 4, 5, 6-12, 13, 14, 15 Regular Width | **\$139.99**

12318 Skyweight (Side Zip) | Black 019, Sage 833 | 4, 5, 6-12, 13, 14, 15 Regular Width | **\$139.99**

12322 Skyweight Rapid Dry | Dark Coyote 106 | 4, 5, 6-12, 13, 14, 15 Regular, 6-12, 13 Wide Width | **\$139.99**



OrthoLite®

NEW

EVO Desert



Featuring a cemented, fully-stitched EVO Prime platform with cutting-edge, dynamic D30 cushioning and OrthoLite® insoles, a full-length EVA midsole with a nylon shank for peak stability and comfort, and a stitched-cup outsole with oil- and slip-resistant climbing lugs, the EVO Desert is the apex of tactical footwear for hot and dry environments. Non-metallic, lightweight, and has a 14mm heel-to-toe drop for a responsive, natural stance, hidden knife pocket and a full-length YKK® side zipper. Imported.

12347 EVO Desert 8" | Coyote 120 | 4, 5, 6-12, 13, 14, 15 Regular | 7-12, 13, 14 Wide | **\$124.99**



OrthoLite®



A.T.A.C.® Coyote/Sage Boot



The toughest desert critters will look the other way when you arrive in 5.11's A.T.A.C. Coyote or Sage Boots. Featuring our Shock Mitigation System® for maximum compression and rebound, an oil-resistant, no-squeak outsole for traction and stealth, a rugged suede and nylon upper with arch vents for enhanced breathability, an antibacterial, moisture-wicking lining, and a polished leather toe, these boots have a bite. A.T.A.C. Boots feature a side zip and knife pocket. Imported.

12220 A.T.A.C. Sage | Sage Green 831 | Regular 4, 5, 6-12, 13, 14, 15 | Wide 7-12, 13 | **\$99.99**

12110 A.T.A.C. Coyote | Coyote 120 | Regular 4, 5, 6-12, 13, 14, 15 | Wide 7-12, 13 | **\$99.99**

12304 A.T.A.C. Sage CST (not pictured) | Sage Green 831 | ASTM F2413-05 M I/75 C/75 Certified | Regular 4, 5, 6-12, 13, 14, 15 | **\$99.99**



Taclite™ Coyote Boot



Built from rugged, lightweight 1200D with a suede upper, featuring integrated air mesh panels, side vents, a moisture-wicking, antibacterial lining for peak breathability, Ortholite® sock-liners, and perforated EVA foam padding at the ankle collar and tongue, Taclite Coyote Boots will keep you dry and comfortable in arid and tropical climates. Featuring a lace-to-toe system with stay-tied "sausage" laces, a slip-resistant, no-squeak outsole and rope tread for stealth and stability, and Strobel-lasting construction to reduce weight and add flexibility. Run ahead of the pack. Imported.

12030 5.11 Taclite™ 6" | Coyote 120 | Regular 4, 5, 6-12, 13, 14, 15 | Wide 7-12, 13, 14, 15 | **\$124.99**

12031 5.11 Taclite 8" | Coyote 120 | Regular 4, 5, 6-12, 13, 14, 15 | Wide 7-12, 13, 14, 15 | **\$134.99**

5.11 RECON® Desert Boot



Engineered from the inside out to be the most lightweight, durable, responsive tactical boot available, 5.11's Recon Desert Boots feature a full-length CMEVA midsole and a nylon shank for torsional rigidity, a broad forefoot for enhanced balance and traction, a molded exoskeleton for additional support, ripstop nylon for breathable toughness, and arch lugs and a HELCOR® Rope Ready™ Zone for steering during rope maneuvers. An 8mm heel-to-toe drop, Ortholite® insoles, and a hidden knife pocket round out this piece of performance footwear. Imported.

11011 5.11 RECON® Desert | Dark Coyote 106 | 4, 5, 6-12, 13, 14, 15 | **\$139.99**





Ortholite®

Part of our Next Level Uniform Collection, Page 72-77

EVO Boots



Mobility is the ability to move freely and easily. If you add durability, stability, and high performance to that definition, you've got 5.11's EVO Boot. Featuring a cemented, fully-stitched* EVO Prime platform with cutting-edge, dynamic D30 cushioning and Ortholite® insoles, a full-length EVA midsole with a nylon shank for peak stability and comfort, and a stitched-cup outsole with oil- and slip-resistant climbing lugs, the EVO Boot is the apex of tactical footwear. Available in 6" and 8" heights, the boot is non-metallic, lightweight, and has a 14mm heel-to-toe drop for a responsive, natural stance. The waterproof model features a breathable eVent® waterproof and bloodborne pathogen-resistant membrane. The insulated model features eVent® and 400g PrimaLoft insulation. This isn't just a boot built for battle. It's a boot built for victory. Imported.

EVO Side Zip

12310 EVO 8" | Black 019 | 4, 5, 6-12, 13, 14, 15 Regular | 7-12, 13, 14 W | **\$124.99**

12311 EVO 6" | Black 019 | 4, 5, 6-12, 13, 14, 15 Regular | 7-12, 13, 14 W | **\$114.99**

EVO Waterproof

12312 EVO 8" Waterproof | Cold weather outsole compound | Black 019 | 4, 5, 6-12, 13, 14, 15 Regular | 7-12, 13, 14 W | **\$144.99**

12313 EVO 6" Waterproof | Cold weather outsole compound | Black 019 | 4, 5, 6-12, 13, 14, 15 Regular | 7-12, 13, 14 W | **\$134.99**

EVO Insulated

12348 EVO 8" Insulated | Black 019 | 4, 5, 6-12, 13, 14, 15 Regular | 7-12, 13, 14 W | **\$144.99**

* Non-waterproof only



EVO Boots feature D30 Impact Protection built into the footbed and securely encased by our stitched-down sole.

D30 is a patented technology used to create a soft and flexible shock-absorbing material featuring unique molecular properties. In standard conditions its molecules flow freely, but on impact, they lock together to absorb impact energy and reduce the force transmitted.

NEW**Speed 3.0 5" Boots**

First, we invented Speed. Then we built a faster, more durable Speed 2.0. Now, meet Speed 3.0, an exceptional entry-level, multi-purpose tactical boot. With our newly developed Speed cupssole platform for superior comfort and stability, plus forefoot lugs, a fence-climbing toe, and oil- and slip-resistant multi-terrain tread, you'll be free to run, hurdle, climb, and hustle to your heart's content. An Agion antimicrobial lining and an OrthoLite insole add all-day comfort and security, while the 14mm heel-to-toe drop ensures an accelerated stance. The faster, the better. Imported.

12355 Speed 3.0 5" | Black 019 | Regular 4, 5, 6-12, 13, 14, 15 | Wide 7-12, 13, 14 | \$84.99



OrthoLite®

NEW**Speed 3.0 Side-Zip Boots**

Speed 3.0 Side-Zip Boots feature a side zipper for easy-on/off. Featuring our newly developed Speed cupssole platform for superior comfort and stability, forefoot lugs, a fence-climbing toe, and oil- and slip-resistant multi-terrain tread, this boot is built for the most challenging, active demands of your job. An Agion antimicrobial treatment and OrthoLite insole enhance comfort and security, and a 14mm heel-to-toe drop ensures an accelerated stance. From stand-still to dead sprint in no time flat. That's functional speed. Imported.

12336 Speed 3.0 Sidezip Boot | Black 019 | Regular 4, 5, 6-12, 13, 14, 15 | Wide 7-12, 13, 14 | \$89.99



OrthoLite®

NEW**Speed 3.0 Jungle Boots**

Who's afraid of a little water? Not you. Built to handle the harshest environments and Speed 3.0 RapidDry Boots feature innovative rapid-dry technology. Using our newly developed Speed cupssole platform for comfort and stability, forefoot lugs, a fence-climbing toe, and oil- and slip-resistant multi-terrain tread, this boot delivers the traction and support you'll need in wet conditions. An Agion antimicrobial treatment and OrthoLite insole enhance comfort and security, and a 14mm heel-to-toe drop ensures an accelerated stance. Imported.

12339 Speed 3.0 Jungle | Black 019 | Regular 4, 5, 6-12, 13, 14, 15 | Wide 7-12, 13, 14 | \$89.99



OrthoLite®

* Antimicrobial technology inhibits the growth of bacteria



A.T.A.C.® Boots

Built to satisfy the needs of military, law enforcement, and special tactics teams across the world, 5.11 A.T.A.C. Boots are constructed from durable, breathable nylon and full-grain leather, providing comfort and utility straight out of the box, no break-in required. Featuring an antibacterial, moisture-wicking lining, dual-density foam cushioning, 5.11®'s Shock Mitigation System® for maximum compression and rebound, and a slip-resistant, quiet outsole, A.T.A.C. Boots give you the support, stability, and stealth you need. Imported.

12002 A.T.A.C. 6 | Black 019 | Regular 4, 5, 6-12, 13, 14, 15 | Wide 7-12, 13 | **\$89.99**

12001 A.T.A.C. 8" Side Zip | Leather and nylon upper | Black 019 | Regular 4, 5, 6-12, 13, 14, 15 | Wide 7-12, 13 | **\$99.99**

12018 A.T.A.C. 6 Side Zip | Black 019 | Regular 4, 5, 6-12, 13, 14, 15 | Wide 7-12, 13 | **\$89.99**

12004 A.T.A.C. 8" Storm | Waterproof leather and nylon upper, waterproof-breathable bloodborne pathogen resistant membrane* | Black 019 | Regular 4, 5, 6-12, 13, 14, 15 | Wide 7-12, 13 | **\$129.99**

12007 Women's A.T.A.C. 8" Side Zip Boot | Black 019 | Women's Sizes 5, 6-10 | **\$99.99**

12025 Women's A.T.A.C. 6" Side Zip Boot | Black 019 | Women's Sizes 5, 6-10 | **\$89.99**

12217 Women's A.T.A.C. 8" Storm | Black 019 | Women's Sizes 5, 6-10 | **\$129.99**

Company Boot 2.0™



Company Boot 2.0 combines slip-on ease with professional performance. Featuring our Quick Call Collar upper for cushioning and stability, a Phylon midsole, Ortholite® sock-liners, a 5.11 Kick Plate for easy removal, a polished, full-grain leather outer, our Shock Mitigation System®, and a slip-resistant, no-squeak outsole, the Company Boot 2.0 gives you the power and elite performance of our A.T.A.C.® boot in a convenient pull-on boot. Also available with an ASTM F2413-05 M I/75 C/75 EH PR certified composite safety toe. Pull on your boots and let's go to work. Imported.

12032 Company 2.0 | Black 019 | Regular 4, 5, 6-12, 13, 14, 15 | Wide 7-12, 13 | **\$119.99**

12033 Company CST 2.0 | Black 019 | ASTM F2413-05 M I/75 C/75 EH PR certified composite safety toe | Regular 4, 5, 6-12, 13, 14 | Wide 7-12, 13 | **\$129.99**



Ortholite®

Skyweight Duty Boots



Skyweight Boots are built to provide superior speed and agility in a lightweight, rugged, high-performance package. Featuring a full CMEVA midsole, board-lasting, and a nylon shank for torsional rigidity and stability, plus a broad forefoot, arch lugs, and integrated rear heel brake for balance and rope work. An Ortholite® insole and an 8mm heel-to-toe drop mean they're comfortable and responsive, too. Available in an eVent® waterproof breathable version as well. Imported.

12318 Skyweight (Side-Zip) | Black 019, Sage 833 | 4, 5, 6-12, 13, 14, 15 Regular Width | **\$139.99**

12321 Skyweight Waterproof (Side-Zip) | Black 019 | 4, 5, 6-12, 13, 14, 15 Regular, 6-12, 13 Wide Width | **\$149.99**



Ortholite®
eVent

Skyweight Waterproof shown.



Tactical Products

Body Armor



pages 398-400

Wound Care



pages 401-402

Hemorrhagic Control



pages 403

Immobilizers



page 404

Packs and Bags



pages 404-407

Diagnostic



pages 407

ARMOR EXPRESS™



Lighthawk® LT Light Tactical Vest (Armor Express)

The Lighthawk LT is Armor Express' latest carrier capable of converting your Alpha Sized concealable vest panels into a sleek and highly functional "Light Tactical" ensemble. The LT is compatible with the Lighthawk modular ballistic accessory kit allowing users the ability to scale up or down based on mission specific threat assessment.

- Utilizes Alpha Sizing System
- Dynamic Cummerbund System with 6"x10" soft armor pockets
- Quick Release Cable System
- MOLLE Webbing Platform
- 3-Dimensional Spacer Mesh Lining
- Removable Sling Hooks
- Front and Rear Hard Armor Plate Pockets
- Front Utility Pouch
- Drag Strap
- Custom ID Tag Attachment Points



- Download **FREE Layer App** (from your App Store)
- Scan this page
- View custom product info

Plates are not included. To discuss the best plates for your situation, contact your Southeastern District Sales Manager or call (800) 334-6656.

AELIGHTHAWKLT	Lighthawk LT Light tactical vest	each	798.00
---------------	----------------------------------	------	--------

Revolution™ Carrier (Armor Express)

The Revolution is AE's top of the line concealable carrier system. Loaded with features, the Revolution sets the mark for superior design with attention to detail, while offering maximum comfort, breathe-ability and durability. The shoulder area offers 3mm thick padding. The low profile padding is porous in nature allowing warm moisture laden air to pass through as it cushions the area thus helping to relieve any potential discomfort.

The Revolution utilizes superior microfiber nylon for its exterior shell material. The slightly denser material results in greater durability and longevity. It is also water repellent and anti-static treated. The standard Revolution carrier inner lining consists of Breeze Knit™, a moisture wicking, antimicrobial material that provides evaporative cooling. Upgrades are available for the Revolution carrier: (1) add a Scent-Lok inner lining for even more odor control, (2) add the Thor Shield™ to your liner for protection from stun devices such as Taser™, (3) add the Tactical Upgrade to your Revolution offering: a hide-a-way medical information strip, a hidden knife pocket, and ID Badge Hook and Loop.

Plates are not included. To discuss the plates best for your situation, contact your Southeastern District Sales Manager or call (800) 334-6656.

AEREVOLUTION-M	Revolution carrier, male	each	165.00
AEREVOLUTION-F	Revolution carrier, female	each	165.00



Rapid Base Plate Carrier (Armor Express)

The Rapid Base Plate Carrier offers a simple and effective tool for any active shooter scenario. Easy to put on, and modular enough to carry any custom load out (magazines, tourniquet, IFAK, etc.), this vest gets the job done and fits nicely in both a cramped trunk as well as your budget. The plate pockets accommodate NIJ III and IV hard armor plates, capable of stopping center fire rifle rounds, ideally placed over your soft lower level duty armor.

Plates are not included. To discuss the plates best for your situation, contact your Southeastern District Sales Manager or call (800) 334-6656.



AERAPIDBASE	Rapid base plate carrier	each	172.99
-------------	--------------------------	------	--------

Responder Base Plate Carrier (Armor Express)

The Responder Base Plate Carrier provides a robust and layered platform for any active shooter response. With reinforced padding for extended duty, this rig is modular enough to handle your custom kit (magazines, tourniquet, IFAK, etc), while keeping you agile enough for any change in environment. The plate pockets accommodate level III and IV hard armor plates, capable of stopping center fire rifle rounds, and front utility pockets offer extra storage for needed gear.

Plates are not included. To discuss the plates best for your situation, contact your Southeastern District Sales Manager or call (800) 334-6656.



AERESPONDER-S	Responder base plate carrier (fits X -medium)	each	194.99
AERESPONDER-L	Responder base plate carrier (fits large-2XL)	each	194.99

First Responder Carry Bag (Armor Express)

The First Responder Carry Bag is the ideal storage for your First Responder gear.

- Accommodates one helmet, two plates, and one plate carrier (depending on size of loadout)
- MOLLE webbing and ID attachment point on front of carry bag
- Extended full-length zipper allows bag to be opened completely flat, allowing quick and easy access to kit
- Two external flap pockets accommodate 10x12 rifle plates on reverse side of bag
- Padding for added product protection
- Dimensions: 22" x 22"



AEFRCARRYBAG	First Responder carry bag	each	75.00
--------------	---------------------------	------	-------

Tex 10 K-9 Vest (Armor Express)

With improved comfort, mobility and reduced weight, the Tex 10 K-9 armor offers outstanding functionality. The K-9 features dual crowd control handles, two D-Rings for short or long leads, MOLLE webbing for attaching flashlights and tracking devices, as well as optional left, right, and front ID tags. Made from durable nylon material, the K-9 has three buckles for ease of getting into, adjusting and removing. The K-9 provides maximum coverage to the vital organs.



AETEX10	Tex 10 K-9 vest	each	450.00
---------	-----------------	------	--------



AEX25 Ballistic Helmet (Armor Express)

The Armor Express ballistic helmet selection has been tailored to match the needs of both law enforcement and military personnel. From the traditional PASGT cut to the popular ACH/MICH high-cut gunfighter style helmet – we’ve got what your team needs for both protection and functionality in the field. Complete customization includes popular choices in dyes/colors, retention systems (including Team Wendy™ BOA Cam Fit Harness), padding systems (including Team Wendy Epic Light Pad System), rails, NVG shrouds (1-hole or 3-hole), velcro kits, and carry bags.

AEX25-FC	AEX25 ballistic helmet	each	610.00
----------	------------------------	------	--------



Agent Ballistic Vest (North American Rescue)

The Agent Ballistic Vest, formerly known as the ELSA™ (Emergency Life Saving Armor™), is an innovative, lightweight and compact armor carrier system that can be used as an individual carrier, a Level IIIA soft armor system, a Level III/IV hard armor system or a combination soft and hard armor system. Designed to provide 11" x 14" soft armor and/or 10" x 12" hard armor front and rear coverage in a small, discreet storage configuration. It quickly and easily deploys with one swift pull of the YKK zipper and quickly transforms into a customizable, mission-configurable soft/hard armor carrier system.

- Fully adjustable hook and loop internal soft armor and hard plate stabilizers
- Front and back, hook and loop, high visibility ID panels
- Front and back, Mil-spec MOLLE modular attachment system (PALS compatible)
- Fully adjustable, padded shoulder straps, with adjustable quick release shoulder and side straps for a comfortable fit

NA70-0070	Agent ballistic vest, black	each	1,241.96
NA70-0071	Agent ballistic vest, red	each	1,241.96



Active Shooter Response Kits (Southeastern)

Southeastern Emergency has customized two active shooter response kits for ballistic threat situations. Both kits are contained in the 5.11 Tactical 6.6 Padded Pouch that is crafted from ultra-durable N500D nylon.

Advanced Shooter Kit (SEEASK-A)

- Hyfin chest seal dressing (twin pack)
- Combat Application Tourniquet (C-A-T) (1)
- 4" high-strength emergency bandage (1)
- Quick Clot rolled gauze, 3" x 4" (1 roll)
- MidKnight nitrile glove, XL (2 gloves)
- 28FR Robertazzi airway (1)
- Lubricant packet (1)
- Gauze pad, 4x4, 12 ply (2)
- Cloth/silk tape, 1" (1)
- ARS for needle decompression, 14ga x 3.25" (1)
- Padded pouch (1)

Basic Shooter Kit (SEEASK-B)

- Hyfin chest seal dressing (twin pack)
- Combat Application Tourniquet (C-A-T) (1)
- 4" high-strength emergency bandage (1)
- Quick Clot rolled gauze, 3" x 4" (1 roll)
- MidKnight nitrile glove, XL (2 gloves)
- 28FR Robertazzi airway (1)
- Lubricant packet (1)
- Padded pouch (1)

SEEASK-A	Active shooter response kit, advanced	each	150.40
SEEASK-B	Active shooter response kit, basic	each	129.40

SAM Chest Seal (SAM Medical)

The SAM Chest Seal is an occlusive dressing designed to treat open chest wounds, a life-threatening situation that could lead to tension pneumothorax. This is the second-leading cause of preventable death on the battlefield. It is available with or without valve. The valved version features a one-way valve when its cap is removed. This provides for low-resistance flow of air out of the chest cavity while preventing ingress. The dome design protects against occlusion from direct external pressure.



- Adheres despite the presence of blood, sweat, hair and sand
- The pouch, dressing backing, and tabs provide optimal contrast for visibility in normal light, low light, and night conditions (using a night vision device)
- Vacuum packed tear and peel pouch

SECS062014	SAM Chest Seal combo pack containing one each of Chest Seal with valve and without valve	2/pkg	1,464.00
SECS062010	SAM Chest Seal with valve, 9.2" x 7.6"	1/pkg	22.49
SECS062011	SAM Chest Seal without valve, 9.2" x 7.6"	2/pkg	27.99

Celox™ Hemostatic Gauzes (Celox)

Celox is a high performance granular hemostatic designed to stop a lethal bleeding fast. It is easy to use, extremely effective (clots blood in 30 seconds), and safe (is a CE Marked Class III Medical Device.) It also does not generate heat and will not burn the casualty or care giver. Celox works independently of the body's normal clotting processes. Its clotting ability has been proven to work in hypothermic conditions and in the presence of common anticoagulants such as Coumadin.



SEC42900-A	Celox hemostatic gauze, 6 gram via barrel and plunger (supplied)	each	29.00
SEC42859-15	Celox hemostatic gauze, 15 gram	each	16.14
SEC42859-35	Celox hemostatic gauze, 35 gram	each	26.00
SEC42859-35MIL	Celox hemostatic gauze, 35 gram (olive drab pack)	each	26.00
FG08839011	Celox hemostatic gauze, Z-fold, 5'	each	57.00
FG08838011	Celox hemostatic gauze, Z-fold, 10'	each	43.31

The Emergency Bandage (First Care)

The Emergency Bandage is a first-aid treatment device for the staunching of blood flow from traumatic hemorrhagic wounds in pre-hospital emergency situations. It consolidates the numerous, currently used treatment equipment into a single unit.

- **Pressure Applicator**—Creating the immediate direct pressure to the wound site
- **Secondary Sterile Dressing**—Keeps the wound area clean, and the pad and pressure on the wound firmly in place, including immobilization of the injured limb or body part
- **Closure Bar**—Enabling closure and fixation of the Emergency Bandage at any point, on all parts of the body; no pins and clips, no tape, no Velcro, no knots
- **Quick and easy application and self-application**—Designed with the end-user in mind; for the first-aid trained and the lay care-giver
- **Non-adherent pad**—Eliminating the risk of causing pain and having the wound re-opened upon removal of the bandage



FCP-01	The Emergency Bandage, 4"	green	each	7.45
FCP-02	The Emergency Bandage, 6"	green	each	7.75

HyFin® Vent Chest Seals North American Rescue

- Patented, new design with 3-channel pressure relief vents
- Advanced adhesive technology for a superior seal in the most adverse conditions, including sweaty or hairy casualties
- Easy-to-grip, large Red-Tip™ tab for single step, peel-and-apply application that allows for the burping of the wound if necessary

NA10-0029	HyFin chest seal, single	each	10.94
NA10-0031	HyFin chest seal, twin pack	2/pkg	15.23



Tactical CricKit (North American Rescue)

The compact all-in-one cricothyroidotomy kit that features all CoTCCC recommendations for a surgical airway kit in the tactical setting

NA10-0017	Tactical CricKit	each	69.51
-----------	------------------	------	-------



Gunshot Wound Kit

Items to treat gunshot wounds are packed in a Cordura nylon bag. Bag can be worn around waist or used as a shoulder strap. You are able to access gloves before entering the pack from the exterior glove slot.

- Black latex-free gloves (5 pair)
- 1" Band-aids (10)
- Celox 15m applicator (1)
- Trauma shears (1 pair)
- 15gm Celox pack (1)
- Antimicrobial hand towelettes (2)
- 4 x 4 sterile pads (10)
- Iodine prep pads (2)
- 5 x 9 ABD pads (2)
- Blood stopper bandage (1)
- Asherman Chest Seal (1)
- Vaseline gauze (1)
- 1" Transpore tape (1 roll)
- 2" Tan Cofl x (1 roll)
- Antibiotic ointment (2)
- Cordura nylon bag, 5½" H x 4" W x 10" L (1)

SEEGSKT	Gunshot wound kit	each	105.70
---------	-------------------	------	--------



Sudecon Decontamination Wipes

Wipes neutralize pepper spray when running water is not available. Sudecon decontamination wipes improve recovery time from exposure to pepper spray. The patented formula in Sudecon works faster and more consistently to clean up individuals exposed to OC, CS, and CN than any other decontamination product ever formulated.

S3820	Sudecon decontamination wipes	10/pkg	2.20
-------	-------------------------------	--------	------



Black Talon™ Trauma Glove (North American Rescue)

The Black Talon Trauma Glove is custom-designed to give the best protection while providing the ultimate in tactile sensitivity. It has an extended beaded cuff for increased protection, textured fingers and palm and an advanced polymer coating for easier donning even under extreme conditions.

GOV-SM	Black Talon trauma glove, small	100/box	24.98
GOV-MED	Black Talon trauma glove, medium	100/box	24.98
GOV-LG	Black Talon trauma glove, large	100/box	24.98
GOV-XLG	Black Talon trauma glove, extra large	100/box	24.98



Combat Application Tourniquet® (C-A-T) (North American Rescue)

The Combat Application Tourniquet (C-A-T) is a small and lightweight one-handed tourniquet that completely occludes arterial blood flow in an extremity. The C-A-T uses a Self-Adhering Band and a Friction Adaptor Buckle to fit a wide range of extremities combined with a one-handed windlass system. The windlass uses a free moving internal band to provide true circumferential pressure to an extremity. The windlass is then locked in place; this requires only one hand, with the Windlass Clip™. The C-A-T also has a Hook-and-Loop Windlass Strap™ for further securing of the windlass during patient transport.



NA30-0001	Combat Application Tourniquet (C-A-T)	black	each	29.99
NA30-0023	Combat Application Tourniquet (C-A-T)	orange	each	29.99
NA30-0033	C-A-T Trainer	blue	each	37.72

Individual First Aid Kits (IFAK) (Southeastern)

We have created two Individual First Aid Kits (IFAK): Advanced and Basic. Both kits are contained in a black 5.11 UCR IFAK Pouch (item 56300).

IFAK Advanced

- Combat Application Tourniquet (C-A-T) (1)
- Quick Clot rolled gauze, 3" x 4" (1)
- Hyfin Vent chest seal (1)
- High strength emergency bandage, 4" (1)
- MidKnight black nitrile glove, XL (pair)
- IV catheter, Angiocath, 14ga x 3¼ (1)
- Vaseline gauze, 3" x 9" (1)
- Cloth/silk tape (roll)
- Para-Med scissors, 5 1/2 (pair)
- Robertazzi nasal airway, 28fr (1)
- Surgical lubricant packet (1)
- UCR IFAK pouch (1)

IFAK Basic

- Combat Application Tourniquet (C-A-T) (1)
- Quick Clot rolled gauze, 3" x 4" (1)
- Hyfin Vent chest seal (1)
- High strength emergency bandage, 4" (1)
- MidKnight black nitrile glove, XL (pair)
- Surgical lubricant packet (1)
- UCR IFAK pouch (1)



SEEIFAK-A	Individual First Aid Kit (IFAK), advanced	each	138.00
SEEIFAK-B	Individual First Aid Kit (IFAK), basic	each	128.00

MAT® Tourniquet (Pyng)

The MAT Tourniquet is a versatile and efficient tourniquet, providing fast application, simple and effective one-handed operation. Stops blood loss with complete occlusion in about 30 seconds. Designed to be self-administered by individual military personnel or civilians—as well as used by medical personnel—it is the only tourniquet that meets all U.S. Department of Defense performance requirements.



CYMAT1	MAT Tourniquet	each	32.31
--------	----------------	------	-------

Racheting Medical Tourniquets (RMTs™) (RMT)

RMTs are self-locking tactical tools for hemorrhage control. Applies precise mechanical pressure. Racheting sound when activated. Simple, intuitive "gross motor" operation.

RMT-PARAMED	Racheting Medical Tourniquet (RMT), paramedic	each	36.95
RMT-TAC	Racheting Medical Tourniquet (RMT), tactical	each	35.95
RMT-CHILD	Racheting Medical Tourniquet (RMT), pediatric	each	35.95





Thomas™ Tactical ET Tube Holder (Laerdal)

The Thomas Tube Holder is the only tube holder with a quick-set screw for a secure hold after tube placement. Not only does it accommodate Combitubes® and LMAs, its special bite block feature protects the patient and the tube.

LA600	Thomas tube holder, adult	olive drab	each	4.50
-------	---------------------------	------------	------	------



Stifneck Select Collar (Olive Drab) (Laerdal)

All the adult Stifnecks in one easily adjustable, fully assembled collar. Just measure the patient, select the size, adjust and lock-four simple steps. This collar fits all adult patients and delivers the same superior immobilization you expect from Stifneck collars.

- Uses the same sizing and application method as the original Stifneck collars
- Now includes new integrated fastener for the Velcro® strap - an Industry first! With no glues or adhesives in-use on any of the Select adjustable products, the in-molded hook will enhance the performance of the collar in various environmental conditions.

LA980012	Stifneck Select collar	olive drab	each	14.00
----------	------------------------	------------	------	-------



BaXstrap® Spineboard (Laerdal)

The BaXstrap Spineboard contoured design allows the board to nest compactly. This unique feature also offers patients more comfort, making it less likely that they would move around and aggravate their injuries.

- Dimensions: 72" x 16" x 2 1/2"; weighs 13.5 lbs (single board); Thickness of 2.3"

LA982600	BaXstrap spineboard	olive drab	each	231.00
LA982500	BaXstrap spineboard	yellow	each	219.00



G3 Load 'N Go Tactical Medic Backpack (StatPacks)

The Load n' Go is an ideal medic backpack for field wing and critical care transport, ambulance and fire engines. No other medic backpack keeps equipment more organized and quickly accessible thanks to thoughtfully designed transparent sleeves, mesh pockets, and elastic holsters that are arranged in three layers. Contents NOT included

STPG35004TK	G3 Load N' Go medic backpack, BBP-resistant	tactical black	each	250.00
-------------	---------------------------------------------	----------------	------	--------



G3 Traverse Tactical Leg Bag (StatPacks)

The Traverse is a straightforward EMT leg bag that provides quick access to small amounts of BLS and ALS equipment.

- Contents NOT included
- Easily attaches to any belt and secures comfortably to either leg
- Accommodates IV fluid, some airway equipment and trauma dressings; also great for non-medical gear

STPG34004TK	G3 Traverse tactical leg bag, BBP-resistant	tactical black	each	45.00
-------------	---------------------------------------------	----------------	------	-------

“Blow Out” Kits (5.11 Tactical)

5.11 Tactical 3.6 Med Kit (511-56096) allows you to design a Basic Kit. Some of our customers have included items such as: C-A-T Tourniquet, Quick Clot Combat Gauze, 4” Roller Gauze, 4” Elastic Bandage, Disposable Gloves, etc. Comes in your choice of black, TAC OD and sandstone.

5.11 Tactical 6.6 Med Pouch (511-58715), lets you design a more Advanced Kit. Some of our customers have included items such as: C-A-T Tourniquet, Quick Clot Combat Gauze, chest decompression needle, chest seal, NPA, lubricating jelly, 4” Roller Gauze, 4” Elastic Bandage, disposable gloves, etc. Comes in your choice of black, dark earth, TAC OD, and sandstone.

Contents not included. Please call your District Sales Manager or our customer service department at (800) 334-6656 for assistance in designing your custom kit.



511-56096-019-BAG	3.6 Med Kit (bag only)	black	each	32.99
511-56096-188-BAG	3.6 Med Kit (bag only)	TAC OD	each	32.99
511-56096-328-BAG	3.6 Med Kit (bag only)	sandstone	each	32.99
511-58715-019-POUCH	6.6 Med Pouch (pouch only)	black	each	29.99
511-58715-131-POUCH	6.6 Med Pouch (pouch only)	dark earth	each	29.99
511-58715-188-POUCH	6.6 Med Pouch (pouch only)	TAC OD	each	29.99
511-58715-328-POUCH	6.6 Med Pouch (pouch only)	sandstone	each	29.99

G3 First Aid Quickroll Tactical Intubation Kit (StatPacks)

The Generation 3 QuickRoll intubation bag provides a lightweight, compact, minimalistic approach to carrying airway equipment.

- Contents NOT included
- This module makes for a quick, easy to use, EMT Intubation kit
- Specifically designed to stow neatly in StatPacks Generation 3 Emergency Medical Services packs
- Organizes laryngoscope, blades, as well as intubation tubes, syringes and forceps
- Holds Oral Pharyngeal Airways / Nasal Pharyngeal Airways and gloves
- Capacity: 400 in; Weight: 11oz



STPG36000TK	G3 First Aid Quickroll intubation module	tactical black	each	52.00
-------------	------------------------------------------	----------------	------	-------

G3 First Aid Tactical Remedy Kit (StatPacks)

The Generation 3 First Aid Remedy Kit is compact and organized. This EMS drug bag brings all your meds together while offering a quick way for central supply or pharmacies to restock.

- Contents NOT included
- This module makes for a quick, easy to use, EMS medication bag
- Specifically designed to stow neatly in StatPacks Generation 3 Emergency Medical Services packs
- Nicely fits in the Generation 3 Perfusion and Backup EMS Backpacks
- Fits into most EMT Jump Bags available in the market today
- Capacity: 240 in; Weight: 9oz



STPG3G001TK	G3 First Aid Tactical Remedy kit	tactical black	each	50.00
-------------	----------------------------------	----------------	------	-------



UCR Slingpack (5.11 Tactical)

The UCR Slingpack is a right-handed bag designed for the aware and prepared. Built from 1050D nylon, featuring a drop-front opening with side retention lashes, haul handles, interior pockets with bungee retention, a customizable pull-out ID panel, and a large front web patch panel, the UCR Slingpack keeps your gear organized and at hand. It also carries 1-4 blow-out kits for additional utility.

511-56298-019	UCR Slingpack, black color	each	134.99
511-56298-092	UCR Slingpack, storm color	each	134.99
511-56298-328	UCR Slingpack, sandstone color	each	134.99



UCR Thigh Rig (5.11 Tactical)

Ideal for carrying 12 blow-out kits and a pair of AR magazines, the UCR Thigh Rig features a drop-down zippered compartment with a light-colored interior, bungee tie-downs, and MOLLE- and web platform-compatibility. Crafted from 1050D nylon, with breathable aero-spacer mesh on the back, this useful rig will faithfully go where you lead.

511-56301-019	UCR Thigh Rig, black color	each	47.99
511-56301-092	UCR Thigh Rig, storm color	each	47.99
511-56301-328	UCR Thigh Rig, sandstone color	each	47.99



UCR Litter (5.11 Tactical)

Engineered from durable 1050D nylon, the innovative UCR Litter is designed for rapid deployment and recovery of an injured person. Two-thirds body length, with leg and waist straps and six grab handles, the UCR Litter works as either a one-man carry system or a traditional two- or four-man carry. Rolls into a compact profile for storage.

511-56299-019-LITTER	UCR Litter, black color	each	79.98
511-56299-092-LITTER	UCR Litter, storm color	each	79.98
511-56299-328-LITTER	UCR Litter, sandstone color	each	79.98



CAMS™ 2.0 Deployment Bag (5.11 Tactical)

Designed to be the ultimate large deployment bag or travel luggage, the CAMS™ (Carry All My Stuff) 2.0 can hold it all – and then some. Measuring a massive 40" high, 15.5" long, and 10" deep, the CAMS 2.0 is a large tactical rolling duffel that can be tethered convoy-style with any other 5.11 Tactical deployment bag. Built from tough and dependable 1600 Denier Nylon, the CAMS 2.0 large rolling duffel bag resists weather and abrasion while remaining surprisingly light and mobile, and the fully customizable interior allows you to choose the most efficient layout for your gear. Reinforcements at all sides and rugged corner guards keep your gear safe and secure, while a weatherproof treatment protects against rain and moisture.

511-50159-019-BAG	CAMS 2.0 Deployment Bag, black color	each	344.99
511-50159-328-BAG	CAMS 2.0 Deployment Bag, double tap black color	each	344.99

UCR IFAK Pouch (5.11 Tactical)

Designed to attach to your vehicle’s headrest or any MOLLE or web platform, 5.11’s UCR IFAK Pouch lets you keep 1-2 blow-out kits or medical essentials within arm’s reach. The pouch features a drop-down zippered compartment with a light-colored interior for easy equipment identification, and bungee tie-downs for added stability.



511-56300-019	UCR IFAK Pouch, black color	each	37.99
511-56300-092	UCR IFAK Pouch, storm color	each	37.99
511-56300-328	UCR IFAK Pouch, sandstone color	each	37.99

SOMS™ 2.0 Rolling Duffel Bag (5.11 Tactical)

The SOMS 2.0 (Some Of My Stuff) rolling duffel bag offers a broad range of customizable storage options and travel-friendly features that keep you organized in any setting. Durable weather-resistant 1600D nylon construction, rugged corner guards, and a reinforced frame ensure stability and keep your gear safe and dry, while a durable roll handle and self-retracting grab handles at both ends offer easy mobility. A MOLLE/5.11 SlickStick® compatible web lining lets you completely customize your accessory storage.



511-56958-019-BAG	SOMS 2.0 rolling duffel bag, black color	each	299.99
511-56958-026-BAG	SOMS 2.0 rolling duffel bag, double tap black color	each	299.99
511-56958-328-BAG	SOMS 2.0 rolling duffel bag, sandstone color	each	299.99

Tactical Products ■ Diagnostic

Adscope Ninja Sprague Stethoscope (ADC)

ADCs legendary Sprague with stealth black chrome for a striking appearance.

- Threaded chest piece drum permits the use of interchangeable chest piece fittings an adult and pediatric diaphragm, and three bells (1¼”, 1”, ¾”) for complete diagnostic capability in most patients
- Measures 30”
- Complete with an accessory pouch containing the bell chest pieces, chest piece key, two spare diaphragms, one pair of mushroom ear tips, and one pair of silicon ear tips
- Adjustable binaurals
- Proprietary valve mechanism eliminates acoustic leakage
- All metal parts finished in black chrome for a striking appearance
- Latex-free double tube configuration



ADC646ST	Adscope Ninja Sprague stethoscope	black	each	24.87
----------	-----------------------------------	-------	------	-------

Littmann® Classic II S.E. Black-Plated Stethoscope (3M)

Featuring a two-sided chestpiece, this classic stethoscope offers high acoustic sensitivity for superior performance. A tunable diaphragm on one side augments the traditional bell function of the opposite side.



3M2218BE	Littmann Classic II S.E. stethoscope	black plated	each	132.66
----------	--------------------------------------	--------------	------	--------



Triage, WMD, MCI

Triage Systems



pages 410-414

Mass Casualty Extraction



page 415

Safety Vests



pages 416-417

Patient Assistance



page 418

Shelter



page 419

Traffic Control



page 420

Rope Accessories



page 421

SMART TRIAGE

The most widely used system in the world, the SMART Incident Command System™ is a scalable approach to triage, working from the first responder on scene through the evacuation process to the receiving hospital.



- Download **FREE** Layer App (from your App Store)
- Scan this page
- View custom product info



Smart Tag™ Triage Tag (Kingfisher)

The Smart Tag is a comprehensive all-risk Triage Tag. The folded design allows for effective triage that is quick and simple, allowing you to reprioritize your casualty quickly without losing information. Made from durable materials, the Smart Tag will survive the worst of conditions. The highly visible design enables quick identification of patient priority, speeding up the treatment of critical patients.

KF73215	Smart Tag triage tags, pkg of 10	10/pkg	18.98
---------	----------------------------------	--------	-------



Smart CBRNE Tag™ (Kingfisher)

The ultimate resource for improving casualty management at scenes suspected to involve nuclear, chemical or biological agents. The Smart CBRNE Tag works alongside the Smart Tag to enable responders to clearly identify those casualties who may have been exposed to contaminants. The Smart CBRNE Tag provides a format for you to record details of the contaminating agents (if known), giving those involved in the treatment of the casualty as much information as possible to assist them in that treatment. The decontamination panel clearly identifies patients who have been decontaminated and records the details of that process. This assures the receiving facility that the casualty poses no secondary contamination risk. The Smart CBRNE Tag is included as standard in the Smart Triage Pack.

KF73221	Smart CBRNE tag, contains 20 tags	20/pkg	19.99
---------	-----------------------------------	--------	-------



Smart Triage™ Pack (Kingfisher)

Holding all the tools you need to carry out rapid effective triage for adults and children, the Smart Triage Pack will allow forward incident personnel to initiate a systematic approach that has proven invaluable in incidents throughout the U.S. and across the world. Compatible with START or any other triage assessment method, the Smart Triage Pack is useable by responders of any level. Its compact design allows for easy storage allows for easy access to contents while the universal attachment will fit over any belt allowing your hands free to render aid.

Standard contents include 20 Smart Tags, 20 Smart CBRNE Tags, a Smart Tape™ and lightsticks for identifying casualties in low light.

KF73212	Smart Triage pack	each	169.99
---------	-------------------	------	--------

Smart TRI™ Pack (Kingfisher)

The Smart Triage & Rapid Intervention (TRI) Pack allows you to perform rapid lifesaving interventions while conducting effective triage. Designed around the equipment most frequently selected to address immediately life threatening conditions typical at a multiple casualty incident. Guided by customer feedback and data from recent incidents, which clearly shows the need for medical equipment such as trauma dressings, tourniquets, airways and chest seals at the incident site. The Smart TRI Pack has been designed to be a valuable resource to the responder, providing them vital equipment, without the need to take a complete trauma bag into the scene. The Smart TRI Pack allows the delivery of rapid lifesaving interventions at point of wounding.



Standard contents include 20 Smart Tags, 20 Smart CBRNE Tags, a Smart Tape and lightsticks for identifying casualties in low light.

KF73257	Smart TRI (Triage and Rapid Intervention) pack	each	224.99
---------	------------------------------------------------	------	--------

Smart Commander™ (Kingfisher)

The Smart Commander enhances your scene management by providing easy access to clearly structured control boards, detachable to assist information handover and flexible enough for an efficient on-scene response. Designed for ease of use, the Smart Commander acts as a mobile command point, providing a structured response to both routine incidents and multiple casualty events. This flexible tool kit has proven to be effective all over the world, with additional CBRNE, Fire, Ground and Hospital control boards available for specific incident response (not shown). The detachable control boards enable an ordered reporting system and an efficient handover that speeds up decision making



Smart Active Shooter Control Boards are clearly laid out to assist law enforcement and EMS to work efficiently together promoting a unified command. Internal asset tracking panels allow for clear accountability of personnel on scene coupled with internal spaces for incident plans and the storage of building plans for pre-assessed high threat locations (such as high schools or stadiums). The external control boards give a clear overview of the scene and allow incident commanders to brief rescue task force personnel clearly on what to expect prior to entering the scene. These control boards allow rescue task force leaders to be ready and properly equipped to coordinate an effective and unified response.

KF73211	Smart Commander with EMS incident control boards	each	209.99
KF73256	Smart Commander with hostile threat/active shooter control boards	each	259.99

Smart MCI Bag™ (Kingfisher)

The Smart MCI Bag is a complete grab bag enabling rapid response with all the resources required to manage triage at a mass casualty event. The Smart MCI Bag comes with four complete Smart Triage Packs, a Smart Commander and additional space for other MCI Response equipment. It is the ideal resource to resupply an ongoing incident or set up a medical command post at a pre-planned event (such as a town fair or large sports event). The Smart MCI Bag has also been adopted by many emergency departments as their frontline response to triage when receiving casualties from a large scale event.



KF73210	Smart MCI bag	each	924.99
---------	---------------	------	--------



IFAK Individual First Aid Kit (Kingfisher)

The IFAK comes fully stocked with specialized medical equipment to treat one casualty, a Priority 1 triage tag and a dead triage tag. Both tags have illumination capabilities for low light or decreased visibility conditions. The IFAK is compact in size and completely MOLLE compatible. Contents can be fully customized based upon your agency's protocols.

KF76656	IFAK individual first aid kit	each	109.95
---------	-------------------------------	------	--------



Smart Pediatric Triage Tape™ (Kingfisher)

The Smart Pediatric Triage Tape is specifically designed to best assess the severity of the injuries to child casualties. Provides rapid, safe, accurate triage of injured children at a multiple casualty scene. The Smart Pediatric Triage Tape is the ONLY evidence-based approach to pediatric triage.

Adult-based assessment methods are not suitable for the triage of children. The stresses of an MCI and the emotional reaction to the presence of multiple injured children can make it easy to over prioritize child casualties beyond the seriousness of their condition and over that of potentially more critically injured adults.

KF73214	Smart pediatric triage tape	each	46.99
---------	-----------------------------	------	-------



SmartSafe™ Property Bags (Kingfisher)

SmartSafe Property Bags are a quick and easy way to keep track of your patient's belongings. They are secure, durable and easy to use and will hold the patient's valuables such as wallets, watches, jewelry, glasses, teeth as well as clothes and shoes. What's more, each SmartSafe Property Bag comes with a unique bar code tracking system, ensuring your patient's belongings are returned to them safely after treatment. The handover of belongings from ambulance to hospital staff is simple and without fuss.

KF73250	SmartSafe property bags, small, 9½" x 11½"	25/box	30.95
KF73251	SmartSafe property bags, large, 25½" x 24"	10/pkg	23.99



Smart Education Pack™ (Kingfisher)

The Smart Education Pack provides a complete package for you to present an MCI Training session. The pack includes an instructors CD, a training DVD and a set of exercises to work through with your students and gives you everything you need to run training, in not only the Smart Incident Command System™ but also multiple casualty incident response in general.

KF73220	Smart education pack	each	219.95
KF73238	Smart education pack for Illinois and North Carolina specific tions	each	219.99

Trauma Kit, 5-Patient (Southeastern)

Each kit will treat 5 patients who are classed as “The Walking Wounded”

- Elastic bandage (1)
- #4 airways (2)
- Scissors (1)
- CPR mask (1)
- Triple antibiotic ointment (5)
- Cold packs (2)
- Safety pins (4)
- 3 x 9 vaseline dressing (1)
- Eye pads (4)
- Rescue blankets (2)
- Ammonia inhalants (2)
- Vinyl gloves (10)
- Triangular bandages (2)
- Penlight (1)
- 5 x 9 combine pads (5)
- 1” tape (1)
- Bulb syringe (1)
- 4 x 4 gauze pads (10)
- Eye wash 4 oz. (1)
- Bio waste bag (1)
- 4” roll gauze (4)
- 4 x 4 burn dressing (2)



92700	Five-patient trauma kit	each	56.40
-------	-------------------------	------	-------

All Risk® Triage Tags (Disaster Management Systems)

These triage tags provide first responders with a tool to identify, process and triage contaminated patients. The tags also provide rescue personnel with a means to tag and identify clothing and other personal property. It should be emphasized that any hazardous materials release is a potential crime scene. Tagging of evidence in the form of clothing and personal effects will aid law enforcement in their investigation.

- NOTE: Florida version uses the term “EXPECTANT” rather than “MORGUE”

DMS-05006	All Risk triage tag, standard	50/pkg	59.97
-----------	-------------------------------	--------	-------



Medical Emergency Triage Tags (METTAG)

The Original METTAG provides first responders and rescue personnel with the standard triaging features needed to enable them to perform a prompt and accurate assessment of a Mass Casualty Incident (MCI) victim’s injuries and to easily record the data.

It is constructed of a high-density damage-resistant synthetic material and is printed using a special thermal printing process, allowing use in the harshest and most demanding field situations. Additionally, each Medical Emergency Triage Tag is equipped with a 30-inch elastic band, which is used for attaching the tag to the victim’s body, usually around the neck or to an available limb.

S4050	METTAG medical emergency triage tags	each	1.06
-------	--------------------------------------	------	------

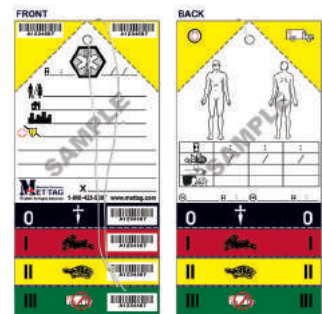

Treatment Area Identification Flag Kit (Disaster Management Systems)

This is a command and control kit for all types of multi-casualty incidents to identify triage sites from a distance.

- Red immediate treatment area flag (1)
- Yellow delayed treatment area flag (1)
- Green minor treatment area flag (1)
- Black morgue treatment area flag (1)
- Fold-up tripod flag pole stand, maximum height 84” (4)
- Durable carry bag (1)
- 5.87” x 5.12” x 28.00”



DMS-05012	Treatment area identification flag kit	each	193.99
-----------	----------------------------------------	------	--------



Triage and Hazmat Tape System

This pre-assembled, custom designed Triage and Hazmat Tape System is a must for every emergency vehicle in your fleet. Includes standard color vinyl flag tape.

- Initial Hazmat and Start® Triage System algorithm for quick reference protected in a clear plastic sleeve
- Includes quick reference for initial Hazmat and START Triage
- Adjustable belt for fanny pack or carry over the shoulder

SEE550	Triage and Hazmat Tape System, triage tape	each	44.08
SEE560	Triage and Hazmat Tape System, triage and hazmat tape	each	47.23
CTTTBW	300' triage replacement tape, black/white stripe	each	2.29
CTTTB	300' triage replacement tape, blue	each	1.89
CTTTG	300' triage replacement tape, green	each	1.89
CTTTR	300' triage replacement tape, red	each	1.89
CTTTY	300' triage replacement tape, yellow	each	1.89

Triage Containers



- Inside measurement 21 1/2" L x 1 W x 13" D
- Lid included with security holes
- Easy stack-n-nest
- Resistant to rust, corrosion, oil, most chemicals, solvents and water
- Holds up to 70lbs per container

Y1095BL	Triage container with lid	blue	each	56.50
Y1095C	Triage container with lid	clear	each	49.68
Y1095G	Triage container with lid	green	each	62.80
Y1095GR	Triage container with lid	grey	each	45.81
Y1095R	Triage container with lid	red	each	56.50
Y1095Y	Triage container with lid	yellow	each	62.80

Vital Stats Notebook (Rite in the Rain)



Ensure that your vital stats are protected with this Vital Stats Notebook. This patient vital sign format is quickly becoming a favorite among EMS professionals everywhere. The size lets you keep your valuable information with you anywhere.

- Measures 3" x 5"

RR112	Vital stats notebook, 3" x 5"	each	4.45
-------	-------------------------------	------	------

All-Weather Tactical Clicker Pen



While a pencil works great on all-weather products, sometimes you just need a pen. This all-weather pen writes on wet paper and upside down in temperatures from -30 to 250 degrees F.

NB37	All-weather tactical clicker pen	each	10.95
------	----------------------------------	------	-------

Rover Active Shooter Response Kit (Kingfisher)

Now that the response paradigm has shifted and EMS and law enforcement are handling hostile threat incidents differently than we used to, the right tools to handle scene command, patient assessment and viable patient extraction are needed. Deployment ready, Rover allows EMS and fire officials to immediately ascertain scene specific information, start unified command and make appropriate decisions. Includes:



- Rapid Treatment provision with four individual trauma kits to deal with life-threatening injuries.
- Rapidly extract patients from the warm zone using tools for Joint Scene Command, Personnel Accountability, Patient Assessment, Rapid Patient Extraction.
- Two military grade extrication devices.

KF76001	Rover active shooter response kit	each	1,499.95
---------	-----------------------------------	------	----------

Xtract² Extraction Device (Kingfisher)

Xtract2 is a lightweight, robust extraction device which can be carried or dragged from the point of injury. Extrication can be achieved by use of some or all of the nine handles which are located at measured intervals around the base layer of the stretcher. When low cube size and minimal weight are paramount, Xtract2 gives responders a viable solution for casualty extraction. Utilizing Duralite fabric, the Xtract2 stretcher has been designed for personnel who perform tactical rescues within an austere environment. The Xtract2 is designed to securely cocoon the casualty, ensuring limbs and exposed medical devices are held securely inside the stretcher, minimizing the chance of disruption.



- Length Unadjusted 6' 10"
- Length Adjusted 3' 8"
- Width (Max) 43
- Maximum Load 660lbs



KF72015	Xtract 2 extraction device with case	each	329.95
---------	--------------------------------------	------	--------

Xtract^{SR} Extraction Device (Kingfisher)

XtractSR is designed for rescue personnel who evacuate seriously injured casualties from hostile environments. Weighing only 7lbs, the XtractSR provides an incredibly lightweight and compact solution to casualty movement. Originally developed for Military use, Tactical EMS Operators, Fire/EMS Rescue and Law enforcement personnel all over the world are seeing the value of this new and innovative extraction device. The padded, replaceable skid sheet provides the new standard in casualty protection for drag stretchers. Enhanced patient care is at the forefront of the XtractSR, providing a platform that will cocoon your casualty and reduce movement, helping to protect critical interventions and reduce secondary injury.



KF72121	XtractSR extraction device, litter, straps and MOLLE backpack	each	599.99
---------	---------------------------------------------------------------	------	--------



Breakaway Vests, ANSI (R&B Fabrications)

Triple trim safety vest with 5-point breakaway. It has a zipper front closure with hook and loop breakaway, reflective tape and contrasting trim. Equipped with a radio pocket with mic loop, pen pocket and two inside pockets. Adjustable at the waist from 48" to 66"(L-4XL).

RB10IMTT-LG	Breakaway, 5-point safety vest, lime green		each	20.38
-------------	--------------------------------------------	--	------	-------



Breakaway Vest, 5-Way (Lakeland)

- Radio pocket with trim
- 2 mic tabs
- Open-sided adjustable gro-grain
- Inside pocket
- Badge tab
- 29" in length
- Front hook and loop closure

LI5PBVEST	Breakaway vest, 5-point (M-2XL)		each	25.00
-----------	---------------------------------	--	------	-------



Command Vests with Reflective Stripes (R&B Fabrications)

Constructed of extra strong vinyl coated nylon mesh, edges bound and double stitched with nylon binding. Adjustable on each side with side release nylon buckles.

RB003OR	Command vest with reflective stripes	orange	each	46.92
RB003RB	Command vest with reflective stripes	royal blue	each	46.92



Triage Vest Set (R&B Fabrications)

Prepackaged kit consists of eight regular size vests (below) and a red carrying case.

- Incident Commander
- Operations
- Medical
- Triage
- Treatment
- Transportation
- Staging
- Window

RB021-3	Triage vest set		set	435.25
---------	-----------------	--	-----	--------

Titled Mesh Vest (R&B Fabrications)

Constructed of extra strong vinyl-coated nylon mesh, edges bound and double-stitched with nylon binding. Adjustable on each side with side release nylon buckles. 4" x 18" 3M Scotchlite® reflective material panel with title in black on front and back. 22"L x 19"W.

- Stock titles included in price. Call customer service for list of available titles.



RB005OR	Titled mesh vest	orange	each	36.92
RB005RD	Titled mesh vest	red	each	36.92
RB005RB	Titled mesh vest	royal blue	each	36.92

Safety Vest, ANSI Class 2 (Aerove)

The ANSI Class 2 Safety Vest is made of 100% polyester high-visibility mesh material. This vest is appropriate for moderate-risk environments including poor weather conditions and traffic approaching over 25 mph.

- Heavy-duty metal zipper secures the front closure
- Adjustable sides with hook and loop straps
- Two vertical 2" Scotchlite® reflective stripes run front to back over the shoulders and one horizontal stripe runs across the waist for 24-hour visibility
- Front chest pocket stores a radio or other items
- Mic strap provides a method to attach a radio mic
- Also includes two other handy pockets
- Complies with the requirement of section 6.1 for Class 2 garments, 6.0, 6.3, and 10 through 12 of ANSI/ISEA 107-2010.



AI1281	ANSI class 2 safety vest, L		each	17.82
AI1282	ANSI class 2 safety vest, XL		each	19.62
AI1283	ANSI class 2 safety vest, 2XL		each	19.62

Hazardous Materials Response Organization Vest Kit (Disaster Management Systems)

The Hazardous Materials Response Organization Vest Kit was designed to help establish an organizational structure that can help facilitate the necessary supervision and control for the essential functions required at all Haz-Mat incidents. After a hazardous material release is confirmed, controlling the tactical operations of first responders and equipment provides a greater degree of safety and helps to reduce the potential for spread of contaminants. This kit includes nine position vests (below).

- Hazardous Materials Group Supervisor
- Entry Leader
- Decontamination Leader
- Site Control Leader
- Assistant Safety Officer
- Technical Specialist HAZMAT
- Safe Refuge Area Manager
- Environmental Health Leader
- Civil Support Team Leader



DMS-05307	Hazardous materials response organization vest kit		each	485.99
-----------	----------------------------------------------------	--	------	--------

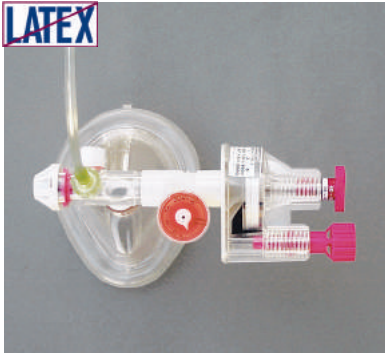

Surevent Emergency Transport Ventilator (Hartwell Medical)

The Surevent is the first disposable automatic resuscitator designed for pre-hospital emergency care providers. Utilizing a continuous gas flow source, the Surevent provides smooth, reliable ventilator support via a mask or endotracheal tube. The Surevent will deliver more consistent ventilation than can be achieved with a manual BVM resuscitator in the prehospital environment. Created for the short-term delivery of ventilator support, the Surevent is ideal for everyday emergency care situations, as well as large scale disasters and mass casualty incidents.

HASV2131	Surevent Emergency Transport Ventilator	4/case	434.15
----------	-----------------------------------------	--------	--------

Medical Cot



- 450+ lbs. working capacity
- Spun tube ends
- Heavy-duty leg locks on all legs
- Reinforced decking with hook and loop springs
- Safety and instructional labeling
- Patient restraint belt
- Stow on board safety rails
- Mattress meets FED STD 1633 for flammability
- Spring and deck design
- 2" convoluted foam mattress
- 32" x 80" sleeping surface
- 2-position Trendelenburg foot elevator
- 5-position head elevator with locking cord
- Lightweight rust proof aluminum frame - 32 lbs.
- Folding design for easy storage - 34" x 42" x 10"
- Stow on board IV pole
- Waterproof, antimicrobial mattress
- Packed inside disposable linen set

WC400-FMI	Medical cot, 18" patient care height with mattress and IV pole	each	340.00
WC400APC	Medical cot, 28" patient care height with mattress and IV pole	each	676.00



Maine Military Cot

The Maine Military Cot is crafted with a full 1 1/4" square aircraft aluminum tubing further reinforced with steel tubing inside the three leg sets. The strong rip stop polyester fabric is treated for water repellency and is reinforced along the center of the sleeping surface. The cot also features a generous gear pouch with multiple pockets. This heavy-duty cot has been strength-tested to a capacity of 1,100 pounds and has a conservative working weight capacity of 375 pounds. The Maine Military is the ideal solution for emergency preparedness when large size and high strength are necessary supplied with a shoulder strap carry bag.

BYE403-30	Maine military cot, forest green	each	85.00
BYE403-BR	Maine military cot back rest	each	98.00
BYE403-IV	Maine military cot IV pole	each	15.00
BYE701-SPE	Maine military cot self-inflating mattress	each	40.77

Portable Generators (Generac)

7000 Watt

- Hardened-steel tube cradle gives extra durability and strength for years of service
- Generac OHVI engine
- Low-oil shutdown detects low oil level and shuts engine down to prevent potential engine damage
- Circuit breaker protected
- Low-tone muffler for added noise reduction



15000 and 17500 watt

In addition to the above features, these units include:

- 16-gallon fuel tank allows for extended run times
- Idle control increases fuel efficiency
- Wheel kit and lifting eye included

GP5978	Portable generator, 7,000 watts, electric start	each	1,302.00
GP5734	Portable generator, 15,000 watts, electric start	each	3,331.05
GP5735	Portable generator, 17,500 watts, electric start	each	3,746.58

Instant Shelters (E-Z Up®)

- Sets up in seconds
- Automatic flexible roof center provides increased stability in the wind
- Pull pin slider
- Adjustable legs with three height options
- Includes convenient roller bag
- Includes standard spikes
- Meets cpai-84 fire resistant requirements



Y2000	10' x 10' Dome II instant shelter, blue	each	270.00
Y2000GR	10' x 10' Dome II instant shelter, green	each	270.00
Y2000R	10' x 10' Dome II instant shelter, red	each	270.00
Y2011	Weight bags for 10' x 10' shelters	4/set	35.00
Y2013BL	10' x 15' Eclipse II instant shelter, blue	each	940.00
Y2010	10' x 20' Eclipse II instant shelter, blue	each	1,210.00
Y2014RD	10' sidewall for Eclipse II instant shelters	each	122.00
Y2015BL	15' sidewall for Eclipse II instant shelters	each	180.00
Y2016	Instant shelter deluxe stake kit	6/set	60.00

Treatment Tarp Set (Disaster Management Systems)

A must have on-site organizational tool for all multi-casualty incidents.

- Red immediate treatment area flag (1)
- Yellow delayed treatment area flag (1)
- Green minor treatment area flag (1)
- Black morgue treatment area flag (1)
- Durable carry bag (1)
- Size: 15' x 20'



DMS-05004	Treatment tarp set	each	648.99
-----------	--------------------	------	--------



Collapsible Safety Cones (Aerove)

- Collapses flat for easy storage
- Made of durable nylon
- Two reflective stripes
- Blinking red LED beacon
- Includes the storage case that holds the cone and light
- Meets NFPA 1901 Standards; Section 6.7.3 Miscellaneous Equipment
- 2 ½ lb. weighted base (AI1193)

AI1193	Collapsible safety cone kit, orange, 28"	5/pkg	134.66
AI1190	Collapsible safety cone, 18"	each	15.24
AI1195	Collapsible safety cone replacement LED light, red	each	3.66
AI1196	Collapsible safety cone replacement LED light, yellow	each	3.66



Traffic Cones (Guardway)

CN18	Traffic cone, 18", non-reflective	each	8.38
CN18CC	Traffic cone, 18" reflective	each	12.46
CN28	Traffic cone, 28", non-reflective	each	14.08
CN28CC	Traffic cone, 28" reflective	each	25.38



Highway Warning Triangles (James King)

- Weight base rotates 90 degrees to prevent triangles from blowing over in wind or highway turbulence
- Set of three triangles packed in molded storage case
- Constructed of molded plastic in high visibility fluorescent orange with red acrylic plastic reflectors for day or night use
- Dimensions including base: 17¾" w x 16¼" h

X1005	Highway warning triangles	3/box	17.69
-------	---------------------------	-------	-------



Megaphone (Able 2)

- Lightweight, only 31/2 lbs.
- Voice mode alternates with either a siren sound or a whistle tone for emergency situations.
- Comfortable pistol grip with a trigger switch.
- Uses eight "C" batteries (not included)
- 14 5/8" length with 9" diameter bell

C1720	Megaphone with siren	each	194.54
C1720A	Megaphone with whistle	each	194.54
T1951	"C" battery	each	0.97

Rope Accessory Cord (Sterling Rope)

Accessory cords come in a wide range of diameters and color options that make them tremendously versatile for climbing, rescue and recreation applications. Sterling twists the sheath yarn in all cords 4mm and up making these cords last longer. These factors give end-users an endless variety of cords that are functional, durable and even fashionable. The smaller diameter cords (4mm-5mm) work great as tent guylines, shoelaces, zipper pulls, fashion accessories and other non-life safety applications. Larger cords (6mm-7mm) are best suited for prusik cords, cordelettes, ice threads, lightweight low-stretch fixing and hauling "tag" lines.



W1866	Rope accessory cord, 4mm diameter	per meter	0.87
W1866A	Rope accessory cord, 5mm diameter	per foot	1.00
W1866B	Rope accessory cord, 6mm diameter	per meter	1.30
W1866C	Rope accessory cord, 7mm diameter	per foot	1.60

Extra-Large Rescue D Carabiner (RescueTech)

A new design in rescue carabiners. Extra-large gate and interior dimensions let this carabiner's gate close over any round structure that will fit through the gate. 1/2" alloy steel plated with gold chromate. Gate locking design. Strength: 12,589 lbf. Gate opening: 1.5"

RT6050159	Extra large rescue "D" carabiner	each	46.45
-----------	----------------------------------	------	-------





Lights and Flashlights

5.11 Tactical



pages 425-428

Pelican



pages 430

Streamlight



pages 431-432

Assorted



page 433

5.11 Duty and Tactical Lights

Popular with Public Safety, First Responder, and Military Professionals, our lights and accessories are built with durability, utility, and high performance in mind. Featuring aerospace-grade aluminum and, virtually unbreakable PC-ABS polymer bodies, regulated circuits for maximum output, Cree® high-output LEDs, silent tail cap switches, gold-plated contacts, and smart, anti-roll designs, our flashlights offer the output, reliability, and functionality required of tactical lights in the field.



Proud Member
Plato-USA.org

251
LUMENS



130
LUMENS



220
LUMENS



212
LUMENS



Style #	511-53225-019-LIGHT	511-53029-019-FLASHL	511-53030-019-FLASHL	511-53031-019-FLASHL
Name	TPT® L2 251	TMT® A1	TMT® A2	TMT® L1
Output: High/ Strobe/Low	251 / 251 / 13 lumens	130 / 130 / 15 lumens	220 / 220 / 12 lumens	212 / 212 / 16 lumens
Runtime: High/ Strobe/Low	3:30 / 6:00 / 59:00	0:53 / 2:00 / 11:00	1:30 / 2:30 / 57:00	2:00 / 3:15 / 25:00
LED	Cree® XPGB	Cree® XPGB	Cree® XPGB	Cree® XPGB
Power	2 CR 123 (included)	1 AA (included)	2 AA (included)	1 CR123 (included)
OAL	5.2"	4.2"	6"	3.9"
Diameter (body)	1"	1"	1"	1"
Output Mode(s)	Momentary or steady-on high, strobe, or low	Momentary or steady-on high, strobe, or low	Momentary or steady-on high, strobe, or low	Momentary or steady-on high, strobe, or low
Switch Location	Tailcap	Tailcap	Tailcap	Tailcap
Lockout	NA	NA	NA	Rotary Safety
Accessories	NA	Breakaway Lanyard	Breakaway Lanyard	Breakaway Lanyard
Price	\$44.99	\$49.99	\$59.99	\$69.99

Black 019, Traffic Yellow 325,
Sandstone 328

The performance of all 5.11 Tactical lights is tested and reported according to the rigorous ANSI FL-1 Standard. Test results are displayed next to each product.



Style #	511-53032-019-FLASHL	511-53232-019-LIGHT	511-53237-019-LIGHT	511-53209-019-LIGHT
Name	TMT® L2	TMT® L2x	TMT® L3x	TMT® R1
Output: High/Stroke/Low	320 / 320 / 15 lumens	638 / NA / 52 lumens	860 / NA / 50 lumens	339 / 339 / 23 lumens
Runtime: High/Stroke/Low	2:30 / 7:00 / 55:00	3:00 / NA / 50:00	2:15 / NA / 29:00	3:00 / 6:30 / 74:00
LED	Cree® XPGB	Cree® XMLB	Cree® XMLB	Cree® XPGB
Power	2 CR123 (included)	2 CR123 (included)	2 CR123 (included)	Li-Ion Rechargeable (included) / 2 CR 123 Cartridge
OAL	5.3"	5.3"	7.375"	5.9"
Diameter (body)	1"	1"	1"	1.2"
Output Mode(s)	Momentary or steady-on high, strobe, or low	Momentary or steady-on high or low	Momentary or steady-on high or low	Momentary or steady-on high, strobe, or low
Switch Location	Tailcap	Tailcap	Tailcap	Tailcap
Lockout	Rotary Safety	Rotary Safety	Rotary Safety	NA
Accessories	Breakaway Lanyard	NA	NA	Breakaway Lanyard, Battery Pack, Battery Cartridge, 120V/12V Charging Station
Price	\$79.99	\$99.99	\$119.99	\$129.99



Our rechargeable lights include a 12V/120V charge cradle, battery, and backup battery cartridge for maximum reliability regardless of where your light is used.



Style #	511-53238-019-LIGHT	511-53210-019-LIGHT	511-53240-019-LIGHT
Name	TPT® R5 14	TMT® R3mc	TPT® R7 14
Output: High/Strobe/Low	301 / 301 / 17 lumens	357 / 357 / 20 lumens (white)	613 / 613 / 50 lumens
Runtime: High/Strobe/Low	3:00 / 6:15 / 86:00	3:15 / 6:45 / 87:00 (white)	5:30 / 13:30 / 102:00
LED	Cree® XPGB	Cree® XPGB (plus Red & Blue)	Cree® XMLB
Power	NiMH (sub-C) Rechargeable (included) / 6 AAA Cartridge	Li-Ion Rechargeable (included) / 2 CR 123 Cartridge	NiMH (D) Rechargeable (included) / 3 D Cartridge
OAL	9.1"	6.1"	12.2"
Diameter (body)	1.3"	1.2"	1.8"
Output Mode(s)	Momentary or steady-on high, strobe, or low	Momentary or steady-on high, strobe, or low	Momentary or steady-on high, strobe, or low
Switch Location	Shoulder	Tailcap	Shoulder
Lockout	NA	Rotary Switch	NA
Accessories	Battery Pack, Battery Cartridge, 120V/12V Charging Station	Breakaway Lanyard, Battery Pack, Battery Cartridge, 120V/12V Charging Station	Battery Pack, Battery Cartridge, 120V/12V Charging Station
Price	\$129.99	\$149.99	\$159.99

XBT™ Lights

5.11®'s high-performance XBT Lights feature aerospace-grade aluminum bodies, regulated circuits for maximum output, Cree® high-output LEDs, water-resistant design.



Style #	511-53019-019-FLASHL	511-53021-019-FLASHL	511-53023-019-FLASHL	511-53025-019-FLASHL
Name	XBT A2	XBT A4	XBT A6	XBT D3
Output: High/Low	256 lumens / NA	355 lumens / NA	629 / 111 lumens	1231 / 100 lumens
Runtime: High/Low	2:15 / NA	2:30 / NA	10:00 / 57:30	2:00 / 72:00
LED	Cree® XPGB	Cree® XPGB	Cree® XMLB	Three Cree® XMLB
Power	2 AA (included)	4 AA (included)	6 AA (included) 10.25"	3 D (not included) 12.15"
OAL	6.25"	8.38"	1.58"	1.78"
Diameter (body)	1"	1.58"	Momentary or steady- on high or low	Momentary or steady- on high or low
Output Mode(s)	Momentary or steady-on high	Momentary or steady-on high		
Switch Location	Tailcap	Shoulder	Shoulder	Shoulder
Price	\$44.99	\$59.99	\$89.99	\$129.99

Flexio™ Penlight

For illumination in hard to reach places. The Flexio Penlight features a flexible 6" arm that lets you focus light exactly where you need it. The Cree® XPEB LED outputs 90 lumens for 4 hours and offers high-output momentary and steady-on settings. Powered by two AAA batteries, with a handy magnetic mount for attachment to any steel surface. Imported.

- + 90 lumens, 4-hour runtime, two AAA batteries included
- + Measures 12.5" OAL with a 6" flexible arm

511-53242-019-LIGHT Flexio™ Penlight | Black 019 | \$39.99



Penlights

Compact, lightweight, and easy to carry, just like a regular pen. Except 5.11 penlights are specially designed to illuminate Driver's Licenses, IDs, and the deep, dark inner corners of your duffel bag. Each penlight features a pocket clip and water- and impact-resistant construction. Imported.

511-53211-019 TMT® PL | Black 019 | 24 lumens, 3-hour runtime, 3.3" length, .7" diameter body | one AAA (inc.) | **\$19.99**

511-53027-019-FLASHL TMT® PLuV | Black 019 | Ultraviolet 375 nm wavelength, 7-hour runtime, 3.3" length, .7" diameter body | one AAA (inc.) | **\$24.99**

511-53028-019-FLASHL TMT® PLx Penlight | Black 019 | 90 lumens, 4-hour runtime, 5" length, .7" diameter body | two AAA (inc.) | **\$26.99**

511-53027-019-FLASHL XBT Scribe Light Pen | 1 lumen, Bezel switch, black ink cartridge | 6.3" length, .59" diameter body | one AAA (inc.) | **\$39.99**



TMT PL TMT PLuV TMT PLx XBT Scribe

TPT® EDC Light

5.11's TPT EDC Light offers tactical light intensity and utility in a compact, easy-carry frame. Featuring a lightweight, impact-resistant body, a durable aluminum head, an over-molded easy-grip handle, and a Cree® XPEB LED that outputs 91 lumens for 4.75 hours, the TPT EDC is incredibly well suited for your everyday lighting needs. With dual lanyard attachment points and a removable spring-steel pocket clip, the light is also water-resistant. Powered by two AAA batteries. Imported.

- + 91 lumens, 4:45 runtime, two AAA batteries included
- + Measures 2.8" long, 1.2" wide, .6" tall

TPT® EDC Light
53243-019-LIGHT, Black
53243-325-LIGHT, Traffic Yellow
53243-328-LIGHT, Sandstone
\$19.99



BLACK 019

TRAFFIC YELLOW 325

SANDSTONE 328

See over 40 pages of 5.11 Tactical clothing beginning on page 354.





1800C PeliLite Xenon Flashlight Pelican

- Unbreakable ABS body with polycarbonate lens
- Provides 400% more light than ordinary flashlig t s
- Includes Xenon lamp and lanyard
- Requires 2 C-cell batteries (not included)

C1960	PeliLite xenon flashlig t	orange	each	37.08
C1960YE	PeliLite xenox flashlig t	yellow	each	37.08
T1951	"C" battery		each	0.97



M11 Rechargeable 8050 Flashlight Pelican

- Easy push button/ water resistant
- Lightweight body made of Xenoy with high impact polycarbonate lens
- Pre-focused laser spot beam / O-ring sealed
- Sure grip vinyl sheath resists chemicals and extreme temperatures
- Available with fast or trickle charger/ LED charge state indicator
- System includes: Rechargeable M11, battery pack, charger base holder and Cordura holster
- Comes with fast charger (110 Volt) and 12 Volt plug in charger

C1965	M11 rechargeable 8050 flashlig t	black	each	183.48
-------	----------------------------------	-------	------	--------



SabreLite™ 2000 Flashlight Pelican

This powerful flashlig t carries a variety of approvals, allowing safe use in many different hazardous environments and conditions. The SabreLite is o-ring sealed with a twist-on shroud and comes with a polarity battery guard tray that safeguards against dangerous "outgassing" of hydrogen from an accidentally reversed cell. It is powered by 3 C alkaline cells, submersible and has an ABS resin body which resists chemicals, corrosion and extreme temperatures. Unlike ordinary flashlig t s that produce a yellow beam, the Sabre-Lite's incredibly bright Xenon lamp produces a powerful collimated white beam.

PE2000C	SabreLite 2000 flashlig t	yellow	each	45.57
---------	---------------------------	--------	------	-------



HeadsUp® Lite LED Pelican

- 60 Lumens of LED light
- 10 hours of battery burn time
- Water resistant for all-weather use
- Comes with adjustable and comfortable cloth strap and heavy duty rubber strap
- Includes 3 AAA batteries

PE2690	HeadsUp Lite LED	black	each	40.26
--------	------------------	-------	------	-------

LiteBox® Lanterns Streamlight

The rugged, rechargeable LiteBox was Streamlight's first lantern with a swivel neck for full right-angle lighting. Whether you need a flood light to illuminate a wide area, a spot light to make inspections from a distance or just high lumens, the LiteBox series is an excellent choice.

Vehicle Mount System

Truck mountable 12 volt DC direct wire mounting and shoulder strap (no AC charger)

Standard System

120 volt AC, 12 volt DC chargers, shoulder strap and mounting rack

Dual Filament Vehicle Mount System

120 volt AC, 12 volt DC chargers, shoulder strap and mounting rack, dual filament for instant backup

- High-intensity halogen bi-pin bulb available in 8 watt and 20 watt spot and flood
- Xenon dual filament 8 watt safety bulb features instant backup beam
- High-impact ABS thermoplastic housing with rubberized impact bumper, lens ring and cushioned-grip handle
- Up to nine hours continuous run time per charge depending on bulb type



C1800	LiteBox vehicle mount system (20WS)	orange	each	234.06
C1800Y	LiteBox vehicle mount system (20WS)	yellow	each	234.06
C1801	LiteBox standard system 120V (8WS)	orange	each	247.44
C1804	LiteBox replacement battery		each	55.04

Fire Vulcan® Lanterns Streamlight

In a smoke-filled room, it's not only important that you can see – it's critical that you can be seen. In addition to the high-intensity halogen lamp, the rechargeable Fire Vulcan is the first to have two powerful, ultra-bright LED taillights. Your partners can follow you through the thickest smoke; and they can find you fast in an emergency. The toggle switch makes it easy to go between strobe and steady modes, so you can use it to increase visibility at a fire or accident scene or signal for help.

Fire Vulcan Standard System contains one Halogen bi-pin bulb and two blue tail light LEDs. 120 volt AC, 12 volt DC chargers, charging rack and quick release shoulder strap included. Fire Vulcan Vehicle Mount System contains one Halogen bi-pin bulb and two blue tail light LEDs. Truck mountable. 12 volt DC direct wire charging rack and quick release shoulder strap included.

- Up to 80,000 peak beam candle power with halogen bulb
- Waterproof
- 6V 4.5 amp-hour rechargeable battery can be recharged up to 500 times
- Bulb Rating:150 lumens typical
- Strobe and Steady Modes
- High-intensity halogen 8 watt spot bi-pin bulb and two ultra-bright value LEDs
- Run times are up to 3 hours with steady halogen and LEDs; up to 6 hours with blinking halogen and LEDs; up to 60 hours with blinking LEDs only



ST44400	Fire Vulcan standard system 120V (8WS)	orange	each	220.69
ST44401	Fire Vulcan vehicle mount system 12V DC (8WS)	orange	each	187.58
ST44007	Fire Vulcan replacement battery		each	45.18



Vulcan Lantern Streamlight

This industrial-duty, lightweight, rechargeable waterproof lantern is virtually indestructible. **Standard System** includes 120 volt AC, 12 volt DC chargers, shoulder strap and charging rack. **Vehicle Mount System** includes truck mountable 12 volt DC direct wire charging rack and shoulder strap.

- 8 watt spot provides up to 80,000 peak beam candle power (bulb lumens: 150 typical)
- Red and green LEDs give charge status
- High impact ABS thermoplastic housing rubberized cushioned grip handle

ST44500	Vulcan standard system	orange	each	172.24
ST44001	Vulcan vehicle mount system	yellow	each	159.58
ST44007	Vulcan replacement battery		each	45.18



Survivor[®] LED Flashlight Streamlight

One of the brightest, right-angle LED flashlights in the world! Class 1, Div. 1 rated!

- C4[®] LED, shock-proof with a 50,000 hour lifetime
- Unbreakable polycarbonate lens with silicone anti-scratch coating is assembled in a heavy-duty bezel. O-ring sealed.
- 4 Modes: High: 4 hour runtime; Low: 15 hour runtime; Flash: 8 hour runtime; Moonlight: 20 day runtime
- Industrial rechargeable nickel-cadmium 4.8 volt, 1.8 amp hour, 4 cell sub-C can be recharged up to 1,000 times

ST90503	Survivor LED flashlight, 120V, steady charge with AC/DC charger/holder	orange	each	219.58
ST90513	Survivor LED flashlight, 120V, steady charge with AC/DC charger/holder	yellow	each	219.58
ST90509	Survivor LED flashlight, 120V, fast charge with DC	orange	each	255.30
ST90540	Survivor LED flashlight, alkaline model	orange	each	101.63
ST90541	Survivor LED flashlight, alkaline model	yellow	each	88.72



- Download **FREE Layar App** (from your App Store)
- Scan this page
- View custom product info

Bring catalog pages to life

View additional content about selected products throughout our catalog by using your mobile device to scan pages that display the AR graphic (left). To get started, simply download the free "Layar" app from your device's App store.

Incandescent Heavy Duty 3-Cell D Flashlight Maglite

- Superior quality craftsmanship with weather-resistant seals and anodized inside and out for improved corrosion resistance
- A premium drop-resistant and water-resistant flashlight renowned for its quality, durability and reliability
- Advanced lighting instrument made in America and built tough enough to last a lifetime with a spare lamp safely secured in the tail cap making it suitable for camping, climbing, fishing, hunting, etc.
- Diamond knurled design with a powerful projecting beam that adjust from spot to flood with just a half turn of the head
- Uses three "D" batteries



MLS3D016	Incandescent heavy duty flashlight, uses three "D" batteries	each	25.28
----------	--------------------------------------------------------------	------	-------

Night Stick Multi-Function LED Flashlight Bayco

This battery-powered all LED Dual Light combines a tight-beam long-throw flashlight with a wide-beam non-focused floodlight. In addition to the flashlight beam, this light incorporates a non-focused 48 lumens floodlight into the handle. Additionally, both the flashlight and the floodlight can be turned on at the same time, thus allowing for dual illumination of both distant objects and ones that are close. That's the idea behind Dual Light. Powered by 4 "AAA" batteries (included), this light will run for 12 hours in Flashlight Mode, 10 hours in Floodlight Mode and 6 hours in Dual Light Mode.

- Three lighting modes: flashlight, floodlight and dual-light (both the flashlight and floodlight at the same time)
- Bright white LEDs with a 35,000 hour life
- Single button design flashlight, floodlight, dual-light, off
- Oval shape, thin design and soft-touch finish feels great in your hand
- Beam distance: 160 meters

Lumens

- Flashlight 150
- Floodlight 150
- Low flood 50
- Dual light 260



NSP-1124	Night Stick multi-function LED flashlight	each	10.77
----------	-------------------------------------------	------	-------

6" SnapLight® Light Sticks Cyalume

The dependable 6" SnapLight is easy to use, identify and dispose of when in emergency situations. Providing 360° of light, the 6" SnapLight is recommended for personal use during evacuations, power outages, camping, auto safety, and utility work. Perfect for survival, first aid, and evacuation kits as they produce no heat, spark, or flame. Individually foil-wrapped for light/moisture protection.

C1500	6" SnapLight light stick, 12 hour	green	each	1.95
C1505	6" SnapLight light stick, 12 hour	orange	each	1.95
C1501	6" SnapLight light stick, 12 hour	yellow	each	1.95
C1504	6" SnapLight light stick, 8 hour	blue	each	1.95
C1503	6" SnapLight light stick, 8 hour	white	each	1.95
C1502	6" SnapLight light stick, 30 minute	red	each	1.95





SSV Ambulances

About SSV



pages 436-437

Remounts



pages 438-440

GX3 Series Ambulances



page 441

Hackney ESVs



pages 442-443

New Ambulances



page 443

Customized Vehicles



pages 444-445



New Ambulances ■ Remounts
Rescue Vehicles ■ Service ■ GX3 Series



- SSV has two fully-equipped facilities in North Carolina that specialize in re-mounting, repairing, refurbishing and servicing all types of emergency vehicles.
- Our newest facility spans 100,000 sq. ft. while our original shop contains 15,000 sq. ft.
- We also offer a full line of vehicle parts and ambulance rentals.

Visit our website at www.SSVsales.com

Graphics application



Electrical hook-up

Our staff consists of certified welders, EVT technicians, painters and experienced fabricators.

Together, they work as a team to ensure your ambulance's appearance and functionality meets your approval.



Body on lift



Prepping cab extension



Fabrication



Reworking interior

REMOUNT

Save 30-50% by remounting your existing ambulance body to a new chassis

Remounting your ambulance maximizes the investment in your existing module while updating the chassis, electrical, lights and diamond plate. This can save you ten of thousands of dollars when compared with the cost of buying a new ambulance.

Which guidelines do your remount facility follow?

As one of only six companies in the United States to have earned acceptance into the Ford QVM Ambulance Remounter Program, SSV guarantees:



- Your remount manufacturing process adheres to the strict manufacturing and quality assurance guidelines required by Ford and
- Your remount is covered by our \$5 million product liability insurance policy

See current participants in the Ford QVM Ambulance Remounter Program
<http://ford.to/1ka2O7B>

SSV Remount Warranty

- 5 year paint warranty/100,000 miles
- 6 year electrical warranty/72,000 miles
- 3 year/36,000 mile conversion warranty

100% financing available!





Piedmont Rescue, AL



Hardin County,



Campbell County, TN



Brantley Fire, AL



Powhatan, VA

REMOUNT



Duke Life Flight, NC

Facts about SSV Remounts

- \$5 million product liability insurance
- One of only eight companies in the United States to have earned acceptance into the Ford QVM Ambulance Remounter Program
- Our "check-off" list contains 1,014 items
- Member of AMD, NFPA and NTEA
- Our manufacturing procedures follow all FMVSS safety standards
100% financing available for qualified buyers



Franklin County, NC



Iredell County, NC

GX3 Series Ambulance

An affordable, "like-new" ambulance built by mounting a pre-owned body to a new chassis



Loaded with Premium Upgrades

A "like-new" ambulance that is friendly to your budget.

Looking to add another ambulance to your existing fleet, but a new unit is not in our budget? Take a look at our GX3 Series unit. We place the module body of a pre-owned ambulance (often a trade-in) on a new chassis to create a "like-new," affordable unit.

SSV refurbishes the modular body from top to bottom including new paint, new electrical, new lighting and new HVAC system. This unit comes with the same warranty as our remounts.

Please call us for more information at (800) 334-6656



Medium Rescue

Standard drop-pinch frame technology provides low profile equipment access and 30% more storage capacity, which is typically wasted space on conventional rescue designs.



Light Duty

The largest storage capacity of any conventional light duty rescue available.



Specialty Vehicles

Command or law enforcement logistics and control can be accomplished in a wide variety of custom body configurations.



It has always been about space!

That was the case in 1986 when a HazMat captain stopped at a local convenience store for coffee on the way to start his next shift. He found himself standing in front of a Hackney delivery truck with coffee in hand staring into a cavernous compartment. **He was amazed at the depth of the compartment and the amount of storage space.** It was the solution the department had been looking for to transport the vast amount of equipment associated with hazardous materials response. A call was placed. A HazMat truck was built and delivered. And the rest is literally history.

Since those days, **Hackney has become the leading manufacturer of emergency support vehicles (ESVs) in North America.** The scope of the products offered covers everything from rescues responding to medical emergencies and traffic accidents, to technical rescues that respond to collapsed buildings and other catastrophic events, to hazardous materials incidents, to the manufacturing of purified breathing air on-scene, to law enforcement tactical response teams and EOD responses and all the way to mobile command and communications centers that provide interoperable communications and logistical support.

What makes a Hackney unique and why it has the most cubic foot storage capacity per body inch is the field proven drop-pinch frame and integrated roll-up doors. The combination of these two unique features creates a body or trailer without an inch of wasted space.

With over 65 years of body building experience, Hackney is more than capable of assisting the emergency services industry with developing an ESV specifically designed for your department's mission critical response, not something that was designed to serve someone else's purposes.

Yes, it is about space. But, it is **also about value and incredible durability,** all of which comes standard with every Hackney.

Hackney Emergency Support Vehicles



Heavy Duty Custom

Spartan custom cabs and the most unique, functional mission-specific bodies make Hackney the choice of high-profile departments nationwide.



Trailers

Roll-up doors and 43" deep floor-to-ceiling compartments maximize storage capacities of upwards of 1500 cubic feet.



Heavy Duty Commercial

You choose the chassis, we provide a custom solution for all types of incident responses.

New Ambulances

SSV represents the ambulance manufacturers shown below.
To determine availability in your state, please call us at (866) 640-2028.





Customized Vehicles for Fire and EMS



Specialty vehicles are called different things by different people.

- Quick Response Vehicles (QRV)
- Emergency Response Vehicles (ERV)
- Paramedic Chase Vehicle
- Fast Response Unit

Whatever you call it, Southeastern Specialty Vehicles can customize your cabinets and consoles. Southeastern's cabinets and consoles are made of smooth aluminum and sprayed with Scorpion liner, NO plywood is used in our cabinets or consoles. We also specialize in custom graphics and light packages.

Please call us for more information at (800) 334-6656



Base storage to complete ALS systems with dry erase board



Custom console with laptop mount



Graphics



LED light packages



Aluminum cabinet before finis

- Custom console
- Emergency light package
- Sirens and speakers
- Inverters
- Temperature control cabinets
- Pull out drawers
- Slide out systems



Vehicle Accessories

Whelen



pages 448-452

Components



pages 454-455



500 Series TIR™ Super-LED® Lighthoods by Whelen

TIR6 Super-LED requires optional mounting for surface mount applications. 25 Scan-Lock flash patterns with Phase 1 and Phase 2 for alternating and simultaneous flashing or up to eight lighthoods which include steady-burn and synchronize wire. The 500 Series offers a wide variety of mounting options. Size: 15/8”H x 5W.

WL50CR3ZCR	500 Series TIR6 LED warning light	clear/red lens	each	173.00
WL50R03ZCR	500 Series TIR6 LED warning light	red/clear lens	each	173.00
WL50R03ZRR	500 Series TIR6 LED warning light	red/red lens	each	173.00
WL50CC3ZCR	500 Series TIR6 LED warning light	clear/clear lens	each	173.00

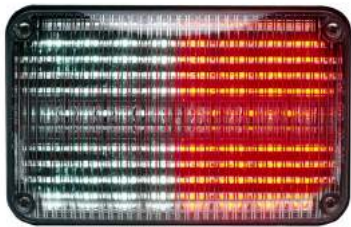

600 Series Super-LED® Lighthoods by Whelen

Mid-sized surface mount, wide angle LEDs with redesigned spreader optic lenses fill the lighthouse evenly with light, rivaling strobe in intensity but with all the advantages of LED. Surface Mount Rota-Beam™ Super-LED Rotating Lighthouse with no motors, no moving parts.

WL60C02SCR	600 Series LED warning light (requires flasher)	clear/clear lens	each	194.00
WL60R02FCR	600 Series LED warning light (includes flasher)	red/clear lens	each	194.00
WL60R02FRR	600 Series LED warning light (includes flasher)	red/red lens	each	194.00
WL60RC6FCR	600 Series LED warning light (includes flasher)	red/clear lens	each	194.00
WL6EFLANGE	600 Series chrome-plated flange		each	20.50



700 Series Super-LED® Lighthoods by Whelen

Mid-sized, surface mount Linear Super-LED lighthouse available in SmartLED design or without an internal flasher. Flasher version has 14 Scan-Lock™ flash patterns plus steady-burn mode and Hi/Low. Size: 31/16”H x 4”W.

WL70C02SCR	700 Series Super-LED warning light (requires flasher)	clear/clear lens	each	194.00
WL70R02FCR	700 Series Super-LED warning light (flasher included)	red/clear lens	each	194.00
WL70R02FRR	700 Series Super-LED warning light (flasher included)	red/red lens	each	194.00
WL70R02SRR	700 Series Super-LED warning light (requires flasher)	red/red lens	each	194.00
WL70RC6FCR	700 Series Super-LED warning light, half red, half white		each	239.00

900 Series Super-LED® Lightheads Whelen

Largest surface mount dual level Linear Super-LED lighthouse in the series. Available in SmartLED design with an internal flasher. SmartLED flasher version has 14 Scan-Lock flash patterns plus steady-burn mode and Hi/Low power. This is the only split color lighthouse in the series with independent pattern plus On/Off control of each level and Hi/Low power. Size: 7 1/8" H x 3 1/8" W.

WL90CC5FCR	900 Series LED single color warning light (includes flasher)	clear	each	309.00
WL90RC5FCR	900 Series LED warning light (includes flasher)	red/clear lens	each	309.00
WL90RR5FRR	900 Series LED single color warning light (includes flasher)	red	each	309.00
WL90RR5SCR	900 Series LED warning light (requires flasher)	red/clear lens	each	309.00
WL9EFLANGES	900 Series LED chrome-plated flange kit		each	25.50



M7 Series Linear Super-LED® Surface Mount Lightheads Whelen

The only patented Linear-LED® lightheads designed to stand-up to the harsh environments and standards of the industry while providing top of the line performance! 7 5/8" Long x 3 3/8" H. Protrudes 1 3/8" Current Draw @ 12.8 VDC in "Solid" mode: 2.25 amps peak, 0.9 amps average

WLM7K	M7 Series Linear Super-LED Surface Mount	red/amber lens	each	229.00
WLM7FB	M7 Series Linear Super-LED Surface Mount flange, black		each	9.20



500 Series Halogen Lightheads Whelen

Small size with 35 watt snap-in halogen lamp fits anywhere on the vehicle with a wide variety of mounting options. Size: 1 5/8" H x 3" W.

WL5FLANGEC	500 Series chrome-plated flange		each	16.50
WL5FLANGEB	500 Series black flange		each	9.20



900 Series Halogen Lightheads Whelen

The largest directional lighthouse in the series with a 60 watt snap-in halogen lamp. Size: 7 1/8" H x 3 1/8" W.

WL90F000RR	900 Series halogen lighthouse	red	each	142.00
WL90F000CR	900 Series halogen lighthouse	clear	each	142.00
C2015	900 Series chrome-plated flange		each	25.50





Super-LED® Scenelights Whelen

600 Series

- Mid-sized 12 diode, gradient 8°-32° Super-LED scenelight. Size: 41/8"H x 1/2"W.

700 Series

- Rectangular 12 diode, gradient 8°-32° Super-LED scenelight. Size: 31/16"H x 7/8"W.

900 Series

- 24 diode Super-LED gradient Opti-Scenelight with a unique internal and external optic design for superior scene-lighting without angle brackets. Surface mount, includes chrome flang . 6500 lumen output. Instant on with no warm up. Size: 71/8"H x 91/8"W.

M6 Series

- Surface mount 12 diode gradient 8°-32° Super-LED scenelight features inner optics that direct light downward without angle brackets. Size: 45/16"H x 3/8"W x 13/8"D

M9 Series

- 24 diode Super-LED gradient Opti-Scenelight with a unique internal and external optic design for superior scenelighting without angle brackets. Surface mount, includes chrome flang . Surface mount lighthouse draws only 6 amps and produces 6500 lumens. Size with flange: 1/2"H x 3/8"W x 13/8"D

WL6SCOENZR	600 Series super-LED Scenelight	each	309.00
WL9SCOENZR	900 Series super-LED Scenelight	each	546.00
WLM6ZC	M6 Series super-LED Scenelight	each	386.00
WL70CELZR	700 Series super-LED Scenelight	each	342.00
WLM9LZC	M9 Series super-LED Scenelight	each	580.00



Scenelights by Whelen

508 Series

- Eliminate large cutouts on your vehicle with surface mounted 8°-32° scenelight model featuring snap-in relampable 27 watt bulbs. Size: 5"H x 85/8"W x 2"D.

810 Series

- 8°-32° Scenelight eliminates large cut-outs on your vehicle. Only four mounting screws and an access hole for cable are needed, making installation and maintenance easier. Size: 8" H x 10" W x 2" D.

600 Series

- Mid-sized directional, lighthouse with 35 watt snap-in halogen lamp. Size: 41/8"H x 6 1/2"W.

700 Series

- Rectangular lighthouse with 35 watt snap-in halogen lamp. Size: 31/16"H x 7/8"W.

900 Series

- Large halogen with snap-in 50 watt halogen bulb. Size: 71/8"H x 91/8"W.

WL580CAAZR	508 Series Scenelight lights	each	221.00
WL60K000YR	600 Series SceneLight lights, halogen lamp, 13 degrees	each	168.00
WL60K000XR	600 Series SceneLight lights, halogen lamp, 26 degrees	each	168.00
WL70K000ZR	700 Series SceneLight lights, halogen lamp, 8-32 degrees	each	155.00
WL810CA0ZR	810 Series SceneLight lights	each	242.00
WL90E000ZR	900 Series SceneLight lights, halogen lamp	each	181.00

Super-LED® Interior Lights (8" Round) Whelen

- Long-life performance
- Direct replacement to outdated halogen and incandescent lighting fixtures
- Eliminates the high cost of lamp replacement associated with halogen or incandescent lamps
- Conformal coating provides moisture and vibration resistance
- Standard 6" pigtail
- Hi/Low intensity standard
- White lightheads offer 950 lumen output
- Five year HDP® (Heavy-Duty Professional) warranty
- Red interior light for the vehicle cab. White has hi/low intensity levels for improved running nighttime vision
- New models with spring clip mounting require no mounting hardware for installation



WL80COEHCR	Super-LED interior light, 8" round, white	each	168.00
WL80CBEHCR	Super-LED interior light, 8" round, 6 white high/low and 3 blue	each	332.00
WL80C00EZR	Super-LED interior light, 8" round, chrome housing, spring clip mounting	each	168.00
WL80CREHCR	Super-LED interior light, 8" round, 6 white high/low and 3 red	each	332.00
WL8WC00EZR	Super-LED interior light, 8" round, white housing, spring clip mounting	each	157.00

Replacement Lenses Whelen

WL68-1183581-10	600 Series LED and halogen replacement lens	each	47.00
WL68-3183587-10	600 Series strobe replacement lens	each	47.00
WL68-1183582-15A	700 Series LED and halogen replacement lens	each	43.00
WL68-1183542-10	900 Series halogen and strobe replacement lens	each	47.00
WL68-3183573-150	700 Series strobe replacement lens	each	44.00



We also distribute Ferno Cots. For information, call Customer Service at (800) 334-6656.

Whelen Replacement Bulbs

Halogen Bi-Pin

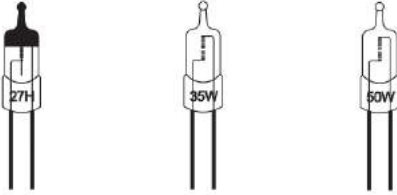

C5041	Halogen bi-pin, 27W (H27W12V)	14.00
C5042	Halogen bi-pin, 35W (H35W12V)	14.00
C5043	Halogen bi-pin, 50W (H50W12V)	14.00

Halogen Twist Lock

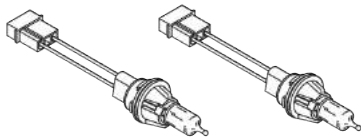

C5048	Halogen twist lock, 27W (H27TL12)	30.00
C5021	Halogen twist lock, 35W (H35TL12)	30.00
C5020	Halogen twist lock, 50W (H50TL12)	30.00

Halogen Snap-In

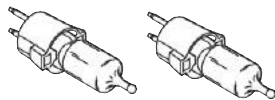

C5044	Halogen snap-in, 27W (H27SN12)	28.00
C5045	Halogen snap-in, 35W (H35SN12)	28.00
C5046	Halogen snap-in, 50W (H50SN12)	28.00
C5060	Halogen snap-in, 60W (H60SN12)	28.00

Weldon Interior Dome Lights



C5033	Weldon interior dome light, high dome	8.54
C5034	Weldon interior dome light, low dome	2.11

Strobe Tubes

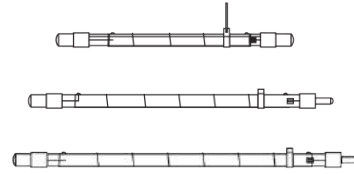

C5022	Strobe tube for 64, 73, 97 series and 9000 series lightbars (S30TL12)	36.28
C5062	Strobe tube for 900, 97 and 9E linear (TURBO5)	65.00
C5019	Strobe tube for 97 series and 9000 series lightbars (TURBOTUBE)	62.00
C5040	Strobe tube for 97 series and Super AdvantEdge Plus (TURBO64)	65.00

Brake/Tail/Turn

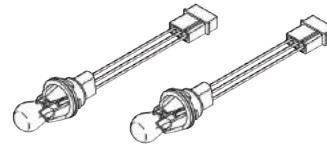

C5016	Brake/tail/turn (BRAKTL12)	28.00
C5047	Brake/tail/turn, 3 pins (STOPSN12)	28.00

700 Series Bulb

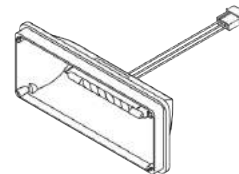

WL7ELTUBE	Tube linear strobe for 700 series bulb	167.00
-----------	----------------------------------------	--------

900 Series Strobe Reflector

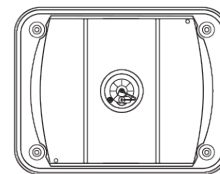

WL900STUBE	Linear strobe/reflector for 900 series	143.00
------------	----------------------------------------	--------

Financing available to all qualified users.

Ambulances and Rescue Trucks



Remounts



Defibrillators and Monitors



EMS Equipment



MCI, Rehab and Mortuary Trailers



Portable Buildings, Shelters and Coolers



- Lower financed rates
- No down payment
- Deferred first payment available
- Terms from 1 to 7 years
- Monthly, quarterly, semi-annually and annually

For more information or to request a credit application, please call



(800) 334-6656



(866) 640-2028



DIH8000A



DIH7000



DIH7000A



DIH1800



DIH1801



DIH1805

Defibrillator Mounts (NCE)

An unsecured defibrillator in an emergency vehicle has the potential to seriously injure both patient and attendant when the vehicle goes around a corner or makes a sudden stop. Secure your equipment with a high-quality mount.

- One hand quick release
- Holds up to 12 G-Force
- 360 degree swivel
- Durable white-baked enamel
- Lifetime warranty
- Dimensions shown are L x W x H.

DIH8000A	Defibrillator mount for Philips MRx with red or black bag. 14.652" x 14.61" x 14.99"	each	700.00
DIH7000	Defibrillator mount for Lifepak 12 or Lifepak 15. 15.680" x 11.907" x 15.04"	each	660.00
DIH7000A	Defibrillator mount for Lifepak 12 with battery charger. 15.680" x 11.907" x 17.127"	each	700.00
DIH9000	Defibrillator mount for Zoll E-Series. 11.6" x 9.3" x 4.7"	each	700.00
DIX9000	Defibrillator mount for Zoll X-Series. 13.5" x 11.866" x 13.24"	each	838.00
DIH1800	Defibrillator mount for Zoll M-Series with Extreme Pack 2. 12.6" x 12" x 2.7"	each	660.00
DIH1801	Defibrillator mount for Zoll M-Series without Extreme Pack 2. 12.6" x 12" x 2.7"	each	640.00
DIH1805	Defibrillator mount for Zoll M-Series with Extreme Pack 2 and NIBP. 10.5" x 9.3" x 2.5"	each	670.00
DIWM1000	Universal wall mount. 13" x 17" x 14"	each	500.00



DIH9000

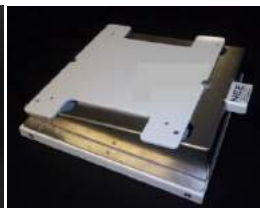

DIX9000

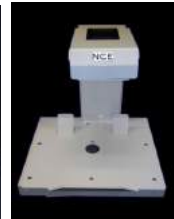

DIWM1000

Fire Extinguisher

- 5 lb. or 10 lb. multi-purpose dry chemical
- Easy-to-read pressure gauge allows instant, accurate pressure check
- Squeeze grip provides positive operation
- Handle and lever made of heavy gauge metal
- Kidde® brand
- UL Listed and DOT approved



X1000	Fire extinguisher, 5 lb	each	61.38
X1001	Fire extinguisher, 10 lb	each	74.15

Star Of Life Emblem

Available in high quality reflective Scotchlite that meets all KKK specifications.

K8501	Star of Life emblem, 2" x 2", square cut	each	3.00
K8502	Star of Life emblem, 3" x 3", square cut	each	3.50
K8504	Star of Life emblem, 4" x 4", die cut	each	5.00
K8508	Star of Life emblem, 6" x 6" die cut	each	6.00
K8513	Star of Life emblem, 16" x 16" die cut	each	25.00
K8514	Star of Life emblem, 12" x 12" die cut	each	20.00



No Smoking/Oxygen In Use

4" x 7" reflective red and black, on white.

K8520	No smoking/oxygen in use decal	each	5.00
-------	--------------------------------	------	------



DON'T SEE WHAT YOU'RE LOOKING FOR?
 Call Customer Service; we're here to help.
 (800) 334-6656

pace
AMERICAN



HAWS RUN EMS - RESCUE
SPECIAL OPERATIONS SUPPORT UNIT

XT



PACEAMERICAN.COM

WE SUPPORT OUR TROOPS



Medical Trailers

MCI



pages 458-459

Medical Support



pages 460-461

Quick Response

Rehab



page 462



page 463



Our trailers are built to meet your needs including MCI, Rehab, Medical Support, Morgue, Command Units and many others.

- All units are ready to be put in service as soon as they arrive at your site
- Our MCI trailers are for 25, 50, 75, 100 and 150 trauma patients and are fully stocked
- Custom cargo nets
- Color-coded containers for medical equipment
- Custom backboard racks (no straps to hold boards)
- Custom shelves 3/16" thickness
- Shelving can be used as a bed

Cargo Nets

We manufacture our cargo nets in-house so every net is customized for each trailer. Nets are constructed of 1" black nylon webbing with a tensile strength of 600 lbs. Webbing is run vertical and horizontal and spaced every 5" apart.

Each intersection is sewn with box style stitching using automated machines.

Nets can be rolled up and fastened with Velcro. Cargo nets are held in place with six quick-style fasteners, eliminating straps needed to hold your equipment in place.



Backboard Racks

Our backboard racks are constructed from .125 thickness and 3003-H22 diamond plate and are designed to hold backboards in the vertical position.

No straps are needed, making it safe and quick to deploy. All legs and braces are mig welded.

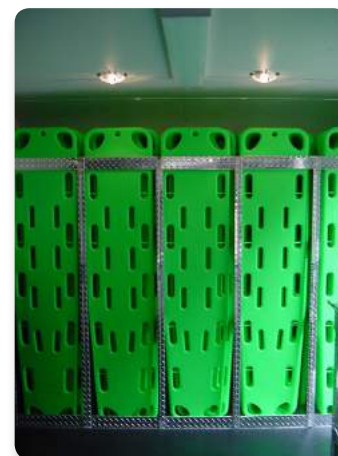

For our brochure, list of equipment or more information please call us at (800) 334-6656.



- Shelving and racks are constructed of .188 thickness smooth aluminum, 23 $\frac{1}{2}$ " deep with $\frac{1}{2}$ " lip
- Each shelf has rubber-ribbed matting with Trim-Lok on rollup lip
- All supports made with .125 Diamond plate



- Oxygen cylinder on cart for quick unloading



- Work station with dry erase board



The **Medical Support Trailer** is designed to give quick support in an emergency situation or at events that have a large number of people. This unit is used for triage and to treat and rehabilitate the injured or sick. The Medical Support Trailer can be fully stocked. Trailers start at 20 feet long. The size depends on the number of bed spaces you require.

- Removable ramp for wheel chair access or person unable to use steps
- Awning
- LED emergency lights
- Interior LEDs
- Generator Two roof-mounted HVAC units
- Work area in front
- Rear storage for bulk equipment
- 50 AMP Shoreline power sources

Bed spaces (number of beds depends on length of trailer)

- 110 Volt outlets
- 12 Volt outlets
- Brackets for monitors
- Mattress
- Adjustable head/foot rest
- Bed rail
- Privacy curtains
- Cabinet storage under bed
- Oxygen outlet



■ Patient area



■ Removable ramp



■ Privacy curtain



■ Adjustable back rest



■ Awning option available



■ Front work area with refrigerator, work desk and drawers



■ Rear storage for bulk equipment



■ Storage for medical supplies



■ Oxygen manifold



**EXTREMELY
POPULAR**



The Quick Response Trailer (QRT) can be pulled by most cars or a small SUV.

We customize our trailers and equipment to fit our specific need . Utilizing the very best in materials, we carefully design each trailer to make the most of the space available.



- Incident Command Module
- Trauma supplies
- Immobilization
 - 25 adult backboards
 - Collars, head immobilizers
- Diagnostic Equipment
- Infection control items
- Blankets
- Suction equipment and supplies
- All MDO plywood sprayed with Scorpion liner
- Interior 8' long x 5' wide
- Oxygen equipment
 - "M" oxygen cylinder
 - Oxygen manifold
 - Portable oxygen system
 - Oxygen supplies
 - Storage for D or E cylinders
- Trailer: Length 12'7" (includes moveable tongue)
- Dry erase board mounted on foldout door
- Interior LED lights

For a complete list of equipment, please call us at (800) 334-6656.

Our Rehab Trailers are designed to provide firefighters, EMTs and other emergency service personnel with safe, clean and reliable rehabilitation facilities. Let Southeastern help you design a rehab trailer that fits your needs.



- Length starting at 14'
- Scorpion-sprayed floor
- Rooftop air conditioners
- Awnings
- 110 Volt lights
- LED interior lights
- LED scene lights
- Generators
- Diamond plate shelves/storage
- Drop-down bunks
- Work station
- On-board oxygen system
- Refrigerator
- Microwave
- Medical equipment
- Portable toilet
- Misting fans
- Chairs
- CoolShirt system



For more information, please call us at (800) 334-6656.

Portable Module Buildings (PMBs)



An 8' x 20' Portable Module Building (PMB) can be assembled by three people within 30 minutes. Once built, simply plug in electrical power and begin enjoying your PMB.



PORTABLE MODULE BUILDINGS

Perfect for temporary housing, office space, medical facilities and command units

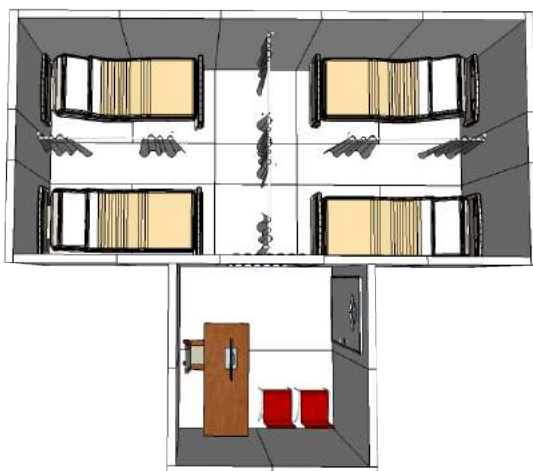

Medical Facility

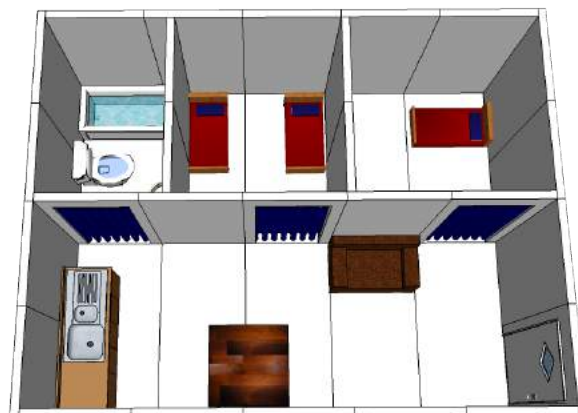

Emergency or Temporary Housing

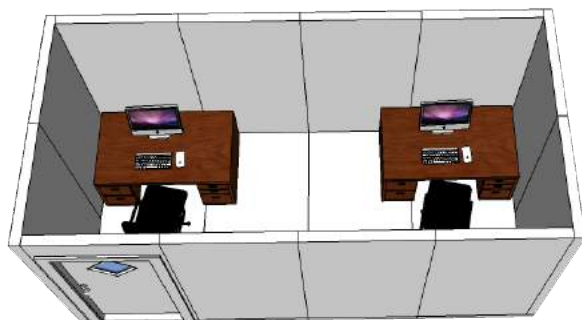

Emergency or Temporary Office Unit

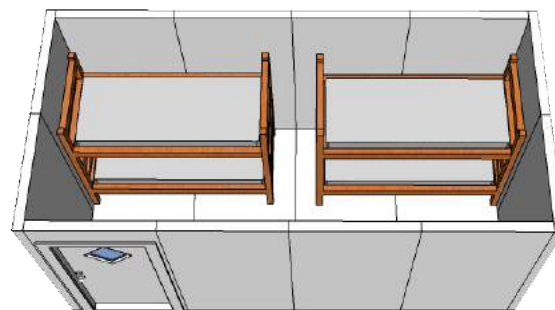

Emergency or Temporary Housing

PMBs are portable, making relocation simple and quick. Supply them with beds, kitchen appliances...whatever is needed for its uses. Customized to fit your specific tions, a PMB can be as wide and as long as desired.

For information, please call (800) 334-6656 (extension 224)

Portable Module Building Features

Wall/Ceiling Panel Specific tions

- 2 x 4 construction with tongue and groove framing
- Panel weight: 96 lbs.
- Polyurethane foamed in place insulation
- 26 gauge stucco embossed G-90 galvanized
- 3½" panel with 25 R-value
- Cam locks used to fasten panels together for ease of installation
- Panel widths come in a variety of sizes to accommodate customer-desired floor pla
- Sealing gaskets on interior/exterior provide tight seal when ceiling panels are locked together

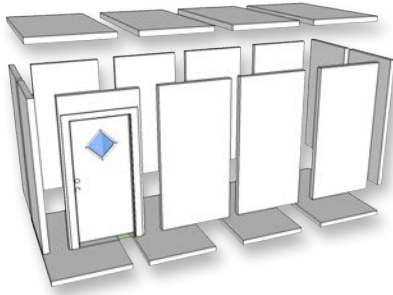

Floor Panel Specific tions

- 2 x 4 construction with tongue and groove framing
- Polyurethane foamed in place insulation
- ½" plywood flooring on interior floor and 26 gauge stucco embossed galvanized on exterior of floor
- Interior floor sp ayed with Scorpion material
- Cam locks used to fasten panels for ease of installation
- Panel widths come in a variety of sizes to accommodate customer-desired floor pla

Cam Lock

- Placed every two feet to provide a strong, fully sealed joint with significant strength
- Slide two panels together using the tongue and groove system, then use the Allen wrench (supplied) to turn the cam locks to their locked position



Electrical

- Fully prewired according to customer needs
- 100 AMP electrical panel with Hubbell connectors
- Configu able to accept 110 V or 220 V power source
- Can accept commercial generator or solar power
- Panel is detached for shipping but easily installed with a screwdriver



HVAC

- Two options are available depending on the usage of your PMB: interior wall mounted unit or a portable unit. Both will come with ducting.



Internal Lighting

- Recessed in-roof panel
- ¾" Lexan protective covering
- Fluorescent bulbs standard
- LED lighting upgrades available

Tools and Equipment

- Panels can be moved by three people
- Hex wrench to activate cam locks
- Screwdriver for electrical boxes and HVAC hoses
- All tools needed are included with PMB

Other available units are portable walk-in coolers, freezers or combinations along with our portable morgue refrigeration unit

Walk in Coolers/Freezers or Combinations

Standard Features

- 26 gauge stucco galvanized steel interior and exterior
- 3½" cooler panels and 5½" freezer panels
- Polyurethane foam insulation
- Wood frame with tongue and groove construction using cam lock panel fasteners
- 36" x 78" insulated door with 9" high standard aluminum diamond patterned kick plates on interior and exterior. Includes chrome hinges and latches.
- 2" dial thermometer-shipped loose
- Non heated pressure vent-installed (cooler only)
- Heated pressure vent-installed (freezer only)
- Light switch with pilot light-shipped loose for surface mount installation
- Complete set installation instructions with layout drawings
- Custom built shipping skids
- NSF approved and ETL listed meeting ASTM E84 specific tions
- Quality craftsmanship

- Sets up in 20 minutes after use; breaks down and stores until ready to deploy again
- 26 gauge stucco galvanized steel interior and exterior
- 4" wall panel thickness
- Insulated cooler door
- Polyurethane foam insulation
- Wood frame with tongue and groove construction using cam lock panel fasteners
- Fluorescent light
- EPDM fl t rubber roof membrane
- NSF approved and ETL listed meeting ASTM E84 specific tions
- Voltage 120-230

Portable Morgue Refrigeration

Standard Features

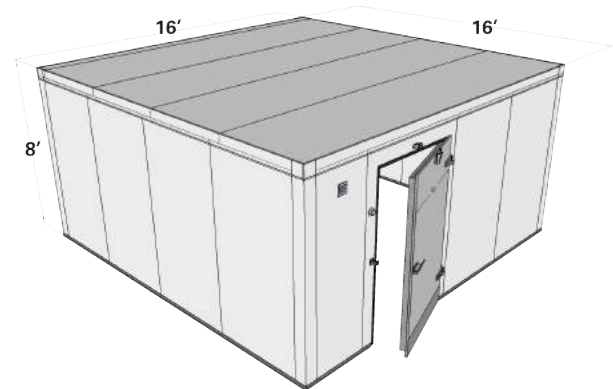
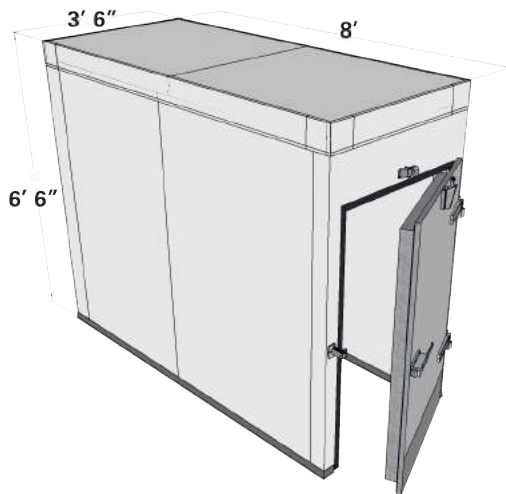

For information, please call
(800) 334-6656 (extension 224)

3-Lead Cable Set, MRx...35
 3-Lead ECG Cable, FR3...6
 5.11 Tactical
 Belts...377
 Flashlights...424–428
 Footwear...390–395
 Outerwear...378–389
 Pants...366–373
 Shirts...358–365
 Uniforms...374–376
 5-Lead Cable Set, MRx...35
 12-Lead ECG Cables and Lead Sets,
 MRx...35
 740 Vital Signs Monitor...62

A

Absorbent Products...280
 ActiSplint...251
 Active Shooter Response Kits...400, 415
 Acuvance Plus Safety IV Catheters...204
 Adapters and Connectors...158
 Adhesive Bandages...291
 Administration Sets...208–213
 Adscope Stethoscopes...76–77
 Adtemp Thermometers...85–86
 Advanced Airways
 Double Lumen...142
 Laryngeal Masks...142
 Supraglottic Airways and Kits...142
 AED25 Ballistic Helmet...400

► AEDs

Cabinets and Signage...19–23
 Data Management...24–25
 HeartStart FR2+...15–17
 HeartStart FR3...4–8
 HeartStart FRx...9–11
 HeartStart OnSite...12–14
 HeartStream ForeRunner...18
 Inspection Tags...21
 Supplies...25–26
 Trainers...8, 11, 14, 17, 92, 93, 94
 Agent Ballistic Vest...400
 AHP300 Transport Ventilator...153
 Air Splints, Inflatable...251
 Airway Management Trainers...111–112
 Airways
 Advanced...142
 Berman...143
 Bitestick...145
 Guedel...144
 Nasopharyngeal...144, 145
 Robertazzi...145
 Alcohol Prep Pads...218, 309
 Alcohol, Rubbing...310
 ALS Baby...119
 Ambulance Child Restraint
 (Q-ACR4)...262, 282

► Ambulances

Cots...272–273
 Customized Vehicles...444–445
 GX3 Series...441
 Hackney ESVs...442–443
 Malley...443
 Miller Coach...443
 Osage...443
 Remounts...438–440
 Southeastern Specialty
 Vehicles...436–437
 Taylor Made...443
 Ammonia Inhalants...313
 Angiotech IV Catheters...206
 APEX Pro 2-Ply Gloves...179
 Armboards...216
 Asherman Chest Seal...287
 Atomizer...158
 AutoVent 4000 Automatic Transport
 Ventilator...154

B

Baby Anne...108
 Backboards...256–258
 Backpacks—*See Equipment Bags and Cases*
 BAG II Disposable Resuscitators...149
 Bags—*See Equipment Bags and Cases*
 Ballistic Helmet...400
 Ballistic Vests...400
 Bandages...291–293
 Basic Buddy CPR Manikins...106
 Batteries, AEDs/Defibrillators...5, 11, 14,
 16, 18, 38
 Batteries, Alkaline...316
 BaXstrap Spineboard...257, 404
 Beck Airway Airflow Monitor...134
 Berman Airways...143
 Best Strap System...268
 Big Yank Suction System...171
 Biohazard Bags...199
 Biohoop Bag...199
 Black-Fire Nitrile Exam Gloves...182
 Blankets and Linens...280–282
 Blood Collection...222–223
 Blood Pressure Cuffs, MRx...37
 Blood Pressure Devices—*See Diagnostic
 Equipment*
 Blue Sensor Adult Electrodes...64
 BOA Constricting Band...218
 Body Armor...398–400
 Body Bags...283
 Bone Injection Gun...219
 Boots...390–395
 Brad CPR Manikin...107
 Burn Relief...298–299
 Butterfly Infusion Set...226
 BVMs/Manual Resuscitators...147–150

C

Cabinets and Signage, AED...19–23
 Cables and Sensors, MRx...34–36
 Cables and Sensors, SpO2...36
 Calibration Kits, MRx...39
 CAMS 2.0 Deployment Bag...406
 Cannulas—*See Nasal Cannulas*
 Carabiner...421
 Cardiac Science AED Supplies...25
 Carrying Cases, AEDs/Defibrillators...4, 10,
 13, 15, 39
 Car Seats...282
 Cases—*See Equipment Bags and Cases*
 Casualty Simulation Kits...109
 Catch-All...283
 C-A-T Tourniquet...286, 403
 Cavicide...195
 Celox Hemostatic Gauze...297
 Cervical Collars...254–255
 Chester Chest...120
 Chest Seals...287, 402
 Child Transport...262, 282
 Chlorascrub...218
 Circuits
 MRx, Intubated, ETCO2...37
 MRx, Non-Intubated CO2...37
 MRx, Non-Intubated CO2/O2...38
 Ventilator...155
 Clean-Up Products...199
 Clothing—*See 5.11 Tactical*
 CO2 Detectors...133
 CO2 Monitors...63–64
 Cobalt Powder-Free Nitrile Exam
 Gloves...185
 Cohesive Bandages...292–293
 Cold and Hot Packs...308–309
 ColorTouch Pink Gloves...186
 Combat Application Tourniquet
 (C-A-T)...286, 403
 CombiCarrierII...258, 275
 Combine Pads...290
 Combitube Double-Lumen Airway...142
 Command Units...458
 Contamination Control Systems...190
 Controlled Substances...236–237
 Cot Fasteners, Stryker...274
 Cots
 Medical...418
 Stryker...272–273
 Coveralls...192
 CPAP
 PORTO2VENT COAPos...146
 Rescuer Emergency CPAP System...146
 Rescuer II Compact CPAP System...146
 WhisperFlow CPAP Procedure
 Packs...147
 CPRmeter...103

CPRmeter Replacement Accessories for FR3...7
 CPRmeter Upgrade Kit for FR3...7
 CPR Prompt Training Manikins...105
 CPR Protection...166
 Crash Kelly...120
 Cricothyrotomy Devices...151
 Cricothyrotomy Simulator...114

D

Data Cable/Adapter, AED, Infrared...25
 Data Card and Tray, FR2+...16
 Data Card, FR3...6
 Data Management, AEDs/
 Defibrillators...24, 33
 DCell Suction Device...168
 DEA 222 Form Information...244
 Defender Gloves...181

► Defibrillators and Monitors

Accessories...58–59
 Electrodes...42–44
 HeartStart MRx and Supplies...30–39
 Holders and Mounts...58, 454
 Intellivue MP2 Patient Monitor...40–41
 LifePak 12 Supplies...44–48
 LifePak 15 Supplies...49–55
 LifePak Supplies, Miscellaneous...54
 Q-CPR...32
 Zoll X-Series Supplies...56–57

► Diagnostic Equipment

Blood Pressure...68–75
 Electrodes...64–66
 Glucometry...67–68
 Monitors and Detectors...62–64
 Pulse Oximetry...82–85
 Stethoscopes...76–81
 Thermometry...85–88
 Diamond Grip Gloves...176
 Difficul Airway Trainer...111
 Disinfection...194–196
 Dressings, IV...294
 Drugs—See *Pharmaceuticals*
 Dyna-Stopper...294

E

Ear Plugs...316
 Econo-Vac Vacuum Splint...250
 EID100 Esophageal Intubation
 Detector...134
 EKG Caliper...59
 EKG Ruler...59
 Electrodes
 Diagnostic...64–66
 Gel...59
 MRx, ECG Monitoring...35

MRx, Multifunction Pads...34
 Emesis Bags...199
 EMS Training and Education...124–125,
 221–222
 Endotracheal Tubes...128–134
 Envirocide...195

► Equipment Bags and Cases

Bags and Packs...332–341
 Intubation Modules...341–344
 IV Modules...346–347
 Kits and Cases...351–353
 Medication Modules...345–346
 Meret Bags...348–350
 Oxygen...328–330
 Oxygen/Trauma...326–327
 Trauma...320–324
 ETCO2 Intubated Circuits, MRx...37
 Evacuation Products...275–279
 Evac-U-Splint Extremity Splint and
 Vacuum Mattress...250
 Extrication Devices...260
 Eye Care, First Aid...310–311
 Eye Protection, Safety...190–191

F

Face Shields...166
 Faspint Vacuum Splint...251
 FAST1® Intraosseous Infusion System...219
 FAST1 Trainer...117
 Fast Response Kit...5, 10, 14, 16
 FernoTrac Traction Splints...249
 Field Guides...121–122
 Fire Blanket...298
 Fire Extinguisher...455

► First Aid and Personal Items

Cold and Hot Packs...308–309
 Eye Care...310–311
 First Aid Kits...302–303
 Instruments...304–305
 Personal Items...306–307
 Solutions...309–310
 Sting and Bite...312
 Supplies...313–316
 First Responder Carry Bag...399

► Flashlights

“D” battery...433
 Duty and Tactical...424–426
 Incandescent...433
 LED...432, 433
 Night Stick...433
 Penlights...428
 Rechargeable...430
 SabreLite...430
 Survivor...432
 TPT® EDC Light...428
 XBT™ Lights...427
 Xenon...430

FlexSense Gloves...182
 Flowmeters...162–163
 Forceps...305
 ForeRunner AED Supplies...18

► FR2+ AED Supplies

AED Trainer 2...17
 Batteries...16
 Carrying Cases...15
 Data Card and Tray...16
 Fast Response Kit...16
 Pads Adapters...17
 Pads, Adult...15
 Pads, Infant/Child...16

► FR3 AED

3-Lead ECG Cable...6
 AED Trainer 3...8, 92
 Battery, Disposable...5
 Battery, Rechargeable Clinical...5
 Carrying Cases...4
 CPRmeter Replacement Accessories...7
 CPR Meter Upgrade Kit...7
 Data Card...6
 Fast Response Kit...5
 FR3 AED Defibrillator...4
 Infant/Child Key...5
 Pads Sentry Replacement...6
 SMART Pads III...5
 Software Upgrade Kit...7
 FreeForm EC Gloves...180
 FreeForm SE Gloves...179
 FrontLine Gloves...182

► FRx AED

Batteries...11
 Fast Response Kit...10
 FRx AED Defibrillator...9
 FRx Trainer...11, 93
 Infant/Child Key...9
 Pads Adapters...10
 Replacement Carrying Cases...10
 SMART Pads II...10

G

Gauze...288–290
 Generators...419

► Gloves

Chloroprene...181
 Colored...185–187
 Exam...178
 Holders...187
 Latex...176–178
 Latex-Free...179–185
 Pouch...306
 Guedel Airways...144
 Gunshot Wound Kit...402
 GX3 Series Ambulances...441

H

Hackney ESVs...442–443
 Halo Chest Seal...287
 Hand Cleaners...197–198
 Head Blocks...261
 Head Immobilizers...260–261
 Healthcare Provider Courses...124–125, 221–222
 HeartStart Config e...24
 HeartStart Config e Software...24
 HeartStart FR2+—*See FR2+ AED Supplies*
 HeartStart FR3—*See FR3 AED*
 HeartStart FRx—*See FRx AED*
 Heartstart MRx Monitor/Defibrillator—
See MRx Defibrillator/Monitor for EMS
 HeartStart OnSite—*See OnSite (HS1) AED*
 HeartStart XLT Supplies...25
 HeartStream ForeRunner (FR)—
See ForeRunner AED
 Hemorrhage Control...286–287
 Hemostatics...297
 Hot and Cold Packs...308–309
 Humane Restraint Transport Hood...189
 Humidifier...160
 Hydrogen Peroxide...310
 HyFin Vent Chest Seals...287, 402

I

ICU911 Gloves...178
 i-gel Supraglottic Airways...142

► Immobilization

Backboards...256–258
 Cervical Collars...254–255
 Extrication...260
 Head Immobilizers...260–261
 Limb Restraints...264
 Pediatric...262–263
 Straps and Strap Systems...265–268
 Traction and Splinting...248–253
 Individual First Aid Kits (IFAK)...403, 412
 Infant/Child Key...5, 9

► Infection Control

Clean-Up...199
 Contamination Control System...190
 Disinfection...194–196
 Eye Protection...190–191
 Glove Holders...187
 Gloves, Colored...185–187
 Gloves, Latex...176–178
 Gloves, Latex Free...179–185
 Hand Cleaners...197–198
 Personal Protection...192–193
 Protective Masks...188–189
 Infrared Data Cable/Adapter...25

Insect Defense...194
 Inspection Tags, AED...21
 Insyte Autoguard IV Catheters...205
 Intellivue MP2 Patient Monitor...40–41, 62
 Intraosseous Infusion Devices...219
 Intraosseous Infusion Simulator...117
 Introcath Safety IV Catheters...206
 Intubation Kits, Tactical...405
 Intubation Trainers...113
 Irrigation Solutions...240
 Isolation Gowns...192–193

► IV Products

Blood Collection...222–223
 Fluids...239
 Intraosseous Infusion...219
 IV Accessories...214–218
 IV Administration...208–213
 IV Catheters...202–207
 IV Dressings...214
 Sharps Containment...227–229
 Syringes and Needles...224–226

J

Jackets...378–380, 382–387, 389
 Jelco IV Catheters...204

K

K-9 Vest...399
 K.E.D...260
 King Supraglottic Airways...141
 King Vision Portable Video
 Laryngoscope...135

L

Laerdal 4000 Supplies...25
 Lancets...68
 Lanterns—*See Lights and Flashlights*

► Laryngoscopy

Blades...136–141
 Bulbs...140
 Fiber Optic Laryngoscopes...135, 136
 Handles...136, 137, 139, 140
 King Vision Portable Video
 Laryngoscope...135
 Lemon-Glycerin Swabs...314
 LifePak Supplies
 500...26
 1000...26
 CR Plus and Express...26
 LP12...44–48
 LP15...49–54
 Miscellaneous...54
 Lighthawk LT Light Tactical Vest...398

► Lights and Flashlights

5.11 Tactical...424–428
 Assorted...433
 Headlights...430
 Lanterns...431–432
 Light Sticks...433
 Pelican...430
 Streamlight...431–432
 Limb Restraints...264
 Little Anne AED Training System...104
 Little Anne CPR Training Manikin...104
 Little Family Pack of Manikins...105
 Little Junior...107
 Littmann Stethoscopes...79–81
 LMA Supreme Laryngeal Mask...142

M

MAD Nasal Atomizer...158
 Magellan Safety Needles...224, 226

► Masks

Aerosol...158
 Dragon Pediatric...158
 Face Masks...155
 High Concentration...159
 Medium Concentration...159
 Multi Vent...159
 Non Rebreather...159
 Oxygen...159, 160
 Pocket...166
 Protective...188–189
 Three-in-One...160
 Tracheostomy...156

► Mass Casualty Extraction

Rover Active Shooter Response
 Kit...415
 Xtract 2 Extraction Device...275, 415
 Xtract SR Extraction Device...415
 MatchMates Combination Kits...73
 MAT Tourniquet...286, 403
 MCI Backboards...256
 MCI Bag...411
 Medical Gas Adapters...165

► Medical Trailers

MCI...457–459
 Medical Support...460–461
 Quick Response...462
 Rehab...463
 Medication Delivery Devices...157–158
 Medicines—*See Pharmaceuticals*
 Med-Rescuer Disposable BVM...148
 MegaCode Kelly Advanced...97
 MegaCode Kid Advanced...98
 MegaMover Transport Units...278
 Megaphones...420
 Microdot EMS Blood Glucose Monitoring
 System...67

MidKnight Gloves...186
 MiniDrip IV Sets...210
 Morgan Lens...310

► **MRx Defibrillator/Monitor for EMS**

Batteries and Chargers...38
 Blood Pressure Cuffs...37
 Cable and Lead Sets, 12-Lead...35
 Cables and Test Loads, External Multifunction...34
 Cable Set, 3-Lead...35
 Cable Set, 5-Lead...35
 Calibration Kits and Supplies...39
 Carrying Cases...39
 Data Management...33
 Electrode Pads, Multifunction...34
 Electrodes, ECG Monitoring...35
 Intubated Circuits, ETCO₂...37
 MRx Monitor/Defibrillator for EMS...30–32, 218–220
 NIBP Interconnect Tubing...36
 Non-Intubated Dual Purpose Circuits (CO₂/O₂)...38
 Non-Intubated Single Purpose Circuits (CO₂)...37
 Paddles, External...34
 Paper...39
 Q-CPR...32, 38
 Sensors and Cables, SpO₂...36
 SMART Pads III...34
 Supplies, Miscellaneous...39
 Supplies, Temperature...38
 Multikuf Blood Pressure System...69
 Multi-Venous IV Training Arm Kits...115
 MX-Pro R3 Manual Ambulance Cot...273

N

N95 Respirators...188–189
 Narcotics Protection...242
 Nasal Airways...145
 Nasal Cannulas...160
 Nasopharyngeal Airways...144–145
 Needles and Syringes...224–226
 Nemesis Safety Eyewear...190
 NeoPro Gloves...180, 181
 Nexiva Closed IV Catheter System...207
 NIBP Interconnecting Tubing, MRx...36
 Nita Newborn Infant Venous Access Simulator...113
 NitriDerm EP Gloves...187
 NitriDerm Ultra Gloves...186
 No Smoking/Oxygen In Use Decal...455
 Notebook, Vital Stats...414
 Nursing Anne...99
 Nursing Baby...99
 Nursing Kelly...98
 Nursing Kid...99

O

Obstetrical Kits...315
 Obstetrical Manikin...118
 Ointments and Gels, First Aid...313
 OLAES Modular Bandages...293
 ► **OnSite (HS1) AED**
 Battery...14
 Carrying Cases...13
 Fast Response Kit...14
 OnSite AED Unit...12
 OnSite Trainer...14, 94
 SMART Pads Cartridges...13
 Opioid Overdose Kit...352
 Optimum Rescue Vest...260
 Optimum Traction Device (OTD)...248
 Otoscope and Ophthalmoscope...88
 Outerwear...378–389
 Overboots...193
 Oxygen Cylinders and Accessories...163–164
 Oxygen Hose...161
 Oxygen Manifold...163
 Oxygen Supply Tubing...161

P

Paddles, External, MRx...34
 Pads Adapters, AEDs...10, 17
 Pads, ForeRunner (FR)...18
 Pads, FR2+...15–16
 Pads Sentry Replacement, FR3...6
 Pants and Shorts...366–373, 376, 380
 Paper, MRx...39
 ParaPAC Transport Ventilator...153
 Parkas...381, 386, 389
 Patient Belongings Bags...283
 ► **Patient Moving and Handling**
 Accessories...283
 Blankets and Linens...280–282
 Child Transport...282
 Evacuation...275–279
 Stryker...272–274
 Patriot Manual Resuscitator/BVM...147
 Pediatric Drug Chart...123
 Pediatric Immobilization...262–263
 Pedi-Immobilizer...262
 Pedi Lite Pediatric Backboard...262
 Pedi-Mate Restraint System...263
 Pedi-Pac...263
 Pedi-Sleeve Pediatric Dosing System...123, 241
 Pedi-Wheel...122
 PEEP Valves...148
 Pen, All Weather...414
 Penlights...306, 428

Perfit E trication Collars...255
 Performance Pro-XT Manual Ambulance Cot...272
 Personal Protection...192–193
 Petrolatum Gauze...290
 ► **Pharmaceuticals**
 Irrigation Solutions...240
 IV Fluids...239
 Narcotics Protection...242
 Over-Counter-Medications...237–238
 Pedi-Sleeve Pediatric Medication Dosing...241
 Pharmaceutical Training...238
 Prescription Pharmaceuticals...233–236
 Schedule II Controlled Substances...236
 Schedule IV and III Controlled Substances...237
 Syringe Comparison Chart...232
 Training...238
 Philadelphia Tracheostomy Collar...255
 Pigtail Quick Connect Kit...165
 Pillows and Cases...281
 Pink Pearl Gloves...186
 Pneumothorax Trainer...114
 Pocket BVM...150
 Pocket Guides...121
 Pocket Masks...166
 Pole Stretcher...277–278
 Portable Module Buildings (PMBs)...464–467
 PortO₂Vent Oxygen Delivery System...146
 PosiTube...134
 Povidone Iodine...314
 Power-Pro XT Powered Ambulance Cot...272
 Prep Razors...59
 Prescription Authorization Form...245
 Pressure Infuser...217
 Pro-Eco Spineboard...256
 Pro-Lite XT Spineboard...256
 Property Bags...412
 Proscope Stethoscopes...78–79
 Proshyng 760 Series Blood Pressure Cuff...70
 Prosplints...252
 Protectiv and Protectiv Plus Safety IV Catheters...203
 Pulse Oximetry...83–85
 Purple Nitrile Gloves...184

Q

QCPR—*See Simulation (QCPR)*
 QD-4 and QD-3 Traction Splints...249
 Quickdraw Suction Unit...169
 QuikClot...297

R

Racheting Medical Tourniquets (RMTs™)...286, 403
 Rad-57 CO Monitor...63
 Radian Convertible+ Booster Car Seats...282
 Rapid Base Plate Carrier...399
 Raptor Medical Shears...304
 Razors...315
 Ready Heat II...282
 Red Dot Electrodes...65–66
 RED Z Absorbent Powder...196
 Regulators...161–162
 Rescue Kit and Holsters...306
 Res-Cue Pump...171
 Rescue Randy...120
 Rescuer Emergency CPAP System...146
 Rescuer II Compact CPAP System...146
 Rescuer MVP Manual Vacuum Pump...171
 Rescue Vests...260

► **Respiratory Care**
 Advanced Airways...141–142
 Airways...143–145
 BVMs/Manual Resuscitators...147–150
 CPAP...146–147
 CPR Protection...166
 Cricothyrotomy Devices...151
 Endotracheal Tubes...128–134
 Laryngoscopy...135–140
 Masks...155–156
 Medical Gas Fittings...165
 Medication Delivery Devices...157–158
 Oxygen Delivery...159–164
 Suction...167–173
 Tension Pneumothorax...152
 Ventilators...153–155
 Responder Base Plate Carrier...399
 Res-Q-Vac Handheld Suction Device...171
 Resusci Anne Advanced SkillTrainer with SimPad...103
 Resusci Anne QCPR...100
 Resusci Anne Simulator with SimPad...102
 Resusci Anne Wireless SkillReporter Software...103
 Resusci Baby QCPR...102
 Resusci Junior Basic and SkillGuide...107
 Revolution Carrier...398
 Robertazzi Airways...145
 Rover Active Shooter Response Kit...415
 RS-4X Aspirator...170

S

SafeGrip Gloves...176
 Safe-Touch Gloves...184
 Safety Goggles...190–191
 Safety-Lok Syringe and Needle...224
 Saf-T Holder Blood Draw Devices...223
 Sager Splints...249
 SAM Chest Seal...287, 401
 SAM Pelvic Sling II...248
 SAM Splint...248
 Sani-Cloth...194, 198
 Saniguard Sanitizing Fogger...194
 Scalpels...305
 Scenelights...450
 Schedule II Controlled Substance Ordering Information...244
 Scissors...305
 Scorpion Eyewear...191
 Seat Belt Cutter...307
 Security Seals...20, 242
 Sensors, LifePak 12...46–48
 Sensors, LifePak 15...51–55
 Sharps Containment...227–229
 Shears...304
 Sheets...280
 Shelters, Pop Up...419
 Shirts...358–365, 367, 370, 374–375
 ShockLink...95
 Shoe Covers...193
 Shorts...366
 SimMan ALS...97

► **SimPad Plus-Capable Patient Simulators**
 MegaCode Kelly Advanced...97
 MegaCode Kid Advanced...98
 Nursing Anne...99
 Nursing Baby...99
 Nursing Kelly...98
 Nursing Kid...99
 SimMan ALS...97
 SimPad Touchscreen Patient Monitor...100
 SimPad Plus System...96
 SimPad Plus with SkillReporter...96
 Simulation (QCPR)...100–103
 Simulators, Cardiac...110
 SkillGuide...102
 Smart Bag MO Disposable Resuscitators...149

► SMART Incident Command System

SMART CBRNE Tag...410
 SMART Commander...411
 SMART Education Pack...412
 SMART MCI Bag...411
 SMART Pediatric Triage Tape...412
 SMART Safe Property Bags...412
 SMART Tag Triage Tag...410
 SMART Triage Pack...410
 SMART Pads Cartridges...13
 SMART Pads II...10
 SMART Pads III...5, 34
 SOF Tactical Tourniquet...286
 Southeastern Specialty Vehicles...436–437
 SpeedBlocks Head Immobilizer...260
 Spider-Strap...268
 Spineboards—*See Backboards*
 Splints—*See Traction and Splinting*
 SpO2 Sensors and Cables, MRx...36
 SPUR II Disposable Resuscitator...148
 S-SCORT III Suction Unit...169
 SSV Ambulances—*See Ambulances*
 Sta-Blok Head Immobilizer...260
 Stair Chairs...273, 275
 Star Of Life Emblem...455
 STAT2 Extension Set...213
 Sterling Gloves...184
 Stethoscopes—*See Diagnostic Equipment*
 Stifneck Extrication Collars...254
 Straps and Strap Systems...265–268
 Stretchers...276–280

► **Suction**
 Big Yank Suction System...171
 Canisters and Accessories...170
 Catheters...172
 Compact Suction Unit 4 (LCSU4)...167
 Compact Suction Unit Accessories (LCSU 2 and 3)...168
 DCell Suction Device...168
 HI-D-The “Big Stick” Suction Tip...173
 Laerdal Suction Unit (LSU)...167
 Meconium Aspirator...172
 Quickdraw Suction Unit...169
 Res-Cue Pump...171
 Rescuer MVP Manual Vacuum Pump...171
 Res-Q-Vac Handheld Suction Device...171
 RS-4X Aspirator...170
 S-SCORT III Suction Unit...169
 Sump Tubes...173
 Syringe Bulbs...172
 Tote-L-Vac Suction Unit...169
 V-VAC Manual Suction Unit...170
 Yankauer Suction Tips...173

Super Sani-Cloth Germicidal Disposable Wipes...195
 Supraglottic Airways and Kits...142
 Supreno Gloves...179
 Surevent Transport Ventilator...418
 Surflo TFE IV Catheters...207
 Synetron Gloves...178
 Syringe Comparison Chart...232
 Syringes and Needles...224–226

T

Table Paper...282

► Tactical Products

Body Armor...398–400
 Diagnostic...407
 Hemorrhagic Control...403
 Immobilizers...404
 Packs and Bags...404–407
 Wound Care...401–402
 Tape...295–296
 Tarp Sets...419
 Tegaderm IV Dressing...214
 Temperature Supplies, MRx...38
 Tension Pneumothorax...152
 Test Strips...67
 Tex 10 K-9 Vest...399
 Thermometers...85–88
 Thomas Tube Holders...133
 Tincture Of Benzoin...315
 Tongue Depressors...316
 Total Release Sanitizing Fogger...194
 Tote-L-Vac Suction Unit...169
 Tourniquets...217, 286, 403
 Towel Dressings...299
 Trace Prep...59
 Traction and Splinting...248–253
 Traction Splint Trainer...119
 Traffic cones...420
 Trailers—*See Medical Trailers*
 Trainers, AED...8, 11, 14, 92, 93, 94

► Training and Education

AED Trainers...92–95
 Airway Training...111–114
 Birth Training...118
 Books and References...121–123
 CPR Training...118
 IO Training...117
 IV Training...115–116
 SimPad Products...96–100
 Simulation (Accessories)...110
 Simulation (Manikins)...104–108
 Simulation (Moulage)...109–110
 Simulation (QCPR)...100–103
 Southeastern Education and Clinical Services...124–125
 Specialty Training...119–120

Transceiver Module, Bluetooth...25
 Trauma Bags and Kits—*See Equipment Bags and Cases*
 Trauma Modules...110
 TRECK+ EMS Tool...307

► Triage, WMD, MCI

Mass Casualty Extraction...415
 Patient Assistance...418
 Rope Accessories...421
 Safety Vests...416–417
 Shelter...419
 Traffic control...420
 Triage Systems...410–412
 Trigger Tube...132
 True Advantage Gloves...185
 TubeChek...134
 Tuberculin Safety Syringes...225

U

Ultraform Gloves...180
 Ultra One Gloves...176
 UltraSense EC Gloves...180
 UltraSense Gloves...180
 Uniforms...374–376

V

Vacutainer Blood Products...222
 Vehicle Accessories
 Components...454–455
 VeniGard...214
 Venipuncture and Injection Arm...115

► Ventilators

AHP300 Transport Ventilator...153
 AutoVent 4000 Automatic Transport Ventilators...154
 Circuits...155
 Emergency Transport...418
 ParaPAC Transport Ventilator...153

Vests, Safety...416–417
 ViaValve Safety IV Catheters...202
 Video Laryngoscope...135
 Vital Signs Monitor...62

W

Wall Mount Bracket, Philips...19
 Warning Triangles...420
 Whelen Replacement Bulbs...452
 WhisperFlow CPAP Procedure Packs...147
 Wipes, Disinfective...194–195
 WMD/CBRNE/DECON Full-body Trainer...120

► Wound and Burn Care

Bandages...291–293
 Burn Relief...298–299
 Dressings...294
 Gauze...288–290
 Hemorrhage Control...286–287
 Hemostatics...297
 Tape...295–296

X

XCollar and XCollar Plus Cervical Spine...255
 Xtract2 Extraction Device...275, 415
 XtractSR Extraction Device...415

Y

Y Assembly...165

Z

Zoll AED Supplies...26
 Zoll ALS Supplies...57

Index by Item Number begins on page 474

437.....	281	989803144911.....	35	1900-124.....	146	3M3134.....	79
2030.....	233	989803144991.....	35	1900-222.....	146	3M3135.....	79
18247.....	238	989803146981.....	39	1900-333.....	146	3M3146.....	79
21400.....	313	989803149941.....	7	1900-444.....	146	3M37812.....	81
23769.....	313	989803149951.....	7	1900-654.....	146	3M9210.....	188
26043.....	225	989803149971.....	4	1stResponder.....	400	3M9211.....	188
26048.....	225	989803149981.....	5, 34	21075A.....	38	3M9660.....	59
26050.....	225	989803149991.....	5, 34	21076A.....	38	3M9667.....	59
26100.....	224	989803150011.....	67	21082B.....	38	3MR1541.....	291
26101.....	224	989803150031.....	5	21090A.....	38	40457C.....	25, 39
26105.....	224	989803150041.....	6	21091A.....	38	40457D.....	39
26107.....	224	989803150061.....	6	3M1530-0.....	296	4901-25.....	233
26111.....	224	989803150081.....	25	3M1530-1.....	296	4903-34.....	234
26213.....	224	989803150111.....	5	3M1530-2.....	296	4910-34.....	233
26214.....	224	989803150161.....	5	3M1530-3.....	296	4911-34.....	233
51926.....	278	989803150171.....	5	3M1538-0.....	296	4921-34.....	234
53376.....	278	989803150181.....	8, 92	3M1538-1.....	296	511-50159-019-BAG.....	406
56307.....	278	989803150191.....	8, 92	3M1538-2.....	296	511-50159-328-BAG.....	406
92700.....	413	989803150201.....	8, 92	3M1538-3.....	296	511-56003-019.....	339
95029.....	196	989803150241.....	5	3M1582.....	293	511-56037-019.....	339
124275.....	86	989803150291.....	17	3M1583B.....	293	511-56037-131-BAG.....	339
170951.....	68	989803158211.....	15, 18, 25	3M1583N.....	293	511-56037-188.....	339
189100.....	187	989803158661.....	34	3M1624W.....	214	511-56096-019-BAG.....	405
189200.....	187	989803162231.....	7	3M1626W.....	214	511-56096-188-BAG.....	405
189300.....	187	989803162401.....	7, 38	3M1860.....	188	511-56096-328-BAG.....	405
189350.....	187	989803163291.....	7, 38	3M1860EA.....	188	511-56167-026.....	340
199100.....	186	989803164971.....	147	3M1860S.....	188	511-56167-328.....	340
199200.....	186	989803165031.....	147	3M1860S-BX.....	188	511-56176-019-BAG.....	338
199300.....	186	989803165041.....	147	3M2113.....	80	511-56176-026-BAG.....	338
199350.....	186	989803165061.....	147	3M2113R.....	80	511-56176-236-BAG.....	338
199400.....	186	989803165211.....	147	3M2114.....	80	511-56176-328-BAG.....	338
280714.....	353	989803165281.....	147	3M2114R.....	80	511-56177-019-BAG.....	337
300040.....	283	989803166021.....	34	3M2144L.....	80	511-56177-026-BAG.....	337
309020.....	283	989803170891.....	19	3M2146.....	80	511-56177-236-BAG.....	337
309220.....	283	989803170901.....	20	3M2147.....	80	511-56177-328-BAG.....	337
720053.....	353	989803171631.....	8, 92	3M2160.....	80	511-56178-236-BAG.....	338
747046.....	353	989803172501.....	39	3M2163.....	80	511-56178-328-BAG.....	338
747057.....	353	989803176161.....	35	3M2164.....	80	511-56294-019-BAG.....	337
750150.....	169	989803176171.....	35	3M2165.....	80	511-56294-188-BAG.....	337
861304.....	9	989803176411.....	39	3M2201.....	80	511-56294-328-BAG.....	337
861306.....	11, 93	989803176541.....	39	3M2203.....	80	511-56295-019-BAG.....	337
861388.....	4	989803179161.....	4	3M2205.....	80	511-56295-188-BAG.....	337
861389.....	4	989803179181.....	4	3M2208.....	80	511-56295-328-BAG.....	337
861394.....	8, 92	989803180871.....	39	3M2209.....	80	511-56298-019.....	406
861487.....	24	989803184831.....	7	3M2210.....	80	511-56298-092.....	406
861489.....	24	0057-10.....	233	3M2211.....	80	511-56298-328.....	406
990350.....	68	039-0201.....	260	3M2218BE.....	407	511-56299-019-LITTER.....	406
1481966.....	332	039-0325.....	260	3M2230.....	66	511-56299-092-LITTER.....	406
73022608.....	320	05-10000.....	10, 17	3M2236.....	59	511-56299-328-LITTER.....	406
453564063841.....	39	05-10100.....	10, 17	3M2237.....	65	511-56300-019.....	407
453564063851.....	39	05-10200.....	10, 17	3M2259-50.....	65	511-56300-092.....	407
989803133171.....	15	07-10900.....	17	3M2290.....	81	511-56300-328.....	407
989803135301.....	38	0752-21.....	236	3M2298.....	81	511-56301-019.....	406
989803135331.....	38	0856-01.....	234	3M2450.....	81	511-56301-092.....	406
989803136291.....	16	090-4118.....	260	3M2560.....	66	511-56301-328.....	406
989803136531.....	19	11101-000016.....	26	3M2670-5.....	66	511-56878-474-BAG.....	322
989803138171.....	39	11141-000013.....	26	3M2812.....	80	511-56892-019.....	337
989803138181.....	39	11141-000100.....	26	3M2813.....	80	511-56892-026.....	337
989803139251.....	10	11403-000002.....	26	3M2815.....	80	511-56892-328-BAG.....	337
989803139261.....	10	115-CH.....	313	3M2817.....	80	511-56933-694-BAG.....	321
989803139271.....	11, 93	11996-000017.....	26, 44	3M2818.....	80	511-56934-694-BAG.....	321
989803139281.....	11, 14, 93, 94	12VRFE.....	217	3M3127.....	79	511-56936-328-BAG.....	321
989803139291.....	11, 93	12VSS3L02.....	217	3M3128.....	79	511-56936-694-BAG.....	321
989803139301.....	11	13-1276.....	311	3M3129.....	79	511-56947-019.....	336
989803139311.....	9	15210-64010.....	39	3M3130.....	79	511-56958-019-BAG.....	407
989803139321.....	11, 93	1900-001.....	146	3M3131BE.....	79	511-56958-026-BAG.....	407

511-56958-328-BAG	407	8900-2061	57	AB2290-31C	233	AC7200-CP	292
511-56961-019-BAG	339	8900-2065	57	AB2307-60C	237	AC7200GR-036	292
511-56961-021	339	9131-001	25	AB2308-01C	237	AC7200-KP	292
511-56961-193-BAG	339	9141R-001	25	AB2308-02C	237	AC7200LB-036	292
511-56961-475	339	9145-101	25	AB2339-34	234	AC7200LG	292
511-56961-671-BAG	339	9146-101	25	AB3414-01	235	AC7200OR	292
511-56961-726-BAG	339	9146-102	25	AB3579-30	239	AC7200P	292
511-56963-019-BAG	338	9730-002	25	AB3795-01	234	AC7200PU	292
511-56963-026-BAG	338	A4500	304	AB3796-01	234	AC7200RD	292
511-56963-092-BAG	338	A4501	304	AB3977-03C	236	AC7200-SC	292
511-56963-328-BAG	338	A4502	304	AB4277-02	234	AC7200TN-036	292
511-56964-019-BAG	338	A4503	304	AB4350-03C	233	AC7200WH	292
511-56964-026-BAG	338	A4504	304	AB4755-02	235	AC7300BL	292
511-56964-092-BAG	338	A4505	304	AB4887-10	236	AC7300-CP	292
511-56964-328	338	A4506	304	AB4887-20C	236	AC7300-KP	292
511-56997-019	340	A4507	304	AB4888-10	236	AC7300NP	292
511-56997-188	340	A4510	307	AB4888-20C	236	AC7300RD	292
511-56997-328-BAG	340	A4511	307	AB4900-33	235	AC7300-SC	292
511-58601-019	337	A4514	304	AB4902-34	233	AC7300TN	292
511-58601-026	337	A4514BL	304	AB4928-34	233	AC7300WH-024	292
511-58601-131	337	A4514GR	304	AB6102-04	234	AC7400BL	292
511-58601-188	337	A4514OR	304	AB6102-10	234	AC7400TN	292
511-58601-328	337	A4514RD	304	AB6138-03	240	AC7600BL-012	292
511-58602-019	337	A4515BK	304	AB6139-03	240	AC9100BL	293
511-58602-026	337	A4520	305	AB6629-02	236	AC9100RD	293
511-58602-092	337	A4521	305	AB6637-33	235	AC9100TN	293
511-58602-131	337	A4522	305	AB6648-02	233	AC9200BL	293
511-58602-188	337	A4523	305	AB6695-01	234	AC9200CP	293
511-58602-328-BAG	337	A4524	305	AB6695-02	234	AC9200NG	293
511-58715-019-POUCH	405	A4525	310	AB6778-02C	237	AC9200RD	293
511-58715-131-POUCH	405	A4530	305	AB7100-67	239	AC9200TN	293
511-58715-188-POUCH	405	A4531	305	AB7101-66	239	AC9300BL	293
511-58715-328-POUCH	405	A4619	306	AB7101-67	239	AC9300CP	293
511-59012-019	339	A4620	306	AB7138-09	240	AC9300RD	293
511-59049-019	336	A4620B	306	AB7139-09	240	AC9300TN	293
511-59049-328-BAG	336	A4750	306	AB7241-01	233	ACT-IR	25
5534-34	235	AB1120-12C	235	AB7517-16	233	ADC205BK	306
68-PCHAT	10, 14, 16	AB11302-01	216	AB7922-02	239	ADC215BK	306
7560-59	238	AB1144-05	236	AB7922-03	239	ADC320BK	304
7930-02	239	AB1176-30C	236	AB7953-02	239	ADC320NP	304
8000-00901	56	AB1178-30C	236	AB7953-03	239	ADC340	217
8000-0299-01	57	AB11956-01	216	AB7953-09	239	ADC341	217
8000-0301	57	AB1215-01	235	AB7983-02	239	ADC342	217
8000-0302	57	AB1273-32C	237	AB7983-03	239	ADC351P	306
8000-0322	83	AB1276-32C	236	AB7983-09	239	ADC360	307
8000-0807-01	26	AB1312-30C	236	AB7984-36	239	ADC380	307
8000-0860-01	26	AB1323-05	234	AB7984-37	239	ADC394	59
8004-0103-01	57	AB1412-04C	233	AB7984-37-4	239	ADC395	59
8019-0535-01	57	AB1539-31C	237	AB8060-29	234	ADC4010	145
8234-12	233	AB1632-01	236	AB9093-32C	236	ADC413	86
8234-14	233	AB1639-10	234	AB9094-22C	236	ADC415	85
861304-C03	9	AB1754-10	235	AB9104-20	233	ADC416-100	85
861304-OPTA01	9	AB1775-10	233	AB9137-05	234	ADC419	85
861304-OPTR01	9	AB1782-69C	235	AB955-10C	235	ADC421	85
861431-OPTA01	24	AB1890-01C	236	AB9558-05C	235	ADC424	86
861431-OPTA06	24	AB1891-01C	236	AB9631-04	234	ADC425-40	86
861451-A01	24	AB1893-01C	236	AC7100BK	292	ADC427	86
861451-A03	24	AB1902-01	235	AC7100BL	292	ADC5110	88
861467-OPTA01	8, 92, 104	AB1903-01	235	AC7100CP	292	ADC5111	88
861476-ABA	20	AB1966-07	236	AC7100GR	292	ADC5182	88
861478-ABA	20	AB1985-30C	237	AC7100RE	292	ADC5185	88
861489-A02	24	AB2051-05C	237	AC7100TN	292	ADC600-06BK	81
8900-0402	56	AB2053-10C	237	AC7100WH	292	ADC6017	70
8900-0800-01	26	AB2122-01	233	AC7200BK	292	ADC602BK	76
8900-0802-01	26, 57	AB2267-20	234	AC7200BK-036	292	ADC603BD	76
8900-0810-01	26, 56	AB2287-31	234	AC7200BL	292	ADC603BK	76

ADC603FG.....	76	ADC760DB.....	70	ASAI1200.....	63	BA2B0832.....	233
ADC603LV.....	76	ADC760DBLF.....	70	ASK.....	399	BA2B0833.....	233
ADC603NV.....	76	ADC760DBX.....	70	AU199-002-020.....	148	BA2B0842.....	233
ADC603R.....	76	ADC760ILF.....	70	AU199-003-020.....	148	BA2B0843.....	233
ADC603RB.....	76	ADC760OR.....	70	AU252-051.....	155	BA2B0962.....	234
ADC603ST.....	76	ADC760T.....	70	AU252-052.....	155	BA2B0973.....	234
ADC604BK.....	77	ADC760XLF.....	70	AU252-053.....	155	BA2B1301.....	239
ADC604P.....	77	ADC760XOR.....	70	AU252-054.....	155	BA2B1306.....	239
ADC609BK.....	77	ADC776Z.....	68	AU252-055.....	155	BA2B1322Q.....	239
ADC609G.....	77	ADC778-603BK.....	75	AU252-056.....	155	BA2B1323.....	239
ADC609R.....	77	ADC778-603DG.....	75	AU264-008.....	254	BA2B1324.....	239
ADC609RB.....	77	ADC778-603NV.....	75	AU264-034.....	261	BA2B2323.....	239
ADC640-02.....	81	ADC778-603OR.....	75	AU264-501.....	255	BA2B2324.....	239
ADC640-02S.....	81	ADC778-603RB.....	75	AU264-502.....	255	BA2C6401.....	210
ADC640-03.....	81	ADC778-603RE.....	75	AU264-503.....	255	BA2C6402.....	210
ADC640-03S.....	81	ADC804.....	69, 75	AU264-504.....	255	BA2C6425.....	210
ADC641BD.....	77	ADC804C.....	75	AU264-505.....	255	BA2C6425-EA.....	210
ADC641BK.....	77	ADC804N.....	75	AU264-506.....	255	BA2C6714.....	210
ADC641FG.....	77	ADC850DB.....	75	AU276-000-001.....	171	BA2C7564.....	210
ADC641GR.....	77	AEFRCARRYBAG.....	399	AU276-000-010.....	171	BA2C8402.....	210
ADC641LV.....	77	AELIGHTHAWKLT.....	398	AU281-000.....	254	BA2C8537.....	210
ADC641NO.....	77	AERAPIDBASE.....	399	AU281-106.....	254	BA2F7112.....	240
ADC641NP.....	77	AERESPONDER-S.....	399	AU320-264-040.....	133	BA2F7113.....	240
ADC641NY.....	77	AERESPONDER-L.....	399	AU320-264-041.....	133	BA2F7114.....	240
ADC641RB.....	77	AEREVOLUTION-F.....	398	AU520211033.....	148	BA2F7122.....	240
ADC641TL.....	77	AEREVOLUTION-M.....	398	AU520-611-700.....	148	BA2F7123.....	240
ADC646ST.....	407	AETEX10.....	399	AU5220-211-000B.....	148	BA2F7124.....	240
ADC665-10RB.....	78	AEX25-C.....	400	AU530-213-000B.....	148	BA2G3451.....	233
ADC665-10YL.....	78	AHP300.....	153	AU530-215-000B.....	148	BA2N3399.....	215
ADC670N.....	79	AHP300-BAG.....	153	AU540-211-000.....	148	BA2N8378.....	211
ADC670NO.....	78	AHP300-CASE.....	153	AU544-211-000.....	148	BA2N8399.....	215
ADC670RB.....	78	AHP300-HASWHO.....	153	AU900002116.....	135	BA6013-10C.....	233
ADC671.....	79	AHP300-HDLHOOK.....	153	AUKVCABL.....	135	BA6022-25C.....	234
ADC675BK.....	78	AHP300-WMSYS.....	153	AUKVIS01.....	135	BA6028-25C.....	236
ADC675DG.....	78	AHP300-Y.....	153	AUKVL03.....	135	BA6056-10C.....	237
ADC675NY.....	78	AI1190.....	420	AUKVL03C.....	135	BA6057-10C.....	237
ADC675P.....	78	AI1193.....	420	AUKVLKIT3.....	135	BA6059-10C.....	237
ADC675RB.....	78	AI1195.....	420	AUM-00-S/50.....	64	BA6061-10C.....	237
ADC676BK.....	78	AI1196.....	420	AUR-00-S/10.....	64	BA6063-10C.....	237
ADC676DG.....	78	AI1281.....	417	AUR-00-S/25.....	64	BA6125-25C.....	236
ADC676NY.....	78	AI1282.....	417	AUR-00-S/3.....	64	BA6127-25C.....	236
ADC676P.....	78	AI1283.....	417	AUR-00-S/4.....	64	BAEMS3110.....	210
ADC698BK.....	81	AI749001.....	169	AUR-00-S/5.....	64	BB352239.....	209
ADC7002.....	76	AL5194E.....	189	AUSP-00-S/10.....	64	BB352240.....	209
ADC7002C.....	76	AL695.....	188	AUSP-00-S/4.....	64	BB352241.....	209
ADC7002CLF.....	76	AM000606.....	211	AUSP-00-S/50.....	64	BB352242.....	209
ADC7002I.....	76	AM108301.....	208	B2050.....	281	BB352243.....	209
ADC7002LF.....	76	AM108305.....	208	B2052.....	280	BB352244.....	212
ADC7002X.....	76	AM108306.....	208	B2053.....	280	BB352379A.....	209
ADC7002XLF.....	76	AM608305.....	208	B2183.....	281	BB4251601.....	206
ADC700LF.....	68	AM608306.....	208	B2193.....	283	BB4251628.....	206
ADC700XLF.....	68	AMAE3107.....	211	B2194.....	283	BB4251644.....	206
ADC703.....	72	AMAFS107.....	211	B2195.....	283	BB4251687.....	206
ADC703BDLF.....	72	AMAY0200.....	216	B5340.....	281	BB4251695.....	206
ADC720BKLF.....	68	AMP3737.....	21	B5340-G.....	281	BB4251709.....	206
ADC731BK.....	69	AN9720S.....	294	B60307.....	218	BB4251890.....	206
ADC731DB.....	69	AN9740S.....	294	BA0121-25C.....	236	BB4252500.....	206
ADC731OR.....	69	AN9760S.....	294	BA0160-01C.....	236	BB4252519.....	206
ADC740LF.....	69	AN9840S.....	294	BA1A0692.....	235	BB4252535.....	206
ADC746LF.....	69	AOS3111114.....	316	BA1A0694.....	235	BB4252543.....	206
ADC752M.....	70	APP616-09.....	233	BA2B0062.....	239	BB4252560.....	206
ADC760BDLF.....	70	AR1010-25.....	233	BA2B0063.....	239	BB4252586.....	206
ADC760BK.....	70	AR113001.....	234	BA2B0064.....	239	BB4252594.....	206
ADC760BKLF.....	70	AR2602-25.....	235	BA2B0082.....	239	BB4253604.....	206
ADC760C.....	70	AR2610-25.....	235	BA2B0086.....	239	BB4254511.....	206
ADC760CLF.....	70	AR4905-25.....	233	BA2B0162-Q.....	239	BB4254512.....	206

BB4254538W.....	206	BD305908.....	224	BL3112-1730.....	43, 44	C1720A.....	420
BB4254570.....	206	BD305915.....	226	BLS-4000.....	148	C1800.....	431
BB4254597.....	206	BD305916.....	226	BLS-4000M.....	146	C1800Y.....	431
BB473447.....	212	BD305917.....	226	BLS-4010.....	148	C1801.....	431
BB474921.....	212	BD305918.....	226	BLS-4025.....	148	C1804.....	431
BBCSE8SL.....	212	BD305935.....	224	BLS-8700.....	146	C1960.....	430
BBCSU100.....	216	BD309592.....	224	BLS-8700M.....	146	C1960YE.....	430
BBET04TS.....	212	BD309594.....	224	BLS-8705.....	146	C1965.....	430
BBL5100.....	239	BD309595.....	224	BLS-8705M.....	146	C2015.....	449
BBL5101.....	239	BD309596.....	224	BLS-8710M.....	146	CASUS0814HP-05.....	74
BBL5102.....	239	BD363083.....	222	BLS-8750.....	146	CASUS0814ML.....	45, 74
BBL7500.....	239	BD364880.....	223	BLS-8755.....	146	CASUS0814MQML.....	74
BBL7501.....	239	BD364902.....	223	BLS-8800.....	146	CASUS1826ML.....	45, 74
BBL8000.....	239	BD367203.....	217	BLS-8805.....	146	CASUS2635HP-05.....	74
BBL8001.....	239	BD367281.....	223	BMB10.....	213	CASUS2635ML.....	45, 74
BBL8002.....	239	BD367283.....	223	BMB12-102.....	213	CASUS2635MQ.....	74
BBL8502.....	239	BD367814.....	222	BMB30-102.....	213	CASUS3242HP-05.....	74
BBR5000-01.....	240	BD367815.....	222	BMB32-102.....	213	CASUS3242ML.....	45, 74
BBR5001-01.....	240	BD367861.....	222	BOGB-001.....	187	CASUS3242MQ.....	74
BBR5200-01.....	240	BD367886.....	222	BOGB-002.....	187	CASUS4250HP.....	74
BBR5201-01.....	240	BD372610.....	305	BOGB-003.....	187	CASUS4250ML.....	45, 74
BBS5104-5264.....	239	BD372611.....	305	BOGB-059.....	187	CASVST0814ML.....	45, 74
BBS51045384.....	239	BD372615.....	305	BOGP-013.....	187	CASVST1320ML.....	45, 74
BBS8004-5264.....	239	BD381412.....	205	BOGP-014.....	187	CASVST1826ML.....	45, 74
BBS8004-5384.....	239	BD381423.....	205	BOGP-015.....	187	CASVST2635HP.....	74
BBUS1150.....	209	BD381433.....	205	BOGP-020.....	187	CASVST2635ML.....	45, 74
BBUS1160.....	209	BD381434.....	205	BOGP-061.....	187	CASVST2635MQ.....	74
BBUS1165.....	209	BD381444.....	205	BOGS-004.....	187	CASVST3242ML.....	45, 74
BBV1415.....	211	BD381454.....	205	BOGS-005.....	187	CASVST4250ML.....	45, 74
BBV1443.....	211	BD381467.....	205	BOGS-006.....	187	CC144501.....	151
BCI1300.....	84	BD381512.....	205	BOGS-060.....	187	CC155900.....	152
BCI1301.....	84	BD381523.....	205	BOGS-073.....	187	CC175437.....	151
BCI1303.....	84	BD381534.....	205	BS100.....	298	CC175438.....	151
BCI3025.....	84	BD381544.....	205	BT1.....	18	CC219184.....	152
BCI3301.....	83	BD381554.....	205	BT100-10.....	280	CC274208.....	151
BCI3311.....	83	BD382268.....	206	BV20-201-183.....	71	CD001211.....	160
BCI3315.....	83	BD382277.....	206	BV20-201-184.....	71	CD001248.....	156
BCI3318.....	83	BD382287.....	206	BV20-201-186.....	71	CD001266.....	160
BCI3420Y.....	82	BD382512.....	205	BV20-202-182.....	71	CD001269.....	156
BCI3426.....	82	BD382523.....	205	BV20-202-183.....	71	CD001851.....	155
BCI3427.....	82	BD382533.....	205	BV20-202-184.....	71	CD003762.....	155
BD303345.....	215	BD382534.....	205	BV20-202-185.....	71	CD003764.....	155
BD303346.....	225	BD382544.....	205	BV20-202-186.....	71	DDIN1515.....	219
BD303347.....	225	BD382554.....	205	BV30-415-254.....	81	DDIN1518.....	219
BD303348.....	225	BD383519.....	207	BV30-416-014.....	81	CE5260-010.....	38
BD303370.....	215	BD383530.....	207	BV30-416-324.....	81	CF10820.....	155
BD303390.....	215	BD383532.....	207	BVMASSIST.....	150	CF10822.....	155
BD303393.....	215	BD383536.....	207	BVMASSISTDC.....	150	CM401.....	261
BD305344.....	228	BD383540.....	207	BVUB-521.....	71	CM401S.....	261
BD305447.....	229	BD385100.....	214	BY1820.....	67	CM402.....	261
BD305487.....	227	BD386150.....	213	BY7099.....	67	CM403.....	261
BD305488.....	227	BE125020.....	227	BY7109.....	68	CM504.....	252
BD305489.....	228	BE150020.....	227	BY7110.....	67	CM505.....	252
BD305490.....	228	BE410020.....	229	BY7111.....	67	CM506.....	252
BD305491.....	228	BE415020.....	229	BY9556C.....	67	CN0034910U.....	171
BD305517.....	227	BE424410.....	170	BYE403-30.....	418	CN0034920.....	173
BD305554.....	224	BE484410.....	170	BYE403-BR.....	418	CN1620-001.....	66
BD305561.....	224	BE485410.....	170	BYE403-IV.....	418	CN1620-003.....	66
BD305900.....	226	BE494410.....	170	BYE701-SPE.....	418	CN18.....	420
BD305901.....	226	BE532710.....	170	C1500.....	433	CN1870-030.....	66
BD305902.....	226	BE532810.....	170	C1501.....	433	CN1870C-003.....	66
BD305903.....	224	BE534510.....	170	C1502.....	433	CN1870C-004.....	66
BD305904.....	224	BE8002004.....	170	C1503.....	433	CN1870C-050.....	66
BD305905.....	224	BF61075.....	159	C1504.....	433	CN18CC.....	420
BD305906.....	224	BF64059.....	159	C1505.....	433	CN2516M.....	44
BD305907.....	224	BL3111-1720.....	43	C1720.....	420	CN2516P.....	44

CN2516Z.....	44	D5116.....	291	DCER-2T.....	178	DIH8000A.....	58, 454
CN2603M.....	44	D5117.....	291	DCER-3B.....	178	DIH9000.....	58, 454
CN2603P.....	44	D5118.....	291	DCER-3T.....	178	DIWM1000.....	58, 454
CN2603Z.....	44	D5121.....	291	DCER-4B.....	178	DIX9000.....	58, 454
CN28.....	420	D5122.....	291	DCER-4T.....	178	DK6124.....	289
CN28CC.....	420	D5123.....	291	DCER-5B.....	178	DM47552-OR.....	265
CNS2-12.....	213	D5124.....	291	DCER-5T.....	178	DMS-05004.....	419
CPC2050.....	164	D5198.....	288	DCFL12-1.....	182	DMS-05012.....	413
CPC2051.....	164	D5199.....	288	DCFL12-2.....	182	DMS-05307.....	417
CPOA0006-1.....	164	D5210.....	289	DCFL12-3.....	182	DNDSPB01.....	283
CPOA0008-1.....	164	D5220.....	294	DCFL12-4.....	182	DPCLING.....	20
CR2032.....	68	D5225.....	294	DCFL12-5.....	182	DS-100A.....	46, 52
CRA5261.....	291	D5300.....	288	DCFL9-1.....	182	DVPTA105.....	88
CS100-01.....	67	D5301.....	288	DCFL9-2.....	182	DY1129.....	313
CS120-02.....	67	D5302.....	288	DCFL9-3.....	182	DY1137.....	313
CS169-50.....	67	D5303.....	288	DCFL9-4.....	182	DY1171.....	313
CS200-50.....	67	D5320.....	293	DCFL9-5.....	182	DY1505.....	296, 314
CS201-01.....	67	D5326.....	281	DCFL9-6.....	182	DY2131.....	193
CS600-12.....	195	D5327.....	281	DCFS9-1.....	182	DY2132.....	193
CS703-03.....	238	D5400.....	288	DCFS9-2.....	182	DY2145.....	192
CS921-21.....	67	D5401.....	288	DCFS9-3.....	182	DY2511.....	184
CS925-25.....	67	D5402.....	288	DCFS9-4.....	182	DY2512.....	184
CTAPK1.....	343	D5403.....	288	DCFS9-5.....	182	DY2513.....	184
CTBOK1.....	330	D5420.....	290	DD11091.....	265	DY3222.....	289
CTITK1.....	343	D5422.....	290	DD11091-BK.....	265	DY3342.....	289
CTRB1.....	324	D5430.....	289	DD11091-OR.....	265	DY3501.....	290
CTRB2.....	324	D5431.....	289	DD11152-BK.....	265	DY3528.....	251
CTRB41.....	327	D5432.....	289	DD11152-YL.....	265	DY3533.....	251
CTTP1.....	343	D5433.....	289	DD11172-BK.....	265	DY3642.....	214
CTTTB.....	414	D5434.....	289	DD11272-BK.....	265	DY4110.....	305
CTTTBW.....	414	D5435.....	289	DD11272-YL.....	265	DY4111.....	305
CTTTG.....	414	D5436.....	289	DD11652-OR.....	265	DY4112.....	305
CTTTR.....	414	D5437.....	289	DD11672-OR.....	265	DY4115.....	305
CTTTY.....	414	D5438.....	289	DD12091-BK.....	265	DY4251.....	59, 315
CYMAT1.....	286, 403	D5479.....	313	DD12091-BL.....	265	DY4303.....	313
D-20.....	46, 52, 83	D5504.....	291	DD12091-GR.....	265	DY4305.....	313
D-25.....	46, 52, 83	D5508.....	290	DD21091-BK.....	265	DY4312.....	316
D5005.....	299	D5509.....	290	DD21152-BK.....	265	DY4630.....	229
D5020.....	298	D5510.....	290	DD21252-OR.....	265	DY4707.....	199
D5021.....	298	D5520.....	290	DD27152.....	265	DY4806.....	172
D5030.....	295	D5521.....	290	DD31091-OR.....	265	DY4808.....	172
D5031.....	295	D5522.....	290	DD31152-BL.....	265	DY4810.....	172
D5032.....	295	D5552.....	289	DD31252-OR.....	265	DY4812.....	172
D5033.....	295	D5557.....	289	DD31652-BK.....	265	DY4814.....	172
D5040.....	295	D5558.....	289	DD31652-BL.....	265	DY4816.....	172
D5041.....	295	DA-02799.....	277	DD31652-YL.....	265	DY4818.....	172
D5042.....	295	DA-02859-3.....	276	DD31672-BK.....	265	DY4826.....	172
D5043.....	295	DCAP12-1.....	179	DD31672-BL.....	265	DY4828.....	172
D5045.....	295	DCAP12-2.....	179	DD31672-YL.....	265	DY4834.....	172
D5046.....	295	DCAP12-3.....	179	DD47091-OR.....	265	DY6502.....	185
D5047.....	295	DCAP12-4.....	179	DD47091-WH.....	265	DY6503.....	185
D5048.....	295	DCAP12-5.....	179	DD47152.....	265	DY6504.....	185
D5055.....	295	DCAP12-6.....	179	DD47152-BL.....	265	DY6505.....	185
D5056.....	295	DCDFR10-1.....	181	DD47152-WHM.....	265	DYND70837.....	59, 315
D5057.....	295	DCDFR10-2.....	181	DD51021-OR.....	267	EB100-50.....	281
D5058.....	295	DCDFR10-3.....	181	DD51021-YE.....	267	EB500-MA.....	280
D5089.....	296	DCDFR10-4.....	181	DD51652-OR.....	267	EB500-NV.....	280
D5090.....	296	DCDFR10-5.....	181	DD57652-OR.....	267	EC61032713.....	197
D5091.....	296	DCDFR12-1.....	181	DD57652-YE.....	267	EC61032729.....	197
D5092.....	296	DCDFR12-2.....	181	DE42480.....	194	EC68132100.....	197
D5110.....	293	DCDFR12-3.....	181	DE55001.....	194	EC92022357.....	197
D5111.....	293	DCDFR12-4.....	181	DIH1800.....	58, 454	EGA-0100.....	255
D5112.....	293	DCDFR12-5.....	181	DIH1801.....	58, 454	EGA-0120.....	255
D5113.....	293	DCER-1B.....	178	DIH1805.....	58, 454	EGA-H0100.....	255
D5114.....	291	DCER-1T.....	178	DIH7000.....	58, 454	EGA-H0120.....	255
D5115.....	291	DCER-2B.....	178	DIH7000A.....	58, 454	EMP550.....	283

EP503.....	268	G4352.....	315	HAGV2020A.....	138	HU1170.....	144
EP700.....	260	G4353.....	305	HAGV2020A-DS.....	138	HU1171.....	144
EP703.....	260	G4391.....	193	HAGV2020C.....	138	HU1422.....	158
EP705.....	260	G4392.....	193	HALB42MAC1DS.....	138	HU1565.....	158
EP706.....	260	G4395.....	192	HALB42MAC2DS.....	138	HU1639.....	158
EP717.....	260	G43952XL.....	192	HALB42MAC3DS.....	138	HU1641.....	158
EP77.....	264	G43953XL.....	192	HALB42MAC4DS.....	138	HU1705.....	157
EP78.....	264	G4395XL.....	192	HALB42MIL0DS.....	138	HU1734.....	157
EP-800.....	248	G4401.....	352	HALB42MIL1DS.....	138	HU1820.....	160
EP-810.....	248	G4401B.....	352	HALB42MIL2DS.....	138	HU1880.....	157
ES200-20.....	280	G4401BK.....	352	HALB42MIL3DS.....	138	HU1884.....	157
ES500-20.....	280	G4401OK.....	352	HALB42MIL4DS.....	138	HU1895.....	157
ES800-10.....	280	G4500.....	351	HAMT1075-6.....	250	HU1896.....	157
F06YY200OR415-E60C.....	267	G4500B.....	351	HAMT13A.....	250	HU3230.....	160
F06YY200YE417-E60C.....	267	G4500BK.....	351	HAMT3075-6.....	250	HU5362.....	150
F06YY200YE417-P60A.....	267	G4500OK.....	351	HAPD3000.....	250	HU5367.....	150
F233602.....	237	GA24XTM.....	64	HASV2131.....	418	HU5372.....	150
F3162.....	251	GAR5293.....	291	HE100PED-P.....	42	I-20.....	46, 52, 83
F3165.....	251	GM6399-57.....	197	HE100PED-Z.....	42	IB1000.....	139
F3166.....	251	GO100-DS.....	278	HEC100-P.....	42	IB1010.....	139
F3167.....	251	GO7000-AD.....	171	HEC100-Z.....	42	IB1011.....	139
F3168.....	251	GO7000-MVP.....	171	HET100LO-P.....	42	IB1021.....	139
F3169.....	251	GOV-LG.....	402	HET100LO-Z.....	42	IB1022.....	139
F3170.....	251	GOV-MED.....	402	HET100-P.....	42	IB1023.....	139
F3250.....	252	GOV-SM.....	402	HET100-PC.....	42	IB1024.....	139
F3252.....	252	GOV-XLG.....	402	HET100-Z.....	42	IB1030.....	139
F3253.....	252	GP5734.....	419	HL7813.....	242	IB1031.....	139
F3254.....	252	GP5735.....	419	HL7814.....	242	IB1032.....	139
F3255.....	252	GP5978.....	419	HL7816.....	242	IB1033.....	139
F3440.....	255	GW16GB0M.....	191	HL7817.....	242	IB1034.....	139
F3441.....	255	GW16GB80.....	191	HL7820.....	242	IB1039.....	139
F3443.....	255	GW4480.....	191	HL7823.....	242	IB2155.....	139
F3444.....	255	GW80101.....	188	HL7825.....	242	IB4021.....	139
F3445.....	255	GW80201.....	188	HL7827.....	242	IB4022.....	139
F3446.....	255	GW80202V.....	188	HL7828.....	242	IB4023.....	139
F3447.....	255	H6013E.....	68	HL7901.....	242	IB4024.....	139
F3449.....	255	H6014E.....	68	HL7903.....	242	IB4030.....	139
F3490.....	253	H6015.....	68	HL7906.....	242	IB4031.....	139
FA1124200.....	249	H6016E.....	68	HL7910.....	242	IB4032.....	139
FA11250088.....	249	H6040.....	68	HL7912.....	242	IB4033.....	139
FA1125010.....	249	H6420.....	79	HL7914.....	242	IB4034.....	139
FA1126522.....	249	H6421.....	79	HRNIK7000.....	189	IB4039.....	139
FA1126524.....	249	H6422.....	79	HSRC2000.....	22	ICN0746-31.....	238
FA1126716.....	249	H6423.....	79	HSRC2000RSB.....	22	ICN0746-33.....	238
FA1126726.....	249	H6430.....	78	HSRC2000S.....	22	ID32325-GR.....	322
FAQD3.....	249	H6431.....	78	HSRC2000SL.....	22	ID32325-OR.....	322
FAQD4.....	249	HACA3000.....	283	HSRC5000R.....	23	ID32325-RB.....	322
FCP-01.....	401	HACA3600.....	283	HSRC5000RS.....	23	ID32325-RD.....	322
FCP-02.....	401	HACA4000.....	283	HSRC5000W.....	23	ID32440BK.....	340
FG08838011.....	297, 401	HACA6000.....	283	HSRC5000WS.....	23	ID32440GR.....	340
FG08839011.....	297, 401	HACC2200P.....	258, 275	HSRC5300.....	21	ID32440RE.....	340
FMPM2272.....	352	HACC3200H.....	258, 275	HSTL1.....	21	ID32499A-NV.....	322
FRG01.....	64	HAEV101.....	250	HT100-10.....	280	ID32499A-OR.....	322
FW125.....	260	HAEV102.....	250	HT100-10EA.....	280	ID32499AT-NB.....	322
FW441.....	249	HAEV103.....	250	HU1011.....	159	ID32499AT-OR.....	322
FW443.....	249	HAEV14.....	250	HU1059.....	159	ID32499AT-REUP.....	322
FW444.....	249	HAEV3000.....	250	HU1075.....	156	ID34016D-GR.....	326
FW446.....	249	HAFS12C.....	251	HU1076.....	156	ID34016DLF-GR.....	326
FW447.....	249	HAFS15TIP.....	251	HU1101.....	160	ID34016DLF-OR.....	326
FW521.....	164	HAFS801.....	251	HU1103.....	160	ID34016D-OR.....	326
FW65EXL.....	276	HAFS802.....	251	HU1164.....	144	ID34016DP-GR.....	326
FW678.....	263	HAFS803.....	251	HU1165.....	144	ID34016DP-RE.....	326
FW78.....	263	HAFS9000RC.....	251	HU1166.....	144	ID34016DP-UPRE.....	326
G12RH2.....	282	HAFSF1000.....	251	HU1167.....	144	ID34016D-RB.....	326
G4350.....	315	HAFSF3000.....	251	HU1168.....	144	ID34016D-RE.....	326
G4351.....	305	HAGV1008.....	138	HU1169.....	144	ID34016DUP-RE.....	326

ID34018-GR.....	326	IS8225030.....	142	J8225.....	223	JSA-601NAM.....	278
ID34018-OR.....	326	IS8703030.....	142	J8253BX.....	225	JSA-800.....	275
ID34018-RB.....	326	IS8704030.....	142	J8254BX.....	225	JSA-800W.....	275
ID34018-RD.....	326	IS8705030.....	142	J8255.....	225	K8501.....	455
ID34018UP-OR.....	326	IT-AD.....	261	J8256.....	225	K8502.....	455
ID34018UP-RB.....	326	IT-CH.....	261	J8257.....	225	K8504.....	455
ID34018UP-RD.....	326	IT-IN.....	261	J8258.....	225	K8508.....	455
ID35755BL.....	257	IV AMAE3108.....	212	J8259.....	225	K8513.....	455
ID35755LG.....	257	J3000.....	68	J8260.....	225	K8514.....	455
ID35755OD.....	257	J3001.....	68	J8337.....	237	K8520.....	455
ID35755OR.....	257	J7900.....	217	J8375.....	235	KAIV009Y.....	208
ID35755PBL.....	257	J8023A.....	213	J8400T.....	238	KAIV013Y.....	208
ID35755PLG.....	257	J8023E.....	213	J8500.....	228	KAIV016Y.....	208
ID35755POD.....	257	J8023T.....	213	J8501.....	229	KB10-102.....	255
ID35755POR.....	257	J8023V.....	213	J8502.....	229	KB10-104-032.....	320
ID35755PRE.....	257	J8025.....	214	J8550.....	227	KB10-104-BL.....	320
ID35755RD.....	257	J8026.....	214	JJ2015.....	294	KB10-109-GR.....	328
ID35840TE.....	263	J8029.....	217	JJ3042.....	203	KB10-110-RD.....	320
ID35840YE.....	263	J8030.....	217	JJ3048.....	203	KB10-111-RB.....	320
ID35841YE.....	263	J8046.....	217	JJ3050.....	203	KB10-115.....	332
ID35843.....	263	J8047.....	217	JJ3053.....	203	KB10-116.....	341
ID35850BL.....	257	J8049.....	228	JJ3055.....	203	KB10-518.....	283
ID35850LG.....	257	J8053.....	229	JJ3056.....	203	KB10-604.....	281
ID35850P-BK.....	257	J8059.....	229	JJ3057.....	203	KC22475.....	190
ID35850PBL.....	257	J8070.....	216	JJ3060.....	203	KC25676.....	190
ID35850PLG.....	257	J8071.....	216	JJ3062.....	203	KC25679.....	190
ID35850YE.....	257	J8072.....	216	JJ3063.....	203	KC3200-1711.....	43
ID35940BL.....	258	J8081.....	68	JJ3065.....	203	KC3200-1715.....	43
ID35940-CASE.....	258	J8083.....	68	JJ3066.....	203	KC39504.....	184
ID35940OR.....	258	J8084.....	68	JJ3067.....	203	KC39505.....	184
ID35940PBK.....	258	J8089.....	68	JJ3068.....	203	KC39506.....	184
ID35940PBL.....	258	J8110.....	226	JJ3076.....	203	KC39507.....	184
ID35940PYE.....	258	J8111.....	226	JJ3078.....	203	KC39508.....	184
ID35940YE.....	258	J8112.....	226	JJ3080.....	203	KC50705.....	184
ID35955BL.....	258	J8113.....	226	JJ3082.....	203	KC50706.....	184
ID35955LG.....	258	J8128.....	225	JJ3083.....	203	KC50707.....	184
ID35955OR.....	258	J8129.....	225	JJ3085.....	203	KC50708.....	184
ID35955P-BL.....	258	J8132.....	225	JJ3086.....	203	KC50709.....	184
ID35955P-LG.....	258	J8133.....	225	JJ3088.....	203	KC53138.....	184
ID35955P-OR.....	258	J8135.....	225	JJ3342.....	204	KC53139.....	184
ID35955P-RE.....	258	J8139.....	225	JJ3350.....	204	KC53140.....	184
ID36002D-2PK-GR.....	329	J8140BX.....	225	JJ3353.....	204	KC53141.....	184
ID36002D-GR.....	329	J8141BX.....	225	JJ3355.....	204	KC55080.....	184
ID36002DLF-GN.....	329	J8142BX.....	225	JJ3356.....	204	KC55081.....	184
ID36002D-PK-GR.....	329	J8143.....	225	JJ3358.....	204	KC55082.....	184
ID36007RE.....	341	J8145.....	226	JJ4042.....	204	KC55083.....	184
ID36010-BK.....	352	J8146.....	226	JJ4048.....	204	KC55084.....	184
ID36010-YE.....	352	J8147.....	226	JJ4050.....	204	KE1010P.....	42
ID36015-OR.....	347	J8148.....	226	JJ4053.....	204	KE1210H.....	42
ID36015-RB.....	223, 347	J8149.....	226	JJ4055.....	204	KE1310P.....	42, 44
IMS1469.....	235	J8150.....	226	JJ4056.....	204	KE1410Z.....	42
IMS3301.....	233	J8151.....	226	JJ4057.....	204	KE1522SA.....	227
IMS3304.....	233	J8152.....	226	JJ4073.....	204	KE1710H.....	42
IMS3316.....	234	J8153.....	226	JJ4075.....	204	KE1806.....	289
IMS3339.....	233	J8154.....	226	JJ4088.....	204	KE1892.....	288
IMS3352.....	235	J8155.....	226	JJ4430.....	291	KE1903.....	289
IMS3369.....	235	J8156.....	226	JJ4434.....	291	KE1967.....	294
IMS3390.....	234	J8157.....	226	JJ4444.....	291	KE210.....	65
IN2925-R-2.....	161	J8158.....	226	JJ4634.....	291	KE2231.....	288
IS1931030.....	158	J8159.....	226	JJ5716.....	291	KE2232.....	288
IS8201030.....	142	J8201.....	219	JSA-200.....	277	KE2236.....	288
IS8202030.....	142	J8205.....	219	JSA-300CS.....	277	KE2238.....	288
IS8203030.....	142	J8214.....	222	JSA-300W.....	276	KE2239.....	288
IS8204030.....	142	J8215.....	222	JSA-300XSS.....	277	KE2242.....	288
IS8205030.....	142	J8220.....	223	JSA-400.....	276	KE2244.....	288
IS8215030.....	142	J8224.....	223	JSA-601NA.....	277	KE22450.....	65

KE2247.....	288	KE8536.....	296	KLTS422.....	141	LA204-30001.....	96
KE2249.....	288	KE8881-511235.....	225	KLTS4225.....	141	LA204-50150.....	96
KE22550P.....	43	KE8881570125.....	235	KP6L-MED-GEN09.....	122	LA205-05050.....	97
KE22550PC.....	26, 43, 44	KE8881811558.....	224	L5190.....	172	LA206-30001.....	96
KE22661P.....	43	KE8881833110.....	224	L5511.....	172	LA231-01150.....	98
KE22661PC.....	43	KE8881833115.....	224	L5512.....	172	LA231-05050.....	98
KE22770P.....	43	KE8881850010.....	226	L5522.....	173	LA231-15050.....	98
KE22770PC.....	43	KE8881850015.....	226	L5524.....	173	LA25000033.....	111
KE230.....	65	KE8881850110.....	226	L5625.....	169	LA250-00101.....	113
KE2304.....	296	KE8881850115.....	226	L5625B.....	169	LA250-00250.....	112
KE233.....	65	KE8881850310.....	226	L5626.....	169	LA252090.....	119
KE2531.....	296	KE8881850810.....	226	L5628.....	169	LA255-00001.....	113
KE2841.....	293	KE8881850815.....	226	LA02002001.....	104	LA26005001.....	114
KE3033.....	289	KE8884413605.....	290	LA020024.....	104	LA261-10001.....	111
KE30500.....	172	KE8884415600.....	290	LA02002501.....	104	LA27000001.....	115
KE30620.....	172	KE8884433605.....	290	LA020029.....	104	LA27000001B.....	115
KE30820.....	172	KE8888-264911.....	173	LA02008001.....	105	LA27610001.....	110
KE31015.....	172	KE8888-264929.....	173	LA02008501.....	105	LA276-15001.....	98
KE31220.....	172	KE8888-264945.....	173	LA020111.....	104	LA30002PP.....	96
KE31420.....	172	KE8888-264960.....	173	LA020113.....	104	LA30005050.....	98
KE31620.....	172	KE8888-264986.....	173	LA020300.....	104	LA310210.....	104
KE31820.....	172	KE8888268060.....	173	LA020301.....	104	LA312029.....	115
KE3381.....	289	KE8888-268086.....	173	LA021000.....	104	LA318000.....	103
KE42614.....	173	KE8900SA.....	227	LA050000.....	108	LA318001.....	103
KE44101.....	291	KE89671.....	228	LA050002.....	108	LA318003.....	100, 103
KE44114.....	291	KE948.....	280	LA050010.....	108	LA325-00350.....	115
KE44115.....	291	KEBCD43811P.....	155	LA050012.....	108	LA325-00450.....	99
KE4582TN.....	293	KES3511.....	218, 309	LA050100.....	108	LA325-00550.....	99
KE4583C.....	293	KEV8970.....	228	LA050200.....	108	LA325-00650.....	99
KE5000038.....	87	KF72015.....	415	LA050400.....	108	LA325-00750.....	99
KE500036.....	87	KF72121.....	415	LA050500.....	108	LA325-05050.....	99
KE500046.....	87	KF73210.....	411	LA08003040.....	119	LA325-05050B.....	99
KE502000.....	87	KF73211.....	411	LA08003140.....	119	LA325-05050T.....	99
KE5024.....	291	KF73212.....	410	LA082025.....	119	LA350-05050.....	99
KE504000.....	87	KF73214.....	412	LA082305.....	119	LA350-05050B.....	99
KE530.....	65	KF73215.....	410	LA121-03050.....	104	LA365000101.....	116
KE533.....	65	KF73220.....	412	LA150-20001.....	102	LA365-05050.....	99
KE535.....	65	KF73221.....	410	LA151-20089.....	103	LA37550001.....	115
KE6017.....	294	KF73238.....	412	LA15120103.....	104	LA381450.....	98
KE6132.....	289	KF73250.....	412	LA152400.....	108	LA381500.....	98
KE6309.....	289	KF73251.....	412	LA152401.....	108	LA400-29301.....	100
KE6613.....	296	KF73256.....	411	LA161-01250.....	102	LA400P.....	133
KE6640.....	214	KF73257.....	411	LA170-30050.....	100, 102	LA460000.....	166
KE6640WF.....	214	KF76001.....	415	LA171-00150.....	100	LA46000001.....	166
KE6641.....	214	KF76656.....	412	LA172-01250.....	100	LA500.....	133
KE6715.....	288	KLTD202.....	141	LA18001001.....	107	LA600.....	404
KE6720.....	288	KLTD2025.....	141	LA18001101.....	107	LA600-42500.....	133
KE6939.....	289	KLTD2025P.....	141	LA18001201.....	107	LA780020.....	167
KE7046.....	296	KLTD202P.....	141	LA18001301.....	107	LA780210.....	167
KE7134.....	280	KLTD203.....	141	LA18002050.....	107	LA780400.....	167
KE7136.....	280	KLTD204.....	141	LA18002250.....	107	LA780421.....	167
KE7137C.....	295	KLTD205.....	141	LA183211.....	107	LA782400.....	167
KE7138C.....	295	KLTS403.....	141	LA184511.....	107	LA782600.....	167
KE7139C.....	295	KLTS403K.....	141	LA185-10050.....	95	LA782610.....	167
KE7140C.....	295	KLTS403K-NG.....	141	LA198-80150.....	95	LA801-00149.....	103
KE7643.....	294	KLTS404.....	141	LA200-05050.....	97	LA801-10550.....	103
KE8303.....	228	KLTS404K.....	141	LA200-05050B.....	97	LA801-10650.....	103
KE85021.....	227	KLTS404K-NG.....	141	LA200-11950.....	100	LA801-10850.....	103
KE8503-1.....	227	KLTS405.....	141	LA200-30150.....	96, 102, 103	LA820019.....	166
KE8506SA.....	227	KLTS405K.....	141	LA200-30350.....	96	LA820050.....	166
KE8507SA.....	227	KLTS405K-NG.....	141	LA20110001.....	120	LA830011.....	166
KE8513-1.....	227	KLTS413.....	141	LA202-30001.....	102	LA845011.....	149
KE8518X.....	229	KLTS414.....	141	LA202-40050.....	96	LA845021.....	149
KE8533.....	296	KLTS415.....	141	LA202-40100.....	96	LA845031.....	149
KE8534.....	296	KLTS420.....	141	LA202-50050.....	102	LA845041.....	149
KE8535.....	296	KLTS421.....	141	LA204-30001PP.....	96	LA88005006.....	168

LA880051	167	LF03729U	106	M1194A.....	36	M4763A.....	34
LA880061	167	LF03734U	95	M1195A.....	36	M5066-89100.....	14, 94
LA884301	168	LF06050U	105	M1196A.....	36	M5066A-OPTC01	12, 25
LA884500	167, 168	LF06051U	105	M1196T.....	36	M5066A-OPTC02	12
LA884901	167	LF06100U	105	M1500A.....	35	M5066A-OPTC03	12
LA884904	167	LF06206U	105	M1520A.....	35	M5066A-OPTR01	12
LA884905	167	LF06208U	105	M1598B.....	36	M5070A.....	11, 14
LA886100	167, 168	LF06209U	105	M1599B.....	36	M5071A.....	13
LA886102	167	LF06700U	105	M1605A.....	35	M5072A.....	13
LA886106	167, 168	LIPBVEST.....	416	M1625A.....	35	M5073A.....	14, 94
LA886108	167	LICTL414-2X	192	M1663A.....	35	M5074A.....	14, 94
LA886109	167, 168	LICTL414-3X	192	M1781A.....	34	M5075A.....	13
LA886110	167, 168	LICTL414-4X	192	M1837A.....	38	M5076A.....	13
LA886111	167, 168	LICTL414-L.....	192	M1920A.....	45, 56	M5085A.....	14, 94
LA886112	167, 168	LICTL414-M.....	192	M1941A.....	56	M5088A.....	11, 14, 93, 94
LA886113	167, 168	LICTL414-S.....	192	M1943A.....	25, 36	M5089A.....	11, 14, 93, 94
LA886115	167	LICTL414-XL.....	192	M1943AL.....	36	M5090A.....	11, 14, 93, 94
LA886125	168	LMA175010.....	142	M2202A.....	35, 65	M5093A.....	14, 94
LA886126	167, 168	LMA175015.....	142	M2520A.....	45, 56	M5094A.....	14, 94
LA980011	254	LMA175020.....	142	M2522A.....	45, 56	M5529A.....	38
LA980012	404	LMA175025.....	142	M3501A.....	25, 34	M5530A.....	35
LA980020	254	LMA175030.....	142	M3504A.....	36	M6500.....	307
LA980100	254	LMA175040.....	142	M3507A.....	25, 34	M6503.....	307
LA980200	254	LMA175050.....	142	M3508A.....	25, 34	M8102A-C01.....	41
LA980300	254	LN6739	238	M3526A.....	35	MA01-100-011.....	72
LA980400	254	LP500B.....	26	M3527A.....	35	MA01-130-011.....	71
LA980500	254	LSP370-220A.....	162	M3536A.....	30	MA01-130-013.....	71
LA980600	254	LSP484040.....	263	M3538A.....	38	MA01-130-015.....	71
LA980700	254	LSP484-075.....	263	M3539A.....	38	MA01-130-016.....	71
LA982001	261	LSP670-040.....	149	M3541A.....	39	MA01-130-017.....	71
LA982500	257, 404	LSP670-101.....	149	M3543A.....	34	MA01-133-011.....	72
LA982600	257, 404	LSP670-200.....	149	M3544A.....	39	MA01-133-015.....	72
LA983060	260	LSP800148.....	154	M3549A.....	39	MA01-133-016.....	72
LA983090	260	LSP812000.....	258	M3713A.....	34	MA01-260BK.....	73
LA983092	260	LSP812014.....	258	M3717A.....	34	MA01-260BU.....	73
LA983097	260	LSP815000.....	258	M3725A.....	34	MA01-260NV.....	73
LA985001	170	LSP815014.....	258	M3752A.....	17, 104	MA01-260PU.....	73
LA985002	170	LSP816000.....	258	M3753A.....	17	MA01-260RB.....	73
LA985003	170	LSP816014.....	258	M3754A.....	17	MA01-260RE.....	73
LA985004	170	LSP818000.....	258	M3756A.....	17	MA01-260TL.....	73
LA985015	170	LSP818014.....	258	M3848A.....	16	MA01-350-018.....	75
LA985030	170	LSP830-054.....	299	M3854A.....	16	MA01-350-058.....	75
LCLIFE-EMS-D.....	163	LSP830-056.....	299	M3859A.....	20	MA01-360BK.....	73
LF00698U	115	LSP830-058.....	299	M3863A.....	16	MA01-360BU.....	73
LF01022U	115, 116	LSP830-066.....	299	M3868A.....	15	MA01-360HG.....	73
LF01075U	114	LSPL599-130.....	154	M3869A.....	15	MA01-360MA.....	73
LF01081U	114	LSPL599-600.....	153	M3870A.....	16	MA01-360NV.....	73
LF01082U	114	LSPL760.....	154	M3871A.....	17	MA01-360OR.....	73
LF01087U	119	LSPL760CPAP	154	M4552B.....	37	MA01-360PU.....	73
LF01093U	119	LSPL761.....	154	M4553B.....	37	MA01-360RB.....	73
LF01108U	117	LSPL761CPAP	154	M4554B.....	37	MA01-360RE.....	73
LF01109U	117	LSPL762.....	154	M4555B.....	37	MA01-360TL.....	73
LF01110U	117	LSPL762CPAP	154	M4556B.....	37	MA01-550-018.....	75
LF01112U	119	LSPL763.....	154	M4557B.....	37	MA01-550-058.....	75
LF01121U	115	LSPL763CPAP	154	M4558B.....	37	MA09-361-211.....	73
LF01122U	115	LSPLPEEP	154	M4572B.....	37	MA1005.....	48
LF01139U	116	LT831741.....	304	M4573B.....	37	MA1006.....	48
LF01146U	116	LT832168.....	304	M4574B.....	37	MA10-414-010.....	81
LF03601U	112	M1131A.....	36	M4575B.....	37	MA10-414-020.....	81
LF03619U	117	M1132A.....	36	M4576B.....	37	MA10-414-050.....	81
LF03622U	117	M1191B.....	25, 36	M4577B.....	37	MA10-414-080.....	81
LF03694U	106	M1191BL.....	36	M4578B.....	37	MA10-414-110.....	81
LF03695U	106	M1191T.....	36	M4579B.....	37	MA10-414-120.....	81
LF03696U	106	M1192A.....	25, 36	M4737A.....	39	MA10-414-130.....	81
LF03721U	106	M1192T.....	36	M4761A.....	38	MA10-414-150.....	81
LF03723U	106	M1193A.....	36	M4762A.....	38	MA10-414-160.....	81

MA1165.....	48	MDI82-E2215.....	250	MO1261-OR.....	267	MS113280.....	252
MA1173.....	48	MDI82-E2222.....	250	MO1280.....	268	MS113310.....	252
MA1269.....	48	MDI82-E2580.....	250	MO1285-BK.....	268	MS113315.....	252
MA1276.....	48	MDI82-E7700.....	250	MO1286-7-BK.....	268	MS113899.....	252
MA15-690-000.....	87	MDMC02.....	63	MO1286-BK.....	268	MS113908.....	252
MA15-705-000.....	88	MDMC15.....	63	MO1300X-BK.....	266	MS113919.....	252
MA1651.....	48	MDS098002.....	310	MO1300X-BL.....	266	MSC097030.....	197
MA1798.....	48	MEDPQ10014.....	231, 241	MO1300X-OR.....	266	MSC097042.....	197
MA1814.....	47, 83	MEDPQR10014B.....	241	MO1300X-YE.....	266	MT2000.....	310
MA18-535-000.....	88	MEDPQR10015.....	241	MO1301X-BK.....	266	MT202.....	310
MA1859.....	47	MEDPQR10015B.....	241	MO1301X-BL.....	266	MUM5001.....	348
MA1860.....	83	MEDPQR10016.....	241	MO1301X-YE.....	266	MUM5001A.....	350
MA1861.....	47, 83	MEDPQR10016B.....	241	MO1309X-BK.....	266	MUM5001A-F.....	350
MA1863.....	47	MEDPQR2001.....	241	MO1309X-BL.....	266	MUM5001A-TB.....	350
MA1864.....	47	MEDPQR2002.....	241	MO1309X-OR.....	266	MUM5001B.....	350
MA2017.....	47, 83	MEDPQR2003.....	241	MO1309X-YE.....	266	MUM5001B-F.....	350
MA2021.....	47	MEDPQR2004.....	241	MO1310X-BK.....	266	MUM5001C.....	350
MA2053.....	5, 57, 83	MEDPQR2005.....	241	MO1310X-BL.....	266	MUM5001C-F.....	350
MA2054.....	54, 57	MEDPQR2006.....	241	MO1310X-OR.....	266	MUM5001C-TB.....	350
MA2055.....	57, 83	MEDPQR2007.....	241	MO1310X-YE.....	266	MUM5001DP.....	350
MA2056.....	57, 83	MEDPQR2008.....	241	MO1381.....	268	MUM5001DP2-IV.....	350
MA2069.....	51, 57	MEDPQR2009.....	241	MO1385X-BK.....	268	MUM5001E.....	350
MA2070.....	51, 57	MEDPTR3001.....	241	MO1390-BK.....	267	MUM5001F.....	348
MA2201.....	51	ME-FPAF.....	238	MO1390-BL.....	267	MUM5001TB.....	348
MA2202.....	51, 57	MEMX412SL.....	216	MO1390-OR.....	267	MUM5001X.....	350
MA2208.....	63	MI184R.....	227	MO1390-RE.....	267	MUM5003.....	349
MA2219.....	51, 57	MI69244.....	213	MO1390-WH.....	267	MUM5003F.....	349
MA2220.....	51, 57	MI8702.....	227	MO1390-YE.....	267	MUM5008.....	348
MA2221.....	51, 57	MLA149GP.....	57	MO1392-BK.....	267	MUM5008F.....	348
MA2222.....	51, 57	MLS3D016.....	433	MO1392-OR.....	267	MUM5010.....	349
MA2256.....	54, 57	MM052391.....	316	MO1392-RE.....	267	MUM5010F.....	349
MA2257.....	54, 57	MM1402ED.....	163	MO1392-WH.....	267	MUM5010TB.....	349
MA2320.....	47, 83	MNS300.....	249	MO1394-OR.....	267	MUM5101.....	348
MA2404.....	51, 57	MNS300-1.....	250	MO1394-WH.....	267	MUM5101A.....	350
MA2405.....	63	MNS300-4.....	250	MO1396LOR.....	267	MUM5101A-F.....	350
MA2406.....	51, 57	MNS301.....	249	MO1396-OR.....	267	MUM5101B.....	350
MA2407.....	51, 57	MNS304.....	249	MO1396-WH.....	267	MUM5101B-F.....	350
MA2412.....	47	MO1103.....	264	MO1396-YE.....	267	MUM5101C.....	350
MA2501.....	53	MO1115.....	264	MO1500.....	253	MUM5101C-F.....	350
MA2502.....	53	MO1130.....	264	MO1504.....	253	MUM5101F.....	348
MA2508.....	53	MO1200-BK.....	266	MO1507.....	253	MUM5105.....	349
MA2510.....	53	MO1200-BL.....	266	MO1510.....	253	MUM5107.....	348
MA2512.....	53	MO1200-MA.....	266	MO1520.....	253	MUM5108.....	348
MA2514.....	53	MO1200-OR.....	266	MO1530.....	253	MUM5108F.....	348
MA2516.....	53	MO1200-RE.....	266	MO1540.....	253	MUM5128F.....	348
MA2640.....	51	MO1200-YE.....	266	MO1550.....	253	MUMLS1.....	350
MA2652.....	48	MO1201-BK.....	266	MO1560.....	253	MUMS3601.....	350
MA2653.....	47	MO1201-MA.....	266	MO1570.....	253	MV1217-10.....	173
MA2696.....	51, 57, 63	MO1209-BK.....	266	MO1573.....	253	MV1217-12.....	173
MA2697.....	51, 57, 63	MO1209-OR.....	266	MO1576.....	253	MV1217-14.....	173
MA3734.....	63	MO1209-YE.....	266	MO3000.....	279	MV1217-16.....	173
MA5-18141.....	142	MO1210-BK.....	266	MO3010.....	279	MV1217-18.....	173
MA5-18437.....	142	MO1210-BL.....	266	MO3020.....	279	MX10-1510.....	198
MA5-18441.....	142	MO1210-MA.....	266	MO3030.....	279	MX10-1624.....	198
MA5-18537.....	142	MO1210-OR.....	266	MO320.....	261	MX10-1628.....	198
MA5-18541.....	142	MO1210-RE.....	266	MO322.....	261	MX13-1000.....	195
MD1030-1.....	294	MO1210-YE.....	266	MS113010.....	252	MX13-1024.....	195
MD300C2.....	82	MO1211OR-9.....	266	MS113011.....	252	MX13-1100.....	195
MD3301.....	63	MO1211YL-9.....	266	MS113031.....	252	MX5311L.....	216
MDI73-200.....	118	MO1217-1-BK.....	266	MS113032.....	252	MXCTP233-L.....	186
MDI73-204V.....	118	MO1217-2-BK.....	266	MS113034.....	252	MXCTP233-M.....	186
MDI73-402.....	118	MO1250-BK.....	267	MS113051.....	252	MXCTP233-S.....	186
MDI73-500.....	118	MO1250-OR.....	267	MS113052.....	252	MXFFE775-L.....	180
MDI82-E2010.....	250	MO1260-BK.....	267	MS113054.....	252	MXFFE775-M.....	180
MDI82-E2014.....	250	MO1260-OR.....	267	MS113070.....	252	MXFFE775-S.....	180
MDI82-E2024.....	250	MO1261-BK.....	267	MS113071.....	252	MXFFE775-XL.....	180

MXFFE775-XXL.....	180	MXUL315-XL.....	176	N7296.....	160	NO9590RE.....	82
MXFFS700-L.....	179	MXUS220-L.....	180	N7297.....	160	NOJM2-CC.....	82
MXFFS700-M.....	179	MXUS220-M.....	180	N7298.....	159	NON70600.....	199
MXFFS700-S.....	179	MXUS220-S.....	180	N7299.....	159	NON80328.....	199
MXFFS700-XL.....	179	MXUS220-XL.....	180	N7300.....	159	NON80328DH.....	199
MXFFS700-XS.....	179	MXUS220-XS.....	180	N7301.....	160	NP0201-01.....	233
MXMF300-L.....	176	MXUSE880-2XL.....	180	N7314.....	140	NP9501-01.....	233
MXMF300-M.....	176	MXUSE880-3XL.....	180	N7315.....	140	NP9801-01.....	234
MXMF300-S.....	176	MXUSE880-L.....	180	N7316.....	140	NP-EC4.....	46, 52
MXMF300-XL.....	176	MXUSE880-M.....	180	N7317.....	140	NP-EC8.....	46
MXMF300-XS.....	176	MXUSE880-S.....	180	N7318.....	140	NP-OXI-A/N.....	46, 52
MXMK296-L.....	186	MXUSE880-XL.....	180	N7319.....	140	NP-OXI-P/I.....	46, 52
MXMK296-M.....	186	MXUSE880-XS.....	180	N7320.....	140	NS11095L.....	193
MXMK296-S.....	186	N-25.....	46, 52	N7321.....	140	NS11095M.....	193
MXMK296-XL.....	186	N2540.....	164	N7322.....	140	NS11095S.....	193
MXMK296-XS.....	186	N2545.....	164	N7323.....	140	NS11095XL.....	193
MXMK296-XXL.....	186	N2551.....	161	N7324.....	162	NSP-1124.....	433
MXN191.....	185	N2553.....	161	N7325.....	163	OT01BM3200.....	149
MXN192.....	185	N2554.....	161	N7326.....	163	OT01BM3200W.....	149
MXN193.....	185	N2555.....	161	N7453.....	163	OT01BM3210-MO.....	149
MXN194.....	185	N6050.....	134	N7455.....	163	OT01BM3210W.....	149
MXN211.....	185	N6063.....	54	N7456.....	163	OTBM3500.....	150
MXN212.....	185	N6065.....	57	N7457.....	163	OTBM3510.....	150
MXN213.....	185	N6067.....	57	N7490.....	166	OTBM3520.....	150
MXN214.....	185	N6082.....	44, 54	N7491.....	166	OTU100I.....	67
MXN481.....	185	N6986.....	162	N7492.....	166	OTU50I.....	67
MXN482.....	185	N6991.....	162	N7580.....	134	P250500.....	313
MXN483.....	185	N6997.....	162	N7652.....	132	P751018.....	282
MXN484.....	185	N6998.....	161	N7653.....	132	P754048.....	282
MXNEC288-L.....	181	N6999.....	161	N7654.....	132	P7800.....	121
MXNEC288-M.....	181	N7012.....	161	N7655.....	132	P7800BLS.....	121
MXNEC288-S.....	181	N7013.....	161	N7695.....	134	P7800EC.....	121
MXNEC288-XL.....	181	N7014F.....	162	N7696.....	134	P7800PG.....	122
MXNEC288-XXL.....	181	N7061.....	148	N7697.....	133	P7801.....	123
MXNPG888-L.....	181	N7062.....	148	N7698.....	133	P7803.....	122
MXNPG888-M.....	181	N7063.....	148	NA10-0017.....	402	PAS400RE.....	343
MXNPG888-SM.....	181	N7064.....	148	NA10-0029.....	287	PAS600RB.....	223, 347
MXNPG888-XL.....	181	N7131.....	305	NA10-0031.....	287	PAS600RE.....	223, 347
MXNPG888-XS.....	181	N7132.....	305	NA30-0001.....	286	PAT108-EM.....	212
MXSEC375-L.....	179	N7157.....	160	NA30-0009.....	218	PD0069-30.....	238
MXSEC375-M.....	179	N7174.....	164	NA30-0023.....	286	PD0070-30.....	238
MXSEC375-S.....	179	N7175.....	164	NA30-0033.....	286	PDIB10800.....	218
MXSEC375-XL.....	179	N7178.....	165	NA70-0070.....	400	PDID43600.....	198
MXSEC375-XXL.....	179	N7179.....	165	NA70-0071.....	400	PDIH04082.....	195
MXSG375-L.....	176	N7180.....	164	NAZZ-0056.....	152	PDIP10901.....	194
MXSG375-M.....	176	N7280.....	159	NAZZ-0298.....	152	PDIP13472.....	198
MXSG375-S.....	176	N7281.....	157	NB37.....	414	PDIP25784.....	198
MXSG375-XL.....	176	N7281-ADULT.....	158	NLTKINST5748.....	308	PDIP28072.....	198
MXSU690-L.....	179	N7281M.....	157	NLTKINST6824.....	308	PDIQ08472.....	194
MXSU690-M.....	179	N7281NICKIT.....	158	NO7000A.....	84	PDIQ55172.....	195
MXSU690-S.....	179	N7281-PEDI.....	158	NO7000A-EA.....	84	PDIQ85084.....	194
MXSU690-XL.....	179	N7281PM.....	157	NO7000I.....	84	PDIQ85484.....	194
MXSU690-XS.....	179	N7281R.....	157	NO7000I-EACH.....	84	PDIQ89072.....	194
MXSY911-L.....	178	N7283.....	159	NO7000N.....	84	PDIU87295.....	195
MXSY911-M.....	178	N7284.....	159	NO7000P.....	84	PE1010.....	353
MXSY911-S.....	178	N7285.....	159	NO7000P-EACH.....	84	PE1012.....	353
MXSY911-XL.....	178	N7286.....	159	NO8000AA-1.....	84	PE1120.....	353
MXSY911-XXL.....	178	N7287.....	159	NO8000AA-2.....	84	PE1120BL.....	353
MXUF524-L.....	180	N7288.....	159	NO8000AA-3.....	84	PE1120OR.....	353
MXUF524-M.....	180	N7289.....	161	NO8000AP.....	84	PE1120YE.....	353
MXUF524-S.....	180	N7289C.....	161	NO8000AP-3.....	84	PE1550EMS.....	353
MXUF524-XL.....	180	N7291.....	160	NO8500.....	83	PE1550EMS-OR.....	353
MXUF524-XS.....	180	N7292.....	160	NO8500C.....	83	PE2000C.....	430
MXUL315-L.....	176	N7293.....	159	NO8500CC-B.....	83	PE2690.....	430
MXUL315-M.....	176	N7294.....	160	NO9500CC-B.....	82	PFE7023D.....	19
MXUL315-S.....	176	N7295.....	159	NO9590.....	82	PFE7024D.....	19

PHIBT1.....	18	PRDE01FR-RB.....	323	RB829.....	340	RU004852200.....	137
PHPT3M.....	255	PRDE01FR-RE.....	323	RB929IM-OR.....	321	RU004853300.....	137
PINK5084.....	186	PRDE01-OR.....	323	RBS400XRB.....	343	RU1000.....	132
PINK5085.....	186	PRDE01-RB.....	323	RD717NY.....	256	RU100382025.....	130
PINK5086.....	186	PRDE01-RE.....	323	RD717OR.....	256	RU100382030.....	130
PINK5087.....	186	PRFI01FR-RB.....	323	RD717P-BL.....	256	RU100382035.....	130
PK12-001.....	313	PRFI01FR-RE.....	323	RD717PIL.....	256	RU100382040.....	130
PK12-110.....	309	PRFI01-OR.....	323	RD717PK.....	256	RU100382045.....	130
PK13-011.....	313	PRFI01-RB.....	323	RD717P-OR.....	256	RU100382050.....	130
PK18-125.....	313	PRFI01-RE.....	323	RD718P-BL.....	256	RU100382055.....	130
PK20-125.....	237	PRFI04FR-RB.....	324	RD718P-RD.....	256	RU100382060.....	130
PK20-150.....	237	PRFI04FR-RE.....	324	RD719BL.....	256	RU100382065.....	130
PK20-365.....	237	PRFI04-OR.....	324	RD719BU.....	256	RU112082050.....	130
PK20-425.....	237	PRFI04-RB.....	324	RD719LG.....	256	RU112082055.....	130
PK20-450.....	237	PRFI04-RE.....	324	RD719NY.....	256	RU112082060.....	130
PK20-450TYL.....	237	PRMD01-OR.....	346	RD719P-BL.....	256	RU112082065.....	130
PK20-525.....	238	PRMD01-RB.....	346	RD719P-LG.....	256	RU112082070.....	130
PK20-550.....	238	PRMD01-RE.....	346	RD719P-NY.....	256	RU112082075.....	130
PK20-550ADV.....	238	PRMD02-OR.....	346	RD719P-OR.....	256	RU112082080.....	130
PK20-725.....	238	PRMD02-RB.....	346	RD719P-RE.....	256	RU112082085.....	130
PK20-750.....	238	PRMD02-RE.....	346	RD719RE.....	256	RU112082090.....	130
PK24-101.....	310	PRME01-OR.....	344	RD721.....	262	RU112082095.....	130
PK24-102.....	310	PRME01-RB.....	344	RD721K-BL.....	262	RU112082100.....	130
PK24-201.....	310	PRME01-RE.....	344	RD721K-GR.....	262	RU112480025.....	130
PK4-006.....	289	PRME03-OR.....	344	RD721RS.....	262	RU112480030.....	130
PK6100.....	302	PRME03-RB.....	344	RI1001B.....	170	RU112480035.....	130
PK7-110.....	311	PRME03-RE.....	344	RI1019.....	170	RU112480040.....	130
PK7-600.....	311	PRMI01-OR.....	223, 347	RMT-CHILD.....	286, 403	RU112480045.....	130
PK90754.....	302	PRMI01-RB.....	223, 347	RMT-PARAMED.....	286, 403	RU120900020.....	151
PKL15-25.....	59	PRMI01-RE.....	223, 347	RMT-TAC.....	286, 403	RU120900040.....	151
PKL15-60.....	59	PRPK08-RB.....	341	RPP1F1S110NLED.....	171	RU121801.....	143
PL100-20.....	281	PRPK08-RE.....	341	RPP1N00110S.....	171	RU121802.....	143
PL144900.....	353	PRPK09-RB.....	341	RPP1N1S000S.....	171	RU121803.....	143
PL1450.....	353	PRPK09-RE.....	341	RPR1F1R110N.....	171	RU121804.....	143
PL200-20.....	281	PRSA02-GR.....	330	RPR1N00110S.....	171	RU121805.....	143
PL747M.....	353	PRSA02-RB.....	330	RPR1N1R000S.....	171	RU121806.....	143
PM1110.....	133	PRSA02-RE.....	330	RPR1N1S000S.....	171	RU121850.....	143
PM1824.....	281	PSBIG-A.....	219	RR112.....	414	RU121870.....	143
PM2105.....	165	PSBIG-P.....	219	RSS0003.....	278	RU1229100.....	144
PM2108.....	165	PSPBVM-C.....	150	RSS0004.....	279	RU122950.....	144
PM2165.....	165	PSPBVM-G.....	150	RSS0005.....	279	RU122960.....	144
PM2168.....	165	PSSOFFT-01.....	286	RT6050159.....	421	RU122970.....	144
PM2301.....	170	PSSOFFT-02.....	286	RTI10131.....	225	RU122980.....	144
PM3105.....	165	PSSOFFT-W.....	286	RTI10151.....	225	RU122990.....	144
PM3114.....	165	PSSOFFT-W-R.....	286	RTI10301.....	225	RU1231.....	145
PM7211.....	165	Q-100.....	275	RTI10311.....	225	RU123120.....	145
PO2510.....	264	Q-110.....	275	RTI10361.....	225	RU123122.....	145
PO2526.....	264	Q-120.....	275	RTI10381.....	225	RU123124.....	145
PO2528.....	264	Q-6217C.....	276	RTI10391.....	225	RU123126.....	145
PO2532.....	264	Q-ACR.....	262	RTI10561.....	225	RU123128.....	145
PO2631.....	264	Q-ACR4.....	262, 282	RTI11061.....	225	RU123130.....	145
PRDC01FR-RB.....	327	Q-BABY/ADD.....	262, 282	RU004670000.....	137	RU123132.....	145
PRDC01FR-RE.....	327	Q-CONT.....	190	RU004670001.....	137	RU123134.....	145
PRDC01-OR.....	327	QDISSKIT.....	165	RU004670002.....	137	RU123136.....	145
PRDC01-RB.....	327	QMPL1750.....	262	RU004670003.....	137	RU1233.....	144
PRDC01-RE.....	327	Q-STRAP.....	262, 282	RU004670004.....	137	RU123312.....	144
PRDC03FR-RB.....	327	RB003OR.....	416	RU004671002.....	137	RU123314.....	144
PRDC03FR-RE.....	327	RB003RB.....	416	RU004671003.....	137	RU123316.....	144
PRDC03-OR.....	327	RB005OR.....	417	RU004671004.....	137	RU123318.....	144
PRDC03-RB.....	327	RB005RB.....	417	RU0048.....	137	RU123319.....	144
PRDC03-RE.....	327	RB005RD.....	417	RU004801100.....	137	RU123320.....	144
PRDE01AFR-RB.....	323	RB021-3.....	416	RU004802200.....	137	RU123322.....	144
PRDE01AFR-RE.....	323	RB10IMTT-LG.....	416	RU004803300.....	137	RU123324.....	144
PRDE01A-OR.....	323	RB177YL.....	299	RU004804400.....	137	RU123326.....	144
PRDE01A-RB.....	323	RB475GR.....	329	RU004850050.....	137	RU123328.....	144
PRDE01A-RE.....	323	RB475OR.....	329	RU004851100.....	137	RU123330.....	144

RU123332.....	144	RU8629100.....	140	S3901.....	314	SI031.....	119
RU123334.....	144	S3020.....	191	S3902.....	314	SI072.....	111
RU123336.....	144	S3030.....	190	S4050.....	413	SI086.....	111
RU1234.....	144	S3040.....	316	S42450.....	315	SI088FB.....	120
RU150020.....	131	S3499.....	312	SA17121.....	196	SI090.....	108
RU150025.....	131	S3500.....	312	SA17350.....	197	SI091.....	108
RU150030.....	131	S3501.....	312	SA17360.....	197	SI092.....	108
RU150035.....	131	S3502.....	310	SA27500.....	197	SI093.....	108
RU150040.....	131	S3503.....	313	SA34400.....	198	SI094.....	108
RU150045.....	131	S3504.....	313	SA41101.....	196	SI095.....	108
RU150050.....	131	S3504.....	237	SAL000909.....	240	SI098.....	108
RU150055.....	131	S3507.....	199	SAV-A-TOOTH.....	315	SI115.....	112
RU157100300.....	149	S3508.....	310	SE1005.....	248	SI121.....	112
RU157300100.....	149	S3509.....	314	SE1121.....	248	SI122.....	112
RU157400100.....	149	S3510.....	218, 309	SE1121F.....	248	SI125.....	112
RU158000.....	155	S3512.....	218, 309	SE1121-XL.....	248	SI1344.....	120
RU158100.....	155	S3514.....	313	SE1410.....	248	SI1345.....	120
RU158200.....	155	S3520.....	314	SE556652.....	248	SI140.....	116
RU158300.....	155	S3520.....	238	SE556652-LG.....	248	SI146.....	116
RU158400.....	155	S3521.....	308	SE556652-SM.....	248	SI1475.....	120
RU158600.....	155	S3522.....	308	SEC42859-15.....	297, 401	SI147R.....	116
RU170055.....	131	S3527.....	309	SEC42859-35.....	297, 401	SI180.....	118
RU170060.....	131	S3545.....	308	SEC42859-35MIL.....	297, 401	SI1800.....	114
RU170065.....	131	S3546.....	308	SEC42900-A.....	297, 401	SI1801.....	114
RU170070.....	131	S3600.....	308	SECS062010.....	287, 401	SI1805.....	114
RU170075.....	131	S3601.....	308	SECS062011.....	287, 401	SI201.....	117
RU170080.....	131	S3602.....	309	SECS062013.....	287, 401	SI202.....	117
RU170085.....	131	S3603.....	306	SEE1000.....	147	SI2023.....	107
RU170090.....	131	S3604.....	306	SEE2000.....	147	SI203.....	117
RU395497.....	159	S3606.....	87	SEE3000.....	147	SI204.....	117
RU396218.....	159	S3607.....	87	SEE500P.....	256	SI2135.....	106
RU500.....	132	S3640.....	195	SEE500R.....	256	SI2144.....	106
RU502501.....	132	S3641.....	195	SEE501.....	256	SI2145.....	106
RU502503.....	132	S3665.....	197	SEE550.....	414	SI2151.....	106
RU502505.....	132	S3665D.....	197	SEE560.....	414	SI2801.....	107
RU502507.....	132	S3699.....	199	SEEAIR.....	143	SI2805.....	107
RU504550.....	131	S3700.....	199	SEEAIR-1.....	143	SI2850.....	107
RU504555.....	131	S3701.....	199	SEEAIR-1.....	143	SI500.....	111
RU504560.....	131	S3701.....	199	SEEAIR-1.....	143	SI610.....	116
RU504565.....	131	S3702.....	199	SEEAIR-1.....	143	SI815.....	109
RU504565.....	131	S3703.....	199	SEEAIR-1.....	143	SI816.....	109
RU504570.....	131	S3706.....	316	SEEAIR-1.....	143	SI818.....	109
RU504575.....	131	S3707.....	178	SEEAIR-1.....	143	SLB250100.....	68
RU504580.....	131	S3708.....	178	SEEAIR-1.....	143	SLN3001001501.....	68
RU504585.....	131	S3709.....	196	SEEAIR-1.....	143	SM100100010.....	128
RU504590.....	131	S3710.....	310	SEEAIR-1.....	143	SM100100030.....	128
RU506525.....	131	S3711.....	310	SEEAIR-1.....	143	SM100100035.....	128
RU506530.....	131	S3714.....	313	SEEAIR-1.....	143	SM100100040.....	128
RU506535.....	131	S3715.....	309	SEEAIR-1.....	143	SM100100045.....	128
RU506540.....	131	S3716.....	313	SEEAIR-1.....	143	SM100100050.....	128
RU506545.....	131	S3717.....	313	SEEAIR-1.....	143	SM100100055.....	128
RU506550.....	131	S3718.....	178	SEEAIR-1.....	143	SM100100060.....	128
RU750.....	132	S3719.....	314	SEEAIR-1.....	143	SM100100065.....	128
RU77700.....	140	S3720.....	310	SEEAIR-1.....	143	SM100100070.....	128
RU849100.....	287	S3721.....	192	SEEAIR-1.....	143	SM100100075.....	128
RU8601100.....	138	S3723.....	189	SEEAIR-1.....	143	SM100100080.....	128
RU8602200.....	138	S3724.....	189	SEEAIR-1.....	143	SM100100085.....	128
RU8603300.....	138	S3726.....	190	SEEAIR-1.....	143	SM100100090.....	128
RU8604400.....	138	S3727.....	189	SEEAIR-1.....	143	SM100101030.....	128
RU8615050.....	138	S3796.....	199	SEEAIR-1.....	143	SM100101035.....	128
RU8616100.....	138	S3811.....	315	SEEAIR-1.....	143	SM100101040.....	128
RU8617200.....	138	S3815.....	312	SEEAIR-1.....	143	SM100101045.....	128
RU8618300.....	138	S3816.....	312	SEEAIR-1.....	143	SM100101050.....	128
RU8619400.....	138	S3820.....	402	SEEAIR-1.....	143	SM100101055.....	128
RU8620100.....	140	S3851P.....	302	SEEAIR-1.....	143	SM100101060.....	128
RU8621000.....	140	S3852P.....	302	SEEAIR-1.....	143	SM100102010.....	129
RU8628300.....	140	S3900.....	314	SEEAIR-1.....	143		

SM100102030.....	129	ST44401.....	431	SU1-7330-45.....	129	SU9-0213-82.....	132
SM100102035.....	129	ST44500.....	432	SU1-7330-50.....	129	SU9-0213-92.....	132
SM100102040.....	129	ST65030.....	316	SU1-7330-55.....	129	SXV7148.....	156
SM100102045.....	129	ST90503.....	432	SU1-7333-10.....	129	SY6070-140-000.....	273
SM100102050.....	129	ST90509.....	432	SU1-7333-30.....	129	SY6080-140-000.....	272, 273
SM100102055.....	129	ST90513.....	432	SU1-7333-35.....	129	SY6080-215-010.....	273
SM100102060.....	129	ST90540.....	432	SU1-7333-40.....	129	SY6080-216-010.....	273
SM100102065.....	129	ST90541.....	432	SU1-7333-45.....	129	SY6082.....	273
SM100102070.....	129	STI975.....	260	SU1-7333-50.....	129	SY6082-128-000.....	272, 273
SM100102075.....	129	STPG31000GN.....	342	SU1-7333-55.....	129	SY6082-128-012.....	273
SM100102080.....	129	STPG31001BU.....	220, 346	SU1-7333-60.....	129	SY6082-140-000.....	273
SM100102085.....	129	STPG31002BK.....	333	SU1-7333-65.....	129	SY6082-170-000.....	273
SM100102090.....	129	STPG31003RE.....	345	SU1-7333-70.....	129	SY6082-260-010.....	273
SM100103030.....	128	STPG33004GN.....	328	SU1-7333-75.....	129	SY6082-260-10.....	273
SM100103035.....	128	STPG34004TK.....	404	SU1-7333-80.....	129	SY6085-032-000.....	272
SM100103040.....	128	STPG35000RE.....	336	SU1-7333-85.....	129	SY6085-035-000.....	272
SM100103045.....	128	STPG35001RE.....	333	SU1-7333-90.....	129	SY6086.....	272
SM100103050.....	128	STPG35002GN.....	328	SU1-7333-95.....	129	SY6250-001-089.....	273
SM120002.....	153	STPG35002RE.....	328	SU1-7343-30.....	130	SY6250-001-127.....	273
SM120003.....	153	STPG35003RE.....	334	SU1-7343-35.....	130	SY6250-025-000.....	273
SM122002.....	153	STPG35004RE.....	334	SU1-7343-40.....	130	SY6250-140-000.....	273
SM122003.....	153	STPG35004TK.....	404	SU1-7343-45.....	130	SY6250-160-000.....	273
SM3260.....	202	STPG35005BU.....	335	SU1-7343-50.....	130	SY6250-161-000.....	273
SM3262.....	202	STPG35005GN.....	335	SU1-7343-55.....	130	SY6252.....	273
SM3263.....	202	STPG35005RE.....	335	SU1-7343-60.....	130	SY6370-000-000.....	274
SM3265.....	202	STPG35006BU.....	333	SU1-7343-65.....	130	SY6371-000-000.....	274
SM3266.....	202	STPG35006GN.....	333	SU1-7343-70.....	130	SY6400-000-000.....	274
SM3267.....	202	STPG35006RE.....	333	SU1-7343-75.....	130	SY6410-000-000.....	274
SM3268.....	202	STPG35007BU.....	335	SU1-7343-80.....	130	SY6500-033-000.....	274
SM96000.....	223	STPG35007RE.....	335	SU1-7343-85.....	130	SY6500-034-000.....	274
SM96002.....	223	STPG35008BU.....	342	SU1-7343-90.....	130	SY6500-035-000.....	274
SO1021326.....	242	STPG35008GN.....	342	SU2201.....	159	SY6500-130-000.....	272, 273
SO1029134.....	242	STPG35008RE.....	342	SU5-0236-09.....	136	SY6500-147-000.....
SO1043643.....	242	STPG35010BU.....	345	SU5-0236-10.....	136	SY6500-201-000.....	274
SO1046381.....	242	STPG35010RE.....	345	SU5-0236-69.....	135	SY6500-240-000.....	272
SO1046645.....	242	STPG35011BU.....	334	SU5-0236-90.....	136	SY6500-315-000.....	272
SP301-67.....	233	STPG35011RE.....	334	SU5-0236-99.....	136	SY6500-316-000.....	272
SP301-68.....	233	STPG36000RE.....	342	SU5-0237-01.....	137	SY6500-700-040.....	274
SP302-66.....	233	STPG36000TK.....	405	SU5-0237-03.....	137	SY6500-700-041.....	274
SP402-01C.....	234	STPG36001RE.....	345	SU5-0240-52.....	136	SY6506.....	272
SROX1451.....	207	STPG36002RE.....	220, 347	SU5-0240-53.....	136	SY6506-170-000.....	272
SROX1632.....	207	STPG36004BK.....	336	SU5-5132-01.....	136	SYCS1201-000.....	110
SROX1651.....	207	STPG36005BK.....	345	SU5-5132-02.....	136	SYCS1201-001.....	110
SROX1832.....	207	STPG3G001TK.....	405	SU5-5132-03.....	136	SYCS1201-006.....	110
SROX1851.....	207	SU1-1506-11.....	143	SU5-5132-04.....	136	T1750.....	123
SROX2032.....	207	SU1-1506-40.....	143	SU5-5133-00.....	136	T1751.....	123
SROX2225.....	207	SU1-1506-50.....	143	SU5-5133-01.....	136	T1753.....	123
SROX2419.....	207	SU1-1506-60.....	143	SU5-5133-02.....	136	T1754.....	123
SS16812.....	282	SU1-1506-70.....	143	SU5-5133-03.....	136	T1949.....	169, 316
SS16910.....	282	SU1-1506-80.....	143	SU5-5133-04.....	136	T1950.....	11, 14, 93, 94, 95, 136, 137, 140, 316
SS2400.....	169	SU1-1506-90.....	143	SU5-5133-20.....	136	T1951.....	17, 136, 137, 140, 316, 420, 430
SS2403.....	169	SU1-1506-99.....	143	SU5-5332-01.....	135	T1952.....	168, 316
SS2480-20.....	169	SU1-5075-20.....	145	SU5-5332-02.....	135	T1954.....	19, 21, 22, 23
SS2480-36.....	169	SU1-5075-22.....	145	SU5-5332-03.....	135	T1955.....21
SS2488-20.....	169	SU1-5075-24.....	145	SU5-5332-04.....	135	T1956.....	22, 23
SS44241.....	173	SU1-5075-26.....	145	SU5-5333-00.....	135	TH44-TT4080.....	279
SS74000.....	169	SU1-5075-28.....	145	SU5-5333-01.....	135	TH90-BSS3084.....	280
SS80529.....	168	SU1-5075-30.....	145	SU5-5333-02.....	135	TMFCS.....	287
SS80636.....	169	SU1-5075-32.....	145	SU5-5333-03.....	135	TMHALO.....	287
SS80638.....	169	SU1-5075-34.....	145	SU5-5333-04.....	135	TMOAL-4C.....	293
SS80665.....	168, 169	SU1-5075-36.....	145	SU5-5333-57.....	135	TMOAL-6C.....	293
SSDM10-001.....	168	SU1-7330-20.....	129	SU8-3550-01.....	160	TRECK+.....	307
ST100.....	229	SU1-7330-25.....	129	SU8-3550-02.....	160	TRECK+HOLSTER.....	307
ST44001.....	432	SU1-7330-30.....	129	SU9-0211-70.....	132	TT102.....	344
ST44007.....	431, 432	SU1-7330-35.....	129	SU9-0212-70.....	132		
ST44400.....	431	SU1-7330-40.....	129	SU9-0212-82.....	132		

TT300.....	319	WH03013	238	WJ0404.....	298	WNLWL220ES05.....	95
TT400.....	344	WH0311-19.....	233	WJ0416.....	298	WNLXFAP.....	95
TT890.....	324	WH0351-50.....	238	WJ0818.....	298	WTMAD100.....	158
TT892.....	324	WH0362-10C.....	235	WJ0820.....	298	WTMAD300.....	158
TT894.....	324	WH0400-15.....	236	WJ100U.....	299	X1000.....	455
TT896.....	324	WH0410-04.....	235	WJ1216.....	298	X1001.....	455
TFFF1250.....	330	WH0410-08.....	235	WJ600U.....	299	X1005.....	420
UF300-10.....	280	WH0479-62.....	238	WJ7260C.....	298	X2315.....	192
UF400-10.....	281	WH0500-02.....	234	WJ7260P.....	298	X2320.....	193
UF500-20.....	280	WH0501-02.....	234	WJBJ4.....	299	X2322.....	192
UP100-20.....	280	WH0593-03.....	234	WJEBK1.....	299	X2322-2XL.....	192
VP0201-08.....	237	WH0605-01.....	236	WJEBK2.....	299	X2322-3XL.....	192
VP0202-04.....	237	WH0657-05.....	237	WL50CC3ZCR.....	448	X2322M.....	192
VP0202-08.....	237	WH0657-11.....	237	WL50CR3ZCR.....	448	X2322XL.....	192
VP0203-04.....	237	WH0752-22.....	236	WL50K000CR.....	449	X2323.....	193
VP0203-08.....	237	WH0821-52.....	234	WL50K000RR.....	449	X2324.....	193
VT1800.....	113	WH0872-30.....	238	WL50R03ZCR.....	448	X2325.....	193
VT2400.....	120	WH101-3358.....	236	WL50R03ZRR.....	448	X2332.....	199
W1866.....	421	WH102-0700.....	233	WL580CAAZR.....	450	X2334.....	199
W1866A.....	421	WH104-6218.....	235	WL5FLANGEB.....	449	X2340.....	199
W1866B.....	421	WH106-2256.....	234	WL5FLANGEC.....	449	X2342.....	199
W1866C.....	421	WH107-4939.....	236	WL60C025CR.....	448	X2343.....	199
WA01690-200.....	87	WH109-4515.....	238	WL60K000XR.....	450	X2344.....	199
WA01690-400.....	87	WH113-5458.....	236	WL60K000YR.....	450	X2400.....	189
WA02892-000.....	87	WH120-4213.....	235	WL60R02FCR.....	448	X2400S.....	189
WA02893-000.....	87	WH1228-20.....	238	WL60R02FRR.....	448	X2401.....	189
WA05031-101.....	87	WH1255-94.....	238	WL60RC6FCR.....	448	X4413.....	199
WA05031-750.....	87	WH129-4420.....	235	WL68-1183542-10.....	451	Y1095BL.....	414
WA21326-0000.....	87	WH129-8579.....	235	WL68-1183581-10.....	451	Y1095C.....	414
WA5098-30.....	69	WH131-9276.....	233	WL68-1183582-1SA.....	451	Y1095G.....	414
WADS44-09.....	74	WH132-4433.....	234	WL68-3183573-1S0.....	451	Y1095GR.....	414
WADS44-11.....	74	WH1354.....	236	WL68-3183587-10.....	451	Y1095R.....	414
WADS44-12.....	74	WH137-7936.....	234	WL6EFLANGE.....	448	Y1095Y.....	414
WAREUSE-07-2MQ.....	56	WH1394-47.....	235	WL6SCOENZR.....	450	Y2000.....	419
WAREUSE-08-2MQ.....	56	WH141-1602.....	234	WL70C025CR.....	448	Y2000GR.....	419
WAREUSE-09-2MQ.....	56	WH141-1636.....	234	WL70CELZR.....	450	Y2000R.....	419
WAREUSE-10-2MQ.....	56	WH144-3308C.....	235	WL70K000ZR.....	450	Y2010.....	419
WAREUSE-11-2MQ.....	56	WH147-2273C.....	233	WL70R02FCR.....	448	Y2011.....	419
WAREUSE-11L-2MQ.....	56	WH148-5622.....	235	WL70R02FRR.....	448	Y2013BL.....	419
WAREUSE-12-2MQ.....	56	WH153-1854.....	234	WL70R02SRR.....	448	Y2014RD.....	419
WAREUSE-12L-2MQ.....	56	WH170-4261.....	235	WL70RC6FCR.....	448	Y2015BL.....	419
WAREUSE-13-2MQ.....	56	WH184-7755.....	235	WL80C00EZR.....	451	Y2016.....	419
WASOFT-07-2MQ.....	56	WH218-1444.....	237	WL80CBEHCR.....	451	YC.....	10, 13
WASOFT-08-2MQ.....	56	WH2243-11.....	235	WL80COEHCR.....	451	ZIQR-CL.....	164
WASOFT-09-2MQ.....	56	WH243-7010.....	233	WL80CREHCR.....	451	ZIQR-D-2.....	164
WASOFT-10-2MQ.....	56	WH253-7918C.....	234	WL810CA0ZR.....	450	ZMQC100.....	297
WASOFT-11-2MQ.....	56	WH281-2444.....	237	WL8WC00EZR.....	451	ZMQC102.....	297
WASOFT-12-2MQ.....	56	WH282-1494.....	235	WL90CC5FCR.....	449	ZMQC473.....	297
WASOFT-12L-2MQ.....	56	WH2919-23.....	234	WL90E000ZR.....	450	ZMQC475.....	297
WASOFT-13-2MQ.....	56	WH2920-23.....	234	WL90F000CR.....	449		
WC100-10.....	280	WH294-2290.....	235	WL90F000RR.....	449		
WC1507N.....	238	WH3222-01.....	237	WL90RC5FCR.....	449		
WC400APC.....	418	WH323-5652.....	235	WL90RR5FRR.....	449		
WC400-FMI.....	418	WH342-1104.....	235	WL90RR5SCR.....	449		
WC619PI.....	238	WH349-8359.....	235	WL9EFLANGES.....	449		
WC730NP.....	238	WH350-7233.....	235	WL9SCOENZR.....	450		
WE562134.....	134	WH357-9810.....	236	WLM6ZC.....	450		
WE562135.....	134	WH358-6807.....	233	WLM7FB.....	449		
WEMD-8.....	163	WH516-9997.....	233	WLM7K.....	449		
WEMPV-4027.....	164	WH5201-79.....	238	WLM9LZC.....	450		
WEPX1025.....	163	WH550-02.....	234	WNL1100.....	118		
WEPX-1027.....	163	WH5711-35.....	134	WNL3136.....	118		
WH0074-71.....	238	WH5711-35.....	238	WNL5000-TV.....	118		
WH0101-02.....	234	WH6710.....	233	WNLFAK4100.....	303		
WH0102-02.....	234	WH7732-93.....	235	WNLFAK5000SGI.....	166		
WH0122-25.....	234	WJ0206.....	298	WNLMAT.....	110		

Choose the ordering methods that work best for you

Online



Place your order 24 hours per day using eSEE Store™, our convenient online ordering system. Simply go to www.SEEquip.com and click on Order > eCommerce Store in the upper right hand corner.

If your organization has established contract pricing with us, be sure to register for an online account. This allows us to link your contract pricing to online orders.

Visit our site dedicated to 5.11 Tactical and everything they sell. A new, user-friendly interface lets you choose colors, sizes and other details...then pay using a credit card or a PO number.



Phone



Our customer service personnel are waiting to help you Monday through Friday from 8:00 am to 5:00 pm EST. They can advise on the products we carry, delivery times, pricing and bid information.

- (800) 334-6656 (toll free)
- (919) 556-1890 (local)

Fax



Our fax machine operates 24 hours a day. Simply fill out one of our own purchase orders with our product numbers from the catalog or list the products you need on your letterhead or stationery and fax it to us along with your contact information. If you need further assistance, just indicate that on your order. Our customer service personnel will confirm your order via return fax or phone call the next business day.

- (888) 556-1048 (toll free FAX)
- (919) 556-1048 (local FAX)

Email



We also accept orders sent via e-mail to customerservice@seequip.com or sent directly to our customer service or outside sales staff. Please visit www.seequip.com for a staff listing. Our staff will confirm your order via return e-mail or by phone the next business day. Please be sure to include your name, organization (if applicable) and a telephone number.

Operative IQ Inventory and Fleet Management

For information on placing your orders via this popular web-based system, please contact your Southeastern District Sales Manager or call customer service at (800) 334-6656. More than 30,000 Fire and EMS professionals use Operative IQ.

Go to www.OperativeIQ.com to learn about



- Inventory Management
- Asset Management
- Purchasing Software
- Fleet Maintenance

TERMS

Net 30 days, F.O.B. Youngsville, North Carolina for established accounts. Delinquent accounts will be assessed a finance charge equal to 1.5% per month (18% annum). Accounts past due 45 days are subject to revert to C.O.D. status.

PRICING

Due to manufacturer cost fluctuations, **all prices are subject to change without notice.** We will make every attempt to notify you prior to shipment of any price changes so that you can make a determination.

We are required to collect sales tax on shipments to Alabama, Arkansas, Connecticut, Florida, Georgia, Louisiana, Maryland, New Jersey, North Carolina, Ohio, Pennsylvania, South Carolina, Tennessee, Texas and Virginia. Please add applicable state and local sales tax for your location. Exempt organizations must have a signed exemption or resale certificate on file with us; otherwise we are required to collect sales tax.

CREDIT POLICY

All volunteer EMS/Fire/Rescue squads and government agencies and municipalities may purchase on open account. All others may pay by credit card (MasterCard, VISA or American Express) or apply for open account status by completing a credit application. Individuals may purchase prepaid by credit card, cashier's check or money order.

MINIMUM ORDER

Please, no orders less than \$25.

RESTRICTIONS

Our distribution contracts with manufacturers may restrict the sale of some products in select states, regions or countries.

CLAIMS

Southeastern Emergency Equipment carefully inspects and documents for accuracy and electronically weighs and protectively packages all orders prior to shipping. In the rare event your shipment was damaged in transit or is incorrect (shortages, etc.), this must be reported to our Customer Service Department within 5 business days of receipt of the products. Failure to so report shall be deemed as acceptance of all products.

Special Notes for Commercial Truck Shipments: Please inspect all commercial truck shipments for damage and correct quantity of packages prior to signing the Bill of Lading. Damages or incorrect quantities must be noted on the Bill of Lading/Delivery Receipt for a claim to be filed against the carrier.

WARRANTIES

Southeastern Emergency Equipment is a distributor and not a manufacturer. ALL APPLICABLE WARRANTIES ARE PROVIDED BY THE MANUFACTURER. A copy of the Manufacturer's Warranty will be provided by Southeastern upon request. Our Customer Service Department will be happy to assist you with securing replacement and/or reimbursement under the Manufacturer's guidelines.

LATEX-FREE / ITEM DESCRIPTION DISCLAIMER

In an effort to assist our customers, Southeastern Emergency Equipment has marked many products as "Latex Free." It is our intent to sell non-latex products where indicated; however, we cannot control changes due to manufacturing and may sell a product containing latex even though it is indicated as "Latex Free." Southeastern Emergency Equipment strongly recommends that customers closely and thoroughly inspect all products and product labels for latex information before providing patient care.

Southeastern Emergency Equipment continuously tries to maintain the accuracy of the information provided on our web site and in our printed materials. We, however, rely on the item descriptions received from manufacturers and, therefore, accept no liability for incorrect information or typographical errors. **Prices and products are subject to change without notice.**

INTERNATIONAL ORDERS

All orders with a destination outside the United States are subject to special terms and conditions. Also, some products are not available for sale outside the United States. Please contact our international sales department.

Return Goods Policy

We hope you are always completely satisfied with our purchase from us. If you are not satisfied for any reason, please let us know. In the event it does become necessary to return an item, we ask that you observe the policies below. Please recognize that some items are non-returnable unless they need to be returned due to our error. Non-returnable items include:

- Goods not in original sealed package
- Any sterile product that has been opened
- Special order items
- Items that have been marked or engraved
- Merchandise with invoice date beyond **60 days**
- Goods not in resaleable condition
- Goods without a return goods authorization (RGA) number

Within 5 business days of receiving a product you wish to return, please contact our Customer Service Department by phone at (800) 334-6656 or via email at customerservice@SEEquip.com for an RGA number. Items not returned within 30 days are subject to a 15% restocking fee.

Prior to requesting an RGA number, please be prepared to provide the following information as this will expedite your request.

- Our order number (on the packing slip) or our invoice number
- Product description, model number and serial number (if applicable)
- Reason for returning

Before you send the merchandise back to us, please do the following to enable us to give you prompt and proper credit.

- Write the RGA number provided on a copy of the packing slip or invoice and enclose it in the box.
- Write the RGA number on the outside of the box. Packages may be refused if the RGA number is not visible on the shipping label or outside of the box.
- Send the package, freight prepaid, to us at the address below. We suggest packages returned to us be done via a traceable method (i.e. UPS, FedEx, etc.)

Southeastern Emergency Equipment

5790 Hwy 96 West
Youngsville, NC 27596
(800) 334-6656

Note: If you are returning an item due to our error, we will provide you with a shipping label to return the item to us at our expense.

- Upon receipt of an authorized return, charges to your account will be reversed - minus any restocking fee.

CLAIMS

Southeastern Emergency Equipment carefully inspects and documents for accuracy and electronically weighs and protectively packages all orders prior to shipping. In the rare event your shipment was damaged in transit or is incorrect (shortages, etc.), this must be reported to our Customer Service Department within 5 business days of receipt of the products. Failure to so report shall be deemed as acceptance of all products.

Special Notes for Commercial Truck Shipments: Please inspect all commercial truck shipments for damage and correct quantity of packages prior to signing the Bill of Lading. Damages or incorrect quantities must be noted on the Bill of Lading/Delivery Receipt for a claim to be filled against the carrier.

Download a fillable PDF version of this Credit Application at www.seequip.com/creditapp

CREDIT APPLICATION



Date: _____

Company Information					
Name					
Federal ID#			SS#		
Partnership	<input type="checkbox"/> Individual	<input type="checkbox"/> Corporation	<input type="checkbox"/> LLC	<input type="checkbox"/>	<input type="checkbox"/>
Date Established			In What State		
Type of Business					
Business Phone #			Fax #		
Mailing Address					
Shipping Address					
Name of President and Officers	Name		Title		
Contact person who will deal with Southeastern					

PHONE 800-334-6656

FAX 888-556-1048

PO Box 1097
Youngsville, NC 27596
www.SEEquip.com



Bank Name and Address: _____

Account# _____

Contact person at this bank: _____

Do you require purchase order numbers? _____

Are you tax exempt? _____ Yes _____ No

Sales Tax Exempt Number: _____

(Attach Copy of Sales Tax Exempt Certificate)

Accounts Payable Contact: _____

Please LIST FOUR (4) TRADE REFERENCES (NAME, ADDRESS, PHONE & FAX #)

- 1. _____

- 2. _____

- 3. _____

- 4. _____

PHONE 800-334-6656

FAX 888-556-1048

PO Box 1097
Youngsville, NC 27596
www.SEEquip.com



For the convenience of the undersigned, applicant applies for a monthly charge account with the understanding that all invoices for equipment and service are payable and due within 30 days of date shown on invoice. FINANCE CHARGES will be applied if the new balance is unpaid one month from the due date of the invoice. The FINANCE CHARGES are computed by a periodic contract rate of 1.5% per month, which is an annual percentage rate of 18% applied to the unpaid balance after deducting current payments and/or credits from the previous balance.

In the event that an outstanding balance shall remain unpaid and Southeastern Emergency Equipment shall deem any debts under this agreement unsafe or insecure, the entire outstanding balance shall become immediately due and payable without notice. If the undersigned applicant fails to pay the entire outstanding balance on demand, it is understood and agreed that said applicant shall pay all collection expenses, including reasonable attorney's fees, it being stipulated that 15% of the outstanding balance shall be reasonable attorney's fees and that interest shall continue at the contract rate after default and after judgment.

As used herein, the singular or plural hereunder shall each be deemed to include the other, whenever the context so indicates.

The applicant submits this application as an inducement to Southeastern Emergency Equipment to extend credit hereon and hereby represents that all statements and information herein given are correct and complete. The applicant authorized Southeastern Emergency Equipment to check all of its credit and business associations and adopts as its seal the "SEAL" appearing beside its signature.

BUSINESS NAME: _____

WITNESS:

By: _____

(Corp. Seal) By: _____

Print Name: _____

Print Name: _____

Co-Applicant: _____

(Corp. Seal) By: _____

Print Name: _____

Print Name: _____

PHONE 800-334-6656
 FAX 888-556-1048

PO Box 1097
 Youngsville, NC 27596
 www.SEEquip.com



NORTH CAROLINA

GUARANTY AGREEMENT

FRANKLIN COUNTY

GUARANTY given by the undersigned to SOUTHEASTERN EMERGENCY EQUIPMENT COMPANY, INC. (the "Company") in order to induce it to extend credit to, or otherwise become the creditor of, _____ ("Debtor").

I hereby guarantee to the Company the prompt payment, when due, of every claim of the Company which may hereafter arise in favor of the Company against Debtor. This is a continuing guaranty and shall remain in force until revoked by me by notice in writing to the Company, but such revocation shall be effective only as to claims of the Company which arise out of transactions entered into after its receipt of such notice. This obligation shall cover the renewal of any claims guaranteed by this instrument or extensions of time of payment thereof and shall not be affected by any surrender or release by the Company of any other security held by it for any claim hereby guaranteed. In the event of default of Debtor to make payment on any claims of the Company when due, I agree, without the Company first having to proceed against Debtor, to pay on demand all sums due and to become due to the Company from Debtor and all losses, costs, attorney's fees, or expenses which the Company may suffer by reason of Debtor's default.

In witness whereof I have signed and sealed this Guaranty on this the ____ day of _____, 20__.

WITNESS:

By: _____

Print Name: _____

Co-Applicant: _____

Print Name: _____

(Corp. Seal) By: _____

Print Name: _____

(Corp. Seal) By: _____

Print Name: _____

Email completed application to Rebecca.Holbrook@SEEquip.com or fax it to (888) 556-1048.

PHONE 800-334-6656

FAX 888-556-1048

PO Box 1097
Youngsville, NC 27596
www.SEEquip.com



- Download FREE Layar App (from your App Store)
- Scan this page
- View custom product info

Bring these catalog pages to life

View additional information about these products by using your mobile device to scan pages that display the AR graphic (left). Download the free "Layar" app from your device's App store.



**HeartStart FR3
Defibrillator**
Page 4



**MRx Defibrillator/
Monitor for EMS**
Page 30



**King Vision Portable
Video Laryngoscope**
Page 135



**Rescuer Disposable
CPAP System**
Page 146



**Patriot Manual
Resuscitator/BVM**
Page 147



**Pedi-Sleeve Pediatric
Dosing System**
Page 241



**Ambulance Child
Restraint (ACR)**
Page 282



**Tactical
Body Armor**
Page 398



**SMART Incident
Command System**
Page 410



Southeastern EMERGENCY EQUIPMENT

Led by...dedicated to...we are EMS and Fire.

Trusted ■ Respected ■ Accountable ■ Committed ■ Knowledgeable

Southeastern Emergency Equipment is a full-line specialty distributor providing equipment, supplies, pharmaceuticals and training/education solutions to the EMS and Fire communities. We were founded more than three decades ago to serve the professional people who serve their communities.

We are led by and dedicated to EMS and Fire, as a large percentage of our management, sales and customer service teams are current or former EMS and Fire professionals.

And while we are changing and expanding to serve our customers even better, our "DNA" will never change. A friendly, knowledgeable EMS professional will be on-hand to assist you when needed.



© **Southeastern Emergency Equipment**
5760 Hwy 96W, PO Box 1097 ■ Youngsville, NC 27596
(800) 334-6656 ■ www.SEEquip.com ■ info@SEEquip.com