

Tire Lubricants & Sealants

Markers

Tire Branding Inserts

Bead Breakers

Hydraulic Pumps & Rams

OTR Service Tools

Cribbing Sets & Wheel Chocks

Bead Seating Devices

Chloride Pumps

Mount/Demount Tools

Hammers & Wedges

Wrenches & Lug Wrenches

Shop Service Tools

Tire Inflation Systems

Safety Inflation Cages

# TIRE & WHEEL SERVICE

# Tire Lubricants & Sealants

## ASCOT TIRE AND TUBE MOUNTING COMPOUND

- Versatile formula-dilutes to any strength your job requires • Approved by major tire companies world-wide
- Made from natural, renewable resources • Totally safe for all tires • Economical when diluted
- Ultra-thick concentrate for excellent performance when packing beads



432-02029

## ASCOT BLACK TIRE LUBRICANT

- Stops the bonding or "freezing" of tire beads to tire rims which allows for easy, damage free removal of tires • Will not swell or affect rubber, especially inner tubes



432-02786

ASCOT NO.	MFG. NO.	DESCRIPTION
432-02012	2012	Tire/Tube Mounting Compound, 125 lb. Drum
432-02014	2014	Tire/Tube Mounting Compound, 445 lb. Drum
432-02028	2028	Tire/Tube Mounting Compound, 8 lb. Pail (4 per Case)
432-02029	2029	Tire/Tube Mounting Compound, 25 lb. Pail
432-02035	2035	Tire/Tube Mounting Compound, 40 lb. Pail

ASCOT NO.	MFG. NO.	DESCRIPTION
435-02785	2785	Ascot Black Tire Lubricant, 8 lb. Pail (4 per Case)
435-02786	2786	Ascot Black Tire Lubricant, 25 lb. Pail

## BLACK RIM RUST RETARDANT & TIRE LUBE

- Makes tire mounting and dismounting faster and easier • Now with rust inhibitor • Approved by major rubber companies
- Lubricates all rubber parts, stops rubber squeaks



435-08001

435-06002

ASCOT NO.	MFG. NO.	DESCRIPTION
435-06001	065-2539	Black Rim Rust Retardant Tire Lube, 6 - 5 lb.
435-06008	048-2539	Black Rim Rust Retardant Tire Lube, 4 - 8 lb.
435-06002	025-2539	Black Rim Rust Retardant Tire Lube, 25 lb.
435-06003	040-2539	Black Rim Rust Retardant Tire Lube, 40 lb.
435-06004	120-2539	Black Rim Rust Retardant Tire Lube, 120 lb.
435-07001	041-2541	Tire Mounting & Rubber Lubricant, 4 Gal.
435-07002	005-2541	Tire Mounting & Rubber Lubricant, 5 Gal.
435-08001	025-2540	Tire Mounting & Rubber Lubricant Paste, 25 lb.
435-08002	048-2540	Tire Mounting & Rubber Lubricant Paste, 8 lb.
435-08003	040-2540	Tire Mounting & Rubber Lubricant Paste, 40 lb.

## MISCELLANEOUS TIRE SWABS AND BRUSHES



437-00001

437-00002

437-00003

437-40006

437-13014

ASCOT NO.	MFG. NO.	DESCRIPTION
437-00001	TS-1	Tire Swab - 11" OAL X 2" Diameter
437-00002	TS-2	Tire Swab - 15" OAL X 2" Diameter
437-00003	TS-3	Tire Swab - 18" OAL X 3" Diameter
437-40006	40006	Tire Lubricating Brush
437-13014	313014	Hunter-Style Tire Lubricating Brush



### MURPHY'S CONCENTRATED TIRE & TUBE MOUNTING COMPOUND

• Versatile formula-dilutes to any strength your job requires • Approved by major tire companies world-wide • Made from natural, renewable resources • Totally safe for all tires • Economical when diluted • Ultra-thick concentrate for excellent performance when packing beads



432-02005

ASCOT NO.	MFG. NO.	DESCRIPTION
432-02000	2000	Murphy's Concentrated Tire & Tube Mounting Compound, 8 lb. Pail (4 per Case)
432-02005	2005	Murphy's Concentrated Tire & Tube Mounting Compound, 25 lb. Pail
432-02008	2008	Murphy's Concentrated Tire & Tube Mounting Compound, 40 lb. Pail
432-02014	2014	Murphy's Concentrated Tire & Tube Mounting Compound, 445 lb. Drum

### MURPHY'S WHITE TIRE MOUNTING PASTE

• Designed for alloy wheels, low profile and run flat tires • Extra Slippery to help mount tires with stiff beads • No water, no mixing. Use right from the container • Contains rust inhibitor to help fight rim rust



432-02146

ASCOT NO.	MFG. NO.	DESCRIPTION
432-02146	2146	8 lb. Pail
432-02167	2167	8 lb. Pail (Low Profile)

### MURPHY'S NON-RUST RIM-KOTE

• Acts as tire mounting lubricant - prevents tire bead "freezing" • Contains no petroleum - prevents rim rust and scale • Great for seating tubeless bias, belted and radial tires • APPLICATIONS: Recommended for mounting tires on heavy duty trucks, buses and off-the-road vehicles



434-02110

ASCOT NO.	MFG. NO.	DESCRIPTION
434-02110	2110	Non-Rust Rim-Kote, 30 lb. Pail
434-02120	2120	Non-Rust Rim-Kote, 40 lb. Pail

### NO RIM RUST

• Protects tires. Tire bead won't fuse to rim • Helps prevent corrosion on rims and rigs • Helps you comply with OSHA Regulation 3086



435-00125



ASCOT NO.	MFG. NO.	DESCRIPTION
435-00015	FL4-1	No Rim Rust, 4-1/2 lb. Pail
435-00125	FL25-1	No Rim Rust, 25 lb. Pail
435-01120	FL120-1	No Rim Rust, 120 lb. Drum

TIRE & WHEEL SERVICE





## Tire Lubricants & Sealants (cont.)



### MURPHY'S LIQUID LUBRICANT

- Designed to assist in mounting rubber tires and tubes on all types of wheels • Ready to use liquid for easy application • Easy clean up and non-toxic
- Contains rust inhibitor to help fight rust



433-02020

ASCOT NO.	MFG. NO.	DESCRIPTION
433-02020	2020	Murphy's Liquid Lubricant, 1 Gallon (4 per Case)
433-02023	2023	Murphy's Liquid Lubricant, 5 Gallons
433-02022	2022	Murphy's Liquid Lubricant, 55 Gallons

### MURPHY'S CONCENTRATED EXTRA SLIPPERY LIQUID LUBRICANT

- Contains improved super lubricity polymers • Rust inhibitor added to help fight rim rust • ECONOMICAL: Dilutes 2 to 1
- Formulated for super-fast mount of passenger tires



433-01950

ASCOT NO.	MFG. NO.	DESCRIPTION
433-01950	1950	Murphy's Concentrated Extra Slippery Liquid Lubricant, 1 Gallon (4 per Case)
433-01957	1957	Murphy's Concentrated Extra Slippery Liquid Lubricant, 5 Gallons
433-01958	1958	Murphy's Concentrated Extra Slippery Liquid Lubricant, 55 Gallons

### UNIVERSAL MOUNTING PASTE

- Makes mounting and demounting tires easier and faster and helps alleviate stress on and damage to the bead area of tires
- Tire mounting paste applies with a sponge and will not corrode or discolor aluminum or alloy wheels, won't freeze or harden
- Rubber Lubricant is a liquid concentrate that makes one gallon of rust-inhibiting water-based mounting lubricant



432-00751



437-00730

432-00740

432-00750

432-01750

ASCOT NO.	MFG. NO.	DESCRIPTION	QTY./BOX
432-00730	73	Mounting Paste Brush for Car/Light Truck	1
432-00731	73T	Mounting Paste Brush for Trucks	1
432-00740	74	Universal Mounting Paste, 22 lb.	1
432-00750	75	High Profile Universal Mounting Paste, 7.7 lb.	1
432-01750	75N	Low Profile Universal Mounting Paste, 7.7 lb.	1
432-00751	75B	Bracket For Mounting Paste	1
437-00001	TS-1	Swab - 11" OAL x 2" Diameter	1
437-00002	TS-2	Swab - 15" OAL x 2" Diameter	1
437-00003	TS-3	Swab - 18" OAL x 3" Diameter	2

### OTR MOUNTING/PACKING COMPOUND

- Extra thick for Superior Bead Packing on OTR tires • Makes OTR Tire Mounting Faster and Easier • Will not separate or liquefy



432-12490

ASCOT NO.	MFG. NO.	DESCRIPTION
432-12490	2490	OTR Mounting/Packing Compound, 25 lb.
432-12492	2492	OTR Mounting/Packing Compound, 40 lb.





### TIRE MOUNTING COMPOUNDS

- Excellent Lubrication • Will not separate or liquefy • Superior for tire bead packing
- Concentrated; water soluble, can be diluted



432-12180

432-12280

ASCOT NO.	MFG. NO.	DESCRIPTION
432-12178	2178	Tire Mounting Compound (Honey Color), 8 lb. (4 per Case)
432-12180	2180X	Tire Mounting Compound (Honey Color), 25 lb.
432-12183	2183	Tire Mounting Compound (Honey Color), 40 lb.
432-12012	2012	Tire Mounting Compound (Honey Color), 125 lb.
432-12014	2014	Tire Mounting Compound (Honey Color), 55 Gal.
432-12278	2278	Tire Mounting Compound (Brown Color), 8 lb. (4 per Case)
432-12280	2280	Tire Mounting Compound (Brown Color), 25 lb.
432-12282	2282	Tire Mounting Compound (Brown Color), 40 lb.
432-12214	2214	Tire Mounting Compound (Brown Color), 55 Gal.

### BEAD BUTTER BLUE TIRE MOUNTING LIQUID LUBE

- Excellent Lubrication • No Residue • Concentrated; water soluble, can be diluted



433-02054

433-02053

ASCOT NO.	MFG. NO.	DESCRIPTION
433-02053	2053B	Bead Butter Blue Tire Mounting Liquid Lube, 1 Gal. (4 per Case)
433-02054	2054B	Bead Butter Blue Tire Mounting Liquid Lube, 5 Gal.
433-02055	2055B	Bead Butter Blue Tire Mounting Liquid Lube, 55 Gal.

### LIQUID LUBE BLUE TIRE MOUNTING LIQUID

- Excellent Lubrication • Superior "Tack" and Bead Sealing qualities • Reduces tire/rim slippage • Concentrated; water soluble, can be diluted • Near neutral pH factor



433-81505

433-81511

433-81515

ASCOT NO.	MFG. NO.	DESCRIPTION
433-81505	81505	Liquid Lube Blue Tire Mounting Liquid, 2 Gal. (5 Gal. Mixing Pail)
433-81511	81511	Liquid Lube Blue Tire Mounting Liquid, 1 Gal. (4 per Case)
433-81515	81515	Liquid Lube Blue Tire Mounting Liquid, 5 Gal.
433-81555	81555	Liquid Lube Blue Tire Mounting Liquid, 55 Gal.

### BLACK-ICE STOP RUST RIM RELEASE

- Lubricates rim and tire for easy mounting & demounting • Protects against rust & corrosion • Prevents rim and bead from bonding



435-02480

ASCOT NO.	MFG. NO.	DESCRIPTION
435-02480	2480	Black-Ice Stop Rust Rim Release, 25 lb. Pail

TIRE & WHEEL SERVICE

## Tire Lubricants & Sealants (cont.)

### SURE SHOT PRESSURE SPRAYERS

- Air pressurized and refillable
- Environmentally safe, eliminates aerosol usage
- For brake and parts cleaner, penetrating oils, lubricants, degreasers, solvents
- MADE IN USA



632-01002

ASCOT NO.	MFG. NO.	DESCRIPTION
632-00005	K-5	Partial Repair Kit for Model A Sure Shot Sprayers
632-00010	K-10	Complete Repair Kit for Model A Sure Shot Sprayers
632-01002	A1002	Sure Shot Black Enameled Steel Sprayer w/ Adjustable Nozzle
632-10001	A1000R	Sure Shot Enameled Steel Sprayer - Red



### EZ CHECK LEAK DETECTOR

- Finds leaks in all tires
- Environmentally friendly
- Excellent foam formation
- Skin friendly
- Commercial use only



433-25430

433-25431

### ANODIZED ALUMINUM SPRAYER

- Adjustable pistol-grip nozzle
- Features a chemical resistant anodized finish
- Will work with water, solvent & oil-based materials
- Replaces Model "A" plated brass sprayers
- 24 oz. capacity
- MAX PRESSURE: 200 PSI
- MADE IN USA



632-02400

ASCOT NO.	MFG. NO.	DESCRIPTION
632-02400	M2400S	Anodized Aluminum Sprayer

### INDUSTRIAL SPRAY BOTTLE

- Industrial sprayer for use with light oils, solvents, and detergents
- The durable polyethylene bottle is impervious to high and low temperatures
- The trigger mechanism is resistant to damage caused by caustic materials



632-00922

632-00923

ASCOT NO.	MFG. NO.	DESCRIPTION
632-00922	TS-922	16 Oz. Spray Bottle
632-00923	3210B32	32 Oz. Spray Bottle

ASCOT NO.	MFG. NO.	DESCRIPTION
433-25430	2543	Ascot EZ Check Leak Detector, Quart (12 per case)
433-25431	2543-1G	Ascot EZ Check Leak Detector, Gallon (4 per case)





**B'LASTER PENETRANT W/ PROSTRAW**

- #1 selling penetrant
- Breaks free rusted or frozen parts
- Protects against further rust and corrosion
- Use on automotive, industrial, marine, plumbing and other equipment
- New ProStraw™ with Control Flow Technology™
- Quantity: 12 cans per case



408-00116

ASCOT NO.	MFG. NO.	DESCRIPTION
408-00116	16-PB-DS	B'laster Penetrant w/ ProStraw, 11 oz. can (12 per case)

**B'LASTER 26PB PENETRANT**

- #1-selling penetrant • Breaks free rusted or frozen parts • Protects against further rust and corrosion
- Use on automotive, industrial, marine, plumbing & other equipment • QUANTITY: 6 per case



408-00026

ASCOT NO.	MFG. NO.	DESCRIPTION
408-00026	26PB	B'laster 26PB Penetrant, 18 oz. (6 per Case)

**B'LASTER NON-CHLORINATED BRAKE CLEANER**

- Removes brake fluid, oil, grease & contaminants
- Non-chlorinated • Fast, evaporating formula
- Stops brake squeal • QUANTITY: 6 per case



417-00020

ASCOT NO.	MFG. NO.	DESCRIPTION
417-00020	20BC	B'laster Non-Chlorinated Brake Cleaner, 14 oz. (6 per Case)



**LIQUITUBE**

- Effective for tire life. Seals ALL sources of air-loss • Helps balance truck tires
- Helps maintain proper air pressure
- Keeps tires cooler for increased tread wear
- Does NOT rust or corrode wheels • Water soluble for easy clean out for recapping tire casings



451-20516

451-00640

ASCOT NO.	MFG. NO.	DESCRIPTION
451-00640	1220-0640	LiquiTube 5-Gallon Pail
451-20516	1220-516	LiquiTube 5-Gallon Injector Pump

**PENETRANTS/AIR LEAK DETECTOR**

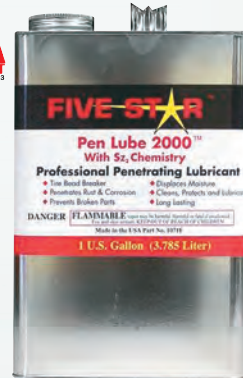

328-05003



433-35805

ASCOT NO.	MFG. NO.	DESCRIPTION
328-05003	001-1071P	Ultra Pen Lube 2000 Penetrant Lubricant, 1 Gal.
328-05005	005-1071P	Ultra Pen Lube 2000 Penetrant Lubricant, 5 Gal.
433-35805	35805	Detecto Mist Air Leak Locator, 1 Qt.

TIRE & WHEEL SERVICE





**STS SEALANTS**  
MORE SEALING. MORE SECURITY

## Tire Lubricants & Sealants (cont.)

### STS TIRE SEALANTS

• Seals 2x more punctures than the competition • Permanently seals punctures up to 1/4" • Prevents wheel corrosion, glycol free • Non-toxic, non-flammable, non-combustible • 100% bio-degradable and water soluble • Lasts for the lifetime of the tire • Wide range of applications • Low freeze point, freeze/thaw stable

STS Tire Sealants



ASCOT NO. MFG. NO. DESCRIPTION

#### STS TIRE SEALANT

451-04128	STSCS4128	4 (1) Gallon Per Case
451-00640	STS640	5-Gallon Pail
451-00006	STS6G	6-Gallon Pail
451-00055	STS55G	55-Gallon Drum
451-00275	STS275T	275-Gallon Tote

#### STS CONCENTRATE TIRE SEALANT

451-14128	STSCONCS4128	4 (1) Gallon Per Case
451-01640	STSCON640	5-Gallon Pail
451-00026	STSCON6G	6-Gallon Pail

#### STS OTR TIRE SEALANT

451-24128	STSOTRCS4128	4 (1) Gallon Per Case
451-02640	STSOTR640	5-Gallon Pail
451-00036	STSOTR6G	6-Gallon Pail
451-00255	STSOTR55G	55-Gallon Drum

### STS TOOLS AND ACCESSORIES

ASCOT NO. MFG. NO. DESCRIPTION

451-00101	ST-XM-1	1 Gal. Hand Pump
451-00440	ST-XM-44	5 Gal. Hand Pump
451-00551	STXM55	55 Gal. Transfer Pump
451-00707	ST-TTS-WW	STS Display Stand
469-02311	VCR-A	Auto Valve Core Tool
469-02312	VCR-F	Farm Valve Core Tool

### ECO SEAL

• 7x corrosion resistance • Maintains non-acidic pH levels, even in high temperatures • Permanently seals punctures up to 1/4" • Glycol-free; prevents wheel corrosion • Environmentally friendly formula, uses recycled rubber and 100% biodegradable ingredients • Non-toxic, non-flammable, non-combustible • Low freeze point (-10°F)

ASCOT NO. MFG. NO. DESCRIPTION

451-05510	ST-XM55	5 Gal. EcoSeal Hand Pump
504-00005	ECO5G	5 Gal. Pail
504-00055	ECO55G	55 Gal. Drum
504-00275	ECO275G	275 Gal. Tote
504-02424	ECOCS2424	24 oz. Bags
504-01832	ECOCS1832	32 oz. Bags
504-01248	ECOCS1248	48 oz. Bags



# Markers

## PAINTSTIK® MARKERS

- Real paint in stick form • Ideal for coding tire casings • Marks are long lasting, water resistant and weather resistant • Marks will withstand vulcanizing and recap temperatures • Non-toxic, contains no lead • Marking range -50°F to 150°F (-46°C to 66°C) • INCLUDES: 12 sticks per box, 12 boxes per case



ASCOT NO.	COLOR	ASCOT NO.	COLOR	ASCOT NO.	COLOR
459-80220	White (Markal B)	459-80226	Green	459-80232	Aluminum
459-80221	Yellow (Markal B)	459-80227	Pink	459-80257	White
459-80222	Red	459-80228	Purple	459-80258	Yellow
459-80223	Black	459-80229	Brown	459-80271	Orange
459-80225	Blue	459-80230	Gray		
		459-80231	Gold		

## MARKAL TYRE MARQUE

- Ideal for temporary marking of tires • Marks easily on wet or cold surfaces • Lead-free, zinc-free marks can be painted over • SIZE: 1/2" X 4-5/8" • MARKING RANGE: -20°F to 130°F (-29°C to 24°C) • INCLUDES: 12 sticks per box, 12 boxes per case



ASCOT NO.	MFG. NO.	COLOR
459-54220	51420	White
459-54222	51421	Yellow

The White Markal Crayon in use.

## B® HEX WHITE TIRE PAINTSTIK

- Ideal for temporary marking of tires • Marks easily on wet or cold surfaces • INCLUDES: 12 sticks per box, 12 boxes per case



ASCOT NO.	MFG. NO.	DESCRIPTION
459-80250	80250	B® Hex White Tire Paintstik

## PAINTSTIK® MARKER HOLDER



459-85100

ASCOT NO.	MFG. NO.	DESCRIPTION
459-85100	85100	6" Push-Button Metal Holder for B-Paintstik

## QUIK STIK® MINI

- Fast-drying, vibrant paint marks dry in 5 to 7 minutes • Compact plastic holder with clip cap stores easily in pocket and keeps hands and clothing clean • Marks on virtually any surface; wet, smooth, rough, or hot • Weather- and UV-resistant paint for long-lasting marks • Solid paint marker advances and retracts by turning twist-up knob • Xylene and 2-Butoxyethanol free formula to reduce health risks • MARKING RANGE: 0°F to 392°F (-18°C to 200°C)



ASCOT NO.	MFG. NO.	DESCRIPTION	QTY./BOX
459-61126	61126	Mini Quik Stik® Marker (White)	12
459-61127	61127	Mini Quik Stik® Marker (Yellow)	12
459-61128	61128	Mini Quik Stik® Marker (Red)	12
459-61129	61129	Mini Quik Stik® Marker (Black)	12

## E-Z BREAK® ANTI-SEIZE COMPOUND-COPPER GRADE

- Copper-based anti-seize and lubricating compound • Prevents seizing of aluminum wheels to steel brake drums or rotors • Will not wash off in rain or snow • Other applications include head bolts, exhaust manifolds and muffler connections, brackets and engine bolts • Withstands temperatures to 1800°F (982°C)



ASCOT NO.	MFG. NO.	DESCRIPTION
494-01010	08910	10 Oz. Can With Brush in Cap
494-08907	08907	16 Oz. Can with Brush in Cap
494-08916	08916	14 Oz. Aerosol Can

494-08916

TIRE & WHEEL SERVICE



⚠️ WARNING: For more information go to [www.P65Warnings.ca.gov](http://www.P65Warnings.ca.gov).



# Tire Branding Inserts



1" Letters and Numbers



1/2" Letters and Numbers



1/4" Letters and Numbers

ASCOT NO.	MFG. NO.	DESCRIPTION
<b>1" CHARACTERS - INDIVIDUAL</b>		
452-00100	BI-CC-1BZ-0	<b>0</b>
452-00101	BI-CC-1BZ-1	<b>1</b>
452-00102	BI-CC-1BZ-2	<b>2</b>
452-00103	BI-CC-1BZ-3	<b>3</b>
452-00104	BI-CC-1BZ-4	<b>4</b>
452-00105	BI-CC-1BZ-5	<b>5</b>
452-00106	BI-CC-1BZ-6	<b>6</b>
452-00107	BI-CC-1BZ-7	<b>7</b>
452-00108	BI-CC-1BZ-8	<b>8</b>
452-00109	BI-CC-1BZ-9	<b>9</b>
452-00201	BI-CC-1BZ-A	<b>A</b>
452-00202	BI-CC-1BZ-B	<b>B</b>
452-00203	BI-CC-1BZ-C	<b>C</b>
452-00204	BI-CC-1BZ-D	<b>D</b>
452-00205	BI-CC-1BZ-E	<b>E</b>
452-00206	BI-CC-1BZ-F	<b>F</b>
452-00207	BI-CC-1BZ-G	<b>G</b>
452-00208	BI-CC-1BZ-H	<b>H</b>
452-00209	BI-CC-1BZ-I	<b>I</b>
452-00210	BI-CC-1BZ-J	<b>J</b>
452-00211	BI-CC-1BZ-K	<b>K</b>
452-00212	BI-CC-1BZ-L	<b>L</b>
452-00213	BI-CC-1BZ-M	<b>M</b>
452-00214	BI-CC-1BZ-N	<b>N</b>
452-00215	BI-CC-1BZ-O	<b>O</b>
452-00216	BI-CC-1BZ-P	<b>P</b>
452-00217	BI-CC-1BZ-Q	<b>Q</b>
452-00218	BI-CC-1BZ-R	<b>R</b>
452-00219	BI-CC-1BZ-S	<b>S</b>
452-00220	BI-CC-1BZ-T	<b>T</b>
452-00221	BI-CC-1BZ-U	<b>U</b>
452-00222	BI-CC-1BZ-V	<b>V</b>
452-00223	BI-CC-1BZ-W	<b>W</b>
452-00224	BI-CC-1BZ-X	<b>X</b>
452-00225	BI-CC-1BZ-Y	<b>Y</b>
452-00226	BI-CC-1BZ-Z	<b>Z</b>

ASCOT NO.	MFG. NO.	DESCRIPTION
<b>1/2" CHARACTERS - INDIVIDUAL</b>		
452-02100	BI-CC-1/2BR-0	<b>0</b>
452-02101	BI-CC-1/2BR-1	<b>1</b>
452-02102	BI-CC-1/2BR-2	<b>2</b>
452-02103	BI-CC-1/2BR-3	<b>3</b>
452-02104	BI-CC-1/2BR-4	<b>4</b>
452-02105	BI-CC-1/2BR-5	<b>5</b>
452-02106	BI-CC-1/2BR-6	<b>6</b>
452-02107	BI-CC-1/2BR-7	<b>7</b>
452-02108	BI-CC-1/2BR-8	<b>8</b>
452-02109	BI-CC-1/2BR-9	<b>9</b>
452-00501	BI-CC-1/2BR-A	<b>A</b>
452-00502	BI-CC-1/2BR-B	<b>B</b>
452-00503	BI-CC-1/2BR-C	<b>C</b>
452-00504	BI-CC-1/2BR-D	<b>D</b>
452-00505	BI-CC-1/2BR-E	<b>E</b>
452-00506	BI-CC-1/2BR-F	<b>F</b>
452-00507	BI-CC-1/2BR-G	<b>G</b>
452-00508	BI-CC-1/2BR-H	<b>H</b>
452-00509	BI-CC-1/2BR-I	<b>I</b>
452-00510	BI-CC-1/2BR-J	<b>J</b>
452-00511	BI-CC-1/2BR-K	<b>K</b>
452-00512	BI-CC-1/2BR-L	<b>L</b>
452-00513	BI-CC-1/2BR-M	<b>M</b>
452-00514	BI-CC-1/2BR-N	<b>N</b>
452-00515	BI-CC-1/2BR-O	<b>O</b>
452-00516	BI-CC-1/2BR-P	<b>P</b>
452-00517	BI-CC-1/2BR-Q	<b>Q</b>
452-00518	BI-CC-1/2BR-R	<b>R</b>
452-00519	BI-CC-1/2BR-S	<b>S</b>
452-00520	BI-CC-1/2BR-T	<b>T</b>
452-00521	BI-CC-1/2BR-U	<b>U</b>
452-00522	BI-CC-1/2BR-V	<b>V</b>
452-00523	BI-CC-1/2BR-W	<b>W</b>
452-00524	BI-CC-1/2BR-X	<b>X</b>
452-00525	BI-CC-1/2BR-Y	<b>Y</b>
452-00526	BI-CC-1/2BR-Z	<b>Z</b>

ASCOT NO.	MFG. NO.	DESCRIPTION
<b>1/4" CHARACTERS - INDIVIDUAL</b>		
452-01100	BI-CC-1/4BR-0	<b>0</b>
452-01101	BI-CC-1/4BR-1	<b>1</b>
452-01102	BI-CC-1/4BR-2	<b>2</b>
452-01103	BI-CC-1/4BR-3	<b>3</b>
452-01104	BI-CC-1/4BR-4	<b>4</b>
452-01105	BI-CC-1/4BR-5	<b>5</b>
452-01106	BI-CC-1/4BR-6	<b>6</b>
452-01107	BI-CC-1/4BR-7	<b>7</b>
452-01108	BI-CC-1/4BR-8	<b>8</b>
452-01109	BI-CC-1/4BR-9	<b>9</b>
452-00401	BI-CC-1/4BR-A	<b>A</b>
452-00402	BI-CC-1/4BR-B	<b>B</b>
452-00403	BI-CC-1/4BR-C	<b>C</b>
452-00404	BI-CC-1/4BR-D	<b>D</b>
452-00405	BI-CC-1/4BR-E	<b>E</b>
452-00406	BI-CC-1/4BR-F	<b>F</b>
452-00407	BI-CC-1/4BR-G	<b>G</b>
452-00408	BI-CC-1/4BR-H	<b>H</b>
452-00409	BI-CC-1/4BR-I	<b>I</b>
452-00410	BI-CC-1/4BR-J	<b>J</b>
452-00411	BI-CC-1/4BR-K	<b>K</b>
452-00412	BI-CC-1/4BR-L	<b>L</b>
452-00413	BI-CC-1/4BR-M	<b>M</b>
452-00414	BI-CC-1/4BR-N	<b>N</b>
452-00415	BI-CC-1/4BR-O	<b>O</b>
452-00416	BI-CC-1/4BR-P	<b>P</b>
452-00417	BI-CC-1/4BR-Q	<b>Q</b>
452-00418	BI-CC-1/4BR-R	<b>R</b>
452-00419	BI-CC-1/4BR-S	<b>S</b>
452-00420	BI-CC-1/4BR-T	<b>T</b>
452-00421	BI-CC-1/4BR-U	<b>U</b>
452-00422	BI-CC-1/4BR-V	<b>V</b>
452-00423	BI-CC-1/4BR-W	<b>W</b>
452-00424	BI-CC-1/4BR-X	<b>X</b>
452-00425	BI-CC-1/4BR-Y	<b>Y</b>
452-00426	BI-CC-1/4BR-Z	<b>Z</b>

ASCOT NO.	MFG. NO.	DESCRIPTION
<b>1" CHARACTERS - SETS</b>		
452-00001	TB1NOSET	1" Set - Numbers
452-00011	TB1LETSET	1" Set - Letters

ASCOT NO.	MFG. NO.	DESCRIPTION
<b>1/2" CHARACTERS - SETS</b>		
452-00012	TB1/2NOSET	1/2" Set - Numbers
452-00112	TB1/2LETSET	1/2" Set - Letters

ASCOT NO.	MFG. NO.	DESCRIPTION
<b>1/4" CHARACTERS - SETS</b>		
452-00014	TB1/4NOSET	1/4" Set - Numbers
452-00114	TB1/4LETSET	1/4" Set - Letters





TIRE REGROOVER

Ergonomic handle design makes working with this tool easier and reduces hand-fatigue • An 8-position heat control modulates cutting intensity resulting in fast and accurate regrooving of Truck or Tractor tires • Not intended for Passenger vehicle tires • Blades are not included



455-00003



455-00406



The Rubber Cut 414 in use.

ASCOT NO.	MFG. NO.	DESCRIPTION
455-00003	RC414	Rubber Cut 414 Rema Regroover
455-00129	N/A	Set Screw for PS-15 Regroover
455-00401	W-1	Regroover Blades 20-Pack
455-00402	W-2	Regroover Blades 20-Pack
455-00403	W-3	Regroover Blades 20-Pack
455-00404	W-4	Regroover Blades 20-Pack
455-00405	W-5	Regroover Blades 20-Pack
455-00406	W-6	Regroover Blades 10-Pack
455-00444	No. 4 Head	Replacement Head for 125 Groover
455-04444	No. 4 Bld.	Replacement Blades for 125 Groover
455-12500	125	Heavy Duty Pistol Grip Tire Groover
455-15017	N/A	Transformer for PS-15 Regroover
455-15019	N/A	Rotative Switch for PS-15 Regroover

SERIAL NUMBER REMOVER TOOL

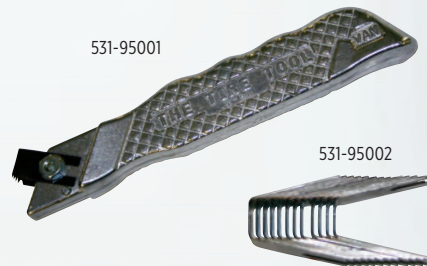

ASCOT NO.	MFG. NO.	DESCRIPTION
531-95001	TTHB-1	Serial Number Remover Tool
531-95002	RRB-1	12-Pack Replacement Blades

TIRE & WHEEL SERVICE

# Bead Breakers

## “COMBI” TIRE BEAD BREAKER

- Works on a single, two and three-piece truck, agricultural and earthmover tire/rim • Breaks beads in seconds using 10,000 lbs. of force • No screws, bolts or attachments • “Combi” bead breaker will not work on five-piece earth mover giant wheel/rim

QUICKLY BREAKS BEADS



ASCOT NO.	MFG. NO.	DESCRIPTION
422-11010	11010	Bead Breaker
422-12000	12000	Bead Breaker Kit. <b>INCLUDES:</b> 11010 Bead Breaker, 15000 Pump and 16040 Hose Assembly
422-12020	12020	Bead Breaker Kit. <b>INCLUDES:</b> 11010 Bead Breaker, 15920 Pump and 16040 Hose Assembly
422-16200	16200	Conversion Kit for Combi Bead Breaker

## MODIFIED “COMBI” TIRE BEAD BREAKER

- Modified 11010, the most popular tool for breaking beads on all agriculture wheels
- Most affordable bead breaker for new 3 piece wheel assemblies • Modified jaw and feet allow for larger grab on larger wheel assemblies
- Can be used on the front and back side of the wheel assembly
- All parts (except for modified feet and jaw) can be interchanged with 11010

MOST POPULAR



ASCOT NO.	MFG. NO.	DESCRIPTION
422-11020	11020	Modified “Combi” Tire Bead Breaker

## GIANT TIRE/EARTHMOVER TIRE BEAD BREAKER

- Use on 5-piece rims 15” to 51” without pry bar/ bead loosening pockets • Model 15000, 15920 or 15040 air/hydraulic pump recommended for operation • Replaces Goodyear TO-100-HA



ASCOT NO.	MFG. NO.	DESCRIPTION
422-11040	11040	Giant Tire/Earthmover Tire Bead Breaker

## GIANT TIRE/EARTHMOVER TIRE BEAD BREAKER

- 4-1/4” stroke, 14-ton ram will break the toughest beads • Use on 5-piece rim 25” to 51” with pry bar/bead loosening pocket • Replaces Goodyear TO-1600-HA • Same as IMT-1800 • Model 15000, 15020 or 15040 air/hydraulic pump recommended

BREAKS TOUGHEST BEADS



The Giant Tire/Earthmover Tire Bead Breaker in use.



ASCOT NO.	MFG. NO.	DESCRIPTION
422-11000	11000	Bead Breaker
422-12070	12070	Bead Breaker Kit. <b>INCLUDES:</b> 11000 Bead Breaker, 15000 Pump, 16040 Hose Assembly
422-12090	12090	Bead Breaker Kit. <b>INCLUDES:</b> 11000 Bead Breaker, 15920 Pump, 16040 Hose Assembly

## TITAN EARTHMOVER BEAD BREAKER

- Ideal for tire dealer who requires occasional use of bead breaker • 10-ton cylinder has enough force to break most beads • 4” (10 cm) stroke length • Unit will work on 5 piece wheels with bead loosening pockets • WEIGHT: 34 lbs. (15.5 kg)



ASCOT NO.	MFG. NO.	DESCRIPTION
422-11005	11005	Titan Earthmover Bead Breaker





### OTR GIANT TIRE BEAD BREAKER

- Compact, lightweight tool used primarily on 25" and 29" earthmover wheels • Originally marketed as Goodyear TO-1600-HA • Works only on 5 piece wheels with bead loosening pockets • 2 1/8" (5.4 cm) stroke • 10 tons of hydraulic force • Used with 10,000 PSI (700 bar) air/hydraulic pump • WEIGHT: 23 lbs. (10 kg)

COMPACT & LIGHTWEIGHT



422-11050

ASCOT NO.	MFG. NO.	DESCRIPTION
422-11050	11050	OTR Giant Tire Bead Breaker

### OTR 3000 GIANT TIRE BEAD BREAKER

- Designed specifically to work on Topy and Rimex OE wheels found on Terex, Komatsu, Liebherr and Le Tourneau • Designed to prevent the tool from kicking out while under load • 6" Stroke ram delivers maximum force • New Universal Jaw design works on ALL wheels 51" – 63" • WEIGHT: 54 lbs. (24.5 kg)



422-11044

MAXIMUM FORCE

ASCOT NO.	MFG. NO.	DESCRIPTION
422-11044	11044	OTR 3000 Giant Tire Bead Breaker

### GIANT TIRE/EARTHMOVER TIRE BEAD BREAKER

- Use on all 39", 45", 49", 51", 57" and 63" wheel sizes • In most cases you must first use Model 10105 or 10100 bead breaker to start the movement of the rim flange. Model 11030 can then be used • Model 15020 or 15040 air/hydraulic pump recommended for operation • Replaces Goodyear TO-2000-HA



422-10103

ASCOT NO.	MFG. NO.	DESCRIPTION
422-10103	11030	Giant Tire Earthmover Bead Breaker
422-12110	12110	Kit Contains 11030 Bead Breaker, 15040 Pump And 16020 Hose Assembly

### DUAL AGRICULTURAL TRACTOR TIRE BEAD BREAKER

- HEAVY DUTY: 10-tons of force breaks the toughest beads • Breaks inside bead on outside dual farm tractor tires • Requires just 3" of operating space between dual tractor tires • Use with 10,000 PSI air/hydraulic pump • No need to remove outside wheel to change tire on outside dual



422-11060

ASCOT NO.	MFG. NO.	DESCRIPTION
422-11060	11060	Dual Agricultural Tractor Tire Bead Breaker

### DUAL AGRICULTURAL 300 TIRE BEAD BREAKER

- Designed for all agricultural applications • Lightweight and easy to handle • Requires only 4 1/2" (11.5 cm) operating space • 5 Tons of pushing force • Opens to 12" (30.5 cm) wide • WEIGHT: 20 lbs. (9kg)



422-11065

ASCOT NO.	MFG. NO.	DESCRIPTION
422-11065	11065	Dual Agricultural 300 Tire Bead Breaker

### TITAN FARM TIRE BEAD BREAKER

- Ideal for tire dealer who requires occasional use of bead breaker • 10-ton cylinder has enough force to break most beads • 4" (10 cm) stroke length • Unit will break all single and 2-piece and most 3-piece wheels • WEIGHT: 34 lbs. (15.5 kg)



FOR OCCASIONAL USE

422-11015

ASCOT NO.	MFG. NO.	DESCRIPTION
422-11015	11015	Titan Farm Tire Bead Breaker

### GIANT TIRE/EARTHMOVER BEAD BREAKER

- Use on 5-piece 25" to 51" with pry bar/bead loosening pockets • Ram will break the toughest of beads • Use with 10,000 PSI Hydraulic Pump



422-10100

ASCOT NO.	MFG. NO.	DESCRIPTION
422-10100	10100	Giant Tire/Earthmover Bead Breaker

TIRE & WHEEL SERVICE



## Bead Breakers (cont.)



## TITAN PRO MODIFIED COMBI BEAD BREAKER

- Compact design allows tool to be used on front or back of wheel
- Ideal to break large OTR 3-piece wheels
- Larger clamp and feet allow tool to easily clamp onto wheels
- Most parts interchange with common bead breakers in the market
- Designed for use on 25" multi-piece wheels
- Tire Sizes: 23.5x25, 26.5x25, 29.5x25
- 11 Ton - 10,000 PSI (700 BAR)



422-11025

ASCOT NO.	MFG. NO.	DESCRIPTION
422-11025	11025	Titan Pro Modified Combi Bead Breaker

## STINGER BEAD BREAKER

- OTR Bead Breaker for heavy duty • 3-piece rims that replace standard 5-piece rims • Works on both front and back of wheel without dismantling wheel from vehicle • Works on all new 3-piece 25" wheels or larger • Works on all wheels with CAT "Shur-Lok" safety feature



318-11090



"SHUR-LOK"  
SAFETY  
FEATURE

ASCOT NO.	MFG. NO.	DESCRIPTION
318-11090	11090	Stinger Bead Breaker

## "COMBI" HYDRAULIC TIRE BEAD BREAKER

- Works on single, two and three-piece truck tires/rims • Breaks beads in seconds using 13.8 tons of force • "Combi" Bead Breaker will not work on five-piece Earthmover giant wheel/rim, Model #10100 or Model #10105 is required



422-10101

ASCOT NO.	MFG. NO.	DESCRIPTION
422-10101	10101	"COMBI" Hydraulic Tire Bead Breaker



## MAXI BEAD BREAKER

- Works on ALL 3-piece wheels with extended flange that have replaced the older 5-piece wheels • Designed to work on front or back of the wheel with no attachments or accessories • Clamps easily to the wheel • Longer feet and claw than the "Combi" Bead Breaker Model #10101
- No setup time



ASCOT NO.	MFG. NO.	DESCRIPTION	422-10102
422-10102	10102	Maxi Bead Breaker	

## COMBI STYLE ALUMINUM BEAD BREAKER

- Lightweight aluminum construction
- 10 tons of bead breaking force • Comparable to the Model #10101 Combi bead breaker • To be used on 3-piece wheel assemblies • Extended jaw for deep dish style wheels (extended flange)



422-40801

ASCOT NO.	MFG. NO.	DESCRIPTION
422-40801	40801	COMBI Style Aluminum Bead Breaker



422-11076

LIGHTWEIGHT  
ALUMINUM

## DIAMONDBACK ALUMINUM BEAD BREAKER KIT

- Lightweight Aluminum reduces weight by 40%
- Longer feet allow better fit onto wheel/rim • Feet fully engage rim flange and push against the bead of the tire • WEIGHT: 31 lb. (14kg)



ASCOT NO.	MFG. NO.	DESCRIPTION
422-11076	11076	Diamondback Aluminum Bead Breaker Kit



### PNEUMATIC BEAD BREAKER

- Recommended for agricultural, small OTR and most truck tires
- EXTREMELY FAST: saves time over conventional hydraulic bead breakers
- LIGHTER WEIGHT THAN CONVENTIONAL BEAD BREAKERS: only 17 lb. • Includes storage case • Requires a minimum of 85 psi



423-00101

ASCOT NO.	MFG. NO.	DESCRIPTION
423-00101	GTABB-01	Pneumatic Bead Breaker

### SLIDE HAMMER BEAD BREAKER

- Protect your expensive wheels from swinging hammers by breaking the bead loose with this slide hammer
- Use only on wheels without a hump



427-12026



ASCOT NO.	MFG. NO.	DESCRIPTION
427-12026	12026B	Slide Hammer Bead Breaker

### WINNTEC WHEEL BREAKER SET

- Provides a safe and easy way to loosen oxidized (stuck) wheels
- Simply place the ram between the duals or between the inside wheel & frame
- The manual pump allows the technician to feel how much pressure is being applied
- Adaptors included for wider work spaces



The Winntec Wheel Breaker Set in use.



423-47180

ASCOT NO.	MFG. NO.	DESCRIPTION
422-47180	G471180	Winntec Wheel Breaker Set

### PLATINUM DEMOUNT TOOL

- Demounts tire sizes 17.5" - 24.5"
- Only a single tool needed to demount tires
- Eliminates the need to lift the tire and wheel making a hard job easy and protecting against insurance claims
- Unique design protects valuable tire casings for retreading
- Handle design protects against damage to the tool and other objects that may come in contact



448-12100



The Platinum Demount Tool in use.

ASCOT NO.	MFG. NO.	DESCRIPTION
448-12100	G12100	Platinum Demount Tool



## Bead Breakers (cont.)

### IMPACT BEAD BREAKER

• Loosens the most stubborn beads with floating bead breaking foot and ram bar • Forces wedge foot between head and rim flange • Delivers blow directly to the tip • Designed for shop or road use



LOOSENS  
STUBBORN  
BEADS

ASCOT NO.	MFG. NO.	DESCRIPTION	LENGTH	LENGTH EXT.	WEIGHT
427-35924	T24B	Economy	46"	72"	13.5 lb.
427-35926	T26B	Heavy Duty	50"	80"	23 lb.
427-45926	35926-11	Impact Bead Breaker Replacement Grips			

### FLOOR TYPE BEAD BREAKER

• Use on custom wheels, without center holes, wide based motorcycle tires, ATV tires • Used to prevent bending of wheels



PREVENTS  
BENDING OF  
WHEELS

ASCOT NO.	MFG. NO.	DESCRIPTION	TREAD WIDTH	WEIGHT
421-00098	T98	Deluxe	Up to 11"	28.5 lb.

### PORTABLE BEAD BREAKER

• Breaks beads on most sizes of passenger tires & light trucks



ASCOT NO.	MFG. NO.	DESCRIPTION	HANDLE LENGTH	WEIGHT
421-00100	T100	Portable Bead Breaker	36"	5.2 lb.

### DRIVING IRON

• Used for loosening rusted truck and bus beads



LOOSENS  
RUSTED  
BEADS

ASCOT NO.	MFG. NO.	DESCRIPTION	LENGTH	STOCK	WEIGHT
427-26000	T26A	Driving Iron	11-3/4"	1-1/4"	4.4 lb.

### "SWAN NECK" BEAD BREAKING TOOLS

• PORTABLE TOOLS: Great alternative to handled bead breaking wedges or hydraulic bead breakers

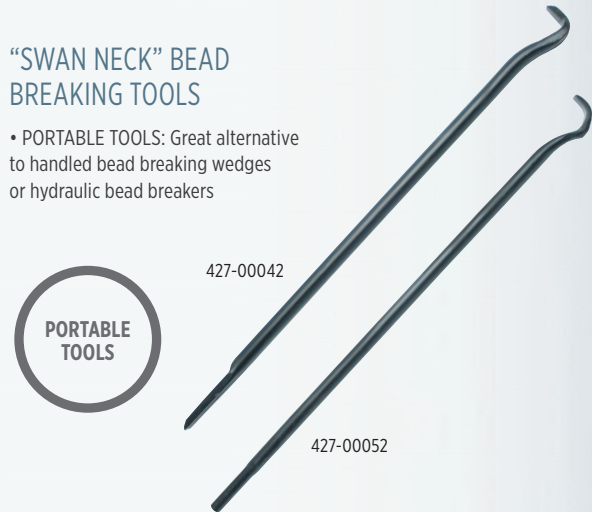

PORTABLE  
TOOLS

ASCOT NO.	MFG. NO.	LENGTH	STOCK	WT.
427-00041	T41	30"	7/8"	5.3 lb.
427-00042	T42	30"	7/8"	4.8 lb.
427-00052	T52	33"	7/8"	5.5 lb.

### ATV BEAD BREAKER

• Constructed of heavy duty steel • Works with any center-post tire changing machine and adjusts to sizes of 6" to 12" ATV rims • No hammers, wrenches or additional tools required



HEAVY DUTY  
STEEL

ASCOT NO.	MFG. NO.	DESCRIPTION	WEIGHT
421-38620	38620	ATV Bead Breaker	7 lb.





### 5-QUART AIR HYDRAULIC PUMP - STEEL RESERVOIR

- Builds 10,000 PSI of pressure • Operates on 80-120 PSI of inlet air pressure • Durable metal air motor assemblies • Designed for conditions associated with OTR sites • WEIGHT: 30 lbs (13.6 kg)



318-15025

ASCOT NO.	MFG. NO.	DESCRIPTION
318-15025	15025	5-Quart Air/Hydraulic Pump with Steel Reservoir

### TURBO II AIR HYDRAULIC PUMP (3.5-QUART OIL CAPACITY)

- Rugged polyglass reservoir with sight gauge • 10,000 PSI hydraulic pressure • Easily works on rams and bead breakers with oil to spare • Unique design easily fits truck storage bins • Turbo II pump-fastest pump available • Redesigned air motor is inexpensive to service • User-friendly foot-actuated design for easy control of moving fluid



318-15000

ASCOT NO.	MFG. NO.	DESCRIPTION
318-15000	15000	3.5-Quart Air Hydraulic Pump
318-15010	15010	Above Pump With Hydraulic Hose
318-15020	15020	5-Quart Air Hydraulic Pump

### AIR HYDRAULIC PUMP (5-QUART OIL CAPACITY)

- Rugged 5-quart metal reservoir • Air inlet filter keeps air clean • All-metal air motor • 10,000 PSI hydraulic pressure



318-15920

ASCOT NO.	MFG. NO.	DESCRIPTION
318-15920	15920	5-Quart Air Hydraulic Pump
318-15930	15930C	Air Hydraulic Pump w/Hose & Coupler

### MILLER MUD FLAP

- Fits AME 15920 and IMT style pumps • Prevents dirt from getting into the release valve assembly • Inexpensive solution to lengthen the life of your pumps

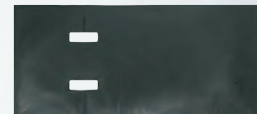

318-15901

ASCOT NO.	MFG. NO.	DESCRIPTION
318-15901	15901	Miller Mud Flap

### AIR HYDRAULIC PUMP (2-GALLON OIL CAPACITY)

- Rugged 2-gallon metal reservoir • Air inlet filter keeps air clean • All metal air motor • 10,000 PSI hydraulic pressure



318-15940

ASCOT NO.	MFG. NO.	DESCRIPTION
318-15940	15940	2-Gallon Air Hydraulic Pump
318-15950	15950C	2-Gallon Air Hydraulic Pump w/Hose & Coupler

TIRE & WHEEL SERVICE

# Hydraulic Pumps, Rams



## 1/2-GALLON AIR/HYDRAULIC PUMP - ALUMINUM RESERVOIR

- For use with a variety of hydraulic rams, cylinders, presses, bead breakers, and other hydraulic equipment requiring 10,000 psi for operation
- Equipped with an air exhaust muffler for quiet pumping of air motor
- Air and oil inlet filters for reducing risk of damage from contamination
- Durable, lightweight design great for service trucks, shop environments or out in the field
- Internal pressure relief valve system (load limit device) for overload protection
- Engineered with durable lightweight and corrosive resistant plastic components, increasing the life of the air motor and hydraulic pump

Kit with Hose, Coupler & Reducer



318-10518

## 2½-QUART TITAN AIR/HYDRAULIC PUMPS - ALUMINUM RESERVOIRS

- Operates with as little as 80 PSI (5.5 bar)
- Heavy duty aluminum reservoir • Durable metal air motor • WEIGHT: 14 lb. (6.4 kg)



318-15905



318-15906



318-15907

ASCOT NO.	MFG. NO.	DESCRIPTION
318-10518	10518	1/2-Gallon Air/Hydraulic Pump
318-11518	10518C	1/2-Gallon Air/Hydraulic Pump Kit. <b>INCLUDES</b> Hose, Coupler & Reducer

## SINGLE ACTING ALUMINUM LOCK NUT CYLINDER

- Safety lock nut for mechanical load holding
- Low weight and good portability • High flow quick coupler • Overflow port functions as a stroke limiter • Spring return • Features a carrying handle



318-10808

ASCOT NO.	MFG. NO.	CAPACITY (TONS)	COLLAPSED HEIGHT	EXTENDED HEIGHT	WEIGHT (LBS.)
318-10808	10808	50	12-1/2"	18-3/4"	26.4
318-10809	10809	100	13-1/3"	19-3/4"	66

ASCOT NO.	MFG. NO.	DESCRIPTION
318-15905	15905	2-1/2-Quart Titan Air/Hydraulic Pump, 10,000 PSI
318-15906	15906	2-1/2-Quart Titan Air/Hydraulic Pump, 5,500 PSI
318-15907	15907	2-1/2-Quart Titan Air/Hydraulic Pump, 3,900 PSI





### 100-TON ALUMINUM RAMS

- Lightweight yet durable
- The preferred jack for road service
- Includes "Shut-Off Valve" to allow the pump to be removed while ram is extended



ALUMINUM LOCK NUT FOR EXTENDED LOADS

ASCOT NO.	MFG. NO.	CAP. (TONS)	STROKE	MIN. HEIGHT	MAX. HEIGHT	WEIGHT (LBS.)
318-13000	13000	100	6"	12"	18"	53
318-13164	13164	100	6"	15.59"	21.5"	59

### 55-TON ALUMINUM RAMS

- Lightweight aluminum for easy handling and placement under the vehicle
- Includes "Shut-Off Valve" which allows the pump to be removed while the ram is extended



ASCOT NO.	MFG. NO.	CAP. (TONS)	STROKE	MIN. HEIGHT	MAX. HEIGHT	WEIGHT (LBS.)
318-13120	13120	55	6"	12.25"	18.25"	29
318-13165	13165	55	6"	15.59"	21.5"	33



### 55-TON HYDRAULIC JACKS - ALUMINUM

- Lightweight Aluminum constructed Hydraulic Cylinder
- For use with 10,000 psi pumps
- Ships completely assembled with valve, coupler, and 8" x 8" base
- Ideal for OTR, mining, agricultural and construction applications
- Robust 11/16" cylinder wall for heavy-duty use



ASCOT NO.	MFG. NO.	CAP. (TONS)	STROKE	MIN. HEIGHT	MAX. HEIGHT	WEIGHT (LBS.)
318-10312	10312	55	6"	12"	18"	33
318-10314	10314	55	6"	16"	26"	41

### 100-TON HD LIGHTWEIGHT HYDRAULIC JACK

- Lightweight yet durable
- For use with 10,000 PSI pumps
- Ships completely assembled with valve and coupler

PERFECT FOR OFF-HIGHWAY WORK



ASCOT NO.	MFG. NO.	CAP. (TONS)	STROKE	MIN. HEIGHT	MAX. HEIGHT	WEIGHT (LBS.)
318-10300	10300	100	6"	11.75"	17.75"	55

TIRE & WHEEL SERVICE





## Hydraulic Pumps, Rams (cont.)

### HYDRAULIC RAMS

• Used to push off rear rim flange and tire bead on earthmover wheels • For all earthmover tires, trucks and perfect for construction

ASCOT NO.	MFG. NO.	CAP. (TONS)	COLLAPSED HEIGHT	STROKE
422-13010	13010	10	4-3/4"	2-1/8"
422-13020	13020	10	6-3/4"	4"
422-13030	13030	10	9-3/4"	6-1/8"
422-13040	13040	10	11-3/4"	8"
422-13050	13050	10	13-3/4"	10-1/8"
422-13060	13060	30	4-5/8"	2-7/16"
422-13090	13090	25	12-3/4"	8-1/4"
422-13100	13100	25	10"	6-1/4"



TIRE & WHEEL SERVICE

### STEEL-A-STACK HYDRAULIC RAM KIT

• Versatile ram kit allows you to select your ram length from 3.5" (9 cm) up to 11.5" (29.21 cm) • Extensions can be used individually or together • Steel Extensions are durable enough for OTR applications • Extensions include 1" (2.5 cm), 2" (5 cm), and 3" (7.5 cm) options • 3" Extension includes a screw in saddle that extends another 2" • Ships in HD carrying case • 10 Ton 1.5" (3.8 cm) stroke



ASCOT NO.	MFG. NO.	DESCRIPTION
422-13075	13075	Steel-A-Stack Hydraulic Ram Kit





### HYDRAULIC COUPLERS

• High-flow hydraulic coupler, 10,000 PSI working pressure

ASCOT NO.	MFG. NO.	DESCRIPTION
135-10605	PVV-38-M	3/8" Male Hose Half Coupler - For Hydraulic Rams
135-10606	PVV-38-F	3/8" Female Ram Half Coupler - For Hydraulic Rams



### HYDRAULIC QUICK CONNECT COUPLER/PLUG

• 10,000 PSI maximum operating pressure • Safety sleeve lock prevents accidental disconnection  
 • Heavy duty back-up ring prevents o-ring extrusion • Heat treated and plated steel for greater wear and corrosion resistance • Self-sealing poppet valves provide excellent high and low pressure seating

ASCOT NO.	MFG. NO.	DESCRIPTION
135-11606	FD35-1001-0606	Hydraulic Quick Connect Coupler
135-12606	FD35-1002-0606	Hydraulic Quick Connect Plug



### RUBBER DUST COVER FOR HYDRAULIC COUPLERS

• Used to keep dirt and debris from your hydraulic coupler when not connected • Equipped with a pre-slit ring to allow coupler to slide easily over the counter • Comes standard with 8' and 10' hydraulic hoses

ASCOT NO.	MFG. NO.	DESCRIPTION
319-03732	03-RDC	Rubber Dust Cover for Hydraulic Couplers



### 3/8" HYDRAULIC HOSES

• 10,000 PSI Working Pressure, 20,000 PSI Burst Pressure • High flow valve for fast inflation • Includes half coupler and plastic dust cover

ASCOT NO.	MFG. NO.	DESCRIPTION
318-04960	9010-08	8' Hydraulic Hose Assembly
318-04120	9010-10	10' Hydraulic Hose Assembly



### QUICK COUPLERS

• Precision built and designed for high pressure • Permits disconnecting without loss of oil • 3/8" NPTF

ASCOT NO.	MFG. NO.	DESCRIPTION
318-09795	9795	Complete Quick Coupler
318-09796	9796	Ram Half Coupler And Dust Cap
318-09798	9798	Hose Half Coupler Only
318-09799	9799	Hose Half Coupler Dust Cap Only

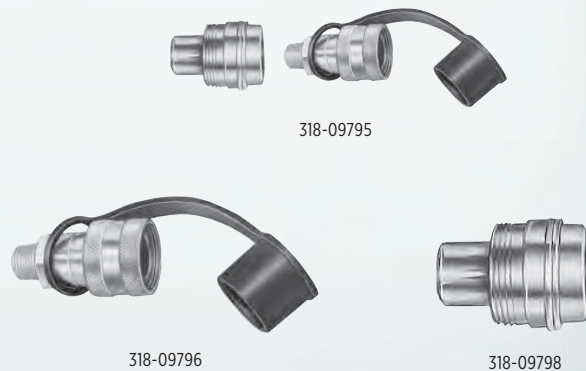

TIRE & WHEEL SERVICE



⚠️ **WARNING:** For more information go to [www.P65Warnings.ca.gov](http://www.P65Warnings.ca.gov).





## OTR Service Tools

### FLANGE RING PULLER

- Lifts the rim base and bead seat band from the tire
- Aids in bead seating during inflation
- Attaches to a standard boom style service truck
- 4-point hook/chain assembly for optimal lifting
- Chain lengths of 30" (76.2 cm)
- Includes 2 flat hooks and 2 tapered hooks to allow use on all rim styles
- WEIGHT: 32 lb.

AIDS IN  
BEAD  
SEATING



402-08029

ASCOT NO.	MFG. NO.	CAPACITY
402-08029	93000	5,000 lb.

### 2-WAY PUSH BAR

- Two-way push bar allows for quick and easy depression of the bead seat band flange ring and rim for removal of the lock ring and O-ring
- Can also be used to retain the tire during inflation

QUICK AND  
EASY



429-08837



The 2-Way Push Bar in use.

ASCOT NO.	MFG. NO.	CAPACITY
429-06661	92005	33" to 57"
429-08837	92000	25" to 51"

### BEAD PUSH OFF TOOL

- Lightweight tool for removing combine and tractor tires after breaking the bead
- Pushing force of 8,000 lbs. and a 5.5" stroke, a removable handle for compact storage and uses hydraulic pressure to force the tire off the rim
- Hooks between the rim and the tire bead



429-10108



The Bead Push Off Tool in use.

ASCOT NO.	MFG. NO.	DESCRIPTION
429-10108	11080	Bead Push Off Tool

### BEAD HOOKS



429-00441

429-01601

ASCOT NO.	MFG. NO.	DESCRIPTION	CAPACITY
429-00441	B0441PC	Bead Hook	12,000 lb.
429-01601	D1601PC	Bead Hook	16,000 lb.



### EARTHMOVER TIRE BEAD HOOKS

• Used to connect with hydraulic boom on tire service truck for transport of tires • Model 94000 has slim design which will fit inside all tires, even ones that have been stacked



429-90401



429-90402



429-90403

CONNECT WITH HYDRAULIC BOOM



The Earthmover Tire Bead Hook in use.

ASCOT NO.	MFG. NO.	DESCRIPTION	CAPACITY
429-90401	94010	Earthmover Tire Bead Hook	16,000 lb.
429-90402	94020	Earthmover Tire Bead Hook	12,000 lb.
429-90403	94000	Earthmover Tire Bead Hook	4,000 lb.

### TIRE SLING

• Adjustable locking sling for dismantling single or dual assembly tires • With locking mechanism so tires don't rotate • MADE IN THE USA

CAN ADJUST LOCKING SLING



402-06662

ASCOT NO.	MFG. NO.	DESCRIPTION	CAPACITY
402-06662	91000	Small Sling Assembly	6,500 lb.

### RING MASTER O-RING AND LOCK RING INSTALLER

• Pushes & Holds rim flange & tire back for easy O-ring and lock ring installation • Lightweight and easy to use • PORTABLE: Fits in tire truck tool box • Eliminates use of boom crane & cumbersome tire tools • Easy one-man operation • Works on all 3-piece and 5-piece rim/wheels up to 30" in diameter • Great for tough to handle forestry tires/wheels • Eliminates danger of pushing equipment off jack with crane • MADE IN THE USA



The Ring Master O-Ring and Lock Ring Installer in use.



PORTABLE

429-70162

ASCOT NO.	MFG. NO.	DESCRIPTION
429-70162	70162	Ring Master O-Ring and Lock Ring Installer



# Cribbing Sets & Wheel Chocks



## CRIB STANDS FOR 55-TON CYLINDERS

- Steel cribbing is durable, will not bend or warp • Recessed area on cribbing fits 7" square plate on 55-ton cylinders
- Each unit contains a built in carrying handle
- Tested/Certified up to 100 tons • Available in three sizes • Also available in a kit (Ascot No. 429-08074) that includes all three sizes

**WILL NOT BEND OR WARP**



429-08075



429-08076



429-08077

ASCOT NO.	MFG. NO.	DESCRIPTION
429-08075	15012	3" Steel Crib Stand
429-08076	15022	6" Steel Crib Stand
429-08077	15032	9" Steel Crib Stand

## STEEL CRIB KIT

- Durable Steel Cribbing, will not bend or warp • MODEL 15002 IS A COMPLETE SET: 3", 6" and 9" stands • Units can be nested together for 18" of total lift • Recessed area on cribbing fits 7" square plate on 55-Ton Cylinders • Each unit has a carry handle



429-08074



The Steel Crib Stand in use.

ASCOT NO.	MFG. NO.	DESCRIPTION
429-08074	15002	Steel Crib Kit

## SUPER STACKER CRIBBING BLOCKS

- 100% recycled plastic • Unmatched strength - stronger than wood • Resistant to gas, oil and chemicals • Certified tested • 50-year warranty against splitting, rot, fluid absorption, termites or mold caused by the environment • Color-coded lanyards depict each block's working load limit • MADE IN THE USA

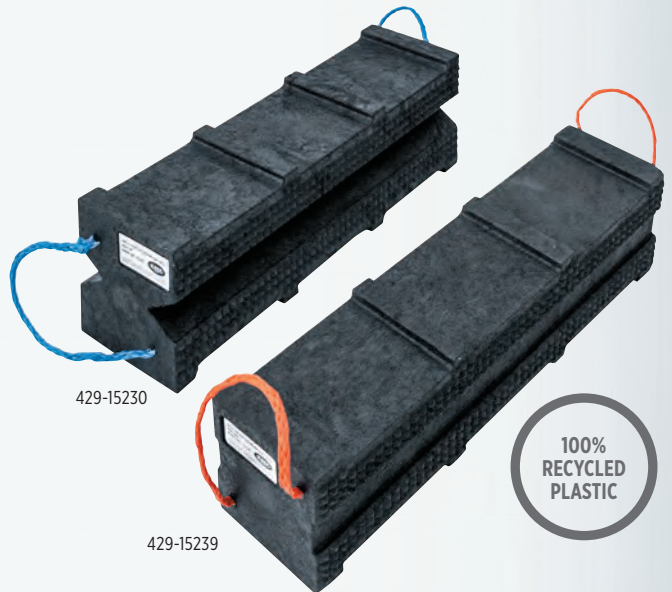

429-15230

429-15239

**100% RECYCLED PLASTIC**

ASCOT NO.	MFG. NO.	DESCRIPTION
429-15230	15230	6" x 7" x 24" Cribbing Block with Blue Lanyard, <b>WORKING LOAD LIMIT: 110,010 lb. (49,900 kg)</b>
429-15239	15239	6" x 7" x 24" Cribbing Block with Orange Lanyard, <b>WORKING LOAD LIMIT: 129,631 lb. (58,800 kg)</b>

## SUPER STACKER CRIBBING KIT

- 100% recycled plastic
- Unmatched strength - stronger than wood
- Resistant to gas, oil and chemicals • Certified tested
- 50-year warranty against splitting, rot, fluid absorption, termites or mold caused by the environment
- Compatible with 14500-14503 & 14468LT Jack Plates • MADE IN THE USA



429-15266

ASCOT NO.	MFG. NO.	DESCRIPTION
429-15266	15266	<b>KIT INCLUDES:</b> (12) 15239 & (1) 14468LT



POLYURETHANE WHEEL CHOCKS

- Solid light weight construction, high impact polyurethane material
- Non-conductive, no threat to puncture the tire
- Durable, light weight, and easy to use
- Extensively field tested
- High-visibility yellow color



396-15339



396-15338



396-15339



396-15342

ASCOT NO.	MFG. NO.	TIRE SIZE	SIZE (L X W X H)	WEIGHT
396-15337	15337	15.25" to 86.75"	18" x 12" x 9"	13 lb.
396-15338	15338	71" to 118"	22.5" x 13" x 14"	19.8 lb.
396-15339	15339	86.75" to 137.75"	24" x 13.5" x 12"	24.3 lb.
396-15342	15342	110.25" to 177"	26.7" x 13" x 14"	30.86 lb.



POLYURETHANE WHEEL CHOCKS

- Rugged yet lightweight, weather-resistant Polyurethane wheel chocks
- Safety yellow for high-visibility and meets OSHA/MSHA standards
- Built-in carrying handle & holes for installation of ropes, chains and/or mounting brackets

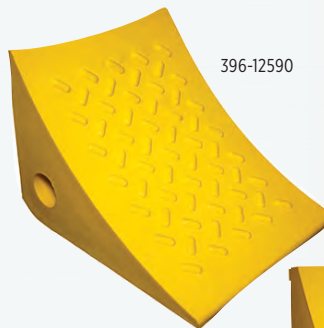

396-12590



396-12594

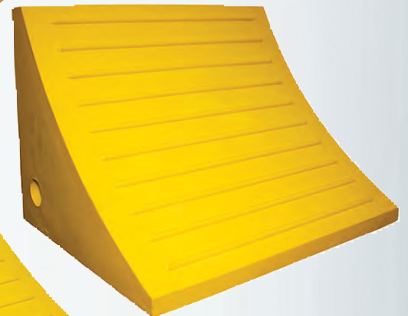

396-12593



396-12596

ASCOT NO.	MFG. NO.	TIRE SIZE	SIZE (L X W X H)	WEIGHT
396-12590	12590	Up to 27 in.	8" x 7" x 6"	2
396-12593	12593	46" to 65"	12.125" x 15.25" x 10.75"	16
396-12594	12594	Up to 65 in.	16.25" x 14.5" x 13.25"	20
396-12596	12596	Up to 165 in.	24.5" x 14.25" x 16"	34

TIRE & WHEEL SERVICE





# Bead Seating Devices

## RPG 5-GALLON BEAD SEATERS

- 5-gallon capacity
- Equipped with a butterfly valve for maximum air discharge
- Designed for commercial use on large truck tires, passenger and ATV tires to 24.5"
- Rubber foot pads to lessen vibration
- Made in Taiwan

ASCOT NO.	MFG. NO.	DESCRIPTION
473-01500	RPG-05GAL	5-Gallon Bead Seater with Butterfly Valve
473-02505	RPG-05GALED	5-Gallon Bead Seater with Butterfly Valve - End Discharge
473-02501	RPG-05GALAL	5-Gallon Bead Seater with Butterfly Valve - ALUMINUM



## RPG 10-GALLON BEAD SEATERS

- 10-gallon capacity
- Equipped with a butterfly valve for maximum air discharge
- Designed for commercial use on large truck tires, passenger and ATV tires to 24.5"
- Made in Taiwan

ASCOT NO.	MFG. NO.	DESCRIPTION
473-02510	RPG-10GAL	10-Gallon Bead Seater with Butterfly Valve
473-02511	RPG-10GALAL	10-Gallon Bead Seater with Butterfly Valve - ALUMINUM



## RPG 13-GALLON BEAD SEATER

- Aluminum tank
- 10-gallon capacity
- Equipped with a butterfly valve for maximum air discharge
- Designed for commercial large truck tires 24" to 54"
- Made in Taiwan

ASCOT NO.	MFG. NO.	DESCRIPTION
473-02513	RPG-13GALAL	13-Gallon Bead Seater with Butterfly Valve - ALUMINUM



### 5-GALLON CHEETAH BEAD SEATER

- Makes seating the most difficult bead safe and simple • 5-gallon capacity
- APPLICATIONS: Designed for commercial use on large truck tires, passenger and ATV tires to 24.5" • Fill tank from any service station chuck or service truck air compressor



473-00500

ASCOT NO.	MFG. NO.	DESCRIPTION
473-00500	CH-5	Cheetah Bead Seater, 5-Gallon
473-00501	CH-5AL	Same As Above With Aluminum Tank

### BS-07 CHEETAH BEAD SEATER

- "End of Tank" discharge design, flared discharge barrel and a 2" discharge valve for maximum bead seating power • Makes seating the most difficult bead not only safe but simple, fast and economical • 5-gallon capacity, ASME certified tank • SIZE: 34"(L) x 12"(W) x 15"(H)

ASCOT NO.	MFG. NO.	DESCRIPTION
473-00207	BS-07	BS-07 Cheetah



473-00207



### 10-GALLON CHEETAH BEAD SEATER

- 10-gallon capacity with ASME certified tank • APPLICATIONS: Designed for small rear agri/grader or smaller tires; Standard for fleet work, farm and service trucks



473-00010

ASCOT NO.	MFG. NO.	DESCRIPTION
473-00010	CH-10	10-Gallon
473-00011	CH-10AL	10-Gallon With Aluminum Tank

### 13-GALLON CHEETAH BEAD SEATER

- 13-gallon capacity with ASME certified tank • APPLICATIONS: Seats bead on tractor & heavy equipment tires from 24.5" to 54" • Includes a straight barrel, new Magnum barrel (for larger tires) and safety goggles as standard equipment
- Extends tire



473-00013

ASCOT NO.	MFG. NO.	DESCRIPTION
473-00013	CH-13AL	13-Gallon With Aluminum Tank

### VIPER™ BEAD SEATERS

- Push button discharge
- Unique handle design for stability and control
- ASME Certified
- Rapid release of air
- Newly designed jet barrel for greatly increased air volume delivery
- More power less air pressure
- Reduces air noise
- Greater air distribution
- No wheel damage
- Works on large range of tires

ASCOT NO.	MFG. NO.	DESCRIPTION
473-01110	VP 10S	Viper™ 11.5 Liter Bead Seater, Steel Tank
473-01113	VP 13AL	Viper™ 13 Liter Bead Seater, Aluminum Tank
473-01118	VP 18AL	Viper™ 18 Liter Bead Seater, Aluminum Tank



473-01110

473-01113

473-01118



\*Please note we recommend the use of a good quality inline filter to remove contaminants and moisture.  
\*Please note we recommend the use of silicone spray or air tool oil occasionally to properly maintain the valve.





**JET PAK BEAD SEATER UPGRADE DEVICE**

- Faster and easier than standard ball or butterfly discharge valve operation
- Discharges tank with the press of a button
- Safety cover prevents accidental trigger release
- TWO PORT SIZES AVAILABLE: CH1.5JP (1.5") and CH2.0JP (2") to fit any standard bead seater in a variety of tank sizes
- Attaches easily to existing pipe nipple, replacing manual discharge valve
- Includes our new improved Jet Barrel (VP 3.103 or VP 2.103) for greater air volume delivery
- Comfortable handle assures firm grip and ease of use
- All internal components can be removed and serviced if required



ASCOT NO.	MFG. NO.	DESCRIPTION
473-00020	CH-2.0JP	Jet Pak Bead Seater Upgrade Device - 2" Port Size
473-00015	CH-1.5JP	Jet Pak Bead Seater Upgrade Device - 1.5" Port Size

**GAITHER RAR VALVE UPGRADE KITS**

- The Gaither RAR Valves are the most powerful inflation valves available - same as used on the popular Bead Bazookas
- 1.5" and 2" available to upgrade your current inflation tank
- Completely serviceable!! This means that if something should become defective down the road, the seal, valve, spring or all three can be replaced!
- Push-button release trigger allows technician to keep both hands on the tank for optimum control during use
- Reversible handle allows for both right hand and left hand users based on preference
- Each valve includes a barrel for immediate use after installation



ASCOT NO.	MFG. NO.	DESCRIPTION
473-12941	12941R	1.5" RAR Valve Upgrade Kit
473-12942	12942R	2" RAR Valve Upgrade Kit

**BEAD SEAT BAND INSTALLER**

- Uses hydraulic force to install bead seat bands in earthmover tires
- 25 tons of hydraulic force to ensure that all bead seat bands are installed effortlessly
- The angled plate rests against a large section of the tire, ensuring protection of the bead during installation
- WEIGHT: 40 lbs (18.1 kg)



ASCOT NO.	MFG. NO.	DESCRIPTION
429-11900	11900	Bead Seat Band Installer

**EASY-LIFT™ BEAD SEATING STAND**

- Portable for field service, or can be bolted to the floor
- With hub facing out, simply roll mounted tire and wheel assembly to front of stand
- Push assembly onto crown - tire and wheel will automatically fall onto center of stand and rest with bead centered on bottom wheel flange
- Seat beads by inflating tire to 4 PSI (max.)
- Step around stand and easily lift assembly into vertical position
- Roll assembly into tire inflation safety cage for final inflation
- SIZE: 4"H x 26"W x 27"L
- Made of high grade steel



ASCOT NO.	MFG. NO.	DESC.	WEIGHT
473-36016	36016	Std. Crown for 8-3/4" Dia. Hubs	16,000 lb.
473-36017	36017	Large Crown for 11" Euro Hubs	12,000 lb.

HIGH GRADE STEEL

PORTABLE IF NEEDED

USES HYDRAULIC FORCE

HEAVY DUTY

# BEAD BAZOOKA®

SMALLER & MORE POWERFUL

UPGRADED RELEASE VALVE



- Smaller and more powerful than previous designs
- Serviceable/Replaceable 2" RAR valve
- Utilizes ultra-compact design
- Anti-corrosion interior tank coating
- Perfect for motorcycle, cars, or light commercial vehicle tire service (3L2)
- Perfect for cars and commercial vehicle tire service (6L2)
- Perfect for commercial and light agricultural vehicle tire service (10L2)

ASCOT NO.	MFG. NO.	DESCRIPTION	WEIGHT	DIMENSIONS	INNER DIAMETER
473-00103	GBB3L2	Bead Bazooka 3L2	14 lbs.	23" x 6" x 12"	4 in.
473-00106	GBB6L2	Bead Bazooka 6L2	15 lbs.	23" x 7" x 12"	4.75 in.
473-00110	GBB10L2	Bead Bazooka 10L2	18 lbs.	30" x 7" x 12"	5.5 in.
473-00100	BBVRK	Bead Bazooka	N/A	N/A	N/A



The Bead Bazooka® 3L2 in use.

TIRE & WHEEL SERVICE

## BEAD BAZOOKA® SPARE PARTS:

ASCOT NO.	MFG. NO.	DESCRIPTION
473-12913	12913B	Slotted Double Barrel
473-12914	12914B	Pressure Gauge
473-12915	12915B	Y-Connect
473-12916	12916B	Intake Valve
473-12917	12917B	Safety Valve
473-12919	12919B	Switch Valve
473-12920	12920B	Grip with Trigger Guard
473-12921	12921B	Plastic Plug
473-12923	12913BC	Slotted Double Barrel without Clip
473-12930	12930M	F3 Connector





## Bead Seating Devices (cont.)

## GAITHER'S BEAD SAVER SYSTEM

• By using simple principles of leverage, the Bead Saver System actually works with tire and rim to do the work for you • Patented design • Safest, fastest, easiest way ever invented to change tubeless truck tires • Guaranteed not to damage tire beads

ASCOT NO.	MFG. NO.	DESCRIPTION
448-12880	12880	Bead Saver System



## 5-GALLON BEAD BOOSTER

• Creates a blast of air used for seating tubeless tire beads • Release valve safety lock prevents inadvertent discharge • Powder-coated inside and out to protect from rust and deterioration caused by moisture • Double Barrel directs the air around the tire for a better "lift" • Safety pop-off valve prevents overloading with too much air pressure

ASCOT NO.	MFG. NO.	DESCRIPTION
473-00005	GB-5Z	5-Gallon Bead Booster

## 5-GALLON BEAD BOOSTER WITH MIS VALVE

• The BEAD BOOSTER® GB-5M comes equipped with the same MIS valve as the famous BEAD BAZOOKA® Tommy Gun giving it the ability to seat almost any tire • CE/ASME certified tank • New MIS valve with a 2" opening • Internal proprietary coating protects against rust • Includes Gaither's trusted 3 year warranty

ASCOT NO.	MFG. NO.	DESCRIPTION
473-42561	GB-5M	5-Gallon Bead Booster with MIS Valve



## GAITHER J1 MOUNT/DEMOUNT TOOL

• Slightly altered and condensed version of the original Bead Saver System • 2-piece system that mounts and dismounts all standard 19.5", 22.5" and 24.5" tubeless tires up to a 315/80R22.5, including those mounted on aluminum wheels • Differs from the original system in that each process is done completely while the tire is flat on the ground • The first Bead is dismounted with the clevis & crook/spoon end • The second Bead is dismounted with the J-1 end without picking the tire up • The first bead can be mounted with the J-1 end • The second Bead is mounted with the spoon end • Two Beadkeepers can be used to assist with mounting

ASCOT NO.	MFG. NO.	DESCRIPTION
448-00001	J1	Mount/DEMOUNT Tool

## GAITHER SUPER SLICK'EM™

• Gaither's Super Slick'em™ should be applied to all tires before being mounted or before deflation if being dismounted • Super Slick'em™ is a special non-water based lubricant that penetrates and aids in breaking the tire bead from the wheel by eating away rust and grease. Because it does not contain water, Super Slick'em™ will not freeze or cause rust to form • SUPER SLICK'EM™ 12904 INCLUDES: 4-1 gallon (3.8 liter) containers and 1 applicator bottle

ASCOT NO.	MFG. NO.	DESCRIPTION
421-12904	G12904	Gaither Super Slick'em™



WILL NOT FREEZE

421-12904

### AIR BLAST BEAD SEATER FOR SMALL TIRES

- Fast and easy way to seat beads in one simple operation
- Seat the bead on most small tubeless tires with rims ranging from 4" to 12"
- ONE-MAN OPERATION: just point and release



473-31440

ASCOT NO.	MFG. NO.	WEIGHT
473-31440	31440	5.6 lb.

### PNEUMATIC BEAD EXPANDERS

- Fits most bias ply passenger tires
- Pliable neoprene rubber tube encased in tough nylon cover
- Withstands contact with oil, grease, solvents and acid



471-31432

ASCOT NO.	MFG. NO.	MIN./MAX. DIAM.	TUBE DIAM.	WEIGHT
471-31432	31432	24"-34"	2-1/4"	2.8 lb.
471-31433	31433	22"-32"	3/4"	.75 lb.



### YELLOW RUBBER COATED BEADKEEPER

- Keeps truck tire bead from slipping during mounting of top bead
- Rubber coated steel construction
- Will not scratch aluminum wheels
- Great for hard to mount tires, a must for all super singles
- Equivalent to Gaither 12894C & ESCO 70140



448-12894

ASCOT NO.	MFG. NO.	DESCRIPTION
448-12894	12894C	Yellow Rubber Coated Beadkeeper

### BLUE WIDE MOUTH RUBBER COATED BEADKEEPER

- Wider mouth works on newer, wider Alcoa wheels
- Keeps truck tire bead from slipping during mounting of top bead
- Rubber coated steel construction
- Will not scratch aluminum wheels
- Great for hard to mount tires, a must for all super singles
- Equivalent to Gaither 12894-CW



448-32894

ASCOT NO.	MFG. NO.	DESCRIPTION
448-32894	12894-CW	Wide Mouth Blue Rubber Coated Beadkeeper

### STEEL BEADKEEPER

- THE ORIGINAL BEADKEEPER®
- Used to hold a tire bead in place during the mounting process
- Eliminates the need to stand on the tire and/or use a second mounting bar

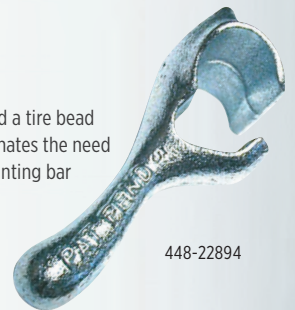

448-22894

ASCOT NO.	MFG. NO.	DESCRIPTION
448-22894	12894	Steel Beadkeeper

### BEADKEEPERS-ON-A-ROPE

- Used to hold the tire in place while mounting the second bead
- These tools eliminate the dangerous job of standing on the tire in order to mount it
- After the first bead is mounted, simply place two Beadkeepers on the flange of the wheel and spread them apart as far as possible
- Use the Spoon End of the bar to mount a small part of the bead and slide the closest Beadkeeper to the bar
- Repeat this step until the entire second bead is mounted



448-42894

ASCOT NO.	MFG. NO.	DESCRIPTION
448-42894	12894-P	Beadkeepers-On-A-Rope



# Chloride Pumps

## MTP, Inc.

### VALVE ADAPTER GUN

- Will attach to any calcium tire filling pump • 1/2" female pipe thread
- Will extract valve core from a standard bore valve or core housing from tractor valve • Securely holds valve core or core housing up in the gun body during the filling or evacuation of liquid from tire

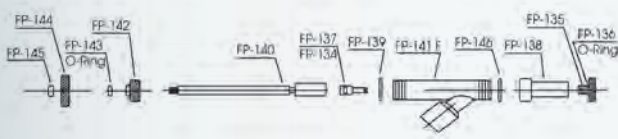

ASCOT NO. MFG. NO. DESCRIPTION

#### VALVE ADAPTER GUN PARTS

ASCOT NO.	MFG. NO.	DESCRIPTION
464-00134	FP-134	Large Bore Core Remover
464-00135	FP-135	Adapter For Standard Valve
464-00136	FP-136	O-Ring For FP-135
464-00137	FP-137	Standard Valve Core Remover
464-00138	FP-138	Ejector Union With FP-136 O-Ring
464-00139	FP-139	Gasket
464-00140	FP-140	Stem
464-00141	FP-141F	Adapter Body
464-00142	FP-142	Stem Sealing Nut
464-00143	FP-143	O-Ring For FP-142
464-00144	FP-144	Hand Wheel
464-00145	FP-145	Lock Nut
464-00146	FP-146	Teflon Gasket

### CALCIUM CHLORIDE PUMP

- Now available with polyvinyl valve (Model #10509) or anodized aircraft aluminum valve (Model #10509M) • Pumps 34 gallons of calcium chloride per minute • Newly designed valve will not leak
- Spring reinforced hoses for fill and evacuate • Comes complete with valve adapters for all valves (large bore and standard) • Gauges are protected • Unit is portable or can be mounted in tire service trucks
- Double diaphragm pump, 1 to 1 ratio • 10' hoses gives plenty of room to operate • Includes hoses & calcium tire filled gun • USA MADE PUMP



475-11590

ASCOT NO.	MFG. NO.	DESCRIPTION
475-10509	10509	Calcium Chloride Pump with Polyvinyl Valve
475-11590	10509M	Calcium Chloride Pump with Aircraft Aluminum Valve

### GRACO CALCIUM CHLORIDE PUMP

- 50-gallon (189 liter) per minute capacity; 1 to 1 ratio double diaphragm pump • WEIGHT: 38 lb. (17.2 kg) • Pump only P/N 15091, pump with quick connectors 15090-Q



475-15090

ASCOT NO.	MFG. NO.	DESCRIPTION
475-15090	15090	GRACO Calcium Chloride Pump



**DOUBLE DIAPHRAGM  
CALCIUM CHLORIDE PUMP**

- No lubrication required
- Self-priming, non-stalling, low noise level
- Diaphragms have no stress points and less flex for longer life
- No gradual loss of pump performance due to wear
- Can run dry indefinitely
- Protected by an air filter/regulator
- 35 gallon per minute free flow



ASCOT NO.	MFG. NO.	DESCRIPTION
475-15103	15103	Double Diaphragm Calcium Chloride Pump
475-30280	A3028	Replacement 4-Way Valve for Calcium Chloride Pump
475-30281	HL-B	Replacement Handle for Calcium Chloride Pump 4-Way Valve

**“WONDER PUMP” PNEUMATIC DOUBLE DIAPHRAGM CALCIUM CHLORIDE PUMP**

- No lubrication required • Self-priming; non-stalling; low noise level
- Diaphragms have no stress points and “less flex” for longer life
- No gradual loss of pump performance due to wear • Can run dry indefinitely • Protected by an air filter/regulator • 4-WAY VALVE: 1/4 turn reverses the flow - no need to change hoses
- 35 gallon per minute free flow



ASCOT NO.	MFG. NO.	DESCRIPTION
<b>“WONDER PUMP” PARTS &amp; ACCESSORIES</b>		
475-13011	30A-11	310 Calcium Gun
475-13018	30A-18	3/4" Brass Quick Coupler-Hose Saver
475-13019	30A-19	3/4" Brass Plug - Hose Saver (Needed for 30A-18)
475-13021	30A-21	1/2" Brass Quick Coupler - Calcium Gun
475-13022	30A-22	1/2" Brass Plug - Calcium Gun (Needed for 30A-21)
475-13026	30A-26	1/8" Back Mount Air Gauge - 0-100 PSI
475-13027	30A-27	2-1/2" Dia. S.S. 1/4" Back Mount Press/Vac Gauge - 30/0/150 Glycerin Filled
475-82515	682515	Extra Large Exhaust Muffler
475-13028	30A-28	3/4" Brass 4-Way Directional Valve w/ O-Ring Seals w/ Handle
475-13029	30A-29	Handle for 30A-28
475-13030	30A-30	10' Supply Hose (3/4" x 1" MPT Ends) 300 PSI - Wingfoot
475-13031	30A-31	15' Fill/Evac Hose (3/4" x 1/2" MPT Ends) 300 PSI - Wingfoot
475-13032	30A-32	PVC Suction Bypass Hose for Silver Pump
475-13033	30A-33	1" FPT Stainless Steel Strainer for 30A-30 Prior to 2002
475-13034	30A-34	3/4" FPT Stainless Steel Strainer for Current 30A-Plus
475-12532	25A-32	PVC Bypass Hose for Black Pump

TIRE & WHEEL SERVICE



**WARNING:** For more information go to [www.P65Warnings.ca.gov](http://www.P65Warnings.ca.gov).



# Mount/Demount Tools



## GOLDEN TOOL TUBELESS TRUCK TIRE MOUNT/DEMOUNT TOOL

• Demounts most tubeless tires in 8 seconds with ease - remount them in 20 seconds with equal ease - all without the need to lift tire and rim to remove rear bead • Demounts/mounts 17.5" to 44.5" tires • APPLICATIONS: Use on tubeless truck tires including super single/duplex tires, radial and bias • For Dayton-type wheels (centerless) and Budd type disc wheels • Eliminates the need to lift tire and rim to remove the bottom bead, preventing possible strain or even serious injury

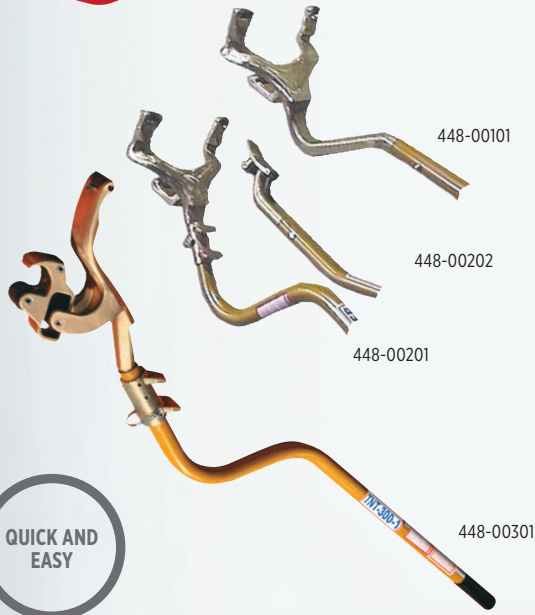

QUICK AND EASY

ASCOT NO.	MFG. NO.	DESCRIPTION
448-00100	TNT-100	Tire Mount/Demout Tool Complete
448-00101	TNT-100-1	Demount Tool Only (17.5-31.5)
448-00200	TNT-200	Super Single Tire Mount/Demount Tool
448-00201	TNT-200D	Super Demount Tool (17.5-44.5)
448-00202	TNT200M	Single Mount Tool
448-00301	TNT-300-1	New 445 Super Single Demount Tool (17.5-X1)



## TUBELESS TRUCK TIRE DEMOUNT TOOL

- High Quality, economical price
- Nylon rollers
- 3-Step demount of 22.5 and 24.5 tires
- Parts Available



HIGH QUALITY

ASCOT NO.	MFG. NO.	DESCRIPTION
448-00400	EZT-100D	Tubeless Truck Tire Demount Tool

## BL-100 BEAD LOCK

- Helps prevent bead damage • Large roller directs bead into drop center, making tire mounting easier • Prevent damage to rims
- Tool will not slip or dislodge during the mounting process



ASCOT NO.	MFG. NO.	DESCRIPTION
448-01100	BL-100	Bead Lock



**STEEL TRUCK BEAD HOLDER**

- Clamps securely to the wheel to prevent tire from “walking”
- Eliminates the use of vise grips which can damage wheels
- For use with automatic tire changers and/or manual tire changing tools • Heavy duty steel construction

ASCOT NO.	MFG. NO.	DESCRIPTION
448-00010	BJ-BP10	Steel Truck Bead Holder

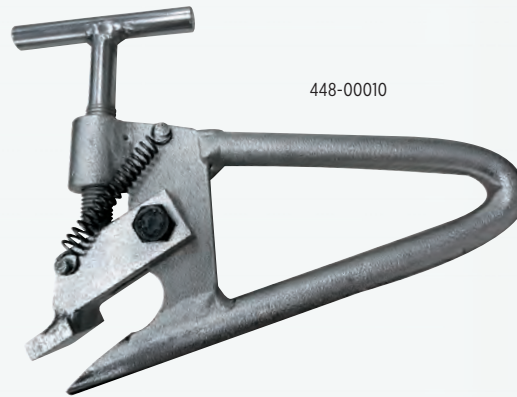

448-00010



**GOLDEN BUDDY TIRE CHANGING SYSTEM**

- Mount and demount tool assemblies for 22.5 & 24.5 tires/wheels • Heavy duty steel construction ensures long life • Nylon rollers protect the bead • Bead holder • WEIGHT: 32 lb. (14.5 kg) • Sold as a complete set

ASCOT NO.	MFG. NO.	DESCRIPTION
448-12320	71050	Golden Buddy Tire Mount/Demount Tool Set
448-22320	71051	Golden Buddy Dismount Assembly
448-32320	71052	Golden Buddy Mount Tool Assembly



448-12320

**EASY BUDDY TIRE DEMOUNT TOOL**

- Mount and dismount tire assemblies for 22.5 and 24.5 tires/wheels • Easy-to-follow instructions • WEIGHT: 35 lb. (16 kg) • Includes top bead removal tool and bottom bead removal tool • Includes Rim Protector to prevent rim scarring

ASCOT NO.	MFG. NO.	DESCRIPTION
448-71000	71000	Easy Buddy Tire Demount Tool



448-71000



**WARNING:** For more information go to [www.P65Warnings.ca.gov](http://www.P65Warnings.ca.gov).





## Mount/Demount Tools (cont.)

### TRUCK TIRE DEMOUNT & MOUNTING TOOL KITS



402-90518  
ESC100 Kit

402-90519  
ESC200 Kit

ASCOT NO.	MFG. NO.	DESCRIPTION
402-90518	90518-100-KIT	<b>ESC100 Kit</b> - INCLUDES: 90518-100-1 Demounting Tool, 90518-200M Mounting Tool & 70141 Bead Holder
402-90519	90518-200-KIT	<b>ESC200 Kit</b> - INCLUDES: 90518-200-1 Demounting Tool, 90518-200M Mounting Tool & 70141 Bead Holder

### TYR-X TRUCK TIRE DEMOUNT SYSTEM

- A safe, quick, and reliable tire demounting tool that makes tire demounting a simple process
- The pivot hooks ensure easy and positive operation and its design eliminates aggressive stretching of the tire bead
- One of the easiest and fastest manual truck tire demounting tool on the market
- Works on standard truck tires (22.5-24.5) and can be used for the first bead of super singles or double wide truck tires
- WEIGHT: 17 lb. (8 kg)



402-20397

402-20396



402-20406

### UNIVERSAL DEMOUNT TOOL - HEAVY DUTY TIRE KIT

- Safe, simple, fast, economical, and the most universal tire demounting system on the market
- Works as a hand-held tire machine and shines where other tools fall short
- Tackles the hard 19.5 reverse hubs and grader tires and can be used on all tire sizes from 10" ATV tires and up
- Great for agricultural tires, one-piece grader, loader, forestry and backhoe tires



402-20415



402-20430

ASCOT NO.	MFG. NO.	DESCRIPTION
402-20415	20415	<b>Universal Demount Tool - Heavy Duty Tire Kit</b> - INCLUDES: 20408 Universal Demounter, 20404 52" Mounting Bar, 20403 35" Mounting Bar, 20406 Pair of HD Bead Holders

ASCOT NO.	MFG. NO.	DESCRIPTION
402-20396	20396	Demount Tool, Truck Tire, "Tyr-X", All In One Demount System
402-20397	20397	Bead Wedge (Puts Tire In Drop Center)
402-20406	20406	Bead Holder, Commercial Truck Tires (Pair)
402-20430	20430	Mounting Bar, Truck Tires



### BLUE COBRA™ TRUCK TIRE DEMOUNT TOOL

• Ergonomic shaped steel handle with no-slip grip for optimum leverage • APPLICATIONS: Change nearly any 20", 22.5" and 24.5" tube-type and tubeless truck tires, up to a 13" wide one-piece wheel

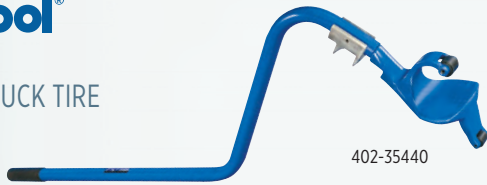

402-35440

ASCOT NO.	MFG. NO.	LENGTH	WEIGHT
402-35440	35440	54"	22 lb.

### TIRE MOUNT TOOL

• Demounts both beads on most truck tires with the need for lifting the tire/wheel assembly off the ground and then dropping it  
• Heat-treated alloy steel for maximum durability and strength

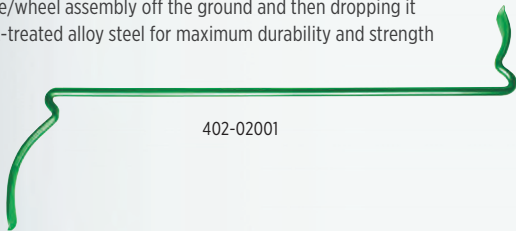

402-02001

ASCOT NO.	MFG. NO.	LENGTH	STOCK	WEIGHT
402-02001	T2001	39"	3/4"	6.5 lb.

### TIRE MOUNT TOOL

• Wing shaped designed to stop against rim, remove itself from between rim and bead • Small end gets under stretched bead for last pull



402-02002

ASCOT NO.	MFG. NO.	LENGTH	STOCK	WEIGHT
402-02002	T2002	38"	11/16"	4 lb.

### SUPER SERPENT MOUNT TOOL

• It may seem funny looking, but every inch of this innovative design is purely serious • Delivers Twice the leverage of any "Straight-type" tire mounting tool



402-02005

ASCOT NO.	MFG. NO.	LENGTH	STOCK	WEIGHT
402-02005	T2005	37"	3/4"	6.6 lb.

### SUPER SERPENT DEMOUNT TOOL

• At only 5-1/2 pounds, this unique, lightweight demount tool for super singles can be lugged around on a fingertip  
• Delivers incredible leverage right where it's needed

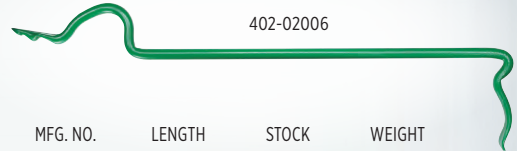

402-02006

ASCOT NO.	MFG. NO.	LENGTH	STOCK	WEIGHT
402-02006	T2006	37"	3/4"	5.5 lb.

### TIRE SPOONS

• General purpose tire irons for all mounting and demounting needs • APPLICATIONS: Use 18" and 24" spoons to mount or demount passenger car, motorcycle, ATV and light truck tires; 30" spoons provide enough strength and leverage to work on large truck, bus, off-road vehicle, tractor and aircraft tires

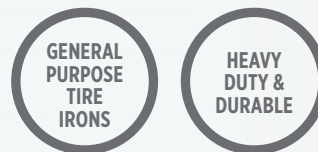

ASCOT NO.	MFG. NO.	LENGTH	STOCK	WEIGHT
-----------	----------	--------	-------	--------

#### A. STRAIGHT

402-32101	T1X	18"	11/16"	1.8 lb.
402-32119	T19	24"	11/16"	2.5 lb.
402-33022	33022	30"	3/4"	3.4 lb.
402-33219	T19A	30"	11/16"	3 lb.
402-33238	T38	30"	7/8"	4.8 lb.

#### B. DROP-CENTER

402-02100	T21R	18"	11/16"	1.8 lb.
402-02101	T21F	24"	11/16"	2.5 lb.
402-02102	T21HD	30"	7/8"	4.5 lb.
402-33020	33020	30"	11/16"	3.1 lb.
402-33024	33024	30"	3/4"	3.4 lb.

#### C. CURVED

402-31820	31820	18"	11/16"	1.8 lb.
402-32102	T2X	18"	11/16"	1.8 lb.
402-32120	T20	24"	11/16"	2.4 lb.
402-32420	32420	24"	11/16"	2.5 lb.
402-33021	33021	30"	11/16"	3.1 lb.
402-33052	33052	30"	3/4"	3.1 lb.
402-33062	33062	30"	7/8"	3.4 lb.
402-33220	T20A	30"	11/16"	3.1 lb.
402-33239	T39	30"	7/8"	4.5 lb.

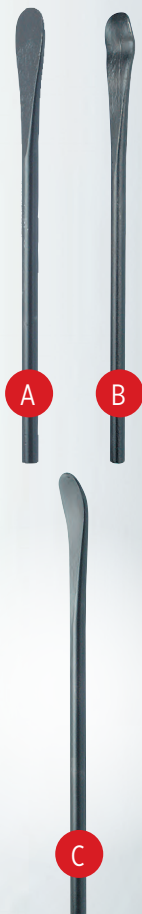



## Mount/Demount Tools (cont.)

### IRONMAN™ ERGONOMIC WHEEL LIFTING BAR

- Easily and safely lift heavy, awkward truck tire and wheel assemblies
- Extremely useful in outdoor conditions when truck tire and wheel assemblies can become wet & slippery
- Protect your workers and yourself: reduce injuries & claims, keep insurance premiums down
- Specially designed forged ends work from either side of the wheel assembly as it lays flat
- APPLICATIONS: Lift all sizes and types of small and large heavy truck wheels: Standard sizes including 22.5" and 24.5" wheels, plus European (which have 1" lug holes), Super Wide and even the Super Single (a 340 lb. assembly) size



402-34950



The Ironman™ Ergonomic Wheel Lifting Bar in use.

ASCOT NO.	MFG. NO.	LENGTH	WEIGHT
402-34950	34950	58"	10 lb.

### NINETEEN-FIVE™ TIRE MOUNTING & DEMOUNTING TOOL SET FOR 19.5" TRUCK TIRES

- New tire bar uniquely designed to work on hub side of wheel, where hub protrudes above rim
- Specially designed ends manipulate tire with less effort
- Forged from high-grade carbon steel and heat-treated for longlasting strength and durability
- APPLICATIONS: Specially designed Bead Holder to hold bead on 19.5" aluminum wheels
- Solid brass Bead Holder for steel wheels
- Aluminum Wheel Protector - thick leather pad helps protect rims from marring and scratching

ASCOT NO. MFG. NO. DESCRIPTION LENGTH WEIGHT

NINETEEN-FIVE™ TIRE MOUNTING & DEMOUNTING TOOL SET				
402-33195	33195	Nineteen-Five™ Tire Mounting and Demounting Set. <b>INCLUDES:</b> 31710, 31810, 33196, 33199		
472-31710	31710	Bead Holder for Steel Wheels - Solid Brass	4-1/2"	2.5 lb.
472-31810	31810	Aluminum Wheel Protector - Leather	6"	3.4 lb.
402-33196	33196	Bead Holder for 19.5" Aluminum Wheels	7-1/2"	3 lb.
402-33199	33199	Tire Mounting/ Demounting Tool	38"	2.5 lb.



### BEAD HOLDER

- Holds the bead in place against the wheel when mounting the tire on the wheel
- 31713 Bead Holder works on Super Singles and Super Wides



ASCOT NO.	MFG. NO.	MATERIAL	STOCK	WEIGHT
472-31710	31710	Solid Brass	1.4 lb.	1.8 lb.
472-31713	31713	Aluminum Bead Holder - Works on Super Singles		

### ALUMINUM WHEEL PROTECTOR

- Protects wheel rims from damage
- U.S. Patent No. 6,991,018



ASCOT NO.	MFG. NO.	WEIGHT
472-31810	31810	12 lb. (5.4 kg)

472-31810



### CLASSIC TUBELESS TIRE IRON

• Ken-Tool's patented designs offer one-piece construction and assure long life for many tire changing applications • Tip ends insert easily and will not cut or rip bead or sidewall • These designs make it easier to mount and demount tires without changing the way the tool is used • MOUNT END: Precision-forged knob grips rim. Tip designs won't slip during tire mounting. Special curve design always grabs the bead edge • DEMOUNT END: Precision-forged angled tip slides between bead and rim easily. Forged design won't slip when demounting the second bead



402-34645

ASCOT NO.	MFG. NO.	LENGTH	STOCK	WEIGHT
402-34645	T45AC	37"	3/4"	4.6 lb.
402-34649	T45AS	52"	7/8"	8.25 lb.

### TUBELESS TIRE IRON SETS

• Sets provide all irons necessary for a variety of tire changing applications • APPLICATIONS: Use C bar with the B extension bar for easier use on large, wide-base truck tires; Use on standard and large truck tires, including industrial, farm, buses and tractors

ASCOT NO.	MFG. NO.	DESCR.	LENGTH	STOCK	WEIGHT
<b>ADAPTER PLUGS</b>					
402-46000	T46	Tire Iron Set. <b>INCLUDES:</b> T46A, T46B, T46C	—	3/4"	12 lb.
402-46001	T46A	Med. Duty Mount/Demount Iron	36"	3/4"	4.5 lb.
402-46002	T46B	Mount/Demount Iron	36"	3/4"	4.5 lb.
402-46003	T46C	Offset Bar For Deep Well Tires	22"	3/4"	3 lb.

<b>HEAVY</b>					
ASCOT NO.	MFG. NO.	DESCR.	LENGTH	STOCK	WEIGHT
402-47000	T47	Tire Iron Set. <b>INCLUDES:</b> T47A, T47B, T47C	—	1"	29 lb.
402-47001	T47A	Ultra Duty Mount/Demount Iron	52"	1"	11 lb.
402-47002	T47B	Mount/Demount Iron	49-1/2"	1"	11 lb.
402-47003	T47C	Offset Bar For Deep Well Tires	27"	1"	6.66 lb.



402-46001  
402-46002

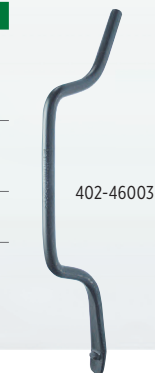

402-46003

## Small Mount/ Demount Tools

Design based on popular European styles. Extended length of the flat curved sliding surface provides comparable mounting ability of much longer traditional tire irons.

### TIRE IRONS - SMALL TIRE

• Pro tire changing tools for small tires • APPLICATIONS: Ideal for mounting and demounting motorcycle, ATV, lawn, golf cart and small tires by hand • Rounded ends will not pinch tube



ASCOT NO.	MFG. NO.	LENGTH	STOCK	WEIGHT
402-00050	T5	16"	.8 Lbs	
402-00060	T6A	16-1/2"	5/8"	1.5 lb.
402-00080	T8	16"	.8 Lbs	
402-00160	T16A	16"	7/16"	.7 lb.
402-00900	T9A	9"	7/16"	.4 lb.
402-01160	T16C	2 Piece Set. <b>INCLUDES:</b> (2) T16A 16" Bars		
402-01900	T9C	2 Piece Set. <b>INCLUDES:</b> (2) T9A 9" Bars		

### MOTORCYCLE/SMALL WHEEL TIRE TOOL

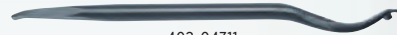

402-04311

ASCOT NO.	MFG. NO.	LENGTH	STOCK	WEIGHT
402-04311	T43A	15"	3/4"	1.8 lb.

### EUROPEAN STYLE TOOLS

• APPLICATIONS: Use on car, motorcycle, truck and agricultural tires • Designed for mounting and demounting tires • Best if used in pairs

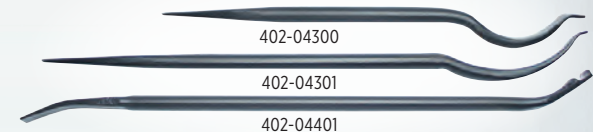

402-04300

402-04301

402-04401

ASCOT NO.	MFG. NO.	LENGTH	STOCK	WEIGHT
402-04300	T43C	21"	7/8"	3.1 lb.
402-04301	T43D	30"	7/8"	4.5 lb.
402-04401	T44	31"	7/8"	5.3 lb.

TIRE & WHEEL SERVICE



⚠️ **WARNING:** For more information go to [www.P65Warnings.ca.gov](http://www.P65Warnings.ca.gov).



# Lock Ring Tools

## TRUCK LOCK RING REMOVER

- APPLICATIONS: Designed for small diameter wheels

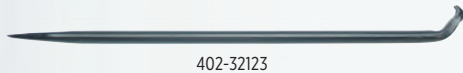

402-32123

ASCOT NO.	MFG. NO.	LENGTH	DIAMETER	WEIGHT
402-32123	T23	24"	11/16"	2.4 lb.
402-33223	T23A	30"	11/16"	3.1 lb.

## COMBINATION RIM/RING TOOL

- Flat tapered end • APPLICATIONS: Ideal for all around ring and rim work



402-33224

ASCOT NO.	MFG. NO.	LENGTH	DIAMETER	WEIGHT
402-33224	T23B	23-1/2"	11/16"	2.4 lb.

## RIM LOCK TOOL

- APPLICATIONS: For servicing wide base rims



402-32125

ASCOT NO.	MFG. NO.	LENGTH	DIAMETER	WEIGHT
402-32125	T25	18"	5/8"	1.8 lb.

## SPECIAL LOCK RING TOOL

- Long tapered curved end • APPLICATIONS: For continuous side rings



402-32127

ASCOT NO.	MFG. NO.	LENGTH	DIAMETER	WEIGHT
402-32127	T27	18"	11/16"	1.8 lb.

## LOCK RING TOOL

- APPLICATIONS: Removes continuous side rings on two-piece truck rims



402-32128

ASCOT NO.	MFG. NO.	LENGTH	DIAMETER	WEIGHT
402-32128	T27A	18"	11/16"	1.8 lb.

## HEAVY DUTY LOCK RING TOOL

- APPLICATIONS: Use for multi-piece wheels, especially hub type



402-34648

ASCOT NO.	MFG. NO.	LENGTH	DIAMETER	WEIGHT
402-34648	T48A	37"	3/4"	4.6 lb.

## INDUSTRIAL WHEEL LOCK RING TOOL SET

- Helps prevent injury, easier to keep hands safely outside of press cage • Bright orange color helps prevent lost tools
- Forged from high-grade carbon steel and heat-treated for long lasting strength and durability • SET INCLUDES: #3130 Mount/Demount Tool: Demount end lifts split ring progressively around wheel until fully demounted, mount end used to mount split ring; #3132 Demount Prep Tool: Separator end separates split ring from solid flange ring to form gap, pry-out end reaches behind slotted end of split ring to pry in out and over the flange of the wheel

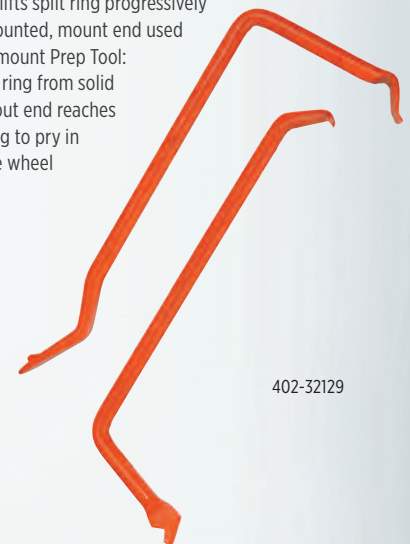

402-32129

ASCOT NO.	MFG. NO.	DESCRIPTION	LENGTH	WEIGHT
<b>INDUSTRIAL WHEEL LOCK RING TOOL SET PARTS</b>				
402-32130	32130	Mount/Demount Tool	15-3/4"	1.8 lb.
402-32131	32131	Demount Prep Tool	15-1/2"	1.5 lb.

ASCOT NO.	MFG. NO.	DESCRIPTION
402-32129	32129	2 Pc. Industrial Wheel Lock Ring Set

# Heavy Duty Hammers



## WOODEN HANDLE HAMMERS

• Used for mounting and demounting tires • APPLICATIONS: Makes tire changing easier for passenger car, truck, bus, farm tractor and aircraft tires



425-35321



425-35325



425-35323



425-35105

## FIBERGLASS HANDLE HAMMERS



425-35421



425-35423



425-35425

TIRE & WHEEL SERVICE

ASCOT NO.	MFG. NO.	HANDLE NO.	LENGTH	WEIGHT
425-35321	T34	T11CH	17"	4.8 lb.
425-35323	T35	T11CH	16-1/2"	5.5 lb.
425-35325	T36	T11CH	16-1/2"	5.8 lb.
425-35105	T34RH	Rubberhead Replacement		

ASCOT NO.	MFG. NO.	HANDLE NO.	LENGTH	HEAD WEIGHT	WEIGHT
425-35421	TG34	TG11CH	18"	5.5 lb.	6 lb.
425-35423	TG35	TG11CH	18"	4.8 lb.	6.6 lb.
425-35425	TG36	TG11CH	18"	5.8 lb.	6 lb.



# General Purpose Hammers & Wedges

## WOODEN HANDLE HAMMERS

- Designed for tire service in variety of sizes



ASCOT NO.	MFG. NO.	HANDLE NO.	LENGTH	WEIGHT
426-35311	T11B	T11BH	14-1/2"	4.5 lb.
426-35317	T33R	T11HN	14"	2.3 lb.

## FIBERGLASS HANDLE HAMMERS



ASCOT NO.	MFG. NO.	HANDLE NO.	LENGTH	WEIGHT
426-35411	TG11B	TG11BH	16"	4.8 lb.
426-35417	TG33R	TG31H	16"	2.5 lb.

## DOUBLE FACED SLEDGE HAMMER

- High carbon steel, heat treated • Machined, polished face • Top grade U.S. hickory handle



ASCOT NO.	MFG. NO.	HANDLE LENGTH.	FACE	EYE SIZE	WEIGHT
428-37302	84H-2	15"	1-1/2"	3/4" x 1"	2 lb.
428-37304	84H-4	15"	1-3/4"	3/4" x 1"	4 lb.
428-37308	84H-8	32"	2"	1" x 1-3/8"	8 lb.
428-37310	84H-10	36"	2-1/8"	1" x 1-3/8"	10 lb.
428-37312	84H-12	36"	2-1/8"	1" x 1-3/8"	12 lb.
428-37316	84H-16	36"	2-3/8"	1" x 1-3/8"	16 lb.
428-37320	84H-20	36"	3"	2" x 1-1/2"	20 lb.

## DUCK BILLED BEAD BREAKING WEDGES - WOOD HANDLED



ASCOT NO.	MFG. NO.	HANDLE NO.	LENGTH	WEIGHT
424-35327	T11D	T11DH	17"	4.8 lb.
424-35329	T11E	T11EH	30"	9.2 lb.

## DUCK BILLED BEAD BREAKING WEDGES-FIBERGLASS HANDLED



ASCOT NO.	MFG. NO.	HANDLE NO.	LENGTH	WEIGHT
424-35427	TG11D	TG11DH	18"	4.8 lb.
424-35429	TG11E	TG11EH	32"	9.1 lb.

## DUCK BILLED POLYMER HANDLED BEAD BREAKING WEDGE

- Hump design prevents tool from wedging between rim and bead • Breaks bead with little or no prying • New polymer handle design with fiberglass core

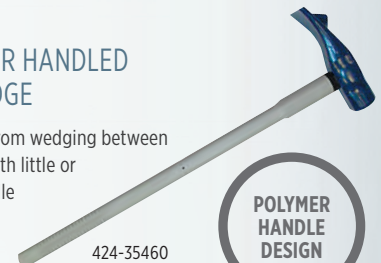

POLYMER HANDLE DESIGN

ASCOT NO.	MFG. NO.	HANDLE NO.	LENGTH	WEIGHT
424-35460	T11K	T11KH	32"	10.5 lb.
429-35230	T11KH	Replacement Handle for T11K		

## 2 LB. RUBBER MALLET

- Rubber head prevents marring surfaces



RUBBER HEAD

ASCOT NO.	MFG. NO.	HANDLE LENGTH	WEIGHT
426-35310	T32	17"	2 lb.



CROSS-PEIN/BLACKSMITH HAMMER



426-37103

ASCOT NO.	MFG. NO.	HANDLE LENGTH.	FACE	EYE SIZE	WEIGHT
426-37103	85H-3	16"	1-5/8"	1" x 1-3/4"	3 lb.

NEW ENGLAND PATTERN HAND-DRILLING HAMMERS



426-37003

ASCOT NO.	MFG. NO.	HANDLE LENGTH.	FACE	EYE SIZE	WEIGHT
426-37003	80H-3	10-1/2"	1-1/2"	1" x 3/4"	3 lb.
426-37004	80H-4	10-1/2"	1-5/8"	1" x 3/4"	4 lb.

TIRE KNOCKER



426-35110

ASCOT NO.	MFG. NO.	HANDLE LENGTH.	WEIGHT
426-35110	35110	18"	.7 lb.

DEAD BLOW HAMMERS

- Economy version for DIYers or home workshops
- One-piece polypropylene outer jacket provides a lifetime of use
- Head is shot-filled for maximum force with no bounce effect



426-35310

ASCOT NO.	MFG. NO.	LENGTH	WEIGHT
426-35335	T335	12"	1.5 lb.

PROFESSIONAL DEAD BLOW HAMMERS



426-35332

426-35337

ASCOT NO.	MFG. NO.	DESCRIPTION	LENGTH	WEIGHT
426-35331	TG331	1 lb. Head	12-1/4"	1.8 lb.
426-35332	TG332	2 lb. Head	13-1/2"	1.9 lb.
426-35333	TG333	3 lb. Head	14-1/2"	2.7 lb.
426-35334	TG334	4 lb. Head	15-1/2"	3.4 lb.
426-35337	TG337	Steel Face/Soft Face	13-1/2"	2.2 lb.

Replacement Handles



FIBERGLASS REPLACEMENT HANDLE FOR DUCK-BILLED BEAD BREAKING WEDGES

- Handles are constructed with a solid core which has thousands of fiberglass strands and a unique resin making them super strong all-weather, chemical and insect-resistant
- Ergonomic non-slip grips for slippery conditions
- Replacement Adapters available
- MADE IN THE USA



429-35229

ASCOT NO.	MFG. NO.	DESCRIPTION
429-35229	TG11EH	32" Fiberglass Hammer Handle

FIBERGLASS REPLACEMENT HANDLES



ASCOT NO.	MFG. NO.	FOR HAMMER NO.	LENGTH	WEIGHT
429-35206	TG31H	TG11R, TG31, TG33R	16"	1 lb.
429-35211	TG11BH	TG11B	16"	1.3 lb.
429-35219	TG11CH	TG11C, TG34, TG35, TG36	18"	2.5 lb.
429-35218	TG11DH	TG11D	18"	1.2 lb.
429-35832	TG11EH	TG11E	32"	2.3 lb.

ALUMINUM REPLACEMENT HANDLES



ASCOT NO.	MFG. NO.	FOR HAMMER NO.	LENGTH	WEIGHT
429-35529	T11AH	T11E, TG11E	32"	4.3 lb.

HICKORY REPLACEMENT HANDLES



ASCOT NO.	MFG. NO.	FOR HAMMER NO.	LENGTH	WEIGHT
429-35111	T11BH	T11B	15"	.75 lb.
429-35113	T11HN	T11R, T31, T33R	15"	.75 lb.
429-35119	T11CH	T11C, T34, T35, T36	17"	.75 lb.
429-35127	T11DH	T11D	17"	.75 lb.
429-35129	T11EH	T11E	30"	1.2 lb.

TIRE & WHEEL SERVICE



⚠️ WARNING: For more information go to [www.P65Warnings.ca.gov](http://www.P65Warnings.ca.gov).



# Wrenches & Lug Wrenches



## KENTOOL PORKCHOP™ WRENCHES

- Holds outer cap nut on dual wheels while turning inner nut
- Lip fits in hole to secure wrench in place
- Fits standard and metric cap nuts



406-30609

ASCOT NO.	MFG. NO.	DESCRIPTION	SIZE	WEIGHT
406-30609	TX9	SAE	1-1/2"	.4 lb.
406-30610	TX10	Metric	35mm	.4 lb.
406-30612	TX12	Metric	41mm	.4 lb.

## COMBINATION CAP NUT WRENCHES

- Combination wrench offers you the versatility of two wrenches in one
- Fit one end onto the outer cap nut with other end through center hole
- Slides underneath center disc of wheel reducing slipping during nut removals



406-30620

ASCOT NO.	MFG. NO.	DESCRIPTION	SIZE	WEIGHT
406-30620	TX50	SAE & Metric	41mm	1.3 lb.

## HEAVY DUTY NUT WRENCHES

- Heavy duty design will not slip out of position
- Rests snugly against the center hole reducing the possibility of rim damage
- Great for aluminum rims

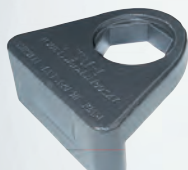

406-30618



ASCOT NO.	MFG. NO.	DESCRIPTION	SIZE	WEIGHT
406-30618	TX200	SAE	1-1/2"	2.6 lb.
406-30619	TX241	Metric	41mm	2.6 lb.



## HANDS FREE BUDD NUT WRENCHES

- Eliminates the need for hand and foot aid in separating the nuts, therefore reducing needless injury
- Reduces the work and potential for back strain because there is no need to lay down the tire
- Will not lose its grip on the outer cap nut so there is no loss of torque, which will give the impact wrench maximum power and efficiency



The Budd Nut Wrench in use.



406-60300

ASCOT NO.	MFG. NO.	DESCRIPTION
406-60300	60300	Budd Nut Wrench

## BUDD NUT WRENCHES

- New design won't slip out of rim hole
- Will not damage aluminum/chrome rim
- Holds outer cap nut securely
- This adaptation of an old product solves the problem of damage to wheels, as well as broken toes and injuries to the feet
- Model 60301 has a replaceable polymer covered tail that locks the tool securely in place



406-60301

406-60302

406-60303

ASCOT NO.	MFG. NO.	DESCRIPTION
406-60301	60301	Budd Nut Wrench
406-60302	60302	Budd Nut Wrench - 35mm
406-60303	60303	Budd Nut Wrench - 41mm
406-60908	60908	Replaceable Polymer Tail





### HEAVY DUTY TRUCK WRENCHES

• Use for off-the-road Budd-type wheels • Use TR11 handle

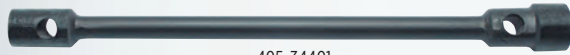

405-34401

ASCOT NO.	MFG. NO.	LENGTH	STOCK	WEIGHT
405-34401	TR10	29-1/2"	1-3/4" Hex x 15/16" Square	12.2 lb.
402-34402	TR11	30"	1-1/4"	6.5 lb.

### POWER WRENCH

• Designed for dual nut systems • Has 13/16" square end to hold inner nut, with a 1-1/2" hex drive to spin outer nut off



406-34547



The Budd Wheel Set in use.

ASCOT NO.	MFG. NO.	DESCRIPTION
404-34543	TR43	<b>BASIC SET INCLUDES:</b> Power Drive And Two Handles (Solid Bar - 20-1/2" Long And Tube - 20" Long)
404-34545	TR44X	<b>BUDD WHEEL SET INCLUDES:</b> Power Drive, One Bar, One Tube Handle, A 3/4" Service Adapter And One 13/16" Square Adapter
404-34547	TR44SW	<b>UNIVERSAL SET INCLUDES:</b> Power Drive, One 20-1/2" Bar, One 36" Tube Handle, A 3/4" Service Adapter, A 13/16" Square Adapter, And Six 3/4" Impact Sockets (7/8", 15/16", 1-1/16", 1-1/8", 1-3/16", 1-1/2")

### DOUBLE END TRUCK WRENCHES

• Double end truck wrenches for on-the-road service • Sizes available for all standard lug nuts • Constructed from 1" high quality steel for greatest strength and durability • All will take our standard TR5 (ASCOT Order No. 405-32318) leverage handle • HANDLE HEX OPENING: 3/4" • LENGTH: 16"; WEIGHT: 4-1/2 lb.



402-32508

ASCOT NO.	MFG. NO.	SOCKET SIZE	WEIGHT
<b>SAE</b>			
405-32501	TR1	1-1/8", 13/16" Square, 1-1/2"	4.6 lb.
405-32502	TR2	1, 1-1/4", 5/8" Square	4.3 lb.
405-32504	TR2X	15/16", 7/8"	4.5 lb.
405-32503	TR3	7/8", 1-1/16"	4.5 lb.
405-32505	TR3A	1-1/8", 1-1/16"	4.5 lb.
405-32506	TR3X	1-1/16", 1-3/16"	4.5 lb.
405-32509	TR9	1-1/4", 1-1/16"	4.5 lb.
405-32508	TR98	1-1/2", 13/16" Square	4.5 lb.
<b>METRIC</b>			
405-32551	TRM1	35mm Sq. x 17mm Square	4.5 lb.
405-32552	TRM2	24mm x 33mm	4.4 lb.
405-32553	TRM3	27mm x 30mm	4.5 lb.
405-32556	TRM6	41mm x 21mm Square	4.5 lb.
405-32557	TRM7	33mm x 30mm Square	4.5 lb.

### DUAL WHEEL LUG STUD REMOVER

• Special self-tapping splines provide maximum grip to remove stripped lug studs • Use with TR1 and TR98 truck wrenches • Also used with open end wrench • Use with soft-faced hammer

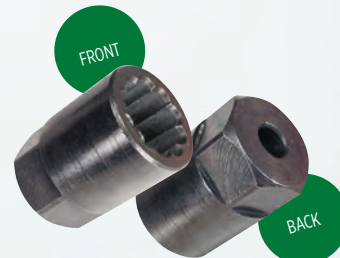

492-30165

ASCOT NO.	MFG. NO.	DESCRIPTION	WEIGHT
492-30165	30165	Fits 13/16" Sq. Inner Nut	1 lb.



## Wrenches & Lug Wrenches (cont.)



### STOW & GO™ 4-WAY HD LUG WRENCH

• The Stow & Go™ 4-Way HD Lug Wrench folds to save space in your trunk and locks into place for easy use • Push button in center allows wrench to fold after use • Sliding arms give extra leverage for removing lug nuts • Made of heavy duty and durable alloy steel • 17mm, 19mm, 21mm sockets, and 1/2" square drive adaptor to be used with other sockets • 16" in length

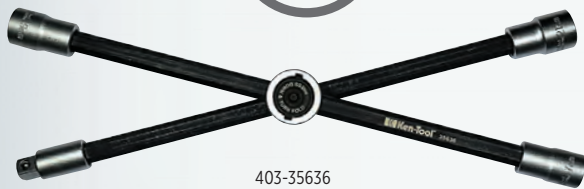

403-35636

ASCOT NO.	MFG. NO.	DESCRIPTION
403-35636	35636	Stow & Go™ 4-Way HD Lug Wrench

### HEAVY DUTY TRUCK FOUR-WAY LUG WRENCHES

• Drop-forged center • APPLICATIONS: Heavy duty truck, bus, tractor four-way • Center hole for leverage bar • T96 with heavy duty solid center



403-35595

403-35697

ASCOT NO.	MFG. NO.	LENGTH	STOCK	SOCKET SIZE	WEIGHT
403-35595	TC95	27-1/2"	1"	1-1/2", 13/16" Sq., 30, 33mm	14.2 lb.
403-35695	T95	27-1/2"	1"	1-1/16", 1-1/4", 1-1/2", 13/16" Sq.	13.8 lb.
403-35696	T96	27-1/2"	1"	1-1/16", 1-1/4", 1-1/2", 13/16" Sq.	13.5 lb.
403-35697	T95A	27-1/2"	1"	1-1/4", 1-1/2", 13/16" Sq., 3/4" Service Arm (will take any standard 3/4" drive socket)	13.5 lb.
403-35795	TM95	27-1/2"	1"	24, 27, 30, 33mm	13.5 lb.

### LUG WRENCHES

- Most popular 4-way lug wrench, polished sockets
- Welded center construction for strength and durability
- Premium grade bar quantity steel



403-35656



403-35659



403-35620

ASCOT NO.	MFG. NO.	LENGTH	STOCK	SOCKET SIZE	WEIGHT
<b>PROFESSIONAL</b>					
403-35656	T56	20"	5/8"	17, 19, 21, 22mm	4 lb.
403-35657	T57	23"	5/8"	3/4", 13/16", 7/8", 15/16"	4-1/2 lb.
<b>STANDARD</b>					
403-35659	T59	22"	5/8"	3/4", 13/16", 7/8", 15/16"	4.5 lb.
405-35690	T90	25"	3/4"	7/8", 15/16", 1", 1-1/16"	7.2 lb.
<b>ECONOMY</b>					
403-35620	T9520	20"	9/16"	3/4", 13/16", 7/8", 17mm	3.4 lb.
403-35661	T61	22"	9/16"	3/4", 13/16", 7/8", 17mm	3.8 lb.
403-35662	T62	18"	9/16"	3/4", 13/16", 7/8", 17mm	3.2 lb.
403-35663	T63	18"	9/16"	17, 19, 21, 22mm	3.2 lb.

# Shop Service Tools

## WHEEL COVER PULLERS/REPLACERS

- Remove wheel covers quickly and easily without gouging or scratching
- Rubber head T11RH prevents damage to hubcap and is replaceable



ASCOT NO.	MFG. NO.	LENGTH	STOCK	WEIGHT
402-31567	T67	17-1/2"	9/16"	1.8 lb.
402-31568	T68	14"	7/16"	1.3 lb.

## CENTER CAP REMOVERS



ASCOT NO.	MFG. NO.	LENGTH	STOCK	WEIGHT
402-31565	T65	7-3/4"	5/16"	.2 lb.
402-31566	T66	7-3/4"	5/16"	.2 lb.



## SMALL TIRE SNAKE

- Included with T600 Tire Changer



ASCOT NO.	MFG. NO.	LENGTH	STOCK	WEIGHT
402-34672	34672	22"	5/8"	2 lb.

## MEDIUM TIRE SNAKE

- Included with T601 Tire Changer • APPLICATIONS: Designed for wheels from 4" to 13" • Longer length provides greater strength



ASCOT NO.	MFG. NO.	LENGTH	STOCK	WEIGHT
402-34674	34674	28"	5/8"	2.5 lb.

## LARGE TIRE SNAKE

- Included with T600 Tire Changer



ASCOT NO.	MFG. NO.	LENGTH	STOCK	WEIGHT
402-34678	34678	40"	3/4"	5.3 lb.

## SHARK FIN DUAL WHEEL SEPARATION BAG

- The first wheel separation solution for steel, aluminum and chrome wheels • No metal on metal contact • 5000 lb. of static pressing force • Works on 15" to 24.5" dual and single wheels and tires on trucks & trailers • Kevlar inner inflation bag is industrial grade and nearly puncture proof • SMALL BUT MIGHTY: Portable, durable, and fast • Full inflation only takes a matter of seconds • 3-foot inflation hose makes access easy and safe • Deflation is controlled with a quick turn of the slotted valve cap • 9.75" x 8" x 3/8" height deflated, 5.5" height when fully inflated • 90 psi max pushing pressure, 150 psi maximum rated pressure



ASCOT NO.	MFG. NO.	DESCRIPTION
429-36455	364555	Shark Fin™ Dual Wheel Separation Bag

TIRE & WHEEL SERVICE





## DUAL WHEEL SEPARATOR

- Makes removing stuck or frozen dual steel wheels quick and easy
- Ideal for use on nearly any truck, bus, van or trailer with dual steel wheels
- Innovative "one-piece" pusher won't fall apart during use
- Forcing screw and pullers have powerful 1-1/8" diameter x 7 threads for years of reliable service
- Pusher is ball bearing-driven for near-zero turning resistance
- Pusher is heat treated for long-lasting strength and durability
- Includes two pullers to cover large truck, trailer and smaller light truck dual wheel applications
- Use with air or electric impact wrench
- Blow molded case



422-94549

ASCOT NO.	MFG. NO.	DESCRIPTION
422-94549	ASC94549	Dual Wheel Separator



## DUAL WHEEL SEPARATOR

- Makes removing stuck or frozen dual steel wheels quick and easy
- APPLICATIONS: Ideal for use on nearly any truck, bus, van or trailer that has dual steel wheels
- WEIGHT: 6.5" x 9.5" x 2.5", 5.3 lb.
- MADE IN USA



422-34549

ASCOT NO.	MFG. NO.	DESCRIPTION
422-34549	34549	Dual Wheel Separator

## BENCH MOUNT RIM-CLAMP MANUAL TIRE CHANGER

- APPLICATIONS: Mounts and demounts a full range of tires on rim diameters from 4" to 12"
- Mounts easily to a bench or in any standard, four-position rim-clamp tire changer
- Built-in, three-fin centering device mounts standard lug-type rims with 2" and larger center hole
- Square base prevents turning in the changer during use
- Includes a 22" tire snake mount/demount tool (Ascot # 402-34672)



441-38600

ASCOT NO.	MFG. NO.	HEIGHT	WEIGHT
441-38600	T600	16.5"	21.7 lb.



## FLOOR MOUNT MANUAL TIRE CHANGER

- APPLICATIONS: Mounts and demounts a full range of tires on rim diameters from 4" to 15"
- Tapered bearing guide positively centers straight shaft hubs of all diameters
- Built-in adjustable bead breaker works on rims up to 13" in diameters and 24" in width without disassembly
- Includes a 28" tire snake mount/demount tool (Ascot # 402-34674)



441-38601

ASCOT NO.	MFG. NO.	HEIGHT	WEIGHT
441-38601	T601	32"	31 lb.

## Shop Service Tools (cont.)

### TRUCK WHEEL & RIM REMOVAL TOOL

- The easiest & quickest way to loosen stubborn, locked up rims • Retire that back-breaking 20 lb sledge that you use to break seized rims apart • Eliminate damaged tire side walls and rims • Fits all standard (22.5 and 24.5) semi truck rims; aluminum or steel • Safe and efficient

422-71650



ASCOT NO.	MFG. NO.	DESCRIPTION
422-71650	71650	RIMWIT - Truck Wheel & Rim Removal Tool - Fits Standard 22.5 & 24.5 Wheels
422-71655	71655	RIMWIT JR- Truck Wheel & Rim Removal Tool - Fits 19.5" Wheels



### MANUAL TIRE CHANGER & OPTIONAL BASE PLATE

- Small tire changing system for lawn & garden, ATV and other small tires/wheels
- Not for passenger tires
- Adjustable to accommodate multiple tire/wheel sizes
- High quality, energy saving & environmentally friendly
- Portable and equipped with professional accessories
- Can be operated easily without the use of power or pneumatic supplies
- Works for an impressive range of tires
- Great for family and commercial garages, racing teams, emergencies and any time a convenient changer is required

ASCOT NO.	MFG. NO.	DESCRIPTION
441-00202	BJ-CO2	Manual Tire Changer
441-00002	BJ-CO2-BASEPLATE	Optional Base Plate for Manual Tire Changer



441-00202

Shown with Optional Base Plate (441-00002)



### MANUAL TIRE CHANGING SYSTEM

- APPLICATIONS: For changing small tires and wheels
- INCLUDES: Everything needed to change 4" to 16.5" tires including rim • Rim clamp mechanism • 2 center posts (for open or hub type wheels and bearing type wheels) • Also includes the CH-4 Mongoose tire tool • Can be mounted on a bench, tire stand or tire changer

ASCOT NO.	MFG. NO.	HEIGHT	WEIGHT
441-00220	CH-22	Manual Tire Changer	23 lb.
441-00230	CH-23	Tire Changing Stand	70 lb.



441-00220

The CH-22 Manual Tire Changer & CH-23 Tire Changing Stand shown with Floor Plate.





# Automatic Tire Inflation Systems

All systems feature an operating range of 5-145 PSI, accurate within 0.3 PSI. Units are housed in weather resistant aluminum casings. All provide an easy to use and affordable way to assure precise inflation. Units available with 110 volt AC electric or battery hook up. Optional heater available for outdoor units. Custom faceplates with corporate logo and color available. Can be hardwired and mounted to mobile service trucks. Systems confirm calibration every six minutes when in use and everytime they are powered on. INTERNATIONAL PROTECTION RATING: IP66, provides complete weather protection (except submersions). Automatically inflates or deflates to target PSI when attached to tire position. All systems can be programmed to specific PSI parameters to help organizations better manage consistent and accurate tire inflation. Wirelessly receives/transmits gauged and corrected pressure via Bluetooth, Zigbee, or hardwired to PC. Designed to be operated with specific Haltec air chucks. NITROGEN COMPATIBLE: PSI is PSI, accuracy is main goal. All systems allow technician remote control of inflation/deflation process, keeping themselves out of "blast zone" of tire.

## SINGLE TIRE INFLATOR

- Ideal for vehicle service centers, automobile dealerships and rental facilities • 1/4" inlet/outlet
- OPERATING RANGE: 5-145 PSI



ASCOT NO.	MFG. NO.	DESCRIPTION	475-89001
475-89001	89XDA	Single Tire Inflation System	

## HIGH VOLUME TIRE INFLATOR

- For Fleet Operations, Service Centers, or Mounters
- APPLICATIONS: For 19.5" and larger rims • Capable of inflating four 22.5" tires from 5 to 100 PSI in 5 minutes



ASCOT NO.	MFG. NO.	DESCRIPTION	475-89003
475-89003	89XDB	High Volume Tire Inflation System	

## SINGLE TIRE INFLATION HOSES & ACCESSORIES



ASCOT NO.	MFG. NO.	DESCRIPTION
475-00896	SVL-STD	4' Mounting Steel Swivel Stand
475-01892	89HKC-L	Straight Hose w/Coupler & CH3600P Chuck
475-01893	89HKC-LC	Coil Hose w/ Coupler and CH-3600P Chuck
475-01894	89HKT-L	Straight Hose w/Coupler & CH 330-LO-OP Chuck
475-01895	89HK1-25	Straight Hose w/Coupler & IN-20 Tool
475-01896	89-2 WASV	2 Way Automatic Switching Valve (2 Hoses)
475-01897	89-3 WASV	3 Way Automatic Switching Valve (3 Hoses)
475-01898	89-3 WTK	3 Way Automatic Switching Valve Kit
478-00820	IN20	Core Removal and Inflation Tire Chuck

Specify Hose length when ordering. Components available separately.

## OVER INFLATION & HIGH VOLUME INFLATION SYSTEM

- For Retreaders, Fleets or Mounters
- Inflate single or multiple tires to a preset over-pressure setting • Unit then performs a leak test for "zipper leaks"
- Deflates to final preset required PSI setting • Features 3 preset PSI settings



ASCOT NO.	MFG. NO.	DESCRIPTION	475-89004
475-89004	89XDZ	Over Inflation & High Volume System	

3 PRESET  
PSI  
SETTINGS

INFLATE  
SINGLE OR  
MULTIPLE  
TIRES



ASCOT NO.	MFG. NO.	DESCRIPTION
475-89004	89 XDZ	Over Inflation & High Volume System





## Automatic Tire Inflation Systems (cont.)

### MULTIPLE TIRE INFLATION HOSES & ACCESSORIES

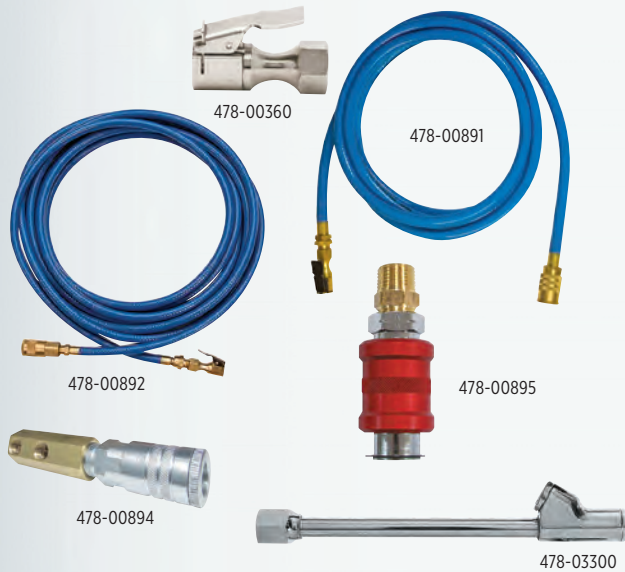

ASCOT NO.	MFG. NO.	DESCRIPTION
478-00360	CH-360S	Chip-On Style Air Chuck (Closed) w/Spring
475-00891	89HKC-LM	Straight Hose w/ CH-360S Air Chuck
475-00892	89HKT-LM	Straight Hose w/Coupler & CH-330-LO Air Chuck
475-00893	89HKI-25	Straight Hose w/Coupler & IN-20 Tool (Single Tire)
475-00894	89-HMVN	4-Way Manifold
475-00895	89-3W	Air Flow Control Valve
475-00896	SVL-STD	4' Mounting Steel Swivel Stand
478-03300	CH-330-LO	Lock-On Style Air Chuck (Dual Wheels)

### MULTIPLE TIRE INFLATION SYSTEM (3-WAY)

- Inflates up to three wheels simultaneously at a 5-145 PSI pressure
- Semi-pneumatic locking swivel wheel
- Color-coded 0.25" inflation hose
- 1/2" and 3/8" inlet/outlet
- Suitable for use with standard or large bore valves and core extraction tools
- Inlet pressure gauge
- Dual LCD screens indicate gauged and targeted pressure



ASCOT NO.	MFG. NO.	DESCRIPTION
475-89103	89MTIS-3DS	Multiple Tire Inflation System (3-Way)



### 4-WAY INFLATOR KIT

- Quick coupler connects directly to the inflator
- Slide valve allows air supply to be turned on/off
- Includes all hoses (25 ft) and connections

ASCOT NO.	MFG. NO.	DESCRIPTION
477-11623	11.0623NA	4-Way Inflator Kit

### 4-WAY INFLATOR ACCESSORY BLOCK

- Lightweight aluminum manifold splits air lines into (4) separate lines
- Slide valve turns air on/off to start inflation
- (4) 1/4" universal quick couplers allow for any type fitting
- 3' whip hose



ASCOT NO.	DESCRIPTION
477-11624	4-Way Inflator Accessory Block

TIRE & WHEEL SERVICE

# Safety Inflation Cages

A safety inflation cage is mandatory in any shop for tubeless and multi-piece rims. Ascot offers a size and design for all your needs. Constructed of heavy gauge steel welded to a steel base. Guards against blown lock rings, exploding rims and ruptured tire explosions when used properly. These cages meet OSHA safety requirements (29-CFR Part 1910.177).



## BRANICK SAFETY INFLATION CAGES

- Constructed of heavy gauge steel welded to a steel base
- No-mar wheel protection available
- Multiple sizes for passenger and commercial locations
- Side mesh option provides complete protection
- Arch design for maximum energy displacement
- These cages meet OSHA safety requirements (29-CFR Part 1910.177)



ASCOT NO.	MFG. NO.	DESCRIPTION	MAX. HEIGHT X MAX. TIRE WIDTH	DIMENSIONS	WEIGHT
<b>2-BAR SAFETY INFLATION CAGES</b>					
479-02220	2220	Portable 2-Bar Safety Cage	54" x 21.5"	28" W x 17" D x 60" H	76 lb.
<b>3-BAR SAFETY INFLATION CAGES</b>					
479-02130	2130	3-Bar Passenger/Light Truck Cage	34" x 21.5"	28" W x 20" D x 40" H	120 lb.
<b>4-BAR SAFETY INFLATION CAGES</b>					
479-02240	2240	4-Bar Safety Cage with No Mar Coating	54" x 21.5"	28" W x 28" D x 60" H	170 lb.
<b>6-BAR SAFETY INFLATION CAGES</b>					
479-02260	2260	6-Bar Safety Cage	59" x 29"	35" W x 41" D x 62" H	385 lb.



Work safely. Always use an inflation cage when inflating tires.  
Follow OSHA regulation 29-CFR Part 1910.177 whenever changing tires.





## MARTINS SUPPLY SAFETY INFLATION CAGES

- A safety inflation cage is mandatory in any shop for tubeless and multi-piece rims and Ascot offers a size and design for all your needs
- Constructed of heavy gauge steel welded to a steel base
- Guards against blown lock rings, exploding rims and ruptured tire explosions when used properly
- These cages meet OSHA safety requirements (29-CFR Part 1910.177)



ASCOT NO.	MFG. NO.	DESCRIPTION	HANDLES TIRES	DIMENSIONS	WEIGHT
<b>2-BAR SAFETY INFLATION CAGES</b>					
479-36001	MIC-2	Portable 2-Bar Safety Cage	Up to 48" OD X 13" W	21-1/2" x 16-3/4" x 51"	69 lb.
479-36011	MIC-2WB	Portable 2-Bar Safety Cage (Super Single)	Up to 48" OD X 21" W	29" x 16-3/4" x 52"	78 lb.
479-36201	MIC-2G	Galvanized Portable 2-Bar Safety Cage	Up to 48" OD X 13" W	21-1/2" x 16-3/4" x 51"	69 lb.
479-36211	MIC-2WBG	Galvanized Portable 2-Bar Safety Cage (Super Single)	Up to 48" OD X 21" W	29" x 16-3/4" x 52"	78 lb.
<b>3-BAR SAFETY INFLATION CAGES</b>					
479-36006	MIC-3	3-Bar Safety Cage	Up to 47" OD X 19" W	22-1/4" x 26-1/4" x 57-5/16"	108 lb.
479-36013	MIC-PCR	3-Bar Passenger-SUV Safety Cage	Up to 35" OD X 12.5" W	21" x 28" x 40"	93 lb.
<b>4-BAR SAFETY INFLATION CAGES</b>					
479-36002	MIC-4	4-Bar Safety Cage	Up to 47" OD X 19" W	31-5/8" x 26-1/4" x 57-5/16"	147 lb.
<b>5-BAR SAFETY INFLATION CAGES</b>					
479-36005	MIC-5	5-Bar Safety Cage	Up to 47" OD X 19" W	41" x 26-1/4" x 57-5/16"	182 lb.
479-36015	MIC-OTR	OTR 5-Bar Safety Cage	Up to 62" OD X 33" W	41" x 39-3/8" x 66"	277 lb.



Work safely. Always use an inflation cage when inflating tires.  
Follow OSHA regulation 29-CFR Part 1910.177 whenever changing tires.



### KEN-TOOL® SAFETY INFLATION CAGES

- Constructed of heavy gauge steel welded to a steel base
- Guards against blown lock rings, exploding rims and ruptured tire explosions when used properly
- These cages meet OSHA safety requirements (29-CFR Part 1910.177)



TIRE & WHEEL SERVICE

ASCOT NO.	MFG. NO.	DESCRIPTION	HANDLES TIRES	BASE PLATE	INSIDE HEIGHT	INSIDE DIMENSIONS	WEIGHT
<b>2-BAR SAFETY INFLATION CAGES</b>							
479-46001	36001	2-Bar Safety Cage	—	7" x 21-1/2"	41"	41" H x 16" W	60 lb.
479-46011	36007	2-Bar Wide Base Safety Cage	—	7" x 27"	43.5"	43.5" H x 20.5" W	72 lb.
<b>3-BAR SAFETY INFLATION CAGES</b>							
479-36003	T103	3-Bar Safety Cage/Light Truck Cage	—	21-1/2" x 22"	30"	30" H x 16" W	80 lb.
479-36004	T104	3-Bar Safety Cage for Off Road	—	30" x 27"	65"	65" H x 24" W	158 lb.
479-46006	36006	3-Bar Tire Inflation Cage	—	31.5" x 26"	43.5"	43.5" H x 20.5" W	146 lb.
<b>4-BAR SAFETY INFLATION CAGES</b>							
479-46002	36002	4-Bar Safety Cage	—	31.5" x 26"	43.5"	43.5 H x 20.5 W	146 lb.
<b>5-BAR SAFETY INFLATION CAGES</b>							
479-46005	36005	5-Bar Safety Cage	—	41" x 26"	43.5"	43.5" H x 20.5" W	182 lb.
479-46010	36010	5-Bar Super Magnum	—	48" x 30"	41.5"	41.5" H x 24" W	248 lb.



Work safely. Always use an inflation cage when inflating tires.  
Follow OSHA regulation 29-CFR Part 1910.177 whenever changing tires.



## Safety Inflation Cages (cont.)



### TRUCK TIRE CHANGING STAND

• APPLICATIONS: Handles wheels or open rims 16.5" to 24" • Double-slide adjustment with locking device prevents twisting so it stays aligned with the wheel or rim • Ideal height for driving off beads or demounting tire

479-36115



ASCOT NO.	MFG. NO.	DESCRIPTION
479-36115	T115	Truck Tire Changing Stand

### EZ TIRE ROTATOR FOR INFLATION CAGES

• APPLICATIONS: EZ Tire Rotator fits any Ken-Tool 3-Bar, 4-Bar and 5-Bar Inflation Cage, plus many competitive cages • No need to lift or remove rim/wheel assembly from cage when repositioning valve stem for access through the cage tubes • Allows tire tech to easily and quickly rotate rim/wheel assembly inside the safety cage in order to adjust position of valve stem • Reduces handling, back strain and user fatigue; increases safety • Easily installed or moved to another cage - no fastening required • No assembly required; simply place in the center of the cage • Features heavy-duty 2" ball-bearing steel rollers and 1/4" thick steel stock for long service • Boxed and UPS shippable • MADE IN USA

NO ASSEMBLY REQUIRED

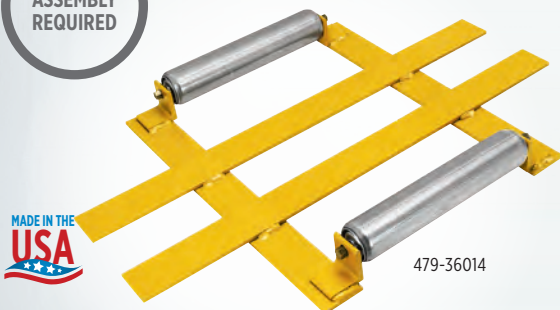

479-36014

ASCOT NO.	MFG. NO.	DESCRIPTION
479-36014	T114	EZ Tire Rotator for Inflation Cages



### ROLLER FOR TIRE INFLATION CAGES

• Used to roll the tires easily directly into the inflation cage • Allows an easy access to the tire valve because it is easy to turn the tire to have the valve to any position • For use with all 3-bar, 4-bar & 5-bar inflation cages • Prevent back injuries when handling heavy tires • WEIGHT: 12 lbs.

ALLOWS FOR EASY ACCESS TO TIRE VALVE



479-36111

ASCOT NO.	MFG. NO.	DESCRIPTION
479-36111	MIC-ROLLER	Roller for Tire Inflation Cages

### TIRE CAGE STAND FOR AUTOMATIC INFLATORS

• Used to support automatic inflators to tire inflation cages • Reduces movement and allows for faster inflation of tires • Install directly on the top of one of the inflation cage bars with the mounting bracket • WEIGHT: 8 lbs.

ALLOWS FOR FASTER INFLATION OF TIRES



479-36112

ASCOT NO.	MFG. NO.	DESCRIPTION
479-36112	MW-STAND	Tire Cage Stand for Automatic Inflators