



U.S. Department of
Transportation

**Federal Railroad
Administration**

Compliance Testing for Locomotive LED Headlights and Auxiliary Lights, Phase I

Office of Research,
Development, and
Technology
Washington, DC 20590

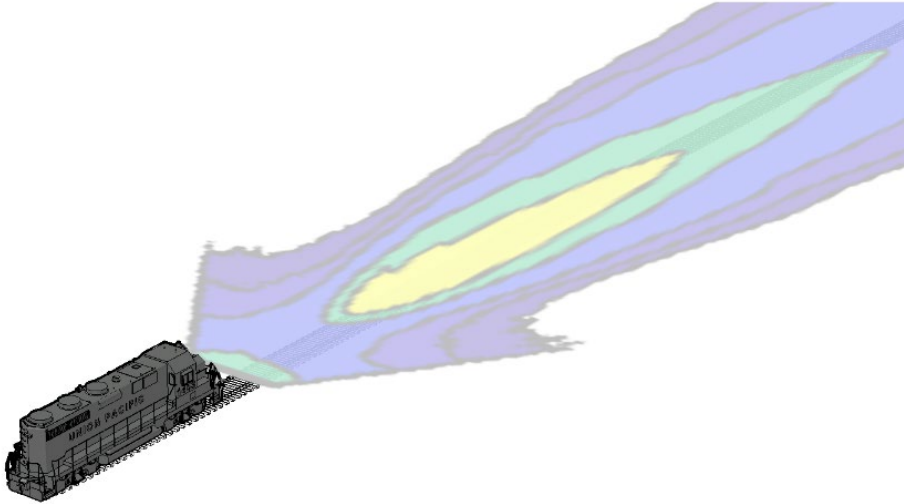

NOTICE

This document is disseminated under the sponsorship of the Department of Transportation in the interest of information exchange. The United States Government assumes no liability for its contents or use thereof. Any opinions, findings and conclusions, or recommendations expressed in this material do not necessarily reflect the views or policies of the United States Government, nor does mention of trade names, commercial products, or organizations imply endorsement by the United States Government. The United States Government assumes no liability for the content or use of the material contained in this document.

NOTICE

The United States Government does not endorse products or manufacturers. Trade or manufacturers' names appear herein solely because they are considered essential to the objective of this report.

REPORT DOCUMENTATION PAGE*Form Approved
OMB No. 0704-0188*

Public reporting burden for this collection of information is estimated to average 1 hour per response, including the time for reviewing instructions, searching existing data sources, gathering and maintaining the data needed, and completing and reviewing the collection of information. Send comments regarding this burden estimate or any other aspect of this collection of information, including suggestions for reducing this burden, to Washington Headquarters Services, Directorate for Information Operations and Reports, 1215 Jefferson Davis Highway, Suite 1204, Arlington, VA 22202-4302, and to the Office of Management and Budget, Paperwork Reduction Project (0704-0188), Washington, DC 20503.

1. AGENCY USE ONLY (Leave blank)		2. REPORT DATE October 2020		3. REPORT TYPE AND DATES COVERED Technical Report, May 2018	
4. TITLE AND SUBTITLE Compliance Testing for Locomotive LED Headlights and Auxiliary Lights, Phase I				5. FUNDING NUMBERS DTFR53-17-F-00759	
6. AUTHOR(S) Manuel Meza-Arroyo, Ph.D., AHFP; Peggy A. Shibata, P.E.; Sean Woods				8. PERFORMING ORGANIZATION REPORT NUMBER ENSCO SERV-REPT-0001902	
7. PERFORMING ORGANIZATION NAME(S) AND ADDRESS(ES) ENSCO, Inc. Engineering Systems, Inc. 5400 Port Royal Road 5697 North 13 th Street Springfield, VA 22151 Omaha, NE 68110				10. SPONSORING/MONITORING AGENCY REPORT NUMBER DOT/FRA/ORD-20/41	
9. SPONSORING/MONITORING AGENCY NAME(S) AND ADDRESS(ES) U.S. Department of Transportation Federal Railroad Administration Office of Railroad Policy and Development Office of Research, Development and Technology Washington, DC 20590				11. SUPPLEMENTARY NOTES COR: Tarek Omar, Ph.D.	
12a. DISTRIBUTION/AVAILABILITY STATEMENT This document is available to the public through the FRA website .				12b. DISTRIBUTION CODE	
13. ABSTRACT (Maximum 200 words) This report describes Phase I compliance testing of light-emitting diode (LED) fixtures as locomotive headlights and auxiliary lights. The purpose was to validate that all LED samples submitted by participating suppliers complied with applicable regulatory requirements and standards, and to compare the photometric features of LED samples to halogen locomotive lights currently used in the rail industry. Luminous intensity and color temperature values were measured for LED and halogen samples. These measurements were obtained by following both the guidelines provided by the Association of American Railroads' Locomotive Committee – LED Headlight-Auxiliary Light Standard Technical Advisory Group in its scope of work and the standard requirements in 49 Code of Federal Regulations §229.125. Phase II and Phase III testing will involve subjective field testing for LED sample fixtures on static and moving locomotives, respectively. These test phases will be documented in future reports.					
14. SUBJECT TERMS Locomotive headlights, auxiliary lights, LED, halogen, Phase I compliance testing, photometry, colorimetry, Code of Federal Regulations §229.125				15. NUMBER OF PAGES 255	
				16. PRICE CODE	
17. SECURITY CLASSIFICATION OF REPORT Unclassified	18. SECURITY CLASSIFICATION OF THIS PAGE Unclassified	19. SECURITY CLASSIFICATION OF ABSTRACT Unclassified	20. LIMITATION OF ABSTRACT		

NSN 7540-01-280-5500

Standard Form 298 (Rev. 2-89)

Prescribed by ANSI
Std. 239-18
298-102

METRIC/ENGLISH CONVERSION FACTORS

ENGLISH TO METRIC

METRIC TO ENGLISH

<p style="text-align: center;">LENGTH (APPROXIMATE)</p> <p>1 inch (in) = 2.5 centimeters (cm) 1 foot (ft) = 30 centimeters (cm) 1 yard (yd) = 0.9 meter (m) 1 mile (mi) = 1.6 kilometers (km)</p>	<p style="text-align: center;">LENGTH (APPROXIMATE)</p> <p>1 millimeter (mm) = 0.04 inch (in) 1 centimeter (cm) = 0.4 inch (in) 1 meter (m) = 3.3 feet (ft) 1 meter (m) = 1.1 yards (yd) 1 kilometer (km) = 0.6 mile (mi)</p>
<p style="text-align: center;">AREA (APPROXIMATE)</p> <p>1 square inch (sq in, in²) = 6.5 square centimeters (cm²) 1 square foot (sq ft, ft²) = 0.09 square meter (m²) 1 square yard (sq yd, yd²) = 0.8 square meter (m²) 1 square mile (sq mi, mi²) = 2.6 square kilometers (km²) 1 acre = 0.4 hectare (he) = 4,000 square meters (m²)</p>	<p style="text-align: center;">AREA (APPROXIMATE)</p> <p>1 square centimeter (cm²) = 0.16 square inch (sq in, in²) 1 square meter (m²) = 1.2 square yards (sq yd, yd²) 1 square kilometer (km²) = 0.4 square mile (sq mi, mi²) 10,000 square meters (m²) = 1 hectare (ha) = 2.5 acres</p>
<p style="text-align: center;">MASS - WEIGHT (APPROXIMATE)</p> <p>1 ounce (oz) = 28 grams (gm) 1 pound (lb) = 0.45 kilogram (kg) 1 short ton = 2,000 pounds (lb) = 0.9 tonne (t)</p>	<p style="text-align: center;">MASS - WEIGHT (APPROXIMATE)</p> <p>1 gram (gm) = 0.036 ounce (oz) 1 kilogram (kg) = 2.2 pounds (lb) 1 tonne (t) = 1,000 kilograms (kg) = 1.1 short tons</p>
<p style="text-align: center;">VOLUME (APPROXIMATE)</p> <p>1 teaspoon (tsp) = 5 milliliters (ml) 1 tablespoon (tbsp) = 15 milliliters (ml) 1 fluid ounce (fl oz) = 30 milliliters (ml) 1 cup (c) = 0.24 liter (l) 1 pint (pt) = 0.47 liter (l) 1 quart (qt) = 0.96 liter (l) 1 gallon (gal) = 3.8 liters (l) 1 cubic foot (cu ft, ft³) = 0.03 cubic meter (m³) 1 cubic yard (cu yd, yd³) = 0.76 cubic meter (m³)</p>	<p style="text-align: center;">VOLUME (APPROXIMATE)</p> <p>1 milliliter (ml) = 0.03 fluid ounce (fl oz) 1 liter (l) = 2.1 pints (pt) 1 liter (l) = 1.06 quarts (qt) 1 liter (l) = 0.26 gallon (gal) 1 cubic meter (m³) = 36 cubic feet (cu ft, ft³) 1 cubic meter (m³) = 1.3 cubic yards (cu yd, yd³)</p>
<p style="text-align: center;">TEMPERATURE (EXACT)</p> <p style="text-align: center;">[(x-32)(5/9)] °F = y °C</p>	<p style="text-align: center;">TEMPERATURE (EXACT)</p> <p style="text-align: center;">[(9/5)y + 32] °C = x °F</p>

QUICK INCH - CENTIMETER LENGTH CONVERSION

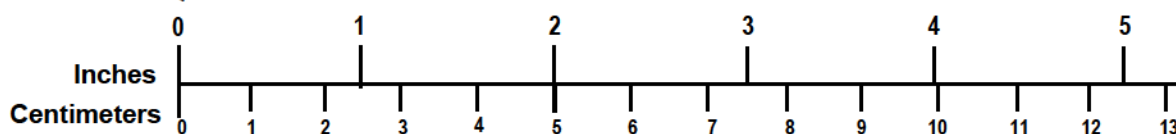

QUICK FAHRENHEIT - CELSIUS TEMPERATURE CONVERSION

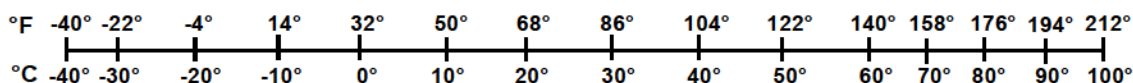

For more exact and or other conversion factors, see NIST Miscellaneous Publication 286, Units of Weights and Measures. Price \$2.50 SD Catalog No. C13 10286

Contents

Executive Summary	1
1. Introduction.....	2
1.1 Background.....	2
1.1.1 Regulation Overview: 49 CFR §229.125.....	2
1.1.2 Implementation of LED Fixtures in Transportation	2
1.2 Objectives	3
1.3 Overall Approach.....	3
1.4 Scope.....	4
1.5 Organization of the Report.....	4
2. Methodology	5
2.1 Submitted Samples.....	5
2.2 Testing Protocol.....	6
2.2.1 Photometric Testing	7
2.2.2 Colorimetric Testing	8
3. Analysis and Results	9
3.1 Photometric Distributions	9
3.2 Luminous Intensity Comparisons	13
3.2.1 Luminous Intensity at 0°	13
3.2.2 Luminous Intensity at 7.5°	13
3.2.3 Luminous Intensity at 20°	13
3.3 Luminous Intensity in Dim Mode.....	15
3.4 Colorimetric Results	18
3.5 Colorimetric Comparisons	19
3.5.1 CIE Chromaticity Diagrams	19
3.5.2 Colorimetry in Dim Mode	22
4. Discussion	24
4.1 Human Factors Considerations on Luminous Intensity and Illuminance.....	25
4.2 Human Factors Considerations on Colorimetry	32
4.2.1 Virtual Renderings of Color Temperature	32
5. Conclusion	34
6. References.....	35
Abbreviations and Acronyms	36
Appendix A. Calibration Data for Test Instrumentation	37
Appendix B. Circuit Diagram for LED Lights	75
Appendix C. Candela Plots of Lights – Bright Mode.....	76
Appendix D. Candela Plots of Lights – Dim Mode.....	82
Appendix E. Candela Plots of Halogen Lights	88
Appendix F. Intertek Photometry and Colorimetry Measurement Summaries	92
Appendix G. Illuminance Maps of Test Samples	96
Appendix H. Color Rendering of Test Samples	214
Appendix I. Intertek Measurement Results	218

Illustrations

Figure 1: LED Samples Supplied by J.W. Speaker, Hydra-Tech International, Railhead/Divvali, and Smart Light Source Co. (Left to Right)	6
Figure 2: Halogen Samples Supplied by AMGLO, CML, and ePowerRail (Left to Right).....	6
Figure 3. Test Setup at Intertek’s Photometrics Lab.....	7
Figure 4. Photometric Test Setup for Colorimetric Measurements	8
Figure 5. Raw Photometric Distribution for J.W. Speaker LED Samples.....	10
Figure 6. Raw Photometric Distribution for Hydra-Tech 2800 K LED Samples.....	10
Figure 7. Raw Photometric Distribution for Hydra-Tech 7000 K LED Samples.....	10
Figure 8. Raw Photometric Distribution for Railhead/Divvali Samples	11
Figure 9. Raw Photometric Distribution for Smart Light Source Samples	11
Figure 10. Raw Photometric Distribution for AMGLO Halogen Samples	11
Figure 11. Raw Photometric Distribution for ePowerRail Halogen Samples	12
Figure 12. Raw Photometric Distribution for CML Halogen Samples	12
Figure 13. Ranges of Measured Luminous Intensity	14
Figure 14. CIE Chromaticity Diagram for All Samples	20
Figure 15. CIE Chromaticity Diagram by Supplier	21
Figure 16. CIE Chromaticity Diagram by Type of Light	22
Figure 17. Basic Train-Human Schematic (All Dimensions Shown in ft)	24
Figure 18. Illuminance Maps for a Smart Light Source Sample Arranged in a Vertical Dual-Lamp Headlight	26
Figure 19. Three-Way View of an Illuminance Map at Ground Level for a Smart Light Source Dual-Lamp Headlight (S3 LED).....	28
Figure 20. Three-Way View of an Illuminance Map at 4 Feet Above Ground Level for a Smart Light Source Dual-Lamp Headlight (S3 LED).....	29
Figure 21. Illuminance Maps for LED Samples at 4 Feet Above the Ground.....	30
Figure 22. Illuminance Maps for Halogen Samples at 4 Feet Above Ground.....	31
Figure 23. Virtual Color Renderings of Halogen Lamps.....	33
Figure 24. Virtual Color Renderings of LED Lamps ³	33

Tables

Table 1. Summary of Lab-Based Results of Locomotive and Auxiliary Lights Error! Bookmark not defined.	
Table 2. LED Sample Specifications Provided by Suppliers	5
Table 3. Halogen Sample Specifications Provided by Suppliers.....	6
Table 4. Photometric Results for All Samples in Bright Mode	15
Table 5. Photometric Results for All Samples in Dim Mode	16
Table 6. Estimated Photometric Values for LED Samples at a Hypothetical ‘70%-Dim Mode’.	17
Table 7. Maximum Candela and Colorimetric Results for All Samples in Bright Mode.....	19
Table 8. Colorimetric Comparisons Between Bright and Dim Mode for LED Samples	23
Table 9. Color Temperature Change of Halogen Sample with Respect to Dimming Percentage	23

Executive Summary

This report describes Phase I compliance testing of light-emitting diode (LED) lamps for use as locomotive headlights and auxiliary lights. The purpose was to validate that all LED samples submitted by participating suppliers complied with applicable regulatory requirements, and to compare the photometric features of LED lamps to halogen lamps currently used in the rail industry.

To evaluate the suitability of LED lamps for use as locomotive headlights, researchers at ENSCO, Inc. and Engineering Systems Inc. measured luminous intensity and color temperature values. Comparing the measured values with both the guidelines provided by the Association of American Railroads' (AAR) Locomotive Committee – LED Headlight-Auxiliary Light Standard Technical Advisory Group (TAG) and the requirements established in 49 Code of Federal Regulations (CFR) §229.125 revealed the following: The luminous intensity measurements for LED and halogen lamps showed that all suppliers considered in this study complied with the 200,000 candela minimum intensity requirement for a dual-lamp headlight. All but one supplier met the intensity requirement for a single-lamp headlight. Only three of the five tested LED light models fell within the color temperature range of 2,700 K to 3,300 K recommended by TAG.

Analysis of the distribution of light produced by the lamps tested in bright mode revealed that halogen lamps produced a wide lateral spread of illuminance, similar to a flood light. In contrast, the illuminance produced by LED lamps provided greater focus directly along the track centerline. The differences in illuminance distribution between the two types of lamps were evident by the higher levels of luminous intensity produced by halogen lamps at 7.5° and 20° off, of the track centerline. The levels of luminous intensity produced in dim mode varied significantly between models, as did the method for engaging dim mode. Currently there is no regulation for luminous intensity for lamps operated in dim mode; however, ENSCO researchers propose that paragraph (b) of 49 CFR 229.125 serve as a guideline for fulfilling regulatory requirements of luminous intensity for a headlight operating in dim mode.

Three of the five LED lamp models tested produced colorimetric results that fell within the color temperature range and allowable variation recommended by the TAG. The J.W. Speaker and Hydra-Tech (7,000 K) LED models produced higher color temperatures but met suppliers' specifications. All halogen lamps produced colorimetric results that fell within the recommended color temperature range. As expected, color temperatures produced by halogen lamps decreased significantly as the lamps were dimmed. The dominant and peak wavelengths of the color spectrum for the LED and halogen lamp models were consistent across all lamps as well as within model samples.

1. Introduction

The railroad industry is introducing light-emitting diode (LED) technology for locomotive headlights. The Association of American Railroads (AAR) Locomotive Committee has formed an LED Headlight-Auxiliary Light Standard Technical Advisory Group (TAG) to update locomotive headlight standards and recommended practices to enable the safe and effective use of this relatively new application of LED technology. One important step in this process was to understand the characteristics of LED lamps currently available to the railroad industry. To this end, potential suppliers provided sample LED headlights to the Engineering Systems Inc. (ESi) and ENSCO, Inc. research team for evaluation. Halogen lamps were also provided to the researchers for comparison.

According to the Federal Railroad Administration (FRA) standards, locomotive headlights and auxiliary lights shall comply with 49 Code of Federal Regulation (CFR) §229.125. The present study was designed for the compliance testing of LED technology to the current 49 CFR §229.125 regulation as well as guidelines provided by the TAG. Based on the results of compliance testing, appropriate revisions and recommendations are made for a safe and effective implementation of LED technology.

1.1 Background

1.1.1 Regulation Overview: 49 CFR §229.125

Part 229 of Title 49 of the CFR prescribes minimum safety standards for locomotives except those propelled by steam power. Section 229.125 stipulates the regulatory requirements for locomotive headlights and auxiliary lights.

The luminous intensity of locomotive lights is a focus of 49 CFR §229.125. According to paragraph (a): “each lead locomotive used in road service shall illuminate its headlight while the locomotive is in use. When illuminated, headlights shall produce a peak intensity of at least 200,000 candela and produce at least 3,000 candela an angle of 7.5° and at least 400 candela at an angle of 20 degrees measured horizontally from the centerline of the locomotive, assuming the light is aimed parallel to the tracks” [1]. These same thresholds of luminous intensity are required for each auxiliary light on the locomotive.

49 CFR §229.125 addresses, among other issues, the placement and use requirements of locomotive auxiliary lights. The code specifies the allowable vertical distance from the track to the auxiliary light and the horizontal distance between two auxiliary lights. The code also states that auxiliary lights should continuously illuminate immediately prior to and during movement of the locomotive.

Researchers integrated the stated requirements for the luminous intensity into the current analysis to compare performance characteristics between types of lamps and lamp models. However, 49 CFR §229.125 provides no requirements related to colorimetry features for either headlights or auxiliary lights. Colorimetry comparisons were based on the guidelines provided by the TAG and on scientific literature related to color perception and the effects of LED lighting on visual perception.

1.1.2 Implementation of LED Fixtures in Transportation

LEDs began appearing in the 1970s in watches, calculators, and other small devices, and gradually became omnipresent in many other electronics over the next several decades [2]. Especially as manufacturing costs were reduced, LEDs became commonplace in cars and

trucks in the 2000s. LEDs are now a common bulb used for motor vehicle headlights as well as for numerous other interior and exterior locations both by original equipment manufacturers and aftermarket vendors. They are also being used on the roadway for applications such as street lighting, road studs, and signage. The aviation and marine industries have also begun transitioning to LEDs for both interior and exterior lighting [3] [4].

With LEDs becoming more prevalent in the transportation industry, human factors research has begun to focus on the effects of LEDs in terms of glare and color perception, often with respect to other light sources such as high intensity discharge (HID) and traditional halogen bulbs. Glare is frequently categorized as either “disability glare” or “discomfort glare.” Disability glare impairs visibility and interferes with task performance, while discomfort glare is either annoying or painful but does not necessarily reduce task performance. Regulatory bodies and standards organizations in the transportation industry – Federal Aviation Administration, U.S. Coast Guard, Society for Automotive Engineers (SAE), to name a few – have developed recommendations for their respective domains regarding the maximum luminous intensity to help counteract the effects of glare. SAE has developed J2650, a recommended practice specific to the performance of LED road illumination devices [5].

As LEDs for automobiles first came into production, a 2006 SAE paper compared the spectral effects of LED forward lighting on visibility and glare [6]. SAE proffered that due to the modular nature of LED systems, manufacturers would be in a good position to tailor spectral distributions to improve off-axis visual performance but cautioned of the potential increase in discomfort glare. A 2007 SAE paper found that individuals were better able to perceive and recognize different-colored LED bulbs than traditional halogen bulbs [7]. A 2014 study surveyed British night-time taxi drivers and asked them specifically about LEDs on other vehicles [8]. Glare was reported as the greatest problem, and red braking lights were worse than white lights around headlights. A 2015 article on the discomfort glare of LED road studs suggested tuning the luminous intensity according to illumination and road surface conditions [9].

A large portion of the scholarship related to locomotive lighting has investigated locomotive conspicuity, particularly at crossing points with motorists [10]. Limited research has investigated locomotive lighting with respect to glare and other human factors aspects. However, a 1995 paper sponsored by FRA identified glare as a safety concern for auxiliary alerting lights and recommended considering glare when specifying minimum and maximum levels of luminous intensity [11]. It also referenced a British recommendation that glare illuminance be no greater than 0.4 lux at the eyes of a train engineer approaching from the opposite direction.

1.2 Objectives

Phase I testing, conducted in a laboratory setting, had two main objectives. The first was to validate that all submitted LED samples complied with applicable regulatory requirements and standards. The second was to compare the photometric features of LED samples to currently used halogen lamps.

1.3 Overall Approach

To achieve the objectives stated above, luminous intensity distributions and colorimetry features were measured and compared in two operating modes – “bright” and “dim.” In

addition, researchers created illuminance maps to better understand the lighting distribution and to verify that all samples complied with the requirements regarding the illumination of a person at specific distances from the light sources.

1.4 Scope

The scope of this effort was limited to laboratory testing of 32 lamp samples, including 20 LED lamps provided by 4 suppliers and 12 halogen lamps provided as references by 3 other suppliers. All testing was arranged, conducted, or supervised by the research team. Phase II and Phase III testing will involve subjective field testing for LED sample fixtures on static and moving locomotives, respectively. These test phases will be documented in future reports.

1.5 Organization of the Report

The methodology used for the program is detailed in [Section 2](#). Results of the test programs are detailed in [Section 3](#). Human factors associated with the light samples tested in this program are discussed in [Section 4](#), and conclusions are presented in [Section 5](#). Detailed test instrumentation calibration information and test data are provided in [Appendices A-I](#).

2. Methodology

2.1 Submitted Samples

The research team received a total of 32 lamp samples that included 20 LED lamps and 12 halogen lamps. Four suppliers provided LED lamps, and three other suppliers provided halogen lamps. The number of samples provided by each supplier was:

- J. W. Speaker: Four LED samples
- Hydra-Tech: Eight LED samples – including four samples each of two types defined by color temperatures of 7,000 K and 2,800 K
- Railhead/Divvali: Four LED samples
- Smart Light Source: Four LED samples
- AMGLO: Four halogen samples
- ePowerRail: Four halogen samples
- CML: Four halogen samples

The specifications provided by the suppliers for each of the LED and halogen lamp samples are summarized in [Tables 1](#) and [2](#), respectively.

Table 1. LED Sample Specifications Provided by Suppliers

Supplier	Model	Specifications
J.W. Speaker	554601	<ul style="list-style-type: none"> • Input voltage: 50–90 VDC • Operating voltage: 75 VDC • Current Draw: 1.25 A @ 50 VDC, 0.85 A @ 75 VDC, 0.70 A @ 90 VDC • Candela output: 200,000 cd min. • Nominal LED color temperature: 5000 K
Hydra-Tech International	HYD-LOC001.28K (Hydra-Tech 2800 K) HYD-LOC001 (Hydra-Tech 7000 K)	<ul style="list-style-type: none"> • Wattage: 35 W • Input voltage: 14-30 VDC • Amp draw: 1.09 A @ 32 VDC • 32–75 VDC Max brightness ditch light • Output (cd): Exceeds 200,000 cd Requirement. • Color temperatures: 7000 K & 2800 K
Railhead/Divvali	KE-PAR56 75V LED	<ul style="list-style-type: none"> • Wattage: 50W • Input voltage: 75 VDC • CCT: 5500 K • Candela: 174,000 cd • 7.5° off center brightness (2x the brightness) • 20° beam cut off
Smart Light Source Co.	SLS-75VDC-60W-LED-PAR56	<ul style="list-style-type: none"> • Operating voltage: 75 VDC • Rated wattage: 60 W • Average bulb life: 50,000 hours • Color temperature: 3000 K



Figure 1: LED Samples Supplied by J.W. Speaker, Hydra-Tech International, Railhead/Divvali, and Smart Light Source Co. (Left to Right)

Table 2. Halogen Sample Specifications Provided by Suppliers

Supplier	Model	Specification Summary
AMGLO	AHQV56-75V350WCS	<ul style="list-style-type: none"> • Design voltage: 75 VDC • Design watts: 350 W • Minimum candela: 200,000 cd • Lab life: 2,000 hours
CML	CMQ5630250	<ul style="list-style-type: none"> • Design voltage: 30 VDC • Design Power: 250 W • Cd peak: 200,000 cd min. • Cd \pm 7.5°: 3,000 cd min. • Cd \pm 20°: 400 cd min. • Average life: 2,000 hours
ePowerRail	FRA350PAR56-SP	<ul style="list-style-type: none"> • Average life: 4,000 hours • Candela: 200,000 cd • Wattage: 200 W • Input voltage: 75 VDC



Figure 2: Halogen Samples Supplied by AMGLO, CML, and ePowerRail (Left to Right)

2.2 Testing Protocol

Three samples of each lamp model were tested, with one reserved as a backup in the event of any unforeseen circumstances. A total of 24 samples, 15 LED and 9 halogen lamps, were tested at Intertek’s photometric lab under the researchers’ guidance and supervision.

For each sample, photometric and colorimetric measurements were recorded and analyzed. Each LED sample was operated for a period such that stabilization and temperature equilibrium were reached. In addition, the testing order was randomized for LED and halogen samples separately (see [Appendix D](#)). The following measurements were recorded for testing of the lamps set to “dim” and “bright” modes:

1. Room temperature (°C) where measurements were taken
2. The candela (cd) distribution over the range of $\pm 30^\circ$ horizontally and $\pm 30^\circ$ vertically at intervals of 0.5°

3. Voltage (V), Current (A), and Power (W)
4. Color temperature (K)
5. Dominant wavelength (nm)

2.2.1 Photometric Testing

The researchers completed all photometric testing at Intertek’s photometric lab in Kentwood, Michigan. Intertek’s lab equipment includes a light tunnel and a type A goniophotometer (see [Figure 3](#)). All equipment was properly calibrated and traceable to the National Institute of Standards and Technology, National Research Council Canada, and Euromet members (see [Appendix A](#)). The average ambient temperature inside the light tunnel was approximately 24 °C.

Each lamp sample was mounted and aligned to approximate locomotive orientations, meaning the headlamp was aimed parallel to the tracks. The inherent design differences in the light fixtures resulted in an expected variation in the alignment between samples – i.e., variability in alignment within samples of the same model and between headlight models. Alignment of the candela distribution was adjusted during post-processing of the data by orienting the maximum candela location to 0° vertical and 0° horizontal. After each LED sample was powered on and allowed to reach steady-state operation, luminous intensity values in the bright and dim modes were taken for a total range of ±30° horizontally and ±30° vertically with respect to the centerline of the headlights, at intervals of 0.5°. Note that, depending on the lamp model, different modes for engaging the dim mode were required. Upon discussion with Smart Light Source and Railhead/Divvali, a 4.5-ohm and a 15-ohm series resistance on the 75 VDC power supply was needed to test their LED samples in dim mode (see [Appendix B](#) for circuit diagram).

Raw candela values were reported in two different formats:

1. Raw candela values saved in “.csv” format.
2. Raw candela values saved in “.ies” format per the LM-63 standard from the Illuminating Engineering Society.

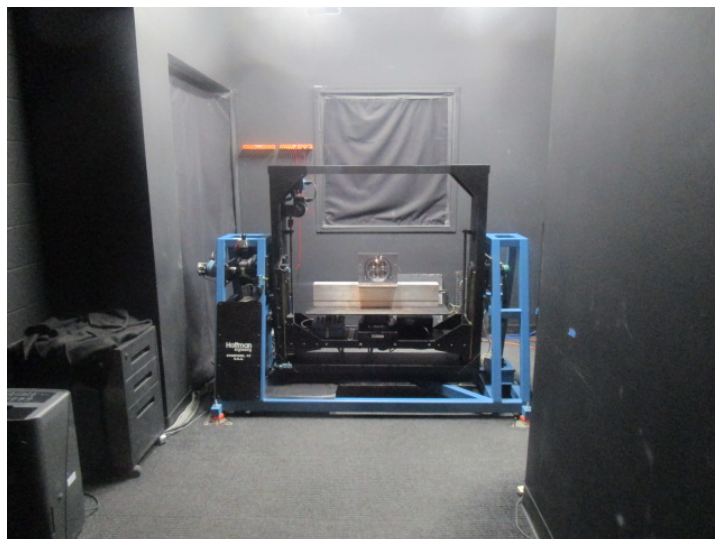

**Figure 3. Test Setup at Intertek’s Photometrics Lab
(Frontal View of the Hoffman Goniometer)**

2.2.2 Colorimetric Testing

After luminous intensity measurements were recorded, and while the sample was still installed and aligned in the goniometer, the Sony ILX511B spectrometer (see [Appendix A](#)) was introduced into the light tunnel to measure the color temperature of the sample in both bright and dim modes.¹ The dominant wavelength of the light was also measured.

Figure 4 shows two color temperature measurements being taken inside the light tunnel, one for a lamp with a relatively warm light color temperature ([Figure 4a](#)) and another for a lamp with a cooler light color temperature ([Figure 4b](#)). For LED samples, color temperature measurements for the bright and dim modes were taken. For halogen samples, color temperature measurements were taken only in bright mode due to the continuously variable light output produced during operation in dim mode. All halogen samples included a PAR 56 keyed back plate; however, the rear surface was not smooth and added additional uncertainty in sample alignment.

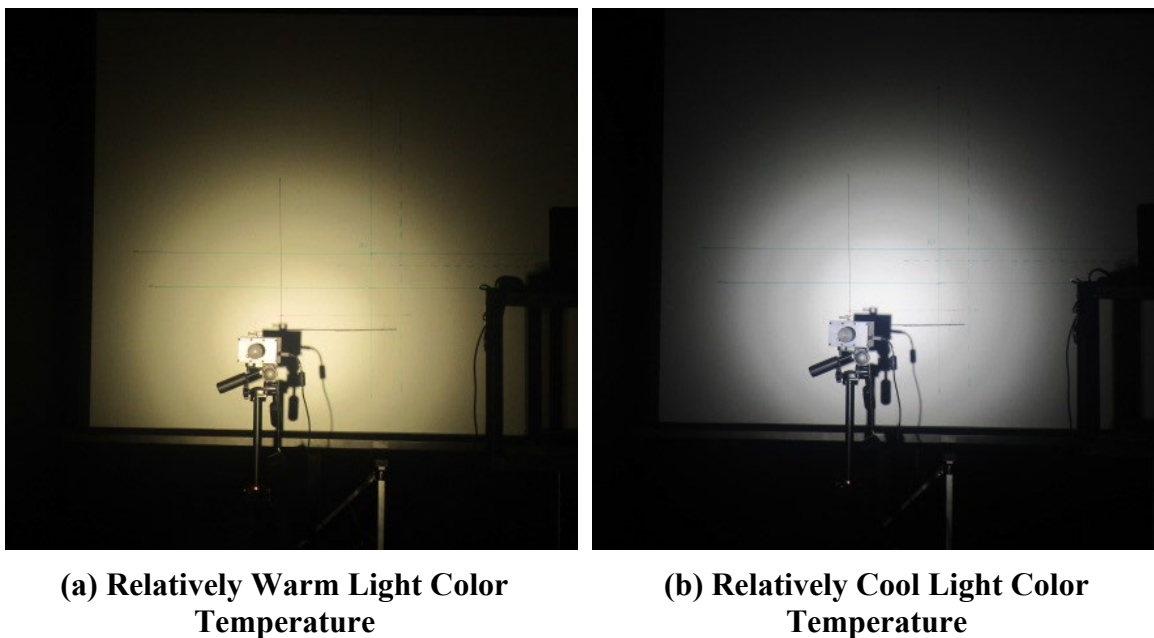

Figure 4. Photometric Test Setup for Colorimetric Measurements

¹ Only valid for LED samples; values for halogen samples only include bright mode.

3. Analysis and Results

Raw candela data was analyzed using custom software developed in MATLAB (MathWorks, Inc.) to develop photometric plots and calculate the appropriate candela and color temperature values. In addition, Autodesk 3DS MAX and the V-Ray rendering engine rendered accurate representations of the light color temperatures. The results in this report are based on a limited number of random samples and may not represent the overall performance of their corresponding population. These samples were assumed to be from a homogenous population produced under consistent manufacturing processes.

3.1 Photometric Distributions

To visualize the different photometric features of samples, ISO-candela and surface plots were generated (see [Figure 5](#) and [Figure 12](#)). These plots provided a method for evaluating the photometric characteristics of a light source. For instance, [Figure 5](#) shows a set of two plots, an ISO-candela plot (left) and surface plot of photometric distribution (right). The ISO-candela plot shows a 2-dimensional view of luminous intensity with respect to the vertical and horizontal angles. The surface plot shows the same relationship, but with luminous intensity as a third dimension.

The telling feature in these plots is shape. In the ISO-candela plot, the outer-most contour shows that for all LED samples, other than the sample submitted by Smart Light Source, most of the light was contained approximately within $\pm 10^\circ$ of the center of light source. This outer-most contour can be thought of as the base of a mountain, as represented in the 3-dimensional surface plot. A wider base would represent wider distribution of illumination, and a taller peak would represent greater luminous intensity. The Smart Light Source sample ([Figure 9](#)) had a wider base, approximately $\pm 15^\circ$. This implies a greater area of illumination and potentially higher candela values at 7.5° horizontally from the centerline of the light source when compared to other samples tested.

The different colors in the ISO-candela plot illustrate different levels of luminous intensity, transitioning from blue to yellow, with yellow representing higher candela values. Each contour line represents a change in luminous intensity. Closer to the origin, the $0^\circ - 0^\circ$ point, the number of contour lines is correlated with the change in luminous intensity. A greater number of yellow contours lines in the center of the ISO-candela plot is associated with more rounded peaks in the surface plot (see [Figure 8](#)), while fewer contour lines are associated with more pointed peaks (see [Figure 5](#)).

Overall, the shape of the LED samples' illuminance maps showed contours and surfaces within the ranges of those shown by the halogen lamps. In fact, the shapes and contours of the halogen lamps were less uniform and consistent than those of the LED lamps. For instance, the dual filaments inside the AMGLO halogen lamp produced a double-peaked distribution with greater lateral light spread (see [Figure 10](#)) than lamps with a single filament. The ePowerRail lamp produced contour lines that were less rounded and uniform when compared to LED samples. In short, the more uniform and constant photometric shapes demonstrated by the LED samples suggest less variability in the amount of luminous intensity produced in all directions, especially those relevant to 49 CFR §229.125.

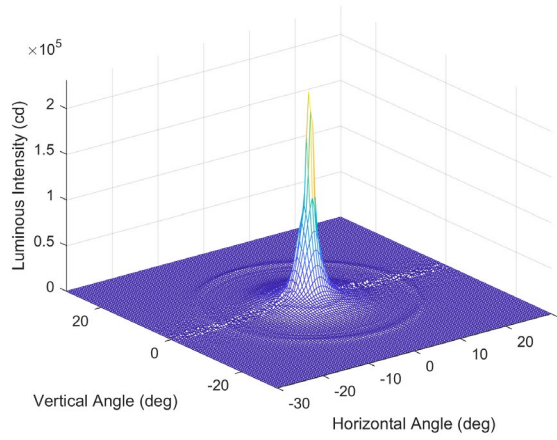
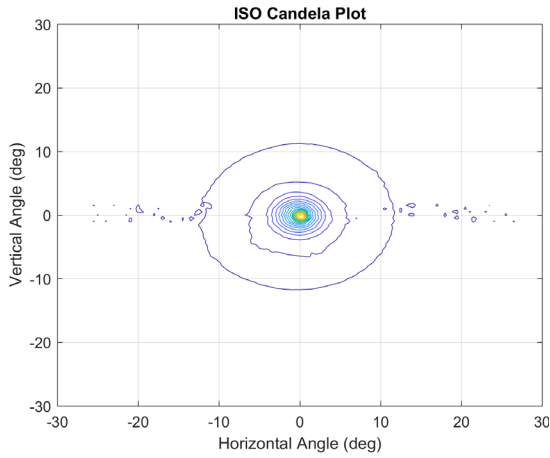
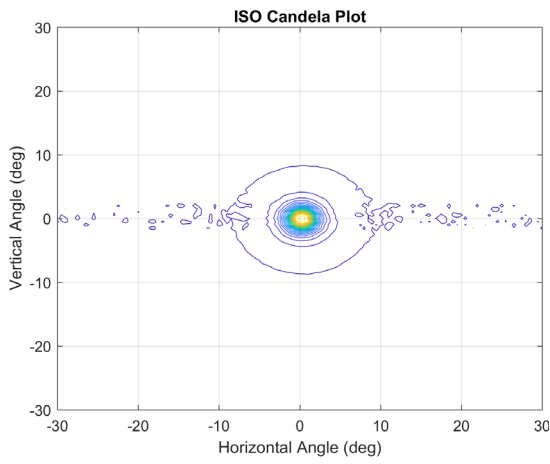

Figure 5. Raw Photometric Distribution for J.W. Speaker LED Samples



6

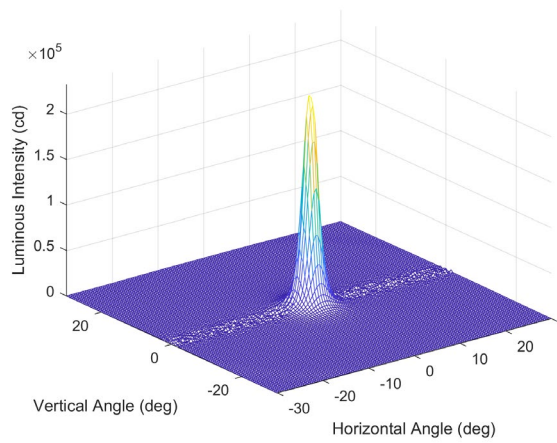

Figure 6. Raw Photometric Distribution for Hydra-Tech 2800 K LED Samples

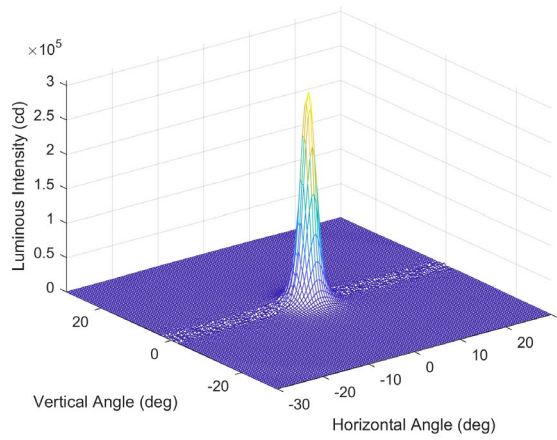
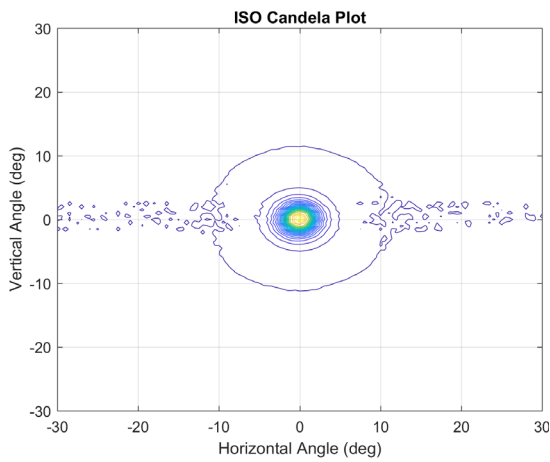

Figure 7. Raw Photometric Distribution for Hydra-Tech 7000 K LED Samples

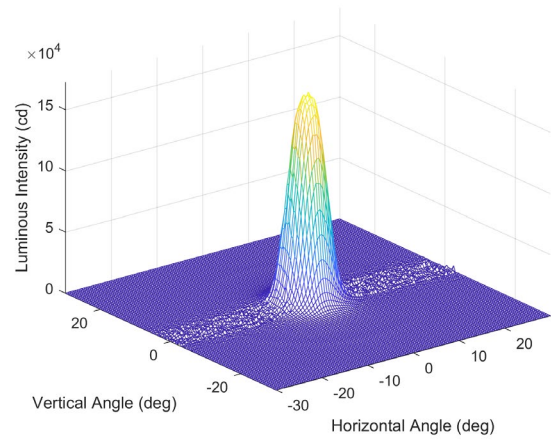
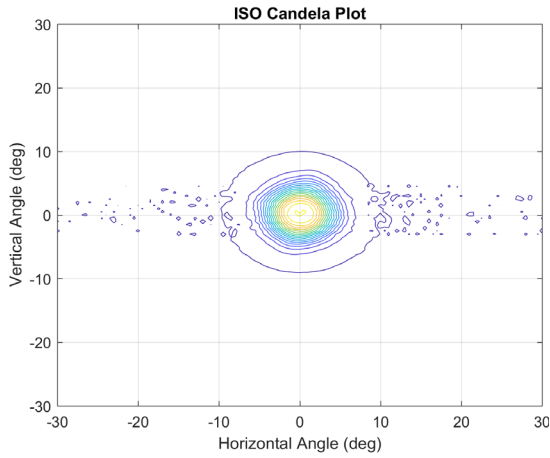

Figure 8. Raw Photometric Distribution for Railhead/Divvali Samples

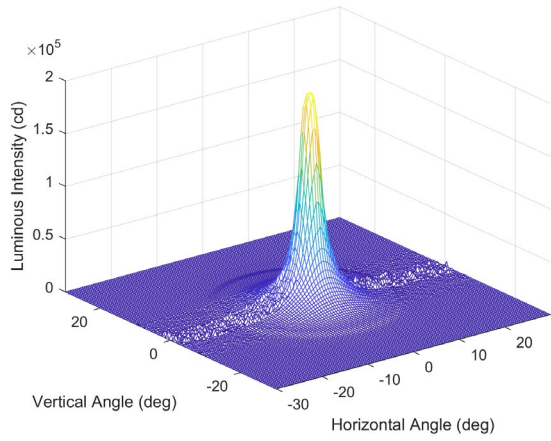
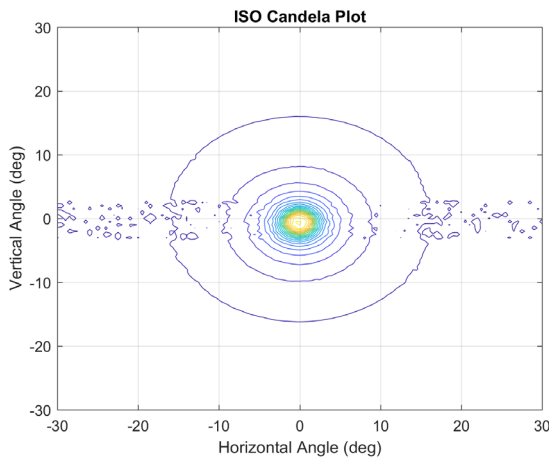

Figure 9. Raw Photometric Distribution for Smart Light Source Samples

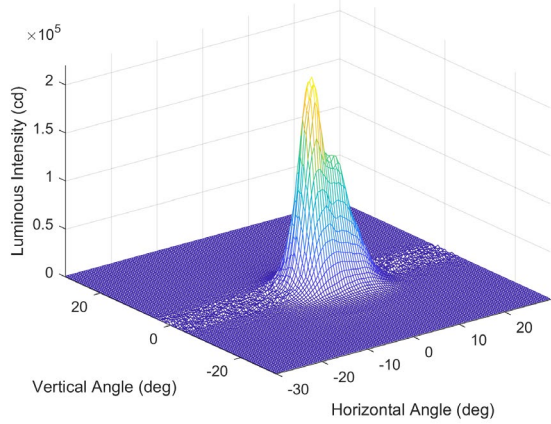
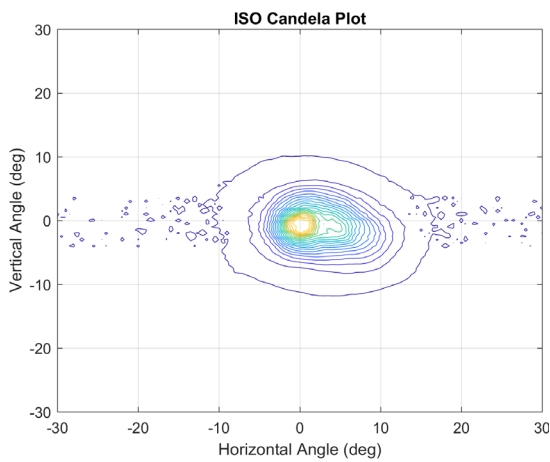

Figure 10. Raw Photometric Distribution for AMGLO Halogen Samples

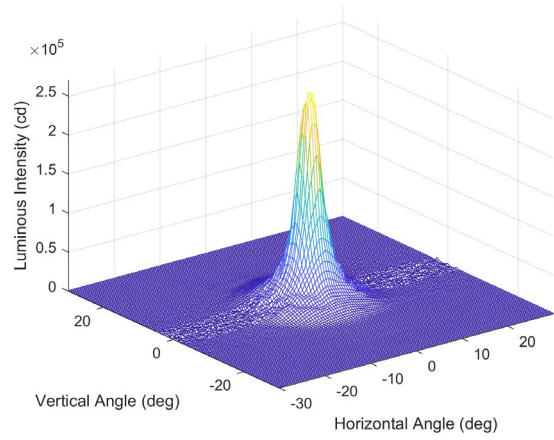
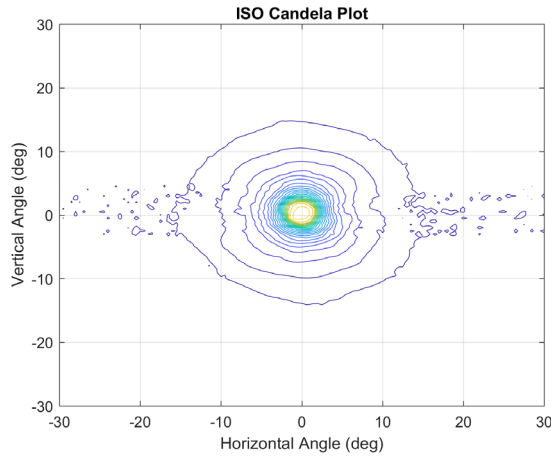

Figure 11. Raw Photometric Distribution for ePowerRail Halogen Samples

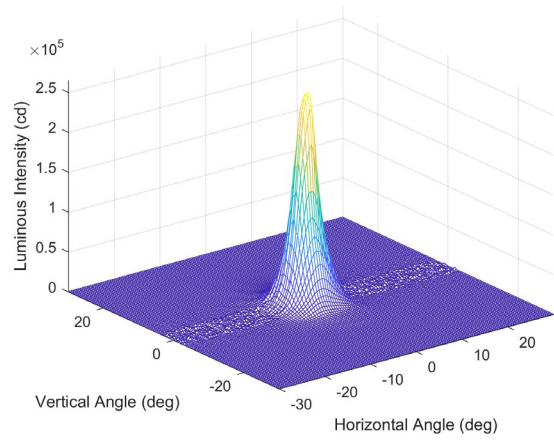
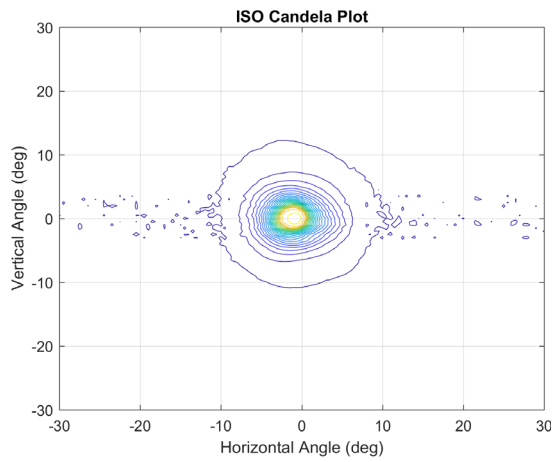

Figure 12. Raw Photometric Distribution for CML Halogen Samples

3.2 Luminous Intensity Comparisons

Due to the inherent design of each lamp, alignment variations ($\pm 2^\circ$) within and between samples were found – i.e., variation within samples of the same model and between headlight models. To fairly compare the luminous intensity of all samples to the 49 CFR §229.125 regulation, the raw orientation with respect to the maximum candela value was realigned and set to 0° on both the horizontal and vertical orientations.

3.2.1 Luminous Intensity at 0°

Of all 24 samples tested, 6 lamps did not meet the required minimum peak luminous intensity (200,000 cd) when operating in a single-lamp headlight arrangement. However, all samples tested met the requirement when operating in a dual-lamp headlight arrangement. Three of the six lamps that did not meet the single-lamp requirement were supplied by Railhead/Divvali. Via a written note to the research team, Railhead/Divvali provided specifications of their lamps. The specifications provided in the note claimed a luminous intensity of 170,000 cd and color temperature of 3,000 K, which matches the measured values in this study (see [Table 4](#)).

Of the three remaining lamp samples that did not meet the minimum luminous intensity requirement, two samples (one LED sample from Smart Light Source at 199,933 cd and one halogen sample from CML at 195,110 cd) were borderline compliant with the 200,000 cd requirement. These values are within measurement variation and should not be of concern, particularly given that the other two tested samples of the same models produced values well over the regulation. Only one sample, submitted by Hydra-Tech International (LED sample Hydra-Tech 2,800 K producing 172,297 cd) was found to be well below the regulatory requirement and the claimed intensity provided in the supplier's specifications.

3.2.2 Luminous Intensity at 7.5°

At an angle of 7.5° from the headlamp center, all samples tested were well above the required minimum intensity of 3,000 cd. However, a noteworthy difference was found between the measured luminous intensity of halogen and LED samples at this orientation. Some halogen samples produced an intensity greater than 60,000 cd, while LED lamps produced a maximum of approximately 16,000 cd.

3.2.3 Luminous Intensity at 20°

At an angle of 20° from the headlamp center, all samples tested exceeded the required intensity of 400 cd. This orientation contained the least amount of variance between the measured luminous intensity across all samples, including both halogen and LED lamps.

These results indicate key differences in the type of light distribution provided by halogen and LED lights. The higher candela values of halogen lamps at 7.5° , and the similar values in both types of lamps at 20° from the centerline of the locomotive, suggest different illuminance patterns (i.e., amount of light falling on a surface). Halogen lamps produced a wider lateral spread of light than LED lamps. These differences become more apparent by quantifying the amount of light that reaches a surface (e.g., ground) away from the light source at given distances. Such quantification of light can be referred to as an illuminance map, as discussed later in this report.

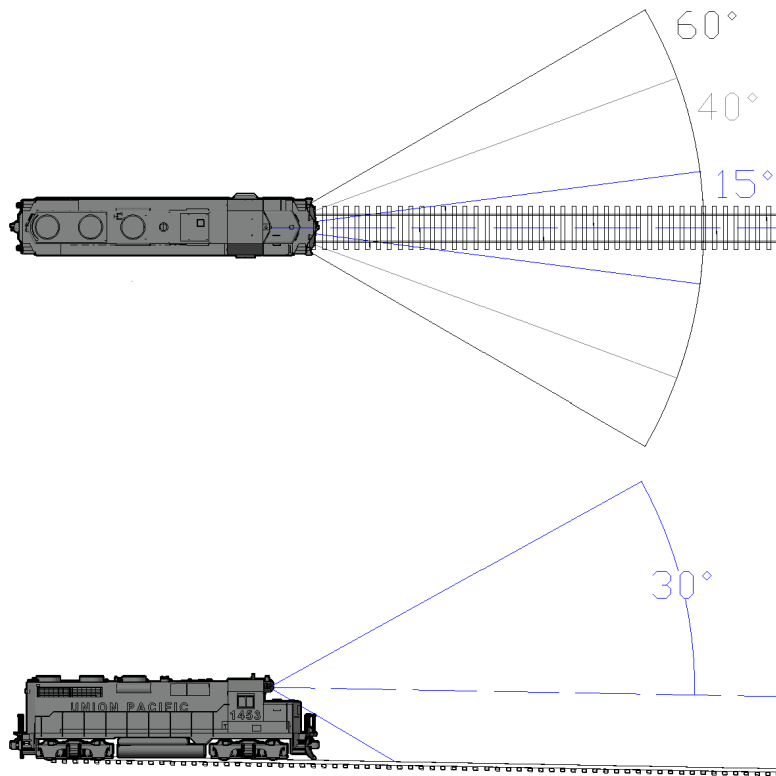

Figure 13. Ranges of Measured Luminous Intensity

Table 3. Photometric Results for All Samples in Bright Mode

Supplier	Sample ID	Light Type	Max. Candela @ 0° (cd)	Avg. Candela @ 7.5° (cd)	Avg. Candela @ 20° (cd)	DC Input Voltage (V)	Input Current (A)	Input Power (W)
Hydra-Tech (2800 K)	S5 LED	LED	232,437	3,312	817	75	0.6075	45.56
Hydra-Tech (2800 K)	S9 LED	LED	244,603	3,984	924	75	0.609	45.68
Hydra-Tech (2800 K)	S13 LED	LED	172,297	3,606	1,461	75	0.6105	45.79
Hydra-Tech (7000 K)	S1 LED	LED	307,361	3,827	2,494	75	0.618	46.35
Hydra-Tech (7000 K)	S10 LED	LED	282,960	4,286	2,894	75	0.6215	46.62
Hydra-Tech (7000 K)	S15 LED	LED	298,094	4,752	2,658	75	0.6225	46.69
J.W. Speaker	S2 LED	LED	231,009	8,287	1,072	75	0.4815	36.11
J.W. Speaker	S4 LED	LED	208,883	7,526	1,381	75	0.48	36
J.W. Speaker	S8 LED	LED	201,350	7,141	1,261	75	0.479	35.92
Railhead/Divvali	S7 LED	LED	172,446	6,222	530	75	0.525	39.38
Railhead/Divvali	S11 LED	LED	176,280	6,465	1,603	75	0.5265	39.49
Railhead/Divvali	S12 LED	LED	173,694	7,481	756	75	0.5225	39.19
Smart Light Source	S3 LED	LED	200,291	15,991	505	75	0.969	72.67
Smart Light Source	S6 LED	LED	199,933	15,582	436	75	0.879	65.92
Smart Light Source	S14 LED	LED	202,525	15,940	536	75	0.9305	69.78
AMGLO	S4 HAL	Halogen	220,264	53,394	1,557	75	4.8605	364.53
AMGLO	S6 HAL	Halogen	223,469	41,588	811	75	4.884	366.3
AMGLO	S7 HAL	Halogen	221,568	51,907	914	75	4.959	371.91
CML	S1 HAL	Halogen	265,120	8,250	949	30	8.2425	247.27
CML	S2 HAL	Halogen	235,968	13,380	1,110	30	8.2415	247.25
CML	S9 HAL	Halogen	195,110	13,645	736	30	8.295	248.85
ePowerRail	S3 HAL	Halogen	255,044	26,091	1,078	75	4.713	353.48
ePowerRail	S5 HAL	Halogen	270,328	22,470	1,206	75	4.574	343.05
ePowerRail	S8 HAL	Halogen	238,264	23,542	1,152	75	4.659	349.42

3.3 Luminous Intensity in Dim Mode

During certain movements of a locomotive, the headlamps are set to dim mode instead of bright mode. The locomotive's electrical system accomplishes this by switching the normal 75 VDC supply to a lower voltage 30 VDC supply. One of the technical issues that arose during testing was the different method required to engage dim mode for the various lamps tested. For instance, Hydra-Tech samples could operate in dim mode by reducing the input voltage. J.W. Speaker samples had an additional wire integrated in their circuitry that allowed dim mode to be engaged. For the samples submitted by Railhead/Divvali and Smart Light Source, a direct reduction in voltage did not allow the sample to operate in dim mode. Per these manufacturers' specifications, a 15-ohm and a 4.5-ohm series

resistance on the 75 VDC power supply was used. Due to the difference in lamp circuitry, different modes of engaging the dim setting were tested for different samples (see [Table 5](#)).

Another technical issue found while measuring lamp color temperature was the diverse geometry of the lamps. For instance, all halogen samples use housings with similar geometry and a PAR 56 keyed back plate. However, the rear surface of the lamps was not smooth and added uncertainty in aligning the lamp with the target. Most LED samples, which also included PAR 56 keyed back plates, had flat rear surfaces and allowed for more repeatable photometry alignments.

Table 4. Photometric Results for All Samples in Dim Mode

Sample Name	Sample ID	Max. Candela @ 0° (cd)	Avg. Candela @ 7.5° (cd)	Avg. Candela @ 20° (cd)	Input Voltage (V)	Input Current (A)	Input Power (W)	Engaging Mode
Hydra-Tech (2800 K)	S5 LED	214,962	2,414	769	30	1.22	36.55	Reduced Voltage
Hydra-Tech (2800 K)	S9 LED	222,321	2,664	822	30	1.22	36.68	Reduced Voltage
Hydra-Tech (2800 K)	S13 LED	162,482	2,668	762	30	1.22	36.46	Reduced Voltage
Hydra-Tech (7000 K)	S1 LED	286,104	3,527	1,597	30	1.22	36.55	Reduced Voltage
Hydra-Tech (7000 K)	S10 LED	265,542	3,604	1,026	30	1.21	36.17	Reduced Voltage
Hydra-Tech (7000 K)	S15 LED	220,982	3,664	1,066	30	1.19	35.62	Reduced Voltage
J.W. Speaker	S2 LED	26,117	928	104	75	0.07	5.1	Integrated Wire
J.W. Speaker	S4 LED	17,817	824	97	75	0.07	4.99	Integrated Wire
J.W. Speaker	S8 LED	21,582	856	102	75	0.07	4.91	Integrated Wire
Railhead/Divvali	S7 LED	99,906	4,719	306	75	0.29	21.69	15 Ohms Series Resistance
Railhead/Divvali	S11 LED	94,863	4,393	279	75	0.27	19.93	15 Ohms Series Resistance
Railhead/Divvali	S12 LED	92,519	4,451	259	75	0.25	18.83	15 Ohms Series Resistance
Smart Light Source	S3 LED	51,677	4,240	139	75	0.19	14.18	4.5 Ohms Series Resistance
Smart Light Source	S6 LED	49,780	3,934	124	75	0.20	15.42	4.5 Ohms Series Resistance
Smart Light Source	S14 LED	53,257	3,958	135	75	0.19	14.18	4.5 Ohms Series Resistance

As shown in [Table 5](#), a direct reduction of voltage to 30 VDC did not dim the Hydra-Tech lamps in a significant manner, resulting in a 7 percent reduction of light output compared

to its maximum candela value. However, they did produce a continuously variable output from 14 to 30 VDC. In other words, these lamps could be dimmed at greater percentages by further decreasing the input voltage; however, this would not be backward compatible with existing locomotives that utilize 30 VDC supply for dimming the headlamps.

Samples from J.W. Speaker dimmed significantly (89 percent of its peak luminous intensity) when engaged via the integrated wire. Similarly, the series resistance used for the Railhead/Divvali and the Smart Light Source Co. dimmed their samples by 43 percent and 74 percent, respectively. When direct reduction of voltage was applied to these three light models, the samples did not dim in the same manner as the Hydra-Tech samples.

Based on these results, it seemed that the samples submitted by Smart Light Source and Railhead/Divvali were suitable to retrofit the headlights and auxiliary lights on a locomotive equipped with halogen lamps.

Without any existing guideline there was no objective point of reference to declare which level of dimming is more suitable for a locomotive. In addition, there is no specific required luminous intensity in 49 CFR §229.125 for headlights and auxiliary lights in dim mode. There is, however, in paragraph (b) of the 49 CFR §229.125, some indication regarding the luminous intensity that locomotives in yard service should produce, which is a minimum of 60,000 cd. This is 30 percent of the required luminous intensity for a headlight used in road service. This could serve as an evaluation guideline or reference point. Some guidance may be borrowed from the automobile industry; for instance, the Federal Motor Vehicle Safety Standards 108 specifies the following limits [1]:

1. For Type 2 or 2A: Upper beam limited to 20,000 to 75,000 cd per lamp. Lower beam limited to 15,000 to 20,000 cd per lamp.
2. For Type 1 or 1A Lights: Upper beam limited to 18,000 to 60,000 cd per lamp.

For the purposes of this report and to establish an equal basis for comparison, two assumptions were made: (1) dim mode is engaged via a series resistance that dims headlights by 70 percent, and (2) paragraph (b) of 49 CFR 229.125 is assumed as a reference point for evaluation. Based on these two assumptions, most single-lamp headlights meet this proposed requirement. As stated previously, Railhead/Divvali specified a value of 174,000 cd for their samples; hence, the lower value seen in Table 6.

Table 5. Estimated Photometric Values for LED Samples at a Proposed 70%-Dim Mode

Sample Name	Max. Candela	Avg. Candela	Avg. Candela
	@ 0° (cd)	@ 7.5° (cd)	@ 20° (cd)
Hydra-Tech (2,800 K)	64,934	1,090	320
Hydra-Tech (7,000 K)	88,842	1,286	805
J.W. Speaker	64,124	2,295	371
Railhead/Divvali	52,242	2,017	289
Smart Light Source	60,275	4,751	148

3.4 Colorimetric Results

Of the 24 samples tested, 6 samples fell outside of the recommended range of color temperature provided by the AAR TAG (2,700 K – 3,300 K). Note, however, that these lights did match the color temperature specified by the supplier, within $\pm 10\%$ variation also recommended by the AAR TAG. These six samples were provided by two suppliers, J.W. Speaker and the 7,000 K model provided by Hydra-Tech International (see [Table 7](#)).

All halogen samples produced color temperatures around 3,100 K. Additionally, LED samples provided by Railhead/Divvali and Smart Light Source, as well as the Hydra-Tech 2,800 K lamps, fell within the guidelines recommended by the AAR TAG. The dominant wavelength was found to be consistent between LED and halogen samples, with LED averaging approximately 487 nm and halogen samples averaging approximately 490 nm. These wavelengths correspond to a point between the pure spectral colors of blue and green.

Table 6. Maximum Candela and Colorimetric Results for All Samples in Bright Mode

Supplier	Sample ID	Light Type	Max. Candela @ 0° (cd)	CCT (K)	λ_{Dom} (nm)	Peak λ (nm)
Hydra-Tech (2,800 K)	S5 LED	LED	232,437	3,181	491	622
Hydra-Tech (2,800 K)	S9 LED	LED	244,603	3,203	489	617
Hydra-Tech (2,800 K)	S13 LED	LED	172,297	3,188	492	616
Hydra-Tech (7,000 K)	S1 LED	LED	307,361	6,475	483	450
Hydra-Tech (7,000 K)	S10 LED	LED	282,960	6,614	482	450
Hydra-Tech (7,000 K)	S15 LED	LED	298,094	6,482	483	450
J.W. Speaker	S2 LED	LED	231,009	5,743	484	445
J.W. Speaker	S4 LED	LED	208,883	5,984	484	448
J.W. Speaker	S8 LED	LED	201,350	5,915	484	448
Railhead/Divvali	S7 LED	LED	172,446	2,947	490	603
Railhead/Divvali	S11 LED	LED	176,280	2,930	500	603
Railhead/Divvali	S12 LED	LED	173,694	2,937	496	603
Smart Light Source	S3 LED	LED	200,291	3,233	484	599
Smart Light Source	S6 LED	LED	199,933	3,210	484	600
Smart Light Source	S14 LED	LED	202,525	3,184	484	604
AMGLO	S4 HAL	Halogen	220,264	3,068	491	622
AMGLO	S6 HAL	Halogen	223,469	3,100	491	617
AMGLO	S7 HAL	Halogen	221,568	3,102	491	616
CML	S1 HAL	Halogen	265,120	3,109	491	450
CML	S2 HAL	Halogen	235,968	3,086	490	450
CML	S9 HAL	Halogen	195,110	3,049	492	450
ePowerRail	S3 HAL	Halogen	255,044	3,148	490	445
ePowerRail	S5 HAL	Halogen	270,328	3,126	490	448
ePowerRail	S8 HAL	Halogen	238,264	3,113	490	448

3.5 Colorimetric Comparisons

To visualize and compare these different colors, two methods were employed – Commission Internationale de l'Éclairage (CIE) chromaticity diagrams and accurate virtual renderings of color temperature.

3.5.1 CIE Chromaticity Diagrams

The x - y coordinates corresponding to each lamp were plotted on a CIE 1931 chromaticity diagram.² As shown in [Figure 14](#), all samples tested fell close to the standard illuminant

² Plotted using the Colour toolbox accompanying the 2nd of Computational Colour Science using MATLAB [14].

curve (defined by the dashed white line), which was integrated by using the white points of standard illuminants as defined by the CIE illuminants (i.e., incandescent/tungsten, direct sun light at noon, horizon light, etc.) [12].

The CIE diagrams were plotted in three different versions; Figure 14 includes all samples.

Figure 15 shows data points by supplier, and Figure 16 shows the average coordinates of each model submitted by type of lamp. As shown in Figure 16, there are two points in the region closer to the blue color region. These samples corresponded to the light models that fell outside the color temperature range recommended by the AAR TAG.

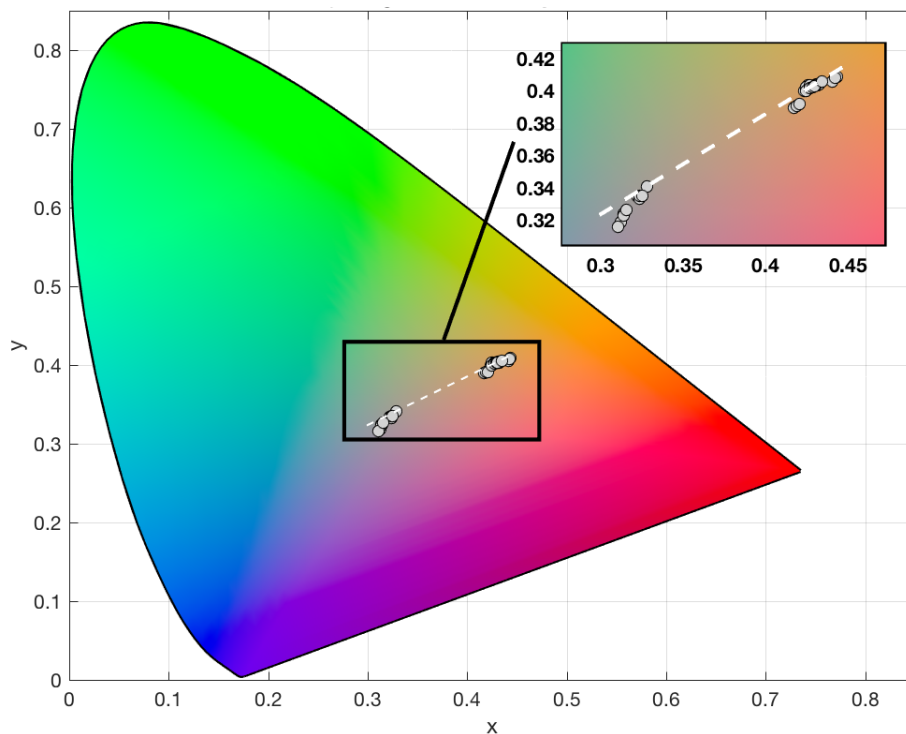

Figure 14. CIE Chromaticity Diagram for All Samples

To provide additional context to these results, three white points of standard illuminants were also plotted in Figure 15 and Figure 16 – a square representing the standard illuminant D65 (also referred to as noon daylight), a triangle representing the equal energy standard illuminant (also referred to as illuminant E), and a diamond representing standard illuminant A (also referred to as incandescent/tungsten).

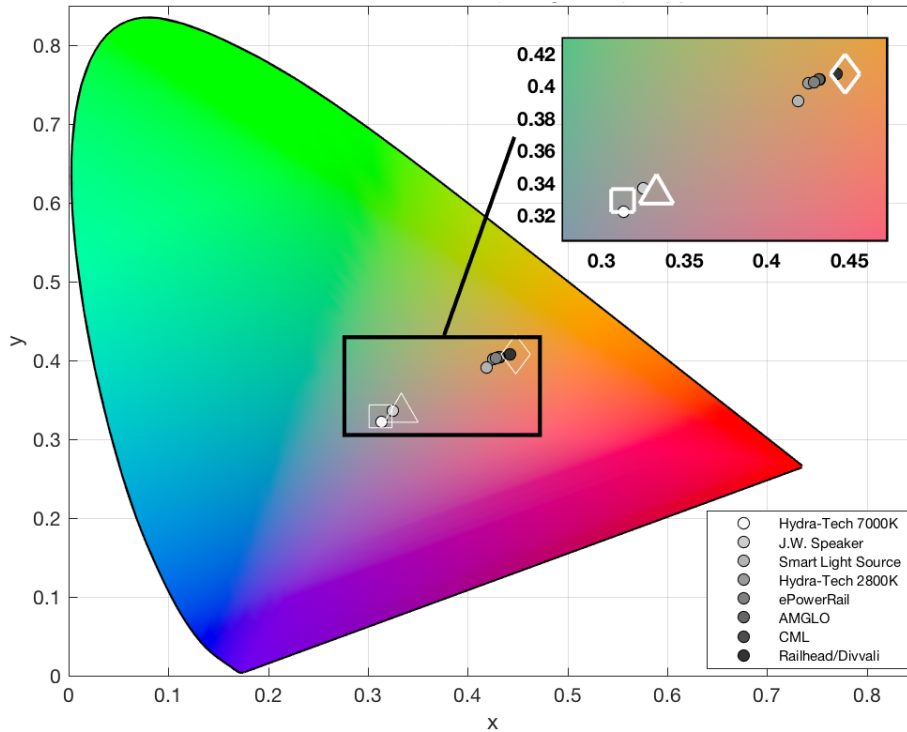

Figure 15. CIE Chromaticity Diagram by Supplier

In [Figure 15](#), data points corresponding to the x - y coordinates of each lamp model are color-coded in different shades of gray, with the lightest data point corresponding to the coolest light (Hydra-Tech 7,000 K) and the darkest data point corresponding to the warmest light (Railhead/Divvali). The latter has a color temperature similar to that of the standard illuminant A, which was intended to represent tungsten-filament lighting.

The data points presented in [Figure 16](#) have a binary color code, black points for halogen models, and white points for LED lights. As shown in [Figure 16](#), the two LED light models (Hydra-Tech 7,000 K and J.W. Speaker) outside of the AAR TAG-recommended color range are close to the standard illuminants E and D65. Illuminant D65 was used as a theoretical reference that assigns equal weight to each wavelength and is often used to represent natural daylight.

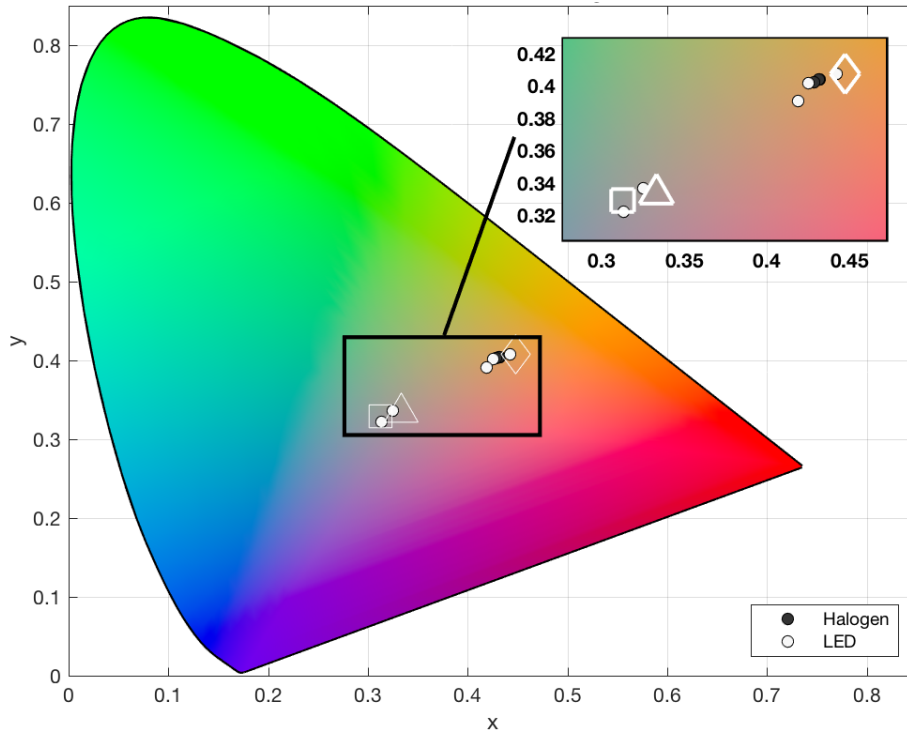

Figure 16. CIE Chromaticity Diagram by Type of Light

3.5.2 Colorimetry in Dim Mode

The current state of LED technology allows for LEDs to be dimmed without significantly changing their color characteristics. This is primarily achieved through pulse-width modulation. Therefore, LED samples were not expected to vary significantly in color temperature between bright and dim modes.

As expected, color temperatures between the bright and dim modes did not vary significantly (see [Table 8](#)), although there was a slight decrease in color temperature for all LED samples. This change in color temperature was neither significant nor detectable for human perception.

Table 7. Colorimetric Comparisons Between Bright and Dim Mode for LED Samples

No.	Supplier	Bright Mode			Dim Mode		
		Avg. CCT (K)	Avg. λ_{Dom} (nm)	Avg. Peak (nm)	Avg. CCT (K)	Avg. λ_{Dom} (nm)	Avg. Peak λ (nm)
1	Hydra-Tech 7000 K	6,567	483	450	6,475	483	449
2	Hydra-Tech 2800 K	3,198	491	618	3,177	490	618
3	J.W. Speaker	5,881	484	447	5,811	484	447
4	Smart Light Source Co.	3,209	484	601	3,100	481	603
5	Railhead Co / Divvali	2,938	495	603	2,892	545	605

Due to the nature of halogen lamps, a decrease in color temperature is expected with the dimming of the lamp. Dimming a halogen lamp requires lowering the actual temperature of the filament by reducing the input voltage. To demonstrate this relationship, a halogen lamp selected at random was tested in three different modes. As shown in [Table 9](#), the color temperature of the sample decreased significantly as the halogen light dimmed. Compared to halogen lamps, LEDs exhibited greater color temperature stability with respect to changes in luminous intensity.

Table 8. Color Temperature Change of Halogen Sample with Respect to Dimming Percentage

Approximate Dimming %	Resistor (± 0.5 Ohms)	CCT (K)	Color Change (%)
0	-	3,153	-
55	4.5	2,853	~ 10
95	15	2,310	~ 26

4. Discussion

The combination of light produced from a locomotive and projected onto any surface will vary based on the geometry of the headlights and auxiliary lights. Some locomotives are equipped with a dual-lamp headlight, while others have a single-lamp headlight. Additionally, locomotives equipped with dual-lamp headlights can have two different arrangements, either vertically stacked or horizontally aligned.

In addition, the height of the lamps above the rails can differ between locomotive models. For example, the dual-lamp headlight housing may be located below the cab on the locomotive's nose or above the cab near the roof. Regardless of the locomotive's geometry and light arrangement, all designs must comply with the requirements established in 49 CFR §229.125. To illustrate the illumination created by the lamp samples tested in this study, AutoCAD was used to create a 3-dimensional model of a locomotive and a human. The geometry of a GP-38 locomotive was used and a human male with 50th percentile height (69.1 inches), resulting in the model shown in Figure 17. The locomotive and human representations were placed on a model of typical railroad tracks with the human located 800 feet from the locomotive's headlights. Illuminance maps were then imported and overlaid onto the locomotive-human model, with the illuminance map origin centered on the GP-38's headlights.

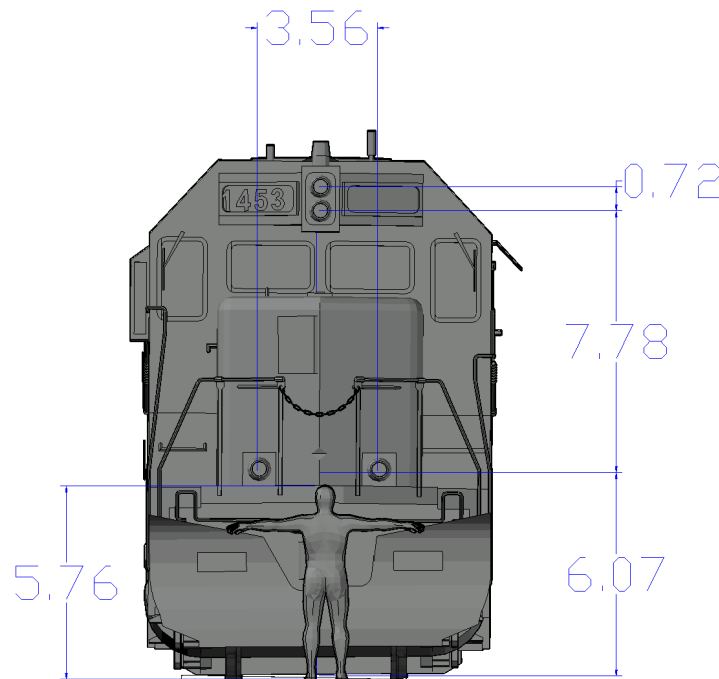

Figure 17. Basic Train-Human Schematic (All Dimensions Shown in ft)

4.1 Human Factors Considerations on Luminous Intensity and Illuminance

Paragraph (a) of 49 CFR §229.125 states that a locomotive operating in road service should be able to illuminate a person 800 feet directly ahead of the locomotive. To test for compliance with this requirement, it is necessary to calculate the amount of light falling on a person located at this distance.

The amount of light falling on a given surface is referred to as illuminance and is measured in lux (or foot-candles). It is the common measurement offered by most handheld light meters used for photography and safety purposes. In the case of the lamps tested in the present study, illuminance produced in a particular direction can be calculated using the inverse square law, as indicated in the following equation:

$$E = \frac{I}{d^2} \quad (4.1)$$

Where,

E is the illuminance at any point on a plane perpendicular to the line joining the point and the light source,

I is the luminous intensity in a given direction, and

d is the distance between the source and the plane.

Using custom software developed in MATLAB, illuminance maps were developed to simulate various arrangements of lamps and housing heights. The geometry utilized to calculate illuminance maps shown below was based on the locomotive model detailed in [Figure 17](#).

To evaluate compliance with the illumination requirement established in 49 CFR §229.125(a) it is necessary to set an illuminance threshold, a level of light at which an observer would have minimum visibility. No threshold is specified in 49 CFR §229.125(a); however, the automotive industry standard SAE J2829 uses a threshold of 3 lux (lx) (approximately 0.279 foot-candles) [\[13\]](#). Based on this standard, low beam headlamps for the automotive industry in the USA are designed to project 3 lx of light up to 100 meters in front of the vehicle. An illuminance of 3 lx is equivalent to the amount of natural light just before sunrise and after sunset, also called civil twilight.

The illuminance maps produced in this study used this detection threshold as the minimum illuminance contour line for each lamp tested. [Figure 18](#) shows two illuminance maps, one for a dual-lamp headlight (a) and another for a combination of one dual-lamp headlight and two auxiliary lights (b). The outer-most contour line of these illuminance maps represents the 3 lx threshold; the region inside the colored contour represents a higher level of illumination with the yellow region representing illuminance greater than 53.82 lx (~5 foot-candles). Plot (a) in [Figure 18](#) shows that more than 3 lx of illuminance reaches the ground 800 feet away from the light source, and within a lateral spread of ± 25 feet from the track centerline. Considering the amount of light falling only on the ground is not sufficient to ensure full illumination of a person. A headlight should produce similar levels of illuminance at heights corresponding to a typical human's knees to chest. [Figure 18 \(b\)](#) shows that the illuminance level at 4 feet above the ground is equal to the illuminance projected on the ground.

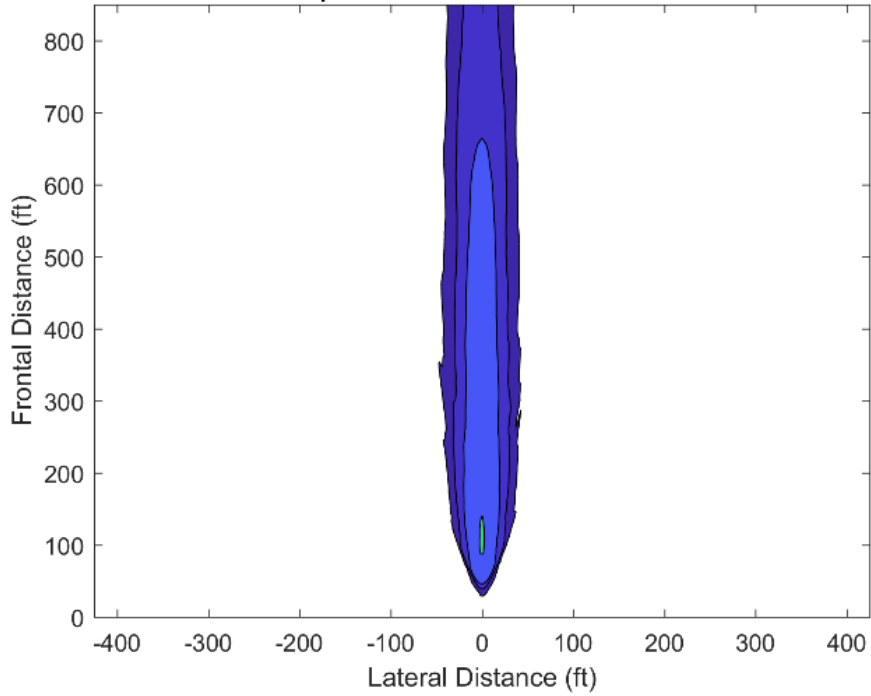

(a) Illuminance Map at Ground Level

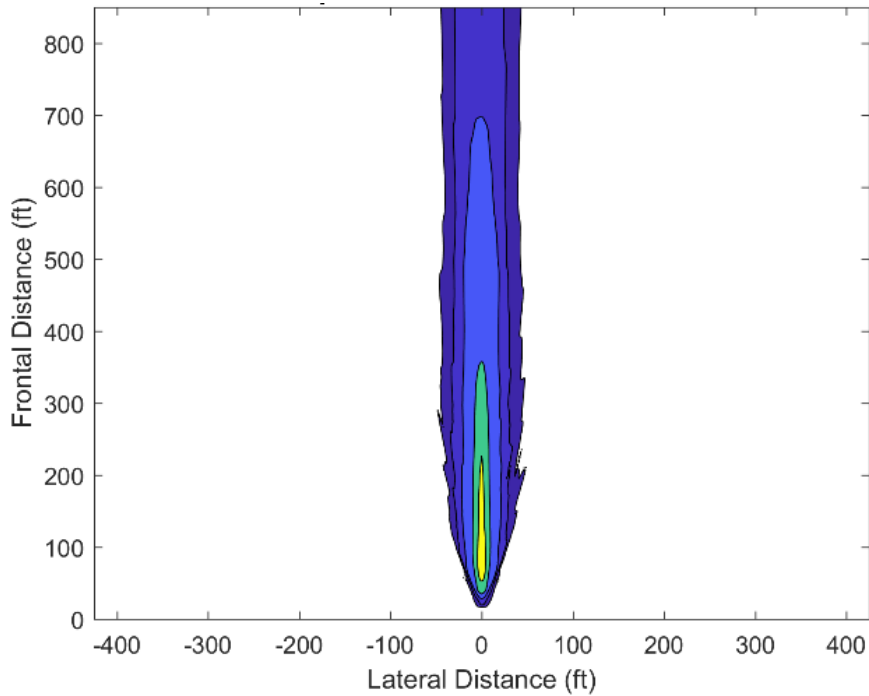

(b) Illuminance Map at 4 Feet Above Ground Level

Figure 18. Illuminance Maps for a Smart Light Source Sample Arranged in a Vertical Dual-Lamp Headlight

To better understand the role of illuminance in the context of a locomotive in road service, illuminance maps were superimposed onto the locomotive-human model previously described. Figure 19 and Figure 20 show a 3-way view of this integration; in Figure 19 the illuminance map is projected at ground level, and in Figure 20 projected 4 feet above

ground level. Both figures show that levels of illuminance greater than 3 lx surround the human figure, from feet to chest height. In addition, the vertical lamp arrangement, aimed parallel to the track, and the height of the locomotive's headlights produces greater levels of illuminance for planes higher than ground level. This is evident by the additional contour lines and yellow area shown in the illuminance maps projected 4 feet above ground in plot (b) of Figure 18 and the 3-way views in Figure 20.

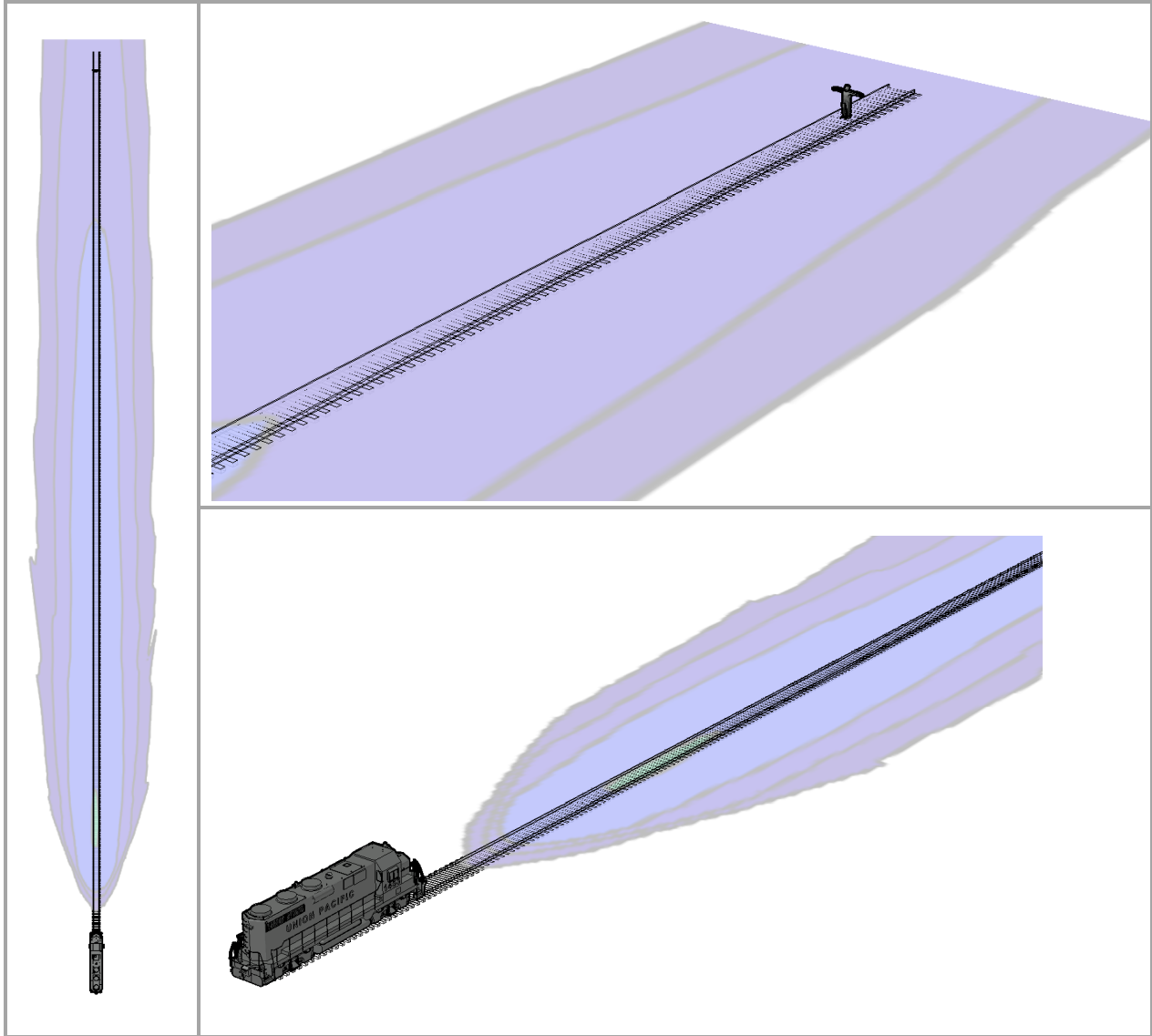
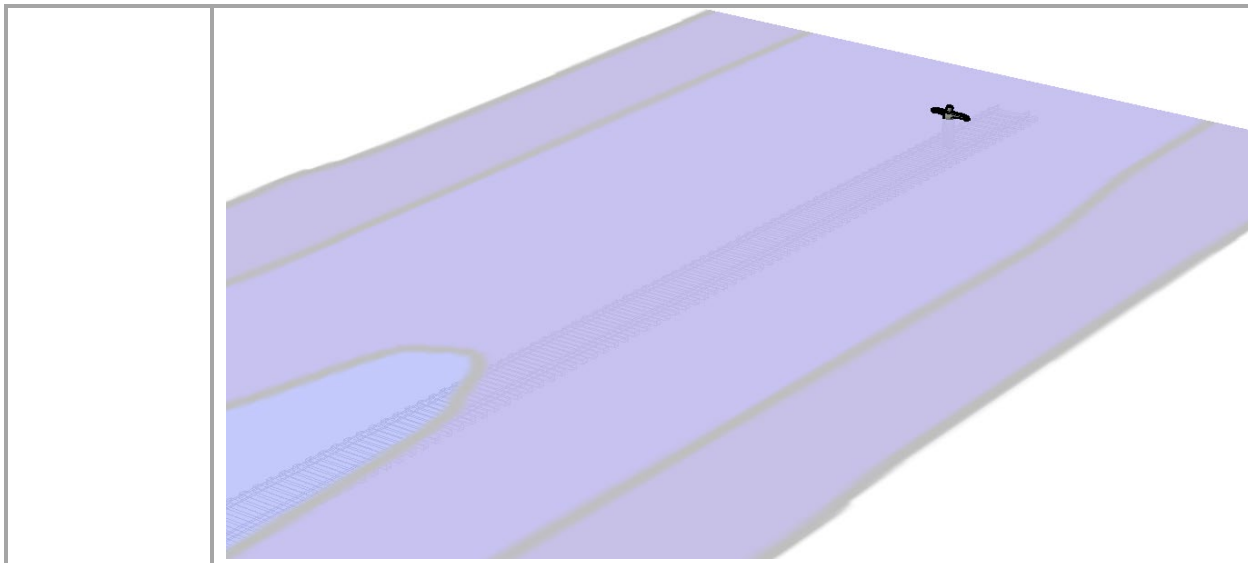

Figure 19. Three-Way View of an Illuminance Map at Ground Level for a Smart Light Source Dual-Lamp Headlight (S3 LED)



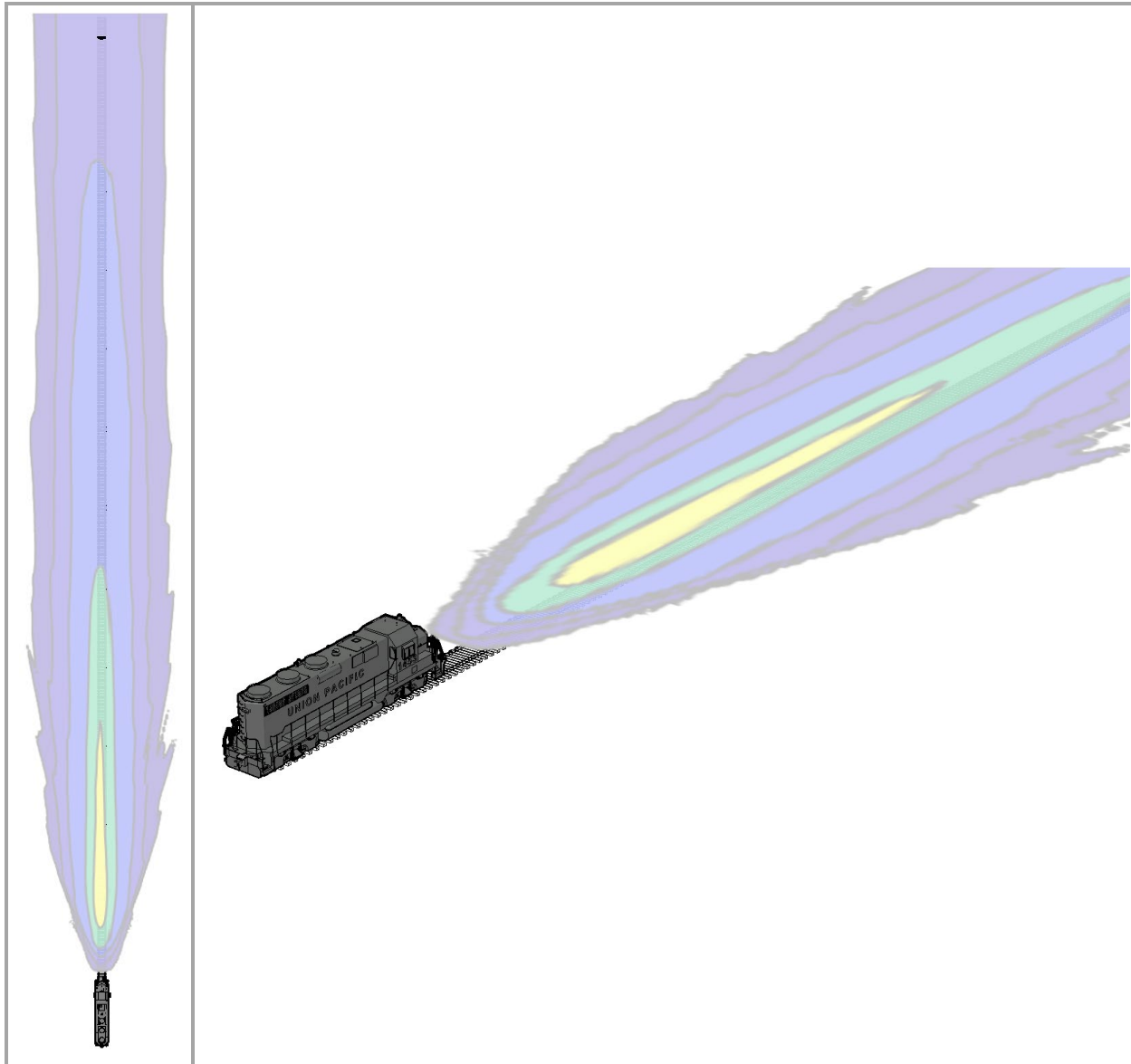
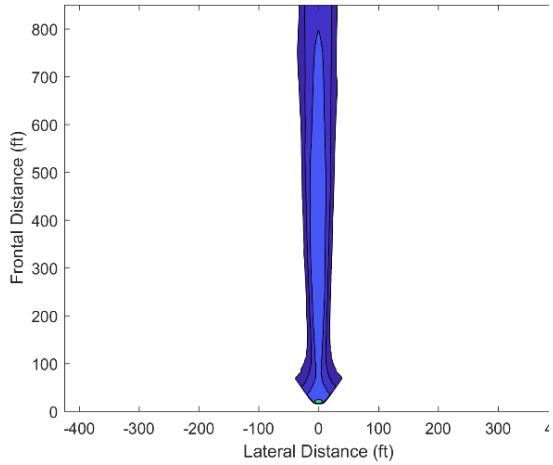
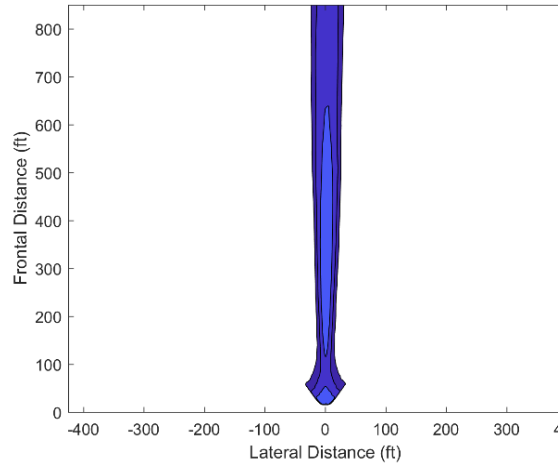

Figure 20. Three-Way View of an Illuminance Map at 4 Feet Above Ground Level for a Smart Light Source Dual-Lamp Headlight (S3 LED)

Each sample produced a different combination of contour lines that represent levels of illuminance. The total illuminance coverage of each sample is defined by different shapes and light intensities. All LED samples produced different but comparable areas of illuminance. The samples submitted by Hydra-Tech and J.W. Speaker have an area focused along around the track, while the Railhead/Divvali and the Smart Light Source samples produced wider distribution of illuminance along the track wayside (see Figure 21). Additional 3-way views of illuminance maps for all samples can be found in Appendix G.



(a) Hydra-Tech 7000 K (S1 LED)



(b) Hydra-Tech 2800 K (S5 LED)

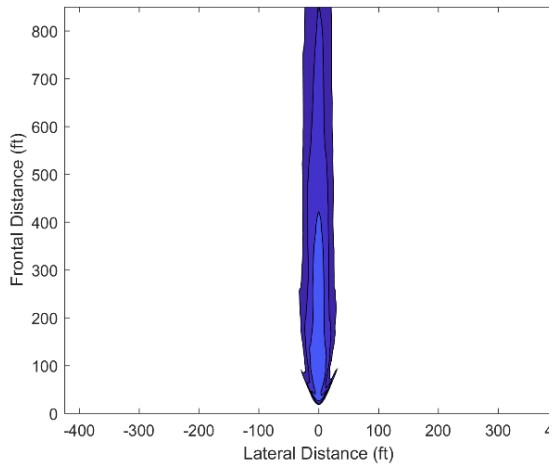

(c) J.W. Speaker (S2 LED)

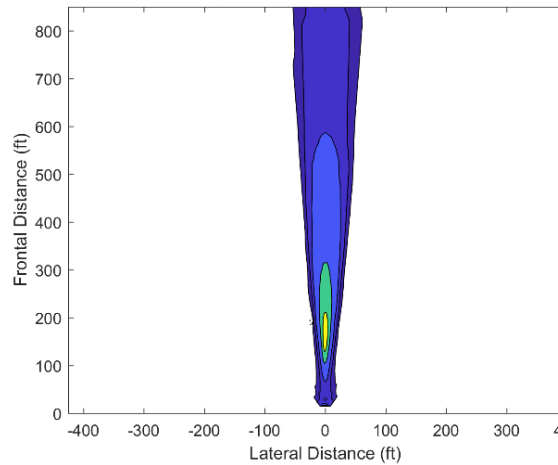

(d) Railhead/Divvali (S7 LED)

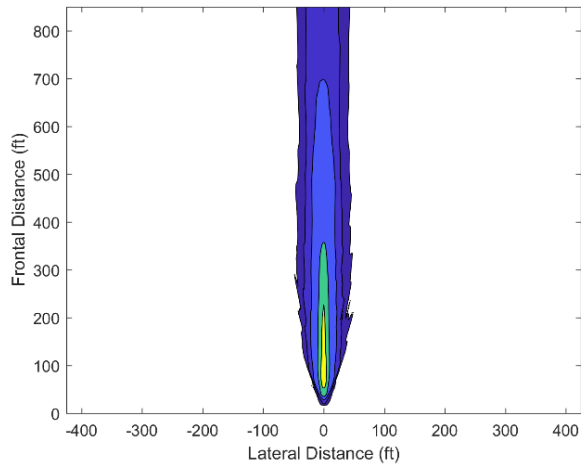

(e) Smart Light Source Co. (S3 LED)

Figure 21. Illuminance Maps for LED Samples at 4 Feet Above the Ground

Compared to halogen samples, all LED samples exhibited a more focused and uniform pattern of illumination along the tracks. In contrast, halogen samples exhibited a wider distribution of illuminance coverage away from the track centerline, similar to the illumination produced by floodlights. The LED samples with the widest distribution of illumination was the Railhead/Divvali lamps, but this distribution was more uniform than observed in halogen samples. In general, all LED samples produce more focused illumination along the tracks than halogen lamps. Additional illuminance maps for all samples can be found in Appendix F.

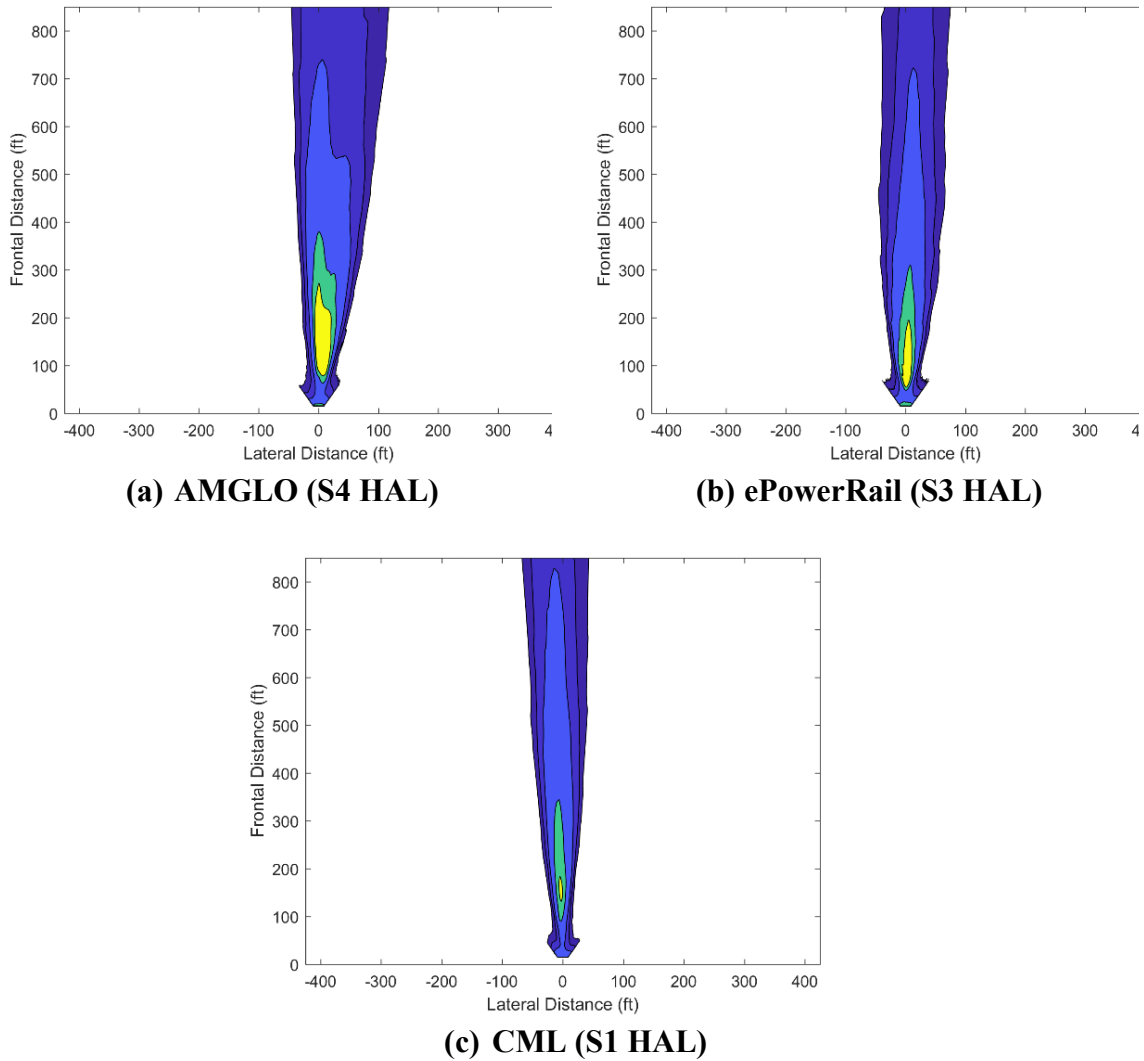

Figure 22. Illuminance Maps for Halogen Samples at 4 Feet Above Ground

4.2 Human Factors Considerations on Colorimetry

4.2.1 Virtual Renderings of Color Temperature

CIE chromaticity diagrams provide a standard reference for colors that can be perceived by the human eye; however, these diagrams cannot provide an immediate sense of color perception or recognition when multiple colors must be compared. An alternative method to compare two or more colors is to have accurate representations of each color.

For this study, virtual renderings of color temperature were used. Using Autodesk's 3DS Max in conjunction with the V-Ray rendering engine, accurate representations of each lamp's color temperature were rendered. These images were rendered using a virtual illuminant defined by a single ".ies" file projected onto a white wall, and changing the corresponding color temperature of each sample. These results provided a side-by-side comparison of color temperature for all lamp models (see Figure 23 and Figure 24).

These renderings showed significant differences in color between LED samples. The samples submitted by Smart Light Source, Railhead/Divvali, and Hydra-Tech (2,800 K) displayed a warmer color that is more comparable to halogen lights than the LED samples submitted by J.W. Speaker and Hydra-Tech (7,000 K). However, in any of these comparisons there are advantages and disadvantages to consider. A cooler light such as that produced by the J.W. Speaker and Hydra-Tech (7,000 K) samples offers higher contrast ratios for the locomotive operator in low light conditions and potentially greater detectability for observers external to the locomotive. However, lamps producing a cooler light at such high intensities may be more likely to cause discomfort glare for observers outside the locomotive compared to warmer lights.

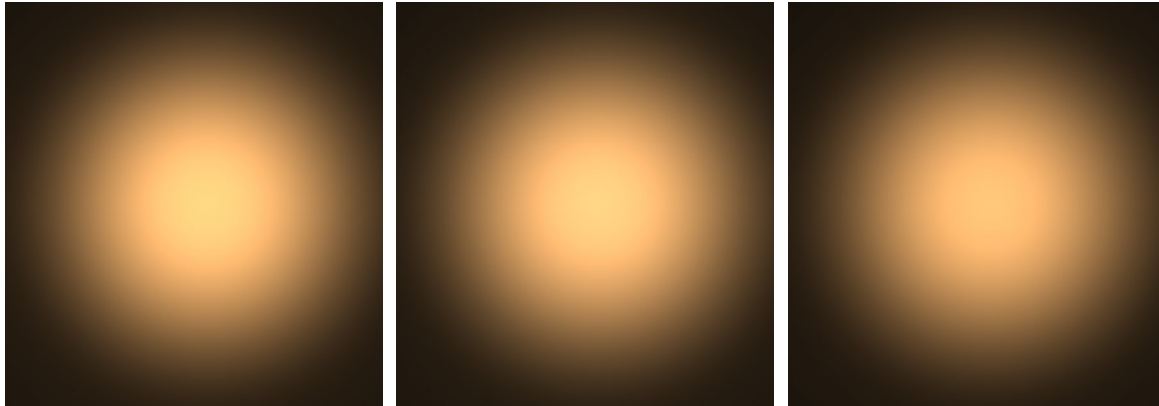

(a) CML – 3,081 K (b) ePowerRail – 3,129 K (c) AMGLO – 3,090 K

Figure 23. Virtual Color Renderings of Halogen Lamps³

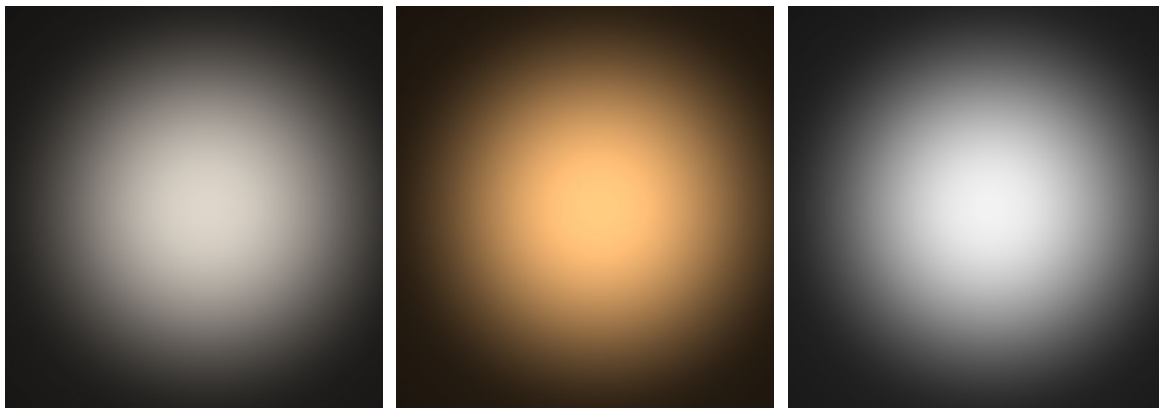

(a) J.W. Speaker – 5,888 K (b) Hydra-Tech (2800 K) – 3,198 K (c) Hydra-Tech (7000 K) – 6,567 K

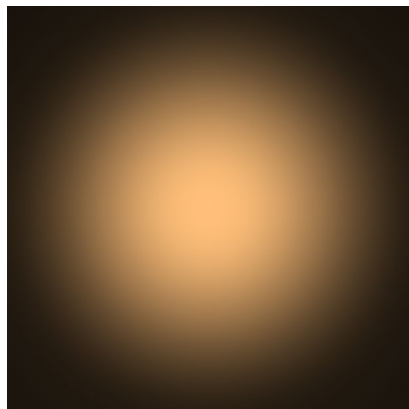

(d) Smart Light Source – 3,209 K

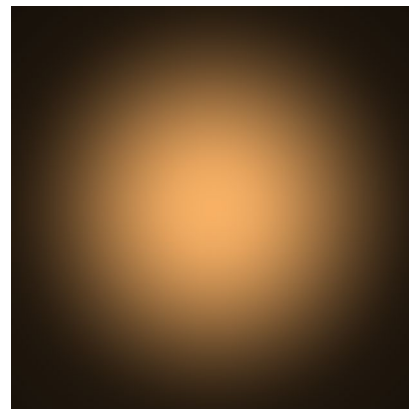

(e) Railhead/Divvali – 2,938 K

Figure 24. Virtual Color Renderings of LED Lamps³

³ The accuracy of these renderings depends upon the displaying method – e.g., print v. digital display.

5. Conclusion

Comparison of LED and halogen lamps for use as locomotive headlights is a multi-faceted issue which requires a careful analysis to ensure the safety of railroad operations is not compromised. At a basic level, the regulatory requirements established in 49 CFR §229.125 must be satisfied, specifically the headlights must produce at least 200,000 candela and be able to illuminate a person standing 800 feet directly in front of the locomotive. Additionally, the AAR Locomotive LED Headlight-Auxiliary Light Standard TAG provided a recommend color temperature range for suitable locomotive headlights. The following findings are based on testing completed as part of this study as well as a literature review of relevant work in the automotive, marine, and aviation industries.

1. When used in a dual-lamp headlight arrangement, all LED lamps were capable of meeting the peak luminous intensity requirements established in 49 CFR §229.125. If used in a single-lamp headlight arrangement, four of the five tested lamp models were capable of meeting the CFR luminous intensity requirements. However, all lamp models met their own claimed specifications, and it is likely that with slight modifications the Railhead/Divvali LED lamps could meet the applicable regulatory requirements in a single-lamp headlight arrangement.
2. All tested LED lamps exhibited more uniform and consistent photometric distributions than halogen lamps. These attributes of LED lamps suggest less variability in luminous intensity produced in all directions, especially those relevant to 49 CFR §229.125.
3. Halogen lamps produced a wider lateral spread of illuminance than LED lamps. In contrast, the illuminance produced by LED lamps focused along the tracks and ahead of the locomotive. The difference in illuminance between the two types of lamps was evident by the higher levels of luminous intensity produced by halogen lamps at the 7.5° and 20° orientations.
4. The levels of luminous intensity produced in dim mode varied significantly between models, as did the method for engaging dim mode. The authors propose that paragraph (b) of 49 CFR §229.125 be used as a guideline for fulfilling regulatory requirements of luminous intensity for a headlight operating in dim mode.
5. Three of the five tested LED lamp models produced colorimetric results that fell within the color temperature range and allowable variation recommended by the TAG. The J.W. Speaker and Hydra-Tech (7,000 K) LED models produced higher color temperatures but met suppliers' specifications for color temperature.
6. All halogen lamps produced colorimetric results that fell within the recommended color temperature range. As expected, color temperatures decreased significantly with dimming percentage.
7. The dominant and peak wavelengths of the color spectrum for the LED and halogen lamp models was consistent across all lamps as well as within model samples.
8. When operating in bright mode, all tested models and samples (both LED and halogen) can produce significantly more than 3 lx of illuminance at a distance of 800 feet directly ahead of the locomotive.



6. References

- [1] 49 CFR 229.125. (2018).
- [2] Baldwin, R. (2012). 50 Years of LED Technology. *Wired*.
- [3] Aero LEDs. (2018). Aero LEDs Products. Available: <https://aeroleds.com>. Accessed: 30-Apr-2018.
- [4] APEX Lighting. (2018). Boat Lights. Available: <http://www.apexlighting.com/marine-lights>. Accessed: 30-Apr-2018.
- [5] SAE. (2013). Performance Requirements for Light Emitting Diode (LED) Road Illumination Device Systems.
- [6] Van Derlofske, J., and Bullough, J. (2006). Spectral Effects of LED Forward Lighting: Visibility and Glare. SAE.
- [7] Kita, Y., Kojima, S., Sato, T., and Yaguchi, H. (2007). Color Perception and Recognition under Automotive Headlight with LED. SAE.
- [8] Flannagan, M. Uchida, J. Sullivan, M., and Buonarosa, M.L. (2014). Subjective and Objective Effects of Driving with LED Headlamps. SAE.
- [9] C. Villa, C., R. Bremond, R., and E. Saint Jacques, E. (2015). Visibility and discomfort glare of LED road studs. *Light. Res. Technol.* 47(8), 945–963.
- [10] Federal Railroad Administration. (2008). Driver Behavior at Highway-Railroad Grade Crossings : A Literature Review from 1990-2006 [DOT/FRA/ORD-08/03]. Washington, DC: U.S. Department of Transportation.
- [11] Federal Railroad Administration. (1995). Safety of Highway-Railroad Crossings: Use of Auxiliary External Alerting Devices to Improve Locomotive Conspicuity [DOT/FRA/ORD-95/13]. Washington, DC: U.S. Department of Transportation.
- [12] Schanda, J. (2015). CIE Standard Illuminants and Sources. *Encyclopedia of Color Science and Technology*. Berlin, Heidelberg: Springer Berlin Heidelberg, 1–5.
- [13] SAE. (2009). Pedestrian visibility: Low beam optimization to reduce night-time fatalities, vol. 4970, 377–415.
- [14] Westland, S., and Ripamonti, C. (2004). *Computational Colour Science Using MATLAB*, 2nd ed.

Abbreviations and Acronyms

AAR	Association of American Railroads
ANSI	American National Standards Institute
CCT	Correlated Color Temperature
cd	Candela
CFR	Code of Federal Regulations
CIE	Commission Internationale de l'Éclairage
FRA	Federal Railroad Administration
HID	High Intensity Discharge
K	Kelvin
LED	Light-Emitting Diode
lx	Lux
nm	Nanometer
SAE	Society for Automotive Engineers
TAG	Technical Advisory Group

Appendix A. Calibration Data for Test Instrumentation

	<p>Sapphire Technical Solutions, L.L.C. 10230 Rodney Street Pineville, NC 28134</p> <hr/> <p>www.sapphiresolutions.com msl@sapphiresolutions.com (704) 889-8080 (Phone); (704) 829-1502 (Fax)</p>	 <p>NVLAP LAB CODE: 200862-D ISO/IEC 17025 Accredited</p>
---	---	--

Certificate of Calibration # 4309

Calibration Date: 06/08/2017

Part Number: STD-DZE

Customer	Description
<p>Intertek Testing Service 4700 Broadmoor Ave. SE Suite #300 Kentwood , MI 49512</p> <p>Purchase Order # CC Asset I.D.: 133021 , 133033</p>	<p>Manufacturer: Hoffman Engineering Description: Luminous Intensity Standards Model Number: STD-DZE S/N: HEO-3207 , HEO-4655 Procedure: TP2(Luminous Intensity), TP3(Corr. Color Temperature) Technician: W.B.C. WOC#: 1449</p>

INTERTEK CERTIFICATION 2008

Traceability Information: Traceability is to national standards administered by the U.S. N.I.S.T. (National Institute of Standards and Technology), NRC-Canada, Euramet members (NPL, PTB, BNM) etc.), or other recognized standards laboratories. Some measurements are traceable to natural physical constants, consensus standards, or ratio-type measurements. Supporting documentation relative to traceability is maintained by the laboratories at Sapphire Technical Solutions, and is available for review at Sapphire Technical Solutions by appointment.

Specific Customer Requirements: Measure and record bulb current and voltage at manufacturer's specified candela value and approx. 2856K Correlated Color Temperature.

<u>Incoming Inspection / Item Condition As Received:</u>
Items boxed in a plastic case, in good condition.
<u>As Shipped Conditions:</u>
In tolerance per customer request / manufacturer specifications.

Maintaining Calibration Accuracy: Sapphire Technical Solutions does not make claim to past or future product performance. Actual reliability in an application will depend on: applied voltage and current, orientation, shock, vibration, temperature, and other environmental influences including proper storage and handling of samples.

Remarks or Special Requirements:

Lab Director
Michael C. Piscitelli

Certificate
Approved By:

Lab Manager
Ronald E. Wathan

THIS REPORT MUST NOT BE USED TO CLAIM PRODUCT CERTIFICATION, APPROVAL, OR ENDORSEMENT BY NVLAP, NIST, OR ANY AGENCY OF THE FEDERAL GOVERNMENT. THIS REPORT SHALL NOT BE REPRODUCED, EXCEPT IN FULL, WITHOUT WRITTEN APPROVAL FROM SAPPHIRE TECHNICAL SOLUTIONS.



Sapphire Technical Solutions, L.L.C.
 10230 Rodney Street
 Pineville, NC 28134

www.sapphireats.com
 mail@sapphireats.com
 (704) 829-3080 (Phone); (888) 829-1502 (Fax)



NVLAP LAB CODE: 200862-D
 ISO/IEC 17025 Accredited

Certificate of Calibration # 4309

Calibration Date: 06/08/2017

Part Number: STD-DZE

Procedure Description: Bulb was positioned 10 feet from the detector, with serial numbers facing away from the detector. Voltage polarity was correctly applied according to bulb markings ("+" on left facing detector from behind the bulb.) Bulb was then slowly ramped up to nominal candela value, and allowed to thermally and electrically stabilize for 10 minutes. Bulb current, voltage and CCT were then measured.

Photometric and Electrical Data

Bulb Type	S/N	Luminous Intensity (Candela)	Measured Voltage (Volts DC)	Set Current (Amps)	Corr. Color Temperature (K)
STD-DZE	HEC-3207				
Incoming Values (in tol. of +0.2% cd)		155.4	16.23	4.886	2889
Outgoing Values (in Tol. of +0.2% cd)		155.0	16.22	4.884	2888
% Deviation from Incoming		-0.21	-0.06	-0.04	-0.02

Temp (°): 22.1
 RH%: 38

Bulb Type	S/N	Luminous Intensity (Candela)	Measured Voltage (Volts DC)	Set Current (Amps)	Corr. Color Temperature (K)
STD-DZE	HEC-4866				
Incoming Values (in tol. of +0.2% cd)		150.8	15.59	4.789	2869
Outgoing Values (in Tol. of +0.2% cd)		150.0	15.56	4.783	2868
% Deviation from Incoming		-0.53	-0.19	-0.11	-0.03

Temp (°): 22.1
 RH%: 38

THIS REPORT MUST NOT BE USED TO CLAIM PRODUCT CERTIFICATION, APPROVAL, OR ENDORSEMENT BY NVLAP, NIST, OR ANY AGENCY OF THE FEDERAL GOVERNMENT. THIS REPORT SHALL NOT BE REPRODUCED, EXCEPT IN FULL, WITHOUT WRITTEN APPROVAL FROM SAPPHIRE TECHNICAL SOLUTIONS.

	<p>Sapphire Technical Solutions, L.L.C. 10230 Rodney Street Pineville, NC 28134</p> <hr/> <p>www.sapphirsts.com mail@sapphirsts.com (704) 889-8080 (Phone); (866) 829-1502 (Fax)</p>	 <p>NVLAP LAB CODE: 200862-0 ISO/IEC 17025 Accredited</p>
---	--	--

Certificate of Calibration # 4547

Calibration Date: 10/24/2017

Part Number: STD-DZE

Expanded Measurement Uncertainty: Uncertainty evaluation is calculated in accordance with the ISO/TAG4/WG3 "Guide to the Expression of Uncertainty in Measurement" (GUM). The uncertainty represents an expanded uncertainty using a coverage factor of k=2 to approximate a 95% confidence level. The results contained herein relate only to the item(s) calibrated.

Expanded Measurement Uncertainty at k=2:	Lamp Serial Number(s)
Luminous Intensity (+/-)%	98663 0.86%
Correlated Color Temp. (+/-) Kelvin	11
DC Current (+/-)%	0.014%
DC Voltage (+/-)%	0.035%

Equipment Used: Luminous Intensity transfer standards traceable to N.I.S.T. Spectro-radiometer calibrated with traceability to N.I.S.T. Digital Multimeters used to measure voltage and current are calibrated with traceability to N.I.S.T. D.C. Power Supply calibrated with traceability to N.I.S.T.

Lamp Maintenance: Comparison of the Measured Voltage over time at the rated current is a possible indication of lamp performance. Increased or decreased lamp voltage can indicate lamp aging, but great care in wiring, electrical contacts, and voltmeter hookup is necessary. A four-wire "kelvin connection" is recommended with separate power and sense lines at a point as close as feasibly possible to the lamp itself for valid voltage readings.

THIS REPORT MUST NOT BE USED TO CLAIM PRODUCT CERTIFICATION, APPROVAL, OR ENDORSEMENT BY NVLAP, NIST, OR ANY AGENCY OF THE FEDERAL GOVERNMENT. THIS REPORT SHALL NOT BE REPRODUCED, EXCEPT IN FULL, WITHOUT WRITTEN APPROVAL FROM SAPPHIRE TECHNICAL SOLUTIONS.

	<p style="text-align: center;"><i>Sapphire Technical Solutions, L.L.C.</i> 10230 Rodney Street Pineville, NC 28134</p> <hr/> <p style="text-align: center;">www.sapphirests.com mail@sapphirests.com (704) 889-8080 (Phone); (866) 829-1502 (Fax)</p>	 <p>NVLAP LAB CODE: 200862-0 ISO/IEC 17025 Accredited</p>
---	---	---

Certificate of Calibration # 4547

Calibration Date: 10/24/2017

Part Number: STD-DZE

By accepting this Certificate of Calibration you agree to the following terms and conditions.

TERMS AND CONDITIONS

1. CLIENT INFORMATION

STS assures the client that all testing and calibration services are done in accordance with standard procedures as applicable and that results of test reports are accurate within generally accepted commercial ranges of accuracy, unless a specific measure of greater accuracy has been agreed to in writing by STS and the client. All contracts between STS and the client shall be deemed to be made in and governed by the laws of the State of North Carolina.

2. REPORTS

All reports produced by STS apply only to the specific sample(s) tested under stated test conditions. Test results are not necessarily indicative of the qualities of apparently identical or similar test or operating conditions. STS is not liable for any deductions, inferences or generalizations drawn by the client or others from STS reports. All work and reports that are the outcome of STS services are not governed by the Uniform Commercial Code. Except as stated in Paragraph 1, STS refuses all warrants of merchantability or fitness for a particular purpose. STS assumes no liability for incidental or consequential damages of any nature whatsoever. Any test reports provided to clients by STS shall not be reproduced **except in full** without the approval of STS. The client shall not advertise or publish the name, the seal or service mark, reports, test results, documentation or procedures of STS without written authorization from STS. Actual or threatened failure by the client to abide by this Paragraph 4 may result in legal action by STS for injunctive and other relief.

3. LIMITS OF LIABILITY

The client agrees to limit STS's liability arising from STS's professional activity, errors, or omissions, such that the total aggregate liability of STS shall not exceed STS's total fee for the services rendered on the project in question, except in the case of a finding of gross negligence or willful misconduct on the part of STS by a court of competent jurisdiction. STS's liability for damage to or loss or destruction of the client's property while it is in possession of STS will be limited to the amount STS has agreed to charge the client for services. STS will not be held liable in the event of delays or failures beyond the control of the laboratory, caused in whole or in part by fire, flood, accident, riot war, operation of law, government action, strikes or other labor disturbances, fuel shortages. The client is solely responsible for any action taken based on any consulting, recommendations, results, observations, conclusions, discussions, or data as provided by STS. It is the responsibility of the client to understand the procedures employed in the testing process. Should witness of testing/calibration or services on STS premises be requested, the client shall comply with all applicable safety regulations and precautions. The client agrees STS shall not be responsible for any injuries to the client's representatives while attending to or observing testing at STS's facility. If testing takes place at the client's facility, the client agrees that STS will not operate and shall not be responsible for any of the client's equipment and that although STS agrees to abide by the client's safety procedures, STS shall not be responsible for injury to any of the client's personnel. If requested, evidence of workers compensation coverage prior to visit shall be supplied by the client.

THIS REPORT MUST NOT BE USED TO CLAIM PRODUCT CERTIFICATION, APPROVAL, OR ENDORSEMENT BY NVLAP, NIST, OR ANY AGENCY OF THE FEDERAL GOVERNMENT. THIS REPORT SHALL NOT BE REPRODUCED, EXCEPT IN FULL, WITHOUT WRITTEN APPROVAL FROM SAPPHIRE TECHNICAL SOLUTIONS.

	<p style="text-align: center;">Sapphire Technical Solutions, L.L.C. 10230 Rodney Street Pineville, NC 28134</p> <hr/> <p style="text-align: center;">www.sapphirests.com mail@sapphirests.com (704) 889-8080 (Phone); (866) 829-1502 (Fax)</p>	 <p>NVLAP LAB CODE: 200862-0 ISO/IEC 17025 Accredited</p>
---	--	--

Certificate of Calibration # 4309

Calibration Date: 06/08/2017

Part Number: STD-DZE

Customer	Description
Intertek Testing Service 4700 Broadmoor Ave. SE Suite #200 Kentwood , MI 49512 Purchase Order # CC Asset I.D.: 133021 , 133033	Manufacturer: Hoffman Engineering Description: Luminous Intensity Standards Model Number: STD-DZE S/N: HEC-3207 , HEC-4655 Procedure: TP2(Luminous Intensity), TP3(Corr. Color Temperature) Technician: W.B.C. W/O#: 1449

STS I.D.: C-INTRTK-MI-0002_0006

Traceability Information: Traceability is to national standards administered by the U.S. N.I.S.T. (National Institute of Standards and Technology), NRC Canada, Euromet members (NPL, PTB, BNM, etc.), or other recognized standards laboratories. Some measurements are traceable to natural physical constants, consensus standards, or ratio-type measurements. Supporting documentation relative to traceability is maintained by the laboratories at Sapphire Technical Solutions, and is available for review at Sapphire Technical Solutions by appointment.

Specific Customer Requirements: Measure and record bulb current and voltage at manufacturer's specified candela value and approx. 2856K Correlated Color Temperature.

<u>Incoming Inspection / Item Condition As Received:</u>
Items boxed in a plastic case, in good condition.
<u>As Shipped Conditions:</u>
In tolerance per customer request / manufacturer specifications.

Maintaining Calibration Accuracy: Sapphire Technical Solutions does not make claim to past or future product performance. Actual reliability in an application will depend on: applied voltage and current, orientation, shock, vibration, temperature, and other environmental influences including proper storage and handling of samples.

Remarks or Special Requirements:

Lab Director
Michael C. Piscitelli

Certificate
Approved By: _____
Lab Manager
Ronald E. Wathan

THIS REPORT MUST NOT BE USED TO CLAIM PRODUCT CERTIFICATION, APPROVAL, OR ENDORSEMENT BY NVLAP, NIST, OR ANY AGENCY OF THE FEDERAL GOVERNMENT. THIS REPORT SHALL NOT BE REPRODUCED, EXCEPT IN FULL, WITHOUT WRITTEN APPROVAL FROM SAPPHIRE TECHNICAL SOLUTIONS.

	<p style="text-align: center;">Sapphire Technical Solutions, L.L.C. 10230 Rodney Street Pineville, NC 28134</p> <hr/> <p style="text-align: center;">www.sapphirests.com mail@sapphirests.com (704) 889-8080 (Phone); (866) 829-1502 (Fax)</p>	 <p>NVLAP LAB CODE: 200862-0 ISO/IEC 17025 Accredited</p>
---	---	---

Certificate of Calibration # 4309

Calibration Date: 06/08/2017

Part Number: STD-DZE

Procedure Description: Bulb was positioned 10 feet from the detector, with serial numbers facing away from the detector. Voltage polarity was correctly applied according to bulb markings ("+" on left facing detector from behind the bulb.) Bulb was then slowly ramped up to nominal candela value, and allowed to thermally and electrically stabilize for 10 minutes. Bulb current, voltage and CCT were then measured.

Photometric and Electrical Data

Bulb Type	S/N	Luminous Intensity (Candela)	Measured Voltage (Volts DC)	Set Current (Amps)	Corr. Color Temperature (K)
STD-DZE	HEC-3207				
Incoming Values (In tol. Of +/-2% cd)		155.4	16.23	4.886	2889
Outgoing Values (In Tol. Of +/-2% cd)		155.0	16.22	4.884	2888
% Deviation from incoming		-0.21	-0.06	-0.04	-0.02

Temp (C): 22.1
 RH%: 38

Bulb Type	S/N	Luminous Intensity (Candela)	Measured Voltage (Volts DC)	Set Current (Amps)	Corr. Color Temperature (K)
STD-DZE	HEC-4655				
Incoming Values (In tol. Of +/-2% cd)		150.8	16.59	4.789	2869
Outgoing Values (In Tol. Of +/-2% cd)		150.0	16.56	4.783	2868
% Deviation from incoming		-0.59	-0.19	-0.11	-0.03

Temp (C): 22.1
 RH%: 38

THIS REPORT MUST NOT BE USED TO CLAIM PRODUCT CERTIFICATION, APPROVAL, OR ENDORSEMENT BY NVLAP, NIST, OR ANY AGENCY OF THE FEDERAL GOVERNMENT. THIS REPORT SHALL NOT BE REPRODUCED, EXCEPT IN FULL, WITHOUT WRITTEN APPROVAL FROM SAPHIRE TECHNICAL SOLUTIONS.



Sapphire Technical Solutions, L.L.C.
 10230 Rodney Street
 Pineville, NC 28134

www.sapphirests.com
 mail@sapphirests.com
 (704) 889-8080 (Phone); (866) 829-1502 (Fax)



NVLAP LAB CODE: 200862-0
 ISO/IEC 17025 Accredited

Certificate of Calibration # 4309

Calibration Date: 06/08/2017

Part Number: STD-DZE

Expanded Measurement Uncertainty: Uncertainty evaluation is calculated in accordance with the ISO/TAG4/WG3 "Guide to the Expression of Uncertainty in Measurement" (GUM). The uncertainty represents an expanded uncertainty using a coverage factor of k=2 to approximate a 95% confidence level. The results contained herein relate only to the item(s) calibrated.

Expanded Measurement Uncertainty at k=2:	Lamp Serial Number(s)	
	HEC-3207	HEC-4655
Luminous Intensity (+/-)%	0.84%	0.84%
Correlated Color Temp. (+/-) Kelvin	11	11
DC Current (+/-)%	0.015%	0.016%
DC Voltage (+/-)%	0.050%	0.098%

Equipment Used: Luminous Intensity transfer standards traceable to N.I.S.T. Spectro-radiometer calibrated with traceability to N.I.S.T. Digital Multimeters used to measure voltage and current are calibrated with traceability to N.I.S.T. D.C. Power Supply calibrated with traceability to N.I.S.T.

Lamp Maintenance: Comparison of the Measured Voltage over time at the rated current is a possible indication of lamp performance. Increased or decreased lamp voltage can indicate lamp aging, but great care in wiring, electrical contacts, and voltmeter hookup is necessary. A four-wire "kelvin connection" is recommended with separate power and sense lines at a point as close as feasibly possible to the lamp itself for valid voltage readings.

THIS REPORT MUST NOT BE USED TO CLAIM PRODUCT CERTIFICATION, APPROVAL, OR ENDORSEMENT BY NVLAP, NIST, OR ANY AGENCY OF THE FEDERAL GOVERNMENT. THIS REPORT SHALL NOT BE REPRODUCED, EXCEPT IN FULL, WITHOUT WRITTEN APPROVAL FROM SAPPHIRE TECHNICAL SOLUTIONS.

	<p>Sapphire Technical Solutions, L.L.C. 10230 Rodney Street Pineville, NC 28134</p> <hr/> <p>www.sapphirests.com mail@sapphirests.com (704) 889-8080 (Phone); (866) 829-1502 (Fax)</p>	 <p>NVLAP LAB CODE: 200862-0 ISO/IEC 17025 Accredited</p>
---	--	---

Certificate of Calibration # 4309

Calibration Date: 06/08/2017

Part Number: STD-DZE

By accepting this Certificate of Calibration you agree to the following terms and conditions.

TERMS AND CONDITIONS

1. CLIENT INFORMATION

STS assures the client that all testing and calibration services are done in accordance with standard procedures as applicable and that results of test reports are accurate within generally accepted commercial ranges of accuracy, unless a specific measure of greater accuracy has been agreed to in writing by STS and the client. All contracts between STS and the client shall be deemed to be made in and governed by the laws of the State of North Carolina.

2. REPORTS

All reports produced by STS apply only to the specific sample(s) tested under stated test conditions. Test results are not necessarily indicative of the qualities of apparently identical or similar test or operating conditions. STS is not liable for any deductions, inferences or generalizations drawn by the client or others from STS reports. All work and reports that are the outcome of STS services are not governed by the Uniform Commercial Code. Except as stated in Paragraph 1, STS refuses all warrants of merchantability or fitness for a particular purpose. STS assumes no liability for incidental or consequential damages of any nature whatsoever. Any test reports provided to clients by STS shall not be reproduced **except in full** without the approval of STS. The client shall not advertise or publish the name, the seal or service mark, reports, test results, documentation or procedures of STS without written authorization from STS. Actual or threatened failure by the client to abide by this Paragraph 4 may result in legal action by STS for injunctive and other relief.

3. LIMITS OF LIABILITY

The client agrees to limit STS's liability arising from STS's professional activity, errors, or omissions, such that the total aggregate liability of STS shall not exceed STS's total fee for the services rendered on the project in question, except in the case of a finding of gross negligence or willful misconduct on the part of STS by a court of competent jurisdiction. STS's liability for damage to or loss or destruction of the client's property while it is in possession of STS will be limited to the amount STS has agreed to charge the client for services. STS will not be held liable in the event of delays or failures beyond the control of the laboratory, caused in whole or in part by fire, flood, accident, riot war, operation of law, government action, strikes or other labor disturbances, fuel shortages. The client is solely responsible for any action taken based on any consulting, recommendations, results, observations, conclusions, discussions, or data as provided by STS. It is the responsibility of the client to understand the procedures employed in the testing process. Should witness of testing/calibration or services on STS premises be requested, the client shall comply with all applicable safety regulations and precautions. The client agrees STS shall not be responsible for any injuries to the client's representatives while attending to or observing testing at STS's facility. If testing takes place at the client's facility, the client agrees that STS will not operate and shall not be responsible for any of the client's equipment and that although STS agrees to abide by the client's safety procedures, STS shall not be responsible for injury to any of the client's personnel. If requested, evidence of workers compensation coverage prior to visit shall be supplied by the client.

THIS REPORT MUST NOT BE USED TO CLAIM PRODUCT CERTIFICATION, APPROVAL, OR ENDORSEMENT BY NVLAP, NIST, OR ANY AGENCY OF THE FEDERAL GOVERNMENT. THIS REPORT SHALL NOT BE REPRODUCED, EXCEPT IN FULL, WITHOUT WRITTEN APPROVAL FROM SAPPHIRE TECHNICAL SOLUTIONS.



EMPRO 20A/400MV SHUNT

SERIAL NUMBER:	6079	WORK ORDER:	180865
ASSET NUMBER:	Z90997	TEST RESULT:	PASS
CUST ASSET NUMBER:	133063	PERFORMED ON:	06/26/17
PROCEDURE NAME:	Shunt Cal_4363_34401A_NS	CAL DUE DATE:	06/26/20
PROCEDURE REV:	1.1	DATA TYPE:	FOUND-LEFT
CALIBRATED BY:	Tom Ferguson	TEMPERATURE:	20.00 °C
CUSTOMER:	INTERTEK GRAND RAPIDS - PHOTOMETRICS 4700 BROADMOOR AVE SE, SUITE 200 GRAND RAPIDS, MI 49512	HUMIDITY:	50 %
PRIMARY CONTACT:	NATHAN DANKS		

This instrument has been processed and calibrated in accordance with the NovaStar Solutions Quality System Manual. All calibrations are traceable to the National Institute of Standards and Technology (NIST) or to another National Metrology Institute to the International System of Units (SI units), acceptable intrinsic standards of measurement, or derived by the ratio type of self-calibration techniques. The NovaStar Solutions quality system is accredited ISO/IEC 17025:2005 and ANSI/NCCL Z540-1-1994.

The results reported herein apply only to the calibration of the item described above. No sampling plan was used for this calibration.

Expanded uncertainties are expressed at the approximate 95% level of confidence using a k=2. Due to any number of factors, the recommended due date on the item does not imply continuing conformance to specifications during the recommended interval. Unless otherwise stated the unit under test meets or exceeds manufacturer specifications.

For range and best measurement capability specifications for the standards used to perform this calibration, see the most recent calibration report maintained by this calibration laboratory (available upon request).

This report may not be reproduced, except in full, without written approval from NovaStar Solutions.

AS RECEIVED CONDITION:	IN TOLERANCE	REMARKS:
AS RETURNED CONDITION:	IN TOLERANCE	
ACTION TAKEN:	FULL CALIBRATION	

Standards Used

Asset #	Cert #	Description	Cal Date	Due Date
1957	1957-1312542221	SORENSEN XG 5-200 POWER SUPPLY	NCR	NCR
2076	2076-1438783344	EXTECH 40280 DATA LOGGER	07/29/2016	07/29/2017
000677	000677-1078754966	LEEDS & NORTHROP 4363 SHUNT	04/01/2016	04/01/2020
2050	2050-1412756993	HEWLETT PACKARD 34401A MULTIMETER	01/11/2017	01/11/2018

QA Signature: *Mark Louder*

Date: 6/27/2017

EMPRO 20A/400MV SHUNT

SERIAL NUMBER:	6079	WORK ORDER:	180885
ASSET NUMBER:	Z90907	TEST RESULT:	PASS
CUST ASSET NUMBER:	133083	PERFORMED ON:	06/28/17
PROCEDURE NAME:	Shunt Cal_4363_34401A_NS	CAL DUE DATE:	06/28/20
PROCEDURE REV:	1.1	DATA TYPE:	FOUND-LEFT
CALIBRATED BY:	Tom Ferguson	TEMPERATURE:	20 °C
CUSTOMER:	INTERTEK GRAND RAPIDS - PHOTOMETRICS 4700 BROADMOOR AVE SE, SUITE 200 GRAND RAPIDS, MI 49512	HUMIDITY:	50 %
PRIMARY CONTACT:	NATHAN DANKS		

This instrument has been processed and calibrated in accordance with the Nov2Star Solutions Quality System Manual. All calibrations are traceable to the National Institute of Standards and Technology (NIST) or to another National Metrology Institute to the International System of Units (SI units), acceptable intrinsic standards of measurement, or derived by the ratio type of self-calibration techniques. The Nov2Star Solutions quality system is accredited ISO/IEC 17025:2005 and ANSI/NCSL Z540-1-1994.

The results reported herein apply only to the calibration of the item described above. No sampling plan was used for this calibration.

Expanded uncertainties are expressed at the approximate 95% level of confidence using a $k=2$. Due to any number of factors, the recommended due date on the item does not imply continuing conformance to specifications during the recommended interval. Unless otherwise stated the unit under test meets or exceeds manufacturer specifications.

For range and best measurement capability specifications for the standards used to perform this calibration, see the most recent calibration report maintained by this calibration laboratory (available upon request).

This report may not be reproduced, except in full, without written approval from Nov2Star Solutions.

REMARKS:

Standards Used

Asset #	Cert #	Description	Cal Date	Due Date
1957	1957-1319546221	SORENSEN XG 8-200 POWER SUPPLY	1900-01-01	1900-01-01
2078	2078-1438783344	EXTECH 42280 DATA LOGGER	07/29/2016	07/29/2017
000677	000677-1078754688	LEEDS & NORTHRUP 4363 SHUNT	04/01/2016	04/01/2020
2050	2050-1412758893	HEWLETT PACKARD 34401A MULTIMETER	01/11/2017	01/11/2018

Test Procedure Results

Test results for calibration with work order : 100000

Test Description	Nominal	Test Result	Limit (Lower)	Limit (Upper)	Units	Uncertainty	Pass/Fail
Resistance Value	20.000000000	19.97038448	19.95000000	20.05000000	mOhm	4.8e-009	Pass

Power Coefficient not verified

- END OF REPORT -



15200 Plymouth Rd. / Livonia, MI 48150 / 734.453.8000



Certificate # 283430-176849

KEITHLEY 2000 DMM

SERIAL NUMBER:	4044413	WORK ORDER:	176849
ASSET NUMBER:	283430	TEST RESULT:	PASS
CUST ASSET NUMBER:	133085	PERFORMED ON:	05/11/17
PROCEDURE NAME:	Keithley 2000: (1 year) CAL VER IEEE /5520	CAL DUE DATE:	05/11/18
PROCEDURE REV:	\$Revision: 1.28 \$	DATA TYPE:	FOUND-LEFT
CALIBRATED BY:	ERVIN D. SHAFFER	TEMPERATURE:	22.00 °C
CUSTOMER:	INTERTEK GRAND RAPIDS - PHOTOMETRICS 4700 BROADMOOR AVE SE, SUITE 200 GRAND RAPIDS, MI 49512	HUMIDITY:	55 %
PRIMARY CONTACT:	NATHAN DANKS		

This instrument has been processed and calibrated in accordance with the NovaStar Solutions Quality System Manual and is traceable to the National Institute of Standards and Technology (NIST) or to NIST accepted intrinsic standards of measurement, or derived by the ratio type of self-calibration techniques. The NovaStar Solutions quality system is accredited ISO/IEC 17025:2005 and ANSI/NCSL Z540-1-1994.

The results reported herein apply only to the calibration of the item described above. No sampling plan was used for this calibration.

Expanded uncertainties are expressed at the approximate 95% level of confidence using a K=2. Due to any number of factors, the recommended due date on the item does not imply continuing conformance to specifications during the recommended interval. Unless otherwise stated the unit under test meets or exceeds manufacturer specifications.

For range and best measurement capability specifications for the standards used to perform this calibration, see the most recent calibration report maintained by this calibration laboratory (available upon request).

This report may not be reproduced, except in full, without written approval from NovaStar Solutions.

AS RECEIVED CONDITION:	OUT OF TOLERANCE	REMARKS:	UUT does not read AC Current. Customer agreed to limited calibration without AC Current. See attached.
AS RETURNED CONDITION:	LIMITED		
ACTION TAKEN:	LIMITED CALIBRATION		

Standards Used

Asset #	Cert #	Description	Cal Date	Due Date
1405	1405-1193663229	FLUKE 5520A W50C600 OPTION CALIBRATOR	04/04/2017	04/04/2018
2078	2078-1435783344	EXTECH 42280 DATA LOGGER	07/29/2016	07/29/2017

QA Signature: *Mark Cavatone*

Date: 5/16/2017

KEITHLEY 2000 DMM

SERIAL NUMBER:	4044413	WORK ORDER:	176849
ASSET NUMBER:	Z83430	TEST RESULT:	PASS
CUST ASSET NUMBER:	133085	PERFORMED ON:	05/11/17
PROCEDURE NAME:	Keithley 2000: (1 year) CAL VER IEEE /5520	CAL DUE DATE:	05/11/18
PROCEDURE REV:	\$Revision: 1.28 \$	DATA TYPE:	FOUND-LEFT
CALIBRATED BY:	ERVIN D. SHAFFER	TEMPERATURE:	22 °C
CUSTOMER:	INTERTEK GRAND RAPIDS - PHOTOMETRICS 4700 BROADMOOR AVE SE, SUITE 200 GRAND RAPIDS, MI 49512	HUMIDITY:	55 %
PRIMARY CONTACT:	NATHAN DANKS		

This instrument has been processed and calibrated in accordance with the NovaStar Solutions Quality System Manual and is traceable to the National Institute of Standards and Technology (NIST) or to NIST accepted intrinsic standards of measurement, or derived by the ratio type of self-calibration techniques. The NovaStar Solutions quality system is accredited ISO/IEC 17025:2005 and ANSI/ISO/IEC 17025-1:2005.

The results reported herein apply only to the calibration of the item described above. No sampling plan was used for this calibration.

Expanded uncertainties are expressed at the approximate 95% level of confidence using a $k=2$. Due to any number of factors, the recommended due date on the item does not imply continuing conformance to specifications during the recommended interval. Unless otherwise stated the unit under test meets or exceeds manufacturer specifications.

For range and best measurement capability specifications for the standards used to perform this calibration, see the most recent calibration report maintained by this calibration laboratory (available upon request).

This report may not be reproduced, except in full, without written approval from NovaStar Solutions.

REMARKS: UUT does not read AC Current. Customer agreed to limited calibration without AC Current. See attached.

Standards Used

Asset #	Cert #	Description	Cal Date	Due Date
1485	1485-1193883229	FLUKE 5820A WIS0600 OPTION CALIBRATOR	04/04/2017	04/04/2018
2076	2076-1438783344	EXTECH 40280 DATA LOGGER	07/28/2016	07/28/2017

Test Procedure Results

Test results for calibration with work order : 178848

Test Description	Nominal	Test Result	Limit (Lower)	Limit (Upper)	Units	Uncertainty	Pass/Fail
LUT IDENTIFICATION							
Serial Number: 4044413							
Firmware Level: B01 /A02							
DC VOLTAGE							
100 mV Range							
100.0000 mV	100.00000	99.9957	99.9900	100.0100	mV	2.3e-005	Pass
-100.0000 mV	-100.00000	-99.9992	-100.0100	-99.9900	mV	2.3e-005	Pass
1 V Range							
1.000000 V	1.0000000	0.999999	0.999951	1.000039	V	1.0e-005	Pass
-1.000000 V	-1.0000000	-0.999999	-1.000039	-0.999951	V	1.0e-005	Pass
10 V Range							
10.00000 V	10.000000	10.00005	9.99965	10.00035	V	1.1e-004	Pass
-10.00000 V	-10.000000	-10.00005	-10.00035	-9.99965	V	1.1e-004	Pass
100 V Range							
100.0000 V	100.00000	99.9975	99.9947	100.0053	V	1.5e-003	Pass
-100.0000 V	-100.00000	-99.9977	-100.0053	-99.9947	V	1.5e-003	Pass
1000 V Range							
1000.000 V	1000.0000	999.983	999.939	1000.061	V	1.5e-002	Pass
-1000.000 V	-1000.0000	-999.984	-1000.061	-999.939	V	1.5e-002	Pass
AC VOLTAGE							
100 mV Range							
100.0000 mV @ 1 kHz	100.00000	99.9823	99.9100	100.0900	mV	1.7e-005	Pass
100.0000 mV @ 50 kHz	100.00000	99.9919	99.9300	100.1700	mV	3.3e-005	Pass
1 V Range							
1.000000 V @ 1 kHz	1.0000000	0.999793	0.999100	1.000900	V	1.6e-004	Pass
1.000000 V @ 50 kHz	1.0000000	1.000052	0.999300	1.001700	V	2.7e-004	Pass
10 V Range							
10.00000 V @ 1 kHz	10.000000	9.99540	9.99100	10.00900	V	1.6e-003	Pass
10.00000 V @ 50 kHz	10.000000	9.99571	9.99300	10.01700	V	3.2e-003	Pass
100 V Range							
100.0000 V @ 1 kHz	100.00000	99.9958	99.9100	100.0900	V	1.6e-002	Pass
100.0000 V @ 50 kHz	100.00000	99.9919	99.9300	100.1700	V	2.6e-002	Pass

Test Procedure Results

Test results for calibration with work order : 176648

Test Description	Nominal	Test Result	Limit (Lower)	Limit (Upper)	Units	Uncertainty	Pass/Fail
750 V Range							
700.000 V @ 1 kHz	700.0000	699.797	699.355	700.645	V	1.7e-001	Pass
320.000 V @ 50 kHz	320.0000	319.777	319.241	320.759	V	7.9e-002	Pass
DC CURRENT							
10 mA Range							
10.00000 mA	10.000000	9.99954	9.99410	10.00590	mA	9.7e-007	Pass
-10.00000 mA	-10.000000	-9.99979	-10.00590	-9.99410	mA	9.7e-007	Pass
100 mA Range							
100.0000 mA	100.00000	99.9952	99.9550	100.1340	mA	9.7e-006	Pass
-100.0000 mA	-100.00000	-99.9914	-100.1340	-99.9550	mA	9.7e-006	Pass
1 A Range							
1.000000 A	1.0000000	0.999949	0.999110	1.000890	A	1.9e-004	Pass
-1.000000 A	-1.0000000	-0.999975	-1.000890	-0.999110	A	1.9e-004	Pass
3 A Range							
2.90000 A	2.900000	2.90018	2.89540	2.90380	A	8.9e-004	Pass
-2.90000 A	-2.900000	-2.90027	-2.90380	-2.89540	A	8.9e-004	Pass
4-WIRE OHMS							
100 Ohm Range							
100.0000 Ohm	100.00000	100.0043	99.9545	100.0155	Ohm	3.3e-003	Pass
1 kOhm Range							
1.000000 kOhm	1.0000000	1.000055	0.999555	1.000112	kOhm	2.3e-002	Pass
10 kOhm Range							
10.00000 kOhm	10.000000	10.00044	9.99555	10.00112	kOhm	2.3e-001	Pass
100 kOhm Range							
100.0000 kOhm	100.00000	100.0014	99.9555	100.0112	kOhm	2.3e+000	Pass
1 MOhm Range							
1.000000 MOhm	1.0000000	1.000039	0.999590	1.000110	MOhm	2.6e+001	Pass
2-WIRE OHMS							
10 MOhm Range							
10.00000 MOhm	10.000000	10.00004	9.99590	10.00410	MOhm	1.0e+003	Pass
100 MOhm Range							
100.0000 MOhm	100.00000	99.9951	99.9470	100.1530	MOhm	4.1e+004	Pass

CERTIFICATE OF CALIBRATION

Report Number: 0014209-00

Sales Order: 0014209 RMA Number: JA5598 Customer: Intertek Consumer Goods NA Address: 4700 Broadmoor-SE Suite 200 Kentwood MI 48512 Temperature (°C): 20° Rel. Humidity (%): 57% Date Calibrated: 04/13/2017	Model: RS-10D Serial Number: HL1965 Description: Standard of Spectral Irradiance Manufacturer: Gamma Scientific Technician: M.Parotkina Due Date: 04/13/2018
--	---



Procedure: QOP0168A - RS-10 Series Spectral Irradiance Calibration

Incoming: Within spec

Outgoing: Calibrated to meet manufacturers specifications.

Special Notes: Relamp, Replace fans, Calibrated to OCT of 2858K and Reset timer.

Results

The RS-10 is calibrated at 25cm from the Quartz Window to the aperture plane of the photometer.

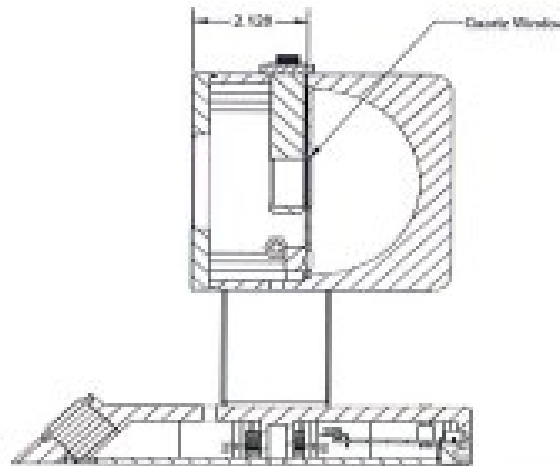

Measurement	Precheck	Calibration	Units
Illuminance	724.1	747.1	Lumen/m ² (lux)
Color Temperature	2853	2856	Kelvin
Chromaticity - x	0.4488	0.4485	1931 (x)
Chromaticity - y	0.4094	0.4092	1931 (y)

Spectral Irradiance data from 300-1100nm in 5nm step-size is included in the attachments.

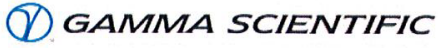

9925 CARROLL CANYON ROAD, SAN DIEGO, CA 92131 PHONE (858) 279-8034 FAX (858) 576-9286 WEBSITE: www.gamma-sci.com

CERTIFICATE OF CALIBRATION

Report Number: 0014209-00

<p>Sales Order: 0014209 RMA Number: JA5598 Customer: Intertek Consumer Goods NA Address: 4700 Broadmoor-SE Suite 200 Kentwood MI 49512 Temperature (°C): 20° Rel. Humidity (%): 57% Date Calibrated: 04/13/2017</p>	<p>Model: RS-10D Serial Number: HL1965 Description: Standard of Spectral Irradiance Manufacturer: Gamma Scientific Technician: M.Parotkina Due Date: 04/13/2018</p>
--	--

Calibration Standards Used

Manufacturer	Model No.	Serial No.	Description	Traceability No.	Cal Date	Due Date
NIST	FEL	F-675	Irradiance Standard	685/285196-14	06/24/14	29h logged of 200h
Gamma Scientific	DRIP	13	Photometer Standard	PAR-2016-3304	02/07/17	02/07/18

Expanded Uncertainty (k=2)

Illuminance	lux	0.74%
Color Temperature	Kelvin	7
CIE Color 1931	x	0.0008
CIE Color 1931	y	0.0004
Irradiance ($\mu\text{W}/\text{cm}^2 \cdot \text{nm}$)	300-400nm	2.7%
	400-930nm	1.8%
	930-1200nm	1.4%

Gamma Scientific's quality management system is ISO/IEC 17025:2005 accredited. This calibration was performed in accordance with the requirements of ISO/IEC 17025:2005(E) with measurements standards traceable to the National Institute of Standards & Technology (NIST). The information shown on this certificate applies only to the instrument identified above and may not be reproduced, except in full, without prior written consent from Gamma Scientific. There is no implied warranty that the instrument will maintain specified tolerances during the calibration interval due to possible drift, environmental conditions, or other factors beyond our control. This is a NVLAP accredited calibration. This report must not be used by Client to claim product certification, approval, or endorsement by NVLAP, NIST, or any agency of the Federal Government.

AUTHORIZED APPROVAL	QUALITY ASSURANCE



Data File Analysis (HL1965 IRRADIANCE @ 25 cm.dat)

Title: RS-10D S/N: HL1965 IRRADIANCE @ 25 cm
Date/Time: 04-13-2017 / 11:34:35
Standard/Reference Illuminant applied: FEL 1000W LAMP S/N: F-675 IRRADIANCE @ 50 cm / None
Units: Irradiance, $\mu\text{W}/(\text{cm}^2 \cdot \text{nm})$
Hardware: NM-26 200-1700nm, NM-9DH 190-820nm, D-49CQ 200-1010nm, (N/A)
Notes: T: 20C - RH: 57%
Number of points: 801
X-Axis-Low, High, Step: 300, 1100, 1 / Y-Axis-Low, High: 5.6389e-03, 2.8673e+00

(Ir)Radiance/Photon (Ir)Radiance/Integral
Irradiance: 1.352e+03 $\mu\text{W}/(\text{cm}^2)$ / Photon Irradiance: 5.709e+15 Photons/(sec $\cdot\text{cm}^2$)

Tristimulus (CIE 1931, 2° observer)
X=8.188e+02 Y=7.471e+02 Z=2.598e+02

Chromaticity (CIE 1931 xy and CIE 1976 UCS u'v')
x=0.4485 y=0.4092 u'=0.2558 v'=0.5251

Color Space (CIE 1976 L*u*v* and CIE 1976 L*a*b*)
L*=2.108e+02 u*=1.240e+02 v*=1.409e+02 a*=3.032e+01 b*=1.160e+02

(Il)Luminance
Illuminance: 7.471e+02 lm/m^2 (Lux) 6.940e+01 lm/ft^2 (Footcandles) 7.471e-02 lm/cm^2 (Photos)

Correlated Color Temperature/MPCD
3.502e+02 Mk^{-1} 2.856e+03 Kelvin / 01.6 MPCDs

Tristimulus (CIE 1964, 10° observer)
X=8.738e+02 Y=7.876e+02 Z=2.703e+02

Chromaticity (CIE 1964 xy)
x=0.4523 y=0.4077

LED - Illuminant E
Dominant WL 583.3 / Peak WL 968.00 / Luminous Intensity @ 10 cm (cd) 7.471e+00

Title: RS-10D S/N: HL1965 IRRADIANCE @ 25 cm
 Date/Time: 04-13-2017 / 11:34:35
 Standard/Reference Illuminant applied: FEL 1000W LAMP S/N: F-675 IRRADIANCE @ 50 cm / None
 Units: Irradiance, $\mu\text{W}/(\text{cm}^2 \cdot \text{nm})$
 Hardware: NM-26 200-1700nm, NM-9DH 190-820nm, D-49CQ 200-1010nm, (N/A)
 Notes: T: 20C - RH: 57%
 Number of points: 801
 X-Axis-Low, High, Step: 300, 1100, 1 / Y-Axis-Low, High: 5.6389e-03, 2.8673e+00

0300.0 nm	5.6389e-03	0350.0 nm	3.4764e-02	0400.0 nm	1.2797e-01
0301.0 nm	5.9099e-03	0351.0 nm	3.5813e-02	0401.0 nm	1.3098e-01
0302.0 nm	6.1816e-03	0352.0 nm	3.6888e-02	0402.0 nm	1.3405e-01
0303.0 nm	6.4645e-03	0353.0 nm	3.7990e-02	0403.0 nm	1.3717e-01
0304.0 nm	6.7586e-03	0354.0 nm	3.9119e-02	0404.0 nm	1.4035e-01
0305.0 nm	7.0640e-03	0355.0 nm	4.0276e-02	0405.0 nm	1.4357e-01
0306.0 nm	7.3808e-03	0356.0 nm	4.1461e-02	0406.0 nm	1.4684e-01
0307.0 nm	7.7087e-03	0357.0 nm	4.2675e-02	0407.0 nm	1.5016e-01
0308.0 nm	8.0478e-03	0358.0 nm	4.3918e-02	0408.0 nm	1.5352e-01
0309.0 nm	8.3982e-03	0359.0 nm	4.5192e-02	0409.0 nm	1.5694e-01
0310.0 nm	8.7598e-03	0360.0 nm	4.6496e-02	0410.0 nm	1.6040e-01
0311.0 nm	9.1330e-03	0361.0 nm	4.7831e-02	0411.0 nm	1.6390e-01
0312.0 nm	9.5172e-03	0362.0 nm	4.9197e-02	0412.0 nm	1.6745e-01
0313.0 nm	9.9126e-03	0363.0 nm	5.0594e-02	0413.0 nm	1.7105e-01
0314.0 nm	1.0319e-02	0364.0 nm	5.2023e-02	0414.0 nm	1.7469e-01
0315.0 nm	1.0737e-02	0365.0 nm	5.3483e-02	0415.0 nm	1.7838e-01
0316.0 nm	1.1166e-02	0366.0 nm	5.4976e-02	0416.0 nm	1.8211e-01
0317.0 nm	1.1606e-02	0367.0 nm	5.6499e-02	0417.0 nm	1.8588e-01
0318.0 nm	1.2058e-02	0368.0 nm	5.8053e-02	0418.0 nm	1.8970e-01
0319.0 nm	1.2522e-02	0369.0 nm	5.9638e-02	0419.0 nm	1.9356e-01
0320.0 nm	1.2997e-02	0370.0 nm	6.1254e-02	0420.0 nm	1.9747e-01
0321.0 nm	1.3484e-02	0371.0 nm	6.2900e-02	0421.0 nm	2.0141e-01
0322.0 nm	1.3984e-02	0372.0 nm	6.4576e-02	0422.0 nm	2.0540e-01
0323.0 nm	1.4496e-02	0373.0 nm	6.6283e-02	0423.0 nm	2.0942e-01
0324.0 nm	1.5021e-02	0374.0 nm	6.8021e-02	0424.0 nm	2.1348e-01
0325.0 nm	1.5559e-02	0375.0 nm	6.9790e-02	0425.0 nm	2.1757e-01
0326.0 nm	1.6111e-02	0376.0 nm	7.1590e-02	0426.0 nm	2.2170e-01
0327.0 nm	1.6677e-02	0377.0 nm	7.3423e-02	0427.0 nm	2.2585e-01
0328.0 nm	1.7258e-02	0378.0 nm	7.5289e-02	0428.0 nm	2.3004e-01
0329.0 nm	1.7854e-02	0379.0 nm	7.7190e-02	0429.0 nm	2.3425e-01
0330.0 nm	1.8466e-02	0380.0 nm	7.9128e-02	0430.0 nm	2.3848e-01
0331.0 nm	1.9095e-02	0381.0 nm	8.1103e-02	0431.0 nm	2.4273e-01
0332.0 nm	1.9740e-02	0382.0 nm	8.3119e-02	0432.0 nm	2.4700e-01
0333.0 nm	2.0403e-02	0383.0 nm	8.5175e-02	0433.0 nm	2.5128e-01
0334.0 nm	2.1084e-02	0384.0 nm	8.7275e-02	0434.0 nm	2.5559e-01
0335.0 nm	2.1783e-02	0385.0 nm	8.9419e-02	0435.0 nm	2.5991e-01
0336.0 nm	2.2501e-02	0386.0 nm	9.1610e-02	0436.0 nm	2.6424e-01
0337.0 nm	2.3239e-02	0387.0 nm	9.3850e-02	0437.0 nm	2.6859e-01
0338.0 nm	2.3996e-02	0388.0 nm	9.6141e-02	0438.0 nm	2.7295e-01
0339.0 nm	2.4774e-02	0389.0 nm	9.8483e-02	0439.0 nm	2.7733e-01
0340.0 nm	2.5572e-02	0390.0 nm	1.0088e-01	0440.0 nm	2.8172e-01
0341.0 nm	2.6392e-02	0391.0 nm	1.0333e-01	0441.0 nm	2.8613e-01
0342.0 nm	2.7232e-02	0392.0 nm	1.0584e-01	0442.0 nm	2.9056e-01
0343.0 nm	2.8095e-02	0393.0 nm	1.0841e-01	0443.0 nm	2.9502e-01
0344.0 nm	2.8979e-02	0394.0 nm	1.1103e-01	0444.0 nm	2.9950e-01
0345.0 nm	2.9885e-02	0395.0 nm	1.1371e-01	0445.0 nm	3.0400e-01
0346.0 nm	3.0814e-02	0396.0 nm	1.1645e-01	0446.0 nm	3.0854e-01
0347.0 nm	3.1765e-02	0397.0 nm	1.1924e-01	0447.0 nm	3.1311e-01
0348.0 nm	3.2740e-02	0398.0 nm	1.2210e-01	0448.0 nm	3.1772e-01
0349.0 nm	3.3740e-02	0399.0 nm	1.2500e-01	0449.0 nm	3.2236e-01

Title: RS-10D S/N: HL1965 IRRADIANCE @ 25 cm
 Date/Time: 04-13-2017 / 11:34:35
 Standard/Reference Illuminant applied: FEL 1000W LAMP S/N: F-675 IRRADIANCE @ 50 cm / None
 Units: Irradiance, $\mu\text{W}/(\text{cm}^2 \cdot \text{nm})$
 Hardware: NM-26 200-1700nm, NM-9DH 190-820nm, D-49CQ 200-1010nm, (N/A)
 Notes: T: 20C - RH: 57%
 Number of points: 801
 X-Axis-Low,High,Step: 300, 1100, 1 / Y-Axis-Low,High: 5.6389e-03, 2.8673e+00

0450.0 nm	3.2705e-01	0500.0 nm	6.0445e-01	0550.0 nm	9.4371e-01
0451.0 nm	3.3177e-01	0501.0 nm	6.1092e-01	0551.0 nm	9.5059e-01
0452.0 nm	3.3654e-01	0502.0 nm	6.1742e-01	0552.0 nm	9.5748e-01
0453.0 nm	3.4136e-01	0503.0 nm	6.2395e-01	0553.0 nm	9.6437e-01
0454.0 nm	3.4622e-01	0504.0 nm	6.3050e-01	0554.0 nm	9.7127e-01
0455.0 nm	3.5112e-01	0505.0 nm	6.3708e-01	0555.0 nm	9.7818e-01
0456.0 nm	3.5607e-01	0506.0 nm	6.4367e-01	0556.0 nm	9.8512e-01
0457.0 nm	3.6105e-01	0507.0 nm	6.5028e-01	0557.0 nm	9.9208e-01
0458.0 nm	3.6608e-01	0508.0 nm	6.5691e-01	0558.0 nm	9.9907e-01
0459.0 nm	3.7115e-01	0509.0 nm	6.6355e-01	0559.0 nm	1.0061e+00
0460.0 nm	3.7626e-01	0510.0 nm	6.7019e-01	0560.0 nm	1.0132e+00
0461.0 nm	3.8140e-01	0511.0 nm	6.7684e-01	0561.0 nm	1.0203e+00
0462.0 nm	3.8658e-01	0512.0 nm	6.8350e-01	0562.0 nm	1.0274e+00
0463.0 nm	3.9179e-01	0513.0 nm	6.9016e-01	0563.0 nm	1.0346e+00
0464.0 nm	3.9703e-01	0514.0 nm	6.9682e-01	0564.0 nm	1.0418e+00
0465.0 nm	4.0230e-01	0515.0 nm	7.0349e-01	0565.0 nm	1.0490e+00
0466.0 nm	4.0759e-01	0516.0 nm	7.1016e-01	0566.0 nm	1.0563e+00
0467.0 nm	4.1291e-01	0517.0 nm	7.1683e-01	0567.0 nm	1.0636e+00
0468.0 nm	4.1825e-01	0518.0 nm	7.2351e-01	0568.0 nm	1.0710e+00
0469.0 nm	4.2361e-01	0519.0 nm	7.3019e-01	0569.0 nm	1.0784e+00
0470.0 nm	4.2899e-01	0520.0 nm	7.3689e-01	0570.0 nm	1.0858e+00
0471.0 nm	4.3438e-01	0521.0 nm	7.4359e-01	0571.0 nm	1.0932e+00
0472.0 nm	4.3980e-01	0522.0 nm	7.5031e-01	0572.0 nm	1.1007e+00
0473.0 nm	4.4523e-01	0523.0 nm	7.5704e-01	0573.0 nm	1.1082e+00
0474.0 nm	4.5068e-01	0524.0 nm	7.6378e-01	0574.0 nm	1.1157e+00
0475.0 nm	4.5616e-01	0525.0 nm	7.7055e-01	0575.0 nm	1.1233e+00
0476.0 nm	4.6166e-01	0526.0 nm	7.7734e-01	0576.0 nm	1.1308e+00
0477.0 nm	4.6718e-01	0527.0 nm	7.8415e-01	0577.0 nm	1.1384e+00
0478.0 nm	4.7273e-01	0528.0 nm	7.9099e-01	0578.0 nm	1.1460e+00
0479.0 nm	4.7831e-01	0529.0 nm	7.9785e-01	0579.0 nm	1.1536e+00
0480.0 nm	4.8392e-01	0530.0 nm	8.0473e-01	0580.0 nm	1.1612e+00
0481.0 nm	4.8956e-01	0531.0 nm	8.1164e-01	0581.0 nm	1.1688e+00
0482.0 nm	4.9523e-01	0532.0 nm	8.1857e-01	0582.0 nm	1.1764e+00
0483.0 nm	5.0094e-01	0533.0 nm	8.2552e-01	0583.0 nm	1.1841e+00
0484.0 nm	5.0668e-01	0534.0 nm	8.3248e-01	0584.0 nm	1.1917e+00
0485.0 nm	5.1246e-01	0535.0 nm	8.3945e-01	0585.0 nm	1.1993e+00
0486.0 nm	5.1828e-01	0536.0 nm	8.4643e-01	0586.0 nm	1.2068e+00
0487.0 nm	5.2414e-01	0537.0 nm	8.5341e-01	0587.0 nm	1.2144e+00
0488.0 nm	5.3005e-01	0538.0 nm	8.6040e-01	0588.0 nm	1.2220e+00
0489.0 nm	5.3600e-01	0539.0 nm	8.6738e-01	0589.0 nm	1.2296e+00
0490.0 nm	5.4199e-01	0540.0 nm	8.7437e-01	0590.0 nm	1.2371e+00
0491.0 nm	5.4804e-01	0541.0 nm	8.8134e-01	0591.0 nm	1.2446e+00
0492.0 nm	5.5413e-01	0542.0 nm	8.8831e-01	0592.0 nm	1.2521e+00
0493.0 nm	5.6026e-01	0543.0 nm	8.9527e-01	0593.0 nm	1.2596e+00
0494.0 nm	5.6644e-01	0544.0 nm	9.0222e-01	0594.0 nm	1.2670e+00
0495.0 nm	5.7267e-01	0545.0 nm	9.0916e-01	0595.0 nm	1.2744e+00
0496.0 nm	5.7895e-01	0546.0 nm	9.1609e-01	0596.0 nm	1.2817e+00
0497.0 nm	5.8526e-01	0547.0 nm	9.2301e-01	0597.0 nm	1.2889e+00
0498.0 nm	5.9162e-01	0548.0 nm	9.2991e-01	0598.0 nm	1.2962e+00
0499.0 nm	5.9802e-01	0549.0 nm	9.3681e-01	0599.0 nm	1.3033e+00

Title: RS-10D S/N: HL1965 IRRADIANCE @ 25 cm

Date/Time: 04-13-2017 / 11:34:35

Standard/Reference Illuminant applied: FEL 1000W LAMP S/N: F-675 IRRADIANCE @ 50 cm / None

Units: Irradiance, $\mu\text{W}/(\text{cm}^2 \cdot \text{nm})$

Hardware: NM-26 200-1700nm, NM-9DH 190-820nm, D-49CQ 200-1010nm, (N/A)

Notes: T: 20C - RH: 57%

Number of points: 801

X-Axis-Low, High, Step: 300, 1100, 1 / Y-Axis-Low, High: 5.6389e-03, 2.8673e+00

0600.0 nm	1.3104e+00	0650.0 nm	1.6599e+00	0700.0 nm	1.9897e+00
0601.0 nm	1.3175e+00	0651.0 nm	1.6661e+00	0701.0 nm	1.9968e+00
0602.0 nm	1.3245e+00	0652.0 nm	1.6723e+00	0702.0 nm	2.0038e+00
0603.0 nm	1.3315e+00	0653.0 nm	1.6786e+00	0703.0 nm	2.0109e+00
0604.0 nm	1.3384e+00	0654.0 nm	1.6849e+00	0704.0 nm	2.0181e+00
0605.0 nm	1.3453e+00	0655.0 nm	1.6913e+00	0705.0 nm	2.0252e+00
0606.0 nm	1.3522e+00	0656.0 nm	1.6978e+00	0706.0 nm	2.0323e+00
0607.0 nm	1.3591e+00	0657.0 nm	1.7043e+00	0707.0 nm	2.0393e+00
0608.0 nm	1.3660e+00	0658.0 nm	1.7109e+00	0708.0 nm	2.0464e+00
0609.0 nm	1.3729e+00	0659.0 nm	1.7175e+00	0709.0 nm	2.0534e+00
0610.0 nm	1.3798e+00	0660.0 nm	1.7242e+00	0710.0 nm	2.0604e+00
0611.0 nm	1.3867e+00	0661.0 nm	1.7309e+00	0711.0 nm	2.0673e+00
0612.0 nm	1.3937e+00	0662.0 nm	1.7377e+00	0712.0 nm	2.0741e+00
0613.0 nm	1.4007e+00	0663.0 nm	1.7445e+00	0713.0 nm	2.0809e+00
0614.0 nm	1.4077e+00	0664.0 nm	1.7513e+00	0714.0 nm	2.0877e+00
0615.0 nm	1.4149e+00	0665.0 nm	1.7581e+00	0715.0 nm	2.0943e+00
0616.0 nm	1.4221e+00	0666.0 nm	1.7650e+00	0716.0 nm	2.1009e+00
0617.0 nm	1.4293e+00	0667.0 nm	1.7718e+00	0717.0 nm	2.1074e+00
0618.0 nm	1.4367e+00	0668.0 nm	1.7786e+00	0718.0 nm	2.1138e+00
0619.0 nm	1.4441e+00	0669.0 nm	1.7855e+00	0719.0 nm	2.1201e+00
0620.0 nm	1.4516e+00	0670.0 nm	1.7923e+00	0720.0 nm	2.1263e+00
0621.0 nm	1.4592e+00	0671.0 nm	1.7990e+00	0721.0 nm	2.1325e+00
0622.0 nm	1.4668e+00	0672.0 nm	1.8057e+00	0722.0 nm	2.1387e+00
0623.0 nm	1.4745e+00	0673.0 nm	1.8124e+00	0723.0 nm	2.1447e+00
0624.0 nm	1.4822e+00	0674.0 nm	1.8191e+00	0724.0 nm	2.1508e+00
0625.0 nm	1.4899e+00	0675.0 nm	1.8257e+00	0725.0 nm	2.1567e+00
0626.0 nm	1.4976e+00	0676.0 nm	1.8322e+00	0726.0 nm	2.1627e+00
0627.0 nm	1.5053e+00	0677.0 nm	1.8387e+00	0727.0 nm	2.1686e+00
0628.0 nm	1.5130e+00	0678.0 nm	1.8452e+00	0728.0 nm	2.1744e+00
0629.0 nm	1.5206e+00	0679.0 nm	1.8517e+00	0729.0 nm	2.1803e+00
0630.0 nm	1.5282e+00	0680.0 nm	1.8581e+00	0730.0 nm	2.1862e+00
0631.0 nm	1.5357e+00	0681.0 nm	1.8645e+00	0731.0 nm	2.1920e+00
0632.0 nm	1.5430e+00	0682.0 nm	1.8709e+00	0732.0 nm	2.1979e+00
0633.0 nm	1.5503e+00	0683.0 nm	1.8772e+00	0733.0 nm	2.2037e+00
0634.0 nm	1.5575e+00	0684.0 nm	1.8836e+00	0734.0 nm	2.2095e+00
0635.0 nm	1.5646e+00	0685.0 nm	1.8900e+00	0735.0 nm	2.2154e+00
0636.0 nm	1.5715e+00	0686.0 nm	1.8963e+00	0736.0 nm	2.2212e+00
0637.0 nm	1.5783e+00	0687.0 nm	1.9027e+00	0737.0 nm	2.2270e+00
0638.0 nm	1.5850e+00	0688.0 nm	1.9091e+00	0738.0 nm	2.2329e+00
0639.0 nm	1.5916e+00	0689.0 nm	1.9156e+00	0739.0 nm	2.2387e+00
0640.0 nm	1.5981e+00	0690.0 nm	1.9221e+00	0740.0 nm	2.2445e+00
0641.0 nm	1.6045e+00	0691.0 nm	1.9286e+00	0741.0 nm	2.2503e+00
0642.0 nm	1.6108e+00	0692.0 nm	1.9352e+00	0742.0 nm	2.2560e+00
0643.0 nm	1.6171e+00	0693.0 nm	1.9418e+00	0743.0 nm	2.2618e+00
0644.0 nm	1.6232e+00	0694.0 nm	1.9485e+00	0744.0 nm	2.2675e+00
0645.0 nm	1.6294e+00	0695.0 nm	1.9552e+00	0745.0 nm	2.2732e+00
0646.0 nm	1.6355e+00	0696.0 nm	1.9620e+00	0746.0 nm	2.2788e+00
0647.0 nm	1.6416e+00	0697.0 nm	1.9689e+00	0747.0 nm	2.2845e+00
0648.0 nm	1.6477e+00	0698.0 nm	1.9758e+00	0748.0 nm	2.2901e+00
0649.0 nm	1.6538e+00	0699.0 nm	1.9827e+00	0749.0 nm	2.2956e+00

Title: RS-10D S/N: HL1965 IRRADIANCE @ 25 cm
 Date/Time: 04-13-2017 / 11:34:35
 Standard/Reference Illuminant applied: FEL 1000W LAMP S/N: F-675 IRRADIANCE @ 50 cm / None
 Units: Irradiance, $\mu\text{W}/(\text{cm}^2 \cdot \text{nm})$
 Hardware: NM-26 200-1700nm, NM-9DH 190-820nm, D-49CQ 200-1010nm, (N/A)
 Notes: T: 20C - RH: 57%
 Number of points: 801
 X-Axis-Low, High, Step: 300, 1100, 1 / Y-Axis-Low, High: 5.6389e-03, 2.8673e+00

0750.0 nm	2.3011e+00	0800.0 nm	2.5231e+00	0850.0 nm	2.6814e+00
0751.0 nm	2.3066e+00	0801.0 nm	2.5266e+00	0851.0 nm	2.6842e+00
0752.0 nm	2.3120e+00	0802.0 nm	2.5301e+00	0852.0 nm	2.6869e+00
0753.0 nm	2.3174e+00	0803.0 nm	2.5336e+00	0853.0 nm	2.6896e+00
0754.0 nm	2.3227e+00	0804.0 nm	2.5370e+00	0854.0 nm	2.6923e+00
0755.0 nm	2.3280e+00	0805.0 nm	2.5404e+00	0855.0 nm	2.6950e+00
0756.0 nm	2.3332e+00	0806.0 nm	2.5437e+00	0856.0 nm	2.6976e+00
0757.0 nm	2.3384e+00	0807.0 nm	2.5471e+00	0857.0 nm	2.7003e+00
0758.0 nm	2.3435e+00	0808.0 nm	2.5504e+00	0858.0 nm	2.7029e+00
0759.0 nm	2.3485e+00	0809.0 nm	2.5537e+00	0859.0 nm	2.7054e+00
0760.0 nm	2.3535e+00	0810.0 nm	2.5569e+00	0860.0 nm	2.7080e+00
0761.0 nm	2.3585e+00	0811.0 nm	2.5602e+00	0861.0 nm	2.7106e+00
0762.0 nm	2.3634e+00	0812.0 nm	2.5634e+00	0862.0 nm	2.7131e+00
0763.0 nm	2.3683e+00	0813.0 nm	2.5666e+00	0863.0 nm	2.7156e+00
0764.0 nm	2.3731e+00	0814.0 nm	2.5698e+00	0864.0 nm	2.7181e+00
0765.0 nm	2.3779e+00	0815.0 nm	2.5729e+00	0865.0 nm	2.7206e+00
0766.0 nm	2.3826e+00	0816.0 nm	2.5761e+00	0866.0 nm	2.7231e+00
0767.0 nm	2.3873e+00	0817.0 nm	2.5792e+00	0867.0 nm	2.7255e+00
0768.0 nm	2.3919e+00	0818.0 nm	2.5823e+00	0868.0 nm	2.7280e+00
0769.0 nm	2.3965e+00	0819.0 nm	2.5854e+00	0869.0 nm	2.7304e+00
0770.0 nm	2.4011e+00	0820.0 nm	2.5885e+00	0870.0 nm	2.7327e+00
0771.0 nm	2.4056e+00	0821.0 nm	2.5916e+00	0871.0 nm	2.7351e+00
0772.0 nm	2.4101e+00	0822.0 nm	2.5947e+00	0872.0 nm	2.7374e+00
0773.0 nm	2.4146e+00	0823.0 nm	2.5978e+00	0873.0 nm	2.7397e+00
0774.0 nm	2.4190e+00	0824.0 nm	2.6009e+00	0874.0 nm	2.7420e+00
0775.0 nm	2.4234e+00	0825.0 nm	2.6041e+00	0875.0 nm	2.7443e+00
0776.0 nm	2.4278e+00	0826.0 nm	2.6072e+00	0876.0 nm	2.7465e+00
0777.0 nm	2.4322e+00	0827.0 nm	2.6104e+00	0877.0 nm	2.7487e+00
0778.0 nm	2.4365e+00	0828.0 nm	2.6135e+00	0878.0 nm	2.7508e+00
0779.0 nm	2.4408e+00	0829.0 nm	2.6167e+00	0879.0 nm	2.7530e+00
0780.0 nm	2.4451e+00	0830.0 nm	2.6199e+00	0880.0 nm	2.7551e+00
0781.0 nm	2.4493e+00	0831.0 nm	2.6231e+00	0881.0 nm	2.7571e+00
0782.0 nm	2.4536e+00	0832.0 nm	2.6263e+00	0882.0 nm	2.7592e+00
0783.0 nm	2.4578e+00	0833.0 nm	2.6295e+00	0883.0 nm	2.7612e+00
0784.0 nm	2.4619e+00	0834.0 nm	2.6327e+00	0884.0 nm	2.7631e+00
0785.0 nm	2.4660e+00	0835.0 nm	2.6360e+00	0885.0 nm	2.7651e+00
0786.0 nm	2.4701e+00	0836.0 nm	2.6392e+00	0886.0 nm	2.7670e+00
0787.0 nm	2.4742e+00	0837.0 nm	2.6424e+00	0887.0 nm	2.7689e+00
0788.0 nm	2.4782e+00	0838.0 nm	2.6455e+00	0888.0 nm	2.7708e+00
0789.0 nm	2.4821e+00	0839.0 nm	2.6487e+00	0889.0 nm	2.7726e+00
0790.0 nm	2.4861e+00	0840.0 nm	2.6518e+00	0890.0 nm	2.7744e+00
0791.0 nm	2.4899e+00	0841.0 nm	2.6550e+00	0891.0 nm	2.7762e+00
0792.0 nm	2.4938e+00	0842.0 nm	2.6580e+00	0892.0 nm	2.7779e+00
0793.0 nm	2.4976e+00	0843.0 nm	2.6611e+00	0893.0 nm	2.7797e+00
0794.0 nm	2.5013e+00	0844.0 nm	2.6641e+00	0894.0 nm	2.7814e+00
0795.0 nm	2.5051e+00	0845.0 nm	2.6671e+00	0895.0 nm	2.7831e+00
0796.0 nm	2.5088e+00	0846.0 nm	2.6700e+00	0896.0 nm	2.7848e+00
0797.0 nm	2.5124e+00	0847.0 nm	2.6729e+00	0897.0 nm	2.7865e+00
0798.0 nm	2.5160e+00	0848.0 nm	2.6758e+00	0898.0 nm	2.7882e+00
0799.0 nm	2.5196e+00	0849.0 nm	2.6786e+00	0899.0 nm	2.7899e+00

Title: RS-10D S/N: HL1965 IRRADIANCE @ 25 cm

Date/Time: 04-13-2017 / 11:34:35

Standard/Reference Illuminant applied: FEL 1000W LAMP S/N: F-675 IRRADIANCE @ 50 cm / None

Units: Irradiance, $\mu\text{W}/(\text{cm}^2\cdot\text{nm})$

Hardware: NM-26 200-1700nm,NM-9DH 190-820nm,D-49CQ 200-1010nm, (N/A)

Notes: T: 20C - RH: 57%

Number of points: 801

X-Axis-Low,High,Step: 300, 1100, 1 / Y-Axis-Low,High: 5.6389e-03, 2.8673e+00

0900.0 nm	2.7916e+00	0950.0 nm	2.8572e+00	1000.0 nm	2.8509e+00
0901.0 nm	2.7933e+00	0951.0 nm	2.8580e+00	1001.0 nm	2.8504e+00
0902.0 nm	2.7951e+00	0952.0 nm	2.8589e+00	1002.0 nm	2.8498e+00
0903.0 nm	2.7969e+00	0953.0 nm	2.8597e+00	1003.0 nm	2.8491e+00
0904.0 nm	2.7987e+00	0954.0 nm	2.8605e+00	1004.0 nm	2.8483e+00
0905.0 nm	2.8005e+00	0955.0 nm	2.8613e+00	1005.0 nm	2.8474e+00
0906.0 nm	2.8023e+00	0956.0 nm	2.8621e+00	1006.0 nm	2.8464e+00
0907.0 nm	2.8042e+00	0957.0 nm	2.8628e+00	1007.0 nm	2.8452e+00
0908.0 nm	2.8061e+00	0958.0 nm	2.8635e+00	1008.0 nm	2.8439e+00
0909.0 nm	2.8080e+00	0959.0 nm	2.8641e+00	1009.0 nm	2.8424e+00
0910.0 nm	2.8100e+00	0960.0 nm	2.8647e+00	1010.0 nm	2.8408e+00
0911.0 nm	2.8119e+00	0961.0 nm	2.8652e+00	1011.0 nm	2.8390e+00
0912.0 nm	2.8139e+00	0962.0 nm	2.8657e+00	1012.0 nm	2.8372e+00
0913.0 nm	2.8159e+00	0963.0 nm	2.8661e+00	1013.0 nm	2.8351e+00
0914.0 nm	2.8178e+00	0964.0 nm	2.8665e+00	1014.0 nm	2.8330e+00
0915.0 nm	2.8198e+00	0965.0 nm	2.8668e+00	1015.0 nm	2.8308e+00
0916.0 nm	2.8217e+00	0966.0 nm	2.8671e+00	1016.0 nm	2.8284e+00
0917.0 nm	2.8235e+00	0967.0 nm	2.8672e+00	1017.0 nm	2.8260e+00
0918.0 nm	2.8253e+00	0968.0 nm	2.8673e+00	1018.0 nm	2.8235e+00
0919.0 nm	2.8271e+00	0969.0 nm	2.8673e+00	1019.0 nm	2.8210e+00
0920.0 nm	2.8288e+00	0970.0 nm	2.8672e+00	1020.0 nm	2.8184e+00
0921.0 nm	2.8304e+00	0971.0 nm	2.8670e+00	1021.0 nm	2.8158e+00
0922.0 nm	2.8319e+00	0972.0 nm	2.8668e+00	1022.0 nm	2.8131e+00
0923.0 nm	2.8334e+00	0973.0 nm	2.8664e+00	1023.0 nm	2.8104e+00
0924.0 nm	2.8348e+00	0974.0 nm	2.8660e+00	1024.0 nm	2.8077e+00
0925.0 nm	2.8361e+00	0975.0 nm	2.8655e+00	1025.0 nm	2.8050e+00
0926.0 nm	2.8373e+00	0976.0 nm	2.8649e+00	1026.0 nm	2.8023e+00
0927.0 nm	2.8384e+00	0977.0 nm	2.8643e+00	1027.0 nm	2.7995e+00
0928.0 nm	2.8394e+00	0978.0 nm	2.8636e+00	1028.0 nm	2.7968e+00
0929.0 nm	2.8404e+00	0979.0 nm	2.8629e+00	1029.0 nm	2.7940e+00
0930.0 nm	2.8413e+00	0980.0 nm	2.8621e+00	1030.0 nm	2.7912e+00
0931.0 nm	2.8422e+00	0981.0 nm	2.8613e+00	1031.0 nm	2.7884e+00
0932.0 nm	2.8430e+00	0982.0 nm	2.8605e+00	1032.0 nm	2.7856e+00
0933.0 nm	2.8437e+00	0983.0 nm	2.8597e+00	1033.0 nm	2.7827e+00
0934.0 nm	2.8445e+00	0984.0 nm	2.8588e+00	1034.0 nm	2.7798e+00
0935.0 nm	2.8452e+00	0985.0 nm	2.8581e+00	1035.0 nm	2.7769e+00
0936.0 nm	2.8459e+00	0986.0 nm	2.8573e+00	1036.0 nm	2.7740e+00
0937.0 nm	2.8467e+00	0987.0 nm	2.8566e+00	1037.0 nm	2.7710e+00
0938.0 nm	2.8474e+00	0988.0 nm	2.8559e+00	1038.0 nm	2.7680e+00
0939.0 nm	2.8481e+00	0989.0 nm	2.8553e+00	1039.0 nm	2.7650e+00
0940.0 nm	2.8489e+00	0990.0 nm	2.8548e+00	1040.0 nm	2.7619e+00
0941.0 nm	2.8496e+00	0991.0 nm	2.8543e+00	1041.0 nm	2.7587e+00
0942.0 nm	2.8504e+00	0992.0 nm	2.8538e+00	1042.0 nm	2.7556e+00
0943.0 nm	2.8512e+00	0993.0 nm	2.8534e+00	1043.0 nm	2.7524e+00
0944.0 nm	2.8520e+00	0994.0 nm	2.8531e+00	1044.0 nm	2.7492e+00
0945.0 nm	2.8528e+00	0995.0 nm	2.8527e+00	1045.0 nm	2.7459e+00
0946.0 nm	2.8537e+00	0996.0 nm	2.8524e+00	1046.0 nm	2.7427e+00
0947.0 nm	2.8545e+00	0997.0 nm	2.8521e+00	1047.0 nm	2.7394e+00
0948.0 nm	2.8554e+00	0998.0 nm	2.8517e+00	1048.0 nm	2.7361e+00
0949.0 nm	2.8563e+00	0999.0 nm	2.8513e+00	1049.0 nm	2.7328e+00

Title: RS-10D S/N: HL1965 IRRADIANCE @ 25 cm
 Date/Time: 04-13-2017 / 11:34:35
 Standard/Reference Illuminant applied: FEL 1000W LAMP S/N: F-675 IRRADIANCE @ 50 cm / None
 Units: Irradiance, $\mu\text{W}/(\text{cm}^2 \cdot \text{nm})$
 Hardware: NM-26 200-1700nm, NM-9DH 190-820nm, D-49CQ 200-1010nm, (N/A)
 Notes: T: 20C - RH: 57%
 Number of points: 801
 X-Axis-Low, High, Step: 300, 1100, 1 / Y-Axis-Low, High: 5.6389e-03, 2.8673e+00

1050.0 nm 2.7295e+00
 1051.0 nm 2.7263e+00
 1052.0 nm 2.7230e+00
 1053.0 nm 2.7197e+00
 1054.0 nm 2.7165e+00
 1055.0 nm 2.7133e+00
 1056.0 nm 2.7100e+00
 1057.0 nm 2.7068e+00
 1058.0 nm 2.7036e+00
 1059.0 nm 2.7005e+00
 1060.0 nm 2.6973e+00
 1061.0 nm 2.6941e+00
 1062.0 nm 2.6910e+00
 1063.0 nm 2.6879e+00
 1064.0 nm 2.6847e+00
 1065.0 nm 2.6816e+00
 1066.0 nm 2.6785e+00
 1067.0 nm 2.6753e+00
 1068.0 nm 2.6722e+00
 1069.0 nm 2.6690e+00
 1070.0 nm 2.6659e+00
 1071.0 nm 2.6627e+00
 1072.0 nm 2.6595e+00
 1073.0 nm 2.6563e+00
 1074.0 nm 2.6531e+00
 1075.0 nm 2.6499e+00
 1076.0 nm 2.6466e+00
 1077.0 nm 2.6434e+00
 1078.0 nm 2.6401e+00
 1079.0 nm 2.6368e+00
 1080.0 nm 2.6336e+00
 1081.0 nm 2.6303e+00
 1082.0 nm 2.6270e+00
 1083.0 nm 2.6237e+00
 1084.0 nm 2.6205e+00
 1085.0 nm 2.6172e+00
 1086.0 nm 2.6139e+00
 1087.0 nm 2.6107e+00
 1088.0 nm 2.6075e+00
 1089.0 nm 2.6042e+00
 1090.0 nm 2.6011e+00
 1091.0 nm 2.5979e+00
 1092.0 nm 2.5948e+00
 1093.0 nm 2.5917e+00
 1094.0 nm 2.5887e+00
 1095.0 nm 2.5857e+00
 1096.0 nm 2.5827e+00
 1097.0 nm 2.5798e+00
 1098.0 nm 2.5769e+00
 1099.0 nm 2.5741e+00

1100.0 nm 2.5714e+00

RS-100 S/N: HL1965 IRRADIANCE @ 25 cm

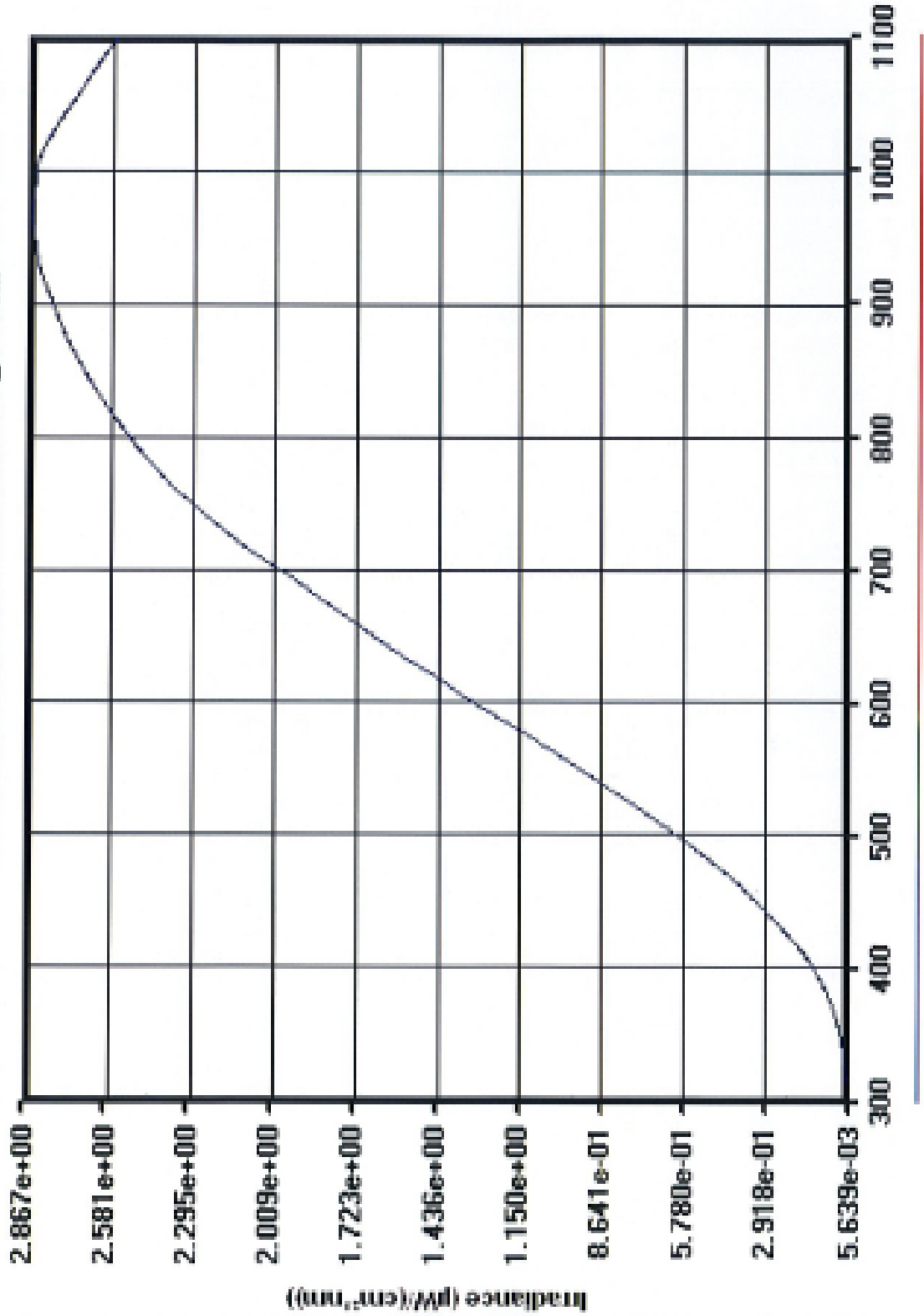

Wavelength (nm)

Peak W/L: 968

Data File Analysis (PRECHECK HL1965 IRRADIANCE @ 25 cm.dat)

Title: PRECHECK B8-100 S/N: HL1965 IRRADIANCE @ 25 cm
Date/Time: 03-23-2017 / 11:35:04
Standard/Reference Illuminant applied: FEL 1000W LAMP S/N: P-675 IRRADIANCE @ 50 cm / None
Units: Irradiance, $\mu\text{W}/(\text{cm}^2\cdot\text{nm})$
Hardware: NM-26 200-1700nm, NM-90H 190-820nm, D-49CQ 200-1010nm, (N/A)
Notes: T: 20C - RH: 57%
Number of points: 801
X-Axis-Low,High,Step: 300, 1100, 1 / Y-Axis-Low,High: 5.0028e-03, 2.7952e+00

(I_r)Radiance/Photon (I_r)Radiance/Integral
Irradiance: 1.318e+03 $\mu\text{W}/(\text{cm}^2)$ / Photon Irradiance: 5.568e+15 Photons/(sec $\cdot\text{cm}^2$)

Tristimulus (CIE 1931, 2° observer)
X=7.937e+02 Y=7.241e+02 Z=2.507e+02

Chromaticity (CIE 1931 xy and CIE 1976 UCS u'v')
x=0.4488 y=0.4094 u'=0.2559 v'=0.5252

Color Space (CIE 1976 L*u*v* and CIE 1976 L*a*b*)
L*=2.084e+02 u*=1.229e+02 v*=1.197e+02 a*=1.006e+01 b*=1.153e+02

(I_l)Luminance
Illuminance: 7.241e+02 lm/m^2 (Lux) 6.727e+01 lm/ft^2 (Footcandle) 7.241e-02 lm/cm^2 (Photoc)

Correlated Color Temperature/MPCD
3.506e+02 Mk^{-1} 2.853e+03 Kelvin / 01.8 MPCDs

Tristimulus (CIE 1964, 10° observer)
X=8.470e+02 Y=7.634e+02 Z=2.608e+02

Chromaticity (CIE 1964 xy)
x=0.4527 y=0.4090

LSD - Illuminant E
Dominant WL 583.3 / Peak WL 969.00 / Luminous Intensity @ 10 cm (cd) 7.241e+00

Title: PRECHECK RS-100 S/N: HL1965 IRRADIANCE @ 25 cm
 Date/Time: 03-23-2017 / 11:35:04
 Standard/Reference Illuminant applied: FSL 1000W LAMP S/N: P-675 IRRADIANCE @ 50 cm / None
 Units: Irradiance, $\mu\text{W}/(\text{cm}^2\text{nm})$
 Hardware: NM-26 200-1700nm, NM-90H 190-820nm, D-490Q 200-1010nm, (N/A)
 Notes: T: 20C - RH: 57%
 Number of points: 801
 X-Axis-Low,High,Step: 300, 1100, 1 / Y-Axis-Low,High: 5.0628e-03, 2.7952e+00

0300.0 nm	5.9028e-03	0350.0 nm	3.3079e-02	0400.0 nm	1.2292e-02
0301.0 nm	5.2689e-03	0351.0 nm	3.4063e-02	0401.0 nm	1.2582e-02
0302.0 nm	5.5310e-03	0352.0 nm	3.5071e-02	0402.0 nm	1.2877e-02
0303.0 nm	5.8043e-03	0353.0 nm	3.6103e-02	0403.0 nm	1.3177e-02
0304.0 nm	6.0890e-03	0354.0 nm	3.7160e-02	0404.0 nm	1.3482e-02
0305.0 nm	6.3849e-03	0355.0 nm	3.8243e-02	0405.0 nm	1.3792e-02
0306.0 nm	6.6927e-03	0356.0 nm	3.9351e-02	0406.0 nm	1.4106e-02
0307.0 nm	7.0114e-03	0357.0 nm	4.0486e-02	0407.0 nm	1.4426e-02
0308.0 nm	7.3410e-03	0358.0 nm	4.1647e-02	0408.0 nm	1.4749e-02
0309.0 nm	7.6816e-03	0359.0 nm	4.2836e-02	0409.0 nm	1.5078e-02
0310.0 nm	8.0334e-03	0360.0 nm	4.4053e-02	0410.0 nm	1.5411e-02
0311.0 nm	8.3965e-03	0361.0 nm	4.5297e-02	0411.0 nm	1.5749e-02
0312.0 nm	8.7710e-03	0362.0 nm	4.6571e-02	0412.0 nm	1.6092e-02
0313.0 nm	9.1569e-03	0363.0 nm	4.7873e-02	0413.0 nm	1.6439e-02
0314.0 nm	9.5545e-03	0364.0 nm	4.9206e-02	0414.0 nm	1.6790e-02
0315.0 nm	9.9638e-03	0365.0 nm	5.0568e-02	0415.0 nm	1.7146e-02
0316.0 nm	1.0385e-02	0366.0 nm	5.1962e-02	0416.0 nm	1.7506e-02
0317.0 nm	1.0818e-02	0367.0 nm	5.3388e-02	0417.0 nm	1.7871e-02
0318.0 nm	1.1263e-02	0368.0 nm	5.4845e-02	0418.0 nm	1.8239e-02
0319.0 nm	1.1720e-02	0369.0 nm	5.6336e-02	0419.0 nm	1.8611e-02
0320.0 nm	1.2190e-02	0370.0 nm	5.7860e-02	0420.0 nm	1.8987e-02
0321.0 nm	1.2672e-02	0371.0 nm	5.9418e-02	0421.0 nm	1.9367e-02
0322.0 nm	1.3167e-02	0372.0 nm	6.1012e-02	0422.0 nm	1.9750e-02
0323.0 nm	1.3674e-02	0373.0 nm	6.2641e-02	0423.0 nm	2.0137e-02
0324.0 nm	1.4194e-02	0374.0 nm	6.4306e-02	0424.0 nm	2.0527e-02
0325.0 nm	1.4727e-02	0375.0 nm	6.6009e-02	0425.0 nm	2.0919e-02
0326.0 nm	1.5273e-02	0376.0 nm	6.7751e-02	0426.0 nm	2.1315e-02
0327.0 nm	1.5833e-02	0377.0 nm	6.9531e-02	0427.0 nm	2.1713e-02
0328.0 nm	1.6406e-02	0378.0 nm	7.1351e-02	0428.0 nm	2.2114e-02
0329.0 nm	1.6993e-02	0379.0 nm	7.3213e-02	0429.0 nm	2.2517e-02
0330.0 nm	1.7593e-02	0380.0 nm	7.5115e-02	0430.0 nm	2.2922e-02
0331.0 nm	1.8208e-02	0381.0 nm	7.7061e-02	0431.0 nm	2.3330e-02
0332.0 nm	1.8837e-02	0382.0 nm	7.9050e-02	0432.0 nm	2.3739e-02
0333.0 nm	1.9481e-02	0383.0 nm	8.1083e-02	0433.0 nm	2.4151e-02
0334.0 nm	2.0140e-02	0384.0 nm	8.3161e-02	0434.0 nm	2.4564e-02
0335.0 nm	2.0814e-02	0385.0 nm	8.5284e-02	0435.0 nm	2.4980e-02
0336.0 nm	2.1504e-02	0386.0 nm	8.7455e-02	0436.0 nm	2.5397e-02
0337.0 nm	2.2211e-02	0387.0 nm	8.9672e-02	0437.0 nm	2.5817e-02
0338.0 nm	2.2934e-02	0388.0 nm	9.1936e-02	0438.0 nm	2.6238e-02
0339.0 nm	2.3674e-02	0389.0 nm	9.4249e-02	0439.0 nm	2.6662e-02
0340.0 nm	2.4431e-02	0390.0 nm	9.6609e-02	0440.0 nm	2.7088e-02
0341.0 nm	2.5206e-02	0391.0 nm	9.9018e-02	0441.0 nm	2.7517e-02
0342.0 nm	2.6000e-02	0392.0 nm	1.0148e-01	0442.0 nm	2.7948e-02
0343.0 nm	2.6813e-02	0393.0 nm	1.0398e-01	0443.0 nm	2.8382e-02
0344.0 nm	2.7645e-02	0394.0 nm	1.0654e-01	0444.0 nm	2.8819e-02
0345.0 nm	2.8498e-02	0395.0 nm	1.0915e-01	0445.0 nm	2.9259e-02
0346.0 nm	2.9370e-02	0396.0 nm	1.1180e-01	0446.0 nm	2.9703e-02
0347.0 nm	3.0264e-02	0397.0 nm	1.1451e-01	0447.0 nm	3.0151e-02
0348.0 nm	3.1180e-02	0398.0 nm	1.1728e-01	0448.0 nm	3.0602e-02
0349.0 nm	3.2118e-02	0399.0 nm	1.2007e-01	0449.0 nm	3.1057e-02

Title: PRTCHECK R8-100 S/N: HL1965 IRRADIANCE @ 25 cm

Date/Time: 03-23-2017 / 11:35:04

Standard/Reference Illuminant applied: FEL 1000W LAMP S/N: F-675 IRRADIANCE @ 50 cm / None

Units: Irradiance, $\mu\text{W}/(\text{cm}^2\text{nm})$

Hardware: NM-25 200-1700nm,NM-90H 190-820nm,D-49CQ 200-1010nm, (N/A)

Notes: T: 20C - RH: 57%

Number of points: 801

X-Axis-Low,High,Step: 390, 1100, 1 / Y-Axis-Low,High: 5.0028e-03, 2.7952e+00

0450.0 nm	3.1516e-01	0500.0 nm	5.8480e-01	0550.0 nm	9.1441e-01
0451.0 nm	3.1980e-01	0501.0 nm	5.9105e-01	0551.0 nm	9.2122e-01
0452.0 nm	3.2447e-01	0502.0 nm	5.9732e-01	0552.0 nm	9.2803e-01
0453.0 nm	3.2919e-01	0503.0 nm	6.0363e-01	0553.0 nm	9.3486e-01
0454.0 nm	3.3396e-01	0504.0 nm	6.0996e-01	0554.0 nm	9.4170e-01
0455.0 nm	3.3876e-01	0505.0 nm	6.1631e-01	0555.0 nm	9.4856e-01
0456.0 nm	3.4361e-01	0506.0 nm	6.2269e-01	0556.0 nm	9.5544e-01
0457.0 nm	3.4849e-01	0507.0 nm	6.2908e-01	0557.0 nm	9.6234e-01
0458.0 nm	3.5342e-01	0508.0 nm	6.3550e-01	0558.0 nm	9.6926e-01
0459.0 nm	3.5838e-01	0509.0 nm	6.4193e-01	0559.0 nm	9.7620e-01
0460.0 nm	3.6338e-01	0510.0 nm	6.4837e-01	0560.0 nm	9.8317e-01
0461.0 nm	3.6842e-01	0511.0 nm	6.5482e-01	0561.0 nm	9.9017e-01
0462.0 nm	3.7348e-01	0512.0 nm	6.6128e-01	0562.0 nm	9.9719e-01
0463.0 nm	3.7858e-01	0513.0 nm	6.6775e-01	0563.0 nm	1.0042e+00
0464.0 nm	3.8370e-01	0514.0 nm	6.7424e-01	0564.0 nm	1.0113e+00
0465.0 nm	3.8885e-01	0515.0 nm	6.8072e-01	0565.0 nm	1.0184e+00
0466.0 nm	3.9402e-01	0516.0 nm	6.8722e-01	0566.0 nm	1.0255e+00
0467.0 nm	3.9921e-01	0517.0 nm	6.9372e-01	0567.0 nm	1.0326e+00
0468.0 nm	4.0442e-01	0518.0 nm	7.0024e-01	0568.0 nm	1.0398e+00
0469.0 nm	4.0965e-01	0519.0 nm	7.0676e-01	0569.0 nm	1.0470e+00
0470.0 nm	4.1490e-01	0520.0 nm	7.1329e-01	0570.0 nm	1.0542e+00
0471.0 nm	4.2016e-01	0521.0 nm	7.1983e-01	0571.0 nm	1.0614e+00
0472.0 nm	4.2544e-01	0522.0 nm	7.2638e-01	0572.0 nm	1.0686e+00
0473.0 nm	4.3073e-01	0523.0 nm	7.3294e-01	0573.0 nm	1.0758e+00
0474.0 nm	4.3604e-01	0524.0 nm	7.3952e-01	0574.0 nm	1.0830e+00
0475.0 nm	4.4137e-01	0525.0 nm	7.4611e-01	0575.0 nm	1.0901e+00
0476.0 nm	4.4671e-01	0526.0 nm	7.5271e-01	0576.0 nm	1.0975e+00
0477.0 nm	4.5208e-01	0527.0 nm	7.5933e-01	0577.0 nm	1.1047e+00
0478.0 nm	4.5746e-01	0528.0 nm	7.6597e-01	0578.0 nm	1.1120e+00
0479.0 nm	4.6287e-01	0529.0 nm	7.7262e-01	0579.0 nm	1.1193e+00
0480.0 nm	4.6831e-01	0530.0 nm	7.7928e-01	0580.0 nm	1.1264e+00
0481.0 nm	4.7377e-01	0531.0 nm	7.8597e-01	0581.0 nm	1.1337e+00
0482.0 nm	4.7926e-01	0532.0 nm	7.9266e-01	0582.0 nm	1.1409e+00
0483.0 nm	4.8478e-01	0533.0 nm	7.9937e-01	0583.0 nm	1.1481e+00
0484.0 nm	4.9034e-01	0534.0 nm	8.0609e-01	0584.0 nm	1.1553e+00
0485.0 nm	4.9593e-01	0535.0 nm	8.1282e-01	0585.0 nm	1.1625e+00
0486.0 nm	5.0154e-01	0536.0 nm	8.1956e-01	0586.0 nm	1.1697e+00
0487.0 nm	5.0723e-01	0537.0 nm	8.2631e-01	0587.0 nm	1.1769e+00
0488.0 nm	5.1294e-01	0538.0 nm	8.3307e-01	0588.0 nm	1.1840e+00
0489.0 nm	5.1869e-01	0539.0 nm	8.3984e-01	0589.0 nm	1.1912e+00
0490.0 nm	5.2449e-01	0540.0 nm	8.4661e-01	0590.0 nm	1.1984e+00
0491.0 nm	5.3033e-01	0541.0 nm	8.5338e-01	0591.0 nm	1.2055e+00
0492.0 nm	5.3621e-01	0542.0 nm	8.6015e-01	0592.0 nm	1.2126e+00
0493.0 nm	5.4214e-01	0543.0 nm	8.6693e-01	0593.0 nm	1.2198e+00
0494.0 nm	5.4811e-01	0544.0 nm	8.7371e-01	0594.0 nm	1.2269e+00
0495.0 nm	5.5412e-01	0545.0 nm	8.8048e-01	0595.0 nm	1.2340e+00
0496.0 nm	5.6018e-01	0546.0 nm	8.8726e-01	0596.0 nm	1.2412e+00
0497.0 nm	5.6628e-01	0547.0 nm	8.9404e-01	0597.0 nm	1.2481e+00
0498.0 nm	5.7243e-01	0548.0 nm	9.0083e-01	0598.0 nm	1.2552e+00
0499.0 nm	5.7869e-01	0549.0 nm	9.0762e-01	0599.0 nm	1.2622e+00

Title: PMECHCK RS-10D S/M: HL1965 IRRADIANCE @ 25 cm
 Date/Time: 03-23-2017 / 11:35:04
 Standard/Reference Illuminant applied: FEL 1000W LAMP S/N: F-675 IRRADIANCE @ 50 cm / Norm
 Units: Irradiance, $\mu\text{W}/(\text{cm}^2 \cdot \text{nm})$
 Hardware: NM-26 200-1700nm, NM-90H 190-820nm, D-490Q 200-1410nm, (N/A)
 Notes: T: 20C - RH: 57h
 Number of points: 801
 X-Axis=Low,High,Step: 300, 1100, 1 / Y-Axis=Low,High: 5.0028e-03, 2.7952e+00

0600.0 nm	1.2692e+00	0650.0 nm	1.6141e+00	0700.0 nm	1.9379e+00
0601.0 nm	1.2762e+00	0651.0 nm	1.6205e+00	0701.0 nm	1.9446e+00
0602.0 nm	1.2832e+00	0652.0 nm	1.6269e+00	0702.0 nm	1.9513e+00
0603.0 nm	1.2902e+00	0653.0 nm	1.6332e+00	0703.0 nm	1.9580e+00
0604.0 nm	1.2971e+00	0654.0 nm	1.6395e+00	0704.0 nm	1.9647e+00
0605.0 nm	1.3041e+00	0655.0 nm	1.6458e+00	0705.0 nm	1.9714e+00
0606.0 nm	1.3110e+00	0656.0 nm	1.6522e+00	0706.0 nm	1.9781e+00
0607.0 nm	1.3179e+00	0657.0 nm	1.6585e+00	0707.0 nm	1.9848e+00
0608.0 nm	1.3249e+00	0658.0 nm	1.6648e+00	0708.0 nm	1.9914e+00
0609.0 nm	1.3318e+00	0659.0 nm	1.6712e+00	0709.0 nm	1.9981e+00
0610.0 nm	1.3387e+00	0660.0 nm	1.6776e+00	0710.0 nm	2.0047e+00
0611.0 nm	1.3456e+00	0661.0 nm	1.6839e+00	0711.0 nm	2.0112e+00
0612.0 nm	1.3525e+00	0662.0 nm	1.6903e+00	0712.0 nm	2.0177e+00
0613.0 nm	1.3594e+00	0663.0 nm	1.6967e+00	0713.0 nm	2.0242e+00
0614.0 nm	1.3663e+00	0664.0 nm	1.7032e+00	0714.0 nm	2.0306e+00
0615.0 nm	1.3732e+00	0665.0 nm	1.7096e+00	0715.0 nm	2.0370e+00
0616.0 nm	1.3802e+00	0666.0 nm	1.7161e+00	0716.0 nm	2.0433e+00
0617.0 nm	1.3871e+00	0667.0 nm	1.7225e+00	0717.0 nm	2.0496e+00
0618.0 nm	1.3941e+00	0668.0 nm	1.7290e+00	0718.0 nm	2.0558e+00
0619.0 nm	1.4011e+00	0669.0 nm	1.7355e+00	0719.0 nm	2.0620e+00
0620.0 nm	1.4081e+00	0670.0 nm	1.7420e+00	0720.0 nm	2.0681e+00
0621.0 nm	1.4151e+00	0671.0 nm	1.7485e+00	0721.0 nm	2.0741e+00
0622.0 nm	1.4222e+00	0672.0 nm	1.7550e+00	0722.0 nm	2.0801e+00
0623.0 nm	1.4292e+00	0673.0 nm	1.7615e+00	0723.0 nm	2.0860e+00
0624.0 nm	1.4363e+00	0674.0 nm	1.7681e+00	0724.0 nm	2.0919e+00
0625.0 nm	1.4434e+00	0675.0 nm	1.7746e+00	0725.0 nm	2.0977e+00
0626.0 nm	1.4505e+00	0676.0 nm	1.7811e+00	0726.0 nm	2.1035e+00
0627.0 nm	1.4576e+00	0677.0 nm	1.7876e+00	0727.0 nm	2.1093e+00
0628.0 nm	1.4647e+00	0678.0 nm	1.7941e+00	0728.0 nm	2.1150e+00
0629.0 nm	1.4718e+00	0679.0 nm	1.8006e+00	0729.0 nm	2.1207e+00
0630.0 nm	1.4789e+00	0680.0 nm	1.8070e+00	0730.0 nm	2.1264e+00
0631.0 nm	1.4860e+00	0681.0 nm	1.8135e+00	0731.0 nm	2.1320e+00
0632.0 nm	1.4931e+00	0682.0 nm	1.8200e+00	0732.0 nm	2.1376e+00
0633.0 nm	1.5001e+00	0683.0 nm	1.8265e+00	0733.0 nm	2.1432e+00
0634.0 nm	1.5072e+00	0684.0 nm	1.8329e+00	0734.0 nm	2.1488e+00
0635.0 nm	1.5142e+00	0685.0 nm	1.8394e+00	0735.0 nm	2.1544e+00
0636.0 nm	1.5211e+00	0686.0 nm	1.8459e+00	0736.0 nm	2.1600e+00
0637.0 nm	1.5281e+00	0687.0 nm	1.8524e+00	0737.0 nm	2.1655e+00
0638.0 nm	1.5351e+00	0688.0 nm	1.8588e+00	0738.0 nm	2.1711e+00
0639.0 nm	1.5421e+00	0689.0 nm	1.8653e+00	0739.0 nm	2.1766e+00
0640.0 nm	1.5491e+00	0690.0 nm	1.8718e+00	0740.0 nm	2.1821e+00
0641.0 nm	1.5561e+00	0691.0 nm	1.8784e+00	0741.0 nm	2.1877e+00
0642.0 nm	1.5631e+00	0692.0 nm	1.8849e+00	0742.0 nm	2.1932e+00
0643.0 nm	1.5701e+00	0693.0 nm	1.8915e+00	0743.0 nm	2.1987e+00
0644.0 nm	1.5771e+00	0694.0 nm	1.8980e+00	0744.0 nm	2.2042e+00
0645.0 nm	1.5841e+00	0695.0 nm	1.9046e+00	0745.0 nm	2.2096e+00
0646.0 nm	1.5911e+00	0696.0 nm	1.9112e+00	0746.0 nm	2.2151e+00
0647.0 nm	1.5981e+00	0697.0 nm	1.9179e+00	0747.0 nm	2.2205e+00
0648.0 nm	1.6051e+00	0698.0 nm	1.9245e+00	0748.0 nm	2.2259e+00
0649.0 nm	1.6121e+00	0699.0 nm	1.9312e+00	0749.0 nm	2.2313e+00

Title: PRTCHECK RS-10D S/N: HL1965 IRRADIANCE @ 25 cm

Date/Time: 03-23-2017 / 11:35:04

Standard/Reference Illuminant applied: FEL 1000W LAMP S/N: P-675 IRRADIANCE @ 50 cm / None

Units: Irradiance, $\mu\text{W}/(\text{cm}^2\cdot\text{nm})$

Hardware: MM-26 200-1700nm,MM-SDM 190-820nm,D-49CQ 200-1010nm, (N/A)

Notes: T: 30C - RH: 57%

Number of points: 801

X-Axis-Low,High,Step: 300, 1100, 1 / Y-Axis-Low,High: 5.0028e-03, 2.7952e+00

0750.0 nm	2.2367e+00	0800.0 nm	2.4576e+00	0850.0 nm	2.6152e+00
0751.0 nm	2.2420e+00	0801.0 nm	2.4611e+00	0851.0 nm	2.6178e+00
0752.0 nm	2.2473e+00	0802.0 nm	2.4646e+00	0852.0 nm	2.6204e+00
0753.0 nm	2.2526e+00	0803.0 nm	2.4681e+00	0853.0 nm	2.6230e+00
0754.0 nm	2.2578e+00	0804.0 nm	2.4715e+00	0854.0 nm	2.6255e+00
0755.0 nm	2.2630e+00	0805.0 nm	2.4749e+00	0855.0 nm	2.6281e+00
0756.0 nm	2.2681e+00	0806.0 nm	2.4783e+00	0856.0 nm	2.6305e+00
0757.0 nm	2.2732e+00	0807.0 nm	2.4816e+00	0857.0 nm	2.6330e+00
0758.0 nm	2.2783e+00	0808.0 nm	2.4849e+00	0858.0 nm	2.6354e+00
0759.0 nm	2.2833e+00	0809.0 nm	2.4882e+00	0859.0 nm	2.6379e+00
0760.0 nm	2.2883e+00	0810.0 nm	2.4914e+00	0860.0 nm	2.6403e+00
0761.0 nm	2.2933e+00	0811.0 nm	2.4947e+00	0861.0 nm	2.6426e+00
0762.0 nm	2.2983e+00	0812.0 nm	2.4979e+00	0862.0 nm	2.6450e+00
0763.0 nm	2.3033e+00	0813.0 nm	2.5011e+00	0863.0 nm	2.6473e+00
0764.0 nm	2.3078e+00	0814.0 nm	2.5043e+00	0864.0 nm	2.6497e+00
0765.0 nm	2.3126e+00	0815.0 nm	2.5075e+00	0865.0 nm	2.6520e+00
0766.0 nm	2.3173e+00	0816.0 nm	2.5106e+00	0866.0 nm	2.6543e+00
0767.0 nm	2.3220e+00	0817.0 nm	2.5138e+00	0867.0 nm	2.6566e+00
0768.0 nm	2.3267e+00	0818.0 nm	2.5169e+00	0868.0 nm	2.6588e+00
0769.0 nm	2.3313e+00	0819.0 nm	2.5201e+00	0869.0 nm	2.6611e+00
0770.0 nm	2.3359e+00	0820.0 nm	2.5232e+00	0870.0 nm	2.6633e+00
0771.0 nm	2.3404e+00	0821.0 nm	2.5264e+00	0871.0 nm	2.6656e+00
0772.0 nm	2.3449e+00	0822.0 nm	2.5295e+00	0872.0 nm	2.6678e+00
0773.0 nm	2.3494e+00	0823.0 nm	2.5327e+00	0873.0 nm	2.6700e+00
0774.0 nm	2.3538e+00	0824.0 nm	2.5359e+00	0874.0 nm	2.6721e+00
0775.0 nm	2.3582e+00	0825.0 nm	2.5390e+00	0875.0 nm	2.6743e+00
0776.0 nm	2.3626e+00	0826.0 nm	2.5422e+00	0876.0 nm	2.6764e+00
0777.0 nm	2.3670e+00	0827.0 nm	2.5454e+00	0877.0 nm	2.6785e+00
0778.0 nm	2.3713e+00	0828.0 nm	2.5486e+00	0878.0 nm	2.6806e+00
0779.0 nm	2.3755e+00	0829.0 nm	2.5518e+00	0879.0 nm	2.6827e+00
0780.0 nm	2.3798e+00	0830.0 nm	2.5550e+00	0880.0 nm	2.6847e+00
0781.0 nm	2.3840e+00	0831.0 nm	2.5582e+00	0881.0 nm	2.6867e+00
0782.0 nm	2.3882e+00	0832.0 nm	2.5614e+00	0882.0 nm	2.6887e+00
0783.0 nm	2.3923e+00	0833.0 nm	2.5646e+00	0883.0 nm	2.6907e+00
0784.0 nm	2.3964e+00	0834.0 nm	2.5678e+00	0884.0 nm	2.6926e+00
0785.0 nm	2.4005e+00	0835.0 nm	2.5709e+00	0885.0 nm	2.6945e+00
0786.0 nm	2.4046e+00	0836.0 nm	2.5741e+00	0886.0 nm	2.6964e+00
0787.0 nm	2.4086e+00	0837.0 nm	2.5772e+00	0887.0 nm	2.6983e+00
0788.0 nm	2.4126e+00	0838.0 nm	2.5803e+00	0888.0 nm	2.7001e+00
0789.0 nm	2.4165e+00	0839.0 nm	2.5834e+00	0889.0 nm	2.7019e+00
0790.0 nm	2.4204e+00	0840.0 nm	2.5865e+00	0890.0 nm	2.7038e+00
0791.0 nm	2.4243e+00	0841.0 nm	2.5895e+00	0891.0 nm	2.7056e+00
0792.0 nm	2.4282e+00	0842.0 nm	2.5925e+00	0892.0 nm	2.7074e+00
0793.0 nm	2.4320e+00	0843.0 nm	2.5955e+00	0893.0 nm	2.7092e+00
0794.0 nm	2.4357e+00	0844.0 nm	2.5984e+00	0894.0 nm	2.7110e+00
0795.0 nm	2.4395e+00	0845.0 nm	2.6013e+00	0895.0 nm	2.7127e+00
0796.0 nm	2.4432e+00	0846.0 nm	2.6042e+00	0896.0 nm	2.7145e+00
0797.0 nm	2.4468e+00	0847.0 nm	2.6070e+00	0897.0 nm	2.7163e+00
0798.0 nm	2.4505e+00	0848.0 nm	2.6097e+00	0898.0 nm	2.7181e+00
0799.0 nm	2.4541e+00	0849.0 nm	2.6125e+00	0899.0 nm	2.7199e+00

Title: PRECHECK RS-100 S/N: HL1965 IRRADIANCE @ 25 cm
 Date/Time: 03-23-2017 / 11:35:04
 Standard/Reference Illuminant applied: FEL 1600W LAMP S/N: F-675 IRRADIANCE @ 50 cm / None
 Units: Irradiance, $\mu\text{W}/(\text{cm}^2\text{nm})$
 Hardware: MM-26 200-1700nm,MM-90H 190-820nm,D-49CQ 200-1010nm,IM/A)
 Notes: T: 20C - RH: 57%
 Number of points: 801
 X-Axis=Low,High,Step: 300, 1100, 1 / Y-Axis=Low,High: 5.0828e-03, 2.7952e+00

0900.0 nm	2.7217e+00	0950.0 nm	2.7840e+00	1000.0 nm	2.7813e+00
0901.0 nm	2.7235e+00	0951.0 nm	2.7849e+00	1001.0 nm	2.7806e+00
0902.0 nm	2.7253e+00	0952.0 nm	2.7858e+00	1002.0 nm	2.7799e+00
0903.0 nm	2.7272e+00	0953.0 nm	2.7867e+00	1003.0 nm	2.7792e+00
0904.0 nm	2.7290e+00	0954.0 nm	2.7876e+00	1004.0 nm	2.7783e+00
0905.0 nm	2.7308e+00	0955.0 nm	2.7884e+00	1005.0 nm	2.7774e+00
0906.0 nm	2.7327e+00	0956.0 nm	2.7893e+00	1006.0 nm	2.7764e+00
0907.0 nm	2.7345e+00	0957.0 nm	2.7901e+00	1007.0 nm	2.7754e+00
0908.0 nm	2.7364e+00	0958.0 nm	2.7908e+00	1008.0 nm	2.7742e+00
0909.0 nm	2.7382e+00	0959.0 nm	2.7915e+00	1009.0 nm	2.7729e+00
0910.0 nm	2.7400e+00	0960.0 nm	2.7922e+00	1010.0 nm	2.7716e+00
0911.0 nm	2.7418e+00	0961.0 nm	2.7928e+00	1011.0 nm	2.7702e+00
0912.0 nm	2.7436e+00	0962.0 nm	2.7934e+00	1012.0 nm	2.7687e+00
0913.0 nm	2.7453e+00	0963.0 nm	2.7938e+00	1013.0 nm	2.7671e+00
0914.0 nm	2.7470e+00	0964.0 nm	2.7942e+00	1014.0 nm	2.7654e+00
0915.0 nm	2.7487e+00	0965.0 nm	2.7946e+00	1015.0 nm	2.7636e+00
0916.0 nm	2.7503e+00	0966.0 nm	2.7948e+00	1016.0 nm	2.7618e+00
0917.0 nm	2.7519e+00	0967.0 nm	2.7950e+00	1017.0 nm	2.7599e+00
0918.0 nm	2.7535e+00	0968.0 nm	2.7951e+00	1018.0 nm	2.7579e+00
0919.0 nm	2.7550e+00	0969.0 nm	2.7952e+00	1019.0 nm	2.7559e+00
0920.0 nm	2.7564e+00	0970.0 nm	2.7951e+00	1020.0 nm	2.7538e+00
0921.0 nm	2.7578e+00	0971.0 nm	2.7950e+00	1021.0 nm	2.7516e+00
0922.0 nm	2.7591e+00	0972.0 nm	2.7949e+00	1022.0 nm	2.7495e+00
0923.0 nm	2.7603e+00	0973.0 nm	2.7946e+00	1023.0 nm	2.7472e+00
0924.0 nm	2.7615e+00	0974.0 nm	2.7943e+00	1024.0 nm	2.7450e+00
0925.0 nm	2.7627e+00	0975.0 nm	2.7940e+00	1025.0 nm	2.7427e+00
0926.0 nm	2.7638e+00	0976.0 nm	2.7936e+00	1026.0 nm	2.7404e+00
0927.0 nm	2.7648e+00	0977.0 nm	2.7931e+00	1027.0 nm	2.7380e+00
0928.0 nm	2.7658e+00	0978.0 nm	2.7926e+00	1028.0 nm	2.7356e+00
0929.0 nm	2.7667e+00	0979.0 nm	2.7921e+00	1029.0 nm	2.7332e+00
0930.0 nm	2.7676e+00	0980.0 nm	2.7916e+00	1030.0 nm	2.7308e+00
0931.0 nm	2.7684e+00	0981.0 nm	2.7910e+00	1031.0 nm	2.7283e+00
0932.0 nm	2.7692e+00	0982.0 nm	2.7905e+00	1032.0 nm	2.7258e+00
0933.0 nm	2.7700e+00	0983.0 nm	2.7899e+00	1033.0 nm	2.7233e+00
0934.0 nm	2.7708e+00	0984.0 nm	2.7893e+00	1034.0 nm	2.7208e+00
0935.0 nm	2.7716e+00	0985.0 nm	2.7888e+00	1035.0 nm	2.7182e+00
0936.0 nm	2.7723e+00	0986.0 nm	2.7882e+00	1036.0 nm	2.7156e+00
0937.0 nm	2.7731e+00	0987.0 nm	2.7877e+00	1037.0 nm	2.7129e+00
0938.0 nm	2.7738e+00	0988.0 nm	2.7872e+00	1038.0 nm	2.7103e+00
0939.0 nm	2.7746e+00	0989.0 nm	2.7867e+00	1039.0 nm	2.7076e+00
0940.0 nm	2.7754e+00	0990.0 nm	2.7862e+00	1040.0 nm	2.7048e+00
0941.0 nm	2.7762e+00	0991.0 nm	2.7857e+00	1041.0 nm	2.7021e+00
0942.0 nm	2.7770e+00	0992.0 nm	2.7853e+00	1042.0 nm	2.6993e+00
0943.0 nm	2.7778e+00	0993.0 nm	2.7848e+00	1043.0 nm	2.6964e+00
0944.0 nm	2.7786e+00	0994.0 nm	2.7843e+00	1044.0 nm	2.6936e+00
0945.0 nm	2.7795e+00	0995.0 nm	2.7839e+00	1045.0 nm	2.6907e+00
0946.0 nm	2.7804e+00	0996.0 nm	2.7834e+00	1046.0 nm	2.6879e+00
0947.0 nm	2.7812e+00	0997.0 nm	2.7829e+00	1047.0 nm	2.6850e+00
0948.0 nm	2.7821e+00	0998.0 nm	2.7824e+00	1048.0 nm	2.6821e+00
0949.0 nm	2.7830e+00	0999.0 nm	2.7819e+00	1049.0 nm	2.6792e+00

Title: PRECHECK RS-100 S/N: HL1965 IRRADIANCE @ 25 cm
 Date/Time: 03-23-2017 / 11:35:04
 Standard/Reference Illuminant applied: FEL 1000W LAMP S/S: F-675 IRRADIANCE @ 50 cm / None
 Units: Irradiance, $\mu\text{W}/(\text{cm}^2\cdot\text{nm})$
 Hardware: MM-26 200-1700nm,MM-3DH 190-820nm,D-49CQ 200-1610nm, (M/A)
 Notes: T: 20C - RH: 53%
 Number of points: 801
 X-Axis-Low,High,Step: 300, 1100, 1 / Y-Axis-Low,High: 5.0028e-03, 2.7952e+00

1050.0 nm	2.6763e+00	1100.0 nm	2.5236e+00
1051.0 nm	2.6734e+00		
1052.0 nm	2.6706e+00		
1053.0 nm	2.6677e+00		
1054.0 nm	2.6649e+00		
1055.0 nm	2.6620e+00		
1056.0 nm	2.6592e+00		
1057.0 nm	2.6564e+00		
1058.0 nm	2.6537e+00		
1059.0 nm	2.6510e+00		
1060.0 nm	2.6483e+00		
1061.0 nm	2.6457e+00		
1062.0 nm	2.6432e+00		
1063.0 nm	2.6408e+00		
1064.0 nm	2.6384e+00		
1065.0 nm	2.6361e+00		
1066.0 nm	2.6339e+00		
1067.0 nm	2.6317e+00		
1068.0 nm	2.6296e+00		
1069.0 nm	2.6275e+00		
1070.0 nm	2.6254e+00		
1071.0 nm	2.6234e+00		
1072.0 nm	2.6214e+00		
1073.0 nm	2.6194e+00		
1074.0 nm	2.6174e+00		
1075.0 nm	2.6153e+00		
1076.0 nm	2.6132e+00		
1077.0 nm	2.6110e+00		
1078.0 nm	2.6088e+00		
1079.0 nm	2.6065e+00		
1080.0 nm	2.6041e+00		
1081.0 nm	2.6015e+00		
1082.0 nm	2.5989e+00		
1083.0 nm	2.5961e+00		
1084.0 nm	2.5931e+00		
1085.0 nm	2.5900e+00		
1086.0 nm	2.5867e+00		
1087.0 nm	2.5832e+00		
1088.0 nm	2.5796e+00		
1089.0 nm	2.5759e+00		
1090.0 nm	2.5718e+00		
1091.0 nm	2.5678e+00		
1092.0 nm	2.5635e+00		
1093.0 nm	2.5591e+00		
1094.0 nm	2.5546e+00		
1095.0 nm	2.5498e+00		
1096.0 nm	2.5449e+00		
1097.0 nm	2.5399e+00		
1098.0 nm	2.5348e+00		
1099.0 nm	2.5292e+00		

PRECHECK RS-10D S/N: HL1965 IRRADIANCE @ 25 cm

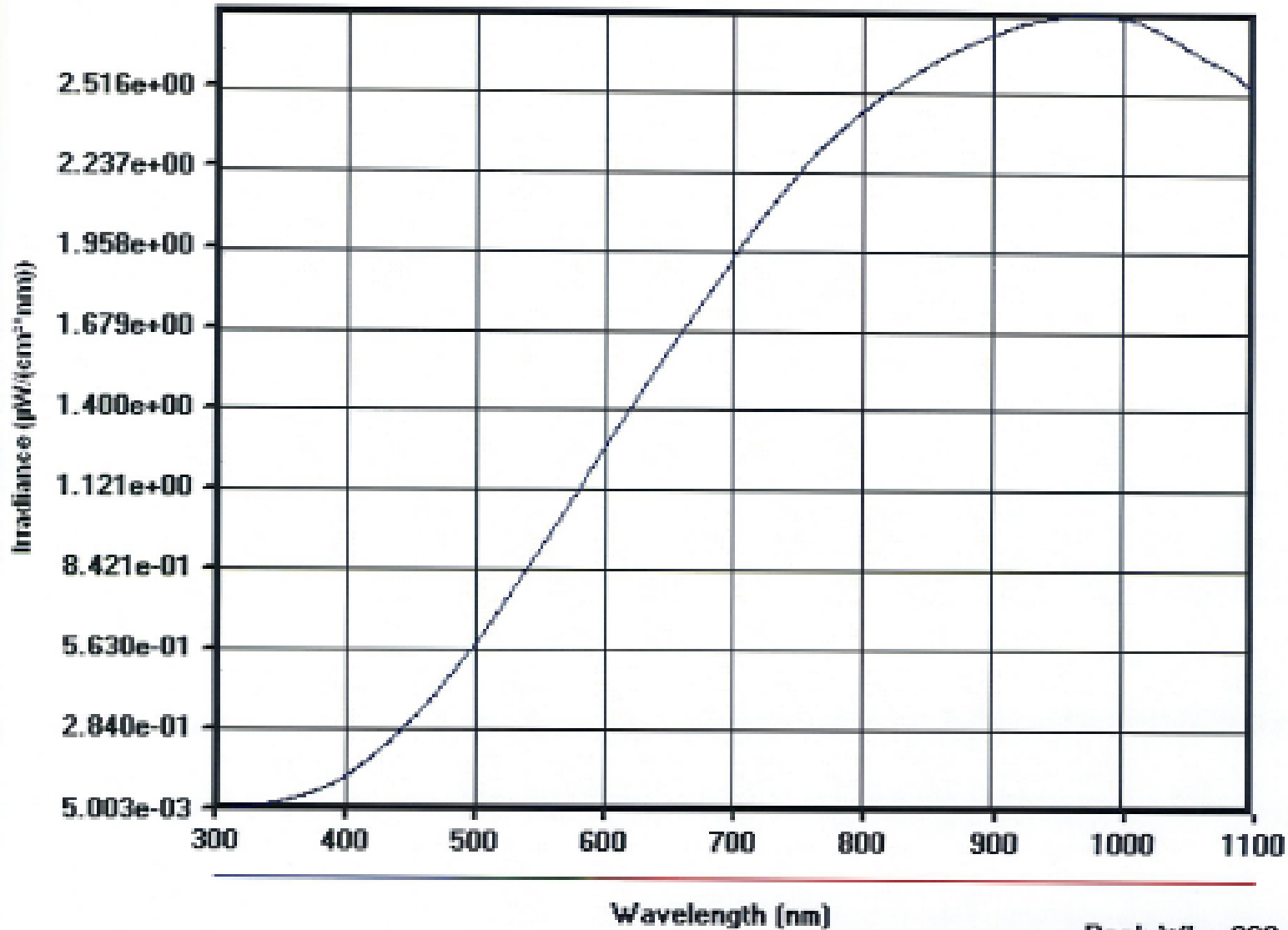

Detector:	Sony ILX511B (2048-element linear silicon CCD array)
Wavelength range:	350-1000 nm
Integration time:	1 ms – 65 seconds (20 seconds typical)
Dynamic range:	8.5×10^7 (system); 1300:1 for a single acquisition
Signal-to-noise ratio:	250:1 (full signal)
Dark noise:	50 RMS counts
Grating:	600 lines/mm, set to 350-1000 nm (blazed at 500 nm)
Slit:	25 μm
Detector collection lens:	No
Order-sorting:	OFLV-350-1000
Optical resolution:	1.5 nm FWHM
Stray light:	<0.05% at 600 nm; <0.10% at 435 nm
Fiber optic connector:	SMA 905 to 0.22 numerical aperture single-strand fiber
Wavelength range:	350-1000 nm

Goniometer System Specs:

Table 2 - Adaptability and Motor Control Specs.

X (Longitudinal) Range mm	*H-V" +/- 150mm (6")
Y(Lateral) Range mm	*H-V" +/- 300mm (12")
Z (Vertical) Range mm	*H-V" down to 500mm (20")
X Resolution	0.5 mm
Y Resolution	0.5 mm
Z Resolution	0.5 mm
X Accuracy	0.5 +/- 0.25 mm
Y Accuracy	0.5 +/- 0.25 mm
Z Accuracy	0.5 +/- 0.25 mm
H Range in degrees	180 degrees left and right
V Range in degrees	110 degrees up, 110 degrees down
H Resolution	0.01 degrees
V Resolution	0.01 degrees
H Accuracy	0.01 +/- 0.005 degrees
V Accuracy	0.01 +/- 0.005 degrees
H Rotation Speed degrees/second	20 degrees per sec (user variable)
V Rotation Speed degrees/second	20 degrees per sec (user variable)

Table 3 - Computer Specs.

Operating system	Windows XP Professional
Hard Disk Size	40GB (Typically)
System Memory	512MB (Typically)

Table 4 - Forward Lighting Capabilities

ECE	Yes
SAE/FMVSS	Yes
JIS	Yes
Other	Yes

Table 5 - Signal Lighting Capabilities

ECE	Yes
SAE/FMVSS	Yes
JIS	Yes
Other	Yes

Table 6 - Retro Reflex Capabilities

ECE	Yes
SAE/FMVSS	Yes
JIS	Yes
Other	Yes

Table 7 - Isocandela capabilities

H Section	Yes
V Section	Yes

Table 8 - Other capabilities

Road Illumination (BEV)	Yes
Scans	Yes

Table 9 - Detector capabilities

Intensity Range for detector at 60'	Hoffman detectors are capable of measuring from 0.01 cd to 17,000,000 cd as configured.
Detector Resolution	16 BIT Resolution - all ranges
Detector Accuracy	Accuracy for luminous intensity: 2%; Non-Linearity: < 2% throughout range; Color response relative to SAE color limits: SAE Amber <2% error, SAE Medium Red <3% error
Size (Light sensitive surface area)	5.8mm sq
Sampling Rate (kHz)	up to 200kHz

Asset #	Description	Manufacturer	Model	Serial #	Last Cal	Next Due
133004	HOFFMAN STANDARD LAMP #3	HOFFMAN ENGINEERING	S80-17F	98663	10/24/2017	10/24/2018
133009	ALIGNMENT LASER	MELLES GRIOT	05-LHR-141	9261BI	VBU	VBU
133011	POWER SUPPLY, 60V / 10A / 200W	HOFFMAN	6038A	US36510144	VBU	VBU
133021	STANDARD LAMP	HOFFMAN ENGINEERING	S80-17F	HEC-3207	6/8/2017	6/8/2018
133027	GONIOPHOTOMETER	HOFFMAN ENGINEERING	AGS-1100	NA	VBU	VBU
133027.1	PC	HOFFMAN ENGINEERING	IPC-6908BP	X12-51822	VBU	VBU
133027.2	SOFTWARE FOR GONIOMETER	HOFFMAN ENGINEERING	HGS-1100	V2.07.35	VBU	VBU
133033	STANDARD LAMP	HOFFMAN ENGINEERING	S80-17F	HEC-4655	6/8/2017	6/8/2018
133063	SHUNT	EMPRO	20A/400MV	6079	6/26/2017	6/26/2020
133065	DMM	KEITHLEY	2000	4044413	5/11/2017	5/11/2018
133030	DETECTOR .33 ft	HOFFMAN ENGINEERING	TSP-1101	HEC-4189	VBU	VBU
133054	RADIOMETER 350 - 1000nm	HOFFMAN ENGINEERING	SMS-1000	HEC-10767	VBU	VBU
133071	Standard of spectral Radiance/Irradiance	Gamma Scientific	RS-10B/RS-70-2	HL 1965	4/13/2017	4/13/2018
130718	DC POWER SUPPLY, 60V / 50A / 1000W	HEWLETT PACKARD	6032-A	US35420127	VBU	VBU

Appendix B. Circuit Diagram for LED Lights

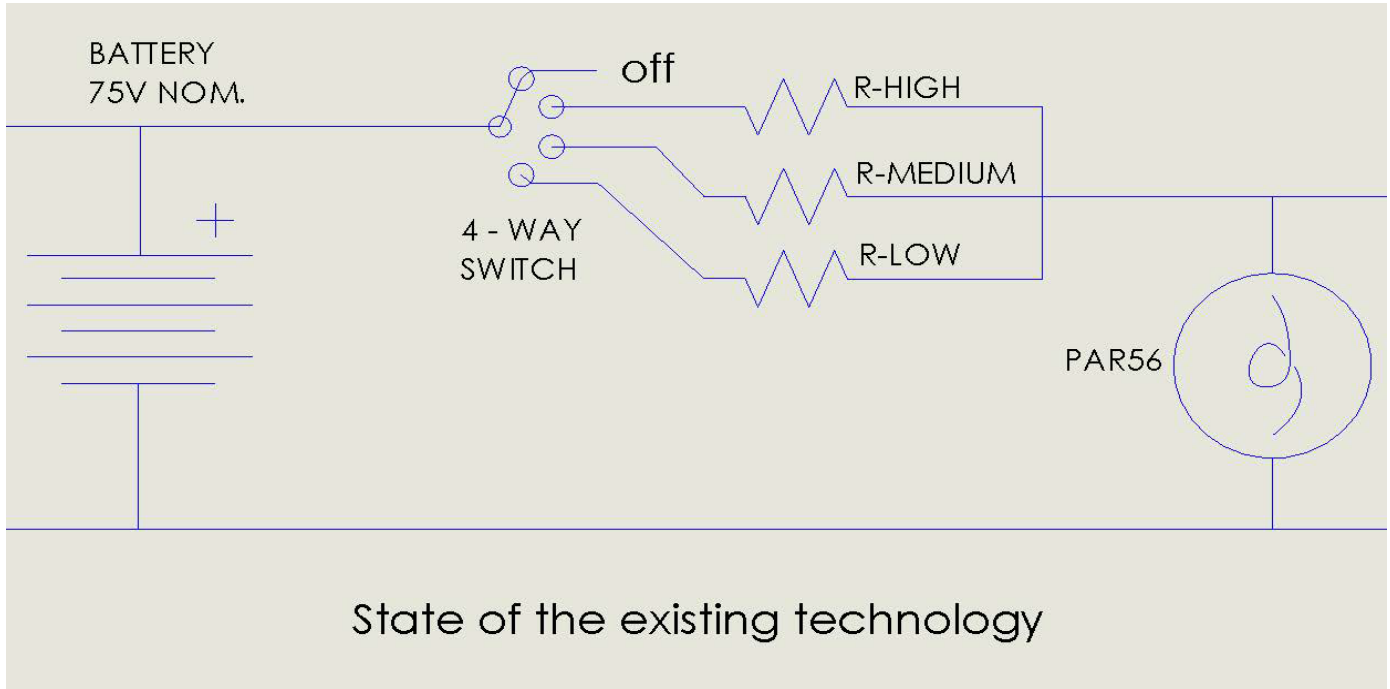

Appendix C. Candela Plots of Lights – Bright Mode

Candela Plots of LED Lights in Bright Mode

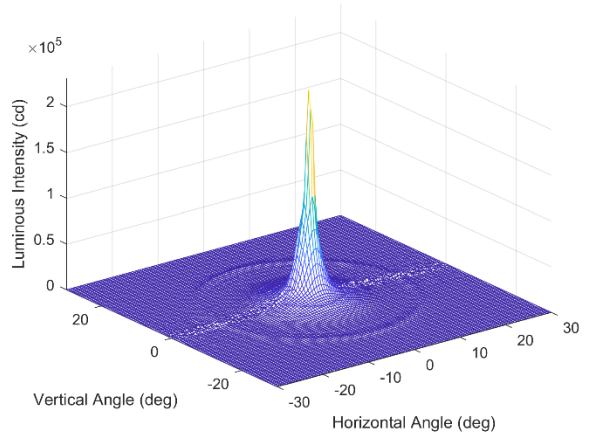
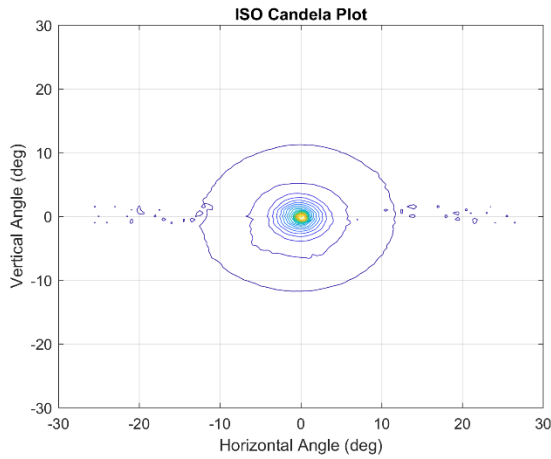

Figure 1. Raw photometric distribution for J.W. Speaker (S2 LED)

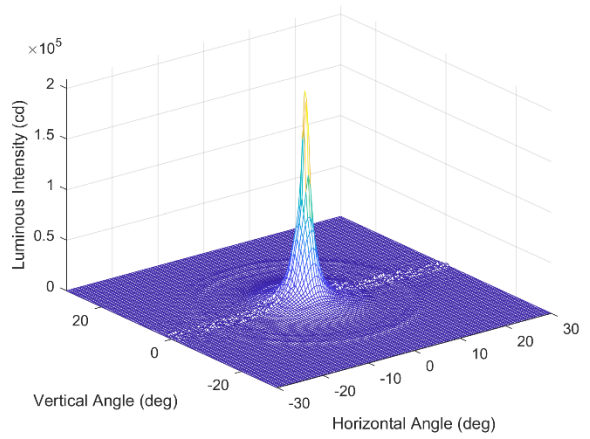
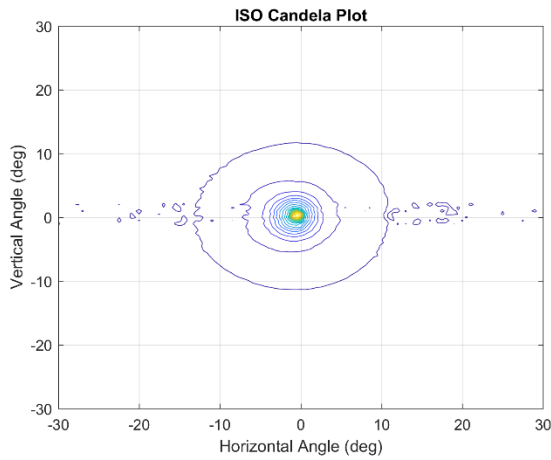

Figure 2. Raw photometric distribution for J.W. Speaker (S4 LED)

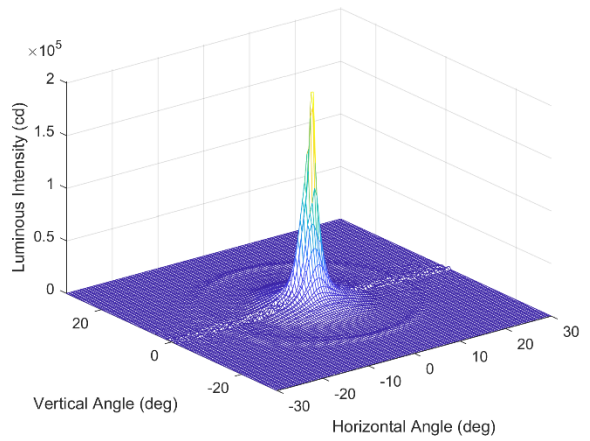
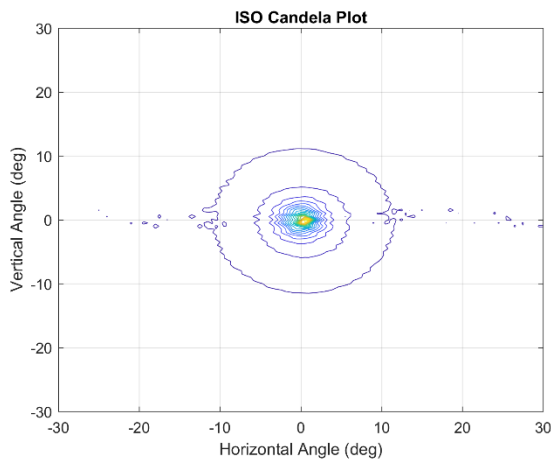

Figure 3. Raw photometric distribution for J.W. Speaker (S8 LED)

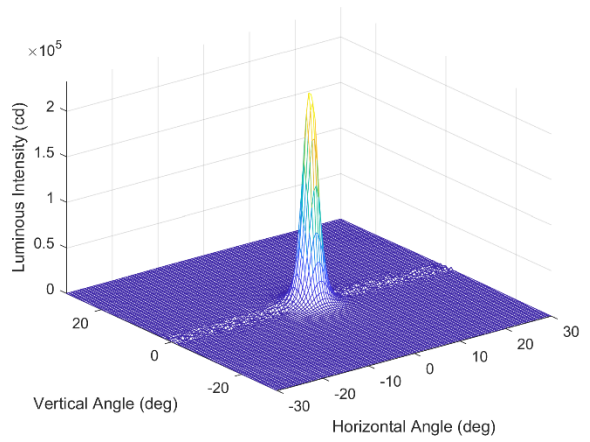
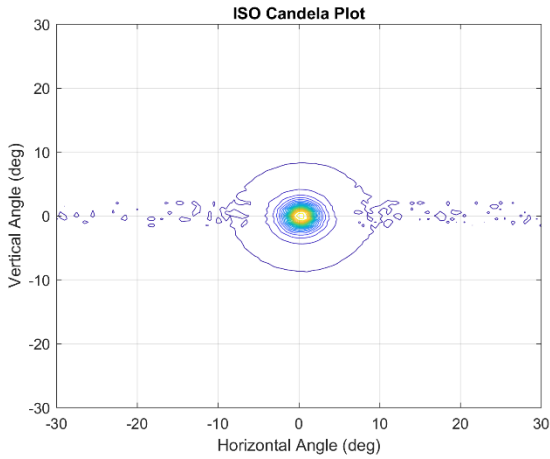

Figure 4. Raw photometric distribution for Hydra-Tech 2800K (S5 LED)

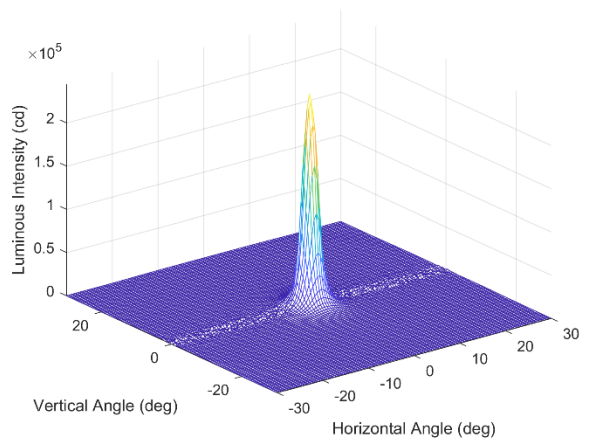
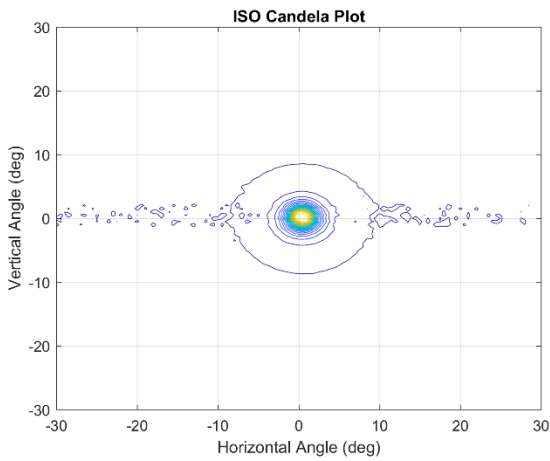

Figure 5. Raw photometric distribution for Hydra-Tech 2800K (S9 LED)

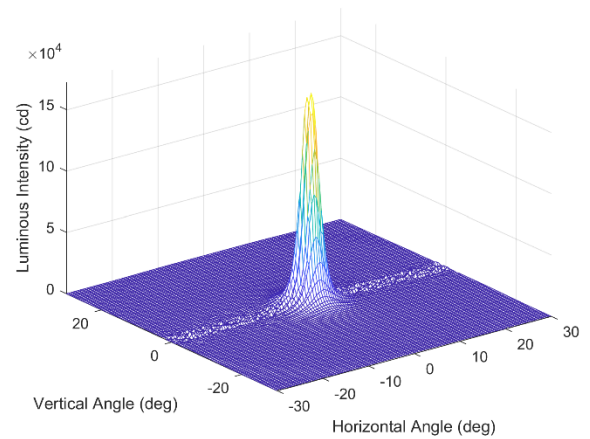
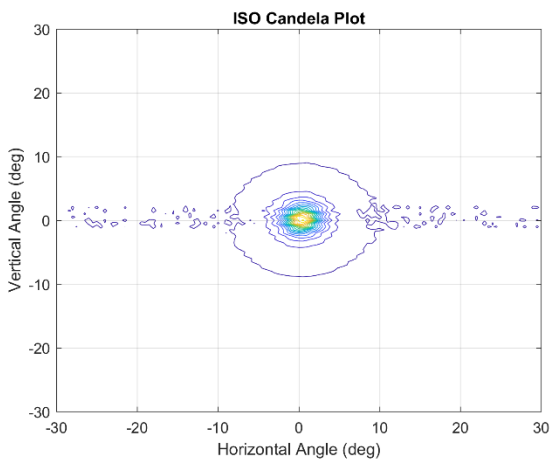

Figure 6. Raw photometric distribution for Hydra-Tech 2800K (S13 LED)

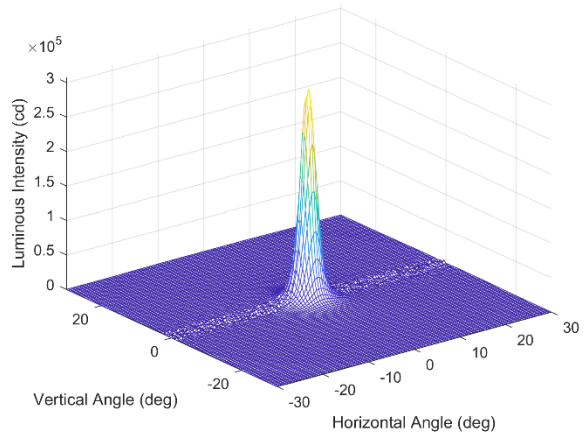
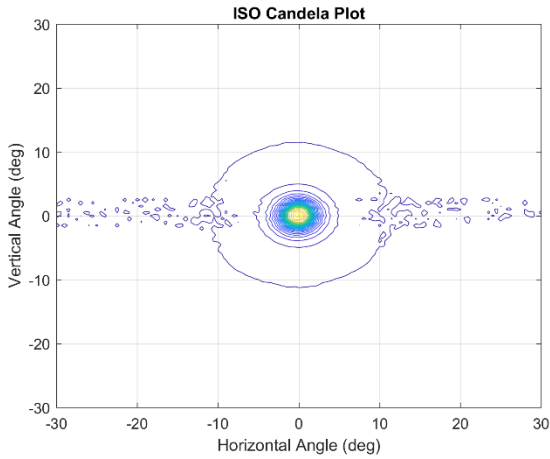

Figure 7. Raw photometric distribution for Hydra-Tech 7000K (S1 LED)

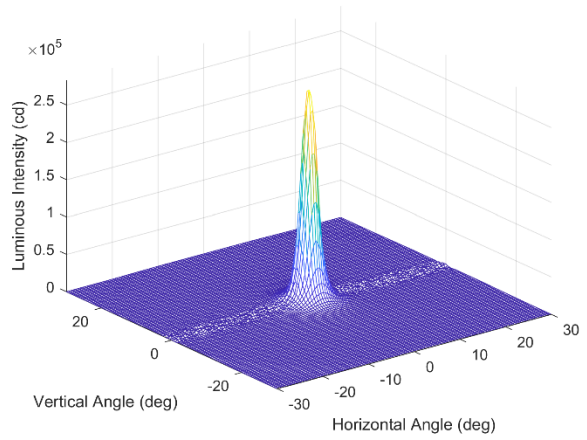
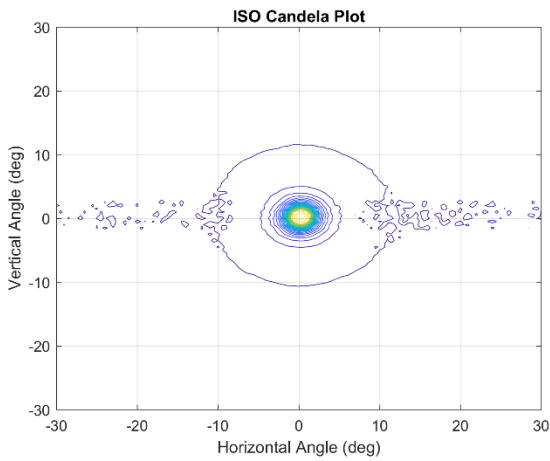

Figure 8. Raw photometric distribution for Hydra-Tech 7000K (S10 LED)

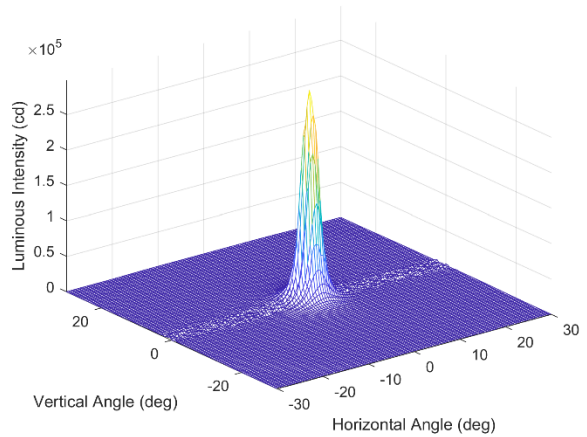
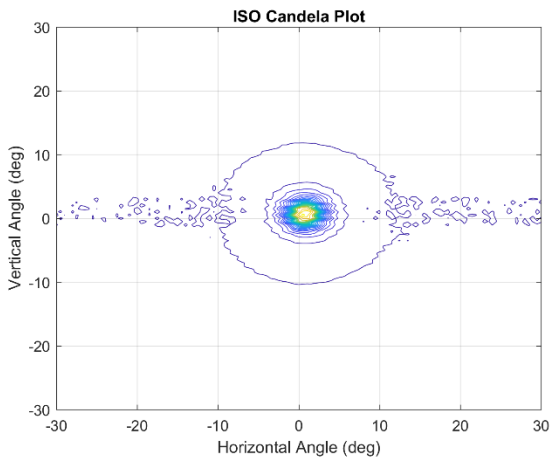

Figure 9. Raw photometric distribution for Hydra-Tech 7000K (S15 LED)

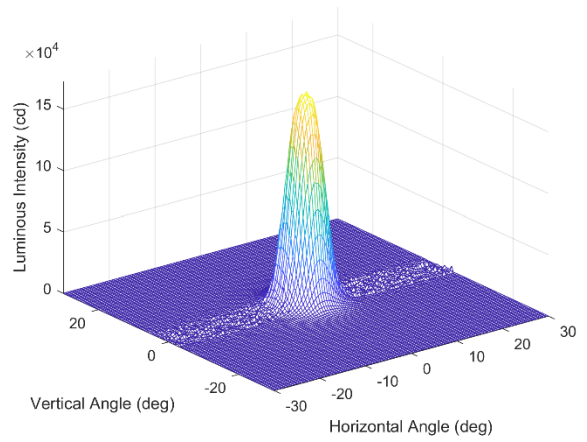
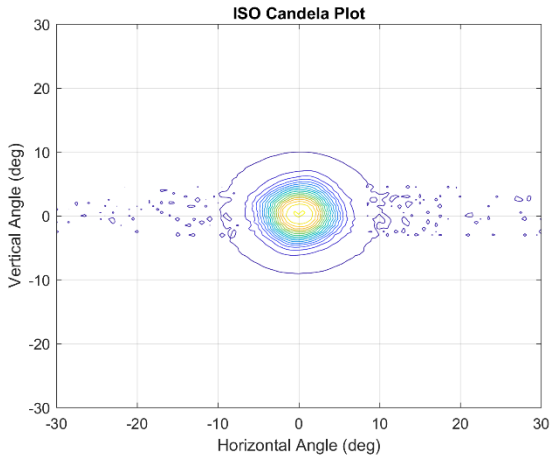

Figure 10. Raw photometric distribution for Railhead/Divvali (S7 LED)

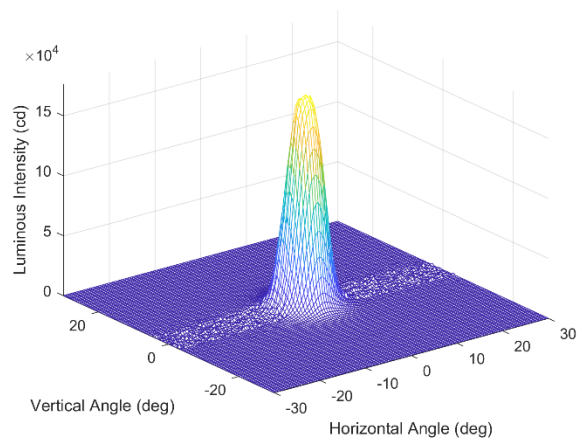
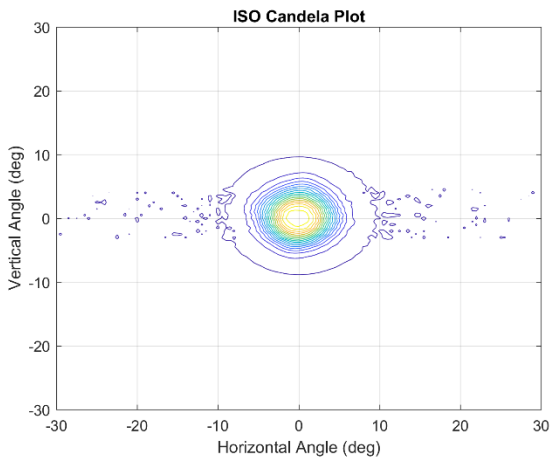

Figure 11. Raw photometric distribution for Railhead/Divvali (S11 LED)

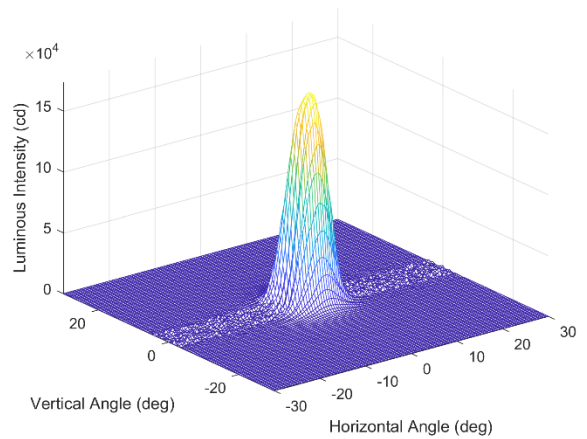
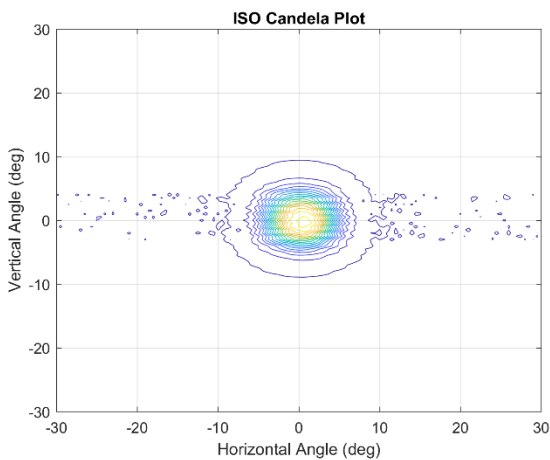

Figure 12. Raw photometric distribution for Railhead/Divvali (S12 LED)

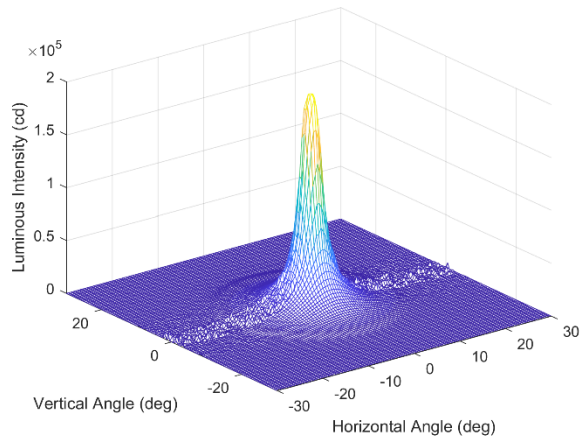
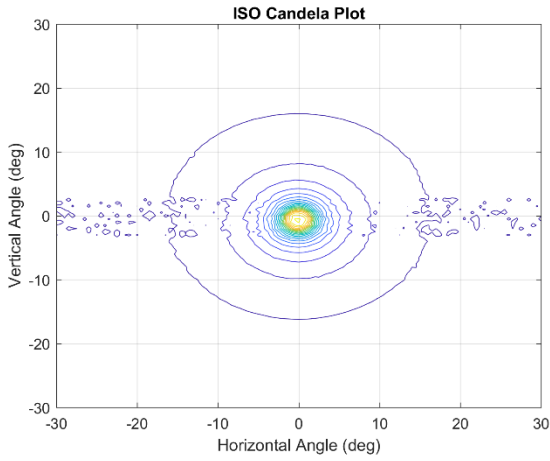

Figure 13. Raw photometric distribution for Smart Light Source (S3 LED)

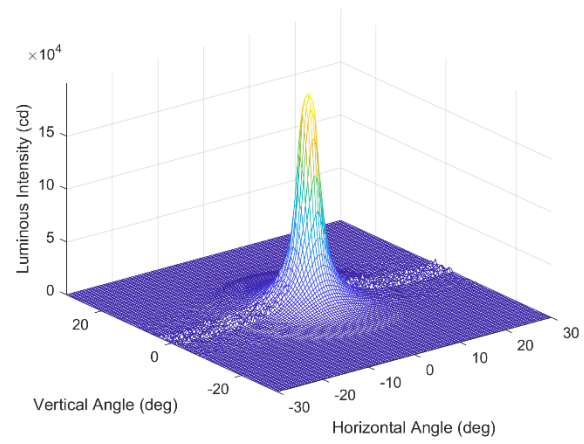
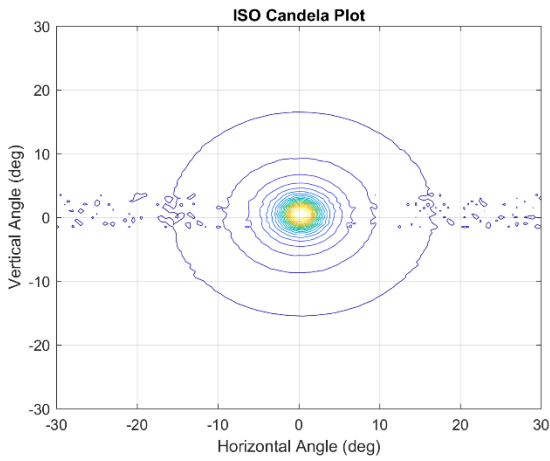

Figure 14. Raw photometric distribution for Smart Light Source (S6 LED)

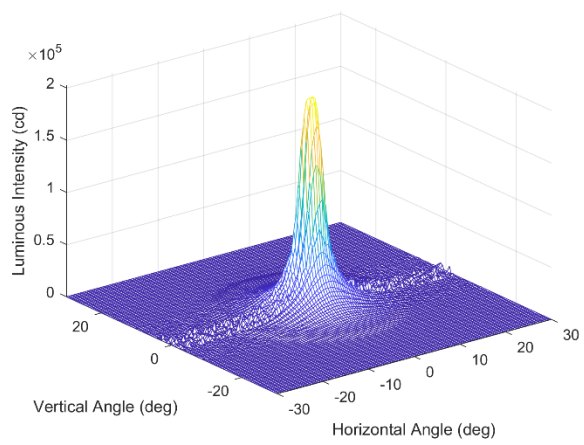
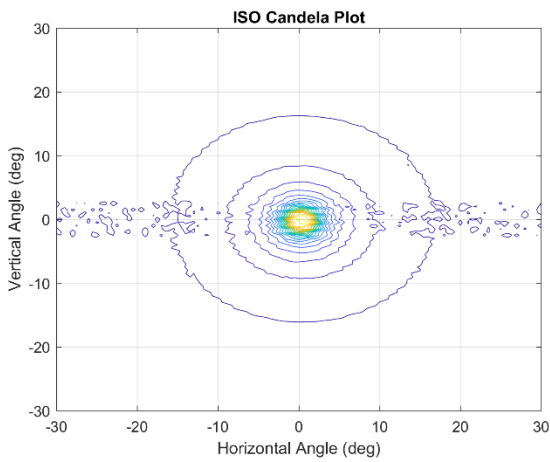

Figure 15. Raw photometric distribution for Smart Light Source (S14 LED)

Appendix D. Candela Plots of Lights – Dim Mode

Candela Plots of LED Lights in Dim Mode

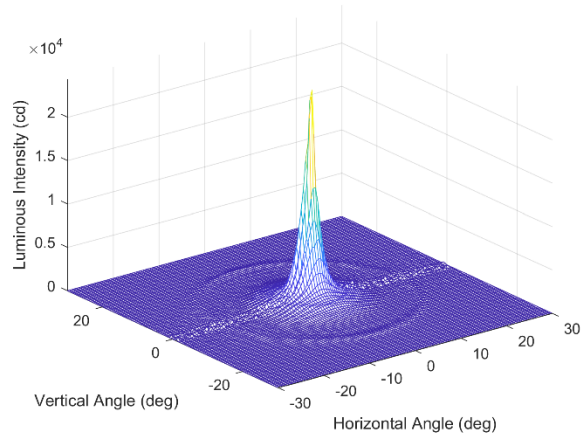
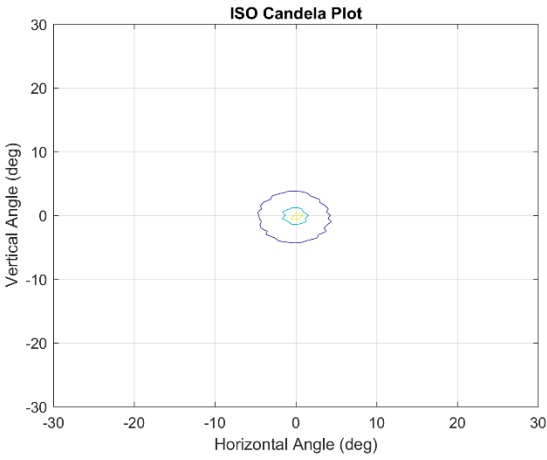

Figure 1. Raw photometric distribution for J.W. Speaker (S2 LED)

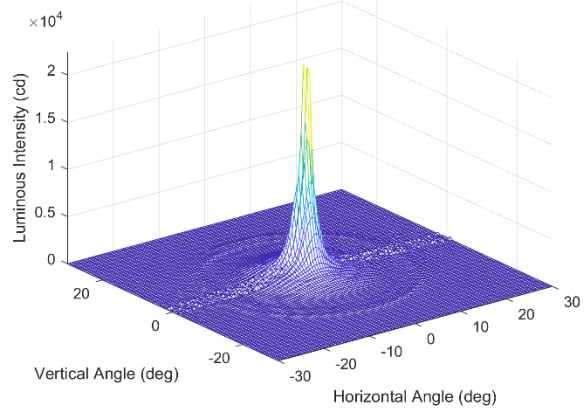
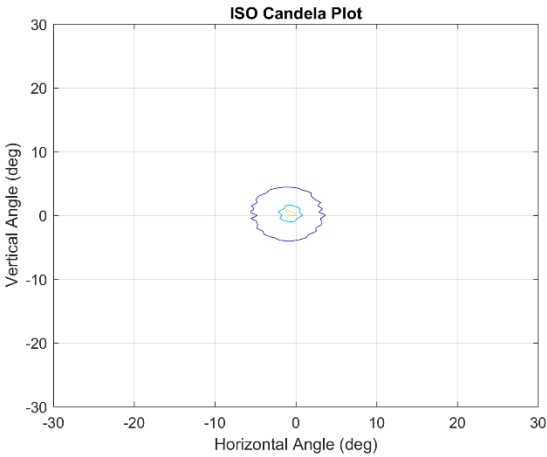

Figure 2. Raw photometric distribution for J.W. Speaker (S4 LED)

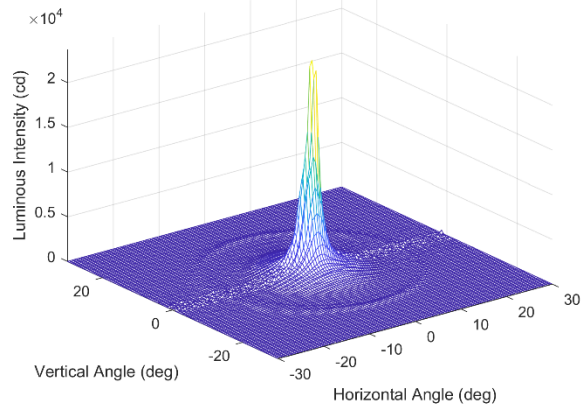
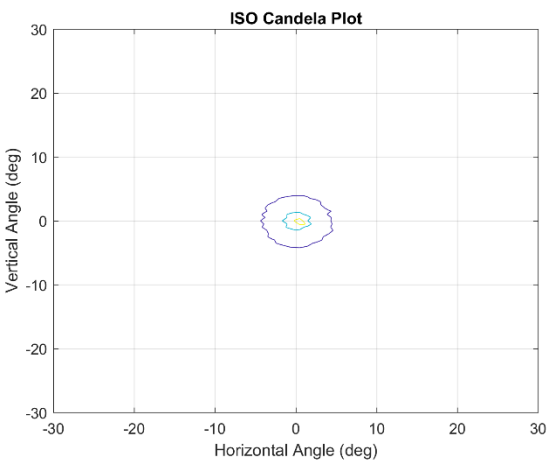

Figure 3. Raw photometric distribution for J.W. Speaker (S8 LED)

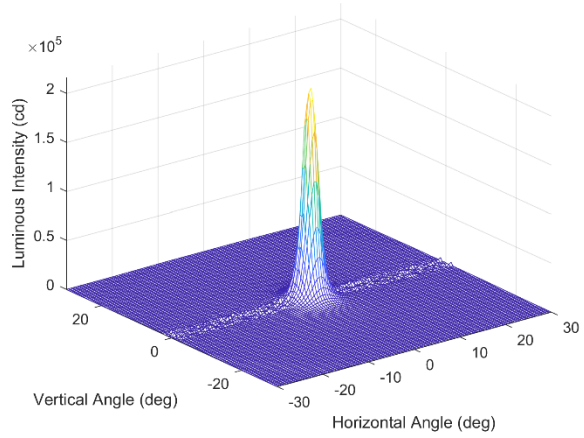
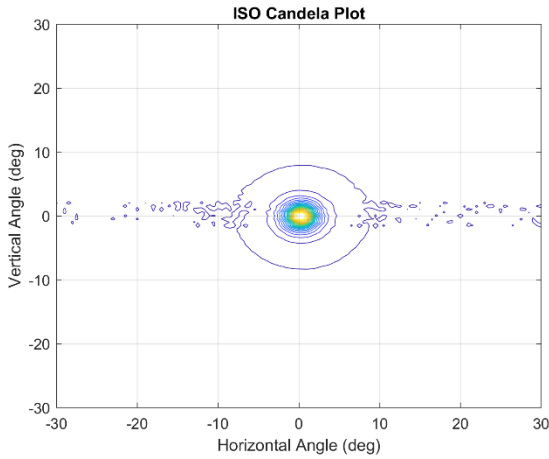

Figure 4. Raw photometric distribution for Hydra-Tech 2800K (S5 LED)

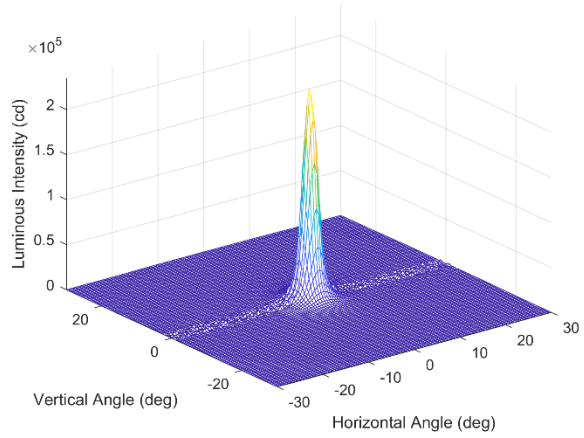
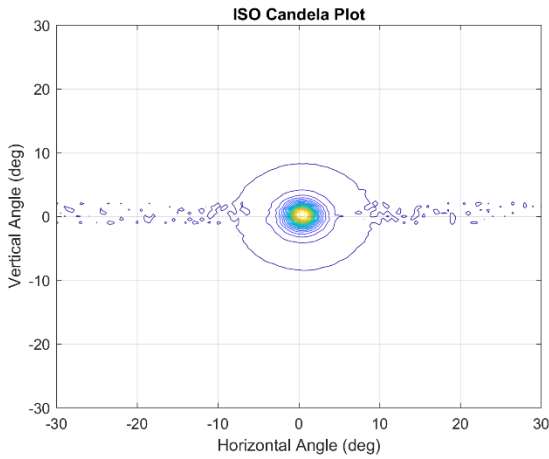

Figure 5. Raw photometric distribution for Hydra-Tech 2800K (S9 LED)

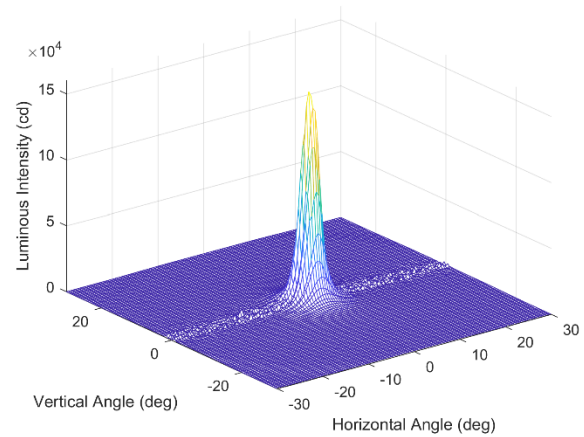
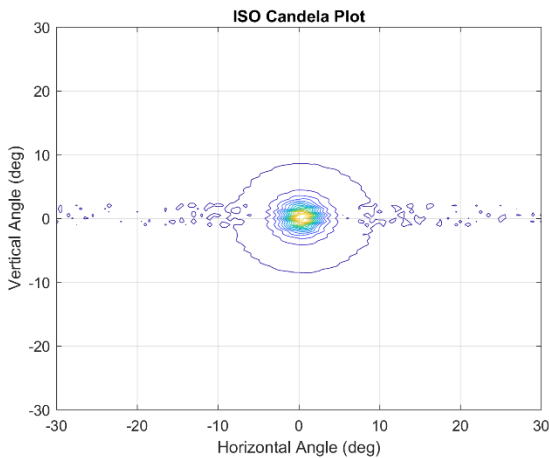

Figure 6. Raw photometric distribution for Hydra-Tech 2800K (S13 LED)

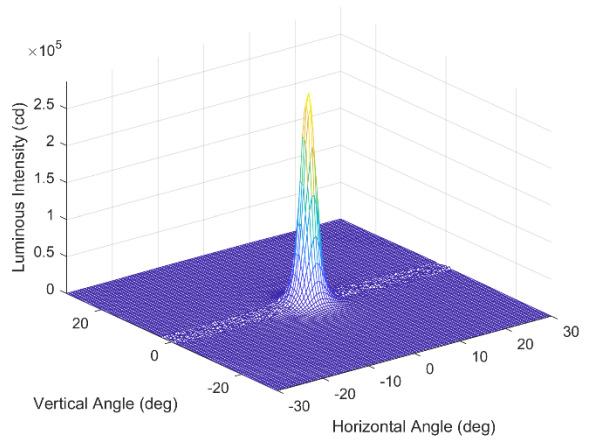
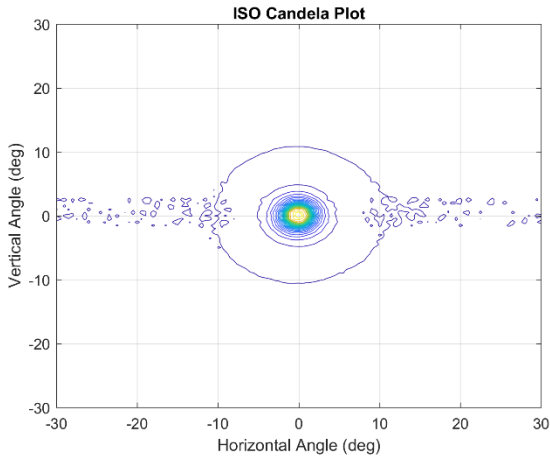

Figure 7. Raw photometric distribution for Hydra-Tech 7000K (S1 LED)

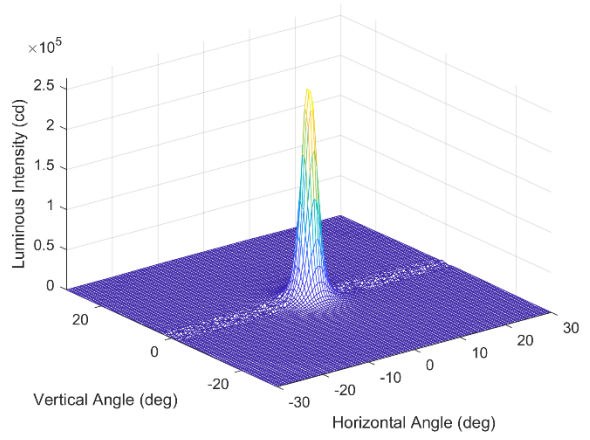
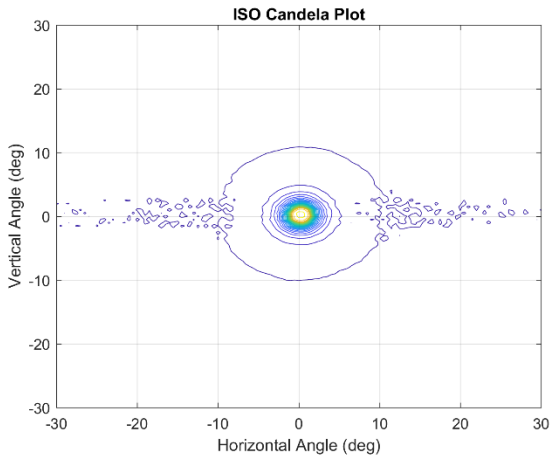

Figure 8. Raw photometric distribution for Hydra-Tech 7000K (S10 LED)

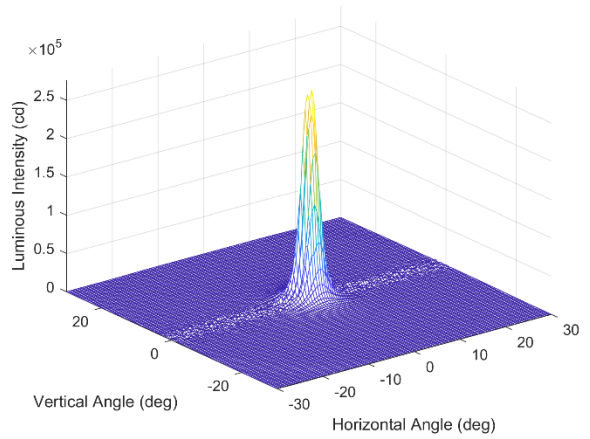
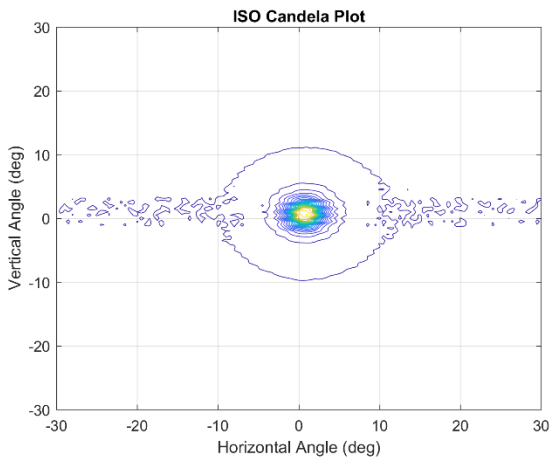

Figure 9. Raw photometric distribution for Hydra-Tech 7000K (S15 LED)

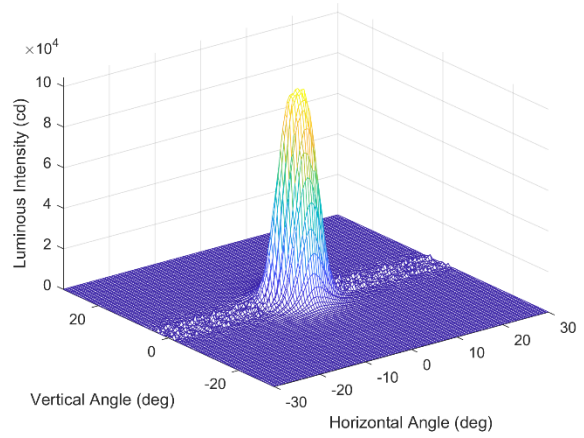
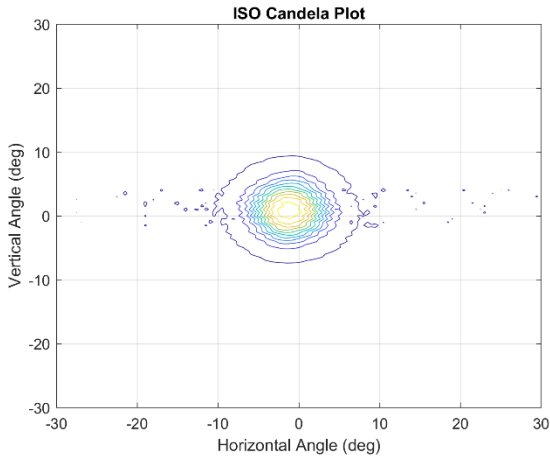

Figure 10. Raw photometric distribution for Railhead/Divvali (S7 LED)

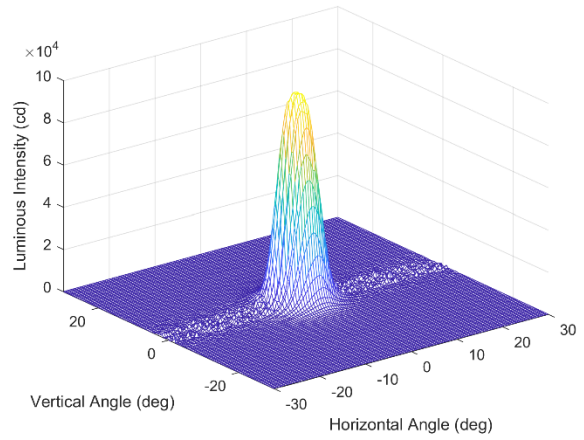
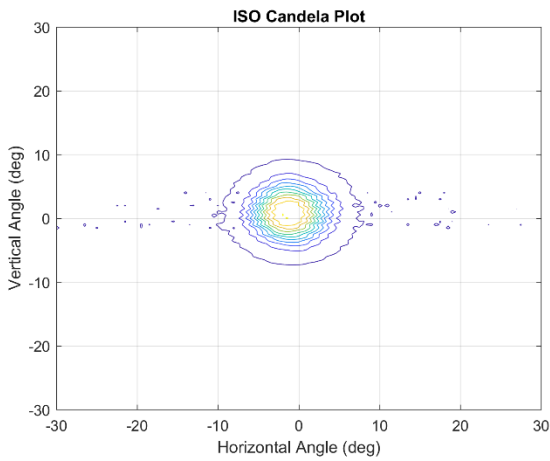

Figure 11. Raw photometric distribution for Railhead/Divvali (S11 LED)

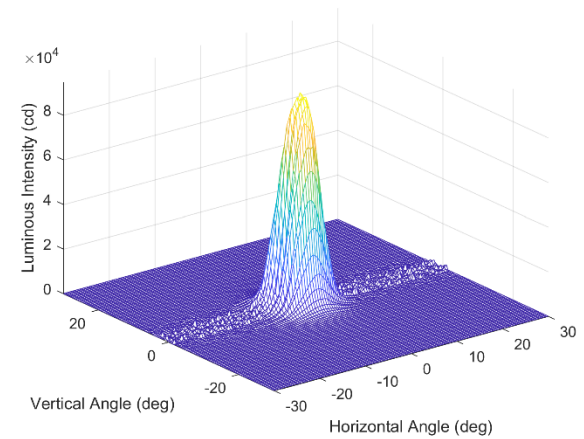
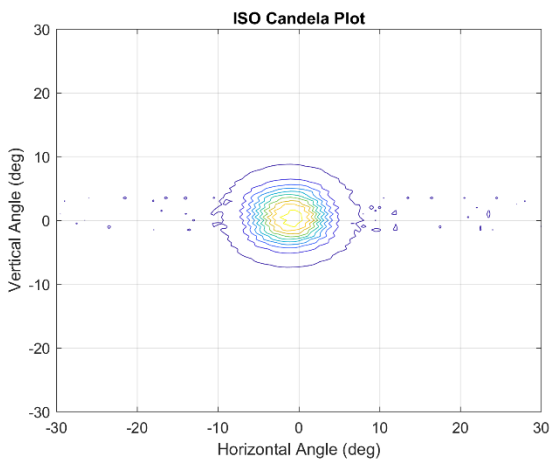

Figure 12. Raw photometric distribution for Railhead/Divvali (S12 LED)

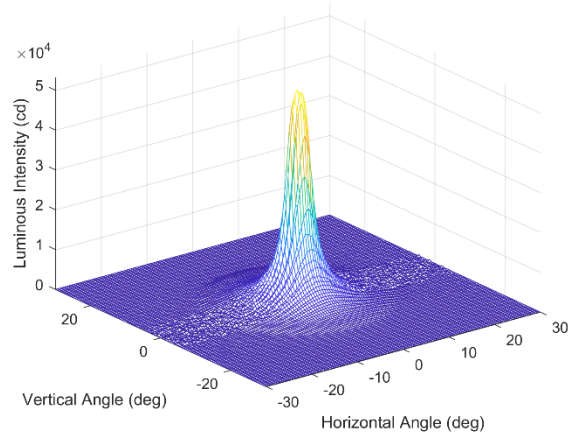
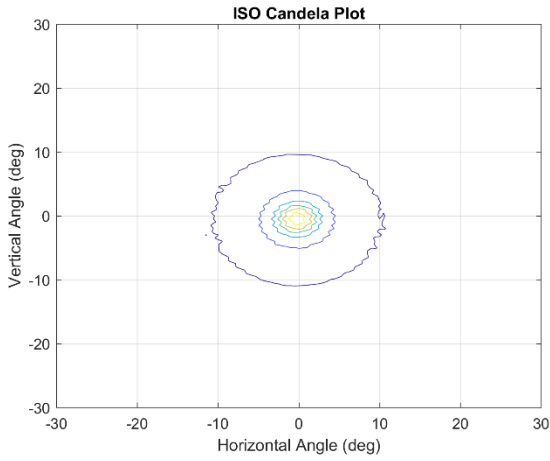

Figure 13. Raw photometric distribution for Smart Light Source (S3 LED)

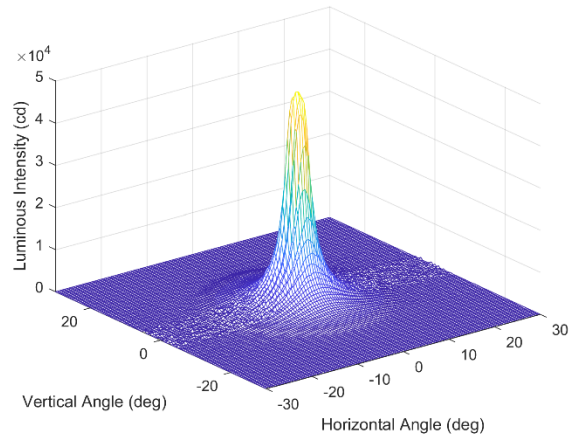
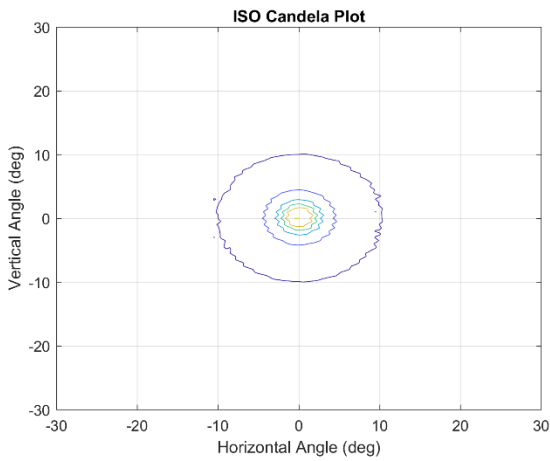

Figure 14. Raw photometric distribution for Smart Light Source (S6 LED)

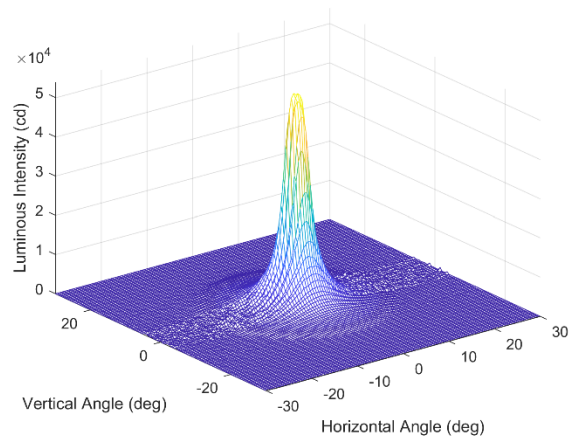
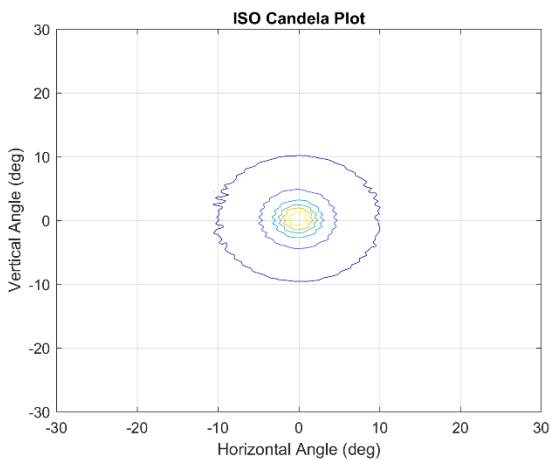

Figure 15. Raw photometric distribution for Smart Light Source (S14 LED)

Appendix E. Candela Plots of Halogen Lights

Candela Plots of Halogen Lights

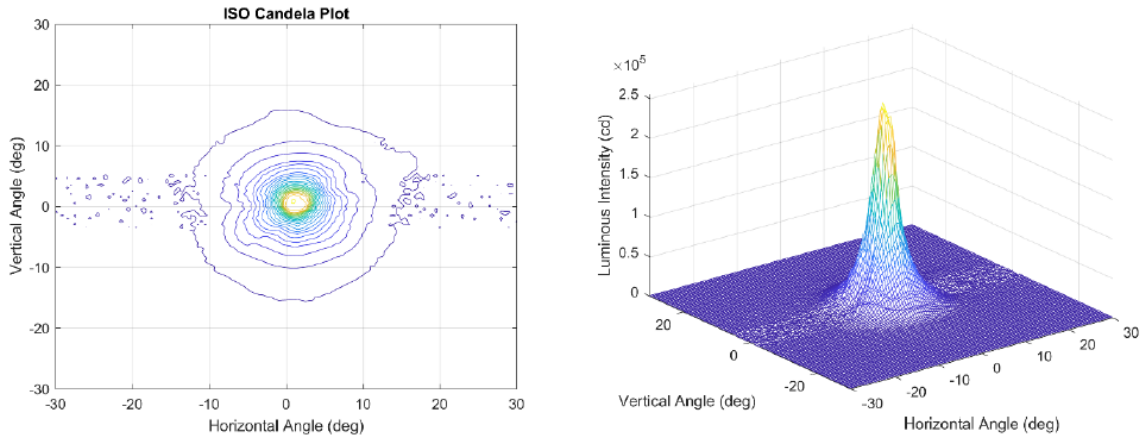

Figure 1. Raw photometric distribution for ePowerRail (S3 HAL)

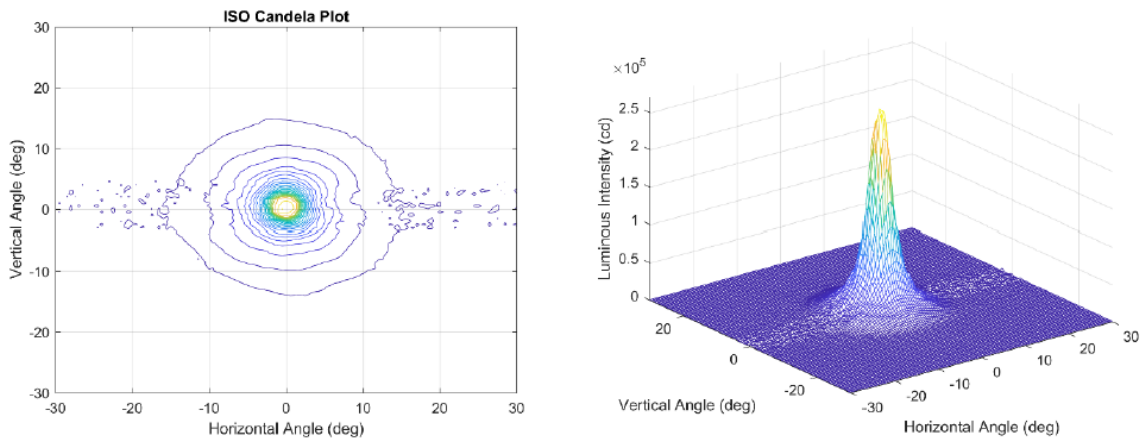

Figure 2. Raw photometric distribution for ePowerRail (S5 HAL)

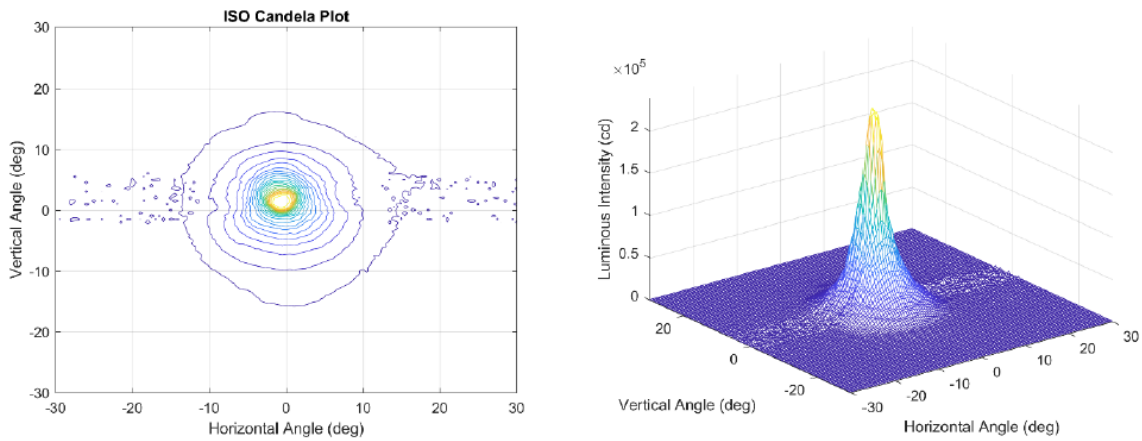

Figure 3. Raw photometric distribution for ePowerRail (S8 HAL)

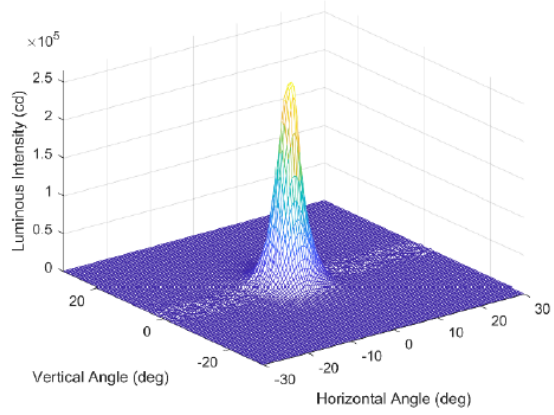
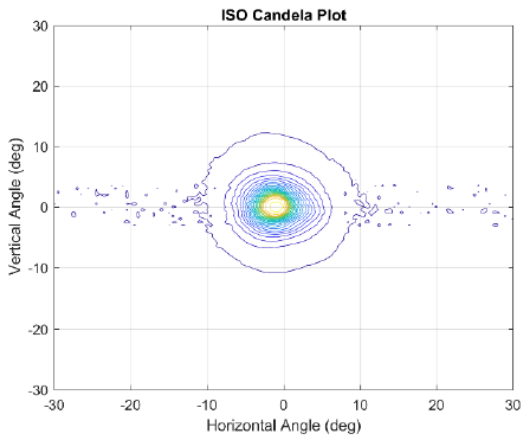

Figure 4. Raw photometric distribution for CML (S1 HAL)

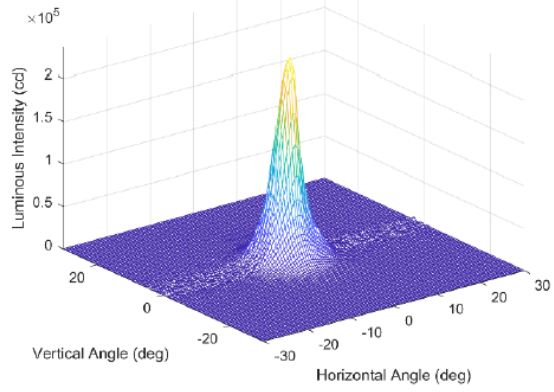
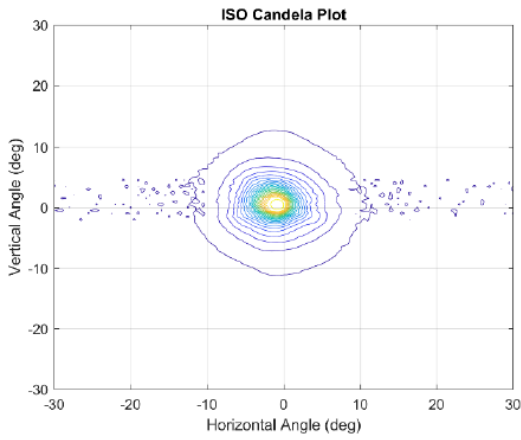

Figure 5. Raw photometric distribution for CML (S2 HAL)

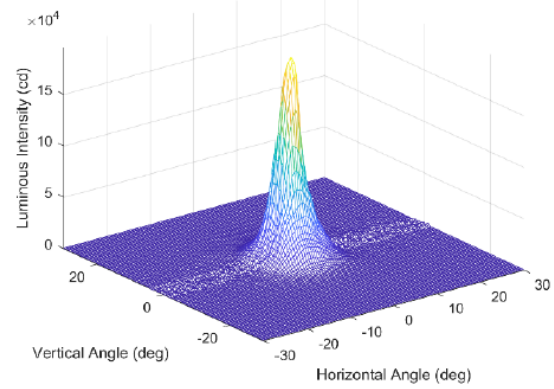
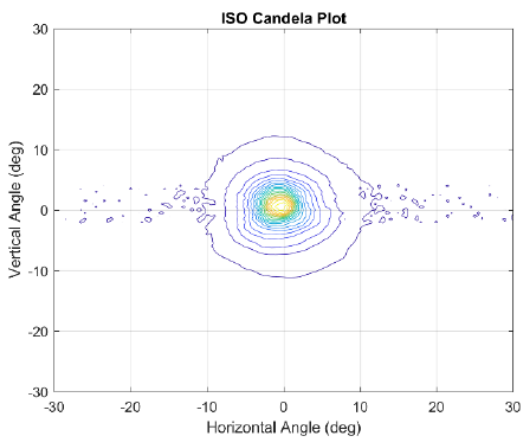

Figure 6. Raw photometric distribution for CML (S9 HAL)

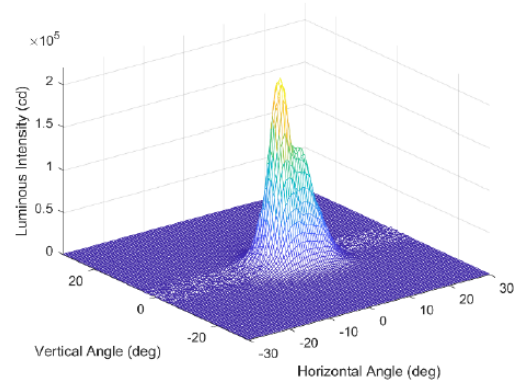
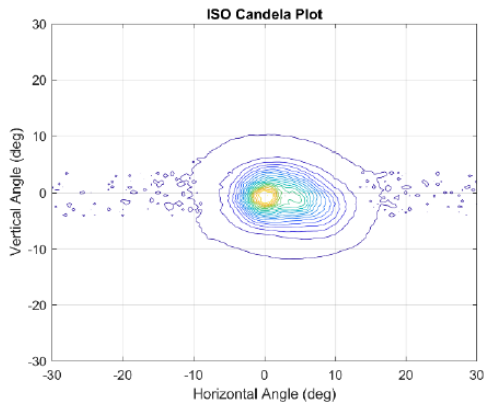

Figure 7. Raw photometric distribution for AMGLO (S4 HAL)

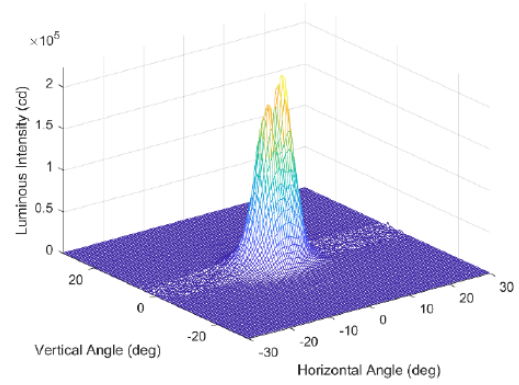
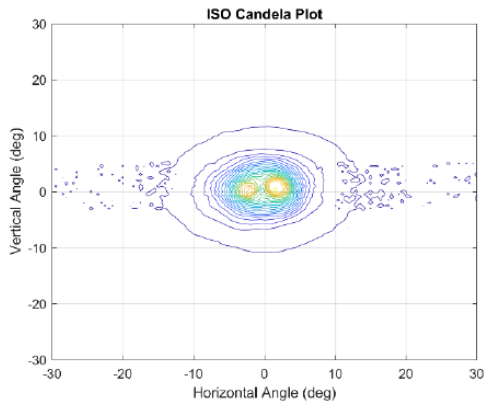

Figure 8. Raw photometric distribution for AMGLO (S6 HAL)

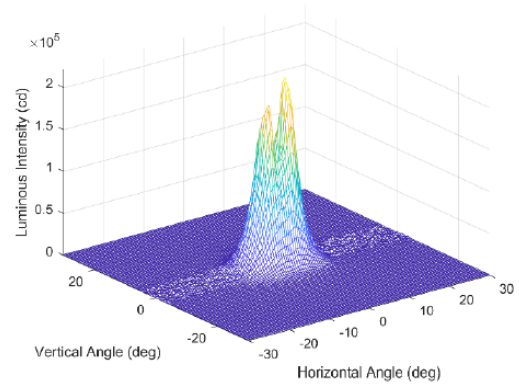
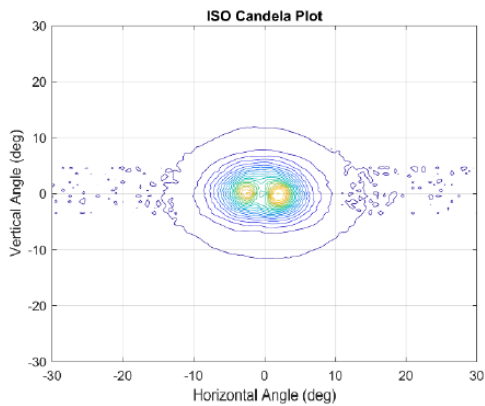

Figure 9. Raw photometric distribution for AMGLO (S7 HAL)

Appendix F. Intertek Photometry and Colorimetry Measurement Summaries

Intertek Data Summary Table														Colorimetry				FRA Guideline (g)		Distance (m)		Bright Mode						
Sample Name	Sample #	Bright Mode Photometry					Dim Mode Photometry					Bright Mode		Dim Mode		Other	3300	Measured Virtual Ev (Lux)	15.24	Difference (Lux)	Bright Mode				cd @ 7.5 deg			
		FRA Passed?	Max cd	DC Input Voltage (V)	Input Current (A)	Input Power (W)	Comments	Max cd	DC Input Voltage (V)	Input Current (A)	Input Power (W)	Comments	OCT (K)	$\lambda_{max}(nm)$	OCT (K)						$\lambda_{max}(nm)$	Max cd	cd/ft ² x H	cd/ft ² x V	cd @ 0-0 deg	cd 7.5-H	cd 7.5-VH	cd 7.5-V
Hydra 70	S1 LED	Yes	307361	75	0.618	46.35		286542	30	1.218	36.55	DM 1	6475	483	6432	483	A1	FAIL	1282.1	1323.36	41.26	307361	0	0	307361	3867	2323	3608
JW	S2 LED	Yes	231009	75	0.4815	36.11		24355	75	0.068	5.1	DM 2	5743	484	5691	485	A1	FAIL	963	994.62	31.62	231009	0	0	231009	6652	8790	5948
SmartUp	S3 LED	No	200291	75	0.969	72.67	BM1	53189	75	0.1905	14.18	DM 3	3233	484			A1	PASS	835.4	862.37	26.97	200291	0.5	0	192829	18578	16964	11797
JW	S4 LED	No	208883	75	0.48	36	BM1	22414	75	0.0665	4.99	DM 2	5984	484	5909	484	A1	FAIL	871.1	899.36	28.26	208883	-0.5	0.5	163839	5262	8531	6931
Hydra 28	S5 LED	No	232437	75	0.6075	45.56		216156	30	1.218	36.55	DM 1	3181	491	3181	491	A1	PASS	968.8	1000.77	31.97	232437	0	0	232437	4056	1670	2287
SmartUp	S6 LED	No	199933	75	0.879	65.92		50168	75	0.1965	15.42	DM 3	3210	484			A1	PASS	834.1	860.82	26.72	199933	-0.5	-0.5	198483	15483	13003	16150
Rail	S7 LED	No	172446	75	0.525	39.38		104371	75	0.2905	21.69	DM 4	2947	490			A2	PASS	718.6	742.48	23.88	172446	-0.5	-0.5	171183	5073	4441	6663
JW	S8 LED	No	201350	75	0.479	35.92	BM1	23698	75	0.0655	4.91	DM 2	5915	484	5832	484	A1	FAIL	839.6	866.93	27.33	201350	0	-0.5	147757	7683	4478	5525
Hydra 28	S9 LED	No	244603	75	0.609	45.68		234637	30	1.2225	36.68	DM 1	3203	489	3180	489	A1	PASS	1021.6	1053.15	31.55	244603	-0.5	-0.5	228789	2724	2303	2490
Hydra 70	S10 LED	Yes	282960	75	0.6215	46.62		263755	30	1.2055	36.17	DM 1	6614	482	6614	483	A1	FAIL	1181.4	1218.30	36.90	282960	-0.5	-0.5	282843	1385	3630	3697
Rail	S11 LED	No	176280	75	0.5265	39.49		100139	75	0.269	19.93	DM 4	2930	500			A2	PASS	734.9	758.98	24.08	176280	0	0	176280	5211	6498	7198
Rail	S12 LED	No	173694	75	0.5225	39.19		94781	75	0.2525	18.83	DM 4	2937	496			A2	PASS	723.8	747.83	24.05	173694	0	-0.5	171892	6694	5689	3095
Hydra 28	S13 LED	No	172294	75	0.6105	45.79		160296	30	1.215	36.46	DM 1	3188	492	3169	492	A1	PASS	719.1	741.82	22.72	172297	0	-0.5	162448	4011	127.9	2702
SmartUp	S14 LED	Yes	202525	75	0.9305	69.78		53894	75	0.1905	14.18	DM 3	3184	484			A1	PASS	844.2	871.98	27.78	202525	0.5	-0.5	200818	14192	13938	12489
Hydra 70	S15 LED	No	298094	75	0.6225	46.69	BM1	276175	30	1.1875	35.62	DM 1	6482	483	6380	484	A1	FAIL	1242.6	1283.46	40.86	298094	-0.5	-0.5	213904	6576	5150	4369
CVL	S1 HAL	Yes	265120	30	8.2425	247.27	BM 2					DM 5	3109	491			A3	PASS	1105.8	1141.49	35.69	265120	0	0.5	249189	7732	11007	8015
CVL	S2 HAL	No	235968	30	8.2415	247.25	BM 1, BM 2					DM 5	3086	490			A3	PASS	983.4	1015.98	32.58	235968	-0.5	0.5	219032	9903	14979	12374
ePower	S3 HAL	Yes	255044	75	4.713	353.48						DM 5	3148	490			A3	PASS	1064.3	1098.11	33.81	255044	-1	-1	229570	33892	8464	25041
Amglo	S4 HAL	Yes	220264	75	4.8605	364.53						DM 5	3068	491			A3	PASS	917.7	948.36	30.66	220264	0.5	-0.5	214276	75137	6761	4095
ePower	S5 HAL	Yes	270328	75	4.574	343.05						DM 5	3126	490			A3	PASS	1126.6	1163.91	37.31	270328	0	0.5	267170	14765	20145	27579
Amglo	S6 HAL	No	223469	75	4.884	366.3	BM 3					DM 5	3100	491			A3	PASS	932	962.16	30.16	223469	-0.5	-1.5	139724	15439	29171	9676
Amglo	S7 HAL	No	221568	75	4.959	371.91	BM 3					DM 5	3102	491			A3	PASS	924.2	953.98	29.78	221568	0	-2	116395	23293	31831	11871
ePower	S8 HAL	No	238264	75	4.659	349.42	BM 1					DM 5	3113	490			A3	PASS	993.8	1025.86	32.06	238264	-1.5	1	179104	20994	19006	43561
CVL	S9 HAL	No	195110	30	8.295	248.85	BM 2					DM 5	3049	492			A3	PASS	813.5	840.06	26.56	195110	-1	0	189987	8344	10286	14088

Comments

- DM 1: "DIM" Mode activated by reducing source voltage to 14-30Vdc. Measurements at 30 Vdc. Output appears
- DM 2: "DIM" Mode engaged by connecting a wire to power.
- DM 3: "DIM" Mode engaged by connecting 4.5 Ohm series resistance on +75Vdc Line. Appeared to operate the same
- DM 4: "DIM" Mode engaged by connecting 15 Ohm series resistance on +75Vdc Line. Appeared to operate the same
- DM 5: Sample has continuously variable light output dependent on the source voltage.
- BM 1: FRA Points are borderline, and could potentially be met with a slight re-alignment of the sample.
- BM 2: Sample designed for 30V Source Voltage.
- BM 3: There are two local maximums near H-V with a "dead" spot in between.
- A1: Sample included a PAR56 keyed back plate, and had a flat rear surface which allowed for repeatable alignment
- A2: Sample back plate was not keyed and did not mate well with a PAR56 fixture, creating additional uncertainty in
- A3: Sample included a PAR 56 keyed back plate, however the rear surface was not smooth and added additional

Data Analysis Summary Table

cd 7.5 +V	cd @ 20 deg				cd @ 0-0 deg Corrected	cd @ 7.5 deg Corrected				cd @ 20 deg Corrected				FRA Requirements				Dim Mode			cd @ 7.5 deg								
	cd 20-H	cd 20- +H	cd 20- V	cd 20- +V	cd 0-0c	cd 7.5-Hc	cd 7.5-+Hc	cd 7.5-Vc	cd 7.5- +Vc	cd 7.5 Max	cd 20- Hc	cd 20- +Hc	cd 20- Vc	cd 20- +Vc	cd 20 Max	dH @ 0-0	dH @ 7.5 deg	dH @ 20 deg	PASS 0-0	PASS 7.5 deg	PASS 20 deg	Max cd	cdMa x H	cdMa x V	cd @ 0-0 deg	cd 7.5- H	cd 7.5- +H	cd 7.5- V	cd 7.5- +V
3638	0	1200	1087	1095	0	0	0	0	0	3867	0	0	0	0	1200	107361	867	800	YES	YES	YES	3E+05	0	0	286342	5621	2697	3349	3395
8234	0	1014	1205	1120	0	0	0	0	0	8780	0	0	0	0	1205	31009	5780	805	YES	YES	YES	24355	0	-0.5	23242	913	698.2	662.5	1047
18578	0	0	441	427.7	200291	15023	13221	13729	16304	16304	0	0	492.7	385.1	492.7	291	13304	92.7	YES	YES	YES	53189	0.5	0.5	52378	4240	4446	3458	4930
6647	638.5	0	1210	1064	208883	7457	8181	6312	7402	8181	428.4	1946	1003	1235	1946	8883	5181	1546	YES	YES	YES	22414	-0.5	1	21381	798	891	822.7	802.2
2340	547.1	0	791	813.5	0	0	0	0	0	4056	0	0	0	0	813.5	32437	1096	413.5	YES	YES	YES	2E+05	0	-0.5	212085	1459	2489	2163	2403
13519	465.1	0	450	345.6	199933	11208	14851	13718	15678	15678	0	0	404.2	395.9	404.2	-67	12678	4.2	NO	YES	YES	50168	0	0.5	50034	3830	4040	3845	3875
3853	324.4	324.4	499	469.6	172446	4137	6851	5034	5017	6851	0	0	480.9	515.4	515.4	-27554	3851	115.4	NO	YES	YES	1E+05	-1	1	96782	1850	9472	6460	1833
7330	1086	1203	1228	597.7	201350	7262	6560	5664	7174	7262	267.7	1671	1253	382.4	1671	1350	4262	1271	YES	YES	YES	23898	0	-0.5	23125	1117	826.9	707.5	872.5
2598	0	0	806	816.1	244603	5204	665.6	2349	3024	5204	993.1	314.7	780.6	828.5	993.1	44603	2204	593.1	YES	YES	YES	2E+05	-0.5	-0.5	217374	3496	2233	2361	2480
3262	285.2	542.6	1066	1048	282960	4706	4145	3314	3694	4706	1923	1736	1052	1094	1923	82960	1706	1523	YES	YES	YES	3E+05	-0.5	0	260433	3584	2461	3452	3066
3918	2708	1094	431	424.1	0	0	0	0	0	7198	0	0	0	0	2708	-23720	4198	2308	NO	YES	YES	1E+05	0	1.5	93461	360	9047	5322	1780
4031	1478	869.7	421	429.3	173694	4887	9385	5114	4063	9385	1033	963.3	422.8	427.8	1033	-26306	6385	633	NO	YES	YES	94781	-1	0.5	93240	2591	4879	3854	1766
2665	1485	1765	755	768	172297	4385	4034	2695	2684	4385	782.9	2116	760.8	787.2	2116	-27703	1385	1716	NO	YES	YES	2E+05	0	0	160296	2912	2537	2544	2477
16085	0	1186	493	460.1	202525	14800	16181	14646	14066	16181	0	0	536.1	406.5	536.1	2525	13181	136.1	YES	YES	YES	53894	-0.5	0.5	53892	4382	4406	4090	3622
2962	0	3652	1099	1050	298094	4167	5571	3771	3291	5571	1383	0	1079	1103	1383	98094	2571	983	YES	YES	YES	3E+05	-0.5	-1	227261	4588	2366	4001	2752
5122	410.2	2492	676	642.2	265120	6001	7217	8336	5591	8336	1393	1135	718.3	638.3	1393	65120	5536	993	YES	YES	YES								
8082	2487	592.4	679	652	237968	11727	15353	10396	10505	15353	1645	335.1	648.8	664.6	1645	35968	12353	1245	YES	YES	YES								
24363	861.5	721.1	1193	1306	255044	23552	18336	21256	31327	31327	884.9	0	1099	1289	1289	55044	28327	889	YES	YES	YES								
9144	1685	3696	834	723.2	220264	67207	7299	5341	6917	67207	795.7	2129	850.5	702.9	2129	20264	64207	1729	YES	YES	YES								
19357	0	191.3	1114	1140	270328	17946	17806	27123	19518	27123	0	1478	1120	1147	1478	70328	24123	1078	YES	YES	YES								
5494	1076	2410	864	693.2	223469	7556	60961	6616	6485	60961	772.1	0	832.1	703.5	832.1	23469	57961	432.1	YES	YES	YES								
7054	204.7	1211	973	743.5	221568	10357	76839	9345	7237	76839	0	953.3	960.8	733.4	960.8	21568	73839	560.8	YES	YES	YES								
18093	1461	1227	1097	1183	238264	24105	12900	25498	27439	27439	1391	432.1	925.2	1340	1391	38264	24439	991	YES	YES	YES								
8757	0	833.3	619	599.4	195110	8906	10379	9789	17071	17071	718.4	928.9	550.8	659.6	928.9	-4890	14071	528.9	NO	YES	YES								

cd @ 20 deg				deg	cd @ 7.5 deg Corrected					cd @ 20 deg Corrected					FRA Requirements					
cd 20-H	cd 20+H	cd 20-V	cd 20+V	cd 0-0c	cd 7.5-Hc	cd 7.5+Hc	cd 7.5-Vc	cd 7.5+Vc	cd 7.5 Max	cd 20-Hc	cd 20+Hc	cd 20-Vc	cd 20+Vc	cd 20 Max	diff @ 0-0	diff @ 7.5 deg	diff @ 20 deg	PASS 0-0	PASS 7.5 deg	PASS 20 deg
0	1597	1025	1004	0	0	0	0	0	5621	0	0	0	0	1597	86542	2621	1197	YES	YES	YES
242	52.54	145.2	128.1	24355	714.5	962.5	681.2	1016	1016	0	213.9	144	128.4	213.9	-175645	-1984	-186.1	NO	NO	NO
0	151.3	130.6	109.1	53189	4595	4224	4004	4330	4595	179.3	289.1	144	93.73	289.1	-146811	1595	-110.9	NO	YES	NO
74.65	144.8	144.8	138.4	22414	837.2	998.7	795.4	885	998.7	76.99	149.5	117	141.9	149.5	-177586	-2001.3	-250.5	NO	NO	NO
0	2676	744.2	714.5	216156	3120	55.85	2152	2407	3120	1085	1740	730	736.8	1740	16156	120	1340	YES	YES	YES
91.2	261.7	124.2	90.8	50168	4159	3673	3841	3850	4159	250	53.84	125	90.63	250	-149832	1159	-150	NO	YES	NO
1183	225.2	313.6	253.8	104371	3051	2257	3268	3369	3369	38.38	201.8	279	308.6	308.6	-95629	369	-91.4	NO	YES	NO
108.7	108.7	145.7	76.05	23698	709.9	550.8	726	886	886	136.8	174.2	144	72.86	174.2	-176302	-2114	-225.8	NO	NO	NO
478.4	899.5	746.9	778.7	234637	2397	3379	2099	2871	3379	993.1	1367	735	797.2	1367	34637	379	967	YES	YES	YES
402.2	2437	969.4	970.3	263755	846.7	3911	3074	3469	3911	612.7	1736	971	994.4	1736	63755	911	1336	YES	YES	YES
0	710.5	279.8	232.4	100139	3770	2812	6793	1749	6793	897.3	757.2	282	232.1	897.3	-99861	3793	497.3	NO	YES	YES
0	326	255.9	222.4	94781	3011	3805	2227	3218	3805	0	0	225	261.2	261.2	-105219	805	-138.8	NO	YES	NO
0	0	725.9	716.1	0	0	0	0	0	2912	0	0	0	0	725.9	-39704	-88	325.9	NO	NO	YES
312.5	109.4	144.9	105.9	53894	4518	4037	3563	4282	4518	0	373.2	132	119.4	373.2	-146106	1518	-26.8	NO	YES	NO
0	2202	1030	989.4	276175	3442	2927	3525	3058	3525	1266	330.7	1001	1004	1266	76175	525	866	YES	YES	YES

Appendix G. Illuminance Maps of Test Samples

Illuminance Maps of LED Samples at Ground Height in Bright Mode

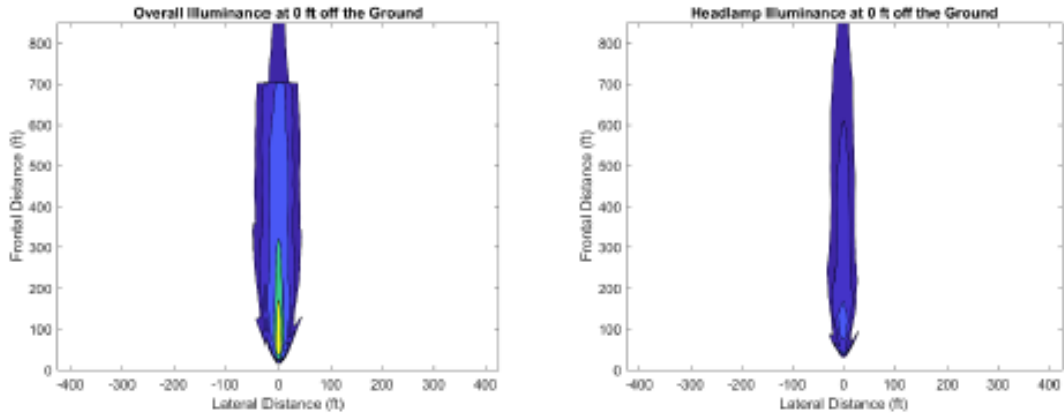

Figure 1. Illuminance map of J.W. Speaker (S2 LED)

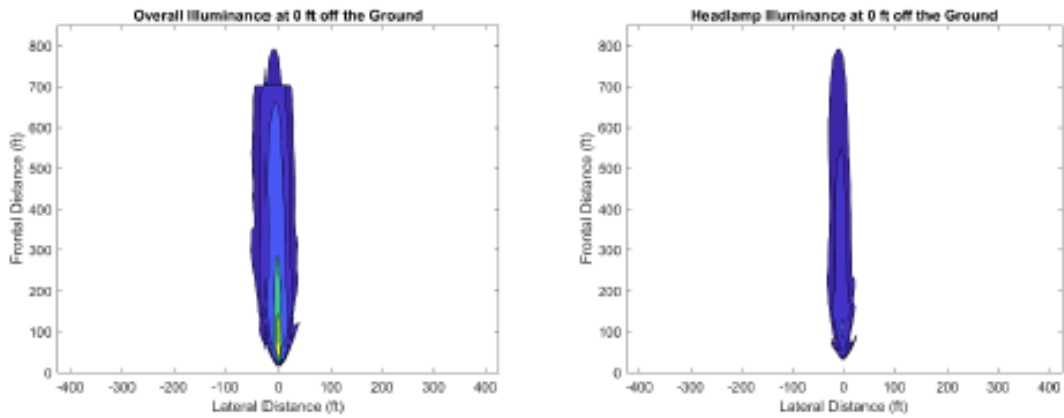

Figure 2. Illuminance map of J.W. Speaker (S4 LED)

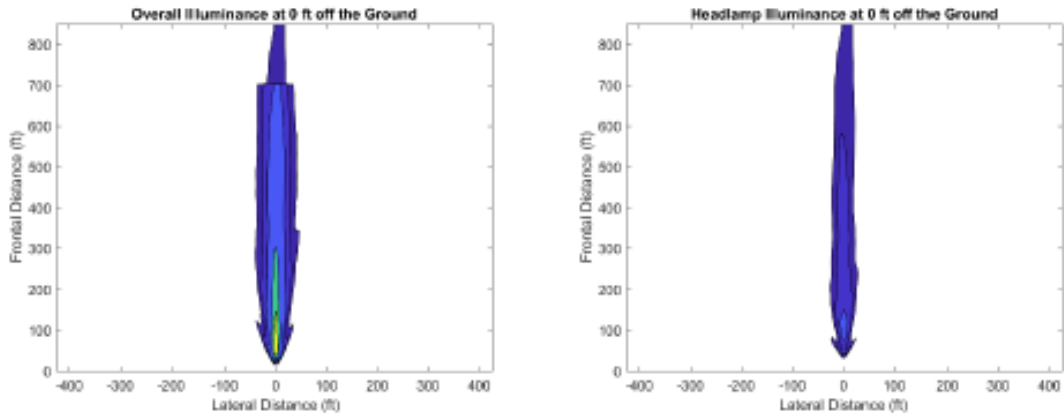

Figure 3. Illuminance map of J.W. Speaker (S8 LED)

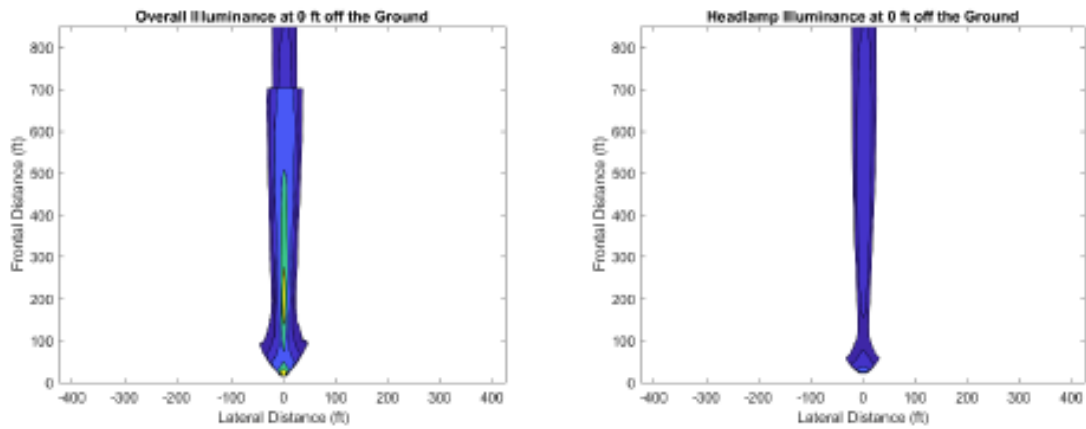

Figure 4. Illuminance map of Hydra-Tech 2800K (S5 LED)

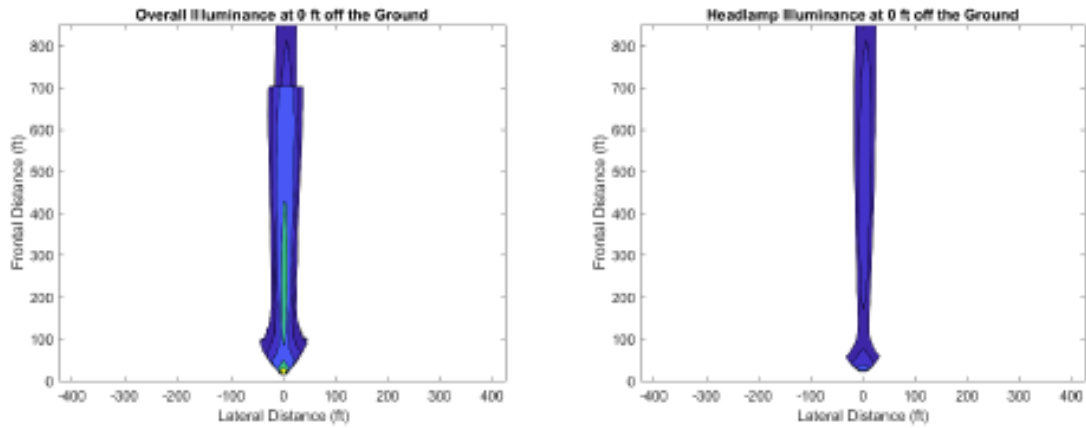

Figure 5. Illuminance map of Hydra-Tech 2800K (S9 LED)

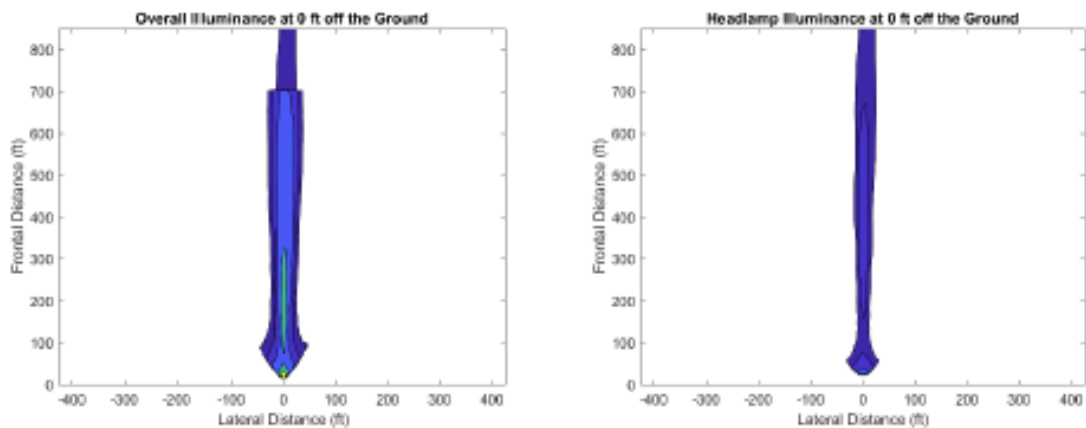

Figure 6. Illuminance map of Hydra-Tech 2800K (S13 LED)

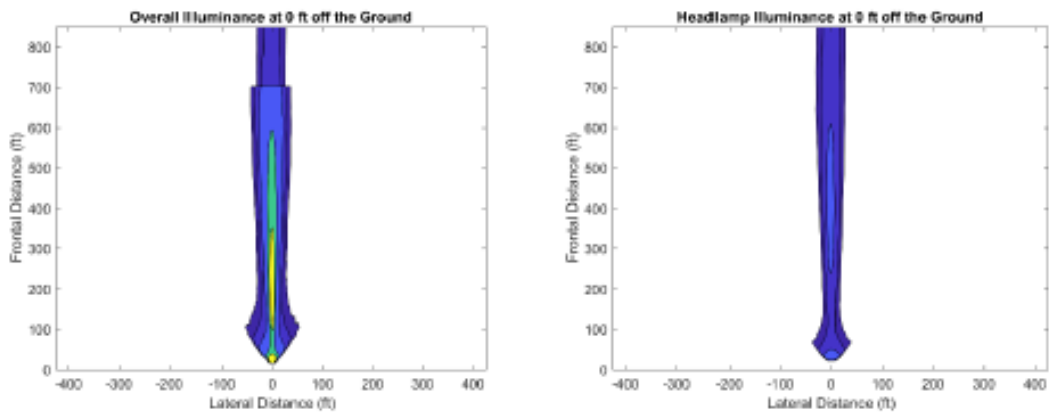

Figure 7. Illuminance map of Hydra-Tech 7000K (S1 LED)

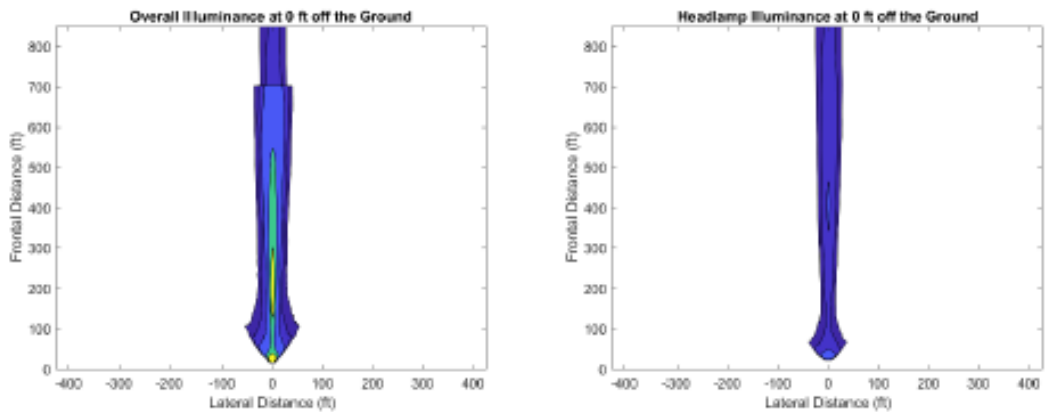

Figure 8. Illuminance map of Hydra-Tech 7000K (S10 LED)

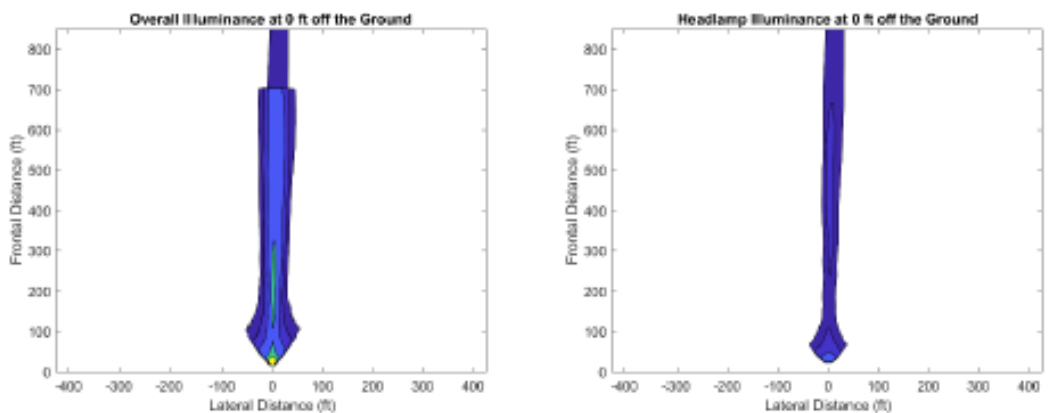

Figure 9. Illuminance map of Hydra-Tech 7000K (S15 LED)

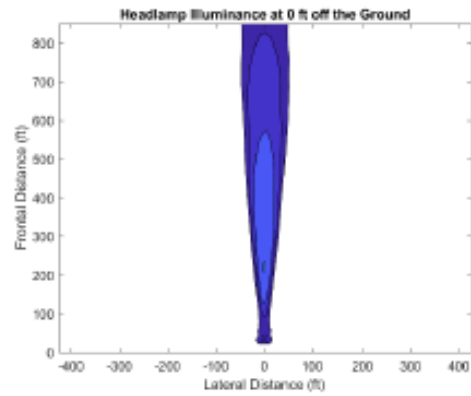
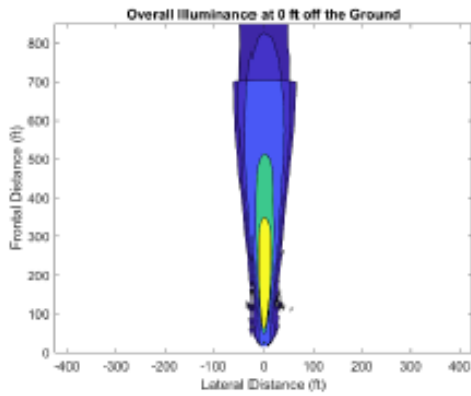

Figure 10. Illuminance map of Railhead/Divvali (S7 LED)

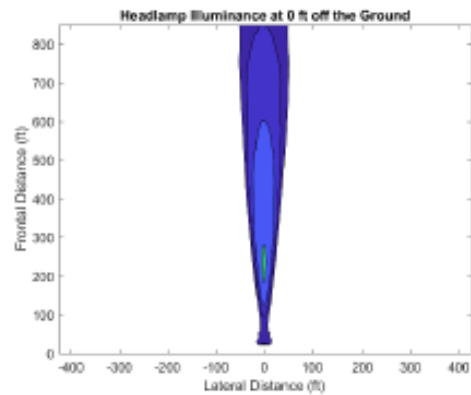
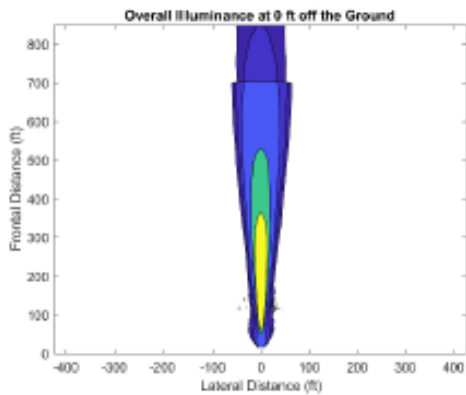

Figure 11. Illuminance map of Railhead/Divvali (S11 LED)

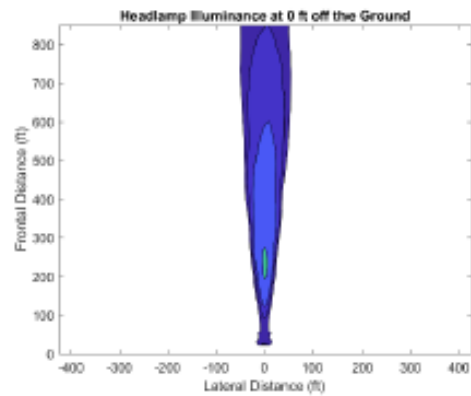
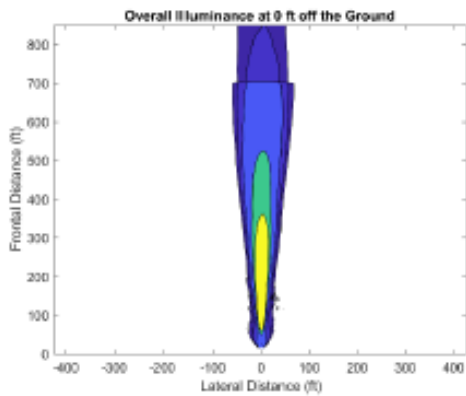

Figure 12. Illuminance map of Railhead/Divvali (S12 LED)

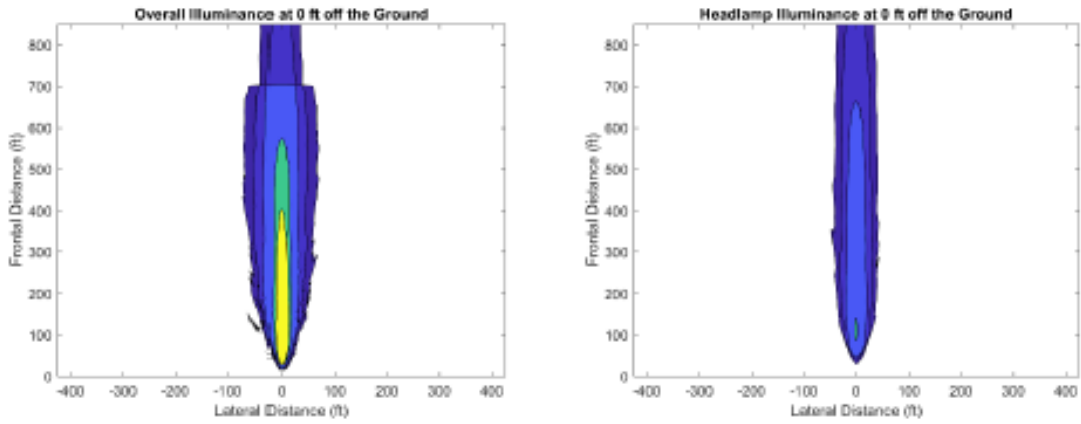

Figure 13. Illuminance map of Smart Light Source (S3 LED)

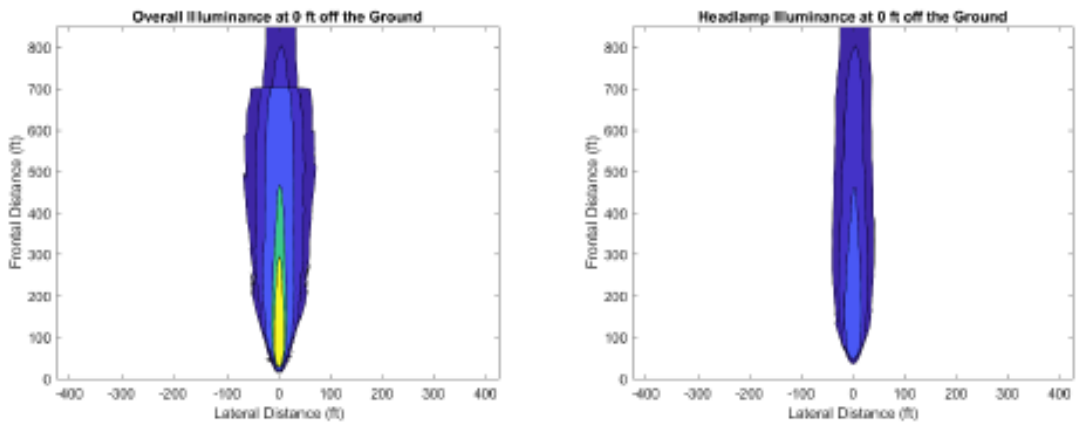

Figure 14. Illuminance map of Smart Light Source (S6 LED)

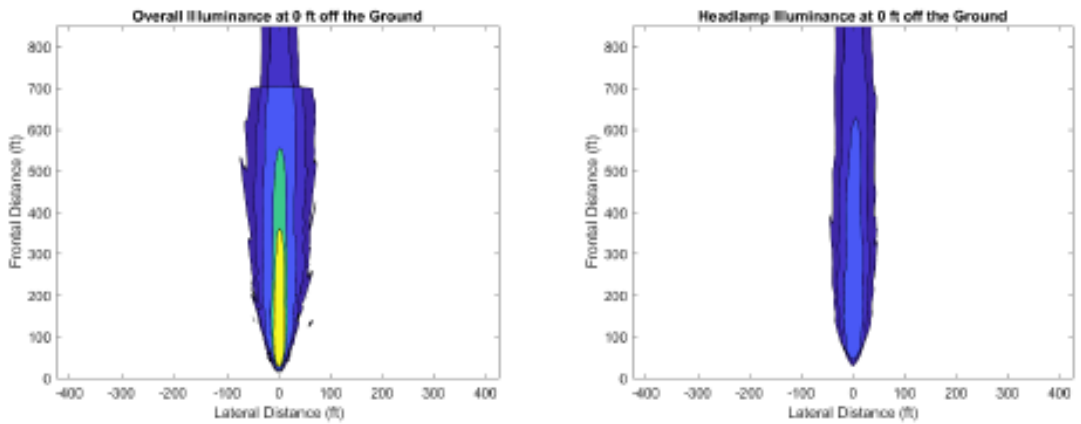

Figure 15. Illuminance map of Smart Light Source (S14 LED)

2 Feet High, Bright Mode

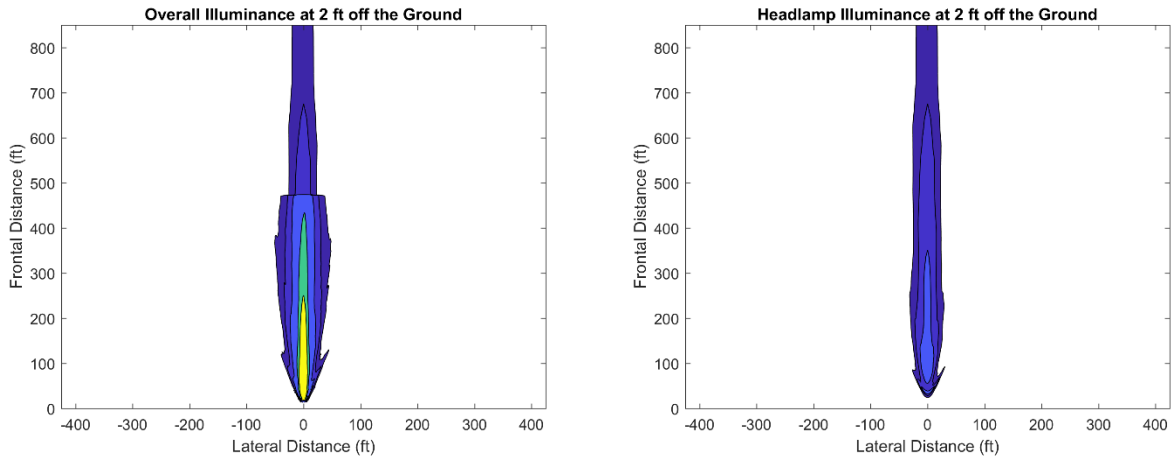

Figure 1. Illuminance map of J.W. Speaker (S2 LED)

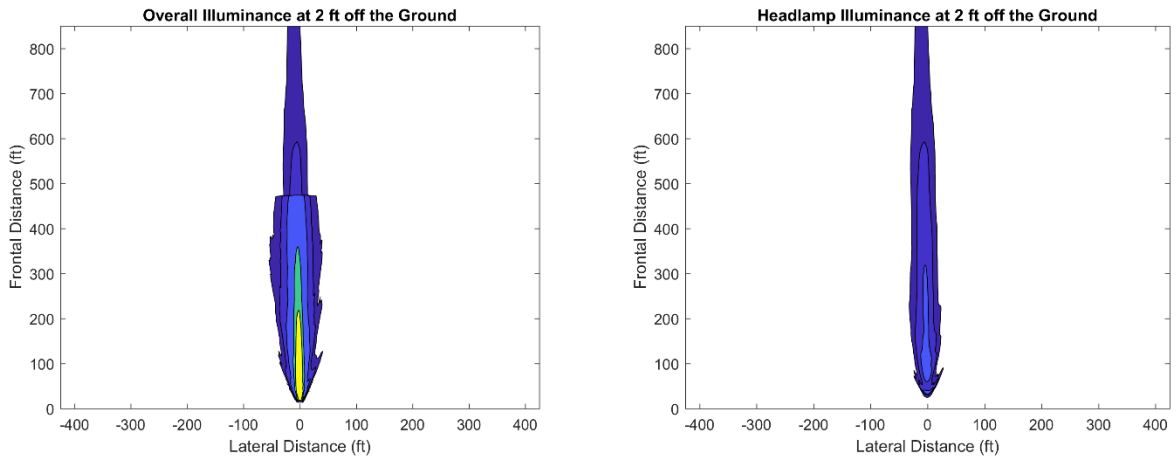

Figure 2. Illuminance map of J.W. Speaker (S4 LED)

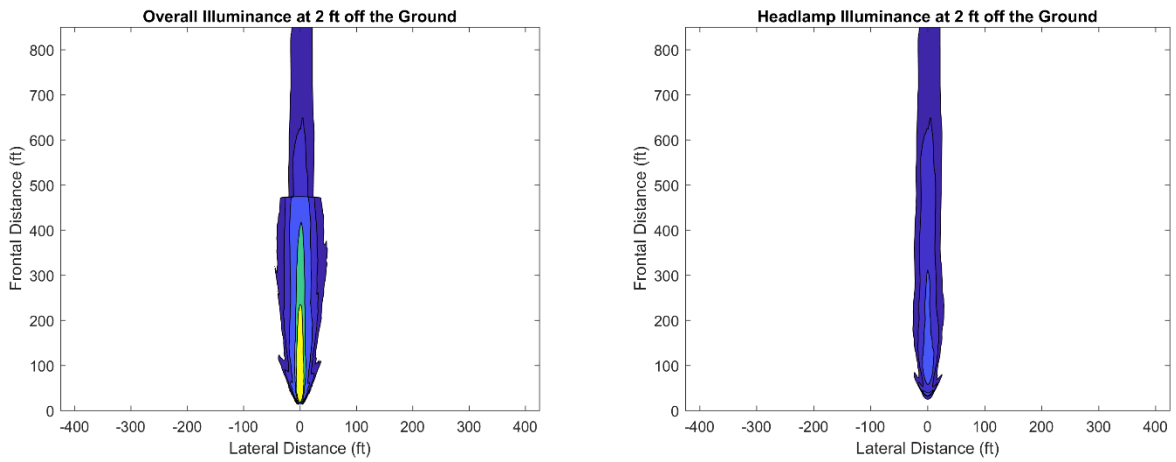

Figure 3. Illuminance map of J.W. Speaker (S8 LED)

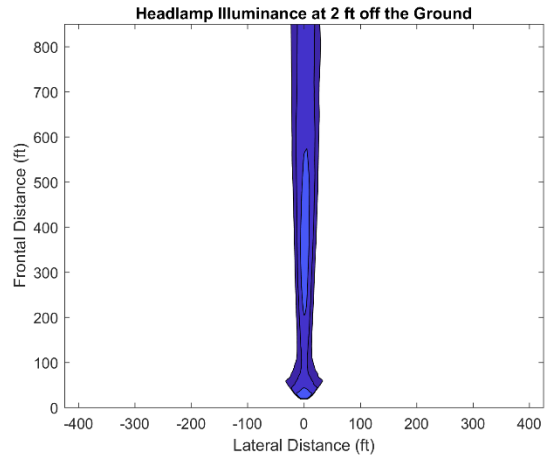
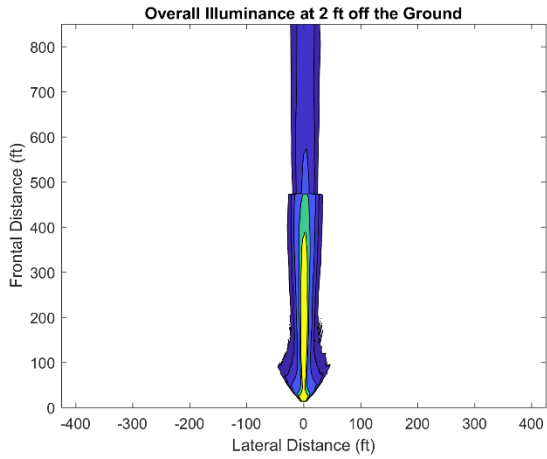

Figure 4. Illuminance map of Hydra-Tech 2800K (S5 LED)

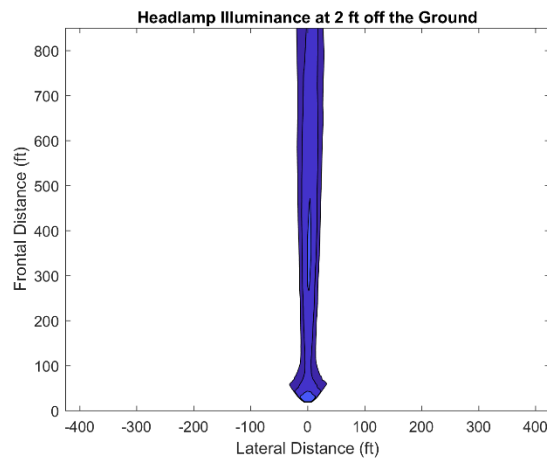
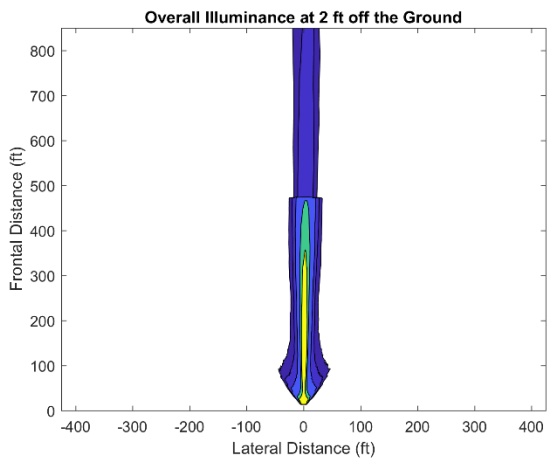

Figure 5. Illuminance map of Hydra-Tech 2800K (S9 LED)

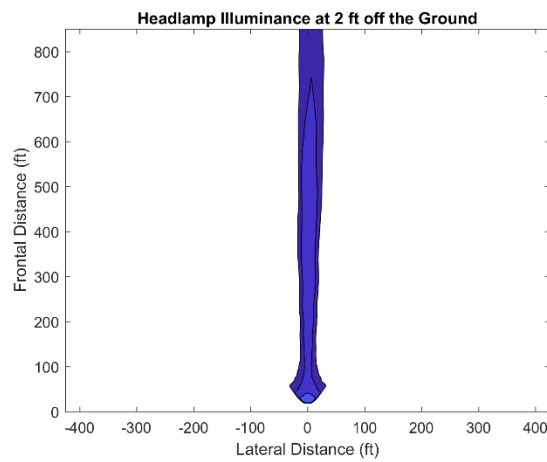
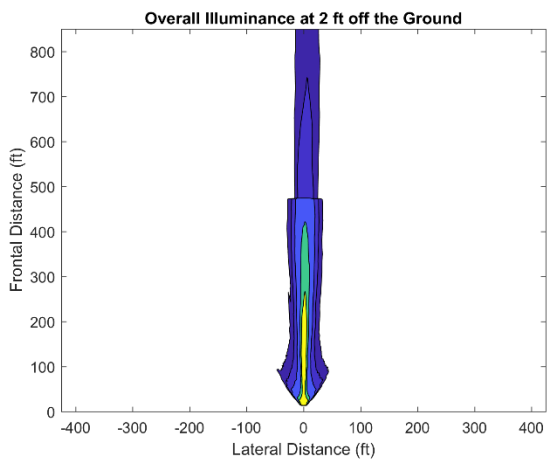

Figure 6. Illuminance map of Hydra-Tech 2800K (S13 LED)

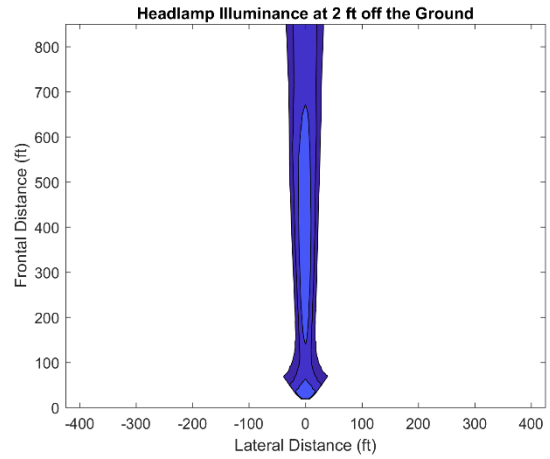
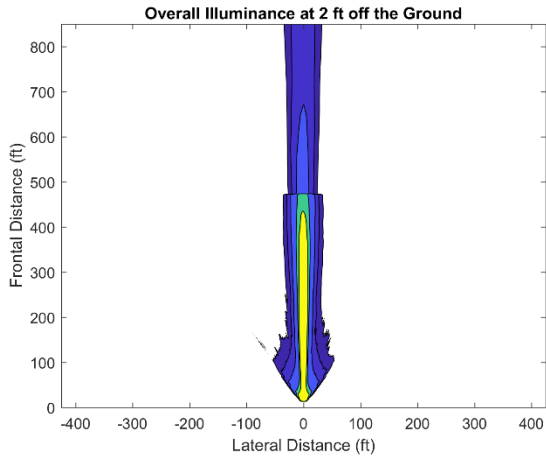

Figure 7. Illuminance map of Hydra-Tech 7000K (S1 LED)

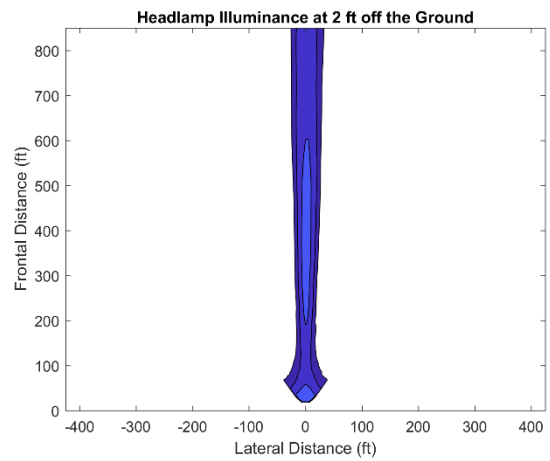
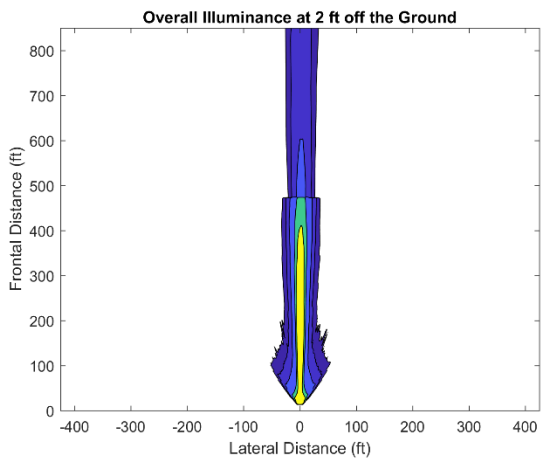

Figure 8. Illuminance map of Hydra-Tech 7000K (S10 LED)

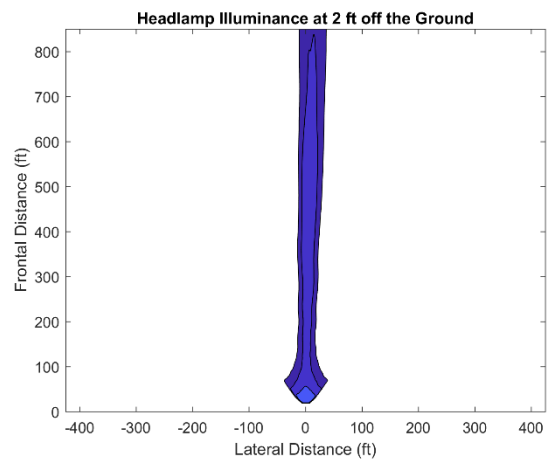
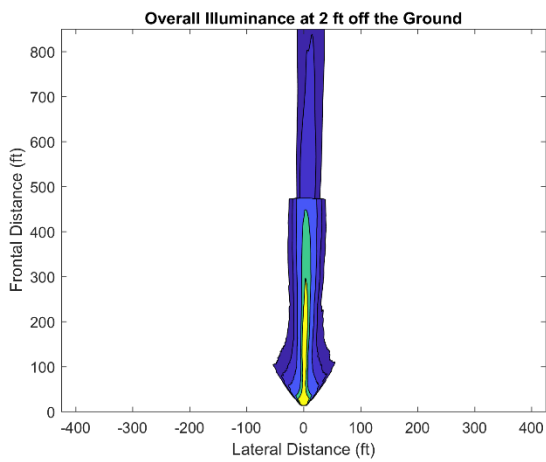

Figure 9. Illuminance map of Hydra-Tech 7000K (S15 LED)

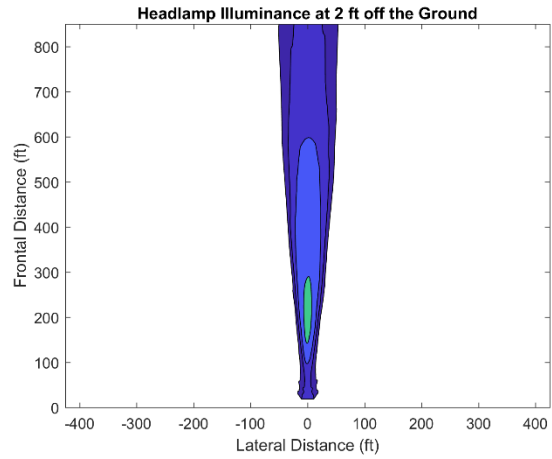
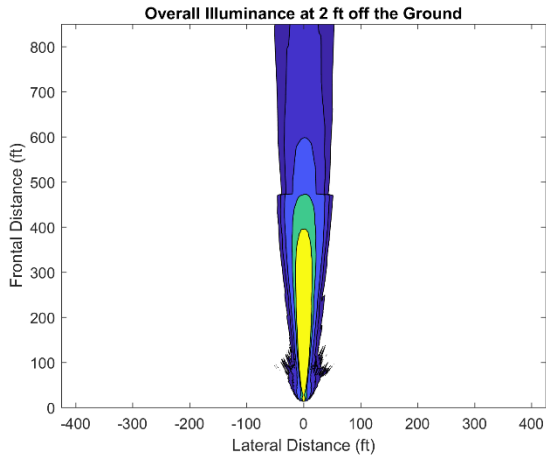

Figure 10. Illuminance map of Railhead/Divvali (S7 LED)

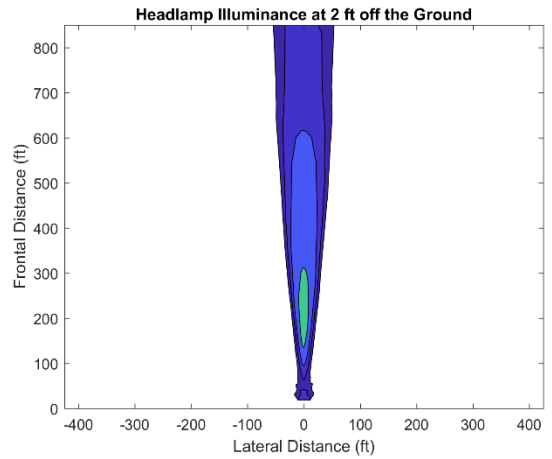
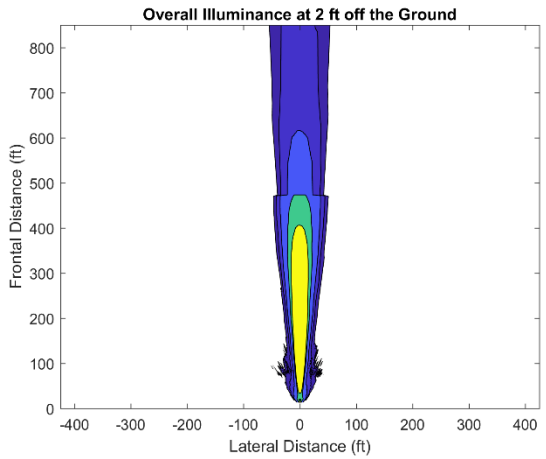

Figure 11. Illuminance map of Railhead/Divvali (S11 LED)

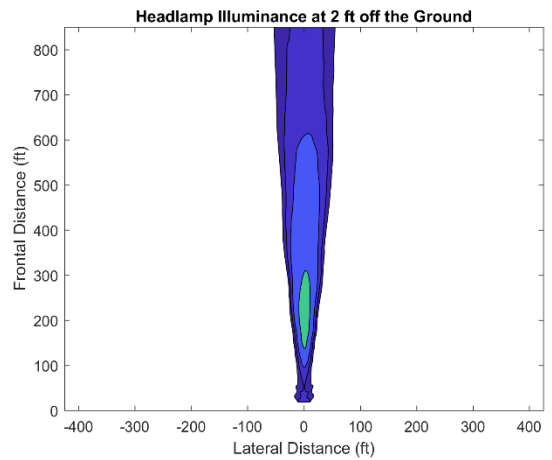
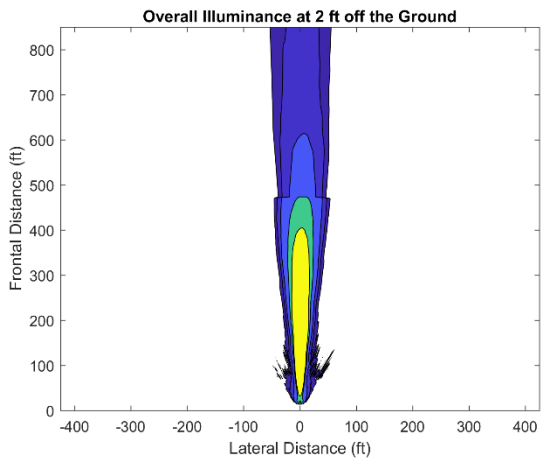

Figure 12. Illuminance map of Railhead/Divvali (S12 LED)

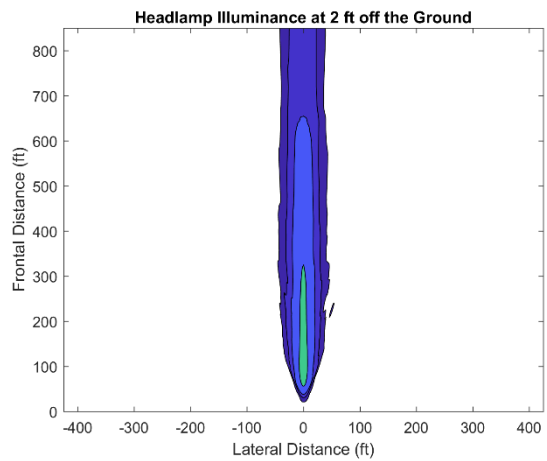
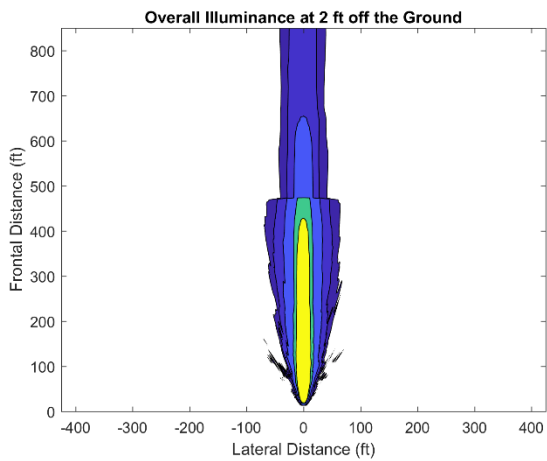

Figure 13. Illuminance map of Smart Light Source (S3 LED)

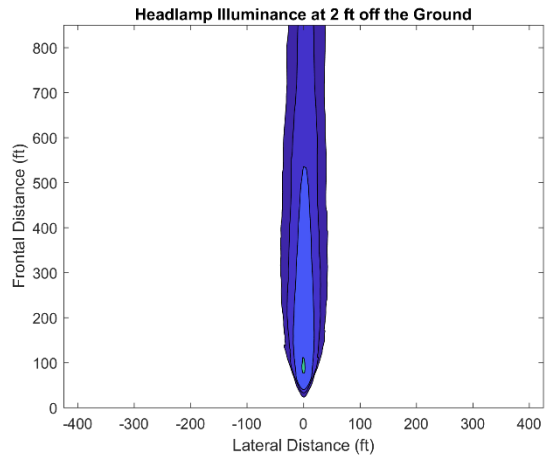
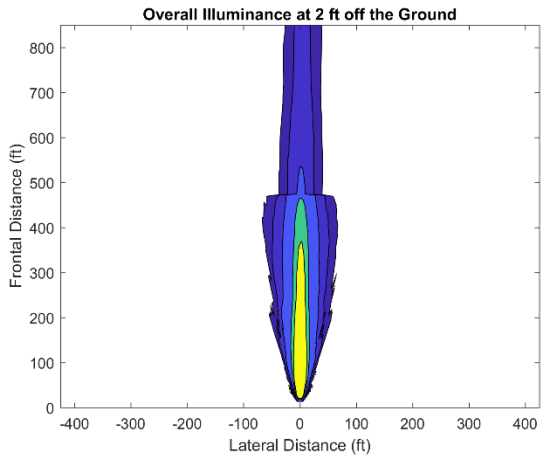

Figure 14. Illuminance map of Smart Light Source (S6 LED)

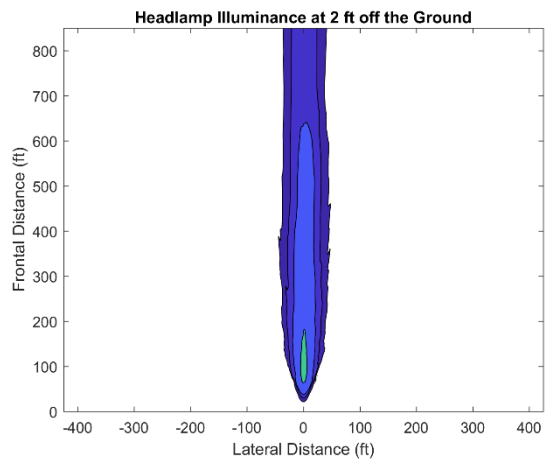
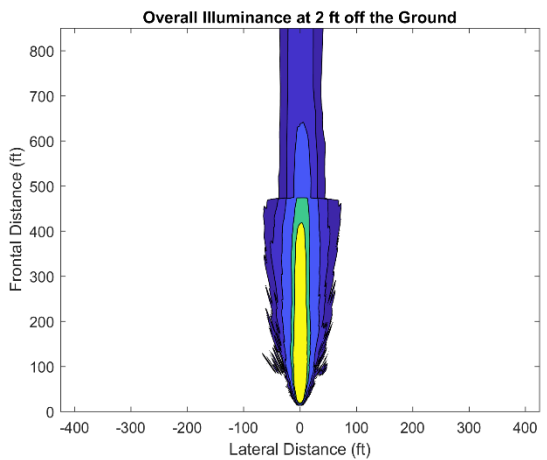

Figure 15. Illuminance map of Smart Light Source (S14 LED)

4 Feet High, Bright Mode

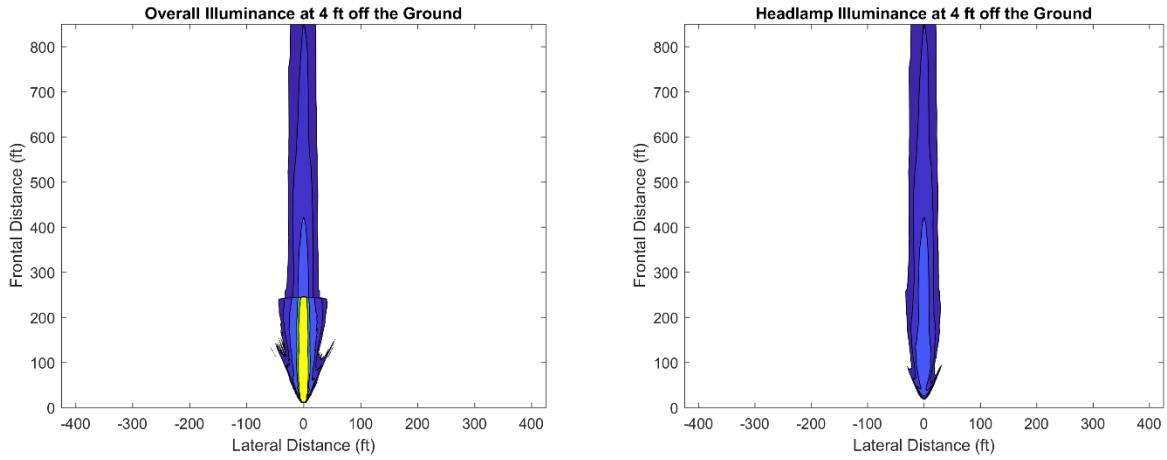

Figure 1. Illuminance map of J.W. Speaker (S2 LED)

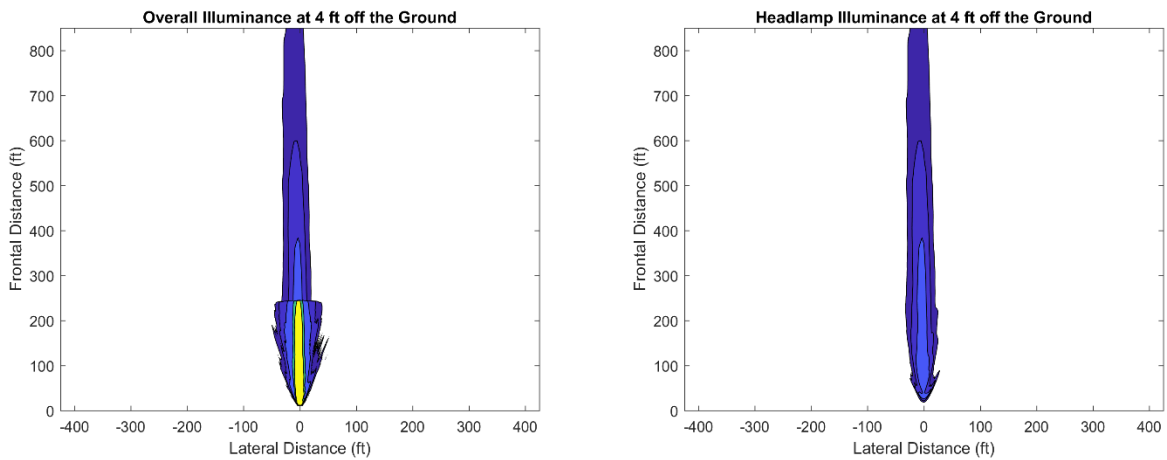

Figure 2. Illuminance map of J.W. Speaker (S4 LED)

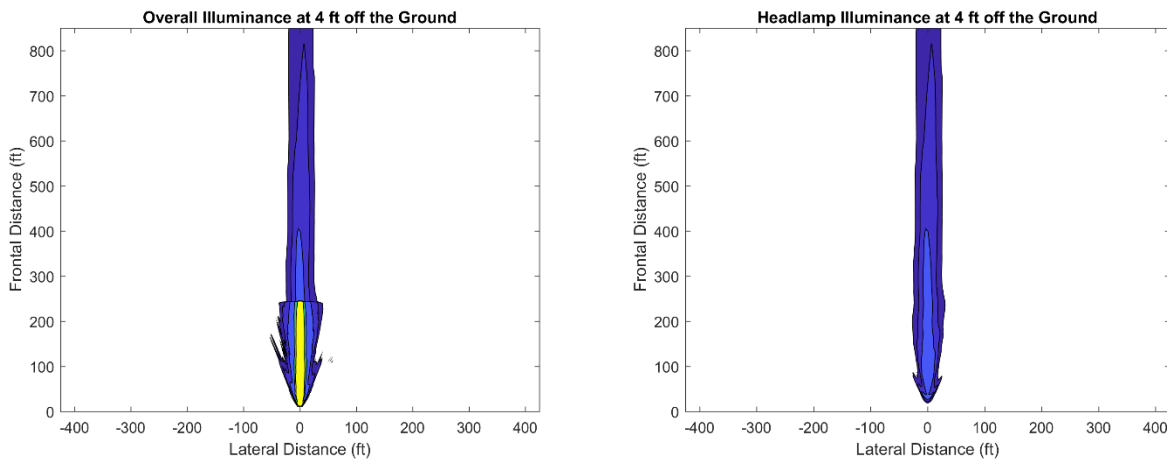

Figure 3. Illuminance map of J.W. Speaker (S8 LED)

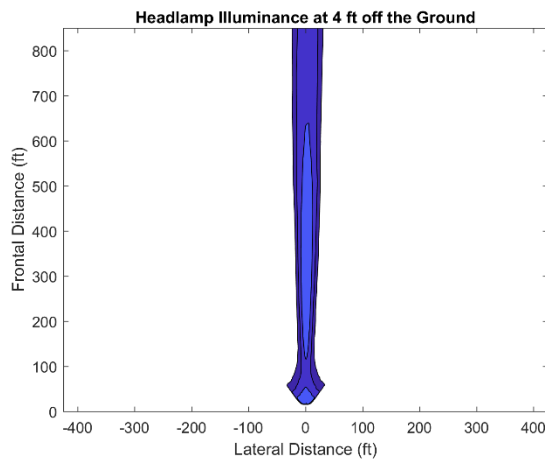
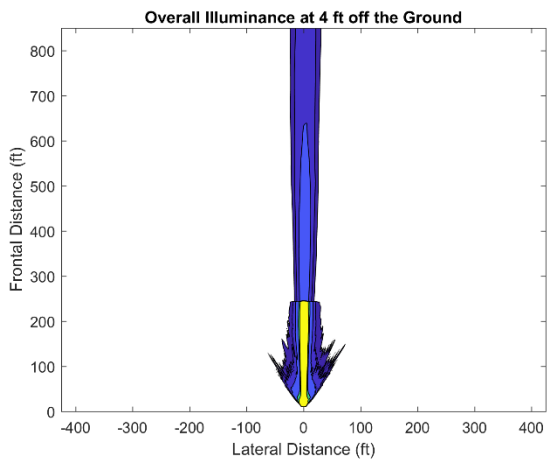

Figure 4. Illuminance map of Hydra-Tech 2800K (S5 LED)

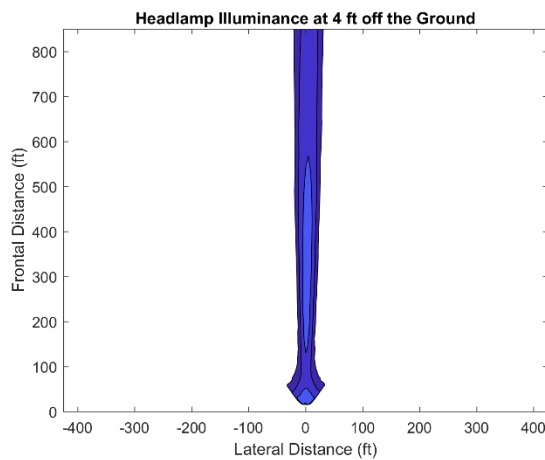
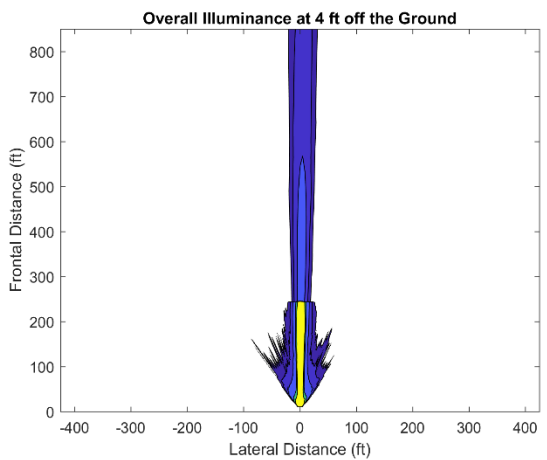

Figure 5. Illuminance map of Hydra-Tech 2800K (S9 LED)

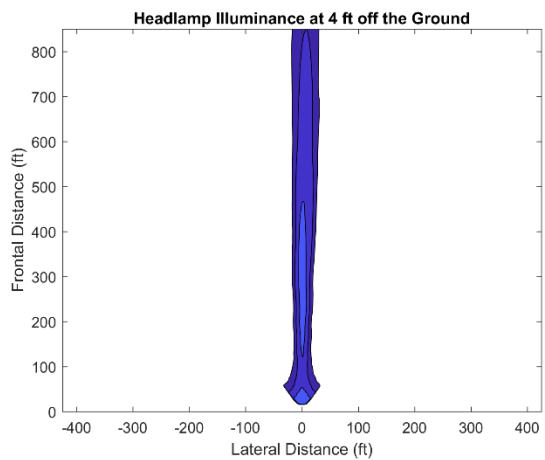
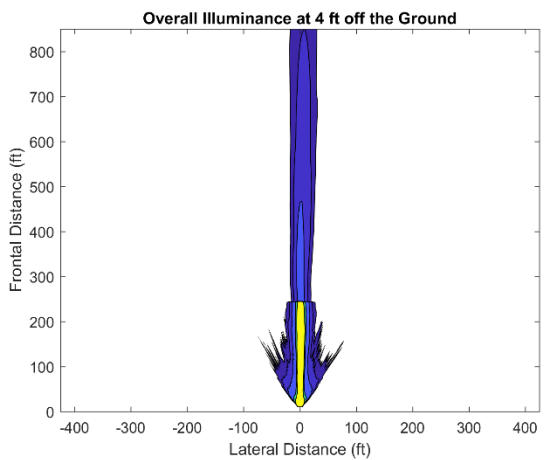

Figure 6. Illuminance map of Hydra-Tech 2800K (S13 LED)

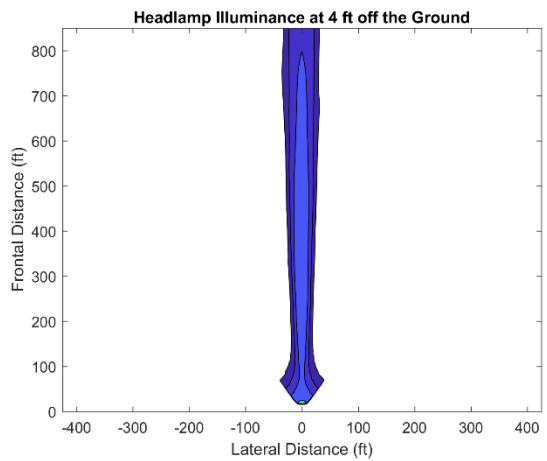
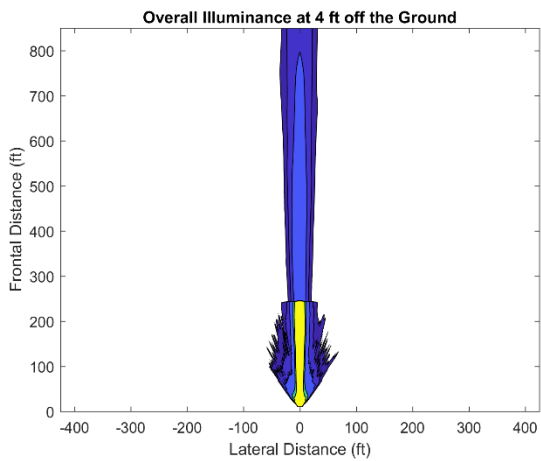

Figure 7. Illuminance map of Hydra-Tech 7000K (S1 LED)

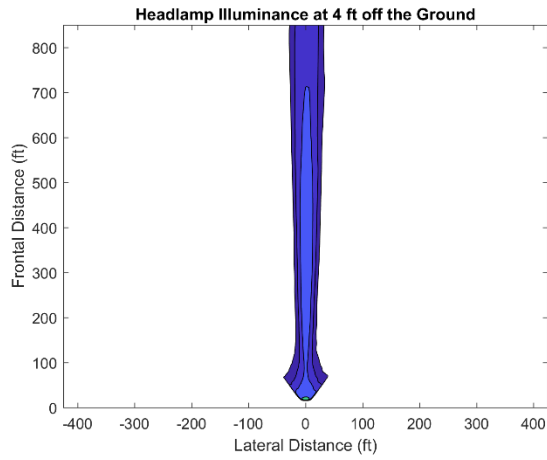
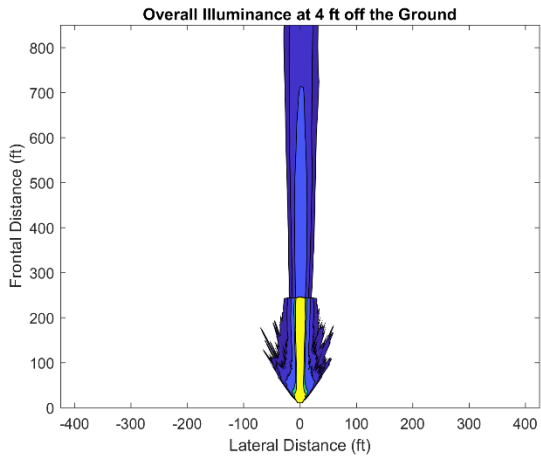

Figure 8. Illuminance map of Hydra-Tech 7000K (S10 LED)

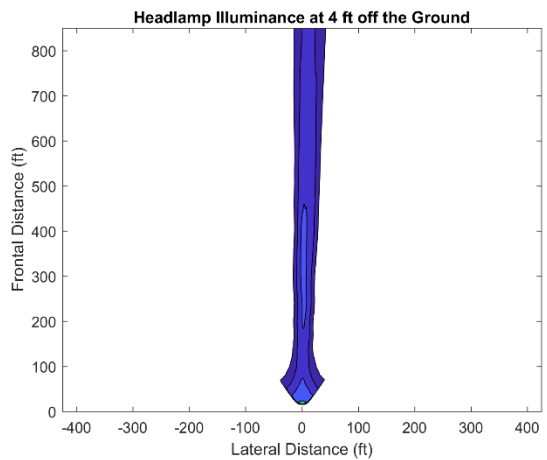
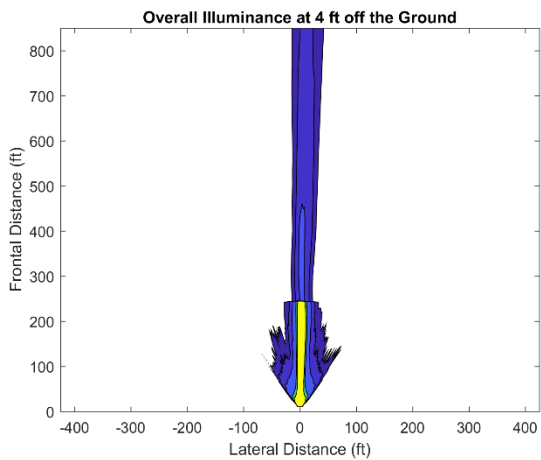

Figure 9. Illuminance map of Hydra-Tech 7000K (S15 LED)

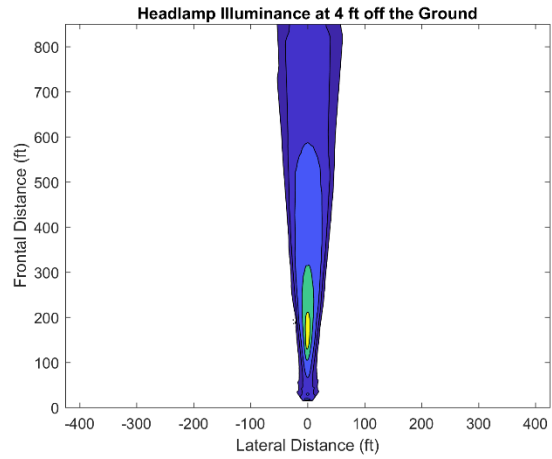
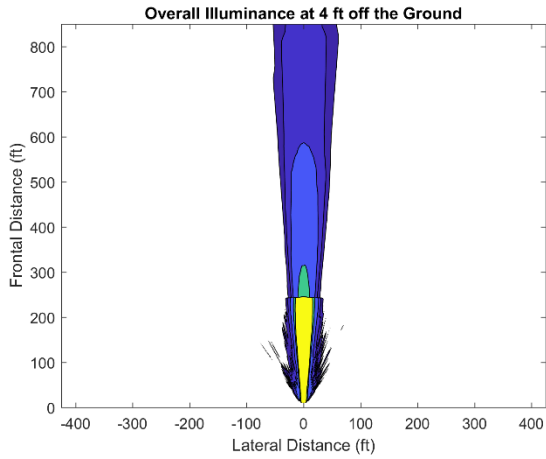

Figure 10. Illuminance map of Railhead/Divvali (S7 LED)

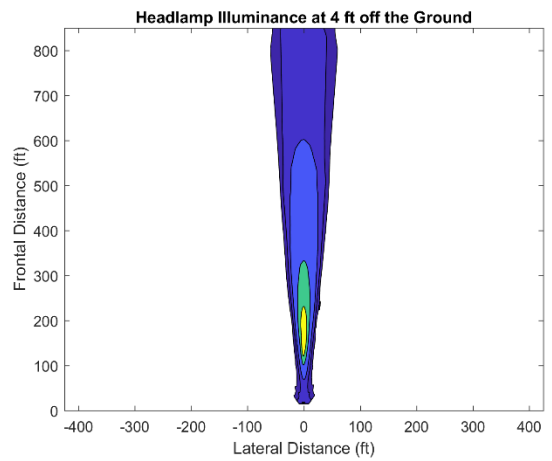
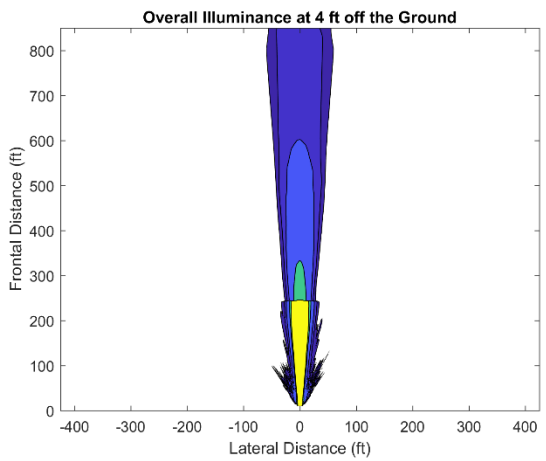

Figure 11. Illuminance map of Railhead/Divvali (S11 LED)

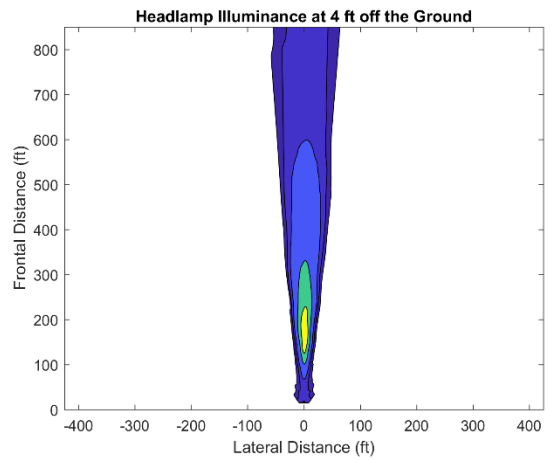
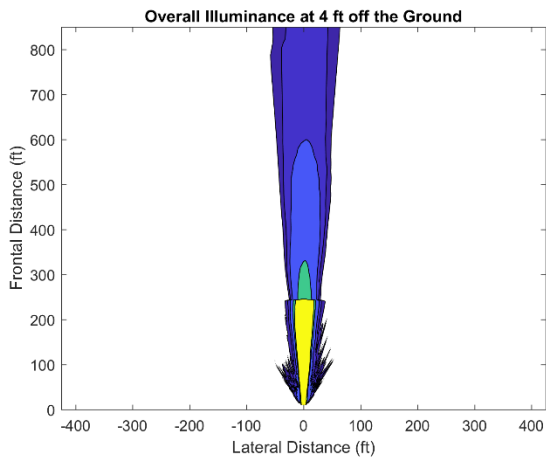

Figure 12. Illuminance map of Railhead/Divvali (S12 LED)

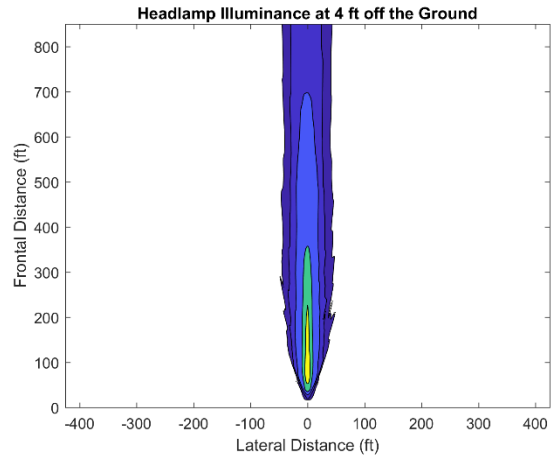
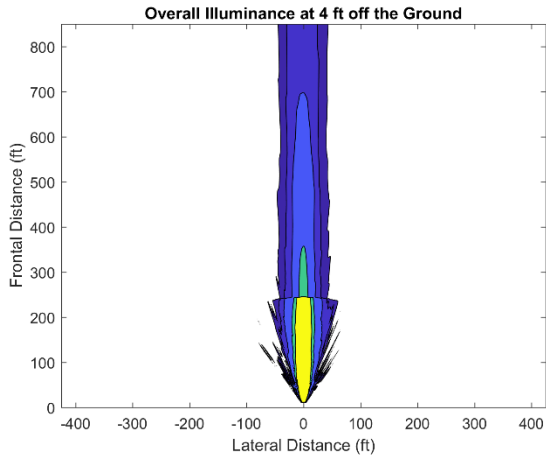

Figure 13. Illuminance map of Smart Light Source (S3 LED)

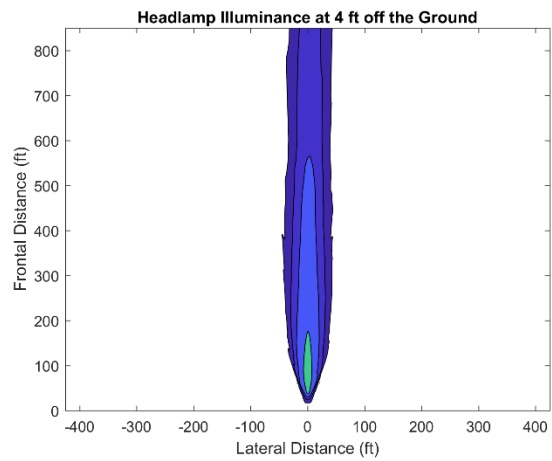
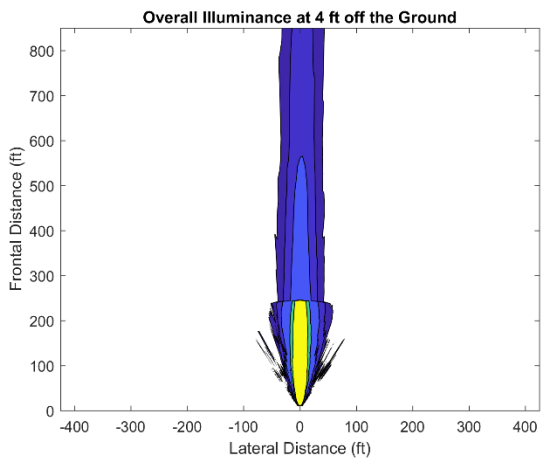

Figure 14. Illuminance map of Smart Light Source (S6 LED)

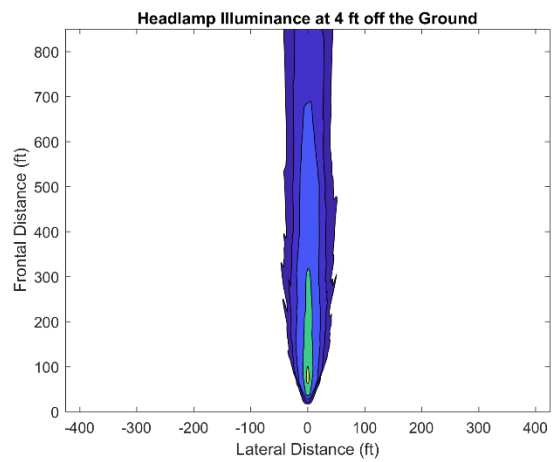
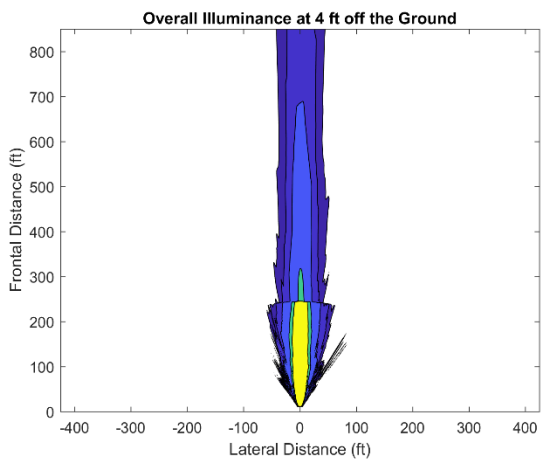

Figure 15. Illuminance map of Smart Light Source (S14 LED)

Ground Height, Dim Mode

Illuminance Maps of LED Samples at Ground Height in Dim Mode

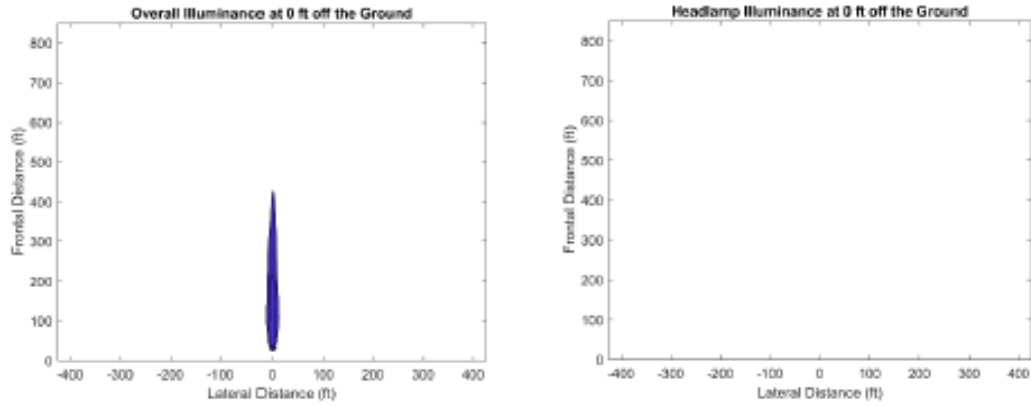

Figure 1. Illuminance map of J.W. Speaker (S2 LED)

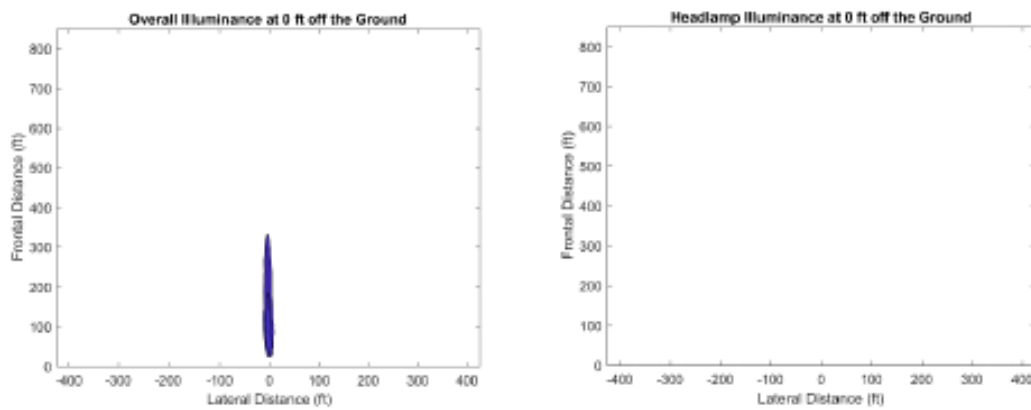

Figure 2. Illuminance map of J.W. Speaker (S4 LED)

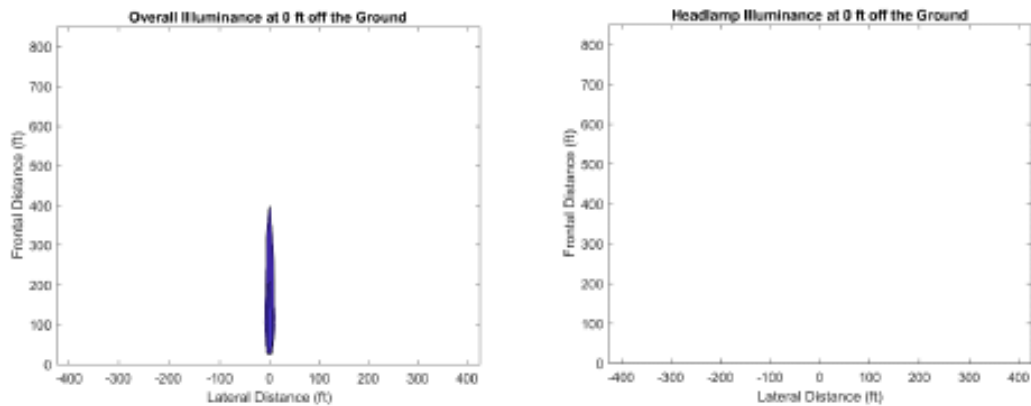

Figure 3. Illuminance map of J.W. Speaker (S8 LED)

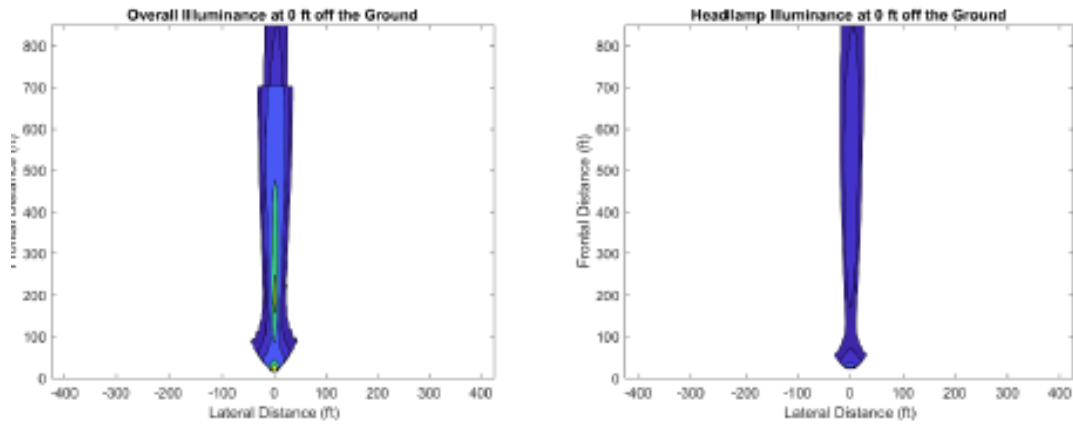

Figure 4. Illuminance map of Hydra-Tech 2800K (S5 LED)

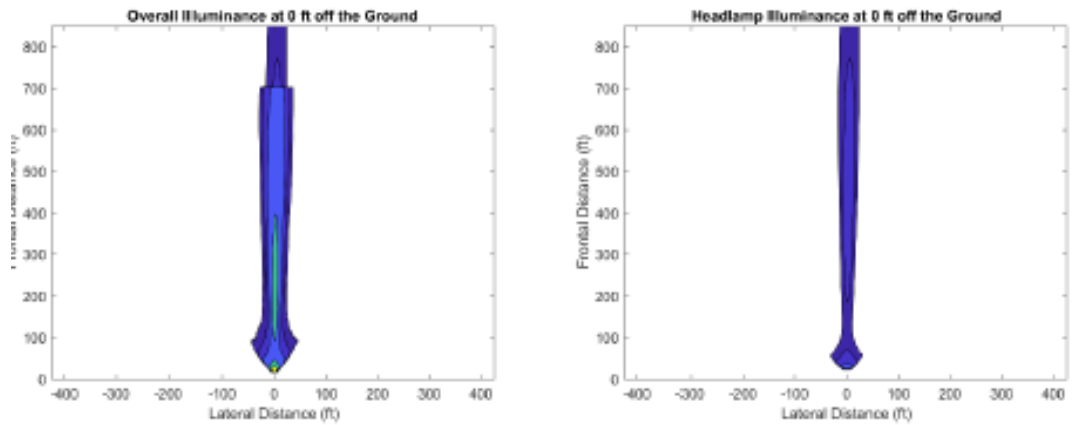

Figure 5. Illuminance map of Hydra-Tech 2800K (S9 LED)

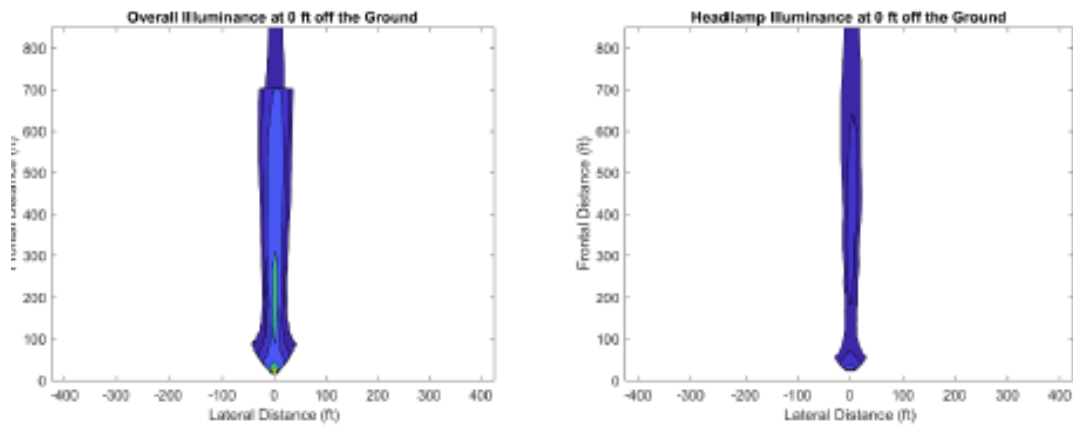

Figure 6. Illuminance map of Hydra-Tech 2800K (S13 LED)

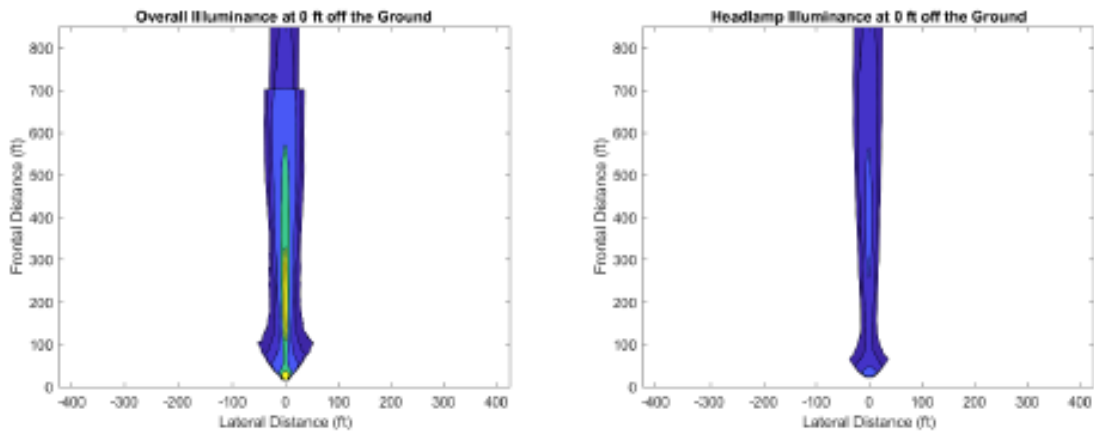

Figure 7. Illuminance map of Hydra-Tech 7000K (S1 LED)

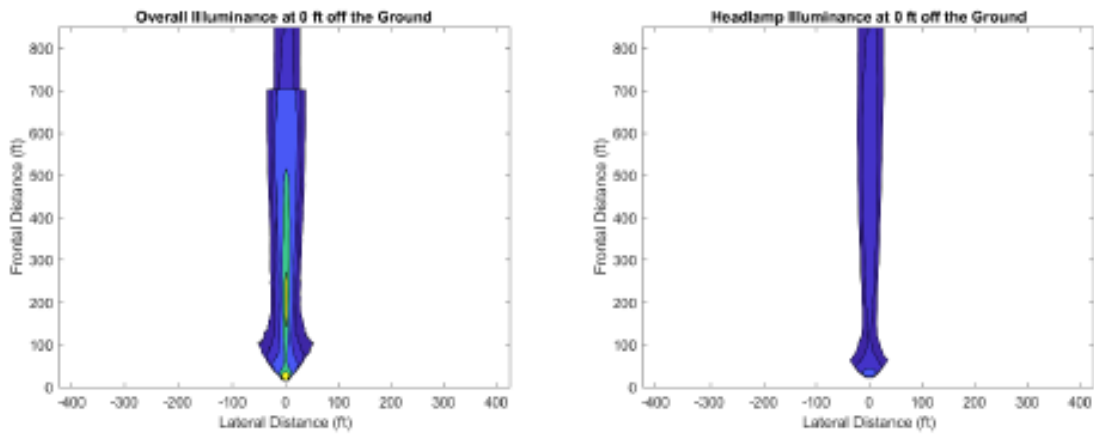

Figure 8. Illuminance map of Hydra-Tech 7000K (S10 LED)

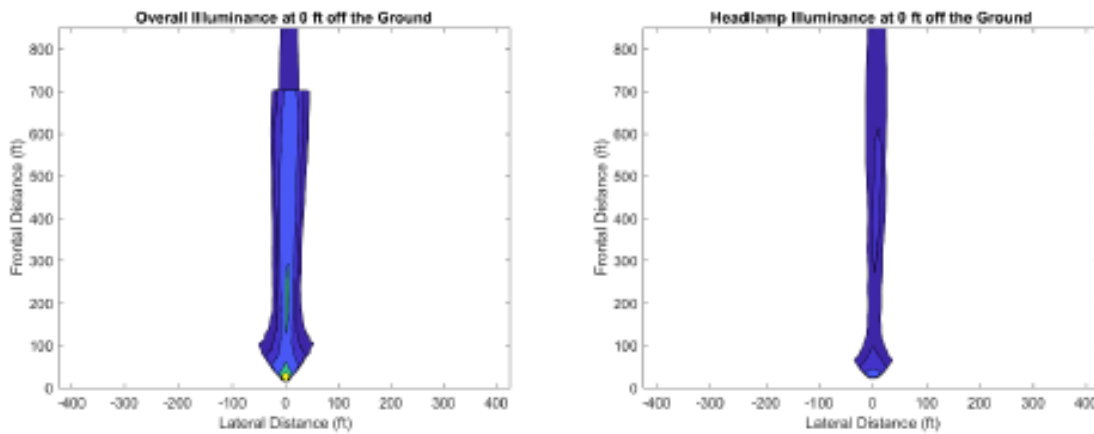

Figure 9. Illuminance map of Hydra-Tech 7000K (S15 LED)

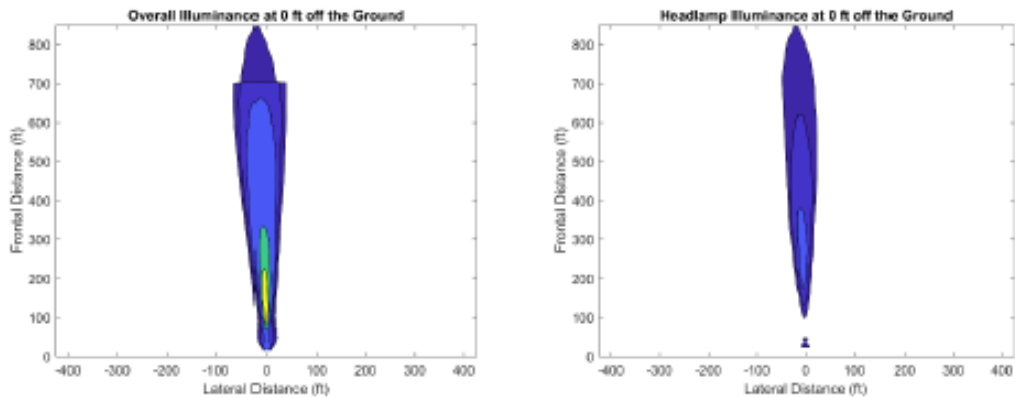

Figure 10. Illuminance map of Railhead/Divvali (S7 LED)

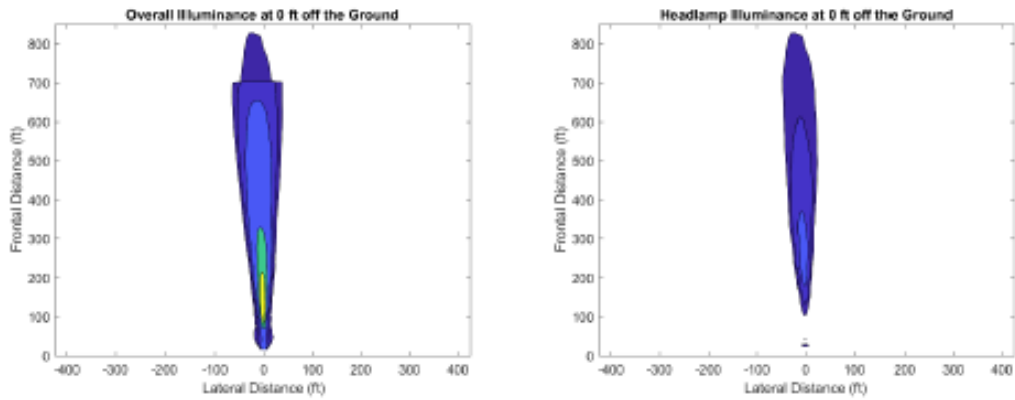

Figure 11. Illuminance map of Railhead/Divvali (S11 LED)

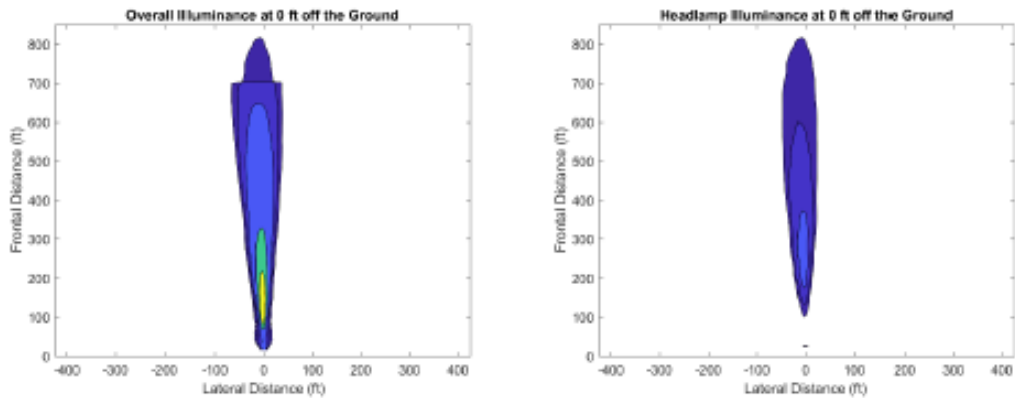

Figure 12. Illuminance map of Railhead/Divvali (S12 LED)

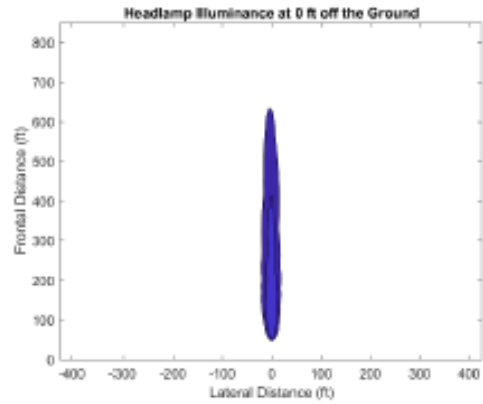
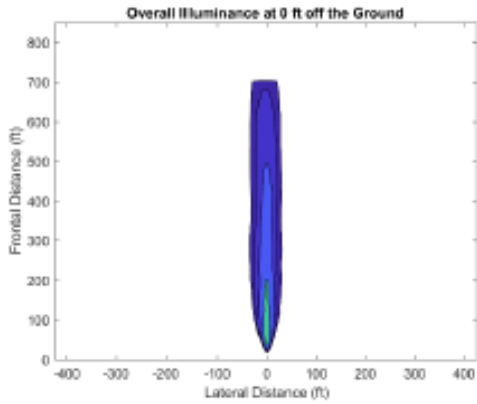

Figure 13. Illuminance map of Smart Light Source (S3 LED)

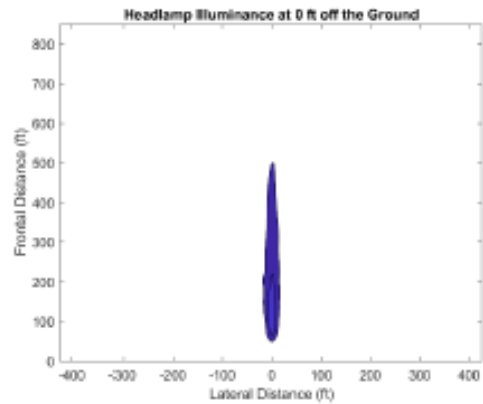
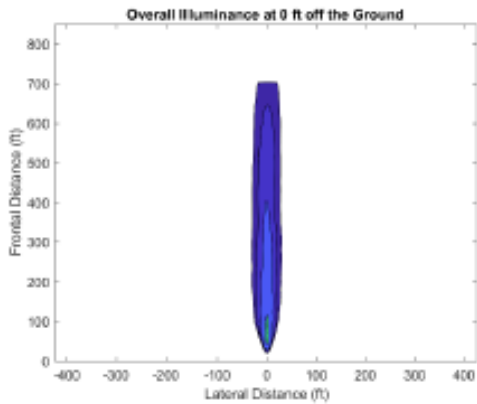

Figure 14. Illuminance map of Smart Light Source (S6 LED)

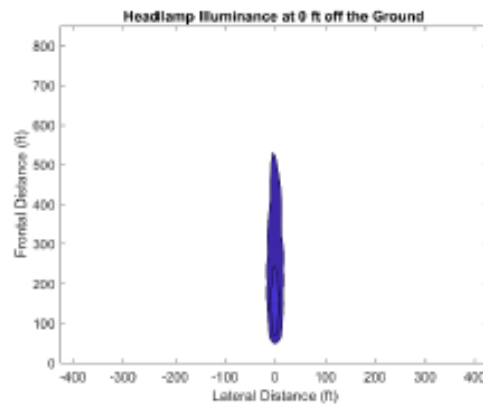
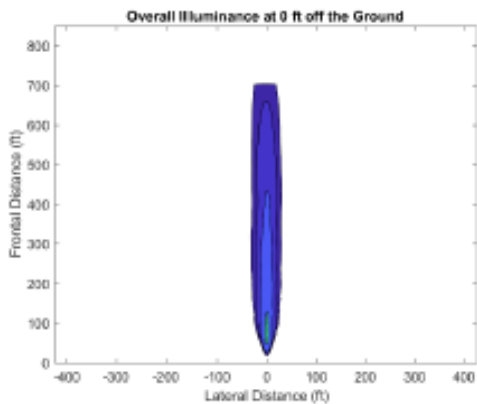

Figure 15. Illuminance map of Smart Light Source (S14 LED)

2 Feet High, Dim Mode

Illuminance Maps of LED Samples at 2 ft Height from the Ground in Dim Mode

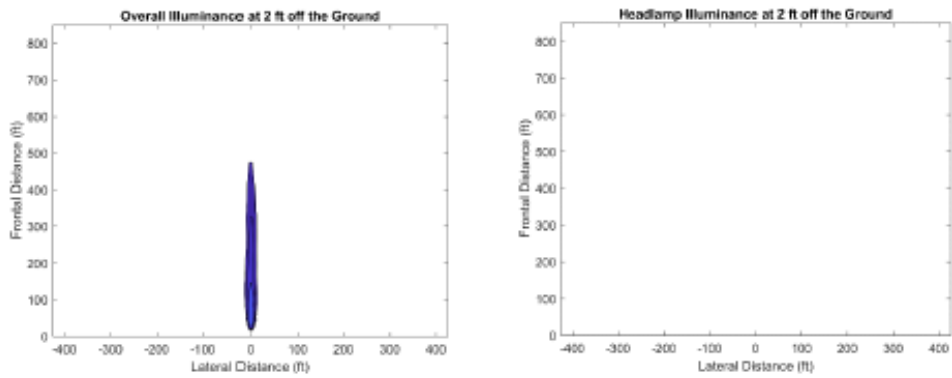

Figure 1. Illuminance map of J.W. Speaker (S2 LED)

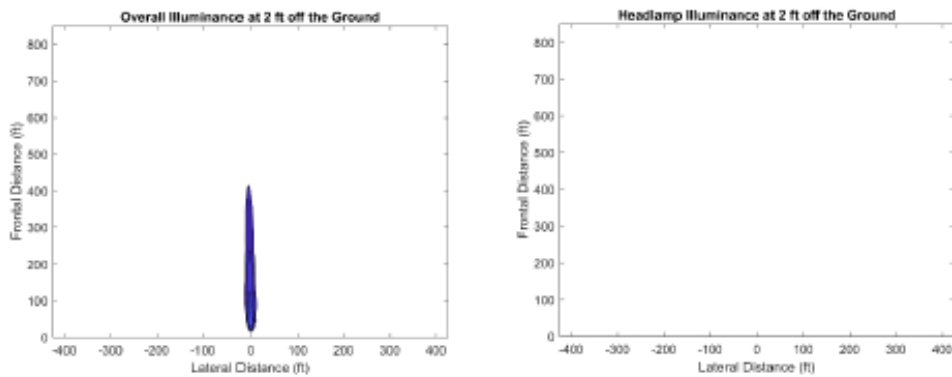

Figure 2. Illuminance map of J.W. Speaker (S4 LED)

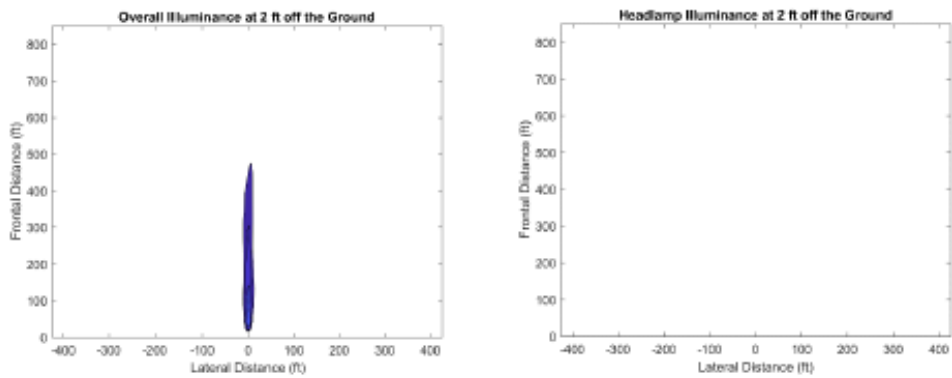

Figure 3. Illuminance map of J.W. Speaker (S8 LED)

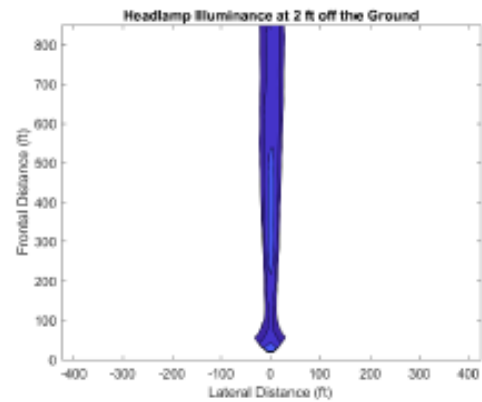
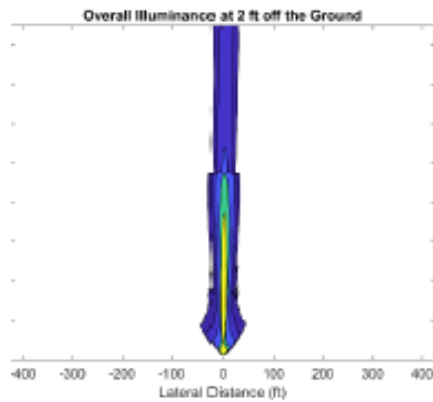

Figure 4. Illuminance map of Hydra-Tech 2800K (S5 LED)

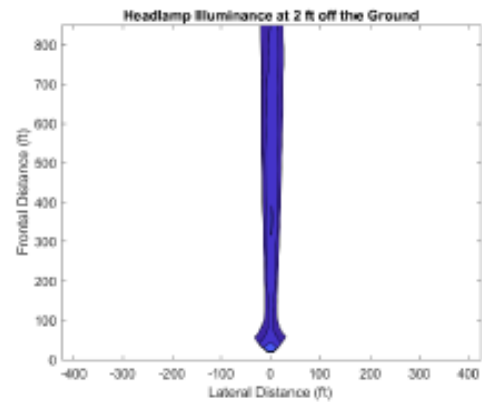
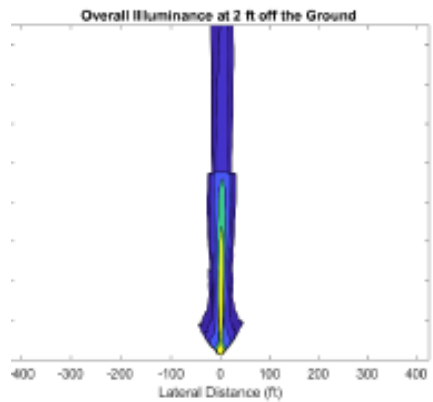

Figure 5. Illuminance map of Hydra-Tech 2800K (S9 LED)

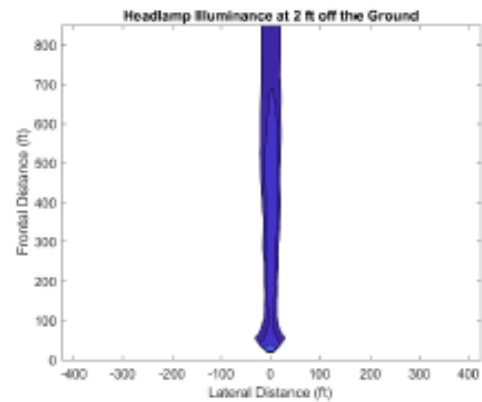
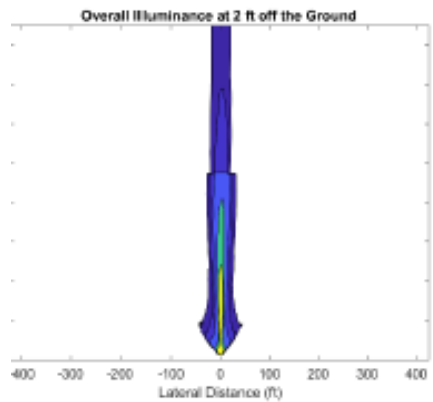

Figure 6. Illuminance map of Hydra-Tech 2800K (S13 LED)

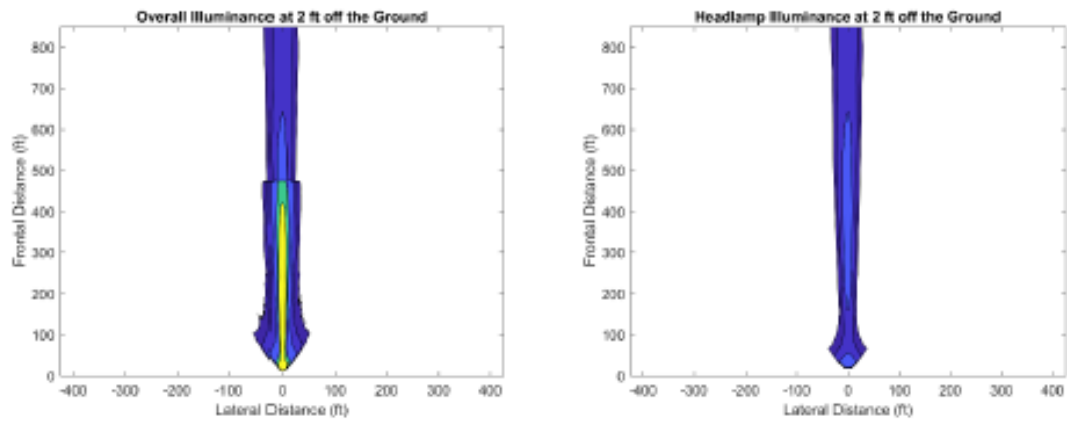

Figure 7. Illuminance map of Hydra-Tech 7000K (S1 LED)

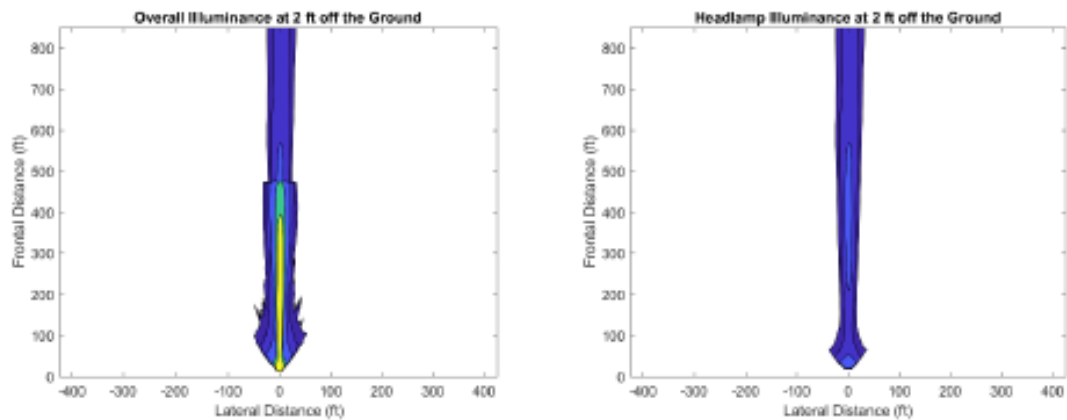

Figure 8. Illuminance map of Hydra-Tech 7000K (S10 LED)

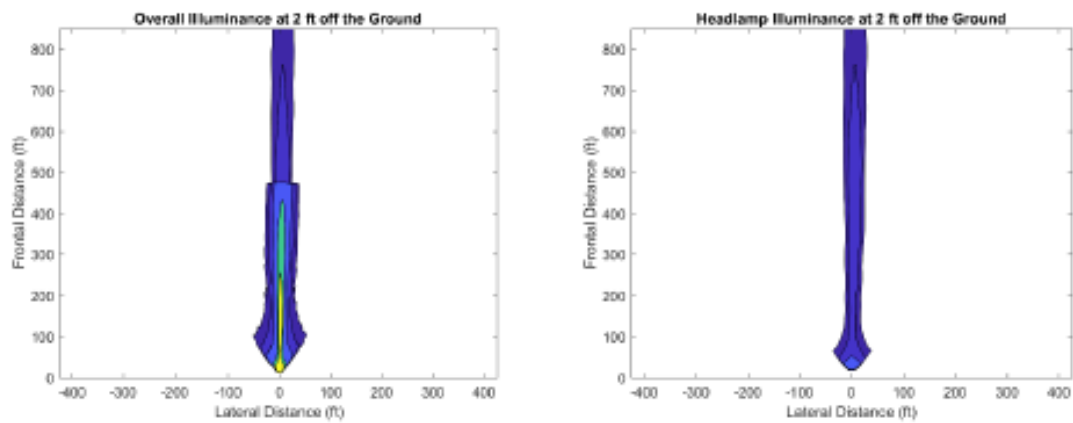

Figure 9. Illuminance map of Hydra-Tech 7000K (S15 LED)

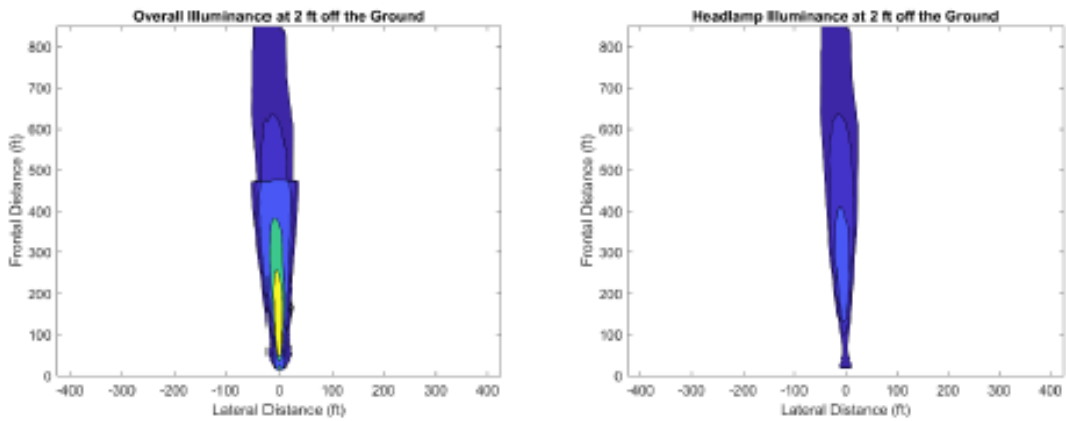

Figure 10. Illuminance map of Railhead/Divvali (S7 LED)

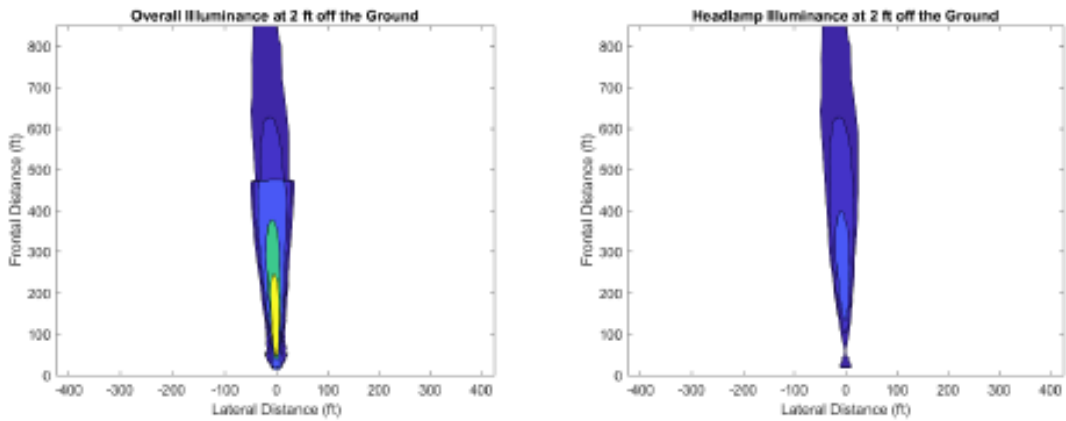

Figure 11. Illuminance map of Railhead/Divvali (S11 LED)

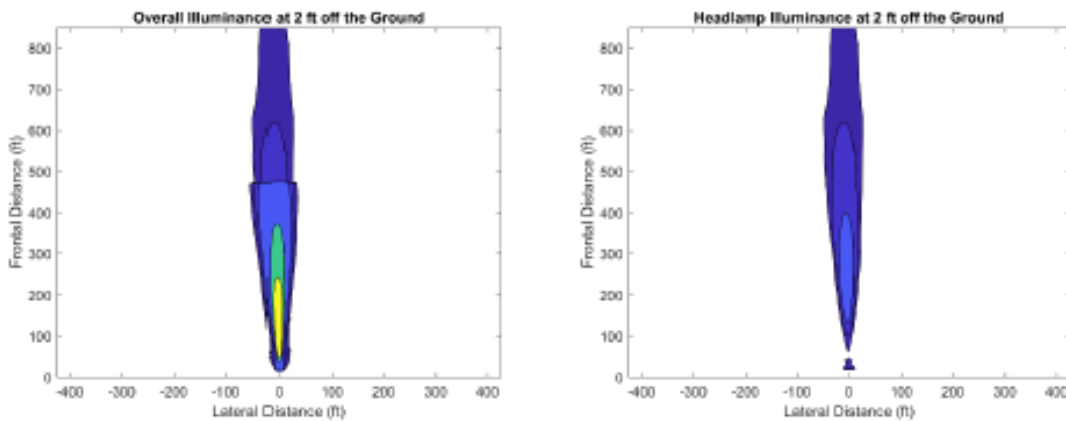

Figure 12. Illuminance map of Railhead/Divvali (S12 LED)

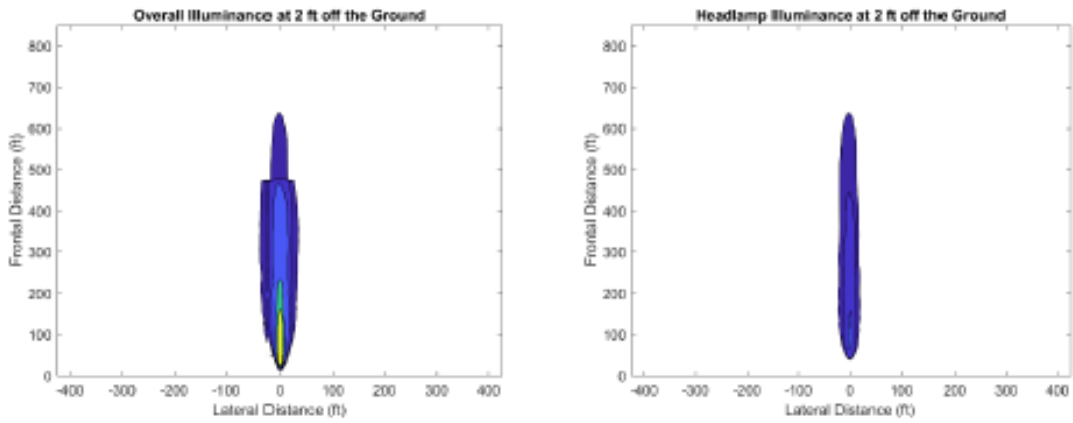

Figure 13. Illuminance map of Smart Light Source (S3 LED)

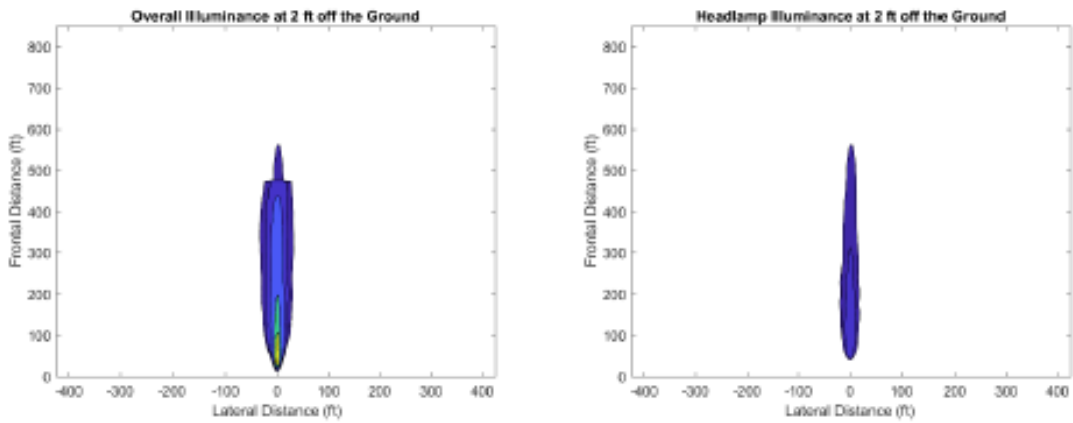

Figure 14. Illuminance map of Smart Light Source (S6 LED)

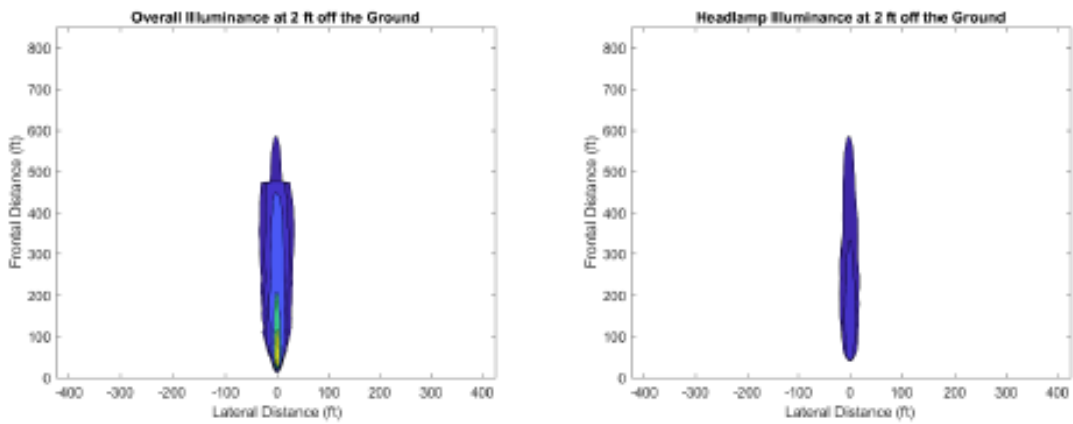

Figure 15. Illuminance map of Smart Light Source (S14 LED)

4 Feet from Ground, Dim Mode

Illuminance Maps of LED Samples at 4 ft Height from the Ground in Dim Mode

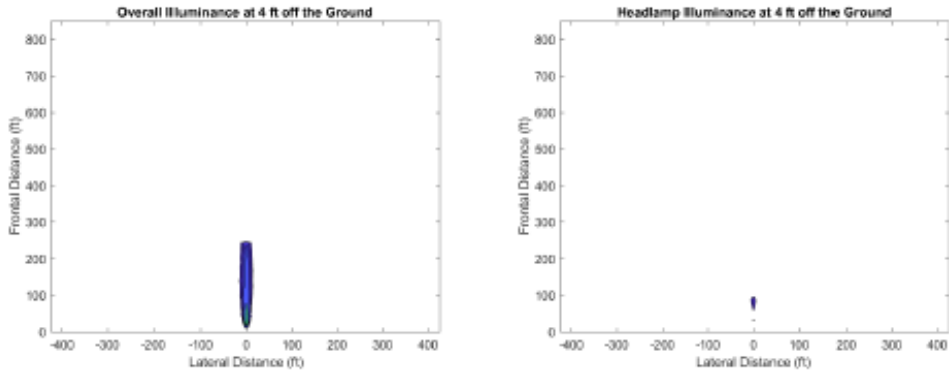

Figure 1. Illuminance map of J.W. Speaker (S2 LED)

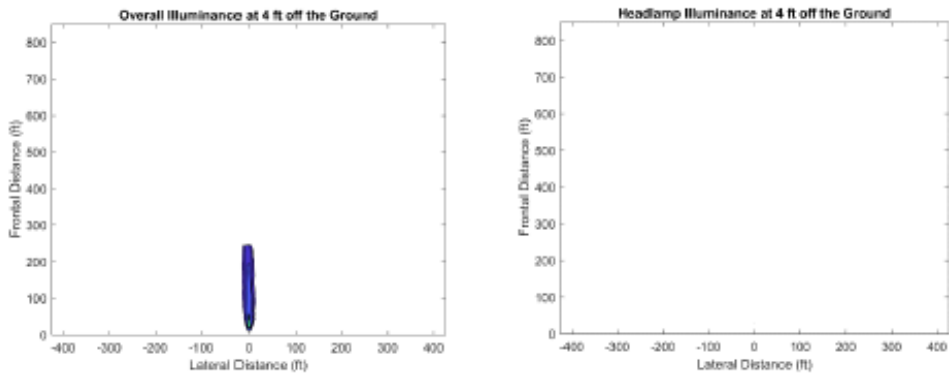

Figure 2. Illuminance map of J.W. Speaker (S4 LED)

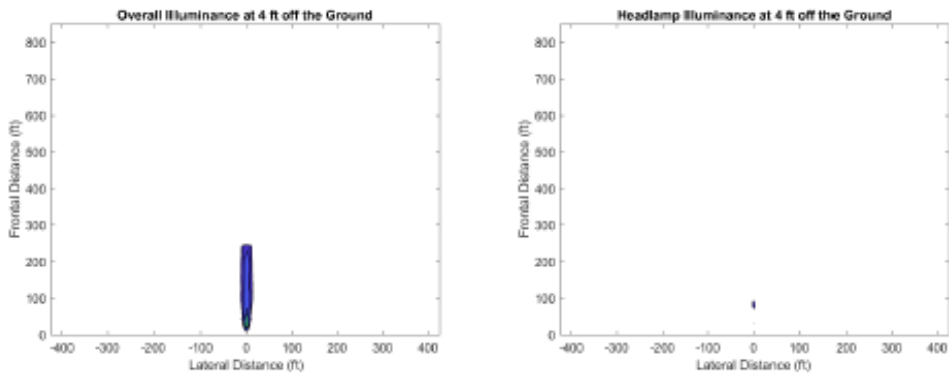

Figure 3. Illuminance map of J.W. Speaker (S8 LED)

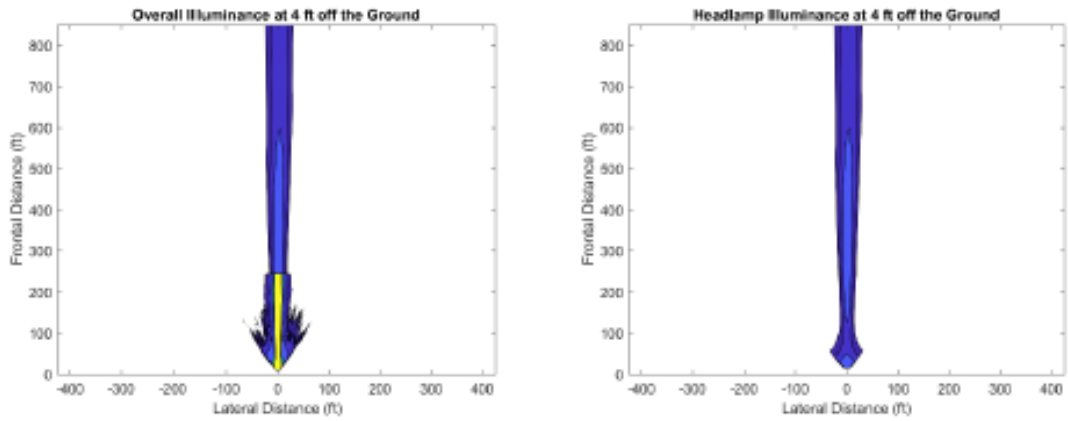

Figure 4. Illuminance map of Hydra-Tech 2800K (S5 LED)

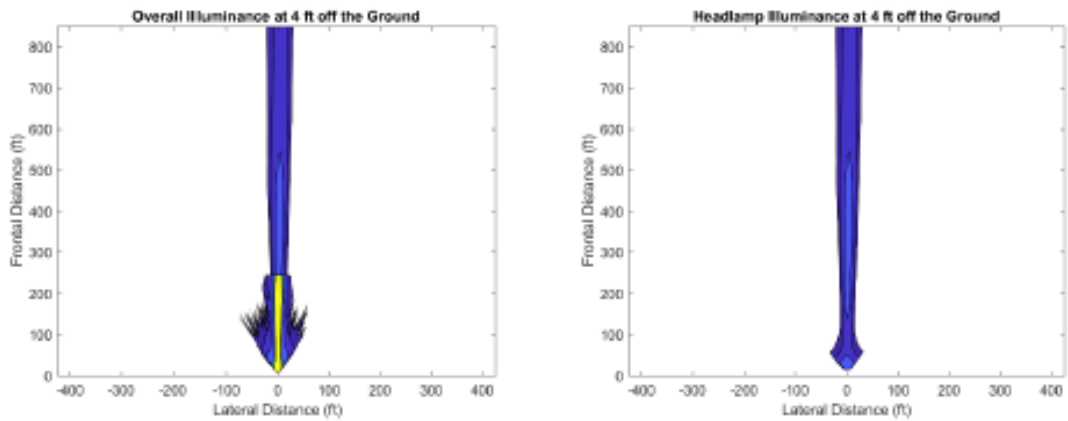

Figure 5. Illuminance map of Hydra-Tech 2800K (S9 LED)

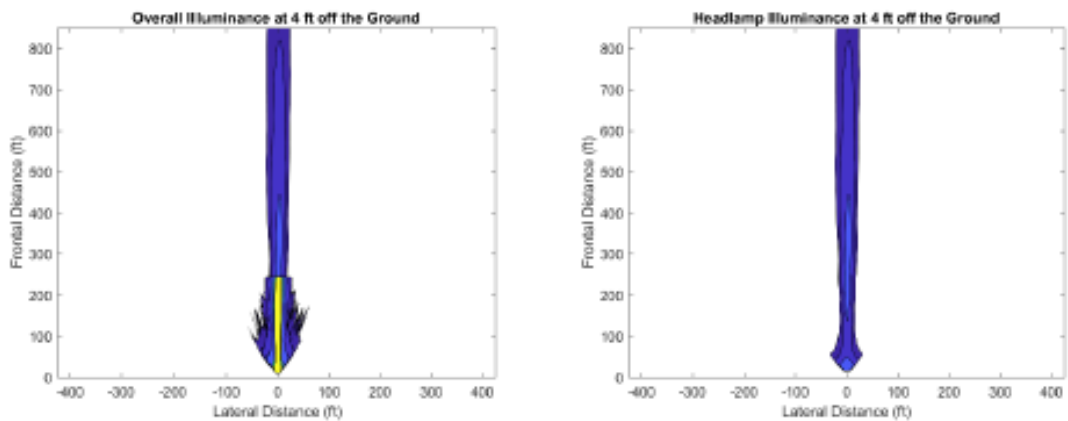

Figure 6. Illuminance map of Hydra-Tech 2800K (S13 LED)

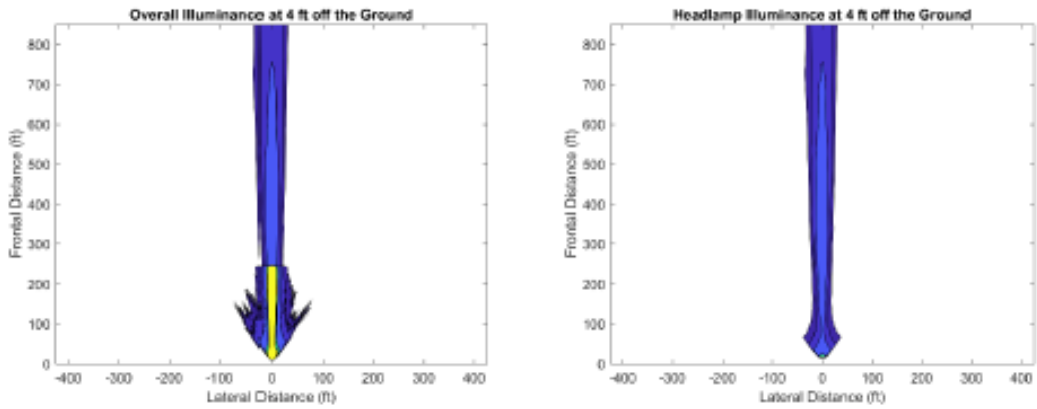

Figure 7. Illuminance map of Hydra-Tech 7000K (S1 LED)

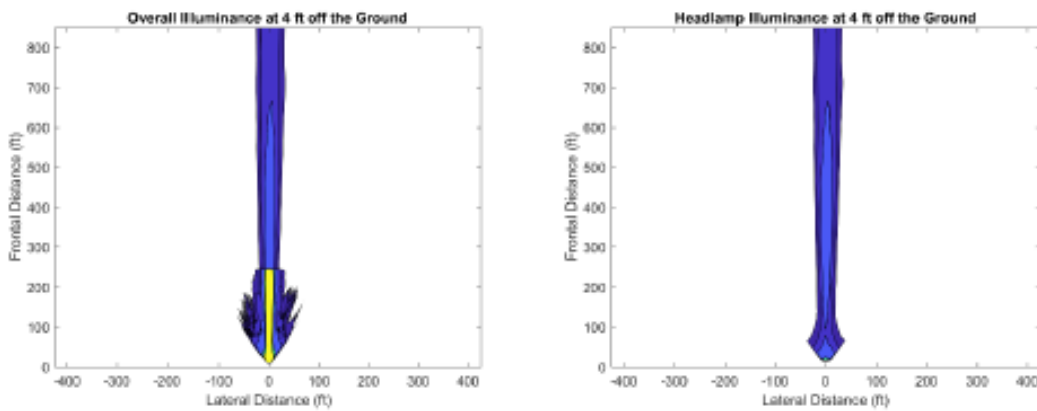

Figure 8. Illuminance map of Hydra-Tech 7000K (S10 LED)

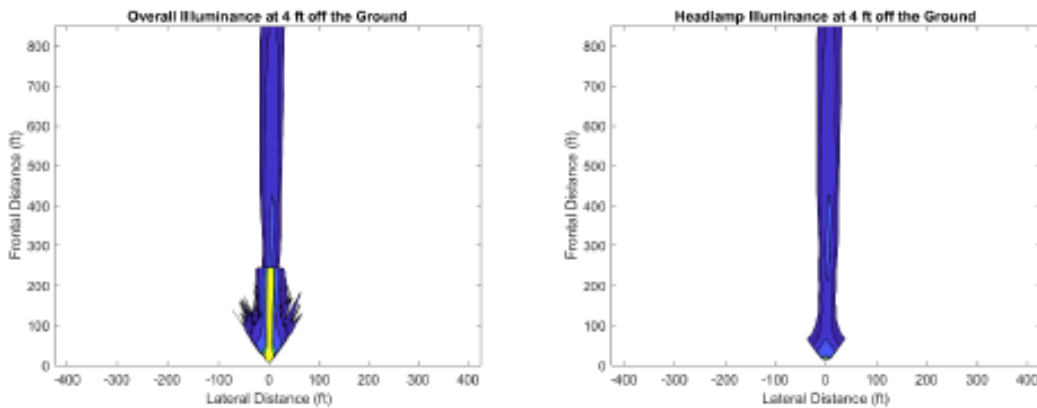

Figure 9. Illuminance map of Hydra-Tech 7000K (S15 LED)

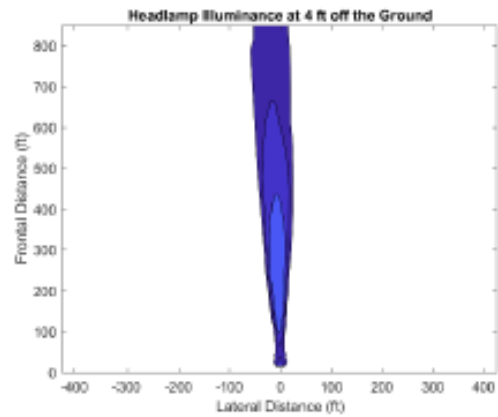
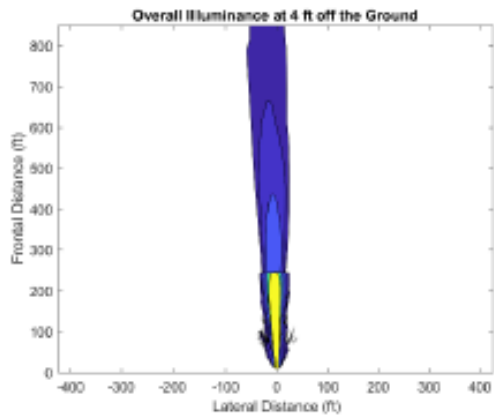

Figure 10. Illuminance map of Railhead/Divvali (S7 LED)

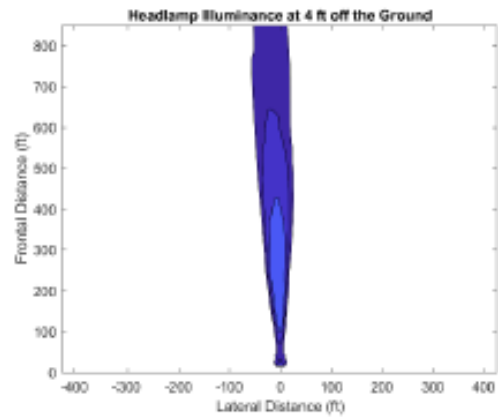
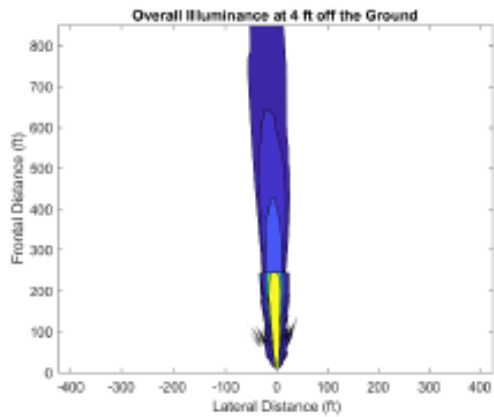

Figure 11. Illuminance map of Railhead/Divvali (S11 LED)

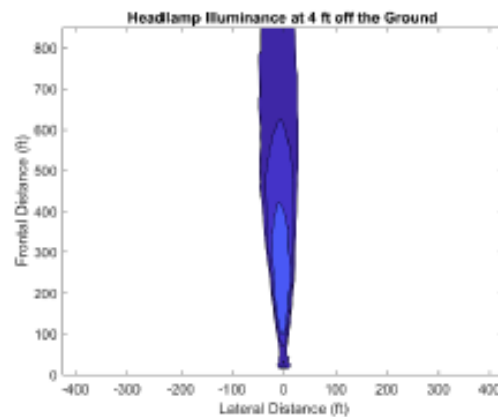
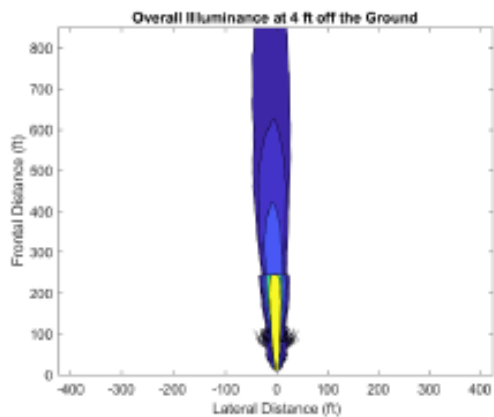

Figure 12. Illuminance map of Railhead/Divvali (S12 LED)

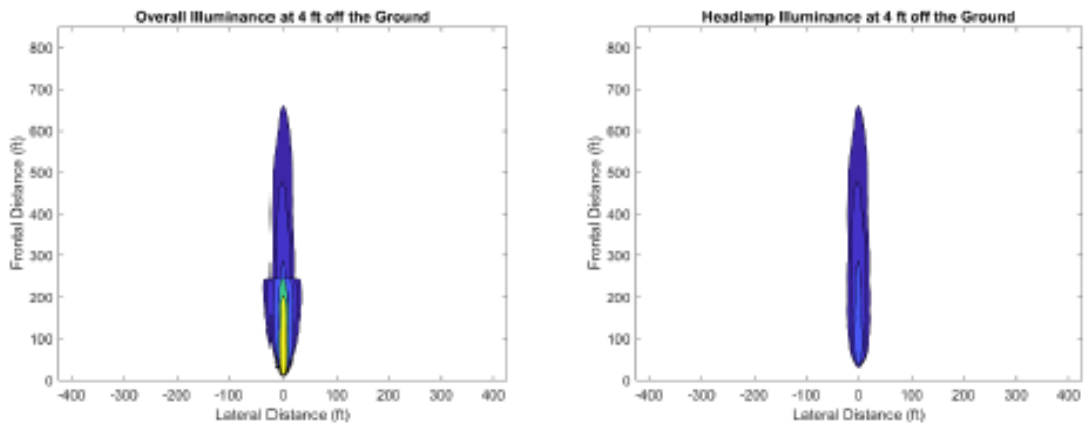

Figure 13. Illuminance map of Smart Light Source (S3 LED)

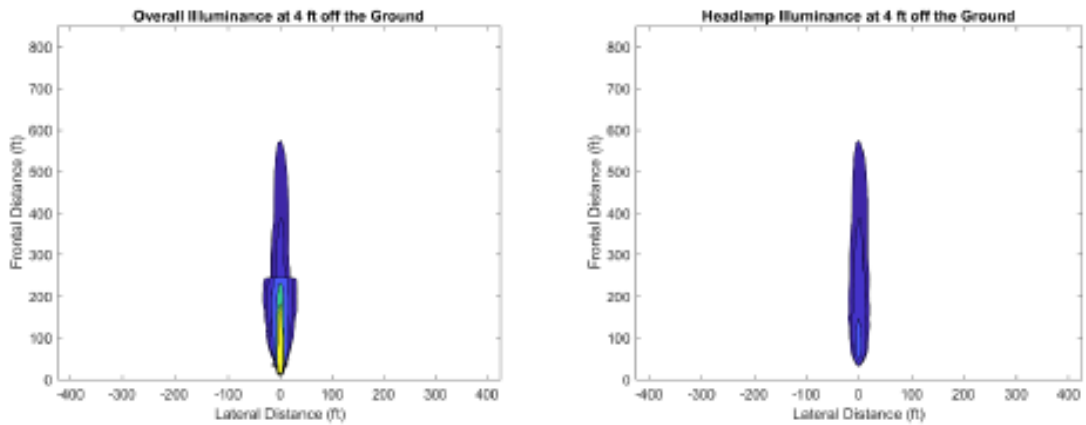

Figure 14. Illuminance map of Smart Light Source (S6 LED)

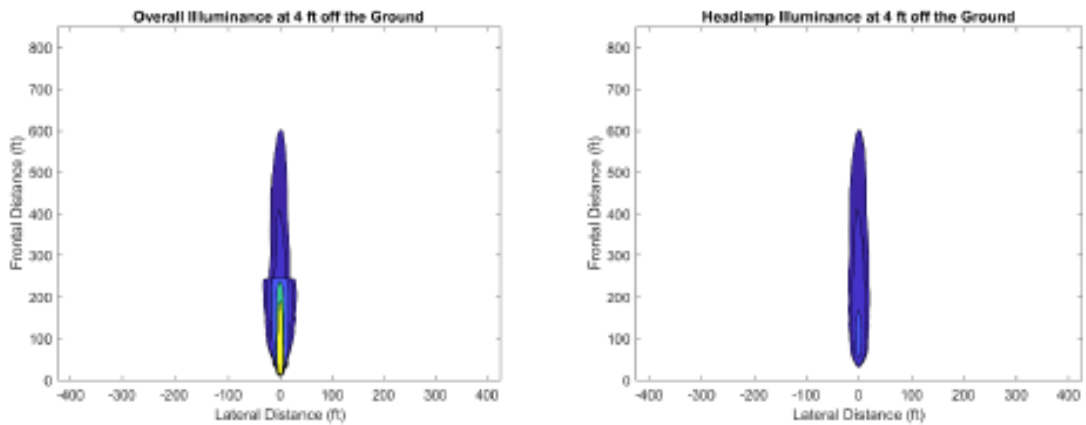

Figure 15. Illuminance map of Smart Light Source (S14 LED)

Illuminance Maps of Halogen Samples at Ground Height

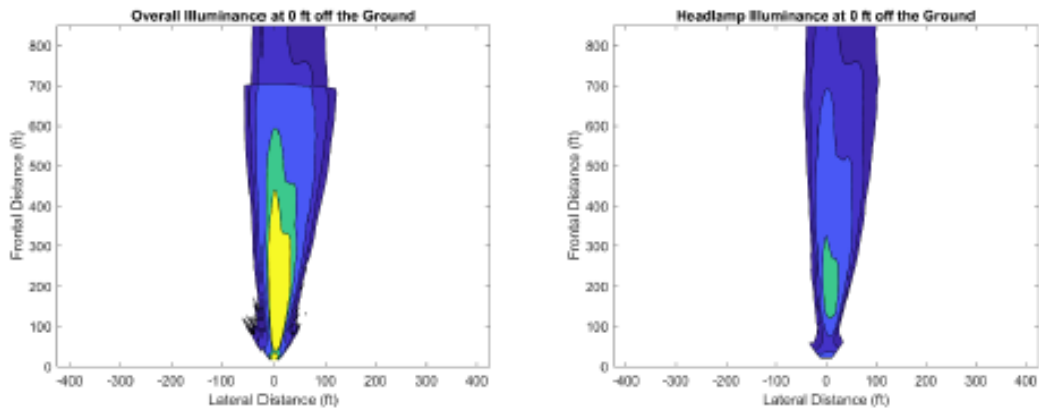

Figure 1. Illuminance map of AMGLO (S4 HAL)

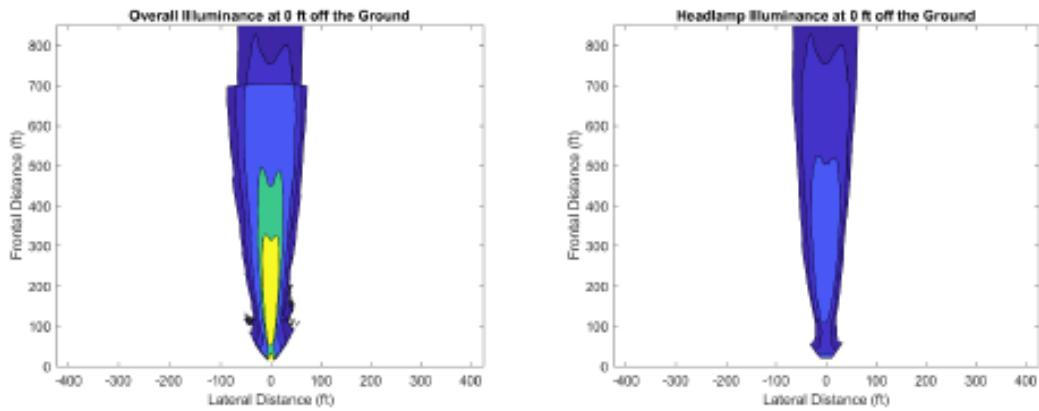

Figure 2. Illuminance map of AMGLO (S6 HAL)

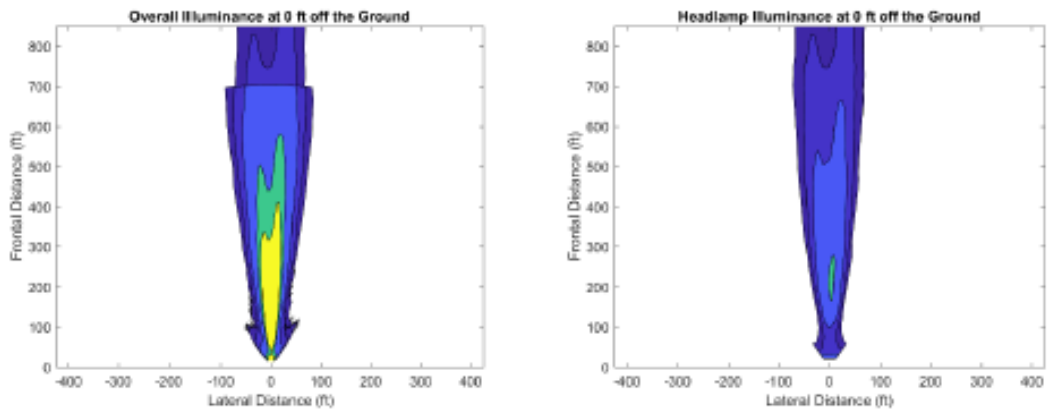

Figure 3. Illuminance map of AMGLO (S7 HAL)

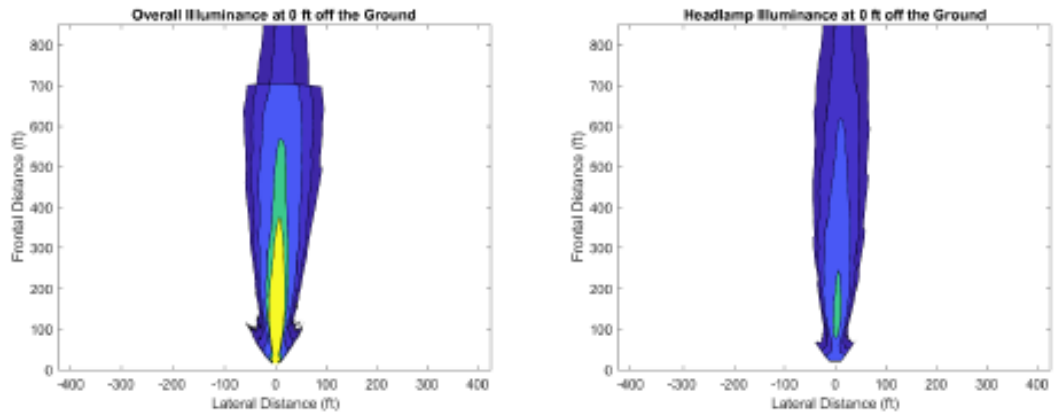

Figure 4. Illuminance map of ePowerRail (S3 HAL)

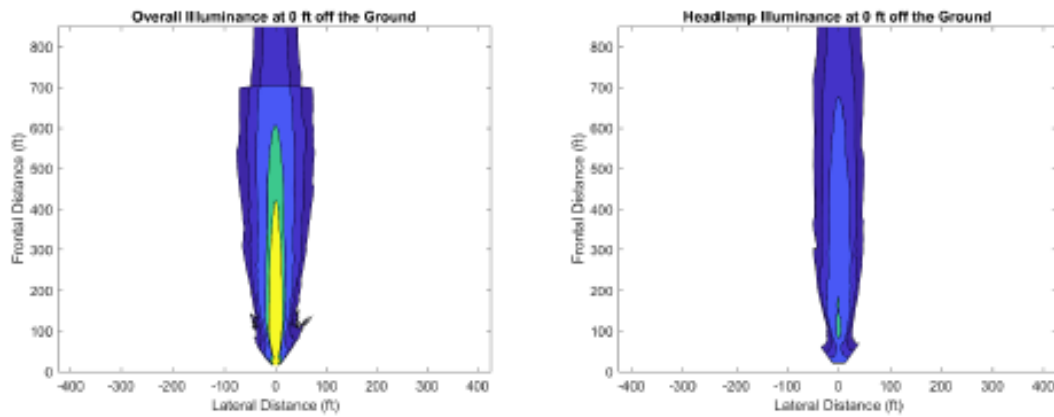

Figure 5. Illuminance map of ePowerRail (S5 HAL)

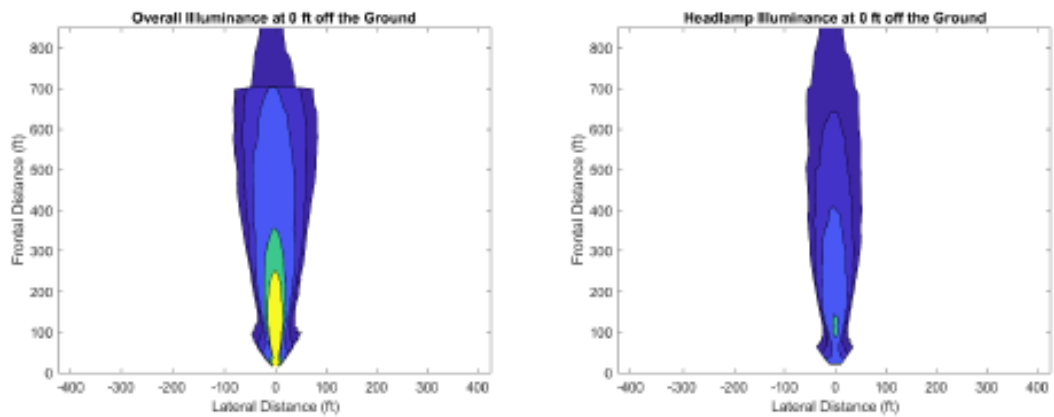

Figure 6. Illuminance map of ePowerRail (S8 HAL)

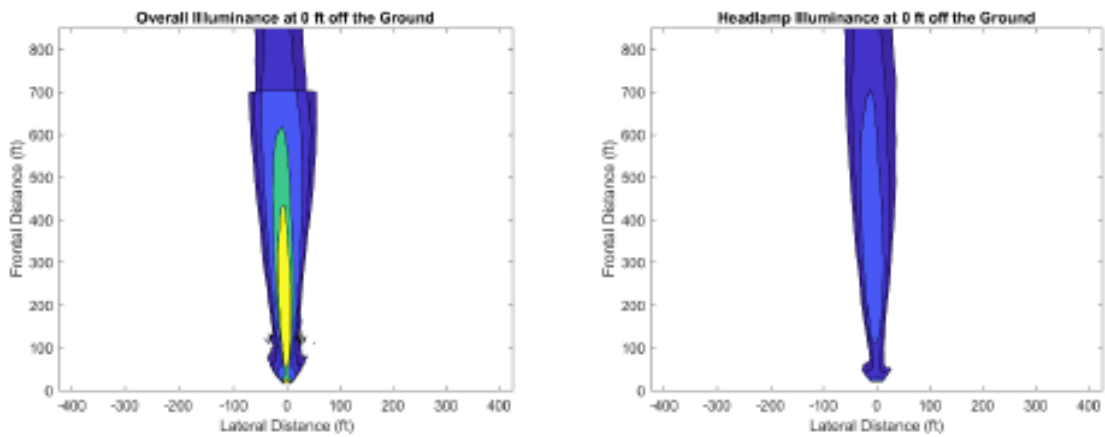

Figure 7. Illuminance map of CML (S1 HAL)

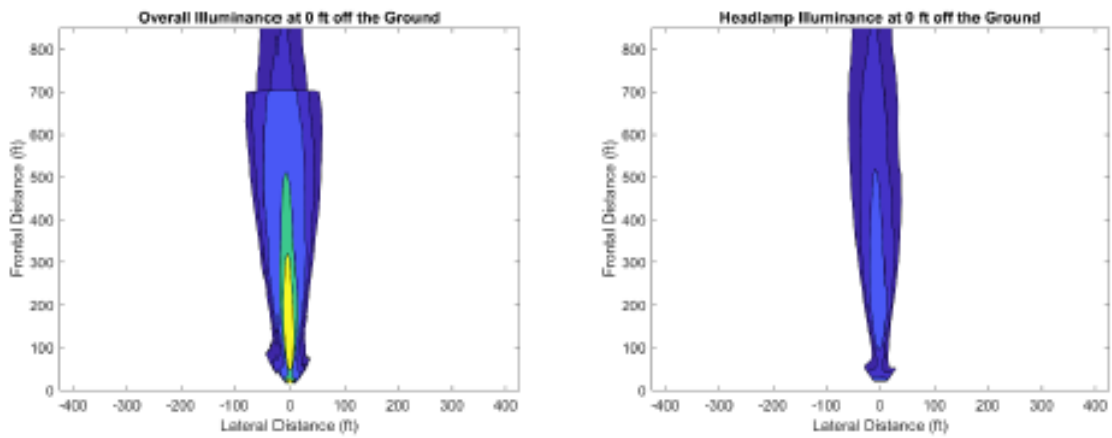

Figure 8. Illuminance map of CML (S2 HAL)

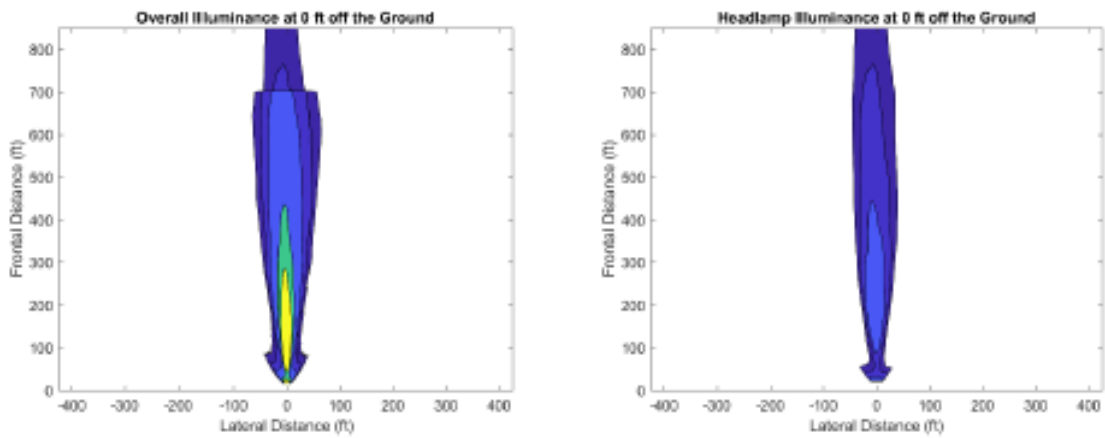

Figure 9. Illuminance map of CML (S9 HAL)

Illuminance Maps of Halogen Samples at 2 ft Height from the Ground

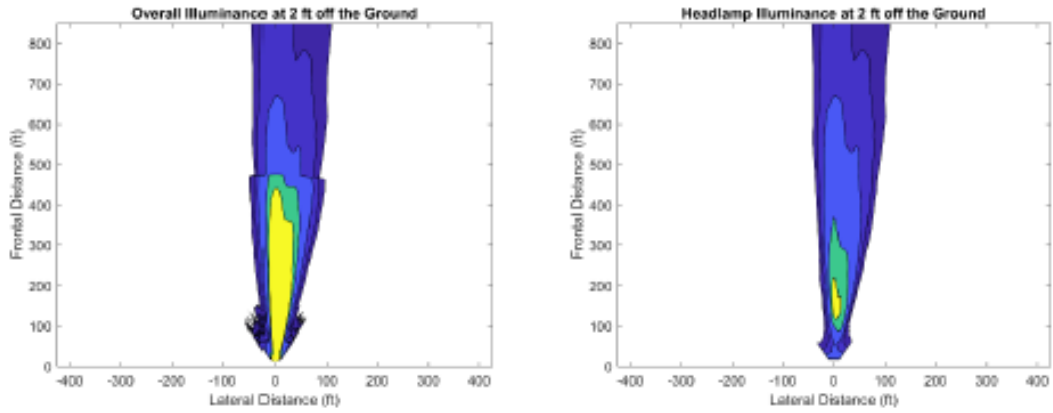

Figure 1. Illuminance map of AMGLO (S4 HAL)

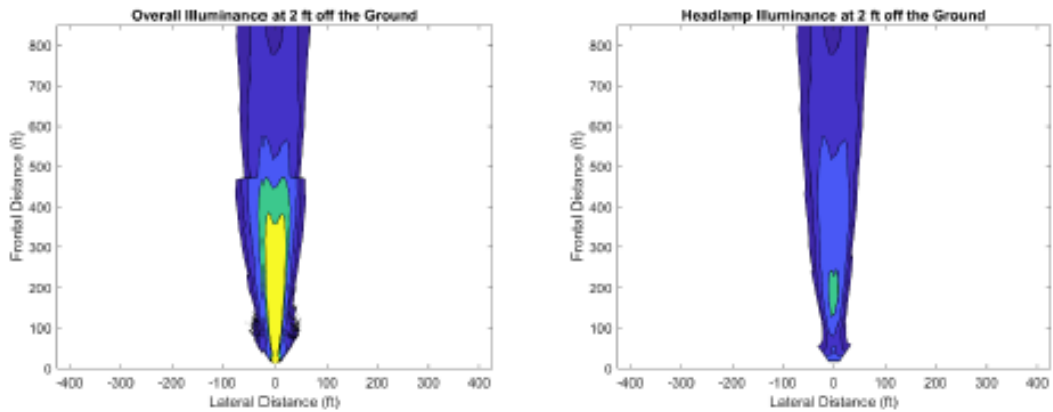

Figure 2. Illuminance map of AMGLO (S6 HAL)

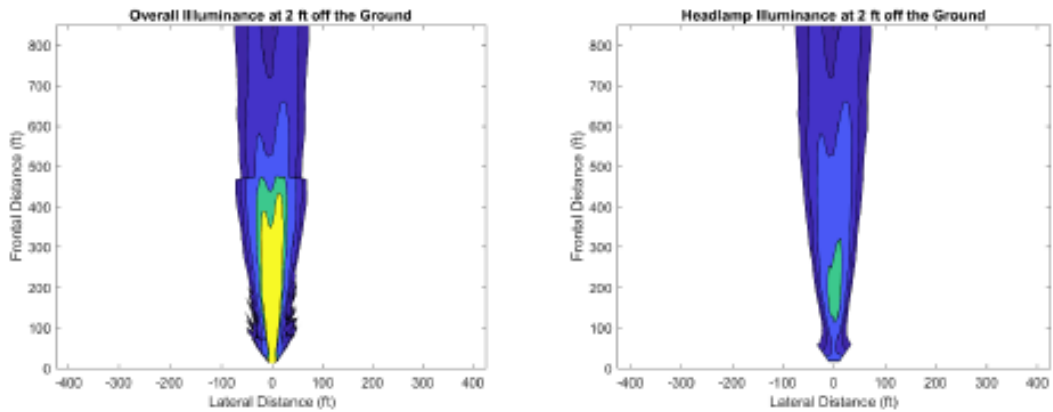

Figure 3. Illuminance map of AMGLO (S7 HAL)

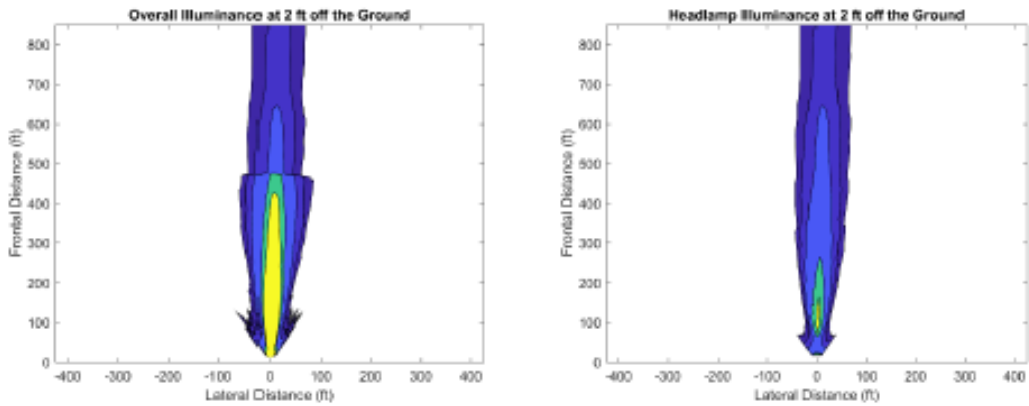

Figure 4. Illuminance map of ePowerRail (S3 HAL)

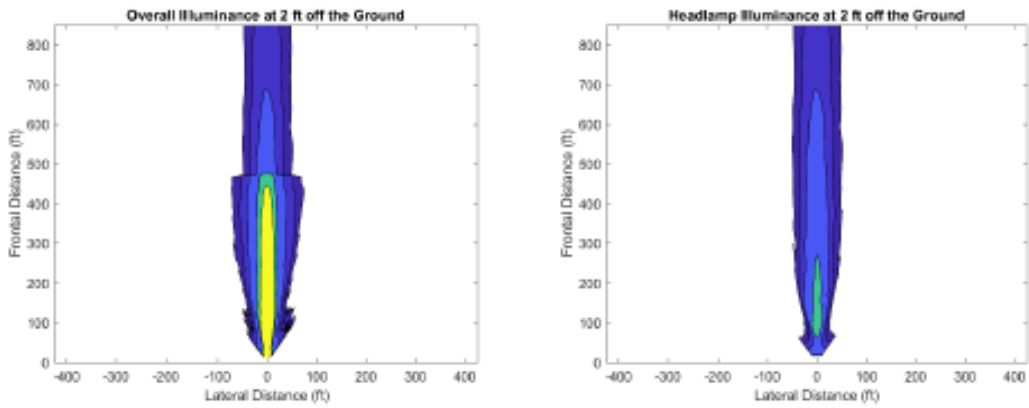

Figure 5. Illuminance map of ePowerRail (S5 HAL)

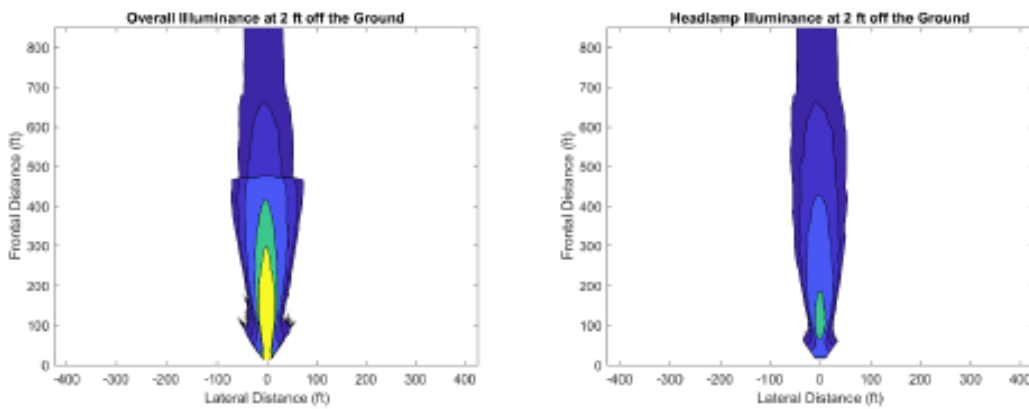

Figure 6. Illuminance map of ePowerRail (S8 HAL)

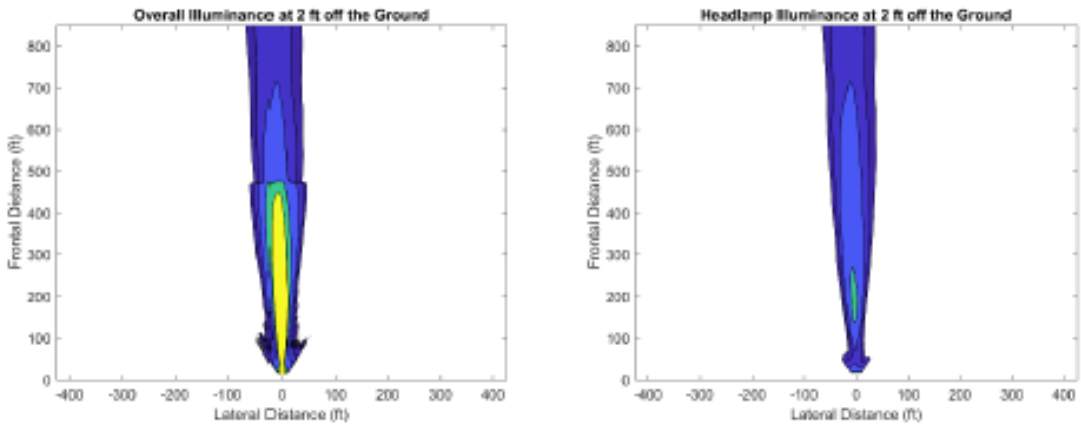

Figure 7. Illuminance map of CML (S1 HAL)

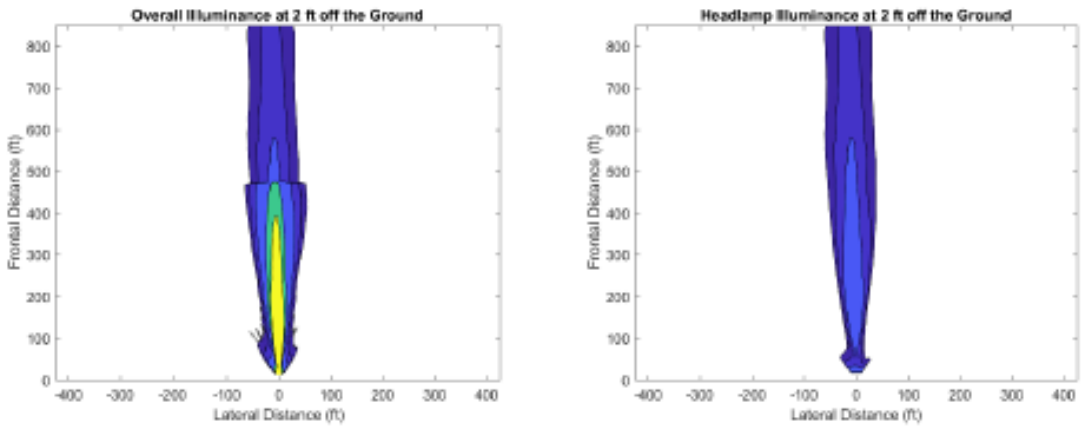

Figure 8. Illuminance map of CML (S2 HAL)

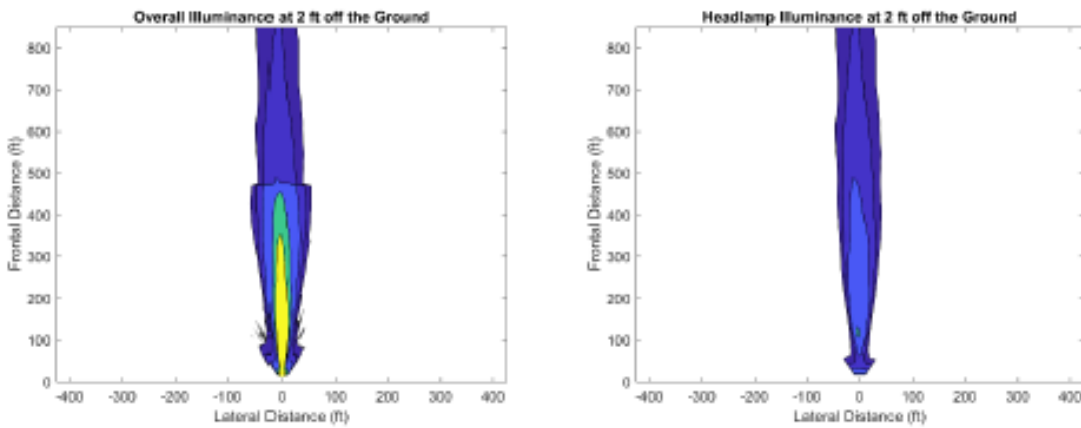

Figure 9. Illuminance map of CML (S9 HAL)

Illuminance Maps of Halogen Samples at 4 ft Height from the Ground

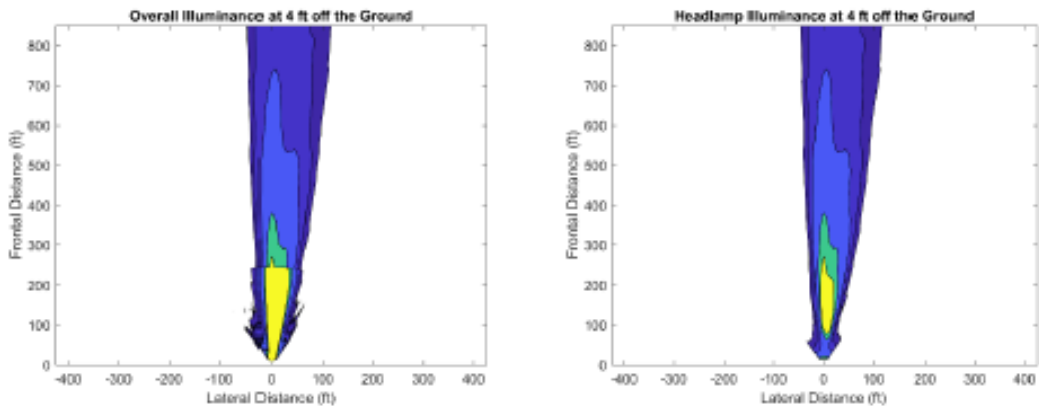

Figure 1. Illuminance map of AMGLO (S4 HAL)

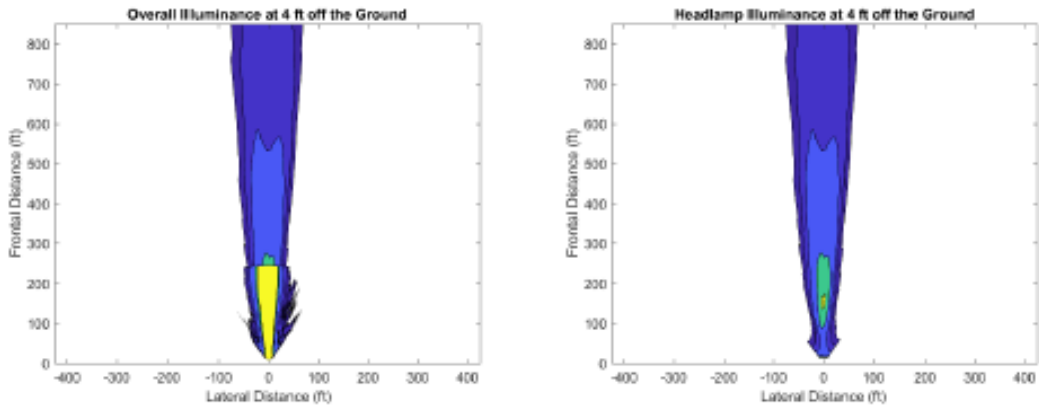

Figure 2. Illuminance map of AMGLO (S6 HAL)

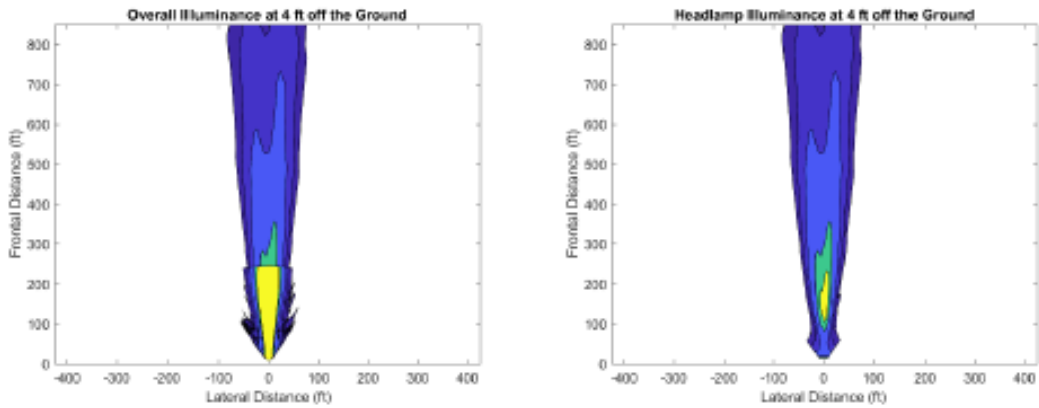

Figure 3. Illuminance map of AMGLO (S7 HAL)

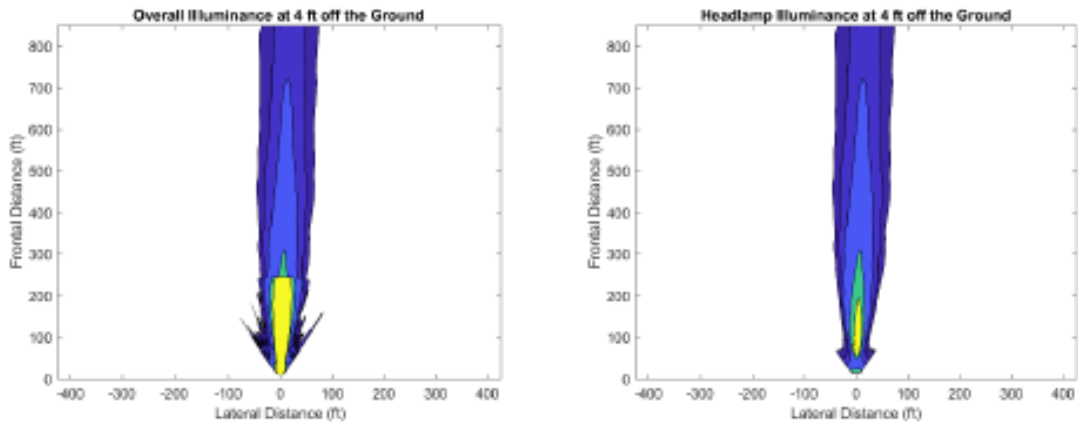

Figure 4. Illuminance map of ePowerRail (S3 HAL)

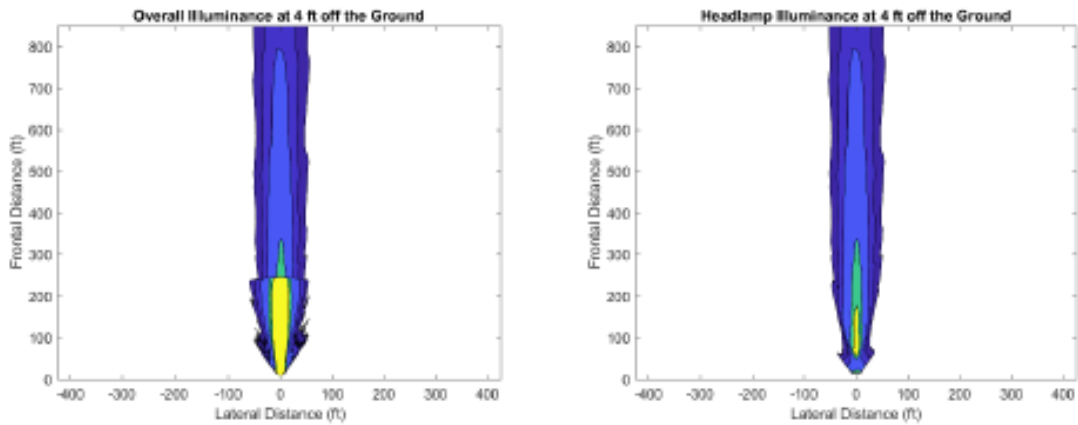

Figure 5. Illuminance map of ePowerRail (S5 HAL)

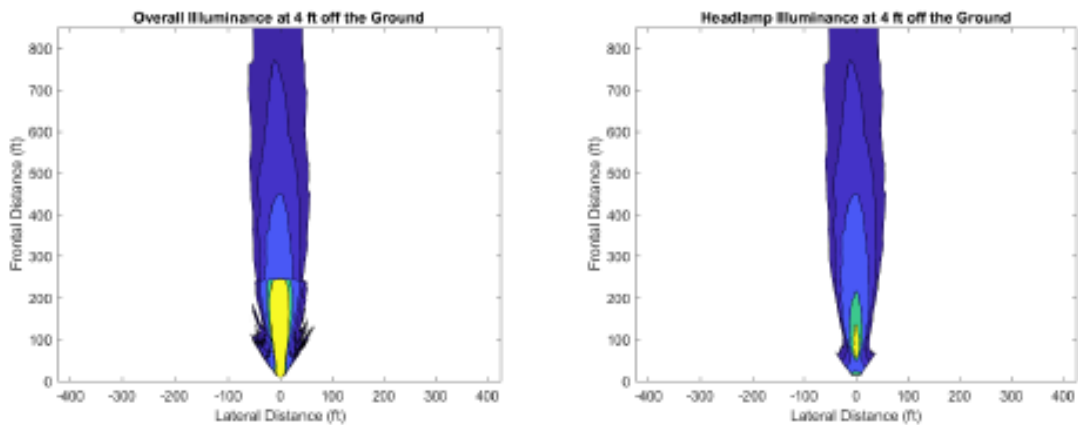

Figure 6. Illuminance map of ePowerRail (S8 HAL)

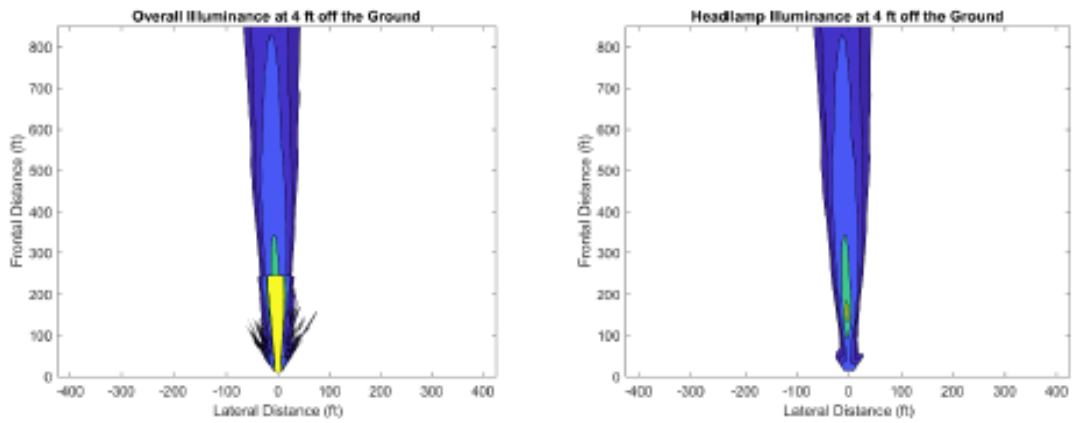

Figure 7. Illuminance map of CML (S1 HAL)

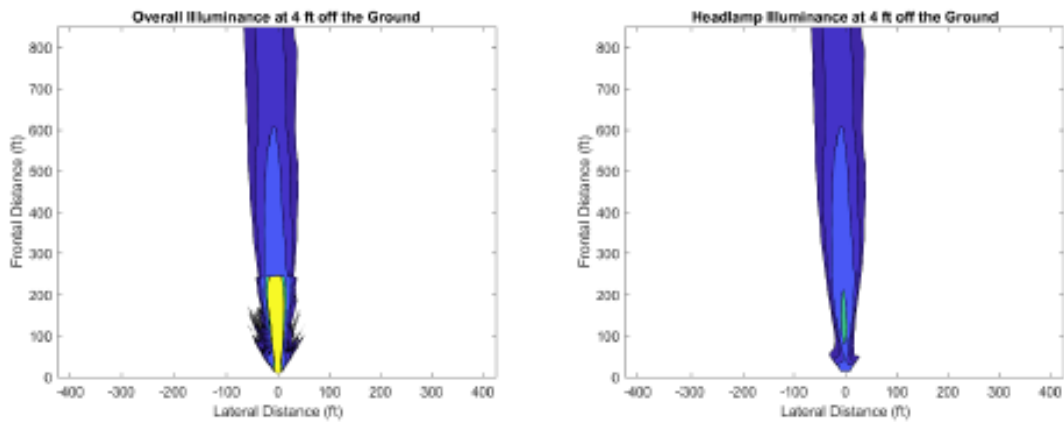

Figure 8. Illuminance map of CML (S2 HAL)

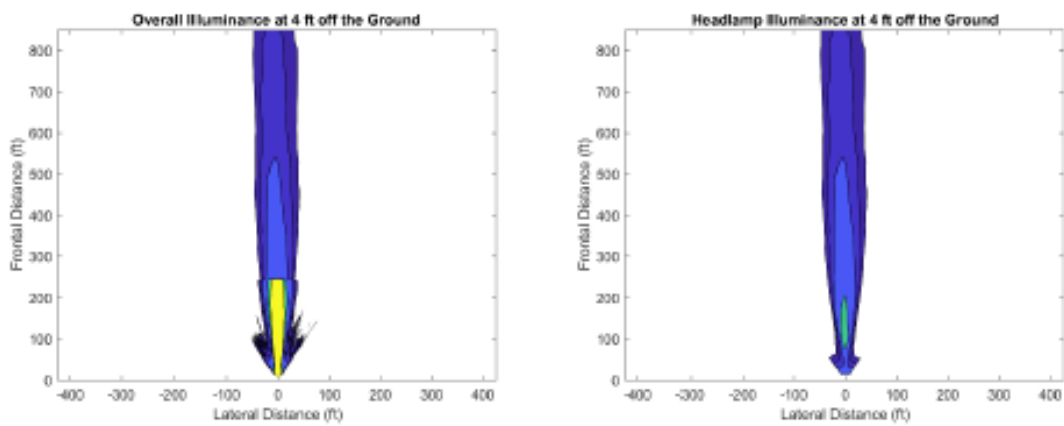

Figure 9. Illuminance map of CML (S9 HAL)

Three-Way View of Illuminance Map of LED All Lights at Ground Height in Bright Mode

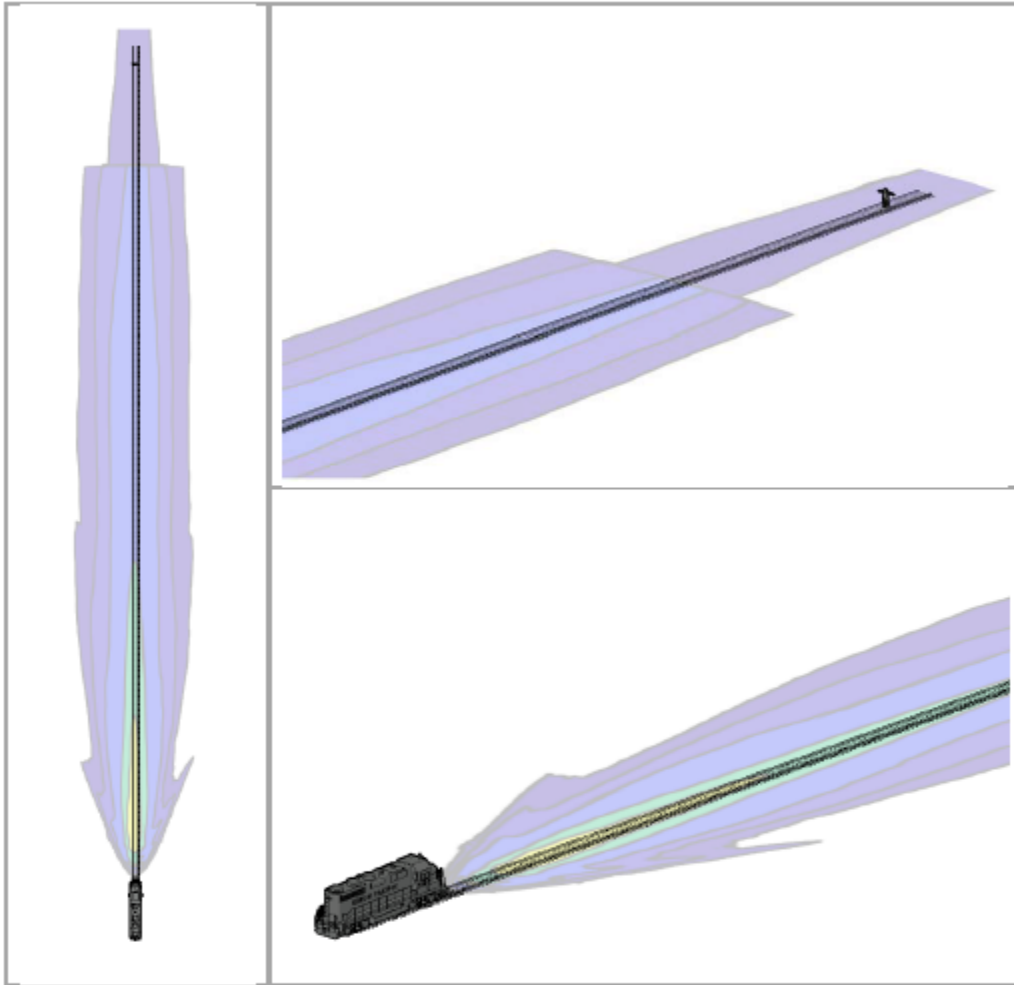

Figure 1. 3-Way View of an Illuminance map for a J.W. Speaker dual-lamp headlight and auxiliary lights (S2 LED). The humanoid figure (upper-right plot) stands 800 ft away from the light source.

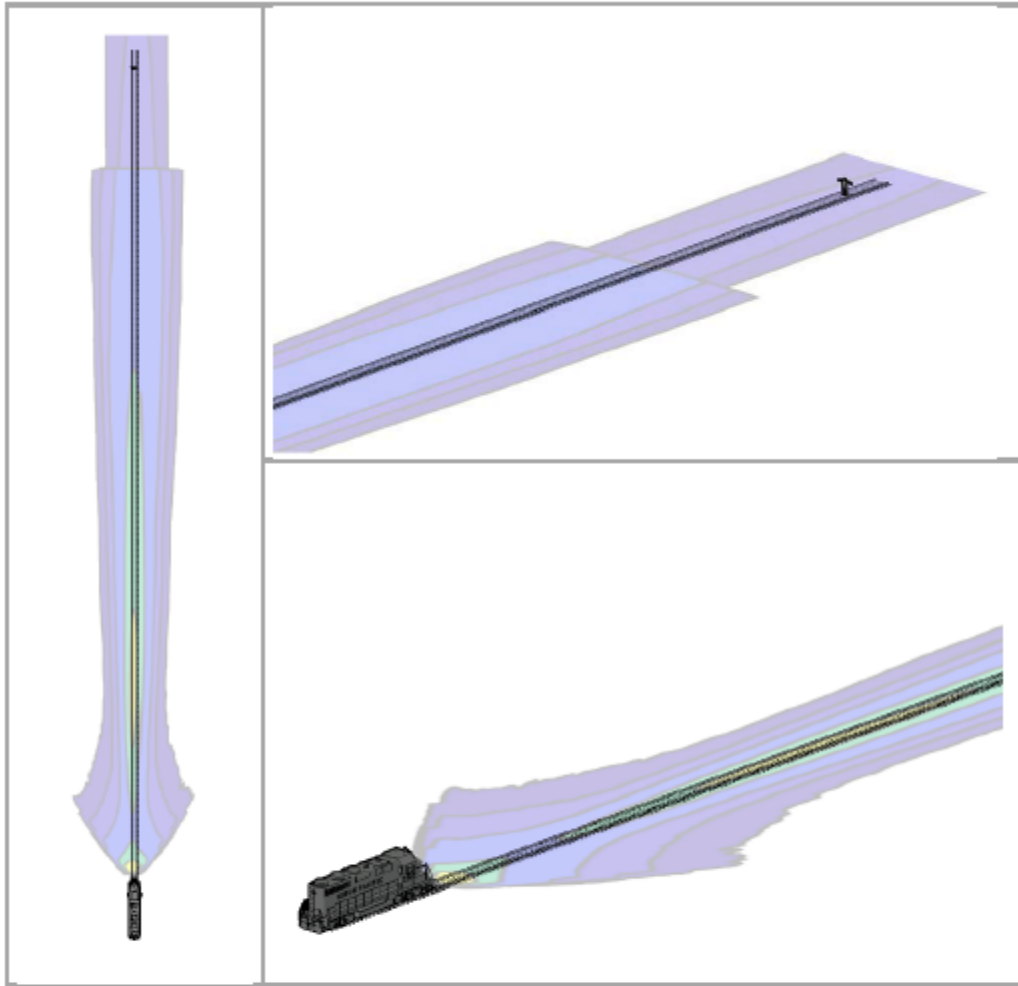

Figure 2. 3-Way View of an Illuminance map for a Hydra-Tech 2800K dual-lamp headlight and auxillary lights (S5 LED). The humanoid figure (upper-right plot) stands 800 ft away from the light source.

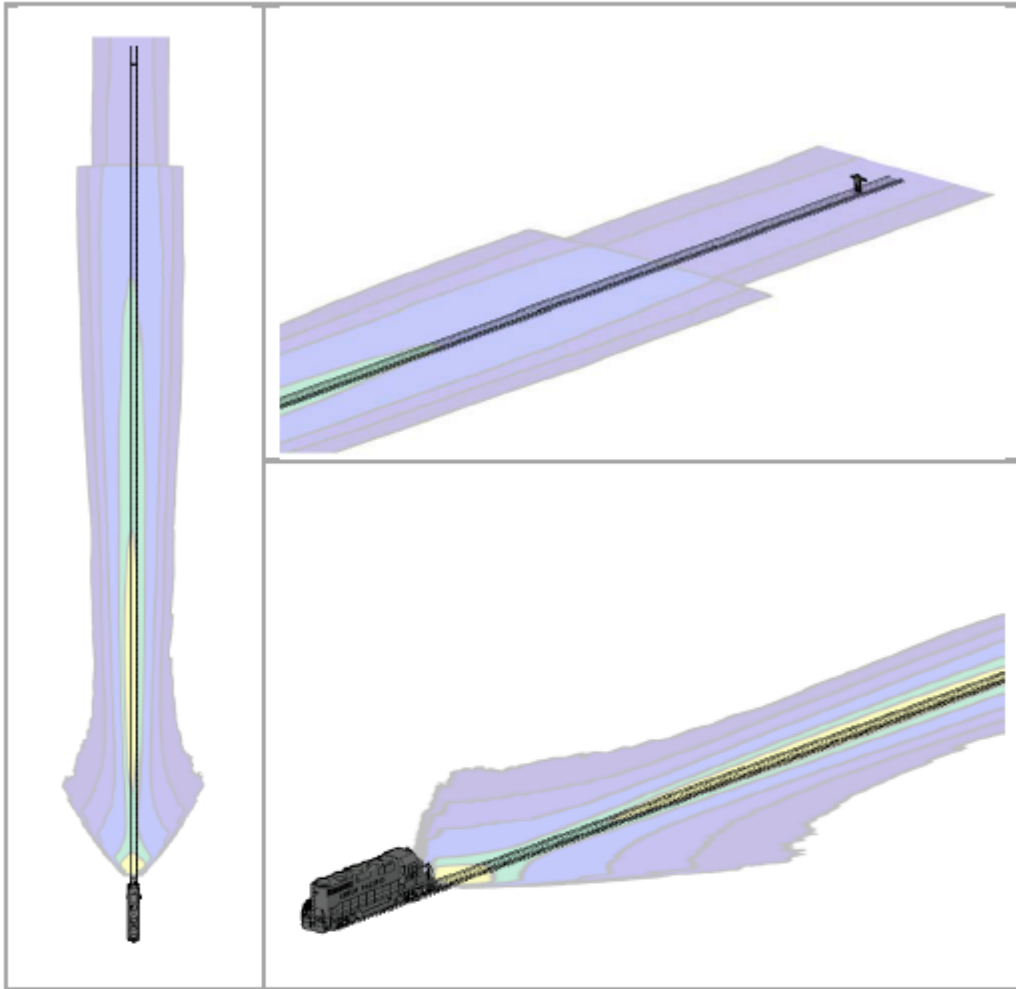

Figure 3. 3-Way View of an Illuminance map for a Hydra-Tech 7000K dual-lamp headlight and auxillary lights (S1 LED). The humanoid figure (upper-right plot) stands 800 ft away from the light source.

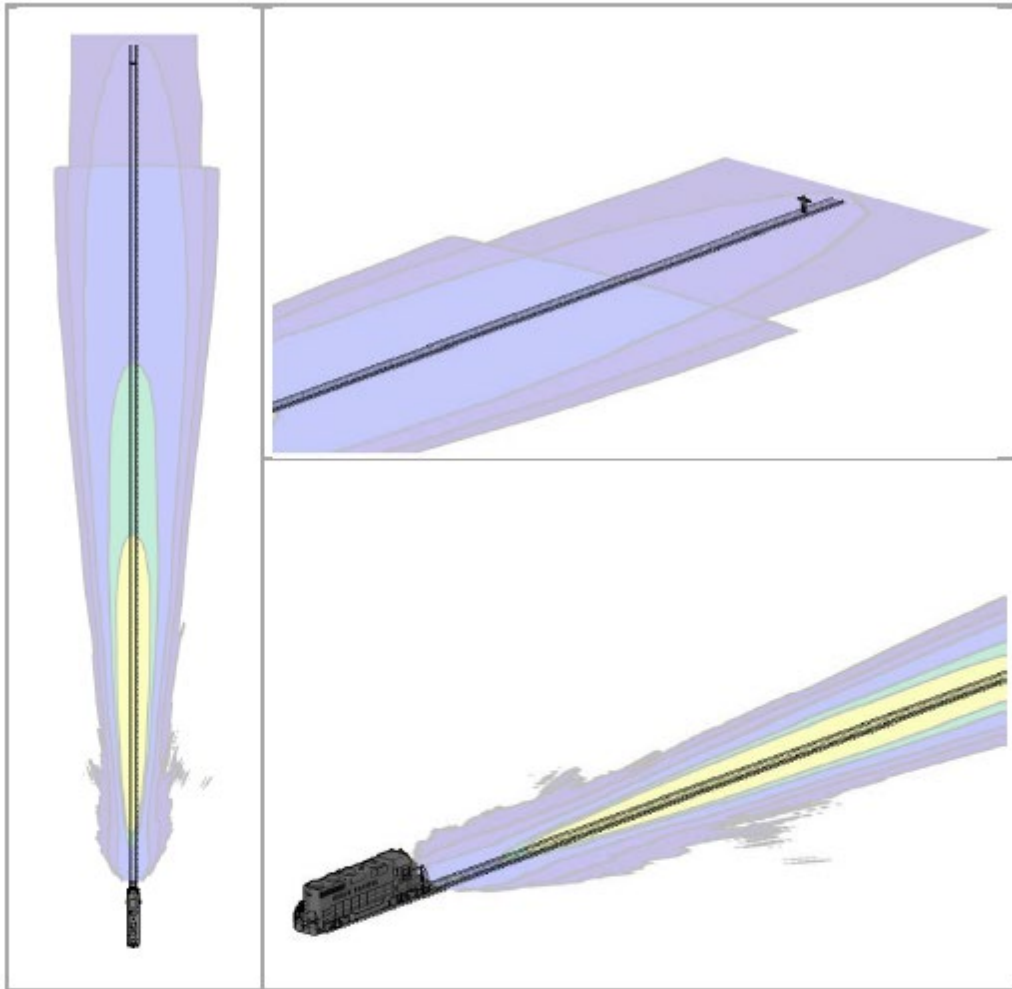

Figure 4. 3-Way View of an Illuminance map for a Railhead/Divvali dual-lamp headlight and auxiliary lights (S7 LED). The humanoid figure (upper-right plot) stands 800 ft away from the light source.

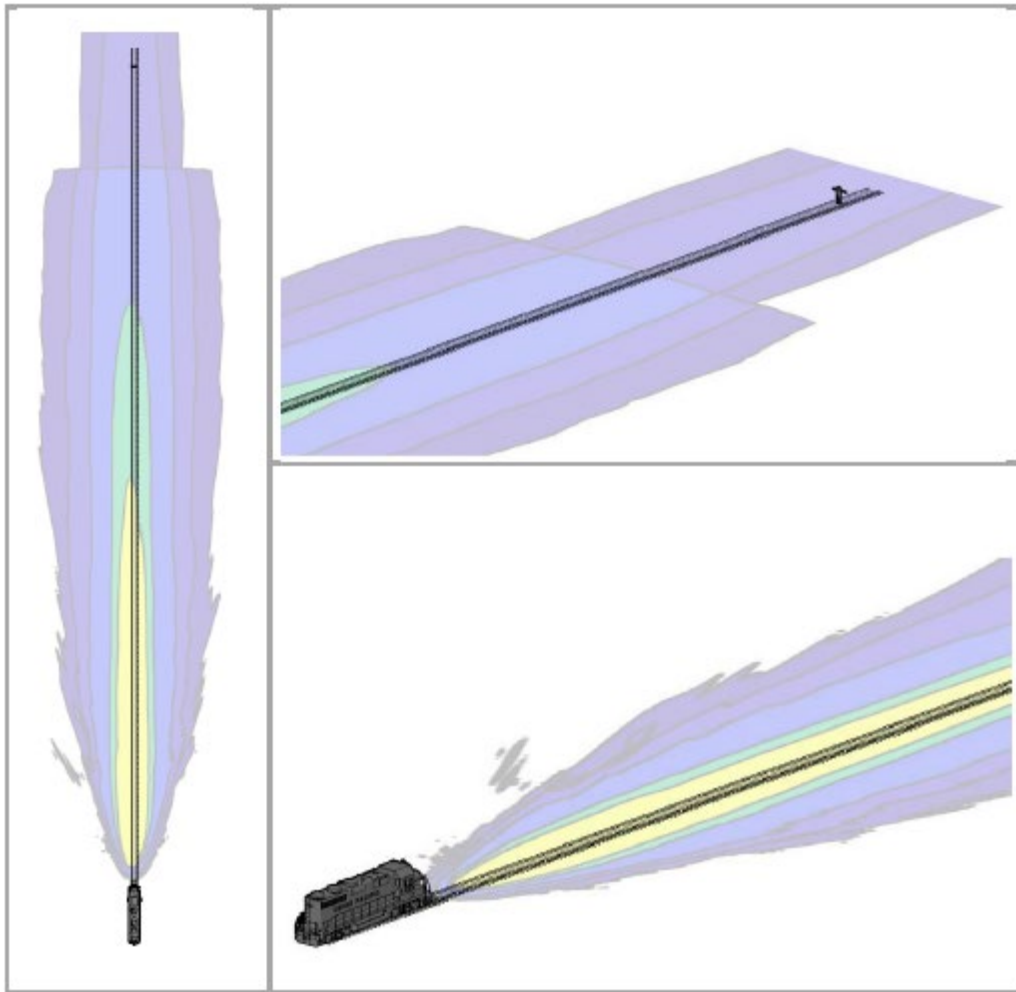

Figure 5. 3-Way View of an Illuminance map for a Smart Light Source dual-lamp headlight and auxillary lights (S3 LED). The humanoid figure (upper-right plot) stands 800 ft away from the light source.

Three-Way View of Illuminance Map of LED All Lights at 2 ft Height from the Ground in Bright Mode

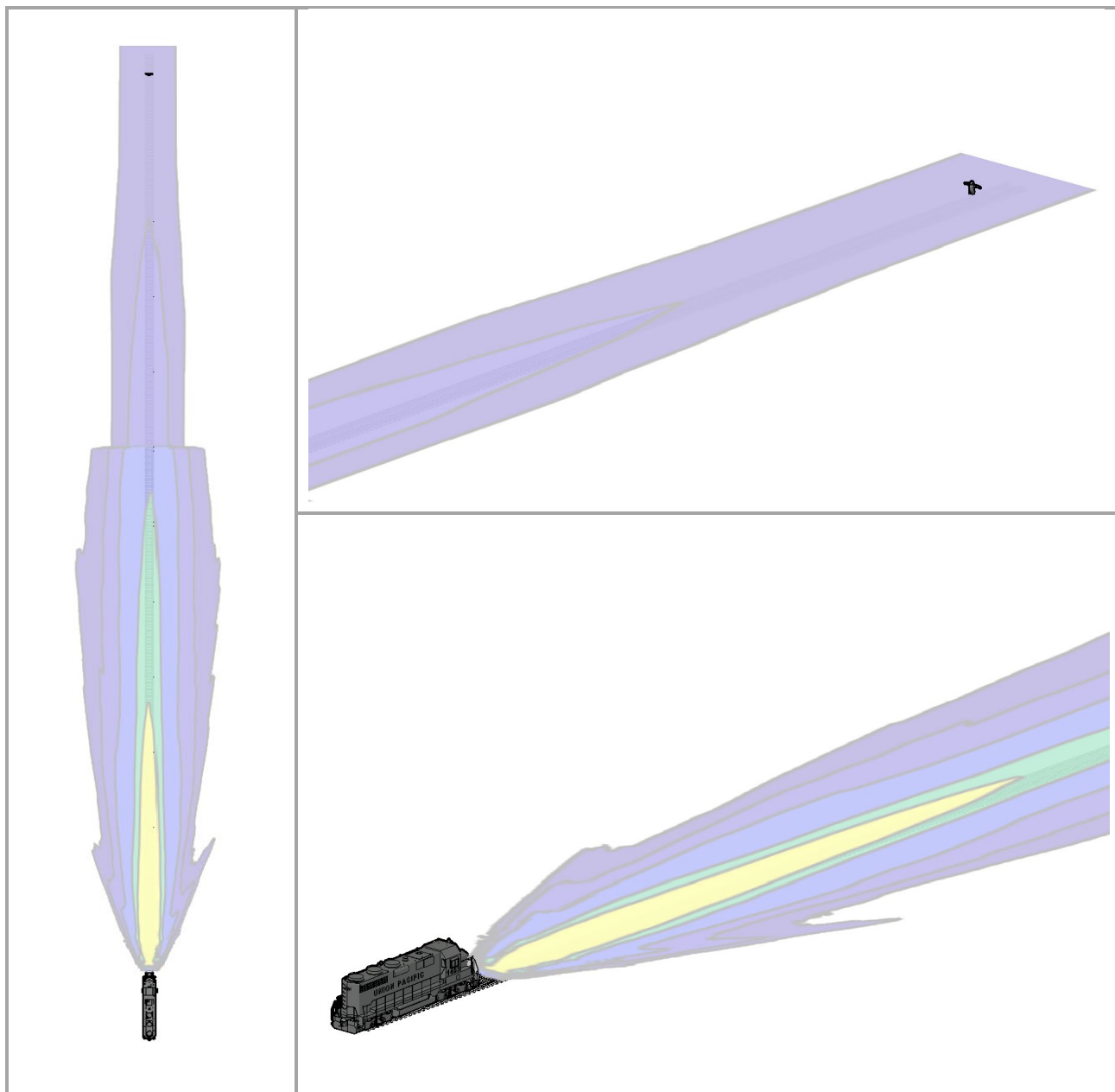

Figure 1. 3-Way View of an Illuminance map for a J.W. Speaker dual-lamp headlight and auxillary lights (S2 LED). The human figure (upper-right plot) stands 800 ft away from the light source.



Figure 2. 3-Way View of an Illuminance map for a Hydra-Tech 2800K dual-lamp headlight and auxillary lights (S5 LED). The human figure (upper-right plot) stands 800 ft away from the light source.

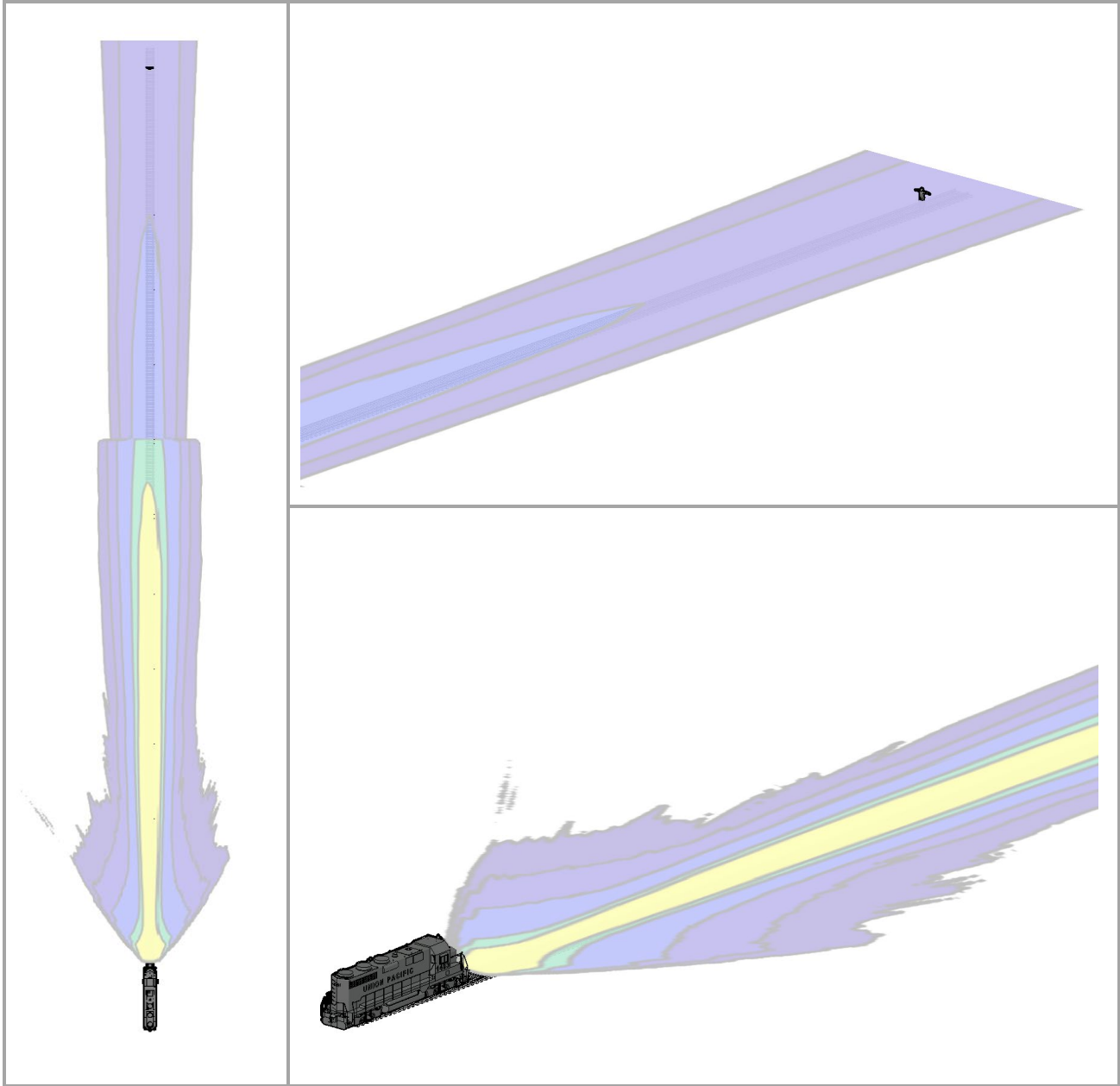

Figure 3. 3-Way View of an Illuminance map for a Hydra-Tech 7000K dual-lamp headlight and auxillary lights (S1 LED). The human figure (upper-right plot) stands 800 ft away from the light source.

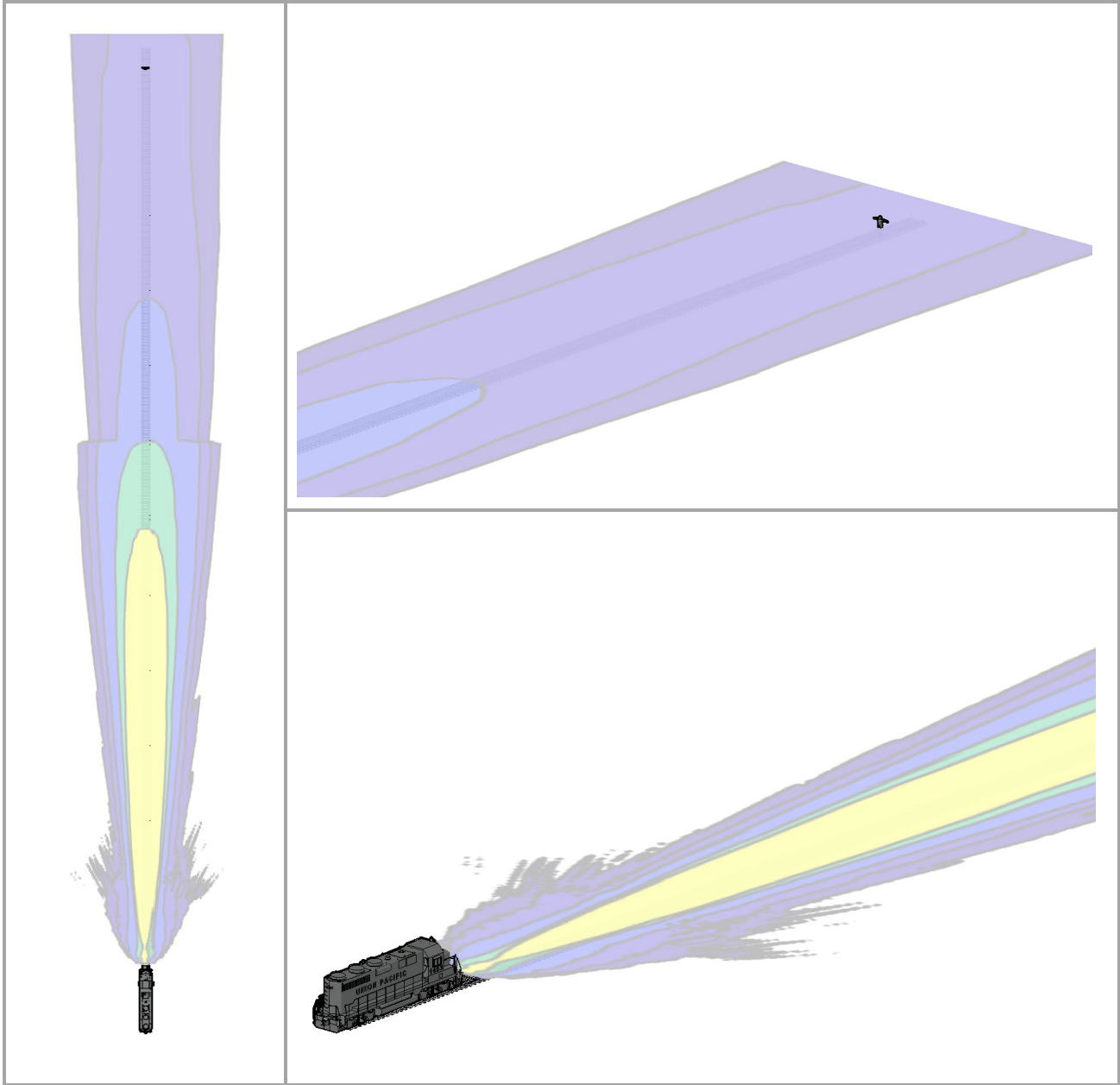

Figure 4. 3-Way View of an Illuminance map for a Railhead/Divvali dual-lamp headlight and auxillary lights (S7 LED). The human figure (upper-right plot) stands 800 ft away from the light source.

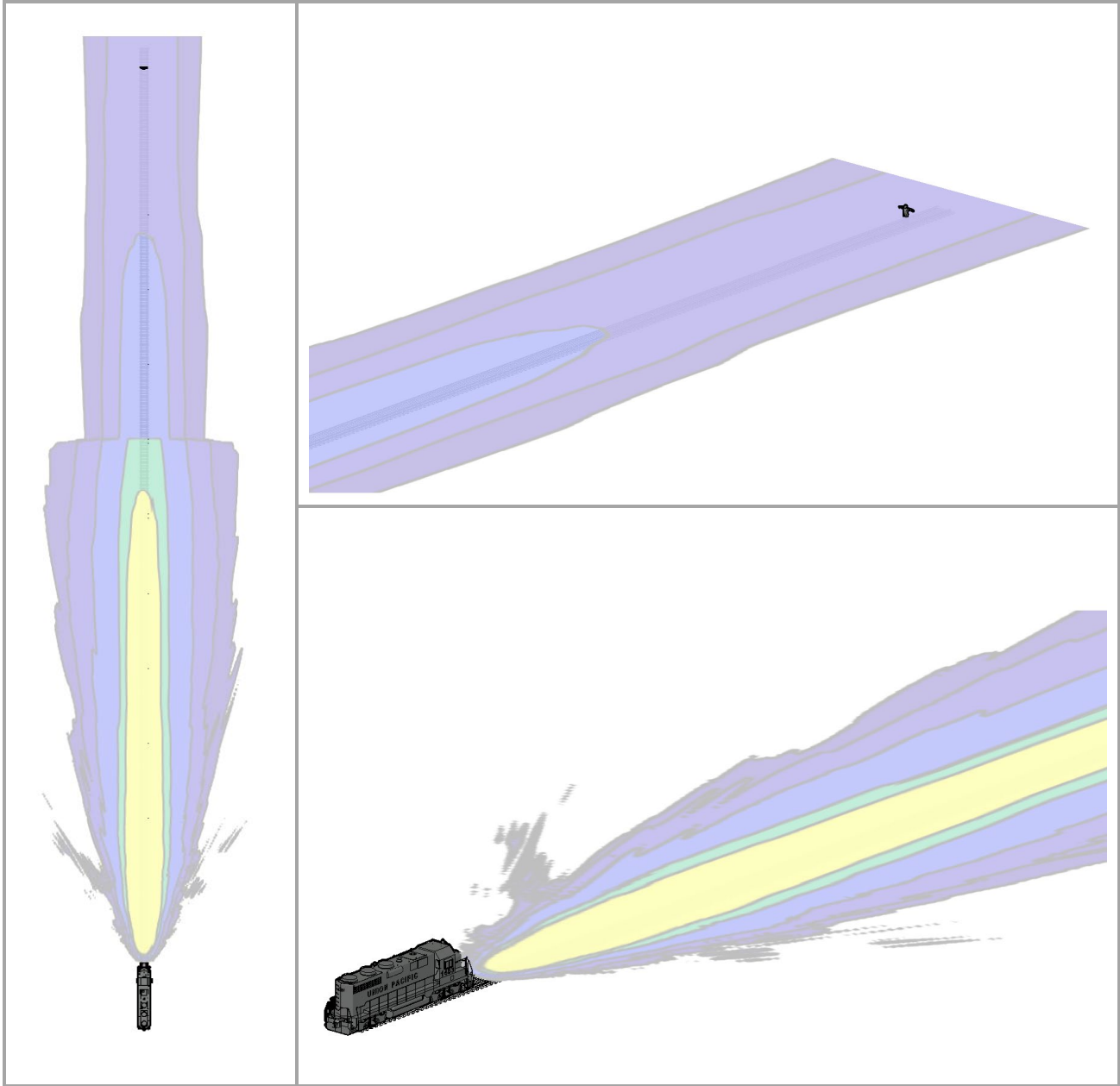

Figure 5. 3-Way View of an Illuminance map for a Smart Light Source dual-lamp headlight and auxillary lights (S3 LED). The human figure (upper-right plot) stands 800 ft away from the light source.

Three-Way View of Illuminance Map of LED All Lights at 4 ft Height from the Ground in Bright Mode

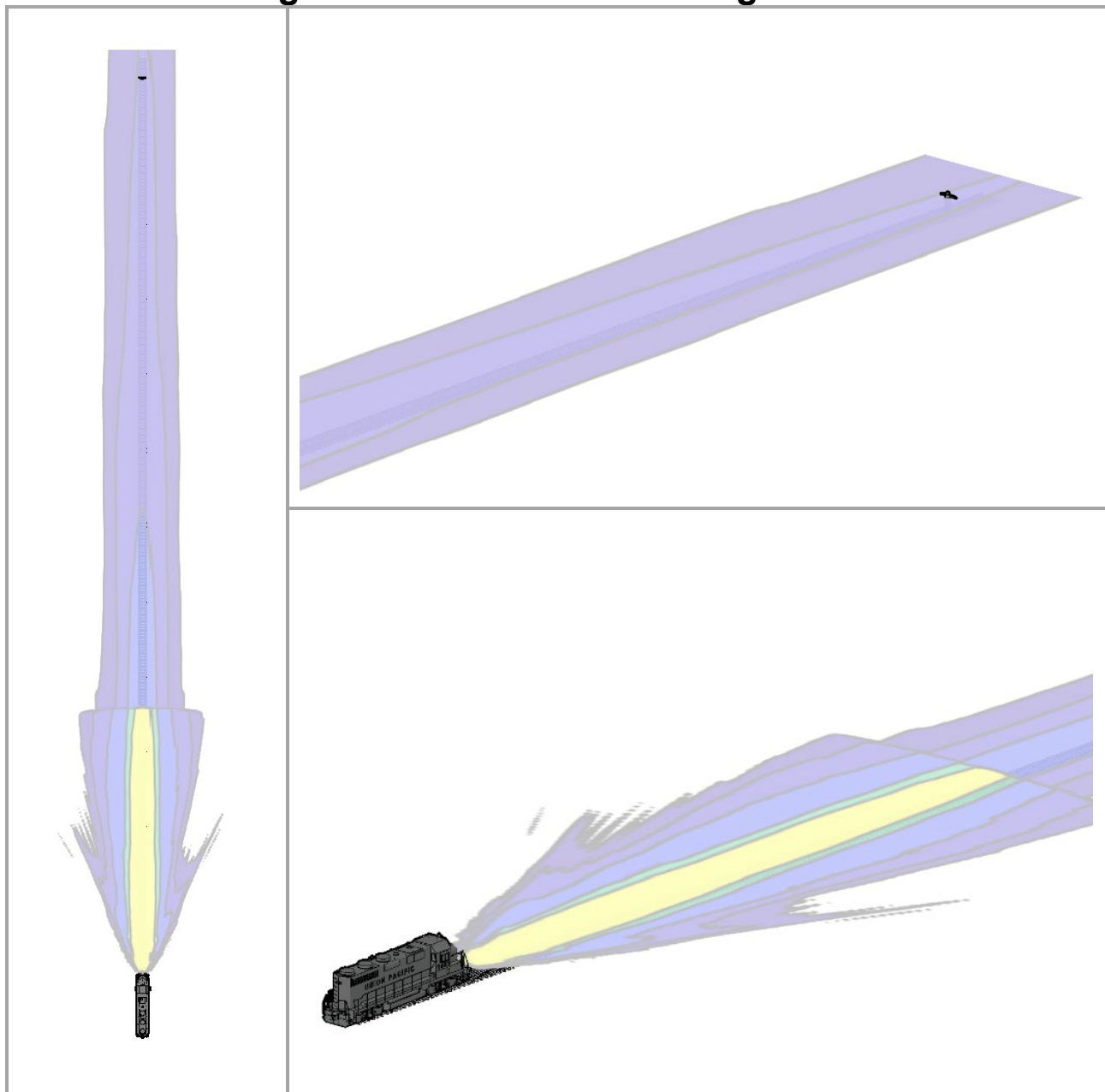

Figure 1. 3-Way View of an Illuminance map for a J.W. Speaker dual-lamp headlight and auxillary lights (S2 LED). The human figure (upper-right plot) stands 800 ft away from the light source.



Figure 2. 3-Way View of an Illuminance map for a Hydra-Tech 2800K dual-lamp headlight and auxillary lights (S5 LED). The human figure (upper-right plot) stands 800 ft away from the light source.

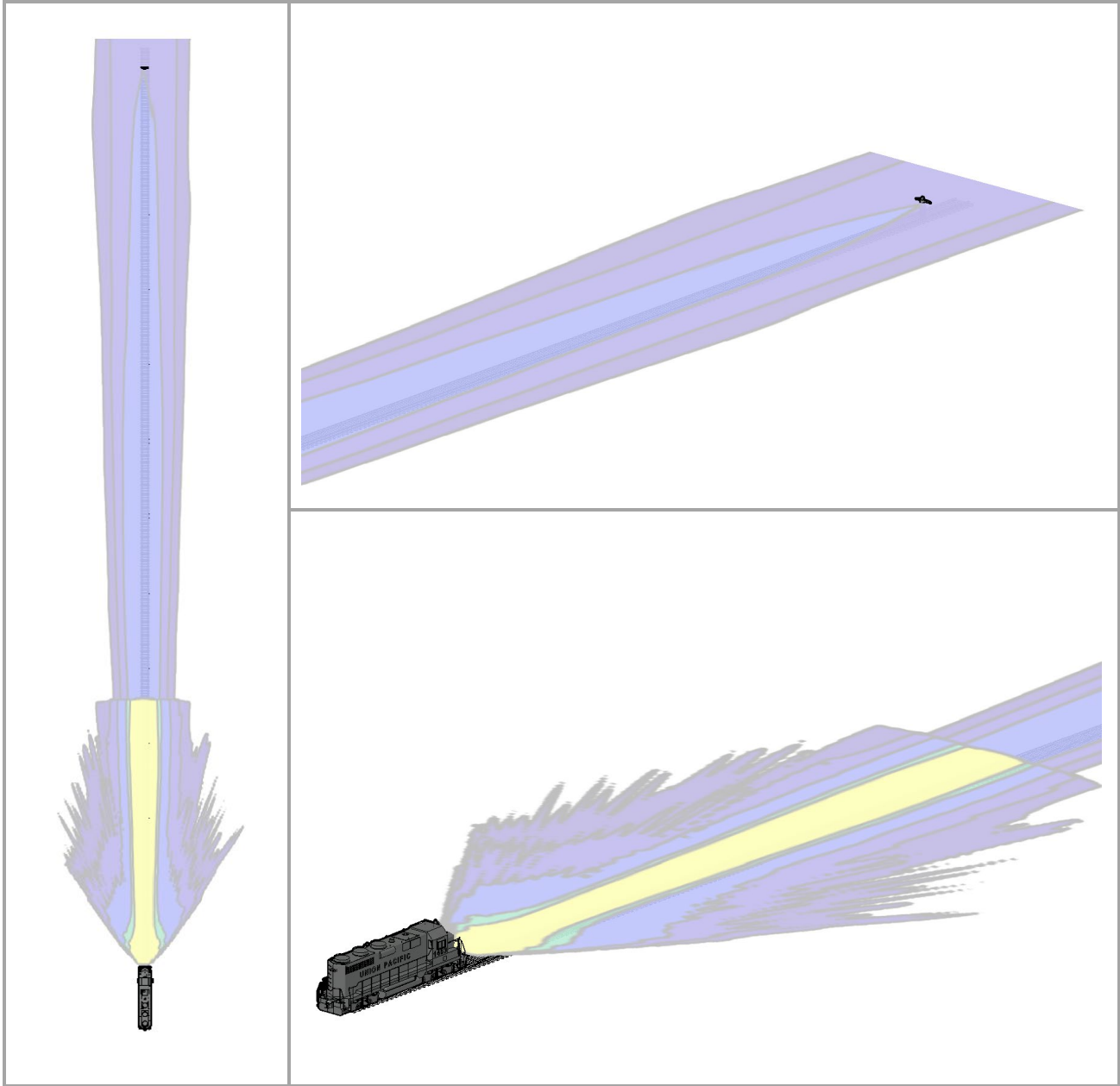

Figure 3. 3-Way View of an Illuminance map for a Hydra-Tech 7000K dual-lamp headlight and auxillary lights (S1 LED). The human figure (upper-right plot) stands 800 ft away from the light source.

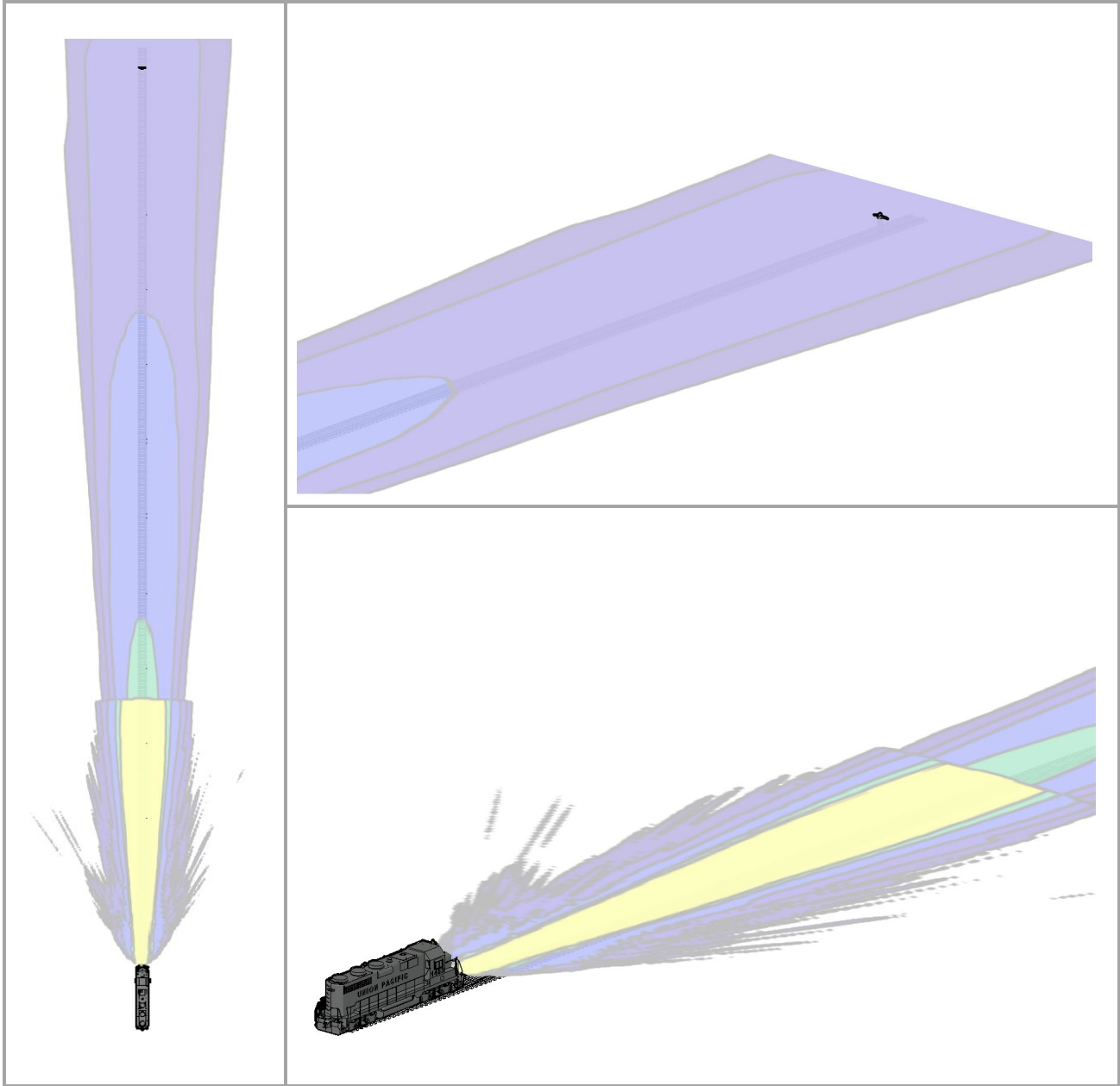

Figure 4. 3-Way View of an Illuminance map for a Railhead/Divvali dual-lamp headlight and auxillary lights (S7 LED). The human figure (upper-right plot) stands 800 ft away from the light source.

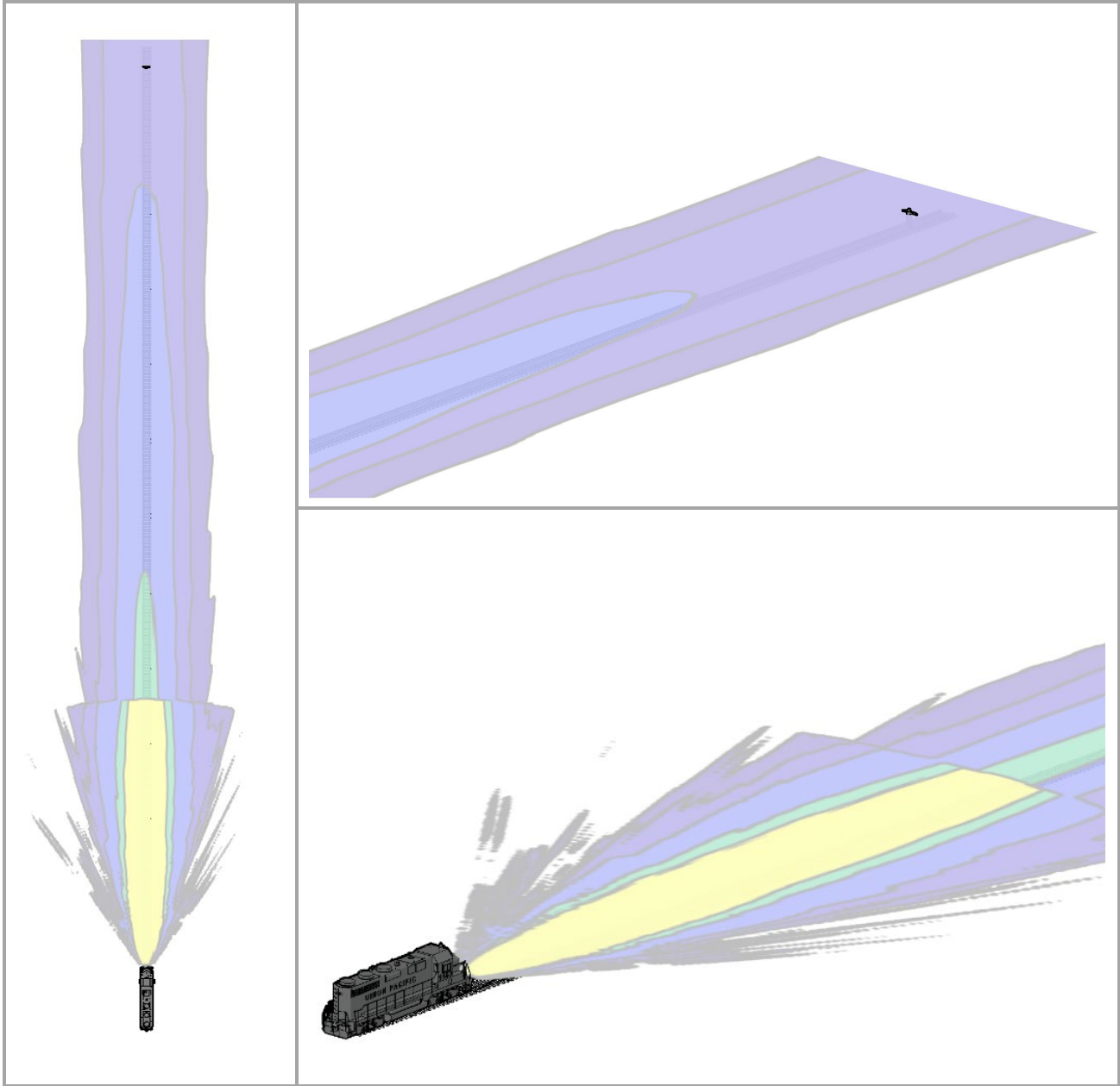

Figure 5. 3-Way View of an Illuminance map for a Smart Light Source dual-lamp headlight and auxillary lights (S3 LED). The human figure (upper-right plot) stands 800 ft away from the light source.

Three-Way View of Illuminance Map of LED All Lights at Ground Height in Dim Mode

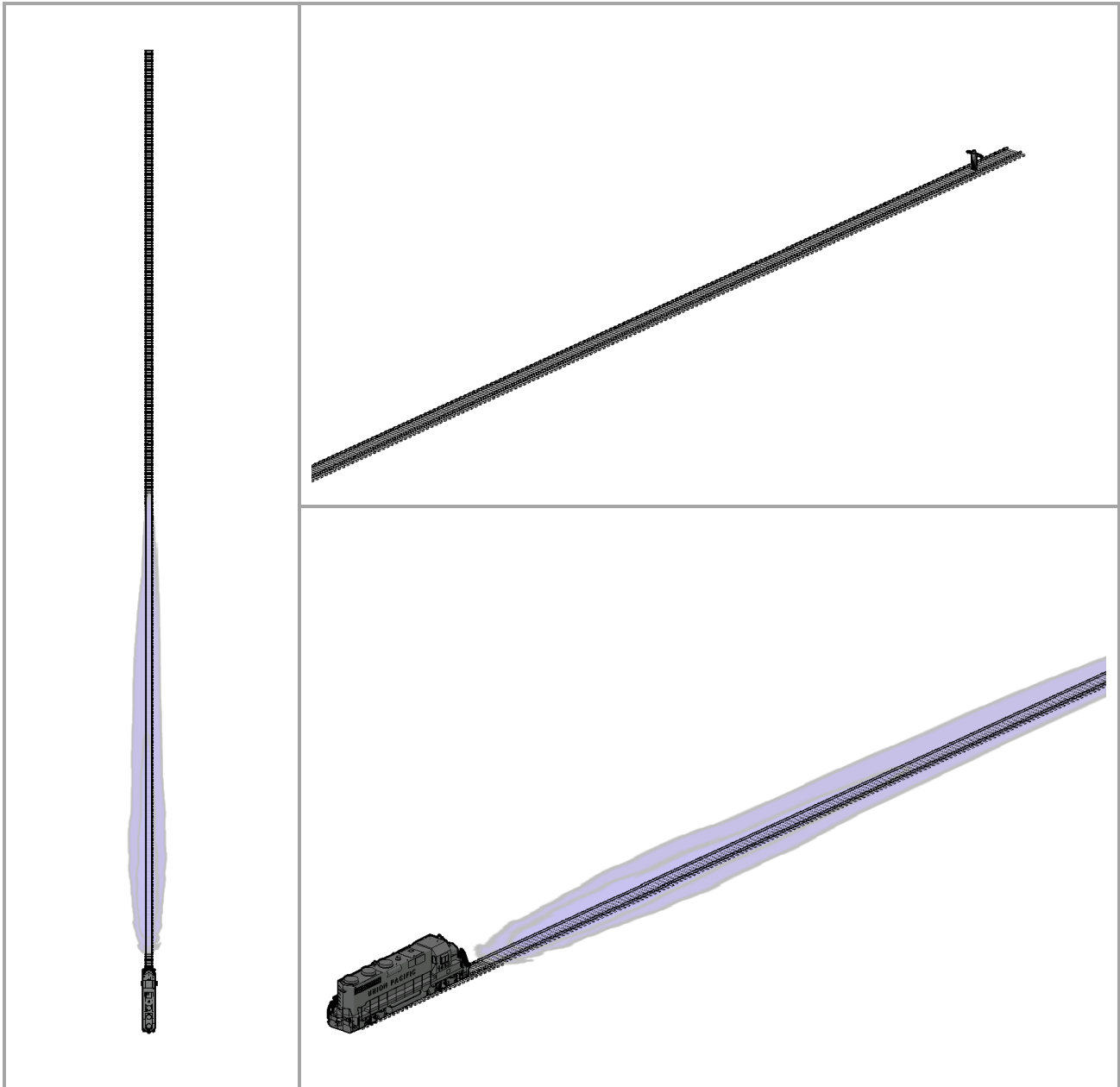

Figure 1. 3-Way View of an Illuminance map for a J.W. Speaker dual-lamp headlight and auxillary lights (S2 LED). The human figure (upper-right plot) stands 800 ft away from the light source.

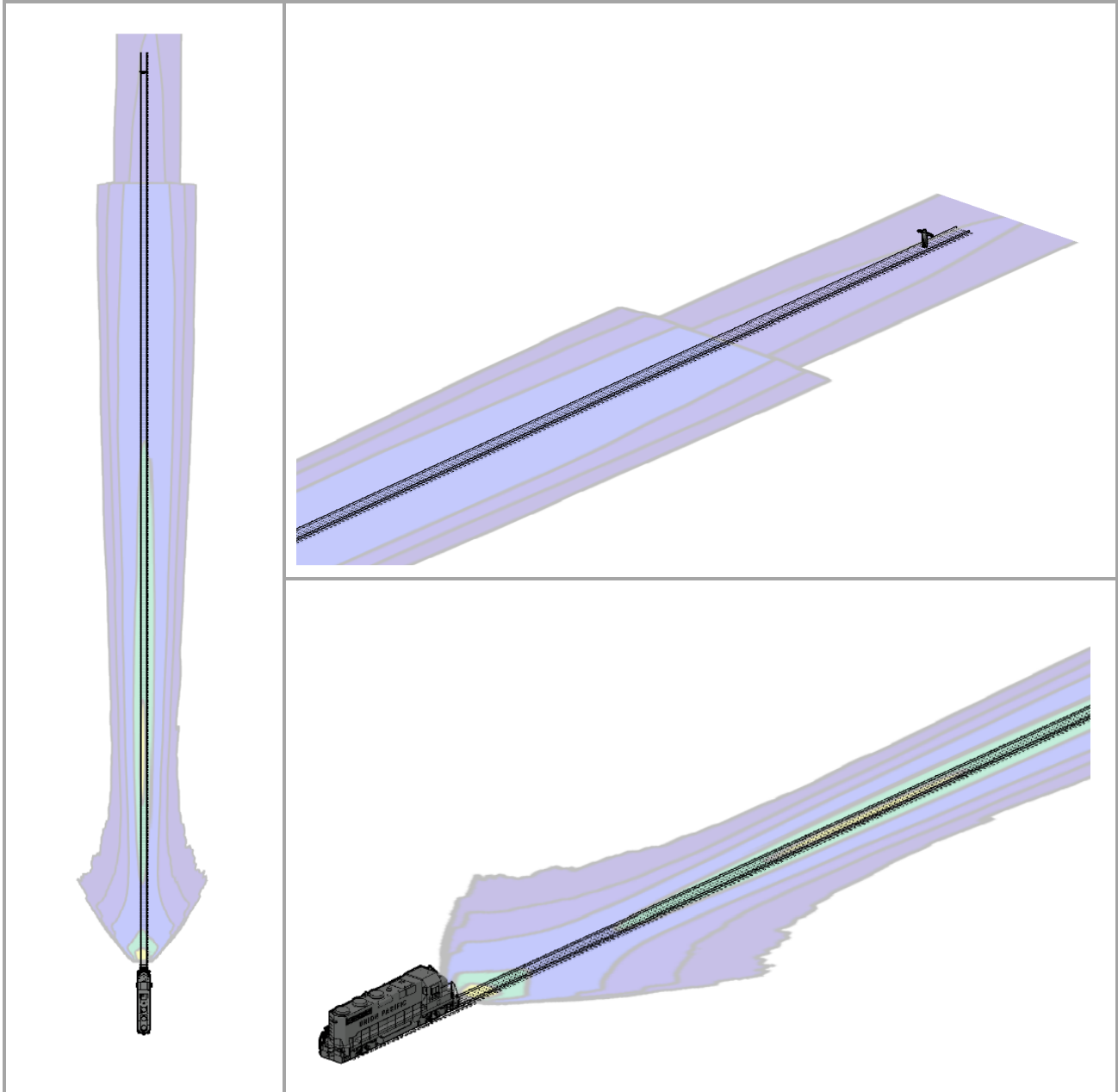

Figure 2. 3-Way View of an Illuminance map for a Hydra-Tech 2800K dual-lamp headlight and auxillary lights (S5 LED). The human figure (upper-right plot) stands 800 ft away from the light source.

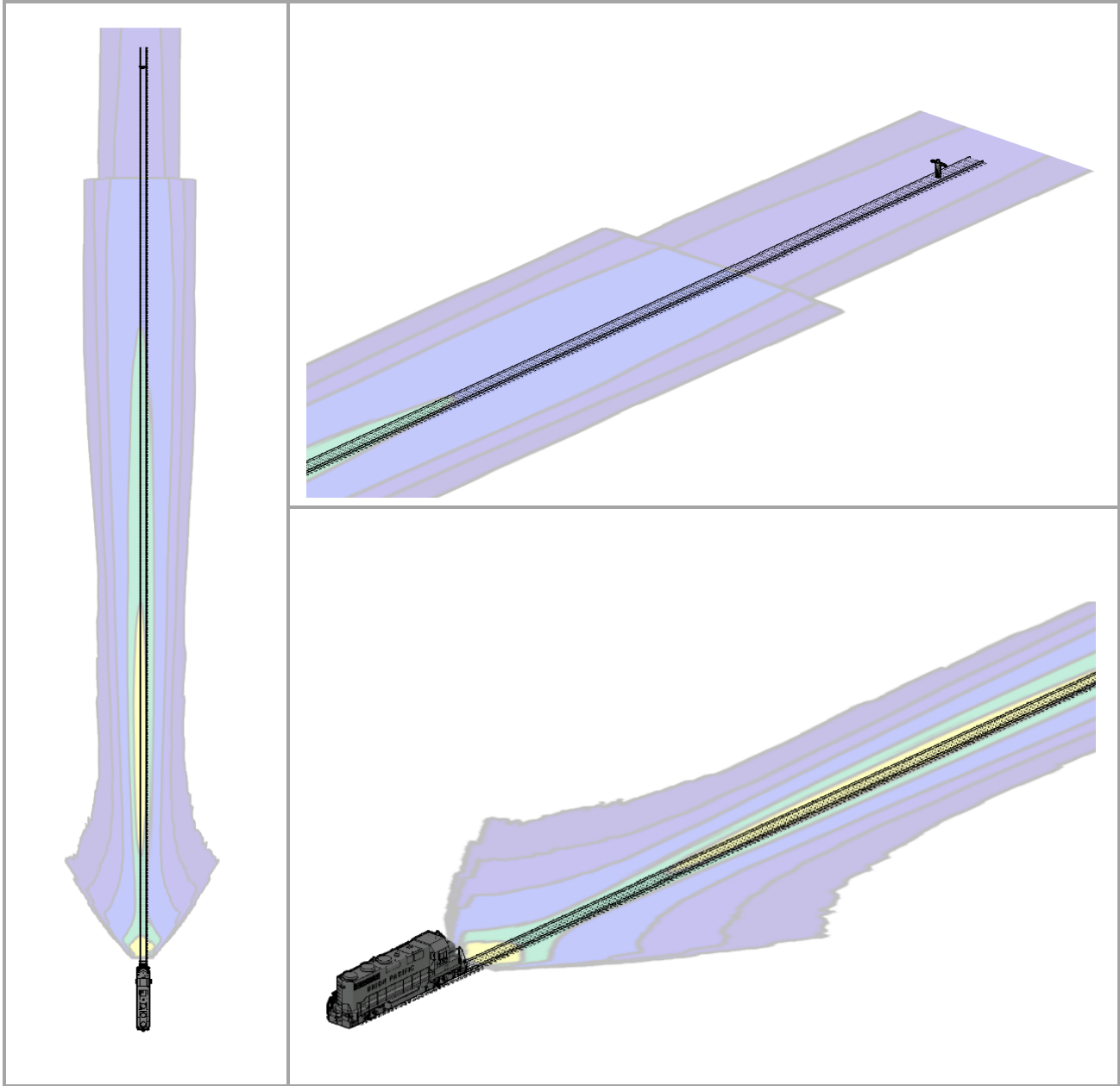

Figure 3. 3-Way View of an Illuminance map for a Hydra-Tech 7000K dual-lamp headlight and auxillary lights (S1 LED). The human figure (upper-right plot) stands 800 ft away from the light source.

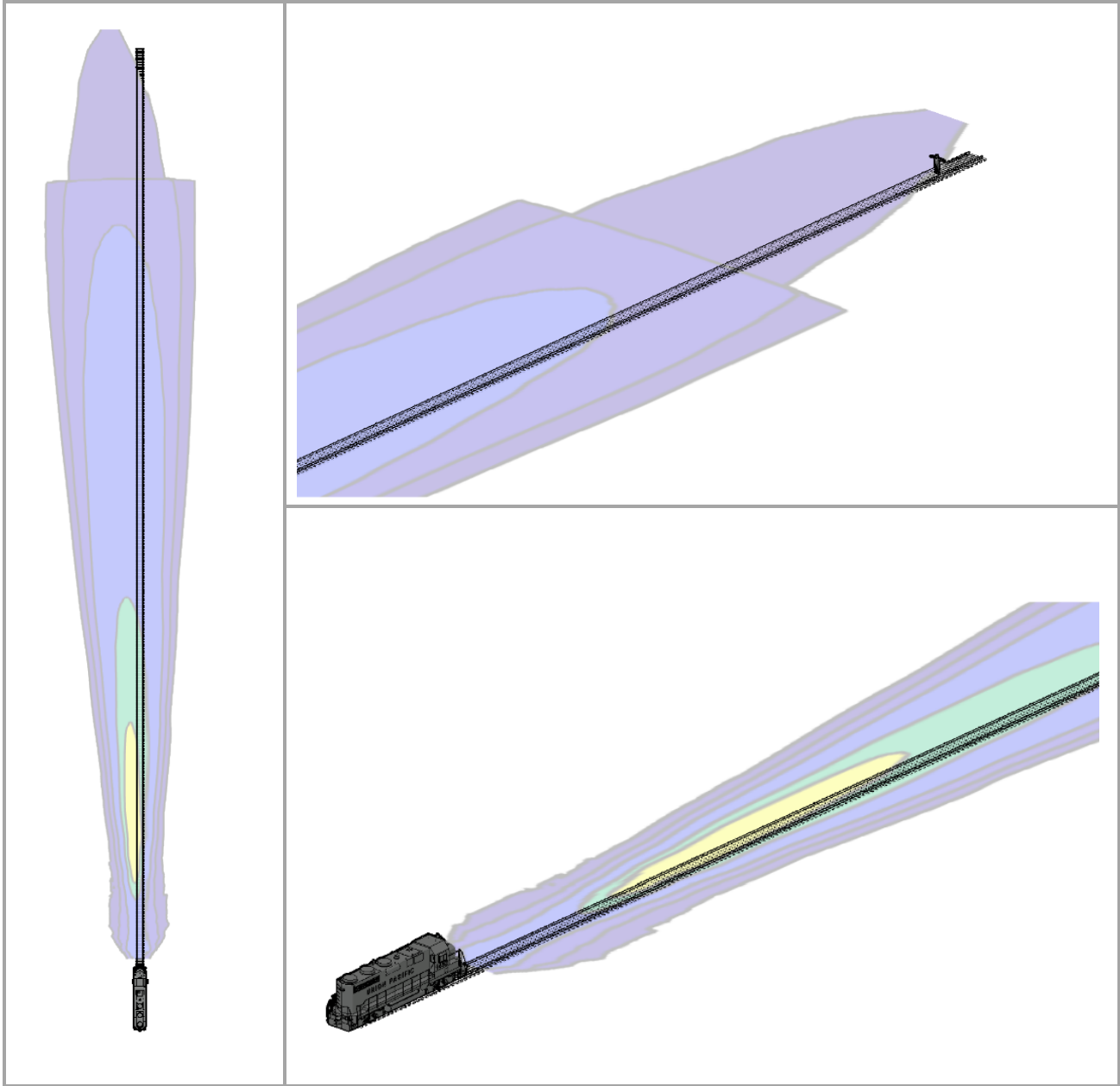

Figure 4. 3-Way View of an Illuminance map for a Railhead/Divvali dual-lamp headlight and auxillary lights (S7 LED). The human figure (upper-right plot) stands 800 ft away from the light source.

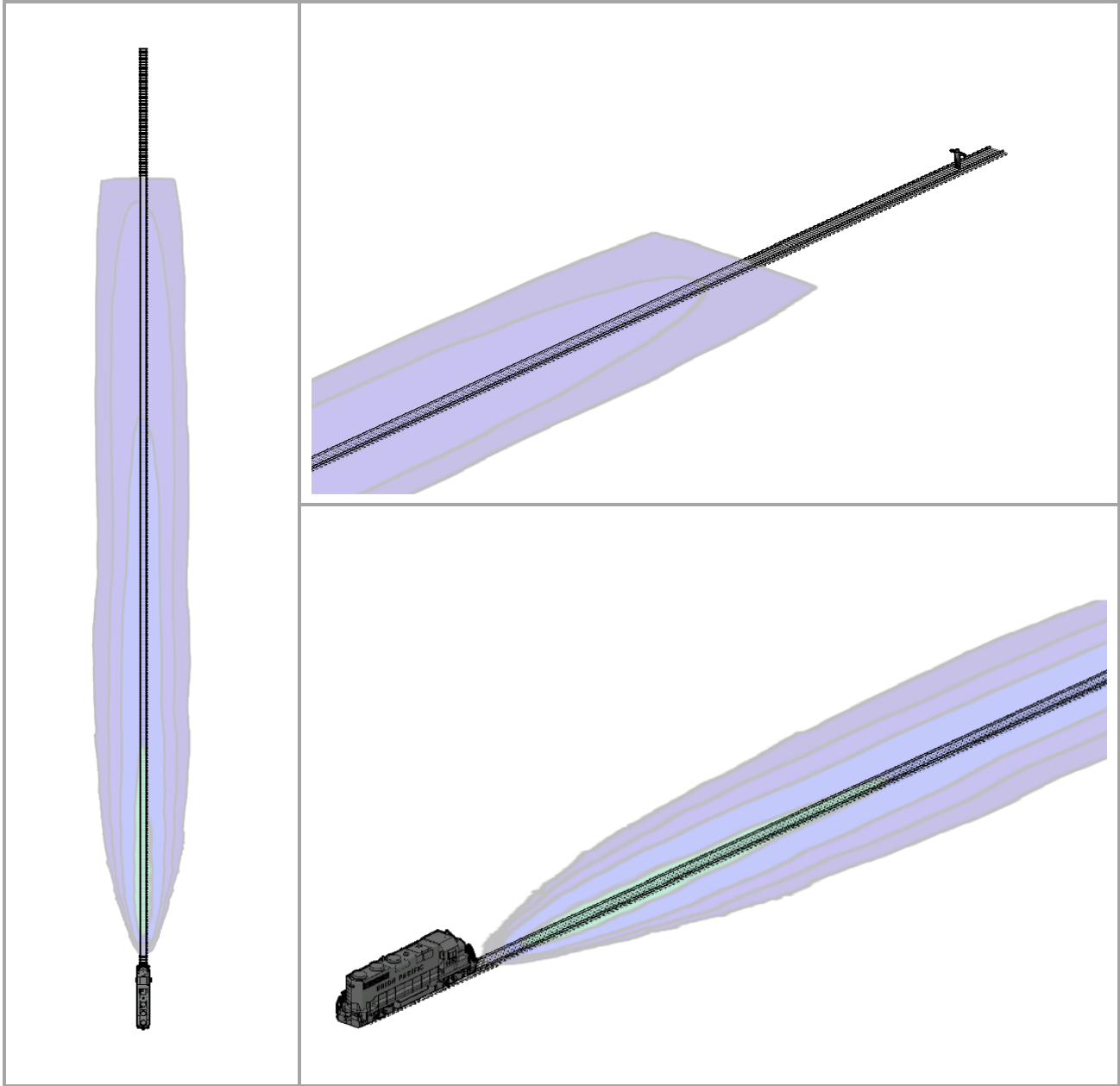

Figure 5. 3-Way View of an Illuminance map for a Smart Light Source dual-lamp headlight and auxillary lights (S3 LED). The human figure (upper-right plot) stands 800 ft away from the light source.

Three-Way View of Illuminance Map of LED All Lights at 2ft Height from the Ground in Dim Mode

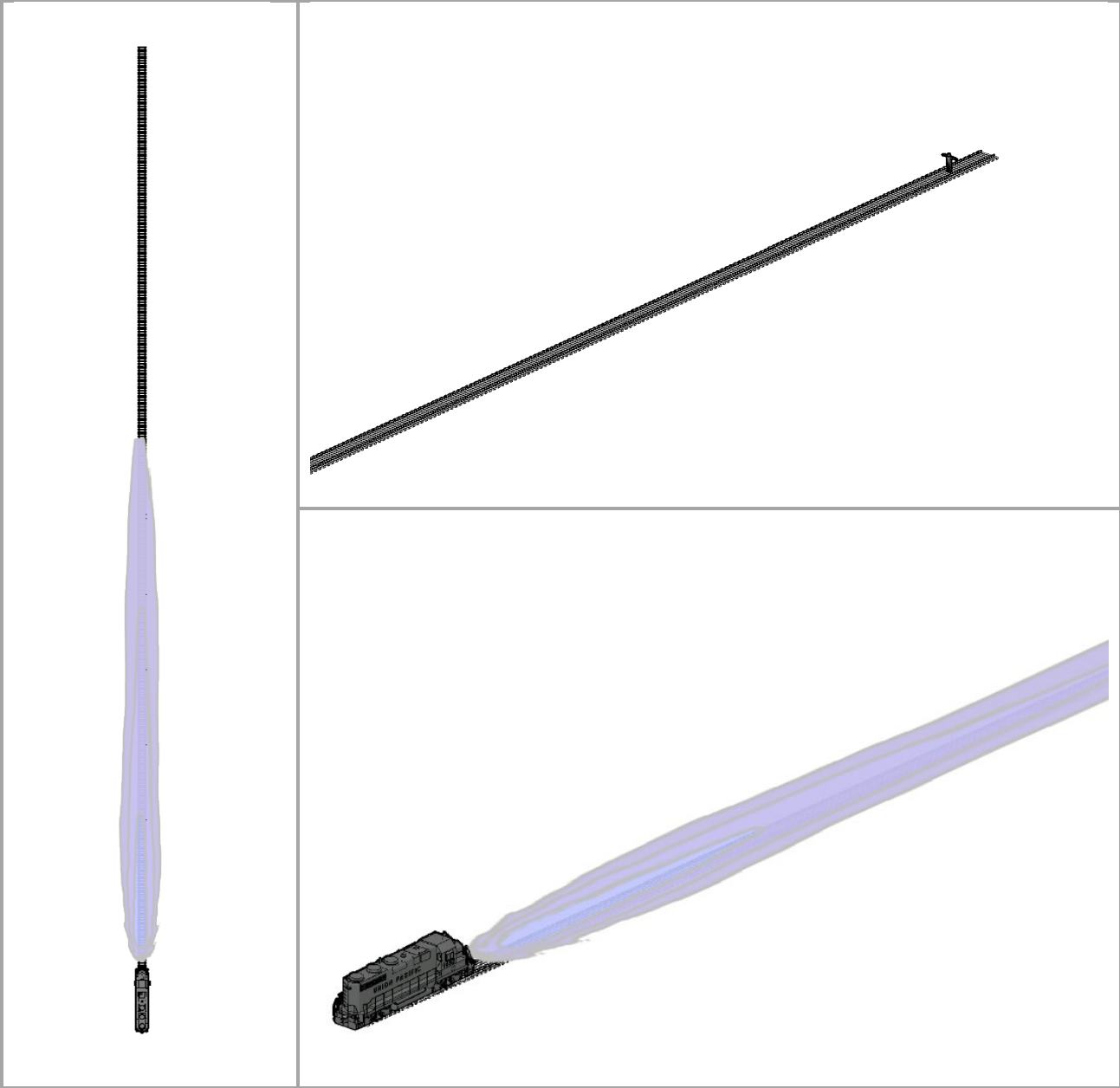

Figure 1. 3-Way View of an Illuminance map for a J.W. Speaker dual-lamp headlight and auxillary lights (S2 LED). The human figure (upper-right plot) stands 800 ft away from the light source.



Figure 2. 3-Way View of an Illuminance map for a Hydra-Tech 2800K dual-lamp headlight and auxillary lights (S5 LED). The human figure (upper-right plot) stands 800 ft away from the light source.

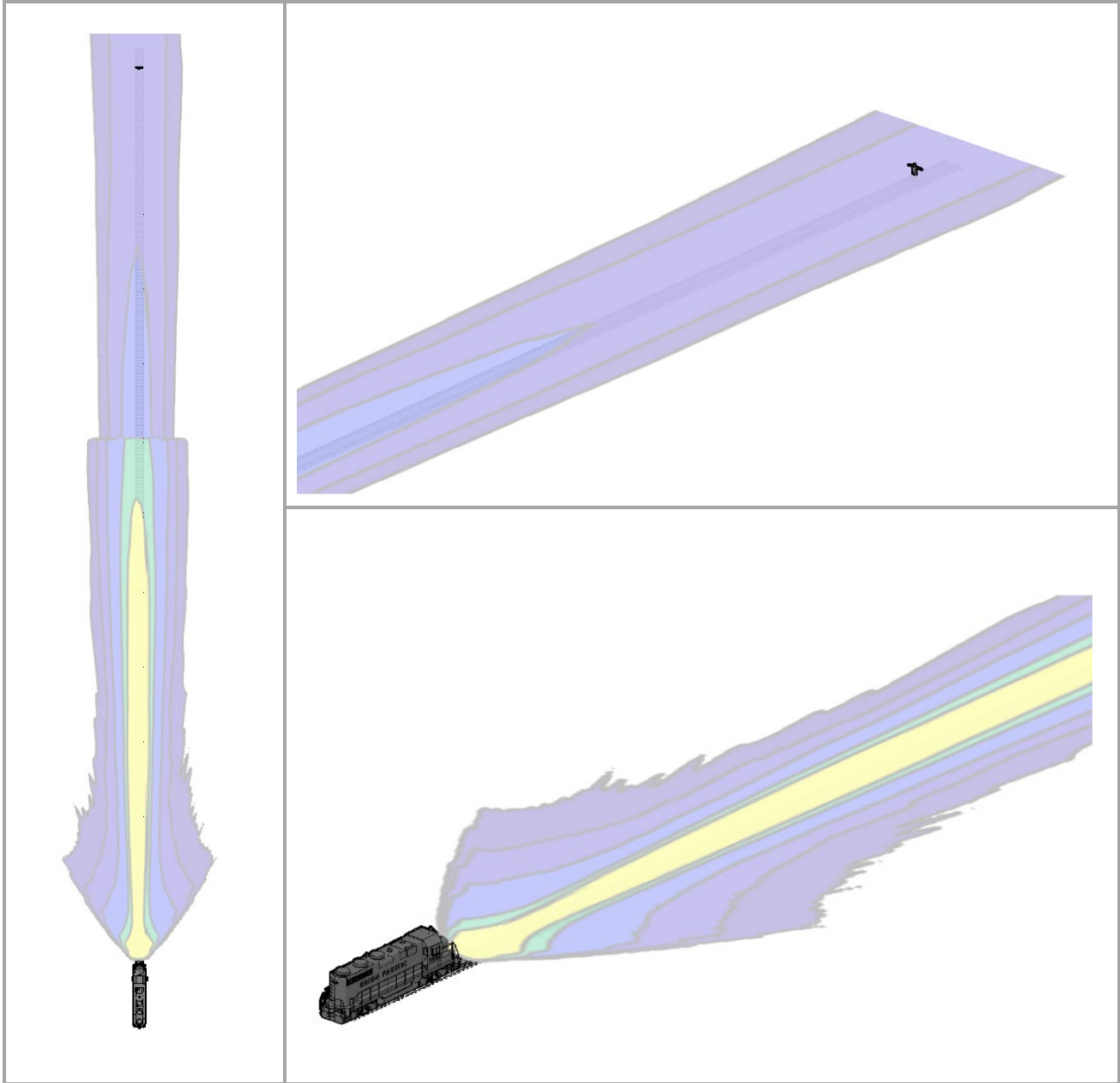

Figure 3. 3-Way View of an Illuminance map for a Hydra-Tech 7000K dual-lamp headlight and auxillary lights (S1 LED). The human figure (upper-right plot) stands 800 ft away from the light source.

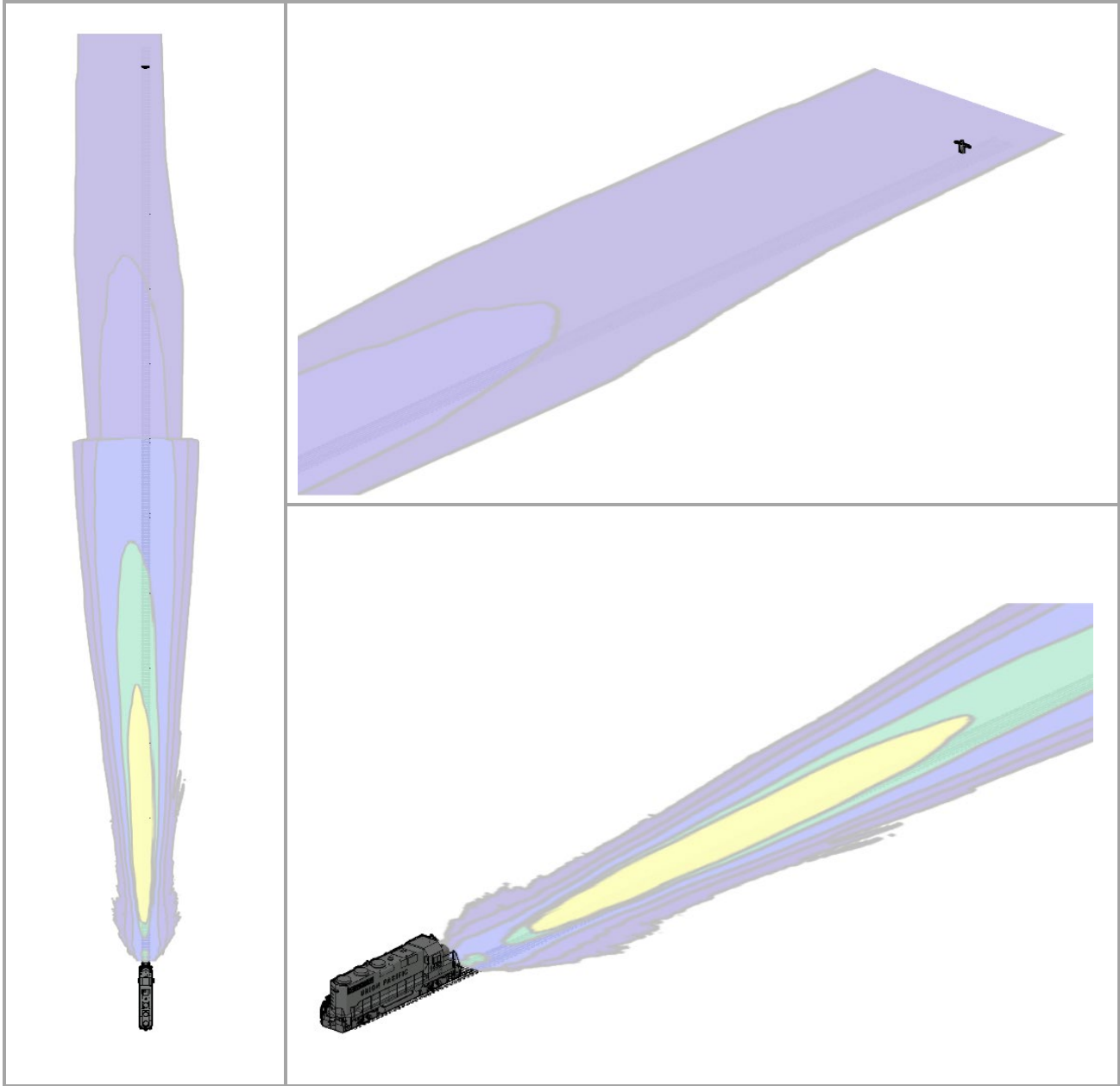

Figure 4. 3-Way View of an Illuminance map for a Railhead/Divvali dual-lamp headlight and auxillary lights (S7 LED). The human figure (upper-right plot) stands 800 ft away from the light source.

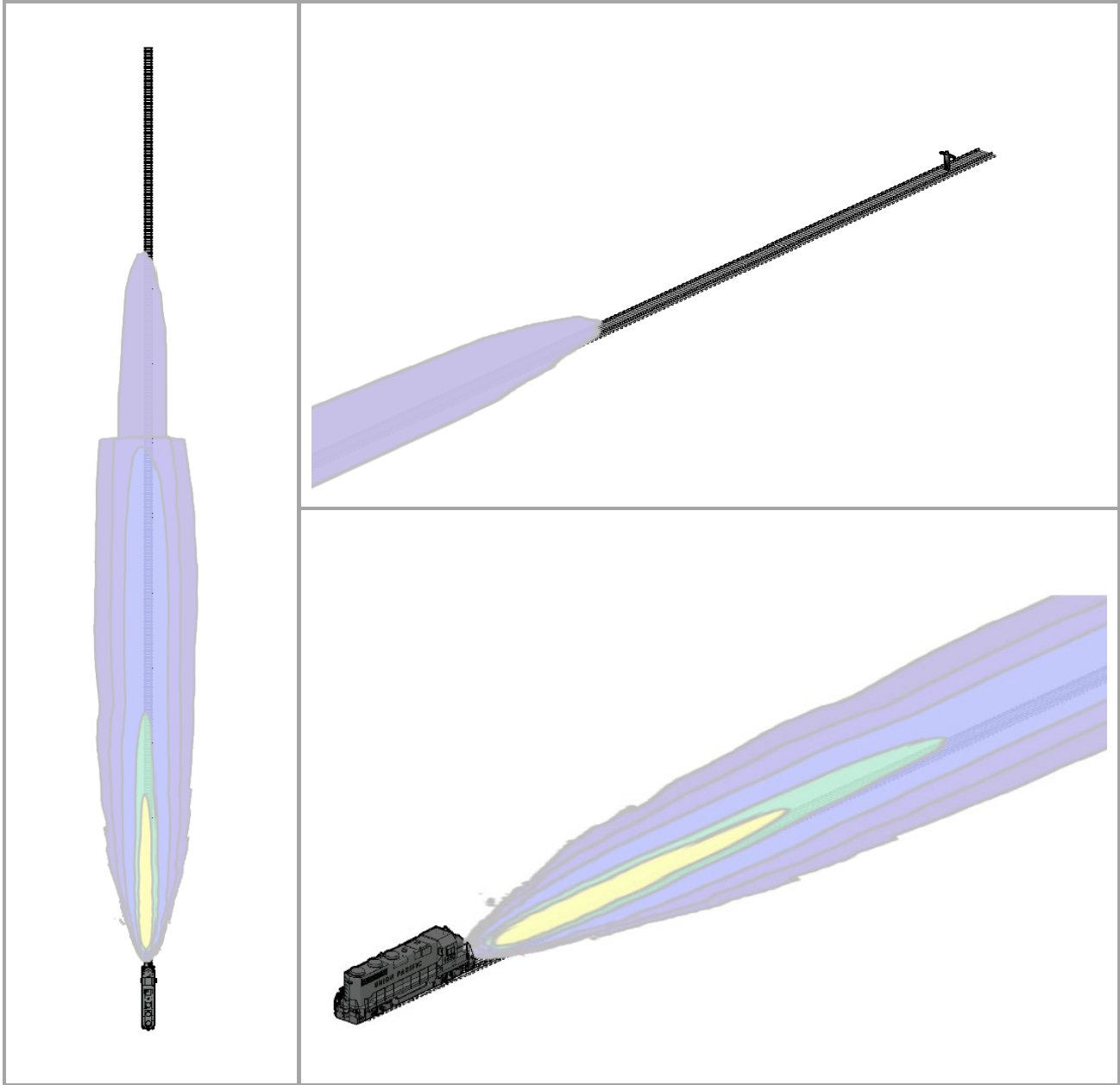

Figure 5. 3-Way View of an Illuminance map for a Smart Light Source dual-lamp headlight and auxillary lights (S3 LED). The human figure (upper-right plot) stands 800 ft away from the light source.

Three-Way View of Illuminance Map of LED All Lights at 4 ft Height from the Ground in Dim Mode

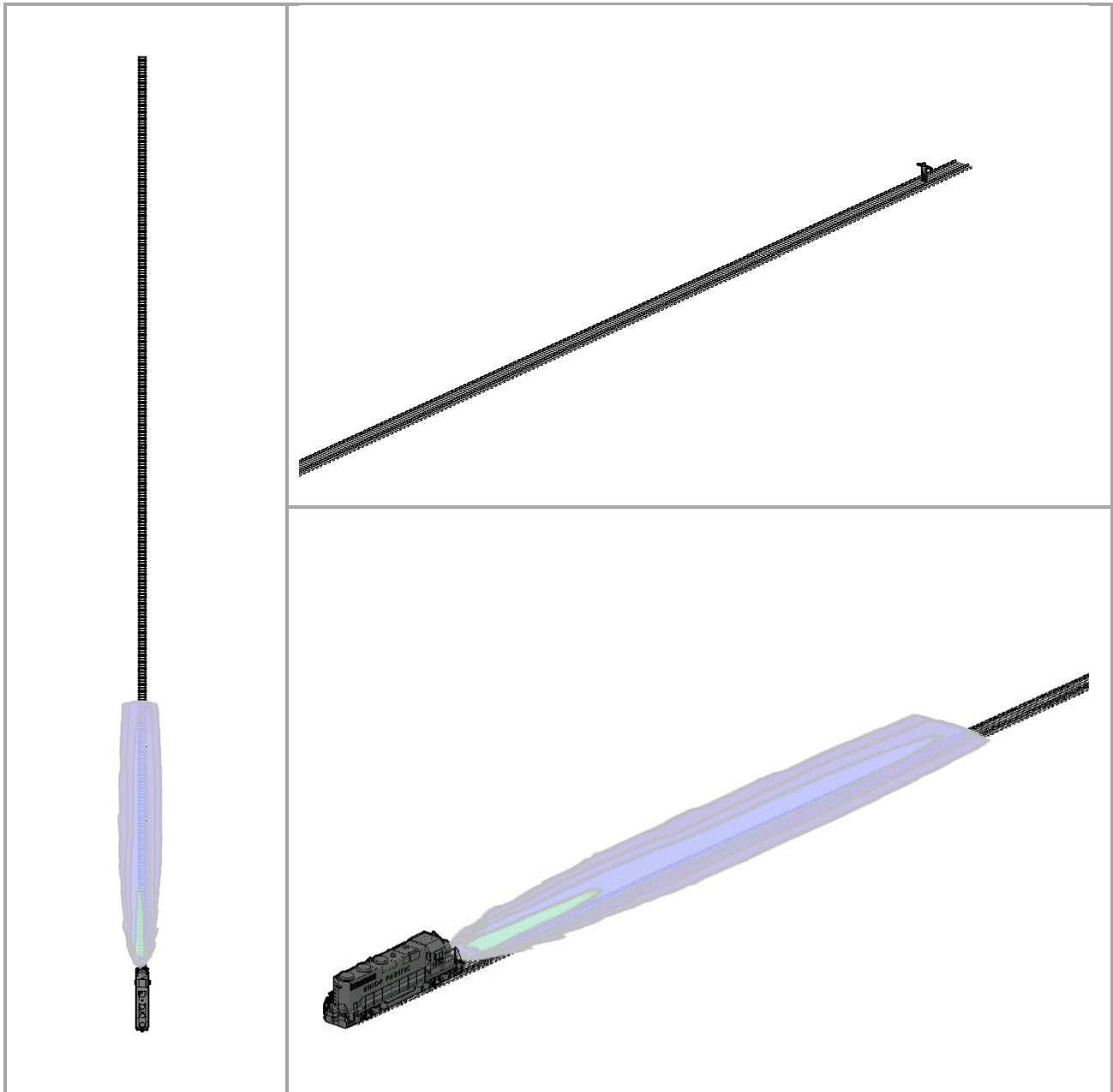

Figure 1. 3-Way View of an Illuminance map for a J.W. Speaker dual-lamp headlight and auxillary lights (S2 LED). The human figure (upper-right plot) stands 800 ft away from the light source.

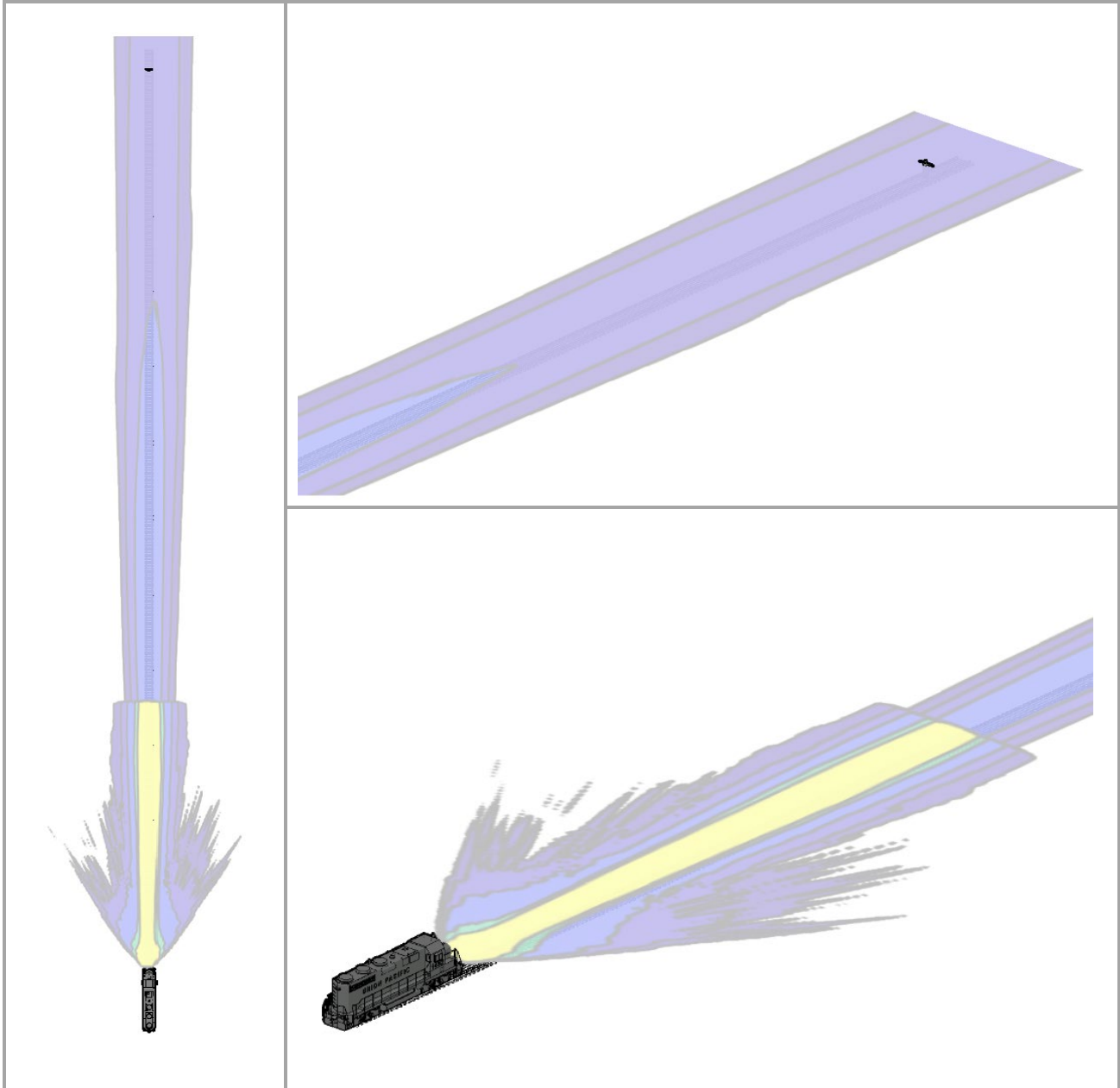

Figure 2. 3-Way View of an Illuminance map for a Hydra-Tech 2800K dual-lamp headlight and auxillary lights (S5 LED). The human figure (upper-right plot) stands 800 ft away from the light source.



Figure 3. 3-Way View of an Illuminance map for a Hydra-Tech 7000K dual-lamp headlight and auxillary lights (S1 LED). The human figure (upper-right plot) stands 800 ft away from the light source.

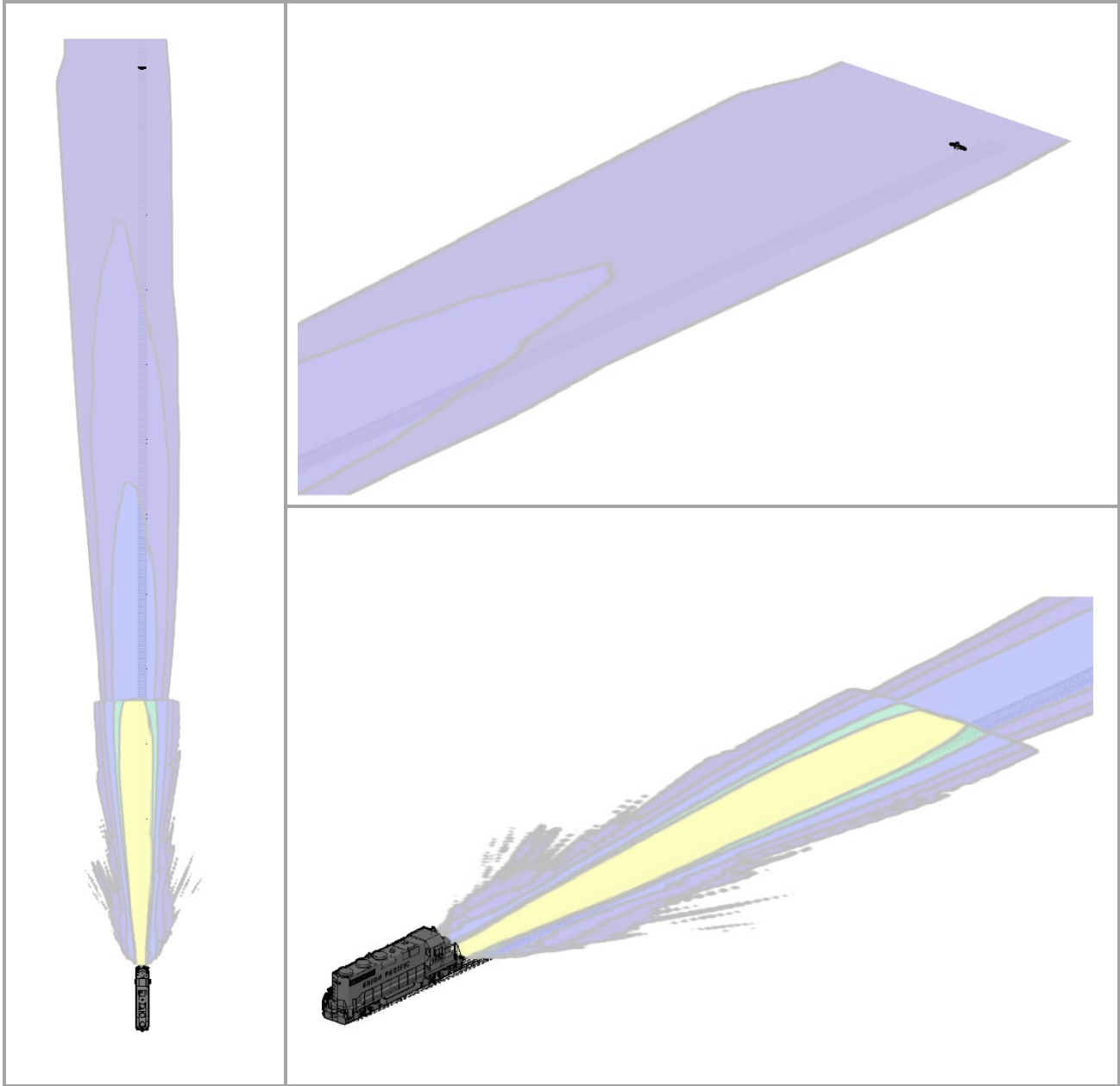

Figure 4. 3-Way View of an Illuminance map for a Railhead/Divvali dual-lamp headlight and auxillary lights (S7 LED). The human figure (upper-right plot) stands 800 ft away from the light source.



Figure 5. 3-Way View of an Illuminance map for a Smart Light Source dual-lamp headlight and auxillary lights (S3 LED). The human figure (upper-right plot) stands 800 ft away from the light source.

Three-Way View of Illuminance Map of Halogen All Lights at Ground Height

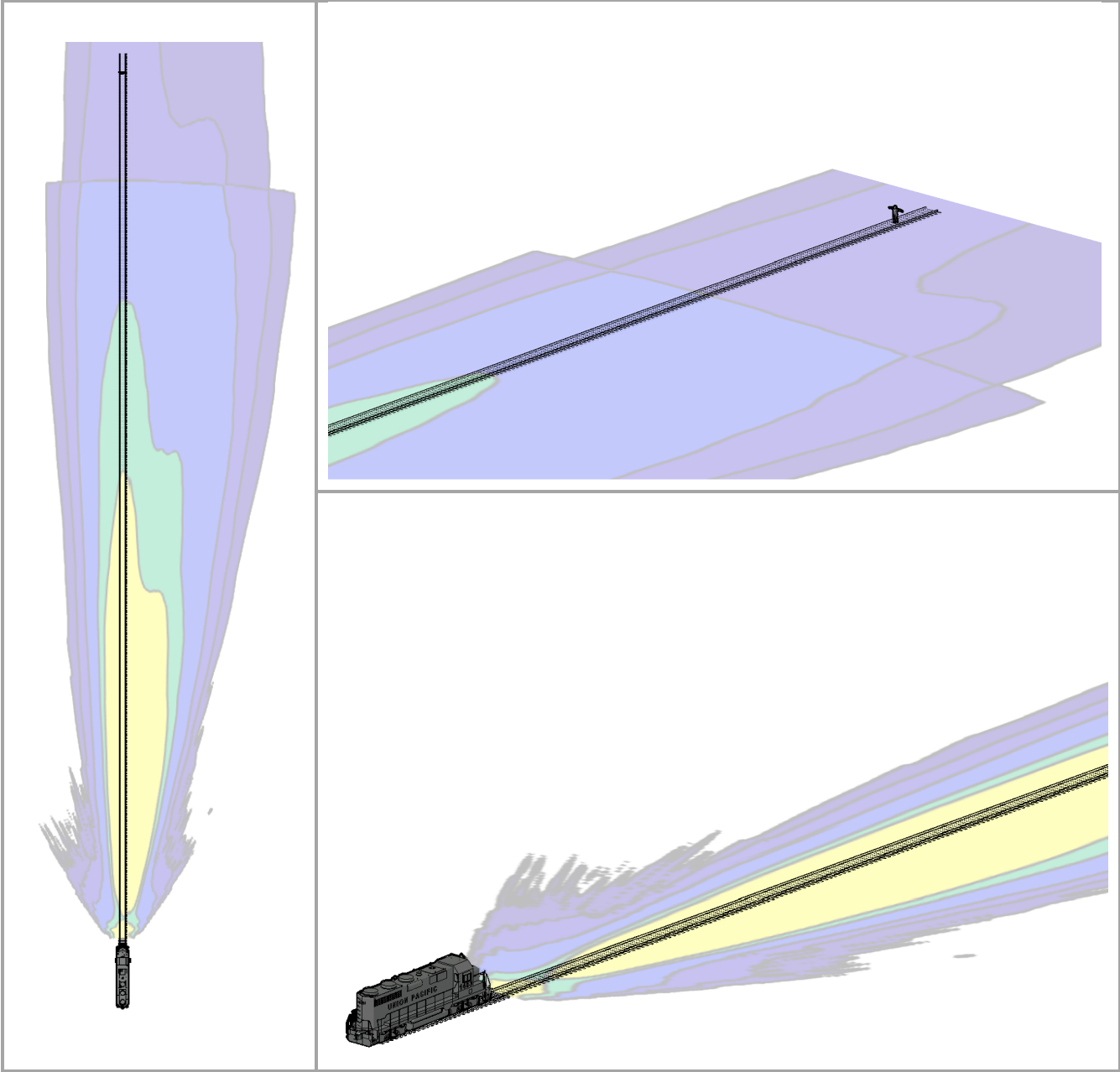

Figure 1. 3-Way View of an Illuminance map for a AMGLO dual-lamp headlight and auxillary lights (S4 HAL). The human figure (upper-right plot) stands 800 ft away from the light source.

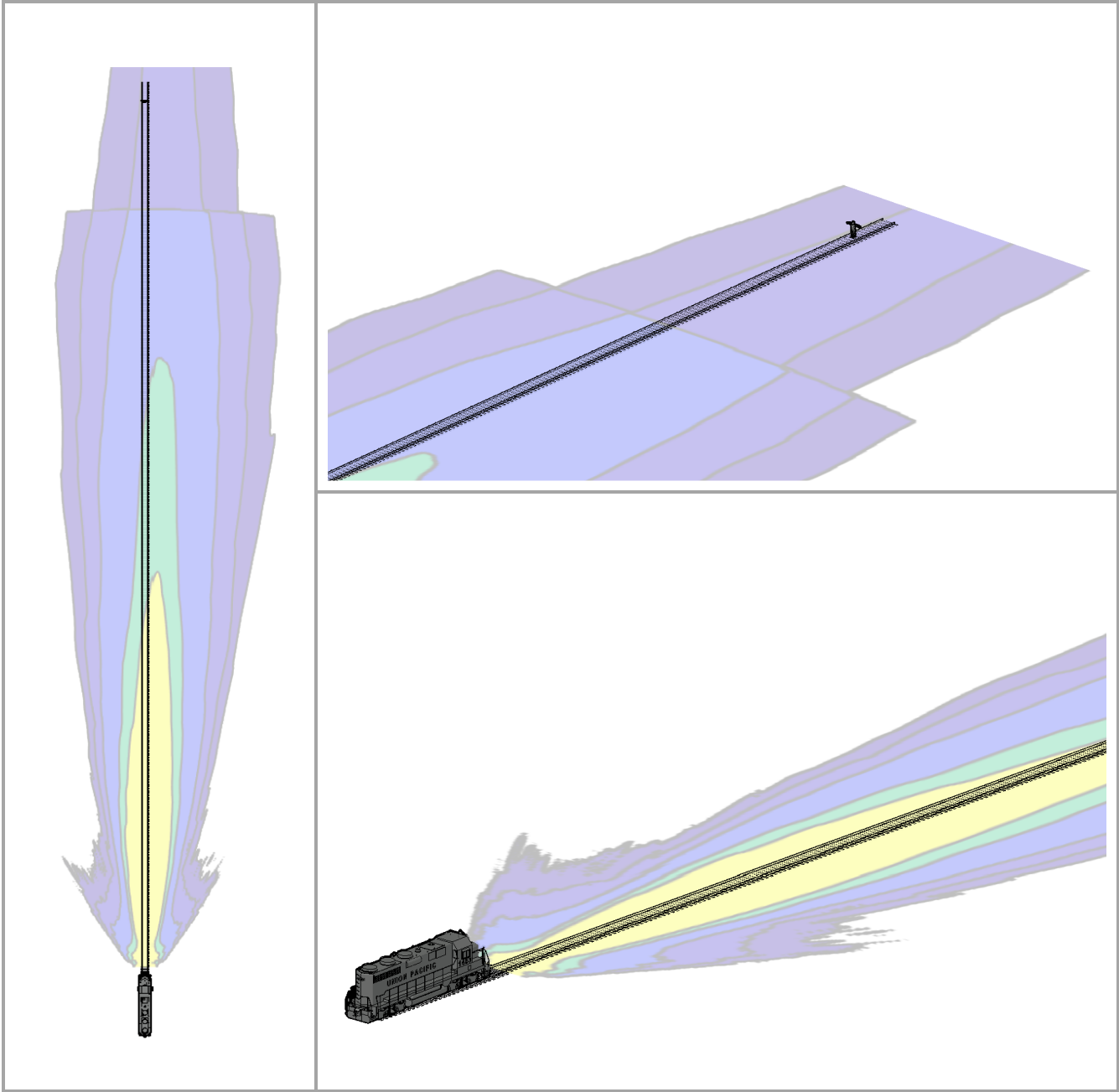

Figure 2. 3-Way View of an Illuminance map for an ePowerRail dual-lamp headlight and auxillary lights (S3 HAL). The human figure (upper-right plot) stands 800 ft away from the light source.

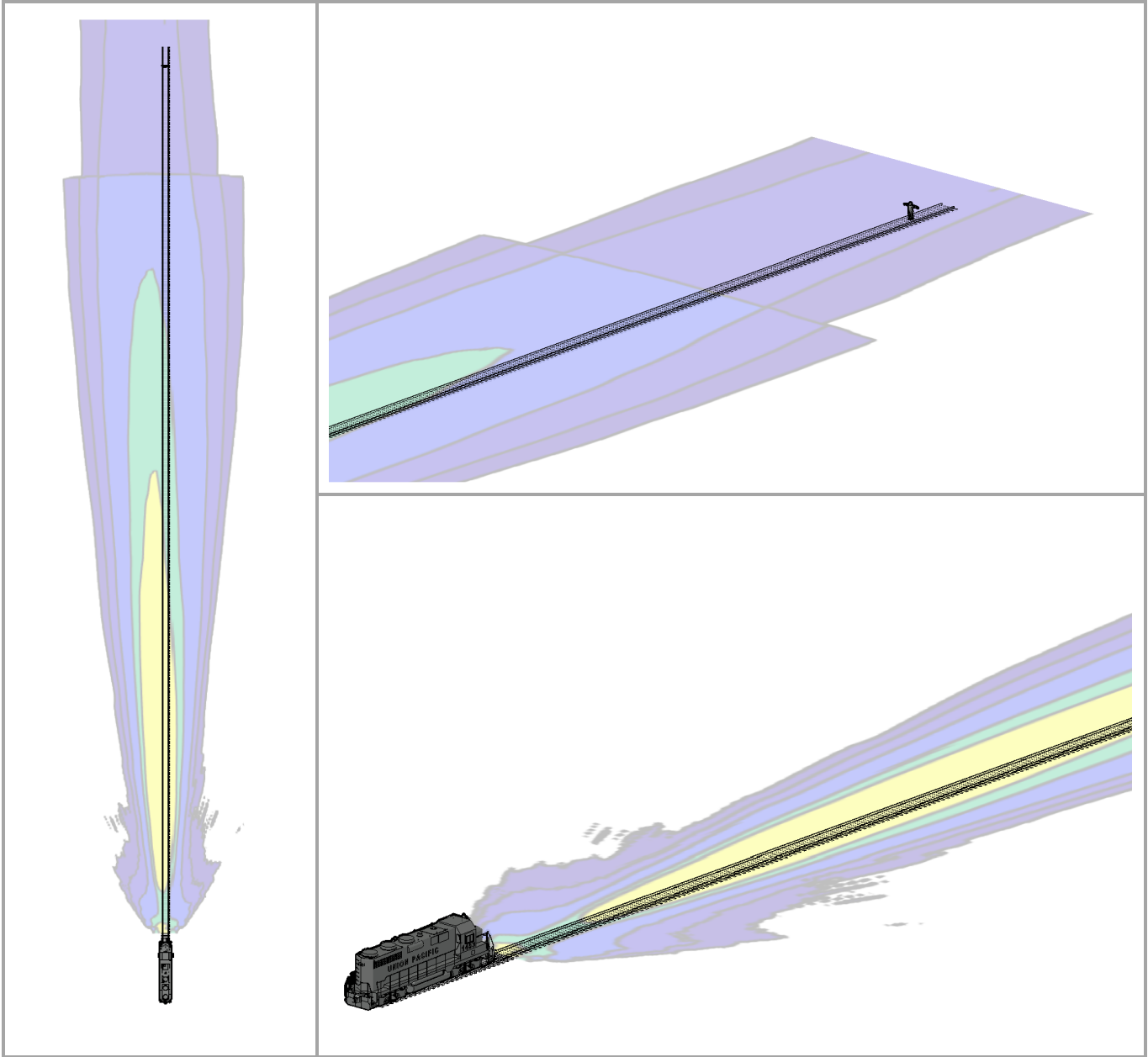

Figure 3. 3-Way View of an Illuminance map for a CML dual-lamp headlight and auxillary lights (S1 HAL). The human figure (upper-right plot) stands 800 ft away from the light source.

Three-Way View of Illuminance Map of Halogen All Lights at 2 ft Height from the Ground

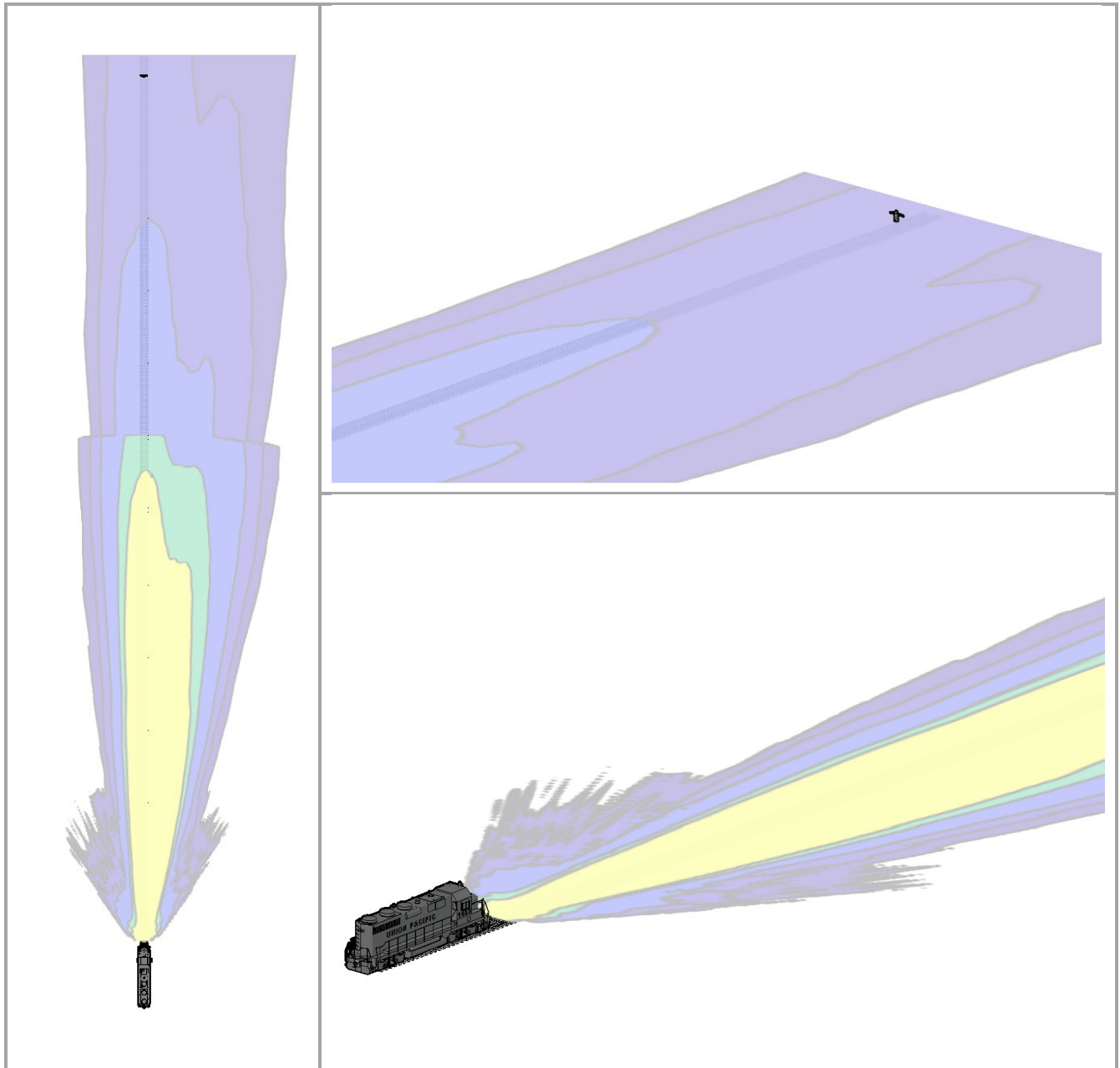

Figure 1. 3-Way View of an Illuminance map for a AMGLO dual-lamp headlight and auxillary lights (S4 HAL). The human figure (upper-right plot) stands 800 ft away from the light source.

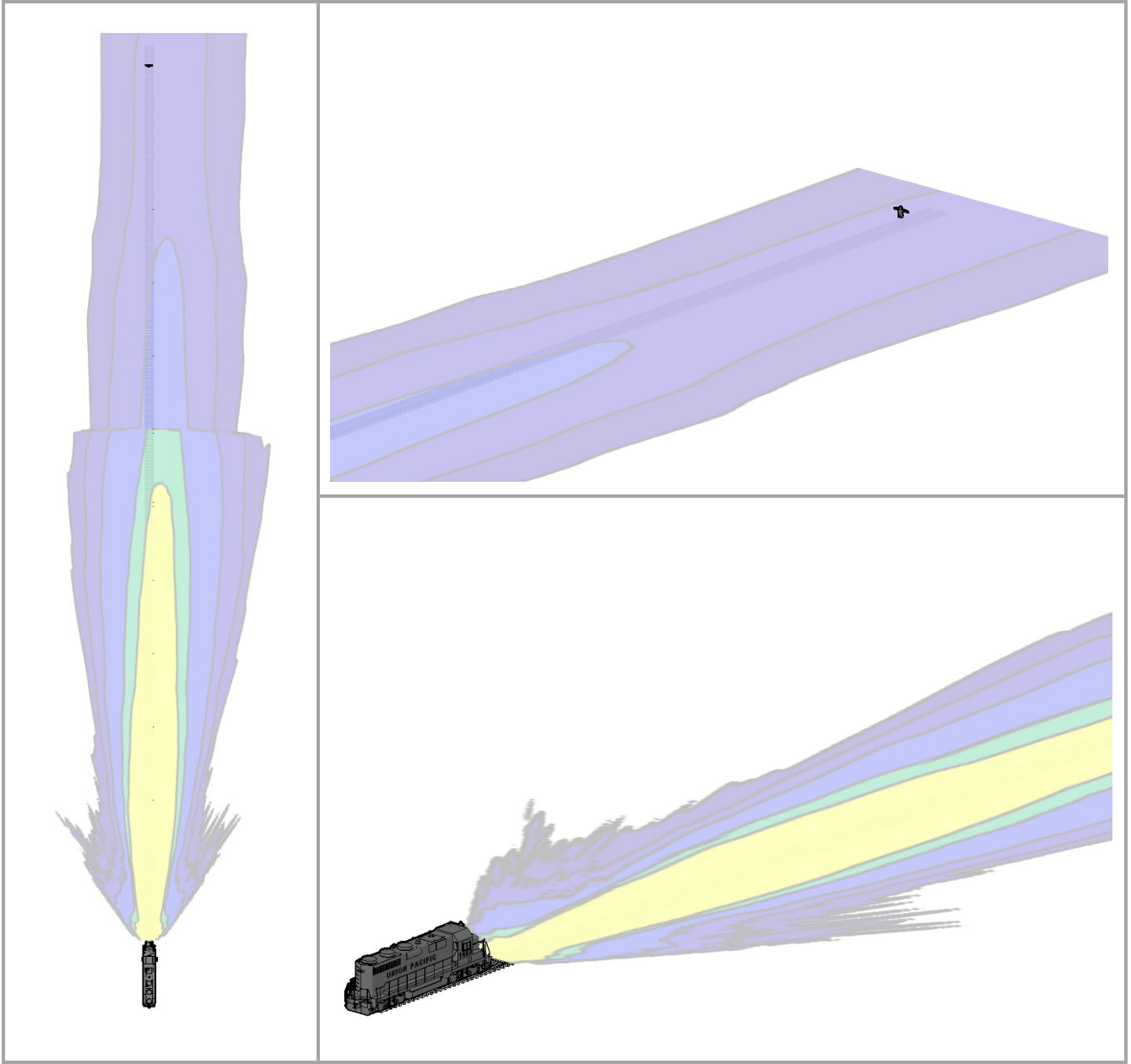

Figure 2. 3-Way View of an Illuminance map for a ePowerRail dual-lamp headlight and auxillary lights (S3 HAL). The human figure (upper-right plot) stands 800 ft away from the light source.

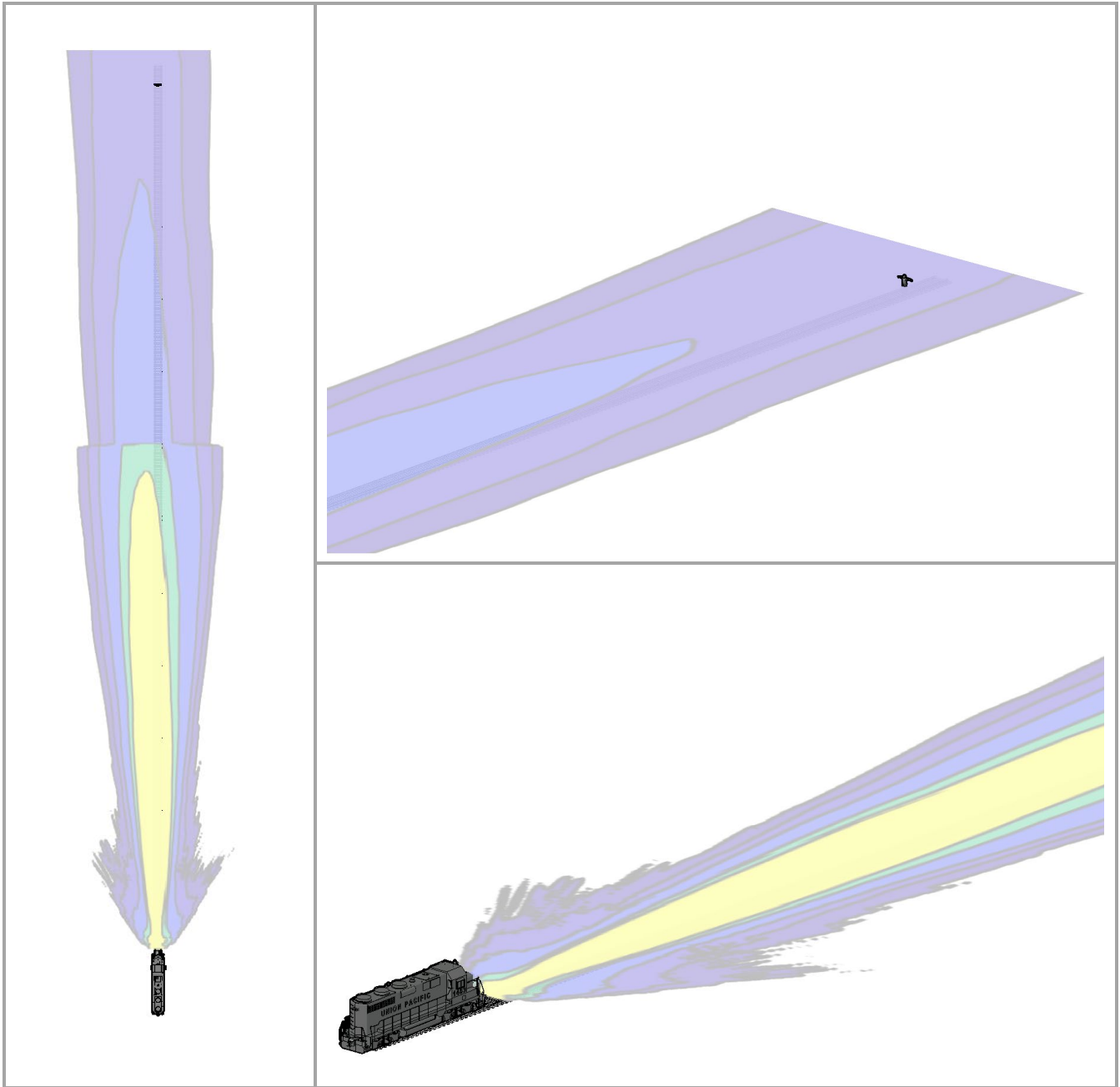

Figure 3. 3-Way View of an Illuminance map for a CML dual-lamp headlight and auxillary lights (S1 HAL). The human figure (upper-right plot) stands 800 ft away from the light source.

Three-Way View of Illuminance Map of Halogen All Lights at 4 ft Height from the Ground

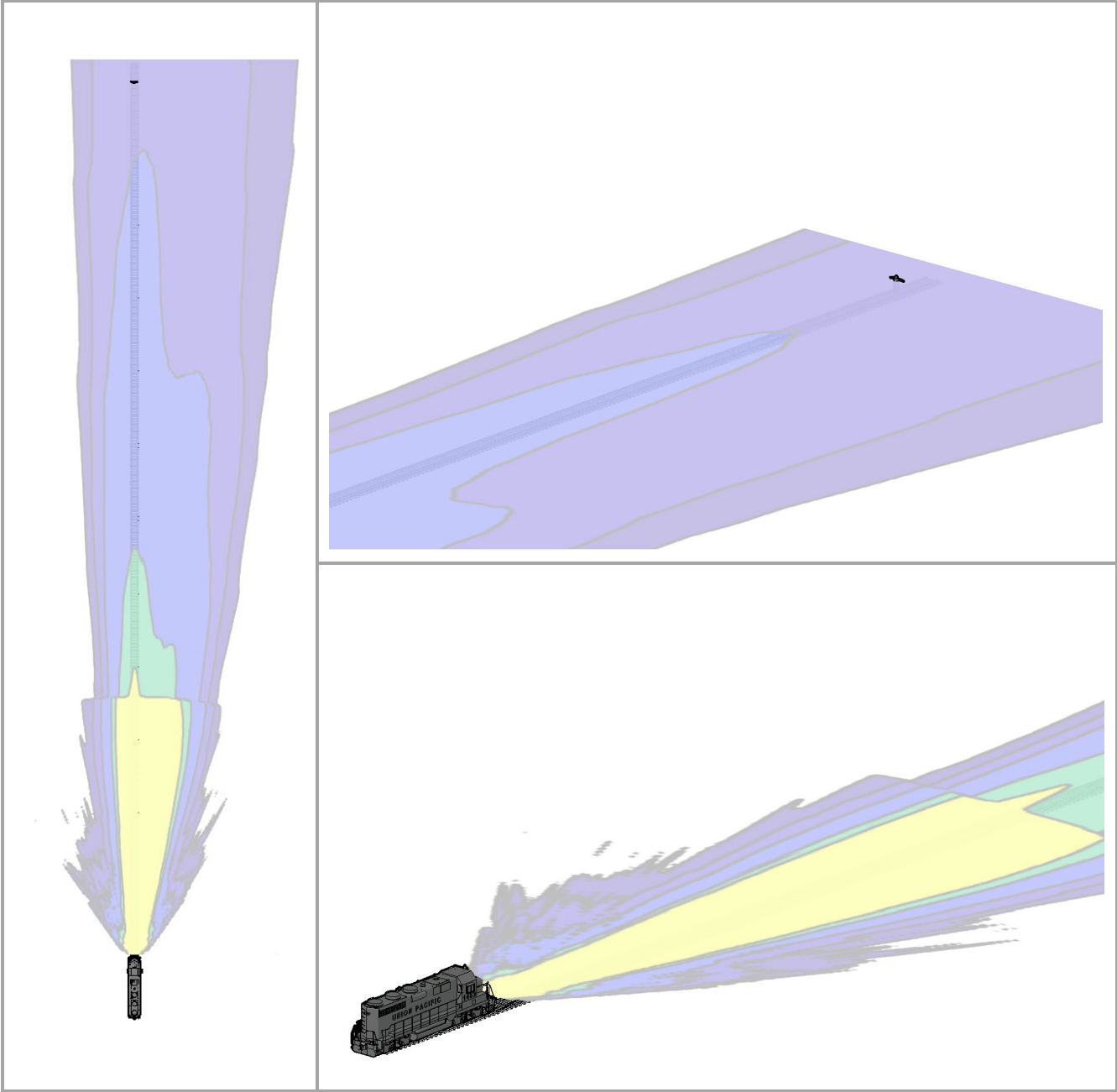

Figure 1. 3-Way View of an Illuminance map for a AMGLO – dual-lamp headlight and auxillary lights (S4 HAL). The human figure (upper-right plot) stands 800 ft away from the light source.

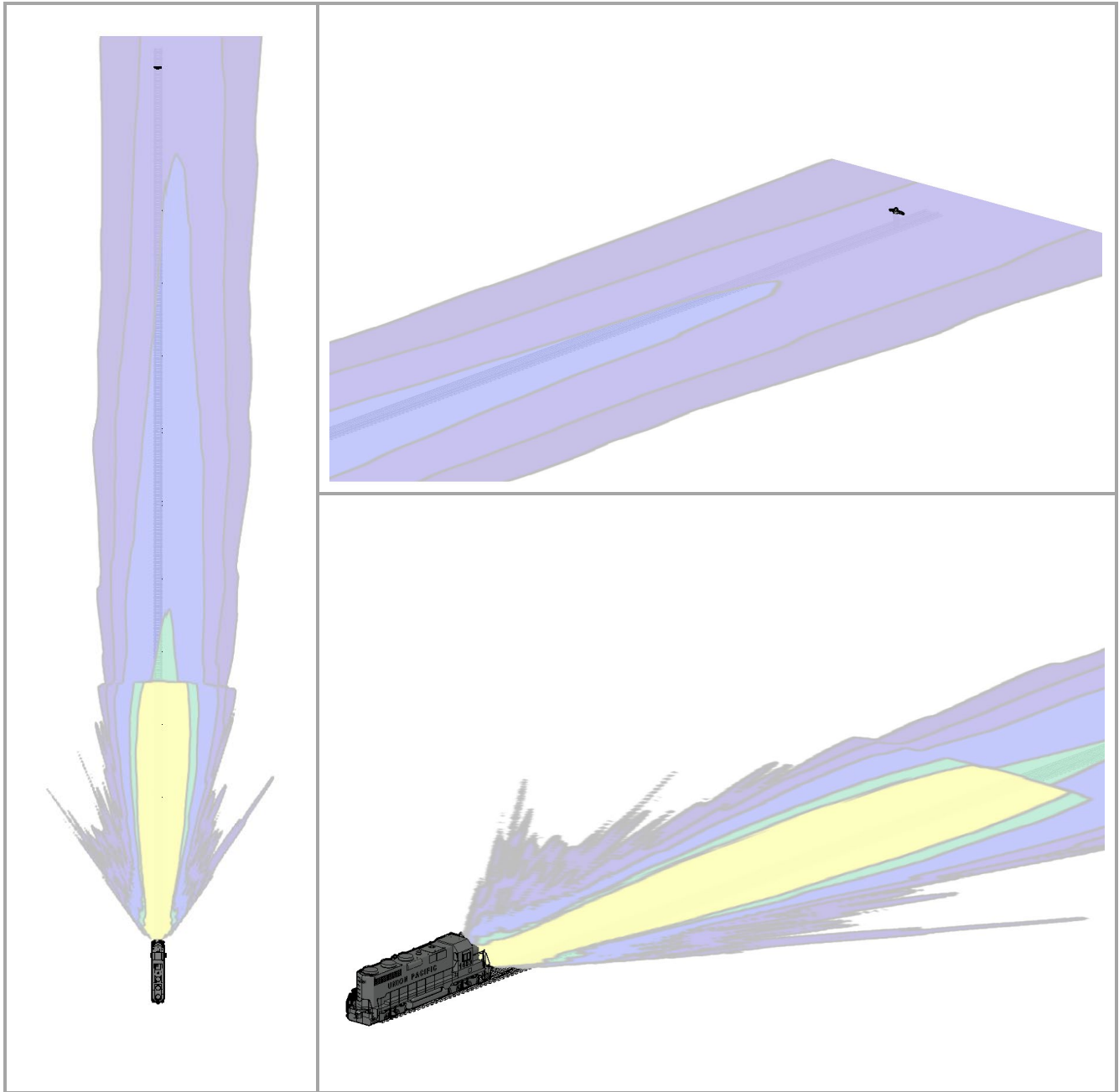

Figure 2. 3-Way View of an Illuminance map for a ePowerRail dual-lamp headlight and auxillary lights (S3 HAL). The human figure (upper-right plot) stands 800 ft away from the light source.

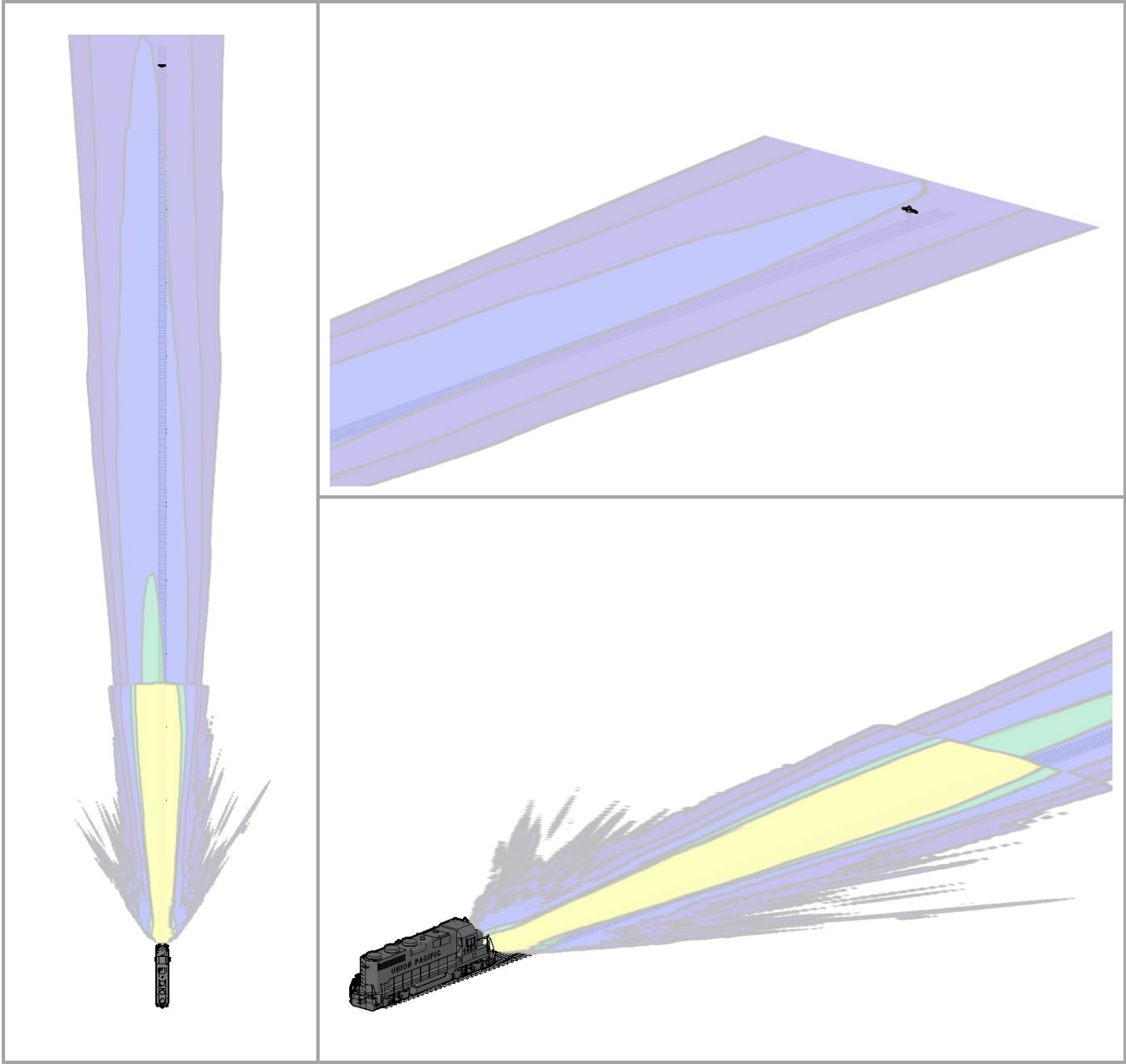

Figure 3. 3-Way View of an Illuminance map for a CML dual-lamp headlight and auxillary lights (S1 HAL). The human figure (upper-right plot) stands 800 ft away from the light source.

Three-Way View of Illuminance Map of LED Headlights at Ground Height in Bright Mode

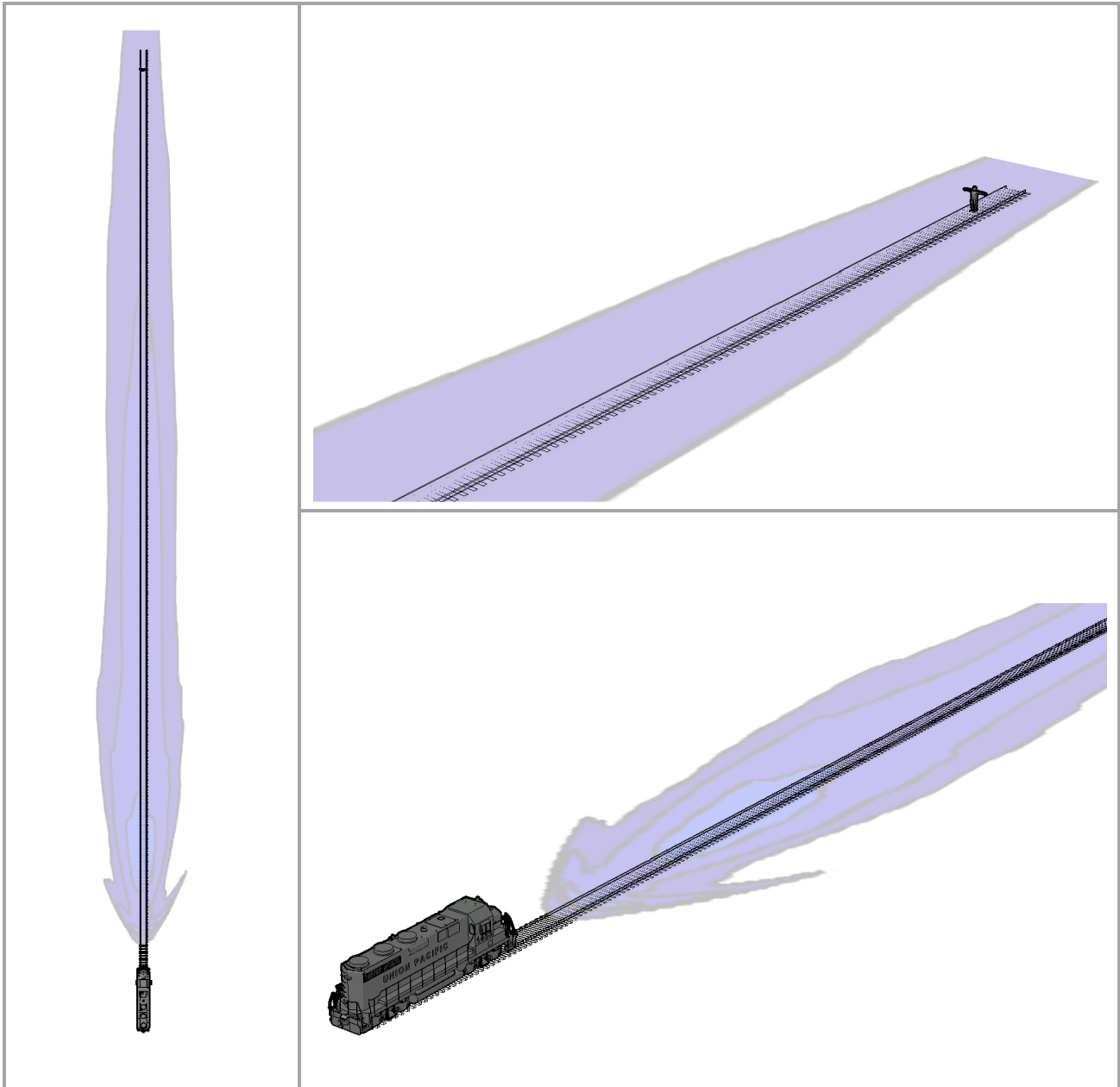

Figure 1. 3-Way View of an Illuminance map for a J.W. Speaker dual-lamp headlight (S2 LED). The human figure (upper-right plot) stands 800 ft away from the light source.

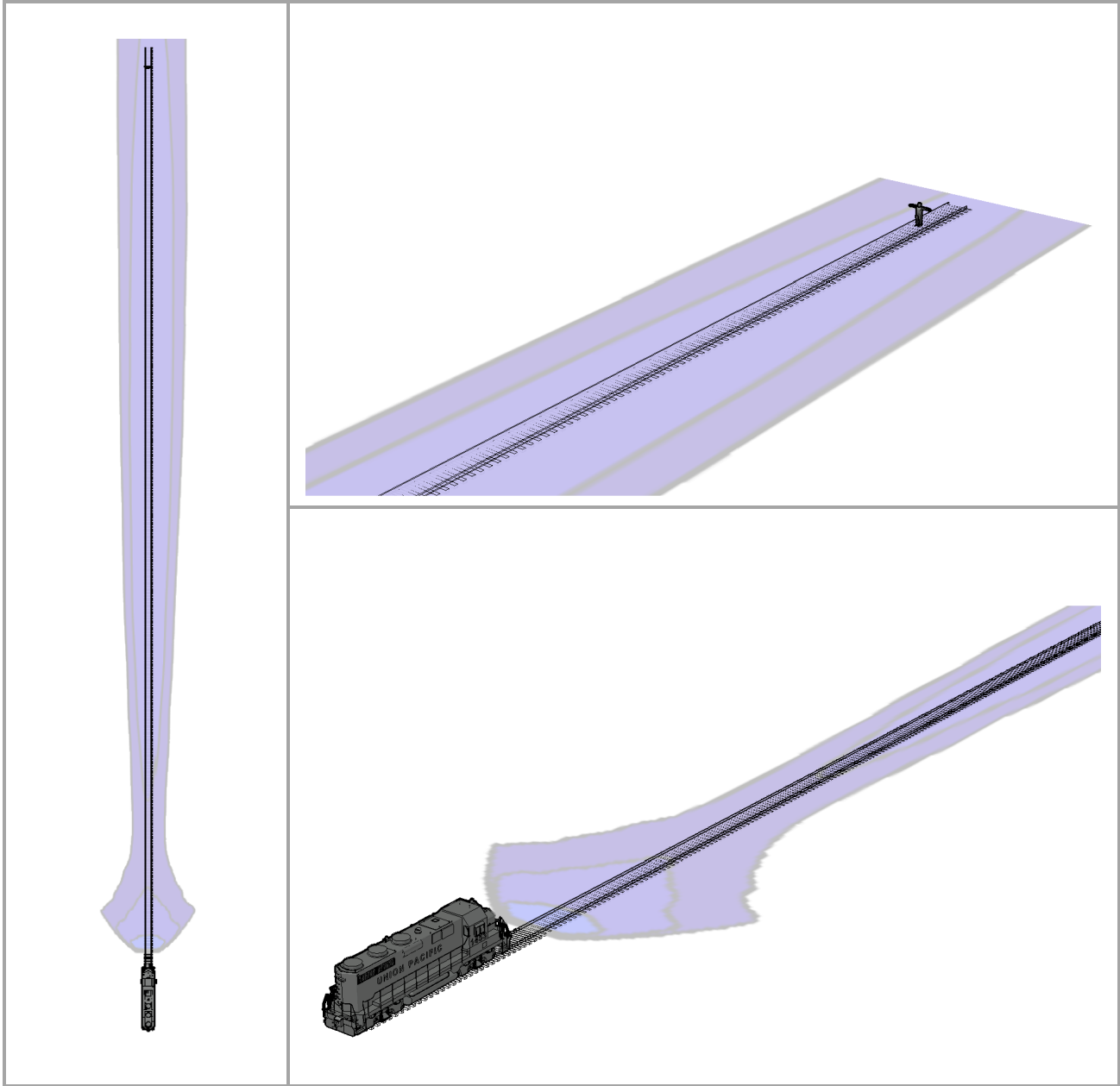

Figure 2. 3-Way View of an Illuminance map for a Hydra-Tech 2800K dual-lamp headlight (S5 LED). The human figure (upper-right plot) stands 800 ft away from the light source.

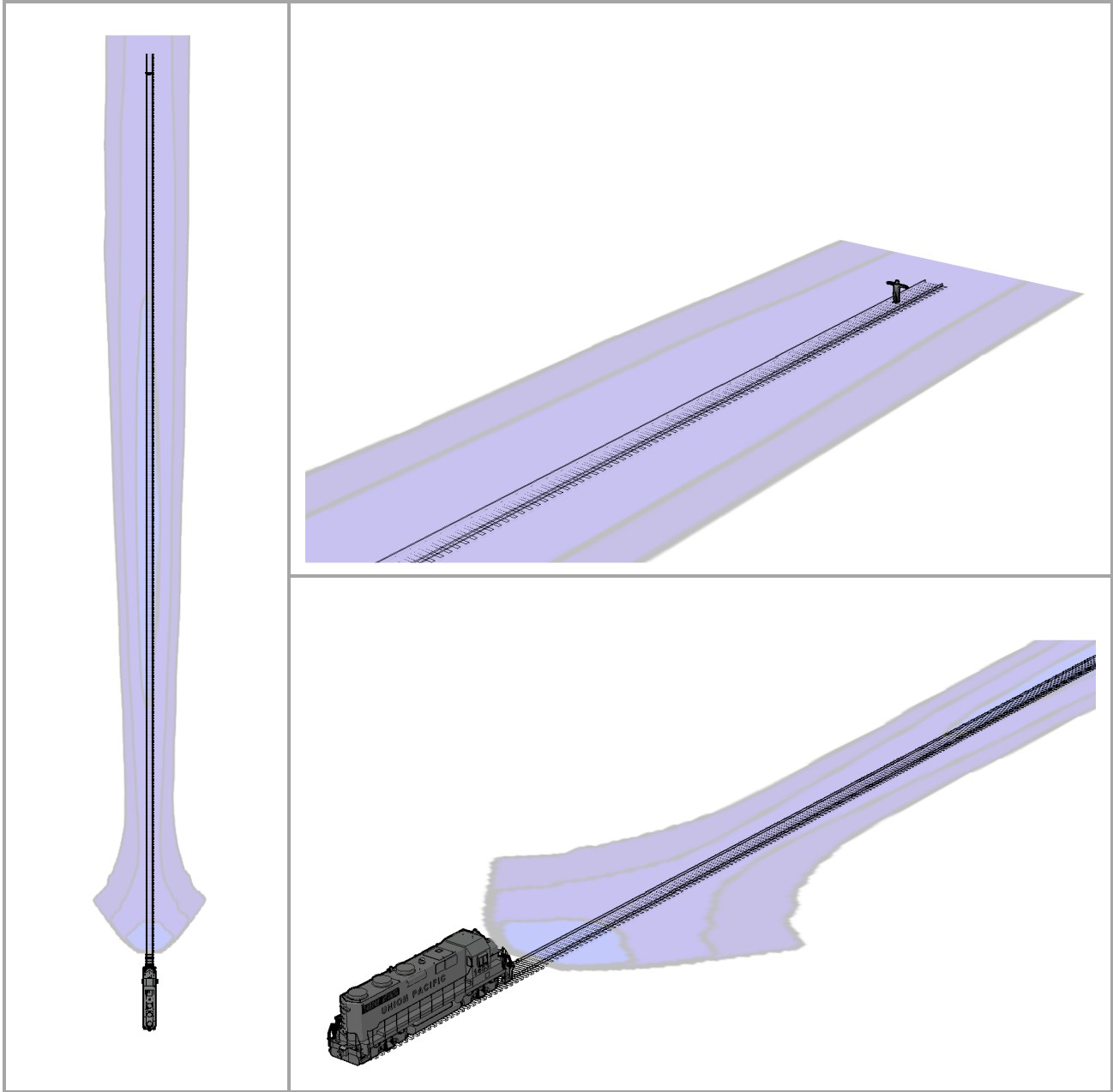

Figure 3. 3-Way View of an Illuminance map for a Hydra-Tech 7000K dual-lamp headlight (S1 LED). The human figure (upper-right plot) stands 800 ft away from the light source.

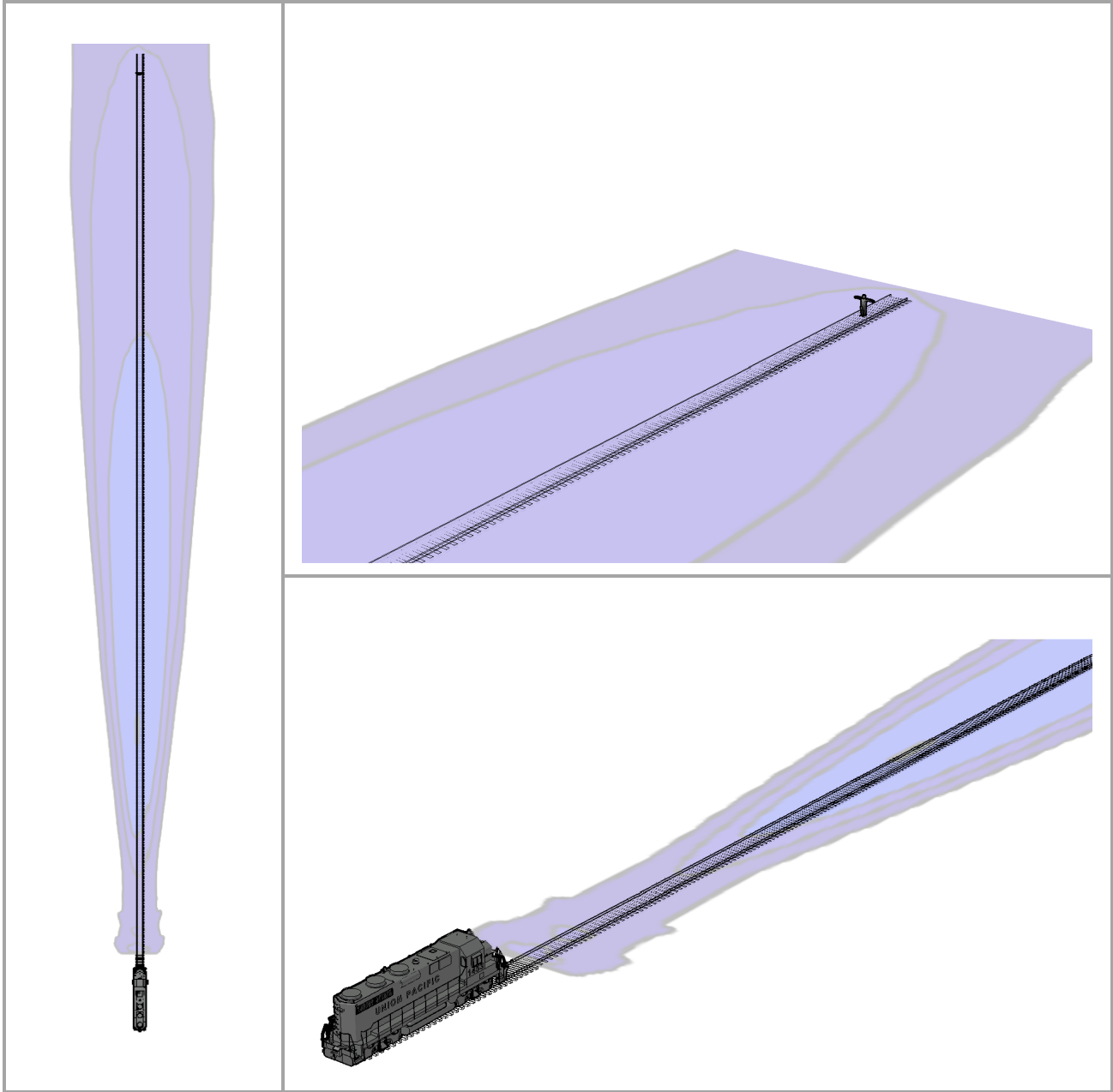

Figure 4. 3-Way View of an Illuminance map for a Railhead/Divvali dual-lamp headlight (S7 LED). The human figure (upper-right plot) stands 800 ft away from the light source.

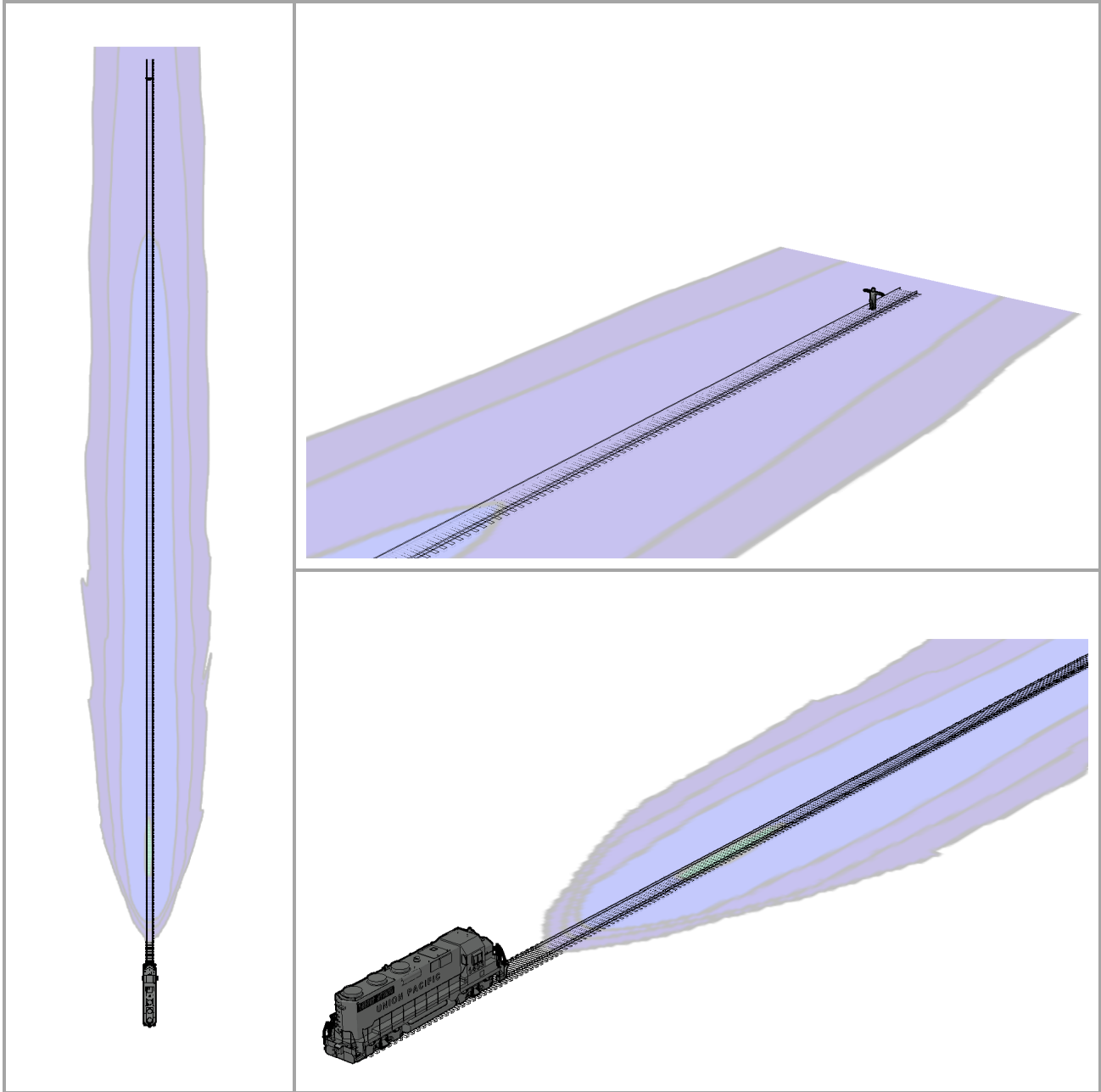

Figure 5. 3-Way View of an Illuminance map for a Smart Light Source dual-lamp headlight (S3 LED). The human figure (upper-right plot) stands 800 ft away from the light source.

Three-Way View of Illuminance Map of LED Headlights at 2 ft Height from the Ground in Bright Mode

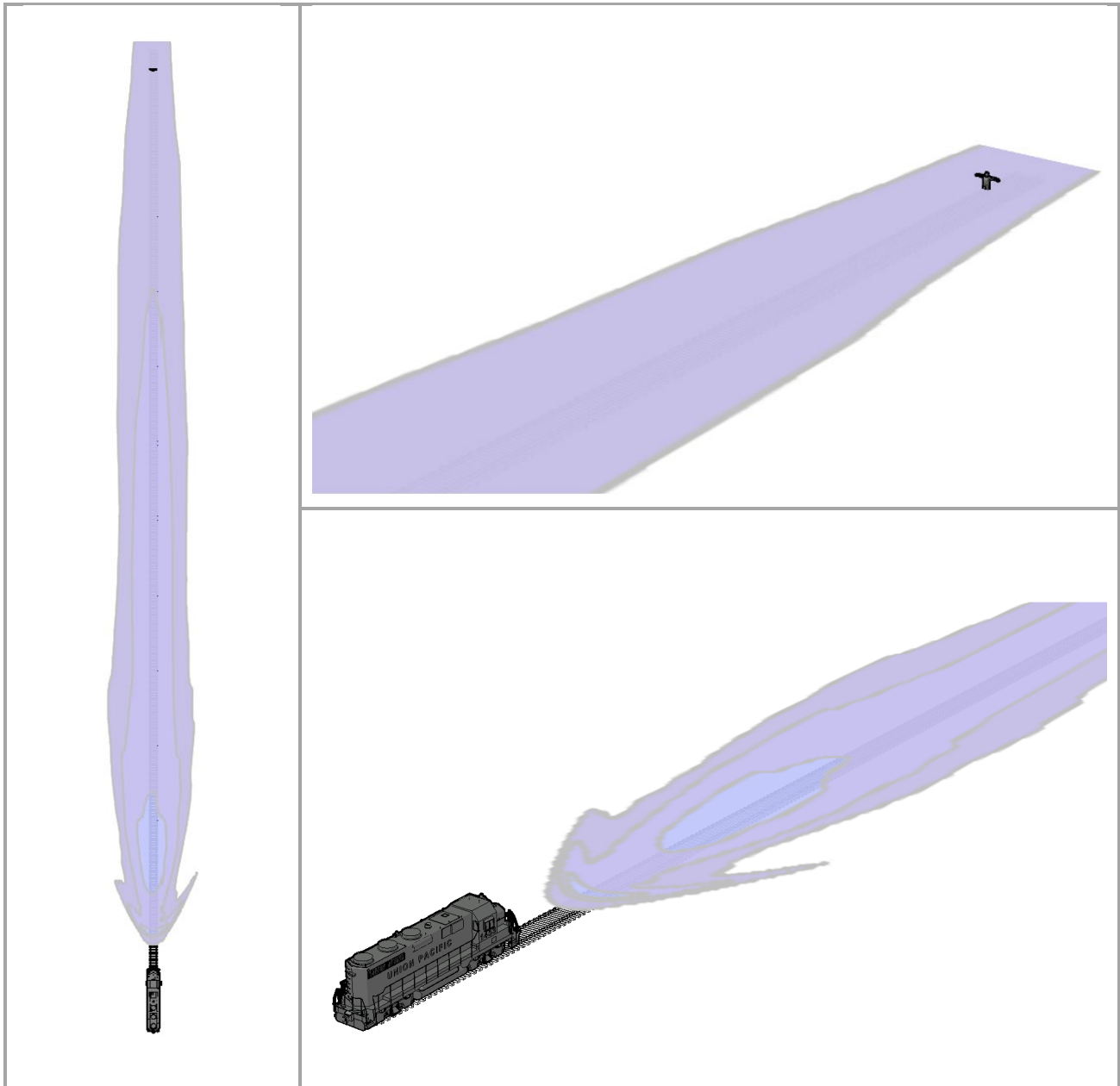

Figure 1. 3-Way View of an Illuminance map for a J.W. Speaker dual-lamp headlight (S2 LED). The human figure (upper-right plot) stands 800 ft away from the light source.

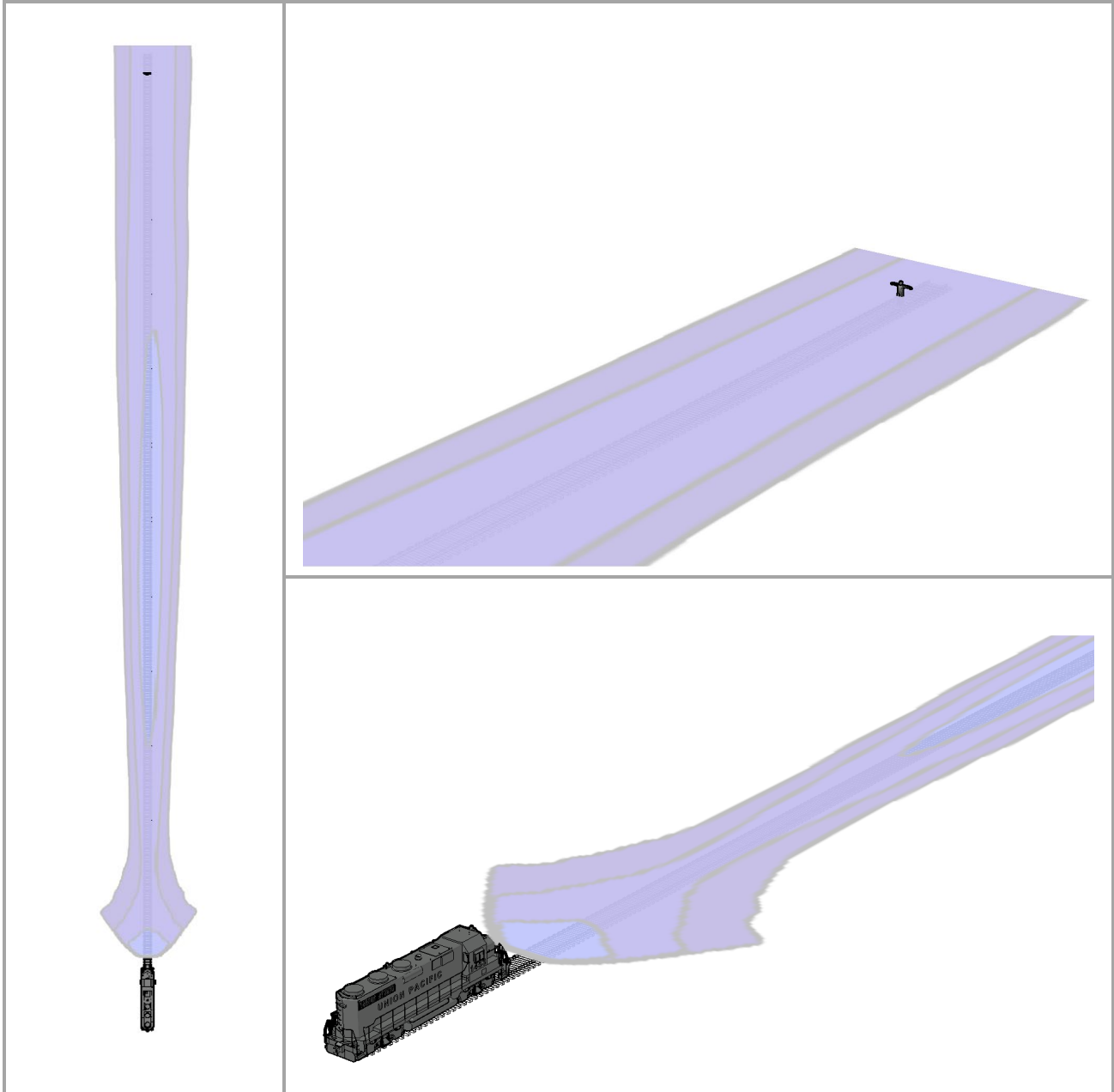

Figure 2. 3-Way View of an Illuminance map for a Hydra-Tech 2800K dual-lamp headlight (S5 LED). The human figure (upper-right plot) stands 800 ft away from the light source.

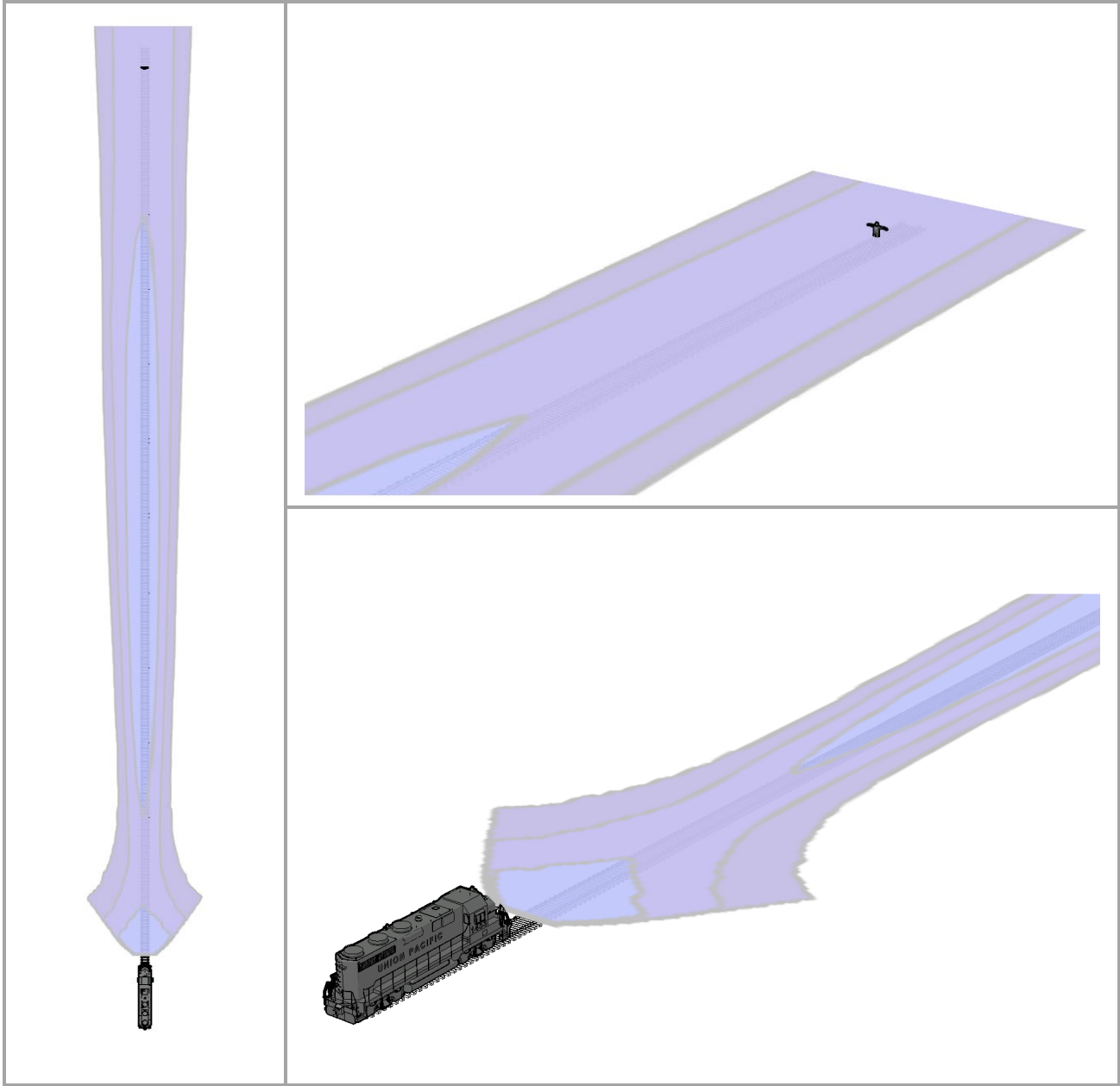

Figure 3. 3-Way View of an Illuminance map for a Hydra-Tech 7000K dual-lamp headlight (S1 LED). The human figure (upper-right plot) stands 800 ft away from the light source.

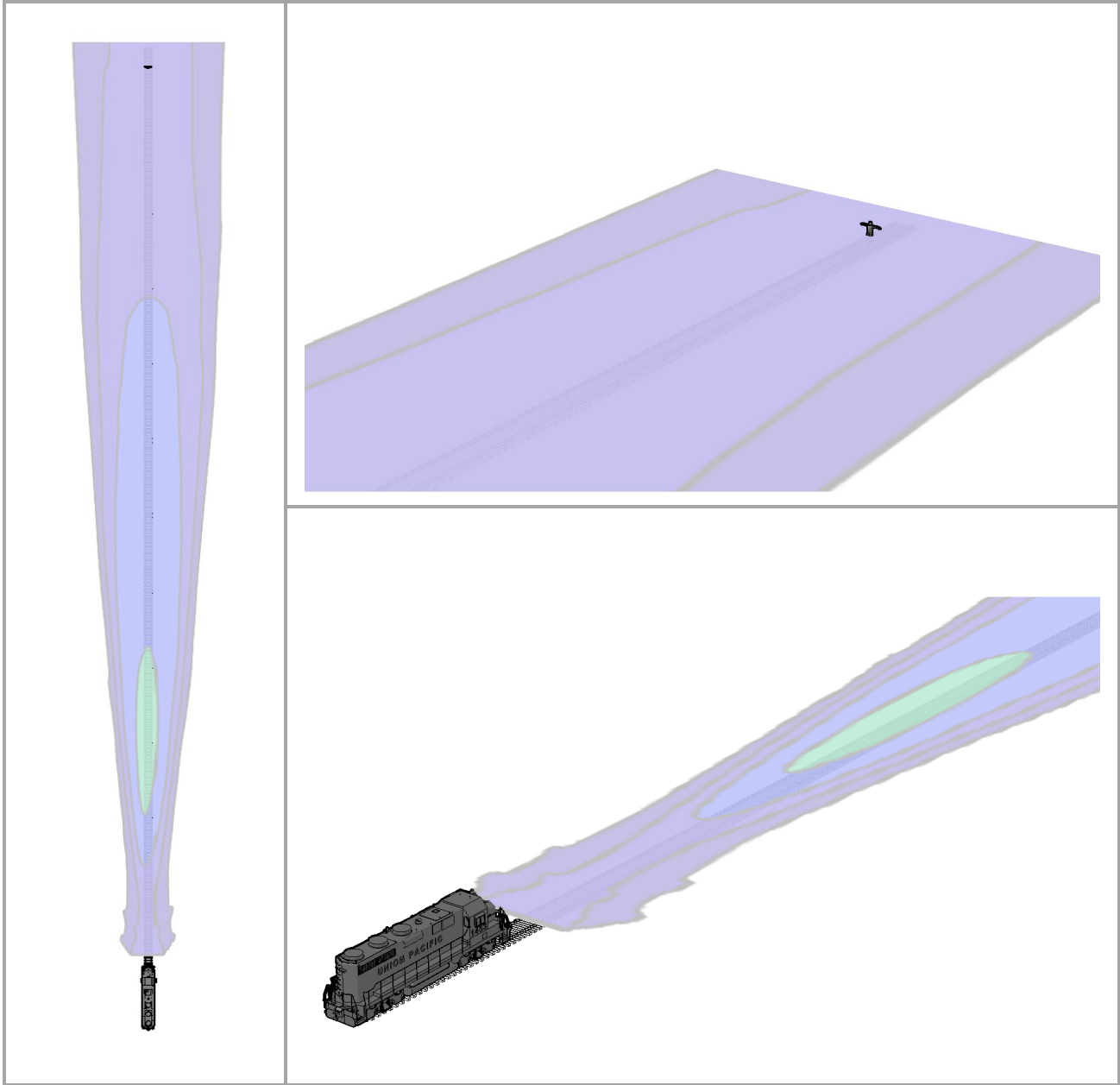

Figure 4. 3-Way View of an Illuminance map for a Railhead/Divvali dual-lamp headlight (S7 LED). The human figure (upper-right plot) stands 800 ft away from the light source.

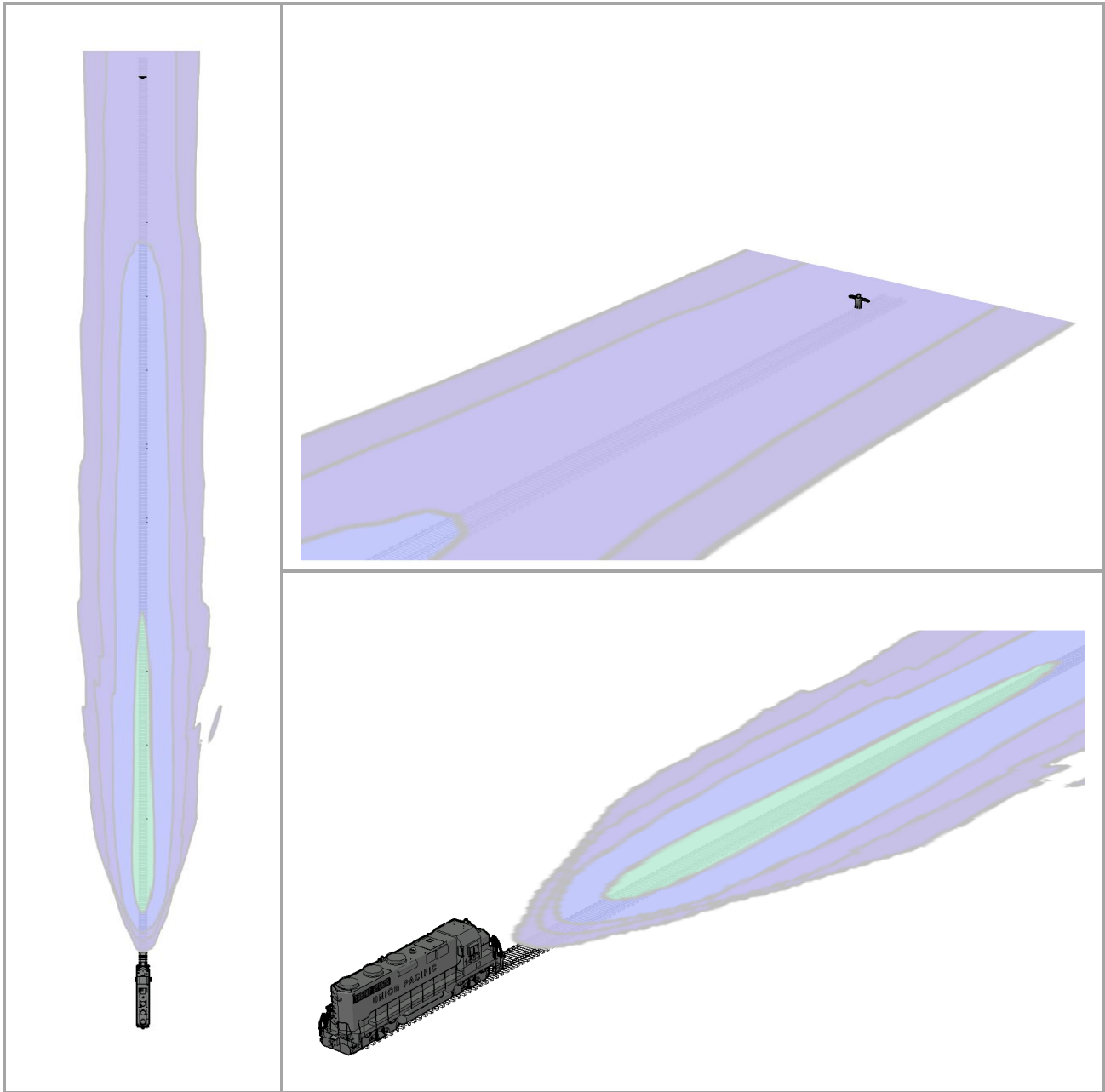

Figure 5. 3-Way View of an Illuminance map for a Smart Light Source dual-lamp headlight (S3 LED). The human figure (upper-right plot) stands 800 ft away from the light source.

Three-Way View of Illuminance Map of LED Headlights at 4 ft Height from the Ground in Bright Mode

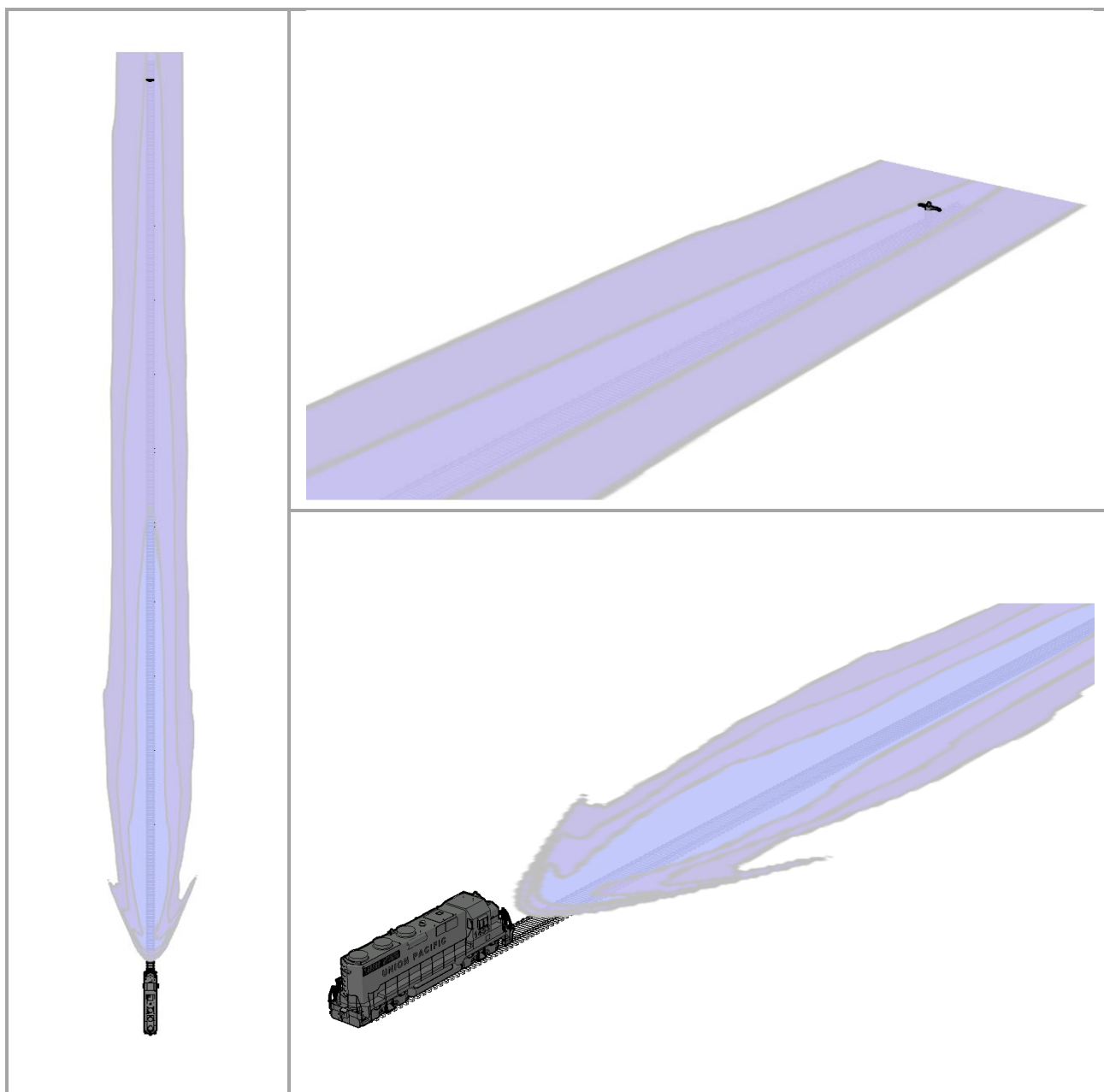

Figure 1. 3-Way View of an Illuminance map for a J.W. Speaker dual-lamp headlight (S2 LED). The human figure (upper-right plot) stands 800 ft away from the light source.

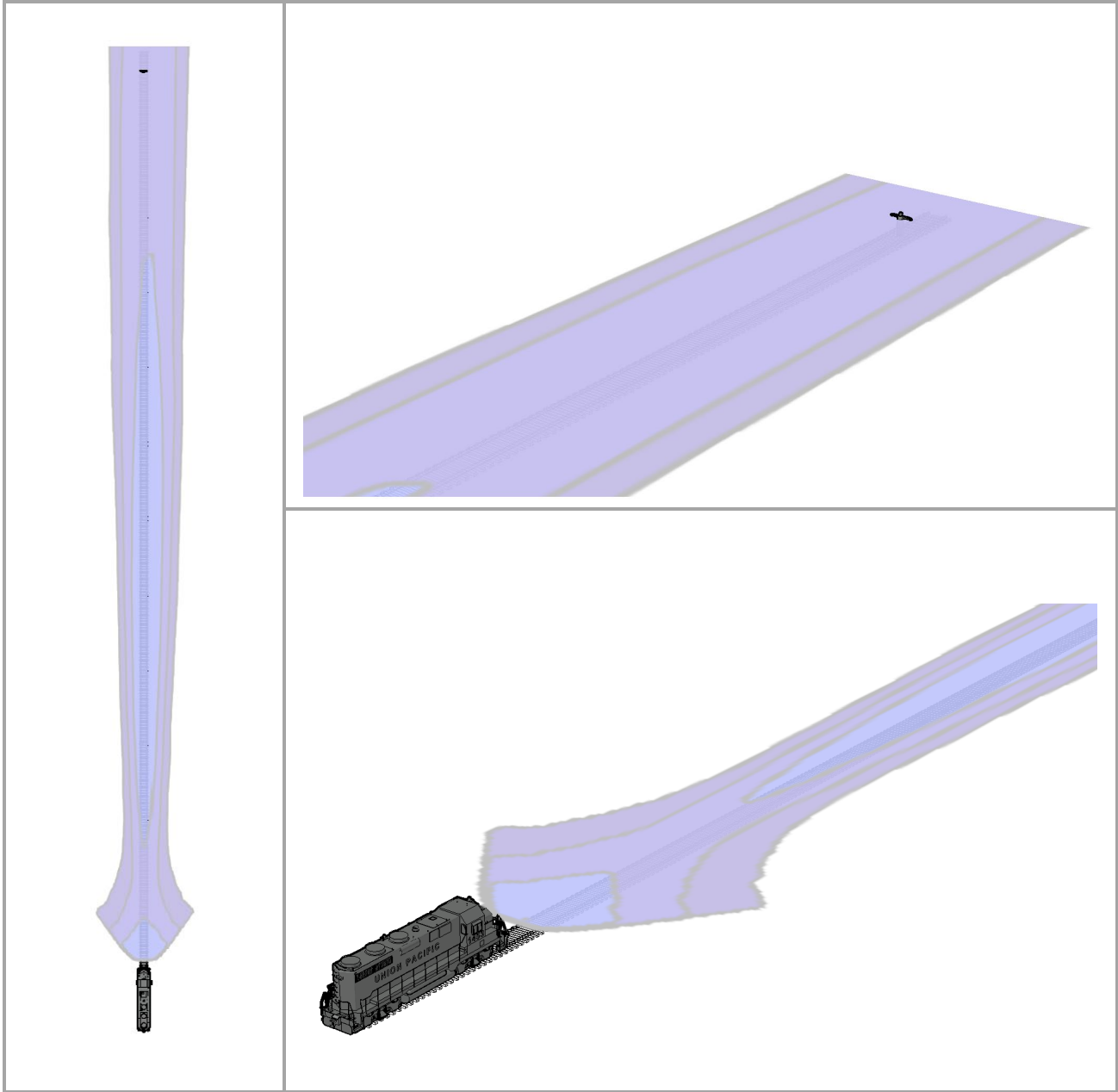

Figure 2. 3-Way View of an Illuminance map for a Hydra-Tech 2800K dual-lamp headlight (S5 LED). The human figure (upper-right plot) stands 800 ft away from the light source.

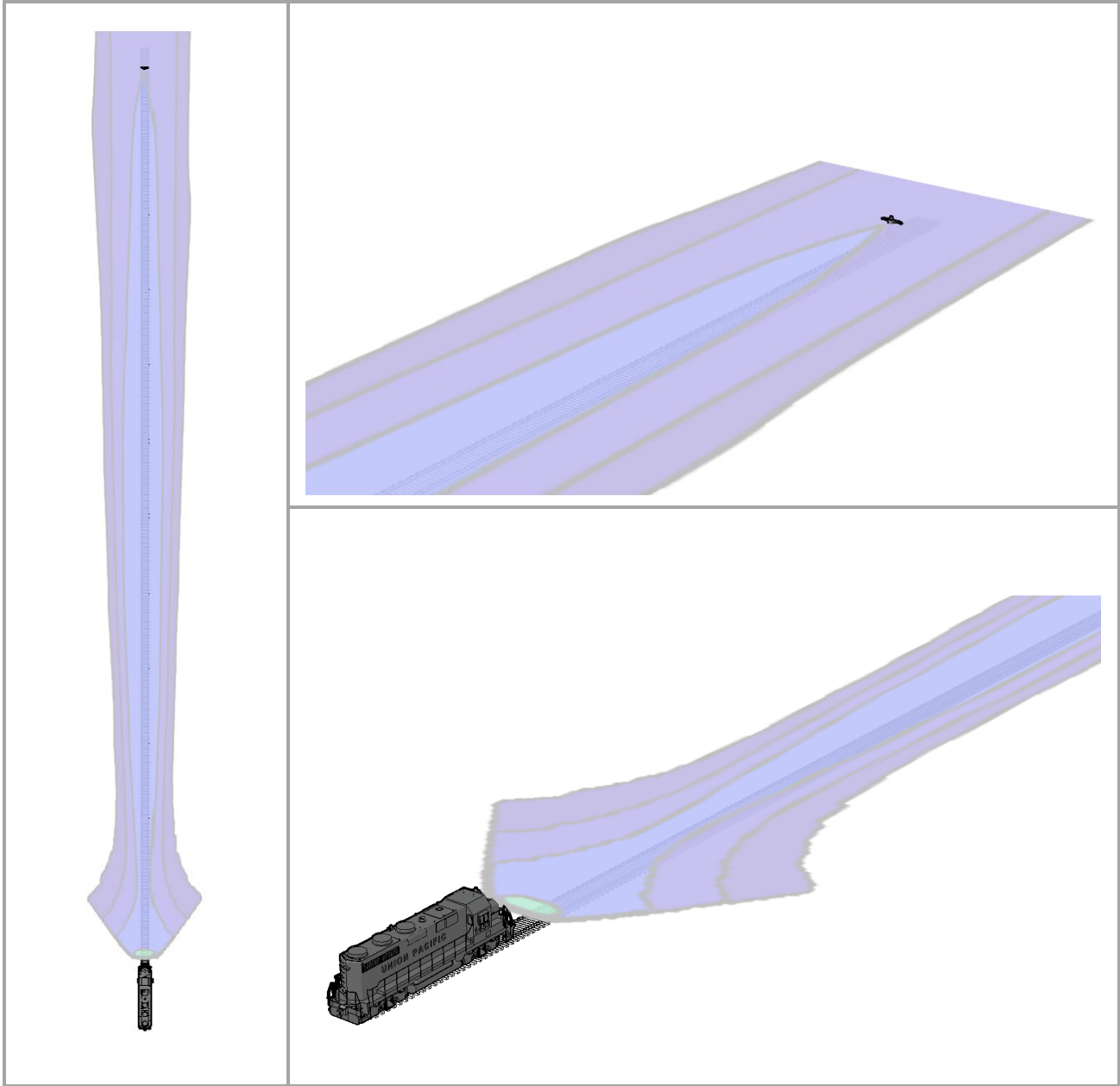

Figure 3. 3-Way View of an Illuminance map for a Hydra-Tech 7000K dual-lamp headlight (S1 LED). The human figure (upper-right plot) stands 800 ft away from the light source.

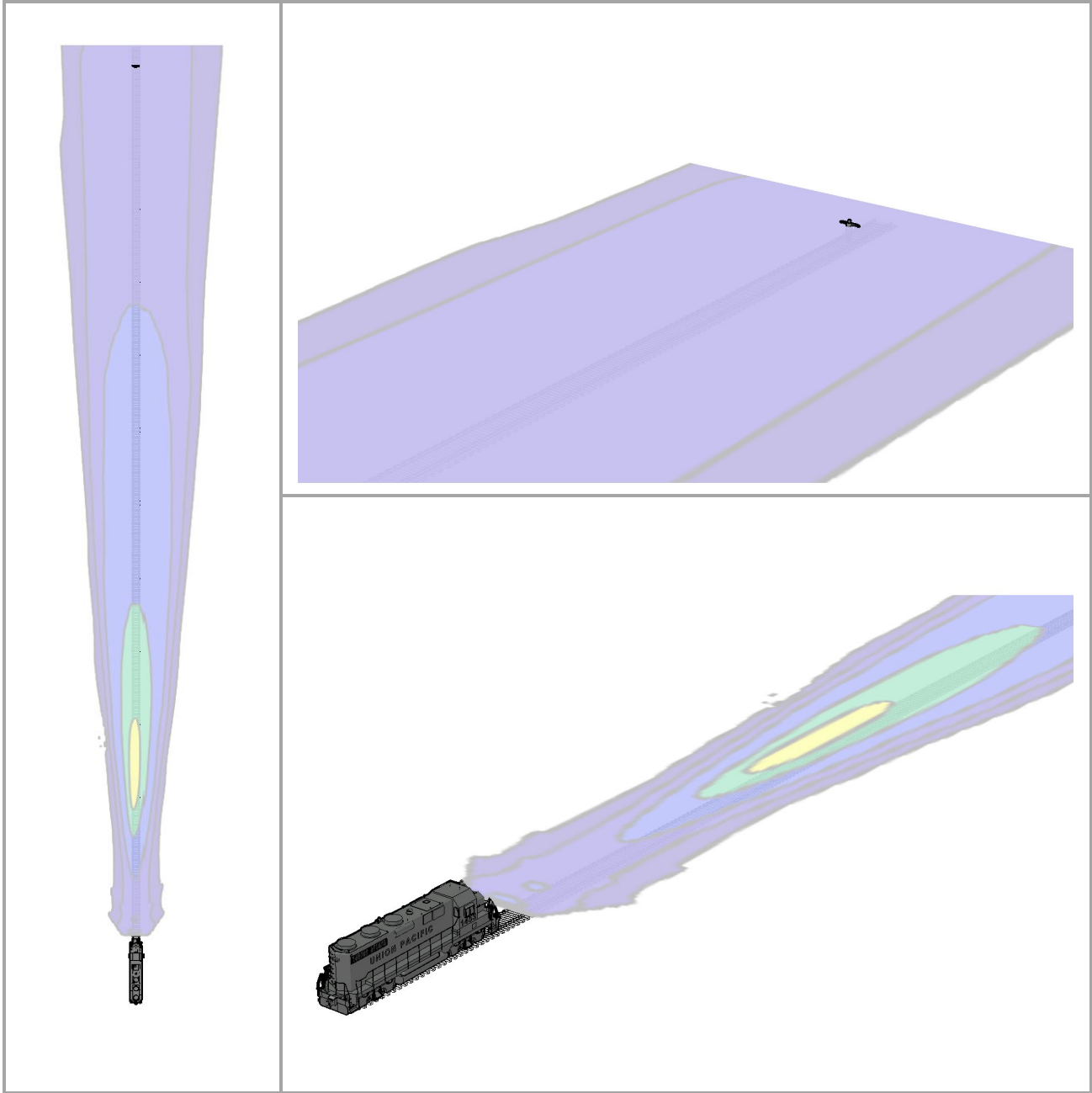

Figure 4. 3-Way View of an Illuminance map for a Railhead/Divvali dual-lamp headlight (S7 LED). The human figure (upper-right plot) stands 800 ft away from the light source.

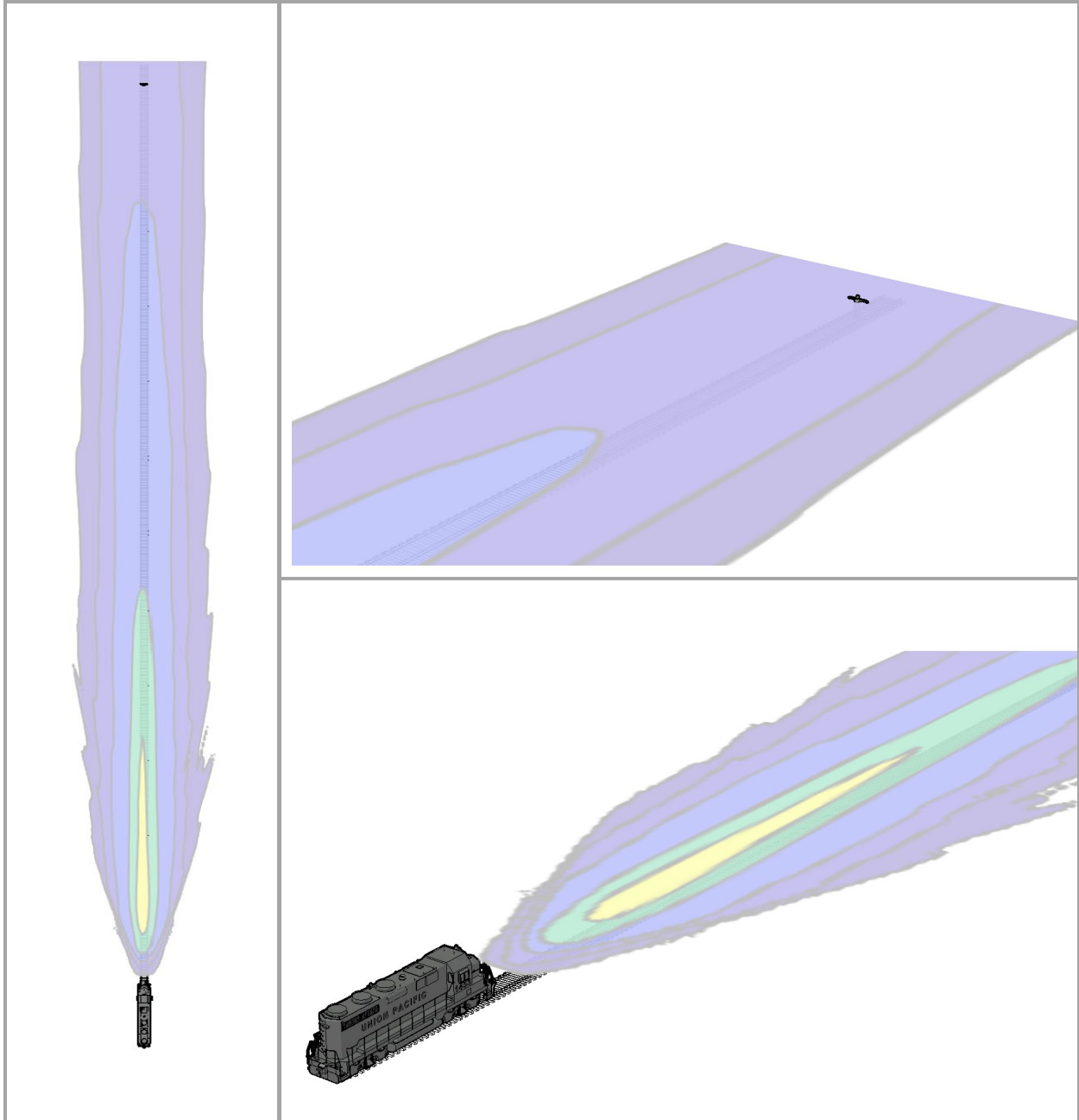

Figure 5. 3-Way View of an Illuminance map for a Smart Light Source dual-lamp headlight (S3 LED). The human figure (upper-right plot) stands 800 ft away from the light source.

Three-Way View of Illuminance Map of LED Headlights at Ground Height in Dim Mode

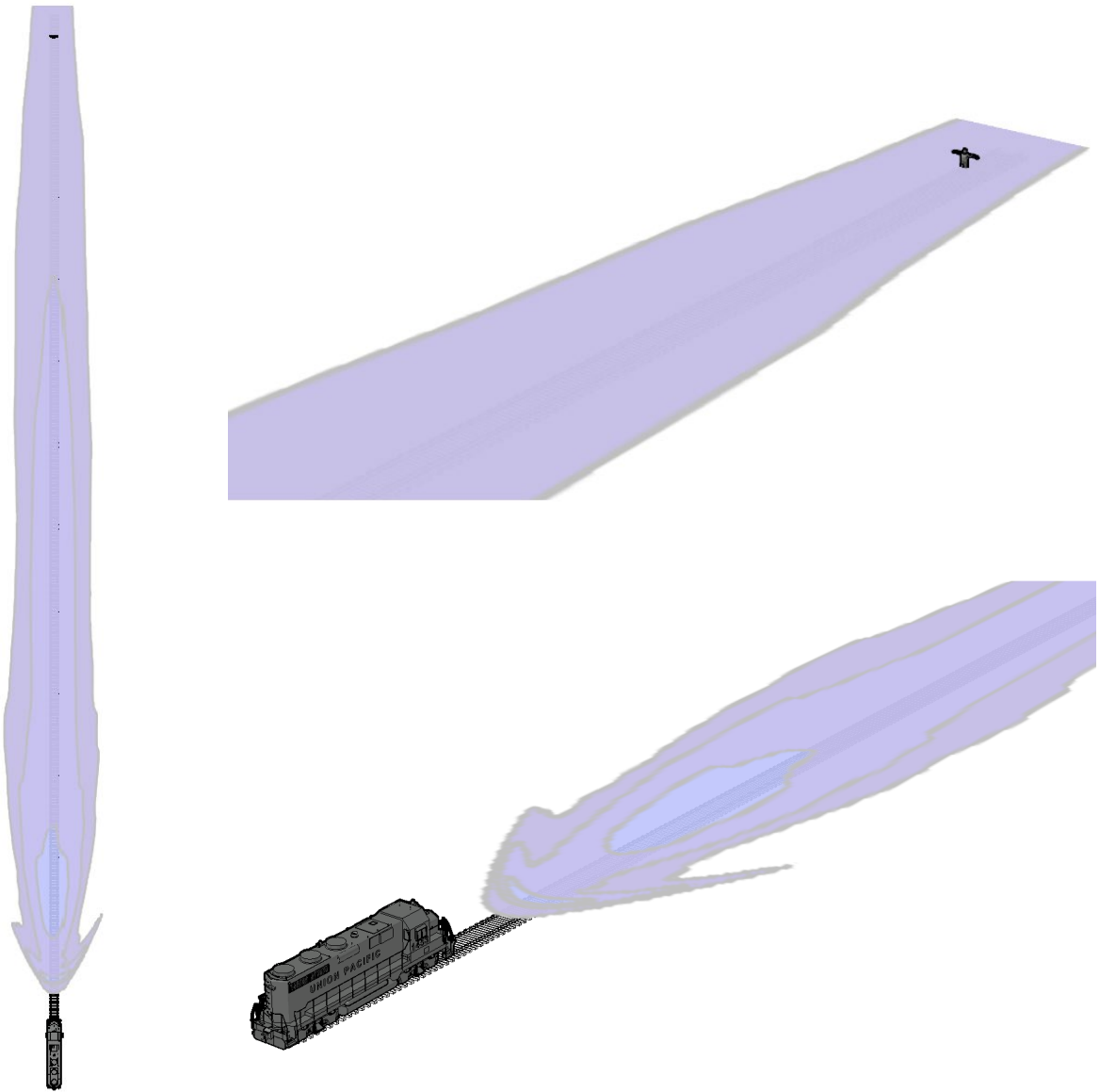

Figure 1. 3-Way View of an Illuminance map for a J.W. Speaker dual-lamp headlight (S2 LED). The human figure (upper-right plot) stands 800 ft away from the light source.

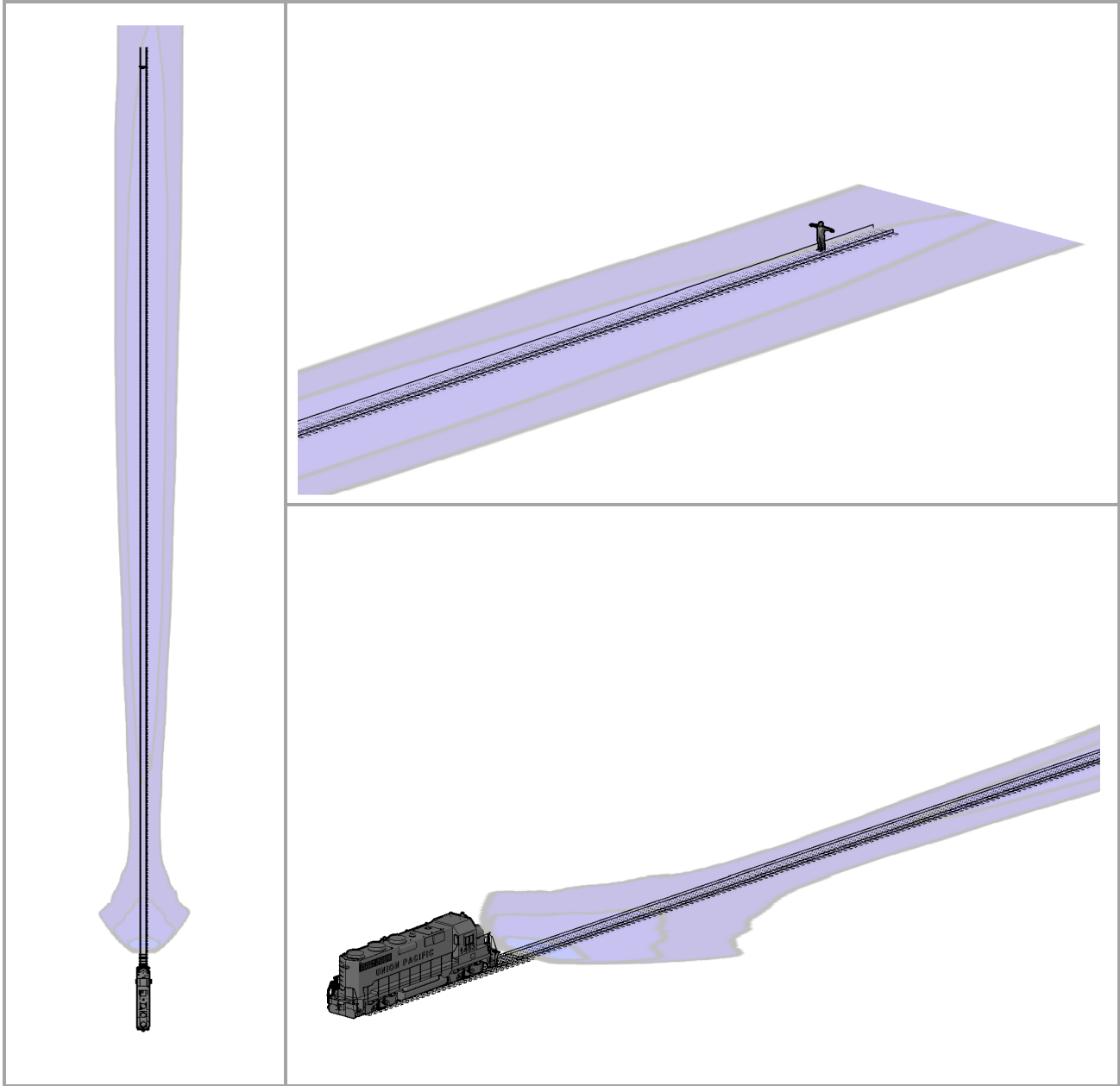

Figure 2. 3-Way View of an Illuminance map for a Hydra-Tech 2800K dual-lamp headlight (S5 LED). The human figure (upper-right plot) stands 800 ft away from the light source.

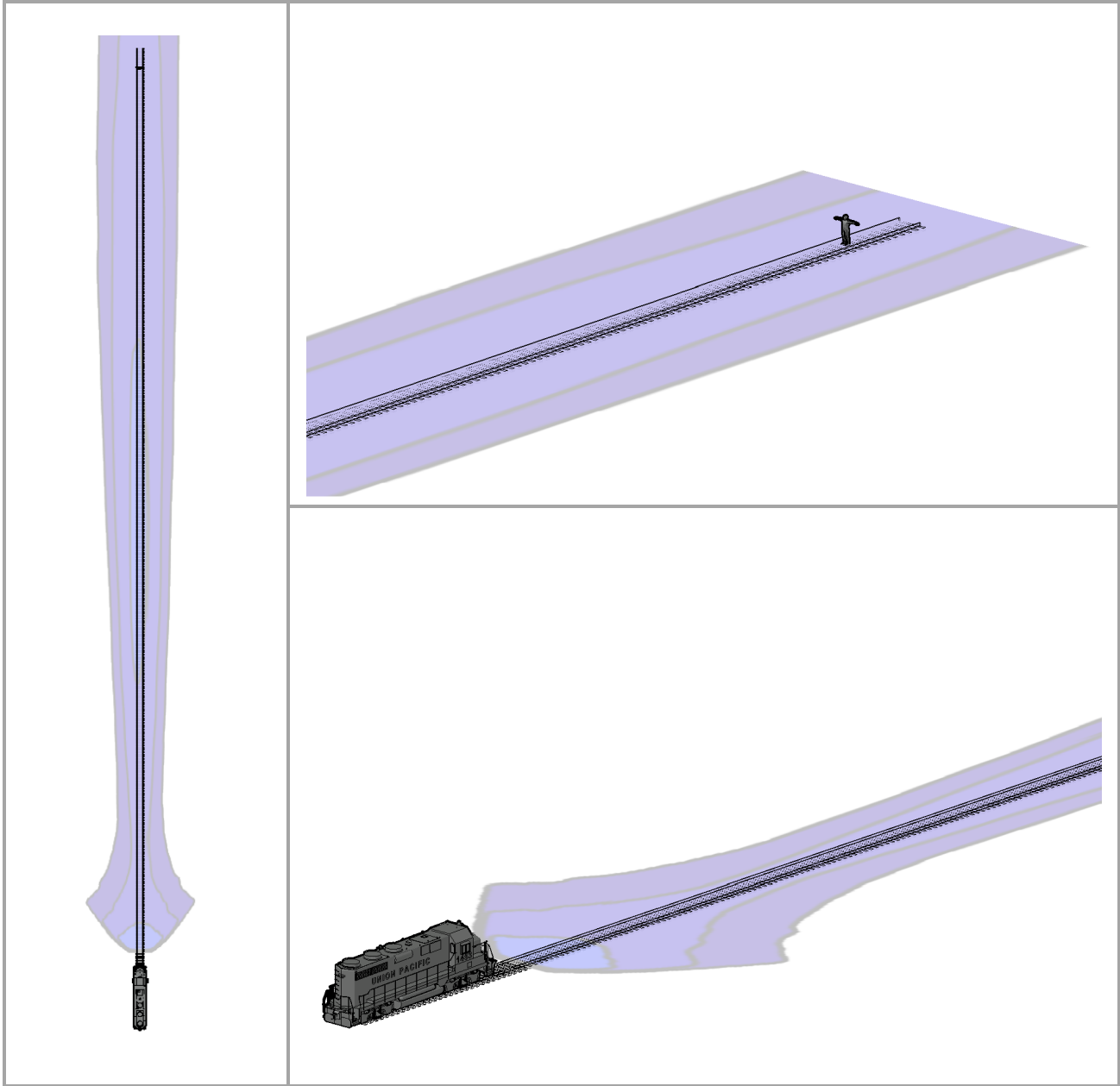

Figure 3. 3-Way View of an Illuminance map for a Hydra-Tech 7000K dual-lamp headlight (S1 LED). The human figure (upper-right plot) stands 800 ft away from the light source.

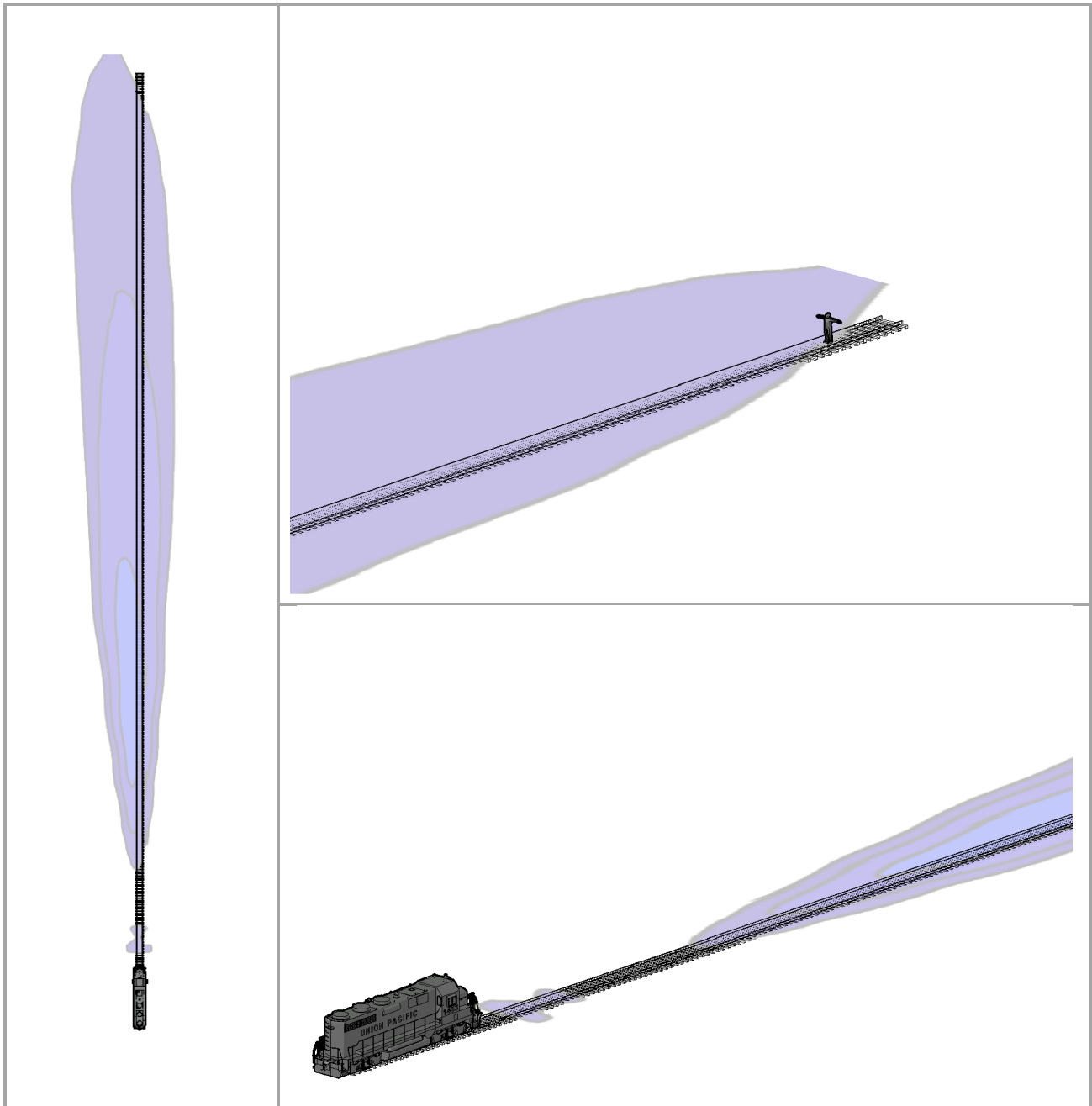

Figure 4. 3-Way View of an Illuminance map for a Railhead/Divvali dual-lamp headlight (S7 LED). The human figure (upper-right plot) stands 800 ft away from the light source.

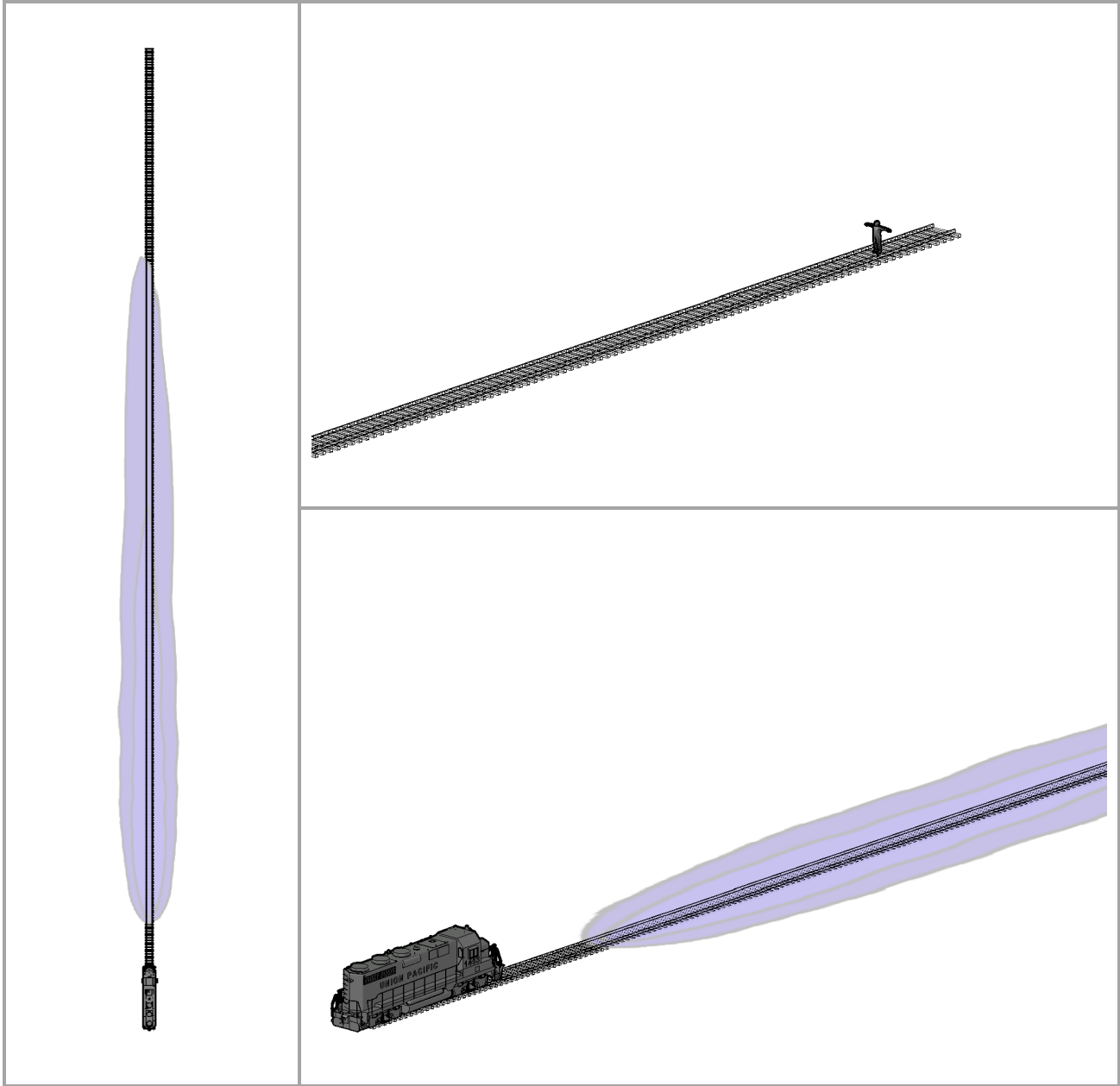

Figure 5. 3-Way View of an Illuminance map for a Smart Light Source dual-lamp headlight (S3 LED). The human figure (upper-right plot) stands 800 ft away from the light source.

Three-Way View of Illuminance Map of LED Headlights at 2 ft Height from the Ground in Dim Mode

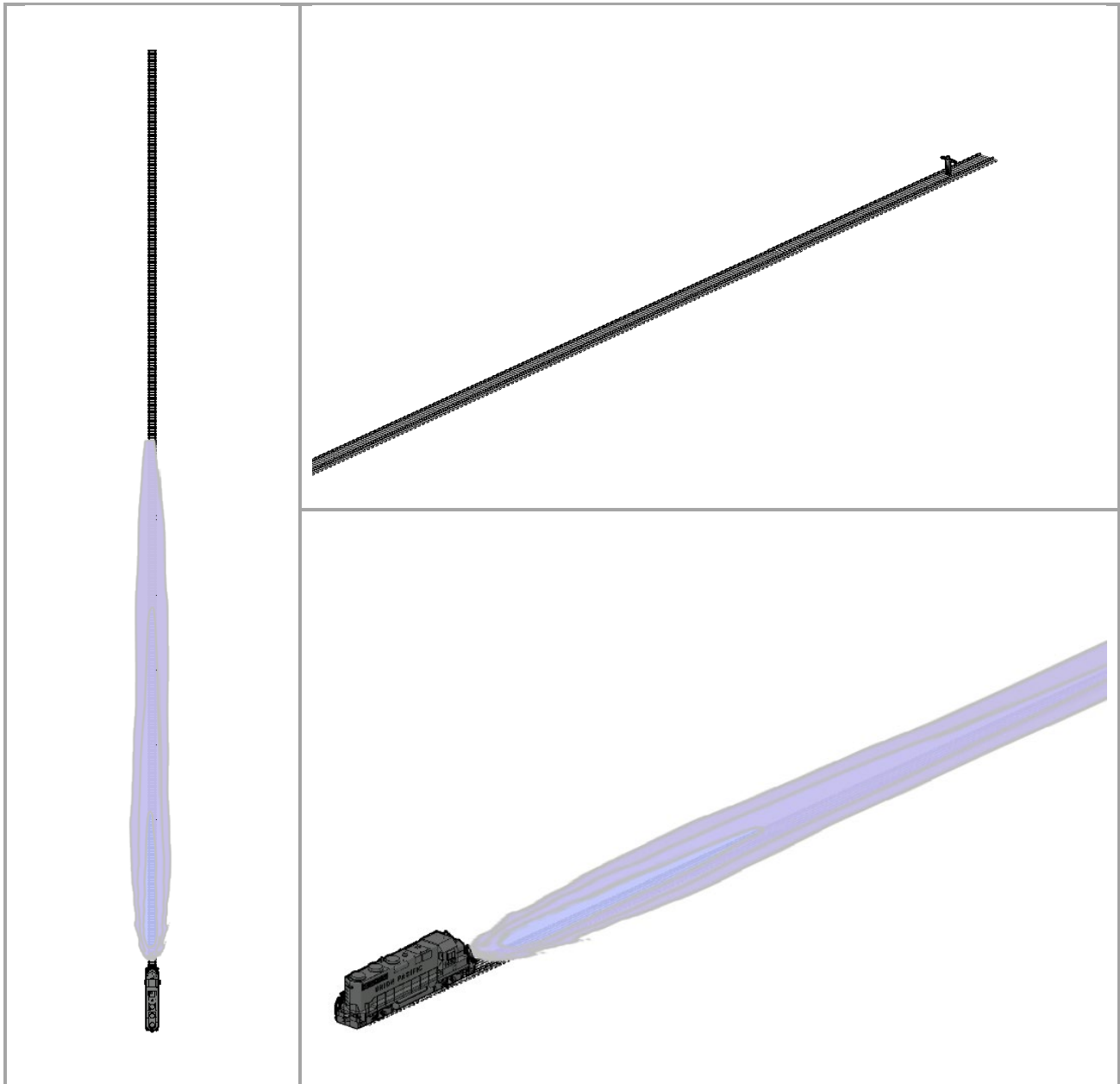

Figure 1. 3-Way View of an Illuminance map for a J.W. Speaker dual-lamp headlight (S2 LED). The human figure (upper-right plot) stands 800 ft away from the light source.

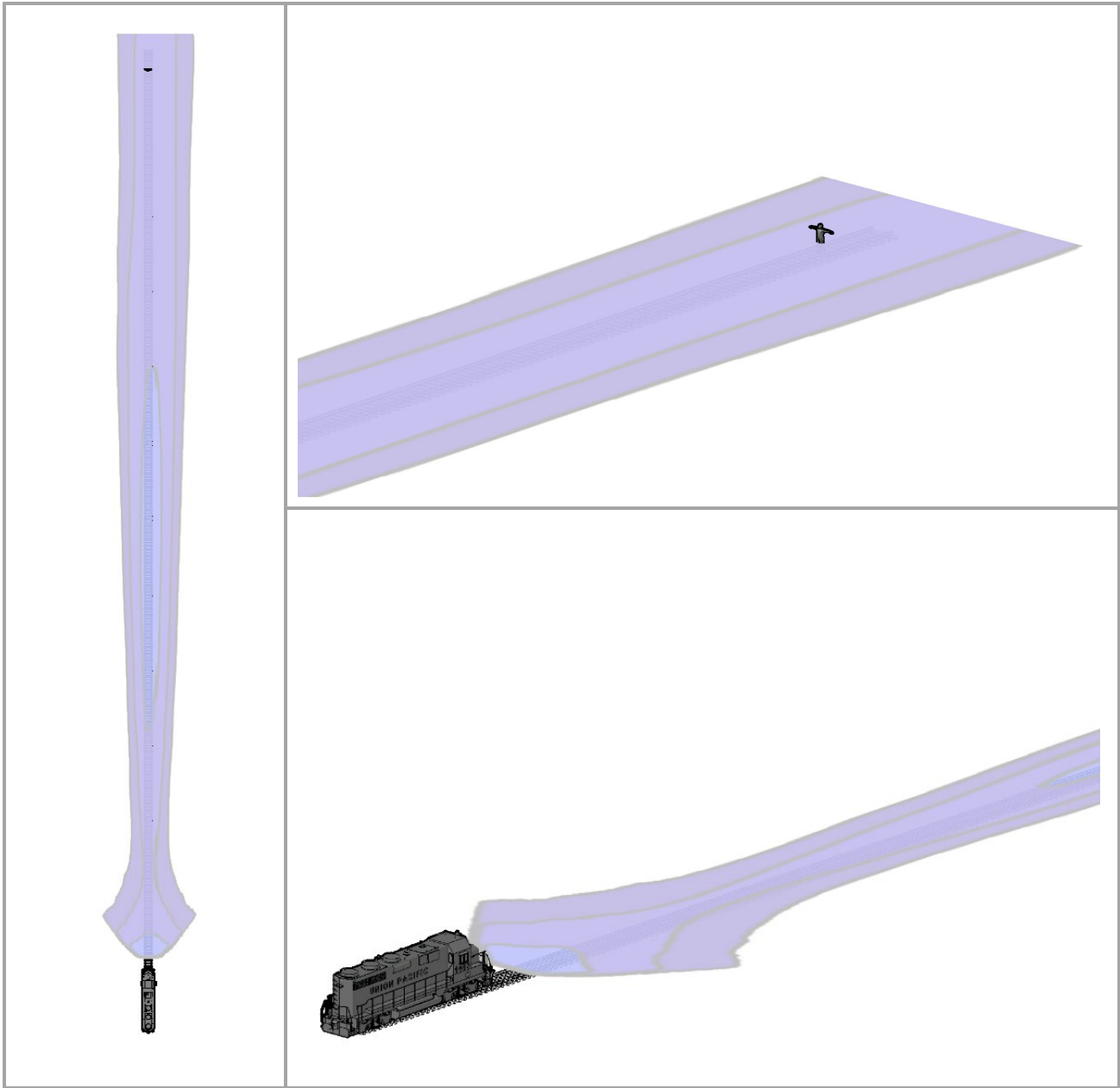

Figure 2. 3-Way View of an Illuminance map for a Hydra-Tech 2800K dual-lamp headlight (S5 LED). The human figure (upper-right plot) stands 800 ft away from the light source.



Figure 3. 3-Way View of an Illuminance map for a Hydra-Tech 7000K dual-lamp headlight (S1 LED). The human figure (upper-right plot) stands 800 ft away from the light source.

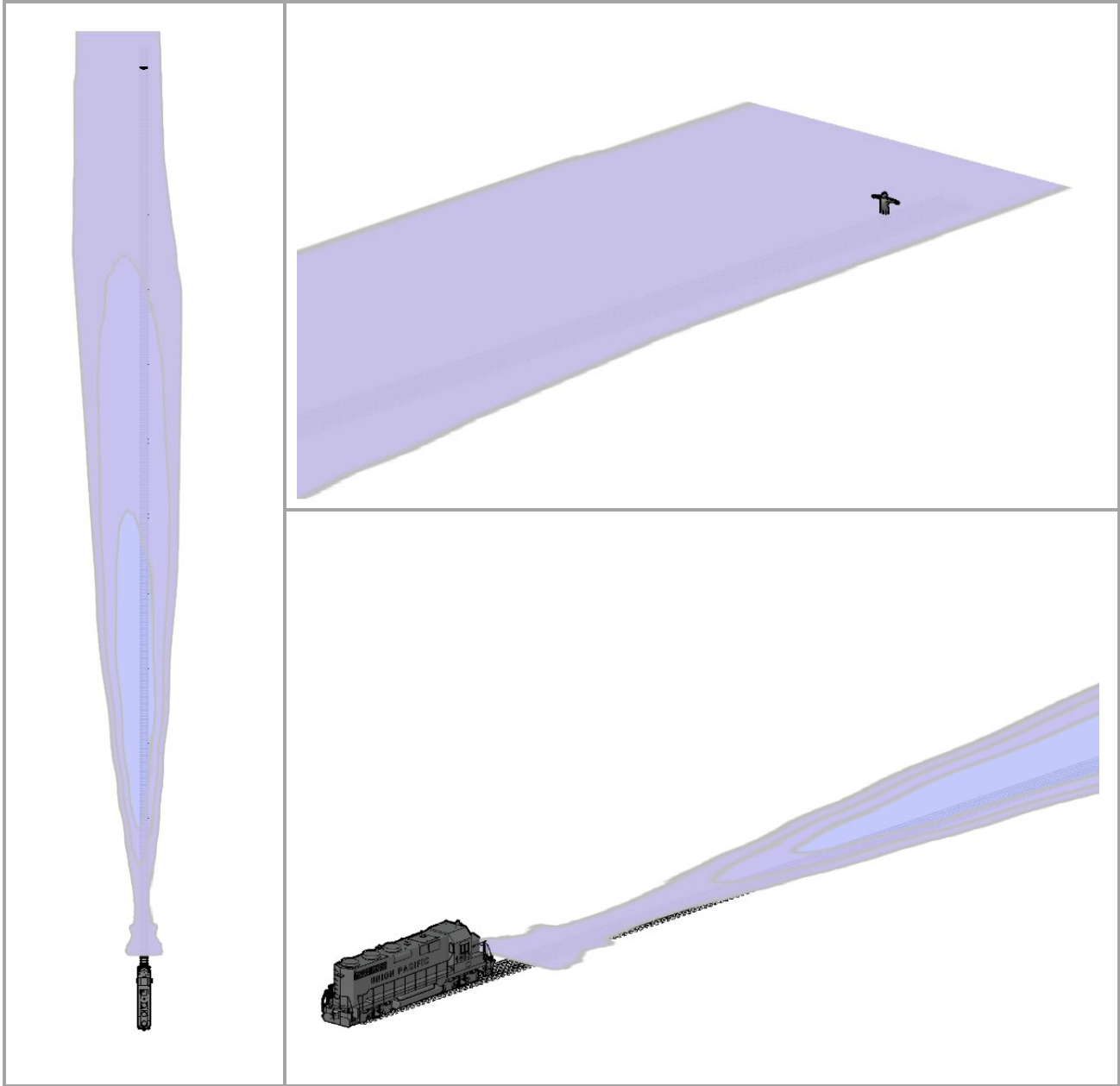

Figure 4. 3-Way View of an Illuminance map for a Railhead/Divvali dual-lamp headlight (S7 LED). The human figure (upper-right plot) stands 800 ft away from the light source.

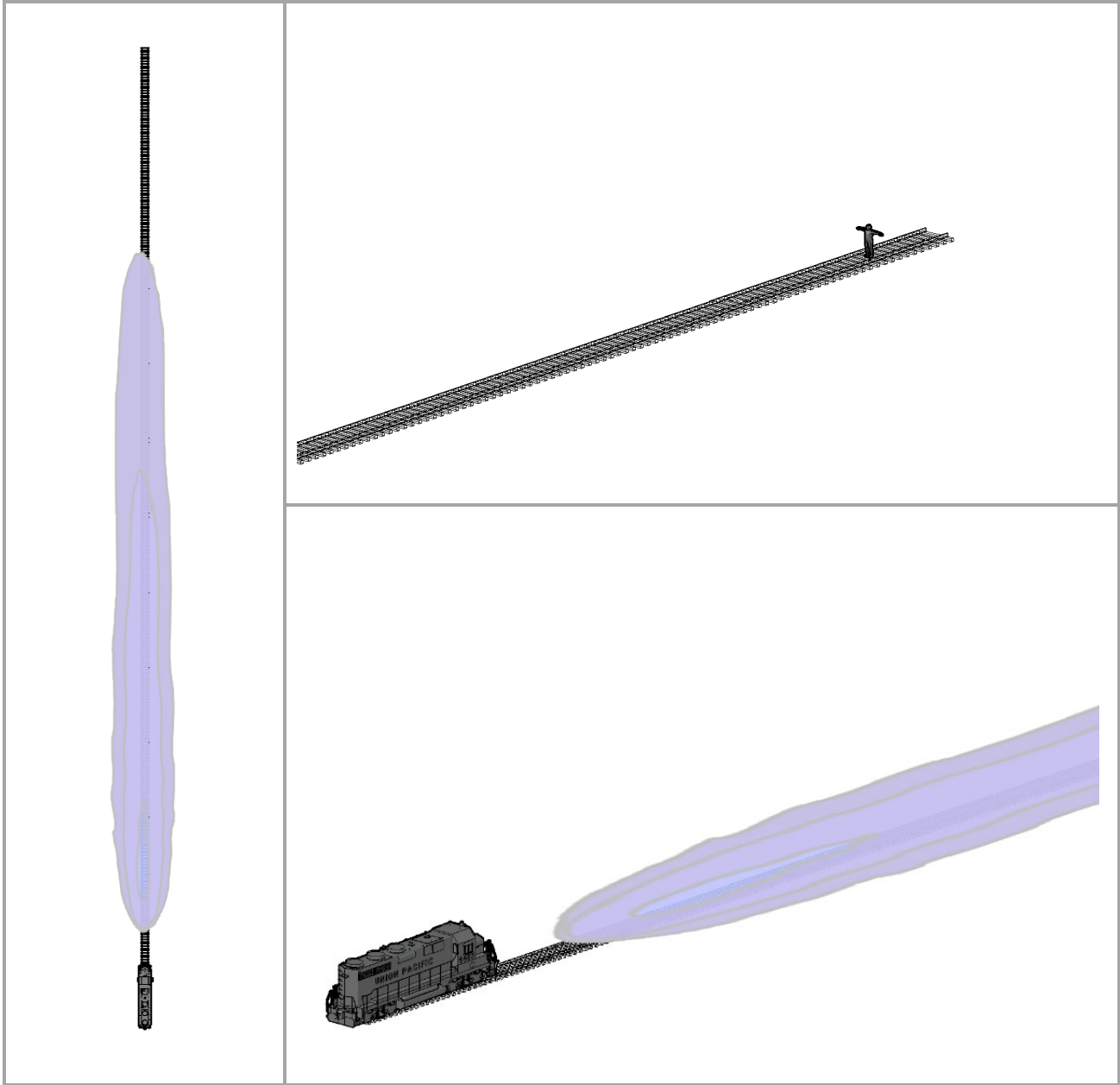

Figure 5. 3-Way View of an Illuminance map for a Smart Light Source dual-lamp headlight (S3 LED). The human figure (upper-right plot) stands 800 ft away from the light source.

Three-Way View of Illuminance Map of LED Headlights at 4 ft Height from the Ground in Dim Mode



Figure 1. 3-Way View of an Illuminance map for a J.W. Speaker dual-lamp headlight (S2 LED). The human figure (upper-right plot) stands 800 ft away from the light source.



Figure 2. 3-Way View of an Illuminance map for a Hydra-Tech 2800K dual-lamp headlight (S5 LED). The human figure (upper-right plot) stands 800 ft away from the light source.

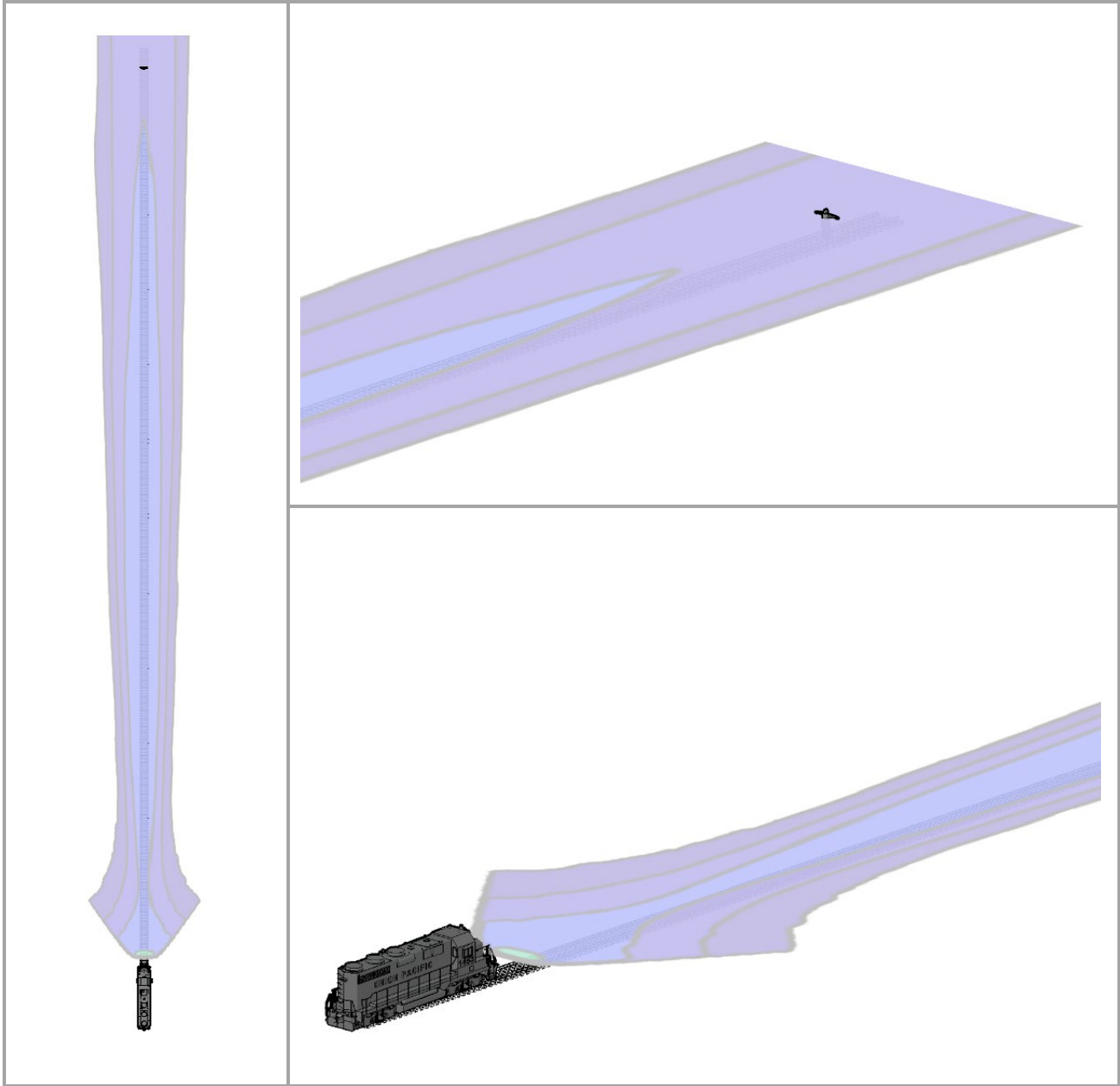

Figure 3. 3-Way View of an Illuminance map for a Hydra-Tech 7000K dual-lamp headlight (S1 LED). The human figure (upper-right plot) stands 800 ft away from the light source.

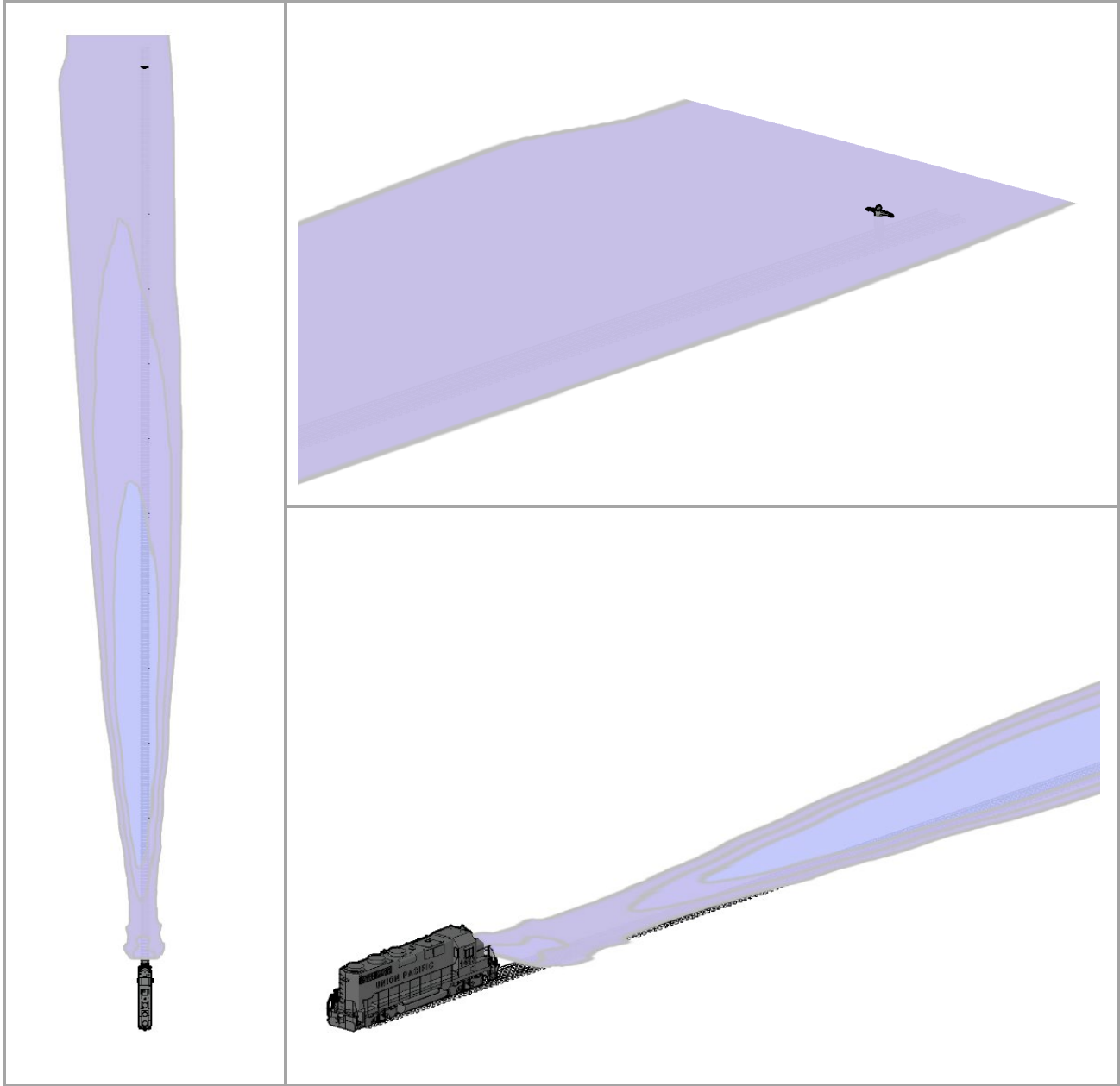

Figure 4. 3-Way View of an Illuminance map for a Railhead/Divvali dual-lamp headlight (S7 LED). The human figure (upper-right plot) stands 800 ft away from the light source.



Figure 5. 3-Way View of an Illuminance map for a Smart Light Source dual-lamp headlight (S3 LED). The human figure (upper-right plot) stands 800 ft away from the light source.

Three-Way View of Illuminance Map of Halogen Headlights at Ground Height

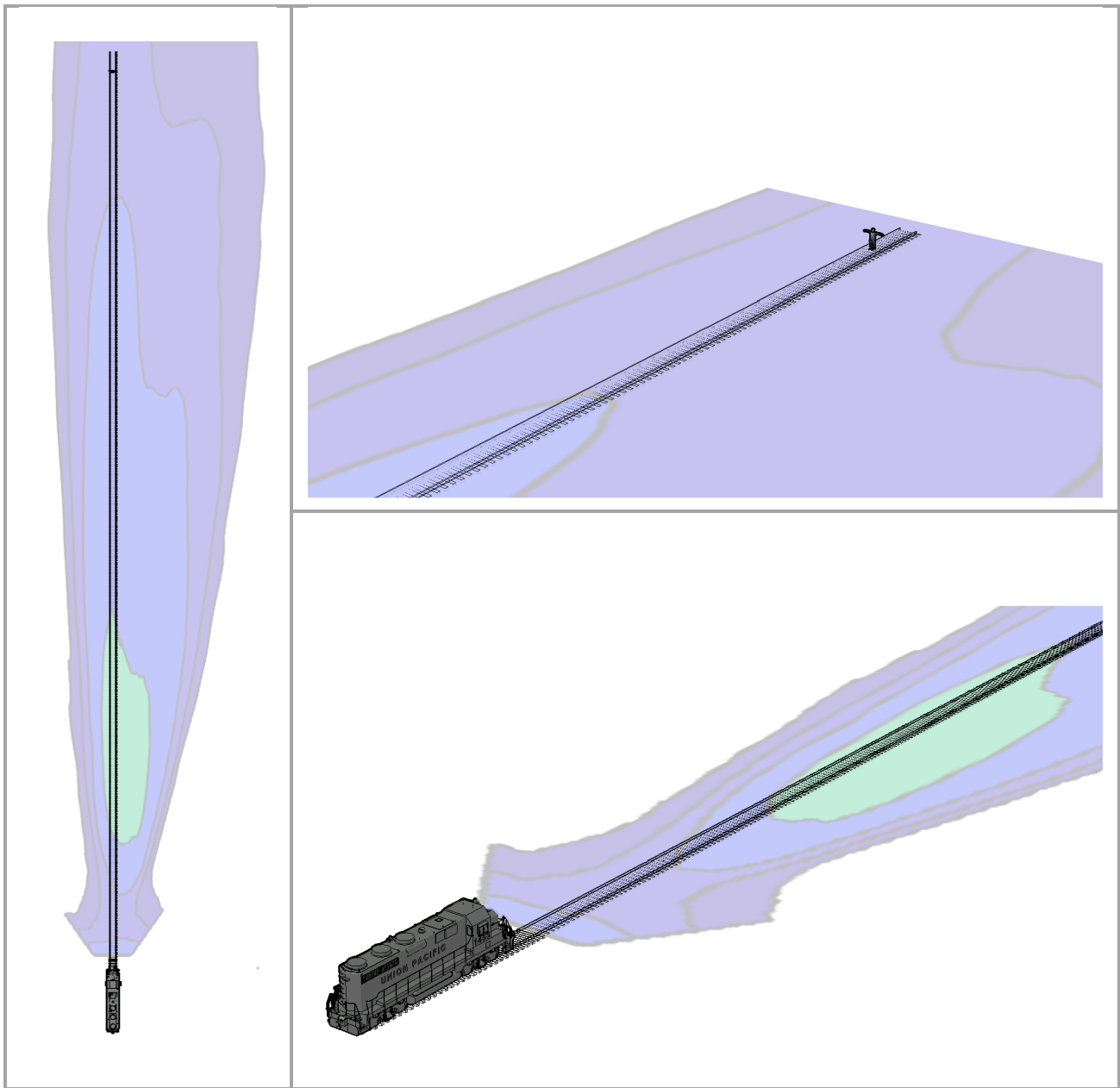

Figure 1. 3-Way View of an Illuminance map for an AMGLO dual-lamp headlight (S4 HAL). The human figure (upper-right plot) stands 800 ft away from the light source.

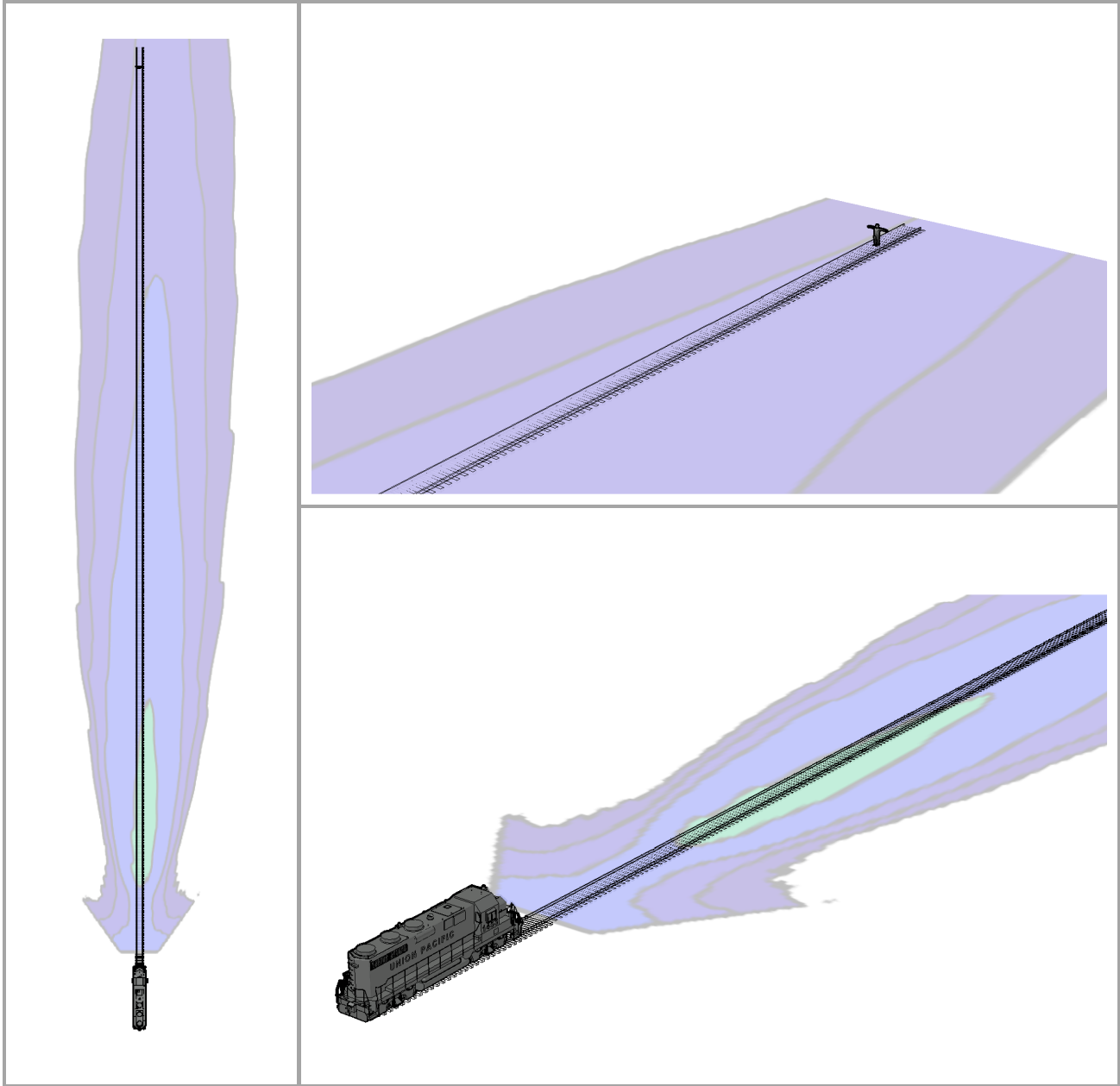

Figure 2. 3-Way View of an Illuminance map for an ePowerRail dual-lamp headlight (S3 HAL).
The human figure (upper-right plot) stands 800 ft away from the light source.

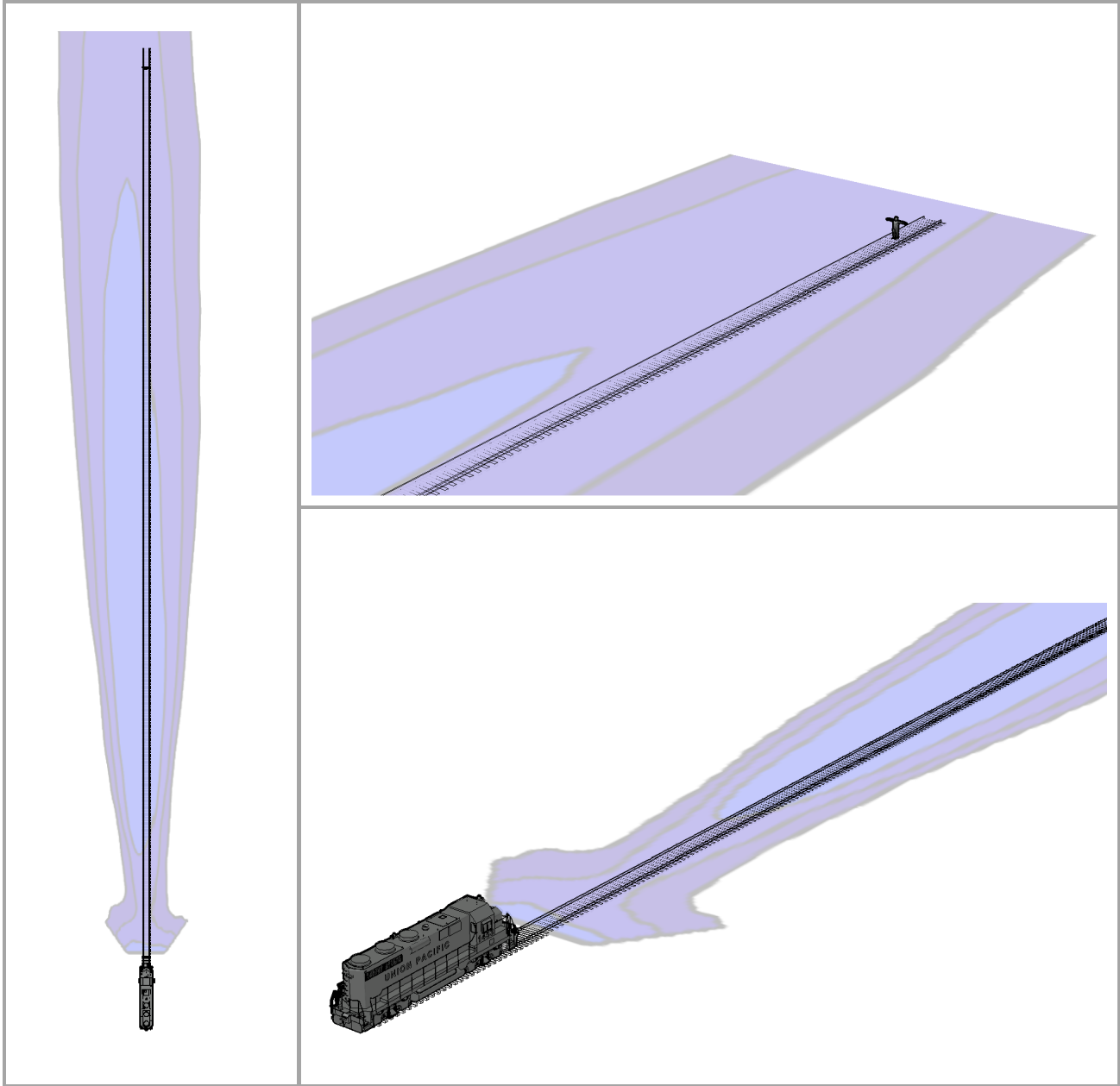

Figure 3. 3-Way View of an Illuminance map for a CML dual-lamp headlight (S1 HAL). The human figure (upper-right plot) stands 800 ft away from the light source.

Three-Way View of Illuminance Map of Halogen Headlights at 2 ft Height from the Ground

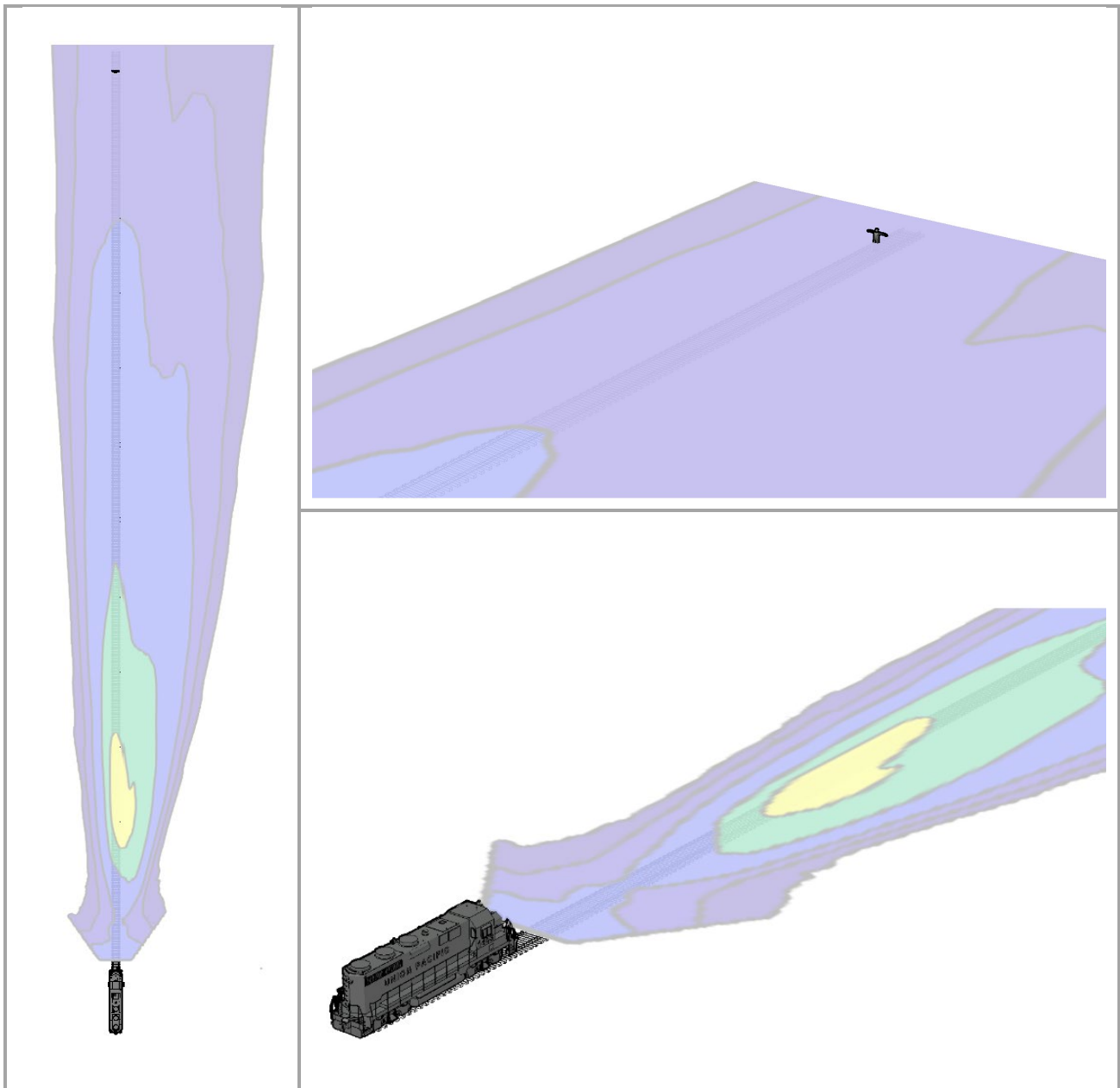

Figure 1. 3-Way View of an Illuminance map for an AMGLO dual-lamp headlight (S4 HAL). The human figure (upper-right plot) stands 800 ft away from the light source.

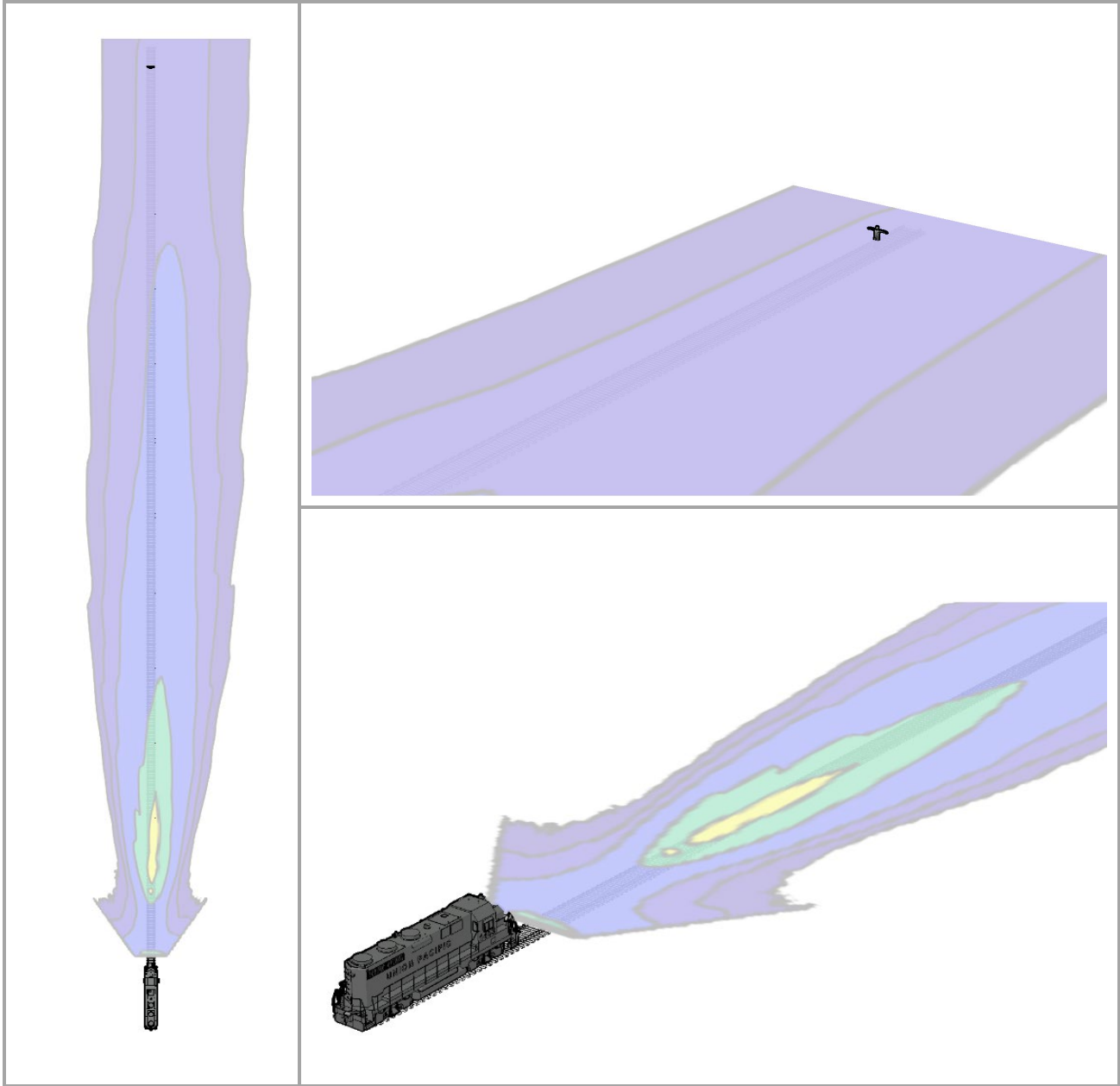

Figure 2. 3-Way View of an Illuminance map for an ePowerRail dual-lamp headlight (S3 HAL).
The human figure (upper-right plot) stands 800 ft away from the light source.

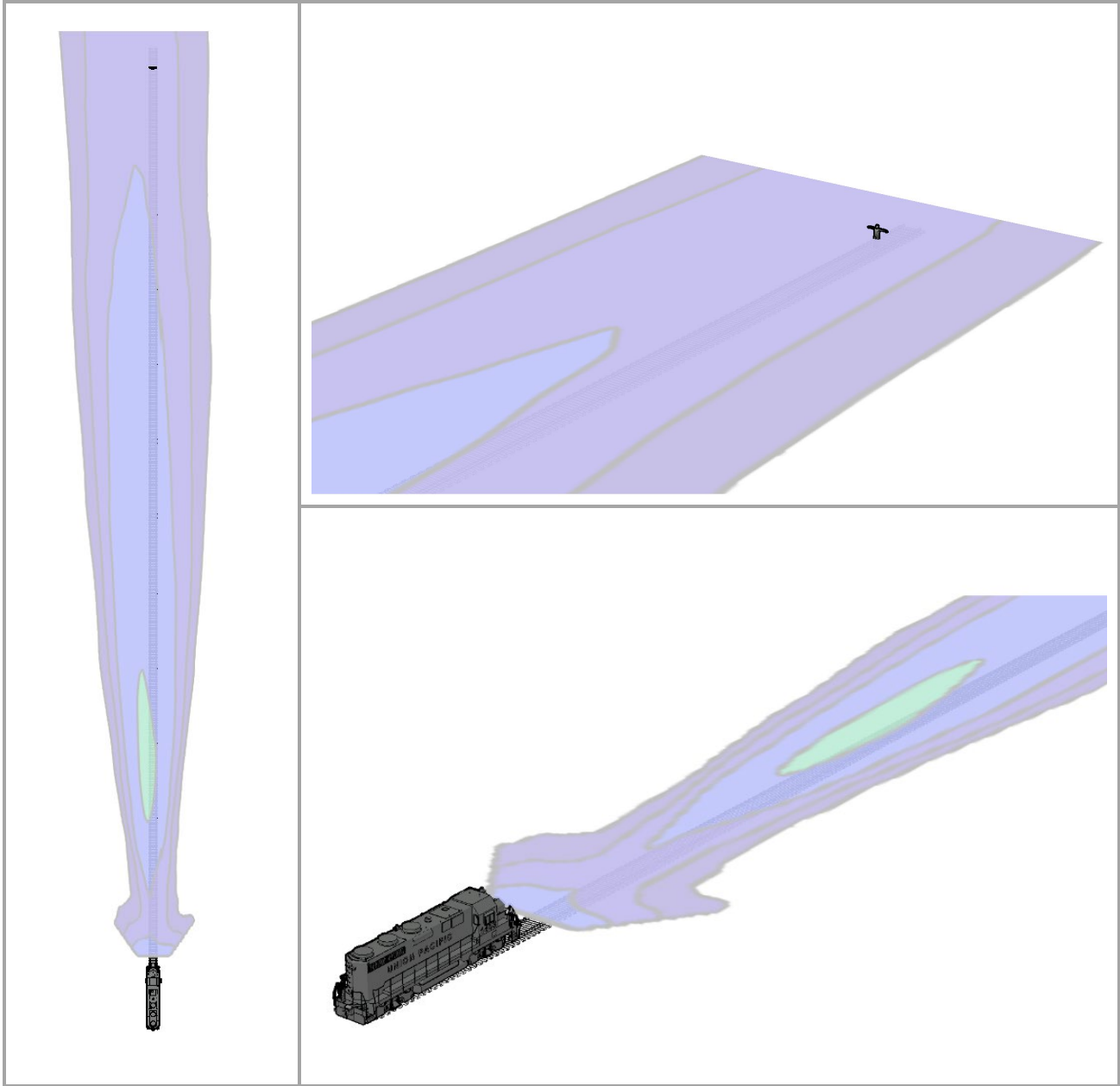

Figure 3. 3-Way View of an Illuminance map for a CML dual-lamp headlight (S1 HAL). The human figure (upper-right plot) stands 800 ft away from the light source.

Three-Way View of Illuminance Map of Halogen Headlights at 4 ft Height from the Ground

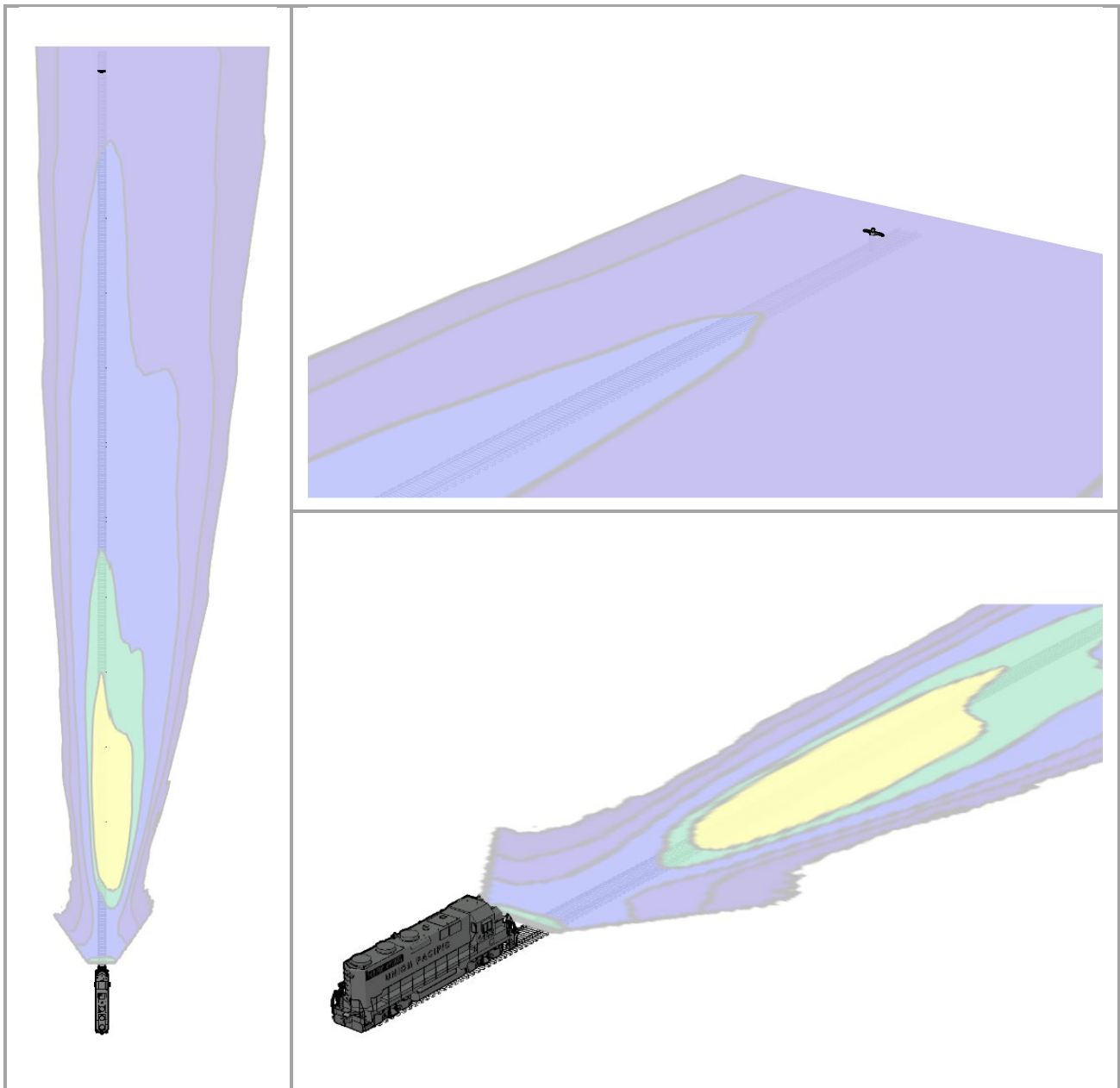

Figure 1. 3-Way View of an Illuminance map for an AMGLO dual-lamp headlight (S4 HAL). The human figure (upper-right plot) stands 800 ft away from the light source.

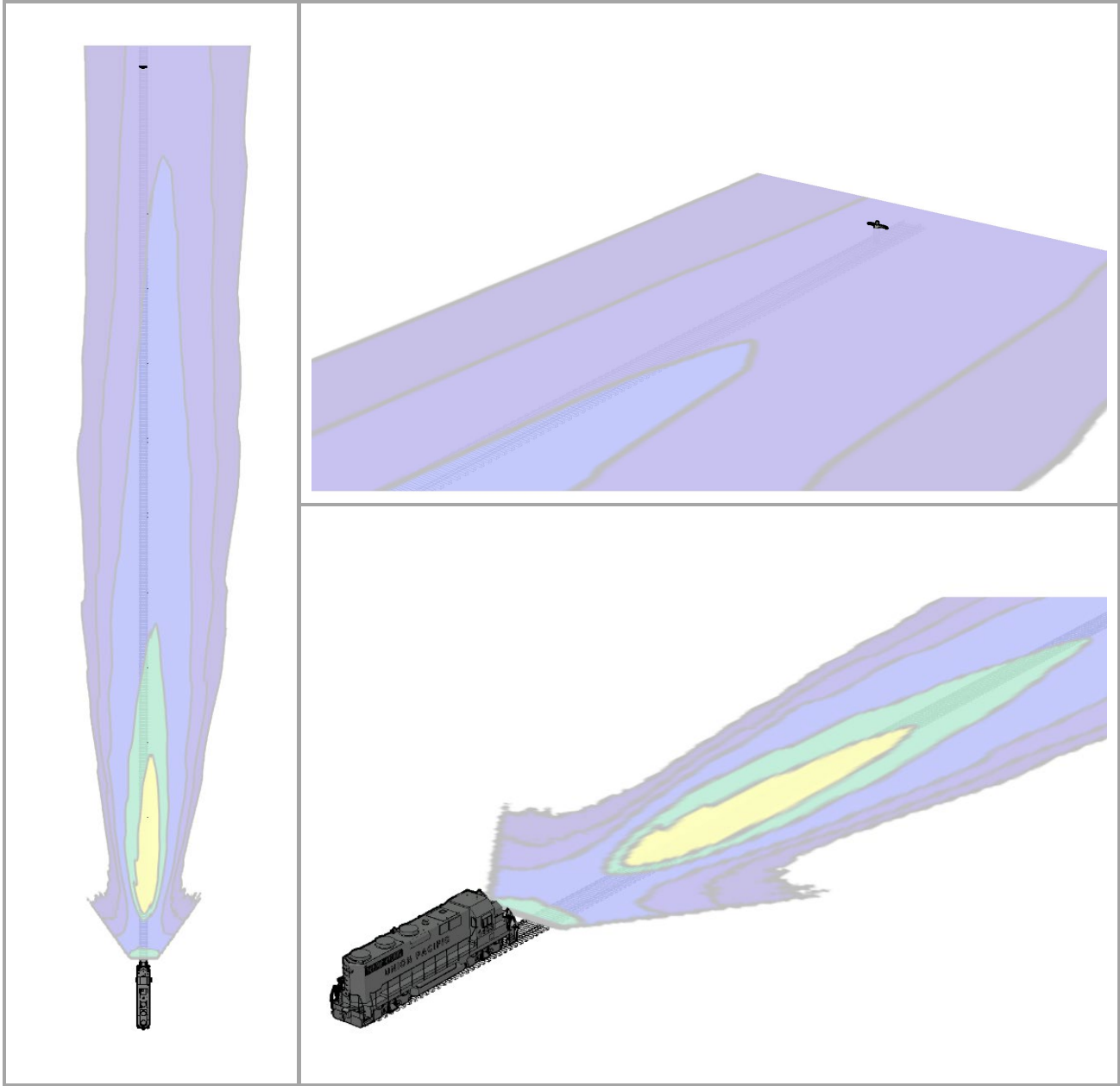

Figure 2. 3-Way View of an Illuminance map for an ePowerRail dual-lamp headlight (S3 HAL).
The human figure (upper-right plot) stands 800 ft away from the light source.

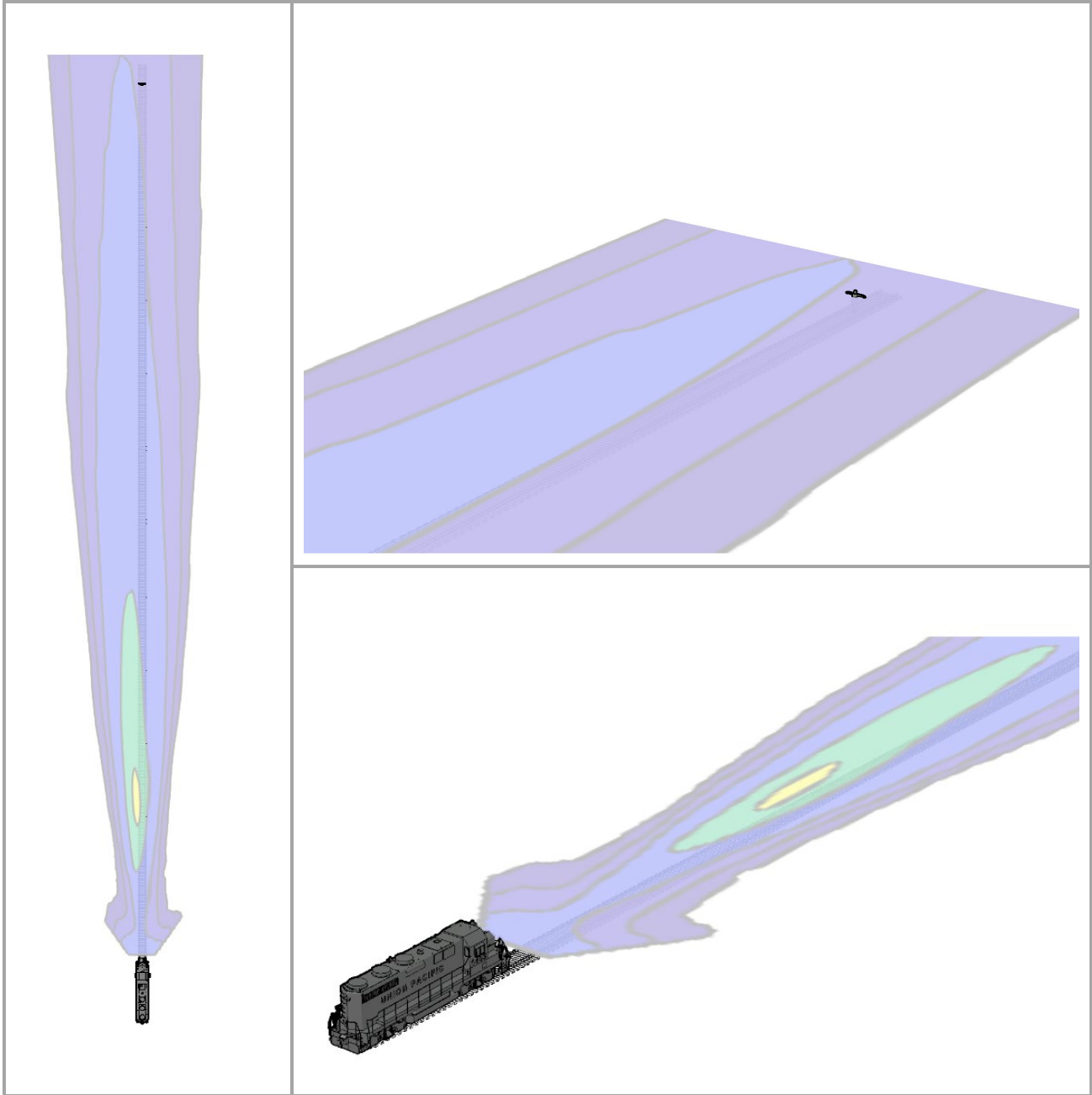

Figure 3. 3-Way View of an Illuminance map for a CML dual-lamp headlight (S1 HAL). The human figure (upper-right plot) stands 800 ft away from the light source.

Appendix H. Color Rendering of Test Samples

Color Renderings of LED Samples in Bright Mode

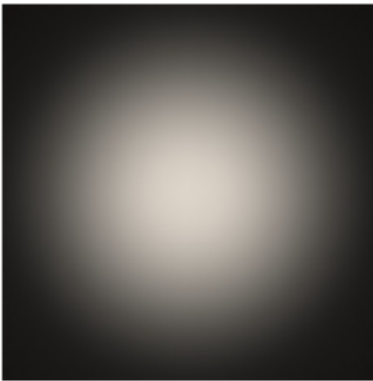

Figure 1. Color Rendering of J.W. Speaker (S2 LED) (5,880 K)

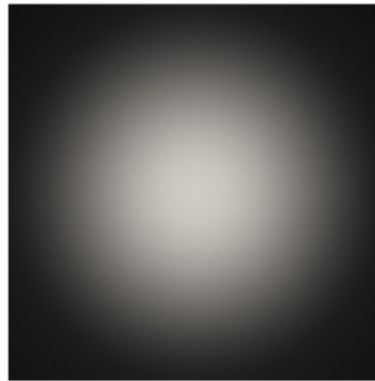

Figure 2. Color Rendering of J.W. Speaker (S4 LED) (5,880 K)

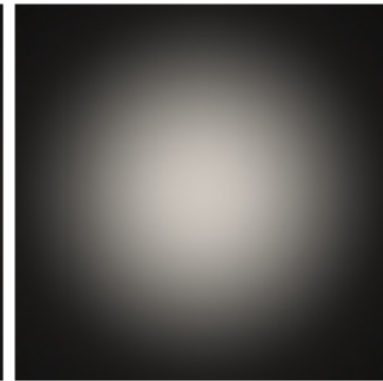

Figure 3. Color Rendering of J.W. Speaker (S8 LED) (5,880 K)



Figure 4. Color Rendering of Hydra-Tech 2800K (S5 LED) (3,198 K)



Figure 5. Color Rendering of Hydra-Tech 2800K (S9 LED) (3,198 K)

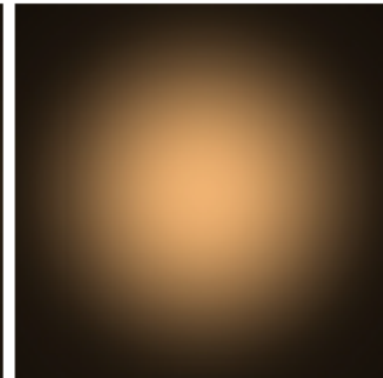

Figure 6. Color Rendering of Hydra-Tech 2800K (S13 LED) (3,198 K)

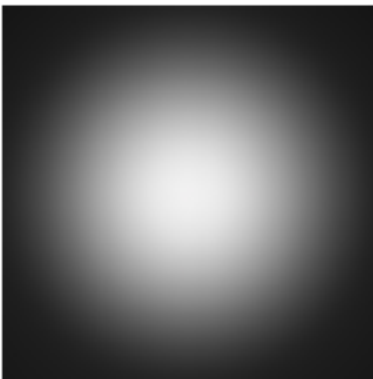

Figure 7. Color Rendering of Hydra-Tech 7000K (S1 LED) (6,567 K)



Figure 8. Color Rendering of Hydra-Tech 7000K (S10 LED) (6,567 K)

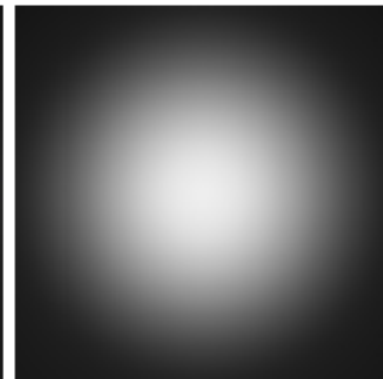

Figure 9. Color Rendering of Hydra-Tech 7000K (S15 LED) (6,567 K)

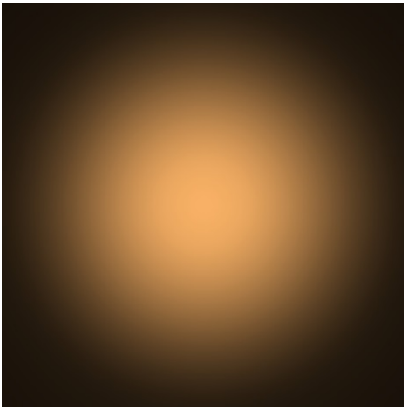

Figure 10. Color Rendering of Railhead/Divvali (S7 LED) (2,938 K)

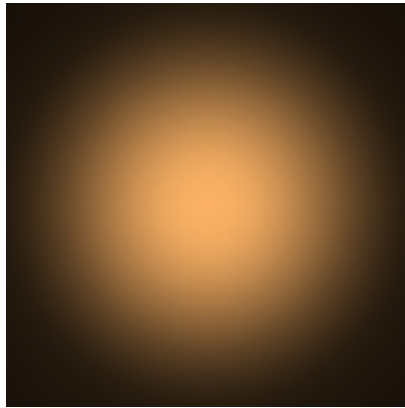

Figure 11. Color Rendering of Railhead/Divvali (S11 LED) (2,938 K)

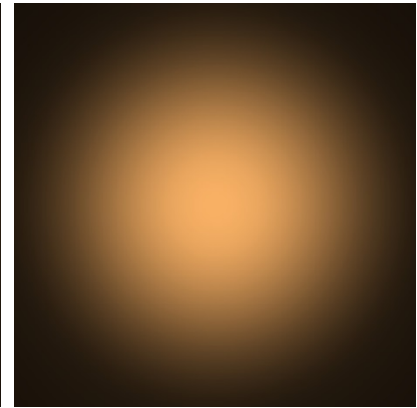

Figure 12. Color Rendering of Railhead/Divvali (S12 LED) (2,938 K)

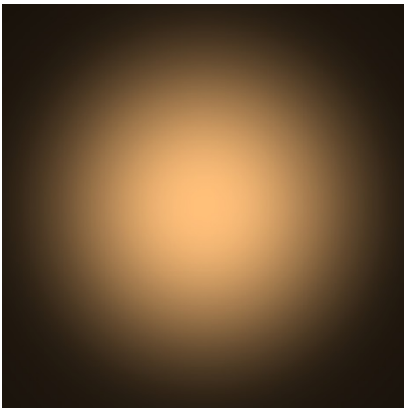

Figure 13. Color Rendering of Smart Light Source (S3 LED) (3,209 K)

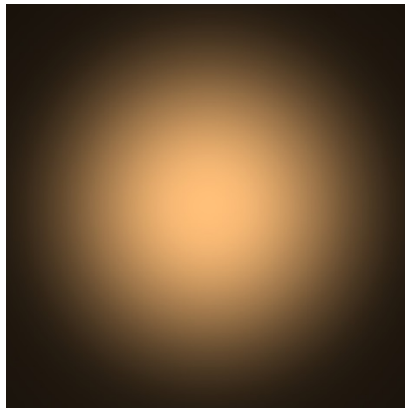

Figure 14. Color Rendering of Smart Light Source (S6 LED) (3,209 K)

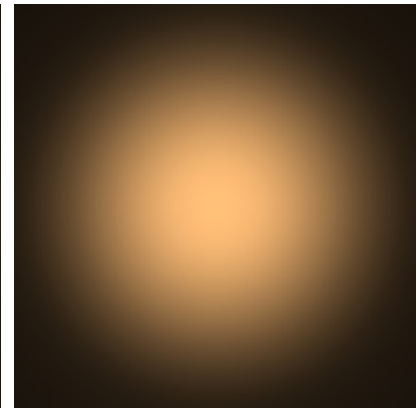

Figure 15. Color Rendering of Smart Light Source (S14 LED) (3,209 K)

Color Renderings of Halogen Samples

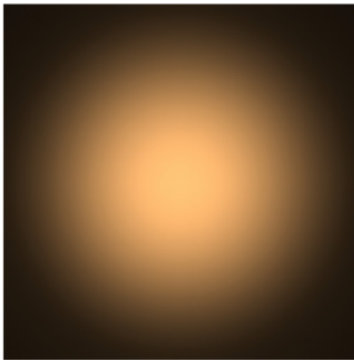

Figure 1. Color Rendering of AMGLO (S4 HAL) (3,090 K)

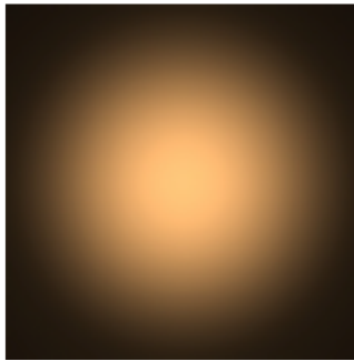

Figure 2. Color Rendering of AMGLO (S6 HAL) (3,090 K)

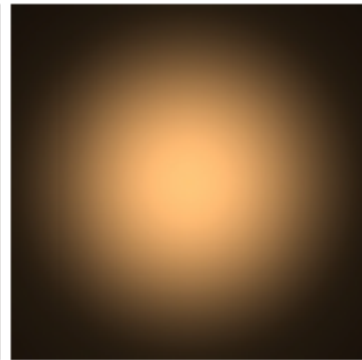

Figure 3. Color Rendering of AMGLO (S7 HAL) (3,090 K)

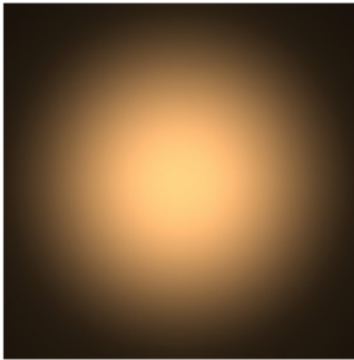

Figure 4. Color Rendering of ePowerRail (S3 HAL) (3,129 K)

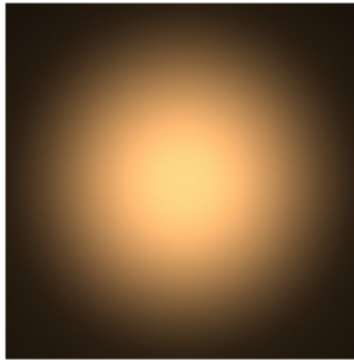

Figure 5. Color Rendering of ePowerRail (S5 HAL) (3,129 K)

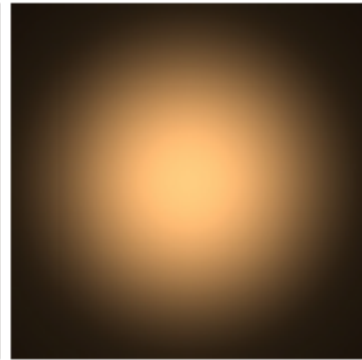

Figure 6. Color Rendering of ePowerRail (S8 HAL) (3,129 K)



Figure 7. Color Rendering of CML (S1 HAL) (3,081 K)



Figure 8. Color Rendering of CML (S2 HAL) (3,081 K)

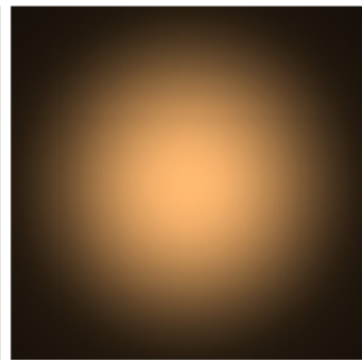

Figure 9. Color Rendering of CML (S9 HAL) (3,081 K)

Appendix I. Intertek Measurement Results

Times for LED Samples to Reach “Stable” State, Bright Mode

Bulb	37.5V 5A; 37.5V 5A	P/N: Sample 1 LED	Room Temp: 25C - 26%
Power	37.50v 5.000a; 37.50v 5.000a	JOB #: G103303532	Quote #: Qu-00830398
Run Date, [ID#]	11/28/2017 5:44 PM [013353-04]	Total time: 29 mins 45 sec	

Sample #1

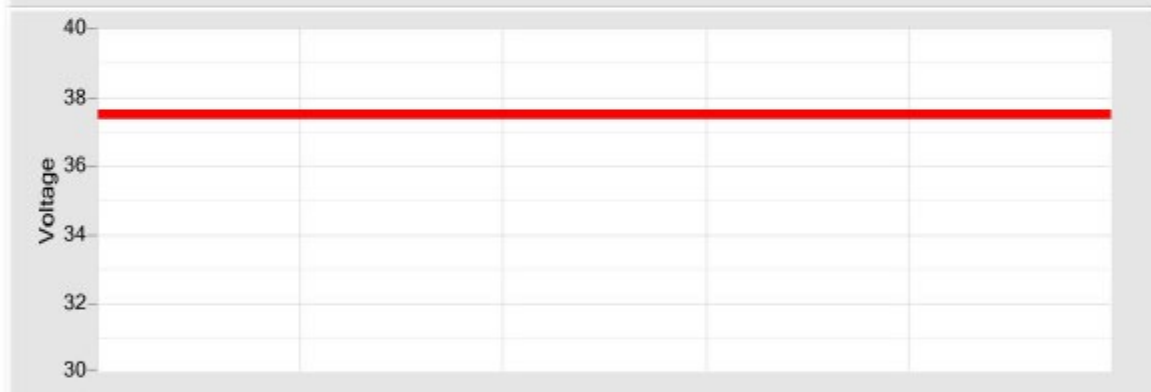
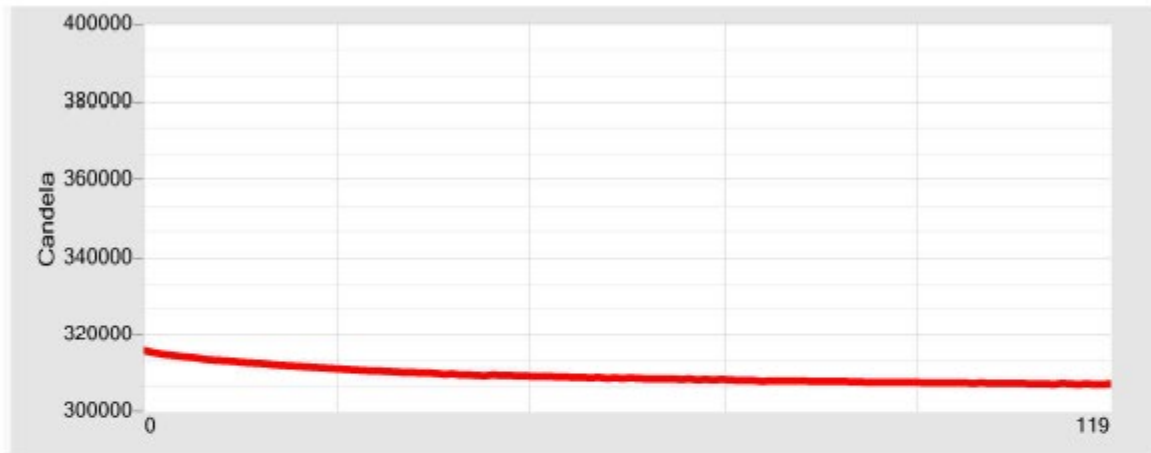

Intertek, Grand Rapids - Photometric Lab

Equipment: Hoffman Engineering AGS-1140UG-007

Bulb	37.5V 5A; 37.5V 5A	P/N: Sample 2 LED	Room Temp: 24C - 25% RH
Power	37.50v 5.000a; 37.50v 5.000a	JOB #: G103303532	Quote #: Qu-00830398
Run Date, [ID#]	11/27/2017 1:57 PM [013346-01]	Total time: 29 mins 45 sec	

Sample #2

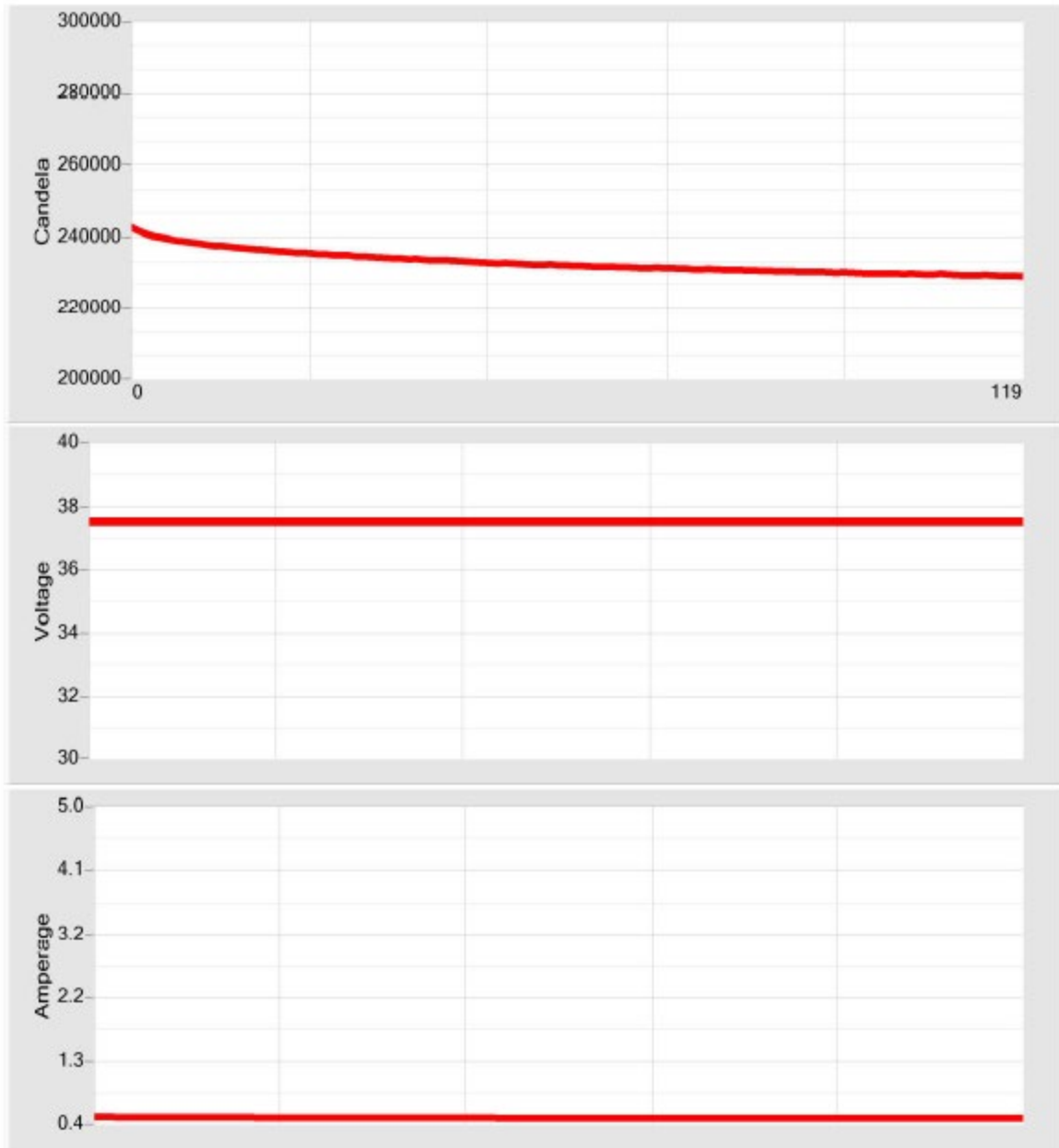

Intertek, Grand Rapids - Photometric Lab

Equipment: Hoffman Engineering AGS-1140UG-007

Bulb	37.5V 5A; 37.5V 5A	P/N: Sample 3 LED	Room Temp: 24C - 26%
Power	37.50v 5.000a; 37.50v 5.000a	JOB #: G103303532	Quote #: Qu-00830398
Run Date, [ID#]	11/27/2017 4:18 PM [013347-01]	Total time 19 mins 30 sec	

Sample #3

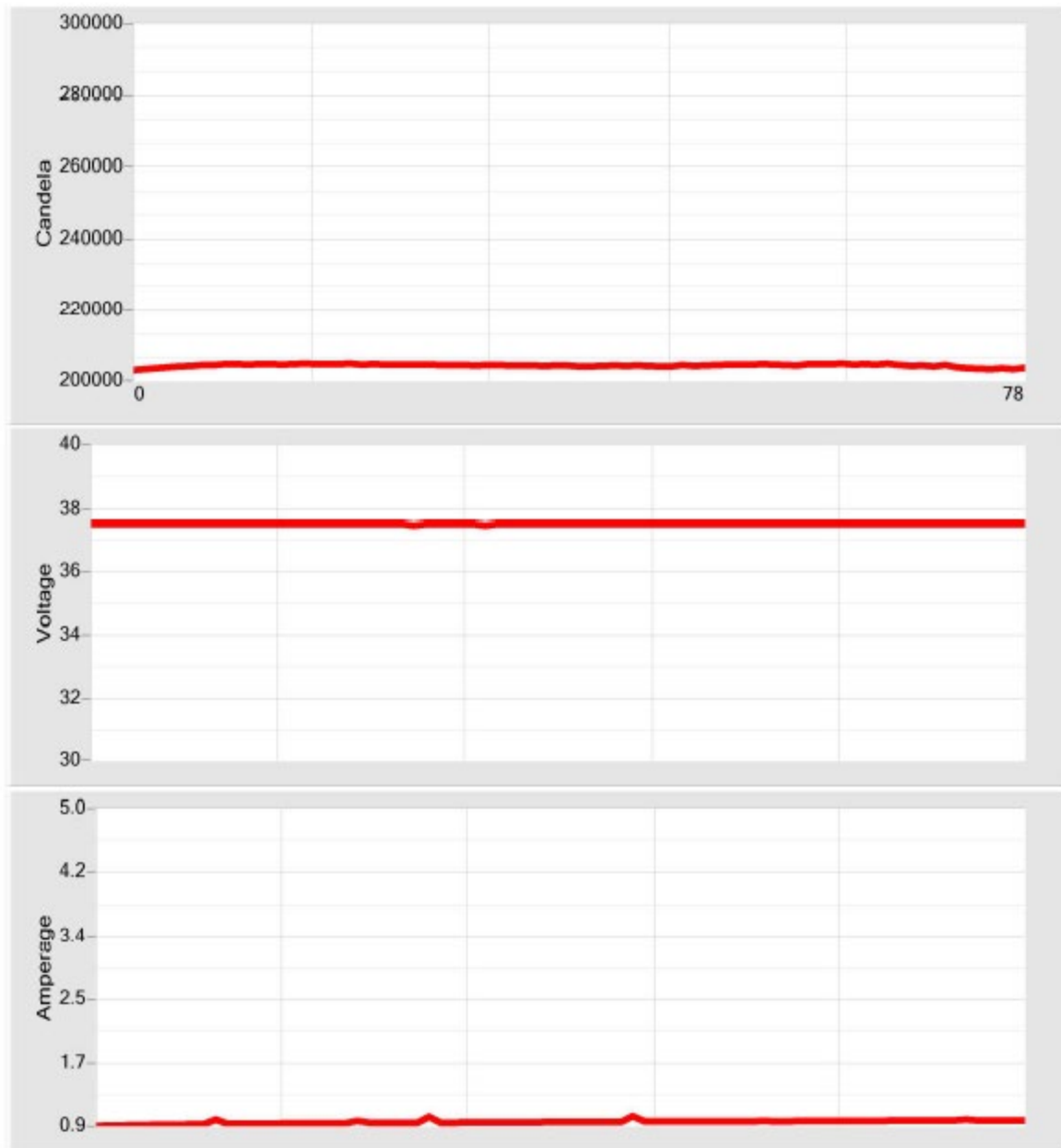

Intertek, Grand Rapids - Photometric Lab

Equipment: Hoffman Engineering AGS-1140UG-007

Bulb	37.5V 5A; 37.5V 5A	P/N: Sample #4	Room Temp: 23C <25% RH
Power	37.50v 5.000a; 37.50v 5.000a	JOB #: G103303532	Quote #: Qu-00830398
Run Date, [ID#]	12/21/2017 01:19 PM [013463-01]	Total time 29 mins 45 sec	

Sample #4 - Bright Mode

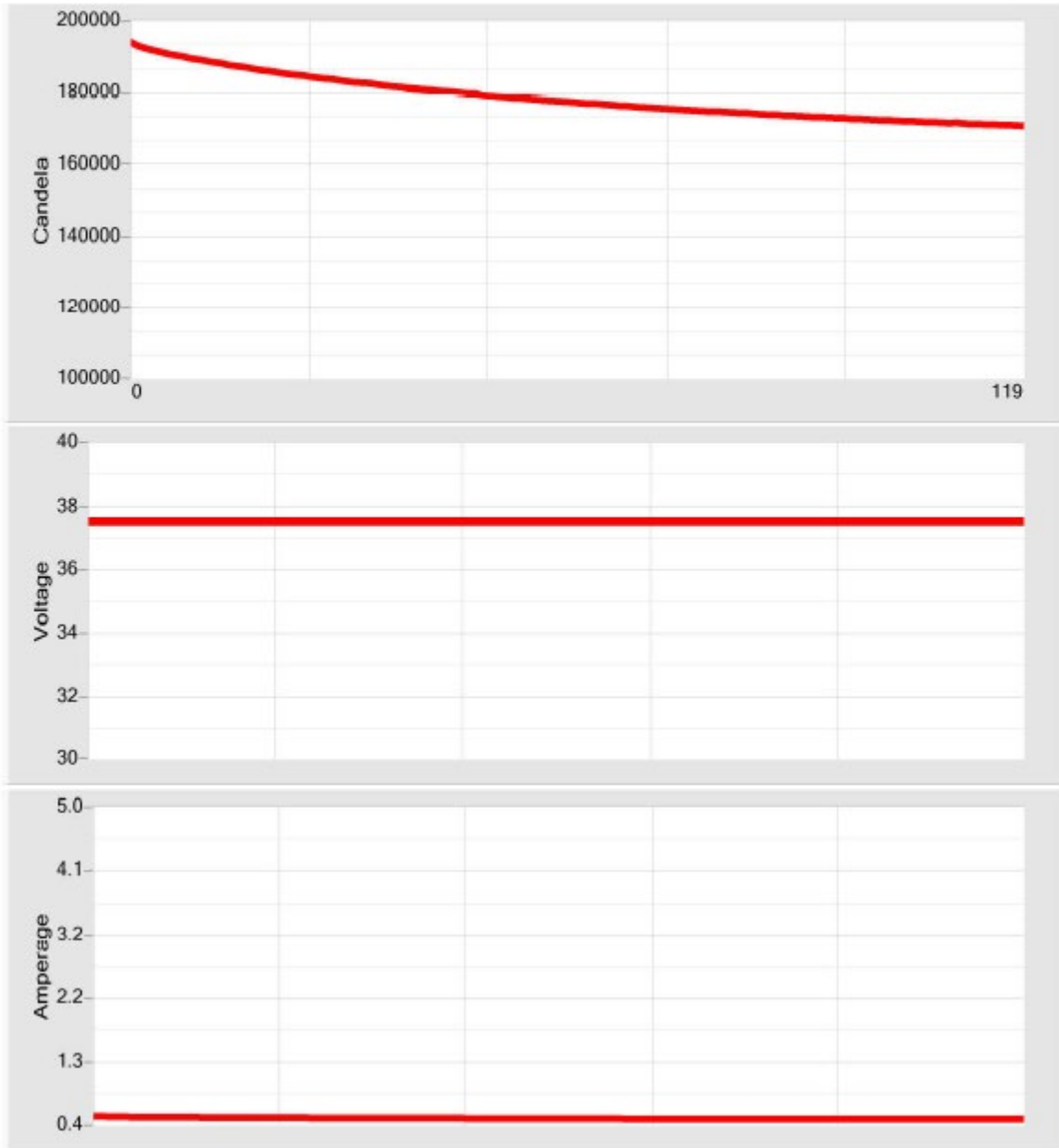

Intertek, Grand Rapids - Photometric Lab

Equipment: Hoffman Engineering AGS-1140UG-007

Bulb	37.5V 5A; 37.5V 5A	P/N: Sample 5 LED	Room Temp: 25C - 26%
Power	37.50v 5.000a; 37.50v 5.000a	JOB #: G103303532	Quote #: Qu-00830398
Run Date, [ID#]	11/28/2017 3:53 PM [013352-04]	Total time 29 mins 45 sec	

Sample #5

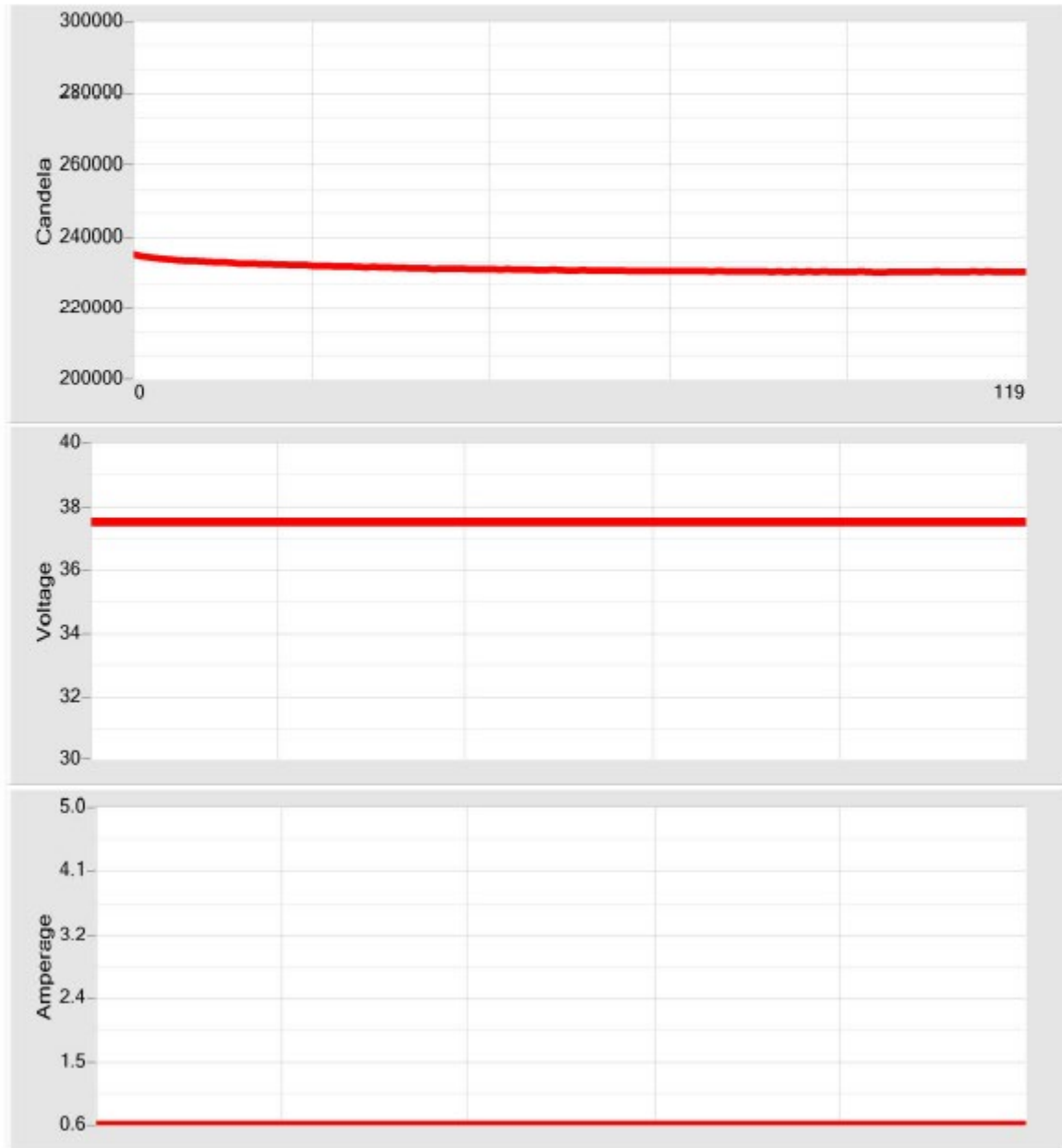

Intertek, Grand Rapids - Photometric Lab

Equipment: Hoffman Engineering AGS-1140UG-007

Bulb	37.5V 5A; 37.5V 5A	P/N: Sample 6	Room Temp: 24C - 26%
Power	37.50v 5.000a; 37.50v 5.000a	JOB #: G103303532	Quote #: Qu-00830398
Run Date, [ID#]	11/29/2017 11:53 AM [013366-01]	Total time 8 mins 45 sec	

Sample 6

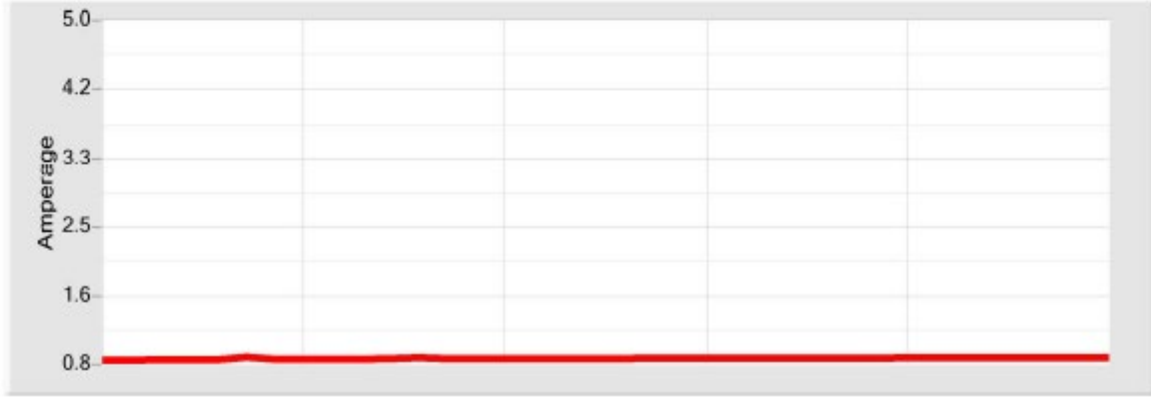
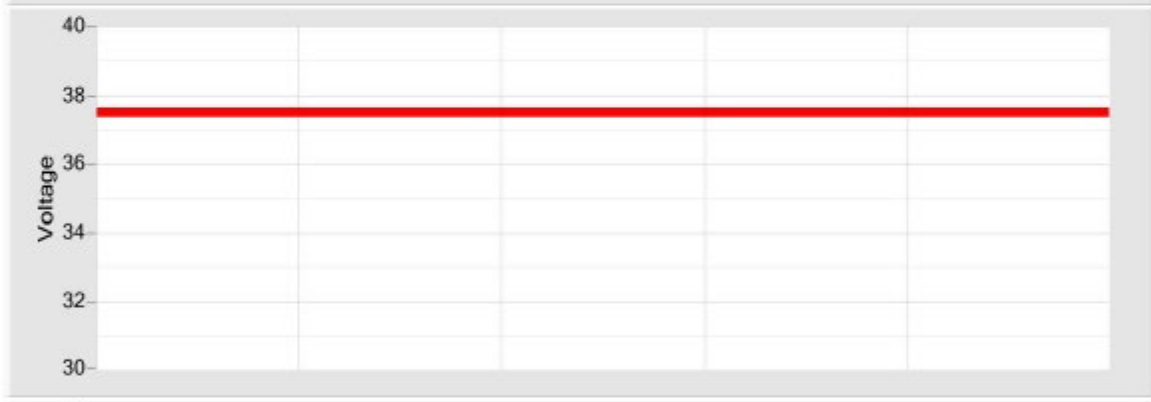

Intertek, Grand Rapids - Photometric Lab

Equipment: Hoffman Engineering AGS-1140UG-007

Bulb	37.5V 5A; 37.5V 5A
Power	37.50v 5.000a; 37.50v 5.000a
Run Date, [ID#]	11/29/2017 1:35 PM [013367-01]

P/N: Sample 7 LED	Room Temp: 24C - 26%
JOB #: G103303532	Quote #: Qu-00830398
Total time: 29 mins 45 sec	

Sample 7

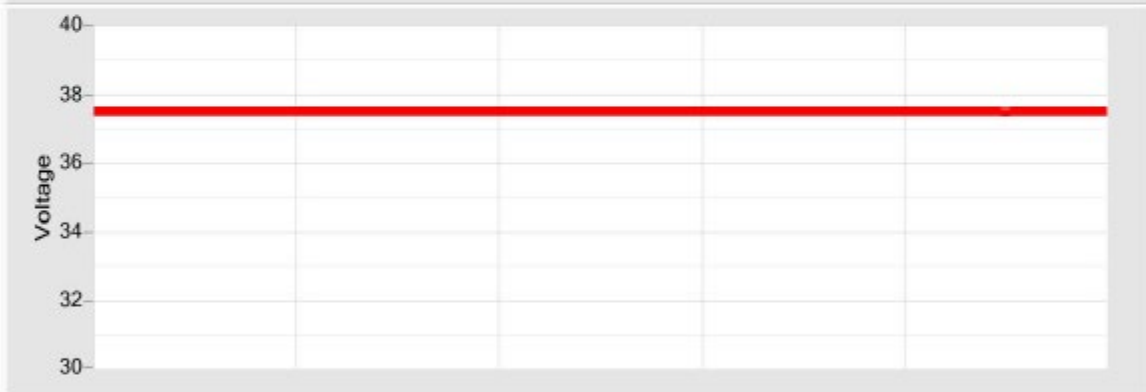
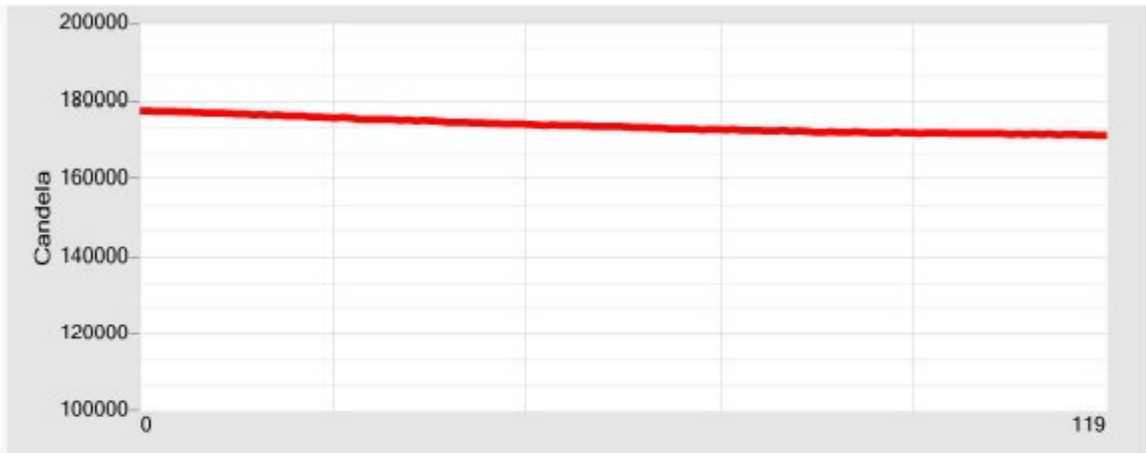

Intertek, Grand Rapids - Photometric Lab

Equipment: Hoffman Engineering AGS-1140UG-007

Bulb	37.5V 5A; 37.5V 5A	P/N: Sample 8	Room Temp: 24C - 26%
Power	37.50v 5.000a; 37.50v 5.000a	JOB #: G103303532	Quote #: Qu-00830398
Run Date, [ID#]	11/29/2017 4:13 PM [013370-01]	Total time 9 mins 45 sec	

Sample 8

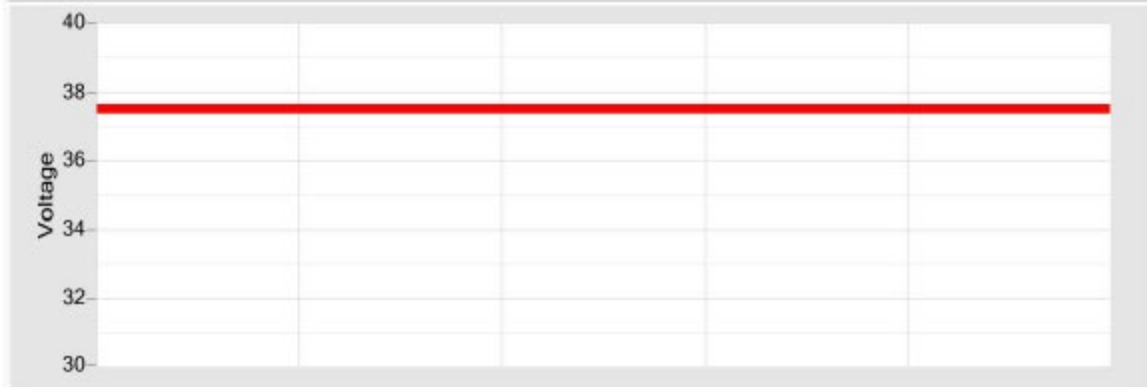

Intertek, Grand Rapids - Photometric Lab

Equipment: Hoffman Engineering AGS-1140UG-007

Bulb	37.5V 5A; 37.5V 5A	P/N: Sample 9 LED	Room Temp: 23C-26%
Power	37.50v 5.000a; 37.50v 5.000a	JOB #: G103303532	Quote #: Qu-00830398
Run Date, [ID#]	11/30/2017 10:03 AM [013373-04]	Total time 2 mins 45 sec	

Sample 9

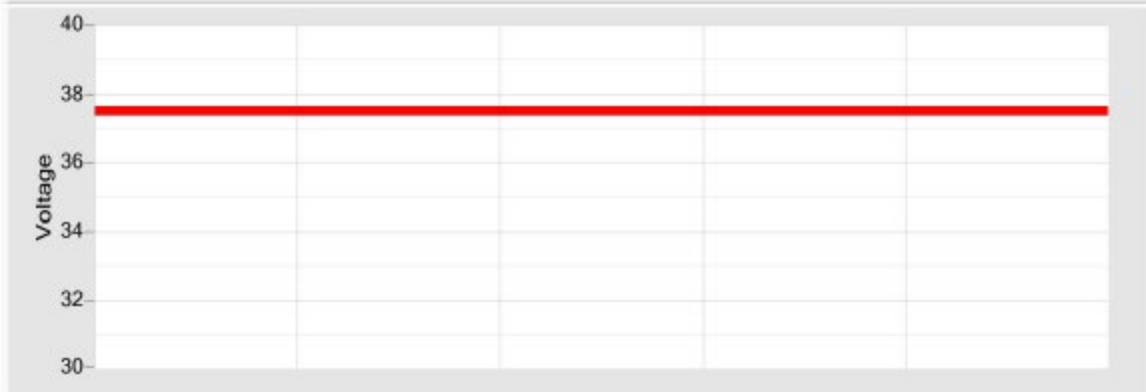

Intertek, Grand Rapids - Photometric Lab

Equipment: Hoffman Engineering AGS-1140UG-007

Bulb	37.5V 5A; 37.5V 5A	P/N: Sample 10 LED	Room Temp: 24C-26%
Power	37.50v 5.000a; 37.50v 5.000a	JOB #: G103303532	Quote #: Qu-00830398
Run Date, [ID#]	11/30/2017 11:31 AM [013374-04]	Total time 6 mins	

Sample 10

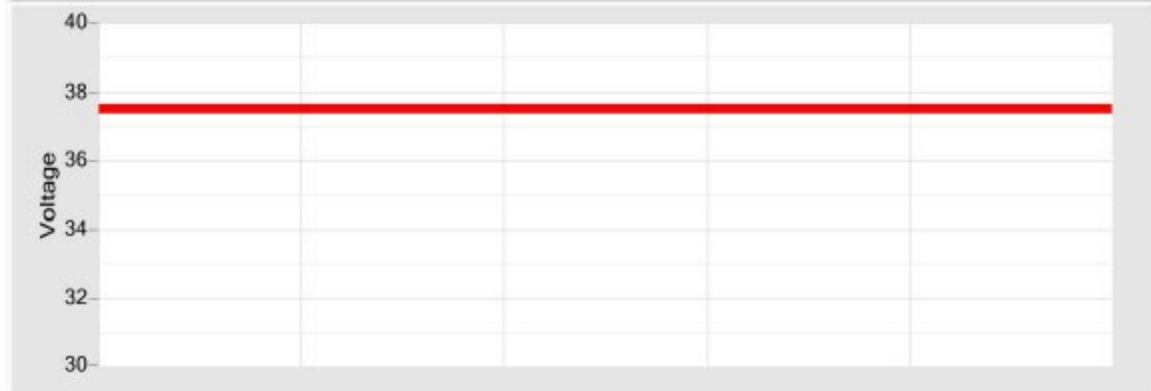
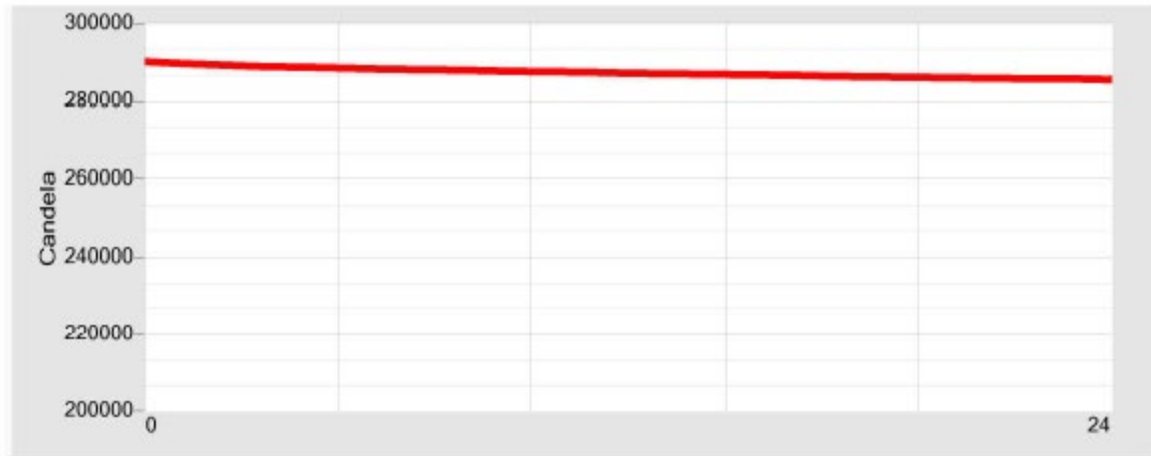

Intertek, Grand Rapids - Photometric Lab

Equipment: Hoffman Engineering AGS-1140UG-007

Bulb	37.5V 5A; 37.5V 5A	P/N: Sample 11 LED	Room Temp: 24C - 26%
Power	37.50v 5.000a; 37.50v 5.000a	JOB #: G103303532	Quote #: Qu-00830398
Run Date, [ID#]	11/30/2017 12:13 PM [013375-01]	Total time 8 mins	

Sample 11

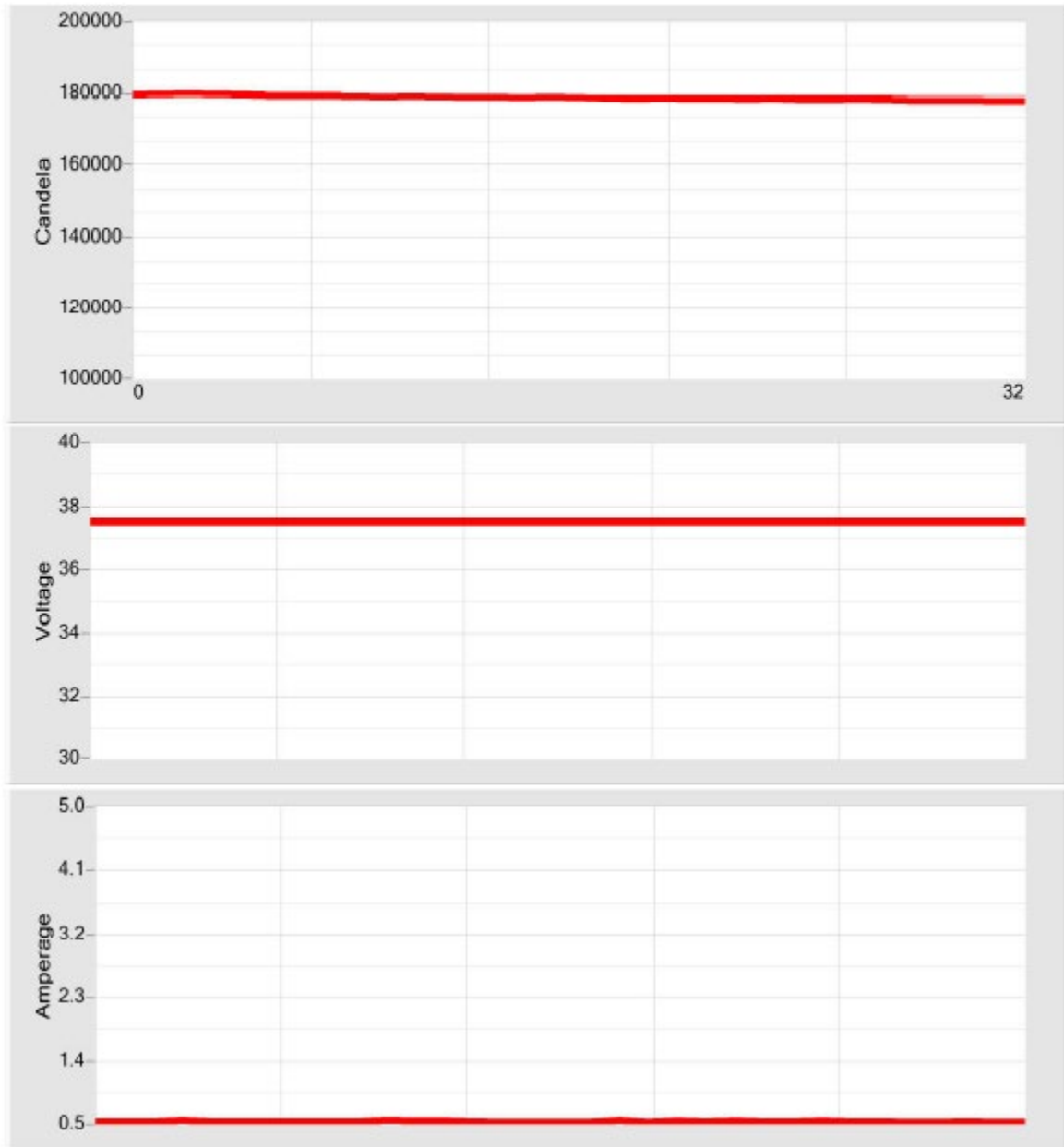

Intertek, Grand Rapids - Photometric Lab

Equipment: Hoffman Engineering AGS-1140UG-007

Bulb	37.5V 5A; 37.5V 5A	P/N: Sample 12 LED	Room Temp: 24C - 26%
Power	37.50v 5.000a; 37.50v 5.000a	JOB #: G103303532	Quote #: Qu-00830398
Run Date, [ID#]	11/30/2017 1:36 PM [013376-01]	Total time 6 mins 15 sec	

Sample 12

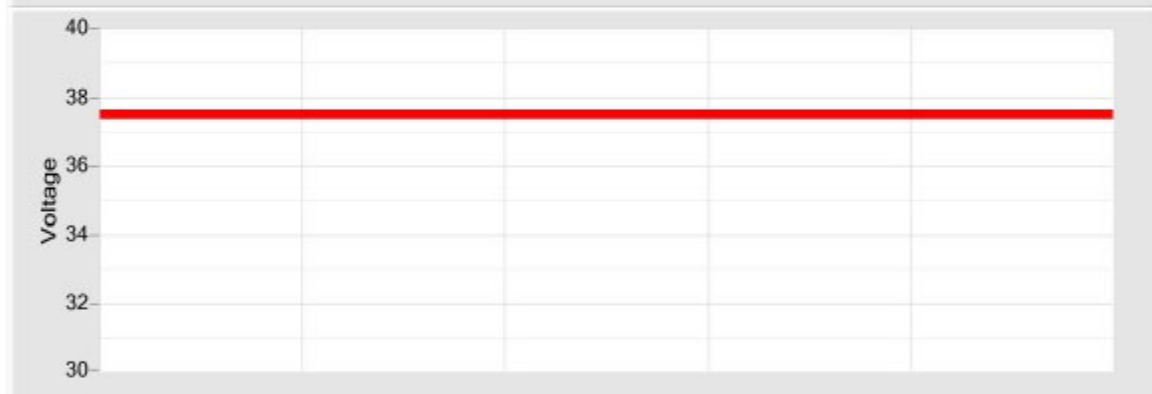
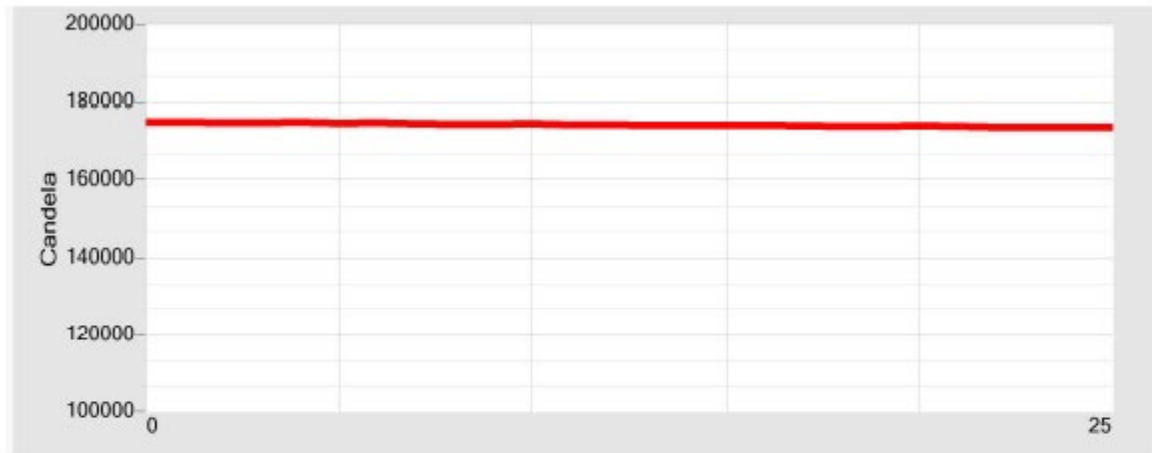

Intertek, Grand Rapids - Photometric Lab

Equipment: Hoffman Engineering AGS-1140UG-007

Bulb	37.5V 5A; 37.5V 5A	P/N: Sample 13 LED	Room Temp: 24C - 26%
Power	37.50v 5.000a; 37.50v 5.000a	JOB #: G103303532	Quote #: Qu-00830398
Run Date, [ID#]	11/30/2017 3:23 PM [013377-04]	Total time 13 mins	

Sample 13

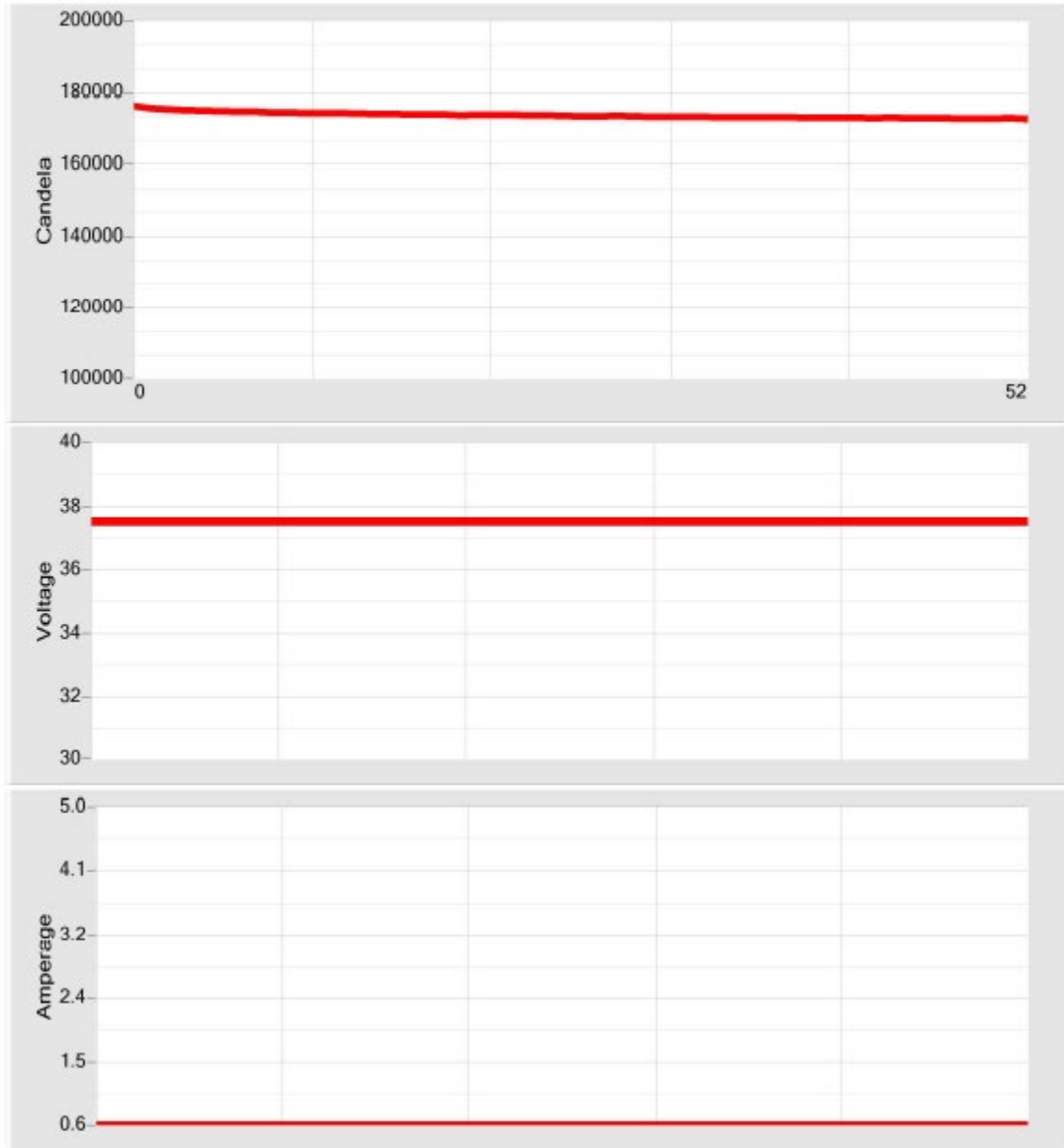

Intertek, Grand Rapids - Photometric Lab

Equipment: Hoffman Engineering AGS-1140UG-007

Bulb	37.5V 5A; 37.5V 5A	P/N: Sample 14 LED	Room Temp: 24C - 25%
Power	37.50v 5.000a; 37.50v 5.000a	JOB #: G103303532	Quote #: Qu-00830398
Run Date, [ID#]	11/30/2017 4:36 PM [013378-01]	Total time 8 mins 30 sec	

Sample 14

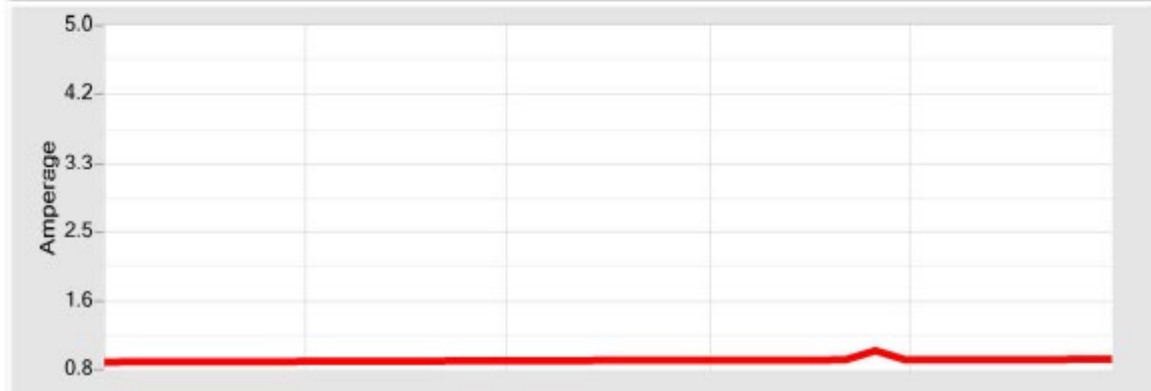
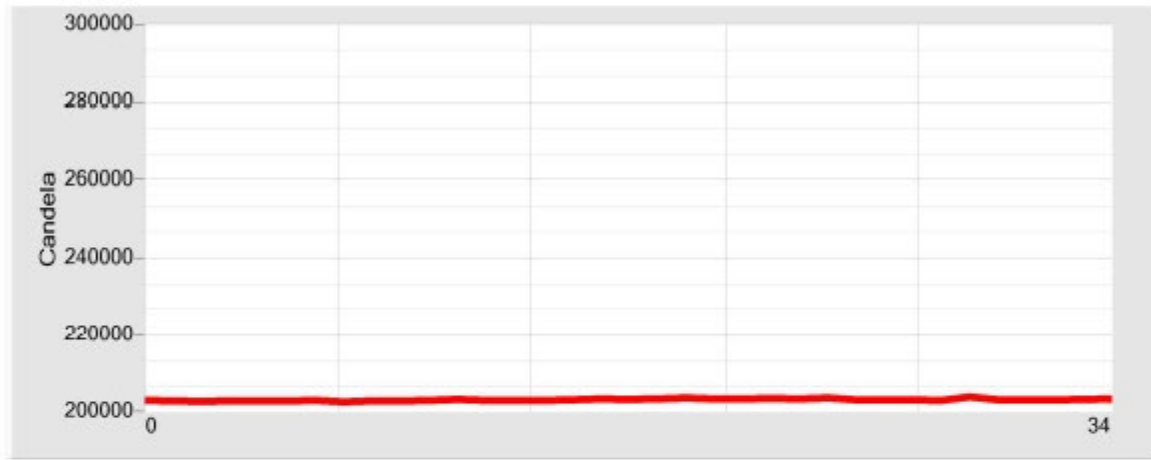

Intertek, Grand Rapids - Photometric Lab

Equipment: Hoffman Engineering AGS-1140UG-007

Bulb	37.5V 5A; 37.5V 5A	P/N: Sample 15 LED	Room Temp: 24C -25%
Power	37.50v 5.000a; 37.50v 5.000a	JOB #: G103303532	Quote #: Qu-00830398
Run Date, [ID#]	11/30/2017 6:43 PM [013379-04]	Total time 29 mins 45 sec	

Sample 15 LED

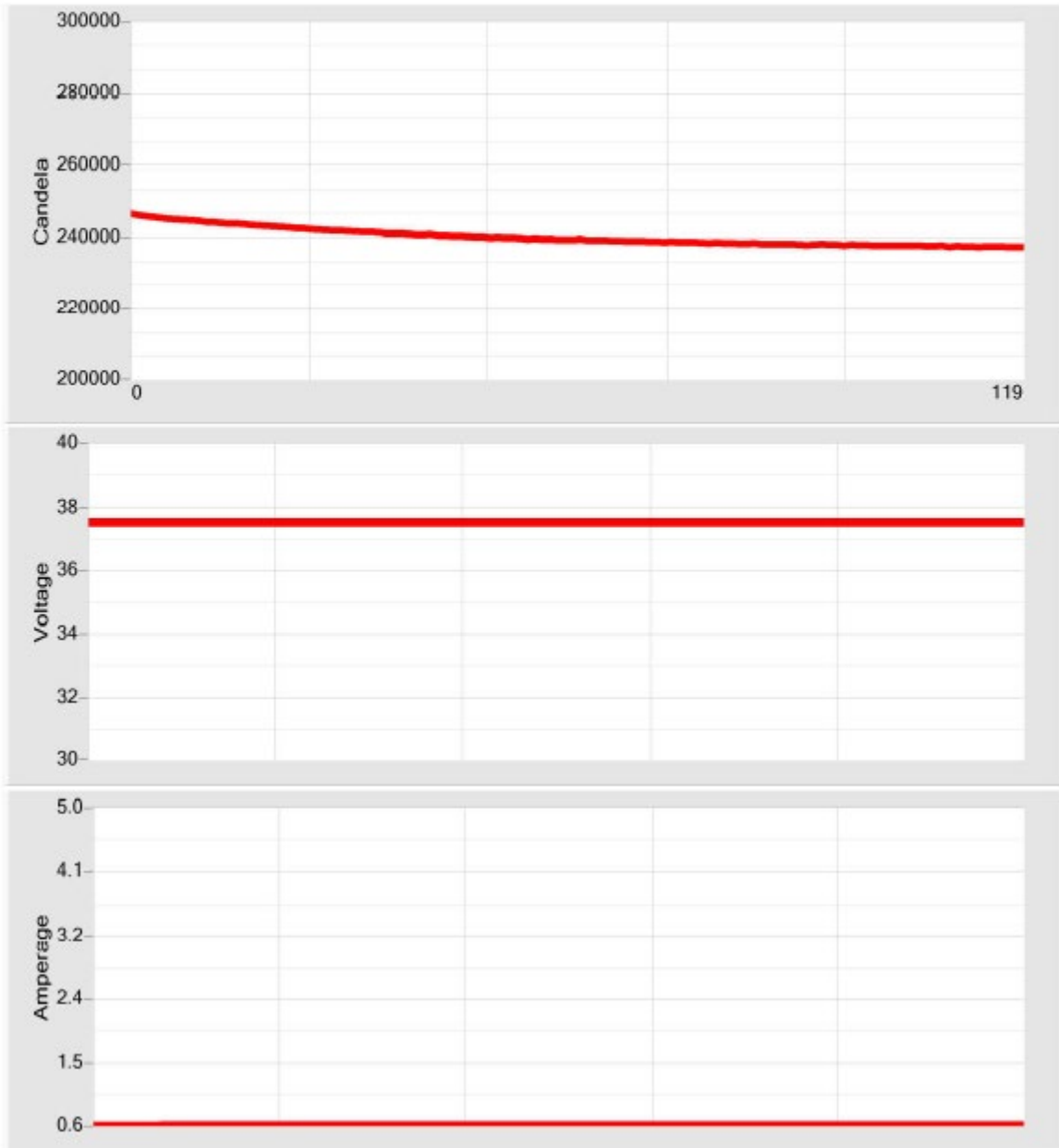

Times for LED Samples to Reach “Stable” State, Dim Mode

Intertek, Grand Rapids - Photometric Lab

Equipment: Hoffman Engineering AGS-1140UG-007

Bulb	15.0V / 5A; 15.0V / 5A	P/N: Sample 1 LED	Room Temp: 25C - 26%
Power	15.00v 5.000a; 15.00v 5.000a	JOB #: G103303532	Quote #: Qu-00830398
Run Date, [ID#]	11/28/2017 4:55 PM [013353-01]	Total time: 29 mins 45 sec	

Sample #1

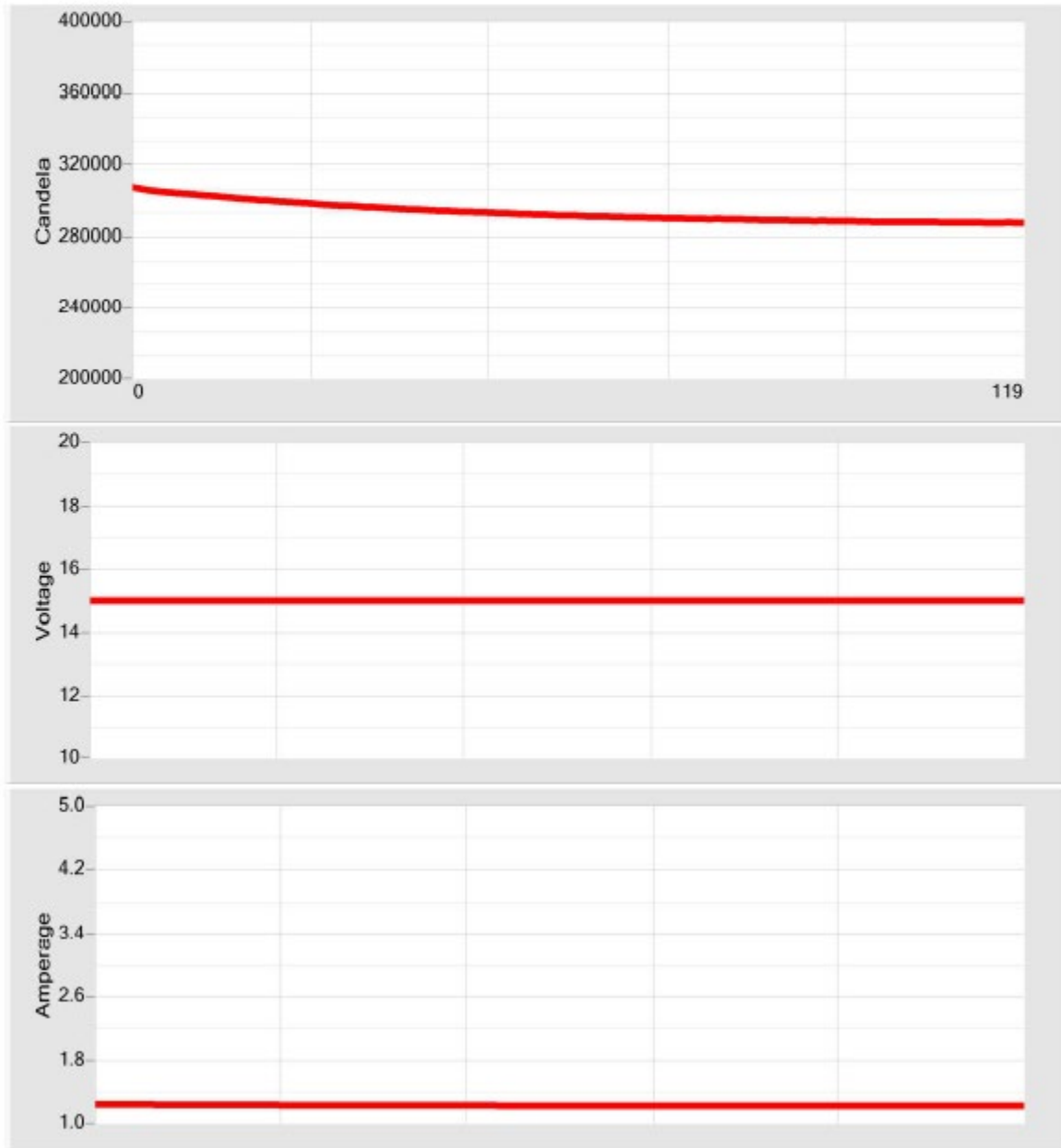

Intertek, Grand Rapids - Photometric Lab

Equipment: Hoffman Engineering AGS-1140UG-007

Bulb	37.5V 5A; 37.5V 5A	P/N: Sample 2 LED	Room Temp: 24C - 25%
Power	37.50v 5.000a; 37.50v 5.000a	JOB #: G103303532	Quote #: Qu-00830398
Run Date, [ID#]	11/27/2017 12:05 PM [013345-01]	Total time 27 mins 30 sec	

Sample #2

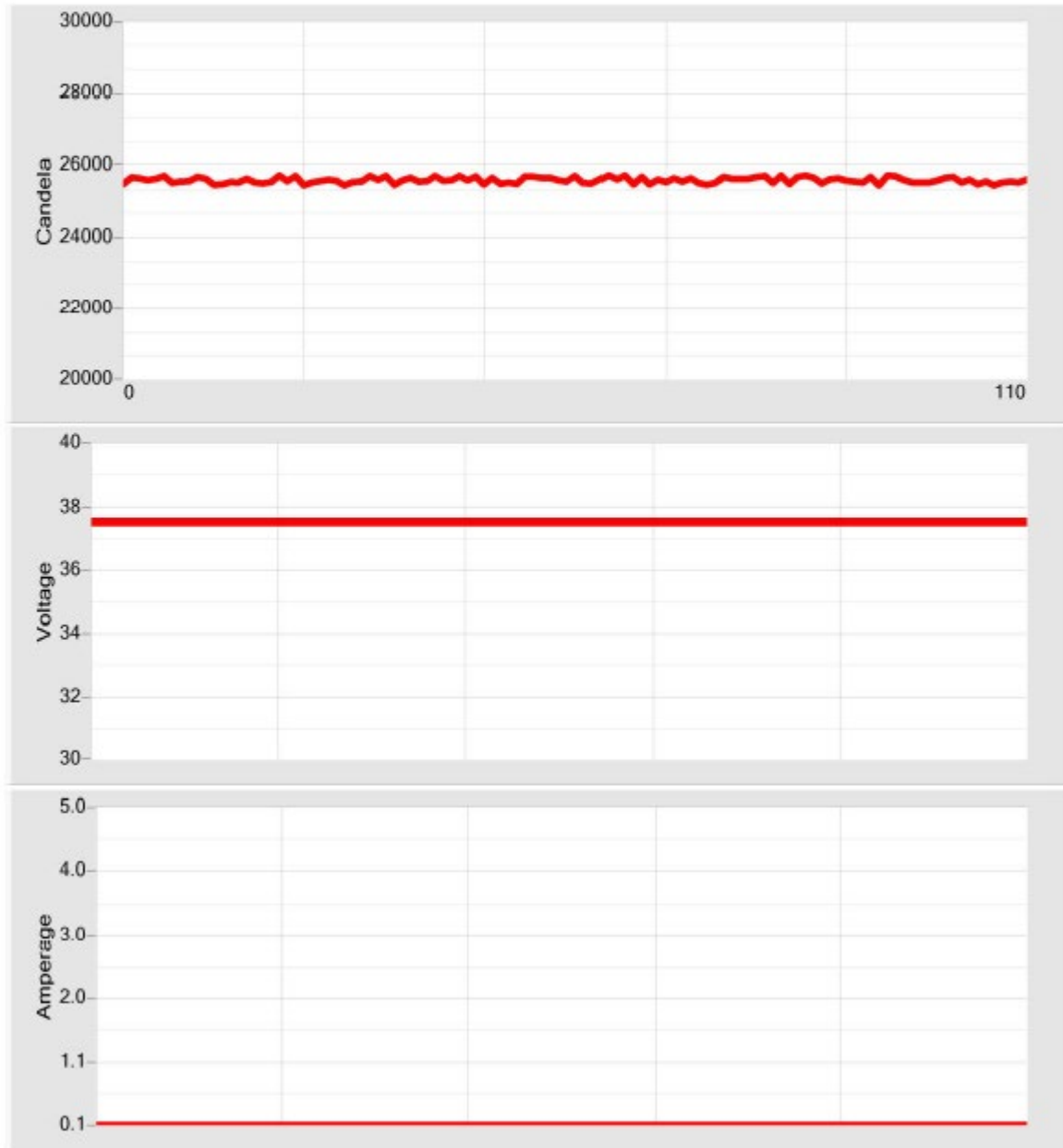

Intertek, Grand Rapids - Photometric Lab

Equipment: Hoffman Engineering AGS-1140UG-007

Bulb	17V - 10A; 58V - 10A	P/N: Sample #3	Room Temp: 22C <25% RH
Power	17.00v 10.000a; 58.00v 10.000a	JOB #: G103303532	Quote #: Qu-00830398
Run Date, [ID#]	12/14/2017 11:24 AM [013452-01]	Total time	29 mins 45 sec

Sample #3 - Dim Mode

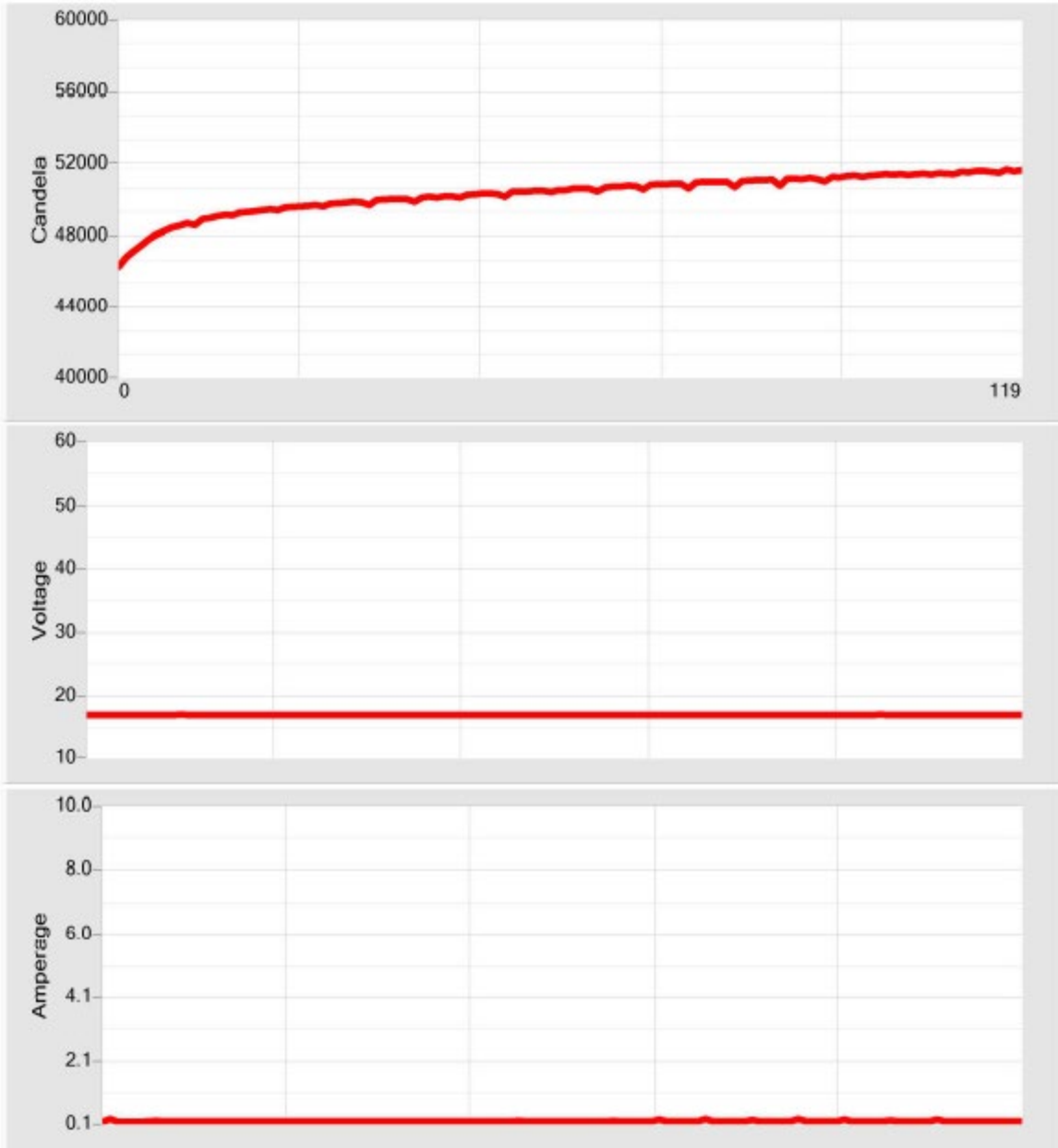

Intertek, Grand Rapids - Photometric Lab

Equipment: Hoffman Engineering AGS-1140UG-007

Bulb	37.5V 5A; 37.5V 5A	P/N: Sample 4 LED	Room Temp: 24C - 26%
Power	37.50v 5.000a; 37.50v 5.000a	JOB #: G103303532	Quote #: Qu-00830398
Run Date, [ID#]	11/28/2017 9:34 AM [013349-01]	Total time 2 mins 15 sec	

Sample #4

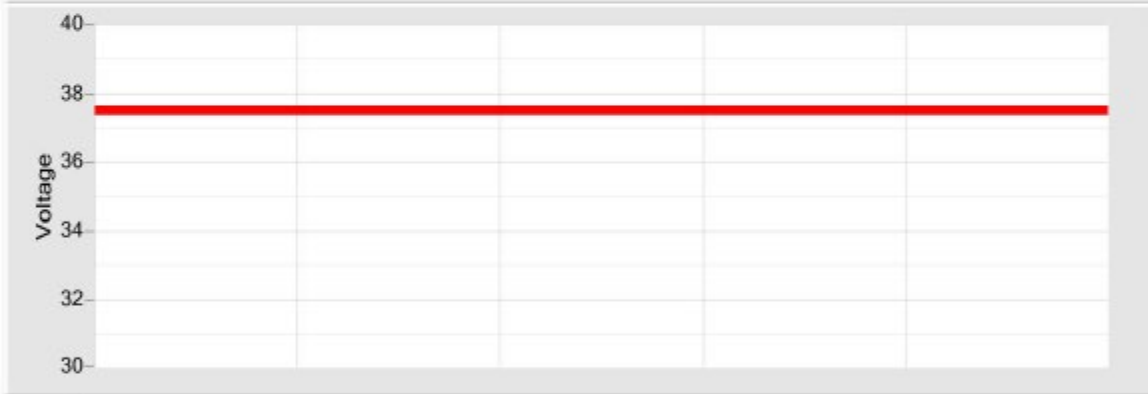

Intertek, Grand Rapids - Photometric Lab

Equipment: Hoffman Engineering AGS-1140UG-007

Bulb	15.0V / 5A; 15.0V / 5A	P/N: Sample 5 LED	Room Temp: 25C - 26%
Power	15.00v 5.000a; 15.00v 5.000a	JOB #: G103303532	Quote #: Qu-00830398
Run Date, [ID#]	11/28/2017 3:04 PM [013352-01]	Total time: 29 mins 45 sec	

Sample #5

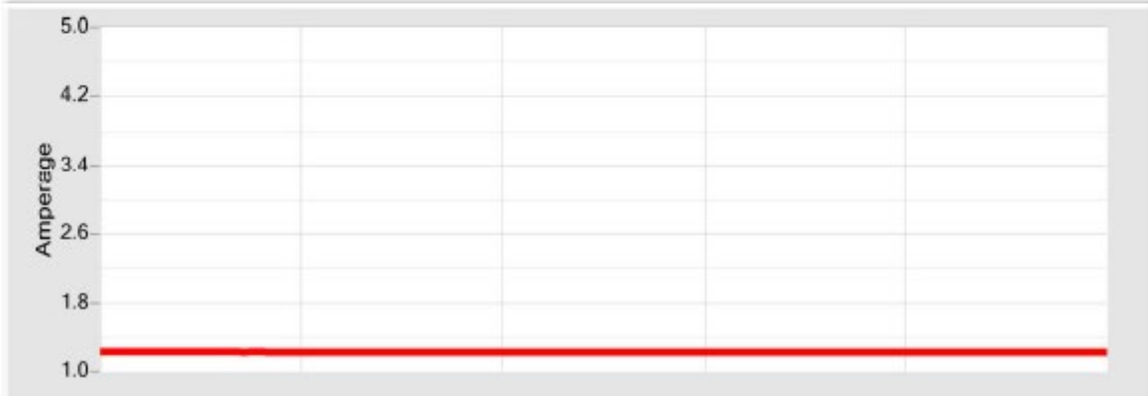
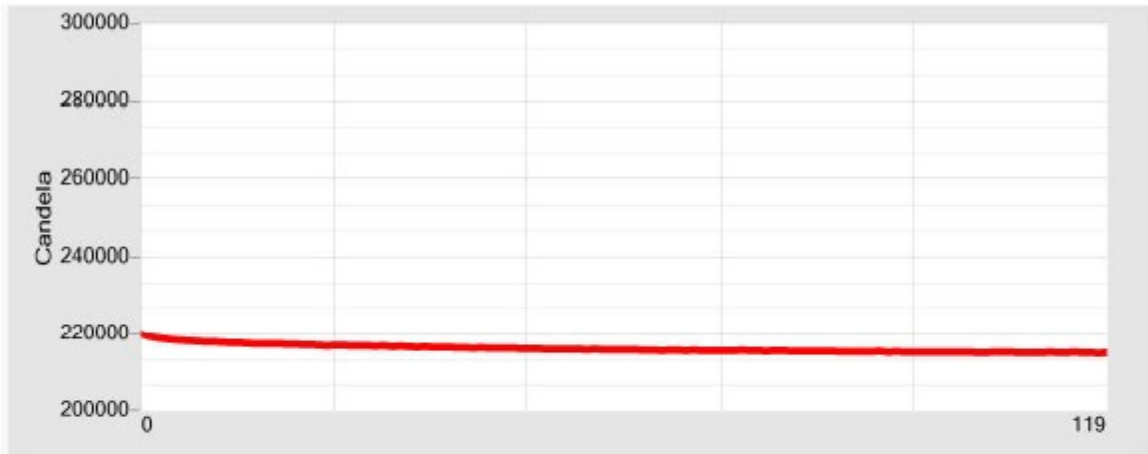

Intertek, Grand Rapids - Photometric Lab

Equipment: Hoffman Engineering AGS-1140UG-007

Bulb	17V - 10A; 58V - 10A	P/N: Sample #6	Room Temp: 22C <25% RH
Power	17.00v 10.000a; 58.00v 10.000a	JOB #: G103303532	Quote #: Qu-00830398
Run Date, [ID#]	12/15/2017 11:27 AM [013453 01]	Total time 29 mins 45 sec	

Sample #6 - Dim Mode

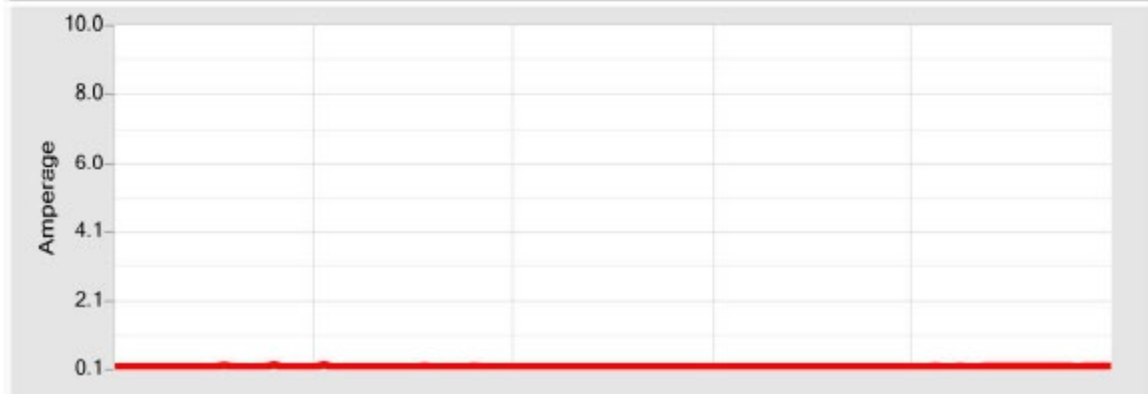
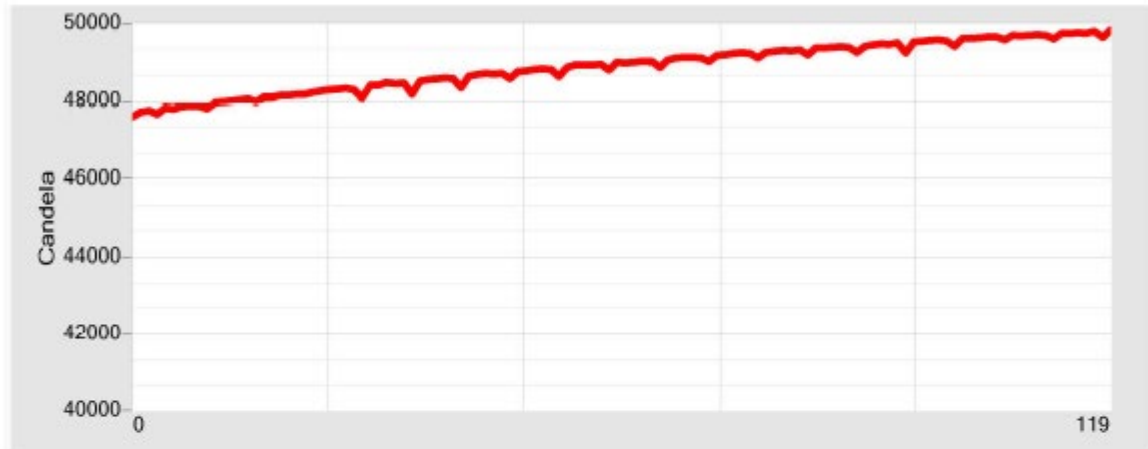

Intertek, Grand Rapids - Photometric Lab

Equipment: Hoffman Engineering AGS-1140UG-007

Bulb	17V - 10A; 58V - 10A	P/N: Sample #7	Room Temp: 23C <25% RH
Power	17.00v 10.000a; 58.00v 10.000a	JOB #: G103303532	Quote #: Qu-00830398
Run Date, [ID#]	12/15/2017 2:28 PM [013455-01]	Total time	29 mins 45 sec

Sample #7 - Dim Mode

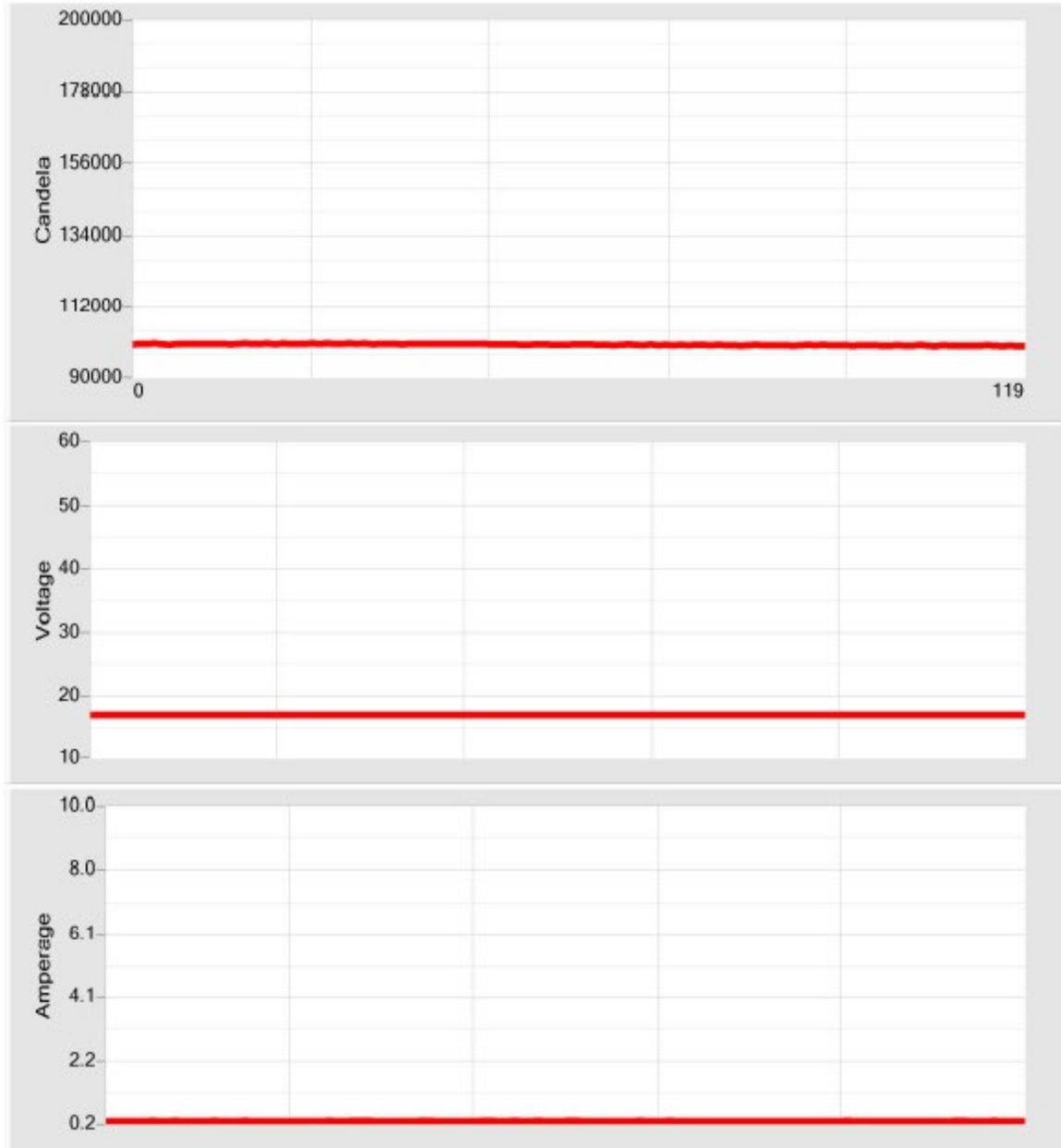

Intertek, Grand Rapids - Photometric Lab

Equipment: Hoffman Engineering AGS-1140UG-007

Bulb	37.5V 5A; 37.5V 5A	P/N: Sample 8	Room Temp: 24C - 26%
Power	37.50v 5.000a; 37.50v 5.000a	JOB #: G103303532	Quote #: Qu-00830398
Run Date, [ID#]	11/29/2017 3:14 PM [013369-01]	Total time 1 min 30 sec	

Sample 8

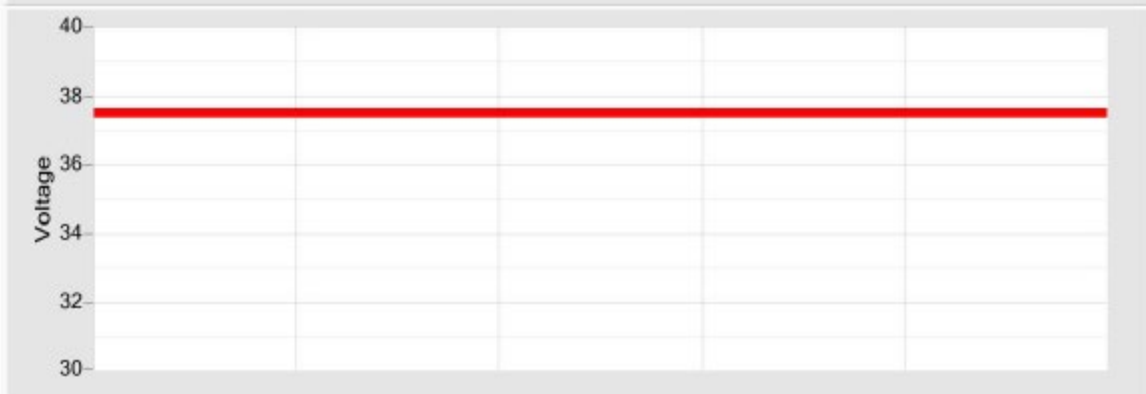
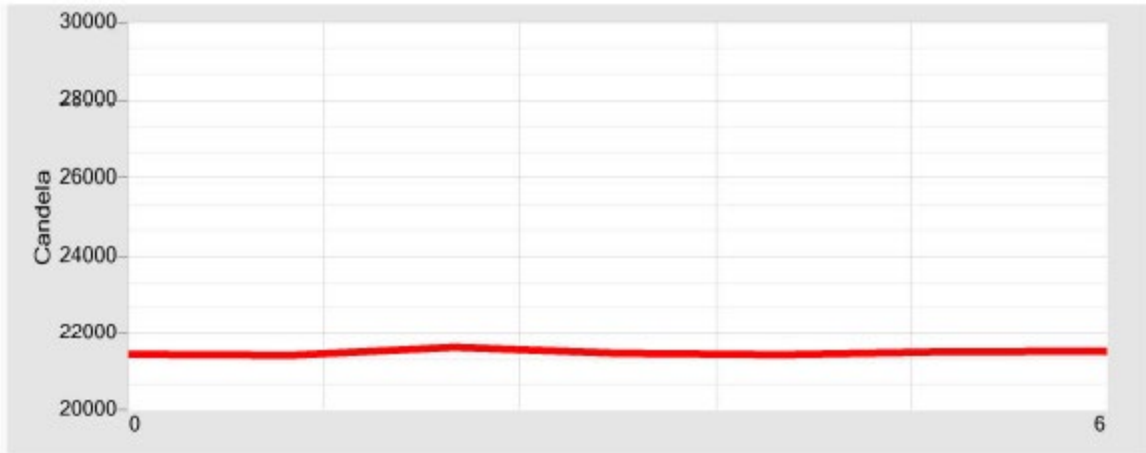

Intertek, Grand Rapids - Photometric Lab

Equipment: Hoffman Engineering AGS-1140UG-007

Bulb	15.0V / 5A; 15.0V / 5A	P/N: Sample 9 LED	Room Temp: 23C-26%
Power	15.00v 5.000a; 15.00v 5.000a	JOB #: G103303532	Quote #: Qu-00830398
Run Date, [ID#]	11/30/2017 9:40 AM [013373-01]	Total time 4 mins 45 sec	

Sample 9

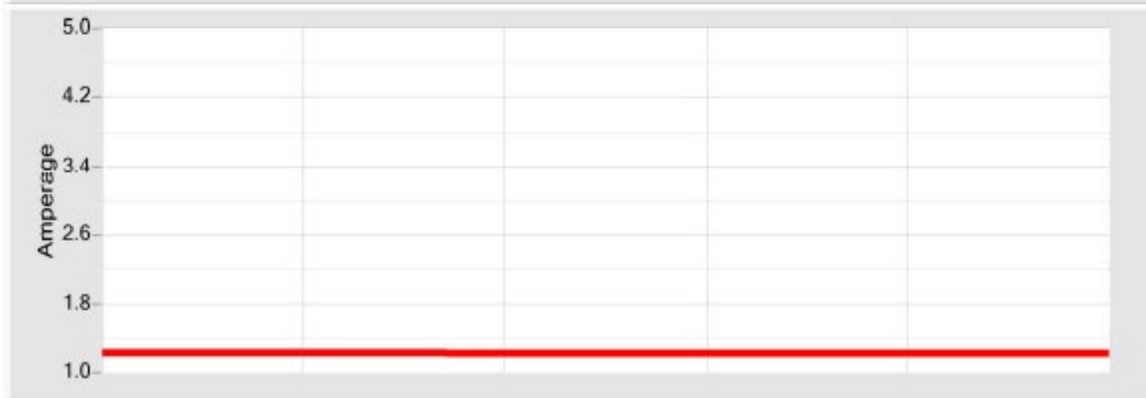
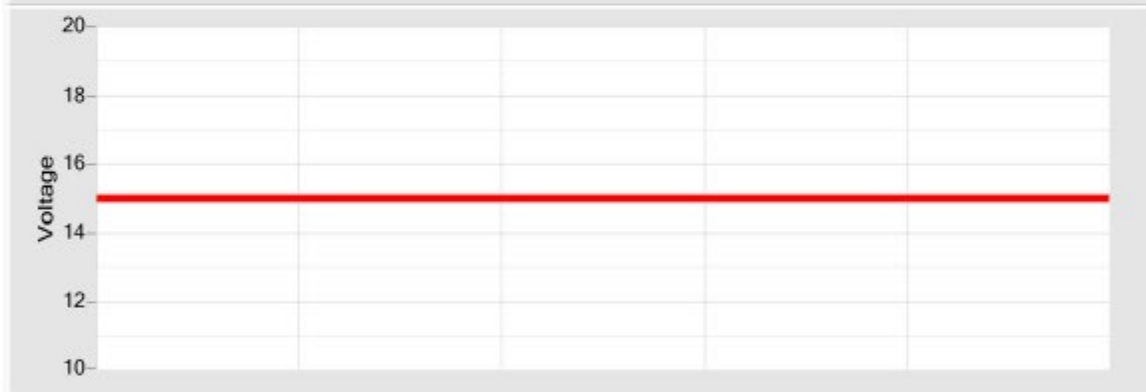

Intertek, Grand Rapids - Photometric Lab

Equipment: Hoffman Engineering AGS-1140UG-007

Bulb	15.0V / 5A; 15.0V / 5A	P/N: Sample 10 LED	Room Temp: 24C-26%
Power	15.00v 5.000a; 15.00v 5.000a	JOB #: G103303532	Quote #: Qu-00830398
Run Date, [ID#]	11/30/2017 11:06 AM [013374-01]	Total time 6 mins 30 sec	

Sample 10

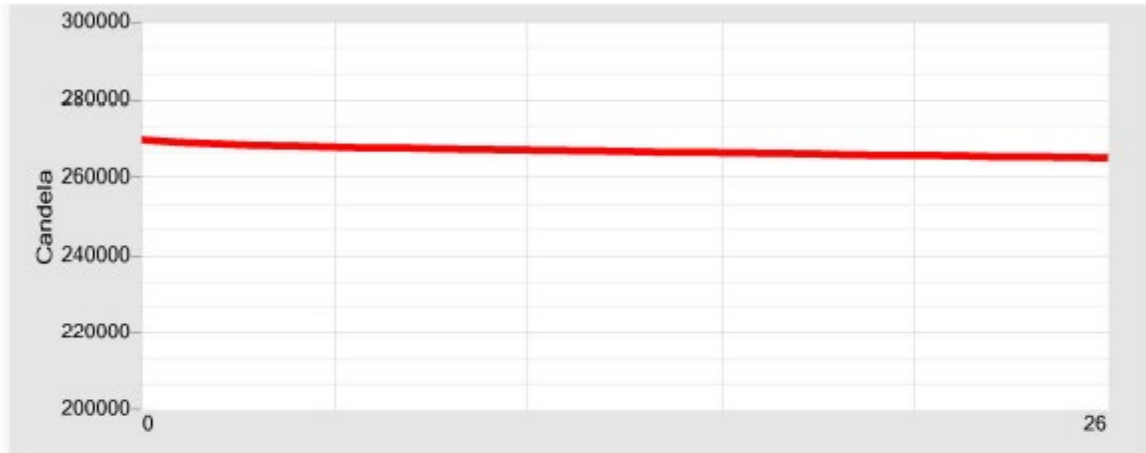

Intertek, Grand Rapids - Photometric Lab

Equipment: Hoffman Engineering AGS-1140UG-007

Bulb	17V - 10A; 58V - 10A	P/N: Sample #11	Room Temp: 23C <25% RH
Power	17.00v 10.000a; 58.00v 10.000a	JOB #: G103303532	Quote #: Qu-00830398
Run Date, [ID#]	12/15/2017 3:47 PM [013456-01]	Total time 3 mins 45 sec	

Sample #11 - Dim Mode

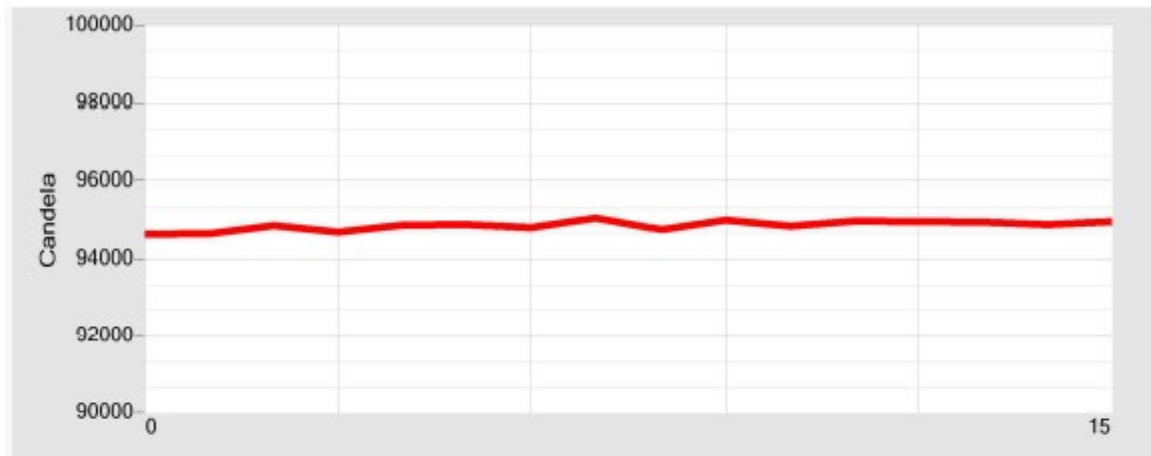

Intertek, Grand Rapids - Photometric Lab

Equipment: Hoffman Engineering AGS-1140UG-007

Bulb	17V - 10A; 58V - 10A	P/N: Sample #12	Room Temp: 23C <25% RH
Power	17.00v 10.000a; 58.00v 10.000a	JOB #: G103303532	Quote #: Qu-00830398
Run Date, [ID#]	12/15/2017 5:33 PM [013457-01]	Total time: 29 mins 45 sec	

Sample #12 - Dim Mode

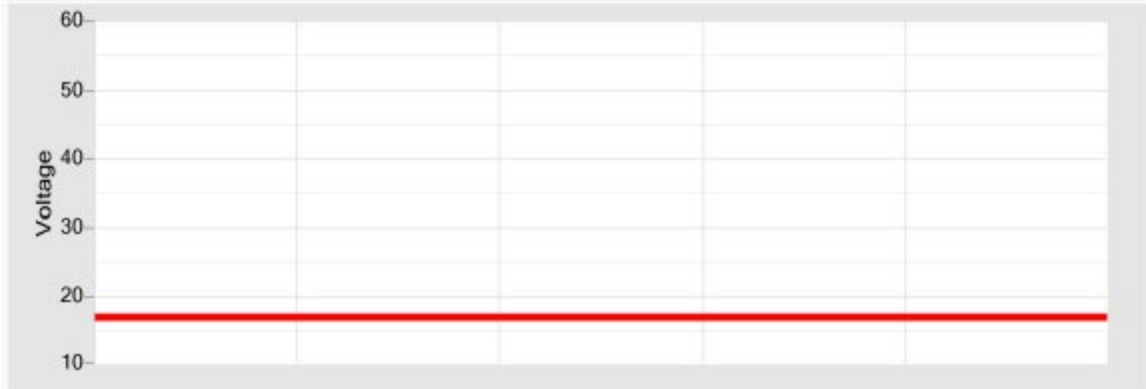
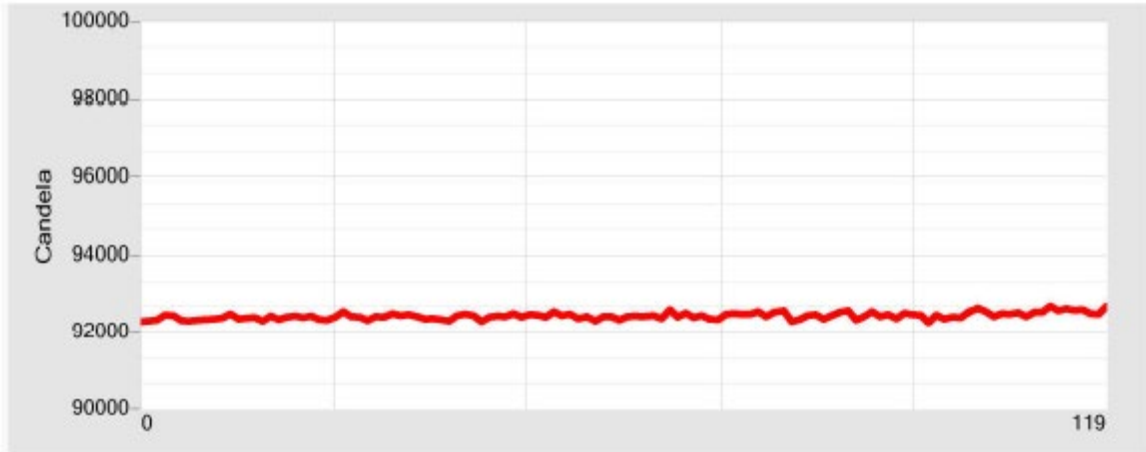

Intertek, Grand Rapids - Photometric Lab

Equipment: Hoffman Engineering AGS-1140UG-007

Bulb	15.0V / 5A; 15.0V / 5A	P/N: Sample 13 LED	Room Temp: 24C - 26%
Power	15.00v 5.000a; 15.00v 5.000a	JOB #: G103303532	Quote #: Qu-00830398
Run Date, [ID#]	11/30/2017 2:29 PM [013377-01]	Total time 19 mins	

Sample 13

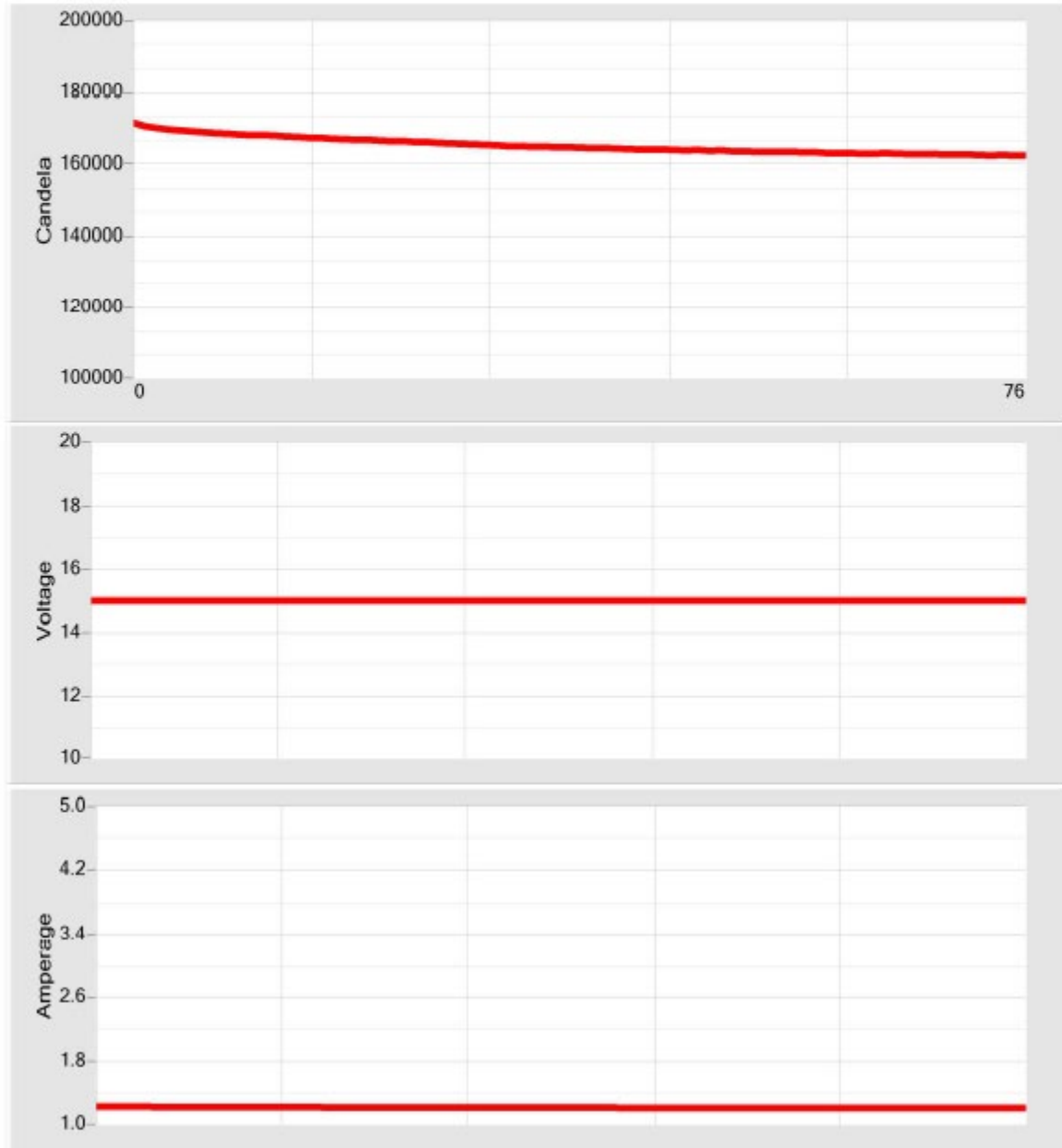

Intertek, Grand Rapids - Photometric Lab

Equipment: Hoffman Engineering AGS-1140UG-007

Bulb	17V - 10A; 58V - 10A
Power	17.00v 10.000a; 58.00v 10.000a
Run Date, [ID#]	12/15/2017 12:57 PM [013454-01]

P/N: Sample #14	Room Temp: 22C <25% RH
JOB #: G103303532	Quote #: Qu-00830398
Total time: 29 mins 45 sec	

Sample #14 - Dim Mode

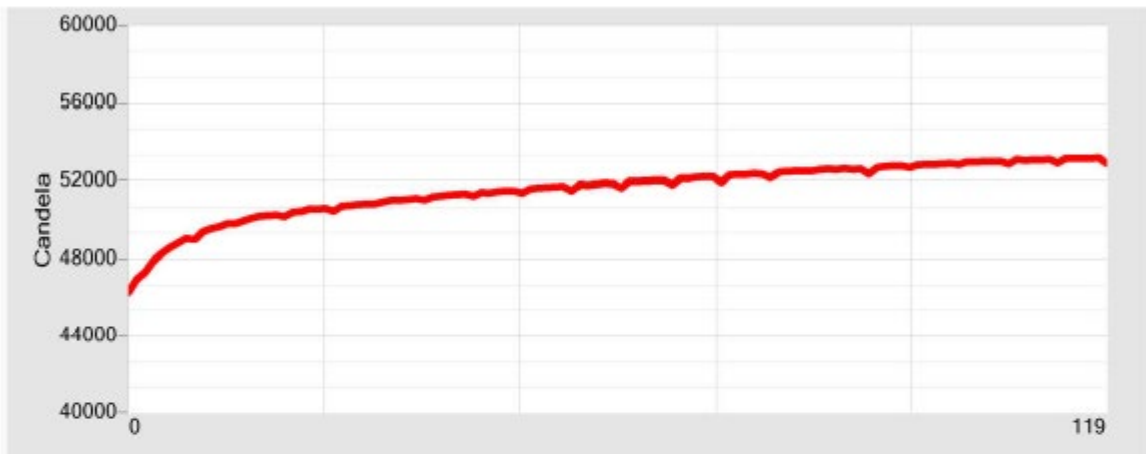

Intertek, Grand Rapids - Photometric Lab

Equipment: Hoffman Engineering AGS-1140UG-007

Bulb	15.0V / 5A; 15.0V / 5A	P/N: Sample 15 LED	Room Temp: 24C -25%
Power	15.00v 5.000a; 15.00v 5.000a	JOB #: G103303532	Quote #: Qu-00830398
Run Date, [ID#]	11/30/2017 5:38 PM [013379-01]	Total time 29 mins 45 sec	

Sample 15 LED

