

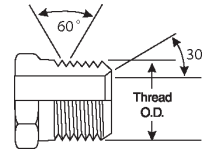



SAE to SAE

Male Pipe NPTF Plug

For use up to SAE 100R2 maximum working pressure.



Descr.	Prod. No.			Weight (Lbs.)
				
2MP-PLUG	7259-22815	1/8-27		.04
4MP-PLUG	7259-22825	1/4-18		.04
6MP-PLUG	7259-22835	3/8-18		.10
8MP-PLUG	7259-22845	1/2-14		.18
12MP-PLUG	7259-22855	3/4-14		.33
16MP-PLUG	7259-22865	1-11 1/2		.55
20MP-PLUG	7259-22875	1 1/4-11 1/2		.92
24MP-PLUG	7259-24395	1 1/2-11 1/2		1.59
32MP-PLUG	7259-32765	2-11 1/2		2.84

Male Pipe NPTF to Male Pipe NPTF

For use up to SAE 100R2 maximum working pressure.

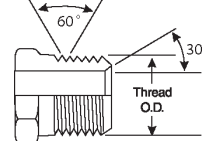

Descr.	Prod. No.			Weight (Lbs.)
				
2MP-2MP	7259-23695	1/8-27	1/8-27	.02
4MP-2MP	7259-23705	1/4-18	1/8-27	.05
4MP-4MP	7259-23715	1/4-18	1/4-18	.10
6MP-4MP	7259-23725	3/8-18	1/4-18	.10
6MP-6MP	7259-23735	3/8-18	3/8-18	.09
8MP-4MP	7259-23745	1/2-14	1/4-18	.14
8MP-6MP	7259-23755	1/2-14	3/8-18	.13
8MP-8MP	7259-23765	1/2-14	1/2-14	.15
12MP-4MP	7259-07405	3/4-14	1/4-18	.22
12MP-6MP	7259-06395	3/4-14	3/8-18	.22
12MP-8MP	7259-23775	3/4-14	1/2-14	.28
12MP-12MP	7259-23785	3/4-14	3/4-14	.28
16MP-6MP	7259-07325	1-11 1/2	3/8-18	.28
16MP-8MP	7259-06235	1-11 1/2	1/2-14	.50
16MP-12MP	7259-23795	1-11 1/2	3/4-14	.36
16MP-16MP	7259-23805	1-11 1/2	1-11 1/2	.50
20MP-12MP	7259-08015	1 1/4-11 1/2	3/4-14	.57
20MP-16MP	7259-05875	1 1/4-11 1/2	1-11 1/2	.61
20MP-20MP	7259-23815	1 1/4-11 1/2	1 1/4-11 1/2	.62
24MP-12MP	7259-08545	1 1/2-11 1/2	3/4-14	.73
24MP-16MP	7259-08025	1 1/2-11 1/2	1-11 1/2	.73
24MP-20MP	7259-08125	1 1/2-11 1/2	1 1/4-11 1/2	1.32
24MP-24MP	7259-23825	1 1/2-11 1/2	1 1/2-11 1/2	.99

- HOSE
- HOSE/CPLG. SELECTION
- G8K COUPLINGS
- GLOBAL SPIRAL COUPLINGS
- PCM / PCS FERRULES
- MEGACRIMP COUPLINGS
- STAINLESS STEEL
- POWER CRIMP COUPLINGS
- LOC. GL AND GLP COUPLINGS
- POLARSEAL COUPLINGS
- POLARSEAL II COUPLINGS
- C14 COUPLINGS
- PCTS THERMOPLASTIC COUPLINGS
- FIELD ATTACHABLE G1 & G2 COUPLINGS
- FIELD ATTACHABLE C5 & C5E COUPLINGS
- SURELOK AIR BRAKE COUPLINGS
- ADAPTERS
- QUICK DISCONNECT COUPLERS
- LIVE SWIVEL
- BALL VALVES
- ACCESSORIES
- EQUIPMENT AND PARTS



SAE to SAE

- HOSE
- HOSE/CPLG. SELECTION
- G8K COUPLINGS
- GLOBALSPIRAL COUPLINGS
- PCM / PCS FERRULES
- MEGACRIMP COUPLINGS
- STAINLESS STEEL
- POWER CRIMP COUPLINGS
- LOC. GL AND GLP COUPLINGS
- POLARSEAL COUPLINGS
- POLARSEAL II COUPLINGS
- C14 COUPLINGS
- PCTS THERMOPLASTIC COUPLINGS
- FIELD ATTACHABLE G1 & G2 COUPLINGS
- FIELD ATTACHABLE C5 & C5E COUPLINGS
- SURELOK AIR BRAKE COUPLINGS
- ADAPTERS
- QUICK DISCONNECT COUPLERS
- LIVE SWIVEL
- BALL VALVES
- ACCESSORIES
- EQUIPMENT AND PARTS

Male Pipe NPTF to Male Pipe NPTF - Continued

Descr.	Prod. No.			Weight (Lbs.)
		"	"	
32MP-24MP	7259-08555	2-11 1/2	1 1/2-11 1/2	1.59
32MP-32MP	7259-23835	2-11 1/2	2-11 1/2	1.26

Male Pipe NPTF to Male Pipe NPTF - 90°

For use up to SAE 100R2 maximum working pressure.

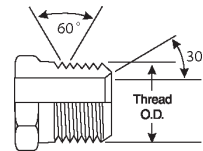

Descr.	Prod. No.			Weight (Lbs.)
		"	"	
2MP-2MP90	7259-25205	1/8-27	1/8-27	.06
4MP-4MP90	7259-25215	1/4-18	1/4-18	.10
6MP-4MP90	7259-70755	3/8-18	1/4-18	.17
6MP-6MP90	7259-25225	3/8-18	3/8-18	.18
8MP-4MP90	7259-08565	1/2-14	1/4-18	.26
8MP-6MP90	7259-70855	1/2-14	3/8-18	.26
8MP-8MP90	7259-25235	1/2-14	1/2-14	.28
12MP-8MP90	7259-05725	3/4-14	1/2-14	.43
12MP-12MP90	7259-25245	3/4-14	3/4-14	.46
16MP-12MP90	7259-09835	1-11 1/2	3/4-14	.73
16MP-16MP90	7259-25255	1-11 1/2	1-11 1/2	1.15
20MP-20MP90	7259-08575	1 1/4-11 1/2	1 1/4-11 1/2	1.26
24MP-24MP90	7259-07155	1 1/2-11 1/2	1 1/2-11 1/2	3.85

Male Pipe NPTF to Female Pipe NPTF Reducer Bushing - Short

For use up to SAE 100R2 maximum working pressure.

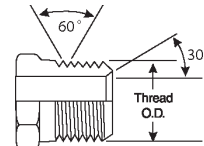
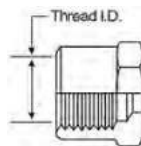

Descr.	Prod. No.			Weight (Lbs.)
		"	"	
4MP-2FPS	7259-22595	1/4-18	1/8-27	.04
6MP-2FPS	7259-22605	3/8-18	1/8-27	.07
6MP-4FPS	7259-22615	3/8-18	1/4-18	.07
8MP-2FPS	7259-05815	1/2-14	1/8-27	.12
8MP-4FPS	7259-22635	1/2-14	1/4-18	.10
8MP-6FPS	7259-22645	1/2-14	3/8-18	.10
12MP-2FPS	7259-07335	3/4-14	1/8-27	.20



SAE to SAE

Male Pipe NPTF to Female Pipe NPTF Reducer Bushing - Short - Continued

Descr.	Prod. No.			Weight (Lbs.)
		"	"	
12MP-4FPS	7259-22665	3/4-14	1/4-18	.70
12MP-6FPS	7259-22675	3/4-14	3/8-18	.21
12MP-8FPS	7259-22685	3/4-14	1/2-14	.16
16MP-2FPS	7259-08585	1-11 1/2	1/8-27	.36
16MP-4FPS	7259-05355	1-11 1/2	1/4-18	.39
16MP-6FPS	7259-06665	1-11 1/2	3/8-18	.33
16MP-8FPS	7259-22725	1-11 1/2	1/2-14	.31
16MP-12FPS	7259-22735	1-11 1/2	3/4-14	.32
20MP-4FPS	7259-07475	1 1/4-11 1/2	1/4-18	.64
20MP-8FPS	7259-05525	1 1/4-11 1/2	1/2-14	.57
20MP-12FPS	7259-22755	1 1/4-11 1/2	3/4-14	.57
20MP-16FPS	7259-22765	1 1/4-11 1/2	1-11 1/2	.45
24MP-12FPS	7259-22785	1 1/2-11 1/2	3/4-14	.77
24MP-16FPS	7259-22795	1 1/2-11 1/2	1-11 1/2	.69
24MP-20FPS	7259-22805	1 1/2-11 1/2	1 1/4-11 1/2	.45
32MP-20FPS	7259-05425	2-11 1/2	1 1/4-11 1/2	1.20
32MP-24FPS	7259-32825	2-11 1/2	1 1/2-11 1/2	1.00

Male Pipe NPTF to Female Pipe NPTF Increasing Bushing - Long

For use up to SAE 100R2 maximum working pressure.

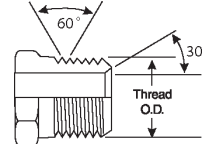
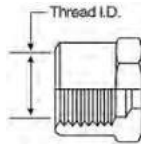
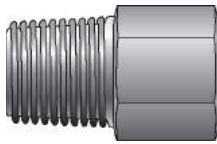

Descr.	Prod. No.			Weight (Lbs.)
		"	"	
2MP-4FPL	7259-25365	1/8-27	1/4-18	.08
2MP-6FPL	7259-08365	1/8-27	3/8-18	.12
4MP-2FPL	7259-08615	1/4-18	1/8-27	.07
4MP-4FPL	7259-00475	1/4-18	1/4-18	.09
4MP-6FPL	7259-25385	1/4-18	3/8-18	.13
4MP-8FPL	7259-05515	1/4-18	1/2-14	.26
6MP-4FPL	7259-05025	3/8-18	1/4-18	.11
6MP-6FPL	7259-00535	3/8-18	3/8-18	.12
6MP-8FPL	7259-25415	3/8-18	1/2-14	.26
8MP-8FPL	7259-05175	1/2-14	1/2-14	.28
8MP-12FPL	7259-25435	1/2-14	3/4-14	.36
8MP-16FPL	7259-07755	1/2-14	1-11 1/2	.57
12MP-8FPL	7259-00315	3/4-14	1/2-14	.30
12MP-12FPL	7259-06545	3/4-14	3/4-14	.40
12MP-16FPL	7259-25455	3/4-14	1-11 1/2	.66
16MP-12FPL	7259-05735	1-11 1/2	3/4-14	.52
16MP-16FPL	7259-08635	1-11 1/2	1-11 1/2	.76
16MP-20FPL	7259-25475	1-11 1/2	1 1/4-11 1/2	1.05
16MP-24FPL	7259-08645	1-11 1/2	1 1/2-11 1/2	1.25
20MP-20FPL	7259-07345	1 1/4-11 1/2	1 1/4-11 1/2	.95
20MP-24FPL	7259-25495	1 1/4-11 1/2	1 1/2-11 1/2	1.29
24MP-32FPL	7259-07765	1 1/2-11 1/2	2-11 1/2	1.82

- HOSE
- HOSE/CPLG. SELECTION
- G8K COUPLINGS
- GLOBAL SPIRAL COUPLINGS
- PCM / PCS FERRULES
- MEGACRIMP COUPLINGS
- STAINLESS STEEL
- POWER CRIMP COUPLINGS
- LOC, GL AND GLP COUPLINGS
- POLARSEAL COUPLINGS
- POLARSEAL II COUPLINGS
- C14 COUPLINGS
- PCTS THERMOPLASTIC COUPLINGS
- FIELD ATTACHABLE G1 & G2 COUPLINGS
- FIELD ATTACHABLE C5 & C5E COUPLINGS
- SURELOK AIR BRAKE COUPLINGS
- ADAPTERS
- QUICK DISCONNECT COUPLERS
- LIVE SWIVEL
- BALL VALVES
- ACCESSORIES
- EQUIPMENT AND PARTS



SAE to SAE

HOSE

HOSE/CPLG. SELECTION

G8K COUPLINGS

GLOBALSPIRAL COUPLINGS

PCM / PCS FERRULES

MEGACRIMP COUPLINGS

STAINLESS STEEL

POWER CRIMP COUPLINGS

LOC. GL AND GLP COUPLINGS

POLARSEAL COUPLINGS

POLARSEAL II COUPLINGS

C14 COUPLINGS

PCTS THERMOPLASTIC COUPLINGS

FIELD ATTACHABLE G1 & G2 COUPLINGS

FIELD ATTACHABLE G5 & C5E COUPLINGS

SURELOK AIR BRAKE COUPLINGS

ADAPTERS

QUICK DISCONNECT COUPLERS

LIVE SWIVEL

BALL VALVES

ACCESSORIES

EQUIPMENT AND PARTS

Female Pipe NPTF to Male Pipe NPTF - 45°

For use up to SAE 100R2 maximum working pressure.

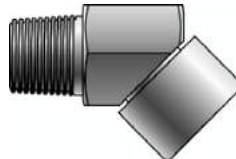

Descr.	Prod. No.			Weight (Lbs.)
		"	"	
6FP-6MP45	7259-50465	3/8-18	3/8-18	.30
8FP-8MP45	7259-50475	1/2-14	1/2-14	.30

Male Pipe NPTF to Female Pipe NPTF - 90°

For use up to SAE 100R2 maximum working pressure.

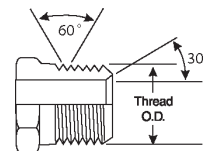
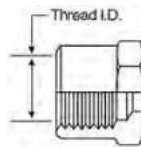
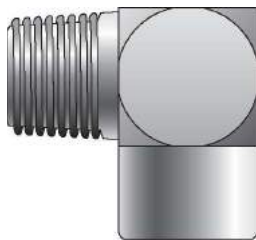

Descr.	Prod. No.			Weight (Lbs.)
		"	"	
2MP-2FP90	7259-24105	1/8-27	1/8-27	.07
2MP-4FP90	7259-32835	1/8-27	1/4-18	.17
4MP-2FP90	7259-32845	1/4-18	1/8-27	.16
4MP-4FP90	7259-24115	1/4-18	1/4-18	.15
4MP-6FP90	7259-32855	1/4-18	3/8-18	.22
6MP-4FP90	7259-32865	3/8-18	1/4-18	.25
6MP-6FP90	7259-24125	3/8-18	3/8-18	.25
6MP-8FP90	7259-32875	3/8-18	1/2-14	.35
8MP-4FP90	7259-08655	1/2-14	1/4-18	.26
8MP-6FP90	7259-32885	1/2-14	3/8-18	.31
8MP-8FP90	7259-24135	1/2-14	1/2-14	.45
8MP-12FP90	7259-32895	1/2-14	3/4-14	.57
12MP-8FP90	7259-32905	3/4-14	1/2-14	.40
12MP-12FP90	7259-24145	3/4-14	3/4-14	.70
12MP-16FP90	7259-08375	3/4-14	1-11 1/2	1.03
16MP-12FP90	7259-08155	1-11 1/2	3/4-14	1.11
16MP-16FP90	7259-24155	1-11 1/2	1-11 1/2	1.13
20MP-16FP90	7259-08665	1 1/4-11 1/2	1-11 1/2	1.12
20MP-20FP90	7259-24165	1 1/4-11 1/2	1 1/4-11 1/2	1.68
24MP-24FP90	7259-24175	1 1/2-11 1/2	1 1/2-11 1/2	3.66
32MP-32FP90	7259-24185	2-11 1/2	2-11 1/2	4.45



SAE to SAE

Male Pipe NPTF to Female Pipe Swivel NPSM

For use up to SAE 100R2 maximum working pressure.

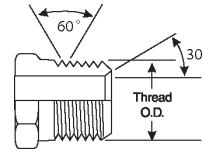
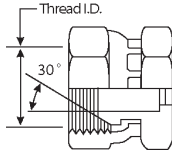
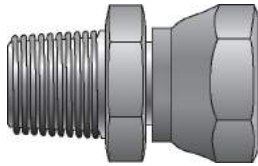

Descr.	Prod. No.			Weight (Lbs.)
		"	"	
2MP-2FPX	7259-00735	1/8-27	1/8-27	.07
2MP-4FPX	7259-10635	1/8-27	1/4-18	.08
4MP-2FPX	7259-05095	1/4-18	1/8-27	.08
4MP-4FPX	7259-00775	1/4-18	1/4-18	.09
4MP-6FPX	7259-10455	1/4-18	3/8-18	.12
4MP-8FPX	7259-07355	1/4-18	1/2-14	.14
6MP-4FPX	7259-10625	3/8-18	1/4-18	.12
6MP-6FPX	7259-00815	3/8-18	3/8-18	.16
6MP-8FPX	7259-10375	3/8-18	1/2-14	.19
8MP-6FPX	7259-10365	1/2-14	3/8-18	.22
8MP-8FPX	7259-00895	1/2-14	1/2-14	.24
8MP-12FPX	7259-10865	1/2-14	3/4-14	.33
12MP-6FPX	7259-06345	3/4-14	3/8-18	.26
12MP-8FPX	7259-10645	3/4-14	1/2-14	.30
12MP-12FPX	7259-00255	3/4-14	3/4-14	.35
12MP-16FPX	7259-32935	3/4-14	1-11 1/2	.49
12MP-20FPX	7259-08675	3/4-14	1 1/4-11 1/2	.77
16MP-12FPX	7259-10935	1-11 1/2	3/4-14	.49
16MP-16FPX	7259-00275	1-11 1/2	1-11 1/2	.50
16MP-20FPX	7259-11285	1-11 1/2	1 1/4-11 1/2	.93
20MP-16FPX	7259-05595	1 1/4-11 1/2	1-11 1/2	.88
20MP-20FPX	7259-10745	1 1/4-11 1/2	1 1/4-11 1/2	1.08
20MP-24FPX	7259-06375	1 1/4-11 1/2	1 1/2-11 1/2	1.08
24MP-20FPX	7259-06305	1 1/2-11 1/2	1 1/4-11 1/2	1.14
24MP-24FPX	7259-11345	1 1/2-11 1/2	1 1/2-11 1/2	1.17
32MP-32FPX	7259-11435	2-11 1/2	2-11 1/2	1.70

Male Pipe NPTF to Female Pipe Swivel NPSM - 45°

For use up to SAE 100R2 maximum working pressure.

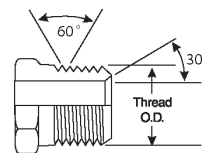
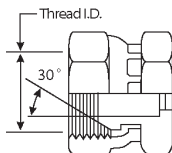
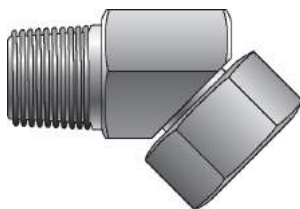

Descr.	Prod. No.			Weight (Lbs.)
		"	"	
2MP-2FPX45	7259-32945	1/8-27	1/8-27	.07
2MP-4FPX45	7259-00505	1/8-27	1/4-18	.09
4MP-2FPX45	7259-05985	1/4-18	1/8-27	.08

- HOSE
- HOSE/CPLG. SELECTION
- G8K COUPLINGS
- GLOBAL SPIRAL COUPLINGS
- PCM / PCS FERRULES
- MEGACRIMP COUPLINGS
- STAINLESS STEEL
- POWER CRIMP COUPLINGS
- LOC. GL AND GLP COUPLINGS
- POLARSEAL COUPLINGS
- POLARSEAL II COUPLINGS
- C14 COUPLINGS
- PCTS THERMOPLASTIC COUPLINGS
- FIELD ATTACHABLE G1 & G2 COUPLINGS
- FIELD ATTACHABLE C5 & C5E COUPLINGS
- SURELOK AIR BRAKE COUPLINGS
- ADAPTERS
- QUICK DISCONNECT COUPLERS
- LIVE SWIVEL
- BALL VALVES
- ACCESSORIES
- EQUIPMENT AND PARTS



SAE to SAE

Male Pipe NPTF to Female Pipe Swivel NPSM - 45° - Continued

Descr.	Prod. No.			Weight (Lbs.)
		"	"	
4MP-4FPX45	7259-02115	1/4-18	1/4-18	.09
4MP-6FPX45	7259-05265	1/4-18	3/8-18	.19
6MP-4FPX45	7259-05555	3/8-18	1/4-18	.14
6MP-6FPX45	7259-02155	3/8-18	3/8-18	.18
6MP-8FPX45	7259-32955	3/8-18	1/2-14	.23
8MP-4FPX45	7259-06465	1/2-14	1/4-18	.21
8MP-6FPX45	7259-32965	1/2-14	3/8-18	.23
8MP-8FPX45	7259-02125	1/2-14	1/2-14	.25
8MP-12FPX45	7259-06115	1/2-14	3/4-14	.39
12MP-8FPX45	7259-11535	3/4-14	1/2-14	.32
12MP-12FPX45	7259-02235	3/4-14	3/4-14	.37
12MP-16FPX45	7259-06125	3/4-14	1-11 1/2	.68
16MP-12FPX45	7259-11625	1-11 1/2	3/4-14	.66
16MP-16FPX45	7259-10765	1-11 1/2	1-11 1/2	.60
16MP-20FPX45	7259-07855	1-11 1/2	1 1/4-11 1/2	1.01
20MP-16FPX45	7259-06685	1 1/4-11 1/2	1-11 1/2	.99
20MP-20FPX45	7259-11355	1 1/4-11 1/2	1 1/4-11 1/2	.99
24MP-24FPX45	7259-11745	1 1/2-11 1/2	1 1/2-11 1/2	1.40
32MP-32FPX45	7259-32975	2-11 1/2	2-11 1/2	2.37

Male Pipe NPTF to Female Pipe Swivel NPSM - 90°

For use up to SAE 100R2 maximum working pressure.

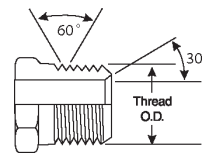
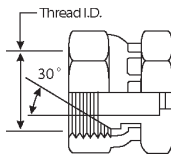
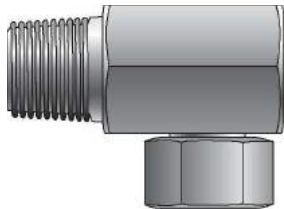

Descr.	Prod. No.			Weight (Lbs.)
		"	"	
2MP-2FPX90	7259-08305	1/8-27	1/8-27	.06
2MP-4FPX90	7259-00415	1/8-27	1/4-18	.14
4MP-2FPX90	7259-05565	1/4-18	1/8-27	.11
4MP-4FPX90	7259-02135	1/4-18	1/4-18	.14
4MP-6FPX90	7259-10705	1/4-18	3/8-18	.22
4MP-8FPX90	7259-08685	1/4-18	1/2-14	.33
6MP-4FPX90	7259-10525	3/8-18	1/4-18	.20
6MP-6FPX90	7259-02165	3/8-18	3/8-18	.21
6MP-8FPX90	7259-10325	3/8-18	1/2-14	.02
8MP-4FPX90	7259-11175	1/2-14	1/4-18	.28
8MP-6FPX90	7259-10265	1/2-14	3/8-18	.29
8MP-8FPX90	7259-02205	1/2-14	1/2-14	.33
8MP-12FPX90	7259-11075	1/2-14	3/4-14	.49
12MP-6FPX90	7259-06045	3/4-14	3/8-18	.49
12MP-8FPX90	7259-02245	3/4-14	1/2-14	.50
12MP-12FPX90	7259-02265	3/4-14	3/4-14	.55
12MP-16FPX90	7259-05195	3/4-14	1-11 1/2	.77
12MP-20FPX90	7259-08705	3/4-14	3/4-14	1.98
16MP-8FPX90	7259-06775	1-11 1/2	1/2-14	.77



SAE to SAE

Male Pipe NPTF to Female Pipe Swivel NPSM - 90° - Continued

Descr.	Prod. No.			Weight (Lbs.)
		"	"	
16MP-12FPX90	7259-11275	1-11 1/2	3/4-14	.77
16MP-16FPX90	7259-10335	1-11 1/2	1-11 1/2	.82
16MP-20FPX90	7259-11475	1-11 1/2	1 1/4-11 1/2	1.57
20MP-12FPX90	7259-08165	1 1/4-11 1/2	3/4-14	1.30
20MP-16FPX90	7259-05435	1 1/4-11 1/2	1-11 1/2	1.29
20MP-20FPX90	7259-11055	1 1/4-11 1/2	1 1/4-11 1/2	1.68
20MP-24FPX90	7259-07865	1 1/4-11 1/2	1 1/2-11 1/2	1.98
24MP-20FPX90	7259-06355	1 1/2-11 1/2	1 1/4-11 1/2	1.65
24MP-24FPX90	7259-11655	1 1/2-11 1/2	1 1/2-11 1/2	1.74
32MP-32FPX90	7259-32995	2-11 1/2	2-11 1/2	3.80

Female Pipe NPTF to Female Pipe NPTF

For use up to SAE 100R2 maximum working pressure.

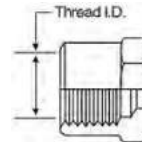
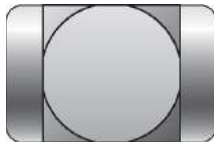

Descr.	Prod. No.			Weight (Lbs.)
		"	"	
2FP-2FP	7259-24415	1/8-27	1/8-27	.04
4FP-2FP	7259-05035	1/4-18	1/8-27	.08
4FP-4FP	7259-24425	1/4-18	1/4-18	.08
6FP-2FP	7259-08385	3/8-18	1/8-27	.10
6FP-4FP	7259-00495	3/8-18	1/4-18	.09
6FP-6FP	7259-24435	3/8-18	3/8-18	.10
8FP-4FP	7259-05575	1/2-14	1/4-18	.28
8FP-6FP	7259-00715	1/2-14	3/8-18	.20
8FP-8FP	7259-24445	1/2-14	1/2-14	.25
12FP-8FP	7259-00525	3/4-14	1/2-14	.31
12FP-12FP	7259-24455	3/4-14	3/4-14	.33
16FP-8FP	7259-08715	1-11 1/2	1/2-14	.07
16FP-12FP	7259-05745	1-11 1/2	3/4-14	.46
16FP-16FP	7259-24465	1-11 1/2	1-11 1/2	.49
20FP-16FP	7259-08395	1 1/4-11 1/2	1-11 1/2	.89
20FP-20FP	7259-24475	1 1/4-11 1/2	1 1/4-11 1/2	1.32
24FP-24FP	7259-24885	1 1/2-11 1/2	1 1/2-11 1/2	1.32
32FP-32FP	7259-24895	2-11 1/2	2-11 1/2	1.41

HOSE

HOSE/CPLG. SELECTION

G8K COUPLINGS

GLOBAL SPIRAL COUPLINGS

PCM / PCS FERRULES

MEGACRIMP COUPLINGS

STAINLESS STEEL

POWER CRIMP COUPLINGS

LOC, GL AND GLP COUPLINGS

POLARSEAL COUPLINGS

POLARSEAL II COUPLINGS

C14 COUPLINGS

PCTS THERMOPLASTIC COUPLINGS

FIELD ATTACHABLE G1 & G2 COUPLINGS

FIELD ATTACHABLE C5 & C5E COUPLINGS

SURELOK AIR BRAKE COUPLINGS

ADAPTERS

QUICK DISCONNECT COUPLERS

LIVE SWIVEL

BALL VALVES

ACCESSORIES

EQUIPMENT AND PARTS

R7



SAE to SAE

Female Pipe NPTF to Female Pipe NPTF - 90°

For use up to SAE 100R2 maximum working pressure.

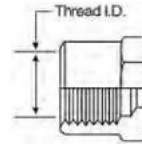
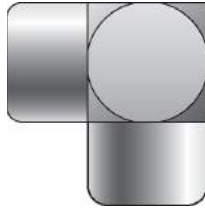

Descr.	Prod. No.			Weight (Lbs.)
		"	"	
2FP-2FP90	7259-25015	1/8-27	1/8-27	.07
4FP-2FP90	7259-33005	1/4-18	1/8-27	.15
4FP-4FP90	7259-25025	1/4-18	1/4-18	.15
6FP-4FP90	7259-33015	3/8-18	1/4-18	.23
6FP-6FP90	7259-25035	3/8-18	3/8-18	.21
8FP-4FP90	7259-08725	1/2-14	1/4-18	.42
8FP-6FP90	7259-33025	1/2-14	3/8-18	.40
8FP-8FP90	7259-25045	1/2-14	1/2-14	.40
12FP-8FP90	7259-33035	3/4-14	1/2-14	.68
12FP-12FP90	7259-25055	3/4-14	3/4-14	.57
16FP-12FP90	7259-08175	1-11 1/2	3/4-14	1.14
16FP-16FP90	7259-25065	1-11 1/2	1-11 1/2	1.13
20FP-20FP90	7259-25075	1 1/4-11 1/2	1 1/4-11 1/2	1.15
24FP-24FP90	7259-33055	1 1/2-11 1/2	1 1/2-11 1/2	3.80
32FP-32FP90	7259-07485	2-11 1/2	2-11 1/2	1.68

Female Pipe NPTF to Female Pipe Swivel NPSM

For use up to SAE 100R2 maximum working pressure.

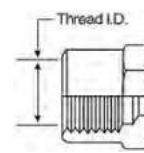
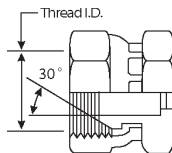
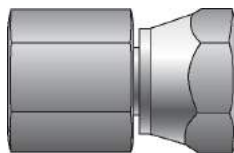

Descr.	Prod. No.			Weight (Lbs.)
		"	"	
2FP-2FPX	7259-33065	1/8-27	1/8-27	.06
2FP-4FPX	7259-00435	1/8-27	1/4-18	.07
4FP-2FPX	7259-07515	1/4-18	1/8-27	.08
4FP-4FPX	7259-00795	1/4-18	1/4-18	.10
4FP-6FPX	7259-05205	1/4-18	3/8-18	.12
6FP-4FPX	7259-33085	3/8-18	1/4-18	.13
6FP-6FPX	7259-00835	3/8-18	3/8-18	.16
6FP-8FPX	7259-05105	3/8-18	1/2-14	.29
8FP-4FPX	7259-08735	1/2-14	1/4-18	.19
8FP-6FPX	7259-33095	1/2-14	3/8-18	.20
8FP-8FPX	7259-00915	1/2-14	1/2-14	.24
8FP-12FPX	7259-06695	1/2-14	3/4-14	.33
12FP-8FPX	7259-07165	3/4-14	1/2-14	.29
12FP-12FPX	7259-00925	3/4-14	3/4-14	.36
12FP-16FPX	7259-07775	3/4-14	1-11 1/2	.60



SAE to SAE

Female Pipe NPTF to Female Pipe Swivel NPSM - Continued

Descr.	Prod. No.			Weight (Lbs.)
		"	"	
16FP-12FPX	7259-11595	1-11 1/2	3/4-14	.49
16FP-16FPX	7259-00905	1-11 1/2	1-11 1/2	.56
20FP-20FPX	7259-11015	1 1/4-11 1/2	1 1/4-11 1/2	.77
24FP-24FPX	7259-11545	1 1/2-11 1/2	1 1/2-11 1/2	1.01
32FP-32FPX	7259-11725	2-11 1/2	2-11 1/2	1.42

Female Pipe NPTF to Female Pipe Swivel NPSM - 45°

For use up to SAE 100R2 maximum working pressure.

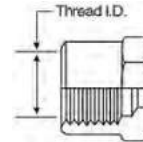
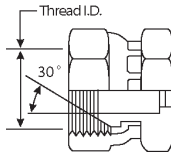
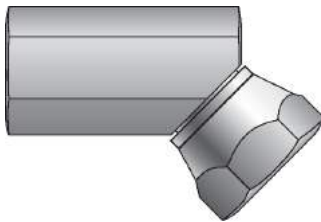

Descr.	Prod. No.			Weight (Lbs.)
		"	"	
2FP-2FPX45	7259-06145	1/8-27	1/8-27	.07
2FP-4FPX45	7259-08745	1/8-27	1/4-18	.08
4FP-4FPX45	7259-11575	1/4-18	1/4-18	.14
6FP-4FPX45	7259-06785	3/8-18	1/4-18	.20
6FP-6FPX45	7259-11455	3/8-18	3/8-18	.22
6FP-8FPX45	7259-08185	3/8-18	1/2-14	.26
8FP-6FPX45	7259-06415	1/2-14	3/8-18	.37
8FP-8FPX45	7259-11305	1/2-14	1/2-14	.37
12FP-12FPX45	7259-11325	3/4-14	3/4-14	.54
16FP-12FPX45	7259-06565	1-11 1/2	3/4-14	.92
16FP-16FPX45	7259-11515	1-11 1/2	1-11 1/2	.92
20FP-20FPX45	7259-33105	1 1/4-11 1/2	1 1/4-11 1/2	1.20

Female Pipe NPTF to Female Pipe Swivel NPSM - 90°

For use up to SAE 100R2 maximum working pressure.

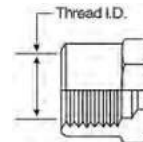
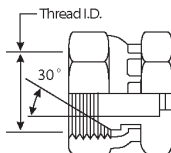
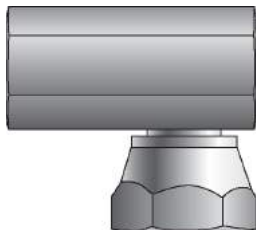

Descr.	Prod. No.			Weight (Lbs.)
		"	"	
2FP-2FPX90	7259-05475	1/8-27	1/8-27	.08

- HOSE
- HOSE/CPLG. SELECTION
- G8K COUPLINGS
- GLOBAL SPIRAL COUPLINGS
- PCM / PCS FERRULES
- MEGACRIMP COUPLINGS
- STAINLESS STEEL
- POWER CRIMP COUPLINGS
- LOC. GL AND GLP COUPLINGS
- POLARSEAL COUPLINGS
- POLARSEAL II COUPLINGS
- C14 COUPLINGS
- PCTS THERMOPLASTIC COUPLINGS
- FIELD ATTACHABLE G1 & G2 COUPLINGS
- FIELD ATTACHABLE C5 & C5E COUPLINGS
- SURELOK AIR BRAKE COUPLINGS
- ADAPTERS
- QUICK DISCONNECT COUPLERS
- LIVE SWIVEL
- BALL VALVES
- ACCESSORIES
- EQUIPMENT AND PARTS



SAE to SAE

Female Pipe NPTF to Female Pipe Swivel NPSM - 90° - Continued

Descr.	Prod. No.			Weight (Lbs.)
		"	"	
2FP-4FPX90	7259-08755	1/8-27	1/4-18	.11
4FP-2FPX90	7259-06285	1/4-18	1/8-27	.14
4FP-4FPX90	7259-11005	1/4-18	1/4-18	.17
4FP-6FPX90	7259-06245	1/4-18	3/8-18	.20
6FP-4FPX90	7259-06825	3/8-18	1/4-18	.24
6FP-6FPX90	7259-10955	3/8-18	3/8-18	.26
6FP-8FPX90	7259-06965	3/8-18	1/2-14	.28
8FP-6FPX90	7259-06855	1/2-14	3/8-18	.40
8FP-8FPX90	7259-10615	1/2-14	1/2-14	.43
8FP-12FPX90	7259-06485	1/2-14	3/4-14	.55
12FP-8FPX90	7259-06585	3/4-14	1/2-14	.68
12FP-12FPX90	7259-11095	3/4-14	3/4-14	.93
16FP-12FPX90	7259-06595	1-11 1/2	3/4-14	1.11
16FP-16FPX90	7259-11765	1-11 1/2	1-11 1/2	1.19
20FP-16FPX90	7259-08405	1 1/4-11 1/2	1-11 1/2	1.37
20FP-20FPX90	7259-33115	1 1/4-11 1/2	1 1/4-11 1/2	1.54
24FP-24FPX90	7259-33125	1 1/2-11 1/2	1 1/2-11 1/2	3.70
32FP-32FPX90	7259-33135	2-11 1/2	2-11 1/2	4.56

Female Pipe NPTF - Tee

For use up to SAE 100R2 maximum working pressure.

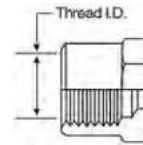
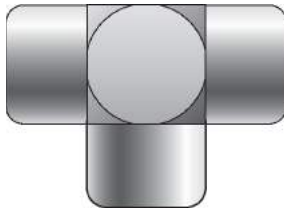

Descr.	Prod. No.			Weight (Lbs.)
		"	"	
2FP-2FP-2FP	7259-23145	1/8-27		.08
4FP-4FP-4FP	7259-23155	1/4-18		.21
6FP-6FP-6FP	7259-23165	3/8-18		.26
8FP-8FP-8FP	7259-23175	1/2-14		.45
12FP-12FP-12FP	7259-23185	3/4-14		.67
16FP-16FP-16FP	7259-23195	1-11 1/2		1.32
20FP-20FP-20FP	7259-33145	1 1/4-11 1/2		1.40
24FP-24FP-24FP	7259-33155	1 1/2-11 1/2		4.20
32FP-32FP-32FP	7259-07245	2-11 1/2		4.30



SAE to SAE

Female Pipe NPTF on Run to Male Pipe NPTF - Tee

For use up to SAE 100R2 maximum working pressure.

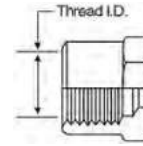
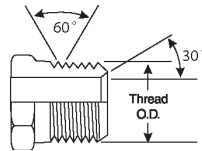

Descr.	Prod. No.		Weight (Lbs.)
		"	
2FP-2FP-2MP	7259-24905	1/8-27	.08
4FP-4FP-4MP	7259-24915	1/4-18	.18
6FP-6FP-6MP	7259-24925	3/8-18	.21
8FP-8FP-8MP	7259-24935	1/2-14	.44
12FP-12FP-12MP	7259-24945	3/4-14	.88
16FP-16FP-16MP	7259-24955	1-11 1/2	1.22
20FP-20FP-20MP	7259-07875	1 1/4-11 1/2	1.45
24FP-24FP-24MP	7259-08765	1 1/2-11 1/2	4.19

Female Pipe Swivel NPSM - Tee

For use up to SAE 100R2 maximum working pressure.

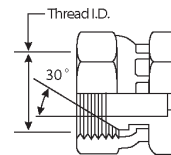
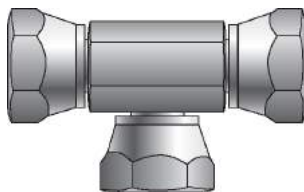

Descr.	Prod. No.		Weight (Lbs.)
		"	
2FPX-2FPX-2FPX	7253-33165	1/8-27	.12
4FPX-4FPX-4FPX	7253-33175	1/4-18	.20
6FPX-6FPX-6FPX	7253-33185	3/8-18	.35
8FPX-8FPX-8FPX	7259-33195	1/2-14	.44
12FPX-12FPX-12FPX	7259-33205	3/4-14	.76
16FPX-16FPX-16FPX	7253-33215	1-11 1/2	1.32
20FPX-20FPX-20FPX	7253-33225	1 1/4-11 1/2	2.32

HOSE

HOSE/CPLG. SELECTION

G8K COUPLINGS

GLOBALSPIRAL COUPLINGS

PCM / PCS FERRULES

MEGACRIMP COUPLINGS

STAINLESS STEEL

POWER CRIMP COUPLINGS

LOC. GL AND GLP COUPLINGS

POLARSEAL COUPLINGS

POLARSEAL II COUPLINGS

C14 COUPLINGS

PCTS THERMOPLASTIC COUPLINGS

FIELD ATTACHABLE G1 & G2 COUPLINGS

FIELD ATTACHABLE C5 & C5E COUPLINGS

SURELOK AIR BRAKE COUPLINGS

ADAPTERS

QUICK DISCONNECT COUPLERS

LIVE SWIVEL

BALL VALVES

ACCESSORIES

EQUIPMENT AND PARTS

R11



SAE to SAE

Female Pipe Swivel NPSM on Run to Male Pipe NPTF - Tee

For use up to SAE 100R2 maximum working pressure.

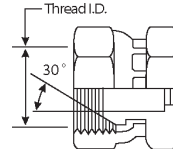
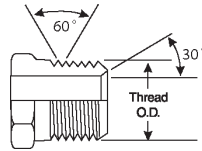
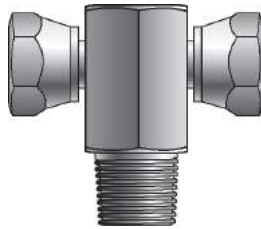

Descr.	Prod. No.		Weight (Lbs.)
		"	
2FPX-2FPX-2MP	7253-86585	1/8-27	.10
4FPX-4FPX-4MP	7253-86586	1/4-18	.21
6FPX-6FPX-6MP	7253-86587	3/8-18	.39
8FPX-8FPX-8MP	7253-86588	1/2-14	.53
12FPX-12FPX-12MP	7253-86589	3/4-14	.87
16FPX-16FPX-16MP	7253-86591	1-11 1/2	1.47
20FPX-20FPX-20MP	7253-33235	1 1/4-11 1/2	2.50

Male O-Ring Boss Plug

For use up to SAE 100R2 maximum working pressure.

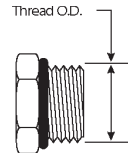

Descr.	Prod. No.		Weight (Lbs.)
		"	
2MB-PLUG	7259-05415	5/16-24	.02
3MB-PLUG	7259-05255	3/8-24	.13
4MB-PLUG	7259-22975	7/16-20	.04
5MB-PLUG	7259-22985	1/2-20	.05
6MB-PLUG	7259-22995	9/16-18	.06
8MB-PLUG	7259-23005	3/4-16	.10
10MB-PLUG	7259-23015	7/8-14	.15
12MB-PLUG	7259-23025	1 1/16-12	.26
14MB-PLUG	7259-23035	1 3/16-12	.32
16MB-PLUG	7259-23045	1 5/16-12	.37
20MB-PLUG	7259-23055	1 5/8-12	.64
24MB-PLUG	7259-05185	1 7/8-12	.86
32MB-PLUG	7259-07615	2 1/2-12	1.66



SAE to SAE

Male O-Ring Boss to Male Pipe NPTF

For use up to SAE 100R2 maximum working pressure.



Descr.	Prod. No.			Weight (Lbs.)
		"	"	
8MB-8MP	7259-50725	3/4-16	1/2-14	.15
10MB-8MP	7259-50735	7/8-14	1/2-14	.30

Male O-Ring Boss to Female Pipe NPTF

For use up to SAE 100R2 maximum working pressure.

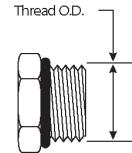
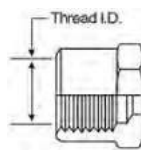
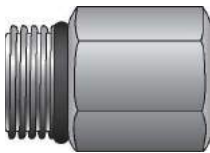

Descr.	Prod. No.			Weight (Lbs.)
		"	"	
3MB-2FP	7259-08785	3/8-24	1/8-27	.04
4MB-2FP	7259-24205	7/16-20	1/8-27	.05
4MB-4FP	7259-00395	7/16-20	1/4-18	.09
4MB-6FP	7259-05145	7/16-20	3/8-18	.11
5MB-2FP	7259-05945	1/2-20	1/8-27	.05
5MB-4FP	7259-05755	1/2-20	1/4-18	.09
6MB-2FP	7259-08805	9/16-18	1/8-27	.02
6MB-4FP	7259-24215	9/16-18	1/4-18	.10
6MB-6FP	7259-00205	9/16-18	3/8-18	.14
6MB-8FP	7259-06605	9/16-18	1/2-14	.23
8MB-4FP	7259-00245	3/4-16	1/4-18	.13
8MB-6FP	7259-24225	3/4-16	3/8-18	.12
8MB-8FP	7259-33255	3/4-16	1/2-14	.23
8MB-12FP	7259-06715	3/4-16	3/4-14	.34
10MB-4FP	7259-07255	7/8-14	1/4-18	.11
10MB-6FP	7259-00335	7/8-14	3/8-18	.23
10MB-8FP	7259-24235	7/8-14	1/2-14	.24
10MB-12FP	7259-05315	7/8-14	3/4-14	.37
12MB-8FP	7259-24245	1 1/16-12	1/2-14	.30
12MB-12FP	7259-24255	1 1/16-12	3/4-14	.35
12MB-16FP	7259-06155	1 1/16-12	1-11 1/2	.54
14MB-12FP	7259-24265	1 3/16-12	3/4-14	.36
16MB-8FP	7259-05495	1 5/16-12	7/8-14	.47
16MB-12FP	7259-33265	1 5/16-12	3/4-14	.43
16MB-16FP	7259-24275	1 5/16-12	1-11 1/2	.51
20MB-16FP	7259-05445	1 5/8-12	1-11 1/2	.70

- HOSE
- HOSE/CPLG. SELECTION
- G8K COUPLINGS
- GLOBAL SPIRAL COUPLINGS
- PCM / PCS FERRULES
- MEGACRIMP COUPLINGS
- STAINLESS STEEL
- POWER CRIMP COUPLINGS
- LOC, GL AND GLP COUPLINGS
- POLARSEAL COUPLINGS
- POLARSEAL II COUPLINGS
- C14 COUPLINGS
- PCTS THERMOPLASTIC COUPLINGS
- FIELD ATTACHABLE G1 & G2 COUPLINGS
- FIELD ATTACHABLE C5 & C5E COUPLINGS
- SURELOK AIR BRAKE COUPLINGS
- ADAPTERS
- QUICK DISCONNECT COUPLERS
- LIVE SWIVEL
- BALL VALVES
- ACCESSORIES
- EQUIPMENT AND PARTS



SAE to SAE

Male O-Ring Boss to Female Pipe Swivel NPSM

For use up to SAE 100R2 maximum working pressure.

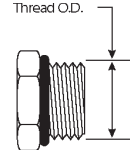
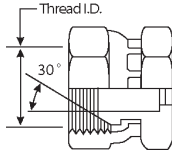
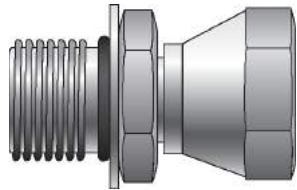

Descr.	Prod. No.			Weight (Lbs.)
4MB-2FPX	7259-06725	7/16-20	1/8-27	.15
4MB-4FPX	7259-10475	7/16-20	1/4-18	.07
4MB-6FPX	7259-05395	7/16-20	3/8-18	.11
5MB-4FPX	7259-11065	1/2-20	1/4-18	.08
5MB-8FPX	7259-11735	1/2-20	1/2-14	.17
6MB-4FPX	7259-10585	9/16-18	1/4-18	.09
6MB-6FPX	7259-10445	9/16-18	3/8-18	.11
6MB-8FPX	7259-07495	9/16-18	1/2-24	.15
8MB-4FPX	7259-11115	3/4-16	1/4-18	.13
8MB-6FPX	7259-10535	3/4-16	3/8-18	.16
8MB-8FPX	7259-00295	3/4-16	1/2-14	.18
8MB-12FPX	7259-11105	3/4-16	3/4-14	.25
10MB-6FPX	7259-11155	7/8-14	3/8-18	.20
10MB-8FPX	7259-10215	7/8-14	1/2-14	.22
10MB-12FPX	7259-10665	7/8-14	3/4-14	.30
12MB-8FPX	7259-10725	1 1/16-12	1/2-14	.32
12MB-12FPX	7259-10315	1 1/16-12	3/4-14	.34
12MB-16FPX	7259-05535	1 1/16-12	1-11 1/2	.50
14MB-12FPX	7259-33275	1 3/16-12	3/4-14	.44
16MB-12FPX	7259-05115	1 5/16-12	3/4-14	.49
16MB-16FPX	7259-33285	1 5/16-12	1-11 1/2	.53
16MB-20FPX	7259-08035	1 5/16-12	1 1/4-11 1/2	.80
20MB-12FPX	7259-08815	1 5/8-12	3/4-14	.74
20MB-16FPX	7259-06925	1 5/8-12	1-11 1/2	.79
20MB-20FPX	7259-05605	1 5/8-12	1 1/4-11 1/2	.96
24MB-20FPX	7259-08825	1 7/8-12	1 1/4-11 1/2	1.17
24MB-24FPX	7259-07625	1 7/8-12	1 1/2-11 1/2	1.80
32MB-32FPX	7259-07885	2 1/2-12	2-11 1/2	2.21

- HOSE
- HOSE/CPLG. SELECTION
- G8K COUPLINGS
- GLOBALSPIRAL COUPLINGS
- PCM / PCS FERRULES
- MEGACRIMP COUPLINGS
- STAINLESS STEEL
- POWER CRIMP COUPLINGS
- LOC. GL AND GLP COUPLINGS
- POLARSEAL COUPLINGS
- POLARSEAL II COUPLINGS
- C14 COUPLINGS
- PCTS THERMOPLASTIC COUPLINGS
- FIELD ATTACHABLE G1 & G2 COUPLINGS
- FIELD ATTACHABLE C5 & C5E COUPLINGS
- SURELOK AIR BRAKE COUPLINGS
- ADAPTERS
- QUICK DISCONNECT COUPLERS
- LIVE SWIVEL
- BALL VALVES
- ACCESSORIES
- EQUIPMENT AND PARTS



SAE to SAE

Male O-Ring Boss to Female Pipe Swivel NPSM - 45°

For use up to SAE 100R2 maximum working pressure.

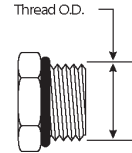
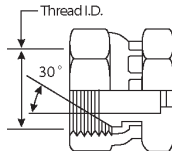
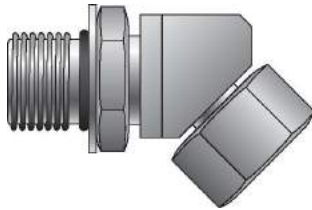

Descr.	Prod. No.			Weight (Lbs.)
		"	"	
4MB-2FPX45	7259-08835	7/16-20	1/8-27	.08
4MB-4FPX45	7259-05015	7/16-20	1/4-18	.25
4MB-6FPX45	7259-07795	7/16-20	3/8-18	.19
6MB-4FPX45	7259-05825	9/16-18	1/4-18	.25
6MB-6FPX45	7259-10915	9/16-18	3/8-18	.17
6MB-8FPX45	7259-06365	9/16-18	1/2-14	.25
8MB-4FPX45	7259-08845	3/4-16	1/4-18	.22
8MB-6FPX45	7259-11495	3/4-16	3/8-18	.24
8MB-8FPX45	7259-10875	3/4-16	1/2-14	.28
8MB-12FPX45	7259-33295	3/4-16	3/4-14	.47
10MB-6FPX45	7259-11645	7/8-14	3/8-18	.33
10MB-8FPX45	7259-10815	7/8-14	1/2-14	.35
10MB-12FPX45	7259-06575	7/8-14	3/4-14	.50
12MB-8FPX45	7259-08205	1 1/16-12	1/2-14	.50
12MB-12FPX45	7259-11315	1 1/16-12	3/4-14	.57
12MB-16FPX45	7259-07265	1 1/16-12	1-11 1/2	.79
16MB-12FPX45	7259-07425	1 5/16-12	3/4-14	.76
16MB-16FPX45	7259-33325	1 5/16-12	1-11 1/2	.79
20MB-20FPX45	7259-06615	1 5/8-12	1 1/4-11 1/2	1.59
24MB-24FPX45	7259-08415	1 7/8-12	1 1/2-11 1/2	.40

Male O-Ring Boss to Female Pipe Swivel NPSM - 90°

For use up to SAE 100R2 maximum working pressure.

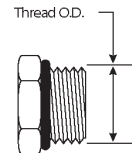
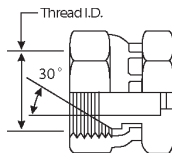
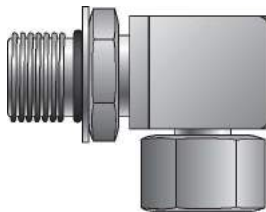

Descr.	Prod. No.			Weight (Lbs.)
		"	"	
4MB-2FPX90	7259-08215	7/16-20	1/8-27	.12
4MB-4FPX90	7259-10835	7/16-20	1/4-18	.12
4MB-6FPX90	7259-06625	7/16-20	3/8-18	.22
6MB-4FPX90	7259-10405	9/16-18	1/4-18	.13
6MB-6FPX90	7259-10285	9/16-18	3/8-18	.23
6MB-8FPX90	7259-05045	9/16-18	1/2-14	.33
8MB-4FPX90	7259-06175	3/4-16	1/4-18	.26

- HOSE
- HOSE/CPLG. SELECTION
- G8K COUPLINGS
- GLOBALSPIRAL COUPLINGS
- PCM / PCS FERRULES
- MEGACRIMP COUPLINGS
- STAINLESS STEEL
- POWER CRIMP COUPLINGS
- LOC, GL AND GLP COUPLINGS
- POLARSEAL COUPLINGS
- POLARSEAL II COUPLINGS
- C14 COUPLINGS
- PCTS THERMOPLASTIC COUPLINGS
- FIELD ATTACHABLE G1 & G2 COUPLINGS
- FIELD ATTACHABLE C5 & C5E COUPLINGS
- SURELOK AIR BRAKE COUPLINGS
- ADAPTERS
- QUICK DISCONNECT COUPLERS
- LIVE SWIVEL
- BALL VALVES
- ACCESSORIES
- EQUIPMENT AND PARTS



SAE to SAE

Male O-Ring Boss to Female Pipe Swivel NPSM - 90° - Continued

Descr.	Prod. No.			Weight (Lbs.)
		"	"	
8MB-6FPX90	7259-10295	3/4-16	3/8-18	.28
8MB-8FPX90	7259-10155	3/4-16	1/2-14	.34
8MB-12FPX90	7259-11335	3/4-16	3/4-14	.57
10MB-6FPX90	7259-11215	7/8-14	3/8-18	.36
10MB-8FPX90	7259-10345	7/8-14	1/2-14	.37
10MB-12FPX90	7259-11295	7/8-14	3/4-14	.60
12MB-6FPX90	7259-07895	1 1/16-12	3/8-18	.61
12MB-8FPX90	7259-00515	1 1/16-12	1/2-14	.65
12MB-12FPX90	7259-10575	1 1/16-12	3/4-14	.67
12MB-16FPX90	7259-06935	1 1/16-12	1-11 1/2	.99
14MB-12FPX90	7259-07175	1 3/16-12	3/4-14	.88
16MB-12FPX90	7259-05805	1 5/16-12	3/4-14	.94
16MB-16FPX90	7259-11125	1 5/16-12	1-11 1/2	1.07
16MB-20FPX90	7259-06875	1 5/16-12	1 1/4-11 1/2	1.79
20MB-12FPX90	7259-06945	1 5/8-12	3/4-14	1.59
20MB-16FPX90	7259-06635	1 5/8-12	1-11 1/2	1.98
20MB-20FPX90	7259-05905	1 5/8-12	1 1/4-11 1/2	1.98
24MB-24FPX90	7259-08855	1 7/8-12	1 1/2-11 1/2	2.19
32MB-32FPX90	7259-08045	2 1/2-12	2-11 1/2	4.54

Female O-Ring Boss to Male Pipe NPTF

For use up to SAE 100R2 maximum working pressure.

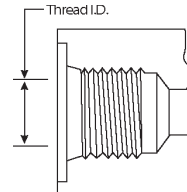
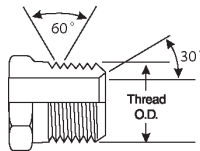
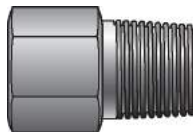

Descr.	Prod. No.			Weight (Lbs.)
		"	"	
4FB-2MP	7259-33335	7/16-20	1/8-27	.07
4FB-4MP	7259-06515	7/16-20	1/4-18	.08
5FB-2MP	7259-33355	1/2-20	1/8-27	.10
6FB-4MP	7259-33345	9/16-18	1/4-18	.12
6FB-6MP	7259-00385	9/16-18	3/8-18	.13
6FB-8MP	7259-00485	9/16-18	1/2-14	.17
8FB-6MP	7259-33365	3/4-16	3/8-18	.17
8FB-8MP	7259-08875	3/4-16	1/2-14	.20
10FB-8MP	7259-33375	7/8-14	1/2-14	.31
12FB-8MP	7259-06955	1 1/16-12	1/2-14	.36
12FB-12MP	7259-33385	1 1/16-12	3/4-14	.37
16FB-12MP	7259-08885	1 5/16-12	3/4-14	.43
16FB-16MP	7259-33395	1 5/16-12	1-11 1/2	.54



SAE to SAE

Male O-Ring Boss to Male JIC 37° Flare

For use up to SAE 100R2 maximum working pressure.

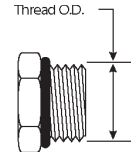
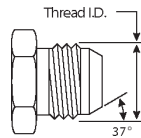
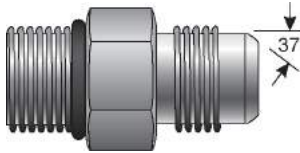

Descr.	Prod. No.			Weight (Lbs.)
		"	"	
2MB-2MJ	7259-07275	5/16-24	5/16-24	.03
2MB-4MJ	7259-08895	5/16-24	7/16-20	.05
3MB-4MJ	7259-06255	3/8-24	7/16-20	.03
4MB-3MJ	7259-08905	7/16-20	3/8-24	.04
4MB-4MJ	7259-10025	7/16-20	7/16-20	.05
4MB-5MJ	7259-05005	7/16-20	1/2-20	.06
4MB-6MJ	7259-33405	7/16-20	9/16-18	.06
4MB-8MJ	7259-08915	7/16-20	3/4-16	.11
5MB-3MJ	7253-86885	1/2-20	3/8-24	.06
5MB-4MJ	7259-10775	1/2-20	7/16-20	.06
5MB-5MJ	7259-10855	1/2-20	1/2-20	.06
5MB-6MJ	7259-33415	1/2-20	9/16-18	.07
6MB-4MJ	7259-10045	9/16-18	7/16-20	.08
6MB-5MJ	7259-00455	9/16-18	1/2-20	.08
6MB-6MJ	7259-04685	9/16-18	9/16-18	.08
6MB-8MJ	7259-10145	9/16-18	3/4-16	.11
6MB-10MJ	7259-33425	9/16-18	7/8-14	.16
6MB-12MJ	7259-07635	9/16-18	1 1/16-12	.28
8MB-4MJ	7259-00025	3/4-16	7/16-20	.11
8MB-5MJ	7259-06885	3/4-16	1/2-20	.11
8MB-6MJ	7259-04775	3/4-16	9/16-18	.16
8MB-8MJ	7259-10015	3/4-16	3/4-16	.14
8MB-10MJ	7259-10425	3/4-16	7/8-14	.18
8MB-12MJ	7259-10305	3/4-16	1 1/16-12	.31
8MB-16MJ	7259-07285	3/4-16	1 5/16-12	.43
10MB-4MJ	7259-00105	7/8-14	7/16-20	.17
10MB-6MJ	7259-10095	7/8-14	9/16-18	.19
10MB-8MJ	7259-10075	7/8-14	3/4-16	.18
10MB-10MJ	7259-10065	7/8-14	7/8-14	.25
10MB-12MJ	7259-00235	7/8-14	1 1/16-12	.29
10MB-16MJ	7259-00355	7/8-14	1 5/16-12	.44
12MB-4MJ	7259-07905	1 1/16-12	7/16-20	.26
12MB-6MJ	7259-00305	1 1/16-12	9/16-18	.33
12MB-8MJ	7259-10035	1 1/16-12	3/4-16	.33
12MB-10MJ	7259-10755	1 1/16-12	7/8-14	.35
12MB-12MJ	7259-10115	1 1/16-12	1 1/16-12	.34
12MB-14MJ	7259-08225	1 1/16-12	1 3/16-12	.35
12MB-16MJ	7259-10885	1 1/16-12	1 5/16-12	.42
12MB-20MJ	7259-06005	1 1/16-12	1 5/8-12	1.13
14MB-10MJ	7259-08425	1 3/16-12	7/8-14	.35
14MB-12MJ	7259-06185	1 3/16-12	1 1/16-12	.38
14MB-14MJ	7259-07525	1 3/16-12	1 3/16-12	.41
14MB-16MJ	7259-08235	1 3/16-12	1 5/16-12	.43
16MB-8MJ	7259-00125	1 5/16-12	3/4-16	.40
16MB-10MJ	7259-11385	1 5/16-12	7/8-14	.40
16MB-12MJ	7259-10135	1 5/16-12	1 1/16-12	.54
16MB-16MJ	7259-10055	1 5/16-12	1 5/16-12	.47
16MB-20MJ	7259-05485	1 5/16-12	1 5/8-12	.66

- HOSE
- HOSE/CPLG. SELECTION
- G8K COUPLINGS
- GLOBALSPIRAL COUPLINGS
- PCM / PCS FERRULES
- MEGACRIMP COUPLINGS
- STAINLESS STEEL
- POWER CRIMP COUPLINGS
- LOC, GL AND GLP COUPLINGS
- POLARSEAL COUPLINGS
- POLARSEAL II COUPLINGS
- C14 COUPLINGS
- PCTS THERMOPLASTIC COUPLINGS
- FIELD ATTACHABLE G1 & G2 COUPLINGS
- FIELD ATTACHABLE C5 & C5E COUPLINGS
- SURELOK AIR BRAKE COUPLINGS
- ADAPTERS
- QUICK DISCONNECT COUPLERS
- LIVE SWIVEL
- BALL VALVES
- ACCESSORIES
- EQUIPMENT AND PARTS



SAE to SAE

Male O-Ring Boss to Male JIC 37° Flare - Continued

Descr.	Prod. No.			Weight (Lbs.)
		"	"	
20MB-10MJ	7253-86907	1 5/8-12	7/8-14	.35
20MB-12MJ	7259-11255	1 5/8-12	1 1/16-12	.69
20MB-16MJ	7259-10245	1 5/8-12	1 5/16-12	.72
20MB-20MJ	7259-11235	1 5/8-12	1 5/8-12	1.01
20MB-24MJ	7259-06315	1 5/8-12	1 7/8-12	.92
24MB-16MJ	7259-00365	1 7/8-12	1 5/16-12	.93
24MB-20MJ	7259-05505	1 7/8-12	1 5/8-12	1.00
24MB-24MJ	7259-05345	1 7/8-12	1 7/8-12	1.05
32MB-24MJ	7259-07645	2 1/2-12	1 7/8-12	1.83
32MB-32MJ	7259-09855	2 1/2-12	2 1/2-12	2.05

Male O-Ring Boss to Male JIC 37° Flare - 45°

For use up to SAE 100R2 maximum working pressure.

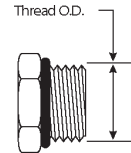
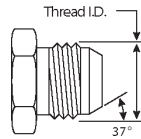
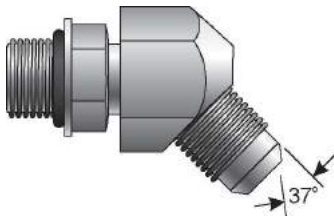

Descr.	Prod. No.			Weight (Lbs.)
		"	"	
4MB-4MJ45	7259-28565	7/16-20	7/16-20	.06
4MB-6MJ45	7259-00095	7/16-20	9/16-18	.10
5MB-5MJ45	7259-28575	1/2-20	1/2-20	.09
5MB-6MJ45	7259-05405	1/2-20	9/16-18	.09
6MB-4MJ45	7259-00065	9/16-18	7/16-20	.10
6MB-6MJ45	7259-28585	9/16-18	9/16-18	.10
6MB-8MJ45	7259-05335	9/16-18	3/4-16	.17
8MB-6MJ45	7259-77595	3/4-16	9/16-18	.19
8MB-8MJ45	7259-28255	3/4-16	3/4-16	.20
8MB-10MJ45	7259-28415	3/4-16	7/8-14	.30
8MB-12MJ45	7259-06895	3/4-16	1 1/16-12	.41
10MB-8MJ45	7259-28425	7/8-14	3/4-16	.30
10MB-10MJ45	7259-10895	7/8-14	7/8-14	.26
10MB-12MJ45	7259-05785	7/8-14	1 1/16-12	.45
12MB-10MJ45	7259-77605	1 1/16-12	7/8-14	.51
12MB-12MJ45	7259-28595	1 1/16-12	1 1/16-12	.41
12MB-16MJ45	7259-28435	1 1/16-12	1 5/16-12	.77
14MB-14MJ45	7259-28605	1 3/16-12	1 3/16-12	.76
16MB-12MJ45	7259-28445	1 5/16-12	1 1/16-12	.75
16MB-16MJ45	7259-28615	1 5/16-12	1 5/16-12	.66
16MB-20MJ45	7259-08065	1 5/16-12	1 5/8-12	1.20
20MB-16MJ45	7259-07295	1 5/8-12	1 5/16-12	1.13
20MB-20MJ45	7259-05955	1 5/8-12	1 5/8-12	1.19
24MB-24MJ45	7259-06975	1 7/8-12	1 7/8-12	2.18



SAE to SAE

Male O-Ring Boss to Male JIC 37° Flare - 90°

For use up to SAE 100R2 maximum working pressure.

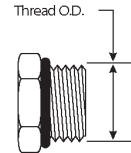
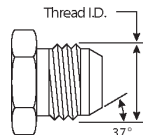
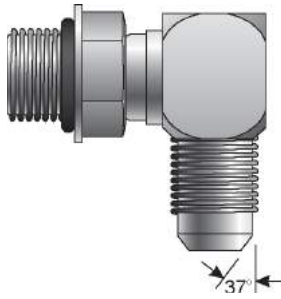

Descr.	Prod. No.			Weight (Lbs.)
		"	"	
2MB-2MJ90	7259-08925	5/16-24	5/16-24	.07
3MB-3MJ90	7259-77615	3/8-24	3/8-24	.06
4MB-4MJ90	7259-28265	7/16-20	7/16-20	.07
4MB-5MJ90	7259-77625	7/16-20	1/2-20	.10
4MB-6MJ90	7259-28455	7/16-20	9/16-18	.11
4MB-8MJ90	7259-09825	7/16-20	3/4-16	.32
5MB-4MJ90	7259-05615	1/2-20	7/16-20	.10
5MB-5MJ90	7259-28625	1/2-20	1/2-20	.12
5MB-6MJ90	7259-05075	1/2-20	9/16-18	.11
5MB-8MJ90	7259-06985	1/2-20	3/4-16	.20
6MB-4MJ90	7259-28465	9/16-18	7/16-20	.13
6MB-5MJ90	7259-28475	9/16-18	1/2-20	.17
6MB-6MJ90	7259-28275	9/16-18	9/16-18	.13
6MB-8MJ90	7259-28485	9/16-18	3/4-16	.21
6MB-10MJ90	7259-28495	9/16-18	7/8-14	.30
6MB-12MJ90	7259-07915	9/16-18	1 1/16-12	.50
8MB-4MJ90	7259-05165	3/4-16	7/16-20	.24
8MB-5MJ90	7259-08075	3/4-16	1/2-20	.22
8MB-6MJ90	7259-28505	3/4-16	9/16-18	.23
8MB-8MJ90	7259-28285	3/4-16	3/4-16	.25
8MB-10MJ90	7259-28515	3/4-16	7/8-14	.35
8MB-12MJ90	7259-28525	3/4-16	1 1/16-12	.54
8MB-16MJ90	7259-08445	3/4-16	3/4-16	.78
10MB-5MJ90	7259-08935	7/8-14	1/2-20	.35
10MB-6MJ90	7259-00215	7/8-14	9/16-18	.34
10MB-8MJ90	7259-28295	7/8-14	3/4-16	.36
10MB-10MJ90	7259-28635	7/8-14	7/8-14	.35
10MB-12MJ90	7259-28535	7/8-14	1 1/16-12	.56
10MB-16MJ90	7259-05275	7/8-14	1 5/16-12	.84
12MB-6MJ90	7259-05065	1 1/16-12	9/16-18	.62
12MB-8MJ90	7259-00055	1 1/16-12	3/4-16	.66
12MB-10MJ90	7259-28545	1 1/16-12	7/8-14	.60
12MB-12MJ90	7259-28645	1 1/16-12	1 1/16-12	.60
12MB-14MJ90	7259-08945	1 1/16-12	1 3/16-12	.99
12MB-16MJ90	7259-28555	1 1/16-12	1 5/16-12	.92
12MB-20MJ90	7259-08435	1 1/16-12	1 5/8-12	1.44
14MB-12MJ90	7259-06435	1 3/16-12	1 1/16-12	.89
14MB-14MJ90	7259-28655	1 3/16-12	1 3/16-12	.88
14MB-16MJ90	7259-07305	1 3/16-12	1 5/16-12	.88
14MB-20MJ90	7259-08955	1 3/16-12	1 5/8-12	1.37
16MB-8MJ90	7259-05885	1 5/16-12	3/4-16	.94
16MB-10MJ90	7259-08965	1 5/16-12	7/8-14	.89

- HOSE
- HOSE/CPLG. SELECTION
- G8K COUPLINGS
- GLOBAL SPIRAL COUPLINGS
- PCM / PCS FERRULES
- MEGACRIMP COUPLINGS
- STAINLESS STEEL
- POWER CRIMP COUPLINGS
- LOC, GL AND GLP COUPLINGS
- POLARSEAL COUPLINGS
- POLARSEAL II COUPLINGS
- C14 COUPLINGS
- PCTS THERMOPLASTIC COUPLINGS
- FIELD ATTACHABLE G1 & G2 COUPLINGS
- FIELD ATTACHABLE C5 & C5E COUPLINGS
- SURELOK AIR BRAKE COUPLINGS
- ADAPTERS
- QUICK DISCONNECT COUPLERS
- LIVE SWIVEL
- BALL VALVES
- ACCESSORIES
- EQUIPMENT AND PARTS



SAE to SAE

HOSE

HOSE/CPLG. SELECTION

G8K COUPLINGS

GLOBALSPIRAL COUPLINGS

PCM / PCS FERRULES

MEGACRIMP COUPLINGS

STAINLESS STEEL

POWER CRIMP COUPLINGS

LOC. GL AND GLP COUPLINGS

POLARSEAL COUPLINGS

POLARSEAL II COUPLINGS

C14 COUPLINGS

PCTS THERMOPLASTIC COUPLINGS

FIELD ATTACHABLE G1 & G2 COUPLINGS

FIELD ATTACHABLE C5 & C5E COUPLINGS

SURELOK AIR BRAKE COUPLINGS

ADAPTERS

QUICK DISCONNECT COUPLERS

LIVE SWIVEL

BALL VALVES

ACCESSORIES

EQUIPMENT AND PARTS

Male O-Ring Boss to Male JIC 37° Flare - 90° - Continued

Descr.	Prod. No.				Weight (Lbs.)
		"	"	"	
16MB-12MJ90	7259-28315	1 5/16-12	1 1/16-12		.79
16MB-14MJ90	7259-08975	1 5/16-12	1 3/16-12		1.04
16MB-16MJ90	7259-28325	1 5/16-12	1 5/16-12		.93
16MB-20MJ90	7259-77655	1 5/16-12	1 5/8-12		1.44
16MB-24MJ90	7259-08255	1 5/16-12	1 7/8-12		2.01
20MB-10MJ90	7259-08265	1 5/8-12	7/8-14		1.59
20MB-12MJ90	7259-05995	1 5/8-12	1 1/16-12		1.59
20MB-16MJ90	7259-05055	1 5/8-12	1 5/16-12		1.68
20MB-20MJ90	7259-77665	1 5/8-12	1 5/8-12		1.25
20MB-24MJ90	7259-06015	1 5/8-12	1 7/8-12		1.98
24MB-20MJ90	7259-06525	1 7/8-12	1 5/8-12		2.06
24MB-24MJ90	7259-77675	1 7/8-12	1 7/8-12		1.87
32MB-32MJ90	7259-07135	2 1/2-12	2 1/2-12		4.48

Male O-Ring Boss to Female JIC 37° Flare Swivel

For use up to SAE 100R2 maximum working pressure.

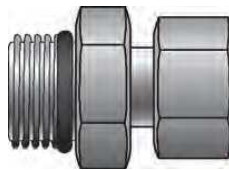

Descr.	Prod. No.			Weight (Lbs.)
		"	"	
6MB-6FJX	7259-42155	9/16-18		.09
8MB-8FJX	7259-42185	3/4-16		.16

Male JIC 37° Flare on Run to Male O-Ring Boss - Tee

For use up to SAE 100R2 maximum working pressure.

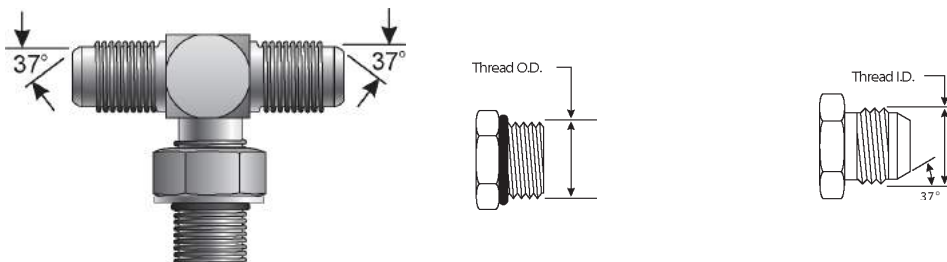

Descr.	Prod. No.				Weight (Lbs.)
		"	"	"	
4MJ-4MJ-4MB	7259-33615	7/16-20	7/16-20	7/16-20	.09
5MJ-5MJ-5MB	7259-33625	1/2-20	1/2-20	1/2-20	.13
6MJ-6MJ-6MB	7259-33635	9/16-18	9/16-18	9/16-18	.17
6MJ-6MJ-8MB	7259-06165	9/16-18	9/16-18	3/4-16	.29



SAE to SAE

Male JIC 37° Flare on Run to Male O-Ring Boss - Tee - Continued

Descr.	Prod. No.				Weight (Lbs.)
		"	"	"	
8MJ-8MJ-8MB	7259-33645	3/4-16	3/4-16	3/4-16	.32
8MJ-8MJ-10MB	7259-07655	3/4-16	3/4-16	7/8-14	.50
10MJ-10MJ-10MB	7259-33655	7/8-14	7/8-14	7/8-14	.46
12MJ-12MJ-10MB	7259-08985	1 1/16-12	1 1/16-12	7/8-14	.72
12MJ-12MJ-12MB	7259-33665	1 1/16-12	1 1/16-12	1 1/16-12	.80
14MJ-14MJ-14MB	7259-08995	1 3/16-12	1 3/16-12	1 3/16-12	1.10
16MJ-16MJ-16MB	7259-33675	1 5/16-12	1 5/16-12	1 5/16-12	1.07
20MJ-20MJ-20MB	7259-09005	1 5/8-12	1 5/8-12	1 5/8-12	1.98
24MJ-24MJ-24MB	7259-09015	1 7/8-12	1 7/8-12	1 7/8-12	2.65

Male O-Ring Boss to Male JIC 37° Flare to Male JIC 37° Flare - Tee

For use up to SAE 100R2 maximum working pressure.

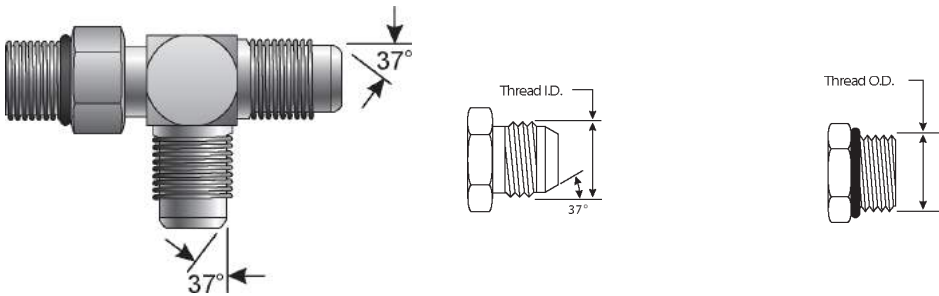

Descr.	Prod. No.				Weight (Lbs.)
		"	"	"	
4MB-4MJ-4MJ	7259-33685	7/16-20	7/16-20	7/16-20	.09
5MB-5MJ-5MJ	7259-33695	1/2-20	1/2-20	1/2-20	.15
6MB-6MJ-6MJ	7259-33705	9/16-18	9/16-18	9/16-18	.15
6MB-8MJ-6MJ	7259-00185	9/16-18	3/4-16	9/16-18	.28
8MB-8MJ-8MJ	7259-33715	3/4-16	3/4-16	3/4-16	.32
10MB-10MJ-10MJ	7259-33725	7/8-14	7/8-14	7/8-14	.46
12MB-12MJ-12MJ	7259-33735	1 1/16-12	1 1/16-12	1 1/16-12	.80
12MB-12MJ-16MJ	7259-09025	1 1/16-12	1 1/16-12	1 5/16-12	1.09
14MB-14MJ-14MJ	7259-09035	1 3/16-12	1 3/16-12	1 3/16-12	1.13
16MB-16MJ-16MJ	7259-33745	1 5/16-12	1 5/16-12	1 5/16-12	1.13
20MB-20MJ-20MJ	7259-07535	1 5/8-12	1 5/8-12	1 5/8-12	1.85
24MB-24MJ-24MJ	7259-09045	1 7/8-12	1 7/8-12	1 7/8-12	2.51

- HOSE
- HOSE/CPLG. SELECTION
- G8K COUPLINGS
- GLOBAL SPIRAL COUPLINGS
- PCM / PCS FERRULES
- MEGACRIMP COUPLINGS
- STAINLESS STEEL
- POWER CRIMP COUPLINGS
- LOC. GL AND GLP COUPLINGS
- POLARSEAL COUPLINGS
- POLARSEAL II COUPLINGS
- C14 COUPLINGS
- PCTS THERMOPLASTIC COUPLINGS
- FIELD ATTACHABLE G1 & G2 COUPLINGS
- FIELD ATTACHABLE C5 & C5E COUPLINGS
- SURELOK AIR BRAKE COUPLINGS
- ADAPTERS
- QUICK DISCONNECT COUPLERS
- LIVE SWIVEL
- BALL VALVES
- ACCESSORIES
- EQUIPMENT AND PARTS



SAE to SAE

- HOSE
- HOSE/CPLG. SELECTION
- G8K COUPLINGS
- GLOBALSPIRAL COUPLINGS
- PCM / PCS FERRULES
- MEGACRIMP COUPLINGS
- STAINLESS STEEL
- POWER CRIMP COUPLINGS
- LOC. GL AND GLP COUPLINGS
- POLARSEAL COUPLINGS
- POLARSEAL II COUPLINGS
- C14 COUPLINGS
- PCTS THERMOPLASTIC COUPLINGS
- FIELD ATTACHABLE G1 & G2 COUPLINGS
- FIELD ATTACHABLE C5 & C5E COUPLINGS
- SURELOK AIR BRAKE COUPLINGS
- ADAPTERS
- QUICK DISCONNECT COUPLERS
- LIVE SWIVEL
- BALL VALVES
- ACCESSORIES
- EQUIPMENT AND PARTS

Female JIC 37° Flare Cap

For use up to SAE 100R2 maximum working pressure.

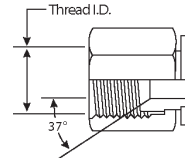

Descr.	Prod. No.		Weight (Lbs.)
		"	
2FJ-CAP	7259-09865	5/16-24	.01
3FJ-CAP	7259-07435	3/8-24	.02
4FJ-CAP	7259-24305	7/16-20	.03
5FJ-CAP	7259-24315	1/2-20	.05
6FJ-CAP	7259-24325	9/16-18	.04
8FJ-CAP	7259-24335	3/4-16	.08
10FJ-CAP	7259-24345	7/8-14	.10
12FJ-CAP	7259-24355	1 1/16-12	.20
14FJ-CAP	7259-00445	1 3/16-12	.24
16FJ-CAP	7259-24365	1 5/16-12	.30
20FJ-CAP	7253-24375	1 5/8-12	.10
24FJ-CAP	7259-24385	1 7/8-12	.82
32FJ-CAP	7259-24405	2 1/2-12	1.30

Male JIC 37° Flare Plug

For use up to SAE 100R2 maximum working pressure.

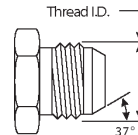
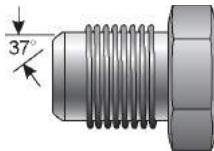

Descr.	Prod. No.		Weight (Lbs.)
		"	
3MJ-PLUG	7259-09775	3/8-24	.02
4MJ-PLUG	7259-22885	7/16-20	.04
5MJ-PLUG	7259-22895	1/2-20	.05
6MJ-PLUG	7259-22905	9/16-18	.05
8MJ-PLUG	7259-22915	3/4-16	.09
10MJ-PLUG	7259-22925	7/8-14	.13
12MJ-PLUG	7259-22935	1 1/16-12	.22
14MJ-PLUG	7259-22945	1 5/16-12	.29
16MJ-PLUG	7259-22955	1 5/8-12	.34
20MJ-PLUG	7259-22965	1 7/8-12	.56
32MJ-PLUG	7259-33765	2 1/2-12	1.76



SAE to SAE

Male JIC 37° Flare to Female Braze - On

For use up to SAE 100R2 maximum working pressure.

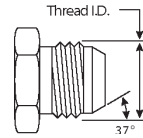
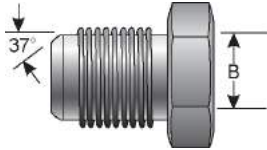

Descr.	Prod. No.			Weight (Lbs.)
			B	
20MJ-20FBO	7253-28735	1 5/8-12	1 1/4	.40

Male JIC 37° Flare to Male JIC 37° Flare

For use up to SAE 100R2 maximum working pressure.

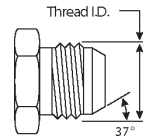

Descr.	Prod. No.			Weight (Lbs.)
2MJ-2MJ	7259-77775	5/16-24	5/16-24	.01
3MJ-2MJ	7259-09065	3/8-24	5/16-24	.26
3MJ-3MJ	7259-77785	3/8-24	3/8-24	.17
4MJ-3MJ	7259-09075	7/16-20	3/8-24	.03
4MJ-4MJ	7259-10125	7/16-20	7/16-20	.04
5MJ-4MJ	7259-77795	1/2-20	7/16-20	.04
5MJ-5MJ	7259-10735	1/2-20	1/2-20	.06
6MJ-4MJ	7259-00285	9/16-18	7/16-20	.06
6MJ-5MJ	7259-77805	9/16-18	1/2-20	.05
6MJ-6MJ	7259-06265	9/16-18	9/16-18	.07
8MJ-4MJ	7259-06505	3/4-16	7/16-20	.10
8MJ-5MJ	7259-09085	3/4-16	1/2-20	.10
8MJ-6MJ	7259-00075	3/4-16	9/16-18	.14
8MJ-8MJ	7259-06275	3/4-16	3/4-16	.12
10MJ-4MJ	7259-07195	7/8-14	7/16-20	.14
10MJ-6MJ	7259-07805	7/8-14	9/16-18	.14
10MJ-8MJ	7259-00375	7/8-14	3/4-16	.18
10MJ-10MJ	7259-10225	7/8-14	7/8-14	.21
12MJ-4MJ	7259-09095	1 1/16-12	7/16-20	.23
12MJ-6MJ	7259-08455	1 1/16-12	9/16-18	.23
12MJ-8MJ	7259-77815	1 1/16-12	3/4-16	.26
12MJ-10MJ	7259-00565	1 1/16-12	7/8-14	.28
12MJ-12MJ	7259-10235	1 1/16-12	1 1/16-12	.32
14MJ-12MJ	7259-09105	1 3/16-12	1 1/16-12	.35
14MJ-14MJ	7259-77825	1 3/16-12	1 3/16-12	.40
16MJ-8MJ	7259-07205	1 5/16-12	3/4-16	.34
16MJ-10MJ	7259-07505	1 5/16-12	7/8-14	.38
16MJ-12MJ	7259-77835	1 5/16-12	1 1/16-12	.42
16MJ-16MJ	7259-10655	1 5/16-12	1 5/16-12	.45
20MJ-12MJ	7259-09115	1 5/8-12	1 1/16-12	.60

- HOSE
- HOSE/CPLG. SELECTION
- G8K COUPLINGS
- GLOBALSPIRAL COUPLINGS
- PCM / PCS FERRULES
- MEGACRIMP COUPLINGS
- STAINLESS STEEL
- POWER CRIMP COUPLINGS
- LOC. GL AND GLP COUPLINGS
- POLARSEAL COUPLINGS
- POLARSEAL II COUPLINGS
- C14 COUPLINGS
- PCTS THERMOPLASTIC COUPLINGS
- FIELD ATTACHABLE G1 & G2 COUPLINGS
- FIELD ATTACHABLE C5 & C5E COUPLINGS
- SURELOK AIR BRAKE COUPLINGS
- ADAPTERS
- QUICK DISCONNECT COUPLERS
- LIVE SWIVEL
- BALL VALVES
- ACCESSORIES
- EQUIPMENT AND PARTS



SAE to SAE

Male JIC 37° Flare to Male JIC 37° Flare - Continued

Descr.	Prod. No.			Weight (Lbs.)
		"	"	
20MJ-16MJ	7259-06555	1 5/8-12	1 5/16-12	.63
20MJ-20MJ	7259-11145	1 5/8-12	1 5/8-12	1.59
24MJ-12MJ	7259-09125	1 7/8-12	1 1/16-12	.88
24MJ-20MJ	7259-09135	1 7/8-12	1 5/8-12	.94
24MJ-24MJ	7259-33845	1 7/8-12	1 7/8-12	1.00
32MJ-32MJ	7259-33855	2 1/2-12	2 1/2-12	2.19

Male JIC 37° Flare to Male JIC 37° Flare - 90°

For use up to SAE 100R2 maximum working pressure.

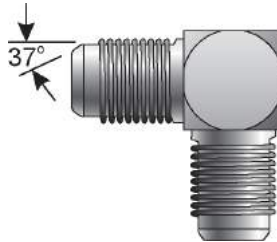

Descr.	Prod. No.			Weight (Lbs.)
		"	"	
2MJ-2MJ90	7259-09145	5/16-24	5/16-24	.03
4MJ-4MJ90	7259-77845	7/16-20	7/16-20	.08
5MJ-5MJ90	7259-05865	1/2-20	1/2-20	.08
6MJ-4MJ90	7259-07925	9/16-18	7/16-20	.09
6MJ-6MJ90	7259-77855	9/16-18	9/16-18	.10
8MJ-6MJ90	7259-06745	3/4-16	9/16-18	.20
8MJ-8MJ90	7259-77865	3/4-16	3/4-16	.21
10MJ-10MJ90	7259-77875	7/8-14	7/8-14	.32
12MJ-12MJ90	7259-77885	1 1/16-12	1 1/16-12	.49
14MJ-14MJ90	7259-08275	1 3/16-12	1 3/16-12	.79
16MJ-12MJ90	7259-09155	1 5/16-12	1 1/16-12	.79
16MJ-16MJ90	7259-77895	1 5/16-12	1 5/16-12	.77
20MJ-20MJ90	7259-07095	1 5/8-12	1 5/8-12	1.28
24MJ-24MJ90	7259-07105	1 7/8-12	1 7/8-12	2.08
32MJ-32MJ90	7259-08465	2 1/2-12	2 1/2-12	4.41

- HOSE
- HOSE/CPLG. SELECTION
- G8K COUPLINGS
- GLOBAL SPIRAL COUPLINGS
- PCM / PCS FERRULES
- MEGACRIMP COUPLINGS
- STAINLESS STEEL
- POWER CRIMP COUPLINGS
- LOC. GL AND GLP COUPLINGS
- POLARSEAL COUPLINGS
- POLARSEAL II COUPLINGS
- C14 COUPLINGS
- PCTS THERMOPLASTIC COUPLINGS
- FIELD ATTACHABLE G1 & G2 COUPLINGS
- FIELD ATTACHABLE C5 & C5E COUPLINGS
- SURELOK AIR BRAKE COUPLINGS
- ADAPTERS
- QUICK DISCONNECT COUPLERS
- LIVE SWIVEL
- BALL VALVES
- ACCESSORIES
- EQUIPMENT AND PARTS



SAE to SAE

Male JIC 37° Flare to Female JIC 37° Flare

For use up to SAE 100R2 maximum working pressure.

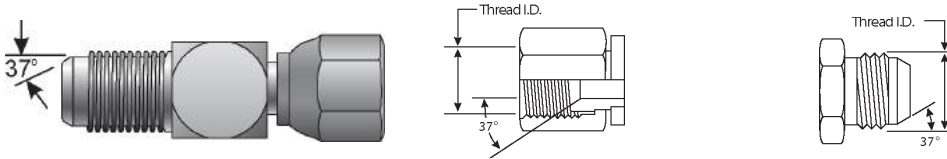

Descr.	Prod. No.			Weight (Lbs.)
		"	"	
4MJ-6FJ	7259-33865	7/16-20	9/16-18	.06
5MJ-4FJ	7259-07445	1/2-20	7/16-20	.04
5MJ-6FJ	7259-09175	1/2-20	9/16-18	.06
6MJ-4FJ	7259-00015	9/16-18	7/16-20	.06
6MJ-6FJ	7259-09195	9/16-18	9/16-18	.05
6MJ-8FJ	7259-33875	9/16-18	3/4-16	.12
6MJ-10FJ	7259-33885	9/16-18	7/8-14	.13
8MJ-4FJ	7259-00935	3/4-16	7/16-20	.12
8MJ-8FJ	7259-06135	3/4-16	3/4-16	.20
8MJ-10FJ	7253-33895	3/4-16	7/8-14	.14
8MJ-12FJ	7259-33905	3/4-16	3/4-16	.32
10MJ-4FJ	7259-05915	7/8-14	7/16-20	.13
10MJ-6FJ	7259-05375	7/8-14	9/16-18	.13
10MJ-8FJ	7259-00705	7/8-14	3/4-16	.15
10MJ-12FJ	7259-33915	7/8-14	1 1/16-12	.30
10MJ-16FJ	7259-33925	7/8-14	1 5/16-12	.38
12MJ-4FJ	7259-05235	1 1/16-12	7/16-20	.13
12MJ-6FJ	7259-00145	1 1/16-12	9/16-18	.20
12MJ-8FJ	7259-00115	1 1/16-12	3/4-16	.23
12MJ-12FJ	7259-09205	1 1/16-12	1 1/16-12	.30
12MJ-16FJ	7253-33935	1 1/16-12	1 5/16-12	.35
12MJ-20FJ	7253-33945	1 1/16-12	1 5/8-12	.76
16MJ-16FJ	7259-09215	1 5/16-12	1 5/16-12	.39
16MJ-20FJ	7259-33955	1 5/16-12	1 5/8-12	.75
20MJ-16FJ	7259-05085	1 5/8-12	1 5/16-12	.72

Male JIC 37° Flare to Female JIC 37° Flare Swivel - 45°

For use up to SAE 100R2 maximum working pressure.

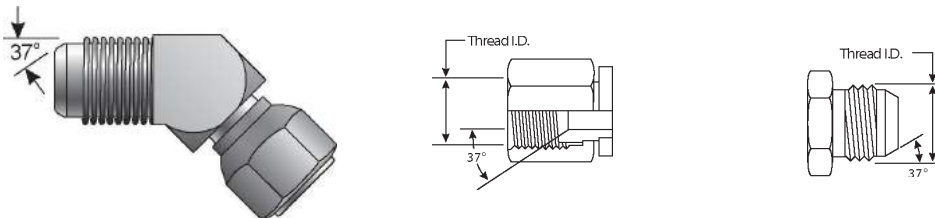

Descr.	Prod. No.			Weight (Lbs.)
		"	"	
4MJ-4FJX45	7259-23215	7/16-20	7/16-20	.06
5MJ-5FJX45	7259-33965	1/2-20	1/2-20	.08
6MJ-6FJX45	7259-23225	9/16-18	9/16-18	.10
8MJ-8FJX45	7259-23235	3/4-16	3/4-16	.19

- HOSE
- HOSE/CPLG. SELECTION
- G8K COUPLINGS
- GLOBAL SPIRAL COUPLINGS
- PCM / PCS FERRULES
- MEGACRIMP COUPLINGS
- STAINLESS STEEL
- POWER CRIMP COUPLINGS
- LOC, GL AND GLP COUPLINGS
- POLARSEAL COUPLINGS
- POLARSEAL II COUPLINGS
- C14 COUPLINGS
- PCTS THERMOPLASTIC COUPLINGS
- FIELD ATTACHABLE G1 & G2 COUPLINGS
- FIELD ATTACHABLE C5 & C5E COUPLINGS
- SURELOK AIR BRAKE COUPLINGS
- ADAPTERS
- QUICK DISCONNECT COUPLERS
- LIVE SWIVEL
- BALL VALVES
- ACCESSORIES
- EQUIPMENT AND PARTS



SAE to SAE

- HOSE
- HOSE/CPLG. SELECTION
- G8K COUPLINGS
- GLOBALSPIRAL COUPLINGS
- PCM / PCS FERRULES
- MEGACRIMP COUPLINGS
- STAINLESS STEEL
- POWER CRIMP COUPLINGS
- LOC. GL AND GLP COUPLINGS
- POLARSEAL COUPLINGS
- POLARSEAL II COUPLINGS
- C14 COUPLINGS
- PCTS THERMOPLASTIC COUPLINGS
- FIELD ATTACHABLE G1 & G2 COUPLINGS
- FIELD ATTACHABLE C5 & C5E COUPLINGS
- SURELOK AIR BRAKE COUPLINGS
- ADAPTERS
- QUICK DISCONNECT COUPLERS
- LIVE SWIVEL
- BALL VALVES
- ACCESSORIES
- EQUIPMENT AND PARTS

Male JIC 37° Flare to Female JIC 37° Flare Swivel - 45° - Continued

Descr.	Prod. No.			Weight (Lbs.)
		"	"	
10MJ-10FJX45	7259-23245	7/8-14	7/8-14	.26
12MJ-12FJX45	7259-23255	1 1/16-12	1 1/16-12	.67
14MJ-14FJX45	7259-06995	1 3/16-12	1 3/16-12	.69
16MJ-16FJX45	7259-23265	1 5/16-12	1 5/16-12	.66
20MJ-20FJX45	7259-23275	1 5/8-12	1 5/8-12	1.61
24MJ-24FJX45	7259-05455	1 7/8-12	1 7/8-12	1.87
32MJ-32FJX45	7259-07935	2 1/2-12	2 1/2-12	6.62

Male JIC 37° Flare to Female JIC 37° Flare Swivel - 90°

For use up to SAE 100R2 maximum working pressure.

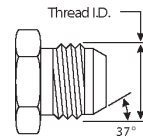
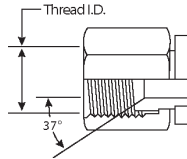
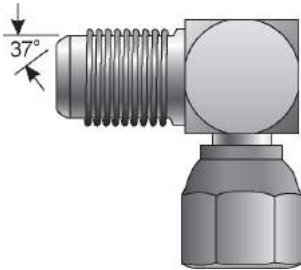

Descr.	Prod. No.			Weight (Lbs.)
		"	"	
4MJ-4FJX90	7259-23285	7/16-20	7/16-20	.07
5MJ-5FJX90	7259-24025	1/2-20	1/2-20	.09
6MJ-4FJX90	7259-06905	9/16-18	7/16-20	.11
6MJ-6FJX90	7259-23295	9/16-18	9/16-18	.13
8MJ-6FJX90	7259-06205	3/4-16	9/16-18	.20
8MJ-8FJX90	7259-23305	3/4-16	3/4-16	.25
8MJ-10FJX90	7259-06385	3/4-16	3/4-16	.35
10MJ-10FJX90	7259-23315	7/8-14	7/8-14	.35
12MJ-12FJX90	7259-23325	1 1/16-12	1 1/16-12	.51
14MJ-14FJX90	7259-06215	1 3/16-12	1 3/16-12	.79
16MJ-16FJX90	7259-23335	1 5/16-12	1 5/16-12	.85
20MJ-20FJX90	7259-24075	1 5/8-12	1 5/8-12	1.50
24MJ-24FJX90	7259-24085	1 7/8-12	1 7/8-12	1.87
32MJ-32FJX90	7259-24095	2 1/2-12	2 1/2-12	4.72



SAE to SAE

Male JIC 37° Flare to Male JIC 37° Flare Bulkhead

For use up to SAE 100R2 maximum working pressure.

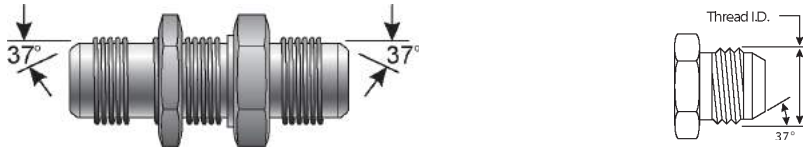

Descr.	Prod. No.		
			Weight (Lbs.)
3MJ-3BKHD	7259-09295	3/8-24	.05
4MJ-4BKHD	7259-24505	7/16-20	.09
5MJ-5BKHD	7259-24515	1/2-20	.16
6MJ-6BKHD	7259-24525	9/16-18	.11
8MJ-8BKHD	7259-24535	3/4-16	.21
10MJ-10BKHD	7259-24545	7/8-14	.31
12MJ-12BKHD	7259-24555	1 1/16-12	.51
14MJ-14BKHD	7259-08495	1 3/16-12	.79
16MJ-16BKHD	7259-24565	1 5/16-12	.67
20MJ-20BKHD	7259-34155	1 5/8-12	1.32
24MJ-24BKHD	7259-34165	1 7/8-12	1.35

Male JIC 37° Flare to Male JIC 37° Flare Bulkhead - 45°

For use up to SAE 100R2 maximum working pressure.

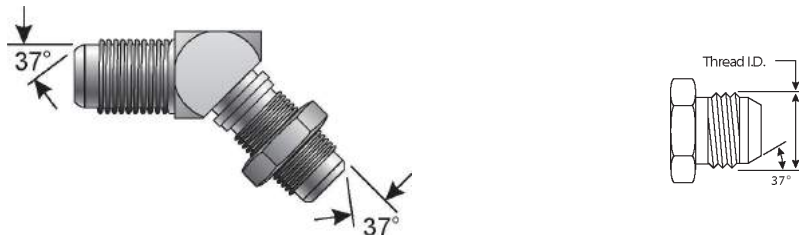

Descr.	Prod. No.		
			Weight (Lbs.)
4MJ-4BKHD45	7259-34175	7/16-20	.08
5MJ-5BKHD45	7259-34185	1/2-20	.10
6MJ-6BKHD45	7259-34195	9/16-18	.10
8MJ-8BKHD45	7259-34205	3/4-16	.23
10MJ-10BKHD45	7259-34215	7/8-14	.34
12MJ-12BKHD45	7259-34225	1 1/16-12	.56
16MJ-16BKHD45	7259-34235	1 5/16-12	.83

- HOSE
- HOSE/CPLG. SELECTION
- G8K COUPLINGS
- GLOBALSPIRAL COUPLINGS
- PCM / PCS FERRULES
- MEGACRIMP COUPLINGS
- STAINLESS STEEL
- POWER CRIMP COUPLINGS
- LOC. GL AND GLP COUPLINGS
- POLARSEAL COUPLINGS
- POLARSEAL II COUPLINGS
- C14 COUPLINGS
- PCTS THERMOPLASTIC COUPLINGS
- FIELD ATTACHABLE G1 & G2 COUPLINGS
- FIELD ATTACHABLE C5 & C5E COUPLINGS
- SURELOK AIR BRAKE COUPLINGS
- ADAPTERS
- QUICK DISCONNECT COUPLERS
- LIVE SWIVEL
- BALL VALVES
- ACCESSORIES
- EQUIPMENT AND PARTS



SAE to SAE

Male JIC 37° Flare to Male JIC 37° Flare Bulkhead - 90°

For use up to SAE 100R2 maximum working pressure.

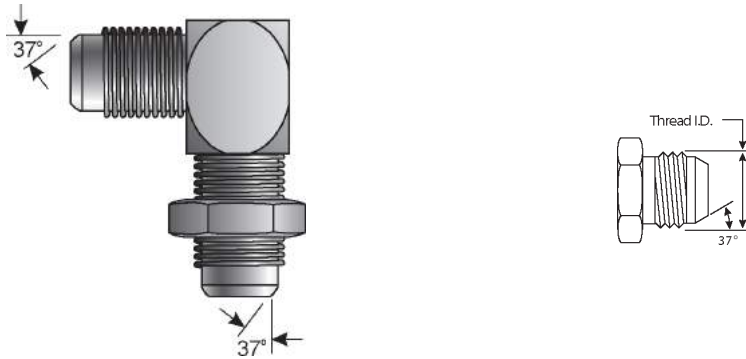

Descr.	Prod. No.			Weight (Lbs.)
		"		
4MJ-4BKHD90	7259-34255	7/16-20		.09
5MJ-5BKHD90	7259-34265	1/2-20		.13
6MJ-6BKHD90	7259-34275	9/16-18		.14
8MJ-8BKHD90	7259-34285	3/4-16		.30
10MJ-10BKHD90	7259-34295	7/8-14		.42
12MJ-12BKHD90	7259-34305	1 1/16-12		.75
14MJ-14BKHD90	7259-09315	1 3/16-12		1.05
16MJ-16BKHD90	7259-34315	1 5/16-12		1.01
20MJ-20BKHD90	7259-34325	1 5/8-12		1.75
24MJ-24BKHD90	7259-09325	1 7/8-12		2.65

Male JIC 37° Flare Tee

For use up to SAE 100R2 maximum working pressure.

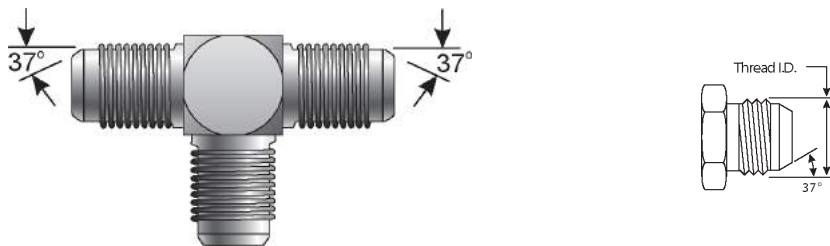

Descr.	Prod. No.			Weight (Lbs.)
		"		
2MJ-2MJ-2MJ	7259-77905	5/16-24		.04
3MJ-3MJ-3MJ	7259-08095	3/8-24		.07
4MJ-4MJ-4MJ	7259-23345	7/16-20		.12
5MJ-5MJ-5MJ	7259-34335	1/2-20		.10
6MJ-6MJ-6MJ	7259-23355	9/16-18		.13
6MJ-6MJ-8MJ	7253-34345	9/16-18		.32
8MJ-8MJ-8MJ	7259-23365	3/4-16		.25
10MJ-10MJ-10MJ	7259-23375	7/8-14		.42
12MJ-12MJ-12MJ	7259-23385	1 1/16-12		.66
14MJ-14MJ-14MJ	7259-09335	1 3/16-12		1.01



SAE to SAE

Male JIC 37° Flare Tee - Continued

Descr.	Prod. No.			Weight (Lbs.)
		"	"	
16MJ-16MJ-12MJ	7259-34365	1 5/16-12		.95
16MJ-16MJ-16MJ	7259-23395	1 5/16-12		.95
20MJ-20MJ-20MJ	7259-23405	1 5/8-12		1.98
24MJ-24MJ-24MJ	7259-07555	1 7/8-12		2.65
32MJ-32MJ-32MJ	7259-07455	2 1/2-12		6.62

Male JIC 37° Flare on Run to Female JIC 37° Flare Swivel - Tee

For use up to SAE 100R2 maximum working pressure.

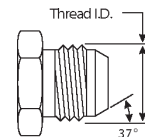
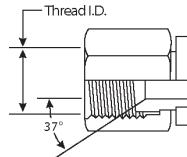
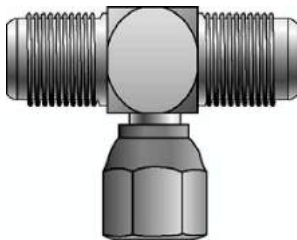

Descr.	Prod. No.			Weight (Lbs.)
		"	"	
4MJ-4MJ-4FJX	7259-24805	7/16-20	7/16-20	.10
5MJ-5MJ-5FJX	7259-06535	1/2-20	1/2-20	.17
6MJ-6MJ-6FJX	7259-24815	9/16-18	9/16-18	.17
8MJ-8MJ-8FJX	7259-24825	3/4-16	3/4-16	.30
10MJ-10MJ-10FJX	7259-34405	7/8-14	7/8-14	.44
12MJ-12MJ-12FJX	7259-24835	1 1/16-12	1 1/16-12	.72
14MJ-14MJ-14FJX	7259-07945	1 3/16-12	1 3/16-12	.99
16MJ-16MJ-16FJX	7259-24845	1 5/16-12	1 5/16-12	.93
20MJ-20MJ-20FJX	7259-34415	1 5/8-12	1 5/8-12	1.98
24MJ-24MJ-24FJX	7259-08505	1 7/8-12	1 7/8-12	2.50
32MJ-32MJ-32FJX	7259-09345	2 1/2-12	2 1/2-12	5.67

HOSE

HOSE/CPLG. SELECTION

G8K COUPLINGS

GLOBAL SPIRAL COUPLINGS

PCM / PCS FERRULES

MEGACRIMP COUPLINGS

STAINLESS STEEL

POWER CRIMP COUPLINGS

LOC. GL AND GLP COUPLINGS

POLARSEAL COUPLINGS

POLARSEAL II COUPLINGS

C14 COUPLINGS

PCTS THERMOPLASTIC COUPLINGS

FIELD ATTACHABLE G1 & G2 COUPLINGS

FIELD ATTACHABLE C5 & C5E COUPLINGS

SURELOK AIR BRAKE COUPLINGS

ADAPTERS

QUICK DISCONNECT COUPLERS

LIVE SWIVEL

BALL VALVES

ACCESSORIES

EQUIPMENT AND PARTS



SAE to SAE

Male JIC 37° Flare on Run to Male JIC 37° Flare Bulkhead - Tee

For use up to SAE 100R2 maximum working pressure.

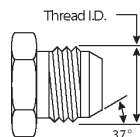
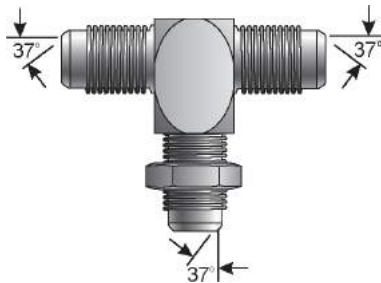

Descr.	Prod. No.		Weight (Lbs.)
		"	
4MJ-4MJ-4BKHD	7259-34425	7/16-20	.10
5MJ-5MJ-5BKHD	7259-34435	1/2-20	.14
6MJ-6MJ-6BKHD	7259-34445	9/16-18	.16
8MJ-8MJ-8BKHD	7259-34455	3/4-16	.36
10MJ-10MJ-10BKHD	7259-34465	7/8-14	.53
12MJ-12MJ-12BKHD	7259-34475	1 1/16-12	.90
16MJ-16MJ-16BKHD	7259-34485	1 5/16-12	1.40

Male JIC 37° Flare to Male JIC 37° Flare Bulkhead to Male JIC 37° Flare - Tee

For use up to SAE 100R2 maximum working pressure.

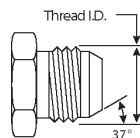
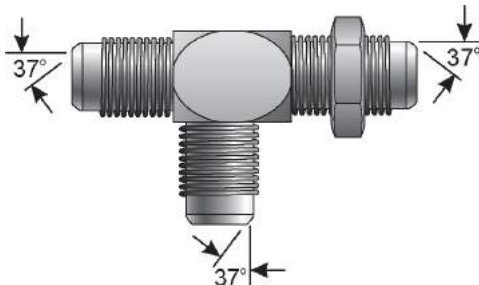

Descr.	Prod. No.		Weight (Lbs.)
		"	
4MJ-4BKHD-4MJ	7259-34495	7/16-20	.10
6MJ-6BKHD-6MJ	7259-34515	9/16-18	.17
8MJ-8BKHD-8MJ	7259-34525	3/4-16	.35
10MJ-10BKHD-10MJ	7259-34535	7/8-14	.55
12MJ-12BKHD-12MJ	7259-34545	1 1/16-12	.86
16MJ-16BKHD-16MJ	7259-34555	1 5/16-12	1.25



SAE to SAE

Male JIC 37° Flare to Female JIC 37° Flare Swivel to Male JIC 37° Flare - Tee

For use up to SAE 100R2 maximum working pressure.

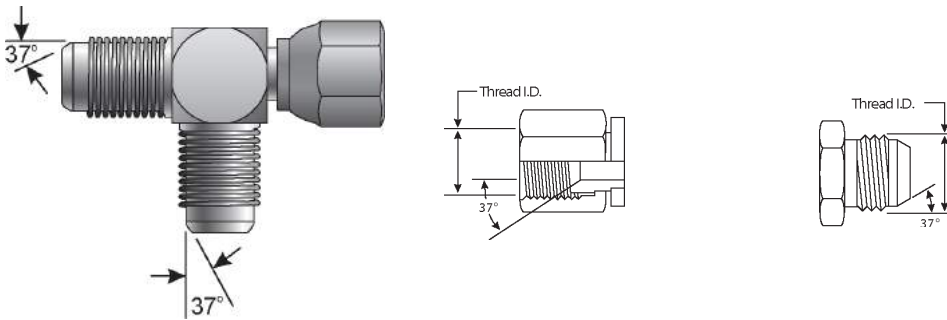

Descr.	Prod. No.			Weight (Lbs.)
		"	"	
4MJ-4FJX-4MJ	7259-24705	7/16-20	7/16-20	.09
5MJ-5FJX-5MJ	7259-77915	1/2-20	1/2-20	.12
6MJ-6FJX-6MJ	7259-24725	9/16-18	9/16-18	.15
8MJ-8FJX-8MJ	7259-24735	3/4-16	3/4-16	.29
10MJ-10FJX-10MJ	7259-24745	7/8-14	7/8-14	.40
12MJ-12FJX-12MJ	7259-24755	1 1/16-12	1 1/16-12	.72
14MJ-14FJX-14MJ	7259-08325	1 3/16-12	1 3/16-12	1.01
16MJ-16FJX-16MJ	7259-24765	1 5/16-12	1 5/16-12	.94
20MJ-20FJX-20MJ	7259-77925	1 5/8-12	1 5/8-12	1.98
24MJ-24FJX-24MJ	7259-07955	1 7/8-12	1 7/8-12	2.50
32MJ-32FJX-32MJ	7259-09355	2 1/2-12	2 1/2-12	7.94

Male JIC 37° Flare to Male Pipe NPTF

For use up to SAE 100R2 maximum working pressure.

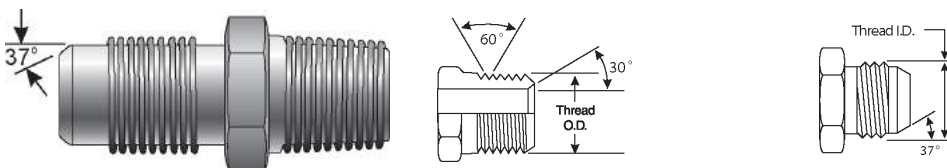

Descr.	Prod. No.			Weight (Lbs.)
		"	"	
2MJ-2MP	7259-77935	5/16-24	1/8-27	.02
3MJ-2MP	7259-77945	3/8-24	1/8-27	.03
4MJ-2MP	7259-10085	7/16-20	1/8-27	.04
4MJ-4MP	7259-04195	7/16-20	1/4-18	.07
4MJ-6MP	7259-10385	7/16-20	3/8-18	.09
4MJ-8MP	7259-70455	7/16-20	1/2-14	.12
4MJ-12MP	7259-07215	7/16-20	3/4-14	.21
5MJ-2MP	7259-10995	1/2-20	1/8-27	.05
5MJ-4MP	7259-10415	1/2-20	1/4-18	.09
5MJ-6MP	7259-25665	1/2-20	3/8-18	.09
5MJ-8MP	7259-07835	1/2-20	1/2-14	.15
6MJ-2MP	7259-10565	9/16-18	1/8-27	.06

- HOSE
- HOSE/CPLG. SELECTION
- G8K COUPLINGS
- GLOBAL SPIRAL COUPLINGS
- PCM / PCS FERRULES
- MEGACRIMP COUPLINGS
- STAINLESS STEEL
- POWER CRIMP COUPLINGS
- LOC. GL AND GLP COUPLINGS
- POLARSEAL COUPLINGS
- POLARSEAL II COUPLINGS
- C14 COUPLINGS
- PCTS THERMOPLASTIC COUPLINGS
- FIELD ATTACHABLE G1 & G2 COUPLINGS
- FIELD ATTACHABLE C5 & C5E COUPLINGS
- SURELOK AIR BRAKE COUPLINGS
- ADAPTERS
- QUICK DISCONNECT COUPLERS
- LIVE SWIVEL
- BALL VALVES
- ACCESSORIES
- EQUIPMENT AND PARTS



SAE to SAE

Male JIC 37° Flare to Male Pipe NPTF - Continued

Descr.	Prod. No.			Weight (Lbs.)
		"	"	
6MJ-4MP	7259-25635	9/16-18	1/4-18	.18
6MJ-6MP	7259-04225	9/16-18	3/8-18	.08
6MJ-8MP	7259-10205	9/16-18	1/2-14	.14
6MJ-12MP	7259-00425	9/16-18	3/4-14	.20
8MJ-2MP	7259-09875	3/4-16	1/8-27	.10
8MJ-4MP	7259-10435	3/4-16	1/4-18	.10
8MJ-6MP	7259-10105	3/4-16	3/8-18	.16
8MJ-8MP	7259-04235	3/4-16	1/2-14	.17
8MJ-12MP	7259-10545	3/4-16	3/4-14	.26
8MJ-16MP	7259-05835	3/4-16	1-11 1/2	.53
10MJ-4MP	7259-07965	7/8-14	1/4-18	.38
10MJ-6MP	7259-10785	7/8-14	3/8-18	.18
10MJ-8MP	7259-25715	7/8-14	1/2-14	.18
10MJ-12MP	7259-10595	7/8-14	3/4-14	.26
12MJ-6MP	7259-07225	1 1/16-12	3/8-18	.21
12MJ-8MP	7259-10255	1 1/16-12	1/2-14	.30
12MJ-12MP	7259-25735	1 1/16-12	3/4-14	.28
12MJ-16MP	7259-10355	1 1/16-12	1-11 1/2	.62
12MJ-20MP	7259-05765	1 1/16-12	1 1/4-11 1/2	.56
12MJ-24MP	7259-07665	1 1/16-12	1 1/2-11 1/2	.77
14MJ-12MP	7259-77965	1 3/16-12	3/4-14	.32
14MJ-16MP	7259-07975	1 3/16-12	1-11 1/2	.51
16MJ-8MP	7259-06095	1 5/16-12	1/2-14	.36
16MJ-12MP	7259-10485	1 5/16-12	3/4-14	.42
16MJ-16MP	7259-04275	1 5/16-12	1-11 1/2	.46
16MJ-20MP	7259-34565	1 5/16-12	1 1/4-11 1/2	.77
16MJ-24MP	7259-06065	1 5/16-12	1 1/2-11 1/2	.80
20MJ-12MP	7259-07675	1 5/8-12	3/4-14	.60
20MJ-16MP	7259-11465	1 5/8-12	1-11 1/2	.79
20MJ-20MP	7259-10465	1 5/8-12	1 1/4-11 1/2	.79
20MJ-24MP	7259-34575	1 5/8-12	1 1/2-11 1/2	.99
24MJ-16MP	7259-07125	1 7/8-12	1-11 1/2	1.40
24MJ-20MP	7259-34585	1 7/8-12	1 1/4-11 1/2	.99
24MJ-24MP	7259-11245	1 7/8-12	1 1/2-11 1/2	.89
24MJ-32MP	7259-09375	1 7/8-12	2-11 1/2	1.80
32MJ-16MP	7259-09385	2 1/2-12	1-11 1/2	1.66
32MJ-20MP	7259-09395	2 1/2-12	1 1/4-11 1/2	1.78
32MJ-24MP	7259-34595	2 1/2-12	1 1/2-11 1/2	1.80
32MJ-32MP	7259-11365	2 1/2-12	2-11 1/2	1.98

HOSE
HOSE/CPLG. SELECTION
G8K COUPLINGS
GLOBALSPIRAL COUPLINGS
PCM / PCS FERRULES
MEGACRIMP COUPLINGS
STAINLESS STEEL
POWER CRIMP COUPLINGS
LOC. GL AND GLP COUPLINGS
POLARSEAL COUPLINGS
POLARSEAL II COUPLINGS
C14 COUPLINGS
PCTS THERMOPLASTIC COUPLINGS
FIELD ATTACHABLE G1 & G2 COUPLINGS
FIELD ATTACHABLE C5 & C5E COUPLINGS
SURELOK AIR BRAKE COUPLINGS
ADAPTERS
QUICK DISCONNECT COUPLERS
LIVE SWIVEL
BALL VALVES
ACCESSORIES
EQUIPMENT AND PARTS



SAE to SAE

Male JIC 37° Flare to Male Pipe NPTF - 45°

For use up to SAE 100R2 maximum working pressure.

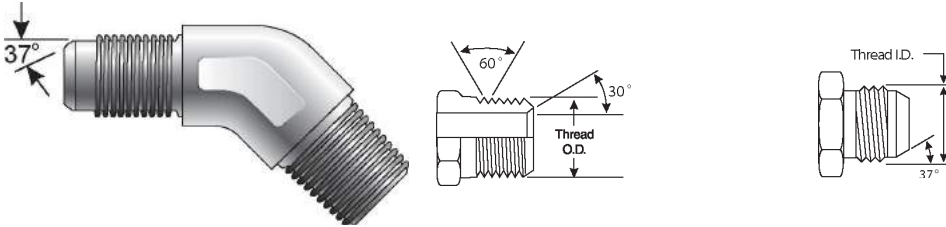

Descr.	Prod. No.			Weight (Lbs.)
2MJ-2MP45	7259-09415	5/16-24	1/8-27	.03
3MJ-2MP45	7259-77975	3/8-24	1/8-27	.05
4MJ-2MP45	7259-10505	7/16-20	1/8-27	.04
4MJ-4MP45	7259-10825	7/16-20	1/4-18	.07
4MJ-6MP45	7259-34605	7/16-20	3/8-18	.11
4MJ-8MP45	7259-09425	7/16-20	1/2-14	.15
5MJ-2MP45	7259-11635	1/2-20	1/8-27	.07
5MJ-4MP45	7259-11265	1/2-20	1/4-18	.07
5MJ-6MP45	7259-07685	1/2-20	3/8-18	.12
6MJ-2MP45	7259-77985	9/16-18	1/8-27	.07
6MJ-4MP45	7259-10925	9/16-18	1/4-18	.07
6MJ-6MP45	7259-10715	9/16-18	3/8-18	.11
6MJ-8MP45	7259-11135	9/16-18	1/2-14	.08
6MJ-12MP45	7259-07315	9/16-18	3/4-14	.28
8MJ-4MP45	7259-77995	3/4-16	1/4-18	.13
8MJ-6MP45	7259-10695	3/4-16	3/8-18	.15
8MJ-8MP45	7259-10495	3/4-16	1/2-14	.22
8MJ-12MP45	7259-11395	3/4-16	3/4-14	.26
10MJ-6MP45	7259-11505	7/8-14	3/8-18	.20
10MJ-8MP45	7259-10395	7/8-14	1/2-14	.21
10MJ-12MP45	7259-34615	7/8-14	3/4-14	.31
12MJ-8MP45	7259-11375	1 1/16-12	1/2-14	.33
12MJ-12MP45	7259-10845	1 1/16-12	3/4-14	.36
12MJ-16MP45	7259-05775	1 1/16-12	1-11 1/2	.66
14MJ-12MP45	7259-09885	1 3/16-12	3/4-14	.70
16MJ-8MP45	7259-09435	1 5/16-12	1/2-14	.51
16MJ-12MP45	7259-11585	1 5/16-12	3/4-14	.52
16MJ-16MP45	7259-11035	1 5/16-12	1-11 1/2	.56
16MJ-20MP45	7259-07845	1 5/16-12	1 1/4-11 1/2	.88
20MJ-16MP45	7259-07985	1 5/8-12	1-11 1/2	.99
20MJ-20MP45	7259-11485	1 5/8-12	1 1/4-11 1/2	.87
20MJ-24MP45	7259-08105	1 5/8-12	1 1/2-11 1/2	1.05
24MJ-24MP45	7259-11695	1 7/8-12	1 1/2-11 1/2	.90
32MJ-32MP45	7259-11675	2 1/2-12	2-11 1/2	2.79

- HOSE
- HOSE/CPLG. SELECTION
- G8K COUPLINGS
- GLOBAL SPIRAL COUPLINGS
- PCM / PCS FERRULES
- MEGACRIMP COUPLINGS
- STAINLESS STEEL
- POWER CRIMP COUPLINGS
- LOC, GL AND GLP COUPLINGS
- POLARSEAL COUPLINGS
- POLARSEAL II COUPLINGS
- C14 COUPLINGS
- PCTS THERMOPLASTIC COUPLINGS
- FIELD ATTACHABLE G1 & G2 COUPLINGS
- FIELD ATTACHABLE C5 & C5E COUPLINGS
- SURELOK AIR BRAKE COUPLINGS
- ADAPTERS
- QUICK DISCONNECT COUPLERS
- LIVE SWIVEL
- BALL VALVES
- ACCESSORIES
- EQUIPMENT AND PARTS



SAE to SAE

Male JIC 37° Flare to Male Pipe NPTF - 90°

For use up to SAE 100R2 maximum working pressure.

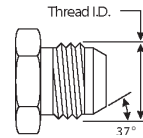
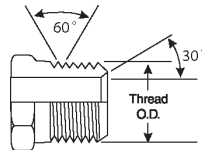

Descr.	Prod. No.			Weight (Lbs.)
		"	"	
2MJ-2MP90	7259-11755	5/16-24	1/8-27	.04
3MJ-2MP90	7259-78005	3/8-24	1/8-27	.05
4MJ-2MP90	7259-10175	7/16-20	1/8-27	.06
4MJ-4MP90	7259-10195	7/16-20	1/4-18	.10
4MJ-6MP90	7259-34645	7/16-20	3/8-18	.17
4MJ-8MP90	7259-09815	7/16-20	1/2-14	.25
4MJ-12MP90	7259-07695	7/16-20	3/4-14	.46
5MJ-2MP90	7259-11425	1/2-20	1/8-27	.07
5MJ-4MP90	7259-11045	1/2-20	1/4-18	.10
5MJ-6MP90	7259-34655	1/2-20	3/8-18	.17
6MJ-2MP90	7259-11085	9/16-18	1/8-27	.09
6MJ-4MP90	7259-28385	9/16-18	1/4-18	.10
6MJ-6MP90	7259-28185	9/16-18	3/8-18	.20
6MJ-8MP90	7259-10185	9/16-18	1/2-14	.24
6MJ-12MP90	7259-05545	9/16-18	3/4-14	.44
8MJ-4MP90	7259-11025	3/4-16	1/4-18	.20
8MJ-6MP90	7259-10165	3/4-16	3/8-18	.20
8MJ-8MP90	7259-28205	3/4-16	1/2-14	.28
8MJ-12MP90	7259-10275	3/4-16	3/4-14	.44
8MJ-16MP90	7259-07575	3/4-16	1-11 1/2	.55
10MJ-6MP90	7259-11195	7/8-14	3/8-18	.29
10MJ-8MP90	7259-28375	7/8-14	1/2-14	.30
10MJ-12MP90	7259-10555	7/8-14	3/4-14	.42
10MJ-16MP90	7259-07705	7/8-14	1-11 1/2	.71
12MJ-6MP90	7259-07995	1 1/16-12	3/8-18	.46
12MJ-8MP90	7259-10795	1 1/16-12	1/2-14	.83
12MJ-12MP90	7259-28395	1 1/16-12	3/4-14	.49
12MJ-16MP90	7259-34665	1 1/16-12	1-11 1/2	.75
12MJ-20MP90	7259-06835	1 1/16-12	1 1/4-11 1/2	1.32
14MJ-8MP90	7259-09445	1 3/16-12	1/2-14	.79
14MJ-12MP90	7259-07585	1 3/16-12	3/4-14	.72
16MJ-8MP90	7259-09455	1 5/16-12	1/2-14	.84
16MJ-12MP90	7259-11205	1 5/16-12	3/4-14	.84
16MJ-16MP90	7259-28405	1 5/16-12	1-11 1/2	.74
16MJ-20MP90	7259-34675	1 5/16-12	1 1/4-11 1/2	1.22
16MJ-24MP90	7259-07715	1 5/16-12	1 1/2-11 1/2	1.71
20MJ-16MP90	7259-11565	1 5/8-12	1-11 1/2	1.43
20MJ-20MP90	7259-10905	1 5/8-12	1 1/4-11 1/2	1.30
24MJ-20MP90	7259-34695	1 7/8-12	1 1/4-11 1/2	1.83
24MJ-24MP90	7259-11445	1 7/8-12	1 1/2-11 1/2	1.69
32MJ-24MP90	7259-08335	2 1/2-12	1 1/2-11 1/2	4.18
32MJ-32MP90	7259-11685	2 1/2-12	2-11 1/2	2.98



SAE to SAE

Male JIC 37° Flare to Female Pipe NPTF

For use up to SAE 100R2 maximum working pressure.

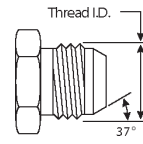
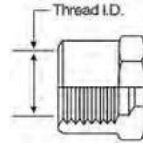
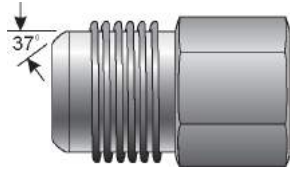

Descr.	Prod. No.			Weight (Lbs.)
		"	"	
2MJ-2FP	7259-78015	5/16-24	1/8-27	.05
3MJ-2FP	7259-08515	3/8-24	1/8-27	.04
3MJ-4FP	7259-08525	3/8-24	1/4-18	.09
4MJ-2FP	7259-11165	7/16-20	1/8-27	.04
4MJ-4FP	7259-10965	7/16-20	1/4-18	.09
4MJ-6FP	7259-06915	7/16-20	3/8-18	.20
4MJ-8FP	7259-09475	7/16-20	1/2-14	.37
5MJ-2FP	7259-11665	1/2-20	1/8-27	.04
5MJ-4FP	7259-11615	1/2-20	1/4-18	.09
6MJ-2FP	7259-09485	9/16-18	1/8-27	.07
6MJ-4FP	7259-10515	9/16-18	1/4-18	.11
6MJ-6FP	7259-10685	9/16-18	3/8-18	.13
6MJ-8FP	7259-34715	9/16-18	1/2-14	.26
8MJ-4FP	7259-09495	3/4-16	1/4-18	.14
8MJ-6FP	7259-10945	3/4-16	3/8-18	.14
8MJ-8FP	7259-10605	3/4-16	1 7/8-12	.26
8MJ-12FP	7259-34725	3/4-16	3/4-14	.56
10MJ-6FP	7259-34735	7/8-14	3/8-18	.23
10MJ-8FP	7259-10805	7/8-14	1/2-14	.28
10MJ-12FP	7259-34745	7/8-14	3/4-14	.41
12MJ-8FP	7259-34755	1 1/16-12	1/2-14	.33
12MJ-12FP	7259-10675	1 1/16-12	3/4-14	.40
12MJ-16FP	7259-06655	1 1/16-12	1-11 1/2	1.05
14MJ-12FP	7259-08345	1 3/16-12	3/4-14	.46
16MJ-12FP	7259-07005	1 5/16-12	3/4-14	.45
16MJ-16FP	7259-10985	1 5/16-12	1-11 1/2	.72
16MJ-20FP	7259-34765	1 5/16-12	1 1/4-11 1/2	.72
20MJ-16FP	7259-08535	1 5/8-12	1-11 1/2	.78
20MJ-20FP	7259-25925	1 5/8-12	1 1/4-11 1/2	.99
24MJ-24FP	7259-25935	1 7/8-12	1 1/2-11 1/2	1.44
32MJ-32FP	7259-34775	2 1/2-12	2-11 1/2	2.65

HOSE

HOSE/CPLG. SELECTION

G8K COUPLINGS

GLOBALSPIRAL COUPLINGS

PCM / PCS FERRULES

MEGACRIMP COUPLINGS

STAINLESS STEEL

POWER CRIMP COUPLINGS

LOC. GL AND GLP COUPLINGS

POLARSEAL COUPLINGS

POLARSEAL II COUPLINGS

C14 COUPLINGS

PCTS THERMOPLASTIC COUPLINGS

FIELD ATTACHABLE G1 & G2 COUPLINGS

FIELD ATTACHABLE C5 & C5E COUPLINGS

SURELOK AIR BRAKE COUPLINGS

ADAPTERS

QUICK DISCONNECT COUPLERS

LIVE SWIVEL

BALL VALVES

ACCESSORIES

EQUIPMENT AND PARTS

R35



SAE to SAE

Male JIC 37° Flare to Female Pipe NPTF - 90°

For use up to SAE 100R2 maximum working pressure.

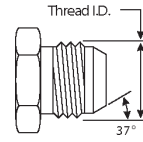
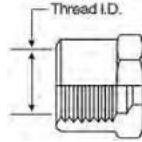
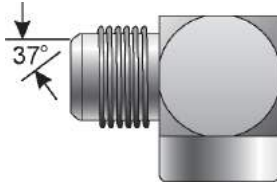

Descr.	Prod. No.			Weight (Lbs.)
		"	"	
4MJ-2FP90	7259-25105	7/16-20	1/8-27	.08
4MJ-4FP90	7259-34785	7/16-20	1/4-18	.17
5MJ-2FP90	7259-07365	1/2-20	1/8-27	.08
5MJ-4FP90	7259-34805	1/2-20	1/4-18	.17
6MJ-2FP90	7259-09505	9/16-18	1/8-27	.09
6MJ-4FP90	7259-25115	9/16-18	1/4-18	.26
6MJ-6FP90	7259-34825	9/16-18	3/8-18	.25
6MJ-8FP90	7259-00405	9/16-18	1/2-14	.40
8MJ-4FP90	7259-09515	3/4-16	1/4-18	.32
8MJ-6FP90	7259-25125	3/4-16	3/8-18	.25
8MJ-8FP90	7259-34835	3/4-16	1/2-14	.39
10MJ-8FP90	7259-25135	7/8-14	1/2-14	.41
12MJ-8FP90	7259-34845	1 1/16-12	1/2-14	.86
12MJ-12FP90	7259-25145	1 1/16-12	3/4-14	.72
14MJ-12FP90	7259-09525	1 3/16-12	3/4-14	.72
16MJ-16FP90	7259-25155	1 5/16-12	1-11 1/2	1.40
20MJ-20FP90	7259-34855	1 5/8-12	1 1/4-11 1/2	1.55
24MJ-24FP90	7259-07725	1 7/8-12	1 1/2-11 1/2	4.13

Female JIC 37° Flare Swivel to Male Pipe NPTF

For use up to SAE 100R2 maximum working pressure.

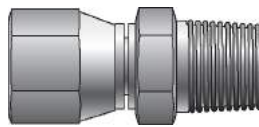

Descr.	Prod. No.			Weight (Lbs.)
		"	"	
4FJX-2MP	7253-34865	7/16-20	1/8-27	.04
4FJX-4MP	7259-34875	7/16-20	1/4-18	.07
6FJX-4MP	7259-34885	9/16-18	1/4-18	.08
6FJX-6MP	7259-34895	9/16-18	3/8-18	.11
8FJX-6MP	7259-34905	3/4-16	3/8-18	.15
8FJX-8MP	7259-34915	3/4-16	1/2-14	.15
10FJX-8MP	7259-09565	7/8-14	1/2-14	.26
12FJX-8MP	7259-51055	1 1/16-12	1/2-14	.36
12FJX-12MP	7259-34925	1 1/16-12	3/4-14	.34
16FJX-16MP	7253-34935	1 5/16-12	1-11 1/2	.60
20FJX-20MP	7259-34945	1 5/8-12	1 1/4-11 1/2	.86



SAE to SAE

Female JIC 37° Flare Swivel to Male Pipe NPTF - 90°

For use up to SAE 100R2 maximum working pressure.

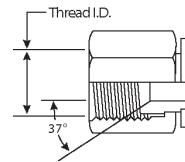
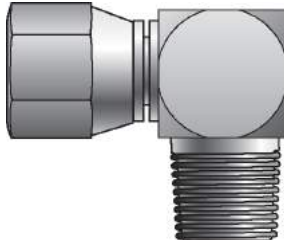

Descr.	Prod. No.			Weight (Lbs.)
		"	"	
4FJX-2MP90	7253-34955	7/16-20	1/8-27	.08
4FJX-4MP90	7259-05325	7/16-20	1/4-18	.10
6FJX-4MP90	7253-34965	9/16-18	1/4-18	.14
6FJX-6MP90	7253-34975	9/16-18	3/8-18	.20
8FJX-6MP90	7253-34985	3/4-16	3/8-18	.25
8FJX-8MP90	7253-34995	3/4-16	1/2-14	.32
10FJX-8MP90	7253-35015	7/8-14	1/2-14	.34
12FJX-12MP90	7253-35025	1 1/16-12	3/4-14	.58
16FJX-16MP90	7259-35285	1 5/16-12	1-11 1/2	.88
20FJX-20MP90	7259-35295	1 5/8-12	1 1/4-11 1/2	1.50
24FJX-24MP90	7259-35035	1 7/8-12	1 1/2-11 1/2	2.10

Female JIC 37° Flare Swivel to Female Pipe NPTF

For use up to SAE 100R2 maximum working pressure.

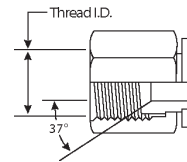
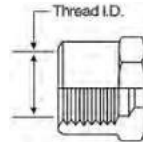
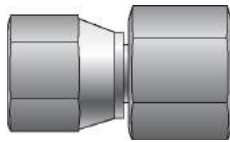

Descr.	Prod. No.			Weight (Lbs.)
		"	"	
4FJX-2FP	7253-35045	7/16-20	1/8-27	.06
4FJX-4FP	7253-35055	7/16-20	1/4-18	.10
6FJX-6FP	7253-35075	9/16-18	3/8-18	.14
8FJX-6FP	7253-35095	3/4-16	3/8-18	.15
8FJX-8FP	7253-35105	3/4-16	1/2-14	.28
10FJX-8FP	7253-35115	7/8-14	1/2-14	.30
12FJX-12FP	7253-35125	1 1/16-12	3/4-14	.46
16FJX-16FP	7259-35135	1 5/16-12	1-11 1/2	.75
20FJX-20FP	7259-35145	1 5/8-12	1 1/4-11 1/2	1.26

HOSE

HOSE/CPLG. SELECTION

G8K COUPLINGS

GLOBALSPIRAL COUPLINGS

PCM / PCS FERRULES

MEGACRIMP COUPLINGS

STAINLESS STEEL

POWER CRIMP COUPLINGS

LOC. GL AND GLP COUPLINGS

POLARSEAL COUPLINGS

POLARSEAL II COUPLINGS

C14 COUPLINGS

PCTS THERMOPLASTIC COUPLINGS

FIELD ATTACHABLE G1 & G2 COUPLINGS

FIELD ATTACHABLE C5 & C5E COUPLINGS

SURELOK AIR BRAKE COUPLINGS

ADAPTERS

QUICK DISCONNECT COUPLERS

LIVE SWIVEL

BALL VALVES

ACCESSORIES

EQUIPMENT AND PARTS



SAE to SAE

Male JIC 37° Flare Bulkhead to Male Pipe NPTF

For use up to SAE 100R2 maximum working pressure.

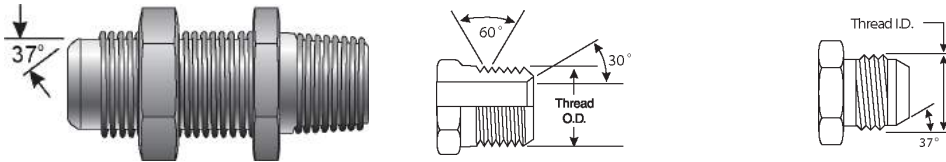

Descr.	Prod. No.			Weight (Lbs.)
		"	"	
4MJBKHD-2MP	7259-09945	7/16-20	1/8-27	.09
4MJBKHD-4MP	7259-35155	7/16-20	1/4-18	.10
6MJBKHD-4MP	7259-35165	9/16-18	1/4-18	.14
8MJBKHD-6MP	7259-35175	3/4-16	3/8-18	.24
8MJBKHD-8MP	7259-09905	3/4-16	1/2-14	.29
10MJBKHD-8MP	7259-35185	7/8-14	1/2-14	.35
12MJBKHD-8MP	7259-35275	1 1/16-12	1/2-14	.42
12MJBKHD-12MP	7259-35195	1 1/16-12	3/4-14	.60
16MJBKHD-16MP	7253-35205	1 5/16-12	1-11 1/2	.80
20MJBKHD-20MP	7259-09965	1 5/8-12	1 1/4-11 1/2	.93

Male JIC 37° Flare on Run to Male Pipe NPTF - Tee

For use up to SAE 100R2 maximum working pressure.

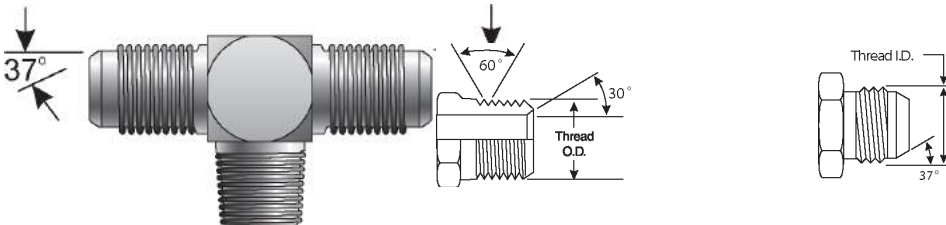

Descr.	Prod. No.				Weight (Lbs.)
		"	"	"	
3MJ-3MJ-2MP	7259-09605	3/8-24	3/8-24	1/8-27	.06
4MJ-4MJ-2MP	7259-23415	7/16-20	7/16-20	1/8-27	.07
4MJ-4MJ-4MP	7259-35215	7/16-20	7/16-20	1/4-18	.12
4MJ-4MJ-6MP	7259-05855	7/16-20	3/8-18	3/8-18	.19
5MJ-5MJ-2MP	7259-07385	1/2-20	1/2-20	1/8-27	.10
5MJ-5MJ-4MP	7259-35225	1/2-20	1/2-20	1/4-18	.13
6MJ-6MJ-4MP	7259-23425	9/16-18	9/16-18	1/4-18	.13
6MJ-6MJ-6MP	7259-35235	9/16-18	9/16-18	3/8-18	.29
6MJ-6MJ-8MP	7259-35245	9/16-18	9/16-18	1/2-14	.30
8MJ-8MJ-6MP	7259-23435	3/4-16	3/4-16	3/8-18	.32
8MJ-8MJ-8MP	7259-35255	3/4-16	3/4-16	1/2-14	.35
8MJ-8MJ-12MP	7259-09615	3/4-16	3/4-16	3/4-14	.57
10MJ-10MJ-8MP	7259-23445	7/8-14	7/8-14	1/2-14	.38
12MJ-12MJ-8MP	7259-07395	1 1/16-12	1 1/16-12	1/2-14	.63
12MJ-12MJ-12MP	7259-23455	1 1/16-12	1 1/16-12	3/4-14	.61
12MJ-12MJ-16MP	7259-07735	1 1/16-12	1 1/16-12	1-11 1/2	.97
14MJ-14MJ-12MP	7259-09625	1 3/16-12	1 3/16-12	3/4-14	.99
16MJ-16MJ-12MP	7259-09635	1 5/16-12	1 5/16-12	3/4-14	1.13



SAE to SAE

Male JIC 37° Flare on Run to Male Pipe NPTF - Tee - Continued

Descr.	Prod. No.				Weight (Lbs.)
		"	"	"	
16MJ-16MJ-16MP	7259-23465	1 5/16-12	1 5/16-12	1-11 1/2	.92
20MJ-20MJ-20MP	7259-35265	1 5/8-12	1 5/8-12	1 5/8-12	1.76
24MJ-24MJ-24MP	7259-08355	1 7/8-12	1 7/8-12	1 1/2-11 1/2	2.65

Female Flat-Face O-Ring Cap

For use up to SAE 100R2 maximum working pressure.

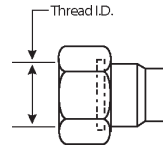
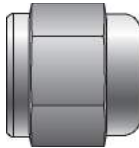

Descr.	Prod. No.			Weight (Lbs.)
		"	"	
4FFOR-CAP	7253-32125	9/16-18		.04
6FFOR-CAP	7253-32135	11/16-16		.08
8FFOR-CAP	7253-32145	13/16-16		.12
10FFOR-CAP	7253-32155	1-14		.14
12FFOR-CAP	7253-32165	1 3/16-12		.26
16FFOR-CAP	7253-32175	1 7/16-12		.37
20FFOR-CAP	7253-32185	1 11/16-12		.54
24FFOR-CAP	7253-32195	2-12		.81

Male Flat-Face O-Ring Plug

For use up to SAE 100R2 maximum working pressure.

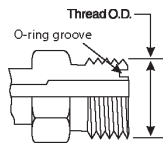
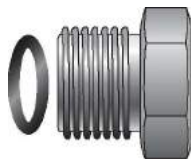

Descr.	Prod. No.			Weight (Lbs.)
		"	"	
4MFFOR-PLUG	7259-32045	9/16-18		.05
6MFFOR-PLUG	7259-32055	11/16-16		.08
8MFFOR-PLUG	7259-32065	13/16-16		.11
10MFFOR-PLUG	7259-32075	1-14		.22
12MFFOR-PLUG	7259-32085	1 3/16-12		.40
16MFFOR-PLUG	7259-32095	1 7/16-12		.45
20MFFOR-PLUG	7259-32105	1 11/16-12		.58
24MFFOR-PLUG	7259-32115	2-12		1.32
32MFFOR-PLUG	7259-09655	2 1/2-12		1.26

- HOSE
- HOSE/CPLG. SELECTION
- G8K COUPLINGS
- GLOBAL SPIRAL COUPLINGS
- PCM / PCS FERRULES
- MEGACRIMP COUPLINGS
- STAINLESS STEEL
- POWER CRIMP COUPLINGS
- LOC, GL AND GLP COUPLINGS
- POLARSEAL COUPLINGS
- POLARSEAL II COUPLINGS
- C14 COUPLINGS
- PCTS THERMOPLASTIC COUPLINGS
- FIELD ATTACHABLE G1 & G2 COUPLINGS
- FIELD ATTACHABLE C5 & C5E COUPLINGS
- SURELOK AIR BRAKE COUPLINGS
- ADAPTERS
- QUICK DISCONNECT COUPLERS
- LIVE SWIVEL
- BALL VALVES
- ACCESSORIES
- EQUIPMENT AND PARTS



SAE to SAE

Male Flat-Face O-Ring to Male Flat-Face O-Ring

For use up to SAE 100R2 maximum working pressure.

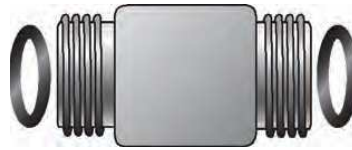

Descr.	Prod. No.			Weight (Lbs.)
		"	"	
4MFFOR-4MFFOR	7259-43965	9/16-18	9/16-18	.07
6MFFOR-4MFFOR	7259-43975	11/16-16	9/16-18	.10
6MFFOR-6MFFOR	7259-43985	11/16-16	11/16-16	.11
10MFFOR-10MFFOR	7259-44025	1-14	1-14	.28
12MFFOR-12MFFOR	7259-44045	1 3/16-12	1 3/16-12	.35
16MFFOR-16MFFOR	7259-44065	1 7/16-12	1 7/16-12	.61
20MFFOR-20MFFOR	7259-44075	1 11/16-12	1 11/16-12	.40
24MFFOR-24MFFOR	7259-44085	2-12	2-12	.40

Male Flat-Face O-Ring to Male Flat-Face O-Ring - 90°

For use up to SAE 100R2 maximum working pressure.



Descr.	Prod. No.			Weight (Lbs.)
		"	"	
4MFFOR-4MFFOR90	7259-44105	9/16-18		.08
8MFFOR-8MFFOR90	7259-44125	13/16-16		.22

- HOSE
- HOSE/CPLG. SELECTION
- G8K COUPLINGS
- GLOBAL SPIRAL COUPLINGS
- PCM / PCS FERRULES
- MEGACRIMP COUPLINGS
- STAINLESS STEEL
- POWER CRIMP COUPLINGS
- LOC. GL AND GLP COUPLINGS
- POLARSEAL COUPLINGS
- POLARSEAL II COUPLINGS
- C14 COUPLINGS
- PCTS THERMOPLASTIC COUPLINGS
- FIELD ATTACHABLE G1 & G2 COUPLINGS
- FIELD ATTACHABLE C5 & C5E COUPLINGS
- SURELOK AIR BRAKE COUPLINGS
- ADAPTERS
- QUICK DISCONNECT COUPLERS
- LIVE SWIVEL
- BALL VALVES
- ACCESSORIES
- EQUIPMENT AND PARTS



SAE to SAE

Male Flat-Face O-Ring to Female Flat-Face Swivel - 90°

For use up to SAE 100R2 maximum working pressure.

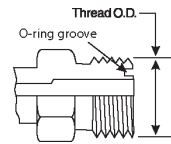
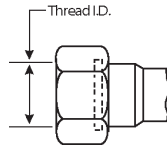
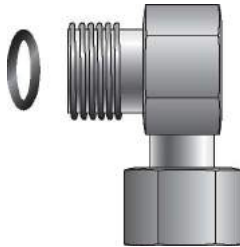

Descr.	Prod. No.			Weight (Lbs.)
		"	"	
4MFFOR-4FFORX90	7259-06075	9/16-18	9/16-18	.13
6MFFOR-6FFORX90	7259-31905	11/16-16	11/16-16	.22
8MFFOR-8FFORX90	7259-00345	13/16-16	13/16-16	.28
10MFFOR-10FFORX90	7259-05585	1-14	1-14	.57
12MFFOR-12FFORX90	7259-06085	1 3/16-12	1 3/16-12	.79
16MFFOR-16FFORX90	7259-05285	1 7/16-12	1 7/16-12	1.21
20MFFOR-20FFORX90	7259-09665	1 11/16-12	1 11/16-12	1.98
24MFFOR-24FFORX90	7259-09675	2-12	2-12	2.25

Male Flat-Face O-Ring Tee

For use up to SAE 100R2 maximum working pressure.



Descr.	Prod. No.			Weight (Lbs.)
		"	"	
4MFFOR-4MFFOR-4MFFOR	7259-04805	9/16-18		.14
6MFFOR-6MFFOR-6MFFOR	7259-04815	11/16-16		.25
8MFFOR-8MFFOR-8MFFOR	7259-04825	13/16-16		.30
10MFFOR-10MFFOR-10MFFOR	7259-04835	1-14		.64
12MFFOR-12MFFOR-12MFFOR	7259-04845	1 3/16-12		.86
16MFFOR-16MFFOR-16MFFOR	7259-04855	1 7/16-12		1.35
20MFFOR-20MFFOR-20MFFOR	7259-04865	1 11/16-12		1.65

- HOSE
- HOSE/CPLG. SELECTION
- G8K COUPLINGS
- GLOBALSPIRAL COUPLINGS
- PCM / PCS FERRULES
- MEGACRIMP COUPLINGS
- STAINLESS STEEL
- POWER CRIMP COUPLINGS
- LOC, GL AND GLP COUPLINGS
- POLARSEAL COUPLINGS
- POLARSEAL II COUPLINGS
- C14 COUPLINGS
- PCTS THERMOPLASTIC COUPLINGS
- FIELD ATTACHABLE G1 & G2 COUPLINGS
- FIELD ATTACHABLE C5 & C5E COUPLINGS
- SURELOK AIR BRAKE COUPLINGS
- ADAPTERS
- QUICK DISCONNECT COUPLERS
- LIVE SWIVEL
- BALL VALVES
- ACCESSORIES
- EQUIPMENT AND PARTS



SAE to SAE

- HOSE
- HOSE/CPLG. SELECTION
- G8K COUPLINGS
- GLOBAL SPIRAL COUPLINGS
- PCM / PCS FERRULES
- MEGACRIMP COUPLINGS
- STAINLESS STEEL
- POWER CRIMP COUPLINGS
- LOC. GL AND GLP COUPLINGS
- POLARSEAL COUPLINGS
- POLARSEAL II COUPLINGS
- C14 COUPLINGS
- PCTS THERMOPLASTIC COUPLINGS
- FIELD ATTACHABLE G1 & G2 COUPLINGS
- FIELD ATTACHABLE C5 & C5E COUPLINGS
- SURELOK AIR BRAKE COUPLINGS
- ADAPTERS
- QUICK DISCONNECT COUPLERS
- LIVE SWIVEL
- BALL VALVES
- ACCESSORIES
- EQUIPMENT AND PARTS

Male Flat-Face O-Ring on Run to Female Flat-Face Swivel - Tee

For use up to SAE 100R2 maximum working pressure.

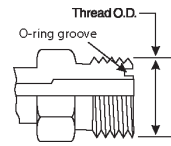
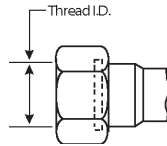
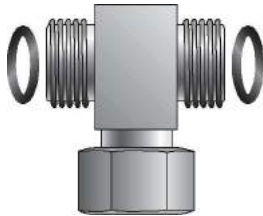

Descr.	Prod. No.			Weight (Lbs.)
		"	"	
4MFFOR-4MFFOR-4FFORX	7259-31805	9/16-18	9/16-18	.20
6MFFOR-6MFFOR-6FFORX	7259-31815	11/16-16	11/16-16	.29
8MFFOR-8MFFOR-8FFORX	7259-31825	13/16-16	13/16-16	.40
10MFFOR-10MFFOR-10FFORX	7259-09685	1-14	1-14	.68
12MFFOR-12MFFOR-12FFORX	7259-09695	1 3/16-12	1 3/16-12	1.03
16MFFOR-16MFFOR-16FFORX	7259-09705	1 1/16-12	7/16-20	1.40
20MFFOR-20MFFOR-20FFORX	7259-09715	1 11/16-12	1 11/16-12	2.00

Male Flat-Face O-Ring to Female Flat-Face O-Ring to Male Flat-Face O-Ring - Tee

For use up to SAE 100R2 maximum working pressure.

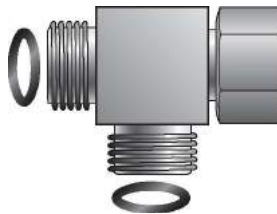

Descr.	Prod. No.			Weight (Lbs.)
		"	"	
4MFFOR-4FFORX-4MFFOR	7259-00265	9/16-18	9/16-18	.17
6MFFOR-6FFORX-6MFFOR	7259-00135	11/16-16	11/16-16	.29
8MFFOR-8FFORX-8MFFOR	7259-00225	13/16-16	13/16-16	.35
10MFFOR-10FFORX-10MFFOR	7259-06815	1-14	1-14	.69
12MFFOR-12FFORX-12MFFOR	7259-00555	1 3/16-12	1 3/16-12	1.03
16MFFOR-16FFORX-16MFFOR	7259-06025	1 7/16-12	1 7/16-12	1.50
20MFFOR-20FFORX-20MFFOR	7259-04785	1 11/16-12	1 11/16-12	1.98



SAE to SAE

Male Flat-Face O-Ring to Male Pipe NPTF

For use up to SAE 100R2 maximum working pressure.

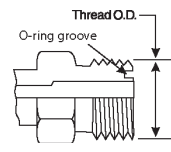
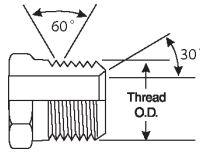
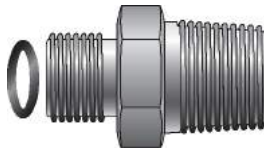

Descr.	Prod. No.			Weight (Lbs.)
		"	"	
4MFFOR-2MP	7259-30615	9/16-18	1/8-27	.06
4MFFOR-4MP	7259-30625	9/16-18	1/4-18	.07
4MFFOR-6MP	7259-30635	9/16-18	3/8-18	.10
6MFFOR-4MP	7259-30645	11/16-16	1/4-18	.10
6MFFOR-6MP	7259-30655	11/16-16	3/8-18	.10
6MFFOR-8MP	7259-30665	11/16-16	1/2-14	.14
8MFFOR-4MP	7259-09845	13/16-16	1/4-18	.14
8MFFOR-6MP	7259-30675	13/16-16	3/8-18	.14
8MFFOR-8MP	7259-30685	13/16-16	1/2-14	.16
8MFFOR-12MP	7259-06845	13/16-16	3/4-14	.24
10MFFOR-8MP	7259-30695	1-14	1/2-14	.24
10MFFOR-12MP	7259-06755	1-14	3/4-14	.30
12MFFOR-8MP	7259-06035	1 3/16-12	1/2-14	.40
12MFFOR-12MP	7259-30705	1 3/16-12	3/4-14	.36
12MFFOR-16MP	7259-08115	1 3/16-12	1-11 1/2	.44
16MFFOR-12MP	7259-07075	1 7/16-12	3/4-14	.47
16MFFOR-16MP	7259-30715	1 7/16-12	1-11 1/2	.57
20MFFOR-20MP	7259-30725	1 11/16-12	1 1/4-11 1/2	.99
24MFFOR-24MP	7259-07595	2-12	1 1/2-11 1/2	1.13

Male Flat-Face O-Ring to Female JIC 37° Flare Swivel

For use up to SAE 100R2 maximum working pressure.

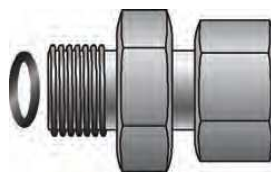

Descr.	Prod. No.			Weight (Lbs.)
		"	"	
4MFFOR-4FJX	7259-09995	9/16-18	7/16-20	.08
6MFFOR-6FJX	7259-05135	11/16-16	9/16-18	.14
8MFFOR-8FJX	7259-05365	13/16-16	3/4-16	.18
10MFFOR-10FJX	7259-06335	1-14	7/8-14	.28
12MFFOR-12FJX	7259-05215	1 3/16-12	1 1/16-12	.47
16MFFOR-16FJX	7259-06765	1 7/16-12	1 5/16-12	.64

- HOSE
- HOSE/CPLG. SELECTION
- G8K COUPLINGS
- GLOBAL SPIRAL COUPLINGS
- PCM / PCS FERRULES
- MEGACRIMP COUPLINGS
- STAINLESS STEEL
- POWER CRIMP COUPLINGS
- LOC, GL AND GLP COUPLINGS
- POLARSEAL COUPLINGS
- POLARSEAL II COUPLINGS
- C14 COUPLINGS
- PCTS THERMOPLASTIC COUPLINGS
- FIELD ATTACHABLE G1 & G2 COUPLINGS
- FIELD ATTACHABLE C5 & C5E COUPLINGS
- SURELOK AIR BRAKE COUPLINGS
- ADAPTERS
- QUICK DISCONNECT COUPLERS
- LIVE SWIVEL
- BALL VALVES
- ACCESSORIES
- EQUIPMENT AND PARTS



SAE to SAE

- HOSE
- HOSE/CPLG. SELECTION
- G8K COUPLINGS
- GLOBALSPIRAL COUPLINGS
- PCM / PCS FERRULES
- MEGACRIMP COUPLINGS
- STAINLESS STEEL
- POWER CRIMP COUPLINGS
- LOC. GL AND GLP COUPLINGS
- POLARSEAL COUPLINGS
- POLARSEAL II COUPLINGS
- C14 COUPLINGS
- PCTS THERMOPLASTIC COUPLINGS
- FIELD ATTACHABLE G1 & G2 COUPLINGS
- FIELD ATTACHABLE C5 & C5E COUPLINGS
- SURELOK AIR BRAKE COUPLINGS
- ADAPTERS
- QUICK DISCONNECT COUPLERS
- LIVE SWIVEL
- BALL VALVES
- ACCESSORIES
- EQUIPMENT AND PARTS

Male Flat-Face O-Ring to Male O-Ring Boss

For use up to SAE 100R2 maximum working pressure.

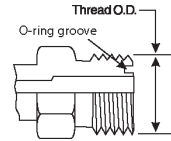
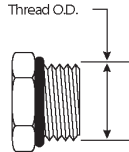

Descr.	Prod. No.			Weight (Lbs.)
		"	"	
4MFFOR-4MB	7259-30015	9/16-18	7/16-20	.07
4MFFOR-6MB	7259-29905	9/16-18	9/16-18	.08
4MFFOR-8MB	7259-30115	9/16-18	3/4-16	.12
6MFFOR-4MB	7259-30025	11/16-16	9/16-18	.11
6MFFOR-6MB	7259-00085	11/16-16	7/16-20	.10
6MFFOR-8MB	7259-29925	11/16-16	3/4-16	.15
8MFFOR-10MB	7259-30095	11/16-16	7/8-14	.20
8MFFOR-6MB	7259-30035	13/16-16	3/4-16	.14
8MFFOR-8MB	7259-29915	13/16-16	9/16-18	.15
8MFFOR-10MB	7259-30105	13/16-16	7/8-14	.22
8MFFOR-12MB	7259-30125	13/16-16	1 1/16-12	.31
8MFFOR-16MB	7259-08005	13/16-16	1 5/16-12	.45
10MFFOR-8MB	7259-00155	1-14	3/4-16	.26
10MFFOR-10MB	7259-30045	1-14	7/8-14	.26
10MFFOR-12MB	7259-00165	1-14	1 1/16-12	.36
12MFFOR-8MB	7259-30135	1 3/16-12	3/4-16	.40
12MFFOR-10MB	7259-05385	1 3/16-12	7/8-14	.44
12MFFOR-12MB	7259-30055	1 3/16-12	1 1/16-12	.40
12MFFOR-16MB	7259-30175	1 3/16-12	1 5/16-12	.52
16MFFOR-12MB	7259-30185	1 7/16-12	1 1/16-12	.79
16MFFOR-16MB	7259-50255	1 7/16-12	1 5/16-12	.56
16MFFOR-20MB	7259-00045	1 7/16-12	1 5/8-20	.73
20MFFOR-16MB	7259-30145	1 11/16-12	1 5/16-12	.87
20MFFOR-20MB	7259-30075	1 11/16-12	1 5/8-12	.88
20MFFOR-24MB	7259-09745	1 11/16-12	1 7/8-12	1.06
24MFFOR-20MB	7259-09755	2-12	1 5/8-12	1.13
32MFFOR-32MB	7259-00325	2 1/2-12	2 1/2-12	1.93

Male Flat-Face O-Ring to Male O-Ring Boss - 45°

For use up to SAE 100R2 maximum working pressure.

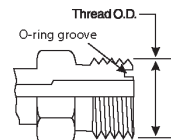
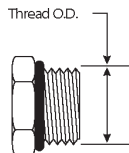
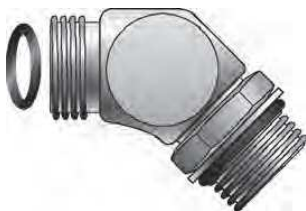

Descr.	Prod. No.			Weight (Lbs.)
		"	"	
4MFFOR-4MB45	7259-30935	9/16-18	7/16-20	.11
4MFFOR-6MB45	7259-30305	9/16-18	9/16-18	.15



SAE to SAE

Male Flat-Face O-Ring to Male O-Ring Boss - 45° - Continued

Descr.	Prod. No.			Weight (Lbs.)
		"	"	
6MFFOR-4MB45	7259-30945	11/16-16	7/16-20	.20
6MFFOR-6MB45	7259-30225	11/16-16	9/16-18	.18
6MFFOR-8MB45	7259-30955	11/16-16	3/4-16	.24
8MFFOR-6MB45	7259-30965	13/16-16	9/16-18	.20
8MFFOR-8MB45	7259-30975	13/16-16	3/4-16	.24
8MFFOR-10MB45	7259-30295	13/16-16	7/8-14	.41
8MFFOR-12MB45	7259-30985	13/16-16	1 1/16-12	.58
10MFFOR-8MB45	7259-30995	1-14	3/4-16	.40
10MFFOR-10MB45	7259-31005	1-14	7/8-14	.44
10MFFOR-12MB45	7259-31015	1-14	1 1/16-12	.65
12MFFOR-10MB45	7259-31025	1 3/16-12	7/8-14	.55
12MFFOR-12MB45	7259-31035	1 3/16-12	1 1/16-12	.70
12MFFOR-16MB45	7259-31045	1 3/16-12	1 5/16-12	.87
16MFFOR-12MB45	7259-31055	1 7/16-12	1 1/16-12	.94
16MFFOR-16MB45	7259-31065	1 7/16-12	1 5/16-12	1.00
16MFFOR-20MB45	7259-31075	1 7/16-12	1 5/8-12	1.30
20MFFOR-20MB45	7259-31085	1 11/16-12	1 5/8-12	1.85
24MFFOR-24MB45	7259-31095	2-12	1 7/8-12	1.83

Male Flat-Face O-Ring to Male O-Ring Boss - 90°

For use up to SAE 100R2 maximum working pressure.

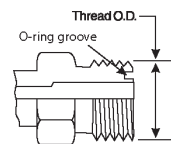
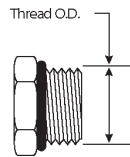

Descr.	Prod. No.			Weight (Lbs.)
		"	"	
4MFFOR-4MB90	7259-30415	9/16-18	7/16-20	.13
4MFFOR-6MB90	7259-30735	9/16-18	9/16-18	.15
4MFFOR-8MB90	7259-30745	9/16-18	3/4-16	.27
6MFFOR-4MB90	7259-30495	11/16-16	7/16-20	.22
6MFFOR-6MB90	7259-30425	11/16-16	9/16-18	.24
6MFFOR-8MB90	7259-30755	11/16-16	3/4-16	.28
6MFFOR-12MB90	7259-30765	11/16-16	1 1/16-12	.72
8MFFOR-6MB90	7259-66215	13/16-16	9/16-18	.24
8MFFOR-8MB90	7259-30435	13/16-16	3/4-16	.30
8MFFOR-10MB90	7259-30515	13/16-16	7/8-14	.44
8MFFOR-12MB90	7259-30525	13/16-16	1 1/16-12	.82
10MFFOR-8MB90	7259-30555	1-14	3/4-16	.50
10MFFOR-10MB90	7259-30445	1-14	7/8-14	.57
10MFFOR-12MB90	7259-30775	1-14	1 1/16-12	.84
12MFFOR-8MB90	7259-30785	1 3/16-12	3/4-16	.71
12MFFOR-10MB90	7259-30795	1 3/16-12	7/8-14	.73
12MFFOR-12MB90	7259-30455	1 3/16-12	1 1/16-12	.86
12MFFOR-16MB90	7259-30805	1 3/16-12	1 5/16-12	1.40
16MFFOR-12MB90	7259-30545	1 7/16-12	1 1/16-12	1.40

- HOSE
- HOSE/CPLG. SELECTION
- G8K COUPLINGS
- GLOBAL SPIRAL COUPLINGS
- PCM / PCS FERRULES
- MEGACRIMP COUPLINGS
- STAINLESS STEEL
- POWER CRIMP COUPLINGS
- LOC, GL AND GLP COUPLINGS
- POLARSEAL COUPLINGS
- POLARSEAL II COUPLINGS
- C14 COUPLINGS
- PCTS THERMOPLASTIC COUPLINGS
- FIELD ATTACHABLE G1 & G2 COUPLINGS
- FIELD ATTACHABLE C5 & C5E COUPLINGS
- SURELOK AIR BRAKE COUPLINGS
- ADAPTERS
- QUICK DISCONNECT COUPLERS
- LIVE SWIVEL
- BALL VALVES
- ACCESSORIES
- EQUIPMENT AND PARTS



SAE to SAE

- HOSE
- HOSE/CPLG. SELECTION
- G8K COUPLINGS
- GLOBAL SPIRAL COUPLINGS
- PCM / PCS FERRULES
- MEGACRIMP COUPLINGS
- STAINLESS STEEL
- POWER CRIMP COUPLINGS
- LOC. GL AND GLP COUPLINGS
- POLARSEAL COUPLINGS
- POLARSEAL II COUPLINGS
- C14 COUPLINGS
- PCTS THERMOPLASTIC COUPLINGS
- FIELD ATTACHABLE G1 & G2 COUPLINGS
- FIELD ATTACHABLE C5 & C5E COUPLINGS
- SURELOK AIR BRAKE COUPLINGS
- ADAPTERS
- QUICK DISCONNECT COUPLERS
- LIVE SWIVEL
- BALL VALVES
- ACCESSORIES
- EQUIPMENT AND PARTS

Male Flat-Face O-Ring to Male O-Ring Boss - 90° - Continued

Descr.	Prod. No.			Weight (Lbs.)
		"	"	
16MFFOR-16MB90	7259-30465	1 7/16-12	1 5/16-12	1.28
16MFFOR-20MB90	7259-30815	1 7/16-12	1 5/8-12	1.75
20MFFOR-16MB90	7259-30825	1 11/16-12	1 5/16-12	1.70
20MFFOR-20MB90	7259-30475	1 11/16-12	1 5/8-12	1.80
20MFFOR-24MB90	7259-30835	1 11/16-12	1 7/8-12	2.24
24MFFOR-20MB90	7259-30845	2-12	1 5/8-12	2.16
24MFFOR-24MB90	7259-30855	2-12	1 7/8-12	2.46

Male Flat-Face O-Ring to Male O-Ring Boss - 90° Long Drop

For use up to SAE 100R2 maximum working pressure.

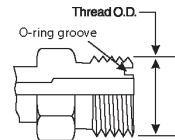
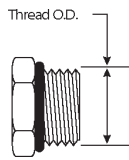

Descr.	Prod. No.			Weight (Lbs.)
		"	"	
4MFFOR-4MB90L	7259-30875	9/16-18	7/16-20	.20
6MFFOR-6MB90L	7259-30885	11/16-16	9/16-18	.40
12MFFOR-12MB90L	7259-30915	1 3/16-12	1 1/16-12	1.30
16MFFOR-16MB90L	7259-30925	1 7/16-12	1 5/16-12	2.07

Male Flat-Face O-Ring on Run to Male O-Ring Boss - Tee

For use up to SAE 100R2 maximum working pressure.

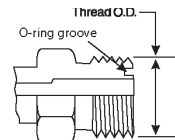
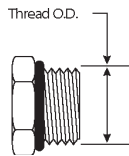

Descr.	Prod. No.				Weight (Lbs.)
		"	"	"	
4MFFOR-4MFFOR-4MB	7259-31405	9/16-18	9/16-18	7/16-20	.17
6MFFOR-6MFFOR-6MB	7259-31515	11/16-16	11/16-16	9/16-18	.26
8MFFOR-8MFFOR-8MB	7259-31415	13/16-16	13/16-16	3/4-16	.35
10MFFOR-10MFFOR-10MB	7259-31425	1-14	1-14	7/8-14	.70
12MFFOR-12MFFOR-12MB	7259-31545	1 3/16-12	1 3/16-12	1 1/16-12	1.02
16MFFOR-16MFFOR-16MB	7259-31555	1 7/16-12	1 7/16-12	1 5/16-12	1.60
20MFFOR-20MFFOR-20MB	7259-31435	1 11/16-12	1 11/16-12	1 5/8-12	1.90



SAE to SAE

Male Flat-Face O-Ring to Male O-Ring Boss to Male Flat-Face O-Ring - Tee

For use up to SAE 100R2 maximum working pressure.

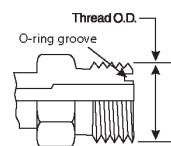
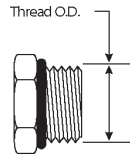

Descr.	Prod. No.				Weight (Lbs.)
		"	"	"	
4MFFOR-4MB-4MFFOR	7259-31455	9/16-18	7/16-20	9/16-18	.15
6MFFOR-6MB-6MFFOR	7259-31605	11/16-16	9/16-18	11/16-16	.28
8MFFOR-8MB-8MFFOR	7259-31465	13/16-16	3/4-16	13/16-16	.35
10MFFOR-10MB-10MFFOR	7259-31615	1-14	7/8-14	1-14	.68
12MFFOR-12MB-12MFFOR	7259-31475	1 3/16-12	1 1/16-12	1 3/16-12	1.06
16MFFOR-16MB-16MFFOR	7259-31485	1 7/16-12	1 5/16-12	1 7/16-12	1.54
20MFFOR-20MB-20MFFOR	7259-31495	1 11/16-12	1 5/8-12	1 11/16-12	1.90

Female Flat-Face Swivel to Male JIC 37° Flare

For use up to SAE 100R2 maximum working pressure.

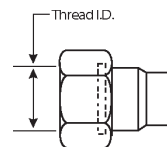
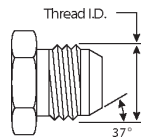
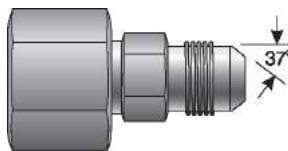

Descr.	Prod. No.			Weight (Lbs.)
		"	"	
4FFORX-4MJ	7253-31705	9/16-18	7/16-20	.06
6FFORX-6MJ	7253-31715	11/16-16	9/16-18	.13
8FFORX-8MJ	7253-31725	13/16-16	3/4-16	.14
10FFORX-10MJ	7253-31735	1-14	7/8-14	.31
12FFORX-12MJ	7253-31745	1 3/16-12	1 1/16-12	.50
16FFORX-16MJ	7253-31755	1 7/16-12	1 1/16-13	.76

- HOSE
- HOSE/CPLG. SELECTION
- G8K COUPLINGS
- GLOBALSPIRAL COUPLINGS
- PCM / PCS FERRULES
- MEGACRIMP COUPLINGS
- STAINLESS STEEL
- POWER CRIMP COUPLINGS
- LOC, GL AND GLP COUPLINGS
- POLARSEAL COUPLINGS
- POLARSEAL II COUPLINGS
- C14 COUPLINGS
- PCTS THERMOPLASTIC COUPLINGS
- FIELD ATTACHABLE G1 & G2 COUPLINGS
- FIELD ATTACHABLE C5 & C5E COUPLINGS
- SURELOK AIR BRAKE COUPLINGS
- ADAPTERS
- QUICK DISCONNECT COUPLERS
- LIVE SWIVEL
- BALL VALVES
- ACCESSORIES
- EQUIPMENT AND PARTS



SAE to SAE - High Pressure

Code 61 O-Ring Flange to Male JIC 37° Flare

O-Ring not included. Must be ordered separately.

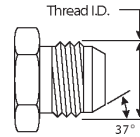
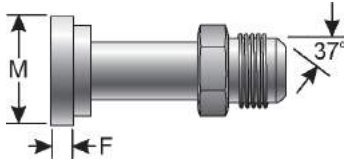

Descr.	Prod. No.	M		F		Weight (Lbs.)	
		"	mm	"	mm		
8FL-8MJ	7253-86931	3/4-16	1.19	30.2	.27	6.9	.24
12FL-12MJ	7253-86932	1 1/16-12	1.50	38.1	.27	6.9	.39
16FL-16MJ	7253-86933	1 5/16-12	1.75	44.5	.32	8.1	.66
20FL-20MJ	7253-86934	1 5/8-12	2.00	50.8	.32	8.1	.98
24FL-24MJ	7253-86935	1 7/8-12	2.38	60.5	.32	8.1	1.38
32FL-32MJ	7253-86936	2 1/2-12	2.81	71.4	.38	9.7	2.43

Code 61 O-Ring Flange to Male JIC 37° Flare - High Pressure

No braze joints, solid one-piece construction for increased reliability.
O-Ring not included. Must be ordered separately.

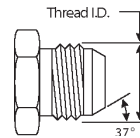
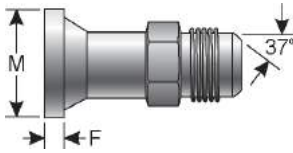

Descr.	Prod. No.	M		F		Weight (Lbs.)		
		"	mm	"	mm			
12FL5K-12MJ	7253-13015	1 1/16-12	1 1/16-12	1.50	38.1	.27	6.9	.59
16FL5K-12MJ	7253-12405	1 1/16-12	1 1/16-12	1.75	44.5	.32	8.1	.92
16FL5K-16MJ	7253-13035	1 5/16-12	1 1/16-12	1.75	44.5	.32	8.1	.82
16FL5K-20MJ	7253-12425	1 5/8-12	1 5/16-12	1.75	44.5	.32	8.1	2.43
20FL4K-16MJ	7253-12485	1 5/16-12	1 5/8-12	2.00	50.8	.32	8.1	1.52
20FL4K-20MJ	7253-12475	1 5/8-12	1 7/8-12	2.00	50.8	.32	8.1	1.52

NOTE: FL5K maximum working pressure is 5,000 psi; FL4K maximum working pressure is 4,000 psi.

- HOSE
- HOSE/CPLG. SELECTION
- G8K COUPLINGS
- GLOBALSPIRAL COUPLINGS
- PCM / PCS FERRULES
- MEGACRIMP COUPLINGS
- STAINLESS STEEL
- POWER CRIMP COUPLINGS
- LOC. GL AND GLP COUPLINGS
- POLARSEAL COUPLINGS
- POLARSEAL II COUPLINGS
- C14 COUPLINGS
- PCTS THERMOPLASTIC COUPLINGS
- FIELD ATTACHABLE G1 & G2 COUPLINGS
- FIELD ATTACHABLE C5 & C5E COUPLINGS
- SURELOK AIR BRAKE COUPLINGS
- ADAPTERS
- QUICK DISCONNECT COUPLERS
- LIVE SWIVEL
- BALL VALVES
- ACCESSORIES
- EQUIPMENT AND PARTS



SAE to SAE - High Pressure

Code 61 O-Ring Flange to Male JIC 37° Flare - 45°

O-Ring not included. Must be ordered separately.

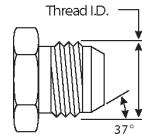
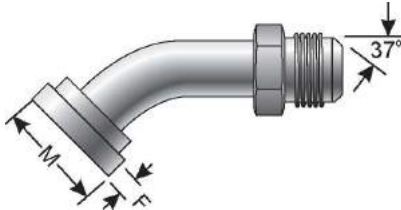

Descr.	Prod. No.	Thread		M		F		Weight (Lbs.)
		"	"	"	mm	"	mm	
8FL-8MJ45	7253-86937	3/4-16	2 1/2-12	1.19	30.2	.27	6.9	.27
12FL-12MJ45	7253-86938	1 1/16-12	1 1/16-12	1.50	38.1	.27	6.9	.40
16FL-16MJ45	7253-86939	1 5/16-12	1 5/16-12	1.75	44.5	.32	8.1	.79
20FL-20MJ45	7253-86941	1 5/8-12	1 1/16-12	2.00	50.8	.32	8.1	1.14
24FL-24MJ45	7253-86942	1 7/8-12	1 5/16-12	2.38	60.5	.32	8.1	1.72
32FL-32MJ45	7253-86943	2 1/2-12	1 5/8-12	2.81	71.4	.38	9.7	3.10

Code 61 O-Ring Flange to Male JIC 37° Flare - 45° - High Pressure

No braze joints, solid one-piece construction for increased reliability.
O-Ring not included. Must be ordered separately.

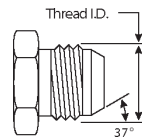
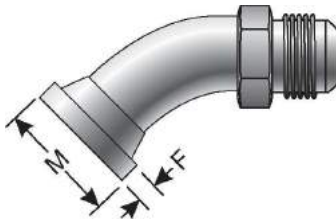

Descr.	Prod. No.	Thread		M		F		Weight (Lbs.)
		"	"	"	mm	"	mm	
12FL5K-12MJ45	7253-13105	1 1/16-12	1 7/8-12	1.50	38.1	.27	6.9	1.58
16FL5K-16MJ45	7253-13125	1 1/16-13	2 1/2-12	1.75	44.5	.32	8.1	1.64
20FL4K-16MJ45	7253-12625	1 5/16-12	1 1/16-12	2.00	50.8	.37	9.4	.90
20FL4K-20MJ45	7253-12395	1 5/8-12	1 1/16-13	2.00	50.8	.37	9.4	1.86

NOTE: FL5K maximum working pressure is 5,000 psi; FL4K maximum working pressure is 4,000 psi.

HOSE

HOSE/CPLG. SELECTION

G8K COUPLINGS

GLOBALSPIRAL COUPLINGS

PCM / PCS FERRULES

MEGACRIMP COUPLINGS

STAINLESS STEEL

POWER CRIMP COUPLINGS

LOC. GL AND GLP COUPLINGS

POLARSEAL COUPLINGS

POLARSEAL II COUPLINGS

C14 COUPLINGS

PCTS THERMOPLASTIC COUPLINGS

FIELD ATTACHABLE G1 & G2 COUPLINGS

FIELD ATTACHABLE C5 & C5E COUPLINGS

SURELOK AIR BRAKE COUPLINGS

ADAPTERS

QUICK DISCONNECT COUPLERS

LIVE SWIVEL

BALL VALVES

ACCESSORIES

EQUIPMENT AND PARTS



SAE to SAE - High Pressure

Code 61 O-Ring Flange to Male JIC 37° Flare - 90°

O-Ring not included. Must be ordered separately.

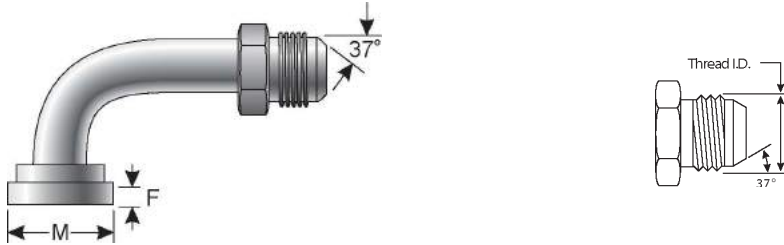

Descr.	Prod. No.	Thread		M		F		Weight (Lbs.)
		"	"	"	mm	"	mm	
8FL-8MJ90	7253-86944	1/2	3/4-16	1.19	30.2	.27	6.9	.30
12FL-12MJ90	7253-86945	3/4	1 1/16-12	1.50	38.1	.27	6.9	.51
16FL-16MJ90	7253-86946	1	1 5/16-12	1.75	44.5	.32	8.1	.92
20FL-20MJ90	7253-86947	1 1/4	1 5/8-12	2.00	50.8	.32	8.1	1.30
24FL-24MJ90	7253-86948	1 1/2	1 7/8-12	2.38	60.5	.32	8.1	1.95
32FL-32MJ90	7253-86949	2	2 1/2-12	2.81	71.4	.38	9.7	3.64

Code 61 O-Ring Flange to Male JIC 37° Flare - 90° - High Pressure

No braze joints, solid one-piece construction for increased reliability.
O-Ring not included. Must be ordered separately.

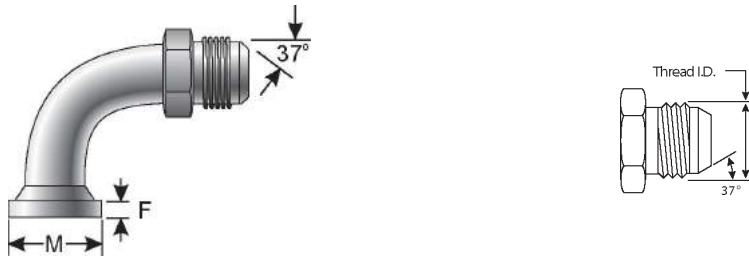

Descr.	Prod. No.	Thread		M		F		Weight (Lbs.)
		"	"	"	mm	"	mm	
12FL5K-12MJ90	7253-13205	1 1/16-12	1 1/16-12	1.50	38.1	.27	6.9	.70
16FL5K-12MJ90	7253-12415	1 1/16-12	1 1/16-12	1.75	44.5	.32	8.1	1.47
16FL5K-16MJ90	7253-13225	1 5/16-12	1 5/16-12	1.75	44.5	.32	8.1	1.99
20FL4K-16MJ90	7253-12495	1 1/4	1 5/16-12	2.00	50.8	.32	8.1	1.35
20FL4K-20MJ90	7253-12505	1 1/4	1 5/8-12	2.00	50.8	.32	8.1	2.12

NOTE: FL5K maximum working pressure is 5,000 psi; FL4K maximum working pressure is 4,000 psi.



SAE to SAE - High Pressure

Code 61 O-Ring Flange to Male Flat-Face O-Ring - High Pressure

For use up to SAE 100R2 maximum working pressure.
No braze joints, solid one-piece construction for increased reliability.
O-Ring not included. Must be ordered separately.

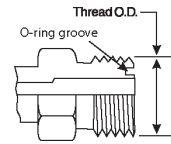
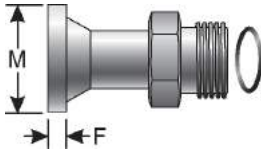

Descr.	Prod. No.	O-ring groove		M		F		Weight (Lbs.)
		"	"	"	mm	"	mm	
12FL5K-12MFFOR	7253-13695	1 3/16-12	1 1/16-12	1.50	38.1	.27	6.9	.58
16FL5K-12MFFOR	7253-17155	1	1 1/16-12	1.75	44.5	.32	8.1	.64
16FL5K-16MFFOR	7253-13705	1 7/16-12	1 1/16-12	1.75	44.5	.32	8.1	.80
20FL4K-20MFFOR	7253-13715	1 1/4	1 5/8-12	2.00	50.8	.32	8.1	1.18

NOTE: FL5K maximum working pressure is 5,000 psi; FL4K maximum working pressure is 4,000 psi.

Code 61 O-Ring Flange to Male Flat-Face O-Ring 45° - High Pressure

No braze joints, solid one-piece construction for increased reliability.
O-Ring not included. Must be ordered separately.

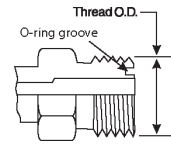
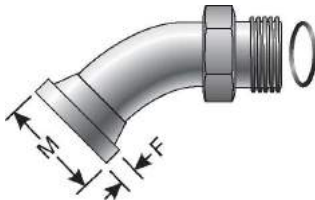

Descr.	Prod. No.	O-ring groove		M		F		Weight (Lbs.)
		"	"	"	mm	"	mm	
12FL5K-12MFFOR45	7253-13725	1 3/16-12	1 1/16-12	1.50	38.1	.27	6.9	.20
16FL5K-16MFFOR45	7253-13735	1 7/16-12	1 1/16-12	1.75	44.5	.32	8.1	1.02
20FL4K-20MFFOR45	7253-13745	1 1/4	1 5/8-12	2.00	50.8	.32	8.1	1.68

NOTE: FL5K maximum working pressure is 5,000 psi; FL4K maximum working pressure is 4,000 psi.

- HOSE
- HOSE/CPLG. SELECTION
- G8K COUPLINGS
- GLOBALSPIRAL COUPLINGS
- PCM / PCS FERRULES
- MEGACRIMP COUPLINGS
- STAINLESS STEEL
- POWER CRIMP COUPLINGS
- LOC, GL AND GLP COUPLINGS
- POLARSEAL COUPLINGS
- POLARSEAL II COUPLINGS
- C14 COUPLINGS
- PCTS THERMOPLASTIC COUPLINGS
- FIELD ATTACHABLE G1 & G2 COUPLINGS
- FIELD ATTACHABLE C5 & C5E COUPLINGS
- SURELOK AIR BRAKE COUPLINGS
- ADAPTERS
- QUICK DISCONNECT COUPLERS
- LIVE SWIVEL
- BALL VALVES
- ACCESSORIES
- EQUIPMENT AND PARTS



SAE to SAE - High Pressure

Code 61 O-Ring Flange to Male Flat-Face O-Ring 90° - High Pressure

No braze joints, solid one-piece construction for increased reliability.
O-Ring not included. Must be ordered separately.

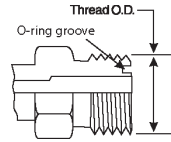
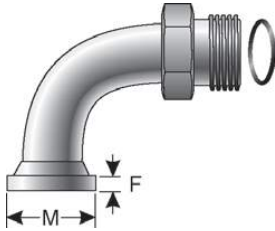

Descr.	Prod. No.	Thread		M		F		Weight (Lbs.)
		"	"	"	mm	"	mm	
12FL5K-12MFFOR90	7253-13755	1 3/16-12	1 1/16-12	1.50	38.1	.27	6.9	.80
16FL5K-16MFFOR90	7253-13765	1 7/16-12	1 1/16-12	1.50	38.1	.32	8.1	1.94
20FL4K-20MFFOR90	7253-13775	1 1/4	1 5/8-12	2.00	50.8	.32	8.1	2.40

NOTE: FL5K maximum working pressure is 5,000 psi; FL4K maximum working pressure is 4,000 psi.

Code 62 O-Ring Flange Heavy to Male JIC 37° Flare - (6,000 psi)

No braze joints, solid one-piece construction for increased reliability.
O-Ring not included. Must be ordered separately.

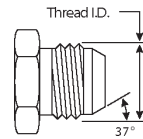
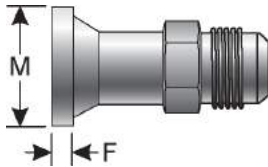

Descr.	Prod. No.	Thread		M		F		Weight (Lbs.)
		"	"	"	mm	"	mm	
12FLH6K-12MJ	7253-13305	3/4	1 1/16-12	1.63	41.4	.35	8.9	.65
16FLH6K-12MJ	7253-12445	1	1 1/16-12	1.88	47.8	.38	9.7	.92
16FLH6K-16MJ	7253-13325	1	1 5/16-12	1.88	47.8	.38	9.7	.89
16FLH6K-20MJ	7253-12465	1	1 5/8-12	1.88	47.8	.38	9.7	2.43
20FLH6K-16MJ	7253-12515	1 1/4	1 5/16-12	2.13	54.1	.41	10.4	1.52
20FLH6K-20MJ	7253-13345	1 1/4	1 5/8-12	2.13	54.1	.41	10.4	1.35
24FLH6K-20MJ	7253-13375	1 1/2	1 5/8-12	2.50	63.5	.50	12.7	.18
24FLH6K-24MJ	7253-13365	1 1/2	1 7/8-12	2.50	63.5	.50	12.7	1.52



SAE to SAE - High Pressure

Code 62 O-Ring Flange Heavy to Male JIC 37° Flare 45° - (6,000 psi)

No braze joints, solid one-piece construction for increased reliability.
O-Ring not included. Must be ordered separately.

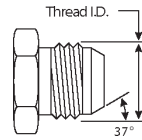
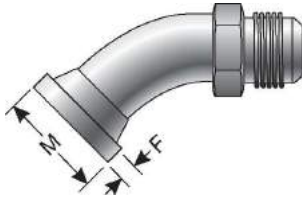

Descr.	Prod. No.	Thread		M		F		Weight (Lbs.)
		"	"	"	mm	"	mm	
12FLH6K-12MJ45	7253-13405	3/4	1 1/16-12	1.63	41.4	.35	8.9	1.61
16FLH6K-16MJ45	7253-13425	1	1 5/16-12	1.88	47.8	.38	9.7	1.64
20FLH6K-20MJ45	7253-13445	1 1/4	1 5/8-12	2.13	54.1	.41	10.4	1.87

Code 62 O-Ring Flange Heavy to Male JIC 37° Flare 90° - (6,000 psi)

No braze joints, solid one-piece construction for increased reliability.
O-Ring not included. Must be ordered separately.

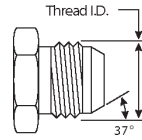
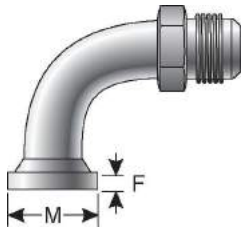

Descr.	Prod. No.	Thread		M		F		Weight (Lbs.)
		"	"	"	mm	"	mm	
12FLH6K-12MJ90	7253-13505	3/4	1 1/16-12	1.63	41.4	.35	8.9	.08
12FLH6K-16MJ90	7253-13515	3/4	1 5/16-12	1.63	41.4	.35	8.9	1.95
16FLH6K-12MJ90	7253-12455	1	1 1/16-12	1.88	47.8	.38	9.7	1.47
16FLH6K-16MJ90	7253-13535	1	1 5/16-12	1.88	47.8	.38	9.7	1.32
16FLH6K-20MJ90	7253-13545	1	1 5/8-12	1.88	47.8	.38	9.7	2.00
20FLH6K-16MJ90	7253-12525	1 1/4	1 5/16-12	2.13	54.1	.41	10.4	2.70
20FLH6K-20MJ90	7253-13565	1 1/4	1 5/8-12	2.13	54.1	.41	10.4	2.19
24FLH6K-20MJ90	7253-13575	1 1/2	1 5/8-12	2.50	63.5	.50	12.7	2.83

- HOSE
- HOSE/CPLG. SELECTION
- G8K COUPLINGS
- GLOBAL SPIRAL COUPLINGS
- PCM / PCS FERRULES
- MEGACRIMP COUPLINGS
- STAINLESS STEEL
- POWER CRIMP COUPLINGS
- LOC, GL AND GLP COUPLINGS
- POLARSEAL COUPLINGS
- POLARSEAL II COUPLINGS
- C14 COUPLINGS
- PCTS THERMOPLASTIC COUPLINGS
- FIELD ATTACHABLE G1 & G2 COUPLINGS
- FIELD ATTACHABLE C5 & C5E COUPLINGS
- SURELOK AIR BRAKE COUPLINGS
- ADAPTERS
- QUICK DISCONNECT COUPLERS
- LIVE SWIVEL
- BALL VALVES
- ACCESSORIES
- EQUIPMENT AND PARTS



SAE to SAE - High Pressure

Code 62 O-Ring Flange Heavy to Male Flat-Face O-Ring - (6,000 psi)

No braze joints, solid one-piece construction for increased reliability.
O-Ring not included. Must be ordered separately.

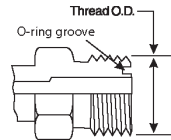
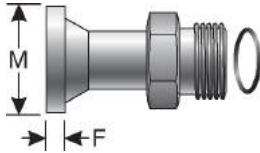

Descr.	Prod. No.	O-ring groove		M		F		Weight (Lbs.)
		"	"	"	mm	"	mm	
12FLH6K-12MFFOR	7253-13605	3/4	1 3/16-12	1.63	41.4	.35	8.9	.65
16FLH6K-16MFFOR	7253-13615	1	1 7/16-12	1.88	47.8	.38	9.7	.90
20FLH6K-20MFFOR	7253-13625	1 1/4	1 7/16-13	2.13	54.1	.41	10.4	1.35

Code 62 O-Ring Flange Heavy to Male Flat-Face O-Ring 45° - (6,000 psi)

No braze joints, solid one-piece construction for increased reliability.
O-Ring not included. Must be ordered separately.

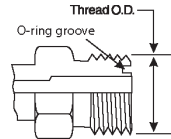
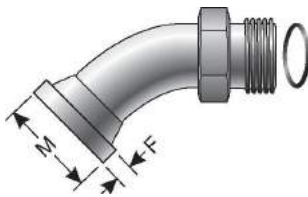

Descr.	Prod. No.	O-ring groove		M		F		Weight (Lbs.)
		"	"	"	mm	"	mm	
12FLH6K-12MFFOR45	7253-13635	3/4	1 3/16-12	1.63	41.4	.35	8.9	.75
16FLH6K-16MFFOR45	7253-13645	1	1 7/16-12	1.88	47.8	.38	9.7	1.60
20FLH6K-20MFFOR45	7253-13655	1 1/4	1 7/16-13	2.13	54.1	.41	10.4	2.65

Code 62 O-Ring Flange Heavy to Male Flat-Face O-Ring 90° - (6,000 psi)

No braze joints, solid one-piece construction for increased reliability.
O-Ring not included. Must be ordered separately.

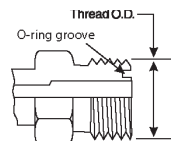
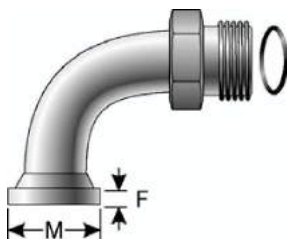

Descr.	Prod. No.	O-ring groove		M		F		Weight (Lbs.)
		"	"	"	mm	"	mm	
12FLH6K-12MFFOR90	7253-13665	3/4	1 3/16-12	1.63	41.4	.35	8.9	2.11
16FLH6K-12MFFOR90	7253-13465	1 1/16-12	1 7/16-14	1.88	47.8	.38	9.7	.95



SAE to SAE - High Pressure

Code 62 O-Ring Flange Heavy to Male Flat-Face O-Ring 90° - (6,000 psi) - Continued

Descr.	Prod. No.			M		F		Weight (Lbs.)
		"	"	"	mm	"	mm	
16FLH6K-16MFFOR90	7253-13675	1	1 7/16-12	1.88	47.8	.38	9.7	1.36
20FLH6K-20MFFOR90	7253-13685	1 1/4	1 11/16-12	2.13	54.1	.41	10.4	2.15

- HOSE
- HOSE/CPLG. SELECTION
- G8K COUPLINGS
- GLOBAL SPIRAL COUPLINGS
- PCM / PCS FERRULES
- MEGACRIMP COUPLINGS
- STAINLESS STEEL
- POWER CRIMP COUPLINGS
- LOC. GL AND GLP COUPLINGS
- POLARSEAL COUPLINGS
- POLARSEAL II COUPLINGS
- C14 COUPLINGS
- PCTS THERMOPLASTIC COUPLINGS
- FIELD ATTACHABLE G1 & G2 COUPLINGS
- FIELD ATTACHABLE C5 & C5E COUPLINGS
- SURELOK AIR BRAKE COUPLINGS
- ADAPTERS
- QUICK DISCONNECT COUPLERS
- LIVE SWIVEL
- BALL VALVES
- ACCESSORIES
- EQUIPMENT AND PARTS



British to SAE

British Male Standard Pipe Tapered Thread to Male JIC 37° Flare

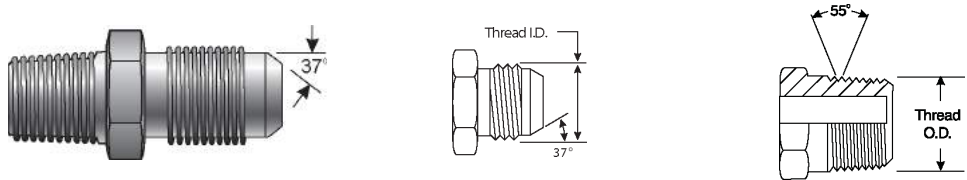

Descr.	Prod. No.			Weight (Lbs.)
		"	"	
2MBSPT-4MJ	7253-14255	1/8-28	7/16-20	.08
STAINLESS STEEL	2MBSPT-5MJ	1/8-28	1/2-20	.02
	2MBSPT-6MJ	1/8-28	9/16-18	.05
POWER CRIMP COUPLINGS	4MBSPT-4MJ	1/4-19	7/16-20	.12
	4MBSPT-5MJ	1/4-19	1/2-20	.05
LOC. GL AND GLP COUPLINGS	4MBSPT-6MJ	1/4-19	9/16-18	.05
	4MBSPT-8MJ	1/4-19	3/4-16	.10
POLARSEAL COUPLINGS	6MBSPT-4MJ	3/8-19	7/16-20	.05
	6MBSPT-5MJ	3/8-19	1/2-20	.05
POLARSEAL II COUPLINGS	6MBSPT-6MJ	3/8-19	9/16-18	.14
	6MBSPT-8MJ	3/8-19	3/4-16	.10
C14 COUPLINGS	6MBSPT-10MJ	3/8-19	7/8-14	.15
	8MBSPT-6MJ	1/2-14	9/16-18	.15
PCTS THERMOPLASTIC COUPLINGS	8MBSPT-8MJ	1/2-14	3/4-16	.20
	8MBSPT-10MJ	1/2-14	7/8-14	.03
FIELD ATTACHABLE G1 & G2 COUPLINGS	8MBSPT-12MJ	1/2-14	1 1/16-12	.25
	12MBSPT-8MJ	3/4-14	3/4-16	.20
FIELD ATTACHABLE C5 & C5E COUPLINGS	12MBSPT-10MJ	3/4-14	7/8-14	.25
	12MBSPT-12MJ	3/4-14	1 1/16-12	.40
SURELOK AIR BRAKE COUPLINGS	12MBSPT-14MJ	3/4-14	1 3/16-12	.35
	12MBSPT-16MJ	3/4-14	1 5/16-12	.35
ADAPTERS	16MBSPT-12MJ	1-11	1 1/16-12	.45
	16MBSPT-16MJ	1-11	1 5/16-12	.50
QUICK DISCONNECT COUPLERS	16MBSPT-20MJ	1-11	1 5/8-12	.70
	20MBSPT-16MJ	1 1/4-11	1 5/16-12	.70
LIVE SWIVEL	20MBSPT-20MJ	1 1/4-11	1 5/8-12	.75
	24MBSPT-24MJ	1 1/2-11	1 7/8-12	1.10
BALL VALVES	32MBSPT-32MJ	2-11	2 1/2-12	2.05

British Male Standard Pipe Tapered Thread to Male JIC 37° Flare - 45°

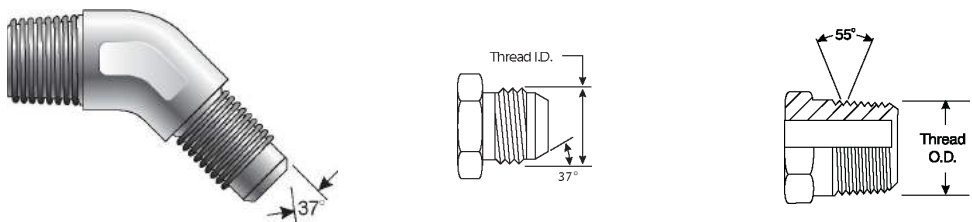

Descr.	Prod. No.			Weight (Lbs.)
		"	"	
2MBSPT-4MJ45	7253-60215	1/8-28	3/4-16	.01
4MBSPT-4MJ45	7253-60225	1/4-19	7/16-20	.05





British to SAE

British Male Standard Pipe Tapered Thread to Male JIC 37° Flare - 45° - Continued

Descr.	Prod. No.			Weight (Lbs.)
		"	"	
4MBSPT-6MJ45	7253-60235	1/4-19	9/16-18	.05
6MBSPT-6MJ45	7253-60245	3/8-19	9/16-18	.10
6MBSPT-8MJ45	7253-60255	3/8-19	3/4-16	.10
8MBSPT-8MJ45	7253-60265	1/2-14	3/4-16	.20
8MBSPT-10MJ45	7253-60275	1/2-14	7/8-14	.20
12MBSPT-12MJ45	7253-60285	3/4-14	1 1/16-12	.35
12MBSPT-16MJ45	7253-60295	3/4-14	1 5/16-12	.55
16MBSPT-16MJ45	7253-60305	1-11	1 5/16-12	.55

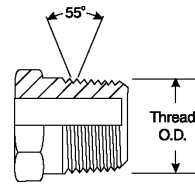
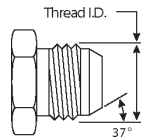
British Male Standard Pipe Tapered Thread to Male JIC 37° Flare - 90°



Descr.	Prod. No.			Weight (Lbs.)
		"	"	
2MBSPT-4MJ90	7253-60315	1/8-28	3/4-16	.05
4MBSPT-4MJ90	7253-60325	1/4-19	7/16-20	.10
4MBSPT-5MJ90	7253-60335	1/4-19	1/2-20	.10
4MBSPT-6MJ90	7253-60345	1/4-19	9/16-18	.05
6MBSPT-6MJ90	7253-60355	3/8-19	9/16-18	.15
6MBSPT-8MJ90	7253-60365	3/8-19	3/4-16	.20
8MBSPT-6MJ90	7253-60375	1/2-14	3/4-16	.15
8MBSPT-8MJ90	7253-60385	1/2-14	3/4-16	.25
8MBSPT-10MJ90	7253-60395	1/2-14	7/8-14	.25
8MBSPT-12MJ90	7253-60405	1/2-14	1 1/16-12	.45
12MBSPT-12MJ90	7253-60415	3/4-14	1 1/16-12	.50
12MBSPT-16MJ90	7253-60425	3/4-14	1 5/16-12	.75
16MBSPT-16MJ90	7253-60435	1-11	1 5/16-12	.80
20MBSPT-20MJ90	7253-60445	1 1/4-11	1 5/8-12	1.45
24MBSPT-24MJ90	7253-60455	1 1/2-11	1 7/8-12	2.00

HOSE

HOSE/CPLG. SELECTION

G8K COUPLINGS

GLOBAL SPIRAL COUPLINGS

PCM / PCS FERRULES

MEGACRIMP COUPLINGS

STAINLESS STEEL

POWER CRIMP COUPLINGS

LOC. GL AND GLP COUPLINGS

POLARSEAL COUPLINGS

POLARSEAL II COUPLINGS

C14 COUPLINGS

PCTS THERMOPLASTIC COUPLINGS

FIELD ATTACHABLE G1 & G2 COUPLINGS

FIELD ATTACHABLE C5 & C5E COUPLINGS

SURELOK AIR BRAKE COUPLINGS

ADAPTERS

QUICK DISCONNECT COUPLERS

LIVE SWIVEL

BALL VALVES

ACCESSORIES

EQUIPMENT AND PARTS

R57



British to SAE

British Male Standard Pipe Parallel to Male Pipe NPTF

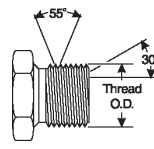
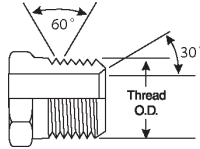

Descr.	Prod. No.			Weight (Lbs.)
		"	"	
2MBSPP-2MP	7253-60475	1/8-28	1/8-27	.05
2MBSPP-4MP	7253-60485	1/8-28	1/4-18	.05
4MBSPP-2MP	7253-60495	1/4-19	1/8-27	.05
4MBSPP-4MP	7253-15075	1/4-19	1/4-18	.07
4MBSPP-6MP	7253-60505	1/4-19	3/8-18	.05
4MBSPP-8MP	7253-60515	1/4-19	1/2-14	.10
6MBSPP-2MP	7253-60525	3/8-19	1/8-27	.04
6MBSPP-4MP	7253-60535	3/8-19	1/4-18	.10
6MBSPP-6MP	7253-15085	3/8-19	3/8-18	.11
6MBSPP-8MP	7253-60545	3/8-19	1/2-14	.10
6MBSPP-12MP	7253-60555	3/8-19	3/4-14	.20
6MBSPP-16MP	7253-60565	3/8-19	1-11 1/2	.35
8MBSPP-4MP	7253-60575	1/2-14	1/4-18	.10
8MBSPP-6MP	7253-60585	1/2-14	3/8-18	.10
8MBSPP-8MP	7253-15095	1/2-14	1/2-14	.17
8MBSPP-12MP	7253-60595	1/2-14	3/4-14	.15
8MBSPP-16MP	7253-60605	1/2-14	1-11 1/2	.35
10MBSPP-8MP	7253-60615	5/8-14	1/2-14	.15
10MBSPP-12MP	7253-60625	5/8-14	3/4-14	.20
12MBSPP-8MP	7253-60635	3/4-14	1/2-14	.15
12MBSPP-12MP	7253-15105	3/4-14	3/4-14	.28
12MBSPP-16MP	7253-60645	3/4-14	1-11 1/2	.35
12MBSPP-20MP	7253-60655	3/4-14	1 1/4-11 1/2	.60
16MBSPP-12MP	7253-60665	1-11	3/4-14	.40
16MBSPP-16MP	7253-15115	1-11	1-11 1/2	.53
16MBSPP-20MP	7253-60675	1-11	1 1/4-11 1/2	.65
20MBSPP-16MP	7253-60685	1 1/4-11	1-11 1/2	.70
20MBSPP-20MP	7253-60695	1 1/4-11	1 1/4-11 1/2	.70
20MBSPP-24MP	7253-60705	1 1/4-11	1 1/2-11 1/2	.85
24MBSPP-20MP	7253-60715	1 1/2-11	1 1/4-11 1/2	.85
24MBSPP-24MP	7253-60725	1 1/2-11	1 1/2-11 1/2	1.00
32MBSPP-32MP	7253-60735	2-11	2-11 1/2	1.40

British Male Standard Pipe Parallel to Female Pipe NPTF

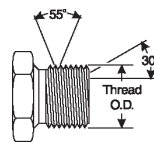
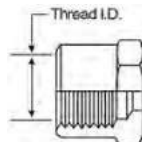
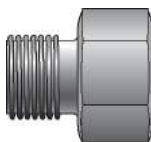

Descr.	Prod. No.			Weight (Lbs.)
		"	"	
2MBSPP-2FP	7253-60745	1/8-28	1/8-27	.05
2MBSPP-4FP	7253-60755	1/8-28	1/4-18	.05





British to SAE

British Male Standard Pipe Parallel to Female Pipe NPTF - Continued

Descr.	Prod. No.			Weight (Lbs.)
		"	"	
4MBSPP-2FP	7253-60765	1/4-19	1/8-27	.10
4MBSPP-4FP	7253-60775	1/4-19	1/4-18	.05
4MBSPP-6FP	7253-60785	1/4-19	3/8-18	.15
6MBSPP-2FP	7253-60795	3/8-19	1/8-27	.15
6MBSPP-4FP	7253-60805	3/8-19	1/4-18	.15
6MBSPP-6FP	7253-60815	3/8-19	3/8-18	.10
8MBSPP-4FP	7253-60825	1/2-14	1/4-18	.20
8MBSPP-6FP	7253-60835	1/2-14	3/8-18	.25
8MBSPP-8FP	7253-60845	1/2-14	1/2-14	.25
12MBSPP-8FP	7253-60855	3/4-14	1/2-14	.35
12MBSPP-12FP	7253-60865	3/4-14	3/4-14	.35
16MBSPP-16FP	7253-60875	1-11	1-11 1/2	.55
20MBSPP-16FP	7253-60885	1 1/4-11	1-11 1/2	1.30
20MBSPP-20FP	7253-60895	1 1/4-11	1 1/4-11 1/2	1.00
24MBSPP-20FP	7253-60905	1 1/2-11	1 1/4-11 1/2	1.30
24MBSPP-24FP	7253-60915	1 1/2-11	1 1/2-11 1/2	1.10
32MBSPP-32FP	7253-60925	2-11	2-11 1/2	1.60

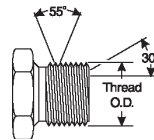
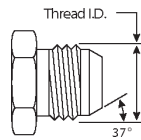
British Male Standard Pipe Parallel to Male JIC 37° Flare



Descr.	Prod. No.			Weight (Lbs.)
		"	"	
2MBSPP-4MJ	7253-60935	1/8-28	7/16-20	.02
2MBSPP-5MJ	7253-60945	1/8-28	1/2-20	.02
2MBSPP-6MJ	7253-60955	1/8-28	9/16-18	.05
4MBSPP-4MJ	7253-15015	1/4-19	7/16-20	.12
4MBSPP-5MJ	7253-60965	1/4-19	1/2-20	.05
4MBSPP-6MJ	7253-60975	1/4-19	9/16-18	.05
4MBSPP-8MJ	7253-60985	1/4-19	3/4-16	.10
6MBSPP-4MJ	7253-60995	3/8-19	7/16-20	.05
6MBSPP-5MJ	7253-61005	3/8-19	1/2-20	.05
6MBSPP-6MJ	7253-15025	3/8-19	9/16-18	.02
6MBSPP-8MJ	7253-61015	3/8-19	3/4-16	.10
8MBSPP-6MJ	7253-61025	1/2-14	9/16-18	.10
8MBSPP-8MJ	7253-15035	1/2-14	3/4-16	.20
8MBSPP-10MJ	7253-61035	1/2-14	7/8-14	.15
8MBSPP-12MJ	7253-61045	1/2-14	1 1/16-12	.20
10MBSPP-8MJ	7253-61055	5/8-14	3/4-16	.15
10MBSPP-10MJ	7253-15045	5/8-14	7/8-14	.20
10MBSPP-12MJ	7253-61065	5/8-14	1 1/16-12	.20
12MBSPP-8MJ	7253-61075	3/4-14	3/4-16	.20
12MBSPP-10MJ	7253-61085	3/4-14	7/8-14	.25
12MBSPP-12MJ	7253-15055	3/4-14	1 1/16-12	.22
12MBSPP-14MJ	7253-61095	3/4-14	1 3/16-12	.25
12MBSPP-16MJ	7253-61105	3/4-14	1 5/16-12	.35
16MBSPP-12MJ	7253-61115	1-11	1 1/16-12	.40

- HOSE
- HOSE/CPLG. SELECTION
- G8K COUPLINGS
- GLOBAL SPIRAL COUPLINGS
- PCM / PCS FERRULES
- MEGACRIMP COUPLINGS
- STAINLESS STEEL
- POWER CRIMP COUPLINGS
- LOC, GL AND GLP COUPLINGS
- POLARSEAL COUPLINGS
- POLARSEAL II COUPLINGS
- C14 COUPLINGS
- PCTS THERMOPLASTIC COUPLINGS
- FIELD ATTACHABLE G1 & G2 COUPLINGS
- FIELD ATTACHABLE C5 & C5E COUPLINGS
- SURELOK AIR BRAKE COUPLINGS
- ADAPTERS
- QUICK DISCONNECT COUPLERS
- LIVE SWIVEL
- BALL VALVES
- ACCESSORIES
- EQUIPMENT AND PARTS



British to SAE

HOSE
HOSE/CPLG. SELECTION
G8K COUPLINGS
GLOBALSPIRAL COUPLINGS
PCM / PCS FERRULES
MEGACRIMP COUPLINGS
STAINLESS STEEL
POWER CRIMP COUPLINGS
LOC, GL AND GLP COUPLINGS
POLARSEAL COUPLINGS
POLARSEAL II COUPLINGS
C14 COUPLINGS
PCTS THERMOPLASTIC COUPLINGS
FIELD ATTACHABLE G1 & G2 COUPLINGS
FIELD ATTACHABLE C5 & C5E COUPLINGS
SURELOK AIR BRAKE COUPLINGS
ADAPTERS
QUICK DISCONNECT COUPLERS
LIVE SWIVEL
BALL VALVES
ACCESSORIES
EQUIPMENT AND PARTS

British Male Standard Pipe Parallel to Male JIC 37° Flare - Continued

Descr.	Prod. No.			Weight (Lbs.)
		"	"	
16MBSPP-14MJ	7253-61125	1-11	1 3/16-12	.45
16MBSPP-16MJ	7253-15065	1-11	1 5/16-12	.64
16MBSPP-20MJ	7253-61135	1-11	1 5/8-12	.60
20MBSPP-16MJ	7253-61145	1 1/4-11	1 5/16-12	.60
20MBSPP-20MJ	7253-61155	1 1/4-11	1 5/8-12	.70
20MBSPP-24MJ	7253-61165	1 1/4-11	1 7/8-12	.85
24MBSPP-20MJ	7253-61175	1 1/2-11	1 5/8-12	.90
24MBSPP-24MJ	7253-61185	1 1/2-11	1 7/8-12	.95
32MBSPP-32MJ	7253-61195	2-11	2 1/2-12	1.90

British Male Standard Pipe Parallel to Male JIC 37° Flare - 45°

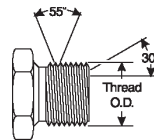
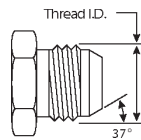
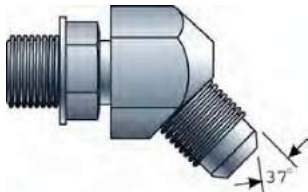

Descr.	Prod. No.			Weight (Lbs.)
		"	"	
2MBSPP-4MJ45	7253-61205	1/8-28	7/16-20	.05
4MBSPP-4MJ45	7253-61215	1/4-19	7/16-20	.10
4MBSPP-6MJ45	7253-61225	1/4-19	9/16-18	.10
6MBSPP-6MJ45	7253-61235	3/8-19	9/16-18	.15
6MBSPP-8MJ45	7253-61245	3/8-19	3/4-16	.20
8MBSPP-8MJ45	7253-61255	1/2-14	3/4-16	.25
8MBSPP-10MJ45	7253-61265	1/2-14	7/8-14	.30
8MBSPP-12MJ45	7253-61275	1/2-14	1 1/16-12	.45
12MBSPP-12MJ45	7253-61285	3/4-14	1 1/16-12	.55
16MBSPP-16MJ45	7253-61295	1-11	1 5/16-12	.85



British to SAE

British Male Standard Pipe Parallel to Male JIC 37° Flare - 90°

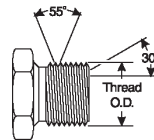
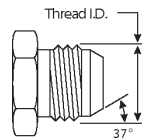
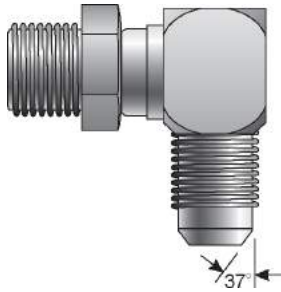

Descr.	Prod. No.			Weight (Lbs.)
		"	"	
2MBSPP-4MJ90	7253-61305	1/8-28	7/16-20	.05
4MBSPP-4MJ90	7253-61315	1/4-19	7/16-20	.10
4MBSPP-5MJ90	7253-61325	1/4-19	1/2-20	.10
4MBSPP-6MJ90	7253-61335	1/4-19	9/16-18	.10
4MBSPP-8MJ90	7253-61345	1/4-19	3/4-16	.20
6MBSPP-4MJ90	7253-61355	3/8-19	7/16-20	.20
6MBSPP-5MJ90	7253-61365	3/8-19	1/2-20	.20
6MBSPP-8MJ90	7253-61385	3/8-19	3/4-16	.20
8MBSPP-6MJ90	7253-61395	1/2-14	9/16-18	.30
8MBSPP-10MJ90	7253-61415	1/2-14	7/8-14	.35
8MBSPP-12MJ90	7253-61425	1/2-14	1 1/16-12	.55
12MBSPP-8MJ90	7253-61435	3/4-14	3/4-16	.60
12MBSPP-10MJ90	7253-61445	3/4-14	7/8-14	.65
12MBSPP-16MJ90	7253-61465	3/4-14	1 5/16-12	.90
16MBSPP-12MJ90	7253-61475	1-11	1 1/16-12	.95
16MBSPP-16MJ90	7253-61485	1-11	1 5/16-12	.95
16MBSPP-20MJ90	7253-61495	1-11	1 5/8-12	1.45
20MBSPP-16MJ90	7253-61505	1 1/2-11	1 5/16-12	1.55
20MBSPP-20MJ90	7253-61515	1 1/2-11	1 5/8-12	1.55
24MBSPP-24MJ90	7253-61525	1 1/2-11	1 7/8-12	2.10

British Male Standard Pipe Parallel to Female JIC 37° Flare Swivel

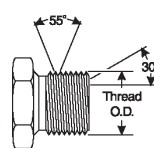
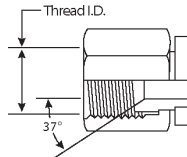
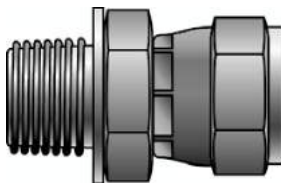

Descr.	Prod. No.			Weight (Lbs.)
		"	"	
2MBSPP-4FJX	7253-61535	1/8-28	7/16-20	.01
4MBSPP-4FJX	7253-15125	1/4-19	7/16-20	.07
4MBSPP-5FJX	7253-61545	1/4-19	1/2-20	.05
4MBSPP-6FJX	7253-61555	1/4-19	9/16-18	.05
6MBSPP-4FJX	7253-61565	3/8-19	7/16-20	.05
6MBSPP-6FJX	7253-15135	3/8-19	9/16-18	.14
6MBSPP-8FJX	7253-61575	3/8-19	3/4-16	.15

- HOSE
- HOSE/CPLG. SELECTION
- G8K COUPLINGS
- GLOBAL SPIRAL COUPLINGS
- PCM / PCS FERRULES
- MEGACRIMP COUPLINGS
- STAINLESS STEEL
- POWER CRIMP COUPLINGS
- LOC, GL AND GLP COUPLINGS
- POLARSEAL COUPLINGS
- POLARSEAL II COUPLINGS
- C14 COUPLINGS
- PCTS THERMOPLASTIC COUPLINGS
- FIELD ATTACHABLE G1 & G2 COUPLINGS
- FIELD ATTACHABLE C5 & C5E COUPLINGS
- SURELOK AIR BRAKE COUPLINGS
- ADAPTERS
- QUICK DISCONNECT COUPLERS
- LIVE SWIVEL
- BALL VALVES
- ACCESSORIES
- EQUIPMENT AND PARTS





British to SAE

British Male Standard Pipe Parallel to Female JIC 37° Flare Swivel - Continued

Descr.	Prod. No.			Weight (Lbs.)
		"	"	
8MBSPP-4FJX	7253-61585	1/2-14	7/16-20	.10
8MBSPP-6FJX	7253-61595	1/2-14	9/16-18	.15
8MBSPP-8FJX	7253-15145	1/2-14	3/4-16	.17
8MBSPP-10FJX	7253-61605	1/2-14	7/8-14	.15
8MBSPP-12FJX	7253-61615	1/2-14	1 1/16-12	.30
10MBSPP-8FJX	7253-61625	5/8-14	3/4-16	.15
10MBSPP-10FJX	7253-15155	5/8-14	7/8-14	.02
12MBSPP-8FJX	7253-61635	3/4-14	3/4-16	.25
12MBSPP-12FJX	7253-15165	3/4-14	1 1/16-12	.43
12MBSPP-16FJX	7253-61645	3/4-14	1 5/16-12	.50
16MBSPP-16FJX	7253-15175	1-11	1 5/16-12	.69
16MBSPP-20FJX	7253-61655	1-11	1 5/8-12	.85
20MBSPP-16FJX	7253-61665	1 1/4-11	1 5/16-12	.80
20MBSPP-20FJX	7253-61675	1 1/4-11	1 5/8-12	.90
24MBSPP-24FJX	7253-61685	1 1/2-11	1 7/8-12	1.30
32MBSPP-32FJX	7253-61695	2-11	2 1/2-12	2.15

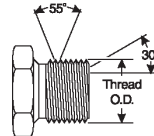
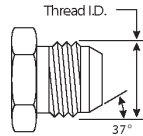
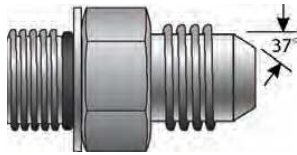
British Male Standard Pipe Parallel with O-Ring to Male JIC 37° Flare



Descr.	Prod. No.			Weight (Lbs.)
		"	"	
2MBSPPOR-4MJ	7253-14005	1/8-28	7/16-20	.10
4MBSPPOR-4MJ	7253-14015	1/4-19	7/16-20	.16
4MBSPPOR-5MJ	7253-61705	1/4-19	1/2-20	.05
4MBSPPOR-6MJ	7253-14025	1/4-19	9/16-18	.14
6MBSPPOR-4MJ	7253-14035	3/8-19	7/16-20	.02
6MBSPPOR-5MJ	7253-61715	3/8-19	1/2-20	.10
6MBSPPOR-6MJ	7253-14045	3/8-19	9/16-18	.02
6MBSPPOR-8MJ	7253-14055	3/8-19	3/4-16	.02
8MBSPPOR-6MJ	7253-14075	1/2-14	9/16-18	.20
8MBSPPOR-8MJ	7253-14085	1/2-14	3/4-16	.20
8MBSPPOR-10MJ	7253-61725	1/2-14	7/8-14	.20
8MBSPPOR-12MJ	7253-14605	1/2-14	1 1/16-12	.32
12MBSPPOR-8MJ	7253-61735	3/4-14	3/4-16	.35
12MBSPPOR-10MJ	7253-61745	3/4-14	7/8-14	.35
12MBSPPOR-12MJ	7253-14095	3/4-14	1 1/16-12	.40
12MBSPPOR-16MJ	7253-61755	3/4-14	1 5/16-12	.40
16MBSPPOR-12MJ	7253-61765	1-11	1 1/16-12	.50
16MBSPPOR-16MJ	7253-14105	1-11	1 5/16-12	.20
20MBSPPOR-20MJ	7253-14115	1 1/4-11	1 5/8-12	.94
20MBSPPOR-24MJ	7253-61775	1 1/2-11	1 7/8-12	.95
24MBSPPOR-24MJ	7253-61785	1 1/2-11	1 7/8-12	1.25



British to SAE

British Male Standard Pipe Parallel with O-Ring to Male JIC 37° Flare - 90°

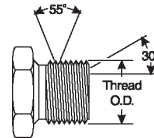
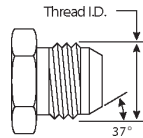
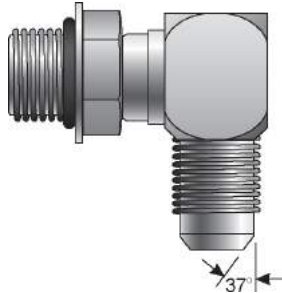

Descr.	Prod. No.			Weight (Lbs.)
		"	"	
6MBSPPOR-6MJ90	7253-14505	3/8-19	9/16-18	.27
8MBSPPOR-8MJ90	7253-14515	1/2-14	3/4-16	.23
12MBSPPOR-12MJ90	7253-14525	3/4-14	1 1/2-12	.72

British Male Standard Pipe Parallel with O-Ring to Male Flat-Face O-Ring

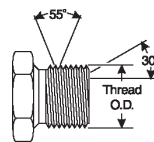
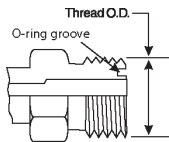

Descr.	Prod. No.			Weight (Lbs.)
		"	"	
2MBSPPOR-4MFFOR	7253-61795	1/8-28	9/16-18	.05
4MBSPPOR-4MFFOR	7253-61805	1/4-19	9/16-18	.05
4MBSPPOR-6MFFOR	7253-61815	1/4-19	11/16-16	.05
6MBSPPOR-6MFFOR	7253-61825	3/8-19	11/16-16	.15
6MBSPPOR-8MFFOR	7253-61835	3/8-19	13/16-16	.15
8MBSPPOR-6MFFOR	7253-61845	1/2-14	11/16-16	.20
8MBSPPOR-8MFFOR	7253-61855	1/2-14	13/16-16	.15
8MBSPPOR-10MFFOR	7253-61865	1/2-14	1-14	.20
12MBSPPOR-12MFFOR	7253-61875	3/4-14	1 3/16-12	.40
12MBSPPOR-16MFFOR	7253-61885	3/4-14	1 7/16-12	.55
16MBSPPOR-12MFFOR	7253-61895	1-11	1 3/16-12	.55
16MBSPPOR-16MFFOR	7253-61905	1-11	1 7/16-12	.55
20MBSPPOR-20MFFOR	7253-61915	1 1/4-11	1 11/16-12	.90
24MBSPPOR-24MFFOR	7253-61925	1 1/2-11	2-12	1.25

- HOSE
- HOSE/CPLG. SELECTION
- G8K COUPLINGS
- GLOBALSPIRAL COUPLINGS
- PCM / PCS FERRULES
- MEGACRIMP COUPLINGS
- STAINLESS STEEL
- POWER CRIMP COUPLINGS
- LOC. GL AND GLP COUPLINGS
- POLARSEAL COUPLINGS
- POLARSEAL II COUPLINGS
- C14 COUPLINGS
- PCTS THERMOPLASTIC COUPLINGS
- FIELD ATTACHABLE G1 & G2 COUPLINGS
- FIELD ATTACHABLE C5 & C5E COUPLINGS
- SURELOK AIR BRAKE COUPLINGS
- ADAPTERS
- QUICK DISCONNECT COUPLERS
- LIVE SWIVEL
- BALL VALVES
- ACCESSORIES
- EQUIPMENT AND PARTS



British to SAE

- HOSE
- HOSE/CPLG. SELECTION
- G8K COUPLINGS
- GLOBAL SPIRAL COUPLINGS
- PCM / PCS FERRULES
- MEGACRIMP COUPLINGS
- STAINLESS STEEL
- POWER CRIMP COUPLINGS
- LOC. GL AND GLP COUPLINGS
- POLARSEAL COUPLINGS
- POLARSEAL II COUPLINGS
- C14 COUPLINGS
- PCTS THERMOPLASTIC COUPLINGS
- FIELD ATTACHABLE G1 & G2 COUPLINGS
- FIELD ATTACHABLE C5 & C5E COUPLINGS
- SURELOK AIR BRAKE COUPLINGS
- ADAPTERS
- QUICK DISCONNECT COUPLERS
- LIVE SWIVEL
- BALL VALVES
- ACCESSORIES
- EQUIPMENT AND PARTS

British Male Standard Pipe Parallel with O-Ring to Male Flat-Face O-Ring - Long

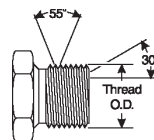
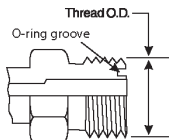
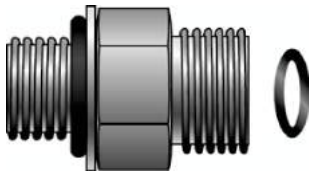

Descr.	Prod. No.			Weight (Lbs.)
		"	"	
6MBSPPOR-8MFFORL	7253-61935	3/8-19	1/2-16	.25
8MBSPPOR-8MFFORL	7253-61945	1/2-14	1/2-16	.35
8MBSPPOR-10MFFORL	7253-61955	1/2-14	5/8-14	.45
12MBSPPOR-10MFFORL	7253-61965	3/4-14	5/8-14	.65
12MBSPPOR-12MFFORL	7253-61975	3/4-14	3/4-12	.85
16MBSPPOR-16MFFORL	7253-61985	1-11	1-12	1.25
20MBSPPOR-20MFFORL	7253-61995	1 1/4-11	1 1/4-12	2.00

British Male Standard Pipe Parallel with O-Ring to Male Flat-Face O-Ring - 45°

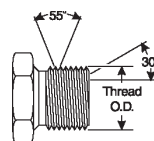
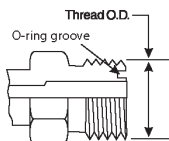

Descr.	Prod. No.			Weight (Lbs.)
		"	"	
2MBSPPOR-4MFFOR45	7253-62005	1/8-28	1/4-18	.05
4MBSPPOR-4MFFOR45	7253-62015	1/4-19	1/4-18	.15
4MBSPPOR-6MFFOR45	7253-62025	1/4-19	3/8-16	.15
6MBSPPOR-6MFFOR45	7253-62035	3/8-19	3/8-16	.20
6MBSPPOR-8MFFOR45	7253-62045	3/8-19	1/2-16	.20
8MBSPPOR-8MFFOR45	7253-62055	1/2-14	1/2-16	.35
8MBSPPOR-10MFFOR45	7253-62065	1/2-14	5/8-14	.40



British to SAE

British Male Standard Pipe Parallel with O-Ring to Male Flat-Face O-Ring - 90°

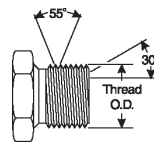
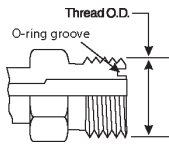

Descr.	Prod. No.			Weight (Lbs.)
2MBSPPOR-4MFFOR90	7253-62075	1/8-28	1/4-18	.10
4MBSPPOR-4MFFOR90	7253-62085	1/4-19	1/4-18	.20
4MBSPPOR-6MFFOR90	7253-62095	1/4-19	3/8-16	.20
4MBSPPOR-8MFFOR90	7253-62105	1/4-19	1/2-16	.20
6MBSPPOR-6MFFOR90	7253-62115	3/8-19	3/8-16	.25
6MBSPPOR-8MFFOR90	7253-62125	3/8-19	1/2-16	.25
8MBSPPOR-6MFFOR90	7253-62135	1/2-14	3/8-16	.50
8MBSPPOR-8MFFOR90	7253-62145	1/2-14	1/2-16	.55
8MBSPPOR-10MFFOR90	7253-62155	1/2-14	5/8-14	.55
8MBSPPOR-12MFFOR90	7253-62165	1/2-14	3/4-12	.70
12MBSPPOR-12MFFOR90	7253-62175	3/4-14	3/4-12	.85
12MBSPPOR-16MFFOR90	7253-62185	3/4-14	1-12	1.20
16MBSPPOR-12MFFOR90	7253-62195	1-11	3/4-12	1.40
16MBSPPOR-16MFFOR90	7253-62205	1-11	1-12	1.30
20MBSPPOR-16MFFOR90	7253-62215	1 1/4-11	1-12	1.65
20MBSPPOR-20MFFOR90	7253-62225	1 1/4-11	1 1/4-12	1.70
24MBSPPOR-24MFFOR90	7253-62235	1 1/2-11	1 1/2-12	2.35

Female British Standard Pipe Parallel to Male Pipe NPTF

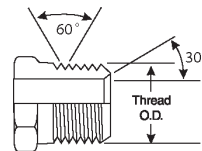

Descr.	Prod. No.			Weight (Lbs.)
2FBSPP-2MP	7253-62245	1/8-28	1/8-27	.01
2FBSPP-4MP	7253-62255	1/8-28	1/4-18	.01
4FBSPP-4MP	7253-62265	1/4-19	1/4-18	.10
4FBSPP-6MP	7253-62275	1/4-19	3/8-18	.15
4FBSPP-8MP	7253-62285	1/4-19	1/2-14	.10
6FBSPP-6MP	7253-62295	3/8-19	3/8-18	.10
6FBSPP-8MP	7253-62305	3/8-19	1/2-14	.15
8FBSPP-8MP	7253-62315	1/2-14	1/2-14	.25
8FBSPP-12MP	7253-62325	1/2-14	3/4-14	.45
12FBSPP-12MP	7253-62335	3/4-14	3/4-14	.35
12FBSPP-16MP	7253-62345	3/4-14	1-11 1/2	.20
16FBSPP-16MP	7253-62355	1-11	1-11 1/2	.55
20FBSPP-20MP	7253-62365	1 1/4-11	1 1/4-11 1/2	.95
20FBSPP-24MP	7253-62375	1 1/4-11	1 1/4-11 1/2	1.10

- HOSE
- HOSE/CPLG. SELECTION
- G8K COUPLINGS
- GLOBAL SPIRAL COUPLINGS
- PCM / PCS FERRULES
- MEGACRIMP COUPLINGS
- STAINLESS STEEL
- POWER CRIMP COUPLINGS
- LOC. GL AND GLP COUPLINGS
- POLARSEAL COUPLINGS
- POLARSEAL II COUPLINGS
- C14 COUPLINGS
- PCTS THERMOPLASTIC COUPLINGS
- FIELD ATTACHABLE G1 & G2 COUPLINGS
- FIELD ATTACHABLE C5 & C5E COUPLINGS
- SURELOK AIR BRAKE COUPLINGS
- ADAPTERS
- QUICK DISCONNECT COUPLERS
- LIVE SWIVEL
- BALL VALVES
- ACCESSORIES
- EQUIPMENT AND PARTS



British to SAE

HOSE

HOSE/CPLG. SELECTION

G8K COUPLINGS

GLOBALSPIRAL COUPLINGS

PCM / PCS FERRULES

MEGACRIMP COUPLINGS

STAINLESS STEEL

POWER CRIMP COUPLINGS

LOC. GL AND GLP COUPLINGS

POLARSEAL COUPLINGS

POLARSEAL II COUPLINGS

C14 COUPLINGS

PCTS THERMOPLASTIC COUPLINGS

FIELD ATTACHABLE G1 & G2 COUPLINGS

FIELD ATTACHABLE C5 & C5E COUPLINGS

SURELOK AIR BRAKE COUPLINGS

ADAPTERS

QUICK DISCONNECT COUPLERS

LIVE SWIVEL

BALL VALVES

ACCESSORIES

EQUIPMENT AND PARTS

Female British Standard Pipe Parallel to Male Pipe NPTF - Continued

Descr.	Prod. No.			Weight (Lbs.)
		"	"	
24FBSP-24MP	7253-62385	1 1/2-11	1 1/2-11 1/2	.54
32FBSP-32MP	7253-62395	2-11	2-11 1/2	1.70

Female British Standard Pipe Parallel to Female Pipe NPTF

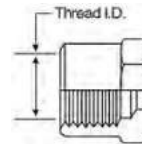
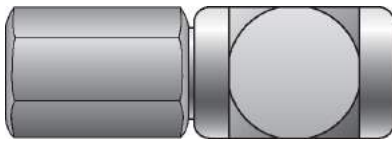

Descr.	Prod. No.			Weight (Lbs.)
		"	"	
4FBSP-4FP	7253-65525	1/4-19	1/4-18	.05
6FBSP-6FP	7253-65535	3/8-19	3/8-18	.10
8FBSP-8FP	7253-65545	1/2-14	1/2-14	.30
12FBSP-12FP	7253-65555	3/4-14	3/4-14	.50
16FBSP-16FP	7253-65565	1-11	1-11 1/2	.60
20FBSP-20FP	7253-65575	1 1/4-11	1 1/4-11 1/2	1.00

Female British Standard Pipe Parallel to Male JIC 37° Flare

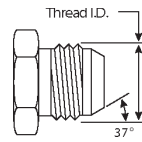

Descr.	Prod. No.			Weight (Lbs.)
		"	"	
2FBSP-4MJ	7253-14155	1/8-28	7/16-20	.10
4FBSP-4MJ	7253-14225	1/4-19	7/16-20	.02
4FBSP-6MJ	7253-14165	1/4-19	9/16-18	.18
6FBSP-6MJ	7253-14175	3/8-19	9/16-18	.08
8FBSP-8MJ	7253-14185	1/2-14	3/4-16	.26
12FBSP-12MJ	7253-14195	3/4-14	1 1/16-12	.54
16FBSP-16MJ	7253-14205	1-11	1 5/16-12	.66
20FBSP-20MJ	7253-14215	1 1/4-11	1 5/8-12	.92
24FBSP-24MJ	7253-62415	1 1/2-11	1 7/8-12	1.05



British to SAE

Female British Standard Pipe Parallel Swivel to Male Pipe NPTF - 90°

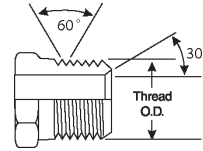

Descr.	Prod. No.			Weight (Lbs.)
		"	"	
2FBSPPX-2MP90	7253-62425	1/8-28	1/8-27	.05
4FBSPPX-4MP90	7253-62435	1/4-19	1/4-18	.10
6FBSPPX-6MP90	7253-62445	3/8-19	3/8-18	.20
8FBSPPX-8MP90	7253-62455	1/2-14	1/2-14	.35
12FBSPPX-12MP90	7253-62465	3/4-14	3/4-14	.55
16FBSPPX-16MP90	7253-62475	1-11	1-11 1/2	1.00
20FBSPPX-20MP90	7253-62485	1 1/4-11	1 1/4-11 1/2	1.70
24FBSPPX-24MP90	7253-62495	1 1/2-11	1 1/4-11 1/2	2.70

Female British Standard Pipe Parallel Swivel to Male JIC 37° Flare

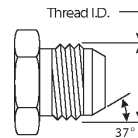

Descr.	Prod. No.			Weight (Lbs.)
		"	"	
2FBSPPX-4MJ	7253-62545	1/8-28	7/16-20	.05
4FBSPPX-4MJ	7253-15245	1/4-19	7/16-20	.07
4FBSPPX-5MJ	7253-62555	1/4-19	1/2-20	.05
4FBSPPX-6MJ	7253-62565	1/4-19	9/16-18	.05
6FBSPPX-4MJ	7253-62575	3/8-19	7/16-20	.15
6FBSPPX-5MJ	7253-62585	3/8-19	1/2-20	.15
6FBSPPX-6MJ	7253-15255	3/8-19	9/16-18	.15
6FBSPPX-8MJ	7253-62595	3/8-19	3/4-16	.15
6FBSPPX-10MJ	7253-62605	3/8-19	7/8-14	.15
8FBSPPX-6MJ	7253-62615	1/2-14	9/16-18	.15
8FBSPPX-8MJ	7253-15265	1/2-14	3/4-16	.24
8FBSPPX-10MJ	7253-62625	1/2-14	7/8-14	.20
10FBSPPX-8MJ	7253-62635	5/8-14	3/4-16	.20
10FBSPPX-10MJ	7253-15275	5/8-14	7/8-14	.27
12FBSPPX-8MJ	7253-62645	3/4-14	3/4-16	.35
12FBSPPX-10MJ	7253-62655	3/4-14	7/8-14	.35
12FBSPPX-12MJ	7253-15285	3/4-14	1 1/16-12	.53
12FBSPPX-16MJ	7253-62665	3/4-14	1 5/16-12	.45
16FBSPPX-12MJ	7253-62675	1-11	1 1/16-12	.55
16FBSPPX-16MJ	7253-15295	1-11	1 5/16-12	.47
20FBSPPX-20MJ	7253-62685	1 1/4-11	1 5/8-12	.90
24FBSPPX-24MJ	7253-62695	1 1/2-11	1 7/8-12	1.25

- HOSE
- HOSE/CPLG. SELECTION
- G8K COUPLINGS
- GLOBAL SPIRAL COUPLINGS
- PCM / PCS FERRULES
- MEGACRIMP COUPLINGS
- STAINLESS STEEL
- POWER CRIMP COUPLINGS
- LOC. GL AND GLP COUPLINGS
- POLARSEAL COUPLINGS
- POLARSEAL II COUPLINGS
- C14 COUPLINGS
- PCTS THERMOPLASTIC COUPLINGS
- FIELD ATTACHABLE G1 & G2 COUPLINGS
- FIELD ATTACHABLE C5 & C5E COUPLINGS
- SURELOK AIR BRAKE COUPLINGS
- ADAPTERS
- QUICK DISCONNECT COUPLERS
- LIVE SWIVEL
- BALL VALVES
- ACCESSORIES
- EQUIPMENT AND PARTS



British to SAE

Female British Standard Pipe Parallel Swivel to Female JIC 37° Flare Swivel

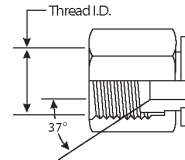
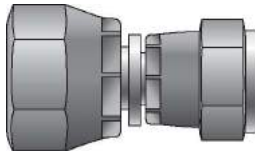

Descr.	Prod. No.			Weight (Lbs.)
		"	"	
4FBSPPX-4FJX	7253-15305	1/4-19	7/16-20	.02
4FBSPPX-6FJX	7253-62505	1/4-19	9/16-18	.05
6FBSPPX-6FJX	7253-15315	3/8-19	9/16-18	.02
6FBSPPX-8FJX	7253-62515	3/8-19	3/4-16	.15
8FBSPPX-6FJX	7253-62525	1/2-14	9/16-18	.15
8FBSPPX-8FJX	7253-15325	1/2-14	3/4-16	.20
10FBSPPX-10FJX	7253-15335	5/8-14	7/8-14	.21
12FBSPPX-12FJX	7253-15345	3/4-14	1 1/16-12	.40
16FBSPPX-16FJX	7253-15355	1-11	1 5/16-12	.42
20FBSPPX-20FJX	7253-62535	1 1/4-11	1 5/8-12	.80

Female British Flat-Face O-Ring to Male JIC 37° Flare

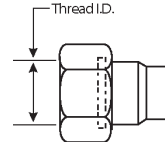
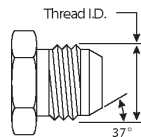
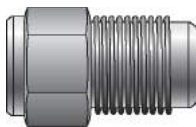

Descr.	Prod. No.			Weight (Lbs.)
		"	"	
6FBFFOR-6MJ	7253-62705	3/8-19	9/16-18	.10
8FBFFOR-6MJ	7253-62715	1/2-14	9/16-18	.15
8FBFFOR-8MJ	7253-62725	1/2-14	3/4-16	.20
8FBFFOR-10MJ	7253-62735	1/2-14	7/8-14	.20
10FBFFOR-8MJ	7253-62745	5/8-14	3/4-16	.20
12FBFFOR-8MJ	7253-62755	3/4-14	3/4-16	.30
12FBFFOR-10MJ	7253-62765	3/4-14	7/8-14	.30
12FBFFOR-12MJ	7253-62775	3/4-14	1 1/16-12	.35



Metric Conversion

Male Metric O-Ring Plug



Descr.	Prod. No.			Weight (Lbs.)
		"	"	
12MMOR-PLUG	7253-65415	M12X1.5		.01
14MMOR-PLUG	7253-65425	M14X1.5		.01
16MMOR-PLUG	7253-65435	M16X1.5		.05
18MMOR-PLUG	7253-65445	M18X1.5		.05
20MMOR-PLUG	7253-65455	M20X1.5		.05
22MMOR-PLUG	7253-65465	M22X1.5		.10
24MMOR-PLUG	7253-65475	M24X1.5		.10
26MMOR-PLUG	7253-65485	M26X1.5		.15
30MMOR-PLUG	7253-65495	M30X2.0		.15
36MMOR-PLUG	7253-65505	M36X2.0		.30
42MMOR-PLUG	7253-65515	M42X2.0		.45

Male Metric with O-Ring to Female Pipe NPTF

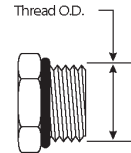
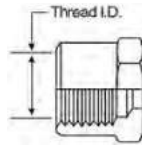

Descr.	Prod. No.			Weight (Lbs.)
		"	"	
10MM-2FP	7253-62785	M10X1.0	1/8-27	.05
12MM-2FP	7253-62795	M12X1.5	1/8-27	.03
12MM-4FP	7253-62805	M12X1.5	1/4-18	.05
12MM-6FP	7253-62815	M12X1.5	3/8-18	.10
14MM-4FP	7253-62825	M14X1.5	1/4-18	.05
16MM-6FP	7253-62835	M16X1.5	3/8-18	.10
16MM-8FP	7253-62845	M16X1.5	1/2-14	.25
18MM-6FP	7253-62855	M18X1.5	3/8-18	.15
18MM-8FP	7253-62865	M18X1.5	1/2-14	.25
20MM-4FP	7253-62875	M20X1.5	1/4-18	.30
20MM-6FP	7253-62885	M20X1.5	3/8-18	.30
20MM-8FP	7253-62895	M20X1.5	1/2-14	.20
22MM-6FP	7253-62905	M22X1.5	3/8-18	.25
22MM-8FP	7253-62915	M22X1.5	1/2-14	.25
22MM-12FP	7253-62925	M22X1.5	3/4-14	.35
24MM-12FP	7253-62935	M24X1.5	3/4-14	.35
26MM-12FP	7253-62945	M26X1.5	3/4-14	.18
27MM-12FP	7253-62955	M27X2.0	3/4-14	.35
33MM-16FP	7253-62965	M33X2.0	1-11 1/2	.55

- HOSE
- HOSE/CPLG. SELECTION
- G8K COUPLINGS
- GLOBAL SPIRAL COUPLINGS
- PCM / PCS FERRULES
- MEGACRIMP COUPLINGS
- STAINLESS STEEL
- POWER CRIMP COUPLINGS
- LOC. GL AND GLP COUPLINGS
- POLARSEAL COUPLINGS
- POLARSEAL II COUPLINGS
- C14 COUPLINGS
- PCTS THERMOPLASTIC COUPLINGS
- FIELD ATTACHABLE G1 & G2 COUPLINGS
- FIELD ATTACHABLE C5 & C5E COUPLINGS
- SURELOK AIR BRAKE COUPLINGS
- ADAPTERS
- QUICK DISCONNECT COUPLERS
- LIVE SWIVEL
- BALL VALVES
- ACCESSORIES
- EQUIPMENT AND PARTS



Metric Conversion

Male Metric with O-Ring to Male JIC 37° Flare

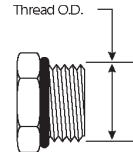
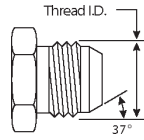

Descr.	Prod. No.			Weight (Lbs.)
		"	"	
10MM-4MJ	7253-14355	M10X1.0	7/16-20	.10
12MM-4MJ	7253-14365	M12X1.5	7/16-20	.14
12MM-5MJ	7253-62975	M12X1.5	1/2-20	.05
12MM-6MJ	7253-62985	M12X1.5	9/16-18	.05
14MM-4MJ	7253-62995	M14X1.5	7/16-20	.05
14MM-6MJ	7253-14375	M14X1.5	9/16-18	.02
14MM-8MJ	7253-63005	M14X1.5	3/4-16	.10
16MM-5MJ	7253-63015	M16X1.5	1/2-20	.10
16MM-6MJ	7253-14385	M16X1.5	9/16-18	.20
16MM-8MJ	7253-14395	M16X1.5	3/4-16	.02
18MM-8MJ	7253-14405	M18X1.5	3/4-16	.02
18MM-10MJ	7253-14415	M18X1.5	7/8-14	.02
20MM-10MJ	7253-14425	M20X1.5	7/8-14	.20
22MM-8MJ	7253-63025	M22X1.5	3/4-16	.20
22MM-10MJ	7253-14435	M22X1.5	7/8-14	.28
22MM-12MJ	7253-14445	M22X1.5	1 1/16-12	.34
26MM-12MJ	7253-63035	M26X1.5	1 1/16-12	.35
27MM-12MJ	7253-14455	M27X2.0	1 1/16-12	.40
27MM-16MJ	7253-63045	M27X2.0	1 5/16-12	.40
33MM-16MJ	7253-14465	M33X2.0	1 5/16-12	.42
33MM-20MJ	7253-63055	M33X2.0	1 5/8-12	.60
42MM-20MJ	7253-14475	M42X2.0	1 5/8-12	.96
48MM-24MJ	7253-63065	M48X2.0	1 7/8-12	1.30

Male Metric with O-Ring to Male JIC 37° Flare - 90°

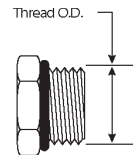
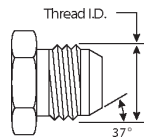

Descr.	Prod. No.			Weight (Lbs.)
		"	"	
10MM-4MJ90	7253-65585	M10X1.0	7/16-20	.05
12MM-4MJ90	7253-65595	M12X1.5	7/16-20	.10
12MM-5MJ90	7253-65615	M12X1.5	1/2-20	.10
12MM-6MJ90	7253-65625	M12X1.5	9/16-18	.40
14MM-4MJ90	7253-65605	M14X1.5	7/16-20	.10
14MM-6MJ90	7253-65635	M14X1.5	9/16-18	.10
16MM-6MJ90	7253-65645	M16X1.5	9/16-18	.20



Metric Conversion

Male Metric with O-Ring to Male JIC 37° Flare - 90° - Continued

Descr.	Prod. No.			Weight (Lbs.)
		"	"	
16MM-8MJ90	7253-65655	M16X1.5	3/4-16	.20
18MM-8MJ90	7253-65665	M18X1.5	3/4-16	.25
18MM-10MJ90	7253-65685	M18X1.5	7/8-14	.35
20MM-10MJ90	7253-65695	M20X1.5	7/8-14	.35
22MM-8MJ90	7253-65675	M22X1.5	3/4-16	.35
22MM-10MJ90	7253-65705	M22X1.5	7/8-14	.35
22MM-12MJ90	7253-65715	M22X1.5	1 1/16-12	.55
26MM-12MJ90	7253-65725	M26X1.5	1 1/16-12	.65
27MM-16MJ90	7253-65735	M27X2.0	1 5/16-12	.95
33MM-16MJ90	7253-65745	M33X2.0	1 5/16-12	.95
42MM-20MJ90	7253-65755	M42X2.0	1 5/8-12	1.60

Male DIN 24° Cone - Light Series to Male JIC 37° Flare

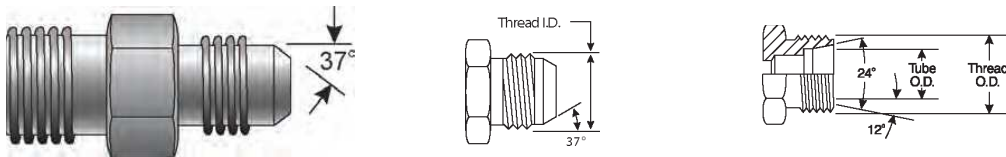

Descr.	Prod. No.			Weight (Lbs.)
		"	"	
6MDL-4MJ	7253-63075	M12X1.5	7/16-20	.05
8MDL-4MJ	7253-15365	M14X1.5	7/16-20	.08
8MDL-6MJ	7253-63095	M14X1.5	9/16-18	.05
10MDL-4MJ	7253-63105	M16X1.5	7/16-20	.05
10MDL-6MJ	7253-15375	M16X1.5	9/16-18	.09
10MDL-8MJ	7253-63115	M16X1.5	3/4-16	.10
12MDL-6MJ	7253-15585	M18X1.5	9/16-18	.21
12MDL-8MJ	7253-63135	M18X1.5	3/4-16	.15
15MDL-8MJ	7253-15385	M22X1.5	3/4-16	.20
15MDL-10MJ	7253-63145	M22X1.5	7/8-14	.20
15MDL-12MJ	7253-63155	M22X1.5	1 1/16-12	.25
18MDL-10MJ	7253-15515	M26X1.5	7/8-14	.33
18MDL-12MJ	7253-63165	M26X1.5	1 1/16-12	.30
22MDL-12MJ	7253-15395	M30X2.0	1 1/16-12	.26
28MDL-16MJ	7253-15405	M36X2.0	1 5/16-12	.40
35MDL-20MJ	7253-63175	M45X2.0	1 5/8-12	.85
42MDL-24MJ	7253-63185	M52X2.0	1 7/8-12	1.10

- HOSE
- HOSE/CPLG. SELECTION
- G8K COUPLINGS
- GLOBAL SPIRAL COUPLINGS
- PCM / PCS FERRULES
- MEGACRIMP COUPLINGS
- STAINLESS STEEL
- POWER CRIMP COUPLINGS
- LOC, GL AND GLP COUPLINGS
- POLARSEAL COUPLINGS
- POLARSEAL II COUPLINGS
- C14 COUPLINGS
- PCTS THERMOPLASTIC COUPLINGS
- FIELD ATTACHABLE G1 & G2 COUPLINGS
- FIELD ATTACHABLE C5 & C5E COUPLINGS
- SURELOK AIR BRAKE COUPLINGS
- ADAPTERS
- QUICK DISCONNECT COUPLERS
- LIVE SWIVEL
- BALL VALVES
- ACCESSORIES
- EQUIPMENT AND PARTS



Metric Conversion

Female DIN 24° Cone Swivel - Light Series to Male JIC 37° Flare

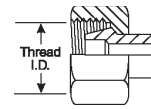
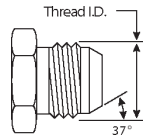
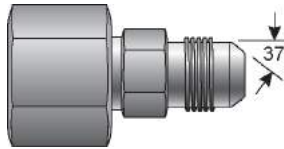

Descr.	Prod. No.			Weight (Lbs.)
		"	"	
6FDLX-4MJ	7253-64725	M12X1.5	7/16-20	.05
6FDLX-5MJ	7253-64735	M6X1.5	1/2-20	.05
8FDLX-4MJ	7253-15465	M14X1.5	7/16-20	.09
8FDLX-6MJ	7253-64755	M14X1.5	9/16-18	.05
10FDLX-6MJ	7253-15475	M16X1.5	9/16-18	.12
10FDLX-8MJ	7253-64775	M16X1.5	3/4-16	.15
12FDLX-6MJ	7253-15545	M18X1.5	9/16-18	.16
12FDLX-8MJ	7253-64795	M18X1.5	3/4-16	.15
12FDLX-10MJ	7253-64805	M18X1.5	7/8-14	.15
15FDLX-6MJ	7253-64815	M22X1.5	9/16-18	.15
15FDLX-8MJ	7253-15485	M22X1.5	3/4-16	.22
15FDLX-10MJ	7253-64835	M22X1.5	7/8-14	.20
22FDLX-12MJ	7253-15495	M30X2.0	1 1/16-12	.39
28FDLX-16MJ	7253-15505	M36X2.0	1 5/16-12	.51

Male DIN 24° Cone - Heavy Series to Male JIC 37° Flare

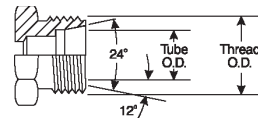
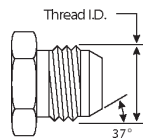
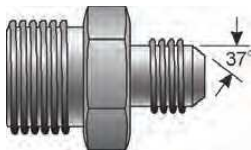

Descr.	Prod. No.			Weight (Lbs.)
		"	"	
6MDH-4MJ	7253-63195	M14X1.5	7/16-20	.05
8MDH-4MJ	7253-63205	M16X1.5	7/16-20	.10
8MDH-6MJ	7253-63215	M16X1.5	9/16-18	.10
10MDH-4MJ	7253-15415	M18X1.5	7/16-20	.10
10MDH-8MJ	7253-63225	M18X1.5	3/4-16	.15
12MDH-6MJ	7253-63235	M20X1.5	9/16-18	.15
12MDH-8MJ	7253-63245	M20X1.5	3/4-16	.15
12MDH-10MJ	7253-63255	M20X1.5	7/8-14	.20
14MDH-6MJ	7253-15425	M22X1.5	9/16-18	.17
14MDH-8MJ	7253-63265	M22X1.5	3/4-16	.20
16MDH-8MJ	7253-15435	M24X1.5	3/4-16	.19
16MDH-10MJ	7253-63285	M24X1.5	1 7/8-12	.30
16MDH-12MJ	7253-63275	M24X1.5	1 1/16-12	.30
20MDH-10MJ	7253-15525	M30X2.0	7/8-14	.33
20MDH-12MJ	7253-63295	M30X2.0	1 1/16-12	.40
25MDH-12MJ	7253-15445	M36X2.0	1 1/16-12	.62
25MDH-16MJ	7253-63305	M36X2.0	1 5/16-12	.55
30MDH-16MJ	7253-15455	M42X2.0	1 5/16-12	.78
38MDH-20MJ	7253-63315	M52X2.0	1 5/8-12	1.20
38MDH-24MJ	7253-63325	M52X2.0	1 7/8-12	1.15



Metric Conversion

Female DIN 24° Cone Swivel - Heavy Series to Male JIC 37° Flare

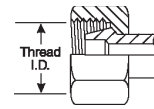
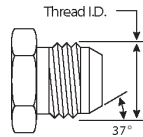
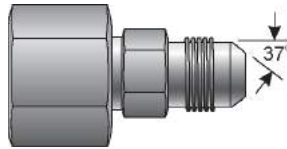

Descr.	Prod. No.			Weight (Lbs.)
		"	"	
10FDHX-4MJ	7253-15605	M18X1.5	7/16-20	.05
12FDHX-5MJ	7253-15615	M20X1.5	1/2-20	.19
12FDHX-6MJ	7253-64845	M20X1.5	9/16-18	.15
12FDHX-8MJ	7253-64855	M20X1.5	3/4-16	.15
12FDHX-10MJ	7253-64865	M20X1.5	7/8-14	.20
14FDHX-6MJ	7253-15625	M22X1.5	9/16-18	.15
16FDHX-8MJ	7253-15635	M24X1.5	3/4-16	.26
20FDHX-10MJ	7253-15645	M30X2.0	7/8-14	.33
25FDHX-12MJ	7253-15655	M36X2.0	1 1/16-12	.48
30FDHX-16MJ	7253-15665	M42X2.0	1 5/16-12	.86
38FDHX-20MJ	7253-15675	M52X2.0	1 5/8-12	.92

Male Kobelco Plug

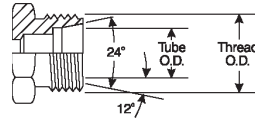

Descr.	Prod. No.			Weight (Lbs.)
		"	"	
22MKB-PLUG	7253-65295	M30X1.5		.35

Male Kobelco to Male JIC 37° Flare

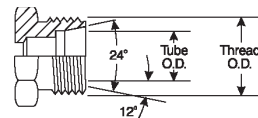
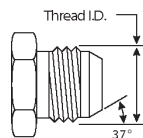
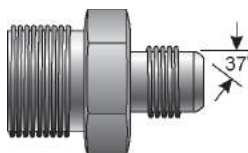

Descr.	Prod. No.			Weight (Lbs.)
		"	"	
22MKB-12MJ	7253-66105	M30X1.5	1 1/16-12	.40
28MKB-12MJ	7253-65305	M36X1.5	1 1/16-12	.55
28MKB-16MJ	7253-65315	M36X1.5	1 5/16-12	.45
35MKB-16MJ	7253-65325	M45X1.5	1 5/16-12	.85
35MKB-20MJ	7253-65335	M45X1.5	1 5/8-12	.85

- HOSE
- HOSE/CPLG. SELECTION
- G8K COUPLINGS
- GLOBAL SPIRAL COUPLINGS
- PCM / PCS FERRULES
- MEGACRIMP COUPLINGS
- STAINLESS STEEL
- POWER CRIMP COUPLINGS
- LOC, GL AND GLP COUPLINGS
- POLARSEAL COUPLINGS
- POLARSEAL II COUPLINGS
- C14 COUPLINGS
- PCTS THERMOPLASTIC COUPLINGS
- FIELD ATTACHABLE G1 & G2 COUPLINGS
- FIELD ATTACHABLE C5 & C5E COUPLINGS
- SURELOK AIR BRAKE COUPLINGS
- ADAPTERS
- QUICK DISCONNECT COUPLERS
- LIVE SWIVEL
- BALL VALVES
- ACCESSORIES
- EQUIPMENT AND PARTS



International to International

- HOSE
- HOSE/CPLG. SELECTION
- G8K COUPLINGS
- GLOBALSPIRAL COUPLINGS
- PCM / PCS FERRULES
- MEGACRIMP COUPLINGS
- STAINLESS STEEL
- POWER CRIMP COUPLINGS
- LOC. GL AND GLP COUPLINGS
- POLARSEAL COUPLINGS
- POLARSEAL II COUPLINGS
- C14 COUPLINGS
- PCTS THERMOPLASTIC COUPLINGS
- FIELD ATTACHABLE G1 & G2 COUPLINGS
- FIELD ATTACHABLE C5 & C5E COUPLINGS
- SURELOK AIR BRAKE COUPLINGS
- ADAPTERS
- QUICK DISCONNECT COUPLERS
- LIVE SWIVEL
- BALL VALVES
- ACCESSORIES
- EQUIPMENT AND PARTS

British Bonded Seal



Descr.	Prod. No.		Weight (Lbs.)
		"	
2BBDS	7253-63335	3/8	.01
4BBDS	7253-63345	17/32	.01
6BBDS	7253-63355	21/32	.01
8BBDS	7253-63365	13/16	.01
10BBDS	7253-63375	29/32	.01
12BBDS	7253-63385	1 1/32	.01
16BBDS	7253-63395	1 11/32	.01
20BBDS	7253-63405	1 21/32	.01
24BBDS	7253-63415	1 7/8	.01
32BBDS	7253-63425	2 11/32	.01
40BBDS	7253-63435	2 1/2	.05
48BBDS	7253-63445	3	.05

Male British Standard Pipe Parallel with O-Ring Plug

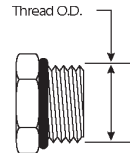

Descr.	Prod. No.		Weight (Lbs.)
		"	
2MBSPOR-PLUG	7253-65345	1/8-28	.01
4MBSPOR-PLUG	7253-65355	1/4-19	.05
6MBSPOR-PLUG	7253-65365	3/8-19	.05
8MBSPOR-PLUG	7253-65375	1/2-14	.10
12MBSPOR-PLUG	7253-65385	3/4-14	.15
16MBSPOR-PLUG	7253-65395	1-11	.25
20MBSPOR-PLUG	7253-65405	1 1/4-11	.40



International to International

Female British Standard Pipe Parallel Cap



Descr.	Prod. No.		Weight (Lbs.)
		"	
2FBSPP-CAP	7253-63455	1/8-28	.01
4FBSPP-CAP	7253-63465	1/4-19	.05
6FBSPP-CAP	7253-63475	3/8-19	.10
8FBSPP-CAP	7253-63485	1/2-14	.15
10FBSPP-CAP	7253-63495	5/8-14	.15
12FBSPP-CAP	7253-63505	3/4-14	.20
16FBSPP-CAP	7253-63515	1-11	.30
20FBSPP-CAP	7253-63525	1 1/4-11	.55
24FBSPP-CAP	7253-63535	1 1/2-11	1.00
32FBSPP-CAP	7253-63545	2-11	1.80

Male British Standard Pipe Tapered Thread Plug

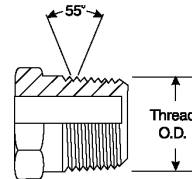

Descr.	Prod. No.		Weight (Lbs.)
		"	
2MBSPT-PLUG	7253-63555	1/8-28	.01
4MBSPT-PLUG	7253-63565	1/4-19	.05
6MBSPT-PLUG	7253-63575	3/8-19	.10
8MBSPT-PLUG	7253-63585	1/2-14	.15
10MBSPT-PLUG	7253-63595	5/8-14	.20
12MBSPT-PLUG	7253-63605	3/4-14	.30
16MBSPT-PLUG	7253-63615	1-11	.55
20MBSPT-PLUG	7253-63625	1 1/4-11	1.05
24MBSPT-PLUG	7253-63635	1 1/2-11	1.40

HOSE

HOSE/CPLG. SELECTION

G8K COUPLINGS

GLOBALSPIRAL COUPLINGS

PCM / PCS FERRULES

MEGACRIMP COUPLINGS

STAINLESS STEEL

POWER CRIMP COUPLINGS

LOC. GL AND GLP COUPLINGS

POLARSEAL COUPLINGS

POLARSEAL II COUPLINGS

C14 COUPLINGS

PCTS THERMOPLASTIC COUPLINGS

FIELD ATTACHABLE G1 & G2 COUPLINGS

FIELD ATTACHABLE C5 & C5E COUPLINGS

SURELOK AIR BRAKE COUPLINGS

ADAPTERS

QUICK DISCONNECT COUPLERS

LIVE SWIVEL

BALL VALVES

ACCESSORIES

EQUIPMENT AND PARTS

R75



International to International

Male British Standard Pipe Parallel Plug

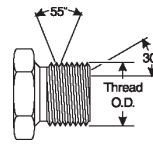

Descr.	Prod. No.			Weight (Lbs.)
		"		
2MBSPP-PLUG	7253-63655	1/8-28		.01
4MBSPP-PLUG	7253-63665	1/4-19		.01
6MBSPP-PLUG	7253-63675	3/8-19		.05
8MBSPP-PLUG	7253-63685	1/2-14		.15
10MBSPP-PLUG	7253-63695	5/8-14		.15
12MBSPP-PLUG	7253-63705	3/4-14		.25
16MBSPP-PLUG	7253-63715	1-11		.45
20MBSPP-PLUG	7253-63725	1 1/4-11		.65
24MBSPP-PLUG	7253-63735	1 1/2-11		.80
32MBSPP-PLUG	7253-63745	2-11		1.65

Male British Standard Pipe Parallel to Female British Standard Pipe Parallel Swivel

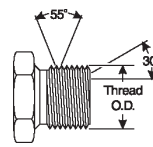
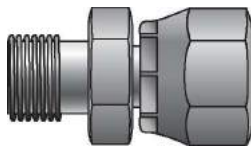

Descr.	Prod. No.			Weight (Lbs.)
		"		
2MBSPP-2FBSPPX	7253-63775	1/8-28	1/8-28	.05
2MBSPP-4FBSPPX	7253-63785	1/8-28	1/4-19	.05
4MBSPP-2FBSPPX	7253-63795	1/4-19	1/8-28	.05
4MBSPP-4FBSPPX	7253-15185	1/4-19	1/4-19	.10
4MBSPP-6FBSPPX	7253-63805	1/4-19	3/8-19	.10
4MBSPP-8FBSPPX	7253-63815	1/4-19	1/2-14	.15
6MBSPP-4FBSPPX	7253-63825	3/8-19	1/4-19	.10
6MBSPP-6FBSPPX	7253-15195	3/8-19	3/8-19	.03
6MBSPP-8FBSPPX	7253-63835	3/8-19	1/2-14	.25
8MBSPP-6FBSPPX	7253-63845	1/2-14	3/8-19	.15
8MBSPP-8FBSPPX	7253-15205	1/2-14	1/2-14	.21
8MBSPP-10FBSPPX	7253-63855	1/2-14	5/8-14	.20
8MBSPP-12FBSPPX	7253-63865	1/2-14	3/4-14	.35
10MBSPP-8FBSPPX	7253-63875	5/8-14	1/2-14	.25
10MBSPP-10FBSPPX	7253-15215	5/8-14	7/8-14	.21
10MBSPP-12FBSPPX	7253-63885	5/8-14	3/4-14	.30
12MBSPP-6FBSPPX	7253-63895	3/4-14	3/8-19	.30
12MBSPP-8FBSPPX	7253-63905	3/4-14	1/2-14	.30
12MBSPP-10FBSPPX	7253-63915	3/4-14	5/8-14	.30
12MBSPP-12FBSPPX	7253-15225	3/4-14	3/4-14	.40
12MBSPP-16FBSPPX	7253-63925	3/4-14	1-11	.45
12MBSPP-20FBSPPX	7253-63935	3/4-14	1 1/4-11	.90
16MBSPP-12FBSPPX	7253-63945	1-11	3/4-14	.55



International to International

Male British Standard Pipe Parallel to Female British Standard Pipe Parallel Swivel - Continued

Descr.	Prod. No.			Weight (Lbs.)
		"	"	
16MBSPP-16FBSPPX	7253-15235	1-11	1-11	.62
16MBSPP-20FBSPPX	7253-63955	1-11	1 1/4-11	.85
20MBSPP-16FBSPPX	7253-63965	1 1/4-11	1-11	.85
20MBSPP-20FBSPPX	7253-63975	1 1/4-11	1 1/4-11	.95
20MBSPP-24FBSPPX	7253-63985	1 1/4-11	1 1/2-11	1.15
24MBSPP-20FBSPPX	7253-63995	1 1/2-11	1 1/4-11	1.05
24MBSPP-24FBSPPX	7253-64005	1 1/2-11	1 1/2-11	1.30
32MBSPP-32FBSPPX	7253-64015	2-11	2-11	2.15

Metric Bonded Seal



Descr.	Prod. No.		Weight (Lbs.)
		mm	
6MBDS	7253-64025	6.0	.01
8MBDS	7253-64035	8.0	.01
10MBDS	7253-64045	10.0	.01
12MBDS	7253-64055	12.0	.01
14MBDS	7253-64065	14.0	.01
16MBDS	7253-64075	16.0	.01
18MBDS	7253-64085	18.0	.01
20MBDS	7253-64095	20.0	.01
22MBDS	7253-64105	22.0	.01
24MBDS	7253-64115	24.0	.01
26MBDS	7253-64125	26.0	.01
27MBDS	7253-64135	27.0	.01
30MBDS	7253-64145	30.0	.01
33MBDS	7253-64155	33.0	.01
36MBDS	7253-64165	36.0	.01
42MBDS	7253-64175	42.0	.01
45MBDS	7253-64185	45.0	.01
50MBDS	7253-64195	50.0	.02
52MBDS	7253-64205	52.0	.01

- HOSE
- HOSE/CPLG. SELECTION
- G8K COUPLINGS
- GLOBAL SPIRAL COUPLINGS
- PCM / PCS FERRULES
- MEGACRIMP COUPLINGS
- STAINLESS STEEL
- POWER CRIMP COUPLINGS
- LOC, GL AND GLP COUPLINGS
- POLARSEAL COUPLINGS
- POLARSEAL II COUPLINGS
- C14 COUPLINGS
- PCTS THERMOPLASTIC COUPLINGS
- FIELD ATTACHABLE G1 & G2 COUPLINGS
- FIELD ATTACHABLE C5 & C5E COUPLINGS
- SURELOK AIR BRAKE COUPLINGS
- ADAPTERS
- QUICK DISCONNECT COUPLERS
- LIVE SWIVEL
- BALL VALVES
- ACCESSORIES
- EQUIPMENT AND PARTS



International to International

- HOSE
- HOSE/CPLG. SELECTION
- G8K COUPLINGS
- GLOBALSPIRAL COUPLINGS
- PCM / PCS FERRULES
- MEGACRIMP COUPLINGS
- STAINLESS STEEL
- POWER CRIMP COUPLINGS
- LOC. GL AND GLP COUPLINGS
- POLARSEAL COUPLINGS
- POLARSEAL II COUPLINGS
- C14 COUPLINGS
- PCTS THERMOPLASTIC COUPLINGS
- FIELD ATTACHABLE G1 & G2 COUPLINGS
- FIELD ATTACHABLE C5 & C5E COUPLINGS
- SURELOK AIR BRAKE COUPLINGS
- ADAPTERS
- QUICK DISCONNECT COUPLERS
- LIVE SWIVEL
- BALL VALVES
- ACCESSORIES
- EQUIPMENT AND PARTS

Male Metric Plug



Descr.	Prod. No.		Weight (Lbs.)
		"	
8MM-PLUG	7253-64215	M08X1.0	.01
10MM-PLUG	7253-64225	M10X1.5	.01
12MM-PLUG	7253-64235	M12X1.5	.01
14MM-PLUG	7253-64245	M14X1.5	.05
16MM-PLUG	7253-64255	M16X1.5	.05
18MM-PLUG	7253-64265	M18X1.5	.10
20MM-PLUG	7253-64275	M20X1.5	.10
22MM-PLUG	7253-64285	M22X1.5	.15
24MM-PLUG	7253-64295	M24X1.5	.15
26MM-PLUG	7253-64305	M26X1.5	.15
30MM-PLUG	7253-64315	M30X1.5	.40

Male DIN 24° Cone - Light Series Plug

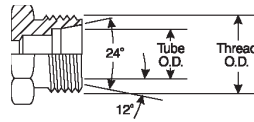



Descr.	Prod. No.		Weight (Lbs.)
		"	
6MDL-PLUG	7253-64325	M12X1.5	.01
8MDL-PLUG	7253-64335	M14X1.5	.01
10MDL-PLUG	7253-64345	M16X1.5	.01
12MDL-PLUG	7253-64355	M18X1.5	.05
15MDL-PLUG	7253-64365	M22X1.5	.05
18MDL-PLUG	7253-64375	M26X1.5	.10
22MDL-PLUG	7253-64385	M30X2.0	.15
28MDL-PLUG	7253-64395	M36X2.0	.30
35MDL-PLUG	7253-64405	M45X2.0	.45
42MDL-PLUG	7253-64415	M52X2.0	.70

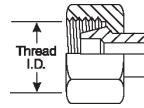

International to International

Female DIN 24° Cone - Light Series Cap



Descr.	Prod. No.		Weight (Lbs.)
		"	
6FDL-CAP	7253-64425	M12X1.5	.01
8FDL-CAP	7253-64435	M14X1.5	.01
10FDL-CAP	7253-64445	M16X1.5	.05
12FDL-CAP	7253-64455	M18X1.5	.05
15FDL-CAP	7253-64465	M22X1.5	.15
18FDL-CAP	7253-64475	M26X1.5	.20
22FDL-CAP	7253-64485	M30X2.0	.30
28FDL-CAP	7253-64495	M36X2.0	.35
35FDL-CAP	7253-64505	M45X2.0	.60
42FDL-CAP	7253-64515	M52X2.0	.43

Male DIN 24° Cone - Heavy Series Plug

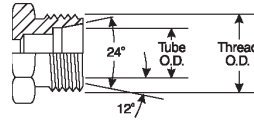

Descr.	Prod. No.		Weight (Lbs.)
		"	
8MDH-PLUG	7253-64535	M16X1.5	.05
10MDH-PLUG	7253-64545	M18X1.5	.05
12MDH-PLUG	7253-64555	M20X1.5	.10
14MDH-PLUG	7253-64565	M22X1.5	.10
16MDH-PLUG	7253-64575	M24X1.5	.15
20MDH-PLUG	7253-64585	M30X2.0	.25
25MDH-PLUG	7253-64595	M36X2.0	.50
30MDH-PLUG	7253-64605	M42X2.0	.65
38MDH-PLUG	7253-64615	M52X2.0	1.10

HOSE

HOSE/CPLG. SELECTION

G8K COUPLINGS

GLOBAL SPIRAL COUPLINGS

PCM / PCS FERRULES

MEGACRIMP COUPLINGS

STAINLESS STEEL

POWER CRIMP COUPLINGS

LOC. GL AND GLP COUPLINGS

POLARSEAL COUPLINGS

POLARSEAL II COUPLINGS

C14 COUPLINGS

PCTS THERMOPLASTIC COUPLINGS

FIELD ATTACHABLE G1 & G2 COUPLINGS

FIELD ATTACHABLE C5 & C5E COUPLINGS

SURELOK AIR BRAKE COUPLINGS

ADAPTERS

QUICK DISCONNECT COUPLERS

LIVE SWIVEL

BALL VALVES

ACCESSORIES

EQUIPMENT AND PARTS

R79



International to International

Female DIN 24° Cone - Heavy Series Cap

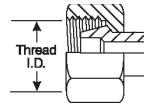

Descr.	Prod. No.		Weight (Lbs.)
		"	
8FDH-CAP	7253-64635	M16X1.5	.05
10FDH-CAP	7253-64645	M18X1.5	.05
12FDH-CAP	7253-64655	M20X1.5	.10
14FDH-CAP	7253-64665	M22X1.5	.15
16FDH-CAP	7253-64675	M24X1.5	.20
20FDH-CAP	7253-64685	M30X2.0	.35
25FDH-CAP	7253-64695	M36X2.0	.60
30FDH-CAP	7253-64705	M42X2.0	.75
38FDH-CAP	7253-64715	M52X2.0	1.15

- HOSE
- HOSE/CPLG. SELECTION
- G8K COUPLINGS
- GLOBAL SPIRAL COUPLINGS
- PCM / PCS FERRULES
- MEGACRIMP COUPLINGS
- STAINLESS STEEL
- POWER CRIMP COUPLINGS
- LOC, GL AND GLP COUPLINGS
- POLARSEAL COUPLINGS
- POLARSEAL II COUPLINGS
- C14 COUPLINGS
- PCTS THERMOPLASTIC COUPLINGS
- FIELD ATTACHABLE G1 & G2 COUPLINGS
- FIELD ATTACHABLE C5 & C5E COUPLINGS
- SURELOK AIR BRAKE COUPLINGS
- ADAPTERS
- QUICK DISCONNECT COUPLERS
- LIVE SWIVEL
- BALL VALVES
- ACCESSORIES
- EQUIPMENT AND PARTS



Japanese Conversion

Female Japanese Industrial Standard Cap

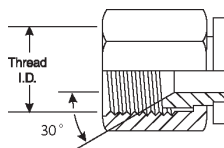

Descr.	Prod. No.			Weight (Lbs.)
				
4FJIS-CAP	7253-64875	1/4-19		.05
6FJIS-CAP	7253-64885	3/8-19		.10
8FJIS-CAP	7253-64895	1/2-14		.15
12FJIS-CAP	7253-64905	3/4-14		.30
16FJIS-CAP	7253-64915	1-11		.65
20FJIS-CAP	7253-64925	1 1/4-11		1.20
32FJIS-CAP	7253-64945	2-11		3.50

Male Japanese Industrial Standard Plug

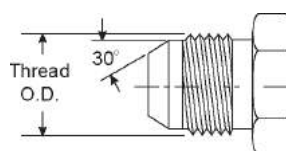
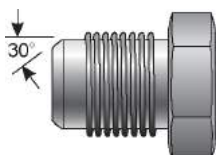

Descr.	Prod. No.			Weight (Lbs.)
				
4MJIS-PLUG	7253-64955	1/4-19		.05
6MJIS-PLUG	7253-64965	3/8-19		.10
8MJIS-PLUG	7253-64975	1/2-14		.15
12MJIS-PLUG	7253-64985	3/4-14		.35
16MJIS-PLUG	7253-64995	1-11		.55
20MJIS-PLUG	7253-65005	1 1/4-11		1.00
24MJIS-PLUG	7253-65015	1 1/2-11		1.50
32MJIS-PLUG	7253-65025	2-11		2.75

Female Japanese Industrial Standard to Male JIC 37° Flare

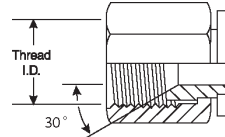
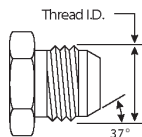
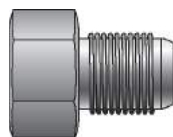

Descr.	Prod. No.			Weight (Lbs.)
				
4FJIS-4MJ	7253-65035	1/4-19	7/16-20	.05
6FJIS-4MJ	7253-65045	3/8-19	7/16-20	.15
6FJIS-6MJ	7253-65055	3/8-19	9/16-18	.15

- HOSE
- HOSE/CPLG. SELECTION
- G8K COUPLINGS
- GLOBAL SPIRAL COUPLINGS
- PCM / PCS FERRULES
- MEGACRIMP COUPLINGS
- STAINLESS STEEL
- POWER CRIMP COUPLINGS
- LOC, GL AND GLP COUPLINGS
- POLARSEAL COUPLINGS
- POLARSEAL II COUPLINGS
- C14 COUPLINGS
- PCTS THERMOPLASTIC COUPLINGS
- FIELD ATTACHABLE G1 & G2 COUPLINGS
- FIELD ATTACHABLE C5 & C5E COUPLINGS
- SURELOK AIR BRAKE COUPLINGS
- ADAPTERS
- QUICK DISCONNECT COUPLERS
- LIVE SWIVEL
- BALL VALVES
- ACCESSORIES
- EQUIPMENT AND PARTS





Japanese Conversion

Female Japanese Industrial Standard to Male JIC 37° Flare - Continued

Descr.	Prod. No.			Weight (Lbs.)
		"	"	
8FJIS-8MJ	7253-65075	1/2-14	3/4-16	.20
12FJIS-12MJ	7253-65085	3/4-14	1 1/16-12	.45
16FJIS-16MJ	7253-65095	1-11	1 5/16-12	.55
20FJIS-20MJ	7253-65105	1 1/4-11	1 5/8-12	1.10

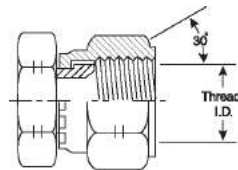
Female Komatsu Cap



Descr.	Prod. No.			Weight (Lbs.)
		"	"	
4FK-CAP	7253-65115	M14X1.5		.45
6FK-CAP	7253-65125	M18X1.5		.10
8FK-CAP	7253-65135	M22X1.5		.15
10FK-CAP	7253-65145	M24X1.5		.20
12FK-CAP	7253-65155	M30X1.5		.50
16FK-CAP	7253-65165	M33X1.5		.65

Male Komatsu Plug

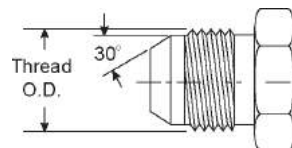
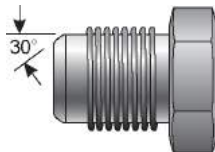

Descr.	Prod. No.			Weight (Lbs.)
		"	"	
4MK-PLUG	7253-65175	M14X1.5		.05
6MK-PLUG	7253-65185	M18X1.5		.10
8MK-PLUG	7253-65195	M22X1.5		.15
10MK-PLUG	7253-65205	M24X1.5		.25
12MK-PLUG	7253-65215	M30X1.5		.55
16MK-PLUG	7253-65225	M33X1.5		.60



Japanese Conversion

Female Komatsu to Male JIC 37° Flare

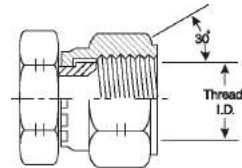
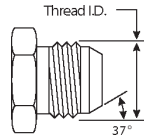
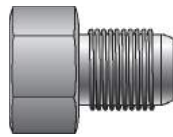

Descr.	Prod. No.			Weight (Lbs.)
		"	"	
4FK-4MJ	7253-65235	M14X1.5	7/16-20	.05
6FK-6MJ	7253-65245	M18X1.5	9/16-18	.10
8FK-8MJ	7253-65255	M22X1.5	3/4-16	.20
10FK-10MJ	7253-65265	M24X1.5	7/8-14	.20
12FK-12MJ	7253-65275	M30X1.5	1 1/16-12	.60
16FK-16MJ	7253-65285	M33X1.5	1 5/16-12	.60

Male Komatsu to Male Komatsu

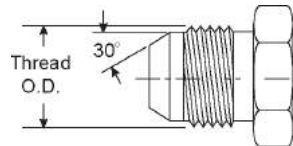

Descr.	Prod. No.			Weight (Lbs.)
		"	"	
4MK-4MK	7253-65765	M14X1.5		.05
6MK-6MK	7253-65775	M18X1.5		.15
8MK-8MK	7253-65785	M22X1.5		.25
10MK-10MK	7253-65795	M24X1.5		.30
12MK-12MK	7253-65805	M30X1.5		.55
16MK-16MK	7253-65815	M33X1.5		.75

Male Komatsu to Male JIC 37° Flare

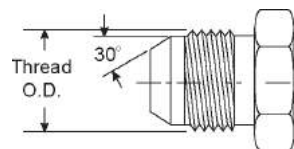
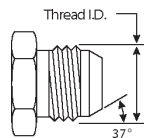

Descr.	Prod. No.			Weight (Lbs.)
		"	"	
4MK-4MJ	7253-65825	M14X1.5	1/2-20	.05
6MK-6MJ	7253-65835	M18X1.5	9/16-18	.10
8MK-8MJ	7253-65845	M22X1.5	3/4-16	.20
10MK-10MJ	7253-65855	M24X1.5	7/8-14	.30
12MK-12MJ	7253-65865	M30X1.5	1 1/16-12	.45
16MK-16MJ	7253-65875	M33X1.5	1 5/16-12	.60

- HOSE
- HOSE/CPLG. SELECTION
- G8K COUPLINGS
- GLOBALSPIRAL COUPLINGS
- PCM / PCS FERRULES
- MEGACRIMP COUPLINGS
- STAINLESS STEEL
- POWER CRIMP COUPLINGS
- LOC, GL AND GLP COUPLINGS
- POLARSEAL COUPLINGS
- POLARSEAL II COUPLINGS
- C14 COUPLINGS
- PCTS THERMOPLASTIC COUPLINGS
- FIELD ATTACHABLE G1 & G2 COUPLINGS
- FIELD ATTACHABLE C5 & C5E COUPLINGS
- SURELOK AIR BRAKE COUPLINGS
- ADAPTERS
- QUICK DISCONNECT COUPLERS
- LIVE SWIVEL
- BALL VALVES
- ACCESSORIES
- EQUIPMENT AND PARTS



Japanese Conversion

- HOSE
- HOSE/CPLG. SELECTION
- G8K COUPLINGS
- GLOBAL SPIRAL COUPLINGS
- PCM / PCS FERRULES
- MEGACRIMP COUPLINGS
- STAINLESS STEEL
- POWER CRIMP COUPLINGS
- LOC. GL AND GLP COUPLINGS
- POLARSEAL COUPLINGS
- POLARSEAL II COUPLINGS
- C14 COUPLINGS
- PCTS THERMOPLASTIC COUPLINGS
- FIELD ATTACHABLE G1 & G2 COUPLINGS
- FIELD ATTACHABLE C5 & C5E COUPLINGS
- SURELOK AIR BRAKE COUPLINGS
- ADAPTERS
- QUICK DISCONNECT COUPLERS
- LIVE SWIVEL
- BALL VALVES
- ACCESSORIES
- EQUIPMENT AND PARTS

Male Komatsu to Female Komatsu - 90°

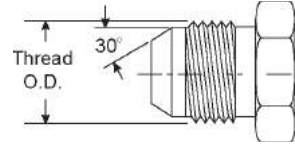
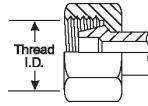

Descr.	Prod. No.			Weight (Lbs.)
		"	"	
4MK-4FK90	7253-65945	M14X1.5	M14X1.5	.15
6MK-6FK90	7253-65965	M18X1.5	M18X1.5	.25
8MK-8FK90	7253-65975	M22X1.5	M22X1.5	.35
10MK-10FK90	7253-65985	M24X1.5	M24X1.5	.60
12MK-12FK90	7253-65995	M30X1.5	M30X1.5	.90
16MK-16FK90	7253-66005	M33X1.5	M33X1.5	1.00

Male Komatsu to Female Komatsu to Male Komatsu - Tee

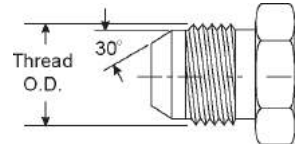
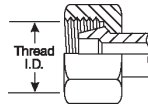

Descr.	Prod. No.			Weight (Lbs.)
		"	"	
4MK-4FK-4MK	7253-65885	M14X1.5	M14X1.5	.15
6MK-6FK-6MK	7253-65905	M18X1.5	M18X1.5	.30
8MK-8FK-8MK	7253-65915	M22X1.5	M22X1.5	.50
10MK-10FK-10MK	7253-65925	M24X1.5	M24X1.5	.80
12MK-12FK-12MK	7253-65935	M30X1.5	M30X1.5	1.15