



**SureLok™ Air Brake Couplings**

**Air Brake Plugs**

Recommended For: Compressed air as a connector on all air brake systems at locations other than between chassis frame and axle or between towed and towing vehicle. Also as a connector on all air operated systems as applicable to suspension, steering, engine, transmission and auxiliary mechanisms. Fittings and tubing comply to D.O.T. FMVSS 106, mandatory requirements for inch tube fittings is U.S.A., Society for Automotive Engineers (SAE J1131, inch tube and fittings) and meets DIN 74324 and German TUV requirements (metric tube and fittings).

Temperature Range: -40°F to +200°F (-40°C to +100°C).

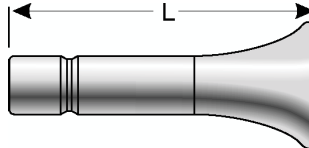

Descr.	Prod. No.	Ø	L		Weight (Lbs.)
		"	"	mm	
2.5AB-PLUG	7250-14535	5/32	1.04	26.4	.01
4AB-PLUG	7250-14505	1/4	1.12	28.5	.01
6AB-PLUG	7250-14515	3/8	1.34	34.0	.01
8AB-PLUG	7250-14525	1/2	1.48	37.6	.01

**Air Brake Cartridge**



Descr.	Prod. No.	Ø	Weight (Lbs.)
		"	
3CARTRIDGE-AB	7250-00705	3/16	.10
4CARTRIDGE-AB	7250-00715	1/4	.02
6CARTRIDGE-AB	7250-00725	3/8	.04
8CARTRIDGE-AB	7250-00735	1/2	.06
10CARTRIDGE-AB	7250-00745	5/8	.08
12CARTRIDGE-AB	7250-00755	3/4	.12
25CARTRIDGE-AB	7250-00765	5/32	.02

- HOSE
- HOSE/CPLG. SELECTION
- G8K COUPLINGS
- GLOBAL SPIRAL COUPLINGS
- PCM / PCS FERRULES
- MEGACRIMP COUPLINGS
- STAINLESS STEEL
- POWER CRIMP COUPLINGS
- LOC, GL AND GLP COUPLINGS
- POLARSEAL COUPLINGS
- POLARSEAL II COUPLINGS
- C14 COUPLINGS
- PCTS THERMOPLASTIC COUPLINGS
- FIELD ATTACHABLE G1 & G2 COUPLINGS
- FIELD ATTACHABLE C5 & C5E COUPLINGS
- SURELOK AIR BRAKE COUPLINGS**
- ADAPTERS
- QUICK DISCONNECT COUPLERS
- LIVE SWIVEL
- BALL VALVES
- ACCESSORIES
- EQUIPMENT AND PARTS



**SureLok™ Air Brake Couplings**

HOSE
HOSE/CPLG. SELECTION
G8K COUPLINGS
GLOBALSPIRAL COUPLINGS
PCM / PCS FERRULES
MEGACRIMP COUPLINGS
STAINLESS STEEL
POWER CRIMP COUPLINGS
LOC. GL AND GLP COUPLINGS
POLARSEAL COUPLINGS
POLARSEAL II COUPLINGS
C14 COUPLINGS
PCTS THERMOPLASTIC COUPLINGS
FIELD ATTACHABLE G1 & G2 COUPLINGS
FIELD ATTACHABLE C5 & C5E COUPLINGS
<b>SURELOK AIR BRAKE COUPLINGS</b>
ADAPTERS
QUICK DISCONNECT COUPLERS
LIVE SWIVEL
BALL VALVES
ACCESSORIES
EQUIPMENT AND PARTS

**Air Brake to Male Pipe**

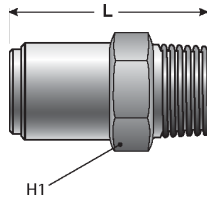

Descr.	Prod. No.			H1	L		Weight (Lbs.)
		"	"	"	"	mm	
2.5AB-1MP	7250-00915	5/32	1/16-32	11/32	.43	10.9	.04
2.5AB-2MP	7250-00925	5/32	1/8-27	7/16	.89	22.6	.10
2AB-2MP	7250-14545	1/8	1/8-27	7/16	.67	17.0	.01
3AB-2MP	7250-00775	3/16	1/8-27	1/2	1.02	25.9	.04
4AB-1MP	7250-14555	1/4	1/16-32	7/16	.94	23.9	.35
4AB-2MP	7250-00785	1/4	1/8-27	1/2	1.04	26.4	.15
4AB-4MP	7250-00795	1/4	1/4-18	9/16	1.17	29.7	.15
4AB-6MP	7250-00805	1/4	3/8-18	11/16	1.20	30.5	.15
6AB-2MP	7250-00815	3/8	1/8-27	11/16	1.32	33.5	.08
6AB-4MP	7250-00825	3/8	1/4-18	11/16	1.48	37.6	.20
6AB-6MP	7250-00835	3/8	3/8-18	11/16	1.42	36.1	.20
6AB-8MP	7250-00845	3/8	1/2-14	7/8	1.46	37.1	.16
8AB-4MP	7250-00855	1/2	1/4-18	7/8	1.68	42.7	.14
8AB-6MP	7250-00865	1/2	3/8-18	7/8	1.64	41.7	.14
8AB-8MP	7250-00875	1/2	1/2-14	7/8	1.72	43.7	.25
10AB-6MP	7250-00885	5/8	3/8-18	11/16	1.87	47.5	.30
10AB-8MP	7250-00895	5/8	1/2-14	11/16	2.12	53.9	.28
12AB-8MP	7250-14565	3/4	1/2-14	13/16	2.11	53.6	.32
12AB-12MP	7250-00905	3/4	3/4-14	1 1/16	2.21	56.1	.36

**Air Brake to Male Pipe - 45°**

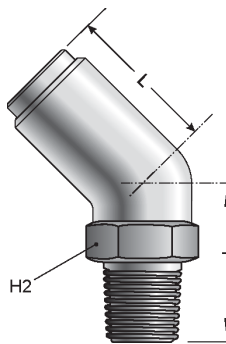

Descr.	Prod. No.			H2	T		L		Weight (Lbs.)
		"	"	"	"	mm	"	mm	
4AB-2MP45	7250-00935	1/4	1/8-27	14.30	.81	20.6	1.68	42.7	.15
4AB-4MP45	7250-00945	1/4	1/4-18	14.30	.98	24.9	1.87	47.5	.08
6AB-2MP45	7250-00955	3/8	1/8-27	19	.93	23.6	1.95	49.5	.10
6AB-4MP45	7250-00965	3/8	1/4-18	19	1.10	27.9	2.16	54.9	.12
6AB-6MP45	7250-00975	3/8	3/8-18	19	1.12	28.5	2.22	56.4	.12



**SureLok™ Air Brake Couplings**

**Air Brake to Male Pipe - 45° - Continued**

Descr.	Prod. No.			H2	T		L		Weight (Lbs.)
		"	"		"	mm	"	mm	
6AB-8MP45	7250-00985	3/8	1/2-14	22	1.30	33.0	2.44	62.0	.20
8AB-4MP45	7250-00995	1/2	1/4-18	22	1.10	27.9	2.32	58.9	.16
8AB-6MP45	7250-01005	1/2	3/8-18	22	1.12	28.5	2.38	60.5	.16
8AB-8MP45	7250-01015	1/2	1/2-14	22	1.30	33.0	2.60	66.0	.18
10AB-6MP45	7250-01025	5/8	3/8-18	27	1.02	25.9	2.48	63.0	.30
10AB-8MP45	7250-01035	5/8	1/2-14	27	1.22	31.0	2.68	68.1	.30
12AB-8MP45	7250-14575	3/4	1/2-14	25.40	1.30	33.0	2.82	71.6	.36
12AB-12MP45	7250-01045	3/4	3/4-14	27	1.91	48.5	3.92	99.6	.42

**Air Brake to Male Pipe - 90°**

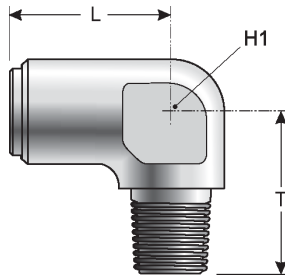

Descr.	Prod. No.			H1	T		L		Weight (Lbs.)
		"	"		mm	mm	"	mm	
2.5AB-2MP90	7250-01195	5/32	1/8-27	7	1.00	25.4	.87	22.1	.04
2AB-2MP90	7250-14585	1/8	1/8-27	7	.66	16.8	.67	17.0	.04
3AB-2MP90	7250-01055	3/16	1/8-27	12	.75	19.1	.81	20.6	.06
4AB-2MP90	7250-01065	1/4	1/8-27	14	.79	20.1	.81	20.6	.15
4AB-4MP90	7250-01075	1/4	1/4-18	18	1.02	25.9	.87	22.1	.10
4AB-6MP90	7250-01085	1/4	3/8-18	22	1.10	27.9	.94	23.9	.15
4AB-8MP90	7250-14595	1/4	1/2-14	24	1.38	35.1	.96	24.4	.18
6AB-2MP90	7250-01095	3/8	1/8-27	18	.87	22.1	1.08	27.4	.10
6AB-4MP90	7250-01105	3/8	1/4-18	18	1.02	25.9	1.06	26.9	.20
6AB-6MP90	7250-01115	3/8	3/8-18	22	1.10	27.9	1.14	29.0	.20
6AB-8MP90	7250-01125	3/8	1/2-14	24	1.38	35.1	1.14	29.0	.20
8AB-4MP90	7250-01135	1/2	1/4-18	22	1.14	29.0	1.22	31.0	.16
8AB-6MP90	7250-01145	1/2	3/8-18	22	1.14	29.0	1.26	32.0	.16
8AB-8MP90	7250-01155	1/2	1/2-14	24	1.38	35.1	1.28	32.5	.20
10AB-6MP90	7250-01165	5/8	3/8-18	22	1.22	31.0	1.44	36.9	.30
10AB-8MP90	7250-01175	5/8	1/2-14	30	1.42	36.1	1.54	39.1	.30
12AB-8MP90	7250-14605	3/4	1/2-14	24	1.48	37.6	1.52	38.6	.32
12AB-12MP90	7250-14615	3/4	3/4-14	27	2.00	50.8	2.15	54.6	.54
25AB-1MP90	7250-01185	5/32	1/16-32	7	1.00	25.4	1.00	25.4	.04

- HOSE
- HOSE/CPLG. SELECTION
- G8K COUPLINGS
- GLOBAL SPIRAL COUPLINGS
- PCM / PCS FERRULES
- MEGACRIMP COUPLINGS
- STAINLESS STEEL
- POWER CRIMP COUPLINGS
- LOC, GL AND GLP COUPLINGS
- POLARSEAL COUPLINGS
- POLARSEAL II COUPLINGS
- C14 COUPLINGS
- PCTS THERMOPLASTIC COUPLINGS
- FIELD ATTACHABLE G1 & G2 COUPLINGS
- FIELD ATTACHABLE C5 & C5E COUPLINGS
- SURELOK AIR BRAKE COUPLINGS**
- ADAPTERS
- QUICK DISCONNECT COUPLERS
- LIVE SWIVEL
- BALL VALVES
- ACCESSORIES
- EQUIPMENT AND PARTS



**SureLok™ Air Brake Couplings**

HOSE

HOSE/CPLG. SELECTION

G8K COUPLINGS

GLOBALSPIRAL COUPLINGS

PCM / PCS FERRULES

MEGACRIMP COUPLINGS

STAINLESS STEEL

POWER CRIMP COUPLINGS

LOC, GL AND GLP COUPLINGS

POLARSEAL COUPLINGS

POLARSEAL II COUPLINGS

C14 COUPLINGS

PCTS THERMOPLASTIC COUPLINGS

FIELD ATTACHABLE G1 & G2 COUPLINGS

FIELD ATTACHABLE C5 & C5E COUPLINGS

**SURELOK AIR BRAKE COUPLINGS**

ADAPTERS

QUICK DISCONNECT COUPLERS

LIVE SWIVEL

BALL VALVES

ACCESSORIES

EQUIPMENT AND PARTS

**Air Brake to Male Pipe - 90° with Port**

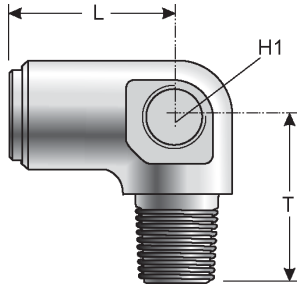

Descr.	Prod. No.			H1	T		L		Weight (Lbs.)
		"	"	mm	"	mm	"	mm	
6AB-4MP-2PT90	7250-14625	3/8	1/4-18	22	1.10	27.9	1.20	30.5	.24
6AB-6MP-2PT90	7250-14635	3/8	3/8-18	22	1.10	27.9	1.12	28.5	.24
8AB-6MP-2PT90	7250-14645	1/2	3/8-18	22	1.14	29.0	1.26	32.0	.22
8AB-8MP-4PORT90	7250-14655	1/2	1/2-14	24	1.38	35.1	1.28	32.5	.34
12AB-12MP-4PORT90	7250-14665	3/4	3/4-14	24	1.48	37.6	1.52	38.6	.40

**Air Brake to Male Pipe Swivel - 45°**

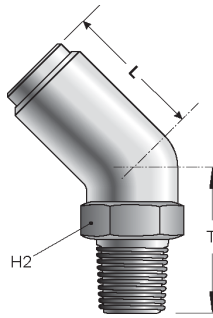

Descr.	Prod. No.			H2	T		L		Weight (Lbs.)
		"	"	"	"	mm	"	mm	
4AB-2MPX45	7250-01205	1/4	1/8-27	7/16	1.06	26.9	.74	18.8	.08
4AB-4MPX45	7250-01215	1/4	1/4-18	9/16	1.11	28.2	.77	19.6	.08
6AB-4MPX45	7250-01225	3/8	1/4-18	11/16	1.26	32.0	1.05	26.7	.16
8AB-8MPX45	7250-01255	1/2	1/2-14	7/8	1.62	41.2	1.25	31.8	.36
10AB-8MPX45	7250-14695	5/8	1/2-14	7/8	1.42	36.1	1.51	38.4	.45



**SureLok™ Air Brake Couplings**

**Air Brake to Male Pipe Swivel - 90°**

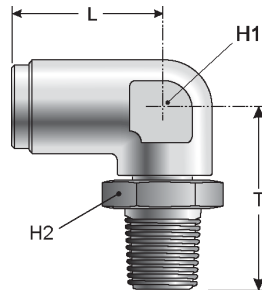

Descr.	Prod. No.			H1	H2	T		L		Weight (Lbs.)
		"	"	mm	mm	"	mm	"	mm	
2.5AB-2MPX90	7250-14725	5/32	1/8-27	7	11	.91	23.1	.83	21.1	.04
4AB-2MPX90	7250-01265	1/4	1/8-27	14	11	.91	23.1	.83	21.1	.06
4AB-4MPX90	7250-01275	1/4	1/4-18	18	14	1.12	28.5	.83	21.1	.10
4AB-6MPX90	7250-01285	1/4	3/8-18	22	19	1.25	31.8	.85	21.6	.15
6AB-2MPX90	7250-01295	3/8	1/8-27	18	14	1.05	26.7	1.07	27.2	.14
6AB-4MPX90	7250-01305	3/8	1/4-18	18	19	1.29	32.8	1.07	27.2	.20
6AB-6MPX90	7250-01315	3/8	3/8-18	22	19	1.24	31.5	1.07	27.2	.06
6AB-8MPX90	7250-01325	3/8	1/2-14	24	22	1.44	36.6	1.07	27.2	.22
8AB-4MPX90	7250-01335	1/2	1/4-18	22	22	1.27	32.3	1.27	32.3	.25
8AB-6MPX90	7250-01345	1/2	3/8-18	22	22	1.42	36.1	1.27	32.3	.25
8AB-8MPX90	7250-01355	1/2	1/2-14	24	22	1.62	41.2	1.27	32.3	.30
10AB-6MPX90	7250-01365	5/8	3/8-18	30	22	1.48	37.6	1.54	39.1	.26
10AB-8MPX90	7250-01375	5/8	1/2-14	30	22	1.48	37.6	1.54	39.1	.48
12AB-8MPX90	7250-14705	3/4	1/2-14	24	22	1.53	38.9	1.55	39.4	.58

**Air Brake Run Tee to Male Pipe**

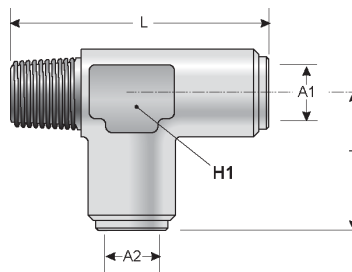

Descr.	Prod. No.	A1	A2		H1	T		L		Weight (Lbs.)
		"	"	"	mm	"	mm	"	mm	
2MP-4AB-4AB	7250-01385	1/4	1/4	1/8-18	14	.89	22.6	1.67	42.4	.12
4MP-4AB-4AB	7250-01395	1/4	1/4	1/4-18	18	.89	22.6	1.85	47.0	.18
4MP-4AB-6AB	7250-14775	1/4	3/8	1/4-18	18	1.08	27.4	1.85	47.0	.20
4MP-6AB-4AB	7250-14805	3/8	1/4	1/4-18	18	.93	23.6	2.05	52.1	.20
4MP-6AB-6AB	7250-14745	1/4	3/8	1/4-18	18	1.08	27.4	2.05	52.1	.20
6MP-4AB-4AB	7250-01405	1/4	1/4	3/8-18	22	.93	23.6	2.03	51.6	.30
6MP-4AB-6AB	7250-14785	1/4	3/8	3/8-18	22	1.14	29.0	2.03	51.6	.32
6MP-6AB-4AB	7250-14815	3/8	1/4	3/8-18	22	.93	23.6	2.24	56.9	.30
6MP-6AB-6AB	7250-01415	3/8	3/8	3/8-18	22	1.14	29.0	2.24	56.9	.32

HOSE
HOSE/CPLG. SELECTION
G8K COUPLINGS
GLOBALSPIRAL COUPLINGS
PCM / PCS FERRULES
MEGACRIMP COUPLINGS
STAINLESS STEEL
POWER CRIMP COUPLINGS
LOC, GL AND GLP COUPLINGS
POLARSEAL COUPLINGS
POLARSEAL II COUPLINGS
C14 COUPLINGS
PCTS THERMOPLASTIC COUPLINGS
FIELD ATTACHABLE G1 & G2 COUPLINGS
FIELD ATTACHABLE C5 & C5E COUPLINGS
<b>SURELOK AIR BRAKE COUPLINGS</b>
ADAPTERS
QUICK DISCONNECT COUPLERS
LIVE SWIVEL
BALL VALVES
ACCESSORIES
EQUIPMENT AND PARTS



**SureLok™ Air Brake Couplings**

- HOSE
- HOSE/CPLG. SELECTION
- G8K COUPLINGS
- GLOBALSPIRAL COUPLINGS
- PCM / PCS FERRULES
- MEGACRIMP COUPLINGS
- STAINLESS STEEL
- POWER CRIMP COUPLINGS
- LOC. GL AND GLP COUPLINGS
- POLARSEAL COUPLINGS
- POLARSEAL II COUPLINGS
- C14 COUPLINGS
- PCTS THERMOPLASTIC COUPLINGS
- FIELD ATTACHABLE G1 & G2 COUPLINGS
- FIELD ATTACHABLE C5 & C5E COUPLINGS
- SURELOK AIR BRAKE COUPLINGS
- ADAPTERS
- QUICK DISCONNECT COUPLERS
- LIVE SWIVEL
- BALL VALVES
- ACCESSORIES
- EQUIPMENT AND PARTS

**Air Brake Run Tee to Male Pipe - Continued**

Descr.	Prod. No.	A1	A2		H1	T		L		Weight (Lbs.)
		"	"	"	mm	"	mm	"	mm	
6MP-6AB-8AB	7250-14795	3/8	1/2	3/8-18	22	1.30	33.0	2.36	59.9	.38
6MP-8AB-6AB	7250-14825	1/2	3/8	3/8-18	22	1.22	31.0	2.44	62.0	.38
6MP-8AB-8AB	7250-01425	1/2	1/2	3/8-18	22	1.30	33.0	2.44	62.0	.36
8MP-6AB-6AB	7250-14755	3/8	3/8	1/2-14	24	1.22	31.0	2.64	67.1	.46

**Air Brake Branch Tee to Male Pipe**

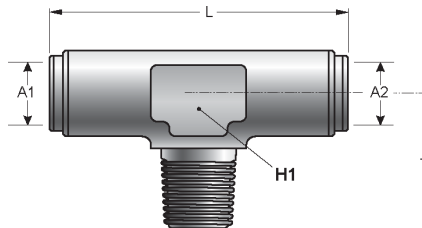

Descr.	Prod. No.	A1	A2		H1	T		L		Weight (Lbs.)
		"	"	"	mm	"	mm	"	mm	
3AB-3AB-2MP	7250-01435	3/16	3/16	1/8-27	14	.79	20.1	1.69	42.9	.06
4AB-4AB-2MP	7250-01445	1/4	1/4	1/8-27	14	.79	20.1	1.69	42.9	.12
4AB-4AB-4MP	7250-01455	1/4	1/4	1/4-18	18	.96	24.4	1.77	45.0	.18
4AB-4AB-6MP	7250-14835	1/4	1/4	3/8-18	22	1.10	27.9	1.93	49.0	.30
6AB-4AB-4MP	7250-14845	3/8	1/4	1/4-18	18	.96	24.4	1.97	50.0	.20
6AB-6AB-4MP	7250-01465	3/8	3/8	1/4-18	18	.96	24.4	2.17	55.1	.18
6AB-6AB-6MP	7250-01475	3/8	3/8	3/8-18	22	1.10	27.9	2.28	57.9	.32
8AB-6AB-8MP	7250-14865	1/2	3/8	1/2-14	22	1.22	31.0	2.48	63.0	.46
8AB-8AB-4MP	7250-01485	1/2	1/2	1/4-18	22	1.14	29.0	2.44	62.0	.32
8AB-8AB-6MP	7250-01495	1/2	1/2	3/8-18	22	1.14	29.0	2.60	66.0	.36
8AB-8AB-8MP	7250-01505	1/2	1/2	1/2-14	24	1.42	36.1	2.68	68.1	.46
10AB-8AB-8MP	7250-14885	5/8	1/2	1/2-14	30	1.46	37.1	2.78	70.6	.08

**Air Brake Branch Y to Male Pipe**





Descr.	Prod. No.	A1	A2		H2	T		L		Weight (Lbs.)
		"	"	"	mm	"	mm	"	mm	
6AB-6AB-6MP90	7250-14895	3/8	3/8	3/8-18	22	1.34	34.0	1.18	30.0	.38
8AB-8AB-6MP90	7250-14905	1/2	1/2	3/8-18	20	1.34	34.0	1.30	33.0	.36

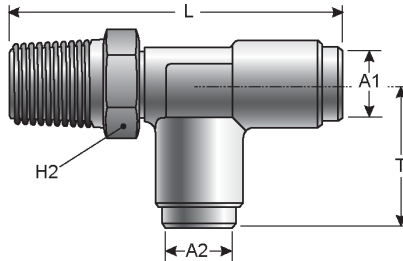

**SureLok™ Air Brake Couplings**

**Air Brake Run Tee to Male Pipe Swivel**



Descr.	Prod. No.	A1	A2		H2	T		L		Weight (Lbs.)
		"	"	"	mm	"	mm	"	mm	
2MPX-4AB-4AB	7250-01515	1/4	1/4	1/8-27	11	.83	21.1	1.75	44.5	.08
4MPX-4AB-4AB	7250-01525	1/4	1/4	1/4-18	14	.83	21.1	1.95	49.5	.12
4MPX-6AB-6AB	7250-14925	3/8	3/8	1/4-18	19	1.07	27.2	2.36	59.9	.20
6MPX-6AB-6AB	7250-01545	3/8	3/8	3/8-18	19	1.07	27.2	2.32	58.9	.20
6MPX-8AB-8AB	7250-01555	1/2	1/2	3/8-18	22	1.27	32.3	2.69	68.3	.32
8MPX-8AB-8AB	7250-01565	1/2	1/2	1/2-14	22	1.27	32.3	2.89	73.4	.36

**Air Brake Branch Tee to Male Pipe Swivel**

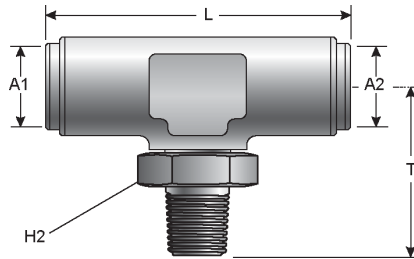

Descr.	Prod. No.	A1	A2		H2	T		L		Weight (Lbs.)
		"	"	"	mm	"	mm	"	mm	
3AB-3AB-2MPX	7250-14935	3/16	3/16	1/8-27	11	.89	22.6	1.57	39.9	.08
4AB-4AB-2MPX	7250-01575	1/4	1/4	1/8-27	11	.91	23.1	1.67	42.4	.08
4AB-4AB-4MPX	7250-01585	1/4	1/4	1/4-18	14	1.12	28.5	1.67	42.4	.15
6AB-6AB-2MPX	7250-14945	3/8	3/8	1/8-27	14	1.09	27.7	1.92	48.8	.18
6AB-6AB-4MPX	7250-01595	3/8	3/8	1/4-18	19	1.29	32.8	2.17	55.1	.22
6AB-6AB-6MPX	7250-14955	3/8	3/8	3/8-18	19	1.24	31.5	2.17	55.1	.20
8AB-8AB-4MPX	7250-01605	1/2	1/2	1/4-18	22	1.39	35.3	2.56	65.0	.32
8AB-8AB-6MPX	7250-01615	1/2	1/2	3/8-18	22	1.42	36.1	2.56	65.0	.32
8AB-8AB-8MPX	7250-14965	1/2	1/2	1/2-14	22	1.62	41.2	2.56	65.0	.36

- HOSE
- HOSE/CPLG. SELECTION
- G8K COUPLINGS
- GLOBALSPIRAL COUPLINGS
- PCM / PCS FERRULES
- MEGACRIMP COUPLINGS
- STAINLESS STEEL
- POWER CRIMP COUPLINGS
- LOC. GL AND GLP COUPLINGS
- POLARSEAL COUPLINGS
- POLARSEAL II COUPLINGS
- C14 COUPLINGS
- PCTS THERMOPLASTIC COUPLINGS
- FIELD ATTACHABLE G1 & G2 COUPLINGS
- FIELD ATTACHABLE C5 & C5E COUPLINGS
- SURELOK AIR BRAKE COUPLINGS**
- ADAPTERS
- QUICK DISCONNECT COUPLERS
- LIVE SWIVEL
- BALL VALVES
- ACCESSORIES
- EQUIPMENT AND PARTS



**SureLok™ Air Brake Couplings**

HOSE

HOSE/CPLG. SELECTION

G8K COUPLINGS

GLOBALSPIRAL COUPLINGS

PCM / PCS FERRULES

MEGACRIMP COUPLINGS

STAINLESS STEEL

POWER CRIMP COUPLINGS

LOC, GL AND GLP COUPLINGS

POLARSEAL COUPLINGS

POLARSEAL II COUPLINGS

C14 COUPLINGS

PCTS THERMOPLASTIC COUPLINGS

FIELD ATTACHABLE G1 & G2 COUPLINGS

FIELD ATTACHABLE C5 & C5E COUPLINGS

**SURELOK AIR BRAKE COUPLINGS**

ADAPTERS

QUICK DISCONNECT COUPLERS

LIVE SWIVEL

BALL VALVES

ACCESSORIES

EQUIPMENT AND PARTS

**Air Brake to Female Pipe**

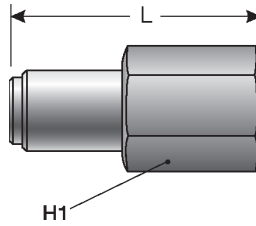

Descr.	Prod. No.			H1	L		Weight (Lbs.)
		"	"	"	"	mm	
2.5AB-2FP	7250-14975	5/32	1/8-27	9/16	1.18	30.0	.04
4AB-2FP	7250-01625	1/4	1/8-27	9/16	1.31	33.3	.06
4AB-4FP	7250-01635	1/4	1/4-18	11/16	1.59	40.4	.10
6AB-2FP	7250-01645	3/8	1/8-27	9/16	1.74	44.2	.10
6AB-4FP	7250-01655	3/8	1/4-18	11/16	1.74	44.2	.12
6AB-6FP	7250-01665	3/8	3/8-18	7/8	1.78	45.2	.16
8AB-4FP	7250-01675	1/2	1/4-18	11/16	2.00	50.8	.14
8AB-8FP	7250-01695	1/2	1/2-14	11/16	2.11	53.6	.32

**Air Brake to Female Pipe - 90°**

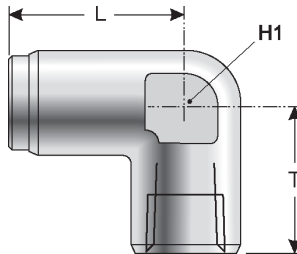

Descr.	Prod. No.			H1	T		L		Weight (Lbs.)
		"	"	mm	"	mm	"	mm	
3AB-2FP90	7250-14985	3/16	1/8-27	14	.71	18.0	.87	22.1	.08
4AB-2FP90	7250-01705	1/4	1/8-27	14	.71	18.0	.94	23.9	.08
4AB-4FP90	7250-01715	1/4	1/4-18	18	.79	20.1	1.08	27.4	.14
4AB-6FP90	7250-14995	1/4	3/8-18	18	.79	20.1	1.08	27.4	.22
6AB-2FP90	7250-01725	3/8	1/8-27	13	.79	20.1	1.31	33.3	.20
6AB-4FP90	7250-01735	3/8	1/4-18	18	.79	20.1	1.31	33.3	.14
6AB-6FP90	7250-01745	3/8	3/8-18	22	.79	20.1	1.31	33.3	.22
8AB-4FP90	7250-01755	1/2	1/4-18	18	.94	23.9	1.16	29.5	.22
8AB-6FP90	7250-01765	1/2	3/8-18	22	.94	23.9	1.16	29.5	.22
8AB-8FP90	7250-01775	1/2	1/2-14	16	.94	23.9	1.16	29.5	.56





**SureLok™ Air Brake Couplings**

**Air Brake Branch Tee to Female Pipe with Mounting Hole**

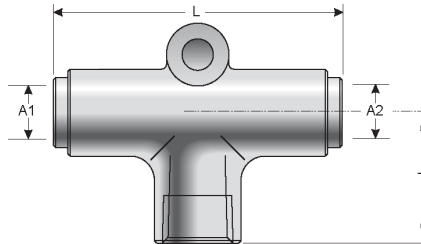

Descr.	Prod. No.	A1	A2		T		L		Weight (Lbs.)
		"	"	"	"	mm	"	mm	
6AB-6AB-4FP	7250-01785	3/8	3/8	1/4-18	1.06	26.9	2.34	59.4	.24

**Air Brake to Male Pipe to Female Pipe Split Run Tee - Block Style**



Descr.	Prod. No.			H1	T		L		Weight (Lbs.)	
		"	"	"	"	mm	"	mm		
4MP-6AB-4FP	7250-15015	1/4	1/4-18	1/4-18	18	.96	24.4	2.05	52.1	.18
8MP-8AB-2FP	7250-15045	1/2	1/2-14	1/8-27	24	.96	24.4	2.40	61.0	.32

**Air Brake to Male Pipe to Female Pipe Split Run Tee**

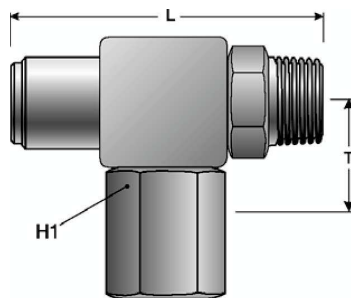

Descr.	Prod. No.			H1	T		L		Weight (Lbs.)	
		"	"	"	mm	"	mm	"		mm
6AB-6MP-4FP	7250-01795	1/2	3/8-18	1/4-18	22	1.14	29.0	2.05	52.1	.22

- HOSE
- HOSE/CPLG. SELECTION
- G8K COUPLINGS
- GLOBALSPIRAL COUPLINGS
- PCM / PCS FERRULES
- MEGACRIMP COUPLINGS
- STAINLESS STEEL
- POWER CRIMP COUPLINGS
- LOC. GL AND GLP COUPLINGS
- POLARSEAL COUPLINGS
- POLARSEAL II COUPLINGS
- C14 COUPLINGS
- PCTS THERMOPLASTIC COUPLINGS
- FIELD ATTACHABLE G1 & G2 COUPLINGS
- FIELD ATTACHABLE C5 & C5E COUPLINGS
- SURELOK AIR BRAKE COUPLINGS**
- ADAPTERS
- QUICK DISCONNECT COUPLERS
- LIVE SWIVEL
- BALL VALVES
- ACCESSORIES
- EQUIPMENT AND PARTS



**SureLok™ Air Brake Couplings**

- HOSE
- HOSE/CPLG. SELECTION
- G8K COUPLINGS
- GLOBALSPIRAL COUPLINGS
- PCM / PCS FERRULES
- MEGACRIMP COUPLINGS
- STAINLESS STEEL
- POWER CRIMP COUPLINGS
- LOC. GL AND GLP COUPLINGS
- POLARSEAL COUPLINGS
- POLARSEAL II COUPLINGS
- C14 COUPLINGS
- PCTS THERMOPLASTIC COUPLINGS
- FIELD ATTACHABLE G1 & G2 COUPLINGS
- FIELD ATTACHABLE C5 & C5E COUPLINGS
- SURELOK AIR BRAKE COUPLINGS
- ADAPTERS
- QUICK DISCONNECT COUPLERS
- LIVE SWIVEL
- BALL VALVES
- ACCESSORIES
- EQUIPMENT AND PARTS

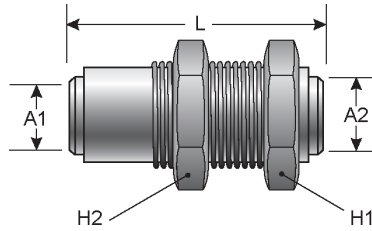

**Air Brake Bulkhead Union**



Descr.	Prod. No.	A1	A2		H1	H2	L		Weight (Lbs.)
		"	"	"	"	"	"	mm	
4AB-4AB-BKHD	7250-01805	1/4	1/4	1/4-18	15/16	15/16	1.41	35.8	.14
6AB-6AB-BKHD	7250-01815	3/8	3/8	3/8-18	1 1/8	1 1/8	1.75	44.5	.24
8AB-6AB-BKHD	7250-15055	1/2	3/8	3/8-18	1 1/8	1 1/8	1.89	48.0	.34
8AB-8AB-BKHD	7250-01825	1/2	1/2	1/2-14	1 5/16	1 5/16	2.02	51.3	.34
10AB-10AB-BKHD	7250-01835	5/8	5/8	1/2-14	1 1/2	1 1/2	2.34	59.4	.70

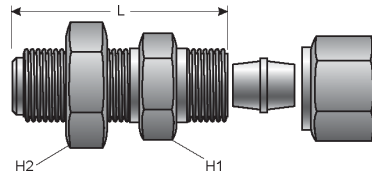

**Air Brake to Copper Tubing Industrial Compression Assembly Bulkhead**

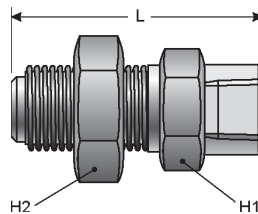

Descr.	Prod. No.			H1	H2	L		Weight (Lbs.)
		"	"	"	"	"	mm	
4AB-4MFA-BKHD	7250-15065	1/4	1/4	11/16	15/16	.50	12.7	.28
6AB-6MFA-BKHD	7250-15075	3/8	3/8	7/8	7/8	.68	17.3	.42

**Air Brake to Female Pipe Bulkhead**



Descr.	Prod. No.			H1	H2	L		Weight (Lbs.)
		"	"	mm	"	"	mm	
4AB-2FP-BKHD	7250-15085	1/4	1/8-27	22	15/16	1.32	33.5	.24
4AB-4FP-BKHD	7250-01845	1/4	1/4-18	22	15/16	1.59	40.4	.20
6AB-4FP-BKHD	7250-15095	3/8	1/4-18	24	1 1/8	2.20	55.9	.30
6AB-6FP-BKHD	7250-01855	3/8	3/8-18	27	1 1/8	2.20	55.9	.30
6AB-8FP-BKHD	7250-15105	3/8	1/2-14	27	1 1/8	2.20	55.9	.38



**SureLok™ Air Brake Couplings**

**Air Brake to Female Pipe Bulkhead - Continued**

Descr.	Prod. No.			H1	H2	L		Weight (Lbs.)
		"	"	mm	"	"	mm	
8AB-6FP-BKHD	7250-15115	1/2	3/8-18	27	1 5/16	1.89	48.0	.32
8AB-8FP-BKHD	7250-01865	1/2	1/2-14	27	1 5/16	2.64	67.1	.48

**Air Brake Union**

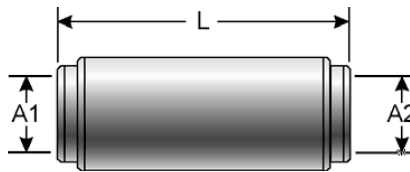

Descr.	Prod. No.	A1	A2	L		Weight (Lbs.)
		"	"	"	mm	
2.5AB-2.5AB	7250-01915	5/32	5/32	1.18	30.0	.10
2AB-2AB	7250-15135	1/8	1/8	1.15	27.2	.08
3AB-3AB	7250-15145	3/16	3/16	1.36	24.5	.05
4AB-4AB	7250-01875	1/4	1/4	1.40	35.6	.06
6AB-4AB	7250-15155	3/8	1/4	1.71	43.4	.12
6AB-6AB	7250-01885	3/8	3/8	1.74	44.2	.20
8AB-6AB	7250-15165	1/2	3/8	1.91	48.5	.18
8AB-8AB	7250-01895	1/2	1/2	2.01	51.1	.25
10AB-10AB	7250-01905	5/8	5/8	2.42	61.5	.32
12AB-12AB	7250-15175	3/4	3/4	2.48	63.0	.44

**Air Brake Union - 90°**

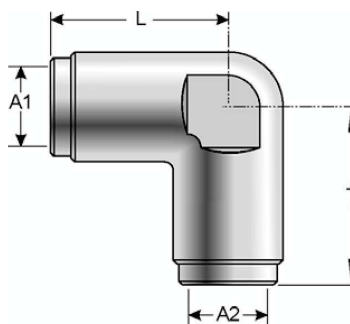

Descr.	Prod. No.	A1	A2	T		L		Weight (Lbs.)
		"	"	"	mm	"	mm	
4AB-4AB90	7250-01925	1/4	1/4	.83	21.1	.83	21.1	.08
6AB-6AB90	7250-01935	3/8	3/8	1.07	27.2	1.07	27.2	.14
8AB-8AB90	7250-01945	1/2	1/2	1.26	32.0	1.26	32.0	.20
10AB-10AB90	7250-15185	5/8	5/8	1.48	37.6	1.61	40.9	.50

- HOSE
- HOSE/CPLG. SELECTION
- G8K COUPLINGS
- GLOBAL SPIRAL COUPLINGS
- PCM / PCS FERRULES
- MEGACRIMP COUPLINGS
- STAINLESS STEEL
- POWER CRIMP COUPLINGS
- LOC, GL AND GLP COUPLINGS
- POLARSEAL COUPLINGS
- POLARSEAL II COUPLINGS
- C14 COUPLINGS
- PCTS THERMOPLASTIC COUPLINGS
- FIELD ATTACHABLE G1 & G2 COUPLINGS
- FIELD ATTACHABLE C5 & C5E COUPLINGS
- SURELOK AIR BRAKE COUPLINGS**
- ADAPTERS
- QUICK DISCONNECT COUPLERS
- LIVE SWIVEL
- BALL VALVES
- ACCESSORIES
- EQUIPMENT AND PARTS



**SureLok™ Air Brake Couplings**

- HOSE
- HOSE/CPLG. SELECTION
- G8K COUPLINGS
- GLOBALSPIRAL COUPLINGS
- PCM / PCS FERRULES
- MEGACRIMP COUPLINGS
- STAINLESS STEEL
- POWER CRIMP COUPLINGS
- LOC, GL AND GLP COUPLINGS
- POLARSEAL COUPLINGS
- POLARSEAL II COUPLINGS
- C14 COUPLINGS
- PCTS THERMOPLASTIC COUPLINGS
- FIELD ATTACHABLE G1 & G2 COUPLINGS
- FIELD ATTACHABLE C5 & C5E COUPLINGS
- SURELOK AIR BRAKE COUPLINGS**
- ADAPTERS
- QUICK DISCONNECT COUPLERS
- LIVE SWIVEL
- BALL VALVES
- ACCESSORIES
- EQUIPMENT AND PARTS

**Air Brake Union - Tee**

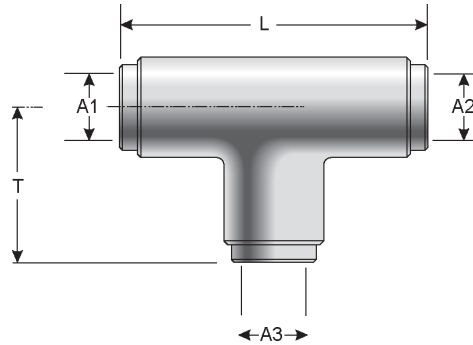

Descr.	Prod. No.	A1	A2	A3	T		L		Weight (Lbs.)
		"	"	"	"	mm	"	mm	
2AB-2AB-2AB	7250-15195	1/8	1/8	1/8	.63	16.0	1.26	32.0	.02
3AB-3AB-3AB	7250-15205	3/16	3/16	3/16	.72	18.3	1.44	36.9	.06
4AB-4AB-4AB	7250-01955	1/4	1/4	1/4	.93	23.6	1.65	41.9	.08
6AB-4AB-4AB	7250-15295	3/8	1/4	1/4	.93	23.6	2.01	51.1	.85
6AB-6AB-4AB	7250-15245	3/8	3/8	1/4	.93	23.6	2.17	55.1	.18
6AB-6AB-6AB	7250-01965	3/8	3/8	3/8	1.07	27.2	2.13	54.1	.18
6AB-6AB-8AB	7250-15255	3/8	3/8	1/2	1.28	32.5	2.36	59.9	.30
8AB-6AB-6AB	7250-15305	1/2	3/8	3/8	1.18	30.0	2.46	62.5	.32
8AB-8AB-4AB	7250-15265	1/2	1/2	1/4	.98	24.9	2.52	64.0	.28
8AB-8AB-6AB	7250-15275	1/2	1/2	3/8	1.22	31.0	2.44	62.0	.30
8AB-8AB-8AB	7250-01975	1/2	1/2	1/2	1.26	32.0	2.53	64.3	.28
10AB-8AB-10AB	7250-15285	5/8	1/2	5/8	1.56	39.6	3.01	76.5	.68
10AB-10AB-10AB	7250-15215	5/8	5/8	5/8	1.54	39.1	3.07	78.0	.66
12AB-12AB-12AB	7250-15225	3/4	3/4	3/4	1.56	39.6	3.12	79.3	.78

**Air Brake Union - Tee with Mounting Hole**

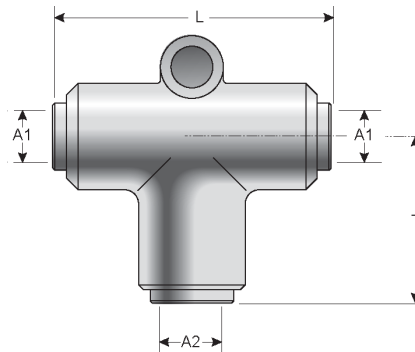

Descr.	Prod. No.	A1	A2	T		L		Weight (Lbs.)
		"	"	"	mm	"	mm	
6AB-6AB-8ABMH	7250-15315	3/8	3/8	1.42	36.1	2.36	59.9	.48



**SureLok™ Air Brake Couplings**

**6-Port Manifold**

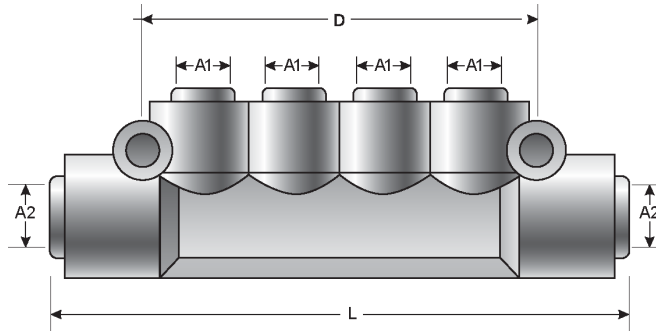

Descr.	Prod. No.	A1	A2	D Mounting Hole Length		L		Weight (Lbs.)
		"	"	"	mm	"	mm	
6AB-4MANIFOLD	7250-15325	1/4	3/8	2.76	70.10	4.10	104.1	.20

**Coiled Nylon Air Brake Tubing Assemblies**

Recommended For: Truck air brake lines from back of cab to trailer. Conforms to SAE J844 specifications. Meets D.O.T. FMVSS 106. 12" Leads.

Tube: Heat and light stabilized seamless extruded Nylon 11.

Reinforcement: One open ply of fibrous nylon.

Cover: Heat and light stabilized seamless extruded nylon.

Temperature Range: -40°F to +200°F



Descr.	Prod. No.				Weight (Lbs.)
		"	"	"	
8CABHX12*	7250-18655	1/2	150	600	2.95
8CABHX15	7250-18665	1/2	150	600	2.75

\*Program purpose

NOTE: Program purpose

- HOSE
- HOSE/CPLG. SELECTION
- G8K COUPLINGS
- GLOBALSPIRAL COUPLINGS
- PCM / PCS FERRULES
- MEGACRIMP COUPLINGS
- STAINLESS STEEL
- POWER CRIMP COUPLINGS
- LOC, GL AND GLP COUPLINGS
- POLARSEAL COUPLINGS
- POLARSEAL II COUPLINGS
- C14 COUPLINGS
- PCTS THERMOPLASTIC COUPLINGS
- FIELD ATTACHABLE G1 & G2 COUPLINGS
- FIELD ATTACHABLE C5 & C5E COUPLINGS
- SURELOK AIR BRAKE COUPLINGS**
- ADAPTERS
- QUICK DISCONNECT COUPLERS
- LIVE SWIVEL
- BALL VALVES
- ACCESSORIES
- EQUIPMENT AND PARTS

