

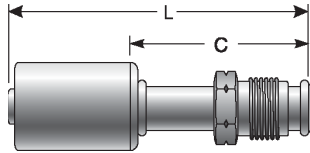

PolarSeal® Couplings

Male SAE 45° Flare - Aluminum



Descr.	Prod. No.	⊖		L	C	Weight (Lbs.)
		"	"	"	"	
6ACA-6MS	7332-00015	5/16	5/8-18	3.38	2.13	.50
8ACA-8MS	7332-00025	13/32	3/4-16	3.50	2.25	.66
10ACA-10MS	7332-00035	1/2	7/8-14	3.81	2.56	.50
12ACA-12MS	7332-00045	5/8	1 1/16-14	4.00	2.75	.20

Male SAE 45° Flare - 45° Bent Tube - Aluminum

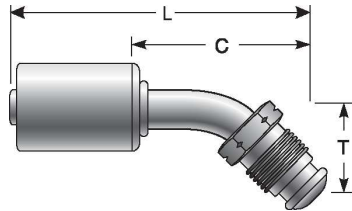

Descr.	Prod. No.	⊖		T	L	C	Weight (Lbs.)
		"	"	"	"	"	
6ACA-6MS45	7332-00055	5/16	5/8-18	.94	3.25	2.00	.08
8ACA-8MS45	7332-00065	13/32	3/4-16	1.06	3.50	2.25	.10
10ACA-10MS45	7332-00075	1/2	7/8-14	1.12	3.87	2.62	.16
12ACA-12MS45	7332-00085	5/8	1 1/16-14	1.25	4.25	3.00	.22

Male SAE 45° Flare - 90° Bent Tube - Aluminum

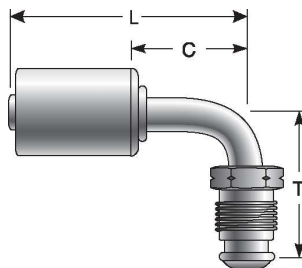

Descr.	Prod. No.	⊖		T	L	C	Weight (Lbs.)
		"	"	"	"	"	
6ACA-6MS90	7332-00095	5/16	5/8-18	1.75	2.56	1.31	.10
8ACA-8MS90	7332-00105	13/32	3/4-16	1.81	2.75	1.50	.10

- HOSE
- HOSE/CPLG. SELECTION
- G8K COUPLINGS
- GLOBALSPIRAL COUPLINGS
- PCM / PCS FERRULES
- MEGACRIMP COUPLINGS
- STAINLESS STEEL
- POWER CRIMP COUPLINGS
- LOC, GL AND GLP COUPLINGS
- POLARSEAL COUPLINGS**
- POLARSEAL II COUPLINGS
- C14 COUPLINGS
- PCTS THERMOPLASTIC COUPLINGS
- FIELD ATTACHABLE G1 & G2 COUPLINGS
- FIELD ATTACHABLE C5 & C5E COUPLINGS
- SURELOK AIR BRAKE COUPLINGS
- ADAPTERS
- QUICK DISCONNECT COUPLERS
- LIVE SWIVEL
- BALL VALVES
- ACCESSORIES
- EQUIPMENT AND PARTS



PolarSeal® Couplings

HOSE

HOSE/CPLG. SELECTION

G8K COUPLINGS

GLOBAL SPIRAL COUPLINGS

PCM / PCS FERRULES

MEGACRIMP COUPLINGS

STAINLESS STEEL

POWER CRIMP COUPLINGS

LOC. GL AND GLP COUPLINGS

POLARSEAL COUPLINGS

POLARSEAL II COUPLINGS

C14 COUPLINGS

PCTS THERMOPLASTIC COUPLINGS

FIELD ATTACHABLE G1 & G2 COUPLINGS

FIELD ATTACHABLE C5 & C5E COUPLINGS

SURELOK AIR BRAKE COUPLINGS

ADAPTERS

QUICK DISCONNECT COUPLERS

LIVE SWIVEL

BALL VALVES

ACCESSORIES

EQUIPMENT AND PARTS

Male SAE 45° Flare - 90° Bent Tube - Aluminum - Continued

Descr.	Prod. No.			T	L	C	Weight (Lbs.)
		"	"	"	"	"	
10ACA-10MS90	7332-00115	1/2	7/8-14	2.19	3.00	1.75	.16
12ACA-12MS90	7332-00125	5/8	1 1/16-14	2.45	3.25	2.00	.24

Female SAE 45° Flare Swivel - Aluminum

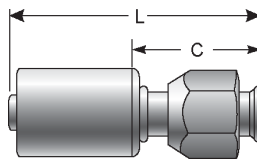

Descr.	Prod. No.			L	C	Weight (Lbs.)
		"	"	"	"	
6ACA-6FSX	7332-00135	5/16	5/8-18	2.88	1.63	.08
6ACA-8FSX	7332-00145	5/16	3/4-16	2.69	1.44	.12
8ACA-6FSX	7332-02825	13/32	5/8-18	2.69	1.44	.10
8ACA-8FSX	7332-00155	13/32	3/4-16	2.69	1.44	.10
10ACA-8FSX	7332-02835	1/2	3/4-16	3.00	1.75	.15
10ACA-10FSX	7332-00165	1/2	7/8-14	3.00	1.75	.20
12ACA-10FSX	7332-00175	5/8	7/8-14	3.25	2.00	.20
12ACA-12FSX	7332-00185	5/8	1 1/16-14	3.25	2.00	.28

Female SAE 45° Flare Swivel - Steel

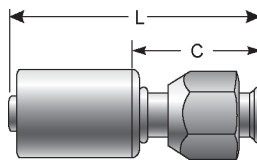

Descr.	Prod. No.			L	C	Weight (Lbs.)
		"	"	"	"	
6ACA-6FSX-S	7332-01755	5/16	5/8-18	2.88	1.60	.12
8ACA-8FSX-S	7332-01765	13/32	3/4-16	2.69	1.44	.18
10ACA-10FSX-S	7332-01775	1/2	7/8-14	3.00	1.75	.26



PolarSeal® Couplings

Female SAE 45° Flare Swivel - 45° Bent Tube - Aluminum

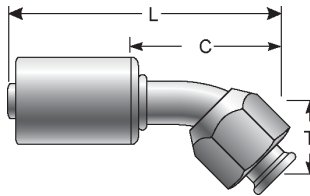

Descr.	Prod. No.			T	L	C	Weight (Lbs.)
		"	"	"	"	"	
6ACA-6FSX45	7332-00195	5/16	5/8-18	.56	2.87	1.62	.10
8ACA-6FSX45	7332-02855	13/32	5/8-18	.63	3.04	1.79	.10
8ACA-8FSX45	7332-00205	13/32	3/4-16	.63	3.07	1.82	.12
10ACA-10FSX45	7332-00215	1/2	7/8-14	.88	3.63	2.38	.20
12ACA-10FSX45	7332-02875	5/8	7/8-14	1.00	3.97	2.72	.25
12ACA-12FSX45	7332-00225	5/8	1 1/16-14	1.00	4.00	2.75	.28

Female SAE 45° Flare Swivel - 90° Bent Tube - Aluminum

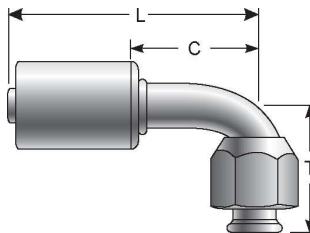

Descr.	Prod. No.			T	L	C	Weight (Lbs.)
		"	"	"	"	"	
6ACA-6FSX90	7332-00235	5/16	5/8-18	1.06	2.56	1.31	.10
6ACA-8FSX90	7332-00245	5/16	3/4-16	1.25	2.75	1.50	.12
8ACA-6FSX90	7332-02885	13/32	5/8-18	1.25	2.75	1.50	.10
8ACA-8FSX90	7332-00255	13/32	3/4-16	1.25	2.75	1.50	.14
10ACA-8FSX90	7332-02895	1/2	3/4-16	1.50	3.00	1.75	.15
10ACA-10FSX90	7332-00265	1/2	7/8-14	1.50	3.00	1.75	.18
12ACA-10FSX90	7332-00275	5/8	7/8-14	1.50	3.25	2.00	.22
12ACA-12FSX90	7332-00285	5/8	1 1/16-14	1.50	3.85	2.00	.28

- HOSE
- HOSE/CPLG. SELECTION
- G8K COUPLINGS
- GLOBALSPIRAL COUPLINGS
- PCM / PCS FERRULES
- MEGACRIMP COUPLINGS
- STAINLESS STEEL
- POWER CRIMP COUPLINGS
- LOC. GL AND GLP COUPLINGS
- POLARSEAL COUPLINGS**
- POLARSEAL II COUPLINGS
- C14 COUPLINGS
- PCTS THERMOPLASTIC COUPLINGS
- FIELD ATTACHABLE G1 & G2 COUPLINGS
- FIELD ATTACHABLE C5 & C5E COUPLINGS
- SURELOK AIR BRAKE COUPLINGS
- ADAPTERS
- QUICK DISCONNECT COUPLERS
- LIVE SWIVEL
- BALL VALVES
- ACCESSORIES
- EQUIPMENT AND PARTS



PolarSeal® Couplings

Female SAE 45° Flare Swivel - 90° Bent Tube - Steel

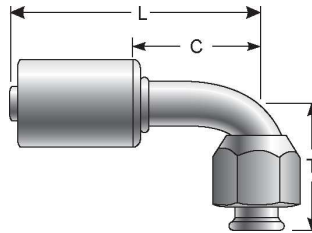

Descr.	Prod. No.			T	L	C	Weight (Lbs.)
		"	"	"	"	"	
6ACA-6FSX90-S	7332-01785	5/16	5/8-18	1.06	2.56	1.31	.12
8ACA-8FSX90-S	7332-01795	13/32	3/4-16	1.25	2.75	1.50	.22
10ACA-10FSX90-S	7332-01805	1/2	7/8-14	1.50	3.00	1.75	.30

Male SAE Flareless Assembly - Aluminum

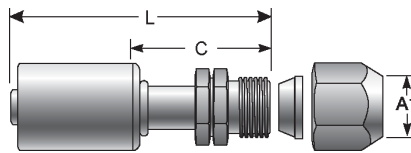

Descr.	Prod. No.			A1	L	C	Weight (Lbs.)
		"	"	"	"	"	
6ACA-6MFA	7332-00295	5/16	5/8-18	3/8	2.69	1.44	.16
6ACA-8MFA	7332-02905	5/16	3/4-16	1/2	2.81	1.56	.20
8ACA-6MFA	7332-02915	13/32	5/8-18	3/8	2.75	1.50	.20
8ACA-8MFA	7332-00305	13/32	3/4-16	1/2	2.88	1.63	.22
8ACA-10MFA	7332-00315	13/32	7/8-14	5/8	3.00	1.75	.34
10ACA-8MFA	7332-00325	1/2	3/4-16	1/2	2.94	1.69	.22
10ACA-10MFA	7332-00335	1/2	7/8-14	5/8	3.00	1.75	.32
12ACA-10MFA	7332-00345	5/8	7/8-14	5/8	3.13	1.88	.50
12ACA-12MFA	7332-00355	5/8	1 1/16-12	3/4	3.25	2.00	.50

- HOSE
- HOSE/CPLG. SELECTION
- G8K COUPLINGS
- GLOBALSPIRAL COUPLINGS
- PCM / PCS FERRULES
- MEGACRIMP COUPLINGS
- STAINLESS STEEL
- POWER CRIMP COUPLINGS
- LOC. GL AND GLP COUPLINGS
- POLARSEAL COUPLINGS
- POLARSEAL II COUPLINGS
- C14 COUPLINGS
- PCTS THERMOPLASTIC COUPLINGS
- FIELD ATTACHABLE G1 & G2 COUPLINGS
- FIELD ATTACHABLE C5 & C5E COUPLINGS
- SURELOK AIR BRAKE COUPLINGS
- ADAPTERS
- QUICK DISCONNECT COUPLERS
- LIVE SWIVEL
- BALL VALVES
- ACCESSORIES
- EQUIPMENT AND PARTS



PolarSeal® Couplings

Male SAE Flareless Assembly - 90° Block - Aluminum

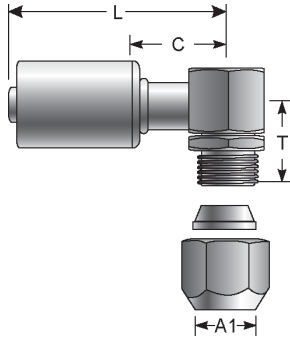

Descr.	Prod. No.			A1	T	L	C	Weight (Lbs.)
		"	"	"	"	"	"	
6ACA-6MFA90	7332-00365	5/16	5/8-18	3/8	.78	2.24	.99	.18
6ACA-8MFA90	7332-02925	5/16	3/4-16	1/2	.96	2.31	1.06	.20
8ACA-6MFA90	7332-02935	13/32	5/8-18	3/8	.78	2.28	1.03	.20
8ACA-8MFA90	7332-00375	13/32	3/4-16	1/2	.96	2.37	1.12	.26
8ACA-10MFA90	7332-00385	13/32	7/8-14	5/8	1.08	2.43	1.18	.28
10ACA-8MFA90	7332-00395	1/2	3/4-16	1/2	.96	2.38	1.13	.28
10ACA-10MFA90	7332-00405	1/2	7/8-14	5/8	1.08	2.44	1.19	.38
12ACA-10MFA90	7332-00415	5/8	7/8-14	5/8	1.08	2.56	1.31	.28
12ACA-12MFA90	7332-00425	5/8	1 1/16-12	3/4	1.19	2.66	1.41	.58

Male Metric Flareless Assembly - Aluminum

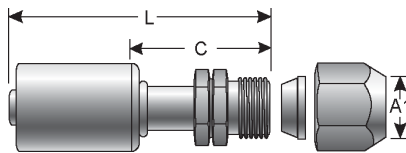

Descr.	Prod. No.			A1	L	C	Weight (Lbs.)
		"	"	mm	"	"	
6ACA-8MMFA	7332-01025	5/16	5/8-18	8.0	2.77	1.52	.14
8ACA-12MMFA	7332-01035	13/32	3/4-16	12.0	3.00	1.75	.22
10ACA-14.5MMFA	7332-01045	1/2	7/8-14	14.5	3.12	1.87	.34

- HOSE
- HOSE/CPLG. SELECTION
- G8K COUPLINGS
- GLOBALSPIRAL COUPLINGS
- PCM / PCS FERRULES
- MEGACRIMP COUPLINGS
- STAINLESS STEEL
- POWER CRIMP COUPLINGS
- LOC, GL AND GLP COUPLINGS
- POLARSEAL COUPLINGS**
- POLARSEAL II COUPLINGS
- C14 COUPLINGS
- PCTS THERMOPLASTIC COUPLINGS
- FIELD ATTACHABLE G1 & G2 COUPLINGS
- FIELD ATTACHABLE C5 & C5E COUPLINGS
- SURELOK AIR BRAKE COUPLINGS
- ADAPTERS
- QUICK DISCONNECT COUPLERS
- LIVE SWIVEL
- BALL VALVES
- ACCESSORIES
- EQUIPMENT AND PARTS



PolarSeal® Couplings

HOSE

HOSE/CPLG. SELECTION

G8K COUPLINGS

GLOBALSPIRAL COUPLINGS

PCM / PCS FERRULES

MEGACRIMP COUPLINGS

STAINLESS STEEL

POWER CRIMP COUPLINGS

LOC. GL AND GLP COUPLINGS

POLARSEAL COUPLINGS

POLARSEAL II COUPLINGS

C14 COUPLINGS

PCTS THERMOPLASTIC COUPLINGS

FIELD ATTACHABLE G1 & G2 COUPLINGS

FIELD ATTACHABLE C5 & C5E COUPLINGS

SURELOK AIR BRAKE COUPLINGS

ADAPTERS

QUICK DISCONNECT COUPLERS

LIVE SWIVEL

BALL VALVES

ACCESSORIES

EQUIPMENT AND PARTS

Female Flareless Nut - Aluminum

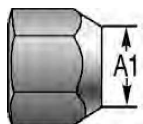

Descr.	Prod. No.		A1	Weight (Lbs.)
		"	"	
8ACFFN	7332-04145	3/4-16	1/2	.05

Female Braze-On Stems - Aluminum

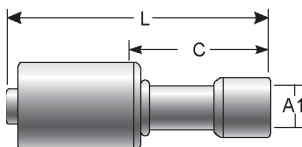

Descr.	Prod. No.		A1	L	C	Weight (Lbs.)
		"	"	"	"	
6ACA-6FBO	7332-02945	5/16	3/8	2.10	.85	.05
8ACA-8FBO	7332-02955	13/32	1/2	2.10	.85	.05
10ACA-10FBO	7332-02965	1/2	5/8	2.10	.85	.10
12ACA-10FBO	7332-02975	5/8	5/8	2.10	.85	.10
12ACA-12FBO	7332-02985	5/8	3/4	2.10	.85	.10

Female Braze-On Stems - Steel

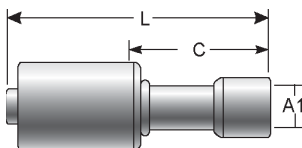

Descr.	Prod. No.		A1	L	C	Weight (Lbs.)
		"	"	"	"	
6ACA-6FBO-S	7332-01905	5/16	3/8	2.10	.85	.06
8ACA-8FBO-S	7332-01915	13/32	1/2	2.10	.85	.08
10ACA-10FBO-S	7332-01925	1/2	5/8	2.10	.85	.10
12ACA-10FBO-S	7332-01945	5/8	5/8	2.10	.85	.12
12ACA-12FBO-S	7332-01935	5/8	3/4	2.10	.85	.12



PolarSeal® Couplings

Hose Length Extender - Aluminum

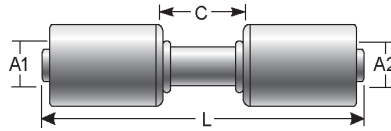

Descr.	Prod. No.		A1	A2	L	C	Weight (Lbs.)
		"	"	"	"	"	
6ACA-6HLE	7332-01385	5/16	5/16	5/16	4.00	1.50	.08
6ACA-8HLE	7332-01395	5/16	5/16	13/32	4.00	1.50	.10
8ACA-8HLE	7332-01405	13/32	13/32	13/32	4.00	1.50	.12
8ACA-10HLE	7332-01415	13/32	13/32	1/2	4.13	1.63	.12
10ACA-10HLE	7332-01425	1/2	1/2	1/2	4.13	1.63	.14
12ACA-10HLE	7332-02995	5/8	5/8	1/2	4.25	1.75	.15
12ACA-12HLE	7332-01435	5/8	5/8	5/8	4.25	1.75	.16

Hose Length Extender - Steel

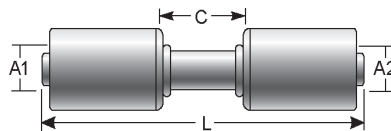

Descr.	Prod. No.		L	C	Weight (Lbs.)
		"	"	"	
12ACA-10HLE-S	7332-04485	5/8	1.75	5.27	.28

Hose Length Extender - 90° Bent Tube - Aluminum

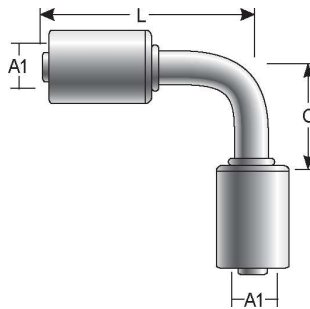

Descr.	Prod. No.		A1	L	C	Weight (Lbs.)
		"	"	"	"	
6ACA-6HLE90	7332-01445	5/16	5/16	2.50	1.25	.08
8ACA-8HLE90	7332-01455	13/32	13/32	2.62	1.37	.12
10ACA-10HLE90	7332-01465	1/2	1/2	2.88	1.63	.14
12ACA-12HLE90	7332-01475	5/8	5/8	3.25	2.00	.18

- HOSE
- HOSE/CPLG. SELECTION
- G8K COUPLINGS
- GLOBALSPIRAL COUPLINGS
- PCM / PCS FERRULES
- MEGACRIMP COUPLINGS
- STAINLESS STEEL
- POWER CRIMP COUPLINGS
- LOC. GL AND GLP COUPLINGS
- POLARSEAL COUPLINGS**
- POLARSEAL II COUPLINGS
- C14 COUPLINGS
- PCTS THERMOPLASTIC COUPLINGS
- FIELD ATTACHABLE G1 & G2 COUPLINGS
- FIELD ATTACHABLE C5 & C5E COUPLINGS
- SURELOK AIR BRAKE COUPLINGS
- ADAPTERS
- QUICK DISCONNECT COUPLERS
- LIVE SWIVEL
- BALL VALVES
- ACCESSORIES
- EQUIPMENT AND PARTS



PolarSeal® Couplings

HOSE
HOSE/CPLG. SELECTION
G8K COUPLINGS
GLOBALSPIRAL COUPLINGS
PCM / PCS FERRULES
MEGACRIMP COUPLINGS
STAINLESS STEEL
POWER CRIMP COUPLINGS
LOC. GL AND GLP COUPLINGS
POLARSEAL COUPLINGS
POLARSEAL II COUPLINGS
C14 COUPLINGS
PCTS THERMOPLASTIC COUPLINGS
FIELD ATTACHABLE G1 & G2 COUPLINGS
FIELD ATTACHABLE C5 & C5E COUPLINGS
SURELOK AIR BRAKE COUPLINGS
ADAPTERS
QUICK DISCONNECT COUPLERS
LIVE SWIVEL
BALL VALVES
ACCESSORIES
EQUIPMENT AND PARTS

Hose Length Extender - 180° Bent Tube - Aluminum

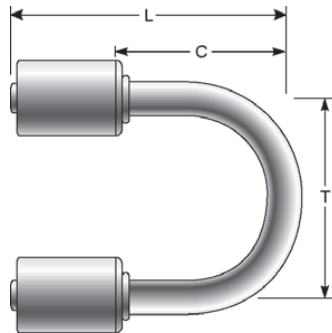

Descr.	Prod. No.	⊘	T	L	C	Weight (Lbs.)
		"	"	"	"	
6ACA-6HLE180	7332-02255	5/16	3.00	3.88	2.63	.18
8ACA-8HLE180	7332-02265	13/32	3.00	4.00	2.75	.14
10ACA-10HLE180	7332-02275	1/2	3.00	4.13	2.88	.20
12ACA-12HLE180	7332-02285	5/8	3.00	4.50	3.25	.22

Hose Length Extender - Tee - Aluminum

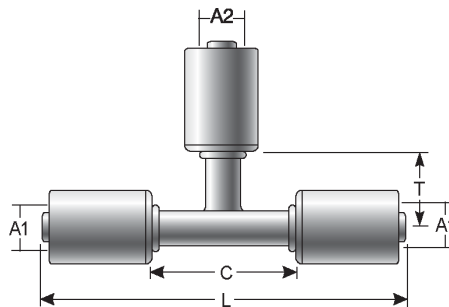

Descr.	Prod. No.	⊘	A1	A2	T	L	C	Weight (Lbs.)
		"	"	"	"	"	"	
6ACA-6HLET	7332-02295	5/16	5/16	5/16	1.13	4.75	2.25	.15
8ACA-8HLET	7332-02305	13/32	13/32	13/32	1.19	4.88	2.38	.18
10ACA-10HLET	7332-02315	1/2	1/2	1/2	1.25	5.00	2.50	.20
12ACA-10HLET	7332-03015	5/8	5/8	1/2	1.34	5.25	2.75	.25
12ACA-12HLET	7332-02325	5/8	5/8	5/8	1.37	5.25	2.75	.24



PolarSeal® Couplings

Hose Length Extender with Sight Glass - Aluminum

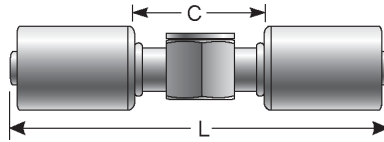

Descr.	Prod. No.	⊖	L	C	Weight (Lbs.)
		"	"	"	
6ACA-6HLESG	7332-01485	5/16	4.12	1.62	.22

Hose Splicer with R12 Thread Service Port - Aluminum

Service Ports: High Side; 6-8 Hose; 3/8" Schrader Valve
Service Ports: Low Side; 10-12 Hose; 1/4" Schrader Valve

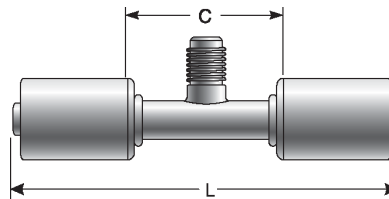

Descr.	Prod. No.	⊖	L	C	Weight (Lbs.)
		"	"	"	
6ACA-R12SP	7332-01135	5/16	4.50	2.00	.10
8ACA-R12SP	7332-01145	13/32	4.50	2.00	.14
10ACA-R12SP	7332-01155	1/2	4.63	2.13	.60
12ACA-R12SP	7332-01165	5/8	4.75	2.25	.18

Hose Splicer with R134a Service Port - Aluminum

Service Ports: High Side; 6-8 Hose; 3/8" Schrader Valve
Service Ports: Low Side; 10-12 Hose; 1/4" Schrader Valve

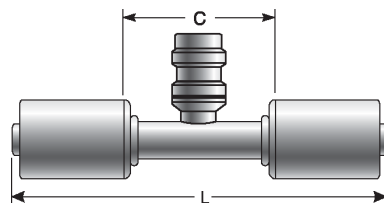

Descr.	Prod. No.	⊖	L	C	Weight (Lbs.)
		"	"	"	
6ACA-R134SP	7332-01175	5/16	4.50	2.00	.12
8ACA-R134SP	7332-01185	13/32	4.50	2.00	.14
10ACA-R134SP	7332-01195	1/2	4.63	2.13	.50
12ACA-R134SP	7332-01205	5/8	4.75	2.25	.18

- HOSE
- HOSE/CPLG. SELECTION
- G8K COUPLINGS
- GLOBALSPIRAL COUPLINGS
- PCM / PCS FERRULES
- MEGACRIMP COUPLINGS
- STAINLESS STEEL
- POWER CRIMP COUPLINGS
- LOC, GL AND GLP COUPLINGS
- POLARSEAL COUPLINGS**
- POLARSEAL II COUPLINGS
- C14 COUPLINGS
- PCTS THERMOPLASTIC COUPLINGS
- FIELD ATTACHABLE G1 & G2 COUPLINGS
- FIELD ATTACHABLE C5 & C5E COUPLINGS
- SURELOK AIR BRAKE COUPLINGS
- ADAPTERS
- QUICK DISCONNECT COUPLERS
- LIVE SWIVEL
- BALL VALVES
- ACCESSORIES
- EQUIPMENT AND PARTS



PolarSeal® Couplings

- HOSE
- HOSE/CPLG. SELECTION
- G8K COUPLINGS
- GLOBAL SPIRAL COUPLINGS
- PCM / PCS FERRULES
- MEGACRIMP COUPLINGS
- STAINLESS STEEL
- POWER CRIMP COUPLINGS
- LOC. GL AND GLP COUPLINGS
- POLARSEAL COUPLINGS**
- POLARSEAL II COUPLINGS
- C14 COUPLINGS
- PCTS THERMOPLASTIC COUPLINGS
- FIELD ATTACHABLE G1 & G2 COUPLINGS
- FIELD ATTACHABLE C5 & C5E COUPLINGS
- SURELOK AIR BRAKE COUPLINGS
- ADAPTERS
- QUICK DISCONNECT COUPLERS
- LIVE SWIVEL
- BALL VALVES
- ACCESSORIES
- EQUIPMENT AND PARTS

Hose Splicer with R134a Service Port - Steel

Pressure Ports: High Side; 6-8 Hose
Pressure Ports: Low Side; 10-12 Hose

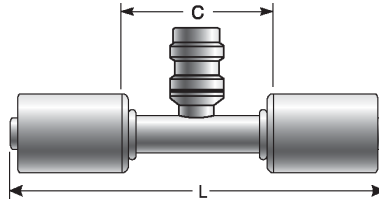

Descr.	Prod. No.	⊖	L	C	Weight (Lbs.)
		"	"	"	
6ACA-R134SP-S	7332-01955	5/16	4.50	2.00	.18
8ACA-R134SP-S	7332-01965	13/32	4.50	2.00	.24
10ACA-R134SP-S	7332-01975	1/2	4.63	2.13	.26
12ACA-R134SP-S	7332-03005	5/8	4.75	2.25	.30

Male SAE Tube O-Ring Nut Swivel - Aluminum

O-Ring not included. Must be ordered separately.

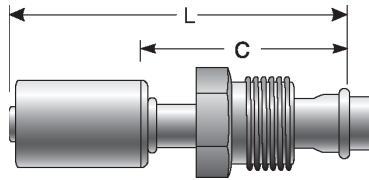

Descr.	Prod. No.	⊖	🌀	L	C	Weight (Lbs.)
		"	"	"	"	
6ACA-6MTON	7332-00435	5/16	5/8-18	3.19	1.94	.50
6ACA-7MTON	7332-02115	5/16	11/16-16	3.00	1.75	.10
6ACA-8MTON	7332-03065	5/16	3/4-18	3.25	2.00	.10
8ACA-6MTON	7332-03075	13/32	5/8-18	3.25	2.00	.10
8ACA-8MTON	7332-00445	13/32	3/4-18	3.25	2.00	.12
10ACA-10MTON	7332-00455	1/2	7/8-18	3.38	2.13	.14
12ACA-10MTON	7332-03085	5/8	7/8-18	3.88	2.63	.15
12ACA-12MTON	7332-00465	5/8	1 1/16-12	3.88	2.63	.22



PolarSeal® Couplings

Male SAE Tube O-Ring Nut Swivel - Steel

O-Ring not included. Must be ordered separately.

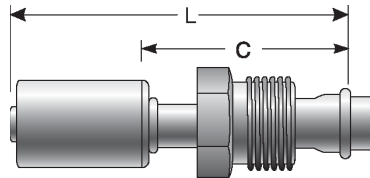

Descr.	Prod. No.			L	C	Weight (Lbs.)
		"	"	"	"	
6ACA-6MTON-S	7332-01285	5/16	5/8-18	3.19	1.94	.10
6ACA-7MTON-S	7332-02125	5/16	11/16-16	3.00	1.75	.12
10ACA-10MTON-S	7332-01865	1/2	7/8-18	3.38	2.13	.20

Male SAE Tube O-Ring Nut - 45° Bent Tube - Aluminum

O-Ring not included. Must be ordered separately.

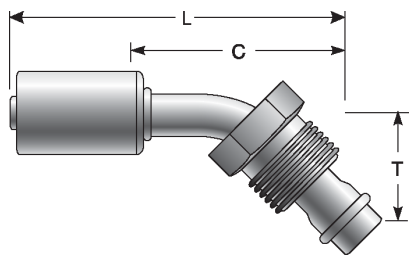

Descr.	Prod. No.			T	L	C	Weight (Lbs.)
		"	"	"	"	"	
6ACA-6MTON45	7332-00475	5/16	5/8-18	.88	3.19	1.94	.10
6ACA-8MTON45	7332-03095	5/16	3/4-18	1.00	3.47	2.22	.10
8ACA-6MTON45	7332-03105	13/32	5/8-18	1.00	3.47	2.22	.10
8ACA-8MTON45	7332-00485	13/32	3/4-18	1.00	3.44	2.19	.12
10ACA-10MTON45	7332-00495	1/2	7/8-18	1.06	3.81	2.56	.16
12ACA-12MTON45	7332-00505	5/8	1 1/16-12	1.19	4.19	2.94	.22

- HOSE
- HOSE/CPLG. SELECTION
- G8K COUPLINGS
- GLOBALSPIRAL COUPLINGS
- PCM / PCS FERRULES
- MEGACRIMP COUPLINGS
- STAINLESS STEEL
- POWER CRIMP COUPLINGS
- LOC, GL AND GLP COUPLINGS
- POLARSEAL COUPLINGS**
- POLARSEAL II COUPLINGS
- C14 COUPLINGS
- PCTS THERMOPLASTIC COUPLINGS
- FIELD ATTACHABLE G1 & G2 COUPLINGS
- FIELD ATTACHABLE C5 & C5E COUPLINGS
- SURELOK AIR BRAKE COUPLINGS
- ADAPTERS
- QUICK DISCONNECT COUPLERS
- LIVE SWIVEL
- BALL VALVES
- ACCESSORIES
- EQUIPMENT AND PARTS



PolarSeal® Couplings

HOSE
HOSE/CPLG. SELECTION
G8K COUPLINGS
GLOBALSPIRAL COUPLINGS
PCM / PCS FERRULES
MEGACRIMP COUPLINGS
STAINLESS STEEL
POWER CRIMP COUPLINGS
LOC. GL AND GLP COUPLINGS
POLARSEAL COUPLINGS
POLARSEAL II COUPLINGS
C14 COUPLINGS
PCTS THERMOPLASTIC COUPLINGS
FIELD ATTACHABLE G1 & G2 COUPLINGS
FIELD ATTACHABLE C5 & C5E COUPLINGS
SURELOK AIR BRAKE COUPLINGS
ADAPTERS
QUICK DISCONNECT COUPLERS
LIVE SWIVEL
BALL VALVES
ACCESSORIES
EQUIPMENT AND PARTS

Male SAE Tube O-Ring Nut - 45° Bent Tube - Steel

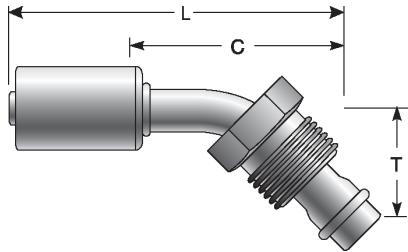

Descr.	Prod. No.	⊖	🌀	T	L	C	Weight (Lbs.)
		"	"	"	"	"	
6ACA-6MTON45S	7332-04415	5/16	5/8-18	.88	1.69	4.03	.11
10ACA-10MTON45-S	7332-04425	1/2	7/8-18	1.06	2.31	4.63	.22

Male SAE Tube O-Ring Nut - 90° Bent Tube - Aluminum

O-Ring not included. Must be ordered separately.

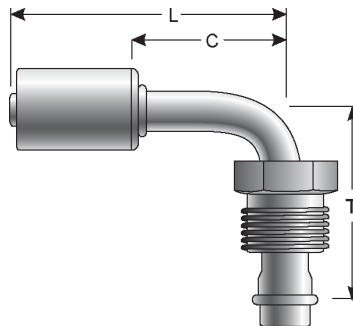

Descr.	Prod. No.	⊖	🌀	T	L	C	Weight (Lbs.)
		"	"	"	"	"	
6ACA-6MTON90	7332-00515	5/16	5/8-18	1.63	2.56	1.31	.08
6ACA-7MTON90	7332-03115	5/16	11/16-16	1.56	2.56	1.31	.10
6ACA-8MTON90	7332-03125	5/16	3/4-18	1.88	2.75	1.50	.10
8ACA-6MTON90	7332-03135	13/32	5/8-18	1.88	2.75	1.50	.10
8ACA-8MTON90	7332-00525	13/32	3/4-18	1.88	2.75	1.50	.20
10ACA-10MTON90	7332-00535	1/2	7/8-18	2.12	3.00	1.75	.16
12ACA-10MTON90	7332-03145	5/8	7/8-18	2.25	3.25	2.00	.20
12ACA-12MTON90	7332-00545	5/8	1 1/16-12	2.25	3.25	2.00	.14



PolarSeal® Couplings

Male SAE Tube O-Ring Nut - 90° Bent Tube - Steel

O-Ring not included. Must be ordered separately.

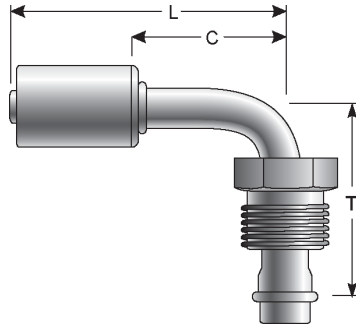

Descr.	Prod. No.			T	L	C	Weight (Lbs.)
		"	"	"	"	"	
6ACA-6MTON90S	7332-01295	5/16	5/8-18	1.63	2.56	1.31	.16
8ACA-8MTON90-S	7332-04435	13/32	3/4-16	1.88	1.25	4.73	.24
10ACA-10MTON90-S	7332-01875	1/2	7/8-18	2.12	3.00	1.75	.24

Male SAE Tube O-Ring Nut Swivel with R134a Service Port - Aluminum

O-Ring not included. Must be ordered separately.

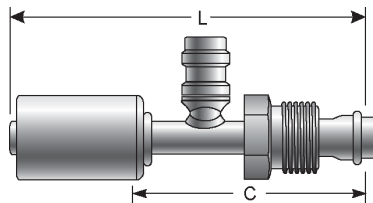

Descr.	Prod. No.			L	C	Weight (Lbs.)
		"	"	"	"	
6ACA-6MTON134SP	7332-03025	5/16	5/8-18	3.35	2.10	.15
8ACA-8MTON134SP	7332-03035	13/32	3/4-18	3.35	2.10	.15
10ACA-10MTON134SP	7332-03045	1/2	7/8-18	3.59	2.34	.20
12ACA-12MTON134SP	7332-03055	5/8	1 1/16-12	3.72	2.47	.25

- HOSE
- HOSE/CPLG. SELECTION
- G8K COUPLINGS
- GLOBALSPIRAL COUPLINGS
- PCM / PCS FERRULES
- MEGACRIMP COUPLINGS
- STAINLESS STEEL
- POWER CRIMP COUPLINGS
- LOC, GL AND GLP COUPLINGS
- POLARSEAL COUPLINGS**
- POLARSEAL II COUPLINGS
- C14 COUPLINGS
- PCTS THERMOPLASTIC COUPLINGS
- FIELD ATTACHABLE G1 & G2 COUPLINGS
- FIELD ATTACHABLE C5 & C5E COUPLINGS
- SURELOK AIR BRAKE COUPLINGS
- ADAPTERS
- QUICK DISCONNECT COUPLERS
- LIVE SWIVEL
- BALL VALVES
- ACCESSORIES
- EQUIPMENT AND PARTS



PolarSeal® Couplings

Male SAE Tube O-Ring Nut Swivel with R134a Service Port - 90° Bent Tube - Aluminum

O-Ring not included. Must be ordered separately.

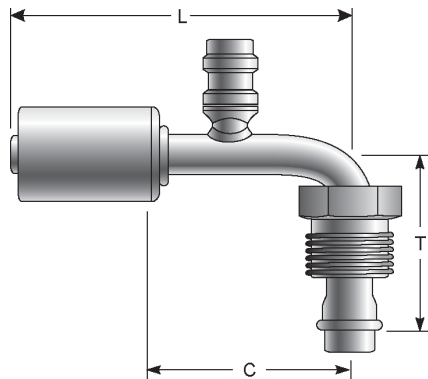

Descr.	Prod. No.			T	L	C	Weight (Lbs.)
		"	"	"	"	"	
10ACA-10MTON134SP90	7332-02585	1/2	7/8-18	1.50	3.85	2.60	.20

Female SAE Tube O-Ring Nut Swivel - Aluminum

O-Ring not included. Must be ordered separately.

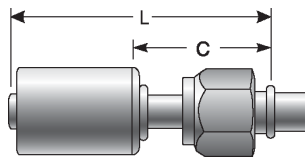

Descr.	Prod. No.			L	C	Weight (Lbs.)
		"	"	"	"	
6ACA-5FTON* **	7332-00635	5/16	9/16-18	2.81	1.56	.10
6ACA-6FTON	7332-00645	5/16	5/8-18	2.88	1.63	.10
6ACA-8FTON	7332-00655	5/16	3/4-16	3.00	1.75	.12
8ACA-6FTON	7332-03165	13/32	5/8-18	3.00	1.75	.10
8ACA-8FTON	7332-00665	13/32	3/4-16	3.00	1.75	.10
10ACA-8FTON	7332-01505	1/2	3/4-16	3.19	1.94	.16
10ACA-10FTON	7332-00675	1/2	7/8-14	3.19	1.94	.20
10ACA-12FTON	7332-01515	1/2	1 1/16-14	3.31	2.06	.28
12ACA-10FTON	7332-00685	5/8	7/8-14	3.31	2.06	.24
12ACA-12FTON	7332-00695	5/8	1 1/16-14	3.31	2.06	.30

*Standard and Metric threads are equivalent for 6ACA-5FTON.
**Used on Toyota Receivers and Dryers.

- HOSE
- HOSE/CPLG. SELECTION
- G8K COUPLINGS
- GLOBAL SPIRAL COUPLINGS
- PCM / PCS FERRULES
- MEGACRIMP COUPLINGS
- STAINLESS STEEL
- POWER CRIMP COUPLINGS
- LOC. GL AND GLP COUPLINGS
- POLARSEAL COUPLINGS**
- POLARSEAL II COUPLINGS
- C14 COUPLINGS
- PCTS THERMOPLASTIC COUPLINGS
- FIELD ATTACHABLE G1 & G2 COUPLINGS
- FIELD ATTACHABLE C5 & C5E COUPLINGS
- SURELOK AIR BRAKE COUPLINGS
- ADAPTERS
- QUICK DISCONNECT COUPLERS
- LIVE SWIVEL
- BALL VALVES
- ACCESSORIES
- EQUIPMENT AND PARTS



PolarSeal® Couplings

Female SAE Tube O-Ring Nut Swivel - Steel

O-Ring not included. Must be ordered separately.

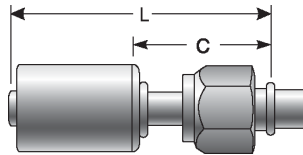

Descr.	Prod. No.			L	C	Weight (Lbs.)
		"	"			
6ACA-6FTON-S	7332-01275	5/16	5/8-18	2.88	1.63	.12
8ACA-8FTON-S	7332-01645	13/32	3/4-16	3.00	1.75	.12
10ACA-10FTON-S	7332-01655	1/2	7/8-14	3.19	1.94	.28
12ACA-10FTON-S	7332-01815	5/8	7/8-14	3.31	2.06	.30
12ACA-12FTON-S	7332-03175	5/8	1 1/16-14	3.31	2.06	.30

Female SAE Tube O-Ring Nut Swivel - 45° Bent Tube - Aluminum

O-Ring not included. Must be ordered separately.

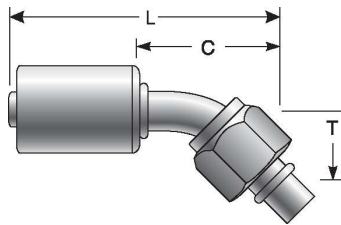

Descr.	Prod. No.			T	L	C	Weight (Lbs.)
		"	"	"	"	"	
6ACA-6FTON45	7332-00705	5/16	5/8-18	.56	2.87	1.52	.10
8ACA-6FTON45	7332-03185	13/32	5/8-18	.63	3.04	1.79	.10
8ACA-8FTON45	7332-00715	13/32	3/4-16	.63	3.07	1.82	.12
10ACA-8FTON45	7332-03195	1/2	3/4-16	.88	3.60	2.35	.15
10ACA-10FTON45	7332-00725	1/2	7/8-14	.88	3.63	2.38	.22
12ACA-10FTON45	7332-03205	5/8	7/8-14	.94	3.91	2.66	.25
12ACA-12FTON45	7332-00735	5/8	1 1/16-14	.94	3.94	2.69	.30

- HOSE
- HOSE/CPLG. SELECTION
- G8K COUPLINGS
- GLOBALSPIRAL COUPLINGS
- PCM / PCS FERRULES
- MEGACRIMP COUPLINGS
- STAINLESS STEEL
- POWER CRIMP COUPLINGS
- LOC, GL AND GLP COUPLINGS
- POLARSEAL COUPLINGS
- POLARSEAL II COUPLINGS
- C14 COUPLINGS
- PCTS THERMOPLASTIC COUPLINGS
- FIELD ATTACHABLE G1 & G2 COUPLINGS
- FIELD ATTACHABLE C5 & C5E COUPLINGS
- SURELOK AIR BRAKE COUPLINGS
- ADAPTERS
- QUICK DISCONNECT COUPLERS
- LIVE SWIVEL
- BALL VALVES
- ACCESSORIES
- EQUIPMENT AND PARTS



PolarSeal® Couplings

Female SAE Tube O-Ring Nut Swivel - 45° Bent Tube - Steel

O-Ring not included. Must be ordered separately.

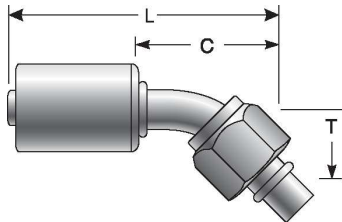

Descr.	Prod. No.			T	L	C	Weight (Lbs.)
		"	"	"	"	"	
6ACA-6FTON45-S	7332-01665	5/16	5/8-18	.56	2.87	1.52	.14
8ACA-8FTON45-S	7332-02055	13/32	3/4-16	.63	3.07	1.82	.20
10ACA-10FTON45-S	7332-01675	1/2	7/8-14	.88	3.63	2.38	.30

Female SAE Tube O-Ring Nut Swivel - 90° Bent Tube - Aluminum

O-Ring not included. Must be ordered separately.

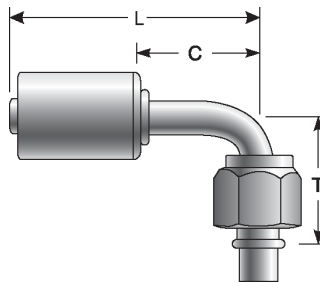

Descr.	Prod. No.			T	L	C	Weight (Lbs.)
		"	"	"	"	"	
6ACA-5FTON90*	7332-00745	5/16	9/16-18	1.12	2.75	1.63	.10
6ACA-6FTON90	7332-00755	5/16	5/8-18	1.12	2.56	1.31	.10
6ACA-8FTON90	7332-00765	5/16	3/4-16	1.31	2.75	1.50	.12
8ACA-6FTON90	7332-03155	13/32	5/8-18	1.31	2.75	1.50	.10
8ACA-8FTON90	7332-00775	13/32	3/4-16	1.31	2.75	1.50	.14
10ACA-8FTON90	7332-01545	1/2	3/4-16	1.50	3.00	1.75	.14
10ACA-10FTON90	7332-00785	1/2	7/8-14	1.50	3.00	1.75	.20
10ACA-12FTON90	7332-01555	1/2	1 1/16-14	1.75	3.25	2.00	.28
12ACA-10FTON90	7332-00795	5/8	7/8-14	1.75	3.25	2.00	.24
12ACA-12FTON90	7332-00805	5/8	1 1/16-14	1.75	3.25	2.00	.32

*Used on Toyota Receivers and Dryers.

- HOSE
- HOSE/CPLG. SELECTION
- G8K COUPLINGS
- GLOBALSPIRAL COUPLINGS
- PCM / PCS FERRULES
- MEGACRIMP COUPLINGS
- STAINLESS STEEL
- POWER CRIMP COUPLINGS
- LOC. GL AND GLP COUPLINGS
- POLARSEAL COUPLINGS
- POLARSEAL II COUPLINGS
- C14 COUPLINGS
- PCTS THERMOPLASTIC COUPLINGS
- FIELD ATTACHABLE G1 & G2 COUPLINGS
- FIELD ATTACHABLE C5 & C5E COUPLINGS
- SURELOK AIR BRAKE COUPLINGS
- ADAPTERS
- QUICK DISCONNECT COUPLERS
- LIVE SWIVEL
- BALL VALVES
- ACCESSORIES
- EQUIPMENT AND PARTS



PolarSeal® Couplings

Female SAE Tube O-Ring Nut Swivel - 90° Bent Tube - Steel

O-Ring not included. Must be ordered separately.

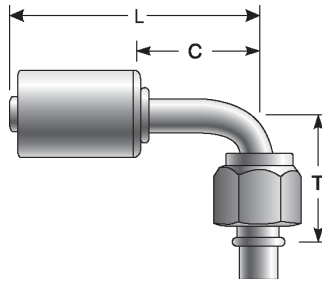

Descr.	Prod. No.			T	L	C	Weight (Lbs.)
		"	"	"	"	"	
6ACA-6FTON90-S	7332-01305	5/16	5/8-18	1.12	2.56	1.31	.14
8ACA-8FTON90-S	7332-01685	13/32	3/4-16	1.31	2.75	1.50	.20
10ACA-10FTON90-S	7332-01695	1/2	7/8-14	1.50	3.00	1.75	.32
12ACA-10FTON90-S	7332-01825	5/8	7/8-14	1.50	3.25	2.00	.34

Female SAE Tube O-Ring Nut Swivel - 90° Block - Steel

O-Ring not included. Must be ordered separately.

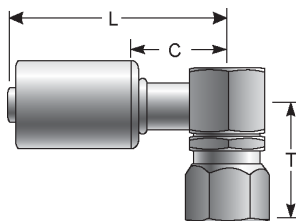

Descr.	Prod. No.			T	L	C	Weight (Lbs.)
		"	"	"	"	"	
8ACA-8FTON90BL-S	7332-01835	13/32	3/4-16	.71	2.44	1.19	.28
10ACA-10FTON90BL-S	7332-01845	1/2	7/8-14	.71	2.50	1.25	.34
12ACA-10FTON90BL-S	7332-01855	5/8	7/8-14	.71	2.62	1.37	.34

- HOSE
- HOSE/CPLG. SELECTION
- G8K COUPLINGS
- GLOBALSPIRAL COUPLINGS
- PCM / PCS FERRULES
- MEGACRIMP COUPLINGS
- STAINLESS STEEL
- POWER CRIMP COUPLINGS
- LOC. GL AND GLP COUPLINGS
- POLARSEAL COUPLINGS**
- POLARSEAL II COUPLINGS
- C14 COUPLINGS
- PCTS THERMOPLASTIC COUPLINGS
- FIELD ATTACHABLE G1 & G2 COUPLINGS
- FIELD ATTACHABLE C5 & C5E COUPLINGS
- SURELOK AIR BRAKE COUPLINGS
- ADAPTERS
- QUICK DISCONNECT COUPLERS
- LIVE SWIVEL
- BALL VALVES
- ACCESSORIES
- EQUIPMENT AND PARTS



PolarSeal® Couplings

HOSE
HOSE/CPLG. SELECTION
G8K COUPLINGS
GLOBALSPIRAL COUPLINGS
PCM / PCS FERRULES
MEGACRIMP COUPLINGS
STAINLESS STEEL
POWER CRIMP COUPLINGS
LOC. GL AND GLP COUPLINGS
POLARSEAL COUPLINGS
POLARSEAL II COUPLINGS
C14 COUPLINGS
PCTS THERMOPLASTIC COUPLINGS
FIELD ATTACHABLE G1 & G2 COUPLINGS
FIELD ATTACHABLE C5 & C5E COUPLINGS
SURELOK AIR BRAKE COUPLINGS
ADAPTERS
QUICK DISCONNECT COUPLERS
LIVE SWIVEL
BALL VALVES
ACCESSORIES
EQUIPMENT AND PARTS

Female SAE Tube O-Ring Nut - 180° Bent Tube - Aluminum

O-Ring not included. Must be ordered separately.

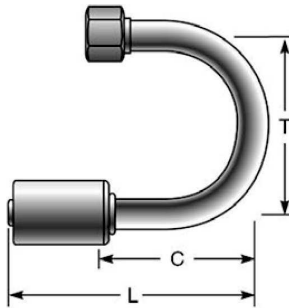

Descr.	Prod. No.			T	L	C	Weight (Lbs.)
		"	"	"	"	"	
6ACA-6FTON180	7332-03575	5/16	5/8-18	1.63	3.50	2.25	.10
8ACA-8FTON180	7332-03585	13/32	3/4-18	1.75	3.50	2.25	.15
12ACA-12FTON180	7332-03595	5/8	1 1/16-14	2.12	4.50	3.25	.35

Female SAE Tube O-Ring Nut Swivel with R12 Service Port - Aluminum

O-Ring not included. Must be ordered separately.
Service Ports: High Side; 6-8 Hose; 3/8" Schrader Valve
Service Ports: Low Side; 10-12 Hose; 1/4" Schrader Valve

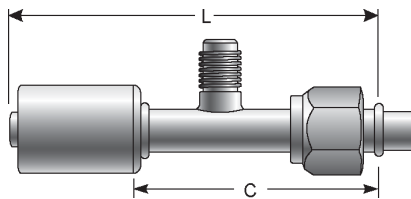

Descr.	Prod. No.			L	C	Weight (Lbs.)
		"	"	"	"	
6ACA-6FTONR12SP	7332-01985	5/16	5/8-18	3.38	2.13	.10
8ACA-8FTONR12SP	7332-01995	13/32	3/4-16	3.38	2.13	.12
10ACA-10FTONR12SP	7332-02005	1/2	7/8-14	3.62	2.37	.18



PolarSeal® Couplings

Female SAE Tube O-Ring Nut Swivel with R12 Service Port - 90° Bent Tube - Aluminum

O-Ring not included. Must be ordered separately.

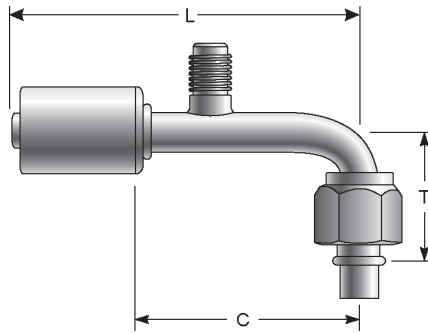

Descr.	Prod. No.			T	L	C	Weight (Lbs.)
		"	"	"	"	"	
6ACA-6FTONR12SP90	7332-02015	5/16	5/8-18	1.12	3.62	2.37	.14
8ACA-8FTONR12SP90	7332-02025	13/32	3/4-16	1.31	3.62	2.37	.18
10ACA-10FTONR12SP90	7332-02035	1/2	7/8-14	1.50	3.88	2.63	.24
12ACA-10FTONR12SP90	7332-02045	5/8	7/8-14	1.75	4.19	2.94	.28

Female SAE Tube O-Ring Nut Swivel with R134a Service Port - Aluminum

O-Ring not included. Must be ordered separately.

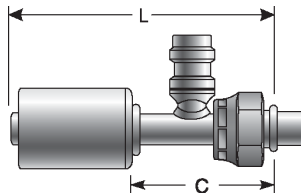

Descr.	Prod. No.			L	C	Weight (Lbs.)
		"	"	"	"	
6ACA-6FTON134SP	7332-00555	5/16	5/8-18	3.30	2.05	.10
8ACA-8FTON134SP	7332-00565	13/32	3/4-16	3.38	2.13	.68
10ACA-10FTON134SP	7332-00575	1/2	7/8-14	3.62	2.37	.18
12ACA-10FTON134SP	7332-00585	5/8	7/8-14	3.75	2.50	.14

- HOSE
- HOSE/CPLG. SELECTION
- G8K COUPLINGS
- GLOBALSPIRAL COUPLINGS
- PCM / PCS FERRULES
- MEGACRIMP COUPLINGS
- STAINLESS STEEL
- POWER CRIMP COUPLINGS
- LOC, GL AND GLP COUPLINGS
- POLARSEAL COUPLINGS**
- POLARSEAL II COUPLINGS
- C14 COUPLINGS
- PCTS THERMOPLASTIC COUPLINGS
- FIELD ATTACHABLE G1 & G2 COUPLINGS
- FIELD ATTACHABLE C5 & C5E COUPLINGS
- SURELOK AIR BRAKE COUPLINGS
- ADAPTERS
- QUICK DISCONNECT COUPLERS
- LIVE SWIVEL
- BALL VALVES
- ACCESSORIES
- EQUIPMENT AND PARTS



PolarSeal® Couplings

- HOSE
- HOSE/CPLG. SELECTION
- G8K COUPLINGS
- GLOBALSPIRAL COUPLINGS
- PCM / PCS FERRULES
- MEGACRIMP COUPLINGS
- STAINLESS STEEL
- POWER CRIMP COUPLINGS
- LOC. GL AND GLP COUPLINGS
- POLARSEAL COUPLINGS**
- POLARSEAL II COUPLINGS
- C14 COUPLINGS
- PCTS THERMOPLASTIC COUPLINGS
- FIELD ATTACHABLE G1 & G2 COUPLINGS
- FIELD ATTACHABLE C5 & C5E COUPLINGS
- SURELOK AIR BRAKE COUPLINGS
- ADAPTERS
- QUICK DISCONNECT COUPLERS
- LIVE SWIVEL
- BALL VALVES
- ACCESSORIES
- EQUIPMENT AND PARTS

Female SAE Tube O-Ring Nut Swivel with R134a Service Port - Steel

O-Ring not included. Must be ordered separately.

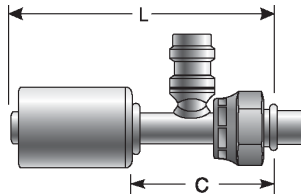

Descr.	Prod. No.			L	C	Weight (Lbs.)
		"	"	"	"	
6ACA-6FTON134SP-S	7332-04405	5/16	5/8-18	1.88	3.98	.26
8ACA-8FTON134SP-S	7332-02685	13/32	3/4-16	3.38	2.13	.25
10ACA-10FTON134SP-S	7332-02695	1/2	7/8-14	3.62	2.37	.35

Female SAE Tube O-Ring Nut Swivel with R134a High Pressure Service Port - Aluminum

O-Ring not included. Must be ordered separately.

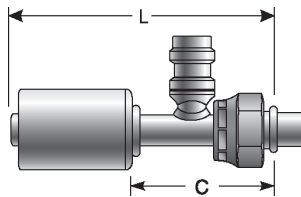

Descr.	Prod. No.			L	C	Weight (Lbs.)
		"	"	"	"	
10ACA-10FTON134SPH	7332-04245	1/2	7/8-14	3.62	2.37	.18



PolarSeal® Couplings

Female SAE Tube O-Ring Nut Swivel with R134a Service Port - 90° Bent Tube - Aluminum

O-Ring not included. Must be ordered separately.

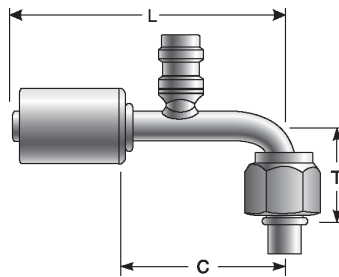

Descr.	Prod. No.			T	L	C	Weight (Lbs.)
		"	"	"	"	"	
6ACA-6FTON134SP90	7332-00595	5/16	5/8-18	1.12	3.62	2.37	.12
8ACA-8FTON134SP90	7332-00605	13/32	3/4-16	1.31	3.62	2.37	.18
10ACA-10FTON134SP90	7332-00615	1/2	7/8-14	1.50	3.88	2.63	.24
12ACA-10FTON134SP90	7332-00625	5/8	7/8-14	1.75	4.19	2.94	.28

Female SAE Tube O-Ring Nut Swivel with R134a Service Port - 90° Bent Tube - Steel

O-Ring not included. Must be ordered separately.

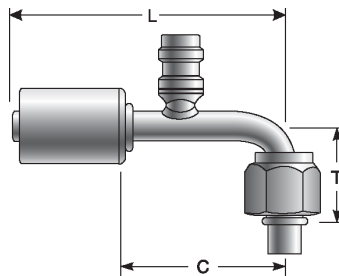

Descr.	Prod. No.			T	L	C	Weight (Lbs.)
		"	"	"	"	"	
6ACA-6FTON134SP90-S	7332-02075	5/16	5/8-18	1.12	3.62	2.37	.20
8ACA-8FTON134SP90-S	7332-01705	13/32	3/4-16	1.50	3.62	2.37	.40
10ACA-10FTON134SP90-S	7332-01715	1/2	7/8-14	1.75	3.88	2.63	.30
12ACA-10FTON134SP90-S	7332-02085	5/8	7/8-14	1.75	4.19	2.94	.38

- HOSE
- HOSE/CPLG. SELECTION
- G8K COUPLINGS
- GLOBALSPIRAL COUPLINGS
- PCM / PCS FERRULES
- MEGACRIMP COUPLINGS
- STAINLESS STEEL
- POWER CRIMP COUPLINGS
- LOC, GL AND GLP COUPLINGS
- POLARSEAL COUPLINGS**
- POLARSEAL II COUPLINGS
- C14 COUPLINGS
- PCTS THERMOPLASTIC COUPLINGS
- FIELD ATTACHABLE G1 & G2 COUPLINGS
- FIELD ATTACHABLE C5 & C5E COUPLINGS
- SURELOK AIR BRAKE COUPLINGS
- ADAPTERS
- QUICK DISCONNECT COUPLERS
- LIVE SWIVEL
- BALL VALVES
- ACCESSORIES
- EQUIPMENT AND PARTS



PolarSeal® Couplings

- HOSE
- HOSE/CPLG. SELECTION
- G8K COUPLINGS
- GLOBALSPIRAL COUPLINGS
- PCM / PCS FERRULES
- MEGACRIMP COUPLINGS
- STAINLESS STEEL
- POWER CRIMP COUPLINGS
- LOC. GL AND GLP COUPLINGS
- POLARSEAL COUPLINGS**
- POLARSEAL II COUPLINGS
- C14 COUPLINGS
- PCTS THERMOPLASTIC COUPLINGS
- FIELD ATTACHABLE G1 & G2 COUPLINGS
- FIELD ATTACHABLE C5 & C5E COUPLINGS
- SURELOK AIR BRAKE COUPLINGS
- ADAPTERS
- QUICK DISCONNECT COUPLERS
- LIVE SWIVEL
- BALL VALVES
- ACCESSORIES
- EQUIPMENT AND PARTS

Female SAE Tube Dual O-Ring Nut - Aluminum

O-Ring not included. Must be ordered separately.

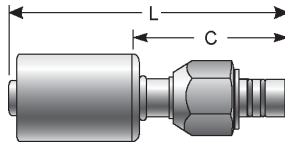

Descr.	Prod. No.			L	C	Weight (Lbs.)
		"	"	"	"	
8ACA-8FTDON	7332-03395	13/32	13/16-16	3.55	2.30	.20
10ACA-10FTDON	7332-03405	1/2	15/16-16	3.79	2.54	.25
12ACA-12FTDON	7332-03415	5/8	1 1/16-14	3.96	2.71	.30

Female SAE Tube Dual O-Ring Nut - 45° Bent Tube - Aluminum

O-Ring not included. Must be ordered separately.

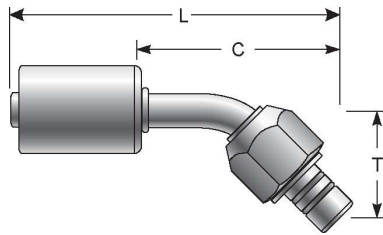

Descr.	Prod. No.			T	L	C	Weight (Lbs.)
		"	"	"	"	"	
8ACA-8FTDON45	7332-03425	13/32	13/16-16	1.02	3.43	2.18	.20
12ACA-12FTDON45	7332-03445	5/8	1 1/16-14	1.40	4.37	3.12	.30

Female SAE Tube Dual O-Ring Nut - 90° Bent Tube - Aluminum

O-Ring not included. Must be ordered separately.

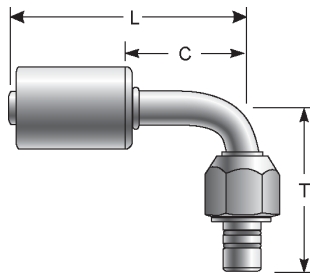

Descr.	Prod. No.			T	L	C	Weight (Lbs.)
		"	"	"	"	"	
8ACA-8FTDON90	7332-03455	13/32	13/16-16	1.86	2.75	1.50	.20
10ACA-10FTDON90	7332-03465	1/2	15/16-16	1.91	3.00	1.75	.25



PolarSeal® Couplings

Female SAE Tube Dual O-Ring Nut - 90° Bent Tube - Aluminum - Continued

Descr.	Prod. No.			T	L	C	Weight (Lbs.)
		"	"	"	"	"	
12ACA-12FTDON90	7332-03475	5/8	1 1/16-14	2.40	3.25	2.00	.30

Female SAE Tube O-Ring Metric Nut Swivel - Aluminum

O-Ring not included. Must be ordered separately.

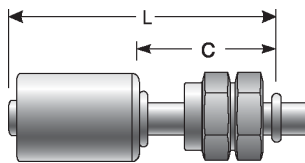

Descr.	Prod. No.			L	C	Weight (Lbs.)
		"	"	"	"	
6ACA-16FTOMN	7332-00815	5/16	M16X1.5	2.81	1.56	.12
6ACA-18FTOMN	7332-03215	5/16	M18X1.5	2.87	1.62	.10
6ACA-20FTOMN	7332-03225	5/16	M20X1.5	2.94	1.69	.15
8ACA-20FTOMN	7332-03235	13/32	M20X1.5	2.94	1.69	.15
10ACA-22FTOMN	7332-00825	1/2	M22X1.5	3.19	1.94	.16
10ACA-24FTOMN	7332-00835	1/2	M24X2.0	3.19	1.94	.20
12ACA-27FTOMN	7332-00845	5/8	M27X2.0	3.31	2.06	.28

Female SAE Tube O-Ring Metric Nut Swivel - 45° Bent Tube - Aluminum

O-Ring not included. Must be ordered separately.

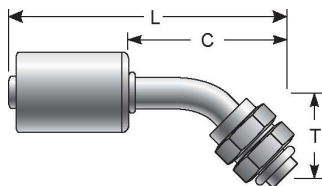

Descr.	Prod. No.			T	L	C	Weight (Lbs.)
		"	"	"	"	"	
6ACA-14FTOMN45	7332-03245	5/16	M14X1.5	.63	3.47	2.22	.10
6ACA-16FTOMN45	7332-03255	5/16	M16X1.5	.63	3.47	2.22	.10
6ACA-18FTOMN45	7332-03265	5/16	M18X1.5	.69	3.53	2.28	.15
6ACA-20FTOMN45	7332-03275	5/16	M20X1.5	.75	3.72	2.47	.15
8ACA-20FTOMN45	7332-03285	13/32	M20X1.5	.75	3.72	2.47	.15
10ACA-22FTOMN45	7332-03295	1/2	M22X1.5	.88	3.60	2.35	.20
10ACA-24FTOMN45	7332-03305	1/2	M24X2.0	.88	3.60	2.35	.25
12ACA-27FTOMN45	7332-03315	5/8	M27X2.0	1.00	4.59	3.34	.25

- HOSE
- HOSE/CPLG. SELECTION
- G8K COUPLINGS
- GLOBAL SPIRAL COUPLINGS
- PCM / PCS FERRULES
- MEGACRIMP COUPLINGS
- STAINLESS STEEL
- POWER CRIMP COUPLINGS
- LOC, GL AND GLP COUPLINGS
- POLARSEAL COUPLINGS**
- POLARSEAL II COUPLINGS
- C14 COUPLINGS
- PCTS THERMOPLASTIC COUPLINGS
- FIELD ATTACHABLE G1 & G2 COUPLINGS
- FIELD ATTACHABLE C5 & C5E COUPLINGS
- SURELOK AIR BRAKE COUPLINGS
- ADAPTERS
- QUICK DISCONNECT COUPLERS
- LIVE SWIVEL
- BALL VALVES
- ACCESSORIES
- EQUIPMENT AND PARTS



PolarSeal® Couplings

Female SAE Tube O-Ring Metric Nut Swivel - 90° Bent Tube - Aluminum

O-Ring not included. Must be ordered separately.

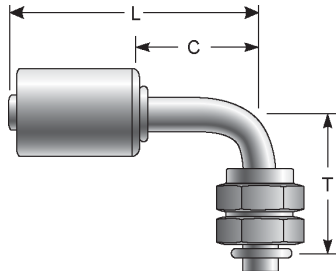

Descr.	Prod. No.			T	L	C	Weight (Lbs.)
		"	"	"	"	"	
6ACA-16FTOMN90	7332-00855	5/16	M16X1.5	1.12	2.75	1.50	.10
6ACA-18FTOMN90	7332-03325	5/16	M18X1.5	1.12	2.75	1.50	.15
6ACA-20FTOMN90	7332-03335	5/16	M20X1.5	1.25	2.75	1.50	.15
8ACA-20FTOMN90	7332-03345	13/32	M20X1.5	1.37	2.94	1.69	.15
10ACA-22FTOMN90	7332-00865	1/2	M22X1.5	1.63	3.13	1.88	.18
10ACA-24FTOMN90	7332-00875	1/2	M24X2.0	1.50	3.13	1.88	.20
12ACA-27FTOMN90	7332-00885	5/8	M27X2.0	1.75	3.38	2.13	.28

Female SAE Tube Dual O-Ring Metric Nut - Aluminum

O-Ring not included. Must be ordered separately.

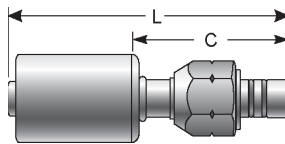

Descr.	Prod. No.			L	C	Weight (Lbs.)
		"	"	"	"	
8ACA-24FTDOMN	7332-03485	13/32	M24X2.0	3.55	2.30	.10
10ACA-24FTDOMN	7332-03495	1/2	M24X2.0	3.79	2.54	.20
12ACA-27FTDOMN	7332-03505	5/8	M27X2.0	3.96	2.71	.25

- HOSE
- HOSE/CPLG. SELECTION
- G8K COUPLINGS
- GLOBAL SPIRAL COUPLINGS
- PCM / PCS FERRULES
- MEGACRIMP COUPLINGS
- STAINLESS STEEL
- POWER CRIMP COUPLINGS
- LOC. GL AND GLP COUPLINGS
- POLARSEAL COUPLINGS**
- POLARSEAL II COUPLINGS
- C14 COUPLINGS
- PCTS THERMOPLASTIC COUPLINGS
- FIELD ATTACHABLE G1 & G2 COUPLINGS
- FIELD ATTACHABLE C5 & C5E COUPLINGS
- SURELOK AIR BRAKE COUPLINGS
- ADAPTERS
- QUICK DISCONNECT COUPLERS
- LIVE SWIVEL
- BALL VALVES
- ACCESSORIES
- EQUIPMENT AND PARTS



PolarSeal® Couplings

Female SAE Tube Dual O-Ring Metric Nut - 45° Bent Tube - Aluminum

O-Ring not included. Must be ordered separately.

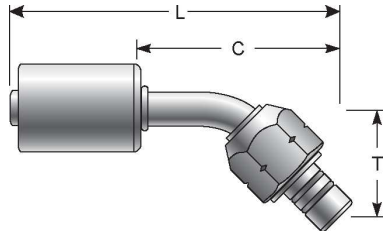

Descr.	Prod. No.			T	L	C	Weight (Lbs.)
		"	"	"	"	"	
8ACA-24FTDOMN45	7332-03515	13/32	M24X2.0	1.02	3.43	2.18	.15
10ACA-24FTDOMN45	7332-03525	1/2	M24X2.0	1.30	4.02	2.77	.20
12ACA-27FTDOMN45	7332-03535	5/8	M27X2.0	1.40	4.37	3.12	.30

Female SAE Tube Dual O-Ring Metric Nut - 90° Bent Tube - Aluminum

O-Ring not included. Must be ordered separately.

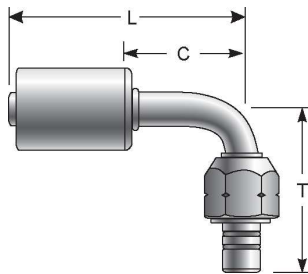

Descr.	Prod. No.			T	L	C	Weight (Lbs.)
		"	"	"	"	"	
8ACA-24FTDOMN90	7332-03545	13/32	M24X2.0	1.86	2.75	1.50	.20
10ACA-24FTDOMN90	7332-03555	1/2	M24X2.0	1.91	3.00	1.75	.20
12ACA-27FTDOMN90	7332-03565	5/8	M27X2.0	2.40	3.25	2.00	.25

- HOSE
- HOSE/CPLG. SELECTION
- G8K COUPLINGS
- GLOBALSPIRAL COUPLINGS
- PCM / PCS FERRULES
- MEGACRIMP COUPLINGS
- STAINLESS STEEL
- POWER CRIMP COUPLINGS
- LOC, GL AND GLP COUPLINGS
- POLARSEAL COUPLINGS**
- POLARSEAL II COUPLINGS
- C14 COUPLINGS
- PCTS THERMOPLASTIC COUPLINGS
- FIELD ATTACHABLE G1 & G2 COUPLINGS
- FIELD ATTACHABLE C5 & C5E COUPLINGS
- SURELOK AIR BRAKE COUPLINGS
- ADAPTERS
- QUICK DISCONNECT COUPLERS
- LIVE SWIVEL
- BALL VALVES
- ACCESSORIES
- EQUIPMENT AND PARTS



PolarSeal® Couplings

- HOSE
- HOSE/CPLG. SELECTION
- G8K COUPLINGS
- GLOBALSPIRAL COUPLINGS
- PCM / PCS FERRULES
- MEGACRIMP COUPLINGS
- STAINLESS STEEL
- POWER CRIMP COUPLINGS
- LOC. GL AND GLP COUPLINGS
- POLARSEAL COUPLINGS**
- POLARSEAL II COUPLINGS
- C14 COUPLINGS
- PCTS THERMOPLASTIC COUPLINGS
- FIELD ATTACHABLE G1 & G2 COUPLINGS
- FIELD ATTACHABLE C5 & C5E COUPLINGS
- SURELOK AIR BRAKE COUPLINGS
- ADAPTERS
- QUICK DISCONNECT COUPLERS
- LIVE SWIVEL
- BALL VALVES
- ACCESSORIES
- EQUIPMENT AND PARTS

Compressor Female SAE Tube O-Ring Nut Swivel - 90° Bent Tube - Steel

O-Ring not included. Must be ordered separately.

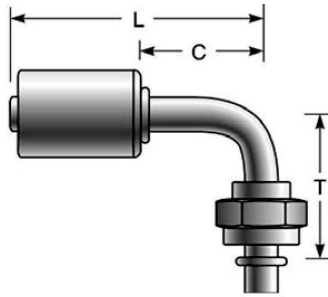

Descr.	Prod. No.			T	L	C	Weight (Lbs.)
		"	"	"	"	"	
6ACA-6CFTON90S	7332-04465	13/32	1-14	.84	.94	2.44	.34
8ACA-10CFTON90-S	7332-02335	13/32	1-14	1.50	3.01	1.42	.25
10ACA-10CFTON90S	7332-04475	1/2	1-14	.84	.94	2.63	.36
12ACA-10CFTON90-S	7332-02065	5/8	1-14	1.63	3.18	1.60	.26

Compressor Female SAE Tube O-Ring Nut Swivel - 90° Block - Steel

O-Ring not included. Must be ordered separately.

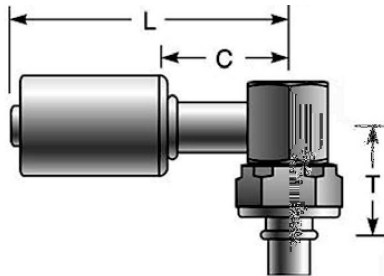

Descr.	Prod. No.			T	L	C	Weight (Lbs.)
		"	"	"	"	"	
8ACA-10CFTON90BL-S	7332-02095	13/32	1-14	.80	3.02	1.43	.38
12ACA-10CFTON90BL-S	7332-02105	5/8	1-14	.80	3.14	1.55	.40



PolarSeal® Couplings

Compressor Female Tube O-Ring Nut with 134a Service Port - 90° Block - Steel

O-Ring not included. Must be ordered separately.

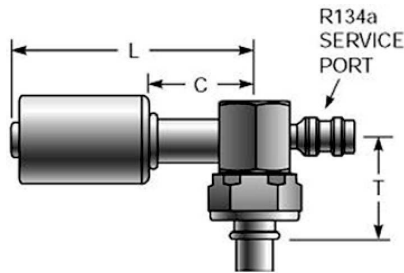

Descr.	Prod. No.			T	L	C	Weight (Lbs.)
		"	"	"	"	"	
8ACA-10CFTON134SP90BL-S	7332-03865	13/32	1-14	.78	2.45	1.20	.40
10ACA-10CFTON134SP90BL-S	7332-03875	1/2	1-14	.78	2.51	1.26	.40
12ACA-10CFTON134SP90BL-S	7332-02755	5/8	1-14	.78	2.67	1.42	.45

Female Rotalok (Compressor Connection) with R134a Service Port - 90° Block - Aluminum

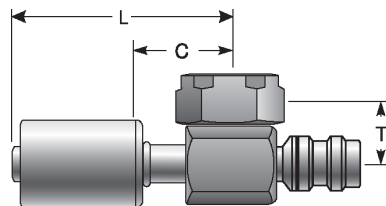

Descr.	Prod. No.			T	L	C	Weight (Lbs.)
		"	"	"	"	"	
8ACA-R134SP-RL	7332-01215	13/32	1-14	.78	2.45	1.20	.42
10ACA-R134SP-RL	7332-01225	1/2	1-14	.78	2.51	1.26	.42

- HOSE
- HOSE/CPLG. SELECTION
- G8K COUPLINGS
- GLOBALSPIRAL COUPLINGS
- PCM / PCS FERRULES
- MEGACRIMP COUPLINGS
- STAINLESS STEEL
- POWER CRIMP COUPLINGS
- LOC, GL AND GLP COUPLINGS
- POLARSEAL COUPLINGS**
- POLARSEAL II COUPLINGS
- C14 COUPLINGS
- PCTS THERMOPLASTIC COUPLINGS
- FIELD ATTACHABLE G1 & G2 COUPLINGS
- FIELD ATTACHABLE C5 & C5E COUPLINGS
- SURELOK AIR BRAKE COUPLINGS
- ADAPTERS
- QUICK DISCONNECT COUPLERS
- LIVE SWIVEL
- BALL VALVES
- ACCESSORIES
- EQUIPMENT AND PARTS



PolarSeal® Couplings

- HOSE
- HOSE/CPLG. SELECTION
- G8K COUPLINGS
- GLOBAL SPIRAL COUPLINGS
- PCM / PCS FERRULES
- MEGACRIMP COUPLINGS
- STAINLESS STEEL
- POWER CRIMP COUPLINGS
- LOC. GL AND GLP COUPLINGS
- POLARSEAL COUPLINGS
- POLARSEAL II COUPLINGS
- C14 COUPLINGS
- PCTS THERMOPLASTIC COUPLINGS
- FIELD ATTACHABLE G1 & G2 COUPLINGS
- FIELD ATTACHABLE C5 & C5E COUPLINGS
- SURELOK AIR BRAKE COUPLINGS
- ADAPTERS
- QUICK DISCONNECT COUPLERS
- LIVE SWIVEL
- BALL VALVES
- ACCESSORIES
- EQUIPMENT AND PARTS

Male Inverted O-Ring - Aluminum

O-Ring not included. Must be ordered separately.

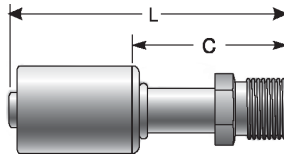

Descr.	Prod. No.			L	C	Weight (Lbs.)
		"	"	"	"	
6ACA-6MIO	7332-00895	5/16	5/8-18	2.94	1.69	.08
8ACA-8MIO	7332-00905	13/32	3/4-18	3.13	1.88	.12
10ACA-10MIO	7332-00915	1/2	7/8-14	3.62	2.37	.14
12ACA-12MIO	7332-00925	5/8	1 1/16-14	3.88	2.63	.20

Male Inverted O-Ring - Steel

O-Ring not included. Must be ordered separately.

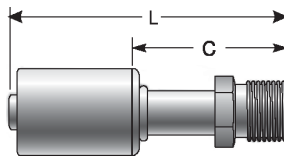

Descr.	Prod. No.			L	C	Weight (Lbs.)
		"	"	"	"	
6ACA-6MIO-S	7332-01885	5/16	5/8-18	2.94	1.69	.10
8ACA-8MIO-S	7332-01895	13/32	3/4-18	3.13	1.88	.16
10ACA-10MIO-S	7332-03355	1/2	7/8-14	3.62	2.37	.20

Male Inverted O-Ring - 45° Bent Tube - Aluminum

O-Ring not included. Must be ordered separately.

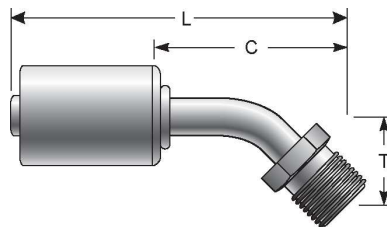

Descr.	Prod. No.			T	L	C	Weight (Lbs.)
		"	"	"	"	"	
6ACA-6MIO45	7332-03365	5/16	5/8-18	.75	3.03	1.78	.10
8ACA-8MIO45	7332-03375	13/32	3/4-18	1.00	3.41	2.16	.10
10ACA-10MIO45	7332-03385	1/2	7/8-14	1.25	3.97	2.72	.25



PolarSeal® Couplings

Male Inverted O-Ring - 90° Bent Tube - Aluminum

O-Ring not included. Must be ordered separately.

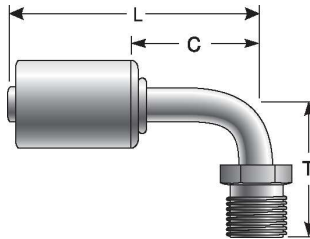

Descr.	Prod. No.			T	L	C	Weight (Lbs.)
		"	"	"	"	"	
6ACA-6MIO90	7332-00935	5/16	5/8-18	1.50	2.56	1.31	.08
8ACA-8MIO90	7332-00945	13/32	3/4-18	1.75	2.75	1.50	.10
10ACA-10MIO90	7332-00955	1/2	7/8-14	2.00	3.00	1.75	.14

Male Inverted O-Ring Bulkhead - Aluminum

O-Ring not included. Must be ordered separately.

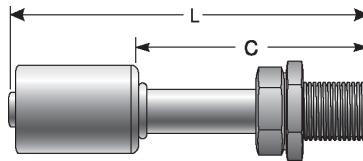

Descr.	Prod. No.			L	C	Weight (Lbs.)
		"	"	"	"	
6ACA-6MIOBKHD	7332-00965	5/16	5/8-18	4.00	2.75	.20
8ACA-8MIOBKHD	7332-00975	13/32	3/4-18	4.25	3.00	.22
10ACA-10MIOBKHD	7332-00985	1/2	7/8-14	4.44	3.19	.24

Male Inverted O-Ring Bulkhead - Steel

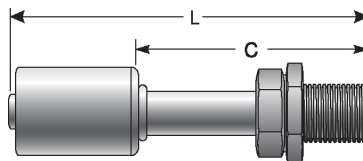

Descr.	Prod. No.			L	C	Weight (Lbs.)
		"	"	"	"	
6ACA-6MIOBKHD-S	7332-04445	5/16	5/8-18	1.82	2.36	.25
10ACA-10MIOBKHD-S	7332-04455	1/2	7/8-14	2.13	2.57	.31

- HOSE
- HOSE/CPLG. SELECTION
- G8K COUPLINGS
- GLOBALSPIRAL COUPLINGS
- PCM / PCS FERRULES
- MEGACRIMP COUPLINGS
- STAINLESS STEEL
- POWER CRIMP COUPLINGS
- LOC, GL AND GLP COUPLINGS
- POLARSEAL COUPLINGS**
- POLARSEAL II COUPLINGS
- C14 COUPLINGS
- PCTS THERMOPLASTIC COUPLINGS
- FIELD ATTACHABLE G1 & G2 COUPLINGS
- FIELD ATTACHABLE C5 & C5E COUPLINGS
- SURELOK AIR BRAKE COUPLINGS
- ADAPTERS
- QUICK DISCONNECT COUPLERS
- LIVE SWIVEL
- BALL VALVES
- ACCESSORIES
- EQUIPMENT AND PARTS



PolarSeal® Couplings

HOSE
HOSE/CPLG. SELECTION
G8K COUPLINGS
GLOBAL SPIRAL COUPLINGS
PCM / PCS FERRULES
MEGACRIMP COUPLINGS
STAINLESS STEEL
POWER CRIMP COUPLINGS
LOC. GL AND GLP COUPLINGS
POLARSEAL COUPLINGS
POLARSEAL II COUPLINGS
C14 COUPLINGS
PCTS THERMOPLASTIC COUPLINGS
FIELD ATTACHABLE G1 & G2 COUPLINGS
FIELD ATTACHABLE C5 & C5E COUPLINGS
SURELOK AIR BRAKE COUPLINGS
ADAPTERS
QUICK DISCONNECT COUPLERS
LIVE SWIVEL
BALL VALVES
ACCESSORIES
EQUIPMENT AND PARTS

Male Inverted O-Ring Bulkhead - 90° Bent Tube - Aluminum

O-Ring not included. Must be ordered separately.

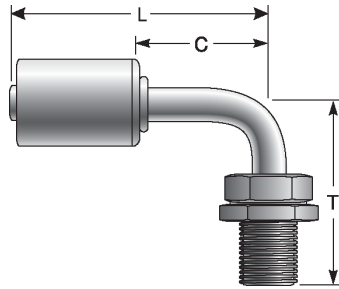

Descr.	Prod. No.			T	L	C	Weight (Lbs.)
		"	"	"	"	"	
6ACA-6MIOBKHD90	7332-00995	5/16	5/8-18	2.12	3.13	1.88	.20
8ACA-8MIOBKHD90	7332-01005	13/32	3/4-18	2.44	3.25	2.00	.10
10ACA-10MIOBKHD90	7332-01015	1/2	7/8-14	2.50	3.50	2.25	.26

Male Inverted O-Ring with R134a Service Port - Aluminum

O-Ring not included. Must be ordered separately.

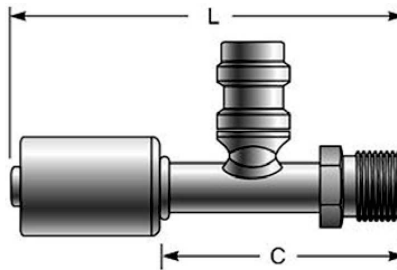

Descr.	Prod. No.			L	C	Weight (Lbs.)
		"	"	"	"	
6ACA-6MIO134SP	7332-03605	5/16	5/8-18	3.47	2.22	.10
8ACA-8MIO134SP	7332-03615	13/32	3/4-18	4.22	2.97	.15
10ACA-10MIO134SP	7332-03625	1/2	7/8-14	4.22	2.97	.15
12ACA-12MIO134SP	7332-03635	5/8	1 1/16-14	4.47	3.22	.25



PolarSeal® Couplings

Male Inverted O-Ring with R134a Service Port - 90° Bent Tube - Aluminum

O-Ring not included. Must be ordered separately.

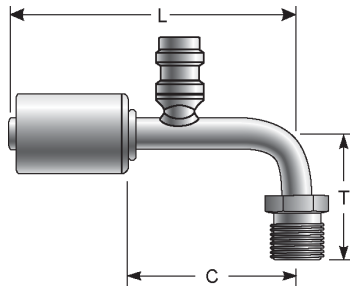

Descr.	Prod. No.			T	L	C	Weight (Lbs.)
		"	"				
6ACA-6MIO134SP90	7332-03645	5/16	5/8-18	1.50	3.59	2.34	.10
8ACA-8MIO134SP90	7332-03655	13/32	3/4-18	1.80	3.59	2.34	.15
10ACA-10MIO134SP90	7332-03665	1/2	7/8-14	2.00	3.85	2.60	.20

Universal Tee O-Ring Splicer English Threads - Aluminum

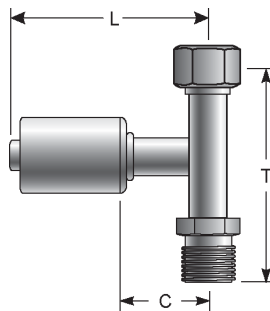

Descr.	Prod. No.			T	L	C	Weight (Lbs.)
		"	"				
6ACA-6TORSP	7332-03675	5/16	5/8-18	2.47	2.50	1.25	.15
6ACA-8TORSP	7332-03685	5/16	3/4-16	2.97	2.62	1.37	.20
10ACA-10TORSP	7332-03695	1/2	7/8-14	3.53	2.75	1.50	.30
10ACA-12TORSP	7332-03705	1/2	1 1/16-14	4.10	2.94	1.69	.45

- HOSE
- HOSE/CPLG. SELECTION
- G8K COUPLINGS
- GLOBALSPIRAL COUPLINGS
- PCM / PCS FERRULES
- MEGACRIMP COUPLINGS
- STAINLESS STEEL
- POWER CRIMP COUPLINGS
- LOC, GL AND GLP COUPLINGS
- POLARSEAL COUPLINGS**
- POLARSEAL II COUPLINGS
- C14 COUPLINGS
- PCTS THERMOPLASTIC COUPLINGS
- FIELD ATTACHABLE G1 & G2 COUPLINGS
- FIELD ATTACHABLE C5 & C5E COUPLINGS
- SURELOK AIR BRAKE COUPLINGS
- ADAPTERS
- QUICK DISCONNECT COUPLERS
- LIVE SWIVEL
- BALL VALVES
- ACCESSORIES
- EQUIPMENT AND PARTS



PolarSeal® Couplings

HOSE
HOSE/CPLG. SELECTION
G8K COUPLINGS
GLOBALSPIRAL COUPLINGS
PCM / PCS FERRULES
MEGACRIMP COUPLINGS
STAINLESS STEEL
POWER CRIMP COUPLINGS
LOC, GL AND GLP COUPLINGS
POLARSEAL COUPLINGS
POLARSEAL II COUPLINGS
C14 COUPLINGS
PCTS THERMOPLASTIC COUPLINGS
FIELD ATTACHABLE G1 & G2 COUPLINGS
FIELD ATTACHABLE C5 & C5E COUPLINGS
SURELOK AIR BRAKE COUPLINGS
ADAPTERS
QUICK DISCONNECT COUPLERS
LIVE SWIVEL
BALL VALVES
ACCESSORIES
EQUIPMENT AND PARTS

Female (Ford) Spring Lock Tee O-Ring Splicer - Aluminum

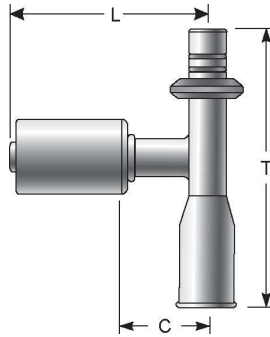

Descr.	Prod. No.	⊘	T	L	C	Weight (Lbs.)
		"	"	"	"	
6ACA-8FSLTORSP	7332-03735	5/16	1.72	5.13	3.88	.10
10ACA-12FSLTORSP	7332-03775	1/2	1.97	5.62	4.37	.20

Female (Ford) Spring Lock Liquid Line Splicer - Aluminum

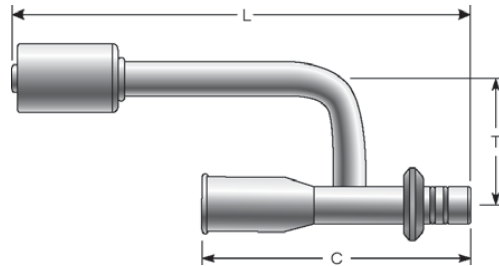

Descr.	Prod. No.	⊘	T	L	C	Weight (Lbs.)
		"	"	"	"	
6ACA-8FSLSP	7332-03715	5/16	1.75	5.13	3.88	.15

Male (Ford) Spring Lock - Aluminum

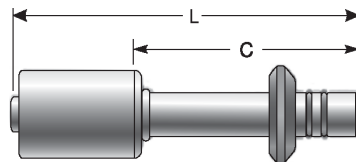

Descr.	Prod. No.	⊘	L	C	Weight (Lbs.)
		"	"	"	
6ACA-6MSL	7332-01055	5/16	3.81	2.56	.22
6ACA-8MSL	7332-01575	5/16	3.88	2.63	.10



PolarSeal® Couplings

Male (Ford) Spring Lock - Aluminum - Continued

Descr.	Prod. No.		L	C	Weight (Lbs.)
		"	"	"	
8ACA-8MSL	7332-01065	13/32	3.88	2.63	.55
10ACA-10MSL	7332-01075	1/2	4.00	2.75	.12
12ACA-10MSL	7332-01585	5/8	4.00	2.75	.14
12ACA-12MSL	7332-01085	5/8	4.25	3.00	.16

Male (Ford) Spring Lock - 45° Bent Tube - Aluminum

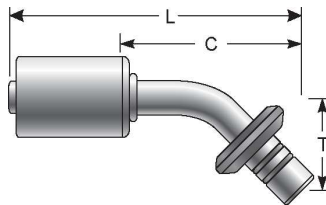

Descr.	Prod. No.		T	L	C	Weight (Lbs.)
		"	"	"	"	
6ACA-6MSL45	7332-03725	5/16	1.25	3.97	2.72	.20
6ACA-8MSL45	7332-03745	5/16	1.31	4.09	2.84	.10
8ACA-8MSL45	7332-03755	13/32	1.31	4.09	2.84	.10
10ACA-10MSL45	7332-03765	1/2	1.63	4.48	3.23	.15
12ACA-10MSL45	7332-03785	5/8	1.63	4.48	3.23	.15
12ACA-12MSL45	7332-03795	5/8	1.75	4.72	3.47	.20

Male (Ford) Spring Lock - 90° Bent Tube - Aluminum

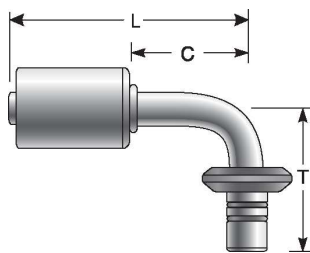

Descr.	Prod. No.		T	L	C	Weight (Lbs.)
		"	"	"	"	
6ACA-6MSL90	7332-02135	5/16	2.19	2.88	1.63	.08
6ACA-8MSL90	7332-02185	5/16	2.38	3.12	1.88	.12
8ACA-8MSL90	7332-02145	13/32	2.38	2.94	1.69	.12
10ACA-10MSL90	7332-02155	1/2	2.50	1.95	1.89	.15
12ACA-10MSL90	7332-02175	5/8	2.50	3.13	1.89	.16
12ACA-12MSL90	7332-02165	5/8	2.38	3.69	2.44	.18

- HOSE
- HOSE/CPLG. SELECTION
- G8K COUPLINGS
- GLOBAL SPIRAL COUPLINGS
- PCM / PCS FERRULES
- MEGACRIMP COUPLINGS
- STAINLESS STEEL
- POWER CRIMP COUPLINGS
- LOC, GL AND GLP COUPLINGS
- POLARSEAL COUPLINGS**
- POLARSEAL II COUPLINGS
- C14 COUPLINGS
- PCTS THERMOPLASTIC COUPLINGS
- FIELD ATTACHABLE G1 & G2 COUPLINGS
- FIELD ATTACHABLE C5 & C5E COUPLINGS
- SURELOK AIR BRAKE COUPLINGS
- ADAPTERS
- QUICK DISCONNECT COUPLERS
- LIVE SWIVEL
- BALL VALVES
- ACCESSORIES
- EQUIPMENT AND PARTS



PolarSeal® Couplings

- HOSE
- HOSE/CPLG. SELECTION
- G8K COUPLINGS
- GLOBAL SPIRAL COUPLINGS
- PCM / PCS FERRULES
- MEGACRIMP COUPLINGS
- STAINLESS STEEL
- POWER CRIMP COUPLINGS
- LOC. GL AND GLP COUPLINGS
- POLARSEAL COUPLINGS
- POLARSEAL II COUPLINGS
- C14 COUPLINGS
- PCTS THERMOPLASTIC COUPLINGS
- FIELD ATTACHABLE G1 & G2 COUPLINGS
- FIELD ATTACHABLE C5 & C5E COUPLINGS
- SURELOK AIR BRAKE COUPLINGS
- ADAPTERS
- QUICK DISCONNECT COUPLERS
- LIVE SWIVEL
- BALL VALVES
- ACCESSORIES
- EQUIPMENT AND PARTS

Female (Ford) Spring Lock - Aluminum

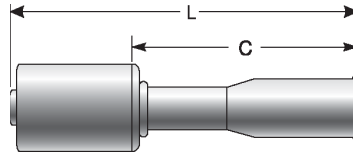

Descr.	Prod. No.	⊖	L	C	Weight (Lbs.)
		"	"	"	
6ACA-6FSL	7332-01095	5/16	3.81	2.56	.04
6ACA-8FSL	7332-01595	5/16	3.85	2.59	.06
8ACA-8FSL	7332-01105	13/32	3.88	2.63	.57
10ACA-10FSL	7332-01115	1/2	4.13	2.88	.08
12ACA-10FSL	7332-01605	5/8	4.28	3.10	.10
12ACA-12FSL	7332-01125	5/8	4.25	3.00	.02

Female (Ford) Spring Lock - 45° Bent Tube - Aluminum

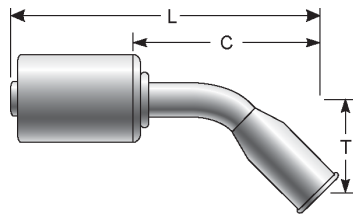

Descr.	Prod. No.	⊖	T	L	C	Weight (Lbs.)
		"	"	"	"	
6ACA-6FSL45	7332-03805	5/16	1.31	4.03	2.78	.05
6ACA-8FSL45	7332-03815	5/16	1.37	4.15	2.90	.05
8ACA-8FSL45	7332-03825	13/32	1.37	4.15	2.90	.15
10ACA-10FSL45	7332-03835	1/2	1.69	4.54	3.29	.10
12ACA-10FSL45	7332-03845	5/8	1.75	4.60	3.35	.15
12ACA-12FSL45	7332-03855	5/8	1.75	4.72	3.47	.15



PolarSeal® Couplings

Female (Ford) Spring Lock - 90° Bent Tube - Aluminum

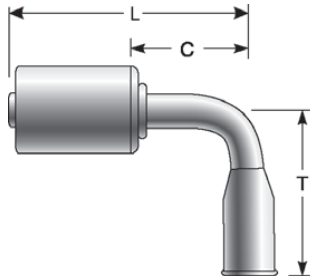

Descr.	Prod. No.	⊕	T	L	C	Weight (Lbs.)
		"				
6ACA-6FSL90	7332-02195	5/16	2.19	2.88	1.63	.06
6ACA-8FSL90	7332-02245	5/16	2.38	3.12	1.88	.10
8ACA-8FSL90	7332-02205	13/32	2.38	2.94	1.69	.08
10ACA-10FSL90	7332-02215	1/2	2.50	3.13	1.89	.12
12ACA-10FSL90	7332-02235	5/8	2.50	3.13	1.89	.12
12ACA-12FSL90	7332-02225	5/8	3.20	3.69	2.44	.12

Inline Orifice Tube

Description: The orifice tube is found on an accumulator air conditioning system. It is the dividing point between high and low pressure sides of the refrigeration system. The orifice tube filters and restricts high-pressure refrigerant in the liquid line and meters refrigerant flow as a low-pressure liquid. It is located in the refrigerant line between the condenser outlet and the evaporator inlet. The tube should be replaced any time the air conditioning system is opened for service.

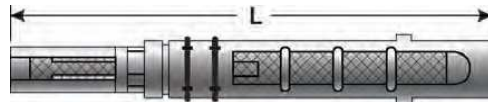

Descr.	Prod. No.	⊕	L		Weight (Lbs.)
		"	"	mm	
IOT-BLACK	7332-02815	.072	3.50	88.9	.01
IOT-BLUE	7332-02785	.072	3.50	88.9	.01
IOT-ORANGE	7332-02795	.057	3.50	88.9	.01
IOT-RED	7332-02805	.062	3.50	88.9	.01
IOT-WHITE	7332-02775	.072	3.50	88.9	.01

- HOSE
- HOSE/CPLG. SELECTION
- G8K COUPLINGS
- GLOBALSPIRAL COUPLINGS
- PCM / PCS FERRULES
- MEGACRIMP COUPLINGS
- STAINLESS STEEL
- POWER CRIMP COUPLINGS
- LOC, GL AND GLP COUPLINGS
- POLARSEAL COUPLINGS**
- POLARSEAL II COUPLINGS
- C14 COUPLINGS
- PCTS THERMOPLASTIC COUPLINGS
- FIELD ATTACHABLE G1 & G2 COUPLINGS
- FIELD ATTACHABLE C5 & C5E COUPLINGS
- SURELOK AIR BRAKE COUPLINGS
- ADAPTERS
- QUICK DISCONNECT COUPLERS
- LIVE SWIVEL
- BALL VALVES
- ACCESSORIES
- EQUIPMENT AND PARTS



PolarSeal® Couplings

O-Rings for PolarSeal® Couplings

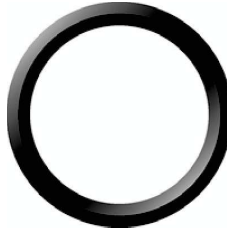

Descr.	Prod. No.	Inside Diameter	W Wall Thickness	Weight (Lbs.)
		"	"	
6ACOR	7332-01235	.30	.07	.01
8ACOR	7332-01245	.43	.07	.06
10ACOR	7332-01255	.55	.07	.06
12ACOR	7332-01265	.68	.07	.05

HOSE
HOSE/CPLG. SELECTION
G8K COUPLINGS
GLOBALSPIRAL COUPLINGS
PCM / PCS FERRULES
MEGACRIMP COUPLINGS
STAINLESS STEEL
POWER CRIMP COUPLINGS
LOC, GL AND GLP COUPLINGS
POLARSEAL COUPLINGS
POLARSEAL II COUPLINGS
C14 COUPLINGS
PCTS THERMOPLASTIC COUPLINGS
FIELD ATTACHABLE G1 & G2 COUPLINGS
FIELD ATTACHABLE C5 & C5E COUPLINGS
SURELOK AIR BRAKE COUPLINGS
ADAPTERS
QUICK DISCONNECT COUPLERS
LIVE SWIVEL
BALL VALVES
ACCESSORIES
EQUIPMENT AND PARTS