

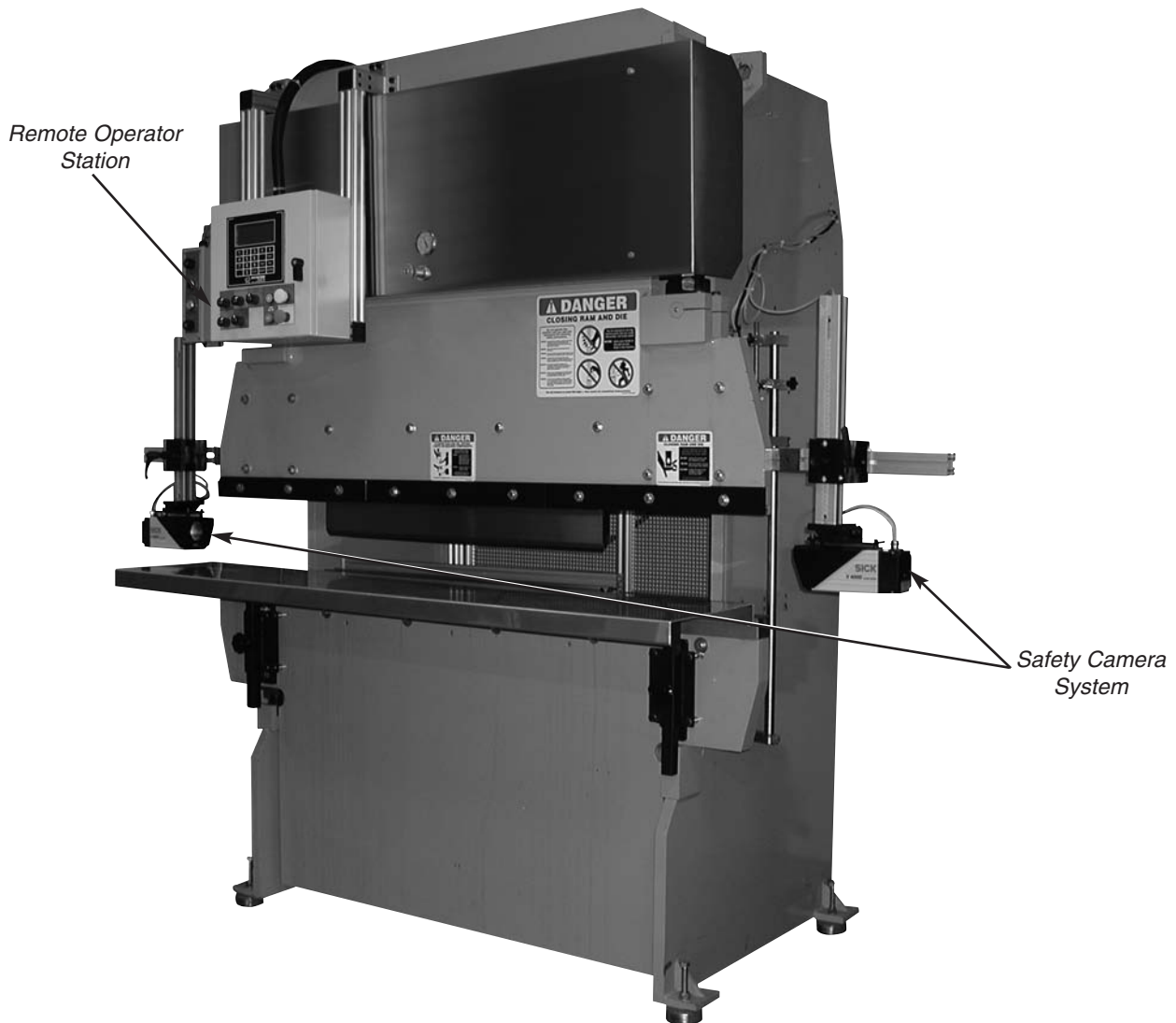

"The Machine Safeguarding People"

ROCKFORD
SYSTEMS, INC.

INSTALLATION MANUAL FOR RHPS CONTROL SYSTEMS ON HYDRAULIC PRESS BRAKES



IMPORTANT: PLEASE REVIEW THIS ENTIRE PUBLICATION BEFORE INSTALLING, OPERATING, OR MAINTAINING THE SOLID-STATE HYDRAULIC CONTROL SYSTEM.

P.O. Box 5525 • Rockford, Illinois 61125-0525 • Toll-Free 1-800-922-7533 • Phone 815-874-7891
Fax 815-874-6144 • Web Site www.rockfordsystems.com • E-Mail sales@rockfordsystems.com

Manual No. KSL-278

TABLE OF CONTENTS

RHPS Hydraulic Solid-State Control

SECTION 1—IN GENERAL	3-5
SECTION 2—INTRODUCTION	6-13
SECTION 3—INSTALLATION OF COMPONENTS	13-32
Introduction.....	13-15
Control Box.....	15-22
Timing Devices.....	23-24
Palm Button Assembly	25-27
Foot Switch.....	28-29
Supervisory Control Station.....	29
Multiple Operator Junction Box	29
Other Components.....	30-31
Other Installation Considerations	31-32
SECTION 4—PROGRAMMING.....	33-45
Power-Up Procedure.....	33-34
User Inputs.....	35-36
Counters.....	37-38
Anti-Tie-Down.....	39
Security Code.....	40
Restore Factory Default Settings.....	41
Muting.....	42
Auto Return	43
Decompress Timer	44
Block Valve Delay.....	45
Spanish	46
Configuration Menu.....	47-48
Configuration Security Code	49
Bottom Dwell	42-45
SECTION 5—TROUBLESHOOTING AND FAULT MESSAGES	51-52
SECTION 6—OPERATING CONSIDERATIONS.....	53-54
SECTION 7—MAINTENANCE AND INSPECTION	55
SECTION 8—METHODS OF SAFEGUARDING	56-57
SECTION 9—RETURN MATERIALS AUTHORIZATION REQUEST FORM.....	58
SECTION 10—ORDER FORM FOR SIGNS AND LITERATURE	59

Safety Precautions

DANGER

DANGER indicates an imminently hazardous situation which, if not avoided, will result in death or serious injury.



This safety alert symbol identifies important safety messages in this manual. When you see this symbol, be alert to the possibility of personal injury, and carefully read the message that follows.

CAUTION

CAUTION used without the safety alert symbol indicates a potentially hazardous situation which, if not avoided, may result in property damage.

Efficient and safe machine operation depends on the development, implementation and enforcement of a safety program. This program requires, among other things, the proper selection of point-of-operation guards and safety devices for each particular job or operation and a thorough safety training program for all machine personnel. This program should include instruction on the proper operation of the machine, instruction on the point-of-operation guards and safety devices on the machine, and a regularly scheduled inspection and maintenance program.

Rules and procedures covering each aspect of your safety program should be developed and published both in an operator's safety manual, as well as in prominent places throughout the plant and on each machine. Some rules or instructions which must be conveyed to your personnel and incorporated in to your program include:

 DANGER **Never place your hands or any part of your body in this machine.**



Never operate this machine without proper eye, face and body protection.



Never operate this machine unless you are fully trained and instructed and unless you have read the instruction manual.



Never operate this machine if it is not working properly—stop operating it and advise your supervisor immediately.



Never use a foot switch to operate this machine unless a point-of-operation guard or device is provided and properly maintained.



Never operate this machine unless two-hand trip, two-hand control or presence-sensing device is installed at the proper safety distance. Consult your supervisor if you have any questions regarding the proper safety distance.



Never tamper with, rewire or bypass any control or component on this machine.

A company's safety program must involve everyone in the company, from top management to operators, since only as a group can any operational problems be identified and resolved. It is everyone's responsibility to implement and communicate the information and material contained in catalogs and instruction manuals to all persons involved in machine operation. If a language barrier or insufficient education would prevent a person from reading and understanding various literature available, it should be translated, read or interpreted to the person, with assurance that it is understood.



FOR MAINTENANCE AND INSPECTION ALWAYS REFER TO THE OEM'S (ORIGINAL EQUIPMENT MANUFACTURER'S) MAINTENANCE MANUAL OR OWNER'S MANUAL. If you do not have an owner's manual, please contact the original equipment manufacturer.

SECTION 1—IN GENERAL

RHPS Hydraulic Solid-State Control

Safety References

OSH ACT AND FEDERAL REGULATIONS

Since the enclosed equipment can never overcome a mechanical deficiency, defect or malfunction in the machine itself, OSHA (Occupational Safety and Health Administration) has established certain safety regulations that the employers (users) must comply with so that the machines used in their plants, factories or facilities are thoroughly inspected and are in first-class operating condition before any of the enclosed equipment is installed.

1. U.S. Government—An Act—Public Law 91-596, 91st Congress, S. 2193, December 29, 1970:

Duties

SEC. 5. (a) Each employer—

(1) shall furnish to each of his employees employment and a place of employment which are free from recognized hazards that are causing or are likely to cause death or serious physical harm to his employees;

(2) shall comply with occupational safety and health standards promulgated under this Act.

(b) Each employee shall comply with occupational safety and health standards and all rules, regulations, and orders issued pursuant to this Act which are applicable to his own actions and conduct.

2. OSHA 29 CFR Sections that an employer (user) must comply with include:

1910.211 Definitions.

1910.212 General requirements for all machines.

1910.217 Mechanical power presses.

1910.219 Mechanical power-transmission apparatus.

3. OSHA 29 CFR 1910.147 The control of hazardous energy (lockout/tagout).

4. OSHA Publication

“General Industry Safety and Health Regulations Part 1910,” Code of Federal Regulations, Subpart O

This publication can be obtained by contacting:

U.S. Government Printing Office

P.O. Box 371954

Pittsburgh, PA 15250-7954

Phone 202-512-1800

<http://bookstore.gpo.gov>

ANSI SAFETY STANDARDS FOR MACHINES

The most complete safety standards for machine tools are published in the ANSI (American National Standards Institute) B11 series. The following is a list of each ANSI B11 Standard available at the printing of this publication.

- B11.1 Mechanical Power Presses
- B11.2 Hydraulic Power Presses
- B11.3 Power Press Brakes
- B11.4 Shears
- B11.5 Iron Workers
- B11.6 Manual Turning Machines (Lathes)
- B11.7 Cold Headers and Cold Formers
- B11.8 Drilling, Milling and Boring Machines
- B11.9 Grinding Machines
- B11.10 Metal Sawing Machines
- B11.11 Gear and Spline Cutting Machines
- B11.12 Roll Forming and Roll Bending Machines
- B11.13 Automatic Screw/Bar and Chucking Machines
- B11.14 Coil Slitting Machines/Systems
- B11.15 Pipe, Tube, and Shape Bending Machines
- B11.16 Metal Powder Compacting Presses
- B11.17 Horizontal Hydraulic Extrusion Presses
- B11.18 Coil Processing Systems
- B11.19 Performance Criteria for Safeguarding
- B11.20 Manufacturing Systems/Cells
- B11.21 Lasers
- B11.22 Turning Centers and CNC Turning Machines
- B11.23 Machining Centers and CNC Milling, Drilling, and Boring Machines
- B11.24 Transfer Machines
- B11.TR1 Ergonomic Guidelines
- B11.TR2 Mist Control Considerations
- B11.TR3 Risk Assessment and Risk Reduction
- R15.06 Robotic Safeguarding
- O1.1 Woodworking Machinery

These standards can be purchased by contacting:

American National Standards Institute

25 West 43rd Street

New York, New York 10036

Phone 212-642-4900

www.ansi.org

OR

AMT—The Association for Manufacturing Technology

7901 Westpark Drive

McLean, Virginia 22102

Phone 703-893-2900

www.amtonline.org

(Continued on next page.)

NATIONAL SAFETY COUNCIL SAFETY MANUALS

Other good references for safety on machine tools are the National Safety Council's Safety Manuals. These manuals are written by various committees including the Power Press, Forging and Fabricating Executive Committee. Copies of the following publications are available from their library:

- Power Press Safety Manual - 4th Edition
- Safeguarding Concept Illustrations - 6th Edition
- Forging Safety Manual

These manuals can be obtained by contacting:

National Safety Council
1121 Spring Lake Drive
Itasca, IL 60143-3201
1-800-621-7619 ext. 2199
www.nsc.org

OTHER SAFETY SOURCES

National Institute of Occupational Safety and Health (NIOSH)
4676 Columbia Parkway
Cincinnati, OH 45226
Toll-Free 1-800-CDC-INFO (1-800-232-4636)
Phone 513-533-8328
www.cdc.gov/niosh

OTHER SAFETY SOURCES (continued)

Robotic Industries Association (RIA)
900 Victors Way, Suite 140
P.O. Box 3724
Ann Arbor, MI 48106
Phone 734-994-6088
www.robotics.org

NEMA (National Electrical Manufacturers Association)
1300 North 17th Street, Suite 1752
Rosslyn, VA 22209
Phone 703-841-3200
www.nema.org

NFPA (National Fire Protection Association)
1 Batterymarch Park
Quincy, MA 02169-7471
Phone 617-770-3000
www.nfpa.org

For additional safety information and assistance in devising, implementing or revising your safety program, please contact the machine manufacturer, your state and local safety councils, insurance carriers, national trade associations and your state's occupational safety and health administration.

Warranty, Disclaimer and Limitation of Liability

WARRANTY

Rockford Systems, Inc. warrants that this product will be free from defects in material and workmanship for a period of 12 months from the date of shipment thereof. ROCKFORD SYSTEMS INC.'S OBLIGATION UNDER THIS WARRANTY IS EXPRESSLY AND EXCLUSIVELY LIMITED to repairing or replacing such products which are returned to it within the warranty period with shipping charges prepaid and which will be disclosed as defective upon examination by Rockford Systems, Inc. This warranty will not apply to any product which will have been subject to misuse, negligence, accident, restriction and use not in accordance with Rockford Systems, Inc.'s instructions or which will have been altered or repaired by persons other than the authorized agent or employees of Rockford Systems, Inc. Rockford Systems, Inc.'s warranties as to any component part is expressly limited to that of the manufacturer of the component part.

DISCLAIMER

The foregoing Warranty is made in lieu of all other warranties, expressed or implied, and of all other liabilities and obligations on the part of Rockford Systems, Inc., including any liability for negligence, strict liability, or otherwise, and any implied warranty of merchantability or fitness for a particular purpose is expressly disclaimed.

LIMITATION OF LIABILITY

Under no circumstances, including any claim of negligence, strict liability, or otherwise, shall Rockford Systems, Inc. be liable for any incidental or consequential damages, or any loss or damage resulting from a defect in the product of Rockford Systems, Inc.

SECTION 2—INTRODUCTION

RHPS Hydraulic Solid-State Control

RHPS Press Brake Control—Connection Diagram

NOTE: This connection diagram is a convenient reference that shows some of the typical connections to the modules; it should not be used for reference during installation. Please refer to the enclosed wiring schematics when installing the control system.

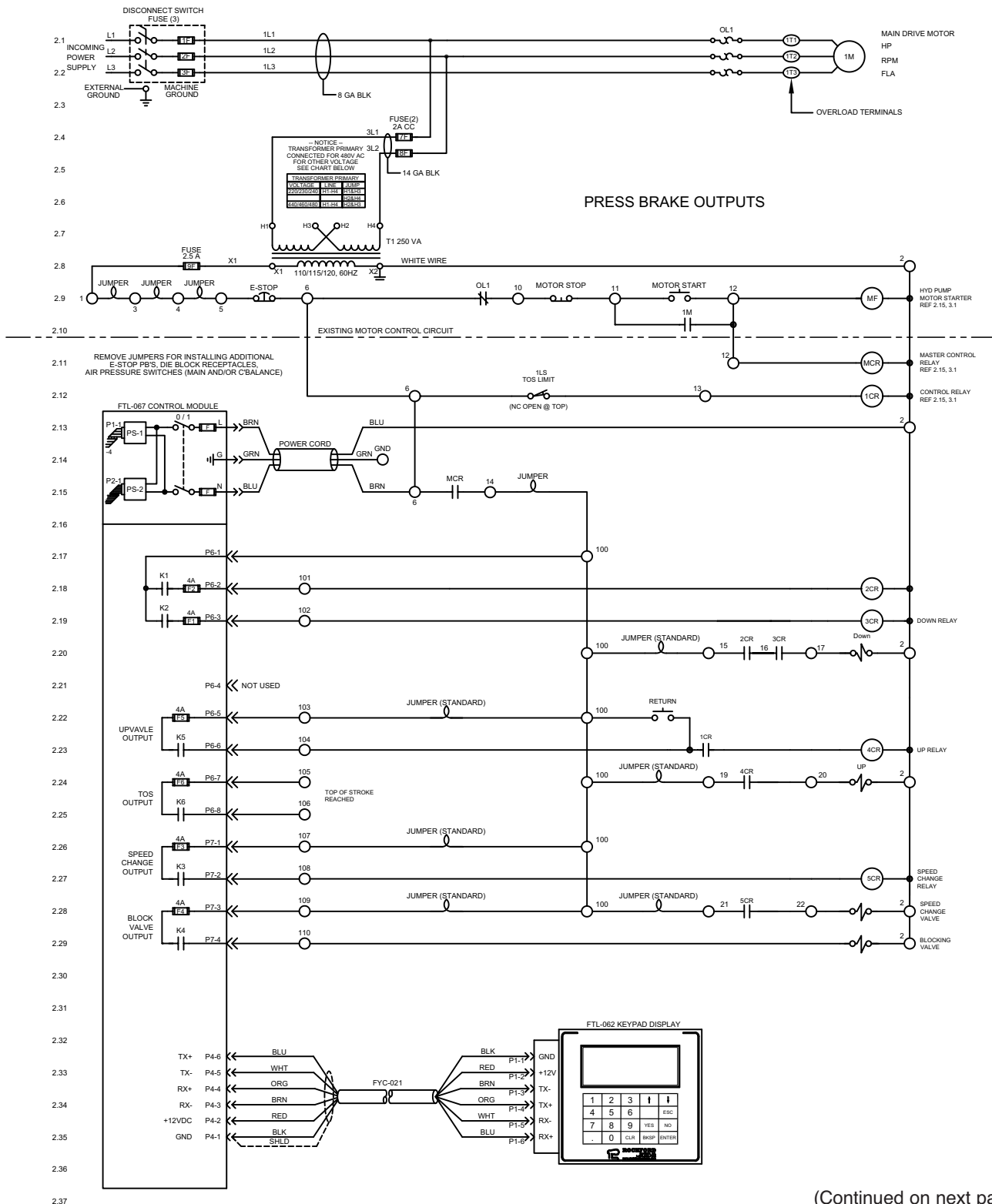

(Continued on next page.)

SECTION 2—INTRODUCTION

RHPS Hydraulic Solid-State Control

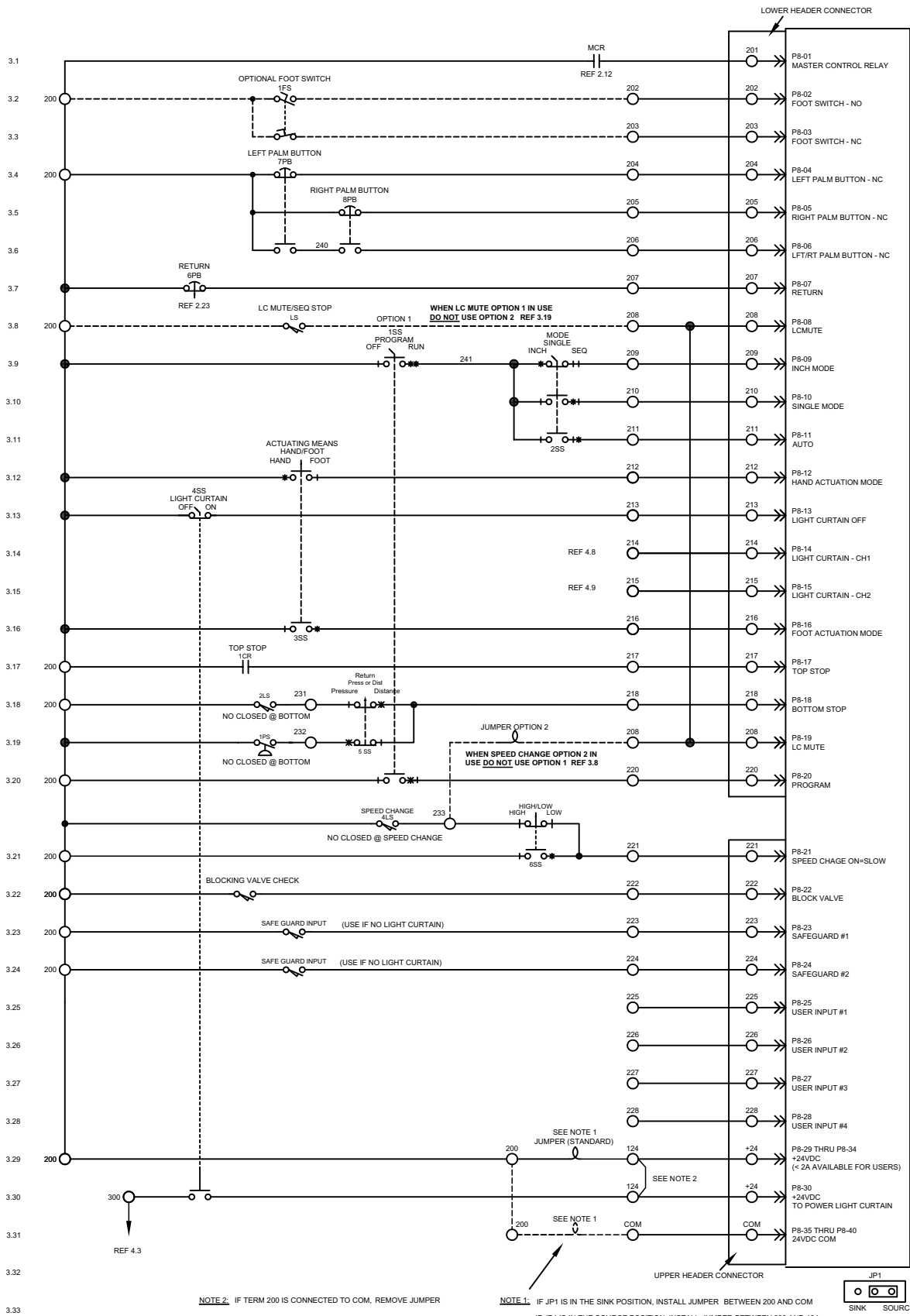

SECTION 2—INTRODUCTION

RHPS Hydraulic Solid-State Control

General Description of Components in the System

A complete control package for hydraulic machines includes the following:

1. Literature folder (see pages 13-15) containing installation manuals, Operator Safety Precautions sign, danger sign(s), and electrical control schematics
2. Control box—a standard (custom or special may include motor controls and/or disconnect switch) with danger and warning signs attached
3. Palm button assembly (Includes two run/inch palm buttons, two palm button guards, one red emergency-stop button, one yellow return button, and mounting boxes.) If multiple operator stations are on a machine, more than one assembly is furnished.
4. Foot switch (optional)—If multiple operator stations are on a machine, more than one foot switch is furnished.
5. Supervisory control station (Required when multiple operator stations are used on the machine; one station is required for each operator.)
6. Multiple operator junction box (When multiple operator stations are required, this junction box is furnished separately for wiring up to four operator stations.)
7. Other required components and safeguarding that may be necessary for the machine (See packing list for details.)

Individual packages may vary in contents. However, a packing list is always enclosed showing exactly what material was shipped on this order. Please check the components actually received against this packing list immediately. In most cases, this control package system includes two-hand control which can be used as a point-of-operation safeguarding device provided the palm buttons are mounted correctly and at the proper safety distance (see formula on page 26 of this manual). If the optional foot switch is provided, a safeguard must always be used. Examples of safeguards include barrier guards, presence-sensing devices, pullbacks, restraints, gates, or two-hand control. The hands or any other part of the body of an operator, maintenance person, setup person, etc., must never be put into the point-of-operation hazard for any reason, at any time.



This control can neither cure nor overcome a malfunctioning machine. It cannot compensate for or prevent a mechanical defect or failure of a machine part. This control cannot prevent an unintended stroke (cycle) resulting from a mechanical malfunction, defect or failure of the machine itself.

Preliminary Steps Before Installation

Before proceeding with the installation of the enclosed equipment, you should undertake the following preliminary steps.

1. Read and make sure you understand this entire installation manual.
2. Refer to the front cover, other line drawings and photos, then make a sketch of your installation to plan the location of the enclosed equipment on the machine.
3. This may be an opportunity to strip down the entire machine by removing all components, piping, wire, etc. Clean, paint, and check the entire mechanical condition of the machine for proper adjustment and required replacement parts before proceeding with the installation of the furnished equipment.
4. **Please make sure the machine is in first-class condition.** Before starting any installation, it is essential that the machine is thoroughly inspected. Be sure all mechanical components and all collateral equipment are in first-class operating condition. Your inspection should be done according to the machine manufacturer's installation and maintenance instruction manual. If you have any doubts or questions concerning the condition of the machine, contact the machine manufacturer for assistance. **Repair or replace all parts not operating properly before proceeding.**



Inspection and maintenance programs must be established and implemented to keep machines in first-class condition. Safety programs must include thorough inspections of each machine on a weekly basis and records kept of these inspections. Any part of the machine that is worn, damaged or is not operating properly must be replaced immediately or repaired before the machine is used.

(Continued on next page.)

Preliminary Steps Before Installation (continued)

5. Verify that the machine is in first-class condition and operating properly; shut off all power to the machine. Padlock all electrical and hydraulic energy in the off position and do not actuate the machine again until the installation of all package components has been completed. Lockout/tagout energy isolation procedures must always be practiced and enforced.

Safeguard Interlocks and Other Types Of Interlocks

SAFEGUARD INTERLOCKS

The machine will not operate or must not be operated until you either: (1) electrically interlock or (2) mechanically safeguard the machine's point of operation with a guard or device.

When an electrically interlocked method of safeguarding the point of operation is chosen, connect the interlock to the **safeguard interlock** terminals (P8-23 and P8-24) in the control box, and as shown on the control wiring schematic (wire numbers 223 and 224).

Point-of-operation electrically interlocked safeguards, when opened, prevent or stop normal machine operation during operator cycling modes. Examples of these types of interlocks are barrier guard interlocks and gate device interlocks.

When a mechanical guard or device (nonelectrically interlocked) is chosen, the safeguard interlock terminals (P8-23 and P8-24) are not used. In order for the machine to operate with the use of a mechanical guard or device, the safeguard interlock terminals must be connected. Please see the wiring schematic.



The mechanical guard or device must be properly installed, used and maintained and must always prevent all personnel from bodily injury.



If the mechanical guard or device is not used, is removed, or is defeated, an electrically interlocked method of safeguarding must be used and connected to the safeguard interlock terminals (P8-23 and P8-24).



Never operate this machine without point-of-operation safeguarding.

OTHER ELECTRICAL INTERLOCKS

There are basically two types of electrical interlocks as applied to machine control circuitry:

- Interlocks for the purpose of personnel protection.
- Interlocks intended for the purpose of protecting the machine and its control components.

There are other locations for interlocks that, when opened, prevent all machine functions. Examples of these types of interlocks are safety block electrical cutoff systems, lubricating systems, die protection equipment, and tonnage monitoring systems.

Be sure to connect the various electrical interlocks to the proper terminals, in the control box, according to the machine wiring schematics. If your schematics do not include these electrical interlocks, please send this information to the factory and they can be added to your drawings. There is an additional charge for this service.

SECTION 2—INTRODUCTION

RHPS Hydraulic Solid-State Control

General Features of the RHPS Control

- Meets and exceeds OSHA 29 CFR 1910.212 and ANSI B11.2, B11.3, and B11.19
 - Provides two-hand control safeguarding device
 - Redundant and cross-checking microprocessors
 - Redundant switching style DC power supplies
 - Two monitored ram advance (up or down) 120-V force-guided output relays
 - Blocking valve monitoring
 - Press control operates on 85-135 V AC
 - Provisions for optional light curtain interface with off/on supervised keyed selector switch
 - Easy to read back-lit liquid crystal operator interface display having 4 lines x 20 characters
 - Four (4) 24-V DC digital user inputs, programmable, selectable canned messages
 - One (1) ram speed change (fast-slow) output, standard 120 V AC with a selector switch for high, high/low, low speed (to support machines with a speed change solenoid valve)
 - One (1) ram return (up or down) output, standard 120 V AC with a selector switch for pressure, pressure/distance, distance return
 - Bottom dwell timer (0-600 seconds)
 - Decompression timer (50-250 ms)
 - 7-digit stroke counter
 - 7-digit batch counter with preset
 - Operator interface keypad and display, text in English or Spanish
- For control reliability

MODES OF OPERATION

- Off
- Two-hand inch
- Two-hand single stroke
- Foot single stroke
- Foot switch trip or one-hand trip single stroke (used in conjunction with a point-of-operation safeguard)*
- High, high/low, low speed change
- Sequence stop (hand/hand—hand/foot—foot/foot)

*Additional components may be required to use this mode of operation.

Overview of Motion and Settings

The redundant inputs are used by both processors to control the operation of the press brake. When the actuating means are depressed, and the primary safeguard interlock conditions are met, the processors turn on their appropriate relays (SSR1 and SSR2). The solenoid valve(s) is energized sending hydraulic fluid to the cylinders, allowing the ram to move. If the actuating means are released prior to the BOS (bottom of stroke) timing device, the ram movement will stop. The stroke can be finished by depressing the actuating means again.

Sequence of Operation

This sequence of operation applies to all standard modes provided with the RHPS press brake control.

OFF

The press brake is inoperable in this mode of operation. The **OFF** position cannot be used solely as the lockout/tagout means. To use any of the following modes of operation, turn the mode selector switch from **OFF** to the appropriate position.

TWO-HAND INCH

Two-Hand Inch is a mode of operation in which the ram travels as long as the operator(s) maintains actuation of the palm buttons during the die-closing portion of the stroke. Each time the buttons are released, the ram will stop. Once the BOS (bottom-of-stroke) timing device is reached, the ram will stop. To return the ram to its initial position, continuous or intermittent actuation of the yellow return button may be used.

To use *Two-Hand Inch*, the mode selector switch must be set to **INCH**, and the actuating means selector switch must be set to **HAND**.



The *Inch* mode of operation is used for die setup, tool setup, and maintenance only. It is not intended for use during production operations.

TWO-HAND SINGLE STROKE

Two-Hand Single Stroke is a mode of operation in which the ram makes one complete stroke or cycle upon actuation of the palm buttons. The palm buttons must be held depressed until the BOS (bottom-of-stroke) timing device is reached. If they are released before this timing device is reached, the ram will stop and the buttons will need to be released and then reactuated. Once the ram reaches the BOS timing device, the palm buttons can be released and the ram will automatically return to the top.

To use *Two-Hand Single Stroke*, the mode selector switch must be set to **SINGLE**, and the actuating means selector switch must be set to **HAND**.

FOOT SINGLE STROKE

Foot Single Stroke is a mode of operation in which the ram makes one complete stroke or cycle upon actuation of the foot switch. The foot switch must be held depressed until the BOS (bottom-of-stroke) timing device is reached. If it is released before this timing device is reached, the ram will stop and it will need to be released and then reactuated. Once the ram reaches the BOS timing device, the foot switch can be released and the ram will automatically return to the top.

To use *Foot Single Stroke*, the mode selector switch must be set to **SINGLE**, and the actuating means selector switch must be set to **FOOT**.



A point-of-operation safeguard must be used when using this mode of operation.

HAND/HAND SEQUENCE STOP

Hand/Hand Sequence Stop is a mode of operation in which the palm buttons are held depressed until the ram automatically stops at the sequence stop timing device (usually $\frac{1}{4}$ " above the workpiece). If the palm buttons are released during this portion of the stroke, the ram will stop and the buttons will need to be released and then reactuated. Once the sequence stop point is reached, the palm buttons must be released, and the operator can position the workpiece or make sure it is in place. The palm buttons must then be reactuated to finish the stroke.

To use *Hand/Hand Sequence Stop*, the mode selector switch must be set to **SEQ**, and the actuating means selector switch must be set to **HAND**.

SECTION 2—INTRODUCTION

RHPS Hydraulic Solid-State Control

Sequence of Operation (continued)

HAND/FOOT SEQUENCE STOP

Hand/Foot Sequence Stop is a mode of operation in which the palm buttons are held depressed until the ram automatically stops at the sequence stop timing device (usually $\frac{1}{4}$ " above the workpiece). If the palm buttons are released during this portion of the stroke, the ram will stop and the buttons will need to be released and then reactuated. Once the sequence stop point is reached, the palm buttons must be released, and the operator can position the workpiece or support it in place. The foot switch must then be actuated to finish the stroke.

To use *Hand/Foot Sequence Stop*, the mode selector switch must be set to **SEQ**, and the actuating means selector switch must be set to **HAND/FOOT**.

FOOT/FOOT SEQUENCE STOP

Foot/Foot Sequence Stop is a mode of operation in which the foot switch is held depressed until the ram automatically stops at the sequence stop limit switch (usually $\frac{1}{4}$ " above the workpiece). If the foot switch is released during this portion of the stroke, the slide will stop and the foot switch will need to be released and then reactuated. Once the sequence stop point is reached, the foot switch must be released, and the operator can position the workpiece or support it in place. The foot switch must then be reactuated to finish the stroke.

To use *Foot/Foot Sequence Stop*, the mode selector switch must be set to **SEQ**, and the actuating means selector switch must be set to **FOOT**.



A point-of-operation safeguard must be used when using this mode of operation.

NOTE: *The following feature can only be used with two-speed press brakes.*

HIGH, HIGH/LOW, LOW SPEED CHANGE

Speed Change is a feature in which the ram switches from high to low speed at the speed change timing device (usually $\frac{1}{4}$ " above the workpiece). This reduces whip-up action and allows more control when forming the part. The ram continues in low speed until the BOS (bottom-of-stroke) timing device is reached. During the return portion of the stroke, the ram continues in low speed until the speed change timing device drops out (unless the return speed selector switch is set to HIGH). It then returns to the top in high speed.

Note: Some machines may not be able to return in low speed, due to the design of their hydraulic system, even if the return speed selector switch is set to LOW.

To use *Speed Change*, the mode selector switch can be in any position, and the speed selector switch must be set to **HIGH, HIGH/LOW, or LOW**.

RAM RETURN

The key-operated return selector switch is used to select the method of ram return. The three choices are **PRESS** (pressure), **PRESS/DIST** (pressure or distance), and **DIST** (distance). An optional pressure switch can be wired in to the control so when **PRESS** is selected, the ram will return when the predetermined amount of pressure (set by the user) is reached. When **PRESS/DIST** is selected, the ram will return when either the set amount of pressure or the BOS (bottom-of-stroke) timing device is reached, whichever occurs first. When **DIST** is selected, the ram will return when the BOS timing device is reached.

The BOS timing device logic can be set to either N.O. (normally open) or N.C. (normally closed) in the configurations programming (see page 47). The factory default setting is N.O.

*Note: If a pressure switch is wired in to the control and the **PRESS/DIST** (pressure or distance) method of ram return is selected, both the timing device and the pressure switch must use a N.O. (normally open) contact in order for this feature to work properly.*

SECTION 3—INSTALLATION OF COMPONENTS

RHPS Hydraulic Solid-State Control

Sequence of Operation (continued)

ONE-HAND OR FOOT TRIP SINGLE STROKE

One-Hand or *Foot Trip Single Stroke* is a mode of operation provided with the RHPS control. This mode of operation is turned on or off in the configurations programming. See pages 48-49 of this installation manual for programming information.



A point-of-operation safeguard must be used when using these modes of operation.

SECTION 3—INSTALLATION OF COMPONENTS

Introduction

The following additional materials are required to install the equipment in this shipment.

1. Wire: Size and type will depend on local ordinances or plant practices. We recommend stranded machine tool wire with appropriate color-coding. **Never use solid wire**—the vibration caused by these machines precludes the successful use of solid wire for these installations.
2. Numbered wire markers: Made of suitable material to resist oil, grease, etc., and remain firmly attached to the wire.
3. Conduit: Rigid, liquid-tight flexible, or any other suitable tubular connecting means which complies with local ordinances and provides adequate mechanical protection for the wires. Most of the electrical products supplied have an oil-tight construction.
4. Miscellaneous wiring components such as electrical tape, wire connectors, and terminals, as required.

ILLUSTRATION OF ELECTRICAL SYSTEM ON HYDRAULIC POWER PRESS BRAKE

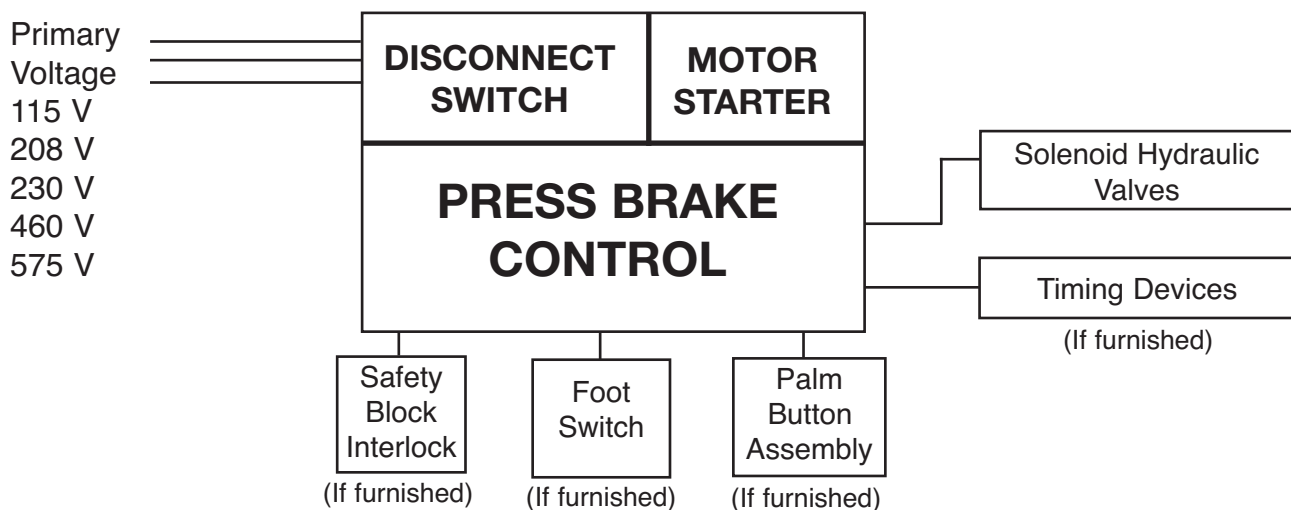

LITERATURE FOLDER

Included with every shipment is a literature folder. This includes installation manuals, Operator Safety Precautions sign (Part No. KSC-000), danger signs, and electrical schematics. These publications must be available and fully understood by all appropriate personnel, before any retrofit installation begins. Please notify Rockford Systems immediately if there are any questions about the components received.

(Continued on next page.)

SECTION 3—INSTALLATION OF COMPONENTS

RHPS Hydraulic Solid-State Control

OPERATOR SAFETY PRECAUTIONS SIGN

Photo 3.1 - Part No. KSC-000 Operator Safety Precautions Sign

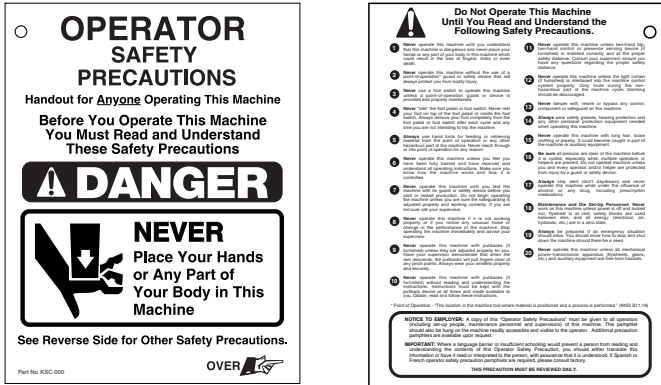

Front

Back

Photo 3.2



Photo 3.3



Photo 3.4



Attachment of Precautions Sign

1. Locate the Operator Safety Precautions sign.
2. Attach the sign to the machine with a nylon tie through the hole provided. See Photo 3.2.



Attach it to the machine where it is readily accessible and visible to the operator. Additional copies of these precautions are available. Please call, write, fax, e-mail or use the order form found on a later page in this manual.



When a language barrier or insufficient education prevents a person from reading or understanding the contents of this sign, you should either translate this information or have it read or interpreted to the person. Make sure the person understands the information. To order this sign in Spanish, use Part No. KSC-000S; in French, use Part No. KSC-000F.



These precautions must be reviewed daily.

DANGER SIGNS

1. Locate the furnished danger signs.
2. Determine the mounting location for the danger signs on the machine.



They must be permanently mounted in a prominent location on the machine where they are readily accessible and visible to the operator, setup person, or other personnel who work on or around this machine.

3. Drill a hole(s) in the sign and the machine at the mounting location. See Photo 3.3.
4. Attach the signs to the machine with screws or rivets. See Photo 3.4.



Never operate this machine unless the danger signs are in place. Also make sure the signs are read and understood before operating the machine.

(Continued on next page.)

SECTION 3—INSTALLATION OF COMPONENTS

RHPS Hydraulic Solid-State Control

Figure 3.1 - Illustration of the Placement of the Operator Safety Precautions Sign and Danger Signs

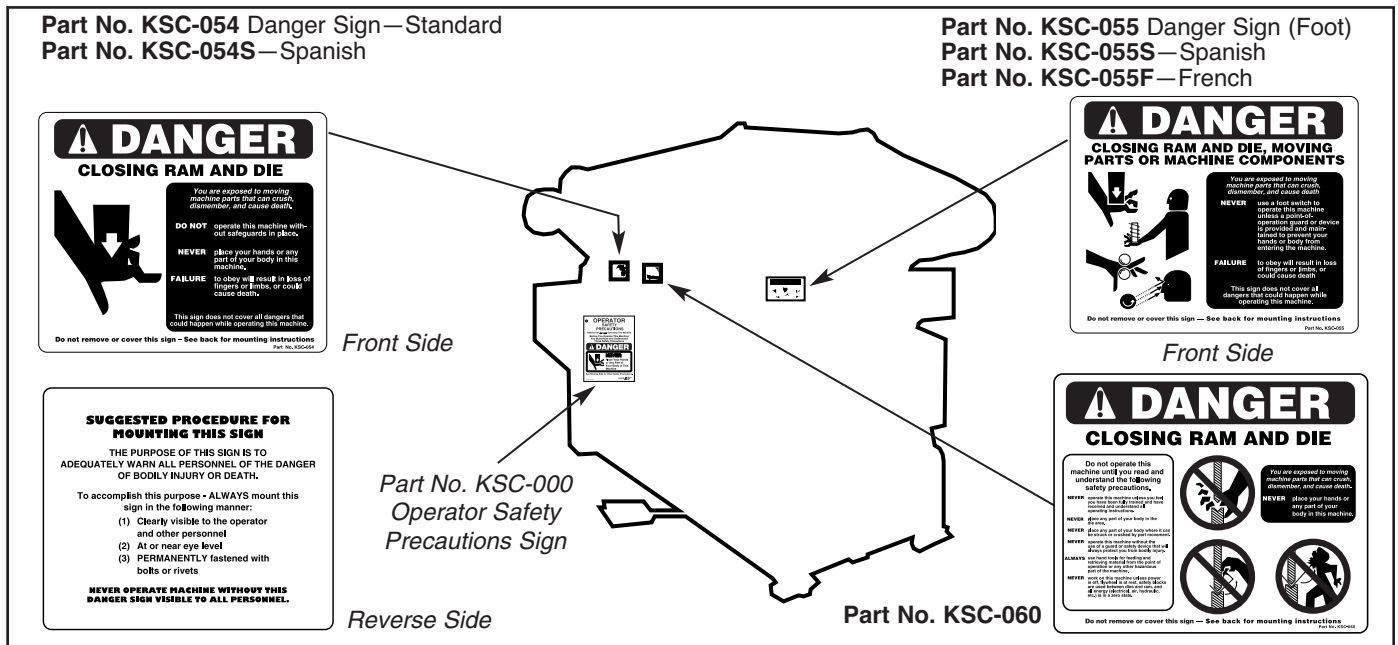

Control Box

DANGER AND WARNING LABELS PROVIDED

The illustrated danger and warning labels are affixed to all control boxes provided. All personnel operating or working around the machine, where this control box is installed, must be required to read, understand and adhere to all dangers and warnings. If any of these labels become destroyed or unreadable, they MUST be replaced. Contact the factory immediately for replacement labels and do not operate the equipment until danger and warning labels are all in place.

Photo 3.5
 RHPS Standard Control Box Outside View



(Continued on next page.)

SECTION 3—INSTALLATION OF COMPONENTS

RHPS Hydraulic Solid-State Control

Control Box (continued)

The RHPS is an economic, full-featured, dual-microprocessor-based control for hydraulic power press brakes. This control system is designed to comply with **OSHA 29 CFR 1910.212 and ANSI B11.3**. It can update or replace existing control systems found in users' plants, or can be furnished for new or rebuilt press brakes.

This control can be supplied in a custom box with a motor starter and a disconnect, or as a standard control to interface with existing press brake motor controls. Enclosure systems for the control include a standard 20" x 20" x 8" box with the keypad/display mounted on the door of the enclosure. A plain-door enclosure with the keypad/display mounted in a remote operator station may have been furnished.

When the control box is wired to an existing main motor starter, the starter must have a 120-V coil and in most cases, an auxiliary contact. If the starter does not have these components and they are not readily available, please contact Rockford Systems for a replacement magnetic motor starter.

The system uses redundant inputs from devices such as palm buttons, foot switches, and a light curtain. The system output to the solenoid valves is provided by two force-guided relays. These output relays are independently controlled and cross-checked by the microprocessors. This allows control-reliable operation of the outputs in the event of a single control component failure. Each microprocessor also has its own logic power supply. This decreases the possibility of simultaneous control failure because of a fault within the power supply system. All the inputs are optically isolated for electrical noise immunity. The operator provides setup information through the use of the keypad/display and messages are shown on the 4-line x 20-character LCD.

This solid-state control operates at a low voltage. Any component such as the valves or anything the control will operate (i.e., relay, solenoids) that is at a higher voltage (115 V) must be suppressed. Three (3) suppressors are furnished with all control boxes. Make sure they are installed on the solenoid contacts to filter out electrical noise that could affect the operation of the control.

Two extra fuses are also furnished with all control boxes. Use the corresponding replacement fuse if the original fuse should blow on one of the printed circuit boards (fuses F1 through F6—see page 20), or to replace a blown fuse inside the off/on switch on the side of the control module (see photo 3.6).



Photo 3.6
Suppressors, ferrules, and extra fuses are furnished with each control.

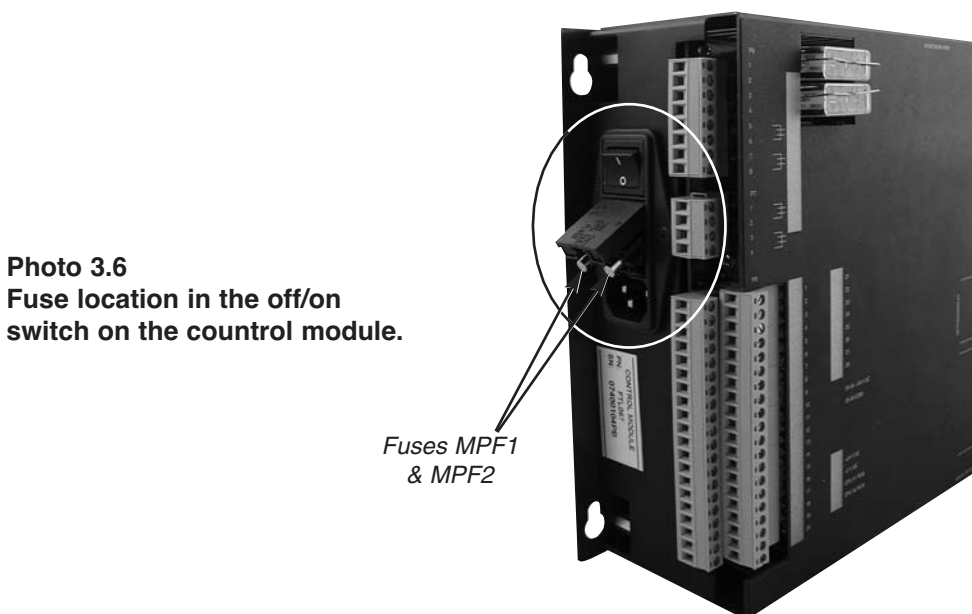

Photo 3.6
Fuse location in the off/on switch on the control module.

Fuses MPF1
& MPF2

(Continued on next page.)

SECTION 3—INSTALLATION OF COMPONENTS

RHPS Hydraulic Solid-State Control

STANDARD CONTROL BOX

The standard control box (20" x 20" x 8") is furnished with the operator controls and keypad/display mounted on the front of the enclosure door. This NEMA 12 enclosure contains the control module assembly, control relays, primary multi-tap transformer, and terminal strips. A standard box with a plain door is also available for use with a remote operator station.



Photo 3.7
Standard Control Box



Photo 3.8
Inside View of Standard Control Box

CUSTOM CONTROL BOX

A custom control box contains the standard control module and components described above plus the following:

- main power disconnect switch
- main pump motor starter

This NEMA 12 enclosure will vary in size based on the size of the disconnect switch and motor starter components. The enclosure contains the disconnect switch, main motor starter, control module, control relays, primary multi-tap transformer, and terminal strips. The keypad/display, selector switches, motor controls, and disconnect switch handle may have been furnished on the door of the enclosure, or furnished as a plain-door enclosure for use with a remote operator station.



Photo 3.10
Plain-Door Custom Control Box With
Remote Operator Station

(Continued on next page.)

SECTION 3—INSTALLATION OF COMPONENTS

RHPS Hydraulic Solid-State Control

REMOTE OPERATOR-STYLE CONTROL BOXES

Remote operator-style control boxes include the same features and modes of operation as the standard control box described on page 17. **However, they do not have a control transformer.** These controls are for applications where the machine's existing magnetic motor starter, fused disconnect switch, and **control transformer** meet the safety requirements and can be reused. If the existing control transformer cannot be reused or a new control transformer is required, contact the factory.

The keypad/display and all operator controls are located on the door (front) of the remote operator-style control box. The remote operator-style control boxes available are:

- Style X**—Standard RHPS control box without the control transformer
- Style Y**—Standard RHPS control box without the control transformer, but with an emergency-stop button, and a return button
- Style Z**—Standard RHPS control box without the control transformer, but with an emergency-stop button, a return button, and two (2) guarded run/inch buttons on the sides of the enclosure

Photo 3.11



CONTROL MODULE KIT

When a control module kit is furnished, it is supplied without the control enclosure, panel, control transformer, control fuse, terminal strips, wire duct, and wiring. This control module kit includes the control module, control relays, shock mounts, fasteners, suppressors, extra fuses, ferrules, danger labels, and electrical prints. The minimum area required to install this kit on an existing control panel is 18" x 18" x 8". The electrical schematics supplied with this kit show typical wiring and all dimensions.

KEYPAD/DISPLAY KIT

When a keypad/display kit is furnished for use with any of the control boxes or control module kit, it includes the keypad/display, an off/run/program selector switch, a light curtain off/on selector switch, a hand/foot selector switch, an inch/single/automatic selector switch, a speed selector switch, nameplates, and 25' of cable. Additional push buttons and nameplates for the motor starter, etc., may have been furnished depending on the features required. The area needed to mount the keypad/display kit is 10" x 6¾" x 3".



Photo 3.12

(Continued on next page.)

SECTION 3—INSTALLATION OF COMPONENTS

RHPS Hydraulic Solid-State Control

CONTROL MODULE

The solid-state control module assembly below, Part No. FTL-067, measures 8 $\frac{1}{4}$ " high x 8 $\frac{1}{4}$ " wide x 4" deep. It is considered an open device and must be installed inside a NEMA 12 rated enclosure. Four (4) shock/vibration mounting pads and four (4) $\frac{1}{4}$ -20 socket head cap screws are used to secure it to an enclosure subpanel. The module cover is held in place with four (4) 8-32 socket button-head screws for easy removal during troubleshooting.

LED indicators on each input and output are used as aids in troubleshooting problems. Inputs to the press control may be configured for sinking or sourcing inputs. Whichever type is selected, **ALL inputs must be sinking or ALL inputs must be sourcing**. Mixing of sinking and sourcing inputs is **NOT** allowed.

Photo 3.13
Top View of Control Module With Cover

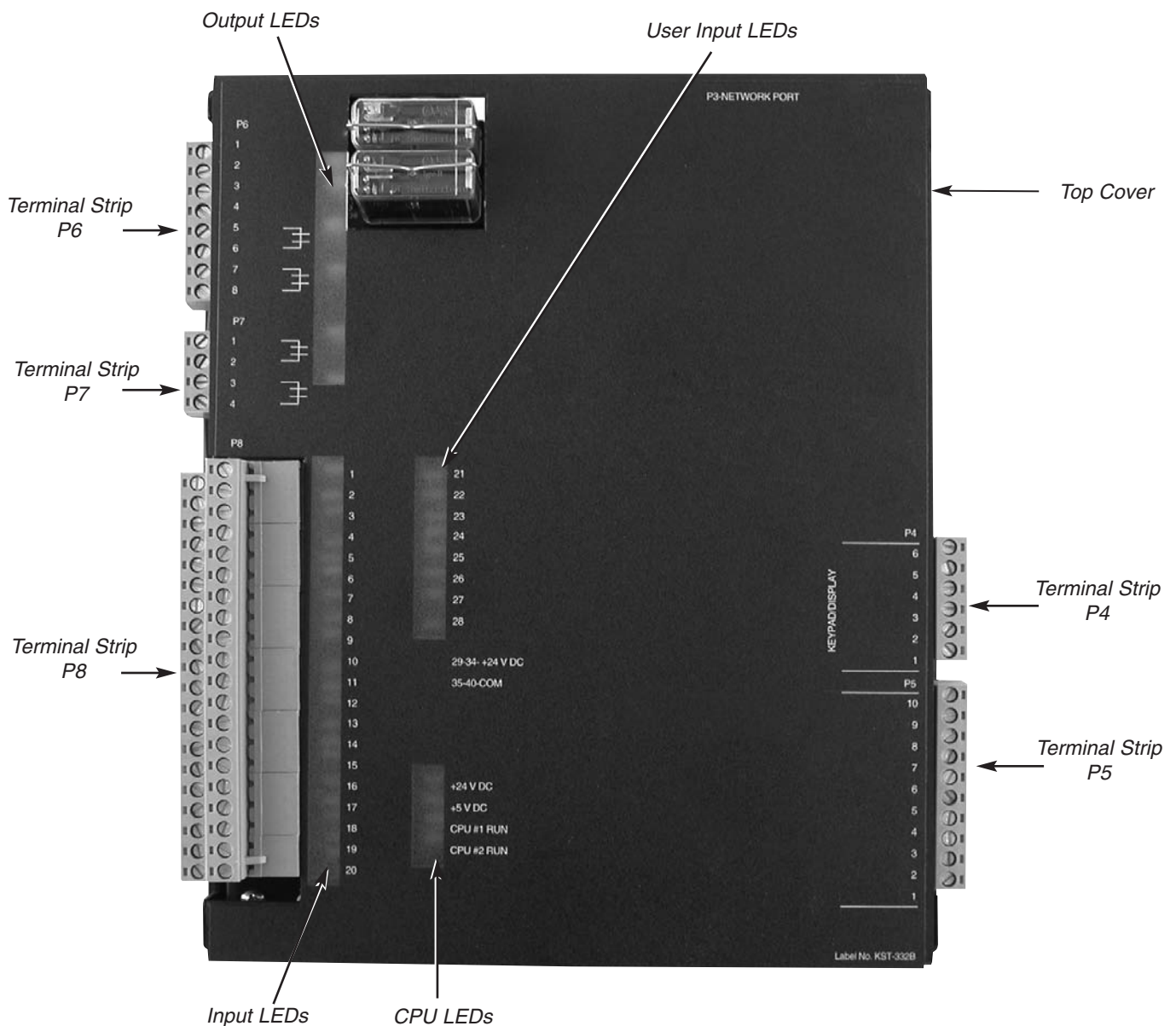

(Continued on next page.)

SECTION 3—INSTALLATION OF COMPONENTS

RHPS Hydraulic Solid-State Control

CONTROL MODULE (continued)

If necessary, the covers of the modules can be taken off by removing the screws on the corners and pulling the top straight off. The circuit boards are then exposed as shown in the photos below.

Photo 3.14

Control Module without Cover

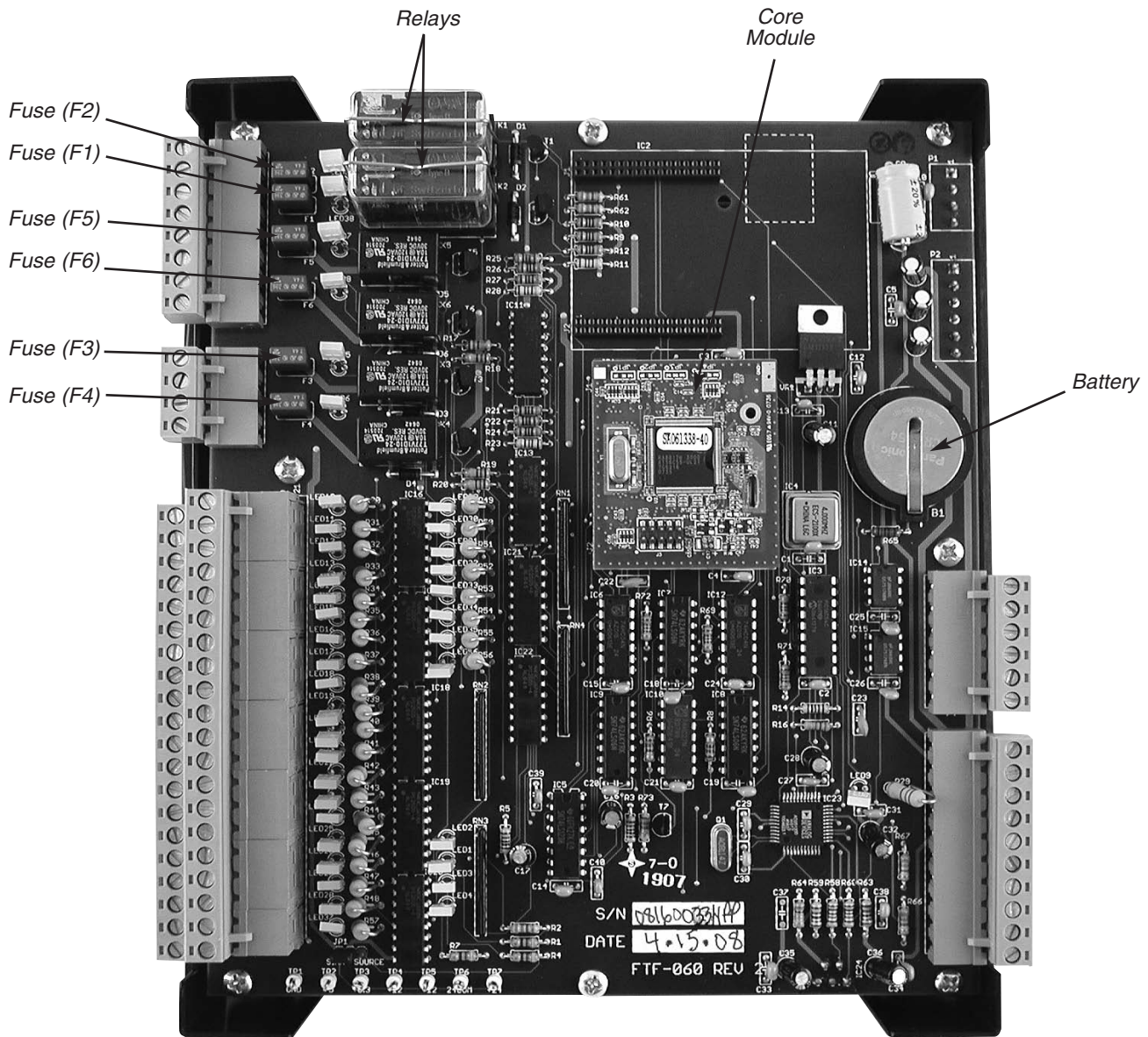

User-serviceable parts on the dual CPU board are the relays, core module, fuses F1-F6, and the battery. If any changes to the circuit boards are required, instructions will be sent with the new parts.

(Continued on next page.)

SECTION 3—INSTALLATION OF COMPONENTS

RHPS Hydraulic Solid-State Control

KEYPAD/DISPLAY ASSEMBLY

The keypad/display assembly, Part No. FTL-062 (Photo 3.15) is used to enter setup information and to monitor machine operation. The keypad/display can be furnished in a remote enclosure up to a maximum of 150' from the RHPS control module. All programming is accessed by a keyed selector switch on the keypad/display unit. See pages 33-50 of this manual for programming information.

Photo 3.15
Keypad/Display



Mounting the Control Box

Solidly mount the control box in an accessible location, either on or near the machine to be controlled. A convenient location will keep conduit runs to a minimum length.

Although operation of this control will not be adversely affected by normal machine operation, excessive shock or vibration may require shock mounting in specific applications, and some applications may require remote mounting of the control box (off the press brake). Special stands or mounting brackets may need to be fabricated to accommodate remote mounting.

CAUTION

Do not run cable in conduit or in bundles with higher voltages that may cause electrical interference.

If your control has the keypad/display assembly mounted on the door of the enclosure, the keypad/display wires will already be ferruled and connected to Terminal Strip P4 on the RHPS control module. For all other controls, this will have to be done during installation.

Twenty-five feet of cable is supplied as standard (if the keypad/display is remote) and can be cut to length, if required. Do not splice the cable or interrupt the signals. If a longer cable is required, please contact the factory.

When connecting the keypad/display wires to control module Terminal Strip P4, please follow the wiring schematics included with the control and see Photo 3.16. Strip the wires and crimp the supplied ferrules on each wire.* Match each wire with the appropriate terminal in accordance with the wiring schematics. Make sure each wire is tight and making good contact with the metal part of the ferrule.

The bare silver shield wire should be twisted and put in a larger ferrule with the black wire and connected to Terminal P4-1.

Note: There is a green wire in the keypad/display cable that is not used. Cut this wire off and discard it.

*A special crimping tool is required to properly crimp the ferrules on the wires. If you do not have one, it is available from:

Weidmuller Inc.
821 Southlake Boulevard
Richmond, Virginia 23236
Toll-Free: 1-800-849-9343
Phone: (804) 794-2877
Fax: (804) 794-0252
www.weidmuller.com

Photo 3.16—Control Module Wiring Connection



P4-6—Blue
P4-5—White
P4-4—Orange
P4-3—Brown
P4-2—Red
P4-1—Black and Bare Silver Shield
(together in larger ferrule)

We use the Weidmuller Type PZ 3, Part No. 0567300000 crimping tool.

(Continued on next page.)

SECTION 3—INSTALLATION OF COMPONENTS

RHPS Hydraulic Solid-State Control

KEYPAD/DISPLAY ASSEMBLY (continued)

When connecting the keypad/display wires to keypad/display Terminal Strip P4, please follow the wiring schematics included with the control and see Photo 3.17. Strip the wires and crimp the supplied ferrules on each wire.* Match each wire with the appropriate terminal in accordance with the wiring schematics. Make sure each wire is tight and making good contact with the metal part of the ferrule.

The bare silver shield wire should not be connected to keypad/display Terminal Strip P4. Cut this wire off and discard it.

Note: There is a green wire in the keypad/display cable that is not used. Cut this wire off and discard it.

*A special crimping tool is required to properly crimp the ferrules on the wires. If you do not have one, it is available from:

Weidmuller Inc.
821 Southlake Boulevard
Richmond, Virginia 23236
Toll-Free: 1-800-849-9343
Phone: (804) 794-2877
Fax: (804) 794-0252
www.weidmuller.com

We use the Weidmuller Type PZ 3,
Part No. 0567300000 crimping tool.

**Photo 3.17—Keypad/Display Terminal Strip P4
Wiring Connection**

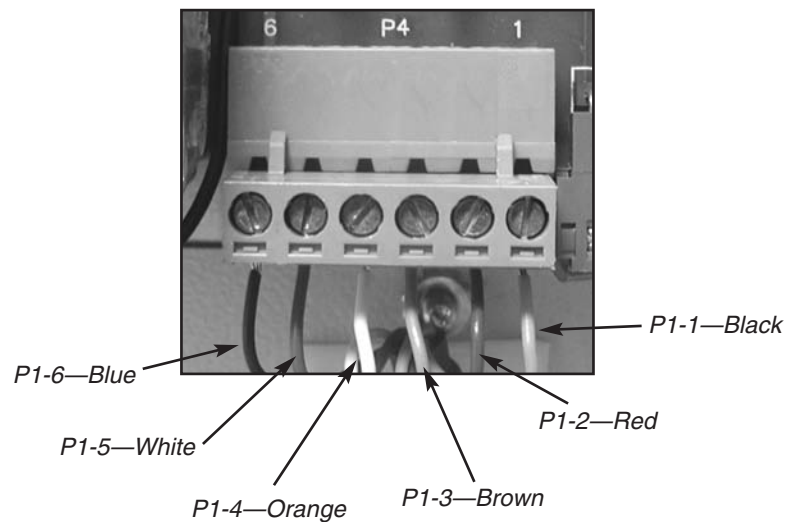

(Continued on next page.)

Timing Devices

Timing devices are required on the press brake to provide stroke timing signals to the RHPS control. These timing devices are usually operated by the linear motion of the ram. TOS (top-of-stroke) and BOS (bottom-of-stroke) timing devices are always required. A speed change timing device is required only if the machine has two-speed capability and the speed change feature is used. A sequence stop timing device is required only if the sequence stop mode of operation is used. A light curtain mute timing device is required only if a light curtain is installed and needs to be muted during the nonhazardous portion of the machine cycle.

Note: Three separate timing devices can be used to provide the speed change, sequence stop, and light curtain mute timing signals; however, two (or even all three) of these functions may be controlled by a single timing device. See the enclosed wiring schematics for wiring instructions.

The timing devices can be mechanical limit switches or proximity sensors. If proximity sensors are used, they must be 24-V DC current-sinking (NPN) sensors.

In order to be switched and provide signals to the control, timing devices must be actuated by cams (when mechanical limit switches are used) or targets (when proximity sensors are used). The timing devices must be mounted in a way such that either the cams (or targets) or devices are stationary, and the others move with the ram of the machine. In most cases, the timing devices are mounted to the ram of the machine, and the cams (or targets) are mounted on an adjustable bracket to the machine. This allows for easy adjustment of where the timing signals are given in the stroke.

In most cases, the machine will have existing timing devices that can be reused. If new timing devices are needed, the following can be furnished:

TOS AND BOS LIMIT SWITCH ASSEMBLY PART NO. CMT-048

This linear cam and limit switch assembly consists of two roller-wheel-style limit switches and two adjustable cams mounted on an extruded-aluminum bracket. The limit switches have one N.O. (normally open) and one N.C. (normally closed) contact. This assembly can be used to provide the TOS and BOS timing signals.

HIGH/LOW LIMIT SWITCH ASSEMBLY PART NO. CMT-049

This assembly consists of one roller-wheel-style limit switch and one adjustable cam mounted on an extruded-aluminum bracket. The limit switch has one N.O. (normally open) and one N.C. (normally closed) contact. A single assembly can be used to provide the speed change, sequence stop, and light curtain mute timing signals, or a separate assembly can be used for each function.

Photo 3.18
Part No. CMT-048
TOS and BOS Limit Switch Assembly



(Continued on next page.)

SECTION 3—INSTALLATION OF COMPONENTS

RHPS Hydraulic Solid-State Control

Timing Devices (continued)

TOS (TOP OF STROKE)

The TOS (top-of-stroke) timing device gives the signal for the machine to stop at the top of the stroke.

The TOS logic can be set to either N.O. (normally open) or N.C. (normally closed) in the configurations programming (see pages 47-49). The factory default setting is N.O.

BOS (BOTTOM OF STROKE)

The BOS (bottom-of-stroke) timing device gives the signal for the machine to stop at the bottom of the stroke (when in the *Inch* mode of operation) or return to the top (when in any other mode). An optional pressure switch can be wired in to the control to provide this signal. This optional pressure switch can be used instead of, or in addition to, the BOS timing device. For more information, see the Ram Return sequence of operation on page 12.

The BOS logic can be set to either N.O. (normally open) or N.C. (normally closed) in the configurations programming (see pages 47-49). The factory default setting is N.O.

*Note: If a pressure switch is wired in to the control and the **PRESS/DIST** (pressure or distance) method of ram return is selected, both the timing device and the pressure switch must use a N.O. (normally open) contact in order for this feature to work properly.*

SPEED CHANGE

The speed change timing device gives the signal for the machine to change from high to low speed during the die-closing portion of the stroke (when the speed selector switch is set to **HIGH/LOW**). This timing device is usually mounted so that it switches at ¼" above the workpiece. Once the device is switched, it must remain in the switched position until the BOS timing device is reached.

The speed change timing device must have a N.O. (normally open) contact. This contact must be open at the top of the stroke, and it must close at the speed change point and remain closed through the bottom of the stroke.

SEQUENCE STOP

The sequence stop timing device gives the signal for the machine to stop above the workpiece when in the sequence stop mode of operation. This timing device is usually mounted so that the ram stops at ¼" above the workpiece when it is switched.

The sequence stop logic can be set to either N.O. (normally open) or N.C. (normally closed) in the configurations programming (see pages 47-49). The factory default setting is N.O.

LIGHT CURTAIN MUTE

The light curtain mute timing device gives the signal to mute the light curtain. This is the point in the stroke beyond which the light curtain is no longer active. This means that once the light curtain mute timing device is reached, the machine will not stop if the light curtain beams are interrupted. This timing device is usually mounted so that it switches at ¼" above the workpiece. Once the device is switched, it must remain in the switched position until the BOS timing device is reached.

The light curtain mute timing device must have a N.O. (normally open) contact. This contact must be open at the top of the stroke, and it must close at the light curtain mute point and remain closed through the bottom of the stroke.

(Continued on next page.)

SECTION 3—INSTALLATION OF COMPONENTS

RHPS Hydraulic Solid-State Control

Palm Button Assembly (If furnished—See enclosed Manual KSL-073)

1. A palm button assembly will consist of four buttons (two black run/inch buttons with ring guards, one red emergency-stop button, and one yellow return button). Four mounting boxes are supplied (three double-hub and one single-hub). Optionally available are the Touchdown!TM, chrome light-push, or articulated palm buttons. These may be furnished in place of the standard black run/inch palm buttons. These palm buttons can be assembled in the order shown in Figure 3.2 and mounted according to the requirement of the application. Nipples, conduit, and wire for connecting the mounting boxes are not furnished.

 **Install the palm run buttons in such a way that it requires the use of both hands to cycle the press brake.**

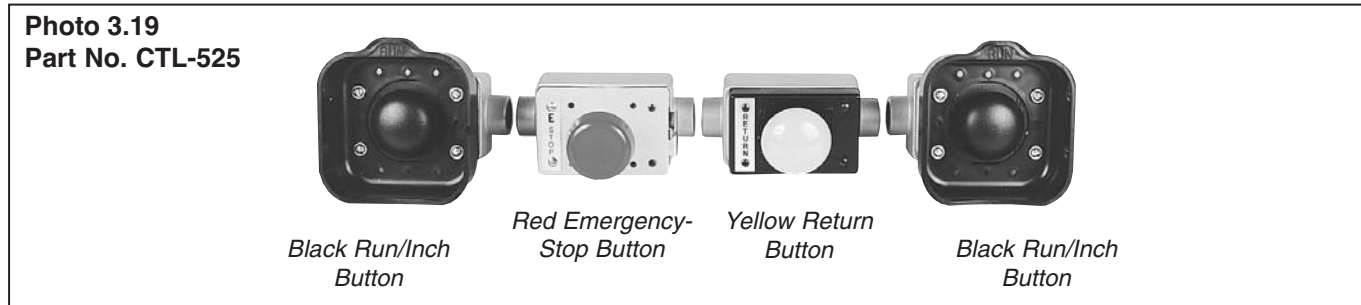

2. The two run palm buttons, on hydraulic machines, can be used to initiate a machine cycle and as a method of safeguarding the point of operation. In both instances, OSHA and ANSI have established certain requirements for these buttons. For your convenience we have reproduced the pertinent sections of ANSI B11.3 as well as the safety distance formula for two-hand control. These sections cover two-hand control as an initiating means and two-hand control as a point-of-operation safeguard for hydraulic press brakes.

Please read and make sure you understand the following sections before proceeding with the mounting of the two run buttons.

ANSI B11.3:

6.11.3.2 Two-hand control

When a two-hand operator control is provided, each hand control shall be protected against unintended actuation and arranged by design, construction, or separation, or a combination thereof, so that the concurrent activation from both hands is required to actuate the press brake.

8.6.5 Two-hand control safeguarding device

8.6.5.1 Design and construction

8.6.5.1.1 The two-hand control device shall have individual hand controls arranged by design, construction, or separation to require the use of both hand controls for actuation.

8.6.5.1.2 The two-hand control device shall meet the requirements of ANSI/NFPA 79 and shall be a type 3 control.

8.6.5.1.3 If more than one operator is to be safeguarded by the use of two-hand controls, each operator shall have individual hand controls. The selection of the two-hand control shall be capable of being supervised by the user.

The control system shall be designed and constructed so as to prevent cycling of the machine if all the operator's stations are deselected.

(Continued on next page.)

SECTION 3—INSTALLATION OF COMPONENTS

RHPS Hydraulic Solid-State Control

Palm Button Assembly (continued)

ANSI B11.3 (continued):

8.6.5.1.4 A single failure of a component, a subassembly or a module of the two-hand control device that affects the performance of the safety-related functions shall not prevent a normal stop command from being initiated or shall cause an immediate stop command. In the event of a failure, re-initiation of the press brake shall be prevented until the failure is corrected or the system or device is manually reset.

In the presence of a failure, repetitive manual reset of the system or device shall not be used for production operation.

8.6.5.2 Installation and operation

8.6.5.2.1 A two-hand operating lever, trip, or control device shall be installed, operated, and maintained in accordance with this standard.

8.6.5.2.2 The device shall be located at a distance from the nearest hazard such that the operator cannot reach the hazard before cessation of hazardous motion. The two-hand operating lever, trip, or control device shall require concurrent actuation of both of the operating levers or hand controls to initiate a machine cycle.

8.6.5.2.3 The two-hand control device shall require the concurrent actuation of the operator's hand controls during the hazardous portion of the machine cycle such that the operator cannot reach the hazard before the hazardous motion has ceased.

8.6.5.2.4 The interface of the device and the machine control system shall be such that a single failure of a component, a subassembly or a module of the interface that affects the performance of the safety-related functions shall not prevent a normal stop command from being initiated or shall cause an immediate stop command. In the event of a failure, re-initiation of the press brake shall be prevented until the failure is corrected or the system or device is manually reset.

In the presence of a failure, repetitive manual reset of the system or device shall not be used for production operation.

8.6.6 Single control safeguarding device

Actuating controls used for single control safeguarding devices shall be located at a safe distance.

3. According to ANSI B11.3-2002, the total stopping time of the press brake (for two-hand control) should include the total response time of the control system and the time it takes the press brake to cease ram motion. The following formula should be used when calculating the safety distance:

$$D_S = K (T_S + T_C + T_r + T_{spm}); \text{ where:}$$

K = the hand speed constant = 63 inches/second.

T_S = stop time of the press measured from the final de-energized control element, usually the air valve.

T_C = the reaction time of the control system.

Note: $T_S + T_C$ are usually measured by a portable or built-in stop-time measuring device.

T_r = the reaction time of the two-hand control and its interface.

T_{spm} = the additional time allowed by the stopping performance monitor before it detects stop-time deterioration.

When the press stroke stop command is changed, because the machine is taking longer to stop, the safety distance should be recalculated. The safeguarding device should also be placed at a greater safety distance if the stopping time or distance has increased.

Note: When obtaining the stopping time using the ANSI formula, a stopping position in the stroke is not provided. To calculate the safety distance, the stop signal should be given on the downstroke at a point that would provide the longest stopping time.

(Continued on next page.)

Palm Button Assembly (continued)



When applying the two run palm buttons to meet the requirements for a point-of-operation safeguarding device, make certain these buttons are located on the machine so they meet the minimum safety distance required by the ANSI formula.

Simply stated, safety distance is the mounting location of the palm buttons at a distance where the operator cannot reach into the point-of-operation hazard before the ram has stopped or completed its travel.

To obtain the stopping time, a portable stop-time measurement unit can be used.

WHEN USING FOOT SINGLE STROKE, FOOT/FOOT SEQUENCE STOP, AND ONE-HAND OR FOOT TRIP SINGLE STROKE MODES OF OPERATION:

A method of safeguarding the point of operation must be provided before using any of the above modes of operation.

The machine will not operate or must not be operated until you either:

1. Electrically interlock or
2. Mechanically safeguard the machine's point of operation with a guard or device.

Install either the electrically interlocked method of safeguarding or the mechanical guard or device.

1. When an electrically interlocked method of safeguarding the point of operation is chosen, connect the interlock to the **safeguard interlock** terminals (P8-23 and P8-24) in the control box, and as shown on the control wiring schematic (wire numbers 223 and 224).
2. When a mechanical guard or device (nonelectrically interlocked) is chosen, the safeguard interlock terminals (P8-23 and P8-24) are not used. In order for the machine to operate with the use of a mechanical guard or device, the safeguard interlock terminals must be connected.

Note: When the mechanical guard or device is removed for other modes of operation, the safeguard interlock terminals must be disconnected.

RED EMERGENCY-STOP BUTTON (Required)

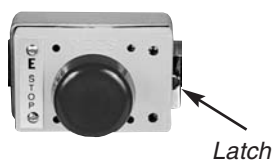

Photo 3.20
Part No. CTC-736

The red emergency-stop button is used to stop the machine anywhere in its cycle. When the operator depresses the button, it should stop the hazardous motion of the machine immediately. This palm button assembly requires either a double-hub mounting box **Part No. CTK-003**, or a single-hub mounting box **Part No. CTK-004**. The button can be located between the two run/inch palm buttons as part of the operator's control station (refer to page 25). A latch on the side trips when the button is pushed. To reset the button, push the latch in.

Note: More than one emergency-stop button may be furnished for additional control stations or for convenience.

YELLOW RETURN BUTTON



Photo 3.21
Part No. CTC-740

Momentary actuation of the yellow return button is used to stop the closing motion of the ram and automatically return it to its initial position, when in the *Single Stroke* or *Sequence Stop* mode of operation. When in the *Inch* mode of operation, momentary actuation of the yellow return button will cause the ram closing motion to stop. To return the ram to its initial position while in the *Inch* mode, continuous or intermittent actuation of the return button may be used. This palm button assembly requires either a double-hub mounting box **Part No. CTK-003**, or a single-hub mounting box **Part No. CTK-004**. The button can be located between the two run/inch palm buttons and red emergency-stop button as part of the operator's control station (refer to page 25).

(Continued on next page.)

SECTION 3—INSTALLATION OF COMPONENTS

RHPS Hydraulic Solid-State Control

FUNCTION TESTS OF TWO-HAND CONTROL

Two-hand control is furnished with the RHPS press brake control and can be used as a point-of-operation device. If it is going to be used as a point-of-operation device, the following function tests should be run before operating the press. These tests should be done at every operator, die, or shift change, and every time maintenance is performed.

1. Verify the two-hand control complies with the following before stroking the press brake.
 - a. Are the palm buttons protected against accidental operation (with ring guards or fabricated shields)?
 - b. Are the palm buttons separated by enough distance or configured to require the use of both hands to actuate the press brake?
 - c. Are the palm buttons at the proper safety distance based on the stopping time of the machine during the die-closing portion of the stroke? (See page 26 for details.)
 - d. Are the palm buttons fixed in position?
2. With the main motor on, the actuating means selector switch set to **HAND**, and the mode selector switch set to **SINGLE**, perform the following tests.
 - a. Depress both palm buttons concurrently within the programmed anti-tie-down setting (100-7,000 ms) and the machine will begin a stroke.
 - b. Hold the palm buttons down for the entire stroke. Release one palm button and try to start another stroke by reactuating the palm button that was just released. The machine should not begin another stroke. Repeat this step with the other palm button. The machine should not begin another stroke. This verifies that the control has antirepeat.
 - c. Depress both palm buttons and release only one palm button during the die-closing portion of the stroke. The machine's slide should stop. Reactuate the palm button that was released. The machine should not finish the stroke. Both palm buttons must be released and reactivated in order for the machine to finish the stroke. Repeat this test while releasing the other palm button. The machine should not finish the stroke. Both palm buttons must be released and reactivated in order for the machine to finish the stroke. This verifies that the control has nonresumption of an interrupted stroke.



If any of these function tests fail, corrective action must be taken before running production.

Foot Switch (If furnished—See enclosed Manual KSL-001)



If you elect to use a foot switch, all personnel must be warned that it is impossible for a foot switch to provide any form of point-of-operation safeguarding. It is the responsibility of the employer (user) to always provide an appropriate guard and/or device to prevent bodily injury whenever a foot switch is used to initiate a machine cycle. (See ANSI B11.3.)

The following steps should be taken when using a foot switch:

A method of safeguarding (light curtain, guard, gate, pullback, or restraint) the point of operation must be provided before installing or using a foot switch.

The machine will not operate or must not be operated until you either:

1. Electrically interlock or
2. Mechanically safeguard the machine's point of operation with a guard or device.



Photo 3.22
Part No. CTD-011

(Continued on next page.)

Foot Switch (continued)

Install either the electrically interlocked method of safeguarding or the mechanical guard or device.

1. When an electrically interlocked method of safeguarding the point of operation is chosen, connect the interlock to the safeguard interlock terminals (P8-23 and P8-24) in the control box and as shown on the control wiring schematic (wire numbers 223 and 224).
2. When a mechanical guard or device (nonelectrically interlocked) is chosen, the safeguard interlock terminals (P8-23 and P8-24) are not used. In order for the machine to operate with the use of a mechanical guard or device, the **safeguard interlock** terminals must be connected.

Note: When the mechanical guard or device is removed for other modes of operation, the safeguard interlock terminals must be disconnected.



Never use a foot switch to operate this machine unless a point-of-operation guard or device is provided and properly maintained.



The mechanical guard or device must be properly installed, used and maintained. It must always prevent all personnel from bodily injury.



If the mechanical guard or device is not used, is removed or is defeated, an electrically interlocked method of safeguarding must be used and connected to the safeguard interlock terminals P8-23 and P8-24.

When installing the optional foot switch, be sure the wiring schematics are referenced for proper connections. Be sure to maintain the foot switch in first-class condition. It must always be wired properly and the protection on the top, sides, and front must always remain in place.

Supervisory Control Station (If furnished)

PART NO. LLD-6101—SUPERVISORY CONTROL STATION (Required for multiple operator stations)

PART NO. LLD-283—SUPERVISORY CONTROL STATION (Required for multiple operator stations and when a USC-000 is used—see below)

When two or more palm button or foot switch operating stations are required on one machine, one supervisory control station is required at each operator station. This remote control station consists of one station on indicator light and an off/on keyed selector switch in an enclosure. The on position allows the operator to use that station and the off position deactivates only that station. If all the supervisory control stations are in the on position, the palm buttons or foot switches must be depressed within the timing period set in the anti-tie-down program (page 39) in order to initiate a machine stroke.



Supervisory Control Station

Note: If the USC-000 multiple-operator junction box is used, the anti-tie-down setting in the RHPS control becomes irrelevant, since the junction box has its own timers.

Multiple Operator Junction Box (If furnished)



PART NO. USC-000—MULTIPLE OPERATOR JUNCTION BOX

When multiple operator stations are required, this junction box is furnished separately for wiring up to four (4) operator stations. This junction box interfaces palm button assemblies/control bars and foot switches, and will not allow the press brake to run if palm buttons or a foot switch is actuated without its supervisory control station on. Refer to the electrical schematic furnished with your order for proper wiring of each station.

(Continued on next page.)

SECTION 3—INSTALLATION OF COMPONENTS

RHPS Hydraulic Solid-State Control

OTHER COMPONENTS THAT COULD BE INTERFACED TO THE CONTROL

Interlocked Guard	Sliding Bolster*	Die Light
Light Curtain*	Additional Die Protection*	Conveyor
RF Device*	Feed System	Overload Protection*
Gate*	Hour Meter	Robot*
Air Blowoff	Material Feeding Equipment*	Additional Programmable Limit Switch*
Additional Counters	Material Straightener	Safety Block Electrical Interlock System
Indexing Table*	Reel Cradle for Coil	Lubrication System*

**The electrical or electronic schematics are required if Rockford Systems is to interface this equipment to the control.*

Other Components That May Be Required

MAIN POWER DISCONNECT SWITCH

A main power disconnect switch may have been supplied in this control package shipment as a separate component or included in a custom or special control box. This switch is designed to disconnect the primary voltage to the press and lock it out. Please refer to the enclosed wiring schematics for proper wiring of this switch.

ANSI B11.3 and NFPA 79 require that:

- 1. A main power disconnect switch capable of being locked in the off position only shall be provided with every power press brake control system.*
- 2. If the machine already has a main power disconnect switch, it must be checked for the "locking off" feature. Some switches use construction which can be easily altered mechanically to comply with this requirement. If this is not possible, or an electrical disconnect switch is not provided, then you must obtain and install a proper disconnect switch. (For a proper disconnect switch, please contact Rockford Systems.)*

MOTOR STARTER

A nonreversing motor starter may have been supplied with this control package as a separate component or included in a custom or special control box. The main purpose of this starter is to start and stop the main motor and to drop out the main motor when a power failure occurs. Please refer to the enclosed wiring schematics for proper wiring of this starter. If an existing starter is used, a 120-V AC coil and N.O. auxiliary (main motor forward) contact are required.

ANSI B11.3 and NFPA 79 require that:

- 1. When provided, the motor start button shall be protected against unintentional actuation.*
- 2. All press brakes, except air operated press brakes, shall incorporate a type of drive motor starter that will disconnect the drive motor from the power source in the event of control voltage or power source failure, and require actuation of the motor start button to restart the motor when voltage conditions are restored to normal.*

These requirements are normally met by using a magnetic motor starter. This starter should operate with a 120-V AC coil which is powered from the secondary of the control transformer on the control panel. Refer to the electrical schematics supplied to obtain details of how to wire the starter and associated motor start/stop push buttons.

For proper tie-in of the furnished hydraulic control, the starter requires an auxiliary normally open contact. (For a proper starter, please contact Rockford Systems.)

(Continued on next page.)

Other Components That May Be Required (continued)

CUSTOM OR SPECIAL CONTROL BOX

In place of the standard control box previously described, you may have ordered and received a custom or special control box. This box usually includes a magnetic motor starter and disconnect switch complying to the previously described requirements. Be sure to wire in primary voltage and components to terminals as indicated on the enclosed wiring schematics. 120-V electrical power to operator controls, solenoids, etc., must be obtained from a transformer with isolated secondary.

COLLATERAL EQUIPMENT

All collateral press room and plant equipment such as spring or air slide counterbalances, die cushions, feeding equipment, and robots must be safeguarded if they create hazards to personnel.

POINT-OF-OPERATION SAFEGUARDS

OSHA 29 CFR 1910.212 (a)(ii) requires that:

“The point of operation of machines whose operation exposes an employee to injury, shall be guarded. The guarding device shall be in conformity with any appropriate standards therefor, or, in the absence of applicable specific standards, shall be so designed and constructed as to prevent the operator from having any part of his body in the danger zone during the operating cycle.”

Refer to Section 8 for examples of point-of-operation safeguards for power press brakes.

Other Installation Considerations

WIRING

National Electrical Code practices, including NFPA 79, are usually followed for wiring the control system, especially color coding and the use of numbered wire markers on **both ends of every wire**. Color coding is black for line voltage (208, 230, 460, or 575 V) and control at line voltage, red for 120-V AC control circuits, blue for 24-V DC control circuits, white for current-carrying ground (commonly referred to as the neutral) and green for any equipment grounding conductor. All terminal blocks in the control cabinet are color coded for easy identification.

- a. Install and wire the main disconnect switch (unless one already exists or is furnished in a custom control) using black wire. Follow wiring instructions shown on the electrical schematics. Make certain this switch is capable of being locked in the off position only.
- b. Install and wire the motor starter (unless one already exists or is installed in a custom control box) using black wire for the power, red and white wires for the coil and interlock circuit, and blue for the motor connection to the control module.

If an existing starter does not have a 120-V AC coil, a new 120-V AC coil must be obtained, installed and wired in accordance with the schematics provided before proceeding. An additional auxiliary normally open contact may also be required in the starter. (Do not run a separate 120-V line to the machine for operating the hydraulic controls.)

- c. Run two black power lines (any two lines) from the load side of the disconnect switch (or from the line side of the motor starter) to the control enclosure. Connect the two black wires to the proper terminals on the control transformer (see electrical schematic or transformer nameplate for proper connections for different primary voltages). *Note: If a custom control box with a disconnect has been provided, this step is not necessary.*
- d. Run a green ground wire from the incoming system ground to the control panel.
- e. Wire the motor starter and start/stop controls according to the connection schematics. *Note: If a custom control box with a starter has been provided, this step is not necessary.*

(Continued on next page.)

SECTION 3—INSTALLATION OF COMPONENTS

RHPS Hydraulic Solid-State Control

WIRING (continued)

KEYPAD/DISPLAY ASSEMBLY

Refer to pages 21-22 for the wiring of the keypad/display assembly.

PALM BUTTON ASSEMBLY (See pages 25-27)

These are normally wired as an assembly with the blue wires routed from the control box to the nearest palm button and then the others, as required. Wires between the two run/inch buttons are not connected back to the control box. If Touchdown!TM (proximity) palm buttons are furnished, please refer to the enclosed Installation Manual No. KSL-073 and the connection print provided.

If the palm button assembly is not bolted directly to the machine frame, then a separate green ground wire should be run from the control box to all palm buttons. Attach one end of the wire to each mounting box by a lug under one of the mounting bolts and the other end of the wire to the GND terminal in the control box to assure proper grounding.

These operator controls should be mounted in a convenient location, keeping ergonomics in mind. To comply with the ANSI standard for two-hand control, the run/inch buttons must be located according to the minimum safety distance requirements of each individual machine as defined by ANSI B11.3 (see page 27 of this manual). A stop-time measurement is necessary for checking stopping time before installation begins to determine the safety distance of the two-hand control palm buttons furnished with the control. After installation, the stopping time can be obtained from a portable stop-time measurement unit.

FOOT SWITCH (See pages 28-29)

Run ½" nominal flexible conduit or cord from the foot switch to the control box. Connect the contacts according to the control drawing schematic. In general, connect one wire from one side of the normally open and normally closed contacts to a COM terminal, and a wire from the other side of each contact to the appropriate control module input terminal. If multiple foot switches are used, the COM connection may be split up. Refer to the multiple operator drawing for wiring details. Be sure to connect the ground in the foot switch to the GND terminal in the control box with a green wire.

SUPERVISORY CONTROL STATION (See page 29)

Mount the station in a convenient location where it is easily accessible, or as part of a palm button assembly. See wiring schematic LLD-6101 for proper wiring of the supervisory control station.

MULTIPLE OPERATOR JUNCTION BOX (See page 29)

Run ¾" nominal conduit from the junction box to the control box. Pull the cable through the conduit and connect it to the appropriate terminals according to the junction box drawing. Connect each supervisory control station to the multiple operator junction box with the cable. *Note: The junction box should be located for easy access to the fault reset button in case a fault should occur.*

* * * MACHINE GROUND * * *



The machine frame must always be firmly connected to ground in order to avoid problems with the control and to ensure the control potential will never exceed 120 V above ground. Run a green grounding wire from the control box to some convenient location directly on the machine frame. Connect one end solidly to the frame using a mounting bolt or other convenient means of attachment. Scrape any paint, rust, etc., from the area to ensure an adequate ground connection. Connect the other end to the GND terminal in the control box.

Note: All exposed metal components, which may be touched by personnel during normal operation or adjustment, must be firmly grounded to the machine frame. The disconnect switch and motor starter should also be grounded if they are mounted separately.

Setup and Programming

Before programming this control, an understanding is required as to how this control monitors its inputs. It is also important to understand that the control requires the correct input variable to produce an output.

The inputs are monitored N.O. (normally open) and N.C. (normally closed), 1 N.O. & 1 N.C., and 2 N.O. If a N.O. contact is set for an input, the control will monitor that input and give feedback when it changes to N.C.. The logic settings chosen or the error messages that appear is dependant upon the inputs that are being monitored.

It is important to complete all installation procedures before attempting to program the control. This will ensure that all inputs required to produce an output are connected and all safeguards are being monitored.

Power-Up Procedure

1. Unlock and switch on the main power disconnect that supplies power to the machine and control module.
2. The following information is displayed on the screen:
NOTE: If you are receiving tech. support over the phone and your are asked for the software version of your press brake control module, simply turn off the main disconnect to this machine and turn it back on. This message appears every time power is turned on to the control module.

**SSC-1500
RHPB PRESS CONTROL
Version-x.xx
Safeguards in place?**

3. Press **YES** on the keypad if safeguards are in place.
4. The following message appears. Then press start.

**READY TO START

PRESS START**

If this message does not clear once the motor has started, then the control's inputs are not receiving or are missing the correct signal. Check that the existing inputs are sinking (common). The default is set to sourcing inputs (24 V DC), and the JP1 jumper may need to be set to sinking. If the jumper is set to the wrong position, the above screen will be displayed and only CPU lights will be on the control.

5. The following screen is displayed when the Off/Prog/Run selector switch is in the OFF position.

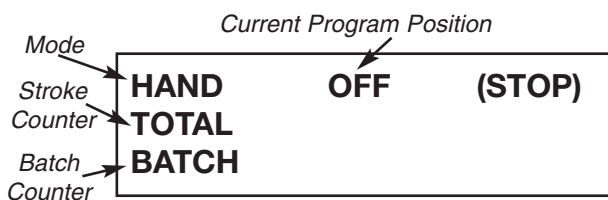

6. The following screen is displayed when PROG is selected and will display all user programmable options. Upon initial installation, parameters need to be set in order for the control to safeguard and operate properly. Skipping this step will result in unsafe operation or nonoperation of the press brake.

**1. USER INPUTS
2. COUNTERS
3. SYSTEM SETUP
4. BOTTOM DWELL**

7. Select **3. SYSTEM SETUP** either by pressing the down key until the cursor is beside this selection and then ENTER, or press 3 on the keypad. The next screen will ask for a security code—default is set to 0.
8. The next menu is the system setup menu which has all of the control's preference settings. Scroll down the list until Configuration is highlighted by the cursor then press ENTER. The next screen will ask for a security code which is default to 1.

**> Configuration
Configuration secure code**

NOTE: This menu is for the logic settings of the limit switches and safeguard functions. It is important not to change any setting unless advised by tech. support or an understanding exists of the results that will be produced by changing the settings. By default, the TOS (top of stroke) limit switch should be the only limit switch set to N.C..

(Continued on next page.)

SECTION 4—PROGRAMMING

RHPS Hydraulic Solid-State Control

Power-Up Procedure (cont.)

9. In this menu, safeguard parameters need to be edited for control operations. Press ENTER when the cursor highlights **Safeguard Type**. This setting is directly related to the light curtain CH1 and CH2 wiring on the inputs. The selection made defines how the light curtain is monitored by the control. If the inputs are connected 1 N.O. and 1 N.C., scroll up and select 1 N.O. and 1 N.C. Select 2 N.O. if it is 2 N.O. relays. **If light curtains are not used, verify that 2 N.O. is selected as the type and connect input 13 (Light Curtain Off) to the input signal (+24 or common).**

Programming:

LIGHT CURTAIN TYPE
2 NO

10. After selecting safeguard type press ENTER and scroll down to **Safeguard Function**; press ENTER. Two options are available: *Always Required* or *Foot/Sing & Cont*. If *Always Required* is selected, the light curtain will always be required unless it is not installed. If *Foot/Sing & Cont* is selected, the light curtain will be required for those modes only. Select the best option for your application.

PWR UP RET REQUEST
LIGHT CURTAIN TYPE
>>SAFEGUARD FUNCTION

11. If the control has been properly installed and the previous steps have been followed, the control's basic functions have been set and is ready for operation. Turn the key switch to **RUN**. The screen will display the current operating configuration that has been selected.

Main Program Screens

The RHPS press brake control has three main programming screens from which you can access all of the programmable features of the control.

To program the control, select the **PROG** position of the Off/Prog/Run selector switch. The MAIN PROGRAM SCREEN will be displayed.

On the screen, a pound symbol (#) will be next to one of the following program options from the list as shown. USER INPUTS is at the top of the list. See Figure 4.1.

When the pound symbol (#) is next to the program option you want to edit, press **ENTER**. Once the new information is input and **ESC** is pressed, the display returns to the MAIN PROGRAM SCREEN. If incorrect information has been entered, return to the setting and reenter the correct information.

Use ↓ and ↑ on the keypad to scroll through the program options. If you press ENTER when the pound symbol (#) is next to SYSTEM SETUP, the SYSTEM SETUP PROGRAM SCREENS will be displayed. See Figures 4.2-4.4.

Each **main** program option is described in detail on the following pages.

USER INPUTS	35-36
COUNTERS	37-38
SYSTEM SETUP	39-49
BOTTOM DWELL	50

Figure 4.1
Main Program Screen

#1. **USER INPUTS**
2. **COUNTERS**
3. **SYSTEM SETUP**
4. **BOTTOM DWELL**

Figure 4.2
System Setup Program Screen

>Anti-Tie-Down
Security Code
Restore Defaults
Muting

Figure 4.3
Second System Setup Program Screen

>Auto Return
Decompress Timer
BLK Valve Dly Ms
Spanish

Figure 4.4
Third System Setup Program Screen

>Configuration
Configuration Secure Code

(Continued on next page.)

USER INPUTS

The RHPS press brake control has four (4) static-type programmable user inputs that can be programmed for equipment monitoring or other user-defined functions.

Static-type means that when the inputs are set to be on, they are continuously monitoring for a change of state in the logic. When a change of state occurs, the input will go true, and the control will stop the machine. The static-type inputs are intended to diagnose fault conditions of auxiliary equipment specific to the machine, such as clutch/brake air pressure fault, counterbalance air pressure fault, and dual solenoid fault.

There are three (3) parameters that can be programmed for the four static-type inputs. All inputs are 24-V DC current-sinking (NPN) inputs.

PROGRAMMABLE PARAMETERS FOR USER INPUTS 1-3

- 1. Logic:** This setting is used to change the logic that activates the input. The programming choices are N.O. (normally open), N.C. (normally closed), and OFF (disabled). Select one setting for each input.
- 2. Stop Type:** When the input is activated or goes true, the machine cycle will stop in one of two ways: E-STOP (emergency stop) will immediately stop the cycle in progress; T-STOP (top stop) will stop the cycle in progress at TDC (top dead center). Select the type of stop that is required for each input.
- 3. Message:** When the input is activated, a fault message is displayed. This fault message is assigned to the input according to its function. Figure 4.5 shows a list of fault messages that can be assigned to each input.

Figure 4.5
User Input Fault Messages

LUBE FAULT
HIGH LUBE PRESSURE
LOW LUBE PRESSURE
LOW LUBE LEVEL
MAIN MOTOR OVERLOAD
LUBE MOTOR OVERLOAD
AUX MOTOR OVERLOAD
GUARD INTERLOCK OPEN
FRONT GUARD OPEN
REAR GUARD OPEN
LEFT SIDE GUARD OPEN
RIGHT SIDE GRD OPEN
FEEDER FAULT
LOAD MONITOR FAULT
SAFETY BLK INTERLOCK
DIE PROTECTION FAULT
HYD OVERLOAD FAULT
HYD SYS OIL LEV LOW
SHORT FEED FAULT
PART EJECTION FAULT
STOCK BUCKLE FAULT
END OF STOCK FAULT
PILOT PIN FAULT

SECTION 4—PROGRAMMING

RHPS Hydraulic Solid-State Control

HOW TO PROGRAM USER INPUTS 1-4

Select the **PROG** position of the Off/Prog/Run selector switch. The MAIN PROGRAM SCREEN will be displayed.

On the MAIN PROGRAM SCREEN, use ↓ and ↑ on the keypad to scroll through the program options. Press **ENTER** when the pound symbol (#) is next to USER INPUTS. The security code screen will be displayed. See Figure 4.6. Enter the security code.

After the correct security code has been entered, the USER INPUTS SCREEN will be displayed. See Figure 4.7.

Use ↓ and ↑ on the keypad to scroll through the program options. Press **ENTER** when the arrow symbol (>) is next to the user input you want to program. The PROGRAMMABLE PARAMETERS SCREEN shown in Figure 4.8 will be displayed.

Use ↓ and ↑ on the keypad to scroll through the programmable parameters. Press **ENTER** when the double arrow symbol (>>) is next to the parameter you want to program. A screen similar to the one shown in Figure 4.9 will be displayed.

Once you are in the programming screen of the parameter you want to program, use ↓ and ↑ on the keypad to reach the setting you desire for that parameter. Press **ENTER** to finish.

Press **ESC** to return to the MAIN PROGRAM SCREEN.

Note: *The appropriate user input terminals in the control box must be wired into so they correspond to the assigned fault messages. If the order of the messages is changed or if other fault messages are assigned, the connections to the terminal strip must also be rearranged to reflect the changes.*

Figure 4.6
Security Code Screen

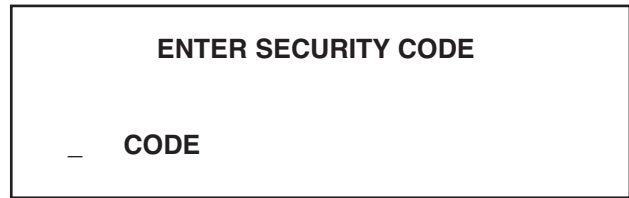

Figure 4.7
User Inputs Screen

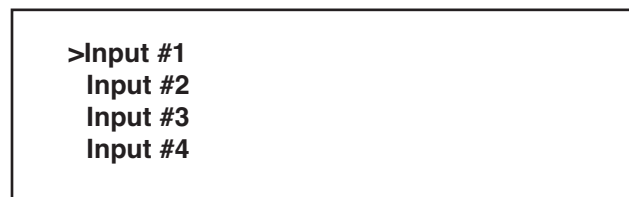

Figure 4.8
Programmable Parameters

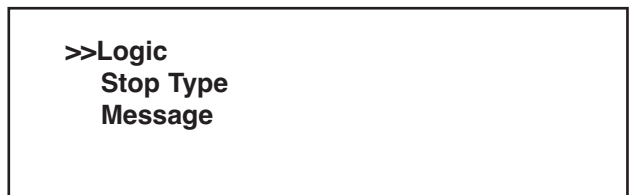
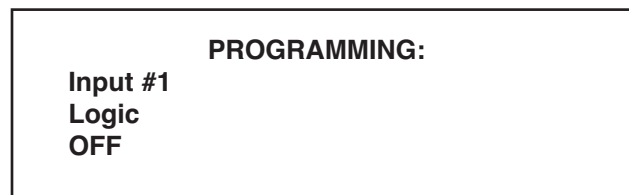

Figure 4.9
Example of a Programming Screen



COUNTERS

The RHPS hydraulic control has a batch counter that can be used for die maintenance, quality control checks, or part bin exchanges. These counters have a programmable preset that will signal the machine to top stop when the preset is reached. There is also a total clear which has security code protection.

When the batch counter has reached its preset value and **BATCH COUNT EXPIRED** is displayed, the machine will not operate until the message has been acknowledged by the operator—press ENTER, CLR, or ESC on the keypad.

HOW TO PROGRAM THE COUNTERS

Select the **PROG** position of the Off/Prog/Run selector switch. The MAIN PROGRAM SCREEN will be displayed.

On the MAIN PROGRAM SCREEN, use ↓ and ↑ on the keypad to scroll through the program options. Press **ENTER** when the pound symbol (#) is next to COUNTERS. The Security Code Screen will be displayed. See Figure 4.10. You will be prompted to enter the security code.

After the correct security code has been entered, the COUNTER PROGRAM SCREEN will be displayed. See Figure 4.11.

To enter a batch preset:

Use ↓ and ↑ on the keypad to scroll up and down. Press **ENTER** when the arrow symbol (>) is next to Batch Preset. You will see the BATCH PRESET SCREEN. See Figure 4.12.

After you have entered a preset, press **ENTER** to finish. This will bring you back to the COUNTER PROGRAM SCREEN.

To clear the batch counter:

Use ↓ and ↑ on the keypad to scroll up and down. Press **ENTER** when the arrow symbol (>) is next to Batch Clear. You will see the CLEAR BATCH SCREEN. See Figure 4.13.

Press **YES** to confirm and the counter will be cleared.

Press **NO** to return to the COUNTER PROGRAM SCREEN.

Figure 4.10
Security Code Screen

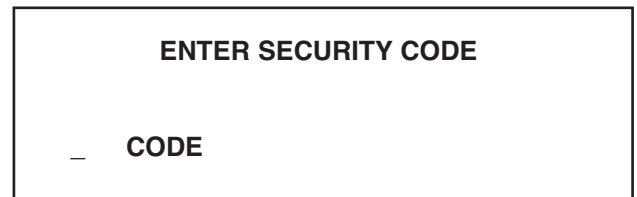

Figure 4.11
Counter Program Screen



Figure 4.12
Batch Preset Screen

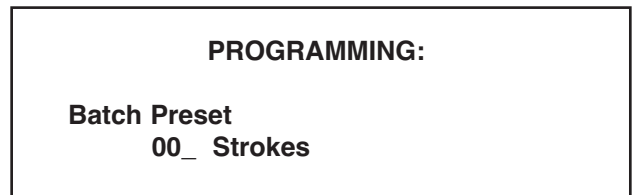
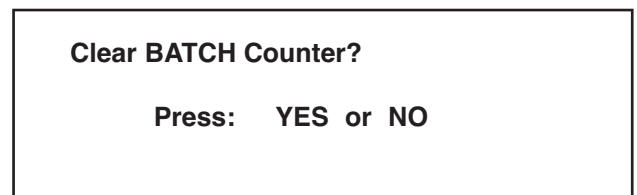

Figure 4.13
Clear Batch Screen



(Continued on next page.)

SECTION 4—PROGRAMMING

RHPS Hydraulic Solid-State Control

HOW TO PROGRAM THE COUNTERS (continued)

To clear the total counter:

Use ↓ and ↑ on the keypad to scroll up and down. Press **ENTER** when the arrow symbol (>) is next to Total Clear. The Security Code Screen will be displayed. See Figure 4.14. You will be prompted to enter the security code.

After the correct security code has been entered, you will see the CLEAR TOTAL SCREEN which also displays the total counter. See Figure 4.15.

To only view the counter and not clear it, press **NO** to return to the COUNTER PROGRAM SCREEN.

To clear the total counter, press **YES** to confirm and the counter will be cleared.

Press **ESC** when finished to return to the MAIN PROGRAM SCREEN.

Figure 4.14
Security Code Screen

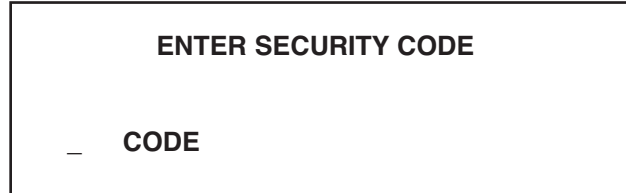

ENTER SECURITY CODE

_ CODE

Figure 4.15
Clear Total Screen

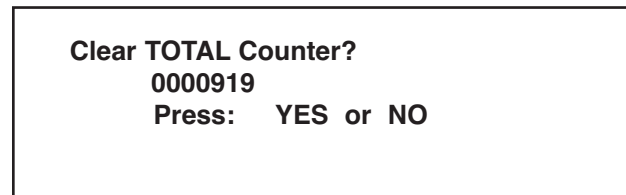

Clear TOTAL Counter?
0000919
Press: YES or NO

SYSTEM SETUP

The RHPS press brake control has a system setup screen that is used to edit operating preferences and parameters.

ANTI-TIE-DOWN

When beginning a machine stroke, all actuating means [palm buttons or foot switch(es)] must be operated concurrently. This means that the operator(s) must depress all actuating means within the set time in order to start the machine stroke. As soon as any one of the actuating means is operated, the timer starts. The time for this setting depends on the number of operators. The range of 0100-7000 ms allows enough time for single or multiple operators to operate all actuating means. The typical setting for one operator is 250 ms or ¼ of a second (factory setting).

HOW TO PROGRAM ANTI-TIE-DOWN

Select the **PROG** position of the Off/Prog/Run selector switch. The MAIN PROGRAM SCREEN will be displayed.

On the MAIN PROGRAM SCREEN, use ↓ and ↑ on the keypad to scroll through the program options. Press **ENTER** when the pound symbol (#) is next to SYSTEM SETUP. The security code screen will be displayed. See Figure 4.16. Enter the security code.

After the correct security code has been entered, the first SYSTEM SETUP SCREEN will be displayed. See Figure 4.17.

Use ↓ and ↑ on the keypad to scroll up and down. Press **ENTER** when the arrow symbol (>) is next to Anti-Tie-Down. The ANTI-TIE-DOWN SCREEN will be displayed. See Figure 4.18

Enter a number between 0-7000 ms for the desired time using the keypad. Press **ENTER** to confirm.

Press **ESC** when finished to return to the MAIN PROGRAM SCREEN.

Figure 4.16
Security Code Screen

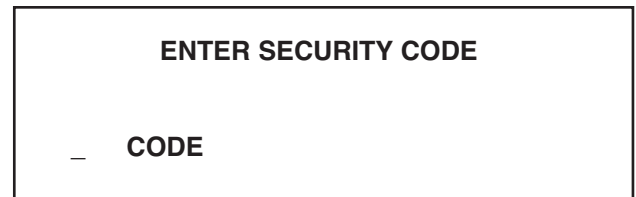

Figure 4.17
System Setup Screen

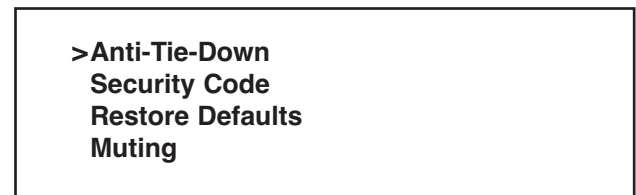
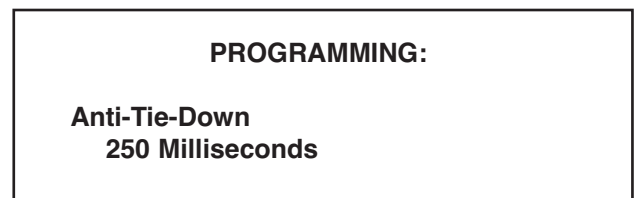

Figure 4.18
Anti-Tie-Down Screen



SECTION 4—PROGRAMMING

RHPS Hydraulic Solid-State Control

SECURITY CODE

The security code is user-programmable up to a 4-digit number which is required to edit certain control parameters that affect operation.

HOW TO PROGRAM THE SECURITY CODE

Select the **PROG** position of the Off/Prog/Run selector switch. The MAIN PROGRAM SCREEN will be displayed.

On the MAIN PROGRAM SCREEN, use ↓ and ↑ on the keypad to scroll through the program options. Press **ENTER** when the pound symbol (#) is next to SYSTEM SETUP. The security code screen will be displayed. See Figure 4.19. Enter the security code (factory default is 0),

After the correct security code has been entered, the first SYSTEM SETUP SCREEN will be displayed. See Figure 4.20.

Use ↓ and ↑ on the keypad to scroll up and down. Press **ENTER** when the arrow symbol (>) is next to Security Code. The SECURITY CODE PROGRAM SCREEN will be displayed. See Figure 4.21.

Use the keypad to enter a new security code up to a 4-digit number. Press **ENTER** when finished.

Press **ESC** when finished to return to the MAIN PROGRAM SCREEN.

Figure 4.19
Security Code Screen

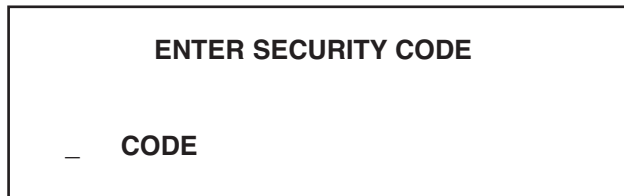

Figure 4.20
First System Setup Screen

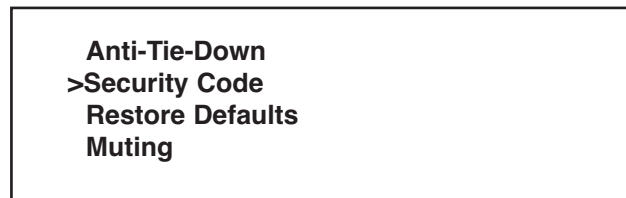
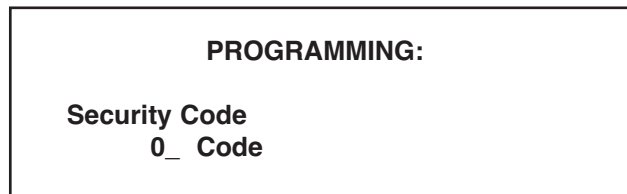

Figure 4.21—Security Code Program Screen



(Continued on next page.)

FACTORY DEFAULT SETTING

The RHPS hydraulic control has factory default settings. The factory default settings can be restored in the Systems Setup screen.

HOW TO RESTORE FACTORY DEFAULT SETTINGS

Select the **PROG** position of the Off/Prog/Run selector switch. The MAIN PROGRAM SCREEN will be displayed.

On the MAIN PROGRAM SCREEN, use ↓ and ↑ on the keypad to scroll through the program options. Press **ENTER** when the pound symbol (#) is next to SYSTEM SETUP. The security code screen will be displayed. See Figure 4.22. Enter the security code.

After the correct security code has been entered, the first SYSTEM SETUP SCREEN will be displayed. See Figure 4.23.

Use ↓ and ↑ on the keypad to scroll up and down. Press **ENTER** when the arrow symbol (>) is next to Restore Defaults. The RESTORE DEFAULTS SCREEN will be displayed. See Figure 4.24.

Press **YES** to confirm and the factory default settings will be restored.

Press **ESC** when finished to return to the MAIN PROGRAM SCREEN.

Figure 4.22
Security Code Screen

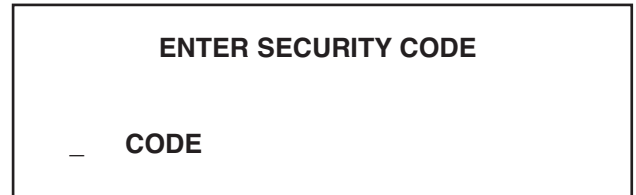

Figure 4.23
First System Setup Screen

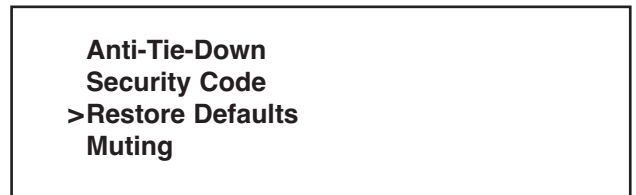
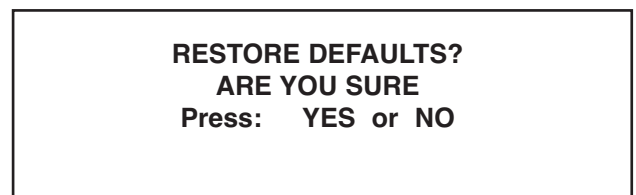

Figure 4.24
Restore Defaults Screen



(Continued on next page.)

SECTION 4—PROGRAMMING

RHPS Hydraulic Solid-State Control

MUTING

When muting is turned on, the control will ignore the light curtain inputs past the user-defined light curtain limit switch and on the upstroke.

HOW TO PROGRAM MUTING

Select the **PROG** position of the Off/Prog/Run selector switch. The MAIN PROGRAM SCREEN will be displayed.

On the MAIN PROGRAM SCREEN, use ↓ and ↑ on the keypad to scroll through the program options. Press **ENTER** when the pound symbol (#) is next to SYSTEM SETUP. The security code screen will be displayed. See Figure 4.25. Enter the security code.

After the correct security code has been entered, the first SYSTEM SETUP SCREEN will be displayed. See Figure 4.26.

Use ↓ and ↑ on the keypad to scroll up and down. Press **ENTER** when the arrow symbol (>) is next to Muting. The MUTING SCREEN will be displayed. See Figure 4.27.

Use ↓ and ↑ on the keypad to reach the setting you desire. Press **ENTER** to finish.

Press **ESC** when finished to return to the MAIN PROGRAM SCREEN.

Figure 4.25
Security Code Screen

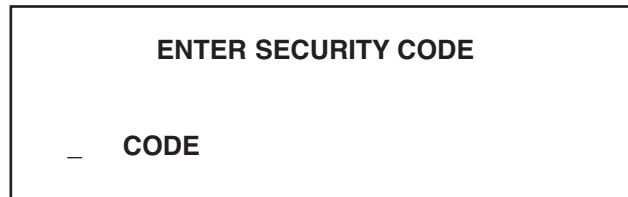

Figure 4.26
First System Setup Screen

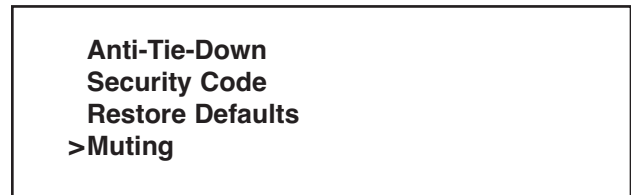
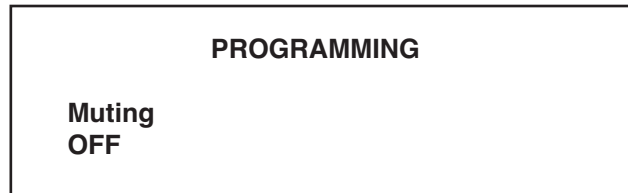

Figure 4.27
Muting Screen



(Continued on next page.)

AUTO RETURN

When auto return is enabled, the ram will automatically return to the top of the stroke once the light curtain has been broken.

HOW TO PROGRAM AUTO RETURN

Select the **PROG** position of the Off/Prog/Run selector switch. The MAIN PROGRAM SCREEN will be displayed.

On the MAIN PROGRAM SCREEN, use ↓ and ↑ on the keypad to scroll through the program options. Press **ENTER** when the pound symbol (#) is next to SYSTEM SETUP. The security code screen will be displayed. See Figure 4.28. Enter the security code.

After the correct security code has been entered, the first SYSTEM SETUP SCREEN will be displayed. Use ↓ and ↑ on the keypad to scroll up and down to the second SYSTEM SETUP SCREEN. See Figure 4.29.

Use ↓ and ↑ on the keypad to scroll up and down. Press **ENTER** when the arrow symbol (>) is next to Auto Return. The AUTO RETURN SCREEN will be displayed. See Figure 4.30.

Use ↓ and ↑ on the keypad to reach the setting you desire. Press **ENTER** to finish.

Press **ESC** when finished to return to the MAIN PROGRAM SCREEN.

Figure 4.28
Security Code Screen

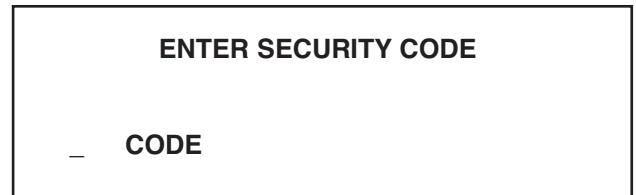
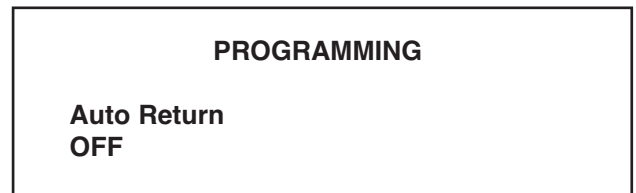

Figure 4.29
Second System Setup Screen



Figure 4.30
Auto Return Screen



SECTION 4—PROGRAMMING

RHPS Hydraulic Solid-State Control

DECOMPRESS TIMER

When the ram reaches the BOS (bottom of stroke) timing device, the down valve will de-energize causing the decompress timer (if programmed) to time out. Once the time runs out, the up valve will energize, returning the ram to the TOS (top of stroke) timing device. The range of time is between 50-250 ms.

HOW TO PROGRAM THE DECOMPRESS TIMER

Select the **PROG** position of the Off/Prog/Run selector switch. The MAIN PROGRAM SCREEN will be displayed.

On the MAIN PROGRAM SCREEN, use ↓ and ↑ on the keypad to scroll through the program options. Press **ENTER** when the pound symbol (#) is next to SYSTEM SETUP. The security code screen will be displayed. See Figure 4.31. Enter the security code.

After the correct security code has been entered, the first SYSTEM SETUP SCREEN will be displayed. Use ↓ and ↑ on the keypad to scroll up and down to the second SYSTEM SETUP SCREEN. See Figure 4.32.

Use ↓ and ↑ on the keypad to scroll up and down. Press **ENTER** when the arrow symbol (>) is next to Decompress Timer. The DECOMPRESS TIMER SCREEN will be displayed. See Figure 4.33.

Enter a number between 50-250 ms for the desired time using the keypad. Press **ENTER** to confirm.

Press **ESC** when finished to return to the MAIN PROGRAM SCREEN.

Figure 4.31
Security Code Screen

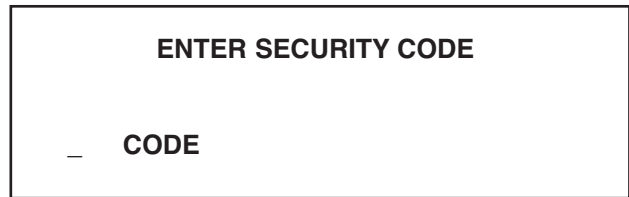

Figure 4.32
Second System Setup Screen

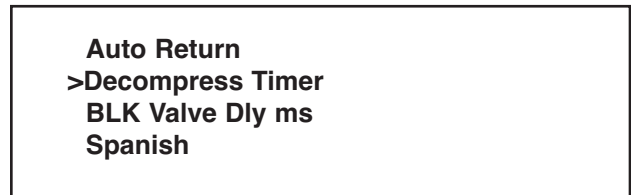
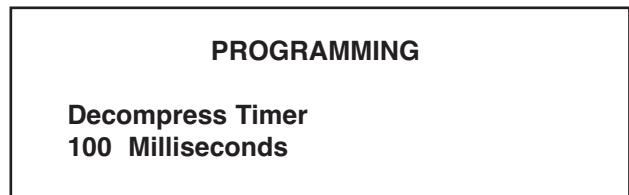

Figure 4.33
Decompress Timer Screen



(Continued on next page.)

BLOCK VALVE DELAY

When the ram reaches the BLk (block) valve timing device, the block valve will de-energize causing the timer (if programmed) to time out. Once the time runs out, the block valve will energize, returning hydraulic fluid back into the tank.

HOW TO PROGRAM THE BLOCK VALVE DELAY

Select the **PROG** position of the Off/Prog/Run selector switch. The MAIN PROGRAM SCREEN will be displayed.

On the MAIN PROGRAM SCREEN, use ↓ and ↑ on the keypad to scroll through the program options. Press **ENTER** when the pound symbol (#) is next to SYSTEM SETUP. The security code screen will be displayed. See Figure 4.34. Enter the security code.

After the correct security code has been entered, the first SYSTEM SETUP SCREEN will be displayed. Use ↓ and ↑ on the keypad to scroll up and down to the second SYSTEM SETUP SCREEN. See Figure 4.35.

Use ↓ and ↑ on the keypad to scroll up and down. Press **ENTER** when the arrow symbol (>) is next to Blk Valve Dly ms. The BLK VALVE DLY SCREEN will be displayed. See Figure 4.36.

Enter a number between 0-250 ms for the desired time using the keypad. Press **ENTER** to confirm.

Press **ESC** when finished to return to the MAIN PROGRAM SCREEN.

Figure 4.34
Security Code Screen

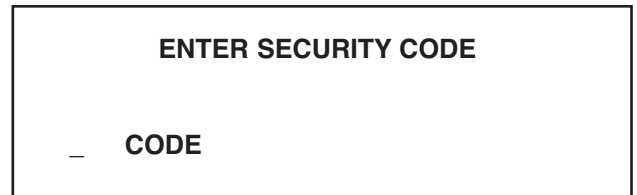

Figure 4.35
Second System Setup Screen

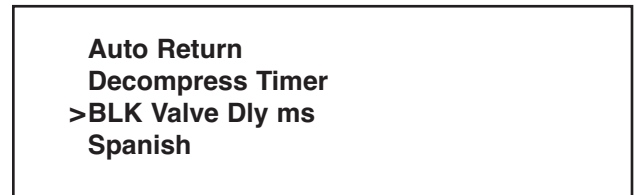
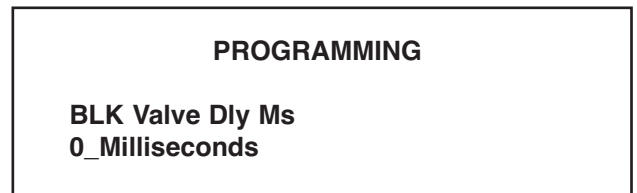

Figure 4.36
Blk Valve Delay Screen



(Continued on next page.)

SECTION 4—PROGRAMMING

RHPS Hydraulic Solid-State Control

SPANISH

When this setting is turned on, the display of text will be in Spanish.

HOW TO PROGRAM SPANISH TEXT DISPLAY

Select the **PROG** position of the Off/Prog/Run selector switch. The MAIN PROGRAM SCREEN will be displayed.

On the MAIN PROGRAM SCREEN, use ↓ and ↑ on the keypad to scroll through the program options. Press **ENTER** when the pound symbol (#) is next to SYSTEM SETUP. The security code screen will be displayed. See Figure 4.37. Enter the security code.

After the correct security code has been entered, the first SYSTEM SETUP SCREEN will be displayed. Use ↓ and ↑ on the keypad to scroll up and down to the second SYSTEM SETUP SCREEN. See Figure 4.38.

Use ↓ and ↑ on the keypad to scroll up and down. Press **ENTER** when the arrow symbol (>) is next to Spanish. The SPANISH SCREEN will be displayed. See Figure 4.39.

Use ↓ and ↑ on the keypad to reach the setting you desire. Press **ENTER** to finish.

Press **ESC** when finished to return to the MAIN PROGRAM SCREEN.

Figure 4.37
Security Code Screen

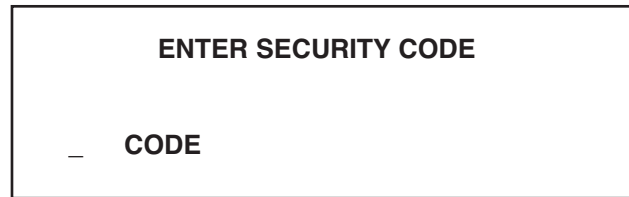

Figure 4.38
Second System Setup Screen

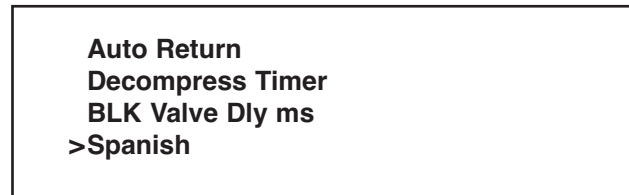
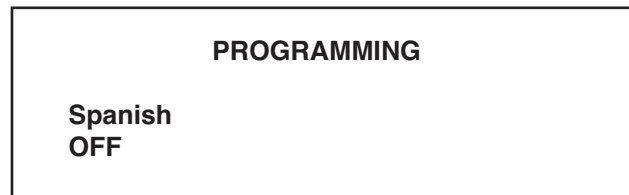

Figure 4.39
Spanish Screen



(Continued on next page.)

CONFIGURATION

The configuration menu is for editing logic setting to the valves, relays, switches, and for safeguard functions. It is important not to change any settings unless advised by tech. support and with supervisor permission. Wiring must reflect any changes to the programming otherwise injury and/or damage to the machine could occur.

CONFIGURATION MENU

TOS LS TYPE—This setting defines what logic the control will monitor the top-of-stroke limit switch. Choice of N.O. or N.C.

BOS LS TYPE—This setting defines what logic the control will monitor the bottom-of-stroke limit switch. Choice of N.O. or N.C.

MUTE LS TYPE—This setting defines what logic the control will monitor the mute limit switch. Choice of N.O. or N.C.

SEQ STOP LS TYPE—This setting defines what logic the control will monitor the sequence stop limit switch. Choice of N.O. or N.C.

BLK VALVE SW TYPE—This setting defines what logic the control will monitor the blocking valve switch. Choice of N.O. or N.C.

SC VALVE POLARITY—This setting defines what logic the control will monitor and energize the speed change if applicable. Choice of ON=Slow or OFF=Slow. If ON=Slow is selected, the press will energize the speed change output when the speed change input signal (P8-21) is supplied. If OFF=Slow is selected, the speed output will energize when the signal is removed for the input.

RETURN SPEED—This setting allows selection of the speed at which the press will return to the top of stroke. Choice of SPEED SELECTOR, HIGH SPEED, or LOW SPEED. If speed selector is selected, then the switch defines the rate of return. If high or low speed is selected in the programming, then this will override any other selection by other switches.

FOOT TRIP—When on, this setting allows the press to be actuated by pressing and releasing a foot switch. Choice of ON or OFF.

MUTE AT BOS—This setting mutes/disables the light curtains from stopping the press at the mute limit switch point until the press reaches the bottom-of-stroke position. Choice of ON or OFF.

FINISH STK ON MUTE—This setting mutes/disables the light curtains from stopping the press at the bottom of the stroke until the press reaches the top-of-stroke position. Choice of ON or OFF

BLK VALVE MONITOR—When on, this setting allows the control to monitor the blocking valve (if applicable). Choice of ON or OFF.

BLK VALVE ON UP—When on, this setting allows block valve input (if applicable). Choice of ON or OFF.

PWR UP RET REQUEST—When on, this setting allows the press to be returned to the top of stroke if the ram is stopped anywhere other than at the top of the stroke. Choice of ON or OFF.

LIGHT CURTAIN TYPE—This setting is directly related to the light curtain CH1 and CH2 wiring on the inputs. The selection made defines how the light curtain is monitored by the control. If the inputs are connected 1 normally open and 1 normally closed, select 1 N.O. & 1 N.C. If the inputs are connected 2 normally open relays, then select 2 N.O.

SAFEGUARD FUNCTION—This selection allows the choice of when the light curtains are activated. When *Always Required* is selected, the light curtains will be activated except when the light curtain is muted. When *Foot/Sing & Cont* is selected, the light curtains will only be required for operation in the foot, single, or continuous modes of operation except when the light curtain is muted.

(Continued on next page.)

SECTION 4—PROGRAMMING

RHPS Hydraulic Solid-State Control

HOW TO EDIT THE CONFIGURATION SCREEN

Select the **PROG** position of the Off/Prog/Run selector switch. The MAIN PROGRAM SCREEN will be displayed.

On the MAIN PROGRAM SCREEN, use ↓ and ↑ on the keypad to scroll through the program options. Press **ENTER** when the pound symbol (#) is next to SYSTEM SETUP. The security code screen will be displayed. See Figure 4.40. Enter the security code (factory default setting is 0).

After the correct security code has been entered, the first SYSTEM SETUP SCREEN will be displayed. Use ↓ and ↑ on the keypad to scroll up and down to the third SYSTEM SETUP SCREEN. See Figure 4.41.

Use ↓ and ↑ on the keypad to scroll up and down. Press **ENTER** when the arrow symbol (>) is next to Configuration. The SUPERVISOR SECURITY CODE SCREEN will be displayed. See Figure 4.42. Enter the security code (factory default setting is 1).

After the correct security code has been entered, the first CONFIGURATION SECURE SCREEN will be displayed. See Figure 4.43.

Use ↓ and ↑ on the keypad to scroll up and down through the configuration menu choices shown on page 39. Press **ENTER** when the double-arrow symbol (>>) is next to the configuration you want to change. Use ↓ and ↑ on the keypad to reach the setting you desire for each menu choice. Press **ENTER** to finish.

Press **ESC** when finished to return to the MAIN PROGRAM SCREEN.

Figure 4.40
Security Code Screen

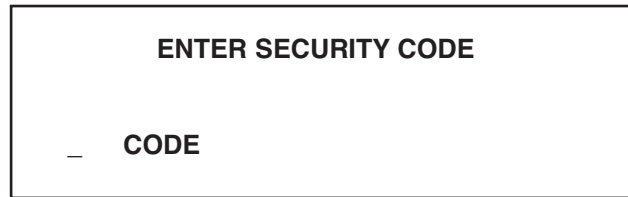

Figure 4.41
Third System Setup Screen

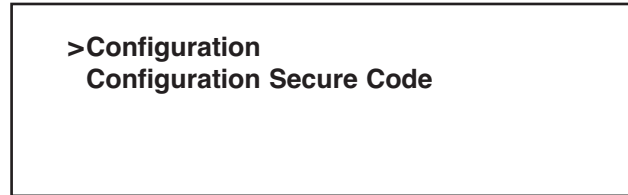

Figure 4.42
Supervisor Security Code Screen

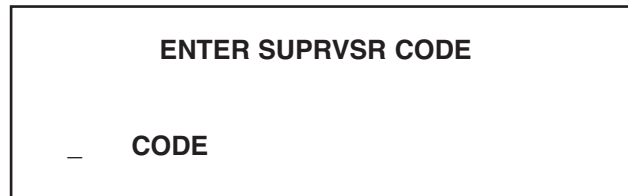
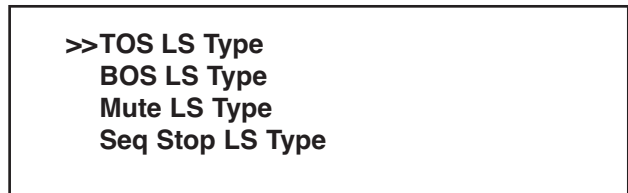

Figure 4.43
Configuration Secure Screen



(Continued on next page.)

HOW TO EDIT THE CONFIGURATION SECURITY CODE SCREEN

Select the **PROG** position of the Off/Prog/Run selector switch. The MAIN PROGRAM SCREEN will be displayed.

On the MAIN PROGRAM SCREEN, use ↓ and ↑ on the keypad to scroll through the program options. Press **ENTER** when the pound symbol (#) is next to SYSTEM SETUP. The security code screen will be displayed. See Figure 4.44. Enter the security code.

After the correct security code has been entered, the first SYSTEM SETUP SCREEN will be displayed. Use ↓ and ↑ on the keypad to scroll up and down to the third SYSTEM SETUP SCREEN. See Figure 4.45.

Use ↓ and ↑ on the keypad to scroll up and down. Press **ENTER** when the arrow symbol (>) is next to Config Secure Code. The SUPERVISOR SECURITY CODE SCREEN will be displayed. See Figure 4.46. Enter the security code (factory default setting is 1).

After the correct security code has been entered, the CONFIGURE SECURE CODE SCREEN will be displayed. See Figure 4.47.

Use the keypad to enter a new security code up to a 4-digit number. Press **ENTER** when finished.

Press **ESC** when finished to return to the MAIN PROGRAM SCREEN.

Figure 4.44
Security Code Screen

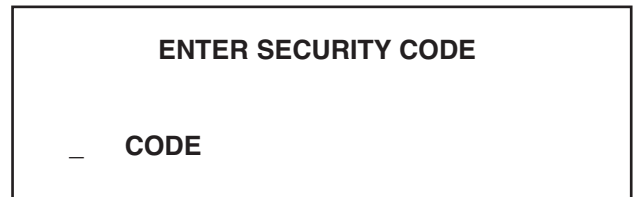

Figure 4.45
Third System Setup Screen

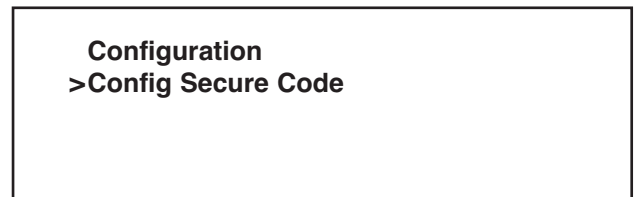

Figure 4.46
Supervisor Security Code Screen

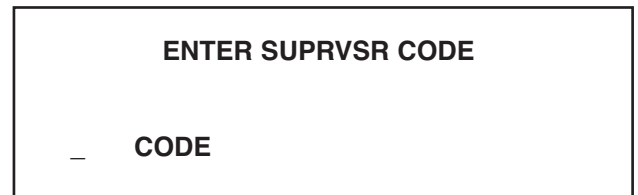
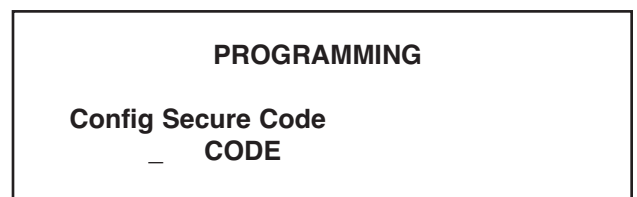

Figure 4.47
Configure Secure Code Screen



(Continued on next page.)

SECTION 4—PROGRAMMING

RHPS Hydraulic Solid-State Control

BOTTOM DWELL

When the ram reaches the BOS (bottom of stroke) timing device, the down valve stays energized until the bottom dwell timer (if programmed) times out. Once the time runs out, the up valve will energize, returning the ram to the TOS (top of stroke) timing device.

HOW TO PROGRAM BOTTOM DWELL

Select the **PROG** position of the Off/Prog/Run selector switch. The MAIN PROGRAM SCREEN will be displayed.

On the MAIN PROGRAM SCREEN, use ↓ and ↑ on the keypad to scroll through the program options. Press **ENTER** when the pound symbol (#) is next to **BOTTOM DWELL**. The security code screen will be displayed. See Figure 4.48. Enter the security code.

After the correct security code has been entered, the **BOTTOM DWELL SCREEN** will be displayed. See Figure 4.49.

Enter the desired number of seconds up to 600 using the keypad. After the desired value is entered, the MAIN PROGRAM SCREEN is displayed.

Figure 4.48
Security Code Screen

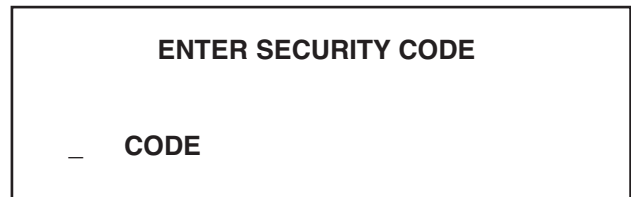
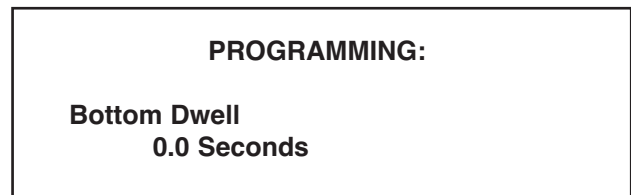

Figure 4.49
Bottom Dwell Screen



(Continued on next page.)

Troubleshooting



All troubleshooting, as well as installation, must be performed by qualified and properly trained personnel. Also, when a defective component is found, do not operate the machine until that component has been replaced with an exact replacement part.

1. This procedure is written as a general guide for troubleshooting most hydraulic control systems. In all cases, please refer to the individual control wiring schematic for particular test points and terminal numbers.
2. Each control system may be slightly different depending on the various functions provided. Be sure to follow the schematic and select the proper modes of operation when troubleshooting.

ABBREVIATIONS

SW—Switch

N.O.—Normally Open

N.C.—Normally Closed

L.S.—Limit Switch

TOS—Top of Stroke

BOS—Bottom of Stroke

FLT—Fault

LC—Light Curtain

SEQ Stop—Sequence Stop

FAULTS

The control will alert you with a message either when a circuit failure has occurred, unsafe conditions are detected, or when certain logical conditions are not met. These messages are categorized three ways; **Warning**, **User Input**, and **Fatal**. Warning and user input fault messages can be cleared by pressing ESC, while fatal faults require an E-Stop or power disconnect to clear.

WARNING FAULTS

These faults generally occur when a setup is wrong or a certain condition has changed. These faults can be cleared by pressing ESC (escape).

NO INTERLOCKS

This message is displayed when the control is in the *Continuous/Foot* operation mode or when the *Always Required* setting is selected in the safeguard function. In either condition, a safety device is required to satisfy the inputs and operate the machine.

USER INPUTS

These messages display when certain logical conditions are not met. User inputs are monitored N.O. or N.C. Selecting the wrong condition or a change in condition will display the error message selected for that user input. These messages can be cleared by pressing ESC. See page 35 for a list of user input fault messages.

(Continued on next page.)

SECTION 5—TROUBLESHOOTING AND FAULT MESSAGES

RHPS Hydraulic Solid-State Control

FATAL FAULTS

When these are displayed, further troubleshooting and/or technical support is usually required. These messages may require an E-stop or power disconnect to clear them.

CPU#2 Fault—Possible circuit failure with CPU#2 or K2 relay. If fault persists after replacing the K2 relay, there may be a CPU or circuit failure. Contact the factory for technical support.

K1 FAILED SAFE TEST—K1 failed to operate upon initial startup. Remove and inspect relays for signs of damage. If fault persists after replacing relay, contact the factory for technical support.

K2 FAILED SAFE TEST—K2 failed to operate upon initial startup. Remove and inspect relays for signs of damage. If fault persists after replacing relay, contact the factory for technical support.

K1 OFF FAULT—Possible component failure or K1 Relay fault. Remove and inspect relay for signs of damage. If fault persists after replacing relay, contact the factory for technical support.

K1 On FAULT—Possible K1 Relay fault or no source voltage. Check the input voltage on the control and inspect relay for signs of damage. If fault persists after replacing relay, contact the factory for technical support.

K2 OFF FAULT—Possible component failure or K2 Relay fault. Remove and inspect relay for signs of damage. If fault persists after replacing relay, contact the factory for technical support.

K2 ON FAULT—Possible K2 Relay fault or no source voltage. Check the input voltage on the control and inspect relay for signs of damage. If fault persists after replacing relay, contact the factory for technical support.

CPU 2 Failed test—Possible CPU#2 fault. Disconnect power and remove battery from circuit board and wait 10 minutes. If fault persists, it is possible it is a CPU#2 fault. Contact the factory for technical support.

LIMIT SWITCH FAULTS

If you are experiencing any of the faults below, it is important not to jump into the software and change logic settings unless you are told to do so or are confident it will fix your problem. The settings programmed into your control are factory default and are set to work with the drawing provided. The basic setup to function your press is as follows: TOS = N.C. and BOS = N.O. Other variables such as sequence stop, muting, and speed change are factory designed to be N.O. Always be careful and remember what settings you change—a wrong setting could cause a fault message to display that masks the root problem. Another consideration is that if the TOS or BOS limits are not correctly set, the press will not display a message or may display the wrong message.

SEQ STOP SW ON FLT (Sequence Stop Switch On Fault)—The control has monitored that the sequence stop limit switch isn't coming on or changing state. If the fault persists, confirm the logical wiring and that the correct logic is selected in the setup. To change logic settings, refer to pages 47-49 for information on configuration programming.

SEQ STOP SW Off FLT (Sequence Stop Switch Off Fault)—The control has monitored that the sequence stop limit switch isn't turning off or the wrong logical state is detected. Confirm that the limit switch isn't being depressed during the whole stroke. Inspect wiring for any possible shorts and reconfirm its logic. Set the software to the correct logic. To change logic settings, refer to pages 47-49 for information on configuration programming.

MUTE SW ON FLT (Mute Switch On Fault)—The control has monitored that the mute limit switch isn't coming on or changing its logical state. If fault persists, confirm the logical wiring and that the correct logic is selected in the setup. To change logic settings, refer to pages 47-49 for information on configuration programming.

MUTE SW OFF FLT (Mute Switch Off Fault)—The control has monitored that the mute limit switch is not turning off or is monitoring the wrong logic in the circuit. Observe the limit switch to confirm it's not being depressed during the whole stroke. If fault persists, confirm the logical wiring and that the correct logic is selected in the setup. To change logic settings, refer to pages 47-49 for information on configuration programming.

RHPS Operation Checklist

1. Is all wiring to the machine, the solid-state control module, and the keypad/display correct when verified with the drawings sent with the solid-state control?.....Y or N
2. When powering up the solid-state control module, do the five (green) LEDs (Power Status and CPU) on the front of the black control module turn on?.....Y or N
3. Is the WAKE-UP SCREEN displayed with the message: “**SAFEGRD IN PLACE**” when the main power disconnect switch is turned on?.....Y or N
4. Was the **POWER-UP PROCEDURE** performed? (See pages 33-34 of this installation manual).....Y or N
5. In normal run modes, such as *Single* or *Sequence Stop*, does the machine make cycles without any faults appearing on the display?.....Y or N

Electrical Troubleshooting

All troubleshooting, as well as installation, must be performed by qualified and properly trained personnel. Also, when a defective component is found, do not operate the machine until that component has been replaced with an exact replacement part.

This procedure is written as a general guide for troubleshooting most hydraulic control systems. In all cases, please refer to the individual control wiring schematic for particular test points and terminal numbers. Be sure to follow the schematic and select the proper modes of operation when troubleshooting.

If a defective component (contact) is found, always verify with an ohm meter. Lock the disconnect switch in the off position, isolate the component or contact from other wiring and check its integrity with an ohm meter. At the same time, manually operate the device (in the case of a contact) to check its function.

TROUBLESHOOTING OUTLINE

Use the control drawing schematics in conjunction with the following troubleshooting outline:

NO VOLTAGE—POSSIBLE CAUSES:

1. Check the line voltage on the transformer primary with a volt meter.
2. Check for correct transformer primary connections (wiring) and the secondary for 120 V AC using a volt meter.
3. A primary or secondary fuse may be blown—replace the fuse with the proper size, type, and amperage in accordance with the control drawing. Using an ohm meter, locate the reason for the blown fuse before reapplying power.

MOTOR DOES NOT START—POSSIBLE CAUSES:

1. Open electrical interlocks. The circuit can be arranged to accommodate machine protective electrical interlocks, overload interlocks, and safety block interlocks. These interlocks are strategically located to prevent machine operation when open. Please refer to the schematic for the location of the various interlocks.

(Continued on next page.)

SECTION 6—OPERATING CONSIDERATIONS

RHPS Hydraulic Solid-State Control

TROUBLESHOOTING OUTLINE (continued)

MOTOR DOES NOT START—POSSIBLE CAUSES (continued):

2. Motor starter does not energize.

Motor starter operating coil may not be 120 V AC.

Motor overload may have tripped out; this may have been caused because no overload is present or because of an improperly rated overload.

Motor start/stop push buttons may be improperly wired or defective.

Motor starter contact may be defective.

- The motor should start if the above checks OK. If the motor still fails to run when the start button is released, check the motor starter holding contact for proper wiring and function.

MACHINE WILL NOT STROKE—POSSIBLE CAUSES:

Solenoid valves will not energize

- Check for proper installation and wiring.
- Solenoid coils may be open (broken wire).

LIGHT CURTAIN (IF FURNISHED) IS NOT FUNCTIONING—POSSIBLE CAUSE:

Fuse F4 may be faulty

Hydraulic Press Brake

A hydraulic power press brake consists of a hydraulic pump, oil reservoir, hoses, pipes, fittings, couplings, cylinders, and other mechanical equipment. Because of this inherent design, machine parts will ultimately wear, leak, or break which could cause a malfunction and/or mechanical failure. The control system furnished can never cure nor overcome a misadjusted, worn, broken or malfunctioning part or mechanical failure. Be sure to inspect all parts for adjustment, excessive wear, looseness or breakage. **Do not operate your machines until all parts are adjusted, repaired, replaced, and each entire machine is working properly.**

Visual inspections and examinations of the machine and its components must be made at least once per shift by qualified personnel.

Machines must always be inspected and tested on a weekly basis to determine the condition of the hydraulic system and antirepeat feature. Necessary maintenance and repair must be done before each machine is operated again, and the employer must maintain records of both the inspections and the maintenance work performed.



After any maintenance, always operate the machine numerous times in all modes of operation (function test) before allowing the operator to start production. Always make sure point-of-operation safeguarding is in place, adjusted and operating properly for the job and for the operator.

ANSI Requirements for Inspections

ANSI B11.3—INSPECTION AND MAINTENANCE RECORDS

It is the user's responsibility to set up and maintain periodic and regular inspections of the press brake to make sure all of its parts, components, auxiliary equipment, and safeguards are adjusted and in safe operating condition. Records of inspections and maintenance on each press brake shall be kept.

ANSI Requirements for Operator Training

ANSI B11.3—TRAINING

It is the user's responsibility to set up a training program to make sure operators, die setters, inspectors, maintenance personnel, and supervisors are qualified for the job they are performing, and that they are properly trained in safe working procedures. These individuals shall also be properly trained in the safe working procedures for lockout/tagout of hazardous energy sources according to 29 CFR 1910.147 & 1910.333.

Electrical Controls

Before inspecting or maintaining electrical controls, be sure to switch the main power disconnect to the off position and lockout all energy. Perform a periodic inspection of the control box and electrical machine components for loose or broken wires. Be sure relays and switches are examined for burned or worn contacts. Look for loose or broken conduit and cable fittings. The control box and other components must be kept closed, covered, and locked to keep unauthorized personnel out. Keys must be removed from all selector switches and door locks to prevent tampering and prevent exposure to the dirt, chips, and oil present in most shops.

Care of the Keypad/Display

To clean the keypad/display, use a clean soft cloth with soap and warm water, but do not saturate. Do not use oily rags, solvents, or ammonia-based glass cleaner.

SECTION 9—METHODS OF SAFEGUARDING

RHPS Hydraulic Solid-State Control

Please refer to the ANSI B11.3 standard for the requirements for point-of-operation safeguarding on press brakes. When updating a press brake, the most important decision is the selection of the proper guard or device. The following are methods of safeguarding hydraulic press brakes.

LIGHT CURTAIN PRESENCE-SENSING DEVICES ON PRESS BRAKES

ANSI B11.3

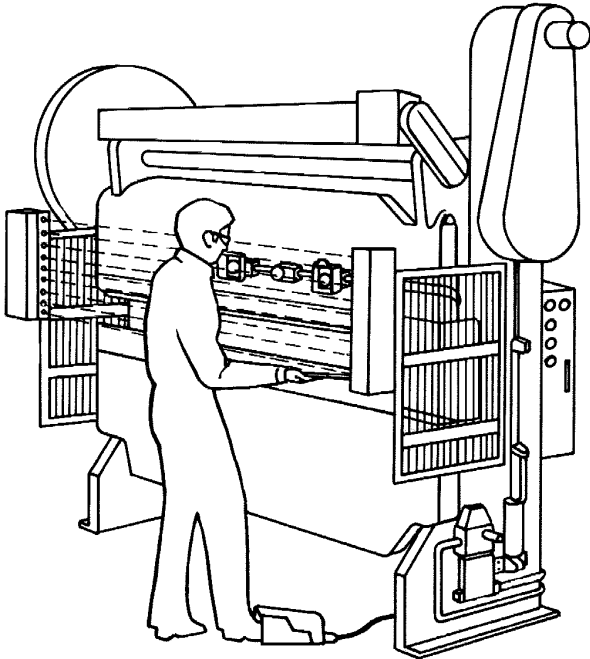

TWO-HAND CONTROL ON PRESS BRAKES

ANSI B11.3

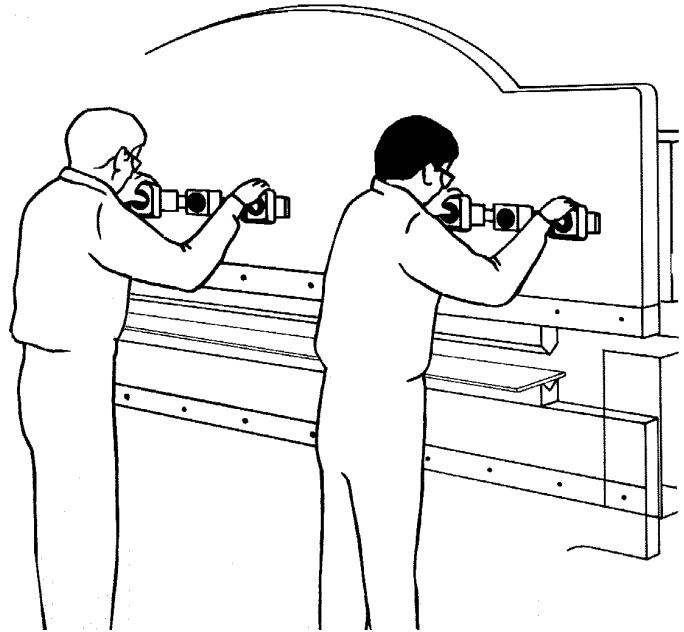

RESTRAINT (HOLDOUT) ON PRESS BRAKES

ANSI B11.3

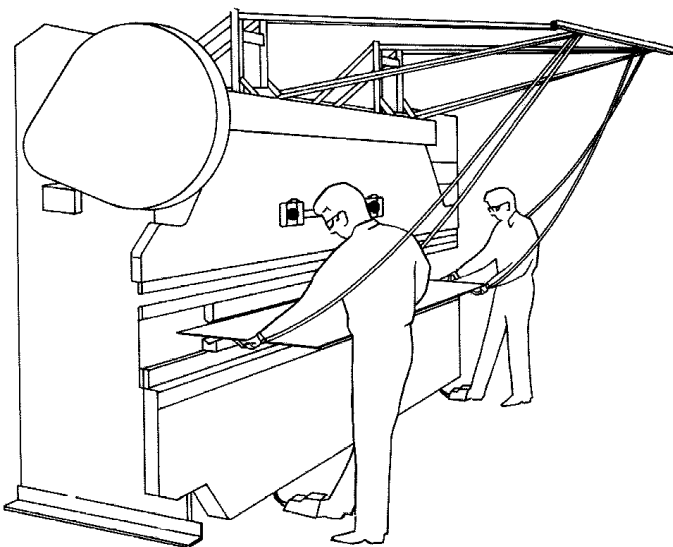

PULLBACK (PULL-OUT) ON PRESS BRAKES

ANSI B11.3

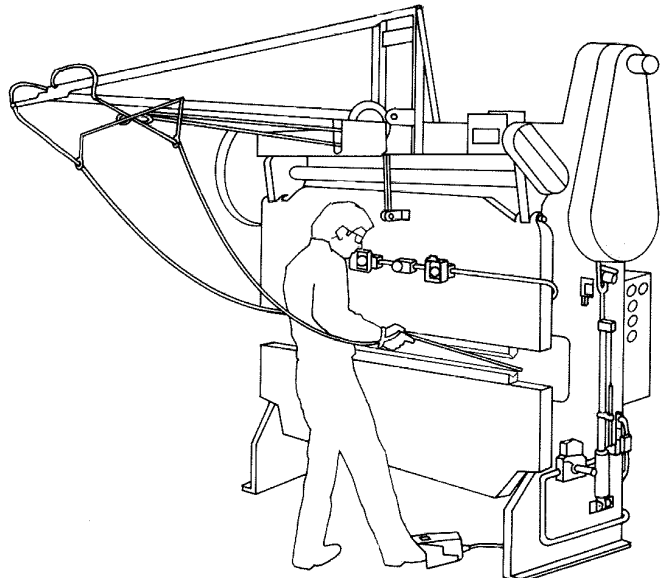

(Continued on next page.)

Auxiliary Safeguarding on Press Brakes

Auxiliary safeguarding can provide additional protection from injuries for all personnel in the machine area. It is most often used in conjunction with primary safeguarding devices. Auxiliary safeguarding also involves the guarding of other components or hazardous openings on machines.

Auxiliary safeguards include such items as point-of-operation side end barriers when light curtains are used, pressure-sensitive floor mats, workpiece tables or horizontal light curtains. Light curtains can be used horizontally to prevent an operator or other persons from standing between the vertical plane of light and the point-of-operation hazard.

Danger signs, used for warning, must be mounted on the machine in a position that is readily visible to the operator, setup person or other personnel. Hand tools can be used as auxiliary safeguarding. They are often used when feeding and retrieving small workpieces. Hand tools by themselves are NOT a point-of-operation safeguarding device.

ANSI B11.3—HAND TOOLS

Hand tools do not provide point-of-operation safeguarding—they are intended only for placing and removing materials in and from the press brake. They should be made of material that does not shatter if they get caught in the machine or its components. Hand tools should not create a hazard to the user based on their structure.



Hand Tool Used for Feeding Parts

Other Safety Considerations

Other areas of machine safety must be considered in order to comply to the OSHA regulations and ANSI standards, as we know them. This includes, but is not limited to, items such as a main power disconnect switch, which must be provided for each machine, and a magnetic type motor starter for the main pump motor. As with all machinery, best safety practices must be a continuing program. The operator, die setter and all personnel must be fully trained and instructed on all safety procedures and have full knowledge of the safeguarding device being used.

When using any of the devices described for point-of-operation safeguarding, the sides and rear of the hazardous point-of-operation area must be safeguarded to protect the operator and other employees in the machine area (OSHA 29 CFR 1910.212).

SECTION 10—RETURN MATERIALS AUTHORIZATION REQUEST FORM

RHPS Hydraulic Solid-State Control

To return material for any reason contact the sales department in our organization at 1-800-922-7533 for an RMA Number. All return materials shipments must be prepaid. Complete this form and send with material to Rockford Systems, Inc., 4620 Hydraulic Road, Rockford, IL 61109-2695. Make sure the RMA Number is plainly identified on the outside of the shipping container.

Company _____

Address _____

City _____ State _____ Zip _____

Phone _____ Fax _____

Contact Name _____ Representative _____

Items Authorized To Return on RMA No. _____ **Original Invoice No.** _____ **Date** _____

Part No.	Serial No.	Description
_____	_____	_____
_____	_____	_____
_____	_____	_____
_____	_____	_____
_____	_____	_____
_____	_____	_____
_____	_____	_____
_____	_____	_____

Service Requested Full Credit 25% Restocking Repair & Return Warranty Replacement

Reason for return (describe in detail):

Return Materials Authorized by _____ Date _____

SECTION 11—ORDER FORM FOR SIGNS AND LITERATURE

RHPS Hydraulic Solid-State Control

This instruction manual references signs and literature available for your machines. This order form is for your convenience to order additional signs and literature as needed. This order form is part of your installation manual so please make a copy of it before writing an order.

Company _____

Address _____

City _____ State _____ Zip _____

Phone _____ Fax _____

Name _____ Purchase Order No. _____ Date _____

Part No.	Description	Quantity Required
KSL-278	Installation Manual—RHPS Press Brake Control	_____
KSC-000	Precaution Pamphlet (English)	_____
KSC-000S	Precaution Pamphlet (Spanish)	_____
KST-134	Danger, Closing Ram and Die Label	_____
KSC-054	Danger Sign 5" x 6" (English)	_____
KSC-054S	Danger Sign 5" x 6" (Spanish)	_____
KSC-055	Danger Sign (Foot Switch) 5" x 6" (English)	_____
KSC-055S	Danger Sign (Foot Switch) 5" x 6" (Spanish)	_____
KSC-055F	Danger Sign (Foot Switch) 5" x 6" (French)	_____
KSC-057	Danger Sign (Pullback Device) 5" x 6"	_____
KSC-060	Danger Sign (Press Brake) 10" x 12"	_____
FAB	Catalog— <i>Controls and Safeguarding for Fabricating Machines</i>	_____
SFM	Catalog— <i>Safeguarding Cutting and Turning Machines</i>	_____

For prices and delivery, please use address, phone or fax number listed on the front cover of this manual.

Your Signature _____ Date _____

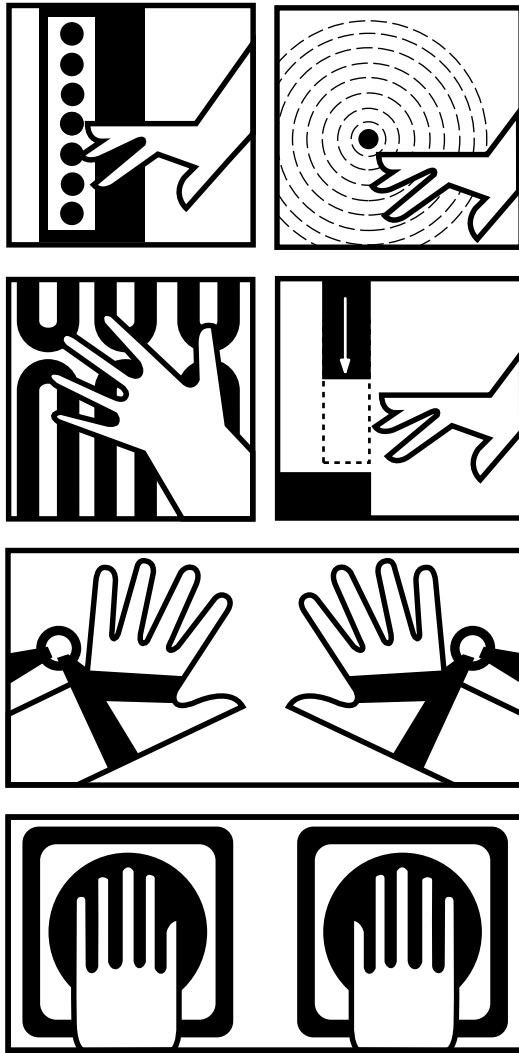

P.O. Box 5525
Rockford, Illinois 61125-0525
Toll-Free 1-800-922-7533
Phone 815-874-7891
Fax 815-874-6144
sales@rockfordsystems.com
www.rockfordsystems.com