

INSTALLATION MANUAL FOR SSC-3000 PRESS AUTOMATION CONTROL SYSTEM

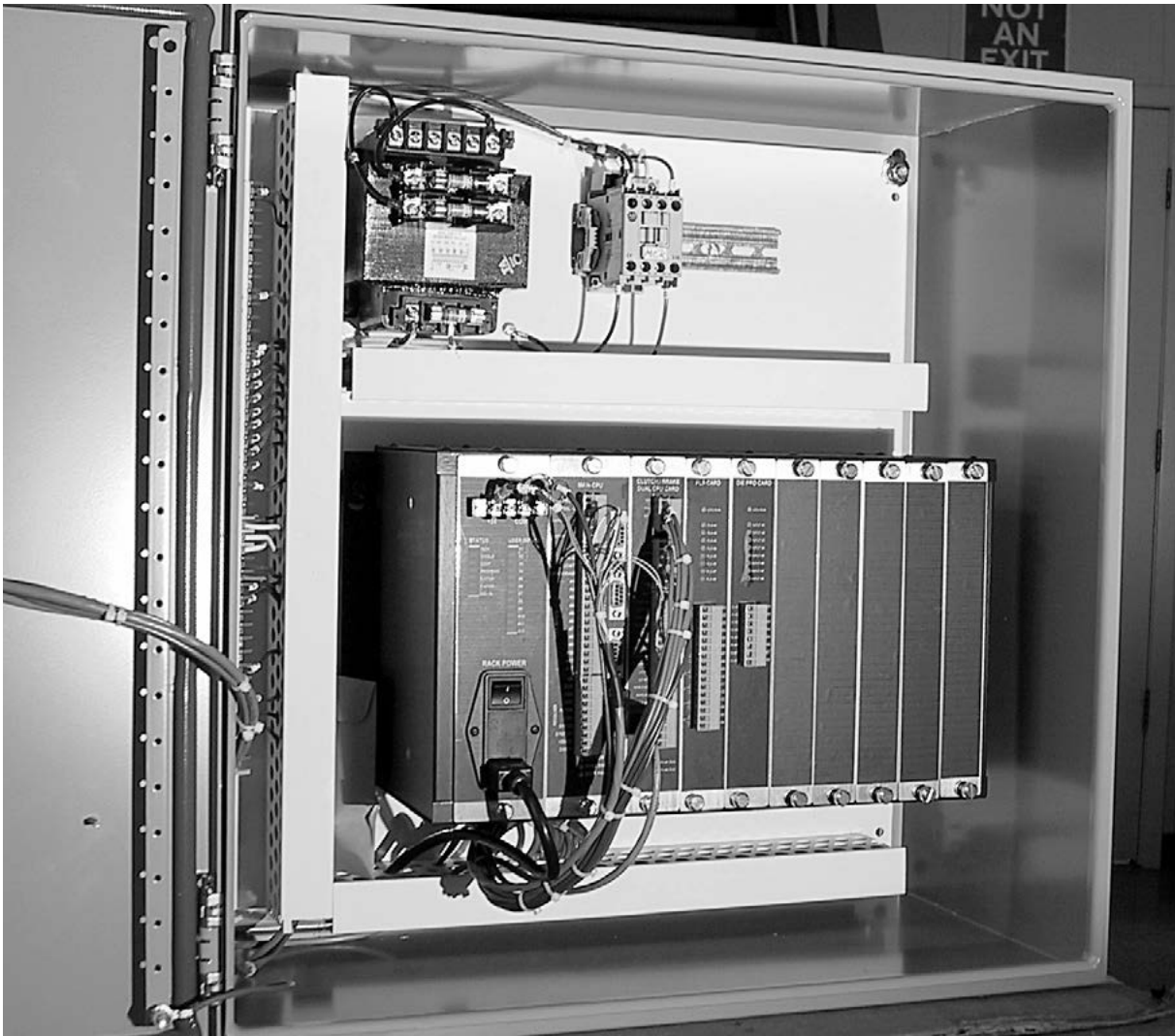

**IMPORTANT: PLEASE REVIEW THIS ENTIRE PUBLICATION
BEFORE INSTALLING, OPERATING, OR MAINTAINING THE
PRESS AUTOMATION CONTROL SYSTEM.**

TABLE OF CONTENTS

SSC-3000 Press Automation Control System

SECTION 1—IN GENERAL	3-5
SECTION 2—INTRODUCTION	6-12
SECTION 3—INSTALLATION OF COMPONENTS	13-58
Introduction	13
Literature Folder	13-15
Control Box	15-16
Main Control Rack	16
Expandable Options	17-39
Remote Operator Station	40
Control Rack Kit	40
Touchscreen/Display Kit	40
Touchscreen/Display Assembly	41
Crankshaft Angle Display	42
Resolver/Pulser Assembly	43-44
Sprocket Assembly	45
Roller Chain	45
Monitored Dual-Solenoid Air Valve	46
Filter-Regulator-Lubricator (FRL) Assembly.....	46
Air Pressure Switch	47
Check Valve for Counterbalance System	47
Palm Button Assembly	47-54
Foot Switch	55
Supervisory Control Station	56
Multiple-Operator Junction Box	56
Bar/Run Station.....	56
Other Components	57-60
Other Installation Considerations	60-62
SECTION 4—PROGRAMMING	63-117
User Inputs.....	68-69
Brake Monitor	69-71
Job Setups.....	72-77
Counters	78-79
System Setup.....	80-82
User-Defined Messages	83
Angle Settings	84-85
Timed Settings	86-87
Optional Modes	88-90
Variable-Speed Top Stop Settings.....	91
Part-in-Place.....	92
PLS Outputs.....	93
Die Protection Inputs	94-95
Air Monitor.....	96-97
Load Monitor System.....	98-99
Servo Feed.....	100-103
Shut Height Controller.....	104-106
Network.....	107-113
Password Control	114-115
Quick Reference Table—Factory Settings and Valid Ranges.....	116-117
SECTION 5—WAKE-UP AND GENERAL FAULT MESSAGES	118-122
SECTION 6—OPERATING CONSIDERATIONS	123-124
SECTION 7—MAINTENANCE AND INSPECTION	125-126
SECTION 8—REPLACEMENT PROCEDURES	127-128
SECTION 9—METHODS OF SAFEGUARDING	129-130
SECTION 10—RETURN MATERIALS REQUEST FORM	131
SECTION 11—ORDER FORM FOR SIGNS AND LITERATURE	132

© 2019 Rockford Systems, LLC. All rights reserved. Not to be reproduced in whole or in part without written permission. Litho in U.S.A.

Safety Precautions

DANGER

DANGER indicates an imminently hazardous situation which, if not avoided, will result in death or serious injury.



This safety alert symbol identifies important safety messages in this manual. When you see this symbol, be alert to the possibility of personal injury, and carefully read the message that follows.

CAUTION

CAUTION used without the safety alert symbol indicates a potentially hazardous situation which, if not avoided, may result in property damage.

Efficient and safe machine operation depends on the development, implementation and enforcement of a safety program. This program requires, among other things, the proper selection of point-of-operation guards and safety devices for each particular job or operation and a thorough safety training program for all machine personnel. This program should include instruction on the proper operation of the machine, instruction on the point-of-operation guards and safety devices on the machine, and a regularly scheduled inspection and maintenance program.

Rules and procedures covering each aspect of your safety program should be developed and published both in an operator's safety manual, as well as in prominent places throughout the plant and on each machine. Some rules or instructions which must be conveyed to your personnel and incorporated in to your program include:

DANGER

Never place your hands or any part of your body in this machine.



Never operate this machine without proper eye, face and body protection.



Never operate this machine unless you are fully trained and instructed and unless you have read the instruction manual.



Never operate this machine if it is not working properly—stop operating it and advise your supervisor immediately.



Never use a foot switch to operate this machine unless a point-of-operation guard or device is provided and properly maintained.



Never operate this machine unless two-hand trip, two-hand control or presence- sensing device is installed at the proper safety distance. Consult your supervisor if you have any questions regarding the proper safety distance.



Never tamper with, rewire or bypass any control or component on this machine.

A company's safety program must involve everyone in the company, from top management to operators, since only as a group can any operational problems be identified and resolved. It is everyone's responsibility to implement and communicate the information and material contained in catalogs and instruction manuals to all persons involved in machine operation. If a language barrier or insufficient education would prevent a person from reading and understanding various literature available, it should be translated, read or interpreted to the person, with assurance that it is understood.



FOR MAINTENANCE AND INSPECTION ALWAYS REFER TO THE OEM'S (ORIGINAL EQUIPMENT MANUFACTURER'S) MAINTENANCE MANUAL OR OWNER'S MANUAL. If you do not have an owner's manual, please contact the original equipment manufacturer.

SECTION 1—IN GENERAL

SSC-3000 Press Automation Control System

Safety References

OSH ACT AND FEDERAL REGULATIONS

Since the enclosed equipment can never overcome a mechanical deficiency, defect or malfunction in the machine itself, OSHA (Occupational Safety and Health Administration) has established certain safety regulations that the employers (users) must comply with so that the machines used in their plants, factories or facilities are thoroughly inspected and are in first-class operating condition before any of the enclosed equipment is installed.

1. U.S. Government—An Act—Public Law 91-596, 91st Congress, S. 2193, December 29, 1970:

Duties

SEC. 5. (a) Each employer—

(1) shall furnish to each of his employees employment and a place of employment which are free from recognized hazards that are causing or are likely to cause death or serious physical harm to his employees;

(2) shall comply with occupational safety and health standards promulgated under this Act.

(b) Each employee shall comply with occupational safety and health standards and all rules, regulations, and orders issued pursuant to this Act which are applicable to his own actions and conduct.

2. OSHA 29 CFR Sections that an employer (user) must comply with include:

1910.211 Definitions.

1910.212 General requirements for all machines.

1910.217 Mechanical power presses.

1910.219 Mechanical power-transmission apparatus.

3. OSHA 29 CFR 1910.147 The control of hazardous energy (lockout/tagout).

4. OSHA Publication

“General Industry Safety and Health Regulations Part 1910,” Code of Federal Regulations, Subpart O

This publication can be obtained by contacting:

Superintendent of Documents
U.S. Government Printing Office
P.O. Box 371954
Pittsburgh, PA 15250-7954
Phone: (202) 512-1800
Fax: (202) 512-2250
www.gpo.gov

ANSI SAFETY STANDARDS FOR MACHINES

The most complete safety standards for machine tools are published in the ANSI (American National Standards Institute) B11 series. The following is a list of each ANSI B11 Standard available at the printing of this publication.

B11.1	Mechanical Power Presses
B11.2	Hydraulic Power Presses
B11.3	Power Press Brakes
B11.4	Shears
B11.5	Iron Workers
B11.6	Manual Turning Machines (Lathes)
B11.7	Cold Headers and Cold Formers
B11.8	Milling, Drilling, and Boring Machines
B11.9	Grinding Machines
B11.10	Metal Sawing Machines
B11.11	Gear and Spline Cutting Machines
B11.12	Roll Forming and Roll Bending Machines
B11.13	Automatic Screw/Bar and Chucking Machines
B11.14	Coil Slitting Machines/Systems
B11.15	Pipe, Tube and Shape Bending Machines
B11.16	Metal Powder Compacting Presses (Withdrawn)
B11.17	Horizontal Hydraulic Extrusion Presses
B11.18	Coil Processing Systems
B11.19	Performance Criteria for Safeguarding
B11.20	Safety Requirements for Manufacturing Systems/Cells
B11.21	Lasers
B11.22	CNC Turning Machines
B11.23	Machining Centers
B11.24	Transfer Machines
B11.TR1	Ergonomics
B11.TR2	Mist Control
B11.TR3	Risk Assessment
R15.06	Robotic Safeguarding

These standards can be purchased by contacting:

American National Standards Institute
25 West 43rd Street
New York, New York 10036
Phone: (212) 642-4900
Fax: (212) 398-0023
www.ansi.org

OR

AMT—The Association for Manufacturing Technology
7901 Westpark Drive
McLean, Virginia 22102
Phone: (703) 893-2900
Toll-Free: 1-800-524-0475
Fax: (703) 893-1151
E-Mail: AMT@amtonline.org
www.amtonline.org

(Continued on next page.)

Rockford Systems, LLC
Call: 1-800-922-7533

NATIONAL SAFETY COUNCIL SAFETY MANUALS

Other good references for safety on machine tools are the National Safety Council's Safety Manuals. These manuals are written by various committees including the Power Press, Forging and Fabricating Executive Committee. Copies of the following publications are available from their library:

- Power Press Safety Manual - 5th Edition
- Safeguarding Concepts Illustrated - 7th Edition
- Forging Safety Manual

These manuals and can be obtained by contacting:

National Safety Council
1121 Spring Lake Drive
Itasca, IL 60143-3201
1-800-621-7619 ext. 2199
Fax: (630) 285-0797
www.nsc.org

OTHER SAFETY SOURCES

National Institute of Occupational Safety and Health (NIOSH)
4676 Columbia Parkway
Cincinnati, OH 45226
Toll-Free: 1-800-35-NIOSH (1-800-356-4674)
Phone: (513) 533-8328
Fax: (513) 533-8573
www.cdc.gov/niosh

OTHER SAFETY SOURCES (continued)

Robotic Industries Association (RIA)
900 Victors Way, Suite 140
P.O. Box 3724
Ann Arbor, MI 48106
Phone: (734) 994-6088
Fax: (734) 994-3338
www.roboticonline.com

NEMA (National Electrical Manufacturers Association)
1300 North 17th Street, Suite 1847
Rosslyn, VA 22209
Phone: (703) 841-3200
Fax: (703) 841-5900
www.nema.org

NFPA (National Fire Protection Association)
1 Batterymarch Park
Quincy, MA 02269-9101
Phone: (617) 770-3000
Fax: (617) 770-0700
www.nfpa.org

For additional safety information and assistance in devising, implementing or revising your safety program, please contact the machine manufacturer, your state and local safety councils, insurance carriers, national trade associations and your state's occupational safety and health administration.

Warranty, Disclaimer and Limitation of Liability

WARRANTY

Rockford Systems, LLC warrants that this product will be free from defects in material and workmanship for a period of 12 months from the date of shipment thereof. ROCKFORD SYSTEMS LLC'S OBLIGATION UNDER THIS WARRANTY IS EXPRESSLY AND EXCLUSIVELY LIMITED to repairing or replacing such products which are returned to it within the warranty period with shipping charges prepaid and which will be disclosed as defective upon examination by Rockford Systems, LLC. This warranty will not apply to any product which will have been subject to misuse, negligence, accident, restriction and use not in accordance with Rockford Systems, LLC's instructions or which will have been altered or repaired by persons other than the authorized agent or employees of Rockford Systems, LLC. Rockford Systems, LLC's warranties as to any component part is expressly limited to that of the manufacturer of the component part.

DISCLAIMER

The foregoing Warranty is made in lieu of all other warranties, expressed or implied, and of all other liabilities and obligations on the part of Rockford Systems, LLC, including any liability for negligence, strict liability, or otherwise, and any implied warranty of merchantability or fitness for a particular purpose is expressly disclaimed.

LIMITATION OF LIABILITY

Under no circumstances, including any claim of negligence, strict liability, or otherwise, shall Rockford Systems, LLC be liable for any incidental or consequential damages, or any loss or damage resulting from a defect in the product of Rockford Systems, LLC.

SECTION 2—INTRODUCTION

SSC-3000 Press Automation Control System

Press Components Identification

Part-Revolution OBI Press

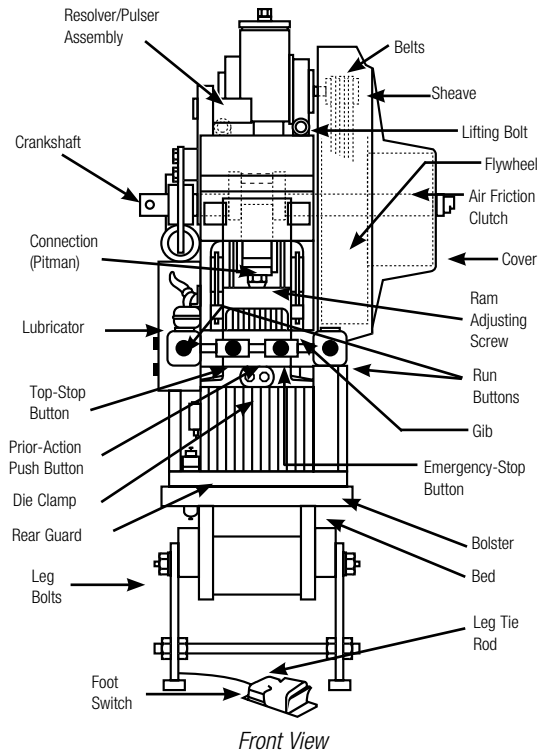
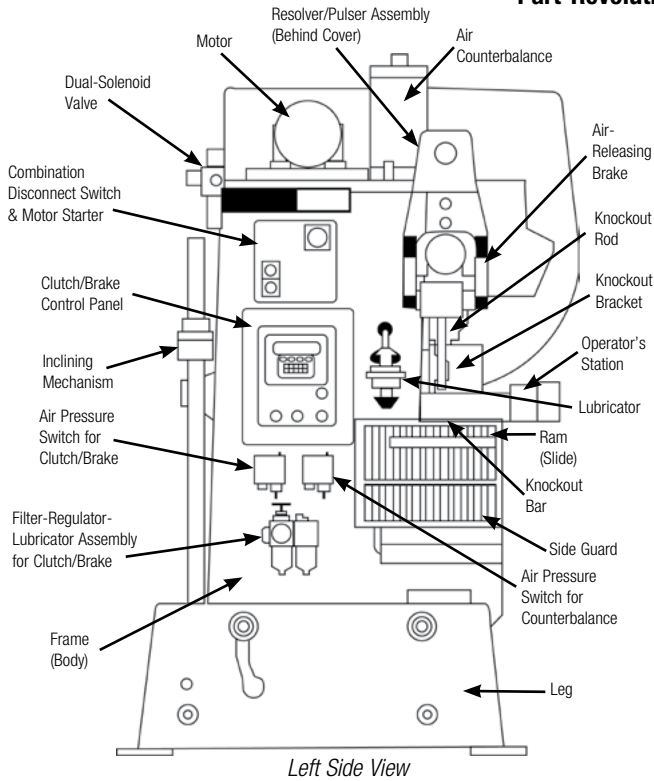

Part-Revolution Straight-Side Press

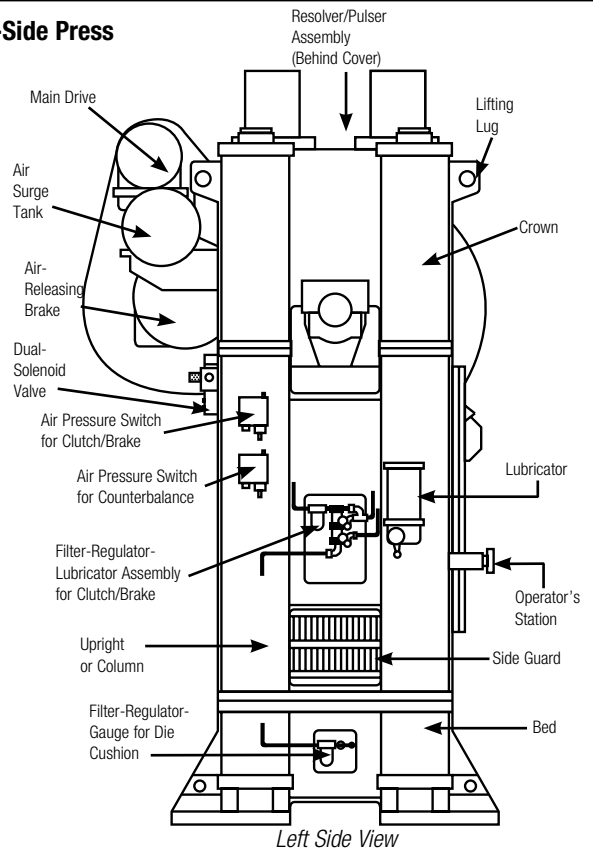
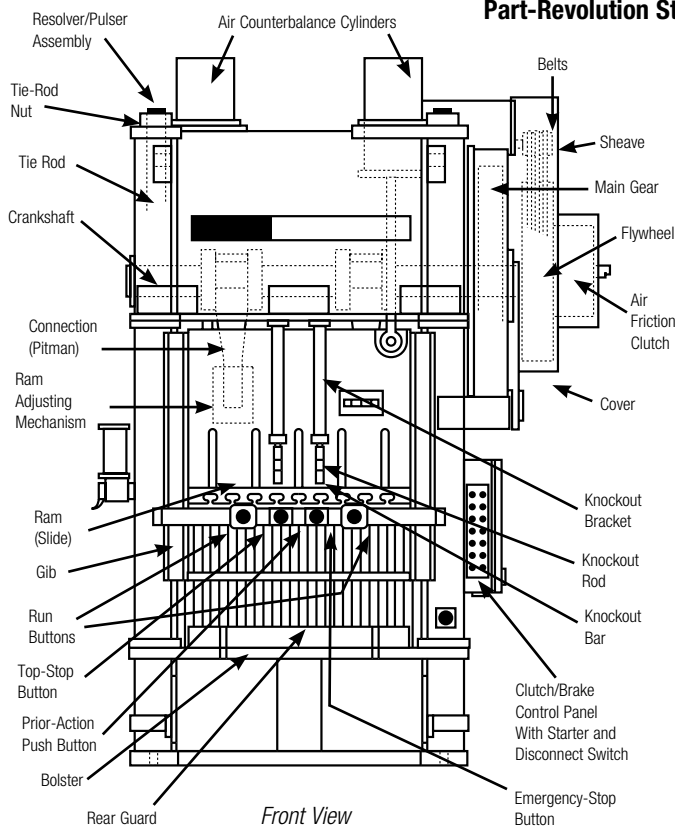

General Description of Components in the System

A complete control package for part-revolution-clutch machines includes the following:

1. Literature folder (see pages 13-14) containing installation manuals, Operator Safety Precautions sign, danger sign(s), electrical control schematics, and a *Mechanical Power Press Safety* booklet
2. Control box—a standard (custom or special may include motor controls and/or disconnect switch) with danger and warning signs attached

Expandable Options

- Resolver/Pulser Assembly
 - Dual CPU Press Clutch/Brake Control Card
 - 8-Output PLS (programmable limit switch) Card (two cards max.—16 inputs)
 - 8-Input Die Protection Card (three cards max.—24 inputs)
 - 4-Input Load Monitor Card (two cards max.—8 inputs)
 - 4-Zone Air Monitor Station
 - 10BaseT Ethernet Network
 - Shut-Height Control Card
3. Monitored dual-solenoid air valve
 4. Filter-regulator-lubricator (FRL) assembly including connector and mounting bracket
 5. Air pressure switch (two required if machine has air counterbalance)
 6. Check valve for counterbalance system (if required)
 7. Resolver/pulser assembly, spring base, and 40' cable
 8. Sprocket set to drive resolver/pulser assembly
 9. Chain (10 feet with master link)
 10. Palm button assembly (Includes two black palm buttons, two palm button guards, one red emergency-stop button, and mounting boxes. When the *Continuous* mode of operation is required, one yellow top-stop button with mounting box is furnished.) If multiple operator stations are on a machine, more than one assembly is furnished.
 11. Foot switch (optional)—If multiple operator stations are on a machine, more than one foot switch is furnished.
 12. Supervisory control station (Required when multiple operator stations are used on the machine; one station is required for each operator.)
 13. Multiple-operator junction box (When multiple operator stations are required, this junction box is furnished separately for wiring up to four operator stations.)
 14. Other required components and safeguarding that may be necessary for the machine (See packing list for details.)

Individual packages may vary in contents. However, a packing list is always enclosed showing exactly what material was shipped on this order. Please check the components actually received against this packing list immediately. In most cases, this control package system includes two-hand control which can be used as a point-of-operation safeguarding device provided the palm buttons are mounted correctly and at the proper safety distance (see formulas on pages 49 and 50 of this manual). If the optional foot switch is provided, a safeguard must always be used. Examples of safeguards include barrier guards, presence-sensing devices, pullbacks, restraints, gates, or two-hand control. The hands or any other part of the body of an operator, maintenance person, setup person, etc., must never be put into the point-of-operation hazard for any reason, at any time.



This control can neither cure nor overcome a malfunctioning machine. It cannot compensate for or prevent a mechanical defect or failure of a machine part. This control cannot prevent a repeat or unintended stroke (cycle) resulting from a mechanical malfunction, defect or failure of the machine itself.

SECTION 2—INTRODUCTION

SSC-3000 Press Automation Control System

Preliminary Steps Before Installation

Before proceeding with the installation of the enclosed equipment, you should undertake the following preliminary steps.

1. Read and make sure you understand this entire installation manual.
2. Refer to the front cover, other line drawings and photos, then make a sketch of your installation to plan the location of the enclosed equipment on the machine.
3. This may be an opportunity to strip down the entire machine by removing all components, piping, wire, etc. Clean, paint and check the entire mechanical condition of the machine, including the clutch and brake, for proper adjustment and required replacement parts before proceeding with the installation of the furnished equipment.
4. **Please make sure the machine is in first-class condition.** Before starting any installation, it is essential that the machine is thoroughly inspected. Be sure all mechanical components and all collateral equipment are in first-class operating condition. Your inspection should be done according to the machine manufacturer's installation and maintenance instruction manual. Special attention must be given to the machine clutch and brake. The clutch and brake must be maintained in an operating condition which is within the specifications set by the machine manufacturer. If you have any doubts or questions concerning the condition of the machine, contact the machine manufacturer for assistance. **Repair or replace all parts not operating properly before proceeding.**



Inspection and maintenance programs must be established and implemented to keep machines in first-class condition. Safety programs must include thorough inspections of each machine on a weekly basis and records kept of these inspections. Any part of the machine that is worn, damaged or is not operating properly must be replaced immediately or repaired before the machine is used.

5. Verify that the machine is in first-class condition and operating properly; shut off all power to the machine. Padlock all electrical and pneumatic energy in the off position and do not actuate the machine again until the installation of all package components has been completed. Lockout/tagout energy isolation procedures must always be practiced and enforced.
6. If the machine has a mechanical-friction clutch (usually found on older presses), an air cylinder is required to engage and disengage the clutch. Install the air cylinder in the most logical place to actuate the clutch. Please see the enclosed Installation Manual No. KSL-096 if an air cylinder was ordered.
Note: On machines equipped with air-operated friction clutches, an air cylinder is not required.

Safeguard Interlocks and Other Types of Interlocks

SAFEGUARD INTERLOCKS

The machine will not operate or must not be operated until you either: (1) electrically interlock or (2) mechanically safeguard the machine's point of operation with a guard or device.

When an electrically interlocked method of safeguarding the point of operation is chosen, connect the interlock to the **safeguard interlock** terminals (P4-14 and P4-15) in the control box, and as shown on the control wiring schematic (wire numbers 90 and 91). If a light curtain(s) is used as the point-of-operation safeguard, it does not need to be interlocked in to P4-14 and P4-15 safeguard interlock terminals. Refer to the control wiring schematic for proper terminal connection of the light curtain.

Point-of-operation electrically interlocked safeguards, when opened, prevent or stop normal machine operation during operator cycling modes. Examples of these types of interlocks are barrier guard interlocks and gate device interlocks.

When a mechanical guard or device (nonelectrically interlocked) is chosen, the safeguard interlock terminals (P4-14 and P4-15) are not used. In order for the machine to operate with the use of a mechanical guard or device, the safeguard interlock terminals must be connected. Please see the wiring schematic.



The mechanical guard or device must be properly installed, used and maintained and must always prevent all personnel from bodily injury.

(Continued on next page.)

Rockford Systems, LLC
Call: 1-800-922-7533

Safeguard Interlocks and Other Types of Interlocks (continued)



If the mechanical guard or device is not used, is removed, or is defeated, an electrically interlocked method of safeguarding must be used and connected to the safeguard interlock terminals (P4-14 and P4-15).



Never operate this machine without point-of-operation safeguarding.

Note: Additional equipment that can help safeguard machines includes indexing tables, electrically controlled sliding bolsters, and automatic feeding systems. These systems usually require additional control logic circuitry. Please contact the factory for a quotation itemizing the interface equipment necessary for these types of systems as well as others (see page 57). Please send complete schematics, including the hydraulic and pneumatic systems, of the particular system to be interfaced.

OTHER ELECTRICAL INTERLOCKS

There are basically two types of electrical interlocks as applied to machine control circuitry:

- Interlocks for the purpose of personnel protection, as explained on page 8.
- Interlocks intended for the purpose of protecting the machine and its control components.

There are other locations for interlocks that, when opened, prevent all machine functions. Examples of these types of interlocks are safety block electrical cut-off systems, lubricating systems, die protection equipment, and tonnage monitoring systems.

Be sure to connect the various electrical interlocks to the proper terminals, in the control box, according to the machine wiring schematics. If your schematics do not include these electrical interlocks, please send this information to the factory and they can be added to your drawings. There is an additional charge for this service.

SSC-3000 Press Automation Control Box

The SSC-3000 press automation control is designed for use on part-revolution-clutch mechanical power presses. The SSC-3000 is a modular system with expandable options. These expandable options allow you to change or add features as your requirements change. If additional features are required, plug-in cards and/or additional equipment can be added.

The basic control is furnished in a 24" W x 24" H x 12" D NEMA 12 enclosure. It can also be furnished in larger custom enclosures, special enclosures, or in kit form. The control is designed with a modular rack so plug-in cards can be added or changed quickly and easily. This means the automation features can be tailored to your press requirements.

An absolute resolver/pulsar timing device is required to provide the angular position and velocity/motion information of the machine crankshaft to the control. Each plug-in card is designed to monitor and verify the position of the resolver.

The touchscreen/display—located on the remote operator station or special enclosure—is used to enter setup information and to monitor machine operation. Press information and messages are also displayed on the touchscreen. An optional color display may have been furnished with your order.

General Features of the SSC-3000 Control

- NEMA 12 Enclosure (24" x 24" x 12")
- 320 x 240 Monochrome Touchscreen/Display (Color display is optional.)
- Keyed Program On/Off Selector Switch
- Modular Rack Design
- Main CPU Card
- Resolver Based
- Time-Based Brake Monitor
- Stop-Time Measurement (STM) Test
- 12 User-Programmable Diagnostic Inputs
- Top-Stop and Emergency-Stop Relay Outputs
- Eight-Digit Stroke, Batch, and Part Counters With Presets
- Total Counter With Security Code Protection
- 100 Job Memory

(Continued on next page.)

SECTION 2—INTRODUCTION

SSC-3000 Press Automation Control System

EXPANDABLE OPTIONS

DUAL CPU PRESS CLUTCH/BRAKE CONTROL CARD

- Active-Redundant Dual Microprocessor
- Triple-Redundant Solid-State Outputs
- Resolver Based
- Modes of Operation:
 - Two-hand inch (regular, timed, or top-stop)
 - Two-hand single stroke
 - Foot-switch single stroke
 - Two-hand “walk-away” continuous
 - Foot-maintained continuous
 - Hand-maintained continuous
 - Automatic single stroke for feed or robot-controlled operation
 - Continuous-on-demand
 - One-hand/foot trip single stroke
- Interface for Light Curtains
- Multiple Vendor Light Curtain Support
- Part-in-Place Die Protection Input

8-OUTPUT PLS CARD

- Form “A” Contact Relay Outputs
- Depluggable Terminal Strips
- Programmable On and Off Angle
- Timed Off Setting
- Counter for Counted Output
- Settings Stored in Job Memory

8-INPUT DIE PROTECTION CARD

- Eight (8) 24-V DC Inputs
- Individual Jumper Selection for Sinking (NPN) or Sourcing (PNP) Inputs
- Depluggable Terminal Strips
- NO or NC Logic
- Emergency-Stop or Top-Stop Fault Choices
- Programmable On and Off Angle
- Programmable Fault Message
- Graphic View for Inputs
- Settings Stored in Job Memory

DIE SENSOR BLOCK

- Four-Port or Eight-Port Receptacle

SHUT HEIGHT CONTROLLER CARD

- Single-Ram or Dual-Ram Shut Height
- Utilizes a Linear Displacement Transducer (LDT) for Accurate Position Sensing of the Ram
- 12”, 24”, 36”, and 48” LDT Rod Lengths
- Provides Absolute Position Data

LOAD MONITOR SYSTEM

Load Monitor Card

- Four (4) 12-Bit Analog Load Cell Inputs
- Tonnage Limits
- Job-Setup Database
- Fault Warning
- Graphic View of Tonnage

Load Monitor Control Module

- Two- or Four-Cell Sensor Kit

REMOTE AIR PRESSURE MONITOR STATION

- NEMA 12 Control Enclosure
- Four (4) Air Pressure Input Ports
- Control Relays
- Fault Warnings
- Graphic View of Air Pressures

10BASET ETHERNET NETWORK

- 10BaseT Ethernet Modem
- Real-Time Data Collection
- Monitor From Anywhere
- Offline Storage
- Graphic View of Press(es)

USER-PROGRAMMABLE FAULT LIST

FAULT MESSAGES FOR USER INPUTS AND DIE PROTECTION

Ten additional messages are available for user customization. An alphanumeric screen is incorporated to allow the user to type a customized message into the control. A screen is also available to view these customized messages.

- | | | |
|-----------------------------|--------------------------|------------------------------|
| • Clutch/Brake Air Fault | • Lube Motor Overload | • Variable Speed Drive Fault |
| • CntrBalance Air Flt | • Aux Motor Overload | • Short Feed Fault** |
| • Dual Solenoid Fault | • Guard Interlock Open | • Part Ejection Fault** |
| • Clutch Valve Fault* | • Front Guard Open | • Stock Buckle Fault** |
| • Brake Valve Fault* | • Rear Guard Open | • End of Stock Fault** |
| • Lube Fault | • Left Side Guard Open | • Pilot Pin Fault** |
| • High Lube Pressure | • Right Side Guard Open | • Part Input #1** |
| • Low Lube Pressure | • Feeder Fault | • Part Input #2** |
| • Low Lube Level | • Load Monitor Fault | • Part Input #3** |
| • Main Motor Overload | • Safety Block Interlock | |
| • Ram Adjust Motor Overload | • Die Protection Fault | |
| | • Shut Height Fault | |

**Only used with machines that have a split clutch and brake, and two dual valves have been furnished*

***Messages typically used for die protection*

Overview of Motion and Settings

The redundant inputs are used by both processors to control the operation of the press. When the actuating means is depressed, and the primary safeguard interlock conditions are met, the processors turn on their appropriate relays (SSR1 and SSR2). The dual-solenoid valve is energized sending air to the clutch and brake. The crankshaft is engaged to the flywheel drive and the brake is released allowing the ram to move. Within the motion reference time window, the microprocessors must see a voltage signal from the DC tachometer in the resolver/pulser unit that represents motion or a motion fault is generated. If the actuating means is released prior to the auto up (holding) angle, the press ram movement will stop. The stroke can be finished by depressing the actuating means again.

For brake monitoring, the control starts a timer when the relays and solenoids are deenergized. This timer stops when the motion from the tachometer in the resolver/pulser has stopped. The stop-time value is then compared to the brake stop-time setpoint. If the stop time exceeds this setting, a BRAKE FAULT message is displayed. The reason for the increased stop time should be investigated and corrected before operating the press again. (See pages 69-71 for programming the brake monitor.)

Sequence of Operation

This sequence of operation applies to all standard modes provided with the plug-in **Dual CPU Press Clutch/Brake Control Card**.

OFF

The press is inoperable in this mode of operation. The **OFF** position cannot be used solely as the lockout/tagout means. To use any of the following modes of operation, turn the mode selector switch from **OFF** to the appropriate position.

TWO-HAND INCH

Two-Hand Inch is a mode of operation in which the ram travels as long as the operator(s) maintains actuation of the palm buttons. Each time the buttons are released, the ram will stop.

If *Timed Inch* is turned on, the clutch will engage and the ram will move only for a set amount of time programmed in to the control, even if the palm buttons are held depressed. See pages 86-87 of this installation manual for *Timed Inch* programming information.

To use *Two-Hand Inch*, the mode selector switch must be set to **INCH**, and the actuating means selector switch must be set to **HAND**.

Top-Stop Inch is similar to normal *Inch*. If *Top-Stop Inch* is turned on, the ram will stop at top every cycle, even if the palm buttons are held depressed. See pages 89-90 of this installation manual for *Top-Stop Inch* programming information.



The *Inch* mode of operation is used for die setup, tool setup, and maintenance only. It is not intended for use during production operations.

TWO-HAND SINGLE STROKE

Two-Hand Single Stroke is a mode of operation in which the ram makes one complete stroke or cycle upon actuation of the palm buttons. The palm buttons must be held depressed until the programmed automatic up (holding) angle is reached. If they are released before this angle is reached, the ram will stop and the buttons will need to be released and then reactivated. The automatic up (holding) angle should be programmed so that the palm buttons are held depressed during the entire die-closing portion of the stroke. Once the ram passes the automatic up (holding) angle, the palm buttons can be released and the ram will automatically return to the top.

To use *Two-Hand Single Stroke*, the mode selector switch must be set to **SINGLE**, and the actuating means selector switch must be set to **HAND**.

(Continued on next page.)

SECTION 2—INTRODUCTION

SSC-3000 Press Automation Control System

Sequence of Operation (continued)

FOOT SINGLE STROKE

Foot Single Stroke is a mode of operation in which the ram makes one complete stroke or cycle upon actuation of the foot switch. The foot switch must be held depressed until the programmed automatic up (holding) angle is reached. If it is released before this angle is reached, the ram will stop and it will need to be released and then reactuated. Once the ram passes the automatic up (holding) angle, the foot switch can be released and the ram will automatically return to the top.

To use *Foot Single Stroke*, the mode selector switch must be set to **SINGLE**, and the actuating means selector switch must be set to **FOOT**.



A point-of-operation safeguard must be used when using this mode of operation.

TWO-HAND “WALK-AWAY” CONTINUOUS

Two-Hand “Walk-Away” Continuous mode allows the press to operate continuously, after initiation, without the operator present. To initiate this mode, press the prior-action push button then depress the palm buttons. The press will run in the continuous mode until the yellow top-stop button or the red emergency-stop button is depressed. The palm buttons must be depressed within five (5) seconds of pressing the prior-action push button. If more than five (5) seconds elapses, the prior-action push button will need to be pressed again before the palm buttons are depressed. Please consult the factory if a prior-action push button is required but was not furnished with the control.

To use *Two-Hand “Walk-Away” Continuous*, the mode selector switch must be set to **CONT**, and the actuating means selector switch must be set to **HAND**.



A point-of-operation safeguard must be used when using this mode of operation.

OPTIONAL MODES

Continuous-on-Demand, Foot-Maintained Continuous, Two-Hand-Maintained Continuous, One-Hand or Foot Trip Single Stroke, Automatic Single Stroke, Inch With Fault, and Inch With Top Stop are optional modes of operation also provided with the plug-in **Dual CPU Press Clutch/Brake Control Card**. These modes of operation are accessed through the optional modes program screen. See pages 88-90 of this installation manual for programming information.

These optional modes (except *One-Hand or Foot Trip Single Stroke, Inch With Fault, and Inch With Top Stop*) require the use of a prior-action push button. Please consult the factory if a prior-action push button is required but was not furnished with the control.



A point-of-operation safeguard must be used when using any of these modes of operation.

(Continued on next page.)

Rockford Systems, LLC
Call: 1-800-922-7533

SECTION 3—INSTALLATION OF COMPONENTS

SSC-3000 Press Automation Control System

Introduction

The following additional materials are required to install the equipment in this shipment.

1. Wire: Size and type will depend on local ordinances or plant practices. We recommend stranded machine tool wire with appropriate color-coding. **Never use solid wire**—the vibration caused by these machines precludes the successful use of solid wire for these installations.
2. Numbered wire markers: Made of suitable material to resist oil, grease, etc., and remain firmly attached to the wire.
3. Conduit: Rigid, liquid-tight flexible, or any other suitable tubular connecting means which complies with local ordinances and provides adequate mechanical protection for the wires. Most of the electrical products supplied have an oil-tight construction.
4. Miscellaneous wiring components such as electrical tape, wire connectors, and terminals, as required.

ILLUSTRATION OF ELECTRICAL SYSTEM ON PART-REVOLUTION-CLUTCH POWER PRESS

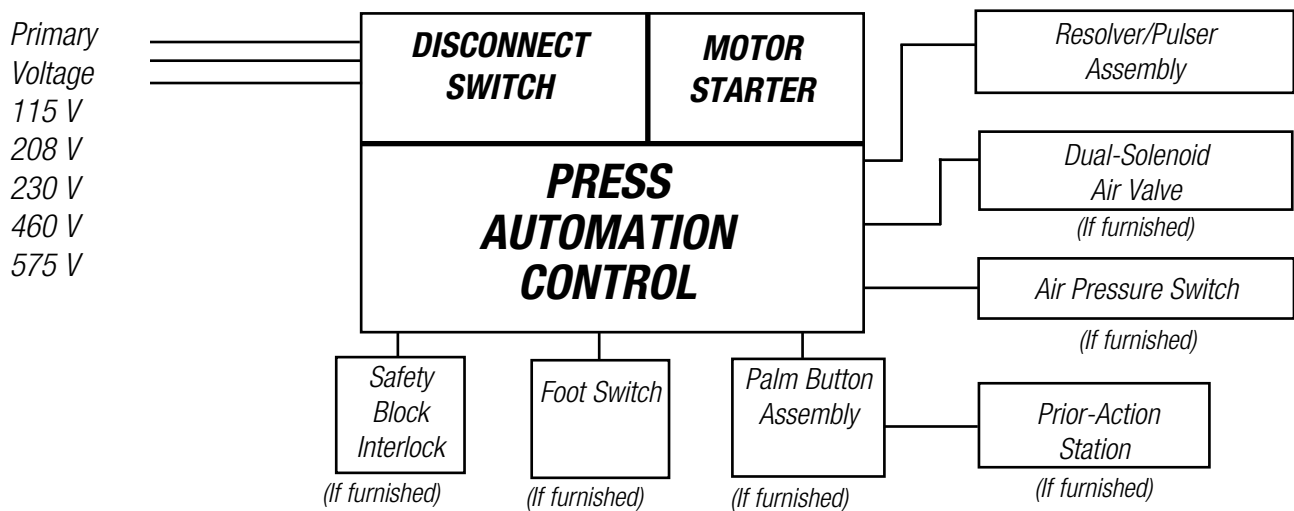

LITERATURE FOLDER

Included with every shipment is a literature folder. This includes installation manuals, Operator Safety Precautions sign (Part No. KSC-000), danger signs, electrical schematics, and a booklet entitled *Mechanical Power Press Safety* (Part No. KSL-051). These publications must be available and fully understood by all appropriate personnel, before any retrofit installation begins. Please notify Rockford Systems immediately if there are any questions about the components received.

MECHANICAL POWER PRESS SAFETY BOOKLET—PART NO. KSL-051

A copy of an MPPS (*Mechanical Power Press Safety*) booklet is enclosed. This booklet is copied verbatim from the CFR (Code of Federal Regulations) and contains all relevant sections of the OSHA standards concerning power presses with which an employer (user) must comply. The enclosed equipment must be installed, used and maintained to meet these standards. Specifically, any time a foot switch is used, a suitable **point-of-operation safeguard or device must be used** to prevent bodily injury. In addition, **every press must be provided with a point-of-operation safeguard!** Please review this booklet and the appropriate ANSI (American National Standards Institute) safety standard before installing the enclosed equipment. If you are unfamiliar with these detailed safety standards, which include standards on safeguarding the point of operation properly, you may want to attend our regularly scheduled machine safeguarding seminar. To obtain detailed information about this training seminar, please call, fax, write, or check our Web site. Our address, telephone, fax number, and Web site address are on the front cover of this manual.

(Continued on next page.)

SECTION 3—INSTALLATION OF COMPONENTS

SSC-3000 Press Automation Control System

OPERATOR SAFETY PRECAUTIONS SIGN

Photo 3.1 - Part No. KSC-000 Operator Safety Precautions Sign



Front



Back

Photo 3.2



Photo 3.3



Photo 3.4



Attachment of Precautions Sign

1. Locate the Operator Safety Precautions sign.
2. Attach the sign to the machine with a nylon tie through the hole provided. See Photo 3.2.



Attach it to the machine where it is readily accessible and visible to the operator. Additional copies of this precaution are available. Please call, write, fax, e-mail or use the order form found on a later page in this manual.



When a language barrier or insufficient education prevents a person from reading or understanding the contents of this pamphlet, you should either translate this information or have it read or interpreted to the person. Make sure the person understands the information. To order this pamphlet in Spanish, use Part No. KSC-000S; in French, use Part No. KSC-000F.



This precaution pamphlet must be reviewed daily.

DANGER SIGNS

1. Locate the furnished danger sign(s).
2. Determine the mounting location for the danger sign(s) on the machine.



It must be permanently mounted in a prominent location on the machine where it is readily accessible and visible to the operator setup person, or other personnel who work on or around this machine.

3. Drill a hole(s) in the sign and the machine at the mounting location. See Photo 3.3.
4. Attach the sign(s) to the machine with screws or rivets. See Photo 3.4.



Never operate this machine unless the danger sign(s) is in place. Also make sure the sign(s) is read and understood before operating the machine.

(Continued on next page.)

Rockford Systems, LLC
Call: 1-800-922-7533

SECTION 3—INSTALLATION OF COMPONENTS

SSC-3000 Press Automation Control System

Figure 3.1 - Illustration of the Placement of the Operator Safety Precautions Sign and Danger Signs

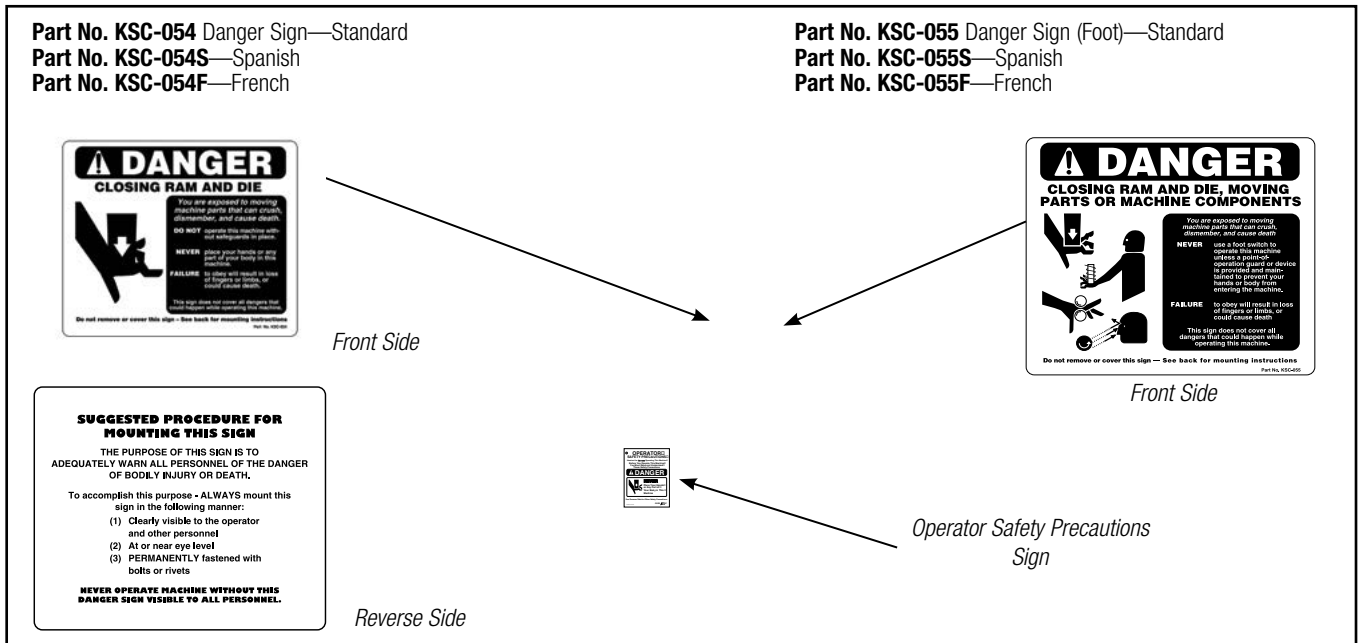

Control Box

DANGER AND WARNING LABELS PROVIDED

The illustrated danger and warning labels are affixed to all control boxes provided. All personnel operating or working around the machine, where this control box is installed, must be required to read, understand and adhere to all dangers and warnings. If any of these labels become destroyed or unreadable, they MUST be replaced. Contact the factory immediately for replacement labels and do not operate the equipment until danger and warning labels are all in place.

Photo 3.5
 SSC-3000 Standard Control Box
 Inside and Outside View

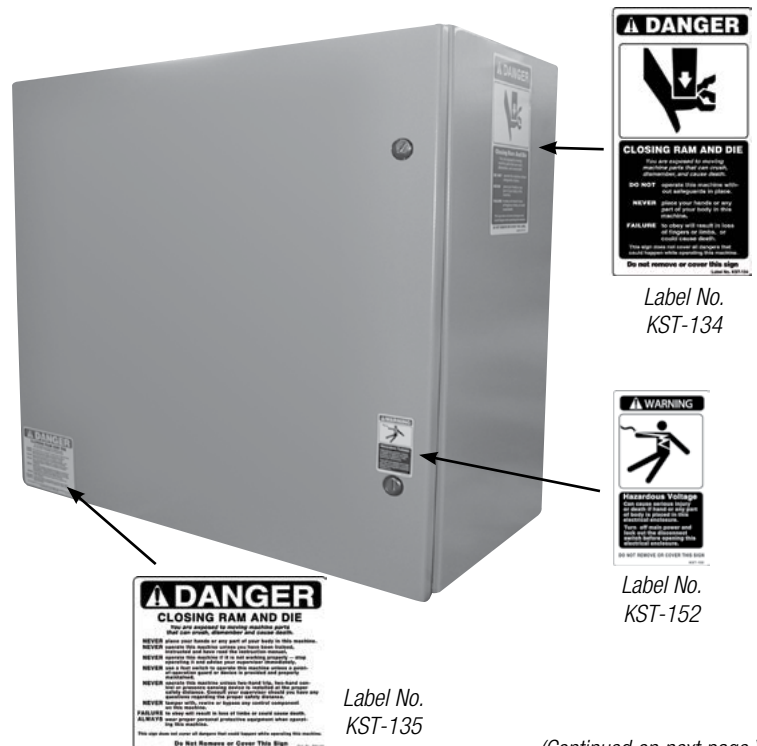
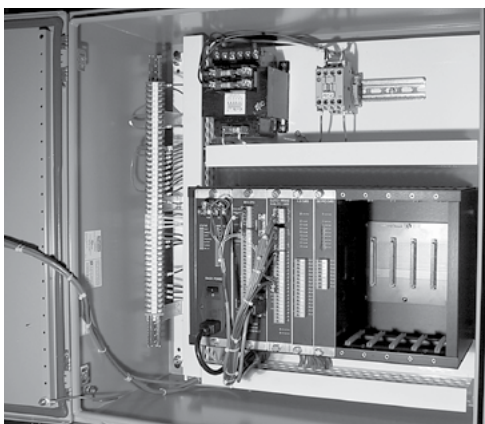

(Continued on next page.)

SECTION 3—INSTALLATION OF COMPONENTS

SSC-3000 Press Automation Control System

Control Box (continued)

As standard, the basic SSC-3000 solid-state press automation control consists of the main control rack with power supply, and the **Main CPU Card**. The plug-in cards and additional equipment furnished with this order were based on the desired features for the machine. Please refer to the descriptions in this manual and the electrical control diagrams provided with this manual for details.

MAIN CONTROL RACK

The control is designed with a modular rack so plug-in cards can be added or changed to meet press requirements. The solid-state main control rack, FSL-030 (see Photo 3.6), measures 17 $\frac{1}{2}$ "W x 9 $\frac{3}{8}$ "H x 7"D. It is mounted to the panel with four shock/vibration mounts and four $\frac{1}{4}$ -20 x $\frac{3}{8}$ " Allen-head bolts. The module case has four keyhole mounting slots that allow for easy removal without removing the Allen-head mounting bolts if replacement is required. To remove the module from the shock/vibration mounts, turn power off to the control. Remove all terminal strips from the individual cards in the rack. Loosen the four Allen-head bolts and lift up on the module. Pull the unit straight out.

There are red and green LEDs (light emitting diodes) that allow for visual indication of control operation and the status of inputs and outputs. All LED names are indicated on the cover of the Main CPU (central processing unit) module to the right of each LED. See the photo below. The one green power and two red status LEDs provide indication of proper operation and logic power to both CPUs.

MAIN CPU CARD—PART NO. FTL-300

The SSC-3000 press automation control **Main CPU Card** provides all the main processing for the base automation system as well as providing the following:

- Generates and distributes resolver data to all cards on the rack
- Controls all job and optional system programming via the touchscreen
- Communicates and provides job setup information to all optional cards in the rack
- Communicates via serial data communications to external systems including:
 - Touchscreen operator interface
 - Optional 4-zone air monitor and control system
 - Servo feed controller (multiple vendor)
 - Ethernet network using an Ethernet modem

Photo 3.6
Main Control Rack With Plug-in Cards

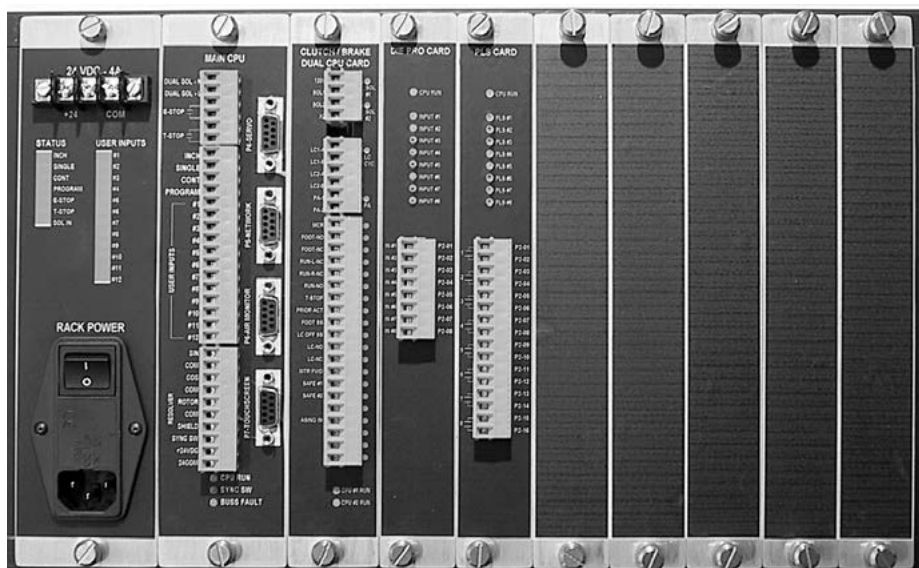

SECTION 3—INSTALLATION OF COMPONENTS

SSC-3000 Press Automation Control System

EXPANDABLE OPTIONS

DUAL CPU PRESS CLUTCH/BRAKE CONTROL CARD

The SSC-3000 press automation control can be configured with a **Dual CPU Press Clutch/Brake Control Card** for a mechanical power press. It is designed to comply with the **ANSI B11.1, B11.19,** and **OSHA 1910.217** standards. This is accomplished by a redundant cross-checking, active dual-microprocessor control system. The system uses redundant inputs from devices such as palm buttons, foot switches, and light curtain(s). The system output to the solenoid valve(s) is provided by triple-redundant solid-state outputs. These primary safety output relays are independently controlled and cross-checked by the microprocessors. This allows control-reliable operation of the outputs in the event of a single control component failure. Each microprocessor also has its own logic power supply. This decreases the possibility of simultaneous control failure because of a fault within the power supply system. All inputs and outputs are optically isolated for electrical noise immunity. Angular position of the crankshaft is provided by a single absolute resolver while a photo switch, mounted in the resolver, provides a synchronous signal which verifies the angular position. The operator provides setup information through the use of a remote operator station with a touchscreen display.

Photo 3.7



8-OUTPUT PLS CARD—PART NO. FTL-304

The SSC-3000 press automation control can be configured with a PLS (programmable limit switch) **8-Output PLS Card**. This card is designed to provide user-programmable outputs that can be used to sequence events during the press stroke. Up to two **8-Output PLS Cards** can be used for a total of 16 outputs. For programming the **PLS Card**, see page 93 in the programming section of this manual.

Photo 3.8

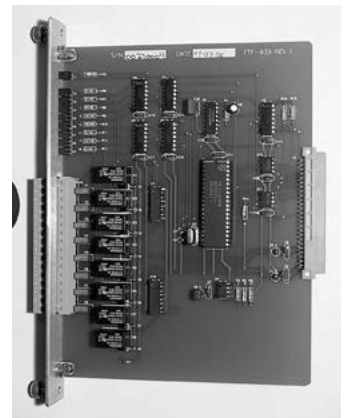

8-INPUT DIE PROTECTION CARD—PART NO. FTL-305

The SSC-3000 press automation control can be configured with a plug-in **8-Input Die Protection Card**. This card is designed to provide user-programmable inputs that can be used to monitor static or cyclic events during the press stroke. Up to three **8-Input Die Protection Cards** can be used for a total of 24 inputs. For programming the **Die Protection Card**, see pages 94-95 in the programming section of this manual.

Photo 3.9



(Continued on next page.)

SECTION 3—INSTALLATION OF COMPONENTS

SSC-3000 Press Automation Control System

EXPANDABLE OPTIONS

DIE SENSOR BLOCK

4-PORT RECEPTACLE BLOCK—PART NO. FYL-067

8-PORT RECEPTACLE BLOCK—PART NO. FYL-068

A die sensor block can provide easy connection of die sensors. It is available as a 4-port receptacle block or an 8-port receptacle block and has a 16½' connection cable. A field connector plugs into a receptacle on the block for each die sensor used. The die sensor block wires into the die protection card and can be wired for either sinking (NPN) or sourcing (PNP).

Photo 3.10

Part No. FYL-068
8-Port Receptacle Block
With Cable

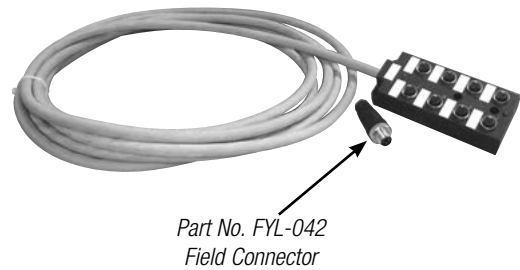

Part No. FYL-042
Field Connector

SHUT HEIGHT CONTROLLER ASSEMBLY

SINGLE-RAM SHUT HEIGHT—PART NO. RYL-084

DUAL-RAM SHUT HEIGHT—PART NO. RYL-085

The shut height controller assembly consists of a **Shut Height Controller Card**, 25' of cable, and mounting bracket assembly. The shut height controller requires a linear displacement transducer (LDT) to provide highly accurate position sensing of the ram (see below).

Photo 3.11

Shut Height
Controller Card

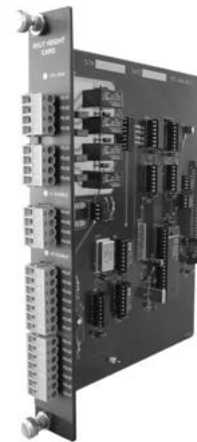

LINEAR DISPLACEMENT TRANSDUCER (LDT) ASSEMBLY

12" MAXIMUM ADJUSTMENT—PART NO. CMT-032

24" MAXIMUM ADJUSTMENT—PART NO. CMT-033

36" MAXIMUM ADJUSTMENT—PART NO. CMT-034

48" MAXIMUM ADJUSTMENT—PART NO. CMT-035

The Gemco Model 952 BlueOx is a magnetostrictive linear displacement transducer (LDT). Each LDT offers highly accurate position sensing. The BlueOx LDT is built to withstand the most severe environmental conditions. The 953 LDTs are completely absolute. Power loss will not cause the unit to lose position information or require rezeroing. Also, the noncontact design allows this device to be used in highly repetitive applications without mechanical wear, and for continuous machine positioning in a variety of industrial applications.

Mounting Bracket
Assembly

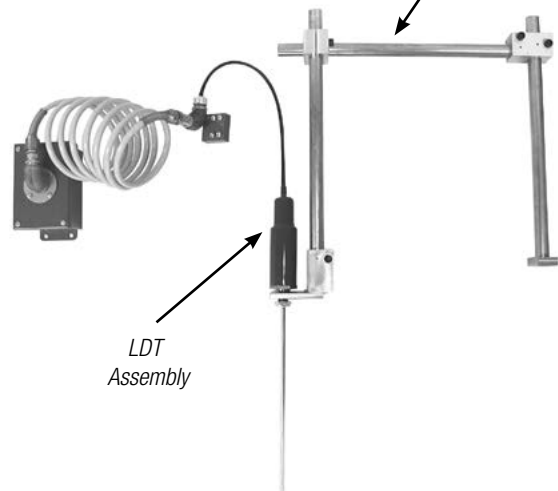

LDT
Assembly

(Continued on next page.)

Rockford Systems, LLC
Call: 1-800-922-7533

EXPANDABLE OPTIONS (continued)

LINEAR DISPLACEMENT TRANSDUCER (LDT) ASSEMBLY (continued)

Installation of the LDT

CAUTION

If a mounting bracket is used that is made of ferromagnetic material (a material readily magnetized), it should be placed no closer than 0.25" from the LDT's rod end.

To minimize the effects of magnetic flux distortion (which could cause an inaccurate measurement of the magnet's position), ferromagnetic material should not be placed closer than 0.25" from the magnet.

Figure 3.2
LDT Dimensions

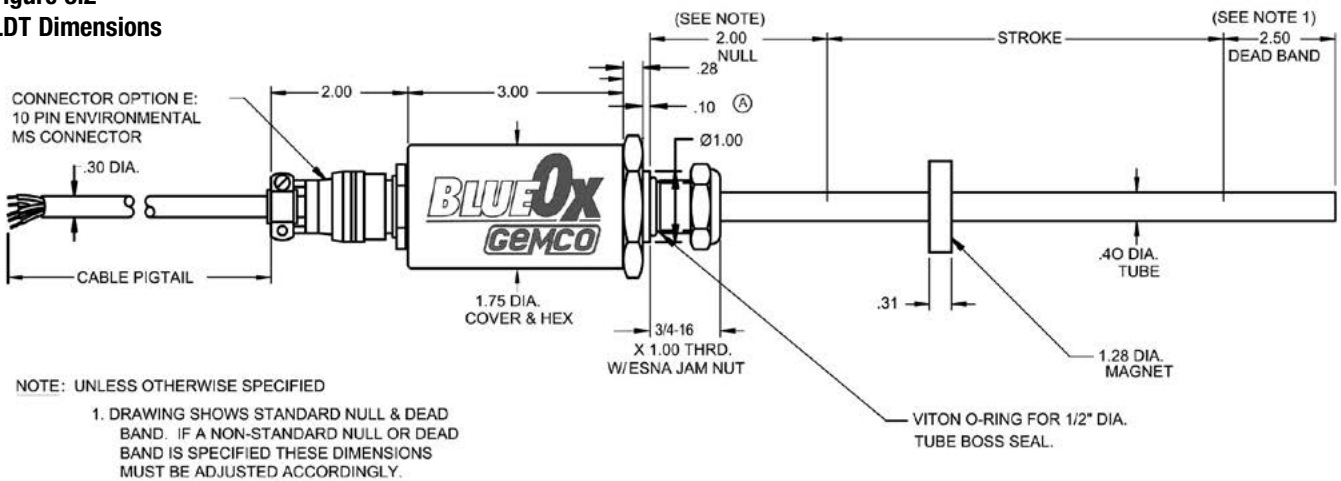

1. Unscrew the LDT's jam nut from the threads protruding from the hex mounting base. See Figure 3.2
2. Insert the LDT's rod end into the mounting bracket's hole. The mounting bracket may contain a 3/4-16 UNF-2B threaded hole. In this case, screw the LDT into this hole using the threads protruding from the hex mounting base.
3. Once the LDT is in place, screw the jam nut back onto the threads of the hex mounting base. Use the 1.75" hex mounting base on the head assembly to tighten the LDT to the bracket.

CAUTION

Do not use the blue aluminum cover of the head assembly or connector/cable nut (either a 1 1/16" Amphenol connector or 13/16" cable nut) to tighten the LDT within the bracket. This may damage the LDT and will void the warranty. To tighten the LDT within the bracket, use the 1.75" hex mounting base on the head assembly.

4. If the support bracket is made of a ferromagnetic material, install the support bracket no closer than 0.25" from where the LDT's dead band ends and the area of stroke begins. Use of the support bracket minimizes operational errors and protects against damage due to shock and vibration.
5. Mount the magnet assembly (see next page).

(Continued on next page.)

SECTION 3—INSTALLATION OF COMPONENTS

SSC-3000 Press Automation Control System

EXPANDABLE OPTIONS (continued)

LINEAR DISPLACEMENT TRANSDUCER (LDT) ASSEMBLY (continued)

Mounting the LDT Magnet Assembly

CAUTION

Ferromagnetic material should not be placed closer than 0.25" from the LDT's magnet assembly or rod end. Failure to do so could cause erratic operations. Nonferrous materials, such as brass, copper, aluminum, nonmagnetic stainless steel, or plastics, can be in direct contact with the magnet assembly and rod end without producing any adverse results.

Minimal clearance between the LDT's rod and the magnet assembly through the full stroke is required. Stress between the magnet and the rod can cause flexing of the mounting brackets. This may appear as nonlinearity.

LDTs using a split magnet assembly must keep the diameter of the magnet assembly around the rod throughout the complete stroke. The diameter of this magnet assembly should not be farther than 0.2" away from the rod. Split magnet assemblies outside this range will cause signal loss.

Figure 3.3
LDT Mounting

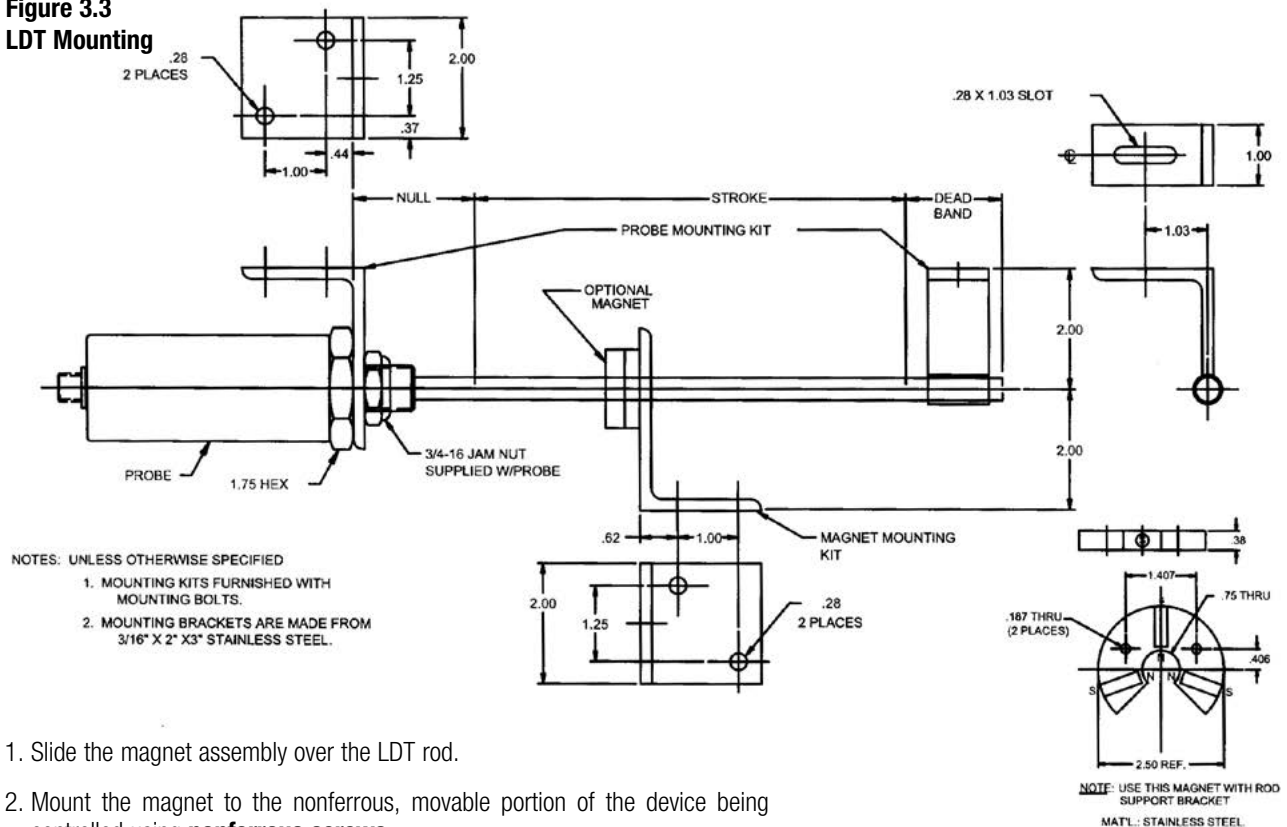

1. Slide the magnet assembly over the LDT rod.
2. Mount the magnet to the nonferrous, movable portion of the device being controlled using **nonferrous screws**.

(Continued on next page.)

Rockford Systems, LLC
Call: 1-800-922-7533

SECTION 3—INSTALLATION OF COMPONENTS

SSC-3000 Press Automation Control System

EXPANDABLE OPTIONS (continued)

LINEAR DISPLACEMENT TRANSDUCER (LDT) ASSEMBLY (continued)

Mounting

Figure 3.4

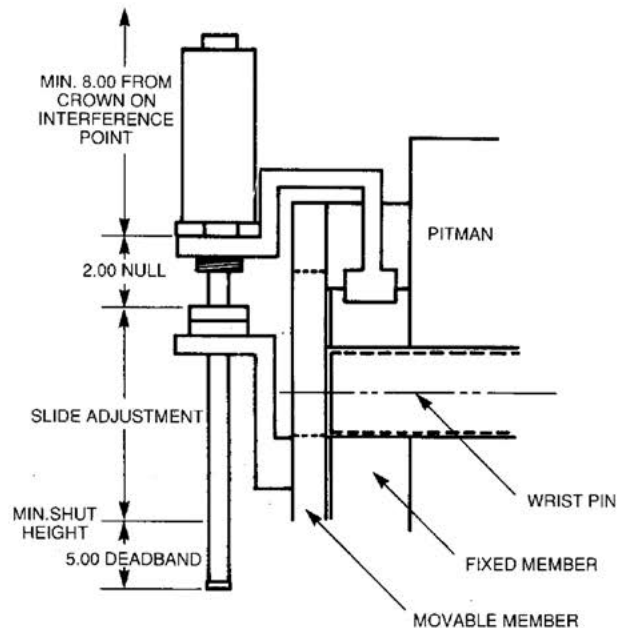
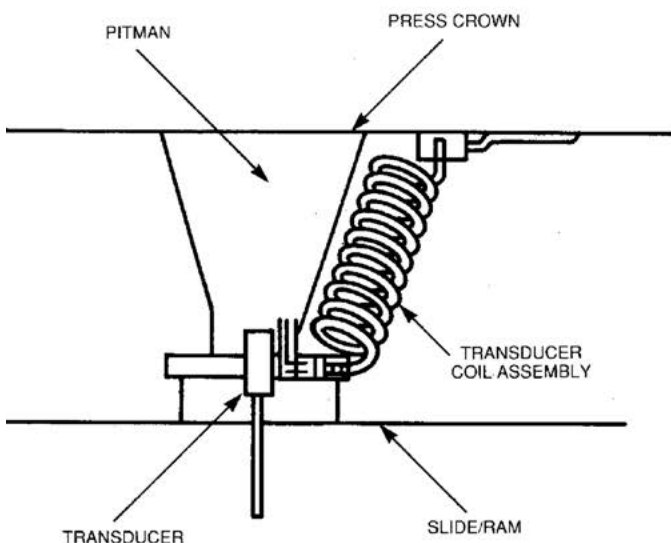
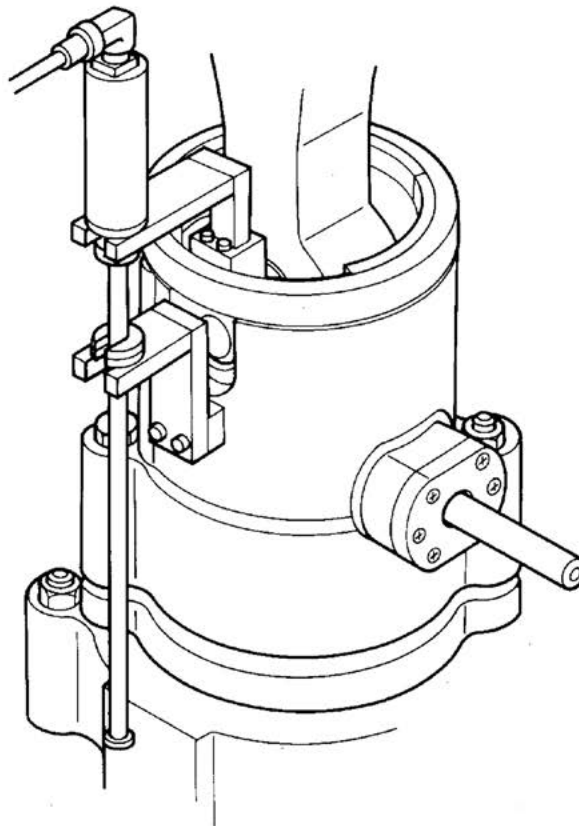

(Continued on next page.)

SECTION 3—INSTALLATION OF COMPONENTS

SSC-3000 Press Automation Control System

EXPANDABLE OPTIONS (continued)

LINEAR DISPLACEMENT TRANSDUCER (LDT) ASSEMBLY (continued)

Mounting the Bracket—Conventional Crank-Action Press

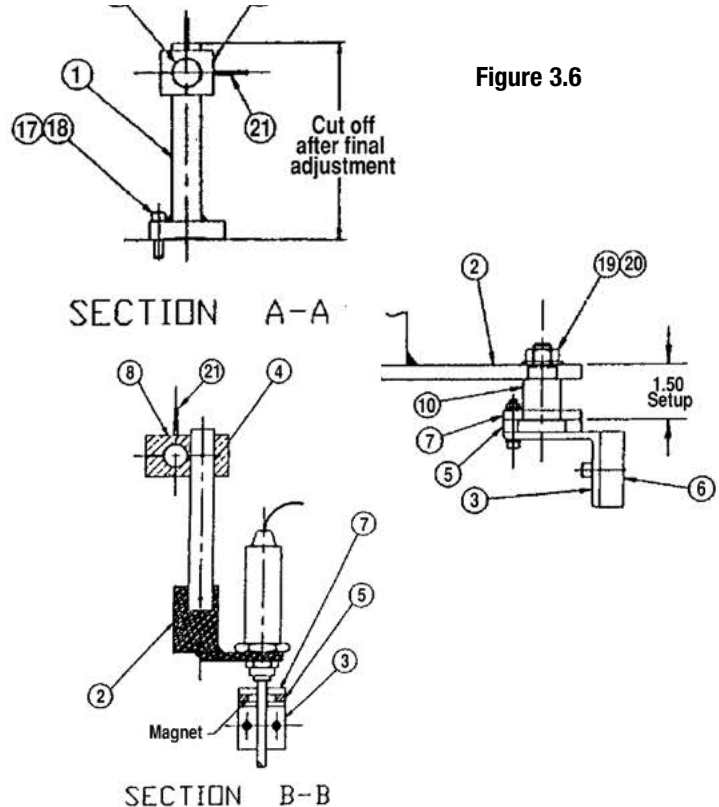
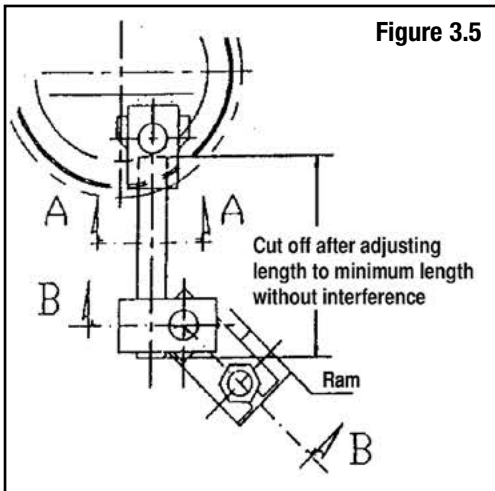

Figure 3.6

1. Attach item 1 to the surface of the Pitman screw pintel.
 2. Assemble item 9 to item 1.
 3. Assemble item 4 (horizontal) to item 9.
 4. Assemble item 8, 4 (vertical), and item 2 as shown in Figure 3.5.
 5. Adjust and tighten cap screws.
 6. Align transducer/magnet bracket subassembly to the movable member of the slide. If item 6 is being used as a spacer instead of a tapping plate, drill taps out for bolt clearance.
 7. **Slide must in a maximum up position for this step.** Remove and discard set-up stud (item 10), insert the magnet, and reattach the magnet cover plate (item 7).
- Note: A magnet and separate spacer is included with the transducer. The magnet has three dots on the side of the aluminum disk. Discard the included spacer.*
8. Attach the transducer to item 2. **Do not grip the metal can with pliers; use flats.**
 9. Attach the cable coil assembly foot (from cable kit) to item 2. **Be certain that the coil and bracket assembly is clear of any interference when the press strokes to TDC with the slide adjustment up.**
 10. After verifying that everything is free from interference, trim the excess tubing and secure the cap screws.
 11. Drill through the boom rods and install the 1/8" rollpins using the existing holes in the blocks and a 1/8" drill.

Item No.	Description	Part No.	Qty.
1	Pedestal base & tube weldment	SD0458300	1
2	Bracket Weldment 3/8-16 x 1-3/4" bold	SD0458400	1
3	Bracket magnet mount	M0809600	1
4	Boom rod 18" long	M0009500	2
5	Housing magnet	M0809700	1
6	Spacer magnet bracket	M0809800	1
7	Cap magnet	M0809900	1
8	Block connecting w/ 3/8-16 x 1-3/4" bolts	M0810100	1
9	Block pedestal w/ 3/8-16 x 1-3/4" bolts	M0810000	1
10	Stud (setup)	M0810200	1
11	Socket-head cap screw 10-32 x 1-1/4"	04560838	2
12	Lockwasher split med. #10	04563082	2
13	Flat washer #10	04563072	2
14	Hex nut #10-32	04562057	2
15	Socket-head cap screw 1/4-20 x 3/4"	04560089	3
16	Lockwasher split med. 1/4	04563001	3
17	Socket-head cap screw 5/16-18 x 1-1/4"	04560373	2
18	Lockwasher split med. 5/16	04563002	2
19	Flat washer 1/2	04563012	1
20	Hex nut 1/2-13	04562008	1
21	Rollpin 1/8 x 1-3/4	04564234	5

(Continued on next page.)

Rockford Systems, LLC
Call: 1-800-922-7533

SECTION 3—INSTALLATION OF COMPONENTS

SSC-3000 Press Automation Control System

EXPANDABLE OPTIONS (continued)

LINEAR DISPLACEMENT TRANSDUCER (LDT) ASSEMBLY (continued)

Mounting the Bracket—Guided Push Rod Press

Figure 3.7

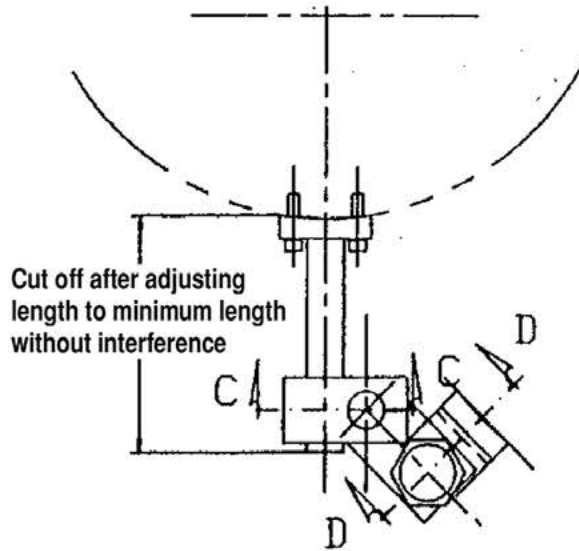

1. Attach item 1 to the surface of the push rod.
2. Assemble item 8, 4 (vertical), and item 2 as shown.
3. Adjust and tighten cap screws.
4. Align transducer/magnet subassembly to the movable member of the slide. If item 6 is being used as a spacer instead of a tapping plate, drill taps out for bolt clearance.
5. **Slide must in a maximum up position for this step.** Remove and discard set-up stud (item 10), insert the magnet, and reattach the magnet cover plate (item 7).
Note: A magnet and separate spacer is included with the transducer. The magnet has three dots on the side of the aluminum disk. Discard the included spacer.
6. Attach the transducer to item 2. **Do not grip the metal can with pliers; use flats.**
7. Attach the cable coil assembly foot (from cable kit) to item 2. **Be certain that the coil and bracket assembly is clear of any interference.**
8. After verifying that everything is free from interference, trim the excess tubing and secure the cap screws.
9. Drill through the boom rods and install the 1/8" rollpins using the existing holes in the blocks and a 1/8" drill.

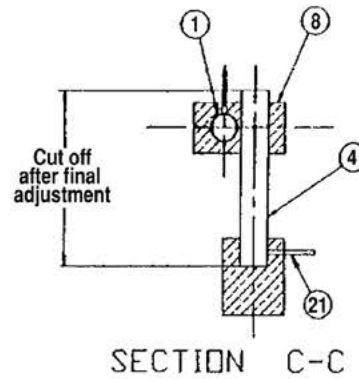
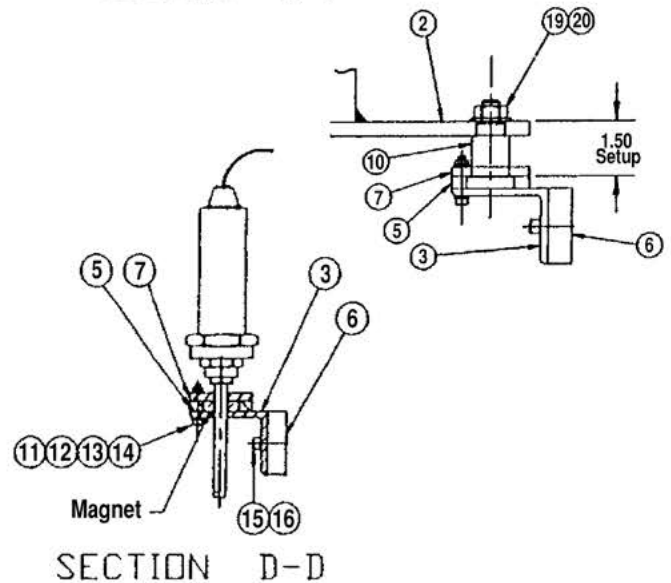

Figure 3.8



Item No.	Description	Part No.	Qty.
1	Pedestal base & tube weldment	SD0458300	1
2	Bracket Weldment 3/8-16 x 1-3/4" bold	SD0458400	1
3	Bracket magnet mount	M0809600	1
4	Boom rod 18" long	M0009500	2
5	Housing magnet	M0809700	1
6	Spacer magnet bracket	M0809800	1
7	Cap magnet	M0809900	1
8	Block connecting w/ 3/8-16 x 1-3/4" bolts	M0810100	1
9	Block pedestal w/ 3/8-16 x 1-3/4" bolts	M0810000	1
10	Stud (setup)	M0810200	1
11	Socket-head cap screw 10-32 x 1-1/4"	04560838	2
12	Lockwasher split med. #10	04563082	2
13	Flat washer #10	04563072	2
14	Hex nut #10-32	04562057	2
15	Socket-head cap screw 1/4-20 x 3/4"	04560089	3
16	Lockwasher split med. 1/4	04563001	3
17	Socket-head cap screw 5/16-18 x 1-1/4"	04560373	2
18	Lockwasher split med. 5/16	04563002	2
19	Flat washer 1/2	04563012	1
20	Hex nut 1/2-13	04562008	1
21	Rollpin 1/8 x 1-3/4	04564234	5

(Continued on next page.)

SECTION 3—INSTALLATION OF COMPONENTS

SSC-3000 Press Automation Control System

EXPANDABLE OPTIONS (continued)

LINEAR DISPLACEMENT TRANSDUCER (LDT) ASSEMBLY (continued)

Quadrature Output

Figure 3.9

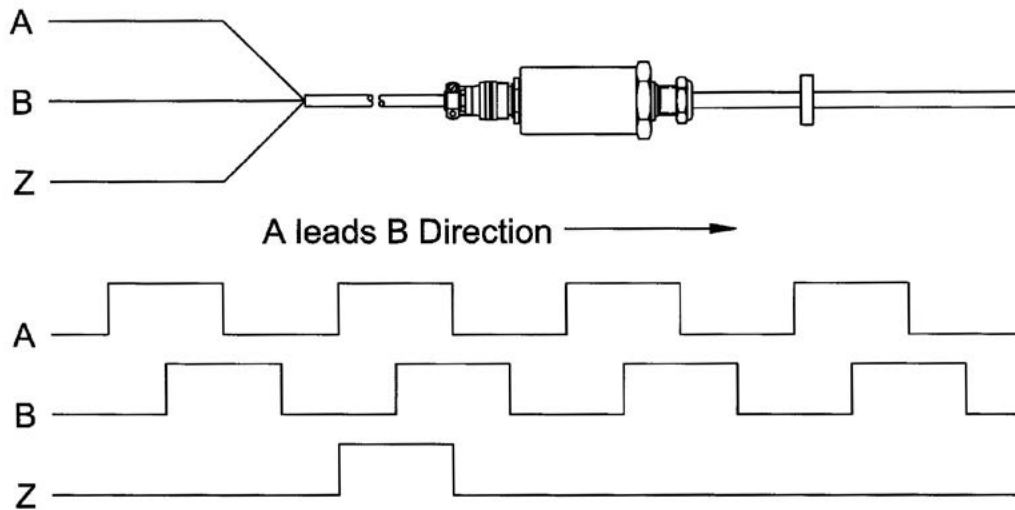

The quadrature output provides absolute position data in engineering units. This means that the need for the calibration constant (wire speed) programming has been removed, thereby eliminating the possibility of having an improperly calibrated system. The output signal wires are driven by differential RS-422 line drivers, similar to the drivers used in most magnetostrictive pulse-type transducers, providing a high degree of noise immunity.

A unique feature of this transducer is a “burst” mode of operation. An input on the transducer triggers a data transfer of all the incremental position data relative to the transducer’s absolute zero position. This can be used to achieve absolute position updates when power is restored to the system or any time an update is needed to re-zero or home the machine. Additionally, another input to the transducer can be used to establish a zero position for the transducer.

Troubleshooting

Troubleshooting describes common problems that may occur when installing the LDT and offers possible solutions to these problems. If, after performing the general checks below, you are unable to resolve a problem, contact the factory.

General Checks

Make sure that the magnet is located within the LDT’s active stroke area. Captive magnet assemblies should be positioned so that they can move freely over the entire area of the active stroke without binding or pushing on the rod. Noncaptive magnet assemblies should be situated so that the magnet is no farther than 0.2” from the rod at any point in the magnet assembly’s movement.

Note: Ferromagnetic material should be located no closer than 0.25” from the magnet or LDT rod end. This includes mounting brackets, magnet spacers, magnet brackets, and mounting screws. Ferromagnetic material can distort the magnetic field, causing adverse operation or failure of the LDT.

Check all LDT wires for continuity and/or shorts. It is preferable that the cable between the LDT and the interface device be one continuous run. If you are using a junction box, it is highly recommended that the splice junction box be free of AC and/or DC transient-producing lines. The shield should be carried through the splice and terminated at the interface device end.

SECTION 3—INSTALLATION OF COMPONENTS

SSC-3000 Press Automation Control System

EXPANDABLE OPTIONS

LOAD MONITOR SYSTEM

Load Monitor Card—Part No. FTL-306

The SSC-3000 control is designed to accept one or two **Load (tonnage) Monitor Cards** in the main rack. Each card is capable of monitoring the machine load at four locations on the machine frame or components. Four to eight load cells can be installed on the machine to read up to a maximum of eight zones of tonnage overload—four load cells per card.

The minimum and maximum tonnage can be set manually or with a learn key. The learn key will add 10% to or subtract 10% from the current high and low settings. When enabled, a stop signal will be given when an over or under tonnage setting is detected. For programming the **Load Monitor Card**, see pages 98-99 in the programming section of this manual. A load monitor control module and sensors are required to complete the load monitor system (see below).

Load Monitor Control Module—Part No. RYL-102

The load monitor control module detects the underload or overload information that is generated at each load sensor on the machine frame or component. The load sensor is available as a two- or four-sensor kit.

In order to use the load monitor system, the machine must be calibrated with calibration cells. This is done after installing the press automation control equipment and sensors. For calibration details, see page 32; for programming information, see pages 98-99 in the programming section of this manual.

Load Monitor Sensor

2-Cell Sensor Kit—Part No. RYT-031

4-Cell Sensor Kit—Part No. RYT-030

Up to four load cells can be installed on the machine for each **Load Monitor Card** purchased (maximum of two **Load Monitor Cards** per machine). It is very important to mount the load sensors in the proper location in order for the system to work properly. Follow the steps on pages 26-32 for locating and mounting the load monitor sensors to the machine frame or connection rod.

Photo 3.12



Photo 3.13
Load Monitor
Control Module



Photo 3.14
Part No. RYT-031

(Continued on next page.)

SECTION 3—INSTALLATION OF COMPONENTS

SSC-3000 Press Automation Control System

EXPANDABLE OPTIONS (continued)

LOAD MONITOR SYSTEM (continued)

Placement of the Load Sensors

Select the location where the load sensors will be mounted to the machine. On mechanical or hydraulic power presses, the locations are usually behind the gap opening of OBS and OBI presses, and on the columns or on the connection rod(s) of straight-side presses (see Figures 3.10 through 3.12).

Sensor Placement on Gap-Type Presses

Figure 3.10

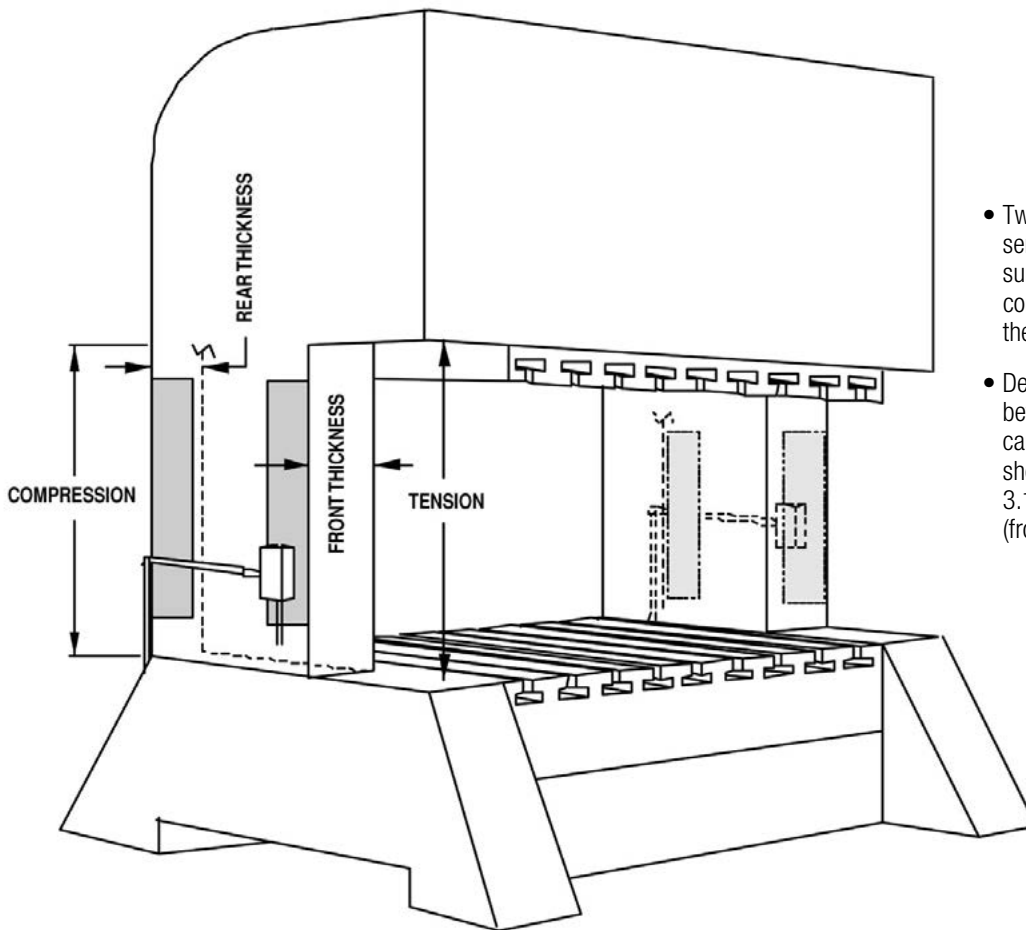

- Two sensors are normally required. The sensors are housed in protective enclosures that include 1/2" knockout holes. If conduit is used, use 1/2" strain reliefs in the knockout holes.
- Determine the location of the sensors before installation begins. The sensors can be mounted in the gap area as shown in the shaded areas in Figure 3.10. They can be arranged for tension (front or compression (back)).

How to Determine the Best Location

Measure the rear frame thickness and multiply by 3 =

Measure the front frame thickness = _____ Front

If the front thickness is smaller than the value in , then mount the sensors in the front. (This is the most common.) If the front thickness is larger, then place the sensor in the rear, Adjust the input connection in the control for compression readings instead of tension.

(Continued on next page.)

Rockford Systems, LLC
Call: 1-800-922-7533

EXPANDABLE OPTIONS (continued)

LOAD MONITOR SYSTEM (continued)

Sensor Placement Columns of Straight Side Presses

- Usually four sensors are installed on the upright columns, as shown in Figure 3.11. This would be a tension-type mounting so the sensors must be wired for tension in the load monitor control module.
- The closer a sensor is to the tie rod, the better its performance will be.

If possible, install sensors on the inside press wall frame, if it is a double-wall frame press.
- Avoid installing the sensors closer than 12" from the top edge or bottom edge of the holes that may be cut out in the press frame.
- Rule of thumb for cast-frame presses or very heavy frame presses: Install sensors in an area of least cross section. Avoid holes as described above.

In all cases, avoid locating the sensors closer than one column width from the crown or bolster, if possible.

Figure 3.11

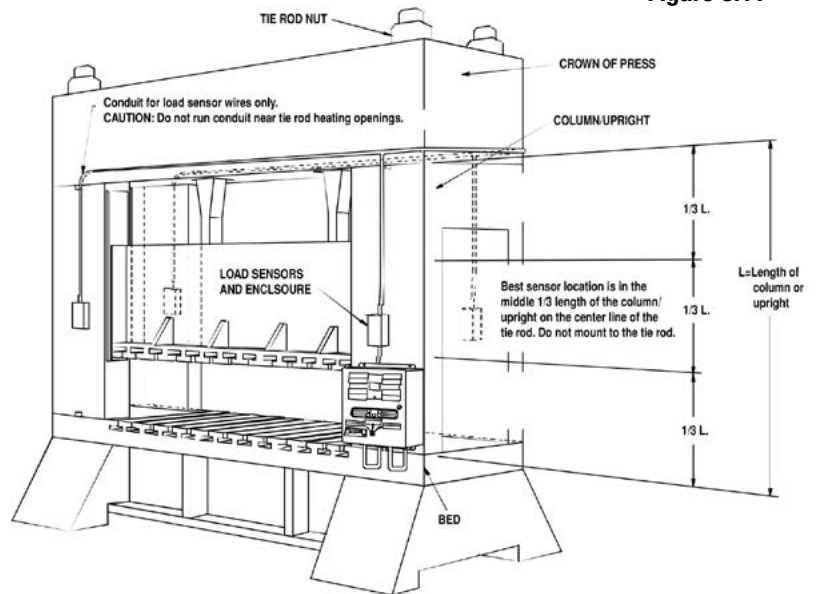

Sensor Placement on Pitman or Connection Rod

- Two sensors for each Pitman are required. One for the front and one for the back. If the press is SSDC, then four sensors are required. This would be a compression-type mounting so the sensors must be wired for compression in the load monitor control module.
- Be sure to mount the sensor to the Pitman only, not to an adjusting screw that would rotate.

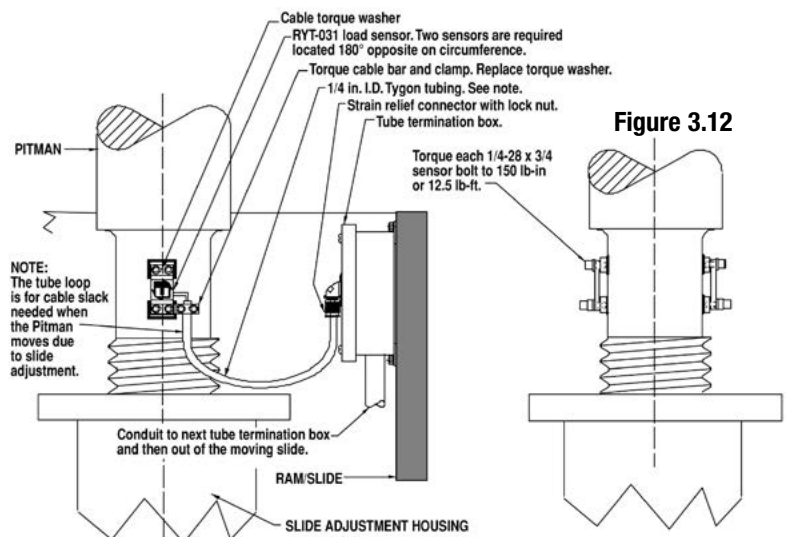

Figure 3.12

View showing both sensors mounted to the Pitman.

(Continued on next page.)

SECTION 3—INSTALLATION OF COMPONENTS

SSC-3000 Press Automation Control System

EXPANDABLE OPTIONS (continued)

LOAD MONITOR SYSTEM (continued)

Alignment must be accurate when installing the load sensors. Use the mounting bracket as a template when drilling the holes to ensure proper alignment. If the fasteners provide too much pressure on the sensors, they will produce a constant voltage and the control will not have the ability to zero the sensors. Mounting screws need to be torqued to 150 in-lb maximum. follow the steps on this page for the drill and tap method or see page 29 for the weld pad method of mounting the sensors.

Drill and Tap Mounting Method

1. Remove all paint and grease from the sensor mount area. If the machine surface is flat (total indicated reading of .002") and smooth (125" μ in.), the load sensor can be bolted directly to the surface.
2. Drill and tap the center hole (1/4-28 x 1/2" depth) for mounting the fixture to the press member. See Figure 3.13.
3. Bolt the fixture to the press member using the 1/4-28 by 1 1/4" (M6-1 x 35) long socket head cap screw in the center of the fixture. See Figure 3.14.
4. Insert the number 3 drill (5 mm) into the smaller corner hole and drill out all four holes to a depth of 3/4 of an inch (19 mm). See Figure 3.14.
5. Loosen the fixture. Rotate the fixture 90 degrees clockwise. Tighten the center screw of the fixture. Insert the number 21 drill into the small centered hole and drill out both holes to a depth of 3/8 of an inch. These holes are for mounting the sensor enclosure. The fixture does not allow for tapping these holes. They are tapped without the fixture. Enclosure mounting is not done in metric. See Figure 3.15.
6. Loosen the fixture. Rotate the fixture another 90 degrees clockwise such that the larger corner holes line up with the holes drilled in step 4. Insert a tap to be sure the holes line up. Lock the fixture in place by tightening the center screw. See Figure 3.16.
7. Insert the tap into the larger tap guide holes and tap each hole. See Figure 3.17. **Be sure to use plenty of tapping fluid.**
8. Remove the fixture and repeat steps 1-7 for each additional sensor mounting position.
9. Mount the sensor with the raised rib to the press. The anti-torque washers should go between the screw and sensor body. Torque each 1/4-28 x 3/4" long socket head cap screw to 150 lb-in or 12.5 lb-ft. See Figure 3.17.

Figure 3.13

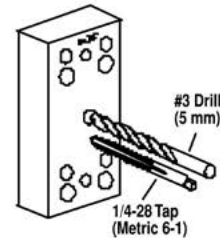

Figure 3.14

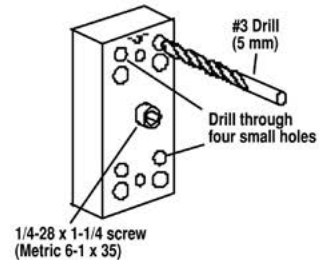

Figure 3.15

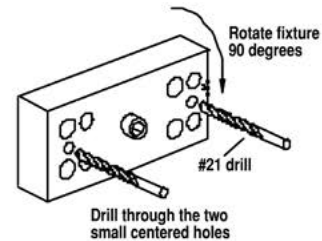

Figure 3.16

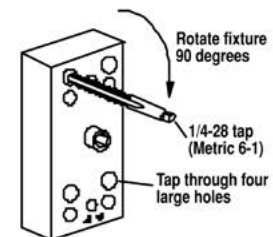
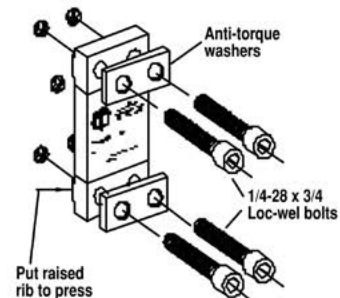

Figure 3.17



(Continued on next page.)

Rockford Systems, LLC
Call: 1-800-922-7533

EXPANDABLE OPTIONS (continued)

LOAD MONITOR SYSTEM (continued)

Weld Pad Mounting Method

1. Remove all paint, grease, and/or rust from the surface to be welded. (Surface should be flat total indicating reading of $\frac{1}{32}$ of an inch.)
2. (Optional) Drill and tap the center hole for mounting the fixture to the press member. This hole should be $\frac{1}{2}$ " deep. See Figure 3.18.
3. (Optional) Bolt the fixture to the press member using the $\frac{1}{4}$ -28 x $1\frac{1}{4}$ " (M6-1 x 35) long socket head cap screw in the center of the fixture. Orient the fixture as shown in Figure 3.14 and drill out the #21 holes to a depth of $\frac{3}{8}$ of an inch for the enclosure mounting. The fixture is not used for tapping these holes. See Figure 3.19.
4. Remove the fixture from the press member. Bolt the weld pads to the fixture with $\frac{1}{4}$ -28 by 1" long socket head cap screws provided. Reattach the fixture with the weld pads bolted on using the center hole as in Figure 3.19. Orient the fixture as shown in Figure 3.20.
5. Weld the weld pads to the press member. **Only weld the weld pads on three sides as shown in Figure 3.21.** A single pass is sufficient. Do not remove the fixture until slag is removed and/or the assembly has cooled. When welding cast iron, use a dry nickel rod such as Lincoln Electric Soft Weld, Hobart NI Cast 99, or MB Weld Product MG 210. Strike arc on steel then puddle into the cast iron.
6. Remove the weld fixture. **Do not weld after the fixture is removed.** The four screws holding the pads to the fixture and the one center screw (if used) may be discarded. **Do not use the four 1" long screws to assemble the sensor.** The sensor kit contains four $\frac{3}{4}$ -inch long screws for assembling the sensor to the press member. Weld pad surface must be clean—no weld bumps, scratches, etc. be sure the weld pad tapped holes are clean and the bottom of the holes are free of weld flash.
7. Mount the sensor with the raised rib to the press. The anti-torque washers should go between the screw and sensor body. Torque each $\frac{1}{4}$ -28 x $\frac{3}{4}$ " long socket head cap screw to 150 lb-in or 12.5 lb-ft. See Figure 3.22.

Figure 3.18

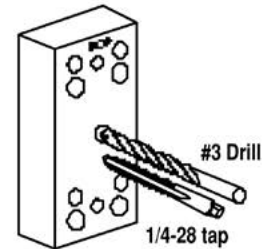

Figure 3.19

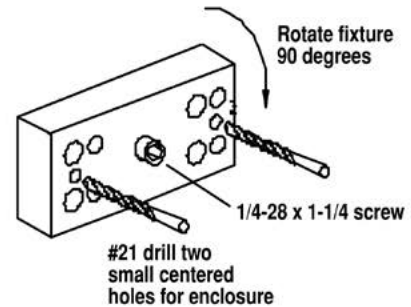

Figure 3.20

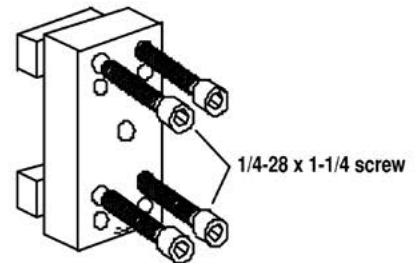

Figure 3.21

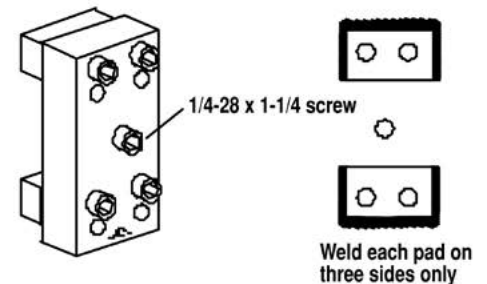
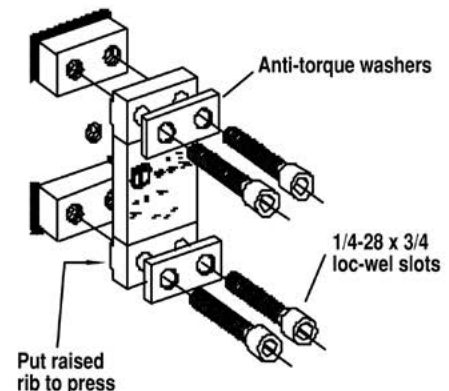

Figure 3.22



(Continued on next page.)

SECTION 3—INSTALLATION OF COMPONENTS

SSC-3000 Press Automation Control System

EXPANDABLE OPTIONS (continued)

LOAD MONITOR SYSTEM (continued)

Sensor Connection

CAUTION Do not run the low-voltage 24-V DC sensor cable in conduit or wire the troughs with higher voltage. do not pull the cable with more than 20 pounds of force or they can become damaged. See Figure 3.23.

1. Use 1-32 tap in the two $\frac{3}{8}$ " deep holes that were drilled with the fixture in the previous instructions. Mount the enclosure to the press member and run $\frac{1}{2}$ " conduit to the load monitor enclosure.
2. Run the sensor cable through the conduit. Place the sensor on the mounting holes. Place the anti-torque washers over the sensor holes. Screw in the sensor bolts, four each, and finger tighten them. Use only the $\frac{1}{4}$ -28 x $\frac{3}{4}$ " locwel bolts furnished. Torque each $\frac{1}{4}$ -28 x $\frac{3}{4}$ " screw to 150 lb-in or 12.5 lb-ft. Assemble the box cover.

Figure 3.23

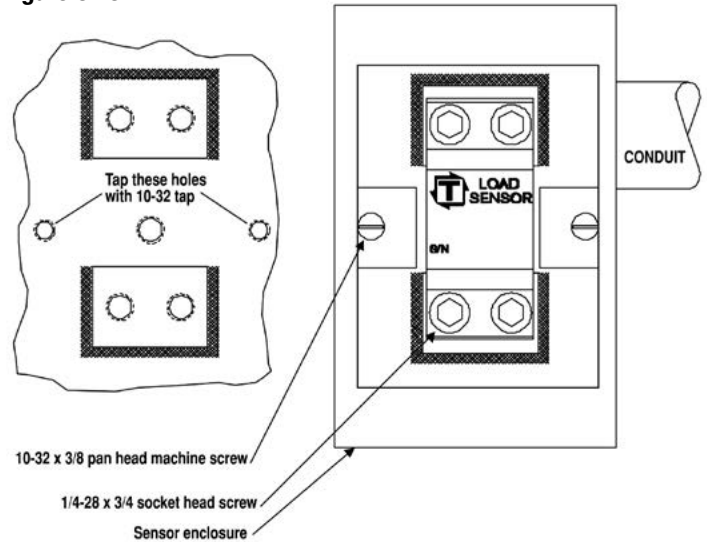

Wiring Connection

1. Cut the cable to the required length. (If longer cable is required, please consult the factory.) Strip the sensor cable as shown in Figure 3.24. Be careful not to nick any of the signal conductors or strip the shield completely away. At least $\frac{1}{2}$ " of cable shield should be exposed for proper insertion into the wire lug. Do not splice or run the cable to an intermediate terminal.
2. Insert the cable through the lug as shown in Figure 3.25. Make sure the cable shield is aligned with the portion of the wire lug which will be crimped.
3. Crimp the lug onto the cable shield. **Do not crimp too tight and risk smashing the wires which could cause them to short to ground.** See Figure 3.26.

Figure 3.24

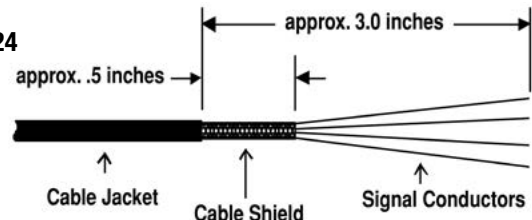

Figure 3.25

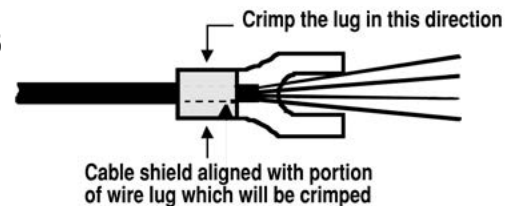

Figure 3.26



(Continued on next page.)

Rockford Systems, LLC
Call: 1-800-922-7533

SECTION 3—INSTALLATION OF COMPONENTS

SSC-3000 Press Automation Control System

EXPANDABLE OPTIONS (continued)

LOAD MONITOR SYSTEM (continued)

Wiring Connection (continued)

4. Attach the wire lug to a ground terminal on the front of the load monitor control module. Use a 6-32 x 1/4" screw of the grounding lug connection. Attach the signal wires to the channel connector following the color codes. See Figure 3.27.

Note: If your sensor is not double shielded with both foil and a braid, electrical noise may affect your output readings.

Figure 3.27

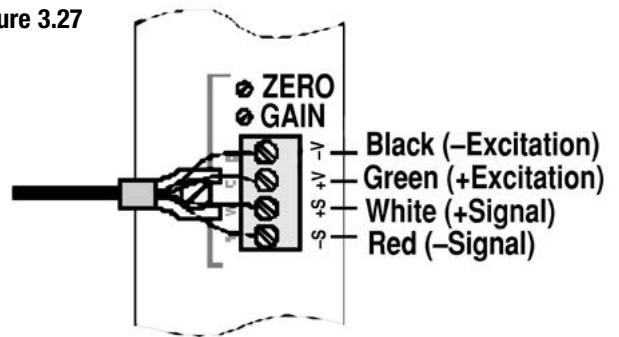

5. The load monitor control module accepts the signals from the T400 sensors as well as other strain gauges. See Figure 3.32 for the sensor connections on the load monitor control module for tension force; see Figure 3.29 for compression force connection.

Figure 3.28

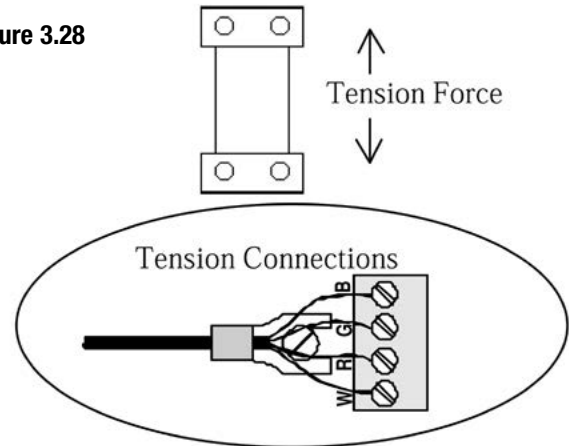
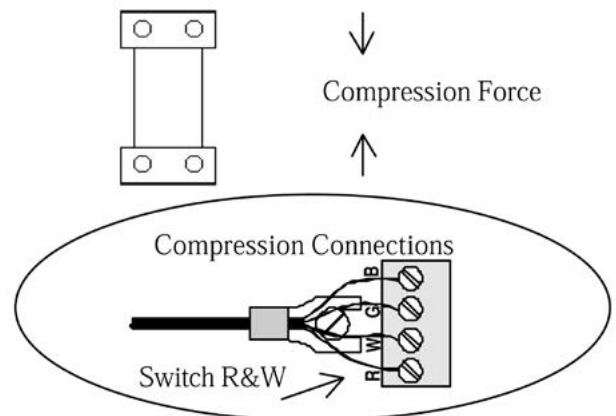

Figure 3.29



(Continued on next page.)

SECTION 3—INSTALLATION OF COMPONENTS

SSC-3000 Press Automation Control System

EXPANDABLE OPTIONS (continued)

LOAD MONITOR SYSTEM (continued)

Calibrating the Load Sensors

Note: The number of sensors and maximum tonnage of the machine must be set before calibrating the machine with a calibration load cell(s). See the programming section on pages 98-99.

Once the sensors are mounted in the proper location and wired into the load monitor control module, the sensors need to be calibrated. Prior to this step, prepare the shims or plates to set the calibration load cell(s) on the press bolster, as necessary. Follow the steps below for calibrating the load sensors.

- 1. Test/Zero Load Sensors**—Set the dip switches on the load monitor control module to **Cal**, **Zero**, and **Track**. To test each of the load sensors, measure the voltage from channel one (CH1) and common (COM). Adjust the zero potentiometer so the voltmeter reads 0.00 V DC. After completing channel one, do the same for the rest of the channels as required.
- 2. Place Calibration Load Cell(s)**—The calibration load cell(s) are placed on the press bolster with shims or plates as necessary to ensure that the ram will contact the calibration cell(s) as the adjustments are made.
 - Without the calibration load cells in the press, move the ram adjust down to 1" above its minimum setting. Inch the ram to DDC (180°) and then measure between the bottom of the ram to the top of the bolster to determine the shim thickness required to make up the difference in the calibration load cell height (approximately 4"). Be careful to allow 1/8" gap between the ram and calibration load cell(s).
 - Cycle the press so the ram is at TDC (0°) and insert the calibration load cell(s). If more than one load cell is used, keep the calibration load cells symmetrical with each other on the bolster plate. Measure and record their placement on a calibration sheet.
- 3. Set the Dip Switches**—The dip switches on the face of the load monitor control module need to be set in the **Run**, **Zero**, **Peak**, and **NC** positions. See Figure 3.30
- 4. Calibrate Channels**—Cycle the press over and over in the single stroke mode of operation while lowering the ram adjust until the maximum rated tonnage of the press is displayed on the calibration load cell(s). *Note: If you are using more than one calibration load cell, you will need to add up the displayed tonnages. Their sum should equal the maximum rated tonnage of the press.* Then inch the machine to just past 180° but do not go beyond 240° of crankshaft rotation. You should be displaying the maximum rated tonnage on the calibration load cell(s). Using a volt meter, check each output (CH1 to COM, CH2 to COM, etc.) and adjust the gain for each channel so the output reads 2.5 V DC at maximum rated tonnage. This can be measured at the load monitor control module terminal strip. Once this is done, the control should read the same as the calibration load cell(s).

Figure 3.30

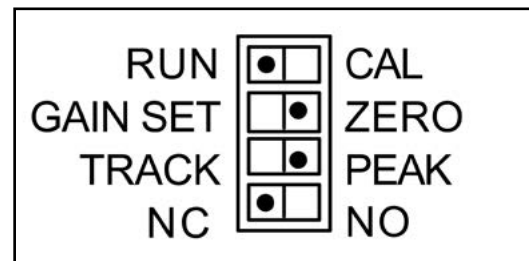

EXPANDABLE OPTIONS (continued)

AIR MONITOR—PART NO. RCL-100

The SSC-3000 control can provide remote monitoring of air pressure with the use of an air monitor station. A plug-in serial communication port is provided on the **Main CPU Card** for connection of this option. The remote air pressure monitor station monitors up to four air pressure settings (1 to 100 PSI). It should be installed near the pneumatic systems on the press.

The station is furnished in a NEMA 12 enclosure which includes four ¼" tube fittings for the input ports, plus one 25' cable for communications. Wire the cable to terminal strip P1 in the air monitor in accordance with the wiring schematics included with the air monitor. **Do not run the cable in conduit or in bundles with higher voltages that may cause electrical interference.** Connect the other end (with the DB-9 connector) to the P6 air monitor port on the **Main CPU Card**. The four input ports are designed to monitor the clutch/brake, counterbalance, die cushion, and auxiliary device air pressure settings.

The remote air pressure station also has output relays to automatically set the air pressure on the counterbalance and die cushion when the die changes. This ensures the pressures are automatically adjusted and held whenever a die change occurs. This feature requires fill-and-dump solenoid valve assemblies to be wired into the station (see below).

The pressures are measured by analog pressure transducers, and then sent to the main CPU processor via the serial communications link. The values are compared to the programmed settings, and a warning message will appear if the pressures are not set properly for a new die. In the event of an air pressure failure, the machine will shut down and will not run until the air pressure is restored.

FILL-AND-DUMP VALVE

With the air monitor option installed, it is possible to automate the pressure setting for the counterbalance and other air-operated devices by providing an optional fill-and-dump valve assembly. The air monitor control provides both relay outputs to energize the valve assembly as required to change, track and hold counterbalance pressure for each tooling. The air pressure settings for each tool are stored and recalled when the die is changed. With the press running, fine tuning can take place to track and hold that pressure during the press operation.

The RCL-101 valve can be added in parallel with your existing manual regulator circuit to provide automatic counterbalance control valve assemblies. RCL-102 through RCL-105 have their own built-in bypass if the electrical power is turned off. Refer to the chart below and page 34 for part numbers and sizes.

Photo 3.15
Air Pressure Monitor Station



Part No.	Description
RCL-101	3/4" Fill-and-dump valve
RCL-102	3/4" Fill-and-dump valve with parallel bypass
RCL-103	1" Fill-and-dump valve with parallel bypass
RCL-104	1" Fill-and-dump valve with remote parallel bypass
RCL-105	1-1/4" Fill-and-dump valve with parallel bypass

(Continued on next page.)

SECTION 3—INSTALLATION OF COMPONENTS

SSC-3000 Press Automation Control System

EXPANDABLE OPTIONS (continued)

FILL-AND-DUMP VALVE (continued)

Dimensions

RCL-101

3/4" fill-dump.

Weight lb (kg)
6.0 (2.8)

Dimensions inches (mm)

Height	Width	Length
4.2 (107)	7.5 (191)	5.7 (145)

NOTE: For counterbalance applications, furnish a manual circuit in parallel to this module. See circuit at right.

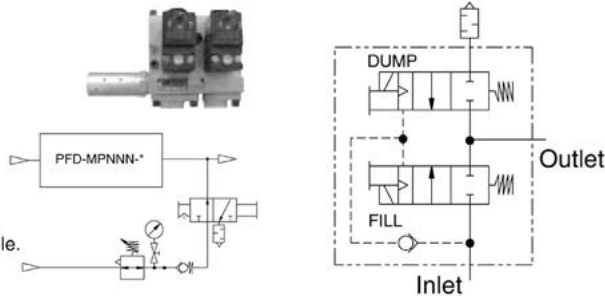

RCL-102

3/4" fill-dump with auto-manual select and parallel manual circuit.

Weight lb (kg)
20.0 (9.1)

Dimensions inches (mm)

Height	Width	Length
7.1 (181)	10.0 (254)	11.7 (298)

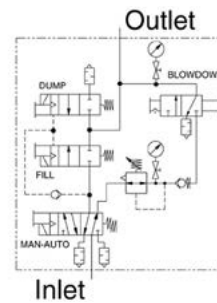

RCL-103

1" fill-dump with auto-manual select and parallel manual circuit.

Weight lb (kg)
45.0 (20.5)

Dimensions inches (mm)

Height	Width	Length
8.3 (211)	15.4 (392)	12.1 (308)

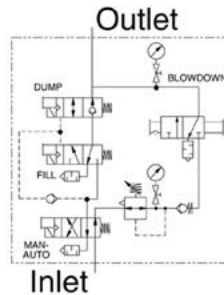

RCL-104

1" fill-dump with auto-manual select and parallel remote manual adjustment circuit.

Weight lb (kg)
45.0 (20.5)

Dimensions inches (mm)

Height	Width	Length
8.3 (211)	15.4 (392)	12.1 (308)

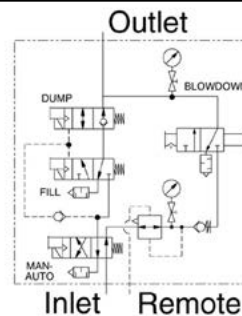

RCL-105

1-1/4" fill-dump with auto-select and parallel manual circuit.

Weight lb (kg)
87.0 (39.5)

Dimensions inches (mm)

Height	Width	Length
10.4 (184)	26.5 (387)	19.2 (82)

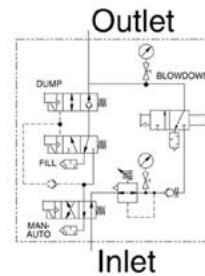
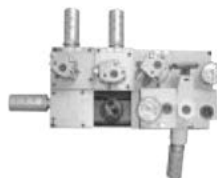

(Continued on next page.)

Rockford Systems, LLC
Call: 1-800-922-7533

EXPANDABLE OPTIONS (continued)

FILL-AND-DUMP VALVE (continued)

Function of Individual Components

- **4/2 Auto Select Directional Valve**—single solenoid spring return. Used to select between manual and automatic operation. Manual operation is the default mode, energize for automatic control.
- **Manual Regulator**—set to minimum counterbalance pressure required. In automatic operation, this regulator provides additional safety for maintaining air in the counterbalance cylinders should a fault occur. In the manual operation, this regulator provides manual air pressure adjustment to the counterbalance cylinders.
- **Gauge**—The first gauge is located just downstream of the manual regulator. It indicates the manual regulator pressure setting. The second gauge is located on or downstream of the lockout valve. It indicates the actual counterbalance tank pressure.
- **Manual Lockout Valve**—used to drain the counterbalance tank and cylinders. Depress the lockout valve handle to initiate counterbalance exhaust.
- **2/2 Directional Fill Valve**—single solenoid—spring return. Used to pressurize the counterbalance tank. Part of the closed loop pressure control circuit. Energize to add air to the tanks.
- **2/2 Directional Dump Valve**—single solenoid—spring return. Used to relieve counterbalance tank pressure. Part of the closed loop pressure control circuit. Energize to remove air to the tanks.
- **Pressure Transducer**—connected to the counterbalance tank isolated from the plumbing supplying the tank and leading to the cylinders. Used to provide a signal to the controller indicating the current tank pressure. Part of the closed loop pressure control circuit,

Sequence of Operation—Start Up

Initial start up from a depressurized system, with all valves deenergized, and the manual lockout valve depressed.

1. Set manual regulator to a midrange position, making sure it is not set for zero pressure.
2. Pull out the lockout valve handle to begin pressurizing the counterbalance accumulator through the manual operation circuit.
3. Energize the auto select and fill valves for faster pressurization.
4. When system is approaching the minimum requirements, deenergize the auto select and fill valves to return to manual operation.
5. Set the manual regulator to the proper default or minimum counterbalance pressure setting using the regulator gauge as a reference. At this time the two gauges should match.
6. Energize the auto select valve for automatic operation.
7. Begin setup for a closed loop, or automatic, counterbalance pressure adjustment. Create a window somewhere near top dead center to read the transducer signal and compare it to the preprogrammed set/target pressure.
 - If the tank pressure falls below the set/target pressure, energize the fill valve solenoid until the set pressure or a preset time limit is reached.
 - If the tank pressure rises above the set/target pressure, energize the dump valve solenoid until the set pressure or a preset time limit is reached.
 - The pressure transducer reading frequency is discretionary. It may be once per cycle or every ten cycles. During actuation of valves, you may continue to monitor the transducer until the desired pressure is approached. Be aware that during press operation, the counterbalance pressure will change so that attempting to use the transducer reading throughout the stroke of the press results in the control system trying to hit a moving target.

Sequence of Operation—Draining System

Drain the system pressure from a pressurized counterbalance system.

1. Deenergize all solenoid valves.
2. Depress the manual lockout valve to drain the tank and cylinders. Lockout the valve by following the appropriate lockout-tagout procedures.
3. Shut off and drain the counterbalance supply line. Lockout as required. Verify that both pressure gauges have a zero pressure reading.
4. Service the counterbalance system as required.

(Continued on next page.)

SECTION 3—INSTALLATION OF COMPONENTS

SSC-3000 Press Automation Control System

EXPANDABLE OPTIONS (continued)

FILL-AND-DUMP VALVE (continued)

Installation



This valve should only be installed by personnel experienced in the installation of such equipment.



This valve requires clean air. Blow all lines clean of dirt, scale, etc., before making the final connection. Drain water from the filter bowl regularly. Should this bowl refill in a short period of time, it may indicate the need for a larger filter in the main air supply line. The air filter must be kept clean at all times. Never operate the machine unless the air filter is clean and water is drained.

Electrical

We recommend that NEC (National Electrical Code) practices be followed for wiring, especially color-coding and the use of numbered wire markers on both ends of every wire. Color-coding is black for power circuits, red for 120-V AC control circuits, white for current-carrying ground (frequently referred to as common), and green for any equipment grounding conductor.

The dual valve incorporates two solenoid coils. Each coil is wired independently to terminals located on the enclosure cover. The solenoids are rated for continuous duty at 100 to 110 V AC (50 Hz), 100 to 120 V AC (60 Hz), and 48 V DC. A supply voltage that does not fall within these ranges can cause nuisance lockouts or premature solenoid burnouts. The transformer should be capable of handling the inrush current of the solenoids without significant voltage drop.

Mounting and Connecting the Valve

Unscrew and remove the black plastic receptacles on top of the solenoids. For the solenoid receptacles: Using a small flat screwdriver, pop out the terminal block in each receptacle by inserting the screwdriver in the slot along the edge. Unscrew the fitting. Using the appropriate multiple-conductor cable (such as SO or SJO), strip the appropriate amount of the jacket off to expose the individual wires. Insert the wires through the fitting. Make sure that only the individual wires, and not the entire cable, are going into the receptacle housing. Connect the wires to the appropriate terminals on each terminal block. The other end of the cable needs to be wired in to the control box. Refer to the wiring schematics furnished with the control for proper wiring. Insert the terminal block back into the receptacle and tighten the fitting on the cable. Replace the receptacles on top of the solenoids and over the fault pressure switch.

Other Installation Considerations

For convenience, an air lockout valve should be installed in the air line just ahead of the filter-regulator-lubricator (FRL) assembly. Make sure that the FRL is consistent in size with that of the fill-and-dump air valve. Port sizes and pipe size must be the same to prevent air flow restriction. If this is not done, it will affect the performance of the machine. An accumulator (air surge tank) is recommended directly ahead of the valve to assure sufficient air volume.

Note: A minimum of 30 psi must be maintained at the valve for proper operation.

When ready to install the fill-and-dump air valve, remove the dust covers from the valve port connections. Avoid getting particles, such as chips, sealing compounds or scale, in the piping. This may affect the performance of the machine.

Inlet Port—Do not restrict air supply. Any restriction of the air supply lines (i.e., sharp bends or undersized lines) will reduce the speed with which the outlet volume is pressurized.

Outlet Port—Any restriction in the outlet lines will reduce both pressurizing and exhausting speeds.



Exhaust Ports—Do not restrict exhaust. Limiting the exhausting speed decreases an important safety feature of the fill-and-dump air valve. Only a properly sized and designed muffler should be used.

The exhaust mufflers must be kept clean at all times. Never operate the machine unless they are clean.

Pipe Installation

To install pipe with tapered threads, engage the pipe one turn, apply pipe thread sealant (tape not recommended), and tighten the pipe. This will prevent sealant from entering and contaminating the valve. To install pipe with parallel threads (e.g., SAE, ISO 228-G, etc.), do not use sealant.

(Continued on next page.)

Rockford Systems, LLC
Call: 1-800-922-7533

EXPANDABLE OPTIONS (continued)

Other Installation Considerations (continued)

Valve Maintenance

Pneumatic equipment should be maintained only by persons trained and experienced in the maintenance of such equipment.

Supply Clean Air. Foreign material lodging in valves is a major cause of breakdowns. The use of a 5-micron-rated air filter located close to the valve is strongly recommended. The filter bowl should be drained regularly, and if its location makes draining difficult, the filter should be equipped with an automatic drain.

Check Lubricator Supply Rate. A lubricator should put a fine oil mist into the air line in direct proportion to the rate of air flow. Excessive lubrication can cause puddling in the valve and lead to malfunctions. For most applications, an oil flow rate in the lubricator of one drop per minute is adequate. *(Note that the valve itself does not require air line lubrication.)*

Compatible Lubricants. Although this valve does not require air line lubrication, it may be used with lubricated air being supplied to other mechanisms. Some oils contain additives that can harm seals or other valve components and so cause the valve to malfunction. Avoid oils with anti-wear or phosphate additives (e.g., zinc dithiophosphate), and diester oils; these substances can harm valve components. The best oils to use are generally petroleum base oils with oxidation inhibitors, an anilin point between 180°F (82°C) and 220°F (104°C), and an ISO 32 or lighter viscosity.

Some compatible oils are listed below. These oils, although believed to be compatible, could change without notice because manufacturers sometimes reformulate their oils. Therefore, use oils specifically compounded for air line service. If it is a synthetic oil, contact the oil manufacturer for compatibility information.

Cleaning the Valve. If the air supplied to the valve has not been well filtered, the interior of the valve may accumulate dirt and varnish which can affect the valve's performance by causing sluggish or erratic valve action which can result in the valve defaulting. A schedule should be established for cleaning all valves, the frequency depending on the cleanliness of the air being supplied.

To clean the valve, use a solvent which will dry without leaving a residue. This is especially important for the spool and sleeve assembly. Do not use a chlorinated solvent or abrasive materials which can damage seals or metal parts. Do **not** scrape varnished surfaces.

To reassemble the spool and sleeve, put one drop of Anderol 735 (or equivalent lubricant) on each spool land. Insert the spool into the sleeve and rotate it several times to ensure even distribution of the lubricant. If the valve is used in a nonlubricated application, do not use a lubricant for reassembly which can dry out or leave a residue. Dry assembly of the spool and sleeve is preferable. Each spool and sleeve is a matched set, so care must be taken not to reverse the position of the spool in the sleeve.

Before inserting the spool-and-sleeve into the valve body, very lightly lubricate the O-rings with a lubricant such as those from the chart to the left. Do not use Anderol; it causes the O-rings to deteriorate.

Electrical Contacts. In the electrical circuits associated with the valve solenoids, keep all switches or relay contacts in good condition to avoid solenoid malfunctions.

Replace Worn Components. In most cases it is not necessary to remove the valve from its installation for servicing. However, turn off the electrical power to the valve, shut off the air supply, and exhaust the air in the system before beginning any disassembly operation.

COMPATIBLE LUBRICANTS

Maker	Brand Name
Amoco	American Industrial Oil 32; Spindle Oil C; Amolite 32
Citgo	Pacemaker 32
Exxon	Spinesstic 22; Teresstic 32
Mobil.....	Velocite 10
Non-Fluid Oil	Air Lube 10H/NR
Shell	Turbo T32
Sun.....	Sunvis 11; Sunvis 722
Texaco	Regal R&O 32
Union Turbine Oil	Union Turbine Oil

(Continued on next page.)

SECTION 3—INSTALLATION OF COMPONENTS

SSC-3000 Press Automation Control System

EXPANDABLE OPTIONS (continued)

FILL-AND-DUMP VALVE (continued)

Valve Specifications

Solenoids:Rated for continuous duty
Standard Voltages:..... 100 to 110 V AC, 50 Hz;
100 to 120 V AC, 60 Hz; 48 V DC
Power Consumption: 8.5 VA, 5.3 W
Media Temperature:..... 40° to 175°F (4° to 80°C)
Ambient Temperature: 40° to 120°F (4° to 50°C)
Flow Media:..... Filtered air (5 micron recommended)
Inlet Pressure: 30 to 150 psi (2 to 10 bar)

Figure 3.31
Solenoid Wiring

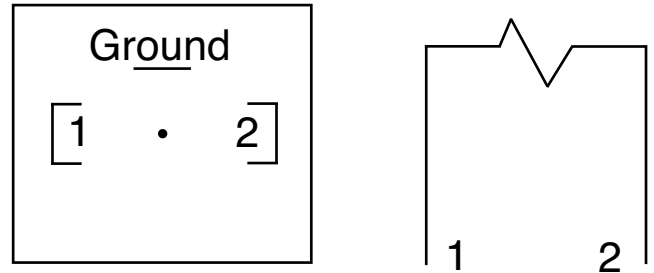

Note: When installing the fill-and-dump valve, a separate check valve is not needed because the fill-and-dump valve has internal check valves. If the existing system has a check valve, remove it.

EXPANDABLE OPTIONS (continued)

SERVO FEED INTERFACE

A servo feed interface will communicate with the existing servo feed controller currently attached to the press or a feed that is being purchased. This interface can automate the setting for the feed length, the rate for each tooling, and the press speed. This speeds up die changeover because this information is stored once and then sent to the servo feed control when the tooling is changed. The interface consists of a connecting cable, electrical print, and special software programmed into the **Main CPU Card**. For programming the servo feed, see pages 100-103. Connect the appropriate end of the cable to the P4 servo feed port on the **Main CPU Card**. Connect the other end to the servo feed in accordance with the print that was furnished with the servo feed interface. **Do not run the cable in conduit or in bundles with higher voltages that may cause electrical interference.**

NETWORKING

In order to network the control, the optional SSC-3000 networking assembly, part No. FTL-313, is required. The networking assembly consists of a TCP/IP (Transmission Control Protocol/Internet Protocol) modem card with mounting plate, a 5' serial cable, and a CD with software for data collection and upload/download of the job setups. Use of the network modem will provide data collection and viewing of current data via a standard Web browser such as Internet Explorer or Netscape Navigator. The current status of the press and what the control is doing can be monitored.

The data-collection software that is furnished with the networking assembly will save data to a text file. Most any database, spreadsheet, or word processing program such as Microsoft Access, Microsoft Excel, dBASE, or Paradox can import the information. This software program can accommodate up to 32 presses. Opening the program again will accommodate 32 more presses.

The following information is available for viewing and data collection; it can be arranged to accommodate your needs.

- Batch counter
- Batch preset
- Brake monitor status
- Current mode
- Date and time
- Die description
- Part counter
- Part preset
- Setup number
- SPM
- Stop time
- Stroke counter
- Stroke preset
- Total counter

The upload/download feature gives you the ability to back up all of your job setups to a file on your computer. The die number, description, PLS outputs, die protection inputs, air monitor, load monitor, shut height, part-in-place input, servo feed, and counter information are stored for each job. After the job setup database has been downloaded, you can upload individual job setups back to the SSC-3000 control on the same machine or to other machines.

Note: Your network administrator or an experienced IT (information technology) person will be required to program the network settings and install the networking assembly.

SECTION 3—INSTALLATION OF COMPONENTS

SSC-3000 Press Automation Control System

Remote Operator Station

A remote operator station for the control provides convenience for the press operator(s). A touchscreen display and selector switches are located on the remote operator station. A 320 x 240 monochrome LCD touchscreen (8" x 5 $\frac{1}{4}$ ") is used to enter setup information and to monitor machine operation. Please refer to the section on wiring (pages 60-61) and the electrical diagrams furnished with the remote operator station for wiring instructions.



The key must be removed from the program on/off selector switch after the control is programmed and before the machine is released to production. All keys must be supervisory-controlled at all times.



Photo 3.16
Remote Operator Station

Control Rack Kit*

The control rack kit can be furnished when the existing control enclosure is retained. The minimum area required on an existing control panel inside the control box to install the rack is 15" H x 18" W x 12" D. This kit includes the modular control rack, a power supply, and a **Main CPU Card**. Rack slot options and other options can be added. A complete sign package, installation manual, instructions, and electrical diagrams are furnished.



Photo 3.17
Control Rack Kit

Touchscreen/Display Kit*

The touchscreen/display kit includes the touchscreen/display, a mylar nameplate, a program off/on selector, a mode selector, an actuating means selector, and a light curtain off/on selector switch. The kit can be furnished plate-mounted or loose. The space required for the plate mount or loose kit is 12" H x 10" W x 3" D.

***A certified electrician is required for the installation of a control rack kit and touchscreen/display kit. If you do not have access to a certified electrician, please contact Rockford Systems at 1-800-922-7533, and we will propose the cost of having our installation team provide the installation.**



Photo 3.18
Plate-Mounted Touchscreen/Display Kit

(Continued on next page.)

Rockford Systems, LLC
Call: 1-800-922-7533

SECTION 3—INSTALLATION OF COMPONENTS

SSC-3000 Press Automation Control System

TOUCHSCREEN/DISPLAY ASSEMBLY

Photo 3.19
Touchscreen/Display



The touchscreen/display assembly, Part No. FTL-308 (photo 3.19), is used to enter setup information and to monitor machine operation.

The touchscreen/display can be furnished in a remote enclosure up to a maximum of 50' from the SSC-3000 control rack. All programming is accessed by a program off/on keyed selector switch. See pages 63-115 of this manual for programming information.

Mounting the Control Box

Solidly mount the control box in an accessible location, either on or near the machine to be controlled. A convenient location will keep conduit runs to a minimum length.

Note: On OBI (open back inclinable) presses, caution must be used to ensure that the control box location does not interfere with the ability to incline the press to its maximum position. On inclined presses, the length and flexibility of each individual conduit run must be carefully planned.

Although operation of this control will not be adversely affected by normal machine operation, excessive shock or vibration may require shock mounting in specific applications, and some applications may require remote mounting of the control box (off the press). Special stands or mounting brackets may need to be fabricated to accommodate remote mounting.

CAUTION

Do not run cable in conduit or in bundles with higher voltages that may cause electrical interference.

Twenty-five feet of cable is supplied as standard (if the touchscreen/display is remote) and can be cut to length, if required. Do not splice the cable or interrupt the signals. If a longer cable is required, please contact the factory.

When connecting the touchscreen/display wires to the P7 touchscreen port on the **Main CPU Card**, use the DB-9-to-terminal adapter board that was furnished with the control, follow the wiring schematics included with the control, and see Photo 3.20. Strip the wires and crimp the supplied ferrules on each wire.* Match each wire with the appropriate terminal in accordance with the wiring schematics. Make sure each wire is tight and is making good contact with the metal part of the ferrule.

*A special crimping tool is required to properly crimp the ferrules on the wires. If you do not have one, it is available from:

Weidmuller Inc.
821 Southlake Boulevard
Richmond, Virginia 23236
Toll-Free: 1-800-849-9343
Phone: (804) 794-2877
Fax: (804) 794-0252
www.weidmuller.com

We use the Weidmuller Type PZ 3,
Part No. 056730 crimping tool.

Photo 3.20—P7 Touchscreen Port Wiring
Connection on the Main CPU Card

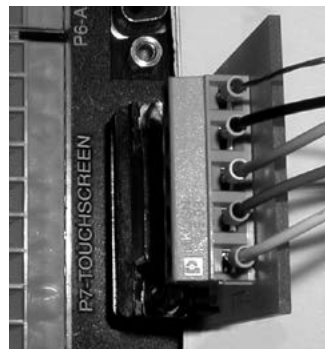

- No. 1—Bare Silver Shield**
- No. 2—Black**
- No. 3—Green**
- No. 4—Red**
- No. 5—White**

(Continued on next page.)

SECTION 3—INSTALLATION OF COMPONENTS

SSC-3000 Press Automation Control System

CRANKSHAFT ANGLE DISPLAY (OPTIONAL)

The crankshaft angle display, Part No. FTL-054 (photo 3.21), is an optional unit that shows the angular position of the crankshaft both graphically (with red LEDs in a circle) and numerically (with a large, red, three-digit LED display). The angle display should be mounted where it is easily viewed to help with setup, removal of stuck workpieces, or for assistance during emergency extraction procedures.

Photo 3.21—Crankshaft Angle Display



CAUTION Do not run cable in conduit or in bundles with higher voltages that may cause electrical interference.

One 25' cable is supplied as standard and can be cut to length, if required. Do not splice the cable or interrupt the signals. If a longer cable is required, please contact the factory.

The cable connects between the P6 air monitor port on the SSC-3000 **Main CPU Card** and Terminal Strip P1 on the crankshaft angle display.

When connecting Terminal Strip P1 on the crankshaft angle display wires to the P6 air monitor port on the SSC-3000 **Main CPU Card**, please follow the wiring schematics included with the crankshaft angle display and see Photo 3.22. Strip the wires and crimp the supplied ferrules on each wire.* Match each wire with the appropriate terminal in accordance with the wiring schematics. Make sure each wire is tight and is making good contact with the metal part of the ferrule.

*A special crimping tool is required to properly crimp the ferrules on the wires. If you do not have one, it is available from:

Weidmuller Inc.
821 Southlake Boulevard
Richmond, Virginia 23236
Toll-Free: 1-800-849-9343
Phone: (804) 794-2877
Fax: (804) 794-0252
www.weidmuller.com

We use the Weidmuller Type PZ 3, Part No. 056730 crimping tool.

Photo 3.22—Terminal Strip P1 Wiring Connection on the Crankshaft Angle Display

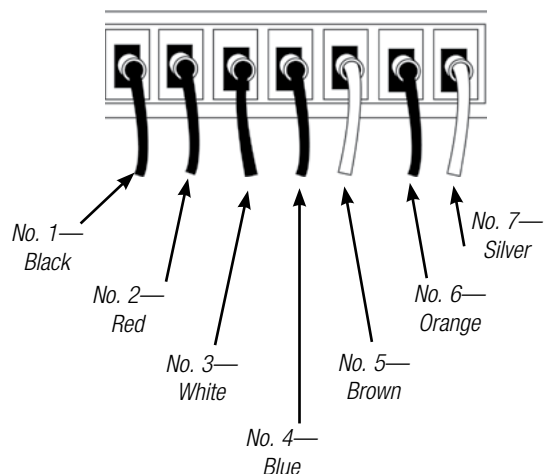

SECTION 3—INSTALLATION OF COMPONENTS

SSC-3000 Press Automation Control System

Resolver/Pulser Assembly

The absolute resolver/pulser assembly with spring-tension base is used to provide position and velocity/motion information of the machine crankshaft to the control. The resolver is a highly accurate and repeatable timing device. The resolver/pulser is contained in a rugged, heavy-duty housing with a spring-tension base. The $\frac{3}{4}$ " diameter steel shaft is mounted in sealed ball bearings. This results in a rugged transducer assembly for press applications. The resolver/pulser is furnished with a 40' cable that attaches to the drive assembly and wires in to the control box. When installing, the cable can be cut to the exact length required (do not splice). For more than 40' of cable, please contact factory. See the enclosed wiring schematics for proper wiring.

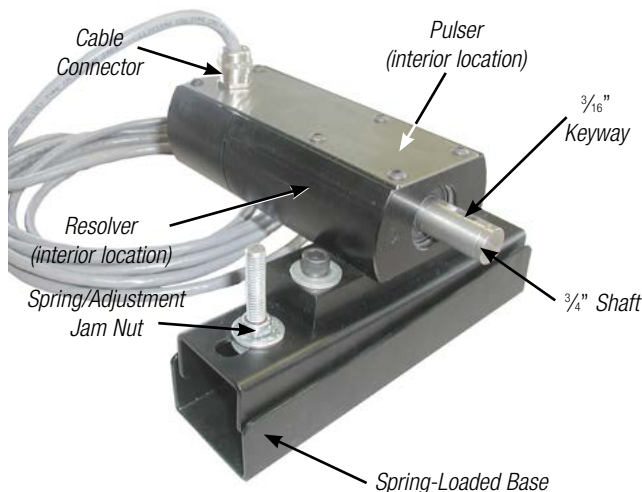

Photo 3.23
Part No. CMS-115
Resolver/Pulser Assembly

CAUTION

Do not run cable in conduit or in bundles with higher voltages that may cause electrical interference.

Photo 3.24
Resolver/Pulser Assembly
(Top of cover has been slid aside for photo)



The photoelectric pulser is monitored by the control logic to verify proper resolver position. Position changes can occur either mechanically or electrically. A mechanical failure can result if the resolver slips, and an electrical failure can result within the resolver cabling or circuitry. If failure occurs, the resolver position and the pulser cam signal will not match and the circuit logic will detect the fault. The pulser cam and resolver are connected internally to the connector provided; therefore, no wiring is necessary. The resolver/pulser is factory arranged for clockwise (CW) rotation (when facing the end of the shaft). A wiring change is required for counterclockwise (CCW) rotation. See the enclosed wiring schematics for further details.

After installation of the resolver/pulser and wiring is complete with the machine at TDC (top dead center), perform the power-up procedure in Section 4 on pages 64-65. This will automatically detect the pulser cam and set up the resolver for normal operation.

When installing a chain and sprocket or drive coupling to the $\frac{3}{4}$ " shaft, start with the machine at TDC (top dead center) and the keyway pointing up, perpendicular to the base. Connect the chain to sprockets or tighten the drive coupling. (See next page for sprocket and chain drive).

Note: If the resolver assembly is mounted on an angle or even upside down from what is illustrated, be sure the keyway on the shaft is always perpendicular to the base. The keyway must always be turned 180° away from the base when initially setting up the machine. The crankshaft of the machine must be at TDC.

(Continued on next page.)

SECTION 3—INSTALLATION OF COMPONENTS

SSC-3000 Press Automation Control System

CONNECTING THE RESOLVER WIRES TO TERMINAL STRIP P8

When connecting the resolver wires to Terminal Strip P8, please follow the wiring schematics included with the control and see Photo 3.26. Strip the wires and crimp the supplied ferrules on each wire.* Terminal Strip P8 has a color-coded number label. Match each wire with the appropriate terminal in accordance with the wiring schematics and the color-coding. Make sure each wire is tight and making good contact with the metal part of the ferrule.

Forty feet of cable is supplied as standard and can be cut to length, if required. Do not splice the cable or interrupt the signals. If a longer cable is required, please contact the factory.

*A special crimping tool is required to properly crimp the ferrules on the wires. If you do not have one, it is available from:

Weidmuller Inc.
821 Southlake Boulevard
Richmond, Virginia 23236
Toll-Free: 1-800-849-9343
Phone: (804) 794-2877
Fax: (804) 794-0252
www.weidmuller.com

We use the Weidmuller Type PZ 3, Part No. 056730 crimping tool.

Photo 3.26—Terminal Strip P8 Wiring Connection on the SSC-3000 Main CPU Card

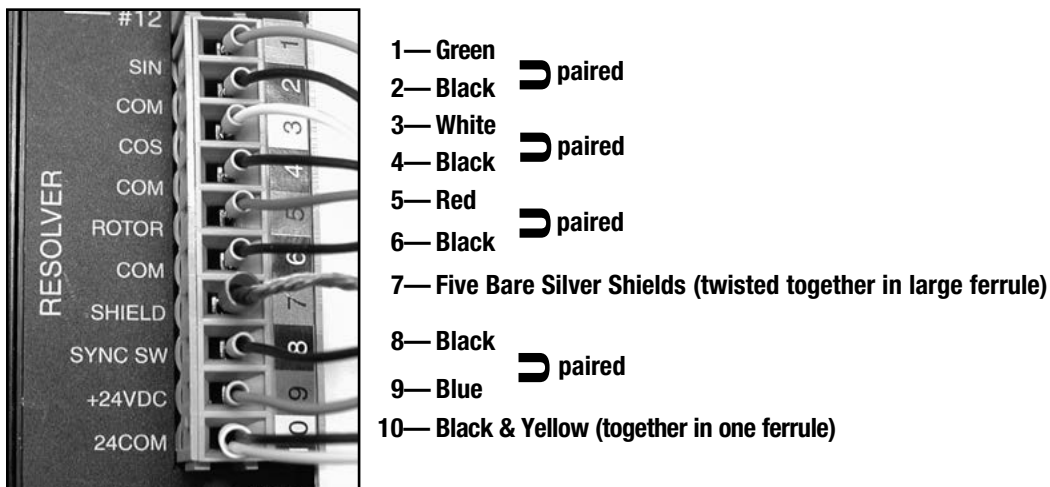

Note: There is a brown and black wire pair with a silver shield in the resolver cable that is not used—cut this off and discard it.

Note: The above wiring is for the resolver shaft to rotate clockwise. If the resolver needs to rotate counterclockwise, the white/black and green/black pairs need to be swapped, such that:

- 1— White **U** paired
2— Black
3— Green **U** paired
4— Black

SECTION 3—INSTALLATION OF COMPONENTS

SSC-3000 Press Automation Control System

Sprocket Assembly (If furnished)

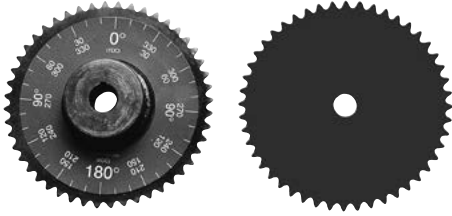

Photo 3.27
Part No. CML-000

Existing sprockets may be reused, or two sprockets with an identical number of teeth (usually 48) may be supplied. They are used to drive the resolver/pulsar assembly. The standard set consists of one sprocket with the proper bore, keyway, and setscrews to mount directly on the shaft extension of the resolver. The other sprocket is flat with a small rough bore. This sprocket is normally mounted on the end of the machine crankshaft by drilling and tapping two suitable mounting holes in the sprockets and crankshaft and using spacer blocks, if necessary, to provide clearance for the chain. These sprockets use a standard ANSI No. 35 roller chain and connecting links.

CAUTION Never hammer a sprocket or coupling on or off the resolver/pulsar assembly shaft—this could damage the resolver/pulsar assembly. It must be pressed on or off.

When installing the drive chain, it will be necessary to adjust the length of the chain in order to obtain proper action of the spring-loaded base of the resolver assembly. The normal position of the two hinged plates, on the resolver/pulsar assembly, is approximately parallel with each other when the chain is installed. The spring is normally positioned between the two plates when the chain is pulling down (see Photo 3.28). When the chain is pulling up, the spring is above the top plate (see Photo 3.29).

Photo 3.28

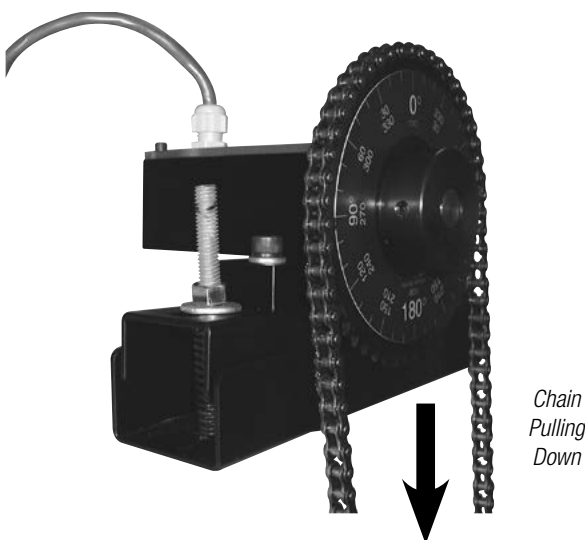
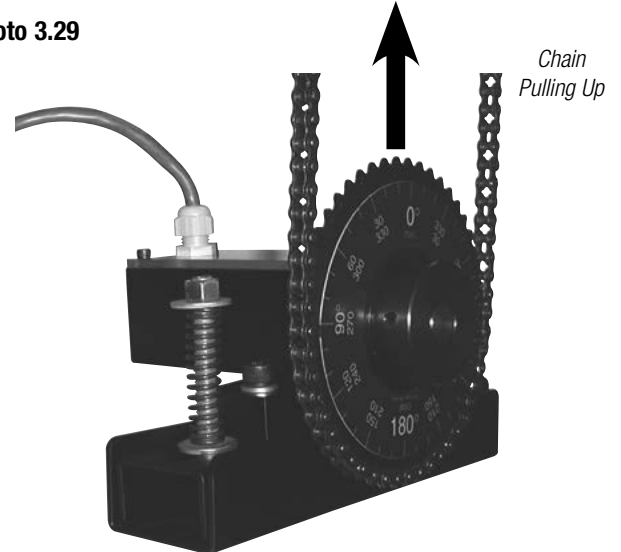

Photo 3.29



If a chain and sprocket drive already exists on a particular machine, it may be modified to drive the resolver. The resolver must always rotate exactly one revolution for each revolution of the machine crankshaft, therefore, the number of sprocket teeth must always match.

Note: If the press has a direct-coupling drive arrangement from the press or other timing device, the sprockets and spring-loaded base are not required. The spring base is furnished as a chain tightener, to help with misalignment and for shock isolation only. It is not used to detect chain breakage. The resolver has built-in motion detection that will sense if the sprocket stops rotating.

Roller Chain (If furnished)



Photo 3.30
Part No. CMS-515

Ten feet of ANSI No. 35 chain is usually furnished with each part-revolution control system. This chain is to be used with the supplied set of sprockets. A special master link for coupling the chain is furnished and this is used to connect the chain once the exact length has been determined.

SECTION 3—INSTALLATION OF COMPONENTS

SSC-3000 Press Automation Control System

Monitored Dual-Solenoid Air Valve (If furnished—See enclosed Manual KSL-036 or KSL-037)

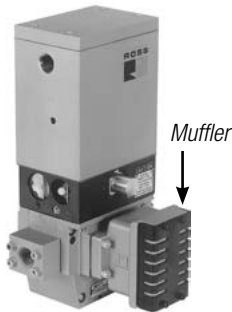

Photo 3.31
Part No. RCL-554
3/4" Dual-Solenoid Air Valve



The exhaust air muffer must be kept clean at all times. Never operate the machine unless the muffer is clean. The muffer must be removed and cleaned on a regular basis. If the machine has a split clutch and brake, two valves may be required. Both valves must be monitored dual valves with an electrical output signal to the control to indicate when one valve may have failed.

A minimum of 30 to 40 PSI must be maintained at the valve for proper operation. Use pipe size at least as large as the valve ports. An accumulator (air surge tank) is recommended. It would be installed in the incoming air line directly ahead of the valve to assure sufficient air volume to the clutch and brake.

Filter-Regulator-Lubricator (FRL) Assembly (If furnished—See enclosed Manual KSL-208)



Photo 3.32
Part No. RCL-045—3/4"

The filter cleans air that goes to the dual-solenoid air valve. The regulator and gauge are used to adjust air pressure to the proper amount to engage the clutch and release the brake. The lubricator keeps the dual-solenoid air valve or the clutch/brake properly lubricated.

This assembly is shipped in two boxes and a plastic envelope. The filter-regulator unit, with one threaded pipe plug, and the lubricator are in the two boxes. The gauge, mounting bracket and a connector or nipple are included.

Unpack the filter-regulator unit and install the connector between the filter/regulator and lubricator (see arrow for air flow direction). Tighten this assembly and position the two units with both bowls in alignment. Be sure to check air flow direction and the location of the dual valve to avoid excessive piping.

Choose an appropriate location on the machine for mounting this assembly. If possible, it should be accessible from floor level.

Install the pressure gauge in the threaded port opposite the mounting surface and plug the unused port. Attach the mounting bracket to the machine and then mount the FRL assembly using the lock nut supplied.

The length of the air line run to the surge tank is not critical; however, the port and pipe sizes should be maintained.

Fill the lubricator with a good quality lubricant (see OEM's specifications) to the level indicated by the maximum fill line. Do not overfill. When the machine is cycled, the lubricator drip rate may be adjusted according to the instruction manual. Please check the machine owner's manual for proper specifications for oil, if required. Some clutch and brake assemblies do not require lubrication.

The air filter must be kept clean at all times. Never operate the machine unless the air filter is clean. The lubricator must not be filled while under pressure.

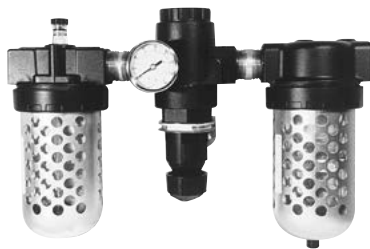

Photo 3.33
RCL-046—1"
RCL-047—1/2"

SECTION 3—INSTALLATION OF COMPONENTS*

SSC-3000 Press Automation Control System

Air Pressure Switch (If furnished—See enclosed Manual KSL-165)



Photo 3.34
Part No. CTD-062

The clutch/brake air supply must be monitored by an air pressure switch on all part-revolution power presses. If an air counterbalance is used, it must also be monitored by a separate air pressure switch. Please check the machine owner's manual for the minimum suggested air pressure for these switches.

Mount this switch at any convenient location on the machine. Electrical and pneumatic connections to the switch are required; therefore, its location is determined by the installer. Flexible hose is often used for air connections. Since only air pressure is being monitored, tubing size can be small and length is not critical. The switch is set to open the electrical circuit any time pressure falls below the preset level. It is normally set in the 30 to 40 PSI range to prevent unnecessary opening due to a surge in line pressure during the clutch engaging period. The minimum setting for the air counterbalance pressure may be in the 20 to 30 PSI range (see machine manufacturer's recommendations).

Check Valve for Counterbalance System (If furnished—See enclosed Manual KSL-038)



Photo 3.35
Part No. RCD-061— $\frac{1}{2}$ "
Part No. RCD-062— $\frac{3}{4}$ "
Part No. RCD-063—1"
Part No. RCD-064— $1\frac{1}{2}$ "
Part No. RCD-065—2"

If the machine is equipped with an air counterbalance system, a check valve is required by OSHA to prevent a sudden loss of air pressure to the system. This valve is available in various sizes. The size is determined by the pipe size of the incoming air supply to the air tank, which supplies the air to the counterbalance system. The valve should be installed in the air line just before the tank. When complete energy isolation is required, for maintenance on the machine or counterbalance system, be sure that air is released from the counterbalance, cylinders, tank, etc.

CAUTION

Do not install this valve between the cylinders and tank.

Palm Button Assembly (If furnished—See enclosed Manual KSL-073)



Figure 3.32
Part No. CTL-507

Black Run/Inch
Button

Red Emergency-Stop
Button

Black Run/Inch
Button

Figure 3.33
Part No. CTL-502



Black Run/Inch
Button

Yellow Top-Stop
Button

Red Emergency-Stop
Button

Black Run/Inch
Button

(Continued on next page.)

SECTION 3—INSTALLATION OF COMPONENTS

SSC-3000 Press Automation Control System

Palm Button Assembly (continued)

1. When the modes of operation of *Two-Hand "Walk-Away" Continuous*, *Automatic Single Stroke*, or *Continuous-on-Demand* are required, a palm button assembly will consist of four buttons (two black run/inch buttons with ring guards, one red emergency-stop button, and one yellow top-stop button). Four mounting boxes are supplied (three double-hub and one single-hub). Optionally available are the Touchdown!™, chrome, or articulated light-push palm buttons. These may be furnished in place of the standard black run/inch palm buttons. These palm buttons can be assembled in the order shown in Figure 3.34 and mounted according to the requirement of the application. Nipples, conduit, and wire for connecting the mounting boxes are not furnished.



Install the palm run buttons in such a way that they require the use of both hands to cycle the press.

2. The two run palm buttons, on part-revolution-clutch machines, can be used to initiate a machine cycle and as a method of safeguarding the point of operation. In both instances, OSHA and ANSI have established certain requirements for these buttons. For your convenience we have reproduced the pertinent sections of OSHA 29 CFR 1910.217 as well as the safety distance formula for two-hand control from ANSI B11.1. These



**Not included in palm button assembly. Must be ordered separately.*

sections cover two-hand control as an initiating means and two-hand control as a point-of-operation safeguard for part-revolution-clutch presses. Please read and make sure you understand the following sections before proceeding with the mounting of the two run buttons.

OSHA 29 CFR 1910.217 (b)(7)(v) for two-hand control used as a method of initiating a press cycle only:

- (v) *Two-hand controls for single stroke shall conform to the following requirements:*
 - (a) *Each hand control shall be protected against unintended operation and arranged by design, construction, and/or separation so that the concurrent use of both hands is required to trip the press.*
 - (b) *The control system shall be designed to permit an adjustment, which will require concurrent pressure from both hands during the die closing portion of the stroke.*
 - (c) *The control system shall incorporate an antirepeat feature.*
 - (d) *The control system shall be designed to require release of all operators' hand controls before an interrupted stroke can be resumed.*



The above description covers the use of two palm buttons as a method of actuating a press cycle. It does not provide any form of point-of-operation safeguarding. Some other properly applied and installed guard or device must be provided in accordance with OSHA 29 CFR 1910.217 (c) using the run palm buttons as an actuating means.

(Continued on next page.)

Rockford Systems, LLC
Call: 1-800-922-7533

SECTION 3—INSTALLATION OF COMPONENTS

SSC-3000 Press Automation Control System

Palm Button Assembly (continued)

OSHA 29 CFR 1910.217 for two-hand control used as a method of safeguarding the point of operation as follows:

(c)(3) Point of operation devices.

(i) Point of operation devices shall protect the operator by:

(e) Requiring the application of both of the operator's hands to machine operating controls and locating such controls at such a safety distance from the point of operation that the slide completes the downward travel or stops before the operator can reach into the point of operation with his hands;

(vii) The two-hand control device shall protect the operator as specified in paragraph (c)(3)(i)(e) of this section.

(a) When used in press operations requiring more than one operator, separate two-hand controls shall be provided for each operator, and shall be designed to require concurrent application of all operator controls to activate the slide. The removal of a hand from any control button shall cause the slide to stop.

(b) Each two-hand control shall meet the construction requirements of paragraph (b)(7)(v) of this section.
(See paragraph (b)(7)(v) on page 48.)

(c) The safety distance (D_S) between the two-hand control device and the point of operation shall be greater than the distance determined by the following formula: (Also, see Figure 3.35.)

$$D_S = 63 \text{ inches/second} \times T_S; \text{ where:}$$

D_S = minimum safety distance (inches);

63 inches/second = hand-speed constant; and

T_S = stopping time of the press measured at approximately 90° position of the crankshaft rotation (seconds).

(d) Two-hand controls shall be fixed in position so that only a supervisor or safety engineer is capable of relocating the controls.

Chart for OSHA Formula Only

T_S = Stopping Time in Seconds

D_S = Safety Distance for Two-Hand Control

Figure 3.35

T_S	D_S	T_S	D_S	T_S	D_S	T_S	D_S	T_S	D_S
.055	3½"	.158	10"	.261	16½"	.365	23"	.468	29½"
.063	4"	.166	10½"	.269	17"	.373	23½"	.476	30"
.072	4½"	.174	11"	.277	17½"	.380	24"	.484	30½"
.079	5"	.182	11½"	.285	18"	.388	24½"	.492	31"
.087	5½"	.190	12"	.293	18½"	.396	25"	.500	31½"
.095	6"	.198	12½"	.301	19"	.404	25½"	.507	32"
.103	6½"	.206	13"	.309	19½"	.412	26"	.515	32½"
.111	7"	.214	13½"	.317	20"	.420	26½"	.523	33"
.119	7½"	.222	14"	.325	20½"	.428	27"	.531	33½"
.126	8"	.230	14½"	.333	21"	.436	27½"	.539	34"
.134	8½"	.238	15"	.341	21½"	.444	28"	.547	34½"
.142	9"	.246	15½"	.349	22"	.452	28½"	.555	35"
.150	9½"	.253	16"	.357	22½"	.460	29"	.563	35½"
								.571	36"

*Based on the 63 inches/second hand-speed constant.

(Continued on next page.)

SECTION 3—INSTALLATION OF COMPONENTS

SSC-3000 Press Automation Control System

Palm Button Assembly (continued)

3. According to ANSI B11.1-2001, the total stopping time of the press (for two-hand control) should include the total response time of the control system and the time it takes the press to cease ram motion. The following formula should be used when calculating the safety distance:

$D_S = K(T_S + T_C + T_R + T_{spm})$; where:

K = the hand speed constant = 63 inches/second.

T_S = stopping time of the press measured from the final deenergized control element (usually the air valve).

T_C = the reaction time of the control system.

Note: $T_S + T_C$ can be measured by a built-in stop-time measurement device.

T_R = the reaction time of the two-hand control and its interface.

Note: $T_S + T_C + T_R$ can be measured by a portable stop-time measurement device.

T_{spm} = the additional time allowed by the stopping performance monitor (brake monitor) before it detects stop-time deterioration.

When the press stroke stop command or stopping performance monitor (brake monitor) timer or angle setting is changed, because the machine is taking longer to stop, the safety distance should be recalculated. The safeguarding device should also be placed at a greater safety distance if the stopping time or distance has increased.

Note: When obtaining the stopping time using the ANSI formula, a stopping position of crankshaft rotation is not provided. (The OSHA formula uses 90°.) To calculate the safety distance, the stop signal should be given on the downstroke at a point that would provide the longest stopping time.



When applying the two run palm buttons to meet the requirements for a point-of-operation safeguarding device, make certain these buttons are located on the machine so they meet the minimum safety distance required by the OSHA or ANSI formulas.

Simply stated, safety distance is the mounting location of the palm buttons at a distance where the operator cannot reach into the point-of-operation hazard before the ram has stopped or completed its downward travel.

To obtain the stopping time at 90° position of crankshaft rotation, either the built-in system (provided with the control system) or a portable stop-time measurement unit can be used.

WHEN USING FOOT SINGLE STROKE, TWO-HAND “WALK-AWAY” CONTINUOUS, AUTOMATIC SINGLE STROKE, CONTINUOUS-ON-DEMAND, FOOT-MAINTAINED CONTINUOUS, AND ONE-HAND OR FOOT TRIP MODES OF OPERATION:

A method of safeguarding the point of operation must be provided before using any of the above modes of operation.

The machine will not operate or must not be operated until you either:

1. Electrically interlock or
2. Mechanically safeguard the machine's point of operation with a guard or device.

Install either the electrically interlocked method of safeguarding or the mechanical guard or device.

1. When an electrically interlocked method of safeguarding the point of operation is chosen, connect the interlock to the **safeguard interlock** terminals (P4-14 and P4-15) in the control box, and as shown on the control wiring schematic (wire numbers 90 and 91). If a light curtain is used as the point-of-operation safeguard, it does not need to be interlocked in to P4-14 and P4-15. Refer to the control wiring schematic for proper terminal connection.
2. When a mechanical guard or device (nonelectrically interlocked) is chosen, the safeguard interlock terminals (P4-14 and P4-15) are not used. In order for the machine to operate with the use of a mechanical guard or device, the safeguard interlock terminals must be connected.

Note: When the mechanical guard or device is removed for other modes of operation, the safeguard interlock terminals must be disconnected.

(Continued on next page.)

Rockford Systems, LLC
Call: 1-800-922-7533

SECTION 3—INSTALLATION OF COMPONENTS

SSC-3000 Press Automation Control System

RED EMERGENCY-STOP BUTTON (REQUIRED)



Photo 3.36
Part No. CTC-736

The red emergency-stop button is used to stop the machine anywhere in its cycle. When the operator depresses the button, it should stop the hazardous motion of the machine immediately. This palm button assembly requires either a double-hub mounting box **Part No. CTK-003**, or a single-hub mounting box **Part No. CTK-004**. The button can be located between the two run palm buttons as part of the operator's control station (refer to page 48). A latch on the side trips when the button is pushed. To reset the button, push the latch in.

Note: More than one emergency-stop button may be furnished for additional control stations or for convenience.

YELLOW TOP-STOP BUTTON



Photo 3.37
Part No. CTC-727

The yellow top-stop button is used to stop the machine when it is in the "Walk-Away" *Continuous*, *Continuous-on-Demand*, or *Automatic Single Stroke* mode of operation. When the operator depresses the button, almost anywhere in the stroke of the machine, it will top stop; i.e., stop the machine at TDC (top dead center). This palm button assembly requires either a double-hub mounting box **Part No. CTK-003**, or a single-hub mounting box **Part No. CTK-004**. The button can be located between the two run palm buttons, along with the red emergency-stop button, as part of the operator's control station (refer to page 48).

PRIOR-ACTION STATION

A prior-action station is a push button that must be depressed and released by the operator before depressing the actuating means in order to initiate the *Continuous* automatic run type of press operation. This is sometimes referred to as "Walk-Away" *Continuous*. The prior-action station is also required when using the *Continuous-On-Demand*, *Automatic Single Stroke*, *Hand-Maintained Continuous*, or *Foot-Maintained Continuous* mode of operation.

Mount the remote station on the machine so it is convenient for the operator to depress and release the prior-action push button prior to depressing the actuating means. It may be mounted as part of the operator's control station (see page 48). After releasing the button, the operator has a 5-second time period in which to depress the actuating means. If the operator should wait longer than this time setting, the prior-action push button must be depressed and released again.



Photo 3.38
Part No. LLD-3000

Continuous Mode of Operation

According to OSHA 29 CFR 1910.217 (b)(7)(viii):

"Those clutch/brake control systems which contain both single and continuous functions shall be designed so that completion of continuous circuits may be supervised by the employer. The initiation of continuous run shall require a prior action or decision by the operator in addition to the selection of Continuous on the stroking selector, before actuation of the operating means will result in continuous stroking."

According to ANSI B11.1-2001, Subclause 6.12.3.3.4, *Continuous*:

A press control system that provides a CONTINUOUS cycling (stroking) mode shall require the selection of the CONTINUOUS mode and a prior action or decision by the operator before operation of the actuating means will initiate continuous cycling (stroking).

(Continued on next page.)

SECTION 3—INSTALLATION OF COMPONENTS

SSC-3000 Press Automation Control System

PRIOR-ACTION STATION (continued)

Continuous-on-Demand Mode of Operation

According to ANSI B11.1-2001, Subclause 6.12.3.3.6, *Continuous-on-Demand*:

When a press control system provides a CONTINUOUS-ON-DEMAND cycling (stroking) mode:

- a) The enabling of CONTINUOUS-ON-DEMAND cycling (stroking) action shall require the selection of the CONTINUOUS-ON-DEMAND mode and a prior action or decision by the operator before operation of the manual actuating means either:
 - 1) manually initiates the first cycle (stroke), after which the demand signal for cycling (stroking) is enabled to initiate intervals of continuous cycling (stroking) as required, or
 - 2) directly enables the cycling (stroking) action to be initiated by the demand signal for cycling (stroking) without a manually initiated first cycle (stroke).
- b) A timer shall be provided to prevent cycling (stroking) in the CONTINUOUS-ON-DEMAND mode if the time between the demand signals for cycling (stroking) exceeds a predetermined time established by the user. Cycling (stroking) must be manually reenabled by the use of the procedure in 6.12.3.3.6 (a) when the predetermined time is exceeded.
- c) A STOP signal from any source shall stop any cycling (stroking) action of the press and shall prevent further cycling (stroking) until CONTINUOUS-ON-DEMAND is manually reenabled by use of the procedure in 6.12.3.3.6 (a).

Automatic Single Stroke Mode of Operation

According to ANSI B11.1-2001, Subclause 6.12.3.3.7, *Automatic Single Stroke*:

When a press control system provides an AUTOMATIC SINGLE STROKE mode:

- a) The enabling of AUTOMATIC SINGLE STROKE cycling (stroking) action shall require the selection of the AUTOMATIC SINGLE STROKE mode and a prior action or decision by the operator before operation of the manual actuating means either:
 - 1) manually initiates the first cycle (stroke), after which the automatic single cycle (stroke) signal is enabled to initiate single cycles (strokes) as required, or
 - 2) directly enables single cycles (strokes) to be initiated by the automatic single cycle (stroke) signal without a manually initiated first cycle (stroke).
- b) A timer shall be provided to prevent cycling (stroking) in the AUTOMATIC SINGLE STROKE mode if the time between automatic single cycle (stroke) actuation signals exceeds a predetermined time established by the user. Cycling (stroking) must be manually reenabled by the used of the procedure of 6.12.3.3.7 (a) when the predetermined time is exceeded.
- c) A STOP signal from any source shall stop any cycling (stroking) action of the press and shall prevent further cycling (stroking) until AUTOMATIC SINGLE STROKE is manually reenabled by use of the procedure in 6.12.3.3.7 (a).

Operator-Maintained (Two-Hand-Maintained or Foot-Maintained) Continuous Mode of Operation

According to ANSI B11.1-2001, Subclause 6.12.3.3.5, *Operator-Maintained Continuous*:

The initiation of OPERATOR-MAINTAINED CONTINUOUS shall require a prior action or decision by the operator, in addition to the selection of OPERATOR-MAINTAINED CONTINUOUS, before initiation of the actuating means will result in cycling (stroking) action. When the actuating means is released, the slide shall stop during the cycle (stroke) or at the completion of the cycle (stroke).

SECTION 3—INSTALLATION OF COMPONENTS

SSC-3000 Press Automation Control System

Palm Button Assembly (continued)

Control bars that include the palm buttons previously shown are also available. A control bar can include the emergency-stop and top-stop palm buttons, the multiple-operator supervisory selector switch and indicator light, and the prior-action push button. See the control bar wiring schematics for proper wiring.

Photo 3.39
Example of a
Control Bar



A palm button assembly or control bar can be mounted on a floor stand. If two-hand control is used as a method of safeguarding the point of operation, the floor stand must be fixed into position at the required safety distance.

Photo 3.40
Part No. KCL-000

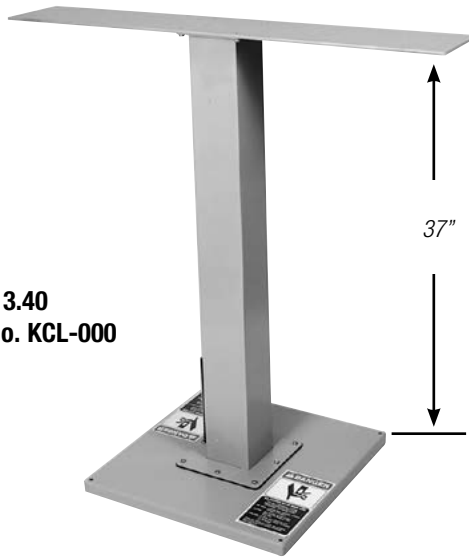

Photo 3.41
Part No. KCL-017



Adjustable
from 28" to
47" above the
floor

(Continued on next page.)

SECTION 3—INSTALLATION OF COMPONENTS

SSC-3000 Press Automation Control System

Palm Button Assembly (continued)

Two-hand control is furnished with the SSC-3000 press control and can be used as a point-of-operation device. If it is going to be used as a point-of-operation device, the following function tests should be run before operating the press. These tests should be done at every setup, operator, and shift change, as well as every time after maintenance is performed.

1. Before turning the machine on, verify that:
 - a. The hand controls are protected against unintended or inadvertent operation. This is usually done with ring guards or fabricated shields. (If the hand controls are nonmechanical such as capacitive or optical touch buttons, make sure that only an operator's hands can actuate them and not other parts of his or her body.)
 - b. The hand controls are separated by enough distance or configured to require the use of both hands.
 - c. The hand controls are fixed in position at the proper safety distance. (See pages 49–50 for details.)
 - d. Two individual hand controls are provided for each operator that is to be safeguarded by two-hand control. When there are multiple two-hand control stations, there must be an indicator at each station to indicate whether the station is on or off (usually accomplished with an indicator light), and the means of turning the station on and off must be supervisable (usually done with a key-operated selector switch).
2. With the main motor on, the flywheel rotating, the actuating means selector switch set to **HAND**, and the mode selector switch set to **SINGLE**, perform the following tests.
 - a. Actuate both hand controls and keep them actuated. The machine should make one complete cycle and then it should stop, even though the hand controls are still being actuated.
 - b. Actuate both hand controls and release them while the machine is still in the hazardous portion of its cycle. The machine should stop. Both hand controls must be continuously actuated during the hazardous portion of the cycle.
 - c. Actuate both hand controls and release only one control during the hazardous portion of the cycle. The hazardous motion of the machine should stop. Reactuate the hand control that was released. The machine should not finish the cycle. Repeat this with the other hand control. Again, the machine should not finish the cycle. Both hand controls must be released and reactivated before the machine can finish the cycle.
 - d. Actuate one hand control, wait until the anti-tie-down time limit has expired, and then actuate the other hand control. The machine should not cycle. The hand controls must be actuated concurrently within the programmed anti-tie-down setting (100–7000 ms) before a machine cycle can be initiated.
 - e. If the machine is equipped with multiple two-hand control stations, turn off all stations and make sure that the machine does not cycle. Also perform the above tests at each two-hand control station.
3. If any of these function tests fail, take corrective action before running production. If all tests pass, remove all keys from the selector switches before running production.

Foot Switch (If furnished—See enclosed Manual KSL-001)



If you elect to use a foot switch, all personnel must be warned that it is impossible for a foot switch to provide any form of point-of-operation safeguarding. It is the responsibility of the employer (user) to always provide an appropriate guard and/or device to prevent bodily injury whenever a foot switch is used to initiate a machine cycle. (See OSHA 29 CFR 1910.217 (c) for safeguarding.)

The following steps should be taken when using a foot switch:

A method of safeguarding (light curtain, guard, gate, pullback, or restraint) the point of operation must be provided before installing or using a foot switch.

The machine will not operate or must not be operated until you either:

1. Electrically interlock or
2. Mechanically safeguard the machine's point of operation with a guard or device.

Install either the electrically interlocked method of safeguarding or the mechanical guard or device.

1. When an electrically interlocked method of safeguarding the point of operation is chosen, connect the interlock to the safeguard interlock terminals (P4-14 and P4-15) in the control box and as shown on the control wiring schematic (wire numbers 90 and 91). If a light curtain is used as the point-of-operation safeguard, it does not need to be interlocked in to P4-14 and P4-15. Refer to the control wiring schematic for proper terminal connection.
2. When a mechanical guard or device (nonelectrically interlocked) is chosen, the safeguard interlock terminals (P4-14 and P4-15) are not used. In order for the machine to operate with the use of a mechanical guard or device, the **safeguard interlock** terminals must be connected.

Note: When the mechanical guard or device is removed for other modes of operation, the safeguard interlock terminals must be disconnected.



Never use a foot switch to operate this machine unless a point-of-operation guard or device is provided and properly maintained.



The mechanical guard or device must be properly installed, used and maintained. It must always prevent all personnel from bodily injury.



If the mechanical guard or device is not used, is removed or is defeated, an electrically interlocked method of safeguarding must be used and connected to the safeguard interlock terminals P4-14 and P4-15.

When installing the optional foot switch, be sure the wiring schematics are referenced for proper connections. Be sure to maintain the foot switch in first-class condition. It must always be wired properly and the protection on the top, sides, and front must always remain in place.

Photo 3.42
Part No. CTD-011



SECTION 3—INSTALLATION OF COMPONENTS

SSC-3000 Press Automation Control System

Supervisory Control Station (If furnished)

When two or more palm button or foot switch operating stations are required on one machine, one supervisory control station is required at each operator station. This remote control station consists of one station on indicator light and an off/on keyed selector switch in an enclosure. The on position allows the operator to use that station and the off position deactivates only that station. If all the supervisory control stations are in the on position, the palm buttons or foot switches must be depressed within the timing period set in the anti-tie-down program (pages 86-87) in order to initiate a machine stroke.

Note: If the USC-000 multiple-operator junction box is used, the anti-tie-down setting in the SSC-3000 control becomes irrelevant, since the junction box has its own timers.



Photo 3.43
Supervisory Station
Part No. LLD-3001
Part No. LLD-283 (Required
when USC-000 multiple-operator
junction box is used; see below)

Multiple-Operator Junction Box (If furnished—See enclosed Manual No. KSL-266)

When multiple operator stations are required, this junction box is furnished separately for wiring up to four (4) operator stations. This junction box interfaces palm button assemblies/control bars and foot switches, and will not allow the press to run if palm buttons or a foot switch is actuated without its supervisory control station on. Refer to the electrical schematic furnished with your order for proper wiring of each station.



Photo 3.44
Multiple-Operator
Junction Box
Part No. USC-000

Bar/Run Station (If furnished)

This remote bar/run station can be used in conjunction with manual turnover bar operation when setting dies in the press. The flywheel must have holes in the periphery for insertion of the spring-loaded turnover bar (or the flywheel can be manually turned when the flywheel cover is removed). The remote station includes a three-position selector switch for bar, off, run, and one push button used for energizing the dual-solenoid air valve to engage the clutch and release the brake. The flywheel must be at rest (static) when engaging the clutch. After the clutch is engaged, the die set-up person can manually turn the flywheel with the spring-loaded turnover bar. This then causes the ram to move.



Photo 3.45
Remote Bar/Run Station
Part No. LLD-3002

Other Components That Could Be Interfaced to the Control

Interlocked Guard	Feed System	Die Light
Light Curtain*	Bumper Pin	Conveyor
RF Device*	Flywheel Brake*	Motion Detector*
Gate*	Tachometer*	Bearing Heat Sensors*
Air Blowoff	Digital Shut-Height Indicator*	Overload Protection*
Additional Counters	Brake Monitor*	Robot*
Indexing Table*	Hour Meter	Additional Programmable Limit Switch*
Sliding Bolster*	Material Feeding Equipment*	Safety Block Electrical Interlock System
Additional Die Protection*	Material Straightener	Lubrication System*
Bar/Run Station	Reel Cradle for Coil	

*The electrical or electronic schematics are required if Rockford Systems is to interface this equipment to the control.

Other Components That May Be Required

AIR LOCKOUT VALVE (If furnished—See enclosed Manual KSL-098)

OSHA 29 CFR 1910.147 requires that all employers develop a complete hazardous energy control program. This standard covers the servicing and maintenance of machines and equipment where the unexpected energization or start-up of the machines or equipment, or release of stored energy could cause injury to employees. The following should be included when establishing a program:

1. Use procedures for affixing lockout or tagout devices to energy isolating devices. Also, disable machines or equipment to prevent unexpected energization, start-up, or release of stored energy in order to prevent injury to employees.
2. After establishing a hazardous energy control program, periodic inspection of the energy control procedure must be done at least annually.
3. Training of employees to ensure the purpose and function of the energy control program is understood.
4. When establishing procedures for shutdown:
 - Identify all energy sources.
 - Know the hazards of the energy to be controlled.
 - Determine the methods or means to control energy.
5. Hazardous energy sources associated with machinery are:
 - Electrical
 - Pneumatic
 - Hydraulic
 - Fluids and Gases
 - Mechanical

INSTALLATION OF LOCKOUT VALVE

When ready to install a lockout valve (if furnished), remove plastic dust covers from the valve port connections. Avoid getting particles such as chips, sealing compounds, or scale in the piping. This can cause valve failure and damage. See Figure 3.36 on page 58 for a diagram of where the lockout valve could be located and for additional instructions on installing lockout valves.

(Continued on next page.)

SECTION 3—INSTALLATION OF COMPONENTS

SSC-3000 Press Automation Control System

Figure 3.36

Illustration of where an air lockout valve could be located in the air line on part-revolution power press

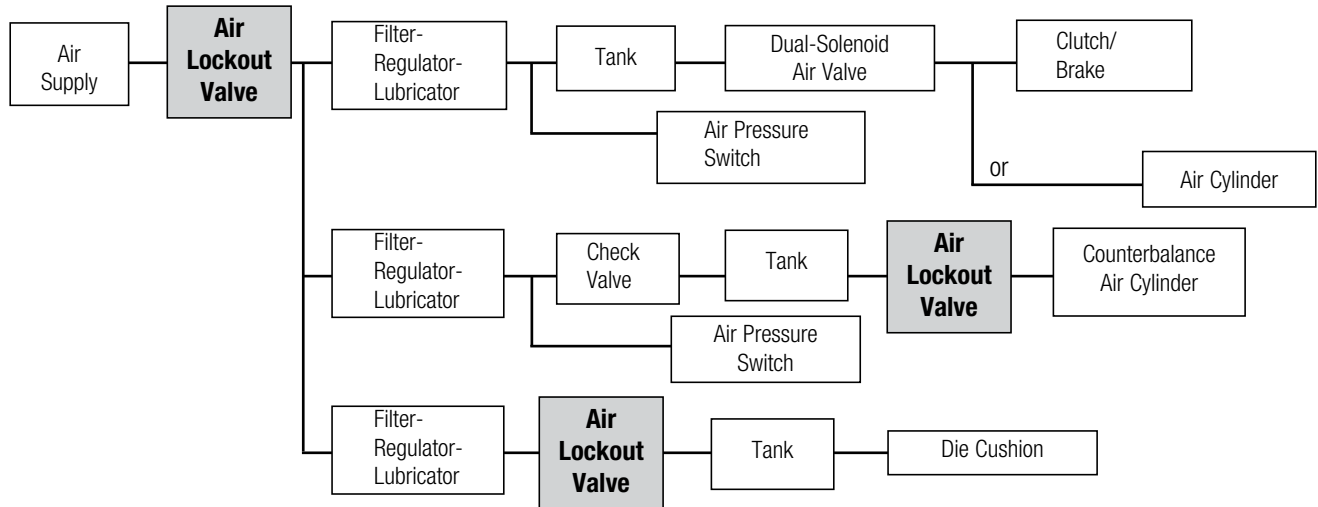

TYPES OF LOCKOUT VALVES THAT CAN BE FURNISHED

Manual Valve

This valve is installed in the air line going to the machine. To exhaust air in the line, the handle is pushed in. This valve is available in port sizes 3/4" and 1".

Photo 3.46



Manual Pilot Valve

This valve is used for air systems that are larger than those that can be used with the manual valve. Port sizes are 1 1/2" and 2 1/2".

Photo 3.48



Slide-Operated Valve

This three-way valve is opened with the manual movement of a slide that opens and closes the valve. This valve shuts off air at the press and then bleeds off downstream air. This valve is available in port sizes 1/2" and 3/4".

Photo 3.47



EEZ-On Valve

This valve shuts off air supply to the machine and bleeds downstream air when the valve is closed. When the valve is open, it gradually allows air into the air system to prevent damage to air components. It can be locked only in the off position. This valve is available in port sizes 1/2" and 3/4".

Photo 3.49



Note: When any of these valves are manually closed, the downstream air is automatically drained, provided there is not a check valve or obstruction in the air line.

(Continued on next page.)

SECTION 3—INSTALLATION OF COMPONENTS

SSC-3000 Press Automation Control System

TYPES OF LOCKOUT VALVES THAT CAN BE FURNISHED (continued)

Figure 3.37

VALVE TYPE	PART NUMBER	IN/OUT PORT	EXHAUST PORT	VALVE BODY WITHOUT MUFFLER	MUFFLER
Manual	RCD-076	3/4"	1"	RCD-086	RCS-044
	RCD-077	1"	1"	RCD-087	RCS-044
Manual Pilot	RCD-078	1-1/2"	1-1/2"	RCD-088	RCS-006
	RCD-079	2-1/2"	2-1/2"	RCD-089	RCS-038
Slide-Operated	RCD-113	1/2"	N/A	N/A	N/A
	RCD-114	3/4"	N/A	N/A	N/A
EEZ-On	RCD-121	1/2"	3/4"	RCD-118	RCS-043
	RCD-122	3/4"	3/4"	RCD-119	RCS-043

MAIN POWER DISCONNECT SWITCH

A main power disconnect switch may have been supplied in this control package shipment as a separate component or included in a custom or special control box. This switch is designed to disconnect the primary voltage to the press and lock it out. Please refer to the enclosed wiring schematics for proper wiring of this switch.

OSHA 29 CFR 1910.217 (b)(8) and ANSI B11.1 require that:

1. A main power disconnect switch capable of being locked in the off position shall be provided with every power press control system.
2. If the machine already has a main power disconnect switch, it must be checked for the "locking off" feature. Some switches use construction which can be easily altered mechanically to comply with this requirement. If this is not possible, or an electrical disconnect switch is not provided, then you must obtain and install a proper disconnect switch. (For a proper disconnect switch, please contact Rockford Systems.)

MOTOR STARTER

A reversing or nonreversing motor starter may have been supplied with this control package as a separate component or included in a custom or special control box. The main purpose of this starter is to start and stop the main motor and to drop out the main motor when a power failure occurs. Please refer to the enclosed wiring schematics for proper wiring of this starter. If an existing starter is used, a 120-V AC coil and N.O. auxiliary (main motor forward) contact are required.

OSHA 29 CFR 1910.217 (b)(8) and ANSI B11.1 require that:

1. The motor start button shall be protected against accidental operation.
2. All mechanical power press controls shall incorporate a type of drive motor starter that disconnects the drive motor from the power source in the event of control voltage or power source failure. It shall also require operation of the motor start button to restart the motor when voltage conditions are restored to normal.

These requirements are normally met by using a magnetic motor starter. This starter should operate with a 120-V AC coil which is powered from the secondary of the control transformer on the control panel. Refer to the electrical schematics supplied to obtain details of how to wire the starter and associated motor start/stop push buttons.

For proper tie-in of the furnished clutch/brake controls, the starter requires an auxiliary normally open contact. (For a proper starter, please contact Rockford Systems.)

CUSTOM OR SPECIAL CONTROL BOX

In place of the standard control box previously described, you may have ordered and received a custom or special control box. This box usually includes a magnetic motor starter and disconnect switch complying to the previously described requirements. Be sure to wire in primary voltage and components to terminals as indicated on the enclosed wiring schematics. 120-V electrical power to clutch/brake controls, operator controls, solenoids, etc., must be obtained from a transformer with isolated secondary.

SECTION 3—INSTALLATION OF COMPONENTS

SSC-3000 Press Automation Control System

FLYWHEEL AND GEAR COVERS

According to OSHA 29 CFR 1910.219 and ANSI B15.1 for mechanical power-transmission apparatus, all rotating components including flywheels, gears, sprockets and chains, sheaves and belts, shaft ends, etc., must be covered if at or below a seven-foot level from the floor or platform.

Note: ANSI states it should be a nine-foot level. Adequate cover material and brackets must be fabricated to retain these components in event of shaft or wheel mounting failure.

COLLATERAL EQUIPMENT

All collateral press room and plant equipment such as spring or air slide counterbalances, die cushions, feeding equipment, and robots must be safeguarded if they create hazards to personnel.

POINT-OF-OPERATION SAFEGUARDS

OSHA 29 CFR 1910.217 (c)(1)(i) states:

“It shall be the responsibility of the employer (user) to provide and insure the usage of ‘point of operation guards’ or properly applied and adjusted point of operation devices on every operation performed on a mechanical power press. See Table O-10.”

Refer to Section 9, pages 129-130, for examples of point-of-operation safeguards for power presses.

Other Installation Considerations

PIPING

1. An air lockout valve must be installed in the air line usually just before the filter-regulator-lubricator assembly to meet OSHA 29 CFR 1910.147 Lockout/tagout requirements. However, a separate lockout valve could be furnished for each air system on the machine such as counterbalance, die cushion, clutch/brake, air cylinder, and blow-off.
2. From the lockout valve, connect at the In threaded opening of the filter-regulator. Try to maintain an appropriate pipe size throughout for proper air flow. Connect the piping to the ports using teflon tape on the male threads only. Do not allow tape to enter the interior of the filter-regulator-lubricator, valve, or air cylinder. Before applying air pressure, make sure the filter and regulator bowls are at least hand tight.
3. Most approved pipe or hose can be used on the press. Make sure the size is consistent throughout the system in order to avoid restriction. Keep air runs as short as possible.
4. See enclosed filter-regulator-lubricator (FRL) assembly Manual No. KSL-208 for additional details.

CAUTION All air components require clean air. Blow all lines clean of water, dirt, scale, etc., before making final connection. Drain water from filter bowl regularly. Should this bowl refill in a short period of time, it may indicate the need for a larger filter in the main air supply line or an air line dryer system. The air filter must be kept clean at all times. Never operate the machine unless the air filter is clean and water is drained.

WIRING

National Electrical Code and NFPA 79 practices are usually followed for wiring the control system, which includes color-coding and the use of numbered wire markers on **both ends of every wire**. Color-coding is black for line voltage (208, 230, 460, or 575 V) and control at line voltage, red for 120-V AC control circuits, blue for 24-V DC control circuits, white for current-carrying ground (commonly referred to as the neutral), and green for any equipment grounding conductor. All terminal blocks in the control cabinet are color-coded for easy identification.

- a. Install and wire the main disconnect switch (unless one already exists or is furnished in a custom control) using black wire. Follow wiring instructions shown on the electrical schematics. Make certain this switch is capable of being locked in the off position only.

(Continued on next page.)

SECTION 3—INSTALLATION OF COMPONENTS

SSC-3000 Press Automation Control System

WIRING (continued)

- b. Install and wire the motor starter (unless one already exists or is installed in a custom control box) using black wire for the power, red and white wires for the coil and interlock circuit, and blue for the motor forward connection to the control module.

If an existing starter does not have a 120-V AC coil, a new 120-V AC coil must be obtained, installed and wired in accordance with the schematics provided before proceeding. An additional auxiliary normally open contact may also be required in the starter. (Do not run a separate 120-V line to the machine for operating the clutch/brake controls.)

- c. All necessary inputs and outputs to the control module are prewired from the printed circuit board terminals to the color-coded terminal strips for installation. No wiring on the printed circuit board terminals is necessary.
- d. Run two black power lines (any two lines) from the load side of the disconnect switch (or from the line side of the motor starter) to the control enclosure. Connect the two black wires to the proper terminals on the control transformer (see electrical schematic or transformer nameplate for proper connections for different primary voltages).
Note: If a custom control box with a disconnect has been provided, this step is not necessary.
- e. Run a green ground wire from the incoming system ground to the control panel.
- f. Wire the motor starter and start/stop controls according to the connection schematics.
Note: If a custom control box with a starter has been provided, this step is not necessary.
- g. To wire the dual-solenoid air valve, see the enclosed Installation Manual No. KSL-036 or KSL-037 and the wiring schematics. The exhaust air muffler must be kept clean at all times. Never operate the machine unless the muffler is clean.

TOUCHSCREEN/DISPLAY ASSEMBLY

Refer to page 41 for the wiring of the touchscreen/display assembly.

RESOLVER/PULSER ASSEMBLY

Refer to page 44 for the wiring of the resolver/pulser assembly.

AIR PRESSURE SWITCH(ES) (See page 47)

Run ½" nominal conduit from pressure switch(es) to the control box. Pull the appropriate number of wires through conduit. Number the wires according to the diagram and connect to terminals at both ends. These pressure switches always use the normally open contact which is held closed by normal air pressure. Loss of air pressure will open this contact and render the control inoperative. The normally closed contact provides a signal to one of the user-programmable diagnostic inputs.

PALM BUTTON ASSEMBLY (See pages 47-54)

These are normally wired as an assembly with the blue wires routed from the control box to the nearest palm button and then the others, as required. Wires between the two run/inch buttons are not connected back to the control box. If Touchdown!TM (proximity) palm buttons are furnished, please refer to the enclosed Installation Manual No. KSL-073 and the connection print provided.

If the palm button assembly is not bolted directly to the machine frame, then a separate green ground wire should be run from the control box to all palm buttons. Attach one end of the wire to each mounting box by a lug under one of the mounting bolts and the other end of the wire to the GND terminal in the control box to assure proper grounding.

(Continued on next page.)

SECTION 3—INSTALLATION OF COMPONENTS

SSC-3000 Press Automation Control System

WIRING (continued)

PALM BUTTON ASSEMBLY (continued)

These operator controls should be mounted in a convenient location, keeping ergonomics in mind. To comply with the OSHA standard for two-hand control, the run/inch buttons must be located according to the minimum safety distance requirements of each individual machine as defined by OSHA 29 CFR 1910.217 (c)(3)(vii) (see page 49 of this manual). A stop-time measurement is necessary for checking stopping time before installation begins to determine the safety distance of the two-hand control palm buttons furnished with the control. After installation, the stopping time can be obtained from the built-in stop-time measurement system or a portable stop-time measurement unit.

CONTROL BAR (See page 53)

Mount the control bar at the required safety distance either on the machine or on a floor stand. See the wiring schematics for proper wiring of the control bar.

FOOT SWITCH (See page 55)

Run ½" nominal flexible conduit or cord from the foot switch to the control box. Connect the contacts according to the control drawing schematic. In general, connect one wire from one side of the normally open and normally closed contacts to a COM terminal, and a wire from the other side of each contact to the appropriate control module input terminal. If multiple foot switches are used, the COM connection may be split up. Refer to the multiple operator drawing for wiring details. Be sure to connect the ground in the foot switch to the GND terminal in the control box with a green wire.

SUPERVISORY CONTROL STATION (See page 56)

Mount the station in a convenient location where it is easily accessible, or as part of a palm button assembly (see page 44). See the wiring schematic for proper wiring of the supervisory control station.

MULTIPLE-OPERATOR JUNCTION BOX (See page 56)

Run ¾" nominal conduit from the junction box to the control box. Pull the cable through the conduit and connect it to the appropriate terminals according to the junction box drawing. Connect each supervisory control station to the multiple-operator junction box with the cable.

Note: The junction box should be located for easy access to the fault reset button in case a fault should occur.

BAR/RUN STATION (See page 56)

Run ½" nominal conduit from the bar/run station to the control box. Pull red wires through the conduit according to the drawing.

Note: The bar/run station should be located for easy access to the bar push button while barring the press.

*** PRESS GROUND ***



The machine frame must always be firmly connected to ground in order to avoid problems with the control and to ensure the control potential will never exceed 120 V above ground. Run a green grounding wire from the control box to some convenient location directly on the machine frame. Connect one end solidly to the frame using a mounting bolt or other convenient means of attachment. Scrape any paint, rust, etc., from the area to ensure an adequate ground connection. Connect the other end to the GND terminal in the control box.

Note: All exposed metal components, which may be touched by personnel during normal operation or adjustment, must be firmly grounded to the machine frame. The disconnect switch and motor starter should also be grounded if they are mounted separately.

Figure 4.1
Programming Flowchart

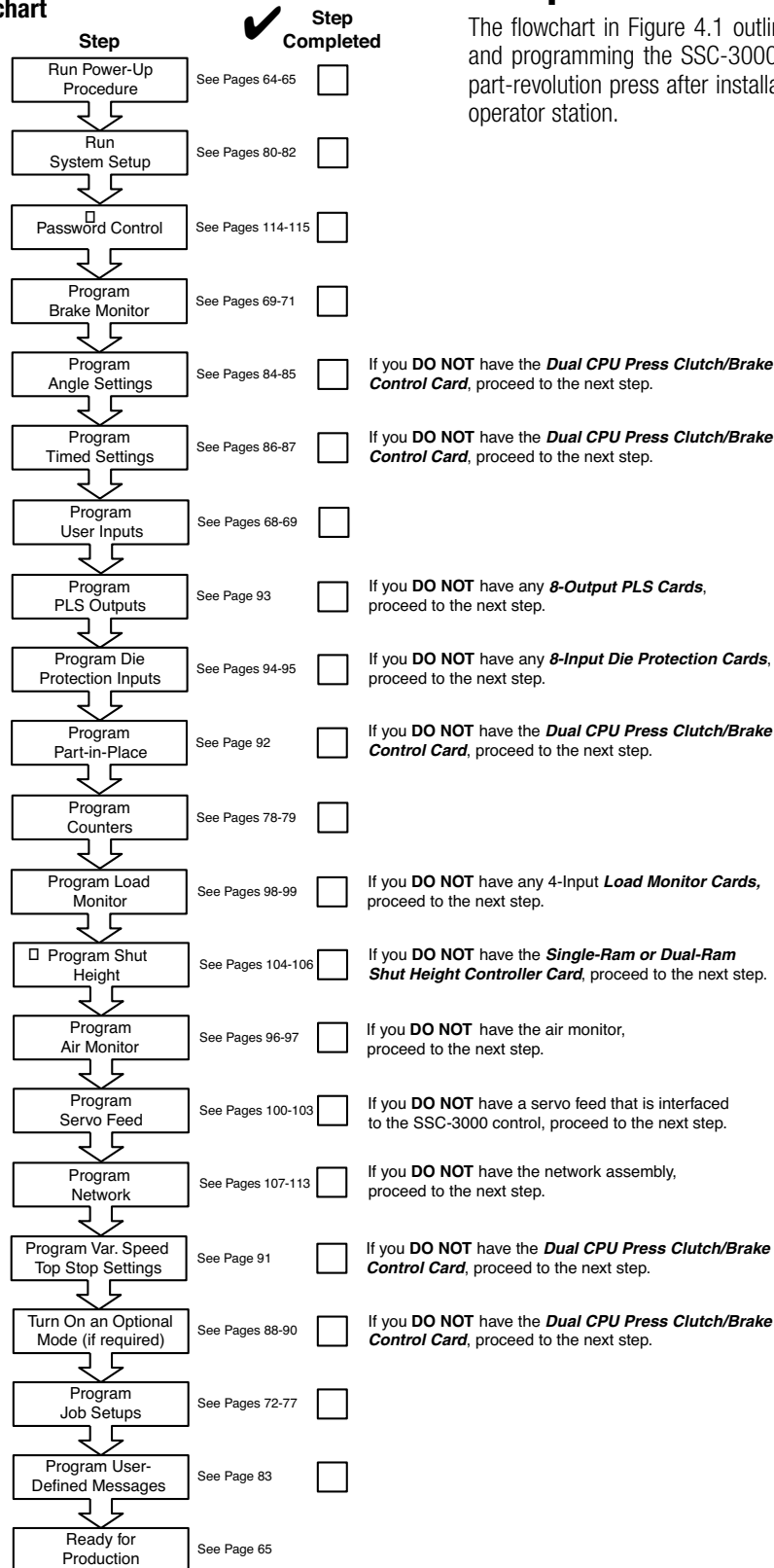

Setup of Control System

The flowchart in Figure 4.1 outlines the order and method of setting up and programming the SSC-3000 press automation control system on a part-revolution press after installation. Refer to the display on the remote operator station.

SECTION 4—PROGRAMMING

SSC-3000 Press Automation Control System

Power-Up Procedure

After completing the installation of the control box and the control components on your part-revolution clutch power press, the SSC-3000 press automation control must be initially programmed in order to get the machine up and running. To do this, you must first go through the following *Power-Up Procedure* of the automation control.

Turn the main power disconnect switch for the control to the **ON** position. If your control does not turn on, open the control box and make sure the main power switch on the bottom left of the rack is in the **ON** position. Once there is power to the control, the current touchscreen software version is displayed on the touchscreen for a brief moment. See Figure 4.2.

Next, the control will check each of the eight circuit board slots to see which cards are installed, and will display the current software version for each card. The current software version of the *Main CPU Card* will also be displayed at the bottom of the screen. See Figure 4.3.

If any of the cards have been removed or placed into different slots since the last time the control was on, a question mark will appear next to the changed slot(s), and CONFIG. CHANGE will blink on the screen, alerting you to a configuration change. See Figure 4.4.

Figure 4.2
Current Software Version

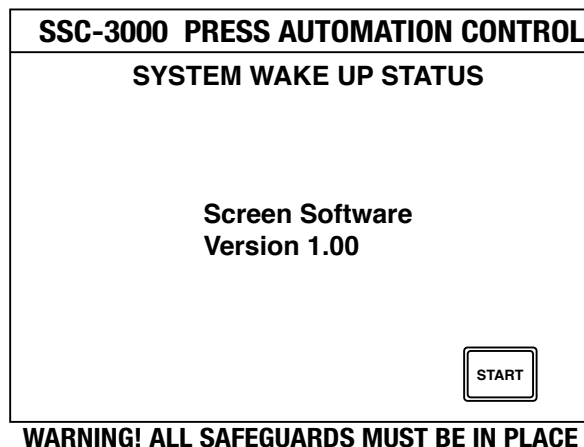

Figure 4.3
Slot Check

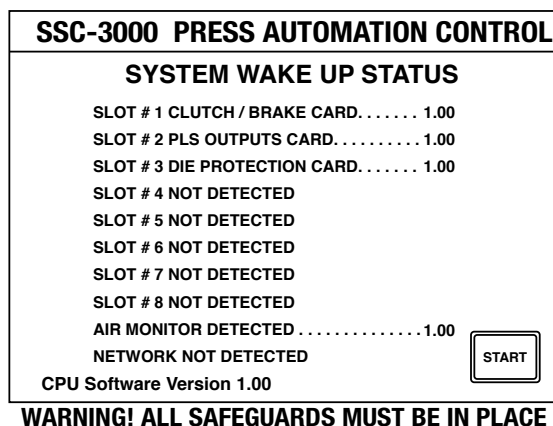
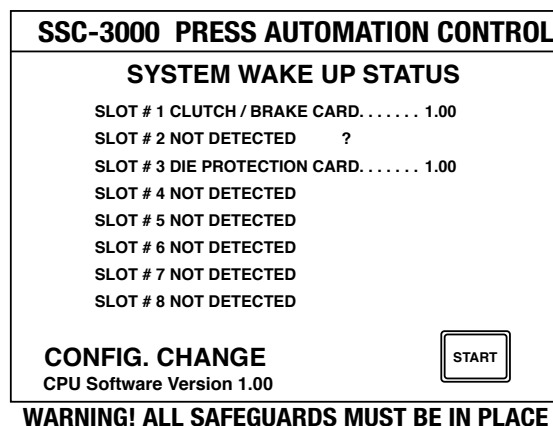

Figure 4.4
Configuration Change



(Continued on next page.)

Rockford Systems, LLC
Call: 1-800-922-7533

If a change in configuration was not intended, turn the power off and inspect the control to make sure all cards are present and pushed completely into the rack. Otherwise, press **START** to acknowledge the configuration change.



Never insert or remove cards while the control is turned on. This may cause damage to the card(s) and/or the control. Be sure to turn off the main power disconnect switch or the main power switch on the bottom left of the rack inside the control before inserting or removing cards.

If the battery or the unpluggable memory board on the *Main CPU Card* has been removed and replaced, NVRAM FAULT will be displayed on the screen as the system checks the slots. After all eight slots have been checked, CONFIG. CHANGE will blink on the screen, and there will be a question mark next to each slot. Once **START** is pressed, NVRAM FAULT will blink on the screen. See Figure 4.5.

Next, check to make sure that all safeguards are in place. Once this has been done, you may press **START** to continue to the main run screens.

Main Run Screens Overview

The following section outlines the navigation of the main run screens on the SSC-3000 press automation control after installation of all components has been completed, and the *Power-Up Procedure* section of the manual has been read and understood.

The SSC-3000 press automation control has at least two main run screens, depending on which cards and auxiliary equipment have been installed. These screens are used to view diagnostic information about the press, such as setup number, die number, stop time, stop angle, mode of operation, counters, crankshaft angle, press speed, and user input settings. The screens that will always be present are the MAIN RUN SCREEN and the USER INPUTS screen. If an 8-Input *Die Protection Card* has been installed, you will have the DIE PROTECTION #1 run screen as well. If a second or third *Die Protection Card* has been furnished, then you will have a second or third die protection run screen. These screens will be the DIE PROTECTION #2 and DIE PROTECTION #3 screens.

Figure 4.5
NVRAM Fault

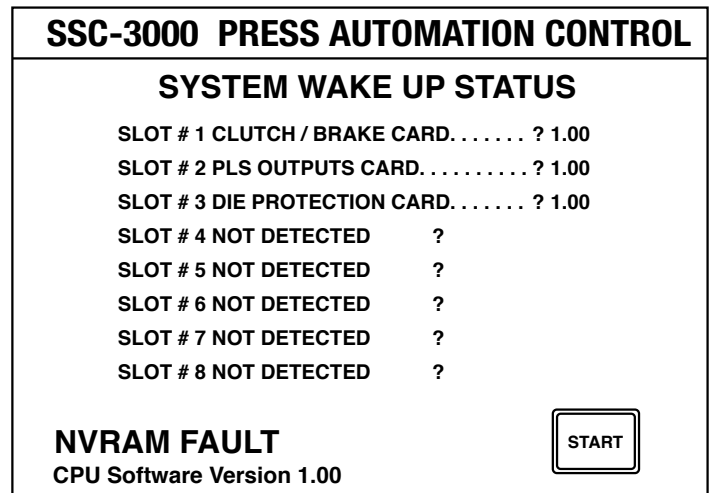

WARNING! ALL SAFEGUARDS MUST BE IN PLACE

(Continued on next page.)

SECTION 4—PROGRAMMING

SSC-3000 Press Automation Control System

MAIN RUN SCREEN

The MAIN RUN SCREEN displays the setup number, die number, stop time (in milliseconds), stop angle (in degrees), mode of operation, counters, crankshaft angle (in degrees), and speed of the press (in SPM). It also has two buttons in the lower left corner for adjusting the contrast of the touchscreen. See Figure 4.6.

Press ▼ to view the next run screen.

USER INPUTS

The USER INPUTS screen displays the programmable parameters (fault message, logic, and stop type), as well as the on/off state of all 12 LEDs. If the LED (light emitting diode) for an input is on, the LED column of the screen will display a 1. If the LED for an input is off, the LED column will display a 0, as in the screen shown in Figure 4.7.

The crankshaft angle and speed of the press are also displayed in the upper right corner of the screen, as in all main run screens.

Press ▼ to view the next run screen.

DIE PROTECTION

The DIE PROTECTION #1 screen displays the programmable parameters (logic, stop type, and open and close angles), as well as the actual on and off angles and the on/off state of eight (8) LEDs at a time. If the LED for an input is on, the LED column of the screen will display a 1. If the LED for an input is off, the LED column will display a 0, as in the screen shown in Figure 4.8.

If a second or third 8-Input **Die Protection Card** has been installed, there will be two more run screens to view. These will be the DIE PROTECTION #2 and DIE PROTECTION #3 run screens.

Press ▼ to view the next run screen.

LOAD MONITOR

The LOAD MONITOR #1 screen displays the maximum, minimum, and peak tonnage values for the load monitor sensors that are in use. See Figure 4.9.

If a second 4-Input **Load Monitor Card** has been installed, there will be a LOAD MONITOR #2 run screen.

Press ▼ and ▲ on the touchscreen to scroll through the various main run screens.

Figure 4.6
Main Run Screen

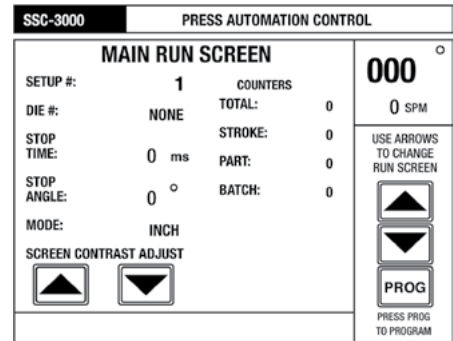

*Will only be displayed when air monitor is installed

Figure 4.7
User Inputs Screen

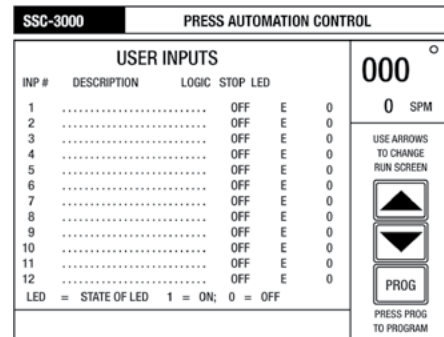

Figure 4.8
Die Protection #1 Screen

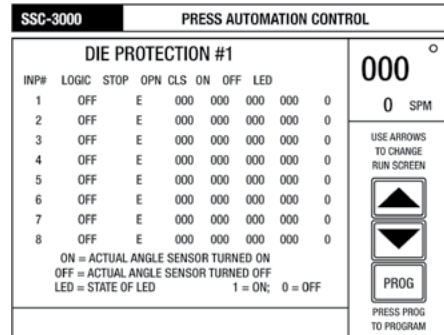
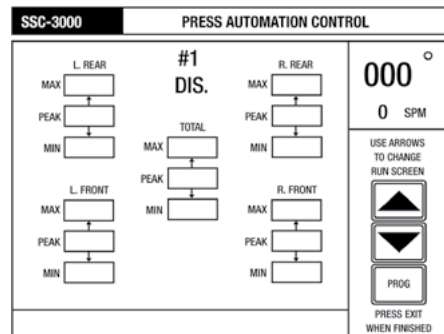

Figure 4.9
Load Monitor #1 Screen



(Continued on next page.)

Rockford Systems, LLC
Call: 1-800-922-7533

Programming Overview

The following sections outline the programming of the SSC-3000 press automation control on a part-revolution press after installation of all components has been completed, and the *Power-Up Procedure* and *Main Runs Screens Overview* sections of this manual have been read and understood.

MAIN PROGRAM SCREEN

The SSC-3000 press automation control has a main programming screen from which you can access all of the programmable features of the control.

To program the control, select the **ON** position of the Program On/Off selector switch. Then press **PROG**, which is located in the bottom right corner of any of the main run screens. The MAIN PROGRAM SCREEN will be displayed.

On the MAIN PROGRAM SCREEN, the touchscreen will highlight one of the following program options from the list as shown. At the top of the list is USER INPUTS. See Figure 4.10.

Use ▼ and ▲ on the touchscreen to scroll through the program options. When the program option you want to edit is highlighted, press **ENTER**. Once the new information is input and **EXIT SCREEN** is pressed, the display returns to the MAIN PROGRAM SCREEN. If incorrect information has been entered, return to the setting and reenter the correct information.

Each program option is described in detail on the following pages.

USER INPUTS	68-69
BRAKE MONITOR*	69-71
JOB SETUPS	72-77
COUNTERS	78-79
SYSTEM SETUP*	80-82
USER-DEFINED MESSAGES	83
ANGLE SETTINGS*	84-85
TIMED SETTINGS*	86-87
OPTIONAL MODES*	88-90
VAR SPD SETTINGS	91
PART-IN-PLACE	92
PLS OUTPUTS	93
DIE PROTECTION	94-95
AIR MONITOR	96-97
LOAD MONITOR	98-99
SERVO FEED	100-103
SHUT HEIGHT	104-106
NETWORK	107-113
PASSWORD CONTROL*	114-115

*Supervisor password protected

Figure 4.10
Main Program Screen

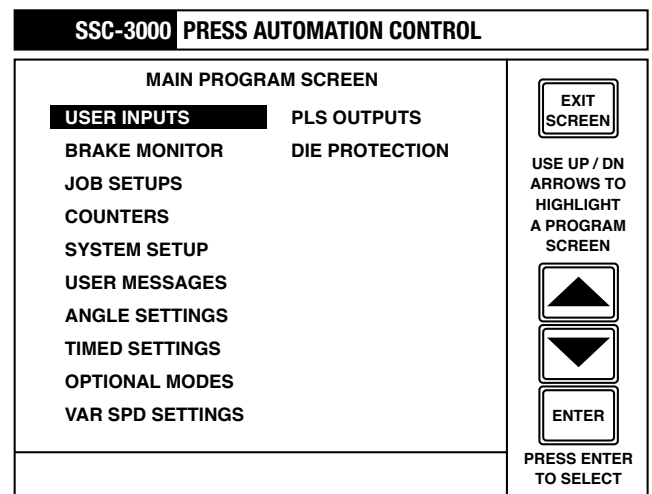

SCREEN SAVER

The SSC-3000 press automation control has a screen saver. To turn this feature on or off, press the SCREEN SAVER OFF/ON button located on the right side of the MAIN PROGRAM SCREEN. The text toward the bottom of the screen indicates whether it is off or on. See Figure 4.10.

When the screen saver is on and the touchscreen is not touched for five (5) minutes, the backlight for the screen will turn off and the screen will go dark. Simply touch the screen to turn the backlight back on.

(Continued on next page.)

SECTION 4—PROGRAMMING

SSC-3000 Press Automation Control System

USER INPUTS

The SSC-3000 press automation control has 12 programmable user inputs that can be programmed for equipment monitoring or other user-defined functions. These inputs are intended to diagnose fault conditions of auxiliary equipment specific to the machine, such as clutch/brake air pressure fault, counterbalance air pressure fault, dual solenoid fault, etc. Their programming stays constant throughout all setups. These inputs are static-type 24 VDC sinking (NPN) inputs. Static-type means that when the inputs are set to be on, they are continuously monitoring for a change of state in the logic. When a change of state occurs, the input will activate, and the control will stop the press. There are three (3) parameters that can be programmed for each input.

PROGRAMMABLE PARAMETERS

- 1. LOGIC:** This setting is used to change the logic that activates the input. The programming choices are N.O. (normally open), N.C. (normally closed), and OFF (disabled). Select one setting for each input.
- 2. STOP TYPE:** When the input is activated or goes true, the press cycle will stop in one of two ways. E-STOP (emergency stop) will immediately stop the cycle in progress. T-STOP (top stop) will stop the cycle in progress at TDC (top dead center). Select the type of stop that is required for each input.
- 3. FAULT MESSAGE:** When the input is activated, a fault message is displayed. This fault message is assigned to the input according to its function. Figure 4.11 shows a list of fault messages that can be assigned to each input. There are also 10 additional user-defined messages that can be tailored to your specific applications. When you scroll through the fault messages, the ten user-defined messages will show up after the last standard message (PART INPUT #3). See page 83 on how to program the user-defined messages. Select any message for each input.

HOW TO PROGRAM THE USER INPUTS

Select the **ON** position of the Program On/Off selector switch. Press **PROG**, which is located in the bottom right corner of any of the main screens. The MAIN PROGRAM SCREEN will be displayed.

Figure 4.11
General Fault Messages

CLUTCH/BRAKE AIR FLT
CNTRBALANCE AIR FLT
DUAL SOLENOID FAULT
CLUTCH VALVE FAULT*
BRAKE VALVE FAULT*
LUBE FAULT
HIGH LUBE PRESSURE
LOW LUBE PRESSURE
LOW LUBE LEVEL
MAIN MOTOR OVERLOAD
RAM ADJ MTR OVERLOAD
LUBE MOTOR OVERLOAD
AUX MOTOR OVERLOAD
GUARD INTERLOCK OPEN
FRONT GUARD OPEN
REAR GUARD OPEN
LEFT SIDE GUARD OPEN
RIGHT SIDE GRD OPEN
FEEDER FAULT
LOAD MONITOR FAULT
SAFETY BLK INTERLOCK
SHUT HEIGHT FAULT
VAR SPEED DRIVE FLT
DIE PROTECTION FAULT**
SHORT FEED FAULT**
PART EJECTION FAULT**
STOCK BUCKLE FAULT**
END OF STOCK FAULT**
PILOT PIN FAULT**
PART INPUT #1**
PART INPUT #2**
PART INPUT #3**

***Only used with machines that have a split clutch and brake, and two dual valves have been furnished**

****Messages typically used for die protection**

(Continued on next page.)

Rockford Systems, LLC
Call: 1-800-922-7533

USER INPUTS (continued)

On the MAIN PROGRAM SCREEN, use ▼ and ▲ on the touchscreen to scroll through the program options. Press ENTER when the touchscreen highlights USER INPUTS. The USER INPUTS PROGRAM SCREEN will be displayed. See Figure 4.12.

Press ▼ and ▲ to change the INPUT# between 1 and 12. When the screen displays the INPUT# that you want to program, touch the button of the programmable parameter (**LOGIC**, **STOP TYPE**, or **MESG**) that needs to be set. Use ▼ and ▲ to reach the setting you desire for that parameter. Touch the button of the programmable parameter (**LOGIC**, **STOP TYPE**, or **MESG**) again to finish.

Press **EXIT SCREEN** when finished to return to the MAIN PROGRAM SCREEN.

Note: The appropriate user input terminals in the control box must be wired into so they correspond to the assigned fault messages. If the order of the messages is changed or if other fault messages are assigned, the connections to the terminal strip must also be rearranged to reflect the changes.

BRAKE MONITOR

The SSC-3000 press automation control has a time-based brake monitor with programmable warning and fault setpoints. The control also includes a stop-time measurement (STM) test. This test is used on the downstroke (usually at 90°) for establishing proper safety distance when applying two-hand control or a light curtain as the safeguarding device. The test is also used on the upstroke (at the appropriate angle that makes the press stop at top) to calculate the warning and fault setpoints for the brake monitor.

Every time the machine stops, the control measures the time between when the valve deenergizes and when the resolver no longer detects motion. This is the actual stopping time of the press. The warning and fault setpoints are automatically compared to this stopping time, and will alert the operator if the stopping time is beyond either of these setpoints.

If the stopping time is greater than only the warning setpoint, a message will be displayed for five (5) seconds on the screen, and then it will disappear. The press will not operate during these five seconds. If the stopping time is greater than the fault setpoint, the press will become inoperable, and a message will be displayed on the screen that will stay there until you touch the message bar to reset the control, acknowledging the fault message.

Figure 4.12
User Inputs Program Screen

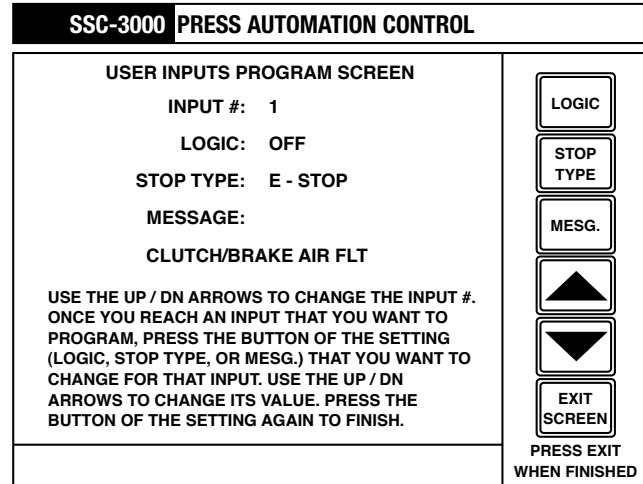

Brake monitor warnings and faults can be caused by several factors. Brake deterioration is one of the main factors that will increase the press's stopping time. If you have a variable speed drive, running the press at higher speeds will increase the stopping time due to the increased inertia. The stopping time may also increase if you use a heavier die, for the same reason. If you have a counterbalance system, the stopping time may increase if the air pressure is not adjusted properly based on the upper die weight. Clogs or particles in the air line or in the valve muffler may increase stopping time. Air pressure variance can also affect the stopping time of the press.

If you are experiencing warning or fault messages more frequently, inspect the machine and perform any necessary repairs to improve the press's stopping ability. For example, if your brake is deteriorating, it may need a new lining, or you may need to tighten or replace the engaging spring(s) on it. DO NOT increase the warning and fault setpoints just to avoid nuisance stops. You will also need to run a new series of STM tests on the downstroke to establish the new safety distance. You will then need to remount or move your light curtain or palm buttons (if they are used for two-hand control) further away from the point of operation according to the new safety distance.

(Continued on next page.)

SECTION 4—PROGRAMMING

SSC-3000 Press Automation Control System

BRAKE MONITOR (continued)

HOW TO RUN A STOP-TIME MEASUREMENT (STM) TEST

Select the **ON** position of the Program On/Off selector switch. Then press **PROG**, which is located in the bottom right corner of any of the main screens. The MAIN PROGRAM SCREEN will be displayed.

On the MAIN PROGRAM SCREEN, use ▼ and ▲ on the touchscreen to scroll through the program options. Press **ENTER** when the touchscreen highlights BRAKE MONITOR. The security code screen will be displayed. See Figure 4.13. You will be prompted to enter the security code.

Press **ABORT** to stop and return to the MAIN PROGRAM SCREEN. Press ► to backspace or press **CLEAR** to delete the entry and start over. Press **ENTER** when finished. After the correct security code has been entered, the BRAKE MONITOR PROGRAM SCREEN will be displayed. See Figure 4.14.

Press **STM TEST** to highlight the STM ANGLE setting. Use ▼ and ▲ to adjust the angle at which the STM will be taken, if needed. Press **STM TEST** again. You will see this in the message bar:

CHECK FOR TDC, THEN CYCLE PRESS

Follow the prompt and visually make sure the crankshaft is at TDC (top dead center). If it is not at TDC, either inch or single stroke the press to get to that position. Then cycle the press. After the press makes a partial stroke, the touchscreen will display the stopping time in milliseconds and the safety distance in inches (if the test was done on the downstroke). See Figure 4.15. Press the actuating means again to return the crankshaft to TDC.

To run more than one STM, press **STM TEST** to highlight the STM ANGLE setting. Use ▼ and ▲ to adjust the angle at which the STM will be taken, if needed. Press **STM TEST** again and follow the prompt in the message bar. After the results of the test have been displayed, press the actuating means again to return the crankshaft to TDC. Repeat this process until the desired number of tests are complete.

When finished, press **EXIT** to return to the MAIN PROGRAM SCREEN.

Figure 4.13
Security Code Screen

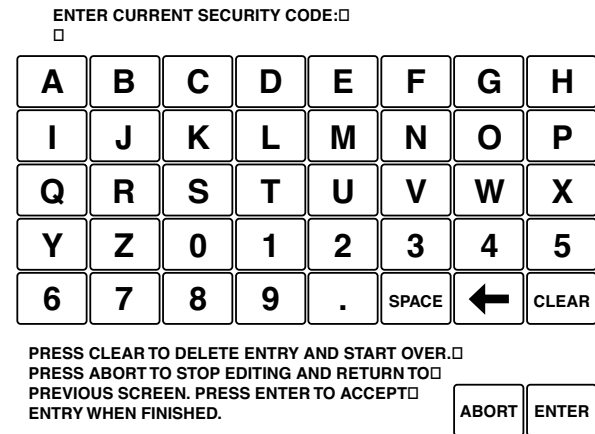

Figure 4.14
Brake Monitor Screen

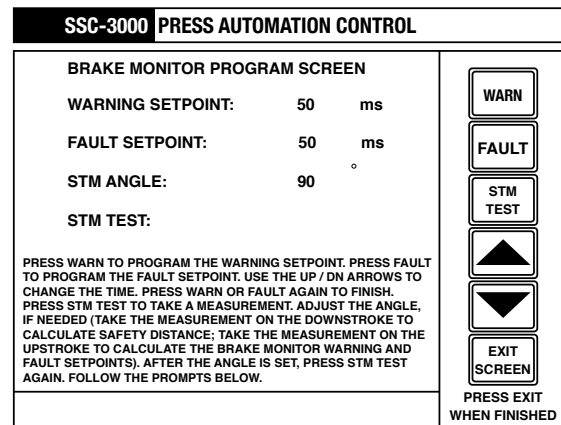
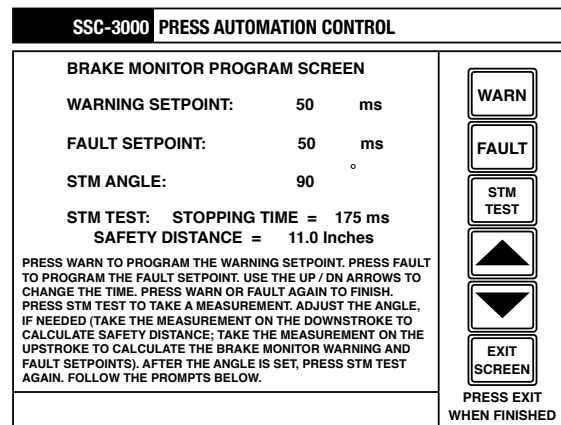

Figure 4.15
Stopping Time and Safety Distance



(Continued on next page.)

Rockford Systems, LLC
Call: 1-800-922-7533

BRAKE MONITOR (continued)

HOW TO CALCULATE THE WARNING AND FAULT SETPOINTS

To determine the brake monitor warning and fault setpoints using the STM test feature, you need to determine the proper STM angle so the stop signal is given on the upstroke, and it makes the press stop at TDC (top dead center). This angle is usually between 200° and 300°. You may have to take several STM tests before you get the correct angle setting for your press, since this setting is determined by trial and error. A good angle to start with is 270°. If the press stops before TDC, a higher STM angle setting is required. Add the number of degrees the machine stopped short of TDC to the STM angle setting. If the press stops beyond TDC, a lower STM angle setting is required. Subtract the number of degrees the machine went over TDC from the STM angle setting. Once you get the correct STM angle setting and your press is stopping at TDC, you are ready to calculate the warning and fault setpoints for the brake monitor.

Take and record several readings (at least ten) of the stopping time using the STM feature and the STM angle setting that makes the press stop at TDC. If any of your readings are excessively high compared to the rest of the readings, disregard them and use the next highest reading. After taking several readings, use the longest time and multiply it by 1.05 (105%) to establish the warning setpoint. To establish the fault setpoint, multiply the highest reading by 1.10 (110%).

HOW TO PROGRAM THE BRAKE MONITOR WARNING AND FAULT SETPOINTS

To adjust the warning setpoint:

Press **WARN** to highlight the setting. Use ▼ and ▲ to adjust the time setting. Press **WARN** again to finish.

To adjust the fault setpoint:

Press **FAULT** to highlight the setting. Use ▼ and ▲ to adjust the time setting. Press **FAULT** again to finish.

Press **EXIT SCREEN** when finished to return to the MAIN PROGRAM SCREEN.

SECTION 4—PROGRAMMING

SSC-3000 Press Automation Control System

JOB SETUPS

The SSC-3000 press automation control has provisions for 100 job setups that can be stored in memory allowing for quick changeover from die to die. The die number, description, PLS outputs, die protection inputs, air monitor, load monitor, shut height, part-in-place input, servo feed, and counter information are saved for each job.

You can search for any job setup by entering the die number of the setup you're looking for. This avoids having to scroll through every job setup to find the setup you need.

The search feature is also used to clear the user-programmed job setups or restore all settings to their factory default.

HOW TO PROGRAM JOB SETUPS

Select the **ON** position of the Program On/Off selector switch. Then press **PROG**, which is located in the bottom right corner of any of the main screens. The MAIN PROGRAM SCREEN will be displayed.

On the MAIN PROGRAM SCREEN, use ▼ and ▲ on the touchscreen to scroll through the program options. Press **ENTER** when the touchscreen highlights JOB SETUPS. The JOB SETUPS SCREEN will be displayed. See Figure 4.16.

Press ▼ and ▲ to change the SETUP# between 1 and 100. When you get to a setup number that you want to change, you are ready to program that setting.

To enter a die number:

Press **DIE #**. The DIE NUMBER screen will be displayed. See Figure 4.17.

Press **CLEAR** to delete the current die number. Enter an alphanumeric die number up to 11 characters. Press **ABORT** to stop editing and return to the JOB SETUPS SCREEN. Press ► to backspace. When you are finished, press **ENTER** to accept the new die number.

Figure 4.16
Job Setups Screen

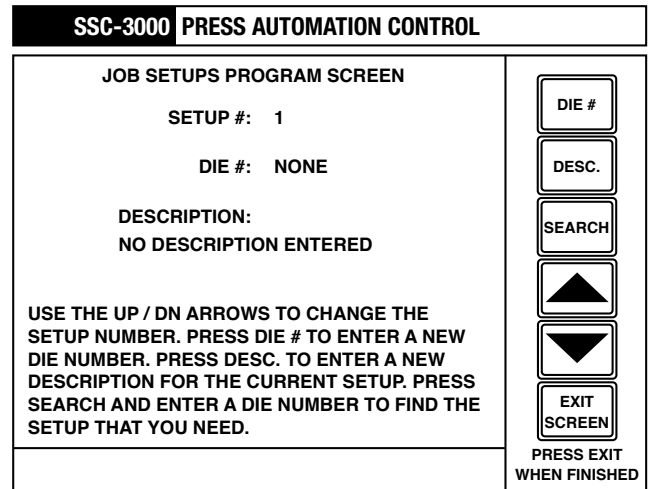
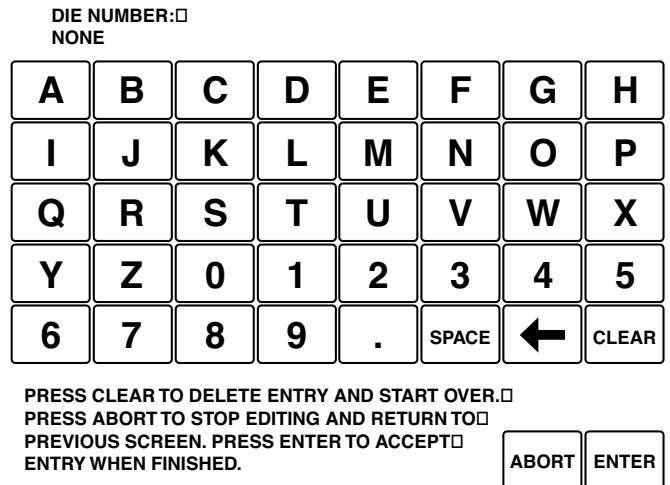

Figure 4.17
Die Number Screen



(Continued on next page.)

Rockford Systems, LLC
Call: 1-800-922-7533

To enter a die description:

Press **DESC**. The DIE DESCRIPTION screen will be displayed. See Figure 4.18.

Press **CLEAR** to delete the current die description. Enter an alphanumeric die description up to 28 characters. Press **ABORT** to stop editing and return to the JOB SETUPS SCREEN. Press **➤** to backspace. When you are finished, press **ENTER** to accept the new description.

Figure 4.18
Die Description Screen

DIE DESCRIPTION:□
NO DESCRIPTION ENTERED

A	B	C	D	E	F	G	H
I	J	K	L	M	N	O	P
Q	R	S	T	U	V	W	X
Y	Z	0	1	2	3	4	5
6	7	8	9	.	SPACE	←	CLEAR

PRESS CLEAR TO DELETE ENTRY AND START OVER.□
PRESS ABORT TO STOP EDITING AND RETURN TO□
PREVIOUS SCREEN. PRESS ENTER TO ACCEPT□
ENTRY WHEN FINISHED.

ABORT	ENTER
-------	-------

To search for a particular job setup:

Press **SEARCH**. The SEARCH FOR screen will be displayed. See Figure 4.19.

Enter an alphanumeric die number up to 11 characters. Press **ABORT** to stop the search and return to the JOB SETUPS SCREEN. Press **➤** to backspace or press **CLEAR** to delete the entry and start over. When you are finished, press **ENTER** to begin the search.

Note: You can search by die number only—not by description.

Figure 4.19
Search For Screen

SEARCH FOR:□
□

A	B	C	D	E	F	G	H
I	J	K	L	M	N	O	P
Q	R	S	T	U	V	W	X
Y	Z	0	1	2	3	4	5
6	7	8	9	.	SPACE	←	CLEAR

PRESS CLEAR TO DELETE ENTRY AND START OVER.□
PRESS ABORT TO STOP EDITING AND RETURN TO□
PREVIOUS SCREEN. PRESS ENTER TO ACCEPT□
ENTRY WHEN FINISHED.

ABORT	ENTER
-------	-------

To copy a job setup:

Press **JOB COPY**. The JOB COPY screen will be displayed. See Figure 4.20.

Enter a setup number to copy the current job to. Press **ABORT** to stop and return to the JOB SETUPS SCREEN. Press **➤** to backspace. When you are finished, press **ENTER**. The JOB SETUPS SCREEN will be displayed with this message in the message bar:

ARE YOU SURE? [YES] [NO]

Touch **YES** to confirm, and the job will be copied.

Figure 4.20
Job Copy Screen

ENTER SETUP # TO COPY CURRENT JOB TO:□
□

A	B	C	D	E	F	G	H
I	J	K	L	M	N	O	P
Q	R	S	T	U	V	W	X
Y	Z	0	1	2	3	4	5
6	7	8	9	.	SPACE	←	CLEAR

PRESS CLEAR TO DELETE ENTRY AND START OVER.□
PRESS ABORT TO STOP EDITING AND RETURN TO□
PREVIOUS SCREEN. PRESS ENTER TO ACCEPT□
ENTRY WHEN FINISHED.

ABORT	ENTER
-------	-------

(Continued on next page.)

SECTION 4—PROGRAMMING

SSC-3000 Press Automation Control System

To clear all the user-programmed job setups:

Press **SEARCH**. The SEARCH FOR screen will be displayed. See Figure 4.21.

Type in **CLRDB** on the touchscreen. Press **ABORT** to stop and return to the JOB SETUPS SCREEN. Press **➤** to backspace or press **CLEAR** to delete the entry and start over. When you are finished, press **ENTER**.

The security code screen will be displayed. See Figure 4.22. You will be prompted to enter the security code. Enter the current security code and the JOB SETUPS SCREEN will be displayed with this message in the message bar:

ARE YOU SURE? [YES] [NO]

Touch **YES** to confirm, and the user-programmed job setups will be cleared.

To restore the factory default settings:

Press **SEARCH**. The SEARCH FOR screen will be displayed. See Figure 4.23.

Type in **CLRSYS** on the touchscreen. Press **ABORT** to stop and return to the JOB SETUPS SCREEN. Press **➤** to backspace or press **CLEAR** to delete the entry and start over. When you are finished, press **ENTER**.

The security code screen will be displayed. See Figure 4.22. You will be prompted to enter the security code. Enter the current security code

ARE YOU SURE? [YES] [NO]

and the JOB SETUPS SCREEN will be displayed with this message in the message bar:

Touch **YES** to confirm, and the factory default settings will be restored.

Press **EXIT SCREEN** when finished to return to the MAIN PROGRAM SCREEN.

Figure 4.21
Clear all User-Programmed Job Setups

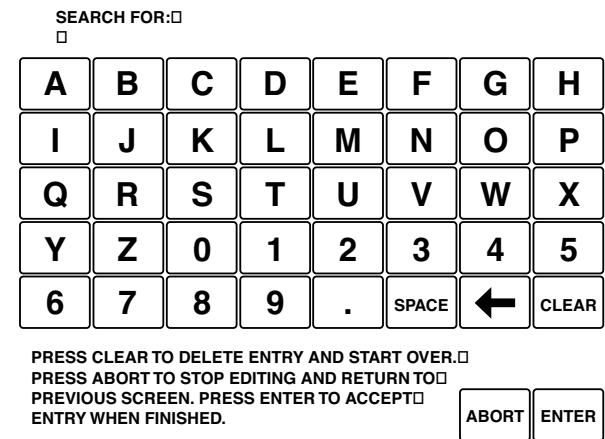

Figure 4.22
Security Code Screen

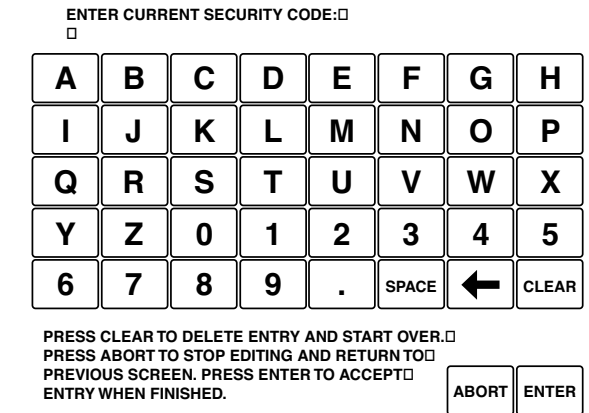
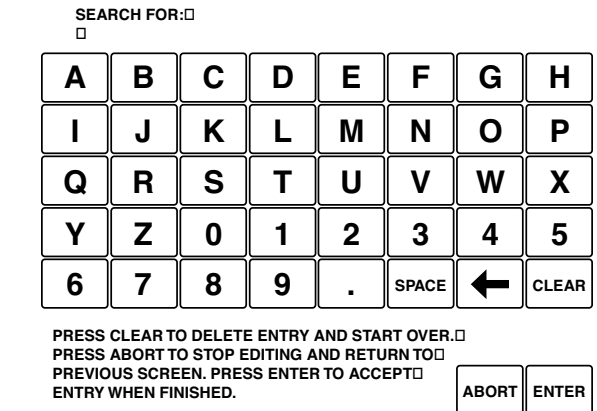

Figure 4.23
Search For Screen



(Continued on next page.)

Rockford Systems, LLC
Call: 1-800-922-7533

UPLOAD/DOWNLOAD OF JOB SETUPS

Note: The upload/download of job setups can also be done through the network assembly. If you have the optional networking assembly, part No. FTL-313, refer to pages 111-113 for how to do this.

The upload/download assembly consists of a 10' serial cable and a CD with upload/download software.

The upload/download feature gives you the ability to back up all of your job setups to a file on your computer. After the job setup database has been downloaded, you can upload individual job setups back to the SSC-3000 control on the same machine or to other machines.

Connecting the Cable

Plug the male DB-9 connector of the 10' serial cable in to the P5 network port on the SSC-3000 **Main CPU Card**. Plug the other end in to a serial port on your computer.

Installing the Software

Insert the Upload/Download Software CD in your computer and double-click the executable Setup file (SETUP.EXE). This will start the installation wizard, which will guide you through the installation.

Setup

Once the program is installed, launch the program called SSC3000 Upload-Download. The program will open; see Figure 4.24.

Before being able to upload/download, you will need to make sure that the correct serial port is selected. At the top of the SSC3000 Upload-Download program window, click Setup. The Setup window will open; see Figure 4.25.

Select the serial port on your computer that you connected the upload/download cable to, and then click OK.

On the SSC-3000 control, select the **ON** position of the Program On/Off selector switch. Then press **PROG**, which is located in the bottom right corner of any of the main program screens. The MAIN PROGRAM SCREEN will be displayed. See Figure 4.26.

The SSC-3000 control is now ready for upload/download of job setups.

Figure 4.24
SSC-3000 Upload/Download Utility

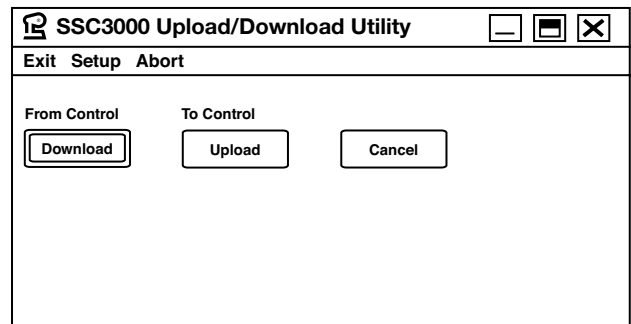

Figure 4.25
Setup

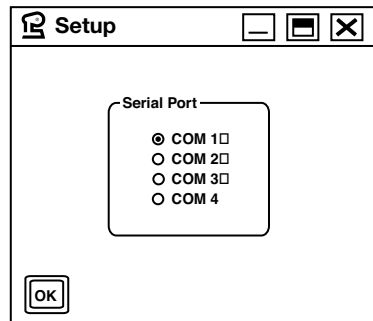
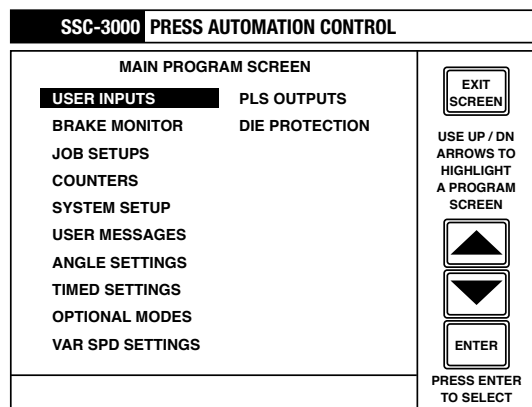

Figure 4.26
Main Program Screen



(Continued on next page.)

SECTION 4—PROGRAMMING

SSC-3000 Press Automation Control System

DOWNLOAD JOB SETUPS FROM SSC-3000 CONTROL

Note: To download job setups, the machine must be stopped.

To download the job setups from the SSC-3000 control to your computer, click Download on the SSC3000 Upload-Download program window. The Select Download Filename window will open. See Figure 4.27.

Choose a location to download the job setups file to. In the File Name field, type in a name for the file (e.g., Machine 1).

When finished, click Open, and the entire job setup database will download from the SSC-3000 control to your computer. The data transfer status will be shown. See Figure 4.28.

When download is complete, a window will open that says Download successful. Click OK to finish.

Figure 4.27
Select Download Filename

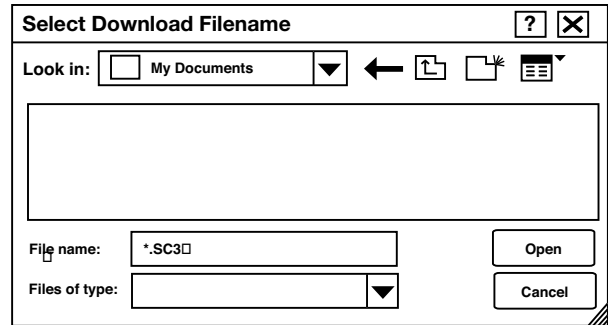
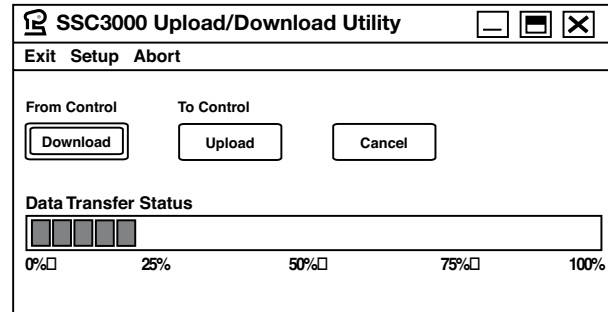

Figure 4.28
Data Transfer Status



(Continued on next page.)

Rockford Systems, LLC
Call: 1-800-922-7533

UPLOAD JOB SETUPS TO SSC-3000 CONTROL

Note: To upload job setups, the machine must be stopped.

To upload a selected range of job setups from your computer to the SSC-3000 control, click Upload on the SSC3000 Upload-Download program window. The Select Upload Filename window will open. See Figure 4.29.

Find the job setups file that you want to upload jobs from. This file has an extension of .SC3, and it should be in the location that you downloaded the job setups to. When you find the file, click its name so that it appears in the File Name field. Click Open to finish.

The Starting Setup (1-100) window will open next. See Figure 4.30. Enter the first job that you want to upload, and then click OK.

The Ending Setup (1-100) window will then open. See Figure 4.31. Enter the last job that you want to upload, and then click OK.

Note: If you want to upload only one job, enter that job number in both the Starting Setup and Ending Setup windows.

The selected jobs will now upload from your computer to the SSC-3000 control. The data transfer status will be shown. See Figure 4.32.

When upload is complete, a window will open that says Upload Complete. Click OK to finish.

Figure 4.29
Select Upload Filename

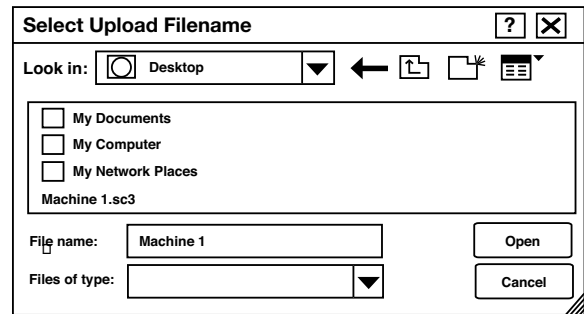

Figure 4.30
Starting Setup

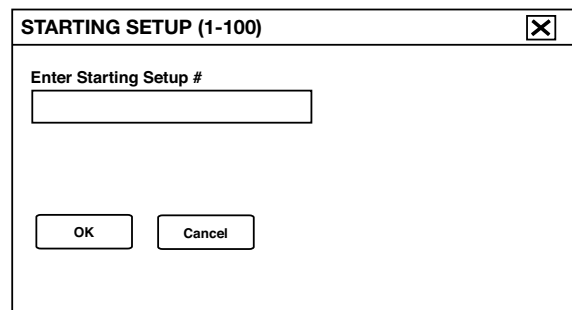

Figure 4.31
Ending Setup

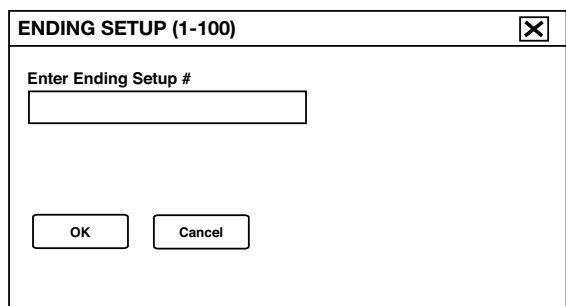
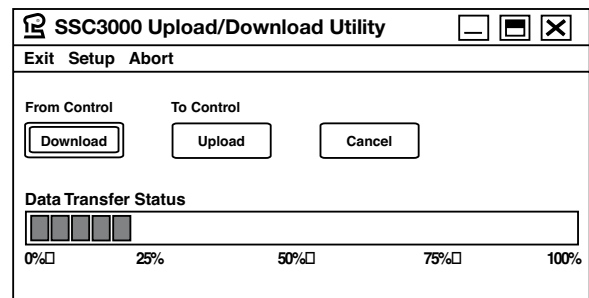

Figure 4.32
Data Transfer Status



SECTION 4—PROGRAMMING

COUNTERS

The SSC-3000 press automation control has batch, stroke, and part counters that can be used for die maintenance, quality control checks, or part bin exchanges. Each of these counters has a programmable preset that will signal the press to top stop when the preset is reached. These presets have a maximum of 99,999,999 strokes. The counters and presets are also saved in job memory. There is also a total counter, which has security code protection. The total counter is not saved in job memory.

When the stroke, part, or batch counter has reached its preset value and **STROKE COUNT EXPIRED**, **PART COUNT EXPIRED**, or **BATCH COUNT EXPIRED** is displayed, the fault message can be cleared by touching the message on the touchscreen **or** by pressing the yellow top-stop palm button. If you do not have a top-stop palm button and would like to use a remote push button to reset the counters, a button with 1 N.C. (normally closed) contact can be wired in where the top stop is shown on the electrical schematics.

HOW TO PROGRAM THE COUNTERS

Select the **ON** position of the Program On/Off selector switch. Then press **PROG**, which is located in the bottom right corner of any of the main screens. The MAIN PROGRAM SCREEN will be displayed.

On the MAIN PROGRAM SCREEN, use ▼ and ▲ on the touchscreen to scroll through the program options. Press **ENTER** when the touchscreen highlights COUNTERS. The COUNTERS PROGRAM SCREEN will be displayed. See Figure 4.33.

To enter a stroke preset, part preset, or batch preset:

Press the **PRESET** button that you want to change. Enter a preset on the data entry screen that comes up. For example, if you are entering a stroke preset, you will see the screen shown in Figure 4.34 after pressing **STROKE PRESET**.

After you have entered a preset, press **ENTER** to finish.

To clear the Stroke, Part, or Batch Counter:

Press the **CLEAR** button of the counter you want to clear. A prompt at the bottom of the touchscreen will ask if you are sure. You will see this in the message bar:

ARE YOU SURE? [YES] [NO]

Touch **YES** to confirm and the counter will be cleared.

Figure 4.33
Counters Program Screen

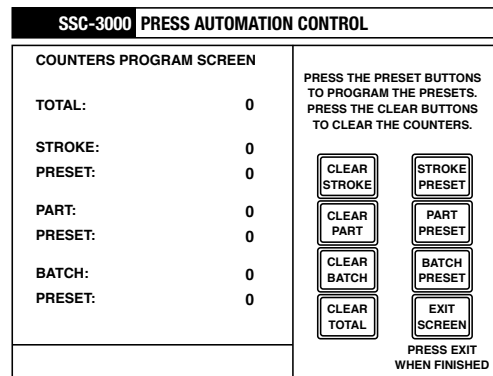
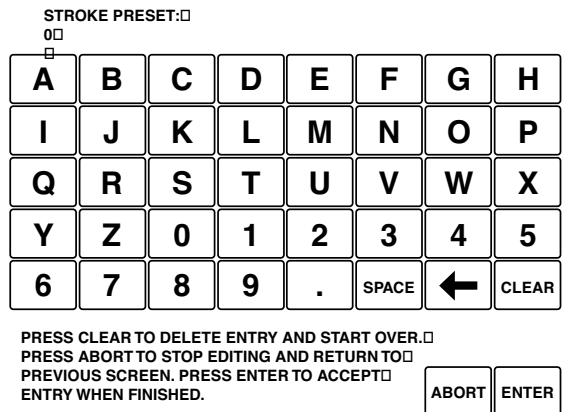

Figure 4.34
Stroke Preset Screen



(Continued on next page.)

HOW TO PROGRAM THE COUNTERS (continued)

To clear the Total Counter:

Press **CLEAR TOTAL**. The security code screen will be displayed. See Figure 4.35. You will be prompted to enter the security code.

Press **ABORT** to stop and return to the COUNTERS PROGRAM SCREEN. Press **➤** to backspace or press **CLEAR** to delete the entry and start over. Press **ENTER** when finished. After the correct security code has been entered, a prompt at the bottom of the touchscreen will ask if you are sure. You will see this in the message bar:

ARE YOU SURE? [YES] [NO]

Touch **YES** to confirm and the counter will be cleared.

Press **EXIT SCREEN** when finished to return to the MAIN PROGRAM SCREEN.

Figure 4.35
Security Code Screen

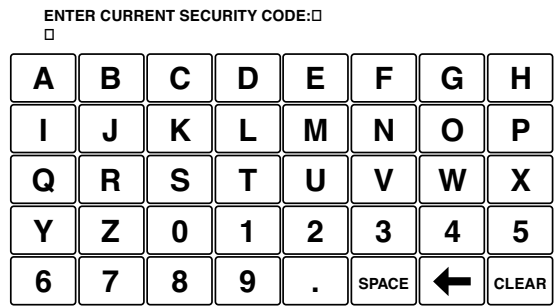

PRESS CLEAR TO DELETE ENTRY AND START OVER. □
PRESS ABORT TO STOP EDITING AND RETURN TO □
PREVIOUS SCREEN. PRESS ENTER TO ACCEPT □
ENTRY WHEN FINISHED.

ABORT ENTER

SECTION 4—PROGRAMMING

SSC-3000 Press Automation Control System

SYSTEM SETUP

The SSC-3000 press automation control has a system setup screen that is used to automatically zero the resolver, set the motion reference threshold, automatically set the sync switch position, set the light curtain input, and set the SPM range.

AUTOMATICALLY ZERO THE RESOLVER

If the resolver is mounted correctly, with the press at TDC (top dead center) and the keyway facing up and perpendicular to the base, it should be very close to its physical 0° point. However, since it is most likely a few degrees off, the resolver will be automatically zeroed, which will reset it to 0°, regardless of where its physical 0° point is located. This will provide the control with more accurate angle settings and readings.

MOTION REFERENCE THRESHOLD

The motion reference threshold is the amount of time the control takes to see motion when the press is stroked. It is used to detect chain breakage, sprocket failure, or uncoupling of the resolver.

When the press setup is run, the control measures the amount of time the press takes to go from 0 to 4 SPM (strokes per minute). This is because any speed less than 4 SPM is not considered as normal motion by the control. This number is then doubled to allow for inconsistencies of the press. Every time a stroke is started, the control looks for motion within this amount of time. If motion is not seen within this amount of time, a fault message will be displayed.

SYNC SWITCH

The sync switch is an optical pulser inside the resolver that provides redundancy in the resolver. It monitors and cross-checks for mechanical or electronic failures within the resolver.

The pulser has a physical cam with a 30° window that is set to activate at 75° and deactivate at 105°, in relation to the resolver's physical 0° point (mounted with the keyway up, perpendicular to the base). The sync switch should not come on between 300° and 60°. If it does, the press setup will fail, and a fault message will be displayed. The keyway on the resolver will have to be rotated so the sync switch does not come on between 300° and 60°.

When a reference cycle is run, the pulser will record the on and off angles of the sync switch. These angles, called sync on and sync off, will then be displayed on the screen. On every subsequent stroke of the press, the control will watch for the sync switch to come on and off at the same angles, +/- 2.5°.

LIGHT CURTAIN INPUT

The SSC-3000 press automation control is factory set for two N.O. (normally open) light curtain inputs (closed in the powered-up "green" state). These inputs are terminals P4-11 (LC-NO) and P4-12 (LC-NC) on the **Clutch/Brake Dual CPU Card**. The inputs can also be set for one N.O. (normally open) and one N.C. (normally closed). For more information, please refer to the wiring schematics included with the control.

SPM RANGE

The SPM range should be set according to the speed of the press in SPM (strokes per minute). The three choices are low (0-30), medium (31-150), and high (151+). This will allow the control to react and process information appropriately in relation to the speed of the machine. Slower machines may need extra time for operations to occur while faster machines usually require tighter settings.

(Continued on next page.)

Rockford Systems, LLC
Call: 1-800-922-7533

HOW TO RUN THE PRESS SETUP

Select the **ON** position of the Program On/Off selector switch. Then press **PROG**, which is located in the bottom right corner of any of the main screens. The MAIN PROGRAM SCREEN will be displayed.

On the MAIN PROGRAM SCREEN, use ▼ and ▲ on the touchscreen to scroll through the program options. Press **ENTER** when the touchscreen highlights SYSTEM SETUP. The security code screen will be displayed. See Figure 4.36. You will be prompted to enter the security code.*

Press **ABORT** to stop and return to the MAIN PROGRAM SCREEN. Press ► to backspace or press **CLEAR** to delete the entry and start over. Press **ENTER** when finished.

After the correct security code has been entered, the SYSTEM SETUP SCREEN will be displayed. See Figure 4.37.

Follow the directions on the touchscreen, and visually check to make sure the press is at TDC (top dead center) with the resolver mounted correctly (see page 43). Press **PRESS SETUP**. The prompt at the bottom of the touchscreen tells you to cycle the press. You should see this in the message bar:

CYCLE PRESS

After the press is cycled, the touchscreen will display the results of the press setup. See Figure 4.38.

Press **EXIT SCREEN** when finished to return to the MAIN PROGRAM SCREEN.

Figure 4.36
Security Code Screen

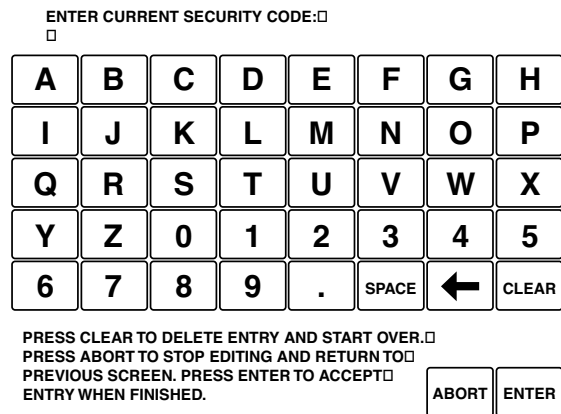

Figure 4.37
System Setup

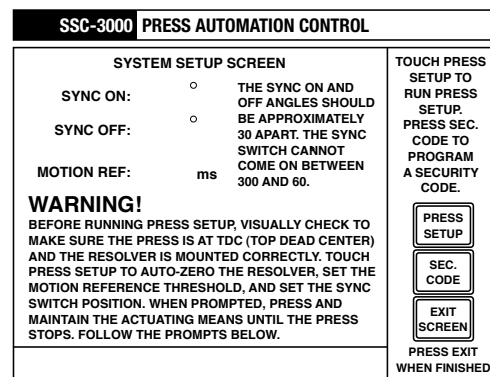
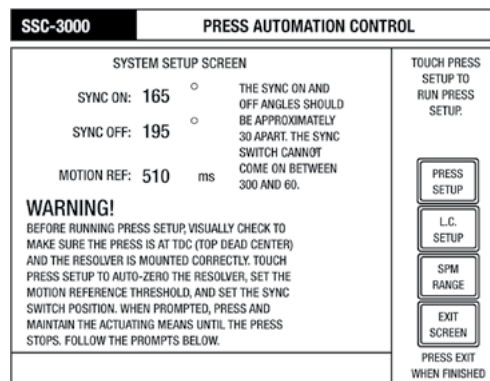

Figure 4.38
Press Setup Results



*The factory default security code is 0. With this code, you can proceed past the security code screen by pressing **0** and then **ENTER** on the touchscreen, or by simply pressing **ENTER**.

To program your own supervisor and operator security code, see pages 114-115. If at any time you forget your security code, call the factory at 1-800-922-7533 or (815) 874-7891 to receive the master security code.

(Continued on next page.)

SECTION 4—PROGRAMMING

SSC-3000 Press Automation Control System

HOW TO PROGRAM THE LIGHT CURTAIN INPUT

Select the **ON** position of the Program On/Off selector switch. Then press **PROG**, which is located in the bottom right corner of any of the main screens. The MAIN PROGRAM SCREEN will be displayed.

On the MAIN PROGRAM SCREEN, use ▼ and ▲ on the touchscreen to scroll through the program options. Press **ENTER** when the touchscreen highlights SYSTEM SETUP. The security code screen will be displayed. See Figure 4.39. You will be prompted to enter the security code.

Press **ABORT** to stop and return to the MAIN PROGRAM SCREEN. Press ► to backspace or press **CLEAR** to delete the entry and start over. Press **ENTER** when finished.

After the correct security code has been entered, the SYSTEM SETUP SCREEN will be displayed. See Figure 4.37 on page 81. Press **L.C. SETUP** and the LIGHT CURTAIN SETUP screen will be displayed. See Figure 4.40. Press the button of the light curtain input type you want.

Press **EXIT SCREEN** when finished to return to the MAIN PROGRAM SCREEN.

HOW TO PROGRAM THE SPM RANGE

Select the **ON** position of the Program On/Off selector switch. Then press **PROG**, which is located in the bottom right corner of any of the main screens. The MAIN PROGRAM SCREEN will be displayed.

On the MAIN PROGRAM SCREEN, use ▼ and ▲ on the touchscreen to scroll through the program options. Press **ENTER** when the touchscreen highlights SYSTEM SETUP. The security code screen will be displayed. See Figure 4.39. You will be prompted to enter the security code.

Press **ABORT** to stop and return to the MAIN PROGRAM SCREEN. Press ► to backspace or press **CLEAR** to delete the entry and start over. Press **ENTER** when finished.

After the correct security code has been entered, the SYSTEM SETUP SCREEN will be displayed. See Figure 4.37 on page 81. Press **SPM RANGE** and the SPM RANGE screen will be displayed. See Figure 4.41. Press the button in front of the range you want on. Only one range can be on at a time.

Press **EXIT SCREEN** when finished to return to the MAIN PROGRAM SCREEN.

Figure 4.39
Security Code Screen

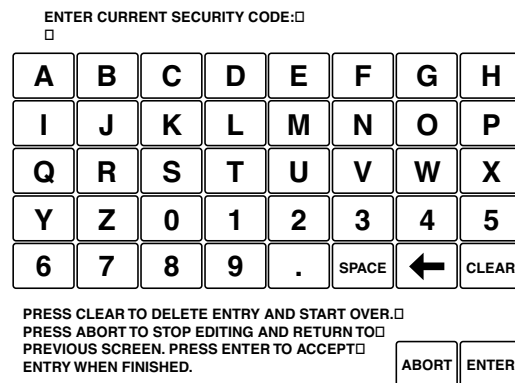

Figure 4.40
Light Curtain Setup Screen

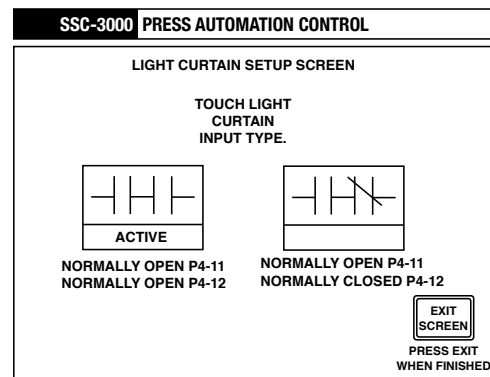
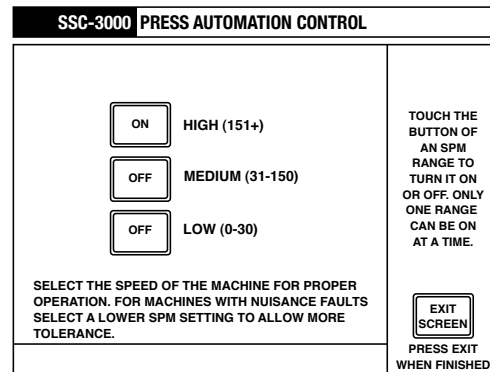

Figure 4.41
SPM Range Program Screen



USER-DEFINED MESSAGES

The SSC-3000 press automation control will accept up to 10 user-defined messages in addition to the *General Fault Messages* on pages 68 and 94. These customized messages can be used with all user inputs and die protection inputs. The messages may be alphanumeric, and may contain up to 24 characters. This feature allows you to create messages specific to your press or any auxiliary equipment.

HOW TO PROGRAM THE USER-DEFINED MESSAGES

Select the **ON** position of the Program On/Off selector switch. Then press **ENTER**, which is located in the bottom right corner of any of the main screens. The MAIN PROGRAM SCREEN will be displayed.

On the MAIN PROGRAM SCREEN, use ▼ and ▲ on the touchscreen to scroll through the program options. Press **ENTER** when the touchscreen highlights USER MESSAGES. The USER-DEFINED MESSAGES PROGRAM SCREEN will be displayed. See Figure 4.42.

The message at the top of the list should be highlighted. Use ▼ and ▲ to scroll through the 10 user-defined messages. When you have highlighted a message that you want to change, press **ENTER**. The screen shown in Figure 4.43 will be displayed.

Press **CLEAR** to delete the current message. Enter an alphanumeric fault message up to 24 characters. Press **ABORT** to stop editing and return to the USER-DEFINED MESSAGES screen. Press ➤ to backspace. When you are finished, press **ENTER** to accept the new message.

Press **EXIT SCREEN** when finished to return to the MAIN PROGRAM SCREEN.

Figure 4.42
User-Defined Message Program Screen

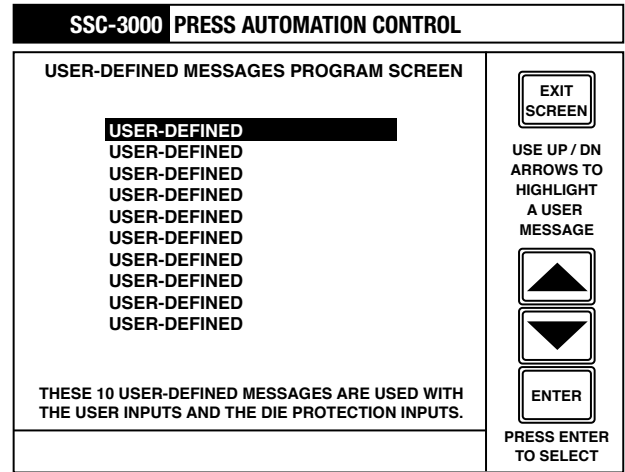
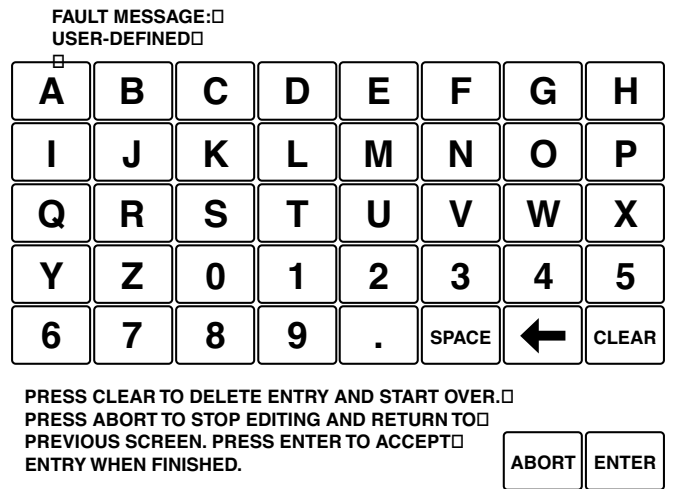

Figure 4.43
Fault Message Data Entry Screen



SECTION 4—PROGRAMMING

SSC-3000 Press Automation Control System

ANGLE SETTINGS

The SSC-3000 press automation control can be configured to provide a clutch/brake press control. A plug-in **Dual CPU Press Clutch/Brake Control Card** is required to do this. If this card has been furnished, the control will have an angle settings screen that is used to program the single stroke top stop, continuous top stop, auto up (holding), and light curtain mute angles.

SINGLE STROKE TOP-STOP ANGLE

The single stroke top-stop angle is the angle at which the control gives the signal to stop the press at TDC (top dead center) while in the *Single Stroke* mode of operation. In most cases, you will need to adjust this setting, since the factory default of 330° will stop your press beyond TDC. A good angle to start with is 270°. If the press stops before TDC, a higher single stroke top-stop setting is required. Add the number of degrees the machine stopped short of TDC to the single stroke top-stop setting. If the press stops beyond TDC, a lower single stroke top-stop setting is required. Subtract the number of degrees the machine went over TDC from the single stroke top-stop setting.

CONTINUOUS TOP-STOP ANGLE

The continuous top-stop angle is the angle at which the control gives the signal to stop the press at TDC, when the top-stop palm button is pressed while in the *Continuous* mode of operation. It is also used when a user or die protection input that is programmed to top stop activates.

The continuous top-stop angle applies only when the press has a constant-speed drive, or has a variable speed drive that is run at only one speed. If your press has a variable speed drive that is run at more than one speed, please refer to the variable speed top-stop settings on page 91.

In most cases, you will need to adjust this setting, since the factory default of 330° will stop your press beyond TDC. A good angle to start with is 270°. If the press stops before TDC, a higher continuous topstop setting is required. Add the number of degrees the machine stopped short of TDC to the continuous top-stop setting. If the press stops beyond TDC, a lower continuous top-stop setting is required. Subtract the number of degrees the machine went over TDC to the continuous top-stop setting.

AUTO UP (HOLDING) ANGLE

The auto up (holding) angle is the angle beyond which the operator no longer needs to depress the palm buttons or foot switch to finish the cycle in progress. It applies only when the press is being run in the *Single Stroke* mode of operation. If the actuating means is released before the auto up angle is reached, the machine will stop. This angle can be changed, but should be programmed so the actuating means must be held depressed during the entire hazardous portion of the stroke.

THE LIGHT CURTAIN MUTE ANGLE

The light curtain mute angle is the angle beyond which the light curtain is no longer active. This means that once the light curtain mute angle is reached, the machine will not stop if the light curtain beams are interrupted. This angle can be changed, but should be programmed so the light curtain is muted only during the nonhazardous portion of the stroke.

HOW TO PROGRAM THE ANGLE SETTINGS

Select the **ON** position of the Program On/Off selector switch. Then press **PROG**, which is located in the bottom right corner of any of the main screens. The MAIN PROGRAM SCREEN will be displayed.

On the MAIN PROGRAM SCREEN, use ▼ and ▲ on the touchscreen to scroll through the program options. Press **ENTER** when the touchscreen highlights ANGLE SETTINGS. The security code screen will be displayed. See Figure 4.44. You will be prompted to enter the security code.

Press **ABORT** to stop and return to the MAIN PROGRAM SCREEN. Press **↵** to backspace or press **CLEAR** to delete the entry and start over. Press **ENTER** when finished.

Figure 4.44
Security Code Screen

ENTER CURRENT SECURITY CODE: □

A	B	C	D	E	F	G	H
I	J	K	L	M	N	O	P
Q	R	S	T	U	V	W	X
Y	Z	0	1	2	3	4	5
6	7	8	9	.	SPACE	←	CLEAR

PRESS CLEAR TO DELETE ENTRY AND START OVER. □
PRESS ABORT TO STOP EDITING AND RETURN TO □
PREVIOUS SCREEN. PRESS ENTER TO ACCEPT □
ENTRY WHEN FINISHED.

ABORT	ENTER
-------	-------

(Continued on next page.)

Rockford Systems, LLC
Call: 1-800-922-7533

HOW TO PROGRAM THE ANGLE SETTINGS (continued)

After the correct security code has been entered, the ANGLE SETTINGS screen will be displayed. See Figure 4.45.

Press the button of the angle setting that you want to program. This will highlight that setting. Use ▼ and ▲ to adjust the angle for that setting. Press the button of the angle setting again to finish.

Press **EXIT SCREEN** when finished to return to the MAIN PROGRAM SCREEN.

Figure 4.45
Angle Settings Screen

SSC-3000 PRESS AUTOMATION CONTROL	
ANGLE SETTINGS	<p>PRESS THE BUTTON OF THE SETTING YOU WANT TO PROGRAM. USE THE UP / DN ARROWS TO CHANGE THE ANGLE. PRESS BUTTON OF THE SETTING AGAIN TO FINISH.</p> <div style="display: flex; flex-direction: column; align-items: center;"> <div style="display: flex; gap: 10px;"> <div style="border: 1px solid black; padding: 2px;">S.S. T-STOP</div> <div style="border: 1px solid black; padding: 2px;">▲</div> </div> <div style="display: flex; gap: 10px;"> <div style="border: 1px solid black; padding: 2px;">CONT. T-STOP</div> <div style="border: 1px solid black; padding: 2px;">▼</div> </div> <div style="display: flex; gap: 10px;"> <div style="border: 1px solid black; padding: 2px;">AUTO UP</div> <div style="border: 1px solid black; padding: 2px;">EXIT SCREEN</div> </div> <div style="border: 1px solid black; padding: 2px;">L.C. MUTE</div> </div> <p>PRESS EXIT WHEN FINISHED</p>
<p>SINGLE STROKE T-STOP: 330 °</p> <p>CONTINUOUS T-STOP: 330 °</p> <p>AUTO UP: 180 °</p> <p>LIGHT CURTAIN MUTE: 170 °</p> <p>USE S.S. T-STOP AND CONT. T-STOP TO PROGRAM TOP STOP ANGLE SETTINGS. USE AUTO UP TO PROGRAM THE HOLDING ANGLE FOR 2-HAND CONTROL. USE L.C. MUTE TO PROGRAM THE MUTING ANGLE FOR THE LIGHT CURTAIN(S).</p>	

SECTION 4—PROGRAMMING

SSC-3000 Press Automation Control System

TIMED SETTINGS

The SSC-3000 press automation control can be configured to provide a clutch/brake press control. A plug-in **Dual CPU Press Clutch/Brake Control Card** is required to do this. If this card has been furnished, the control will have a timed settings screen that is used to program the anti-tie-down, timed inch, and signal time-out settings.

ANTI-TIE-DOWN SETTING

The anti-tie-down setting is the amount of time within which all actuating means (palm buttons or foot switch(es) must be concurrently depressed. Once one of the actuating means is depressed, the timer starts. If the set time is reached before the other actuating means is depressed, the control will not allow the press to begin a stroke. The range of 100-7000 ms allows enough time for single or multiple operator stations to depress all actuating means. The typical setting for one operator is 250 ms, which is the factory default setting.

TIMED INCH SETTING

The timed inch setting is the amount of time for which the clutch will engage when in the *Inch* mode of operation. This prevents the operator from having to depress and release the palm buttons in rapid succession to get small increments of slide movement. The dual-solenoid valve is deenergized when the set time is reached, even though the palm buttons may be held activated.

If timed inch is not required, the programmed setting should be at 0 ms, which will disable this feature. When timed inch is disabled, the normal *Inch* mode of operation will be active. In the normal *Inch* mode, setup or maintenance personnel can hold the palm buttons, allowing continuous movement of the slide, or they can depress and release the palm buttons in rapid succession to allow only small increments of slide movement.

SIGNAL TIME-OUT SETTING

The signal time-out setting is the amount of time within which a signal from an automatic feeding mechanism or other auxiliary equipment must be received by the control in order to cycle the press. This applies only when the press control is in either the *Automatic Single Stroke* or *Continuous-On-Demand* mode of operation. To turn the *Automatic Single Stroke* or *Continuous-on-Demand* mode of operation on, refer to the optional modes section on pages 88-90.

The programmed time must be longer than the entire *Automatic Single Stroke* or *Continuous-on-Demand* sequence of operation. If the signal is not received within the programmed amount of time, the press will not cycle. If the signal is received within the programmed amount of time, the press will cycle, and the signal time-out setting will reset and start over.

Initially, the timer is started on the first stroke by pressing the prior-action button. The palm buttons must then be used to initiate the first stroke. After the first stroke, the timer is started when the signal from an outside source is received. To stop the press once it is in the *Automatic Single Stroke* or *Continuous-on-Demand* mode of operation, press either the emergency-stop or top-stop palm button.

HOW TO PROGRAM THE TIMED SETTINGS

Select the **ON** position of the Program On/Off selector switch. Then press **PROG**, which is located in the bottom right corner of any of the main screens. The MAIN PROGRAM SCREEN will be displayed.

On the MAIN PROGRAM SCREEN, use ▼ and ▲ on the touchscreen to scroll through the program options. Press **ENTER** when the touchscreen highlights TIMED SETTINGS. The security code screen will be displayed. See Figure 4.46. You will be prompted to enter the security code.

Press **ABORT** to stop and return to the MAIN PROGRAM SCREEN. Press ► to backspace or press **CLEAR** to delete the entry and start over. Press **ENTER** when finished.

Figure 4.46
Security Code Screen

ENTER CURRENT SECURITY CODE: □

A	B	C	D	E	F	G	H
I	J	K	L	M	N	O	P
Q	R	S	T	U	V	W	X
Y	Z	0	1	2	3	4	5
6	7	8	9	.	SPACE	←	CLEAR

PRESS CLEAR TO DELETE ENTRY AND START OVER. □
PRESS ABORT TO STOP EDITING AND RETURN TO □
PREVIOUS SCREEN. PRESS ENTER TO ACCEPT □
ENTRY WHEN FINISHED.

ABORT	ENTER
-------	-------

(Continued on next page.)

Rockford Systems, LLC
Call: 1-800-922-7533

HOW TO PROGRAM THE TIMED SETTINGS (continued)

After the correct security code has been entered, the TIMED SETTINGS Screen will be displayed. See Figure 4.47.

Press the button of the timed setting that you want to set. This will highlight that setting. Use ▼ and ▲ to adjust the time for that setting. Press the button of the timed setting again to finish.

Press **EXIT SCREEN** when finished to return to the MAIN PROGRAM SCREEN.

Figure 4.47
Timed Settings Screen

SSC-3000 PRESS AUTOMATION CONTROL							
TIMED SETTINGS							
ANTI-TIE DOWN:	250 ms						
TIMED INCH:	0 ms						
SIGNAL TIMEOUT:	5 seconds						
<p>PRESS BUTTON OF SETTING YOU WANT TO PROGRAM. USE THE UP / DOWN ARROWS TO CHANGE THE TIME. PRESS THE BUTTON OF THE SETTING AGAIN TO FINISH.</p> <p>USE ANTI-TIE DOWN TO SET THE TIME IN WHICH ALL ACTUATING MEANS MUST BE DEPRESSED. USE TIMED INCH TO SET THE TIME INCREMENT OF SLIDE MOVEMENT WHEN IN INCH MODE (LEAVE AT 0 ms FOR OFF). USE SIGNAL TIMEOUT TO SET TIME IN WHICH SIGNAL FROM AN OUTSIDE SOURCE MUST BE RECEIVED TO CYCLE PRESS. THIS IS USED FOR THE CONTINUOUS ON DEMAND AND AUTOMATIC SINGLE STROKE MODES OF OPERATION.</p>							
	<table border="1"><tr><td>ANTI-TIE DOWN</td></tr><tr><td>TIMED INCH</td></tr><tr><td>SIGNAL TIMEOUT</td></tr><tr><td>▲</td></tr><tr><td>▼</td></tr><tr><td>EXIT SCREEN</td></tr></table> <p>PRESS EXIT WHEN FINISHED</p>	ANTI-TIE DOWN	TIMED INCH	SIGNAL TIMEOUT	▲	▼	EXIT SCREEN
ANTI-TIE DOWN							
TIMED INCH							
SIGNAL TIMEOUT							
▲							
▼							
EXIT SCREEN							

SECTION 4—PROGRAMMING

SSC-3000 Press Automation Control System

OPTIONAL MODES

The SSC-3000 press automation control can be configured to provide a clutch/brake press control. A plug-in **Dual CPU Press Clutch/Brake Control Card** is required to do this. If this card has been furnished, the control will have an optional modes program screen that is used to turn on or off the following optional modes of operation: *Continuous-on-Demand*, *Foot-Maintained Continuous*, *Two-Hand-Maintained Continuous*, *One Hand or Foot Trip Single Stroke*, *Automatic Single Stroke*, *Inch With Top Stop*, and *Inch With Fault*. These optional modes (except for *Inch With Fault* and *Inch With Top Stop*) are mutually exclusive, which means that only one of them may be on at a time.

CONTINUOUS-ON-DEMAND

Continuous-on-Demand is a mode of operation where the press control system provides intermittent periods of continuous stroking automatically actuated by demand signals from other machinery or equipment used in association with the press in the production process, without action by an operator after the initial start. This mode is often used in production systems when a machine in the system uses parts in its operation that are produced by the press, but the machine cannot operate fast enough to use the number of parts produced if the press were run in the *Continuous* mode.

The demand signal must be received within a set amount of time, which is programmed by the operator. This timed setting is called signal time-out. For directions on how to program this setting, refer to the timed settings section on pages 86-87.

The programmed time must be longer than the entire *Continuous-on-Demand* sequence of operation. If the signal is not received within the programmed amount of time, the press will not cycle. If the signal is received within the programmed amount of time, the press will cycle and the signal time-out setting will reset and start over.

Initially, the timer is started before the first continuous cycle by pressing the prior-action button. The palm buttons must then be used to initiate the continuous cycle. The press will run continuously until the signal stops. After the first continuous cycle, the timer is started again when the signal from an outside source is received. This must occur before the signal time-out setting expires. To stop the press once it is in the *Continuous-on-Demand* mode of operation, press either the emergency-stop or top-stop palm button.

To use *Continuous-on-Demand*, the mode selector switch must be set to **CONT**, and the actuating means selector switch must be set to **HAND**, and this mode must be turned on in the optional modes programming screen.



A point-of-operation safeguard must be used with this mode of operation.

FOOT-MAINTAINED CONTINUOUS

Foot-Maintained Continuous is a mode of operation whereby the ram strokes continuously as long as the operator(s) maintains actuation of the foot switch. This mode requires the prior-action push button to be depressed prior to actuating the foot switch. If the foot switch is released anytime during a stroke, the press will top stop.

To use *Foot-Maintained Continuous*, the mode selector switch must be set to **CONT**, and the actuating means selector switch must be set to **FOOT**, and this mode must be turned on in the optional modes programming screen.



A point-of-operation safeguard must be used with this mode of operation.

TWO-HAND-MAINTAINED CONTINUOUS

Two-Hand-Maintained Continuous is a mode of operation whereby the ram strokes continuously as long as the operator(s) maintains actuation of the palm buttons. This mode requires the prior-action push button to be depressed prior to actuating the palm buttons. If the palm buttons are released anytime during a stroke, the press will top stop.

To use *Two-Hand-Maintained Continuous*, the mode selector switch must be set to **CONT**, and the actuating means selector switch must be set to **HAND**, and this mode must be turned on in the optional modes programming screen.

(Continued on next page.)

Rockford Systems, LLC
Call: 1-800-922-7533

OPTIONAL MODES (continued)

ONE HAND OR FOOT TRIP SINGLE STROKE

One Hand or Foot Trip Single Stroke is a mode of operation whereby the press will make a cycle as soon as the palm buttons are concurrently depressed or the foot switch is depressed. In this mode, the automatic up (holding) angle does not apply.

To use *One Hand or Foot Trip Single Stroke*, the mode selector switch must be set to **SINGLE**, and the actuating means selector switch must be set to **FOOT**, and this mode must be turned on in the optional modes programming screen.



A point-of-operation safeguard must be used with this mode of operation.

AUTOMATIC SINGLE STROKE

Automatic Single Stroke is a mode of operation where single-stroke actuating signals are sent to the press control system by an automatic feeding mechanism or other auxiliary equipment without action by an operator after the initial start. This mode of operation is often used when automatic feeding or parts removal equipment cannot operate fast enough to insert or remove material with the press stroking continuously.

The signal must be received within a set amount of time, which is programmed by the operator. This timed setting is called signal time-out. For directions on how to program this setting, refer to the timed settings section on pages 86-87.

The programmed time must be longer than the entire *Automatic Single Stroke* sequence of operation. If the signal is not received within the programmed amount of time, the press will not cycle. If the signal is received within the programmed amount of time, the press will cycle and the signal time-out setting will reset and start over.

Initially, the timer is started on the first stroke by pressing the prior-action button. The palm buttons must be used, then, to initiate the first stroke. After the first stroke, the timer is started when the signal from an outside source is received. This must occur before the signal time-out setting expires. To stop the press once it is in the *Automatic Single Stroke* mode of operation, press either the emergency-stop or top-stop palm button.

To use *Automatic Single Stroke*, the mode selector switch must be set to **SINGLE**, and the actuating means selector switch must be set to **HAND**, and this mode must be turned on in the optional modes programming screen.



A point-of-operation safeguard must be used with this mode of operation.

INCH WITH FAULT

Inch With Fault is the same mode of operation as normal *Inch*, but the control will allow the press to be cycled without general fault messages stopping it and being displayed. This allows the press to be set up easily without having to turn off the cyclic die protection inputs that would normally cause nuisance faults during setup.

To use *Inch With Fault*, the mode selector must be set to **INCH**, the actuating means selector switch must be set to **HAND**, and this mode must be turned on in the optional modes programming screen.



The *Inch* mode of operation is used for die setup, tool setup, and maintenance only. It is not intended for use during production operations.

INCH WITH TOP STOP

Inch With Top Stop is a mode of operation that is similar to normal *Inch* (in which the ram travels as long as the operator(s) maintains actuation of the palm buttons). The difference is that if *Inch With Top Stop* is turned on, the ram will stop at the top of every cycle, even if the palm buttons are held depressed.

To use *Inch With Top Stop*, the mode selector must be set to **INCH**, the actuating means selector switch must be set to **HAND**, and this mode must be turned on in the optional modes programming screen.



The *Inch* mode of operation is used for die setup, tool setup, and maintenance only. It is not intended for use during production operations.

(Continued on next page.)

SECTION 4—PROGRAMMING

SSC-3000 Press Automation Control System

HOW TO TURN ON OR OFF THE OPTIONAL MODES

Select the **ON** position of the Program On/Off selector switch. Then press **PROG**, which is located in the bottom right corner of any of the main screens. The MAIN PROGRAM SCREEN will be displayed.

On the MAIN PROGRAM SCREEN, use ▼ and ▲ on the touchscreen to scroll through the program options. Press **ENTER** when the touchscreen highlights OPTIONAL MODES. The security code screen will be displayed. See Figure 4.48. You will be prompted to enter the security code.

Press **ABORT** to stop and return to the MAIN PROGRAM SCREEN. Press ► to backspace or press **CLEAR** to delete the entry and start over. Press **ENTER** when finished.

After the correct security code has been entered, the OPTIONAL MODES PROGRAM SCREEN will be displayed. See Figure 4.49.

Press the button of an optional mode to turn it on or off. The text on the button will change according to whether that mode is on or off.

Press **EXIT SCREEN** when finished to return to the MAIN PROGRAM SCREEN.

Figure 4.48
Security Code Screen

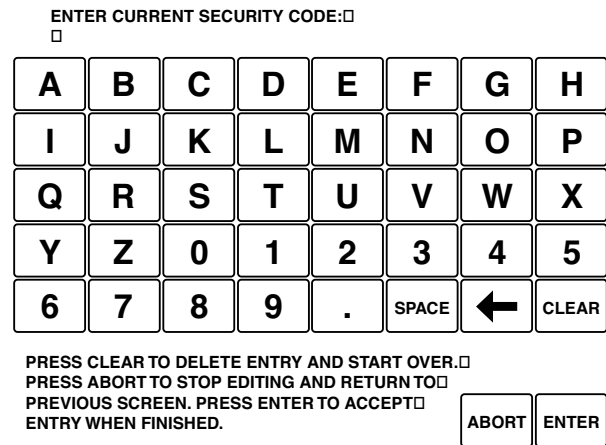
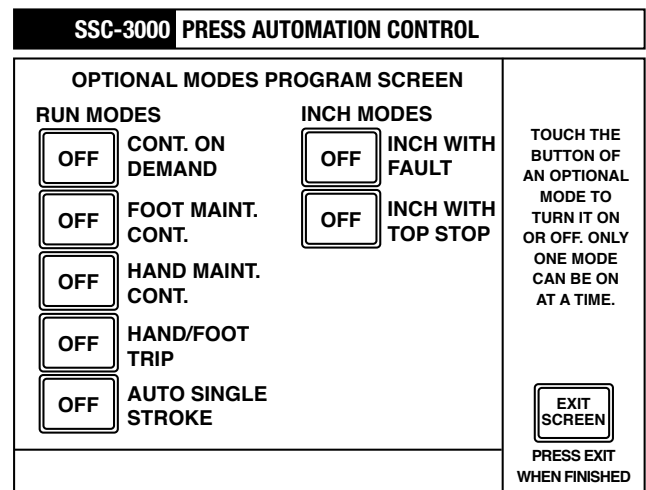

Figure 4.49
Optional Modes Program Screen



VARIABLE-SPEED TOP-STOP SETTINGS

The SSC-3000 press automation control can be configured to provide a clutch/brake press control. A plug-in **Dual CPU Press Clutch/Brake Control Card** is required to do this. If this card has been furnished, the control will have a variable-speed top-stop settings screen that is used to program the angles at which the control gives the signal to stop the press at TDC (top dead center), when the top-stop palm button is pressed while in the *Continuous* mode of operation. This will ensure the press will stop at top, regardless of the speed at which it is run. These settings also apply when a user input or die protection input activates that has been programmed to top stop. These settings should be used **only** if your press has a variable speed drive, and it is run at different speeds. If you have a constant speed press, or if you have a variable speed drive but run it at only one speed, make sure this function is turned off.

HOW TO CALCULATE THE VARIABLE-SPEED TOP-STOP SETTINGS

There are six locations in the table to input your press's speed and corresponding top-stop angle. In the first location, the slowest speed that you run the press at should be input. The fastest speed that you run the press at should be input in the sixth location. The second through the fifth locations should be input with speeds in even increments between your slowest and fastest speeds.

Once all six speeds are input, the corresponding top-stop angles can be set. Start with the first location; a good angle to start with is 270°. If the press stops before TDC, a higher angle setting is required. Add the number of degrees the machine stopped short of TDC to the setting. If the press stops beyond TDC, a lower angle setting is required. Subtract the number of degrees the machine went over TDC from the setting. Repeat this for the rest of the angle settings.

HOW TO PROGRAM THE VARIABLE-SPEED TOP-STOP SETTINGS

Select the **ON** position of the Program On/Off selector switch. Then press **PROG**, which is located in the bottom right corner of any of the main screens. The MAIN PROGRAM SCREEN will be displayed.

On the MAIN PROGRAM SCREEN, use ▼ and ▲ on the touchscreen to scroll through the program options. Press **ENTER** when the touchscreen highlights VAR SPD SETTINGS. The VARIABLE-SPEED TOP-STOP SETTINGS screen will be displayed. See Figure 4.50.

Press **ON/OFF** to activate the Variable-Speed Top-Stop settings. See Figure 4.51.

Touch the speed or angle in the table that you want to program. This will highlight that setting. Use ▼ and ▲ to adjust the speed or angle for that setting. Press the button of the speed or angle again to finish.

Press **EXIT SCREEN** when finished to return to the MAIN PROGRAM SCREEN.

Figure 4.50
Variable-Speed Top-Stop Settings Off

SSC-3000 PRESS AUTOMATION CONTROL			
VARIABLE SPEED TOP STOP SETTINGS			
SPEED	ANGLE	SPEED	ANGLE
1.		4.	
2.		5.	
3.		6.	

SPEEDS ARE IN STROKES PER MINUTE; ANGLES ARE IN DEGREES.

CURRENT STATUS: OFF

ENTER THE MINIMUM SPEED THAT YOU RUN YOUR PRESS AT IN #1 AND THE MAXIMUM SPEED YOU RUN AT IN #6. SET SPEEDS #2 - #5 IN EVEN INCREMENTS BETWEEN YOUR MAXIMUM AND MINIMUM SPEEDS. SET THE ANGLES BY TRIAL AND ERROR FOR EACH SPEED SETTING.

PRESS ON/OFF TO ACTIVATE THE VAR. SPEED SETTINGS. TOUCH A NUMBER IN THE TABLE TO SELECT IT. USE THE ARROWS TO CHANGE ITS VALUE.

ON/OFF

▲

▼

EXIT SCREEN

PRESS EXIT WHEN FINISHED

Figure 4.51
Variable-Speed Top-Stop Settings On

SSC-3000 PRESS AUTOMATION CONTROL			
VARIABLE SPEED TOP STOP SETTINGS			
SPEED	ANGLE	SPEED	ANGLE
1.	20	4.	80
2.	40	5.	100
3.	60	6.	120
	330		318
	326		314
	322		310

SPEEDS ARE IN STROKES PER MINUTE; ANGLES ARE IN DEGREES.

CURRENT STATUS: ON

ENTER THE MINIMUM SPEED THAT YOU RUN YOUR PRESS AT IN #1 AND THE MAXIMUM SPEED YOU RUN AT IN #6. SET SPEEDS #2 - #5 IN EVEN INCREMENTS BETWEEN YOUR MAXIMUM AND MINIMUM SPEEDS. SET THE ANGLES BY TRIAL AND ERROR FOR EACH SPEED SETTING.

PRESS ON/OFF TO ACTIVATE THE VAR. SPEED SETTINGS. TOUCH A NUMBER IN THE TABLE TO SELECT IT. USE THE ARROWS TO CHANGE ITS VALUE.

ON/OFF

▲

▼

EXIT SCREEN

PRESS EXIT WHEN FINISHED

SECTION 4—PROGRAMMING

SSC-3000 Press Automation Control System

PART-IN-PLACE

The SSC-3000 press automation control can be configured to provide a part-in-place die protection input when in the *Single Stroke* mode of operation. A plug-in **Dual CPU Press Clutch/Brake Control Card** is required to do this. If this card has been furnished, the control will have a Part-in-Place screen that is used to set the logic of this input. The stop type for this input is fixed to E-STOP (emergency stop), and the message is fixed to PART-IN-PLACE FAULT.

The part-in-place input is a 24-V DC sinking (NPN) input. This input is tied in to the **Dual CPU Press Clutch/Brake Control Card** at location P4-16. Please refer to the electrical schematics.

The programmed part-in-place logic setting for each die is stored in job memory for QDC (quick die change).

When in the *Single Stroke* mode of operation, the logic will not allow a stroke to begin if the input is not true. Once a stroke is started, the input must stay true until the auto up (holding) angle is reached. If the input does not stay true, the press will E-stop and a PART-IN-PLACE FAULT message will be displayed.

Note: The auto up (holding) angle should not be set at an angle greater than the angle at which the workpiece is contacted by the upper die—if it is, nuisance faults may occur.

HOW TO PROGRAM THE LOGIC FOR THE PART-IN-PLACE INPUT

Select the ON position of the Program On/Off selector switch. Then press **PROG**, which is located in the bottom right corner of any of the main screens. THE MAIN PROGRAM SCREEN will be displayed.

On the MAIN PROGRAM SCREEN, use ▼ and ▲ on the touchscreen to scroll through the program options. Press **ENTER** when the touchscreen highlights PART-IN-PLACE. The USER INPUTS PROGRAM SCREEN will be displayed. See Figure 4.52.

To set the logic, press the **LOGIC** button. Use ▼ and ▲ to scroll through the settings of OFF, N.O. (normally open), and N.C. (normally closed). Press the **LOGIC** button again to finish.

Remember that the stop type is fixed to E-STOP (emergency stop) and the message is fixed to PART-IN-PLACE FAULT.

Press **EXIT SCREEN** when finished to return to the MAIN PROGRAM SCREEN.

Figure 4.52
User Inputs Program Screen

SSC-3000 PRESS AUTOMATION CONTROL	
USER INPUTS PROGRAM SCREEN	
INPUT #: PRT-IN-PL	LOGIC
LOGIC: OFF	STOP TYPE
STOP TYPE: E - STOP	MESG.
MESSAGE:	▲
PART-IN-PLACE FAULT	▼
USE THE UP / DN ARROWS TO CHANGE THE INPUT #. ONCE YOU REACH AN INPUT THAT YOU WANT TO PROGRAM, PRESS THE BUTTON OF THE SETTING (LOGIC, STOP TYPE, OR MESG.) THAT YOU WANT TO CHANGE FOR THAT INPUT. USE THE UP / DN ARROWS TO CHANGE ITS VALUE. PRESS THE BUTTON OF THE SETTING AGAIN TO FINISH.	EXIT SCREEN
	PRESS EXIT WHEN FINISHED

PLS OUTPUTS

The SSC-3000 press automation control can be configured to provide PLS (programmable limit switch) outputs. A plug-in **8-Output PLS Card** is required to do this. This card is designed to provide user-programmable outputs that can be used to sequence events during the press stroke. Up to two **8-Output PLS Cards** can be used for a total of 16 outputs. These outputs are single 10-amp form “A” contacts that are fused for 2 amps at 120 V AC. All outputs have depluggable terminal strips with LED (light emitting diode) indicators for easy installation and maintenance. All programmed PLS settings for each die are stored in job memory for QDC (quick die change).

The PLS outputs can be used for automatic operations such as lube mist, air blowoff, or feed initiation. Each output has a programmable ON and OFF angle. The control turns the output ON when the resolver reaches the ON angle setting and leaves the output on until the OFF angle setting is reached. There is one ON setting and one OFF setting per output, per revolution.

The outputs can also be programmed to turn off after a preset period of time in hundredths of a second. This timed output setting overrides any OFF angle setting, so the PLS output will turn off when the programmed time is reached, regardless of the OFF angle setting.

There is also a counter setting for a counted output. Auxiliary devices, such as lube or oil systems, can be interfaced to the **PLS Card** to provide an output signal when the counter setting is reached. For example, if an oil mist is required every three cycles, the counter setting is set to 3 strokes. When the counter reaches 3 strokes, the PLS output turns on, and the oil mist is given. The counter is then reset, and the cycle starts over.

When an output is activated, a fault message is displayed. This fault message is assigned to the output according to its function. Figure 4.11 on page 68 and Figure 4.54 on page 94 show a list of fault messages that can be assigned to each output. There are also ten (10) additional user-defined messages that can be tailored to your specific applications. When you scroll through the fault messages, the ten (10) user-defined messages will show up after the last standard message. See page 83 on how to program the USER-DEFINED MESSAGES. Select any message for each output.

HOW TO PROGRAM THE PLS OUTPUTS

Select the **ON** position of the Program On/Off selector switch. Then press **PROG**, which is located in the bottom right corner of any of the main screens. The MAIN PROGRAM SCREEN will be displayed.

On the MAIN PROGRAM SCREEN, use ▼ and ▲ on the touchscreen to scroll through the program options. Press **ENTER** when the touchscreen highlights PLS OUTPUTS. The PLS OUTPUTS PROGRAM SCREEN will be displayed. See Figure 4.53.

Press ▼ and ▲ to change the OUTPUT# between 1 and 8 (16 if you have a second card installed). When the screen displays the OUTPUT# that you want to program, touch the button of the programmable parameter (**ON**, **OFF**, **COUNT**, **TIMED OFF**, or **MESG.**) that needs to be set. Use ▼ and ▲ to reach the setting you desire for that parameter. Touch the button of the programmable parameter (**ON**, **OFF**, **COUNT**, **TIMED OFF**, or **MESG.**) again to finish.

Press **EXIT SCREEN** when finished to return to the MAIN PROGRAM SCREEN.

Figure 4.53
PLS Outputs Program Screen

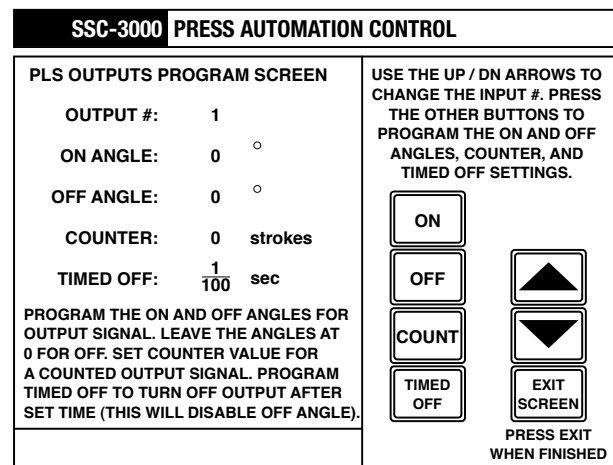

SECTION 4—PROGRAMMING

SSC-3000 Press Automation Control System

DIE PROTECTION INPUTS

The SSC-3000 press automation control can be configured to provide die protection inputs. A plug-in **8-Input Die Protection Card** is required to do this. This card is designed to provide user-programmable inputs that can be used to monitor static or cyclic events during the press stroke. Up to three **8-Input Die Protection Cards** can be used for a total of 24 inputs. The inputs are 24-V DC inputs that have individual jumpers that set each input to sinking (NPN) or sourcing (PNP). The factory setting for all inputs is sinking (NPN). All inputs have depluggable terminal strips with LED (light emitting diode) indicators for easy installation and maintenance.

All programmed die protection settings for each die are stored in job memory for QDC (quick die change).

The die protection inputs can be used for equipment monitoring, die protection, or other user-defined functions. There are six (6) parameters that can be programmed for each input.

PROGRAMMABLE PARAMETERS

- LOGIC:** This setting is used to change the logic that activates the input. The programming choices are N.O. (normally open), N.C. (normally closed), and OFF (disabled). Select one setting for each input.
- STOP TYPE:** When the input is activated or goes true, the press cycle will stop in one of two ways. E-STOP (emergency stop) will immediately stop the cycle in progress. T-STOP (top stop) will stop the cycle in progress at TDC (top dead center). Select the type of stop that is required for each input.
- OPEN ANGLE:** This angle setting is used to activate the window during which the control will look for a change of state of the input. The setting ranges from 0° to 359°. If this setting and the CLOSE angle are both set to 0°, the input will be a static input.
- CLOSE ANGLE:** This angle setting is used to deactivate the window during which the control will look for a change of state of the input. The setting ranges from 0° to 359°. If this setting and the OPEN angle are both set to 0°, the input will be a static input.
- MODE:** There are three different die protection modes—these modes determine what the control expects the input to do between the programmed OPEN and CLOSE angles for each stroke. The three mode settings are 1, 2, and 3.
 - 1:** The control will look for the input to change state and go true between the programmed OPEN and CLOSE angles for each stroke. Anything else that happens after the input goes true will be ignored.
 - 2:** The control will look for the input to change state and go true between the programmed OPEN and CLOSE angles for each stroke, but once the input has gone true, it will have to be maintained until the CLOSE angle is reached or a fault will be generated.
 - 3:** The control will look for the input to have already changed state and be true when the OPEN angle is reached. The input will then have to be dropped and reinitiated between the programmed OPEN and CLOSE angles, and it will then have to be maintained until the CLOSE angle is reached or a fault will be generated.
- FAULT MESSAGE:** When the input is activated, a fault message is displayed. This fault message is assigned to the input according to its function. Figure 4.54 shows a list of fault messages that can be assigned to each input. There are also ten (10) additional user-defined messages that can be tailored to your specific applications.

Note: When you scroll through the fault messages, the ten (10) user-defined messages will show up after the last standard message (PART INPUT #3). See page 83 on how to program the USER-DEFINED MESSAGES. Select any message for each input.

Figure 4.54
General Fault Messages

CLUTCH/BRAKE AIR FLT
CNTRBALANCE AIR FLT
DUAL SOLENOID FAULT
CLUTCH VALVE FAULT*
BRAKE VALVE FAULT*
LUBE FAULT
HIGH LUBE PRESSURE
LOW LUBE PRESSURE
LOW LUBE LEVEL
MAIN MOTOR OVERLOAD
RAM ADJ MTR OVERLOAD
LUBE MOTOR OVERLOAD
AUX MOTOR OVERLOAD
GUARD INTERLOCK OPEN
FRONT GUARD OPEN
REAR GUARD OPEN
LEFT SIDE GUARD OPEN
RIGHT SIDE GRD OPEN
FEEDER FAULT
LOAD MONITOR FAULT
SAFETY BLK INTERLOCK
DIE PROTECTION FAULT
SHUT HEIGHT FAULT
VAR SPEED DRIVE FLT
SHORT FEED FAULT**
PART EJECTION FAULT**
STOCK BUCKLE FAULT**
END OF STOCK FAULT**
PILOT PIN FAULT**
PART INPUT #1**
PART INPUT #2**
PART INPUT #3**

**Only used with machines that have a split clutch and brake, and two dual valves have been furnished*

***Messages typically used for die protection*

(Continued on next page.)

Rockford Systems, LLC
Call: 1-800-922-7533

HOW TO PROGRAM THE DIE PROTECTION INPUTS

Select the **ON** position of the Program On/Off selector switch. Then press **PROG**, which is located in the bottom right corner of any of the main screens. The MAIN PROGRAM SCREEN will be displayed.

On the MAIN PROGRAM SCREEN, use ▼ and ▲ on the touchscreen to scroll through the program options. Press **ENTER** when the touchscreen highlights DIE PROTECTION. The DIE PROTECTION INPUTS screen will be displayed. See Figure 4.55.

Press ▼ and ▲ to change the INPUT# between 1 and 8 (16 or 24 if you have a second or third card installed). When the screen displays the INPUT# that you want to program, touch the programmable parameter (**LOGIC, STOP TYPE, OPEN, CLOSE, MODE, or MESSG.**) that needs to be set. Use ▼ and ▲ to reach the setting you desire for that parameter. Touch the programmable parameter (**LOGIC, STOP TYPE, OPEN, CLOSE, MODE, or MESSG.**) again to finish.

Press **EXIT SCREEN** when finished to return to the MAIN PROGRAM SCREEN.

Figure 4.55
Die Protection Inputs

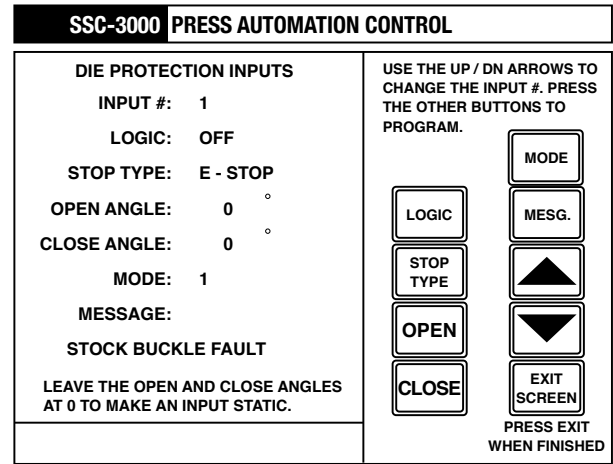

(Continued on next page.)

SECTION 4—PROGRAMMING

SSC-3000 Press Automation Control System

AIR MONITOR

The SSC-3000 press automation control can be configured to provide remote monitoring of air pressure. A plug-in serial communication port is provided for this option on the **Main CPU Card** in the rack.

To use this feature, a remote air pressure monitor station is required. This station will monitor up to four (4) air pressure settings (1-100 PSI). This station should be installed near the pneumatic systems on the press. If this station was not furnished with your control and you would like to add it, please consult the factory.

The station is furnished in a NEMA 12, screw-cover enclosure which includes four ¼" tube fittings for the input ports, plus one 25' cable for communications. The four input ports are designed to monitor the clutch/brake, counterbalance, die cushion, and auxiliary air pressure settings. All programmed air monitor settings for each die are stored in job memory for QDC (quick die change).

The pressures are measured by analog pressure transducers, and then sent to the main CPU processor via the serial communications link. The values are compared to the programmed settings, and a warning message will appear if the pressures are not set properly for a new die. In the event of an air pressure failure, the machine will shut down and will not run until the air pressure is restored.

The remote air pressure station also has output relays to automatically set the air pressure on the counterbalance, die cushion, and auxiliary air when the die changes. This feature ensures that the pressures are automatically adjusted and held when a die change occurs. This feature requires fill-and-dump solenoid valve assemblies to be wired into the station.

If the air monitor equipment is installed, the control will have two air monitor programming screens. The first screen is the AIR MONITOR PROGRAM SCREEN, which is used to set the pressures for the clutch/brake, counterbalance, die cushion, and auxiliary air. It is also used to turn the auto set/hold feature on or off for the counterbalance, die cushion, and auxiliary air. The second screen is the AIR MONITOR ADVANCED PROGRAMMING screen, which is used to program the high fault limit, low fault limit, minimum correction time, and fault time.

AUTO SET/HOLD

The auto set/hold feature is used to automatically adjust air pressures when they rise or fall below the high or low fault limits.

HIGH FAULT LIMIT

The high fault limit is the amount of pressure (in PSI) **above** a setting that must be exceeded before the press becomes inoperable. This limit may be set from 0 to 20 PSI.

LOW FAULT LIMIT

The low fault limit is the amount of pressure (in PSI) **below** a setting that must be exceeded before the press becomes inoperable. This limit may be set from 0 to 20 PSI.

MINIMUM CORRECTION TIME

The minimum correction time is the minimum amount of time (in 1/10 seconds) a fill or dump valve will stay energized when making a correction. This time may be set from 0.1 to 2.55 seconds.

FAULT TIME

The fault time is the amount of time the high or low fault limit must be exceeded before the press becomes inoperable. This time may be set from 1 to 30 seconds.

(Continued on next page.)

*Rockford Systems, LLC
Call: 1-800-922-7533*

HOW TO PROGRAM THE AIR MONITOR

Select the **ON** position of the Program On/Off selector switch. Then press **PROG**, which is located in the bottom right corner of any of the main screens. The MAIN PROGRAM SCREEN will be displayed.

On the MAIN PROGRAM SCREEN, use ▼ and ▲ on the touchscreen to scroll through the program options. Press **ENTER** when the touchscreen highlights AIR MONITOR. The AIR MONITOR PROGRAM SCREEN will be displayed. See Figure 4.56.

Press the button of the pressure setting that you want to program. This will highlight that setting. Use ▼ and ▲ to reach the pressure setting you desire for that parameter. Press the button of the pressure setting again to finish.

Press **EXIT SCREEN** when finished to return to the MAIN PROGRAM SCREEN.

HOW TO TURN THE AUTO SET/HOLD ON OR OFF

Select the **ON** position of the Program On/Off selector switch. Then press **PROG**, which is located in the bottom right corner of any of the main screens. The MAIN PROGRAM SCREEN will be displayed.

On the MAIN PROGRAM SCREEN, use ▼ and ▲ on the touchscreen to scroll through the program options. Press **ENTER** when the touchscreen highlights AIR MONITOR. The AIR MONITOR PROGRAM SCREEN will be displayed. See Figure 4.56.

Press the **ADVNC D PROG.** button and the AIR MONITOR ADVANCED PROGRAMMING screen will be displayed. See Figure 4.57. Press the fault limit or time in the table that you want to program. This will highlight that setting. Use ▼ and ▲ on the touchscreen to adjust the fault limit or time for that setting. Press the button of the fault limit or time again to finish.

Press **EXIT SCREEN** when finished to return to the MAIN PROGRAM SCREEN.

Figure 4.56
Air Monitor Program Screen

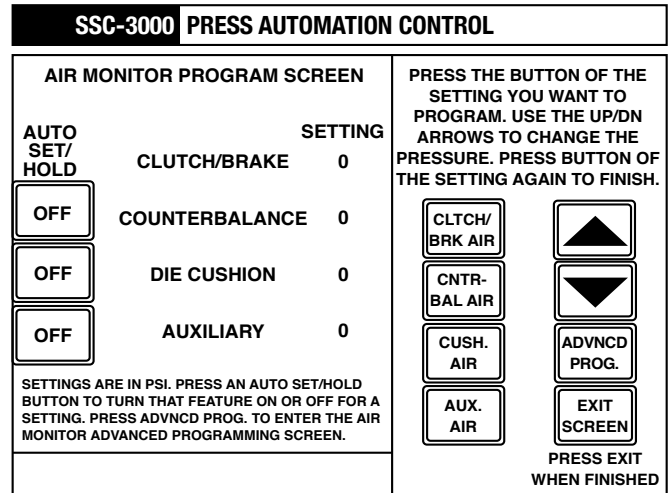
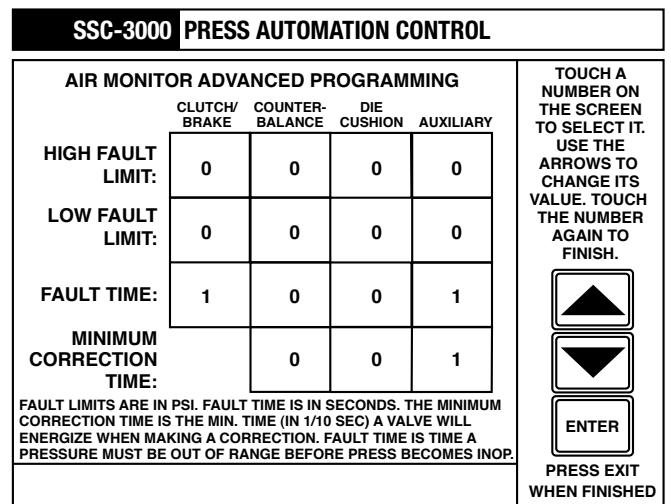

Figure 4.57
Air Monitor Advanced Program Screen



SECTION 4—PROGRAMMING

SSC-3000 Press Automation Control System

LOAD MONITOR SYSTEM

The SSC-3000 press automation control can be configured to provide monitoring of the machine load. A **Load Monitor Card**, load monitor control module, and sensors are required to do this. The minimum and maximum tonnage can be set manually or with a learn key, and is programmable through the touchscreen/display. The learn key will add 10% to or subtract 10% from the current high and low settings. When enabled, a stop signal will be given when an over or under tonnage setting is detected.

All programmed load monitor settings for each die are stored in job memory for QDC (quick die change).

HOW TO PROGRAM THE LOAD MONITOR SYSTEM

Select the ON position of the Program On/Off selector switch. Then press **PROG**, which is located in the bottom right corner of any of the main screens. THE MAIN PROGRAM SCREEN will be displayed.

On the MAIN PROGRAM SCREEN, use ▼ and ▲ on the touchscreen to scroll through the program options. Press **ENTER** when the touchscreen highlights LOAD MONITOR. The LOAD MONITOR PROGRAM SCREEN will be displayed. See Figure 4.58.

Press the **ENABLE/DISABLE** button to turn the load monitor on and off. Press the **CONFIG** button to set up the number of sensors (1 through 8) and the maximum tonnage of the machine. The security code screen will be displayed. See Figure 4.59. You will be prompted to enter the security code.

Press **ABORT** to stop and return to the MAIN PROGRAM SCREEN. Press ► to backspace or press **CLEAR** to delete the entry and start over. Press **ENTER** when finished.

After the correct security code has been entered, the MAXIMUM PRESS TONS screen will be displayed. See Figure 4.60. Press **CLEAR** to delete the current tonnage. Enter the correct tonnage up to 4 characters.

Press **ABORT** to stop editing and return to the LOAD MONITOR PROGRAM SCREEN. Press ► to backspace. When you are finished, press **ENTER** to accept the new tonnage. The NO. OF TRANSDUCERS screen will be displayed. See Figure 4.61 on the next page. Press **CLEAR** to delete the current number of transducers. Enter the correct number of transducers.

Figure 4.58—Load Monitor Program Screen

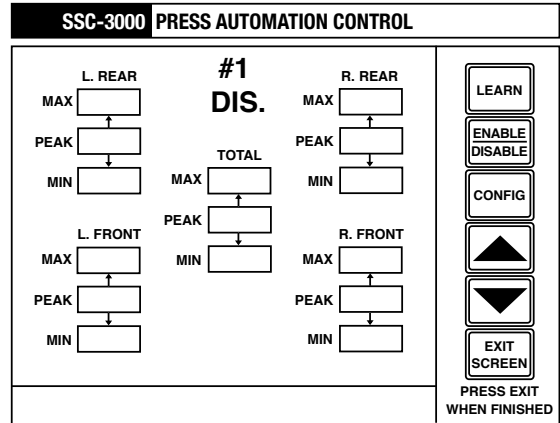

Figure 4.59—Security Code Screen

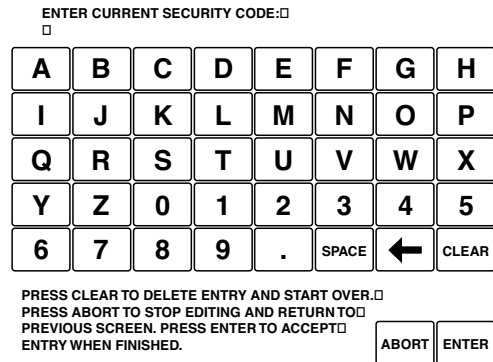
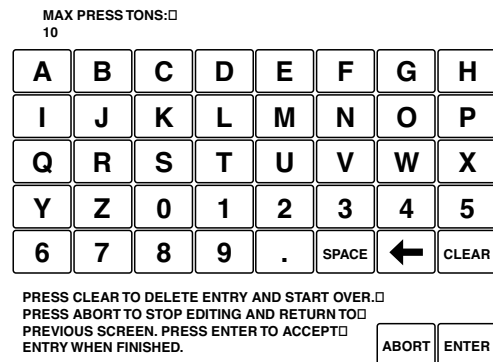

Figure 4.60—Maximum Press Tons Screen



(Continued on next page.)

Rockford Systems, LLC
Call: 1-800-922-7533

HOW TO PROGRAM THE LOAD MONITOR SYSTEM (continued)

Press **ABORT** to stop editing and return to the LOAD MONITOR PROGRAM SCREEN. Press **➤** to backspace. When you are finished, press **ENTER** to accept the new number of transducers and return to the LOAD MONITOR PROGRAM SCREEN.

On the LOAD MONITOR PROGRAM SCREEN, press the box next to either MAX (maximum) or MIN (minimum) and use **▼** and **▲** to change the number values. Select the maximum and minimum amount of tonnage you want the press to have at each sensor.

Press the **LEARN** key to automatically input the tonnage into the MAX and MIN boxes. You will see this message in the message bar:

ARE YOU SURE? [YES] [NO]

Touch **YES** and the actual tonnage plus 10% will be automatically input.

After the maximum tonnage is set, the control will not read any value greater than the maximum tonnage if the machine is overloaded.

Press **EXIT SCREEN** when finished to return to the MAIN PROGRAM SCREEN.

Figure 4.61
No. of Transducers Screen

NO OF TRANSDUCERS:□
2

A	B	C	D	E	F	G	H
I	J	K	L	M	N	O	P
Q	R	S	T	U	V	W	X
Y	Z	0	1	2	3	4	5
6	7	8	9	.	SPACE	←	CLEAR

PRESS CLEAR TO DELETE ENTRY AND START OVER.□
PRESS ABORT TO STOP EDITING AND RETURN TO□
PREVIOUS SCREEN. PRESS ENTER TO ACCEPT□
ENTRY WHEN FINISHED.

ABORT	ENTER
-------	-------

SECTION 4—PROGRAMMING

SSC-3000 Press Automation Control System

SERVO FEED

Certain brands of servo feed controllers can be interfaced to the SSC-3000 press automation control. With the servo feed option installed and turned on, it is possible to automate the settings for stock feed length, stock feed rate, acceleration, and deceleration. All programmed servo feed settings for each die are stored in job memory for QDC (quick die change). The servo feed can also be programmed with a stock description for visual reference.

When the servo feeder is turned on, downloading occurs at power on, after programming the feeder, and after programming a job setup. If a failure occurs at power on, the system will fail every five (5) seconds (except in inch). In order to continue, the problem must be corrected or the feeder turned off. If a failure occurs during programming when the EXIT SCREEN button is pressed, a fault message will appear and an E-stop will be asserted. In order to continue, the problem must be corrected or the feeder turned off before the Servo Feed Program Screen can be exited. If a failure occurs during job setup, a fault message will appear and an E-stop will be asserted. In order to continue in the *Run* mode, clear the message, correct the problem, and program the servo feeder. A fault will recur every five (5) seconds unless the problem is solved or the feeder is turned off. See pages 101-103 for programming information.

When the feeder is turned on, it is monitored for a fault while in the *Run* mode, but not in the *Inch* mode. Status polling occurs every five (5) seconds and each time the dual valve turns off. If a failure occurs during this time, a feeder fault message will be displayed and an E-stop is asserted. After acknowledging the message, the unit is polled again to see if the problem has been corrected. A fault will recur every five (5) seconds until the problem is solved or the feeder is turned off.

Note: If a feeder fault occurs every five (5) seconds in the Inch mode, the feeder did not accept a download at power on or during a job setup change.

FEEDER FAULTS

- Fault at Power On—The system will fail every five (5) seconds (except in inch). The system will fail in inch only when first powered up. Correct the problem or turn the feeder off.
- Fault during Programming—A fault message will appear when the **EXIT SCREEN** is pressed if a problem occurs during programming. Correct the problem or turn the feeder off.
- Fault during the Run Mode—The feeder is monitored for a fault every five (5) seconds and when the dual valve turns off. When a failure occurs, a feeder fault code is displayed. Correct the problem or turn the feeder off. When the problem is corrected, return to the program screen to clear the fault and turn the feeder on; follow the programming instructions on pages 101-103.

If the SSC-3000 control is not connected to the servo feeder, or if the servo feeder is not turned on at power on, a *Servo Feeder Not Responding* fault will occur. This is normal because the feeder is not responding to the information the SSC-3000 is sending out. To use the SSC-3000 control without the servo feeder, go into program and turn the servo feeder off (see page 101). Once you are in the Servo Feed Program Screen, you will not be allowed to exit that screen if you have the servo feeder option turned on but the servo feeder is not connected.

(Continued on next page.)

Rockford Systems, LLC
Call: 1-800-922-7533

HOW TO PROGRAM THE SSC-3000 SERVO FEED

Select the **ON** position of the Program On/Off selector switch. Then press **PROG**, which is located in the bottom right corner of any of the main screens. The MAIN PROGRAM SCREEN will be displayed.

On the MAIN PROGRAM SCREEN, use ▼ and ▲ on the touchscreen to scroll through the program options. Press **ENTER** when the touchscreen highlights SERVO FEED. The SERVO FEED PROGRAM SCREEN will be displayed. See Figure 4.62.

Press **ON/OFF** to turn the servo feed on, off, or to clear a fault.

Figure 4.62
Servo Feed Program Screen

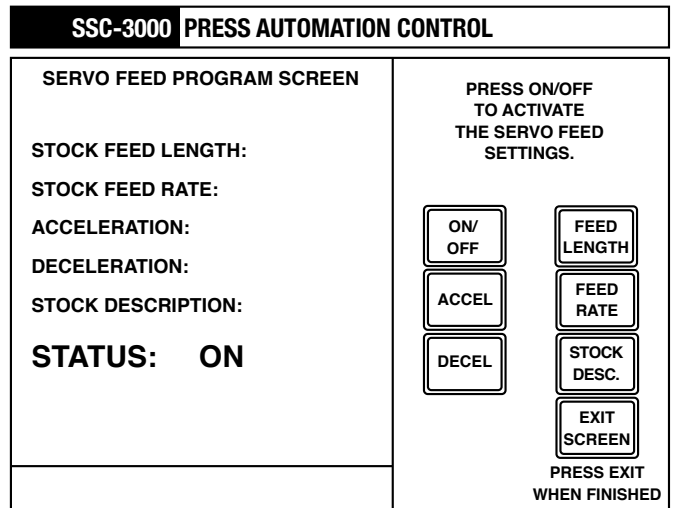

To enter a feed length number:

Press **FEED LENGTH** to program the desired feed length (in inches). The STOCK FEED LENGTH SCREEN will be displayed. See Figure 4.63. Enter a numeric feed length. Press ➤ to backspace. Press **ABORT** to stop editing and return to the SERVO FEED PROGRAM SCREEN. When you are finished, press **ENTER** to accept the feed length and return to the SERVO FEED PROGRAM SCREEN.

Press **EXIT SCREEN** when finished to return to the MAIN PROGRAM SCREEN.

Figure 4.63
Stock Feed Length Screen

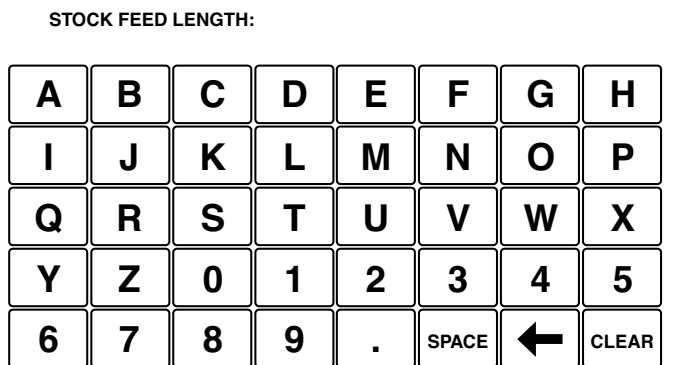

PRESS CLEAR TO DELETE ENTRY AND START OVER. □
PRESS ABORT TO STOP EDITING AND RETURN TO □
PREVIOUS SCREEN. PRESS ENTER TO ACCEPT □
ENTRY WHEN FINISHED.



(Continued on next page.)

SECTION 4—PROGRAMMING

SSC-3000 Press Automation Control System

To enter a feed rate number:

Press **FEED RATE** to program the desired feed rate. The STOCK FEED RATE SCREEN will be displayed. See Figure 4.64. The feed rate will be in inches per minute (IPM), inches per second (IPS), or as a percentage (%); the unit of measure for your particular feeder will be displayed on the screen. Enter a numeric feed rate. Press **➤** to backspace. Press **ABORT** to stop editing and return to the SERVO FEED PROGRAM SCREEN. When you are finished, press **ENTER** to accept the feed length and return to the SERVO FEED PROGRAM SCREEN.

Press **EXIT SCREEN** when finished to return to the MAIN PROGRAM SCREEN.

To enter an acceleration:

Note: Your feeder may not need to have the acceleration programmed. If this is the case, N/A will appear after ACCELERATION on the SERVO FEED PROGRAM SCREEN.

Press **ACCEL** to program the desired acceleration. The ACCELERATION RATE SCREEN will be displayed. See Figure 4.65. Enter a numeric acceleration rate. Press **➤** to backspace or press **CLEAR** to delete the entry and start over. Press **ABORT** to stop editing and return to the SERVO FEED PROGRAM SCREEN. Press **ENTER** when finished.

Press **EXIT SCREEN** when finished to return to the MAIN PROGRAM SCREEN.

To enter a deceleration:

Note: Your feeder may not need to have the deceleration programmed. If this is the case, N/A will appear after DECELERATION on the SERVO FEED PROGRAM SCREEN.

Press **DECEL** to program the desired deceleration. The DECELERATION RATE SCREEN will be displayed. See Figure 4.66. Enter a numeric deceleration rate. Press **➤** to backspace or press **CLEAR** to delete the entry and start over. Press **ABORT** to stop editing and return to the SERVO FEED PROGRAM SCREEN. Press **ENTER** when finished.

Press **EXIT SCREEN** when finished to return to the MAIN PROGRAM SCREEN.

Figure 4.64
Stock Feed Rate Screen

STOCK FEED RATE:

A	B	C	D	E	F	G	H
I	J	K	L	M	N	O	P
Q	R	S	T	U	V	W	X
Y	Z	0	1	2	3	4	5
6	7	8	9	.	SPACE	←	CLEAR

PRESS CLEAR TO DELETE ENTRY AND START OVER. □
PRESS ABORT TO STOP EDITING AND RETURN TO □
PREVIOUS SCREEN. PRESS ENTER TO ACCEPT □
ENTRY WHEN FINISHED.

ABORT	ENTER
-------	-------

Figure 4.65
Acceleration Rate Screen

ACCEL RATE (10-100):

A	B	C	D	E	F	G	H
I	J	K	L	M	N	O	P
Q	R	S	T	U	V	W	X
Y	Z	0	1	2	3	4	5
6	7	8	9	.	SPACE	←	CLEAR

PRESS CLEAR TO DELETE ENTRY AND START OVER. □
PRESS ABORT TO STOP EDITING AND RETURN TO □
PREVIOUS SCREEN. PRESS ENTER TO ACCEPT □
ENTRY WHEN FINISHED.

ABORT	ENTER
-------	-------

Figure 4.66
Deceleration Rate Screen

DECEL RATE (10-100):

A	B	C	D	E	F	G	H
I	J	K	L	M	N	O	P
Q	R	S	T	U	V	W	X
Y	Z	0	1	2	3	4	5
6	7	8	9	.	SPACE	←	CLEAR

PRESS CLEAR TO DELETE ENTRY AND START OVER. □
PRESS ABORT TO STOP EDITING AND RETURN TO □
PREVIOUS SCREEN. PRESS ENTER TO ACCEPT □
ENTRY WHEN FINISHED.

ABORT	ENTER
-------	-------

To enter a stock description:

Press **STOCK DESC.** to program the desired stock description. The STOCK DESCRIPTION SCREEN will be displayed. See Figure 4.67. Enter an alphanumeric stock description up to 30 characters. Press **➤** to backspace. Press **ABORT** to stop editing and return to the SERVO FEED PROGRAM SCREEN. When you are finished, press **ENTER** to accept the stock description and return to the SERVO FEED PROGRAM SCREEN.

Press **EXIT SCREEN** when finished to return to the MAIN PROGRAM SCREEN.

Figure 4.67
Stock Description Screen

STOCK DESCRIPTION:

A	B	C	D	E	F	G	H
I	J	K	L	M	N	O	P
Q	R	S	T	U	V	W	X
Y	Z	0	1	2	3	4	5
6	7	8	9	.	SPACE	←	CLEAR

PRESS CLEAR TO DELETE ENTRY AND START OVER. □
PRESS ABORT TO STOP EDITING AND RETURN TO □
PREVIOUS SCREEN. PRESS ENTER TO ACCEPT □
ENTRY WHEN FINISHED.



SECTION 4—PROGRAMMING

SSC-3000 Press Automation Control System

SHUT HEIGHT CONTROLLER

The SSC-3000 press automation control can be configured to provide single-ram or dual-ram shut height control. A **Shut Height Controller Card** and a linear displacement transducer (LDT) are required to do this. The shut height setting is stored to .001" of accuracy in job memory.

All programmed shut height settings for each die are stored in job memory for QDC (quick die change).

HOW TO PROGRAM THE SHUT HEIGHT CONTROLLER

Select the ON position of the Program On/Off selector switch. Then press **PROG**, which is located in the bottom right corner of any of the main screens. THE MAIN PROGRAM SCREEN will be displayed.

On the MAIN PROGRAM SCREEN, use ▼ and ▲ on the touchscreen to scroll through the program options. Press **ENTER** when the touchscreen highlights SHUT HEIGHT. The SHUT HEIGHT PROGRAM SCREEN will be displayed. See Figure 4.68.

Select **RAM #1** or **RAM #2**. Press INITIAL SETUP to initialize the shut height. The security code screen will be displayed. See Figure 4.69. You will be prompted to enter the security code.

Press **ABORT** to stop and return to the MAIN PROGRAM SCREEN. Press ► to backspace or press **CLEAR** to delete the entry and start over. Press **ENTER** when finished.

After the correct security code has been entered, the SHUT HEIGHT INITIAL SETUP screen will be displayed. See Figure 4.70. Press **SET LIMITS** to set the upper and lower travel limits. A screen similar to the one in Figure 4.71 will be displayed. Press **ENTER** when finished to return to the SHUT HEIGHT INITIAL SETUP screen.

Figure 4.68—Shut Height Program Screen

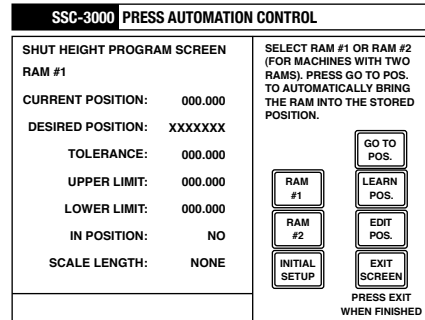

Figure 4.69—Shut Height Program Screen

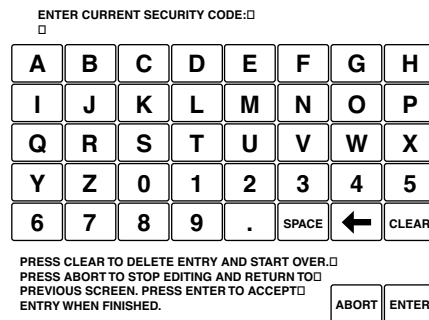

Figure 4.70—Shut Height Program Screen

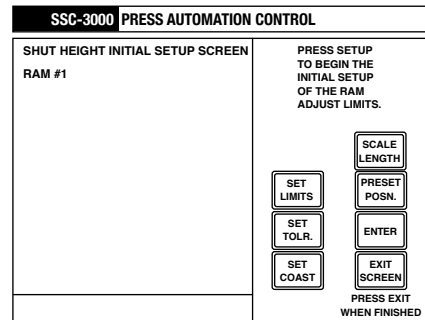
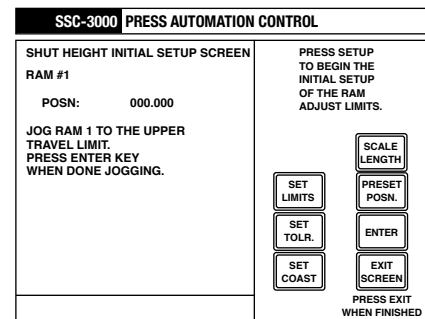

Figure 4.71—Shut Height Program Screen



(Continued on next page.)

Rockford Systems, LLC
Call: 1-800-922-7533

HOW TO PROGRAM THE SHUT HEIGHT CONTROLLER (CONTINUED)

Press **SET TOLR.** to set the tolerance in inches. A screen similar to the one in Figure 4.72 will be displayed.

Press **ABORT** to stop and return to the SHUT HEIGHT PROGRAM SCREEN. Press **➤** to backspace or press **CLEAR** to delete the entry and start over. Press **ENTER** when finished.

Press **SET COAST.** to set the coast time in seconds. A screen similar to the one in Figure 4.73 will be displayed.

Press **ABORT** to stop and return to the SHUT HEIGHT PROGRAM SCREEN. Press **➤** to backspace or press **CLEAR** to delete the entry and start over. Press **ENTER** when finished.

Press **SCALE LENGTH** to select the length of the LDT (linear displacement transducer). A screen similar to the one in Figure 4.74 will be displayed. Touch the button next to the desired scale length and orientation to turn it on or off.

Press **EXIT SCREEN** when finished. You will see this message in the message bar:

ARE YOU SURE? [YES] [NO]

Touch **YES** to accept the setting and return to the SHUT HEIGHT INITIAL SETUP screen.

Note: After changing the scale length setting or orientation, the system must be powered down and back up.

Press **PRESET POSN.** to enter the shut height position. A screen similar to the one in Figure 4.75 will be displayed.

Press **ABORT** to stop and return to the SHUT HEIGHT PROGRAM SCREEN. Press **➤** to backspace or press **CLEAR** to delete the entry and start over. Press **ENTER** when finished.

Press **EXIT SCREEN** when finished to return to the SHUT HEIGHT PROGRAM SCREEN.

Figure 4.72—Set Tolerance Screen

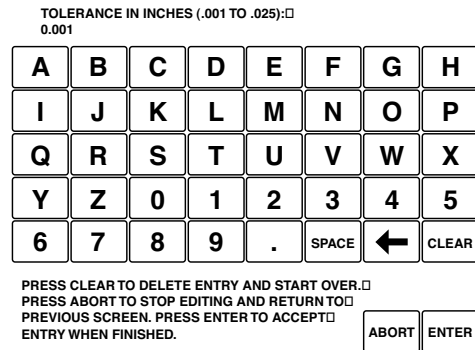

Figure 4.73—Set Coast Time Screen

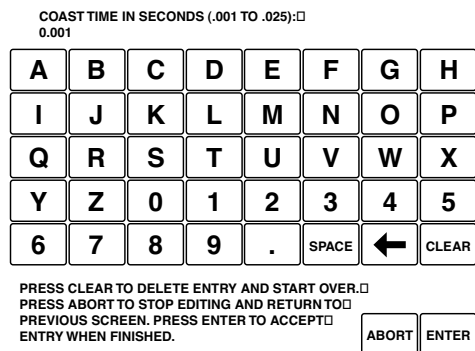

Figure 4.74—Select Scale Length Screen

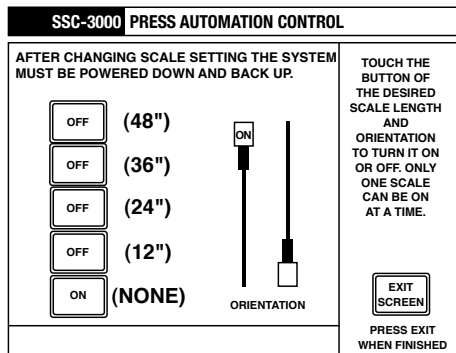
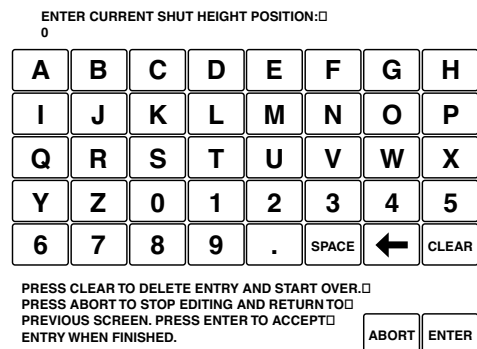

Figure 4.75—Enter Current Shut Height Position



(Continued on next page.)

SECTION 4—PROGRAMMING

SSC-3000 Press Automation Control System

HOW TO PROGRAM THE SHUT HEIGHT CONTROLLER (CONTINUED)

Press **GO TO POS.** to automatically bring the ram to the stored position.

Press **LEARN POS.** to enter the desired shut height position in inches. A screen similar to the one in Figure 4.76 will be displayed.

Press **ABORT** to stop and return to the SHUT HEIGHT PROGRAM SCREEN. Press **➤** to backspace or press **CLEAR** to delete the entry and start over. Press **ENTER** when finished.

Press **EDIT POS.** to make changes to the desired position of the LEARN POS. screen.

Press **EXIT SCREEN** when finished to return to the MAIN PROGRAM SCREEN.

Figure 4.76—Enter Learn Position Screen

DESIRED POSITION (INCHES):□
□

A	B	C	D	E	F	G	H
I	J	K	L	M	N	O	P
Q	R	S	T	U	V	W	X
Y	Z	0	1	2	3	4	5
6	7	8	9	.	SPACE	←	CLEAR

PRESS CLEAR TO DELETE ENTRY AND START OVER.□
PRESS ABORT TO STOP EDITING AND RETURN TO□
PREVIOUS SCREEN. PRESS ENTER TO ACCEPT□
ENTRY WHEN FINISHED.

ABORT	ENTER
-------	-------

NETWORK

In order to network the control, the optional SSC-3000 networking assembly, part No. FTL-313, is required. The networking assembly consists of a TCP/IP (Transmission Control Protocol/Internet Protocol) modem card with mounting plate, a 5' serial cable, and a CD with software for data collection and upload/download of the job setups. Use of the network modem will provide data collection and viewing of current data via a standard Web browser such as Internet Explorer or Netscape Navigator. The current status of the press and what the control is doing can be monitored.

The data-collection software that is furnished with the networking assembly will save data to a text file. Most any database, spreadsheet, or word processing program such as Microsoft Access, Microsoft Excel, dBASE, or Paradox can import the information. This software program can accommodate up to 32 presses. Opening the program again will accommodate 32 more presses.

The following information is available for viewing and data collection; it can be arranged to accommodate your needs.

- Batch counter
- Batch preset
- Brake monitor status
- Current mode
- Date and time
- Die description
- Part counter
- Part preset
- Setup number
- SPM
- Stop time
- Stroke counter
- Stroke preset
- Total counter

The upload/download feature gives you the ability to back up all of your job setups to a file on your computer. The die number, description, PLS outputs, die protection inputs, air monitor, load monitor, shut height, part-in-place input, servo feed, and counter information are stored for each job. After the job setup database has been downloaded, you can upload individual job setups back to the SSC-3000 control on the same machine or to other machines.

Note: Your network administrator or an experienced IT (information technology) person will be required to program the network settings and install the networking assembly.

MOUNTING THE MODEM CARD

Mount the modem card as close as possible to the SSC-3000 control rack, preferably inside the same control box. Do not run the cable in conduit or in bundles with higher voltages that may cause electrical interference. Wire the serial cable to the terminal strip on the modem card according to the print that was furnished with the modem card. Plug the other end of the serial cable (with the DB-9 connector) in to the P5 network port on the SSC-3000 **Main CPU Card**. Now connect the modem card to your network with an Ethernet cable.

PROGRAMMABLE PARAMETERS FOR THE NETWORK SETTINGS

1. NAME: This setting is used to assign a unique name to the SSC-3000 control or machine that it is on. This name must be unique on the network to which you are connecting the control.

Note: If you do not have a DNS (Domain Name System) server, this parameter does not need to be programmed; you may leave the default setting.

2. WORKGROUP: This setting can be used to include the SSC-3000 control in a particular workgroup of devices on your network. When this is done, the SSC-3000 control will show up (with the name you assigned it) within that network when you browse your network.

Note: If you do not have a DNS (Domain Name System) server, this parameter does not need to be programmed; you may leave the default setting.

3. IP ADDRESS: This setting is used to enter the unique IP (Internet Protocol) address assigned to the SSC-3000 control. The IP address must consist of four sets of number, separated by periods; e.g., 127.0.0.1. The IP address can range from 0.0.0.0 to 255.255.255.255, but it must fall within the range of addresses set up for your network.

Note: If DHCP is used (see MODE below), this parameter does not need to be programmed.

(Continued on next page.)

SECTION 4—PROGRAMMING

NETWORK (continued)

PROGRAMMABLE PARAMETERS FOR THE NETWORK SETTINGS (continued)

4. **NET MASK:** This setting is used to enter the subnet mask. The subnet mask is a transformation performed on the IP address that enables the network administrators to create subnets, which are virtual subunits of the physical network. The subnet mask must consist of four sets of numbers, separated by periods; e.g., 255.255.255.0. The subnet mask can range from 0.0.0.0 to 255.255.255.255.

Note: If DHCP is used (see MODE below), this parameter does not need to be programmed.

5. **UPDATE RATE:** This setting is used to enter the rate at which the control updates the data being sent to the Web browser. It can range from 1 to 30 seconds.

6. **MODE:** This setting is used to select the type of IP address that is used. The programming choices are STATIC and DHCP. Static is a permanent IP address that is assigned to a device in a TCP/IP (Transmission Control Protocol/Internet Protocol) network. DHCP, which stands for Dynamic Host Configuration Protocol, is a protocol that enables a TCP/IP device on your network to receive a temporary IP address from another device on your network automatically.

HOW TO PROGRAM THE NETWORK SETTINGS

Note: Your network administrator or an experience IT (information technology) person will be required to program the network settings

Select the **ON** position of the Program On/Off selector switch. Then press **PROG**, which is located in the bottom right corner of any of the main screens. The MAIN PROGRAM SCREEN will be displayed.

On the MAIN PROGRAM SCREEN, use ▼ and ▲ on the touchscreen to scroll through the program options. Press **ENTER** when the touchscreen highlights NETWORK. The 3000 NETWORK PROGRAM SCREEN will be displayed. See Figure 4.77.

Press the button of the setting that you want to program. A screen similar to the one shown in Figure 4.78 will be displayed.

Press **ABORT** to stop and return to the 3000 NETWORK PROGRAM SCREEN. Press ➤ to backspace or press **CLEAR** to delete the entry and start over. Press **ENTER** when finished.

Note: The ADDR MASK button on the touchscreen is used to program both the IP address and the net mask. When pressed, the IP ADDRESS PROGRAM SCREEN is displayed first, and after ENTER is pressed, the NET MASK PROGRAM SCREEN is displayed.

Figure 4.77—3000 Network Program Screen

SSC-3000 PRESS AUTOMATION CONTROL	
<p>3000 NETWORK PROGRAM SCREEN</p> <p>NAME: MYNAME</p> <p>WORKGROUP: MYGROUP</p> <p>IP ADDRESS: 127.0.0.1</p> <p>NET MASK: 255.255.255.0</p> <p>UPDATE RATE: 05.0 SEC.</p> <p>MODE: STATIC</p>	<p>FOR SETUP OF NETWORK PARAMETERS CONTACT YOUR NETWORK ADMINISTRATOR FOR THESE SETTINGS.</p> <p>SYSTEM NAME ADDR MASK</p> <p>WORK GROUP UPDATE RATE</p> <p>STATIC / DHCP JOB UPLOAD / DOWNLOAD</p> <p>EXIT SCREEN</p> <p>PRESS EXIT WHEN FINISHED</p>

Figure 4.78—Name Screen

NAME: □
MYNAME □

A	B	C	D	E	F	G	H
I	J	K	L	M	N	O	P
Q	R	S	T	U	V	W	X
Y	Z	0	1	2	3	4	5
6	7	8	9	.	SPACE	←	CLEAR

PRESS CLEAR TO DELETE ENTRY AND START OVER. □
PRESS ABORT TO STOP EDITING AND RETURN TO □
PREVIOUS SCREEN. PRESS ENTER TO ACCEPT □
ENTRY WHEN FINISHED.

ABORT	ENTER
-------	-------

(Continued on next page.)

VIEWING OF THE CURRENT STATUS OF THE PRESS AND SSC-3000 CONTROL

Once the modem card is installed and connected to the SSC-3000 control and your network, you will be able to view the status of the press and the SSC-3000 control. No software is required to do this.

To view the current status of the press and SSC-3000 control, simply open a Web browser (such as Internet Explorer or Netscape Navigator) and type in the IP address that you have assigned to the SSC-3000 control; e.g., <http://131.107.2.2/>.

A Web page similar to the one shown in Figure 4.79 will be displayed.

Figure 4.79—Current Status Web Page

CURRENT STATUS OF PRESS AND SSC-3000 CONTROL

Total Count	00015655		
Part Count	00015634	Part Preset	00543219
Stroke Count	00015634	Stroke Preset	00300000
Batch Count	00015634	Batch Preset	66978111
Mode	CONT		
Strokes Per Min	064		
Setup #	002		
Die #	1132		
Stop Time	307	Brake Fault Status	NONE

DATA COLLECTION

For data collection, you will need to install the software from the CD that came with the networking assembly.

Installing the Software

Insert the Networking Software CD in your computer, and double-click the executable Setup file (SETUP.EXE). This will start the installation wizard, which will guide you through the installation.

Once the program is installed, launch the program called SSC3000 Networking. The program will open; see Figure 4.80.

Adding a Machine

Before being able to collect data, you will need to add the machine to the SSC3000 Networking Utility program on your computer. At the top of the program window, click Setup, and then click Add Machine from the dropdown menu. The Add Machine window will open. See Figure 4.81.

First, enter the IP address that you have assigned to the SSC-3000 control. Second, in the Control Name field, enter a name for the machine or control. This name will also be the name of the text file that is created when doing data collection. Last, enter the path to the location where you want the data collector to save the data to. You can type the path directly into the field, or you can click Browse to find the location you want. When finished, click Done, and the machine will be added.

Figure 4.80—SSC3000 Networking Utility

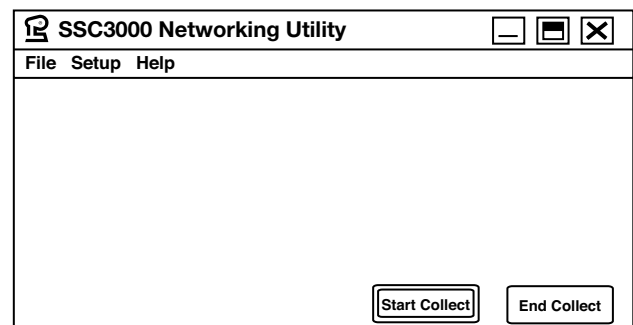
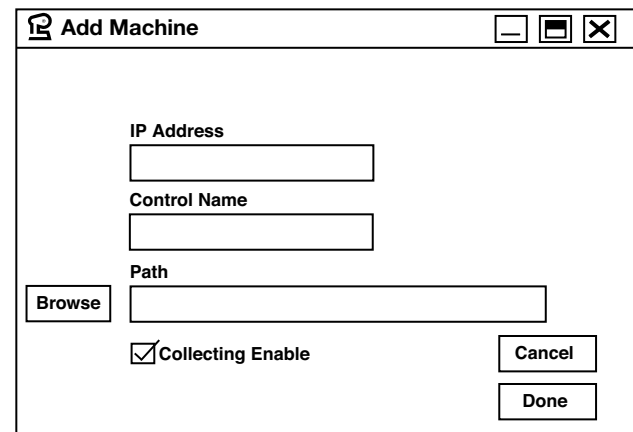

Figure 4.81—Add Machine



(Continued on next page.)

SECTION 4—PROGRAMMING

SSC-3000 Press Automation Control System

DATA COLLECTION (continued)

Editing or Deleting a Machine

To change the information already stored for a machine, click Setup, and then click Edit Machine from the dropdown menu. See Figure 4.82.

Select the machine that you want to edit from the Name List. After editing the necessary information, click Done.

To delete a machine completely, select the machine in under Name List, and click Delete Machine. You will be asked if you are sure you want to delete this machine; click Yes, No, or Cancel to finish.

Setting the Data Collection Rate

The rate at which the data is collected can be set from 2 to 30 minutes. The default rate is 20 minutes.

To program the data collection rate, click Setup, and then click Option from the dropdown menu. See Figure 4.83.

Enter a number from 2.0 to 30.0 in the box, and click Done.

Starting Data Collection

To start data collection, click Start Collect in the SSC3000 Networking Utility program.

Note: The data collector will save the data for all machines that have their Collecting Enable box checked. If you have multiple machines networked but you only want to collect data for one or certain machines, go into Edit Machine and uncheck the Collecting Enable box for those machines that you don't want to collect data for.

Ending Data Collection

To end data collection, click End Collect on the SSC3000 Networking Utility program.

Viewing the Collected Data

The collected data is saved as a text file (.txt) to the location that you specified while adding the machine. The information in the text file is separated by commas, and it is in the following format:

Total count, part count, stroke count, batch count, mode, strokes per min, setup #, die #, stop time, part preset, stroke preset, batch preset, brake fault status, time, date.

See Figure 4.84 for a sample text file.

This information can be imported by most any database, spreadsheet, or word processing program such as Microsoft Access, Microsoft Excel, dBASE, or Paradox to create your own customized reports.

Figure 4.82—Edit Machine

The 'Edit Machine' dialog box features a title bar with a help icon, a minimize button, a maximize button, and a close button. The main area contains several input fields: 'IP Address' with the value '127.0.0.1', 'Control Name' with 'Machine 1', and 'Path' with 'c:\Documents and Settings\Guest\Desktop'. A 'Browse' button is positioned to the left of the path field. To the right is a 'Name List' containing 'Machine 1', 'Machine 2', and 'Machine 3', each with a small square selection icon. At the bottom, there is a 'Collecting Enable' checkbox which is checked, and buttons for 'Delete Machine', 'Done', and 'Cancel'.

Figure 4.83—Options

The 'Options' dialog box has a title bar with a help icon, a minimize button, a maximize button, and a close button. It contains two main settings: 'Data Rate Minutes (2.0 to 30.0)' with a text box containing '20', and 'Enable Dynamic Name Server' with an unchecked checkbox. A 'Done' button is located at the bottom left.

Figure 4.84—Text file

```
Machine 1
0016198, 00000061, 00000091, 00000043, CONT, 063, 002, 1132
, 326, 00543219, 00300000, 66978111, NONE, 1:09:50 PM, 6/22/2002
00016478, 00000341, 00000371, 00000323, CONT, 063, 002, 1132
, 326, 00543219, 00300000, 66978111, NONE, 1:12:05 PM, 6/22/2002
00016729, 00000592, 00000622, 00000574, CONT, 062, 002, 1132
, 326, 00543219, 00300000, 66978111, NONE, 1:14:05 PM, 6/22/2002
00016842, 00000705, 00000735, 00000687, CONT, 000, 002, 1132
, 326, 00543219, 00300000, 66978111, NONE, 1:23:53 PM, 6/22/2002
```

(Continued on next page.)

Rockford Systems, LLC
Call: 1-800-922-7533

UPLOAD/DOWNLOAD OF JOB SETUPS

Note: The upload/download of job setups can also be done with the serial cable and upload/download software that came with the SSC-3000 control. Refer to pages 75-77 for how to do this.

To upload/download job setups, the machine must be stopped.

On the SSC-3000 control, select the **ON** position of the Program On/Off selector switch. Then press **PROG**, which is located in the bottom right corner of any of the main screens. The MAIN PROGRAM SCREEN will be displayed.

On the MAIN PROGRAM SCREEN, use ▼ and ▲ on the touchscreen to scroll through the program options. Press **ENTER** when the touchscreen highlights NETWORK. The 3000 NETWORK PROGRAM SCREEN will be displayed. See Figure 4.85.

Press **JOB UPLOAD DNLOAD**. The following message will appear in the message bar:

READY FOR UPLOAD/DOWNLOAD

The SSC-3000 control is now ready for upload/download of job setups.

On your computer, make sure that the networking software that came with the networking assembly is installed. If this has not been done yet, see **Installing the Software** under **DATA COLLECTION** on page 109.

Launch the program called SSC3000 Networking. The program will open; see Figure 4.86.

Select a Machine

To select a machine for which to upload/download the job setups, click File, and then click Select a Machine from the dropdown menu. The Select Machine window will open. See Figure 4.87.

Click the machine that you want to upload/download, and then click Make Name Active. The SSC3000 Networking Utility window will now display the selected machine. See Figure 4.88.

Figure 4.85—3000 Network Program Screen

SSC-3000 PRESS AUTOMATION CONTROL	
<p>3000 NETWORK PROGRAM SCREEN</p> <p>NAME: MYNAME</p> <p>WORKGROUP: MYGROUP</p> <p>IP ADDRESS: 127.0.0.1</p> <p>NET MASK: 255.255.255.0</p> <p>UPDATE RATE: 05.0 SEC.</p> <p>MODE: STATIC</p>	<p>FOR SETUP OF NETWORK PARAMETERS CONTACT YOUR NETWORK ADMINISTRATOR FOR THESE SETTINGS.</p> <div style="display: flex; flex-direction: column; align-items: center;"> <div style="display: flex; gap: 10px;"> <div style="border: 1px solid black; padding: 2px 5px;">SYSTEM NAME</div> <div style="border: 1px solid black; padding: 2px 5px;">ADDR MASK</div> </div> <div style="display: flex; gap: 10px;"> <div style="border: 1px solid black; padding: 2px 5px;">WORK GROUP</div> <div style="border: 1px solid black; padding: 2px 5px;">UPDATE RATE</div> </div> <div style="display: flex; gap: 10px;"> <div style="border: 1px solid black; padding: 2px 5px;">STATIC / DHCP</div> <div style="border: 1px solid black; padding: 2px 5px;">JOB UPLOAD DNLOAD</div> </div> <div style="border: 1px solid black; padding: 2px 5px; margin-top: 5px;">EXIT SCREEN</div> </div> <p style="font-size: small; text-align: center;">PRESS EXIT WHEN FINISHED</p>

Figure 4.86—SSC3000 Networking Utility

SSC3000 Networking Utility _ □ ×

File Setup Help

Start Collect

End Collect

Figure 4.87—Select Machine

Select Machine _ □ ×

Machine 1

Machine 1

Make Name Active

Machine 2

Machine 3

Done

Figure 4.88—Select Machine

SSC3000 Networking Utility _ □ ×

File Setup Help

Selected Machine for Upload/Download

Machine 1

Start Collect

End Collect

(Continued on next page.)

SECTION 4—PROGRAMMING

SSC-3000 Press Automation Control System

UPLOAD/DOWNLOAD OF JOB SETUPS (CONTINUED)

Download Job Setups From SSC-3000 Control

To download the job setups from the SSC-3000 control to your computer, click File, and then click Download From 3000 from the dropdown menu. This will download the entire job setup database from the SSC-3000 control. The file will be downloaded to the location specified when the machine was added (see **Adding a Machine** under **DATA COLLECTION** on page 109); to change this, click Edit Machine under Setup.

The job setups will now download from the SSC-3000 control to your computer. A window will be displayed that shows the status of the data transfer. See Figure 4.89.

When download is complete, a window will open that says Download Successful. Click OK to finish.

Figure 4.89—Data Transfer Status

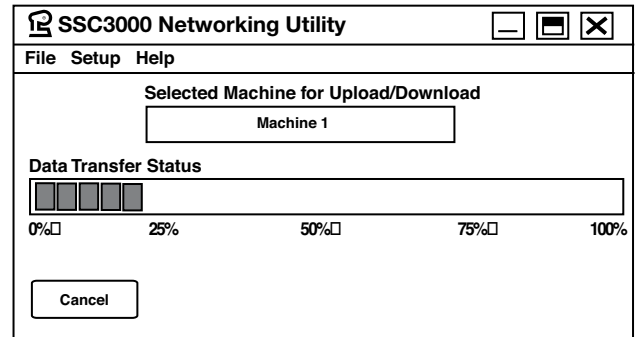

Upload Job Setups to SSC-3000 Control

To upload a selected range of job setups from your computer to the SSC-3000 control, click File, and then click Upload to 3000 from the dropdown menu. The Select Upload Filename window will open. See Figure 4.90.

Find the job setups file that you want to upload jobs from. This file has an extension of .sc3, and it should be in the location that you downloaded the job setups to. When you find the file, click its name so that it appears in the File Name field. Click Open to finish.

The Starting Setup (1-100) window will open next. See Figure 4.91. Enter the first job that you want to upload, and then click OK.

Figure 4.90—Select Upload Filename

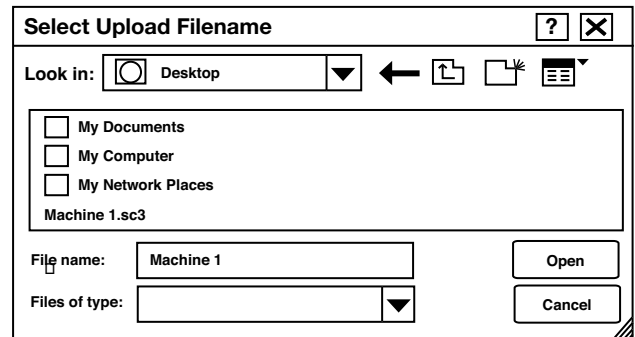
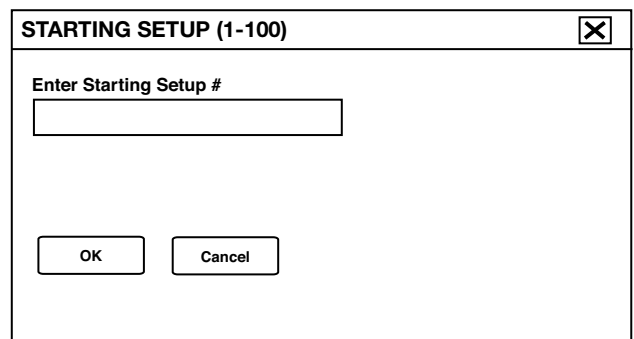

Figure 4.91—Starting Setup



(Continued on next page.)

Rockford Systems, LLC
Call: 1-800-922-7533

UPLOAD/DOWNLOAD OF JOB SETUPS (CONTINUED)

Upload Job Setups to SSC-3000 Control (continued)

The Ending Setup (1-100) window will then open. See Figure 4.92. Enter the last job that you want to upload, and then click OK.

Note: If you want to upload only one job, enter that job number in both the Starting Setup and Ending Setup windows.

The selected jobs will now upload from your computer to the SSC-3000 control. A window will be displayed that shows the status of the data transfer. See Figure 4.93.

When upload is complete, a window will open that says Upload Complete. Click OK to finish.

Figure 4.92—Ending Setup

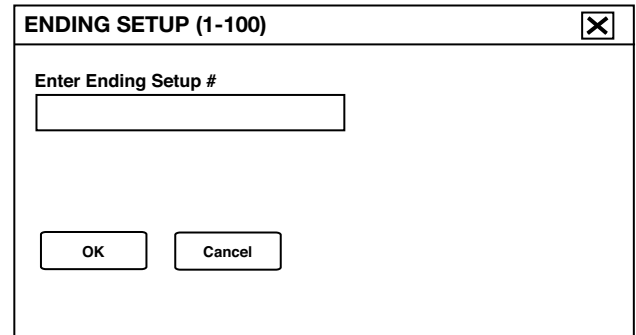

The screenshot shows a dialog box titled "ENDING SETUP (1-100)". Inside the dialog, there is a text input field with the label "Enter Ending Setup #". Below the input field, there are two buttons: "OK" and "Cancel".

Figure 4.93—Data Transfer Status

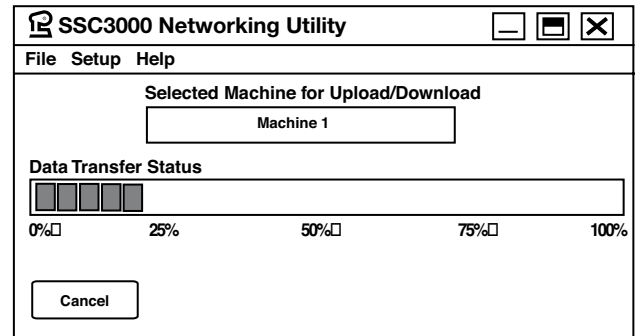

The screenshot shows a window titled "SSC3000 Networking Utility". It has a menu bar with "File", "Setup", and "Help". Below the menu bar, there is a section titled "Selected Machine for Upload/Download" with a text box containing "Machine 1". Below that is a section titled "Data Transfer Status" with a progress bar. The progress bar has markers at 0%, 25%, 50%, 75%, and 100%. At the bottom of the window, there is a "Cancel" button.

SECTION 4—PROGRAMMING

SSC-3000 Press Automation Control System

Password Control

The SSC-3000 press automation control has a password control screen that is used to enter one supervisor security code, one operator security code, and to assign the level of security protection—none, operator, or supervisor. The security code is user-programmed up to 5 alphanumeric characters.

A supervisor security code is always required to access the BRAKE MONITOR PROGRAM SCREEN, SYSTEM SETUP SCREEN, ANGLE SETTINGS, TIMED SETTINGS, OPTIONAL MODES PROGRAM SCREEN, and PASSWORD CONTROL SCREEN. The supervisor security code is also required when the total counter is cleared, when the factory default settings are restored, or when a new security code is programmed.

The following screens have the option of having a supervisor or operator security code assigned to them: USER INPUTS, JOB SETUPS, COUNTERS, USER MESSAGES, VARIABLE SPEED SETTINGS, PART-IN-PLACE, PLS OUTPUTS, DIE PROTECTION, AIR MONITOR, LOAD MONITOR, SERVO FEED, SHUT HEIGHT, AND NETWORK.

Note: The PART-IN-PLACE screen will have the same security code set for it as the USER INPUTS screen.

HOW TO PROGRAM THE SECURITY CODE

Select the **ON** position of the Program On/Off selector switch. Then press **PROG**, which is located in the bottom right corner of any of the main screens. The MAIN PROGRAM SCREEN will be displayed.

On the MAIN PROGRAM SCREEN, use ▼ and ▲ on the touchscreen to scroll through the program options. Press **ENTER** when the touchscreen highlights PASSWORD CONTROL. The security code screen will be displayed. See Figure 4.94. You will be prompted to enter the security code.

Press **ABORT** to stop and return to the MAIN PROGRAM SCREEN. Press ▶ to backspace or press **CLEAR** to delete the entry and start over. Press **ENTER** when finished.

After the current security code has been entered, a PASSWORD CONTROL PROGRAM SCREEN will be displayed. See Figure 4.95. Press **SEC CODE**. The SET SUPERVISOR SEC CODE SCREEN will be displayed. See Figure 4.96. Press **Y** and **ENTER**. An ENTER NEW SUPERVISOR CODE screen will be displayed. See Figure 4.97. Enter a supervisor security code up to five (5) alphanumeric characters. Press **ENTER** when finished.

Note: Press N and ENTER if a code does not need to be programmed.

Figure 4.94—Security Code Screen

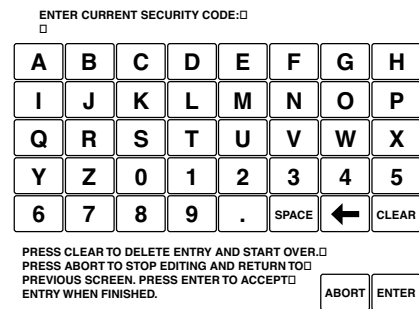

Figure 4.95—Password Control Program Screen

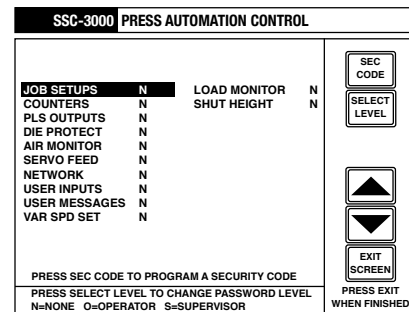

Figure 4.96—Set Supervisor Security Code Screen

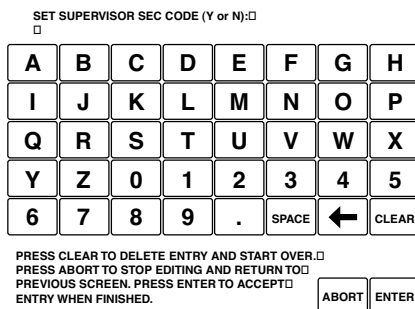

Figure 4.97—Enter New Supervisor Code Screen



(Continued on next page.)

Rockford Systems, LLC
Call: 1-800-922-7533

HOW TO PROGRAM THE SECURITY CODE (continued)

After the supervisor security code has been entered, a SET OPERATOR SECURITY CODE screen will be displayed. See Figure 4.98. Press **Y** and **ENTER**. An ENTER NEW OPERATOR CODE screen will be displayed. See Figure 4.99. Enter an operator security code up to five (5) alphanumeric characters. Press **ENTER** when finished.

Note: Press N and ENTER if a code does not need to be programmed.

Press **EXIT SCREEN** when finished to return to the MAIN PROGRAM SCREEN.

Figure 4.98
Security Code Screen

SET OPERATOR SEC CODE (Y or N):
□

A	B	C	D	E	F	G	H
I	J	K	L	M	N	O	P
Q	R	S	T	U	V	W	X
Y	Z	0	1	2	3	4	5
6	7	8	9	.	SPACE	←	CLEAR

PRESS CLEAR TO DELETE ENTRY AND START OVER.
PRESS ABORT TO STOP EDITING AND RETURN TO
PREVIOUS SCREEN. PRESS ENTER TO ACCEPT
ENTRY WHEN FINISHED.

ABORT ENTER

Figure 4.99
Enter New Operator Security Code Screen

ENTER NEW OPERATOR CODE:
0

A	B	C	D	E	F	G	H
I	J	K	L	M	N	O	P
Q	R	S	T	U	V	W	X
Y	Z	0	1	2	3	4	5
6	7	8	9	.	SPACE	←	CLEAR

PRESS CLEAR TO DELETE ENTRY AND START OVER.
PRESS ABORT TO STOP EDITING AND RETURN TO
PREVIOUS SCREEN. PRESS ENTER TO ACCEPT
ENTRY WHEN FINISHED.

ABORT ENTER

HOW TO PROGRAM THE PASSWORD LEVEL

Select the **ON** position of the Program On/Off selector switch. Then press **PROG**, which is located in the bottom right corner of any of the main screens. The MAIN PROGRAM SCREEN will be displayed.

On the MAIN PROGRAM SCREEN, use ▼ and ▲ on the touchscreen to scroll through the program options. Press **ENTER** when the touchscreen highlights PASSWORD CONTROL. The security code screen will be displayed. See Figure 4.100. You will be prompted to enter the security code.

Press **ABORT** to stop and return to the MAIN PROGRAM SCREEN. Press ▶ to backspace or press **CLEAR** to delete the entry and start over. Press **ENTER** when finished.

After the current security code has been entered, a PASSWORD CONTROL PROGRAM SCREEN will be displayed. See Figure 4.101. Use ▼ and ▲ on the touchscreen to scroll through the program options. With the desired program option highlighted, press **SELECT LEVEL** to scroll through the three password level options. N is for no password, O is for operator password, and S is for supervisor password.

Press **EXIT SCREEN** when finished to return to the MAIN PROGRAM SCREEN.

Figure 4.100
Security Code Screen

ENTER CURRENT SECURITY CODE:
□

A	B	C	D	E	F	G	H
I	J	K	L	M	N	O	P
Q	R	S	T	U	V	W	X
Y	Z	0	1	2	3	4	5
6	7	8	9	.	SPACE	←	CLEAR

PRESS CLEAR TO DELETE ENTRY AND START OVER.
PRESS ABORT TO STOP EDITING AND RETURN TO
PREVIOUS SCREEN. PRESS ENTER TO ACCEPT
ENTRY WHEN FINISHED.

ABORT ENTER

Figure 4.101
Password Control Program Screen

SSC-3000 PRESS AUTOMATION CONTROL	
JOB SETUPS N	LOAD MONITOR N
COUNTERS N	SHUT HEIGHT N
PLS OUTPUTS N	
DIE PROTECT N	
AIR MONITOR N	
SERVO FEED N	
NETWORK N	
USER INPUTS N	
USER MESSAGES N	
VAR SPD SET N	
PRESS SEC CODE TO PROGRAM A SECURITY CODE	
PRESS SELECT LEVEL TO CHANGE PASSWORD LEVEL	
N=NONE O=OPERATOR S=SUPERVISOR	
SEC CODE	
SELECT LEVEL	
EXIT SCREEN	
PRESS EXIT WHEN FINISHED	

SECTION 4—PROGRAMMING

SSC-3000 Press Automation Control System

QUICK REFERENCE TABLE - FACTORY SETTINGS AND VALID RANGES

Table 4.1

PROGRAM SETTING	VALID ENTRY RANGE		FACTORY DEFAULT SETTING	
Screen Saver		On or Off		Off
USER INPUTS 1-12	Logic:	Off, N.O., or N.C.	Logic:	Off
	Stop Type:	E-Stop or Top Stop	Stop Type:	E-Stop
	Message:	See list of page 10 or User Messages on page 68	Message:	Clutch/Brake Air Fault
BRAKE MONITOR	Warning Setpoint:	0-999 ms	Warning Setpoint:	50 ms
	Fault Setpoint:	0-999 ms	Fault Setpoint:	50 ms
	STM Angle:	20°-340°	STM Angle:	90°
JOB SETUPS 1-100	Die #:	User-programmed up to 11 alphanumeric characters	Die #:	None
	Description:	User-programmed up to 28 alphanumeric characters	Description:	No Description Entered
COUNTERS	Stock Preset:	0-99,999,999 strokes	Stock Preset:	0 strokes
	Part Preset:	0-99,999,999 strokes	Part Preset:	0 strokes
	Batch Preset:	0-99,999,999 strokes	Batch Preset:	0 strokes
SYSTEM SETUP	SPM Range:	Low (0-30), Med (31-150), or Hight (151+)	SPM Range:	Low (0-30)
	Light Curtain Input:	2 N.O. or 1 N.O. & 1 N.C.	Light Curtain Input:	2 N.O.
USER-DEFINED MESSAGES 1-10	Message:	User-defined up to 24 alphanumeric characters	Message:	User-Defined
ANGLE SETTINGS	Single Stroke Top Stop:	90°-359°	Single Stroke Top Stop:	330°
	Continuous Top Stop:	0°-359°	Continuous Top Stop:	330°
	Automatic Up:	90°-345°	Automatic Up:	180°
	Light Curtain Mute:	45°-345°	Light Curtain Mute:	170°
TIMED SETTINGS	Anti-Tie Down	100-7000 ms	Anti-Tie Down	250 ms
	Timed Inch:	0-999 ms	Timed Inch:	0 ms (Off)
	Signal Timeout:	1-120 seconds	Signal Timeout:	5 seconds
OPTIONAL MODES	Continuous-On-Demand:	On or Off	Continuous-On-Demand:	Off
	Foot-Maintained Continuous:	On or Off	Foot-Maintained Continuous:	Off
	Two-Hand-Maintained Continuous:	On or Off	Two-Hand-Maintained Continuous:	Off
	One-Hand/Foot Trip:	On or Off	One-Hand/Foot Trip:	Off
	Auto. Single Stroke:	On or Off	Auto. Single Stroke:	Off
	Inch with Fault:	On or Off	Inch with Fault:	Off
	Inch with Top Stop:	On or Off	Inch with Top Stop:	Off
VARIABLE SPEED TOP STOP SETTINGS	Speed:	4-500 SPM	Speed-Angle	Speed-Angle
			20 SPM – 330°	80 SPM – 318°
	Angle:	0°-359°	40 SPM – 326°	100 SPM – 314°
			60 SPM – 322°	120 SPM – 310°
PART-IN-PLACE	Logic:	Off, N.O., or N.C.	Logic:	Off

(Continued on next page.)

Rockford Systems, LLC
Call: 1-800-922-7533

SECTION 4—PROGRAMMING

SSC-3000 Press Automation Control System

QUICK REFERENCE TABLE - FACTORY SETTINGS AND VALID RANGES (Continued)

Table 4.1

PROGRAM SETTING	VALID ENTRY RANGE		FACTORY DEFAULT SETTING	
PLS OUTPUTS 1-8 (1-16 IF A SECOND PLS CARD HAS BEEN FURNISHED)	On Angle:	0°-359°	On Angle:	0°
	Off Angle:	0°-359°	Off Angle:	0°
	Counter:	0-999 strokes	Counter:	0 strokes
	Timed Off:	0-999 1/100 sec	Timed Off:	0 1/100 sec
Die Protection Inputs 1-8 (1-16 or 1-24 if a second or third card has been furnished)	Logic:	Off, N.O., or N.C.	Logic:	Off
	Stop Type:	E-Stop or Top Stop	Stop Type:	E-Stop
	Open Angle:	0°-359°	Open Angle:	0°
	Close Angle:	0°-359°	Close Angle:	0°
	Message:	See list of page 10 or User Messages on page 68	Message:	Clutch/Brake Air Fault
AIR MONITOR	High Fault Limit:	0-20 PSI	High Fault Limit:	0 PSI
	Low Fault Limit:	0-20 PSI	Low Fault Limit:	0 PSI
	Minimum Correction Time:	0.1-2.55 seconds	Minimum Correction Time:	0.1 seconds
	Fault Time	1-30 seconds	Fault Time:	1 seconds
LOAD MONITOR	Maximum Tonnage:	10-9999	Maximum Tonnage:	10
	No. of Sensors:	1-8	No. of Sensors:	2
SERVE FEED	Stock Feed Length:	0-50 inches	Stock Feed Length:	0
	Stock Feed Rate:	Differs depending on your sero feed	Stock Feed Rate:	Differs depending on your sero feed
	Acceleration:		Acceleration:	
	Deceleration:		Deceleration:	
Stock Description:	User-programmed up to 30 alphanumeric characters	Stock Description:	None	
SHUT HEIGHT	Tolerance:	.001-.025 seconds	Tolerance:	.001 seconds
	Coast Time:	.001-.025 seconds	Coast Time:	.001 seconds
NETWORK SETTINGS	Name:	User-programmed up to 17 alphanumeric characters	Name:	MYNAME
	Workgroup:	User-programmed up to 17 alphanumeric characters	Workgroup:	MYGROUP
	IP Address:	User-programmed from 0.0.0.0 to 255.255.255.255	IP Address:	127.0.0.1
	Net Mask:	User-programmed from 0.0.0.0 to 255.255.255.255	Net Mask:	255.255.255.0
	Update Rate:	1-30 seconds	Update Rate:	5 seconds
	Mode:	Static or DHCP	Mode:	Static
PASSWORD CONTROL	Supervisor Security Code:	User-programmed up to 5 alphanumeric characters	Supervisor Security Code:	0
	Operator Security Code:	User-programmed up to 5 alphanumeric characters	Operator Security Code:	0
	Password Level:	N=None, O=Operator, S=Supervisor	Password Level:	None

SECTION 5—WAKE-UP AND GENERAL FAULT MESSAGES

SSC-3000 Press Automation Control System

WAKE-UP FAULT MESSAGES

These messages are displayed on the wake-up screen as the control runs through power on diagnostics and card detection routines. Each slot in the rack is scanned to see what type of card it may contain and if it can communicate with the main CPU. See page 64 for a picture of this wake-up screen.

Table 5.1

MESSAGE	DESCRIPTION/SOLUTION
AIR MONITOR NOT DETECTED	The optional air monitor, part No. RCL-100, is either not present or not connected to the control. If you have the air monitor, make sure that the 25' serial cable that came with the air monitor is connected to the P6 air monitor port on the SSC-3000 Main CPU Card. Also verify that the other end is connected to terminal strip P1 in the air monitor in accordance with the wiring schematics included with the air monitor. Turn power off. Verify the connections and turn power back on. If the air monitor is still not detected, consult the factory.
NETWORK NOT DETECTED	The optional networking assembly, part No. FTL-313, is either not present or not connected to the control. If you have the networking assembly, make sure that the 5' serial cable that came with the networking assembly is connected to the P5 network port on the SSC-3000 Main CPU Card. Also verify that the other end is connected to the terminal strip in the modem card according to the print that was furnished with the modem card. Turn power off. Verify the connections and turn power back on. If the networking assembly is still not detected, consult the factory.
SLOT #X... > LIMIT	There are more of one type of card than are supported; e.g., four or more 8-Output PLS Cards. Remove the excess card(s).
SLOT #X...NOT LOAD	The card is found but refuses to accept the parameter message packet. This will happen when older and newer cards are installed in the same rack; e.g., an older Main CPU Card and a new Dual CPU Clutch/Brake Card. A new rack or card(s) may be required; consult the factory.
SLOT #X INVLID CARD	This message is displayed for a card that was detected in this slot, but is not communicating properly. It may not be seated properly or has a component failure. Turn power off. Remove the card and reseal it in the rack and turn power back on. If the card is still not functioning, consult the factory.
SLOT #X NOT DETECTED	Standard message displayed for an empty slot. No card was detected in this slot. If there is a card in the slot, it may not be seated properly. Turn power off. Remove the card and reseal it in the rack and turn power back on. If the card is still not detected, consult the factory.

GENERAL FAULT MESSAGES

Most general fault messages can be cleared by pressing the message on the touchscreen.

Table 5.2

MESSAGE	DESCRIPTION/SOLUTION
BATCH COUNT EXPIRED	The batch count has reached the programmed preset value and the press is now stopped. Press the message or the yellow top-stop palm button* to clear and reset the batch count to 00000000 to begin another batch. See page 78 for information on programming the batch preset.
BRAKE MONITOR FAULT	The stopping time has exceeded the programmed limit for the brake fault setting. This message is displayed the message is acknowledged by touching the screen and then clears. No press action can be initiated during this time. Once it clears, continue with normal operation. If faults persist, consult your supervisor, as the brake may need inspection or adjustment to improve the stop time. See pages 49-50 for a detailed description of stop time and safety distance.

*If you do not have a top-stop palm button and would like to use a remote push button to reset the counters, a button with 1 N.C. (normally closed) contact can be wired in where the top stop is shown on the electrical schematics.

(Continued on next page.)

SECTION 5—WAKE-UP AND GENERAL FAULT MESSAGES

SSC-3000 Press Automation Control System

GENERAL FAULT MESSAGES (continued)

Table 5.2

MESSAGE	DESCRIPTION/SOLUTION
BRAKE MONITOR WARNING	The stopping time has exceeded the programmed limit for the BRAKE WARNING setting. This message is displayed for 5 seconds and then clears automatically. No press action can be initiated during this time. Wait for it to clear and continue with normal operation. If warnings persist, consult your supervisor, as the brake may need inspection or adjustment to improve the stop time. See pages 49-50 for a detailed description of stop time and safety distance.
(BUSS FAULT, SEE LED'S ON CARDS)	One of the cards on the rack has raised the BUSS FAULT line and has an hardware fault. Check the BUSS FAULT LEDs on the front of each card to find the card that has the problem. Turn the rack power switch off. Remove the card and reseal in the rack and turn power back on. If the card is still not functioning, consult the factory. See page 127 for the card change procedure. Possible circuit failure; consult the factory.
(CARD FAIL IN SLOT X)	A communication error has occurred with the card in this slot. The card may have become unseated. Turn power off. Remove the card and reseal it in the rack and turn power back on. If this message persists, consult the factory.
CLEARING DATABASE	At the operator's request, the job setup database information is being cleared. When the message disappears, it is complete.
CONFIGURATION CHANGE	During power on, the rack was scanned to detect the cards in the slots and was found to have changes since the last power up. This can be caused by a bad card that won't respond, or a card has been added or removed. Press the start touch button to clear the message and accept the configuration change if the message is due to an actual card change. If the message is due to a bad card, turn the rack power off. Remove the card and reseal in the rack and turn power back on. If the card is still not functioning, consult the factory. See page 127 for the card change procedure.
CONFIGURATION FAULT	The main controller attempted to set up a card in the rack configuration and the configuration memory does not show that the card is currently installed. This can be caused by a bad battery or core CPU module memory. Turn the rack power switch off for 5 to 10 seconds. Turn it back on and proceed as normal. If the message persists, the battery may need to be replaced on the Main CPU Card. See page 128 for the replacement procedures. Possible circuit failure; consult the factory.
E-STOPPED	The MCR relay contact has dropped out during the press cycle. Either the emergency-stop button was pressed or the main motor was stopped.
HAND MODE ONLY	The mode selector switch is in INCH or CONT and the actuating means is in FOOT. Inch and Continuous modes cannot be actuated with the foot switch. Change either selector to the proper setting and continue.
INVALID PRESS MESSAGE	A new version of the Dual CPU Clutch/Brake Card is in the rack with an older version of the Main CPU Card, and the Main CPU Card does not recognize a message being sent to it from the Dual CPU Clutch/Brake Card. A new Main CPU Card may be required; consult the factory.
INVALID SECURITY CODE	The entered security code did not match the currently stored security code and access is denied to the desired function. Retype the security code and try again. If you have forgotten the security code, you may call 1-800-922-7533 or (815) 874-7891 to obtain the master security code from tech support.
KEY SELECTOR NOT IN PROGRAM	The PROG touch button was pressed while the key selector for Program Off/On was in the off position. Simply turn the switch to on and the screen will display the main program screen, or touch the message area to clear. See page 67 for programming help.

(Continued on next page.)

SECTION 5—WAKE-UP AND GENERAL FAULT MESSAGES

SSC-3000 Press Automation Control System

GENERAL FAULT MESSAGES (continued)

Table 5.2

MESSAGE	DESCRIPTION/SOLUTION
LC CYCLE FAULT	The light curtain cycle check wired to the MTS input on the light curtain(s) failed to cycle on the upstroke. Check the LED for the K2 relay on the Dual CPU Clutch/Brake Card and the F3 and F4 fuses for the LC CYCLE output contacts.
LIGHT CURTAIN BREAK	The light curtain sensing field was interrupted during a press cycle in CONTINUOUS. If on the downstroke prior to the holding angle, the press will emergency-stop. If on the upstroke after the holding angle, the press will top-stop when this occurs.
MAIN MOTOR NOT FORWARD	Verify that the main motor is running in the forward direction. Verify that Input P4-14 on the Clutch/Brake Dual CPU Card is on.
MOTION DROPPED FAULT	The press cycle lost motion once it was sensed at the start of the cycle. Check that the press is running at 4 SPM or greater. If this message persists, rerun the press setup from TDC and note the reference time reported. Possible circuit failure; consult the factory.
MOTION NO RUN	The control detected motion prior to starting a press cycle. Check for correct wiring to the resolver connection on the Main CPU Card. Verify that the chain is on the sprocket for the resolver and is tight. Check that the SPM display is 0 when the crankshaft is at rest, or prior to starting a press cycle. Verify that the resolver cable is not run near high-voltage lines (motor leads). Possible circuit failure; consult the factory.
MOTION REFERENCE FAULT	The press cycle did not produce motion within the given reference time allotted. Check that the press is running at full speed and the air pressure hasn't dropped. If this message persists, rerun the press setup from TDC and note the reference time reported. Possible circuit failure; consult the factory.
NO INTERLOCKS	An attempt is made to initiate a cycle in either FOOT-SINGLE or CONTINUOUS and there is no interlock; i.e., light curtain(s) or safeguard interlock(s).
NO MOTION WITHIN 1.5 SEC.	The resolver failed to produce a motion signal after a press cycle was initiated during the press setup routine. Ensure the press mode is in INCH and the flywheel is spinning when the dual-solenoid valve is energized. Check that the resolver is wired correctly, and run the press setup again. See pages 80-81 for further explanation on the press setup procedure.
NVRAM FLT	During power-on tests, the memory was scanned and was found to have errors in the memory storage. This can be caused by a bad battery or core CPU module memory. Press the start touch button to clear the message. Turn the rack power switch off for 5 to 10 seconds. Turn it back on and proceed as normal. If the message persists, the battery may need to be replaced on the main CPU card. Every time this message occurs, all settings are set to factory default and will have to be reprogrammed. See page 128 for replacement procedures.
PART COUNT EXPIRED	The part count has reached the programmed preset value and the press is now stopped. Press the message or the yellow top-stop palm button* to clear and reset the part count to 00000000 to begin another part. See page 78 for information on programming the part preset.
PRESS CARD FAULT #1	During a press cycle the Dual CPU Clutch/Brake Card CPU #2 dropped its solenoid output and the main CPU detected this. Turn the rack power switch off for 5 to 10 seconds. Turn it back on and proceed as normal. If the message persists, the Dual CPU Clutch/Brake Card may need to be replaced. Possible circuit failure; consult the factory.

*If you do not have a top-stop palm button and would like to use a remote push button to reset the counters, a button with 1 N.C. (normally closed) contact can be wired in where the top stop is shown on the electrical schematics.

(Continued on next page.)

SECTION 5—WAKE-UP AND GENERAL FAULT MESSAGES

SSC-3000 Press Automation Control System

GENERAL FAULT MESSAGES (continued)

Table 5.2

MESSAGE	DESCRIPTION/SOLUTION
PRESS MODE CHANGED	The mode key selector switch was changed during a press cycle. If in the CONTINUOUS mode, the press will top-stop when this occurs.
PRESS NOT AT TOP	An attempt to initiate a single stroke was made and the resolver/crankshaft angle was between the top stop angle and 345°. Change the press to INCH and inch the ram up past 345°. Change the selector to SINGLE and retry.
(RESOLVER FEEDBACK FAULT 2)	Three successive reads of the resolver position failed to produce the same value. Possible circuit failure; consult the factory.
RESOLVER NOT CHANGING	Velocity is present but the resolver is not moving. Check for correct wiring to the resolver connection on the Main CPU Card. Verify that the resolver cable is not run near high-voltage lines (motor leads). Possible circuit failure; consult the factory.
RESOLVER/SYNC FAULT	The resolver position doesn't match the sync switch position as it should. During the press setup reference cycle, the relationship of the resolver angle and the 30° sync switch pulse is established. If this is changed, check the resolver chain or coupling for tightness and make sure there is no backlash or slop, check the set screws on the resolver coupling inside the resolver housing are tight and that it is not slipping, check the resolver cable and ensure that the sync switch LED on the main CPU is functioning correctly. Rerun the press setup if necessary. See pages 80-81 for running the press setup.
SAFE GUARD INTLK BREAK	The safeguard interlocks were interrupted during a press cycle in CONTINUOUS. If on the downstroke prior to the holding angle, the press will emergency-stop. If on the upstroke after the holding angle, the press will top-stop when this occurs. See page 51 for a description on interlocking different modes of operation.
SELECT INCH, DO REFERENCE CYCLE	A valid reference cycle has not been done. Select the Inch mode of operation and perform a reference cycle. Refer to pages 80-81 for details.
SETUP NOT FOUND	The job setup search has failed to locate the entered DIE#. Retype the DIE# and try again or scroll up and down through the job setups to ensure that DIE# exists. See page 73 for searching the job setup database for a DIE#.
SLOT X LOAD FAILED	The main CPU failed to get an acknowledgment from a card on the rack that it received information sent to it. The X is the slot # in the rack that failed. If the message is due to a bad card, turn the rack power off. Remove the card and reseal in the rack and turn power back on. If the card is still not functioning, consult the factory. See page 127 for the card change procedure.
SSR1 OR K1 OFF FAULT	SSR1 (solid-state relay 1) and/or K1 safety relay, did not shut off and voltage was detected via the redundant feedback circuit. Turn the rack power switch off for 5 to 10 seconds. Turn it back on and proceed as normal. If the message persists, the Dual CPU Clutch/Brake Card may need to be replaced. Possible circuit failure; consult the factory.
SSR1 OR K1 ON FAULT	SSR1(solid-state relay 1) and/or K1 safety relay did not turn on and voltage was not detected via the redundant feedback circuit. Turn the rack power switch off for 5 to 10 seconds. Turn it back on and proceed as normal. If the message persists, the Dual CPU Clutch/Brake Card may need to be replaced. Possible circuit failure; consult the factory.
SSR1 OR SSR2 OFF FAULT	One or both SSRs (solid-state relays) did not shut off and voltage was detected via the redundant feedback circuit. Turn the rack power switch off for 5 to 10 seconds. Turn it back on and proceed as normal. If the message persists, the Dual CPU Clutch/Brake Card may need to be replaced. Possible circuit failure; consult the factory.

(Continued on next page.)

SECTION 5—WAKE-UP AND GENERAL FAULT MESSAGES

SSC-3000 Press Automation Control System

GENERAL FAULT MESSAGES (continued)

Table 5.2

MESSAGE	DESCRIPTION/SOLUTION
SSR2 OFF FAULT	SSR2 (solid-state relay 2) did not shut off and voltage was detected via the redundant feedback circuit. Turn the rack power switch off for 5 to 10 seconds. Turn it back on and proceed as normal. If the message persists, the Dual CPU Clutch/Brake Card may need to be replaced. Possible circuit failure; consult the factory.
SSR2 ON FAULT	SSR2 (solid-state relay 2) did not turn on and voltage was not detected via the redundant feedback circuit. Turn the rack power switch off for 5 to 10 seconds. Turn it back on and proceed as normal. If the message persists, the Dual CPU Clutch/Brake Card may need to be replaced. Possible circuit failure; consult the factory.
STROKE COUNT EXPIRED	The stroke count has reached the programmed preset value and the press is now stopped. Press the message or the yellow top-stop palm button* to clear and reset the stroke count to 00000000 to begin another stroke. See page 78 for information on programming the stroke preset.
SYNCE EYE CAN'T BE ON AT START	The sync switch in the resolver housing is on prior to initiating a cycle in the press setup routine. The sync switch can only come on between 60° and 300°. The ideal location is around 90° for most presses. Ensure the press is at TDC when doing the press setup routine. If needed, remove the chain or coupling from the resolver drive and spin until the sync switch signal is not over top, and falls within 60° and 300°. Run the press setup again.
SYNC EYE NOT DETECTED	The sync switch in the resolver housing did not come on during a cycle for the press setup routine. The sync switch can only come ON between 60° and 300°. The ideal location is around 90° for most presses. Check the wiring for the resolver and check the LED on the main CPU card for the SYNC SW to ensure it is functioning. Ensure the press is at TDC when doing the press setup routine. If needed, remove the chain or coupling from the resolver drive and spin until the sync switch signal is not over top, and falls within 60° and 300°. Run the press setup again.
TOP STOP DEPRESSED	The top-stop palm button was depressed during the press cycle.

*If you do not have a top-stop palm button and would like to use a remote push button to reset the counters, a button with 1 N.C. (normally closed) contact can be wired in where the top stop is shown on the electrical schematics.

SSC-3000 Operation Checklist

1. Is all wiring to the machine, the solid-state control module (black box), and touchscreen correct when verified with the drawings sent with the solid-state control?Y or N
2. Does the connection between the resolver/pulser cable and the P8 connector exist, as referenced in the wiring diagram? (See Sheet No. 2 of the schematics.)Y or N
3. Does the resolver/pulser cable have any splices?Y or N
4. When powering up the solid-state control module, do the four (green) LED's (Power Status and CPU) on the front of the black control box turn on?Y or N
5. Is the WAKE UP SCREEN screen displayed with the message: "**SAFEGUARDS IN PLACE**" when the main power disconnect switch is turned on?Y or N
6. With no ram motion, check the SPM reading on the RUN SCREEN. Visually verify that SPM is displaying 000 with no flickering of the numbers (If numbers are flickering, please consult the factory.)Y or N
7. Was the **POWER-UP PROCEDURE** performed at TDC (Top Dead Center) of crankshaft rotation? (See pages 64-65 of this Installation Manual)Y or N

Note: The shaft extension of the resolver must have the keyway up and perpendicular to the cover on the assembly when setting the resolver.)

8. The resolver/pulser assembly was shipped with the print for clockwise (CW) rotation (when looking at the shaft extension where the sprocket is attached). If this assembly is mounted to operate in a counterclockwise (CCW) rotation, the resolver wiring must be reset for counterclockwise (CCW) rotation. Refer to Sheet No. 2 of the schematics shipped with the control box. Does the above checkout?Y or N
9. In normal run modes, such as SINGLE or CONTINUOUS, does the machine make cycles without any faults appearing on the touchscreen?Y or N

Electrical Troubleshooting

All troubleshooting, as well as installation, must be performed by qualified and properly trained personnel. Also, when a defective component is found, do not operate the machine until that component has been replaced with an exact replacement part.

This procedure is written as a general guide for troubleshooting most part-revolution control systems. In all cases, please refer to the individual control wiring schematic for particular test points and terminal numbers. Be sure to follow the schematic and select the proper modes of operation when troubleshooting.

If a defective component (contact) is found, always verify with an ohm meter. Lock the disconnect switch in the off position, isolate the component or contact from other wiring and check its integrity with an ohm meter. At the same time, manually operate the device (in the case of a contact) to check its function.

The following should be checked if your machine is not functioning properly at this time:

Check the exhaust port and muffler on the monitored dual-solenoid valve. The exhaust port and exhaust muffler must be clean and unobstructed so an unrestricted flow of exhaust air from the clutch/brake is obtained.

(Continued on next page.)

SECTION 6—OPERATING CONSIDERATIONS

SSC-3000 Press Automation Control System

TROUBLESHOOTING OUTLINE

Use the control drawing schematic in conjunction with the following troubleshooting outline:

NO VOLTAGE—POSSIBLE CAUSES:

1. Check the line voltage on the transformer primary with a volt meter.
2. Check for correct transformer primary connections (wiring) and the secondary for 120 V AC using a volt meter.
3. A primary or secondary fuse may be blown—replace the fuse with the proper size, type, and amperage in accordance with the control drawing. Using an ohm meter, locate the reason for the blown fuse before reapplying power.

MOTOR DOES NOT START—POSSIBLE CAUSES:

1. Open electrical interlocks. The circuit can be arranged to accommodate machine protective electrical interlocks, overload interlocks, and safety block interlocks. These interlocks are strategically located to prevent machine operation when open. Please refer to the schematic for the location of the various interlocks.

2. Motor starter does not energize.

Motor starter operating coil is not 120 VAC.

Motor overload may have tripped out; this may have been caused because no overload is present or because of an improperly rated overload.

Motor start/stop push buttons may be improperly wired or defective.

Motor starter contact may be defective.

- The motor should start if the above checks OK. If the motor still fails to run when the start button is released, check the motor starter holding contact for proper wiring and function.

MACHINE WILL NOT STROKE—POSSIBLE CAUSES:

Clutch will not engage and the brake will not release

- Air supply may be off.
- Air pressure may be insufficient.

Dual-solenoid air valve will not energize

- Check for proper installation and wiring.
- Solenoid coils may be open.

LIGHT CURTAIN (IF FURNISHED) IS NOT FUNCTIONING—POSSIBLE CAUSE:

Fuses F3 or F4 may be faulty (if light curtain MTS contact is wired in to P3 on the Dual CPU Card)

PLS NOT FUNCTIONING—POSSIBLE CAUSE:

One or more fuses F1 through F8 may be faulty on the PLS Output Card

Part-Revolution-Clutch Press

A part-revolution-clutch mechanical power press consists of engaging parts, springs, electrical components, air components and other mechanical equipment. Because of this inherent design, machine parts will ultimately wear, get out of adjustment or break which could cause a malfunction and/or mechanical failure. The control system furnished can never cure nor overcome a misadjusted, worn, broken or malfunctioning part or mechanical failure. Be sure to inspect all parts for adjustment, excessive wear, looseness or breakage. **Do not operate your machines until all parts are adjusted, repaired, replaced, and each entire machine is working properly.**

Visual inspections and examinations of the machine and its components must be made at least once per shift by qualified personnel.

Machines must always be inspected and tested on a weekly basis to determine the condition of the clutch/brake mechanism and antirepeat feature. Necessary maintenance and repair must be done before each machine is operated again, and the employer must maintain records of both the inspections and the maintenance work performed.



After any maintenance, always operate the machine numerous times in all modes of operation before allowing the operator to start production. Always make sure point-of-operation safeguarding is in place, adjusted and operating properly for the job and for the operator.

OSHA Regulation for Inspections

OSHA 29 CFR 1910.217 (e)(1) INSPECTION AND MAINTENANCE RECORDS

(i) It shall be the responsibility of the employer to establish and follow a program of periodic and regular inspections of his power presses to insure that all parts, auxiliary equipment, and safeguards are in a safe operating condition and adjustment. The employer shall maintain a certification record of inspections which includes the date of inspection, the signature of the person who performed the inspection, and the serial number, or other identifier, of the power press that was inspected.

(ii) Each press shall be inspected and tested no less than weekly to determine the condition of the clutch/brake mechanism-antirepeat feature and single stroke mechanism. Necessary maintenance or repair or both shall be performed and completed before the press is operated. These requirements do not apply to those presses which comply with paragraphs (b)(13) Control Reliability and (b)(14) Brake Monitoring of this section. The employer shall maintain a certification record of inspections, tests and maintenance work which includes the date of the inspection, test or maintenance; the signature of the person who performed the inspection, test or maintenance; and the serial number or other identifier of the press that was inspected, tested or maintained.

(e)(3) Training of Maintenance Personnel—It shall be the responsibility of the employer to insure the original and continuing competence of personnel caring for, inspecting, and maintaining power presses.

OSHA Regulation for Operator Training

OSHA 29 CFR 1910.217 (f)(2) INSTRUCTION TO OPERATORS

The employer shall train and instruct the operator in the safe method of work before starting work on any operation covered by this section. The employer shall insure by adequate supervision that correct operating procedures are being followed.

SECTION 7—MAINTENANCE AND INSPECTION

SSC-3000 Press Automation Control System

Electrical Controls

Before inspecting or maintaining electrical controls, be sure to switch the main power disconnect to the off position and lockout all energy. Perform a periodic inspection of the control box and electrical machine components for loose or broken wires. Be sure relays and switches are examined for burned or worn contacts. Look for loose or broken conduit and cable fittings. The control box and other components must be kept closed, covered, and locked to keep unauthorized personnel out. Keys must be removed from all selector switches and door locks to prevent tampering and prevent exposure to the dirt, chips and oil present in most shops.

Air System

1. Be sure to turn the air pressure off, bleed air from the system or component, and lockout before maintaining any air equipment.
2. Inspection of the entire air system is dependent on the frequency of machine operation and the cleanliness of the plant air lines. Both free moisture and solids should be removed automatically by the air filter. Be sure to drain the filter bowl whenever the water level in the sump reaches the lower baffle. To remove the filter element for cleaning, shut air line down and exhaust pressure. See Filter-Regulator-Lubricator Installation Manual No. KSL-208 and page 46 of this manual.
3. Be sure to check the lubricator for proper oil level and oil delivery adjustment. See Installation Manual No. KSL-208.
4. The monitored dual-solenoid air valve that operates the clutch and releases the brake must be protected from foreign material getting into the valve. The valve relies on the performance of the air filter. The valve's exhaust muffler must be removed regularly and cleaned so dumping of air is unrestricted. Refer to Installation Manual No. KSL-036 or KSL-037 and page 46 of this manual.



The maintenance and inspection sections in this manual cannot be all-inclusive. Always refer to the original equipment manufacturer's maintenance manuals or the machine owner's manual. If you do not have an owner's manual, contact the machine manufacturer.

Care of the Touchscreen

To clean the touchscreen, use a clean soft cloth with soap and warm water. Do not use oily rags, solvents, or ammonia-based glass cleaner.

SECTION 8—REPLACEMENT PROCEDURES

SSC-3000 Press Automation Control System

Replacing the Cards

Photo 8.1

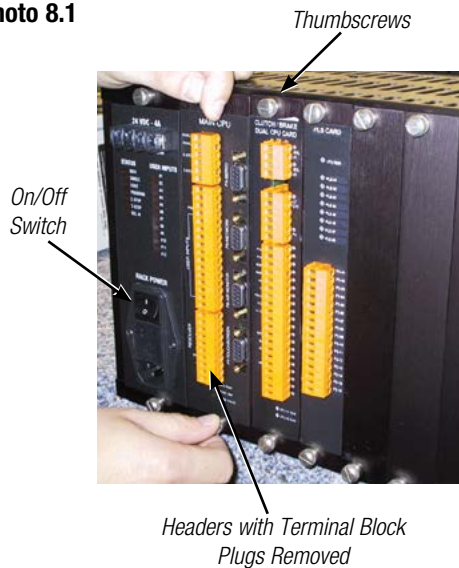

Photo 8.2

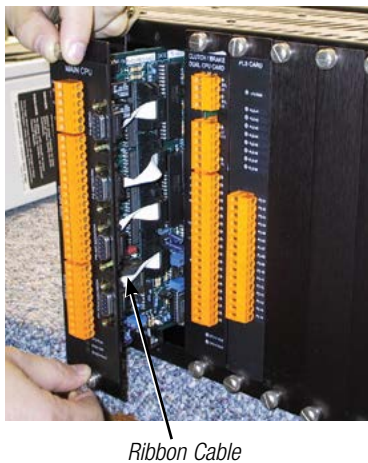
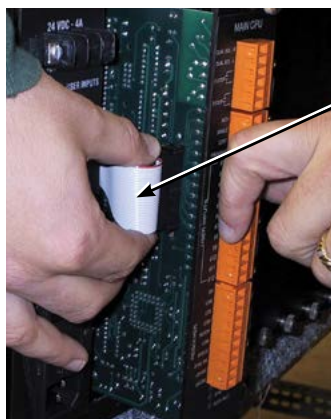

Photo 8.3



All power to the machine and the card rack must be OFF while replacing any cards.

1. Remove all detachable terminal blocks and cables from the face of the card that is being replaced.
 - Pull the terminal block plugs straight out from the header on the card—all wiring can stay attached.
 - Remove the serial cables by loosening the two screws that hold the cable housing to the db9 connector.
2. Loosen the thumbscrews at the top and bottom of the card being replaced.
 - Use a flat-head screwdriver to loosen the thumbscrews if they are too tight.
3. Pull the card out slowly and remove any ribbon cable attached to the card.
 - The **Main CPU Card** has an additional 26-pin ribbon cable on the left side of the card (facing the rack) that must be removed. See Photo 8.3.
4. After all cables, terminal blocks, and ribbons have been removed, the card can be removed from the rack.
5. To install the new card, slide the card into the guides on the rack and attach any ribbon, terminal blocks, and cables as provided. Push the card all the way in and tighten the screws to secure the card to the rack.

SECTION 8—REPLACEMENT PROCEDURES

SSC-3000 Press Automation Control System

Replacing the Core Module

Photo 8.4

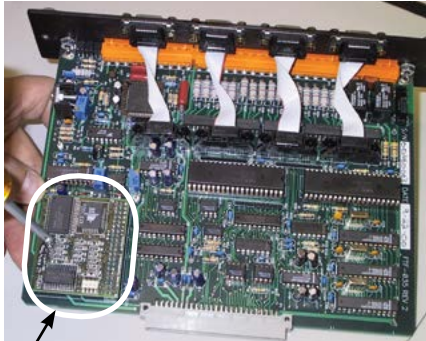

Core Module

Photo 8.5

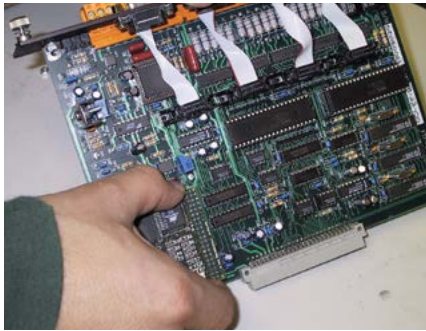
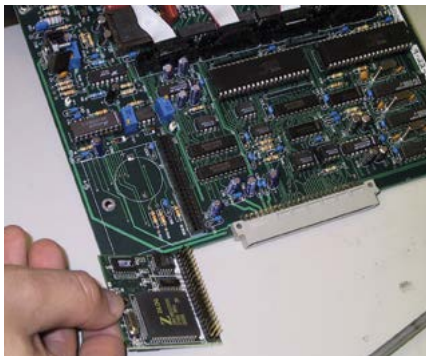

Photo 8.6



All power to the machine and the card rack must be OFF while replacing any cards.

1. Remove the **Main CPU Card** from the rack as described on page 127.
2. Remove the screw, nylon spacer, and nut that secures the core module to the board. See Photo 8.4.
3. Gently pull up on both sides of the core module and rock the core module back and forth until the pins from the header. See Photo 8.5. and Photo 8.6.
4. Put the new core module onto the card by gently inserting the pins into the header.
5. Attach the screw, nylon spacer, and nut back onto the core module and card and tighten. This will ensure shock resistance in the core module.
6. Slide the **Main CPU Card** back into the rack.

Replacing the Battery

1. Remove the **Main CPU Card** from the rack as described on page 127.
2. Remove the battery from the left side of the **Main CPU Card** (facing the rack).
3. Insert the new battery and slide the **Main CPU Card** back into the rack.

SECTION 9—METHODS OF SAFEGUARDING

SSC-3000 Press Automation Control System

OSHA 29 CFR 1910.217 (c)(1), *General Requirements*, states:

“(i) It shall be the responsibility of the employer to provide and insure the usage of ‘point of operation guards’ or properly applied and adjusted point of operation devices on every operation performed on a mechanical power press. See Table O-10.”

This means that for every mechanical power press that is being used in United States industry where a point-of-operation hazard exists, there must be safeguarding for the operator by at least one type of guard or a device. This protection may also be accomplished by the use of a combination of guards and devices.

When updating a power press, the most important decision is the selection of the proper guard or device. The following are safeguarding choices:

BARRIER GUARDS ON POWER PRESSES

OSHA 29 CFR 1910.217 (c)(1), *General Requirements*, (c)(2) *Point of Operation Guards* and Table O-10 (Ref. enclosed MPPS)

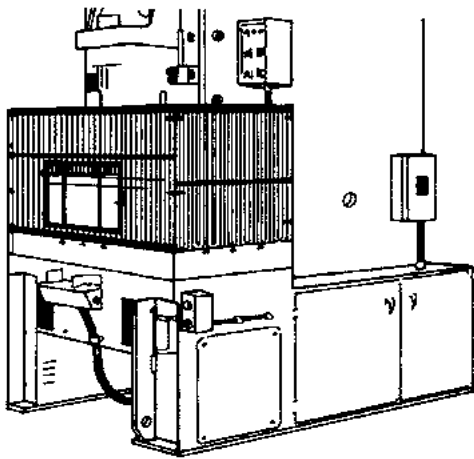

RESTRAINT (HOLDOUT) ON POWER PRESSES

OSHA 29 CFR 1910.217 (c)(3)(vi) *Restraint or Holdout* (Ref. enclosed MPPS)

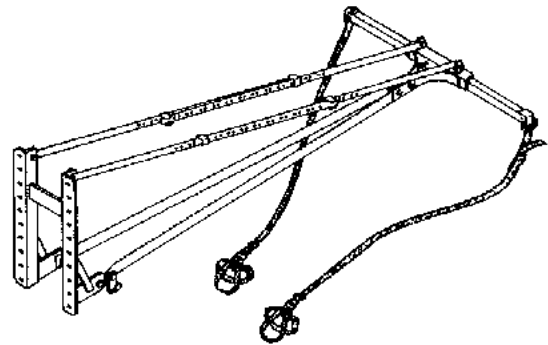

TWO-HAND CONTROL ON POWER PRESSES

OSHA 29 CFR 1910.217 (c)(3)(vii) *Two-Hand Control* (Ref. enclosed MPPS)

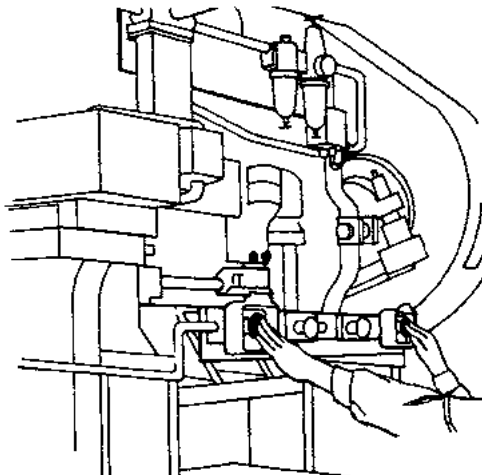

PULLBACK (PULL-OUT) ON POWER PRESSES

OSHA 29 CFR 1910.217 (c)(3)(iv) *Pull-out* (Ref. enclosed MPPS)

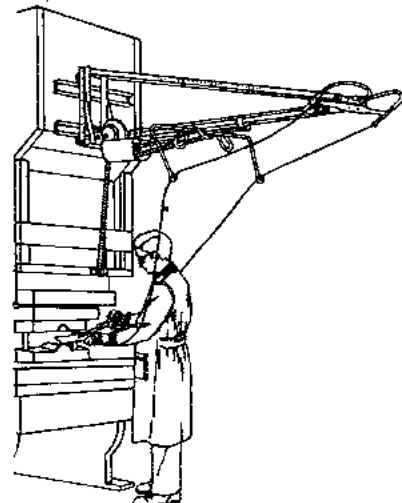

(Continued on next page.)

SECTION 9—METHODS OF SAFEGUARDING

SSC-3000 Press Automation Control System

LIGHT CURTAIN PRESENCE-SENSING DEVICES ON POWER PRESSES

Light Curtain or Radio Frequency
OSHA 29 CFR 1910.217 (c)(3)(iii) Presence-Sensing
(Ref. enclosed MPPS)

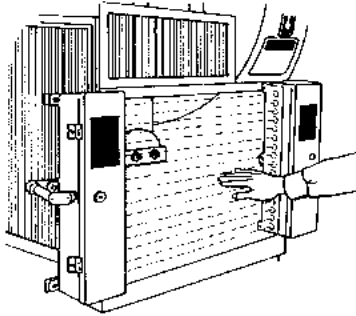

TYPE A OR B GATE ON POWER PRESSES

OSHA 29 CFR 1910.217 (c)(3)(ii) Gate or Movable
Barrier Device
(Ref. enclosed MPPS)

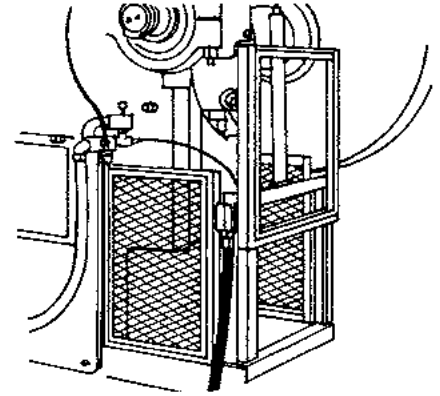

Auxiliary Safeguarding on Power Presses

Auxiliary safeguarding can provide additional protection from injuries for all personnel in the machine area. It is most often used in conjunction with primary safeguarding devices. Auxiliary safeguarding also involves the safeguarding of other hazardous components or openings on machines.

Danger signs, used for warning, must be mounted on the machine in a position that is readily visible to the operator, setup person or other personnel. Hand tools can be used as auxiliary safeguarding. They are often used when feeding and retrieving small pieceparts. Hand tools by themselves are NOT a point-of-operation safeguarding device.

OSHA 29 CFR 1910.217 (c)(4) (Ref. enclosed MPPS)

Hand feeding tools. Hand feeding tools are intended for placing and removing material in and from the press. Hand feeding tools are not a point-of-operation guard for protection device and shall not be used in lieu of the “guards” or devices required in this section.

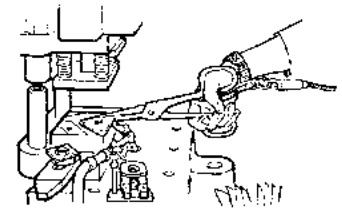

Hand Feeding Tool used for Feeding Parts

Other Safety Considerations

Other areas of machine safety must be considered in order to comply to the OSHA and ANSI standards, as we know them. This includes, but is not limited to, items such as a main power disconnect switch, which must be provided for each machine, and a magnetic type motor starter for the main drive motor. All mechanical power-transmission apparatus of the machine, such as rotating flywheels, gears, sprockets, chains, and shafts, must be covered in accordance with OSHA 29 CFR 1910.219. As with all machinery, best safety practices must be a continuing program. The operator, die setter and all personnel must be fully trained and instructed on all safety procedures and have full knowledge of the safeguarding device being used.

Note: The preceding point-of-operation safeguarding options are explained in OSHA 29 CFR 1910.217 for mechanical power presses and ANSI B11.1 standard entitled Safety Requirements for Mechanical Power Presses. Also see the enclosed Rockford Systems' booklet entitled Mechanical Power Press Safety (MPPS).

When using any of the devices described for point-of-operation safeguarding, the sides and rear of the hazardous point-of-operation area must be safeguarded to protect the operator and other employees in the machine area (OSHA 29 CFR 1910.212).

SECTION 10—RETURN MATERIALS AUTHORIZATION REQUEST FORM

SSC-3000 Press Automation Control System

To return material for any reason contact the sales department in our organization at 1-800-922-7533 for an RMA Number. All return materials shipments must be prepaid. Complete this form and send with material to Rockford Systems, LLC, 5795 Logistics Parkway, Rockford, IL 61109. Make sure the RMA Number is plainly identified on the outside of the shipping container.

Company _____

Address _____

City _____ State _____ Zip _____

Phone _____ Fax _____

Contact Name _____ Representative _____

Items Authorized To Return on RMA No. _____ **Original Invoice No.** _____ **Date** _____

Part No.	Serial No.	Description
_____	_____	_____
_____	_____	_____
_____	_____	_____
_____	_____	_____
_____	_____	_____
_____	_____	_____
_____	_____	_____
_____	_____	_____
_____	_____	_____
_____	_____	_____

Service Requested Full Credit 25% Restocking Repair & Return Warranty Replacement

Reason for return (describe in detail):

Return Materials Authorized by _____ Date _____

SECTION 11—ORDER FORM FOR SIGNS AND LITERATURE

SSC-3000 Press Automation Control System

This instruction manual references signs and literature available for your machines. This order form is for your convenience to order additional signs and literature as needed. This order form is part of your installation manual so please make a copy of it before writing an order.

Company _____

Address _____

City _____ State _____ Zip _____

Phone _____ Fax _____

Name _____ Purchase Order No. _____ Date _____

Part No.	Description	Quantity Required
KSL-252	Installation Manual—SSC-3000 Press Automation Control	_____
KSC-000	Operator Safety Precautions Sign (English)	_____
KSC-000S	Operator Safety Precautions Sign (Spanish)	_____
KSC-000F	Operator Safety Precautions Sign (French)	_____
KST-134	Danger, Closing Ram and Die Label	_____
KSC-054	Danger Sign 5" x 6" (English)	_____
KSC-054S	Danger Sign 5" x 6" (Spanish)	_____
KSC-054F	Danger Sign 5" x 6" (French)	_____
KSC-055	Danger Sign (Foot Switch) 5" x 6" (English)	_____
KSC-055S	Danger Sign (Foot Switch) 5" x 6" (Spanish)	_____
KSC-055F	Danger Sign (Foot Switch) 5" x 6" (French)	_____
KSC-057	Danger Sign (Pullback Device) 5" x 6"	_____
KSL-051	Booklet— <i>Mechanical Power Press Safety</i> (MPPS)	_____
FAB	Catalog— <i>Controls and Safeguarding for Fabricating Machines</i>	_____
SFM	Catalog— <i>Safeguarding Cutting and Turning Machines</i>	_____

For prices and delivery, please use address, phone or fax number listed on the front cover of this manual.

Your Signature _____ Date _____