

INSTALLATION MANUAL FOR SSC-1500 CONTROL SYSTEMS ON PART-REVOLUTION-CLUTCH PRESSES

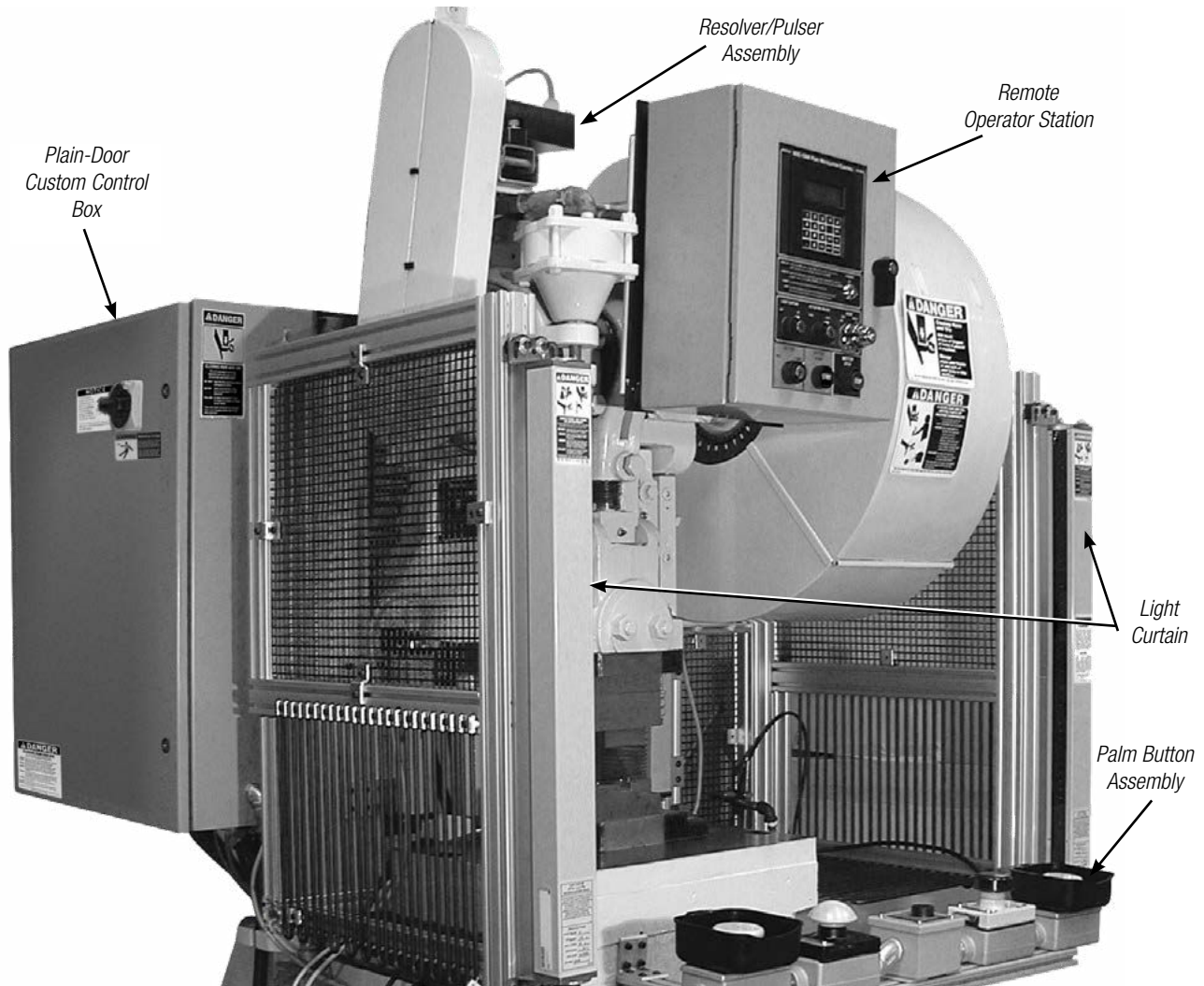

IMPORTANT: PLEASE REVIEW THIS ENTIRE PUBLICATION BEFORE INSTALLING, OPERATING, OR MAINTAINING THE SOLID-STATE CLUTCH/BRAKE CONTROL SYSTEM.

TABLE OF CONTENTS

SSC-3000 Press Automation Control System

SECTION 1—IN GENERAL	3-5
SECTION 2—INTRODUCTION	6-13
SECTION 3—INSTALLATION OF COMPONENTS	13-44
Introduction	14
Literature Folder	14-16
Control Box	16-24
Resolver/Pulser Assembly	25-26
Sprocket Assembly	27
Roller Chain	27
Monitored Dual-Solenoid Air Valve	28
Filter-Regulator-Lubricator (FRL) Assembly	28
Air Pressure Switch	29
Check Valve for Counterbalance System	29
Palm Button Assembly	29-36
Foot Switch	37
Supervisory Control Station	38
Multiple-Operator Junction Box	38
Bar/Run Station	38
Other Components	39-42
Other Installation Considerations	42-44
SECTION 4—PROGRAMMING	45-79
User Inputs	48-51
Brake Monitor	52-54
Counters	55-56
System Setup	57-65
Angle Settings	66-67
Timed Settings	68-69
Optional Modes	70-72
Variable-Speed Top-Stop Settings	73-74
PLS Outputs	75
Auxiliary Output	76-77
Quick Reference Table—Factory Settings and Valid Ranges	78-79
SECTION 5—FATAL AND GENERAL FAULT MESSAGES	80-83
SECTION 6—OPERATING CONSIDERATIONS	84-85
SECTION 7—MAINTENANCE AND INSPECTION	86-87
SECTION 8—REPLACEMENT PROCEDURES	88-90
SECTION 9—METHODS OF SAFEGUARDING	91-92
SECTION 10—RETURN MATERIALS AUTHORIZATION REQUEST FORM	93
SECTION 11—ORDER FORM FOR SIGNS AND LITERATURE	94

Safety Precautions

DANGER

DANGER indicates an imminently hazardous situation which, if not avoided, will result in death or serious injury.



This safety alert symbol identifies important safety messages in this manual. When you see this symbol, be alert to the possibility of personal injury, and carefully read the message that follows.

CAUTION

CAUTION used without the safety alert symbol indicates a potentially hazardous situation which, if not avoided, may result in property damage.

Efficient and safe machine operation depends on the development, implementation and enforcement of a safety program. This program requires, among other things, the proper selection of point-of-operation guards and safety devices for each particular job or operation and a thorough safety training program for all machine personnel. This program should include instruction on the proper operation of the machine, instruction on the point-of-operation guards and safety devices on the machine, and a regularly scheduled inspection and maintenance program.

Rules and procedures covering each aspect of your safety program should be developed and published both in an operator's safety manual, as well as in prominent places throughout the plant and on each machine. Some rules or instructions which must be conveyed to your personnel and incorporated in to your program include:

DANGER

Never place your hands or any part of your body in this machine.



Never operate this machine without proper eye, face and body protection.



Never operate this machine unless you are fully trained and instructed and unless you have read the instruction manual.



Never operate this machine if it is not working properly—stop operating it and advise your supervisor immediately.



Never use a foot switch to operate this machine unless a point-of-operation guard or device is provided and properly maintained.



Never operate this machine unless two-hand trip, two-hand control or presence- sensing device is installed at the proper safety distance. Consult your supervisor if you have any questions regarding the proper safety distance.



Never tamper with, rewire or bypass any control or component on this machine.

A company's safety program must involve everyone in the company, from top management to operators, since only as a group can any operational problems be identified and resolved. It is everyone's responsibility to implement and communicate the information and material contained in catalogs and instruction manuals to all persons involved in machine operation. If a language barrier or insufficient education would prevent a person from reading and understanding various literature available, it should be translated, read or interpreted to the person, with assurance that it is understood.



FOR MAINTENANCE AND INSPECTION ALWAYS REFER TO THE OEM'S (ORIGINAL EQUIPMENT MANUFACTURER'S) MAINTENANCE MANUAL OR OWNER'S MANUAL. If you do not have an owner's manual, please contact the original equipment manufacturer.

(Continued on next page.)

SECTION 1—IN GENERAL

SSC-3000 Press Automation Control System

Safety References

OSH ACT AND FEDERAL REGULATIONS

Since the enclosed equipment can never overcome a mechanical deficiency, defect or malfunction in the machine itself, OSHA (Occupational Safety and Health Administration) has established certain safety regulations that the employers (users) must comply with so that the machines used in their plants, factories or facilities are thoroughly inspected and are in first-class operating condition before any of the enclosed equipment is installed.

1. U.S. Government—An Act—Public Law 91-596, 91st Congress, S. 2193, December 29, 1970:

Duties

SEC. 5. (a) Each employer—

(1) shall furnish to each of his employees employment and a place of employment which are free from recognized hazards that are causing or are likely to cause death or serious physical harm to his employees;

(2) shall comply with occupational safety and health standards promulgated under this Act.

(b) Each employee shall comply with occupational safety and health standards and all rules, regulations, and orders issued pursuant to this Act which are applicable to his own actions and conduct.

2. OSHA 29 CFR Sections that an employer (user) must comply with include:

1910.211 Definitions.

1910.212 General requirements for all machines.

1910.217 Mechanical power presses.

1910.219 Mechanical power-transmission apparatus.

3. OSHA 29 CFR 1910.147 The control of hazardous energy (lockout/tagout).

4. OSHA Publication

“General Industry Safety and Health Regulations Part 1910,” Code of Federal Regulations, Subpart O

This publication can be obtained by contacting:

Superintendent of Documents
U.S. Government Printing Office
P.O. Box 371954
Pittsburgh, PA 15250-7954
Phone: (202) 512-1800
Fax: (202) 512-2250
www.gpo.gov

ANSI SAFETY STANDARDS FOR MACHINES

The most complete safety standards for machine tools are published in the ANSI (American National Standards Institute) B11 series. The following is a list of each ANSI B11 Standard available at the printing of this publication.

B11.1	Mechanical Power Presses
B11.2	Hydraulic Power Presses
B11.3	Power Press Brakes
B11.4	Shears
B11.5	Iron Workers
B11.6	Manual Turning Machines (Lathes)
B11.7	Cold Headers and Cold Formers
B11.8	Milling, Drilling, and Boring Machines
B11.9	Grinding Machines
B11.10	Metal Sawing Machines
B11.11	Gear and Spline Cutting Machines
B11.12	Roll Forming and Roll Bending Machines
B11.13	Automatic Screw/Bar and Chucking Machines
B11.14	Coil Slitting Machines/Systems
B11.15	Pipe, Tube and Shape Bending Machines
B11.16	Metal Powder Compacting Presses (Withdrawn)
B11.17	Horizontal Hydraulic Extrusion Presses
B11.18	Coil Processing Systems
B11.19	Performance Criteria for Safeguarding
B11.20	Safety Requirements for Manufacturing Systems/Cells
B11.21	Lasers
B11.22	CNC Turning Machines
B11.23	Machining Centers
B11.24	Transfer Machines
B11.TR1	Ergonomics
B11.TR2	Mist Control
B11.TR3	Risk Assessment
R15.06	Robotic Safeguarding

These standards can be purchased by contacting:

American National Standards Institute
25 West 43rd Street
New York, New York 10036
Phone: (212) 642-4900
Fax: (212) 398-0023
www.ansi.org

OR

AMT—The Association for Manufacturing Technology
7901 Westpark Drive
McLean, Virginia 22102
Phone: (703) 893-2900
Toll-Free: 1-800-524-0475
Fax: (703) 893-1151
E-Mail: AMT@amtonline.org
www.amtonline.org

(Continued on next page.)

Rockford Systems, LLC
Call: 1-800-922-7533

NATIONAL SAFETY COUNCIL SAFETY MANUALS

Other good references for safety on machine tools are the National Safety Council's Safety Manuals. These manuals are written by various committees including the Power Press, Forging and Fabricating Executive Committee. Copies of the following publications are available from their library:

- Power Press Safety Manual - 5th Edition
- Safeguarding Concepts Illustrated - 7th Edition
- Forging Safety Manual

These manuals and can be obtained by contacting:

National Safety Council
1121 Spring Lake Drive
Itasca, IL 60143-3201
1-800-621-7619 ext. 2199
Fax: (630) 285-0797
www.nsc.org

OTHER SAFETY SOURCES

National Institute of Occupational Safety and Health (NIOSH)
4676 Columbia Parkway
Cincinnati, OH 45226
Toll-Free: 1-800-35-NIOSH (1-800-356-4674)
Phone: (513) 533-8328
Fax: (513) 533-8573
www.cdc.gov/niosh

OTHER SAFETY SOURCES (continued)

Robotic Industries Association (RIA)
900 Victors Way, Suite 140
P.O. Box 3724
Ann Arbor, MI 48106
Phone: (734) 994-6088
Fax: (734) 994-3338
www.roboticonline.com

NEMA (National Electrical Manufacturers Association)
1300 North 17th Street, Suite 1847
Rosslyn, VA 22209
Phone: (703) 841-3200
Fax: (703) 841-5900
www.nema.org

NFPA (National Fire Protection Association)
1 Batterymarch Park
Quincy, MA 02269-9101
Phone: (617) 770-3000
Fax: (617) 770-0700
www.nfpa.org

For additional safety information and assistance in devising, implementing or revising your safety program, please contact the machine manufacturer, your state and local safety councils, insurance carriers, national trade associations and your state's occupational safety and health administration.

Warranty, Disclaimer and Limitation of Liability

WARRANTY

Rockford Systems, LLC warrants that this product will be free from defects in material and workmanship for a period of 12 months from the date of shipment thereof. ROCKFORD SYSTEMS LLC'S OBLIGATION UNDER THIS WARRANTY IS EXPRESSLY AND EXCLUSIVELY LIMITED to repairing or replacing such products which are returned to it within the warranty period with shipping charges prepaid and which will be disclosed as defective upon examination by Rockford Systems, LLC. This warranty will not apply to any product which will have been subject to misuse, negligence, accident, restriction and use not in accordance with Rockford Systems, LLC's instructions or which will have been altered or repaired by persons other than the authorized agent or employees of Rockford Systems, LLC. Rockford Systems, LLC's warranties as to any component part is expressly limited to that of the manufacturer of the component part.

DISCLAIMER

The foregoing Warranty is made in lieu of all other warranties, expressed or implied, and of all other liabilities and obligations on the part of Rockford Systems, LLC, including any liability for negligence, strict liability, or otherwise, and any implied warranty of merchantability or fitness for a particular purpose is expressly disclaimed.

LIMITATION OF LIABILITY

Under no circumstances, including any claim of negligence, strict liability, or otherwise, shall Rockford Systems, LLC be liable for any incidental or consequential damages, or any loss or damage resulting from a defect in the product of Rockford Systems, LLC

(Continued on next page.)

SECTION 2—INTRODUCTION

SSC-1500 Part-Revolution Solid-State Control

Press Components Identification

Part-Revolution OBI Press

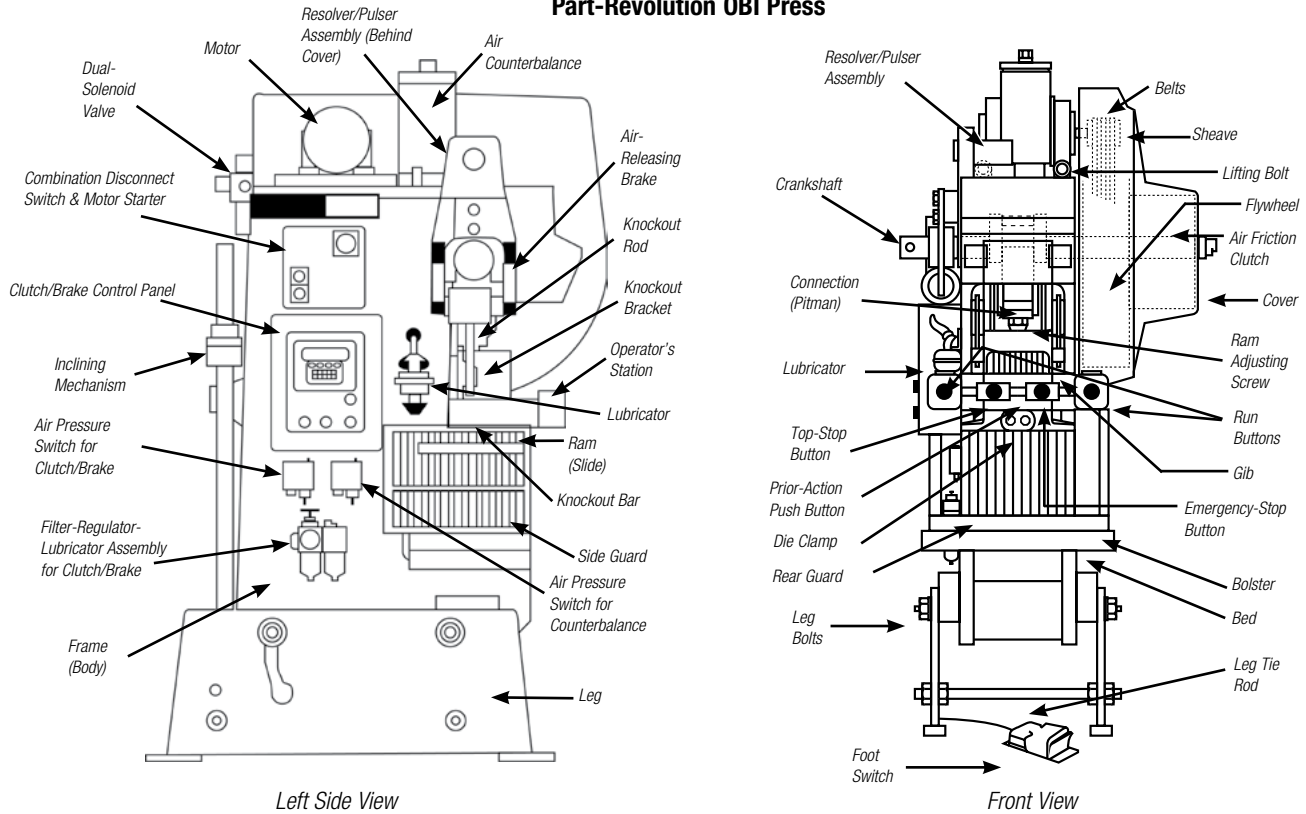

Part-Revolution Straight-Side Press

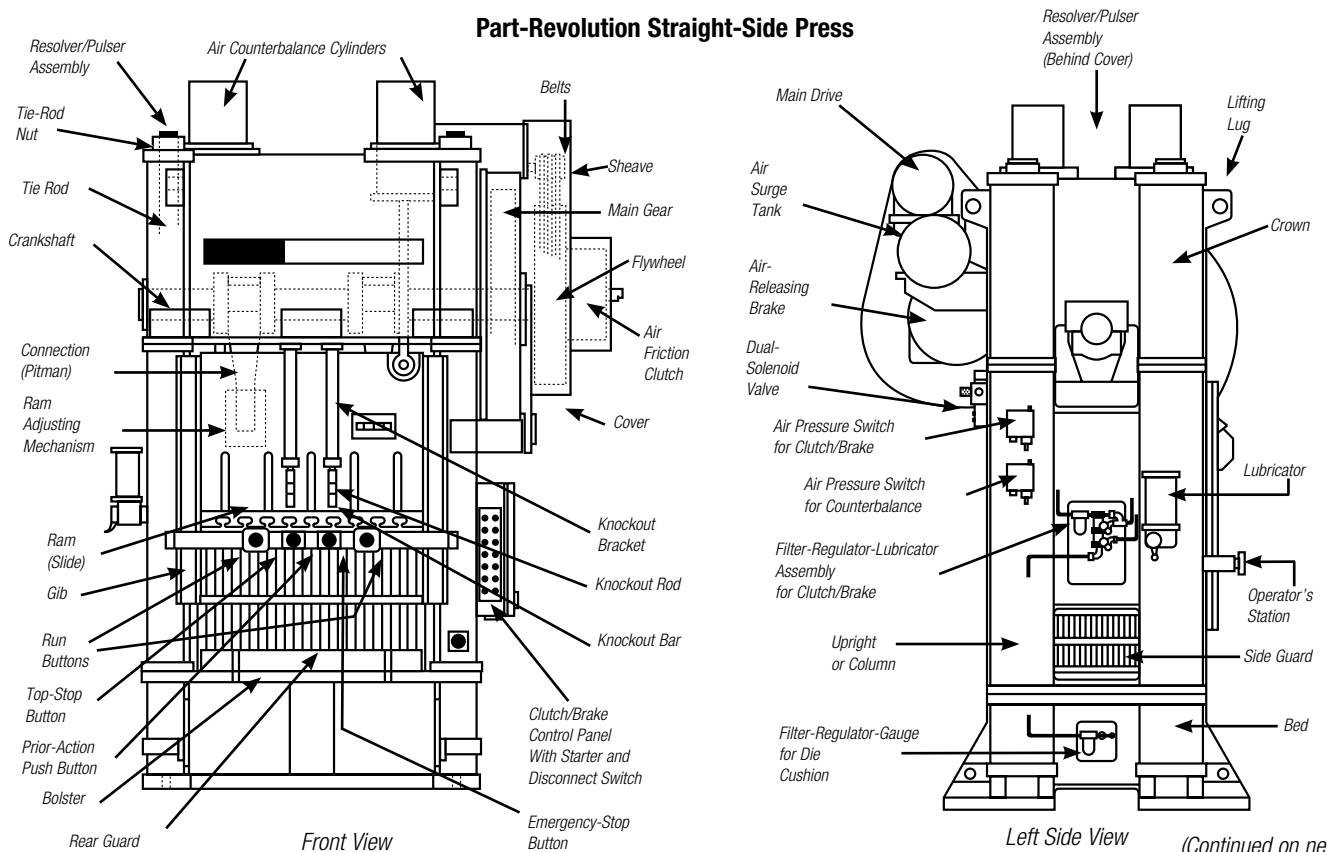

(Continued on next page.)

Rockford Systems, LLC
Call: 1-800-922-7533

General Description of Components in the System

A complete control package for part-revolution-clutch machines includes the following:

1. Literature folder (see pages 14-15) containing installation manuals, Operator Safety Precautions sign, danger sign(s), electrical control schematics, and a *Mechanical Power Press Safety* booklet
2. Control box—a standard (custom or special may include motor controls and/or disconnect switch) with danger and warning signs attached
3. Monitored dual-solenoid air valve
4. Filter-regulator-lubricator (FRL) assembly including connector and mounting bracket
5. Air pressure switch (two required if machine has air counterbalance)
6. Check valve for counterbalance system (if required)
7. Resolver/pulser assembly, spring base, and 40' cable
8. Sprocket set to drive resolver/pulser assembly
9. Chain (10 feet with master link)
10. Palm button assembly (Includes two black palm buttons, two palm button guards, one red emergency-stop button, and mounting boxes. When the *Continuous* mode of operation is required, one yellow top-stop button with mounting box is furnished.) If multiple operator stations are on a machine, more than one assembly is furnished.
11. Foot switch (optional)—If multiple operator stations are on a machine, more than one foot switch is furnished.
12. Supervisory control station (Required when multiple operator stations are used on the machine; one station is required for each operator.)
13. Multiple-operator junction box (When multiple operator stations are required, this junction box is furnished separately for wiring up to four operator stations.)
14. Other required components and safeguarding that may be necessary for the machine (See packing list for details.)

Individual packages may vary in contents. However, a packing list is always enclosed showing exactly what material was shipped on this order. Please check the components actually received against this packing list immediately. In most cases, this control package system includes two-hand control which can be used as a point-of-operation safeguarding device provided the palm buttons are mounted correctly and at the proper safety distance (see formulas on pages 31 and 32 of this manual). If the optional foot switch is provided, a safeguard must always be used. Examples of safeguards include barrier guards, presence-sensing devices, pullbacks, restraints, gates, or two-hand control. The hands or any other part of the body of an operator, maintenance person, setup person, etc., must never be put into the point-of-operation hazard for any reason, at any time.



This control can neither cure nor overcome a malfunctioning machine. It cannot compensate for or prevent a mechanical defect or failure of a machine part. This control cannot prevent a repeat or unintended stroke (cycle) resulting from a mechanical malfunction, defect or failure of the machine itself.

Preliminary Steps Before Installation

Before proceeding with the installation of the enclosed equipment, you should undertake the following preliminary steps.

1. Read and make sure you understand this entire installation manual.
2. Refer to the front cover, other line drawings and photos, then make a sketch of your installation to plan the location of the enclosed equipment on the machine.
3. This may be an opportunity to strip down the entire machine by removing all components, piping, wire, etc. Clean, paint and check the entire mechanical condition of the machine, including the clutch and brake, for proper adjustment and required replacement parts before proceeding with the installation of the furnished equipment.

(Continued on next page.)

SECTION 2—INTRODUCTION

SSC-1500 Part-Revolution Solid-State Control

Preliminary Steps Before Installation (continued)

4. Please make sure the machine is in first-class condition. Before starting any installation, it is essential that the machine is thoroughly inspected. Be sure all mechanical components and all collateral equipment are in first-class operating condition. Your inspection should be done according to the machine manufacturer's installation and maintenance instruction manual. Special attention must be given to the machine clutch and brake. The clutch and brake must be maintained in an operating condition which is within the specifications set by the machine manufacturer. If you have any doubts or questions concerning the condition of the machine, contact the machine manufacturer for assistance. Repair or replace all parts not operating properly before proceeding.



Inspection and maintenance programs must be established and implemented to keep machines in first-class condition. Safety programs must include thorough inspections of each machine on a weekly basis and records kept of these inspections. Any part of the machine that is worn, damaged or is not operating properly must be replaced immediately or repaired before the machine is used.

5. Verify that the machine is in first-class condition and operating properly; shut off all power to the machine. Padlock all electrical and pneumatic energy in the off position and do not actuate the machine again until the installation of all package components has been completed. Lockout/tagout energy isolation procedures must always be practiced and enforced.
6. If the machine has a mechanical-friction clutch (usually found on older presses), an air cylinder is required to engage and disengage the clutch. Install the air cylinder in the most logical place to actuate the clutch. Please see the enclosed Installation Manual No. KSL-096 if an air cylinder was ordered.
Note: On machines equipped with air-operated friction clutches, an air cylinder is not required.

Safeguard Interlocks and Other Types of Interlocks

SAFEGUARD INTERLOCKS

The machine will not operate or must not be operated until you either: (1) electrically interlock or (2) mechanically safeguard the machine's point of operation with a guard or device.

When an electrically interlocked method of safeguarding the point of operation is chosen, connect the interlock to the safeguard interlock terminals (P8-17 and P8-18) in the control box, and as shown on the control wiring schematic (wire numbers 86 and 87). If a light curtain(s) is used as the point-of-operation safeguard, it does not need to be interlocked in to P8-17 and P8-18 safeguard interlock terminals. Refer to the control wiring schematic for proper terminal connection of the light curtain.

Point-of-operation electrically interlocked safeguards, when opened, prevent or stop normal machine operation during operator cycling modes. Examples of these types of interlocks are barrier guard interlocks and gate device interlocks.

When a mechanical guard or device (nonelectrically interlocked) is chosen, the safeguard interlock terminals (P8-17 and P8-18) are not used. In order for the machine to operate with the use of a mechanical guard or device, the safeguard interlock terminals must be connected. Please see the wiring schematic.



The mechanical guard or device must be properly installed, used and maintained and must always prevent all personnel from bodily injury.



If the mechanical guard or device is not used, is removed, or is defeated, an electrically interlocked method of safeguarding must be used and connected to the safeguard interlock terminals (P8-17 and P8-18).



Never operate this machine without point-of-operation safeguarding.

Note: Additional equipment that can help safeguard machines includes indexing tables, electrically controlled sliding bolsters, and automatic feeding systems. These systems usually require additional control logic circuitry. Please contact the factory for a quotation itemizing the interface equipment necessary for these types of systems as well as others (see page 39). Please send complete schematics, including the hydraulic and pneumatic systems, of the particular system to be interfaced.

(Continued on next page.)

Rockford Systems, LLC
Call: 1-800-922-7533

OTHER ELECTRICAL INTERLOCKS

There are basically two types of electrical interlocks as applied to machine control circuitry:

- Interlocks for the purpose of personnel protection, as explained on page 8.
- Interlocks intended for the purpose of protecting the machine and its control components.

There are other locations for interlocks that, when opened, prevent all machine functions. Examples of these types of interlocks are safety block electrical cut-off systems, lubricating systems, die protection equipment, and tonnage monitoring systems.

Be sure to connect the various electrical interlocks to the proper terminals, in the control box, according to the machine wiring schematics. If your schematics do not include these electrical interlocks, please send this information to the factory and they can be added to your drawings. There is an additional charge for this service.

General Features of the SSC-1500 Control

- Redundant/Cross-Checking Microprocessors
- Redundant Microprocessor Logic Power Supplies
- Triple-Redundant Solid-State Solenoid Relays
- 4-Line x 20-Character LCD (Liquid Crystal Display) With 20-Key Operator Interface
- Absolute Resolver/Pulsar With Sync Sensor for Timing and Motion Detection
- Wide Range of Input Power Supply—85 to 135 V AC
- Time-Based Brake Monitor With Programmable Warning and Fault Setpoints
- 6 User-Programmable 24-V DC Static Diagnostic or Die Protection Inputs
- 2 User-Programmable 24-V DC Cyclic Die Protection Inputs
- 7-Digit Total Counter, 7-Digit Batch Counter With Preset, and 7-Digit Stroke Counter With Preset
- Light Curtain(s) Interface With Off/On Selector Switch
- 2 PLS (Programmable Limit Switch) Outputs—Two On/Off Angles, Timed Off, or Counted Output
- 1 Auxiliary Output With 2 Contacts
- Information Displayed When the Machine Is in Operation—Angle, Speed, Batch Counter, Stroke Counter, Mode of Operation, and Stop Time
- Display of Text in English or Spanish

MODES OF OPERATION

- Off
- Two-Hand Inch (Regular, Timed, or Top-Stop)
- Two-Hand Single Stroke
- Foot Single Stroke
- Two-Hand “Walk-Away” Continuous
- Continuous-on-Demand
- Automatic Single Stroke
- Two-Hand-Maintained Continuous
- Foot-Maintained Continuous
- One-Hand or Foot Trip Single Stroke

(Continued on next page.)

SECTION 2—INTRODUCTION

SSC-1500 Part-Revolution Solid-State Control

Overview of Motion and Settings

The redundant inputs are used by both processors to control the operation of the press. When the actuating means is depressed, and the primary safeguard interlock conditions are met, the processors turn on their appropriate relays (SSR1 and SSR2). The dual-solenoid valve is energized sending air to the clutch and brake. The crankshaft is engaged to the flywheel drive and the brake is released allowing the ram to move. Within the motion reference time window, the microprocessors must see a voltage signal from the DC tachometer in the resolver/pulser assembly that represents motion or a motion fault is generated. If the actuating means is released prior to the auto up (holding) angle, the press ram movement will stop. The stroke can be finished by depressing the actuating means again.

For brake monitoring, the control starts a timer when the relays and solenoids are de-energized. This timer stops when the motion from the tachometer in the resolver/pulser has stopped. The stop-time value is then compared to the brake stop-time setpoint. If the stop time exceeds this setting, a brake fault message is displayed. The reason for the increased stop time should be investigated and corrected before operating the press again. (See pages 52-54 for programming the brake monitor.)

Sequence of Operation

This sequence of operation applies to all standard modes provided with the SSC-1500 press control.

OFF

The press is inoperable in this mode of operation. The OFF position cannot be used solely as the lockout/tagout means. To use any of the following modes of operation, turn the mode selector switch from OFF to the appropriate position.

TWO-HAND INCH

Two-Hand Inch is a mode of operation in which the ram travels as long as the operator(s) maintains actuation of the palm buttons. Each time the buttons are released, the ram will stop.

If *Timed Inch* is turned on, the clutch will engage and the ram will move only for a set amount of time programmed in to the control, even if the palm buttons are held depressed. See pages 68-69 of this installation manual for *Timed Inch* programming information.

To use *Two-Hand Inch*, the mode selector switch must be set to INCH, and the actuating means selector switch must be set to HAND.

Top-Stop Inch is similar to normal *Inch*. If *Top-Stop Inch* is turned on, the ram will stop at top every cycle, even if the palm buttons are held depressed. See pages 70-72 of this installation manual for *Top-Stop Inch* programming information.



The *Inch* mode of operation is used for die setup, tool setup, and maintenance only. It is not intended for use during production operations.

TWO-HAND SINGLE STROKE

Two-Hand Single Stroke is a mode of operation in which the ram makes one complete stroke or cycle upon actuation of the palm buttons. The palm buttons must be held depressed until the programmed automatic up (holding) angle is reached. If they are released before this angle is reached, the ram will stop and the buttons will need to be released and then reactivated. The automatic up (holding) angle should be programmed so that the palm buttons are held depressed during the entire die-closing portion of the stroke. Once the ram passes the automatic up (holding) angle, the palm buttons can be released and the ram will automatically return to the top.

To use *Two-Hand Single Stroke*, the mode selector switch must be set to SINGLE, and the actuating means selector switch must be set to HAND.

(Continued on next page.)

Rockford Systems, LLC
Call: 1-800-922-7533

FOOT SINGLE STROKE

Foot Single Stroke is a mode of operation in which the ram makes one complete stroke or cycle upon actuation of the foot switch. The foot switch must be held depressed until the programmed automatic up (holding) angle is reached. If it is released before this angle is reached, the ram will stop and it will need to be released and then reactivated. Once the ram passes the automatic up (holding) angle, the foot switch can be released and the ram will automatically return to the top.

To use *Foot Single Stroke*, the mode selector switch must be set to SINGLE, and the actuating means selector switch must be set to FOOT.



A point-of-operation safeguard must be used when using this mode of operation.

TWO-HAND “WALK-AWAY” CONTINUOUS

Two-Hand “Walk-Away” Continuous mode allows the press to operate continuously, after initiation, without the operator present. To initiate this mode, press the prior-action push button then depress the palm buttons. The press will run in the continuous mode until the yellow top-stop button or the red emergency-stop button is depressed. The palm buttons must be depressed within five (5) seconds of pressing the prior-action push button. If more than five (5) seconds elapses, the prior-action push button will need to be pressed again before the palm buttons are depressed. Please consult the factory if a prior-action push button is required but was not furnished with the control.

To use *Two-Hand “Walk-Away” Continuous*, the mode selector switch must be set to CONT, and the actuating means selector switch must be set to HAND.



A point-of-operation safeguard must be used when using this mode of operation.

OPTIONAL MODES

Continuous-on-Demand, Foot-Maintained Continuous, Two-Hand-Maintained Continuous, One-Hand or Foot Trip Single Stroke, Automatic Single Stroke, Top-Stop Inch, and Inch With Fault are optional modes of operation also provided with the SSC-1500 press control. These modes of operation are accessed through the optional modes program screen. See pages 70-72 of this installation manual for programming information.

These optional modes (except *One-Hand or Foot Trip Single Stroke, Top-Stop Inch, and Inch With Fault*) require the use of a prior-action push button. Please consult the factory if a prior-action push button is required but was not furnished with the control.



A point-of-operation safeguard must be used when using any of these modes of operation.

(Continued on next page.)

SECTION 2—INTRODUCTION

SSC-1500 Part-Revolution Solid-State Control

SSC-1500 Press Control—Connection Diagram

NOTE: This connection diagram is a convenient reference that shows some of the typical connections to the module; it should not be used for reference during installation. Please refer to the enclosed wiring schematics when installing the control system.

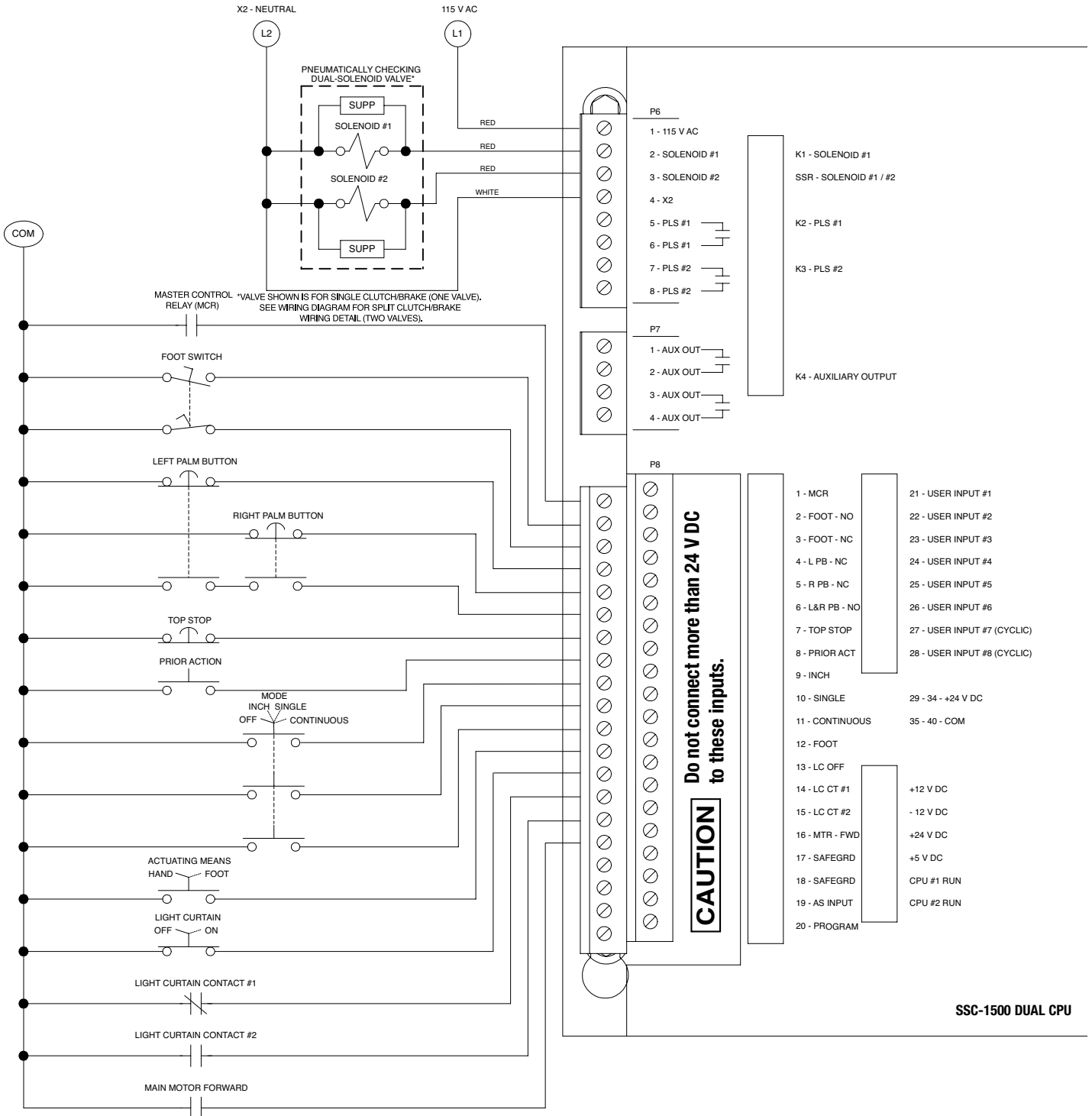

(Continued on next page.)

Rockford Systems, LLC
Call: 1-800-922-7533

SECTION 2—INTRODUCTION

SSC-1500 Part-Revolution Solid-State Control

Wiring When Optional Crankshaft Angle Display Is Furnished

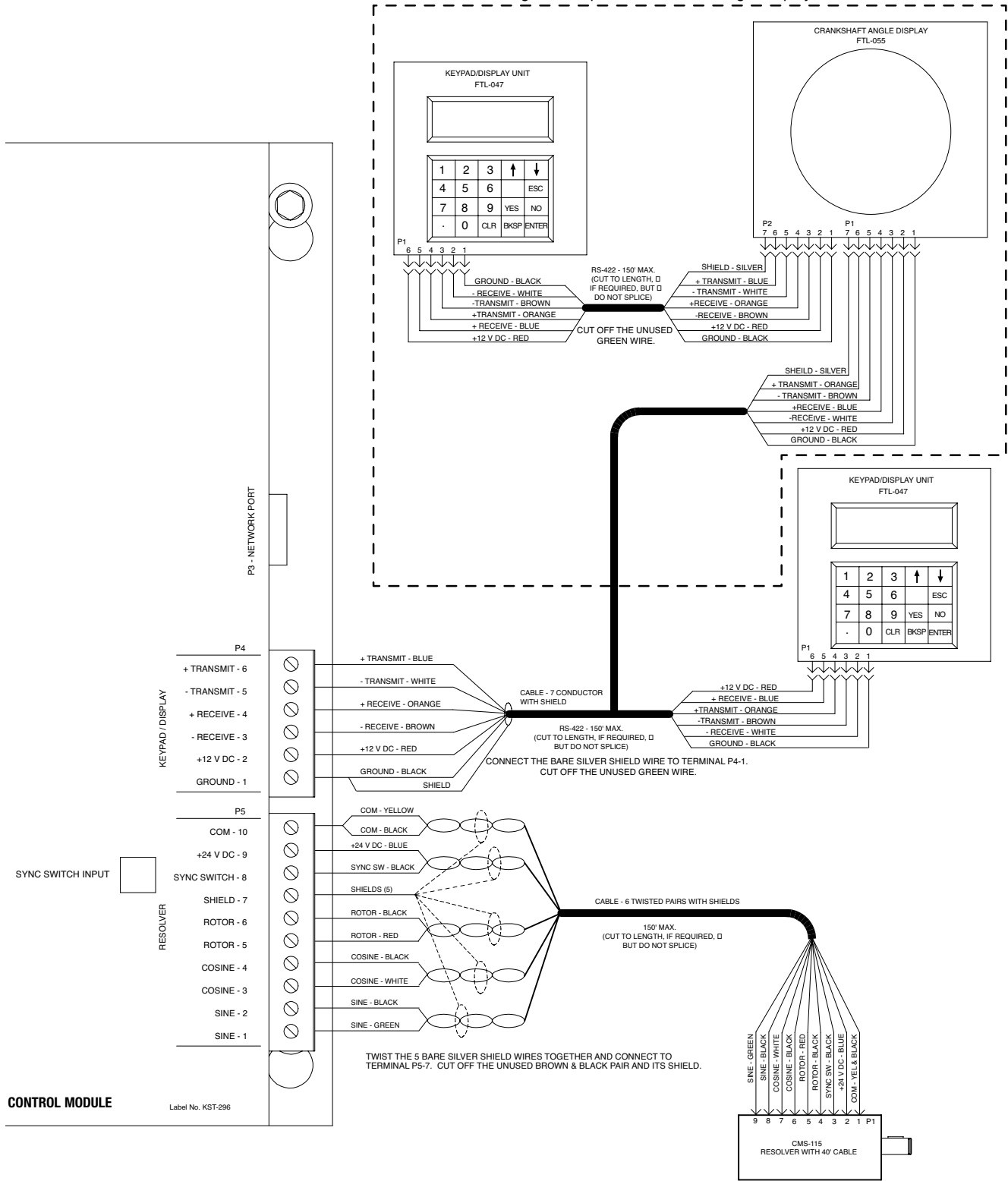

(Continued on next page.)

SECTION 3—INSTALLATION OF COMPONENTS

SSC-1500 Part-Revolution Solid-State Control

Introduction

The following additional materials are required to install the equipment in this shipment.

1. Wire: Size and type will depend on local ordinances or plant practices. We recommend stranded machine tool wire with appropriate color-coding. Never use solid wire—the vibration caused by these machines precludes the successful use of solid wire for these installations.
2. Numbered wire markers: Made of suitable material to resist oil, grease, etc., and remain firmly attached to the wire.
3. Conduit: Rigid, liquid-tight flexible, or any other suitable tubular connecting means which complies with local ordinances and provides adequate mechanical protection for the wires. Most of the electrical products supplied have an oil-tight construction.
4. Miscellaneous wiring components such as electrical tape, wire connectors, and terminals, as required.

ILLUSTRATION OF ELECTRICAL SYSTEM ON PART-REVOLUTION-CLUTCH POWER PRESS

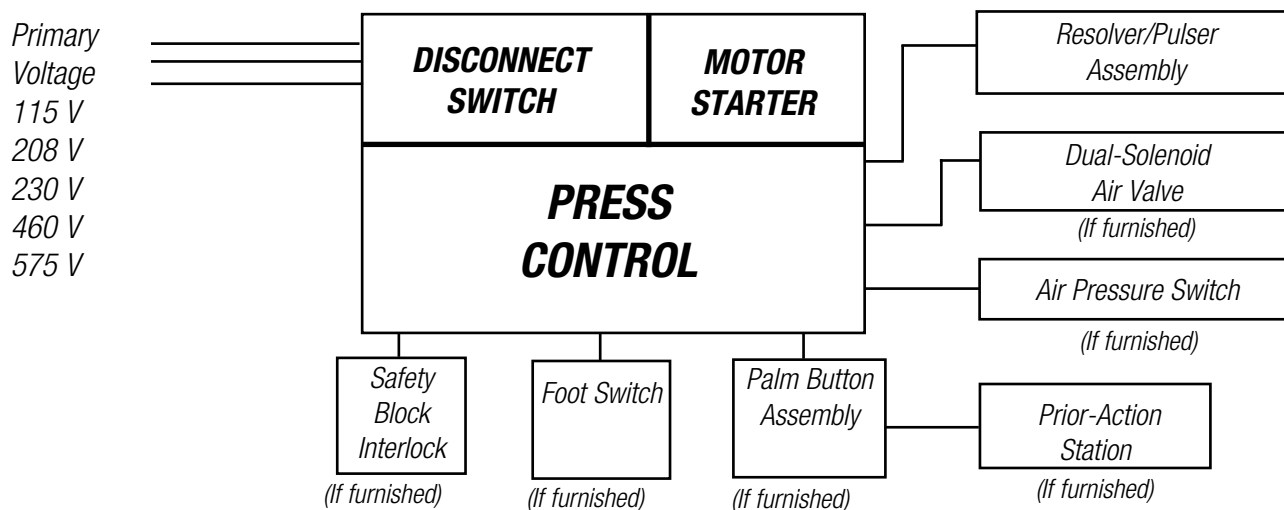

LITERATURE FOLDER

Included with every shipment is a literature folder. This includes installation manuals, Operator Safety Precautions sign (Part No. KSC-000), danger signs, electrical schematics, and a booklet entitled *Mechanical Power Press Safety* (Part No. KSL-051). These publications must be available and fully understood by all appropriate personnel, before any retrofit installation begins. Please notify Rockford Systems immediately if there are any questions about the components received.

MECHANICAL POWER PRESS SAFETY BOOKLET—PART NO. KSL-051

A copy of the MPPS (*Mechanical Power Press Safety*) booklet is enclosed. This booklet is copied verbatim from the CFR (Code of Federal Regulations) and contains all relevant sections of the OSHA standards concerning power presses with which an employer (user) must comply. The enclosed equipment must be installed, used and maintained to meet these standards. Specifically, any time a foot switch is used, a suitable point-of-operation safeguard or device must be used to prevent bodily injury. In addition, every press must be provided with a point-of-operation safeguard! Please review this booklet and the appropriate ANSI (American National Standards Institute) safety standard before installing the enclosed equipment. If you are unfamiliar with these detailed safety standards, which include standards on safeguarding the point of operation properly, you may want to attend our regularly scheduled machine safeguarding seminar. To obtain detailed information about this training seminar, please call, fax, write, or check our Web site. Our address, telephone, fax number, and Web site address are on the front cover of this manual.

(Continued on next page.)

Rockford Systems, LLC
Call: 1-800-922-7533

SECTION 3—INSTALLATION OF COMPONENTS

SSC-1500 Part-Revolution Solid-State Control

OPERATOR SAFETY PRECAUTION PAMPHLET

Photo 3.1 - Part No. KSC-000 Operator Safety Precaution Pamphlet

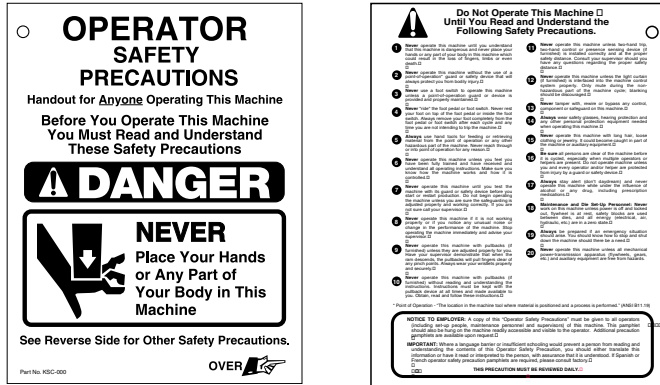

Front

Back

Photo 3.2



Photo 3.3



Photo 3.4



Attachment of Precaution Pamphlet

1. Locate the Operator Safety Precaution Pamphlet.
2. Attach the pamphlet to the machine with a nylon tie through the hole provided. See Photo 3.2.



Attach it to the machine where it is readily accessible and visible to the operator. Additional copies of this precaution are available. Please call, write, fax, e-mail or use the order form found on a later page in this manual.



When a language barrier or insufficient education prevents a person from reading or understanding the contents of this pamphlet, you should either translate this information or have it read or interpreted to the person. Make sure the person understands the information. To order this pamphlet in Spanish, use Part No. KSC-000S; in French, use Part No. KSC-000F.



This precaution pamphlet must be reviewed daily.

DANGER SIGNS

1. Locate the furnished danger sign(s).
2. Determine the mounting location for the danger sign(s) on the machine.



It must be permanently mounted in a prominent location on the machine where it is readily accessible and visible to the operator, setup person, or other personnel who work on or around this machine.

3. Drill a hole(s) in the sign and the machine at the mounting location. See Photo 3.3.
4. Attach the sign(s) to the machine with screws or rivets. See Photo 3.4.



Never operate this machine unless the danger sign(s) is in place. Also make sure the sign(s) is read and understood before operating the machine.

(Continued on next page.)

SECTION 3—INSTALLATION OF COMPONENTS

SSC-1500 Part-Revolution Solid-State Control

Figure 3.1 - Illustration of the Placement of the Operator Safety Precautions Sign and Danger Signs

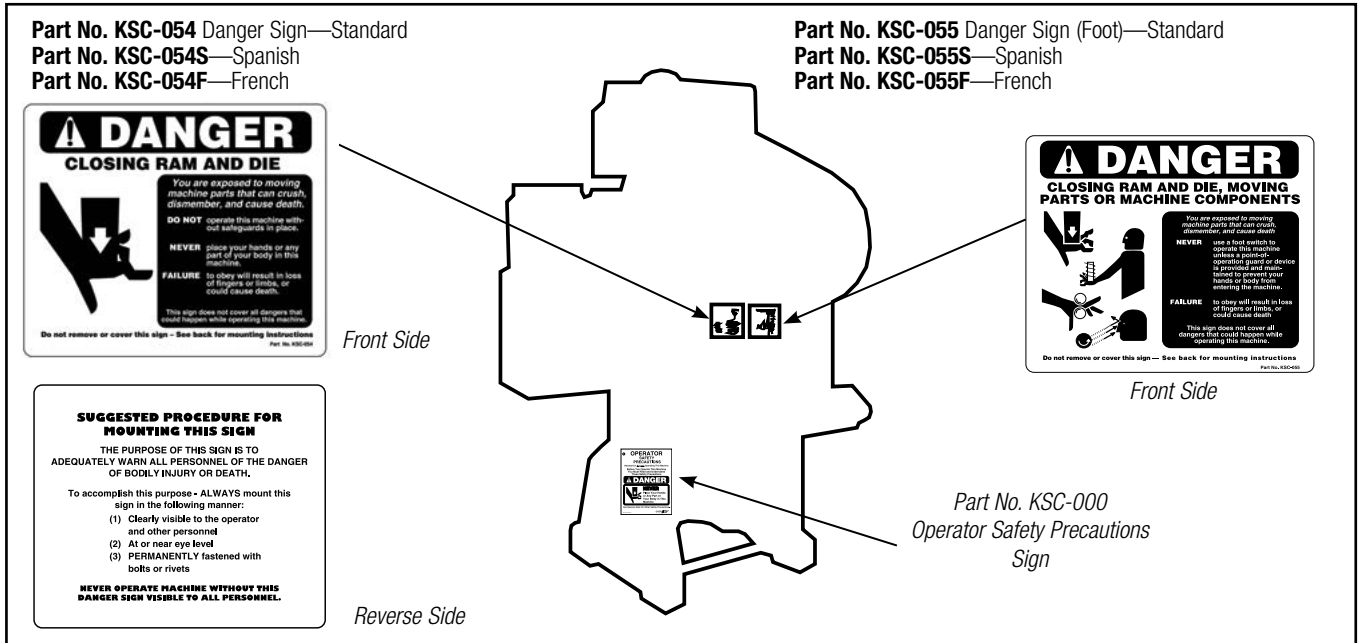

Control Box

DANGER AND WARNING LABELS PROVIDED

The illustrated danger and warning labels are affixed to all control boxes provided. All personnel operating or working around the machine, where this control box is installed, must be required to read, understand and adhere to all dangers and warnings. If any of these labels become destroyed or unreadable, they MUST be replaced. Contact the factory immediately for replacement labels and do not operate the equipment until danger and warning labels are all in place.

Photo 3.5
 SSC-1500 Standard Control Box
 Outside View

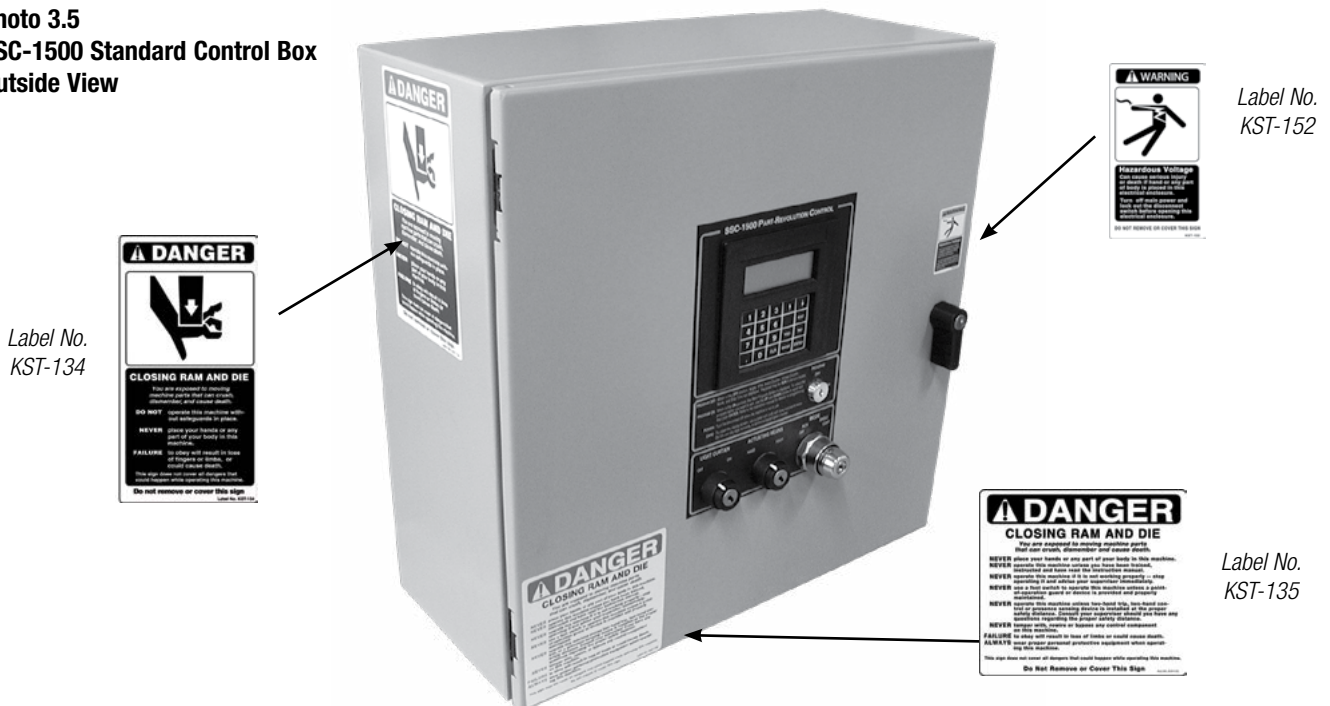

(Continued on next page.)

Rockford Systems, LLC
 Call: 1-800-922-7533

SECTION 3—INSTALLATION OF COMPONENTS

SSC-1500 Part-Revolution Solid-State Control

Control Box (continued)

The SSC-1500 is an economic, full-featured, dual-microprocessor-based press control for part-revolution mechanical power presses. This control system is designed to comply with OSHA 29 CFR 1910.217 and ANSI B11.1. It is a replacement for existing relay-based control systems, found in users' plants, or can be furnished for new or rebuilt presses.

This control can be supplied in a custom box with a motor starter(s) and a disconnect, or as a standard control to interface with existing press motor controls. Enclosure systems for the control include a standard 20" x 20" x 8" box with the keypad/display mounted on the door of the enclosure. A plain-door enclosure with the keypad/display mounted in a remote operator station may have been furnished.

When the control box is wired to an existing main motor starter, the starter must have a 120-V coil and in most cases, an auxiliary contact. If the starter does not have these components and they are not readily available, please contact Rockford Systems for a replacement magnetic motor starter.

The system uses redundant inputs from devices such as palm buttons, foot switches, and light curtain(s). The system output to the dual-solenoid air valve is provided by one safety relay with force-guided contacts and two solid-state relays. These output relays are independently controlled and cross-checked by the microprocessors. This allows control-reliable operation of the outputs in the event of a single control component failure. Each microprocessor also has its own logic power supply. This decreases the possibility of simultaneous control failure because of a fault within the power supply system. All the inputs are optically isolated for electrical noise immunity. Timing and motion detection of the crankshaft is provided by the resolver/pulsar assembly. The operator provides setup information through the use of the keypad/display and messages are shown on the 4-line x 20-character LCD.

This solid-state control operates at a low voltage. Any component such as the dual valve or anything the control will operate (i.e., relay, solenoids) that is at a higher voltage (115 V) must be suppressed. Three (3) suppressors are furnished with all control boxes. Make sure they are installed on the solenoid contacts to filter out electrical noise that could affect the operation of the control.

Two extra fuses are also furnished with all control boxes. Use the corresponding replacement fuse if the original fuse should blow on the printed circuit board (fuses F1 through F6—see page 21), or to replace a blown fuse inside the off/on switch on the side of the control module (see Photo 3.7).

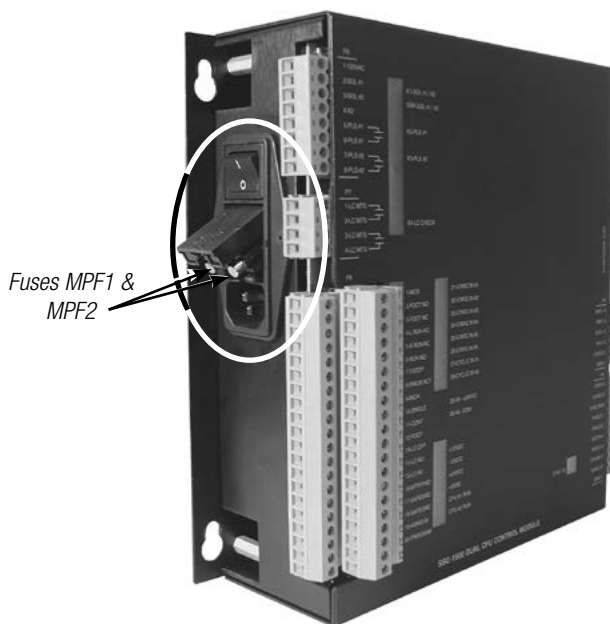

Photo 3.7
Fuse location in the off/on
switch on the control module

(Continued on next page.)

SECTION 3—INSTALLATION OF COMPONENTS

SSC-1500 Part-Revolution Solid-State Control

STANDARD CONTROL BOX

The standard control box (20" x 20" x 8") is furnished with the keypad/display, program off/on selector switch, and other selector switches on the front of the enclosure door. This NEMA 12 enclosure contains the control module assembly, master control relay, primary multi-tap transformer, and terminal strips. A standard box with a plain door is also available for use with a remote operator station.



Photo 3.8
Standard
Control Box

Photo 3.9
Inside View of Standard
Control Box

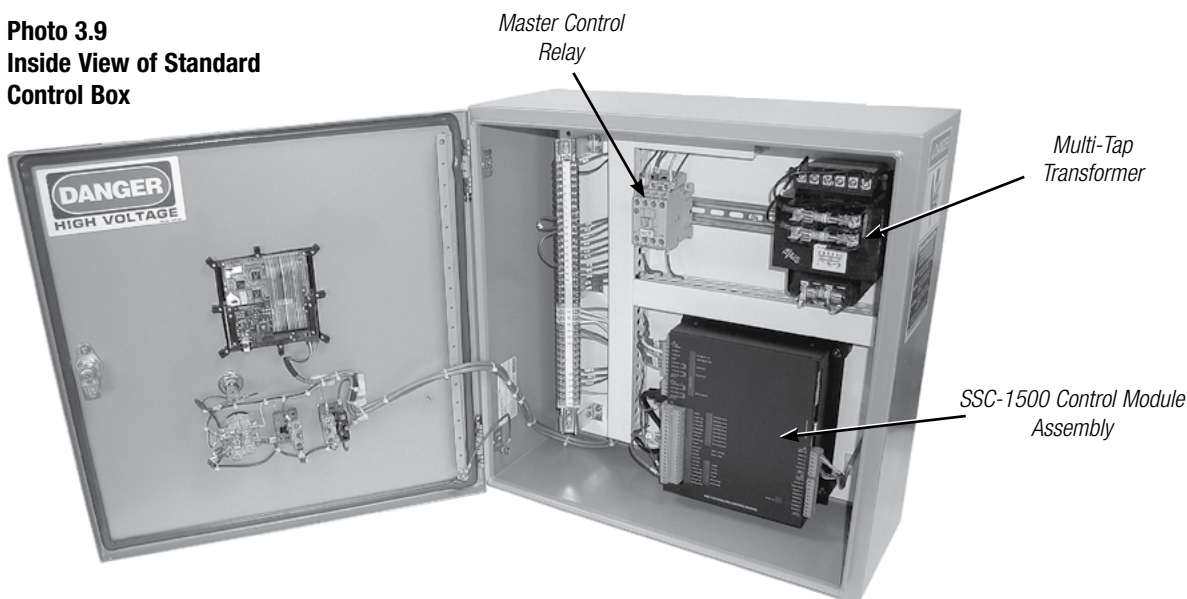

CUSTOM CONTROL BOX

A custom control box contains the standard control module and components described above plus the following:

- main power disconnect switch
- main drive motor starter
- ram-adjust motor starter (if furnished)

This NEMA 12 enclosure will vary in size based on the size of the disconnect switch and motor starter components. The enclosure contains the disconnect switch, main motor starter, ram-adjust motor starter (if furnished), clutch/brake control module, master control relay, primary multi-tap transformer, and terminal strips. The keypad/display, selector switches, motor controls, and disconnect switch handle may have been furnished on the door of the enclosure, or furnished as a plain-door enclosure for use with a remote operator station.



Photo 3.10
Plain-Door Custom Control Box
with Remote Operator Station

(Continued on next page.)

Rockford Systems, LLC
Call: 1-800-922-7533

REMOTE OPERATOR-STYLE CONTROL BOXES

Remote operator-style control boxes include the same features and modes of operation as the standard control box described on page 18. However, they do not have a control transformer. These controls are for applications where the machine's existing magnetic motor starter, fused disconnect switch, and control transformer meet the safety requirements and can be reused. If the existing control transformer cannot be reused or a new control transformer is required, contact the factory.

The three remote operator-style control boxes available have the keypad/display and all operators on the door of the 16" x 16" x 8" enclosure. The remote operator-style control boxes available are:

Style X—Standard SSC-1500 control box without the control transformer

Style Y—Standard SSC-1500 control box without the control transformer, but with an e-stop, top-stop, and prior-action push button in the enclosure

Style Z—Standard SSC-1500 control box without the control transformer, but with an e-stop, top-stop, and prior-action push button, and two (2) guarded run/inch buttons on the sides of the enclosure



Photo 3.11
Style Z Remote Operator
Control Box

CONTROL MODULE KIT*

When a control module kit is furnished, it is supplied without the control enclosure, panel, control transformer, control fuse, terminal strips, wire duct, and wiring. This control module kit includes the control module, master control relay, shock mounts, fasteners, suppressors, extra fuses, ferrules, danger labels, and electrical prints. The minimum area required to install this kit on an existing control panel is 14" x 12" x 6". The electrical prints supplied with this kit show typical wiring and all dimensions.



Photo 3.12

KEYPAD/DISPLAY KIT*

When a keypad/display kit is furnished for use with any of the control boxes or control module kit, it includes the keypad/display, a screen label, a program off/on selector switch, a light curtain off/on selector switch, an actuating means selector switch, a mode selector switch, and 25' of cable. Additional push buttons and nameplates for motor starters, etc., may have been furnished depending on the features required. The area needed to mount the keypad/display kit is 10" x 6 $\frac{1}{4}$ " x 3".

*A certified electrician is required for the installation of a control module kit and keypad/display kit. If you do not have access to a certified electrician, please contact Rockford Systems at 1-800-922-7533, and we will propose the cost of having our installation team provide the installation.



Photo 3.13

SECTION 3—INSTALLATION OF COMPONENTS

SSC-1500 Part-Revolution Solid-State Control

CONTROL MODULE ASSEMBLY

The solid-state control module assembly below, Part No. FTL-046, measures 8¾" W x 8¾" H x 3¾" D. It is mounted to the panel with four shock/vibration mounts and four ¼-20 x ½" Allen-head bolts. The module case has four keyhole mounting slots that allow for easy removal, without taking off the Allen-head mounting bolts.

Red and green LEDs allow for visual indication of control operation and the status of inputs and outputs. There are two green CPU (central processing unit) run indicator status lights. All LED names are indicated on the cover of the module next to each LED. See photo 3.14.

Photo 3.14
Top View of Control Module With Cover

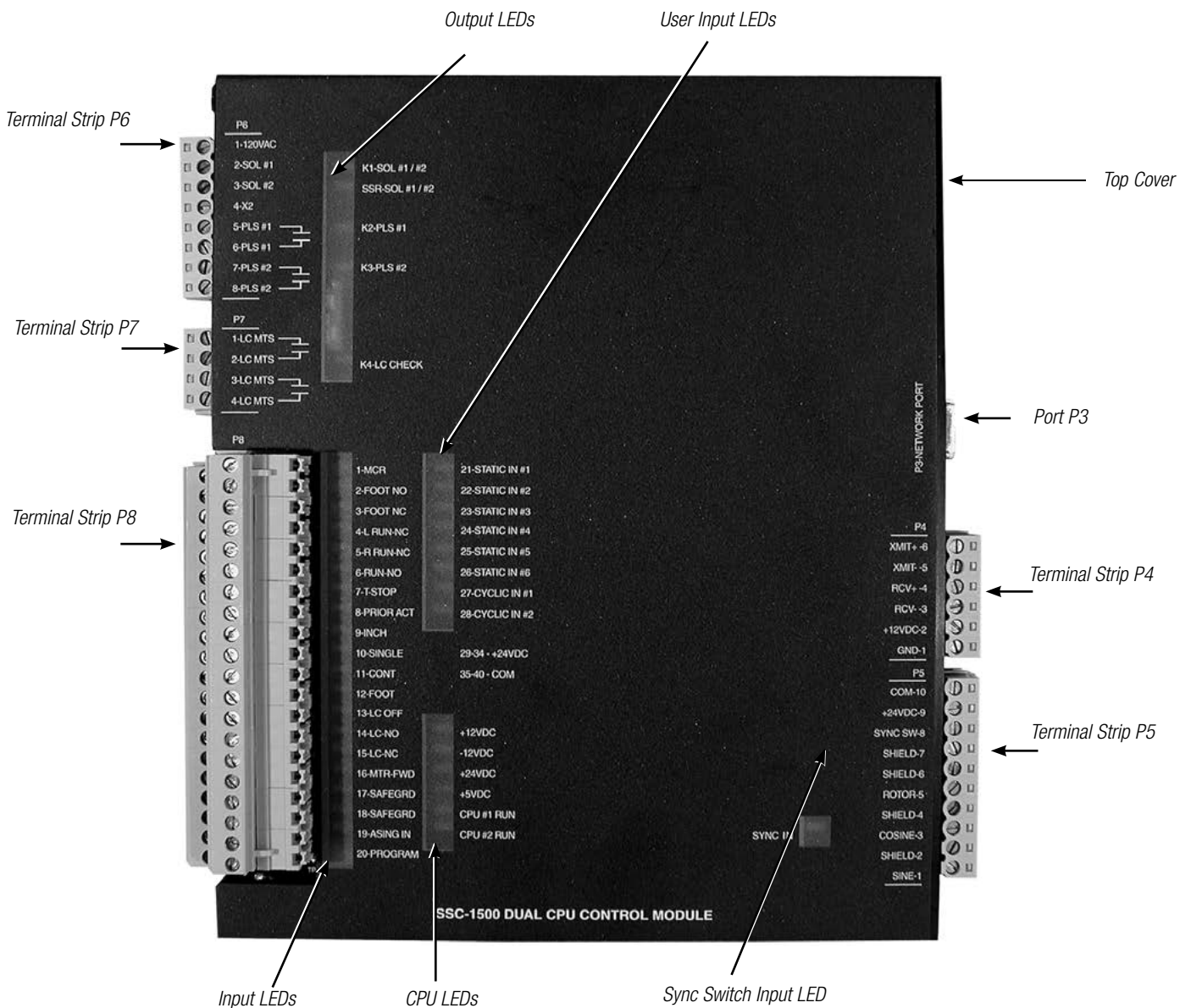

(Continued on next page.)

Rockford Systems, LLC
 Call: 1-800-922-7533

SECTION 3—INSTALLATION OF COMPONENTS

SSC-1500 Part-Revolution Solid-State Control

CONTROL MODULE ASSEMBLY (continued)

If necessary, the cover of the module can be taken off by removing the screws on the corners and pulling the top straight off. The dual-CPU circuit board is then exposed as shown in the photo below.

Photo 3.15

Top View of Control Module Without Cover

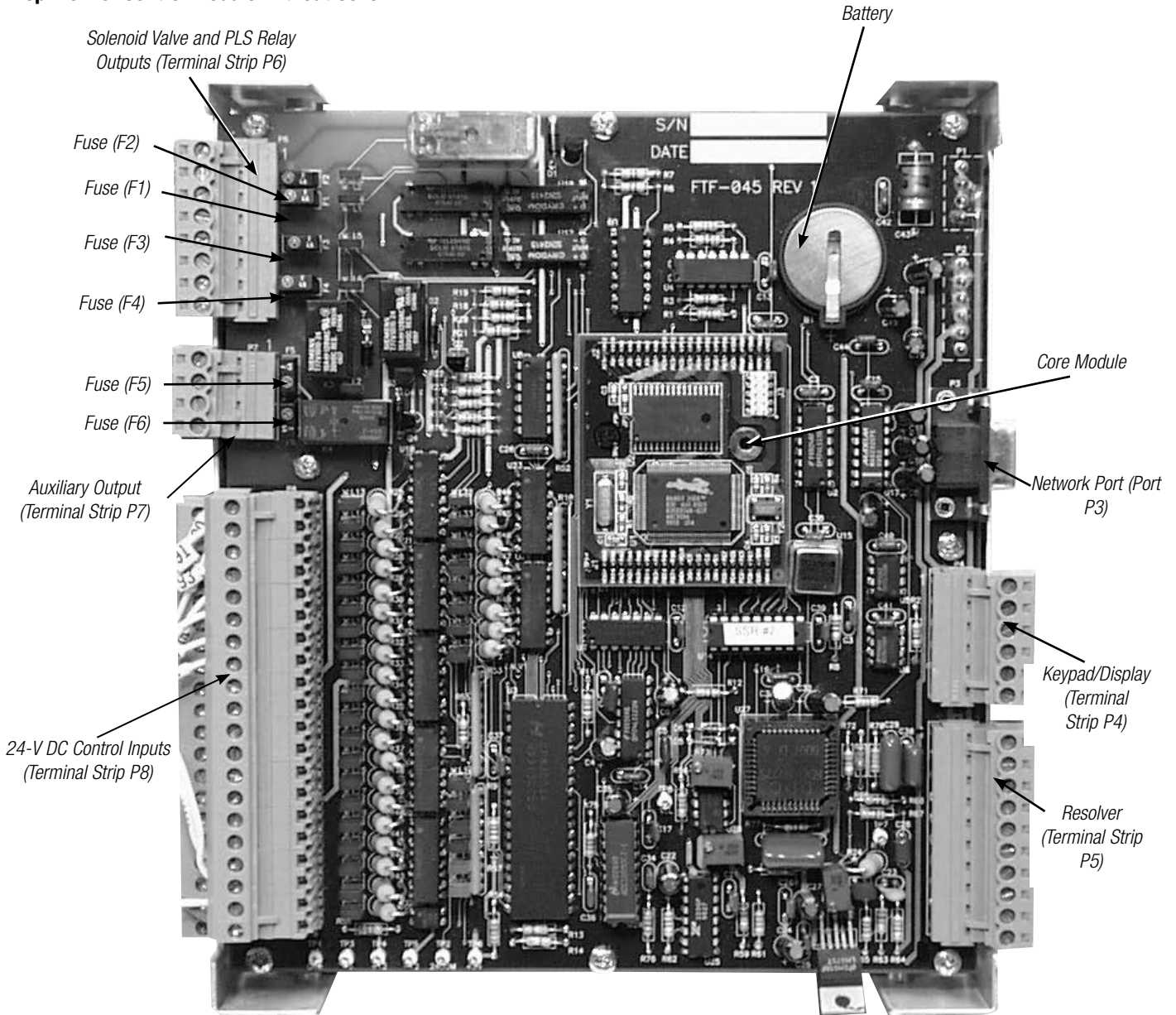

User-serviceable parts on the dual-CPU board are the core module, the battery, and the fuses. F1 and F2 fuses are for circuit protection of S1 and S2 (solenoids). F3 and F4 fuses are for circuit protection for K2 and K3. F5 and F6 fuses are for circuit protection of the auxiliary output relay. MPF1 and MPF2 fuses are the main power supply fuses (see photo 3.7 on page 17).

If any changes to the circuit boards are required, instructions will be sent with the new parts. See Section 8—Replacement Procedures for instructions on replacing the core module, fuses, and battery.

(Continued on next page.)

SECTION 3—INSTALLATION OF COMPONENTS

SSC-1500 Part-Revolution Solid-State Control

Photo 3.16
Keypad/Display



KEYPAD/DISPLAY ASSEMBLY

The keypad/display assembly, Part No. FTL-047 (photo 3.16), is used to enter setup information and to monitor machine operation.

The keypad/display can be furnished in a remote enclosure up to a maximum of 150' from the SSC-1500 control module. Information displayed during the machine run cycle are Angle, Speed, Batch Counter, Stroke Counter, Mode, and Stop Time. All programming is accessed by a program off/on keyed selector switch. See pages 45-79 of this manual for programming information.

Mounting the Control Box

Solidly mount the control box in an accessible location, either on or near the machine to be controlled. A convenient location will keep conduit runs to a minimum length.

Note: On OBI (open back inclinable) presses, caution must be used to ensure that the control box location does not interfere with the ability to incline the press to its maximum position. On inclined presses, the length and flexibility of each individual conduit run must be carefully planned.

Although operation of this control will not be adversely affected by normal machine operation, excessive shock or vibration may require shock mounting in specific applications, and some applications may require remote mounting of the control box (off the press). Special stands or mounting brackets may need to be fabricated to accommodate remote mounting.

CAUTION

Do not run cable in conduit or in bundles with higher voltages that may cause electrical interference.

If your control has the keypad/display assembly mounted on the door of the enclosure, the keypad/display wires will already be ferruled and connected to Terminal Strip P4 on the SSC-1500 control module. For all other controls, this will have to be done during installation.

Twenty-five feet of cable is supplied as standard (if the keypad/display is remote) and can be cut to length, if required. Do not splice the cable or interrupt the signals. If a longer cable is required, please contact the factory.

When connecting the keypad/display wires to Terminal Strip P4, please follow the wiring schematics included with the control and see Photo 3.17. Strip the wires and crimp the supplied ferrules on each wire.* Terminal Strip P4 has a color-coded number label. Match each wire with the appropriate terminal in accordance with the wiring schematics and the color-coding. Make sure each wire is tight and is making good contact with the metal part of the ferrule.

The bare silver shield wire should be twisted and put in a larger ferrule with the black wire and connected to Terminal P4-1.

Note: There is a green wire in the keypad/display cable that is not used. Cut this wire off and discard it.

*A special crimping tool is required to properly crimp the ferrules on the wires. If you do not have one, it is available from:

Weidmuller Inc.
821 Southlake Boulevard
Richmond, Virginia 23236
Toll-Free: 1-800-849-9343
Phone: (804) 794-2877
Fax: (804) 794-0252
www.weidmuller.com

We use the Weidmuller Type PZ 3,
Part No. 056730 crimping tool.

Photo 3.17—Terminal Strip P4 Wiring Connection on the SSC-1500 Control Module

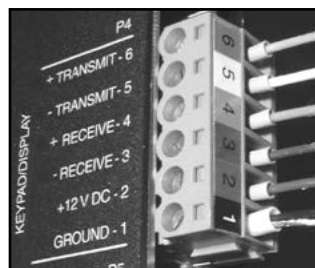

- No. 6—Blue**
- No. 5—White**
- No. 4—Orange**
- No. 3—Brown**
- No. 2—Red**
- No. 1—Black and Bare Silver Shield
(together in larger ferrule)**

(Continued on next page.)

Rockford Systems, LLC
Call: 1-800-922-7533

SECTION 3—INSTALLATION OF COMPONENTS

SSC-1500 Part-Revolution Solid-State Control

Photo 3.18—Crankshaft Angle Display

CRANKSHAFT ANGLE DISPLAY (OPTIONAL)

The crankshaft angle display, Part No. FTL-055 (photo 3.18), is an optional unit that shows the angular position of the crankshaft both graphically (with red LEDs in a circle) and numerically (with a large, red, three-digit LED display). The angle display should be mounted where it is easily viewed to help with setup, removal of stuck workpieces, or for assistance during emergency extraction procedures.



CAUTION

Do not run cable in conduit or in bundles with higher voltages that may cause electrical interference.

Two 25' cables are supplied as standard and can be cut to length, if required. Do not splice the cables or interrupt the signals. If longer cables are required, please contact the factory.

One of the cables connects between Terminal Strip P4 on the SSC-1500 control module and Terminal Strip P1 on the crankshaft angle display. The other cable connects between Terminal Strip P2 on the crankshaft angle display and the keypad/display assembly.

When connecting Terminal Strip P1 on the crankshaft angle display wires to Terminal Strip P4 on the SSC-1500 control module, please follow the wiring schematics included with the crankshaft angle display and see Photos 3.19 and 3.20. Strip the wires and crimp the supplied ferrules on each wire.* Terminal Strip P4 has a color-coded number label. Match each wire with the appropriate terminal in accordance with the wiring schematics and the color-coding. Make sure each wire is tight and is making good contact with the metal part of the ferrule. The bare silver shield wire should be twisted and put in a larger ferrule with the black wire and connected to Terminal P4-1.

Note: There is a green wire in the keypad/display cable that is not used. Cut this wire off and discard it.

Photo 3.19—Terminal Strip P4 Wiring Connection on the SSC-1500 Control Module

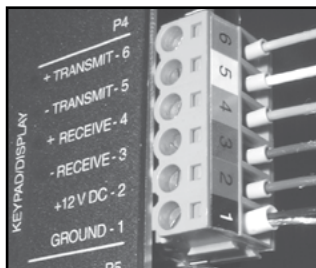

- No. 6—Blue
- No. 5—White
- No. 4—Orange
- No. 3—Brown
- No. 2—Red
- No. 1—Black and Bare Silver Shield (together in larger ferrule)

Photo 3.20—Terminal Strip P1 Wiring Connection on the Crankshaft Angle Display

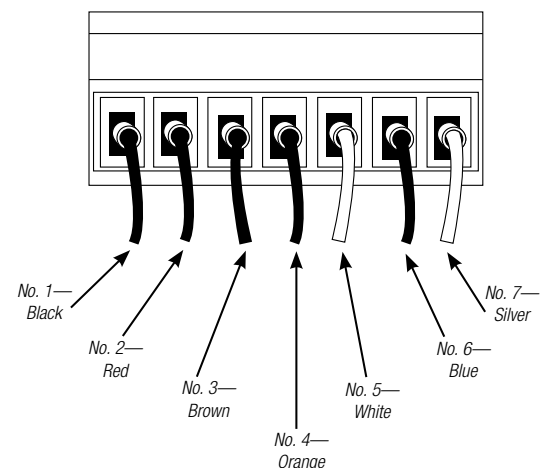

*A special crimping tool is required to properly crimp the ferrules on the wires. If you do not have one, it is available from:

Weidmuller Inc.
821 Southlake Boulevard
Richmond, Virginia 23236
Toll-Free: 1-800-849-9343
Phone: (804) 794-2877
Fax: (804) 794-0252
www.weidmuller.com

We use the Weidmuller Type PZ 3, Part No. 056730 crimping tool.

(Continued on next page.)

SECTION 3—INSTALLATION OF COMPONENTS

SSC-1500 Part-Revolution Solid-State Control

CRANKSHAFT ANGLE DISPLAY (continued)

When connecting Terminal Strip P2 on the crankshaft angle display wires to the keypad/display assembly, the existing cable that came with the control can be used; however, if this cable is too short, discard it and use the cable furnished with the crankshaft angle display. Please follow the wiring schematics included with the crankshaft angle display and see Photo 3.21. Strip the wires and crimp the supplied ferrules on each wire.* Match each wire with the appropriate terminal in accordance with the wiring schematics and the color-coding. Make sure each wire is tight and is making good contact with the metal part of the ferrule.

*Note: There is a green wire in these cables that is not used.
Cut this wire off and discard it.*

Photo 3.21—Terminal Strip P2 Wiring Connection on the Crankshaft Angle Display

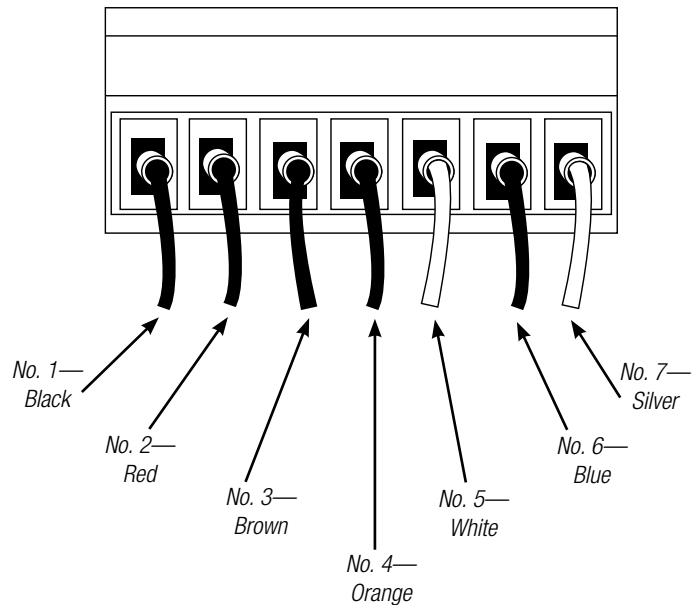

*A special crimping tool is required to properly crimp the ferrules on the wires. If you do not have one, it is available from:

Weidmuller Inc.
821 Southlake Boulevard
Richmond, Virginia 23236
Toll-Free: 1-800-849-9343
Phone: (804) 794-2877
Fax: (804) 794-0252
www.weidmuller.com

We use the Weidmuller Type PZ 3, Part No. 056730 crimping tool.

(Continued on next page.)

Rockford Systems, LLC
Call: 1-800-922-7533

SECTION 3—INSTALLATION OF COMPONENTS

SSC-1500 Part-Revolution Solid-State Control

Resolver/Pulser Assembly

The absolute resolver/pulser assembly with spring-tension base is used to provide position and velocity/motion information of the machine crankshaft to the control. The resolver is a highly accurate and repeatable timing device. The resolver/pulser is contained in a rugged, heavy-duty housing with a spring-tension base. The $\frac{3}{4}$ " diameter steel shaft is mounted in sealed ball bearings. This results in a rugged transducer assembly for press applications. The resolver/pulser is furnished with a 40' cable that attaches to the drive assembly and wires in to the control box. When installing, the cable can be cut to the exact length required (do not splice). For more than 40' of cable, please contact factory. See the next page or the enclosed wiring schematics for proper wiring.



Photo 3.22
Part No. CMS-115
Resolver/Pulser Assembly

CAUTION Do not run cable in conduit or in bundles with higher voltages that may cause electrical interference.

The photoelectric pulser is monitored by the control logic to verify proper resolver position. Position changes can occur either mechanically or electrically. A mechanical failure can result if the resolver slips, and an electrical failure can result within the resolver cabling or circuitry. If failure occurs, the resolver position and the pulser cam signal will not match and the circuit logic will detect the fault. The pulser cam and resolver are connected internally to the connector provided; therefore, no wiring is necessary. The resolver/pulser is factory arranged for clockwise (CW) rotation (when facing the end of the shaft). A wiring change is required for counterclockwise (CCW) rotation. See the bottom of the next page or the enclosed wiring schematics for further details.

After installation of the resolver/pulser and wiring is complete with the machine at TDC (top dead center), perform the power-up procedure in Section 4 on page 46. This will automatically detect the pulser cam and set up the resolver for normal operation.

When installing a chain and sprocket or drive coupling to the $\frac{3}{4}$ " shaft, start with the machine at TDC (top dead center) and the keyway pointing up, perpendicular to the base (Photo 3.24). Connect the chain to sprockets or tighten the drive coupling. (See next page for sprocket and chain drive).

Note: If the resolver assembly is mounted on an angle or even upside down from what is illustrated, be sure the keyway on the shaft is always perpendicular to the base. The keyway must always be turned 180° away from the base when initially setting up the machine. The crankshaft of the machine must be at TDC.

Photo 3.23 & 324
Resolver/Pulser Assembly
(Top of cover has been slid aside for photo)

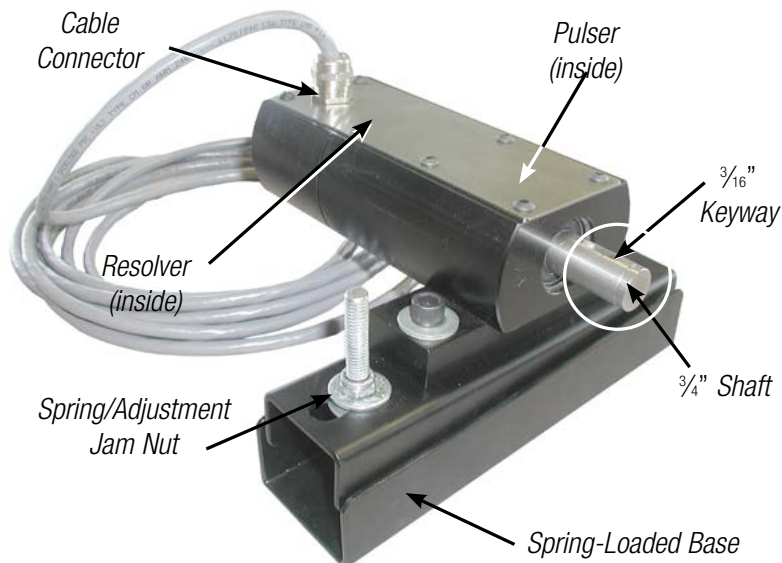

Photo 3.24
Resolver With Keyway in Correct Position

(Continued on next page.)

SECTION 3—INSTALLATION OF COMPONENTS

SSC-1500 Part-Revolution Solid-State Control

CONNECTING THE RESOLVER WIRES TO TERMINAL STRIP P5

When connecting the resolver wires to Terminal Strip P5, please follow the wiring schematics included with the control and see Photo 3.25. Strip the wires and crimp the supplied ferrules on each wire.* Terminal Strip P5 has a color-coded number label. Match each wire with the appropriate terminal in accordance with the wiring schematics and the color-coding. Make sure each wire is tight and making good contact with the metal part of the ferrule.

Forty feet of cable is supplied as standard and can be cut to length, if required. Do not splice the cable or interrupt the signals. If a longer cable is required, please contact the factory.

*A special crimping tool is required to properly crimp the ferrules on the wires. If you do not have one, it is available from:

Weidmuller Inc.
821 Southlake Boulevard
Richmond, Virginia 23236
Toll-Free: 1-800-849-9343
Phone: (804) 794-2877
Fax: (804) 794-0252
www.weidmuller.com

We use the Weidmuller Type PZ 3, Part No. 056730 crimping tool.

Photo 3.25—Terminal Strip P5 Wiring Connection on the SSC-1500 Control Module

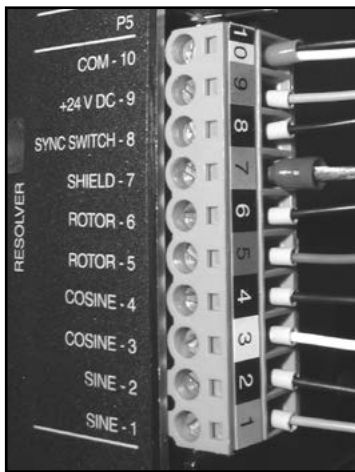

- 10— Black & Yellow (together in one ferrule)
- 9— Blue \cup paired
- 8— Black \cup paired
- 7— Five Bare Silver Shields (twisted together in large ferrule)
- 6— Black \cup paired
- 5— Red
- 4— Black \cup paired
- 3— White \cup paired
- 2— Black \cup paired
- 1— Green

Note: There is a brown and black wire pair with a silver shield in the resolver cable that is not used—cut this off and discard it.

Note: The above wiring is for the resolver shaft to rotate clockwise. If the resolver needs to rotate counterclockwise, the white/black and green/black pairs need to be swapped, such that:

- 4— Black \cup paired
- 3— Green \cup paired
- 2— Black \cup paired
- 1— White \cup paired

(Continued on next page.)

Rockford Systems, LLC
Call: 1-800-922-7533

SECTION 3—INSTALLATION OF COMPONENTS

SSC-1500 Part-Revolution Solid-State Control

Sprocket Assembly (If furnished)

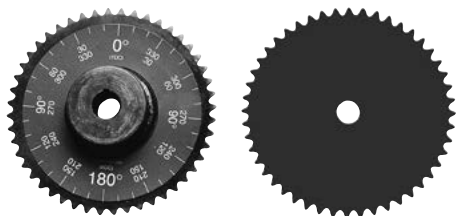

Photo 3.26
Part No. CML-000

Existing sprockets may be reused, or two sprockets with an identical number of teeth (usually 48) may be supplied. They are used to drive the resolver/pulsar assembly. The standard set consists of one sprocket with the proper bore, keyway, and setscrews to mount directly on the shaft extension of the resolver. The other sprocket is flat with a small rough bore. This sprocket is normally mounted on the end of the machine crankshaft by drilling and tapping two suitable mounting holes in the sprockets and crankshaft and using spacer blocks, if necessary, to provide clearance for the chain. These sprockets use a standard ANSI No. 35 roller chain and connecting links.

Never hammer a sprocket or coupling on or off the resolver/pulsar assembly shaft—this could

CAUTION damage the resolver/pulsar assembly. It must be pressed on or off.

When installing the drive chain, it will be necessary to adjust the length of the chain in order to obtain proper action of the spring-loaded base of the resolver assembly. The normal position of the two hinged plates, on the resolver/pulsar assembly, is approximately parallel with each other when the chain is installed. The spring is normally positioned between the two plates when the chain is pulling down (see Photo 3.27). When the chain is pulling up, the spring is above the top plate (see Photo 3.28).

Photo 3.27

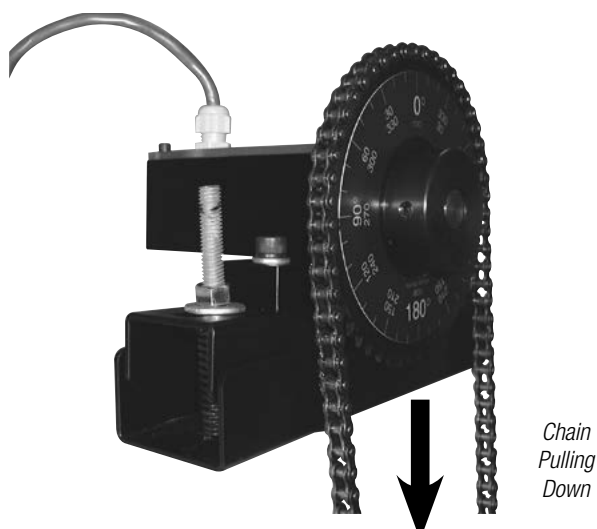
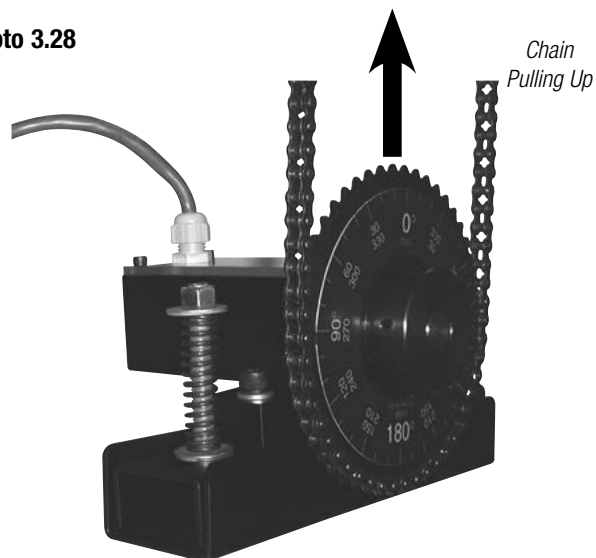

Photo 3.28



If a chain and sprocket drive already exists on a particular machine, it may be modified to drive the resolver. The resolver must always rotate exactly one revolution for each revolution of the machine crankshaft, therefore, the number of sprocket teeth must always match.

Note: If the press has a direct-coupling drive arrangement from the press or other timing device, the sprockets and spring-loaded base are not required. The spring base is furnished as a chain tightener, to help with misalignment and for shock isolation only. It is not used to detect chain breakage. The resolver has built-in motion detection that will sense if the sprocket stops rotating.

Roller Chain (If furnished)



Photo 3.29
Part No. CMS-515

Ten feet of ANSI No. 35 chain is usually furnished with each part-revolution control system. This chain is to be used with the supplied set of sprockets. A special master link for coupling the chain is furnished and this is used to connect the chain once the exact length has been determined.

(Continued on next page.)

SECTION 3—INSTALLATION OF COMPONENTS

SSC-1500 Part-Revolution Solid-State Control

Monitored Dual-Solenoid Air Valve (If furnished—See enclosed Manual KSL-036 or KSL-037)

A minimum of 30 to 40 PSI must be maintained at the valve for proper operation. Use pipe size at least as large as the valve ports. An accumulator (air surge tank) is recommended. It would be installed in the incoming air line directly ahead of the valve to assure sufficient air volume to the clutch and brake.

Photo 3.30
Monitored Dual-Solenoid
Air Valve

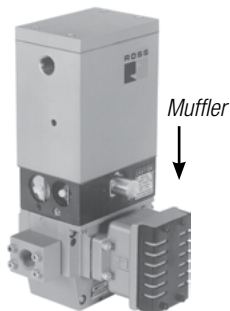

Part No. RCL-552— $\frac{1}{2}$ "

Part No. RCL-554— $\frac{3}{4}$ "

Photo 3.31
Monitored Dual-Solenoid Air
Valve With Remote Reset Button

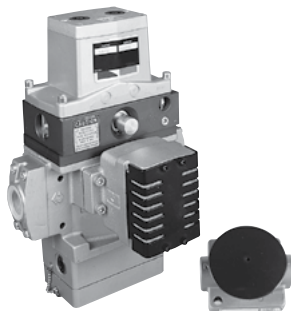

Part No. RCL-556—1"

Part No. RCL-558— $1\frac{1}{2}$ "



The exhaust air muffler must be kept clean at all times. Never operate the machine unless the muffler is clean. The muffler must be removed and cleaned on a regular basis. If the machine has a split clutch and brake, two valves may be required. Both valves must be monitored dual valves with an electrical output signal to the control to indicate when one valve may have failed.

Filter-Regulator-Lubricator (FRL) Assembly (If furnished—See enclosed Manual KSL-208)



Photo 3.32
Part No. RCL-044— $\frac{1}{2}$ "



Photo 3.33
Part No. RCL-045— $\frac{3}{4}$ "

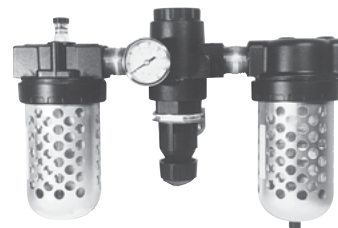

Photo 3.34
Part No. RCL-046—1"
Part No. RCL-047— $1\frac{1}{2}$ "

The filter cleans air that goes to the dual-solenoid air valve. The regulator and gauge are used to adjust air pressure to the proper amount to engage the clutch and release the brake. The lubricator keeps the dual-solenoid air valve or the clutch/brake properly lubricated.

Choose an appropriate location on the machine for mounting this assembly. If possible, it should be accessible from floor level.

The length of the air line run to the surge tank is not critical; however, the port and pipe sizes should be maintained.

The air filter must be kept clean at all times. Never operate the machine unless the air filter is clean. The lubricator must not be filled while under pressure.

(Continued on next page.)

Rockford Systems, LLC
Call: 1-800-922-7533

SECTION 3—INSTALLATION OF COMPONENTS

SSC-1500 Part-Revolution Solid-State Control

Air Pressure Switch (If furnished—See enclosed Manual KSL-165)



Photo 3.35
Part No. CTD-062

The clutch/brake air supply must be monitored by an air pressure switch on all part-revolution power presses. If an air counterbalance is used, it must also be monitored by a separate air pressure switch. Please check the machine owner's manual for the minimum suggested air pressure for these switches.

Mount this switch at any convenient location on the machine. Electrical and pneumatic connections to the switch are required; therefore, its location is determined by the installer. Flexible hose is often used for air connections. Since only air pressure is being monitored, tubing size can be small and length is not critical. The switch is set to open the electrical circuit any time pressure falls below the preset level. It is normally set in the 30 to 40 PSI range to prevent unnecessary opening due to a surge in line pressure during the clutch engaging period. The minimum setting for the air counterbalance pressure may be in the 20 to 30 PSI range (see machine manufacturer's recommendations).

Check Valve for Counterbalance System (If furnished—See enclosed Manual KSL-038)



Photo 3.36
Part No. RCD-061— $\frac{1}{2}$ "
Part No. RCD-062— $\frac{3}{4}$ "
Part No. RCD-063—1"
Part No. RCD-064— $1\frac{1}{2}$ "
Part No. RCD-065—2"

CAUTION Do not install this valve between the cylinders and tank.

If the machine is equipped with an air counterbalance system, a check valve is required by OSHA to prevent a sudden loss of air pressure to the system. This valve is available in various sizes. The size is determined by the pipe size of the incoming air supply to the air tank, which supplies the air to the counterbalance system. The valve should be installed in the air line just before the tank. When complete energy isolation is required, for maintenance on the machine or counterbalance system, be sure that air is released from the counterbalance, cylinders, tank, etc.

Palm Button Assembly (If furnished—See enclosed Manual KSL-073)



Figure 3.2
Part No. CTL-507

Black Run/Inch Button

Red Emergency-Stop Button

Black Run/Inch Button

Figure 3.3
Part No. CTL-502



Black Run/Inch Button

Yellow Top-Stop Button

Red Emergency-Stop Button

Black Run/Inch Button

(Continued on next page.)

SECTION 3—INSTALLATION OF COMPONENTS

SSC-1500 Part-Revolution Solid-State Control

Palm Button Assembly (continued)

1. When the modes of operation of *Two-Hand "Walk-Away" Continuous, Automatic Single Stroke, or Continuous-on-Demand* are required, a palm button assembly will consist of four buttons (two black run/inch buttons with ring guards, one red emergency-stop button, and one yellow top-stop button). Four mounting boxes are supplied (three double-hub and one single-hub). Optionally available are the Touchdown!™, chrome, or articulated light-push palm buttons. These may be furnished in place of the standard black run/inch palm buttons. These palm buttons can be assembled in the order shown in Figure 3.4 and mounted according to the requirement of the application. Nipples, conduit, and wire for connecting the mounting boxes are not furnished.

! Install the palm run buttons in such a way that they require the use of both hands to cycle the press.



**Not included in palm button assembly. Must be ordered separately.*

2. The two run palm buttons, on part-revolution-clutch machines, can be used to initiate a machine cycle and as a method of safeguarding the point of operation. In both instances, OSHA and ANSI have established certain requirements for these buttons. For your convenience we have reproduced the pertinent sections of OSHA 29 CFR 1910.217 as well as the safety distance formula for two-hand control from ANSI B11.1. These sections cover two-hand control as an initiating means and two-hand control as a point-of-operation safeguard for part-revolution-clutch presses.

Please read and make sure you understand the following sections before proceeding with the mounting of the two run buttons.

OSHA 29 CFR 1910.217 (b)(7)(v) for two-hand control used as a method of initiating a press cycle only:

- (v) Two-hand controls for single stroke shall conform to the following requirements:
 - (a) Each hand control shall be protected against unintended operation and arranged by design, construction, and/or separation so that the concurrent use of both hands is required to trip the press.
 - (b) The control system shall be designed to permit an adjustment, which will require concurrent pressure from both hands during the closing portion of the stroke.
 - (c) The control system shall incorporate an antirepeat feature.
 - (d) The control system shall be designed to require release of all operators' hand controls before an interrupted stroke can be resumed.

! The above description covers the use of two palm buttons as a method of actuating a press cycle. It does not provide any form of point-of-operation safeguarding. Some other properly applied and installed guard or device must be provided in accordance with OSHA 29 CFR 1910.217 (c) using the run palm buttons as an actuating means.

(Continued on next page.)

Rockford Systems, LLC
Call: 1-800-922-7533

SECTION 3—INSTALLATION OF COMPONENTS

SSC-1500 Part-Revolution Solid-State Control

Palm Button Assembly (continued)

OSHA 29 CFR 1910.217 for two-hand control used as a method of safeguarding the point of operation as follows:

(c)(3) Point of operation devices.

(i) Point of operation devices shall protect the operator by:

(e) Requiring the application of both of the operator's hands to machine operating controls and locating such controls at such a safety distance from the point of operation that the slide completes the downward travel or stops before the operator can reach into the point of operation with his hands;

(vii) The two-hand control device shall protect the operator as specified in paragraph (c)(3)(i)(e) of this section.

(a) When used in press operations requiring more than one operator, separate two-hand controls shall be provided for each operator, and shall be designed to require concurrent application of all operator controls to activate the slide. The removal of a hand from any control button shall cause the slide to stop.

(b) Each two-hand control shall meet the construction requirements of paragraph (b)(7)(v) of this section.
(See paragraph (b)(7)(v) on page 30.)

(c) The safety distance (D_s) between the two-hand control device and the point of operation shall be greater than the distance determined by the following formula: (Also, see Figure 3.5.)

$$D_s = 63 \text{ inches/second} \times T_s; \text{ where:}$$

D_s = minimum safety distance (inches);

63 inches/second = hand-speed constant; and

T_s = stopping time of the press measured at approximately 90° position of the crankshaft rotation (seconds).

(d) Two-hand controls shall be fixed in position so that only a supervisor or safety engineer is capable of relocating the controls.

Chart for OSHA Formula Only

T_s = Stopping Time in Seconds

D_s = Safety Distance for Two-Hand Control

Figure 3.5

T_s	D_s	T_s	D_s	T_s	D_s	T_s	D_s	T_s	D_s
.055	3½"	.158	10"	.261	16½"	.365	23"	.468	29½"
.063	4"	.166	10½"	.269	17"	.373	23½"	.476	30"
.072	4½"	.174	11"	.277	17½"	.380	24"	.484	30½"
.079	5"	.182	11½"	.285	18"	.388	24½"	.492	31"
.087	5½"	.190	12"	.293	18½"	.396	25"	.500	31½"
.095	6"	.198	12½"	.301	19"	.404	25½"	.507	32"
.103	6½"	.206	13"	.309	19½"	.412	26"	.515	32½"
.111	7"	.214	13½"	.317	20"	.420	26½"	.523	33"
.119	7½"	.222	14"	.325	20½"	.428	27"	.531	33½"
.126	8"	.230	14½"	.333	21"	.436	27½"	.539	34"
.134	8½"	.238	15"	.341	21½"	.444	28"	.547	34½"
.142	9"	.246	15½"	.349	22"	.452	28½"	.555	35"
.150	9½"	.253	16"	.357	22½"	.460	29"	.563	35½"
								.571	36"

*Based on the 63 inches/second hand-speed constant.

(Continued on next page.)

SECTION 3—INSTALLATION OF COMPONENTS

SSC-1500 Part-Revolution Solid-State Control

Palm Button Assembly (continued)

3. According to ANSI B11.1-2001, the total stopping time of the press (for two-hand control) should include the total response time of the control system and the time it takes the press to cease ram motion. The following formula should be used when calculating the safety distance:

$$D_S = K (T_S + T_C + T_R + T_{spm}); \text{ where:}$$

K = the hand speed constant = 63 inches/second.

T_S = stopping time of the press measured from the final deenergized control element (usually the air valve).

T_C = the reaction time of the control system.

Note: $T_S + T_C$ can be measured by a built-in stop-time measurement device.

T_R = the reaction time of the two-hand control and its interface.

Note: $T_S + T_C + T_R$ can be measured by a portable stop-time measurement device.

T_{spm} = the additional time allowed by the stopping performance monitor (brake monitor) before it detects stop-time deterioration.

When the press stroke stop command or stopping performance monitor (brake monitor) timer or angle setting is changed, because the machine is taking longer to stop, the safety distance should be recalculated. The safeguarding device should also be placed at a greater safety distance if the stopping time or distance has increased.

Note: When obtaining the stopping time using the ANSI formula, a stopping position of crankshaft rotation is not provided. (The OSHA formula uses 90°.) To calculate the safety distance, the stop signal should be given on the downstroke at a point that would provide the longest stopping time.



When applying the two run palm buttons to meet the requirements for a point-of-operation safeguarding device, make certain these buttons are located on the machine so they meet the minimum safety distance required by the OSHA or ANSI formulas.

Simply stated, safety distance is the mounting location of the palm buttons at a distance where the operator cannot reach into the point-of-operation hazard before the ram has stopped or completed its downward travel.

To obtain the stopping time at 90° position of crankshaft rotation, either the built-in system (provided with the control system) or a portable stop-time measurement unit can be used.

WHEN USING FOOT SINGLE STROKE, TWO-HAND “WALK-AWAY” CONTINUOUS, AUTOMATIC SINGLE STROKE, CONTINUOUS-ON-DEMAND, FOOT-MAINTAINED CONTINUOUS, AND ONE-HAND OR FOOT TRIP MODES OF OPERATION:

A method of safeguarding the point of operation must be provided before using any of the above modes of operation.

The machine will not operate or must not be operated until you either:

1. Electrically interlock or
2. Mechanically safeguard the machine's point of operation with a guard or device.

Install either the electrically interlocked method of safeguarding or the mechanical guard or device.

1. When an electrically interlocked method of safeguarding the point of operation is chosen, connect the interlock to the safeguard interlock terminals (P8-17 and P8-18) in the control box, and as shown on the control wiring schematic (wire numbers 86 and 87). If a light curtain is used as the point-of-operation safeguard, it does not need to be interlocked in to P8-17 and P8-18. Refer to the control wiring schematic for proper terminal connection.
2. When a mechanical guard or device (nonelectrically interlocked) is chosen, the safeguard interlock terminals (P8-17 and P8-18) are not used. In order for the machine to operate with the use of a mechanical guard or device, the safeguard interlock terminals must be connected.

Note: When the mechanical guard or device is removed for other modes of operation, the safeguard interlock terminals must be disconnected.

(Continued on next page.)

SECTION 3—INSTALLATION OF COMPONENTS

SSC-1500 Part-Revolution Solid-State Control

RED EMERGENCY-STOP BUTTON (REQUIRED)



Photo 3.37
Part No. CTC-736

The red emergency-stop button is used to stop the machine anywhere in its cycle. When the operator depresses the button, it should stop the hazardous motion of the machine immediately. This palm button assembly requires either a double-hub mounting box Part No. CTK-003, or a single-hub mounting box Part No. CTK-004. The button can be located between the two run palm buttons as part of the operator's control station (refer to page 30). A latch on the side trips when the button is pushed. To reset the button, push the latch in.

Note: More than one emergency-stop button may be furnished for additional control stations or for convenience.

YELLOW TOP-STOP BUTTON



Photo 3.38
Part No. CTC-727

The yellow top-stop button is used to stop the machine when it is in the "Walk-Away" *Continuous*, *Continuous-on-Demand*, or *Automatic Single Stroke* mode of operation. When the operator depresses the button, almost anywhere in the stroke of the machine, it will top stop; i.e., stop the machine at TDC (top dead center). This palm button assembly requires either a double-hub mounting box Part No. CTK-003, or a single-hub mounting box Part No. CTK-004. The button can be located between the two run palm buttons, along with the red emergency-stop button, as part of the operator's control station (refer to page 30).

PRIOR-ACTION STATION

The prior-action station has a push button that must be depressed and released by the operator before depressing the actuating means in order to initiate the *Continuous* automatic run type of press operation. This is sometimes referred to as "Walk-Away" *Continuous*. The prior-action station is also required when using the *Continuous-on-Demand*, *Automatic Single Stroke*, *Two-Hand-Maintained Continuous*, or *Foot-Maintained Continuous* mode of operation.

Mount the station on the machine so it is convenient for the operator to depress and release the prior-action push button prior to depressing the actuating means. It may be mounted as part of the operator's control station (see page 30). After releasing the button, the operator has a 5-second time period in which to depress the actuating means. If the operator should wait longer than this time setting, the prior-action push button must be depressed and released again.



Photo 3.40
Part No. LLD-1500

Continuous Mode of Operation

According to OSHA 29 CFR 1910.217 (b)(7)(viii):

"Those clutch/brake control systems which contain both single and continuous functions shall be designed so that completion of continuous circuits may be supervised by the employer. The initiation of continuous run shall require a prior action or decision by the operator in addition to the selection of Continuous on the stroking selector, before actuation of the operating means will result in continuous stroking."

According to ANSI B11.1-2001, Subclause 6.12.3.3.4, *Continuous*:

A press control system that provides a CONTINUOUS cycling (stroking) mode shall require the selection of the CONTINUOUS mode and a prior action or decision by the operator before operation of the actuating means will initiate continuous cycling (stroking).

(Continued on next page.)

SECTION 3—INSTALLATION OF COMPONENTS

SSC-1500 Part-Revolution Solid-State Control

PRIOR-ACTION STATION (continued)

Continuous-on-Demand Mode of Operation

According to ANSI B11.1-2001, Subclause 6.12.3.3.6, *Continuous-on-Demand*:

When a press control system provides a CONTINUOUS-ON-DEMAND cycling (stroking) mode:

- a) The enabling of CONTINUOUS-ON-DEMAND cycling (stroking) action shall require the selection of the CONTINUOUS-ON-DEMAND mode and a prior action or decision by the operator before operation of the manual actuating means either:
 - 1) manually initiates the first cycle (stroke), after which the demand signal for cycling (stroking) is enabled to initiate intervals of continuous cycling (stroking) as required, or
 - 2) directly enables the cycling (stroking) action to be initiated by the demand signal for cycling (stroking) without a manually initiated first cycle (stroke).
- b) A timer shall be provided to prevent cycling (stroking) in the CONTINUOUS-ON-DEMAND mode if the time between the demand signals for cycling (stroking) exceeds a predetermined time established by the user. Cycling (stroking) must be manually reenabled by the use of the procedure in 6.12.3.3.6 (a) when the predetermined time is exceeded.
- c) A STOP signal from any source shall stop any cycling (stroking) action of the press and shall prevent further cycling (stroking) until CONTINUOUS-ON-DEMAND is manually reenabled by use of the procedure in 6.12.3.3.6 (a).

Automatic Single Stroke Mode of Operation

According to ANSI B11.1-2001, Subclause 6.12.3.3.7, *Automatic Single Stroke*:

When a press control system provides an AUTOMATIC SINGLE STROKE mode:

- a) The enabling of AUTOMATIC SINGLE STROKE cycling (stroking) action shall require the selection of the AUTOMATIC SINGLE STROKE mode and a prior action or decision by the operator before operation of the manual actuating means either:
 - 1) manually initiates the first cycle (stroke), after which the automatic single cycle (stroke) signal is enabled to initiate single cycles (strokes) as required, or
 - 2) directly enables single cycles (strokes) to be initiated by the automatic single cycle (stroke) signal without a manually initiated first cycle (stroke).
- b) A timer shall be provided to prevent cycling (stroking) in the AUTOMATIC SINGLE STROKE mode if the time between automatic single cycle (stroke) actuation signals exceeds a predetermined time established by the user. Cycling (stroking) must be manually reenabled by the used of the procedure of 6.12.3.3.7 (a) when the predetermined time is exceeded.
- c) A STOP signal from any source shall stop any cycling (stroking) action of the press and shall prevent further cycling (stroking) until AUTOMATIC SINGLE STROKE is manually reenabled by use of the procedure in 6.12.3.3.7 (a).

Operator-Maintained (Two-Hand-Maintained or Foot-Maintained) Continuous Mode of Operation

According to ANSI B11.1-2001, Subclause 6.12.3.3.5, *Operator-Maintained Continuous*:

The initiation of OPERATOR-MAINTAINED CONTINUOUS shall require a prior action or decision by the operator, in addition to the selection of OPERATOR-MAINTAINED CONTINUOUS, before initiation of the actuating means will result in cycling (stroking) action. When the actuating means is released, the slide shall stop during the cycle (stroke) or at the completion of the cycle (stroke).

(Continued on next page.)

SECTION 3—INSTALLATION OF COMPONENTS

SSC-1500 Part-Revolution Solid-State Control

Palm Button Assembly (continued)

Control bars that include the palm buttons previously shown are also available. A control bar can include the emergency-stop and top-stop palm buttons, the multiple-operator supervisory selector switch and indicator light, and the prior-action push button. See the control bar wiring schematics for proper wiring.



Photo 3.40
Example of a Control Bar

A palm button assembly or control bar can be mounted on a floor stand. If two-hand control is used as a method of safeguarding the point of operation, the floor stand must be fixed into position at the required safety distance.

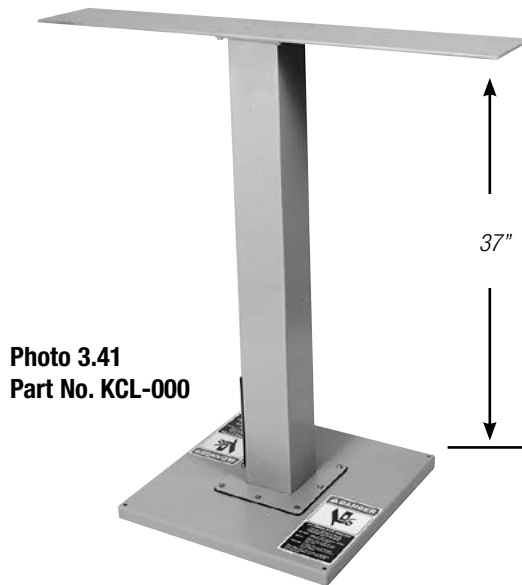

Photo 3.41
Part No. KCL-000



Photo 3.42
Part No. KCL-017

*Adjustable from
28" to 47" above
the floor*

(Continued on next page.)

SECTION 3—INSTALLATION OF COMPONENTS

SSC-1500 Part-Revolution Solid-State Control

Palm Button Assembly (continued)

Two-hand control is furnished with the SSC-1500 press control and can be used as a point-of-operation device. If it is going to be used as a point-of-operation device, the following function tests should be run before operating the press. These tests should be done at every setup, operator and shift change, as well as every time after maintenance is performed.

1. Before turning the machine on, verify that:
 - a. The hand controls are protected against unintended or inadvertent operation. This is usually done with ring guards or fabricated shields. (If the hand controls are nonmechanical such as capacitive or optical touch buttons, make sure that only an operator's hands can actuate them and not other parts of his or her body.)
 - b. The hand controls are separated by enough distance or configured to require the use of both hands.
 - c. The hand controls are fixed in position at the proper safety distance. (See pages 31–32 for details.)
 - d. Two individual hand controls are provided for each operator that is to be safeguarded by two-hand control. When there are multiple two-hand control stations, there must be an indicator at each station to indicate whether the station is on or off (usually accomplished with an indicator light), and the means of turning the station on and off must be supervisable (usually done with a key-operated selector switch).
2. With the main motor on, the flywheel rotating, the actuating means selector switch set to HAND, and the mode selector switch set to SINGLE, perform the following tests.
 - a. Actuate both hand controls and keep them actuated. The machine should make one complete cycle and then it should stop, even though the hand controls are still being actuated.
 - b. Actuate both hand controls and release them while the machine is still in the hazardous portion of its cycle. The machine should stop. Both hand controls must be continuously actuated during the hazardous portion of the cycle.
 - c. Actuate both hand controls and release only one control during the hazardous portion of the cycle. The hazardous motion of the machine should stop. Reactuate the hand control that was released. The machine should not finish the cycle. Repeat this with the other hand control. Again, the machine should not finish the cycle. Both hand controls must be released and reactivated before the machine can finish the cycle.
 - d. Actuate one hand control, wait until the anti-tie-down time limit has expired, and then actuate the other hand control. The machine should not cycle. The hand controls must be actuated concurrently within the programmed anti-tie-down setting (100–7000 ms) before a machine cycle can be initiated.
 - e. If the machine is equipped with multiple two-hand control stations, turn off all stations and make sure that the machine does not cycle. Also perform the above tests at each two-hand control station.
3. If any of these function tests fail, take corrective action before running production. If all tests pass, remove all keys from the selector switches before running production.

(Continued on next page.)

*Rockford Systems, LLC
Call: 1-800-922-7533*

Foot Switch (If furnished—See enclosed Manual KSL-001)



If you elect to use a foot switch, all personnel must be warned that it is impossible for a foot switch to provide any form of point-of-operation safeguarding. It is the responsibility of the employer (user) to always provide an appropriate guard and/or device to prevent bodily injury whenever a foot switch is used to initiate a machine cycle. (See OSHA 29 CFR 1910.217 (c) for safeguarding.)

The following steps should be taken when using a foot switch:

A method of safeguarding (light curtain, guard, gate, pullback, or restraint) the point of operation must be provided before installing or using a foot switch.

The machine will not operate or must not be operated until you either:

1. Electrically interlock or
2. Mechanically safeguard the machine's point of operation with a guard or device.



Photo 3.43
Part No. CTD-011

Install either the electrically interlocked method of safeguarding or the mechanical guard or device.

1. When an electrically interlocked method of safeguarding the point of operation is chosen, connect the interlock to the safeguard interlock terminals (P8-17 and P8-18) in the control box and as shown on the control wiring schematic (wire numbers 86 and 87). If a light curtain is used as the point-of-operation safeguard, it does not need to be interlocked in to P8-17 and P8-18. Refer to the control wiring schematic for proper terminal connection.
2. When a mechanical guard or device (nonelectrically interlocked) is chosen, the safeguard interlock terminals (P8-17 and P8-18) are not used. In order for the machine to operate with the use of a mechanical guard or device, the safeguard interlock terminals must be connected.

Note: When the mechanical guard or device is removed for other modes of operation, the safeguard interlock terminals must be disconnected.



Never use a foot switch to operate this machine unless a point-of-operation guard or device is provided and properly maintained.



The mechanical guard or device must be properly installed, used and maintained. It must always prevent all personnel from bodily injury.



If the mechanical guard or device is not used, is removed or is defeated, an electrically interlocked method of safeguarding must be used and connected to the safeguard interlock terminals P8-17 and P8-18.

When installing the optional foot switch, be sure the wiring schematics are referenced for proper connections. Be sure to maintain the foot switch in first-class condition. It must always be wired properly and the protection on the top, sides, and front must always remain in place.

(Continued on next page.)

SECTION 3—INSTALLATION OF COMPONENTS

SSC-1500 Part-Revolution Solid-State Control

Supervisory Control Station (If furnished)

When two or more palm button or foot switch operating stations are required on one machine, one supervisory control station is required at each operator station. This remote control station consists of one station on indicator light and an off/on keyed selector switch in an enclosure. The on position allows the operator to use that station and the off position deactivates only that station. If all the supervisory control stations are in the on position, the palm buttons or foot switches must be depressed within the timing period set in the anti-tie-down program (pages 68-69) in order to initiate a machine stroke.

Note: If the USC-000 multiple-operator junction box is used, the anti-tie-down setting in the SSC-1500 control becomes irrelevant, since the junction box has its own timers.



Photo 3.44
Supervisory Station
Part No. LLD-1501
Part No. LLD-283 (Required when USC-000 multiple-operator junction box is used; see below)

Multiple-Operator Junction Box (If furnished—See enclosed Manual No. KSL-266)

When multiple operator stations are required, this junction box is furnished separately for wiring up to four (4) operator stations. This junction box interfaces palm button assemblies/control bars and foot switches, and will not allow the press to run if palm buttons or a foot switch is actuated without its supervisory control station on. Refer to the electrical schematic furnished with your order for proper wiring of each station.



Photo 3.45
Multiple-Operator Junction Box
Part No. USC-000

Bar/Run Station (If furnished)

This remote bar/run station can be used in conjunction with manual turnover bar operation when setting dies in the press. The flywheel must have holes in the periphery for insertion of the spring-loaded turnover bar (or the flywheel can be manually turned when the flywheel cover is removed). The remote station includes a three-position selector switch for bar, off, run, and one push button used for energizing the dual-solenoid air valve to engage the clutch and release the brake. The flywheel must be at rest (static) when engaging the clutch. After the clutch is engaged, the die set-up person can manually turn the flywheel with the spring-loaded turnover bar. This then causes the ram to move.



Photo 3.46
Remote Bar/Run Station
Part No. LLD-1502

(Continued on next page.)

Rockford Systems, LLC
Call: 1-800-922-7533

Other Components That Could Be Interfaced to the Control

Interlocked Guard	Feed System	Die Light
Light Curtain*	Bumper Pin	Conveyor
RF Device*	Flywheel Brake*	Motion Detector*
Gate*	Tachometer*	Bearing Heat Sensors*
Air Blowoff	Digital Shut-Height Indicator*	Overload Protection*
Additional Counters	Brake Monitor*	Robot*
Indexing Table*	Hour Meter	Additional Programmable Limit Switch*
Sliding Bolster*	Material Feeding Equipment*	Safety Block Electrical Interlock System
Additional Die Protection*	Material Straightener	Lubrication System*
Bar/Run Station	Reel Cradle for Coil	

*The electrical or electronic schematics are required if Rockford Systems is to interface this equipment to the control.

Other Components That May Be Required

AIR LOCKOUT VALVE (If furnished—See enclosed Manual KSL-098)

OSHA 29 CFR 1910.147 requires that all employers develop a complete hazardous energy control program. This standard covers the servicing and maintenance of machines and equipment where the unexpected energization or start-up of the machines or equipment, or release of stored energy could cause injury to employees. The following should be included when establishing a program:

1. Use procedures for affixing lockout or tagout devices to energy isolating devices. Also, disable machines or equipment to prevent unexpected energization, start-up, or release of stored energy in order to prevent injury to employees.
2. After establishing a hazardous energy control program, periodic inspection of the energy control procedure must be done at least annually.
3. Training of employees to ensure the purpose and function of the energy control program is understood.
4. When establishing procedures for shutdown:
 - Identify all energy sources.
 - Know the hazards of the energy to be controlled.
 - Determine the methods or means to control energy.
5. Hazardous energy sources associated with machinery are:
 - Electrical
 - Pneumatic
 - Hydraulic
 - Fluids and Gases
 - Mechanical

INSTALLATION OF LOCKOUT VALVE

When ready to install a lockout valve (if furnished), remove plastic dust covers from the valve port connections. Avoid getting particles such as chips, sealing compounds, or scale in the piping. This can cause valve failure and damage. See Figure 3.6 on page 40 for a diagram of where the lockout valve could be located and for additional instructions on installing lockout valves.

(Continued on next page.)

SECTION 3—INSTALLATION OF COMPONENTS

SSC-1500 Part-Revolution Solid-State Control

Figure 3.6

Illustration of where an air lockout valve could be located in the air line on part-revolution power press

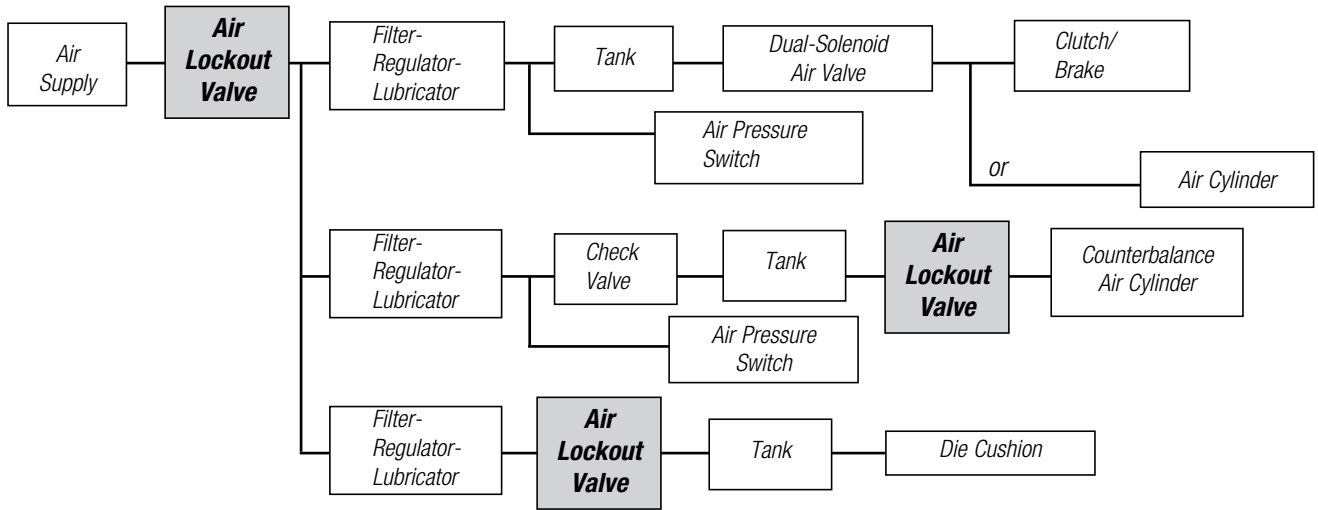

Manual Valve

This valve is installed in the air line going to the machine. To exhaust air in the line, the handle is pushed in. This valve is available in port sizes $\frac{3}{4}$ " and 1".

Photo 3.36

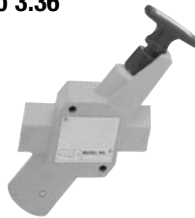

Manual Pilot Valve

This valve is used for air systems that are larger than those that can be used with the manual valve. Port sizes are $1\frac{1}{2}$ " and $2\frac{1}{2}$ ".

Photo 3.37



Slide-Operated Valve

This three-way valve is opened with the manual movement of a slide that opens and closes the valve. This valve shuts off air at the press and then bleeds off downstream air. This valve is available in port sizes $\frac{1}{2}$ " and $\frac{3}{4}$ ".

Photo 3.38



EEZ-On Valve

This valve shuts off air supply to the machine and bleeds downstream air when the valve is closed. When the valve is open, it gradually allows air into the air system to prevent damage to air components. It can be locked only in the off position. This valve is available in port sizes $\frac{3}{8}$ ", $\frac{1}{2}$ ", and $\frac{3}{4}$ ".

Photo 3.39



Note: When any of these valves are manually closed, the downstream air is automatically drained, provided there is not a check valve or obstruction in the air line.

(Continued on next page.)

Rockford Systems, LLC
Call: 1-800-922-7533

SECTION 3—INSTALLATION OF COMPONENTS

SSC-1500 Part-Revolution Solid-State Control

TYPES OF LOCKOUT VALVES THAT CAN BE FURNISHED (continued)

Figure 3.7

VALVE TYPE	PART NUMBER	IN/OUT PORT	EXHAUST PORT	VALVE BODY WITHOUT MUFFLER	MUFFLER
Manual	RCD-076	3/4"	1"	RCD-086	RCS-044
	RCD-077	1"	1"	RCD-087	RCS-044
Manual Pilot	RCD-078	1 1/2"	1 1/2"	RCD-088	RCS-006
	RCD-079	2 1/2"	2 1/2"	RCD-089	RCS-038
Slide-Operated	RCD-113	1/2"	N/A	N/A	N/A
	RCD-114	3/4"	N/A	N/A	N/A
EEZ-On	RCD-121	1/2"	3/4"	RCD-118	RCS-043
	RCD-122	3/4"	3/4"	RCD-119	RCS-043

MAIN POWER DISCONNECT SWITCH

A main power disconnect switch may have been supplied in this control package shipment as a separate component or included in a custom or special control box. This switch is designed to disconnect the primary voltage to the press and lock it out. Please refer to the enclosed wiring schematics for proper wiring of this switch.

OSHA 29 CFR 1910.217 (b)(8) and ANSI B11.1 require that:

1. A main power disconnect switch capable of being locked in the off position shall be provided with every power press control system.
2. If the machine already has a main power disconnect switch, it must be checked for the "locking off" feature. Some switches use construction which can be easily altered mechanically to comply with this requirement. If this is not possible, or an electrical disconnect switch is not provided, then you must obtain and install a proper disconnect switch. (For a proper disconnect switch, please contact Rockford Systems.)

MOTOR STARTER

A reversing or nonreversing motor starter may have been supplied with this control package as a separate component or included in a custom or special control box. The main purpose of this starter is to start and stop the main motor and to drop out the main motor when a power failure occurs. Please refer to the enclosed wiring schematics for proper wiring of this starter. If an existing starter is used, a 120-V AC coil and N.O. auxiliary (main motor forward) contact are required.

OSHA 29 CFR 1910.217 (b)(8) and ANSI B11.1 require that:

1. The motor start button shall be protected against accidental operation.
2. All mechanical power press controls shall incorporate a type of drive motor starter that disconnects the drive motor from the power source in the event of control voltage or power source failure. It shall also require operation of the motor start button to restart the motor when voltage conditions are restored to normal.

These requirements are normally met by using a magnetic motor starter. This starter should operate with a 120-V AC coil which is powered from the secondary of the control transformer on the control panel. Refer to the electrical schematics supplied to obtain details of how to wire the starter and associated motor start/stop push buttons.

For proper tie-in of the furnished clutch/brake controls, the starter requires an auxiliary normally open contact. (For a proper starter, please contact Rockford Systems.)

CUSTOM OR SPECIAL CONTROL BOX

In place of the standard control box previously described, you may have ordered and received a custom or special control box. This box usually includes a magnetic motor starter and disconnect switch complying to the previously described requirements. Be sure to wire in primary voltage and components to terminals as indicated on the enclosed wiring schematics. 120-V electrical power to clutch/brake controls, operator controls, solenoids, etc., must be obtained from a transformer with isolated secondary.

(Continued on next page.)

SECTION 3—INSTALLATION OF COMPONENTS

SSC-1500 Part-Revolution Solid-State Control

FLYWHEEL AND GEAR COVERS

According to OSHA 29 CFR 1910.219 and ANSI B15.1 for mechanical power-transmission apparatus, all rotating components including flywheels, gears, sprockets and chains, sheaves and belts, shaft ends, etc., must be covered if at or below a seven-foot level from the floor or platform. *Note: ANSI states it should be a nine-foot level.* Adequate cover material and brackets must be fabricated to retain these components in event of shaft or wheel mounting failure.

COLLATERAL EQUIPMENT

All collateral press room and plant equipment such as spring or air slide counterbalances, die cushions, feeding equipment, and robots must be safeguarded if they create hazards to personnel.

POINT-OF-OPERATION SAFEGUARDS

OSHA 29 CFR 1910.217 (c)(1)(i) states:

“It shall be the responsibility of the employer (user) to provide and insure the usage of ‘point of operation guards’ or properly applied and adjusted point of operation devices on every operation performed on a mechanical power press. See Table O-10.”

Refer to Section 9, pages 91-92, for examples of point-of-operation safeguards for power presses.

Other Installation Considerations

PIPING

1. An air lockout valve must be installed in the air line usually just before the filter-regulator-lubricator assembly to meet OSHA 29 CFR 1910.147 Lockout/tagout requirements. However, a separate lockout valve could be furnished for each air system on the machine such as counterbalance, die cushion, clutch/brake, air cylinder, and blow-off.
2. From the lockout valve, connect at the In threaded opening of the filter-regulator. Try to maintain an appropriate pipe size throughout for proper air flow. Connect the piping to the ports using teflon tape on the male threads only. Do not allow tape to enter the interior of the filter-regulator-lubricator, valve, or air cylinder. Before applying air pressure, make sure the filter and regulator bowls are at least hand tight.
3. Most approved pipe or hose can be used on the press. Make sure the size is consistent throughout the system in order to avoid restriction. Keep air runs as short as possible.
4. See enclosed filter-regulator-lubricator (FRL) assembly Manual No. KSL-208 for additional details.

CAUTION

require clean air. Blow all lines clean of water, dirt, scale, etc., before making final connection. Drain water from filter bowl regularly. Should this bowl refill in a short period of time, it may indicate the need for a larger filter in the main air supply line or an air line dryer system. The air filter must be kept clean at all times. Never e unless the air filter is clean and water is drained.

WIRING

National Electrical Code and NFPA 79 practices are usually followed for wiring the control system, which includes color-coding and the use of numbered wire markers on both ends of every wire. Color-coding is black for line voltage (208, 230, 460, or 575 V) and control at line voltage, red for 120-V AC control circuits, blue for 24-V DC control circuits, white for current-carrying ground (commonly referred to as the neutral), and green for any equipment grounding conductor. All terminal blocks in the control cabinet are color-coded for easy identification.

- a. Install and wire the main disconnect switch (unless one already exists or is furnished in a custom control) using black wire. Follow wiring instructions shown on the electrical schematics. Make certain this switch is capable of being locked in the off position only.

(Continued on next page.)

Rockford Systems, LLC
Call: 1-800-922-7533

SECTION 3—INSTALLATION OF COMPONENTS

SSC-1500 Part-Revolution Solid-State Control

WIRING (continued)

- b. Install and wire the motor starter (unless one already exists or is installed in a custom control box) using black wire for the power, red and white wires for the coil and interlock circuit, and blue for the motor forward connection to the control module.

If an existing starter does not have a 120-V AC coil, a new 120-V AC coil must be obtained, installed and wired in accordance with the schematics provided before proceeding. An additional auxiliary normally open contact may also be required in the starter. (Do not run a separate 120-V line to the machine for operating the clutch/brake controls.)

- c. All necessary inputs and outputs to the control module are prewired from the printed circuit board terminals to the color-coded terminal strips for installation. No wiring on the printed circuit board terminals is necessary.
- d. Run two black power lines (any two lines) from the load side of the disconnect switch (or from the line side of the motor starter) to the control enclosure. Connect the two black wires to the proper terminals on the control transformer (see electrical schematic or transformer nameplate for proper connections for different primary voltages).

Note: If a custom control box with a disconnect has been provided, this step is not necessary.

- e. Run a green ground wire from the incoming system ground to the control panel.
- f. Wire the motor starter and start/stop controls according to the connection schematics. *Note: If a custom control box with a starter has been provided, this step is not necessary.*
- g. To wire the dual-solenoid air valve, see the enclosed Installation Manual No. KSL-036 or KSL-037 and the wiring schematics. The exhaust air muffler must be kept clean at all times. Never operate the machine unless the muffler is clean.

KEYPAD/DISPLAY ASSEMBLY

Refer to page 22 for the wiring of the keypad/display assembly.

RESOLVER/PULSER ASSEMBLY

Refer to pages 25-26 for the wiring of the resolver/pulser assembly.

AIR PRESSURE SWITCH(ES) (See page 29)

Run ½" nominal conduit from pressure switch(es) to the control box. Pull the appropriate number of wires through conduit. Number the wires according to the diagram and connect to terminals at both ends. These pressure switches always use the normally open contact which is held closed by normal air pressure. Loss of air pressure will open this contact and render the control inoperative. The normally closed contact provides a signal to one of the user-programmable diagnostic inputs.

PALM BUTTON ASSEMBLY (See pages 29-36)

These are normally wired as an assembly with the blue wires routed from the control box to the nearest palm button and then the others, as required. Wires between the two run/inch buttons are not connected back to the control box. If Touchdown!TM (proximity) palm buttons are furnished, please refer to the enclosed Installation Manual No. KSL-073 and the connection print provided.

If the palm button assembly is not bolted directly to the machine frame, then a separate green ground wire should be run from the control box to all palm buttons. Attach one end of the wire to each mounting box by a lug under one of the mounting bolts and the other end of the wire to the GND terminal in the control box to assure proper grounding.

(Continued on next page.)

SECTION 3—INSTALLATION OF COMPONENTS

SSC-1500 Part-Revolution Solid-State Control

WIRING (continued)

PALM BUTTON ASSEMBLY (continued)

These operator controls should be mounted in a convenient location, keeping ergonomics in mind. To comply with the OSHA standard for two-hand control, the run/inch buttons must be located according to the minimum safety distance requirements of each individual machine as defined by OSHA 29 CFR 1910.217 (c)(3)(vii) (see page 31 of this manual). A stop-time measurement is necessary for checking stopping time before installation begins to determine the safety distance of the two-hand control palm buttons furnished with the control. After installation, the stopping time can be obtained from the built-in stop-time measurement system or a portable stop-time measurement unit.

CONTROL BAR (See page 35)

Mount the control bar at the required safety distance either on the machine or on a floor stand. See the wiring schematics for proper wiring of the control bar.

FOOT SWITCH (See page 37)

Run ½" nominal flexible conduit or cord from the foot switch to the control box. Connect the contacts according to the control drawing schematic. In general, connect one wire from one side of the normally open and normally closed contacts to a COM terminal, and a wire from the other side of each contact to the appropriate control module input terminal. If multiple foot switches are used, the COM connection may be split up. Refer to the multiple operator drawing for wiring details. Be sure to connect the ground in the foot switch to the GND terminal in the control box with a green wire.

SUPERVISORY CONTROL STATION (See page 38)

Mount the station in a convenient location where it is easily accessible, or as part of a palm button assembly (see page 30). See the wiring schematic for proper wiring of the supervisory control station.

MULTIPLE-OPERATOR JUNCTION BOX (See page 38)

Run ¾" nominal conduit from the junction box to the control box. Pull the cable through the conduit and connect it to the appropriate terminals according to the junction box drawing. Connect each supervisory control station to the multiple-operator junction box with the cable. *Note: The junction box should be located for easy access to the fault reset button in case a fault should occur.*

BAR/RUN STATION (See page 38)

Run ½" nominal conduit from the bar/run station to the control box. Pull red wires through the conduit according to the drawing. *Note: The bar/run station should be located for easy access to the bar push button while barring the press.*

*** PRESS GROUND ***



The machine frame must always be firmly connected to ground in order to avoid problems with the control and to ensure the control potential will never exceed 120 V above ground. Run a green grounding wire from the control box to some convenient location directly on the machine frame. Connect one end solidly to the frame using a mounting bolt or other convenient means of attachment. Scrape any paint, rust, etc., from the area to ensure an adequate ground connection. Connect the other end to the GND terminal in the control box.

Note: All exposed metal components, which may be touched by personnel during normal operation or adjustment, must be firmly grounded to the machine frame. The disconnect switch and motor starter should also be grounded if they are mounted separately.

(Continued on next page.)

Rockford Systems, LLC
Call: 1-800-922-7533

Setup of Control System

The flowchart in Figure 4.1 outlines the order and method of setting up and programming the SSC-1500 press control system on a part-revolution press after installation. Refer to the display on the control box or on the remote operator station.

Figure 4.1
Programming Flowchart

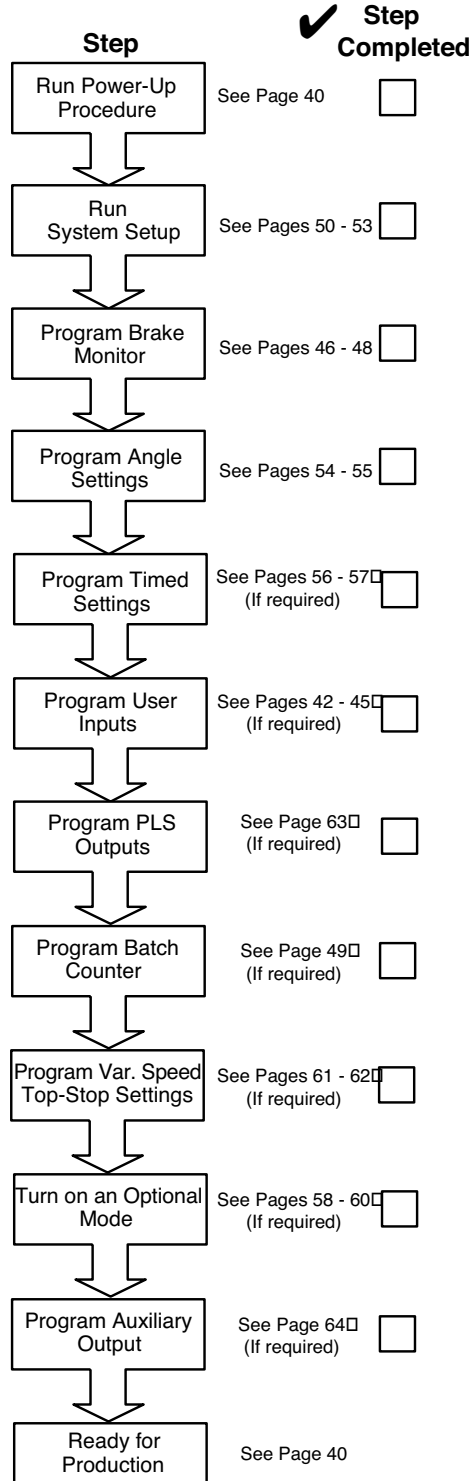

(Continued on next page.)

SECTION 4—PROGRAMMING

SSC-1500 Part-Revolution Solid-State Control

Power-Up Procedure

After completing the installation of the control box and control components, the SSC-1500 press control system must be initially programmed according to the flowchart in Figure 4.1 on page 45 to get the machine up and running. Before programming, the control must first be powered up.

Turn the main power disconnect switch for the control to the ON position and start the main motor. After detecting the network for a few seconds, the current main CPU software version is displayed on the WAKE-UP SCREEN. See Figure 4.2. If safeguards are in place, press YES on the keypad and proceed.

Main Run Screen Overview

The MAIN RUN SCREEN displays the crankshaft angle (in degrees), speed of the press (in SPM), batch counter, stroke counter, mode of operation, and stop time (in milliseconds). See Figure 4.3.

The MAIN RUN SCREEN will be displayed whenever ON is selected on the program off/on selector switch.

When OFF is selected on the mode selector switch, the control will not allow the machine to run and the CONTROL OFF SCREEN will be displayed. See Figure 4.4.

Figure 4.2
Wake-Up Screen



Figure 4.3
Main Run Screen

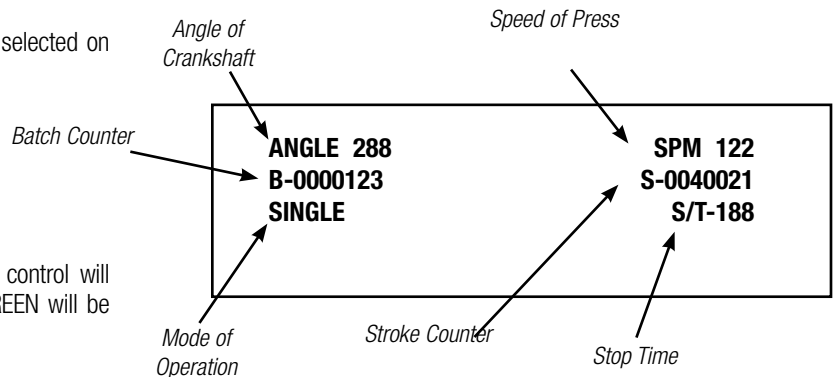
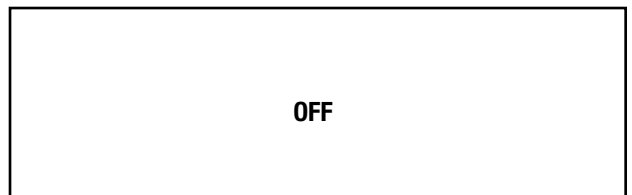

Figure 4.4
Control Off Screen



(Continued on next page.)

Rockford Systems, LLC
Call: 1-800-922-7533

Programming Overview

The following sections outline the programming of the SSC-1500 press control on a part-revolution press after installation of all components has been completed, and the *Power-Up Procedure* and *Main Run Screen Overview* sections of this manual have been read and understood.

MAIN PROGRAM SCREENS

The SSC-1500 press control has three main programming screens from which you can access all of the programmable features of the control.

To program the control, select the ON position of the program off/on selector switch. The first MAIN PROGRAM SCREEN will be displayed.

On the screen, a pound symbol (#) will be next to one of the following program options from the list as shown. USER INPUTS is at the top of the list. See Figure 4.5.

Use ↓ and ↑ on the keypad to scroll through the program options. If you press ↓ when the pound symbol (#) is next to SYSTEM SETUP, the second MAIN PROGRAM SCREEN will be displayed. See Figure 4.6. If you press ↓ when the pound symbol (#) is next to VAR SPD SETTINGS, the third MAIN PROGRAM SCREEN will be displayed. See Figure 4.7.

When the pound symbol (#) is next to the program option you want to edit, press ENTER. Once the new information is input and ESC is pressed, the display returns to the MAIN PROGRAM SCREEN. If incorrect information has been entered, return to the setting and reenter the correct information.

Each program option is described in detail on the following pages.

USER INPUTS	48-51
BRAKE MONITOR	52-54
COUNTERS	55-56
SYSTEM SETUP	57-65
ANGLE SETTINGS	66-67
TIMED SETTINGS	68-69
OPTIONAL MODES	70-72
VARIABLE-SPEED SETTINGS	73-74
PLS OUTPUTS	75
AUXILIARY OUTPUT	76-77

Photo 4.1
Keypad/Display
With Program Off/
On Selector Switch



Figure 4.5
First Main Program Screen

- #1. USER INPUTS**
- 2. BRAKE MONITOR**
- 3. COUNTERS**
- 4. SYSTEM SETUP**

Figure 4.6
Second Main Program Screen

- #5. ANGLE SETTINGS**
- 6. TIMED SETTINGS**
- 7. OPTIONAL MODES**
- 8. VAR SPD SETTINGS**

Figure 4.7
Third Main Program Screen

- #9. PLS OUTPUTS**
- 0. AUXILIARY OUTPUT**

(Continued on next page.)

SECTION 4—PROGRAMMING

SSC-1500 Part-Revolution Solid-State Control

USER INPUTS

The SSC-1500 press control has eight (8) programmable user inputs (5 static-type inputs and 3 static- or cyclic-type inputs) that can be programmed for equipment monitoring or other user-defined functions. User Inputs 4 and 5 can be used as individual static inputs or they can be paired together (see bottom of page 49), and User Input 6 can be used either as a static input or as a part-in-place cyclic input (see top of page 50).

Static-type means that when the inputs are set to be on, they are continuously monitoring for a change of state in the logic. When a change of state occurs, the input will go true, and the control will stop the press. The static-type inputs are intended to diagnose fault conditions of auxiliary equipment specific to the machine, such as clutch/brake air pressure fault, counterbalance air pressure fault, and dual solenoid fault.

Cyclic-type means that when the inputs are set to be on, in addition to monitoring for a change of state in the logic, they are also monitoring for a change during the programmed Open and Close Angle window for each stroke.

There are three (3) parameters that can be programmed for the five static-type inputs, and six parameters that can be programmed for the three static- or cyclic-type inputs. All inputs are 24-V DC current-sinking (NPN) inputs. When Input 6 is used as a static-type input, there are three parameters that can be programmed. When it is used as a cyclic part-in-place input, there is only one programmable parameter; the others are fixed and cannot be changed.

PROGRAMMABLE PARAMETERS FOR USER INPUTS 1-5

1. Logic: This setting is used to change the logic that activates the input. The programming choices are N.O. (normally open), N.C. (normally closed), and OFF (disabled). Select one setting for each input.
2. Stop Type: When the input is activated or goes true, the press cycle will stop in one of two ways. E-STOP (emergency stop) will immediately stop the cycle in progress. T-STOP (top stop) will stop the cycle in progress at TDC (top dead center). Select the type of stop that is required for each input.
3. Message: When the input is activated, a fault message is displayed. This fault message is assigned to the input according to its function. Figure 4.8 shows a list of fault messages that can be assigned to each input.

Figure 4.8
User Input Fault Messages

CLUTCH/BRAKE AIR FLT
CNTRBALANCE AIR FLT
DUAL SOLENOID FAULT
CLUTCH VALVE FAULT*
BRAKE VALVE FAULT*
LUBE FAULT
HIGH LUBE PRESSURE
LOW LUBE PRESSURE
LOW LUBE LEVEL
MAIN MOTOR OVERLOAD
RAM ADJ MTR OVERLOAD
LUBE MOTOR OVERLOAD
AUX MOTOR OVERLOAD
GUARD INTERLOCK OPEN
FRONT GUARD OPEN
REAR GUARD OPEN
LEFT SIDE GUARD OPEN
RIGHT SIDE GRD OPEN
FEEDER FAULT
LOAD MONITOR FAULT
SAFETY BLK INTERLOCK
SHUT HEIGHT FAULT
VAR SPEED DRIVE FLT
DIE PROTECTION FAULT**
SHORT FEED FAULT**
PART EJECTION FAULT**
STOCK BUCKLE FAULT**
END OF STOCK FAULT**
PILOT PIN FAULT**
PART INPUT #1**
PART INPUT #2**
PART INPUT #3**

***Only used with machines that have a split clutch and brake, and two dual valves have been furnished**

****Messages typically used for die protection**

(Continued on next page.)

Rockford Systems, LLC
Call: 1-800-922-7533

HOW TO PROGRAM USER INPUTS 1-5

Select the ON position of the program off/on selector switch. One of the MAIN PROGRAM SCREENS will be displayed.

Use ↓ and ↑ on the keypad to scroll through the program options. Press ENTER when the pound symbol (#) is next to USER INPUTS. The FIRST USER INPUTS SCREEN will be displayed. See Figure 4.9.

Use ↓ and ↑ on the keypad to scroll through the user inputs. If you press ↓ when the arrow symbol (>) is next to INPUT #4, the second USER INPUTS SCREEN will be displayed. See Figure 4.10. Press ENTER when the arrow symbol (>) is next to the user input you want to program. The PROGRAMMABLE PARAMETERS SCREEN shown in Figure 4.11 will be displayed.

Use ↓ and ↑ on the keypad to scroll through the programmable parameters. Press ENTER when the double arrow symbol (>>) is next to the parameter you want to program. A screen similar to the one shown in Figure 4.12 will be displayed.

Once you are in the programming screen of the parameter you want to program, use ↓ and ↑ on the keypad to reach the setting you desire for that parameter. Press ENTER to finish.

Press ESC to return to the MAIN PROGRAM SCREEN.

Note: The appropriate user input terminals in the control box must be wired into so they correspond to the assigned fault messages. If the order of the messages is changed or if other fault messages are assigned, the connections to the terminal strip must also be rearranged to reflect the changes.

USER INPUTS 4 and 5 (When paired together)

For additional reliability, User Inputs 4 and 5 can be paired together to monitor two devices linked together, such as two contacts on a guard interlock switch. When the inputs are paired together, the control will look for both inputs to change state at the same time. If they do, the control will stop the press and the programmed fault message for the pair will be displayed. If they do not, the same will happen, but then a fatal fault will occur (see page 80) with the message "invalid pair signals" displayed.

To pair the inputs together, the logic for User Input 4 must be set to either N.O.(PAIR) for normally open or N.C.(PAIR) for normally closed. The stop type and fault message for the pair are programmed using User Input 4 as well.

Note: When the inputs are paired together, you will not be able to make programming changes to User Input 5 until the inputs are unpaired by changing the logic for User Input 4 to OFF, N.O., or N.C.

Figure 4.9
First User Inputs Screen

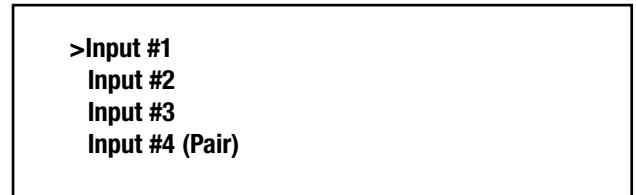

Figure 4.10
Second User Inputs Screen

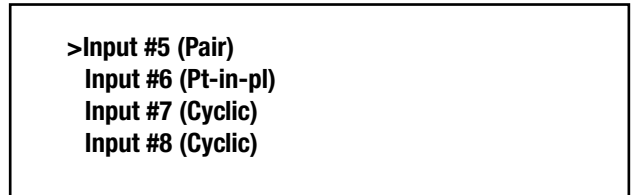
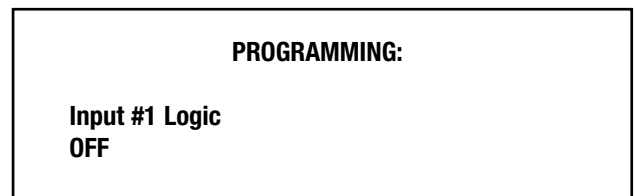

Figure 4.11
Programmable Parameters



Figure 4.12
Example of a Programming Screen



SECTION 4—PROGRAMMING

SSC-1500 Part-Revolution Solid-State Control

USER INPUT 6 (When used as a part-in-place cyclic input)

User Input 6 can be used as a static-type input or as a cyclic-type part-in-place input. When used as a static-type input, it is programmed the same as User Inputs 1-5—refer to the previous instructions.

When used as a part-in-place input, the logic must be set to either N.O.(PT-IN-PL) for normally open or N.C.(PT-IN-PL) for normally closed. When either of these is chosen, the stop type will be fixed to E-STOP (emergency stop), and the message will be fixed to PART-IN-PLACE FAULT.

When in the *Single Stroke* mode of operation, the logic will not allow a stroke to begin if the input is not true. Once the stroke is started, the input must stay true until the auto up (holding) angle is reached. If the input does not stay true, the press will E-stop and a PART-IN-PLACE FAULT message will be displayed.

Note: The auto up (holding) angle should not be set at an angle greater than the angle at which the workpiece is contacted by the upper die—if it is, nuisance faults may occur.

PROGRAMMABLE PARAMETERS FOR USER INPUTS 7-8

1. Logic: This setting is used to change the logic that activates the input. The programming choices are N.O. (normally open), N.C. (normally closed), and OFF (disabled). Select one setting for each input.
2. Stop Type: When the input is activated or goes true, the press cycle will stop in one of two ways. E-STOP (emergency stop) will immediately stop the cycle in progress. T-STOP (top stop) will stop the cycle in progress at TDC (top dead center). Select the type of stop that is required for each input.
3. Message: When the input is activated, a fault message is displayed. This fault message is assigned to the input according to its function. Figure 4.13 shows a list of fault messages that can be assigned to each input.
4. Die Protect Mode: There are three different die protection modes—these modes determine what the control expects the input to do between the programmed Open and close Angles for each stroke. The three mode settings are MODE 1, MODE 2, and MODE 3.

MODE 1: The control will look for the input to change state and go true between the programmed Open and Close Angles for each stroke. Anything else that happens after the input goes true will be ignored.

MODE 2: The control will look for the input to change state and go true between the programmed Open and Close Angles for each stroke, but once the input has gone true, it will have to be maintained until the Close Angle is reached or a fault will be generated.

MODE 3: The control will look for the input to have already changed state and be true when the Open Angle is reached. The input will then have to be dropped and reinitiated between the programmed Open and Close Angles, and it will then have to be maintained until the Close Angle is reached or a fault will be generated.

Figure 4.13
User Input Fault Messages

CLUTCH/BRAKE AIR FLT
CNTRBALANCE AIR FLT
DUAL SOLENOID FAULT
CLUTCH VALVE FAULT*
BRAKE VALVE FAULT*
LUBE FAULT
HIGH LUBE PRESSURE
LOW LUBE PRESSURE
LOW LUBE LEVEL
MAIN MOTOR OVERLOAD
RAM ADJ MTR OVERLOAD
LUBE MOTOR OVERLOAD
AUX MOTOR OVERLOAD
GUARD INTERLOCK OPEN
FRONT GUARD OPEN
REAR GUARD OPEN
LEFT SIDE GUARD OPEN
RIGHT SIDE GRD OPEN
FEEDER FAULT
LOAD MONITOR FAULT
SAFETY BLK INTERLOCK
SHUT HEIGHT FAULT
VAR SPEED DRIVE FLT
DIE PROTECTION FAULT**
SHORT FEED FAULT**
PART EJECTION FAULT**
STOCK BUCKLE FAULT**
END OF STOCK FAULT**
PILOT PIN FAULT**
PART INPUT #1**
PART INPUT #2**
PART INPUT #3**

***Only used with machines that have a split clutch and brake, and two dual valves have been furnished**

****Messages typically used for die protection**

(Continued on next page.)

Rockford Systems, LLC
Call: 1-800-922-7533

PROGRAMMABLE PARAMETERS FOR USER INPUTS 7-8 (continued)

5. Open Angle: This angle setting is used to activate the window during which the control will look for a change of state of the input. The setting ranges from 0° to 359°. If this setting and the Close angle are both set to 0°, the input will be a static input.
6. Close Angle: This angle setting is used to deactivate the window during which the control will look for a change of state of the input. The setting ranges from 0° to 359°. If this setting and the Open angle are both set to 0°, the input will be a static input.

HOW TO PROGRAM USER INPUTS 7-8

Select the ON position of the program off/on selector switch. One of the MAIN PROGRAM SCREENS will be displayed.

Use ↓ and ↑ on the keypad to scroll through the program options. Press ENTER when the pound symbol (#) is next to USER INPUTS. The first USER INPUTS SCREEN will be displayed. See Figure 4.14.

Use ↓ and ↑ on the keypad to scroll through the user inputs. If you press ↓ when the arrow symbol (>) is next to Input #4, the second USER INPUTS SCREEN will be displayed. See Figure 4.15. Press ENTER when the arrow symbol (>) is next to user input #7 or #8. The first PROGRAMMABLE PARAMETERS SCREEN shown in Figure 4.16 will be displayed.

Use ↓ and ↑ on the keypad to scroll through the programmable parameters. If you press ↓ when the double arrow symbol (>>) is next to Die Protect Mode, the second PROGRAMMABLE PARAMETERS SCREEN will be displayed. See Figure 4.17. Press ENTER when the double arrow symbol (>>) is next to the parameter you want to program. A screen similar to the one shown in Figure 4.18 will be displayed.

Once you are in the programming screen of the parameter you want to program, use ↓ and ↑ on the keypad to reach the setting you desire for that parameter. Use the numeric keypad for setting the Open and Close Angles. Press ENTER to finish.

Press ESC when finished to return to the MAIN PROGRAM SCREEN.

Note: The appropriate user input terminals in the control box must be wired so they correspond to the assigned fault messages. If the order of the messages is changed or if other fault messages are assigned, the connections to the terminal strip must also be rearranged to reflect the changes.

Figure 4.1
First User Inputs Screen

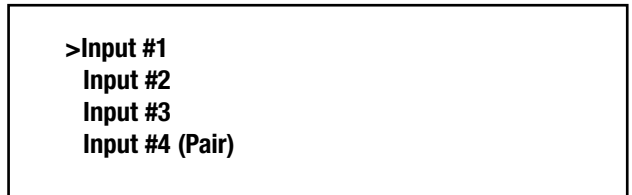

Figure 4.15
Second User Inputs Screen

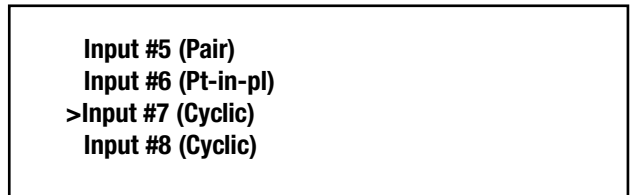

Figure 4.16
First Programmable Parameters Screen

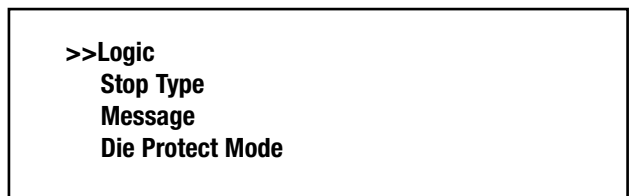

Figure 4.17
Second Programmable Parameters Screen

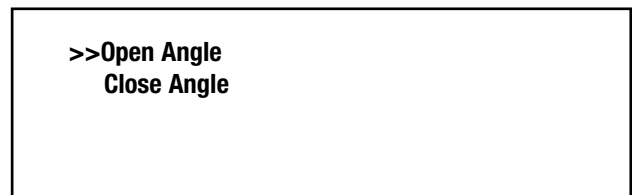
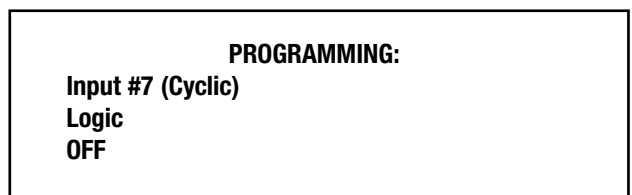

Figure 4.18
Example of a Programming Screen



(Continued on next page.)

SECTION 4—PROGRAMMING

SSC-1500 Part-Revolution Solid-State Control

BRAKE MONITOR

The SSC-1500 press control has a time-based brake monitor with programmable warning and fault setpoints. The control also includes an STM (stop-time measurement) test. This test is used on the downstroke (usually at 90°) for establishing proper safety distance when applying two-hand control or a light curtain as the safeguarding device. The test is also used on the upstroke (at the appropriate angle that makes the press stop at top) to calculate the warning and fault setpoints for the brake monitor.

Every time the machine stops, the control measures the time between when the valve deenergizes and when the resolver no longer detects motion. This is the actual stopping time of the press. The warning and fault setpoints are automatically compared to this stopping time, and will alert the operator if the stopping time is beyond either of these setpoints.

If the stopping time is greater than only the warning setpoint, a message will be displayed for five (5) seconds on the screen, and then it will disappear. The press will not operate during these five seconds. If the stopping time is greater than the fault setpoint, the press will become inoperable, and a message will be displayed on the screen that will stay there until you press ENTER on the keypad to reset the control, acknowledging the fault message.

Brake monitor warnings and faults can be caused by several factors. Brake deterioration is one of the main factors that will increase the press's stopping time. If you have a variable speed drive, running the press at higher speeds will increase the stopping time due to the increased inertia. The stopping time may also increase if you use a heavier die, for the same reason. If you have a counterbalance system, the stopping time may increase if the air pressure is not adjusted properly based on the upper die weight. Clogs or particles in the air line or in the valve muffler may increase stopping time. Air pressure variance can also affect the stopping time of the press.

If you are experiencing warning or fault messages more frequently, inspect the machine and perform any necessary repairs to improve the press's stopping ability. For example, if your brake is deteriorating, it may need a new lining, or you may need to tighten or replace the engaging spring(s) on it. DO NOT increase the warning and fault setpoints just to avoid nuisance stops. You will also need to run a new series of STM tests on the downstroke to establish the new safety distance. You will then need to remount or move your light curtain or palm buttons (if they are used for two-hand control) further away from the point of operation according to the new safety distance.

HOW TO RUN AN STM (STOP-TIME MEASUREMENT) TEST

Select the ON position of the program off/on selector switch. One of the MAIN PROGRAM SCREENS will be displayed.

On the MAIN PROGRAM SCREEN, use ↓ and ↑ on the keypad to scroll through the program options. Press ENTER when the pound symbol (#) is next to BRAKE MONITOR. The security code screen will be displayed. See Figure 4.19. You will be prompted to enter the security code. See page 61 for information on programming the security code.

Press ESC to stop and return to the MAIN PROGRAM SCREEN. Press BKSP to backspace or press CLR to delete the entry and start over. Press ENTER when finished. After the correct security code has been entered, the BRAKE MONITOR SCREEN will be displayed. See Figure 4.20.

Figure 4.19
Security Code Screen

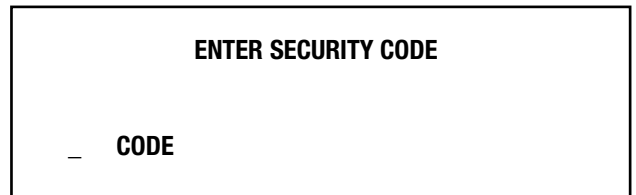
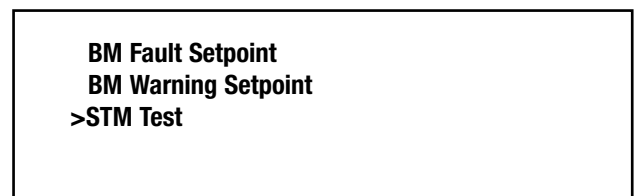

Figure 4.20
Brake Monitor Screen



(Continued on next page.)

Rockford Systems, LLC
Call: 1-800-922-7533

HOW TO RUN AN STM (STOP-TIME MEASUREMENT) TEST

(continued)

Use ↓ and ↑ on the keypad to scroll up and down. Press ENTER when the arrow symbol (>) is next to STM Test. The STM Test Screen will be displayed. See Figure 4.21.

Use the keypad to enter the angle at which the STM will be taken. Press ENTER when finished. You will be prompted to check for TDC (top dead center), and then to cycle the press.

Follow the prompt and visually make sure the crankshaft is at TDC. If it is not at TDC, press ESC to exit and select the OFF position of the program off/on selector switch. Then either inch or single stroke the press to get it to top, then cycle the press. After the press makes a partial stroke, the screen will display the stopping time in milliseconds and the safety distance in inches (if the test was done on the downstroke). See Figure 4.22. Press ESC to exit and select the OFF position of the program off/on selector switch. Then either inch or single stroke the press to return to TDC.

To run more than one STM, select the ON position of the program off/on selector switch. The pound symbol (#) should still be next to BRAKE MONITOR. Press ENTER. If you have not waited more than five minutes since the last STM test, you will not have to enter the security code.

The arrow symbol (>) should still be next to STM Test. Press ENTER. When the angle at which the STM will be taken is correct, press ENTER. Follow the display prompts and cycle the press. After the results of the test have been displayed, return the crankshaft to TDC. Repeat this process until the desired number of tests are complete.

Press ESC when finished to return to the BRAKE MONITOR SCREEN. Press ESC again to return to the MAIN PROGRAM SCREEN.

Figure 4.21
STM Test Screen



Figure 4.22
Sample of the STM Test Results Screen

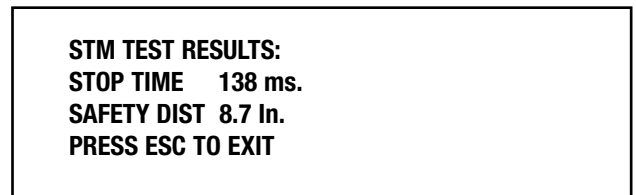

(Continued on next page.)

SECTION 4—PROGRAMMING

SSC-1500 Part-Revolution Solid-State Control

HOW TO CALCULATE THE BRAKE MONITOR WARNING AND FAULT SETPOINTS

To determine the brake monitor warning and fault setpoints using the STM test feature, you need to determine the proper STM angle so the stop signal is given on the upstroke, and the angle stop point makes the press stop at TDC (top dead center). This angle is usually between 200° and 300°. You may have to take several STM tests before you get the correct angle setting for your press, since this setting is determined by trial and error. A good angle to start with is 270°. If the press stops before TDC, a higher STM angle setting is required. Add the number of degrees the machine stopped short of TDC to the STM angle setting. If the press stops beyond TDC, a lower STM angle setting is required. Subtract the number of degrees the machine went over TDC from the STM angle setting. Once you get the correct STM angle setting and your press is stopping at TDC, you are ready to calculate the warning and fault setpoints for the brake monitor.

Take and record several readings (at least ten) of the stopping time using the STM feature and the STM angle setting that makes the press stop at TDC. If any of your readings are excessively high compared to the rest of the readings, disregard them and use the next highest reading. After taking several readings, use the longest time and multiply it by 1.05 (105%) to establish the warning setpoint. To establish the fault setpoint, multiply the highest reading by 1.10 (110%).

HOW TO PROGRAM THE BRAKE MONITOR WARNING AND FAULT SETPOINTS

To adjust the warning setpoint:

Use ↓ and ↑ on the keypad to scroll up and down. Press ENTER when the arrow symbol (>) is next to the BM Warning Setpoint. The BM Warning Setpoint Screen will be displayed. See Figure 4.23.

Use the keypad to enter the time setting. Press ENTER when finished to return to the BRAKE MONITOR SCREEN.

To adjust the fault setpoint:

Use ↓ and ↑ on the keypad to scroll up and down. Press ENTER when the arrow symbol (>) is next to the BM Fault Setpoint. The BM Fault Setpoint Screen will be displayed. See Figure 4.24.

Use the keypad to enter the time setting. Press ENTER when finished to return to the BRAKE MONITOR SCREEN.

Press ESC when finished to return to the MAIN PROGRAM SCREEN.

Figure 4.23
Warning Setpoint Screen

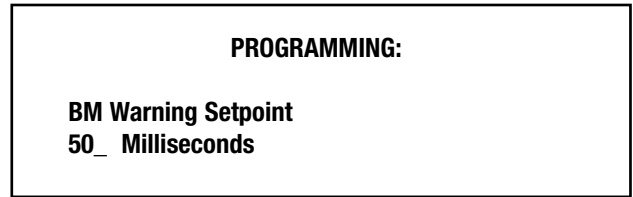
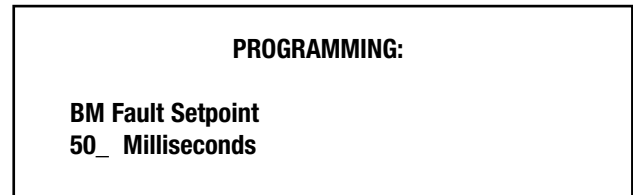

Figure 4.24
Fault Setpoint Screen



(Continued on next page.)

Rockford Systems, LLC
Call: 1-800-922-7533

COUNTERS

The SSC-1500 press control has stroke and batch counters that can be used for die maintenance, quality control checks, or part bin exchanges. These counters have a programmable preset that will signal the press to top stop when the preset is reached. The preset has a maximum of 9,999,999 strokes. There is also a total counter, which has security code protection.

When either the batch counter or stroke counter has reached its preset value and BATCH COUNT EXPIRED or STROKE COUNT EXPIRED is displayed, the fault message can be cleared and the counter can be reset by touching ENTER on the keypad or by pressing the yellow top-stop palm button. If you do not have a top-stop palm button and would like to use a remote push button to reset the counters, a button with 1 N.C. (normally closed) contact can be wired in where the optional top stop is shown on the electrical schematics.

HOW TO PROGRAM THE COUNTERS

Select the ON position of the program off/on selector switch. One of the MAIN PROGRAM SCREENS will be displayed.

On the MAIN PROGRAM SCREEN, use ↓ and ↑ on the keypad to scroll through the program options. Press ENTER when the pound symbol (#) is next to COUNTERS. The first COUNTER PROGRAM SCREEN will be displayed. See Figure 4.25. If you press ↓ when the arrow symbol is next to Stroke Preset, the second COUNTER PROGRAM SCREEN will be displayed. See Figure 4.26.

To enter a batch preset:

Use ↓ and ↑ on the keypad to scroll up and down. Press ENTER when the arrow symbol (>) is next to Batch Preset. You will see the BATCH PRESET SCREEN. See Figure 4.27.

After you have entered a preset, press ENTER to finish. This will bring you back to the COUNTER PROGRAM SCREEN.

To clear the batch counter:

Use ↓ and ↑ on the keypad to scroll up and down. Press ENTER when the arrow symbol (>) is next to Batch Clear. You will see the CLEAR BATCH SCREEN. See Figure 4.28.

Press YES to confirm and the counter will be cleared.

Press NO to return to the COUNTER PROGRAM SCREEN.

Figure 4.25
First Counter Program Screen



Figure 4.26
Second Counter Program Screen



Figure 4.27
Batch Preset Screen

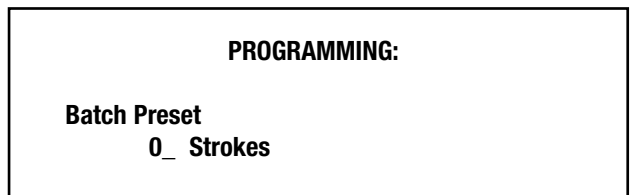
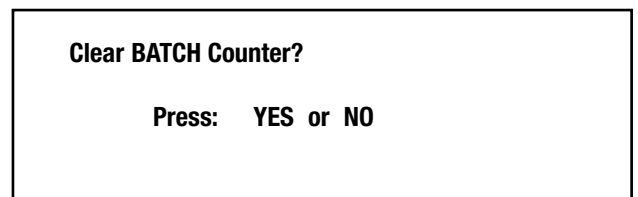

Figure 4.28
Clear Batch Screen



(Continued on next page.)

SECTION 4—PROGRAMMING

SSC-1500 Part-Revolution Solid-State Control

HOW TO PROGRAM THE COUNTERS (continued)

To enter a stroke preset:

Use ↓ and ↑ on the keypad to scroll up and down. Press ENTER when the arrow symbol (>) is next to Stroke Preset. You will see the STROKE PRESET SCREEN. See Figure 4.29.

After you have entered a preset, press ENTER to finish. This will bring you back to the COUNTER PROGRAM SCREEN.

To clear the stroke counter:

Use ↓ and ↑ on the keypad to scroll up and down. Press ENTER when the arrow symbol (>) is next to Stroke Clear. You will see the CLEAR STROKE SCREEN. See Figure 4.30.

Press YES to confirm and the counter will be cleared.

Press NO to return to the COUNTER PROGRAM SCREEN.

To clear or view the total counter:

Use ↓ and ↑ on the keypad to scroll up and down. Press ENTER when the arrow symbol (>) is next to Total Clear. The Security Code Screen will be displayed. See Figure 4.31. You will be prompted to enter the security code.

Press ESC to stop and return to the COUNTERS PROGRAM SCREEN. Press BKSP to backspace or press CLR to delete the entry and start over. Press ENTER when finished. After the correct security code has been entered, you will see the CLEAR TOTAL SCREEN which also displays the total counter. See Figure 4.32.

To only view the counter and not clear it, press NO to return to the COUNTER PROGRAM SCREEN.

To clear the total counter, press YES to confirm and the counter will be cleared.

Press ESC when finished to return to the MAIN PROGRAM SCREEN.

Figure 4.29
Stroke Preset Screen

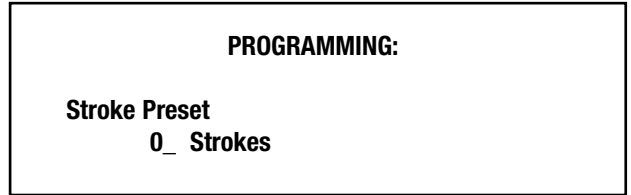

A rectangular screen with a black border. The text is centered and reads: PROGRAMMING: Stroke Preset 0_ Strokes

Figure 4.30
Clear Stroke Screen

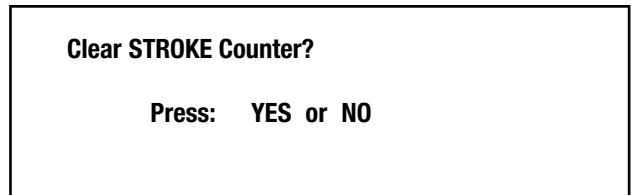

A rectangular screen with a black border. The text is centered and reads: Clear STROKE Counter? Press: YES or NO

Figure 4.31
Security Code Screen



A rectangular screen with a black border. The text is centered and reads: ENTER SECURITY CODE _ CODE

Figure 4.32
Clear Total Screen

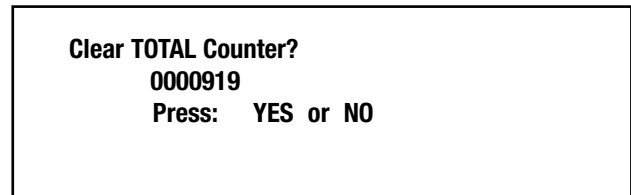

A rectangular screen with a black border. The text is centered and reads: Clear TOTAL Counter? 0000919 Press: YES or NO

(Continued on next page.)

Rockford Systems, LLC
Call: 1-800-922-7533

SYSTEM SETUP

The SSC-1500 press control has a system setup screen that is used to automatically zero the resolver, set the motion reference threshold, automatically set the sync switch position, restore the factory default settings, program the security code, program the network settings, set the SPM range, set the light curtain input, turn on or off the angle display, and turn on or off Spanish display text.

AUTOMATICALLY ZERO THE RESOLVER

If the resolver is mounted correctly, with the press at TDC (top dead center) and the keyway facing up and perpendicular to the base, it should be very close to its physical 0° point. However, since it is most likely a few degrees off, the resolver will be automatically zeroed, which will reset it to 0°, regardless of where its physical 0° point is located. This will provide the control with more accurate angle settings and readings.

MOTION REFERENCE THRESHOLD

The motion reference threshold is the amount of time the control takes to see motion when the press is stroked. It is used to detect chain breakage, sprocket failure, or uncoupling of the resolver.

When a reference cycle is run, the control measures the amount of time the press takes to go from 0 to 4 SPM (strokes per minute). This is because any speed less than 4 SPM is not considered normal motion by the control. This number is then doubled to allow for inconsistencies of the press. Every time a stroke is started, the control looks for motion within this amount of time. If motion is not seen within this amount of time, a fault message will be displayed.

SYNC SWITCH

The sync switch is an optical pulser inside the resolver that provides redundancy in the resolver. It monitors and crosschecks for mechanical or electronic failures within the resolver.

The pulser has a physical cam with a 30° window that is set to activate at 75° and deactivate at 105°, in relation to the resolver's physical 0° point (mounted with the keyway up, perpendicular to the base). The sync switch should not come on between 330° and 30°. If it does, the reference cycle will fail, and a fault message will be displayed. The keyway on the resolver will have to be rotated so the sync switch does not come on between 330° and 30°.

When a reference cycle is run, the pulser will record the on and off angles of the sync switch. These angles, called sync on and sync off, will then be displayed on the screen. On every subsequent stroke of the press, the control will watch for the sync switch to come on and go off at the same angles, +/- 2.5°.

SECURITY CODE

The security code is user-programmed up to a 4-digit number. This code is required to enter the BRAKE MONITOR, SYSTEM SETUP, ANGLE SETTINGS, TIMED SETTINGS, OPTIONAL MODES, VARIABLE-SPEED TOP-STOP SETTINGS, and AUXILIARY OUTPUT SCREENS. It is also required when the total counter is cleared and when the factory default settings are restored.

NETWORK SETTINGS

The network settings are used to configure the control for networking. In order to network the control, the optional networking assembly, part No. FTL-314, is required. The networking assembly consists of a TCP/IP (Transmission Control Protocol/Internet Protocol) modem card with mounting plate, a 5' cable, and a CD with software for data collection. The modem card and cable plug into the P3 network port on the SSC-1500 control module. Use of the network modem will provide data collection and viewing of current data via a standard Web browser such as Internet Explorer or Netscape Navigator. The current status of the press and what the control is doing can be monitored.

The data-collection software that is furnished with the networking assembly will save data to a flat text file. Most any database, spreadsheet, or word processing program such as Microsoft Access, Microsoft Excel, dBASE, or Paradox can import the information. This software program can accommodate up to 32 presses. Opening the program again will accommodate 32 more presses.

(Continued on next page.)

SECTION 4—PROGRAMMING

SSC-1500 Part-Revolution Solid-State Control

NETWORK SETTINGS (continued)

The following information is available for viewing and data collection; it can be arranged to accommodate your needs.

- Batch counter
- Batch preset
- Brake monitor status
- Current mode
- Date and time
- SPM
- Stop time
- Stroke counter
- Stroke preset
- Total counter

Note: Your network administrator or an experienced IT (information technology) person will be required to program the network settings and install the networking assembly.

SPM RANGE

The SPM range should be set according to the speed of the press in SPM (strokes per minute). The three choices are low (0-30), medium (31-150), and high (151+). This will allow the control to react and process information appropriately in relation to the speed of the machine. Slower machines may need extra time for operations to occur while faster machines usually require tighter settings.

LIGHT CURTAIN INPUT

The SSC-1500 press control is factory set for two N.O. (normally open) light curtain inputs (closed in the powered-up “green” state). These inputs are Terminals P8-14 (LC CT #1) and P8-15 (LC CT #2) on the SSC-1500 control module. The inputs can also be set for one N.O. (normally open) and one N.C. (normally closed). For more information, please refer to the connection diagram on page 12 and the wiring schematics included with the control.

ANGLE DISPLAY

The angle display is an optional unit (part No. FTL-055) that shows the angular position of the crankshaft both graphically (with red LEDs in a circle) and numerically (with a large, red, three-digit LED display). The angle display should be mounted where it is easily viewed to help with setup, removal of stuck workpieces, or for assistance during emergency extraction procedures.

SPANISH

When this setting is turned on, all of the display text will be in Spanish.

(Continued on next page.)

HOW TO RUN THE REFERENCE CYCLE

Select the ON position of the program off/on selector switch. One of the MAIN PROGRAM SCREENS will be displayed.

On the MAIN PROGRAM SCREEN, use ↓ and ↑ on the keypad to scroll through the program options. Press ENTER when the pound symbol (#) is next to SYSTEM SETUP. The security code screen will be displayed. See Figure 4.33. You will be prompted to enter the security code.*

Press ESC to stop and return to the MAIN PROGRAM SCREEN. Press BKSP to backspace or press CLR to delete the entry and start over. Press ENTER when finished.

After the correct security code has been entered, the first SYSTEM SETUP SCREEN will be displayed. See Figure 4.34.

Use ↓ and ↑ on the keypad to scroll up and down. Press ENTER when the arrow symbol (>) is next to Reference Cycle. The REFERENCE CYCLE INSTRUCTIONS SCREEN will be displayed. See Figure 4.35. Press YES to run a reference cycle, then cycle the press. A screen similar to the one shown in Figure 4.36 will be displayed.

Press ESC when finished to return to the SYSTEM SETUP SCREEN. Press ESC again to return to the MAIN PROGRAM SCREEN.

Figure 4.33
Security Code Screen

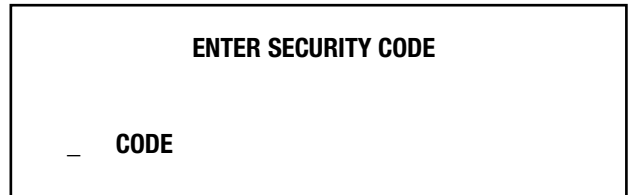

Figure 4.34
First System Setup Screen

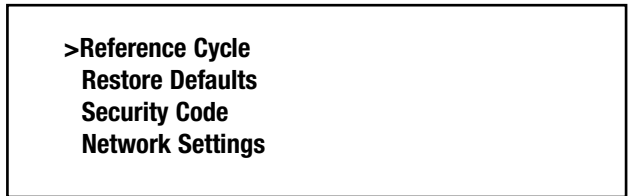

Figure 4.35
Reference Cycle Instructions Screen



Figure 4.36
Sample of Completed Reference Cycle Screen



*The factory default security code is 0. With this code, you can proceed past the security code screen by pressing 0 and then ENTER on the keypad, or by simply pressing ENTER.

To program your own security code, see page 61. If at any time you forget your security code, call the factory at 1-800-922-7533 or (815) 874-7891 to receive the master security code.

(Continued on next page.)

SECTION 4—PROGRAMMING

SSC-1500 Part-Revolution Solid-State Control

HOW TO RESTORE FACTORY DEFAULT SETTINGS

Select the ON position of the program off/on selector switch. One of the MAIN PROGRAM SCREENS will be displayed.

On the MAIN PROGRAM SCREEN, use ↓ and ↑ on the keypad to scroll through the program options. Press ENTER when the pound symbol (#) is next to SYSTEM SETUP. The security code screen will be displayed. See Figure 4.37. You will be prompted to enter the security code.

Press ESC to stop and return to the MAIN PROGRAM SCREEN. Press BKSP to backspace or press CLR to delete the entry and start over. Press ENTER when finished.

After the correct security code has been entered, the first SYSTEM SETUP SCREEN will be displayed. See Figure 4.38.

Use ↓ and ↑ on the keypad to scroll up and down. Press ENTER when the arrow symbol (>) is next to Restore Defaults. The RESTORE DEFAULTS SCREEN will be displayed. See Figure 4.39.

Press YES to confirm and the factory default settings will be restored. See pages 78-79 for the factory default settings.

Press ESC when finished to return to the MAIN PROGRAM SCREEN.

Figure 4.37
Security Code Screen



Figure 4.38
First System Setup Screen



Figure 4.39
Restore Defaults Screen

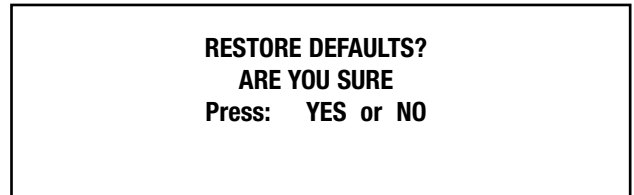

(Continued on next page.)

Rockford Systems, LLC
Call: 1-800-922-7533

HOW TO PROGRAM THE SECURITY CODE

Select the ON position of the program off/on selector switch. One of the MAIN PROGRAM SCREENS will be displayed.

On the MAIN PROGRAM SCREEN, use ↓ and ↑ on the keypad to scroll through the program options. Press ENTER when the pound symbol (#) is next to SYSTEM SETUP. The security code screen will be displayed. See Figure 4.40. You will be prompted to enter the security code.

Press ESC to stop and return to the MAIN PROGRAM SCREEN. Press BKSP to backspace or press CLR to delete the entry and start over. Press ENTER when finished.

After the correct security code has been entered, the first SYSTEM SETUP SCREEN will be displayed. See Figure 4.41.

Use ↓ and ↑ on the keypad to scroll up and down. Press ENTER when the arrow symbol (>) is next to Security Code. The SECURITY CODE PROGRAM SCREEN will be displayed. See Figure 4.42.

Use the keypad to enter a security code up to a 4-digit number. Press ENTER when finished.

Press ESC when finished to return to the MAIN PROGRAM SCREEN.

Figure 4.40—Security Code Screen



Figure 4.41—First System Setup Screen

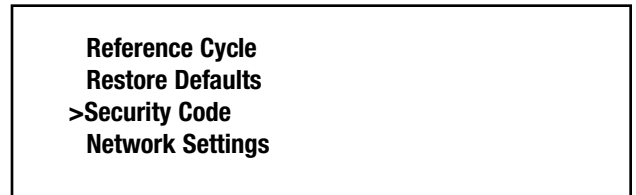
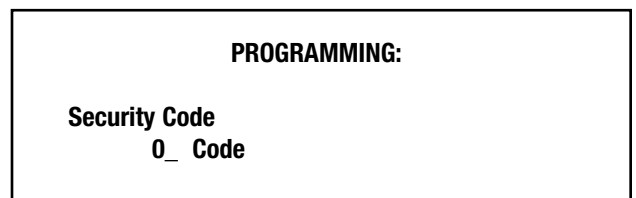

Figure 4.42—Security Code Program Screen



(Continued on next page.)

SECTION 4—PROGRAMMING

SSC-1500 Part-Revolution Solid-State Control

PROGRAMMABLE PARAMETERS FOR THE NETWORK SETTINGS

1. **NAME:** This setting is used to assign a unique name to the SSC-1500 control or machine that it is on. This name must be unique on the network to which you are connecting the control.

2. **WORK GROUP:** This setting can be used to include the SSC-1500 control in a particular workgroup of devices on your network. When this is done, the SSC-1500 control will show up (with the name you assigned it) within that workgroup when you browse your network.

Note: If you do not have a DNS (Domain Name System) server, this parameter does not need to be programmed.

3. **ADDRESS:** This setting is used to enter the unique IP (Internet Protocol) address assigned to the SSC-1500 control. The IP address must consist of four sets of numbers, separated by periods; e.g., 127.0.0.1. The IP address can range from 0.0.0.0 to 255.255.255.255.

Note: If DHCP is used (see MODE below), this parameter does not need to be programmed.

4. **MASK:** This setting is used to enter the subnet mask. The subnet mask is a transformation performed on the IP address that enables the network administrators to create subnets, which are virtual subunits of the physical network. The subnet mask must consist of four sets of numbers, separated by periods; e.g., 255.255.255.0. The subnet mask can range from 0.0.0.0 to 255.255.255.255.

Note: If DHCP is used (see MODE below), this parameter does not need to be programmed.

5. **MODE:** This setting is used to select the type of IP address that is used. The programming choices are STATIC and DHCP. Static is a permanent IP address that is assigned to a device in a TCP/IP (Transmission Control Protocol/Internet Protocol) network. DHCP, which stands for Dynamic Host Configuration Protocol, is a protocol that enables a TCP/IP device on your network to receive a temporary IP address from another device on your network automatically.

HOW TO PROGRAM THE NETWORK SETTINGS

Note: Your network administrator or an experienced IT (information technology) person will be required to program the network settings.

Select the ON position of the program off/on selector switch. One of the MAIN PROGRAM SCREENS will be displayed.

On the MAIN PROGRAM SCREEN, use ↓ and ↑ on the keypad to scroll through the program options. Press ENTER when the pound symbol (#) is next to SYSTEM SETUP. The security code screen will be displayed. See Figure 4.43. You will be prompted to enter the security code.

Press ESC to stop and return to the MAIN PROGRAM SCREEN. Press BKSP to backspace or press CLR to delete the entry and start over. Press ENTER when finished.

After the correct security code has been entered, the first SYSTEM SETUP SCREEN will be displayed. See Figure 4.44.

Use ↓ and ↑ on the keypad to scroll up and down. Press ENTER when the arrow symbol (>) is next to Network Settings. The first NETWORK PARAMETERS SCREEN shown in Figure 4.45 will be displayed.

Figure 4.43—Security Code Screen

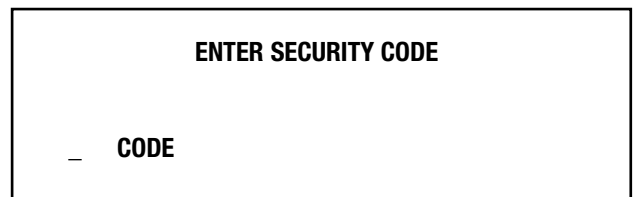

Figure 4.44—First System Setup Screen

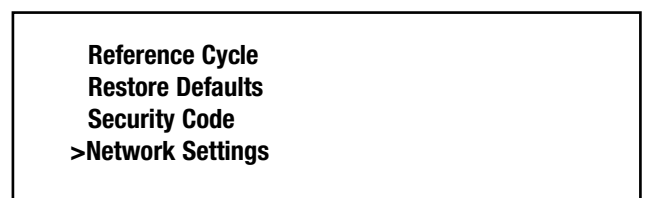

Figure 4.45—First Network Parameters Screen



(Continued on next page.)

Rockford Systems, LLC
Call: 1-800-922-7533

HOW TO PROGRAM THE NETWORK SETTINGS (continued)

Use ↓ and ↑ on the keypad to scroll through the programmable parameters. If you press ↓ when the double arrow symbol (>>) is next to MASK, the second NETWORK PARAMETERS SCREEN will be displayed. See Figure 4.46. Press ENTER when the double arrow symbol (>>) is next to the parameter you want to program. A screen similar to the one shown in Figure 4.47 will be displayed.

Once you are in the programming screen of the parameter you want to program, use the keypad to program the setting you desire for that parameter. To enter letters when programming the Name and Work Group, see Figure 4.48. If an underscore is needed, use the blank key above the YES key. Use ↓ and ↑ on the keypad for setting the Mode. Press ENTER to finish.

Press ESC when finished to return to the MAIN PROGRAM SCREEN.

Figure 4.46—Second Network Parameters Screen



Figure 4.47—Example of a Programming Screen



Figure 4.48—Keypad Numbers and Corresponding Letters

2	3	4	5	6	7	8	9
A	D	G	J	M	P	T	W
B	E	H	K	N	Q	U	X
C	F	I	L	O	R	V	Y
Blank key = underscore						S	Z

The keypad numbers and corresponding letters are the same as those of the keypad on a telephone. To enter a letter, push the corresponding number key until the letter you want appears. Once you get the letter you want, wait for about 2 seconds, and then the cursor will move to the right. You will then be able to input the next letter.

Press ESC to stop and return to the NETWORK PARAMETERS SCREEN. Press BKSP to backspace or press CLR to delete the entry and start over. Press ENTER when finished.

(Continued on next page.)

SECTION 4—PROGRAMMING

SSC-1500 Part-Revolution Solid-State Control

MOUNTING THE MODEM CARD

Mount the modem card as close as possible to the SSC-1500 control, preferably inside the same control box. Do not run in conduit or in bundles with higher voltages that may cause electrical interference. Wire the serial cable to the terminal strip on the modem card according to the print that was furnished with the modem card. Plug the other end of the serial cable (with the DB-9 connector) in to the P3 network port on the SSC-1500 control module. Now connect the modem card to your network with an Ethernet cable.

VIEWING OF THE CURRENT STATUS OF THE PRESS AND SSC-1500 CONTROL

Once the modem card is installed and connected to the SSC-1500 control and your network, you will be able to view the status of the press and the SSC-1500 control. No software is required to do this.

To view the current status of the press and SSC-1500 control, simply open a Web browser (such as Internet Explorer or Netscape navigator) and type in the IP address that you have assigned to the SSC-1500 control; e.g., <http://131.107.2.2/>.

A Web page similar to the one shown in Figure 4.49 will be displayed.

Figure 4.49—Current Status Web Page

CURRENT STATUS OF MACHINE AND SSC-1500 CONTROL			
Total Count	00015655		
Stroke Count	00015634	Stroke Preset	00300000
Batch Count	00015634	Batch Preset	66978111
Mode	CONT		
Strokes Per Min	064		
Stop Time	307	Brake Fault Status	NONE

DATA COLLECTION

For data collection, you will need to install the software from the CD that came with the networking assembly.

Installing the Software

Insert the Networking Software CD in your computer, and double-click the executable Setup file (SETUP.EXE). This will start the installation wizard, which will guide you through the installation.

Once the program is installed, launch the program called SSC1500 Networking. The program will open; see Figure 4.50.

Figure 4.50—SSC1500 Networking Utility

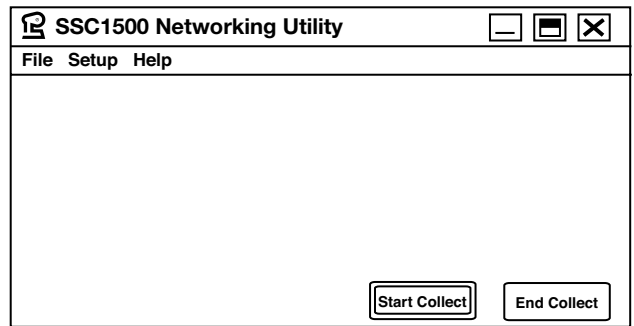

Adding a Machine

Before being able to collect data, you will need to add the machine to the SSC1500 Networking Utility program on your computer. At the top of the program window, click Setup, and then click Add Machine from the dropdown menu. The Add Machine will open. See Figure 4.51.

Figure 4.51—Add Machine

First, enter the IP address that you have assigned to the SSC-1500 control. Second, in the Control Name field, enter a name for the machine or control. This name will also be the name of the text file that is created when doing data collection. Last, enter the path to the location where you want the data collector to save the data to. You can type the path directly into the field, or you can click Browse to find the location you want. When finished, click Done, and the machine will be added.

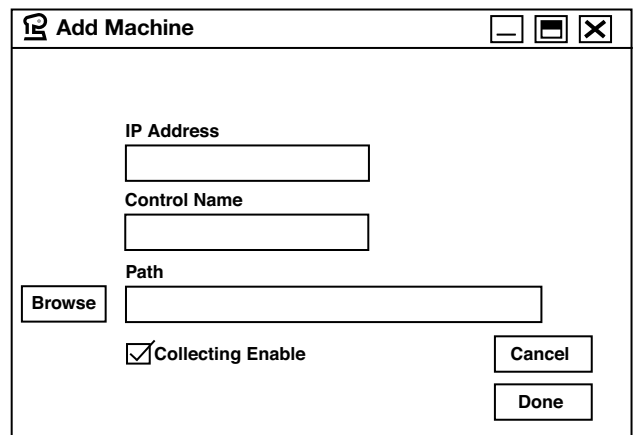

(Continued on next page.)

Rockford Systems, LLC
Call: 1-800-922-7533

Editing or Deleting a Machine

To change the information already stored for a machine, click Setup, and then click Edit Machine from the dropdown menu. See Figure 4.52.

Select the machine that you want to edit from the Name List. After editing the necessary information, click Done.

to delete a machine completely, select the machine in under Name List, and click Delete Machine. You will be asked if you are sure you want to delete this machine; click Yes, No, or Cancel to finish.

Setting the Data Collection Rate

The rate at which the data is collected can be set from 2 to 30 minutes. The default rate is 20 minutes.

To program the data collection rate, click Setup, and then click Option from the dropdown menu. See Figure 4.53.

Enter a number from 2.0 to 30.0 in the box, and click Done.

Starting Data Collection

To start data collection, click Start Collect in the SSC1500 Networking Utility program.

Note: The data collector will save the data for all machines that have their Collecting Enable box checked. If you have multiple machines networked but you only want to collect data for one or certain machines, go into Edit Machine and uncheck the Collecting Enable box for those machines that you don't want to collect data for.

Ending Data Collection

To end data collection, click End Collect on the SSC1500 Networking Utility program.

Viewing the Collected Data

The collected data is saved as a text file (.txt) to the location that you specified while adding the machine. The information in the text file is separated by commas, and it is in the following format:

Total count, stroke count, batch count, mode, strokes per min, stop time, stroke preset, batch preset, brake fault status, time, date.

See Figure 4.54 for a sample text file.

This information can be imported by most any database, spreadsheet, or word processing program such as Microsoft Access, Microsoft Excel, dBASE, or Paradox to create your own customized reports.

Figure 4.52—Edit Machine

Figure 4.53—Options

Figure 4.54—Text File

```

Machine 1
0016198, 00000091, 00000043, CONT, 063, 326, 00300000,
66978111, NONE, 1:09:50 PM, 6/22/2002
00016478, 00000371, 00000323, CONT, 063,
326, 00300000, 66978111, NONE, 1:12:05 PM, 6/22/2002
00016729, 00000622, 00000574, CONT, 062,
326, 00300000, 66978111, NONE, 1:14:05 PM, 6/22/2002
00016842, 00000735, 00000687, CONT, 000,
326, 00300000, 66978111, NONE, 1:23:53 PM, 6/22/2002
    
```

(Continued on next page.)

SECTION 4—PROGRAMMING

SSC-1500 Part-Revolution Solid-State Control

HOW TO PROGRAM THE SPM RANGE

Select the ON position of the program off/on selector switch. One of the MAIN PROGRAM SCREENS will be displayed.

On the MAIN PROGRAM SCREEN, use ↓ and ↑ on the keypad to scroll through the program options. Press ENTER when the pound symbol (#) is next to SYSTEM SETUP. The security code screen will be displayed. See Figure 4.49. You will be prompted to enter the security code.

Press ESC to stop and return to the MAIN PROGRAM SCREEN. Press BKSP to backspace or press CLR to delete the entry and start over. Press ENTER when finished.

After the correct security code has been entered, the first SYSTEM SETUP SCREEN will be displayed. See Figure 4.50.

Use ↓ and ↑ on the keypad to scroll up and down. Press ↓ when the arrow symbol (>) is next to Network Settings, and the second SYSTEM SETUP SCREEN will be displayed. See Figure 4.51.

Press ENTER when the arrow symbol (>) is next to SPM Range. The SPM RANGE SCREEN will be displayed. See Figure 4.52.

Use ↓ and ↑ on the keypad to reach the appropriate SPM range. Press ENTER to finish.

Press ESC when finished to return to the MAIN PROGRAM SCREEN.

HOW TO PROGRAM THE LIGHT CURTAIN INPUT

Select the ON position of the program off/on selector switch. One of the MAIN PROGRAM SCREENS will be displayed.

On the MAIN PROGRAM SCREEN, use ↓ and ↑ on the keypad to scroll through the program options. Press ENTER when the pound symbol (#) is next to SYSTEM SETUP. The security code screen will be displayed. See Figure 4.49. You will be prompted to enter the security code.

Press ESC to stop and return to the MAIN PROGRAM SCREEN. Press BKSP to backspace or press CLR to delete the entry and start over. Press ENTER when finished.

After the correct security code has been entered, the first SYSTEM SETUP SCREEN will be displayed. See Figure 4.50.

Use ↓ and ↑ on the keypad to scroll up and down. Press ↓ when the arrow symbol (>) is next to Network Settings, and the second SYSTEM SETUP SCREEN will be displayed. See Figure 4.51.

Press ENTER when the arrow symbol (>) is next to Light Curtain Input. The LIGHT CURTAIN INPUT SCREEN will be displayed. See Figure 4.53.

Use ↓ and ↑ on the keypad to select the appropriate light curtain input contact arrangement. Press ENTER to finish.

Press ESC when finished to return to the MAIN PROGRAM SCREEN.

Figure 4.49
Security Code Screen

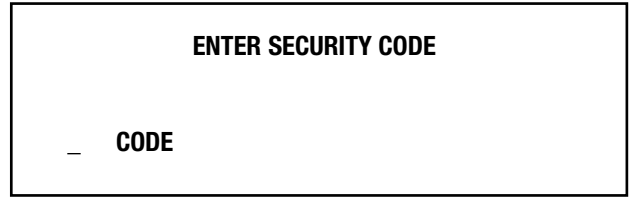

Figure 4.50
First System Setup Screen

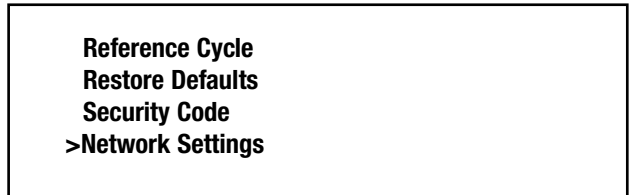

Figure 4.51
Second System Setup Screen

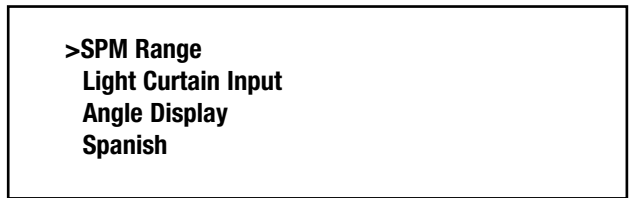

Figure 4.52
SPM Range Screen

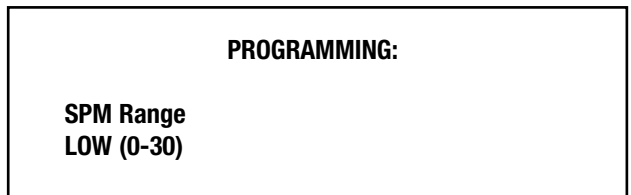
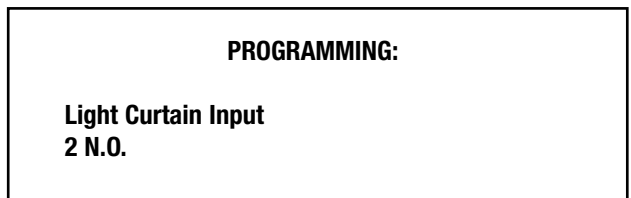

Figure 4.53
Light Curtain Input Screen



(Continued on next page.)

Rockford Systems, LLC
Call: 1-800-922-7533

HOW TO TURN ON OR OFF THE ANGLE DISPLAY

Select the ON position of the program off/on selector switch. One of the MAIN PROGRAM SCREENS will be displayed.

On the MAIN PROGRAM SCREEN, use ↓ and ↑ on the keypad to scroll through the program options. Press ENTER when the pound symbol (#) is next to SYSTEM SETUP. The security code screen will be displayed. See Figure 4.54. You will be prompted to enter the security code.

Press ESC to stop and return to the MAIN PROGRAM SCREEN. Press BKSP to backspace or press CLR to delete the entry and start over. Press ENTER when finished.

After the correct security code has been entered, the first SYSTEM SETUP SCREEN will be displayed. See Figure 4.55.

Use ↓ and ↑ on the keypad to scroll up and down. Press ↓ when the arrow symbol (>) is next to Network Settings, and the second SYSTEM SETUP SCREEN will be displayed. See Figure 4.56.

Press ENTER when the arrow symbol (>) is next to Angle Display. The ANGLE DISPLAY SCREEN will be displayed. See Figure 4.57.

Use ↓ and ↑ on the keypad to toggle between ON and OFF. Press ENTER to finish. Press ESC when finished to return to the MAIN PROGRAM SCREEN.

HOW TO TURN ON OR OFF SPANISH DISPLAY TEXT

Select the ON position of the program off/on selector switch. One of the MAIN PROGRAM SCREENS will be displayed.

On the MAIN PROGRAM SCREEN, use ↓ and ↑ on the keypad to scroll through the program options. Press ENTER when the pound symbol (#) is next to SYSTEM SETUP. The security code screen will be displayed. See Figure 4.54. You will be prompted to enter the security code.

Press ESC to stop and return to the MAIN PROGRAM SCREEN. Press BKSP to backspace or press CLR to delete the entry and start over. Press ENTER when finished.

After the correct security code has been entered, the first SYSTEM SETUP SCREEN will be displayed. See Figure 4.55.

Use ↓ and ↑ on the keypad to scroll up and down. Press ↓ when the arrow symbol (>) is next to Network Settings, and the second SYSTEM SETUP SCREEN will be displayed. See Figure 4.56.

Press ENTER when the arrow symbol (>) is next to Spanish. The SPANISH SCREEN will be displayed. See Figure 4.58.

Use ↓ and ↑ on the keypad to toggle between ON and OFF. Press ENTER to finish. Press ESC when finished to return to the MAIN PROGRAM SCREEN.

Figure 4.54
Security Code Screen

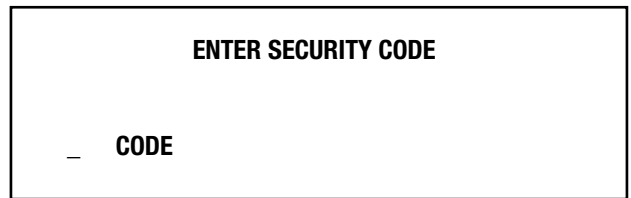

Figure 4.55
First System Setup Screen

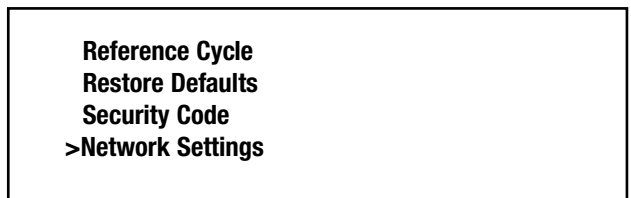

Figure 4.56
Second System Setup Screen

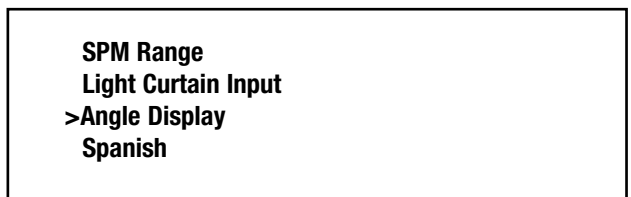

Figure 4.57
Angle Display Screen

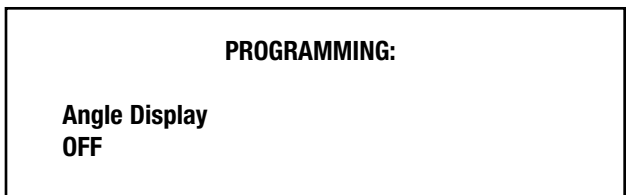
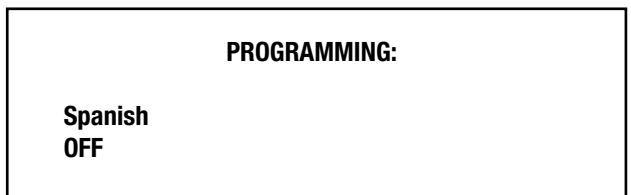

Figure 4.58
Spanish Screen



(Continued on next page.)

SECTION 4—PROGRAMMING

SSC-1500 Part-Revolution Solid-State Control

ANGLE SETTINGS

The SSC-1500 press control has an angle settings screen that is used to program the single stroke top stop, continuous top stop, automatic up (holding), and light curtain mute angles.

SINGLE STROKE TOP-STOP ANGLE

The single stroke top-stop angle is the angle at which the control gives the signal to stop the press at TDC (top dead center) while in the *Single Stroke* mode of operation. In most cases, you will need to adjust this setting, since the factory default of 330° may stop your press beyond TDC. A good angle to start with is 270°. If the press stops before TDC, a higher single stroke top-stop setting is required. Add the number of degrees the machine stopped short of TDC to the single stroke top-stop setting. If the press stops beyond TDC, a lower single stroke top-stop setting is required. Subtract the number of degrees the machine went over TDC from the single stroke top-stop setting.

CONTINUOUS TOP-STOP ANGLE

The continuous top-stop angle is the angle at which the control gives the signal to stop the press at TDC, when the top-stop palm button is pressed while in the *Continuous* mode of operation. It is also used when a user input that is programmed to top stop activates.

The continuous top-stop angle applies only when the press has a constant speed drive, or has a variable speed drive that is run at only one speed. If your press has a variable speed drive that is run at more than one speed, please refer to the variable speed top-stop settings on pages 73-74.

In most cases, you will need to adjust this setting, since the factory default of 330° may stop your press beyond TDC. A good angle to start with is 270°. If the press stops before TDC, a higher continuous top-stop setting is required. Add the number of degrees the machine stopped short of TDC to the continuous top-stop setting. If the press stops beyond TDC, a lower continuous top-stop setting is required. Subtract the number of degrees the machine went over TDC to the continuous top-stop setting.

AUTOMATIC UP (HOLDING) ANGLE

The automatic up (holding) angle is the angle beyond which the operator no longer needs to depress the palm buttons or foot switch to finish the cycle in progress. It applies only when the press is being run in the *Single Stroke* mode of operation. If the actuating means are released before the auto up angle is reached, the machine will stop. This angle can be changed, but should be programmed so the actuating means must be held depressed during the entire hazardous portion of the stroke.

LIGHT CURTAIN MUTE ANGLE

The light curtain mute angle is the angle beyond which the light curtain is no longer active. This means that once the light curtain mute angle is reached, the machine will not stop if the light curtain beams are interrupted. This angle can be changed, but should be programmed so the light curtain is muted only during the nonhazardous portion of the stroke.

HOW TO PROGRAM THE ANGLE SETTINGS

Select the ON position of the program off/on selector switch. One of the MAIN PROGRAM SCREENS will be displayed.

On the MAIN PROGRAM SCREEN, use ↓ and ↑ on the keypad to scroll through the program options. Press ENTER when the pound symbol (#) is next to ANGLE SETTINGS. The security code screen will be displayed. See Figure 4.59. You will be prompted to enter the security code.

Press ESC to stop and return to the MAIN PROGRAM SCREEN. Press BKSP to backspace or press CLR to delete the entry and start over. Press ENTER when finished.

Figure 4.59
Security Code Screen

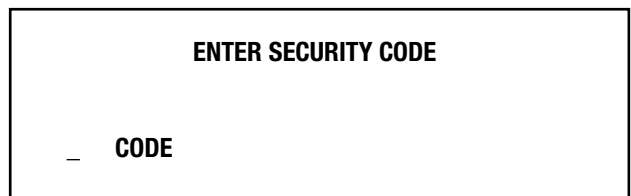

(Continued on next page.)

HOW TO PROGRAM THE ANGLE SETTINGS

(continued)

After the correct security code has been entered, the ANGLE SETTINGS SCREEN will be displayed. See Figure 4.60.

Use ↓ and ↑ on the keypad to scroll through the angle settings. Press ENTER when the arrow symbol (>) is next to the angle setting you want to program. A screen similar to the one shown in Figure 4.61 will be displayed.

Use the numeric keypad to enter a new angle. Press ENTER when finished.

Press ESC when finished to return to the MAIN PROGRAM SCREEN.

Figure 4.60
Angle Settings Screen

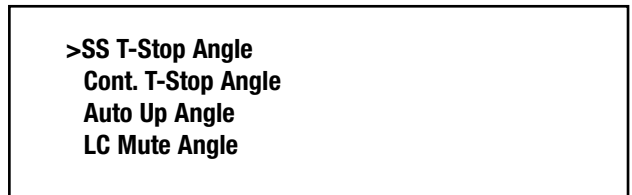
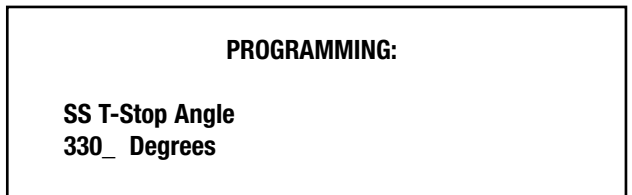

Figure 4.61
Example of a Programming Screen



(Continued on next page.)

SECTION 4—PROGRAMMING

SSC-1500 Part-Revolution Solid-State Control

TIMED SETTINGS

The SSC-1500 press control has a timed settings screen that is used to program the anti-tie-down, timed inch, and signal time-out settings.

ANTI-TIE-DOWN SETTING

The anti-tie-down setting is the amount of time within which all actuating means (palm buttons or foot switch[es]) must be concurrently depressed. Once one of the actuating means is depressed, the timer starts. If the set time is reached before the other actuating means is depressed, the control will not allow the press to begin a stroke. The range of 100-7000 ms allows enough time for single or multiple operator stations to depress all actuating means. The typical setting for one operator is 250 ms, which is the factory default setting.

TIMED INCH SETTING

The timed inch setting is the amount of time for which the clutch will engage when in the *Inch* mode of operation. This prevents the operator from having to depress and release the palm buttons in rapid succession to get small increments of slide movement. The dual-solenoid valve is deenergized when the set time is reached, even though the palm buttons may be held activated.

If timed inch is not required, the programmed setting should be at 0 ms, which will disable this feature. When timed inch is disabled, the normal *Inch* mode of operation will be active. In the normal *Inch* mode, setup or maintenance personnel can hold the palm buttons, allowing continuous movement of the slide, or they can depress and release the palm buttons in rapid succession to allow only small increments of slide movement.

SIGNAL TIME-OUT SETTING

The signal time-out setting is the amount of time within which a signal from an automatic feeding mechanism or other auxiliary equipment must be received by the control in order to cycle the press. This applies only when the press control is in either the *Automatic Single Stroke* or *Continuous-on-Demand* mode of operation. To turn the *Automatic Single Stroke* or *Continuous-on-Demand* mode of operation on, refer to the optional modes section on pages 70-72.

The programmed time must be longer than the entire *Automatic Single Stroke* or *Continuous-on-Demand* sequence of operation. If the signal is not received within the programmed amount of time, the press will not cycle. If the signal is received within the programmed amount of time, the press will cycle, and the signal time-out setting will reset and start over.

Initially, the timer is started on the first stroke by pressing the prior-action button. The palm buttons must then be used to initiate the first stroke. After the first stroke, the timer is started when the signal from an outside source is received. To stop the press once it is in the *Automatic Single Stroke* or *Continuous-on-Demand* mode of operation, press either the emergency-stop or top-stop palm button.

HOW TO PROGRAM THE TIMED SETTINGS

Select the ON position of the program off/on selector switch. One of the MAIN PROGRAM SCREENS will be displayed.

On the MAIN PROGRAM SCREEN, use ↓ and ↑ on the keypad to scroll through the program options. Press ENTER when the pound symbol (#) is next to TIMED SETTINGS. The security code screen will be displayed. See Figure 4.62. You will be prompted to enter the security code.

Press ESC to stop and return to the MAIN PROGRAM SCREEN. Press BKSP to backspace or press CLR to delete the entry and start over. Press ENTER when finished.

Figure 4.62
Security Code Screen

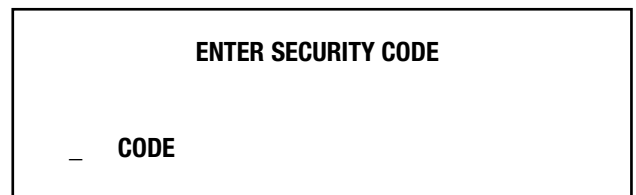

(Continued on next page.)

Rockford Systems, LLC
Call: 1-800-922-7533

HOW TO PROGRAM THE TIMED SETTINGS

(continued)

After the correct security code has been entered, the TIMED SETTINGS SCREEN will be displayed. See Figure 4.63.

Use ↓ and ↑ on the keypad to scroll through the timed settings. Press ENTER when the arrow symbol (>) is next to the timed setting you want to program. A screen similar to the one shown in Figure 4.64 will be displayed.

Use the numeric keypad to enter a new time. Press ENTER when finished.

Press ESC when finished to return to the MAIN PROGRAM SCREEN.

Figure 4.63
Timed Settings Screen



Figure 4.64
Example of a Programming Screen

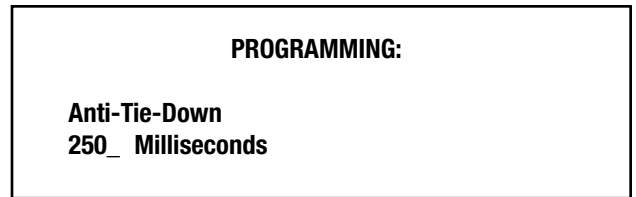

(Continued on next page.)

SECTION 4—PROGRAMMING

SSC-1500 Part-Revolution Solid-State Control

OPTIONAL MODES

The SSC-1500 press control has two (2) optional modes screens that are used to turn on or off the following optional modes of operation: *Continuous-on-Demand*, *Foot-Maintained Continuous*, *Two-Hand-Maintained Continuous*, *One-Hand or Foot Trip Single Stroke*, *Automatic Single Stroke*, *Top-Stop Inch*, and *Inch With Fault*. These optional modes (except for *Top-Stop Inch* and *Inch With Fault*) are mutually exclusive, which means that only one of them may be on at a time.

CONTINUOUS-ON-DEMAND

Continuous-on-Demand is a mode of operation where the press control system provides intermittent periods of continuous stroking automatically actuated by demand signals from other machinery or equipment used in association with the press in the production process, without action by an operator after the initial start. This mode is often used in production systems when a machine in the system uses parts in its operation that are produced by the press, but the machine cannot operate fast enough to use the number of parts produced if the press were run in the *Continuous* mode.

The demand signal must be received within a set amount of time, which is programmed by the operator. This timed setting is called signal time-out. For directions on how to program this setting, refer to the timed settings section on pages 68-69.

The programmed time must be longer than the entire *Continuous-on-Demand* sequence of operation. If the signal is not received within the programmed amount of time, the press will not cycle. If the signal is received within the programmed amount of time, the press will cycle and the signal time-out setting will reset and start over.

Initially, the timer is started before the first continuous cycle by pressing the prior-action button. The palm buttons must then be used to initiate the continuous cycle. The press will run continuously until the signal stops. After the first continuous cycle, the timer is started again when the signal from an outside source is received. This must occur before the signal time-out setting expires. To stop the press once it is in the *Continuous-on-Demand* mode of operation, press either the emergency-stop or top-stop palm button.

To use *Continuous-on-Demand*, the mode selector switch must be set to CONT, the actuating means selector switch must be set to HAND, and this mode must be turned on in the optional modes programming screen.



A point-of-operation safeguard must be used with this mode of operation.

FOOT-MAINTAINED CONTINUOUS

Foot-Maintained Continuous is a mode of operation whereby the ram strokes continuously as long as the operator(s) maintains actuation of the foot switch. This mode requires the prior-action push button to be depressed prior to actuating the foot switch. If the foot switch is released anytime during a stroke, the press will either top-stop or emergency-stop, depending on whether Maint Cont E-Stop is turned on in the optional modes programming screen (see page 72).

To use *Foot-Maintained Continuous*, the mode selector switch must be set to CONT, the actuating means selector switch must be set to FOOT, and this mode must be turned on in the optional modes programming screen.



A point-of-operation safeguard must be used with this mode of operation.

TWO-HAND-MAINTAINED CONTINUOUS

Two-Hand-Maintained Continuous is a mode of operation whereby the ram strokes continuously as long as the operator(s) maintains actuation of the palm buttons. This mode requires the prior-action push button to be depressed prior to actuating the palm buttons. If the palm buttons are released anytime during a stroke, the press will either top-stop or emergency-stop, depending on whether Maint Cont E-Stop is turned on in the optional modes programming screen (see page 72).

To use *Two-Hand-Maintained Continuous*, the mode selector switch must be set to CONT, the actuating means selector switch must be set to HAND, and this mode must be turned on in the optional modes programming screen.

(Continued on next page.)

Rockford Systems, LLC
Call: 1-800-922-7533

OPTIONAL MODES (continued)

ONE-HAND OR FOOT TRIP SINGLE STROKE

One-Hand or Foot Trip Single Stroke is a mode of operation whereby the press will make a cycle as soon as the palm button or the foot switch is depressed. In this mode, the automatic up (holding) angle does not apply.

To use *One-Hand or Foot Trip Single Stroke*, the mode selector switch must be set to SINGLE, the actuating means selector switch must be set to FOOT, and this mode must be turned on in the optional modes programming screen.



A point-of-operation safeguard must be used with this mode of operation.

AUTOMATIC SINGLE STROKE

Automatic Single Stroke is a mode of operation where single-stroke actuating signals are sent to the press control system by an automatic feeding mechanism or other auxiliary equipment without action by an operator after the initial start. This mode of operation is often used when automatic feeding or parts removal equipment cannot operate fast enough to insert or remove material with the press stroking continuously.

The signal must be received within a set amount of time, which is programmed by the operator. This timed setting is called signal time-out. For directions on how to program this setting, refer to the timed settings section on pages 68-69.

The programmed time must be longer than the entire *Automatic Single Stroke* sequence of operation. If the signal is not received within the programmed amount of time, the press will not cycle. If the signal is received within the programmed amount of time, the press will cycle and the signal time-out setting will reset and start over.

Initially, the timer is started on the first stroke by pressing the prior-action button. The palm buttons must be used, then, to initiate the first stroke. After the first stroke, the timer is started when the signal from an outside source is received. This must occur before the signal time-out setting expires. To stop the press once it is in the *Automatic Single Stroke* mode of operation, press either the emergency-stop or top-stop palm button.

To use *Automatic Single Stroke*, the mode selector switch must be set to SINGLE, the actuating means selector switch must be set to HAND, and this mode must be turned on in the optional modes programming screen.



A point-of-operation safeguard must be used with this mode of operation.

TOP-STOP INCH

Top-Stop Inch is a mode of operation that is similar to normal *Inch* (in which the ram travels as long as the operator(s) maintains actuation of the palm buttons). The difference is that if *Top-Stop Inch* is turned on, the ram will stop at the top of every cycle, even if the palm buttons are held depressed.

To use *Top-Stop Inch*, the mode selector must be set to INCH, the actuating means selector switch must be set to HAND, and this mode must be turned on in the optional modes programming screen.



The *Inch* mode of operation is used for die setup, tool setup, and maintenance only. It is not intended for use during production operations.

INCH WITH FAULT

Inch With Fault is the same mode of operation as normal *Inch*, but the control will allow the press to be cycled without general fault messages stopping it and being displayed. This allows the press to be set up easily without having to turn off the cyclic die protection inputs that would normally cause nuisance faults during setup.

To use *Inch With Fault*, the mode selector must be set to INCH, the actuating means selector switch must be set to HAND, and this mode must be turned on in the optional modes programming screen.



The *Inch* mode of operation is used for die setup, tool setup, and maintenance only. It is not intended for use during production operations.

(Continued on next page.)

SECTION 4—PROGRAMMING

SSC-1500 Part-Revolution Solid-State Control

OPTIONAL MODES (continued)

MAINTAINED CONTINUOUS E-STOP

In the *Foot-Maintained Continuous* and *Two-Hand-Maintained Continuous* modes of operation, the press will top-stop when the foot switch or palm buttons are released anytime during a stroke. However, if this setting is turned on in the optional modes programming screen, the press will instead emergency-stop when the foot switch or palm buttons are released during a stroke.

HOW TO TURN ON OR OFF THE OPTIONAL MODES

Select the ON position of the program off/on selector switch. One of the MAIN PROGRAM SCREENS will be displayed.

On the MAIN PROGRAM SCREEN, use ↓ and ↑ on the keypad to scroll through the program options. Press ENTER when the pound symbol (#) is next to OPTIONAL MODES. The security code screen will be displayed. See Figure 4.65. You will be prompted to enter the security code.

Press ESC to stop and return to the MAIN PROGRAM SCREEN. Press BKSP to backspace or press CLR to delete the entry and start over. Press ENTER when finished.

After the correct security code has been entered, the first OPTIONAL MODES SCREEN will be displayed. See Figure 4.66.

Use ↓ and ↑ on the keypad to scroll through the optional modes. If you press ↓ when the arrow symbol (>) is next to Hand/Foot Trip, the second OPTIONAL MODES SCREEN will be displayed. See Figure 4.67.

Press ENTER when the arrow symbol (>) is next to the optional mode you want to turn on or off. A screen similar to the one shown in Figure 4.68 will be displayed.

Once in the programming screen of the optional mode you want to program, use ↓ and ↑ on the keypad to toggle the setting between ON and OFF. Press ENTER to finish.

Press ESC when finished to return to the MAIN PROGRAM SCREEN.

Figure 4.65
Security Code Screen

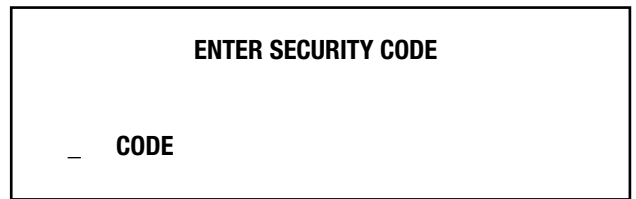

Figure 4.66
First Optional Modes Screen

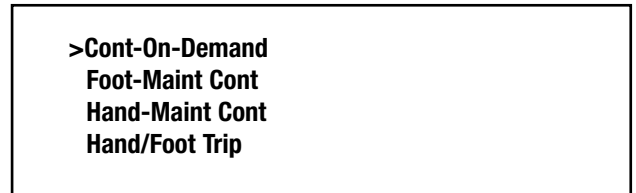

Figure 4.67
Second Optional Modes Screen

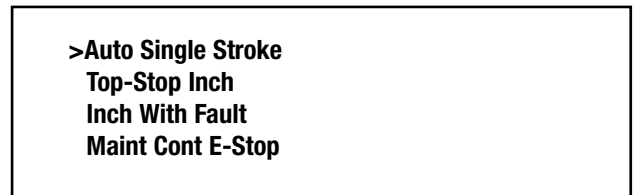
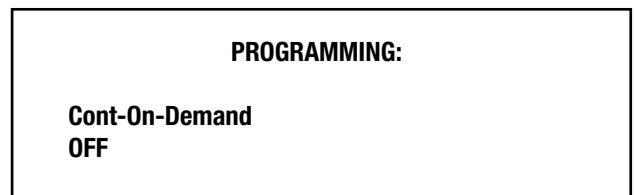

Figure 4.68
Example of a Programming Screen



(Continued on next page.)

Rockford Systems, LLC
Call: 1-800-922-7533

VARIABLE-SPEED TOP-STOP SETTINGS

The variable-speed top-stop settings screens are used to program the angles at which the control gives the signal to stop the press at TDC (top dead center), when the top-stop palm button is pressed while in the *Continuous* mode of operation. This will ensure the press will stop at top, regardless of the speed at which it is run. These settings also apply when a user input activates that has been programmed to top stop. These settings should be used only if your press has a variable-speed drive, and it is run at different speeds. If you have a constant-speed press, or if you have a variable-speed drive but run it at only one speed, make sure this function is turned off.

HOW TO CALCULATE THE VARIABLE-SPEED TOP-STOP SETTINGS

There are six locations to input your press's speed and corresponding top-stop angle. In the first location, the slowest speed that you run the press at should be input. The fastest speed that you run the press at should be input in the sixth location. The second through the fifth locations should be input with speeds in even increments between your slowest and fastest speeds.

Once all six speeds are input, the corresponding top-stop angles can be set. Start with the first location; a good angle to start with is 270°. If the press stops before TDC, a higher angle setting is required. Add the number of degrees the machine stopped short of TDC to the setting. If the press stops beyond TDC, a lower angle setting is required. Subtract the number of degrees the machine went over TDC from the setting. Repeat this for the rest of the angle settings.

HOW TO PROGRAM THE VARIABLE-SPEED TOP- STOP SETTINGS

Select the ON position of the program off/on selector switch. One of the MAIN PROGRAM SCREENS will be displayed.

On the MAIN PROGRAM SCREEN, use ↓ and ↑ on the keypad to scroll through the program options. Press ENTER when the pound symbol (#) is next to VAR SPD SETTINGS. The security code screen will be displayed. See Figure 4.69. You will be prompted to enter the security code.

Press ESC to stop and return to the MAIN PROGRAM SCREEN. Press BKSP to backspace or press CLR to delete the entry and start over. Press ENTER when finished. After the correct security code has been entered, the first VARIABLE-SPEED TOP-STOP SETTINGS SCREEN will be displayed. See Figure 4.70.

Use the ↓ and ↑ on the keypad to scroll through the variable speed top-stop settings options and to view the second through fourth VARIABLE-SPEED TOP-STOP SETTINGS SCREENS. See Figures 4.71 through 4.73.

Figure 4.69
Security Code Screen



Figure 4.70
First Variable-Speed Top-Stop Settings Screen

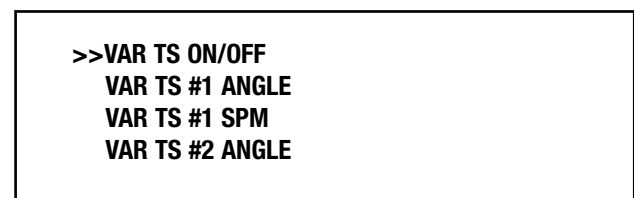
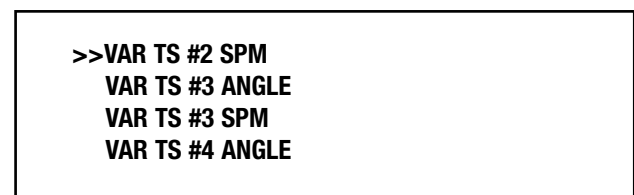

Figure 4.71
Second Variable-Speed Top-Stop Settings Screen



(Continued on next page.)

SECTION 4—PROGRAMMING

SSC-1500 Part-Revolution Solid-State Control

HOW TO PROGRAM THE VARIABLE-SPEED TOP-STOP SETTINGS (continued)

To turn the variable-speed top-stop settings on or off, press ENTER when the double arrow symbol (>>) is next to VAR TS ON/OFF. The programming screen shown in Figure 4.74 will be displayed (if OFF is chosen). Use the ↓ and ↑ on the keypad to toggle the setting between ON and OFF. Press ENTER when finished.

Use the ↓ and ↑ on the keypad to scroll through the variable-speed top-stop settings options. Press ENTER when the double arrow symbol (>>) is next to the variable-speed setting to be programmed. A programming screen similar to Figures 4.75 and 4.76 will be displayed. Use the numeric keypad to enter the degrees and SPM. Do this for all six (6) locations. Press ENTER to finish.

Press ESC to return to the MAIN PROGRAM SCREEN.

Figure 4.72
Third Variable-Speed Top-Stop Settings Screen

```
>>VAR TS #4 SPM
VAR TS #5 ANGLE
VAR TS #5 SPM
VAR TS #6 ANGLE
```

Figure 4.73
Fourth Variable-Speed Top-Stop Settings Screen

```
>>VAR TS #6 SPM
```

Figure 4.74
Variable-Speed Top-Stop Settings ON/OFF Screen

```
PROGRAMMING:

VAR T-Stop ON/OFF
OFF
```

Figure 4.75
Variable-Speed #1 Angle Screen

```
PROGRAMMING:

VAR TS #1 ANGLE
330_ Degrees
```

Figure 4.76
Variable-Speed #1 Speed Screen

```
PROGRAMMING:

VAR TS #1 SPM
20_ SPM
```

(Continued on next page.)

Rockford Systems, LLC
Call: 1-800-922-7533

PLS OUTPUTS

The SSC-1500 press control provides two (2) PLS (programmable limit switch) output relays which are fused for 4 A @ 115 V. These user-programmable outputs can be used to sequence events during the press stroke.

The PLS outputs can be used for automatic operations such as lube mist, air blowoff, or feed initiation. Each output has two programmable ON and OFF angles. The control turns the output ON when the resolver reaches an ON angle setting and leaves the output on until an OFF angle setting is reached. There are two ON settings and two OFF settings per output, per revolution. If any of the ON and OFF angles overlap, the PLS output will stay on.

The outputs can also be programmed to turn off after a preset period of time in milliseconds. This timed off setting overrides any OFF angle setting, so the PLS output will turn off when the programmed time is reached, regardless of any OFF angle setting.

There is also a counter setting for a counted output. Auxiliary devices, such as lube or oil systems, can be interfaced so an output signal is provided when the counter setting is reached. For example, if an oil mist is required every three cycles, the counter setting is set to 3 strokes. When the counter reaches 3 strokes, the PLS output turns on, and the oil mist is given. The counter is then reset, and the cycle starts over.

HOW TO PROGRAM THE PLS OUTPUTS

Select the ON position of the program off/on selector switch. One of the MAIN PROGRAM SCREENS will be displayed.

On the MAIN PROGRAM SCREEN, use ↓ and ↑ on the keypad to scroll through the program options. Press ENTER when the pound symbol (#) is next to PLS OUTPUTS. The PLS OUTPUTS SCREEN will be displayed. See Figure 4.77.

Use ↓ and ↑ on the keypad to scroll through the PLS outputs. Press ENTER when the arrow symbol (>) is next to the PLS output you want to program. The first PLS PARAMETERS SCREEN will be displayed. See Figure 4.78.

Use ↓ and ↑ on the keypad to scroll through the programmable parameters. If you press ↓ when the double arrow symbol (>>) is next to Off Angle #2, the second PLS PARAMETERS SCREEN will be displayed. See Figure 4.79. Press ENTER when the double arrow symbol (>>) is next to the parameter you want to program. A screen similar to the one shown in Figure 4.80 will be displayed. Once in the programming screen of the parameter you want to program, use the numeric keypad to enter a new setting. Press ENTER to finish.

Press ESC when finished to return to the MAIN PROGRAM SCREEN.

Figure 4.77
PLS Outputs Screen



Figure 4.78
First PLS Parameters Screen

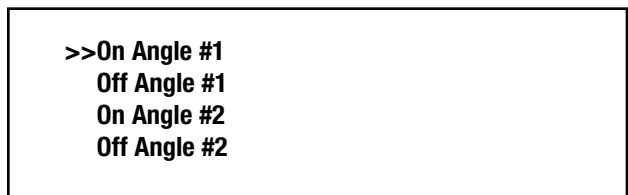
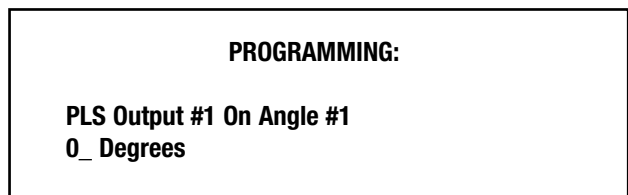

Figure 4.79
Second PLS Parameters Screen



Figure 4.80
Example of a Programming Screen



(Continued on next page.)

SECTION 4—PROGRAMMING

SSC-1500 Part-Revolution Solid-State Control

AUXILIARY OUTPUT

The SSC-1500 press control provides one (1) auxiliary output relay that has two contacts which are fused for 4 A @ 115 V. When this auxiliary output is set to be on, it can be programmed to change state whenever any or all of the following stop conditions occur: the batch counter setting is reached, a fault condition occurs, the press stops, or the press emergency stops. The output contacts can be programmed either N.O. (normally open) or N.C. (normally closed).

This auxiliary output can be tied in to a PLC (programmable logic controller) that's being used to control auxiliary equipment for the press, such as a feeder, robot, or indexing table. This way, the auxiliary equipment will know when the press has stopped, and can be programmed to stop as well. The output can also be used for something as simple as turning an indicator light on or off or sounding an audible alarm. Programming choices are either OFF or ON.

PROGRAMMABLE PARAMETERS FOR THE AUXILIARY OUTPUT

1. **Aux Out Batch Count:** With this function turned on, the auxiliary output contacts will change state when the batch counter setting is reached. The programming choices are OFF or ON.
2. **Aux Out Fault:** With this function turned on, the auxiliary output contacts will change state when a fault occurs. The programming choices are OFF or ON.
3. **Aux Out Stop:** With this function turned on, the auxiliary output contacts will change state when the machine stops. The programming choices are OFF or ON.
4. **Aux Out E-Stop:** With this function turned on, the auxiliary output contacts will change state when the machine is emergency stopped. The programming choices are OFF or ON.
5. **Aux Out Logic:** This setting is used to change the logic that activates the output. The programming choices are N.O. (normally open) or N.C. (normally closed).

HOW TO PROGRAM THE AUXILIARY OUTPUT

Select the ON position of the program off/on selector switch. One of the MAIN PROGRAM SCREENS will be displayed.

On the MAIN PROGRAM SCREEN, use ↓ and ↑ on the keypad to scroll through the program options. Press ENTER when the pound symbol (#) is next to AUXILIARY OUTPUT. The security code screen will be displayed. See Figure 4.81. You will be prompted to enter the security code.

Press ESC to stop and return to the MAIN PROGRAM SCREEN. Press BKSP to backspace or press CLR to delete the entry and start over. Press ENTER when finished.

After the correct security code has been entered, the first PROGRAMMABLE PARAMETERS SCREEN will be displayed. See Figure 4.82.

Figure 4.81
Security Code Screen

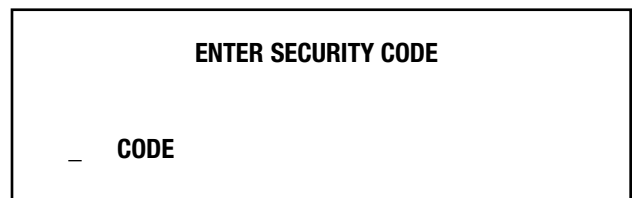
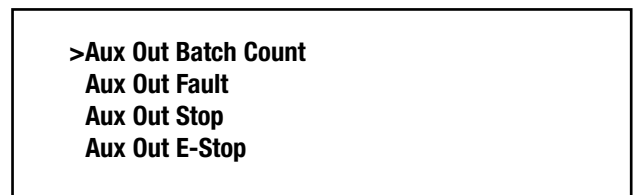

Figure 4.82
First Programmable Parameters Screen



(Continued on next page.)

Rockford Systems, LLC
Call: 1-800-922-7533

HOW TO PROGRAM THE AUXILIARY OUTPUT

(continued)

Use ↓ and ↑ on the keypad to scroll through the programmable parameters. If you press ↓ when the arrow symbol (>) is next to Aux Out E-Stop, the second PROGRAMMABLE PARAMETERS SCREEN will be displayed. See Figure 4.83. Press ENTER when the arrow symbol (>) is next to the parameter you want to program. A screen similar to the one shown in Figure 4.84 will be displayed.

Once you are in the programming screen of the parameter you want to program, use ↓ and ↑ on the keypad to reach the setting you desire for that parameter. Press ENTER to finish.

Press ESC when finished to return to the MAIN PROGRAM SCREEN.

Figure 4.83
Second Programmable Parameters Screen

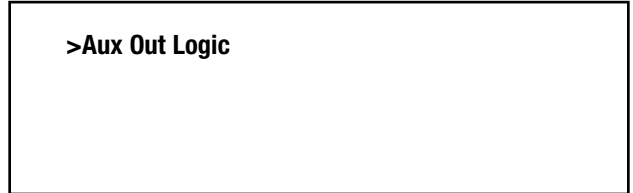
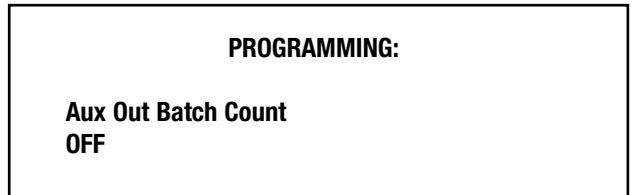

Figure 4.84
Example of Programming Screen



(Continued on next page.)

SECTION 4—PROGRAMMING

SSC-1500 Part-Revolution Solid-State Control

QUICK REFERENCE TABLE - FACTORY SETTINGS AND VALID RANGES

Table 4.1

Program Setting	Valid Entry Range		Factory Default Setting		
User Inputs 1-3	Logic:	Off, N.O., or N.C	Logic:	Off	
	Stop Type:	E-Stop or Top Stop	Stop Type:	E-Stop	
	Message:	See list of User Messages (p. 46)	Message:	Clutch/Brake Air Fault	
User Input 4	Logic:	Off, N.O., N.C., N.O.(PAIR), or N.C.(PAIR)	Logic:	Off	
	Stop Type:	E-Stop or Top Stop	Stop Type:	E-Stop	
	Message:	See list of User Messages (p. 46)	Message:	Clutch/Brake Air Fault	
User Input 5	Logic:	Off, N.O., or N.C.	Logic:	Off	
	Stop Type:	E-Stop or Top Stop	Stop Type:	E-Stop	
	Message:	See list of User Messages (p. 46)	Message:	Clutch/Brake Air Fault	
Note: When paired together with User Input 4, you will not be able to make programming changes to this input until it is unpaired by changing the logic for User Input 4 to OFF, N.O., or N.C.					
User Input 6	Logic:	Off, N.O., N.C., N.O.(PT-IN-PL), or N.C.(PT-IN-PL)	Logic:	Off	
	Stop Type:	E-Stop or Top Stop	Stop Type:	E-Stop	
	Message:	See list of User Messages (p. 46)	Message:	Clutch/Brake Air Fault	
Note: When used as a part-in-place cyclic input—i.e., when the logic is set to N.O.(PT-IN-PL) or N.C.(PT-IN-PL)—the stop type will be fixed to E-Stop and the message will be fixed to Part-in-Place Fault.					
User Inputs 7-8	Logic:	Off, N.O., or N.C.	Logic:	Off	
	Stop Type:	E-Stop or Top Stop	Stop Type:	E-Stop	
	Message:	See list of User Messages (p. 46)	Message:	Clutch/Brake Air Fault	
	Die Protect Mode:	Mode 1, Mode 2, or Mode 3	Die Protect Mode:	Mode 1	
	Open Angle:	0°-359°	Open Angle:	0°	
	Close Angle:	0°-359°	Close Angle:	0°	
Brake Monitor	Warning Setpoint:	0-999 ms	Warning Setpoint:	50 ms	
	Fault Setpoint:	0-999 ms	Fault Setpoint:	50 ms	
	STM Angle:	20°-340°	STM Angle:	90°	
Counters	Batch & Stroke Preset:	0-9,999,999 strokes	Batch & Stroke Preset:	0 strokes	
System Setup	Security Code:	User-programmed up to a 4-digit #	Security Code:	0	
	Network Settings:	Name:	User-programmed up to 17 alphanumeric characters	Name:	MYNAME
		Work Group:	User-programmed up to 17 alphanumeric characters	Work Group:	MYGROUP
		Address:	User-programmed from 0.0.0.0 to 255.255.255.255	Address:	127.0.0.1
		Mask:	User-programmed from 0.0.0.0 to 255.255.255.255	Mask:	255.255.255.0
		Mode:	Static or DHCP	Mode:	Static
	SPM Range:	Low (0-30), Med (31-150), or High (151+)	SPM Range:	Low (0-30)	
	Light Curtain Input:	2 N.O. or 1 N.O. & 1 N.C.	Light Curtain Input:	2 N.O.	
	Angle Display:	On or Off	Angle Display:	Off	
	Spanish:	On or Off	Spanish:	Off	
	Angle Settings	Single Stroke Top Stop:	90°-359°	Single Stroke Top Stop:	330°
Continuous Top Stop:		0°-359°	Continuous Top Stop:	330°	
Automatic Up:		90°-345°	Automatic Up:	180°	
Light Curtain Mute:		45°-345°	Light Curtain Mute:	170°	

(Continued on next page.)

Rockford Systems, LLC
Call: 1-800-922-7533

SECTION 4—PROGRAMMING

SSC-1500 Part-Revolution Solid-State Control

QUICK REFERENCE TABLE - FACTORY SETTINGS AND VALID RANGES (Continued) **Table 4.1** (continued)

Program Setting	Valid Entry Range		Factory Default Setting	
Timed Settings	Anti-Tie-Down:	100-7000 ms	Anti-Tie-Down:	250 ms
	Timed Inch:	0-999 ms	Timed Inch:	0 ms (Off)
	Signal Time-Out:	1-120 seconds	Signal Time-Out:	5 seconds
Optional Modes	Continuous-On-Demand:	On or Off	Continuous-On-Demand:	Off
	Foot-Maintained Continuous:	On or Off	Foot-Maintained Continuous:	Off
	Two-Hand-Maintained Continuous:	On or Off	Two-Hand-Maintained Continuous:	Off
	One-Hand/Foot Trip:	On or Off	One-Hand/Foot Trip:	Off
	Auto. Single Stroke:	On or Off	Auto. Single Stroke:	Off
	Top-Stop Inch:	On or Off	Top-Stop Inch:	Off
	Inch With Fault:	On or Off	Inch With Fault:	Off
Variable-Speed Top-Stop Settings	Speed:	4-500 SPM	Speed—Angle 20 SPM—330°	Speed—Angle 80 SPM—318°
	Angle:	0°-359°	40 SPM—326°	100 SPM—314°
			60 SPM—322°	120 SPM—310°
PLS Outputs 1-2	On Angle #1:	0°-359°	On Angle #1:	0°
	Off Angle #1:	0°-359°	Off Angle #1:	0°
	On Angle #2:	0°-359°	On Angle #2:	0°
	Off Angle #2:	0°-359°	Off Angle #2:	0°
	Counter:	0-999 strokes	Counter:	0 strokes
	Timed Off:	0-999 ms	Timed Off:	0 ms
Auxiliary Output	Aux. Out. Batch Count:	Off	Aux. Out. Batch Count:	Off
	Aux. Out. Fault:	Off	Aux. Out. Fault:	Off
	Aux. Out. Stop:	Off	Aux. Out. Stop:	Off
	Aux. Out. E-Stop:	Off	Aux. Out. E-Stop:	Off
	Aux. Out. Logic:	N.O. or N.C.	Aux. Out. Logic:	N.O.

(Continued on next page.)

SECTION 5—FATAL AND GENERAL FAULT MESSAGES

SSC-1500 Part-Revolution Solid-State Control

Fatal Fault Messages

Fatal fault messages CANNOT be cleared. An emergency stop or a power shut off is required for the control to recover. The problem should be addressed before running the machine again.

For all fatal fault messages (except the two diagnostic faults), the first two lines of the screen will display this followed by the fault message:

<SYSTEM FAULT>
<E-STOP TO CLEAR>

(FAULT MESSAGE IS DISPLAYED HERE)

Table 5.1

MESSAGE	DESCRIPTION/SOLUTION
CPU #2 ACKN FLT	A signal that was being monitored by CPU #2 did not behave as expected. Turn the module power switch off for 5 to 10 seconds. Turn it back on and proceed as normal. If the message persists, the module may need to be replaced. Possible circuit failure; consult the factory.
CPU #2 SSRON FLT	The SSRs (solid-state relays) did not turn on while being monitored by CPU #2. Turn the module power switch off for 5 to 10 seconds. Turn it back on and proceed as normal. If the message persists, the module may need to be replaced. Possible circuit failure; consult the factory.
DIAGNOSTIC FAULT #1 KILL POWER TO CLEAR	A diagnostic test of a monitoring circuit failed during power-up. Turn the module power switch off for 5 to 10 seconds. Turn it back on and proceed as normal. If the message persists, the module may need to be replaced. Possible circuit failure; consult the factory.
DIAGNOSTIC FAULT #2 KILL POWER TO CLEAR	A diagnostic test of a redundant safety circuit failed. Turn the module power switch off for 5 to 10 seconds. Turn it back on and proceed as normal. If the message persists, the module may need to be replaced. Possible circuit failure; consult the factory.
INVALID PAIR SIGNALS	User Inputs 4 and 5 are paired together, but they did not change state within 500 milliseconds of each other. Check the equipment tied in to Inputs 4 and 5 for possible failure.
MOTION DROPPED	The press cycle lost motion once it was sensed at the start of the cycle. Check that the press is running at 4 SPM or greater. If this message persists, rerun the press setup from TDC and note the reference time reported. Possible circuit failure; consult the factory.
MOTION, NO RUN	The control detected motion prior to starting a press cycle. Check for correct wiring to the resolver connection on the SSC-1500 control module. Verify the chain is on the sprocket for the resolver and is tight. Check that the SPM display is 000 when the crankshaft is at rest, or prior to starting a press cycle. Verify the resolver cable is not run near high-voltage lines (motor leads). Possible circuit failure; consult the factory.
MOTION REFERENCE FLT	The press cycle did not produce motion within the given reference time allotted. Check that the press is running at full speed and the air pressure hasn't dropped. If this message persists, rerun a reference cycle from TDC and note the reference time reported. Possible circuit failure; consult the factory.
RESOLVER NOT WORKING	Velocity is present but the resolver is not moving. Check for correct wiring to the resolver connection on the SSC-1500 control module. Verify that the resolver cable is not run near high-voltage lines (motor leads). Possible circuit failure; consult the factory.
RESOLVER READ ERROR	Three successive reads of the resolver position failed to produce the same value. Possible circuit failure; consult the factory.

(Continued on next page.)

Rockford Systems, LLC
Call: 1-800-922-7533

SECTION 5—FATAL AND GENERAL FAULT MESSAGES

SSC-1500 Part-Revolution Solid-State Control

Fatal Fault Messages (continued)

Table 5.1 (continued)

MESSAGE	DESCRIPTION/SOLUTION
RESOLVER/SYNC FLT 1	The sync switch in the resolver housing came on outside its window that was set during the reference cycle. Check that nothing else is turning on the sync switch input. Verify that the resolver cable is not run near high-voltage lines (motor leads). Check the resolver chain or coupling for tightness and make sure there is no backlash or slop. Check the resolver cable and ensure that the sync switch LED on the SSC-1500 control module is functioning and is not coming on during the bottom of the stroke. If it is coming on at the bottom of the stroke, remove the chain or coupling from the resolver shaft and rotate the resolver shaft so the sync switch does not come on at the bottom of the stroke. Run a reference cycle again. Possible circuit failure; consult the factory.
RESOLVER/SYNC FLT 2	The sync switch in the resolver housing never came on during the press cycle. Check that no wires have come loose inside the resolver housing or where the resolver cable connects to the SSC-1500 control module. Make sure the sync switch LED on the SSC-1500 control module is functioning. Make sure the chain has not fallen off during the press cycle. Possible circuit failure; consult the factory.
SSR1 or K1 OFF FLT	SSR1 (solid-state relay 1) and/or K1 safety relay did not shut off and voltage was detected via the redundant feedback circuit. Turn the module power switch off for 5 to 10 seconds. Turn it back on and proceed as normal. If the message persists, the module may need to be replaced. Possible circuit failure; consult the factory.
SSR1 or K1 ON FLT	SSR1 (solid-state relay 1) and/or K1 safety relay did not turn on and voltage was not detected via the redundant feedback circuit. Turn the module power switch off for 5 to 10 seconds. Turn it back on and proceed as normal. If the message persists, the module may need to be replaced. Possible circuit failure; consult the factory.
SSR1 or SSR2 OFF FLT	One or both SSRs (solid-state relays) did not shut off and voltage was detected via the redundant feedback circuit. Turn the module power switch off for 5 to 10 seconds. Turn it back on and proceed as normal. If the message persists, the module may need to be replaced. Possible circuit failure; consult the factory.
SSR2 OFF FLT	SSR2 (solid-state relay 2) did not shut off and voltage was detected via the redundant feedback circuit. Turn the module power switch off for 5 to 10 seconds. Turn it back on and proceed as normal. If the message persists, the module may need to be replaced. Possible circuit failure; consult the factory.
SSR2 ON FLT	SSR2 (solid-state relay 2) did not turn on and voltage was not detected via the redundant feedback circuit. Turn the module power switch off for 5 to 10 seconds. Turn it back on and proceed as normal. If the message persists, the module may need to be replaced. Possible circuit failure; consult the factory.

(Continued on next page.)

SECTION 5—FATAL AND GENERAL FAULT MESSAGES

SSC-1500 Part-Revolution Solid-State Control

General Fault Messages

Table 5.2

Most general fault messages can be cleared by pressing ENTER on the keypad.

MESSAGE	DESCRIPTION/SOLUTION
AUTO SINGLE READY	The control is waiting for a signal to make the next stroke while in the Automatic Single Stroke mode of operation.
BATCH COUNT EXPIRED	The batch count has reached the programmed preset value and the press is now stopped. To clear the message and reset the counter, press ENTER on the keypad or press the yellow top-stop palm button. If you do not have a top-stop palm button and would like to use a remote push button to reset the counters, a button with one N.C. (normally closed) contact can be wired in where the optional top stop is shown on the electrical schematics. See pages 55-56 for information on programming the batch preset.
BATTERY BACK-UP MEMORY FAILED! DEFAULTS WERE SET. PRESS ESC TO EXIT	The battery back-up memory failed. Clear the fault. Turn off the power switch for 5 to 10 seconds. Turn it back on and proceed as normal. If message persists, the battery may need to be replaced on the module. Possible circuit failure; consult the factory.
BRAKE FAULT	The stopping time has exceeded the programmed limit for the brake fault setting. When this message is displayed, acknowledge the message by pressing ENTER and it will clear. No press action can be initiated during this time. Once it clears, continue with normal operation. If faults persist, consult your supervisor, as the brake may need inspection or adjustment to improve the stop time. See pages 52-54 for a detailed description of the brake monitor.
BRAKE WARNING	The stopping time has exceeded the programmed limit for the brake warning setting. This message is displayed for 5 seconds and then clears automatically. No press action can be initiated during this time. Wait for it to clear and continue with normal operation. If warnings persist, consult your supervisor, as the brake may need inspection or adjustment to improve the stop time. See pages 52-54 for a detailed description of the brake monitor.
CONT MODE OFF	An attempt was made to switch to Single Stroke while the machine was running in Continuous.
DO REFERENCE CYCLE	A valid reference cycle has not been done. Perform a reference cycle. See page 59 for detailed instructions.
FOOT OFF	The actuating means selector switch was changed from FOOT to HAND while the machine was running in Foot-Maintained Continuous.
FOOT ONLY	The mode selector switch is in CONT and the Foot-Maintained Continuous optional mode has been turned on, but the actuating means selector is in HAND. The foot switch is the only means of actuation that can be used.
HAND OFF	The actuating means selector switch was changed from HAND to FOOT while the machine was running in Continuous.
HAND ONLY	The mode selector switch is in INCH or CONT and the actuating means selector is in FOOT. Inch and Continuous modes cannot be actuated with the foot switch. Change either selector switch to the proper setting and continue.
LC BROKEN	An attempt was made to perform an STM test while the light curtain was obstructed or was not in the clear (green) state. Make sure there is nothing obstructing the light curtain. If the problem persists, refer to the light curtain installation manual for troubleshooting.
LC CYCLE FAULT	The light curtain cycle check wired to the MTS input on the light curtain(s) failed to cycle on the upstroke. Check the LED for the K4 relay on the SSC-1500 control module, and fused F5 and F6 for the LC cycle output contacts.
LC SS CHANGED	The light curtain selector switch was changed from ON to OFF while the machine was running.

(Continued on next page.)

Rockford Systems, LLC
Call: 1-800-922-7533

SECTION 5—FATAL AND GENERAL FAULT MESSAGES

SSC-1500 Part-Revolution Solid-State Control

General Fault Messages (continued)

Table 5.2 (continued)

MESSAGE	Description/Solution
MOTOR NOT FORWARD	Verify that the main motor is running in the forward direction. Verify that Input P8-16 is on.
NO INTERLOCKS	An attempt was made to initiate a cycle in either Foot Single Stroke or Continuous and there was no interlock; i.e., light curtain(s) or safeguard interlock(s).
PAIRED WITH INPUT #4	An attempt was made to program User Input 5, but it is paired with User Input 4. This message is displayed for 2 seconds and then clears automatically. To unpair the inputs, the logic for Input 4 must be changed to N.O. (normally open), N.C. (normally closed), or OFF (disabled). See pages 48–49 for information on programming the user inputs.
PRESS NOT AT TOP	An attempt to initiate a single stroke has been made when the resolver/crankshaft angle is between the top stop angle and 345°. Change the mode selector to INCH and inch the ram up past 345°. Change the selector to SINGLE and retry.
PROG ON	An attempt was made to switch to program on while the machine was running.
STM TEST FAILED	The palm buttons were released early during the STM test. Refer to pages 52-53 and retry.
REFERENCE FAILED! NO MOTION WITHIN 1.5 SECONDS. PRESS ESC TO EXIT	The resolver did not detect motion within 1.5 seconds during the reference cycle. Check that the resolver is wired correctly, and run the reference cycle again. Possible circuit failure; consult the factory.
REFERENCE FAILED! PALM BUTTONS WERE RELEASED EARLY. PRESS ESC TO EXIT	The palm buttons were released early during the reference cycle. Rerun the reference cycle and hold the palm buttons until the press stops on its own. Verify resolver direction. Switch the mode selector to INCH and verify that SPM is displayed when running.
REFERENCE FAILED! SYNC SWITCH WAS NOT DETECTED. PRESS ESC TO EXIT	The sync switch in the resolver housing did not come on during the reference cycle. The sync switch can only come on between 30° and 330°. The ideal location is around 90° for most presses. Check the wiring for the resolver and check the LED on the control module for the sync switch input to ensure it is functioning. Ensure the press is at TDC when doing the reference cycle. If needed, remove the chain or coupling from the resolver drive and rotate until the sync switch signal is not over top, and falls within 30° and 330°. Run a reference cycle again. Possible circuit failure; consult the factory.
REFERENCE FAILED! SYNC SWITCH CANNOT BE ON WHEN STARTING PRESS ESC TO EXIT	Reposition the resolver so the sync switch in the resolver housing is not on at the top of the stroke. Make sure the resolver shaft keyway is perpendicular to the base at TDC.
STROKE COUNT EXPIRED	The stroke count has reached the programmed preset value and the press is now stopped. To clear the message and reset the counter, press ENTER on the keypad or press the yellow top-stop palm button. If you do not have a top-stop palm button and would like to use a remote push button to reset the counters, a button with one N.C. (normally closed) contact can be wired in where the optional top stop is shown on the electrical schematics. See pages 55-56 for information on programming the stroke preset.
SWITCH TO HAND	When performing a reference cycle or STM test, hand is the only means of actuation. Switch the actuating means selector to HAND and continue.
TOP STOP IS ON	A cycle was attempted when the top stop was on. Make sure the button is released.
WAITING FOR TRIGGER	The control is waiting for a signal to continue stroking while in the Continuous-on-Demand mode of operation.
WRONG SECURITY CODE	The entered security code did not match the currently stored security code and access is denied to the desired function. Retype the security code and try again. If you have forgotten the security code, you may call 1-800-922-7533 or (815) 874-7891 to obtain the master security code from tech support.

(Continued on next page.)

SECTION 6—OPERATING CONSIDERATIONS

SSC-1500 Part-Revolution Solid-State Control

SSC-1500 Operation Checklist

1. Is all wiring to the machine, the solid-state control module (black box), and keypad/display correct when verified with the drawings sent with the solid-state control? Y or N
 2. Does the connection between the resolver/pulser cable and the P5 connector exist, as referenced in the wiring diagram? (See page 26 or Sheet No. 2 of the schematics.) Y or N
 3. Does the resolver/pulser cable have any splices? (Answer should be NO.) Y or N
 4. When powering up the solid-state control module, do the four (green) LEDs (Power Status and CPU) on the front of the black control module turn on? Y or N
 5. Is the WAKE UP SCREEN displayed with the message: "SAFEGUARDS IN PLACE?" when the main power disconnect switch is turned on?
..... Y or N
 6. With no ram motion, check the SPM reading on the RUN SCREEN. Visually verify that SPM is displaying 000 with no flickering of the numbers.
(If numbers are flickering, please consult the factory.) Y or N
 7. Was the POWER-UP PROCEDURE performed at TDC (top dead center) of crankshaft rotation? (See page 44 of this Installation Manual)
..... Y or N
- Note: The shaft extension of the resolver must have the keyway up and perpendicular to the base of the assembly when setting the resolver.)*
8. The resolver/pulser assembly was shipped with the print shown for clockwise (CW) rotation (when looking at the shaft extension where the sprocket is attached). If this assembly is mounted to operate in a counterclockwise (CCW) rotation, the resolver wiring must be reset for counterclockwise rotation. Refer to page 26 or Sheet No. 2 of the schematics shipped with the control box. Does the above checkout?
..... Y or N
 9. In normal run modes, such as SINGLE or CONTINUOUS, does the machine make cycles without any faults appearing on the display?
..... Y or N

Electrical Troubleshooting

All troubleshooting, as well as installation, must be performed by qualified and properly trained personnel. Also, when a defective component is found, do not operate the machine until that component has been replaced with an exact replacement part.

This procedure is written as a general guide for troubleshooting most part-revolution control systems. In all cases, please refer to the individual control wiring schematic for particular test points and terminal numbers. Be sure to follow the schematic and select the proper modes of operation when troubleshooting.

If a defective component (contact) is found, always verify with an ohm meter. Lock the disconnect switch in the off position, isolate the component or contact from other wiring and check its integrity with an ohm meter. At the same time, manually operate the device (in the case of a contact) to check its function.

The following should be checked if your machine is not functioning properly at this time:

Check the exhaust port and muffler on the monitored dual-solenoid valve. The exhaust port and exhaust muffler must be clean and unobstructed so an unrestricted flow of exhaust air from the clutch/brake is obtained.

(Continued on next page.)

Rockford Systems, LLC
Call: 1-800-922-7533

TROUBLESHOOTING OUTLINE

Use the control drawing schematics in conjunction with the following troubleshooting outline:

NO VOLTAGE—POSSIBLE CAUSES:

1. Check the line voltage on the transformer primary with a volt meter.
2. Check for correct transformer primary connections (wiring) and the secondary for 120 V AC using a volt meter.
3. A primary or secondary fuse may be blown—replace the fuse with the proper size, type, and amperage in accordance with the control drawing. Using an ohm meter, locate the reason for the blown fuse before reapplying power.

MOTOR DOES NOT START—POSSIBLE CAUSES:

1. Open electrical interlocks. The circuit can be arranged to accommodate machine protective electrical interlocks, overload interlocks, and safety block interlocks. These interlocks are strategically located to prevent machine operation when open. Please refer to the schematic for the location of the various interlocks.

2. Motor starter does not energize.

Motor starter operating coil may not be 120 V AC.

Motor overload may have tripped out; this may have been caused because no overload is present or because of an improperly rated overload.

Motor start/stop push buttons may be improperly wired or defective.

Motor starter contact may be defective.

- The motor should start if the above checks OK. If the motor still fails to run when the start button is released, check the motor starter holding contact for proper wiring and function.

MACHINE WILL NOT STROKE—POSSIBLE CAUSES:

Clutch will not engage and the brake will not release

- Air supply may be off.
- Air pressure may be insufficient.

Dual-solenoid air valve will not energize

- Check for proper installation and wiring.
- Solenoid coils may be open.

LIGHT CURTAIN (IF FURNISHED) IS NOT FUNCTIONING—POSSIBLE CAUSE:

Fuses F5 or F6 may be faulty (if light curtain MTS contact is wired in to P7)

PLS NOT FUNCTIONING—POSSIBLE CAUSE:

Fuses F3 or F4 may be faulty

(Continued on next page.)

SECTION 7—MAINTENANCE AND INSPECTION

SSC-1500 Part-Revolution Solid-State Control

Part-Revolution-Clutch Press

A part-revolution-clutch mechanical power press consists of engaging parts, springs, electrical components, air components and other mechanical equipment. Because of this inherent design, machine parts will ultimately wear, get out of adjustment or break which could cause a malfunction and/or mechanical failure. The control system furnished can never cure nor overcome a misadjusted, worn, broken or malfunctioning part or mechanical failure. Be sure to inspect all parts for adjustment, excessive wear, looseness or breakage. Do not operate your machines until all parts are adjusted, repaired, replaced, and each entire machine is working properly.

Visual inspections and examinations of the machine and its components must be made at least once per shift by qualified personnel.

Machines must always be inspected and tested on a weekly basis to determine the condition of the clutch/brake mechanism and antirepeat feature. Necessary maintenance and repair must be done before each machine is operated again, and the employer must maintain records of both the inspections and the maintenance work performed.



After any maintenance, always operate the machine numerous times in all modes of operation before allowing the operator to start production. Always make sure point-of-operation safeguarding is in place, adjusted and operating properly for the job and for the operator.

OSHA Regulation for Inspections

OSHA 29 CFR 1910.217 (e)(1) INSPECTION AND MAINTENANCE RECORDS

(i) It shall be the responsibility of the employer to establish and follow a program of periodic and regular inspections of his power presses to insure that all parts, auxiliary equipment, and safeguards are in a safe operating condition and adjustment. The employer shall maintain a certification record of inspections which includes the date of inspection, the signature of the person who performed the inspection, and the serial number, or other identifier, of the power press that was inspected.

(ii) Each press shall be inspected and tested no less than weekly to determine the condition of the clutch/brake mechanism-antirepeat feature and single stroke mechanism. Necessary maintenance or repair or both shall be performed and completed before the press is operated. These requirements do not apply to those presses which comply with paragraphs (b)(13) Control Reliability and (b)(14) Brake Monitoring of this section. The employer shall maintain a certification record of inspections, tests and maintenance work which includes the date of the inspection, test or maintenance; the signature of the person who performed the inspection, test or maintenance; and the serial number or other identifier of the press that was inspected, tested or maintained.

(e)(3) Training of Maintenance Personnel—It shall be the responsibility of the employer to insure the original and continuing competence of personnel caring for, inspecting, and maintaining power presses.

OSHA Regulation for Operator Training

OSHA 29 CFR 1910.217 (f)(2) INSTRUCTION TO OPERATORS

The employer shall train and instruct the operator in the safe method of work before starting work on any operation covered by this section. The employer shall insure by adequate supervision that correct operating procedures are being followed.

(Continued on next page.)

*Rockford Systems, LLC
Call: 1-800-922-7533*

Electrical Controls

Before inspecting or maintaining electrical controls, be sure to switch the main power disconnect to the off position and lockout all energy. Perform a periodic inspection of the control box and electrical machine components for loose or broken wires. Be sure relays and switches are examined for burned or worn contacts. Look for loose or broken conduit and cable fittings. The control box and other components must be kept closed, covered, and locked to keep unauthorized personnel out. Keys must be removed from all selector switches and door locks to prevent tampering and prevent exposure to the dirt, chips and oil present in most shops.

Air System

1. Be sure to turn the air pressure off, bleed air from the system or component, and lockout before maintaining any air equipment.
2. Inspection of the entire air system is dependent on the frequency of machine operation and the cleanliness of the plant air lines. Both free moisture and solids should be removed automatically by the air filter. Be sure to drain the filter bowl whenever the water level in the sump reaches the lower baffle. To remove the filter element for cleaning, shut air line down and exhaust pressure. See Filter-Regulator-Lubricator Installation Manual No. KSL-208 and page 28 of this manual.
3. Be sure to check the lubricator for proper oil level and oil delivery adjustment. See Installation Manual No. KSL-208.
4. The monitored dual-solenoid air valve that operates the clutch and releases the brake must be protected from foreign material getting into the valve. The valve relies on the performance of the air filter. The valve's exhaust muffler must be removed regularly and cleaned so dumping of air is unrestricted. Refer to Installation Manual Nos. KSL-036 or KSL-037 and page 28 of this manual.



The maintenance and inspection sections in this manual cannot be all-inclusive. Always refer to the original equipment manufacturer's maintenance manuals or the machine owner's manual. If you do not have an owner's manual, contact the machine manufacturer.

Care of the Keypad/Display

To clean the keypad/display, use a clean soft cloth with soap and warm water, but do not saturate. Do not use oily rags, solvents, or ammonia-based glass cleaner.

(Continued on next page.)

SECTION 8—REPLACEMENT PROCEDURES

SSC-1500 Part-Revolution Solid-State Control

Replacing the Core Module

Photo 8.1

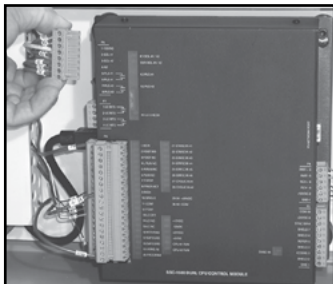

Photo 8.2



Photo 8.3

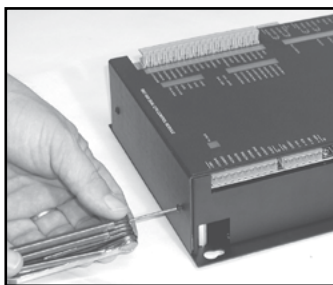

Photo 8.4

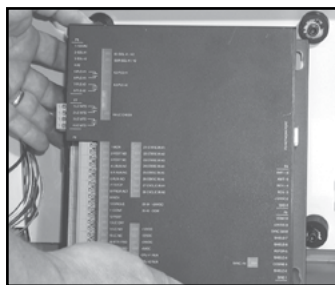

Photo 8.5

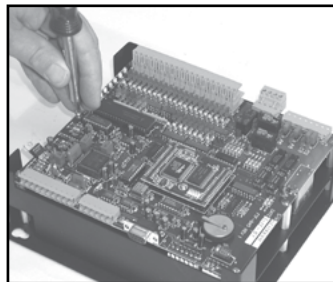
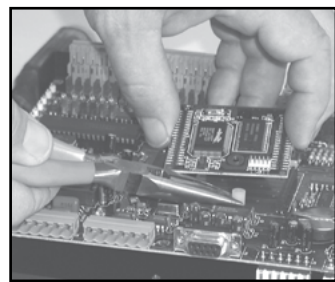

Photo 8.6



All power to the machine must be off before replacing the control module or any other parts.

1. Locate the control module inside the control box.
2. Remove all terminal strips from the left and right sides of the circuit board. Unplug the main power cord from the left side of the module. See Photo 8.1.
3. Loosen the four Allen-head bolts (Photo 8.2) and lift up on the control module. Pull the unit straight out. See Photo 8.3.
4. Remove the four small screws from the cover of the control module (Photo 8.4) and lift the cover straight up.
5. Remove the eight small screws from the circuit board (Photo 8.5) and lift the circuit board straight up.
6. Locate the core module in the center of the circuit board. Remove the small screw and lift the core module out by gently wiggling it back and forth. Keep track of the nylon spacer.
7. Insert the new core module onto the circuit board keeping the nylon spacer in place. See Photo 8.6. Tighten the screw.
8. Place the circuit board back on the control module and secure it with the eight screws.
9. Place the cover back on the control module and secure it with the four screws.
10. Put the control module back in place, tighten the Allen-head bolts, plug in the main power cord, and insert all terminal strips.

(Continued on next page.)

Rockford Systems, LLC
Call: 1-800-922-7533

SECTION 8—REPLACEMENT PROCEDURES

SSC-1500 Part-Revolution Solid-State Control

Replacing Fuses F1 - F6



All power to the machine must be off before replacing the battery or any other parts.

1. Remove the control module from the control box (steps 1-3 on page 88).
2. Remove the top cover plate from the SSC-1500 control module by removing the four small screws.
3. Locate fuses F1-F6. Grasp the faulty fuse and pull straight up. (Fuses are Wickman 4-A/250-V slow-blow Part No. 3961400044.)
4. Insert the new fuse by lining up the pins with the holes on the circuit board. See Photo .
5. Replace the cover plate back on the control module and secure it with the four screws.
6. Put the control module back in place, tighten the Allen-head bolts, plug in the main power cord, and insert all terminal strips.

Replacing the Main Power Fuses

Photo 8.8

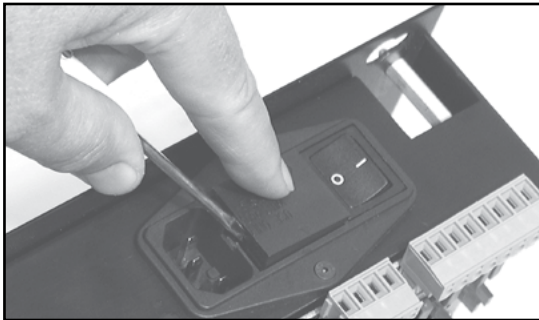
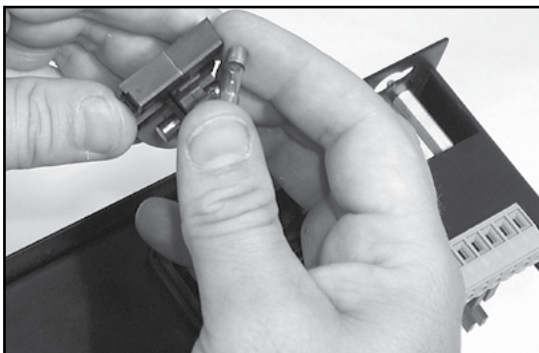

Photo 8.9



All power to the machine must be off before replacing the battery or any other parts.

1. Remove the control module from the control box (steps 1-3 on page 88).
2. Locate the main power on/off switch on the left side of the control module. Insert a small screwdriver in the slot just above the three prongs and lift up (see Photo 8.8). The fuse holder should pop out.
3. Locate and unclip the faulty fuse(s). Insert a new fuse. See Photo 8.9. Snap the fuse holder back into the main power on/off switch. (Fuses are Bussman 4-A/250-V slow-blow Part No. GDC-4A.)
4. Put the control module back in place, tighten the Allen-head bolts, plug in the main power cord, and insert all terminal strips.

(Continued on next page.)

SECTION 8—REPLACEMENT PROCEDURES

SSC-1500 Part-Revolution Solid-State Control

Replacing the Battery

Photo 8.10

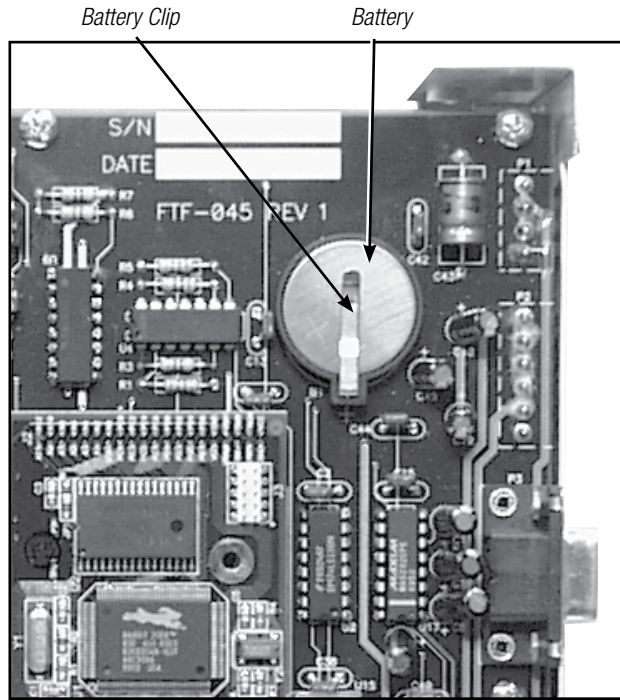

All power to the machine must be off before replacing the battery or any other parts.

1. Remove the control module from the control box (steps 1-3 on page 88).
2. Remove the top cover plate from the SSC-1500 control module by removing the four screws.
3. Locate the battery on the control module. See Photo 8.10. Carefully lift the battery clip up and remove the battery.
4. Insert the new battery.
5. Put the cover plate back onto the control module and secure it with the four screws.
6. Put the control module back in place, tighten the Allen-head bolts, plug in the main power cord, and insert all terminal strips.

Note: When the battery fails or has been removed, all programmable information will return to factory defaults (see pages 78-79). All user inputs will need to be reprogrammed.

(Continued on next page.)

Rockford Systems, LLC
Call: 1-800-922-7533

OSHA 29 CFR 1910.217 (c)(1), *General Requirements*, states:

“(i) It shall be the responsibility of the employer to provide and insure the usage of ‘point of operation guards’ or properly applied and adjusted point of operation devices on every operation performed on a mechanical power press. See Table O-10.”

This means that for every mechanical power press that is being used in United States industry where a point-of-operation hazard exists, there must be safeguarding for the operator by at least one type of guard or a device. This protection may also be accomplished by the use of a combination of guards and devices.

When updating a power press, the most important decision is the selection of the proper guard or device. The following are safeguarding choices:

BARRIER GUARDS ON POWER PRESSES

OSHA 29 CFR 1910.217 (c)(1), General Requirements, (c)(2) Point of Operation Guards and Table O-10 (Ref. enclosed MPPS)

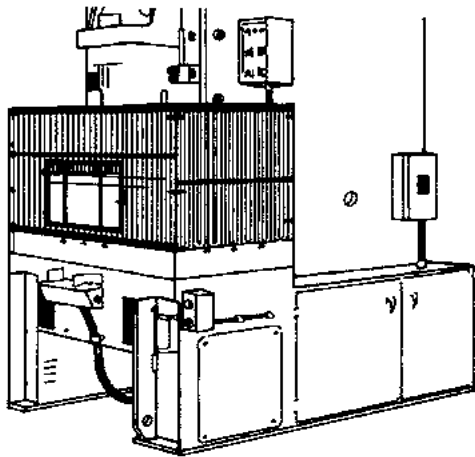

RESTRAINT (HOLDOUT) ON POWER PRESSES

OSHA 29 CFR 1910.217 (c)(3)(vi) Restraint or Holdout (Ref. enclosed MPPS)

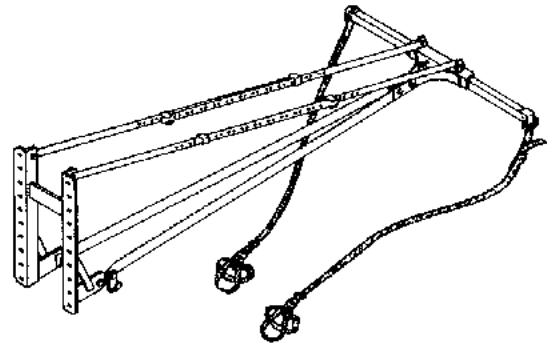

TWO-HAND CONTROL ON POWER PRESSES

OSHA 29 CFR 1910.217 (c)(3)(vii) Two-Hand Control (Ref. enclosed MPPS)

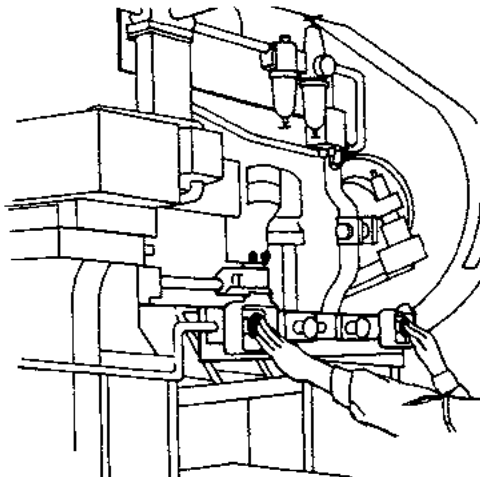

PULLBACK (PULL-OUT) ON POWER PRESSES

OSHA 29 CFR 1910.217 (c)(3)(iv) Pull-out (Ref. enclosed MPPS)

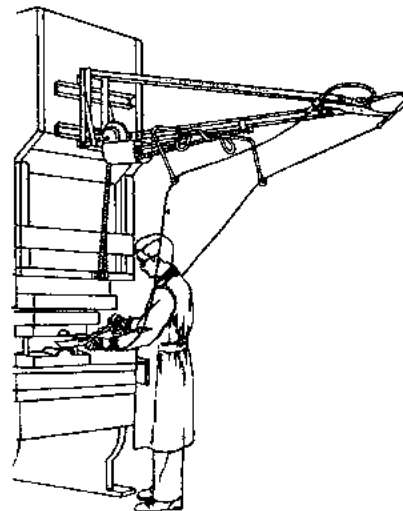

(Continued on next page.)

SECTION 9—METHODS OF SAFEGUARDING

SSC-1500 Part-Revolution Solid-State Control

LIGHT CURTAIN PRESENCE-SENSING DEVICES ON POWER PRESSES

Light Curtain or Radio Frequency
OSHA 29 CFR 1910.217 (c)(3)(iii) Presence-Sensing
(Ref. enclosed MPPS)

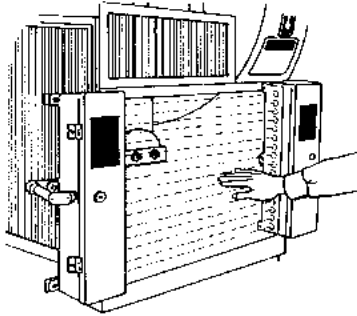

TYPE A OR B GATE ON POWER PRESSES

OSHA 29 CFR 1910.217 (c)(3)(ii) Gate or Movable
Barrier Device
(Ref. enclosed MPPS)

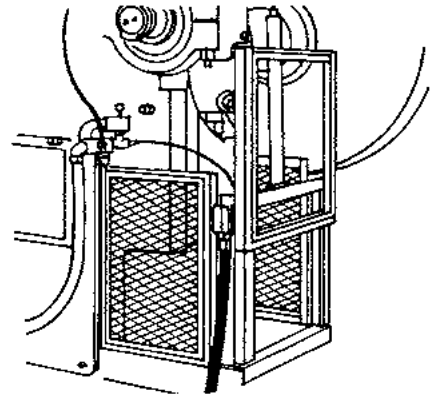

Auxiliary Safeguarding on Power Presses

Auxiliary safeguarding can provide additional protection from injuries for all personnel in the machine area. It is most often used in conjunction with primary safeguarding devices. Auxiliary safeguarding also involves the safeguarding of other hazardous components or openings on machines.

Danger signs, used for warning, must be mounted on the machine in a position that is readily visible to the operator, setup person or other personnel. Hand tools can be used as auxiliary safeguarding. They are often used when feeding and retrieving small pieceparts. Hand tools by themselves are NOT a point-of-operation safeguarding device.

OSHA 29 CFR 1910.217 (c)(4) (Ref. enclosed MPPS)

Hand feeding tools. Hand feeding tools are intended for placing and removing material in and from the press. Hand feeding tools are not a point-of-operation guard for protection device and shall not be used in lieu of the “guards” or devices required in this section.

Other Safety Considerations

Other areas of machine safety must be considered in order to comply to the OSHA and ANSI standards, as we know them. This includes, but is not limited to, items such as a main power disconnect switch, which must be provided for each machine, and a magnetic type motor starter for the main drive motor. All mechanical power-transmission apparatus of the machine, such as rotating flywheels, gears, sprockets, chains, and shafts, must be covered in accordance with OSHA 29 CFR 1910.219. As with all machinery, best safety practices must be a continuing program. The operator, die setter and all personnel must be fully trained and instructed on all safety procedures and have full knowledge of the safeguarding device being used.

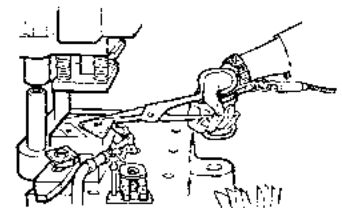

Hand-Feeding Tool Used for Feeding Parts

Note: The preceding point-of-operation safeguarding options are explained in OSHA 29 CFR 1910.217 for mechanical power presses and ANSI B11.1 standard entitled Safety Requirements for Mechanical Power Presses. Also see the enclosed Rockford Systems' booklet entitled Mechanical Power Press Safety (MPPS).

When using any of the devices described for point-of-operation safeguarding, the sides and rear of the hazardous point-of-operation area must be safeguarded to protect the operator and other employees in the machine area (OSHA 29 CFR 1910.212).

(Continued on next page.)

Rockford Systems, LLC
Call: 1-800-922-7533

SECTION 10—RETURN MATERIALS AUTHORIZATION REQUEST FORM

SSC-1500 Part-Revolution Solid-State Control

To return material for any reason contact the sales department in our organization at 1-800-922-7533 for an RMA Number. All return materials shipments must be prepaid. Complete this form and send with material to Rockford Systems, LLC, 5795 Logistics Parkway, Rockford, IL 61109. Make sure the RMA Number is plainly identified on the outside of the shipping container.

Company _____

Address _____

City _____ State _____ Zip _____

Phone _____ Fax _____

Contact Name _____ Representative _____

Items Authorized To Return on RMA No. _____ **Original Invoice No.** _____ **Date** _____

Part No.	Serial No.	Description
_____	_____	_____
_____	_____	_____
_____	_____	_____
_____	_____	_____
_____	_____	_____
_____	_____	_____
_____	_____	_____

Service Requested Full Credit 25% Restocking Repair & Return Warranty Replacement

Reason for return (describe in detail):

Return Materials Authorized by _____ Date _____

(Continued on next page.)

SECTION 11—ORDER FORM FOR SIGNS AND LITERATURE

SSC-1500 Part-Revolution Solid-State Control

This instruction manual references signs and literature available for your machines. This order form is for your convenience to order additional signs and literature as needed. This order form is part of your installation manual so please make a copy of it before writing an order.

Company _____

Address _____

City _____ State _____ Zip _____

Phone _____ Fax _____

Name _____ Purchase Order No. _____ Date _____

Part No.	Description	Quantity Required
KSL-253	Installation Manual—SSC-1500 Press Control	_____
KSC-000	Operator Safety Precautions Sign (English)	_____
KSC-000S	Operator Safety Precautions Sign (Spanish)	_____
KSC-000F	Operator Safety Precautions Sign (French)	_____
KST-134	Danger, Closing Ram and Die Label	_____
KSC-054	Danger Sign 5" x 6" (English)	_____
KSC-054S	Danger Sign 5" x 6" (Spanish)	_____
KSC-054F	Danger Sign 5" x 6" (French)	_____
KSC-055	Danger Sign (Foot Switch) 5" x 6" (English)	_____
KSC-055S	Danger Sign (Foot Switch) 5" x 6" (Spanish)	_____
KSC-055F	Danger Sign (Foot Switch) 5" x 6" (French)	_____
KSC-057	Danger Sign (Pullback Device) 5" x 6"	_____
KSL-051	Booklet— <i>Mechanical Power Press Safety</i> (MPPS)	_____
FAB	Catalog— <i>Controls and Safeguarding for Fabricating Machines</i>	_____
SFM	Catalog— <i>Safeguarding Cutting and Turning Machines</i>	_____

For prices and delivery, please use address, phone or fax number listed on the front cover of this manual.

Your Signature _____ Date _____