

# Physics for Roping Technicians

March 2018

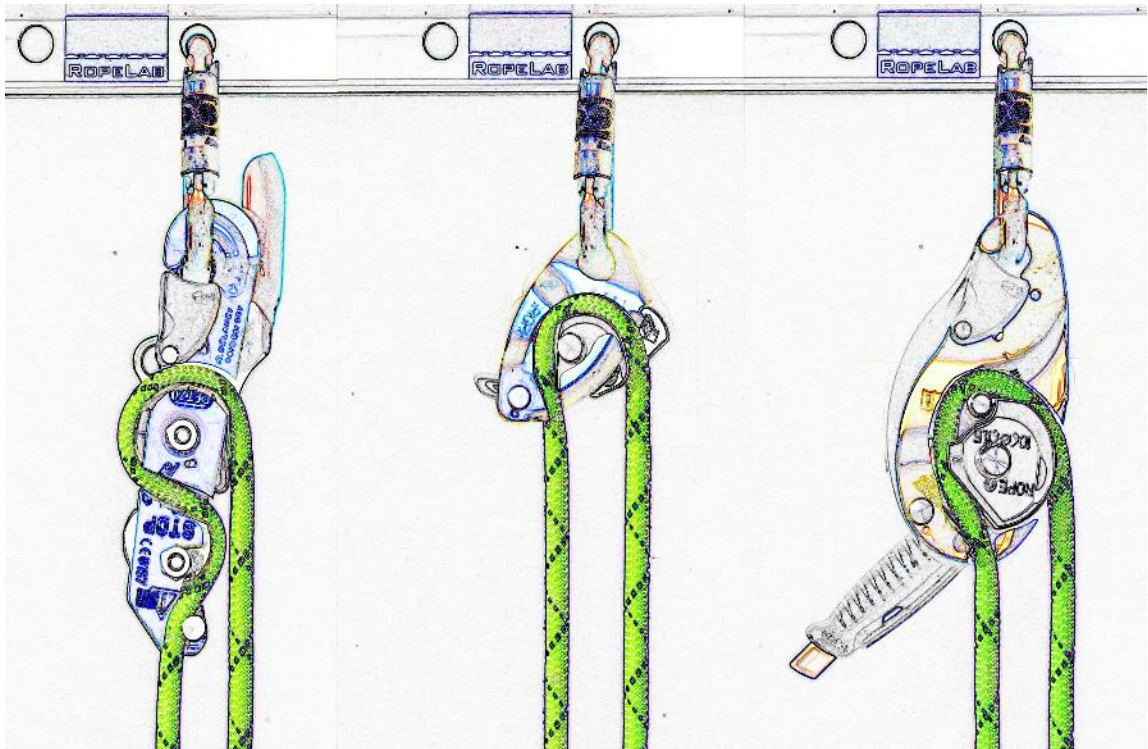

Richard Delaney, RopeLab



This text has been developed to assist roping technicians in gaining an understanding of the fundamental principles of physics that underpin so many rope based activities.

Some of us are fortunate enough to have had teachers and mentors who have managed to make mathematics and physics interesting. My high school maths teacher, the late Mr Kevin Garitty, was a unique individual and had a way of making us understand rather than learn. Through this approach I have managed to grasp and retain much. This stuff is not that hard, I suspect it's just that not many people take the time to explain it well. The following is my effort to restate the basics and build to a place where some of the more common roping scenarios can be better understood.

I have gained this knowledge and understanding through a lifetime of experience and having had the good fortune of working and playing alongside many very talented individuals who have happily shared their craft. In no particular order thanks must go to Glen Nash, Adam Darragh, William Proctor, Pat Rhodes, Dallas Atkinson, Robert Dunshea, Rob Stringer, Lucas Trihey and a host of others for their patience and sharing.

Thanks must also go to my dear wife Sarah and our two sons, Tom and Ben, for their assistance, understanding, and patience over the years. At times they must have questioned my sanity and motivation for this work.

Many of the illustrations in this text have been created with the *vRigger* software package. See [www.vrigger.com](http://www.vrigger.com) for details.

Unless otherwise credited, all text, drawings, and images © Richard Delaney 2016. All rights reserved for the contents of this publication. No unauthorised duplication or distribution by any means without the prior written permission of the author.

For further information, please do not hesitate to contact me at [richard@ropelab.com.au](mailto:richard@ropelab.com.au)



RopeLab, Blue Mountains, Australia



## Contents

Mass .....	5
Force .....	5
Weight .....	6
Fall Factor .....	8
Carabiner and equipment specifications.....	10
Direction of pull arrows.....	10
30kN .....	11
MBS & 3 sigma.....	11
Statistical example of Carabiner rating .....	12
Maximum acceptable load in normal use .....	13
Design Factor .....	13
Safety Factor.....	13
WLL.....	14
SWL.....	14
Example .....	14
Equipment inspection and logging .....	15
Why have formal inspections? .....	15
What should be recorded?.....	16
The inspection .....	17
Case study: aluminium carabiner.....	17
Who does the inspection?.....	18
Unique identifiers.....	19
Marking hardware.....	20
Marking software .....	21
The recording system .....	22
Accessing records .....	24
Summary.....	24
Vectors.....	25
Vector addition.....	25
Vector quiz.....	26
Vectors in rope systems .....	26
Highlines .....	28
Highline forces.....	28
Highline anchor load calculations during movement.....	33
Effect of pre-tension on Highlines.....	35

Skate block .....	36
Detailed analysis of the skate block .....	40
Mechanical Advantage (MA) .....	42
Levers .....	42
Pulleys .....	43
Magic or physics? .....	44
The ‘T-system’ for calculating Mechanical Advantage .....	46
Mechanical Advantage examples .....	47
Mechanical Advantage Worksheets .....	49
Ideal, Theoretical, and Actual Mechanical Advantage .....	51
Friction .....	52
Friction between flat surfaces .....	52
Friction: Same mass, different orientation .....	53
Friction between curved surfaces .....	55
The Capstan Equation .....	56
Measuring coefficients of friction .....	58
Real test results .....	60
Friction through Progress Capture Devices (PCDs) .....	62
Simple 1:1 overhead pulley efficiency tests: force required to lift 1kN .....	63
Raising and lowering over concrete edges .....	64
Tension and Compression .....	65
Guyed mast .....	65
Torque .....	66
Gin Poles: torque, tension, and compression .....	67
Torque and compression using trigonometry .....	68
Gin Poles: rigging for technical rescue .....	69
Gin Pole forces .....	70
Gin Poles: avoid contact with obstacles .....	73
Gin Poles: anchoring and guying .....	74
Load Cells .....	76
Mass of the measuring device .....	76
Resolution and Maximum scale .....	76
Accuracy and Precision .....	77
Sampling rate .....	77
Delphi 100T-5 Tension Load Cell .....	79
Rock Exotica enForcer Load Cell .....	79
Summary .....	80
8mm Roping Systems .....	81

8mm Rope .....	82
Raising or Lowering .....	82
Twin Rope Lower .....	83
Twin Rope Raise .....	84
The Whole System.....	86
Conclusion .....	87
Powered winches .....	89
Roping or Rigging?.....	90
Capacity and Overload Protection .....	90
Remote winching.....	90
Powered winches and tripods .....	91
Appendix A: The language of mathematics and physics .....	93
Mathematical and Scientific notation .....	93
Mathematical equations - BODMAS .....	94
Scientific functions .....	95
Trigonometry.....	96
SOH-CAH-TOA.....	96
Angular measurement.....	98
Right-angle triangles.....	99
Appendix B: ITRS presentation, 2015 .....	100
The Rescue Load .....	101
Medical Assistance .....	101
Litter management.....	101
Single person Rescue Load .....	102
One or two ropes through the AHD? .....	103
Non-live loads.....	104
Summary.....	104
Litter Rigging.....	105
Litter Bridles .....	105
Attaching the Rope.....	107
Ring loading of bowline knots .....	107
Summary.....	109
Tripods.....	110
Confined space tripod = Load Management Solution.....	110
Technical rescue tripod = Friction Management Solution .....	111
Tripod Instability.....	112
Tripod “resultant” forces.....	113
The height of the AHD .....	117

Gin Poles .....	117
Conclusion.....	120
Appendix C: 8mm Technora/Dyneema rope tests.....	121
Tests .....	122
Discussion.....	124
Summary .....	126



## Mass

The mass of an object is determined by its volume and density.

Material	Density (kg/m <sup>3</sup> )
Water	1,000
Steel	7,850
Aluminium	2,700
Concrete	2,400

Mathematically we can express this relationship as:

$$\text{mass} = \text{volume} \times \text{density}$$

So, if we wish to calculate the mass of a block of steel measuring 0.2m x 0.3m x 0.212m:

$$\begin{aligned} \text{mass} &= 0.2\text{m} \times 0.3\text{m} \times 0.212\text{m} \times 7,850 \text{ kg/m}^3 \\ &= 0.01272 \text{ m}^3 \times 7,850 \text{ kgm}^{-3} \\ &= 99.852\text{kg} \\ &\approx 100\text{kg} \end{aligned}$$

Notice that the dimensional units (m<sup>3</sup> x m<sup>-3</sup>) cancel out to produce an answer in kilograms.

## Force

Force describes the interaction between two objects. It is a vector quantity and thus has both magnitude and direction.

In order to undertake any form of analysis it is helpful to be able to 'draw' forces and we normally do this with a straight line with an arrow at one end. The length of the line is proportional to the magnitude and the arrow depicts direction.

Consider a 100kg square block of steel resting on a flat surface.

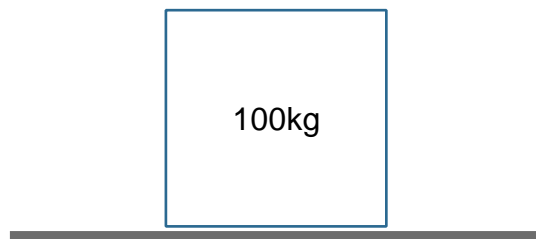

Several interactions are required to keep this block 'at rest':

- The surface (let's say it is a table) needs to be strong enough to support this weight (the force due to gravity).
- The surface needs to be flat, level, and present enough friction to stop the block sliding sideways.

## Weight

It is helpful to explore two terms that are often used interchangeably in common language: 'mass' and 'weight'.

Consider a person equipped with roping gear and tools has a total mass of 100kg. Mass is defined by volume and density and these two factors will not change for this 100kg person.

One of the biggest myths that we are taught from a very young age is that our 'weight' is measured in kilograms (or pounds). While this is fine for most daily situations, it is actually a significant barrier for those wishing to progress with an understanding of rigging physics.

Weight actually describes the force that a mass influenced by gravity applies to a surface and it is measured in Newtons (N).

The weight that a person applies to the surfaces we encounter in everyday life is a result of the gravitational pull towards the centre of our earth. We quantify this force by multiplying the mass (100kg) by the acceleration it would experience towards the centre of the Earth if our surface was not present. This rate of acceleration is normally assumed to be 9.8 metres per second per second, or  $9.81\text{ms}^{-2}$  and is typically denoted as  $g$ .

Force = mass x acceleration, or

$$\mathbf{F = ma.}$$

So, Weight = mass x acceleration due to gravity, or

$$\mathbf{W = mg}$$

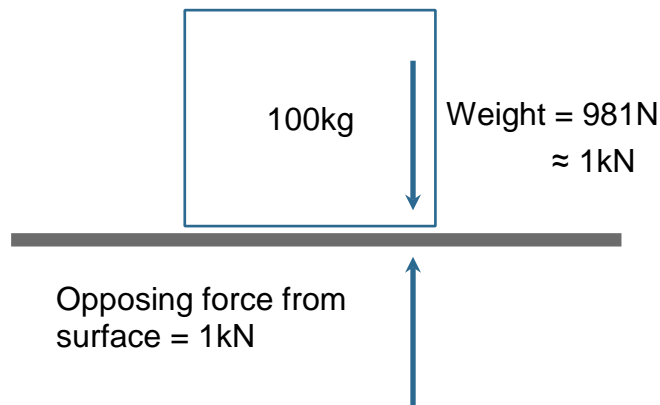

Therefore, in this instance, the weight of a 100kg block of steel is:

$$W = 100\text{kg} \times 9.81\text{ms}^{-2}$$

$$W = 981 \text{ kgms}^{-2} \text{ or } 981 \text{ Newtons}$$

To simplify this for in-the-field calculations we make the approximation that  $g \approx 10\text{ms}^{-2}$  and get:

$$W \approx 100\text{kg} \times 10\text{ms}^{-2}$$

$$W \approx 1000\text{N} \text{ or } 1\text{kN}$$

For an object (such as our 100kg steel block) to remain stationary we can consider that the forces acting on it are all balanced and therefore present a state of equilibrium. Note that, in order to represent forces of equal magnitude but opposite direction, the two forces in the drawing above are shown as equal length vectors with arrows denoting the direction of application.

In practice, a typical aluminium screw-gate carabiner will be rated at 30kN. This means that it should be able to support a stationary suspended mass of  $(30,000\text{N} \div 10\text{ms}^{-2}) = 3,000\text{kg}$ .

Because weight is a function of gravity the weight of a particular mass will vary according to the local gravitational field (it would 'feel' lighter on the moon).

**Person with mass (m) = 100kg**



$g_{\text{earth}} = 9.81 \text{ ms}^{-2}$

$W_{\text{earth}} = m \times g_{\text{earth}}$   
 $= 100 \times 9.81$   
 $= 981 \text{ N}$





$g_{\text{moon}} = 1.62 \text{ ms}^{-2}$

$W_{\text{moon}} = m \times g_{\text{moon}}$   
 $= 100 \times 1.62$   
 $= 162 \text{ N}$



Earth & Moon image credits: NASA

## Fall Factor

The term 'Fall Factor' (FF) is often used to describe the ratio of the distance fallen to the amount of rope in the system that is available to absorb the energy associated with arresting the fall.

$$\text{Fall Factor} = \text{Distance fallen} \div \text{Rope in service}$$

This term probably originated from rock-climbing and an effort to describe the relative severity of the impact felt by the leader during a fall. It is now used by many rope technicians, but we must remember that it is only an approximate indicator and it is often incorrectly applied when attaching to other non-rigid systems.

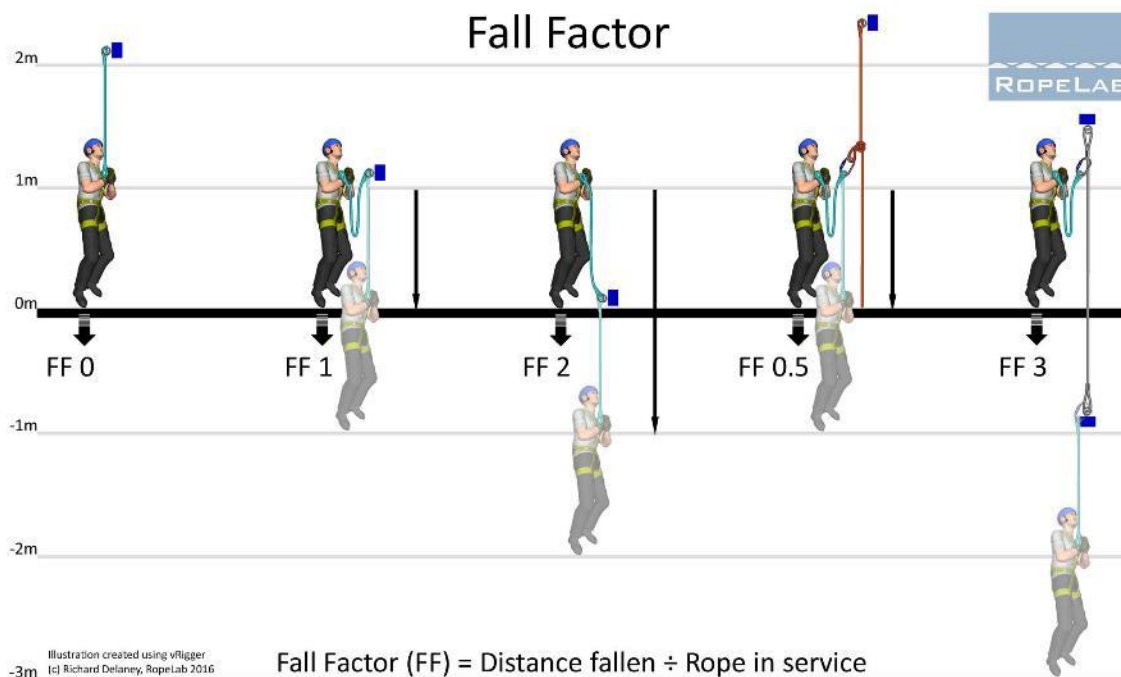

This image shows a range of possible fall scenarios:

The 1m lanyard is tight to an overhead anchor thus no fall is possible and this is effectively FF0.

The ends of the lanyard are attached to the harness and an anchor at the same height. The operator can fall 1m on a 1m lanyard so this is FF1.

Now the 1m lanyard is anchored down at foot level and thus a 2m fall is possible. This is FF2.

This time the 1m lanyard is attached to separate rope which runs another 1m straight up to an overhead anchor. Now there are 2m of rope in the system to absorb the impact of the 1m fall so this becomes FF0.5.

This final situation is unusual but sees the lanyard clipped to a vertical cable. Now the operator can fall 3m on their 1m lanyard which gives FF3. This would be a very dangerous fall.

This ratio is a reasonable indication of the severity of a fall. However, it should only be used as an indicator as it is difficult to account for the following factors:

- Knot tightening.
- Places where there are multiple strands of rope, such as the bight of the knot attached to the anchor sharing the force of impact.
- Flex and movement of static elements within the system.
- Friction between the rope and any intermediate connectors.

Thus, FF is usually expressed in simple ratios like FF2, FF1, FF0.5, and perhaps FF0.2.

## Carabiner and equipment specifications

There is a standard language used in the technical specifications of carabiners but this is not well understood. This article is an attempt to clarify some common markings that appear on carabiners. It should be noted that there is significant industry and international variation in the common use of these terms.

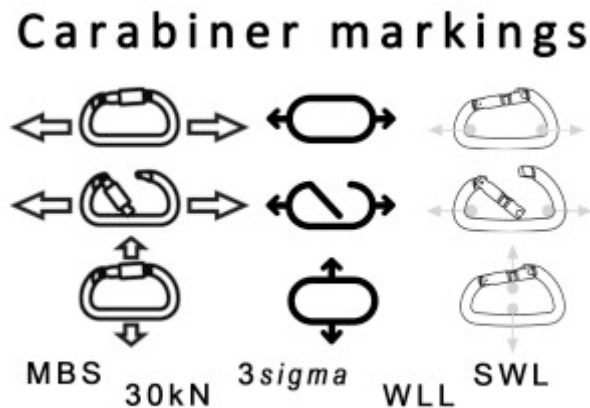

### Direction of pull arrows

This image from the UIAA demonstrates the test methods for the ratings typically seen on carabiners. ([http://www.theuiaa.org/upload\\_area/files/1/UIAA121-Connectors\\_2.jpg](http://www.theuiaa.org/upload_area/files/1/UIAA121-Connectors_2.jpg))

EN-12275	CONNECTORS	UIAA-121														
<small>This representation does not provide full details. Read the Note at the head of page 1. © UIAA, PE Schubert, Neville McMillan, 2009</small>																
<b>Strength in main direction</b> <table border="1"> <tr><td>type K, Q</td><td>25 kN</td></tr> <tr><td>type X</td><td>18 kN</td></tr> <tr><td>all other types</td><td>20 kN</td></tr> </table>		type K, Q	25 kN	type X	18 kN	all other types	20 kN	<b>Strength in transverse direction</b> <table border="1"> <tr><td>type Q</td><td>10 kN</td></tr> <tr><td>type B, H, K, X</td><td>7 kN</td></tr> <tr><td>type D, K/D</td><td>--</td></tr> </table>	type Q	10 kN	type B, H, K, X	7 kN	type D, K/D	--		
type K, Q	25 kN															
type X	18 kN															
all other types	20 kN															
type Q	10 kN															
type B, H, K, X	7 kN															
type D, K/D	--															
<b>Gate-open strength</b> <table border="1"> <tr><td>type B, D</td><td>7 kN</td></tr> <tr><td>type H</td><td>6 kN</td></tr> <tr><td>type X</td><td>5 kN</td></tr> <tr><td>type K, Q</td><td>--</td></tr> </table>		type B, D	7 kN	type H	6 kN	type X	5 kN	type K, Q	--	<b>Marking of strength (in kN)</b> <table border="1"> <tr><td>xx</td><td>in main direction</td></tr> <tr><td>yy</td><td>in transverse direction</td></tr> <tr><td>zz</td><td>gate-open</td></tr> </table>	xx	in main direction	yy	in transverse direction	zz	gate-open
type B, D	7 kN															
type H	6 kN															
type X	5 kN															
type K, Q	--															
xx	in main direction															
yy	in transverse direction															
zz	gate-open															

There are typically three sets of arrows indicating strength when pull tested between parallel pairs of round pins for:

- Gate closed, long axis strength when pulled between 12mm pins.
- Gate open, long axis strength when pulled between 12mm pins.
- Gate closed, short axis strength when pulled between 10mm pins.

The stated values are only for these test conditions and these will differ once slings or other hardware are used in place of these pins.

## 30kN

Values such as 30kN indicate a tensile force in kilo-Newtons (kN). It most commonly refers to the MBS for a specific direction of pull. Users often find it easier to convert this force value to an equivalent suspended static mass value. To achieve this, convert 30kN to 30,000N. Given the relationship  $\text{Force} = \text{Mass} \times \text{Acceleration}$ , dividing 30,000N by 10 (approx. 9.81 m/s/s for acceleration due to gravity) produces the static equivalent mass of 3,000kg.

## MBS & 3 sigma

The Minimum Breaking Strength (MBS) is a statistically derived value and is poorly understood.

If 100 carabiners are submitted for destructive testing, then the measured strengths will vary considerably. Inconsistencies in the manufacturing process may result in larger variations. The batch test results can be plotted on a histogram showing the probability of breaking at particular strengths and this curve should approximate a “normal distribution” or “bell curve”.

The width of the curve is characterised by the “standard deviation” or  $\sigma$  (sigma).  $3\sigma$  for a normal distribution indicates that 99.7% of samples should lie within the range of (mean –  $3\sigma$ ) to (mean +  $3\sigma$ ). Smaller values for  $\sigma$  indicate that samples are more likely to be close to the average, or mean value.

Many carabiner manufacturers state that they use “3-sigma” to determine their MBS values. This means that the MBS is actually the mean breaking strength less 3 times the standard deviation ( $3\sigma$ ).

$$MBS = \text{mean} - 3\sigma$$

Statistically, this also means that 0.3% of samples will lie outside this range and therefore half of these (0.15% or 1.5 in every thousand) may break below the MBS stamped on the carabiner.

## Statistical example of Carabiner rating

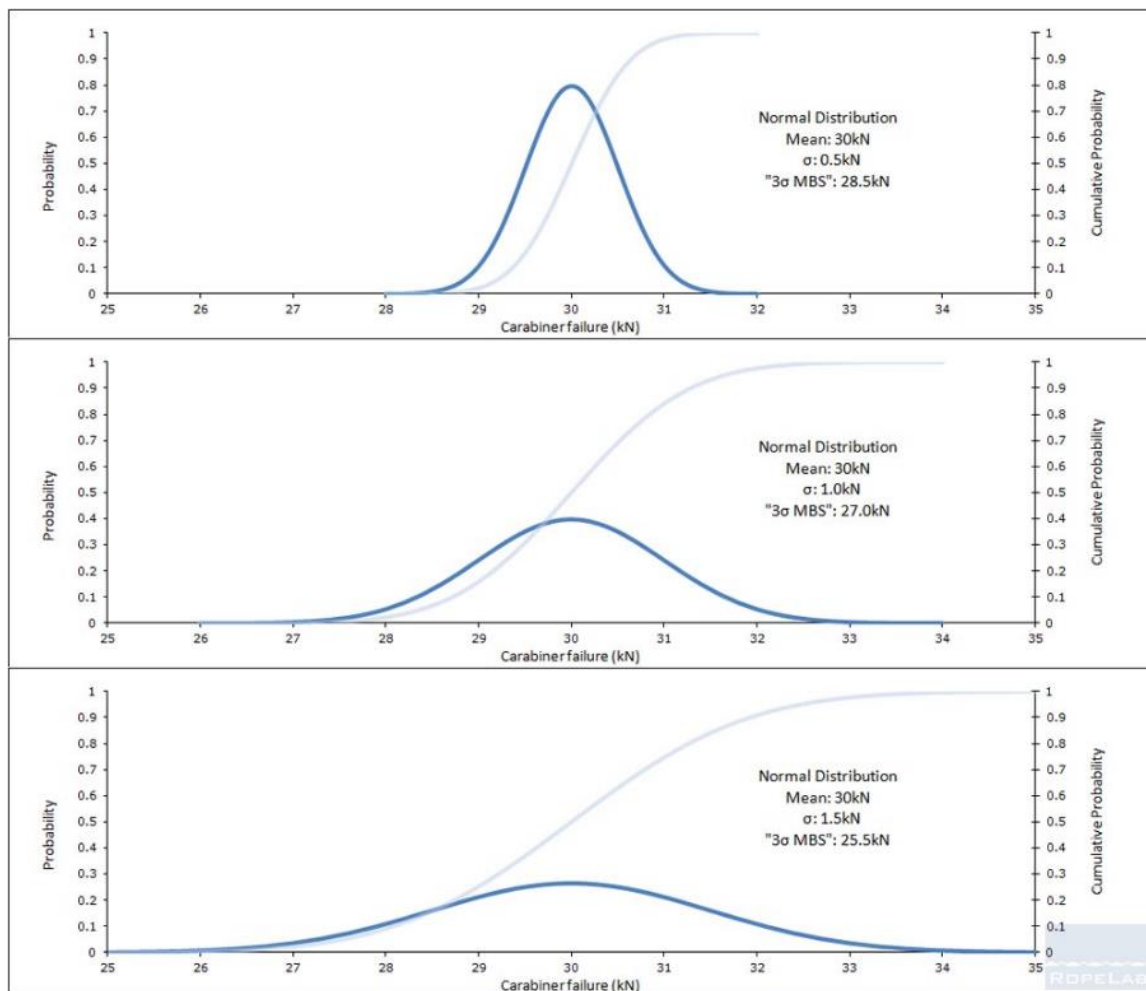

The curves above show three scenarios, each with a mean tested value of 30kN.

- $\sigma = 0.5\text{kN}$ . MBS = mean  $- 3\sigma = 30\text{kN} - 3 \times 0.5\text{kN} = 28.5\text{kN}$
- $\sigma = 1.0\text{kN}$ . MBS = mean  $- 3\sigma = 30\text{kN} - 3 \times 1.0\text{kN} = 27.0\text{kN}$
- $\sigma = 1.5\text{kN}$ . MBS = mean  $- 3\sigma = 30\text{kN} - 3 \times 1.5\text{kN} = 25.5\text{kN}$

Even though the mean value for all tests was 30kN, the MBS for each batch is quite different.

With more and more people undertaking their own testing, it is important to acknowledge that measured values well above the MBS do not necessarily correspond to a well manufactured product. In fact, 99.7% of test samples should break above the MBS. If the test samples are from a well-controlled manufacturing process with a small  $\sigma$  value, then measured values may not be much above the MBS. If, however, the recorded values are well above the MBS then this may indicate a large  $\sigma$  value, and thus a conservative MBS to cover a poor process.



## Maximum acceptable load in normal use

Material behaviour under load is normally characterised by stress vs strain curves. Two terms that are useful in describing this behaviour are Elastic and Plastic Deformation. When any carabiner is stressed by applying tension along the spine it will begin to 'stretch' at a relatively low force. If the carabiner returns to its 'normal' shape once the stress is removed, then we can describe this stretching as 'Elastic Deformation'. As the stress becomes more significant this 'stretching' may enter an irreversible range known as 'Plastic Deformation'.

This image shows a carabiner that failed above its MBS during a pull test. The hinge pin pulled through the host however the body has definitely undergone plastic deformation.



So, carabiners should not fail below their MBS however they will undergo irreversible deformation before reaching this point. Also, it is perfectly reasonable to expect that repeated heavy loading will fatigue the material and result in failure below the MBS.

The question that should come out of this discussion is:

“How much can we load a carabiner without resulting in plastic deformation or significant fatigue?”

Some manufacturers address this explicitly in documentation stating that connector loading should never exceed 1/4 of the MBS.

## Design Factor

The Design Factor (DF) is specified by a designer or manufacturer and this defines the factor applied to the MBS to determine maximum load acceptable load for a component.

## Safety Factor

Safety Factor (SF) or Factor of Safety (FoS) is generally defined by industry rather than manufacturer. It may be significantly different to DF. For example, a particular connector may have an MBS of 50kN, a manufacturer specified DF of 4, but an industry specified SF of 10 when used for a particular application.

## WLL

Working Load Limit (WLL) is a term used by manufacturers to indicate the maximum force that should be applied to a carabiner in normal use, regardless of industry. The ratio of MBS to WLL is referred to as the Design Factor (DF). Many carabiner manufacturers specify a DF of 4 which implies a WLL of a quarter of the MBS. Manufacturers state the WLL to ensure that the carabiner is not subjected to significant fatigue and remains in the range of normal elastic deformation.

$$WLL = \frac{MBS}{DF}$$

## SWL

Safe Working Load (SWL) is typically determined by dividing the MBS of a carabiner by the Safety Factor (SF) required for a particular use. As stated above it possible that an entertainment rigger may calculate a different SWL for a particular use of a carabiner than the value determined by a rescue technician.

$$SWL = \frac{MBS}{SF}$$

## Example

A particular steel carabiner has a 3-sigma rated long-axis MBS of 50kN. The manufacture has specified a DF of 4 for this connector, regardless of use.

This carabiner has a WLL of 12.5kN and this value should never be exceeded in normal use – regardless of industry or application. If this value is exceeded, it should not fail below the MBS however it should then be removed from service and destroyed.

An entertainment rigger, working in a certain country is required by the industry code-of-practice to use a SF of 10 for flying performers and thus, determines the SWL of this carabiner is  $50\text{kN}/10 = 5\text{kN}$ .

A rescue technician in another country is supposed to apply a SF of 5 to hardware and thus determines a SWL of  $50\text{kN}/5 = 10\text{kN}$  for an identical connector.

## Equipment inspection and logging

Many industry Codes of Practice (COP), standards, and other documents ‘suggest’ roping technicians should ensure regular inspection of all equipment and that these inspections are documented to ensure trace-ability of every single item over its working life.

There seems to be tremendous variation both in the way these inspections are conducted and in how the corresponding records are established and maintained. There also seems to be some confusion around whether technicians and companies can inspect their own equipment or whether third-party inspection is required.

Record systems include paper based systems with single page inspection sheets for each component, electronic spreadsheets, and proprietary software packages. The aim of all of these systems are to ensure that equipment is regularly inspected, faults are picked up and rectified early, and to provide proof of this process.



There is no doubt that a detailed six-monthly inspection with signed individual pages with individual check boxes for all aspects of inspection is warranted if it improves safety. However, if the system is overly onerous, we risk it being completed inadequately or not at all. The challenge with any system is to find the balance between a theoretical ideal and something that is appropriate and achievable with the ultimate aim of improving safety.

The documents considered in this discussion included:

- ISO 22846-1-2003 Personal equipment for protection against falls – Rope access systems – Part 1- Fundamental principles for a system of work.
- ISO 22846-2-2012 Personal equipment for protection against falls – Rope access systems – Part 2- Code of practice.
- AS NZS 1891.4-2009 Industrial fall-arrest systems and devices – Selection use and maintenance.
- AS NZS 4488.2-1997 Industrial rope access systems – Selection, use and maintenance.
- IRATA International Code of Practice (ICOP), 3rd edition, July 2014.
- ARAA Industry Code, Industrial Rope Access Method, September 2005.

### Why have formal inspections?

Technicians generally understand the importance of ensuring that their equipment is in good condition and regularly carry out pre-use checks. Faulty equipment is often picked up here. However, occasionally critical wear points may be missed, so the majority of sources recommend formal inspections by a competent person at least once every six months. These

inspections need to be thorough, in accordance with manufacturers' specifications, and be documented.

Documented formal inspections are easy to justify and may simply be the one regular guaranteed time where every piece of equipment is carefully examined and deemed fit for ongoing service.

### What should be recorded?

The first time I came across a technical publication presenting the idea of equipment logs was the 4th edition of Edelrid's "Ropework" published in 1988. Pages 58 & 59 are shown here:

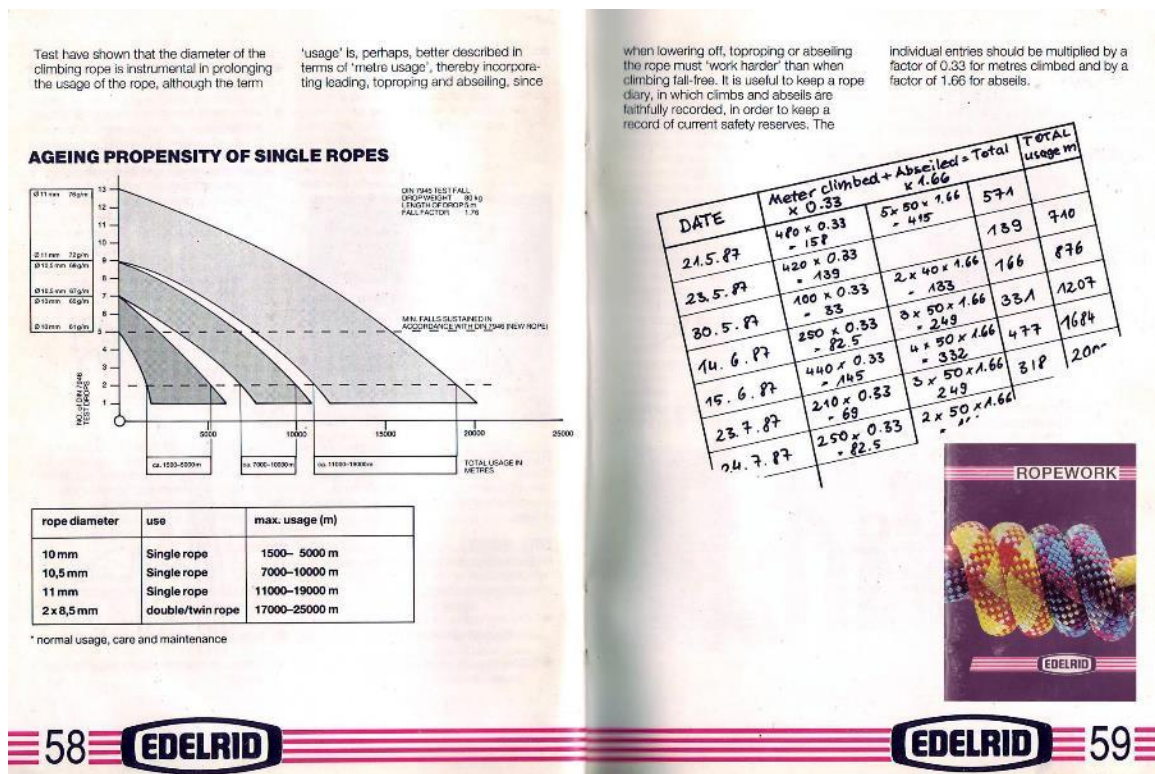

### "Life of the Rope/Rope Diary

Tests have shown that the diameter of the climbing rope is instrumental in prolonging the usage of the rope, although the term 'usage' is, perhaps, better described in terms of 'metre usage', thereby incorporating loading, top-roping and abseiling, since when lowering off, top-roping or abseiling the rope must 'work harder' than when climbing fall-free. It is useful to keep a rope diary, in which climbs and abseils are faithfully recorded, in order to keep a record of current safety reserves. The individual entries should be multiplied by a factor of 0.33 for metres climbed and by a factor of 1.66 for abseils."

I suspect this information resulted in many organisations deeming necessary to record the actual use of not just rope but of all equipment.

At this point it is important to make a clear distinction between two types of record keeping:

- Log book type systems which record use of each piece of equipment. This may include time/date, hours in use, environmental conditions, number of people, number of

descent, number of ascents, weights of applied loads, adverse loadings, pre & post-use inspections and formal inspections.

- Inspection logging systems where the only things that are recorded are formal inspections and interim inspections following unusual uses. These inspections include visual and functional tests in accordance with manufacturer's instructions.

Considering the reasons for equipment inspections will help guide the decision of what type of record keeping is appropriate. Commonly stated reasons for equipment inspections include:

- To remind workers to inspect all equipment on a regular basis and remove faulty items from service.
- Inspection records are required for many worksites.
- Formal inspections are required by a Code of Practice, Regulation, or company audit process.
- Inspection records may be required as supporting evidence during warranty claims.
- Inspection records may be required as supporting evidence in accident investigations

The last of these is the most quoted justification for logging actual in-service use. However, through study and direct involvement, I have never come across a case where equipment logs have been significant in any investigation. One hundred percent of the credible accounts of roping activity accidents that I have studied are the direct result of human error and/or misuse of equipment.

My personal approach is that six-monthly equipment inspections, rather than a log book system, satisfy my current work requirements. If company or organisational policy dictates what is required then it is difficult to do otherwise, however I would suggest that a realistic approach to this issue is very important.

## The inspection

Many documents make recommendations as to what to consider when inspecting individual pieces of equipment however the one that must be followed is that provided by the manufacturer. These details are provided with new equipment, are readily available online, and can be reviewed onsite using a mobile device whenever there is doubt.

It is important that 'sample' inspection records provided in general documents do not become the easy option as these rarely cover the device specific required inspection information provided by manufacturers.

Normally we would simply 'pass' or 'fail' an item however a third 'quarantine' result can be useful if the inspector is unfamiliar with a particular piece. A 'quarantine' result would require temporary removal from service pending better comprehension of inspection requirements and a corresponding compliant inspection.

## Case study: aluminium carabiner

The usual approach to carabiner inspecting is that it must pass a thorough visual and functional inspection. This image shows four carabiners that were all similar prior to being pulled on the RopeLab test bench.





All four of these carabiners still pass a functional test. I suspect that all but the last could also pass the visual inspection conducted by the vast majority of operators.

The rating engraved on each gate is the slow-pull load that was applied to each. The rated MBS of these carabiners is 22kN. These results show that when this carabiner was loaded to 75% of its MBS it underwent irreversible plastic deformation. Interestingly, at least one manufacturer (Kong) states clearly in their carabiner instructions that applied loads must NEVER exceed 1/4 of those marked.

So, the challenge is to be sure that we really know what we are doing when we demand the right to undertake our own equipment inspections.

### Who does the inspection?

In Australia, we have seen a creep in practice towards some expectation that roping equipment needs to be inspected and tagged by a third party. This has long been the case for industrial lifting equipment and electrical tools and it seems that businesses have seen an opportunity to offer similar 'test-and-tag' services for roping equipment. Some of these businesses do an excellent job, however others leave much to be desired. The following photo is of a harness with the test 'tag' attached to the dorsal fall-arrest ring.



I observed the wearer of this harness attempt to reach over his shoulder and clip the fall-arrest lanyard to this dorsal ring. He inadvertently clipped the snap-hook to this tag. This test-tag should have been attached to the harness anywhere but here.

In another situation, a mechanical belay device came back from inspection with the test-tag zipped through the two holes that would normally accommodate the carabiner. This tag rendered the device inoperable as the cheeks could not be split to load the rope.

I make these points because I fear further development of this expectation of third party ‘test-and-tag’. If it becomes easy to transfer the risk to an external agency and the volume of work escalates then quality issues, like the two above, will escalate.

To address this issue, we need to raise our game as an industry and take full responsibility for keeping control of our own inspections. Workers have a vested interest in inspecting their own equipment as their lives, and the lives of those they are working with, depend on it. Encouraging rope technicians to stay aware of and responsible for their equipment will ensure the best industry outcomes.

The majority of the documents mentioned above simply refer to inspections being undertaken by a ‘competent person’. The following definition is from ISO22846-2-2012.

**Competent person:** *designated person suitably trained or qualified by knowledge and practical experience to enable the required task or tasks to be carried out properly.*

This standard then goes on to outline three levels of rope access operator (Operative, Supervisor, and Manager) and clearly states that the second and third levels should be capable of undertaking pre-use, interim, and detailed (formal) inspections.

As basic technicians we must be able to carry out pre-use checks of our own equipment. As intermediate and advanced technicians we should also know the precise details of what each manufacturer says we need to do to ‘pass’ or ‘fail’ any piece of equipment being used by us or those under our supervision.

## Unique identifiers

While there is some variation in recommendations between documents, most say that every item of height safety equipment should have a corresponding inspection record. This certainly includes ropes, harnesses, helmets, carabiners, descenders, slings, and most of the other equipment used by roping technicians.

The direct implication of this is that every item should have a unique identifier so that carabiners from the same batch or lengths of rope cut from the same roll can all be distinguished.

Many manufacturers, but not all, now include printed or laser etched unique serial numbers on software and hardware.



There are still many items that only include batch numbers. Soft items such as ropes may come with accompanying documentation which shows the date of manufacture, however this is rarely kept with the rope, especially if shorter lengths are cut from 200m rolls. Often the only way to establish the age of an unmarked length of rope is to cut a section open and inspect an internal tracer strand. Each manufacturer uses a different combination of thin printed plastic ribbons and coloured fibres to indicate relevant standards and year of manufacture.

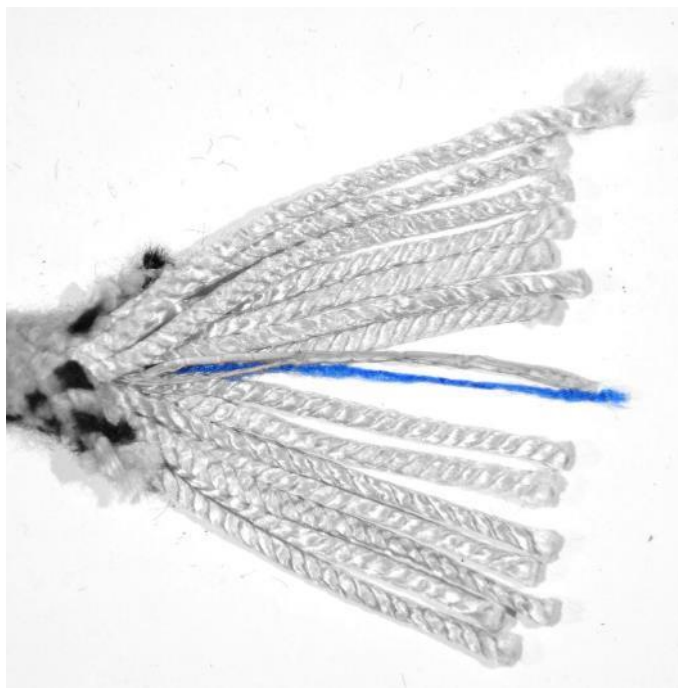

Even though many items have unique serial numbers, they are often long strings of digits and letters that mean differing things for each manufacturer. Technicians normally have many different brands of equipment and management becomes far simpler if a standardised, personal system can be applied.

The system I have settled on has equipment divided into the following categories:

- Connectors (carabiners, maillons, etc).
- Devices (descenders, rope grabs, ascenders, rigging plates, pulleys, swivels, back-up devices, etc).
- Ropes (working ropes, lifelines, lanyards, setup ropes, etc).
- Slings (anchor slings, rigging slings, webbing, etc).
- Harnesses & Helmets.
- Absorbers (shock-packs, force limiting lanyards, etc).

These divisions then enable each component to be marked with a suffix (ie 'C' for Connector) and a 2 or 3-digit number. When a new set of 10 carabiners is added to an existing collection, of say 50, they can simply be numbered 'C51' through 'C60'.

## Marking hardware

At least two well-known manufacturers (SMC and Petzl) have published information stating that is acceptable for individuals to add markings to equipment, however they should adhere to the guidelines in their instructions:

- Petzl: Tips for protecting your equipment



- SMC: Guidelines for Permanent Marking SMC Carabiners and Pulleys



I choose to engrave all of my hardware in accordance with these guidelines. Other technicians may use coloured tape, paint, or nail-polish however, while helping with identification of ownership, many of these are not permanent and they do not easily provide unique identifiers for each piece.

### Marking software

Harnesses, anchor slings, and other sewn items generally come with a sewn-in information 'tag'. This information will normally include at least the date of manufacture and the rated strength. It may also include a serial number but, if not, there is room to handwrite an additional number (such as the 'H02' in the following image) for personal identification. It is important to protect this tag as it is a vital part of the inspection process.



Ropes are supplied with similar information but it is more problematic to keep this with the rope throughout its life. I have seen and tried many systems over the years but the one that seems to serve my needs best is shown below.



This system uses 12mm long sections of copper tubing (11mm ID, 12.65mm OD) which is readily sold in Australia as copper hot water pipe. It is then placed over 11mm rope and carefully crimped with a hex die (10.3mm between flat sides) in a coax connector crimping tool.

Once crimped, there are six flat sides and the relatively soft copper is simple to engrave with any hand-held engraving tool. In this example I have marked both ends of the rope with:

- Rope length (42m)
- Rope number (R03)
- Date of manufacture (2013)
- Owner (RD)

Before each use, I check that both ends are marked to confirm that the rope has not been shortened by someone else on a previous job. The date of manufacture is also important as it is immediately obvious whether the rope has exceeded its standard best case rope life of 10 years.

Other methods include:

- Wrap the end with white PVC tape, write on the tape, place clear heat-shrink tubing over and seal. This system works however it often comes off in heavy use environments.
- Whip the ends with a coloured wax thread. This is an excellent system if a particular colour is chosen for each year of manufacture. For example, if all ropes made in 2009 have a red whipping then they must be removed from service by 2019.
- Dip the ends in a coloured dipping wax. Again this system is excellent if all that is needed is a year of manufacture. It does not cater for tracking individual ropes.

## The recording system

My approach is a simple spreadsheet. The file has multiple pages with one for each of the six categories outlined above (Connectors, Devices, Rope, Slings, Harness/Helmet, Absorbers). Each page has a single line which corresponds to an individual 'record' for each unique piece of equipment. As each inspection falls due, I create a new column and note the overall result for each piece. Two sample pages are shown below.

RD-Equip-Log

fx Devices

	A	B	C	D	E	F	G	H	I	J	K	L
1	Richard Delaney	RopeLab		PO Box 193 Katoomba NSW 2780			0418 861 807		richard@ropelab.com.au			
2	Devices											
							Insp	Insp	Insp	Insp	Insp	
							01/01/14	13/07/14	05/01/15	10/07/15	11/01/16	
3	ID	Brand	Model	Batch/Serial	Manf.	Retire	RD	RD	RD	RD	RD	
4	1	Petzl	I'D	04231I			Pass	Fail	Removed	Removed	Removed	
5	2	Petzl	GriGri	03995B			Pass	Pass	Pass	Pass	Pass	
6	3	Petzl	Grillon	09328FU7457			Pass	Pass	Pass	Pass	Pass	
7	4	Petzl	Stop	97245A			Pass	Pass	Pass	Pass	Pass	
8	5	Petzl	I'D	13197FR1458			Pass	Pass	Pass	Pass	Pass	
9	6	Petzl	Rig	09330FT9498			Pass	Pass	Pass	Pass	Pass	
10	7	Petzl	ASAP	09272LI0002			Pass	Pass	Pass	Pass	Pass	
11	8	DMM	Buddy	121230283M			Pass	Pass	Pass	Pass	Pass	
12	9	Petzl	Ascension L	35992A			Pass	Pass	Pass	Pass	Pass	
13	10	Petzl	Mini Traxion	00353F			Pass	Pass	Pass	Pass	Pass	
14	11	Petzl	Shunt	00693A			Pass	Pass	Pass	Pass	Pass	
15	12	Petzl	GriGri2	11206FJ3740			Pass	Pass	Pass	Pass	Pass	
16	13	Petzl	GriGri	07166FK4280			Pass	Pass	Pass	Pass	Pass	

Connectors Devices Rope Slings HarnessHelmet Absc +

RD-Equip-Log

fx Harnesses & Helmets

	A	B	C	D	E	F	G	H	I	J	K
1	Richard Delaney	RopeLab		PO Box 193 Katoomba NSW 2780			0418 861 807		richard@ropelab.com.au		
2	Harnesses & Helmets										
							Insp	Insp	Insp	Insp	Insp
							01/01/14	13/07/14	05/01/15	10/07/15	11/01/16
3	ID	Brand	Model	Serial	Manf.	Retire	RD	RD	RD	RD	RD
4	H01	Petzl	Navaho Bod croll fast	080175E7445	1-Jan-08	1-Jan-18	Pass	Pass	Pass	Pass	Pass
5	H02	Petzl	Avao bod croll fast	13024SH8856	1-Jan-13	1-Jan-23	Pass	Pass	Pass	Pass	Pass
6	H03	Edelrid	Core - CL	GV0822012016	1-Jan-12	1-Jan-22	Pass	Pass	Pass	Pass	Pass
7	H04	Petzl	Vertex Vent	09209XE0903	1-Jul-06	1-Jul-16	Pass	Pass	Pass	Pass	Pass
8	H05	Petzl	Vertex Vent	11356II4117	1-Sep-11	1-Sep-21	Pass	Pass	Pass	Pass	Pass
9	H06	KASK	Super Plasma 2	12.c917.0023	1-Jun-12	1-Jun-22	in 01/03/14	Pass	Pass	Pass	Pass
10											
11											
12											
13											
14											
15											
16											

Connectors Devices Rope Slings HarnessHelmet Absc +

I have been using this system since the beginning of 2014 and it works. As I reach the end of each six-month period I gather all of my kit and sort it by category and then into numerical order by identifier. I inspect it all and remove any item that does not pass. This is a very rare occurrence as I generally notice issues pre or during use. Once complete I record the appropriate result for each item in the new column. During this final step I also note expiry dates for time-limited equipment such as harnesses, helmets, ropes, and slings.

There are certainly proprietary systems available and in regular use by larger organisations. Some manufacturers include Radio Frequency Identifier (RFID) in their soft goods and hardware, however these are rarely cross compatible. There will no doubt be a day when we can just wave a mobile phone over a kit bag and it will automatically log job use. We may also just be able to tip everything out, sort it into 'pass' and 'fail' piles and pass the mobile phone over each pile to

update the record system once every six months. The challenge is to find a system that achieves what you want it to and that you find easy to work with.

## Accessing records

There are many cloud-based services that allow files to be stored and accessed remotely. I use one of these for my spreadsheet system and this means I can access the records from my mobile phone or even a worksite computer if a safety auditor requires a printed copy of my equipment logs.

## Summary

There are many references to equipment inspection and logging systems, however I rarely see realistic systems that actually work. We need to ensure that we know our kit well and stay ahead of any reasonable inspection and logging requirements. It is essential that roping technicians establish a system that works and achieves desired outcomes. Considerations may include:

- What is the aim of equipment inspections?
- Who should carry out equipment inspections?
- How often will you carry out equipment inspections?
- What equipment should be included?
- How will equipment be identified?
- What information should be recorded?
- How will you ensure that the inspection is carried out thoroughly and in accordance with manufacturer's recommendations?
- How will information be recorded and accessed?

## Vectors

There are two important distinctions we make in quantifying attributes assigned to objects – some need a simple quantity (a ‘scalar’ value) whereas others need both the magnitude and direction described by a ‘vector’.

Some common terms confuse this distinction but, for example, technically there is a significant difference between ‘speed’ and ‘velocity’. Speed is a scalar value and simply describes how fast something is going whereas velocity is a vector and adds a direction to the ‘how fast’. A car may have a speed of 60km/h but we could describe its velocity as 60km/h heading 45degrees true north.

If we want to purchase one apple worth \$1.00 and one orange worth \$0.50 then, given that currency is a scalar value, we simply add these to get \$1.50.

If we were at the back of a train travelling at 60km/h heading true north and then we to run towards the front of the train at 10km/h, our velocity (relative to the ground) would be 70km/h true north.

### Vector addition

If we represent the magnitude and direction of a force with a line where the length of the line is proportional to magnitude and the arrow defines direction, then we could draw two forces as follows:

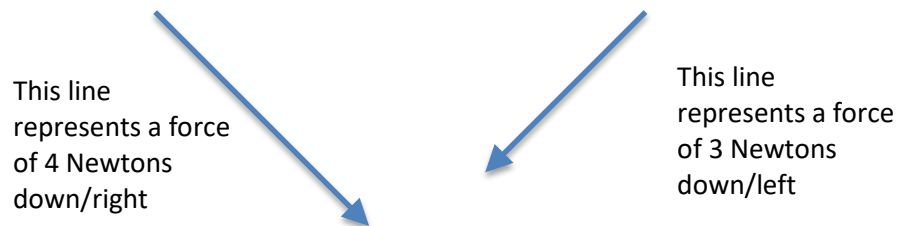

If the forces are applied to an object, whether they are applied one after the other, together, or in the reverse order, the net result will be the same.

To determine the result of adding these forces, one of these lines needs to be moved so that its tail is positioned on the head of the other – and the sum is a new line from the tail of the first to the head of the second:

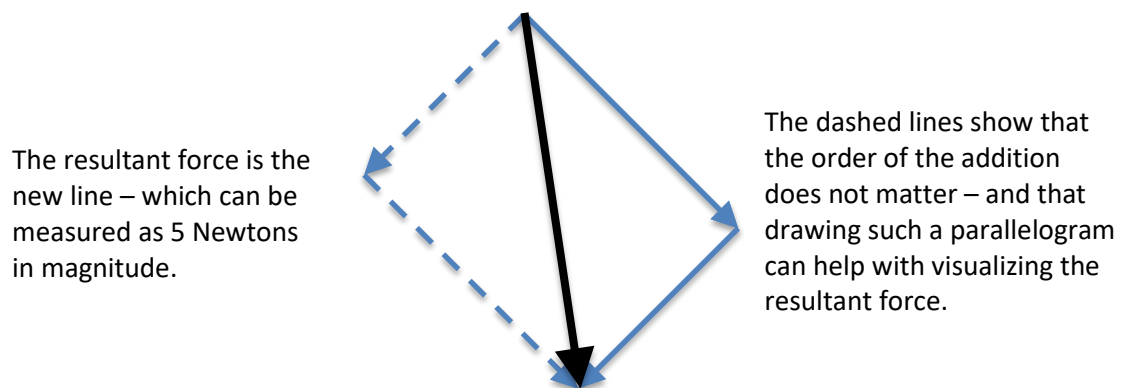

The resultant force is the new line – which can be measured as 5 Newtons in magnitude.

The dashed lines show that the order of the addition does not matter – and that drawing such a parallelogram can help with visualizing the resultant force.



### Vector quiz

The following image shows 3 vector addition problems. Match one answer to each problem.

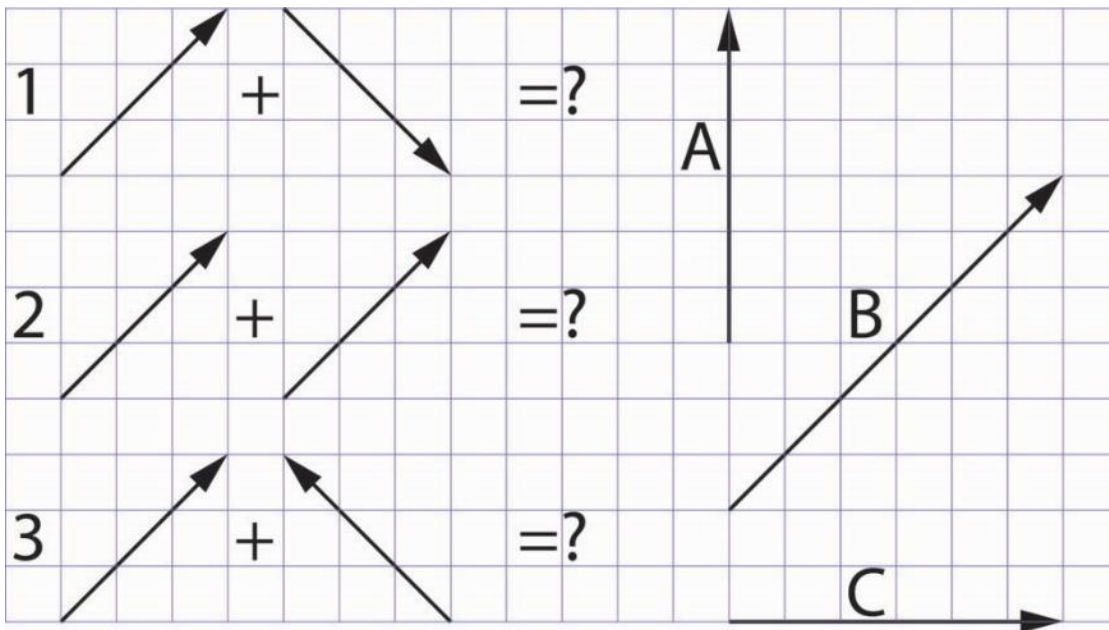

### Vectors in rope systems

This understanding of vectors enables us to estimate the tension in rope systems.

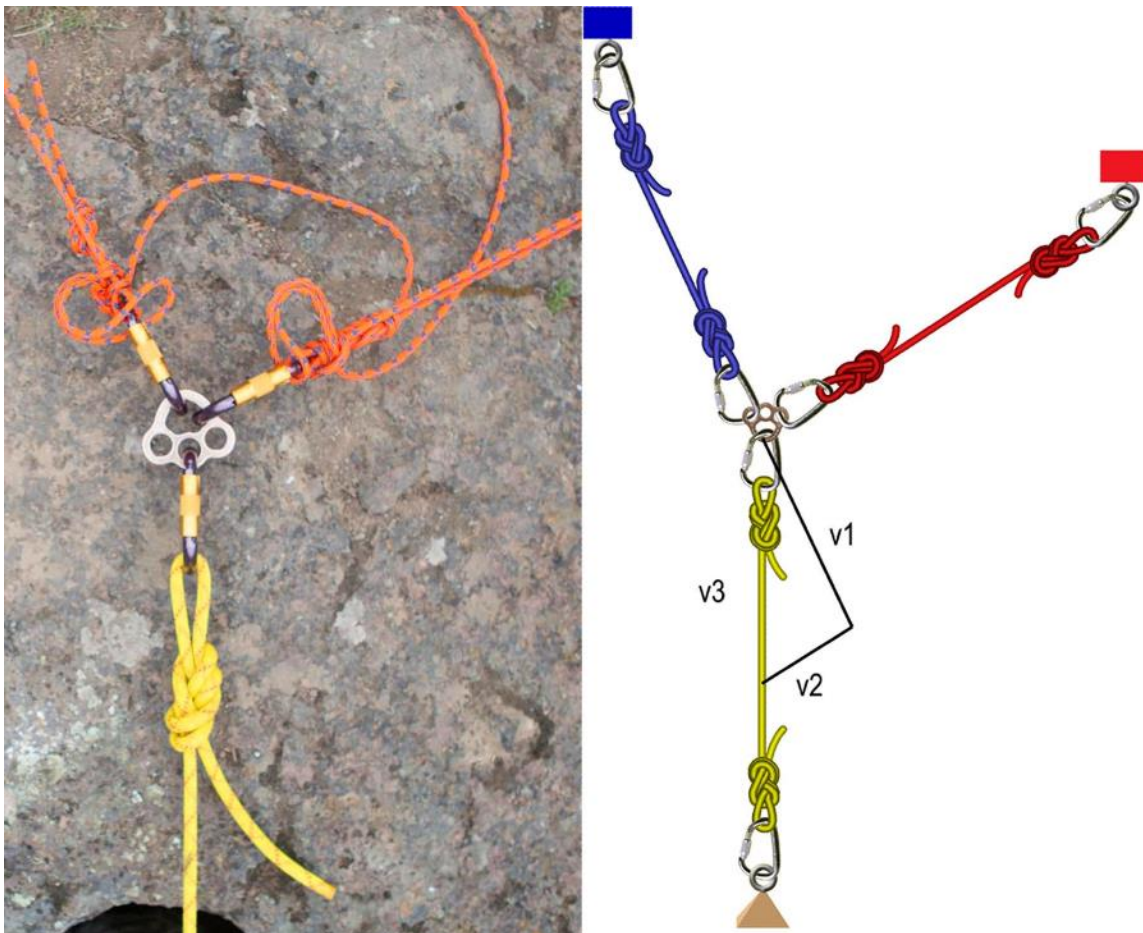

In this diagram we have a 100kg mass suspended by an anchor system focused at a rigging plate. Using the language of vector physics, for the system to be at equilibrium (ie the anchors, the mass and the rigging plate are stationary), all of the forces acting on the rigging plate must be cancel each other out – or add up to equal zero.

Previously we discussed that vectors can be used diagrammatically to represent forces. Conventionally this is done with straight lines where the line length is proportional to magnitude and the arrowhead indicates the direction of application.

The rigging plate has three ropes pulling it in different directions. The force, or tension, in the vertical rope is that produced by the 100kg mass (about 1kN) – this we can call ‘v3’ and it pulls down on the plate. The other two ropes pull on the rigging plate to oppose ‘v3’ with forces ‘v1’ and ‘v2’. If the rigging plate is stationary, then the three forces must “add” up to zero. The triangle to the right of the rigging plate demonstrates this vector addition. Each vector is drawn head to tail and  $v1 + v2 + v3 = 0$ .

The ‘magnitude’ of the vectors ‘v1’ and ‘v2’ can be measured relative to the known length of ‘v3’ (expressed as 100kgf). Note that this can be estimated in the field by drawing lines in the dirt near the anchor focal point and then using string or sticks to estimate the relative lengths of the three sides of the triangle.

In this example, careful measurement yields that, when a mass of 100kg is suspended, the blue anchor ‘feels’ a pull equivalent to 85kg and the red anchor ‘feels’ 43kg. Technically, we should say:

- The 100kg mass applies a force of 1kN (actually 0.98kN) to the rigging plate
- The left anchor experiences a force of 0.85kN (or 0.833kN)
- The right anchor experiences a force of 0.43kN (or 0.421kN)

Note also that vector addition is very different to straight mathematical addition and that 43kg + 85kg does not equal 100kg.

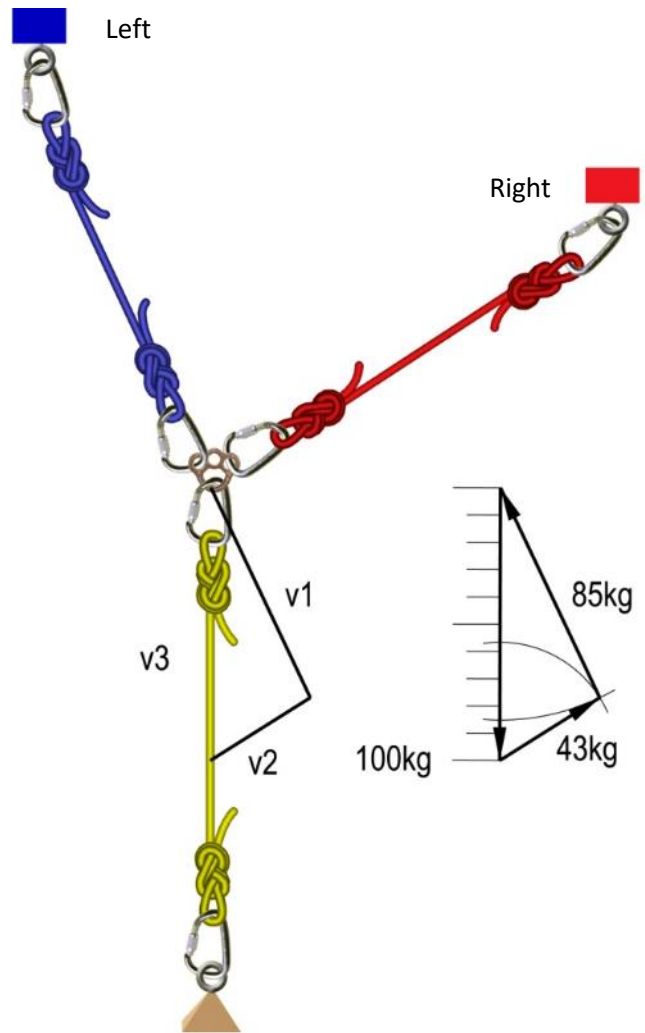

## Highlines

### Highline forces

Consider a highline rigged between two anchors (A1 and A2). If the two anchors are at equal height and the load is applied mid span, then the system can be broken down into two identical halves each taking half of the mass.

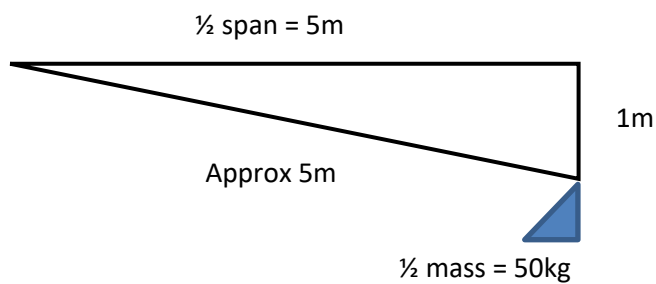
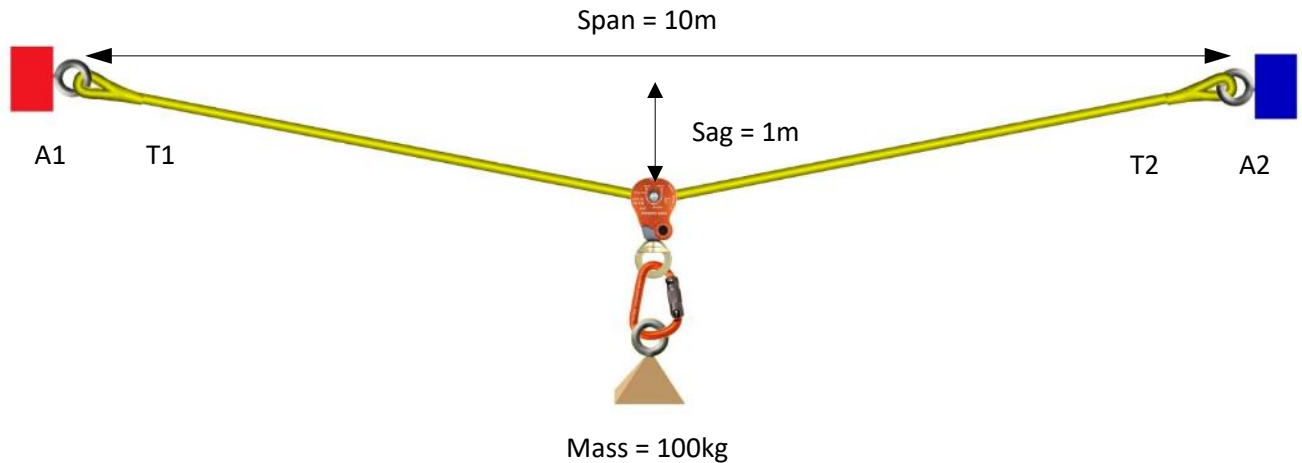

This triangle can be used to produce the component vectors for the applied force and the magnitudes of these forces are directly proportional to the side lengths of the triangle.

- The 50kg mass is hanging and thus applies its weight in proportion to the 1m side of the triangle.
- The rope tension will be proportional to the length of the diagonal side (hypotenuse) of the triangle.



**The easy way**

- For shallow sags, say less than 10%, it is safe to assume that the hypotenuse is approximately the same length as half the span.
- Thus, in this example, the rope tension to applied weight will be approximately be in the ratio 5:1
- So, 5 times 50kg = 250kgf (or 2.50kN).

Many texts quote the highline formula:

$$Tension = \frac{Load \times Span}{4 \times Sag}$$

This equation is exactly what we have derived and, similarly, relies on the assumption that the hypotenuse of the triangle is approximately equal to half of the span and assigns half of the weight to this triangle. In long hand:

$$Tension = \frac{Load}{2} \times \frac{\frac{1}{2}Span}{Sag}$$

$$Tension = \frac{Load}{2} \times \frac{Span}{2 \times Sag}$$

$$Tension = \frac{Load \times Span}{2 \times 2 \times Sag}$$

$$Tension = \frac{Load \times Span}{4 \times Sag}$$

$$Tension = \frac{100kgf \times 10m}{4 \times 1m}$$

$$Tension = 250kgf$$

**The hard way - Pythagoras**

It is possible to calculate this more precisely but it requires familiarity with Pythagoras' theorem. This simple, 2,500-year-old equation states the relationship between the three side lengths of a right-angled triangle.

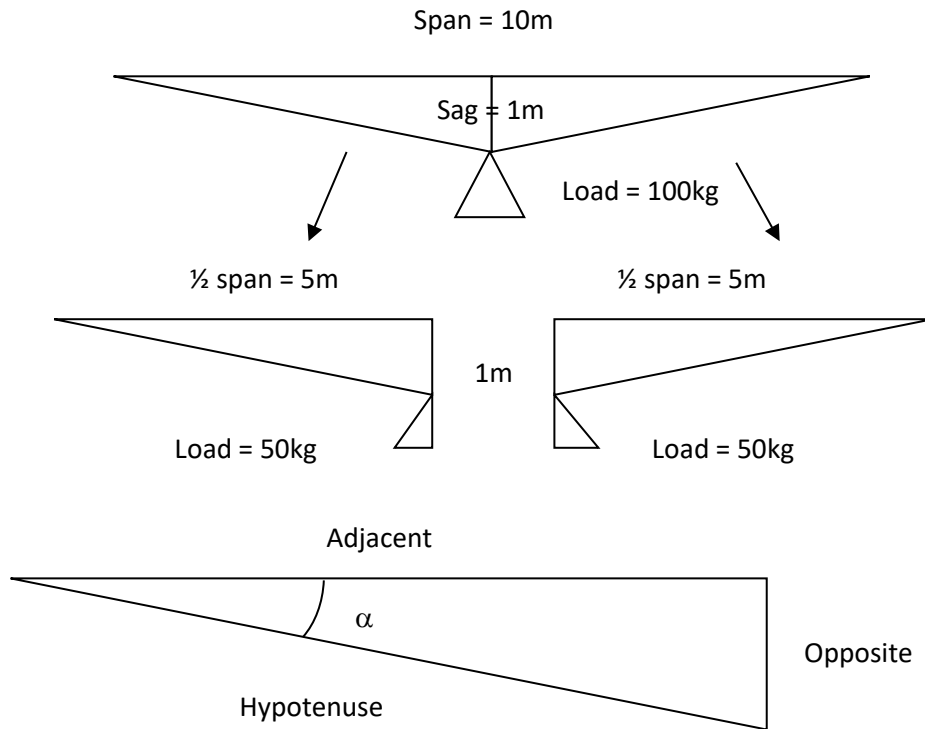

$$Adjacent^2 + Opposite^2 = Hypotenuse^2$$

Or

$$Hypotenuse = \sqrt{Adjacent^2 + Opposite^2}$$

So, for our triangle, the length of the hypotenuse will be:

$$Hypotenuse = \sqrt{1^2 + 5^2}$$

$$Hypotenuse = \sqrt{1 + 25}$$

$$Hypotenuse = \sqrt{26}$$

$$Hypotenuse = 5.1$$

Accordingly, the tension in the rope is in the ratio of 5.1 to 1 for each kilogram of applied mass:

$$T = \frac{100kgf}{2} \times 5.1$$

$$T = 255kgf$$

**The hard way – Trigonometry**

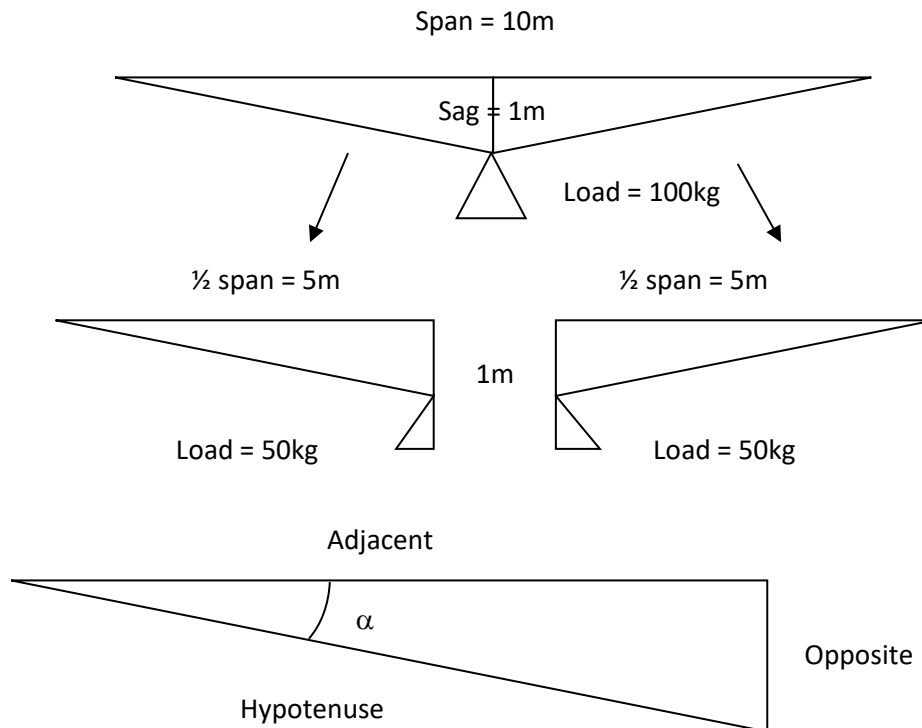

For this triangle (see the Appendix for a detailed discussion of trigonometry),

$$\tan(\alpha) = \text{Opposite/Adjacent.}$$

For the highline,

$$\begin{aligned} \tan(\alpha) &= 1\text{m}/5\text{m} = 0.2 \\ \text{therefore } \alpha &= \tan^{-1}(0.2) = 11.31^\circ \end{aligned}$$

Since the included angles of a triangle must add up to 180°,  
 And, given that the angle between the Opposite and Adjacent is 90°,  
 The remaining angle must be  $180^\circ - 90^\circ - 11.31^\circ = 78.69^\circ$

So, the angle at the load, between the two strands of the highline will be:  
 $2 \times 78.46 = 157.38^\circ$

Now, the tension on an anchor can be calculated using the ratio of the Opposite to the Hypotenuse. In this instance, the length of the Hypotenuse can be calculated as:

$$\begin{aligned} \sin(\alpha) &= \text{Opposite/Hypotenuse,} \\ \text{so } \sin(11.31^\circ) &= 1/\text{Hypotenuse,} \\ \text{thus Hypotenuse} &= 1/\sin(11.31^\circ) = 5.099\text{m} \end{aligned}$$

So, in the triangle, for each 1kg of mass there will be 5.099kgf of anchor tension.  
 The two triangles share the 100kg as 50kg each therefore there is  $50 \times 5.099\text{kg}$  on each anchor or 254.95kgf of tension.

**Summary and comparison of highline calculation methods**

A highline with a sag of 10% has a load magnification factor of 2.55.

A 100kg mass applied to the centre of a highline with a sag of 10% applies a force equivalent to a static load of 255kg to each anchor.

**Highline anchor load calculations and approximations**

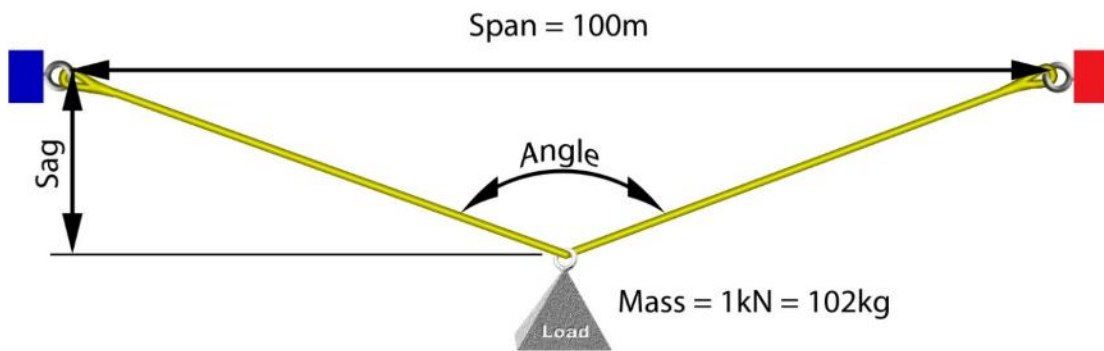

$$\text{Rule of thumb: Anchor load} = \frac{\text{Span} \times \text{Load}}{4 \times \text{Sag}}$$

Highline values						Theory	Rule	Error
Span (m)	Mass (kg)	Weight (kN)	Sag (m)	Sag (%)	Angle (deg)	T (kN)	T (kN)	(%)
100	102	1.00	1	1	178	25.00	25.00	-0.02
100	102	1.00	2	2	175	12.51	12.50	-0.08
100	102	1.00	5	5	169	5.02	5.00	-0.50
<b>100</b>	<b>102</b>	<b>1.00</b>	<b>10</b>	<b>10</b>	<b>157</b>	<b>2.55</b>	<b>2.50</b>	<b>-1.94</b>
100	102	1.00	20	20	136	1.35	1.25	-7.15
100	102	1.00	29	29	120	1.00	0.86	-13.50
100	102	1.00	50	50	90	0.71	0.50	-29.29
100	102	1.00	100	100	53	0.56	0.25	-55.28

(c) Richard Delaney, RopeLab 2014  
 Illustration created using vRigger



## Highline anchor load calculations during movement

There are many ideas circulating about the tension and anchor loads in various highline configurations. Some of these are incorrectly influenced by the load-sharing anchor rules-of-thumb such as I-Y-T or Ideal (parallel = 50% on each leg), Yes (120 degrees = 100% of load on each leg, Terrible (180 degrees = infinite load magnification).

The reality, for highlines, is in fact that this IYT analogy only applies when the load is both at rest and only supported by the spanline - i.e. there is no tension on the fore or aft control lines. For a system with anchors at equal height, this situation occurs mid-span. For all other positions the load can only be at rest if there is tension in one of the control lines. To move the load progressively towards an anchor we must increase the tension in the relevant control line even more.

The following diagram shows a theoretical span of 100m between anchors A and B. To achieve a mid-span sag with an internal angle of 120° we would need a no-stretch rope 115.47m long. To simplify the physics, we need to assume that the rope length stays the same through all load positions. In theory, the load (10kN) can now be positioned anywhere along the ellipse in the diagram. A line 10 units long has been drawn with the load to represent a weight vector pointing down.

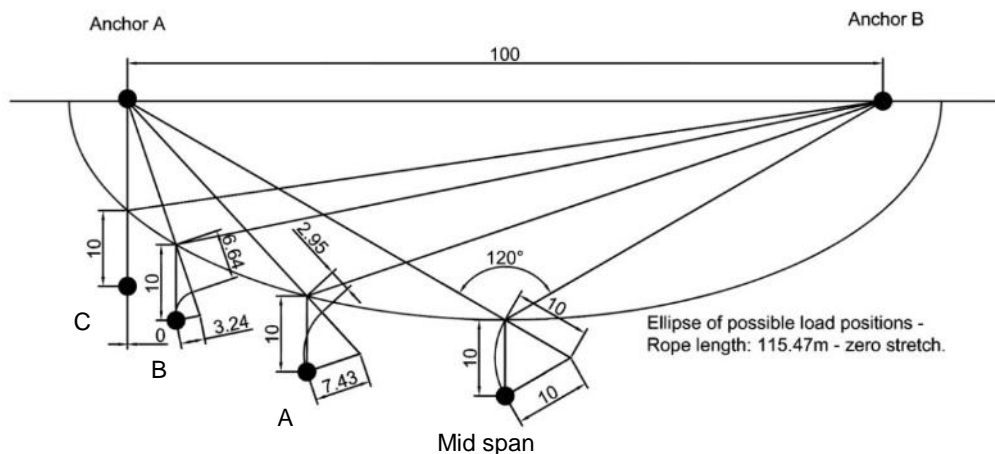

### Mid span

In this position only, the fore and aft control lines can be slack and the load will remain at rest. Thus, for a 10kN load, the tension in the spanline will be 10kN towards each anchor.

### Positions A & B

To hold the load in this position (left of mid span), the control line from anchor A will need to hold some tension. Note that if an object is at rest then all of the forces acting on this object must balance. To complete a vector triangle balanced by the 10kN weight we can only draw forces parallel to those applied by the spanline and the control line. This triangle shows 7.43kN towards anchor B. Since the spanline is continuous, the magnitude of the tension must be the same in both arms - therefore the leg to anchor A can also only provide 7.43kN. Thus, measuring the difference on this triangle, the control line must hold the remainder, or 2.95kN, if the load is to be held in this position.

Similarly, for position B, the spanline will hold 3.24kN and the control line will hold 6.64kN.

**Position C**

In this theoretical position suspended directly under anchor A the control line will support the entire weight of the load - and this is demonstrated by the fact that the vector triangle has become a straight line.

**Summary**

For span lines with equal height anchors, the worst case for span line tension occurs mid span.

## Effect of pre-tension on Highlines

It is interesting to consider whether applying pre-tension to a highline changes the way we calculate anchor loading. The short answer is no. As discussed previously, the loads will be directly proportional to the geometry of the system. Higher pre-tension will certainly result in a shallower system but this is all we need to know.

The term “catenary” often arises in these discussions – this refers to the curved shape the highline takes when suspended between two anchors. This is not normally relevant for our systems as the mass of the load is significantly more than the mass of the highline. In other words, once the load is applied, the highline can be considered to have straight segments rather than curved segments.

## Highline tests: variations in pre-tension, mass, and rope type

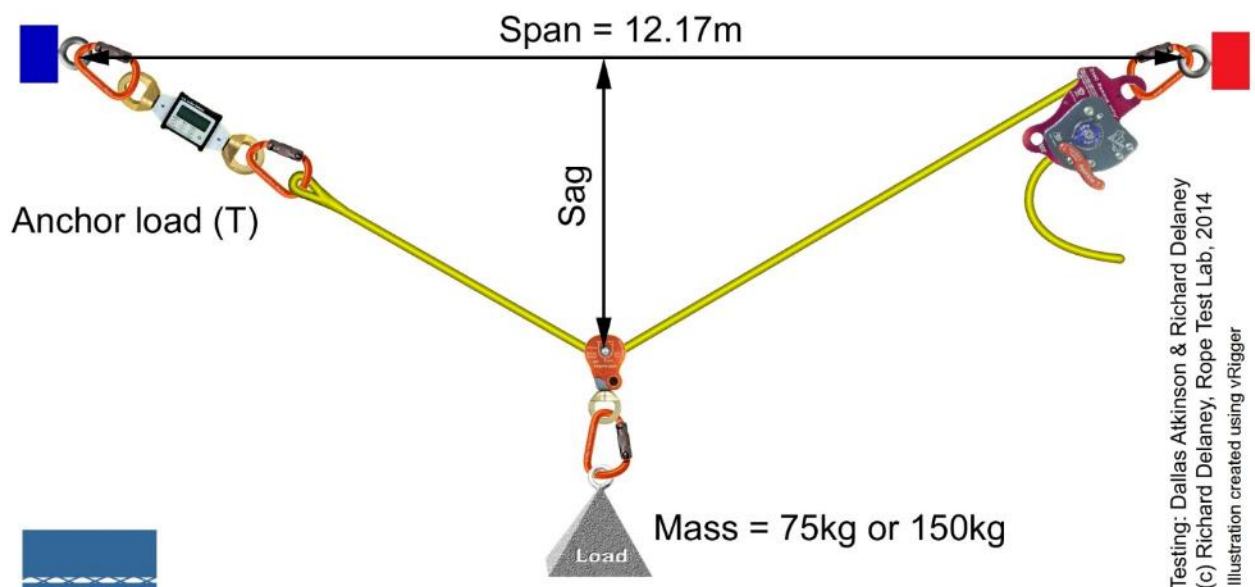

Highline tests 29Jan2014		Measured Data					Theory	
Rope	Span (m)	Mass (kg)	Pretension (kN)	Sag (m)	iPhone (deg)	Anchor load (kN)	Angle (deg)	T (kN)
11mm Nylon Edelrid SuperStatic	12.17	75	1.00	1.09	160	2.20	160	2.09
11mm Nylon Edelrid SuperStatic	12.17	75	1.50	1.02	160	2.35	161	2.23
11mm Nylon Edelrid SuperStatic	12.17	75	2.55	0.76	167	3.10	166	2.97
11mm Nylon Edelrid SuperStatic	12.17	150	1.54	1.41	154	3.41	154	3.26
11.1mm Polyester Sterling HTP	12.17	75	1.00	0.73	167	3.60	166	3.11
11.1mm Polyester Sterling HTP	12.17	75	1.55	0.70	167	3.56	167	3.24
11.1mm Polyester Sterling HTP	12.17	75	2.53	0.60	169	4.15	169	3.78
11.1mm Polyester Sterling HTP	12.17	150	1.50	0.97	161	4.95	162	4.69
11mm Nylon Edelrid Dynamic	12.17	75	1.52	1.15	158	2.10	159	1.98
11mm Nylon Edelrid Dynamic	12.17	150	1.56	1.64	148	2.98	150	2.83

## Skate block

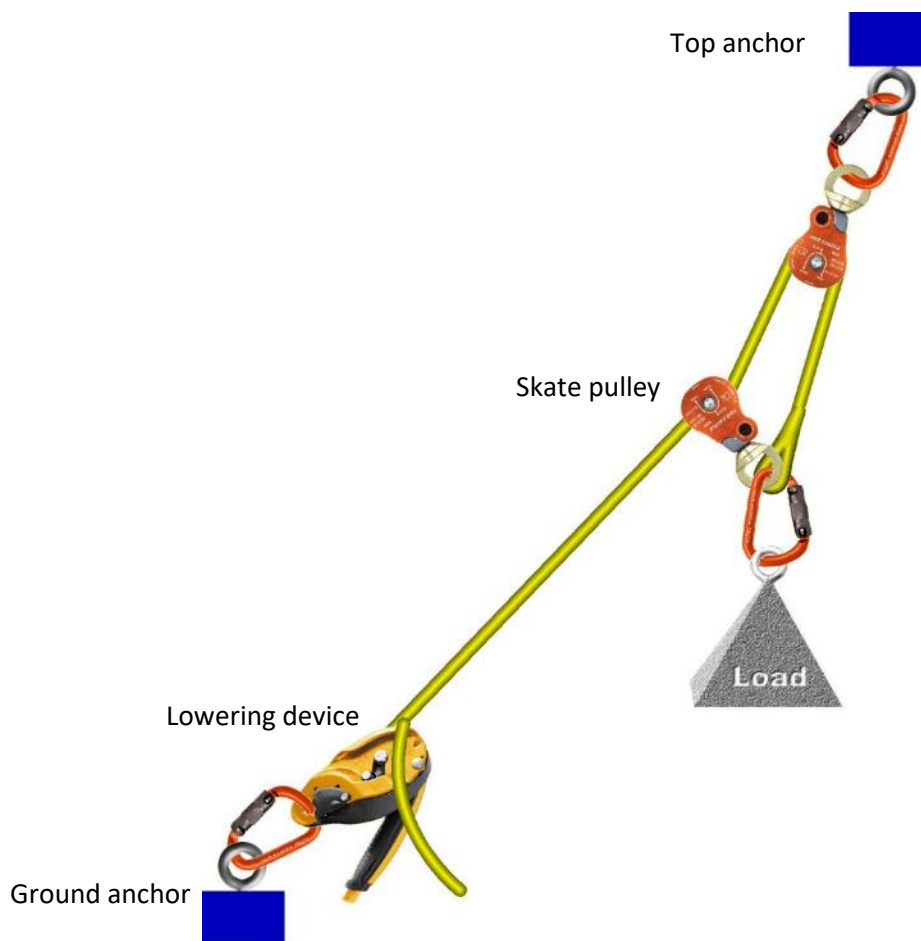

The skate block is commonly used in tower operations because it provides a simple mechanism to keep a load clear of obstacles. Unlike conventional tensioned tracking lines, the skate block is self-tensioning and this tension is limited by the applied load.



The skate block makes a very interesting case study as the physics and mathematics involved in determining the load path are not obvious.

We should start by considering a load held in the same position by three different systems:

- A: fixed anchor lines,
- B: tensioned track line, and
- C: skate block.



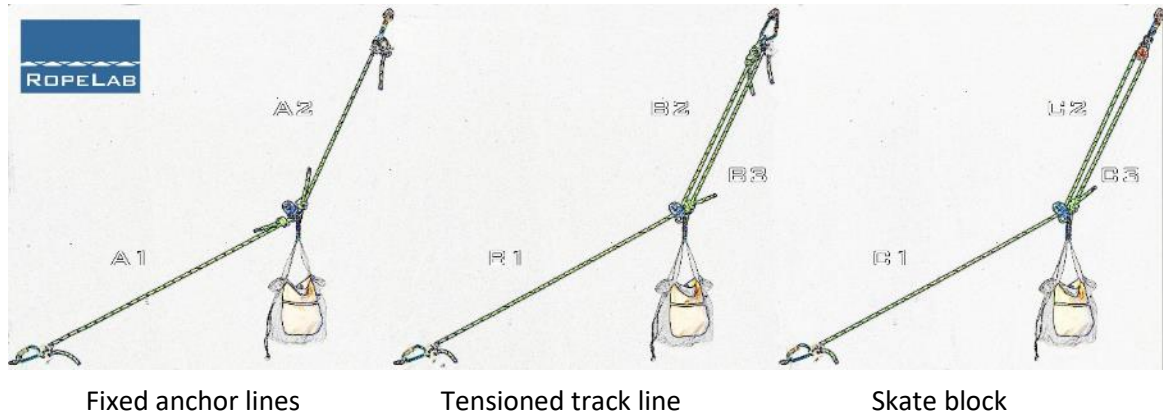

If the pulley above the load in each of these three systems is stationary, then all of the forces acting on it must balance. In the first case these forces are:

- Tension from the ground anchor (A1),
- Tension from the top anchor (A2), and
- Weight of the load.

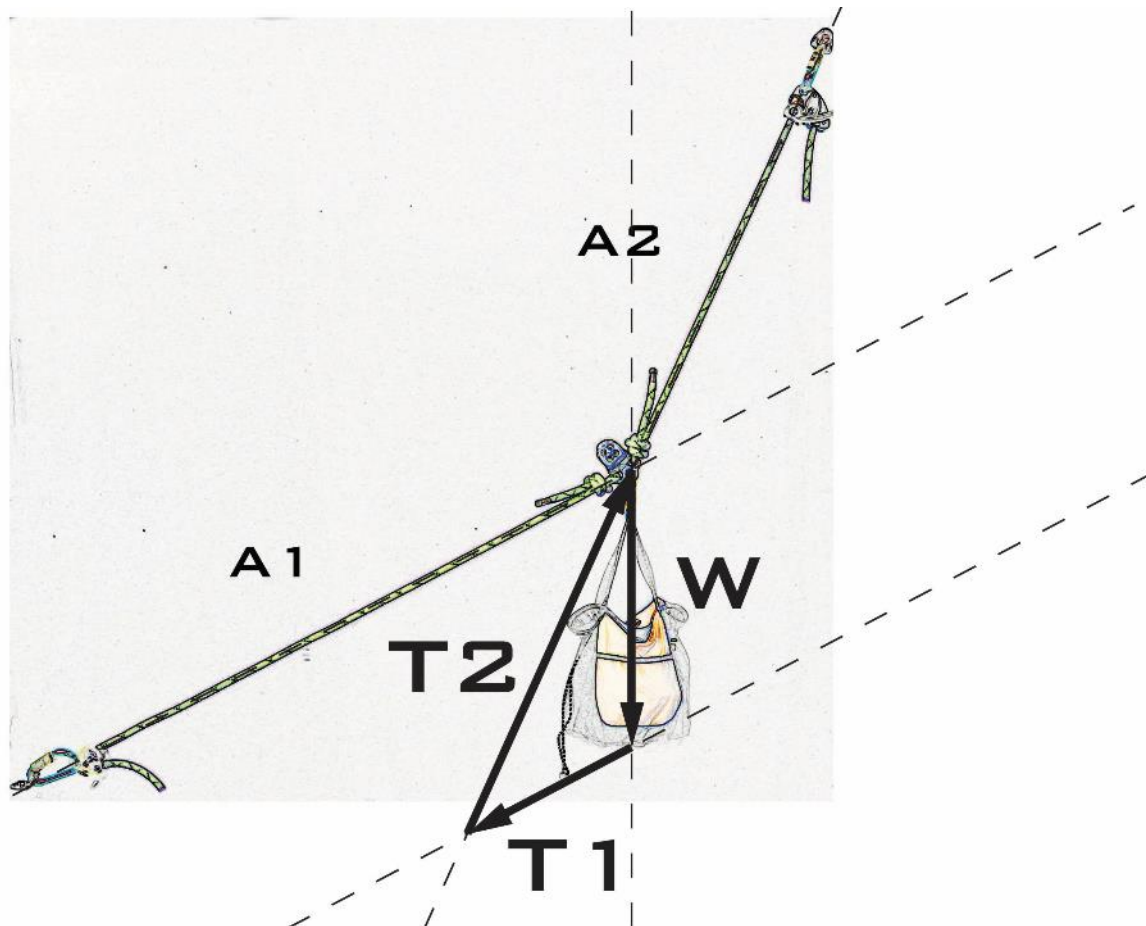

The forces acting on the pulley are represented by **T1**, **T2**, and **W**. The direction of each of these is constrained and thus defined by the physical attachments. The relative magnitudes are represented by the length of the lines with arrows. As the load is stationary, when these vectors are added the result is zero net force.

Note that the lengths of these lines are relative and dependent on the initial length assigned to **W**.

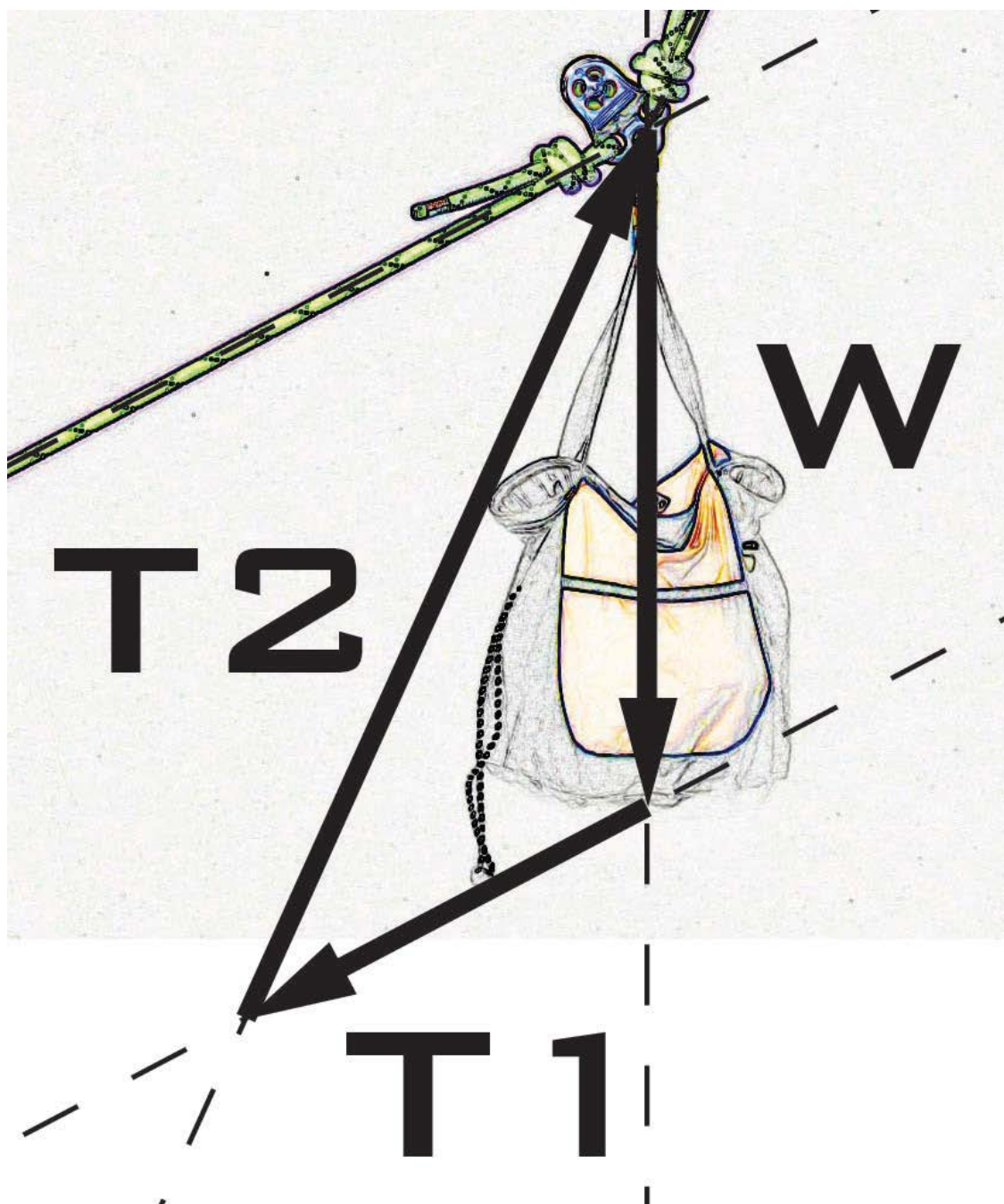

Measuring the lengths of these lines with a ruler shows:

- $W = 100\text{mm}$
- $T1 = 67\text{mm}$
- $T2 = 140\text{mm}$

These values tell us that for any load (100%) the tension to the ground anchor will be 67% and the top anchor will bear 140%. So, for 1kN load, the ground anchor will see 0.67kN and the top anchor 1.40kN.

The triangle geometry for each of the three scenarios (fixed, track, & skate) is the same so the anchors in each case will see the same loadings.

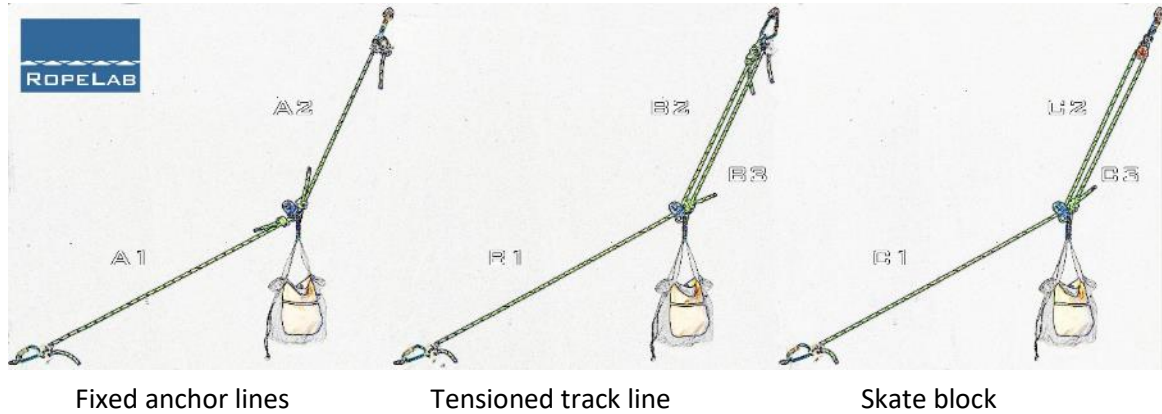

The significant difference for the track line and skate block scenarios is that there are two strands of rope between the load and the top anchor. Assume the load is 1kN for each scenario.

### Tensioned track line

The tensioned track line is continuous between the two anchors so the tension along this line must be constant (assuming the pulley has no friction). We know that B1 is 0.67kN so B2 should be the same. This means that the remainder of the 1.40kN required to hold the load in this position must be provided by B3. Therefore:

- B1 = 0.67kN
- B2 = 0.67kN
- B3 = 1.40kN – 0.67kN = 0.73kN

### Skate block

Now the rope is continuous from bottom anchor, through top anchor and down to the load and thus should have the same tension throughout. We already know that C1 is 0.67kN and therefore C2 and C3 should be the same.

We also know that C2 and C3 should total 1.40kN but half of this is 0.70kN.

The difference between 0.70kN and 0.67kN is less than 5% and can be attributed to real world factors like pulley friction, rope mass, and measurement errors.

## Detailed analysis of the skate block

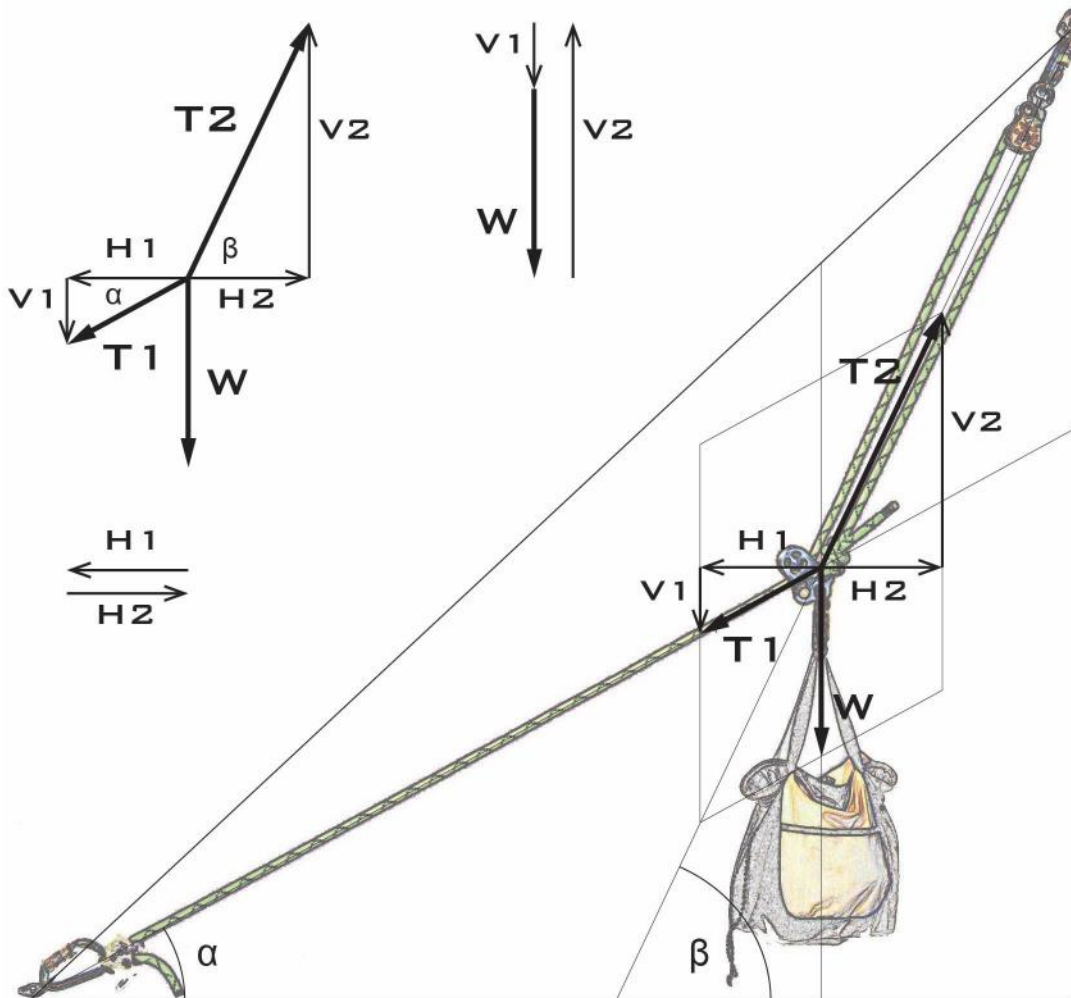

This picture shows that the three forces  $W$ ,  $T_1$ , and  $T_2$  must sum to zero for the load to be stationary. These forces can be split into horizontal and vertical components to demonstrate:

$$H_1 + H_2 = 0$$

And:

$$W + V_1 + V_2 = 0$$

If consider the magnitude of each of these components we can also state:

$$\cos(\alpha) = H_1/T_1$$

And:

$$\cos(\beta) = H_2/T_2$$

Now, given that there is one continuous strand of rope in this system the tension must be of constant magnitude throughout. The tension in the strand from the ground anchor to the load is  $T_1$ . There are two strands running up to the top anchor and each of these also holds the same amount of tension as  $T_1$  therefore we can state:

$$T_2 = 2 \times T_1$$

Now we can rearrange these equations to show:

$$T1 = H1/Cos(\alpha)$$

And:

$$T2 = H2/Cos(\beta)$$

Now:

$$2 \times T1 = H2/Cos(\beta)$$

So:

$$T1 = \frac{H2}{2 \times Cos(\beta)} = \frac{H1}{Cos(\alpha)}$$

Again, rearranging yields:

$$\frac{Cos(\alpha)}{2 \times Cos(\beta)} = \frac{H1}{H2}$$

Given that the load is at rest, the magnitudes of H1 and H2 are the same so:

$$\frac{Cos(\alpha)}{Cos(\beta)} = 2$$

This relationship defines the path of the load as it travels. We can also determine the ground level resting point because here,  $\alpha = 0$  so:

$$Cos(\beta) = \frac{Cos(\alpha)}{2}$$

$$Cos(\beta) = \frac{1}{2}$$

Therefore:

$$\beta = 60^\circ$$

This implies that, regardless of ground anchor position, the load can never land further away than 57.7% ( $1/\tan(60)$ ) of the height.

These calculations assume zero pulley friction and negligible rope mass. If we were to include friction then, moving from the load, the relative strand tensions would be 1, 0.9, and about 0.85. This would change our equations to give:

$$T2 = 2.235 \times T1$$

And a ground angle of:

$$\beta = 63.4^\circ$$

In practice:

**A skate block load will land at a distance out about half of the height of the structure.**

## Mechanical Advantage (MA)

### Levers

Most will be familiar with the concept of a lever however it is useful to distinguish between three fundamental types of lever.

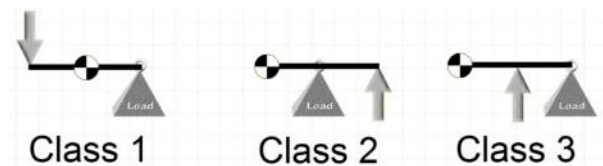

The difference between these is the relative position of the Anchor, Load, and Effort. Common examples of each are:

- Class 1: balance scales, old-fashioned playground see-saw
- Class 2: Wheelbarrow (the wheel is the anchor)
- Class 3: Mobile crane boom with hydraulic ram elevator

Mechanical Advantage (MA) refers to the ratio of load to effort and is determined by the relative positions of load and effort along the lever. To achieve balance in the examples above, using the positions shown and a load of 1kN:

- Class 1: Effort = 1kN so MA is 1:1
- Class 2: Effort = 0.5kN so MA is 2:1 (ie the lever increases the force of the effort by a factor of 2)
- Class 3: Effort = 2kN so the MA is 0.5:1 or 1:2

It is beneficial to introduce the term *Work* at this stage where:

$$Work = Force \times Displacement$$

Work is a measure of the energy required – or roughly how tired you feel once the task is completed. Class 1 and 2 levers will make the task feel easier but you will have to apply that lower effort over a greater distance. In other words, there is no magic and we don't get something for nothing!



## Pulleys

At their simplest, pulleys can be viewed as levers. This becomes more obvious if you consider the static system (where everything is at rest).

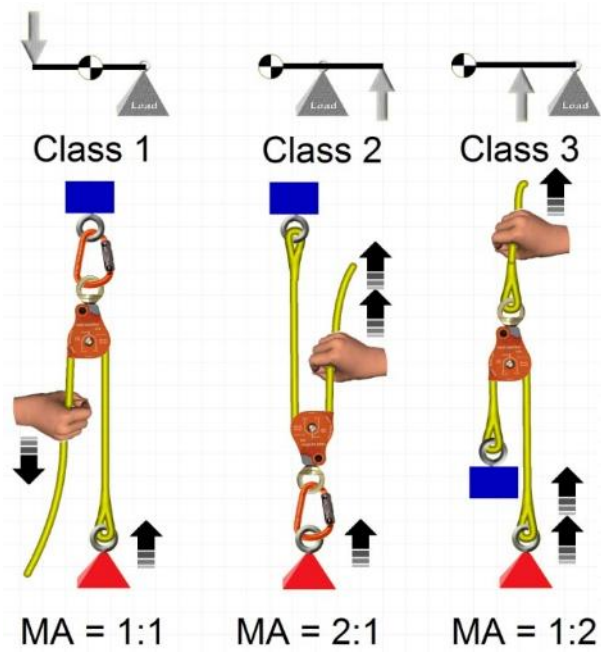

## Magic or physics?

A key moment in understanding for recreational rock climbers is acknowledging the difference in the amount of force applied to a top anchor when either a climber lowers themselves or is lowered by their belayer.

**For a single climber.**

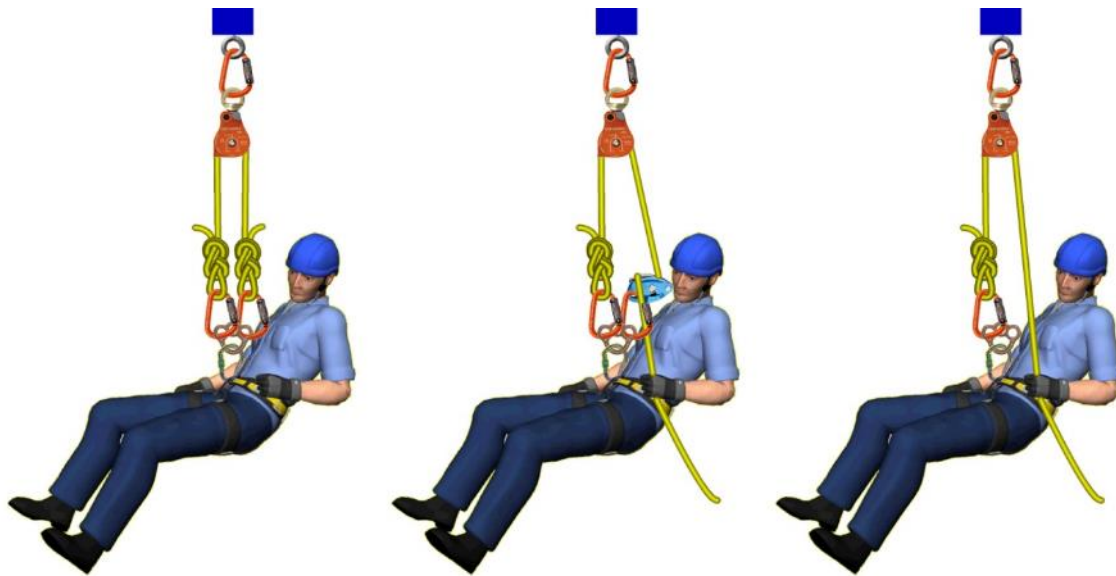

If the climber is stationary, then these three images are effectively the same.

It makes no difference whether the rope closest to the climber's face is attached, belayed, or held.

In all three cases the climber's weight is supported by two strands of rope.

If the climber weighs 1kN then the tension in each strand of the rope is 0.5kN.

As these two strands meet and both pull down on the pulley, their tensions add so that the force applied to the anchor is  $0.5\text{kN} + 0.5\text{kN} = 1\text{kN}$ .

If the belay device in the second image is activated slightly, then slack is introduced in the right hand strand and the system responds by equalizing in the only way possible – the climber goes down.



Now introduce the ground based belayer.

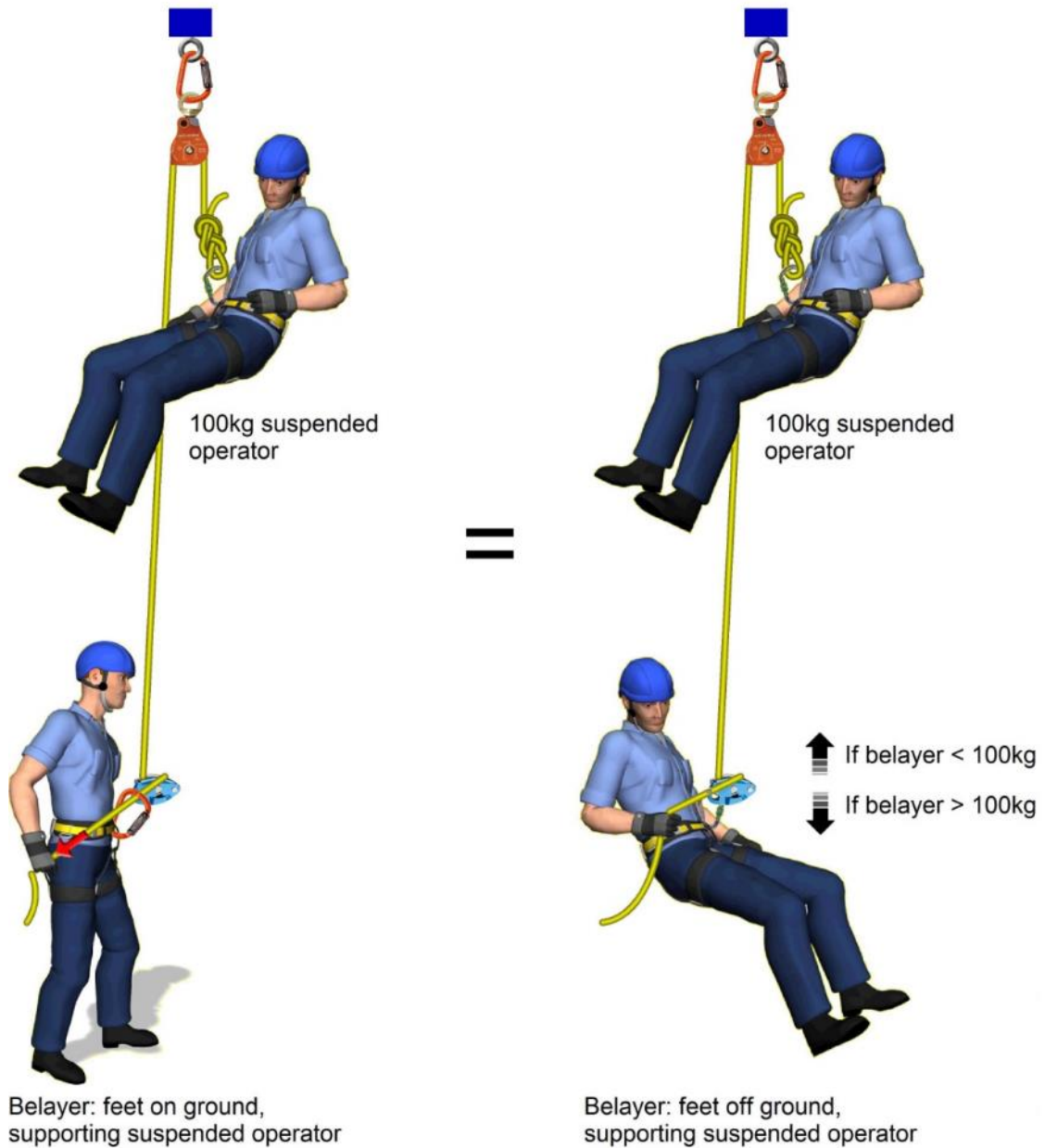

If the 100kg climber sits back on the system and is supported only by the rope, then they apply 1kN tension to the rope. To remain stationary, we would have to hang a 100kg mass on the other side of the rope – any less and the climber would descend, anymore and they would be lifted up. This informs us that the belayer needs to apply a tension equivalent to 1kN to hold the climber in place.

So, the anchor is now supporting 100kg from the climber PLUS 100kg from the belayer giving a total of 200kg. This is a Class 1 Lever/Pulley system.

## The 'T-system' for calculating Mechanical Advantage

Always start with the input (the effort end of the system) and assume that force of 1 unit of tension (or 1 T) is applied.

If a rope is continuous and has no attachments then the tension is of the same magnitude throughout.

At any change in direction in the rope (ie a pulley), an opposing force is required to pull against the ropes going through that change.

At any attachment to a rope (ie a rope grab) tensions are added.

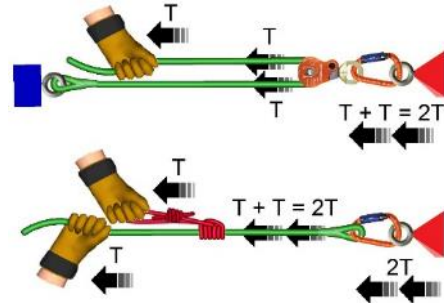

Apply 1T at the input (hand).

The tension in all three strands is T as there are no attachments to the rope in this part of the system

This pulley must oppose the tension applied by both the rope entering the sheave (T) and the rope leaving the sheave (T). So,  $T + T = 2T$

This rope grab now adds the 2T from the pulley to the 1T that is in the host rope.

So,  $2T + T = 3T$

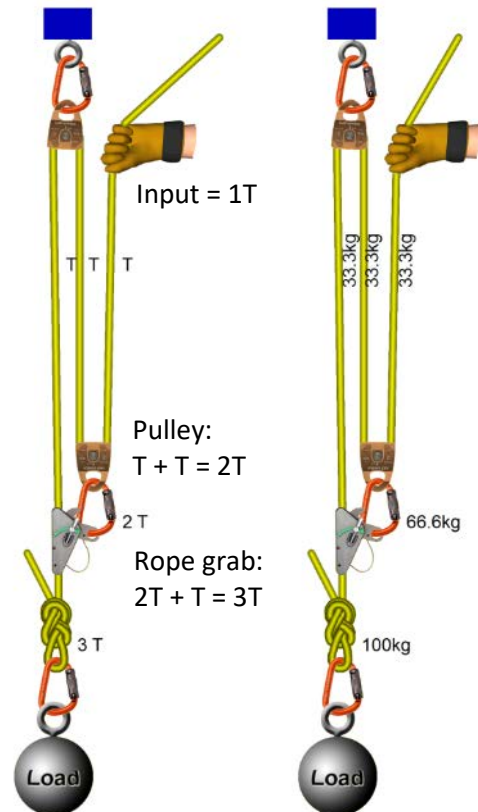

This "T system" now shows that each single unit of tension applied at the input results in three units at the output. Thus, the Ideal Mechanical Advantage (IMA) of this system is 3:1.

In other words, an input force of 33.3kgf will be sufficient to hold a 100kg mass.

### Mechanical Advantage examples

Calculate the anchor load in each of these static systems:

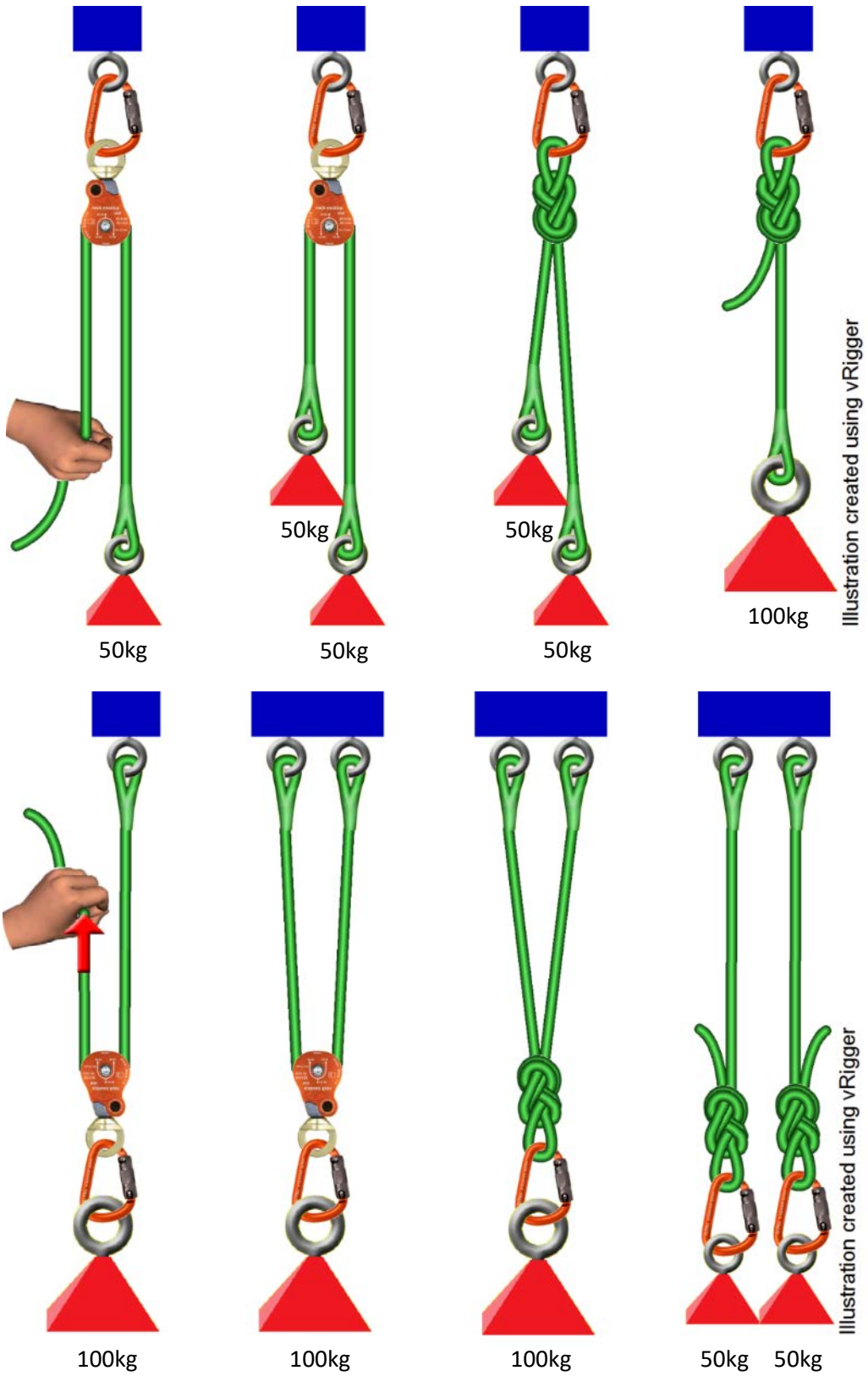

Determine the Ideal Mechanical Advantage and the tension in each strand of rope for the following static systems:

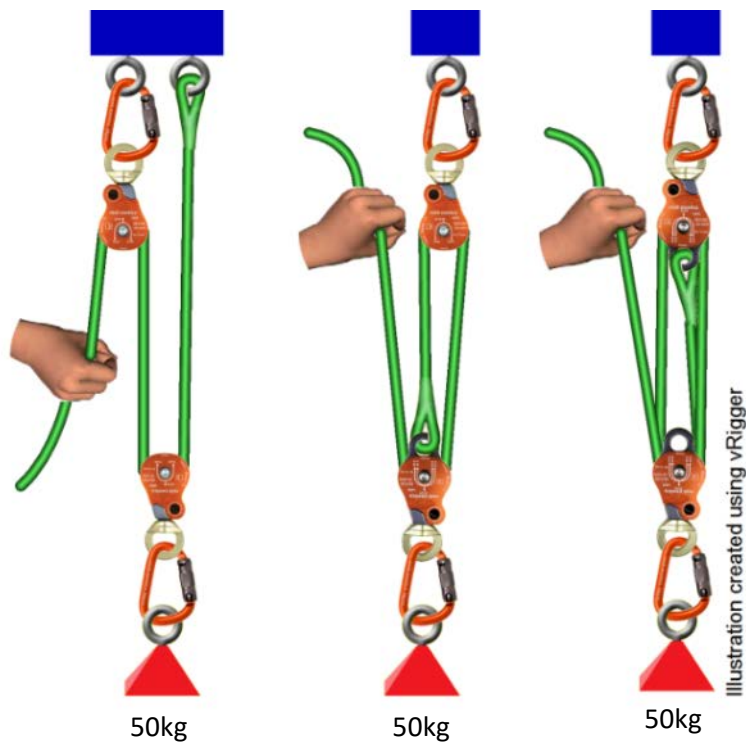
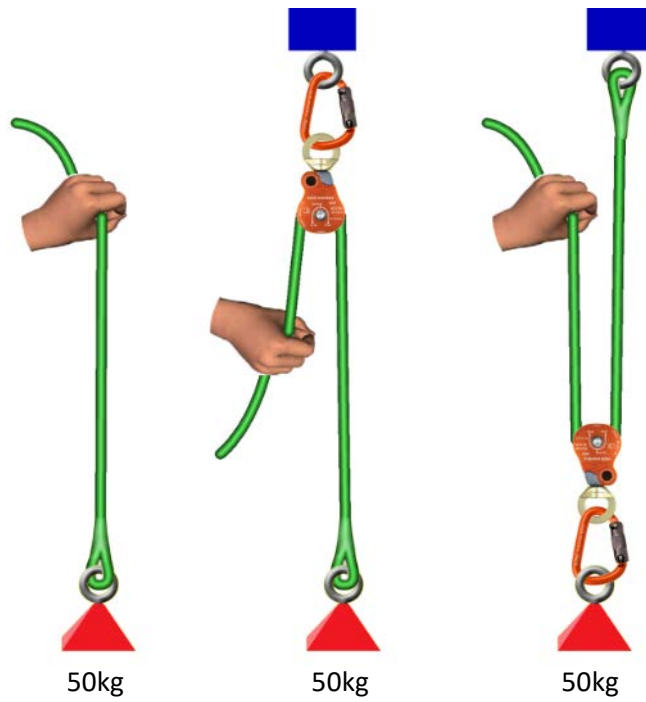

Illustration created using vRigger

## Mechanical Advantage Worksheets

Determine the Ideal Mechanical Advantage and the tension in each strand of rope for the following static systems:

Practice:



Simple systems of MA

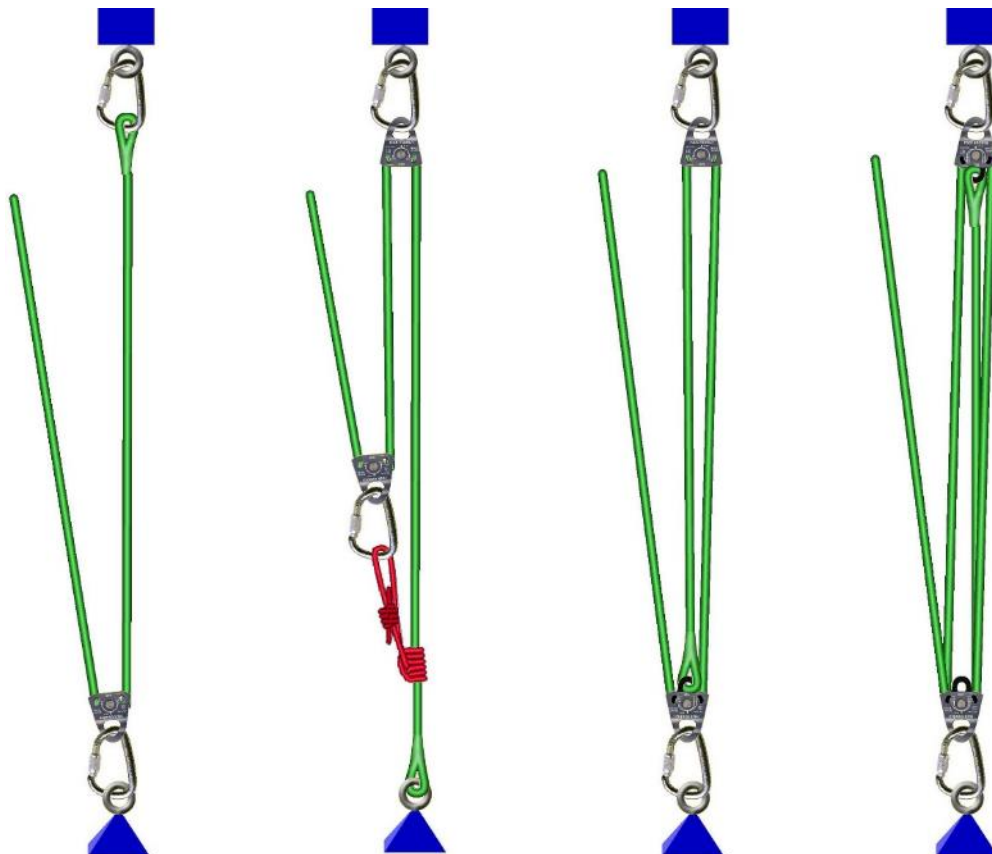

Compound and Complex systems of MA

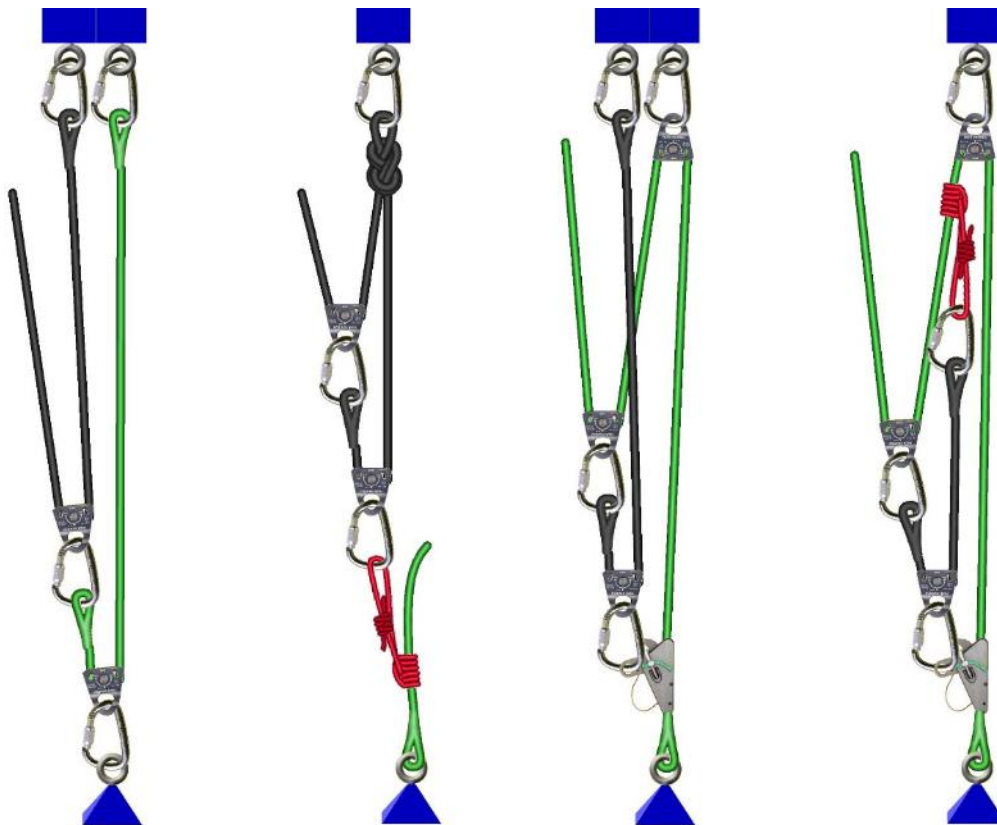

Other examples of MA

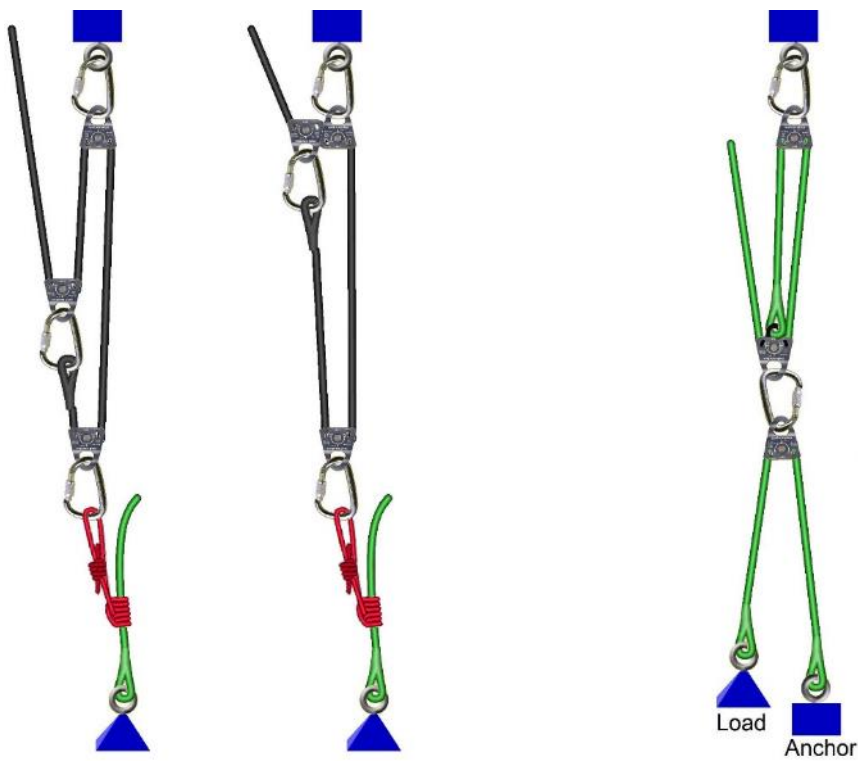



## Ideal, Theoretical, and Actual Mechanical Advantage

**Ideal Mechanical Advantage (IMA)** is the predicted MA assuming that all losses in the system can be ignored. We assume that all pulleys are 100% efficient and that ropes running over objects such as edges and carabiners experience no friction.

**Theoretical Mechanical Advantage (TMA)** is what we can calculate when we attempt to model and include losses in the system. We may make broad assumptions and attribute frictional losses to components and changes in direction of ropes.

**Actual Mechanical Advantage (AMA)** can only be measured during the operation of the system. It cannot be predicted however, with careful consideration, it should be fairly consistent with the TMA.

The following image shows a range of scenarios assuming 50% loss through carabiners and 5% through pulleys.

### Ideal vs. Theoretical Mechanical Advantage

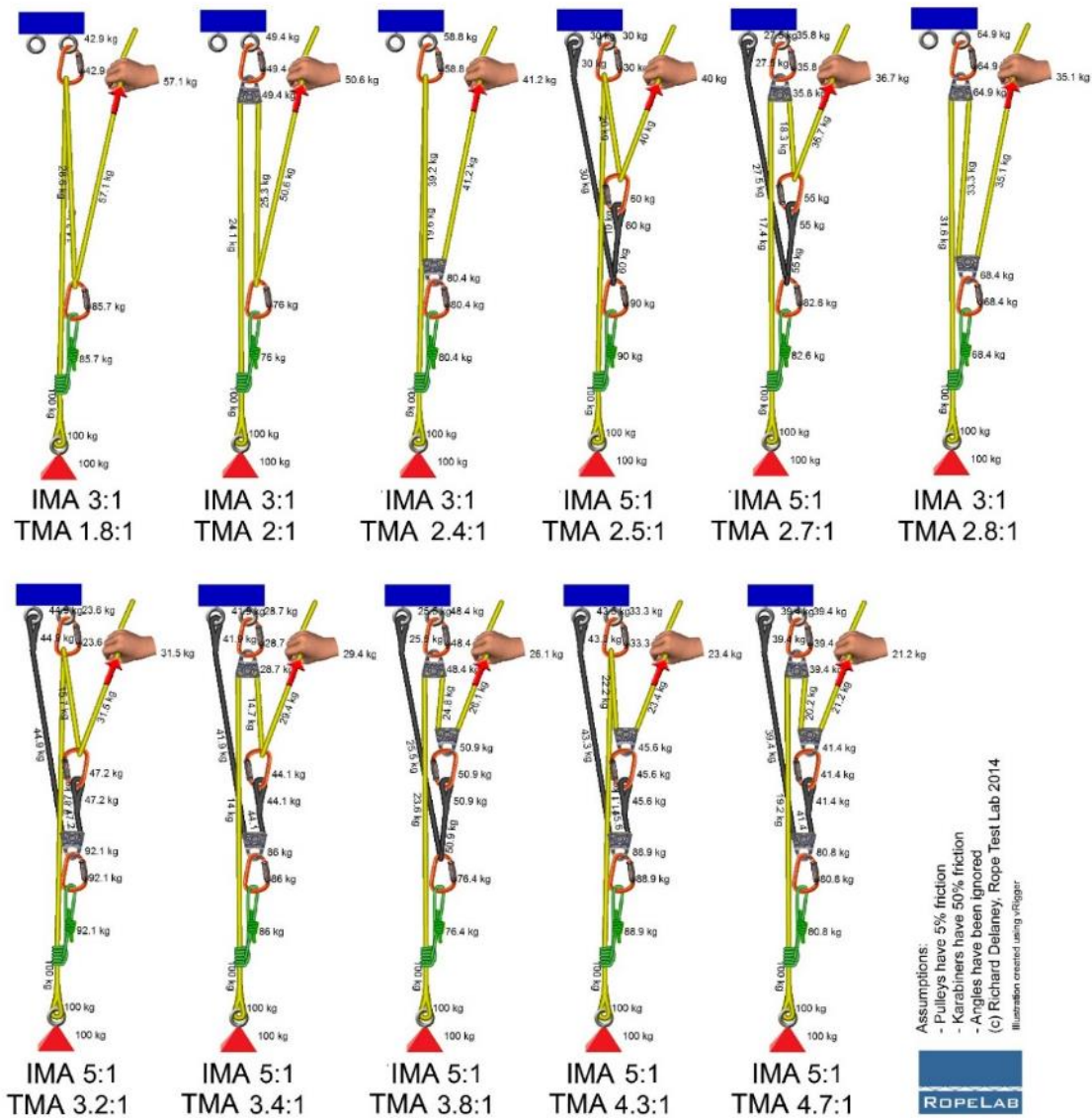

## Friction

### Friction between flat surfaces

If a mass is to be moved along a level surface then the ratio between the mass and the force required to move it can be termed the coefficient of friction, or  $\mu$  (mu, pronounced “mew”), between the two materials.

$$\mu = \frac{\text{Force required to move an object}}{\text{Weight of the object}}$$

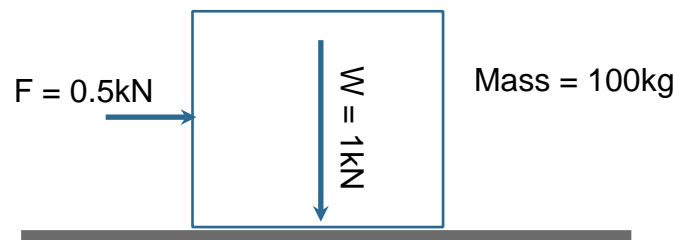

$$\mu = \frac{500\text{N}}{1000\text{N}}$$

$$\mu = 0.5$$

Notice that the units (N / N) cancel out so  $\mu$  is a unit-less value. The following table gives a few interesting (and logical) examples<sup>1</sup>:

Mass	Surface	$\mu$
Steel	Teflon	0.04
Steel	Polythene	0.2
Wood	Concrete	0.62
Solids	Rubber	1.0 – 4.0

It should be noted that there will normally be a difference between the force required to initiate and the force required to maintain motion. This difference is due to subtle differences in what is termed static and dynamic (or kinetic) friction however this will not be discussed further here.

<sup>1</sup> <http://www.engineershandbook.com/Tables/frictioncoefficients.htm>, accessed 3<sup>rd</sup> October 2013



## Friction: Same mass, different orientation

A common question is whether the orientation of a particular object (or the area of contact between object and surface) needs to be considered. For the following image there be any difference between A, B, or C when considering the effort required to push the large block along the surface.

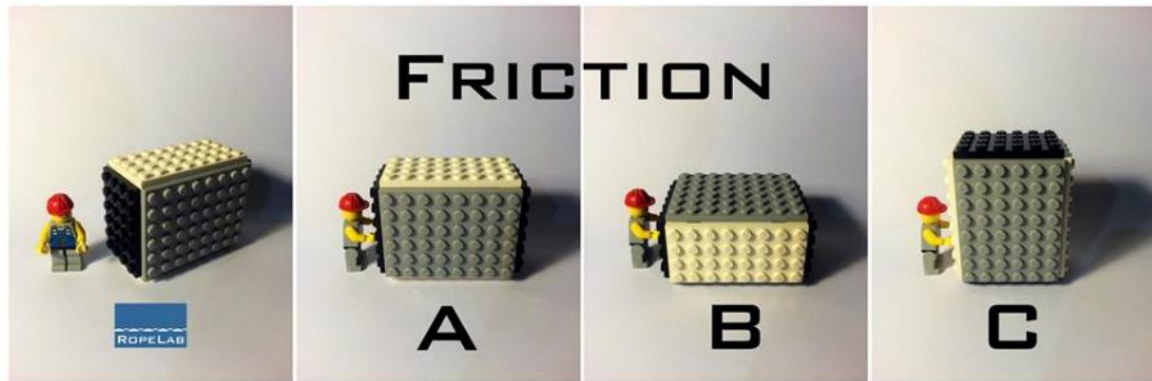

If we keep all assumptions simple:

- there is no keying or interlocking,
- the speed is low so there is no heat buildup
- the object is kept flat
- the object is of uniform density and surface finish
- the surface is consistent

And we assign the following properties:

- the object is made of nylon and has a mass of 48kg
- the flat surface is smooth concrete
- The coefficient of friction for nylon/concrete is 0.44

Then we can consider the following image and state:



The two small shapes represent the same mass (say 2kg) but with that mass applied over either one or two points of contact with the floor. The left hand shape exerts 2kgf on a single point and the right has the same 2kg over two points, each with half the contact pressure of the left.

Now, for the original large shape:

- Orientation A: Contact is 48kgf over 32 points (each supporting 1.5kgf)
- Orientation B: Contact is 48kgf over 48 points (each supporting 1kgf)
- Orientation C: Contact is 48kgf over 24 points (each supporting 2kgf)

Thus if the number of points goes up, the contact force for each goes down in the same proportion but the total contact pressure remains the same 48kgf.

Regardless of the orientation, we can calculate the force required to move this object laterally.

$$\mu = \frac{\text{Force required to move an object}}{\text{Weight of the object}}$$

Rearranging this we get:

$$\text{Force} = \mu \times \text{Weight}$$

$$F = 0.44 \times 48\text{kg} \times 9.81\text{m/s}^2$$

$$F = 0.44 \times 470.88\text{N}$$

$$F = 207\text{N}$$

### Friction between curved surfaces

The previous section is of little significance for a roping technician as moving ropes are generally elevated, moving through a pulley, or sliding around a curved surface such as a structure or belay device. The most important point to grasp is the concept of a coefficient of friction, or  $\mu$ .

In the roping world there are other factors that come into play:

1. The effort in stretching the rope at the outside of the bend and compressing the rope at the inside of the bend.
2. The deformation of the rope as it flattens.
3. The tightening of the rope around a surface – particularly obvious if the rope takes a complete round turn around an object.

We can discount the first two of these if we adhere to the commonly accepted rule-of-thumb that bends in rope should generally take a radius of at least 4 x the rope diameter. This is why most high efficiency pulleys have a sheave diameter of at least 44mm (when working with 11mm ropes).

## The Capstan Equation

It is consideration of the third factor that can really add to our comprehension of friction in practical roping. Two excellent discussions of this and the particular relevance of the Capstan Equation are presented in:

1. *Friction Coefficients of Synthetic Ropes*, W E Brown, Ocean Technology Department, Naval Undersea Centre, San Diego, California, Feb 1977<sup>2</sup>, and
2. *The Mechanics of Friction in Rope Rescue*, Stephen W Attaway, ITRS 1999<sup>3</sup>

In these curved surface scenarios we now consider the tension in the strands of rope either side of a curved object and similarly describe their ratio with the Capstan Equation - namely as a function of both a coefficient of friction ( $\mu$ ), and the angle through which the curve passes ( $\phi$  – phi pronounced “fy” rhyming with pie).

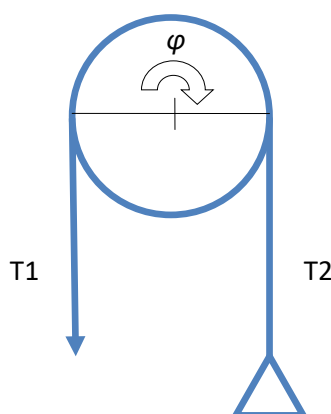

A few observations:

- This curved object does not spin.
- T1 = the tension in the rope on the left-hand-side.
- T2 = the tension in the rope on the right-hand-side.
- These two tensions will be different because of friction.
- If we wish to raise the mass,  $T1 > T2 + \text{friction}$ .
- If we wish to lower the mass,  $T1 + \text{friction} < T2$ .

The Capstan equation states that the ratio of T1 to T2 will be equal to  $e^{\mu\phi}$ , or:

$$\frac{T2}{T1} = e^{\mu\phi}$$

This is an ‘exponential’ function and means ‘e’ raised to the power of  $\mu \times \phi$ . ‘e’ is one of the magic numbers of mathematics (like ‘ $\pi$ ’) and is often truncated to 2.71828. To perform this calculation on scientific calculators, use the button marked  $e^x$ . The inverse function (to reverse the calculation) is denoted  $\ln(x)$  and calculates the natural logarithm of x.

<sup>2</sup> <http://oai.dtic.mil/oai/oai?verb=getRecord&metadataPrefix=html&identifier=ADA036718>, accessed 5<sup>th</sup> October 2013

<sup>3</sup> [http://www.irre.org/att\\_frict.pdf](http://www.irre.org/att_frict.pdf), accessed 5<sup>th</sup> October 2013

To calculate a real world value for this ratio we need to:

1. Measure  $\varphi$  in radians. Most will be more familiar with degrees and understand that an angle can be noted as being from  $0^\circ$  through to  $360^\circ$  around a full circle. In this example, the rope turns through half of a circle or  $180^\circ$ . Radians is an alternative measure of angle and is based upon knowing that there are  $2\pi$  radians (same as  $360^\circ$ ) in a complete circle (See the Appendix for further discussion on units of angular measurement). So, for this example, the rope turns through  $\pi$ , or 3.14159, radians.
2. Use a reference document to look up the value of  $\mu$  for these specific materials. For this example we will assume that we have nylon rope passing over a large galvanized steel structural tube and that  $\mu$  for this combination is 0.2.
3. Assign a value to the mass which then determines the value of 'T2'. We will use 100kg.

Now, for lowering:

$$\begin{aligned}
 T1 &= T2 \div e^{\mu\varphi} \\
 &= m \times g \div e^{\mu\varphi} \\
 &= 100\text{kg} \times 9.8\text{ms}^{-2} \div e^{(0.2 \times 3.14159)} \\
 &= 980\text{N} \div 1.874 \\
 &= 522.9\text{N}
 \end{aligned}$$

In practical terms, this means lowering 100kg will 'feel' like only 53.4kg ( $522.9\text{N} \div 9.8\text{ms}^{-2}$ ) on the T1 side.

For raising:

$$\begin{aligned}
 T1 &= T2 \times e^{\mu\varphi} \\
 &= m \times g \times e^{\mu\varphi} \\
 &= 100\text{kg} \times 9.8\text{ms}^{-2} \times e^{(0.2 \times 3.14159)} \\
 &= 980\text{N} \times 1.874 \\
 &= 1,837\text{N}
 \end{aligned}$$

In other words, raising 100kg will 'feel' like 187kg ( $1837\text{N} \div 9.8\text{ms}^{-2}$ ) on the T1 side.

### Measuring coefficients of friction

Many sources have tables of  $\mu$  for wide ranges of materials however these are not always the most appropriate for roping scenarios. Variables like nylon vs. polyester rope, Blue Mountains sandstone vs. Yosemite granite, and anodised vs. polished aluminium come into play.

Tension load cells are becoming more readily available so we are able to measure aspects of our systems and develop useful sets of data. On first observation it would seem necessary to have two tension load cells to calculate  $\mu$  for any given situation. A standard known mass could be used but then you have the uncertainties associated with the mass of the rope between the edge and the test mass. A far simpler technique is to choose an arbitrary mass, but one that is similar to real-life concerns – say 75kg – and set up the following.

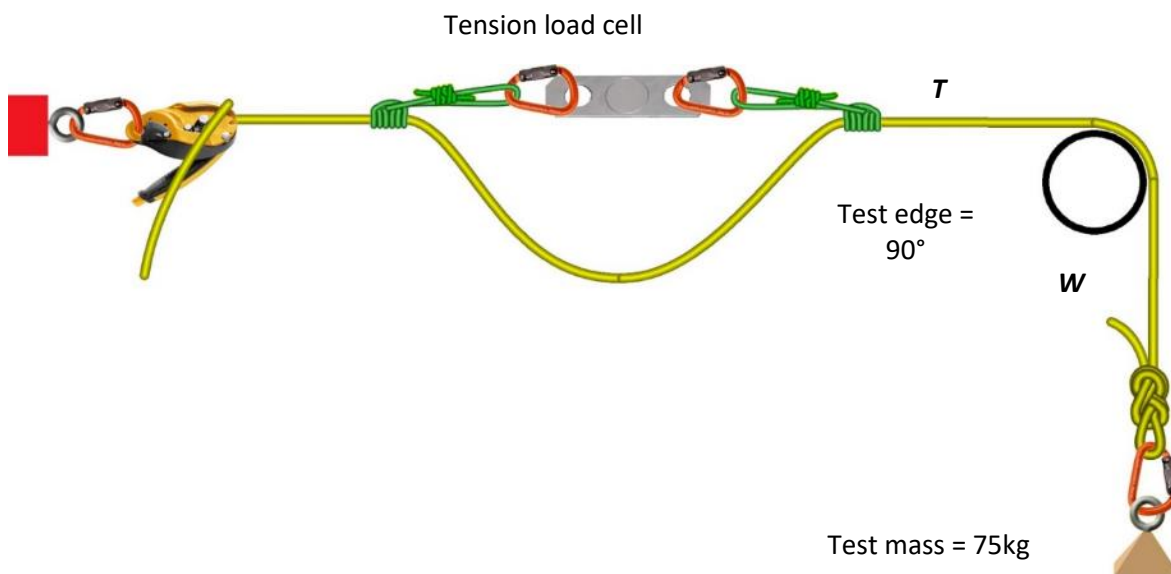

With this equipment it is possible to lower the test mass (applying a weight  $W$ ) and, while lowering, measure the tension ( $T_{lower}$ ) in the rope above the edge. According to the Capstan Equation, during lowering:

$$\frac{W}{T_{lower}} = e^{\mu\phi}$$

thus

$$W = T_{lower} \times e^{\mu\phi}$$

The same apparatus can be reused to measure the tension ( $T_{raise}$ ) required to raise the same mass. This time, the Capstan Equation yields:

$$\frac{T_{raise}}{W} = e^{\mu\phi}$$

So

$$\frac{T_{raise}}{e^{\mu\phi}} = W$$

In both scenarios  $W$  remains the same so we can combine the two equations to get:

$$\frac{T_{raise}}{e^{\mu\phi}} = T_{lower} \times e^{\mu\phi}$$

Rearranging this equation yields

$$\frac{T_{raise}}{T_{lower}} = e^{\mu\phi} \times e^{\mu\phi} = e^{2\mu\phi}$$

Remembering that the inverse function of  $e^x$  is the natural logarithm of  $x$ , or  $\ln(x)$ , gives:

$$\ln\left(\frac{T_{raise}}{T_{lower}}\right) = 2\mu\phi$$

So, finally:

$$\mu = \frac{\ln\left(\frac{T_{raise}}{T_{lower}}\right)}{2\phi}$$

This final equation gives us a practical way to determine the coefficients of friction for particular scenarios directly relevant to the world of roping technicians.

## Real test results

**11.1mm Sterling HTP rope,  
90 degree bend over 60mm polished Aluminium tube,  
75kg test mass: raise, rest, then lower.**

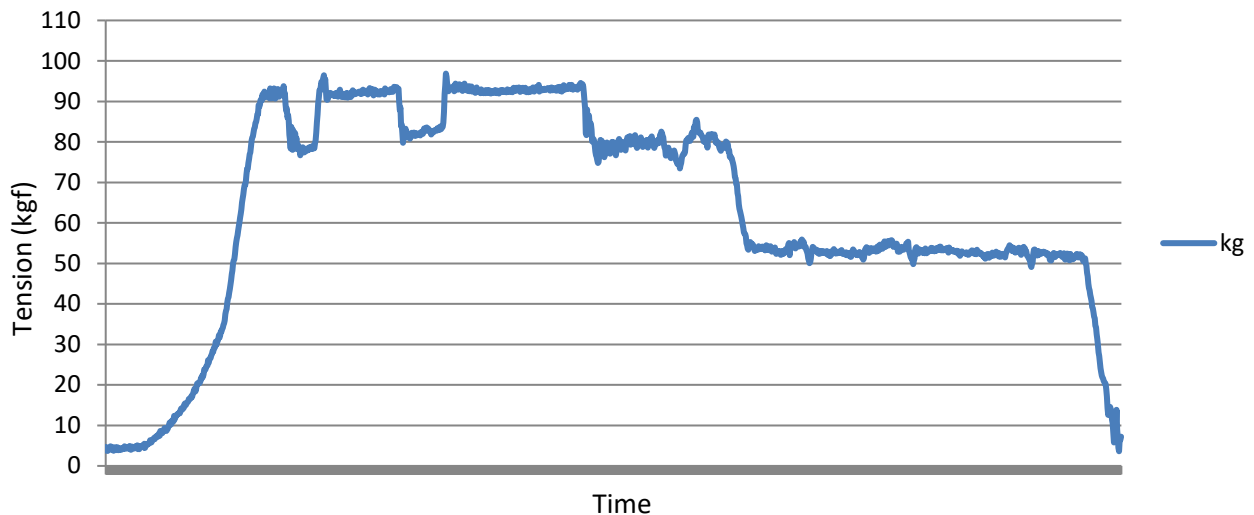

The test begins with a 75kg mass at rest on the ground. Tension is gradually applied (using smooth, low-speed battery operated winch) and measured with the in-line tension load cell.

Observations:

- All tensions have been measured in equivalent kilograms for ease of understanding.
- Once the tension reaches 90kgf, the mass leaves the ground.
- After a short time, hauling stops and the mass is left to rest with a holding tension around 80kgf.
- This sequence is repeated two more times with small spikes up to 96kgf – these show the slightly larger effort required to overcome static friction.
- The tension required to maintain upward movement is about 92kgf.
- After a rest, the system is set to lower and the mass is lowered to the ground in one sequence with a lowering tension of about 53kgf.
- The angle through which contact occurs ( $\varphi$ ) is 90 degrees, or  $\pi/2$  radians.

$$\mu_{\frac{Alu}{polyester}} = \frac{\ln\left(\frac{T_{raise}}{T_{lower}}\right)}{2\varphi}$$

$$\mu = \frac{\ln\left(\frac{92kgf}{53kgf}\right)}{2 \times \frac{\pi}{2}}$$

$$\mu = \frac{0.5515}{3.14159}$$

$$\mu = 0.175$$



This measured  $\mu$  can now be used to calculate the friction produced by aluminium devices when used with polyester rope. The simplest example would be to consider a number of turns around an aluminium tube to provide friction for lowering a 100kg mass:

Turns	Angle	$e^{\mu\phi} = \frac{W}{T_{lower}}$	$T_{lower}$ required to lower 100kg
¼	90 degrees = $\pi/2$ radians	1.32	75.97
½	180 degrees = $\pi$ radians	1.73	57.71
1	360° = $2\pi$ radians	3.00	33.30
2	720° = $4\pi$ rads = 2 round turns	9.02	11.09
3	$6\pi$ rads = 3 round turns	27.08	3.69
4	$8\pi$ rads = 4 round turns	81.31	1.23
5	$10\pi$ rads = 5 round turns	244.15	0.41
6	$12\pi$ rads = 6 round turns	733.15	0.14

In real terms this should be able to be interpreted as meaning we will get almost a 100-fold saving in effort when lowering if we take 4 round turns around an aluminium bar – which is probably where the “4-turn” rule-of-thumb for the tensionless hitch comes from.

Other results from test using a 75kg mass:

Rope	Host	$T_{raise}$	$T_{lower}$	angle	$\mu$
Sterling HTP	50mm alu	98	50	90	0.21
Edelrid SS	50mm alu	88	35	180	0.15
Edelrid SS	50mm alu	89	49	90	0.19
Sterling HTP	60mm anod	92	53	90	0.18
Edelrid SS	60mm anod	87	36	180	0.14
Edelrid SS	60mm anod	92	52	90	0.18
Sterling HTP	43mm gal	103	47	90	0.25
Edelrid SS	43mm gal	125	37	180	0.19
Edelrid SS	43mm gal	92	47	90	0.21
Edelrid SS	10mm steel	127	29	180	0.24
Edelrid SS	12mm steel	140	31	180	0.24
Edelrid SS	Flat 4x2wood	179	17	180	0.37
Edelrid SS	Tall 4x2wood	140	15	180	0.36
Edelrid SS	concrete	135	34	90	0.44

## Friction through Progress Capture Devices (PCDs)

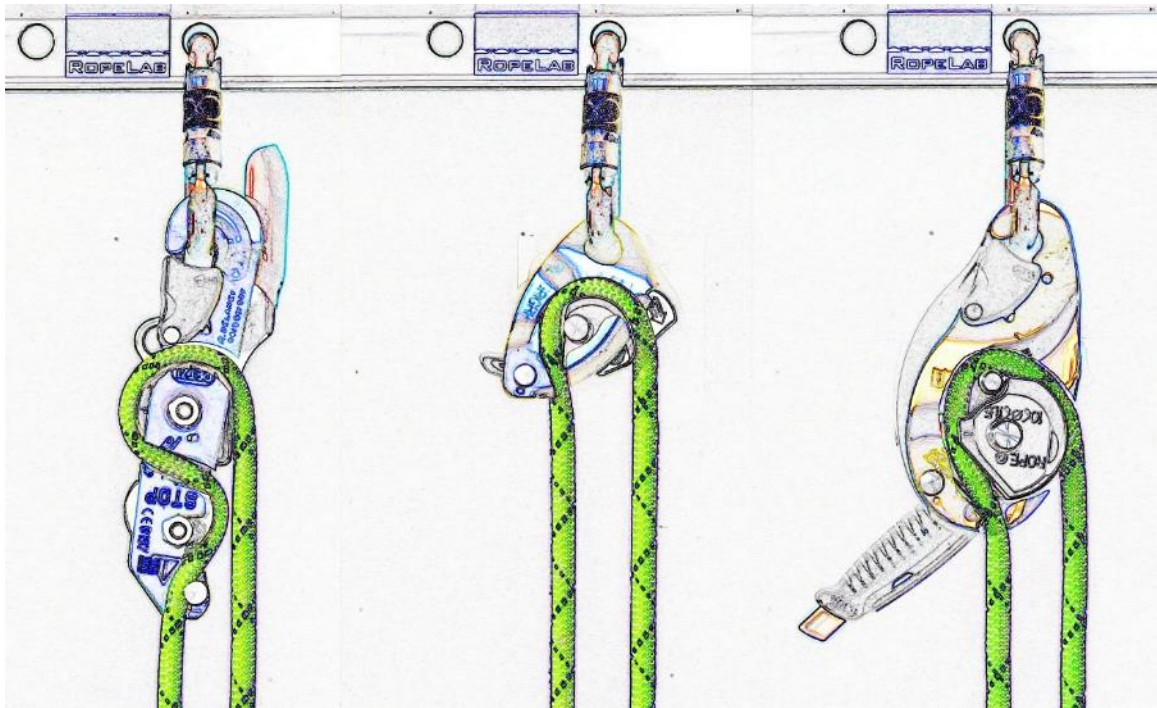

This image shows three different devices rigged and loaded as if positioned at the back of a hauling system. We can use the Capstan equation to predict the loss through each device if it is functioning as a 'pulley'.

Firstly we need to determine the angle through which each rope passes.

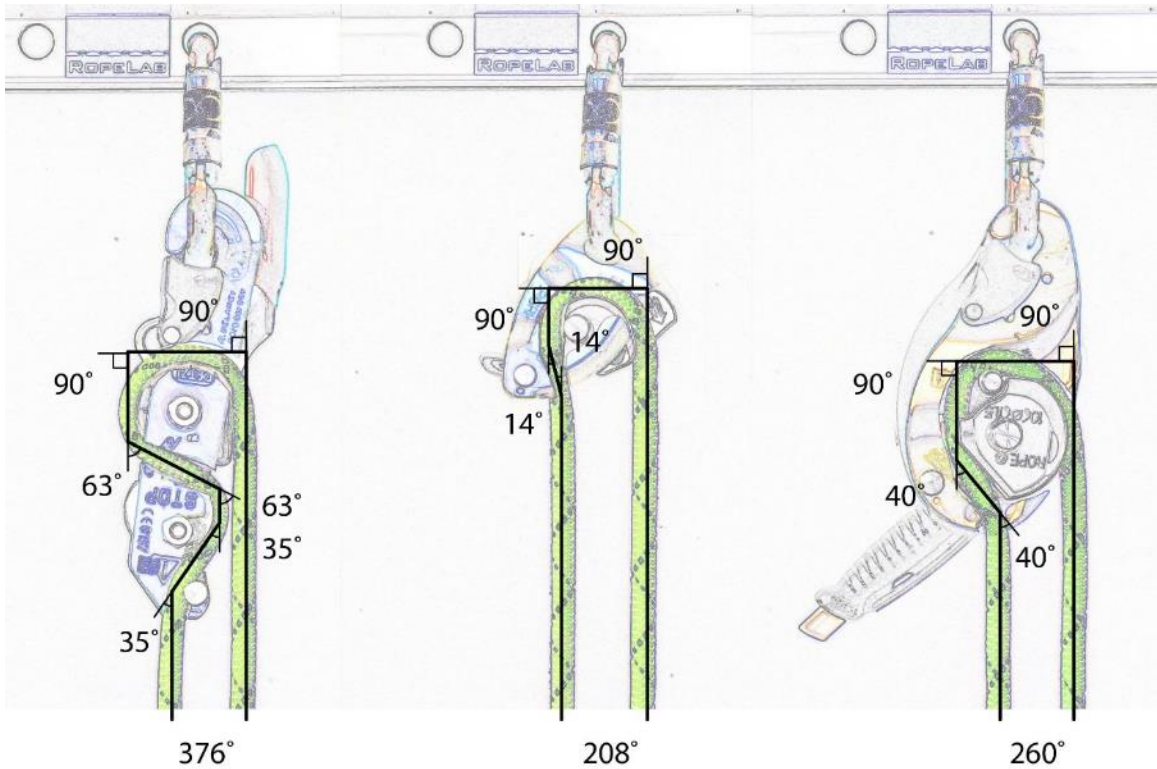

With these angles and assuming a coefficient of friction ( $\mu$ ) of 0.2 we can proceed.

**Petzl Stop**

$$\frac{T_2}{T_1} = e^{\mu\phi}$$

$$\frac{T_2}{T_1} = e^{0.2 \times (376 \div 360 \times 2 \times \pi)}$$

$$\frac{T_2}{T_1} = 3.715$$

**Petzl GriGri2**

$$\frac{T_2}{T_1} = e^{0.2 \times (208 \div 360 \times 2 \times \pi)}$$

$$\frac{T_2}{T_1} = 2.067$$

**Petzl IDs**

$$\frac{T_2}{T_1} = e^{0.2 \times (260 \div 360 \times 2 \times \pi)}$$

$$\frac{T_2}{T_1} = 2.478$$

These numbers are the multipliers, or ratios, of tension-in to tension-out. They imply that, for example, if we set a Petzl IDs as an overhead pulley (with progress capture) we would need to apply 2.478kN of tension to lift a 1kN load.

If you wanted to rank the suitability of each of these as PCDs your first choice would be a GriGri2, then the IDs, and lastly the Stop. This statement assumes that such use in a particular application is within the intended uses as specified by the manufacturer.

**Simple 1:1 overhead pulley efficiency tests: force required to lift 1kN**



- Rock Exotica Omni Block 1.5: 1.10kN
- Petzl P50: 1.12kN
- Petzl mini pmp: 1.15kN
- BD pulley: 1.16kN
- CMI pulley 1.25kN
- Petzl orange plastic on oval: 1.25kN
- Petzl micro traxion: 1.14kN
- Petzl mini traxion: 1.35kN
- Single karabiner: 1.69kN
- Double karabiner: 1.86kN
- Petzl IDs: 2.65kN
- Petzl Gri-Gri1: 2.23kN
- Petzl Gri-Gri2: 2.21kN
- CMC MPD: 1.07kN

Interestingly, the predicted and measured values for the IDs (2.478 & 2.65) and GriGri2 (2.067 & 2.21) are fairly close. The discrepancy is certainly reasonable given the variation in derived coefficients of friction in the previous section.

## Raising and lowering over concrete edges

Rescue and Industrial Rope Access technicians often have ropes rigged horizontally and then running over a 90° edge and down a structure. This is of no concern for static operations but once this rope is used for haul or lower there are some practical considerations.



These measured values show that an edge like this effectively becomes a 2:1 either helping during lowering or hindering during a raise.

If we are raising and we add a non-pulley based progress capture then the situation becomes even worse.

### Theoretical vs. Practical Mechanical Advantage

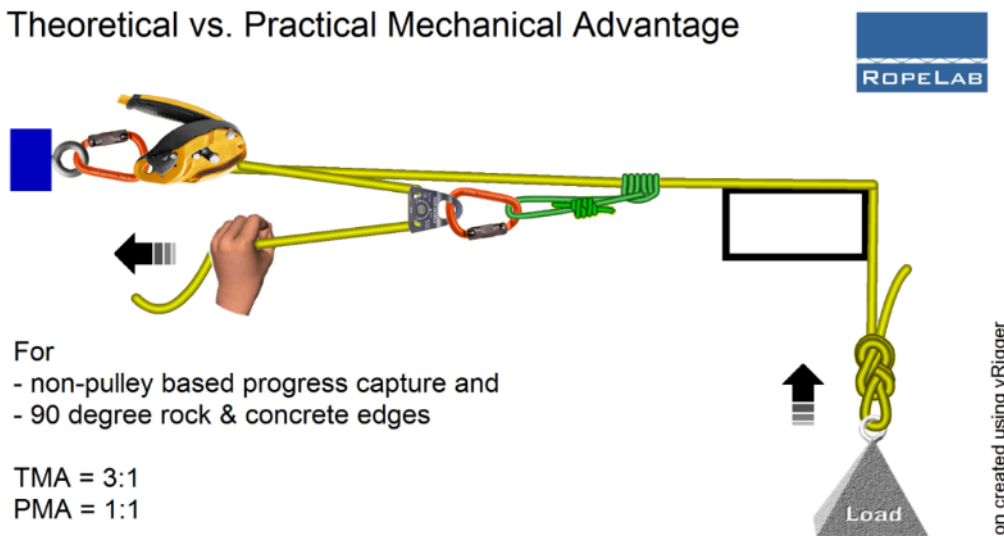

(c) Richard Delaney, Rope Test Lab, 2014



## Tension and Compression

Tension and Compression are two possible forces that can act along the length of a single part of a system. Put simply, tensile forces are those resulting from pulling and compressive forces are those resulting from pushing. A rigid object, such as a length of aluminium tubing, can be placed readily in either tension or compression - it could be used to support our 100kg mass in suspension or it could be used as a pedestal in compression. Flexible elements, such as 11mm rope, will only be useful in tension.

If we assume that the properties of an object (cross sectional area, density, material) are constant along its length and that the object is only in contact with others at its ends then it is also reasonable to assume that the tension/compression does not vary along its length.

### Guyed mast

The guyed mast is makes an interesting study of tension and compression. The vertical mast is in compression down the ground point and, being vertical, theoretically only needs guys to oppose lateral loading from wind. The height may also dictate the need for intermediate guys as subtle lateral movement at mid-height may initiate compression failure.

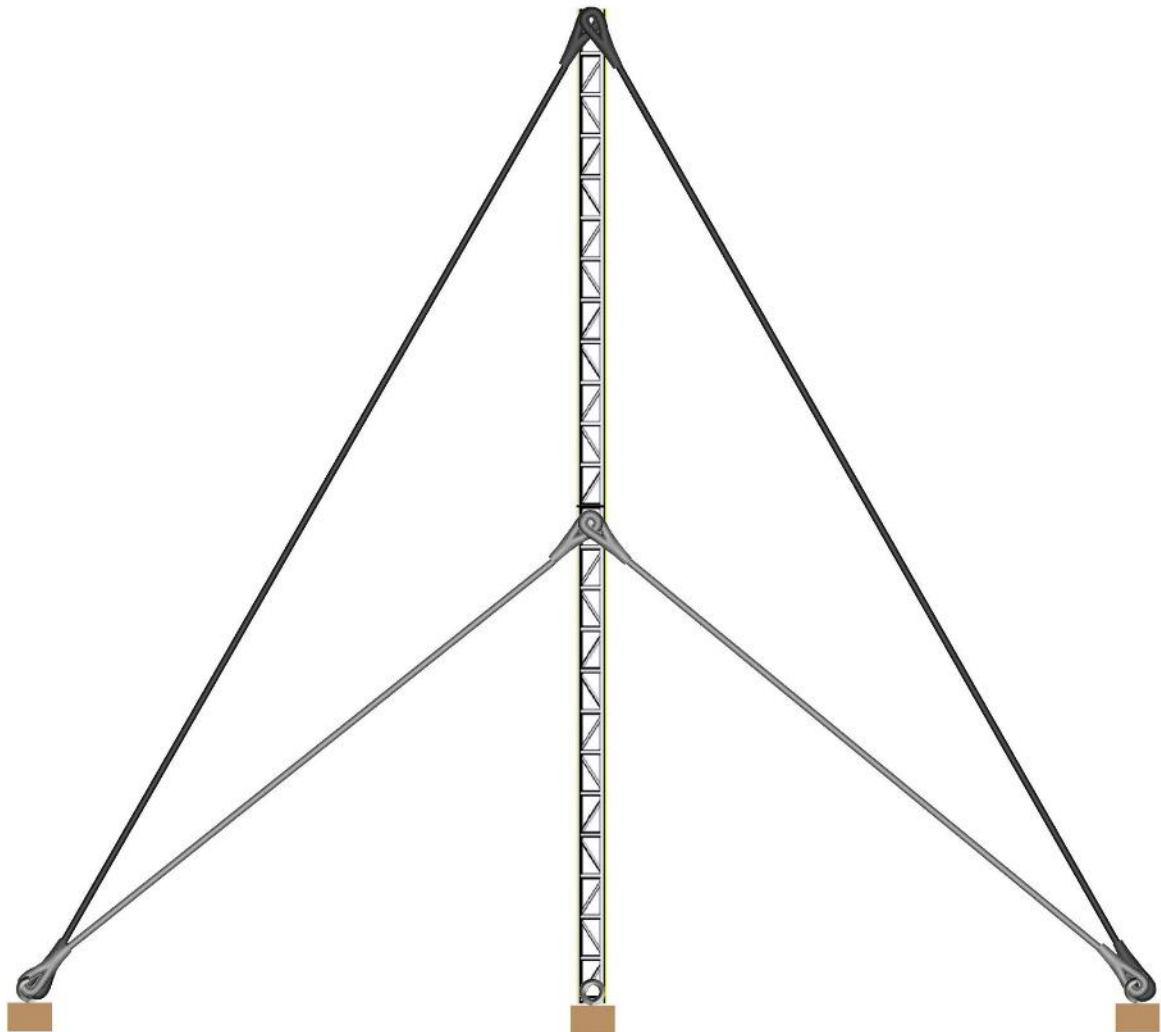

Compression failure of a perfectly vertical mast generally requires initiation at a point of weakness. We often see that a person can stand balanced on an empty aluminium drink can. If

an external influence taps the side of the aluminium can then this rapidly results in compression failure of the entire can/tube. Significant effort is put into modelling the internal and external forces that apply to masts and these may include:

- The weight of the mast applying downwards compression.
- The weight of the installed equipment at various heights.
- The added weight when wet and subject to snow and ice deposition
- Extra forces applied during maintenance (climbers and equipment)
- The wind load applied on both the mast and installed equipment in various weather conditions (including the potential for differing wind strength and directions at different heights on tall masts)
- Potential harmonic oscillation of guys and the mast itself.

## Torque

In order to consider and calculate guy tension resulting from external forces it helps if we break these forces into two components:

- Those parallel to the pole (placing it in either tension or compression)
- Those perpendicular to the pole (placing it in shear)

If the pole is anchored, then all of the shear forces will add effectively result in a rotating force about the anchored base.

This rotational force is called Torque and it is normally measured in Newton metres (Nm).

A torque of 1Nm is equivalent to applying a 1 Newton force at a distance of 1m.

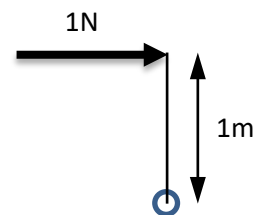

## Gin Poles: torque, tension, and compression

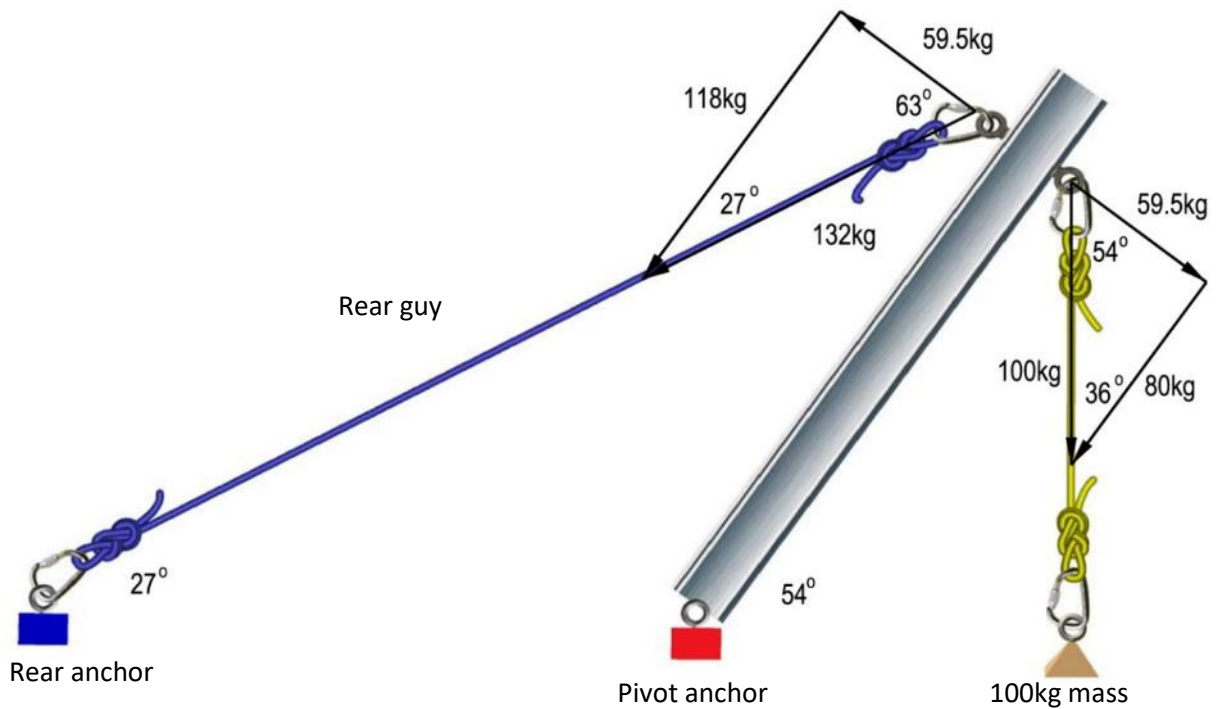

This image depicts a typical 'Gin Pole' or 'Jib' configuration. We need to assume that the foot of the pole is a fixed point of rotation. The main question is, with the suspended 100kg mass, how much tension is being applied to the rear guy/rope?

Even though the system is in equilibrium, to answer this we need to assume that the 100kg mass is attempting to rotate the pole clockwise with the pivot anchor at the centre of the rotation. To calculate this rotating force, or torque, we need to consider how much of the tension in the load rope is actually applied perpendicularly to the pole. Note that there is also a component parallel to the pole and this is the compressive force applied by the 100kg suspended mass.

Drawing these two components and measuring them shows that there is 59.5kgf of rotational force and 80kgf of compression being applied at the head of the pole.

Clockwise rotation of the pole is only being prevented by the tension in the rear guy rope. Again the tension in this rope can be split into components of torque and compression. To prevent rotation, the rear guy needs to apply an equal and opposite force to the 59.5kgf applied by the load rope.

Completing the triangle with a line parallel to the pole and measuring the component along the rear guy rope tells us that the tension in this rope is 132kgf.

## Torque and compression using trigonometry

Because we have broken the rope tensile forces up into perpendicular components (pole compression and rotation) we have produced right-angled triangles and so can use simple trigonometric relationships.

For the load rope:

$$\begin{aligned}\text{The rotating force} &= 100 \times \sin (36.51^\circ) \\ &= 100 \times 0.595 \\ &= 59.5\text{kgf}\end{aligned}$$

For the rear guy rope:

$$\begin{aligned}\text{Tension} &= 59.5 \div \sin (26.8^\circ) \\ &= 59.5 \div 0.45 \\ &= 132\text{kgf}\end{aligned}$$



## Gin Poles: rigging for technical rescue

Careful consideration of the forces acting on a Gin Pole system are required and a minimum of three guy lines are needed before it will stand up. This means operators will have to think much more than they would for a free standing tripod. Given the rate that tripods appear to be falling over, this requirement for extra thought is not a bad thing. A Gin Pole is far less likely to create the illusion of stability.

More rope will be required to stabilise a Gin Pole than a tripod but there are new, lightweight cordage options available that enable 50m of 6mm, 19kN cord to be carried in a small bag weighing only 1.2kg. This length cord can be used for all anchoring and guying in most situations. For comparison, 50m of 30kN, 11mm rope typically weighs 5kg.

A short Gin Pole will also force operators to be more efficient with every aspect of the rigging, particularly the litter bridle.

The following images show the possibilities if all of the above issues are considered. This short Gin Pole weighs 1.2kg – most tripods weigh more than 40kg.

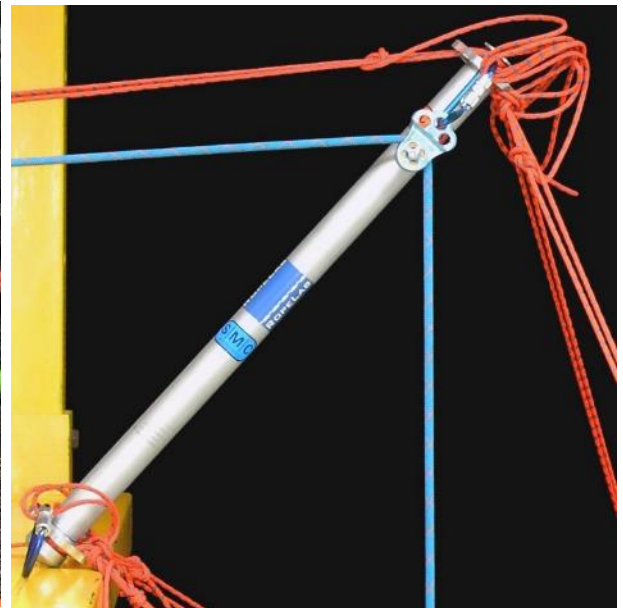

## Gin Pole forces

The forces acting on Gin Poles seem complex however, once understood, they become obvious and form a solid basis for working with all Artificial High Directionals (AHDs).

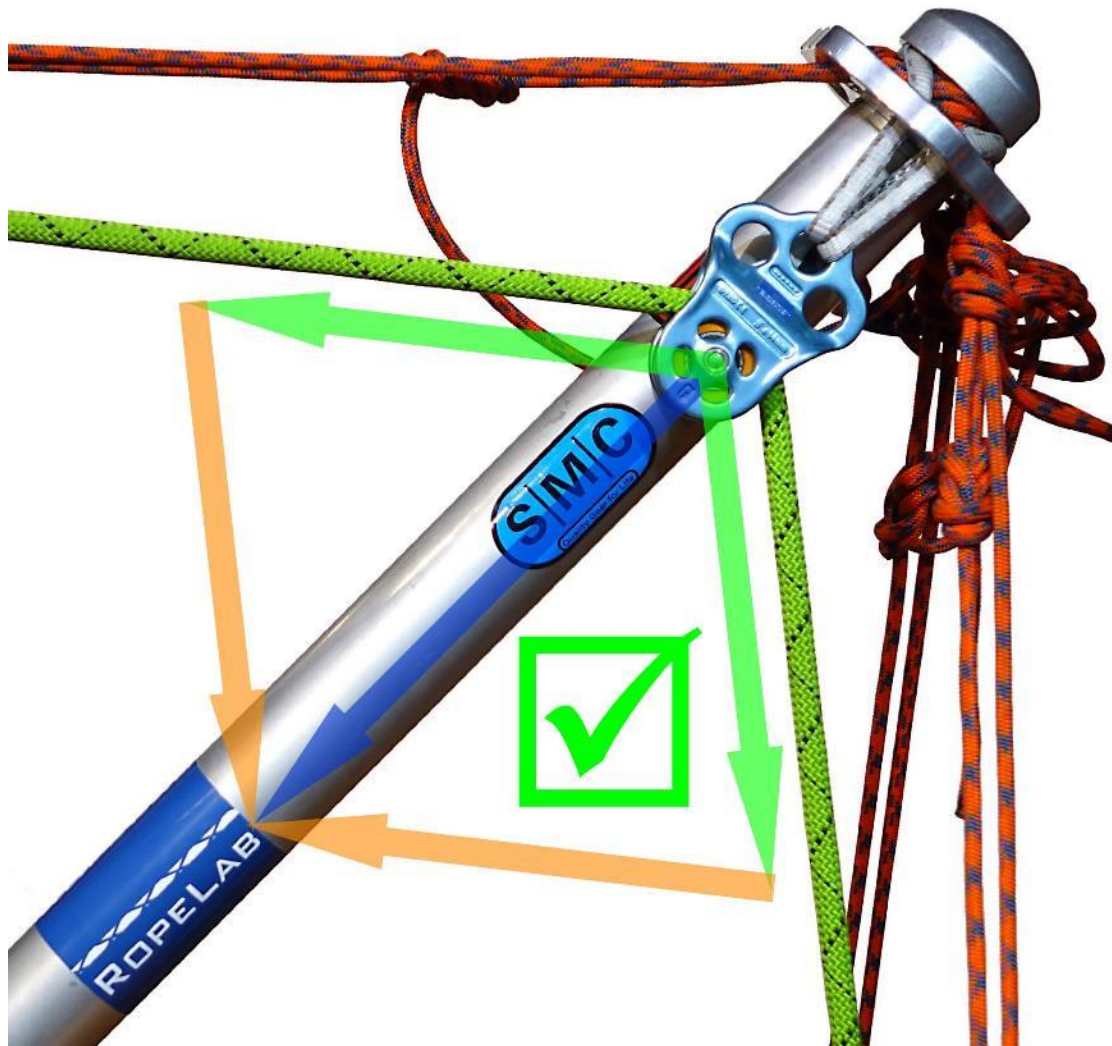

The main rope is elevated by the pulley. If the system is static, then this rope exerts a force represented by the sum of two vectors resulting from the tension applied by the input and output strands of the rope.

If this sum, or resultant, is directly aligned with the Gin Pole then there will be minimal tension on any of the guy ropes. Put simply, the pulley resultant is directly opposed by the compression of the Gin Pole.

The following images show this ideal situation and then one where the Gin Pole is too upright.

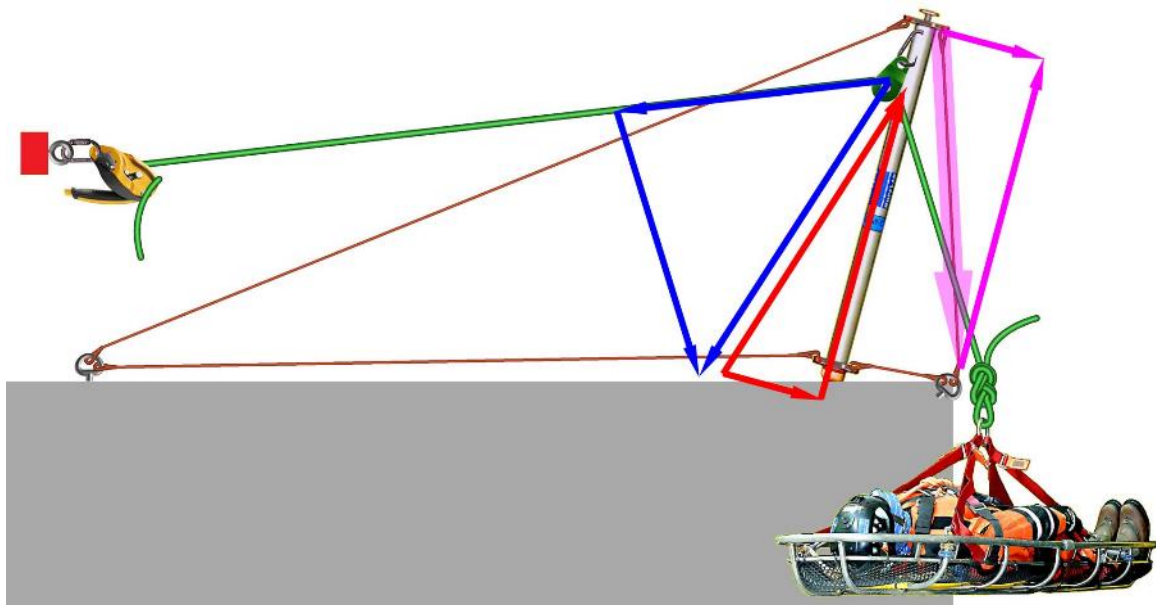
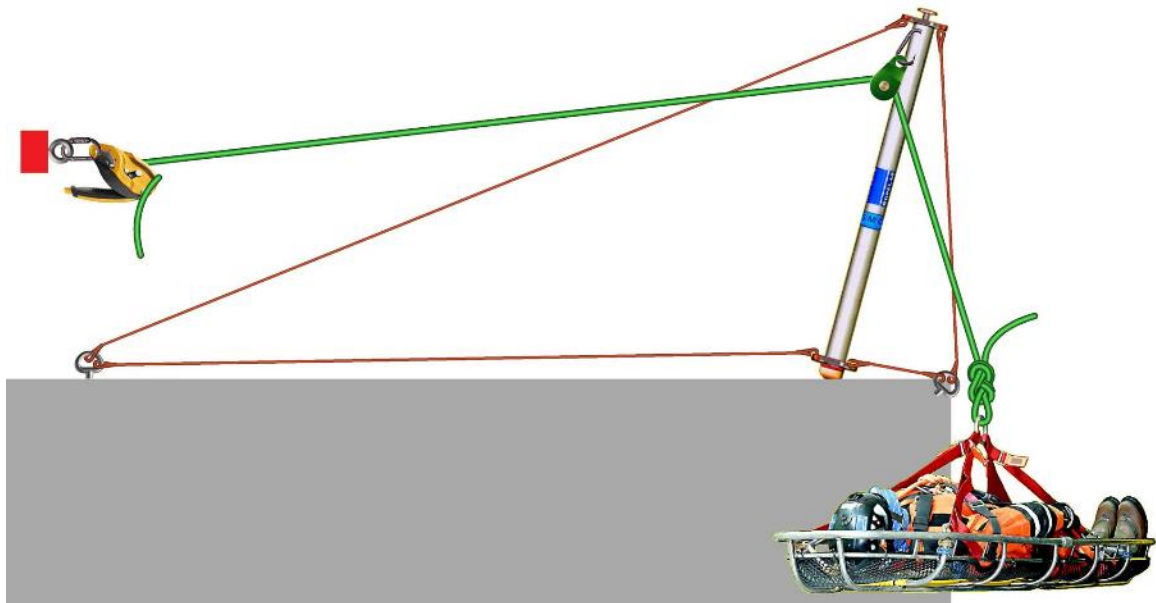
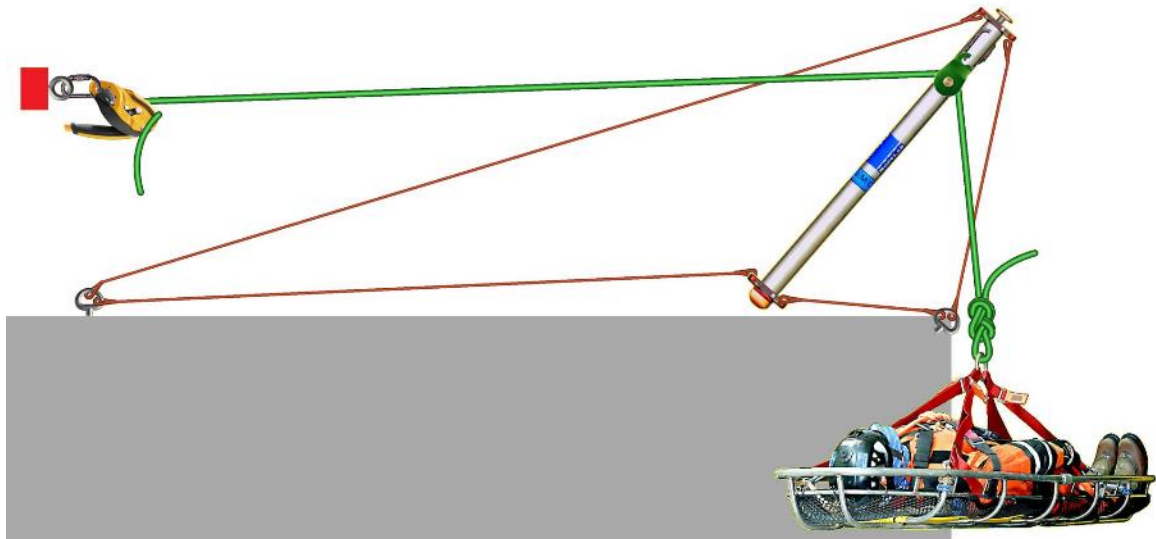

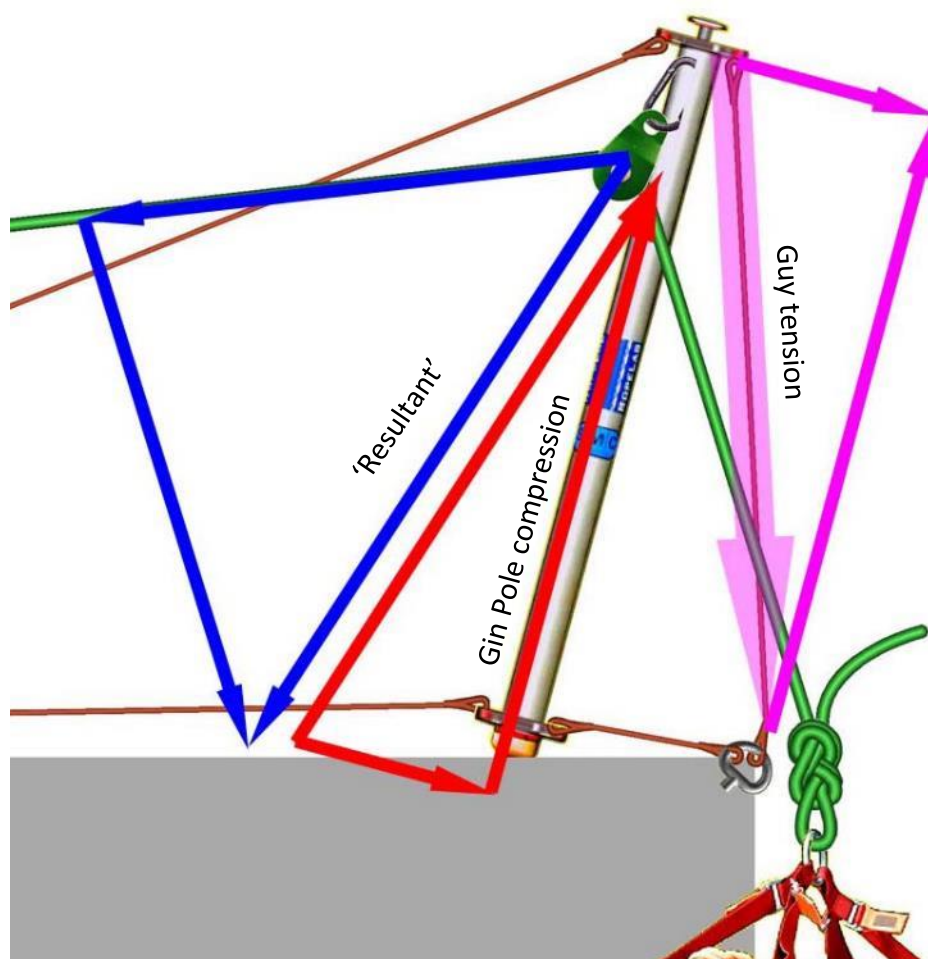

The leftmost vectors in this image represent the in and out tension in the main line and their sum, or the 'resultant'.

The central set of vectors represents the Gin Pole attempting to oppose the resultant in the only way it can, with compression. However, there is still a small component required to offset this difference in direction between the resultant and the Gin Pole (point slightly down and to the right).

The final, rightmost set of vectors represents the tension required by the front guy rope or guy plane. This final guy tension vector is actually about 25% longer than the tension in the main rope which means that a 1kN load will place about 1.25kN of tension in the front guy.

When assessing Gin Pole stability, the most important consideration is the comparing the resultant-pole (R-P) angle with the opposing pole-guy (P-G) angle. P-G must be greater than R-P. When they are equal, the guy (or guy plane) tension will be the same as the magnitude of the resultant.



## Gin Poles: avoid contact with obstacles

Another vital consideration is the potential presence of other external lateral forces part-way along the Gin Pole. These, like the aluminium drink can analogy, can easily initiate compression failure of the tube and must be avoided.



## Gin Poles: anchoring and guying

There are many options for setting up a Gin Pole and these are often dictated by the available anchors.

One of the simplest methods involves using one 50m length of appropriate rope or cord. The following images illustrate how this can be done. Generally, there are 2 strands of cord in each leg with the exception of the link between the Gin Pole and the anchor focal point.

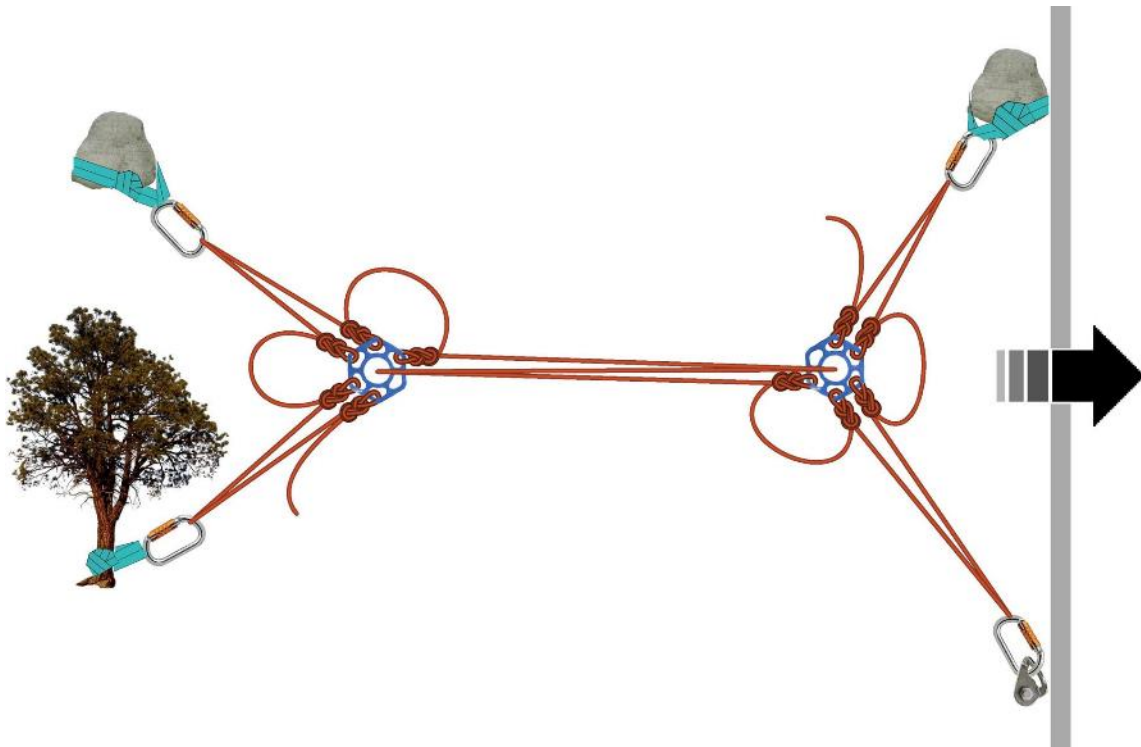

Each leg is initiated with a figure-of-8 on-a-bight on, run to a carabiner, and then back to be terminated by passing a bight through and tying this off with a round turn and two half hitches. The final step is to clip this bight back into a carabiner to ensure it cannot come undone.



Keep in mind that the Gin Pole is being used to manage the friction at the edge and, as a secondary concern, to assist with an edge transition. Where ever possible a second tensioned rope system should be included for protection should the Gin Pole tip.

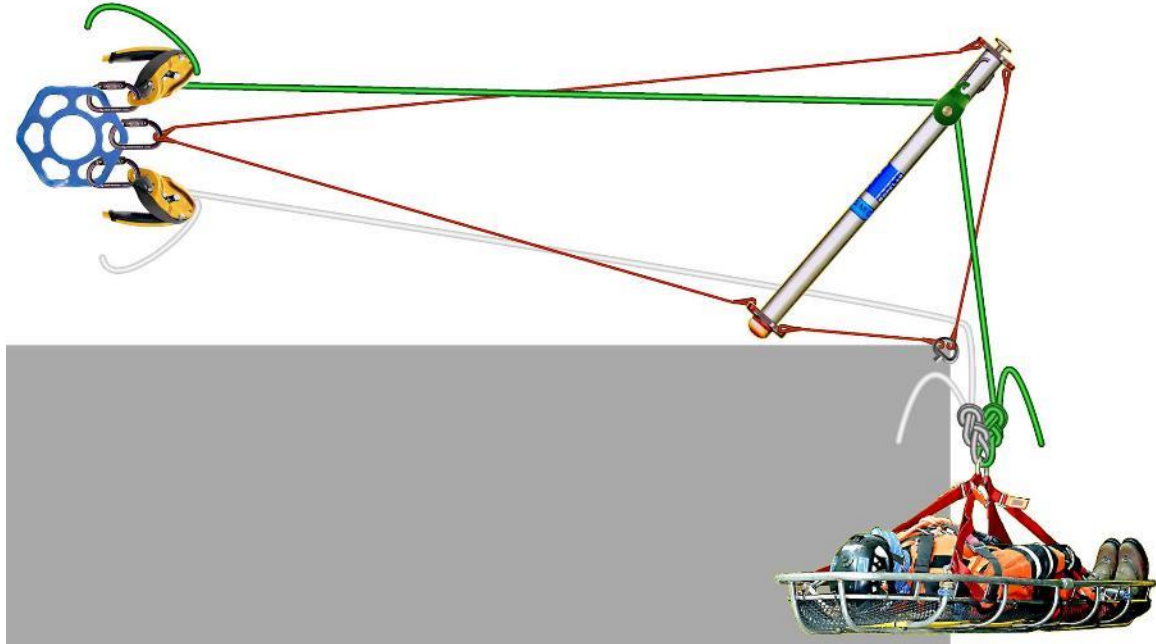

## Load Cells



Recently there has been a surge in the desire to understand and measure the forces within our systems. New gadgets have also become available that make this less like a complex science experiment and thus more achievable for a busy roping technician.

Devices that can measure force (dynamometers) are not new and have been used in the lifting industry for a long time. The majority of these have been heavy (several kilograms) and have offered real-time reading through direct observation of a moving needle or digital display and some form of peak-hold.

There are, however, several key factors that need to be considered in selecting a load cell for rope based systems:

### Mass of the measuring device

A fundamental principle of scientific experimentation is that the presence of an observer actually changes the system. Introducing a 5kg package (dynamometer plus shackles) to a roping system is significant and will certainly change the experiment. If this device is to measure peak force at an attachment point, then its introduction is quite significant as its mass is likely greater than that of all of the rope back to the anchor.

### Resolution and Maximum scale

If you need to measure millimetres, then use a 30cm ruler. If you need to measure 100 metres, then use a 100m tape. The ruler has a maximum scale of 30cm and a resolution of 1mm. The 100m tape has a maximum scale of 100m and a resolution of 1cm. You cannot measure to the nearest 1mm with a 100m tape.

The same consideration applies for load cells. Ideally we would purchase a load cell with a maximum scale of 20 tons (ie 20,000kg or 200kN). However, it is likely that this would have a resolution of 100kg (0.5% of max). Note that it may still be possible to read the display of such a device down to the nearest 1kg but it cannot be claimed to be accurate to any more than the nearest 100kg.

Most load cells can be loaded up to 150% of their maximum without damage, however this should be avoided.



So, for rope based systems, it would be unusual to have any single piece of kit rated with an MBS higher than 50kN thus a 5-ton (50kN) load cell should suffice for dynamic tests – the logic being that the system should fail before the device.

## Accuracy and Precision

Strictly speaking, when used in discussions of physics, the terms accuracy and precision have very different meanings. Accuracy refers to a comparison of a measured value with the actual value. Precision is a measure of repeatability in measurement. For example, a poorly manufactured 30cm ruler may be marked from zero to 30cm but, when compared with an established reference, the 30cm mark may be only 29.6cm from zero. This ruler may give multiple readings with high precision however they will be inaccurate.

Manufacturers of load cells seem to use the term accuracy to describe the tolerance of the reading. A load cell with an accuracy of 0.5% over a full scale reading of 50kN actually means +/- 0.25kN (5,000kg plus or minus 25kg). This tolerance applies over the whole range of measurement so if the same unit gave a reading of 100kg this should be interpreted as 100kg (+/-25kg).

## Sampling rate

Digital load cell systems are like cameras - the sampling rate refers to how often the shutter is opened and can be measured in samples per second, or Hertz (Hz). If you take 1 picture every second you end up with a stop motion movie. For slow pull tests and evaluation of relatively static systems sampling rate does not matter. The 1Hz stop motion movie would still capture all the information unless something breaks in which case the break has occurred somewhere in the 1s between samples.

For dynamic tests where peak forces are important, everything changes. The required sampling rate in electronics is referred to as the “Nyquist Rate” and means that, if you want to observe events occurring at a particular frequency, you need to sample at at least twice that frequency. Humans cannot really hear above 22 kiloHertz (kHz), hence audio compact discs have a sampling rate of around 44kHz – or 44 thousand samples per second.

Most international standards for fall protection state that the maximum allowable force experienced by an operator is 6kN. A problem with this statement is that it does not state the minimum time that this force must be applied to be problematic. 6kN applied for 1 second is obviously bad. But what if that 6kN peak only lasts 1/100<sup>th</sup> of a second? The answer is probably “it depends...”

To be sure that we capture events lasting 1/100<sup>th</sup> of a second, the minimum rate we have to sample (the Nyquist Rate) would be 200 samples per second or 200Hz. This is probably the minimum sample rate for any drop tests however, to get crisp plots and to be sure of the data, it makes sense to sample at 500Hz or more.

The following graph is the data recorded for an actual test where a 75kg steel mass was dropped 1m onto a 1m rope with figure-of-8 knots at each end. The second graph is simply a zoomed in section of the first and details the event between 0.5 and 0.6 seconds.

There are four plots each corresponding to sampling the same event at 500, 100, 20, and 5 samples per second.

The key observations are:

- If we had only sampled at 5 samples/second then the peak force would have been recorded as 1.66kN and approx. 1.6 seconds after the drop.
- Sampling at 20 samples/second would have led us to believe that a 1m knotted cowstail can keep the peak force to approx. 6kN (6.15kN at 0.52s).
- It is only by sampling at 100 samples/second or greater that we manage to observe the true peak of 12+kN at 0.55s.

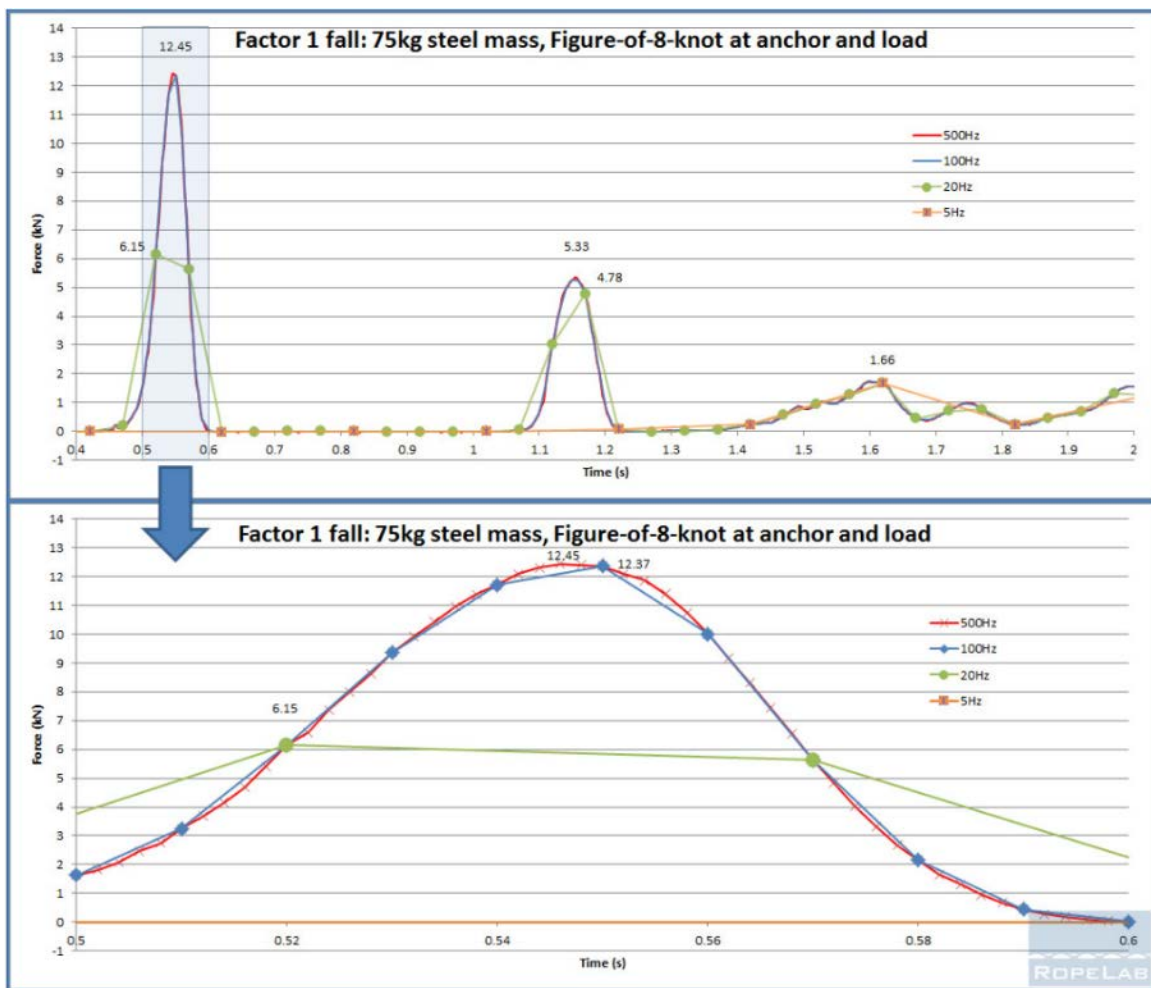

## Delphi 100T-5 Tension Load Cell

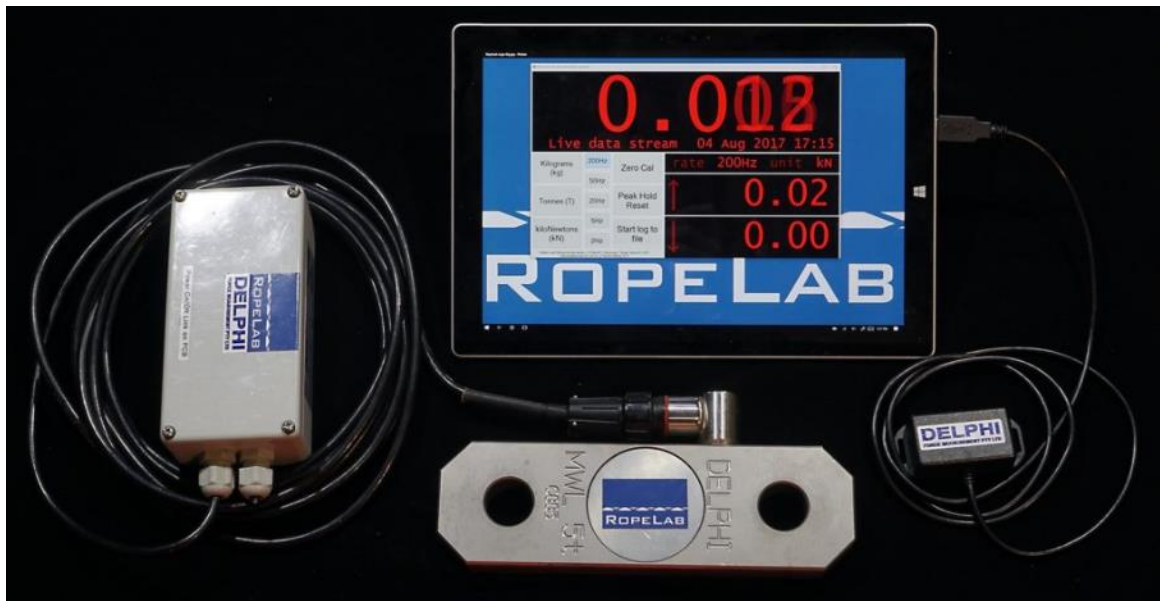

Weight: Laptop plus 3,800g (Load Cell: 2,750g, Transmitter + Cable 1,000g, USB Receiver: 65g)  
 Sample rate: 2,000 samples per second  
 Full scale range: 50kN  
 MBS: 300kN  
 Accuracy: better than +/- 0.25kN (+/- 0.5% of range)

This system cost over \$5,000 Australian Dollars (without the laptop). It is ideal for the testing I do with RopeLab however it has taken a while to become comfortable with its use. I also had to write the software to provide real-time readings on the laptop. Even though this system has a 200m wireless range, it is really only for use indoors as it is heavy, bulky, and dependant on powering a laptop computer.

## Rock Exotica enForcer Load Cell



Weight: 400g plus optional iOS iPhone/iPad for Bluetooth remote display.

Sample rate: selectable at 2 or 500 samples per second

Full scale range: 20kN

MBS: 36kN

Accuracy: better than +/- 0.4kN (+/- 2% of range)

The Rock Exotica enForcer retails for under \$US1,000. It is self-contained in a small unit and is excellent for use in the field and monitoring real loads in rope based systems. The Bluetooth functionality is useful but limited by a range of 10m or less. I have certainly found that the accuracy is "better than +/-2%" but users must keep this value in mind. This +/-2% corresponds to +/-40kg (or +/- 88lbs) so it is not really appropriate for "experiments" measuring hand-held tensions. Stick with minimum tensions of 1kN for robust results.

Users need to be aware of the testing capacity of this device. The technical notice for the enForcer states: "The Enforcer will measure up to 20kN. If you exceed 20kN it will permanently say "Overloaded" on the display. You can still use it for testing, but not for life safety. You should establish your own Working Load Limit depending on use. For example a 6:1 safety factor from the 36kN breaking strength would be a WLL of 6kN."

## Summary



Tension Load Cells come in many shapes and sizes and it has not been easy to understand their specifications and how these potentially limit practical use. Hopefully I have made this a little clearer. In short, the Rock Exotica enForcer has revolutionised the accessibility of these devices however we still need to be attentive in the way they are used.



## 8mm Roping Systems

It is time to reconsider our approach to Vertical Rescue (VR) equipment. Many VR teams train at drive-up venues and use equipment similar to that shown in the following image.



However, back-country rescue teams normally have to carry equipment several kilometres through challenging environments before they actually start the rope part of the job.

In the canyons of Australia's Blue Mountains, like many other adventure hotspots, rescuers expend significant time and energy in simply getting to and from their target. Even the most accessible canyon involves a 20-minute walk before entering the canyon. Wetsuits are required to travel through the canyon, scrambling, wading and swimming, before exiting via a 30m waterfall abseil. The loop is completed via a 30-minute uphill walk. When emergency services are called to an accident in this canyon then they too must approach this with an expeditionary mindset and carry everything they need. Not just personal canyoning kit but medical equipment, team rescue equipment, and some emergency overnight equipment too. Other canyons may involve many hours of travel time with significant challenges in safely accessing their target.



There has been significant progress in the field of light weight equipment in recent years. VR teams that carry and use systems built around 11mm nylon ropes, and an abundance of hardware, are now in a great position to consider some better options.

While there is a temptation to go for extremely lightweight options using high-tech 6mm ropes, the margins in strength and abrasion resistance are simply too tight for the majority of VR teams.

## 8mm Rope

Modern Dyneema core, Technora sheath 8mm rope is worthy of consideration for VR kits. Sterling Rope's 8mm CanyonLux is one such rope. This rope performs very well in abrasion tests and, with an unknotted MBS of 24kN, it is certainly strong enough for rescue use. Its dry weight is only 41g/m, about half of that of traditional 11mm nylon rope.

It is very important to note that this 8mm rope is not to be confused with 8mm nylon accessory cord. 8mm nylon cord has an MBS of 15-16kN, will lose 10-20% of this when wet, and will have poor abrasion resistance.

If we accept the use of such a rope, the remaining consideration becomes compatibility with the other components that are required to make a complete roping system. This system should be capable of lowering or raising single and two-person rescue loads.

## Raising or Lowering

There are few devices that can perform well in VR systems for both a raise and a lower. The ideal device would give good control during a lower and have minimal friction during a raise. CMC's MPD is one of these however, because of its weight, specific function, and limitations with rope diameters, it is rarely considered for inclusion in light-weight systems.

There are also many lowering devices, such as Petzl's I'D, that can be used as Progress Capture Devices (PCDs) during raises. Unlike the MPD, these are generally inefficient "pulleys" so our typical 3:1 z-drag systems end up having an Actual Mechanical Advantage (AMA) of less than 2:1. This is rarely sufficient so these systems then get built up to 5:1 or greater. Thus, we need even more equipment and rope, all resulting in an increase the overall weight and complexity of the system.

I suggest that VR teams know in advance and can make the decision early whether their rescue will require a system that will raise or lower the load.

It is uncommon that the motion would need to be reversed part way, and it is not difficult to lower a short distance during a raise using the hauling system if the load snags or needs adjusting. The same applies if a short raise is required during a lower.

If this decision can be made early, VR teams can build the ideal system for each, rather than one system that can do both. With this change in approach, we open up consideration of many other devices.



### Twin Rope Lower

The Conterra Titanium Scarab is an extremely versatile belay device. Its specifications state it can be used with 6-11mm ropes and a range of configurations. Double 8mm ropes are very manageable for single and double person loads, however there is no auto-locking function. This can be resolved in a few ways, but the one that I have been working with uses a Petzl Shunt on both brake strands behind the device.

Another common consideration is protection against the 'panic-grab' response of the operator. This can be overcome by placing a second operator behind the first whose job is simply to tail both strands and hold on tight if the primary operator loses control. In top-rope rock climbing environments, this second operator is referred to as a 'backup belayer' (this is shown clearly in the video of the whole system further below).





Equipment:

- Conterra Scarab Rescue Tool (Titanium)
- Petzl Shunt Rappel backup ascender
- 3 x locking carabiners
- 2 x 12cm sewn slings
- Small rigging plate

## Twin Rope Raise

Petzl's ProTraxion (95% efficient pulley) would be an excellent choice for progress capture during a raise. With this a twin rope 3:1 system should suffice for most applications, especially if we can limit our rescue loads to a single person and manage friction well at the edge.

With a human operated twin rope raising system, at times one rope will hold more tension than the other. If the operation of that side was to fail suddenly then the slack side of the system would see a shock load. The teeth of the ProTraxion will tear the sheath of an 8mm Technora-sheathed rope at approx. 5kN. A Petzl ASAP'Sorber 20 will tear at approx. 3-3.5kN so including this behind the ProTraxion will prevent rope damage during such events.

The final part of the raising system shown below is the forward rope grab and pulley. The rope grab is a Petzl Tibloc and the Petzl RollClip cleverly combines the connector and a reasonably high efficiency pulley (85%). It should be noted that the Tibloc may strip the sheath off the rope if the applied tension exceeds 4kN. This 4kN should be appropriate for operations, however this highlights two important considerations:

- Edge friction must be managed with a high efficiency edge roller or pulley, and
- An edge attendant must be able to see the load for the whole raise and be prepared to call "stop" anytime the path of the load is compromised.



If the load is kept to a single person then one hauler on each rope should be more than adequate to affect the raise. The only time the hauling tensions should be able to reach 4kN is if the load becomes trapped AND the haulers continue to apply enough tension. The only way that tension could reach 4kN would be if the size of the haul team or the mechanical advantage is increased. For example, 3 people hauling together or a 5:1 system.



Equipment:

- 2 x Petzl ProTraxion progress capture pulleys
- 2 x Petzl ASAP'Sorber 20 energy absorbers
- 2 x Petzl Tibloc rope grabs
- 2 x Petzl RollClip A pulley carabiners
- 4 x locking carabiners
- Small rigging plate

This system should have a Theoretical Mechanical Advantage (TMA) of 2.66:1. Based on experience, these calculations are a reasonable approximation of actual performance.

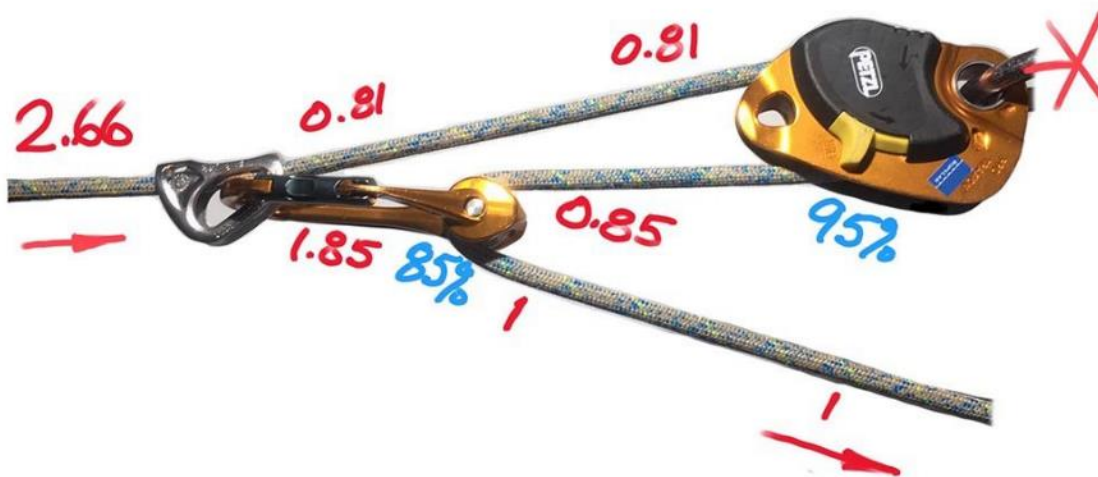

If required, this system can be converted to 5:1's with the addition of two small double pulleys and carabiners.



Additional equipment:

- 2 x Rock Exotica Double-Six pulleys (or Sterling Rope Pico double pulleys)
- 2 x carabiners

## The Whole System

The following picture shows the complete system used for a lower and then a raise on a 15m vertical cliff in Australia's Blue Mountains. The 'victim' weighed approx. 70kg and the 'rescue

team' consisted of three boys: Ben (11), Dash (12), and Tom (13) with a combined weight of 120kg. Rather than a high-directional, a high efficiency ball-bearing edge roller was been used.



## Conclusion

VR teams often fall into the comfortable trap of training at familiar venues with vehicle access. They normally have an abundant supply of equipment and many hands to undertake multiple load carries to the 'edge'. We have also crept to the adoption of the expectation that any VR system must be hot-swappable from full height raise-to-lower or lower-to-raise at any time during an operation.

Consider the reality of many actual rescues:

- Small teams must be able to carry all equipment to remote locations.
- It is known in advance whether the task will involve a raise or a lower.
- The vast majority of VR operations do not really need a bound litter attendant.

Modern 8mm ropes provide VR teams with many opportunities and advantages, however their use will require a significant change in approach. The following image shows all of the equipment needed to conduct a complete VR raise or lower using a redundant, twin rope system on a 50m cliff. In addition to this, as with all operations, there needs to be some thought and inclusion of appropriate equipment to protect ropes running over edges and minimise friction during raises.





## Powered winches

Tower technicians and arborists have been using gas/petrol powered winches to manage people and loads in the outdoor workplace for many years. It is only recently, with vast improvements in battery technology, that rope access techs and rescue operators have seen the potential of these devices.



Some of the winches in common use shown above include:

- Ropetek - Wraptor HD
- Actsafe - ACX Power Ascender
- Skyhook Rescue Systems – SuperLight Winch
- Harken – PowerSeat Battery

Most manufacturers have multiple power options for each unit and the choices include mains electricity, battery, and gas/petrol. Each option has its own advantages/disadvantages.

Power option	Advantages	Disadvantages
<b>Mains electricity</b>	Unlimited run-time Simple	Requires mains Leads for mains Test & tag Can't use in wet conditions
<b>Battery</b>	Portable	Need to carry/recharge batteries Can't use in wet conditions Can't fly with batteries May not be able to use while recharging
<b>Gas/petrol</b>	Ready access to fuel Can be used in wet	Fumes Keep winch & fuel away from rope Engine maintenance

## Roping or Rigging?

With the increase in availability and popularity of powered winches there is a real danger of confusing what has previously been two quite separate areas of work.

The term 'Rigging' has traditionally encompassed the use of machines to sling and move loads. The machine may be anything from a fixed winch to a 500t crane. These machines have mostly been equipped with flexible steel wire ropes however many now use synthetic fibre braids. Industry has strict guidelines detailing the required work methods and operator qualifications for Dogging, Rigging, and Crane operations.

By contrast, 'Roping' has generally referred to the use of synthetic fibre kernmantle ropes for the movement and positioning of people. Roping guidelines cover the skills required for this work but rarely cover non-live loads. There has been a long-held assumption that it is appropriate to use the same 'Roping' skillset and tools to move tools and loads directly related to the roped task with rope systems.

It is difficult to define a place where these two worlds meet. What is of concern is the lack of awareness of many roping technicians in just how far they may have inadvertently crossed the line and gone too far with the use of 'Roping' in what really should be 'Rigging'.

## Capacity and Overload Protection

Operators must understand the capacity of their winch. They should know the maximum tension that can be applied to the incoming rope and how the machine behaves once this tension is reached. The machine may have a dedicated overload cut-out, it may stall, a battery may overheat, or a clutch may slip. Every winch will be different and, once on site, different reeving systems may multiply tensions.

Any winch used for moving live loads should be certified by the manufacturer for that use. There must also be a backup system in place and this should be on a separate rope.

## Remote winching

Many organisations prefer to use a remotely anchored winch to move technicians around worksites. This allows flexibility and repeated use for multiple tasks. It is absolutely desirable to

have any load or person in direct sight of the winch operator. Without this there is a very high likelihood that the load or person will become entangled or snagged on some other object.

Out-of-sight operation should only be considered by very experienced operators. If this occurs, then there must be a perfect system of communication that guarantees an immediate halt if required. It is reasonably foreseeable that a live load could be injured by an unseen obstacle even with no noticeable change in rope tension.

In the 'Rigging' world, most jurisdictions only allow live loads in a rated 'manbox' and, even then, still require a qualified Dogman to ride in the box with a 100% reliable method of communication back to the crane operator.

## Powered winches and tripods

We are seeing an interesting collision of techniques:

- Standard triangular pyramid tripods used for confined space rescue,
- Asymmetrical multi-pods used for technical rope rescue and rope access, and
- Powered winches.



Confined space operators have long been using symmetrical tripods with frame mounted manual winches. These are normally set up over a hole and have a hand operated winch mounted on one of the legs. These tripods are free standing and require no anchoring.

Technical rescue and rope access operators regularly use asymmetrical multi-pods for use in many possible configurations to manage edge friction. Each configuration has varying anchor requirements and these are mostly determined by careful evaluation of the forces acting on each part of the system. These systems have traditionally been operated without winches.

There is now a range of winches suitable for use in technical rescue operations and these winches can be mounted in several possible places including the following:



- Directly attached to and controlled by the operator
- Positioned at the system anchor and thus taking the place of a traditional hauling team
- Mounted directly on a leg of the multi-pod

It is the last of these options that is of concern. Operators now have a reasonable grasp of the forces of tension and compression in these multi-pod based systems. However, it often comes down to bisecting the angle between the operational line over the edge and the line running back to the hauling team to determine the 'resultant' force on the frame. So long as this resultant is within the footprint of the multi-pod, the system is stable.

Few operators realise how much this changes if a frame mounted winch replaces the hauling team. The winch now becomes a part of the frame and thus it would make no difference whether it was mounted down low at one of the feet or right up at the head. The significance of this is that the only external forces acting on the frame are the downwards operational line and the upwards contact pressure of the feet.

The confined space workers know and want this, as the tripod always sits over the hole. Rope access and tech rescue operators, on the other hand, rarely have the operational line within the footprint.

Any rope access and tech rescue operators considering using frame mounted winches must be aware of this fundamental change in their evaluation of resultants.

**Simple rule: If the winch is mounted on the frame, the resultant is the operational line. If this line is outside the footprint, then the frame needs to be guyed to counter this potential tipping force.**

## Appendix A: The language of mathematics and physics

### Mathematical and Scientific notation

Before we delve into the language of physics we need to clarify the standard ways of denoting various relationships and the meanings of certain symbols. The standard 'shorthand' for scientific notation involves abbreviating numbers to the nearest division of 1,000. The metre ( $m$ ) is the standard metric unit of length. This ' $m$ ' will often have another letter immediately before it denoting its nearest range of thousands. The common ones for rope technicians are:

- $\mu$  or 'micro' (1 micrometre =  $1\mu\text{m} = 0.000001\text{m} = 1 \times 10^{-6}\text{m}$ )
- $m$  or 'milli' (1 millimetre =  $1\text{mm} = 0.001\text{m} = 1 \times 10^{-3}\text{m}$ )
- $k$  or 'kilo' (1 kilometre =  $1\text{km} = 1,000\text{m} = 1 \times 10^3\text{m}$ )

Standard units of measurement are:

- length or distance: metre ( $m$ )
- time: second ( $s$ )
- mass: kilogram ( $kg$ )

These units can then be combined for:

- velocity: metres per second ( $\text{ms}^{-1}$ )
- acceleration: metres per second per second ( $\text{ms}^{-2}$ )
- force: Newton ( $N$ )
- work: Joule ( $J$ )
- torque: Newton metre ( $Nm$ )

It is also worth noting that while we would normally abbreviate 'multiplication' with an ' $\times$ ', it is also common to leave it out altogether. The following lines all have exactly the same meaning:

- force equals mass multiplied by acceleration
- force equals mass times acceleration
- force = mass  $\times$  acceleration
- $F = m \times a$
- $F = ma$

Similarly, 'division', or 'divided by', can be denoted in any of the following ways:

- mass equals force divided by acceleration
- $m = F \div a$
- $m = Fa^{-1}$
- $m = F/a$
- $m = \frac{F}{a}$

Another is the expression 'raising to the power of'. Common examples of this would be:

- $3^2 = \text{three squared} = 3 \text{ raised to the power of } 2 = 3 \times 3 = 9$
- $2^3 = \text{two cubed} = 2 \text{ to the power of } 3 = 2 \times 2 \times 2 = 8$
- $2\text{m} \times 3\text{m} = 6\text{m}^2 = 6 \text{ square metres (a measurement of area)}$
- $10 \text{ metres per second} = 10\text{m} \text{ divided by } 1\text{s} = 10\text{m}/1\text{s} = 10\text{m/s} = 10\text{ms}^{-1}$
- $9.8\text{ms}^{-2} = 9.8 \text{ metres per second squared} = 9.8 \text{ metres per second per second}$

## Mathematical equations - BODMAS

We need to have a firm grasp of mathematics and its meaning in the written form. Again, it's not hard, there are just a few basics that need clarity in order to avoid ambiguity. One key concept is a clear definition of the way we resolve equations and which operators ( $\times$ ,  $\div$ ,  $+$ ,  $-$  etc.) take precedence. Without this, the following equation could have two possible answers.

$$2 + 3 \times 4 = ?$$

Is it:

$$2 + 3 \times 4 = 5 \times 4 = 20$$

Or:

$$2 + 3 \times 4 = 2 + 12 = 14$$

The correct answer can only be determined if there is a standard method defined for performing such calculations.

This acronym BODMAS sets out this standard method for operator priority and is as follows.

Letter	Meaning	Example
B	Brackets	$(2 + 3) \times 4 = 5 \times 4 = 20$
O	Order	$5^2 = 25$
D	Division	$20 \div 4 = 5$
M	Multiplication	$4 \times 6 = 24$
A	Addition	$2 + 3 = 5$
S	Subtraction	$7 - 4 = 3$

Applying this to the equation " $2 + 3 \times 4 = ?$ " informs us that multiplication comes before addition so first multiply  $3 \times 4$  and then add 2 to the answer.

$$2 + 3 \times 4 = 2 + 12 = 14$$

Leaping forwards we can now solve:

$$2 \times 4 + 6 \div (1 + 2) - 3^2 = ?$$

$$2 \times 4 + 6 \div 3 - 3^2 = ?$$

$$2 \times 4 + 6 \div 3 - 9 = ?$$

$$2 \times 4 + 2 - 9 = ?$$

$$8 + 2 - 9 = ?$$

$$10 - 9 = 1$$

And this is the only correct answer to this problem.

## Scientific functions

There are a few scientific functions that we will need to use throughout this text.

Abbreviation	Meaning	Inverse function	Example
$\sin(x)$	Calculate the sine of $x$	$\sin^{-1}(x)$ or $\arcsin(x)$	$\sin(30^\circ) = 0.5$
$\cos(x)$	Cosine of $x$	$\cos^{-1}(x)$ or $\arccos(x)$	$\cos(45^\circ) = 0.707$
$\tan(x)$	Tangent of $x$	$\tan^{-1}(x)$ or $\arctan(x)$	$\tan(60^\circ) = 1.732$
$e^x$	The exponential function, or $e$ raised to the power of $x$ .	$\ln(x)$	$e^{2.6} = 13.464$
$\ln(x)$	Natural logarithm of $x$	$e^x$	$\ln(13.464) = 2.6$
$x^2$	$x$ squared, or $x$ multiplied by $x$	$\sqrt{x}$	$5^2 = 5 \times 5 = 25$
$\sqrt{x}$	Square root of $x$	$x^2$	$\sqrt{36} = 6$

## Trigonometry

Triangles appear everywhere in rope based systems and, while there are many ‘rules-of-thumb’ to help us understand and resolve forces, sometimes it is important to be more precise and calculate exact ratios.

The trigonometry covered in high school explained this but, at the time, most of us could not foresee any real-world application for this work so promptly forgot the principles. One term that is often taught is SOH-CAH-TOA (pronounced ‘sock-a-toe-a’) and many probably recall this but forget its application.

## SOH-CAH-TOA

This acronym helps us to remember:

$$\sin \alpha = \textit{Opposite} \div \textit{Hypotenuse}, \textbf{(SOH)}$$

$$\cos \alpha = \textit{Adjacent} \div \textit{Hypotenuse}, \textbf{(CAH)} \text{ and}$$

$$\tan \alpha = \textit{Opposite} \div \textit{Adjacent} \textbf{(TOA)}.$$

This is about all we need to “know” as a calculator is needed to do the rest. Consider a triangle representing one half of a loaded highline. All we know is that the Span is 20m,  $\alpha$  is 15 degrees, and the load is 100kgf (1kN).

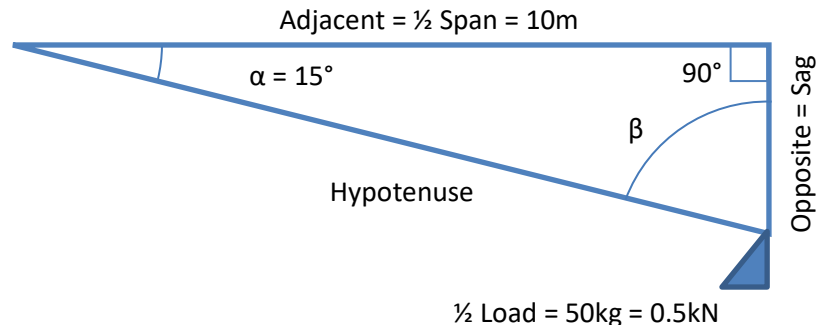

For this triangle we can calculate the Sag using:

$$\tan \alpha = \textit{Opposite} \div \textit{Adjacent},$$

$$\tan 15^\circ = \textit{Sag} \div 10\text{m},$$

$$\textit{Sag} = 10\text{m} \times \tan 15^\circ$$

$$\textit{Sag} = 10\text{m} \times 0.268$$

$$\textit{Sag} = 2.68\text{m}$$

Similarly, we can calculate the length of the rope to the load using:

$$\cos \alpha = \textit{Adjacent} \div \textit{Hypotenuse},$$

$$\cos 15^\circ = 10\text{m} \div \textit{Hypotenuse},$$

$$\textit{Hypotenuse} = 10\text{m} \div \cos 15^\circ$$

$$\textit{Hypotenuse} = 10\text{m} \div 0.966$$

$$\textit{Hypotenuse} = 10.35\text{m}$$

The geometry of the triangle is now well defined and we can use this in several ways to determine the anchor load generated by this system because the geometry of the triangle determines the magnitude and direction of the vectors in the system.

1. Using the side lengths of the triangle we can determine the rope tension and anchor load:

$$\textit{Sag} \div \textit{Hypotenuse} = \frac{1}{2} \textit{Load} \div \textit{Rope tension}$$

$$\textit{Rope Tension} = \frac{\textit{Load} \times \textit{Hypotenuse}}{2 \times \textit{Sag}} = \frac{1\text{kN} \times 10.35\text{m}}{2 \times 2.68\text{m}} = 1.93\text{kN}$$

2. An alternate way to determine the Rope tension would be to use the relationship:

$$\sin \alpha = \frac{\textit{Opposite}}{\textit{Hypotenuse}}$$

$$\sin 15^\circ = \frac{0.5\text{kN}}{T}$$

$$T = \frac{0.5\text{kN}}{\sin 15^\circ} = \frac{0.5\text{kN}}{0.259} = 1.93\text{kN}$$

3. For comparison, consider the often quoted rigger's spanline tension equation:

$$T = \frac{\textit{Load} \times \textit{Span}}{4 \times \textit{Sag}}$$

$$T = \frac{1\text{kN} \times 20\text{m}}{4 \times 2.68\text{m}} = 1.865\text{kN}$$

This is an approximation and it relies upon the Hypotenuse being approximately the same length as half of the Span. As the sag gets bigger, this difference increases, and the equation becomes less accurate.

## Angular measurement

The most common unit for describing angles is the *degree* and, by definition, there are 360 degrees (360°) in a circle. Another unit is the *radian* and, although not common in everyday language, it is used often in mathematical discussions. Common spreadsheet applications use radians as do our equations for calculation Capstan friction. By definition, there are exactly  $2\pi$  (approx. 6.28) radians in a circle.

Why use radians? Even though it may seem unusual, for many mathematical discussions it simplifies things owing to the basic relationship between the radius and circumference of a circle.

$$\text{Circumference} = 2 \times \pi \times \text{radius} \quad \text{or} \quad C = 2\pi r$$

We normally measure these angles starting from 0° at the compass North point and work around the circle in a clockwise direction passing through the compass points at East (90°), South (180°), and West (270°), and finally returning to North (360°) which is back at the 0° point.

Sometimes it is useful to keep this going and we may refer to a rope passing through 720° around an object. In other words it makes two complete turns around the object.

When referring to a specific unknown angles it is often useful to assign these a reference, and these are often denoted with the Greek symbols  $\alpha$ ,  $\beta$ , or  $\gamma$ .

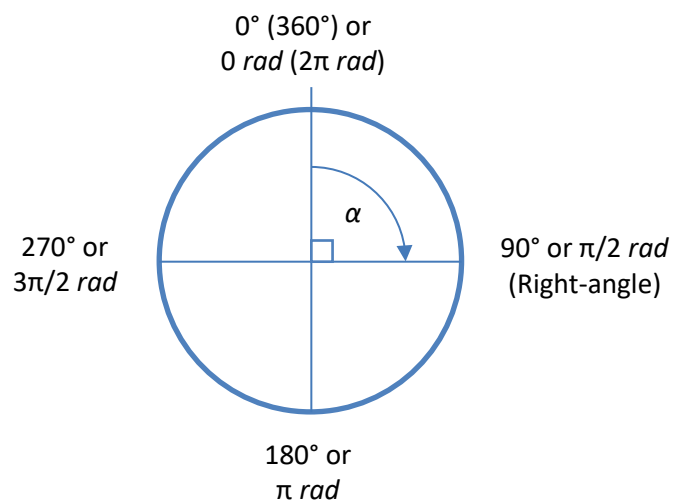



## Right-angle triangles

A Right-angle Triangle is one which has one internal angle of exactly  $90^\circ$ . Trigonometry is used to define the mathematical relationships between the side lengths and the other internal angles of right-angle triangles. Note also that the sum of the internal angles of any triangle will always equal  $180^\circ$ .

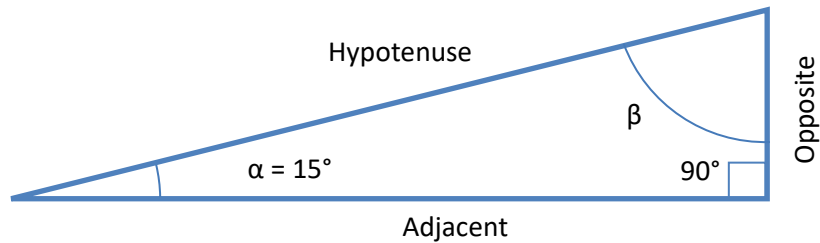

For consideration of the angle  $\alpha$ , we need to name the three sides of the triangle as shown. Notice that the right-angle always faces the hypotenuse. In this triangle we can work out the angle  $\beta$  as follows:

$$\begin{aligned}
 &90^\circ + \alpha + \beta = 180^\circ \\
 \text{So:} & \quad , \quad \beta = 180^\circ - 90^\circ - \alpha \\
 & \quad \quad \beta = 90^\circ - 14^\circ \\
 & \quad \quad \beta = 75^\circ
 \end{aligned}$$

## Appendix B: ITRS presentation, 2015

# Rescue tripods keep

# ‘falling over’

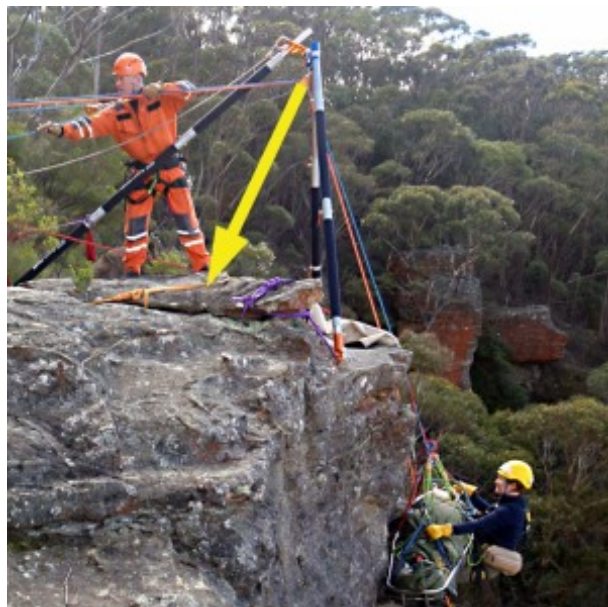

Richard Delaney, RopeLab

ITRS presentation, Portland, OR, USA, 2015

Natural, improvised, and purpose built high directionals are used to manage loads over edges and through openings. They can make otherwise impossible tasks possible.

There are now many proprietary solutions with almost limitless configurations that are being used by rope technicians for access, standby rescue, technical rescue, and load management. High directionals take many forms but the most common is the tripod. Tripods are deceptive because they will stand freely and there is the temptation to assume that, if it's standing up, it should work fine.

Unfortunately, there seems to be an increase in the number of incidents where these devices are ‘falling over’ in situations supporting live loads. These near misses are rarely reported but informal discussions lead me to believe that this is happening at least once every six months somewhere in the world. This rate of incident is unacceptable.

**These incidents are never the result of equipment failure. High directionals fall over because people fail to understand and anticipate the forces acting on the system.**

The last decade has seen significant focus and effort put into improving the back-end of rescue systems. Most organisations now use twin rope systems and are aware of the attention needed to manage these two ropes through appropriate devices during both lowering and raising operations.

The “way it’s always been done” involves applying this general rubber stamp to a particular situation:

- Identify the location of the victim.
- Dispatch a first responder to assess the situation below.
- Choose an appropriate place to put the tripod.
- Establish and anchor system
- Set up the rope based system ready for a two person raise/lower
- Lower a rescue litter and responder using the tripod/rope system
- Raise the Attendant/Patient/Litter using the tripod/rope system

It is now time to shift the focus to the front end and analyse every assumption, component, and technique to see if we can reduce the both the likelihood and consequence of a high directional failure.

The following discussion will start at the load and work up through a few key areas:

- The weight of the rescue load
- Load and litter rigging
- Tripods and other Artificial High Directionals (AHDs)

## The Rescue Load

Many operators have become focused on the need to float an attendant plus litter ‘rescue load’ up, in, and be placed gently down on safe, stable ground.

Perhaps we should revisit the reasoning behind defaulting to inclusion of an attendant in every operation.

The traditional justifications for including a litter attendant are:

- Providing medical assistance to the patient.
- Managing physical obstructions to the path of the litter.

## Medical Assistance

Specific medical concerns are valid, however these should be assessed for each operation. Opportunities for mid-haul treatments like CPR or defibrillation are not realistic. Perhaps the only interventions requiring direct assistance are intubation and bag-ventilation.

## Litter management

If the litter is free-hanging for its entire journey, then it may not require any guidance. This is unlikely so normally an attendant will ‘steer’ the litter past specific obstacles.

There are certainly options other than an in-riding/out-riding litter attendant however these are rarely considered. These others include:

- a vertically mobile attendant on separate ropes.
- the use of tag lines.

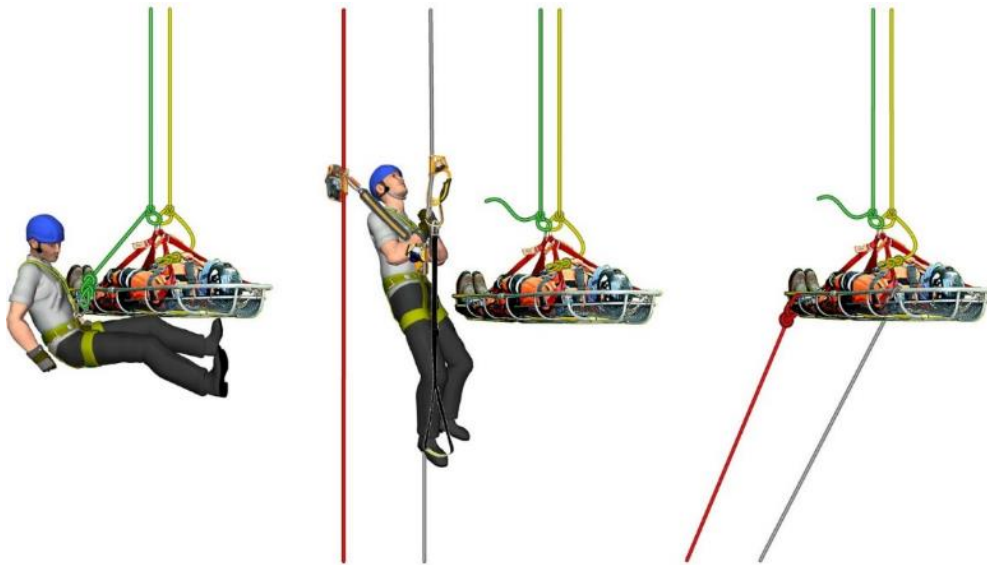

## Single person Rescue Load

If the attendant can be removed from the 'Rescue Load' then the benefits include:

- A lighter load.
- Less strain on all components.
- An easier haul – which may then be faster and result in less exposure to hazards.
- Reduced likelihood of AHD instability.

Even if conditions dictate inclusion of an attendant with the load then the benefits of removing the attendant for edge transitions cannot be ignored. One of the hardest things to monitor is the potential movement of the net (or resultant) force on the AHD. Moving resultants are most likely to occur as the load is brought up and over the edge.

## One or two ropes through the AHD?

Common practice seems to involve running one rope through the AHD and having the second on an adjustable set-of-fours. This second rope is normally set low but it can be raised during edge transitions.

The justification for raising the second rope is based on a critical assessment of comparisons of the likelihood of either AHD failure or human error with rope management at the back end of the system.

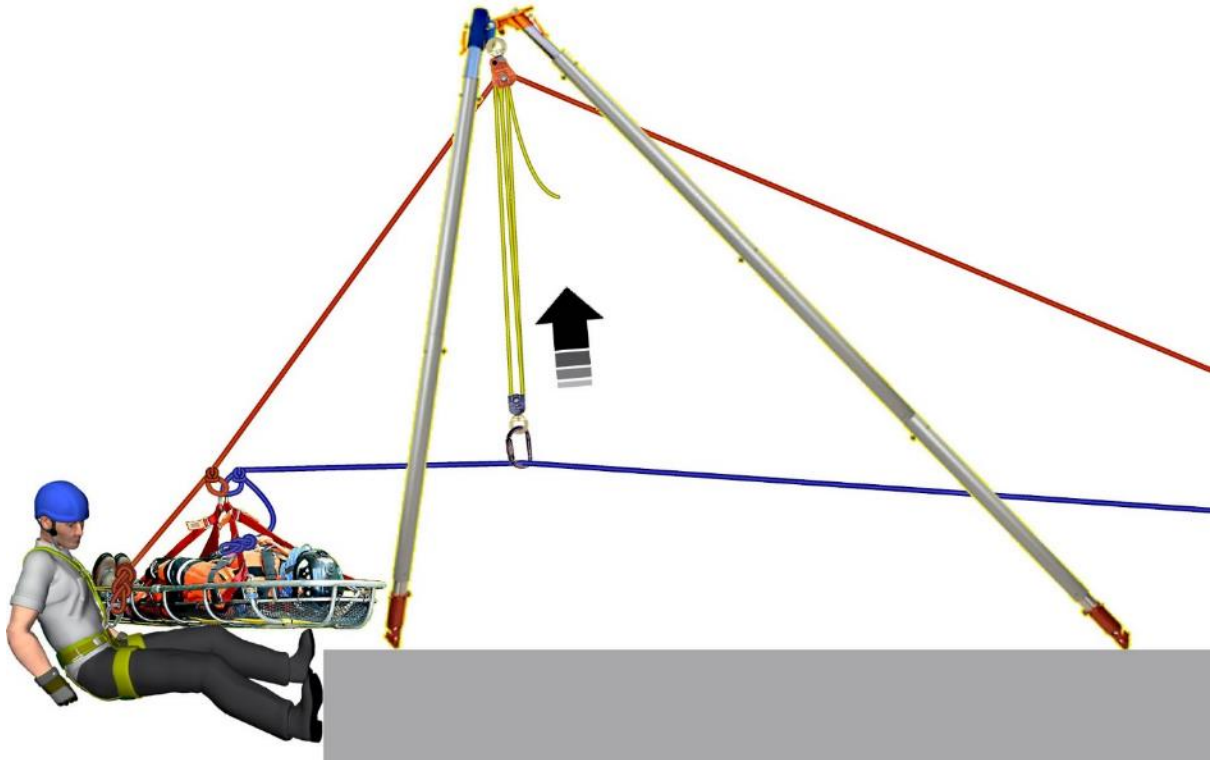

The assumption has been that human error is more likely than tripod failure and thus the second rope is often raised during the edge transition. If the second rope is not elevated and there is a rope management error, then the litter can fall across the attendant's thighs as it pushes them back over the edge.

With so many tripod 'failures', this reasoning must be re-questioned.

It is not necessary to go too far down this path as there is a far safer solution. If the load did actually require an attached attendant then, as a priority, the attendant should be removed from the system BEFORE the edge transition. If this happens, and the bridle is not excessive, then there is absolutely no reason to elevate the second rope.

## Non-live loads

If moving a non-live load, then it becomes difficult to justify the inclusion of a directly-attached litter attendant.

Body recoveries are an unfortunate part of rescue work and it is worth describing a method frequently used in the Blue Mountains of Australia. A fundamental premise with this method is that this is recovery, not rescue, and that hazard exposure to rescuers must be minimised.

The team dispatches a responder who descends using two ropes. On reaching and assessing the scene the preferred recovery is performed using a simple tensioned track line established using the responder's ropes.

Once the recovery is complete, the responder either descends to the cliff base to walk out or ascends the original ropes.

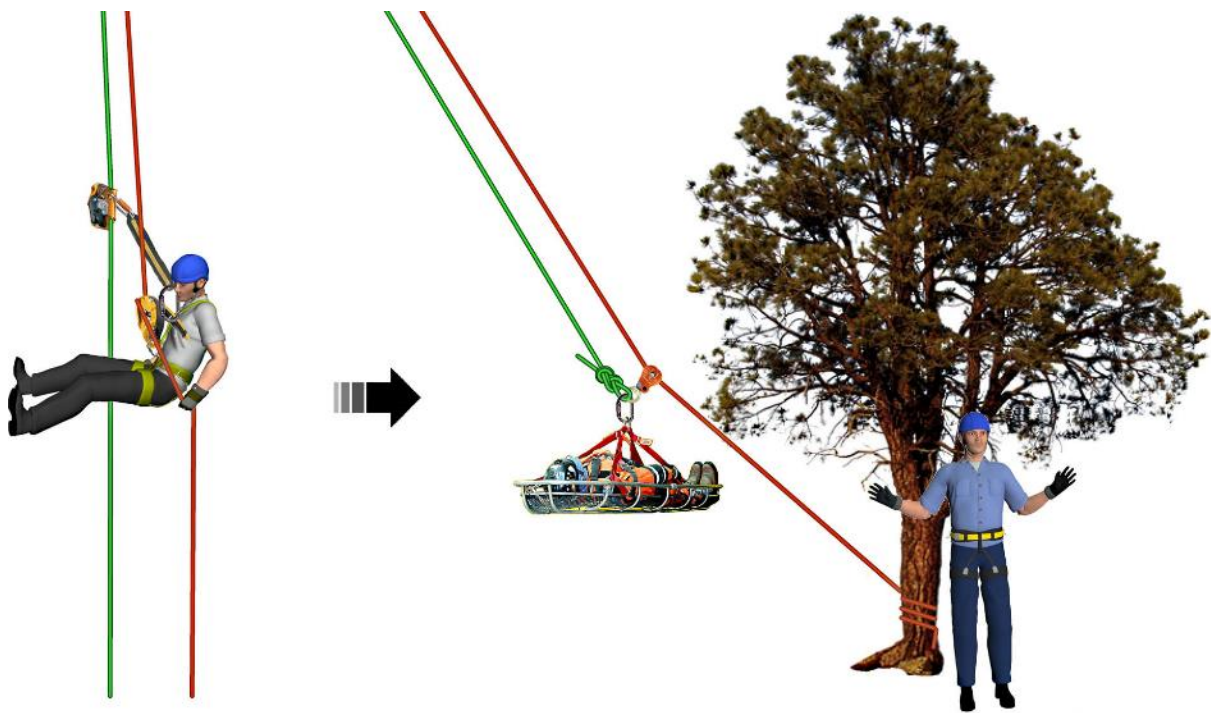

## Summary

It is always important to consider options for lightening the rescue load. Direct attachment of an attendant to the litter should not be the default response. Having made this points, it is still critical that teams understand and train for those rare occasions where two person loads are required.

## Litter Rigging

Many teams train with tall Artificial High Directionals (AHDs). This familiarity and comfort with tall AHDs removes the necessity to focus on efficient rigging and we often see litters rigged with bridle heights exceeding 1m. If minimising AHD height becomes a priority, then the minimum height is in fact dictated by the combined package height of litter, bridle, and attachment to rope.

The Confined Space AHD needs to be tall enough to facilitate the management of a vertical load and thus needs a minimum clearance of 2m. Teams often only have access to generic Confined Space AHDs and thus don't normally give much consideration to load height.



## Litter Bridles

There are many different ways to attach a litter to a rope based rescue system and these range from off-the-shelf clip-and-go bridles to custom rigs tied from components during the job.

The picture below shows two common adjustable bridles. The total package consists of the litter, bridle, and attachment point. On the left is what is often referred to as an AZ Tri-Bridle and has been taught far and wide by Reed Thorne. The AZ Tri-Bridle typically results in a compact package height of 0.65m. On the right is a standard adjustable webbing based solution which is often set with a package height of 1.55m. Note that these are both adjustable but the shortest height the webbing bridle and litter package can achieve is 0.85m.



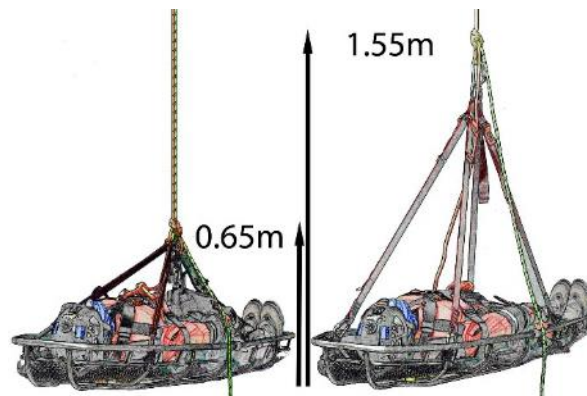

Note that a shorter bridles may increase the potential to ‘fold’ weaker litters.

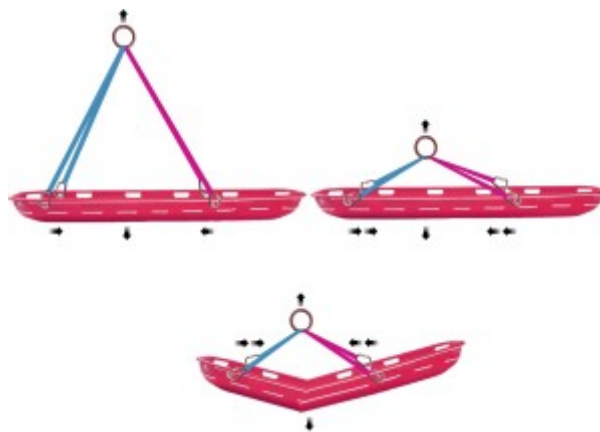

The horizontal component of force pulling the head and foot towards each other increases with the internal bridle angle. Be sure that your litter is designed to handle such forces if rigging tight bridles.

The AZ Tri-Bridle has added flexibility with a set-of-fours at the foot end of the litter, which means the attendant can adjust the litter pitch mid-operation.

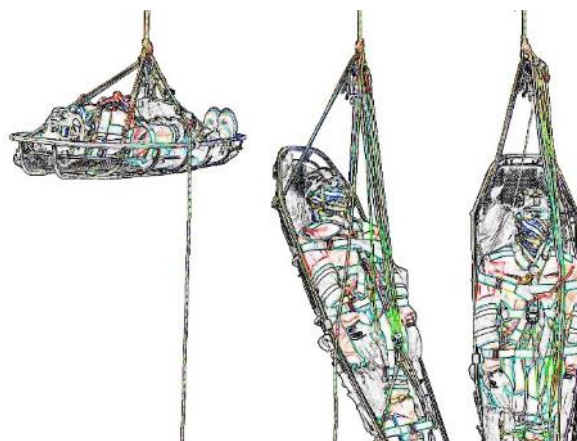



## Attaching the Rope

There are many ways to attach the bridle to the rope system. Common options include tying straight in or using some master-point with knots and connectors. A webbing based bridle typically uses a master point, while the AZ Tri-Bridle focal point is formed with a direct tie-in.



A direct tie-in saves approximately 200mm in height, however it is very important that an appropriate knot is used. When a knot is loaded in this way it is commonly referred to as 'ring loading', meaning it is being loaded in multiple directions. Many common knots become unstable when subjected to ring loading.

## Ring loading of bowline knots

The bowline is clearly the most compact knot for the bridle focal point but, to be used in this way, it must be stable when ring loaded. Two possible bowline options here are:

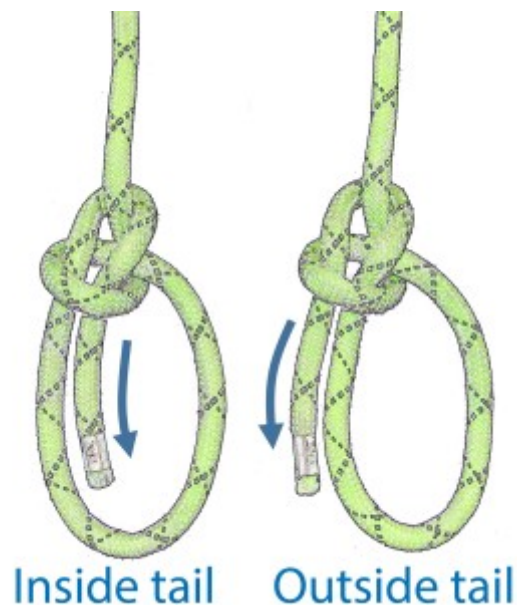

Traditionally, we have used the "inside tail" bowline (with a secured working end) for tying around anchors and into the end of a climbing rope. This is certainly preferred for such end-to-end loading scenarios. However, there seems to be a general understanding that outside tail bowlines do not slip as readily as inside tail bowlines when ring loaded.

RopeLab conducted a series of tests in 2015 assessing the behaviour of several different bowlines when ring loaded. All these tests were slow pulls to maximum of 20kN on new 11mm Sterling HTP rope. Different results may come from using different ropes and rates of pull. From the tests we can make some general observations:

- The single strand, inside tail bowline appears to slip at forces as low as 3kN when ring loaded. This knot is unstable in this configuration.
- The single strand, outside tail bowline appears to be stable when ring loaded.
- The double strand bowline appears to be stable when ring loaded whether it is tied in an outside or inside tail orientation.

Even if stable, all tests were halted at approximately 20kN of applied tension as this value is well above what should reasonably be expected during normal use.

Thus, the outside tail bowline appears to be an excellent choice of knot for this application. It should be noted that even if the knot was to slip, the attendant and patient ends would not pull through the bowline as they are terminated with figure-of-8 knots.

Many teams use two separate interwoven outside tail bowlines rather than the double strand single knot. Having two separate knots gives the advantage of being able to untie one at a time during transfers, however there is also the possibility that one or both may inadvertently be re-tied as inside tail knots. The double strand bowline appears to retain ring load stability regardless of tail configuration so it remains my preference for this use.



It should be restated that inside tail configurations are still preferred for end-to-end loading situations. The common practice of securing the working end of the rope will guard against slippage if the knot is inadvertently ring loaded.

## Summary

The height of AHD in technical rescue work is dictated by the height of the litter and bridle package. Reducing the height of this package may allow the use of shorter and more stable AHDs.

The height of litter and bridle can be reduced by choosing a compact system. The attachment point is a key consideration and using a direct tie-in and can reduce height significantly.

The double-strand, outside-tail bowline is an excellent and appropriate choice of knot and, when combined with the AZ-Tri bridle, results in a package height of 650mm. This in turn means that AHD height can potentially be reduced to 1m or less.

## Tripods

### Confined space tripod = Load Management Solution

Tripods are often used for access and standby rescue with confined space operations where a symmetrical unit is setup over the top of a hole. One of the legs will often incorporate a hauling mechanism attached to a line which runs up to a pulley at the tripod head and then down the hole to an operator. The head is normally hinged so the feet are hobbled to prevent them spreading. In this configuration everything is stable and there is no requirement for guy lines or anchors.



For confined space rescue, management of the load is critical. The tripod needs to be high enough to get a person suspended vertically in a harness up and out of the hole and thus these tripods are normally more than 2m high.

Therefore, a confined space tripod should be considered a LOAD MANAGEMENT SOLUTION.

## Technical rescue tripod = Friction Management Solution

In technical rope rescue applications, a load normally needs to be managed outside the footprint of the tripod. The footprint is an imaginary perimeter line that can be drawn connecting all of the feet. The load may start at the base of a cliff and then, once at the top, be moved inboard and placed on safe ground.



The term “resultant” has become a part of the language of rescue rigging. The “resultant” refers to another imaginary line that represents the net force applied to the tripod head as a result of all external connections. Technical rescue high directionals typically have a rope coming up from the load, through a pulley at the head, and then back to a haul team. The resultant would then be along a line which bisects the incoming and outgoing ropes. To achieve stability this “resultant” should point to a spot on the ground well within the footprint of the high directional.

The key benefit of the technical rescue tripod is managing friction. Any time a rope turns 90 degrees over a rock or concrete edge, we have an effective system of mechanical disadvantage of approximately 1:2. If we are attempting to raise a “standard rescue load” of 272kg/600lbs, then unmanaged edge friction potentially results in a hauling force of twice the load and an equivalent of 5.44kN/1,200lbf. Not only does this mean hard work, but also it shifts us into the realm of forces in excess of the Safe Working Load of much of our equipment.

Thus, a technical rescue tripod should be considered a FRICTION MANAGEMENT SOLUTION. **Any benefit associated with moving a load over an edge is secondary.**

If we acknowledge that high directionals for technical rope rescue have the primary task of reducing edge friction, then a high directional need only be high enough to support a pulley just above an edge. In many cases this may simply be high efficiency, spinning edge rollers. Teams internationally have long trained in managing loads at cliff edges without tripods. It requires practice and a few people, but it is often the only option in wilderness operations.



## Tripod Instability

Confined space and tech rescue high directionals are stable if the resultant remains within the footprint. The biggest challenge is to visualise the resultant for the entire operation. It may be well defined for 90% of the task but another 10% may include:

- Planned movement of the high directional: “luffing” the frame in and out or “slewing” the frame sideways.
- Movement of the load away from the main operational line through tension from an external rope.
- Direct human influence on the path of the load, particularly during edge transitions.
- Some other mid-operation change in an attempt to alter the path of the load.
- Incremental change in organisational practice without external review.
- Introduction of powered winches.



It is fine to have a resultant outside the footprint however this must be anticipated and other components must be introduced to oppose this instability. This may involve a combination of tension and compression elements.

## Tripod “resultant” forces

The following Questions/images represent six ways that tripods could be used to raise loads.

RopeLab conducted an online quiz to test understanding of each of these (<http://www.ropelab.com.au/ropelab-quiz-2/>). To date there have been about 1,200 respondents and the overall average score is just below 50%. The correct answers are provided after the final question.

Question 1:

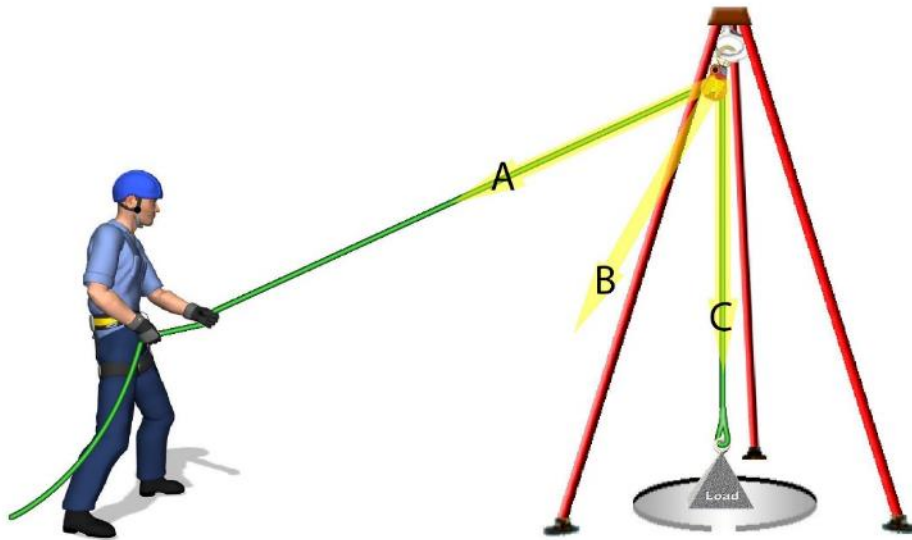

Question 2:

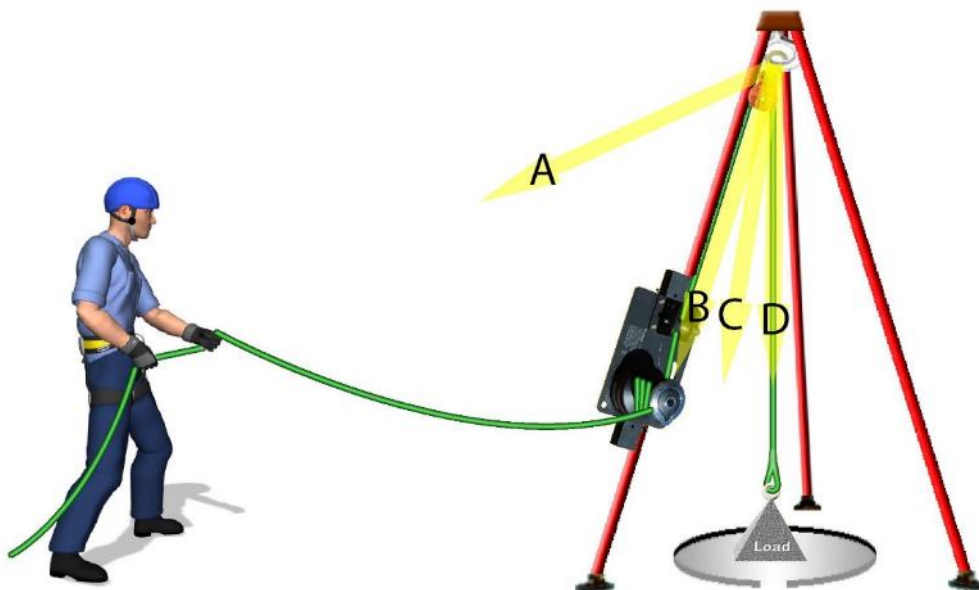



Question 3:

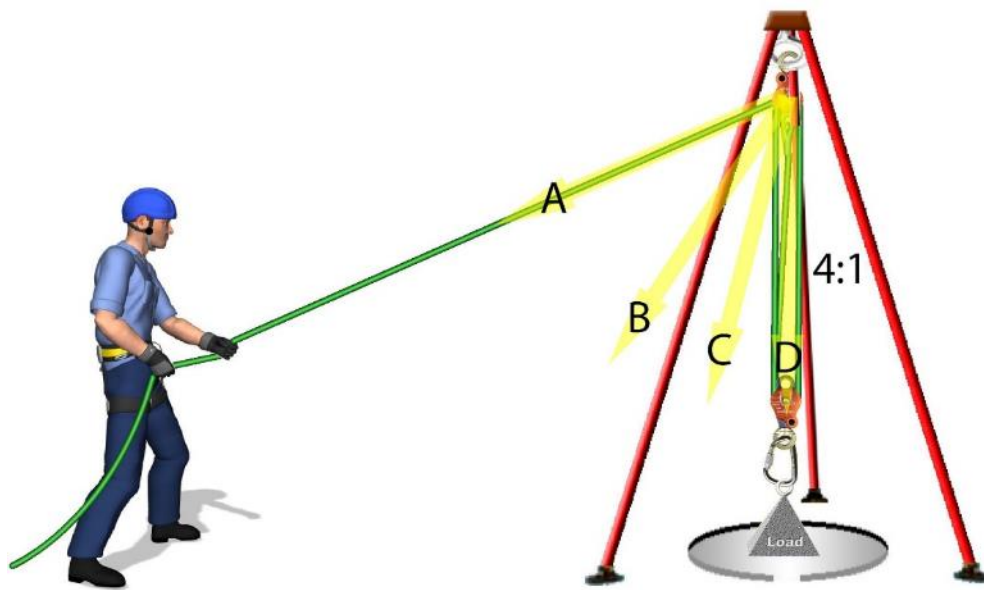

Question 4:



Question 5:

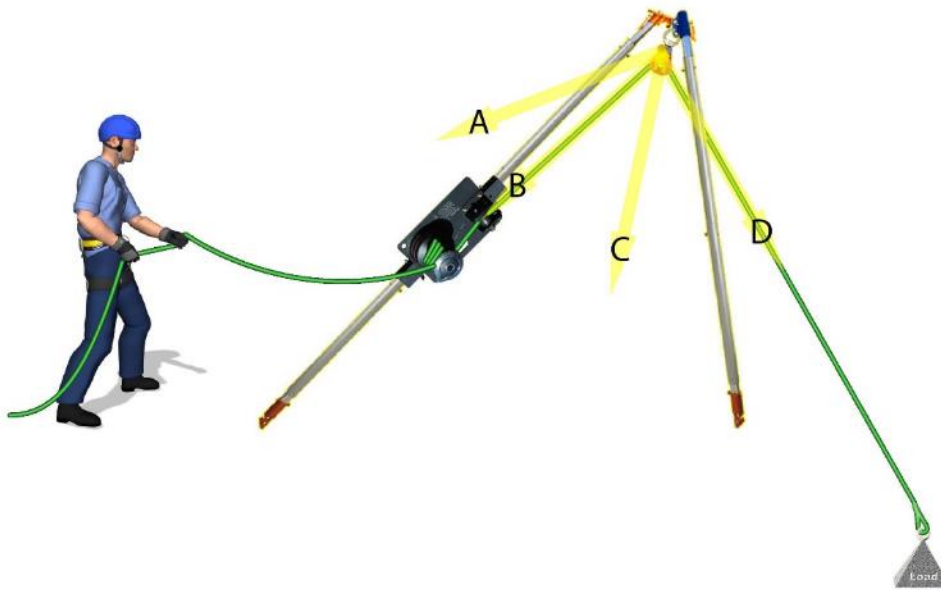

Question 6:

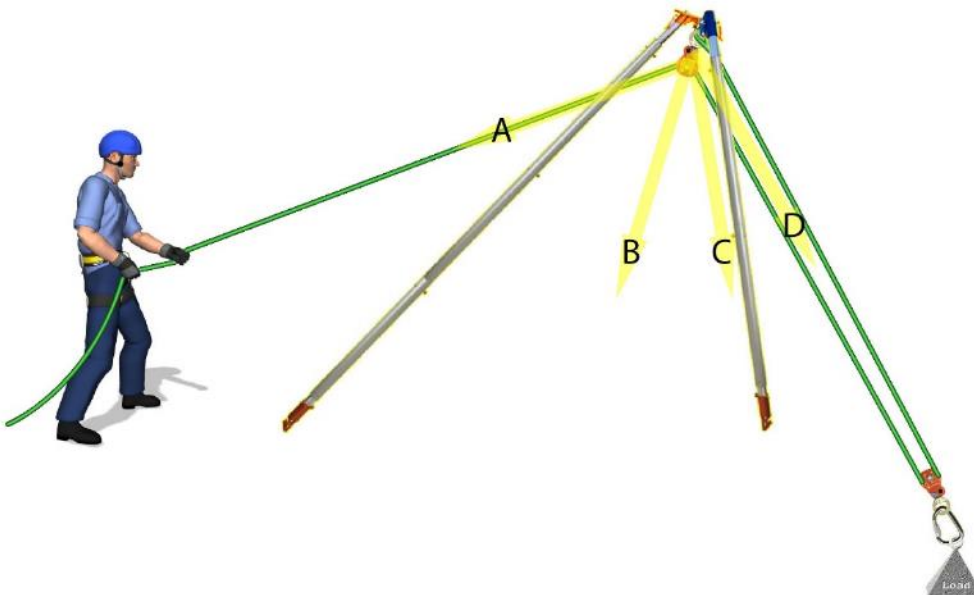

Quiz Answers:

Question	Correct Answer	Online quiz correct result (1,200 responses during 2015)
1	B	77%
2	D	18%
3	C	45%
4	B	86%
5	D	16%
6	C	59%

There are a few key observations from these results:

- There is a general awareness of the idea of a 'resultant' force.
- Most people assume the pulley in the head of the tripod defines this 'resultant'.
- There is a dangerous lack of awareness of the change associated with frame mounted winches.

## The height of the AHD

If the edge is sudden, then a high efficiency edge roller is sufficient. As the edge becomes more rounded, the position and height of the directional needs more careful consideration. More height means more equipment, more weight, and more effort to achieve stability.

Operators have become focused on floating an attendant plus litter 'rescue load' up, in, and placed down on stable ground. This operation typically requires an AHD which supports a pulley at least 1.8m above the ground.

We have already shown that the total load height, from litter base to top of attachment knot, can be as little as 0.65m. We have also discussed the options for removing the attendant from the system, or at least removing them for the final edge transition. Shifting these two considerations to the fore during training and planning then makes it possible to use much shorter AHDs.

Shorter AHDs can be:

- Light and portable.
- Easier to stabilise.
- Manage a significant amount of edge friction.
- High enough to move a horizontal litter in board easily.

## Gin Poles

Careful consideration of the forces acting on a Gin Pole system are required and a minimum of three guy lines are needed before it will stand up. This means operators will have to think much more than they would for a free standing tripod. Given the rate that tripods appear to be falling over, this requirement for extra thought is not a bad thing. A Gin Pole is far less likely to create the illusion of stability.

More rope will be required to stabilise a Gin Pole than a tripod but there are new, lightweight cordage options available that enable 50m of 6mm, 19kN cord to be carried in a small bag weighing only 1.2kg. This length cord can be used for all anchoring and guying in most situations. For comparison, 50m of 30kN, 11mm rope typically weighs 5kg.

A short Gin Pole will also force operators to be more efficient with every aspect of the rigging, particularly the litter bridle.

The following series of images shows the possibilities if all of the above issues are considered. The short Gin Pole weighs 1.2kg – most tripods weigh more than 40kg.







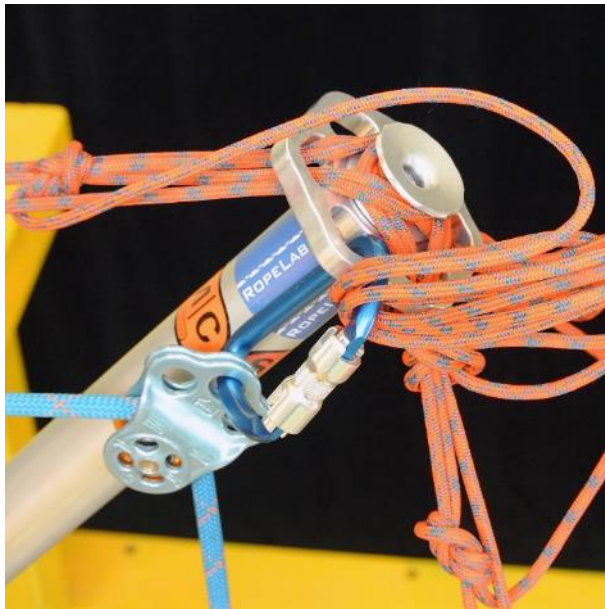
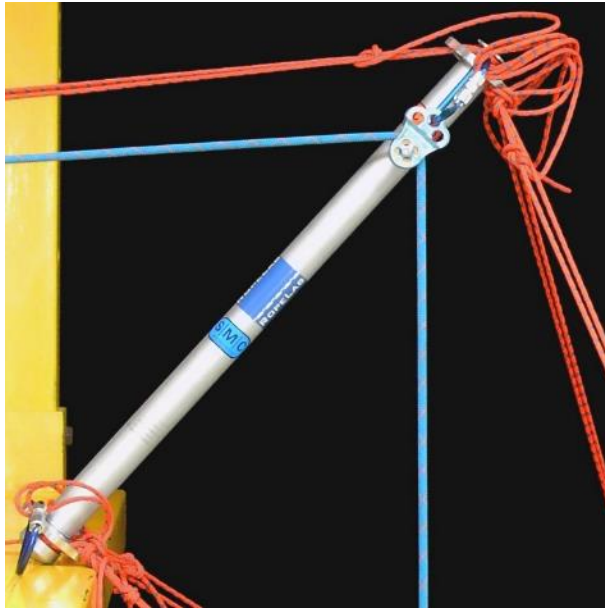



## Conclusion

Many of the systems used for rope based technical rescue have become heavy, unstable, and have lost focus on the key requirements of the task at hand.

The main function of a high directional in technical rope rescue is to manage edge friction. The distraction of managing a tall, heavy load over an edge has led many to rely on unnecessarily tall high directionals which are falling over far too often.

The key considerations of light-weight, portability, function, and stability can still be achieved with short Gin Poles. It's just that we may have to reverse a trend and put a bit more effort into understanding, rather than going for an "NFPA G-rated", one-size fits all approach to technical rope rescue.

## Appendix C: 8mm Technora/Dyneema rope tests

We have had a good selection of 8mm nylon accessory cord for decades however these cords have never been seriously considered to be ‘ropes’ for technical rescue because they have had serious limitations in strength and abrasion resistance. With the increasing popularity of canyoning (or canyoneering) and the desire for lighter equipment, a few manufacturers have risen to the challenge and produced 8mm products that actually stand on their own as ‘ropes’.

The demand has been able to be satisfied by significant advances in the fibres available to be used in rope construction. We are no longer simply considering nylon and polyester. In some roping circles there is a clear distinction between ropes made from class one and class two fibres. Samson Rope has some excellent resources on their website and they define these classes in their [Rope Users Manual](#) as:

*Class I ropes are produced with traditional fibres such as olefins (polypropylene or polyethylene), nylon, or polyester. These fibres impart the strength and stretch characteristics to the rope, which have tenacities of 15 grams per denier (g/den) or less and a total stretch at break of 6% or greater.*

*Class II ropes are produced with high-modulus fibres that impart the strength and stretch characteristics to the rope which have tenacities greater than 15gpd and a total stretch at break of less than 6%. Typical Class II ropes are produced with HMPE (Dyneema), aramid (Technora), LCP (Vectran), or PBO (Zylon).*

See our article on [Rope Materials](#) for a comparative discussion on rope materials. The defining tenacity of 15 g/den used by Samson Rope, equates to 1.32N/tex (the unit used for comparison in our article).

The 8mm rope products that we are considering are commonly made with a Dyneema core and a Technora sheath. According to this classification, these new 8mm ropes fall well into the second category.

One of the biggest common concerns with Class II ropes is their response to knots. This includes both their ability to hold a knot and the strength loss associated with any knot. RopeLab has tested many knots in Class I ropes and generally applies the “50% preserved strength” rule-of-thumb to all knots. A set of tests conducted at Marlow Ropes and published in Sailing Monthly ([here](#)) shows results significantly lower than 50% preserved strength for the Class II knotted ropes.

The tests discussed below will explore the way this rope, along with the BlueWater 8mm Canyon Extreme, behaves when knotted and with rope grabs. These two ropes are slightly different in construction however they are both basically kernmantle ropes with a Technora sheath and Dyneema core.

## Tests

12 separate samples were prepared and tested on the RopeLab test bed. Tension was applied slowly and measured with a 5t tension load cell at 5 samples/second. Tension was increased steadily until each sample failed. The maximum tension prior to each failure was recorded. Failure was taken as any of the following:

- Complete severing of the sample.
- Partial tearing of the sheath.
- Failure of the sheath within an otherwise undamaged core.

Seven tests were simple tug-of-war configurations with a short sample terminated at both ends by Figure-of-8 knots. For each sample, the knots were both tied as either “inside” or “outside” loaded strand configurations.

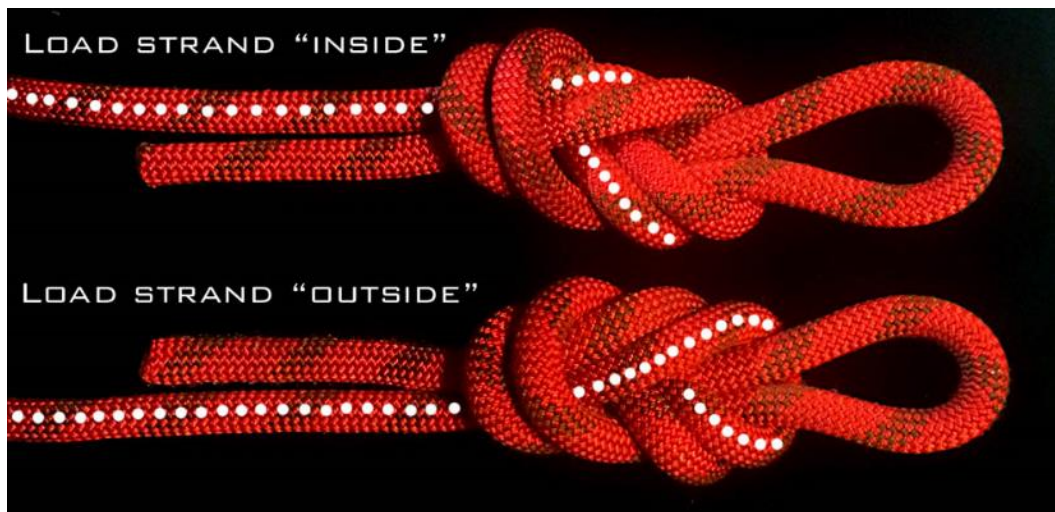

All knots were tied, dressed, and set by the same person. Tests 1 through 7 were set up as shown in the following picture.

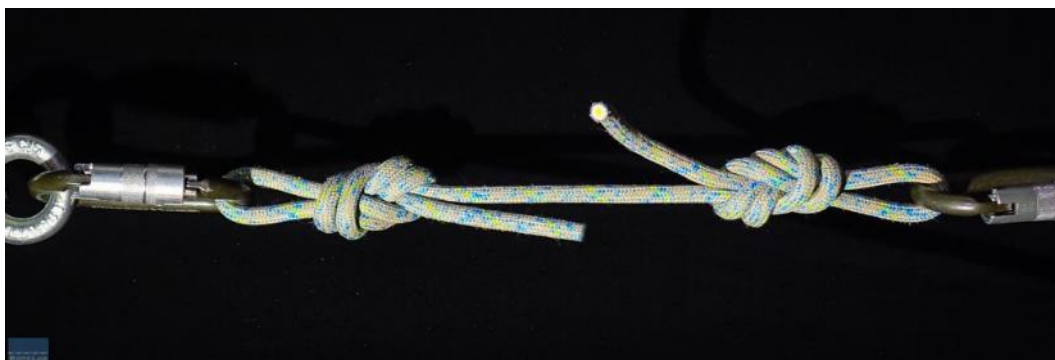

Tests 6, 7, and 10 were set with a Figure-of-8 knot at one end of the sample and a Petzl Tibloc at the other.



Tests 11 and 12 also tested the Tibloc however in a 3:1 configuration. The thought here was that, in a 3:1, the host rope is tensioned behind the Tibloc (rather than slack) and that this may influence the mode of failure.



Test	Rope	MBS (kN)	Configuration	Max (kN)	%MBS
1	Sterling CanyonLux	24.2	Fig8-Fig8 (outside)	19.4	80
2	Sterling CanyonLux	24.2	Fig8-Fig8 (inside)	17.1	71
3	Sterling CanyonLux	24.2	Fig8-Fig8 (inside)	17.5	72
4	Sterling CanyonLux	24.2	Fig8-Fig8 (outside)	16.7	69
5	Sterling CanyonLux	24.2	Fig8-Fig8 (outside)	16.4	68
8	BlueWater Canyon Extreme	24.0	Fig8-Fig8 (inside)	19.0	79
9	BlueWater Canyon Extreme	24.0	Fig8-Fig8 (outside)	18.9	79
6	Sterling CanyonLux	24.2	Tibloc on rope	7.3	30
7	Sterling CanyonLux	24.2	Tibloc on rope	7.5	31
10	BlueWater Canyon Extreme	24.0	Tibloc on rope	6.5	27
12	Sterling CanyonLux	24.2	Tibloc in 3:1	12.5	51
11	BlueWater Canyon Extreme	24.0	Tibloc in 3:1	10.0	42

## Discussion

### Figure-of-8 knots

The following pictures show the results from test 5 (CanyonLux, sheath then core failure at 16.4kN) and test 8 (Canyon Extreme, core failure at 19.0kN).

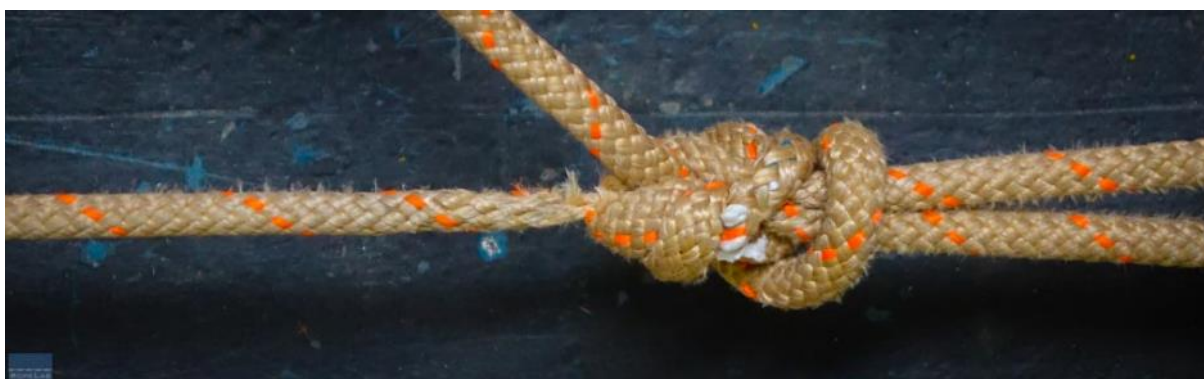

The results show failure of the knotted samples at an average tension of 17.5kN (68-80% of the manufacturer specified MBS of 24kN).

Normally this sort of discussion would stop here however we must acknowledge that it is not reasonable to compare an average with a 3Sigma MBS. To be more correct, we should apply a statistical treatment to these results to get a 3Sigma knotted MBS of 14.3kN which is 59% of the 3Sigma MBS of 24kN.

From these tests, we can again say that it is reasonable to expect a reduction of strength when we knot these ropes that is consistent with our 50% rule-of-thumb.

### Rope grab: Petzl Tibloc

The specifications for the Petzl Tibloc state that it is compatible with 8-11mm ropes and that it will withstand 4-7.6kN.

The assumption from the graphic provided in the instructions is that 8mm ropes will hold up to 4kN and 11mm ropes will hold up to 7.6kN. The Tibloc was released in 1999 and this was well before either of the ropes considered in this set of tests.



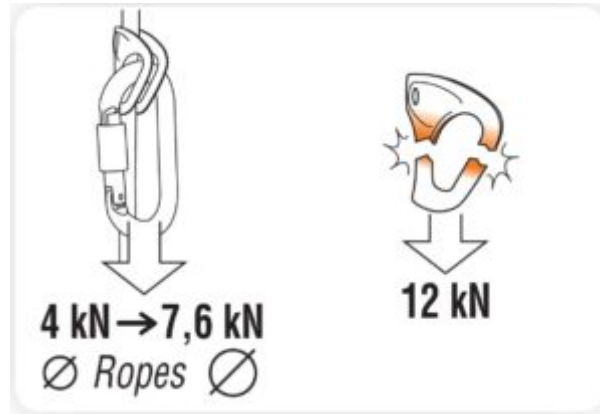

The results in tests 6, 7, & 10 were 6.5-7.5kN. These were well above the expected 4kN which is encouraging as it is common to apply 3+kN during rescue work.

The following picture shows the result of test 10 (Canyon Extreme, sheath failure at 6.5kN).



The results for tests 11 and 12 which used the Tibloc as the forward rope grab in the 3:1 system were even better. The tail loading of the rope through the Tibloc increased the failure tension to 10kN.



This final picture shows the result of test 11 (Canyon Extreme, sheath failure at 10kN).



## Summary

These tests were conducted to assess the suitability of modern 8mm Technora sheath/Dyneema core ropes for use in light-weight vertical rescue applications. The concerns were the knotted strength of such Class II ropes and the performance of these ropes with toothed rope grabs such as Petzl's Tibloc.

The results demonstrated knotted strengths consistent with the general 50% rule-rule-of-thumb that we apply to common knots in kernmantle rope.

The Tibloc performed slightly better than would have been expected for 8mm cordage. This is most likely due to the Technora sheath used on these samples as opposed to the more common nylon sheathed 8mm accessory cords in use when the Tibloc was first produced.