

Bid #: ESCNJ 17/18-31  
Athletic Equipment and Supplies

The Educational Services Commission of New Jersey

Bid term: 5/9/18 - 5/8/20; Extended to 5/8/21

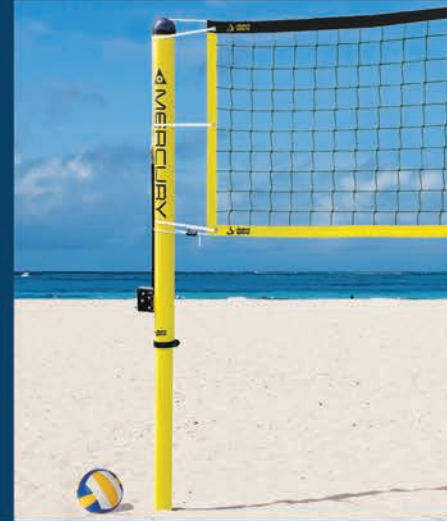

# 2018 ALL SPORT

## INDOOR/OUTDOOR ATHLETIC EQUIPMENT



DESIGNED TO PERFORM. MANUFACTURED TO LAST.™

NJ State Approved Co-Op #65MCE SCOPES





Scoreboards



Ceiling Suspended  
Basketball Backstops



WallGuard  
Wall Padding



Overhead Volleyball  
System



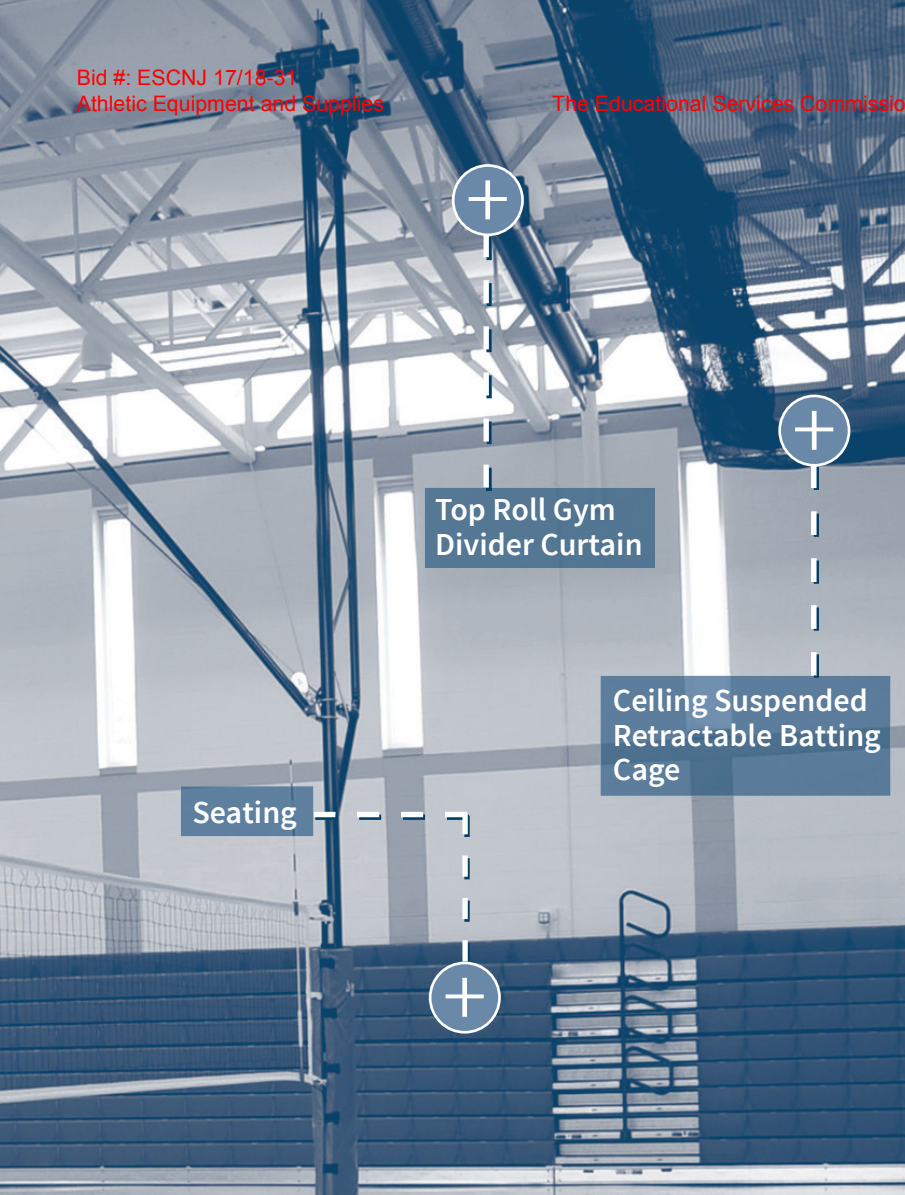

## CATALOG ICONS



**NEW PRODUCT**  
*Our newest products*



**BEST SELLER**  
*Best sellers in our product line*

**FR** TRUCK FREIGHT  
*Product ships by Truck*

**POWDER COATED**  
*Product is powder coated for extra durability*

**X** JAYPRO EXCLUSIVE  
*A feature or product developed exclusively by Jaypro*

**AS** ALL SURFACE FRIENDLY  
*Indoor, Outdoor, Turf, Grass or Dirt*

**12Y** WARRANTY  
*Number of years each product is warranteed*

**★** MADE IN THE U.S.A.  
*Product made in America*

ROYAL BLUE

COLOR CHOICES FROM CHARTS  
*Colors displayed may not be an exact match*

RED

NJ State Approved Co-op #65MCECCPS

## Featured Products New and Innovative Products

2-3



**Volleyball** ..... 4-21  
*Indoor & Outdoor Systems, Floor Sleeves, Nets, Referee Stands & Training Equipment*



**Soccer** ..... 22-47  
*Goals, Indoor/Outdoor, Youth, Futsal, Nets, Rebounders, Anchors & Combo Goals*



**Football** ..... 48-56  
*Goal Posts, Post Pads, Equipment Carts, Training Aids, Field & Turf Accessories*



**Field Hockey/Lacrosse** ..... 57-61  
*Official Goals, Practice Goals, Training Aids & Nets*



**Baseball/Softball** ..... 62-82  
*Batting Cages, Pitching Screens, Bases, Field Mats & Covers, Mounds & Foul Poles*



**Sports Training/Scoreboards** .... 83-85  
*Sports Training Machines & Scoreboards*



**Field Marking** ..... 86-89  
*Dry, Wet & Combo Markers, Line Layout & Marking Systems*



**Basketball** ..... 90-105  
*Outdoor Units, Hoop Rejuvenator, Post Padding, Backboards, Goals & Edge Padding*



**Indoor Gymnasium** ..... 106-123  
*Portables, Wall Mounted Backstops, Safety Strap, Winches, Height Adjusters, Curtains & Wall Pads*



**Field Netting** ..... 124-129  
*Portable Netting, Ball Stop Systems, Perimeter Netting Systems & Discus Cage*



**Ball Storage** ..... 130-133  
*Ball Carriers & Carts*



**Benches & Bleachers** ..... 134-143  
*Player Benches, Scorers Table & Standard or Preferred Bleachers*



**Tennis** ..... 144-146  
*Posts, Nets, Tennis Bench & Wind Screens*



**Physical Education/ Index** ..... 147-153  
*Backboard Adapter, Game Standards, P.E. Equipment & Index*





Mercury Beach Volleyball Systems • Page 21



Batting Cage Shade Canopy • Page 80



Easy Play Game Standard Adapters  
Page 135



Jaypro Sports now offers custom graphics on pole padding, wall padding, net tapes and more.

See pages 122-123 to learn more.



NJ State Approved Co-op #65MCESCCP5





### Beach Volleyball Referee Stand • Page 14



### Deluxe Pickleball Posts • Page 146



### 4' Double Tennis Bench Page 145



### The Titan CVX3 Series • Pages 90-91



### NETX1 Lacrosse Net • Page 60



FEATURED PRODUCTS



www.jaypro.com  
T: 800-243-0533

F: 800-988-3363



Many Jaypro Sports products are made and assembled in the U.S.A.

★ Look for the gray star icon to identify these products  
NJ State Approved Co-op #65MCECCPS



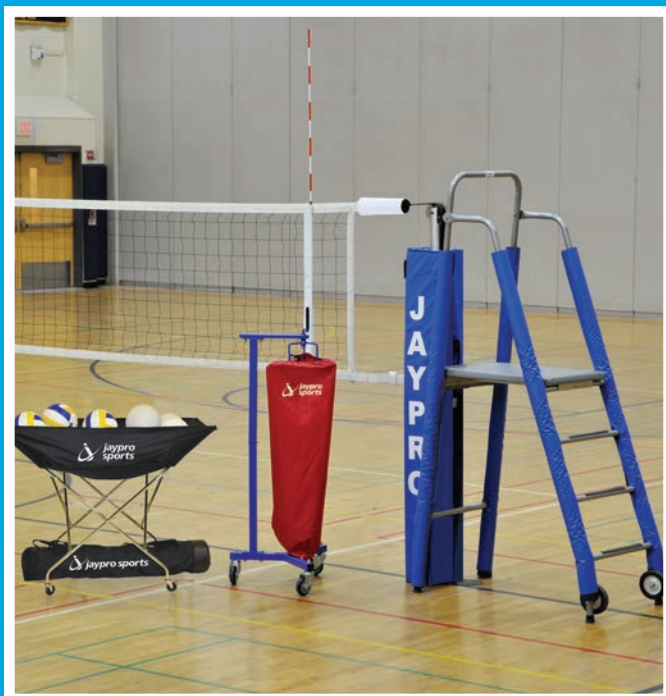

## POWERLite™

### Volleyball System Package

- > Powerlite™ Volleyball System (PVB-6500 or PVB-7000)
- > Folding Referee Stand (VRS-6000)
- > Referee Stand Padding (VRS-60P)
- > Single Net Keeper (VNK11)
- > Hammock Drill Cart (HSVBC24)
- > Cable/Buckle Covers (VCC-12)
- > Custom Lettering (PVL-39) on Upright Padding (single color - white block letters)

#### PVB-7PKG

3½" System 232 lbs \$4,799 package



#### PVB-6PKG

3" System 232 lbs \$4,599 package



## POWERLite™

### Deluxe Volleyball System Package

- > Powerlite™ Volleyball System (PVB-6500 or PVB-7000)
- > Folding Referee Stand (VRS-6000)
- > Referee Stand Padding (VRS-60P)
- > Single Net Keeper (VNK11)
- > Hammock Drill Cart (HSVBC24)
- > Cable/Buckle Covers (VCC-12)
- > Standard Volleyball Equipment Carrier (EC-500)
- > The Spiker (TS612)
- > Custom Lettering (PVL-39) on Upright Padding (single color - white block letters)

#### PVB-7PKGDX

3½" System 294 lbs \$5,299 package



#### PVB-6PKGDX

3" System 294 lbs \$5,099 package



www.jaypro.com  
F: 800-988-3363

T: 800-243-0533



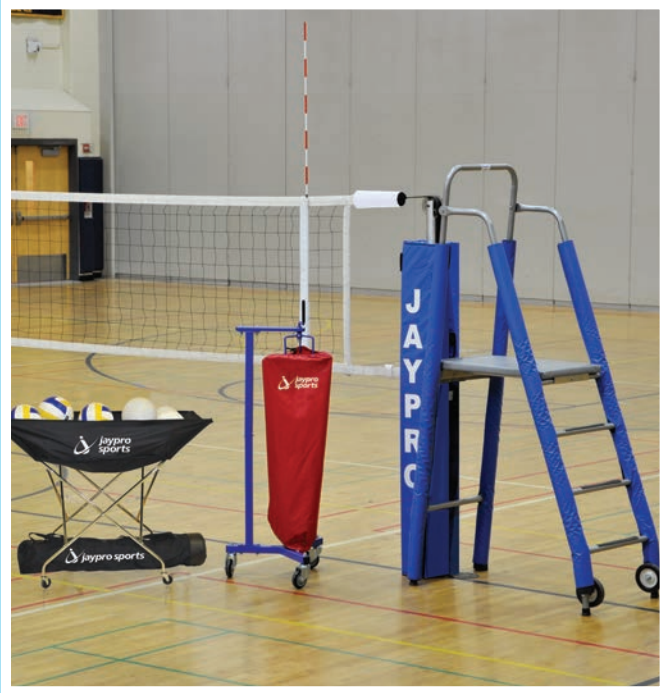

## FEATHERLite™ Volleyball System Package



- > Featherlite™ Volleyball System (PVB-4500 or PVB-5000)
- > Folding Referee Stand (VRS-6000)
- > Referee Stand Padding (VRS-60P)
- > Single Net Keeper (VNK11)
- > Hammock Drill Cart (HSVBC24)
- > Cable/Buckle Covers (VCC-12)
- > Custom Lettering (PVL-39) on Upright Padding (single color - white block letters)

### PVB-5PKG

3½" System 220 lbs \$4,099 package



### PVB-4PKG

3" System 220 lbs \$4,199 package



## FEATHERLite™ Deluxe Volleyball System Package



- > Featherlite™ Volleyball System (PVB-4500 or PVB-5000)
- > Folding Referee Stand (VRS-6000)
- > Referee Stand Padding (VRS-60P)
- > Single Net Keeper (VNK11)
- > Hammock Drill Cart (HSVBC24)
- > Cable/Buckle Covers (VCC-12)
- > Standard Volleyball Equipment Carrier (EC-500)
- > The Spiker (TS612)
- > Custom Lettering (PVL-39) on Upright Padding (single color - white block letters)

### PVB-5PKGDX

3½" System 282 lbs \$4,599 package



### PVB-4PKGDX

3" System 282 lbs \$4,699 package



www.jaypro.com  
T: 800-243-0533

F: 800-988-3363





3" Adapter for PVB-6500

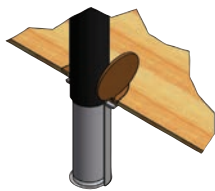

### System Features

Infinite Height



Recessed Pulley Wheel



Worm Drive Winch



Engraved Height Markings



# POWERLite™

a **jaypro sports** product

## 3½" Powerlite™ Volleyball System

- > NCAA, NFHS and USVBA compliant
- > Designed for international, collegiate and advanced high school level play
- > Infinite height adjustment range from 6'6" to 8'2"
- > Lightweight aluminum uprights fit 3½" dia floor sleeves
- > Engraved height markers on uprights
- > Recessed polymer pulley wheel and worm drive winch
- > Flex Net™ (PVBN-6), antennae and upright padding included
- > See chart on page 15 for vinyl colors (specify when ordering)
- > Available as complete system, uprights only or center package
- > Center package includes center pole with winch, Flex Net™ and upright padding (purchase in addition to system for a two court set-up)

**PVB-7000** Complete System 116 lbs  
\$3,599 each **FR** 10Y 3Y 1Y **X**

**PVB-70U** Uprights Only (includes winch) 82 lbs  
\$2,599 pair **FR** 10Y 3Y **★**

**PVBC-700** Center Package 62 lbs  
\$2,633 each **FR** 10Y 3Y 1Y **X**

## 3" Powerlite™ Volleyball System

- > NCAA, NFHS and USVBA compliant
- > Designed for international, collegiate and advanced high school level play
- > Infinite height adjustment range from 6'6" to 8'2"
- > Lightweight aluminum uprights fit 3" dia floor sleeves and have a factory installed adapter
- > Engraved height markers on uprights
- > Recessed polymer pulley wheel and worm drive winch
- > Flex Net™ (PVBN-6), antennae and upright padding included
- > See chart on page 15 for vinyl colors (specify when ordering)
- > Available as complete system, uprights only or center package
- > Center package includes center pole with winch, Flex Net™ and upright padding (purchase in addition to system for a two court set-up)

**PVB-6500** Complete System 117 lbs  
\$3,725 each **FR** 10Y 3Y 1Y **X**

**PVB-65U** Uprights Only (includes winch) 83 lbs  
\$2,675 pair **FR** 10Y 3Y **★**

**PVBC-650** Center Package 63 lbs  
\$2,740 each **FR** 10Y 3Y 1Y **X**

### Complete System

Uprights with Winch



Patented Flex Net



Upright Padding



Antennae







# FEATHERLite™

a **jaypro sports** product

## 3½" Featherlite™ Volleyball System

- > NCAA, NFHS and USVBA compliant
- > Designed for collegiate and high school level play
- > 16 pin-stop height adjustment range from 6'6" to 8'2"
- > Lightweight aluminum uprights fit 3½" dia floor sleeves
- > Engraved height markers on uprights
- > Recessed polymer pulley wheel and worm drive winch
- > Flex Net™ (PVBN-6), antennae and upright padding included
- > See chart on page 15 for vinyl colors (specify when ordering)
- > Available as complete system, uprights only or center package
- > Center package includes center pole with winch, Flex Net™ and upright padding (purchase in addition to system for a two court set-up)



<b>PVB-5000</b>	Complete System	115 lbs
	\$3,099 each	FR ● 10Y 3Y 1Y X
<b>PVB-51U</b>	Uprights Only (includes winch)	70 lbs
	\$2,005 pair	FR ● 10Y 3Y ★
<b>PVBC-500</b>	Center Package	60 lbs
	\$1,988 each	FR ● 10Y 3Y 1Y X

## 3" Featherlite™ Volleyball System

- > NCAA, NFHS and USVBA compliant
- > Designed for collegiate and high school level play
- > 16 pin-stop height adjustment range from 6'6" to 8'2"
- > Lightweight aluminum uprights fit 3" dia floor sleeves and have a factory installed adapter
- > Engraved height markers on uprights
- > Recessed polymer pulley wheel and worm drive winch
- > Flex Net™ (PVBN-6), antennae and upright padding included
- > See chart on page 15 for vinyl colors (specify when ordering)
- > Available as complete system, uprights only or center package
- > Center package includes center pole with winch, Flex Net™ and upright padding (purchase in addition to system for a two court set-up)

<b>PVB-4500</b>	Complete System	115 lbs
	\$3,199 each	FR ● 10Y 3Y 1Y X
<b>PVB-45U</b>	Uprights Only (includes winch)	71 lbs
	\$2,105 pair	FR ● 10Y 3Y ★
<b>PVBC-450</b>	Center Package	56 lbs
	\$2,095 each	FR ● 10Y 3Y 1Y X

3" Adapter for PVB-4500

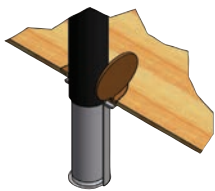

### System Features

Pin Stop	Recessed Pulley Wheel	Worm Drive Winch	Engraved Height Markings

### Complete System

Uprights with Winch	Patented Flex Net	Upright Padding	Antennae

NJ State Approved Co-op #65MCE3CCPS



www.jaypro.com  
T: 800-243-0533

F: 800-988-3363



# LADYPRO CARBON™

The Educational Services Commission of New Jersey Bid term: 5/9/18 - 5/8/20; Extended to 5/8/21  
LadyPro Carbon™ Volleyball System



PVB-8000

PVB-9000

- > Fabricated from state-of-the-art carbon composite material
- > Carbon uprights have the rigidity of steel and are significantly lighter in weight than aluminum
- > Available in 3" or 3½" dia to fit conventional floor sleeves
- > Uprights are in fixed women's height (7' 4½")
- > Adjustable feet have up to 3" of fine tuning
- > Recessed polymer pulley wheel and worm drive winch
- > Flex Net™ (PVBN-6), antennae and upright padding included
- > See chart on page 15 for vinyl colors (specify when ordering)
- > Available as complete system or uprights only
- > Uprights Only package includes winch (net and padding sold separately)
- > Center package includes center pole with winch, Flex Net™ and upright padding (purchase in addition to system for a two court set-up)

<b>PVB-8000</b>	3½" Complete System	74 lbs	\$4,450 system	FR	●●●	3Y	1Y
<b>PVB-80U</b>	3½" Uprights Only (includes winch)	40 lbs	\$3,499 pair	FR	●●●	3Y	★
<b>PVBC-800</b>	3½" Center Package	58 lbs	\$3,250 each	FR	●●●	3Y	1Y
<b>PVB-8500</b>	3" Complete System	77 lbs	\$4,450 system	FR	●●●	3Y	1Y
<b>PVB-85U</b>	3" Uprights Only (includes winch)	43 lbs	\$3,549 pair	FR	●●●	3Y	★
<b>PVBC-850</b>	3" Center Package	60 lbs	\$3,250 each	FR	●●●	3Y	1Y

# CARBON ULTRALITE™

## Carbon Ultralite™ Volleyball System

- > Fabricated from state-of-the-art carbon composite material
- > Carbon uprights have the rigidity of steel and are significantly lighter in weight than aluminum
- > Available in 3" or 3½" dia to fit conventional floor sleeves
- > Uprights have telescoping feature with height adjustment range (from intramurals to men's competition)
- > Recessed polymer pulley wheel and worm drive winch
- > Adjustable feet have up to 3" of fine tuning
- > Flex Net™ (PVBN-6), antennae and upright padding included
- > See chart on page 15 for vinyl colors (specify when ordering)
- > Available as complete system or uprights only
- > Uprights Only package includes winch (net and padding sold separately)
- > Center package includes center pole with winch, Flex Net™ and upright padding (purchase in addition to system for a two court set-up)

<b>PVB-9000</b>	3½" Complete System	78 lbs	\$4,450 system	FR	●●●	3Y	1Y
<b>PVB-90U</b>	3½" Uprights Only (includes winch)	44 lbs	\$3,799 pair	FR	●●●	3Y	★
<b>PVBC-900</b>	3½" Center Package	60 lbs	\$2,558 each	FR	●●●	3Y	1Y
<b>PVB-9500</b>	3" Complete System	81 lbs	\$4,450 system	FR	●●●	3Y	1Y
<b>PVB-95U</b>	3" Uprights Only (includes winch)	47 lbs	\$3,699 pair	FR	●●●	3Y	★
<b>PVBC-950</b>	3" Center Package	62 lbs	\$2,558 each	FR	●●●	3Y	1Y

## Competition Badminton System

- > 2¾" OD steel uprights with fixed net height
- > Official 61" height
- > Comes with easy to use cast aluminum Clamcleat® for securing net cord
- > Designed for high school, intramural and recreational competition level play
- > Badminton net (30"W x 21"L) sold separately
- > Floor sleeves/covers (2¾" ID x 10"D) available in brass or chrome options sold separately

<b>BSO-2U</b>	Badminton System	47 lbs	\$569 pair	●●●	3Y	★
<b>BND-1</b>	Badminton Net	7 lbs	\$52 each		1Y	
<b>BSO-2G</b>	Floor Sleeve & Cover (Brass) 23 lbs		\$349 pair		3Y	
<b>BSO-2G-CP</b>	Floor Sleeve & Cover (Chrome) 23 lbs		\$349 pair		3Y	

See pages 148-151 in the Physical Education section for our Volleyball and Badminton related equipment



Not State Approved Co-op #65MCECCPS



www.jaypro.com  
F: 800-988-3363

T: 800-243-0533



## Steel Collegiate Net System

- > Designed for international, collegiate and high school level play
- > 3½" OD steel uprights with 16 pin-stop height adjustment range from 6'6" to 8'2"
- > Fits 3½" dia floor sleeves
- > Engraved height markers on uprights
- > Recessed polymer pulley wheel and worm drive winch
- > Flex Net™ (PVBN-6), antennae and upright padding included
- > See chart on page 15 for vinyl colors (specify when ordering)
- > Available as complete system, uprights only or center package
- > Center package includes center pole with winch, Flex Net™ and upright padding (purchase in addition to system for a two court set-up)

**PVB-1500** Complete System  
152 lbs \$2,865 system  
FR [3] 3Y 1Y

**PVB-150U** Uprights Only (includes winch)  
118 lbs \$1,725 pair  
FR [3] 3Y ★

**PVBC-150** Center Package  
80 lbs \$1,697 package  
FR [3] 3Y 1Y



## Classic Steel Collegiate Net System

- > Designed for international, collegiate and high school level play
- > 3" OD steel uprights with 16 pin-stop height adjustment range from 6'6" to 8'2"
- > Fits 3" dia floor sleeves
- > Engraved height markers on uprights
- > Recessed pulley wheel and worm drive winch
- > Flex Net™ (PVBN-6), antennae and upright padding included
- > See chart on page 15 for vinyl colors (specify when ordering)
- > Available as complete system, uprights only or center package
- > Center package includes center pole with winch, Flex Net™ and upright padding (purchase in addition to system for a two court set-up)

**PVB-3000** Complete System  
157 lbs \$2,709 system  
FR [3] 3Y 1Y

**PVB-300U** Uprights Only (includes winch)  
123 lbs \$1,645 pair  
FR [3] 3Y ★

**PVBC-300** Center Package  
93 lbs \$1,633 package  
FR [3] 3Y 1Y



## Multi-Purpose Net System

- > 39" approved net is NCAA, NFHS and USVBA compliant
- > 3½" OD anodized aluminum uprights
- > Designed for high school, intramural and recreational competition level play
- > Adjustable infinite height sliding collars convert from competition volleyball system to badminton or tennis systems
- > Fits 3½" dia floor sleeves
- > Complete system includes uprights with worm drive winch, net, pads and antennae
- > See chart on page 15 for vinyl colors (specify when ordering)
- > Center package includes center pole with winch, net and upright padding (purchase in addition to system for a two court set-up)

**PVB-1350** Complete System  
166 lbs \$2,259 system  
FR [10] 10Y 1Y

**PVB-130U** Uprights Only (includes winch)  
83 lbs \$1,569 pair  
FR [10] 10Y ★

**PVBC-130** Center Package  
51 lbs \$1,450 package  
FR [10] 10Y 1Y

**TPV-13** Tennis Net - 36'L x 42"H  
14 lbs \$189 each  
1Y

NJ State Approved Co-op #65MCESCCPS



Use the adjustable sliding collars to convert from volleyball or badminton to tennis.





## Second Floor Competition Net System

Ideal for use where floor sleeves are impractical.

- > NCAA, NFHS and USVBA compliant
- > Designed for collegiate and high school level play
- > Top level performance without the use of cables or wires
- > 3½" OD aluminum uprights with worm drive winch
- > Choice between infinite height adjustment or 16 pin-stop height adjustment (range of 6'6" to 8'2")
- > Hand knobs secure steel T-base to anchors (sold separately) in floor for added safety and security
- > Flex Net™ (PVB-6), antennae and standard/ base padding included
- > See chart on page 15 for vinyl colors (specify when ordering)
- > Available as complete system, uprights only or center package
- > Center package includes center pole with winch, Flex Net™ and upright padding (purchase in addition to system for a two court set-up)



### PVB-2700 Infinite Height Adjustment

**PVB-2700** Complete System  
202 lbs \$3,829 system **FR** **3Y** **1Y**

**PVB-270UB** Uprights Only (includes winch)  
155 lbs \$2,979 pair **FR** **3Y** **★**

**PVBC-270** Center Package  
\$3,010 package **FR** **3Y** **1Y**

### PVB-2500 Pin Stop Height Adjustment

**PVB-2500** Complete System  
192 lbs \$2,795 system **FR** **3Y** **1Y**

**PVB-250UB** Uprights Only (includes winch)  
145 lbs \$2,055 pair **FR** **3Y** **★**

**PVBC-250** Center Package  
\$2,084 package **FR** **3Y** **1Y**



### Replacement Base Pad

Ideal only for Second Floor Competition Net Systems (PVB-2700 or PVB-2500).

- > Standard base pad
- > See chart on page 15 for vinyl colors (specify when ordering)

**PVB-25P**

\$328 pair

11 lbs

**3Y** **★**

← Base Pad



### Cable/Buckle Cover

- > Protects against exposed net cables and buckles
- > 12" long white vinyl covered foam with hook-and-loop attachment

**VCC-12** 4 lbs \$76 pair **3Y** **★**

See page 112 for our line of Keyclean products for a clean gym floor



### Universal Antennae

- > Clamps directly to top and bottom of net
- > Attachment adjustments easily made from floor
- > Fits both 36" and 39" nets
- > 72" long and are colored red and white

**VBA-80**

3 lbs \$159 pair

**3Y**

### Antennae

- > Antennae slide into hook-and-loop attached sleeve
- > Fits both 36" and 39" nets

**VBA-4**

\$109 pair

5 lbs

**3Y**

### Boundary Tape



- > 2" white boundary tape with hook-and-loop closure
- > Fits both 36" and 39" nets

**VA-22** 1 lb \$29 pair

**1Y**



Save on external storage and set-up time with a Ceiling Suspended Volleyball System by Jaypro Sports. This system stores fully assembled and close to the ceiling, raised and lowered using a 1 HP winch, and is offered with or without an attached referee stand. Additionally, the net height is infinitely adjustable to meet both men's and women's regulation heights.



## Ceiling Suspended Volleyball System

Conveniently raises and lowers volleyball system with a turn-key solution for quick set-up in minutes.

- > Meets NCAA and NFHS regulations
- > System raises to fold in either direction (specify fold direction when ordering)
- > Available with or without a 24" x 36" all-welded and attached referee stand with anti-skid diamond plate platform (250 lb capacity)
- > Dual Posilok™ safety straps automatically lock system in position should a malfunction occur during raising or lowering of unit
- > Engraved height markers for quick set-up (0-20" range)
- > Retractable foot system for maximum stability during playing conditions
- > Net height adjustment handles on both uprights
- > Exposed posts and frames fully padded for player safety
- > Collegiate volleyball net included
- > 1 pair of universal net antennae included

**PVBOH-880R**

System with Referee Stand

Call for Pricing

**PVBOH-800**

System without Referee Stand

Call for Pricing



www.jaypro.com  
T: 800-243-0533

F: 800-988-3363



# FLEXNET™ a jaypro sports product

## Flex Net™

Ideal for volleyball uprights set between 35' and 37'.

- > Designed for international, collegiate, and high school competition play
- > Eliminates cumbersome cables by replacing them with heavy-duty woven nylon top and bottom bands
- > Headband attaches directly to winch leader strap for superb net tension
- > Adjustable straps attach to existing bottom band for additional length (not included with all nets)



Due to varying court sizes, the net body may not match your court width.

1Y X

Item	For Uprights set between	Net Size	4' Strap Included	Price
<b>Flex Net™</b>				
PVBN-6	35' - 37'	32'L x 39"H	No	\$489 each
<b>Alternate Flex Net™ Sizes</b>				
PVBN-628	30' - 32'	28'L x 39"H	No	\$489 each
PVBN-628ADJ	32' - 35'	28'L x 39"H	Yes	\$489 each
PVBN-6ADJ	37' - 40'	32'L x 39"H	Yes	\$519 each

## Flex Net™ (with Adapter Cord)

Compatible with most manufacturer's systems such as Porter, Senoh, Bison, MacGregor, Stackhouse, Schelde or other similar volleyball systems.

- > Adapter cord connects existing winch and anchor upright to top of Flex Net™
- > 1/4" dia anchor cord and lips included
- > Note: Anchor cord should be cut to length in the field to adapt to the specific volleyball system

**PVBN-6AK** 14 lbs \$519 each 1Y

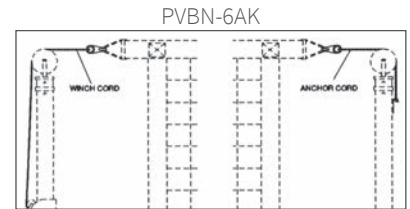

## Flex Net™ (with Adapter Strap)

Compatible with Schelde or other similar volleyball systems.

- > 2" wide adapter strap "bridges" top of Flex Net™ to the anchor upright

**PVBN-6J** 13 lbs \$519 each 1Y

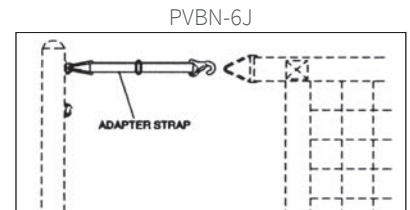

**Volleyball Net**  
**PVBN-5** 32'L x 39"H  
(3.5mm knotless poly net with Plateena top cord)  
12 lbs \$349 each 1Y



**Collegiate Net**  
**PVBN-3** 32'L x 39"H  
(#21 nylon net with coated steel cable)  
11 lbs \$246 each 1Y



**Volleyball Net**  
**VBD-3** 32'L x 36"H  
(2.5mm poly net with coated steel cable)  
5 lbs \$89 each 1Y



**Volleyball Net**  
**VBN-32** 32'L x 36"H  
(nylon net with rope cable)  
4 lbs \$92 each 1Y



**Neat Net**  
**NN1-NET-W** 32'L x 36"H  
(2.5mm black knotless nylon)  
16 lbs \$99 each 1Y

**Volleyball Net**  
**VBD-6** 32'L x 36"H  
(2.5mm poly net with rope cable)  
11 lbs \$92 each 1Y  
NJ State Approved Co-op #65MCESCCPS



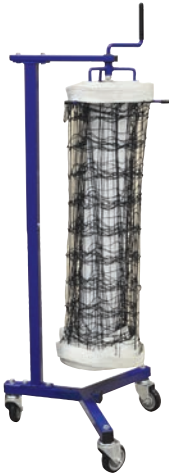

### Single Net Keeper

- > Store nets neatly and securely in minimal space
- > Headband is wound clean and tangle free
- > 1½" thick-walled square steel tube construction
- > 4" non-marking swivel wheels
- > 1 storage bag included

**VNK11**

30 lbs

\$245 each



### Double Net Keeper

- > Store nets neatly and securely in minimal space
- > Headband is wound clean and tangle free
- > 1½" thick-walled square steel tube construction
- > 4" non-marking swivel wheels
- > 2 storage bags included

**VNK22**

34 lbs

\$275 each



### Triple Net Keeper

- > Store nets neatly and securely in minimal space
- > Headband is wound clean and tangle free
- > 1½" thick-walled square steel tube construction
- > 4" non-marking swivel wheels
- > 3 storage bags included

**VNK33**

37 lbs

\$315 each



### Net Keeper Storage Bag

- > Keeps nets, cords and cables off the floor and protected

**VNKBAG**

1 lb

\$31 each

1Y



### Custom Volleyball Net Tape

- > 3" customized vinyl tape with hook-and-loop attachment
- > Sized for 32' nets
- > Extended lead time applies
- > Contact customer service for artwork requirements and shipping options

**CVNT-1**

3 lbs

\$399 each

1Y

### ORDER MORE AND SAVE

- 2 Net Tapes \$349 each **SAVE \$50 each**
- 3 Net Tapes \$299 each **SAVE \$100 each**
- 4 Net Tapes \$249 each **SAVE \$150 each**
- 5 or more Net Tapes Call for Custom Quote

BND-1



### Badminton Net

**BND-1** 21'L x 30"H (lightweight with rope cable)

7 lbs

\$52 each

1Y

TDP-42



### Tennis Net

**TDP-42** 42'L x 42"H (lightweight with rope cable)

10 lbs

\$149 each

1Y







### “MEGA REF” Folding Referee Stand

- > 1 $\frac{5}{8}$ " heavy-walled steel tube construction
- > Platform support with vinyl coated padding is 48" above floor
- > All welded frame support with non-slip foot treads
- > Protective rubber tips on legs
- > (4) 4" non-marking front wheels
- > Folds down to 30"W x 84"H x 10"D for compact storage and easy transport
- > Optional padding (VRS-60P) sold separately

**VRS-8000**

\$849 each

78 lbs



### Folding Referee Stand

Ideal for use with any volleyball system.

- > 1 $\frac{5}{16}$ " dia steel frame construction
- > Platform support with vinyl coated padding is 48" above floor
- > Protective rubber tips on legs
- > (2) 4" non-marking front wheels
- > Folds down to 30"W x 84"H x 10"D for compact storage and easy transport
- > Optional padding (VRS-60P) sold separately

**VRS-6000**

\$645 each

59 lbs



### Adjustable Referee Stand

Clamps onto any telescoping pole volleyball system.

- > 1 $\frac{5}{16}$ " dia steel frame construction
- > Two leg design with telescoping feet allow for height adjustment
- > Platform with vinyl coated padding
- > 2 non-marking front wheels for easy transport
- > Optional padding (VRS-30P) sold separately
- > Note: Does not fit Multi-Purpose Net System (PVB-1350) or Outdoor Competition Volleyball System (OCV-900)

**VRS-3000**

55 lbs

\$679 each



Stand clamps to volleyball pole



### Beach Volleyball Referee Stand



- > Easily transports over sand with two heavy duty 10" dia x 3 $\frac{1}{2}$ "W molded wheels
- > Front base plate prevents stand from sinking into sand
- > Constructed of 1 $\frac{5}{8}$ " heavy wall steel
- > Textured silver durable powder coated finish
- > All welded frame support with non-slip foot treads
- > Folds to 84"H x 30"W x 10"D for compact storage
- > Padded platform is 48" above ground
- > Maximum user weight: 260 lbs
- > Optional referee stand edge padding (VRS-60P) sold separately
- > Optional custom side banners (CVNT-3) sold separately

**OBVRS-8**

98 lbs

\$899 each



**CVNT-3** NJ State Approved Co-op #65MCESCOPS \$159 each

# System & Referee Stand Padding

- PINK
- RED
- NAVY BLUE
- YELLOW
- LIGHT BLUE
- GRAY
- BLACK
- MAROON
- FOREST GREEN
- KELLY GREEN
- ROYAL BLUE
- TAN
- PURPLE
- ORANGE

## Official Standard Pad

- > Meets competitive play specifications
- > 6' tall post pad attaches with hook-and-loop closure flaps
- > 2" thick polyurethane foam wrapped in 14 oz vinyl
- > Custom Lettering (PVL-39) optional
- > See chart for vinyl colors (specify when ordering)

**PVB-60P** 18 lbs \$525 pair 3Y ★

See page 148 for our GymGlide™ Game Standard System that also can be fit with these pads



## Referee Stand Padding

Fits both the "MEGA REF" Folding Referee Stand (VRS-8000) and Folding Referee Stand (VRS-6000).

- > Meets competitive play specifications
- > 1" thick polyurethane foam wrapped in 14 oz vinyl
- > See chart for vinyl colors (specify when ordering)

**VRS-60P** 17 lbs \$320 each 3Y ★

Fits the Adjustable Referee Stand (VRS-3000).

- > Meets competitive play specifications
- > 1" thick polyurethane foam wrapped in 14 oz vinyl
- > See chart for vinyl colors (specify when ordering)

**VRS-30P** 6 lbs \$321 each 3Y ★

## Custom Graphics for Volleyball Standard Pads

Get your school and/or team name in white lettering on your protector pad.

**PVL-39**  
Custom Lettering - Single Color (White)  
\$159 pad 3Y ★

**JSG-VPP**  
Custom Artwork - Multi-Color  
Call for Pricing and Artwork Approval 3Y ★



## Equipment Carriers



EC-500



EC-1000

## Volleyball Equipment Carriers

Ideal for storing volleyballs, uprights, nets, pads and other equipment.

- > Heavy-duty welded steel frame powder coated blue
- > Large non-marking swivel wheels
- > Available in standard, deluxe and vertical models
- > Vinyl storage bag included with deluxe and vertical models

**EC-500** Standard - 32"W x 42"L (4 pole capacity) 3Y ★

**EC-1000** Deluxe - 36"W x 48"L (6 pole capacity) 3Y ★

**VEC-1** Vertical - 35"W x 60"L (6 pole capacity) 3Y ★



VEC-1

NJ State Approved Co-op #65MOESCCPS





## Floor Sleeves &amp; Adapters



Chrome Finish



Brass Finish



Floor sleeves are generally 3", 3½" or 4". Jaypro Sports uprights are 3" or 3½". To ensure a proper fit, measure existing floor sleeves prior to selecting a system. See below for measuring instructions. Select the appropriate adapter that fits the measurements and system of choice. Reduce the inside diameter (ID) or shorten the depth of your floor sleeves with sleeve inserts shown below.

## 3½" Floor Sleeves and Covers

- > Heavy-duty cast brass or chrome finish construction
- > Spring loaded covers help prevent basketball dead spots
- > 3½" ID x 10" deep
- > 7½" OD lockable hinged cover plate

<b>PVB-75S</b>	Brass	16 lbs	\$457 pair	3Y
<b>PVB-75S-CP</b>	Chrome	16 lbs	\$457 pair	3Y

## 3" Floor Sleeves and Covers

- > Heavy-duty cast brass or chrome finish construction
- > Spring loaded covers help prevent basketball dead spots
- > 3" ID x 10" deep
- > 7½" OD lockable hinged cover plate

<b>PVB-70S</b>	Brass	16 lbs	\$445 pair	3Y
<b>PVB-70S-CP</b>	Chrome	16 lbs	\$445 pair	3Y

## 2¾" Floor Sleeves and Covers

- > Heavy-duty cast brass or chrome finish construction
- > Spring loaded covers help prevent basketball dead spots
- > 2¾" ID x 10" deep
- > 7½" OD lockable hinged cover plate

<b>BSO-2G</b>	Brass	23 lbs	\$349 pair	3Y
<b>BSO-2G-CP</b>	Chrome	23 lbs	\$349 pair	3Y

## Cover Plate

<b>PVB-711</b>	Brass	7½" OD	7 lbs	\$210 each	3Y
<b>PVB-75CVR-CP</b>	Chrome	7½" OD	7 lbs	\$210 each	3Y
<b>PVB-85CVR</b>	Brass	8½" OD	7 lbs	\$220 each	3Y

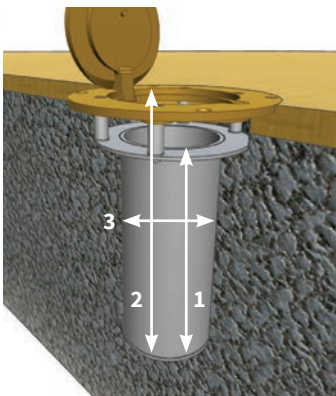

## Sleeve Insert Measurement

To ensure proper fit of sleeve inserts, provide the following dimensions of sleeves when ordering.

1. Depth of sleeve itself
2. Depth from bottom of sleeve to playing surface
3. Inside diameter of sleeve (do not measure cover plate)

Do not measure cover plate

Measure the distance between red arrows for accurate dimension

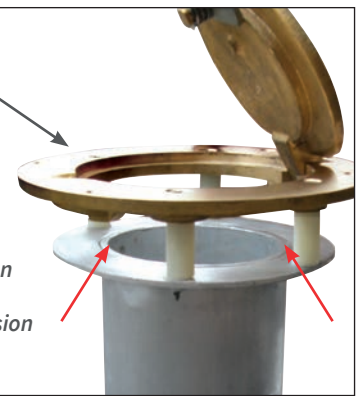

## Sleeve Insert/Adapter

- > Makes larger floor sleeve holes smaller
- > Specify current depth and inside diameter when ordering

Depths other than the standard 10" are special order items (non-returnable). Custom sizes (depths) may require longer lead time.



<b>PVB-DEP</b>	Sleeve Insert	6 lbs	\$77 each	3Y	★
<b>SVL-3238</b>	Modifies 3" inside diameter to 2¾" ID	12 lbs	\$75 each	3Y	★
<b>PVB-ID</b>	Modifies 3½" inside diameter to 3" ID	8 lbs	\$74 each	3Y	★
<b>SVL-3528</b>	Modifies 3½" inside diameter to 2¾" ID	14 lbs	\$82 each	3Y	★
<b>SVL-4035</b>	Modifies 4" inside diameter to 3½" ID	9 lbs	\$69 each	3Y	★

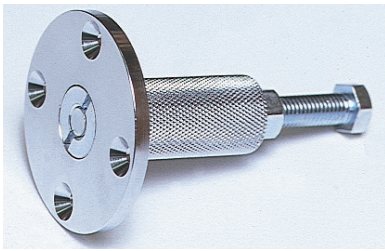

### Floor Anchor (1 1/4" Cylinder)

Ideal for systems with "T" style or round bases that anchor to floor.

- > Billet steel body gives 9000 lb pullout strength
- > Designed for all floor applications except floating wood floors
- > 3 1/4" chrome cover with 1 1/4" wide cylinder
- > 1/2" center - 13 thread with spring loaded closure plug
- > May be used without extension bolt on wood, tile or synthetic surfaces applied directly over concrete slab or on a floating wood floor for light-duty performance
- > Includes removable cylinder in case striping occurs

**FP-89** 3 lbs \$149 each **3Y**

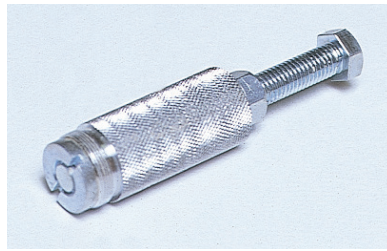

### Floor Anchor (1 1/4" Cylinder)

Ideal for systems with "T" style or round bases that anchor to floor.

- > Billet steel body gives 9000 lb pullout strength
- > Designed for all floor applications except floating wood floors
- > 1 1/4" wide cylinder
- > 1/2" center - 13 thread with spring loaded closure plug
- > May be used without extension bolt on wood, tile or synthetic surfaces applied directly over concrete slab or on a floating wood floor for light-duty performance
- > Includes removable cylinder in case striping occurs

**FP-90** 3 lbs \$129 each **3Y**



### Floating Wood Floor Anchor (1 1/4" Cylinder)

Brass cover plate and anchor work independently to allow for installation into floating wood floors.

- > Billet steel body gives 9000 lb pullout strength
- > 3 1/4" brass cover with 1 1/4" wide cylinder
- > 1/2" center - 13 thread with spring loaded closure plug
- > Includes removable cylinder in case striping occurs

**FP-100** 4 lbs \$169 each **3Y**

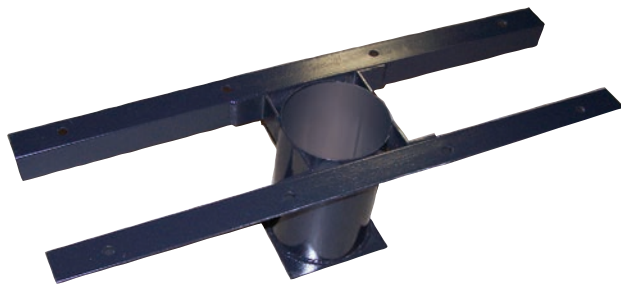

### Second Floor Sleeve Bracket

- > Designed for second story installation of floor sleeves or where there is less than 12" of clearance in the sub-floor
- > Mounting hardware included

**SB-10** 67 lbs \$315 each **3Y** ★

## System Accessories



### Wall Rack

- > Convenient storage rack
- > Heavy-duty steel rack attaches to wall
- > Holds 3 volleyball posts in upright position

**VBWR-1** 7 lbs \$209 each **3Y**

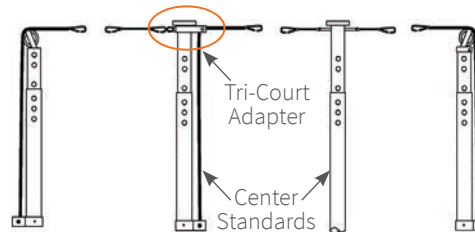

### Volleyball System Tri-Court Adapter

- > Connects two center standards into a third court
- > Improves tension out of middle net
- > 3" dia x 7" tall

#### PVB-303CAK

PVB-3000 System 6 lbs \$143 each **3Y**

#### PVB-35TCA

NJ State Approved Co-op #65MCECCPS PVB-7000, 6500, 5000, 4500 and 1500 Systems 6 lbs \$145 each **3Y**







### Hammock Drill Cart

- > Holds up to 24 balls
- > Low profile making it easier to turn, reach and spike
- > Durable steel frame is collapsible for easy storage
- > Nylon carry bag with shoulder strap included
- > Dimensions: 22"W x 48"L x 40"H x 12"D

**HSVBC24** 15 lbs \$149 each

3Y

See pages 130-133  
for our line of Ball  
Storage Carts and  
Carriers



### ToteMaster™ Open Top

- > Holds up to 33 volleyballs, nets, pads and other equipment
- > 2 full-size open top storage baskets with 4" x 3" wire mesh
- > Upper basket deeper than lower basket and ideal for larger items
- > 4 swivel wheels
- > Dimensions: 26"W x 48"L x 54"H

**TE-PE01** 46 lbs \$249 each

3Y

### Deluxe Ball Carrier

Custom graphics available for the side plates of carrier.

Holds Basketballs, Medicine Balls and Volleyballs.

Call for details



### Deluxe 15 Ball Carrier

- > Highly durable
- > All welded 1" OD steel frame and crossbars
- > Holds up to 15 volleyballs
- > 4 heavy-duty swivel wheels
- > Dimensions: 36"H x 22"W x 39"L

#### BBC-12RB

26 lbs

ROYAL BLUE

\$160 each

3Y

#### BBC-12BK

26 lbs

BLACK

\$160 each

3Y

#### BBC-12RD

26 lbs

RED

\$160 each

3Y

### Deluxe 21 Ball Carrier

- > Highly durable
- > All welded 1" OD steel frame and crossbars
- > Holds up to 21 volleyballs
- > 4 heavy-duty swivel wheels
- > Dimensions: 36"H x 22"W x 60"L

#### BBC-18RB

41 lbs

ROYAL BLUE

\$185 each

3Y

#### BBC-18BK

41 lbs

BLACK

\$185 each

3Y

#### BBC-18RD

41 lbs

RED

\$185 each

3Y

## System Replacement Parts

### Worm Drive Winch

- > 1½" Leader strap & handle included

**PVBWINCH** 6 lbs \$380 each 3Y

### Cargo Buckle Winch

**HM5044** 3 lbs \$85 each 3Y

### Leader Strap (for HM5044)

**PVB101A** 2 lbs \$59 each 3Y

### Leader Strap (for PVBWINCH)

**PVB603** 1½" wide 3 lb \$68 each 3Y



PVBWINCH



HM5044



PVB101A



PVB603



VBW-HANDLE-08



PVB607I



PVB512

### Winch Handle (for PVBWINCH)

**VBW-HANDLE-08** (for winches purchased after 2008)

1 lb \$70 each 3Y

### Handle

- > For telescoping height adjustment and old blue style winch

**PVB607I** (requires 3/8" allen wrench)  
1 lb \$39 each 3Y

### Pin Chain Assembly

**PVB512** (1500/5000/4500)  
2 lbs \$15 each 3Y

NJ State Approved Co-op #65MCESCCPS





### The Spiker

best seller

- > Develop spiking/serving skills
- > 6'-12' aluminum telescoping pole with foam ball holder
- > Polyethylene base included

**TS612** 15 lbs \$239 each



### The Jumper

- > Measure jump reach
- > Color coded spring pegs in 1" increments
- > 6'-12' aluminum telescoping pole
- > Polyethylene base included

**TJ612** 14 lbs \$199 each

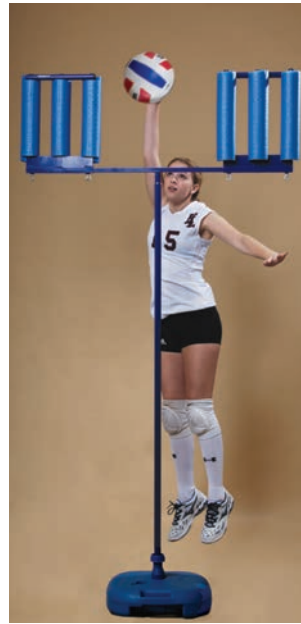

### The Attacker

- > Practice game-like blocking situations
- > 2 adjustable 1' x 1½' foam blocking surfaces
- > Four knobs for easy adjustment
- > Polyethylene base included

**TA115** 17 lbs \$299 each



### The Blocker

- > Practice defending blocked spikes
- > Aluminum pole adjusts up to 11'
- > 2' x 3' foam blocking surface
- > Polyethylene base included

**TB11** 18 lbs \$289 each

## Volleyball Training Package

- > The Spiker (TS612)
- > The Jumper (TJ612)
- > The Attacker (TA115)
- > The Blocker (TB11)

**VTAPACK**  
 64 lbs  
 \$729 package



### Attack Volleyball Machine

Designed for men's games. Maximize daily practice drills with accurate and repeatable reps. **See page 83 for details about this product.**

**VBSA-1** 200 lbs \$3,299 each



### Attack II Volleyball Machine

Designed for women's games. Maximize daily practice drills with accurate and repeatable reps. **See page 83 for details about this product.**

**VBSA-2** 200 lbs \$2,999 each



### Skill Attack Volleyball Machine

Designed for club and youth programs. Maximize daily practice drills with accurate and repeatable reps. **See page 83 for details about this product.**

**VBSA-3** 55 lbs \$1,299 each





## Outdoor Volleyball



## Coastal Competition Volleyball System

- > Designed to withstand coastal winds and weather
- > 4" square extruded heavy-walled aluminum uprights with additional lateral support inside
- > Adjustable winches for play at any height
- > Ground sleeves, installation tool, 2 winches and weather resistant net included

<b>OCC-500</b>	System	178 lbs	\$1,395 system
<b>OCC-500N</b>	Replacement Net	9 lbs	\$179 each



Inside lateral support



OCC-500N



## Outdoor Competition Volleyball System

- > 3½" OD heavy-walled galvanized steel uprights are powder coated silver
- > Fixed net heights for men's and women's play
- > 36" aluminum ground sleeves with cover caps
- > Rust-resistant ratchet included
- > Snap buckles for quick net attachment
- > Net (PVBN-3 or PVBN-6J) sold separately

<b>OCV-900</b>	System	170 lbs	\$997 system
<b>OCV-900C</b>	Center Package	90 lbs	\$589 each



## Recreational Outdoor Volleyball System

Ideal for accommodating volleyball, badminton or tennis.

- > 2¾" OD galvanized steel uprights
- > PVC ground sleeves with top caps
- > Rust-resistant ratchet included
- > Net (VBN-32, VBD-6 or VBD-3) sold separately

Ground sleeves are designed to be set even with playing surface. Contact Jaypro Sports for special installation requirements.

<b>OS-350</b>	80 lbs	\$599 system
---------------	--------	--------------



## Adjustable Volleyball Court Line

- > 2" wide black webbed volleyball boundary line
- > Adjusts from 30' x 60' to FIVB regulation (8m x 16m)
- > 8" corner stakes with bungee cord to ensure adjustment to court boundary
- > Plastic reel for easy assembly and storage included

NJ State Approved Co-op #65MCESSCCPS  
**AVCL-2**

2 lbs \$61 each

3Y



www.jaypro.com  
F: 800-988-3363

T: 800-243-0533



See page 14 for the Beach Referee Stand



Ground Insert



Top Cap



Quik-Collar



## Mercury™ Aluminum Beach Volleyball System



- > Inverted telescoping design
- > Lightweight aluminum poles weigh 29 lbs each
- > Carbon reinforced cap prevents infiltration of sand and water
- > Adjustable height between 5' 6" and 7'-11 5/8" with carbon fiber Quik-Collar
- > 3 1/2" OD bottom pole compatible with any 3 1/2" ID sleeves (OBV-100AK recommended)
- > System includes Mercury™ net, antennae, winch and pole padding (otherwise items sold separately)
- > Ground inserts sold separately

**OBV100** Aluminum System  
115 lbs \$3,299 each **FR** **3Y**

**OBV100U** Uprights Only (includes winch)  
70 lbs \$2,250 pair **FR** **3Y**

## Mercury™ Carbon Beach Volleyball System

- > Inverted telescoping design
- > Lightweight carbon poles weigh 14 lbs each
- > Carbon reinforced cap prevents infiltration of sand and water
- > Adjustable height between 5' 6" and 7'-11 5/8" with carbon fiber Quik-Collar
- > 3 1/2" OD bottom pole compatible with any 3 1/2" ID sleeves (OBV-100AK recommended)
- > System includes Mercury™ net, antennae, winch and pole padding (otherwise items sold separately)
- > Ground inserts sold separately

**OBV200** Carbon System  
85 lbs \$4,450 each **FR** **3Y**

**OBV200U** Uprights Only (includes winch)  
50 lbs \$3,699 pair **FR** **3Y**

## Ground Inserts

- > Inverted design keeps sand out
- > Cap and safety flag included

**OBV-100AK** 15 lbs \$455 pair **3Y**

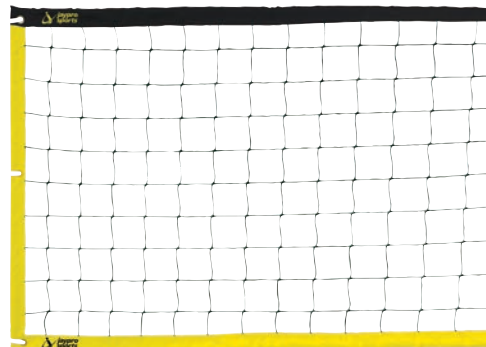

## Mercury™ Beach Volleyball Net



- > 3" vinyl border and headband
- > 1/4" top Plateena cord with swaged loop on one end
- > 1/4" double braided polyester bottom rope
- > (6) 1" white polyester straps with buckles
- > 4" #36 nylon black netting
- > 1/2" fiberglass end dowels
- > Available in two sizes
- > Custom headband (CVNT-1) and side net tapes (CVNT-2) sold separately

**OBVN-1** Official Competition Net 28'L x 39"H 14 lbs \$349 each **1Y**

**OBVN-2** Recreational Size Net 32'L x 39"H 14 lbs \$349 each **1Y**



## Double Play Sand Rake

- > 36" High-grade aluminum head and bracing
- > 66" powder coated aluminum handle with 5" no-slip vinyl grip

**DPR-36** 6 lbs \$90 each **1Y**



## Sand Rake

- > 66" lightweight aluminum magnesium alloy head construction
- > Large 36" grading edge with heavy-duty cleaning teeth

**FR-36** 6 lbs \$80 each **1Y**

NJ State Approved Co-op #65MCESCCPS



www.jaypro.com  
T: 800-243-0533

F: 800-988-3363



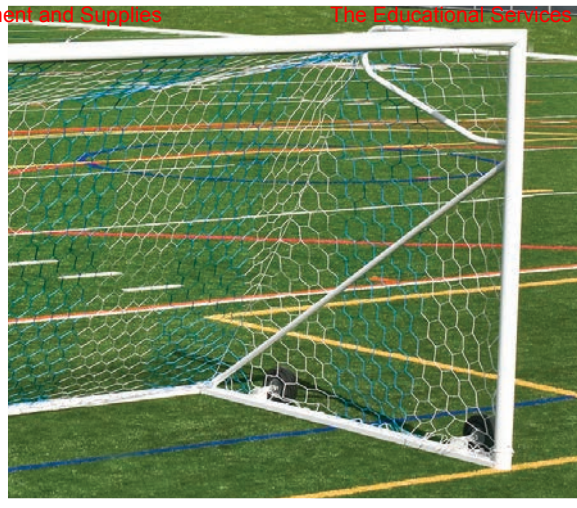

### NOVA™ Premiere Goal Package (Black/White)

- > 2 NOVA™ Premiere Goals (SGP-600)
- > (2) 5mm, 5½” hex mesh two-tone black/white nets (SN-2BLKW)
- > 4 World Cup Anchors - 1 Set (SGA-50)
- > 1 NOVA™ Goal Wheel Kit (NSGWK)

**SGP-600PKGBLK**

531 lbs

\$5,355 package



*In-ground anchors or appropriate amount of counterweight required per goal.  
See chart on page 26 for ASTM counterweight requirements for your specific goal.*



### NOVA™ Premiere Goal Package (Blue/White)

- > 2 NOVA™ Premiere Goals (SGP-600)
- > (2) 5mm, 5½” hex mesh two-tone blue/white nets (SN-2BLUW)
- > 4 World Cup Anchors - 1 Set (SGA-50)
- > 1 NOVA™ Goal Wheel Kit (NSGWK)

**SGP-600PKGBLU**

531 lbs

\$5,355 package



*In-ground anchors or appropriate amount of counterweight required per goal.  
See chart on page 26 for ASTM counterweight requirements for your specific goal.*



### Classic Official Round Goal Package



- > 2 Classic Round Official Goals (SGP-400)
- > (2) 4mm, 5½” sq mesh white nets (SND-8)
- > 4 Sandbag Anchors - 1 Set (SWB-454W)
- > 1 Classic Wheel Kit (CSGWK)

**SGP-400PKG**

496 lbs

\$3,389 package



*In-ground anchors or appropriate amount of counterweight required per goal.  
See chart on page 26 for ASTM counterweight requirements for your specific goal.*

NJ State Approved Co-op #65MCECCPS



www.jaypro.com  
T: 800-243-0533 F: 800-988-3363





### Classic Official Square Goal Package



- > 2 Classic Square Official Goals (SGP-760)
- > (2) 4mm, 5½” sq mesh white nets (SND-8)
- > 4 Sandbag Anchors - 1 Set (SWB-454W)
- > 1 Classic Wheel Kit (CSGWK)

**SGP-760PKG**

500 lbs

\$3,389 package

FR 12Y 3Y 1Y ★



*In-ground anchors or appropriate amount of counterweight required per goal.  
See chart on page 26 for ASTM counterweight requirements for your specific goal.*



### Deluxe Classic Official Round Goal Package

- > 2 Classic Round Official Goals (SGP-400)
- > (2) 4mm, 5½” sq mesh white nets (SND-8)
- > 4 World Cup Anchors - 1 Set (SGA-50)
- > 1 Classic Wheel Kit (CSGWK)

**SGP-400PKGDX**

496 lbs

\$3,799 package

FR 12Y 3Y 1Y ★



*In-ground anchors or appropriate amount of counterweight required per goal.  
See chart on page 26 for ASTM counterweight requirements for your specific goal.*



### Deluxe Classic Official Square Goal Package

- > 2 Classic Square Official Goals (SGP-760)
- > (2) 4mm, 5½” sq mesh white nets (SND-8)
- > 4 World Cup Anchors - 1 Set (SGA-50)
- > 1 Classic Wheel Kit (CSGWK)

**SGP-760PKGDX**

500 lbs

\$3,799 package

FR 12Y 3Y 1Y ★



*In-ground anchors or appropriate amount of counterweight required per goal.  
See chart on page 26 for ASTM counterweight requirements for your specific goal.*

NJ State Approved Co-op #65MCESCCPs





# Check It - Secure It - Test It - Respect It



Jaypro Sports is committed to safety on the field. Because of this we have created the Secure 4 Safety Program, which promotes soccer goal safety.



## ASTM Testing



In our ongoing effort to provide athletes with the safest environment possible, Jaypro Sports has worked with the ASTM (American Standards for Tests and Measurement) to create new standards for portable soccer goals in the U.S. Many of the goals in this catalog have been tested in accordance with the standards set forth by the ASTM committee for portable soccer goal safety. (ASTM Designation: F2056 and F2673). The United States Consumer Product Safety Commission has determined that portable official soccer goals should be anchored or counter-weighted at all times.

*All Jaypro Sports goals that meet NFHS, NCAA and FIFA specification are marked in this section, refer to [www.jaypro.com](http://www.jaypro.com) for more information on ASTM guidelines and standards.*

## Anchor Options

Throughout this section, Jaypro Sports has listed the counterweight required for each soccer goal on page 26. Even with the ASTM requirement met in our testing, all soccer goals not permanently anchored must have a certain counterweight on the rear frame of the goal. Please refer to [www.jaypro.com](http://www.jaypro.com) for a complete list of counterweight requirements for your particular goal. On-goal weights and in-ground anchors are available on pages 38-39 of this section.





**Model #:**  
**RCG-24S**  
**800-243-0533**  
**[www.jaypro.com](http://www.jaypro.com)**

**THIS GOAL MEETS ALL SAFETY REQUIREMENTS OF: ASTM F2056 & ASTM F2673**

WHEN COUNTER BALANCE WEIGHT IS USED AS THE ONLY MEANS OF PREVENTING TIPOVER, **A MINIMUM OF 150 LBS. MUST BE PLACED ON THE REAR CROSSBAR.** WEIGHT SHOULD BE DIVIDED EQUALLY AND PLACED NEAR EACH REAR CORNER.

SEE MANUFACTURER'S INSTRUCTIONS FOR MORE DETAILS ON ANCHORING.

**SL0051**

# NOVA™ a **jaypro sports** product



**EASY TRACK™**  
Net Attachment System



Wheel Kit Included



Optional Premium Counterweights



## NOVA™ Ultimate Folding Goal

Features Jaypro Sports flush mount Easy Track™ net attachment system with clips.

- > NCAA, FIFA and NFHS compliant
- > Official size and powder coated
- > Locks in folded position for storage and safety (lock not included)
- > Spring assist design ensures goal opens and folds safely
- > 4" OD extruded aluminum with a 2" x 4" base frame
- > 1.7" OD aluminum European backstays
- > 4mm white official net
- > 10" no-flat wheels
- > Stainless steel hardware included
- > Ground anchors and counterweights sold separately
- > Dimensions: 24'W x 8'H x 4'B x 10'D

*In-ground anchors or appropriate amount of counterweight required per goal. See chart on page 26 for ASTM counterweight requirements for your specific goal.*

**SGP-600FS**

475 lbs

\$5,957 pair



NJ State Approved Co-op #65MCECCPS



www.jaypro.com  
T: 800-243-0533

F: 800-988-3363



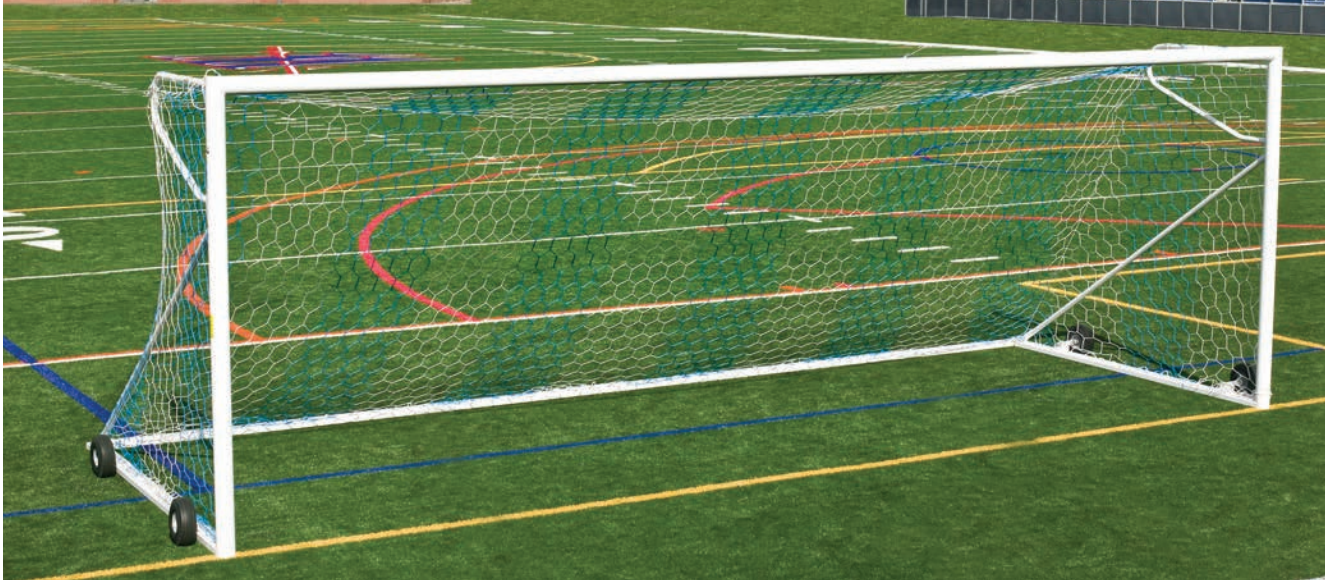

**EASY TRACK™**  
Net Attachment System



Optional Wheel Kit



Optional Premium Counterweights



## NOVA™ Premiere Goal

Features Jaypro Sports flush mount Easy Track™ net attachment system with clips.

- > NCAA, FIFA and NFHS compliant
- > Official size and powder coated
- > International style all aluminum goal
- > 4" OD extruded aluminum with a 2" x 4" base frame
- > 1.7" OD aluminum European and auxiliary backstays
- > Optional Wheel Kit (NSGWK) sold separately
- > Stainless steel hardware included
- > Nets sold separately
- > Ground anchors and counterweights sold separately
- > Dimensions: 24'W x 8'H x 4'B x 10'D

*In-ground anchors or appropriate amount of counterweight required per goal. See chart below for ASTM counterweight requirements for your specific goal.*

**SGP-600**

446 lbs

\$4,929 pair



### Soccer Goal Counterweight Chart

Item #	Counterweight required per goal	NOVA World Cup Anchors or Sand Bags required per goal
SGP-600FS	140 lbs	3 per goal
SGP-600	140 lbs	3 per goal
SGP-400	160 lbs	4 per goal
SGP-760	140 lbs	3 per goal
SGP-100	170 lbs	4 per goal
RCG-24S	150 lbs	3 per goal
CC24S	140 lbs	3 per goal
RCG-21S	170 lbs	4 per goal
CC21S	160 lbs	4 per goal
RCG-18S	240 lbs	5 per goal
CC18S	240 lbs	5 per goal
RCG-12S	240 lbs	5 per goal
CC12S	240 lbs	5 per goal

Which size goal does your program need?

Age Group	Recommended Goal Size	Maximum Ball Size	Minimum Players/Team
U-13	8' x 24'	5	11 vs 11
U-12	Up to 6½' x 18½'	4	9 vs 9
U-11	Up to 6½' x 18½'	4	9 vs 9
U-10	Up to 6½' x 18½'	4	7 vs 7
U-9	Up to 6½' x 18½'	4	7 vs 7
U-8	Up to 4' x 6'	3	4 vs 4
U-6/U-7	Up to 4' x 6'	3	4 vs 4







**EASY TRACK™**  
Net Attachment System



Optional Wheel Kit



Optional Premium Counterweights



**NOVA™ Premiere Adjustable Goal**

Same as NOVA™ Premiere Goal (SGP-600) except with:

- > Infinitely adjustable rear crossbar allows goal to fit under any football goal post
- > No fixed settings and no fixed depth on crossbar (move a yard, a foot or inch)
- > Anchor kits are available for the football goal post
- > Bottom bar adjusts from 4' to 8' deep
- > Optional Wheel Kit (NSGWK) sold separately
- > Stainless steel hardware included
- > Nets sold separately
- > Ground anchors and counterweights sold separately
- > Dimensions: 24'W x 8'H x 4'B x 10'D

*In-ground anchors or appropriate amount of counterweight required per goal. See chart on page 26 for ASTM counterweight requirements for your specific goal.*

**SGP-600AX**

364 lbs

\$5,129 pair



**Soccer/Football Anchor Kit**

- > Fastens the soccer goal rear crossbar to a football goal gooseneck

**SFGA-6** 6<sup>5</sup>/<sub>8</sub>" OD Gooseneck  
10 lbs \$130 each **3Y** ★

**SFGA-5** 5<sup>1</sup>/<sub>16</sub>" OD Gooseneck  
10 lbs \$140 each **3Y** ★

**SFGA-4** 4<sup>1</sup>/<sub>2</sub>" OD Gooseneck  
10 lbs \$150 each **3Y** ★

**NJ State Approved Co-op #65MCESCCPS**



**NOVA™ Wheel Kit**

Attaches to any NOVA™ goal base (SGP-600 and NOVA™ club round and square)

- > (4) 10" no-flat wheels
- > Quick and easy wheel engagement
- > Kit equips 2 goals

**NSGWK** 33 lbs \$489 kit **3Y**



www.jaypro.com  
T: 800-243-0533

F: 800-988-3363





### NOVA™ World Fold-Up Goal

Features Jaypro Sports flush mount Easy Track™ net attachment system with clips.

- > NCAA, FIFA and NFHS compliant
- > Official size International style aluminum goal is powder coated
- > Field maintenance friendly with fold-up rear frame can be temporarily pinned or permanently locked in raised position
- > 4" OD extruded aluminum with a 2" x 4" base frame
- > 2 3/8" galvanized steel back posts
- > Ground sleeves for semi-permanent installation included
- > World competition hex net and stainless steel hardware included
- > Ground anchors and counterweights sold separately
- > Dimensions: 24'W x 8'H x 6'B x 6'D

**SGP-660** 534 lbs \$5,032 pair



### NOVA™ World Classic Goal

Same as NOVA™ World Fold-Up Goal (SGP-660) except without fold-up rear frame.

- > Dimensions: 24'W x 8'H x 6'B x 6'D

**SGP-550** 432 lbs \$3,599 pair



**EASY TRACK™**  
Net Attachment System

## Soccer Field Netting

### FieldPro™ Soccer Ball Stop System

Stop wasting time chasing missed shots or errant passes during practice and games. Ensure the safety of athletes, coaches and spectators.

- > Designed to fit behind soccer goals
- > (4) 4" OD heavy-walled aluminum uprights with ground sleeves and covers
- > #36 knotted black nylon net with 1 3/4" sq mesh and 1/4" rope border
- > Pulley system to raise/lower net included
- > Corrosion resistant hardware included
- > Dimensions: 20'H x 65'L (custom sizes available)

See page 125-127 for more FieldPro™ Net System options.

**FNSB-65** 250 lbs \$2,250 each

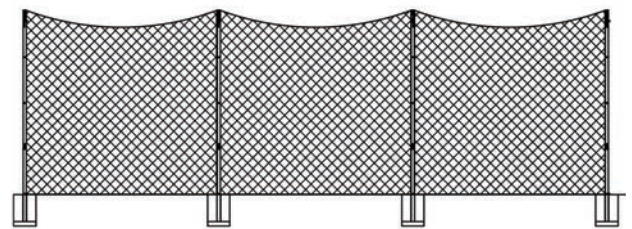

www.jaypro.com  
T: 800-243-0533 F: 800-988-3363





### Classic Official Round Goal



Features Jaypro Sports flush mount Easy Track™ net attachment system with clips.

- > NCAA, FIFA and NFHS compliant
- > Official size and powder coated
- > 4" OD extruded aluminum
- > 1.9" OD galvanized steel backstays and rear crossbar
- > Optional Classic Wheel Kit (CSGWK) sold separately
- > Net sold separately
- > Ground anchors and counterweights sold separately
- > Dimensions: 24"W x 8'H x 4"B x 10'D

*In-ground anchors or appropriate amount of counterweight required per goal. See chart on page 26 for ASTM counterweight requirements for your specific goal.*

**SGP-400** 420 lbs \$2,899 pair  
FR ● 12Y ★ X

### Classic Official Round Goal (Semi-Permanent)

Same as Classic Official Round Goal (SGP-400) except with 10' uprights for insertion into ground.

- > Dimensions: 24"W x 8'H x 4"B x 10'D

**SGP-440** Galvanized Steel Backstays  
306 lbs \$2,599 pair FR ● 12Y ★ X

**SGP-440EB** European Backstays  
306 lbs \$2,699 pair FR ● 12Y ★ X

**SGP-445G** Ground Sleeves (Set of 4)  
28 lbs \$515 set 3Y



### Classic Official Square Goal



Features Jaypro Sports flush mount Easy Track™ net attachment system with clips.

- > NCAA, FIFA and NFHS compliant
- > Official size and powder coated
- > 4" square extruded aluminum
- > 1.9" OD galvanized steel backstays and rear crossbar
- > Optional Classic Wheel Kit (CSGWK) sold separately
- > Net sold separately
- > Ground anchors and counterweights sold separately
- > Dimensions: 24"W x 8'H x 4"B x 10'D

*In-ground anchors or appropriate amount of counterweight required per goal. See chart on page 26 for ASTM counterweight requirements for your specific goal.*

**SGP-760** 416 lbs \$2,899 pair  
FR ● 12Y ★ X

### Classic Official Square Goal (Semi-Permanent)

Same as Classic Official Square Goal (SGP-760) except with 10' uprights for insertion into ground.

- > Dimensions: 24"W x 8'H x 4"B x 10'D

**SGP-730** Galvanized Steel Backstays  
241 lbs \$2,620 pair FR ● 12Y ★ X

**SGP-730EB** European Backstays  
241 lbs \$2,720 pair FR ● 12Y ★ X

**SGP-735G** Ground Sleeves (Set of 4)  
28 lbs \$536 set 3Y

### Classic Wheel Kit



Attaches to any goal base (SGP-760, SGP-400 and SGP-100). Can be used with Classic Club Goal fitted with optional rear ground crossbar.

- > (4) 10" no-flat wheels
- > Quick and easy wheel engagement
- > Kit equips 2 goals

**CSGWK** 33 lbs \$485 kit 3Y







**EASY TRACK™**  
Net Attachment System

## Team Official Square Goal

Features Jaypro Sports flush mount Easy Track™ net attachment system with clips.

- > NCAA and NFHS compliant
- > Official size and powder coated
- > 4" x 2" extruded aluminum crossbar and uprights
- > 1.9" OD galvanized steel backstays and rear crossbar
- > Backstays run back 10' for a more stable base as opposed to 8' and 9' like most goals
- > Rear crossbar and backstays improve stability and safety
- > Economical soccer goal
- > Optional Classic Wheel Kit (CSGWK) sold separately
- > Net sold separately
- > Ground anchors and counterweights sold separately
- > Dimensions: 24'W x 8'H x 4'B x 10'D

*In-ground anchors or appropriate amount of counterweight required per goal. See chart on page 26 for ASTM counterweight requirements for your specific goal.*

**SGP-110**

475 lbs

\$2,495 pair

FR 3Y



## Team Official Round Goal (Semi-Permanent)

Features Jaypro Sports flush mount Easy Track™ net attachment system with clips.

- > Designed without backstays for permanent/semi-permanent installation
- > Official size and powder coated
- > 4" x 2" extruded aluminum crossbar and uprights
- > Nets, net clips and net pegs included
- > Aluminum ground sleeves with locking caps for semi-permanent installation available
- > Dimensions: 24'W x 8'H

**EASY TRACK™**  
Net Attachment System

**SGP-220**

220 lbs

\$2,100 pair

FR 3Y

**SGP-445G**

Ground sleeves (Set of 4)

**NJ State Approved Co-op #65MCECCPS**

28 lbs

\$515 set



www.jaypro.com  
F: 800-988-3363

T: 800-243-0533



# Training Goals & Rebounders



### Stable Anchored Base

The powder coated white ground base assembly lies flat on the ground. The ground stake is inserted through the middle of the base to anchor it to the ground. The upright is placed over a sleeve on the base assembly, resulting in a stable goal with no visible anchor to cause a tripping hazard.

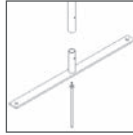

## Portable Training Goal

Ideal for European style training.

- > Lightweight and stable
- > 2" OD heavy-walled aluminum frame with stabilizing ground base plates
- > 4" sq mesh nylon net and carry bag included
- > Available in two sizes
- > Powder coated white

<b>STG-718</b>	Medium Goal - 18W' x 7½'H		<b>3Y</b>	<b>1Y</b>
44 lbs	\$605 each			
<b>STG-718N</b>	Medium Replacement Net		<b>3Y</b>	<b>1Y</b>
4 lbs	\$69 each			
<b>STG-824</b>	Large Goal - 24W' x 8'H	<b>FR</b>	<b>3Y</b>	<b>1Y</b>
62 lbs	\$675 each			
<b>STG-824N</b>	Large Replacement Net			<b>1Y</b>
5 lbs	\$99 each			



### Stable Anchored Base

The powder coated white ground base assembly lies flat on the ground. The ground stake is inserted through the middle of the base to anchor it to the ground. The upright is placed over a sleeve on the base assembly, resulting in a stable goal with no visible anchor to cause a tripping hazard.

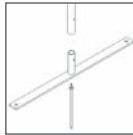

## Soccer Rebounder

- > Lightweight and stable
- > 2" OD heavy-walled aluminum frame with stabilizing ground base plates
- > Crossbar along bottom with additional ground base plate
- > 1½" sq mesh net with 1/8" cord and bungee net attachments
- > Carry bag included
- > Available in two sizes
- > Powder coated white

<b>STGRB718</b>	Medium Rebounder		<b>3Y</b>	<b>1Y</b>
48 lbs	\$715 each			
<b>RB718N</b>	Medium Rebound Net		<b>3Y</b>	<b>1Y</b>
5 lbs	\$89 each			
<b>STGRB824</b>	Large Rebounder		<b>3Y</b>	<b>1Y</b>
67 lbs	\$845 each			
<b>RB824N</b>	Large Rebound Net			<b>1Y</b>
6 lbs	\$109 each			



## Equipment Carry Bag

- Ideal for transporting and storing goals or rebounders.
- > Heavy-duty black Cordura bag with reinforced zipper
  - > Includes carry straps and handles on each end
  - > Large bag holds the Quick Set-up Goal (SEYL-824)
  - > Medium bag holds Portable Training Goal and Soccer Rebounder
  - > Small bag holds Two-For-Youth Goal (MPG-46) and miscellaneous items

<b>ECB-LG</b>	Large Bag	6 lbs	\$85 each	<b>3Y</b>
<b>ECB-MD</b>	Medium Bag	5 lbs	\$74 each	<b>3Y</b>
<b>ECB-SM</b>	Small Bag	4 lbs	\$63 each	<b>3Y</b>

NJ State Approved Co-op #65MCESCCPS



## Bungees

Replace old and worn bungees.

- > (30) 6" long bungees
- > Two bags required for Medium Soccer Rebounder (STGRB718)
- > Three bags required for the Large Soccer Rebounder (STGRB824)

<b>STGRB718B</b>	2 lbs	\$29 bag	<b>3Y</b>
------------------	-------	----------	-----------





# NOVA™ Club Goal



## NOVA™ Club Round Goal

Features Jaypro Sports flush mount Easy Track™ net attachment system with clips.

- > 2 white powder coated all aluminum portable goals
- > 3" OD extruded front frame
- > 1<sup>5</sup>/<sub>16</sub>" European and auxiliary backstays
- > 3" extruded aluminum full ground base frame
- > (2) 4" sq mesh white nets
- > Optional NOVA™ Wheel Kit (NSGWK) sold separately
- > Easy Track™ net clips and sandbags included
- > Stainless steel hardware included

***In-ground anchors or appropriate amount of counterweight required per goal. See chart on page 26 for ASTM counterweight requirements for your specific goal.***



### EASY TRACK™ Net Attachment System



### Optional Wheel Kit



### Optional Premium Counterweights



## NOVA Club Round

Item	Weight	Counter Weight	Size	Price
RCG-24S	402 lbs	150 lbs	8'H x 24'W x 4'B x 9'D	\$3,899 set
RCG-21S	358 lbs	170 lbs	7'H x 21'W x 3'B x 8'D	\$3,599 set
RCG-18S	310 lbs	240 lbs	6½'H x 18½'W x 2'B x 6'D	\$3,499 set
RCG-12S	264 lbs	240 lbs	6½'H x 12'W x 2'B x 6'D	\$3,299 set
RCG-9S	218 lbs	*	4½'H x 9'W x 2'B x 5'D	\$2,625 set
RCG-6S	198 lbs	*	4'H x 6'W x 2'B x 5'D	\$2,325 set

### Which size goal does your program need?

See chart on page 26 for recommended goal size for your age group and number of players



## NOVA™ Wheel Kit

Attaches to any NOVA™ goal base (SGP-600 and NOVA™ club round and square)

- > (4) 10" no-flat wheels
- > Quick and easy wheel engagement
- > Kit equips 2 goals

NSGWK 22 lbs  
NJ State Approved Co-op #65MCESSCPS

\$489 kit

3Y



## Classic Club Goal

Features Jaypro Sports flush mount Easy Track™ net attachment system with clips.

- > 2 powder coated and natural finish portable goals
- > 2" OD galvanized steel rear ground crossbar included on the three largest sizes offered
- > 3" OD extruded aluminum front frame with 2" OD galvanized steel backstays
- > (2) 4" sq mesh white nets
- > Optional NOVA™ Wheel Kit (CSGWK) sold separately
- > Easy Track™ net clips and sandbags included

*In-ground anchors or appropriate amount of counterweight required per goal. See chart on page 26 for ASTM counterweight requirements for your specific goal.*



### EASY TRACK™ Net Attachment System



### Optional Wheel Kit



### Optional Premium Counterweights



## Classic Club Round

Item	Weight	Counter Weight	Size	Price
CC24S	395 lbs	140 lbs	8'H x 24'W x 4'B x 9'D	\$2,398 set
CC21S	345 lbs	160 lbs	7'H x 21'W x 3'B x 8'D	\$2,298 set
CC18S	299 lbs	240 lbs	6½'H x 18½'W x 2'B x 6'D	\$2,098 set
CC12S	188 lbs	240 lbs	6½'H x 12'W x 2'B x 6'D	\$1,898 set
CC9S	157 lbs	*	4½'H x 9'W x 2'B x 5'D	\$1,498 set
CC6S	145 lbs	*	4'H x 6'W x 2'B x 5'D	\$1,398 set

**Which size goal does your program need?**

*See chart on page 26 for recommended goal size for your age group and number of players*



## Classic Wheel Kit

Attaches to any goal base (SGP-760, SGP-400 and SGP-100). Can be used with Classic Club Goal fitted with optional rear ground crossbar.

- > (4) 10" no-flat wheels
- > Quick and easy wheel engagement
- > Kit equips 2 goals

**CSGWK**

NJ State Approved Co-op #65MCESCCPS  
33 lbs \$485 kit 3Y





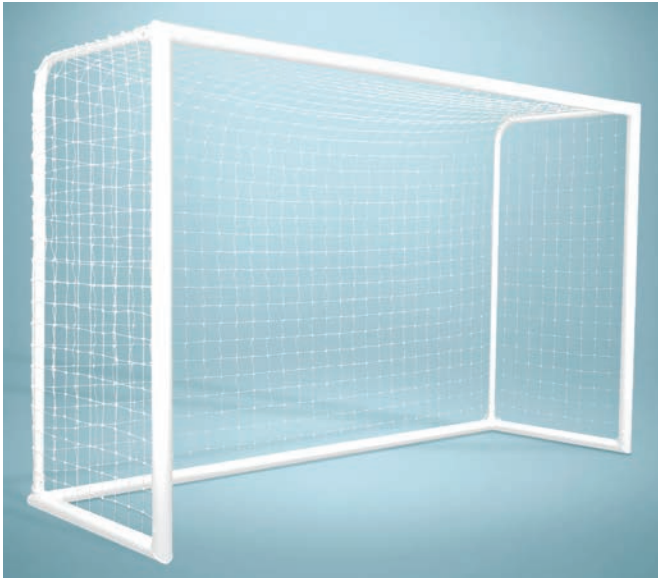

### Deluxe Official Futsal Goal

Features Jaypro Sports flush mount Easy Track™ net attachment system with clips.

- > Official size and powder coated white
- > 3" OD round aluminum goal face and base with extruded channel
- > 1¼" round heavy-walled aluminum backstays
- > Polyethylene white net with 4" sq mesh
- > Stainless steel hardware included
- > Optional NOVA™ Wheel Kit (NSGWK) sold separately
- > Dimensions: 9'10"W x 6'7"H x 3'3"D

**FSG-1** \$1,499 each **FR** **3Y** **1Y** **★** **X** **AS**



### Official Futsal Goal

Features Jaypro Sports flush mount Easy Track™ net attachment system.

- > 1 white powder coated portable goal
- > Extruded aluminum frame
- > Official size 9'10"W (3m) x 6'7"H (2m) meets specifications
- > (1) 4' sq mesh nets
- > Easy Track™ net clips and non-marring floor protectors included

**FSG-2** Goal **FR** **3Y** **★** **X** **AS**  
120 lbs \$1,249 each

**FSG67910NHP** Replacement Net 4 lbs \$85 each **1Y**

**FSGWK** Wheel Kit 20 lbs \$449 set **3Y**



### Practice Futsal Goal

- > Official size and powder coated white
- > Folds for portability and storage
- > 1.90" OD heavy-duty steel galvanized pipe goal face
- > 1½" OD steel galvanized pipe backstays
- > 4" sq mesh net held in place with Velcro straps
- > Non-marring floor protectors
- > Dimensions: 9'10"W x 6'7"H x 3'3"D

**FPG-23** \$749 each **FR** **3Y** **1Y** **★** **X** **AS**



# Indoor/Outdoor Goals

## Quick Set-Up Goal

Ideal for any league or backyard use.

- > Sets up in minutes with quick release push pins
- > 2" OD aluminum frame
- > Goal width adjusts to 8', 16' or 24' x 8'H
- > Net, 6 net pegs, indoor floor pads and carry bag included



### SEYL-824

52 lbs

Goal  
\$809 each

FR 3Y AS

### SEYL-24NHP

7 lbs

Replacement Net  
\$120 each

1Y



## Rugged Play Goal

Ideal for precision shooting drills or short-sided games.

- > Outdoor/indoor use
- > Quick release push-pins make break down easy
- > 2" OD galvanized steel frame powder coated silver
- > 2.5mm orange polyethylene net with 4" sq mesh
- > Includes rubber feet to protect gymnasium floor
- > Dimensions: 8'W x 4'H x 4'D



### SMG-8HP

45 lbs

Goal  
\$235 each

3Y AS

### SMG-8NHP

5 lb

Replacement Net  
\$42 each

1Y

## Two-For-Youth Goal

- > Two sizes in one (4'x6' or flip to 3'x6')
- > Easy quick release push-pin assembly
- > 1½" OD aluminum frame powder coated white
- > 1¾" sq black mesh net
- > Hook-and-loop attachment



### MPG-46

23 lbs

Goal  
\$249 each

3Y

### MPG-46N

2 lbs

Replacement Net  
\$40 each

1Y

NJ State Approved Co-op #MSMCE SCCPS





# Practice/Youth Goals



## Indoor/Outdoor Folding Goal

Ideal for competitive indoor play and as an outdoor training/youth goal.



- > Indoor/outdoor use
- > Versatile and durable
- > 2" OD zinc undercoated steel frame powder coated white
- > 1 5/16" OD backstays fold without removing net
- > 4" sq mesh net
- > Hook-and-loop net straps eliminate lacing
- > Non-marring floor protectors included
- > Dimensions: 12'W x 7'H x 4'D

See pages 38-39 for ground anchors for outdoor use.

### SFG-14HP

Goal 81 lbs  
\$399 each **FR** **3Y** **AS**



### SFG-14NHP

Replacement Net 3 lbs  
\$75 each **1Y**



## Floor Protector Kit

Ideal for using Portable Short-Sided Soccer Goals indoors.

- > Help protect gymnasium floor from being scratched or damaged
- > Kit includes self-threading screws with 4 rubber feet

**PSS-4FT** 2 lbs \$32 kit **3Y**



## Portable Short-Sided Soccer Goals

Ideal for 4 vs 4 play or 3 vs 3 play.

- > 1 5/16" OD galvanized steel frame powder coated white
- > All-welded side frames and rear ground crossbars for increased strength and durability
- > Snap pins lock frame in place for added safety
- > Folds for easy transport and storage
- > 2.5mm twisted net with 4" sq mesh
- > Ground anchors and net ties included
- > Optional Floor Protection Kit (PSS-4FT) sold separately to use indoors

### For 4 vs 4 Play:

**PSS-612** 12'W x 6'H x 31"D Goal  
63 lbs \$290 each **3Y** **AS**

**PSS-612N** Replacement Net  
3 lbs \$51 each **1Y**

**PSS-608** 8'W x 6'H x 31"D Goal  
60 lbs \$290 each **3Y** **AS**

**PSS-608N** Replacement Net  
2 lbs \$48 each **1Y**

**PSS-510** 10'W x 5'H x 34"D Goal  
57 lbs \$269 each **3Y** **AS**

**PSS-510N** Replacement Net  
2 lbs \$46 each **1Y**

### For 3 vs 3 Play:

**PSS-406** 6'W x 4'H x 24"D Goal  
40 lbs \$247 each **3Y** **AS**

**PSS-406N** Replacement Net  
2 lbs \$42 each **1Y**





### Soccer Pop-Up Trainers

Ideal for 3 vs 3 play in the backyard or at the beach and park.

- > Durable and safe lightweight pop-up goals
- > Fiberglass rod frame with steel spring corners and heavy-duty net
- > Equipped with anchoring pegs to ensure stability
- > Folds down to 1" flat oval
- > Available in 2 sizes
- > Zipper nylon bag with handles included

**SGPU4830R** Small Goal - 4'W x 2½'H x 2½'D (Red)  
4 lbs \$79 pair **1Y**

**SGPU7240B** Large Goal - 6'W x 3'4"H x 3'4"D (Blue)  
6 lbs \$99 pair **1Y**



### Goal Runner™

Ideal for short-sided games and developing shooting skills.

- > Indoor/outdoor use
- > 1½" OD steel frame folds flat for compact storage
- > Non-marking front wheels for easy transport
- > Durable knotless nylon net with vinyl sleeves
- > Hook-and-loop closures (no lacing required)
- > Available in 3 sizes

**STG-23** Small Goal - 3'W x 2'H  
25 lbs \$109 each **3Y AS**

**STG-23N** Replacement Net  
3 lbs \$55 each **1Y**

**STG-34** Medium Goal - 4'W x 3'H  
25 lbs \$159 each **3Y AS**

**STG-34N** Replacement Net  
4 lbs \$65 each **1Y**

**STG-46** Large Goal - 6'W x 4'H  
39 lbs \$195 each **3Y AS**

**STG-46N** Replacement Net  
3 lbs \$85 each **1Y**

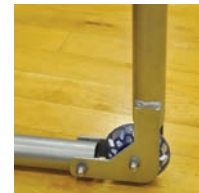
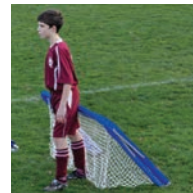

### Adjustable Soccer Rebounder

Ideal training for developing players and especially goalies.

- > 3 adjustable playback angles
- > 1¼" OD heavy-duty steel frame and support base
- > White mesh net with 1/8" cord
- > Powder coated black
- > Folds flat for easy transport and storage
- > Rebound Surface: 40"W x 40"H

NJ State Approved Co-op #65MCECCPS  
**ASR33BK** 27 lbs

\$199 each





# WORLD CUP™ ANCHOR

a **jaypro sports** product



## World Cup Anchor™

Ideal where in-ground anchoring devices are not appropriate.

- > Tank style anchor has 4¾"W x 3¼"H opening designed to fit over any round or flat rear crossbar
- > Hard plastic shell will not crack when filled in the field with 50 lbs concrete, 39 lbs sand or 24 lbs water
- > Built-in carry handle and stackable design for convenient storage
- > Bright yellow color for visibility and safety
- > Dimensions: 12"W x 8½"H

See chart on page 26 for ASTM counterweight requirements for your specific goal.

### SGA-50

Set of 4      12 lbs      \$289 set      3Y ★ X AS

### SGA-51

Single      3 lbs      \$79 each      3Y ★ X AS



## Multi-Use Soccer Cart

Ideal for transporting awkward and heavy soccer field equipment like goal anchors, corner flags and balls.

- > Heavy-duty utility cart
- > Pull by hand or tow by ATV/Utility Tractor
- > Fold-down sides for easy loading
- > (4) 13" x 5" wide pneumatic turn wheels rated to hold up to 350 lbs
- > Holds up to 16 World Cup Anchors™ (SGA-50)
- > Dimensions: 26"W x 51"L

SGA-CART      \$698 each      3Y



## Soccer Goal Roller Assembly Kit

Soccer goal counterweights and wheels for mobility combined into one unit.

- > Exceeds all ASTM F2950 tip over standards
- > Helps eliminate risk of accidental tip overs
- > Replaces ineffective J-hooks, tent stakes, augers and loose sand bags
- > Attaches securely to any rear ground bar
- > Durable polyethylene rollers are immune to weather conditions and roll easily on any surface
- > Fill in the field with sand (customer supplied)
- > Provides permanent ballast system

SSG-R2      \$796 pair      3Y ★

NJ State Approved Co-op #65MCESSCCPS





### Sandbag Anchor

Ideal where in-ground anchoring devices are not appropriate.

- > Fill sandbag in the field with 50 lbs of dry sand
- > Choose from steel carry handle or nylon strap design
- > May come in different colors - available in Team Pink

<b>SWB-451</b>	Bag w/ Steel Handle			
	3 lbs	\$63 each	3Y	★ AS
<b>SWB-454</b>	Bag w/ Steel Handle - Set of 4			
	12 lbs	\$231 set	3Y	★ AS
<b>SWB-451PK</b>	Bag w/ Steel Handle (Pink)			
	3 lbs	\$68 each	3Y	★ AS
<b>SWB-454PK</b>	Bag w/ Steel Handle (Pink) - Set of 4			
	12 lbs	\$242 set	3Y	★ AS

<b>SWB-451W</b>	Bag w/ Nylon Handle			
	2 lbs	\$46 each	3Y	★ AS
<b>SWB-454W</b>	Bag w/ Nylon Handle - Set of 4			
	8 lbs	\$161 set	3Y	★ AS
<b>SWB-451WPK</b>	Bag w/ Nylon Handle (Pink)			
	2 lbs	\$52 each	3Y	★ AS
<b>SWB-454WPK</b>	Bag w/ Nylon Handle (Pink) - Set of 4			
	8 lbs	\$172 set	3Y	★ AS

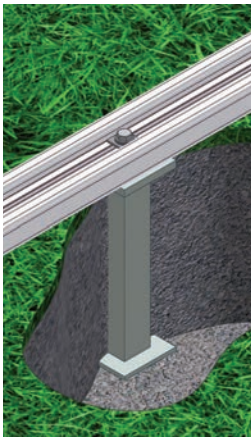

### In-Ground Anchor

Provides the surest means of anchoring soccer goals.

- > Securely anchors any portable NOVA™ goal or existing goal with minor modification
- > Will not pull out or slide off the base frame
- > Set includes 2 anchors for one goal

**SGA-60** Set of 2 13 lbs  
\$205 set **3Y**

### Counterweight Requirements

See chart on page 26 for ASTM counterweight requirements for your specific goal.



### Auger Anchor

Ideal for use in loose and sandy soil.

- > 18" steel auger with steel wire lanyard

**SAS-95** Set of 4 5 lbs  
\$70 set **3Y**



### J-Hook Stake

Ideal for use in firm and compressed soil.

- > 18" durable "J" style steel stake with steel wire lanyard

**SGA-91** Set of 4 16 lbs  
\$99 set **3Y**



### Spike Anchor

Ideal for use in firm and tightly compacted soil.

- > 18" long 3/4" galvanized steel spike with steel wire lanyard

**SS-18** Set of 4 12 lbs  
\$109 set **3Y**



### Youth Goal Anchor

- > 3/8" dia and 15 1/2" long
- > Not appropriate for official goals

**217RP** Set of 4 2 lbs  
\$50 set **3Y**







2 Tone Hexagon

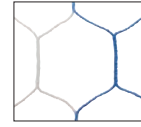

Durable Twisted & Knotted



Durable Braided & Knotted



	Item #	Size	Mesh	Twine	Color	Weight	Price
OFFICIAL	SND-8*	8' x 24' x 4' x 10'	5½" sq	4mm Braid	WHITE	25 lbs	\$249 pair
	SND-7*	8' x 24' x 4' x 10'	5½" sq	4mm Braid	ORANGE	25 lbs	\$249 pair
	SN-40B*	8' x 24' x 4' x 10'	5½" sq	4mm Braid	BLUE	25 lbs	\$306 pair
	SN-40R*	8' x 24' x 4' x 10'	5½" sq	4mm Braid	RED	25 lbs	\$306 pair
	SN-40Y*	8' x 24' x 4' x 10'	5½" sq	4mm Braid	YELLOW	25 lbs	\$306 pair
	SN-HTTP-W*	8' x 24' x 4' x 10'	5½" hex	5mm Braid	WHITE	30 lbs	\$336 pair
	SGP-550N*	8' x 24' x 6' x 6' Box	5½" hex	5mm Braid	WHITE	25 lbs	\$350 pair
	SN-6BLUW*	8' x 24' x 6' x 6' Box	5½" hex	5mm Braid	WHITE BLUE	25 lbs	\$306 pair
	SN-6GRNW*	8' x 24' x 6' x 6' Box	5½" hex	5mm Braid	WHITE GREEN	25 lbs	\$306 pair
	SN-6REDW*	8' x 24' x 6' x 6' Box	5½" hex	5mm Braid	WHITE RED	25 lbs	\$306 pair
	SN-6BLKW*	8' x 24' x 6' x 6' Box	5½" hex	5mm Braid	WHITE BLACK	25 lbs	\$306 pair
	SN-2BLUW*	8' x 24' x 4' x 10'	5½" hex	5mm Braid	WHITE BLUE	30 lbs	\$306 pair
	SN-2GRNW*	8' x 24' x 4' x 10'	5½" hex	5mm Braid	WHITE GREEN	30 lbs	\$306 pair
	SN-2REDW*	8' x 24' x 4' x 10'	5½" hex	5mm Braid	WHITE RED	30 lbs	\$306 pair
SN-2BLKW*	8' x 24' x 4' x 10'	5½" hex	5mm Braid	WHITE BLACK	30 lbs	\$306 pair	
CLUB	SEYL-24NHP*	8' x 24' x 0' x 8'	5½" sq	2.5mm Twist	ORANGE	14 lbs	\$120 pair
	SCN-24*	8' x 24' x 4' x 10'	4" sq	3mm Twist	WHITE	20 lbs	\$179 pair
	SCN-21	7' x 21' x 3' x 8'	4" sq	3mm Twist	WHITE	11 lbs	\$169 pair
	SCN-18	6½' x 18½' x 2' x 6'	4" sq	3mm Twist	WHITE	10 lbs	\$149 pair
	SCN-12	6½' x 12' x 2' x 6'	4" sq	3mm Twist	WHITE	8 lbs	\$139 pair
	SCN-9	4½' x 9' x 2' x 5'	4" sq	3mm Twist	WHITE	6 lbs	\$120 pair
	SCN-6	4½' x 6' x 2' x 5'	4" sq	3mm Twist	WHITE	6 lbs	\$110 pair
YOUTH	SFG-14NHP	7' x 12' x 1' x 4'	4" sq	2.5mm Twist	ORANGE	3 lbs	\$75 each
	SMG-8NHP	4' x 8' x 0' x 4'	4" sq	2.5mm Twist	ORANGE	5 lbs	\$42 each
	PSS-612N	6' x 12' x 0' x 31"	4" sq	2.5mm Twist	ORANGE	3 lbs	\$51 each
	PSS-608N	6' x 8' x 0' x 31"	4" sq	2.5mm Twist	ORANGE	2 lbs	\$48 each
	PSS-510N	5' x 10' x 0' x 34"	4" sq	2.5mm Twist	ORANGE	2 lbs	\$46 each
	PSS-406N	4' x 6' x 0' x 24"	4" sq	2.5mm Twist	ORANGE	2 lbs	\$42 each

\*Official Size Nets

1Y



# EASY TRACK™ a jaypro sports product



## Easy Track™ Net Clips

- > Rigid plastic clips fit securely and flush into Easy Track™ net attachment system so net won't slip
- > 100 clips in a bag (enough clips for a pair of goals)
- > Available in different colors
- > Retail packaging also available

Jaypro Sports Easy Track™ net clips are compatible with other soccer goal brands.

<b>EC-824</b>	WHITE	1 lb	\$83 bag	3Y
<b>EC-824PK</b>	PINK	1 lb	\$83 bag	3Y
<b>EC-824BK</b>	BLACK	1 lb	\$83 bag	3Y
<b>EC-824RD</b>	RED	1 lb	\$83 bag	3Y
<b>EC-824BL</b>	BLUE	1 lb	\$83 bag	3Y

### Hook-and-Loop Closure Strips 3Y

Convenient hook-and-loop closure strips secure net without lacing.



**SINT-20** Kit of 20 - Fits up to 2" OD tubing 2 lbs \$35 kit

**SINT-25** Kit of 25 - Fits up to 2" OD tubing 2 lbs \$44 kit

Kits will fit a pair of classic club goals.

**SINT-40** Kit of 40 4'6" x 6', 4'6" x 9' or 6'6" x 12' Goals 2 lbs \$47 kit

**SINT-60** Kit of 60 6'6" x 18'6", 7' x 21' or 8' x 24' Goals 2 lbs \$57 kit

### Bungees

Replace old and worn bungees.

- > (30) 6" long bungees
- > Two bags required for Medium Soccer Rebounder (STGRB718)
- > Three bags required for the Large Soccer Rebounder (STGRB824)

**STGRB718B** 2 lbs \$29 bag 3Y



### Hook-and-Loop Closure

- > Custom cut your own straps
- > Closure roll is 1½" wide x 75' long
- > Enough to fit a pair of official goals

**VNS-25**  
2 lbs \$82 each 3Y



### Net Clips

- > Exclusive design - treated steel "money clip"
- > For use with existing pre-drilled 5/16" dia holes
- > 70 clips in a kit (enough for a pair of 8' x 24' goals)
- > Plastic retainers included

**SNT-180** 2 lbs \$81 kit 3Y

Same as Net Clips (SNT-180) except with:

- > Self-drilling screws for aluminum goals
- > Space at 14"

**SNT-200** 2 lbs \$75 kit 3Y

NJ State Approved Co-op #65MCESCCPS



### Net Pegs

- > Prevent balls from passing under net

**NP-25**  
Set of 25 3 lbs \$42 set 3Y







**Disk Cone (Single)**

- > Lightweight marker for practice and drills
- > Highly visible and won't tip over
- > 2¼" tall with a 7½" dia base
- > Available in 4 colors

<b>D272BL</b>	<b>BLUE</b>	1 lb	\$.84 each	<b>3Y</b>	<b>AS</b>
<b>D272OR</b>	<b>ORANGE</b>	1 lb	\$.84 each	<b>3Y</b>	<b>AS</b>
<b>D272RD</b>	<b>RED</b>	1 lb	\$.84 each	<b>3Y</b>	<b>AS</b>
<b>D272YW</b>	<b>NEON YELLOW</b>	1 lb	\$.84 each	<b>3Y</b>	<b>AS</b>

**Disk Cone (Set)**

- > Available in quantities of 100 per set

<b>D272BL-100</b>		4 lbs	\$75 set	<b>BLUE</b>	<b>3Y</b>	<b>AS</b>
<b>D272OR-100</b>		4 lbs	\$75 set	<b>ORANGE</b>	<b>3Y</b>	<b>AS</b>
<b>D272RD-100</b>		4 lbs	\$75 set	<b>RED</b>	<b>3Y</b>	<b>AS</b>
<b>D272YW-100</b>		4 lbs	\$75 set	<b>NEON YELLOW</b>	<b>3Y</b>	<b>AS</b>



**Training Cone**

- > Solid plastic stackable cone with perimeter base
- > Bright orange for high visibility
- > Available in 2 heights

<b>D171</b>	9" Cones	1 lb	\$1.80 each	<b>3Y</b>	<b>AS</b>
<b>D175</b>	12" Cones	1.5 lbs	\$3.30 each	<b>3Y</b>	<b>AS</b>



**Disk Package**

- > Disk Cone Carrier (DCC7)
- > 30 Disk Cones (D272) of each color
- > Colors include blue, orange, red and neon yellow
- > 120 cones in package

**DCPKG** 5 lbs \$87 package **3Y** **AS**



**Disk Cone Carrier**

- > Durable white vinyl-coated 5mm steel frame
- > Holds up to 200 disk cones (not included)
- > Dimensions: 7" dia x 12"H

**DCC7**  
1 lb \$7 each **3Y** **AS**



**Field ID Marker**

- > 14" x 14" vinyl marker with corner grommets
- > Place on back of net of each goal
- > Net attachments not included
- > Specify color and numbers when ordering

**FIM-14** 1 lb \$29 each **3Y**





### Corner Flags

- > Use indoor/outdoor or on turf
- > Official 5' tall x 1" dia PVC poles
- > Set includes 4 poles, 4 flags and 4 black rubber bases

**RBF-4** 34 lbs  
\$225 set **3Y AS**



### Coaching Sticks

- > Use indoor/outdoor or on turf
- > Official 5' tall x 1" dia PVC poles
- > Each base weighs over 7 lbs
- > 6 poles and 6 black rubber bases in a set

**RBCS-6** 50 lbs  
\$269 set **3Y AS**



### Corner Flag Bag

- > Convenient storage bag carries up to 8 flags
- > Constructed of washable black vinyl
- > Includes carry handle

**CFCB** 3 lbs \$64 each **3Y**

### Replacement Flags

- > (4) 13½" x 12" red nylon flag

**RBF-FLAG** 2 lbs \$14 set **3Y**

### Deluxe Corner Flags

- > 60" tall x 3/4" thick PVC poles
- > Heavy-duty base and square red/white flag
- > 4 flags in a set

**DCF-251** 7 lbs \$89 set **3Y**

### Deluxe Training Flags

Ideal for training drills and as safety corner flags.

- > Spring loaded base
- > 4 flags in a set

**DCF-255** 7 lbs \$99 set **3Y**



### Flag Base Bag

- > Vinyl carry bag holds 4 rubber bases
- > Dimensions: 2"W x 12"D x 14"H

**RBF-BASE** 3 lbs  
\$30 each **3Y**







## NOVA™ Team Shelter

Used extensively in Europe, team shelters not only provide refuge from the elements, but the sleek look of European styling adds class to any sport facility and a boost to the morale of any program.

- > Unbreakable tinted polycarbonate
- > Heavy-duty extruded aluminum frame
- > Available in five different widths
- > 8½" pneumatic wheels only on 8', 12' and 16' widths
- > 6'10" tall x 4'8" deep base
- > Ground anchors included
- > Natural finish anodized aluminum bench
- > Add team colors to your bench at no extra cost (specify colors when ordering)
- > Call for details and pricing to add team colors or customized graphics to your shelter
- > Call for freight quote

FR 3Y

<b>DARK GREEN</b>	<b>LIGHT BLUE</b>	<b>YELLOW GOLD</b>
<b>KELLY GREEN</b>	<b>ROYAL BLUE</b>	<b>OLD GOLD</b>
<b>NAVY BLUE</b>	<b>RED</b>	<b>GRAY</b>
<b>BLACK</b>	<b>WHITE</b>	<b>MAROON</b>
<b>PURPLE</b>	<b>ORANGE</b>	

Item	Description	Persons	Price
NTS-8	8' Team Shelter with Seat	5	\$2,739 each
NTS-12	12' Team Shelter with Seat	8	\$3,599 each
NTS-16	16' Team Shelter with Seat	10	\$5,049 each
NTS-20	20' Team Shelter with Seat	13	\$6,299 each
NTS-24	24' Team Shelter with Seat	16	\$7,449 each



www.jaypro.com  
T: 800-243-0533 F: 800-988-3363



## Bleachers • Player Benches • Enclosures



See pages 134-143 for details about Jaypro Sports player and spectator seating.



### Soccer Shelter

- > Powder coated steel frame
- > Removable polyester top for quick and easy (dis)assembly
- > Wheel kit included
- > 4 auger stakes for grass or 4 sand bags (filled in the field) for turf anchoring (specify when ordering)
- > Available in 7 colors
- > See page 134-135 for optional player benches
- > Dimensions: 17'W x 6'4"H x 5'D

**SCSHLT-(X)**

\$2,995 each

FR ● 1Y ★

- SCSHLT-G
- SCSHLT-NB
- SCSHLT-B
- SCSHLT-R
- SCSHLT-BK
- SCSHLT-M
- SCSHLT-GR

GRAY
NAVY BLUE
ROYAL BLUE
RED
BLACK
MAROON
GREEN

#### Upgrade your shelter with any of the following options:

#### Shelter Wind Flap

- > Flaps add protection from wind and rain
- > 17' x 2' mesh fabric sewn into cover with wind flap added to rear of shelter

**SCSHLT-WF**

\$549 each

1Y ★

#### 2' x 2' Team Logo

- > Sewn on side panel

**SCSHLT-LOGO22**

\$125 each

1Y ★

#### 3" Team Lettering

- > Letters are sewn across front panel

**SCSHLT-LTR**

\$99 each

1Y ★

#### 4' x 4' Team Logo

- > Sewn on rear panel

**SCSHLT-LOGO44**

\$225 each

1Y ★

Vector files required for team logos. Other file formats requires an art charge. Call customer service for additional options.



### Referee/Scorekeeper Shelter

- > Powder coated steel frame
- > Removable polyester cover
- > Easy to move and assemble
- > Same lettering and logo options listed above are offered
- > Dimensions: 8½' x 6½' x 4'8"
- > Call for freight quote

**RSHLT-(X)**

\$1,849 each

FR ● 1Y ★

NJ State Approved Co-op #65MCESCCPS

- RSHLT-G
- RSHLT-NB
- RSHLT-B
- RSHLT-R
- RSHLT-BK
- RSHLT-M
- RSHLT-GR

GRAY
NAVY BLUE
ROYAL BLUE
RED
BLACK
MAROON
GREEN







## Deluxe Official Soccer/Football Goal

Ideal for multi-purpose athletic facilities.

- > NFHS compliant
- > Durable combination of official soccer and football goals
- > Designed for permanent or semi-permanent installation
- > 4" OD round extruded aluminum soccer uprights and crossbars
- > Reinforced corners for extra strength
- > 2" OD removable soccer backstays
- > 2 3/8" aluminum football uprights
- > Powder coated white
- > Nets, post padding and ground sleeves sold separately
- > Soccer Dimensions: 8' x 24' x 10' x 4'
- > Football Uprights: 10' tall

**FBSC-240** Goal w/ Standard Backstays  
500 lbs \$4,299 pair **FR** **3Y** **★** **X**

**FBSC-240EB** Goal w/ European Backstays  
470 lbs \$4,399 pair **FR** **3Y** **★** **X**



Features Jaypro Sports flush mount  
**EASY TRACK™**  
Net Attachment System

## Aluminum Ground Sleeves

- > Aluminum ground sleeves with locking caps for semi-permanent installation

**SGP-445G** Set of 4 28 lbs \$515 set **3Y**



## Official Soccer/Football Goal

Ideal for shared football and soccer fields.

- > Meets high school regulations for competition football and soccer
- > Designed for permanent or semi-permanent installation
- > Football uprights can be installed at high school (23'4") or collegiate (18'6") widths and removed for soccer play
- > 2" x 4" goal support uprights made of 14 gauge steel tubing
- > 2" square steel tube football uprights are 10' tall
- > "Money Clip" style attachments included
- > Powder coated white over a zinc rich primer
- > Nets and backstays sold separately
- > Ground sleeves (SGP-722G) optional
- > Soccer Dimensions: 8' x 24'

## Goal (without Backstays)

- > Recommended Portable Combo Goal Net (SEYL-24NHP) sold separately

**FBSC-120** 650 lbs \$3,199 pair **FR** **3Y** **★**



## Standard Backstay Kit

- > Removable soccer backstays made from 1.66" OD galvanized steel tubing
- > Recommended standard official size net (8' x 24' x 4' x 10') sold separately

**FBSC-120FBS** Set of 4 140 lbs \$695 set **FR** **3Y** **★**

## European Backstay Kit

- > Removable European backstays made from 1.66" OD galvanized steel tubing with 4' depth
- > Recommended standard official size net (8' x 24' x 4' x 10') sold separately

**FBSC-120EBS** Set of 4 45 lbs \$695 set **FR** **3Y** **★**

## Ground Sleeves

- > Optional 24" ground sleeves for semi-permanent installation
- > 4 ground sleeves and 4 locking caps included

**SGP-722G** 15 lbs \$554 set **3Y**

NJ State Approved Co-op #65MCESCCPS





### Portable Practice Football/Soccer Combo Goal (High School)

Ideal for multi-purpose or practice fields.

- > Lightweight and stable
- > 2" OD galvanized steel construction
- > Double no-flat wheels for easy transport
- > Available in two colors (specify when ordering)
- > Net and wind streamers sold separately
- > Soccer Dimensions: 8' x 24'
- > Football Crossbar: 23'4" wide

**PCG-800**

400 lbs      \$2,049 each      FR   ●   3Y   ★   ✕

**PNT-1**      White or Yellow Powder Coat      \$150 each

### Portable Combo Goal Net

- > 2.5mm orange polyethylene net with 5½" sq mesh

**SEYL-24NHP**      7 lbs      \$120 each      1Y

### Portable Practice Football Goal (High School)

- > H-frame with double no-flat wheels
- > Dimensions: 23'4"W x 20'H

**PPG-4HS**      375 lbs      \$1,825 each      FR   ●   3Y   ★   ✕

### Portable Practice Football Goal (Collegiate)

- > H-frame with double no-flat wheels
- > Dimensions: 18'6"W x 20'H

**PPG-4C**      375 lbs      \$1,825 each      FR   ●   3Y   ★   ✕



### H-Frame Football Goal Post

- > Designed for permanent installation
- > 4" OD heavy-walled aluminum tubing
- > Uprights extend 10' above crossbar
- > Powder coated white
- > Dimensions: 23'4"W x 20'H

**HFGP-3**      426 lbs      \$2,395 pair      FR   ●   3Y   ★



### Official Rugby Goal

- > Designed for permanent installation
- > Official size rugby goal measures 18'-4"W (5.6m) x 32'H (9.8m)
- > Uprights extend 22' above crossbar & made with 4" O.D. Sch 40 aluminum tubing
- > Crossbar is 4" OD 8 gauge aluminum tubing
- > Tough powder coated white finish

**RGP-3**      580 lbs      \$3,995 pair      FR   ●   3Y   ★

NJ State Approved Co-op #65MCESCCPS

### Rugby Goal Pad

- > Call Customer Service for details

**RGP-SQP**      \$635 each      FR   3Y   ★





# MAX-1™ Football Goal Post



## MAX-1™ Aluminum Football Goal Post

- > NCAA and NFHS compliant
- > All aluminum construction
- > Available in high school (23'4") and collegiate (18'6") official sizes
- > 6 5/8" OD crossbar and gooseneck available with 6' or 8' offset
- > 8' offset perfect for multi-purpose fields and can be used with a soccer goal models SGP-600AX, SGP-400, SGP-760 and CC24S
- > 4" OD uprights available in 20' or 30' heights
- > Permanent/Semi-Permanent or adjustable leveling plate installation

Call for freight quote: FBGP-530, FBGP-430, FBGP-830, FBGP-930, FBGP-530C, FBGP-430C, FBGP-830C, FBGP-930C

See page 51 for ground sleeves, access frames, hinge kits and other accessories.

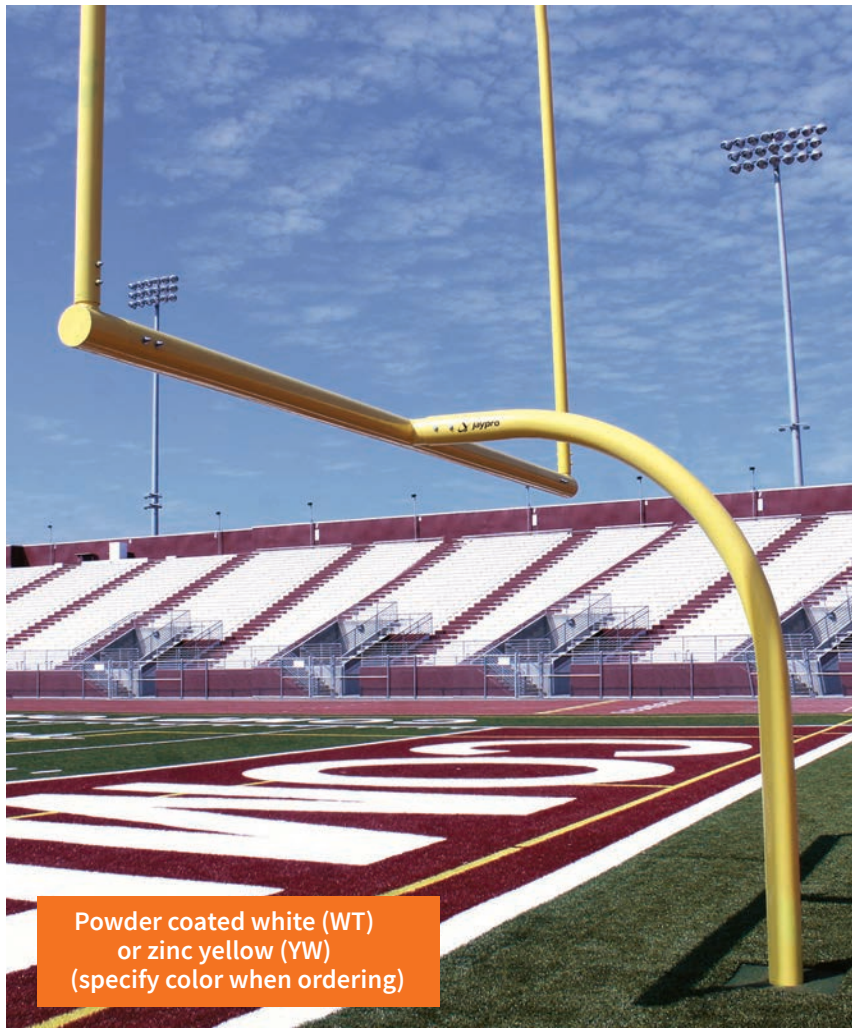

Powder coated white (WT) or zinc yellow (YW) (specify color when ordering)

## MAX-1™ Aluminum Football Goal Post

	Semi-Permanent/Permanent				Leveling Plate			
	Offset	Uprights	Weight	Item #	Price	Weight	Item #	Price
High School 23' 4" wide	6'	20'	930 lbs	FBGP-520XX	\$7,570 pair	900 lbs	FBGP-420XX	\$9,085 pair
	6'	30'	1,060 lbs	FBGP-530XX	\$7,994 pair	1,040 lbs	FBGP-430XX	\$9,388 pair
	8'	20'	940 lbs	FBGP-820XX	\$7,791 pair	920 lbs	FBGP-920XX	\$9,434 pair
Collegiate 18' 6" wide	8'	30'	1,080 lbs	FBGP-830XX	\$8,196 pair	1,060 lbs	FBGP-930XX	\$9,691 pair
	6'	20'	860 lbs	FBGP-520CXX	\$7,469 pair	840 lbs	FBGP-420CXX	\$8,895 pair
	6'	30'	1,000 lbs	FBGP-530CXX	\$7,892 pair	970 lbs	FBGP-430CXX	\$9,287 pair
	8'	20'	880 lbs	FBGP-820CXX	\$7,690 pair	860 lbs	FBGP-920CXX	\$9,287 pair
	8'	30'	1,020 lbs	FBGP-830CXX	\$8,095 pair	1,000 lbs	FBGP-930CXX	\$9,495 pair

## MAX-1™ Expandable Crossbar

- > Telescoping design adjusts crossbar width for official use at 23'4" (high school) and 18'6" (college)
- > Anti-rotation feature holds uprights in place allowing adjustment by one person

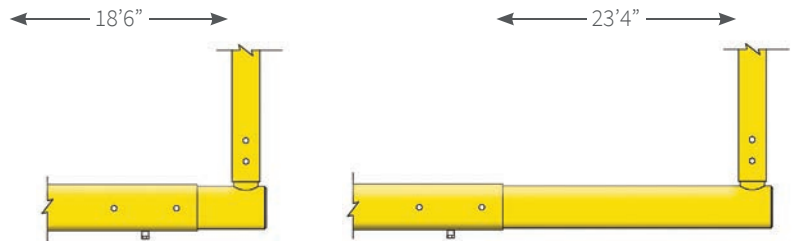

## MAX-1™ Expandable Crossbar

	Semi-Permanent/Permanent				Leveling Plate			
	Offset	Uprights	Weight	Item #	Price	Weight	Item #	Price
Expandable 18' 6" - 23' 4" wide	6'	20'	910 lbs	FBGP-520AXXX	\$8,782 pair	890 lbs	FBGP-420AXXX	\$10,095 pair
	6'	20'	930 lbs	FBGP-820AXXX	\$9,006 pair	910 lbs	FBGP-920AXXX	\$10,449 pair

NJ State Approved Co-op #65MCESSCCPS

## Steel Football Goal Post

- > NCAA and NFHS compliant
- > Zinc and powder coated steel gooseneck
- > Available as 4½" OD with 5' offset or 5⅞" OD with 6' offset
- > 2⅜" top aluminum uprights
- > Adjustable in two directions ensuring crossbar and uprights are level and plumb
- > Permanent or adjustable leveling plate installation options
- > Ground sleeves for semi-permanent installation sold separately

Call for freight quote: **FBGP-630, FBGP-635, FBGP-630YW, FBGP-635YW**

See pages 51-52 for accessories.



Adjustable in two directions

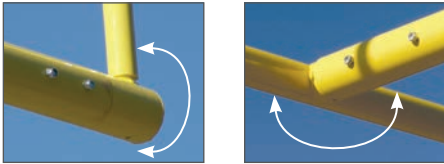

Semi-Permanent  
Permanent

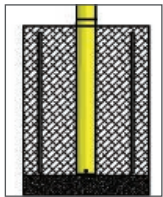

Leveling Plate

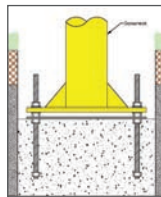

## Steel Football Goal Post

High School  
23' 4" wide

Offset	Uprights	Color	Gooseneck	Weight	Semi-Permanent/Permanent Item #	Price	Weight	Leveling Plate Item #	Price
5'	20'	Yellow	4½"	1,080 lbs	<b>FBGP-620YW</b>	\$4,349 pair	1,060 lbs	<b>FBGP-600YW</b>	\$5,361 pair
5'	20'	White	4½"	1,080 lbs	<b>FBGP-620</b>	\$4,349 pair	1,060 lbs	<b>FBGP-600</b>	\$5,361 pair
5'	30'	Yellow	4½"	1,150 lbs	<b>FBGP-630YW</b>	\$4,754 pair	1,130 lbs	<b>FBGP-635YW</b>	\$5,766 pair
5'	30'	White	4½"	1,150 lbs	<b>FBGP-630</b>	\$4,754 pair	1,130 lbs	<b>FBGP-635</b>	\$5,766 pair
6'	20'	Yellow	5⅞"	1,240 lbs	<b>FBGP-720YW</b>	\$6,374 pair	1,120 lbs	<b>FBGP-700YW</b>	\$7,082 pair
6'	20'	White	5⅞"	1,240 lbs	<b>FBGP-720</b>	\$6,374 pair	1,120 lbs	<b>FBGP-700</b>	\$7,082 pair

Collegiate  
18' 6" wide

6'	20'	Yellow	5⅞"	1,150 lbs	<b>FBGP-720XCYW</b>	\$5,766 pair	1,030 lbs	<b>FBGP-700CYW</b>	\$6,395 pair
6'	20'	White	5⅞"	1,150 lbs	<b>FBGP-720C</b>	\$5,766 pair	1,030 lbs	<b>FBGP-700C</b>	\$6,395 pair



### Ground Sleeves with Height Adjuster

- > Adjustable ground sleeves
- > Easy alignment



**FBGPGS-5** 4½" dia 250 lbs \$895 pair  
**FBGPGS-6** 5⅞" dia 275 lbs \$995 pair

NJ State Approved Co-op #65MCECCPS



### Standard Ground Sleeves

**FBSLV5** 4½" dia 200 lbs \$795 pair  
**FBSLV6** 5⅞" dia 225 lbs \$875 pair







### FieldPro™ Football Ball Stop System

Ideal for keeping field goals and extra point kicks inside the field.

- > 30' or 40' height options
- > 40' wide net easily raises and lowers with a rope and marine style swivel pulley system with integrated ball bearings
- > #36 knotted black nylon net with 3½" sq mesh and ¼" rope border
- > 6½" dia aluminum poles (powder coated black if requested)
- > Ground sleeves and hardware included

See pages 125-127 for more FieldPro™ Net System options.

<b>FNFB-30</b>	40'W x 30'H	530 lbs	\$4,295 each
<b>FNFB-40</b>	40'W x 40'H	762 lbs	\$6,695 each

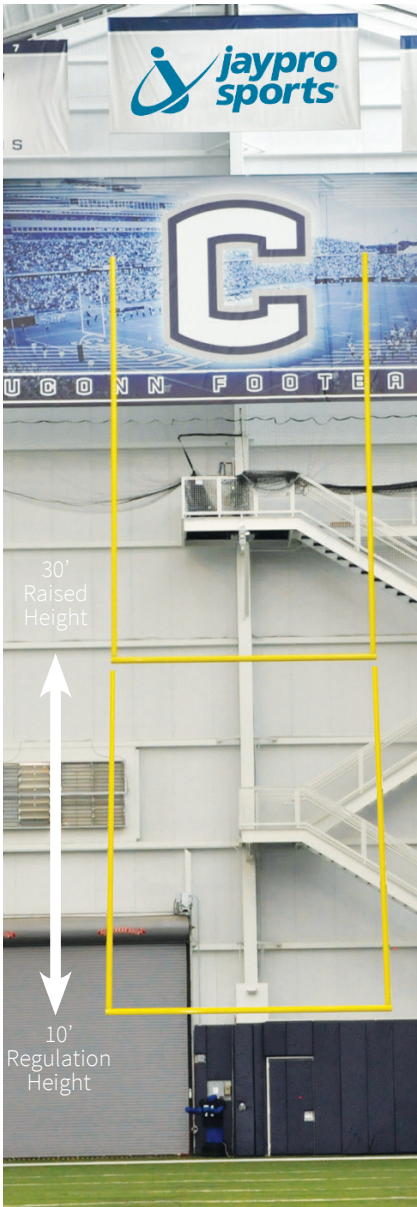
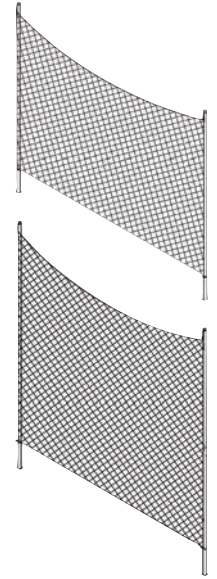

### Ceiling Suspended Football Goal Post

Ideal for indoor practice facilities.

- > Suspended directly beneath building structure
- > Attaches directly to rigid frame girders, building trusses, I-beams or roof purlins
- > 6½" OD aluminum crossbar is 18'6" wide
- > 4" OD aluminum uprights are 20' or 30' tall
- > Crossbar leveling feature included
- > All attachment and suspension hardware included
- > Available in yellow (YW) or white (WT)

<b>CSGP-1XX</b>	30' Uprights	390 lbs	Call for Pricing
<b>CSGP-3XX</b>	20' Uprights	330 lbs	Call for Pricing



### Retractable Motorized Ceiling Suspended Football Goal Post

Ideal for indoor practice facilities.

- > 1 HP electric hoist system raises goal post out of way when not in use
- > Suspended directly beneath building structure
- > Attaches directly to rigid frame girders, building trusses, I-beams or roof purlins
- > 6½" OD aluminum crossbar is 18'6" wide
- > 4" OD aluminum uprights are 20' or 30' tall
- > Crossbar leveling feature included
- > All attachment and suspension hardware included
- > Available in yellow (YW) or white (WT)

<b>CSGP-2XX</b>	30' Uprights	510 lbs	Call for Pricing
<b>CSGP-4XX</b>	20' Uprights	450 lbs	Call for Pricing

Call for Pricing



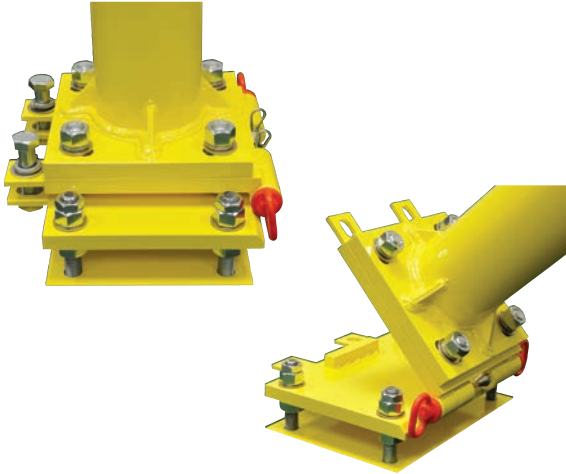

### Football Hinge Kit

Ideal for multi-purpose facilities.

- > Allows any surface-mounted MAX-1™ football goal to be lowered and dismantled from ground level by a maintenance crew
- > Opposing pull pins offer easy separation of hinge plates
- > Welded shackle bracket on the MAX-1™ football gooseneck offers attachment point for cable or hoist
- > Required access frame and cover (FBGPAF-2) sold separately

**FBHG-1** 60 lbs \$729 each **3Y** ★

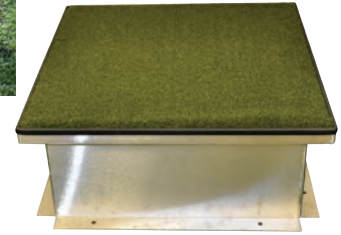

### Access Frame and Cover

- > For use with semi-permanent goals requiring removal from grass or turf fields
- > Constructed of aluminum, pressure-treated plywood and artificial turf
- > Turf cover hides anchoring hardware and allows access when required
- > 2 split panels for use with post and 2 full panels for use when post is removed
- > 2 frames and 4 turf covered plates included
- > Available in two sizes

**FBGPAF-1** 18¼"W x 18¼"L x 8"H (for use with FBSLV8)  
60 lbs \$1,299 pair **3Y** ★

**FBGPAF-2** 29"W x 29"L x 11 5/8"H (for use with FBHG-1)  
60 lbs \$1,499 pair **3Y** ★

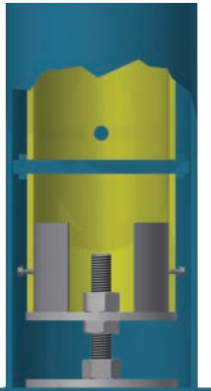

### Ground Sleeves with Height Adjuster

For MAX-1 goal posts

- > Adjustable ground sleeves
- > Easy alignment

**FBGPGS-8** 6½" dia  
300 lbs \$1,159 pair  
**FR** **3Y** ★



### Standard Ground Sleeves

For MAX-1 goal posts

**FBSLV8** 6½" dia  
250 lbs \$905 pair  
**FR** **3Y** ★



### Soccer/Football Anchor Kit

- > Fastens the soccer goal rear crossbar to a football goal gooseneck

**SFGA-6** 6½" OD Gooseneck  
10 lbs \$130 each **3Y** ★

**SFGA-5** 5½" OD Gooseneck  
10 lbs \$140 each **3Y** ★

**SFGA-4** 4½" OD Gooseneck  
10 lbs \$150 each **3Y** ★

NJ State Approved Co-op #65MCESCCPS



### Wind Streamers

- > 4"W x 42"L streamers with grommets and mounting hardware

**WS-42** 2 lbs \$27 pair **3Y** ★





# Football Post Padding



## Pro Style Protector Pad

- > Designed for different round goal post sizes
- > 6'H x 6" thick foam covered by 14 oz vinyl
- > Hook-and-loop attachment included
- > See chart for vinyl colors

<b>PPP-500</b>	FR	3Y	★
4½" OD Post	35 lbs	\$827 pair	
<b>PPP-700</b>	FR	3Y	★
5¾" OD Post	40 lbs	\$887 pair	
<b>PPP-800</b>	FR	3Y	★
6¾" OD Post	45 lbs	\$1,102 pair	

PINK
RED
YELLOW
GRAY
BLACK
MAROON
FOREST GREEN
KELLY GREEN
NAVY BLUE
ROYAL BLUE
TAN
PURPLE
ORANGE

## Economy Post Protector Pad

- > 6'H x 4" thick foam covered by 14 oz vinyl
- > Grommet attachment and cord included
- > See chart for vinyl colors

<b>PPP-5</b>	FR	3Y	★
4½" OD Post	18 lbs	\$461 pair	

## Custom Lettering

Get your school and/or team name in white lettering on your protector pad.

<b>PVL-39</b>	White Lettering	\$159 per pad
---------------	-----------------	---------------

## Custom Graphics



## Football Post Padding Customization

Get your school or team logo on your football goal post padding. Choose from basic white lettering or go full color customization.

<b>PVL-39</b>	Custom Lettering - Single Color (White)	\$159 per pad
---------------	---	---------------

<b>JSG-FPP</b>	Custom Artwork - Multi-Color	NJ State Approved Corp #65MCESCCPS Call for Network Approval & Pricing
----------------	------------------------------	---





## Portable Press Box

Ideal for coaching, filming, and press media.

- > All aluminum construction
- > Weather-resistant canvas top
- > Bench moves forward and backward
- > 16" pneumatic wheels (2 lockable and 2 swivel)
- > Canvas enclosure for inclement weather and tow kit sold separately
- > See chart for canvas colors (specify when ordering)
- > 5'9" platform height
- > 4' x 10'6" platform area
- > Overall Dimensions: 7' x 10'6"
- > Call for freight quote

**PPB-5** Portable Press Box  
1,380 lbs \$13,995 each **FR** **3Y** ★

**PPB-SC** Removable Side Curtains/Enclosure  
50 lbs \$1,395 each **3Y** ★

**PPB-TOW** Tow Bar/Kit  
50 lbs \$435 each **3Y** ★

LIGHT BLUE	YELLOW GOLD	BLACK
ROYAL BLUE	TAN	NAVY BLUE
RED	GRAY	KELLY GREEN
WHITE	MAROON	DARK GREEN
ORANGE	PURPLE	



## Crushable Sideline Markers

- > Self-standing with weighted bottom
- > 12" tall numerals on both sides
- > Heavy-duty cover
- > Stores flat
- > Call for freight quote

**FBWSM** 11 Piece Set 32 lbs \$299 set **1Y**

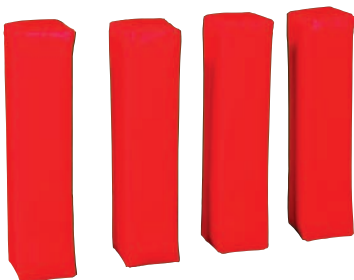

## Free Standing Pylons

- > Self-standing end zone pylon with weighted bottom
- > Anchorless
- > Dimensions: 4"W x 4"L x 18"H
- > Call for freight quote

**FBPYLN** 4 Piece Set  
12 lbs \$44 set **1Y**  
NJ State Approved Group #65MCESCCPS



## Chain Set

- > Completely padded bright orange targets
- > Plated chain and swivel hooks eliminate kinks and knots
- > Available in 2 sizes
- > Call for freight quote

**FCS-8** 8' Height  
19 lbs \$345 set **1Y**

**FCS-7** 7' Height  
15 lbs \$229 set **1Y**



## Flip Down Indicator

- > Completely padded
- > Durable numbers
- > Call for freight quote

**FFD-10**  
12 lbs \$246 each **1Y**





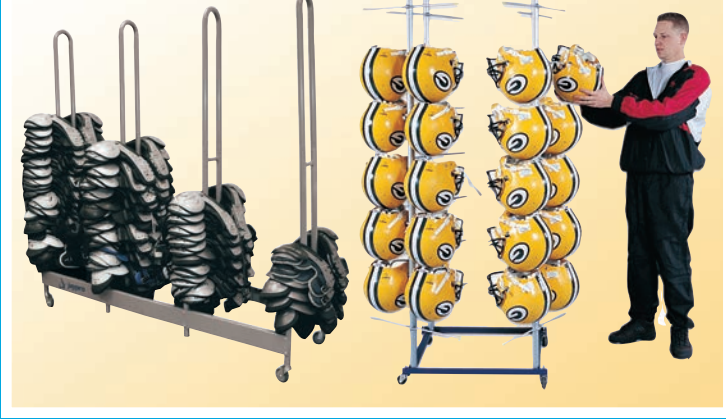

## Football Equipment Storage Rack Package

- > 1 StackMaster™ Shoulder Pad Rack (SP4)
- > 1 StackMaster™ Helmet Rack (H-1)

**FRP-2** 128 lbs \$472 package



## Football Storage Equipment

# STACKMASTER™ a jaypro sports product



### Stackmaster™ Shoulder Pad Rack

- > Transport and store up to 42 shoulder pads
- > 1 5/16" OD steel frame
- > Heavy-duty non-marking swivel wheels
- > Dimensions: 2'W x 6'6"H

**SP-2** 37 lbs  
\$225 each 3Y

### Stackmaster™ Deluxe Shoulder Pad Rack



- > Transport and store 60-80 shoulder pads
- > All steel frame with removable transport handle
- > Heavy-duty non-marking swivel wheels
- > Dimensions: 24"W x 60"L x 70"H

**SP4** 78 lbs  
\$299 each 3Y



### Stackmaster™ Helmet Rack

- > Transport and store up to 56 helmets
- > All-welded steel base
- > Heavy-duty non-marking swivel wheels
- > Dimensions: 2'6"W x 6'3"H

**H-1** 71 lbs  
\$245 each 3Y

### Stackmaster™ Deluxe Helmet Rack



- > Transport and store up to 60 helmets with masks
- > Can also be used for lacrosse and baseball batting helmets
- > 1" OD chrome steel tubing
- > Heavy-duty non-marking swivel wheels
- > Fits through a standard doorway
- > Dimensions: 24"W x 61"L x 64"H

**FHC-1** 115 lbs  
\$279 each 3Y

NJ State Approved Co-op #65MCESCPS



www.jaypro.com  
T: 800-243-0533 F: 800-988-3363



## Lowdown Linemen Chute

Ideal for training linemen and backers to stay low and to run blocking schemes and trap drills.

- > Heavy-walled steel upper frame reinforced for stability
- > Lightweight aluminum lower frame is chain suspended and fully padded
- > Easily adjust height from 42" to 66" with telescoping legs and angle position with support chains
- > Lightweight black weather-resistant mesh fabric screen won't scratch player helmets
- > 12" heavy-duty pneumatic swivel wheels
- > Open access from all sides
- > Available in 2 sizes

<b>FBLC-20</b>	6'W x 20'L	450 lbs	\$2,997 each	FR		3Y	★	X
<b>FBLC-30</b>	6'W x 30'L	500 lbs	\$3,797 each	FR		3Y	★	X



## Linemen Chute

Ideal as an instruction tool to teach the basics of coming off the ball low and drive upward.

- > Adjustable entrance with three height positions
- > 1 5/8" heavy-duty steel tube frame with pin stop adjustment
- > Chutes can be attached to each other to replicate entire line
- > Dimensions: 5'W x 4'L x 40"-50"H

<b>FBLMCH</b>	47 lbs	\$179 each		3Y
---------------	--------	------------	--	----



## Professional Portable Kicking Cage

Ideal for warm-up exercises.

- > 1 5/16" heavy-duty galvanized steel frame
- > Durable knotless nylon kicking net helps contain balls
- > Folds down for convenient storage
- > Black Cordura carry bag included
- > Dimensions: 48"W x 86"H x 48"D

<b>PKC-1</b>	39 lbs	\$489 each		3Y
--------------	--------	------------	--	----

## Replacement Net

<b>PKC-1N</b>	5 lbs	\$135 each		1Y
---------------	-------	------------	--	----

NJ State Approved Co-op #65MCESSCCPS



## Portable Kicking Cage

- > 1 5/8" powder coated frame with 26 lb weighted base
- > Heavy-duty slip-on nylon net included
- > Easy assembly without tools
- > Dimensions: 4'W x 6'6"H

<b>PK-64</b>	35 lbs	\$175 each		3Y
--------------	--------	------------	--	----







## Football Training Package

- > Linemen Chute (FBLMCH)
- > High Stepper Agility Trainer (FBHSTP)
- > Portable Kicking Cage (PK-64)

**FBTP-3** 123 lbs \$497 package  3Y



### Round Stand-Up Blocking Dummy

- > Self-standing with dense foam core
- > Double reinforced 18 oz coated vinyl cover with double web belt handles for sure grip
- > Replaceable lace bottom for extended life
- > Available in 3 sizes
- > See chart for vinyl colors (specify when ordering)
- > Call for freight quote

<b>FBSUD38</b>	14" dia x 38"H	13 lbs	\$125 each	
<b>FBSUD42</b>	14" dia x 42"H	16 lbs	\$135 each	
<b>FBSUD48</b>	13" dia x 48"H	18 lbs	\$145 each	

### Curved Pro Body Shield

- > Pre-curved 4" thick dense foam core
- > Double reinforced coated vinyl cover with web handles
- > See chart for vinyl colors (specify when ordering)
- > Call for freight quote

<b>FBPRCRV</b>	24" x 16" x 4"	4 lbs	\$74 each	
----------------	----------------	-------	-----------	--

### Step Over Agility Dummy

- > Dense foam core
- > Double reinforced 18 oz coated vinyl cover
- > Back side handles for stand up practice
- > Available in 2 sizes
- > See chart for vinyl colors (specify when ordering)
- > Call for freight quote

<b>FBST8</b>	48" x 8" x 17"	11 lbs	\$159 each	
<b>FBST12</b>	48" x 12" x 17"	13 lbs	\$199 each	

	<b>GOLD</b>		<b>KELLY GREEN</b>		<b>ROYAL BLUE</b>
	<b>BLACK</b>		<b>MAROON</b>		<b>NAVY BLUE</b>
	<b>RED</b>		<b>ORANGE</b>		<b>PURPLE</b>
	<b>FOREST GREEN</b>		<b>GRAY</b>		



### High Stepper Agility Trainer

- Ideal for building foot speed and agility.
- > Steel tube frame with suspended rope running a 16 square grid
  - > 5 adjustable heights to increase leg lift
  - > Frame located outside of running grid area for safety
  - > Quick and easy assembly
  - > Dimensions: 6'W x 20'L

<b>FBHSTP</b>	45 lbs	\$249 each	
---------------	--------	------------	--



Shown with cone pad

### SackBack Tackle Sled

- > Durable round steel frame
- > 100 lb impact-resistant foam with 18 oz vinyl cover
- > Round, cone and attack style pads available (specify when ordering)
- > See chart for vinyl colors (specify when ordering)
- > Call for freight quote

<b>TKSLDV</b>	Varsity	225 lbs	\$1,075 each		
<b>TKSLDP</b>	Pro	295 lbs	\$1,259 each		



### Snap Attack Football Machine

*Maximize time on the most difficult to practice phases of the game. See page 83 for details about this product.*

<b>SAFM-1</b>	165 lbs	\$3,999 each		
---------------	---------	--------------	--	--



## Official Field Hockey Package

- > 1 Pair Official Field Hockey Goals (OFHG7124)
- > 1 Pair Official Field Hockey Nets (FHND-8)
- > 1 Wheel Kit (FHGWK)

### OFHG7124PKG

602 lbs \$2,999 package

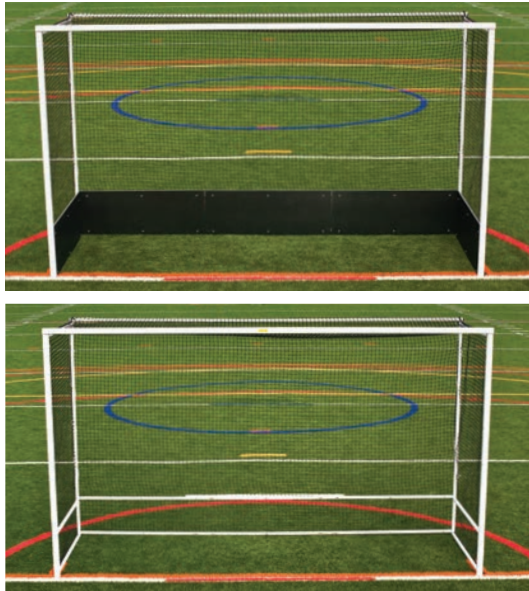

## Official Field Hockey Goal

- > Meets official NCAA, NFHS and FIH specifications
- > Heavy-duty 2" square steel goal face
- > 1 5/16" OD galvanized steel rear frame
- > All welded side frames and top rear crossbar for maximum stability
- > Available with or without official 1/2" thick high density polyethylene black bottom boards that never fade or break
- > Unique "money clip" style net clips (SNT-180) simplify net attachment
- > Nets (FHND-8) sold separately
- > Optional wheel kit (FHGWK) sold separately
- > Dimensions: 12'W x 7'H x 4'D

### OFHG7124

with Bottom Boards 534 lbs \$2,599 pair



### OFHGNBB

without Bottom Boards 370 lbs \$1,499 pair



## Official Bottom Boards

- > Fits most field hockey goals
- > 1/2" thick high density polyethylene
- > Never fade or break
- > Hardware included

### FHG-16

140 lbs \$1,128 pair



## Wheel Kit

Optional "tip & roll" wheel kit makes goals easy to transport.

- > 4 heavy-duty 10" no flat wheels
- > Set modifies 1 pair of goals

### FHGWK

49 lbs \$475 set

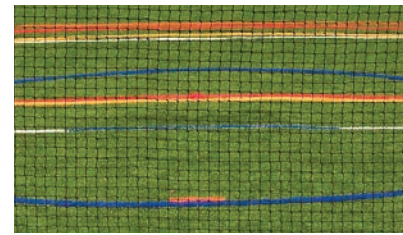

## Official Field Hockey Net

- > Weatherproof 1 3/4" sq mesh
- > 2.5mm polyethylene material
- > Dimensions: 12'W x 7'H x 4'D

### FHND-8

19 lbs \$199 pair

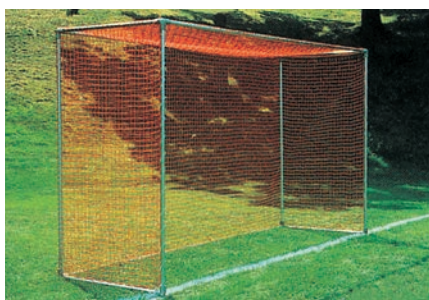

## Practice Field Hockey Goal

- > Official size
- > 1 5/16" OD galvanized steel frame
- > Cast aluminum corner fittings for easy assembly
- > Net (black) included
- > Dimensions: 12'W x 7'H x 4'D

### PFHG-41

63 lbs NJ State Approved Co-op #65MCESCCPS

\$525 each





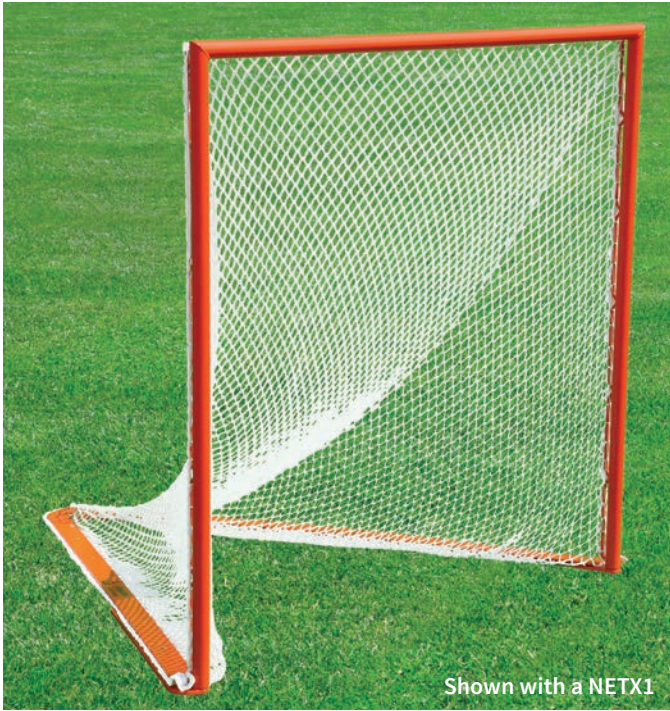

Shown with a NETX1

### Deluxe Field Lacrosse Goal

Designed for professional or collegiate play.

- > Official 6' x 6' size
- > All welded front face attached to a heavy weighted backstay
- > 2" OD thick-walled steel frame
- > 4"W x 3/8"H base plate
- > Net attaches to goal face via 3/8" net rail and is anchored securely along the bottom with an innovative flat cover plate
- > Flat cover plate can display logos and sponsors
- > Nets (NETX1, LGN-50, LGN-30, LGN-25) sold separately
- > Dimensions: 6'W x 6'H x 7'D

#### LG-1X

180 lbs

\$1,699 pair



Display logos and sponsors on flat cover plate



### Lacrosse Goal Transport Cart

Moving lacrosse goals in the field is made easy with this transport cart.

- > Hold-down straps secure goal to cart
- > Vinyl coated handle and rubber base pads protect lacrosse goal finish
- > 3" x 1/4" angle heavy-duty steel base construction
- > 1.315" heavy-walled steel pipe handle
- > 10" no-flat tires
- > Powder coated black
- > Adjustable cart fits multiple sized goals up to 6'8" wide

#### LG-HT

62 lbs

\$449 each



### Box Lacrosse Goal Package



- > 2 Box Lacrosse Goals
- > 2 Box Lacrosse Nets

#### LG-44BPKG

98 lbs

\$568 package



### Official Lacrosse Goal Package

- > 2 Official Lacrosse Goals
- > 2 Competition Lacrosse Nets

#### LG-50PKG

190 lbs

\$869 package







### Official Box Lacrosse Goal

Ideal for 6 vs 6 play.

- > Official 4' x 4' size
- > Indoor and youth use
- > Rust-proof zinc coated steel
- > 2" OD steel frame with mitered and welded corners
- > Net attaches to goal face/bottom via 1/4" steel net rail
- > 3mm knotless polyester net with 1 1/2" sq mesh and lacing cord included
- > Dimensions: 4'W x 4'H x 4'D

**LG-44B** Goal & Net 49 lbs \$299 each

### Replacement Nets (4'W x 4'H x 4'D)

**LGN-44** 4mm knotless polyester 1 1/2" sq mesh White 6 lbs \$79 each

**LGN-44X** 6mm knotless polyester 1 1/2" sq mesh White 7 lbs \$95 each



Shown with a NETX1

### NLL Box Lacrosse Goal

Ideal for professional box lacrosse leagues.

- > Official goal of the National Lacrosse League
- > 2" OD thick-walled steel frame
- > 4"W x 3/8"H base plate
- > All welded front face attached to a heavy weighted backstay
- > Net attaches to goal face via 3/8" net rail and is anchored securely along the bottom with an innovative flat cover plate
- > Flat cover plate can display logos and sponsors
- > Net (NETX1) sold separately
- > Dimensions: 4'9"W x 4'H x 4'D

**NLL-PX1** Goal 150 lbs \$819 each

## Official Lacrosse Goals



### Official Lacrosse Goal

Ideal for men's and women's lacrosse leagues.

- > Official 6' x 6' size
- > Meets NCAA and NFHS requirements for men's lacrosse
- > Rust-proof zinc coated steel pipe
- > 2" OD steel pipe frame for full NCAA compliance
- > Mitered and welded corners
- > Net attaches to goal face/bottom via 1/4" net rail for a professional appearance
- > Rear brace sits flat on the ground to eliminate ball obstruction
- > Nets (LGN-50, LGN-30, LGN-25) sold separately
- > Dimensions: 6'W x 6'H x 7'D

**LG-50** 170 lbs \$649 pair

**LG-50HP** 85 lbs \$399 each



### Practice Lacrosse Goal

Ideal for home or practice fields.

- > Official 6' x 6' size
- > 1 3/4" OD steel frame
- > 3.5mm net included
- > Net pocket slides under backstay for secure fit
- > Dimensions: 6'W x 6'H x 7'D

**LG-540** 38 lbs \$199 each





# NETX1™ a **jaypro sports** product



“Body fit” rope allows for adjustment of the net body



Without “body fit” rope



With “body fit” rope



One piece design

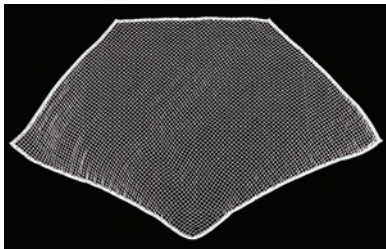

True 7mm thickness



Robust and long lasting

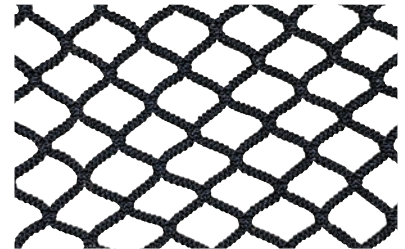

## NETX1™ - Seamless One Piece Lacrosse Net

The NETX1™ lacrosse nets are the most robust and long-lasting lacrosse nets money can buy. The one-piece design eliminates the most common points of failure on traditional lacrosse nets: the diagonal seams, while providing a modern aesthetic that truly sets it apart. The UV/weather stabilized “double-needle” nylon twine has a true 7mm thickness (measured across the depth and width of the twine), with a minimum breaking strength of 770 lbs. The combination of the high strength twine and lack of diagonal seams means the net mesh will outlast every other net on the market, which means you will spend less time repairing your nets throughout the season and spare your fingers the agony of replacing your nets every few months. The included “body fit” ropes allow you to adjust the fit of the net body on your goals for a custom look while maintaining the slack in the net so that balls remain inside the goal without trampolining back out.

- > Meets NCAA and NFHS regulations
- > One-piece design eliminates the diagonal seams, the most common points of failure on lax nets
- > Weather-stabilized 7mm x 1½”square knotless nylon with a breaking strength of 770 lbs
- > 7mm “double-needle” twine actually measures 7mm across depth and width of twine
- > Included “body fit” ropes allow for adjustment of the fit of the net body without affecting net tension

<b>NETX1-G160</b>	Field Lacrosse: 6’W x 6’H x 7’D	Black	17 lbs	\$175 each	1Y
<b>NETX1-G260</b>	Field Lacrosse: 6’W x 6’H x 7’D	White	17 lbs	\$175 each	1Y
<b>NETX1-F160</b>	Box Lacrosse: Fits 4’to 4’9”W x 4’H x 4’to 4’6”D	Black	10 lbs	\$125 each	1Y
<b>NETX1-F260</b>	Box Lacrosse: Fits 4’to 4’9”W x 4’H x 4’to 4’6”D	White	10 lbs	\$125 each	1Y

NJ State Approved Co-op #65MCESCCPS



# Lacrosse Nets & Accessories



## Competition Lacrosse Net

- > Meets NCAA and NFHS regulations
- > 6mm knotless net with 1½" sq mesh
- > Weatherproof white polyester with natural UV stabilizer
- > Triple stitched webbing binder
- > Lacing cord included
- > Dimensions: 6'W x 6'H x 7'D

**LGN-50** 15 lbs \$125 each **1Y**



## Official Lacrosse Net

- > Meets NCAA and NFHS regulations
- > 4mm knotless net with 1½" sq mesh
- > Weatherproof white polyester with natural UV stabilizer
- > Triple stitched webbing binder
- > Lacing cord included
- > Dimensions: 6'W x 6'H x 7'D

**LGN-30** 13 lbs \$109 each **1Y**



## Practice Lacrosse Net

- > Official size
- > 3.5mm knotless net with 1½" sq mesh
- > Lacing cord included
- > Replacement net for LG-540 or tubular style goals without net rail
- > Dimensions: 6'W x 6'H x 7'D

**LGN-25** 6 lbs \$79 each **1Y**



## Lacrosse Rebounder

Ideal for working on shots and passes.

- > Durable steel tube frame
- > Easily adjust angle of target
- > Target Area: 3'W x 4'H
- > Dimensions: 4'W x 8'H

**LAX-RBD**  
65 lbs \$199 each **3Y**



## Lacrosse Training Net

Ideal for improving shooting accuracy.

- > Fits any 6' x 6' goal
- > Attaches to goal face
- > Carry bag included

**LAX-TN** 5 lbs \$71 each **1Y**



## Field ID Markers

- > Vinyl markers available in many colors
- > Corner grommets allow for attachment to back of goal net
- > Net attachments not included
- > Specify vinyl color and numbers needed when ordering
- > Dimensions: 14"W x 14"H

**FIM-14** 1 lb \$29 each **1Y**

## FieldPro™ Multi-Sport Net System

Stop wasting time chasing missed shots or errant passes during practice and games. Ensure the safety of athletes, coaches and spectators. This ball stop net system is ideal for lacrosse and other field sports.

*See page 125 for details about this product.*

**FNMB-65**  
\$2,350 each

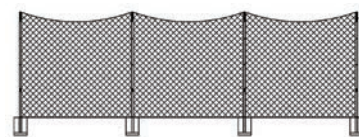

NJ State Approved Co-op #65MCECCPS

**FR** **3Y** **1Y** **★**





# Batting Cages

Item # ESCM-21131  
Athletic Equipment and Supplies

The Educational Services Commission of New Jersey

Bid term: 6/1/18 - 6/1/20, Extended to 6/6/21



Shown with optional ricochet padding upgrade kit

## Big League Portable Batting Cage

- > 2" heavy-duty Schedule 40 aluminum tube construction
- > #42 black climatized nylon net with rear net baffle
- > 4' x 6' x 4" thick thud pad, vinyl skirt and standard black ricochet padding on all overhead framing
- > Dual coach stands with leaning bar also serves as a convenient strut holder
- > Oversized 18" dia x 8"W pneumatic side wheels
- > Rear wheel handle can be lifted or lowered to move cage
- > Optional Tow Hitch (BL-TOWKIT) sold separately
- > Open Inside Dimensions: 18'W x 12'H x 22'D
- > Folded Outer Dimensions: 20'W x 6'H x 15'D

<b>BGLC-7500RB</b>	<b>ROYAL BLUE</b>	600 lbs
<b>BGLC-7500BK</b>	<b>BLACK</b>	
<b>BGLC-7500RD</b>	<b>RED</b>	FR 5Y 1Y
<b>BGLC-7500GR</b>	<b>GREEN</b>	X ★
<b>BGLC-7500NB</b>	<b>NAVY BLUE</b>	\$4,997 each

## Replacement Net

**BLN-3** \$829 each 1Y

Oversized Pneumatic Wheels



Rear Wheel Handle



NJ State Approved Co-op #65MCECCPS

## Vinyl Skirt

- > Royal Blue (RB), Black (BK), Red (RD), Green (GR), Navy Blue (NB)

**SKT-75XX** 30 lbs \$392 each 3Y

See page 80 for details on our batting cage canopy

## Replacement Thud Pad

- > Royal Blue (RB), Black (BK), Red (RD), Green (GR), Navy Blue (NB)

**THUD-46XX** 20 lbs \$360 each 3Y

## Ricochet Padding Upgrade Kit

Ideal for upgrading batting cages with durable vinyl covers.

- > Wraps around ricochet foam padding
- > Hook-and-loop attachment
- > Kit contains (21) 6 foot lengths
- > Royal Blue (RB), Black (BK), Red (RD), Green (GR), Navy Blue (NB)

**RPAD-UKITXX** 10 lbs \$321 kit 3Y

## Tow Hitch Conversion Kit

Ideal for towing batting cages with any utility vehicle.

**BL-TOWKIT** \$250 each 3Y

Optional Tow Hitch Conversion Kit

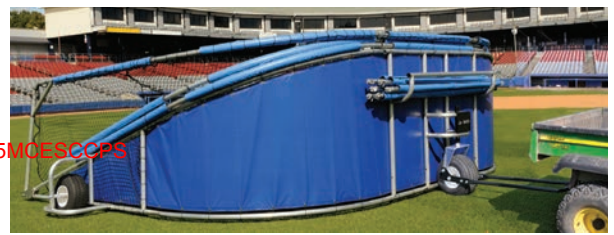





Shown with optional ricochet padding upgrade kit

## Big League Portable Batting Cage

- > 2" heavy-duty Schedule 40 aluminum tube construction
- > #42 black climatized nylon net with rear net baffle
- > 4' x 6' x 4" thick thud pad, vinyl skirt and standard black ricochet padding on all overhead framing
- > Dual coach stands with leaning bar also serves as a convenient strut holder
- > Oversized 18" dia x 8"W pneumatic side wheels
- > Rear wheel handle can be lifted or lowered to move cage
- > Optional Tow Hitch (BL-TOWKIT) sold separately
- > Open Inside Dimensions: 18'W x 12'H x 22'D
- > Folded Outer Dimensions: 20'W x 6'H x 15'D

<b>BGLC-7500RB</b>	<b>ROYAL BLUE</b>	600 lbs
<b>BGLC-7500BK</b>	<b>BLACK</b>	
<b>BGLC-7500RD</b>	<b>RED</b>	FR 5Y 1Y
<b>BGLC-7500GR</b>	<b>GREEN</b>	X ★
<b>BGLC-7500NB</b>	<b>NAVY BLUE</b>	\$4,997 each

## Replacement Net

**BLN-3** \$829 each 1Y

Oversized Pneumatic Wheels



Rear Wheel Handle



## Vinyl Skirt

- > Royal Blue (RB), Black (BK), Red (RD), Green (GR), Navy Blue (NB)

**SKT-75XX** 30 lbs \$392 each 3Y

See page 80 for details on our batting cage canopy

## Replacement Thud Pad

- > Royal Blue (RB), Black (BK), Red (RD), Green (GR), Navy Blue (NB)

**THUD-46XX** 20 lbs \$360 each 3Y

## Ricochet Padding Upgrade Kit

Ideal for upgrading batting cages with durable vinyl covers.

- > Wraps around ricochet foam padding
- > Hook-and-loop attachment
- > Kit contains (21) 6 foot lengths
- > Royal Blue (RB), Black (BK), Red (RD), Green (GR), Navy Blue (NB)

**RPAD-UKITXX** 10 lbs \$321 kit 3Y

## Tow Hitch Conversion Kit

Ideal for towing batting cages with any utility vehicle.

**BL-TOWKIT** \$250 each 3Y

Optional Tow Hitch Conversion Kit



NJ State Approved Co-op #65MCE36CPS







Shown with optional skirt graphics and additional ricochet padding

### Grand Slam Portable Batting Cage

Ideal for spring training camps and designed for semi-professional and collegiate use.



- > 2" heavy-walled aluminum tube construction
- > #42 black climatized nylon net with rear net baffle
- > 60' of ricochet cushion reduces rebound and frame damage
- > Rear safety railing for safe viewing by coaches
- > Frame features handy strut holders
- > Folds down to 5' tall for easy storage
- > Heavy vinyl coated nylon skirt protects frame
- > (3) 16" pneumatic turf wheels
- > Optional Coach Stand (CVS-10) sold separately
- > Call for price quote to add graphics on skirt
- > Open Inside Dimensions: 18'W x 12'H x 22'D
- > Folded Outer Dimensions: 20'W x 6'H x 15'D

<b>BBGS-18</b>	<b>GREEN</b>	500 lbs
<b>BBGS-18RB</b>	<b>ROYAL BLUE</b>	
<b>BBGS-18RD</b>	<b>RED</b>	<b>FR 5Y 1Y ★</b>
<b>BBGS-18NB</b>	<b>NAVY BLUE</b>	
<b>BBGS-18BK</b>	<b>BLACK</b>	\$4,479 each

### Skirt Graphics

Get your team name/logo on a vinyl sticker for your cage skirt.

<b>SKT-LOGO</b>	Up to 8'W multi color	\$299 each	<b>1Y</b>
-----------------	-----------------------	------------	-----------

Collapses Easily



Strut Storage



NJ State Approved Co-op #65MCECCPS

### Vinyl Skirt

> Green (GR), Red (RD), Royal Blue (RB), Navy Blue (NB), Black (BK)

<b>SKT-75XX</b>	30 lbs	\$392 each	<b>3Y</b>
-----------------	--------	------------	-----------

### Replacement Net

<b>BLN-3</b>	18' x 22' x 12'	75 lbs	\$829 each	<b>1Y</b>
<b>GSN-1</b>	17'6" x 18' x 12'	65 lbs	\$829 each	<b>1Y</b>

### Viewing Stand

Ideal for coaches to view batting practice from a convenient adjustable stand attached to the rear of the batting cage.

<b>CVS-10</b>	24 lbs	\$499 each	<b>3Y</b>
---------------	--------	------------	-----------

### Ricochet Cushion

<b>BPD-6</b>	6' lengths	2 lbs	\$31 each	<b>3Y</b>
--------------	------------	-------	-----------	-----------

### Weather Resistant Tape

<b>PDT-3</b>	60 yd rolls	2 lbs	\$64 each	<b>3Y</b>
--------------	-------------	-------	-----------	-----------

Folds to a compact size





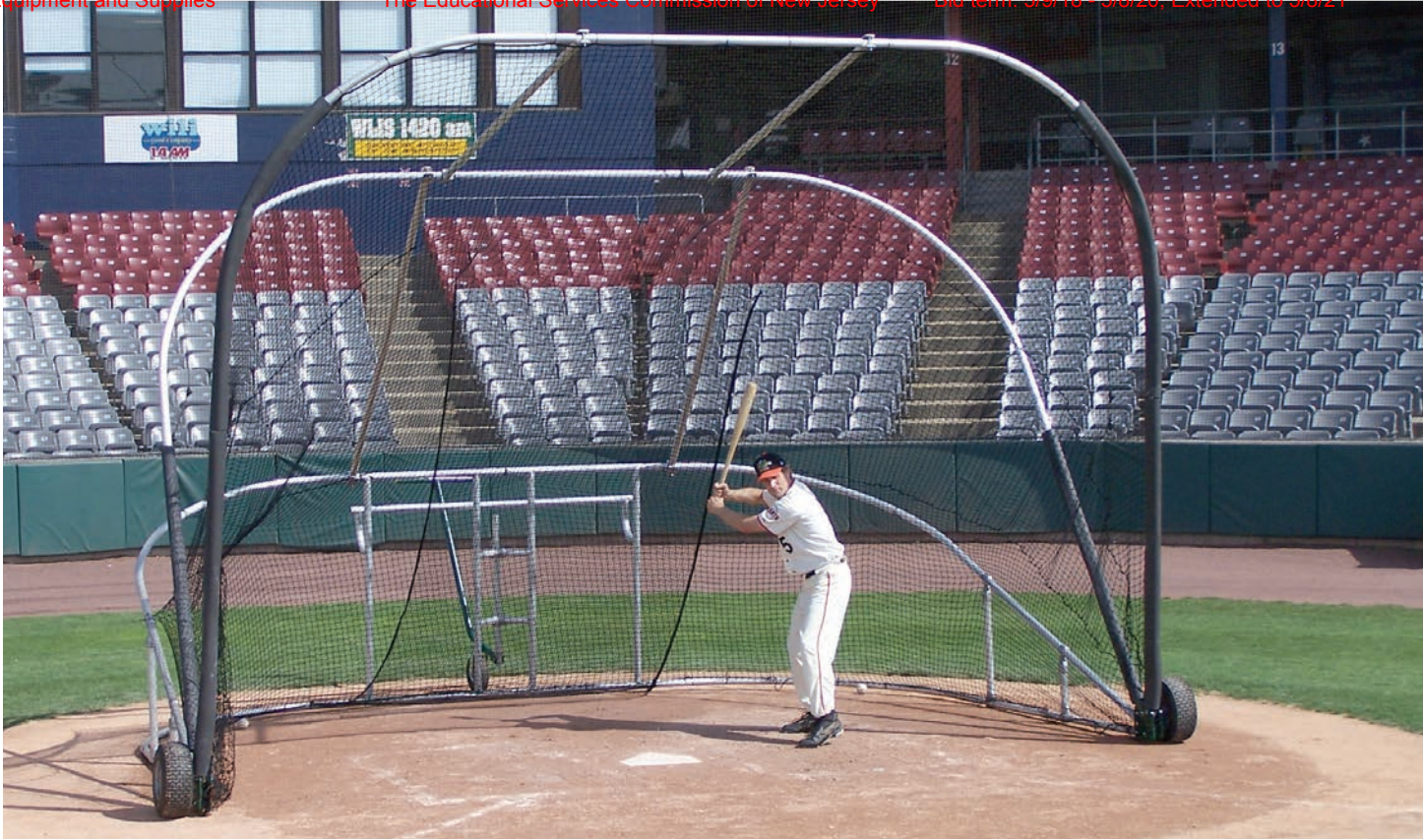

### Little Slam Portable Batting Cage

Ideal for high school and collegiate use.



- > 2" heavy-walled aluminum tube construction
- > #42 black climatized nylon net with rear net baffle
- > 24' of ricochet cushion reduces rebound and frame damage
- > Frame features handy strut holders
- > Folds down for easy storage
- > Heavy vinyl coated nylon skirt protects frame
- > (3) wheels
- > Optional Coach Stand (CVS-10) sold separately
- > Vinyl Skirt Colors (SKT-20XX) sold separately
- > Dimensions: 17'6"W x 12'H x 12'D

**BBL-12** 410 lbs \$3,799 each **FR** **5Y** **1Y** ★

### Vinyl Skirt

<b>SKT-20</b>	<b>GREEN</b>	23 lbs
<b>SKT-20RD</b>	<b>RED</b>	<b>3Y</b> ✕
<b>SKT-20RB</b>	<b>ROYAL BLUE</b>	
<b>SKT-20NB</b>	<b>NAVY BLUE</b>	\$375 each

### Viewing Stand

Ideal for coaches to view batting practice from a convenient adjustable stand attached to the rear of the batting cage.

**CVS-10** 24 lbs \$499 each **3Y**

### Ricochet Cushion

**BPD-6** 6' lengths 2 lbs \$31 each **3Y**

### Weather Resistant Tape

**PDT-3** 60 yd rolls 2 lbs \$64 each **1Y**

### Replacement Net

**LSN-2** 55 lbs \$835 each **1Y**

Collapses Easily



### Line Drive Cage Net

- > Replacement net for the Line Drive Batting Cage
  - > Dimensions: 16'6"W x 12'H x 16'6"D
- NJ State Approved Co-op #65MCESCCPS**

**LDN-5** 34 lbs \$749 each **1Y**







## Permanent Baseball/ Softball Backstops

- > 10'W x 12'H upright sections
- > 2 3/8" OD main upright x .095"W galvanized steel
- > 1 5/8" OD crossbars x .085"W galvanized steel
- > 9 gauge smooth galvanized fence fabric
- > 10'W x 6'D overhang section
- > Backstop sections are not prefabricated chain link
- > All galvanized fitting, nuts and bolts
- > Call for freight quote

FR 3Y ★

Item	Description	Weight	Price
BSP-30	3 Panel only	552 lbs/ea	\$1,999
BSP-30-6	3 Panels, 1 Center Overhang	682 lbs/ea	\$2,299
BSP-33-2	3 Panels, 1 Center, 2 Wing Overhangs	860 lbs/ea	\$3,099
BSP-40	4 Panels only	727 lbs/ea	\$2,599
BSP-40-66	4 Panels, 2 Center Overhangs	956 lbs/ea	\$3,399
BSP-44-22	4 Panels, 2 Center, 2 Wing Overhangs	1,134 lbs/ea	\$4,099

See page  
124-127 for  
details about  
Net style  
backstops



Shown with Optional Graphics



## Backstop Padding

- > 2" thick high-impact foam with grommet flaps on all sides for attachment to chain link fencing
- > 2' folding sections (available in solid or alternating colors)
- > Available in several sizes
- > Eco-friendly padding and optional graphics available (call for details and pricing)
- > See chart for vinyl colors (specify when ordering)
- > Call for freight quote

FR 1Y

Item	Size	Price
BSP236	3' x 6'	\$307
BSP238	3' x 8'	\$318
BSP2310	3' x 10'	\$390
BSP2312	3' x 12'	\$451

Item	Size	Price
BSP246	4' x 6'	\$318
BSP248	4' x 8'	\$390
BSP2410	4' x 10'	\$462
BSP2412	4' x 12'	\$513

SKY BLUE	ROYAL BLUE		
GRAY	TAN	RED	MAROON
WHITE	PURPLE	NAVY BLUE	MAPLE GREEN
BLACK	ORANGE	YELLOW	KELLY GREEN



## Field Wall Padding

- > 2" thick high-impact foam on 3/4" outdoor water sealed wood ply boarding
- > Available in several sizes
- > Eco-friendly padding and optional graphics available (call for details and pricing)
- > See chart for vinyl colors (specify when ordering)
- > Call for freight quote

FR 1Y



Item	Size	Price
FWP246	4' x 6'	\$375
FWP248	4' x 8'	\$495

Item	Size	Price
FWP2410	Custom	\$645
FWP2412	Custom	\$745

NJ State Approved Co-op #65MGE5CCPS



# Batting Tunnel Frames



## Professional Outdoor Batting Tunnel Frame

- > 4" OD aluminum tubing construction
- > Curved supports provide 3' offset
- > Clean design with less structure for ball to ricochet off
- > Ground sleeves (included) accommodate both 12' and 14' wide nets
- > Individual hoist lines make for easy installation and removal of net
- > Net sold separately

### PROTF-70

70'L x 12'H

400 lbs

\$4,135 each

FR 3Y ★

### PROTF-55

55'L x 12'H

350 lbs

\$3,925 each

FR 3Y ★

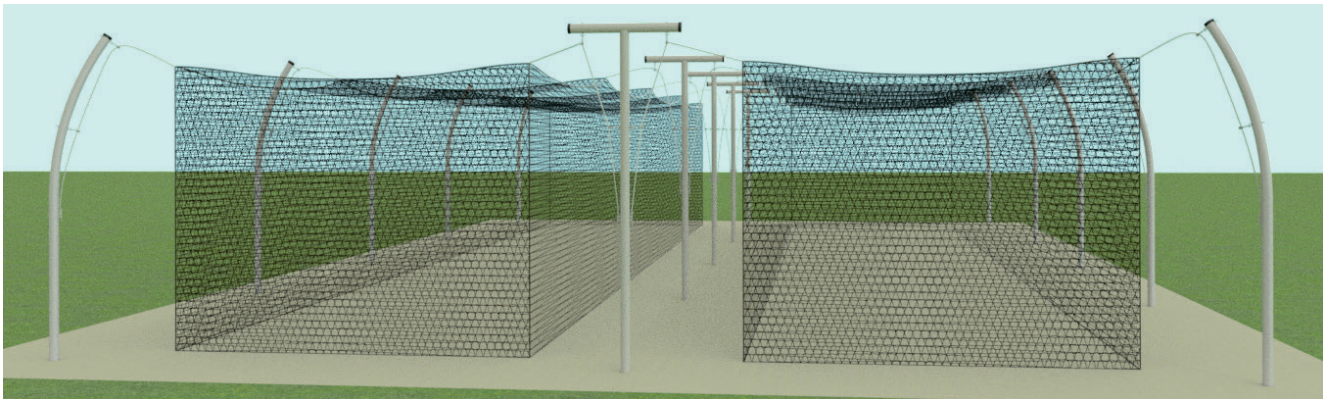

## Tandem Professional Outdoor Batting Tunnel Frame

- > Side by side professional style batting tunnels
- > Tunnels share center supports spaced 5' apart for added safety
- > 4" OD aluminum tubing construction
- > Curved supports provide 3' offset
- > Clean design with less structure for ball to ricochet off
- > Ground sleeves (included) accommodate both 12' and 14' wide nets
- > Individual hoist lines make for easy installation and removal of net
- > Nets sold separately

### PROTF-70T

70'L x 12'H

800 lbs

\$6,205 each

FR 3Y ★

### PROTF-55T

55'L x 12'H

750 lbs

\$4,995 each

FR 3Y ★

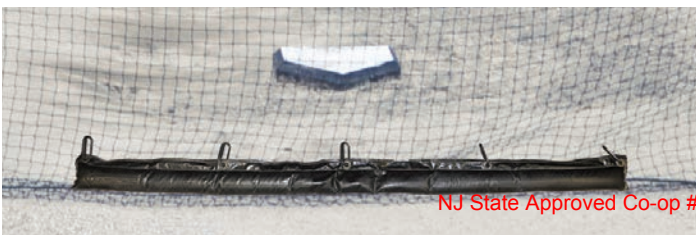

## Weighted Tunnel Sand Tubes

Ideal for keeping batting tunnel nets from blowing around.

- > 18 oz black vinyl tube with 5 clips to attach to the net
- > Add sand easily with 8" zippered opening
- > 14 tubes recommended for a 70'L x 12'W batting tunnel
- > Dimensions: 5"W x 60"L

### SWB-TUBE

1 lb

\$31 each

3Y

NJ State Approved Co-op #65MCESSCCPS



# Batting Tunnel Frames



## Semi-Permanent Outdoor Batting Tunnel Frame

- > 2" OD galvanized steel tube frame
- > Net hangs on 3 rows of 3/16" galvanized aircraft cable
- > Ground sleeves included
- > Accommodates both 12' and 14' wide nets
- > Net sold separately

**BBTF-70** 5 Wickets – 70'L x 12'H  
250 lbs \$1,995 each **FR** **3Y** ★

**BBTF-55** 4 Wickets – 55'L x 12'H  
225 lbs \$1,755 each **FR** **3Y** ★

## Surface-Mounted Outdoor Batting Tunnel Frame

- > 2" OD galvanized steel tube frame has 6" square mounting plate for surface-mount installation
- > Net hangs on 3 rows of 3/16" galvanized aircraft cable
- > Accommodates both 12' and 14' wide nets
- > Net sold separately

**BBTFSM-70** 5 Wickets – 70'L x 12'H  
250 lbs \$2,295 each **FR** **3Y** ★

**BBTFSM-55** 4 Wickets – 55'L x 12'H  
225 lbs \$1,995 each **FR** **3Y** ★

## Batting Tunnel Nets

### All-Star Series Tunnel Nylon Net

- > #36 thread count and UV protected **FR** **1Y**
- > Black twisted knotted nylon net with 1¾" sq mesh
- > 3/8" twisted poly rope borders

Item	Description	Weight	Price
<b>BBC36-7014</b>	14'W x 70'L x 12'H	134 lbs	\$1,639 each
<b>BBC36-7012</b>	12'W x 70'L x 12'H	123 lbs	\$1,589 each
<b>BBC36-5514</b>	14'W x 55'L x 12'H	107 lbs	\$1,389 each
<b>BBC36-5512</b>	12'W x 55'L x 12'H	100 lbs	\$1,339 each

### Major League UV Stabilized Tunnel Nets

- > #42 thread count and UV stabilized **FR** **1Y**
- > Black knotless nylon net with 1¾" sq mesh

Item	Description	Weight	Price
<b>BBC-470</b>	14'W x 70'L x 12'H	106 lbs	\$1,439 each
<b>BBC-370</b>	12'W x 70'L x 12'H	102 lbs	\$1,389 each
<b>BBC-270</b>	14'W x 55'L x 12'H	86 lbs	\$1,189 each

### Pro Climatized Tunnel Nets

- > Best for outdoor use **FR** **1Y**
- > #42 thread count with twisted knot construction
- > 2.5mm polyethylene filament fiber with 1¾" sq mesh
- > High abrasion-resistant with roped perimeter and corners

Item	Description	Weight	Price
<b>BBCP-7014</b>	14'W x 70'L x 12'H	132 lbs	\$1,149 each
<b>BBCP-7012</b>	12'W x 70'L x 12'H	126 lbs	\$989 each
<b>BBCP-5514</b>	14'W x 55'L x 12'H	111 lbs	\$889 each
<b>BBCP-5512</b>	12'W x 55'L x 12'H	100 lbs	\$839 each

### Collegiate Climatized Tunnel Nets

- > Same features as our pro series but for youth **FR** **1Y**
- > #24 thread count
- > 2mm polyethylene filament fiber with 1¾" sq mesh

Item	Description	Weight	Price
<b>BBCC-7014</b>	14'W x 70'L x 12'H	98 lbs	\$889 each
<b>BBCC-7012</b>	12'W x 70'L x 12'H	93 lbs	\$839 each
<b>BBCC-5514</b>	14'W x 55'L x 12'H	80 lbs	\$785 each



# Batting Tunnel Accessories

## Batting Tunnel Turf

Ideal for batting cage floors, dugouts, baselines, bullpens, coach boxes, walkways and more.

- > All turf is green and sold by the square foot
- > Excess turf may be trimmed in the field
- > Call for freight quote

### 34 oz Poly Turf

**TURF34** \$2.29 sq ft  
12'W Rolls - Unitary Backing

FR 1Y

**TURF34P** \$4.09 sq ft  
12'W Rolls - 5mm Padded Backing

FR 1Y

### 30 oz Nylon Turf

**TURF30** \$2.99 sq ft  
12'W Rolls - Unitary Backing

FR 1Y

**TURF30P** \$4.69 sq ft  
12'W Rolls - 5mm Padded Backing

FR 1Y



TURF34



TURF34P

## Batting Mat

- > Indoor/outdoor use
- > Spike-resistant artificial turf with throw down home plate
- > Inlaid white lines and thick foam backing
- > Dimensions: 12'W x 6'L

**BML612G** Green Clay 57 lbs \$375 each 1Y

**BML612CL** Red Clay 57 lbs \$375 each 1Y

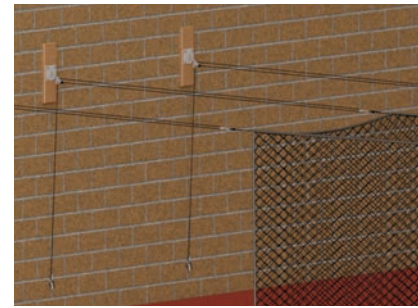

## Quick Set-Up Indoor Batting Cage

A full-size batting cage that sets up in minutes without the need for a ladder.

- > Cage attaches wall to wall using three marine grade rigging blocks with locking cams to both tension and lock net in position
- > When not in use there are no cables or structure left behind to interfere with or obstruct other activities
- > Available in two sizes (other sizes available upon request)
- > Ships complete with all items needed for attaching to building structure
- > Wall Mounting Kit (BBC-WLKT) available if mounting to concrete or block walls

**BBC-QS70** 70'L x 14'W x 14'H  
130 lbs \$3,550 each FR 1Y

**BBC-QS55** 55'L x 14'W x 14'H  
130 lbs \$3,250 each FR 1Y

## Cable Suspended Tunnel Kit

- > Maximize overhead space when net is in stored position
- > Allows support cables to be placed higher in the ceiling (up to 30")
- > Net suspended on 1/8" aircraft cable every 3' on center
- > Net and attachments sold separately

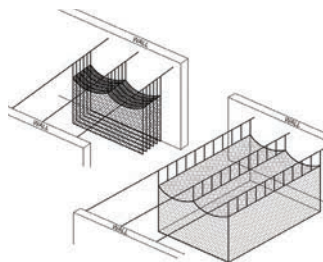

3Y

**BBC-SPDKT** \$1,650 each

## Cable Supported Tunnel Kit

- > (3) 100' rolls of 1/4" galvanized aircraft cable
- > Net attaches directly to cables running from wall to wall (attachment every 1')
- > Net slides easily against wall for storage
- > Ships complete with all necessary hardware
- > Net and attachments sold separately

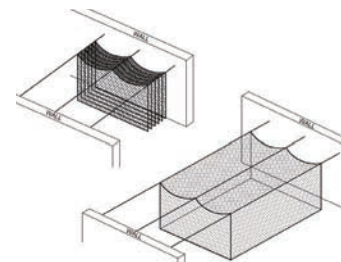

3Y

**BBC-SPRTKT** \$459 each

## Wall Mounting Kit

- > (6) finished wood pads and steel mounting plates
- > Attach to concrete, block or steel framed walls
- > Wall anchors to be supplied by installer based on wall specifications

**BBC-WLKT** \$1,125 each 3Y







## Ceiling Suspended Retractable Batting Cage

- > 2" heavy-walled aluminum tube frame
- > Raise and lower from ceiling using a drive shaft powered by a 1 HP electric winch (key switch operated)
- > Net included
- > Ceiling mounting kit sold separately
- > Dimensions: 70'L x 12'W x 11'H
- > Note: 14' wide cages and custom sizes available (call for quote)

**BBC-700B** Baseball 675 lbs \$7,450 each

**BBC-700M** Multi-Sport 675 lbs \$9,949 each **FR 3Y 1Y ★**

## Indoor Multi-Sport Tunnel Net

- > #252 UV stabilized knotless nylon net with 3/4" sq mesh
- > Dimensions: 70'L x 12'W x 12'H
- > Custom size available (call for pricing)

**BBC-700N** \$2,549 each

**1Y**

See page 67 for Baseball Tunnel Net options.

## Ceiling Mount Kits

### Parallel Ceiling Mounting Kit

Direct Attached:  
For cages centered directly beneath a beam or bar joist (system will be attached directly to single beam or bar joist).

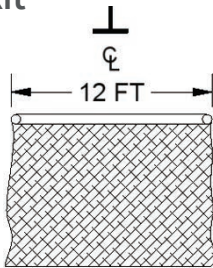

**BBC-UBKIT** \$489 each **3Y**

### Parallel Ceiling Mounting Kit

> Spanning Parallel 8' on Center or Less:  
For cages with a centerline located between two beams or bar joists spaced 8' apart or less.

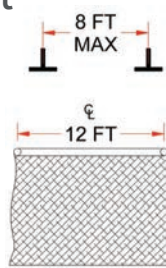

**BBC-PARKITA** \$977 each **3Y**

### Parallel Ceiling Mounting Kit

> Spanning Parallel 8'-12' on Center: For cages with a centerline located between two beams or bar joists spaced greater than 8' but not over 12' apart.

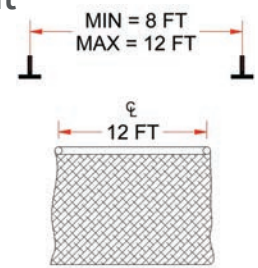

**BBC-PARKITB** \$2,499 each **3Y**

### Perpendicular Ceiling Mounting Kit

- > Spanning Perpendicular Not Greater Than 8' on Center: For cages oriented perpendicular to beams or bar joists spaced no greater than 8' apart.

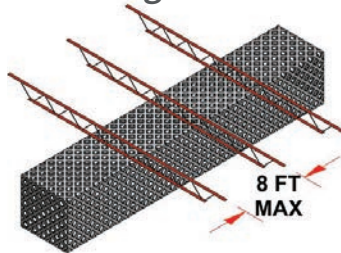

**BBC-PERPKITA** \$1,845 each **3Y**

### Perpendicular Ceiling Mounting Kit

- > Spanning Perpendicular 8'-12' on Center: For cages oriented perpendicular to beams or bar joists spaced greater than 8' but not over 12' apart.

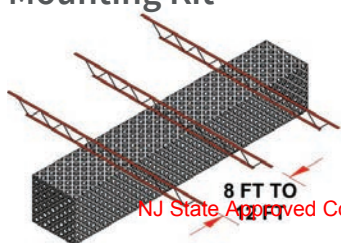

**BBC-PERPKITB** \$3,064 each **3Y**

### Rigid Frame Ceiling Mounting Kit

- > Peaked or Rigid Frame Building (call for pricing)
- > For cages being placed in a peaked rigid frame building
- > Drive supports to be chained down from roof purlins with rigid winch support

**BBC-RIGKIT** Call for Pricing **3Y**

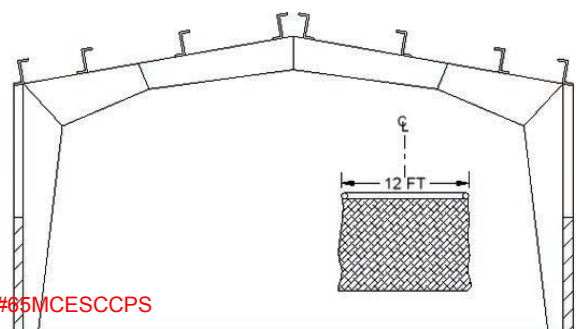

Foul Poles

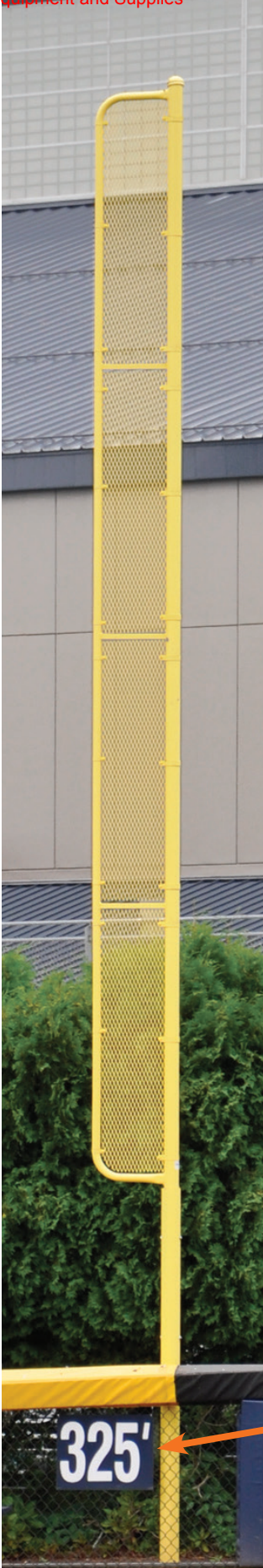

### 20' Professional Foul Pole

- > Designed to optimize air passage and engineered to withstand up to 120 mph winds
- > Main upright is 3½" OD Schedule 40 zinc coated steel tubing
- > 18"W x 12"H all-welded wing panel with heavy-duty 1½" x 13 gauge expanded metal mesh
- > Single piece welded steel construction designed for permanent, semi-permanent or surface-mount installation
- > Wall-mount installation available

See page 71 for optional ground sleeves for semi-permanent installation.

#### Baseball

FR 3Y

<b>BBFP-20</b>		Permanent/Semi-Permanent	570 lbs	\$2,429 pair
<b>BBFP-20SM</b>		Surface Mount	570 lbs	\$3,245 pair

#### Softball

FR 3Y

<b>SBFP-200-WT</b>		Permanent/Semi-Permanent	570 lbs	\$2,595 pair
<b>SBFP-200SM-WT</b>		Surface Mount	570 lbs	\$3,295 pair
<b>SBFP-200-OR</b>		Permanent/Semi-Permanent	570 lbs	\$2,595 pair
<b>SBFP-200SM-OR</b>		Surface Mount	570 lbs	\$3,295 pair

### 30' Professional Foul Pole

- > Designed to optimize air passage and engineered to withstand up to 120 mph winds
- > Main upright is 5" OD Schedule 40 zinc coated steel tubing
- > 18"W x 18"H all-welded 2" steel tube wing panel with heavy-duty 1½" x 13 gauge expanded metal mesh
- > 4" OD 8 gauge zinc coated upper pole
- > Two piece telescoping design for permanent, semi-permanent or surface-mount installation
- > Wall-mount installation available

See page 71 for optional ground sleeves for semi-permanent installation.

#### Baseball

FR 3Y

<b>BBFP-30</b>		Permanent/Semi-Permanent	850 lbs	\$4,055 pair
<b>BBFP-30SM</b>		Surface Mount	850 lbs	\$4,995 pair

#### Softball

FR 3Y

<b>SBFP-30-WT</b>		Permanent/Semi-Permanent	850 lbs	\$4,195 pair
<b>SBFP-30SM-WT</b>		Surface Mount	850 lbs	\$4,595 pair
<b>SBFP-30-OR</b>		Permanent/Semi-Permanent	850 lbs	\$4,195 pair
<b>SBFP-30SM-OR</b>		Surface Mount	850 lbs	\$4,595 pair

### Over 30' Professional Foul Pole

- > Permanent, semi-permanent or surface-mount options available
- > Wall-mount installation available

Call customer service for details.

FR 3Y

### Outfield Distance Markers

- > Printed digitally on 13 oz reinforced vinyl fabric
- > Specify colors and numbers when ordering
- > Marker Colors: Forest Green, Red, Yellow, Royal Blue, Gray, Tan and Black
- > Number Colors: White, Yellow, Black and Blue

<b>ODM-23</b>	27" x 36" Marker w/ 18" Numbers	\$129 each	
<b>ODM-35</b>	38" x 56" Marker w/ 24" Numbers	\$139 each	







## 20' Collegiate Foul Pole

- > Main upright is 3½" OD steel tubing
- > 18"W x 12"H bolt-on wing panel is all steel expanded metal
- > 20' tall when installed
- > Powder coated finish over zinc undercoating
- > Designed for permanent or semi-permanent (with optional sleeve) installation
- > Wall-mount installation available

### Baseball

#### BBCFP-20

**YELLOW**  
300 lbs

Permanent/Semi-Permanent  
\$1,449 pair

FR 3Y

### Softball

#### SBCFP-200-WT

**WHITE**  
300 lbs

Permanent/Semi-Permanent  
\$1,449 pair

FR 3Y

#### SBCFP-200-OR

**ORANGE**  
300 lbs

Permanent/Semi-Permanent  
\$1,449 pair

## 30' Collegiate Foul Pole

- > Main upright is 4½" OD heavy-walled steel tubing with 4" OD upper pole
- > 18"W x 18"H bolt-on wing panel is all steel expanded metal
- > 30' tall when installed
- > Powder coated finish over zinc undercoating
- > Two piece telescoping design for permanent or semi-permanent (with optional sleeve) installation
- > Wall-mount installation available

### Baseball

#### BBCFP-30

**YELLOW**  
650 lbs

Permanent/Semi-Permanent  
\$2,495 pair

FR 3Y

### Softball

#### SBCFP-30-WT

**WHITE**  
650 lbs

Permanent/Semi-Permanent  
\$2,595 pair

FR 3Y

#### SBCFP-30-OR

**ORANGE**  
650 lbs

Permanent/Semi-Permanent  
\$2,595 pair

## 12' Baseball/Softball Foul Pole

- > Main upright is 3½" OD heavy-duty steel tubing
- > 18"W x 6'H bolt-on wing panel is all steel expanded metal
- > 12' tall when installed
- > Powder coated finish over zinc undercoating
- > Designed for permanent or semi-permanent (with optional sleeve) installation
- > Wall-mount installation available

### Baseball

#### BBSBFP-12

**YELLOW**  
200 lbs

Permanent/Semi-Permanent  
\$999 pair

FR 3Y

### Softball

#### SBCFP-12-WT

**WHITE**  
200 lbs

Permanent/Semi-Permanent  
\$1,074 pair

FR 3Y

#### SBCFP-12-OR

**ORANGE**  
200 lbs

Permanent/Semi-Permanent  
\$1,074 pair

## Foul Pole Ground Sleeves

- > For semi-permanent installation of foul poles
- > Facilitates installation and maintenance

	<b>FPS-12</b>	12' Sleeves	18 lb	\$242 pair
	<b>FPS-20</b>	20' Sleeves	24 lbs	\$289 pair
	<b>FPS-30C</b>	30' Sleeves (for BBCFP-30 only)	36 lbs	\$321 pair
	<b>FPS-30P</b>	30' Sleeves (for BBFP-30 only)	40 lbs	\$493 pair

NJ State Approved Co-op #65MCESCCPS





# Big League Screens

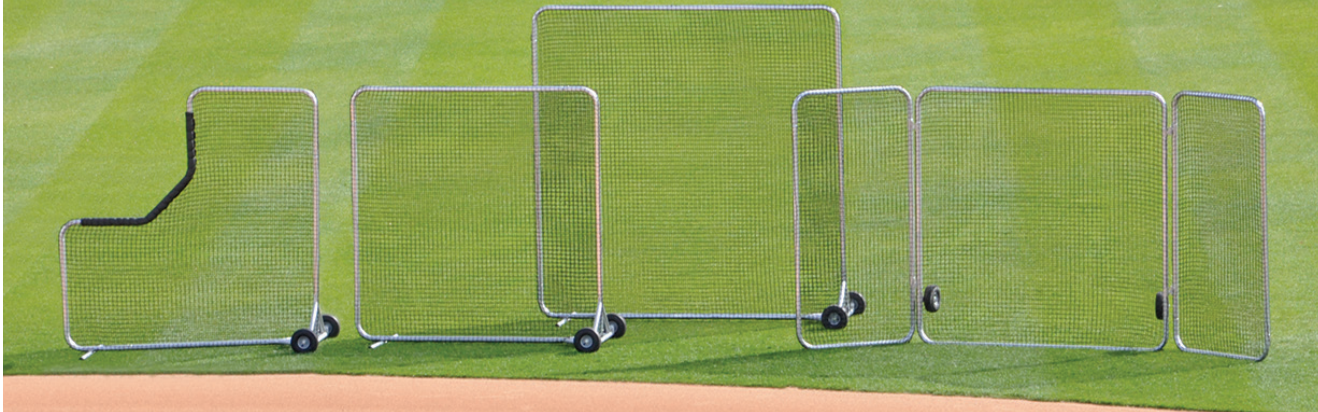

## Big League Pitchers Screen

- > Larger size for the pro player
- > 2" OD heavy-walled Schedule 40 aluminum L-shaped construction
- > 2" heavy-duty legs and supports welded for extra strength
- > #42 knotless weatherproof double-sided slip-on nylon net
- > (2) 10" dia x 4" wide no-flat tires
- > Padded hip protector included for pitcher safety
- > Dimensions: 8'W x 8'H

See page 39 for optional sandbags to counterweight screen.

<b>BLPS-84</b>	Screen	
45 lbs	\$699 each	
<b>BLPS-84N</b>	Replacement Net	
3 lbs	\$199 each	
		<b>3Y 1Y ★</b>



## Big League Fungo Screen

- > Larger size to protect fielders from stray balls
- > 2" OD heavy-walled Schedule 40 aluminum construction
- > 2" heavy-duty legs and supports welded for extra strength
- > #42 knotless weatherproof double-sided slip-on nylon net
- > (2) 10" dia x 4" wide no-flat tires
- > Available in 2 sizes

See page 39 for optional sandbags to counterweight screen.

<b>BLFS-88</b>	8' x 8' Screen	
45 lbs	\$789 each	
<b>BLFS-101</b>	10' x 10' Screen	
55 lbs	\$869 each	
<b>BLFS-88N</b>	8' x 8' Replacement Net	
3 lbs	\$205 each	
<b>BLFS-101N</b>	10' x 10' Replacement Net	
4 lbs	\$245 each	
		<b>FR 3Y 1Y ★</b>



## Big League Fungo Screen with Wings

- > Larger size for 2nd base or infield protection
- > Wings fold in for easy transport
- > 2" OD heavy-walled Schedule 40 aluminum construction
- > #42 knotless weatherproof double-sided slip-on nylon net
- > (2) 10" dia x 4" wide no-flat tires
- > Center Screen: 8'W x 8'H
- > Wing Screens: 4'W x 8'H
- > Dimensions: 16'W x 8'H

See page 39 for optional sandbags to counterweight screen.

<b>BLFSW</b>	Screen	
90 lbs	\$1,029 each	
<b>BLFSW-N</b>	Wing Replacement Net	
3 lbs	\$115 each	
<b>BLFS-88N</b>	Center Replacement Net	
3 lbs	\$205 each	
		<b>FR 3Y 1Y ★</b>

## Safefoam Padding

Provide another layer of safety to pitcher and fielder screens.

- > Ships in 8' lengths
- > Available in 4 colors
- > Colored ties to attach padding sold separately

<b>SF-PREMRB</b>	<b>ROYAL BLUE</b>	
Padding	\$59 each	
<b>SF-PREMRD</b>	<b>RED</b>	
Padding	\$59 each	
<b>SF-PREMGR</b>	<b>GREEN</b>	
Padding	\$59 each	
<b>SF-PREMYW</b>	<b>YELLOW</b>	
Padding	\$59 each	
		<b>1Y</b>

<b>SF-TIESRB</b>	<b>ROYAL BLUE</b>	
19" Ties (Bag of 100)	\$42 bag	
<b>SF-TIESRD</b>	<b>RED</b>	
19" Ties (Bag of 100)	\$42 bag	
<b>SF-TIESGR</b>	<b>GREEN</b>	
19" Ties (Bag of 100)	\$42 bag	
<b>SF-TIESYW</b>	<b>YELLOW</b>	
19" Ties (Bag of 100)	\$42 bag	

NJ State Approved Co-op #65MCESSCCPS





# Collegiate Screens



## Collegiate Pitchers Screen



- Required protection screens for players during batting and fielding practice
- Works with pitching machines or live arm delivery
- 1 1/2" OD heavy gauge galvanized steel L-shaped construction
- 2" heavy-duty square galvanized steel legs
- #36 knotless weatherproof double-sided slip-on nylon net
- (2) 8" dia wheels

<b>PS-84</b>	7' x 7' Screen	67 lbs	\$321 each
<b>PS-84N</b>	7' x 7' Replacement Net	3 lbs	\$117 each
<b>PSE-76N</b>	7' x 6' Green Economy Net	3 lbs	\$88 each



## Collegiate Fielders Screen

- Required protection screens for players during batting and fielding practice
- 1 1/2" OD heavy gauge galvanized steel construction
- 2" heavy-duty square galvanized steel legs
- #36 knotless weatherproof double-sided slip-on nylon net
- (2) 8" dia wheels
- Available in 2 sizes

<b>FS-77</b>	7' x 7' Screen	67 lbs	\$299 each
<b>FS-101</b>	10' x 10' screen	77 lbs	\$349 each
<b>FS-77N</b>	7' x 7' Replacement Net	3 lbs	\$119 each
<b>FS-101N</b>	10' x 10' Replacement Net	4 lbs	\$149 each
<b>FSE-76N</b>	7' x 6' Green Economy Net	3 lbs	\$79 each



## Softball Protector Screen

- Ideal for softball pitchers
- 7'W x 7'H frame with cutout
- Net and wheel kit included

<b>SBPE-77</b>	7' x 7' Screen	67 lbs	\$299 each
<b>SBPE-77N</b>	7' x 7' Replacement Net	3 lbs	\$109 each



## Portable Soft Toss/ Batting Practice Screen

- Heavy duty frame for use with baseball/softball
- Balls collected in sock for reuse
- Pillowcase style net and wheel kit included

<b>PSTS-77</b>	7' x 7' Screen	67 lbs	\$375 each
<b>PSTS-77N</b>	7' x 7' Replacement Net	3 lbs	\$160 each
<b>PSTS-76N</b>	7' x 6' Green Economy Net	3 lbs	\$88 each

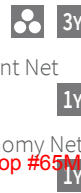

## Short Sided Pitchers Screen

Ideal for use in batting tunnels or indoors.

- Narrow width screen
- 1 1/2" OD heavy gauge galvanized steel L-shaped construction
- 2" heavy-duty square galvanized steel legs
- #36 knotless weatherproof double-sided slip-on nylon net
- (2) 8" dia wheels
- Dimensions: 7' x 5'

<b>PS-75</b>	Screen	65 lbs	\$534 each
<b>PS-75N</b>	Replacement Net	3 lbs	\$171 each



Bases



**Flex Style Bases**

- Ideal for recreational or competition level of play.
- > 3 impact bases are shock absorbing and compress on impact
- > 3 anchors and (3) 1½" solid rubber plugs included
- > Base Dimensions: 15" x 15" x 3"

**BB-200** 33 lbs \$199 set **3Y**



**Pro-Style Hollywood Bases**

- Used by the pros and ideal for advanced levels of play.
- > 3 bases with a tapered lip that digs into the dirt (bases do not compress)
- > 3 anchors and (3) 1½" solid rubber plugs included
- > Base Dimensions: 15" x 15" x 3"

**BB-500** 39 lbs \$199 set **3Y**



**Breakaway Style Bases**

Fully compliant with Little League® Rule 1.06

- > 3 quick release bases disengage from stationary rubber base plate upon impact
- > 3 anchors and (3) 1½" solid rubber plugs included
- > Base Dimensions: 15" x 15" x 3"

**BB-700** 39 lbs \$299 set **3Y**



**Bolco Style Bases**

- > 3 bases are heavy-duty injected vinyl cover with a bonded polyester foam core
- > (3) 1" anchors and bolt-on plates included
- > Base Dimensions: 15" x 15" x 3"

**BB-600** 28 lbs \$215 set **3Y**



**Double First Base**

- > Double first base reduces collisions and compresses on impact
- > 2 anchors and (2) 1½" solid rubber plugs included
- > Base Dimensions: 30" x 15" x 3"

**BB-400** 26 lbs \$149 each **3Y**



**Recreation Double First Base**

- > Foam-filled with nylon quilted cover
- > Straps and 3 spikes included
- > Base Dimensions: 30" x 15" x 3"

**BB-150** 5 lbs \$49 each **3Y**



**Official Size Economy Bases**

- > 3 foam-filled bases with heavy-duty quilted covers
- > 2 nylon straps and 4 steel anchors included
- > Base Dimensions: 15" x 15" x 3"

**BB-100** 10 lbs \$56 set **3Y**



**Home Plate Extension**

- > Provides an extended strike zone
- > More visible for umpires to make calls
- > White molded vinyl composition

**HPEXT** 2 lbs \$20 each **3Y**



**Rubber Throw Down Home Plate & Bases**

- > Heavy-duty molded rubber with waffle bottom
- > Bases are 13½" square and 1/2" thick

**HP-300** Home Plate 7 lbs \$18 each **3Y**

**BB-350** Bases (Set of 3) 9 lbs \$38 set **3Y**



**Throw Down Bases**

- > Flexible and washable rubber bases for indoor/outdoor use
- > 3 bases, home plate and pitching rubber included

**BB-50** 5 lbs \$16 set **3Y**

NJ State Approved Co-op #65MCECCPS





# Home Plates & Pitching Rubbers



HP-200



HP-250

## Major League Home Plate

- > Durable molded rubber construction
- > Stanchion-mounted steel plate
- > Easily removed for maintenance or storage

**HP-200** Plate w/ 1½" Anchor  
16 lbs \$99 each **3Y**

**HP-250** Plate w/ 5 Zinc-Plated Spikes  
16 lbs \$129 each **3Y**



## Professional Pitching Rubber

- > Major League Size: 6" x 24"
- > Durable four-sided molded rubber exterior
- > Interior PVC tube provides maximum longevity
- > Fill with dirt or concrete for added stability

**PR-624** 20 lbs  
\$99 each **3Y**

## Professional Pitching Rubber

- > Little League Size: 18" long
- > Same features as the (PR-624)

**PR-618** 10 lbs  
\$79 each **3Y**

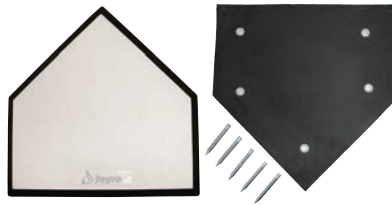

## Economy Home Plate

- > Durable molded rubber construction
- > 5 removable spikes included

**HP-50** 10 lbs \$33 each **3Y**

## Bury-All Home Plate

- > Durable all rubber construction
- > No-skid rubber waterproof surface
- > No corners or edges to catch spikes

**HP-100** 24 lbs \$89 each **3Y**

## Bury-All Home Plate

- > Durable wood-filled construction
- > No-skid rubber waterproof surface
- > No corners or edges to catch spikes

**HP-150** 29 lbs \$99 each **3Y**



## Step Down Pitching Rubber

- > Official Size: 24" long
- > Heavy-duty all rubber construction or wood-filled
- > Step down style for better footing
- > Reduces pitcher's mound maintenance

**PR-524** 19 lbs \$82 each **3Y**

## Step Down Pitching Rubber

- > Little League Size: 18" long
- > Same features as the (PR-524)

**PR-518** 10 lbs \$69 each **3Y**

## Step Down Pitching Rubber

- > Official Size: 24" long
- > Heavy-duty wood-filled construction
- > Step down style for better footing
- > Reduces pitcher's mound maintenance

**PR-550** 19 lbs \$92 each **3Y**



## Removable Pitching Rubber

Ideal for diamonds where various levels of play may require different pitching distances.

- > Heavy molded rubber
- > Steel ground anchors included

**PR-424** Official (24" long)  
14 lbs \$75 each **3Y**

**PR-418** Youth (18" long)  
10 lbs \$65 each **3Y**

## Movable Pitching Rubber

Ideal for diamonds where various levels of play may require different pitching distances.

- > Heavy molded rubber
- > 3 removable metal spikes included

**PR-324** Official (24" long)  
10 lbs \$20 each **3Y**

**PR-318** Youth (18" long)  
10 lbs \$17 each **3Y**





### StackMaster™ Professional Base Package

- > Pro-Style Hollywood Bases (BB-500)
- > StackMaster™ Professional Base Cart (BBCART)

**BCARTSET**  
\$349 package

72 lbs



## STACKMASTER™

### Professional Base Cart

- > Transports and stores heavy pro bases and male/female receptacles
- > Heavy-duty square steel frame
- > Pneumatic tires for easy transport
- > Note: Cannot be used with "Flex" Style Bases (BB-200) or Double First Bases (BB-400)

**BBBCART**  
\$229 each

33 lbs



### Cleat Cleaner

Ideal for use at pitcher's mound, on-deck circle or dugout areas.

- > Polyurethane composition with molded handle
- > 4 steel spikes included
- > 8 rows of 13 spikes (14" x 19½")

**CLTCLN** 4 lbs \$43 each

3Y



### Pre-Assembled Anchor Foundation

The fastest and easiest way to install base anchors.

- > Pre-assembled recycled rubber base foundation is ready to install
- > Fits 1½" anchors and includes a polycarbonate stem
- > Base(s) sold separately
- > Call for freight quote

For Hollywood, Magnetic, Bolco Style Bases

**PABF1** Single 3 lbs \$59 each

1Y

**PABF3** Set of 3 9 lbs \$155 set

1Y

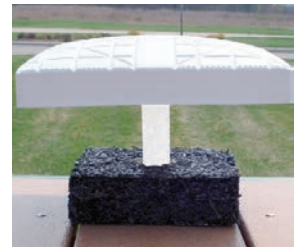

### Base Dig-Out Tool

**BB-DIGOUT** 1 lb  
\$14 each

3Y

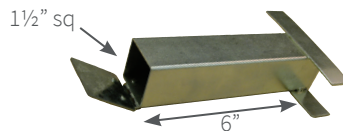

### Base Anchors

**BB-ANCHOR** 1 lbs \$9 each

3Y

### Base Rubber Plug

**BB-PLUG** 1 lb  
\$7 each

3Y

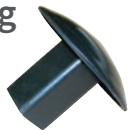

### Big League Base Plug

**BB-BLBP** 1 lb  
\$12 each

3Y



- > For both 1½" and 1¾" sleeves
- > Order 3 for a complete set

### Anchor Plug

**BB-RAP** 1 lb  
\$8 each

3Y



NJ State Approved Co-op #65MCESCCPS

### 1¾" Base Anchors (Set of 3)

**BB-ANCHOR175**  
3 lbs \$36 set

3Y

### 1½" Base Anchor

**BB-ANCHOR150**  
1 lb \$11 each

3Y







### Ball Cart

- > Large capacity basket holds hundreds of baseball/softballs
- > 1½" OD heavy-duty steel frame is powder coated
- > 14" oversized no-flat tires
- > Dimensions: 17"W x 16"H x 24"D

**BCT-100** \$225 each  
35 lbs  3Y



### Super Batting Tee

Ideal for all ages and abilities.

- > Heavy-weighted rubber base with steel insert for added weight
- > Telescoping height is 22" to 37" (approx.)
- > Baseball not included

**BT-1** 12 lbs \$29 each  3Y





### Game Mounds

Instantly convert a softball field to a youth baseball field.

- > Official Little League height specifications
- > Indoor/outdoor use
- > High-density foam and protected for durability
- > Use with turf shoes only (no metal cleats)
- > Call for freight quote

#### Major League Game Mound

**PPM-660G** Green - 60"W x 99"L x 6"H  
70 lbs \$1,149 each   1Y

**PPM-660CL** Red Clay - 60"W x 99"L x 6"H  
70 lbs \$1,149 each   1Y

#### Youth Game Mound

**PPM-652G** Green - 52"W x 45"L x 6"H  
36 lbs \$549 each   1Y

**PPM-652CL** Red Clay - 52"W x 45"L x 6"H  
36 lbs \$549 each   1Y



### Carry Bag

- > Store and transport 64 baseballs or 36 softballs
- > Zipper top and carry straps included
- > Dimensions: 12"W x 14"H x 12"D

**RBF-BASE** \$30 each  3Y  
3 lbs



### Deluxe Batting Tee

- > Durable official size rubber home plate
- > Telescoping height is 22" to 37" (approx.)
- > Baseball not included

**BT-4** 11 lbs \$39 each  3Y

### Cage Saver Target



- > Heavy-duty 40 oz reinforced black vinyl tarp with white strike zone
- > Brass grommets along edges
- > 2 straps with clips to hang included
- > Call for freight quote
- > Dimensions: 5'W x 6'H

**CST65** 11 lbs  
\$139 each  1Y



### Permanent Bat Rack

- > Heavy-duty galvanized steel bat rack holds up to 14 bats
- > Permanently mounts to dugout surface

**PBR-14** 33 lbs \$177 each  3Y



### Hanging Bat Rack Attachment

- > Heavy-duty galvanized steel bat rack holds up to 14 bats
- > Attaches to dugout fence or wall with included hardware

**PBR-14WM** 5 lbs  
\$124 each  3Y



### StackMaster™ Batting Helmet Storage Rack

- > Galvanized steel frame stores up to 12 helmets
- > Anchor to ground is recommended for secure installation

**BHR-1** 28 lbs  
\$225 each  3Y



# Field Covers & Wind Screens

## Field Covers • Rolling Tubes Fitted Sideline Covers

Assorted sizes and colors available  
Call customer service for details



### Weighted Spot Covers

- > 6 oz polyethylene silver/white cover with weighted hem
- > Stakes or sandbags not required
- > Color options available
- > Call for freight quote

1Y ★

Item	Description	Price
WWMC18	Mound Cover 18' round	\$625 each
WWMC20	Mound Cover 20' round	\$740 each
WWMC26	Mound Cover 26' round	\$935 each

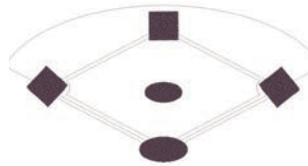

SILVER WHITE



### Spot Covers

- > Lightweight and durable rip-resistant 6 oz woven polyethylene covers
- > Heat sealed to ensure waterproof protection
- > Grommets spaced at 3'-4' intervals
- > Stakes included
- > Color options available
- > Call for freight quote

1Y ★

Item	Description	Dimensions	Price
AFC-PM	Pitcher's Mound (7 stakes)	20' Round	\$266 each
AFC-HP	Home Plate (9 stakes)	26' Round	\$375 each
AFC-BC3	Bases - Set (15 stakes)	10' x 10' set of 3	\$246 each



www.jaypro.com  
F: 800-988-3363

T: 800-243-0533



### Armor Mesh Wind Screen



- > Provides 75% shade and available in two heights
- > 14 oz woven extrusion vinyl coated polyester mesh
- > IncrediSeal™ heat sealed hem provides a clean look and eliminates risk of stitches/seams coming undone
- > Wind vents and cable ties sold separately
- > See chart for colors (specify when ordering)
- > Call for freight quote

WSCRN-6	6' Height	\$0.96 sq ft	FR	5Y
WSCRN-9	9' Height	\$1.06 sq ft	FR	5Y

#### TuffPrint Lettering and Logos

WSCRNLG Call for Details and Pricing



### Classic Wind Screen

- > Provides 84% shade and available in two heights
- > 8.2 oz/sq yd PVC coated polyester open mesh
- > Reinforced hems and rust-resistant grommets spaced at 18" intervals
- > 18" dia half-moon wind vents (HMV-18) recommended to allow wind passage (sold separately)
- > Plastic cable ties (PCT-100) for installation sold separately
- > Windscreen customization available
- > See chart for colors (specify when ordering)
- > Call for freight quote

FR 3Y

Item	Description	Price
TWS-6	6' High Screen	\$.73 sq ft
TWS-9	9' High Screen	\$.75 sq ft
PCT-100	Plastic Cable Ties	\$13 set of 100
HMV-18	Half Moon Wind Flap	\$5 each

Maximum length of a single piece wind screen is 100'. Screens over 100' will be made in sections. Custom heights above 6' will be charged at 9' pricing. Heights cannot exceed 9'. Wind screens higher than 6' require a centered horizontal lacing lip along entire length.





# Fence & Rail Accessories

## Temporary Fencing Available One-Piece Kits for Baseball & Softball

Call customer service for details



### Poly-Cap Fence Top Protection



Ideal for reducing player injuries and increase visibility of fence.

- > 4½" dia pre-slit corrugated polyethylene for durability and UV protection
- > Secure with tie wraps every 2' (sold separately)
- > Available colors: Yellow (YW), Orange (OR), Forest Green (FG), Black (BK)
- > Call for freight quote

FR 2Y ★



Item	Description	Price
CFC-100XX	100' Coil Fence Crown	\$179 each
CFC-250XX	250' Coil Fence Crown	\$240 each
CFC-TIESXX	19" Ties (Bag of 100)	\$51 bag
CFC-ITool	Installation Tool	\$74 each



### Fence Guard

Ideal for reducing player injuries and increase visibility of fence.

- > Maintenance free exterior grade UV-resistant polyethylene
- > Set of (10) 8' long sections per carton
- > Pre-drilled every 24"
- > Fence guard ties are included
- > 6 colors available
- > Call for freight quote

STC-8XX \$125 set 3Y ★



### Safefoam Tubular Padding

Ideal for railings and tubing. Even better for pitchers and fielders screens.

- > Tubular thick foam padding with durable skin coating
- > Fits any 2½" diameter or less round pipe
- > 8' long sections pre-slit for installation
- > Minimum order of 6 pieces
- > Secure with tie wraps every 2' (sold separately)
- > Available in 4 colors
- > Call for freight quote

1Y



Item	YELLOW	ROYAL BLUE	RED	GREEN	Price
Padding	SF-PREMYW	SF-PREMRB	SF-PREMRD	SF-PREMGR	\$59 each
100 Ties	SF-TIESYW	SF-TIESRB	SF-TIESRD	SF-TIESGR	\$42 bag

### Deluxe FenceTop & Rail Padding

Ideal for padding dug-out railings and fence tops.

- > 2" thick foam in 6' long sections encased in 18 oz vinyl
- > Grommets every 6" for attachment
- > See chart for vinyl colors (specify when ordering)
- > Call for freight quote

PRAFTP6 \$99 per 6' Section 1Y



ROYAL BLUE	GRAY
FOREST GREEN	WHITE
RED	BLACK



NJ State Approved Co-op #65MCFESCPCS





# Batting Cage Sun Canopy



## Batting Cage Sun Canopy

- > 6'W x 25'6"L with hemmed perimeter and grommets
- > Made from 8.2 oz/sq yd PVC coated polyester wind screen
- > Comes with bungee loops for easy attachment

**BBBCSC**

15 lbs

\$250 each

3Y

## Field Maintenance

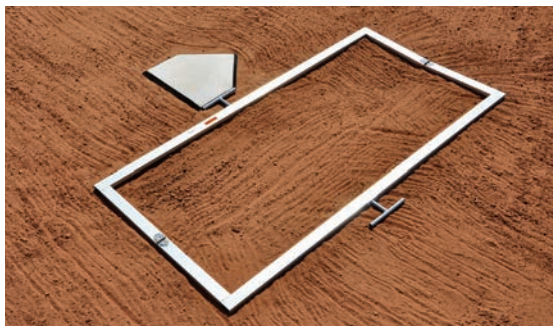

### Batter's Box Template

- > Lightweight aluminum frame template imprints 2" pattern for chalking
- > Carry handle aligns with home plate form proper positioning
- > Available in official, little league and softball sizes
- > Folds for easy transport and storage

<b>BBTMOFF</b>	Official - 4' x 6'	29 lbs	\$249 each	3Y
<b>BBTMLL</b>	Little League - 3' x 6'	28 lbs	\$249 each	3Y
<b>BBTMSB</b>	Softball - 3' x 7'	29 lbs	\$249 each	3Y

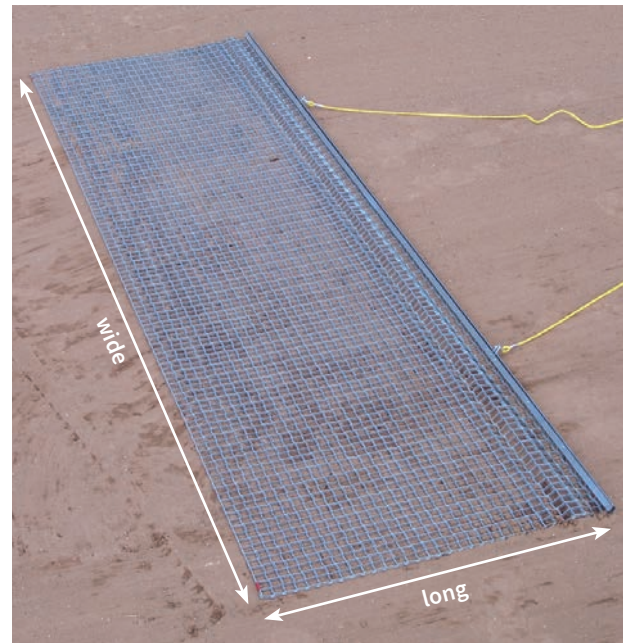

### Infield Drag Mat

- > Flexible plated steel mesh mat with 1<sup>9</sup>/<sub>16</sub>" galvanized steel drag bar
- > 3/8" polypropylene rope handle
- > Available in 3', 5' and 6' widths

<b>DM-34</b>	3'W x 4'L	21 lbs	\$139 each	3Y
<b>DM-5</b>	5'W x 3'L	27 lbs	\$159 each	3Y
<b>DM-63</b>	6'W x 3'L	33 lbs	\$229 each	3Y
<b>DM-6</b>	6'W x 6'L	65 lbs	\$329 each	3Y







### Monster Drag Broom

- > Heavy-duty aluminum construction with foam covered handle
- > 7' head with 2 rows of removable bristles

**MDB-84** 13 lbs \$240 each **1Y**

### Double Play Monster Drag Broom

- > Heavy-duty aluminum construction with foam covered handle
- > 7' head with scarifying edge and 2 rows of removable bristles

**DPMDB-84** 17 lbs \$279 each **1Y**



### Double Play Scarifier Broom

- > Aluminum powder coated blue handle
- > 28" head with scarifying edge and two rows of removable bristles

**DPSB-28** 8 lbs \$145 each **1Y**



### Base Runner Rake

- > Lightweight aluminum/magnesium alloy head construction
- > Double locking telescopic fiberglass handle adjusts from 30" to 70"
- > 36" grading edge with cleaning teeth
- > Breaks down for convenient storage

**BRR-36** 5 lbs \$113 each **1Y**

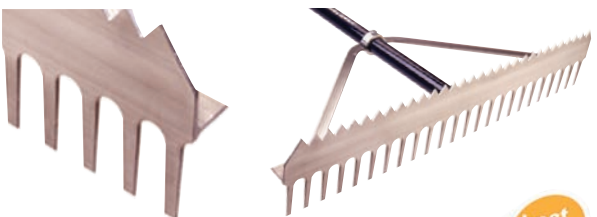

### Double Play Rake

- > High-grade aluminum head and bracing
- > 66" powder coated aluminum handle with 5" no-slip vinyl grip
- > Available in two head sizes

**DPR-24** 24" Rake 6 lbs \$85 each **1Y**

**DPR-36** 36" Rake 6 lbs \$90 each **1Y**



### Field Rake

- > 66" lightweight aluminum/magnesium alloy head construction
- > Large 36" or 42" grading edge with heavy-duty cleaning teeth

**FR-36** 36" Rake 6 lbs \$80 each **1Y**

**FR-42** 42" Rake 6 lbs \$90 each **1Y**



### Dirt Tamp

- > Durable all steel construction
- > 12" double-dipped vinyl grip handle included
- > Available in two sizes

**DT-88** 8" x 8" 12 lbs \$85 each **1Y**

**DT-1010** 10" x 10" 15 lbs \$90 each **1Y**

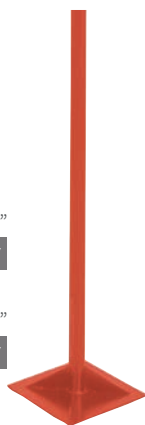

### Loop Hoe

- > 60" powder coated aluminum handle with 6" non-slip vinyl grip
- NJ State Approved Co-op #65MCESCCPS**  
**LH-60** 2 lbs \$42 each **1Y**



### Sifting Shovel

Ideal for spreading top dressing.

- > Perforated scoop sifts debris from all types of soil
- > 42" long handle with 14" x 17" scoop

**SS42** 5 lbs \$109 each **1Y**



# Water Hoses & Nozzles



new

## GH Series Irrigation Hose

Durable hose produces burst pressures to work well with golf and turf irrigation systems.

- > Smooth black PVC inner tube
- > Sleek opaque PVC compound exterior reinforced with high tensile strength yarn
- > Abrasion resistant cover
- > Weather, ozone, and UV resistant
- > Widths: ¾" and 1", Lengths: 50', 75', and 100'
- > Available with Full Flow Couplings

1Y

Item	Size	Weight	Price
GH1-1	¾" x 50'	19 lbs	\$109 each
GH1-2	¾" x 75'	21 lbs	\$139 each
GH1-3	¾" x 100'	23 lbs	\$179 each
GH2-1	1" x 50'	24 lbs	\$159 each
GH2-2	1" x 75'	27 lbs	\$195 each
GH2-3	1" x 100'	30 lbs	\$249 each



new

## Ultralite High Pressure Irrigation Hose

Multi-purpose, lightweight irrigation hose for golf, sports turf, and all irrigation market applications.

- > Pliable and abrasion resistant cover
- > Lightweight and kink resistant
- > Polyester exterior with polyurethane coating
- > Weather and UV resistant; maintains flexibility
- > Normal service conditions between -50° to 112°F
- > UL abrasion test of 15,000 cycles minimum
- > Width: 1", Lengths: 50', 75', and 100'

1Y

Item	Size	Weight	Price
UPH2-1	1" x 50'	14 lbs	\$189 each
UPH2-2	1" x 75'	16 lbs	\$269 each
UPH2-3	1" x 100'	18 lbs	\$309 each



new

## Multi-Mist Nozzle

This syringing and infield conditioning tool comes with four adjustable tips for precise and accurate water patterns.

1Y

- > 1" heavy-duty aluminum nozzle
- > For light syringing or dampening fields
- > Spray patterns from 10-35 GPM
- > Adjust droplet size and water flow

MNZ-1 2 lbs \$109 each



new

## Dual Size Shower Head Nozzle

Provides a heavy shower of water for flushing or heavy irrigating.

1Y

- > 1" lightweight aluminum nozzle
- > For flushing or heavily irrigating
- > Reducer bushing for ¾" GHT

DSNZ-2 2 lbs \$34 each



new

## Garden Hose Thread Nozzle

Ideal for hand watering.

1Y

GNZ-1 2 lbs

\$92 each NJ State Approved Co-op #65MCESCCPS



new

## Adjustable Fan Stream Nozzle

Nozzle creates a wide band or smooth bore.

1Y

- > 1" adjustable fan stream nozzle
- > Reaches up to 80ft
- > Reducer bushing for ¾" GHT

AFNZ-1 2 lbs \$102 each







### Hack Attack Pitching Machine

Training equipment designed for all-levels of play emulates a live pitcher with speeds of 35-100 mph and a distance of 43 ft. Various settings include: fastballs, risers, drops, right- and left-handed screwballs, pop-ups, fly balls, and grounders.

<b>HABPM-100</b>	Baseball	195 lbs	\$3,299 each	FR	1Y
<b>HASPM-200</b>	Softball	195 lbs	\$3,299 each	FR	1Y

### Hack Attack Junior Pitching Machine

Designed for high school and youth league play with all of the same features as Hack Attack Machine except with speeds of 35-70 mph.

<b>HABPM-100JR</b>	Baseball Junior	96 lbs	\$2,199 each	1Y
<b>HASPM-200JR</b>	Softball Junior	96 lbs	\$2,199 each	1Y



### Blast Attack Pitching Machine

Designed for club and other youth programs, it's a feature rich, affordable youth training tool.

- > Allows complete vision of the ball, just like a live pitcher
- > Delivers fastballs up to 70 mph
- > Unique design also incorporates easy elevation adjustment and full fungo capabilities
- > Many safety features and extreme portability

<b>BAPM-1</b>	115 lbs	\$1,299 each	1Y
---------------	---------	--------------	----

Call for FREIGHT quotes on all FREIGHT products on this page

### Snap Attack Football Machine



Maximize time on various phases of the game with speeds up to 70+mph. Ball release points at 5' for passes and ground level for snaps. Distance abilities: 100 yards for passes and punts, 70+ yards for kick-offs, and 5 -15 yards for snap tight spirals.

<b>SAFM-1</b>	165 lbs	\$3,999 each	FR	1Y
---------------	---------	--------------	----	----



### Attack Volleyball Machine

Designed for men's game and maximize daily practice drills with repeatable reps for serve receive, sets, digs, and spikes. Features include: sharp topspins, breaking floaters, spike speeds up to 80+mph over men's net, and ball release point of 6' to 9'3".

<b>VBSA-1</b>	200 lbs	\$3,299 each	FR	3Y
---------------	---------	--------------	----	----

### Attack II Volleyball Machine

Designed for women's game and maximize daily practice drills with repeatable reps for serve receive, sets, digs, and spikes. Features include: sharp topspins, breaking floaters, spike speeds up to 70mph over women's net, and ball release point of 5'6" to 8'6". One ball bag included.

<b>VBSA-2</b>	200 lbs	\$3,149 each	FR	3Y
---------------	---------	--------------	----	----

### Skill Attack Volleyball Machine

Designed for club and youth programs to deliver unlimited reps during daily practice drills for serve receive, sets, digs, and spikes. Features include: sharp downspins, breaking floaters, spike speeds up to 40mph on the same side of net, and ball release point of 5'3".

<b>VBSA-3</b>	55 lbs	\$1,299 each	FR	3Y
---------------	--------	--------------	----	----

### Attack II Ball Bag

A heavy-duty canvas allows convenient access to volleyballs during machine use. Bag can hold 15 balls. Compatible with Attack II Volleyball Machine (VBSA-2). Two bags per machine recommended.

<b>VBSA-BAG</b>	10 lbs	\$139 each	1Y
-----------------	--------	------------	----





### Multi-Sport Portable Scoreboard Package

Ideal for multi-sport facilities.

- > 10" LED digital scoring and timer
- > Periods and timeouts included
- > 2.4GHz integrated wireless with handheld controller (WHC-1)
- > Adjustable 8 tone 125db horn
- > Portable caddy for easy transport
- > Board: 6'W x 2'4"H x 4 1/4"D
- > Caddy: 5'6"W x 4'7"H x 2'7"D
- > See chart for powder coat and LED colors
- > Call for freight quote



**MSPS-26PKG** 255 lbs \$5,395 package **FR** **1Y**



### Baseball/Softball Scoreboard

- > 18" LED digital scoring and innings
- > Balls, strikes, outs, H & E included
- > 2.4GHz integrated wireless
- > Recommended tabletop controller (WTTC-1) sold separately
- > Adjustable 8 tone 125db horn
- > Dimensions: 9'W x 4'H x 4 1/4"D
- > See chart for powder coat and LED colors
- > Call for freight quote

**BBSBS-49** 120 lbs \$3,895 each **FR** **1Y**

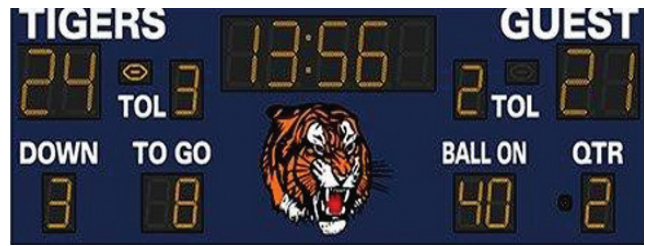

### Football Scoreboard

- > 24" LED digital scoring and timer
- > Downs, to go, ball on, quarter, TOL, possession indicator included
- > 2.4GHz integrated wireless with tabletop controller (WTTC-1)
- > Adjustable 8 tone 125db horn
- > Dimensions: 22'4"W x 7'6"H x 4 1/4"D
- > See chart for powder coat and LED colors
- > Call for freight quote

**FBS-722** 900 lbs \$18,720 each **FR** **1Y**



### Basketball Scoreboard

- > 13" LED digital scoring and timer
- > Periods, fouls, TOL, bonus and possession indicators included
- > 2.4GHz integrated wireless with tabletop controller (WTTC-1)
- > Adjustable 8 tone 125db horn
- > Dimensions: 9'W x 5'H x 4 1/4"D
- > See chart for powder coat and LED colors
- > Call for freight quote

**BSKS-59** 150 lbs \$5,795 each **FR** **1Y**



### Lacrosse Scoreboard

- > 18" LED digital scoring, timer and quarter
- > Player, penalty, TOL included
- > 2.4GHz integrated wireless with tabletop controller (WTTC-1)
- > Adjustable 8 tone 125db horn
- > Dimensions: 11'W x 8'2"H x 4 1/4"D
- > See chart for powder coat and LED colors
- > Call for freight quote

**LXS-811** 290 lbs \$7,995 each **FR** **1Y**





# Scoreboard Accessories



## Wireless Tabletop Controller

- > 2.4GHz controller with 1,000 ft operating distance
- > Rechargeable lithium-polymer battery (up to 24 hours between charges)
- > Carry case included
- > Power: DC-5V, max 1.0 amp, from external power supply or PC
- > Dimensions: 4"W x 12"H x 9"D

**WTTC-1** 3 lbs \$795 each **1Y**



## Wireless Handheld Controller

- > 2.4GHz controller with 1,000 ft operating distance
- > Power: 2 AA alkaline or rechargeable batteries

**WHC-1** 1 lbs \$355 each **1Y**

## Tabletop Scoreboard

- > Rear control panel with visual display
- > Amber and gold LED lights
- > Scores up to 199 and timer up/down to 99:59
- > Buzzer sounds automatically/manually at end of period
- > Uses 110v with 15' power cord
- > Dimensions: 24"W x 15"H x 10"D

**TTS10** 12 lbs \$679 each **3Y**



Digital display control panel on back for operator



## Shot and Play Clock

Can be used with our Shot Clock Mounting Bracket

- > 13" LED digital display
- > 2.4GHz integrated wireless
- > Tabletop controller (WTTC-1) or hand-held controller (WHC-1) sold separately
- > Adjustable 8 tone 125db horn
- > Dimensions: 1'9"W x 2'H x 4 1/4"D
- > See chart for powder coat and LED colors
- > Call for freight quote

**SPC-2** 25 lb \$3,195 set **FR** **1Y**

### Enclosure Colors

- BRIGHT RED**
- CARDINAL RED**
- BLACK**
- MAROON**
- NAVY BLUE**
- ROYAL BLUE**
- PURPLE**
- WHITE**
- FOREST GREEN**

### Numerals

- Amber **49**
- Red **13**

## Shot Clock Mounting Bracket



- > Designed for Jaypro Sports Elite Portable systems
- > Shot clock not included

**PBEL-SCBEA**  
30 lbs \$386 each **3Y**



## LED Backboard Light Kit

- > Backboard lights up when shot clock or game time reaches zero and when final segment counts down to zero
- > 5 bright LED strips fit 72"W x 42"H backboards
- > Requires 9VDC-17VDC (formal specified voltage is 10.5VDC)
- > Specify shot clock manufacturer/model when ordering (connects with most shot clocks)
- > Kit includes all items required for your specific shot clock model
- > Connection by a qualified installer recommended
- > Call for freight quote

**BB-LED42**

25 lbs Call for Pricing **1Y**

## Possession Indicator



- > Red LED display in a durable plastic case
- > Toggle switch operation, top red indicator lights and AC adapter with 15' long cord

**POSIND1** 3 lbs \$141 each **3Y**



## Basic Field Marking Package

- > 50 lb EasyLiner™ Field Marker (FLMR-50HD)
- > Base Runner Rake (BRR-36)
- > Base Dig-Out Tool (BB-DIGOUT)
- > ProLine Layout & Marking System (FM-LM1)
- > Official Batter's Box Template (BBTMOFF)



**FMP-10FF** 85 lbs

\$699 package



**FMP-1SB** 85 lbs

\$689 package



Same products as FMP-10FF  
except with:

- > Softball Batter's Box Template (BBTMSB)

**FMP-1LL** 84 lbs

\$689 package



Same products as FMP-10FF  
except with:

- > Little League Batter's Box Template (BBTMLL)

## Deluxe Field Marking Package

- > Includes all items in Basic Package
- > Infield Drag Mat (DM-5)
- > 10 lb EasyLiner™ Field Marker (FLMR-10)
- > EasyLiner™ Aerosol Spray Kit (FLMR-AKIT)



**FMPD-2OFF** 144 lbs

\$989 package



**FMPD-2SB** 144 lbs

\$975 package



Same products as FMPD-2OFF  
except with:

- > Softball Batter's Box Template (BBTMSB)

**FMPD-2LL** 143 lbs

\$975 package



Same products as FMPD-2OFF  
except with:

- > Little League Batter's Box Template (BBTMLL)



www.jaypro.com  
T: 800-243-0533 F: 800-988-3363

T: 800-243-0533 F: 800-988-3363



# EasyLiner™ a jaypro sports product



## 100 lb EasyLiner™ Field Marker

- > 100 lb capacity
- > 2" or 4" line precision control
- > Heavy-duty 18 gauge steel hopper and frame
- > Line dispenser viewing window
- > (4) 10" no-flat wheels
- > Dual wheel drive for no-slip feed consistency
- > Instant on/off gate control
- > Adjustable fold in handles for off-season storage
- > Side mounted storage box
- > Dry line to spray capable with optional aerosol spray kit (FLMR-AKIT)

**FLMR-100HD** 70 lbs \$370 each



## 50 lb EasyLiner™ Field Marker

- > 50 lb capacity
- > 2" or 4" line precision control
- > Heavy-duty 18 gauge steel hopper and frame
- > Line dispenser viewing window
- > (4) 10" no-flat wheels
- > Dual wheel drive for no-slip feed consistency
- > Instant on/off gate control
- > Adjustable fold in handles for off-season storage
- > Side mounted storage box
- > Dry line to spray capable with optional aerosol spray kit (FLMR-AKIT)



**FLMR-50HD** 62 lbs \$340 each



## 25 lb EasyLiner™ Field Marker

- > 25 lb capacity
- > 2" or 4" line precision control
- > Heavy-duty 18 gauge steel hopper and frame
- > (2) 8" wheels
- > Dual wheel drive for no-slip feed consistency
- > Instant on/off gate control

**FLMR-25** 28 lbs \$170 each



## 10 lb EasyLiner™ Field Marker

Ideal for touch-ups and small applications.

- > 10 lb capacity
- > 2" wide line
- > Heavy-duty 18 gauge steel hopper and frame
- > 2 wheels
- > 200 yard capacity

**FLMR-10** 13 lbs \$95 each

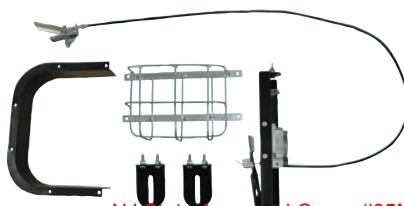

## EasyLiner™ Aerosol Spray Kit

Add aerosol spray capability to your dry line marker.

- > Easy setup
- > 100/50 lb EasyLiner™ Field Marker compatible
- > Side mount aerosol can basket included
- > Applicator assembly, mounting brackets, air deflector included

**FLMR-AKIT** 3 lbs \$85 kit





FM-TXE353PRO

### Battery Powered High Pressure Field Marker

### SupaTurf TXE Pro Line Marker

Recognized as the industry standard and ideal for venues with multiple fields.

- > Robust, lightweight, easy to operate
- > 1" to 5" line width capable
- > Battery powered/No engine noise or pollution
- > Handlebar controls
- > Single lever control switches between clean water and paint mode
- > High pressure spray nozzle
- > Mark multiple fields with a single tank
- > Fold over handle for off-season storage
- > 2.5 liter flush tank uses water to flush filter, pump, pipes, spray line and head
- > Return tank system adjusts pressure at spray nozzle to suit conditions and agitates paint in main tank for consistent line color
- > No need to empty main tank between jobs or sites
- > FREE marking disks included
- > Accessories available at [www.jaypro.com](http://www.jaypro.com)

**FM-TXE353PRO** 7 amp (minimum 2 hours per charge)  
69 lbs \$1,779 each **3Y** **X**

**FM-TXE606PRO** 18 amp (minimum 5 hours per charge)  
76 lbs \$1,895 each **3Y** **X**

**Exclusively supplied in the U.S. by  
Jaypro Sports through authorized dealers**

### SupaTurf TXE Standard Line Marker

Recognized as the industry standard and ideal for venues with multiple fields.

- > Robust, lightweight, easy to operate
- > 1" to 5" line width capable
- > Battery powered/No engine noise or pollution
- > Handlebar controls
- > High pressure spray nozzle
- > Mark multiple fields with a single tank
- > Fold over handle for off-season storage
- > Easy to clean and maintain
- > FREE marking disks included
- > Accessories available at [www.jaypro.com](http://www.jaypro.com)

**FM-TXE353** 7 amp (minimum 2 hours per charge)  
67 lbs \$1,499 each **3Y** **X**

**FM-TXE606** 18 amp (minimum 5 hours per charge)  
74 lbs \$1,649 each **3Y** **X**



### TXE Line Marker Paint



#### Stadia

A technically well-balanced formulation that has excellent price/performance characteristics. Popular for multiple grounds/large areas to mark, Stadia delivers a high standard of line whiteness combined with excellent longevity.

**FSP-SWT** 37 lbs \$65 each



#### SupaStadia

Recognized as the benchmark product for line marking. It delivers superior performance for professional users, produces excellent whiteness and has the stamina to outperform alternative products.

**FSP-SSWT** 41 lbs \$87 each



#### Stadia Colours

Smooth, flowable marking liquids containing blends of water-dispersible coloured pigments that provide excellent colour coverage when applied to turf and a wide range of other surfaces. Specify color: Red, Blue, Green, Yellow or Black when ordering.

**FSP-SXX** 31 lbs \$68 each





## Economy Paint Marker

- > 2" to 4" line width
- > 4 wheels
- > Fold in handle for off-season storage
- > Aerosol paint sold separately



**FME-501**

28 lbs

\$139 each

3Y



## Field Marking Wand

Ideal for quick and easy lines.

- > Lightweight
- > Single spray can dispenser
- > Aerosol paint sold separately

**FMWAND**

5 lbs

\$59 each

3Y



## Athletic Field Marking Dust

- > Pure white
- > Pallet of (40) 50 lb bags
- > NCAA compliant
- > Non-toxic/Safe for skin, clothes, turf
- > Call for freight quote

**AFMD50**

2,060 lbs

\$338 each

FR 1Y



## Pro-Stripe Athletic Field Marking Paint

- > Concentrate can be diluted with water
- > Natural and artificial turf-friendly
- > Non-toxic/Halogen-free
- > Safe for players and uniforms
- > Stimulates grass root growth
- > Call for freight quote

**FSP-5WT**

BRIGHT WHITE

5 gal bucket

45 lbs \$60 each

1Y

**FSP-5YW**

SOCCER YELLOW

5 gal bucket

45 lbs \$97 each

1Y

## Aerosol Paint (Case)

- > Universal spray tip included
- > Ozone friendly/Contains no CFCs
- > Call for freight quote
- > More colors available at [www.jaypro.com](http://www.jaypro.com)



**GL-101**

WHITE

18 lbs

(12) 18 oz cans

\$52 case

1Y

**GL-107**

ROYAL BLUE

18 lbs

(12) 18 oz cans

\$62 case

1Y

**GL-108**

YELLOW

18 lbs

(12) 18 oz cans

\$62 case

1Y

**GL-110**

RED

18 lbs

(12) 18 oz cans

\$62 case

1Y

## Aerosol Paint (Bulk)

Buy in bulk and save with FREE FREIGHT.

**PNTPKG-1**

WHITE

1,150 lbs

NJ State Approved Co-op #65MCESCCPS

Pallet (60 cases)

\$2,599 each

FR 1Y



## ProLine Layout & Marking System

Quick and economical way to line athletic fields.

- > Durable polypropylene locators
- > Starting tool and 600' cord included
- > Easy restriping year after year

**FM-LM1**

Baseball

12 pc

\$99 kit

1Y

**FM-LM2**

Soccer

25 pc

\$189 kit

1Y

**FM-LM4**

Lacrosse

14 pc

\$109 kit

1Y

**FM-LM5**

Football

50 pc

\$329 kit

1Y

**FM-LM0**

Replacement Kit

10 pc

\$89 kit

1Y



[www.jaypro.com](http://www.jaypro.com)  
T: 800-243-0533

F: 800-988-3363

# THE TITAN™

## CVX SERIES

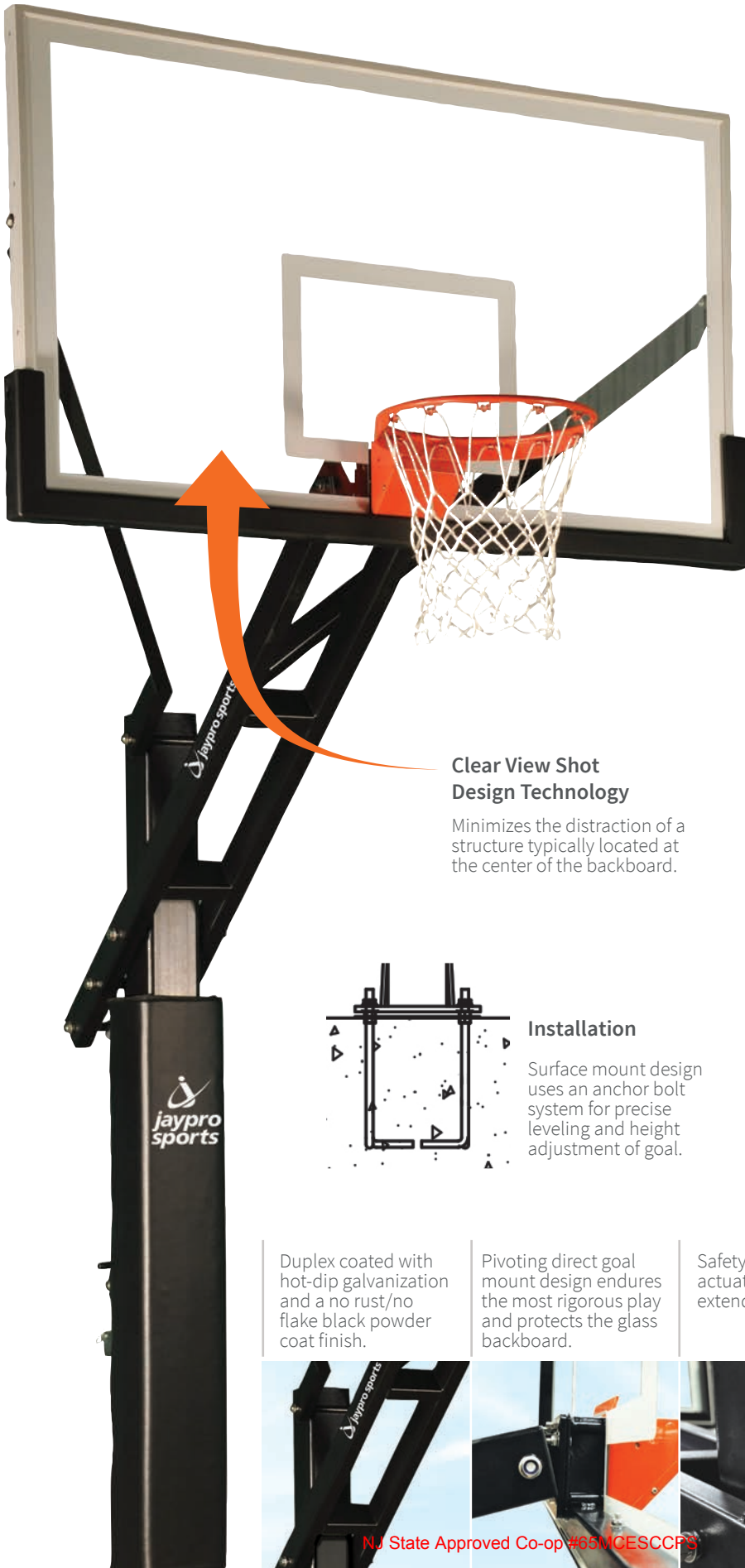

### Clear View Shot Design Technology

Minimizes the distraction of a structure typically located at the center of the backboard.

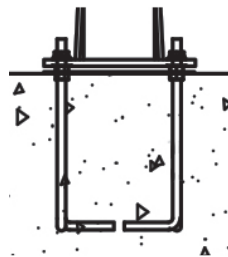

### Installation

Surface mount design uses an anchor bolt system for precise leveling and height adjustment of goal.



### Lift Assist Technology

A heavy-duty actuator with dual assist springs makes for effortless height adjustment.

Crank handle removes to prevent unauthorized adjustment.

Duplex coated with hot-dip galvanization and a no rust/no flake black powder coat finish.

Pivoting direct goal mount design endures the most rigorous play and protects the glass backboard.

Safety pin stop keeps actuator from over extending.

1/2" thick tempered glass backboard will not scratch, tint or shatter.



NJ State Approved Co-op #65MGESCCPS



jaypro sports

www.jaypro.com  
F: 800-988-3363

T: 800-243-0533



### The Titan CVX3

- > 6" x 8" heavy gauge steel upright
- > 4' offset with adjustable height of 5½' to 10'
- > 42" x 72" tempered glass backboard
- > 2" x 4" heavy gauge steel extension arms
- > Duplex coating "hot dip" galvanized and powder coated black
- > Heavy-duty actuator and safety pin stop
- > Breakaway rim with nylon net
- > All stainless steel hardware included
- > Pole padding and backboard edge padding included (black)

**CV684A** 623 lbs \$2,895 each **FR** **3Y** **1Y**

### The Titan CVX2

- > 6" x 6" heavy gauge steel upright
- > 4' offset with adjustable height of 5½' to 10'
- > 42" x 72" tempered glass backboard
- > 2" x 4" heavy gauge steel extension arms
- > Duplex coating "hot dip" galvanized and powder coated black
- > Heavy-duty actuator and safety pin stop
- > Breakaway rim with nylon net
- > All stainless steel hardware included
- > Pole padding and backboard edge padding included (black)

**CV664A** 600 lbs \$2,499 each **FR** **3Y** **1Y**

### The Titan CVX1

- > 5" x 5" heavy gauge steel upright
- > 3' offset with adjustable height of 5½' to 10'
- > 36" x 60" tempered glass backboard
- > 2" x 4" heavy gauge steel extension arms
- > Heavy-duty actuator and safety pin stop
- > Duplex coating "hot dip" galvanized and powder coated black
- > Breakaway rim with nylon net
- > All stainless steel hardware included
- > Pole padding and backboard edge padding included (black)

**CV553B** 477 lbs \$1,695 each **FR** **3Y** **1Y**



#### The Titan CVX Replacement Edge Padding

- > Black only

<b>CVEP72</b>	42" x 72"	8 lbs	\$179 each
<b>CVEP60</b>	36" x 60"	8 lbs	\$179 each



#### The Titan CVX Replacement Backboard

- > Tempered glass

<b>GBCV-72</b>	42" x 72"	245 lbs	\$875 each
<b>GBCV-60</b>	36" x 60"	163 lbs	\$845 each



#### The Titan CVX Replacement Goal

- > Breakaway goal with nylon net

<b>GBR360</b>	6" x 8"/6" x 6"	30 lbs	\$189 each
<b>GBR361</b>	5" x 5"	30 lbs	\$189 each



#### Replacement Pole and Gusset Padding

- > Black pole and gusset padding

<b>PP-68</b>	6" x 8"	3 lbs	\$205 each
<b>PP-66</b>	6" x 6"	3 lbs	\$199 each
<b>PP-55</b>	5" x 5"	3 lbs	\$175 each



THE TITAN™



Acrylic

Steel

Perforated



The Titan

- > Fixed height unit buries 48" into ground
- > Height can be adjusted after court resurfacing or for kids play
- > 6" square steel upright and angled extension arm
- > Acrylic, rectangular or perforated steel backboard choices
- > Backboard and goal mounted directly to extension arm for exceptional strength and reinforced with a rear support brace
- > Available galvanized or powder coated black
- > Heavy-duty goal and nylon net included
- > Bolt-on backboard edge padding (MBBP-6) sold separately
- > Backboard: 72"W x 42"H

Galvanized Post

<b>660-AC-UG</b>	Acrylic Backboard	500 lbs	\$2,256 each
<b>660-RS-UG</b>	Steel Backboard	520 lbs	\$2,256 each
<b>660-PF-UG</b>	Perforated Backboard	500 lbs	\$2,256 each

Black Powder Coated Post

<b>770-AC-UG</b>	Acrylic Backboard	500 lbs	\$2,359 each
<b>770-RS-UG</b>	Steel Backboard	520 lbs	\$2,359 each
<b>770-PF-UG</b>	Perforated Backboard	500 lbs	\$2,359 each



Acrylic



The Church Yard

- > Fixed height unit buries 48" into ground
- > Height can be adjusted after court resurfacing or for kids play
- > 4" square steel upright and angled extension arm
- > 40" extension arm for "play safe area"
- > Heavy-duty flex goal and nylon net included
- > Post padding and backboard edge padding included
- > Fan backboard (400-FA-FG) does not include edge padding
- > Acrylic Backboard: 48"W x 36"H
- > Aluminum Fan Backboard: 54"W x 36"H

400-AC-FG

Acrylic Backboard  
350 lbs \$1,434 each

400-FA-FG

Aluminum Fan Backboard  
300 lbs \$1,387 each



Double



Steel



The Playground

- > Fixed height unit buries 48" into ground
- > Height can be adjusted after court resurfacing or for kids play
- > 6" square steel upright and angled extension arm
- > 66" extension arm for "play safe area"
- > Heavy-duty flex goal and nylon net included
- > Post padding and backboard edge padding included
- > Steel backboard (LS-200RS) does not include edge padding
- > Backboards: 72"W x 42"H

LS-200

Acrylic Backboard 550 lbs \$2,575 each

LS-200RS

Steel Backboard 550 lbs \$2,575 each

LD-200

Double Acrylic Backboard 903 lbs \$3,800 each







### 3½” Gooseneck System

- > 3½” OD zinc undercoated steel upright
- > Direct mount style with 36” extension for “play safe area”
- > Backboard and goal mounted directly to extension for exceptional strength
- > Upright galvanized or powder coated
- > Aluminum fan backboard included
- > Single Rim Goal (GB-55) and nylon net included
- > Backboard: 54”W x 36”H

<b>455-FABT-SR-BK</b>	<b>BLACK</b>	144 lbs	\$1,023 each
<b>455-FABT-SR-RB</b>	<b>ROYAL BLUE</b>	144 lbs	\$1,023 each
<b>455-FABT-SR-FG</b>	<b>FOREST GREEN</b>	144 lbs	\$1,023 each
<b>455-FABT-SR</b>	Galvanized	144 lbs	\$920 each

FR 3Y

## Round Post Padding



### Basketball Post Padding

- > 30” wide pad wraps around 4½” OD post
- > 4” thick high-density polyurethane foam filler
- > 14 oz vinyl cover with grommet flaps for rear lacing
- > Lacing cord included
- > See chart for vinyl colors
- > Dimensions: 30”W x 6”H

**PPP-5HP** 9 lbs  
\$278 each **FR** **3Y** ★



### Pro Style Protector Pad

- > 6’ tall pad with rear cut-out for easy wrap around gooseneck post
- > Available in sizes to fit 4½” OD or 5½” OD posts
- > 6” thick cylindrical high-density polyurethane foam filler
- > 14 oz nylon reinforced vinyl cover with full length hook-and-loop closure flap
- > See chart for vinyl colors

**PPP-500HP** 4½” OD Pole  
15 lbs \$429 each

**PPP-700HP** 5½” OD Pole  
20 lbs \$515 each

**FR** **3Y** ★

<b>PINK</b>	<b>MAROON</b>
<b>RED</b>	<b>FOREST GREEN</b>
<b>NAVY BLUE</b>	<b>KELLY GREEN</b>
<b>YELLOW</b>	<b>ROYAL BLUE</b>
<b>LIGHT BLUE</b>	<b>TAN</b>
<b>GRAY</b>	<b>PURPLE</b>
<b>BLACK</b>	<b>ORANGE</b>

## Square Post Padding



### 6” Post Padding

- > Designed for 6” square posts
- > 6’H x 2” thick black padding
- > Attaches to post with hook-and-loop closure

**PP-66**  
3 lbs \$199 each **3Y** ★

### 4” Post Padding

- > Designed for 4” square posts
- > 6’H x 2” thick black padding
- > Attaches to post with hook-and-loop closure

**PP-44**  
3 lbs \$165 each **3Y** ★

## Custom Graphics for Pro Style Pads

### Custom Graphics for Basketball Pole Padding



Get your school logo or team name on protector pads.

**JSG-BPP1** Custom Lettering - Single Color (White)

Call for Artwork Approval & Pricing

**JSG-BPP2** Custom Artwork - Multi-Color

Call for Artwork Approval & Pricing



# Hoop Rejuvenator™



## HOOP REJUVENATOR™

a **jaypro sports** product

### Hoop Rejuvenator™ Kit

Is your basketball gooseneck system leaning, rusting or non-regulation height? Is budget a concern? Upgrade your existing system with the Hoop Rejuvenator™ by Jaypro Sports. Replace rusted backboards or regain regulation heights without the added cost of excavating and replacing your system.

- > Plumbs backboards on leaning goosenecks
- > Designed to fit standard mount plates and gooseneck systems 4½" OD and up
- > Acrylic, rectangular steel or aluminum fan backboard choices
- > H-frame kit or direct mount kit
- > Allows for goal height adjustment after court resurfacing (up to 6" for H-frames and 5" for direct mount units)
- > Ultimate Breakaway Playground Goal (UBG-500F) included
- > Stainless steel hardware and zinc galvanizing spray to cover rust spots included
- > NOTE: 3½" OD goosenecks only use aluminum fan backboard (HRKIT-FA)



## Hoop Rejuvenator™ H-Frame Kits

### Acrylic



### Hoop Rejuvenator™ H-Frame Kit

- > 72" x 42" Rectangular Acrylic Backboard
- > Ultimate Breakaway Playground Goal (UBG-500F)
- > H-frame kit included **FR 3Y X**

**HRKIT-AC** 215 lbs \$1,499 each

### Aluminum Fan



### Hoop Rejuvenator™ H-Frame Kit

- > 54" x 36" Aluminum Fan Backboard
- > Ultimate Breakaway Playground Goal (UBG-500F)
- > H-frame kit included **FR 3Y X**

**HRKIT-FA** 119 lbs \$1,249 each

### Steel

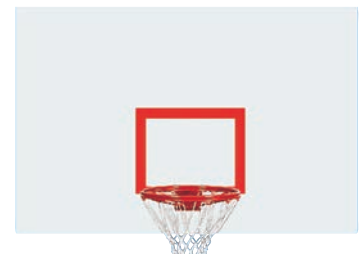

### Hoop Rejuvenator™ H-Frame Kit

- > 72" x 42" Rectangular Steel Backboard
- > Ultimate Breakaway Playground Goal (UBG-500F)
- > H-frame kit included **FR 3Y X**

**HRKIT-RC** 206 lbs \$1,549 each

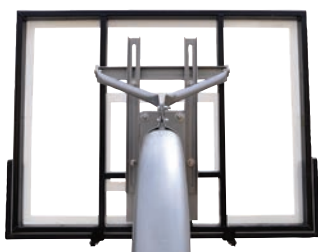

### H-Frame Design:

The H-Frame design is to be used on systems where the gooseneck mounts near the center of the backboard, not at the rim but above it.

NJ State Approved Co-op #65MCESCCPS





Acrylic



Aluminum Fan



Steel



Hoop Rejuvenator™  
Direct Mount Kit

- > 72" x 42" Rectangular Acrylic Backboard
- > Ultimate Breakaway Playground Goal (UBG-500F)
- > Direct mount kit included **FR** **3Y** **X**

**HRKIT-AC-DIR** 190 lbs \$1,299 each

Hoop Rejuvenator™  
Direct Mount Kit

- > 54" x 36" Aluminum Fan Backboard
- > Ultimate Breakaway Playground Goal (UBG-500F)
- > Direct mount kit included **FR** **3Y** **X**

**HRKIT-FA-DIR** 101 lbs \$1,049 each

Hoop Rejuvenator™  
Direct Mount Kit

- > 72" x 42" Rectangular Steel Backboard
- > Ultimate Breakaway Playground Goal (UBG-500F)
- > Direct mount kit included **FR** **3Y** **X**

**HRKIT-RC-DIR** 185 lbs \$1,299 each



Direct Mount Design:

The Direct Mount design is to be used on systems where both the backboard and rim are mounted directly to the gooseneck.

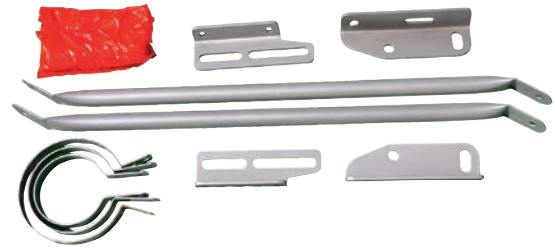

Ultimate Adjustable Gooseneck



Ultimate Adjustable Gooseneck  
with Hoop Rejuvenator™

A complete adjustable gooseneck system with the benefits of a Hoop Rejuvenator™ kit.

- > 4½" OD heavy-walled galvanized steel upright
- > H-frame style with 48" extension for "play safe area"
- > Acrylic, rectangular steel or aluminum fan backboard
- > Ultimate Breakaway Playground Goal (UBG-500F) included
- > Hoop Rejuvenator™ Kit included

**UAG-AC** 72" x 42" Rectangular Acrylic Backboard  
370 lbs \$2,315 each



**UAG-FA** 54" x 36" Aluminum Fan Backboard  
274 lbs \$2,025 each



**UAG-RC** 72" x 42" Rectangular Steel Backboard  
361 lbs \$2,315 each



NJ State Approved Co-op #65MCESCCPS



www.jaypro.com  
T: 800-243-0533 F: 800-988-3363



FR 3Y 1Y

Step 1:

Choose Post



Step 2:

Choose Board



Step 3:

Choose Goal



4 1/2" Diameter Gooseneck Post 4' Offset	Flex Rim GBR361	Double Rim GDR-54	Playground Goal UBG-500	Breakaway Playground UBG-500F
	<b>Aluminum Fan ALB-24BT</b> 	<b>996-FABT-SG</b> 277 lbs \$1,228	<b>996-FABT-DR</b> 279 lbs \$1,233	<b>996-FABT-UG</b> 288 lbs \$1,315
<b>Steel 850-RB-BB</b> 	<b>996-RS-SG</b> 361 lbs \$1,434	<b>996-RS-DR</b> 363 lbs \$1,438	<b>996-RS-UG</b> 372 lbs \$1,505	<b>996-RS-UB</b> 374 lbs \$1,577
<b>Perforated Steel SR-PERF</b> 	<b>996-PERF-SG</b> 391 lbs \$1,609	<b>996-PERF-DR</b> 343 lbs \$1,614	<b>996-PERF-UG</b> 402 lbs \$1,676	<b>996-PERF-UB</b> 404 lbs \$1,748
<b>Perforated Aluminum AL-PERF</b> 	<b>996-ALP-SG</b> 341 lbs \$1,619	<b>996-ALP-DR</b> 343 lbs \$1,624	<b>996-ALP-UG</b> 352 lbs \$1,686	<b>996-ALP-UB</b> 354 lbs \$1,758
<b>Acrylic ACRB-72</b> 	<b>996-AC-SG</b> 366 lbs \$1,572	<b>996-AC-DR</b> 369 lbs \$1,577	<b>996-AC-UG</b> 377 lbs \$1,592	<b>996-AC-UB</b> 379 lbs \$1,716
5 9/16" Diameter Gooseneck Post 6' Offset	Flex Rim GBR361	Double Rim GDR-54	Playground Goal UBG-500	Breakaway Playground UBG-500F
	<b>Aluminum Fan ALB-24BT</b> 	<b>656-FABT-SG</b> 357 lbs \$1,830	<b>656-FABT-DR</b> 359 lbs \$1,835	<b>656-FABT-UG</b> 368 lbs \$1,908
<b>Steel 850-RB-BB</b> 	<b>656-RS-SG</b> 441 lbs \$2,149	<b>656-RS-DR</b> 443 lbs \$2,154	<b>656-RS-UG</b> 452 lbs \$2,133	<b>656-RS-UB</b> 454 lbs \$2,205
<b>Perforated Steel SR-PERF</b> 	<b>656-PERF-SG</b> 471 lbs \$2,267	<b>656-PERF-DR</b> 473 lbs \$2,272	<b>656-PERF-UG</b> 482 lbs \$2,339	<b>656-PERF-UB</b> 484 lbs \$2,411
<b>Perforated Aluminum AL-PERF</b> 	<b>656-ALP-SG</b> 421 lbs \$2,277	<b>656-ALP-DR</b> 423 lbs \$2,282	<b>656-ALP-UG</b> 432 lbs \$2,349	<b>656-ALP-UB</b> 434 lbs \$2,421
<b>Acrylic ACRB-72</b> 	<b>656-AC-SG</b> 446 lbs \$2,235	<b>656-AC-DR</b> 448 lbs \$2,240	<b>656-AC-UG</b> 457 lbs \$2,307	<b>656-AC-UB</b> 459 lbs \$2,307

NJ State Approved Co-op #65MCESCCPS







FR 3Y 1Y

### Step 1:

Choose Post



### Step 2:

Choose Board



### Step 3:

Choose Goal



## 4 1/2" Diameter Straight Post 4' Offset

	Super Goal GBSG-50	Double Rim GDR-54	Playground Goal UBG-500	Breakaway Playground UBG-500F
Aluminum Fan ALB-24BT	SPA4-FABT-SG 322 lbs \$1,202	SPA4-FABT-DR 324 lbs \$1,207	SPA4-FABT-UG 333 lbs \$1,274	SPA4-FABT-UB 335 lbs \$1,346
Steel 850-RB-BB	SPA4-RS-SG 406 lbs \$1,511	SPA4-RS-DR 408 lbs \$1,516	SPA4-RS-UG 417 lbs \$1,583	SPA4-RS-UB 419 lbs \$1,655
Perforated Steel SR-PERF	SPA4-PERF-SG 436 lbs \$1,510	SPA4-PERF-DR 438 lbs \$1,515	SPA4-PERF-UG 447 lbs \$1,582	SPA4-PERF-UB 449 lbs \$1,654
Perforated Aluminum AL-PERF	SPA4-ALP-SG 386 lbs \$1,520	SPA4-ALP-DR 388 lbs \$1,525	SPA4-ALP-UG 397 lbs \$1,592	SPA4-ALP-UB 399 lbs \$1,664
Acrylic ACRB-72	SPA4-AC-SG 411 lbs \$1,511	SPA4-AC-DR 413 lbs \$1,516	SPA4-AC-UG 322 lbs \$1,583	SPA4-AC-UB 424 lbs \$1,655

## 5 9/16" Diameter Straight Post 6' Offset

	Super Goal GBSG-50	Double Rim GDR-54	Playground Goal UBG-500	Breakaway Playground UBG-500F
Aluminum Fan ALB-24BT	SPA6-FABT-SG 402 lbs \$1,730	SPA6-FABT-DR 404 lbs \$1,736	SPA6-FABT-UG 413 lbs \$1,809	SPA6-FABT-UB 415 lbs \$1,881
Steel 850-RB-BB	SPA6-RS-SG 451 lbs \$2,050	SPA6-RS-DR 453 lbs \$2,055	SPA6-RS-UG 462 lbs \$2,034	SPA6-RS-UB 464 lbs \$2,106
Perforated Steel SR-PERF	SPA6-PERF-SG 481 lbs \$2,168	SPA6-PERF-DR 483 lbs \$2,173	SPA6-PERF-UG 492 lbs \$2,240	SPA6-PERF-UB 494 lbs \$2,312
Perforated Aluminum AL-PERF	SPA6-ALP-SG 431 lbs \$2,178	SPA6-ALP-DR 433 lbs \$2,184	SPA6-ALP-UG 442 lbs \$2,251	SPA6-ALP-UB 444 lbs \$2,323
Acrylic ACRB-72	SPA6-AC-SG 456 lbs \$2,136	SPA6-AC-DR 458 lbs \$2,141	SPA6-AC-UG 467 lbs \$2,208	SPA6-AC-UB 469 lbs \$2,208

NJ State Approved Co-op #65MCECCPS



www.jaypro.com  
T: 800-243-0533 F: 800-988-3363

# FREE FREIGHT



## Unbreakable Replacement Package

- > 42" Unbreakable Glass Backboard (GBRUB-42)
- > Collegiate "Revolution" Goal (GBA-642)
- > Safe-Pro Edge Padding (MBBP-6)
- > Specify edge padding color when ordering

FR 3Y 1Y

**BBRP-42** 228 lbs \$1,345 package

## Glass Conversion Package

- > Same as above but with a 42" Rectangular Glass Conversion Backboard (GCBB-35)

FR 3Y 1Y

**GCBB-35PKG** 250 lbs \$1,345 package



## Unbreakable Rectangular Glass Backboard

- > NCAA and NFHS compliant
- > Unique design allows impact load on goal to transfer directly to an engineered lower reinforced steel frame member without putting stress on glass
- > Direct mount (4" x 5" hole pattern) or 4 corner mounting (35 1/2" x 62/66")
- > 1/2" thick rectangular tempered glass
- > Lightweight high strength clear anodized aluminum channel outer frame
- > Predrilled for Safe-Pro Edge Padding (MBBP-6)
- > Goal and net sold separately

**GBRUB-42** 72" x 42" Backboard 195 lbs \$899 each

**GBRUB-54** 54" x 42" Backboard 160 lbs \$695 each

FR 3Y

*Note: The glass itself is not unbreakable. Breakage in transit, during mounting, malicious act or deliberate attempts to damage are not covered under warranty. Boards used with height adjusters below 10' are not covered under warranty.*

## 48" Rectangular Glass Backboard

- > Similar features to the Unbreakable Glass Rectangular Backboard
- > Direct mount (5" x 5" hole pattern) or 4 corner mounting (42" x 63/66")
- > Goal and net sold separately

**GBAFR-48** 72" x 48" Backboard 200 lbs \$899 each

FR 3Y

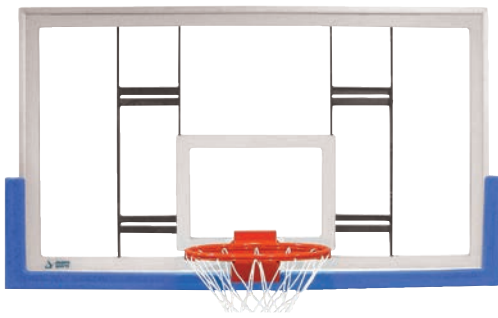

## 42" Rectangular Glass Conversion Backboard

- > NCAA and NFHS compliant
- > Converts fan-shaped backboard to rectangular backboard
- > Eliminates need to alter playing court or backstop system
- > Direct mount (4" x 5" hole pattern) or 4 corner mounting (20" x 35")
- > 1/2" thick rectangular tempered glass
- > High-strength clear anodized aluminum frame
- > Goal and net sold separately
- > Backboard: 72"W x 42"H

**GCBB-35** 230 lbs \$915 each

FR 3Y



## Patented Perforated Polycarbonate Backboard

- > Retrofits most indoor/outdoor support structures
- > 1/2" thick polycarbonate backboard is shatterproof
- > 250x stronger and 30% lighter than conventional glass backboards
- > Perforated holes release ball's energy achieving a "true bounce" off backboard
- > Sound and wind resistant construction
- > Graffiti, UVF and scratch resistant coating
- > Available in 3 sizes
- > See chart for custom trim colors
- > Goal and net sold separately
- > Call for freight quote

RED
ATHLETIC GOLD
GRAY
BLACK
BURGUNDY
FOREST GREEN
PURPLE
ROYAL BLUE
WHITE
ORANGE

**3654CB** 54" x 36" Backboard 75 lbs \$1,509 each

**4272CB** 72" x 42" Backboard 130 lbs \$2,075 each

**4872CB** 72" x 48" Backboard 150 lbs \$2,095 each

FR 1Y ★

NJ State Approved Co-op #65MCESCCPS







### 42" Rectangular Acrylic Backboard

- > 5" x 5" goal mounting pattern
- > Border and target included
- > Goal and net sold separately
- > Dimensions: 72"W x 42"H

**ACRB-72M** 145 lbs \$934 each **FR** **3Y**



### 36" Rectangular Acrylic Backboard

- > 5" x 5" goal mounting pattern
- > Border and target included
- > Goal and net sold separately
- > Dimensions: 48"W x 36"H

**LS-44AB** 99 lbs \$595 each **FR** **3Y**



### 42" Rectangular Perforated Steel Backboard

- > 5" x 5" goal mounting pattern
- > Rear support frame allows for multiple mounting conversions
- > 11 gauge steel face with 1/4" dia perforations provides open area to minimize wind resistance
- > Goal and net sold separately
- > Dimensions: 72"W x 42"H

**SR-PERF** 133 lbs \$825 each **FR** **3Y**



### 42" Rectangular Steel Backboard

- > 5" x 5" goal mounting pattern
- > Rear welded mounting pattern (35" x 20")
- > 12 gauge steel
- > Goal and net sold separately
- > Dimensions: 72"W x 42"H

**850RB-BB-BT** w/ Border & Target 200 lbs \$848 each **FR** **3Y**

**850RB-BB** w/ Target 200 lbs \$809 each



### 42" Rectangular Perforated Aluminum Backboard

- > 5" x 5" goal mounting pattern
- > Rear support frame allows for multiple mounting conversions
- > Aluminum face with 1/4" dia perforations provides open area to minimize wind resistance
- > Goal and net sold separately
- > Dimensions: 72"W x 42"H

**AL-PERF** 83 lbs \$860 each **FR** **3Y**



### 36" Aluminum Fan Backboard

- > 5" x 5" goal mounting pattern
- > Cast aluminum with 1 1/2" flange
- > Goal and net sold separately
- > Dimensions: 56"W x 36"H

**ALB-24BT** 56 lbs \$499 each **FR** **3Y**  
NJ State Approved Co-op #65MCE SCCPS



### 35" Graphite Backboard

- > 2 3/4" x 3 1/2" goal mounting pattern
- > Rear mounting pattern (17 1/2" x 15 1/2")
- > Recommended goal (G-35) and net sold separately
- > Replacement board for the Little Champ™ backboard adapter
- > Dimensions: 48"W x 35"H

**FSGB-1** 20 lbs \$239 each **FR** **3Y**

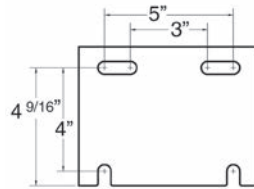

Mounting Plate  
(GBA-642, GBA-542)

### “Revolution” Breakaway Goal

- > NCAA, NFHS and FIBA compliant and adapts to all levels of play
- > Case hardened wear pin allows rim to safely break from too much pressure
- > Adjust from 140 lbs to 250 lbs
- > Maintains rebound features after 50,000 test cycles
- > Hideaway net attachment system
- > Mounting hardware and anti-whip net included
- > **Note: GBA-648 will fit on both a 42” and 48” backboard**
- > Note: Check existing hole pattern for correct placement

**GBA-642** 42” Backboard  
27 lbs \$289 each



**GBA-648** 42” & 48” Backboard  
27 lbs \$289 each

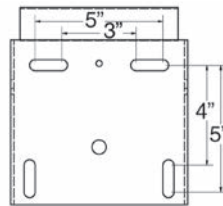

Mounting Plate  
(GBA-648, GBA-548)

### “Shot” Breakaway Goal

- > NCAA, NFHS and FIBA compliant and adapts to all levels of play
- > Case hardened wear pin allows rim to safely break from too much pressure
- > Adjust from 140 lbs to 250 lbs
- > Maintains rebound features after 50,000 test cycles
- > Pigtail ring net attachment system
- > Mounting hardware and anti-whip net included
- > **Note: GBA-548 will fit on both a 42” and 48” backboard**
- > Note: Check existing hole pattern for correct placement

**GBA-542** 42” Backboard  
27 lbs \$279 each



**GBA-548** 42” & 48” Backboard  
27 lbs \$279 each



## Competitor Goals (Indoor)

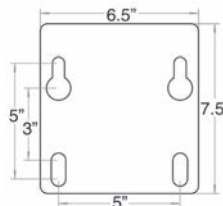

Mounting Plate  
(GBA-180)

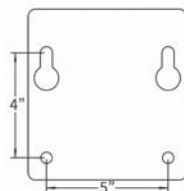

Mounting Plate  
(GBA-18042)

### Competitor 180° Breakaway Goal

- > NCAA, NFHS and FIBA compliant
- > Adjustable to withstand different levels or pressure
- > Designed to safely break from any angle
- > Hideaway net attachment system
- > Nylon net and zinc plated mounting hardware included

**GBA-18042** 42” Backboard  
39 lbs \$485 each



**GBA-180** 48” Backboard  
39 lbs \$440 each





### Competitor Adjustable Breakaway Goal

- > NCAA and NFHS compliant
- > 5" x 4" goal mounting pattern
- > Adjustable to withstand different levels or pressure
- > Pigtail ring net attachment system
- > Nylon net and mounting hardware included

**GBA-342A** 42" Backboard  
27 lbs \$266 each  **3Y**  **1Y**

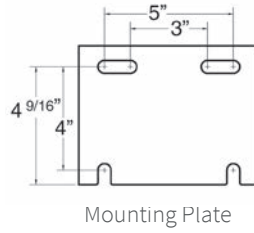

### Competitor Pro Adjustable Breakaway Goal

- > NCAA and NFHS compliant
- > 5" x 4" goal mounting pattern
- > Adjustable to withstand different levels or pressure
- > Pro level hideaway net attachment system
- > Nylon net and mounting hardware included

**GBA-600** 25 lbs  
\$274 each  **3Y**  **1Y**

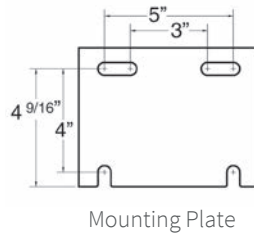

## Indoor/Outdoor Goals

### Flex Goal

- > Pigtail ring net attachment system
- > Fits 5"x 5" or 5"x 4" hole pattern
- > Nylon net and mounting hardware included

**GBR361** 30 lbs  
\$189 each  **3Y**  **1Y**

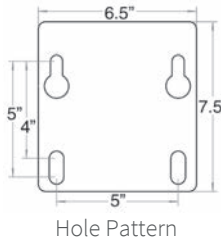

### Breakaway Goal

- > Withstands different levels of pressure
- > Pigtail ring net attachment system
- > Fits 5"x 5" or 5"x 4" hole pattern
- > Nylon net and mounting hardware included

**GBR360** 30 lbs  
\$189 each  **3Y**  **1Y**

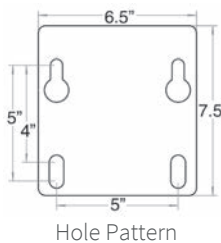

# Single Goals (Indoor/Outdoor)

## Economy Single Rim Goal

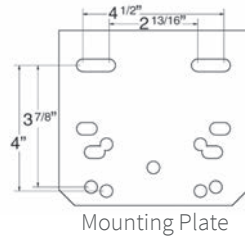

- > Official orange powder coating
- > Nylon net and zinc plated mounting hardware included

**G-35** 13 lbs \$56 each  3Y  1Y



## Single Rim Goal

- > Official orange powder coating
- > Official size 18" ring of 5/8" steel with 7/16" round steel brace
- > Universal hole pattern
- > Nylon net and zinc plated mounting hardware included

**GB-55** 14 lbs \$73 each  3Y  1Y

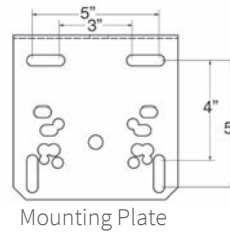

## Super Goal

- > Official orange powder coating
- > Official size 5/8" high-tensile alloy rim 1 1/2" times the strength of average rim material
- > Superior support with 5/8" support arms
- > Universal hole pattern
- > Nylon net and zinc plated mounting hardware included

**GBSG-50** 17 lbs \$127 each  3Y  1Y

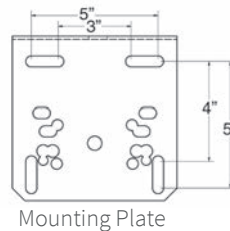

# Double Goals (Outdoor)

## Double Rim Goal

- > Official orange powder coating
- > Official size 18" double ring of 5/8" steel and 1/2" welded together for added strength and rigidity
- > Universal hole pattern
- > Nylon net and zinc plated mounting hardware included

**GDR-54** 18 lbs \$119 each  3Y  1Y

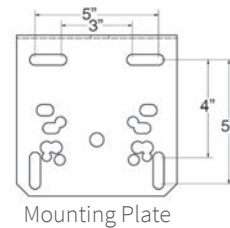

## Playground Goal

- > Official orange powder coating
- > Outdoor fixed double solid steel rim
- > No-fail net lock system
- > Universal hole pattern
- > Nylon net included
- > Can be used with a chain net

**UBG-500** 27 lbs \$185 each  3Y  1Y

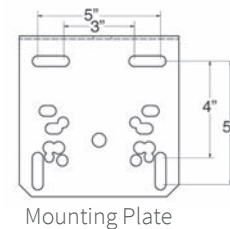

## Playground Breakaway Goal

- > Indoor/outdoor use
- > Universal hole pattern
- > Nylon net included
- > Can be used with a chain net

**UBG-500F** 29 lbs \$299 each  3Y  1Y

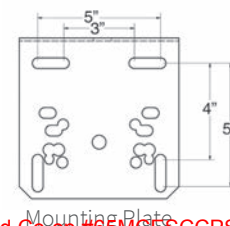





### Shooters Ring

- > Creates smaller diameter rim (16"W) for shooting practice
- > Attaches to standard basketball goals
- > Metal ring design requires no tools for quick and easy installation

**SHOTRING** 5 lbs \$25 each 3Y



### Rebound Ring

- > Designed to develop rebounding skills
- > Keep balls from falling through rim
- > Attaches to 18" goal with 3 screws

**RBRING** 3 lbs \$27 each 3Y



### Hideaway Rim Steel Replacement Ring

- > For any rim with hideaway net attachment system
- > Easily slide through brackets to attach net

**BBSR-R** 1 lb \$13 each 3Y

## Removable Goal Bracket Kit

Ideal for park and recreation courts.

- > Stop theft, potential damage and unwanted play
- > Stainless steel bracket fits most front mount backboards with 5" x 5" goal mounting pattern
- > Recommended for GB-55, GBSG-50 or GDR-54 goals
- > Bracket, hardware and padlock included
- > Note: Not to be used with breakaway goals

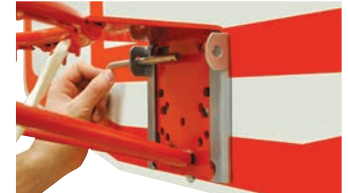

Mount the GAK-5 bracket to your backboard and be able to slide your rim on and off. It can also be locked in place.

**GAK-5** 5 lbs \$61 each 3Y



### Nylon Net

12 loop, 680/32 braided white

**JNY-4HP**  
1 lb \$5 each 1Y



### Anti-Whip Nylon Net

12 loop, 120 threaded, braided cord stops from flipping onto rim

**JNY-6HP**  
1 lb \$12 each 1Y



### Standard Chain Net

Heavy-duty "S" hooks, fits any style goal

**J-3**  
2 lbs \$29 each 3Y

## Little Champ™ Goals

### For Little Champ™ Easy Adjust & 8.5



### Little Champ™ Goal

- > Foldable goal, facilitates storage
- > For youth play only
- > Fits all Little Champ™ models
- > Hole pattern: 2¾"H x 3½"W

**LC-RIM** 12 lbs \$125 each 3Y 1Y

### For Little Champ™ Classic



### Economy Single Rim Goal

- > Official orange powder coating
- > Nylon net and zinc plated mounting hardware included

**G-35** 13 lbs \$56 each 3Y 1Y



# Safe-Pro™ Edge Padding

## Safe-Pro™ a *jaypro sports* product

### Safe-Pro™ Edge Padding

- > NCAA, NFHS and FIBA compliant
- > Bolts easily to all 72" official glass backboards
- > Perfect pad alignment with steel connectors
- > Pin style attachment eliminates pad sagging under rim
- > See chart for edge padding colors

<b>MBBP- 6PK</b>	Pink
<b>MBBP- 6C</b>	Cardinal Red
<b>MBBP- 6TO</b>	Burnt Orange
<b>MBBP- 6P</b>	Purple
<b>MBBP- 6OG</b>	Old Gold
<b>MBBP- 6RB</b>	Royal Blue
<b>MBBP- 6S</b>	Scarlet Red
<b>MBBP- 6NB</b>	Navy Blue
<b>MBBP- 6YW</b>	Yellow

<b>MBBP- 6FG</b>	Forest Green
<b>MBBP- 6OR</b>	Orange
<b>MBBP- 6M</b>	Maroon
<b>MBBP- 6KG</b>	Kelly Green
<b>MBBP- 6BK</b>	Black
<b>MBBP- 6CB</b>	Columbia Blue
<b>MBBP- 6GY</b>	Gray
<b>MBBP- 6LP</b>	Light Purple

13 lbs      \$197 each      10Y

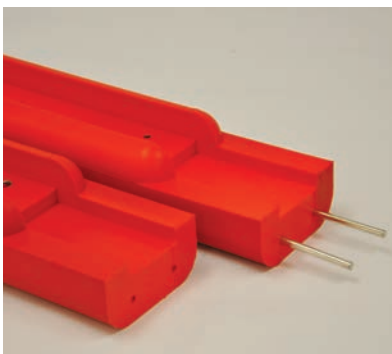

Bolt-on edge padding includes two steel connectors for perfect alignment



### Safe-Pro™ 54" Bolt-On Edge Padding

Same features as MBBP-6 except bolts easily to all 54" official glass backboards.

<b>MBBP-54S</b>	Scarlet Red	16 lbs	\$197 each	<b>MBBP-54BK</b>	Black	16 lbs	\$197 each
<b>MBBP-54GY</b>	Gray	16 lbs	\$197 each	<b>MBBP-54RB</b>	Royal Blue	16 lbs	\$197 each



### 1 1/2" Bolt-On Edge Padding

Designed for wood or acrylic backboards.

- > Fits any 48" acrylic backboard
- > Molded tough "L" shape urethane material
- > Indoor/outdoor use
- > Fits any 72" acrylic or wood backboard
- > Molded tough "L" shape urethane material
- > Indoor/outdoor use
- > Fits any 72" wood backboard
- > Molded tough "U" shape urethane material
- > Indoor/outdoor use

**EP-46** Black 9 lbs \$179 each 3Y

**EP-48** Black 9 lbs \$179 each 3Y      **MBBP-WB** Gray 16 lbs \$212 each 3Y





## Little Champ™ Easy Adjust Backboard Adapter

Ideal for youth leagues and elementary schools to develop shooting skills.

- > Complete unit with fan-shaped backboard, lightweight attachment frame, official size goal and nylon net ships partially assembled
- > Complete details and more information on page 147

**LC-6HP** 49 lbs \$729 each 3Y  
**LC-6** 98 lbs \$1,349 pair 3Y



Frame folds down and rim folds up for compact storage



## Little Champ™ 8.5 Backboard Adapter



- > Complete unit with fan-shaped backboard, lightweight attachment frame, official size goal and nylon net
- > Complete details and more information on page 147

**LC-2HP** 38 lbs \$549 each 3Y  
**LC-2** 76 lbs \$1,029 pair 3Y

## Little Champ™ Classic Backboard Adapter



- > Complete unit with fan-shaped backboard, lightweight aluminum frame, official size goal and nylon net
- > Complete details and more information on page 147

**LC-1HP** 46 lbs \$449 each 3Y  
**LC-1** 92 lbs \$849 pair 3Y

## Basketball Accessories



### LED Backboard Light Kit

- > Backboard lights up when shot clock or game time reaches zero and when final segment counts down to zero
- > 5 bright LED strips fit 72"W x 42"H backboards
- > Requires 9VDC-17VDC (formal specified voltage is 10.5VDC)
- > Specify shot clock manufacturer/model when ordering (connects with most shot clocks)
- > Kit includes all items required for your specific shot clock model
- > Connection by a qualified installer recommended
- > Call for freight quote

**BB-LED42** 25 lbs Call for Pricing 1Y

### Shot Clock Mounting Bracket



- > Designed for Jaypro Sports Elite Portable systems
- > Shot clock not included

**PBEL-SCBEA** 30 lbs \$386 each 3Y



### Basketball Court Stencil

- > Precision cut stencils
- > Easily paint a regulation basketball court on a driveway, patio or play area
- > Paint roller included
- > Finished Court Size: 21'W x 13'L

**BGS-1** 5 lbs \$49 each 1Y

### Possession Indicator



- > Red LED display in a durable plastic case
- > Toggle switch operation, top red indicator lights and AC adapter with 15' long cord

**POSIND1** 3 lbs \$141 each 3Y

### Tabletop Scoreboard

- > Rear control panel with visual display
- > Amber and gold LED lights
- > Scores up to 199 and timer up/down to 99:59
- > Buzzer sounds automatically/manually at end of period
- > Uses 110v with 15' power cord
- > Dimensions: 24"W x 15"H x 10"D

**TTS10** 12 lbs \$679 each 3Y



Digital display control panel on back for operator



NJ State Approved Co-op #65MCESCPS



www.jaypro.com  
T: 800-243-0533

F: 800-988-3363



### Elite 9600 Portable System

- > Folds down to compact storage position
- > Designed to fit through standard double size doorways (heightwise) with 76" width
- > Spring assisted one person set-up
- > Adjusts 8' to 10' from floor (6" increments)
- > 96" extension arm for "play safe area"
- > 72" x 42" unbreakable glass rectangular backboard
- > Direct mount "Revolution" breakaway goal
- > Bolt-on backboard edge padding (specify color when ordering)
- > Portable system vinyl padding - see chart on page 93 for vinyl colors (specify when ordering)
- > Optional graphics on padding available - call customer service for details and pricing
- > (6) 8" dia non-marking non-skid wheels - double rear wheels
- > Rear anchor kit included to meet NCAA and NFHS rules for portable competition goals
- > 1000 lb ballast weight included

**PBEL96**    2600 lbs    \$9,836 each    FR ● 3Y

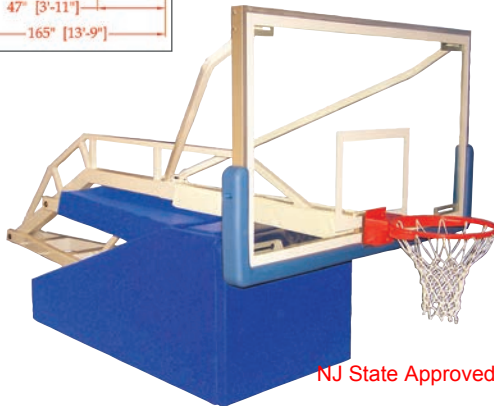
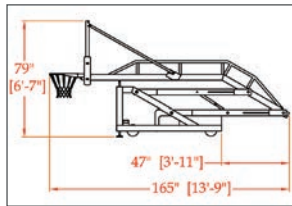

### Elite 6600 Portable System

- > Folds down to compact storage position
- > Designed to fit through standard doorways with 76" width
- > Spring assisted one person set-up
- > Adjusts 8' to 10' from floor (6" increments)
- > 66" extension arm for "play safe area"
- > 72" x 42" unbreakable glass rectangular backboard
- > Direct mount "Revolution" breakaway goal
- > Bolt-on backboard edge padding (specify color when ordering)
- > Portable system vinyl padding - see chart on page 93 for vinyl colors (specify when ordering)
- > Optional graphics on padding available - call customer service for details and pricing
- > 8" dia non-marking non-skid wheels
- > Rear anchor kit sold separately
- > 800 lb ballast weight included

**PBEL66**    2400 lbs    \$8,708 each    FR ● 3Y

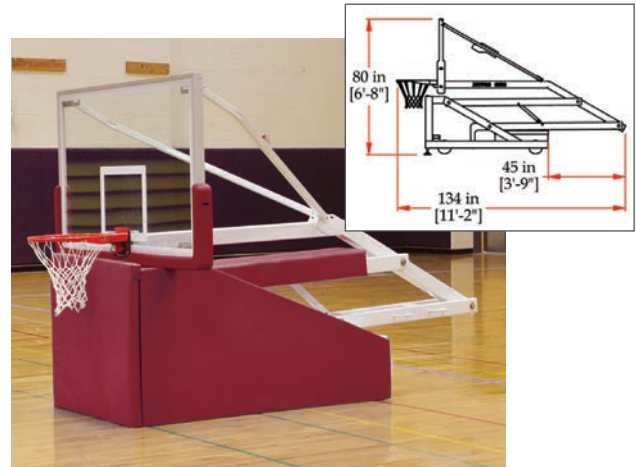

**SHIPPING NOTICE**  
Flatbed tow truck, forklift or loading dock required  
to unload our portable indoor systems.





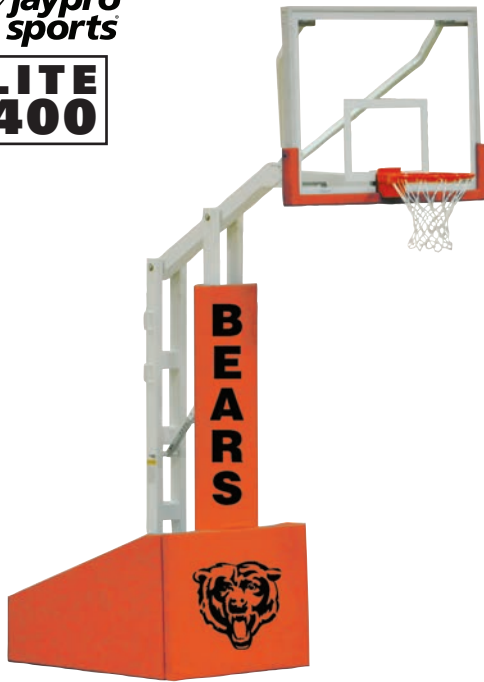

### Elite 5400 Portable System

- > Folds down to compact storage position
- > Designed to fit through standard doorways with 58" width (PBEL54) or 76" width (PBEL5472)
- > Spring assisted one person set-up
- > Adjusts 8' to 10' from floor (6" increments)
- > 54" extension arm for "play safe area"
- > 54" x 42" unbreakable glass rectangular backboard
- > Direct mount "Revolution" breakaway goal
- > Bolt-on backboard edge padding (specify color when ordering)
- > Portable system vinyl padding - see chart on page 93 for vinyl colors (specify when ordering)
- > Optional graphics on padding available - call customer service for details and pricing
- > 8" dia non-marking non-skid wheels
- > Rear anchor kit sold separately
- > 800 lb ballast weight included

**PBEL54** 54" x 42" Backboard 1600 lbs \$7,095 each

**PBEL5472** 72" x 42" Backboard 1850 lbs \$7,901 each

FR ●● 3Y

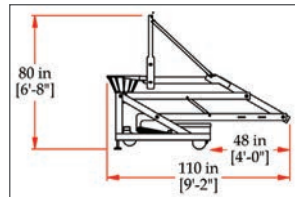

### Rear Anchor Kit

- > Threaded floor anchor
- > Includes all hardware to attach to built-in rear eye bolt

3Y

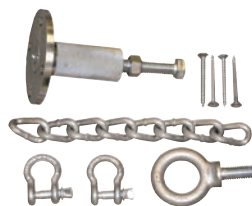

**PBELKIT-100** For floating wood floors 3 lbs \$231 each

**PBELKIT-89** For other type floors 3 lbs \$231 each

NJ State Approved Co-op #65MCESCCPS



### Portable Basketball System

Designed to meet the demands of adult recreation with the flexibility to meet the needs of elementary level activities.

- > Folds down to compact storage position
- > Designed to fit through standard doorways with 48" width
- > Height setting adjusts from 6'6" to 10' - no tools required
- > 48" extension arm at 10' high for "play safe area"
- > 48" x 32" x 3/8" acrylic backboard
- > Direct mount "Revolution" breakaway goal
- > Black backboard edge padding sold separately
- > Portable system vinyl padding - see chart on page 93 for vinyl colors (specify when ordering)
- > Rear anchor kit sold separately
- > Customer supplied ballast required is 300-350 lbs
- > Some assembly required

**PBB-200** System 500 lbs \$3,125 each FR ●● 3Y

**EP-48** Backboard Edge Padding (black only) 16 lbs \$179 each 3Y

**AB-4832** Replacement Backboard - 32" x 48" 75 lbs \$425 each 3Y

**WARNING!** Failure to install customer supplied ballast according to instruction provided could result in serious injury.

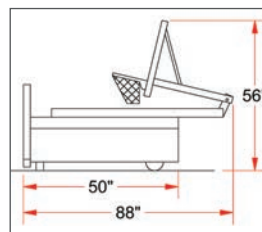

# Rectangular Glass Board Wall Mounted Backstops

Jaypro Sports easy-to-install rectangular glass board kits include numerous features that excel over any competitor system:

**Exclusive Feature:** 2" x 8" Southern Yellow Pine mounting wood boards are pre-drilled and counter-bored, edges rounded and surfaces sanded with lacquer finished front, back and all edges. No drilling, cutting, or finishing needed.

**Exclusive Feature:** Heavy-duty formed steel fittings mount board directly to frame.

Heavy-walled 1.90" OD frame pipes cut and drilled in the field to desired extension off wall.

**Exclusive Feature:** Heavy-duty steel fittings with four 1/2" attachment bolts and grade 5 steel hinge bolts.

Durable black powder coat finish on all fittings and backstop frame.

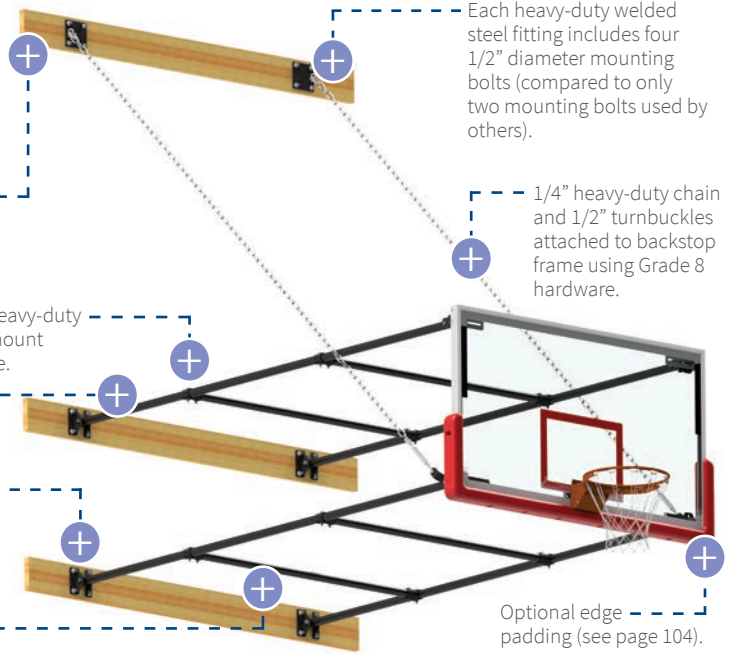

### Wall Mounted Backstops Include:

- > 42" Unbreakable Rectangular Glass Backboard (GBRUB-42)
- > "Revolution" Breakaway Goal (GBA-642)

### Wall Mounted Backstop Options:

- > Manual or Electric Height Adjuster (see page 109)
- > Board Edge Padding (see page 104)
- > Wall Anchors sold separately (see page 110)



## Stationary Backstop System

- > Stationary wall mounted backstop

Wall Ext.	Item	Weight	Price
2'-4'	<b>N24GB</b>	350 lbs	\$1,695
4'-6'	<b>N46GB</b>	398 lbs	\$1,895
6'-8'	<b>N68GB</b>	417 lbs	\$1,995
8'-10'	<b>N810GB</b>	466 lbs	\$2,295
10'-12'	<b>N1012GB</b>	485 lbs	\$2,349

## Fold-Up Backstop System

- > Folds upward for convenient storage
- > System operated with manual or electric winch (sold separately)

Wall Ext.	Item	Weight	Price
4'-6'	<b>U46GB</b>	450 lbs	\$2,349
6'-8'	<b>U68GB</b>	469 lbs	\$2,395
8'-10'	<b>U810GB</b>	518 lbs	\$2,695
10'-12'	<b>U1012GB</b>	537 lbs	\$2,749

## Side-Fold Backstop System

- > Folds to the side for convenient storage
- > System includes manual pull-pin to lock unit in either playing or storage position

Wall Ext.	Item	Weight	Price
4'-6'	<b>S46GB</b>	440 lbs	\$1,949
6'-8'	<b>S68GB</b>	459 lbs	\$1,995
8'-10'	<b>S810GB</b>	499 lbs	\$2,195
10'-12'	<b>S1012GB</b>	518 lbs	\$2,249

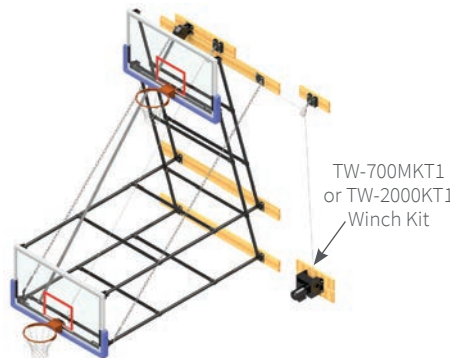
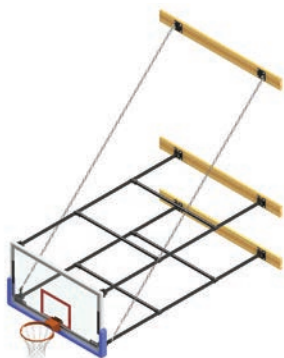

## IMPORTANT NOTES FOR WALL MOUNTED BACKSTOPS:

1. Wall-mounted basketball systems should only be installed on walls capable of supporting the weight of the backstop plus the additional weight of a player hanging off the rim. Consult an architect, structural engineer or contractor if necessary.
2. Wall-mounted backstops require an unobstructed wall and minimum ceiling height. Such requirements are dependent on backstop style and distance from the wall. Refer to the product spec sheet for additional information.
3. Jaypro Sports bears no responsibility for the structural integrity of the wall the backstop is mounted to.
4. Installation should only be done by a qualified installer using suitable wall anchors. Contact Jaypro Sports for assistance in locating a qualified installer.
5. Jaypro Sports recommends all backstops be inspected and serviced on an annual basis to ensure wall anchors are sound, fasteners are secured and worn. Contact Jaypro Sports for assistance in locating a qualified installer.





# Height Adjusters for Glass Board Wall Mounted Backstops

Adjust the height of your backboard and rim from 8' to 10'. Lightweight and easy to operate. Constructed of extruded aluminum interlocking channels, which provide tighter clearances resulting in less shake than other height adjusters on the market – even at the lower playing heights. Choose either manual operation or electric control. The electric height adjuster is driven by a 1/10 HP linear actuator, requiring 120 volt power. Electric height adjusters may be hard wired, or temporarily powered off a standard 120 volt electric wall outlet.

## Wall Mount Height Adjuster Kits:

Kits include the height adjuster, board mounts, and hardware required to install with Jaypro Sports rectangular glass board wall mounted backstops.

**Manual Height Adjuster Wall Mount Kit:** Easily raises and lowers the backboard manually. Method of operation can be done at floor level using a manual hand crank (HA-1H) or a Cordless Drill Operator (CD-80H). Method of operation for manual height adjusters are sold separately.

**Key Switch Electric Height Adjuster Wall Mount Kit:** Electric control of height adjuster using a three-position, momentary operated key switch. Requires dedicated 120 volt, 15/20 amp circuit for the key switch and motor. Key switch included in kit.

**Power Wand Electric Height Adjuster Wall Mount Kit:** Electric control of height adjuster without the added expense of hard wiring. Height adjuster comes with built-in power wand receptacle. Simply plug the Power Wand (HAPW-100) into the receptacle of any 120 volt, 15/20 amp wall outlet. Power Wand sold separately.

**Electric Height Adjuster Wall Mount Kit:** Electric control of height adjuster using an advanced control system such as radio remote controller, MEC2, or ETEC system, sold separately.



### Method of Operation

A) Manual Hand Crank (HA-1H), sold separately	<b>AHA-WM</b>	\$1,343 180 lbs
B) Cordless Drill Operation (CD-80H), sold separately		

Key Switch (KS-13) operation included	<b>EHA-WM-KS</b>	\$2,576 212 lbs
---------------------------------------	------------------	--------------------

Power Wand Controller (HAPW-100), sold separately	<b>EHA-WM-PW</b>	\$2,674 216 lbs
---	------------------	--------------------

For use with Radio Remote, MEC2, or ETEC systems, sold separately	<b>EHA-WM</b>	\$2,530 211 lbs
---	---------------	--------------------

## Height Adjuster Operators:

A) <b>HA-1H</b>	Manual Hand Crank	5 lbs	\$99 each
B) <b>CD-80H</b>	Cordless Manual Height Adjuster Operator	18 lbs	\$780 each
C) <b>KS-13</b>	Momentary Electric Key Switch	2 lbs	\$106 each
D) <b>HAPW-100</b>	Power Wand Controller	10 lbs	\$495 each

Refer to pages 111 & 119 for additional control options such as radio remote, MEC2, or ETEC

Multiple Control Systems available, see page 119



CD-80H



HA-1H



HAPW-100

# Height Adjusters for Existing Ceiling Suspended Backstops

Take the guess work out of how to add a height adjuster to an existing ceiling suspended backstop.

- > Kit fits most common backstop frames
- > Height adjuster (choose manual or electric)
- > 42" unbreakable glass rectangular backboard (GBRUB-42)
- > "Revolution" breakaway goal (GBA-642)
- > Mounting hardware to attach to center strut (6" OD to 6 5/8" OD) or double drop (H-frame) backstops included

To order, choose your style of backstop and desired height adjuster. Double drop kits have mounting holes drilled in the field so they can fit almost any frame width. Call customer service if you have any configuration not listed below.



Center Strut Frame



Double Drop Frame

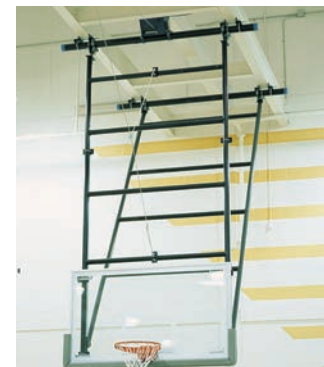

Product	Method of Operation	Center Strut Item	Weight	Price	Double Drop Item	Weight	Price
Manual Height Adjuster Kit	A) Manual Hand Crank (HA-1H), sold separately B) Cordless Drill Operation (CD-80H), sold separately	<b>GBCS-AHA</b>	105 lbs	\$1,800	<b>GBDD-AHA</b>	155 lbs	\$1,981
Electric Height Adjuster Kit Key Switch	Key Switch (KS-13) operation included	<b>GBCS-EHAKS</b>	137 lbs	\$3,121	<b>GBDD-EHAKS</b>	188 lbs	\$3,214
Electric Height Adjuster Kit Power Wand	Power Wand Controller (HAPW-100), sold separately	<b>GBCS-EHAPW</b>	141 lbs	\$3,219	<b>GBDD-EHAPW</b>	192 lbs	\$3,312
Electric Height Adjuster Kit	For use with Radio Remote, MEC2, or ETEC systems, sold separately	<b>GBCS-EHA</b>	136 lbs	\$3,075	<b>GBDD-EHA</b>	187 lbs	\$3,168



# Wall Mount Backstop Winch and Safety Strap Kits

## Electric Winch with Wall Mounting Kit

- > Electric winch w/key switch (TW-2000)
- > Finished wood mount boards and hardware included



**TW-2000KT1** 90 lbs  
\$1,395 each **FR 3Y**

## Manual Winch with Wall Mounting Kit

- > Manual winch (TW-700M)
- > Finished wood mount boards and hardware included
- > Manual winch handle sold separately



**TW-700MKT1** 55 lbs  
\$818 each **FR 3Y**

## Safety Strap with Wall Mounting Kit

- > Safety strap (PL-1000)
- > Finished wood mount boards and hardware included



**PL-1000KT1** 38 lbs  
\$779 each **FR 3Y**

## Shooting Stations

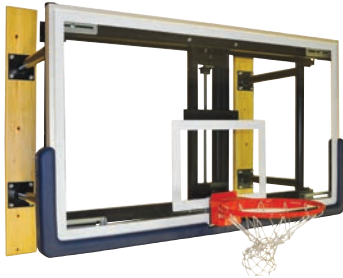

### Wall Mount Shooting Station

Ideal for young children learning shooting skills and the art of free throws.

- > 3' Face of Bank
- > With height adjuster, handle easily adjusts backboard to desired height between 8' and 10'

<b>WMWH</b>	Station with Height Adjuster	440 lbs	\$2,795 each	<b>FR 3Y</b>
<b>WMSS</b>	Station without Height Adjuster	285 lbs	\$1,995 each	<b>FR 3Y</b>

- > Unbreakable Glass Rectangular Backboard (GBRUB-42)
- > "Revolution" Breakaway Goal (GBA-642) with hideaway net attachment
- > Wood backing and height adjuster handle included
- > Backboard edge padding and mounting hardware sold separately



### Adjustable Wall Mount Shooting Station

- > Indoor/outdoor use
- > Hand crank adjusts backboard to desired height between 7½' and 10'
- > Backboard with aluminum backboard frame available in three sizes
- > Extension from wall to backboard ranges from 33" - 44" depending on height
- > Heavy-duty flex goal with nylon net and black edge padding (glass only) included
- > Mounting hardware sold separately

<b>WM-48</b>	Acrylic Backboard - 36" x 48" x 1/2"	250 lbs	\$1,275 each	<b>FR 3Y</b>
<b>WM-65</b>	Acrylic Backboard - 36" x 60" x 1/2"	300 lbs	\$1,350 each	<b>FR 3Y</b>
<b>WM-54</b>	Glass Backboard - 36" x 54" x 1/2"	255 lbs	\$1,379 each	<b>FR 3Y</b>
<b>WM-60</b>	Glass Backboard - 36" x 60" x 1/2"	300 lbs	\$1,389 each	<b>FR 3Y</b>

## 3-Point Fan Board Wall Mount Shooting Station

- > Economy stationary wall mounted backstop
- > 36" Aluminum Fan Backboard (ALB-24BT)
- > "Shot" Breakaway Goal (GBA-548)
- > Frame includes heavy wall 1.90" OD frame pipes with diagonal rigid bracing for maximum stability
- > Direct goal mounted to eliminate any strain on the board
- > Frame pipes are cut and drilled in the field to achieve desired extension off wall
- > 3'-6" extensions and larger include additional wood stringer and chain support

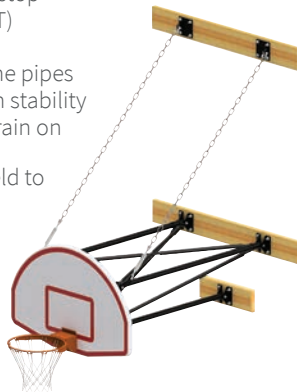

Wall Ext.	36" Alum. Fan Board	Weight	Price
6"-2'	<b>N2FB</b>	264 lbs	\$1,149
2'-3½'	<b>N236FB</b>	280 lbs	\$1,249
3'-6½'	<b>N366FB</b>	359 lbs	\$1,549
6'-8'	<b>N68FB</b>	371 lbs	\$1,749
8'-10'	<b>N810FB</b>	412 lbs	\$1,949

**FR 3Y**

## Column Mounted Shooting Station



- > Designed to mount directly to exposed vertical or tapered column
- > 36" Aluminum Fan Backboard (ALB-24BT)
- > "Shot" Breakaway Goal (GBA-548)
- > Direct goal mounted to eliminate any strain on the board
- > With height adjuster, handle (HA-1H) easily adjusts backboard to desired height between 8' and 10' (included)
- > Maximum beam taper of 4 degrees or 1" to 4½" slope
- > Column mounted wall padding highly recommended
- > Minimum/Maximum flange width of 6"/14" and maximum flange thickness of 1½"

<b>CMWH</b>	Station w/ Height Adjuster	200 lbs	\$1,599 each	<b>FR 3Y</b>
<b>CMSS</b>	Station w/o Height Adjuster	142 lbs	\$1,049 each	

## Wall Mount Backstop Anchors

### "Double" Dual Expansion Machine Bolt Wall Anchor

For solid concrete walls, including pre-cast concrete or filled block.

<b>HM2711</b>	1/2" Expansion Anchor	\$8 each	<b>3Y</b>
<b>SR5187</b>	1/2" Threaded Rod - 12" Long	\$10 each	<b>3Y</b>
<b>SR5276</b>	1/2" Threaded Rod - 18" Long	\$10 each	<b>3Y</b>



### No. 1 Type Tumble Toggle Wall Anchor

For hollow, non-filled CMU walls.

<b>HM6212</b>	\$6 each	<b>3Y</b>
---------------	----------	-----------

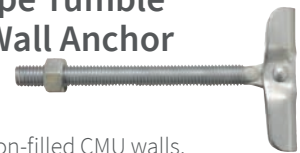



# Backstop Winches & Accessories

## Direct Drive Electric Backstop Winch

- > Designed to raise and lower ceiling suspended (32' attachment height and under) or wall mounted basketball units
- > Universal mounting enclosure to allow easy installation for new or existing conditions (winch includes hardware to mount to 3 1/2" OD pipe)
- > Instantly reversing 1HP 115 volt single phase torque motor delivering 800 pounds of line pull at a speed of 11' per minute
- > Maintenance free operation with uni-directional worm brake and self locking worm drive (no belts or chains)
- > Method of operation (key switch, radio remote, etc.) and lifting cable sold separately



**TW-2000-1**

72 lbs \$1,299 each 1Y  
Winch only

## Manual Backstop Winch

- > Designed to raise and lower ceiling suspended (27' attachment height and under) or wall mounted basketball units
- > Compact and easy to use with self-lubricating composite gears (eliminates the need for oil)
- > Unique worm brake and grooved drum helps prevent backdrive and cable from kinking
- > Cable retention roller prevents unspooling of cable
- > Method of operation (handle or drill operator), lifting cable, and mounting components sold separately



**TW-700M**

24 lbs \$745 each 1Y  
Winch only

## TW-2000-1 Methods of Operation

Key Switch	Ganged Key Switches	Radio Remote Receiver	Radio Remote Transmitter
			
<b>KS-13</b>	<b>GPWKS-XX</b>	<b>DRX-1199</b>	<b>TMX-1199</b>
\$106 each	Call for Pricing	\$415 each	\$225 each

Refer to MEC2 and ETEC for additional methods of operation, page 119

## TW-700M Methods of Operation

Manual Winch Handle	Manual Winch Drill Operator
	
<b>TW700H</b>	<b>ED-902</b>
10 lbs \$299 each	19 lbs \$799 each



## Posilok™ Backstop Safety Strap

- > Designed to automatically lock a ceiling suspended or wall mounted backstop in position should a malfunction occur during raising or lowering of unit
- > Self-checking fail safe mechanism, automatic reset, stronger clamping system and versatile mounting features included
- > Belt capable of withstanding 7,300 lb load
- > Visible maximum safe extension patch and Telltale Indicator notifies when safety strap has been called into action

**PL-1000** 17 lbs \$659 each 1Y

## Scorer Table

### Scorer Table

- > Illuminated table (120VAC, 60Hz) comfortably sits 3-4 people
- > Available in free standing or bleacher mount style and in 8' or 10' lengths
- > Tabletop includes multiple cup holders and folds vertically for storage
- > Large access holes in tabletop for console, laptop cords or other electronics
- > Bins under the table hold extension cords, power adapters and other accessories
- > 3" lockable swivel poly wheels
- > Removable shatterproof face panels for multiple sponsors or team logos
- > Customer provides artwork to go on face panels
- > Colors available include Black, Royal Blue, Purple, Dark Green, Maroon, Red or Green (specify when ordering)
- > Call for freight quote

Free Standing	<b>ST-8FS</b>	8' Long	357 lbs	\$3,439 each	FR	3Y
	<b>ST-10FS</b>	10' Long	454 lbs	\$3,654 each	FR	3Y
Bleacher Mount	<b>ST-8BM</b>	8' Long	397 lbs	\$3,923 each	FR	3Y
	<b>ST-10BM</b>	10' Long	637 lbs	\$4,159 each	FR	3Y

NJ State Approved Co-op #12MCESSCOES



# Facility Accessories



## Gym Guard Floor Cover

- > Protect gymnasium floor during non-athletic events with durable 3-ply fabric
- > Flame retardant, anti-bacterial, anti-fungal and rot/mildew resistant
- > Meets California Fire Marshal specifications
- > 6"-12" overlap for each section recommended
- > 10' wide sections for easy handling
- > 5' wide minimum charge (specific dimensions needed when ordering)
- > See chart for colors (specify when ordering)
- > Note: 18 oz only available in solid colors
- > Call for freight quote

FR 1Y ★

<b>GGFPS-16</b>	18 oz Floor Cover	\$1.00 sq ft
<b>GGFPS-22</b>	22 oz Floor Cover	\$1.07 sq ft
<b>GGFPS-24</b>	27 oz Floor Cover	\$1.28 sq ft

TAN	RED	NAVY BLUE
BROWN/TAN	GREEN	DARK GRAY
ROYAL BLUE	BURGUNDY	BLACK
TAN/ROYAL	TAN/BURGUNDY	ORANGE
LIGHT GRAY	KELLY GREEN	YELLOW

## Safety Storage Rack

- > All steel construction
- > 8" dia non-marking wheels lock and swivel
- > 2 hand cranks included
- > Call for freight quote

FR 1Y ★

<b>MSR-6</b>	6 Roll Rack	\$2,999 each
<b>MSR-8</b>	8 Roll Rack	\$3,449 each
<b>MSR-10</b>	10 Roll Rack	\$3,649 each



## Courtclean

Get a safe, clean floor in minutes with this damp mop system.

- > 6' mop made of rotationally molded linear density polyethylene material
- > Built-in carrying handle, hook-and-loop fasteners to keep towel in place and sturdy metal pull strap fastener included
- > Replacement towels sold separately
- > Call for freight quote

1Y

Item	Description	Price
<b>CCM-6</b>	6' Courtclean Mop	\$499 each
<b>CCT-6</b>	6' Courtclean Towel	\$44 each
<b>CCSS-1</b>	1 gal Super Shine-All	\$50 each
<b>CCSK-6</b>	6' Start Up Kit	\$179 each



KCP-1J



KCP-1



CCSK-6

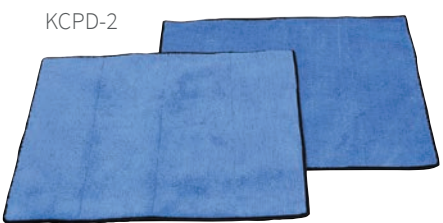

KCPD-2

## Keyclean Pro

- > 2 large 18" x 24" mops made with highly absorbent microfiber pads
- > 6' adjustable two-piece aluminum handle
- > Fast drying and slip resistant to reduce injuries
- > 2 mops and 2 pads included
- > Replacement pads available
- > Can be customized
- > Call for freight quote

1Y

Consists of a 6' adjustable two-piece aluminum handle with a heavy-duty attachment to the pad board.



KCP-1C

Show your team spirit with your school logo



Item	Description	Price
<b>KCP-1</b>	Keyclean Pro Set	\$325 pair
<b>KCPD-2</b>	Keyclean Pro Pads	\$75 pair
<b>KCP-1C</b>	Custom Pro Set	\$450 pair
<b>KCP-1J</b>	Jaypro Pro Set	\$400 pair
<b>CCSS-1</b>	1 gal Super Shine-All	\$50 each
<b>CCSK-6</b>	6' Start Up Kit	\$179 each



NJ State Approved Co-op #65MCESCCPS



www.jaypro.com  
F: 800-988-3363

T: 800-243-0533



**Note:** Due to difference in wall construction, Jaypro Sports does not provide anchors or mounting hardware to attach the wall stringers to gymnasium walls. Consult your architect or contractor to determine the best and safest installation methods for your facility.

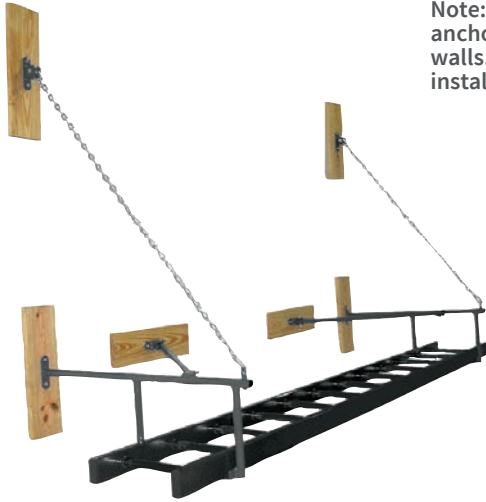

### Wall-Mounted Gym Ladder

Ideal for developing physical fitness, strength and coordination.

- > Steel frame with welded supports for strength and durability
- > Powder coated black finish is textured for safety
- > Inner braces provide stability for lateral movement
- > Ladder is attached with wood stringers (included) and is additionally supported with a heavy duty chain
- > Frame extends 48" from wall
- > Dimensions: 18"W x 12"L

**WML-100** 187 lbs \$1,715 each **FR** **3Y**



### Vertical Climbing Ladder

- > 1<sup>5</sup>/<sub>16</sub>" OD steel tubing construction
- > Powder coated black finish is textured for safety
- > Heavy-duty wall mounting plates
- > Dimensions: 22"W x 60"L

**WVL-7** 77 lbs \$339 each **FR** **3Y**



### Wall Grid Climber

- > 1<sup>5</sup>/<sub>16</sub>" OD steel tubing construction
- > Powder coated black finish is textured for safety
- > Grid is 4 x 5 rows with 6" pattern
- > Heavy-duty wall mounting plates

**WGC-20** 72 lbs \$478 each **FR** **3Y**



### Adjustable Wall Mounted Chinning Bar

Ideal for elementary through university level use.

- > Provides 2' of height adjustment in 6" increments
- > All-welded 30"W steel frame with powder coat finish

**EWM-30** 28 lbs \$249 each **3Y**



### Jump Rope Rack

Keep jump ropes untangled and ready for use.

- > Wall-mounted all steel construction with powder coat finish
- > 27" long with (5) 10" long pegs

**PE-110** 5 lbs \$45 each **3Y**

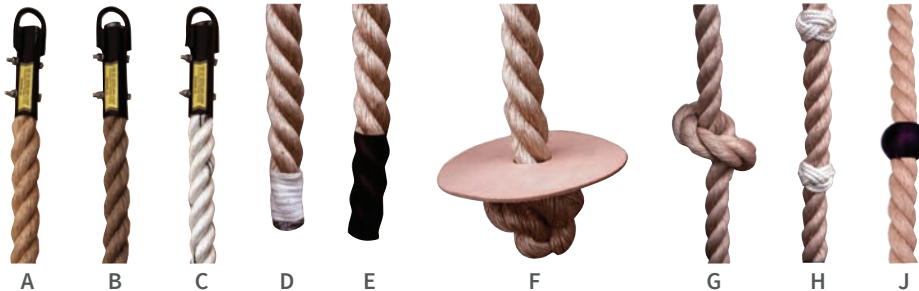

- A. **Natural Manila Rope:** Superior quality manila offers the best grip and durability
- B. **Polypro Unmanila Rope:** Same look and feel as manila with added strength and reduced weight
- C. **Polyplus Rope:** Soft, lightweight and has excellent moisture and UV resistance characteristics
- D. **Whipped End:** Standard wrapped end to prevent unraveling
- E. **Polyboot End:** Poly cover permanently attached to the end to prevent unraveling
- F. **Leather Seat on Turk Knot End:** Provides stable starting point for beginner climbers **1Y**

#### STEP 1: Select Rope Combination

	D	E	F
A	CR-1	CR-2	CR-3
B	CRP-1	CRP-2	CRP-3
C	CRD-1	CRD-2	CRD-3

#### STEP 2: Select Knot Style

- G. **BK-1** Beginner (large) Knots
- H. **RGK-1** Rest/Grip Knots
- J. **RB-1** Rubber Ball



### Climbing Rope Accessories

- K. **SCA-1** Safety Cable Attachment
- L. **RN-1** Rope Hoist
- M. **A-3** Adjustable I-Beam Clamp
- N. **L-1** Quick Link



## Athletic Field/Facility New Construction and Renovations

Renovating a facility or upgrading an athletic field is an enormous undertaking. Jaypro Sports eases that burden by bringing over 65 years of real-world experience to the table and implementing superior institutional sports equipment made for champions. The Custom Projects Team assists from start to finish and delivers results to any new construction or facility upgrade project.



### Outdoor Complexes

Field Netting • Benches/Bleachers • In-Ground Track • Field Maintenance • Soccer Football • Baseball • Basketball • Lacrosse/Field Hockey

### Indoor Facilities

Divider Curtains • Benches/Bleachers • PE Equipment • Equipment Control Systems  
Basketball Backstops • Batting Cages • Volleyball Systems • Wall Padding

### Architect Approved Athletic Equipment

Many Jaypro Sports products are architect approved and files are available online to help designers and architects with projects. Visit [www.jayprospecs.com](http://www.jayprospecs.com) to download CSI Specifications, Product Cut Sheets, Installation Instructions, Technical/Architectural Files and more.



# Replacement Parts



**Hoist Pulley Fitting**  
Mounts to 3/2" OD pipe, rated for 1,550 lbs  
**CA35HD-SP-A**  
9 lbs \$150 each



**Wall Pulley Fitting**  
Mounts to structural wall, rated for 1,550 lbs, anchors by others  
**D-Plate2-A**  
14 lbs \$150 each



**Brace Attachment Fitting**  
Mounts to 3/2" OD pipe, hinge accommodates 2 3/8" OD pipes  
**HP35-238A-A**  
6 lbs \$97 each



**Safe Strap Mast Attachment Fitting**  
Mounts to 6 5/8" OD masts only  
**PL658-A**  
10 lbs \$75 each



**Mast Brace & Pulley Fitting**  
Mounts to 6 5/8" OD mast, hinge accommodates 2 3/8" OD pipes  
**PT65-238-SP-A**  
12 lbs \$134 each



**Cable & Safe Strap Retractor System**  
Retracts cable and safe strap out of playing area  
**SSR-25**  
3 lbs \$104 each



**Cross Over / Under Fitting**  
Connects perpendicular 3/2" OD pipes  
**S35-X-A**  
9 lbs \$59 each



**Standard Beam Clamp Fitting**  
Mounts 3/2" OD pipe only, rated for 1 Ton  
**UDC2-12-A**  
6 lbs \$53 each



**Backstop 50' Cable Kit**  
Replacement 1/4" lifting cable kit  
**RC-53**  
8 lbs \$104 each



**Backstop 75' Cable Kit**  
Replacement 1/4" lifting cable kit  
**RC-78**  
11 lbs \$119 each



**Backstop 100' Cable Kit**  
Replacement 1/4" lifting cable kit  
**RC-100**  
14 lbs \$134 each



**Electrical Quick Disconnect**  
Winch twist-lock pig tail kit  
**PT-72**  
3 lbs \$128 each



**Single Strut Beam Clamp**  
1 5/8" x 1 5/8" clamp, rated for 1,000 ea  
**HM6157**  
1 lb \$11 each



**Double Strut Beam Clamp**  
1 5/8" x 3 1/4" clamp, rated for 1,000 ea  
**HM6159**  
1 lb \$11 each



**Backstop Swivel Eye Pulley**  
1/4" cable, rated for 1,550 lbs  
**HM6077**  
3 lbs \$74 each



**Forged Anchor Shackle**  
3/8", galvanized, rated 1 Ton  
**HM6252**  
1 lb \$29 each



**3 1/2" U-Bolt with Nuts**  
For 3 1/2" OD pipe only  
**HB5040-A**  
1 lb \$9 each



**6 5/8" U-Bolt with Nuts**  
For 6 5/8" OD pipe only  
**HM6074-A**  
2 lbs \$9 each

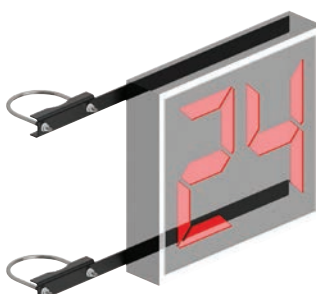

**Shot Clock Mounting Brackets (only)**  
Mount any shot clock to existing backstops

<b>SCMB658-A</b>	\$297 each
6 5/8" OD Mast	19 lbs
<b>SCMB6-A</b>	\$297 each
6" OD Mast	19 lbs
<b>SCMB238-A</b>	\$297 each
2 3/8" Double Drop	16 lbs

NJ State Approved Co-op #65MCESCCPS



# Gym Divider Curtains

Jaypro Sports offers a variety of functional and attractive divider curtains that help divide any sports facility or institutional space. From power-controlled to manual curtains, we custom design divider curtains for any facility size requirements. Also available in solid vinyl or vinyl coated mesh with several color options.

Call for details and pricing.



**Roll Up Curtain (RC-690):** Raised and lowered by heavy-duty hoist belts and stores in a 2' storage space close to the building structure.

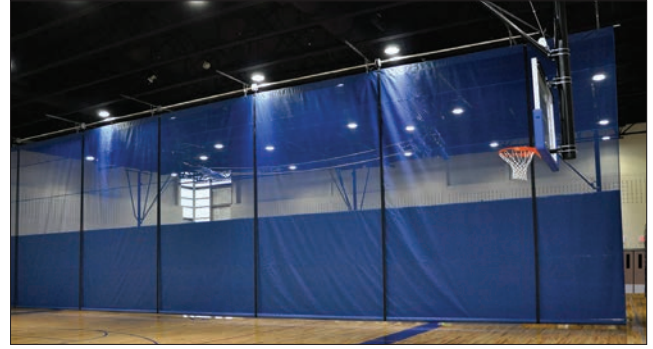

**Slope Fold Curtain (SC-685):** Engineered to fit against the roof frame and conform to virtually any slope while providing maximum clearance for all sporting activities.

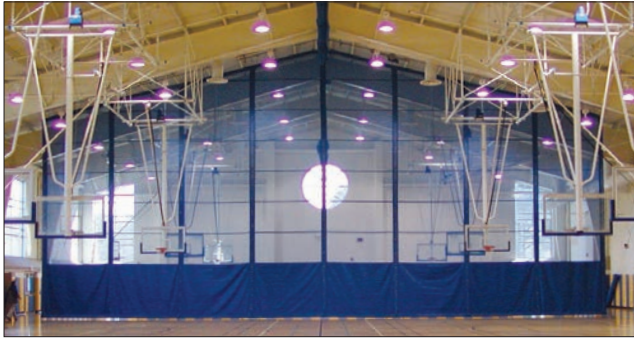

**Walk Draw Curtain (WC-660):** Designed for manual operation, this curtain is moved by pulling it along a ceiling suspended track to store along a perimeter wall.

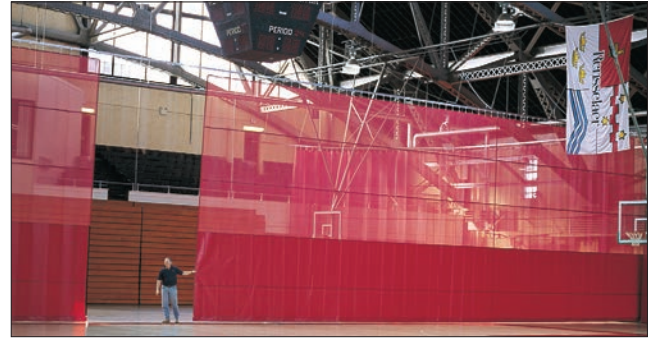

**Top Roll Curtain (TC-701):** Uses no hoist cables or straps to raise and lower the curtain and stores tighter than many other curtain designs for additional clearance with low ceilings.



**Fold-Up Curtain (FC-680):** Mounted to the building structure, this curtain uses accordion style vertical folding action making it virtually invisible in the raised position.





# Mini Top Roll Curtain



## Mini Top Roll Curtain

- > Use in different locations to create closed off areas
- > Designed to be compact and tight fitting to ceiling structure
- > Disappears up into or behind ceiling structure and rolls down at the touch of a button
- > 14 oz or 18 oz reinforced vinyl and 9 oz vinyl coated polyester mesh
- > Driven by an internal tubular motor requiring 120 volt power
- > Print school graphics or advertising on curtain
- > Developed for and used at Barclay's arena in Brooklyn, NY

**TC-710**

Call for Pricing and Details

3Y ★

## Perimeter Divider Curtains & Netting

### Motorized Perimeter Netting & Curtains

Jaypro Perimeter Curtains are ideal for completely following the inside or outside perimeter of running tracks within multi-use facilities and field houses. These curtains are designed to separate the running track from interior basketball or volleyball courts, thereby maximizing facility use and flexibility. Adjoining curtains are overlapped and offset to allow for easy egress.

Curtains are constructed of heavy duty reinforced vinyl and vinyl coated polyester mesh or netting. The one side fold action is accomplished by cables running vertically through "D-Rings" attached to the curtain and anchored to the bottom tube. The radius curtains utilize precision universal joints to allow the drive system to closely follow the required curvature. The smooth folding action is achieved by a heavy duty direct drive winch. The curtain is mounted to existing building structure and curves to match existing facility curvatures.

**FC-680P**

Call for Pricing and Details



### Non-Motorized Netting

Jaypro makes nets to separate outdoor athletic fields in large complexes and to divide indoor athletic facilities. We also provide complete perimeter and ceiling netting protection for your athletic facility. Our netting is found on tennis courts, basketball courts, soccer fields, and golf courses. Everything we make is customized to your needs as no two facilities are alike. Call or e-mail us to discuss your project.

Call for Pricing and Details

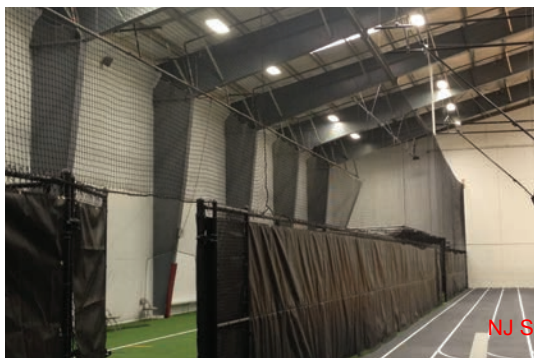

NJ State Approved Co-op #65MCECCPS



www.jaypro.com  
T: 800-243-0533

F: 800-988-3363

# Wrestling Mat Storage System

## Securelift™ Wrestling Mat Storage Systems

Eliminate risk of injury to students, athletes and coaches from manual lifting and transporting of heavy and awkward mats. Gain valuable storage space and extend the life of your wrestling mats. Simply roll the mat(s) onto the sling, attach the sling to the load bar, turn the key to raise the unit and store at ceiling height. Call for details and pricing.



### Securelift™ Wrestling Mat Storage System (Single)

**MH-S-A**

Ceiling Suspended Single Mat Securelift™

Call for Pricing

3Y

**MHWM-S-A**

Wall Mounted Single Mat Securelift™

Call for Pricing

3Y

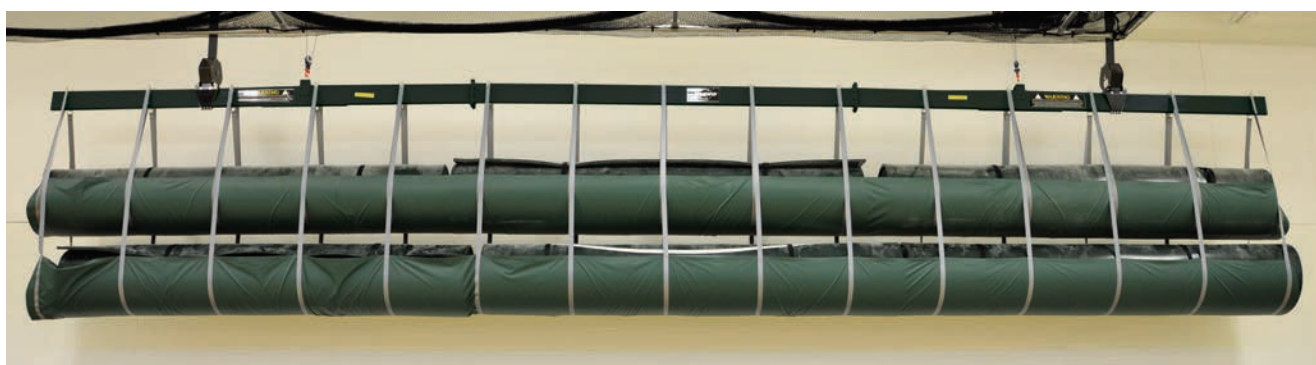

### Securelift™ Wrestling Mat Storage System (Double)

**MH-D-A**

Ceiling Suspended Double Mat Securelift™

Call for Pricing

3Y

**MHWM-D-A**

Wall Mounted Double Mat Securelift™

Call for Pricing

3Y

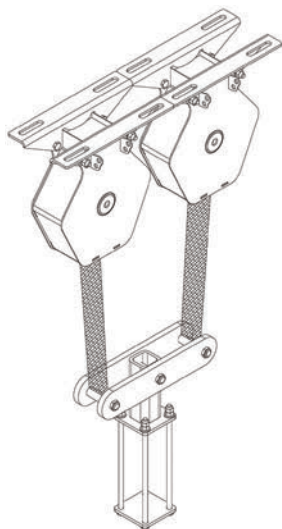

# MATLOK™ a **jaypro sports** product

## Matlok™ Wrestling Mat Storage System Safety Strap

- > Designed to automatically lock a mat hoist system in position should a malfunction occur
- > Self-checking, self-leveling, fail safe mechanism features
- > System comprised of 2 load bar rocker assemblies and 4 Posilok Safety Straps
- > System adaptable to any wrestling mat storage system
- > Versatile mounting clamps included

**MH-MLS**

Call for Pricing

3Y

NJ State Approved Co-op #65MCECCPS



When it comes to gymnasium equipment control systems, Jaypro Sports continues to hold dominant control above the competition. Jaypro Sports was the FIRST in the industry to introduce keyless control systems and was the FIRST to introduce simultaneous UP and DOWN equipment operation. Jaypro Sports offers two state-of-the-art wall mounted touchscreens to control your gymnasium equipment and/or auxiliary components. Each system is specifically tailored to your facility and can save thousands of dollars on installation and operational costs.

## Master Equipment Controller 2

Similar to your touchscreen smartphone, this slick wall mounted touchscreen is one of the best upgrades for any facility. The MEC2 features intuitive menus to allow anyone to easily program at any point in time, without switches or removal of the screen. Simply put, the MEC2 is the leading economical equipment control system in the industry!

### Key Features Include:

- > \*EXCLUSIVE\* Wall mounted 5" capacitive touchscreen
- > Low voltage touch screen, making this system safer than key switches
- > Single and/or grouped operation of up to 8 devices
- > Capable of operating 256 motorized devices and/or 512 auxiliary devices
- > Multiple logins with tiered access levels
- > Easily retrofits from existing methods of operation (key switch, radio remote, etc.)
- > Direct replacement for MEC-99 without additional power requirements
- > System can save thousands of dollars on electrical work and operating costs
- > \*EXCLUSIVE\* Easily expandable at any point in time with multiple expansion relay board sizes to suit any facility

### MEC2

Call for Pricing



## Easy Touch Equipment Controller

With all the same benefits as the MEC2, the ETEC features additional unparalleled benefits, making this system the ultimate gymnasium equipment controller in the industry. The ETEC allows you to simultaneously raise your divider curtains and side court backstops, while lowering you main court backstops. The ETEC is truly a must-have control system for large facilities with quick turn-around time.

### Additional Key Features Include:

- > Wall mounted high resolution LCD touchscreen available in three sizes, 6", 8", or 10.4" with locking enclosure
- > System allows for simultaneous UP and DOWN equipment operation to, for example, quickly turn a basketball facility into a volleyball facility
- > Easily save or edit user programs such as "GAME DAY" or "PRACTICE" with the press of one button
- > On-the-fly quick selection programming with intuitive graphical interface
- > Displays the actual layout of your facility with no confusing codes to remember
- > \*EXCLUSIVE\* Advanced auxiliary component control to allow dimmable lighting and variable speed control fan control
- > \*EXCLUSIVE\* Display your school colors, logo, and/or mascot on the ETEC lock screen and equipment layout screen

### ETEC

Call for Pricing

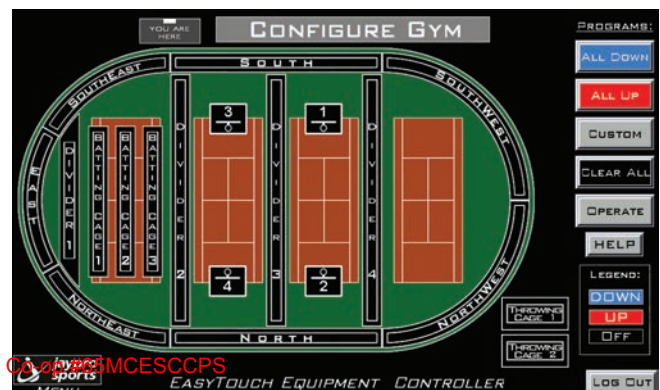

# WallGUARD™ a **jaypro sports** product



## Four levels of player protection to meet various facility needs and atmospheres.

- > Provides excellent wall protection to absorb player impact
- > Reduces noise levels in any facility
- > Wall padding should be installed on all rigid surfaces located in close proximity (within 10') to active playing areas

## Mounting options include:

- > 1" lip, top and bottom
- > Z-clip top, 1" lip bottom
- > Z-clip top and bottom



## WallGUARD™ Basic Wall Padding

### (Level 1) Padding

- > Economy wall padding for areas where impact is less likely
- > 2" thick polyurethane foam with 7/16" Oriented Strand Board backing
- > Minimum of 14 oz fire-retardant vinyl in a variety of colors



## WallGUARD™ Impact Wall Padding

### (Level 2) Padding

- > Optimal for high activity facilities and/or close proximity to activity areas
- > 2" thick high impact foam with 7/16" Oriented Strand Board backing
- > Minimum of 14 oz fire-retardant vinyl in a variety of colors
- > Exceeds impact standards as defined in ASTM F2440-04



## WallGUARD™ Fire Wall Padding

### (Level 3) Padding

- > Class A wall padding for areas where impact is less likely
- > 2" thick fire retardant foam with 7/16" Oriented Strand Board backing
- > Minimum of 14 oz fire-retardant vinyl in a variety of colors
- > Certified class A fire rating in accordance with NFPA 255/ASTM E-84



## WallGUARD™ Fire/Impact Wall Padding

### (Level 4) Padding

- > Highest rated wall padding for maximum player safety and building protection
- > Optimal for high activity facilities and/or close proximity to activity area
- > 2" thick fire retardant and high impact foam with 7/16" Oriented Strand Board backing
- > Minimum of 14 oz fire-retardant vinyl in a variety of colors
- > Exceeds impact standards as defined in ASTM F2440-04
- > Certified class A fire rating in accordance with NFPA 255/ASTM E-84





Custom Sizes • Custom Lettering • Custom Graphics • Eco-Friendly Wall Pads  
Outdoor Wall Pads • Column Pads • Corner Pads • I-Beam Wraps • Stage Padding

**WallGUARD™ Basic** FR 1Y ★

Item	Size	Description	Weight	Price
JWCF-B-2472	2' x 6'	Basic w/1" lip top & bottom	26 lbs	\$129 each
JWCF-B-2472Z	2' x 6'	Basic w/z-clip lip	26 lbs	\$139 each
JWCF-B-2472ZZ	2' x 6'	Basic w/z-clip top & bottom	26 lbs	\$149 each

**WallGUARD™ Impact** FR 1Y ★

Item	Size	Description	Weight	Price
JWCF-I-2472	2' x 6'	Impact w/1" lip top & bottom	26 lbs	\$143 each
JWCF-I-2472Z	2' x 6'	Impact w/z-clip lip	26 lbs	\$153 each
JWCF-I-2472ZZ	2' x 6'	Impact w/z-clip top & bottom	26 lbs	\$163 each

**WallGUARD™ Fire** FR 1Y ★

Item	Size	Description	Weight	Price
JWCF-A-2472	2' x 6'	Fire w/1" lip top & bottom	33 lbs	\$205 each
JWCF-A-2472Z	2' x 6'	Fire w/z-clip lip	33 lbs	\$215 each
JWCF-A-2472ZZ	2' x 6'	Fire w/z-clip top & bottom	33 lbs	\$225 each

**WallGUARD™ Fire/Impact** FR 1Y ★

Item	Size	Description	Weight	Price
JWCF-AI-2472	2' x 6'	Fire/Impact w/1" lip top & bottom	33 lbs	\$225 each
JWCF-AI-2472Z	2' x 6'	Fire/Impact w/z-clip lip	33 lbs	\$235 each
JWCF-AI-2472ZZ	2' x 6'	Fire/Impact w/z-clip top & bottom	33 lbs	\$246 each

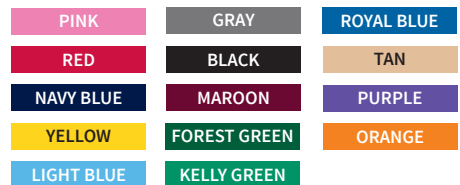
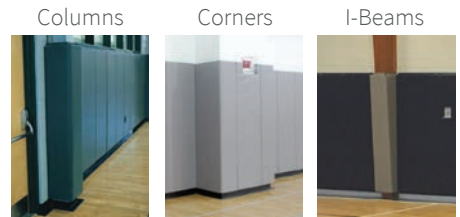
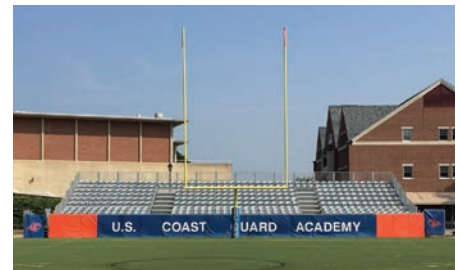

**Dual Purpose Wall/Tumbling Mat**



Serves as wall padding or as a tumbling mats.

- > 4' x 6' non-folding mat with 4 handle
- > 2" thick vinyl covered foam pad
- > 1½" wide hook-and-loop closures on all sides
- > See chart for colors (specify when ordering)

**GMVH-1** \$349 each FR 1Y ★  
NJ State Approved Co-op #65MCECPCS

**Hook-and-Loop Closure Wall Hanging Strip**



For use with Dual Purpose Wall/Tumbling Mat (GMVH-1).

- > 2" wide aluminum strip easily mounts to any gymnasium wall
- > Pressure sensitive 1½" wide hook-and-loop closure securely bonds to aluminum strip for long lasting use
- > Only available in 4' sections

**VMH-13** \$28 each 1Y ★



# Custom Graphics

Put your team logo or name on wall padding, pole padding, net tapes and more!



## Custom Volleyball Net Tape

**CVNT-1** Net Tape w/ Multi-Color Custom Graphics \$399 each  
*See page 13 for quantity discounts*

## Volleyball Post Pad

**PVL-39** Custom Lettering - Single Color (White) \$159 per pad  
**JSG-VPP** Custom Artwork - Multi-Color Call for Artwork Approval & Pricing

## Rugby Goal Pad

**JSG-RGP1** Custom Lettering - Single Color (White) Call for Artwork Approval & Pricing  
**JSG-RGP2** Custom Artwork - Multi-Color Call for Artwork Approval & Pricing

## Football Post Pad

**PVL-39** Custom Lettering - Single Color (White) \$159 per pad  
**JSG-FPP** Custom Artwork - Multi-Color Call for Artwork Approval & Pricing

## Batting Cage Skirt

**SKT-LOGO** Custom Artwork - Multi-Color (8' wide max) \$299 each  
NJ State Approved Co-op #65MCESCCPS





# by Jaypro Sports

Call 1-800-243-0533 to order today!



## Backstop Wall Padding

**JSG-BSP1** Custom Lettering - Single Color (White)

Call for Artwork Approval & Pricing

**JSG-BSP2** Custom Artwork - Multi-Color

Call for Artwork Approval & Pricing

## Field Wall Padding

**JSG-FWP1** Custom Lettering - Single Color (White)

Call for Artwork Approval & Pricing

**JSG-FWP2** Custom Artwork - Multi-Color

Call for Artwork Approval & Pricing

## Basketball Pole Padding

**JSG-BPP1** Custom Lettering - Single Color (White)

Call for Artwork Approval & Pricing

**JSG-BPP2** Custom Artwork - Multi-Color

Call for Artwork Approval & Pricing

## Gymnasium Wall Padding

**JSG-GWP1** Custom Lettering - Single Color (White)

Call for Artwork Approval & Pricing

**JSG-GWP2** Custom Artwork - Multi-Color

Call for Artwork Approval & Pricing



## Portable FieldPro™ Net System Package

- > Dimensions: 60'L x 12'H
- > 4 black powder coated poles
- > 4 bases with (16) 5 gallon jugs
- > 1¾" knotted nylon net
- > Vinyl base covers included

**PFN-1260PKG**

567 lbs

\$2,897 package



# FIELDPRO™ NET SYSTEM a jaypro sports product

## Portable FieldPro™ Net System

Ideal where in-ground net systems are not appropriate.

- > 12' tall net system
- > 2¾" dia aluminum pole on tip & roll base for easy transport
- > Base has (4) 5 gallon jugs (filled in the field) to weight it down
- > (2) 10" dia no-flat tires
- > Cable clamps and sliding rings for easy net assembly
- > Corrosion-resistant hardware included
- > Optional vinyl base covers sold separately
- > Typical pole spacing is 18' apart (should not exceed 20')
- > Pole can be powder coated black (specify when ordering)
- > Can be used inside as a space divider
- > Sold per base dependent on overall length needed (specify when ordering)
- > Call for pricing and details



## Configure a Portable Net System

Follow steps 1 through 3 to create a unique model number in the boxes below.

**MODEL # :**  -  X

**STEP 1:** Select Net (enter net letter in box "1")

- A** #36 knotted multi-sport UV treated nylon net with 1¾" sq mesh and 1/4" rope border
- C** HTPP knotless UV treated net with 1¾" sq mesh and 1/4" rope border

**STEP 2:** Identify Length of System (enter numerical length in box "2")

Determine the length of the net in feet (i.e. 180). Keep in mind typical pole spacing is 18' apart and should not exceed 20'.

**STEP 3:** Call 1-800-243-0533 to provide your unique model number for details and pricing.



## Optional Feature

Consider the following optional features when speaking with us about your Portable FieldPro™ Net System.

- PFN-BCVR** Portable net system base cover (standard color is red). See chart on page 15 for vinyl colors (specify preferred color when ordering).  
2 lbs \$49 each



www.jaypro.com  
F: 800-988-3363

T: 800-243-0533





### FieldPro™ Multi-Sport Net System

Stop wasting time chasing missed shots or errant passes during practice and games. Ensure the safety of athletes, coaches and spectators. This ball stop net system is ideal for lacrosse, field hockey and other field sports.

- > Designed to fit behind lacrosse and field hockey goals
- > (4) 4" OD heavy-walled aluminum uprights with ground sleeves and covers
- > #36 knotted UV treated black nylon net with 1¾" sq mesh and 1/4" rope border
- > Pulley system to raise/lower net included
- > Corrosion resistant hardware included
- > Dimensions: 65'W x 15'H

**FNMB-65**

\$2,350 each

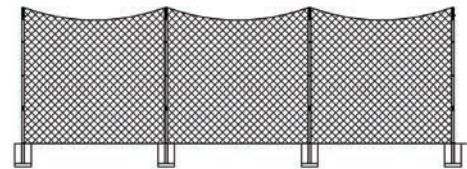

### FieldPro™ Football Net System

Ideal for keeping field goals and extra point kicks inside the field.

- > 30' or 40' height options
- > 40' wide net easily raises and lowers with a rope and marine style swivel pulley system with integrated ball bearings
- > #36 knotted black nylon net with 3½" sq mesh and 1/4" rope border
- > 6½" dia aluminum poles (powder coated black if requested)
- > Ground sleeves and hardware included
- > Call for freight quote

**FNFB-30**

40'W x 30'H

530 lbs

\$4,295 each



**FNFB-40**

40'W x 40'H

762 lbs

\$6,695 each

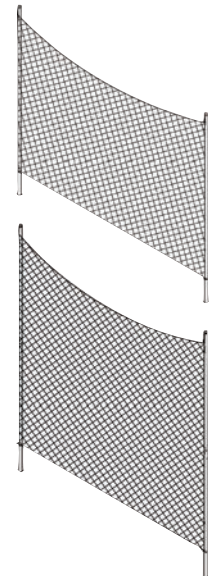

### FieldPro™ Soccer Net System

Stop wasting time chasing missed shots or errant passes during practice and games. Ensure the safety of athletes, coaches and spectators.

- > Designed to fit behind soccer goals
- > (4) 4" OD heavy-walled aluminum uprights with ground sleeves and covers
- > #36 knotted black nylon net with 3½" sq mesh and 1/4" rope border
- > Pulley system to raise/lower net included
- > Corrosion resistant hardware included
- > Dimensions: 65'W x 20'H

**FNSB-65**

250 lbs

\$2,250 each

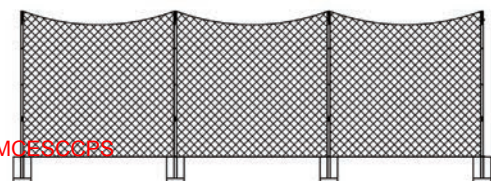



## Perimeter Net Systems for All Turf Fields

In today's congested sports complexes with multi-use fields in close proximity to each other, keeping balls within the confines of the field is important. Stop wasting time during practices and games chasing missed shots or errant passes. Ensure the safety of athletes, coaches, and spectators alike on adjacent fields and tracks. FieldPro™ Net Systems by Jaypro Sports offer ultimate design flexibility to suit all perimeter netting needs.



### Five Different Heights and Pole Styles

**10' Straight Pole** with multi-sport net is ideal for use as a Lacrosse or Field Hockey backstop net. The net is clipped at the top and bottom of each pole for easy removal.

**15', 20' and 30' Straight Pole** comes with an easy to use hoist system allowing quick and easy lowering or removal of the net after the game, season or before a big storm. Reinstalling the net is a snap - all from ground level with no need for a ladder.

**20' Offset Pole** provides 3' of offset which is ideal for use around the perimeter of soccer and baseball/softball fields. It's also an added measure of safety from ricocheting balls.



### Basic Features & Recommendations

- > Pulley system to raise/lower net (excluding 10' poles)
- > Ground sleeves and caps allow for complete system removal (optional but recommended)
- > Corrosion-resistant hardware included
- > Optional vinyl base covers sold separately
- > Pole can be powder coated black (specify when ordering)
- > Typical pole spacing is 18' apart and should not exceed 20'
- > It is recommended net systems are set back at least 25' from the playing field
- > Call for pricing and details





# FIELDPRO™ NET SYSTEM

a **jaypro sports** product

## Configure an In-Ground Net System

Follow steps 1 through 4 to create a unique model number in the boxes below.

MODEL #:  –  X

**1**                      **2**                      **3**

### STEP 1:

Select Pole (enter pole number in box "1")

- FN-10** 10' tall straight 2¾" OD heavy-walled aluminum pole
- FN-15** 15' tall straight 4" OD heavy-walled aluminum pole
- FNS-20** 20' tall straight 4" OD heavy-walled aluminum pole
- FNO-20** 20' tall offset 4" OD heavy-walled aluminum pole
- FNS-30** 30' tall straight 6¾" OD heavy-walled aluminum pole

### STEP 2:

Select Net (enter net letter in box "2")

- A** #36 knotted multi-sport UV treated nylon net with 1¾" sq mesh and 1/4" rope border
- B** #36 knotted soccer/football UV treated nylon net with 3½" sq mesh and 1/4" rope border
- C** HTPP knotless UV treated net with 1¾" sq mesh and 1/4" rope border
- D** HTPP knotless UV treated net with 4" sq mesh and 1/4" rope border

### STEP 3:

Identify Length of System (enter numerical length in box "3")

Determine the length of the net in feet (i.e. 180)  
Keep in mind typical pole spacing is 18' apart and should not exceed 20'.

### STEP 4:

Call 1-800-243-0533 to provide your unique model number for details, pricing, and freight quote.

## Optional Feature

- > Poles can be powder coated black (specify when ordering).
- > Ground Sleeves sold separately.



www.jaypro.com  
T: 800-243-0533 F: 800-988-3363

Jaypro Sports can solve any netting problem. From indoor and outdoor requirements, to pole and structure support, we have the solution for your athletic field or facility.

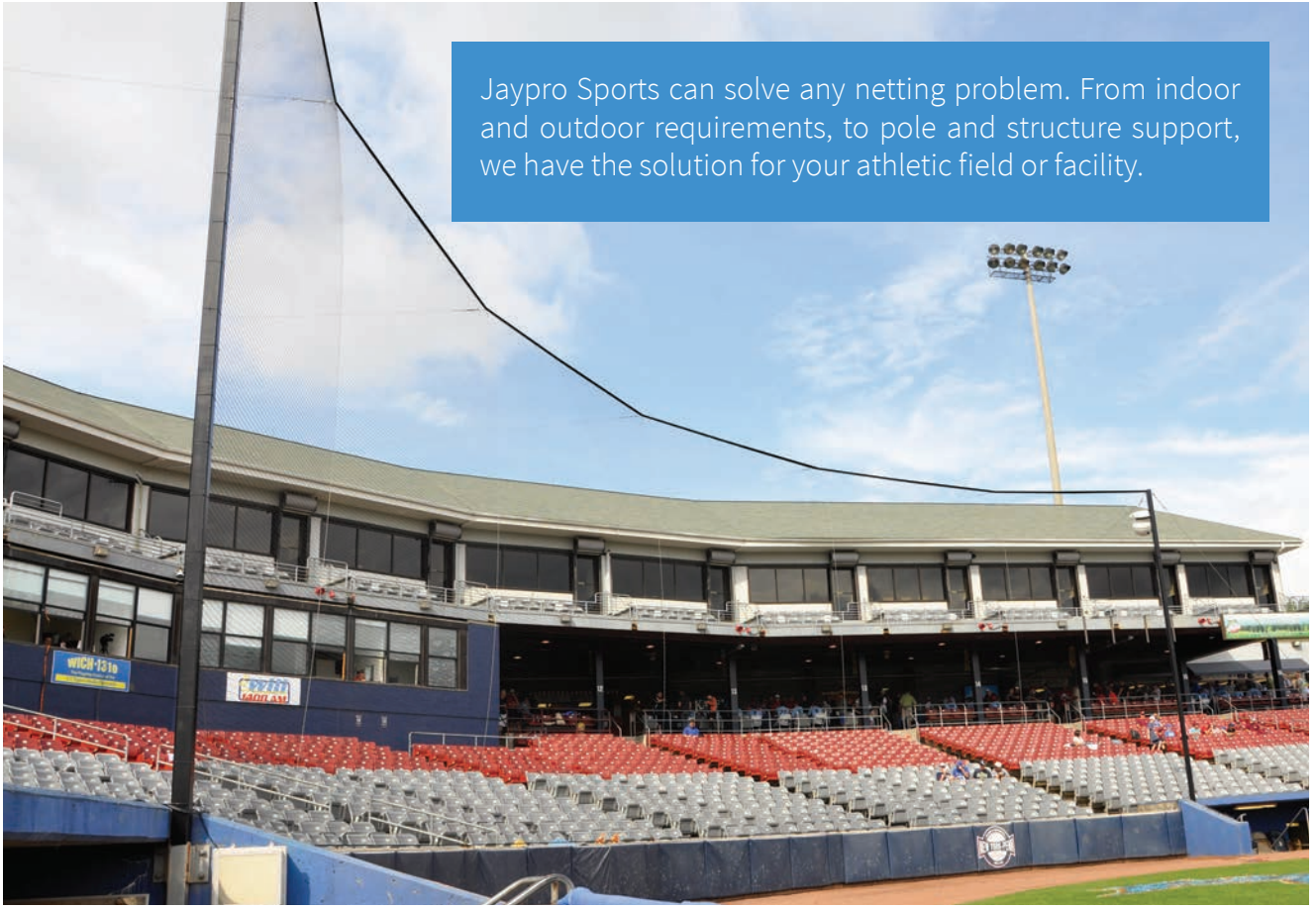

www.jaypro.com  
F: 800-988-3363

T: 800-243-0533





## FieldPro™ Discus Cage

Ideal for high schools.

- > Meets all NFHS rules and regulations
- > Designed to accommodate a 34.92 degree throwing sector
- > (6) 4" OD heavy-walled aluminum poles
- > 14'6" tall poles have 24" offset to minimize ricochet
- > Heavy-duty weather treated black nylon net with 1 7/8" mesh
- > Ground anchors hold net in place
- > Pulley hoisting system allows for easy net removal and set-up
- > Ground sleeves and covers for complete system removal during off season, sold separately
- > Optional 7' tall perimeter barrier net (DCHS-BN) for added protection sold separately
- > Net Dimensions: 54'L x 14'H

FR 3y 1y ★

<b>DCHS-35</b>	Discus Cage w/Net No Sleeves	\$2,725
<b>DCHS-35NET</b>	Replacement Cage Net 14'H x 55'L	\$479
<b>DCHS-6S</b>	Replacement Ground Sleeves Set of 6	\$795

<b>DCHS-35BN</b>	(DCHS-35) plus Barrier Net No Sleeves	\$3,095
<b>DCHS-BN</b>	Replacement Barrier Net 7'H x 63'L	\$435

## FieldPro™ Indoor Discus Cage/Hammer Throw

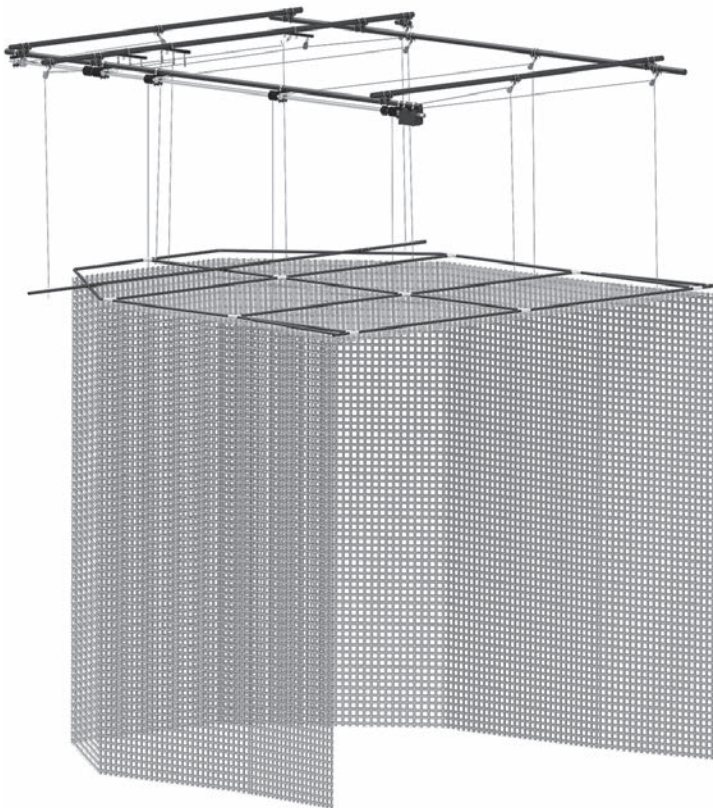

## FieldPro™ Indoor Ceiling Suspended Retractable Throwing Cages



Jaypro Sports offers a variety of discus, hammer throw, and shot put cage designs that allow both throwing into and throwing out of.

Nets can be mounted to a retractable frame or extend the full ceiling height. Net configuration may be a straight inline curtain or U-shaped to meet USTF/ NCAA/ NFHS requirements.

Cage easily raises and lowers from the ceiling using a 1 HP electric winch.

Call for information and pricing



www.jaypro.com  
T: 800-243-0533 F: 800-988-3363



**TOTE**MASTER™ a **jaypro sports** product

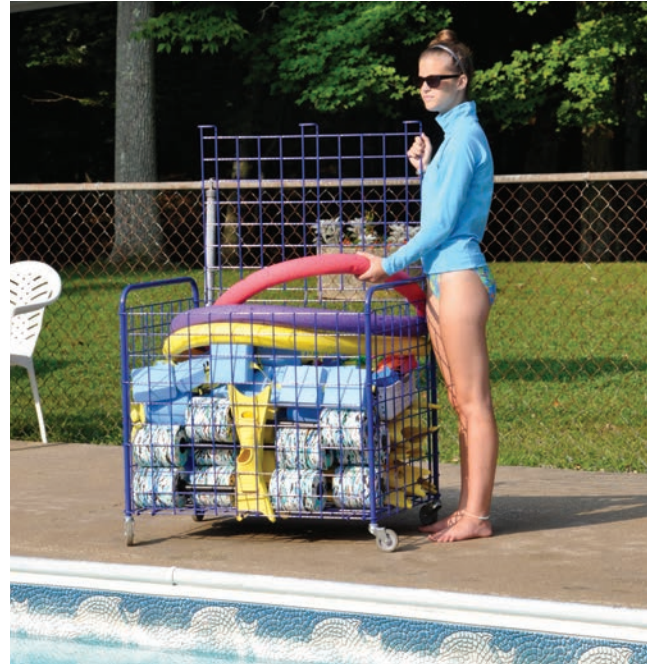

**The Original ToteMaster™**

All-purpose carrier with large holding capacity for all types of equipment.



- > Holds 20-25 balls
- > Indoor or outdoor use
- > 3/16" all-welded steel wire with 3" sq mesh
- > Lockable hinged top (lock not included)
- > 4 heavy-duty swivel wheels
- > No tools required
- > Dimensions: 24"W x 36"L x 36"H

**TE-2** 45 lbs

\$265 each



3Y

**TE-2BK** 45 lbs

\$265 each



3Y



**Replacement Casters and Inserts**

- > 4 swivel wheels and inserts

**TE-2HK** \$34 set

3Y



NJ State Approved Co-op #65MCECCPS

www.jaypro.com  
T: 800-243-0533 F: 800-988-3363





### Mini ToteMaster™

- > Indoor or outdoor all-purpose carrier
- > 3/16" all-welded steel wire with 3" sq mesh
- > Lockable hinged top (lock not included)
- > 4 heavy-duty swivel wheels
- > No tools required
- > Dimensions: 21"W x 21"L x 30"H

**TE-30** 25 lbs \$205 each 



### ToteMaster™ Plus

- > 3/16" all-welded steel wire with 3" sq mesh
- > Lockable dual tops (lock not included)
- > 4 large heavy-duty swivel wheels
- > Divider to separate equipment
- > Dimensions: 24"W x 60"L x 36"H



**TE-60** 70 lbs \$359 each 



### ToteMaster™ All Terrain

- > Holds 20-25 balls
- > Indoor or outdoor all-purpose carrier
- > 3/16" all-welded steel wire with 3" sq mesh
- > Lockable hinged top (lock not included)
- > 2 heavy-duty swivel and (2) 12" fixed all terrain wheels
- > Dimensions: 24"W x 36"L x 36"H

**AT-5** 63 lbs \$299 each 



### ToteMaster™ Field

- > Indoor or outdoor all-purpose carrier
- > 3/16" all-welded steel wire with 3" sq mesh
- > Lockable hinged top (lock not included)
- > 6" semi-pneumatic front swivel casters
- > 20" semi-pneumatic rear all terrain wheels
- > 10" ground clearance
- > Dimensions: 25"W x 51"L x 48"H
- > Basket Size: 23"W x 41"L x 27"H

**AT-10** 65 lbs \$395 each 



# ToteMaster™ Ball Storage Carts



**ToteMaster™  
Open Top**

- > Indoor all-purpose carrier
- > 2 full-size open top storage baskets with 4" x 3" wire mesh
- > (2) 360° rotating hangers for jump rope and hoop storage
- > 4 swivel wheels
- > Optional side shelf (TE-PESHELF) sold separately
- > Dimensions: 26"W x 48"L x 54"H

**TE-PE01** 48 lbs \$249 each  
**TE-PESHELF** 5 lbs \$25 each



**ToteMaster™  
Deluxe  
Open Top**

- > Indoor or outdoor all-purpose carrier
- > 2 full-size open top storage baskets with 4" x 3" wire mesh
- > (4) 360° rotating hangers for jump rope and hoop storage
- > 2 heavy-duty swivel and 2 fixed all terrain wheels
- > Side shelf storage
- > Additional side shelves (TE-PESHELF) sold separately
- > Dimensions: 26"W x 48"L x 54"H

**TE-PE02** 56 lbs \$299 each



# Atlas Series™ Ball Storage Carts



**Atlas  
Series™  
Ball Locker**

- > Highly durable
- > Stores up to 28 basketballs or 35 volleyballs
- > Strong enough to store medicine balls
- > 1" thick-walled square steel tubing frame
- > Lockable hinged top (lock not included)
- > Heavy-duty non-marking swivel wheels
- > Dimensions: 24"W x 47"L x 37"H

**BBABL-1** 63 lbs \$359 each



**Atlas  
Series™  
Ball Locker  
& Hamper**

- > Indoor or outdoor use
- > Stores up to 28 basketballs
- > 1" round steel tubing frame
- > Lockable hinged top (lock not included)
- > 2 heavy-duty swivel and (2) 8" fixed all terrain wheels
- > Mesh hamper liner included for storage of towels or uniforms
- > Dimensions: 24"W x 45"L x 35"H

**BBABL-2** 70 lbs \$379 each



**Atlas  
Series™  
Ball Cart**

- > Multi-level rack stores up to 15 balls
- > 1" thick-walled square steel tubing frame
- > 4 heavy-duty non-marking swivel wheels
- > Dimensions: 18"W x 51½"L x 36"H

**BBABC-1** 31 lbs \$239 each



**Atlas  
Series™  
Double  
Ball Cart**

- > Multi-level rack stores up to 30 balls
- > 1" thick-walled square steel tubing frame
- > 4 heavy-duty non-marking swivel wheels
- > Dimensions: 24"W x 51½"L x 36"H

**BBABC-2** 52 lbs \$339 each







## StackMaster™ Single Wall Rack

- > Stores up to 6 basketballs
- > 1" steel tubing frame
- > Lockable top/bottom bars (lock not included)
- > Mounting hardware not included
- > Dimensions: 15"W x 66"H x 12"D

**PE-140**

18 lbs

\$109 each



3Y



## StackMaster™ Double Wall Rack

- > Stores up to 16 basketballs or 30 volleyballs
- > 1" steel tubing frame
- > Lockable top/bottom bars (lock not included)
- > Mounting hardware not included
- > Dimensions: 37"W x 66"H x 12"D

**PE-240**

49 lbs

\$179 each



3Y



## Deluxe Training Ball Rack

Ideal for shooting competitions and free throw practice.

- > Highly durable
- > 1" OD tubing on rails and ends
- > Holds 19 regulation basketballs
- > Feeds top 7 balls to shooter
- > Heavy-duty non-marking swivel wheels (front 2 lockable)
- > Dimensions: 18"W x 61"L x 44"H

**DTBR-19**

40 lbs

\$215 each



3Y

## Ball Carriers

### Deluxe 12 Ball Carrier

Ideal for basketballs, volleyballs and medicine balls.

- > Highly durable
- > All welded 1" OD steel frame and crossbars
- > Holds up to 12 basketballs
- > 4 heavy-duty swivel wheels
- > Includes a free custom graphic on side panels
- > Dimensions: 22"W x 39"L x 36"H



3Y



**BBC-12RB**

ROYAL BLUE

27 lbs

\$160 each

**BBC-12BK**

BLACK

27 lbs

\$160 each

**BBC-12RD**

RED

27 lbs

\$160 each

### Deluxe 18 Ball Carrier

Ideal for basketballs, volleyballs and medicine balls.

- > Highly durable
- > All welded 1" OD steel frame and crossbars
- > Holds up to 18 basketballs
- > 4 heavy-duty swivel wheels
- > Includes a free custom graphic on side panels
- > Dimensions: 22"W x 60"L x 36"H



3Y



**BBC-18RB**

ROYAL BLUE

41 lbs

\$185 each

**BBC-18BK**

BLACK

41 lbs

\$185 each

**BBC-18RD**

RED

41 lbs

\$185 each



Holds  
Basketballs  
Medicine Balls  
Volleyballs



NJ State Approved Co-op #65MCESCPS



www.jaypro.com  
T: 800-243-0533

F: 800-988-3363

# Player Benches

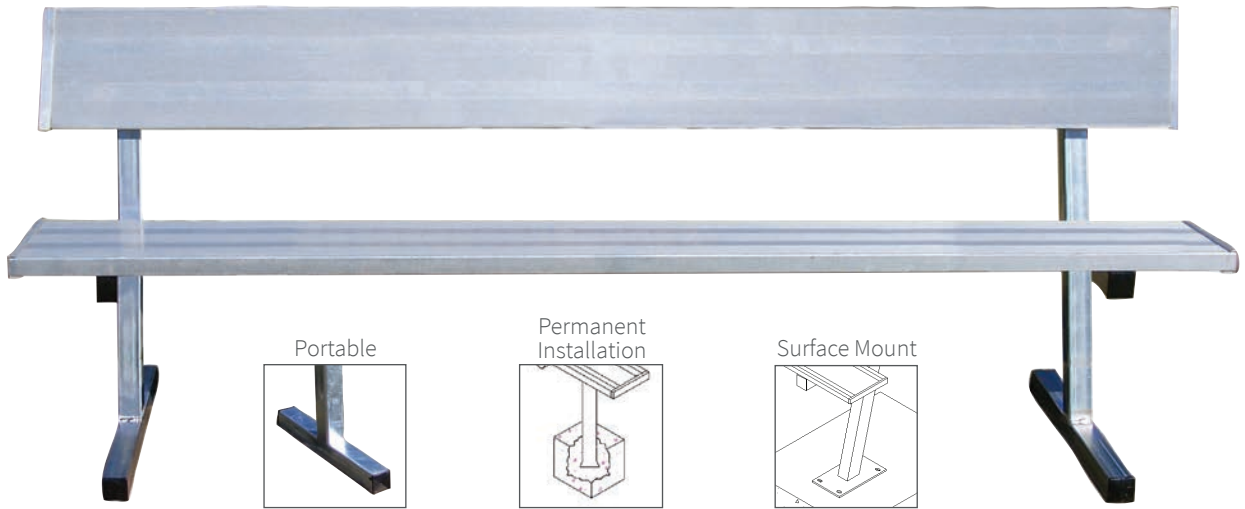

## Player Bench

Ideal for athletic fields, public parks and sport complexes.

- > Rust-resistant and stable
- > Aluminum 10" non-skid seat planks and 2" x 2" heavy-duty galvanized steel legs
- > Available with or without seat back
- > Portable, permanent installation, or surface mount choices

- > Floor protection kit (PSS-4FT) for indoor use sold separately
- > Natural finish or powder coated colors (specify plank and leg colors when ordering)
- > Natural finish benches ship within 48 hours
- > All but 7½' length ships by truck

**FR 3Y**

### Natural Finish - With Seat Back

Length	Portable	Permanent	Surface	Weight	Price
7½'	<b>PB-80</b>	<b>PB-80PI</b>	<b>PB-80SM</b>	60 lbs	\$375
15'	<b>PB-20</b>	<b>PB-20PI</b>	<b>PB-20SM</b>	100 lbs	\$559
21'	<b>PB-10</b>	<b>PB-10PI</b>	<b>PB-10SM</b>	135 lbs	\$710
27'	<b>PB-90</b>	<b>PB-90PI</b>	<b>PB-90SM</b>	175 lbs	\$790

### Natural Finish - Without Seat Back

Portable	Permanent	Surface	Weight	Price
<b>PB-75</b>	<b>PB-75PI</b>	<b>PB-75SM</b>	40 lbs	\$275
<b>PB-15</b>	<b>PB-15PI</b>	<b>PB-15SM</b>	57 lbs	\$345
<b>PB-5</b>	<b>PB-5PI</b>	<b>PB-5SM</b>	79 lbs	\$475
<b>PB-95</b>	<b>PB-95PI</b>	<b>PB-95SM</b>	125 lbs	\$540

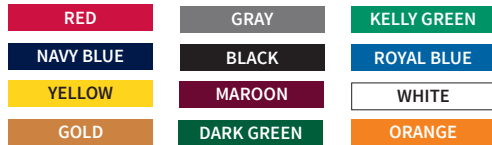

**FR 3Y**

### Powder Coated - With Seat Back

Length	Portable	Permanent	Surface	Weight	Price
7½'	<b>PB-80PC</b>	<b>PB-80PIPC</b>	<b>PB-80SMPC</b>	60 lbs	\$470
15'	<b>PB-20PC</b>	<b>PB-20PIPC</b>	<b>PB-20SMPC</b>	100 lbs	\$700
21'	<b>PB-10PC</b>	<b>PB-10PIPC</b>	<b>PB-10SMPC</b>	135 lbs	\$835
27'	<b>PB-90PC</b>	<b>PB-90PIPC</b>	<b>PB-90SMPC</b>	175 lbs	\$940

### Powder Coated - Without Seat Back

Portable	Permanent	Surface	Weight	Price
<b>PB-75PC</b>	<b>PB-75PIPC</b>	<b>PB-75SMPC</b>	40 lbs	\$330
<b>PB-15PC</b>	<b>PB-15PIPC</b>	<b>PB-15SMPC</b>	57 lbs	\$410
<b>PB-5PC</b>	<b>PB-5PIPC</b>	<b>PB-5SMPC</b>	79 lbs	\$535
<b>PB-95PC</b>	<b>PB-95PIPC</b>	<b>PB-95SMPC</b>	125 lbs	\$640



See page 145 for our  
Tennis Benches



NJ State Approved Co-op #65MCESCCPS





### Player Bench with Shelf

- > Rust-resistant and stable
- > 20" wide shelf can be used for helmets, gloves, water and other items
- > Aluminum 10" non-skid seat planks and 2" x 2" heavy-duty galvanized steel legs
- > Natural finish or powder coated colors (specify plank and leg colors when ordering)
- > Natural finish benches ship within 48 hours

FR 3Y

#### Natural Finish

Length	Item #	Weight	Price
7½'	<b>PBS-80</b>	95 lbs	\$575
15'	<b>PBS-20</b>	130 lbs	\$816
21'	<b>PBS-10</b>	185 lbs	\$1,074
27'	<b>PBS-90</b>	200 lbs	\$1,719

#### Powder Coated

Item #	Price
<b>PBS-80PC</b>	\$719
<b>PBS-20PC</b>	\$1,020
<b>PBS-10PC</b>	\$1,439
<b>PBS-90PC</b>	\$2,095

### Wall-Mounted Player Bench

- > Rust-resistant and stable
- > Aluminum 10" non-skid seat planks and corrosion-resistant understructure
- > Understructure mounted to wall with stainless steel hardware (provided by local installer)
- > Natural finish or powder coated colors (specify plank and understructure colors when ordering)

FR 3Y



#### Natural Finish

Length	Item #	Weight	Price
7½'	<b>PBW-75</b>	20 lbs	\$321
15'	<b>PBW-15</b>	40 lbs	\$386
21'	<b>PBW-5</b>	60 lbs	\$504
27'	<b>PBW-95</b>	80 lbs	\$549

#### Powder Coated

Item #	Price
<b>PBW-75PC</b>	\$375
<b>PBW-15PC</b>	\$472
<b>PBW-5PC</b>	\$612
<b>PBW-95PC</b>	\$699



### Scorer Table

- > Rust-resistant and stable
- > Aluminum 10" non-skid seat planks and 2" x 2" heavy-duty galvanized steel legs
- > Natural finish or powder coated colors (specify plank and leg colors when ordering)
- > Tabletop: 19"W x 7½'L

3Y

#### Natural Finish

Length	Item #	Weight	Price
7½'	<b>ST75</b>	90 lbs	\$526

#### Powder Coated

Item #	Price
<b>ST75PC</b>	\$622



### Floor Protection Kit

- > Optional floor protector kit prevents floor marking
- > 4 rubber feet with self-threading screws (2 per leg)

3Y

**PSS-4FT** 2 lbs. \$32 kit  
NJ State Approved Co-op #65MCECCPS



# Tip & Roll Bleachers

ESCNJ 17018-1  
Athletic Equipment and Supplies

The Educational Services Commission of New Jersey

Bid term: 5/9/18 - 5/9/20, Extended to 5/9/21



BLCH-4TRG with Standard Foot Planks

## Tip & Roll Standard Bleacher

- > Lightweight and stable with single foot planks
- > All aluminum 10" non-skid seat planks and understructure
- > Tips for easy mobility and storage
- > Transition foot prevents floor marking
- > (4) 4" non-marring swivel casters
- > 2, 3 and 4 row configuration
- > 4 row bleachers do not exceed 30" in height
- > Guard rails may not be needed (check your local codes)
- > Natural finish or powder coated colors (specify plank and understructure colors when ordering)
- > Also available as preferred bleachers (double foot planks on all rows)

FR 3Y

## Natural Finish

Rows	Length	Seats	Item #	Weight	Price
2	7½'	10	<b>BLCH-275TRG</b>	75 lbs	\$770
	15'	20	<b>BLCH-2TRG</b>	145 lbs	\$1,105
	21'	30	<b>BLCH-221TRG</b>	180 lbs	\$1,438
	27'	38	<b>BLCH-227TRG</b>	225 lbs	\$1,775
3	7½'	15	<b>BLCH-375TRG</b>	118 lbs	\$1,030
	15'	30	<b>BLCH-3TRG</b>	210 lbs	\$1,399
	21'	42	<b>BLCH-321TRG</b>	270 lbs	\$1,599
	27'	54	<b>BLCH-327TRG</b>	330 lbs	\$2,350
4	7½'	20	<b>BLCH-475TRG</b>	155 lbs	\$1,300
	15'	40	<b>BLCH-4TRG</b>	310 lbs	\$2,030
	21'	52	<b>BLCH-421TRG</b>	415 lbs	\$2,360
	27'	70	<b>BLCH-427TRG</b>	520 lbs	\$2,775

## Powder Coated

Rows	Length	Seats	Item #	Weight	Price
2	7½'	10	<b>BLCH-275TRGPC</b>	75 lbs	\$825
	15'	20	<b>BLCH-2TRGPC</b>	145 lbs	\$1,199
	21'	30	<b>BLCH-221TRGPC</b>	180 lbs	\$1,549
	27'	38	<b>BLCH-227TRGPC</b>	225 lbs	\$2,055
3	7½'	15	<b>BLCH-375TRGPC</b>	118 lbs	\$1,150
	15'	30	<b>BLCH-3TRGPC</b>	210 lbs	\$1,550
	21'	42	<b>BLCH-321TRGPC</b>	270 lbs	\$1,750
	27'	54	<b>BLCH-327TRGPC</b>	330 lbs	\$2,550
4	7½'	20	<b>BLCH-475TRGPC</b>	155 lbs	\$1,450
	15'	40	<b>BLCH-4TRGPC</b>	310 lbs	\$2,130
	21'	52	<b>BLCH-421TRGPC</b>	415 lbs	\$2,600
	27'	70	<b>BLCH-427TRGPC</b>	520 lbs	\$3,250



www.jaypro.com  
T: 800-243-0533 F: 800-988-3363



NJ State Approved Co-op #65MCESCCPS

- RED
- NAVY BLUE
- YELLOW
- GOLD
- GRAY
- BLACK
- MAROON
- DARK GREEN
- KELLY GREEN
- ROYAL BLUE
- WHITE
- ORANGE





BLDP-4TRGPC with Preferred Foot Planks

### Tip & Roll Preferred Bleacher

- > Lightweight and stable with double foot planks
- > All aluminum 10" non-skid seat planks and understructure
- > Transition foot prevents floor marking
- > (4) 4" non-marring swivel casters
- > 2, 3 and 4 row configuration
- > 4 row bleachers do not exceed 30" in height
- > Guard rails may not be needed (check your local codes)
- > Natural finish or powder coated colors (specify plank and understructure colors when ordering)
- > Also available as standard bleachers (single foot planks on all rows)

FR 3Y

### Natural Finish

Rows	Length	Seats	Item #	Weight	Price
2	7½'	10	<b>BLDP-275TRG</b>	100 lbs	\$845
	15'	20	<b>BLDP-2TRG</b>	170 lbs	\$1,235
	21'	30	<b>BLDP-221TRG</b>	230 lbs	\$1,645
	27'	38	<b>BLDP-227TRG</b>	290 lbs	\$2,050
3	7½'	15	<b>BLDP-375TRG</b>	150 lbs	\$1,175
	15'	30	<b>BLDP-3TRG</b>	265 lbs	\$1,600
	21'	42	<b>BLDP-321TRG</b>	360 lbs	\$2,100
	27'	54	<b>BLDP-327TRG</b>	455 lbs	\$2,450
4	7½'	20	<b>BLDP-475TRG</b>	210 lbs	\$1,650
	15'	40	<b>BLDP-4TRG</b>	405 lbs	\$2,375
	21'	52	<b>BLDP-421TRG</b>	540 lbs	\$2,825
	27'	70	<b>BLDP-427TRG</b>	675 lbs	\$3,340

### Powder Coated

Rows	Length	Seats	Item #	Weight	Price
2	7½'	10	<b>BLDP-275TRGPC</b>	100 lbs	\$875
	15'	20	<b>BLDP-2TRGPC</b>	170 lbs	\$1,335
	21'	30	<b>BLDP-221TRGPC</b>	230 lbs	\$1,825
	27'	38	<b>BLDP-227TRGPC</b>	290 lbs	\$2,250
3	7½'	15	<b>BLDP-375TRGPC</b>	150 lbs	\$1,225
	15'	30	<b>BLDP-3TRGPC</b>	265 lbs	\$1,775
	21'	42	<b>BLDP-321TRGPC</b>	360 lbs	\$2,300
	27'	54	<b>BLDP-327TRGPC</b>	455 lbs	\$2,850
4	7½'	20	<b>BLDP-475TRGPC</b>	210 lbs	\$1,750
	15'	40	<b>BLDP-4TRGPC</b>	405 lbs	\$2,465
	21'	52	<b>BLDP-421TRGPC</b>	540 lbs	\$3,099
	27'	70	<b>BLDP-427TRGPC</b>	675 lbs	\$3,750



NJ State Approved Co-op #65MCESCCPS

- RED**
- NAVY BLUE**
- YELLOW**
- GOLD**
- GRAY**
- BLACK**
- MAROON**
- DARK GREEN**
- KELLY GREEN**
- ROYAL BLUE**
- WHITE**
- ORANGE**



# Aluminum Outdoor Bleachers

Bid # ESCC-A-71821  
Athletic Equipment and Supplies

The Educational Services Commission of New Jersey

Bid term: 5/9/18 - 5/9/20, Extended to 5/9/21



BLCH-4AL with Standard Foot Planks



## All Aluminum Standard Bleacher

- > Lightweight and stable with single foot planks
- > All aluminum 10" non-skid seat planks and understructure
- > 3 and 4 row configuration
- > 4 row bleachers do not exceed 30" in height
- > Guard rails may not be needed (check your local codes)
- > Natural finish or powder coated colors (specify plank and understructure colors when ordering)
- > Also available as preferred bleachers (double foot planks on all rows)

FR 3Y

### Natural Finish

Rows	Length	Seats	Item #	Weight	Price
3	15'	30	BLCH-3AL	240 lbs	\$1,365
	21'	42	BLCH-321AL	340 lbs	\$1,695
	27'	54	BLCH-327AL	440 lbs	\$2,199
4	15'	40	BLCH-4AL	320 lbs	\$1,900
	21'	52	BLCH-421AL	440 lbs	\$2,315
	27'	70	BLCH-427AL	560 lbs	\$2,700

### Powder Coated

Rows	Length	Seats	Item #	Weight	Price
3	15'	30	BLCH-3ALPC	240 lbs	\$1,465
	21'	42	BLCH-321ALPC	340 lbs	\$1,899
	27'	54	BLCH-327ALPC	440 lbs	\$2,449
4	15'	40	BLCH-4ALPC	320 lbs	\$2,025
	21'	52	BLCH-421ALPC	440 lbs	\$2,535
	27'	70	BLCH-427ALPC	560 lbs	\$2,999



www.jaypro.com  
F: 800-988-3363

T: 800-243-0533



- RED
- NAVY BLUE
- YELLOW
- GOLD
- GRAY
- BLACK
- MAROON
- DARK GREEN
- KELLY GREEN
- ROYAL BLUE
- WHITE
- ORANGE



## Indoor Conversion Kit

Ideal for converting outdoor bleachers to indoor bleachers.

- > Protects indoor floor surfaces
- > 12 rubber feet attach to bottom of bleacher legs
- > For 2, 3 and 4 row bleachers of lengths of 7½', 15', 21' and 27'
- > 7½' bleacher requires 1 kit
- > 15' and 21' bleachers require 2 kits
- > 27' bleacher require 3 kits

NJ State Approved Co-op #65MCESCCPS

**BLCHICK34** 4 lbs \$50 set **3Y**





BLDP-4ALPC with Preferred Foot Planks

### All Aluminum Preferred Bleacher

- > Lightweight and stable with double foot planks
- > All aluminum 10" non-skid seat planks and understructure
- > 3 and 4 row configuration
- > 4 row bleachers do not exceed 30" in height
- > Guard rails may not be needed (check your local codes)

- > Natural finish or powder coated colors (specify plank and understructure colors when ordering)
- > Also available as standard bleachers (single foot planks on all rows)

FR 3Y

### Natural Finish

Rows	Length	Seats	Item #	Weight	Price
3	15'	30	<b>BLDP-3AL</b>	290 lbs	\$1,525
	21'	42	<b>BLDP-321AL</b>	415 lbs	\$1,900
	27'	54	<b>BLDP-327AL</b>	540 lbs	\$2,365
4	15'	40	<b>BLDP-4AL</b>	395 lbs	\$2,275
	21'	52	<b>BLDP-421AL</b>	550 lbs	\$2,800
	27'	70	<b>BLDP-427AL</b>	705 lbs	\$3,275

### Powder Coated

Rows	Length	Seats	Item #	Weight	Price
3	15'	30	<b>BLDP-3ALPC</b>	290 lbs	\$1,725
	21'	42	<b>BLDP-321ALPC</b>	415 lbs	\$2,199
	27'	54	<b>BLDP-327ALPC</b>	540 lbs	\$2,825
4	15'	40	<b>BLDP-4ALPC</b>	395 lbs	\$2,500
	21'	52	<b>BLDP-421ALPC</b>	550 lbs	\$3,000
	27'	70	<b>BLDP-427ALPC</b>	705 lbs	\$3,475



- RED
- NAVY BLUE
- YELLOW
- GOLD
- GRAY
- BLACK
- MAROON
- DARK GREEN
- KELLY GREEN
- ROYAL BLUE
- WHITE
- ORANGE

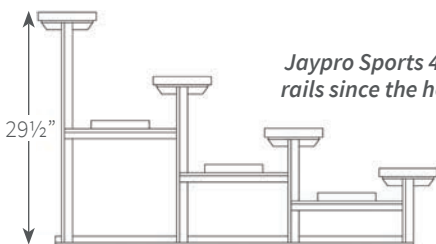

Jaypro Sports 4 row bleachers may not require guard rails since the height is less than 30" from the ground. Check your local code requirements.

NJ State Approved Co-op #65MCESCCPS

**144** Possible Color Combinations



www.jaypro.com  
T: 800-243-0533

F: 800-988-3363



# Back-to-Back Bleachers

Item # ESCN1-210-K1  
Athletic Equipment and Supplies

The Educational Services Commission of New Jersey

Bid term: 5/9/18 - 5/9/20, Extended to 5/6/21



BTBB-321 with Standard Foot Planks

## Back-to-Back Standard Bleacher

Ideal for viewing activities from both sides and between adjoining fields or indoor courts.

- > Lightweight and stable with single foot planks
- > All aluminum 10" non-skid seat planks and understructure
- > Indoor conversion kit (BLCHICK34) sold separately

- > Natural finish or powder coated colors (specify plank and understructure colors when ordering)
- > Also available as preferred bleachers (double foot planks on all rows)

FR 3Y

### Natural Finish

Rows	Length	Seats	Item #	Weight	Price
3	7½'	25	<b>BTBB-375</b>	299 lbs	\$1,879
	15'	50	<b>BTBB-3</b>	540 lbs	\$2,319
	21'	72	<b>BTBB-321</b>	668 lbs	\$2,879

### Powder Coated

Rows	Length	Seats	Item #	Weight	Price
3	7½'	25	<b>BTBB-375PC</b>	299 lbs	\$2,049
	15'	50	<b>BTBB-3PC</b>	540 lbs	\$2,489
	21'	72	<b>BTBB-321PC</b>	668 lbs	\$3,099



- RED
- NAVY BLUE
- YELLOW
- GOLD
- GRAY
- BLACK
- MAROON
- DARK GREEN
- KELLY GREEN
- ROYAL BLUE
- WHITE
- ORANGE

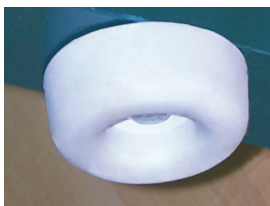

## Indoor Conversion Kit

Ideal for converting outdoor bleachers to indoor bleachers.

- > Protects indoor floor surfaces
- > 12 rubber feet attach to bottom of bleacher legs
- > For 2, 3 and 4 row bleachers, lengths of 7½', 15', 21' and 27'

- > 7½' bleacher requires 1 kit
- > 15' and 21' bleachers require 2 kits
- > 27' bleacher require 3 kits

**BLCHICK34** 4 lbs \$50 set **3Y**





BTDP-321 with Preferred Foot Planks



### Back-to-Back Preferred Bleacher

- > Lightweight and stable with single foot planks
- > All aluminum 10" non-skid seat planks and understructure
- > Indoor conversion kit (BLCHICK34) sold separately
- > Natural finish or powder coated colors (specify plank and understructure colors when ordering)
- > Also available as standard bleachers (single foot planks on all rows)

FR 3Y

### Aluminum, Preferred, Natural Finish

Rows	Length	Seats	Item #	Weight	Price
3	7½'	25	<b>BTDP-375</b>	363 lbs	\$2,099
	15'	50	<b>BTDP-3</b>	670 lbs	\$2,579
	21'	72	<b>BTDP-321</b>	903 lbs	\$3,199

### Aluminum, Preferred, Powder Coated

Rows	Length	Seats	Item #	Weight	Price
3	7½'	25	<b>BTDP-375PC</b>	363 lbs	\$2,399
	15'	50	<b>BTDP-3PC</b>	670 lbs	\$2,899
	21'	72	<b>BTDP-321PC</b>	903 lbs	\$3,549



**144** Possible  
Color Combinations

- RED
- NAVY BLUE
- YELLOW
- GOLD
- GRAY
- BLACK
- MAROON
- DARK GREEN
- KELLY GREEN
- ROYAL BLUE
- WHITE
- ORANGE



# Aluminum & Steel Bleachers

Bid # ESCN-A 7/18/21  
Athletic Equipment and Supplies

The Educational Services Commission of New Jersey

Bid Term: 5/9/18 - 5/9/20, Extended to 5/9/21



- RED
- NAVY BLUE
- YELLOW
- GOLD
- GRAY
- BLACK
- MAROON
- DARK GREEN
- KELLY GREEN
- ROYAL BLUE
- WHITE
- ORANGE

## Outdoor Standard Bleacher

- > Lightweight and stable
- > Aluminum 10" non-skid seat planks
- > Strong galvanized steel understructure made of 3/16" x 1 1/2" angled framing
- > Additional stability with dual braces and rear stabilizing bar

- > 3 and 4 row configuration
- > 4 row bleachers do not exceed 30" in height
- > Guard rails may not be needed (check your local codes)
- > Natural finish or powder coated colors (specify plank and understructure colors when ordering)

FR 3Y

### Natural Finish

Rows	Length	Seats	Item #	Weight	Price
3	15'	30	<b>BLCH-3</b>	305 lbs	\$1,325
	21'	42	<b>BLCH-321</b>	425 lbs	\$1,695
	27'	54	<b>BLCH-327</b>	545 lbs	\$2,210
4	15'	40	<b>BLCH-4</b>	390 lbs	\$1,900
	21'	52	<b>BLCH-421</b>	520 lbs	\$2,350
	27'	70	<b>BLCH-427</b>	650 lbs	\$2,700

### Powder Coated

Rows	Length	Seats	Item #	Weight	Price
3	15'	30	<b>BLCH-3PC</b>	305 lbs	\$1,475
	21'	42	<b>BLCH-321PC</b>	425 lbs	\$1,899
	27'	54	<b>BLCH-327PC</b>	545 lbs	\$2,450
4	15'	40	<b>BLCH-4PC</b>	390 lbs	\$2,050
	21'	52	<b>BLCH-421PC</b>	520 lbs	\$2,535
	27'	70	<b>BLCH-427PC</b>	650 lbs	\$3,025

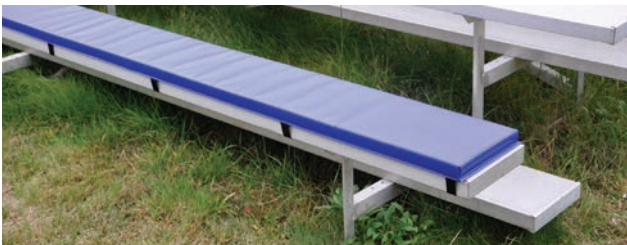

## Bleacher and Bench Plank Pad

Ideal for creating comfortable bleacher seating for players and spectators.

- > Easy installation with straps that buckle under the plank
- > For bleachers at lengths of 7 1/2', 15' and 21'
- > 7 1/2' bleacher requires 1 pad
- > 15' bleachers require 2 pads
- > 21' bleacher require 3 pads
- > Specify pad color when ordering
- > Call for freight quote (extended lead time may apply)
- > Dimensions: 10"W x 7'L x 1 3/8"H

**PLKPAD7**      5 lbs      \$135 each      1y ★

<span style="background-color: pink; padding: 2px;">PINK</span>	<span style="background-color: royalblue; padding: 2px;">ROYAL BLUE</span>	<span style="background-color: burgundy; padding: 2px;">BURGUNDY</span>	<span style="background-color: navyblue; padding: 2px;">NAVY BLUE</span>
<span style="background-color: lime; padding: 2px;">LIME</span>	<span style="background-color: forestgreen; padding: 2px;">FOREST GREEN</span>	<span style="background-color: beige; padding: 2px;">BEIGE</span>	<span style="background-color: gray; padding: 2px;">GRAY</span>
<span style="background-color: kellygreen; padding: 2px;">KELLY GREEN</span>	<span style="background-color: yellow; padding: 2px;">YELLOW</span>	<span style="background-color: brown; padding: 2px;">BROWN</span>	<span style="background-color: charcoal; padding: 2px;">CHARCOAL BLACK</span>
<span style="background-color: lightblue; padding: 2px;">LIGHT BLUE</span>	<span style="background-color: orange; padding: 2px;">ORANGE</span>	<span style="background-color: white; padding: 2px;">WHITE</span>	<span style="background-color: black; padding: 2px;">BLACK</span>



## Bleacher Transport Kit

Ideal for moving bleachers from field to field.

- > (2) 4"W x 12"H heavy-duty wheels
- > Fits any angle framed 2, 3, 4 or 5 row bleachers at lengths of 15', 21' and 27'
- > Wheels and tongue easily remove when not in use or to use with other bleachers
- > Additional mounting bracket and axle receivers (BLCH-TMKIT) sold separately

<b>BLCH-TOW4515</b>	15'	120 lbs	\$799 each	3Y
<b>BLCH-TOW4521</b>	21' - 27'	150 lbs	\$899 each	3Y
<b>BLCH-TMKIT</b>	Mounting Kit	60 lbs	\$235 each	3Y





### Enclosed Bleacher

- > Lightweight and stable
- > Aluminum 10" non-skid seat planks
- > Strong galvanized steel understructure made of 3/16" x 1 1/2" angled framing
- > Additional stability with dual braces and rear stabilizing bar
- > 5 and 10 row configuration
- > Risers and double foot planks added to bleachers over 30" high for increased safety and code regulations

- > Available with vertical guard rails or chain-link enclosure
- > Aisle option includes 2" OD handrail in center of bleacher
- > Natural finish or powder coated colors (specify plank, understructure and guardrail colors when ordering)
- > Call for freight quote
- > Note: Powder coating not available on chain-link enclosures or 10 row bleachers

FR 3Y

### Natural Finish

Rows	Length	Seats	Enclosure	Item #	Weight	Price
5	15'	50	Guard Rail	<b>BLCH-5GR</b>	1,172 lbs	\$4,895
	15'	50	Chain Link	<b>BLCH-5C</b>	1,012 lbs	\$4,295
	21'	62	Guard Rail	<b>BLCH-521GR</b>	1,452 lbs	\$5,495
	21'	62	Chain Link	<b>BLCH-521C</b>	1,252 lbs	\$5,215
	21'	58	Guard Rail w/Aisle	<b>BLCH-521ASGR</b>	1,500 lbs	\$7,995
	27'	80	Guard Rail	<b>BLCH-527GR</b>	1,732 lbs	\$6,995
	27'	80	Chain Link	<b>BLCH-527C</b>	1,492 lbs	\$5,995
10	15'	100	Guard Rail	<b>BLCH-10GR</b>	2,500 lbs	\$11,400
	21'	140	Guard Rail	<b>BLCH-1021GR</b>	2,700 lbs	\$14,250
	21'	114	Guard Rail w/Aisle	<b>BLCH-1021ASGR</b>	3,000 lbs	\$15,595
	27'	170	Guard Rail	<b>BLCH-1027GR</b>	3,464 lbs	\$17,399
	27'	134	Guard Rail w/Aisle	<b>BLCH-1027ASGR</b>	3,700 lbs	\$18,399

### Powder Coated

Rows	Item #	Price
5	<b>BLCH-5GRPC</b>	\$5,399
	N/A	N/A
	<b>BLCH-521GRPC</b>	\$6,995
	N/A	N/A
	<b>BLCH-521ASGRPC</b>	\$8,295
	<b>BLCH-527GRPC</b>	\$7,449
	N/A	N/A
10	N/A	N/A
	N/A	N/A
	N/A	N/A
	N/A	N/A
	N/A	N/A

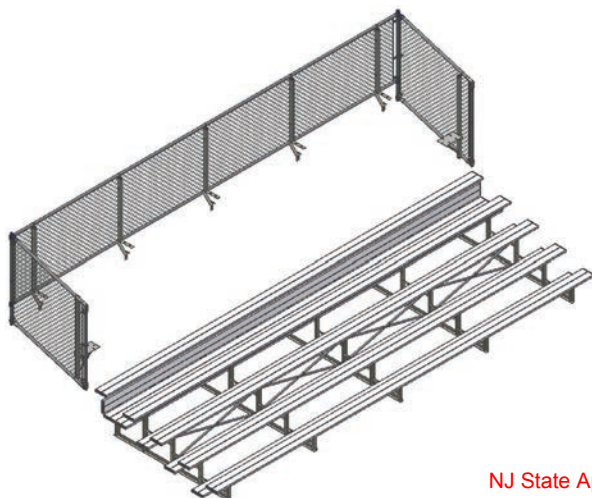

### Universal Enclosure

Ideal for upgrading 5 row bleachers to comply with local safety codes.

- > Designed to enclose bleacher seating higher than 30"
- > Fits most bleacher brands
- > Bolts to 5 row bleachers at lengths of 15', 21' and 27'
- > Footboard and kickboard included
- > Attachment frame and hardware kit included

**BLCH5CUE15** 5 Row 15' Bleacher Enclosure  
250 lbs \$2,295 each **FR** **3Y**

**BLCH5CUE21** 5 Row 21' Bleacher Enclosure  
275 lbs \$2,895 each **FR** **3Y**

**BLCH5CUE27** 5 Row 27' Bleacher Enclosure  
300 lbs \$3,695 each **FR** **3Y**

NJ State Approved Co-op #65MCESCCPS



www.jaypro.com  
T: 800-243-0533

F: 800-988-3363

# Tennis Posts



RTP-300

STP-200

## 3" Club Tennis Posts

- > Available in 3" round or square posts
- > 11 gauge steel construction
- > Solid stainless steel internal worm gear winch with self-locking mechanism to prevent recoiling during winding
- > Removable winch handle
- > Welded lacing rods for net attachment included
- > Nets (TTN-3, TPL-5, CCPTN42) sold separately
- > Ground sleeves (RTPGS-3, STPGS-2) for semi-permanent installation sold separately

<b>RTP-300</b>	Round - Green	47 lbs	\$325 pair	
<b>RTP-300BK</b>	Round - Black	47 lbs	\$325 pair	
<b>STP-200</b>	Square - Green	58 lbs	\$325 pair	
<b>STP-200BK</b>	Square - Black	58 lbs	\$325 pair	

## Replacement Winch

<b>RTP-300WH</b>	Round Winch and Handle	4 lbs	\$89 each	
<b>STP-200WH</b>	Square Winch and Handle	4 lbs	\$89 each	

## 3" Ground Sleeves

<b>RTPGS-3</b>	Ground Sleeves (RTP-300)	24"L	12 lbs	\$105 pair	
<b>STPGS-2</b>	Ground Sleeves (STP-200)	24"L	12 lbs	\$115 pair	

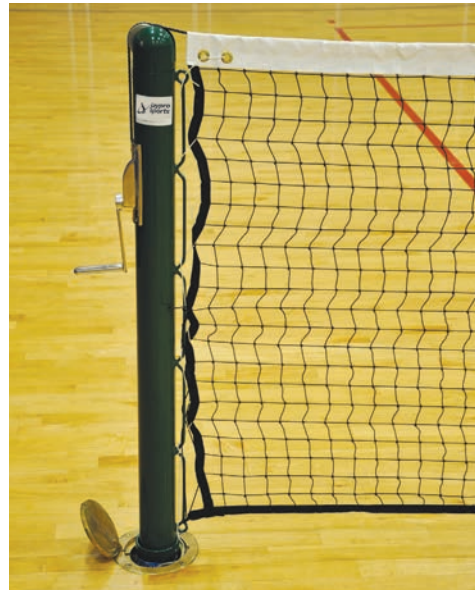

## 3" Deluxe Indoor Tennis Posts

Ideal for use with existing 10" deep floor sleeves at standard volleyball distance of 36 feet.

- > 3" OD round posts
- > 11 gauge steel construction
- > Solid stainless steel internal worm gear winch with self-locking mechanism to prevent recoiling during winding
- > Removable winch handle
- > Net sold separately

See page 16 for Floor Sleeves (PVB-70S or PVB-70S-CP)

<b>ITS-300</b>	46 lbs	\$489 pair	
----------------	--------	------------	---



## 2 7/8" Tennis Posts

- > 2 7/8" OD heavy-walled steel pipe
- > Heavy-duty self-locking winch with removable handle
- > Low profile die cast top cap
- > Adjustable height stop
- > Available for semi-permanent installation
- > 2 powder coat colors with zinc undercoat available
- > Ground sleeves with caps and net sold separately



<b>RTP-278BK</b>	Black Post	45 lbs	\$339 pair	
<b>RTP-278</b>	Green Post	45 lbs	\$339 pair	
<b>TP-278G</b>	Ground Sleeves & Covers	12 lbs	\$129 pair	
<b>RT-10GR</b>	Green Ratchet Reel	3 lbs	\$75 each	
<b>RT-10BLK</b>	Black Ratchet Reel	3 lbs	\$75 each	
<b>CAP-10GR</b>	Green Top Cap	3 lbs	\$22 each	
<b>CAP-10BLK</b>	Black Top Cap	3 lbs	\$23 each	

NJ State Approved Co-op #65MCECCPS







### 3½" Heavy-Duty Tennis Posts

- > 3½" OD heavy-walled round steel posts
- > Steel top pulley caps with 1¾" dia aluminum pulley
- > Tensioning ratchet with spring-loaded safety latch
- > Removable handle
- > Assembly hardware included
- > Nets (TTN-3, TPL-5, CCPTN42) sold separately
- > Ground sleeves (TP-150G) for semi-permanent installation sold separately

**TP-125** 90 lbs \$389 pair 3Y

### 3½" Galvanized Steel Tennis Posts

- > Same product as TP-125 except with galvanized finish

**TPGS-35** 68 lbs \$369 pair 3Y

### 3½" Ground Sleeves

**TP-150G** 12 lbs \$149 pair 3Y



### Ratchet Reel (for TP-125)

- > Heavy-duty ratchet reel fits existing posts
- > Removable galvanized steel handle
- > Safety latch to prevent fly-away

**RT-5GR** 5 lbs \$75 each 3Y  
**RT-5BK** 5 lbs \$75 each 3Y



### Top Cap (for TP-125)

- > Fits 3½" OD post
- > 1¾" pulley sheave and set screws included

**CAP-35** 3 lbs \$22 each 3Y

## Tennis Nets



### Tournament Tennis Net



- > 3mm braided black polyethylene net
- > Top 5 rows double meshed
- > Quadruple stitched heavy-duty polyester headband
- > 3/16" dia vinyl coated steel cable
- > Synthetic taped bottom edges and side pockets with dowels
- > Dimensions: 42'L x 42"H

**TTN-3** 25 lbs \$229 each 1Y

### Collegiate Tennis Net

- > 2.5mm twisted black polyethylene net
- > Top 5 rows double meshed
- > Quadruple stitched heavy-duty polyester headband
- > 1/8" dia vinyl coated steel cable
- > Synthetic taped side and bottom edges
- > Dimensions: 42'L x 42"H

**TPL-5** 18 lbs \$169 each 1Y

### Country Club Tennis Net

- > 3.6mm braided black polyethylene net
- > 38 oz reinforced vinyl headband
- > Heavy-duty vinyl coated side and bottom taped
- > Side pockets with dowels
- > Dimensions: 42'L x 42"H

**CCPTN42** 22 lbs \$199 each 1Y

### Economy Tennis Net

Ideal for use with portable standards.

- > Lightweight and weather-resistant
- > 2mm knotless nylon net with 1½" sq mesh
- > 2" vinyl headband with ¼" dia nylon cord cable
- > Taped side and bottom edges
- > Dimensions: 42'L x 42"H

**TDP-42** 7 lbs \$149 each 1Y

### Tennis Net

- > Use with volleyball systems
- > Dimensions: 36'L x 42"H

**TPV-13** 14 lbs \$189 each 1Y



### 5' Courtside Double Tennis Bench



- > 10" wide non-skid aluminum double seat planks
- > 2" x 2" heavy-duty galvanized steel legs are rust resistant
- > See powder coat chart on page 134 for available colors
- > Floor protection kit (PSS-4FT) sold separately

**DPB50PC** Powdercoated 55 lbs \$345 each 3Y  
**DPB50** Natural Finish 55 lbs \$270 each 3Y



### 5' Courtside Tennis Bench

- > 10" wide non-skid aluminum seat planks
- > 2" x 2" heavy-duty galvanized steel legs are rust resistant
- > See powder coat chart on page 134 for available colors
- > Floor protection kit (PSS-4FT) sold separately

**PB40PC** Powdercoated 55 lbs \$345 each 3Y  
**PB40** Natural Finish 55 lbs \$270 each 3Y

NJ State Approved Co-op #65MCESCCPS



# Pickleball



## Deluxe Pickleball Posts

- > Official 36" height
- > 2 7/8" OD heavy-walled steel pipe
- > Heavy-duty self-locking winch with removable handle
- > Low profile die cast top cap
- > Adjustable height stop
- > Available for semi-permanent installation
- > 2 powder coat colors with zinc undercoat available
- > Ground sleeves with caps and net sold separately



CAP-10GR



RT-10GR



CAP-10BLK



RT-10BLK

<b>PPR10BK</b>	Black Post	45 lbs	\$339 pair		3Y
<b>PPR10GR</b>	Green Post	45 lbs	\$339 pair		3Y
<b>TP-278G</b>	Ground Sleeves & Covers	12 lbs	\$129 pair		3Y
<b>RT-10GR</b>	Green Ratchet Reel	3 lbs	\$75 each		3Y
<b>RT-10BLK</b>	Black Ratchet Reel	3 lbs	\$75 each		3Y
<b>CAP-10GR</b>	Green Top Cap	3 lbs	\$22 each		3Y
<b>CAP-10BLK</b>	Black Top Cap	3 lbs	\$23 each		3Y



See page 150 for the Easy Play Game Standard that can be used for Tennis or Pickleball

## Pickleball Net

- > 2.5mm twisted polyethylene, 1 3/4" square black mesh
- > Double mesh over top 5 rows
- > Top headband is 2 1/2" white woven polyester, 2 1/2" PVC side fabric and 1/2" fiberglass dowel rods
- > Top cord: 4mm vinyl coated steel cable



<b>PT-21N</b>	Pickleball Net	11 lbs	\$149 each		1Y
---------------	----------------	--------	------------	--	----

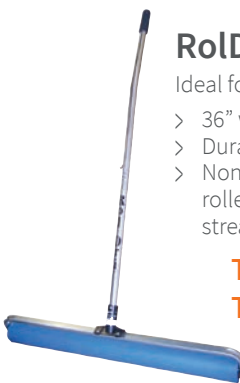

## RolDri® Sponge Roller

- Ideal for removing water from court.
- > 36" wide seamless tennis court roller
  - > Durable polyvinyl alcohol construction
  - > Non-deteriorating foam molded directly to roller core for seamless fit to ensure rapid streak free drying

<b>TCSR</b>	Roller	8 lbs	\$85 each		1Y
<b>TCSR-RR</b>	Replacement Sponge	2 lbs	\$48 each		1Y

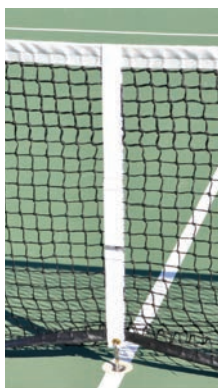

## Center Strap

- > 2" adjustable nylon webbing
- > Double snap hook

<b>CS-1</b>	2 lbs	\$13 each		1Y
-------------	-------	-----------	--	----

## Center Strap Anchor

- > All aluminum construction
- > Stainless steel drive pin for easy snap assembly

<b>A-2</b>	2 lbs	\$38 each		3Y
------------	-------	-----------	--	----



## Classic Wind Screen

Meet privacy and wind control needs with an attractive and economical wind screen. Customizable and ideal for tennis, baseball and other outside sports. See page 78 for details about this product.

<b>TWS-6</b>	6' Height	\$0.71 sq ft		FR 1Y
<b>TWS-9</b>	9' Height	\$0.73 sq ft		

## Armor Mesh Wind Screen

Meet privacy and wind control needs with an attractive wind screen. Customizable and ideal for tennis, baseball and other outside sports. See page 78 for details about this product.

<b>WSCRN-6</b>	6' Height	\$0.89 sq ft		
<b>WSCRN-9</b>	9' Height	\$0.99 sq ft		FR 1Y

NJ State Approved Co-op #65MCECCPS



# Little Champ™ Backboard Adapter

**LITTLE CHAMP™** a **jaypro sports** product



## Little Champ™ Easy Adjust Backboard Adapter

Ideal for youth leagues and elementary schools to develop shooting skills.

- > Complete unit with fan-shaped backboard, lightweight attachment frame, official size goal and nylon net ships partially assembled
- > Easily installs from floor by one person
- > Safely attaches to any goal and 42" rectangular backboard (with or without edge padding)\*
- > Adjust height without disassembly - 6½' to 9' - from floor
- > Moves backboard 2' closer to foul line
- > Adjustable frame overcomes sagging rims
- > Cannot be dislodged during play
- > No structure extends below backboard for safety
- > Dual wheels for convenient transport
- > Frame folds down and rim folds up for compact storage



<b>LC-6HP</b>	49 lbs	\$729 each	 3Y
<b>LC-6</b>	98 lbs	\$1,349 pair	 3Y

For 48" boards add a LC Arm Adapter Kit (LG-AKIT) for \$125 (specify when ordering).



## Little Champ™ 8.5 Backboard Adapter

- > Complete unit with fan-shaped backboard, lightweight attachment frame, official size goal and nylon net
- > Safely attaches to any goal and 42" rectangular backboard (with or without edge padding)\*
- > Convert existing backboard to 8'6" youth regulation height
- > Adjustment hinge on frame to ensure backboard is always plumb
- > Frame folds down and rim folds up for compact storage

<b>LC-2HP</b>	38 lbs	\$549 each	 3Y
<b>LC-2</b>	76 lbs	\$1,029 pair	 3Y

For 48" boards add a LC Arm Adapter Kit (LG-AKIT) for \$125 (specify when ordering).



## Little Champ™ Classic Backboard Adapter

- > Complete unit with fan-shaped backboard, lightweight aluminum frame, official size goal and nylon net
- > Convert regulation height courts to 8'6" youth regulation height
- > Moves backboard 2' closer to foul line
- > Hand knobs secure unit to existing goal
- > Diagonal support adds strength and rigidity

<b>LC-1HP</b>	46 lbs	\$449 each	 3Y
<b>LC-1</b>	92 lbs	\$849 pair	 3Y

## Little Champ™ Replacement Backboard

<b>FSGB-1</b>	20 lbs	\$239 each	 3Y
---------------	--------	------------	--



# GymGlide™ Game Standard

## GymGlide™ a **jaypro sports** product



### GymGlide™ Recreational Game Standard

- > Never tip to move or store
- > 155 lb base with holding capacity equivalent to 220 lb game standard
- > Telescoping upright includes lever-released composite height adjustment collars
- > Cast-iron base rides on retractable front swivel wheels
- > See chart for cast-iron base powder coat colors

**GG-100RB** ROYAL BLUE  
170 lbs \$598 each

**GG-100DG** DARK GREEN  
170 lbs \$598 each

**GG-100YW** YELLOW  
170 lbs \$598 each

**GG-100RD** RED  
170 lbs \$598 each

**GG-100W** WHITE  
170 lbs \$598 each

FR 3Y 1Y X AS

Engage wheels



Slide down telescoping upright and roll to storage





### GymGlide™ Package #1

- > 2 GymGlide™ Game Standards (GG-100XX)
- > 2 GymGlide™ Economy Upright Pads (GG-UPAD)
- > 1 Volleyball Net (VBN-32)

**GG-100PKG**  
(specify colors when ordering)  
348 lbs \$1,275 package

FR 3Y 1Y X AS



### GymGlide™ Package #2

- > 2 GymGlide™ Game Standards (GG-100XX)
- > 2 GymGlide™ Base Pads (GG-BPAD)
- > 2 Official Standard Pads (PVB60PHP)
- > 1 Volleyball Net (VBN-32)
- > See page 15 for custom graphics option

**GG-100PKGDX**  
(specify colors when ordering)  
372 lbs \$2,119 package

FR 3Y 1Y X AS

## GymGlide™ Padding

### GymGlide™ Economy Upright Pad

- > Designed for GymGlide™ uprights
- > 2" thick foam pads are pre-slit for easy installation
- > Delivers as 8' section - can be cut in field
- > Available in the color safety yellow

**GG-UPAD** 5 lbs \$59 each 3Y

### Official Standard Pad

- > 2" thick foam pad covered with vinyl
- > Hook-and-loop attachment
- > See chart for vinyl colors (specify when ordering)
- > See page 15 for custom graphics option

**PVB60PHP** 9 lbs \$288 each 3Y

### GymGlide™ Base Pad

- > Designed for GymGlide™ game standards
- > 2" thick foam pad covered with vinyl
- > See chart for vinyl colors (specify when ordering)

**GG-BPAD** 5 lbs \$399 each 3Y





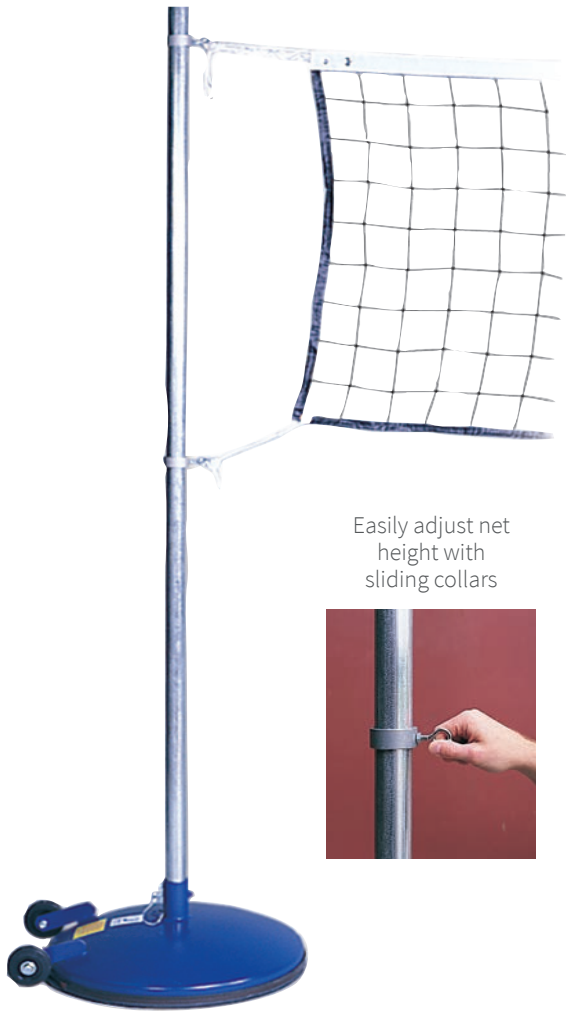

Easily adjust net height with sliding collars



### Multi-Purpose Game Standard

- > Quick set-up
- > 24" dia steel bases available in 3 sizes
- > 2" dia uprights are 10' tall (two piece)
- > Exclusive safety hub with tethered safety bolt and 2 stabilizer jacking screws for an extra margin of safety
- > Rubber rims on base protect floor
- > 4" non-marking wheels for easy transport
- > Sliding eye bolt collars allow for net height adjustment



Item #	Size in lbs	Color	Weight	Price
AS-475R	75	ROYAL BLUE	203 lbs	\$647 pair
AS-475RR	75	RED	203 lbs	\$647 pair
MP-500R	145	ROYAL BLUE	378 lbs	\$798 pair
MP-500RG	145	GREEN	378 lbs	\$798 pair
MP-500RR	145	RED	378 lbs	\$798 pair
MP-500RW	145	WHITE	378 lbs	\$798 pair
MP-500RY	145	YELLOW	378 lbs	\$798 pair
MPC-5145R*	145	ROYAL BLUE	189 lbs	\$425 each
MP-521R	220	ROYAL BLUE	530 lbs	\$998 pair
MP-521RR	220	RED	530 lbs	\$998 pair
MPC-5211R*	220	ROYAL BLUE	265 lbs	\$525 each

\* Center pole allows for a 2 court setup

### IMPORTANT SAFETY NOTICE

Game standards are heavy pieces of gymnasium equipment and require proper set-up, handling and maintenance by only trained supervisory personnel.



### Base Pad

- > Designed for 24" dia portable bases
- > 2" thick pad covered with vinyl

PBC-24RD	RED	6 lbs	\$160 each	3Y
PBC-24RB	ROYAL BLUE	6 lbs	\$160 each	3Y



### Economy Tennis Standards

- > Indoor/outdoor use
- > 2" OD galvanized steel standards are 44" tall
- > (2) 145 lb rubber mounted roll-a-way bases

JT-175R 314 lbs  
\$779 pair



NJ State Approved Co-op #65MCECCPS

### Economy Tennis Net

Ideal for use with Jaypro Sports portable standards.

- > Lightweight construction
- > #36 black weather-resistant knotless nylon net with 1 1/2" sq mesh
- > 2" wide white vinyl headband with black taped side and bottom edges
- > 1/4" dia nylon cord
- > Dimensions: 42' L x 39" H

TDP-42

\$149 each

7 lbs  
1Y





### Easy Play Game Standard

Ideal for volleyball, badminton, tennis, basketball rims and other games.

- > 6 $\frac{5}{8}$ " dia steel base is filled with 105 lbs of customer supplied ballast
- > 2" OD galvanized steel upright is 10' tall (two piece)
- > 6" non-marking wheels
- > Sliding eye bolt collars allow for net height adjustment
- > Weight never leaves the floor during transport
- > Net and other accessories sold separately
- > Dimensions: 40"W x 32"D

**EZ-55HP**  
\$289 each

79 lbs



### Badminton Post

Ideal for setting up a portable regulation size Badminton court. Can be used indoor or out.

- > 1 $\frac{7}{8}$ " OD steel post powder coated white
- > Official 61" height
- > Post fits easily in EZ-55 base
- > Comes with easy to use cast aluminum Clamcleat® for securing net cord
- > EZ-55 base and net (sold separately)

**EZBSO-3**  
\$339 each

6 lbs



### Pickleball Post

Ideal for setting up a portable regulation size Pickleball court. Can be used indoor or out.

- > 2 $\frac{3}{8}$ " OD steel post powder coated black
- > Official 36" height
- > Post fits easily in EZ-55 base
- > Comes with RT-10BLK winch
- > EZ-55 base and net (sold separately)

**EZBPB-4**  
\$339 each

11 lbs



### Tennis Post

Ideal for setting up a portable regulation size Tennis court. Can be used indoor or out.

- > 2 $\frac{3}{8}$ " OD steel post powder coated black
- > Official 42" height
- > Post fits easily in EZ-55 base
- > Comes with RT-10BLK winch
- > EZ-55 base and net (sold separately)

**EZBPB-5**  
\$339 each

13 lbs



### Net Ball Adapter

- > Fits any 2" OD game standard upright
- > Goal, net and mounting hardware included

**EZNB-10**  
\$129 each

15 lbs



### Elementary Basketball Adapter

- > Indoor use only
- > Fits any 2" OD game standard upright
- > 7' maximum goal height for safety
- > Goal, net and mounting frame included

**EZBB-8**  
\$389 each

46 lbs







### Deluxe Game Standards

- > 2 3/8" OD galvanized steel uprights with net tensioning ratchet is 8' tall
- > 24" dia steel base includes hand knob and guy wire for firm anchoring
- > 4" wheels
- > 2 floor anchors required and sold separately

**SS-320R**

\$719 pair

142 lbs



### Deluxe Center Standard

- > Single upright
- > Use with the Deluxe Game Standard (SS-320R) for a two court set-up
- > 2 floor anchors required and sold separately

**SSC-321R**

\$429 each

75 lbs



### Volleyball Net

**VBN-32** 4 lbs

Rope Cable - 36"W x 32'L

\$92 each

1Y



### Badminton Net

**BND-1** 7 lbs

Lightweight Rope Cable - 30"W x 21'L

\$52 each

1Y



### Tennis Net

**TDP-42** 7 lbs

Lightweight Rope Cable - 39"W x 42'L

\$149 each

1Y

## Tetherball

### Semi-Permanent Outdoor Tetherball Pole

- > 2" OD galvanized steel upright
- > 18" long aluminum ground sleeves with cast aluminum top cap for semi-permanent installation
- > Tetherball (TBP-BALL) sold separately
- > Installed Pole Height: 8 1/2'

**TBP-200**

\$169 each

18 lbs



### Portable Tetherball Pole

- > Indoor/outdoor use
- > 2" OD galvanized steel upright is 10' tall
- > 12" long pre-assembled leader chain
- > 24" dia steel base with protective rubber trim weighs 75 lbs
- > 2 non-marking wheels
- > Tetherball (TBP-BALL) sold separately

**TBP-275R**

\$399 each

100 lbs



### Heavy-Duty Permanent Tetherball Pole

- > 2 3/8" OD galvanized steel pole with cap and leader chain
- > Tetherball (TBP-BALL) sold separately

**TBP-250**

\$199 each

38 lbs



### Tetherball

- > Ultra-cushioned, sponge rubber construction in yellow
- > Recessed rope holder and nylon rope included

**TBP-BALL**

\$20 each

3 lbs

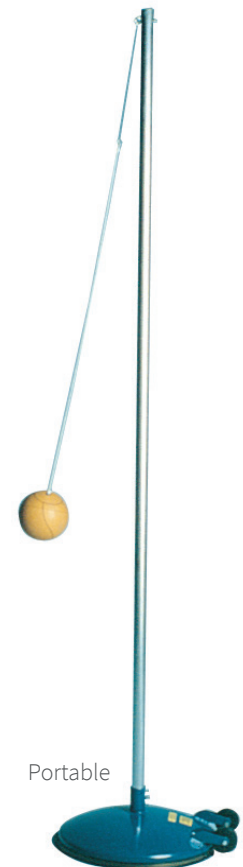

Portable





### Deluxe Floor Hockey Goal

- > Lightweight
- > 1 5/16" OD galvanized steel frame with cast aluminum corner fittings
- > Mounted rubber feet protect gymnasium floor
- > Durable polyethylene net with 1 3/4" sq mesh have colored sleeve-type binding (1 red and 1 blue)
- > Dimensions: 6'W x 4'H x 20"D

**FHGN-33** 73 lbs \$794 pair **3Y**

### Replacement Nets

- > Replacement nets for Deluxe Floor Hockey Goals (FHGN-33)
- > 1 3/4" sq mesh and constructed of extra durable, twisted polyester
- > Colored sleeve-type binding (1 red and 1 blue)



**FHN-36** 5 lbs \$163 pair **1Y**



### Folding Multi-Purpose Goal

Ideal for quick games in the gym, street or driveway.

- > 1 5/16" OD steel frame
- > Rolls easily on non-marking wheels and folds flat for storage
- > Durable knotless nylon net with colored sleeve-type binding (1 red and 1 blue)
- > Hook-and-loop-closure
- > Dimensions: 6'W x 4'H



**FHG-46PR** Goals 39 lbs \$399 pair **3Y**

**FHG-46N** Red Net 5 lbs \$87 each **1Y**

**STG-46N** Blue Net 5 lbs \$85 each **1Y**



### Archery Target Stand

- > Silver steel storage stand
- > Adjustable for 24"-48" targets
- > Includes wheels for easy transport
- > Target not included

**PE-120** 11 lbs \$74 each **3Y**

### Torso Flexibility Box



- > Durable steel construction with foot rest plate
- > Accurately measures in inches and centimeters
- > Dimensions: 12"W x 20"L x 12"H

**PE-FLXBX** 13 lbs \$149 each **3Y**



### Archery Tripod Target Stand

- > Indoor/outdoor use
- > Silver steel storage stand
- > Adjustable for 24"-48" targets
- > Folds to tripod position
- > Cushioned footing
- > Target not included

**PE-121** 10 lbs \$54 each **3Y**



### Throw Down Bases

- > Indoor/outdoor use
- > 3 bases, 1 home plate and 1 pitching rubber

**BB-50** 5 lbs \$16 set **3Y**

### Jump Rope Rack



- > 27" long wall-mounted all steel construction
- > Features five 10" long pegs for storage
- > Powder coated black

**PE-110** 7 lbs \$45 each **3Y**







### Portable Bicycle Rack

- > Available in 4 sizes and designed to hold bicycles or mopeds
- > 1 1/2" galvanized steel all-welded frame with gray powder coat finish

FR 3Y

Item	Capacity	Size	Weight	Price
OBR-16	16	102"L x 30"W x 30"H	67 lbs	\$619 each
OBR-10	10	67"L x 30"W x 30"H	60 lbs	\$549 each
OBR-8	8	55"L x 30"W x 30"H	56 lbs	\$519 each
OBR-6	6	47"L x 30"W x 30"H	49 lbs	\$479 each

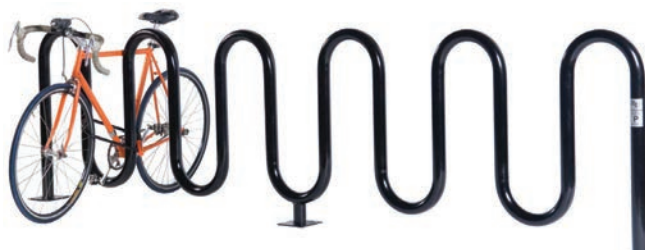

COLUMBIA RED	BROWN
BEIGE	BRIGHT WHITE
ESSEX GREEN	BLUE
JOHN DEERE YELLOW	DARK GRAY
SAFETY YELLOW	GRAY
EMERALD GREEN	BLACK

### Wave Bicycle Rack

- > Contemporary design
- > 2 3/8" OD Schedule 40 tubing construction
- > 36"H with 12" spacing between waves
- > In ground or surface mount styles available
- > See chart for powder coat colors (specify when ordering) - standard color is black
- > Call for freight quote

FR 1Y

### Below Grade Mount - Galvanized

Item	Capacity	Length	Weight	Galvanized
HDWBR-7	7	64"	74 lbs	\$545 each
HDWBR-9	9	87"	96 lbs	\$745 each

### Powder Coated

Item	Powder Coat
HDWBR-7PC	\$545 each
HDWBR-9PC	\$745 each

### Surface Mount - Galvanized

Item	Capacity	Length	Weight	Galvanized
HDWBR-7SM	7	64"	74 lbs	\$565 each
HDWBR-9SM	9	87"	96 lbs	\$765 each

### Powder Coated

Item	Powder Coat
HDWBR-7SMPC	\$565 each
HDWBR-9SMPC	\$765 each

## Terms & Conditions

### Contact your local Jaypro Representative or Jaypro for detailed Information on Terms & Conditions

**Returns:** Jaypro will accept the authorized return of all standard products for any reason within 30 days of the ship date. *SPECIAL ORDER/ CUSTOM COLOR ITEMS ARE NOT RETURNABLE.* Customers must obtain a return authorization number from Jaypro after supplying the invoice number, item number, and reason for return. Customer is responsible for a 20% restocking fee and return freight charges.

**Freight Damages & Discrepancies:** Damages or shortages must be reported within 7 days of the delivery date. It is the responsibility of the customer to sign the delivery receipt as damaged or short. If Jaypro is notified within this time frame, we will replace as needed and file the claim with the carrier.

**Payment Terms:** We accept checks, American Express, Discover, MasterCard, and Visa. Approved accounts are required to submit a purchase order and will be billed Net 30 from the invoice date. All past due accounts are subject to a 1.5% per month (18% per year) interest charge and collection costs. Any approved account choosing to pay by credit card after the invoice date may be subject to a 3% credit card processing fee.

We reserve the right to correct typographical errors. NJ State Approved Co-op #6501 ESCNJCS of Terms & Conditions.

<b>Ball Storage</b> .....	130-133
ToteMaster Storage Carts	130-132
Ball Carriers	132-133
<b>Baseball/Softball</b> .....	62-82
Batting Cages	62-64
Backstops & Padding	65
Batting Tunnels	66-69
Foul Poles	70-71
Protector Screens	72-73
Bases & Plates	74-76
Field Covers, Fence & Rail	78-80
Field Maintenance	80-82
<b>Basketball</b> .....	90-105
Outdoor Units	90-97
Backboards	98-99
Goals	100-103
Edge Padding	104
<b>Benches &amp; Bleachers</b> .....	134-143
Player Benches	134-135
Tip & Roll Bleachers	136-137
Outdoor Bleachers	138-143
<b>Field Hockey</b> .....	57
<b>Field Marking</b> .....	86-89
<b>Field Netting</b> .....	124-129
Portable or Permanent Netting	124-125
FieldPro Custom Netting	126-129
<b>Football</b> .....	48-56
Goal Posts & Accessories	48-52
Football Storage Equipment	54
Football Training Equipment	55-56
<b>Gymnasium</b> .....	106-123
Indoor Portable Systems	106-107
Wall Mounted Backstops	108-110
Height Adjusters	109
Divider Curtains	116-117
Wrestling Mat Storage	118
WallGuard Wall Padding	120-121
Custom Printing	122-123
<b>Lacrosse</b> .....	58-61
Box & Official Goals	58-59
Lacrosse Nets & Accessories	60-61
<b>Physical Education</b> .....	147-153
Little Champ Backboard Adapter	147
GymGlide Game Standard	148
Multi-Purpose Game Standards	149-151
Tetherball	151
Floor Hockey Goals, Archery Stands	152
Torso Flexibility Box	152
<b>Scoreboards</b> .....	84-85
<b>Soccer</b> .....	22-47
Official Goals	22-30
Training Goals & Rebounders	31
Club Goals	32-33
Futsal Goals	34
Indoor/Outdoor/Practice/Youth	35-37
Goal Anchors	38-39
Soccer Nets & Attachment	40-41
Field Accessories	42-43
Soccer Shelters	44-45
Combo Goals	46-47
<b>Sports Training</b> .....	83
<b>Tennis</b> .....	144-146
Tennis Posts	144-145
Pickleball	146
Tennis Nets & Accessories	145-146
<b>Volleyball</b> .....	4-21
Volleyball Systems	4-10
Overhead Volleyball	11
Volleyball Nets & Accessories	12-13
Referee Stands	14-15
Equipment Carriers	15
Floor Sleeves & Anchors	16-17
Volleyball Ball Carts	18
Training Equipment	19
Outdoor & Beach Volleyball	20-21



Contact your Local Jaypro Sports Dealer Today



**BEN  
SHAFFER  
RECREATION**

973-663-2021

[www.benshaffer.com](http://www.benshaffer.com)



Manufactured in Waterford, CT since 1953

Jaypro Sports LLC © 2018

**Sports Equipment and Athletic Field/Facility Solutions • [www.jaypro.com](http://www.jaypro.com)**



## Providing a Complete Line of Exceptional Athletic Equipment for your Sporting Needs:

Benches and Bleachers • Portable Backstops • Field Maintenance and Protection  
Foul Poles • Official & Club Soccer Goals • Youth Training/Practice Goals • Wall Pads  
Soccer Training Aids • Combo Goals • Football Goal Posts • Volleyball Net Systems  
Referee Stands • Lacrosse and Field Hockey Goals • Storage Carts • Ball Carriers  
Outdoor and Indoor Basketball Systems • Basketball Backboards, Rims and Nets  
Field Marking • Game Standards • Tennis Posts and Nets • Windscreens • Field Netting

**Contact your Jaypro Sports Dealer today!**

NY State Approval Po-01-265MCE50055

