

COOLFACADE: State-of-the-art review and evaluation of solar cooling technologies on their potential for facade integration

Prieto Hoces, Alejandro; Knaack, Ulrich; Auer, Thomas; Klein, Tillmann

DOI

[10.1016/j.rser.2018.11.015](https://doi.org/10.1016/j.rser.2018.11.015)

Publication date

2019

Document Version

Final published version

Published in

Renewable and Sustainable Energy Reviews

Citation (APA)

Prieto Hoces, A., Knaack, U., Auer, T., & Klein, T. (2019). COOLFACADE: State-of-the-art review and evaluation of solar cooling technologies on their potential for facade integration. *Renewable and Sustainable Energy Reviews*, 101, 395-414. <https://doi.org/10.1016/j.rser.2018.11.015>

Important note

To cite this publication, please use the final published version (if applicable). Please check the document version above.

Copyright

Other than for strictly personal use, it is not permitted to download, forward or distribute the text or part of it, without the consent of the author(s) and/or copyright holder(s), unless the work is under an open content license such as Creative Commons.

Takedown policy

Please contact us and provide details if you believe this document breaches copyrights. We will remove access to the work immediately and investigate your claim.

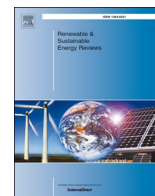

COOLFAÇADE: State-of-the-art review and evaluation of solar cooling technologies on their potential for façade integration

Alejandro Prieto^{a,*}, Ulrich Knaack^a, Thomas Auer^b, Tillmann Klein^a

^a Delft University of Technology, Faculty of Architecture and the Built Environment, Department of Architectural Engineering + Technology, Architectural Façades & Products Research Group, Julianalaan 134, 2628BL Delft, Netherlands

^b Technical University of Munich, Department of Architecture, Chair of Building Technology and Climate Responsive Design, Arcisstraße 21, 80333 Munich, Germany



ARTICLE INFO

Keywords:

Solar cooling
Façade design
Integrated façades
Product development
Barriers

ABSTRACT

Increasing cooling demands in the built environment call for innovative technical solutions and systems for application in buildings. Cooling loads represent an important share of the total energy consumption in warm climates, especially in commercial and office buildings. Moreover, mechanical systems will still be needed in most cases to cope with cooling loads, even after considering passive cooling strategies in the design of the building and its façade. Solar cooling technologies present interesting assets, being based on environmentally friendly cooling processes, driven by solar and thus renewable energy. However, their application in the built environment remains greatly limited.

This paper assesses several solar cooling technologies in terms of their potential for façade integration; aiming to promote widespread application in buildings throughout the development of integrated architectural façade products. The assessment is based on a state-of-the-art review and discussion of key attributes for façade integration of selected technologies; and a qualitative evaluation of their suitability to respond to main product related barriers for the integration of building services identified in an earlier work by the authors. The cooling principles behind the operation of the assessed technologies have been extensively presented in the literature, so this paper focuses exclusively on key aspects to overcome barriers related to the technical feasibility, physical integration, durability, performance, and aesthetics of future integrated concepts.

Results show that the suitability of the assessed technologies varies according to each particular barrier. Hence, no technology currently fits all required aspects. Nonetheless, the use of thermoelectric modules and compact units based on absorption technologies are regarded as the most promising for the development of either integral building components, or modular plug & play systems for façade integration. In any case, this is heavily conditioned to further efforts and explorations in the field to overcome identified challenges and knowledge gaps.

1. Introduction

Cooling demands in the built environment present a highly relevant challenge for the design of sustainable buildings and cities. On the one hand, several studies have attributed around 15–17% of global electricity consumption to air-conditioning and the refrigeration sector [1–3]. This demand is expected to increase continuously during the coming years, following current trends [4,5], due to several factors such as increasing standards of life, climate change, and affordability of air conditioning [6]. Yearly sold room size AC units surpassed 100 mill worldwide on 2014, and they are expected to reach over 1.6 bill by 2050, with yearly sales growing at 10–15% in fast growing developing countries from warm climates [7]. Moreover, it has been stated that just

Non-OECD Asia will account for more than half of the world's total increase in energy consumption between 2012 and 2040 [8], which puts pressure on design guidelines, regulations and further exploitation of renewable sources of energy.

On the other hand, refrigerants used as working fluids have serious environmental impact. Chlorofluorocarbons (CFCs) were banned and hydrochlorofluorocarbons (HCFCs) are being phased out according to the schedules set by the Montreal Protocol in 1987, due to their impact on the ozone layer [9]. The most common refrigerants currently used are hydrofluorocarbons (HFCs), such as R134a, a non-ozone-depleting substance, but with a global warming potential (GWP) 1430 times that of CO₂ [10,11]. As a result of the Kigali amendment to the Montreal Protocol, signed in 2016, the use of these substances will be also phased

* Corresponding author.

E-mail addresses: A.I.Prietohoces@tudelft.nl (A. Prieto), U.Knaack@tudelft.nl (U. Knaack), Thomas.Auer@tum.de (T. Auer), T.Klein@tudelft.nl (T. Klein).

<https://doi.org/10.1016/j.rser.2018.11.015>

Received 16 May 2018; Received in revised form 20 July 2018; Accepted 14 November 2018

1364-0321/© 2018 The Author(s). Published by Elsevier Ltd. This is an open access article under the CC BY license (<http://creativecommons.org/licenses/by/4.0/>).

down, over the period of 2019–2036 and 2024–2047 in developed and developing countries respectively [12]. This milestone means breaking the vicious circle established by the operation of refrigerants that contribute to temperature raise in urban areas, in turn increasing cooling demands and further need for refrigerants.

The current challenge for sustainable cooling in the built environment is then threefold: there is (a) a need for climate-responsive building design to decrease cooling demands as much as possible through the application of passive strategies; while the remaining load is covered by (b) efficient building systems that not only use renewable energies as input, but also (c) consider environmentally friendly working materials and processes. In that regard, solar cooling technologies have experienced increased interest over the last couple of decades, being widely recognised as promising alternatives to traditional vapour compression based refrigeration [13–15]. The main benefits of these systems are the direct use of solar radiation as a renewable energy source, and the use of environmentally friendly working materials in the cooling process. Nonetheless, building application remains mostly limited to demonstration projects and pilot experiences [16,17].

One alternative to promote further application in the built environment, is the development of multifunctional building components for architectural design. Working experiences of decentralised services integration in façade modules, plus the exposed area available for solar collection, point towards façade integration of solar cooling technologies as a clear road to develop small-scale, flexible products for widespread application. The potential for solar collection in facades has been explored through the development of building integrated photovoltaics (BIPV) and building integrated solar thermal collectors (BIST), resulting in guidelines, prototypes and commercialised products [18–20]. On the other hand, solar driven refrigeration has been described and categorised in terms of working principles [21,22], and evaluated and compared considering performance [23,24] and to a lesser degree, economic aspects [25,26]. However, besides stand-alone prototypes and integrated concepts, there is a knowledge gap regarding guidelines for building application and especially integration possibilities within façade components.

The goal of this paper is to assess the potential for façade integration of several solar cooling technologies, based on a state-of-the-art review and discussion of specific attributes, and their capability to respond to main identified barriers for façade integration of building services. The assessment focuses on five main solar electric and solar thermal technologies, based on widespread categorisations: thermoelectric, absorption, adsorption, solid desiccant, and liquid desiccant cooling [22,27]. Even though the energy input is a fundamental part of the system, the assessment will concentrate on the cooling process and the required components to generate, distribute and deliver the cooling effect indoors. Hence, façade integration possibilities of PV panels and/or solar collectors will not be directly addressed. In turn, the outcome of this assessment is expected to serve as complement to previous and established research on BIPV and BIST [28–30], providing feedback to system developers and façade designers for the development of fully self-sustaining solar cooling façade modules for buildings in warm climates.

2. Strategy and methods

The assessment of the defined solar cooling technologies was carried out in two separate stages, sequentially presented in this paper: a state-of-the-art review of the solar cooling technologies focused on relevant aspects for façade integration; and the evaluation of these technologies, based on the addressed aspects, on their potential to overcome previously identified barriers for façade integration of building services.

The review focuses on façade integration potential, by characterising the selected technologies in four main aspects: performance, component complexity, operation, and development level, providing an

Table 1
Key aspects considered in the review.

| KEY ASPECTS | SUB-ASPECTS |
|----------------------|--|
| PERFORMANCE | General reported performance Reported performance of small scale applications |
| COMPONENT COMPLEXITY | Dimensions – size, volume and weight of systems and components Components – number and types of required components Connections – types of required connections and materials involved |
| OPERATIONAL ISSUES | Health, safety and comfort issues Maintenance requirements |
| DEVELOPMENT LEVEL | Technical maturity Market/commercial maturity |

specialised overview of the state-of-the-art of the particular technologies, for each aspect addressed. A brief description of the considered aspects and sub-aspects is shown in Table 1. Many sources were considered for the review, such as peer-reviewed scientific publications, research reports, patented concepts, and technical info from manufacturers and distributors in the case of market-ready products. Façade integration potential means the integration of small decentralised units, so the review focused on small-scale developments, ranging up to 20 kW. Larger capacities were discussed as reference if applied, but they were not explored in detail.

The review does not consider a detailed description of the cooling principles and processes behind each technology, having been extensively described on the literature [21,27]. Similarly, economic aspects were not explicitly considered in the review. Even though cost is a relevant issue for the development of integrated concepts, there is limited amount of information on small-scale concepts, due to their early stages of research and development. Hence, cost estimations of integrated concepts may be troublesome. In any case, broad economic considerations are implicitly considered in the discussed aspects, in terms of the materials used, complexity of the system, and overall performance during operation, providing less payback time with a more efficient solution, compared to a base initial cost.

The potential for façade integration of these technologies was evaluated based on their prospects to overcome main barriers for the integration of building services in façade components. These barriers were identified in a previously published article by the authors [31], validated and discussed along similar experiences in the topic [32–35]. This previous work was based on a survey addressed to specialised professionals with practical experience in the development of façade systems for office buildings. The main outcome was the identification of the main perceived barriers for integration, through open questions, during three main product development stages: design, production, and assembly. Open ended responses by the experts were then categorised into main process and product related issues, as shown in Fig. 1.

Only product related barriers and subsequent issues are considered in the evaluation of solar cooling technologies, focusing the discussion on key characteristics for potential future integrated products, rather than the logistics, knowledge and coordination required to successfully produce them. Moreover, process related aspects need to be tackled in general, to allow further application of all of the assessed technologies, so these barriers do not provide direct and discernible criteria for comparison between current solar cooling technologies. Therefore, the evaluation centres around the identified product related barriers, discussing and assessing the potential of the different technologies in overcoming them.

It is worth pointing out that results from the survey showed that some barriers seem to be more relevant than others, based on the total amount of mentions. This suggests perceived priorities for current exploration; however, the assessment considers them separately, exploring the current state of each technology without attempting an

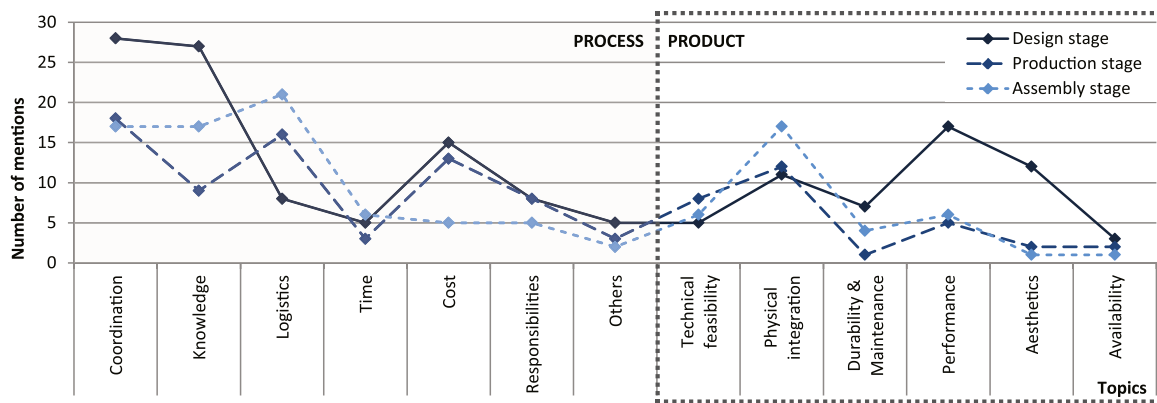

Fig. 1. Main perceived barriers for façade integration of building services: number of mentions per development stage by respondents.

overall comparison. Hence, each barrier is discussed separately, while the barrier-specific integration potential of each technology is illustrated and compared by a qualitative score system depicted in Table 2, along with a brief description of the barriers. The barrier-based assessment of the façade integration potential of the selected technologies aims to identify specific bottlenecks and propose recommendations to bring them closer to façade integration, sketching a roadmap for the future development of solar cooling integrated architectural products.

3. State-of-the-art review of solar cooling technologies on key aspects for façade integration

Solar cooling technologies are usually categorised according to their energy input, under either solar electric or solar thermal processes, hence using electricity from PV panels or heat stored in solar thermal collectors as the main input for the cooling process [22,27]. Table 3 shows the main solar cooling principles and associated common technologies in existence. Even though the use of a vapour compression heat pump could be considered under solar electric processes, provided that is driven by PV panels, it is not considered in the review due to the environmental hazards of commonly used refrigerants. Similarly, thermomechanical cooling technologies are not discussed due to the lack of development and consequent available information compared to the rest. Therefore, the review and evaluation focus on five solar cooling technologies regarded as the most promising options for further development of integrated building components: thermoelectric, absorption, adsorption, and (solid and liquid) desiccant cooling.

All technologies addressed in the review share general advantages and disadvantages compared to commonly used vapour compression systems. The most relevant advantages are the use of renewable energy as main direct input, either directly supplied as electricity or low-grade thermal energy; and the use of environmentally friendly working materials as refrigerants, with no global warming nor ozone depletion potential. The most important disadvantage is the performance of these systems in terms of their electrical or thermal efficiency, besides the technical and commercial maturity of systems and components. Aside from these, specific advantages and disadvantages inherent to each technology are presented in Table 4, as an initial overview of possibilities and constraints for widespread application. The specific review of each technology regarding key aspects for façade integration is carried out separately, in the following sections.

3.1. Thermoelectric cooling

3.1.1. Performance of cooling systems and integrated concepts

3.1.1.1. General reported performance. The efficiency of a thermoelectric (TE) module mostly depends on the ability of the base material to produce thermoelectric power from a temperature differential (or vice versa). This material property is measured with a

dimensionless figure of merit denominated ZT. Commercially available common materials such as Bismuth telluride (Bi_2Te_3) have ZTs around 1.0–1.2 [36], while it has been reported that it is possible to achieve COP values between 1.0 and 1.5 for TE HVAC systems using currently available TE materials of $ZT = 1$ [15,37]. Furthermore, it has been stated that TE cooling reaches Carnot efficiencies between 0.1 and 0.15 [38], with a theoretical potential up to 0.37–0.4 assuming reported developments in material science [13,37,39]. These efficiencies would mean comparable values to vapour compression technologies (~0.45), so research on new materials has been a priority in the field. It has been stated by several authors that achieving a ZT value of 2 [38,40,41], or 3 [15,42–44] would make domestic & commercial HVAC TE systems competitive and practical for widespread application. More conservative estimates declare that a $ZT = 4.4$ would be needed accounting for losses in the system [13]. In the last decades, new nanotechnology driven materials with ZTs of 1.5–2.0 and even 2.4 have been reported [45]; however, these remain experimental and outside of the market.

3.1.1.2. Reported performance of small scale applications. There are several experimental TE driven HVAC concepts in the literature, with reported COP ranging from 0.38 to ~2.00 under diverse operating conditions. It is relevant to mention that in thermoelectric technology, there is a trade-off between COP and cooling power, so a balance between them is usually identified as the optimal operating condition. Tan & Zhao [46] reported a maximum COP of 1.71 for a TE AC system, however, the optimum balance was found to achieve a COP of 0.82, under 5 A and cooling power of 37 W. Cosnier [47] reported COP values around 1.5–2.0 for an air cooling/heating system, with 50 W per module under 4 A, maintaining 5 °C difference between hot and cold sides (10 °C maximum). Shen et al. [48] achieved a COP of 1.77, with 1.2 A and 8.82 W, while Zhao & Tan [40] obtained an average and maximum COP of 0.8 and 1.22 respectively, for a PCM integrated TE AC, with a maximum cooling capacity of 210 W corresponding to the maximum COP value.

Regarding TE cooling integrated façade concepts, COP values range between 0.5 and 1.8 for the reported experiences shown in Table 5. Considering these, it could be feasible to estimate a COP of 1.0–1.2 for performance assessment of building integrated TE cooling systems, although this value needs to be corroborated, taking into account the required cooling capacity of a designed system for a particular context.

3.1.2. Complexity of systems and components

3.1.2.1. Dimensions – size, volume and weight of systems and components. Thermoelectric technologies are conceived for small scale application, such as cooling of electronic equipment or spot AC. Common dimensions of TE modules are in the range of 40×40 mm, so it is highly suitable to be assembled in a compact and modular package [37,40,65]. Because of these characteristics, several authors

Table 2
Main identified barriers for façade integration and score system for the evaluation.

| BARRIERS | DESCRIPTION | SCORE VALUES |
|--------------------------------------|---|--------------|
| TECHNICAL FEASIBILITY | Overall feasibility to integrate systems into façade modules based on each cooling principle. This considers functional and physical constraints for integration | 0 |
| PHYSICAL INTEGRATION | Externalities derived from the physical integration of components and parts, considering compatibility of sub-systems, modularity, working materials and connections. | + |
| DURABILITY & MAINTENANCE PERFORMANCE | Durability of components over time, maintenance requirements and ease to perform repairs or replace components and parts. Technical limitations based on past experiences. It also considers externalities for indoor comfort, derived from the operation of the systems. | ++ |
| AESTHETICS & AVAILABILITY | Potential to allow for design flexibility and variability, which may grant freedom for architectural expression and façade composition. | +++ |
| | Required components cannot be integrated in a façade module. | + |
| | Complex connections between operating sub-systems. | ++ |
| | Robust components w/ complicated maintenance. Isolated in-range experiences / Minor externalities | +++ |
| | Some restrictions and isolated options for façade design | +++ |
| | Standalone examples of compact systems (R&D needed). | +++ |
| | Development of small compact units and stand-alone façades | +++ |
| | Connections of mild complexity / compatible components | +++ |
| | Robust components with periodic but simple maintenance. Several cases of high, reliable performance / Minor externalities. | +++ |
| | Minor restrictions / various options for components. | +++ |
| | High design flexibility and variety of options and components. | +++ |
| | Several façade integrated concepts and tested prototypes | +++ |
| | Modular components with simple plug&play connections. | +++ |
| | Robust systems and components virtually maintenance free. High & proven relative performance, with no externalities. | +++ |

have explored building application through prototype TE cooling façade concepts (Fig. 2)

3.1.2.2. Components – number and types of required components. The core of a TE HVAC system basically consists of a PV panel, a Peltier module (Fig. 2), a heatsink for heat rejection, and the connecting wires for electricity transfer. TE modules are powered by direct current, thus it is not necessary to consider an inverter as part of the system, providing a good match with PV panels [15,39,51,66]. Additionally, heat rejection may be improved by the use of fans, and the system may be benefited by steady current input by means of integrating a battery for electricity storage, between the PV panel and the TE module. [47,62]

3.1.2.3. Connections – types of required connections and materials involved. This technology does not consider moving parts nor working fluids in the core refrigerating machine [37,41,48,51,67]. Hence, the connections between the core components are solved with electrical wires. Furthermore, being a solid-state technology, cooling transmission is produced by direct contact between the cold side of the TE module and the transfer medium (air-water), or directly the indoor environment via a radiant panel/ceiling [27].

3.1.3. Cooling system operation

3.1.3.1. Health, safety and comfort issues. Thermoelectric technology is ecologically clean, given that is refrigerant free. Because of that, its operation does not present particular hazards nor safety concerns [41,47,48,65,66].

3.1.3.2. Maintenance requirements. A basic TE system only requires basic electrical maintenance. Moving parts such as fans will require specific maintenance activities. However, the fact that currently there are not commercially available TE HVAC systems, means that these systems are not fully tested on the long-term. Furthermore, PV panels are commonly guaranteed for around 25 years, so life expectancy has to be accounted for in cost/performance analysis [68].

3.1.4. Level of development / maturity

3.1.4.1. Technical maturity. The thermoelectric principle was discovered in the early 1800s (Seebeck and Peltier effect), and cooling technology driven by it has been explored since, for several applications such as medical and space equipment, electronics, and household devices such as portable refrigerators and camping gear. The principles are quite well understood and their use for small scale applications is well documented. Nonetheless, TE HVAC applications are still in early R&D development, with effort focused on improving the efficiency of several concepts by researching at material level through nanotechnology, or by enhancing the performance of auxiliary components of the system, such as heat rejection units, PV panels, or cooling delivery methods [42,69].

3.1.4.2. Market/commercial maturity. Currently there are not commercially available thermoelectrically driven HVAC systems for building application. Nevertheless, small scale cooling equipment, such as recirculating chillers, refrigerators, or spot air-conditioners are marketed by several companies, with cooling power up to 700 W (CustomChill [70], Solid State cooling systems [71], Sheetak [72]). Besides commercialising these products, companies such as Phononic [73] and Evident Thermoelectrics [36] offer custom made scalable devices, and even distribute ‘test kits’ to encourage research and development of new applications for future market possibilities. This is seen as a promising fact, related to further development and commercial interest for TE technologies.

Table 3
Available cooling technologies based on solar electric and solar thermal processes.

| ENERGY INPUT | COOLING PRINCIPLE | COOLING TECHNOLOGIES |
|--|---|---|
| SOLAR ELECTRIC PROCESSES - ELECTRICITY | Vapor compression cooling Thermoelectric cooling | Compression heat pump Peltier modules |
| SOLAR THERMAL PROCESSES - HEAT | Sorption cooling Desiccant cooling Thermomechanical cooling | Absorption heat pump Adsorption heat pump Solid desiccant (+ Evaporative cooling) Liquid desiccant (+ Evaporative cooling) Steam ejector system Stirling engine Rankine cycle heat pump |

3.2. Absorption cooling

3.2.1. Performance of cooling systems and integrated concepts

3.2.1.1. General reported performance. The performance of absorption chillers has been extensively reported during the last couple of decades, with early developments ranging back to the late 70 s and 80 s [74,75]. The decisive difference regarding the performance of available systems is the number of successive stages where regeneration of the working pair takes place, defining single-effect, double-effect and triple-effect absorption chillers. Common reference COP values are 0.6–0.7 (single); 1.1–1.3 (double); and 1.6–1.7 (triple) [15,76]. Although double and triple effect chillers have markedly higher COP, their application considers higher complexity on systems and connections involved, and higher heat input as driver for the system (input temperatures over 130 °C, compared to 75–100 °C required for single-effect chillers) [21]. For these reasons, double and especially triple-effect chillers are constrained to large scale applications, leaving single-effect chillers for medium sized buildings and potentially decentral applications. Commercially available single-effect absorption chillers cover a wide range of cooling capacities, typically ranging from 4.5 to 20,500 kW, with reported COP from 0.5 to 0.8, depending on their working pair and sizes [16,21,77–80]. This review focuses on small scale applications, exploring possibilities for architectural integration. Hence, the mention of absorption chillers will only consider single-effect technologies from this point onwards.

3.2.1.2. Reported performance of small scale applications. Most commercially available chillers cover large scale requirements.

Table 4
Specific advantages and disadvantages of selected solar cooling technologies.

| SOLAR COOLING | ADVANTAGES | DISADVANTAGES |
|-------------------------|---|--|
| THERMO ELECTRIC | <ul style="list-style-type: none"> – Solid-state technology, refrigerant free. – No moving parts in the core system. – Small size of components comprehend packaging advantages for product development. – Quick operation (quickly reaches steady-state conditions). | <ul style="list-style-type: none"> – Low power/efficiency of current materials. There is a trade-off between reported efficiency (COP) and cooling power of researched concepts. – Technology in early R&D stages for HVAC application. |
| ABSORPTION | <ul style="list-style-type: none"> – Mature technology with high reliability. Current efforts target cost and complexity. – Larger COP than other thermally operated technologies. | <ul style="list-style-type: none"> – Potential solution crystallisation, which could cause irreparable damage, added to corrosion risk and need to maintain vacuum. – High upfront costs. Economics become more favourable for larger buildings. |
| ADSORPTION | <ul style="list-style-type: none"> – Few moving parts and factory sealed units (maintenance free system) – Non-toxic, non-flammable working fluid (silica gel/water) – No crystallisation nor corrosion in inner components | <ul style="list-style-type: none"> – Large sizes and weight (bulkiness) due to inefficiency of the cycle (expected cooling capacity). – Alternating operation and long cycles (intermittent) under simplest mode (1 adsorption bed) |
| SOLID DESICCANT | <ul style="list-style-type: none"> – Non-flammable and non-corrosive materials – Easy to clean and low maintenance costs, due to its operation at almost atmospheric conditions – Temperature and humidity control separately (sensible and latent loads) | <ul style="list-style-type: none"> – Limited performance of materials (adsorption capacity of silica gel is low while zeolites have low water capacities and higher cost of regeneration) – Slightly complicated system instalment – Generally larger in size/shape than conventional systems |
| LIQUID DESICCANT | <ul style="list-style-type: none"> – High potential indoor air quality, capacity of absorbing pollutants and bacteria – Low-pressure drop, for use with low regeneration temp. – Potential small and compact units by pumping solution. – Desiccant storage for use when heat source is not available | <ul style="list-style-type: none"> – All aqueous solutions are highly corrosive (plastic materials must be used) – Health hazards due to carry-over with supply air stream – Aqueous salts are subject to crystallisation, and freezing risk. |

Nonetheless, it is possible to find market-ready units with cooling capacities around 10–12 kW, with COP values between 0.62 and 0.77 (SolarNext [81], Sonnenklima [82]); and even a smaller unit of 4.5 kW, commercialised until 2010 by Rotartica, with nominal COP of 0.67 and reported experimental COP values between 0.58 and 0.66 [83,84]. Small size heat pumps have been consistently designed and prototyped in the last years. Said et al. tested an ammonia-water heat pump of 5 kW, reporting a COP of 0.6 [85]. Similarly, Franchini et al. designed a micro-scale chiller of 5 kW nominal cooling capacity. Experimental results showed 3.25 kW on average with a COP of 0.358 [86]. Besides considering smaller sizes, several researchers have explored concepts that integrate heat rejection into the cooling unit, hence devising air cooled absorption heat pumps, depicted in Table 6. Evidence seems to show that a COP of 0.6 would be a conservative estimate for the efficiency of a small scale unit, while a solar COP around 0.2–0.25 could be expected for collector integrated concepts. These values should potentially increase following further development of current prototypes.

3.2.2. Complexity of systems and components

3.2.2.1. Dimensions – size, volume and weight of systems and components. Sizes of common small-scale commercially available chillers (4.5 kW–17.5 kW) range from 0.85 to 2.3 m³, (Yazaki WFC-SC5, 17.5 kW and EAW Wegracal SE15, 15 kW), with length and depth as low as 80 × 60 cm and heights from 175 to 220 cm for that given area (Yazaki WFC-SC5 and SolarNext ACS08). Nominal weight of these units ranges from 290 kg to 660 kg (Rotartica, 2.5 kW; EAW Wegracal SE15). Smaller concepts have been explored as ‘micro-scale heat

Table 5
Thermoelectric cooling integrated concepts reported in the review.

| REF | AUTHORS | DESCRIPTION |
|---------|-------------------|---|
| [49,50] | Liu et al. | PV coupled TE wall systems with COP values of 0.95 and 1.28 for tilted PV at 60° and 90° Calculated final COP of 0.74 for both after accounting for thermal losses in the system. |
| [51–53] | Luo et al. | Instantaneous COP values of 0.7–1.8 for an active building integrated PV panel coupled with a TE wall system in the back of the room. |
| [54–57] | Ibanez-Puy et al. | Experimental evaluation of a TE façade mounted on a 1:1 test cell. Façade composed of 16 peltier cells of 51.4 W each, working under variable voltage of 7.2 V and 12 V. Measured COP of 0.66–0.78. |
| [58,59] | Vasquez et al. | COP values of 0.56–2.06 through simulations of TE window unit with electrical currents of 6–1.5 A. COP values of 1.01–1.04 under 4 A for best balance COP/cooling power. |
| [60–62] | Xu et al. | Experimental COP of 0.51–1.42 for a single TE unit. Best COP values of 1.31–1.33, considering balance with cooling power, for 8 TE units connected in series and parallel under 5 V. |
| [60] | Le Pierres et al. | Simulation and experimental evaluation of PV + TE modules for air pre-heating and pre-cooling in dwellings. Cooling COP was only higher than 1 for input currents lower than 3 A. |
| [63] | Khire et al. | Numerical calculations for different TE configurations. Best combination at COP of 1.529 for a TE active wall concept, with a cooling power of 30 W, under 1.393 A and 0.741 V. |
| [64] | Irshad et al. | TE air duct system coupled with a PV wall for the tropical climate, reporting a COP of 1.15, with a cooling capacity of 517.24 W under 6 A, and an optimal T° difference of 6.8 °C. |

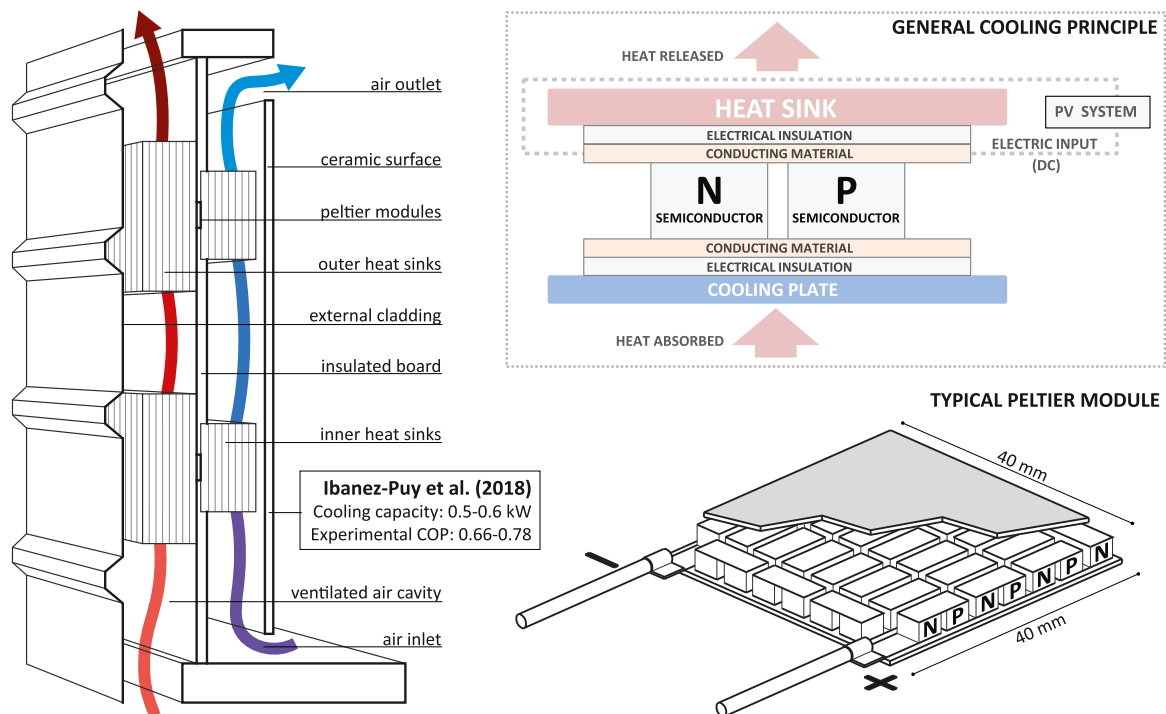

Fig. 2. Thermoelectric cooling façade prototype developed by Ibanez-Puy et al. and general thermoelectric cooling principle.

pumps’ (Franchini 2015), with a 2.5 kW LiBr-H₂O heat pump developed and commercialised by Purix as the leading example [96]. This chiller unit measures (L × W × H) 64 × 45 × 135 cm (0.4 m³) and weighs only 75 kg, driven by a thermal collector array of 5 m², while using decoupled water-based cooling delivery systems in each room. This unit is regarded as a notable example of the sizing limits inherent to the

principles in play. In general, bulky sizes and weight are stated as important drawbacks of the technology, casting doubts about the feasibility and the rationale behind potential decentral applications. Nonetheless, the flexibility given by the use of liquid working materials has been also cited as an advantage for the development of compact machines, compared to solid based adsorption technologies [7,97]. This

Table 6
Absorption based integrated concepts reported in the review.

| REF | AUTHORS | DESCRIPTION |
|---------|------------------------|---|
| [87] | Castro et al. | COP values between 0.37 and 0.68 for a 2 kW LiBr-H ₂ O serpentine based heat pump design, to allow for air currents. |
| [88] | Lizarte et al. | Air-cooled heat pump of 4.5 kW, coupled with a flat-plate collector array (42.2 m ²) and a storage tank (1.5 m ³) in a 40 m ² room in Madrid. Reported experimental COP was of 0.55–0.62. |
| [89] | Izquierdo et al. | Mean daily COP of 1.05, by testing an air-cooled prototype of 7 kW (nominal) coupled with a flat-sheet absorber for solar input, in Madrid. |
| [90–93] | Hallstrom et al. | Integrated LiCl-H ₂ O absorption system within vacuum tubes collector. Experimental solar COP values of 0.19–0.25 through outdoor tests in rooftop application in Sweden. Module operates in absorption-regeneration cycles based on solar availability. |
| [94,95] | Avesani, Bonato et al. | Integrated LiCl-H ₂ O absorption system within vacuum tubes collector for façade application . Simulated solar COP values of 0.27–0.36 and 0.17–0.23 in Stockholm and Rome, with cooling capacities of 1.44 kWh/day per module. Best results in east orientations, regenerating the solution during the morning and providing cold air during the afternoon (alternate operation in sorption/desorption). |

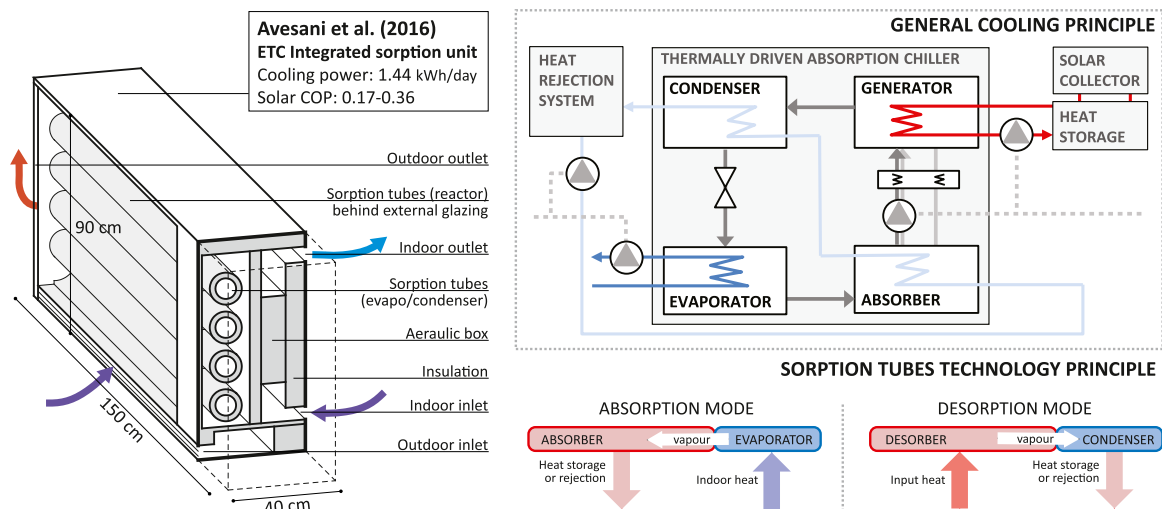

Fig. 3. Integrated sorption collector & sorption tube technology developed by Avesani, Hallstrom et al., and general absorption cooling principle.

characteristic has been greatly explored by a group of researchers for the design of an integrated sorption collector (Fig. 3). This unit has been developed with compactness and simplicity in mind, being tested for rooftop applications and even façade integration as the opaque component of an unitised curtain-wall ensemble [95,98]. The dimensions of the optimised unit for façade integration were $150 \times 40 \times 90$ cm (0.54 m^3), for a fully air-based decentralised unit with all required mechanical components [94], being a promising alternative for building integration and specifically retrofit applications.

3.2.2.2. Components – number and types of required components. Absorption chillers consist of a condenser and evaporator, like vapour compression systems, but with a heat driven generator and absorber instead of the electric compressor commonly used (Fig. 3). This equipment is enclosed in a sealed unit with few moving parts, namely an integrated pump for the circulation of the solution in a closed loop [15]. Besides the inner mechanisms and components, a heat rejection system is needed, as well as input heat from a solar array or a gas fired boiler. Heat/cold storage is optional, although it increases the capabilities and flexibility of the overall system. The common use of cooling towers as heat rejection system for absorption chillers has been cited as one of the disadvantages for their application on small scales [7,21,39,99]. Consequently, air-cooled systems, with integrated heat rejection have been prototyped and tested by several researchers [87,89,100], striving for simplicity and compactness. This line of research was pushed even more in the aforementioned sorption collector unit [95,98], where heat rejection, cooling generation and solar collector were integrated in a stand-alone ventilation unit for façade application. This is regarded as the best available example of integrated modular design based on absorption technology.

3.2.2.3. Connections – types of required connections and materials involved. Absorption chillers are factory sealed units, comprising necessary inner equipment and connections to input and output circuits. Common commercially available water-based chillers require connection to the heat source, heat rejection system and the cooling delivery system through pump driven water pipes. Nonetheless, air-based integrated designs have been prototyped and tested for stand-alone operation, only requiring electric input to power low consumption fans and dampers.

3.2.3. Cooling system operation

3.2.3.1. Health, safety and comfort issues. Health hazards largely

depend on the working fluids used to drive the absorption cycle. The most common absorbent/refrigerant pairs utilised are lithium bromide/water ($\text{LiBr}/\text{H}_2\text{O}$) and water/ammonia ($\text{H}_2\text{O}/\text{NH}_3$), respectively. Additionally, the use of lithium chloride (LiCl) has been explored as absorbent, with water as refrigerant; but its use is still limited in current experiences [101]. All fluids are environmentally friendly, but have certain drawbacks. Ammonia is toxic in high concentrations, causing immediate irritation in eyes and the respiratory track [76,102]. Lithium bromide and lithium chloride have low toxicity, but they are corrosive materials, so proper maintenance must be conducted to ensure correct operation of the system. Regarding general comfort, silent operation has been regarded as an advantage compared to conventional systems, solely depending on pumps to recirculate the solution [7,39].

3.2.3.2. Maintenance requirements. Absorption chillers have minimal moving parts, so maintenance activities are focused on handling their working fluids to allow for correct operation. This may imply complicated maintenance activities to meet optimal operation requirements. One of the main concerns associated with absorption chillers is the risk of crystallisation of lithium bromide by temperature differentials, which may cause irreparable damage [83,103,104]. Hence, measures must be taken to mitigate the risk and prevent this from happening. Additionally, leakages must be checked periodically to prevent health hazards, and avoid corrosion, as mentioned before. In this sense, an added difficulty is that absorption chillers' operation relies on having internal vacuum conditions, which need to be maintained over time, to avoid continuous air leakage into the system that induces corrosion by reacting with the working fluids [39,102,103].

3.2.4. Level of development / maturity

3.2.4.1. Technical maturity. Absorption cooling is regarded as a mature technology with high reliability; being one of the oldest refrigeration technologies registered [39,86,103,105]. First experiences in the field go as far back as the 1700s, with water/ammonia chillers first designed by Ferdinand Carre in 1859 [76,99]. Lithium bromide/water chillers have been around since mid-1900s, with a first commercial absorption chiller developed by Carrier in 1945 [106]. The expected performance of the refrigeration cycle has reached stable and optimised values under single, double and triple effect operation, so its use is justified in large applications when waste heat is available. Hence, current challenges for absorption cooling are directed to allow for widespread application, simplifying the operation of centralised units, while exploring alternatives for small scale decentral application. On the one hand, new working pairs are being tested, such as lithium chloride / water

units, to reach good performances without the risk of crystallisation [107]. On the other hand, new simpler designs are being explored based on proven working principles, reducing sizes and weight of units to lower initial costs. Current examples also consider an integrated and multifunctional approach, striving for direct heat rejection and less connections and overall complexity [103,107].

3.2.4.2. Market/commercial maturity. As mentioned, absorption chillers have been commercialised since the 1940s. Several researchers have estimated that there are currently between 1000 and 1200 solar assisted cooling units installed worldwide [7,17], with absorption chillers accounting for about 80% of the total [39]. It has also been reported that Asian markets have around 85% of the stock of absorption chillers with capacities over 350 kW, being by far the largest regional market followed by Europe [13]. Consequently, the market for large scale systems, ranging from 100 s to 1000 s kW is dominated by Asian companies such as Yazaki [108], Hitachi [109] and Broad [110]; followed by large American corporations with vast experience in refrigeration such as Carrier [111], Trane [112] and York [113]. In recent years, several European companies have been exploring the development of small scale units for light commercial and residential application, either providing small size chillers [114], comprehensive solar kits [81,96], or integrated designs striving for efficiency [101]. Evidence seems to point out that small size absorption is a developing niche, so further products should follow in the coming years.

3.3. Adsorption cooling

3.3.1. Performance of cooling systems and integrated concepts

3.3.1.1. General reported performance. The performance of commercially available adsorption systems has been well documented by several researchers during the last 15 years, with small changing COP values from 0.5 to 0.7, and cooling capacities commonly ranging from 5.5 to 1000 kW [16,21,79,80]. The performance mainly depends on the heat and mass transfer potential of the utilised adsorbent. Possible working pairs of adsorbent/adsorbate are activated carbon / methanol, ethanol or ammonia; zeolites / ethanol or water; or silica gel / water. The latter has been found to be the most efficient combination for AC applications [115], although its performance is still limited to be a competitive alternative against vapour compression technologies [116]. In terms of the adsorption process, the fact that basic operation is intermittent, constrained to adsorption/desorption cycles, is often cited as a disadvantage [116–118]. This is overcome by using two adsorption beds, alternating them for continuous operation, but of course this increases the size of the system. Other factors that have an impact on the performance of adsorption systems are the length of the adsorption/desorption cycle, temperature of hot water from the solar source, and the use of heat/cold storage units. It has been found that longer cycles, allow for larger COP values, with optimum lengths of 10–15 min [119,120]. Similarly, COP has been reported to increase with higher inlet temperatures [121] and when hot storage is considered [116,122].

3.3.1.2. Reported performance of small scale applications. Common commercial applications consider large chiller units, up to 1000 kW. Nonetheless, in the last years, researchers have been increasingly interested in the development of small scale adsorption units, mostly thinking about the residential market [77]. Examples of small capacity commercially available systems are InvenSor LTC10e, and SorTech ACS08, with nominal power of 10 kW and 8 kW and nominal COP values of 0.7 and 0.6 respectively [123,124]. The latter has been tested and monitored in different European countries as part of a standardised assembly, within the SolCoolSys project, measuring COP values between 0.4 and 0.5 [125]. Smaller units have been explored using different methods by several researchers, as shown in Table 7. Based on the presented examples, it would be possible to expect a COP

of 0.4 – 0.5 for adsorption units below 5 kW.

3.3.2. Complexity of systems and components

3.3.2.1. Dimensions – size, volume and weight of systems and components. One of the main disadvantages of adsorption units usually mentioned in the literature, is their large sizes and weight compared to their cooling capacity [103,116,117]. The smallest commercially available chillers (SorTech ACS08, 8 kW nominal cooling power) are 79 × 106 × 94 cm (L×W×H) with a weight without water of 265 kg [124]. Smaller prototypes have been developed, reaching dimensions of 60 × 60 × 100 cm (L × W × H) for a 2.5 kW chiller under the EU project PolySmart [120] (Fig. 4). Moreover, small sizes able to fit in the back of a car have been developed for demonstration purposes of automobile AC applications, reaching a weight without water of 86 kg [131]. Another explored alternative to decrease sizes has been the integration of adsorption systems and solar thermal collectors, to develop so-called adsorption tubes [118,133,134]. Nonetheless, these experiences are in early R&D stages.

3.3.2.2. Components – number and types of required components. A basic solar driven adsorption cooling system needs the adsorption unit, a solar collector, a heat rejection system, and an hydronic system for water circulation, with small pumps to control the flow. Additionally, the use of hot and/or cold storage units could be beneficial to increase the efficiency of the system and achieve higher cooling capacities at the beginning and end of the adsorption/desorption cycle [122]. Furthermore, it is necessary to consider a cooling delivery system, such as fan-coils or water based radiative cooling devices such as chilled ceilings or beams [27].

3.3.2.3. Connections – types of required connections and materials involved. Commercially available adsorption units are factory sealed, so they only require connection to the heat rejection system, the heat source (solar thermal collector), and the cooling delivery system. Connections are made through pipes, in closed water circuits driven by pumps (heat rejection, driving heat, and chiller water circuits). The main issue then, is preventing leakages throughout the whole system.

3.3.3. Cooling system operation

3.3.3.1. Health, safety and comfort issues. Health and safety hazards related to adsorption technology highly depend on the materials used as working pairs. Although all adsorption units are sealed, there could be a risk of contamination through leakages. Direct exposure to ammonia mixed with indoor air could cause problems in the respiratory track, while methanol is regarded as a toxic and highly flammable material [115,135]. Nevertheless, the most common working pair used in adsorption chillers is the combination of silica gel and water, which does not consider any hazard risk to building occupants, being both non-toxic and non-flammable [15]. Moreover, the fact that silica gel/water adsorption chillers are based on an environmentally friendly process, is usually cited as one of the main advantages of adsorption systems [121,136–139]. Regarding other comfort issues, the fact that no moving parts are involved mean that noise levels are lower than conventional cooling systems [116,117,119].

3.3.3.2. Maintenance requirements. Adsorption units are factory sealed and consider no moving parts [119,140]. Additionally, there is no risk of crystallisation nor internal corrosion in inner components [117,121,136], so the basic refrigeration machine is regarded as virtually maintenance free. Nonetheless, water pipe connections from and to the adsorption unit must be checked to prevent leakages, while small pumps needed for water circulation would need basic maintenance to allow for continuous operation.

Table 7
Small-scale adsorption based concepts reported in the review.

| REF | AUTHORS | DESCRIPTION |
|-----------|----------------------|--|
| [126] | Clausse et al. | Model to simulate the performance of a 4.6 kW activated carbon/methanol chiller for residential application in Orly, France, obtaining COP values between 0.12 and 0.6 and an average COP of 0.49. |
| [127] | de Lieto et al. | Simulation of a 2 kW silica gel/water chiller in Rio de Janeiro. COP values of 0.43–0.58 using 20 m ² of solar thermal collectors, which were found to be enough to provide the necessary input. |
| [128] | Luo et al. | Design and construction of a silica gel/water chiller powered by 49.4 m ² of evacuated tubes collectors. Experimental results of max. cooling power of 4.96 kW and a peak average COP of 0.324. |
| [129] | Lu et al. | Experimental assessment of a silica gel/water prototype, reporting a cooling power of 4.9 and 5.7 kW, with COP values of 0.42 and 0.41, respectively. |
| [120,130] | Bakker et al. | Small scale 2.5 kW adsorption heat pump for residential application. Experimental reports of cooling power of nearly 2.5 kW and COP = 0.45 for a 10 min operating cycle. Performance also monitored in a real house, reporting a decrease of 25–30% of cooling power compared to lab results (EU Project PolySmart). |
| [131,132] | De Boer et al. Verde | 1.5 kW silica gel/water adsorption AC unit for car applications, driven by waste heat from the engine. Monitoring results on a Fiat Grande Punto showed a cooling power of 800 W and COP of 0.5–0.6; in contrast to lab results of 2 kW and 0.4 respectively. |

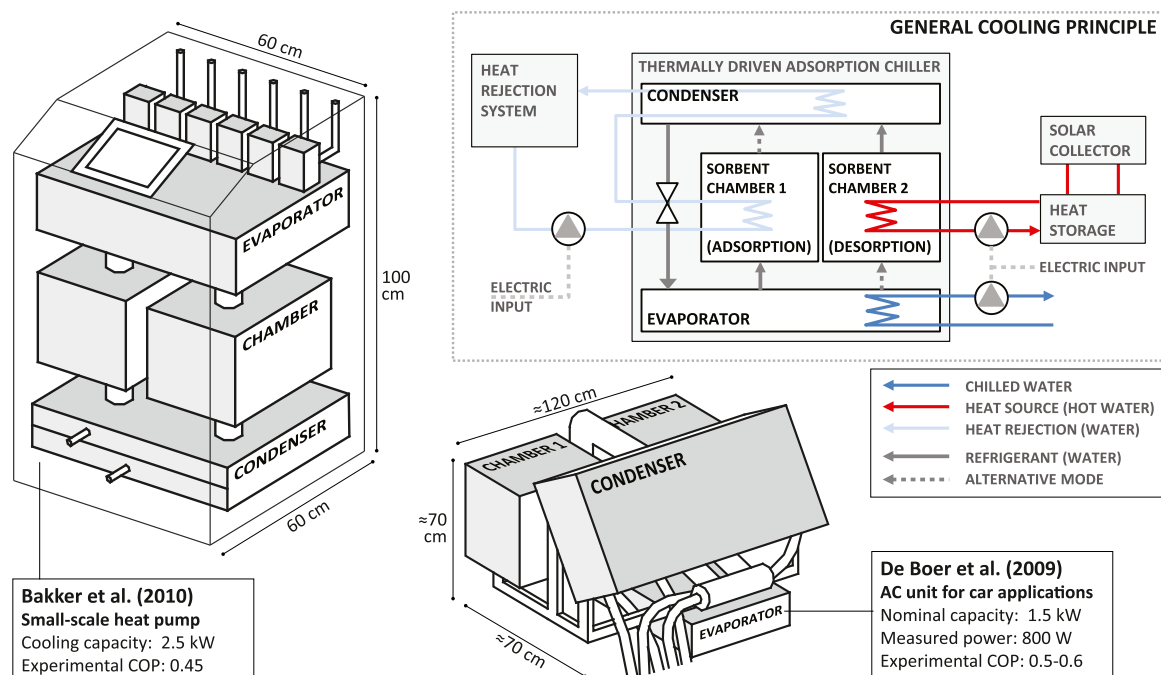

Fig. 4. Small-scale heat pump and AC unit for car application developed by Bakker et al. and De Boer et al.; and adsorption cooling principle.

3.3.4. Level of development / maturity

3.3.4.1. *Technical maturity.* Overall, adsorption chillers are a mature technology, with several decades of research development. First adsorption based refrigerating systems appeared in USA around 1920, while solar driven experiences have been reported since the late 70s [136]. Since then, research has been focused on improving the performance of the units, experimenting with different working pairs of adsorbent/adsorbate; and lately, on decreasing the size of systems to allow for easier application in residential buildings. Given that the performance heavily relies on the working pairs within the process itself, it is difficult to think that there will be an increase of COP values, having been optimised up to this point. Hence, future challenges will keep focusing on decreasing sizes and weight, and achieving shorter cycle times to allow for a greater array of applications.

3.3.4.2. *Market/commercial maturity.* Adsorption chillers represent the second largest market for solar cooling, after absorption chillers. Until 2014, 1200 solar cooling installations had been reported worldwide, mostly located in Europe [7]. Out of this total, 10–11% are reported to be adsorption based technologies with cooling capacities ranging from 8 to 1000 kW [2,121]. Among well-known companies commercialising adsorption chillers, are InvenSor and Fahrenheit (formerly known as

SorTech). The former distributes zeolites/water adsorption chillers in the 10–105 kW range [123], while the latter commercialises silica gel/water and zeolites/water chillers from 8 to 50 kW, as a spinoff of Fraunhofer Institute for Solar Energy (ISE) [141]. It is stated in both websites that zeolites/water chillers are the next generation (eZea was the first one to be commercialised in 2015, by Fahrenheit), being relatively smaller and lighter than conventional silica gel/water units.

3.4. Solid desiccant cooling

3.4.1. Performance of cooling systems and integrated concepts

3.4.1.1. *General reported performance.* Widespread general assessments of solid DEC technology give it COP values between 0.5 and 1.0, with cooling capacities ranging from 6 to 350 kW [21,78–80,142,143]. These values come mostly from several monitoring campaigns carried out over the last 20 years on demonstration projects throughout Europe. Thus, solar driven DEC pilot experiences have been designed and evaluated in Germany [78,80,144], Austria [78,80,145], Spain [78,146], Portugal [80] and Greece [78]; with cooling capacities from 18 kW to 75 kW and thermal COP values ranging from 0.43 to 0.86. Additionally, the potential to reach higher COP values under optimised system configurations has been simulated and experimentally tested. Ge

Table 8
Small-scale solid desiccant based concepts reported in the review.

| REF | AUTHORS | DESCRIPTION |
|-----------|---------------------|---|
| [154] | Goldsworthy & White | Mathematical model for a DEC system, obtaining COP values of 0.2–0.7, where 0.4 was found to be the optimal value to achieve a balance with the system's cooling capacity of about 1.5 kW. |
| [155] | Wang et al. | COP values of 0.46–0.49 obtained from the experimental evaluation of a novel self-cooled solid desiccant coated heat exchanger in Shanghai, with cooling capacities below 714 W. |
| [156] | Kabeel | CaCl based DEC system coupled to a porous type solar air heater of 1.2 m ² in Egypt, achieving cooling capacities of 0.8–1.0 kW and COP values from 0.65 to 0.9. |
| [157,158] | Ge et al. | Design and evaluation of a 5 kW 2-stage DEC using silica gel-LiCl composite desiccant and a flat-plate air collector array of 15 m ² , reporting COP values over 1.0. |
| [159] | Alahmer | Numerically assessment of a DEC system for car application: rotary desiccant dehumidifier, compact heat exchanger and evaporative cooler, with regeneration heat from the engine. Cooling capacity of 4.2 kW with thermal COP of 0.7–0.9. |
| [151–153] | Finocchiaro et al. | Prototype for integrated DEC + thermal collector unit. 2.7 kW unit monitored in Palermo with a daily thermal COP of 1.1. An 5.5 kW unit monitored in Rome, with daily thermal COP of 1.36. |

et al. obtained a COP of 1.28 for a 101 kW 2-stage silica gel rotary DEC for a complete floor in Shanghai, with 680 m² of vacuum tube collectors [147]. Similarly, Fong et al. reported a COP of 1.38 for a solid DEC system driven by 100 m² flat-plate air collectors [148]. Besides the configuration of the system, performance of the cooling cycle relies on the materials. Commonly used silica gel and zeolites have lower sorption capacity than liquid desiccants, so research efforts are focused on advanced materials by combination of silica gel with other salts. Jia et al. experimentally obtained a COP of 1.28 by employing compound desiccants, improving the performance of a silica gel based DEC system by 20–30%; providing evidence of further potential on this field [149].

3.4.1.2. Reported performance of small scale applications. Smaller cooling capacities have been explored in an effort to promote the development of compact units targeting new application niches, depicted in Table 8. Besides these, some of the most relevant experiences in the development of small-scale DEC systems for building integration have been the results and prototypes developed by SolarInvent under their FREESCOO patent [150]. Working prototypes for a rooftop unit have been installed and monitored in Palermo (2.7 kW) and Rome (5.5 kW), obtaining daily thermal COP values of 1.1 and 1.36 [151–153]. As a logical next step, the developers are currently working on the design of façade units, with decoupled solar regeneration modules on the roof (circulating hot water to regenerate the packed-bed desiccant material). These have not been tested on the field yet, but preliminary evaluation shows nominal thermal COP values around 1.25, for maximum cooling power of 2.5 kW [150].

3.4.2. Complexity of systems and components

3.4.2.1. Dimensions – size, volume and weight of systems and components. One of the main drawbacks of solid desiccant evaporative cooling systems (solid DEC) is their dimensions, being larger in size than other solar cooling technologies, especially considering relative dimensions per cooling capacity [15]. Commercially available DEC systems may occupy an entire room, with dimensions (LxWxH) starting from 500 × 160 × 180 cm and weight of 1600 kg (DesiCool® 2.2 unit) [160]. This is due to the different stages needed for air treatment and the accompanying equipment, and particularly due to the use of desiccant wheels as common carrier method. A noteworthy effort in size reduction was conducted by Finocchiaro et al. in the design of their FREESCOO system [152]. The compact rooftop prototype developed in Palermo considered 2.4 m² of PVT surface, and occupied a volume of about 2.5 m³, considering a floor area of 200 × 120 cm (LxW) and a maximum and minimum height of about 150 and 50 cm respectively (Fig. 5). While these dimensions are still considerable, they imply a reduction of over 80% of the total volume compared to a currently commercially available DEC unit, even considering integrated equipment for

desiccant regeneration. Additionally, the developers are currently exploring potentially smaller sizes for façade integration. The dimensions of concepts for façade units (without equipment for solar input) are 200 × 35 × 100 cm (LxWxH), being regarded as a promising alternative for building integration in the coming years [150].

3.4.2.2. Components – number and types of required components. Solar driven solid desiccant cooling systems basically consist of desiccant assisted evaporative coolers as air handling units, comprising a small number of simple and robust components [154,161,162]. Incoming air gets in contact with the desiccant, commonly placed in a slowly rotating wheel (although it could also be stored in adsorbent beds). After dehumidification, the air is cooled down by means of an evaporative cooler (direct or indirect), to then be delivered to the room. Exhaust air gets in contact with heat from the regenerator (solar thermal collectors with optional heat storage), and then passes through the desiccant wheel again on its way out, evaporating the previously absorbed water. Fans are required to drive in and out air streams through separate ducts, while pumps are required to circulate water in the regeneration and evaporative cooling loops. Additional components commonly used are heat exchangers for heat recovery between incoming and outgoing streams and cooling towers for heat rejection.

3.4.2.3. Connections – types of required connections and materials involved. The main connections needed for the operation of the system are between the heat source and the desiccant machine. If heat is supplied by water based solar collectors, this would mean pipes in closed water circuits driven by pumps. Alternatively, an air-based flat plate may be used, directly mixing warm air from the collector with the outgoing air stream for the regeneration of the desiccant, throughout air ducts. Accordingly, the system instalment has been judged as slightly complicated [15,163]. Additionally, a water source and pipes are needed for the evaporative cooler, besides electric input for auxiliary equipment such as fans, pumps and the desiccant wheel rotor [154].

3.4.3. Cooling system operation

3.4.3.1. Health, safety and comfort issues. The use of desiccants to cope with latent loads potentially leads to better indoor air quality when compared to common AC technologies, especially in hot-humid climates. Vapour compression systems cool down the incoming air below dew point, to drop humidity levels, to then reheat it to desired temperatures. This process considers condensation, which creates a suitable environment for microorganisms and mold within the system, which are avoided under desiccant operation [164]. Additionally, common materials such as silica gel and zeolites are non-toxic and non-flammable, working under an entirely environmentally friendly process [154,165].

3.4.3.2. Maintenance requirements. Solid desiccant systems consist of

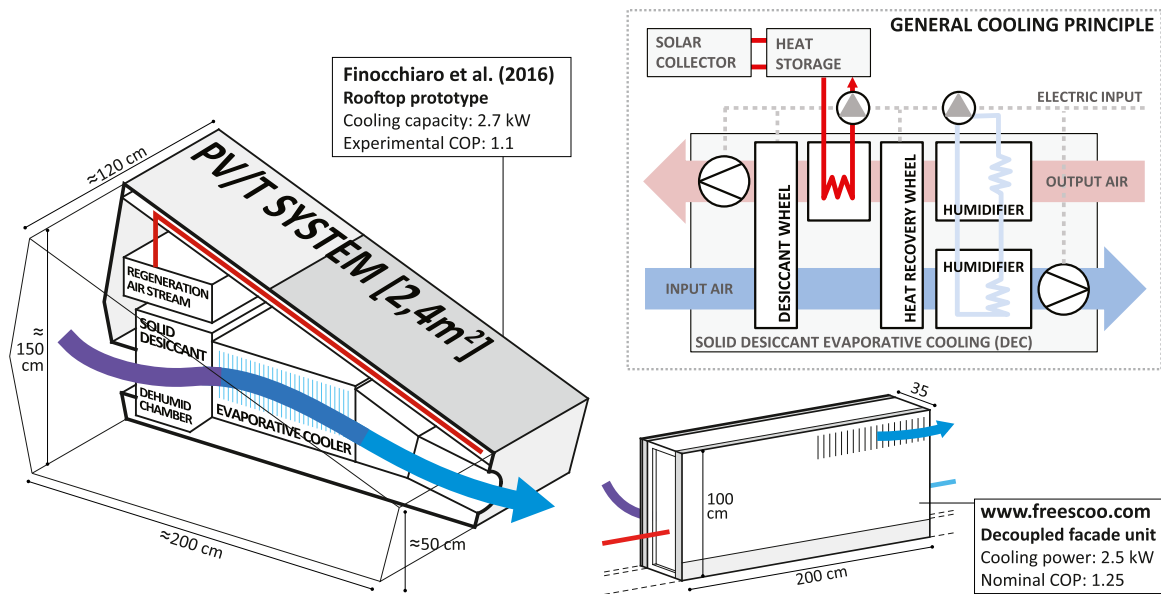

Fig. 5. Compact solid-desiccant prototypes developed by SolarInvent, for rooftop and façade applications; and general cooling principle.

simple and robust components, and non-corrosive working materials [161,166]. Because of this, they are easy to clean and maintain in their simplest forms. Furthermore, the fact that solid desiccant units operate at almost atmospheric conditions (there is no need to maintain vacuum), helps keeping maintenance costs low [163]. Nevertheless, their operation in combination with evaporative coolers, to handle sensible loads, increases the complexity of the entire system, adding water connections that need to be checked for leakages from time to time [15].

3.4.4. Level of development / maturity

3.4.4.1. Technical maturity. Desiccant AC using a rotary wheel has been explored for over 50 years, with the first patent being introduced by Pennington in 1955 [143]. Currently, solid desiccant dehumidification is a mature technology, used for moisture control in large industrial sites; while evaporative cooling is regarded as the oldest cooling technique [166]. However, their combined use was not fully explored until the turn of the century, promoted by the potential to use low-grade heat (and particularly solar energy) as the driver of a refrigerant-free cooling process. Today, solid desiccant cooling installations mount up to around 7% of all solar driven cooling systems installed worldwide, being third in numbers behind absorption and adsorption chillers [39]. These experiences mostly consist of pilot and demonstration projects carried out by researchers with private or governmental funding to promote these systems and overcome present boundaries for mass-application [78]. Current development efforts are focused on performance issues, researching new advanced desiccant materials and optimising the configuration of the overall system; while striving for smaller and compact units for new markets [143].

3.4.4.2. Market/commercial maturity. Solid desiccant components such as rotary wheels have been commercialised since the 1980s, experiencing an important increase in the last decades [15,143]. Companies such as Rotor Source [167] and Proflute [168] have specialised on desiccant rotors, while companies such as DehuTech [169] and big corporations like Munters [170] have achieved large experience on both solid desiccant air dehumidification units, and evaporative coolers. This combined expertise has resulted on the development and commercialisation of solid desiccant AC units, such as DehuTech's DS units and Munters' DesiCool® units, but solar thermal has not been fully explored yet for market introduction under

integrated systems. Nonetheless, the FREESCOO system is being further developed for market release by SolarInvent, a start-up company created in 2014 explicitly with that goal in mind, offering customised units for specific applications for the time being [150].

3.5. Liquid desiccant cooling

3.5.1. Performance of cooling systems and integrated concepts

3.5.1.1. General reported performance. Although LDAC systems are relatively new compared to other solar cooling principles and technologies, the general assessment is that they may reach higher potential efficiencies in comparison, backed by several research projects and standalone experiences. Different overviews on the state of the technology over the last 15 years have shown COP values circling 1.0, with the potential to go higher [21,78,80]. Standalone experiences have been designed and tested, with cooling capacities ranging from 0.3 kW [171,172] to around 25 kW [173,174], besides demonstration projects of 11–30 kW monitored on existing buildings [78,175,176], with registered COP values between 0.47 and 0.8 under real operating conditions. The efficiency of a LDAC system mainly relies on the dehumidification capacity of the desiccant material and its application, and the cooling performance of the evaporative cooler. Hence, current efforts deal with the optimisation of each sub-system separately, testing new materials and performance-based designs; while at the same time exploring integration potential between them striving for compact units for mass-market production.

3.5.1.2. Reported performance of small scale applications. Most experiences on LDAC systems have focused on small capacity ranges (below 30 kW), benefiting on potentially compact units for residential application. Relevant examples are shown in Table 9. Thermal COP values around 0.7 seem to be consistent among small systems, especially on those below 6 kW, with potential for building integration. At the same time, maximum COP values around 1.2 were found, which evidences that there is room for future improvements in the performance of small scale units.

3.5.2. Complexity of systems and components

3.5.2.1. Dimensions – size, volume and weight of systems and components. One of the most reported advantages of LDAC systems is the potentially small and compact sizes that they may reach, being based on a liquid and easy to handle solution [166,182]. Current efforts

Table 9
Small-scale liquid desiccant based concepts reported in the review.

| REF | AUTHORS | DESCRIPTION |
|-----------|----------------|--|
| [177] | Kozubal et al. | Simulation of a desiccant enhanced evaporative cooler in several cities in USA, with cooling capacities of 3.5–14 kW. Estimated cooling energy savings up to 61% compared to common VC technologies. |
| [178] | Zhang et al. | Experimental assessment of a LD unit + 2-stage evaporation cooling system, with cooling capacities from 6 to 12 kW. Measured COP values were 0.4–0.6, with an average of 0.56. |
| [179] | Jain et al. | Experimental evaluation of an indirect contact LDAC system in tropical climates, obtaining COP values of 0.4–0.8 for cooling capacities between 2.5 and 5.5 kW. |
| [180] | Das & Jain | 1.7–5.5 kW LDAC dedicated outdoor air system including a 12.5 m ² ETC array as input for the regeneration. COP values of 0.25–0.83 were experimentally obtained. |
| [181] | Buker et al. | Experimental thermal COP of 0.73 for a 5.2 kW membrane based LDAC with an indirect evaporative cooler and a BIPVT for regeneration and electricity generation. |
| [171,172] | Chen et al. | Experimental thermal COP of 0.7 for a membrane based LDAC based on modular units for dehumidification and regeneration. Solution concentration of 36% CaCl ₂ was found to be optimal in the 0.34–0.43 kW system |
| [161] | Elmer et al. | Novel integrated membrane based LDAC system. Average COP values of 0.72 were experimentally obtained for the 0.57–1.36 kW system, using CHKO ₂ as desiccant material. Maximum reported COP around 1.2. |

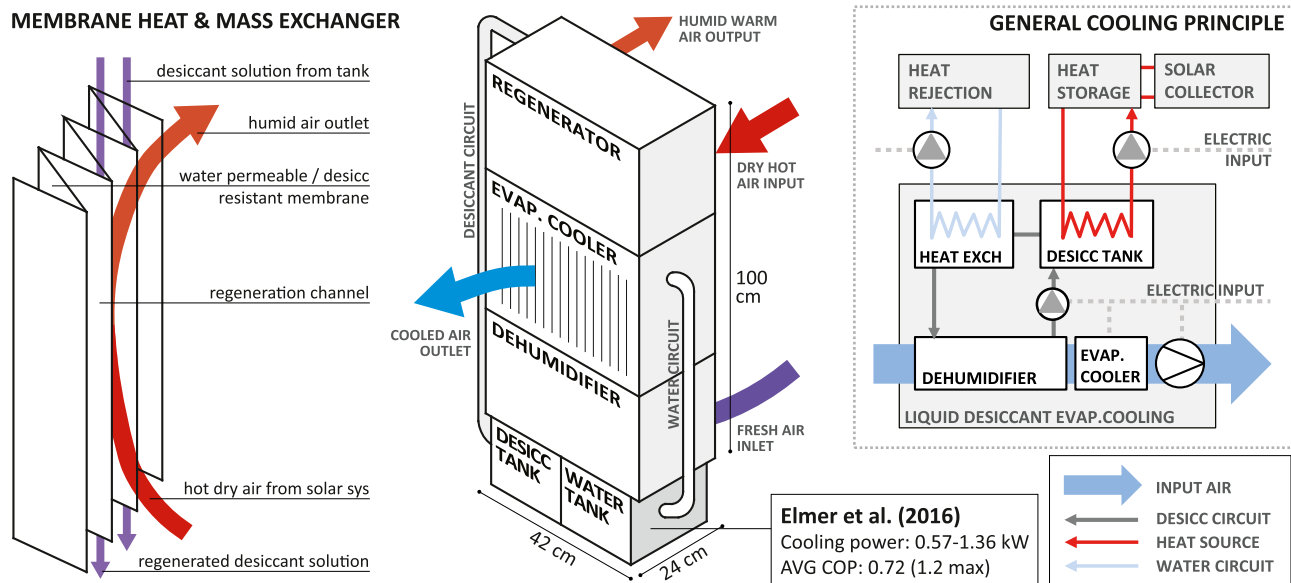

Fig. 6. Integrated small-scale membrane based LDAC unit developed by Elmer et al. and liquid desiccant general cooling principle.

have focused on designing compact systems to explore new markets such as residential air-conditioning. Buker et al. [181] and Das & Jain [180] evaluated the performance of small scale LDAC systems (around 5 kW of cooling capacity), considering dehumidifier units of 90 × 50 × 130 cm and 30 × 60 × 80 cm respectively. Even smaller units were designed and tested by Chen et al. [171,172] and Elmer et al. [161], with integration potential in mind. The former designed a membrane based LDAC, comprised of highly compact modules for regeneration and dehumidification of 41 × 23 × 21 cm each. Elmer et al. designed an integrated system, combining a regenerator, dehumidifier and evaporative intercooler into a single membrane based heat and mass exchanger (Fig. 6). The entire unit dimensions were 100 × 42 × 24 cm plus split desiccant and water tanks and small pumps [161]. Similarly, Kozubal et al. developed and evaluated a membrane based desiccant indirect evaporative system, within a sealed packaged unit of 60 × 50 × 48 cm to cover a cooling demand of around 3.5 kW [177].

3.5.2.2. Components – number and types of required components. Basically, a solar driven liquid desiccant cooling system consists of three main parts: the dehumidifier, the regenerator, and the sensible cooling machine, commonly an evaporative cooler. The dehumidifier is where intake air gets in contact with the desiccant, either directly (applied in packed beds, spray tower, or falling film), or indirectly (membrane based exchangers). It considers a storage tank for

the desiccant solution, and the contact medium within a dehumidification chamber. The regenerator consists of a solar thermal collector array to collect heat to be used to regenerate the desiccant. The regeneration may take place in a regeneration chamber where stored heat is applied to the solution, or the desiccant itself may pass through the collector via permeable pipes. Thermal storage units are advised under the former operation mode. Lastly, evaporative cooling may be direct or indirect, adding moisture to the incoming air or not, respectively. This considers the need for a water tank and a pump, increasing the complexity of LDAC systems [183], thus the design of simple and compact evaporative coolers is an essential aspect in the promotion of LDAC systems.

3.5.2.3. Connections – types of required connections and materials involved. A common arrangement for LDAC systems requires two independent circuits of circulating liquid: the first carries the desiccant solution and goes from the dehumidifier to the regenerator and back; while the second carries water for the evaporation cooler. An hydronic system and pumps are needed, besides storage tanks for the desiccant and water [27]. These circuits come in contact sequentially with the incoming air flow, which needs to be carried inside through vents and ducts, driven by fans. Electricity is needed to power these components, causing parasitic loads of varying importance depending on the specific design. Among relevant new developments aimed to simplify these systems, natural convection driven units and

photovoltaic electrolysis stand out. The former benefit by the concentration gradient of the solution to generate free motion of the desiccant without pumps [184]; while photovoltaic electrolysis (PV-ED), uses PV panels instead of thermal collectors for desiccant regeneration by transporting ions through selective membranes under the influence of an electrical field [185,186]. Nonetheless, these technologies are still in early development stages.

3.5.3. Cooling system operation

3.5.3.1. Health, safety and comfort issues. The use of desiccants directly improves indoor air quality in humid environments, by avoiding overcooling to cope with latent loads. Condensation derived by lowering ambient temperature below dew-point creates an environment suitable for mold and bacteria, present when using common compressor based HVAC technologies [164]. Additionally, liquid desiccant materials exhibit the capacity of absorbing pollutants and bacteria present in the incoming air [15,165]. On the other hand, one of the main concerns regarding the use of desiccants is the risk of material carry-over with the supply air stream, being an open cycle air treatment system [3,166,187]. Liquid desiccants have reported low-toxicity, but may still be a source for discomfort and a hazard in high concentrations. Nonetheless, this issue has been solved in latter experiences, by using semi-permeable membranes as contact barrier between desiccants and inlet air, allowing heat and moisture transfer but preventing transfer of the desiccant material, in liquid-to-air membrane heat exchangers [172,173].

3.5.3.2. Maintenance requirements. The most common liquid desiccant materials currently available are aqueous halide salts, which have strong dehumidification capabilities but are highly corrosive [165,188]. Hence, periodical maintenance is mandatory to assess possibly damage in the system due to filtration or material carry-over through the air flow. Among these salts, lithium chloride (LiCl) has low vapour pressure and more stability, while the regeneration performance of lithium bromide (LiBr) is better, and calcium chloride (CaCl₂) has less absorption ability but is cheaper and easily available. Additionally, these salts are subject to crystallisation at higher concentrations, which needs to be checked [15,183]. Alternatively, there are current explorations of salts of weak organic acids such as potassium formate (HCOOK/CHKO₂) and sodium formate (HCOONa), which have low toxicity and are not corrosive, but have less absorption capacity, so higher concentrations are needed (50% of CHKO₂ solution concentration roughly equals the performance of 27% of LiCl) [161]. In any case, these latter materials are not fully explored so there is room for new developments in the coming years.

3.5.4. Level of development / maturity

3.5.4.1. Technical maturity. Solar driven liquid desiccant systems for space cooling are still in early R&D stages, with different levels of development depending on particular applications. First experimental studies on LD systems go back to the 1950s [189], but interest on these materials and technologies really sparked in the mid-90s conducing to an increasing number of experiences over the last 20 years [3,174,190]. The use of liquid desiccants as complement to vapour compression chillers has been widely explored in the last years, seeking an energy efficient way to handle latent heat in hot-humid climates, instead of recurring to overcooling and subsequent heating to control humidity. This has given room for experiences coupling LD with evaporative cooling systems, as the best alternative to vapour compression chillers. Hence, the development of LDAC goes hand in hand with the development of evaporative cooling systems. The dehumidification capacity of common LD materials has been largely explored, designing and testing several application modes; while evaporative coolers are regarded as a mature technology but have only achieved limited market penetration [15]. Hence, current development efforts focus on integration and simplicity on the design of the system to allow

for small capacity LDAC+EC units, while at the same time exploring efficient ways to use solar heat for regeneration purposes.

3.5.4.2. Market/commercial maturity. Currently, there are no solar driven LDAC systems commercially available. The most developed experiences consist of several prototypes and patents, besides a few demonstration projects for long term monitoring purposes and raising awareness and interest in the technology. Advantix Systems, an US based company founded on 2006 received great attention between 2010 and 2013, by manufacturing and commercialising hybrid LDAC systems (LiCl system coupled with a vapour compressor) for commercial and industrial buildings, being regarded as pioneers in the field [191–194]. Nonetheless, there are no signs of the company after 2014, suggesting that it went out of business. Additionally, Alfa Laval Kathabar [195], a company specialised on dehumidification and HVAC, has recently developed large scale LD based dedicated outdoor air systems using LiCl, also considering a compressor as part of the unit. In any case, ostensibly R&D efforts are still needed to allow for the integration of small size units into the market.

4. Evaluation & discussion: potential for façade integration

An assessment of the technologies is presented, discussing their potential to overcome identified barriers for façade integration of building services. The evaluation was conducted following the strategy and rubrics presented in the methods section of the present document (Table 2), seeking to provide a referential qualitative assessment of the current state-of-the-art, and specifically how each technology fares regarding different relevant aspects for façade integration. Fig. 7 shows maps for each technology, while barriers are discussed separately.

4.1. Technical feasibility

This refers to the overall practicability of integrating all required components for cooling in façade modules. Hence, addressing sizes of the entire system and its components, and their adequate operation in small scales. First of all, it is relevant to point out that the review showcased small scale working examples, with cooling capacities below 3 kW for all selected technologies, which, leaving efficiencies aside for the moment, shows that all of them may operate in the small capacity range.

Besides the existence of small scale concepts, the most clear proof of technical feasibility is the development of working integrated façade prototypes. In this regard, the simplicity of the cooling principle and sizes of the required components have made thermoelectric cooling the technology of choice for the development of most façade integrated concepts found in the literature. These prototypes, even in cases with underwhelming efficiencies, are regarded as evidence of the feasibility of integrated concepts for façade applications. Second to thermoelectric based systems, there are also stand-alone façade concepts based on absorption and solid desiccant principles. Both technologies are quite mature (especially absorption) but are commonly employed in larger scales, considering bulky components. The fact that compact experiences for façade integration are being developed and tested seems promising for future applications.

On the other hand, although compact systems are being designed and tested, liquid desiccant systems still need further research and development to allow for façade integrated concepts. Finally, adsorption based systems still present certain issues related to the intrinsic bulkiness of their components, and the need for another conduit for air supply, being based on closed refrigerating cycles.

4.2. Physical integration

Barriers related to physical integration refer to externalities derived from the connection of the required components, and the compatibility

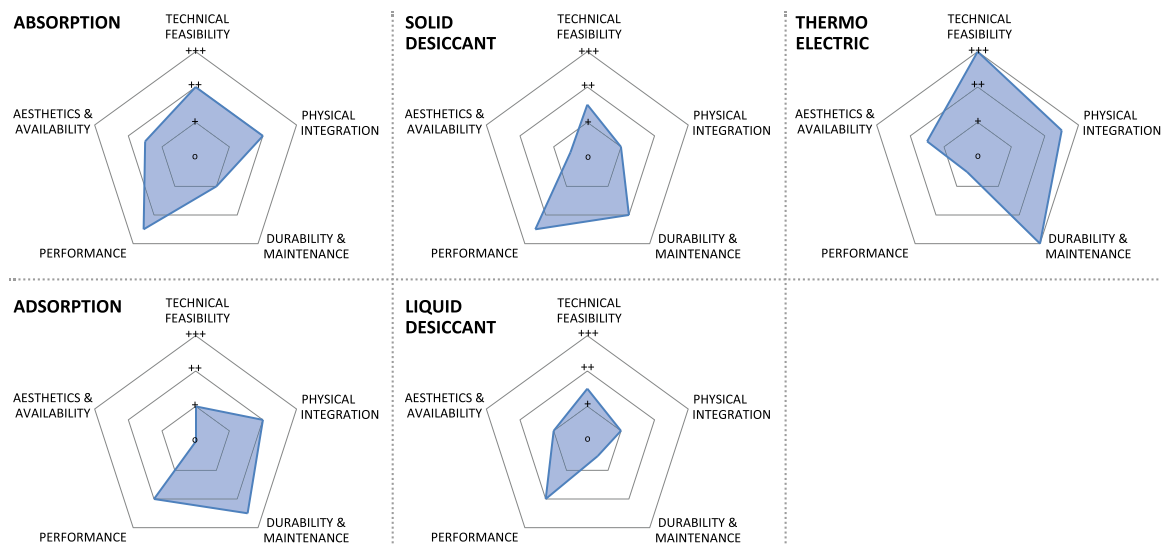

Fig. 7. Qualitative assessment maps for the facade integration potential of selected solar cooling technologies.

of sub-systems and working materials. In these aspects, technologies based on solid-state heat transfer, such as thermoelectric cooling, have clear advantages, being based on simple direct contact between components, besides simple electrical connections to the PV array for energy input. Peltier modules are easy to handle and integrate, although further exploration is needed in order to develop ready-made building components to use in architectural designs.

For all other technologies, a basic distinction could be made between closed cycle and open cycle processes; namely absorption/adsorption, and desiccant cooling respectively. Both absorption and adsorption heat pumps commonly consist of factory sealed units, only needing connections to the heat source, heat rejection system and cooling distribution network, usually carried out throughout pipes. Of course, the fact that refrigerant is carried in a closed cycle, implies that a heat exchanger is needed for cooling delivery, commonly using fan-coils in central water-air applications. Nonetheless, these types of connections are quite common, and easy to solve, dealing with cooling and ventilation requirements through two separate but complementary channels. Furthermore, the current research and development of sorption based integrated concepts, considering a collector array, sorption heat pump, and decentralised air intake [94]; is pushing the boundaries on packaged systems, with no further needs than a discrete electric input for fans, following a plug & play approach.

More complex connections are present in the case of desiccant technologies, mostly due to the fact that a complementary system is needed to take care of sensible loads. While desiccants account for latent loads, evaporative cooling is commonly used to provide sensible cooling. Solid desiccant installations have been judged as slightly complicated [15,163], while liquid desiccant units present the added challenge of handling liquid material for dehumidification on a separate hydronic circuit, with the associated pumps and storage tanks. Future applications of liquid desiccant enhanced evaporative cooling systems largely depend on the simplification and compatibility of their components. Early experiences of natural convection driven units [184], membrane based systems [161], and the use of photovoltaic electrocatalysis for regeneration purposes [186] are steps in the right direction, but further research & development is still needed to advocate for the application of liquid desiccant based cooling systems in buildings.

4.3. Durability & maintenance

This refers to both the durability of required components over time,

and maintenance requirements that have an impact on operational costs associated to each technology. Following the aforementioned simplicity associated with the technology, and the lack of moving parts nor the use of refrigerants; thermoelectric components are regarded as the most durable, being virtually maintenance free besides basic electrical maintenance. However, their lifetime within building components has not been fully tested. Regarding thermal driven technologies, durability of components and maintenance requirements highly depend on the working materials used in the cooling process. Liquid desiccant and absorption cooling rely on liquid dehumidification materials, while the principles behind solid desiccant and adsorption cooling are based on the use of solid materials on carrier surfaces.

The most common liquid desiccants currently used are aqueous halide salts, such as lithium bromide (LiBr) and lithium chloride (LiCl). These salts are highly corrosive and are subject to crystallisation at high concentrations, so careful maintenance must be conducted to assure that there is no corrosion in components nor carry-over to the supply air stream, assuring optimal operational conditions. This is more troublesome for liquid desiccant systems, based on open refrigerant cycles, although further exploration of indirect contact membrane based systems could lead to carry-over free products. An alternative option to overcome these issues is further exploration of other non-corrosive materials, but experiences are still in early stages.

On the other hand, solid materials such as silica gel and zeolites do not present any hazard and are corrosion free. This fact, plus the lack of moving parts in their inner mechanism, makes adsorption heat pumps virtually maintenance free. Solid desiccant systems, comprising more complex connections but simple and robust components, require periodic but simple maintenance.

4.4. Performance

The performance of the selected technologies was mainly addressed in terms of cooling output and efficiency values reported by the reviewed experiences, besides considering potential hazardous externalities for indoor comfort. The aforementioned hazard risk by carry-over associated to liquid desiccant materials is the only health concern worth mentioning, being solved by means of indirect contact with the air stream. On the other hand, the use of desiccant materials (solid or liquid) to deal with latent loads may prove beneficial for indoor comfort by avoiding condensation derived from re-heating the air stream to comfort temperatures.

The reported cooling power and the coefficient of performance

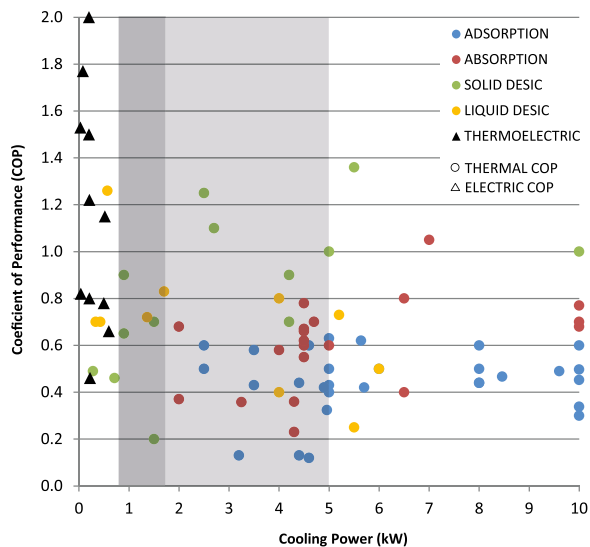

Fig. 8. Cooling power (kW) and coefficient of performance of reported small-scale solar cooling prototypes.

(COP) of the reviewed systems and prototypes are shown in the graph below (Fig. 8). The COP refers to the input energy so it is electrical efficiency in the case of thermoelectric cooling, and thermal COP for solar thermal driven technologies. Moreover, this only considers the efficiency of the cooling system for purposes of the comparison, so the efficiencies of PVs or solar thermal collectors are not accounted for. Regarding cooling power, only experiences below 10 kW were considered. Also, the graph shows the range of cooling design capacities for a single office in different orientations, based on simulations conducted by the authors in a previous work [196], with dark and light grey marking the design values for low and high cooling demands respectively.

First of all, it is possible to see that although thermoelectric concepts may reach high COP values, they are out of range for the cooling power required for a single office room. Hence, current integrated thermoelectric concepts do not seem to be able to meet decentral cooling demands, by lack of cooling power, requiring a back-up system. Further development and testing of larger concepts is needed to fully assess their in-range efficiencies, keeping in mind that there is a trade-off between the efficiency of the system and its cooling output.

Discussing thermal driven technologies, possibilities greatly open up. Closed-cycle systems, and particularly adsorption heat pumps ($N = 36$), comprise the majority of reviewed small-scale experiences. The performance of closed systems seems to be consistent among the sample, usually reaching thermal COP values of 0.6 and 0.8 for adsorption and absorption systems, respectively. The high amount of adsorption based experiences follows current research trends aimed to boost the development of small scale systems for residential application, considering several prototypes in the 3–5 kW range. Regarding absorption, most experiences are higher than 4 kW, with smaller capacities only tailored to façade integrated purposes in the aforementioned sorption collector unit [94].

In general, desiccant based cooling systems discussed in the review comprise lower cooling capacities than closed-cycle systems. However, this does not seem to present a problem due to their close match with the required range for the design of cooling systems. Regarding efficiency, these technologies reach higher in-range thermal COP values, especially in the case of solid desiccants. Nonetheless, more research is required to ensure reliable results following the maturity achieved by closed-cycle technologies.

4.5. Aesthetics & availability

Aesthetics is a highly complex topic of discussion not only regarding façade integration, but in architecture and the arts in the wider sense, opening different trends of thought that fall out of the scope of the present research. Hence, it is necessary to constrain its understanding for the evaluation at hand. Moreover, the external appearance of façade integrated solar cooling concepts will be heavily, if not totally, influenced by the solar energy conversion system utilised, namely photovoltaics or solar thermal collectors. While there are several options to choose for any given design or preferred appearance, they do not make any difference for the evaluation of the solar cooling systems driven by them. Therefore, for the purpose of addressing this aspect in the evaluation of the selected solar cooling technologies, the aesthetical potential is understood as the potential to allow for flexibility and variability in façade design.

Sizes and overall complexity of the components and overall current systems are regarded as a relevant hindrance for design flexibility, limiting the application of adsorption and desiccant technologies respectively. The lack of standardised components, or plug & play modular systems; limits the applicability of these technologies at best to tailor-made solutions under an integral façade design. The development of integrated compact solutions are steps in the right direction in order to develop building products for architects and façade designers to use, but further efforts need to be conducted in the field. This is also true in the case of thermoelectric components. Due to their dimensions and low complexity, they do not greatly restrict design choices, but exploration and research should eventually conduct to the development of architectural products, easy to integrate in early stages of façade design, while ensuring reliable operation.

4.6. General assessment: charting a roadmap for the development of façade integrated concepts

The qualitative assessment of solar cooling technologies in terms of their potential for façade integration, clearly shows what is currently possible, but at the same time serves to identify shortcomings and bottlenecks related to each technology, if façade integration is the final goal. Table 10 shows recommendations for further development of all assessed technologies, drafting a roadmap for future R&D experiences focusing on key aspects to overcome for façade integration. Furthermore, the most pressing issues to solve per technology are highlighted, following the lower ranked aspects at the assessment (below + +).

In general, it is quite evident that these technologies are not ready yet for façade application, with all of them ranking low in ‘aesthetics & availability’ aspects. Further developments and exploration focused on the generation of integrated building products, or plug & play compact systems, are needed for all assessed technologies. At the same time, the fact that liquid desiccant cooling technologies have been more recently explored, compared to other thermal driven systems, gives them a disadvantage in development level and maturity, needing further research in most aspects to be up to date. In any case, the rate of new developments in the field is seen as highly promising. Although the conducted assessment only considers current possibilities, it is the authors’ opinion that liquid desiccant cooling technologies have large unexplored potential, with auspicious opportunities for application in the built environment.

In the case of technologies that consider solid desiccants as basis of their operation (adsorption, solid desiccant cooling), the main current bottlenecks are related to the size of components and generation of compact integrated systems. Even considering latest developments of compact desiccant units [150], they still need to be field tested and thoroughly validated under different working conditions. The technologies that currently seem closer to commercial façade applications are thermoelectric cooling and absorption based systems. However, important bottlenecks still remain regarding performance issues and the

Table 10
Recommendations for further development of solar cooling technologies, to overcome identified barriers for façade integration.

| BARRIERS | SOLAR COOLING TECHNOLOGIES | | | | |
|---------------------------|--|--|---|--|--|
| | THERMO ELECTRIC | ABSORPTION | ADSORPTION | SOLID DESICCANT | LIQUID DESICCANT |
| TECHNICAL FEASIBILITY | Prototype testing and experimental measurement of facade integrated concepts. | Further exploration and development of compact systems for façade integration. | Size reduction of components and exploration of alternative processes. | Development and validation of compact systems for façade integration. | Development and testing of compact units. |
| PHYSICAL INTEGRATION | Standardise connections and components for development of architectural products. | Further exploration of plug & play integrated approaches to system design. | Exploration of integrated systems. | Exploration of integrated compact systems. | Exploration of alternative processes to simplify connections and increase compatibility. |
| DURABILITY & MAINTENANCE | Testing of durability of TE modules applied in building components over time and different climate conditions. | Exploration of non-corrosive working pairs and vacuum sealed compact systems. | Testing of compact adsorption systems over time and different climate conditions. | Testing of compact solid desiccant systems over time and different climate conditions. | Exploration and testing of alternative non-corrosive materials. |
| PERFORMANCE | Increase cooling power of peltier modules, balancing adequate COP values. Explore up-scaled components. | Further development and testing of compact systems below 3kW. | Increase COP values of small scale systems. | Further development and testing of compact systems below 3kW for reliability of COP values. | Further development and testing of compact systems below 3 kW for reliability of COP values. |
| AESTHETICS & AVAILABILITY | Development of architectural products and integrated building components. | Development of plug & play systems for façade integration. | Size reduction of components for development of plug & play systems. | Size reduction and simplification of connections for development of decentralised ventilation systems. | Development and validation of compact integrated systems for future product development. |

development of compact units with durable components and working materials, respectively.

The assessment above has shown current possibilities and bottlenecks for façade integration of selected technologies, drafting recommendations for further development. However, the discussed topics also allow to debate façade integration itself, defining different paths for product development depending on the understanding of integration and its implications. Authors have proposed the distinction between ‘integral’ and ‘modular’ construction as two ways to integrate extra functions into the building envelope. The former considers functions embedded in a multifunctional component, while the latter refers to different mono-functional parts, connected to form a multifunctional whole [197]. Following this distinction, there are two clear product development paths for façade integration: (a) the development of integral building components for architectural design, and (b) the development of modular packaged systems ready to be installed if the required connections are space are provided.

Current strengths and shortcomings of each assessed solar cooling technology make them more suitable for either one of these product development paths, defining potential product types worth exploring. Based on the review and assessment, the most viable options for the development of distinct façade integrated products are depicted in Fig. 9, using a chart for the categorisation of solar cooling technologies for façade integration purposes, proposed in an earlier work by the authors [27].

Performance issues aside, thermoelectric cooling technologies are regarded as the most suitable for developing integral building components. The compact dimensions of their basic elements and the simplicity of their connections and operation principles give them an important advantage for the design of active building components, at different scales, ranging from window elements [58,60] to entire radiant walls and façade units [53,54]. On the other hand, the sorption collector integrated with decentral ventilation showcased in the review [94] is regarded as the best current example for the development of self-

sufficient compact systems under absorption processes. In this case, the challenge for designers would be how to plan the connection of these modular packaged systems, while assimilating them into the overall façade composition. Similarly, future developments on liquid desiccant units should follow this path, taking advantage of the flexibility given by the use of liquids as working material.

Finally, a third possible path for product development is incorporated in the discussion, as partial façade integration (c). This refers to the integration of certain components of the solar cooling system in façade units, such as the solid desiccant based facade ventilation unit, with decoupled solar regeneration (thermal collectors located in the roof) developed by SolarInvent [150]. Also, even if small-scale absorption/adsorption chillers remain too big for façade integration, cooling distribution may be conducted through especially designed façade elements for central or semi-decentral applications (various rooms or an entire floor). Furthermore, façade integrated water-based systems may be alternatively connected to cooling delivery elements far from the façade, such as cooled ceilings or beams, through an hydronic system, providing further application possibilities for deep plan buildings. Based on current possibilities, solid desiccant cooling and sorption chillers seem to be apt for partial façade integration. While breakthroughs may come in the future, for the time being, the generation of self-sustaining solar cooling facades based on these technologies seems unlikely. Hence, in this case, seems logical to promote façade integration of certain key components to enhance new application possibilities based on the comparative strengths of these technologies.

5. Conclusions

This paper sought to discuss the potential for façade integration of selected solar cooling technologies, based on a state-of-the-art review of technology-specific attributes and the assessment of their capability to respond to previously identified barriers for façade integration of building services. The review focused on small-scale systems and

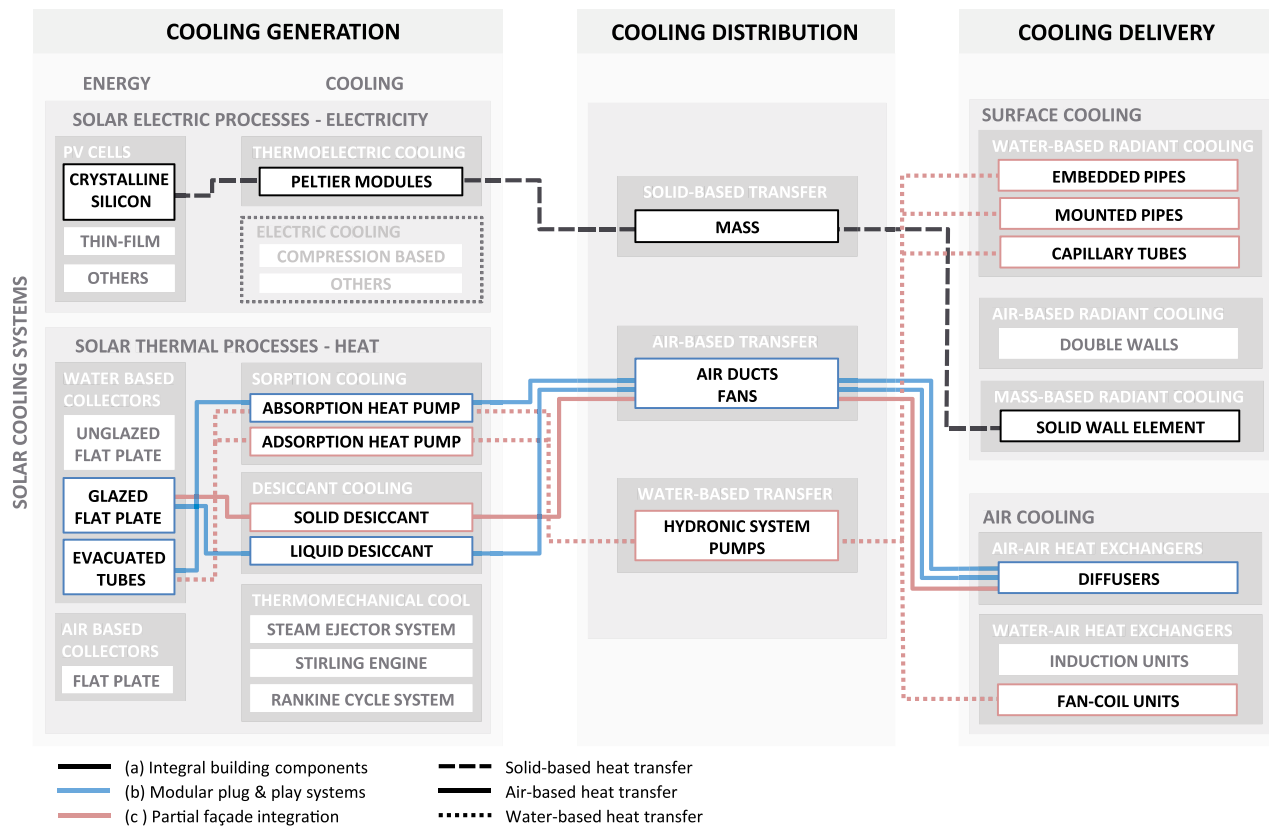

Fig. 9. Research and development paths for the generation of distinct architectural products for façade integration.

concepts, exploring current boundaries and development level of compact units for integration purposes. Moreover, the evaluation tackled the aforementioned barriers, categorised in five groups of aspects to overcome for façade integration: technical feasibility, physical connections, durability & maintenance, performance; and aesthetics & availability.

The review showcased examples of small-scale units for all technologies; and even façade integrated concepts for some of them. On the other hand, the assessment showed that the suitability of the selected technologies varies according to each particular barrier for façade integration. Hence, currently there is no technology that fits all required aspects. Further research and development are needed for all technologies to allow for widespread application of integrated concepts, and future commercialisation of architectural products. Therefore, current possibilities were mapped, identifying certain bottlenecks and drafting recommendations for further development, focusing on key aspects to solve per technology.

Although they are not ready for widespread application yet, the use of thermoelectric modules and compact units based on absorption technologies, are regarded as the most promising ones for the development of either integral building components, or modular plug & play systems for façade integration. In the case of thermoelectric cooling concepts, the main constraint is their comparative performance in terms of the expected cooling output; requiring the development and testing of scaled-up components that maintain high efficiencies reported by systems out of the required range. For absorption units, the main challenges are the exploration of non-corrosive working materials, and further development and testing of compact packaged units under a modular design approach. On a separate note, liquid desiccant cooling technologies are deemed as potentially promising, based on the rate of new developments and the flexibility given by liquid working materials. Nevertheless, they are less mature in comparison to the rest, so general

research is required to explore their potential.

Finally, it is recommended that further explorations on compact adsorption and solid desiccant cooling systems focus on partial façade integration. Thus, promoting an alternative development path based on the strengths and shortcomings associated with the technologies. Specific challenges are size reduction and simplification of the cooling processes, however, the integration of only certain components in façade units mitigates size constraints, while opens new possibilities for semi-decentral applications and cooling distribution to areas far from the façade.

The presented assessment and recommendations aim to coordinate future efforts and explorations in the field, charting paths for the development of a variety of architectural products and new building applications; and specific challenges to overcome. This supports a general vision for further promotion and widespread integration of renewable energy sources and environmentally friendly cooling processes in the built environment; however, this has to be thoroughly combined with campaigns and measures to reduce our energy demands, and the climate responsive design of buildings and cities, particularly in warm climate contexts.

Acknowledgements

This paper is part of the ongoing Ph.D. research project titled COOLFACADE: Architectural integration of solar cooling technologies in the building envelope, developed within the Architectural Façades & Products Research Group (AF&P) of the Department of Architectural Engineering + Technology, Delft University of Technology (TU Delft). The research project is being funded through a scholarship granted by CONICYT, the National Commission for Scientific and Technological Research of Chile (Resolution N°7484/2013).

References

- [1] CICA. Industry as a partner for sustainable development-refrigeration. Confederation of International Contractors' Associations; 2002.
- [2] Reda AM, Ali AHF, Morsy MG, Taha IS. Design optimization of a residential scale solar driven adsorption cooling system in upper Egypt based. *Energy Build* 2016;130:843–56.
- [3] Mujahid Rafique M, Gandhidasan P, Ibrahim NI, Bahaidarah HM. Recent developments in liquid desiccant-based cooling systems; 2017. p. 441–53.
- [4] Weiss W, Biermayr P. Potential of solar thermal in Europe. Final report of RESTMAC. Brussels, Belgium; 2009.
- [5] Jochem E, Schade W. 2-degree scenario for Europe - policies and impacts. ADAM: adaptation and mitigation strategies: supporting European climate policy. Karlsruhe: Fraunhofer Institute for Systems and Innovation Research (Fraunhofer-ISI); 2009.
- [6] Santamouris M, Kolokotsa D. Passive cooling dissipation techniques for buildings and other structures: the state of the art. *Energy Build* 2013;57:74–94.
- [7] Montagnino FM. Solar cooling technologies. Design, application and performance of existing projects. *Sol Energy* 2017.
- [8] DOE/EIA. International energy outlook 2016. Washington, DC, USA: US Energy Information Administration, US Department of Energy; 2016.
- [9] UNEP. Handbook for the montreal protocol on substances that deplete the ozone layer. 11th edition Ozone Secretariat, United Nations Environment Programme; 2017.
- [10] IPCC/TEAP. Special report: safeguarding the ozone layer and the global climate System; 2005.
- [11] EIA. EU F-gas regulation handbook: keeping ahead of the curve as Europe phases down HFCs. London, UK: Environmental Investigation Agency; 2015.
- [12] UN. Decision XXVIII/1 Further Amendment to the Montreal Protocol on Substances that Deplete the Ozone Layer. Kigali, Rwanda; 2016.
- [13] Brown JS, Domanski PA. Review of alternative cooling technologies. *Appl Therm Eng* 2014;64:252–62.
- [14] Prieto A, Knaack U, Klein T, Auer T. 25 Years of cooling research in office buildings: review for the integration of cooling strategies into the building façade (1990–2014). *Renew Sustain Energy Rev* 2017;71:89–102.
- [15] Goetzler W, Zogg R, Young J, Johnson C. Energy savings potential and RD&D opportunities for non-vapor-compression HVAC technologies. USA: U.S. Department of Energy, Office of Energy Efficiency and Renewable Energy, Building Technologies Office; 2014.
- [16] Balaras CA, Grossman G, Henning H-M, Infante Ferreira CA, Podesser E, Wang L, et al. Solar air conditioning in Europe—an overview. *Renew Sustain Energy Rev* 2007;11:299–314.
- [17] Henning H-M, Döll J. Solar systems for heating and cooling of buildings. *Energy Procedia* 2012;30:633–53.
- [18] Me Munari-Probst, Ce Roecker. Solar energy systems in architecture. Report T.41. A.2 IEA SHC Task 41 Solar energy and Architecture; 2012.
- [19] Schüler A, Boudaden J, Oelhafen P, De Chambrier E, Roecker C, Scartezzini JL. Thin film multilayer design types for colored glazed thermal solar collectors. *Sol Energy Mater Sol Cells* 2005;89:219–31.
- [20] Escarré J, Li H-Y, Sansonnens L, Galliano F, Cattaneo G, Heinstejn P, et al. When PV modules are becoming real building elements: white solar module, a revolution for BIPV. In: Proceedings of IEEE 42nd photovoltaic specialist conference (PVSC) . New Orleans, LA2015; 2015.
- [21] Kohlenbach P, Jakob U. Solar cooling: the earthscan expert guide to solar cooling systems. Taylor & Francis; 2014.
- [22] Henning H-M. Solar assisted air conditioning of buildings – an overview. *Appl Therm Eng* 2007;27:1734–49.
- [23] Eicker U, Pietruschka D, Haag M, Schmitt A. Systematic design and analysis of solar thermal cooling systems in different climates. *Renew Energy* 2015;80:827–36.
- [24] Ma Y, Saha S, Miller W, Guan L. Comparison of different solar-assisted air conditioning systems for Australian office buildings. *Energies* 2017;10:1463.
- [25] Otanicar T, Taylor RA, Phelan PE. Prospects for solar cooling – an economic and environmental assessment. *Sol Energy* 2012;86:1287–99.
- [26] Eicker U, Colmenar-Santos A, Teran L, Cotrado M, Borge-Diez D. Economic evaluation of solar thermal and photovoltaic cooling systems through simulation in different climatic conditions: an analysis in three different cities in Europe. *Energy Build* 2014;70:207–23.
- [27] Prieto A, Knaack U, Auer T, Klein T. Solar coolfacades: framework for the integration of solar cooling technologies in the building envelope. *Energy* 2017;137:353–68.
- [28] Munari Probst MC, Roecker C. Towards an improved architectural quality of building integrated solar thermal systems (BIST). *Sol Energy* 2007;81:1104–16.
- [29] Cappel C, Streicher W, Lichtblau F, Maurer C. Barriers to the market penetration of façade-integrated solar thermal systems. *Energy Procedia* 2014;48:1336–44.
- [30] Prieto A, Knaack U, Auer T, Klein T. Solar façades – main barriers for widespread façade integration of solar technologies. *J Facade Des Eng* 2017;5:51–62.
- [31] Prieto A, Klein T, Knaack U, Auer T. Main perceived barriers for the development of building service integrated facades: results from an exploratory expert survey. *J Build Eng* 2017;13:96–106.
- [32] Zelenay K, Perpelitz M, Lehrer D. High-performance facades: design strategies and applications in North America and Northern Europe. in: Centre for the Built Environment (CBE) UoC (editor) Berkeley, USA; 2011.
- [33] Haase M, Andresen I, Helge Dokka T. The role of advanced integrated facades in the design of sustainable buildings. *J Green Build* 2009;4:76–98.
- [34] Ledbetter S. Barriers to the integration of cladding and building services. In: Proceedings of the 22nd annual AIVC conference. Bath, UK; 2001.
- [35] Mach T, Grobbauer M, Streicher W, Müller MJ. MPPF - the multifunctional plug & play approach in facade technology: verlag d. Technischen Universität Graz; 2015.
- [36] Evident. Evident Thermoelectrics - (<http://evidentthermo.com/>); n.d.
- [37] Brown DR, Fernandez N, Dirks JA, Stout TB. The prospects of alternatives to vapor compression technology for space cooling and food refrigeration applications. USA: Pacific Northwest National Laboratory (PNNL); 2010. [Prepared for the U.S. DOE under contract DE-AC05-76RL01830].
- [38] Bell L. Addressing the challenges of commercializing new thermoelectric materials. International conference on thermoelectrics. Oregon, USA; 2008.
- [39] Allouhi A, Kousksou T, Jamil A, Bruel P, Mourad Y, Zeraouli Y. Solar driven cooling systems: an updated review. *Renew Sustain Energy Rev* 2015;44:159–81.
- [40] Zhao D, Tan G. A review of thermoelectric cooling: materials, modeling and applications. *Appl Therm Eng* 2014;66:15–24.
- [41] Liu Z, Zhang L, Gong G, Li H, Tang G. Review of solar thermoelectric cooling technologies for use in zero energy buildings. *Energy Build* 2015:207–16.
- [42] Riffat SB, Ma X. Improving the coefficient of performance of thermoelectric cooling systems: a review. *Int J Energy Res* 2004;28:753–68.
- [43] Yilmazoglu MZ. Experimental and numerical investigation of a prototype thermoelectric heating and cooling unit. *Energy Build* 2016;113:51–60.
- [44] Sales BC. Smaller is cooler. *Science* 2002;295:1248–9.
- [45] Venkatasubramanian R, Siivola E, Colpitts T, O'Quinn B. Thin-film thermoelectric devices with high room-temperature figures of merit. *Nature* 2001;413:597–602.
- [46] Tan G, Zhao D. Study of a thermoelectric space cooling system integrated with phase change material. *Appl Therm Eng* 2015;86:187–98.
- [47] Cosnier M, Fraisse G, Luo L. An experimental and numerical study of a thermoelectric air-cooling and air-heating system. *Int J Refrig* 2008;31:1051–62.
- [48] Shen L, Xiao F, Chen H, Wang S. Investigation of a novel thermoelectric radiant air-conditioning system. *Energy Build* 2013;59:123–32.
- [49] Liu Z, Zhang L, Gong G, Han T. Experimental evaluation of an active solar thermoelectric radiant wall system. *Energy Convers Manag* 2015;94:253–60.
- [50] Liu Z, Zhang L, Gong G. Experimental evaluation of a solar thermoelectric cooled ceiling combined with displacement ventilation system. *Energy Convers Manag* 2014;87:559–65.
- [51] Luo Y, Zhang L, Liu Z, Wang Y, Meng F, Wu J. Thermal performance evaluation of an active building integrated photovoltaic thermoelectric wall system. *Appl Energy* 2016;177:25–39.
- [52] Luo Y, Zhang L, Liu Z, Wu J, Zhang Y, Wu Z, et al. Performance analysis of a self-adaptive building integrated photovoltaic thermoelectric wall system in hot summer and cold winter zone of China. *Energy* 2017;140:584–600.
- [53] Luo Y, Zhang L, Liu Z, Wu J, Zhang Y, Wu Z. Numerical evaluation on energy saving potential of a solar photovoltaic thermoelectric radiant wall system in cooling dominant climates. *Energy* 2018;142:384–99.
- [54] Ibañez-Puy M, Martín-Gómez C, Bermejo-Busto J, Sacristán JA, Ibañez-Puy E. Ventilated Active Thermoelectric Envelope (VATE): analysis of its energy performance when integrated in a building. *Energy Build* 2018;158:1586–92.
- [55] Ibañez-Puy M, Martín-Gómez C, Vidaurre-Arbizu M, Sacristán-Fernández JA. Theoretical design of an active façade system with peltier cells. *Energy Procedia* 2014;61:700–3.
- [56] Ibañez-Puy M, Sacristán Fernández JA, Martín-Gómez C, Vidaurre-Arbizu M. Development and construction of a thermoelectric active facade module. *J Facade Des Eng* 2015;3:15–25.
- [57] Ibañez-Puy M, Sacristán-Fernández JA, Martín-Gómez C. Construction of an active facade envelope with peltier cells. In: Proceedings of 39th world congress on housing science - changing needs, adaptive buildings, smart cities. Milan, Italy: Politecnico di Milano; 2013. p. 517–24.
- [58] Vasquez J, Sanz-Bobi M, Palacios R, Arenas A. An active thermal wall based on thermoelectricity. In: Proceedings of the 6th European workshop on thermoelectrics. Freiburg, Germany; 2001.
- [59] Arenas A, Palacios R, Rodriguez-Pecharroman R, Pagola F. Full-size prototype of active thermal windows based on thermoelectricity. In: ECT2008 Proceedings of the 6th European conference on thermoelectrics. Paris, France; 2008.
- [60] Xu X, Van Dessel S. Evaluation of an active building envelope window-system. *Build Environ* 2008;43:1785–91.
- [61] Xu X, Van Dessel S. Evaluation of a prototype active building envelope window-system. *Energy Build* 2008;40:168–74.
- [62] Xu X, Van Dessel S, Messac A. Study of the performance of thermoelectric modules for use in active building envelopes. *Build Environ* 2007;42:1489–502.
- [63] Khire RA, Messac A, Van Dessel S. Design of thermoelectric heat pump unit for active building envelope systems. *Int J Heat Mass Transf* 2005;48:4028–40.
- [64] Irshad K, Habib K, Basrawi F, Saha BB. Study of a thermoelectric air duct system assisted by photovoltaic wall for space cooling in tropical climate. *Energy* 2017;119:504–22.
- [65] Cheng T-C, Cheng C-H, Huang Z-Z, Liao G-C. Development of an energy-saving module via combination of solar cells and thermoelectric coolers for green building applications. *Energy* 2011;36:133–40.
- [66] Shen L, Pu X, Sun Y, Chen J. A study on the thermoelectric technology application in net zero energy buildings. *Energy* 2016;113:9–24.
- [67] He W, Zhou J, Hou J, Chen C, Ji J. Theoretical and experimental investigation on a thermoelectric cooling and heating system driven by solar. *Appl Energy* 2013;107:89–97.
- [68] VDMA. International technology roadmap for photovoltaic (ITRPV): 2016 results including maturity report. 8th ed. Germany: VDMA; 2017.
- [69] Jeong ES. A new approach to optimize thermoelectric cooling modules. *Cryogenics* 2014;59:38–43.

- [70] CustomChill. CustomChill - Innovative cooling solutions. <<http://www.customchill.com/>>; n.d.
- [71] SScooling. Solid State cooling systems - <<http://www.sscolling.com/>>; n.d.
- [72] Sheetak. Sheetak - <<http://www.sheetak.com/>>; n.d.
- [73] Phononic. Phononic - <<http://phononic.com/>>; n.d.
- [74] Bong T, Ng K, Tay A. Performance study of a solar-powered air-conditioning system. *Sol Energy* 1987;39:173–82.
- [75] Nakahara N, Miyakawa Y, Yamamoto M. Experimental study on house cooling and heating with solar energy using flat plate collector. *Sol Energy* 1977;19:657–62.
- [76] Sarbu I, Sebarchievici C. Review of solar refrigeration and cooling systems. *Energy Build* 2013;67:286–97.
- [77] Jaehnic D. D-A1: Market available components for systems for Solar Heating and Cooling with a Cooling Capacity < 20 kW / A technical report of subtask A of IEA SHC Task 38: Solar Air-Conditioning and Refrigeration. Austria: AEE Intec; 2009.
- [78] SOLAIR. Solair Project: Increasing the market implementation of Solar Air-Conditioning Systems for small and medium applications in residential and commercial buildings; 2009.
- [79] KeepCool. Unterperntinger F, editor. Service buildings KeepCool: Promotion of sustainable cooling in the service building sector. Final Report. Vienna, Austria: Austrian Energy Agency; 2005.
- [80] ClimaSol. ClimaSol - Promoting Solar Air Conditioning: Technical overview of active techniques. ALTENER Project Number 4.1030/Z/02-121/2002; 2002.
- [81] SolarNext. SolarNext - <<http://www.solarnext.eu/>>; n.d.
- [82] Solarcombi + . SonnenKlima package solution description. Report of Solarcombi + project: Identification of most promising markets and promotion of standardised system configurations for the market entry of small scale combined solar heating & cooling applications. Intelligent Energy Europe; 2009.
- [83] Ullah KR, Saidur R, Ping HW, Akikur RK, Shuvo NH. A review of solar thermal refrigeration and cooling methods. *Renew Sustain Energy Rev* 2013;24:499–513.
- [84] Agyenim F, Knight I, Rhodes M. Design and experimental testing of the performance of an outdoor LiBr/H₂O solar thermal absorption cooling system with a cold store. *Sol Energy* 2010;84:735–44.
- [85] Said SAM, El-Shaarawi MAI, Siddiqui MU. Alternative designs for a 24-h operating solar-powered absorption refrigeration technology. *Int J Refrig* 2012;35:1967–77.
- [86] Franchini G, Notarbartolo E, Padovan LE, Perdichizzi A. Modeling, design and construction of a micro-scale absorption chiller. *Energy Procedia* 2015;82:577–83.
- [87] Castro J, Oliva A, Perez-Segarra CD, Oliet C. Modelling of the heat exchangers of a small capacity, hot water driven, air-cooled H₂O–LiBr absorption cooling machine. *Int J Refrig* 2008;31:75–86.
- [88] Lizarte R, Izquierdo M, Marcos JD, Palacios E. An innovative solar-driven directly air-cooled LiBr–H₂O absorption chiller prototype for residential use. *Energy Build* 2012;47:1–11.
- [89] Izquierdo M, Marcos JD, Palacios ME, González-Gil A. Experimental evaluation of a low-power direct air-cooled double-effect LiBr–H₂O absorption prototype. *Energy* 2012;37:737–48.
- [90] Blackman C, Hallstrom O, Bales C. Demonstration of solar heating and cooling system using sorption integrated solar thermal collectors. EuroSun. Aix-les-Bains, France: International Solar Energy Society (ISES); 2014.
- [91] Hallström O, Földner G, Spahn H-J, Schnabel L, Salg F. Development of collector integrated sorption modules for solar heating and cooling: performance simulation. *Energy Procedia* 2014;48:67–76.
- [92] Hallström O. Design optimization of a sorption integrated Sydney type vacuum tube collector. *J Sol Energy Eng* 2016;139:021007.
- [93] Hallstrom O, Földner G. Integration of sorption modules in Sydney type vacuum tube collector with air as heat transfer fluid. *Energy Procedia* 2015;70:445–53.
- [94] Avesani S. Design of a solar façade solution with an integrated sorption collector for the systemic retrofit of the existing office buildings. Innsbruck, Austria: Leopold-Franzens-Universität Innsbruck; 2016.
- [95] Bonato P, D'Antoni M, Fedrizzi R. Integration of a sorption collector coupled with a decentralized mechanical ventilation unit in curtain wall module. Bern, Switzerland: Advance Building Skins; 2016.
- [96] Purix. Purix - <<http://www.purix.com/>>; n.d.
- [97] Infante Ferreira C, Kim D-S. Techno-economic review of solar cooling technologies based on location-specific data. *Int J Refrig* 2014;39:23–37.
- [98] Avesani S, Hallstrom O, Földner G. Integration of sorption collector in office curtain wall: simulation based comparison of different system configurations. Eurosun 2014. France: Aix-les-Bains; 2014.
- [99] Aliane A, Abboudi S, Seladji C, Guendouz B. An illustrated review on solar absorption cooling experimental studies. *Renew Sustain Energy Rev* 2016;65:443–58.
- [100] Weber C, Berger M, Mehling F, Heinrich A, Núñez T. Solar cooling with water–ammonia absorption chillers and concentrating solar collector – operational experience. *Int J Refrig* 2014;39:57–76.
- [101] SaltX. SaltX Technology - <<http://saltxtechnology.com/>>; n.d.
- [102] Bolocan S, Chiriac F, Serban A, Dragomir G, Nastase G. Development of a small capacity solar cooling absorption plant. *Energy Procedia* 2015;74:624–32.
- [103] Banyounes AM, Ghadi YY, Rasul MG, Khan MMK. An overview of solar assisted air conditioning in Queensland's subtropical regions, Australia. *Renew Sustain Energy Rev* 2013;26:781–804.
- [104] Soussi M, Balghouthi M, Guizani A, Bouden C. Model performance assessment and experimental analysis of a solar assisted cooling system. *Sol Energy* 2017;143:43–62.
- [105] Eicker U, Pietruschka D, Haag M, Schmitt A. Energy and economic performance of solar cooling systems world wide. *Energy Procedia* 2014;57:2581–9.
- [106] Kalogirou SA. Solar energy engineering: processes and systems. Elsevier Science; 2013.
- [107] Preisler A, Selke T, Focke H, Hartl N, Geissegger G, Podesser E, et al. Development of a technology roadmap for solar thermal cooling in Austria. *Energy Procedia* 2012;30:1422–31.
- [108] Yazaki. YAZAKI Corporation - <<https://www.yazaki-group.com/>>; n.d.
- [109] Hitachi. Hitachi Group - <<http://www.hitachi.com/>>; n.d.
- [110] Broad. BROAD Group - <<http://en.broad.com/>>; n.d.
- [111] Carrier. Carrier - <<https://www.carrier.com/>>; n.d.
- [112] Trane. TRANE - <<http://www.trane.com/>>; n.d.
- [113] York. YORK - <<http://www.york.com/>>; n.d.
- [114] MultiChill. MultiChill Technologies Inc., - <<http://multichilltech.com/>>; n.d.
- [115] Allouhi A, Kousksou T, Jamil A, El Rhafiki T, Mourad Y, Zeraouli Y. Optimal working pairs for solar adsorption cooling applications. *Energy* 2015;79:235–47.
- [116] El Fadar A. Novel process for performance enhancement of a solar continuous adsorption cooling system. *Energy* 2016;114:10–23.
- [117] Bataineh K, Taamneh Y. Review and recent improvements of solar sorption cooling systems. *Energy Build* 2016;128:22–37.
- [118] Khattab NM, Sharawy H, Helmy M. Development of novel solar adsorption cooling tube. *Energy Procedia* 2012;18:709–14.
- [119] Habib K, Saha BB, Koyama S. Study of various adsorbent–refrigerant pairs for the application of solar driven adsorption cooling in tropical climates. *Appl Therm Eng* 2014;72:266–74.
- [120] Bakker EJ, de Boer R. Development of a new 2,5 kW adsorption chiller for heat driven cooling. The Netherlands: ECN; 2010.
- [121] Alahmer A, Wang X, Al-Rbaihat R, Amanul Alam KC, Saha BB. Performance evaluation of a solar adsorption chiller under different climatic conditions. *Appl Energy* 2016;175:293–304.
- [122] El-Sharkawy II, AbdelMeguid H, Saha BB. Potential application of solar powered adsorption cooling systems in the Middle East. *Appl Energy* 2014;126:235–45.
- [123] InvenSor. InvenSor - <<http://invensor.com/>>; n.d.
- [124] Jakob U, Mittelbach W. Development and investigation of a compact silica gel/water adsorption chiller integrated in solar cooling systems. In: Proceedings of VII minsk international seminar heat pipes, heat pumps, refrigerators, power sources. Minsk, Belarus; 2008.
- [125] Weber C, Mehling F, Fregin A, Daßler I, Schossig P. On standardizing solar cooling – field test in the small capacity range. *Energy Procedia* 2014;48:1027–35.
- [126] Clause M, Alam KCA, Meunier F. Residential air conditioning and heating by means of enhanced solar collectors coupled to an adsorption system. *Sol Energy* 2008;82:885–92.
- [127] de Lieto Vollaro R, Botta F, de Lieto Vollaro A, Galli G. Solar cooling system for buildings: thermal analysis of solid adsorbents applied in low power adsorption system. *Energy Build* 2014;80:436–40.
- [128] Luo H, Wang R, Dai Y. The effects of operation parameter on the performance of a solar-powered adsorption chiller. *Appl Energy* 2010;87:3018–22.
- [129] Lu Z, Wang R, Xia Z, Gong L. Experimental investigation adsorption chillers using micro-porous silica gel–water and compound adsorbent–methanol. *Energy Convers Manag* 2013;65:430–7.
- [130] Sijpheer NC, Bakker EJ, De Boer R. Testing a prototype adsorption cooler in a research dwelling. In: Proceedings of the 10th international conference for enhanced building operations (ICEBO). Kuwait; 26–28 October 2010.
- [131] De Boer R, Smeding SF, Mola S. Silicagel-water adsorption cooling prototype system for mobile air conditioning. In: Proceedings of heat powered cycles conference. Berlin; 7–9 September 2009.
- [132] Verde M. Modelling and optimization of an adsorption cooling system for automotive applications. Valencia, Spain: Universidad politecnica de Valencia; 2015.
- [133] Chekirou W, Boukheit N, Karaali A. Performance improvement of adsorption solar cooling system. *Int J Hydrog Energy* 2016;41:7169–74.
- [134] Islam MP, Morimoto T. Thermodynamic performances of a solar driven adsorption system. *Sol Energy* 2016;139:266–77.
- [135] NIOSH. The National Institute for Occupational Safety and Health (NIOSH) - <<https://www.cdc.gov/niosh/index.htm>> [Accessed November 16, 2017]; 2017.
- [136] Choudhury B, Saha BB, Chatterjee PK, Sarkar JP. An overview of developments in adsorption refrigeration systems towards a sustainable way of cooling. *Appl Energy* 2013;104:554–67.
- [137] Mahesh A. Solar collectors and adsorption materials aspects of cooling system. *Renew Sustain Energy Rev* 2017;73:1300–12.
- [138] Rouf RA, Alam KCA, Khan MAH. Solar adsorption cooling and hot water supply for climatic condition of Dhaka. *Procedia Eng* 2015;105:705–12.
- [139] Rouf RA, Alam KCA, Khan MAH, Saha BB, Meunier F, Alim MA, et al. Advancement of solar adsorption cooling by means of heat storage. *Procedia Eng* 2014;90:649–56.
- [140] Yeo THC, Tan IAW, Abdullah MO. Development of adsorption air-conditioning technology using modified activated carbon – a review. *Renew Sustain Energy Rev* 2012;16:3355–63.
- [141] Fahrenheit. FAHRENHEIT - <<https://fahrenheit.cool/>>; n.d.
- [142] Jani DB, Mishra M, Sahoo PK. Solid desiccant air conditioning – A state of the art review. *Renew Sustain Energy Rev* 2016;60:1451–69.
- [143] La D, Dai YJ, Li Y, Wang RZ, Ge TS. Technical development of rotary desiccant dehumidification and air conditioning: a review. *Renew Sustain Energy Rev* 2010;14:130–47.
- [144] Henning HM, Erpenbeck T, Hindenburg C, Santamaria IS. The potential of solar energy use in desiccant cooling cycles. *Int J Refrig* 2001;24:220–9.
- [145] Selke T, Frein A, Muscherà M, Sethuvenkatraman S, Hands S, White S. SHC Task 48 B2 – three GOOD practice examples of solar heat driven desiccant evaporative cooling systems. *Energy Procedia* 2016;91:832–43.
- [146] Eicker U, Schneider D, Schumacher J, Ge T, Dai Y. Operational experiences with solar air collector driven desiccant cooling systems. *Appl Energy*

- 2010;87:3735–47.
- [147] Ge TS, Ziegler F, Wang RZ, Wang H. Performance comparison between a solar driven rotary desiccant cooling system and conventional vapor compression system (performance study of desiccant cooling). *Appl Therm Eng* 2010;30:724–31.
- [148] Fong KF, Chow TT, Lee CK, Lin Z, Chan LS. Solar hybrid air-conditioning system for high temperature cooling in subtropical city. *Renew Energy* 2010;35:2439–51.
- [149] Jia CX, Dai YJ, Wu JY, Wang RZ. Use of compound desiccant to develop high performance desiccant cooling system. *Int J Refrig* 2007;30:345–53.
- [150] SolarInvent. Freescoo / SolarInvent S.r.l. - <<http://www.freescoo.com>>; n.d.
- [151] Finocchiaro P, Beccali M, Brano VL, Gentile V. Monitoring results and energy performances evaluation of freescoo solar DEC systems. *Energy Procedia* 2016;91:752–8.
- [152] Finocchiaro P, Beccali M, Calabrese A, Moreci E. Second generation of freescoo solar DEC prototypes for residential applications. *Energy Procedia* 2015;70:427–34.
- [153] Finocchiaro P, Beccali M, Gentile V. Experimental results on adsorption beds for air dehumidification. *Int J Refrig* 2016;63:100–12.
- [154] Goldsworthy M, White S. Optimisation of a desiccant cooling system design with indirect evaporative cooler. *Int J Refrig* 2011;34:148–58.
- [155] Wang HH, Ge TS, Zhang XL, Zhao Y. Experimental investigation on solar powered self-cooled cooling system based on solid desiccant coated heat exchanger. *Energy* 2016;96:176–86.
- [156] Kabeel AE. Solar powered air conditioning system using rotary honeycomb desiccant wheel. *Renew Energy* 2007;32:1842–57.
- [157] Ge TS, Dai YJ, Wang RZ, Li Y. Experimental investigation on a one-rotor two-stage rotary desiccant cooling system. *Energy* 2008;33:1807–15.
- [158] Ge TS, Li Y, Wang RZ, Dai YJ. Experimental study on a two-stage rotary desiccant cooling system. *Int J Refrig* 2009;32:498–508.
- [159] Alahmer A. Thermal analysis of a direct evaporative cooling system enhancement with desiccant dehumidification for vehicular air conditioning. *Appl Therm Eng* 2016;98:1273–85.
- [160] Munters. DesiCool air conditioning - product brochure. in: Munters, editor.n.d.
- [161] Elmer T, Worall M, Wu S, Riffat S. An experimental study of a novel integrated desiccant air conditioning system for building applications. *Energy Build* 2016;111:434–45.
- [162] Enteria N, Mizutani K. The role of the thermally activated desiccant cooling technologies in the issue of energy and environment. *Renew Sustain Energy Rev* 2011;15:2095–122.
- [163] Mujahid Rafique M, Gandhidasan P, Rehman S, Al-Hadhrami LM. A review on desiccant based evaporative cooling systems. *Renew Sustain Energy Rev* 2015;45:145–59.
- [164] Angrisani G, Minichiello F, Sasso M. Improvements of an unconventional desiccant air conditioning system based on experimental investigations. *Energy Convers Manag* 2016;112:423–34.
- [165] Sahlot M, Riffat SB. Desiccant cooling systems: a review. *Int J Low-Carbon Technol Build* 2017;139:665–79.
- [166] Daou K, Wang R, Xia Z. Desiccant cooling air conditioning: a review. *Renew Sustain Energy Rev* 2006;10:55–77.
- [167] RotorSource. RotorSource - <<https://www.rotorsource.com/>>; n.d.
- [168] ProFlute. ProFlute - <<http://www.proflute.se/>>; n.d.
- [169] DehuTech. DehuTech AB - <<http://dehutech.com/>>; n.d.
- [170] Munters. Munters - <<https://www.munters.com/>>; n.d.
- [171] Chen Z, Zhu J, Bai H. Performance assessment of a membrane liquid desiccant dehumidification cooling system based on experimental investigations. *Energy Build* 2017;139:665–79.
- [172] Chen Z, Zhu J, Bai H, Yan Y, Zhang L. Experimental study of a membrane-based dehumidification cooling system. *Appl Therm Eng* 2017;115:1315–21.
- [173] Abdel-Salam AH, Ge G, Simonson CJ. Thermo-economic performance of a solar membrane liquid desiccant air conditioning system. *Sol Energy* 2014;102:56–73.
- [174] Hellmann H-M, Grossman G. Simulation and analysis of an open-cycle dehumidifier-evaporator-regenerator (DER) absorption chiller for low-grade heat utilization. *Int J Refrig* 1995;18:177–89.
- [175] Crofoot L, Harrison S. Performance Evaluation of a Liquid Desiccant Solar Air Conditioning System. *Energy Procedia* 2012;30:542–50.
- [176] Gommed K, Grossman G. Experimental investigation of a liquid desiccant system for solar cooling and dehumidification. *Sol Energy* 2007;81:131–8.
- [177] Kozubal E, Woods J, Burch J, Boranian A, Merrigan T. Desiccant enhanced evaporative air-conditioning (DEVap): evaluation of a new concept in ultra efficient air conditioning. Colorado, US: National Renewable Energy Laboratory (NREL); 2011.
- [178] Zhang F, Yin Y, Zhang X. Performance analysis of a novel liquid desiccant evaporative cooling fresh air conditioning system with solution recirculation. *Build Environ* 2017;117:218–29.
- [179] Jain S, Tripathi S, Das RS. Experimental performance of a liquid desiccant dehumidification system under tropical climates. *Energy Convers Manag* 2011;52:2461–6.
- [180] Das RS, Jain S. Experimental investigations on a solar assisted liquid desiccant cooling system with indirect contact dehumidifier. *Sol Energy* 2017;153:289–300.
- [181] Buker MS, Mempoou B, Riffat SB. Experimental investigation of a building integrated photovoltaic/thermal roof collector combined with a liquid desiccant enhanced indirect evaporative cooling system. *Energy Convers Manag* 2015;101:239–54.
- [182] Shukla DL, Modi KV. A technical review on regeneration of liquid desiccant using solar energy. *Renew Sustain Energy Rev* 2017;78:517–29.
- [183] Abdel-Salam AH, Simonson CJ. State-of-the-art in liquid desiccant air conditioning equipment and systems. *Renew Sustain Energy Rev* 2016;58:1152–83.
- [184] Fazilati MA, Alemrajabi AA, Sedaghat A. Liquid desiccant air conditioning system with natural convection. *Appl Therm Eng* 2017;115:305–14.
- [185] Buker MS, Riffat SB. Recent developments in solar assisted liquid desiccant evaporative cooling technology—a review. *Energy Build* 2015;96:95–108.
- [186] Cheng Q, Zhang X. Review of solar regeneration methods for liquid desiccant air-conditioning system. *Energy Build* 2013;67:426–33.
- [187] McNevin C, Harrison SJ. Multi-stage liquid-desiccant air-conditioner: experimental performance and model development. *Build Environ* 2017;114:45–55.
- [188] Baniyounes AM, Liu G, Rasul MG, Khan MMK. Comparison study of solar cooling technologies for an institutional building in subtropical Queensland, Australia. *Renew Sustain Energy Rev* 2013;23:421–30.
- [189] Lof GOG. Cooling with solar energy. Congress on Solar Energy. Tucson, Arizona, USA; 1955.
- [190] Lowenstein A, Slayzak S, Kozubal E. A zero carryover liquid-desiccant air conditioner for solar applications. In: Proceedings of ISEC. 2006 ASME International Solar Energy Conference. Denver, CO, USA; 2006.
- [191] Cool innovation: an upstart hopes to make rival cooling companies sweat. *The Economist*; 2012. <<http://www.economist.com/node/21559655>> [Accessed December 13 2017].
- [192] Advantix announces exclusive Rep. agreement with Trane in Southeast. ACHR News: <<https://www.achrnews.com/articles/128003-advantix-announces-exclusive-rep-agreement-with-trane-in-southeast>> [Accessed December 13 2017]; 2014.
- [193] Brinkmann P. Growing Advantix Systems relocates HQ to Sunrise. South Florida Bus. J. <<https://www.bizjournals.com/southflorida/news/2012/08/02/growing-company-advantix-systems.html>> [Accessed December 13 2017]; 2012.
- [194] Advantix Systems' Dehumidification & Cooling System reduces energy consumption in schools by more than 40 percent. *Business Wire*: <<https://www.businesswire.com/news/home/20101109006478/en/Advantix-Systems%E2%80%99-Dehumidification-Cooling-System-Reduces-Energy>> [Accessed December 13 2017]; 2010.
- [195] Kathabar. Alfa Laval Kathabar - <<http://www.kathabar.com/>>; n.d.
- [196] Prieto A, Knaack U, Auer T, Klein T. Passive cooling & climate responsive facade design - exploring the limits of passive cooling strategies to improve the performance of commercial buildings in warm climates. *Energy Build* 2018;175:30–47. <https://doi.org/10.1016/j.enbuild.2018.06.016>.
- [197] Klein T. Integral facade construction: towards a new product architecture for curtain walls. TU Delft; 2013.