



WELCOME T-3

NEW PRODUCTS T-4

**BUILDERS TOOLS/
WOODWORKING T-5 – T-30**

- Wood Joining Jigs
- Wood Joining Accessories
- Precision Drill Guide
- Circle Cutters
- Countersinks
- Drill Bits
- Gages
- Digital Layout Tools
- Layout Tools
- Compasses
- Calipers
- Squares
- Trammels
- Moisture Meters

PLUMBING TOOLS T-31 – T-46

- Tubing Cutters
- Mini Tubing Cutters
- Cutting Tools
- Flaring Tools
- Bending Tools
- Reamers
- Deburring Tools
- Cleaning Brushes
- Wrenches
- Pliers
- Faucet Tools

MACHINIST TOOLS T-47 – T-70

- Center Punches
- Drive Pin Punches
- Scribers
- Dividers
- Tap Wrenches
- Measuring & Repair Tools
- Steel Rules
- Feeler Gages
- Gages
- Protractors
- Calipers
- Micrometers
- Dial Indicators
- Square Sets

SCREWDRIVERS T-71 – T-85

- Precision Screwdriver Sets:
 - Lighted
 - Slotted
 - Phillips
 - Torx®
 - Probe
 - ESD
 - Ball Hex
 - Nut Driver
- Power Screwdriver
- Multi-Blade Sets
- Offset Screwdrivers
- Precision Screwdrivers
- Pin Vises

SPECIALTY TOOLS T-86 – T-123

- Power Engraver
- Plumb Bobs
- Pin Vises
- Retrieving Tools
- Tweezers
- Holding Tools
- Calipers
- Micrometers
- Meters
- Magnifiers
- Inspection Mirrors
- Magnetic Retrieving Tools
- Sweepers
- Magnets
- Knives
- Cutting & Carving Tools
- Grommets, Fasteners
- Punches
- Pliers
- File Sets
- Probe Sets
- Voltage/Stud/Metal Detectors

**COUNTERTOP
DISPLAYS T-124 – T-127**

**TOOLS REFERENCES
AND INDEXES T-128 – T-136**

- Tools References
- Alphabetical Index
- Numerical Index



Joe Ennis



Greetings from the President

Looking forward...to serving you

Over the past decade, we've made a lot of changes at General to grow our business. Those initiatives continue to bear fruit. Last year, they contributed—once again—to the best year we've ever had, both in terms of new product launches and revenue generated.

At General, the quality of our tools and instruments is something we work hard to improve every day. As an example of initiatives bearing fruit, take a closer look at the housing of our newest instruments. On them you'll find many new compliance markings that represent the end result of many new QA and QC policies and procedures. You can feel more confident than ever that your new precision instrument from General meets or exceeds all industry-standard testing requirements.

Our QA/QC initiative has also yielded better instrument precision. This, in turn, has allowed us to add many more instruments to our NIST certification program. Our full-line catalog now reflects this important performance option by using the NIST logo to identify qualifying products. If your application requires testing that is traceable to a national standard, we can provide a turnkey solution with NIST compliance.

At General, we haven't forgotten that we're in business to satisfy your demand for new productivity tools and instruments. So it is with great pride that I announce our first full line of electrical instruments for the industry professional. On pages 124 to 143 of this catalog you'll find the features and specifications of many new clamp meters, multimeters, electrical testers and multi-component kits targeted to contractors and

MRO professionals. We've even provided comparison charts for the clamp meters and multimeters to help you choose. With rugged mechanical designs, state-of-the-art electronics, improved CAT ratings and unique features, these can be considered "best of breed" electrical instruments that offer the best value in the market.

"Best of breed" is a term that applies equally well to our high-performance and Seeker families of video inspection borescopes. In 2013, General added VGA resolution probes with anti-glare and light boost to our high-performance line. Last year also saw the introduction of what has become the fastest-growing product in company history: the iBorescope. We think video inspection—using the iBorescope—may prove to be a "killer app" for those millions of iOS and Android smartphones and tablets now taking the world by storm. But our first-generation iBorescope only scratches the surface of tasks that compact, WiFi-enabled scopes can perform more quickly and conveniently. Keep an eye out for even more exciting video inspection products soon.

At General, we value your data as much as we value having your business. Whether your data is a series of home inspection images, a video clip of a commercial drain system, on-site thermal images of a power plant, a week's worth of logged temperature/humidity points, or voice annotation of a water-damage restoration project, General Tools & Instruments gives you the wherewithal to make precision measurement and inspection your business as well.

Joe Ennis, President and CEO



880 E-Z Pro™
Crown King
Crown Molding Jig
See pages
T-6 - T-8



502
Lighted Cordless Power
Precision Screwdriver
See pages T-73 & T-75

70390 - 24"
& 70391 - 36"
Lighted Mechanical /
Magnetic Pick-Up
See page T-91

75108
8-in-1 Lighted
Precision
Screwdriver
See pages T-74 & T-75

Builder's Tools /Woodworking



**Wood Joining
Jigs**

**Wood Joining
Accessories**

**Drill
Accessories**

**Circle
Cutters**

Countersinks

Drill Bits

Gages

**Digital Layout
Tools**

Layout Tools

Compasses

Calipers

Squares

Trammels

Moisture

Meters

Here's Our **Crowning** **Achievement**

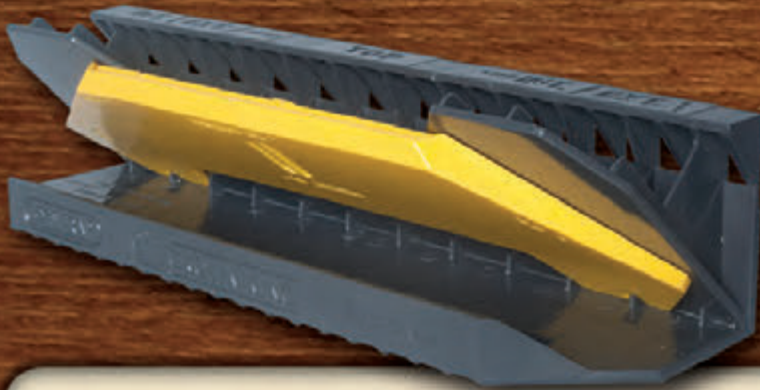

NEW E•Z Pro™ **Crown King**

helps you create seamless,
perfectly mitered interior
and exterior corner joints.

#880

Now you can make it yours!

Cutting crown molding has never been so easy. The **E•Z Pro™ Crown King** allows you to cut precise joining angles without tedious trial and error process, *right out of the box*. With just one base unit, an insert, and your miter saw, you can create interior and exterior joints for the three most common crown molding spring angles: 38°, 45°, and 52°. It doesn't matter if you're a professional or a DIYer, you should check out this new addition to General's E•Z Pro™ line. Whether it's for ceiling and wall corners, decorative elements for cabinetry and furniture, or enhancements for doors and windows, General's Crown King produces crown molding joints that are affordable, yet fit for a castle!

For more information on General's new Crown King and the rest of our line of E•Z Pro™ products, visit:
generaltools.com/ckmolding



General Tools & Instruments

Precision, Specialty & Innovation...since 1922



Meet the Joint Chiefs



**The E•Z Pro™
Mortise & Tenon Jig**
lets you make perfectly matched mortise & tenon joints with one jig.
#870

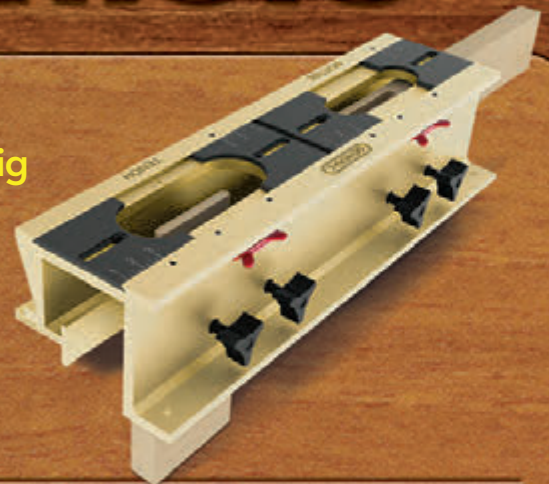

**The E•Z Pro™
Dovetail Jig**
lets you make dovetail and box joints – through or half-blind.
#861

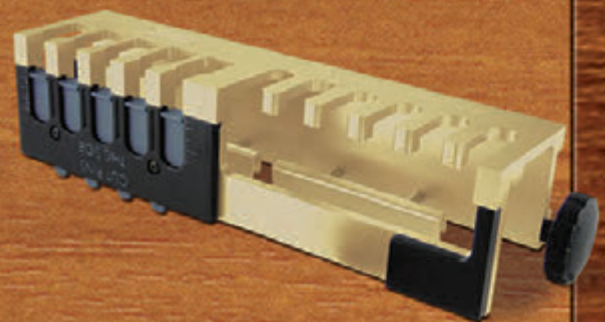

**The E•Z Pro™
Pocket Hole Jig**
has everything you need to make flush, corner and angle pocket hole joints.
#850



**The E•Z Pro™
Doweling Jig**
lets you make perfectly aligned dowel joints every time.
#851





E-Z Pro



CROWN KING

A Cutting Guide for Crown Moldings

**Professionally Cut
Crown Molding Joints...
Easily and Precisely.
Cut perfectly mitered interior
and exterior corner joints –
Right Out of the Box!**



**45° Spring Angle
Crown Molding Jig with
Adapter for 52° and 38° Spring Angles**

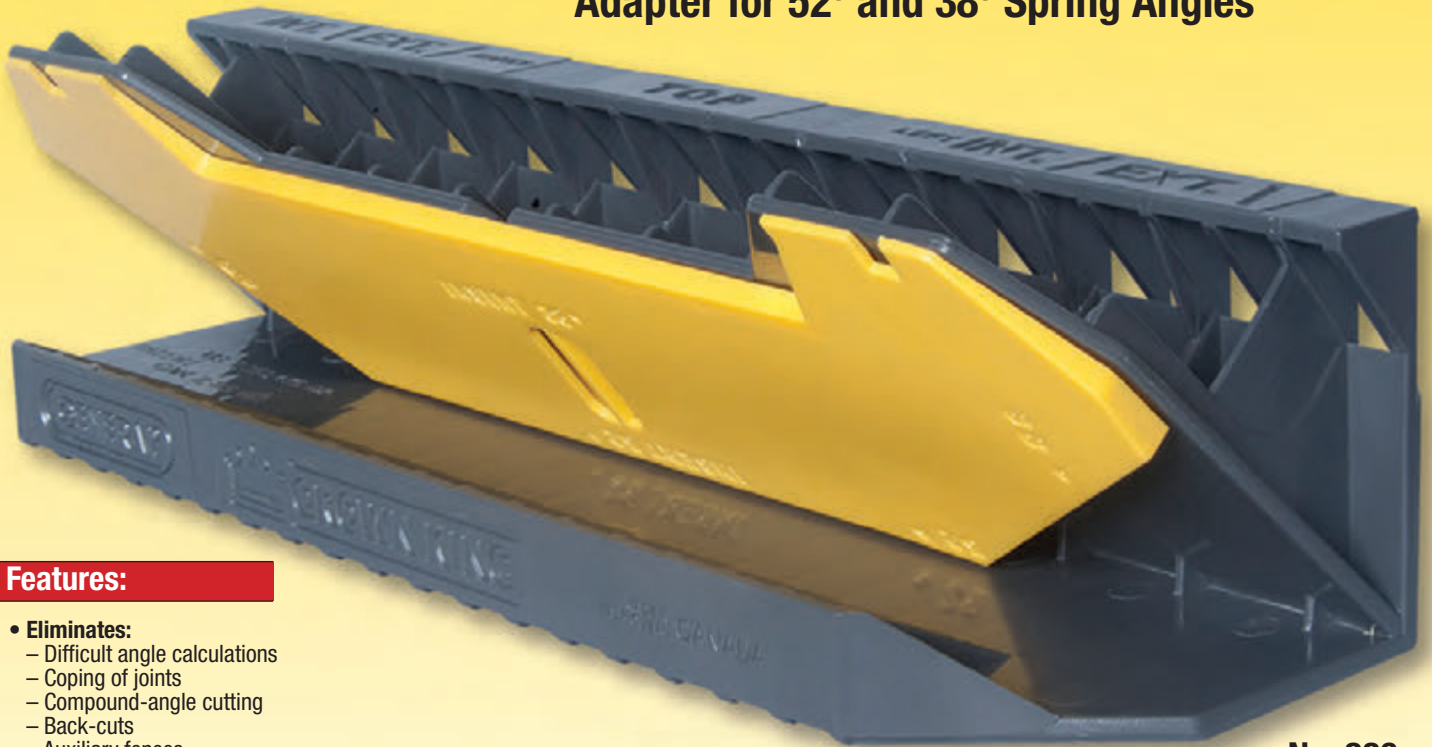

No. 880

Features:

- **Eliminates:**
 - Difficult angle calculations
 - Coping of joints
 - Compound-angle cutting
 - Back-cuts
 - Auxiliary fences
 - Confusing upside-down
 - Miter box positioning

UPC	NO.
00880 0	880



Create perfectly fitting interior crown molding joints



Create perfectly fitting exterior crown molding joints



General's Wood Joining Program features all the necessary pieces for... Wood Joining! Included in this program are: fluted dowel pins, screw hole plugs, Shaker pegs, biscuits and pocket hole accessories. These wood items can be

painted or stained and used in the creation of furniture, cabinets, trim, crafts and much more. Also, included in this program are wood joining jigs, screws and drills.

WOODWORKING



"Precision, Specialty and Innovation . . . Since 1922"



Pocket Hole Jigs

E•Z Pro™

“The Easy Way to Make Professional Furniture Joints”

THE DOVETAILER II

DOVETAIL JIG



With the E•Z Pro™ Dovetailer II and your router, you can cut Professional Dovetail Joints, Simply and Accurately... Right Out Of The Box!

- Self-aligning design ensures that both ends of the dovetail joint match-up evenly every time
- Sturdy machined one piece aluminum construction
- Easily adjusts the dovetail interference to create loose or tight joints
- Portable to your worksite or home workshop
- Use with hand or table router
- New table router control knobs assure safe, comfortable and accurate use
- No need to bolt the jig onto workbench like many expensive dovetail jigs
- Integrated clamps allow precise clamping of jig to work piece
- Accommodates boards of any widths
- Length: 12"; Width: 3"; Height: 3"; Weight: 2-lbs. 1.1oz.



Cuts Half-Blind Joints



Cuts Through Joints



Includes: 1/2" Dovetail Router bit, User's Manual

UPC	NO.
02124 3	861



NEW COLOR SHOWN



Woodworking Made Easy!

No. 861
Patent No. 7828024



Pocket Hole Jigs

General Tools offers one of the best assortments of wood joining jigs available, including our new Mortise and Tenon Jig, The Dovetailer II Jig, and the award-winning Pocket Hole Jig and Joiner Clamp Kits. These heavy-duty

woodworking tools are ideal for furniture building, cabinetry making and other professional carpentry projects. In addition, we offer plenty of wood joining accessories such as screws, plugs and drill bits.



WOODWORKING

E•Z Pro™

MORTISE & TENON JIG

- Create professional matching Mortise & Tenon Joints Right Out of the Box
- The first of its kind, all-in-one precision machined Mortise & Tenon Jig
- Produce 1/4", 3/8" and 1/2" Mortise and Tenons
- Includes: 1/4" high-speed steel spiral upcut router bit and User's Manual



The Mortise & Tenon joint has been used for thousands of years. Not until now has someone figured out how to provide a fast and straightforward all-in-one solution for cutting both a matching mortise & tenon with a single affordable jig. General's E•Z Pro™ Mortise & Tenon Jig is ready to use right out-of-the-box to produce the widely used 1/4" mortise and tenon joint. Using a plunge router with the jig, woodworkers of all levels can quickly and easily cut both mortises and tenons ranging from 1/4" to 1/2" thick, and from 1" to 3" wide. Without difficulty, this unit can easily handle wood stock ranging from 1/2" to 1-1/2" thick and can cut multiple mortises in a single long piece.

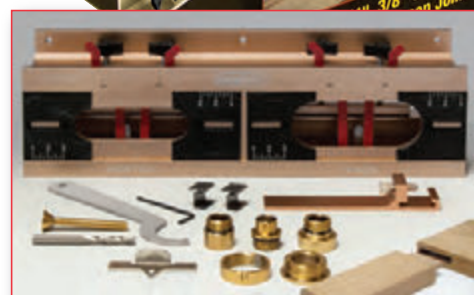
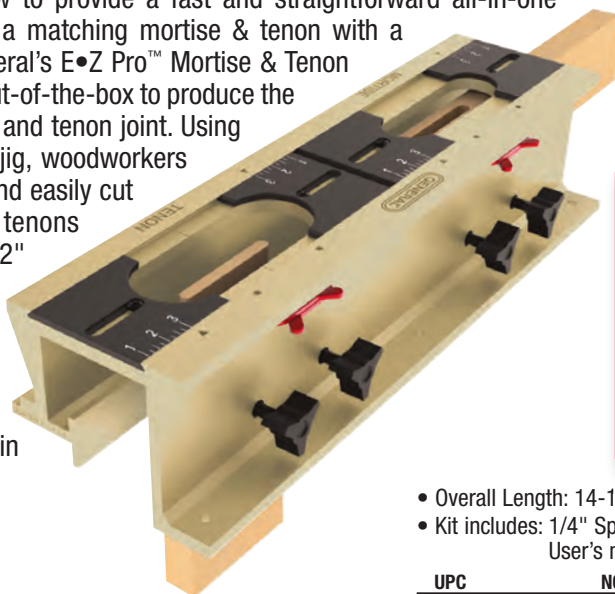

- Overall Length: 14-1/2" Width: 4-1/2" Height: 4" Weight: 2-1/2 lbs
- Kit includes: 1/4" Spiral upcut router bit, Bushing kit, Wrench, User's manual

No. 870

Patent #8,016,005

UPC
26008 3

NO.
870



Woodworking Made Easy!

"Precision, Specialty and Innovation . . . Since 1922"

E-Z Pro Woodworking

For the Professional and the Do-It-Yourselfer



No. 850

E-Z Pro

Deluxe Pocket Hole Jig Kit

Award Winning Ingenuity!

850 KIT INCLUDES:

- 1 Pocket Hole Jig with Clamps; 3/8" Step Drill Bit; 1-3/8" Drill Stop and Hex Wrench; 6" Steel Square Drive Bit; 25 Course Square Drive Screws; 25 Fine Square Drive Screws; 25 Wooden Pocket Hole Plugs, Instructions and Hard, Molded Carrying Case

849 KIT INCLUDES:

- 1 Pocket Hole Jig with Clamps; 3/8" Step Drill Bit; 1 3/8" Drill Stop and Hex Wrench; 6" Steel Square Drive Bit; Square Drive Screws, Instructions

SMART DESIGN

- Heavy-duty aluminum extrusion & hardened steel drill bushings
- Built to be portable or bench mounted, and designed with a built-in clamping system

THREE TYPES OF POCKET HOLE JOINTS

- Flush, Corner & Angle

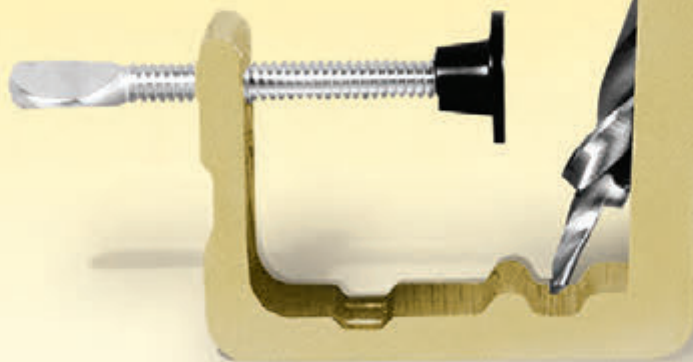

Patent No. 6,254,320

NEW COLOR SHOWN



No. 849



Photos property of
Woodworker's Journal



For more information visit
www.generaltools.com/joiningtools



Pocket Hole Jigs



Pocket hole joints are sturdy and simple to make with a drilling jig. By drilling steeply pitched counter bores in one joint member, you can drive self-

tapping screws into the other without pilot holes. Ideal for leg and rail connections and face frame cabinet construction.

E•Z Pro™ POCKET HOLE JIG KITS

- Ideal for leg-and-rail connections, cabinet construction, sneaking screws into tight-squeeze spots or fastening picture frame miters
- Heavy-duty aluminum extrusion and hardened steel bushings
- By drilling steeply pitched counterbores in one joint member, you can drive self-tapping screws into the other joint member without pilot holes
- Built to be portable or bench mounted

- **850 Kit includes:** 1 Pocket Hole Jig with Clamp; 3/8" Step Drill Bit; 1-3/8" Drill Stop and Hex Wrench; 6" Steel Square Drive Bit; 25 Course Square Drive Screws; 25 Fine Square Drive Screws; 25 Wooden Pocket Hole Plugs, Instructions and Hard, Molded Carrying Case

UPC	NO.	
708200000515	849	E•Z Pro Pocket Hole Jig Kit
00850 0	850	E•Z Pro Deluxe Pocket Hole Jig Kit



849 - Patented

- **849 Kit includes:** 1 Pocket Hole Jig with Clamp; 3/8" Step Drill Bit; 1-3/8" Drill Stop and Hex Wrench; 6" Steel Square Drive Bit; Square Drive Screws; Instructions



The mark of responsible forestry



850

POCKET HOLE JIG ACCESSORIES

E•Z™ STEP DRILL BIT

UPC	NO.
70820000052 2	32

SQUARE DRIVE BITS

UPC	NO.	DESCRIPTION
02122 9	8492	2-#2 Square Drive Bits 3" and 6" long

POCKET HOLE PLUGS

UPC	NO.	DESCRIPTION	QTY.
02123 6	8495	Pocket Hole Plugs, Hardwood	50

POCKET HOLE SCREWS

UPC	NO.	THREAD	QTY.
08497 2	8497	Coarse	100
08498 9	8498	Fine	100



32



8492



8495



The mark of responsible forestry



100 COUNT

No. 8497 shown
actual size of 1-1/4"

8497



8495

50 COUNT

BUILDER'S TOOLS/WOODWORKING

Pocket Hole Accessories



Pocket-hole joinery or pocket-screw joinery is one of the best methods for joining two pieces of wood to ever come down the pike. Fixing a squeaky chair, or a wiggly table, is as easy as adding a few pocket holes

and screws to pull the separating pieces together. General's Pocket Hole Screws No. 8497 and 8498 are used specifically for this purpose and are offered in both fine and coarse thread.

WOODWORKING



8497
8498

8497 shown



No. 8497 shown
actual size of 1-1/4"



POCKET HOLE SCREWS

- Self-tapping
- Use a coarse thread screw in soft material (8497)
- Use a fine thread screw in hardwoods (8498)
- Nickel-plated
- Phillips square drive pan head
- Size: 1-1/4"

UPC	NO.	DESCRIPTION	QTY.
08497 2	8497	Coarse Screws	100
08498 9	8498	Fine Screws	100



8495

POCKET HOLE PLUGS

Pocket Holes are often hidden from sight on the back surface of a face frame, under a table top, or on the back of picture frame. What do you do about unattractive pocket holes that will be visible on a finished product? The answer. Pocket hole plugs! These wood plugs, made from 100% hardwood, can make the pocket holes beautifully disappear.

UPC	NO.	DESCRIPTION	QTY.
02123 6	8495	Pocket Hole Plugs, Hardwood	50



The mark of responsible forestry



32



E•Z™ PRO STEP DRILL BIT

The E-Z Step Drill Bit is great for creating pocket hole joints or counter boring. The 3/8" bit is made of high speed steel and includes a drill stop and hex wrench for accurate setting of drill depth. This item can also be used as a replacement bit for General's Pocket Hole Jig Kit (#849) and Deluxe Pocket Hole Jig Kit (#850).

- Replacement bit for General's E•Z Pocket Hole Jig Kit (No. 849)

- 3/8" x 6" (9.5 x 152mm) step drill bit
- High speed steel
- Ideal for creating pocket hole joints and counter-boring
- Includes 3/8" (9.5mm) steel drill stop with hex wrench

UPC	NO.
7082000052 2	32



Pocket Hole & Drill Accessories



General's Drill Accessories are engineered to do precision work in the many specialized drilling and cutting operations required for fine carpentry and metal working.

They expand the capabilities of portable electric drills, drill presses, drill stands, bit braces and hand drills. Our Drill Accessories are built for precision and durability.

SQUARE DRIVE BITS

For use with General's Pocket Hole Screws. These drive bits are essential for building decks, benches, tables and other woodworking projects. General's Square Drive Bits have a hardened steel tip that assures perfect fit and lasts longer.

- #2 Square drive bits
- 3" (76mm) length
- 6" (152mm) length
- Use with deck screws

UPC	NO.	DESCRIPTION
02122 9	8492	2-#2 Square Drive Bits 3" and 6" long

8492



WOODWORKING

PLUG CUTTERS

Whether you're building cabinets, toys, decks, furniture or railings, wooden plugs are a neat way to cover up the screw heads. Made from hardened alloy steel, General's Plug Cutters will cut a 3/8-inch plug from any wood stock and eject it, whether it's chucked in a press or hand-held drill. This is a great economical bit, perfect for homeowners.

- General's Plug Cutters produce accurate plugs for covering screw holes in decking, flooring and other woodworking projects
- Permits choice of matching or contrasting plugs for decorative effect
- Engineered to start cutting plugs easily with hand-held drills or drill press

- Cutter will produce and eject straight plugs from stock up to 3/4" thickness
- Made of hardened alloy steel

• Individual sizes:

UPC	NO.	SHANK	DIA.
23024 9	31A	3/8"	3/8" dia.
23030 0	31B	3/8"	1/2" dia.
23033 1	31C	3/8"	5/8" dia.

• Set of 3 Diameters - 1/4", 3/8", 1/2":

UPC	NO.	SHANK
23036 2	S31	3/8"



31A

31B

31C

ADJUSTABLE PILOT BITS

Drill, countersink and counter-bore precision screw holes in a single operation with General's Adjustable Pilot Bit Set. Featuring four high-speed bits with adjustable lengths, this set can be a great time saver for fine carpentry and woodworking. The 1/4" hex shank allows the set to be used in both electric drills and power screwdrivers.

- Drill, countersink and counterbore precision screw holes in a single operation when doing fine carpentry and woodworking

- Hardened high-speed pilot bits give long life
- Black oxide finish deters rust
- 1/4" hex shanks prevents slippage in electric drills and can be used in power screwdrivers
- Adjustable drill and high performance angle on countersink

UPC	NO.	SCREW SIZES
23041 6	34ST	Set of 4 Pilot Bits 6 - 7 (3/32") 8 - 9 (7/64") 10 - 11 (1/8") 12 - 14 (9/64")

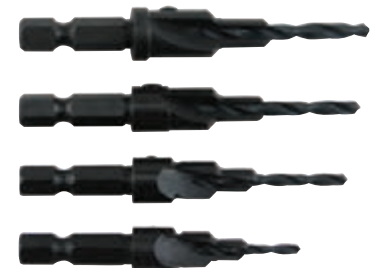

34ST



Dowling Kits and Accessories

Our E•Z Pro Doweling Kit includes everything you need to make beautiful wood joints like a pro! This heavy-duty aluminum jig simplifies the doweling process, allowing you to create Edge-to-Edge,

Right Angle and Edge-to-Surface joints with little effort. No. 8401 Dowel Accessory Kit can be used with both the No. 840 and No. 841 Doweling Jigs.

WOODWORKING



E•Z Pro™ DOWELING JIG KIT

- Dowels add mechanical strength to butt joints and keep miters lined up during clamping
- The pointed notches on the working edges of our jig centers the drill bit automatically for precise registration
- Create 3 types of dowel joints: Edge to edge, right angle, edge to surface, as well as 3 sizes of dowel joints; 1/4", 5/16" and 3/8"

- Ideal for 5/8", 3/4" and 1" thick stock
- **Kit includes:** 1 Dowel Jig; 3 Brad Point Drill Bits; 1/4", 5/16", 3/8"; 3 steel stops 1/4", 5/16" and 3/8" with Hex Wrench, 6 Dowel Center Points; 2 each of 1/4", 5/16" 3/8", supply of wood dowels, Instructions

UPC	NO.
708200000317	841 E•Z Pro Doweling Jig Kit



841



Patent No. 7,001,118



Photos property of Woodworker's Journal



851

DELUXE DOWELING JIG KIT

This new addition to General's E•Z Pro Line of Precision Wood Joining Jigs, the **Deluxe Doweling Jig Kit** allows users to produce three types of strong, precision dowel joints in three sizes (1/4 in., 5/16 in. and 3/8 in.) with little effort. Whether creating edge-to-edge, right angle corner or right angle edge-to-surface dowel joints, the heavy duty aluminum jig effectively simplifies the process and is anodized in a gold color to impede corrosion. The pointed notches on the working edges of the jig center the drill bit automatically for precise registration. The included wood dowels add mechanical strength to butt joints and keep miters lined up during clamping.

- **Kit includes:** 1 Dowel Jig; 3 Brad Point Drill Bits (1/4 in., 5/16 in. and 3/8 in. diameter); 3 Steel Stop Collars (1/4 in., 5/16 in. and 3/8 in. diameter) with Hex Wrench; 3 Bushings (1/4 in., 5/16 in. and 3/8 in. diameter); 6 Dowel Center Points (2 each of 1/4 in., 5/16 in. and 3/8 in. diameter); 3 sets of 1-1/2 in. long Wood Dowels (24 each of 1/4 in., 5/16 in. and 3/8 in. diameter); Wood Glue; Instructions

UPC	NO.
08401 9	851



841516



8401

DOWEL ACCESSORY KITS

- **8401 Kit** includes: 3 Drill Bits - 1/4", 5/16", 3/8"; 3 Drill Stop Collars, 6 Dowel Centers, 10 ea. Fluted Dowel Pins 1/4", 5/16", 3/8"
- Replacement bit for General's E•Z Pocket Hole Jig Kit (No. 849)
- Accessories Kit for General's Pro Doweling Kit (No. 840) and E•Z Dowel Kit (No. 841)
- **841014 Kit** includes: 12-1/4" Dowel Pins, 1-1/4" Brad Point Drill Bit, 1-1/4" Drill Stop Collar, 2-1/4" Dowel Centers, 1 Hex Key
- **841516 Kit** includes: 12-5/16" Dowel Pins, 1-5/16" Brad Point Drill Bit, 1-5/16" Drill Stop Collar, 2- 5/16" Dowel Centers, 1 Hex Key
- **841038 Kit** includes: 10-3/8" dowel Pins, 1-3/8" Brad Point Drill Bit, 1-3/8" Drill Stop Collar, 2-3/8" Dowel Centers, 1 Hex Key

UPC	NO.	
08401 9	8401	Dowel Accessory Kit
02119 6	841014	1/4" Dowel Accessory Kit
02120 2	841516	5/16" Dowel Accessory Kit
02121 9	841038	3/8" Dowel Accessory Kit





BUILDER'S TOOLS/WOODWORKING

Pro-Dowling Kit



General's Pro Doweling Jig is a precision jig that assures the accurate line-up of dowel holes in furniture and carpentry. Simply clamp the jig onto

your workpiece to quickly and accurately drill holes for dowel pins requiring exact alignment in the edge, end or surface of your work.

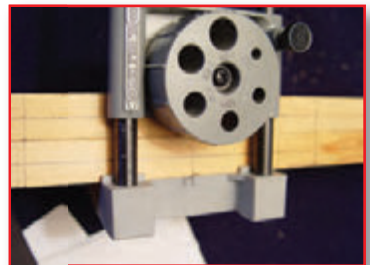
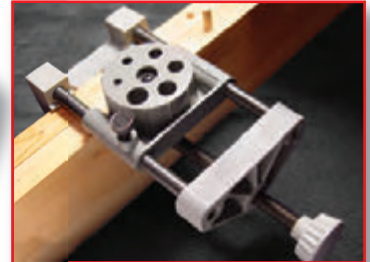
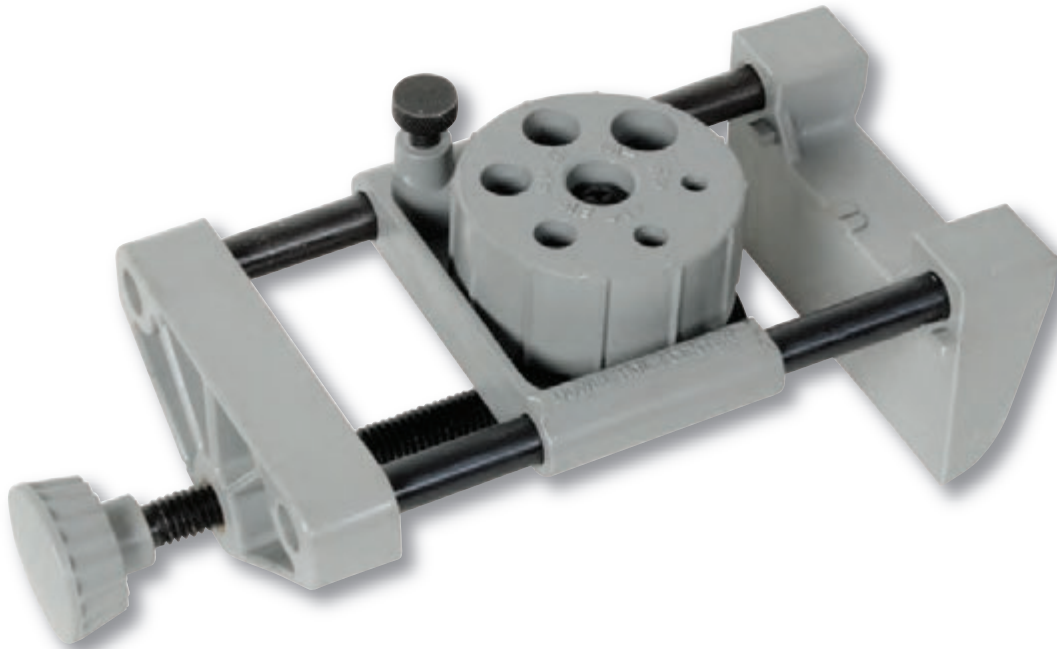

WOODWORKING

For clean joints that need to be strong and fastener-free, there's almost no substitute for the dowel joint. However, if dowel holes are even slightly askew, the dowels won't mesh rendering the joint unusable. General's E•Z Pro Doweling Jig offers a simple, versatile way to produce precision edge-to-edge, right angle, or edge-to-surface joints. The Kit features three size dowels (1/4", 5/16" and 3/8"), and the jig has three different drilling positions designed for stock of 5/8", 3/4" and 1" thick. Steel stops allow you to vary the depth of the cut. Perfect for joints that will be press fit or glued.



PRO-DOWELING KIT

- A precision jig that assures accurate line up of dowel holes in furniture and carpentry
- Revolving hardened sintered turret has six twist drill sizes
- Instructions included
- Drill sizes: 3/16", 1/4", 5/16", 3/8", 7/16", 1/2"
- **Package Contents:**
 - 1 Doweling Jig;
 - 3 Brad Point Drill Bits, 1/4", 5/16", 3/8";
 - Dowel and Tenon Centers Set from 3/16" ID to 1/2" OD;
 - 3 Drill Stops, 1/4", 5/16", 3/8";
 - 30 Dowel Pins, 10 each 1/4", 5/16", 3/8"

UPC	NO.
24120 7	840



Wood Pins & Plugs

As an FSC (Forest Stewardship Council), certified company, General's Wood Joining Program includes wood based products that are manufactured in accordance with FSC standards. The FSC is an independent, non-

governmental, not-for-profit organization established to promote the responsible management of the world's forests and is nationally represented in more than 50 countries around the world.

WOODWORKING



840014
840516
840038
840012

840014 shown

FLUTED DOWEL PINS

A fluted dowel pin has a series of parallel grooves cut along its length providing channels through which excess glue—that is used to secure the dowel pin in its hole—can escape as the dowel is inserted. This relieves the hydraulic pressure that might otherwise split timber when mating pieces are clamped together. General's fluted dowels are ideal for creating strong and secure joints in furniture, cabinets, trim and special woodworking projects.



- Made of straight-grained solid hardwood
- Expands when used with water-based glue for extra tight join
- Fluted for easy insertion

UPC	NO.	DESCRIPTION	QTY.
02101 4	840014	1/4" Fluted Dowel Pins	72
02102 1	840516	5/16" Fluted Dowel Pins	50
02103 8	840038	3/8" Fluted Dowel Pins	35
02104 5	840012	1/2" Fluted Dowel Pins	20



313038
313012
315516
315038
315012

313038 shown

FLAT HEAD PLUGS

- Premium Flat Head Screw hole Plugs have a tapered tenon to insure a tight fit
- Designed to form a flush finish in furniture and other woodworking applications
- Paint or stain for a perfect wood-color match or for accentuated contrast



UPC	NO.	DESCRIPTION	QTY.
02109 0	313038	3/8" Flat Head Plugs, Oak	50
02110 6	313012	1/2" Flat Head Plugs, Oak	50
02113 7	315516	5/16" Flat Head Plugs, Hardwood	50
02114 4	315038	3/8" Flat Head Plugs, Hardwood	50
02115 1	315012	1/2" Flat Head Plugs, Hardwood	40



311038
311012
312038
312012

311038 shown

BUTTON HEAD PLUGS

Button Head plugs are ideal for filling in those unsightly screw holes and can be installed easily with wood glue. Button Head plugs can be used for a variety of craft, woodworking and furniture projects.

- When fully-seated, the domed, button head protrudes above the wood surface and over the screw hole edge adding a more decorative look
- Slightly tapered plug body ensures a tight secure fit

- Wood grain runs in the direction of the plug width for best match
- Paint or stain for a perfect wood-color match or for accentuated contrast

UPC	NO.	DESCRIPTION	QTY.
02105 2	311038	3/8" Button Plugs, Oak	50
02106 9	311012	1/2" Button Plugs, Oak	50
02107 6	312038	3/8" Button Plugs, Hardwood	50
02108 3	312012	1/2" Button Plugs, Hardwood	50





BUILDER'S TOOLS/WOODWORKING

Wood Plugs, Pegs & Biscuits



The important characteristics of wood joints are strength, flexibility, toughness and appearance. Both exterior and interior temperature changes can cause major shifts in the moisture content of wood and can

compromise the strength and longevity of a joint. General's wood based joining products have been developed to provide strong joints that adjust to every day environmental changes.

ROUND HEAD PLUGS

- Premium Round Head Screw hole Plugs with tapered tenon to insure tight fit
- Designed to form a slightly raised round finish in woodworking applications
- Paint or stain for a perfect wood-color match or for accentuated contrast

UPC	NO.	DESCRIPTION	QTY.
02112 0	314038	3/8" Round Head Plugs, Oak	50
02116 8	316038	3/8" Round Head Plugs, Hardwood	50
02117 5	316012	1/2" Round Head Plugs, Hardwood	40



314038
316038
316012

314038 shown



The mark of responsible forestry

WOODWORKING

SHAKER PEGS

Made from solid hardwood, General's Classic Shaker pegs can be useful throughout the entire house. Install them in the foyer or mud-room, kitchen, bathroom, child's room etc. Hang your favorite coffee mugs, towels, hats, neck ties, toys and even herbs!

- Create customized pegboards to better organize your work and living spaces
- Use General's Shaker pegs to replace damaged pegs in your pegboards
- Paint or stain for a perfect wood-color match or for accentuated contrast

UPC	NO.	DESCRIPTION	QTY.
02118 2	317000	Shaker Pegs	2

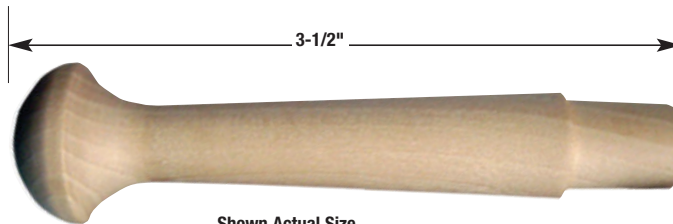

Shown Actual Size



317000



The mark of responsible forestry

BISCUITS

Wood Biscuits, sometimes referred to as Wood Plates or Wafers, are used for edge or corner-jointing. When General's biscuits come into contact with water based glue they swell, thus creating a locked joint for a strong secure fit.

- Used for Wood Joinery with Biscuit Joiners
- Great for furniture, cabinets and trim
- Biscuits soak up water-based glue for a tighter wood joint

UPC	NO.	DESCRIPTION	QTY.
02134 2	318000	Size #0	50
02135 9	318010	Size #10	50
02136 6	318020	Size #20	50
02133 5	318050	Size FF	50



318000



The mark of responsible forestry



Jointer Clamp

General's E-Z Pro™ Jointer Clamp Kit is the alternative to expensive jointers. Now, you can straight-line rip crooked boards using your table saw! Just attach your crooked board to a piece of straight stock using the Jointer Clamps

and run the stock along the rip fence to rip the crooked board. Works in two easy passes. Great for use with long stock. Patented swing arm design allows you to accurately rip wide boards with ease.

WOODWORKING



888

DOWEL CENTERS

- General's dowel centers are the quickest and most accurate method to locate, transfer and match dowel holes
- Made of nickel plated steel

- **Set includes:** 8 pcs., two of each size: 1/4", 5/16", 3/8", 1/2" diameter

UPC	NO.	
25099 5	888	Dowel centers



S838

DRILL STOP SET

- For use on twist or brad point drills to prevent excessive drill penetration
- Positive depth control assures exact hole depths for multiple drilling jobs
- Black oxide finish on cold rolled steel

- Includes hex wrench

UPC	NO.	SIZES INCLUDED
23096 6	S838	3/16" dia., 1/4" dia., 5/16" dia., 3/8" dia., 7/16" dia., 1/2" dia.



NEW COLOR SHOWN

846

E-Z Pro™ TRU-EDGER JOINTER CLAMP

- The long awaited alternative to expensive jointers!
- Straight line rip crooked boards on your table saw
- Just mount the clamps to a guide board to create a flat reference edge
- The guide board can be made from any straight edged scrap
- Clamp the stock to the guide board and make your rip cut
- Get a dead-flat edge every time, with no extra waste
- The jointer clamps work on any length stock up to 2" thick
- Instructions included

UPC	NO.	CAPACITY
708200000010	846	2" stock



NEW COLOR SHOWN



New Swing Arm

NEW COLOR SHOWN



Photos property of Woodworker's Journal

Patent No. 7,000,519



General has a full range of specialized digital tools designed for measurement operations necessary in construction jobs, cabinet making and fine

carpentry. Woodworkers trust the quality, accuracy and value that General Tools gives them.



DIGITAL SLIDING T-BEVEL

- 2 Tools in 1 - Digital Sliding T-Bevel and Protractor
- Large digital angle readout
- Holds measurement for transfers
- Reverse Display button, Flip Display button, Locking Knob for manual measurement transfer
- 4 function control buttons
- Auto Shut-off feature
- 8" Stainless Steel blade
- Impact resistant ABS handle
- Full LCD Display

- Measures and transfers angles
- Range: 0-360°
- Resolution: 0.05°
- Accuracy: $\pm 0.3^\circ$
- Power Source: 1 "CR2032" 3V Lithium-ion battery (included)

UPC	NO.
08280 7	828

THE 1st OF ITS KIND!

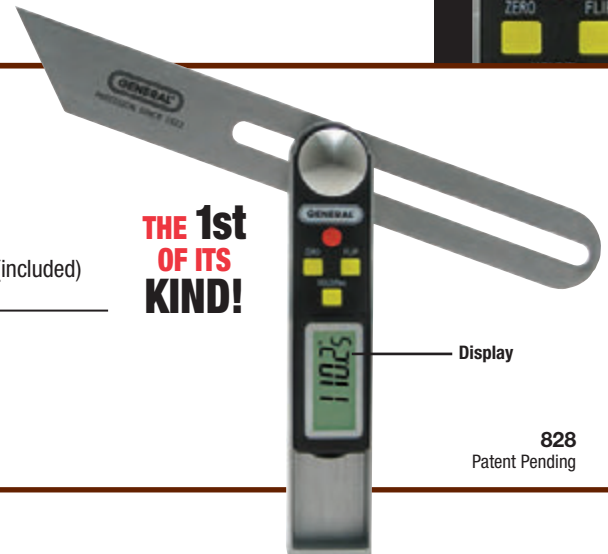

Display

828 Patent Pending



DIGITAL PRECISION PROTRACTOR

The Digital Protractor displays absolute and relative angle measurements in a large, easy-to-read LCD window

- Installing crown molding, cabinetry, counters, staircases, roofs, windows or flooring
- Takes the guesswork out of measuring, marking, reading and transferring angles
- 6" (150mm) stainless steel protractor arm with knurled locking nut
- Large, easy-to-read display
- Absolute and relative measurements

- Accuracy: $\pm 0.1^\circ$
- Resolution: 0.05°
- Range: 0 to 180°
- Display can be inverted for easy reading
- Measurement hold function
- Power Source: 1 "CR2032" 3V Lithium-ion battery (included)

UPC	NO.
26008 6	1702



1702 Patented



5" AND 10" DIGITAL ANGLE FINDER RULES

- Digital stainless steel angle rules make precise measurements for easy woodworking
- Calculates interior (inside) and exterior (outside) angles easily and accurately in seconds
- Lock and reverse angle features for all types of work
- Large easy to read LCD display
- Hinge mechanism allows a full 360 degrees to measure inside/outside and reverse angles
- Can be zeroed at any point in the swing
- Leg Dimension of 822: 7" (L) x 1-3/8" (W); 6/8"
- Leg Dimension of 823: 10-7/8" (L) x 1-3/8" (W)
- Height of 822/823: 3/4"
- Accuracy: $\pm 0.3^\circ$
- Resolution: 0.1°
- Range: 0 to 360°
- Power Source: 1 "CR2032" 3V Lithium-ion battery (included)

UPC	No.	Description
00822 7	822	5" Digital Angle Finder
00823 4	823	10" Digital Angle Finder



822 Patented

823 Patented

WOODWORKING

Layout Tools

General's Contour Gages can duplicate any shape. The pins on our gage slide to conform to irregular surfaces. This tool can be used for pattern and mold making, duplicating parts and contours.

Great for fitting carpet, floor tiles and linoleum against door casings and pipes. The **ANGLE-IZER™** can replace the need for making templates and can be used again and again. **The Ultimate Template Tool.**

WOODWORKING



833



10" CONTOUR GAGE

- Extra length is ideal for woodworking, linoleum installation, ceramic tile installation or any job where contour duplication is essential
- Gage will fit profiles up to 10" long
- Inch/mm graduations on body
- 3" (76mm) deep fingers will measure profiles up to 1-1/4" (32mm)
- Made from tough, durable plastic

UPC	NO.
08330 2	833



837



6" CONTOUR GAGE

- Ideal for woodworking, linoleum installation, or any job or hobby where contour duplication is essential
- Inch graduation on body
- Stainless steel pins
- Component parts are enamel painted and brass plated
- Size is 6" x 3-1/2" (152 x 89mm) with an overall travel of 5-1/4" (133mm)

UPC	NO.
24116 0	837



836

THE ANGLE-IZER™

- The unique and versatile **ANGLE-IZER™**, the Ultimate Template Tool eliminates the need for making templates and can be used again and again
- The **ANGLE-IZER™** can be set-up in seconds not only improving quality but saving time
- Just form the tool into the shape of your work area, then use it to mark your work-piece to be cut
- Repeat accurate marking for creating bulls eyes, arches, repetitive angles or shapes

- Tool can be set to mark bricks, tiles, lumber and laminates
- All the arms are dual-calibrated in inches and metric measures
- Unique tightening mechanism for one-handed operations
- Fiberglass filled nylon for added strength and flexibility
- Includes FREE instructional **ANGLE-IZER™** CD program

UPC	NO.
08360 9	836



REPETITIVE MARKING



MARKING LUMBER



ANGLES FOR PAVER BRICKS

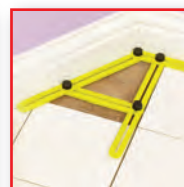

TILING



SPACING AND GAUGING

Patent No. Des. 402,217



General's Compasses and Layout Tools are designed for the specialized operations of measuring and layout necessary in construction

jobs, cabinet-making and fine carpentry. Woodworkers trust the quality and the value that General Tools provides.

OUTSIDE, INSIDE & SLOPED ANGLE PROTRACTOR

- Use this protractor/angle finder to measure and mark the degrees of an angle on outside, inside and sloped angles
- Fine black graduations from 0° to 165° in opposite directions
- Brass lock nut

UPC	NO.
22148 3	29

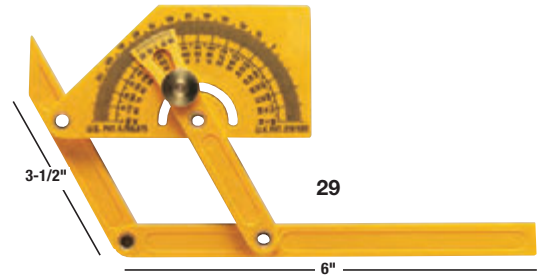

WOODWORKING

PROFESSIONAL QUALITY T-BEVEL

- Our T-bevel is the tool preferred by the craftsman who wants the finest quality tools
- Solid mahogany 5-1/2" (140mm) handle with brass trim and locking wing nut
- 10" (254mm) blade
- Conforms to government specifications GGG-B-211b

UPC	NO.
24100 9	829



PENCIL COMPASS AND SCRIBER

- Accepts and holds standard pens and pencils
- Designed for marking contours and circles
- Positive wing nut adjustment
- Full-length hardened steel pin in metal frame for greater rigidity
- Constructed of brass plated steel

UPC	NO.	CAPACITY
24132 0	843/1	8" (203mm)



PRECISION PENCIL COMPASS

- Carpenter quality compass is made of long lasting die-cast rust proof metal
- Spring tension adjustment for marking up to 9" (229mm) diameters
- Scribe guide for edge marking
- For use with pencil (included) or slim ballpoint pen

UPC	NO.	CAPACITY
24126 9	842	9" (229mm)



Precision Drill Guide

The AccuDrill Precision Drill Guide adds a whole new level of accuracy to your standard power drill. The AccuDrill is great for angle drilling, doweling, plug cutting and even edge sanding. With the easy-to-use protractor scale, you can

adjust the Drill Guide in five degree increments from 0-45°, left and right. In addition, V-Guides on the base permit drilling through dowel or other rounded stock. Attaches to all 3/8" and 1/2" power drills. Folds for tool-box storage.

WOODWORKING

PRECISION DRILL GUIDE

- Attaches to all 3/8" and 1/2" power drills
- Cross slide lock for accurate shaping and carving
- 3/8" capacity drill chuck with key
- Positive stop for accurate drill depth control
- Dual locking knob and handle holds precise angle setting
- Folds flat for tool box storage
- Easy-to-read protractor scale has 5° graduations (0° - 45° left or right)
- V-guides automatically center round stock for drilling
- Self centering channel for edge drilling

UPC	NO.
23059 1	36/37

AccuDrill Precision Drill Guide

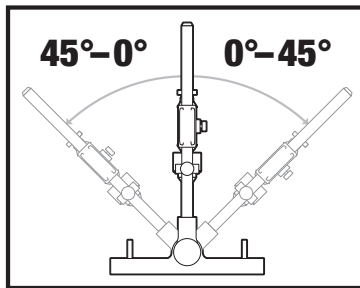

1 For round Bar Center Drilling
2 Straight Edge Center Drilling





BUILDER'S TOOLS/WOODWORKING

Circle Cutters



General's Circle Cutters produce precision circles in sheet metal, brass, copper, soft steel, aluminum, plastic, wood and composition materials. Bodies are constructed of heat treated tool steel for durability.

The replaceable cutter blades are made of high-speed steel for precise and clean cuts. Circle Cutters are adjustable for cutting various diameter holes. A hex wrench is included for adjustments.

4" MAX CIRCLE CUTTER

- Round shank circle cutter
- Replaceable high-speed steel cutting blade and replaceable 1/4" pilot drill
- All adjustments are made with a hex wrench which is included
- **Maximum safe speed is 500 RPM**
- **For use with drill press only**

UPC	NO.	DESCRIPTION
21003 6	04	4" Circle Cutter
27003 0	4/5 Blade	Replacement Blade

- Capacity: 7/8" to 4"
- Shank: 3/8" Round

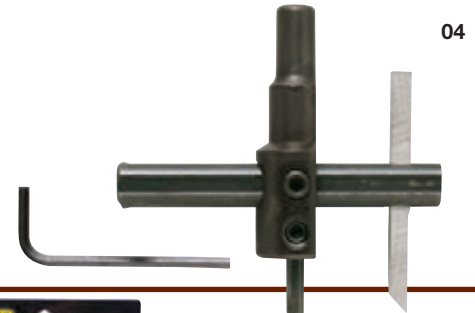

04

WHEEL AND CIRCLE CUTTER

- General's Wheel and Circle Cutter is the only one that cuts the exact diameter you need anywhere from 1" to 6" (26 to 152mm)
- Ideal for woodworkers, model builders, clockmakers, and hobbyists
- Produces precision circles and holes in sheet metal, brass, copper, aluminum, plastic, wood, and composition materials
- Change from circle to wheel cutting by simply reversing the double ended blade
- Sturdy round shank for use in any drill press or drill stand with 3/8" chuck

- Replaceable double ended 9/32" cutter blade is made of high-speed steel for precise clean cuts
- All adjustments are made with a hex wrench which is included
- **Maximum safe speed is 500 RPM**
- **For use with drill press only**

UPC	NO.	DESCRIPTION
21010 4	06	Circle Cutter
21014 2	5/6/55 Drill	Replacement Drill
21013 5	6 Blade	Replacement Wheel

- Capacity: 1" to 6"
- Shank: 3/8" Round

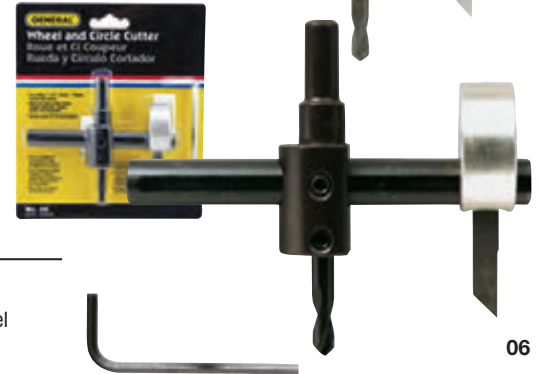

06

6" MAX CIRCLE CUTTER

- Has been a General Tools customer favorite for more than 30 years
- Adjusts from 1" to 6" (26 to 152mm) diameter circles
- Replaceable high-speed steel blade and replaceable 1/4" pilot drill
- All adjustments are made with a hex wrench which is included
- **Maximum safe speed is 500 RPM**
- **For use with drill press only**

UPC	NO.	DESCRIPTION
21009 8	5B	Circle Cutter
21014 2	5/6/55 Drill	Replacement Drill
27003 0	4/5 Blade	Replacement Blade

- Capacity: 1" to 6"
- Shank: 3/8" Round

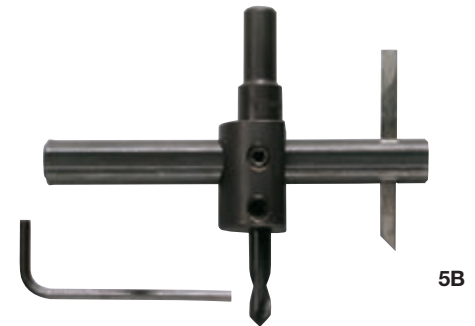

5B

HEAVY-DUTY CIRCLE CUTTER

- General's industrial quality cutter is most preferred by professionals
- 1/2" round shank for drill press use
- Replaceable high-speed tool steel blade and replaceable 1/4" pilot drill
- Markings on beam for easy measurement

- All adjustments are made with a hex wrench which is included
- **Maximum safe speed is 500 RPM**
- **For use with drill press only**

UPC	NO.	DESCRIPTION
21012 8	55	Circle Cutter
21014 2	5/6/55 Drill	Replacement Drill
27015 3	55 Blade	Replacement Blade

- Capacity: 1-3/4" to 7-7/8"
- Shank: 1/2" Round

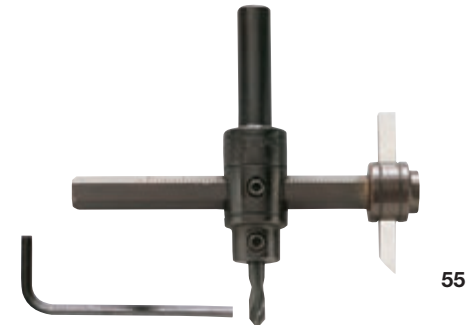

55

WASHER AND GASKET CUTTER

- This tool cuts washers and gaskets in leather, rubber, cork, graphite, fiber, copper and other soft materials
- Combination round and square shank permits use with bit brace or hand drill
- Made of steel with graduated beam to adjust to diameters from 5/8" to 6-1/2" (16 to 165mm)
- Replaceable tool steel Cutter Blades No. 11B

- Two independently adjustable cutter blades cut inside and outside diameters simultaneously
- **Maximum safe speed is 100 RPM**
- **For hand held variable speed drills only**

UPC	NO.	DESCRIPTION
21024 1	11	
27024 5	11B	Replacement blades (Pair)

- Capacity: 5/8" to 6-1/2" (16 to 165mm)



11



Calipers & Squares

General's newest "Fraction +" Caliper has a three mode digital display. Measuring in inches, metric and fractions it offers everything for the hobbyist to the professional.

The Combination Squares are specifically designed for carpenters, the woodworking trade, the do-it-yourselfer and home mechanics. A necessary tool for every carpenter and home workshop.

WOODWORKING



147



FRACTION+

DIGITAL FRACTIONAL CALIPERS

- No. 147, No. 1478, No. 14712 are heavy-duty stainless steel construction
- No. 146, No. 1433 are constructed of non-marring carbon fiber
- Convenient auto-off feature
- Three mode digital display: Decimal Inches, Fractional and Metric
- Inside, outside, depth & step measurements
- Accuracy: +/- 0.001" +/- 0.02mm
- Resolution: 0.0005", 0.01mm, 1/64"
- Power Source: 1 "SR44" battery (included)



No. 146 Digital Display



No. 147 Fractional Display

UPC	NO.	RANGE
01433 7	1433	0 - 3" (0 - 76mm)
01460 3	146	0 - 6" (0 - 153mm)
01470 2	147	0 - 6" (0 - 153mm)
01478 3	1478	0 - 8" (0 - 203mm)
14712 7	14712	0 - 12" (0 - 305mm)

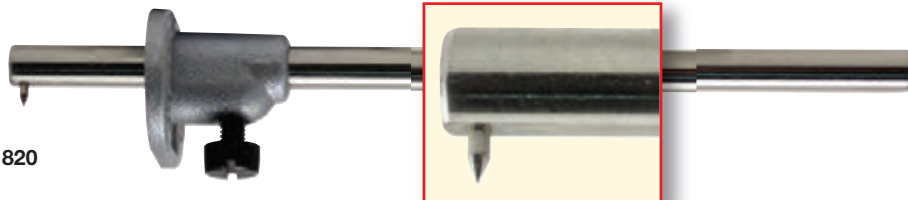

820

SINGLE BAR MARKING GAGE

- 6" (153mm) adjustable bar is nickel plated steel graduated in 16ths
- Die-cast head
- Fine needle point for precision marking

UPC	NO.
24050 7	820



812

PROFESSIONAL CARPENTER'S COMBINATION SQUARE

- Specially designed for carpenters and the woodworking trades
- Machined and enameled cast iron head has precision level and scriber for producing right and 45° angles
- 12" x 1" (305 x 26mm) steel blade is graduated in 8ths, 16ths, and 32nds
- Conforms to government specifications GGG-S-656C

UPC	NO.	GRADS	
		FRONT	BACK
24036 1	812	8ths, 16ths	16ths, 32nds
22193 3	812-CA	Clamp Assembly	

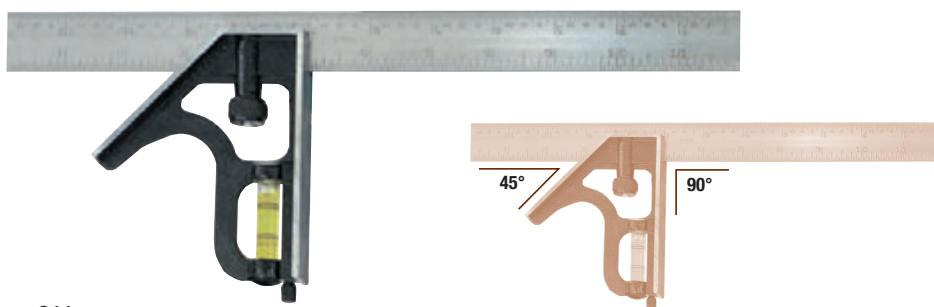

811

UTILITY COMBINATION SQUARE

- Economy version of the carpenter's combination square is perfect for the do-it-yourselfer and home mechanic
- 12" x 1" (305 x 26mm) steel blade is graduated in 8ths, 16ths, and 32nds
- Heavy zinc cast head with level and scriber

UPC	NO.	GRADS	
		FRONT	BACK
24030 9	811	8ths, 16ths	16ths, 32nds





General's Adjustable Trammels accurately measure and mark distances that are too great for conventional compasses and dividers. Trammels will accurately transfer measurements, scribe arcs

and lay out circles. Points can be replaced with pencils, ballpoint pens, crayons or soap-stone sticks for marking various materials.

PRECISION ADJUSTABLE TRAMMELS

- Draw large circles and measure sizable distances with the accuracy of a divider
- Fine adjusting screw sets points accurately
- Points are removable and may be replaced with the pencil holder
- Die-cast bodies with hardened and ground 3" (76mm) needlepoint legs
- Clamp opening for beam is 3/8" x 3/4" (10 x 19mm)
- Conform to government specifications GGG-T-661b

UPC	NO.
23090 4	520
31104 7	84P Replacement points (12 per pkg.)

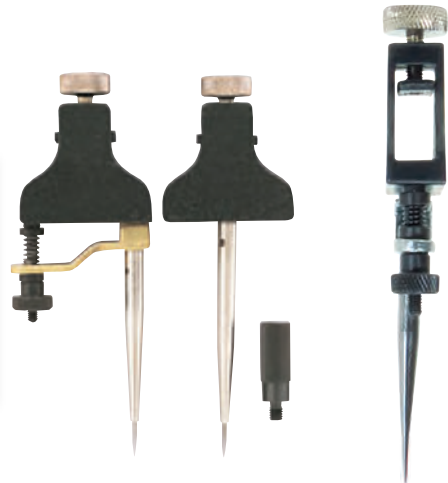
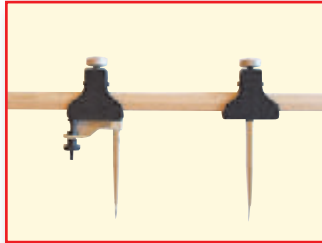

PROFILE VIEW

520

ADJUSTABLE TRAMMELS

- General's adjustable trammels accurately measure and mark distances that are too great for conventional compasses and dividers
- For layouts, marking templates, and drawing large circles
- 6" (153mm) eccentric points provide fine adjustments
- Points can be replaced with pencils, ballpoints pens, crayons, or soapstone sticks for marking various materials
- Clamps onto beam 5/8" to 1-1/2" (16 to 38mm) thick of any length

UPC	NO.
23093 5	523

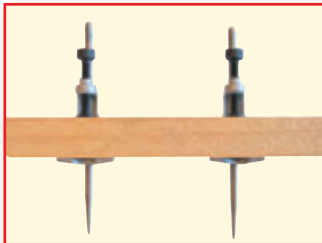

PROFILE VIEW

523

PRECISION TRAMMEL SET

- Will accurately transfer measurements, scribe arcs, and lay out circles too large for conventional compasses
- Will fit any scale, 1/2" to 1-1/8" (13 to 29mm) wide
- Two scriber points and two pencil points included
- Up to four points can be stored in body
- Free-wheeling thimble for greater precision
- Aluminum knurled body
- Steel collet holds replacement leads, scribes and crayons
- Points reverse into body for safety
- Ruler not included in set

UPC	NO.
23095 9	524



PROFILE VIEW

524

WOODWORKING



Countersinks, Drill Bits, Gages

Pilot Bits, countersink and counterbore precision screw holes in a single operation. Self-Centering Hinge Bits drill highly accurate pilot holes in cabinet and door hinges.

Stair gages assure fast and uniform layout in repetitive work including angle cuts on rafters and stair stringers.

WOODWORKING

5 FLUTE ROSE PATTERN COUNTERSINKS

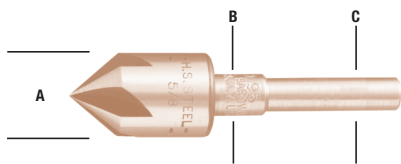

NO.	A	B	C
195-1/2	1/2"	3/8"	1/4"
195-5/8	5/8"	3/8"	1/4"
195-3/4	3/4"	3/8"	1/4"

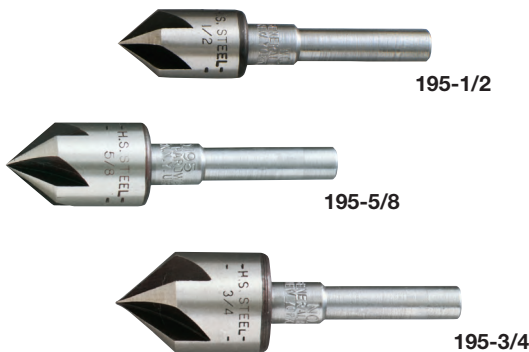

- The rose pattern cutting flutes assure chatter free countersinking on steel, brass, aluminum, plastic, wood & other materials
- Made of high-speed steel with five flutes
- 82° point angle
- Stepped shank for use with 1/4" and 3/8" chucks

UPC	NO.
23047 8	195-1/2
23053 9	195-5/8
23050 8	195-3/4

SELF-CENTERING HINGE BITS



- Highly accurate bits are used for drilling pilot holes in cabinet and door hinges, door butts and all large and small hardware

- Spring loaded outer guide keeps the high speed drill centered for perfect pilot holes
- Adjustable drill depth

UPC	NO.	DRILL SIZE	DRILL DEPTH	SCREW SIZE
22154 4	291	5/64"	1/8"	3 & 4 screw size
22149 0	292	7/64"	7/32"	5 & 6 screw size
22150 6	293	9/64"	5/16"	8 & 10 screw size

JIFFY CENTERING PUNCH



806

- For quickly starting screw holes when attaching countersunk hardware such as hinges, hasps, hangers and drawer pulls
- Countersunk end ensures starting hole is centered in hardware screw hole
- Hardened steel pin

- Length: 2-1/2" (68mm)
- Body diameter: 3/8" (10mm)

UPC	NO.
24018 7	806

STAIR GAGE SET



803

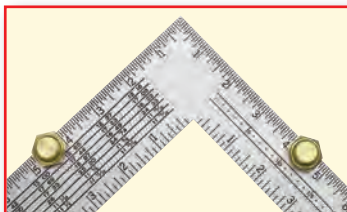

- Brass plated steel stair gage assures fast and uniform layout in repetitive work including angle cuts on rafters and stair stringers
- Attaches easily to all metal rafter squares
- Set of 2 pieces

UPC	NO.
24009 5	803

Scratch Awl & Blade Sharpener



General's Scratch Awl is made from the finest materials for long life. This tool is designed for scribing and layout work, starting screw holes and piercing soft materials.

The Chisel/Plane Blade Sharpener keeps blades razor sharp. The graduated settings maintain the correct 30° cutting angle necessary for these blades.

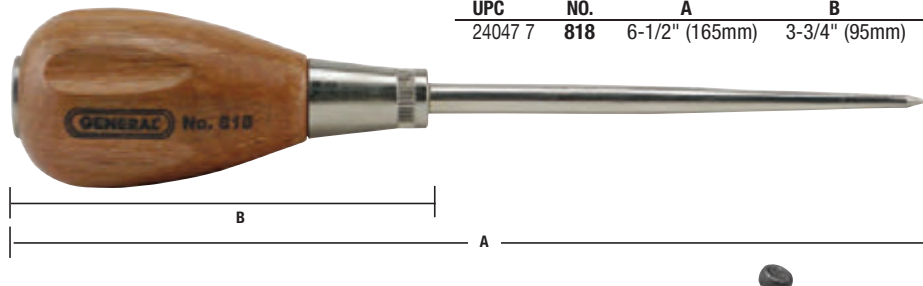

HARDWOOD HANDLE SCRATCH AWL

- Alloy steel blade runs through the handle and is securely fastened to both the plated steel ferrule and the cap
- Hardwood fluted handle is contoured for comfortable grip

UPC	NO.	A	B
24047 7	818	6-1/2" (165mm)	3-3/4" (95mm)

818

WOODWORKING

"ORIGINAL" DRILL GRINDING ATTACHMENT

- Engineered to permit sharpening of drill bits to factory accuracy
- Extends the life of drill bits
- Angle adjustments lock in to grind drill bits for more accurate drilling in a variety of materials
- Automatically adjusts to give correct clearance angle
- For use with ANSI, OSHA, and UL approved standard electric bench grinders or surface grinders
- Equally at home in machine shop and home workshop
- Instructions included

UPC	NO.	CAPACITY
24070 5	825	Fractional drills 1/8" to 3/4", Number size drills 30 to 1 Letter size drills A to Z, Millimeter size drills 3.0 to 19.0



825

CHISEL/PLANE BLADE SHARPENER

- Keeps chisel and plane blades razor sharp
- Graduated settings maintain correct 30° cutting angle on chisel or plane blade
- Spring clamp locks in blades up to 2-5/8" (67mm) wide
- Made of high impact fiberglass reinforced Lexan®
- Folds for storage

UPC	NO.
24024 8	809



809

FIBERGLASS FOLDING RULE

- Constructed of tough, flexible high-impact plastic, with fiberglass reinforcement for added durability
- 72" (1929mm) folding ruler with a 6" (152mm) extension for accurate inside measurements

UPC	NO.	GRADS
25300 2	7200	Outside readings graduated in 16ths.



7200



Whether you're a professional contractor or a conscientious homeowner, General's ultra-sensitive hand-held pin or pinless Moisture Meters help you to easily detect hidden leaks in wood, concrete, plaster and carpet. Available as

both analog and digital models, the Meters provide accurate moisture level readings and are great for new home inspections, locating roof leaks or even selecting dry lumber at the yard.

WOODWORKING

CE
RoHS



MM1E

PIN-TYPE LED BAR GRAPH MOISTURE METER

Ideal for use in woodworking, building construction and home inspection. Examples include:

- Checking for moisture in carpets and sub-flooring
- Checking wood, drywall and concrete before painting/wallpapering, sealing or treating
- Locating water leaks in roofs, floors and walls
- Selecting dry lumber

FEATURES

- 10-LED display
- Two measurement ranges: 7 to 15% and 16 to 35%
- Protective cap doubles as calibration checker
- Full and low battery indications
- CE and RoHS approved

SPECIFICATIONS

- ◆ Low Measurement Range: 7 to 15% WME (Wood Moisture Equivalent)
- ◆ High Measurement Range: 16 to 35% WME
- ◆ Measurement Accuracy: ±1 LED (~1%)

- ◆ Calibration Check Point: 21% ±2%
- ◆ Low Battery Level: <7.5V
- ◆ Current Consumption: <15mA
- ◆ Operating Temperature: 32° to 140°F (0° to 60°C)
- ◆ Dimensions: 6.5 x 2.7 x 1 in. (164 x 69 x 26mm)
- ◆ Weight: 3.2 oz. (91g) w/out battery
- ◆ Power Source: 1 "9V" battery (included)

Includes: • Protective Cap • Battery • User's Manual

UPC	NO.
10188 9	MM1E

CE



MMD4E

PIN-TYPE LCD MOISTURE METER

Ideal for use in woodworking, building construction, home inspection, lumber selection, water-damage restoration.

FEATURES

- 99.9 count LCD w/0.4 in. high digits
- Wood/building materials selection switch
- Low, Medium and High moisture sounds and on-screen icons
- High accuracy and resolution
- Data hold + auto power off + low battery indicator
- Replaceable stainless steel pins (#PIND4E)
- Powered by "9V" battery (included)

SPECIFICATIONS

- ◆ Overall Moisture Measurement Range: 5 to 50% for wood, 1.5 to 33% for building materials
- ◆ Wood Moisture Scales: 5 to 11.9% (low); 12 to 15.9% (medium); 16 to 50% (high)

- ◆ Building Materials Scales: 1.5 to 16.9% (low); 17 to 19.9% (medium); 20 to 33% (high)
- ◆ Measurement Accuracy: ±3% of reading
- ◆ Measurement Resolution: 0.1%
- ◆ Low Battery Level: <7.5V
- ◆ Auto Power Off Trigger: 3 minutes of inactivity
- ◆ Current Consumption: <15mA
- ◆ Power Source: 1 "9V" battery (included)

Includes: • Protective Cap • Battery • User's Manual

UPC	NO.
41447 7	MMD4E
01499 8	PIND4E Replacement pins

CE
RoHS



MMD5NP

PINLESS LCD MOISTURE METER

Ideal for measuring moisture content of wood and other construction materials.

FEATURES

- Non-invasive measurement technique
- Jumbo display
- Wide measurement range
- Intuitive on-screen icons: Low/Medium/High moisture content; wood/concrete mode
- Hold function
- Audible peak reading alert
- Auto-calibrating
- Auto Power Off
- Low and very low battery warnings

SPECIFICATIONS

- ◆ Measurement Ranges: 0 to 99.9% WME (Wood Moisture Equivalent) for wood; 0 to 56.5% for building materials

- ◆ Measurement Accuracy/Resolution: ±3%/0.1%
- ◆ Measuring Depth: 3/4 in. (20mm)
- ◆ Display Type/Size: 99.9 count LCD with 0.4 in. (10mm) high digits
- ◆ Auto Power Off Trigger: 3 to 4 minutes with 0% reading
- ◆ Low/Very Low Battery Warning Triggers: <7.5V/<6.5V
- ◆ Operating Temperature: 32° to 122°F (0° to 50°C)
- ◆ Operating Relative Humidity: <80%
- ◆ Power Source: 1 "9V" battery (included)

Includes: • Battery • User's Manual

UPC	NO.
40142 2	MMD5NP

Plumbing Tools



**Tubing
Cutters**
**Mini
Tubing
Cutters**
**Cutting
Tools**
**Flaring
Tools**
**Bending
Tools**
Reamers
**Deburring
Tools**
**Cleaning
Brushes**
Wrenches
Pliers
**Faucet
Tools**

PLUMBING TOOLS

Tubing Cutters



All General Tools Professional Tubing Cutters, come standard with these customer proven features:

- **One** Bearing tool steel cutting wheel, machined to the perfect geometry and Through-Hardened, that fits all General cutters.
- **Wider** hardened and polished Flared Grooved Rollers for reliable, stable and true

close end cutting on flared tubing. Our rollers are mounted on hardened solid pins for longer, friction free operation. • **Powder Coated** baked on painted finish for durability, and great look. • **All fasteners** are drilled and tapped for precision fit and strength, not riveted or pinned.

THE GOLD STANDARD PROFESSIONAL SERIES

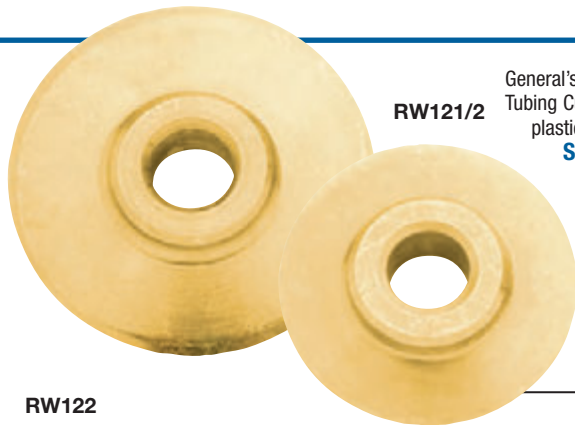

General's Gold Standard Tubing Cutter Wheels are the new Quality Standard Replacement Cutters for all General Tubing Cutters! Now with our new slim-line design, only two cutter wheels are needed to cut copper, plastic, iron pipe and stainless steel. • Our Gold Standard cutter wheels include these features:

Shape: New, sleek, slim-line geometry provides for smooth, clean, effortless cutting on all Pipes and Tube Materials.

Strength: Bearing Tool Steel for superior strength to withstand the greater cutting pressure.

Durability: Hardened and tempered to maintain its sharp edge and reduce chipping or breaking.

Speed: The combination of shape, strength and durability enable General's New GOLD Standard to repeatedly provide quicker cutting without deforming the pipe OD and cuts with minimum ID burring.

RW121/2 - For thin wall cutting-Fits all General tubing cutters, Pro or Classic series; mini, standard or high performance sizes. (Packed 2 per card).

RW122 - Larger capacity: For iron or PVC pipe-Fits Nos. 120, 125 and 126 cutters.

UPC	NO.
12023 6	RW121/2
12027 4	RW122

PLUMBING

RW122

Capacity
1/8" - 1-1/8"



120

TUBING CUTTER

- Newly redesigned contoured shape comfort grip design
- Bearing tool steel cutter wheel
- Wide hardened flared grooved rollers allow cuts close to a flared end to avoid tube replacement in existing installations
- Full sized fold out reamer with double cutting edges

- Cuts copper, aluminum, brass, thin wall tubing and stainless steel
- Large knob with a covered extra cutter wheel storage space
- Replaceable cutting wheels: RW121/2, RW122

UPC	NO.	CAPACITY
12003 8	120	1/8" to 1-1/8" (3mm - 30mm)

Capacity
1/4" - 1-5/8"



125

HEAVY-DUTY CUTTER

- Newly redesigned comfort grip for heavy-duty and industrial applications
- Bearing tool steel cutter wheel
- Wider, hardened flared grooved rollers allow cuts close to a flared end to avoid tube replacement in existing installations
- Full size fold-out reamer
- Cuts copper, aluminum, brass, thin wall tubing and stainless steel

- Oversize knob for additional leverage
- Spare cutting wheel storage position in handle
- Replaceable cutting wheels: RW121/2, RW122

UPC	NO.	CAPACITY
12015 1	125	1/4" to 1-5/8" (6mm - 41mm)

Capacity
1/4" - 2-5/8"



126

PIPE AND TUBING CUTTER

- General's best quality tubing and pipe cutter is designed to meet the demanding needs of the professional
- Quick release button to speed use
- Capacity 1/4" - 2-5/8" (6 - 67mm)
- For cutting copper, aluminum, thin wall tubing, iron and PVC
- Heavy-duty construction for tube or pipe
- Four rollers to accommodate multiple pipe sizes and prevent spiraling

- Removable machinists reamer to easily deburr pipe
- Quick open and close mechanism to speed use
- Extra wheel storage available in handle
- Uses standard General Tools cutting wheels #RW122 or #RW121

UPC	NO.	CAPACITY
12017 5	126	1/4" to 2-5/8" (6mm - 67mm)



Our new mini cutters work in tighter locations than the Pro and DIY'er encounter. We call it Spin Radius. We've designed in contoured finger grip locations to increase comfort, working torque and speed. We added a large fluted, easy turning, adjusting knob, fine threaded feed screw and unique tracking rail

system, to ensure reliable, smooth, friction free operation and greater torque. Adding our standard full sized bearing tool steel cutter to every General Mini makes our Pro Series our best ever.

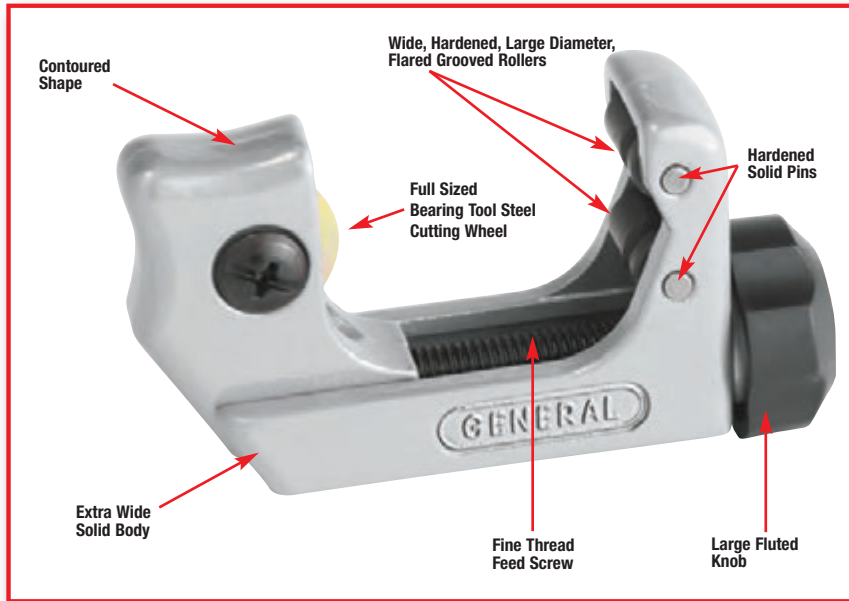

SUPER MINI TUBING CUTTER

- Comfort grip design for easy turning
- Full size bearing tool steel cutter wheel
- Large fluted adjusting knob for greater torque
- Cuts copper, aluminum, brass, thin wall tubing and stainless steel
- Wide hardened flared grooved rollers allows true cuts close to flared end tubing to avoid tube replacement in existing installations

- 1-11/16" swing radius
- Replaceable cutting wheel, RW121/2

UPC	NO.	CAPACITY
01240 1	124	1/8" to 1-1/8" (3mm - 30mm)

Capacity
1/8" - 1-1/8"



124

MINI TUBING CUTTER

- Comfort grip design for easy turning
- Full size bearing tool steel cutter wheel
- Large fluted adjusting knob for greater torque
- Cuts copper, aluminum, brass, thin wall tubing and stainless steel
- Wide hardened flared grooved rollers allows true cuts close to flared end tubing to avoid tube replacement in existing installations

- 1-1/2" swing radius
- Replaceable cutting wheel, RW121/2

UPC	NO.	CAPACITY
12032 8	129X	1/8" to 7/8" (3mm - 22mm)

Capacity
1/8" - 7/8"



129X

MICRO TUBING CUTTER

- Comfort grip design for easy turning
- Full size bearing tool steel cutter wheel
- Large fluted adjusting knob for greater torque
- Cuts copper, aluminum, brass, thin wall tubing and stainless steel
- Wide hardened flared grooved rollers allows true cuts close to flared end tubing to avoid tube replacement in existing installations

- 1-3/8" swing radius
- Replaceable cutting wheel, RW121/2

UPC	NO.	CAPACITY
12009 0	123R	1/8" to 5/8" (3mm - 15mm)

Capacity
1/8" - 5/8"



123R
Patented

PLUMBING TOOLS

Tubing Cutters



General's full range of cutters makes the job easier to do for the professional plumber as well as the do-it-yourselfer. Each of our cutters produces cuts on copper, aluminum and thin wall tubing. Our 126

cutter is perfect for cutting iron pipe, tubing and PVC. Sizes range from 1/8" to 2-5/8" O.D. capacity. RW122 gold standard replacement cutter wheel fits No's. 120, 125, 126 cutters.

PLUMBING



133

E-Z™ RATCHET TUBING CUTTER

- Ratcheting action rotates the cutter around the tube allowing a standard size cutter to be used in close quarter applications
- Longer handle requires less effort to rotate cutter reducing hand fatigue
- Wide hardened flared grooved rollers allow true cuts close to flared end tubing to avoid tube replacement in existing installations
- Cuts copper, aluminum, brass, thin wall tubing and stainless steel
- Spare cutting wheel supplied in handle
- Replaceable cutting wheel: RW121/2

UPC	NO.	CAPACITY
13300 7	133	5/16" to 1-1/8" (8mm – 30mm)



135
Patented

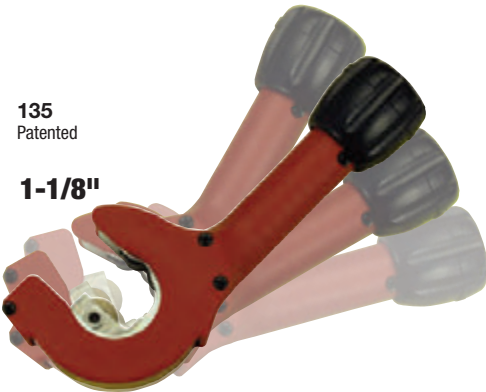

1-1/8"

E-Z™ RATCHET II TUBE AND PIPE CUTTER

- Cuts without rotating tool completely around tube or pipe
- Exclusive "One-Hand" operation
- Ratchets in 5° increments while cutting 360° around tube
- Large cutting diameter 1/8" to 1-1/8" (3mm-28mm)
- Cuts copper, brass, aluminum, stainless steel, PVC and thin wall conduit
- Replaceable cutting wheels: RW135/2

UPC	NO.	CAPACITY
01350 7	135	1/8" to 1-1/8" (3mm-28mm)
01351 4	RW135/2	Replacement Wheel (2)



HOSE AND TUBING CUTTER

- Cuts flexible rubber, PVC, ABS & polyethylene tubing
- Long handles provide added leverage for easy cuts
- Curved holder supports hose for square cuts
- Replaceable steel blade
- Capacities: rubber hose 2", polyethylene and ABS pipe 1", PVC pipe 1"



115

UPC	NO.	CAPACITY
01150 3	115	1" to 2" (25mm – 50mm)
LENGTH		
11500 3	115B	Replacement Blade



PLUMBING TOOLS Tubing Cutters



General's PVC Cutters are used for cutting PVC, PE and ABS pipe. All metal construction allows for greater durability. Ergonomically designed handle for

greater comfort and control. The hose and tubing cutter cuts flexible rubber, PVC, ABS and Polyethylene tubing.

TRIGGER ACTION PLASTIC PIPE AND HOSE CUTTER

- For cutting PVC, CPVC, Polyethylene, PEX, ABS
- Easily fits into tight spaces
- Quick blade replacement

UPC	NO.	CAPACITY
01170 1	117	1-5/8" (42mm)
01171 8	117BG	Replacement Blade



117

HEAVY-DUTY PIPE AND HOSE CUTTER

- For repeated heavy-duty cutting
- Cuts hose, PVC, CPVC, polyethylene, PEX and ABS up to 2"
- Ratchet action for easy cutting
- High carbon steel blade provides longer sharpness and clean cuts
- Aluminum body is lighter and corrosion proof
- Safety locking clasp

UPC	NO.	CAPACITY	LENGTH
01181 7	118	up to 2" (50mm)	17" (425mm)
01180 0	118BG	Replacement Blade	



118

ONE-HANDED PVC/HOSE CUTTER

- For cutting PVC, PE, PEX, ABS pipe
- Professional quality, all-metal construction for greater durability
- Ratcheting action for easy cutting
- High carbon steel blade provides longer sharpness and clean cuts
- Handle locks for safety
- Ergonomically designed handle for comfort

UPC	NO.	CAPACITY	LENGTH
01191 6	1191	up to 1-5/8" (40mm)	9-1/8" (231mm)



1191

ONE-HANDED PLASTIC PIPE AND HOSE CUTTER

- For cutting PVC, CPVC, Polyethylene, PEX and ABS tubing
- One-handed Operation
- Quick-Blade Reset
- Comes with extra blade
- Ratchet system holds blade in place while you adjust your grip to increase pressure
- High carbon steel blade maintains sharpness and resists chipping

- Handle locking strap for safe storage
- Exclusive, easy replaceable blade feature
- Ergonomically designed handle for comfort
- Replacement Blade, No.119BG

UPC	NO.	CAPACITY	LENGTH
31173 3	119	1/8" to 1-5/8" (210mm)	8-1/4" (210mm)
01194 7	119BG	Replacement Blade	



119
Patented

PLUMBING TOOLS

Cutting/Bending



General's PVC Cutters are used for cutting PVC, PE and ABS pipe. All-metal construction allows for greater durability. Ergonomically designed handle

allows for comfort and control. The hose and tubing cutter cuts flexible rubber, PVC, ABS and Polyethylene tubing.

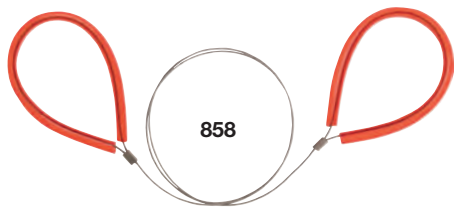

PVC PIPE CABLE SAW

- For cutting PVC pipe in confined work areas
- 24" stainless steel serrated cutting cable
- Easily cuts pipe up to 8" in diameter
- Comfort grip handles

UPC	NO.	CAPACITY
08580 1	858	8" dia. (200mm)

PLUMBING



JUNIOR HACKSAW

- Handy cutting tool for hobbyists, do-it-yourselfers and professionals
- Ergonomically designed with a comfortable high-impact plastic handle
- 6" (150mm) replaceable heat treated blade for cutting metal
- Sturdy tubular frame

- Reversible blade for push or pull cutting
- No. 864B, set of 6 replacement blades: 3 wood and 3 metal are available

UPC	NO.
43067 0	864

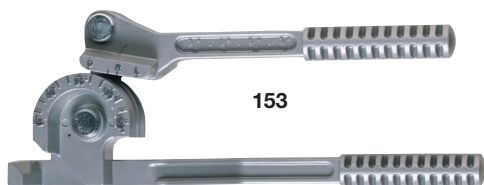

COMPOUND TUBING BENDER

- Bending copper, brass, thin wall tubing, aluminum, soft wire and rods
- 180 bends in a single action
- Bender dial is calibrated in twelve 15° increments
- Bends four different diameter tubes
- Ergonomically designed handles for greater comfort

- Durable die-cast alloy construction
- Extra-long handle for greater leverage
- Includes vinyl storage case

UPC	NO.	CAPACITY
14019 7	153	3/16" (5mm), 1/4" (6mm), 5/16" (8mm), 3/8" (10mm)



TUBING BENDERS

- These tools eliminate crimping and collapsing of copper and other thin wall tubing. Made of oil hardened and tempered spring steel
- Our tubing bender set contains one each of the sizes listed below, packaged in a display box

UPC	NO.	TUBE SIZE OUTSIDE DIA.
11009 1	S106	1/4", 5/16", 3/8", 7/16", 1/2", 5/8"

NO.	TUBE SIZE OUTSIDE DIA.	LENGTH
100-1/4	1/4"	10-1/2"
100-5/16	5/16"	10-1/2"
100-3/8	3/8"	10-1/2"
100-7/16	7/16"	10-3/8"
100-1/2	1/2"	11-3/4"
100-5/8	5/8"	11-3/4"



General's Flaring Tools are essential for setting up or repairing flared tubing installations. Accurately flare copper, aluminum and thin wall tubing for leak free connections.

Each flaring tool forms 45° flares in seven popular sizes. Made of rust resistant plated steel bars. Tubing Benders will bend copper, brass, thin wall tubing, aluminum, soft wire and rods.

DOUBLE FLARING TOOL

- Specially designed to double flare tubing for high pressure applications in automotive, air conditioning and refrigeration
- Accurately single or double flares copper, aluminum and thin wall tubing for leak free connections
- Quick opening plated steel bars for easy insertion and removal of tubing

- Plated steel yoke and hardened steel bars for accurate flaring
- Double flare inserts are case hardened steel
- All parts have rust resistant finish
- Portable storage case

UPC	NO.	CAPACITY
14015 9	157	3/16", 1/4", 5/16" 3/8", 7/16", 1/2", 5/8"

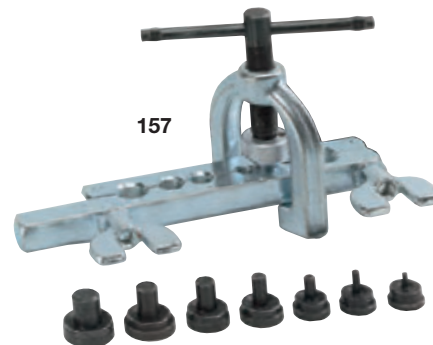

157

PLIER FLARING TOOL

- All-steel construction
- Freewheeling cone self centers accurately over tubing
- Quick release allows insertion and removal of tubing easily
- Quick release plier action handles hold tubing securely while flaring

- Can be used in confined areas
- Industrial quality
- Vinyl handles for greater comfort

UPC	NO.	CAPACITY
14022 7	152	3/16", 1/4", 5/16", 3/8", 1/2", 5/8"

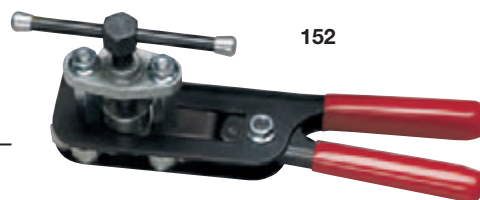

152

FLARING TOOLS

- High quality tool moderately priced
- Screw yoke slips quickly over bars without removing heavy-duty wing nuts
- Yokes have a freewheeling 45° plated cone for faster, smoother flaring and greater strength in flaring copper, aluminum, brass and thin wall tubing
- Large heavy-duty hardened feed thread for durability
- Long sliding T-handle provides maximum leverage

- Quick opening plated bars for easy insertion and removal of tubing
- Size individually marked on bars
- Extra long bars to fit in vice, for easier flaring
- No. 155 has a steel yoke and hardened bars
- No. 151 has a cast iron yoke

UPC	NO.	CAPACITY
14008 1	151	3/16", 1/4", 5/16", (Standard) 3/8", 7/16" 1/2", 5/8"
14009 8	155	3/16", 1/4", 5/16" (Industrial) 3/8", 7/16", 1/2", 5/8"

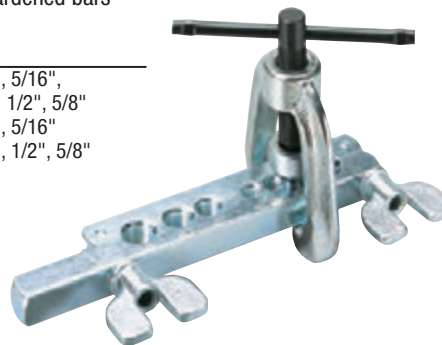

151
155





General offers a wide selection of Reamers and Deburring Tools to plumbers, auto mechanics, steam-fitters, metal workers and mechanics. All of General's Reamers are precision hardened with

ground cutting edges for durability. Reamers are used for removing burrs from cut pipe, tubing and conduit as well as for enlarging and counter-sinking holes in sheet metal, plastic and other material.

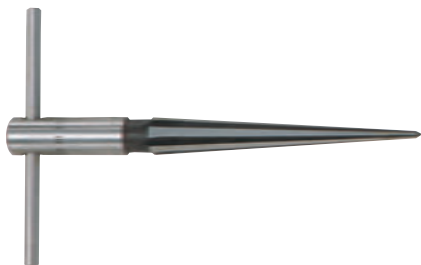

130



T-HANDLE REAMER

- Made of hardened and tempered tool steel with precision ground cutting edges
- T-handle provides leverage for easier reaming

UPC	NO.	CAPACITY
13003 7	130	1/8" to 1/2" (3mm – 12mm) 5-3/4" (146mm)

PLUMBING



131

SCREWDRIVER HANDLE REAMER

- General's easy-to-use reamer is perfect for in-home plumbing
- Fluted plastic handle
- Hardened and ground tempered steel

UPC	NO.	CAPACITY	LENGTH
13006 8	131	3/8" (10mm)	6-1/2" (165mm)



134

INNER/OUTER REAMER

- Inner/Outer Reamer will work on steel, iron, copper and PVC
- Zinc die-cast body
- Capacity 1-1/2" diameter (12.7mm)
- Grooved outer body gives you an easy grip

- Internal and external reamers are made of heat treated high carbon steel

UPC	NO.	CAPACITY
22077 6	134	1-1/2" (38mm)



196

HAND REAMER AND COUNTERSINK

- Handy tool for countersinking or deburring small jobs
- The 3/4" five-flute tool steel cutter makes fast work of deburring. Deburring plastic, copper, iron pipe and sheet metal

- Heavy-duty, ergonomically designed handle

UPC	NO.	CAPACITY	LENGTH
23054 6	196	3/4" (19mm)	5-1/8" (130mm)



154ST

4-PIECE SWAGING TOOL SET

- An easy and economical method of joining copper tubing
- Eliminates the need for coupling
- Hex body prevents rolling and allows easy removal from tube
- Heat treated alloy steel, plated to prevent rust

UPC	NO.	SPECIFICATIONS
14018 0	154ST	Set of 4 Swaging Tools

SIZES:
1/4", 3/8", 1/2", 5/8"



1545



6-IN-1 SWAGING TOOL

- Handy swaging tool expands tubing eliminating the need for couplings
- Expands six tubing sizes: 3/16", 1/4", 5/16", 3/8", 1/2" and 5/8" O.D. tubing
- Use with a flaring bar to hold tubing

UPC	NO.	LENGTH
01545 7	1545	5-1/4" (133mm)

Deburring/Cleaning Brushes

Deburring Tools are used for removing burrs from cut pipe, tubing, conduit and PVC tubing. Swaging Tools are an easy and economical method of joining copper tubing.

The Pipe and Fitting Brushes are used for cleaning inside and outside diameters of tubing and fittings in preparation for solder when sweating pipes.



SWIVEL HEAD DEBURRING TOOL

- Professional quality and performance of higher price deburring tools
- Two interchangeable blades

UPC	NO.	HANDLE LENGTH
42324 5	482	5-1/8" (130mm)
42327 6	482A	Blade for steel, copper, aluminum and plastic
42330 6	482B	Blade for brass and cast iron.

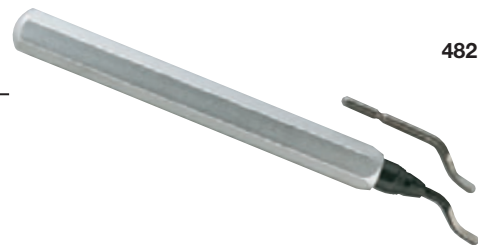

DEBURRING TOOL

- Pivot blade allows easy burr removal from iron pipe, copper and PVC tubing
- Includes one replacement blade in storage handle
- High impact plastic for durability
- Replacement blades 482A & B are available

UPC	NO.	HANDLE LENGTH
00481 9	481	5" (127mm)
42327 6	482A	Blade for steel, copper, aluminum and plastic
42330 6	482B	Blade for brass and cast iron.



BRASS AND STAINLESS STEEL CLEANING BRUSHES

- Handy utility brushes clean pipe, battery terminals, spark plugs and more
- Brass brush is recommended for cleaning softer materials
- Steel brush provides extra abrasion needed to clean pipe

UPC	NO.
01102 2	1102 (set of 2)

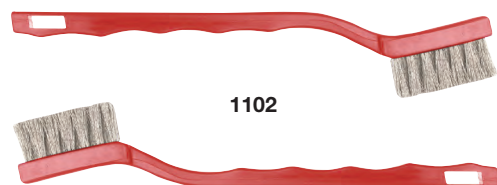

4-IN-1 PLUMBING BRUSH

- 4-IN-1 brush cleans both the inside and outside of copper tubing in preparation for solder when sweating pipes
- Cleans most popular 1/2" and 3/4" I.D. tube and 5/8" and 7/8" O.D. tube

- Hardened steel brushes and polypropylene body for strength and durability

UPC	NO.
01140 4	114



2-IN-1 PIPE AND FITTING BRUSHES

- Cleans I.D. and O.D. of tubing and fittings
- Long lasting steel bristles
- Designed for comfortable use and easy storage

UPC	NO.	CAPACITY
22075 2	110	1/2" (12mm)
22076 9	111	3/4" (19mm)

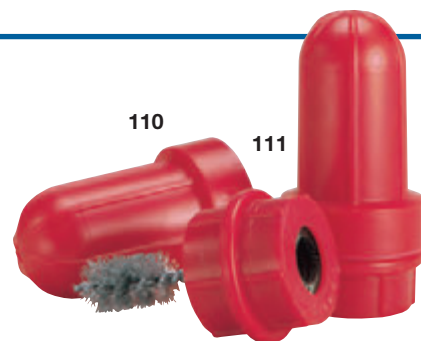

Basin Wrenches / Seat Wrenches

Basin Wrenches are used to turn fasteners in confined spaces. The pivoting jaws and long handle permits access to holding nuts behind basins.

The Faucet Valve Seat Wrench is a simple tool used to remove the faucet body valve so it may be replaced.

PLUMBING

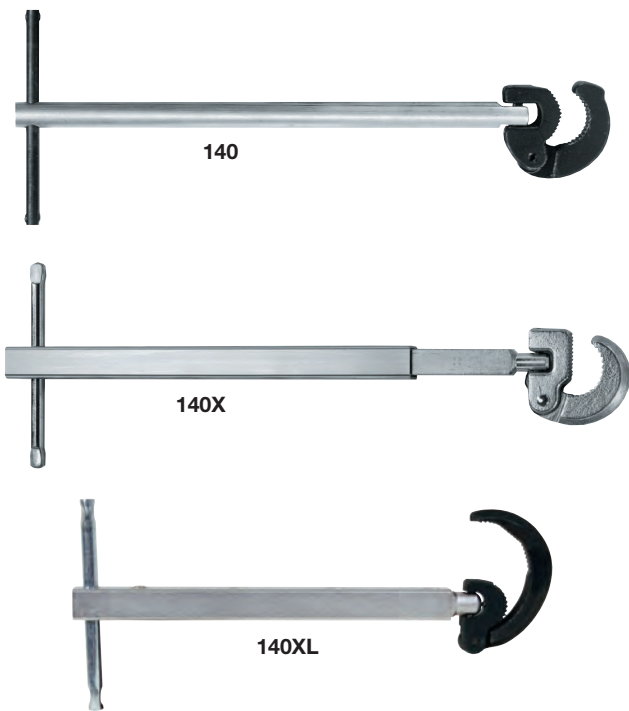

BASIN WRENCHES

- Pivoting jaws and long handle permits access to holding nuts behind basin
- Sliding T-handle for working in confined areas
- Spring loaded jaws for one-hand ratcheting
- All handles are plated to prevent rust
- 140X, 140XL extends from 11" (280mm) to 16" (400mm)
- The 140 is 11" long

UPC	NO.	CAPACITY
13019 8	140	3/8" - 1-1/4" (10mm - 31mm)
13033 4	140X	3/8" - 1-1/4" (10mm - 31mm)
01401 6	140XL	1" - 2" (25mm - 50mm)

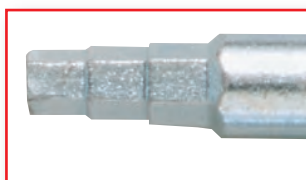

138S

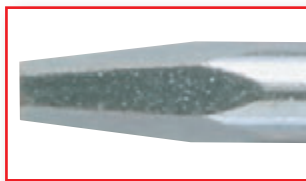

138T

SEAT WRENCHES

- Tapered seat wrenches for the removal of faucet seats
- Hardened alloy steel
- Plated to prevent rust

UPC	NO.	SIZE
13020 4	138S	.235 - .300" Stepped
13016 7	138T	.230 - .400" Tapered

Internal Pipe Wrenches



Internal Pipe Wrenches are used for the removal of broken thread ends of pipe, pipe plugs and fittings lodged inside other pipes.

The Nipple Extractor is used to remove broken iron pipe nipples by tapping them snugly into the broken pipe end and then turning counterclockwise with a wrench or socket that fits the hex end.

INTERNAL PIPE WRENCHES

General's Internal Pipe Wrenches make it easy to remove broken thread ends of pipe, pipe plugs and fittings lodged inside other pipe

- HVAC/R, plumbing
- Hex body is designed for standard wrenches
- Pipe size is marked on each wrench
- Heat treated alloy steel cams are plated to resist rust
- Conforms to Government Specification GGG-W643b
- Available individually or in set of four sizes

INDIVIDUAL SIZES

UPC	NO.	SPECIFICATIONS	LENGTH
13013 6	139A	3/8" (9.7mm)	3-3/4" (95.25mm)
13014 3	139B	1/2" (12mm)	3-3/4" (95.25mm)
13015 0	139C	3/4" (20mm)	3-3/4" (95.25mm)
13023 5	139D	1" (25mm)	3-3/4" (95.25mm)

SETS

13017 4	139ST	Set of 3 Internal Pipe Wrenches (139A, 139B, 139C)	
13026 6	139/4	Set of 4 Internal Pipe Wrenches (139A, 139B, 139C, 139D)	



UTILITY INTERNAL PIPE WRENCHES AND SET

- For the removal of broken threaded ends of pipe, pipe plugs and fittings
- Hex body can be used with a wrench
- Pipe sizes are marked on each wrench
- Heat treated alloy steel, plated to prevent rust
- Size stamped on body

UPC	NO.	SPECIFICATIONS
	1391	3/8" (9.7mm)
01392 7	1392	1/2" (12mm)
01393 4	1393	3/4" (20mm)

SET		
01390 3	1390	Set of 3 (3/8", 1/2", 3/4")

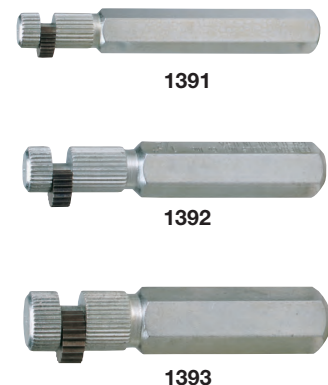

5-PIECE IRON PIPE NIPPLE EXTRACTOR SET

- Used to remove broken iron pipe nipples by tapping them snugly into the broken pipe end; then turn counterclockwise with a wrench or socket that fits the hex end
- Fits iron pipe nipples: NPT 1/8", 1/4", 3/8", 1/2" and 3/4"

- Plated to prevent rust
- Tapered design for a snug fit and heat-treated for longer life
- Size stamped on body

UPC	NO.
01395 8	1395





Plumbing Pliers, which have chrome plated forged steel jaws, provide ample capacity for most pipes, nipples and fittings up to 2". The plier has removable jaw covers to protect plated nuts or pipes from

damage. Pipe Wrenches have forged and ground jaws which provide ample capacity for most pipes, nipples and fittings up to 3". Both pipe wrenches have long handles for extra leverage and torquing.

PLUMBING

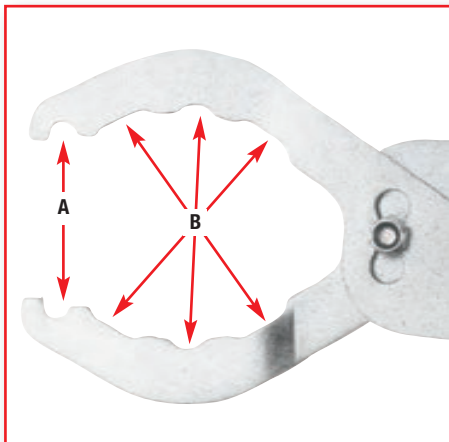

A. Fits Strainer Drain Nut Tabs
B. Fits Tabs for Plastic Traps, Slip and Compression Nuts

UNDERSINK DRAIN PLIER

- Our exclusive designed pliers fits all sink drain, slip, trap and compression nuts, basin and sink lock nuts
- A true fits-everything drain pliers
- The 3 position slip joint allows the pliers to work on all 1-1/4", 1-1/2" and 2" plastic and metal drain systems
- Jaws expand to a huge 4" opening for large strainer nuts

- Removable rubber jaw covers to protect plated nuts or pipes from damage
- The textured handles provide a sure grip even with wet hands
- Replaces jaw wrenches, slip nut and combination wrenches
- Corrosion resistant chrome-plated
- Can be used as oil filter pliers

UPC	NO.	CAPACITY
18900 4	189	up to 4" (102mm) 10-1/4" (260mm)



Removable Soft Jaw Covers



GENERAL® No 189
189

IRON PIPE WRENCHES

- Professional quality
- Forged and ground jaws
- Hang hole in handle

UPC	NO.	SIZE	CAPACITY
01491 7	1491	10" (250mm)	1-1/2" (38mm)
01492 4	1492	14" (350mm)	2" (50mm)
01493 1	1493	18" (450mm)	2-1/2" (65mm)



1493 Shown - 18" (450mm)

1493



159

SOFT JAW PLUMBING PLIER

- Adjustable forged pliers with removable protective soft grip jaws
- Remove soft jaws for standard work
- Textured cushion grips provide a sure grip even with wet hands
- Includes a spare set of soft jaws
- Durable chrome plated forged steel jaws provide ample capacity for most pipes, nipples and fittings up to 2"
- 10" overall length provides extra torque

UPC	NO.	CAPACITY	LENGTH
01590 7	159	2" (50mm)	10" (254mm)



Removable Soft Jaw Covers



The Strainer Lock Nut Wrench is useful in applications where shorter wrenches cannot reach. The dual-ended Plug Wrench tool accommodates different styles of basket strainers and pop-up plugs. Our

Adjustable Sink Wrench gives you the power to tackle all types of stubborn fittings, including spud, slip, lock and basket-strainer nuts. The Spud Wrench removes stubborn slip nuts, locknuts and spuds in tight places.

STRAINER LOCK NUT WRENCH

- Adjustable jaw wrench is used to install or remove all strainer basket lock nuts
- Extra long comfort grip handle allows access to lock nuts other wrenches can't reach
- Non-rusting finish
- Use with Model No. 183, Basket Strainer Wrench, to prevent slipping

UPC	NO.	LENGTH
01860 1	186	12" (300mm)



186

PLUG WRENCH

- Holds pop-up plugs and basket strainers in position
- Prevents rotation of basket strainers during installation
- Zinc plated to prevent rust

UPC	NO.
22157 5	193



193

ADJUSTABLE WRENCH

- Jaws have a cutout for convenient locknut installation
- Fits spudnuts, slip and locknuts and basket strainer nuts
- Adjusts from 1" to 3" (25-75mm)
- Zinc plated to prevent rust

UPC	NO.	LENGTH
22155 1	190	10-1/4" (260mm)



190

SPUD WRENCH

- Even in tight spaces, stubborn slip nuts, locknuts and spuds are no match for this tool
- Handles three sizes of hex nuts: 1-3/4" (45mm), 2" (51mm), 2-1/2" (64mm)
- 1/2" lug turn and pivot hook

- Stamped steel construction
 - Nickel plated to prevent rust
- | UPC | NO. | LENGTH |
|---------|-----|----------------|
| 22156 8 | 191 | 9-3/8" (238mm) |



191

PLUMBING TOOLS

Specialty Wrenches



General's durable Tub Drain Remover and Shower Valve Wrench Set provide easy solutions for problematic bathroom plumbing repairs. Our Basket Strainer Wrench has a sliding handle for secure grip

and needed torque. The Stub Wrench has 8-tapered flutes that fit inside broken pipes for effortless removal of plastic plumbing and garden hose debris.

TUB DRAIN REMOVER

- Used to install or remove tub drains with or without crossbars. Tap in for a snug fit then turn with a wrench or large screwdriver
- Double ended to fit most tub drains
- Durable cast construction

UPC	NO.
01850 2	185

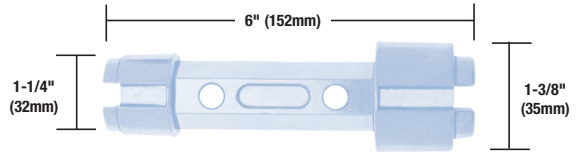
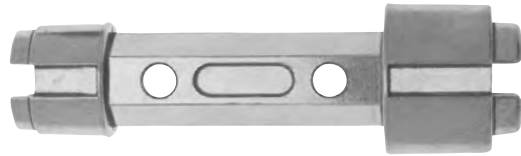

185

DOUBLE ENDED BASKET STRAINER WRENCH

- Holds strainer in position for easy installation while tightening the locking nut
- Sliding handle provides a secure grip and needed torque
- Two sizes to fit most basket strainers
- Plated steel prevents rust

UPC	NO.
01830 4	183

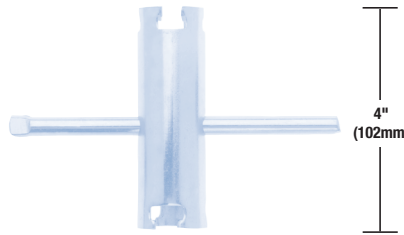

183

SHOWER VALVE WRENCHES

- Five-piece set comes with five double end wrenches, bar handle and a bar wire holder for easy storage
- Sizes: 21/32 x 27/32; 29/32 x 31/32; 1-1/32 x 1-3/32; 1-5/32 x 1-9/32; 1-11/32 x 1-7/16
- Longer length for access to recessed valve stems in tile covered walls

UPC	NO.	TYPE	SIZES
22161 2	188	(Five-piece set)	21/32" x 1-7/16"
01881 6	1881	Individual	21/32" x 27/32"
01882 3	1882	Individual	29/32" x 31/32"
01883 0	1883	Individual	1-1/32" x 1-3/32"



188

STUB WRENCH

- Removes PVC and CPVC broken plastic plumbing and garden sprinkler risers
- Serrated and tapered jaws are tapped into the riser for a tight fit for easy extraction
- Comfort grip T-handle for added torque

UPC	NO.	SIZES	LENGTH
01399 6	1399	1/2", 3/4" (12, 20mm)	7-3/4" (197mm)



1399

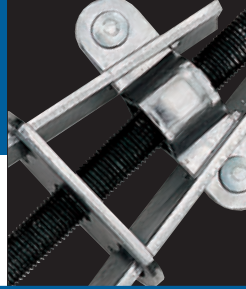

Our Garbage Disposal Wrench positions easily at the top of a disposal's shredder plate for fast removal of stubborn clogs. Old shower and sink faucet handles are rapidly removed with General's Faucet Handle

Puller. The 4-Way Faucet Wrench Stem works on stop cocks, sill cocks and valves with square heads while our Cartridge Puller makes quick, economic repairs to leaking valve stems and cartridges.

GARBAGE DISPOSAL WRENCH

- This universal wrench safely dislodges garbage disposal shredder plate jams
- Swivel head design provides easy position on the shredder plate
- The large flat surface cushion grip handle provides a comfortable grip

UPC	NO.	LENGTH
01920 2	192	11.5" (292mm)



192

FAUCET HANDLE PULLER

- Removes large and small faucet handles with ease
- Two adjustable fingers four inches long for a more secure grip

UPC	NO.
22158 2	180

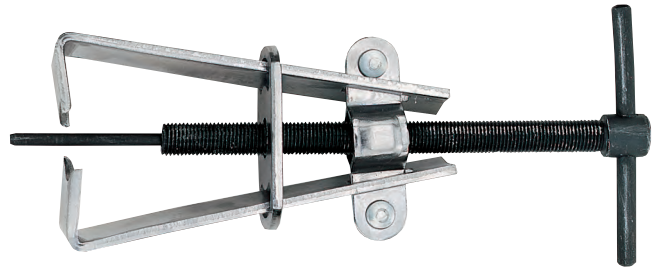

180

4-WAY FAUCET WRENCH

- One tool does the work of four individual wrenches
- Sizes: 1/4", 9/32", 5/16", 11/32" internal square
- Fits stopcocks, sillcocks and valves
- Heat treated steel for greater strength

UPC	NO.
22159 9	182



182

STEM AND CARTRIDGE PULLER

- Works on plastic and brass cartridge stems for faucets, tubs and shower valves
- For easy removal of Moen® style single lever faucet stem and cartridge and other plastic and cartridge sleeve
- Works on plastic and brass faucets and shower valves

UPC	NO.
01809 0	1809

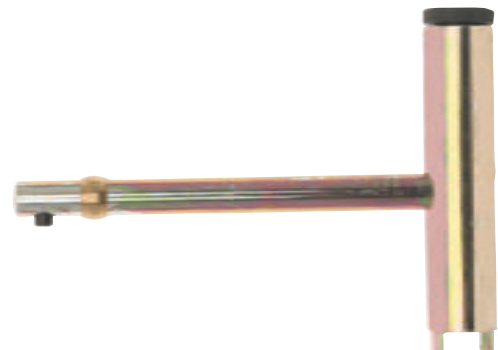

1809

Strap Wrench / Drain Snake

Strap Wrenches provide a non-marring, slip-resistant grip. These wrenches are ideal for working on decorative finishes or irregular shapes.

The Mini-Drain Snake will clean out most problems of blocking sinks, bathtubs or toilets within 2 feet of the openings.

PLUMBING



1566



RUBBER STRAP WRENCH

- Fits any shape
- Rubber strap for a non-marring, slip resistant grip
- Tough thin strap works in tight spaces
- Holds, loosens or tightens
- Can also be used for removing tight jar lids

UPC	NO.	CAPACITY
01566 2	1566	6" O.D. (152mm)

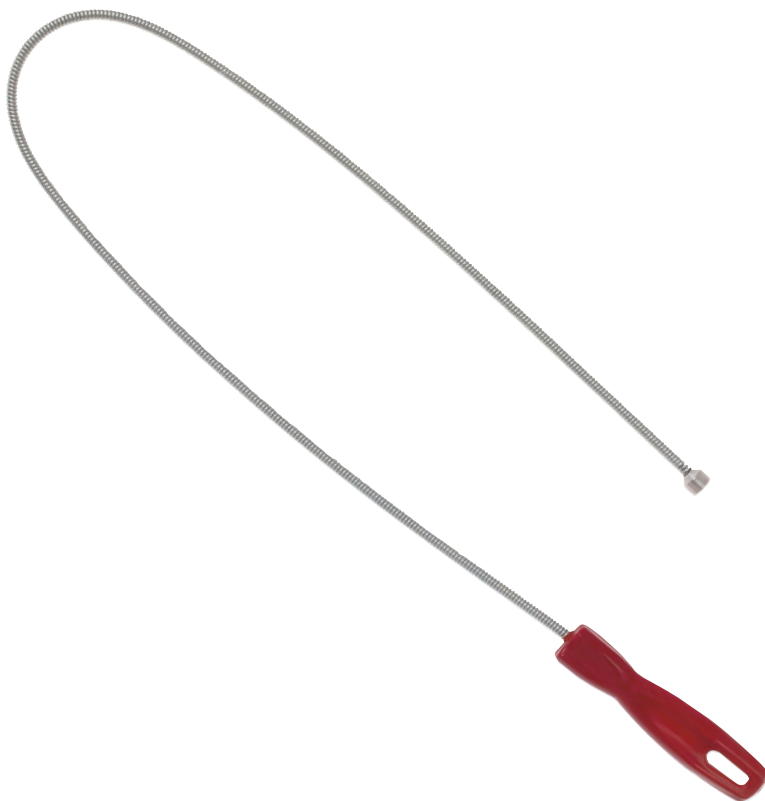

201

MINI-DRAIN SNAKE

- The Mini Snake will clean out most problems of blocked sinks, bathtubs or toilets within two feet of the opening
- The sharp ended scraper will cut through most debris in openings 1/2" or larger
- The flexible rod conforms to drain pipe without binding
- The rod is plated to prevent rust and last for years
- Useful for central vacuum clogs

UPC	NO.	LENGTH
00201 3	201	24" (600mm)

Machinist Tools

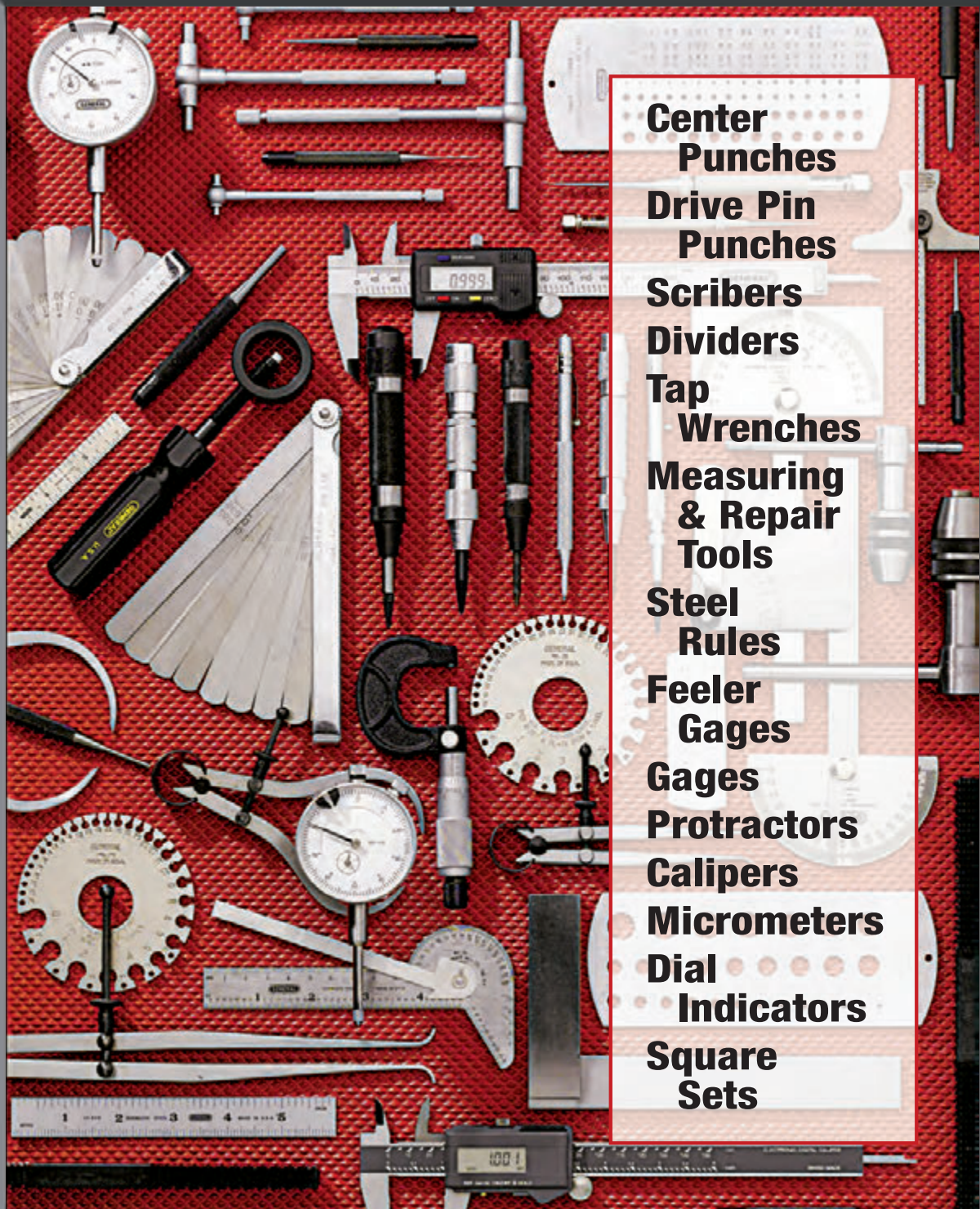

**Center
Punches
Drive Pin
Punches
Scribers
Dividers
Tap
Wrenches
Measuring
& Repair
Tools
Steel
Rules
Feeler
Gages
Gages
Protractors
Calipers
Micrometers
Dial
Indicators
Square
Sets**

MACHINIST TOOLS

Center Punches



General's Automatic Center Punches offer a precise way to punch center holes for drilling in layout work. Single-handed operation with stored energy design eliminates the need for striking the punch

with a hammer. Spring tension cap can be adjusted for light to heavy strokes. Punch depth can be set for repetitive work.

PROFESSIONAL AUTOMATIC CENTER PUNCH



79

- Punches, marks, scribes and starts drill, nail or screw holes
- One-hand spring impact operation, no hammer needed
- Spring tension adjusts for light or heavy markings
- Ball bearing action
- Black oxide finish inhibits rust
- All-steel body with threaded, replaceable hardened steel point

UPC	NO.	A	B	C	D	E
31072 9	79	3/16" (5mm)	4-7/8" (124mm)	3-29/32" (99mm)	1/2" (12mm)	.055" (1.4mm)
31078 1	79P	Replacement point				
31079 8	79P/2	Replacement points (2)				



HEAVY-DUTY PROFESSIONAL AUTOMATIC CENTER PUNCH

- Heavy-duty center punch
- Punches, marks, scribes and starts drill, nail or screw holes
- One-hand spring impact operation, no hammer needed
- Spring tension adjusts for light or heavy markings
- Black oxide finish inhibits rust
- All-steel body with replaceable hardened steel point

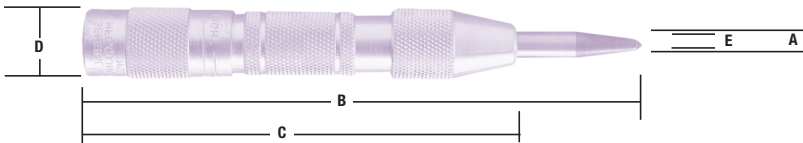

78

UPC	NO.	A	B	C	D	E
31066 8	78	17/64" (7mm)	5-5/8" (143mm)	4-9/32" (109mm)	5/8" (16mm)	.083" (2.1mm)
31068 2	78P	Replacement point				



MACHINIST'S AUTOMATIC CENTER PUNCH

- Punches, marks, scribes and starts drill, nail or screw holes
- One-hand spring impact operation, no hammer needed
- Spring tension adjusts for light or heavy markings
- Ball bearing action
- Lightweight aluminum body with long wearing alloy steel parts
- Hardened steel point



77

UPC	NO.	A	B	C	D	E
31062 0	77	1/4" (6mm)	5" (127mm)	3-29/32" (99mm)	5/8" (16mm)	.104" (2.6mm)



STAINLESS STEEL AUTOMATIC CENTER PUNCH

- Provides accurate center punches to prevent drill bits from traveling
- One-hand spring impact operation, no hammer needed
- For marking, punching & staking
- Durable stainless steel body will not rust.

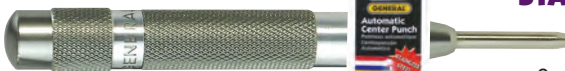

89

UPC	NO.	A	B	C	D	E
02131 1	89	5/32" (4mm)	5-1/4" (133mm)	4" (102mm)	9/16" (14mm)	.070" (1.8mm)



POCKET AUTOMATIC CENTER PUNCH

- Pencil slim design with pocket clip
- Punches, marks, scribes and starts drill, nail or screw holes
- One-hand spring impact operation, no hammer needed
- Spring tension adjusts for light or heavy markings
- Lightweight aluminum body with long wearing alloy steel parts
- Hardened steel point



87

UPC	NO.	A	B	C	D	E
31108 5	87	1/8" (3mm)	5-3/4" (146mm)	5-11/16" (144mm)	5/16" (8mm)	.058" (1.5mm)



MACHINIST

Center & Drive Pin Punches

Drive Pin Punches are well proportioned, hardened, tempered and have a knurled finger grip. Designed to withstand hard use, they are perfect in the machine shop as well as in the motor service industry.

Machinists use our shank punches for marking work in layout and drilling operations. These tools are constructed of hardened and ground alloy tool steel for maximum strength and durability.



UTILITY AUTOMATIC CENTER PUNCH

- Punches, marks, scribes and starts drill, nail or screw holes
- One-hand spring impact operation, no hammer needed
- Ball bearing action
- Lightweight aluminum body with long wearing alloy steel parts
- Hardened steel point

UPC	NO.	A	B	C	D	E
22339 5	70079	5/32" (4mm)	5" (127mm)	3-15/16" (100mm)	1/2" (12mm)	.070" (1.8mm)



70079

ROUND SHANK CENTER PUNCHES

- Points are ground to size for maximum strength and penetration
- Knurled body
- Stamped with size for quick identification
- Packed in a vinyl case

UPC	NO.	Set contains five punches, AA-D, listed below				
31018 7	SPC74					
SIZE	A	B	C	D	E	
1/16" (2mm)	3-1/16" (78mm)	2" (51mm)	1/4" (6mm)	5/32" (4mm)		
5/64" (2mm)	3-19/32" (91mm)	2-1/4" (57mm)	1/4" (6mm)	3/16" (5mm)		
3/32" (2mm)	3-7/8" (98mm)	2-15/32" (63mm)	5/16" (8mm)	7/32" (6mm)		
9/64" (4mm)	4" (102mm)	2-5/8" (67mm)	5/16" (8mm)	1/4" (6mm)		
5/32" (4mm)	4" (102mm)	2-19/32" (66mm)	3/8" (10mm)	9/32" (7mm)		

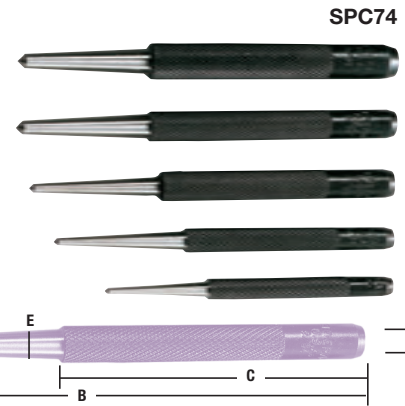

SPC74

EXTRA LONG DRIVE PIN PUNCHES

- Made of tool steel, hardened and centerless ground
- For use on work not accessible with shorter punches
- Knurled body
- Packed in a vinyl case
- Conforms to gov. specs, GGG-P-831E

UPC	NO.	Set contains five punches, A-E, listed below.				
31050 7	SPC76					
UPC	NO.	A	B	C	D	E
31052 1	76A	1/8" (3mm)	8" (203mm)	4-1/2" (114mm)	3/8" (10mm)	3-1/2" (89mm)
31054 5	76B	3/16" (5mm)	8" (203mm)	4-1/2" (114mm)	7/16" (11mm)	3-1/2" (89mm)
31056 9	76C	1/4" (6mm)	8" (203mm)	4-1/2" (114mm)	7/16" (11mm)	3-1/2" (89mm)
31058 3	76D	5/16" (8mm)	8" (203mm)	4-1/2" (114mm)	7/16" (11mm)	3-1/2" (89mm)
31060 6	76E	3/8" (10mm)	8" (203mm)	4-1/2" (114mm)	1/2" (12mm)	3-1/2" (89mm)

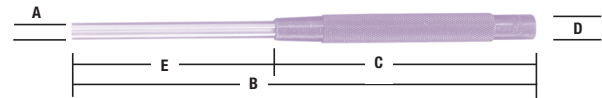

SPC76

DRIVE PIN PUNCHES

- Tool steel punches are uniformly heat treated and centerless ground to withstand the hardest use
- Ends are ground square for accurate pin driving
- Packed in a plastic case

UPC	NO.	Set contains eight punches, A-H, listed below				
31032 3	SPC75					
UPC	NO.	A	B	C	D	E
31034 7	75A	1/16" (2mm)	4" (102mm)	2-5/8" (67mm)	1/4" (6mm)	3/4" (19mm)
31036 1	75B	3/32" (2mm)	4" (102mm)	2-9/16" (65mm)	1/4" (6mm)	3/4" (19mm)
31038 5	75C	1/8" (3mm)	4" (102mm)	2-7/16" (62mm)	5/16" (8mm)	3/4" (19mm)
31040 8	75D	5/32" (4mm)	4" (102mm)	2-9/16" (65mm)	5/16" (8mm)	3/4" (19mm)
31042 2	75E	3/16" (5mm)	4" (102mm)	2-5/8" (67mm)	5/16" (8mm)	1" (25mm)
31044 6	75F	7/32" (6mm)	4" (102mm)	2-5/8" (67mm)	3/8" (10mm)	1" (25mm)
31046 0	75G	1/4" (6mm)	4" (102mm)	2-9/16" (65mm)	3/8" (10mm)	1" (25mm)
31048 4	75H	5/16" (8mm)	4" (102mm)	2-3/4" (70mm)	3/8" (10mm)	1" (25mm)



SPC75

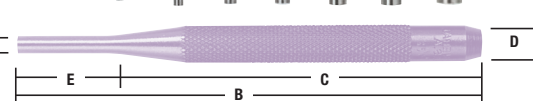

MACHINIST TOOLS

Scribers



General manufactures a complete line of Scribers for machinists, engravers, mechanics and craftspeople. A basic tool for layout work and tool marking.

General's Scribers are used for marking and engraving on metal, glass, plastics and ceramics.

CARBIDE TIP SCRIBER WITH MAGNET

- Tungsten carbide tip marks hard materials including hardened steel, stainless steel, ceramics and glass
- Permanent magnet picks up small parts and retrieves steel chips from hard-to-reach places
- Screw chuck for reversing tungsten carbide point when not in use
- Knurled aluminum handle provides maximum control and comfort

- Point is replaceable
- Convenient pocket-clip

UPC	NO.
31116 0	88CM
31114 6	88P Replaceable point

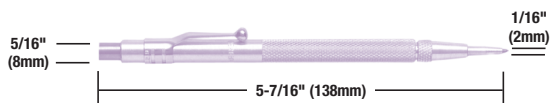

TUNGSTEN CARBIDE TIP SCRIBER/ETCHING PEN

- Tungsten carbide tip marks hard materials including hardened steel, stainless steel, ceramics and glass
- Screw chuck for reversing tungsten carbide point when not in use
- Knurled aluminum handle provides maximum control and comfort
- Point is replaceable
- Convenient pocket-clip

UPC	NO.
31112 2	88
31114 6	88P Replaceable point

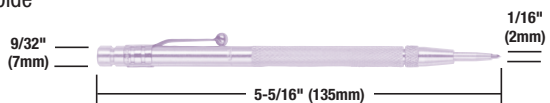

UTILITY CARBIDE TIP SCRIBER/ETCHING PEN

- Tungsten carbide point for marking and scribing steel, ceramics and glass
- Magnet picks up small parts and retrieves steel chips from hard-to-reach places
- Knurled aluminum handle provides maximum control and comfort
- Convenient pocket-clip

UPC	NO.
22340 1	70088

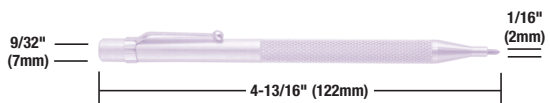

POCKET SCRIBER

- Replaceable hardened and centerless ground steel point
- Point reverses into knurled body for safety
- Hex cap prevents rolling
- Conforms to government specifications GGG-S-131E

UPC	NO.
31092 7	81
31094 1	81P Replaceable point

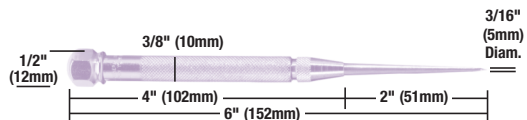
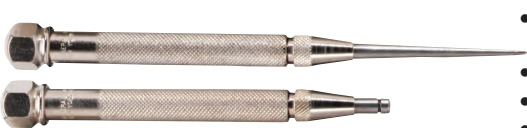

POCKET SCRIBER

- Replaceable hardened and centerless ground steel point
- Point reverses into knurled body for safety
- Hex cap prevents rolling
- Conforms to government specifications GGG-S-131E

UPC	NO.
31098 9	83
31100 9	83P Replaceable point

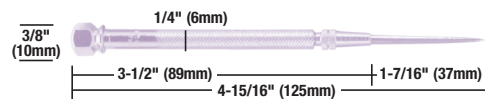

REPLACEABLE NEEDLEPOINT SCRIBER

- Scribes stainless steel, copper and brass
- Nork pattern scriber
- Four extra points are stored under cap

UPC	NO.
31102 3	84
31104 7	84P Replaceable point (12 per pkg.)

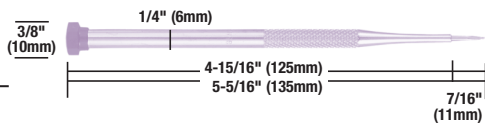

MACHINIST

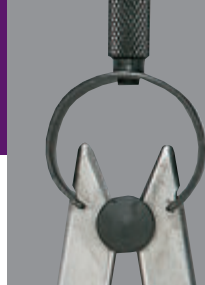

All Dividers' legs and Calipers' legs are forged of special caliper steel. Hardened and tempered bow springs and fulcrum spools assure uniform tension without side play. Adjusting screw has a self-seating

washer and nut to permit quick and positive adjustment. Dividers have hardened points. Calipers have hardened measurement faces and meet government specifications GGG-C-95.

FIXED TWO POINT SCRIBER

- Hardened and ground steel needle points are fixed to a knurled body
- Has one straight point and one 90° bent point

UPC	NO.
31090 3	80
31091 0	80C Individually carded

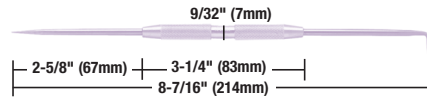

80



THREE POINT SCRIBER

- Finest quality machinist's scriber
- Aluminum knurled body, with three interchangeable threaded steel points: short straight, short bent and long bent

UPC	NO.
31400 0	380A

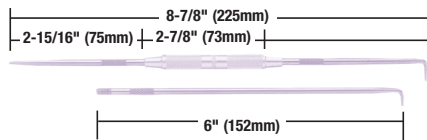

380A



TWO POINT SCRIBER

- This scriber consists of short straight and short 90° bent steel removeable points which thread into knurled body

UPC	NO.
31403 1	380B

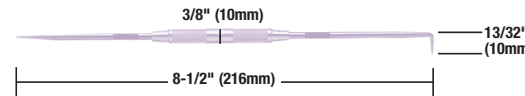

380B



SINGLE POINT SCRIBER

- Hardened tempered steel point

UPC	NO.
31106 1	85

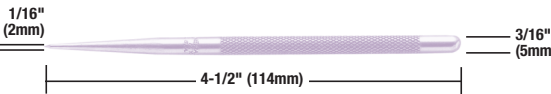

85

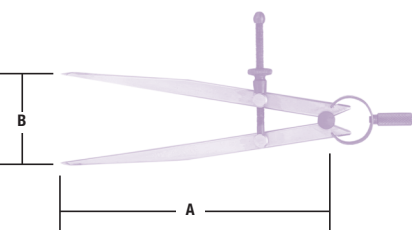

FLAT LEG DIVIDERS

- Legs are forged of special caliper steel
- Hardened and tempered bow springs
- Hardened points

UPC	NO.	A	B
31598 4	450-4	4" (102mm)	4-1/8" (105mm)
31601 1	450-6	6" (152mm)	6-1/4" (159mm)
31604 2	450-8	8" (203mm)	8-1/4" (210mm)
31592 2	450-10	10" (254mm)	10-1/4" (260mm)
31595 3	450-12	12" (305mm)	12-1/4" (311mm)

450

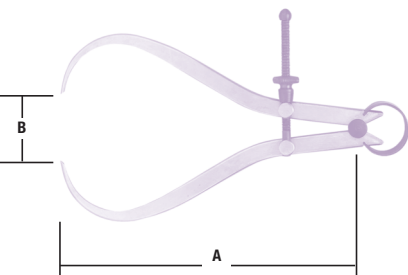

OUTSIDE CALIPERS

- Legs are forged of special caliper steel
- Hardened and tempered bow springs
- Hardened measurement points

UPC	NO.	A	B
31615 8	452-4	4-3/16" (106mm)	4-3/16" (106mm)
31618 9	452-6	6-1/8" (156mm)	6-5/16" (160mm)
31621 9	452-8	8" (203mm)	8-1/16" (205mm)
31607 3	452-10	10" (254mm)	10" (254mm)
31610 3	452-12	12-3/4" (324mm)	12-1/4" (311mm)

452

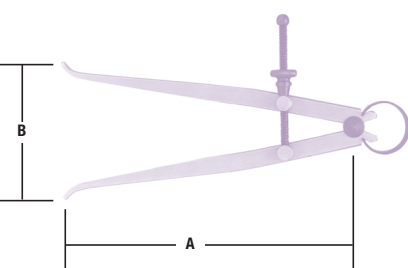

INSIDE CALIPERS

- Legs are forged of special caliper steel
- Hardened and tempered bow springs
- Hardened measurement points

UPC	NO.	A	B
31636 3	454-4	4" (102mm)	4-7/16" (113mm)
31639 4	454-6	6-5/16" (160mm)	6-1/2" (165mm)
31641 7	454-8	8" (203mm)	8-11/16" (221mm)
31624 0	454-10	10" (254mm)	10-11/16" (271mm)
31627 1	454-12	12-5/16" (313mm)	12" (305mm)

454



MACHINIST TOOLS

Tap Wrenches



General's Tap Wrenches provide good leverage in tight spaces. These top quality tools are designed to give the user the reach and leverage needed for

accurate tapping. The T-handle tap wrenches are for holding taps, drills, reamers and other small tools to be turned by hand.



161R

REVERSIBLE RATCHET TAP WRENCHES

- Ratchet can be set for right- or left-hand operation or locked for non-ratchet use
- Self-centering hardened steel jaws and knurled chuck sleeve provide positive grip on taps, reamers and small tools
- Sliding T-handle for fitting into tight spaces with operator leverage
- No. 161R conforms to government specifications GGG-W-680a

UPC	NO.	TAP CAPACITY	LENGTH
31200 6	160R	No. 0 to No. 8 (1.6 to 4mm)	2-3/4" (70mm)
31203 7	161R	No. 0 to 1/4" (1.6 to 6.3mm)	3-1/2" (88mm)
31209 9	162R	No. 12 to 1/2" (6 to 12mm)	4-1/4" (106mm)



165

PROFESSIONAL REVERSIBLE RATCHETING TAP WRENCH SET

- Set includes: No. 161R Ratcheting Tap Wrench, No. 162R Ratcheting Tap Wrench and No. 715P Reference Table
- Self-centering, hardened steel jaws and knurled chuck sleeve
- For holding taps, reamers, screw extractors, hand turned tools and drill bits
- The No. 715P Plastic Reference Table is the essential reference table for tool makers, machinists and mechanics
- The front has machine screw size tap drill chart for recommended 75% depth thread
- The back has decimal equivalents table in 64ths from 1/64" to 63/64"
- Packaged in a sturdy, fitted foam lined plastic case designed specifically for this set

UPC	NO.
01650 8	165



164

PLAIN TAP WRENCHES

- Self-centering hardened steel jaws and knurled chuck sleeve
- No. 163 has rigid T-handle
- Nos. 164 and 166 have sliding T-handle for fitting into tight spaces with greater leverage

UPC	NO.	TAP CAPACITY (NOS. & INCHES)	LENGTH
31212 9	163	No. 0 to No. 8 (1.6 to 4mm)	2-1/4" (57mm)
31215 0	164	No. 0 to 1/4" (1.6 to 6.3mm)	2-3/4" (70mm)
31218 1	166	No. 12 to 1/2" (6 to 12mm)	3-3/4" (95mm)



167

PROFESSIONAL PLAIN TAP WRENCH SET

- Set includes: No. 164 Plain Tap Wrench, No. 166 Plain Tap Wrench and No. 715P Reference Table
- Nos. 164 and 166 has sliding T-handles for fitting into tight spaces with greater leverage
- Self-centering, hardened steel jaws and knurled chuck sleeve
- For holding taps, reamers, screw extractors, hand turned tools and drill bits
- The No. 715P Plastic Reference Table is the essential reference table for tool makers, machinists and mechanics
- The front has machine screw size tap drill chart for recommended 75% depth thread
- The back has decimal equivalents table in 64ths from 1/64" to 63/64"
- Packaged in a sturdy, fitted foam lined plastic case designed specifically for this set

UPC	NO.
01670 6	167

Measuring & Repair Tools



Telescoping Gages are used for quick and accurate measurements of inside diameters of holes and widths of slots from which micrometer measure-

ments are taken. Thread Repair Files restore damaged external threads on studs, bolts, screws, plumbing pipes and pipe fittings.

NUT SPLITTER

- Here is a real timesaver for the removal of frozen, hard to remove rusted nuts
- Only 4-3/4" long, this compact tool will split nuts up to 1/2" automotive series (3/4" or 19mm across flats)
- Standard 3/4" driving hex head for use with wrenches or sockets
- Angled body for getting into hard-to-reach work areas

- Replaceable hardened steel chisel point can be reversed to achieve best cutting angle
- Made of high-grade heat treated forged steel for durability. Plated and black oxide finishes to prevent rust

UPC	NO.
31325 6	175



175

THREAD REPAIR FILES

- These indispensable files restore damaged external threads on studs, bolts, screws, plumbing pipe and pipe fittings
- Four different high carbon steel files are available. Each file provides 4 to 8 different thread pitches
- Restores rusted or corroded fasteners
- Doubles as a screw pitch gage
- Black oxide to prevent rust

UPC	FILE NO.	THREAD PITCHES
31236 5	177-1	11,12,13, 14, 16, 18, 20, 24, T.P.I.
31240 2	177-2	9, 10, 12, 16, 20, 27, 28, 32, T.P.I.
31242 6	177-8	0.75, 1.0, 1.25, 1.5, 1.75, 2.0, 2.5, 3.0mm



177-1



177-2



177-8



TELESCOPING GAGE SET

- These gages are used for quick and accurate measurements of inside diameters of holes and widths of slots from which micrometer measurements are taken
- Both gaging ends are heat treated tool steel and ground to a radius for measuring the smallest hole the gage will enter
- Self-centering action ensures accuracy
- Long handled design provides improved reach in deep holes and slots
- Satin chrome finish
- Swivel lock at base of handle
- Set of Six, AA-E, listed below, packed in vinyl case

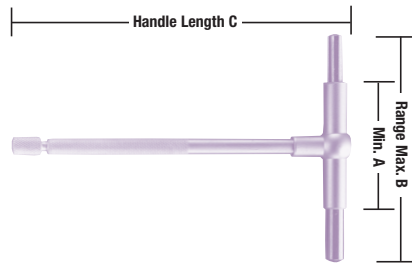

UPC	NO.	A	B	C
31130 6	S98-6			
		AA 5/16" (7.5mm)	1/2" (12mm)	4-13/32" (112mm)
		A 1/2" (12mm)	3/4" (20mm)	4-1/4" (108mm)
		B 3/4" (20mm)	1-1/4" (31mm)	4-1/4" (108mm)
		C 1-1/4" (31mm)	2-1/8" (53mm)	5-3/16" (132mm)
		D 2-1/8" (53mm)	3-1/2" (88mm)	5-3/16" (132mm)
		E 3-1/2" (88mm)	6" (140mm)	5-1/4" (133mm)



S98-6

EDGE FINDERS

- General's edge finders accurately locate working edges, shoulders, grooves, centerpoints and scribed lines
- Time-saving positioning tools for jig borers, milling and other machines
- Hardened and centerless ground precision tolerance
- All sizes 3" long

UPC	NO.	END	SIZE	SHANK
31329 4	260	Single	.500"	1/2" (12mm)
31331 7	262	Double	.200" and 500"	1/2" (12mm)
31334 8	263	Single	.200"	3/8" (10mm)
31337 9	264	Double	.200" and point	1/2" (12mm)



260

262

263

264



General's Industrial Quality Steel Rules and Economy Steel Rules are precision made with etched fine black graduations for easy reading and long life.

The two types of rules available are flex and rigid in satin or polished finishes.

STEEL RULES: ULTRATEST®, INDUSTRIAL & ECONOMY

UPC CODE	ITEM NO	SIZE	GRAD TYPE	GRADUATION SIDE 1	GRADUATION SIDE 2	WIDTH
ULTRATEST® STEEL RULES						
6" CHROME PLATED HARDENED STEEL RULES						
39021 9	CF640MM	150mm Flex	-	mm, .5mm	mm, .5mm	1/2"
33020 8	CF645	6" Flex	5R	10, 100	32, 64	1/2"
33035 2	CF649MD	6" Flex	-	10, 100	mm, .5mm	1/2"
33040 6	CF661	6" Rigid	4R	8, 16 w/32nd End Grads	32, 64	3/4"
33050 5	CF664	6" Rigid	4R	8, 16	32, 64	3/4"
33065 9	CF667ME	6" Rigid	-	32, 64	mm, .5mm	3/4"
12" CHROME PLATED HARDENED STEEL RULES						
33085 7	CF1245	12" Flex	5R	10, 100	32, 64	1/2"
33090 1	CF1246	12" Flex	16R	32, 64	50, 100	1/2"
33095 6	CF1247ME	12" Flex	-	32, 64	mm, .5mm	1/2"
33100 7	CF1249MD	12" Flex	-	10, 100	mm, .5mm	1/2"
33110 6	CF1264	12" Rigid	4R	8, 16	32, 64	1"
18" CHROME PLATED HARDENED STEEL RULE						
33140 3	CF1845	18" Flex	5R	10, 100	32, 64	3/4"
24" CHROME PLATED HARDENED STEEL RULE						
33190 8	CF2445	24" Flex	5R	10, 100	32, 64	3/4"
INDUSTRIAL STEEL RULES						
6" PRECISION STAINLESS STEEL RULES						
32096 4	616	6" Flex	5R	10, 100	32, 64	15/32"
32108 4	634	6" Flex	4R	8, 16	32, 64	15/32"
32111 4	676	6" Rigid	4R	8, 16	32, 64	3/4"
32114 5	678MED	6" Rigid	-	mm, .5mm	10, 20, 50, 100	3/4"
12" PRECISION STAINLESS STEEL RULES						
32162 6	1201ME	12" Flex	-	16, 32, 64, mm, .5mm	8, 16, 32, 64	7/8"
32171 8	1210	12" Flex Center Finding	16, 32	32, 64	1"	
32174 9	1216	12" Flex	5R	10, 100	32, 64	15/32"
32180 0	1251	12" Flex	Model RR	HO, S, O, Gage	N Gg., mm, 64 Dec Equiv.	1"
31286 0	1276	12" Rigid	4R	8, 16	32, 64	1"
6" AND 12" PRECISION SATIN CHROME STAINLESS STEEL RULES						
32123 7	CF616	6" Flex	5R	10, 100	32, 64	15/32"
32141 1	CF676	6" Flex	4R	8, 16	32, 64	3/4"
32147 3	CF678MED	6" Flex	-	mm, .5mm	10, 20, 50, 100, 16, 32, 64	3/4"
32150 3	CF1216	12" Flex	5R	10, 100	32, 64	15/32"
32153 4	CF1227ME	12" Rigid	-	32, 64	mm, .5mm	1"
32159 8	CF1276	12" Rigid	4R	8, 16	32, 64	1"
ECONOMY STEEL RULES						
6" PRECISION STAINLESS STEEL RULES						
32036 0	300/1*	6" Flex		32, 64	Dec. Equiv.	15/32"
32041 4	300MM*	150mm Flex		mm, .5mm		15/32"
32042 1	300ME*	6" Flex (150 mm)		mm, 64	Metric Equiv.	15/32"
32046 9	301/1*	6" Flex		32, 64		1/4"
32049 0	301ME	6" Flex		mm, 16		1/4"
32060 5	305ME	6" Flex		mm, 16		15/32"
32063 6	307	6" Flex		8, 16 w/32nd End Grads		3/4"
30266 3	308	6" Flex		32, 64	Dec. Equiv.	3/4"
32072 8	310	6" Flex		32, 64	B&S Wire Gg.	3/4"
32075 9	311ME	6" Flex		mm-inch 16, 32	Comparison	3/4"
32093 3	CF306MD*	6" Flex		10, 50	mm, .5mm	15/32"

*Furnished with pocket clip

MACHINIST

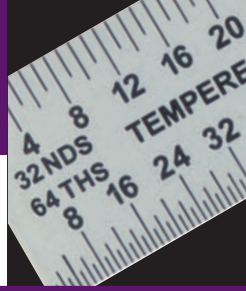

**ULTRATEST®
STEEL RULES**

ULTRATEST® Steel Rules are manufactured by a special process to meet or exceed federal specification GGG-R-791f for accuracy. They have ultra-fine black graduations against a hard satin chrome finish for easy reading and long life. All Ultratest® Rules are supplied with a plastic sleeve.

4R Graduation - 8ths, 16ths, 32nds, 64ths

5R Graduation - 32nds, 64ths, 10ths, 100ths

16R Graduation - 32nds, 64ths, 50ths, 100ths

Metric English - 32nds, 64ths, 0.5mm, mm

MACHINIST

ULTRATEST® 150mm FLEX STEEL RULE

- Graduations - mm, .5mm, for both sides
- Ultra fine black graduations
- Hard satin chrome finish
- Length is 150mm long
- Width is 13mm
- Comes in a plastic sleeve

UPC	NO.
39021 9	CF640mm



ULTRATEST® 6" FLEX STEEL RULE

- 5R Graduation - 32nds, 64ths; 10ths, 100ths
- Ultra fine black graduations
- Hard satin chrome finish
- Length is 6" long
- Width is 1/2"
- Comes in a plastic sleeve

UPC	NO.
33020 8	CF645

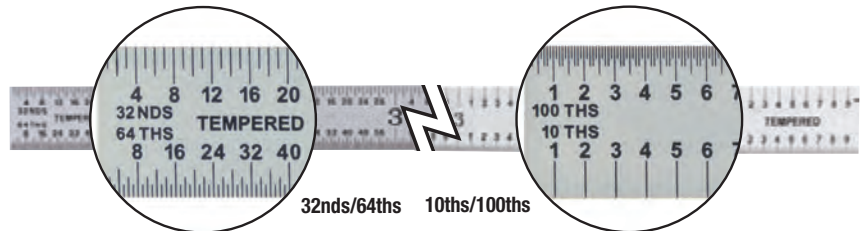

ULTRATEST® 6"/150mm FLEX STEEL RULE

- Graduation - 10ths, 100ths; mm, .5mm
- Ultra fine black graduations
- Hard satin chrome finish
- Length is 6" (150mm) long
- Width is 1/2" (13mm)
- Comes in a plastic sleeve

UPC	NO.
33035 2	CF649MD

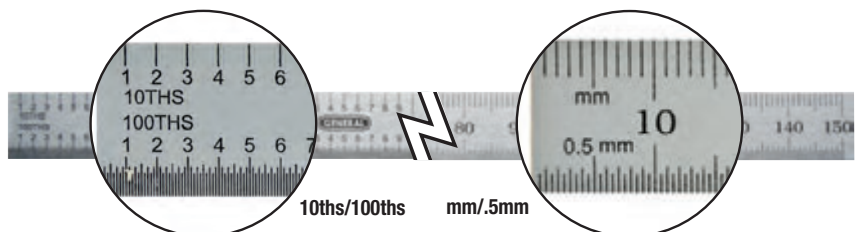



ULTRATEST® STEEL RULES

ULTRATEST® Steel Rules are manufactured by a special process to meet or exceed federal specification GGG-R-791f for accuracy. They have ultra-fine black graduations against a hard satin chrome finish for easy reading and long life. All Ultratest® Rules are supplied with a plastic sleeve.

MACHINIST

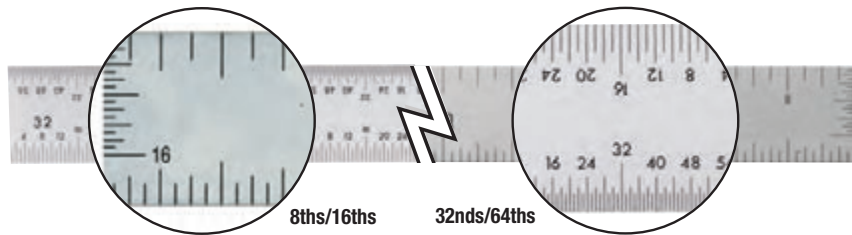

CF661

ULTRATEST® 6" RIGID STEEL RULE

- 4R Graduation - 8ths, 16ths w/32nd End Grads; 32nds, 64ths
- Ultra fine black graduations
- Hard satin chrome finish
- Length is 6" long
- Width is 3/4"
- Comes in a plastic sleeve

UPC	NO.
33040 6	CF661

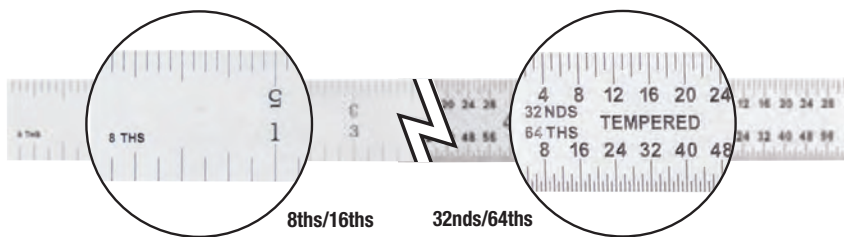

CF664

ULTRATEST® 6" RIGID STEEL RULE

- 4R Graduation - 8ths, 16ths; 32nds, 64ths
- Ultra fine black graduations
- Hard satin chrome finish
- Length is 6" long
- Width is 3/4"
- Comes in a plastic sleeve

UPC	NO.
33050 5	CF664

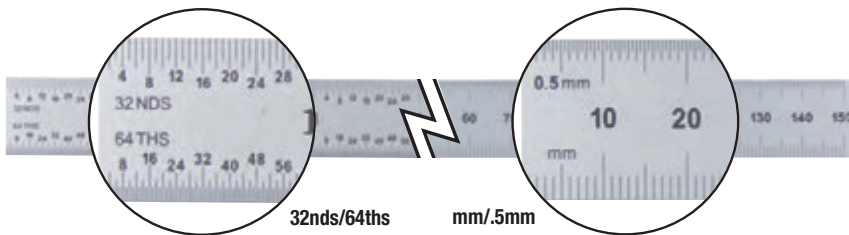

CF667ME

ULTRATEST® 6"/150mm RIGID STEEL RULE

- Graduation - 32nds, 64ths; mm, .5mm
- Ultra fine black graduations
- Hard satin chrome finish
- Length is 6" (150mm) long
- Width is 3/4" (19mm)
- Comes in a plastic sleeve

UPC	NO.
33065 9	CF667ME

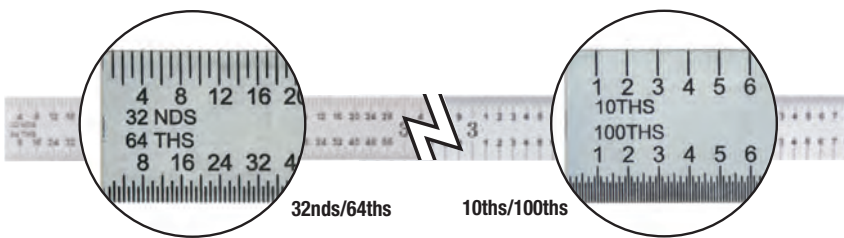

CF1245

ULTRATEST® 12" FLEX STEEL RULE

- 5R Graduation - 32nds, 64ths; 10ths, 100ths
- Ultra fine black graduations
- Hard satin chrome finish
- Length is 12" long
- Width is 1/2"

• Comes in a plastic sleeve

UPC	NO.
33085 7	CF1245

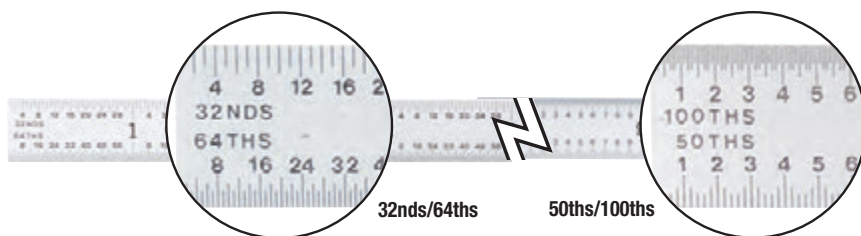

CF1246

ULTRATEST® 12" FLEX STEEL RULE

- 16R Graduation - 32nds, 64ths; 50ths, 100ths
- Ultra fine black graduations
- Hard satin chrome finish
- Length is 12" long
- Width is 1/2"

• Comes in a plastic sleeve

UPC	NO.
33090 1	CF1246



TYPE OF GRADUATIONS:

4R Graduation - 8ths, 16ths, 32nds, 64ths.
5R Graduation - 32nds, 64ths, 10ths, 100ths.

16R Graduation - 32nds, 64ths, 50ths, 100ths.
Metric English - 32nds, 64ths, 0.5mm, mm.

ULTRATEST® 12"/300mm FLEX STEEL RULE

- Graduation - 32nds, 64ths; mm, .5mm
- Ultra fine black graduations
- Hard satin chrome finish
- Length is 12" (300mm) long
- Width is 1/2" (13mm)
- Comes in a plastic sleeve

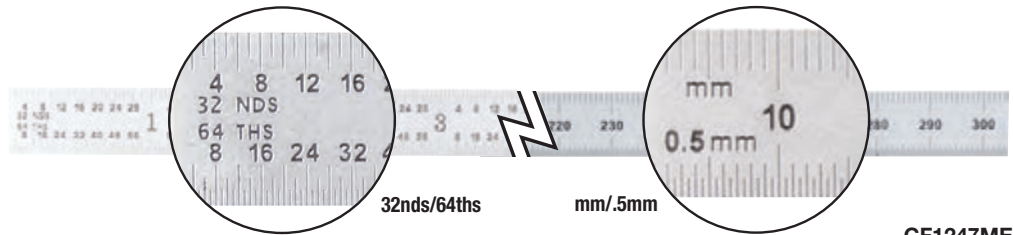

CF1247ME

UPC NO.
33095 6 CF1247ME

ULTRATEST® 12"/300mm FLEX STEEL RULE

- Graduation - 10ths, 100ths; mm, .5mm
- Ultra fine black graduations
- Hard satin chrome finish
- Length is 12" (300mm) long
- Width is 1/2" (13mm)
- Comes in a plastic sleeve

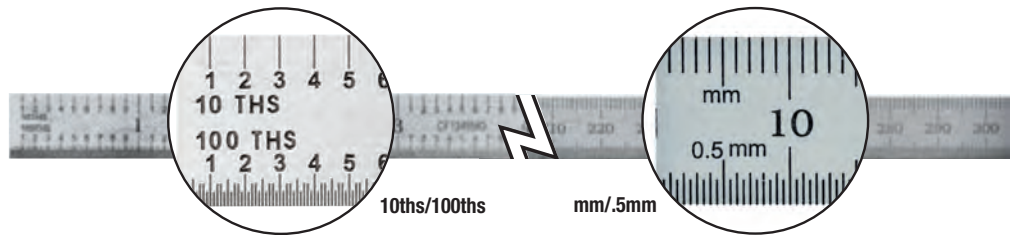

CF1249MD

UPC NO.
33040 6 CF1249MD

ULTRATEST® 12" RIGID STEEL RULE

- 4R Graduation - 8ths, 16ths; 32nds, 64ths
- Ultra fine black graduations
- Hard satin chrome finish
- Length is 12" long
- Width is 1"
- Comes in a plastic sleeve

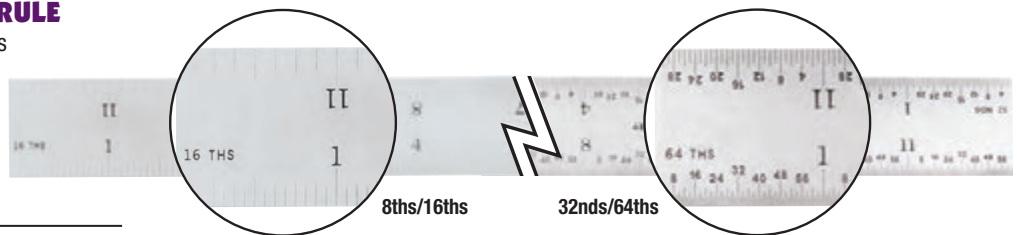

CF1264

UPC NO.
33110 6 CF1264

ULTRATEST® 18" RIGID STEEL RULE

- 5R Graduation - 32nds, 64ths; 10ths, 100ths
- Ultra fine black graduations
- Hard satin chrome finish
- Length is 18" long
- Width is 3/4"
- Comes in a plastic sleeve

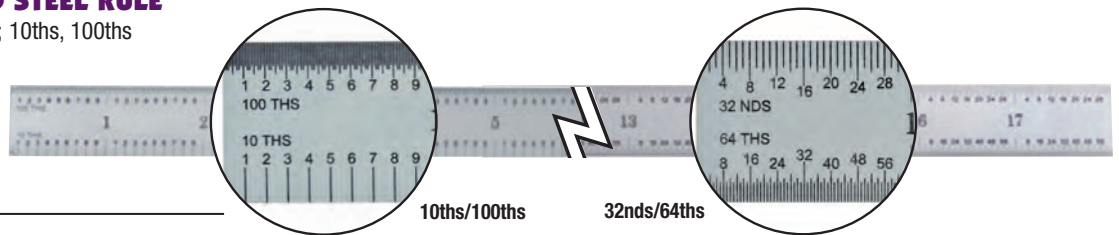

CF1845

UPC NO.
33140 3 CF1845

ULTRATEST® 24" FLEX RULE

- 5R Graduation - 32nds, 64ths; 10ths, 100ths
- Ultra fine black graduations
- Hard satin chrome finish
- Length is 24" long
- Width is 3/4"
- Comes in a plastic sleeve

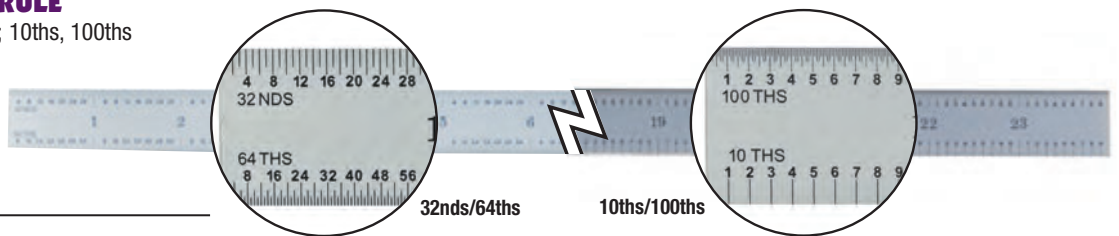

CF2445

UPC NO.
39190 8 CF2445



General's Industrial Steel Rules and Economy Steel Rules are precision made with etched fine black graduations for easy reading and long life.

The two finishes available are polished stainless steel or satin chrome.

MACHINIST

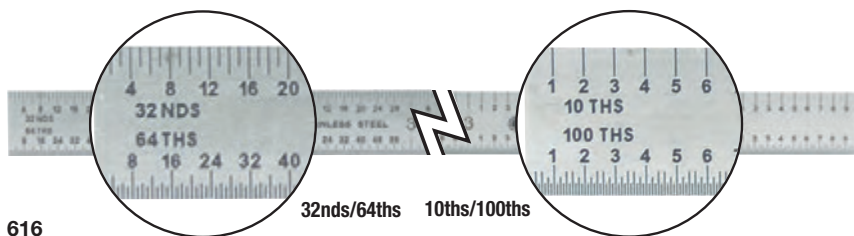

616

PRECISION 6" FLEX STEEL RULE

- 5R Graduation - 32nds, 64ths; 10ths, 100ths
- Ultra fine black graduations
- Polished Stainless Steel finish
- Length is 6" long
- Width is 15/32"

UPC	NO.
32096 4	616

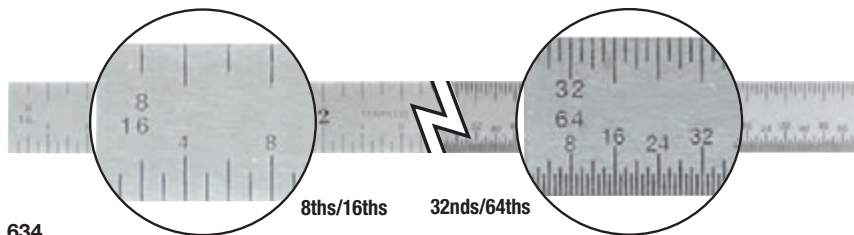

634

PRECISION 6" FLEX STEEL RULE

- 4R Graduation - 8ths, 16ths; 32nds, 64ths
- Ultra fine black etched graduations
- Polished Stainless Steel finish
- Length is 6" long
- Width is 15/32"

UPC	NO.
32108 4	634

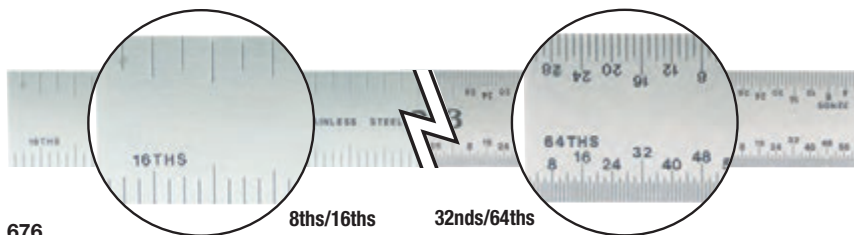

676

PRECISION 6" RIGID STEEL RULE

- 4R Graduation - 8ths, 16ths; 32nds, 64ths
- Ultra fine black etched graduations
- Polished Stainless Steel finish
- Length is 6" long
- Width is 3/4"

UPC	NO.
32111 4	676

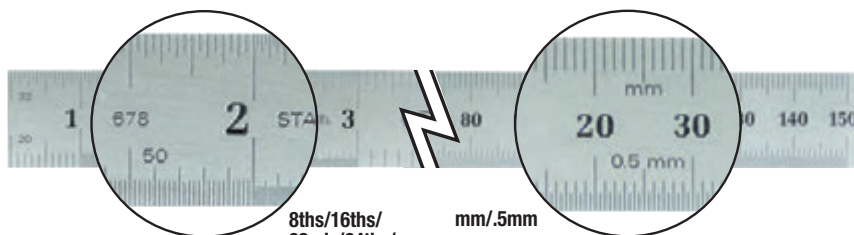

678MED

PRECISION 6"/150mm RIGID STEEL RULE

- 4R Graduation - 8ths, 16ths, 32nds, 64ths, Side 2 - 10, 20, 50, 100; mm, .5mm
- Ultra fine black graduations
- Polished Stainless Steel finish
- Length is 6" (150mm) long
- Width is 3/4" (19mm)

UPC	NO.
32114 5	678MED

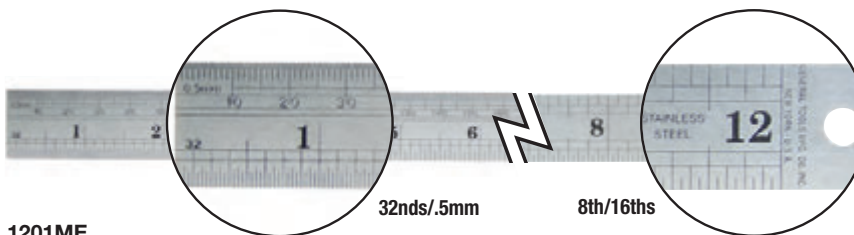

1201ME

PRECISION 300mm/12" FLEX STEEL RULE

- Graduation - .5mm, 32nds; 8ths, 16ths
- Ultra fine black graduations
- Polished Stainless Steel finish
- Length is 330mm (13") overall
- Width is 22mm (7/8") • Hanging hole

UPC	NO.
32162 6	1201ME

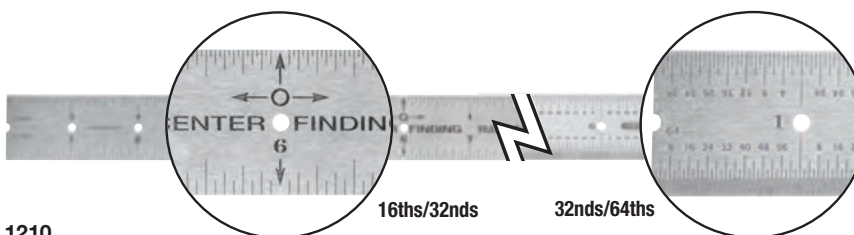

1210

PRECISION 12" FLEX STEEL RULE

- Center finding graduation - 16ths, 32nds, 32nds, 64ths
- Ultra fine black graduations
- Polished Stainless Steel finish
- Width is 15/32"

UPC	NO.
32171 8	1210

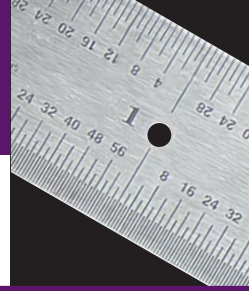

TYPE OF GRADUATIONS:

4R Graduation - 8ths, 16ths, 32nds, 64ths.
5R Graduation - 32nds, 64ths, 10ths, 100ths.

16R Graduation - 32nds, 64ths, 50ths, 100ths.
Metric English - 32nds, 64ths, 0.5mm, mm.

PRECISION 12" FLEX STEEL RULE

- 5R Graduation - 32nds, 64ths; 10ths, 100ths
- Ultra fine black graduations
- Polished Stainless Steel finish
- Length is 12" long
- Width is 15/32"

UPC NO.
32174 9 1216

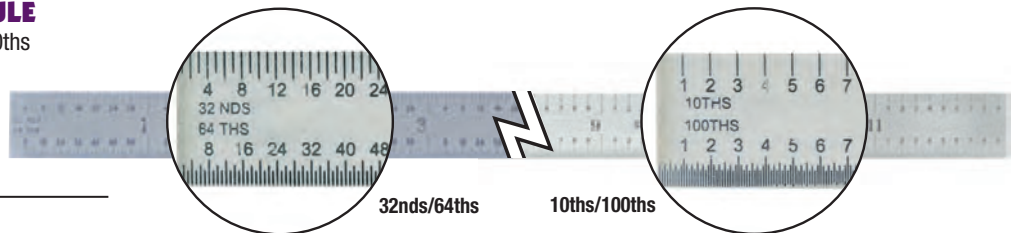

1216

PRECISION 12" FLEX STEEL RULE

- Model RR Graduation - HO, S, O Gage;
N Gg, mm, 64ths Dec Equiv
- Ultra fine black graduations
- Polished Stainless Steel finish
- Length is 12" long
- Width is 1"

UPC NO.
32180 0 1251

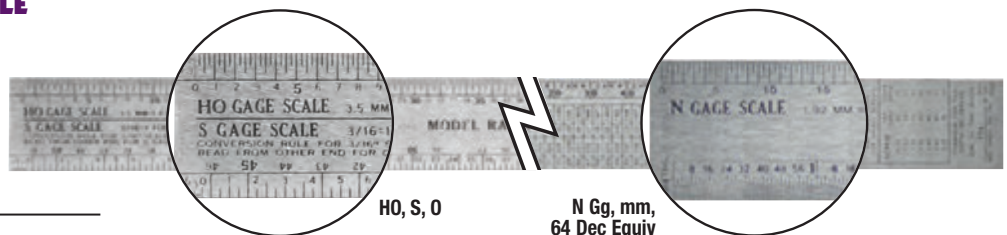

1251

PRECISION 12" RIGID STEEL RULE

- 4R Graduation - 8ths, 16ths; 32nds, 64ths
- Ultra fine black graduations
- Polished Stainless Steel finish
- Length is 12" long
- Width is 1"

UPC NO.
31286 0 1276

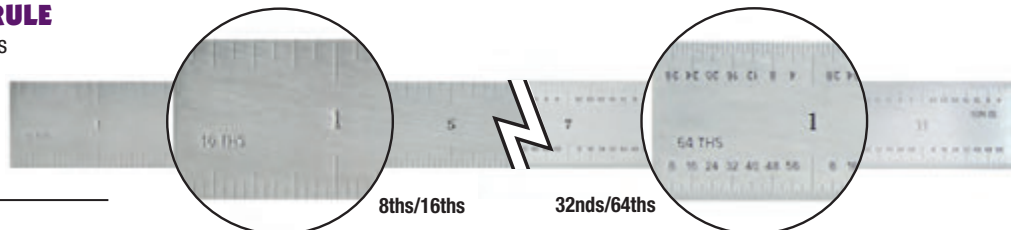

1276

PRECISION 6" FLEX STEEL RULE

- 5R Graduation - 32nds, 64ths; 10ths, 100ths
- Ultra fine black graduations
- Satin chrome finish
- Length is 6" long
- Width is 15/32"

UPC NO.
32123 7 CF616

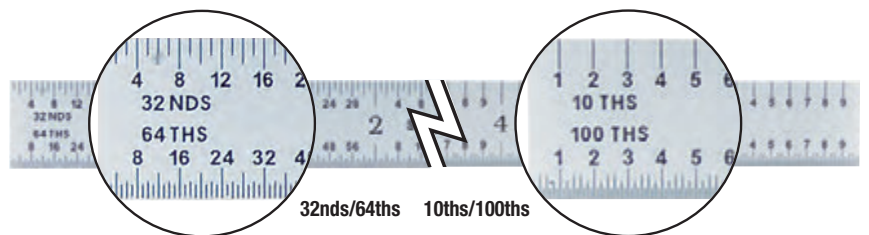

CF616

PRECISION 6" FLEX RULE

- 4R Graduation - 8ths, 16ths; 32nds, 64ths
- Ultra fine black graduations
- Satin chrome finish
- Length is 6" long
- Width is 3/4"

UPC NO.
32141 1 CF676 Carded

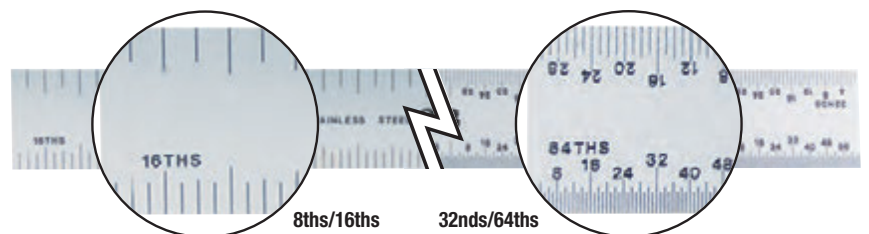

CF676



General's Industrial Steel Rules and Economy Steel Rules are precision made with etched fine black graduations for easy reading and long life.

The two finishes available are polished stainless steel or satin chrome.

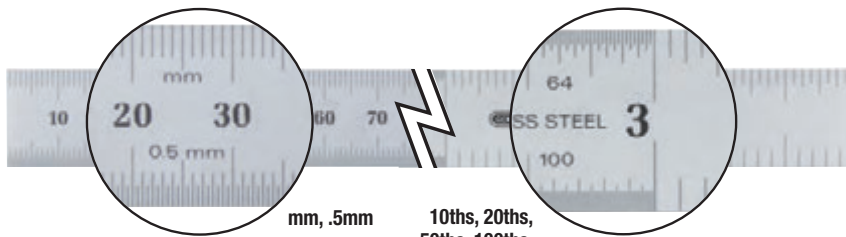

CF678MED

mm, .5mm
10ths, 20ths,
50ths, 100ths,
16ths, 64ths

PRECISION 150mm/6" FLEX STEEL RULE

- Graduation - mm, .5mm; 10ths, 20ths, 50ths, 100ths, 16ths, 32nds, 64ths
- Ultra fine black etched graduations
- Satin chrome finish
- Length is 150mm (6") long
- Width is 19mm (3/4")

UPC NO.
32147 3 CF678MED

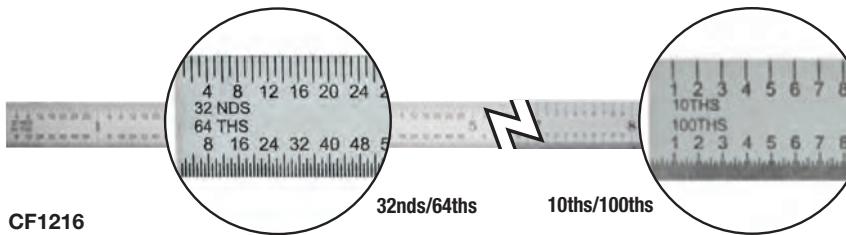

CF1216

32nds/64ths 10ths/100ths

PRECISION 12" FLEX STEEL RULE

- 5R Graduation - 32nds, 64ths; 10ths, 100ths
- Ultra fine black graduations
- Satin chrome finish
- Length is 12" long
- Width is 15/32"

UPC NO.
32150 3 CF1216

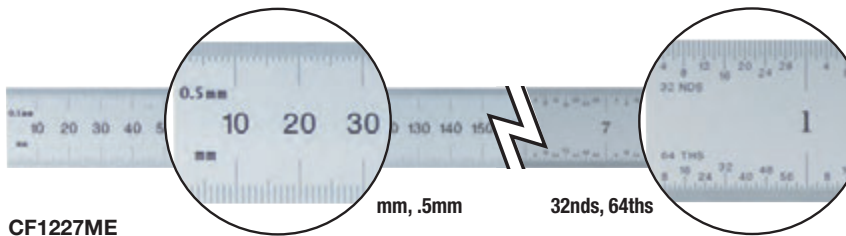

CF1227ME

mm, .5mm 32nds, 64ths

PRECISION 300mm/12" RIGID STEEL RULE

- Graduation - mm, .5mm; 32nds, 64ths
- Ultra fine black graduations
- Satin chrome finish
- Length is 300mm (12") long
- Width is 26mm (1")

UPC NO.
32153 4 CF1227ME

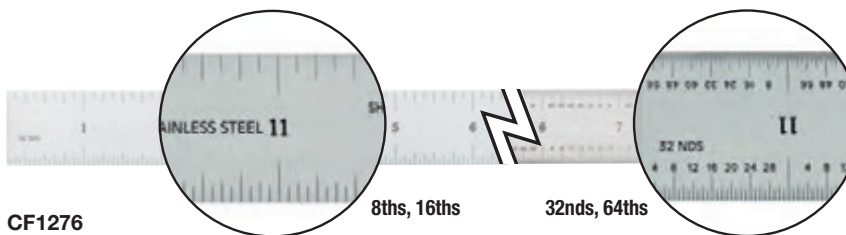

CF1276

8ths, 16ths 32nds, 64ths

PRECISION 12" RIGID STEEL RULE

- 4R Graduation - 8ths, 16ths; 32nds, 64ths
- Ultra fine black graduations
- Satin chrome finish
- Length is 12" long
- Width is 1"

UPC NO.
32159 8 CF1276

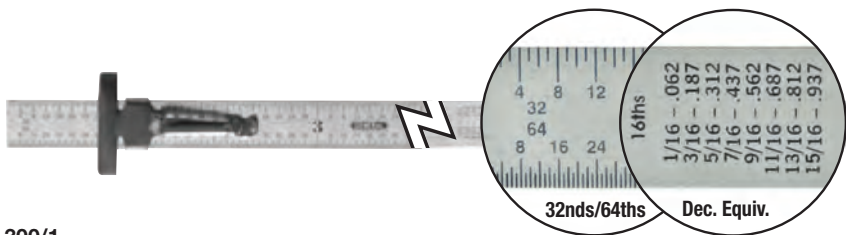

300/1

32nds/64ths Dec. Equiv.

PRECISION 6" FLEX STEEL RULE

- Graduation - 32nds, 64ths; Dec. Equiv
- Ultra fine black graduations
- Polished Stainless Steel finish
- Length is 6" long • Width is 15/32"
- Convenient Pocket Clip
- Comes in a plastic sleeve

UPC NO.
32036 0 300/1

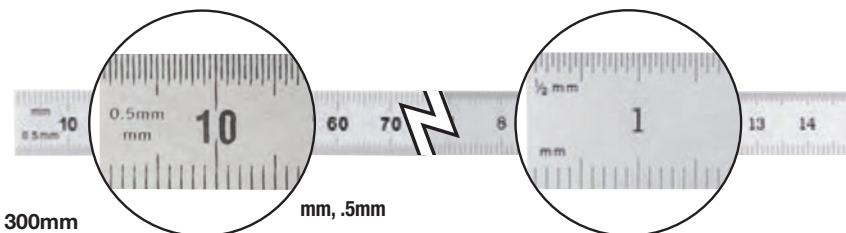

300mm

mm, .5mm

PRECISION 150mm FLEX STEEL RULE

- Graduation - mm, .5mm
- Ultra fine black etched graduations
- Polished Stainless Steel finish
- Length is 150mm long • Width is 12mm
- Convenient Pocket Clip

UPC NO.
32041 4 300MM



TYPE OF GRADUATIONS:

4R Graduation - 8ths, 16ths, 32nds, 64ths.
 5R Graduation - 32nds, 64ths, 10ths, 100ths.

16R Graduation - 32nds, 64ths, 50ths, 100ths.
 Metric English - 32nds, 64ths, 0.5mm, mm.

PRECISION 150mm/6" FLEX STEEL RULE

- Graduation - mm, 64ths; Metric Equiv.
- Ultra fine black etched graduations
- Polished Stainless Steel finish
- Length is 150mm (6") long
- Width is 12mm (15/32")
- Convenient Pocket Clip

UPC NO.
 32042 1 300ME

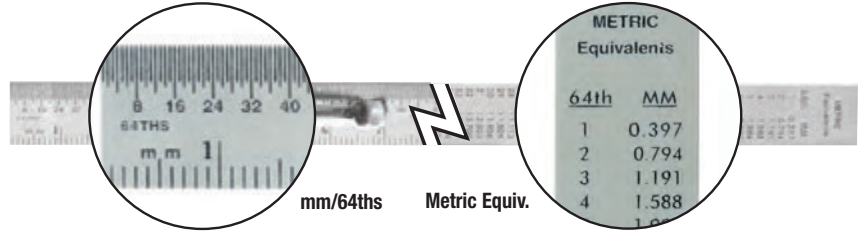

300ME

PRECISION 6" FLEX STEEL RULE

- Graduation - 32nds, 64ths
- Ultra fine black graduations
- Polished Stainless Steel finish
- Length is 6" long
- Width is 1/4"
- Convenient Pocket Clip

UPC NO.
 32046 9 301/1

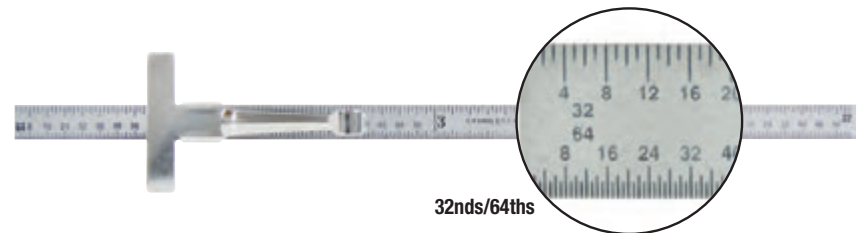

301/1

PRECISION 150mm/6" FLEX STEEL RULE

- Graduation - mm, 16ths
- Ultra fine black graduations
- Polished Stainless Steel finish
- Length is 150mm (6") long
- Width is 6mm (1/4")

UPC NO.
 32049 0 301ME

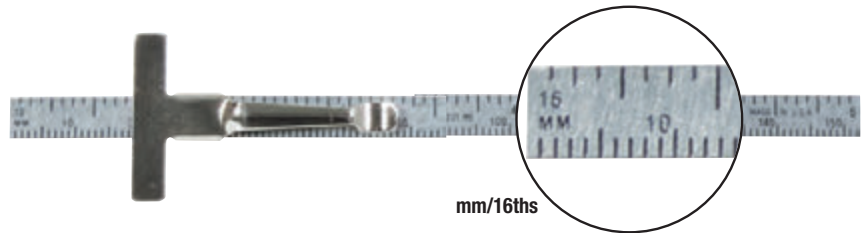

301ME

PRECISION 150mm/6" FLEX STEEL RULE

- Graduation - mm, 16ths
- Ultra fine black etched graduations
- Polished Stainless Steel finish
- Length is 150mm (6") long
- Width is 12mm (15/32")

UPC NO.
 32060 5 305ME

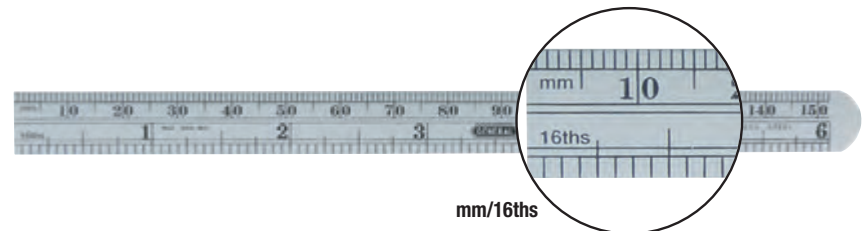

305ME

PRECISION 6" FLEX STEEL RULE

- Graduation - 8ths, 16ths w/32nd End Grads.
- Ultra fine black etched graduations
- Polished Stainless Steel finish
- Length is 6" long
- Width is 3/4"

UPC NO.
 32063 6 307 Carded

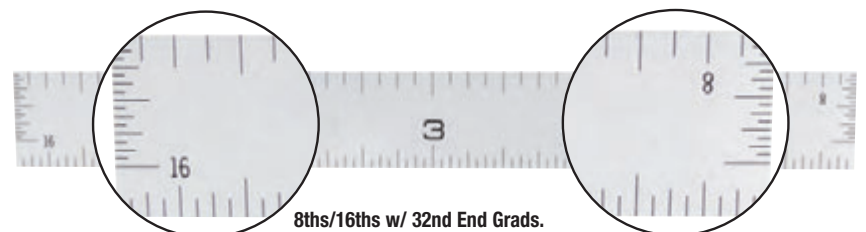

307

Economy Precision Rules

ULTRA RULE™ STAINLESS STEEL RULES

General's **ULTRA RULE™** Precision Marking Rule looks like an ordinary ruler. Look closer and you will see micro-fine marking holes and slots at every scale position to instantly locate a sharp pencil point or scriber exactly where you want it. You can effortlessly place your mark precisely on target with zero uncertainty and no eye strain.

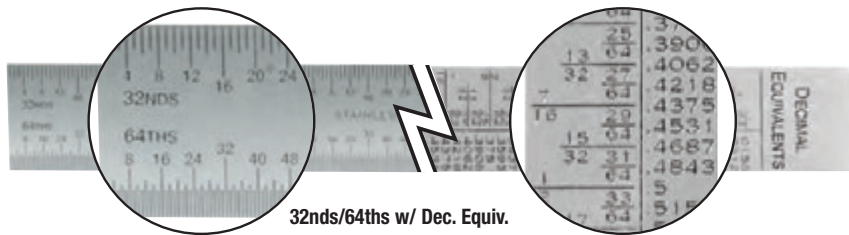

308

PRECISION 6" FLEX STEEL RULE

- Graduation - 32nds, 64ths w/ Dec. Equiv. Table
- Ultra fine black etched graduations
- Polished Stainless Steel finish
- Length is 6" long
- Width is 3/4"

UPC	NO.
30266 3	308 Carded

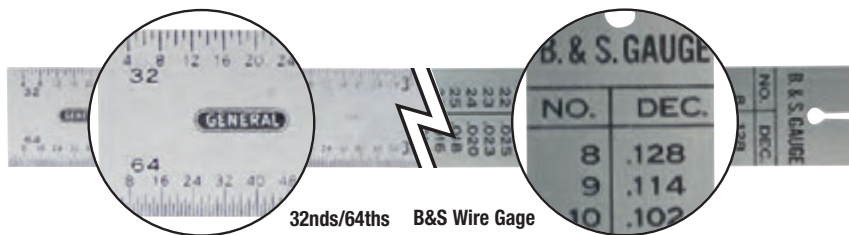

310

PRECISION 6" FLEX STEEL RULE

- Graduation - 32nds, 64ths; B & S Wire Gage
- Ultra fine black etched graduations
- Polished Stainless Steel finish
- Length is 6" long
- Width is 3/4"

UPC	NO.
32072 8	310 Carded

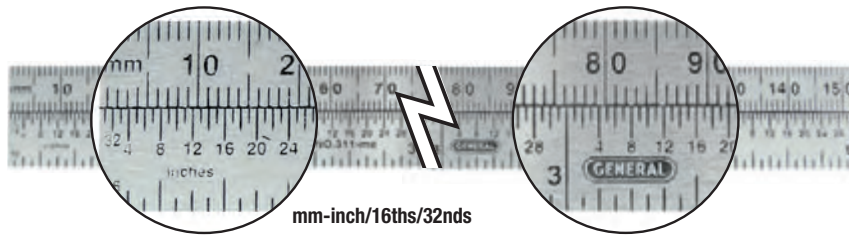

311ME

PRECISION 150mm/6" FLEX STEEL RULE

- Graduation - Comparison mm-inch, 16ths, 32nds
- Ultra fine black etched graduations
- Polished Stainless Steel finish
- Length is 150mm (6") long
- Width is 19mm (3/4")

UPC	NO.
32075 9	311ME Carded

ULTRA RULE™ STAINLESS STEEL RULES

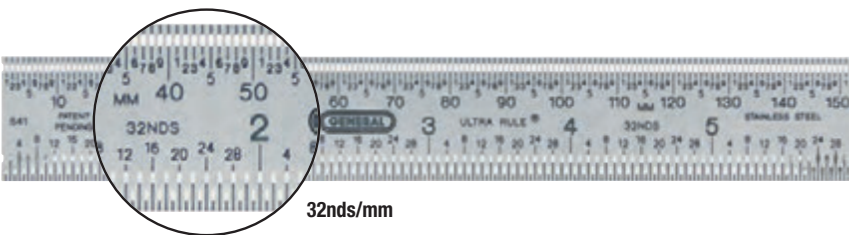

641

6"/150mm FLEXIBLE MARKING ULTRA-RULE

- Graduation - 32nds, mm's
- Ultra fine black graduations
- Micro-fine marking holes
- Polished Stainless Steel finish
- Width is 7/8" (22mm)
- Comes with a No. 640 0.5mm Mechanical Pencil

UPC	NO.
32112 1	641

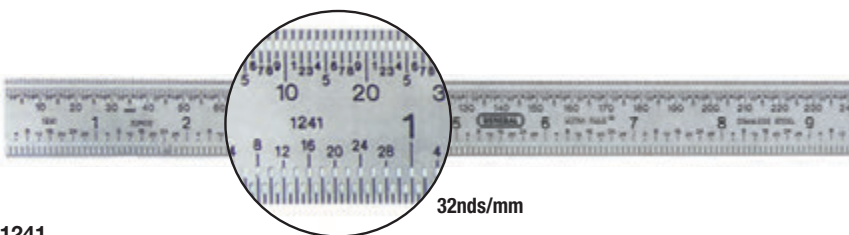

1241

12"/300mm FLEXIBLE MARKING RULE

- Graduation - 32nds, mm's
- Ultra fine black graduations
- Micro-fine marking holes
- Polished Stainless Steel finish
- Width is 7/8" (22mm)
- Comes with a No. 640 0.5mm Mechanical Pencil

UPC	NO.
32181 7	1241

MACHINIST



General's Feeler Gages are used for adjusting and gaging spark plugs, distributors points, valve clearances and measuring spaces between parts. All of the feeler gages are made of the finest high

grade precision gage steel. Each leaf is etched with size numbers in the thousandths of an inch, as well as corresponding millimeter sized, for inch identification.

PRECISION FEELER GAGES

- Made of the finest high grade precision gage steel
- Each leaf is etched with size numbers in the thousandths for quick identification
- Knurled locknut holds the leaves in desired position
- Conforms to government specifications GGG-G-17b
- Special holder prevents edges from damage
- Leaves include the following sizes: .0015, .002, .0025, .003, .004, .005, .006, .007, .008, .009, .010, .011, .012, .013, .014, .015, .016, .017, .018, .019, .020, .021, .022, .023, .024, and .025"

PRECISION 26 STRAIGHT LEAF FEELER GAGE

- 3" (75mm) leaves are 1/2" (12mm) wide

UPC	NO.	LEAVES	SIZES
31306 5	226	26	.0015" to .025"

PRECISION 26 TAPER LEAF FEELER GAGE

- 3" (75mm) leaves taper from 1/2" (12mm) to just 1/4" (6.5mm) wide for working in confined spaces

UPC	NO.	LEAVES	SIZES
31309 6	226T	26	.0015" to .025"



226T

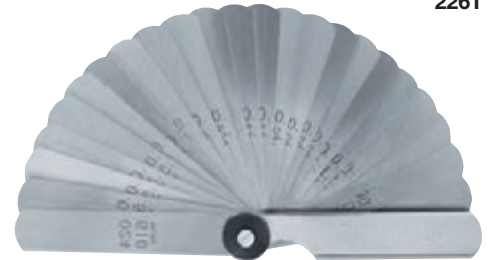

226

26-LEAF ECONOMY GAGE

- General's best selling feeler gage provides precision accuracy at a reasonable price
- 3" leaves include the following sizes: .0015, .002, .0025, .003, .004, .005, .006, .007, .008, .009, .010, .011, .012, .013, .014, .015, .016, .017, .018, .019, .020, .021, .022, .023, .024, and .025"

- Metric range is from .037 to .635mm

UPC	NO.	LEAVES	SIZES
31311 9	230	26	.0015" to .025"



230

15-LEAF ECONOMY GAGE WITH 3" (75MM) LEAVES

- Gage includes .002, .003, .004, .005, .006, .007, .008, .010, .011, .012, .013, .014, .015, .020, and .025"
- Metric range is from .051 to .635mm

UPC	NO.	LEAVES	SIZES
31313 3	231	15	.002" to .025"



231

15-LEAF ECONOMY GAGE WITH 6" (150MM) LEAVES

- Longer leaves allow accurate measuring in hard-to-reach places
- Gage includes .002, .003, .004, .005, .006, .007, .008, .010, .011, .012, .013, .014, .015, .020, and .025"
- Metric range is from .051 to .635mm

UPC	NO.	LEAVES	SIZES
31316 4	232	15	.051 to .635mm



232

Precision Squares and Gages

General's Precision Squares are used for checking internal and external 90° angles. Screw Pitch Gages are notched for measuring inside threads of small holes and nuts as well as external threads.

Center Gages improve efficiency and speed up set-up time for lathe thread cutting. Wiggler/Center Finders locate spindle centers and working points on drill presses, milling and other machines.



251



255mm

SCREW PITCH GAGES

- These finely crafted measuring devices are used for gaging V, American National or U.S. standard 60° threads
- Gages are notched for measuring inside threads of small holes and nuts as well as external threads

- Set of 51 screw pitches combines all sizes from 4 to 84, including 11-1/2 and 27 pipe thread sizes
- Knurled thumb nuts lock the case in an open or closed position

UPC	NO.	NO. OF PITCHES	SIZES
31321 8	251	51	4 to 84
31326 3	255mm	22	.35 to 6.0mm



S389-4

WIGGLER/CENTER FINDER SET

- The snap-in ball and socket wiggler is essential for precise set-ups in machine shops
- Locates spindle centers and working points on drill presses, milling and other machines
- Four interchangeable point attachments snap into adjustable spring tension clutch holder

- Set includes snap-in holder, needle point, disk point, ball shaft and indicator shaft packed in a vinyl case

UPC	NO.
31418 5	S389-4



270-6

PRECISION SQUARES

- Use where accurate right angles are essential
- For checking external and internal 90° angles. Beam is riveted to the fully ground and polished carbon steel blade
- Groove on inside corner of beam for clearance of dirt or burrs

UPC	NO.	BLADE LENGTH	BEAM LENGTH
31340 9	270-2	2-1/8" (53mm)	1-3/8" (35mm)
31343 0	270-3	3" (75mm)	1-1/2" (38mm)
31346 1	270-4	4-1/4" (107mm)	2-3/8" (60mm)
31349 2	270-6	6-1/4" (147mm)	3-1/4" (82mm)
02701 6	S270	Set of all 4 Squares	



CF778

CENTER GAGE

- General's center gage improves efficiency and speeds set-ups for lathe thread cutting
 - The gage is graduated in 14ths, 20ths, 24ths, and 32nds of an inch for checking the number of threads per inch
- 60° angles for U.S. standard threads and double depth of American National thread

- Made of hardened spring tempered steel with protective satin chrome finish
- Notches have clearance slots

UPC	NO.
35010 7	CF778

REFERENCE TABLE

715



- Essential tap drill and decimal equivalents reference table for toolmakers, machinists and mechanics

- Front has machine screw size tap drill chart for recommended 75% depth thread

- Back has decimal equivalents table in 64ths from 1/64" to 63/64"
- For National Fine and National Coarse, American Standard Pipe and metric threads
- Convenient 6" rule is graduated in 64ths

UPC	NO.
35015 2	715

MACHINIST

Wire Gages are used for gaging the thickness of non-ferrous wire and metals such as copper, brass and aluminum. Sheet Metal Gages are used for

gaging uncoated sheet metal, plate iron and steel. Drill Gages and Hobby Gages are used to quickly and conveniently identify drill bit sizes.

DRILL GAGES

- General's drill gages are used to quickly and conveniently identify drill bit sizes
- Made of heat treated heavy gage steel, machined and ground to close tolerances
- Hole sizes and decimal equivalents are permanently marked on the face
- No. 13 is 3" x 1-1/8" wide. Nos. 14 and 15 are 6-1/2" x 2-1/2" wide
- No. 14 and No. 15 conform to government specifications GG-G-86b

UPC	NO.	
22006 6	13	Number size drills 61 to 80
22009 7	14	Fractional size drills 1/16" to 1/2" x 64ths
22012 7	15	Number size drills 1 to 60

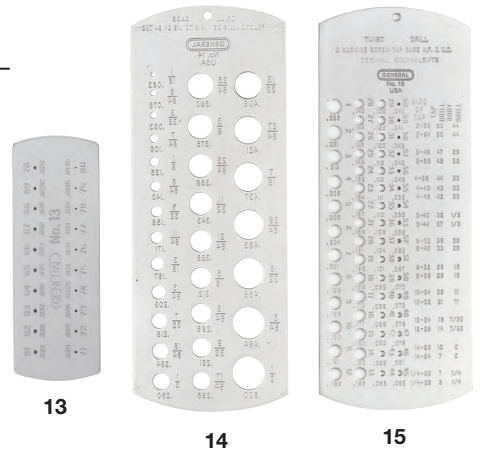

13 14 15

HOBBY DRILL GAGE

- Made of heat treated heavy gage steel, machined and ground to close tolerances
- Etched graduations are filled in black to give high contrast and will not wear off
- Gage measures 2-3/8" x 6-3/4" (60 x 172mm) overall
- Stainless steel will not rust

UPC	NO.	SPECIFICATIONS
22011 0	24	Fractional size drills 1/16" to 1/2" x 64ths



24

WIRE GAGE

- American Standard wire gage 0 to 36
- For gaging non-ferrous wire and metals such as copper, brass and aluminum
- Decimal equivalents of each size are stamped on reverse side
- Satin finished, heavy gage hardened and tempered steel
- 3-1/4" diameter, 3/32" thick

UPC	NO.
22036 3	20



20

SHEET METAL GAGE

- Gage numbers are U.S. Standard 0 to 36
- For gaging uncoated sheet metal, plate iron and steel
- Decimal equivalents of each size are stamped on reverse side
- Satin finished, heavy gage steel is hardened and tempered
- 3-1/4" diameter, 3/32" thick

UPC	NO.
22041 7	21



21



MACHINIST TOOLS

Gages/Protractors



The Multi-Use Rule and Gage performs five separate functions: drill point gage, bevel protractor, center finder, circle divider and tap and drill gage.

Steel Protractors are preferred by machinists, draftspeople, and mechanics for setting bevels, measuring and transferring angles.

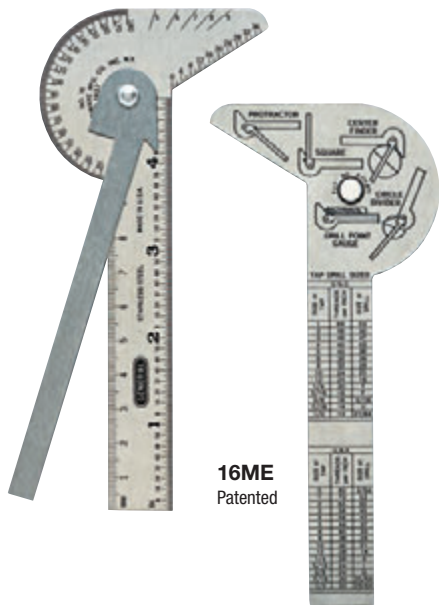

16ME
Patented

MULTI USE RULE AND GAGE

- One of our most popular pocket tools performs five separate and distinct functions
- Drill point gage is used for checking 59° angle drill points
- Bevel protractor is used for measuring and laying out angles
- Center finder locates centers of shafts or circles

- Center finder locates centers of shafts or circles
- Circle divider (up to nine equal parts) is used for dividing circles into sectors, regular polygons and polygrams
- Tap and drill table shows popular tap sizes with correct drill sizes for National form of thread
- Made of long-wearing stainless steel
- 4" rule has etched graduations in 64ths and millimeters



UPC	NO.
22015 8	16ME

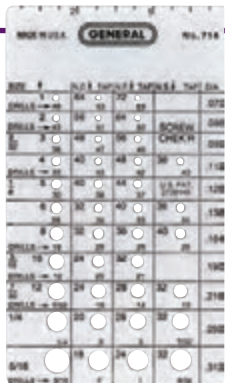

714
Patented

QUICK CHECK SCREW GAGE

- Quick way to identify machine screws, bolts, wood screws, standard size rivets and common cotter pin sizes up to 5/16" (8mm)
- 3" scale to check screw lengths
- Checker gives required drill size for corresponding tap size and proper drill size for like hole

- Threaded holes indicate threads per inch while unthreaded indicate size by number and fractions of an inch
- Durable engineering plastic

UPC	NO.
35018 3	714



17



18



STEEL PROTRACTORS

- Preferred by machinists, draftspeople and mechanics for setting bevels, measuring and transferring angles
- Made of ground stainless steel for optimum accuracy
- Permanently etched graduations from 0 to 180° in opposite directions
- 3-3/8" x 2" head
- 6" adjustable protractor arm locks into desired position with knurled thumb nut

UPC	NO.	STYLE
22018 9	17	Square head
22021 9	CF17	Square head (Stain chrome finish)
22024 0	18	Round head



The Digital Protractor takes the guesswork out of measuring, marking, reading and transferring angels. The 6" Stainless Steel Protractor arm has a knurled

locking nut. The large digital display can be inverted for easy instant reading. The Hold Function can be used to freeze measurements.

DIGITAL PRECISION PROTRACTOR

Take the guesswork out of measuring, marking, reading and transferring angles

- 6" (150mm) stainless steel protractor arm with knurled locking nut
- Large, easy-to-read display
- Absolute and Relative measurements
- Accuracy: 0.1°
- Resolution: 0.05°
- Range: 0.00° to 180.00°
- Display can be inverted for easy reading
- Hold function to freeze measurement
- Power Source: 1 "CR2032" (3.0V) battery (included)

UPC	NO.
26008 6	1702
	CR2032 replacement battery



Inverted Display

1702
Patented

6" FLEXIBLE ULTRA-RULE PROTRACTOR

- Graduation - Degrees, 1/2 Degrees, 32nds
- Ultra fine black graduations
- Micro-fine marking holes
- Polished stainless steel finish
- Width is 3-7/8"
- Comes with a No. 640 0.5mm mechanical pencil

UPC	NO.
22165 0	30

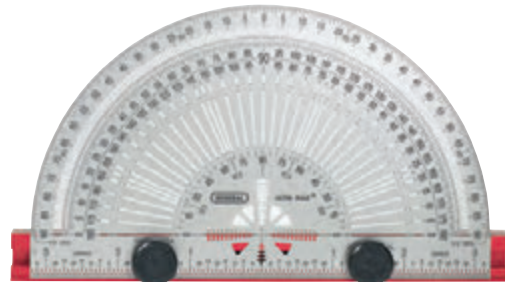

30

PROTRACTOR AND DEPTH GAGE

- Permanently etched with graduations from 0 to 180° in opposite directions
- Narrow 6" x 1/4" depth gage rule has etched graduations in 32nds and 64ths
- Spring tension nut locks rule for making both depth and angle measurements

- Made of stainless steel

UPC	NO.	STYLE
22027 1	19	Square head



19

MACHINIST TOOLS

Digital Calipers



Electronic Digital Calipers with high-contrast liquid crystal display provides easy, instant readings with no need for calculations. Microprocessor-based calipers convert from inch to metric and fractions at the

push of a button. General's high quality, easy-to-read Electronic Digital Calipers make precise inside, outside, depth and step measurements.



147



No. 147 Digital Display

UPC	NO.	RANGE
01470 2	147	0 - 6" (0 - 153mm)
01478 3	1478	0 - 8" (0 - 203mm)
14712 7	14712	0 - 12" (0 - 305mm)

FRACTION+

6", 8" & 12" STAINLESS STEEL DIGITAL FRACTIONAL CALIPERS

- 6" (153mm) range
- Heavy-duty stainless steel construction
- Convenient auto-off feature
- Three mode digital display: Decimal Inches, Fractions, Metric
- Inside, outside, depth & step measurements
- Accuracy: +/- 0.001", +/- 0.02mm
- Resolution: 0.0005", 0.01mm, 1/64"
- Power Source: 1 "SR44" (1.5V) silver oxide battery included



146



No. 146 Digital Display



FRACTION+

6" CARBON FIBER DIGITAL FRACTIONAL CALIPER

- 6" (153mm) range
- Lightweight, non-marring carbon fiber composite
- Convenient auto-off feature
- Three mode digital display: Decimal Inches, Fractions, Metric
- Inside, outside, depth & step measurements
- Accuracy: +/- 0.008", +/- 0.2mm
- Resolution: 0.0005", 0.01mm, 1/64"
- Power Source: 1 "SR44" (1.5V) silver oxide battery included

UPC	NO.	RANGE
01460 3	146	0 - 6" (0 - 153mm)



1433



No. 1433 Digital Display



FRACTION+

3" CARBON FIBER DIGITAL FRACTIONAL CALIPER

- 3" (76mm) range
- Lightweight non-marring carbon fiber composite
- Convenient auto-off feature
- Three mode digital display: Decimal Inches, Fractional and Metric
- Convenient pocket clip
- Accuracy: +/- 0.005" +/- 0.1mm
- Inside, outside, & step measurements
- Resolution: 0.0005", 0.01mm, 1/64"
- Power Source: 1 "SR54" (1.5V) silver oxide battery included

UPC	NO.	RANGE
01433 7	1433	0 - 3" (0 - 76mm)

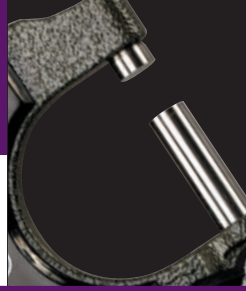

General's Micrometer is used to measure distances to the nearest ten thousandth of an inch. The measurement is usually expressed or written as a decimal. The types of micrometers commonly used

are made so that the longest movement possible between the spindle and the anvil is 1 inch. This movement is called the "range".

6" DIAL CALIPER

- Stainless steel construction for accuracy and durability
- Large, clear dial accurately reads to .001"
- Satin chrome scale with clearly etched tenths of inch graduations
- Covered rack ensures smooth operation by preventing dirt and chips from entering rack and gear mechanism

- Inside, outside, depth and step measurement
- Lock for repetitive measurement
- Free wheeling thumb roller
- Depth stop rod
- Adjustable bezel for zero setting

UPC	NO.	CAPACITY
10700 8	107	0 - 6" (0 - 153mm)



107

PRECISION VERNIER CALIPER

- General's vernier caliper is an extremely accurate measuring tool guaranteed to .001" accuracy
- Vernier scale is extra long for easier and more accurate readings
- Permanent black graduations
- Hardened stainless steel construction with beveled lower jaws and pointed beveled upper jaws

- Inside, outside, depth and step measurement
- Automatic thumb lock
- Conversion table on back
- Plastic case with instructions
- Satin chrome finish

UPC	NO.	GRADS
33450 3	MG6001DC	0-6" range, .001" bottom and 1/20mm top grads

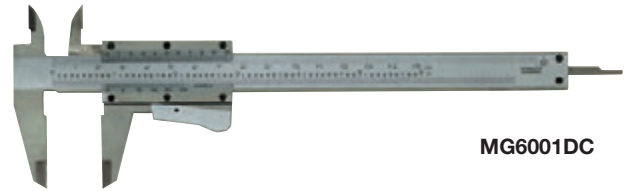

MG6001DC

6" ELECTRONIC DIGITAL CALIPER

- Fiberglass reinforced plastic gives precision measurements at an economical price
- Accurate digital measurements in both inches, metric & fractional
- Freewheeling friction roller for repetitive and accurate readings
- Measuring capacity 0 - 6" (150mm)

- Inside, outside, depth and step measurement
- Swiss precision crafted
- Direct reading .0005/.01mm
- Accuracy 0.001"/0.1mm
- Adjustable zero
- Includes "LR44" battery

UPC	NO.
22064 6	143



143

UTILITY MICROMETER

- A practical and economical measuring device for beginners and hobbyists
- Well-suited for use in training programs, general toolroom and machine shop use and automotive work
- Accuracy guaranteed to .001"
- Satin chrome thimble and barrel with easy-to-read black contrasting graduations

- Special wrench is included for simple zero adjustments
- Ground and polished carbide measuring faces
- Engraved graduations on barrel
- Lock for repetitive measurement

UPC	NO.	RANGE INCLUDES
44103 4	102	0" to 1"



102

DEPTH/ANGLE GAGE

- Our easy to read gage makes precise depth measurements in small holes and slots; also doubles as a protractor
- Spring tension nut eases depth and angle measuring by securing rule in milled slot at 90° angle to base

- Permits easy setting of protractor angle to 30°, 45° and 60° settings on both sides
- 6" x 1/4" etched stainless steel rule graduated in 32nds and 64ths
- 2-1/2" wide hardened steel base

UPC	NO.
31586 1	444

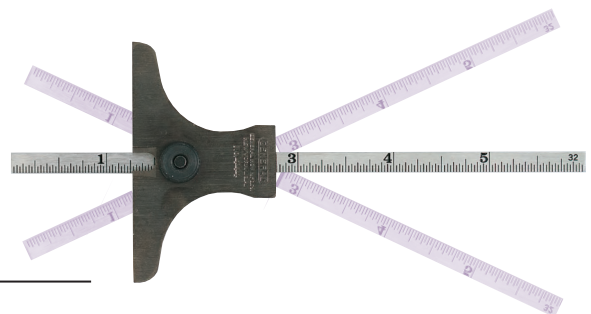

444



General's Dial Indicators provide all the features necessary for precise quality control functions. Large dials provide easy to read measurements. The combination square sets for toolmakers and

machinists consists of square and miter heads, center head and bevel protractor head. The 12" blade is fully hardened and tempered steel.

MACHINIST

MG1780



PLUNGER DIAL INDICATOR

- Large 2-1/2" diameter dial indicator is made to the highest standards, with extreme accuracy throughout its full range
- Dial is continuous and may be rotated for setting at any point
- Full 1" travel
- Revolution accumulator counter
- Direct decimal two-way reading left and right

- Adjustable limit indicators
- Lug mount standard

UPC	NO.	READINGS
33605 7	MG1780	0 to .100" by .001"

109



ECONOMY PLUNGER DIAL INDICATOR

- Large 2-1/4" diameter dial indicator
- Accuracy to .001"
- Dial is continuous and may be rotated for setting at any point
- Full 1" travel
- Revolution accumulator counter

- Direct decimal two-way reading left and right
- Adjustable limit indicators
- Lug mount standard

UPC	NO.	READINGS
10900 2	109	0 to .100" by .001"

MG1758



MAGNETIC BASE

- No residual magnetism, when in the off position, to prevent scratching or other damage from inadvertent magnetism of chips or work pieces
- On/Off switch energizes only when in use on work surface
- V-groove for round surfaces
- Works on vertical or horizontal surfaces
- Switching adapts easily to cam action for automatic setups, using magnetic base as an on/off holding device

- Holds most dial indicators with center lug backs, universal indicator attachments, as well as other fixtures
- 60 lb. pull
- Base 2-3/4"L x 2-1/8"H; overall height 9-3/4"

UPC	NO.
33587 6	MG1758

MG-S281-4R
Patented

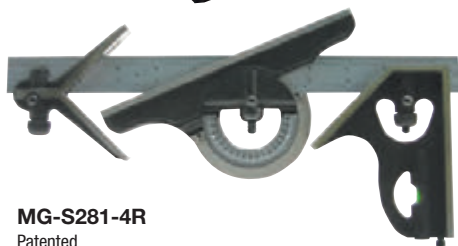

COMBINATION SET WITH HARDENED SQUARE AND CENTER HEADS, REVERSIBLE PROTRACTOR AND PATENTED LOCATING DEVICE

- Patented locating screw automatically positions all heads for quick assembly
- With hardened square and center heads for durability
- Double shoulder reversible protractor head
- Satin chrome 12" blade

- Square head has spirit level and hardened scriber
- Meets gov. specification GGG-S-656C.

UPC	NO.	GRADUATIONS
33840 2	MG-S281-4R	8, 16, 32, 64

MG-S278-4R

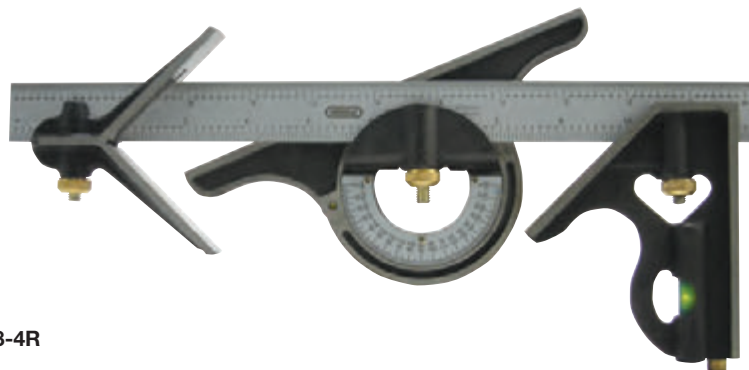

COMBINATION SET WITH SQUARE HEAD, CENTER HEAD, AND REVERSIBLE PROTRACTOR HEAD

- Double shoulder reversible protractor head
- 12" etched, high carbon steel ruler with satin chrome finish
- Square head has spirit level and hardened scriber
- Meets gov. specification GGG-S-656C

UPC	NO.	GRADUATIONS
33800 6	MG-S278-4R	8, 16, 32, 64

Screwdrivers



**Power
Screwdrivers**

**Lighted
Screwdrivers**

**Versa Grip™
Handle**

**Precision
Screwdriver
Sets:**

- **Lighted**
- **Slotted**
- **Phillips**
- **Torx®**
- **Probe**

Pin Vises

Ratchet Offset

**Precision
Engraver**



CORDLESS PRECISION SCREWDRIVER

Precision use for computers, electronics, industrial applications, hobbies and crafts.

Features & Benefits

- Uses Standard 4mm Precision Bits
- Quick Change Chuck
- 8+ Hours of Power
- 100+ RPM
- Super-Torque Drive
- Cordless (2 "AAA" alkaline batteries included)



- 4mm Precision Bit
- Quick Change Chuck
- 100+ RPM Super-Torque Drive
- Ergonomically Designed Rubber Cushion Grip
- Push and Hold for Forward Mode
- ON/OFF Switch
- Pull and Hold for Reverse Mode
- To Replace Batteries Unscrew End Cap



Includes Six Precision Bits



No. 500

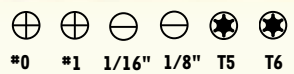

UPC	NO.	PKG.
02132 8	500	Carded
05001 4	500B	Carded

Shown Actual Size
Patent # D604,581 S



CORDLESS LIGHTED SCREWDRIVER

Precision use for computers, electronics, and industrial applications

Features & Benefits

- Super Bright LED Light
- 6+ Hours of Power
- 100+ RPM
- Super-Torque Drive
- Cordless (2 "AAA" alkaline batteries included)

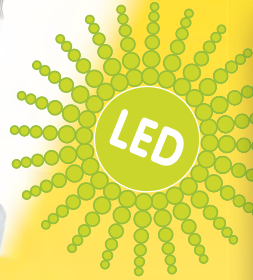

Includes Six Precision Bits

No. 502



Shown Actual Size

UPC	NO.	PACK
05020 5	502	Carded

"Precision, Specialty and Innovation . . . Since 1922"

T-73



8-IN-1 LIGHTED SCREWDRIVER

Perfect for Computers, Electronics, Industrial and Residential Applications, Hobbies and Crafts

Features & Benefits

- Unique Design Features Two Drivers in One Handle
- Two Super Bright LED Lights Provide 360° Tip Illumination
- Transparent Collar Maximizes Illumination
- Convenient Bit Storage in Handle
- Cordless (3 "LR41" Batteries Included)

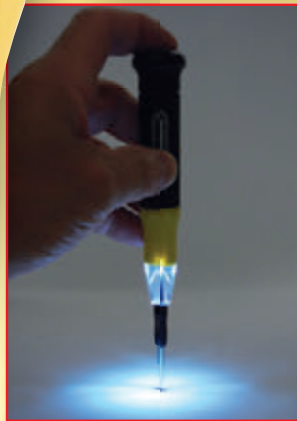

Four Double Ended Blades Store in Handle for Convenience

No. 75108



Double Ended Blades

Removable Mini-Screwdriver

Transparent Collar Maximizes illumination

2 Super Bright LED Lights

Ergonomic Cushion Grip

ON/OFF Switch

Convenient Bit Storage in Handle

Rotation Cap

UPC 26002 4 NO. 75108 PKG. Carded

⊕	⊖	⊛	⊛
#0	1/8"	T5	T6
#000	5/64"	T8	T10



Lighted Screwdrivers



CORDLESS LIGHTED SCREWDRIVER

- Super Bright LED Light
- 6+ Hours of Power
- 100+ RPM
- Super-Torque Drive
- Ergonomically Designed
- Cordless (2 "AAA" alkaline batteries included)

Includes: 6 – 4mm Precision Bits

- #0, #1
- 1/16", 1/8"
- T5, T6

UPC	NO.	PACK
05020 5	502	Carded

502

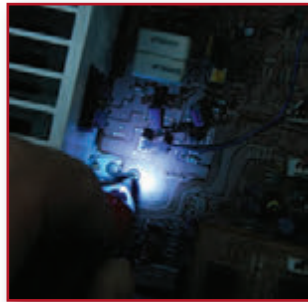

8-IN-1 LIGHTED SCREWDRIVER

- Perfect for Computers, Electronics, Industrial and Residential Applications, Hobbies and Crafts
- Unique Design Features Two Drivers in One Handle
- Two Super Bright LED Lights Provide 360° Tip Illumination
- Transparent Collar Maximizes Illumination
- Convenient Bit Storage in Handle
- Cordless (3 "LR41" Batteries Included)
- Removable Mini-Screwdriver
- Ergonomic Cushion Grip

• Four Double Ended Blades Store in Handle for Convenience

- #0, #000
- 1/8", 5/16"
- T5, T8
- T6, T10

UPC	NO.	PACK
26002 4	75108	Carded

75108

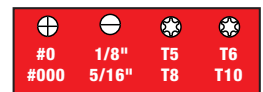

SCREWDRIVERS

SCREWDRIVERS Versa-Grip™



An innovative line of premium specialty tools for both the professional and do-it-yourselfer. At the heart of the UltraTech™ Tool System lies the exclusive Versa-Grip™ handle with its ergonomic design and the versatility of four (4) distinct grip positions. The Versa-Grip™ handle provides the maneuverability to meet the needs of nearly any job. What's more, Versa-Grip's eight-sided cushion grip and contoured head ensure maximum control as well as accurate pressure transfer onto the fastener or working surface.

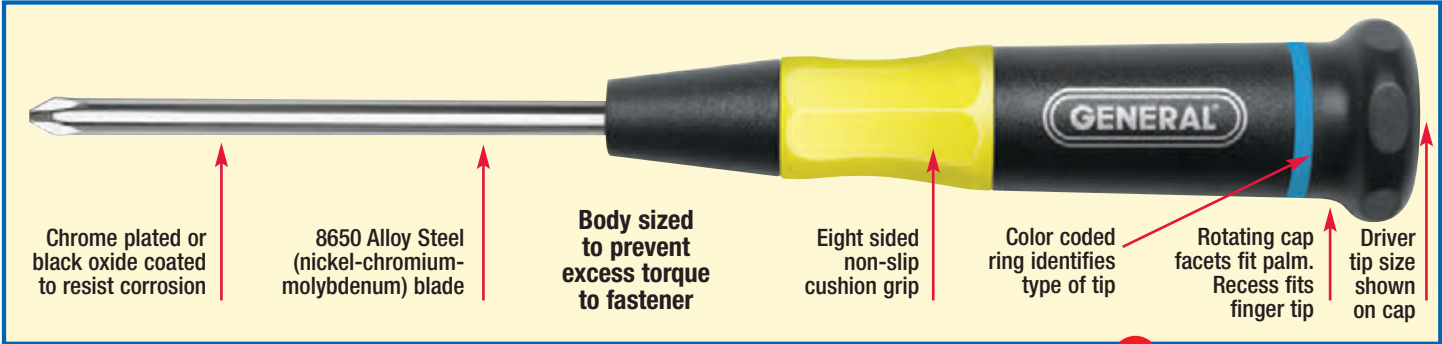

VERSA-GRIP™

4 Handle Sizes matched with 4 Blade Sizes. Specific tip torque requirements minimize the possibility of over-torquing of the fastener.

SCREWDRIVERS ARE SHOWN ACTUAL SIZE

- SLOTTED
- PHILLIPS®
- TORX®
- NUT DRIVER
- BALL HEX DRIVER

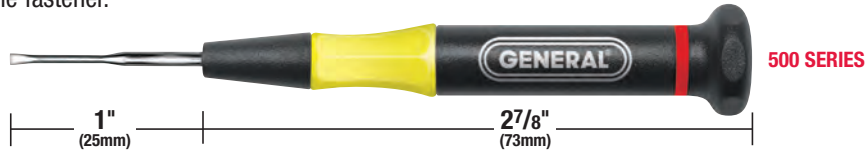



SCREWDRIVERS Precision Sets



General's high quality Precision Screwdriver Sets are ideal for hobbyists, technicians, mechanics and do-it-yourselfers. Also used by jewelers, watchmakers, instrument makers, subminiature parts

assemblers and model makers. The ergonomically designed handle provides greater control and comfort. Black oxide blades ensure a precise fit and prevent corrosion.

18-PIECE PRECISION SCREWDRIVER SET

- 1 Black oxide blades ensure a precision fit and prevent corrosion
 - 2 Eight sided cushion grip has a non-slip surface
 - 3 Close tolerance locking screw chuck holds blades securely in place
 - 4 Ergonomically designed handle for greater control and comfort
 - 5 Contoured fingertip swivel head allows greater pressure to be applied to the blade, for maximum torque and grip, while turning the fastening screw
 - 6 Packaged in a pocket sized fitted zipper case for secure storage
- Set includes: • 1 Multi-Blade Handle • 17 Interchangeable Blades:
 - Slotted - 3/64", 1/16", 5/64", 3/32" • Phillips - #000, #00
 - Torx® - T5, T6, T7, T8 • Hex - .050, 1/16", 5/64"
 - Nut-Drivers - 3/32", 1/8", 5/32" • Awl/Scribe
 - Precision engineered 600 Series Versa-Grip™ handle for maximum performance

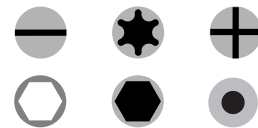

63518
Patented

UPC	NO.	PKG.
63518 1	63518	Zippered Case/Carded



735
Patented



5-IN-1 MULTI-BLADE PRECISION SCREWDRIVER

- High-quality jewelers style precision screwdriver for mechanics, technicians, jewelers and do-it-yourselfers
- Five heat-treated blades conveniently store in handle.
- Blade sizes: 1/16", 5/64", 3/32" slotted tips; #00 Phillips and T6 Torx®
- Easy-twist screw chuck holds blade securely in place.
- Precision engineered 600 Series Versa-Grip™ handle for maximum performance

UPC	NO.	PKG.
22412 5	735	Carded

28-PIECE MULTI-BLADE SET

- Close tolerance locking screw chuck holds blades securely in place
- Black Oxide Blades ensure a precision fit and prevent corrosion
- Set includes: • 26 Interchangeable Blades
 - 1 Multi-Blade Handle • 1 Blade Extension;
 - Slotted - 1/32", 3/64", 1/16", 5/64", 3/32";
 - Phillips - #0000, #000, #00 • Torx® - T6, T7, T8, T9 • Hex - .050, 1/16", 5/64"
 - Nut Driver - 3/32", 1/8", 5/32"
 - Probes - 35° Bend, 90° Bend, 180° Loop, Straight, 180° Hook, Triple Bend, Double Bend
 - Scratch Awl
- Precision engineered 600 Series Versa-Grip™ handle for maximum performance

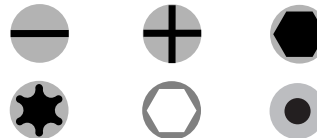

UPC	NO.	PKG.
63528 0	63528	Zippered Case/Carded

63528
Patented

SCREWDRIVERS

SCREWDRIVERS

Precision Sets



751016
Patented

16-IN-1 SCREWDRIVER SET

- The ultimate screwdriver for all applications
- Unique 2 drivers in 1 handle design; Jewelers and Full Size
- Set Includes: • 8 Double-ended hardened alloy steel blades Zinc plated to prevent rust
 - Phillips - #0 x #000
 - Phillips/Slotted - #0000 x 3/64",
 - Slotted - 1/8" x 5/64";
 - Hex - .050" x 1/16", 5/64" x 3/32",
 - Torx® - T5 x T8, T6 x T10
 - Square Recess - #0 x #1
- Double-ended blades are held in a carrier which snugly fits in handle
- Powerful magnet in handle allows the handle to be used as a driver with any power shank bit (not included)
- Precision engineered 750 Series Versa-Grip™ handle for maximum performance

UPC	NO.	PKG.
75106 5	751016	Carded



8 HARDENED ALLOY STEEL BLADES SHOWN WITH JEWELERS SIZE HANDLE



CONVENIENT STORAGE UNDER CAP FOR ALL 8 BLADES



8 HARDENED ALLOY STEEL BLADES SHOWN WITH JEWELERS SIZE HANDLE



INDUSTRY STANDARD INSERT BITS WITH MAGNETIC BIT HOLDER



28-PIECE BIT DRIVER SET - 16-IN-1 PLUS

- All the features of the 16-in-1, Model No. 751016, with the added full size bit capabilities
- Set Includes: • 8 double-ended hardened alloy steel precision blades. Zinc plated to prevent rust • Phillips - #0 x #000 • Phillips/Slotted - #0000 x 3/64" • Slotted - 1/8" x 5/64" • Hex - .050" x 1/16", 5/64" x 3/32" • Torx® - T5 x T8, T6 x T10 • Square Recess - #0 x #1 • Magnetic Insert Bit Holder • Industry Standard Insert Bits • Slotted - 3/16", 1/4" • Phillips - #1, #2 • Torx® - T15, T20, T25 • Hex - 1/8", 5/32", 3/16" • #2 Square Recess
- Convenient storage under cap for all 8 blades
- Packaged in a fitted Ballistic Nylon Holster
- Vinyl holster insert holds 11 insert bits and one magnetic insert bit holder
- Precision engineered 750 Series Versa-Grip™ handle for maximum performance

UPC	NO.	PKG.
75102 7	751028	Holster/Carded



751028
Patented



741
Patented



4-IN-1 PRECISION SCREWDRIVER

- High-quality precision screwdriver for mechanics, technicians, hobbyists and do-it-yourselfers
- Two double-ended blades are held in a reversible carrier which snugly fits in handle Phillips #0, #000; Slotted 5/64", 1/8"
- Change blade sizes instantly.

UPC	NO.	PKG.
22394 4	741	Carded





General's High Quality Screwdrivers Sets are ideal for hobbyists, technicians, mechanics and do-it-yourselfers. Also used by jewelers, watchmakers, instrument makers, subminiature parts assemblers

and model makers. The patented, ergonomically designed handle provides greater rotation, comfort and control. The plated alloy steel blades ensure a long life.

5-PC PRECISION SCREWDRIVER SET - SLOTTED & PHILLIPS

- Driver tip size shown on cap
- Rotating cap; facets fit palm, recess fits finger tip
- Color coded ring identifies type of tip
- Body sized to prevent excessive torque to fastener
- 8-Sided non-slip cushion grip
- 8650 Alloy steel (nickel-chromium-molybdenum)
- Chrome plated to resist corrosion

UPC	NO.	DESCRIPTION	PACK
22066 0	700	5-Piece Set	Carded

Set contains:

NO.	TYPE	SIZE	BLADE LENGTH
611094	Slotted	3/32 (2.5mm)	1-1/2 (38mm)
711125	Slotted	1/8 (3.0mm)	2-1/2 (64mm)
612020	Phillips	No. 00	1-1/2 (38mm)
712010	Phillips	No. 0	2-1/2 (64mm)
712001	Phillips	No. 1	2-1/2 (64mm)



700
Patented

5-PC PRECISION TORX® SCREWDRIVER SET

- Driver tip size shown on cap
- Rotating cap; facets fit palm, recess fits finger tip
- Color coded ring identifies type of tip
- Body sized to prevent excessive torque to fastener
- 8-Sided non-slip cushion grip
- 8650 Alloy steel (nickel-chromium-molybdenum)
- Black oxide coated to resist corrosion

UPC	NO.	DESCRIPTION	PACK
22121 6	711	5-Piece Set	Carded

Set contains:

NO.	TYPE	SIZE	BLADE LENGTH
613006	Torx®	T6	1-1/2 (38mm)
613007	Torx®	T7	1-1/2 (38mm)
713008	Torx®	T8	2-1/2 (64mm)
713009	Torx®	T9	2-1/2 (64mm)
713010	Torx®	T10	2-1/2 (64mm)



711
Patented

7-PC PRECISION SCREWDRIVER SET SLOTTED, PHILLIPS & TORX®

- Driver tip size shown on cap
- Rotating cap; facets fit palm, recess fits finger tip
- Color coded ring identifies type of tip
- Body sized to prevent excessive torque to fastener
- 8-Sided non-slip cushion grip
- 8650 Alloy steel (nickel-chromium-molybdenum)
- Chrome plated/black oxide coated to resist corrosion

UPC	NO.	DESCRIPTION	PACK
67123 3	67123	7-Piece Set	Carded

Set contains:

NO.	TYPE	SIZE	BLADE LENGTH
511062	Slotted	1/16 (1.5mm)	1 (25mm)
611094	Slotted	3/32 (2.5mm)	1-1/2 (38mm)
711125	Slotted	1/8 (3.0mm)	2-1/2 (64mm)
612020	Phillips	No. 00	1-1/2 (38mm)
712010	Phillips	No. 0	2-1/2 (64mm)
712001	Phillips	No. 1	2-1/2 (64mm)
613006	Torx®	T6	1-1/2 (38mm)

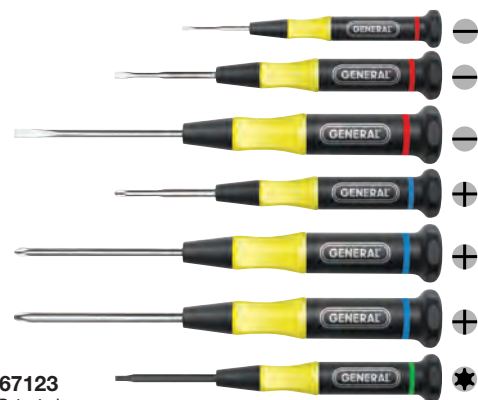

67123
Patented

SCREWDRIVERS Precision Sets



General's High Quality Screwdrivers Sets are ideal for hobbyists, technicians, mechanics and do-it-yourselfers. Also used by jewelers, watchmakers, instrument makers, subminiature parts assemblers

and model makers. The Jeweler's Screwdriver bodies are nickel plated with swivel heads. All the precision screwdrivers share the same features, quality and value that you have come to expect from General.

POCKET 4-IN-1 MINI SCREWDRIVER

- This screwdriver is ideal for technicians, hobbyists and do-it-yourselfers
- 2 double-ended chrome vanadium blades
- 1/16" and 1/8" slotted tip and #1 and #00 cross-point tip
- Blades are held in carrier handle

- Change blade sizes instantly
- Convenient pocket clip and capped ends



UPC	NO.	LENGTH
74401 2	744	5-1/8" (130mm)
74400 5	744DB	Bulk in 24 pieces
00744 5	744CD	Countertop Display 20 pieces

(see Page T-132 for dis-

4-IN-1 POCKET SCREWDRIVER

- This screwdriver is ideal for technicians, hobbyists and do-it-yourselfers
- 2 double-ended chrome vanadium blades
- 1/8" and 5/32" Slotted tip and #0 & #1 cross-point tip
- Blades are held in carrier handle
- Change blade sizes instantly
- Convenient pocket clip and capped ends
- Length is 5-1/4" (133mm)

UPC	NO.	
02147 3	745DB	Counter Display 24 pieces

(Sold only as a counter display - see Page T-126 for display)



FIVE BLADE SCREWDRIVER SET

- Blades are black oxide and screwdriver body is plated to prevent rust
- Four tempered steel straight blades and one No. 0 crosspoint blade
- Injection molded plastic case

UPC	NO.	BLADE WIDTH
42565 2	S605	Sizes: .040", .055", .070", 100" and # 0 crosspoint



JEWELER'S SCREWDRIVER AND HOBBY KIT

- Blades are black oxide and body is plated to prevent rust
- Three tempered straight blade sizes, one crosspoint blade and one scratch awl in a fitted vinyl case

UPC	NO.	BLADE WIDTH
42571 3	SPC606	Straight blade sizes .100", .070", .040", No. 0 crosspoint and scratch awl



SET OF SIX JEWELER'S SCREWDRIVERS

- Black oxide blade sizes: .100", .080", .070", .055", .040", .025"
- Screw chucks have identification rings showing blade size
- Overall length 3-7/8"
- Conforms to government specifications GGG-S-1808
- Plastic case
- Individual screwdrivers available

UPC	NO.	
42568 3	SPC600	Set of 6 in Vinyl Case

INDIVIDUAL SCREWDRIVERS		
UPC	NO.	BLADE WIDTH
42515 7	600-0	.100
42518 8	600-1	.080
42521 8	600-2	.070
42524 9	600-3	.055
42527 0	600-4	.040
42530 0	600-5	.025
42566 9	S607	Seven Blade Screwdriver Set

Sizes: .100", .080", .070", .055", .040", .025" and #0 crosspoint.
Comes in plastic tube

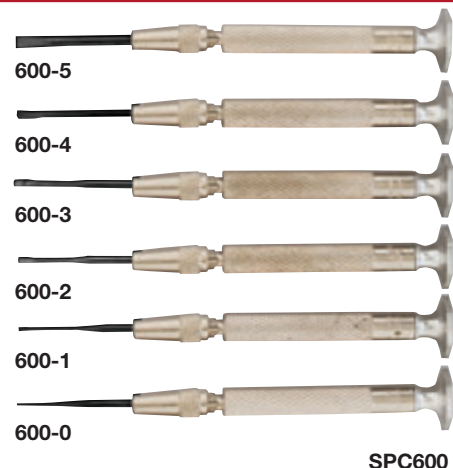

SCREWDRIVERS

General Tools Precision Screwdrivers feature a full range of best selling screwdrivers made to exceed ANSI specifications. The screwdrivers have been

engineered with four handle sizes matched to tip torque requirements to minimize over torquing fasteners.

10-PIECE MINI SCREWDRIVER SET

- Patented, ergonomically designed handle for rotation, greater comfort and control
- Plated alloy steel blades ensure a long life
- Hardened tips and shafts ensure a maximum workload
- Three different blade configurations with color-coded large swivel heads
- Overall screwdriver length is 4-5/8" (117mm)
- Blade length is 1-1/2" (38mm)
- Set includes one each of the following sizes.
Slotted: 3/64" x 1-1/2", 1/16" x 1-1/2", 5/64" x 1-1/2", 3/32" x 1-1/2";
Phillips: #000 x 1-1/2", #00 x 1-1/2", #0 x 1-1/2";
Torx®: T-6 x 1-1/2", T-7 x 1-1/2", T-8 x 1-1/2"

UPC	NO.	PACK
22200 8	690	Carded



690

EYEGLASS REPAIR KIT

- Travel-size with plastic carry case
- Great for emergencies
- Includes: screwdriver, tweezers, screws, nose pads and rubber rings for tightening side arm/frame
- Available individually carded or in a countertop display box

UPC	NO.	PACK
00601 1	601	
00601 2	601CD	Countertop Display/50 pieces



601

2-PIECE PRECISION MICRO SCREWDRIVER SET

- Ideal for close, delicate work
- Durable and rust-resistant
- Includes: Phillips #0 and Slotted tip 3/32"
- Available individually carded or in a countertop display box

UPC	NO.	PACK
06020 4	602	
06020 5	602CD	Countertop Display/18 pieces

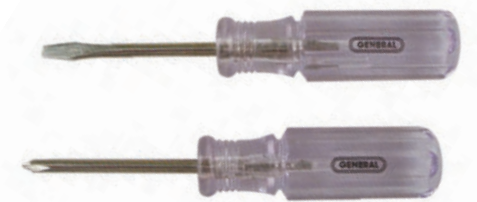

602

6-PIECE PRECISION SCREWDRIVER SET

- For repairing jewelry, cameras, eyeglasses and instruments
- Fingertip swivel head for greater control
- Convenient screwdriver stand
- Includes: Phillips #1, #0 and Slotted tip 1/8", 3/32", 6/64", 1/16"
- Handles plated to prevent rust
- Available individually carded or in a countertop display box

UPC	NO.	PACK
06090 7	609	
06090 8	609CD	Countertop Display/18 pieces



609



SCREWDRIVERS Carded Sets



A-OVERALL LENGTH B-LENGTH OF BLADE B1-BLADE TIP DIAMETER B2-BLADE TIP THICKNESS C-HANDLE LENGTH D-HANDLE DIAMETER E-KNOB DIAMETER

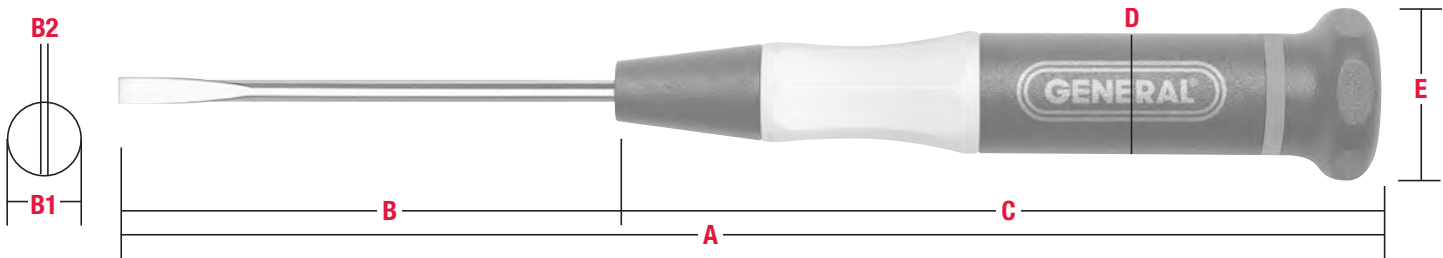

PRECISION SLOTTED SCREWDRIVERS

- Driver tip size shown on cap
- Rotating cap; facets fit palm, recess fits finger tip
- Color coded ring identifies type of tip
- Body sized to prevent excessive torque to fastener
- 8-Sided non-slip cushion grip
- Blades constructed of heat treated 8650 Alloy steel (nickel-chromium-molybdenum)
- Chrome plated to resist corrosion

PRECISION SLOTTED SCREWDRIVERS - CARDED (OPEN STOCK)

UPC	NO.	A	mm	B	mm	B1	mm	B2	mm	C	mm	D	mm	E	mm
61108 6	611078	4-7/8"	(124)	1-1/2"	(38)	5/64"	(2)	0.014"	(0.356)	3-3/8"	(86)	1/2"	(13)	3/4"	(19)
61100 0	611094	4-7/8"	(124)	1-1/2"	(38)	3/32"	(2)	0.015"	(0.381)	3-3/8"	(86)	1/2"	(13)	3/4"	(19)
71110 6	711125	6-3/8"	(162)	2-1/2"	(64)	1/8"	(3)	0.020"	(0.508)	3-7/8"	(98)	5/8"	(16)	15/16"	(23)
71140 3	711140	6-3/8"	(162)	2-1/2"	(64)	9/64"	(4)	0.022"	(0.559)	3-7/8"	(98)	5/8"	(16)	15/16"	(23)

All Patented



PRECISION TORX® SCREWDRIVERS

- Driver tip size shown on cap
- Rotating cap; facets fit palm, recess fits finger tip
- Color coded ring identifies type of tip
- Body sized to prevent excessive torque to fastener
- 8-Sided non-slip cushion grip
- Blades constructed of heat treated 8650 Alloy steel (nickel-chromium-molybdenum)
- Black oxide coated to resist corrosion

PRECISION TORX® SCREWDRIVERS - CARDED (OPEN STOCK)

UPC	NO.	A	mm	B	mm	B1	C	mm	D	mm	E	mm
61305 6	613005	4-7/8"	(124)	1-1/2"	(38)	T5	3-3/8"	(86)	1/2"	(13)	3/4"	(19)
61360 8	613006	4-7/8"	(124)	1-1/2"	(38)	T6	3-3/8"	(86)	1/2"	(13)	3/4"	(19)
61307 0	613007	4-7/8"	(124)	1-1/2"	(38)	T7	3-3/8"	(86)	1/2"	(13)	3/4"	(19)
71380 3	713008	6-3/8"	(162)	2-1/2"	(64)	T8	3-7/8"	(98)	5/8"	(16)	15/16"	(23)
71306 3	713015	6-3/4"	(170)	2-1/2"	(64)	T15	4-1/4"	(107)	13/16"	(21)	1-5/64"	(27)

All Patented



PRECISION PHILLIPS SCREWDRIVERS

- Driver tip size shown on cap
- Rotating cap; facets fit palm, recess fits finger tip
- Color coded ring identifies type of tip
- Body sized to prevent excessive torque to fastener
- 8-Sided non-slip cushion grip
- Blades constructed of heat treated 8650 Alloy steel (nickel-chromium-molybdenum)
- Chrome plated to resist corrosion

PRECISION PHILLIPS SCREWDRIVERS - CARDED (OPEN STOCK)

UPC	NO.	A	mm	B	mm	B1	C	mm	D	mm	E	mm
61203 8	612020	4-7/8"	(124)	1-1/2"	(38)	No. 00	3-3/8"	(86)	1/2"	(13)	3/4"	(19)
71202 8	712010	4-7/8"	(124)	2-1/2"	(64)	No. 0	3-3/8"	(86)	1/2"	(13)	3/4"	(19)
71211 0	712101	7-1/4"	(183)	3"	(76)	No. 1	4-1/4"	(107)	13/16"	(21)	1-5/64"	(23)

All Patented



General's high quality Pin Vises are ideal for hobbyists, technicians, mechanics and do-it-yourselfers. Also used by jewelers, watchmakers, instrument makers, subminiature parts assemblers

and model makers. The pin vise bodies are ergonomically designed for greater control and comfort. The precision collet is made of hardened tool steel for longer life.

T6 CELL PHONE SCREWDRIVER

- For repairs, battery changes or phone cover (faceplate) changes
- For use in any application requiring a T-6 Torx® screwdriver
- Fingertip swivel head for greater control
- Patented, ergonomically designed handle
- 1-1/2 inch (38mm) Chrome vanadium steel blade

UPC	NO.	OAL	PACK
22415 6	666	4-5/8" (117mm)	Carded
22415 7	666CD		Countertop Display/18 pieces

666

MINIATURE PIN VISE

- An exceptional pin vise for precise work on models, instruments and jewelry
- Precision collet is made of hardened tool steel for longer life
- Precision engineered 700 Series Versa-Grip™ handle for maximum performance

UPC	NO.	CAPACITY	PKG.
70965 3	70801	0 – 0.059"	Carded (0 – 1.5mm)

70801

4-IN-1 PIN VISE

- An exceptional pin vise for multiple projects
- Contains:
 - 2 double ended collets:
 - 0 – 0.031" and 0.093" – 0.125"
 - 0.031" – 0.062" • .062" – .093"
- Internal storage under cap for spare collet
- Precision engineered 750 Series Versa-Grip™ handle for maximum performance

UPC	NO.	PKG.
75973 3	75801	Carded

75801

6-PIECE - 4-IN-1 PIN VISE SET

- An exceptional pin vise for multiple projects
- Set contains: No. 75801 pin vise, 2 double ended collets:
 - 0 – 0.031" and 0.093" – 0.125",
 - 0.031" – 0.062" • .062" – .093"
- 5 Drills • 1/32" • 3/64" • No. 43
- No. 50 • No. 53.

- Internal storage under cap for spare collet and drill bits
- Precision engineered 750 Series Versa-Grip™ handle for maximum performance

UPC	NO.	PKG.
75974 0	75806	Carded

75806



SCREWDRIVERS

Ratchet Offset



For hard-to-reach screws, use the Ratchet Offset Screwdriver, especially where leverage is required. The ratchet drive reverses instantly for clockwise or counterclockwise rotation. The blades are made of

machined ground and hardened tool steel. Recessed head screws have a hex shaped recess. A hex wrench is used to remove or tighten this type of screw.



8078

RATCHET OFFSET SCREWDRIVER SET, 19PC.

- Combines hex wrench and screwdriver functions
- Ratchet drive handle reverses instantly for clockwise and counter-clockwise rotation
- Hardened tempered steel, black oxide bits and nickel plated steel ratchet handle
- Packaged in a convenient storage case
- Convenient storage case

19-PIECE 8078 INCLUDES:

One reversible ratchet handle, one 3-1/4" extension shaft, one spinner screwdriver handle. One 1/4" square drive adapter with 1 each #1, #2 cross-point bits, 1 each 1/4" and 3/8" straight bits, 11 hex bits in sizes: .050", 1/16", 5/64", 3/32", 7/64", 1/8", 9/64", 5/32", 3/16", 7/32" and 1/4"

UPC	NO.
80780 9	8078

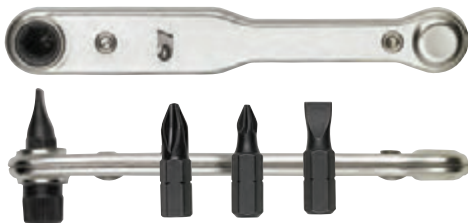

8075

RATCHET OFFSET SCREWDRIVER SET, 5PC.

- For reaching inaccessible screws where leverage is desired
- Use in guns and camera repair work
- Ratchet driver is plated steel and instantly adjusts for right or left-hand use
- Has hardened tempered steel blades
- Uses standard insert bits

- Five-piece set includes: 1/4" and 3/8" straight blades, No. 1 and No. 2 cross - point blades, and handle

UPC	NO.
80750 2	8075



8071

RATCHET OFFSET SCREWDRIVER SET, 5PC.

- For reaching inaccessible screws where leverage is desired
- Ratchet driver is plated steel and instantly adjusts for right or left-hand use
- Has hardened tempered steel blades
- Five-piece set includes: 1/4" and 3/8" straight blades, No. 1 and No. 2 crosspoint blades and handle

- Conforms to government specifications GGG-S-1408

UPC	NO.
42673 4	8071

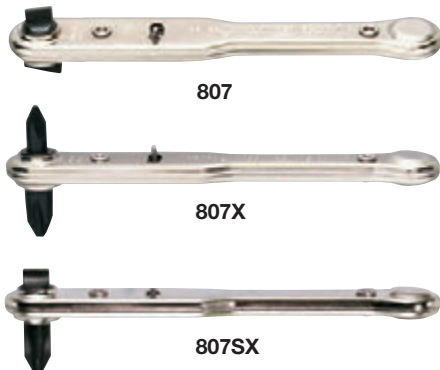

807

807X

807SX

RATCHET OFFSET SCREWDRIVERS

For hard-to-reach screws, use a ratchet offset screwdriver, especially where leverage is required. The ratchet drive reverses instantly for clockwise or counterclockwise rotation. The blades are made of machined, ground and hardened tool steel. Recessed head screws have a hex shaped recess. A hex wrench is used to remove or tighten this type of screw.

- For reaching hard-to-get-at screws, especially where leverage is required

- Blades are made of machined, ground and hardened tool steel
- Ratchet reverses for clockwise or counterclockwise rotation
- Conforms to government specification GGG-S-1408

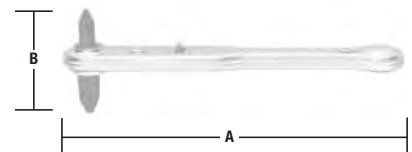

UPC	NO.	TIPS	(A)	(B)
42664 2	807	1/4" and 3/8" straight blades	4" (102mm)	5/8" (16mm)
42670 3	807X	No.1 and No. 2 crosspoint blades	4" (102mm)	1-1/4" (32mm)
42667 3	807SX	1/4" straight and No. 2 crosspoint blades	4" (102mm)	1" (25mm)



9-PIECE RATCHET OFFSET SCREWDRIVER SET

- The Ratchet Offset Screwdriver is used for reaching concealed or obstructed screws, and is helpful in situations where leverage is required
- The Ratchet drive handle reverses instantly for clockwise and counter-clockwise rotation
- Permits short radius movements where turning space is limited
- 72 tooth ultra-fine ratchet requires only 5° turning radius
- The Chrome Vanadium Steel ratcheting handle is ergonomically designed which allows for greater control, comfort and torque
- Hardened tempered alloy steel bits included
- 1/4" magnetic bit-holder can be used in power tools
- Accepts industry standard insert bits

9-PIECE SET INCLUDES:

- 1/4" and 3/16" Slotted bits, • No. 1 and No. 2 Phillips bits,
- T15 and T20 Torx, • 1/8" and 5/32" Hex

UPC	NO.	PKG.
80075 6	80075	Carded

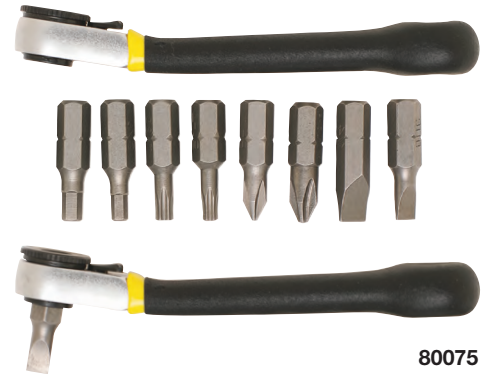

80075

18-PIECE RATCHET OFFSET SCREWDRIVER SET

- For reaching hard-to-get-at screws, the Ratchet Offset Screwdriver is used, especially where leverage is required
- The Ratchet Drive Handle reverses instantly for clockwise and counter-clockwise rotation
- Permits short radius movements where turning space is limited
- 72 tooth ultra-fine ratchet requires only 5° turning radius
- The Chrome Vanadium Steel ratcheting handle is ergonomically designed which allows for greater control, comfort and torque
- Hardened tempered alloy steel bits included
- 1/4" magnetic bit-holder can be used in power tools
- Accepts industry standard insert bits
- Packaged in a pocket-sized fitted zippered case for secure storage

- 18-PIECE SET INCLUDES:** • One reversible ratchet handle • 1 - 2-3/8" extension shaft
- 1 - 1/4" square drive adapter • 1 each No. 1 and No. 2 Phillips bits • 1 each 3/16" and 1/4" slotted bits • 1 each T15 and T20 Star bits • 1 each S1 and S2 Square Drive bits
 - 1 each 1/8" and 5/32" Hex bits • 6 Socket sizes: 3/8", 11/32", 5/16", 9/32", 1/4", 7/32".
- All Sockets are for use with the 1/4" Square Drive adapter.

UPC	NO.	PKG.
80078 7	80078	Zippered Case/Boxed



SCREWDRIVERS

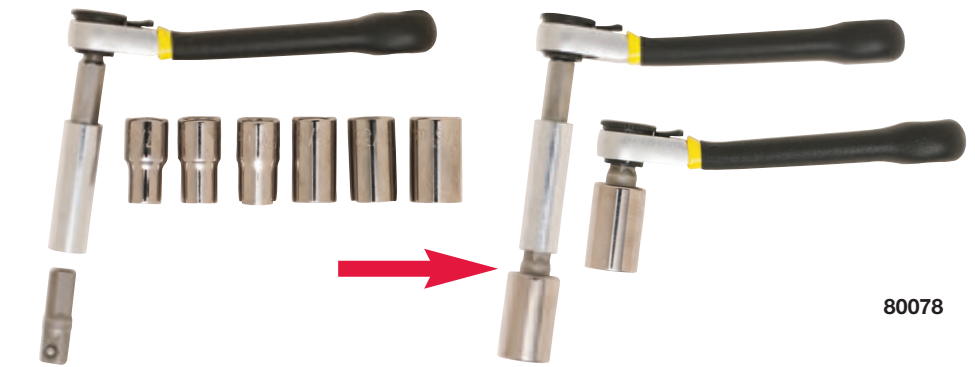
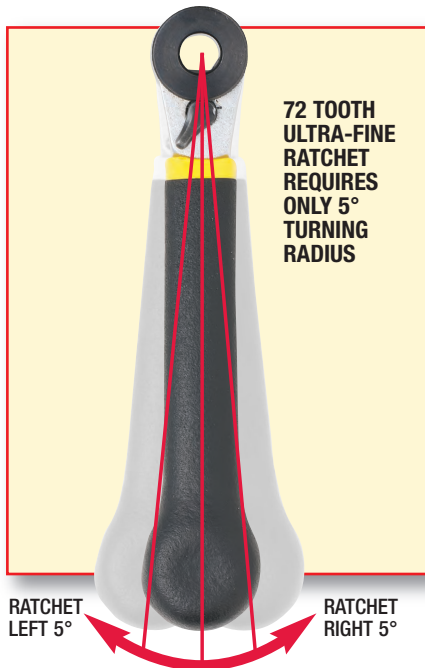

80078



CORDLESS PRECISION ENGRAVER

- Diamond Tip Bit
- 20,000 RPM Motor Engraves Glass, Metal, Ceramic and Plastic
- Aluminum Body
- Uses Standard 3/32" Engraving Bit
- 2 "AAA" Batteries Included



No. 505
Patented

UPC	NO.	CAPACITY
02139 4	505	Overall Length: 6-1/2" Width: 1/2" 0.0 to 3.2mm



Precision Engraver/Plumb Bobs

A Plumb Bob is a pointed, tapered brass or steel weight which is suspended from a cord for determining the vertical or plumb line to a point on

the ground. General's Plumb Bobs are available in a wide range of sizes and conform to government specifications.



CORDLESS PRECISION ENGRAVER

- Diamond Tip Bit
- Precision cordless engraving anywhere
- Use on metal, plastic, ceramic or glass surfaces
- Protects all types of valuables
- Uses standard 3/32" engraving bit
- Aluminum body

- 20,000 RPM motor
- 2 "AAA" batteries (included)

UPC	NO.	CAPACITY
02139 4	505	Overall Length: 6-1/2" Width: 1/2" 0.0 to 3.2mm

505
Patented



800

BRASS PLUMB BOBS

- Machined of solid brass, fully polished and lacquered
- Removable self-centering cord cap for easy cord replacement. Cap used with 5/64" (0.078) braided cord
- Replaceable hardened steel point
- Conforms to government specs GGG-P-501e
- Now with extra string and tip
- 10' (3mm) long braided cord
- Available in six sizes

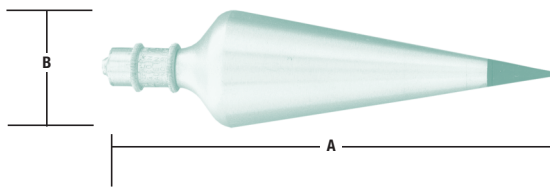

UPC	NO.	WEIGHT	(A)	(B)
42624 6	800-8	8 oz.	4-1/2" (114mm)	1-3/16" (30mm)
42630 7	800-12	12 oz.	5" (127mm)	1-3/8" (35mm)
42633 8	800-16	16 oz.	5-3/4" (146mm)	1-1/2" (38mm)
42639 0	800-32	32 oz.	7-1/4" (184mm)	1-7/8" (48mm)
42641 3	800NP	Replacement Point	10-33 Thread	

SPECIALTY



790

HEXAGON STEEL PLUMB BOBS

- Made of hexagonal cold drawn steel and nickel plated to prevent rust
- Removable cord cap for 3/32" (0.094)
- 10' (3mm) long braided cord

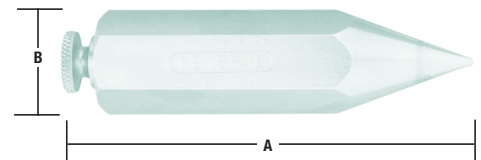

UPC	NO.	WEIGHT	(A)	(B)
42612 3	790-5	5 oz.	3-3/8" (86mm)	3/4" (19mm)
42615 4	790-8	8 oz.	4" (102mm)	7/8" (22mm)
42618 5	790-12	12 oz.	4-1/2" (114mm)	1" (25mm)



General's Pin Vises are useful for securely holding small stock, taps, drills, reamers, scribes, wire, files and other tools. The tool steel collets are hardened

and grip firmly when the screw chuck is tightened. The Swivel Head Pin Vise is an exceptional tool for precise work on models, instruments and jewelry.

SINGLE END PIN VISE SET

- For holding small rods, wire, drills, taps and other small tools
- Tool steel collets are hardened and grip firmly when screw chuck is tightened

- Nickel plated body is hollow to permit holding of long rods of wire
- Available in individual sizes
- Conforms to government specifications GGG-V-412a

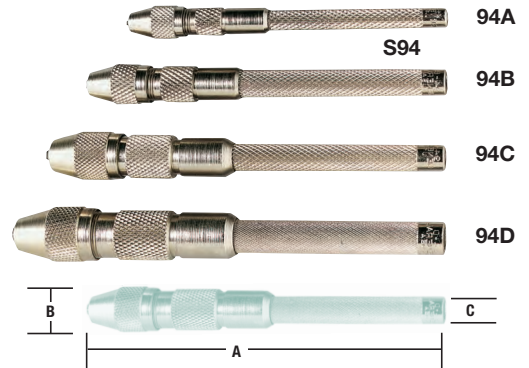

UPC	NO.	RANGE	(A)	(B)	(C)
41068 9	S94	Set of 4 sizes, A-D			
41074 0	94A	0 to 0.055" (0 to 1.4mm)	3-1/8" (79mm)	5/16" (8mm)	3/16" (5mm)
41077 1	94B	0.025 to 0.075" (.6 to 1.9mm)	3-1/2" (89mm)	3/8" (10mm)	1/4" (6mm)
41080 1	94C	0.045 to 0.125" (1.1 to 3.2mm)	3-13/16" (97mm)	7/16" (11mm)	1/4" (6mm)
41083 2	94D	0.110 to 0.187" (2.8 to 4.8mm)	4" (102mm)	9/16" (14mm)	5/16" (8mm)

SWIVEL HEAD PIN VISE

- An exceptional pin vise for precise work on models, instruments and jewelry
- Two double end collets made of hardened tool steel
- Has large freewheeling swivel head
- Collets stored in handle

UPC	NO.	CAPACITY
41062 7	92	0.0 to 0.125" 0.0 to 3.2mm



DOUBLE END PIN VISE

- Each end has a double end collet which may be reversed to desired size
- Nickel plated body is hollow to permit use of long wire or rods
- Collets stored in handle
- Holds a variety of small tools for fine detail work

UPC	NO.	CAPACITY
41058 0	90	0.0 to 0.0125" 0.0 to 3.2mm

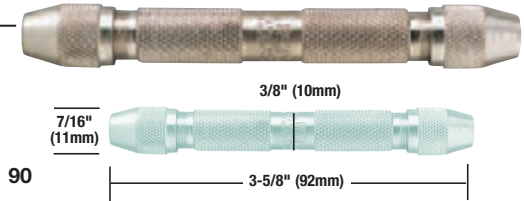

ADJUSTABLE PIN VISE

- Use for electronic assembling, tool-making, model making and hobbies
- Holds small drills, deburrers, wires, files, reamers and other small tools
- 3-jaw hardened steel keyless chuck and sturdy plastic handle

UPC	NO.	CAPACITY
41065 8	93	0.040 to 0.250" 1mm to 6.4mm



SWIVEL VACUUM VISE

- This popular vise grips firmly to glass, metal, laminate, fiberglass, or any smooth nonporous surface with quick lever action
- Universal ball joint swivels 360° to any position and tilts 90° to any angle
- V-grooved hardened steel jaws are 3" wide and open to 2-5/8"

- Furnished with slide-on rubber jaws for fragile work
 - Folds for storage
- | UPC | NO. | SIZE | BASE HEIGHT | OVERALL WEIGHT |
|---------|-------------|----------------------|-------------|----------------|
| 43960 4 | 1850 | 6-1/4"
triangular | 6-1/4" | 5 lbs. |



ADJUSTABLE FILE/TOOL HANDLE

- For holding files, reamers, hacksaw blades and other tang handled tools
- Exclusive steel parallel clamping jaws grip the entire length of the inserted tang to prevent slipping
- Large, quick adjusting knurled knob ensures positive locking
- Rustproof handle with steel parts

- Conforms to government specifications NN-H-0085
- | UPC | NO. |
|---------|------------|
| 43666 5 | 890 |
-



LED

Mechanical Pick-Ups

The new Lighted Mechanical Pick-Ups allow you to retrieve items from dark, hard to reach places. The powerful LED light sheds a beam of light on your

subject. The strong 4-prong steel jaws allows you to retrieve small items. The shaft comes in 3 different lengths, 12", 24", and 36".

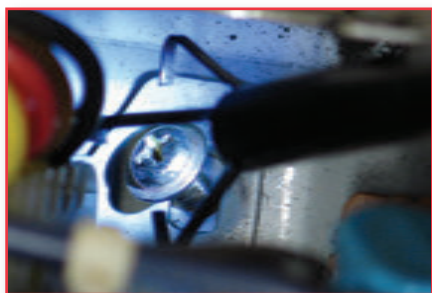

LIGHTED MECHANICAL PICK-UPS

Let that flashlight sleep! General's new Lighted Mechanical Pick-Up has a powerful white LED that sheds a bright light on your quarry. Its strong 4-prong steel jaws can capture objects up to 1 in. (52mm) across.

- Push on powerful LED light
- Continued push opens retrieval claw
- Comfortable ergonomically designed hand controls

- Flexible shaft
- Strong spring steel retrieval claw
- Power Source: 3 "LR41" batteries (included)

UPC	NO.		
70399 6	70393	12" OAL	Patented
26003 1	70396	24" OAL	Patented
70393 4	70399	36" OAL	Patented

LR41 replacement battery



MINI MECHANICAL PICK-UP

- Strong four prong steel jaws retrieve small objects up to 1/2" (12mm)
- Knurled body with tapered point for hard-to-reach work areas
- Smooth traveling plunger actuator for greater control
- Chrome finish to prevent rust
- Can be used as a screw starter

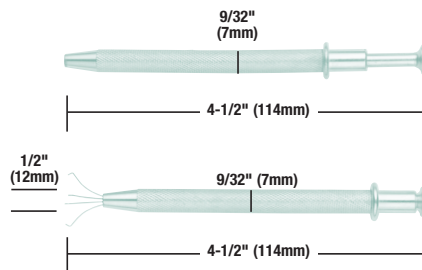

MECHANICAL PICK-UP

- Strong four prong steel jaws retrieve small items from hard-to-reach places
- Smooth actuator for greater control

- Chrome finish to prevent rust
- Flexible shaft to avoid obstacles

UPC	NO.
22145 2	396

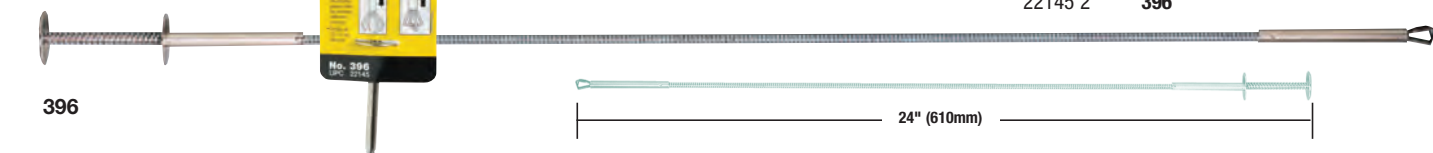

TELESCOPING ALLIGATOR CLIP

- Ideal for lighting pilot lights and barbecues
- Jaw capacity: .170" (4.30mm)
- Chrome finish to prevent rust
- Convenient pocket-clip

UPC	NO.
42217 0	400

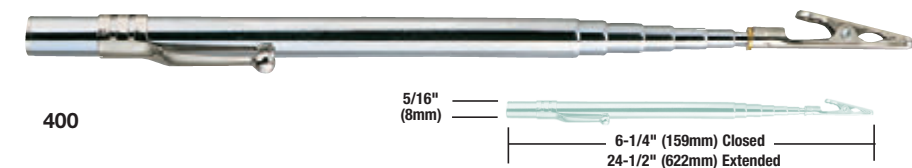

SPECIALTY



Lighted Mechanical & Mechanical/Magnetic

PICK-UPS

Lighted mechanical pick-ups are ideal for retrieving items from dark or hard-to-reach areas

Features: (70390/70391)

- Lighted Magnetic/Mechanical Pick-Up 24" (610mm) and 36" (914mm) with Flexi-Shaft™
- Push on powerful LED light
- Continued pushing opens strong spring steel retrieval claw
- Comfortable ergonomically designed hand control
- Flexible shaft
- Corrosion resistant black finish
- Sliding magnetic sleeve
- Includes 3 "LR41" batteries

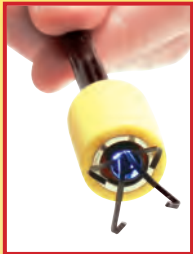

No. 70390
24" (610 mm)

No. 70391
36" (914 mm)



No. 70393
12" (305 mm)



Features: (70393/70396/70399)

- Lighted Mechanical Pick-Up 24" (610mm) and 36" (914mm) with Flexi-Shaft™
- Push on powerful LED light
- Continued pushing opens retrieval claw
- Comfortable ergonomically designed hand control
- Flexible shaft
- Strong spring steel retrieval claw
- Includes 3 "LR41" batteries

No. 70396
24" (610 mm)

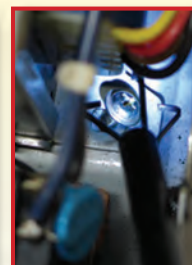

No. 70399
36" (914 mm)

UPC	NO.		
70399 6	70393	12" OAL	Patented
26003 1	70396	24" OAL	Patented
70393 4	70399	36" OAL	Patented
		LR41 replacement battery	

SPECIALTY TOOLS

Tweezers



General's Precision Tweezers are used for electronics, computer, instrument, radio and other small or subminiature assembly, servicing and repairs. The Industrial Tweezers or General's quality line are

used by toolmakers, repair-people, electronic assemblers and other professionals. Utility Tweezers are used by mechanics, crafts-people and hobbyists where value is desired.

UTILITY TWEEZERS. Designed for mechanics, hobbyists and craftspeople



INDIVIDUAL STYLES OF UTILITY TWEEZERS

UPC	NO.	POINT STYLE	LENGTH
42291 0	414	Blunt serrated (self closing)	6-1/2"
42294 1	415	Curved	6-1/2"
42297 2	416	Spade	4-1/2"



SWISS PATTERN TWEEZERS

- Light tension and hardened points for subminiature assemblies
- Stainless steel construction
- Finest quality precision points

UPC	NO.	POINT STYLE	LENGTH
42249 1	423-3	Very fine	4-5/8"
42251 4	423-3C	Very fine	4-1/8"



C421



SIX-PIECE TWEezer SET

- Consists of six tweezers for home and industrial use
- One each of Nos. 401XX, 403, 412, 414, 415, 417
- In clear vinyl pouch

UPC	NO.
42309 2	C421



TWEezer MAGNIFIER

- Useful for detailed projects
- 5-power lens
- Stainless steel tweezer
- Double hinged adjustable arm

- Durable plastic handle and frame
- Finely ground points
- Length 2-1/4" (57mm)

UPC	NO.
42258 3	425

PRECISION TWEEZERS. For electronic, computer, instrument, radio and other small or subminiature assembly, servicing and repairs

401AA

BOLEY PATTERN TWEezer

- Jewelry/watchmaking, instrument assembly, computer and electronics repair
- Hardened stainless steel construction

- Ultra-fine point
- Manufactured to close tolerances



UPC	NO.	POINT STYLE	LENGTH
42240 8	401AA	Strong bevel	5"

INDUSTRIAL TWEEZERS. Toolmaking, equipment assembly, computer and electronics repair

INDIVIDUAL STYLES OF INDUSTRIAL TWEEZERS



UPC	NO.	POINT STYLE	LENGTH
42263 7	401XX	Strong sharp	4-1/2"
42266 8	403	Blunt serrated	6"
42271 2	408	Sharp bent	4-1/4"
42280 4	410	Narrow sharp	4-1/4"



Lighted Tweezers & Holding Tools

General's Lighted Tweezers allow you to retrieve items from dark, hard-to-reach places. The powerful LED light allows you to put the light exactly where you need it. Available in three tip configurations.

Ideal for electronics, computer, instrument, radio and other small or sub-miniature assembly, servicing and repairs.

LIGHTED TWEEZERS

Now, put the light exactly where you need it!

- Push ON/ Push OFF powerful LED light
- Non-slip comfort grip
- Heat treated steel
- Corrosion resistant non-glare black finish
- 6.25" (159mm) long
- Sets of two and three available in heavy-duty nylon carrying case
- Power Source: 3 "LR41" batteries per tweezer (included)

UPC	NO.	
26004 8	70401	Smooth Point Tip
26005 5	70403	Serrated Blunt Tip
26006 2	70408	Serrated Bent Tip
70402 3	70402	(2 pc. set) 70401, 70408
70400 9	70400	(3 pc. set) 70401, 70403, 70408

All Patented



70402



70400



70401

Smooth Point Tip



70403

Serrated Blunt Tip



70408

Serrated Bent Tip

NUT STARTER

- For starting or removing threaded nuts in hard-to-reach areas. Can also be used when nuts are too small to be held by hand while being threaded
- Easy-to-use spring steel chuck will hold nut sizes from 3-48 thread (3/32" or 2.5mm) to 5/16" (8mm)

- Knurled aluminum handle

UPC	NO.	CAPACITY
42682 6	8081	3-48 thread (3/32" or 2.5mm) to 5/16" (8mm)

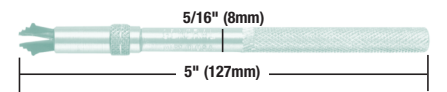

8081



SLOTTED SCREW STARTER

- For starting or removing slotted screws in hard-to-reach areas. Can also be used when screws are too small to be held by hand while being threaded
- Spring loaded steel chuck holds slotted screws from No. 3 to 7/16" sizes

- Knurled aluminum handle

UPC	NO.	CAPACITY
42684 0	8082	No. 3 to 7/16"

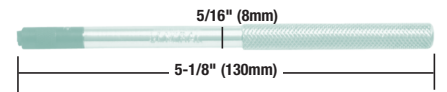

8082



CROSS POINT SCREW STARTER

- For starting or removing cross point screws in hard-to-reach areas. Can also be used when screws are too small to be held by hand while being threaded
- Easy-to-use spring steel chuck holds screws from No. 6 to 1/4" size

- Knurled aluminum handle

UPC	NO.	CAPACITY
42686 4	8083	No. 6 to 1/4"

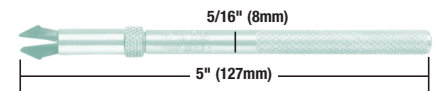

8083



FRACTION+™

Digital Fractional Caliper

Light Weight Non-Marring
Carbon Fiber Construction

3 Mode Digital Display

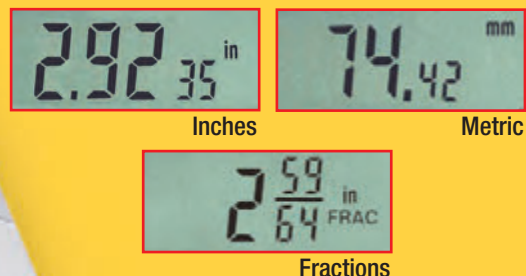

2 Sizes Now Available
3" (76mm) / 6" (150mm)

3" Fraction+ Caliper
Clips into Your Pocket

Convenient Auto
On/Off Feature

Specifications:

Range:

No. 1433 (3")
0 - 3" (0-76mm)

No. 146 (6")
0 - 6" (0 - 150mm)

Accuracy:

No. 1433 (3")
+/- 0.005", +/- 0.1mm

No. 146 (6")
+/- 0.008", +/- 0.2mm

Resolution:

0.0005"
0.01mm
1/64"

Repeatability:

0.0005"
0.01mm
1/64"

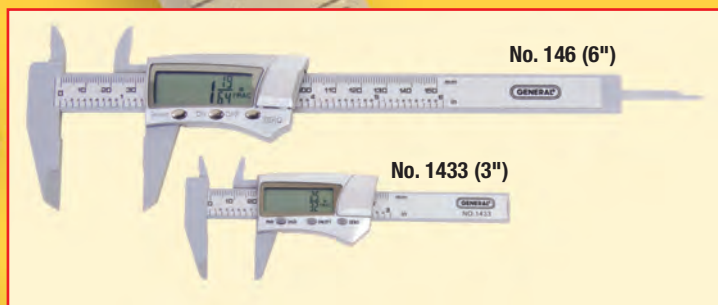

From the Hobbyist
to the Technician and
Measuring Everything
in Between

GENERAL®

GENERAL®
NO. 1433



FRACTION+

The Digital Fractional Caliper Family

General's newest "Fraction+" Calipers measure in fractional inches as well as decimal inches and millimeters. It's perfect for everyone from the DIYer to the professional.

FRACTION+

6", 8" & 12" STAINLESS STEEL DIGITAL FRACTIONAL CALIPERS

- Heavy-duty stainless steel construction
- Convenient auto-off feature
- Three mode digital display: Decimal inches, fractional inches and millimeters
- Inside, outside, depth & step measurements
- Accuracy: +/- 0.001", +/- 0.02mm
- Resolution: 0.0005", 0.01mm, 1/64"
- Power Source: 1 "SR44" battery (included)



UPC	NO.	RANGE
01470 2	147	0 - 6" (0 - 153mm)
01478 3	1478	0 - 8" (0 - 203mm)
14712 7	14712	0 - 12" (0 - 305mm)



No. 147 Digital Display

FRACTION+

6" CARBON FIBER DIGITAL FRACTIONAL CALIPER

- 6" (153mm) range
- Lightweight, non-marring carbon fiber composite
- Convenient auto-off feature
- Three mode digital display: Decimal inches, fractional inches and millimeters
- Inside, outside, depth & step measurements
- Accuracy: +/- 0.001", +/- 0.02mm
- Power Source: 1 "SR44" (1.5V) battery (included)

UPC	NO.	RANGE
01460 3	146	0 - 6" (0 - 153mm) SR44 replacement battery



No. 146 Digital Display

FRACTION+

3" CARBON FIBER DIGITAL FRACTIONAL CALIPER

- 3" (76mm) range
- Lightweight non-marring carbon fiber composite
- Convenient auto-off feature
- Three mode digital display: Decimal inches, fractional inches and millimeters
- Inside, outside, & step measurements
- Accuracy: +/- 0.001", +/- 0.02mm
- Power Source: 1 "SR54" (1.5V) battery

UPC	NO.	RANGE
01433 7	1433	0 - 3" (0 - 76mm) SR54 replacement battery



No. 1433 Digital Display



1433

SPECIALTY



SPECIALTY TOOLS

Dial Calipers



General's high quality, easy-to-read Dial Calipers give precise readings – Inside, Outside, Depth and Step measurements. The 6" Plastic Dial Caliper is made of fiberglass reinforced plastic and gives

precision measurements at an economical price. The 6" Dial Caliper is a stainless steel construction for greater accuracy and durability.



107

6" DIAL CALIPER

- Stainless steel construction for accuracy and durability
- Large, clear dial accurately reads to .001"
- Satin chrome scale with clearly etched tenths of inch graduations
- Covered rack ensures smooth operation by preventing dirt and chips from entering rack and gear mechanism

- Inside, outside, depth and step measurement
- Lock for repetitive measurement
- Free wheeling thumb roller
- Depth stop rod
- Adjustable bezel for zero setting

UPC	NO.
10700 8	107



142

6" PLASTIC DIAL CALIPER, INCHES READOUT

Wherever precision spatial measurements are needed

- FRP construction offers precision measurements at an economical price
- Maximum length: 6 in.

- Easy-to-read dial with no-glare lens cover is color-coded to highlight graduations of both 0.01in. and 1/64in.
- Inside, outside, depth and step measurements
- Bar has inch and mm graduations on the front and a fractional conversion table on the back

UPC	NO.
44145 4	142



145

6" PLASTIC DIAL CALIPER, THOUSANDTHS READING, SINGLE REVOLUTION

- Capacity 0 to 6"
- Readings in .001"
 - Single revolution of dial is .100"
 - Resolution .001"
- 6" scale is graduated in tenths/mm
- Non-glare dial with adjustable bezel
- Packed in reusable plastic hang-up case

- Inside, outside, depth and step measurements
- Freewheeling friction roller for repetitive and accurate readings

UPC	NO.
44150 8	145



144MM

150mm PLASTIC DIAL CALIPER, METRIC READOUT

Wherever precision spatial measurements are needed

- FRP construction offers precision measurements at an economical price
 - Maximum length: 150mm
 - Large, clear dial accurately reads to 0.001mm

- Easy-to-read dial with no-glare lens
- Inside, outside, depth and step measurements
- Bar has inch and mm graduations on the front and a fractional conversion table on the back

UPC	NO.
44148 5	144MM

SPECIALTY



SPECIALTY TOOLS Slide Calipers



Slide Calipers come in different styles - Electronic Digital Calipers, Mechanical Dial Calipers, Vernier Calipers and Plain Slide Calipers. General's all-

purpose Slide Calipers, sized to slip into your pocket, can make quick, accurate, inside and outside diameter measurements.

METRIC AND ENGLISH VERNIER CALIPER

- Graduated in mm and 16ths of an inch with vernier reading of .1mm and 1/128"
- Economical steel vernier calipers have 5" (125mm) capacity
- Inside and outside jaws and full length depth gage
- Caliper has inside, outside, depth and step measurement

- Caliper has lock for repetitive measurement
- Friction roller adjustment
- Slide lock for gaging

UPC	NO.
72200 3	722



722

4-INCH SLIDE CALIPERS

- Stainless steel caliper with inside and outside readings in 16ths and 32nds
- Decimal equivalents table on back
- Scale has etched and filled graduations
- 4" (102mm) capacity

UPC	NO.	GRADS
42581 2	729	16ths and 32nds
42594 2	729ME	mm and 16ths



729

POCKET CALIPER

- Stainless steel slide caliper with inside and outside readings in metric and inches
- Decimal equivalents on back
- Scale has etched and filled graduations
- 3" (76mm) capacity

UPC	NO.	GRADS
44136 2	132ME	32nds and mm



132ME

POCKET CALIPER

- Precision made high strength, fiberglass reinforced plastic caliper
- Opens to 3" (76mm) outside measurement capacity
- 4" (102mm) rule graduated in 16ths on back
- Inside and outside readings graduated in 32nds and mm

UPC	NO.	GRADS
44139 3	141ME	32nds and mm



141ME



SPECIALTY TOOLS

Measuring/Marking Kits



The "Measure 'N Mark" is a pocket pen with a 3 foot removable tape measure. A handy little pen tool for those on the go. The Precision Measuring Kit

contains four of the most useful measuring and marking tools for mechanics and machinists: Micrometer, Dial Caliper, 6" Steel Rule and Carbide Scriber.

MEASURE 'N MARK

POCKET PEN WITH REMOVABLE TAPE MEASURE

- 3' (914mm) removable tape measure
- Pen with comfort grip
- Convenient pocket clip
- Great for high-traffic areas like checkout counters and end-cap shelving
- Available only as a 15-piece counter display

UPC	NO.
02126 8	309CD Countertop Display 15 pieces (Sold only as a counter display - see Page T-125 for display)



309



309CD

Patent Pending

PRECISION MEASURING KIT

- This kit contains four of the most useful measuring and marking tools for mechanics or machinists
- Kit includes: No. 102, 0 to 1" micrometer; No. 145, 0 to 6" thousandths reading dial caliper; No. 676, 6" rigid stainless steel rule graduated in 8ths, 16ths, 32nds, and 64ths; No. 88CM, tungsten carbide scriber with magnetic pickup

- Packaged in sturdy, fitted, blow molded case designed specifically for these tools
- Instructions and conversion table (fractions to decimals to millimeters) included

UPC	NO.
34106 8	S004



S004

ECONOMY PLUNGER DIAL INDICATOR

- Large 2-1/4" (57mm) diameter dial indicator
- Accuracy to .001"
- Dial is continuous and may be rotated for setting at any point
- Full 1" travel
- Revolution accumulator counter
- Direct decimal two-way reading left and right
- Adjustable limit indicators
- Lug mount standard

UPC	NO.	READINGS
10900 2	109	0 to .001" by .001"



109



POCKET PROTECTOR TOOL/MARKING KIT

- This handy pocket size tool kit is designed for the mechanic, machinist or hobbyist
- The kit contains four of General's best selling tools: No. 300/1, 6" rule; No. 383NX, telescoping magnetic pickup; No. 87, automatic center punch and No. 88, scriber
- All tools packaged in vinyl pocket protector which can be snapped closed

UPC	NO.	KIT INCLUDES ONE EACH:
34112 9	S008	6" rule, magnetic pickup, automatic center punch, scriber



S008





General's **LumiLENS™** Lighted Magnifier puts the light directly on your subject to be viewed. With its powerful extra bright LED light you will never be left in the dark again. Two lens magnifications,

3x and 6x, as well as an integrated stand for Hands-Free use make this tool a must in laboratory quality control, inspection and assembly functions.



• Hands-Free Use



• 3x Magnification, 6x Inset Lens



• Extra-Bright LED



800543
Patented

LumiLENS™
LIGHTED MAGNIFIER

- Push On / Push Off Powerful LED light
 - Contoured Handle for Handheld Use
 - Integrated Stand for Hands-Free Use
 - Shatter-Resistant Lens
 - 3-1/2" Lens Diameter (89mm)
 - 3X Magnification (6X Inset lens)
 - Power Source: 2 "AA" batteries (included)
- Includes • Protective pouch

UPC	NO.
26001 7	800543

4" POWER POCKET ILLUMINATED MAGNIFIER

- Handy 4" power magnifier has plastic body and lens
- Power Source: "AAA" batteries and No. 222 bulb (included)

UPC	NO.	POWER
42456 3	553	4



553

4" ILLUMINATED MAGNIFIER

- 4" diameter with three power lens covers large areas of print
- Five power bifocal lens insert gives even greater magnification
- Bulb gives wide circle of illumination
- Plastic body and optical plastic lens
- Power Source: 2 "C" batteries (not included)

UPC	NO.	POWER	FOCAL LENGTH
42462 4	554	3.0	3-1/3"
	Bifocal	5.0	2"



554

SPECIALTY TOOLS

Magnifiers

GENERAL®

General's Magnifiers are used by toolmakers, jewelers, instrument assemblers, laboratory technicians, engineers, mechanics and inspectors who need sharp clear magnification without eyestrain. The

Illuminated Magnifier is designed for demanding jobs in laboratory quality control, inspections and assembly functions. The Illuminated Magnifier is of the highest optical quality and offers fine resolution.



750545



700540

GLASS MAGNIFIERS

- Polished optical glass lens with a metal frame
- Versa-Grip™ Handle with non-slip cushion grip
- Full range of sizes from 2" (50mm) to 4-1/2" (115mm)
- Round lens is distortion free
- A powerful magnifier for working in confined or obstructed spaces
- Designed for demanding jobs in laboratory quality control, inspection and assembly functions
- Used by engineers, mechanics, inspectors, lab technicians, toolmakers, instrument assemblers, jewelers, do-it-yourselfers, hobby and crafts people

UPC	NO.	DIAMETER	POWER	FOCAL LENGTH
00540 3	700540	2" (50mm)	1.6	6"
50541 5	750541	2-1/2" (65mm)	1.6	6"
50542 2	750542	3" (75mm)	1.6	6"
50543 9	750543	3-1/2" (90mm)	1.25	8"
50544 6	750544	4" (100mm)	1.25	8"
50545 3	750545	4-1/2" (115mm)	1.25	8"



538

2" MAGNIFIER

- Economical and versatile magnifier for laboratory and industrial uses, for do-it-yourselfers, mechanics and inspectors
- 2" diameter with four power lens
- Lightweight, durable 1-piece molded plastic frame

UPC	NO.	POWER	FOCAL LENGTH
42414 3	538	4	2"



565

RECTANGULAR ILLUMINATED MAGNIFIER

- Lens measures 2" x 4" for distortion-free magnification of large areas
- Reversible light reflector adapts for right- or left-hand use
- 2.5 power shatterproof lens, with 5 power bifocal insert

- Replaceable bulb
- 2 "AA" batteries (included)

UPC	NO.	POWER	FOCAL LENGTH
42509 6	565	2.5	4"
	Bifocal	5.0	2"





General's Magnifiers are used by toolmakers, jewelers, instrument assemblers, laboratory technicians, engineers, mechanics and inspectors who need sharp clear magnification without eyestrain. These

magnifiers are designed for demanding jobs in laboratory quality control, inspections and assembly functions. Our magnifiers are of the highest optical quality and offer fine resolution.

2.5 POWER POCKET MAGNIFIER

- Has 2.5 power ground and polished optical glass
- Folds into case for storage

UPC	NO.	POWER	FOCAL LENGTH
42400 6	532	2.5 Simulated	4"
Black Leather case			



532

EYE LOUPE

- For toolmakers, jewelers, instrument assemblers and others who need sharp, clear magnification without eyestrain
- Clear optical glass lens is ground and polished
- 1" diameter lens

UPC	NO.	POWER	FOCAL LENGTH
42339 9	527	5.0	2"



527

FOLDING POCKET MAGNIFIERS

- Fine quality magnifiers for laboratory technicians, engineers, mechanics and inspectors
- Case and lens rims are made of black molded plastic
- Available in single lens and double lens models

UPC	NO.	IND. MOD.	TOT. POW.	LENS POW.	FOCAL DIA.	LENGTH
42403 7	533	Sing.	4.0	4.0	1"	2.5"
42409 9	536	Dble.	4.0	8.0	1"	1.25"
42412 9	537	Dble.	3.0	6.0	1-1/4"	1.6"



533



536

BINOCULAR MAGNIFIER

- For assemblers and inspectors of electronic and other small or subminiature parts, toolmakers, jewelers and engravers
- Leaves hands free to work
- Ground and polished optical lenses eliminate eyestrain
- Tilt-up lens frame
- Fits over prescription glasses

UPC	NO.	POWER	FOCAL LENGTH
43734 1	950-5	2.25	8"



950-5



The Mini-Light has an LED light bulb which has a life of 100,000 hours of continuous use. These lights require 4 "LR41" batteries which have a life of 48 continuous hours. The Mini's come with either

a telescoping handle which extends up to 28-3/4" (720mm) or with an alligator clip which clips on anything, anytime, anywhere for instant, direct light.



LIGHTED RECTANGULAR INSPECTION MIRROR

- 2 Extra bright LED lights facilitate the inspection of hard-to-see and hard-to-reach areas
- Ideal for toolmakers, machinists, inspectors and mechanics
- Fully polished glass mirror is shatter-resistant
- 2 "CF2032" batteries included
- 360° Swivel double ball joint

UPC	NO.	SIZE	OVERALL LENGTH
02146 5	80560	2" x 3"	12-1/4", extends to 33"

80560



LIGHTED ROUND INSPECTION MIRROR

- New round head LED inspection mirror gets into tight places and its diffused LED bulbs spread light evenly over the viewing area.
- Ideal for toolmakers, machinists, inspectors and mechanics
- Fully polished glass mirror is shatter-resistant
- 2 "CF2032" batteries included
- 360° Swivel double ball joint

UPC	NO.	SIZE	OVERALL LENGTH
80557 7	80557	1.85" dia"	11-1/2", extends to 34"

80557



"LITE-IT" CLIP-ON MINI-LIGHT

- Clips on to anything, anytime, anywhere for instant, direct light
- Light is fastened to a rugged high-impact ABS plastic Alligator Clip with a double ball joint that adjusts to any angle
- Four Alkaline, "LR41", batteries with a battery life of 48 continuous hours
- LED bulb has a life of 100,000 hours of continuous use

UPC	NO.	PKG.
58001 6	580	Carded

580



TELESCOPING MINI-LIGHT WITH MAGNETIC PICK-UP

- Mini Light with 2 lb. Neodymium Magnetic pick-up are both fastened to a stainless steel telescoping wand molded into a rugged high-impact ABS plastic handle
- Telescopes from 7-3/4" – 28-3/4" (197mm – 720mm)
- Four Alkaline, "LR41", batteries with a battery life of 48 continuous hours
- LED bulb has a life of 100,000 hours of continuous use
- Has a 2 lb. smooth surface pull capacity Neodymium donut magnet
- Precision engineered 750 Series Versa-Grip™ handle for maximum performance

UPC	NO.	PKG.
75966 5	759581	Carded
75967 2	759582	Carded

759582



TELESCOPING MINI-LITE WITH MAGNETIC PICK-UP

- A powerful permanent magnetic pick-up tool
- Ideal for retrieving steel and iron parts from hard-to-reach and see work areas
- Magnet is fitted in a 5-1/2" (140mm) long ergonomically designed handle
- Four Alkaline, "LR41", batteries with a battery life of 48 continuous hours
- Light Bulb has a life of 100,000 hours of continuous use
- Mini-Light is fastened to a chrome plated brass wand with a double ball joint
- Ball and socket feature for simple, positive adjustments

UPC	NO.	PKG.
05820 1	582	Carded

582



Inspection Mirrors facilitate inspection of inaccessible workpieces and machines by toolmakers, assemblers, inspectors and mechanics. Fully polished mirrors are enclosed in plated holders

which are attached to knurled handles with ball and socket joints. Telescoping arms and vinyl cushion grip handles are offered on some mirrors.

GLASS INSPECTION MIRRORS

- These mirrors facilitate inspection of inaccessible workpieces and machines by toolmakers, assemblers, inspectors and mechanics
- Fully polished glass mirrors are enclosed in plated holders which are attached to knurled handles with ball and socket joints
- Nos. 557, 577, 560, and 570 have telescoping arms and vinyl cushion grip handles

UPC	NO.	SIZE	OVERALL LENGTH
42465 5	555	1-1/4" dia.	8"
42468 6	557	2-1/4" dia.	10-1/2", extends to 15"
42471 6	558	1" x 2" oval	9"
42473 0	560	3-1/2" x 2" oblong	11-1/2", extends to 16"

ACRYLIC PLASTIC INSPECTION MIRRORS

UPC	NO.	SIZE	OVERALL LENGTH
42480 8	577	2-1/4" dia.	10-1/2" - 15"
42477 8	570	3-1/2" x 2"	11-1/2" - 16"

REPLACEMENT MIRRORS WITH FRAMES

UPC	NO.
42478 5	557RMF for No. 557
42484 6	560RMF for No. 560 and No. MB560



METAL INSPECTION "FLAME" MIRRORS

- Includes plastic protective sheath
- Heavy-duty construction

UPC	NO.	SIZE	OVERALL LENGTH
05531 3	5561	1-1/4" x 2"	9-3/4", extends to 26"
05562 0	5562	2" x 3-3/4"	10-3/4", extends to 26"
05563 7	5563	3-3/4" dia.	9-3/4", extends to 26"



LONG TELESCOPING INSPECTION MIRROR

- Handle has black cushion grip
- Non-slip grip
- Mirror size: 2" diameter
- 36" telescoping

UPC	NO.
05590 3	559



SPECIALTY

SPECIALTY TOOLS

Inspection Mirrors



Inspection Mirrors facilitate inspection of inaccessible workpieces and machines by toolmakers, assemblers, inspectors and mechanics.

Fully polished mirrors are enclosed in plated holders which are attached to ergonomically designed handles with ball and socket joints.

DOUBLE BALL JOINT CONNECTION PERMITS INFINITE ANGLE ADJUSTMENTS



HIGH STRENGTH CORROSION RESISTANT STAINLESS STEEL TELESCOPING WAND

ERGONOMICALLY DESIGNED HANDLE WITH CONTOURED HEAD FOR GREATER CONTROL AND COMFORT

EIGHT SIDED CUSHION GRIP HAS A NON-SLIP SURFACE

RUGGED HIGH IMPACT ABS PLASTIC HANDLE

ROTATING CAP FACETS FIT PALM



70557



70555

UTILITY TELESCOPING INSPECTION MIRRORS

- These mirrors facilitate inspection of inaccessible work pieces and machines by toolmakers, assemblers, inspectors and mechanics
- Fully polished mirrors are enclosed in plated holders which are attached to handles with a double ball and socket joint
- Double ball and socket joints adjust to any angle
- Nos. 70557 have telescoping arms and vinyl cushion grip handles

UPC	NO.	SIZE	OVERALL LENGTH
22344 9	70555	1-3/8" dia.	5" extends to 27-1/2"
22347 0	70557	2-1/4" dia.	9-3/4" extends to 14-3/4"

759570

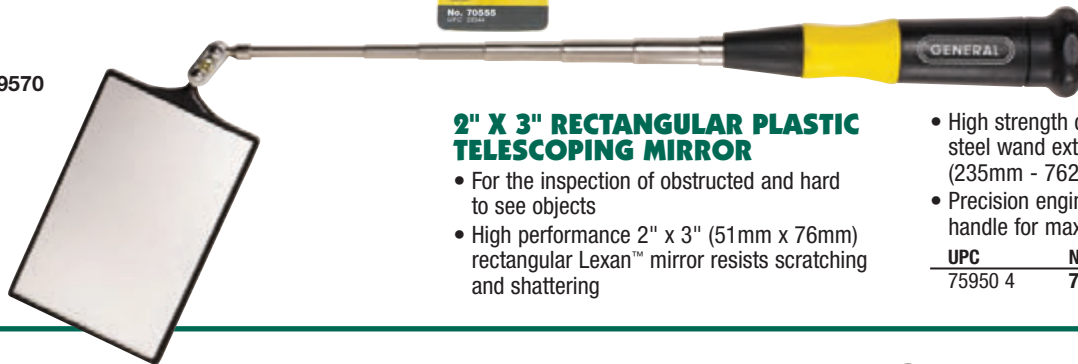

2" X 3" RECTANGULAR PLASTIC TELESCOPING MIRROR

- For the inspection of obstructed and hard to see objects
- High performance 2" x 3" (51mm x 76mm) rectangular Lexan™ mirror resists scratching and shattering

- High strength corrosion resistant stainless steel wand extends from 9-1/4" to 30" (235mm - 762mm)
- Precision engineered 750 Series Versa-Grip™ handle for maximum performance

UPC	NO.	PKG.
75950 4	759570	Carded



759563

2-1/2" ROUND TELESCOPING 3X POWER MAGNIFYING MIRROR

- For the inspection of obstructed and hard to see objects
- High quality 2-1/2" (64mm) diameter magnifying glass mirror improves visibility

- High strength corrosion resistant stainless steel wand extends from 8-1/2" to 29" (216mm - 737mm)
- Precision engineered 750 Series Versa-Grip™ handle for maximum performance

UPC	NO.	PKG.
75959 7	759563	Carded

MB560

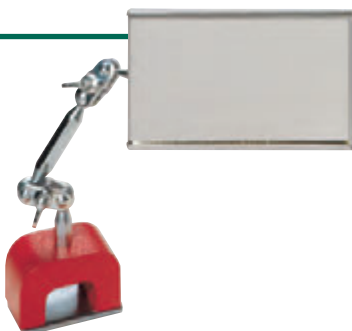

MAGNETIC BASE INSPECTION MIRROR

- Adjustable 3-1/2" x 2" oblong glass inspection mirror mounted to a permanent magnet
- Attaches to any steel or iron machine, tool, appliance or other equipment
- Has wing nut ball joint adjustment

UPC	NO.
42475 4	MB560

TELESCOPING *Speed-Chuck*[™] INSPECTION SETS

- Stainless Steel *Speed-Chuck*[™] and telescoping wand combination provides quick and limitless inspection and retrieval solutions
- Ergonomically designed handle with contoured head for greater control and comfort
- Handle telescopes from 6-3/8" (163mm) to 26" (660mm)
- Spring-loaded *Speed-Chuck*[™] allows blade changes instantly
- All attachments are fastened to a stainless steel *Speed-Chuck*[™] adapter with a double ball joint, adjusts to any angle
- Precision Locking System firmly holds blades in place

- Available attachments:
 - Neodymium magnets: 2 lb., 5 lb. and 10 lb. smooth surface pull capacities
 - Mirrors & Magnifiers: 1-1/2" (38mm) diameter
 - 2" x 3" (51mm x 76mm) rectangular mirror
 - 2-3/8" (60mm) dia. 3x power magnifying mirror
 - 2-1/2" (64mm) dia. 3x power magnifier;
 - Alligator clip
 - Mini-Lite
- All sets are securely and safely protected within a fitted zippered case

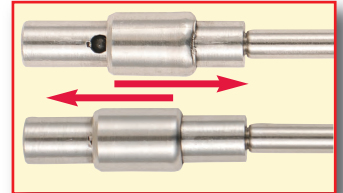

5-PIECE TELESCOPING "SPEED-CHUCK"[™] INSPECTION SET

- Set includes: • 26" stainless steel telescoping wand with *Speed-Chuck*[™] assembly
- 5 lb. magnetic pick-up
- 2" x 3" rectangular plastic mirror
- 3x power magnifier, alligator clip
- Mini-Lite. Batteries included
- Precision engineered 750 Series Versa-Grip[™] handle for maximum performance

UPC	NO.	PKG.
75961 0	759905	Zippered Case/Boxed

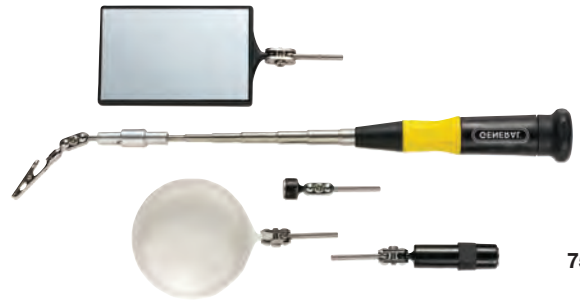

759905

9-PIECE TELESCOPING "SPEED-CHUCK"[™] INSPECTION SET

- Set includes: • 26" stainless steel telescoping wand with *Speed-Chuck*[™] assembly
- 2 lb., 5 lb. and 10 lb. magnetic pick-ups
- 1-1/2" round mirror
- 2" x 3" rectangular mirror
- 2-1/2" round glass magnifying mirror
- 3x power magnifier, alligator clip
- Mini-Lite
- Batteries included
- Precision engineered 750 Series Versa-Grip[™] handle for maximum performance

UPC	NO.	PKG.
75962 7	759909	Zippered Case/Boxed



759909

FIXED LENGTH MAGNETIC PICK-UP, 2 LB. PULL

- Has a 2 lb. smooth surface magnetic pull capacity with an overall length of 6-3/4" (171mm)
- High strength stainless steel shaft resists corrosion
- Durable ball joint connection permits infinite angle adjustments
- High powered neodymium magnet is six times stronger than standard Cobalt Magnets

- Magnet holder is made of high-strength reinforced nylon
- Precision engineered 700 Series Versa-Grip[™] handle for maximum performance



709392

UPC	NO.	PKG.
70972 1	709392	Carded



759383
759398

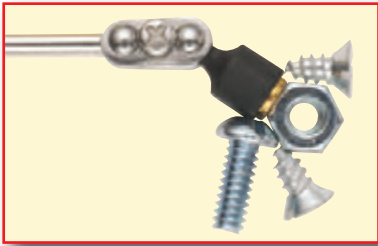

TELESCOPING MAGNETIC PICK-UPS

- High powered 2 lb., 5 lb., 10 lb. Neodymium magnets are 6 times stronger than standard Cobalt magnets
- Double ball joint connection permits infinite angle adjustments
- High strength corrosion resistant stainless steel wand extends from 6-1/2" - 27" (165mm - 686mm)



- Magnet holder is constructed of high-strength reinforced nylon
- Precision engineered 750 Series Versa-Grip™ handle for maximum performance

UPC	NO.	PULL	PKG.
75933 7	759383	2 lb.	Carded
75939 9	759398	10 lb.	Carded



386

POCKET MAGNETIC PICK-UP

- Powerful permanent magnet in a knurled aluminum holder with handy pocket clip
- High-powered neodymium magnet is six times more powerful than standard magnet
- Ideal for retrieving small steel and iron parts from hard-to-reach areas

- Measures 5-1/2" (140mm) overall

UPC	NO.	MAGNET	PULL
42219 4	386	NEO	2 lb. pull



384N

FLEX-O-STIFF MAGNETIC PICK-UP

- An ideal tool for retrieving steel parts from hard-to-reach places
- High-powered neodymium magnet is six times more powerful than standard magnet
- Permanent magnetic power

- Magnet is fitted into an 18" (457mm) nickel plated holder, which can be extended to a 32" (813mm) flexible retriever

UPC	NO.	MAGNET	PULL
42210 1	384N	NEO	2 lb. pull



392

MAGNETIC PICK-UP WITH PIVOT JOINT

- An excellent tool for retrieving small steel parts from hard-to-reach places
- High-power neodymium magnet lifts up to two pounds and will never lose its magnetism
- 8-3/4" (222mm) overall length

- Locking pivot joint allows user to pick up objects around corners
- Nickel plated steel body with cushion grip handle
- Pocket clip for convenient storage

UPC	NO.	PULL
42224 8	392	2 lb. pull



394

EXTRA-LONG, MAGNETIC PICK-UP WITH PIVOT JOINT

- An excellent tool for retrieving steel parts from hard-to-reach places
- High-power neodymium magnet lifts up to five pounds and will never lose its magnetism
- Steel body measures 13" (330mm) and can be extended to 27" (685mm)

- Locking pivot joint allows user to pick up objects around corners
- Body is chrome plated, with a vinyl cushion grip handle

UPC	NO.	PULL
42228 6	394	5 lb. pull



BENDABLE MAGNETIC PICK-UP

- An excellent tool for retrieving steel parts from hard-to-reach places
- High-power neodymium magnet
- Knurled aluminum body with bendable 15" (381mm) wire

- Overall length is 20" (508mm)

- Lifts up to 2 pounds

UPC	NO.	PULL
42229 3	395	2 lb. pull

395

TELESCOPING MAGNETIC PICK-UP

- A powerful permanent magnetic pickup tool
- Ideal for retrieving steel and iron parts from hard-to-reach work areas
- Magnet is fitted in a 5-1/2" long nickel plated steel handle that can extend up to 23-1/2"

- Holder is fitted with a pocket-clip

UPC	NO.	PULL
42208 8	383NX	2 lb. pull

383NX

TELESCOPING MINI-LIGHTS WITH AND WITHOUT MAGNETIC PICK-UP

- Mini Light with 2 lb. neodymium magnetic pick-up are both fastened to a stainless steel telescoping wand molded into a rugged high-impact ABS plastic handle
- Telescopes from 7-3/4" – 28-3/4" (197mm – 720mm)
- 4 Alkaline, "LR41", batteries with a battery life of 48 continuous hours
- LED bulb has a life of 100,000 hours of continuous use

- Has a 2 lb. smooth surface pull capacity Neodymium donut magnet

- Precision engineered 750 Series Versa-Grip™ handle for maximum performance

UPC	NO.	PKG.
75966 5	759581	Carded (light only)
75967 2	759582	Carded (light & magnetic pick-up)

759582

TELESCOPING MINI-LITE WITH MAGNETIC PICK-UP

- A powerful permanent magnetic pick-up tool
- Ideal for retrieving steel and iron parts from hard-to-reach and see work areas
- Magnet is fitted in a 5-1/2" (140mm) long ergonomically designed handle
- 4 Alkaline, "LR41", batteries with a battery life of 48 continuous hours
- Light Bulb has a life of 100,000 hours of continuous use

- Mini-Light is fastened to a chrome plated brass wand with a double ball joint
- Ball and socket feature for simple, positive adjustments

UPC	NO.	PKG.
05820 1	582	Carded

582

PRECISION MAGNETIZER/DEMAGNETIZER

- Magnetize and demagnetize screwdrivers, tweezers, tool bits and other steel objects
- Magnetize by sliding the tool through the (+) opening
- Demagnetize by sliding the tool through the (-) opening

- Demagnetize tools for use in electronics
- Step design permits greater control of magnetism

UPC	NO.	DIMENSIONS
36010 6	3601	2" x 2" x 1-1/8" (58 x 58 x 29mm)

3601

MAGNETIZER/DEMAGNETIZER

- Specially designed for magnetizing and demagnetizing screwdrivers, nut drivers, wrenches, taps and small tools
- Converts any tool blade into a magnetic retriever for screws, nuts and metallic particles

UPC	NO.	DIMENSIONS
42021 3	360	1" x 1" x 1-3/4" (25 x 25 x 44mm)

360



The Magnetic Sweeper is an ideal tool for retrieving iron, steel and all ferrous materials. Especially effective around new construction sites, both

indoors and outdoors. Also effective in machine shops for cleaning up around power equipment such as drill presses, milling machines and lathes.

SPECIALTY



PICK-UP STICK™ SWEEPER

- An ideal tool for retrieving iron, steel and all ferrous materials
- Powerful, permanent magnet for a no-stoop pick-up
- Vinyl-coated magnet for long-life and durability

- 37" (940mm) steel shaft for greater strength and durability
- Plastic handle grip for greater control and comfort

UPC	NO.
31434 5	397 Pick-up Stick

397

354

UTILITY SWEEPER

- An ideal tool for retrieving iron, steel and all ferrous materials
- Powerful, permanent magnets for a no-stoop pick-up
- 39" (991mm) aluminum shaft
- Plastic handle grip for greater control and comfort

- Some assembly required

UPC	NO.	WIDTH
22189 6	354 Sweeper	24" (610mm)

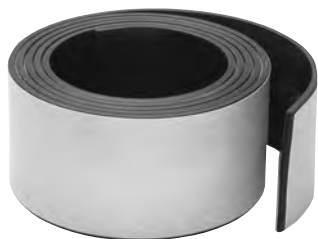

368

MAGNETIC STRIPS

- Our flexible magnetic strip with adhesive backing adheres to most smooth clean surfaces
- Holds small-metal objects
- 1/16" thick and easily cuts to desired length with scissors or knife

UPC	NO.	SIZE
42027 5	366	1/2" x 30"
42033 6	368	1" x 30"
42036 7	369	1" x 10'
42038 1	369-100	1" x 100'



376

SHALLOW POT CERAMIC MAGNETS

- Shallow depth permits use in confined spaces
- Nos. 376A and 376B have 3/16" diameter clearance holes for fastening with rods or bolts
- No. 376C has a 9/32" diameter clearance hole
- No. 376D has a 9/32" diameter clearance hole

UPC	NO.	DIA.	DEPTH	PULL
42111 1	376A	1-3/8"	3/16"	12 lbs.
42114 2	376B	2"	1/4"	20 lbs.
42117 3	376C	2-5/8"	3/8"	35 lbs.
42120 3	376D	3-1/4"	7/16"	50 lbs.



Aluminum, nickel and cobalt alloy make General's Alnico line of magnets strong and permanent. The strong magnetic pull of the Alnico Magnets make it perfect for lifting, holding, sorting, clamping or

retrieving steel or iron parts. Alnico Magnets will retain their magnetic force indefinitely. Removable keepers insure long life and optimum performance.

BUTTON TYPE ALNICO MAGNETS

- Button shaped magnet has almost unlimited applications
- Retrieves screws and steel parts
- Center hole on top of magnet for easy fastening

UPC	NO.	DIA.	HT.	PULL	CORED HOLE
42073 2	372A	1/2"	3/8"	1-1/2 lbs.	1/8"
42076 3	372B	3/4"	1/2"	4 lbs.	1/8"
42079 4	372C	1"	5/8"	6-1/2 lbs.	3/16"
42082 4	372D	1-1/4"	3/4"	14 lbs.	3/16"
42085 5	372E	1-1/2"	7/8"	18-1/2 lbs.	1/4"

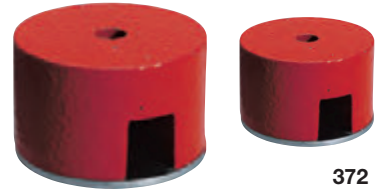

372

POT TYPE ALNICO MAGNETS

- Unique combination of strong magnet with insulating ring gives this magnet the superior holding power of larger magnets
- 1/4" diameter x 20 threads-per-inch hole for attaching to fixtures and machines

UPC	NO.	DIA.	PULL	WT.	HT.
42093 0	374A	11/16"	6 lbs.	6 oz.	5/8"
42096 1	374B	13/16"	10 lbs.	6 oz.	3/4"
42102 9	374C	1-1/16"	18 lbs.	12 oz.	1"
42105 0	374D	1-3/8"	35 lbs.	24 oz.	1-3/16"

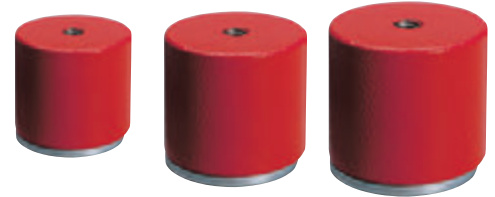

374

POWER ALNICO MAGNETS

- Strong magnetic pull for lifting, holding, sorting, clamping or retrieving steel or iron parts
- Hole in top of magnet for attaching conveyors, racks, and welding jigs

UPC	NO.	SIZE OZ.	APPROX. PULL LBS.	WIDTH IN.	HT. IN.	DEPTH IN.	POLE WIDTH IN.	OPENING BETWEEN POLES, IN.	CORED HOLE	OZ. WEIGHT EACH WITH KEEPER
42041 1	370-1	.8	8	1-1/8"	1"	5/16"	5/16"	1/4"	—	1
42044 2	370-2	2	13	1-1/8"	3/4"	3/4"	1/4"	9/16"	3/16"	3
42050 3	370-4	4	22	1-1/2"	1"	1"	5/16"	3/4"	3/16"	5
42053 4	370-6	6	30	1-3/4"	1-1/8"	1-1/8"	5/16"	7/8"	3/16"	8
42056 5	370-8	8	32	2-3/16"	1-13/16"	15/16"	1/2"	1-3/16"	3/16"	10
42061 9	370-12	12	42	2-5/8"	2-1/4"	15/16"	5/8"	1-3/8"	3/16"	15
42064 0	370-16	16	50	3"	2-1/2"	15/16"	3/4"	1-1/2"	3/16"	20
42067 1	370-24	24	70	2-1/2"	1-13/16"	1-7/8"	5/8"	1-3/8"	1/4"	28



370-1

370-2

MAGNETIC ADJUSTABLE WELDING LINKS AND WELDING MAGNET

Aluminum, nickel and cobalt give General's adjustable welding blocks and welding magnet enough magnetic muscle to hold steel plates in position over a lifetime of high-heat operations

WELDING MAGNET

- Welding, brazing, soldering
- Eliminates need for clamps or temporary fasteners

- Alnico magnets retain force indefinitely
- The welding magnet has the ability to hold steel plates at different angles - 90°, 75°, 45°, 60° and 30°

UPC	NO.	THICKNESS	PULL LBS.	WT. OZ.
42122 7	377	.468	50.0	9.0



377

MAGNETIC ADJUSTABLE WELDING LINK

- Welding, brazing, soldering
- Eliminates need for clamps or temporary fasteners

- Alnico magnets retain force indefinitely
- Wing nuts simplify angle adjustments

UPC	NO.	SIZE OF BLOCK	PULL PER BLOCK
42226 2	375	2.4" x 1" x 1"	25 lbs.

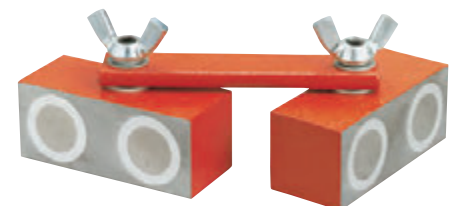

375

SPECIALTY TOOLS

Cutting & Carving Tools



General Tools Professional Quality Knife Sets are designed specifically for the precision cutting of a variety of materials, from fine, intricate cutting to heavy-duty carving and scraping.

General Tools offers a complete line of precision hobby knives for industrial users, crafts people and hobbyists. A broad selection of surgically sharp replacements and accessory blades are available.



95622

22-PIECE TRI-LOBE PRECISION KNIFE SET

- Advanced Tri-Lobe ergonomic handle design for maximum grip control and cutting accuracy
 - Rounded handle fits snugly in palm for added leverage for cutting thicker materials
 - Handle design imparts maximum comfort and ease
 - Heavy-duty locking screw chuck holds blades securely in place
 - Includes protective, hard and durable case
- Set includes: 2-Multi-blade handles (#90601 and #95602), One each: No. 1 and No. 2 and 20 assorted knife blades: • 5 - No. 11 • 5 - No. 16 • 3 - No. 17B • 3 - No. 22 • 2 - No. 28
 - Individual Knives include:
 - 90601** - Tri-Lobe Precision Knife (1 - No. 11 blade)
 - 95602** - Heavy-Duty Precision Knife (1 - 22 blade)



#16 #28 #17B #11 #22
Blades shown actual size

UPC	NO.	PKG.
95622 4	95622	Hard case
90601 4	90601	Carded
95602 6	95602	Carded



Patent Pending



95602



90601



1901 LIGHT-DUTY



1902 MEDIUM-DUTY



1903 HEAVY-DUTY

PRECISION HOBBY KNIVES

- General's three aluminum-handled precision hobby knives can cope with a cornucopia of cutting criteria.
- Light industrial, crafts, hobby
- **1901** - Light-Duty (making fine or angle cuts in wallpaper, cardboard, soft wood and other light materials)
- **1902** - Medium-Duty (slicing and scoring fiberboard, mat-board, linoleum, etc.)
- **1903** - Heavy Duty (cardboard, scoring fiberboard, mat-board, linoleum, etc.)
- Handle: Aluminum

UPC	NO.	HANDLE CONSTRUCTION	KNIFE WEIGHT	PKG. QTY.
43974 1	1901	Aluminum	Light duty	5
43976 5	1902	Aluminum	Medium duty	5
43978 9	1903	Aluminum	Heavy-duty	5

HOBBY KNIFE BLADES

- Light industrial, crafts, hobby
- Packed in a quantity of 5

UPC	NO.	REPLACEMENT FOR
43988 8	1920	1901
43992 5	1922	1902, 1903, 1905
43994 9	1923	1902, 1903, 1905
43996 3	1924	1902, 1903, 1905

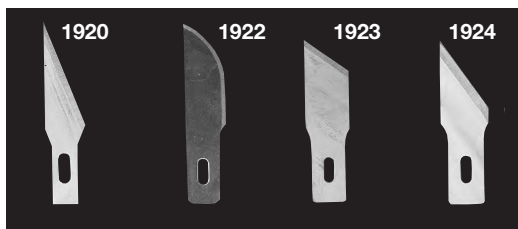

1920 1922 1923 1924



1915

PRECISION KNIFE SET

- Consists of one each of Nos. 1901, 1902 and 1903 knives and 10 assorted blades in a fitted wooden case

UPC	NO.
43984 0	1915



Cutting & Carving Tools

General's classic Utility Knife is used for cutting and scoring fiber-board, matboard, roofing, linoleum, carpet, plasterboard and veneers.

The Five-Piece Carving Tool Set offers a fixed blade that is forged tool steel, ground and hardened for lasting sharpness. Handles are made of hardwood for greater control and comfort grip.

SLIDE LOCKING UTILITY KNIFE

- For cutting and scoring fiberboard, wallboard, matboard, cardboard, corkingboard, roofing, linoleum, carpet, plasterboard, veneers and other materials
- Opens instantly to any one of three cutting positions
- Blade retracts into handle for safety

- Comes with three replaceable heavy-duty alloy steel blades, No. 852, in storage handle

UPC	NO.
43046 5	855 Heavy-duty



855

HEAVY-DUTY UTILITY KNIFE BLADES

UPC	NO.	THICKNESS	PKG. QTY
43030 4	852-100	0.025	100



852

FIVE-PIECE CARVING TOOL SET

- Five different blade shapes
- Blades are made of hand forged tool steel, ground and hardened for lasting sharpness
- Half round palm style handles are made of hardwood
- Comes in vinyl case
- Overall length 5"

UPC	NO.	BLADE SHAPE
43900 0	1293	Bent Large Gouge, 5/16" Straight Small Gouge, 5/32" Bent V Parting Tool, 5/32" Straight Skew Chisel, 5/16" Bent Square Chisel, 5/16"

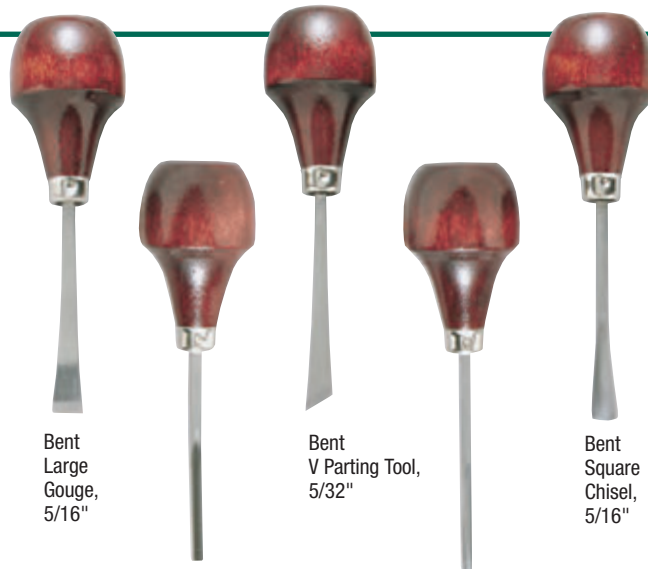

Bent Large Gouge, 5/16"

Bent V Parting Tool, 5/32"

Bent Square Chisel, 5/16"

Straight Small Gouge, 5/32"

Straight Skew Chisel, 5/16"

1293

GLASS CUTTER

- Cuts plate glass from 1/8" to 1/4" thick
- Steel wheel with honed angle of 120° for cutting single and double strength glass
- Ball end handle for snapping of scored glass
- Tooth design to remove rough edges

UPC	NO.	LENGTH
43061 8	8501	5" (125mm)



8501

JUNIOR HACKSAW

- Handy cutting tool for hobbyists, do-it-yourselfers and professionals
- Ergonomically designed with a comfortable high-impact plastic handle
- 6" (150 mm) replaceable heat treated blade for cutting metal
- Sturdy tubular frame

- Reversible blade for push or pull cutting
- Set of 6 replacement blades: 3 wood and 3 metal

UPC	NO.
43067 0	864



864



SPECIALTY TOOLS

Grommets, Snaps & Screw Fasteners



General Tools offers Grommet Kits, which are available in three sizes, Snap Fastener Kits and Screw Fastener Kits. These various kits are used

to repair canvas, tarpaulins, tents, awnings, sailcloth, lawn furniture and pool covers. Each set has handy step-by-step instructions.



UTILITY GROMMET KITS

- These various size kits are used to repair canvas, tarpaulins, tents, awnings, sailcloth, lawn furniture and pool covers
- Contains grommets with hole cutter and hardwood backer block, hardened mandrel and anvil
- Setting tool has knurled body for greater comfort and safety
- Setting tool and anvil are coded with lines for each individual size grommet
- Three sizes available



INDIVIDUAL SIZE

UPC	NO.	DESCRIPTION
22341 8	71260	1/4" Grommet Kit with 48 grommets
22342 5	71262	3/8" Grommet Kit with 24 grommets
22343 2	71264	1/2" Grommet Kit with 12 grommets

GROMMET REFILLS

UPC	NO.	SPECIFICATIONS
41103 7	1261-0	1/4" Grommet Refill with 24 Grommets
41104 4	1261-2	3/8" Grommet Refill with 24 Grommets
41105 1	1261-4	1/2" Grommet Refill with 24 Grommets



SNAP FASTENER KIT

- Contains 2-piece setting tool and 6 fastener sets
- Fasteners with nickel plating will not rust
- Knurled body for greater comfort and safety

UPC	NO.	SPECIFICATIONS
41106 8	1265	Snap Fastener Kit with 6 Fasteners
41107 5	1266	6 Snap Fastener Refills



1265



SCREW SNAP FASTENER KIT

- Screw snap fastener base has 3/8" long screw for attaching to wood, plastic and fiberglass
- Contains 2-piece setting tool and 6 fastener sets
- Fasteners with nickel plating will not rust
- Knurled body for greater comfort and safety

UPC	NO.	SPECIFICATIONS
41108 2	1267	Screw Snap Fastener Kit with 6 Fasteners
41109 9	1268	6 Screw Snap Fastener Refills



1267



Punches & Punch Sets



Arch Punches, Hollow Steel Punches and Gasket Punches are all used for punching round holes in gasket material, leather, rubber, canvas, cardboard, plastic, sheet metal and other soft materials.

These fine quality tools are forged and heat-treated for long life and the cutting edges will stay sharper longer.

ARCH PUNCHES, 7PC.

- For punching holes in leather, rubber, gasket material and soft metals
- Inside taper for clearance
- Heat treated forged steel
- The 1271ST consists of seven punches, one each of 1/4", 3/8", 1/2", 5/8", 3/4", 7/8" and 1", comes in plastic roll pouch

UPC	NO.	SIZE
43849 2	1271ST	Set of 7

- Available in individual sizes listed

UPC	NO.	SIZE
43793 8	1271A	1/4"
43799 0	1271C	3/8"
43804 1	1271E	1/2"
43810 2	1271G	5/8"
43813 3	1271H	11/16"
43816 4	1271-I	3/4"
43819 5	1271J	13/16"
43821 8	1271K	7/8"
43822 5	1271L	15/16"
43825 6	1271M	1"
43827 0	1271N	1-1/8"
43829 4	1271-O	1-1/4"
43831 7	1271P	1-3/8"
43833 1	1271Q	1-1/2"



1271ST

HOLLOW STEEL PUNCHES, 6PC.

- For punching holes in leather, rubber, canvas, cardboard, plastic and other materials
- Made of forged steel with side clearance hole for easy removal of punched material
- The 1280ST which consists of six punches, 3/16", 1/4", 5/16", 3/8", 7/16", and 1/2", comes in a plastic roll pouch

UPC	NO.	SIZE
43896 6	1280ST	Set of 6

- Available in individual sizes listed

UPC	NO.	SIZE
43856 0	1280A	3/32"
43859 1	1280B	1/8"
43862 1	1280C	5/32"
43865 2	1280D	3/16"
43868 3	1280E	7/32"
43870 6	1280F	1/4"
43872 0	1280G	9/32"
43874 4	1280H	5/16"
43876 8	1280-I	11/32"
43878 2	1280J	3/8"
43880 5	1280K	13/32"
43882 9	1280L	7/16"
43884 3	1280M	1/2"
43886 7	1280N	9/16"
43888 1	1280-O	5/8"
43890 4	1280P	3/4"



1280ST

PROFESSIONAL 10-PIECE GASKET PUNCH SET, 10PC.

- For punching holes in gasket material, leather, rubber, canvas, cardboard, plastic and sheet metal
- Nine interchangeable hardened and tempered alloy steel punches: 1/4", 5/16", 3/8", 7/16", 1/2", 5/8", 3/4", 7/8" and 1"
- Heavy-duty, spring-loaded, self-centering steel mandrel
- Both mandrel and punches are knurled and have a threaded coupling to prevent slippage and hold punch securely to mandrel

- Fitted plastic storage case

UPC	NO.	DESCRIPTION
43751 8	S1274	10 pc. set



S1274

GASKET PUNCH SET

- Compact and economical set for punching holes in soft materials and leather
- Set of 10 punches, one each of 1/4", 5/16", 3/8", 7/16", 1/2", 9/16", 5/8", 3/4", 7/8" and 1", with driving mandrel comes in a molded plastic storage case

UPC	NO.
43759 4	S1270



S1270

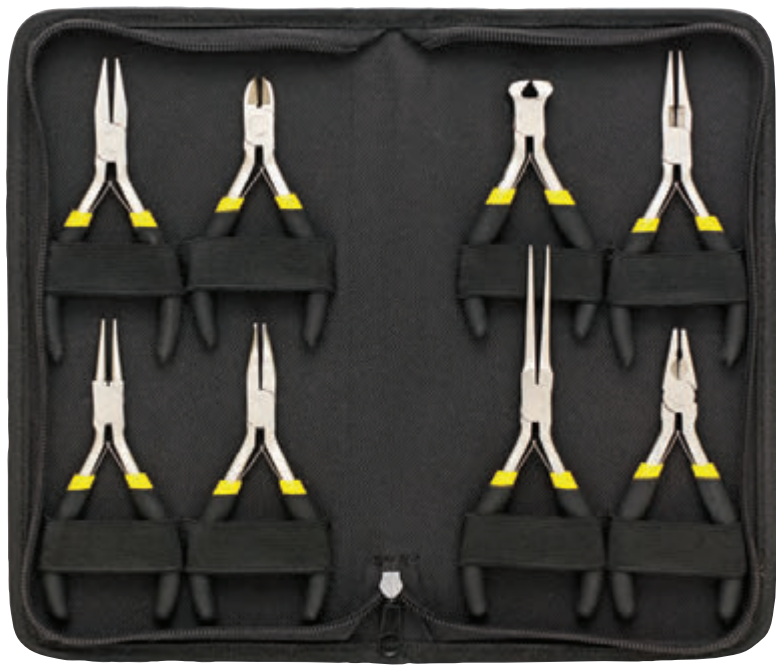
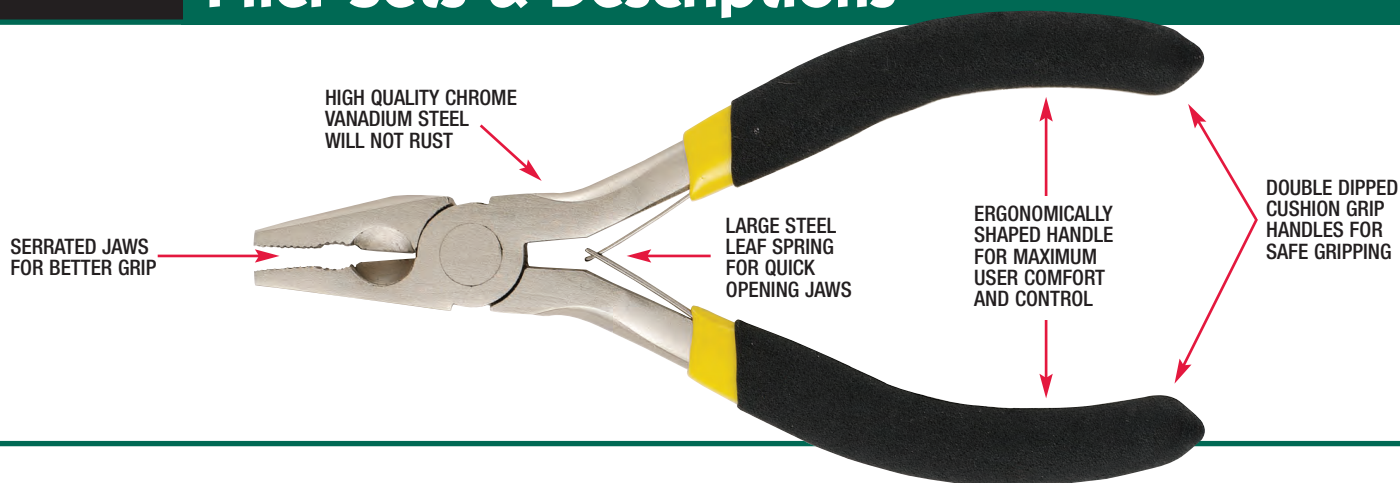

8-PIECE TECHNICIAN'S MINI-PLIER SET

- A compact set designed for electricians, technicians, hobbyists and do-it-yourselfers
- High quality chrome-vanadium steel will not rust
- Serrated jaws for better grip
- Large steel leaf spring for quick opening jaws
- Fully-polished head
- Double dipped cushion grip handles for safe gripping
- Durable vinyl case for the easy and safe storage of these precision pliers
- Consists of eight of the most popular sizes of mini-pliers
 - No. 901 - Chain Nose Serrated Jaw Pliers. OAL - 5"
 - No. 902 - Round Nose Pliers. OAL - 4-3/4"
 - No. 903 - Smooth Jaw Pliers. OAL - 4-7/8"
 - No. 904 - Curved Chain Nose Pliers. OAL - 4-3/4"
 - No. 905 - Long Needle Nose Pliers. OAL - 6"
 - No. 906 - Diagonal Head/Oval Cutter. OAL - 4-1/4"
 - No. 907 - End Cutter. OAL - 4-1/8"
 - No. 908 - "Mini" Linemans Pliers. OAL - 4-1/2"
- No. 938 - 8-piece "Mini" Plier Set
- No. 934 - 4-piece "Mini" Plier Set; Nos. 905, 906, 907, 908

UPC	NO.	PKG.
00938 8	938	8 Piece - Vinyl Case/Boxed
00934 0	934	4 Piece - Vinyl Case/Boxed

SPECIALTY

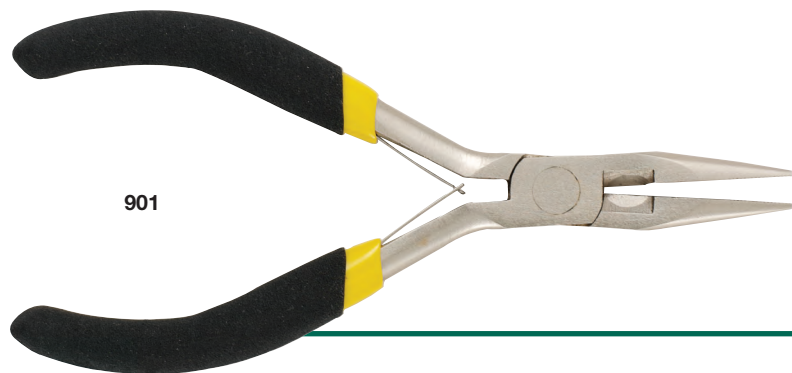

901

CHAIN NOSE, SERRATED JAW PLIERS

- For cutting, shaping, bending and gripping light materials and wire
- Side cutter will handle most cutting requirements
- OAL jaw length - 1-3/16" (30mm)
- OAL length - 5" (127mm)

ROUND NOSE PLIERS

- The perfect jewelers pliers for making loops and jump rings
- OAL jaw length - 1-1/16" (27mm)
- OAL length - 4-3/4" (120mm)

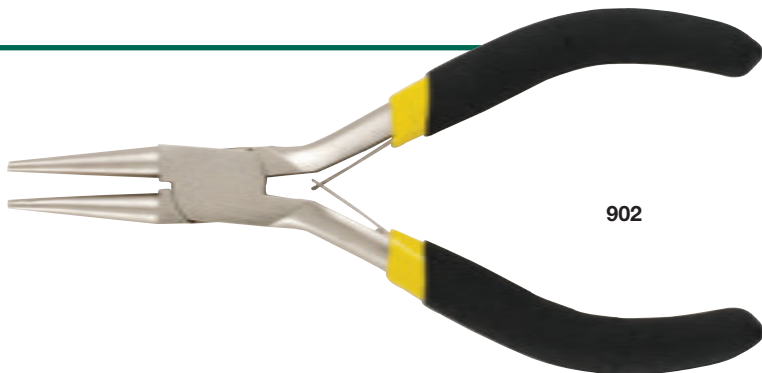

902

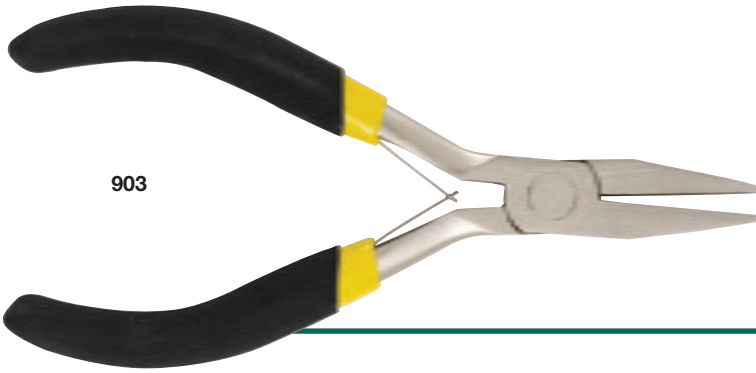

903

FLAT NOSE, SMOOTH JAW PLIERS

- For bending wire, jewelry making and retrieving objects from tight areas
- OAL jaw length - 1-1/16" (27mm)
- OAL length - 4-7/8" (124mm)

CURVED CHAIN NOSE PLIERS

- Used for odd angle access, retrieving and positioning with non-serrated jaws
- OAL jaw length - 1-1/8" (29mm)
- OAL length - 4-3/4" (120mm)

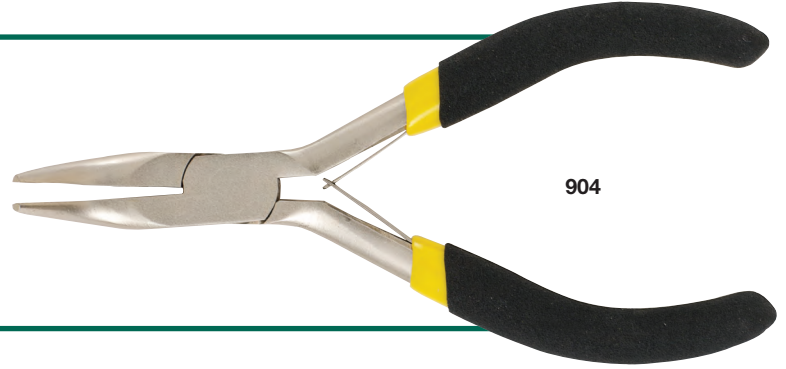

904

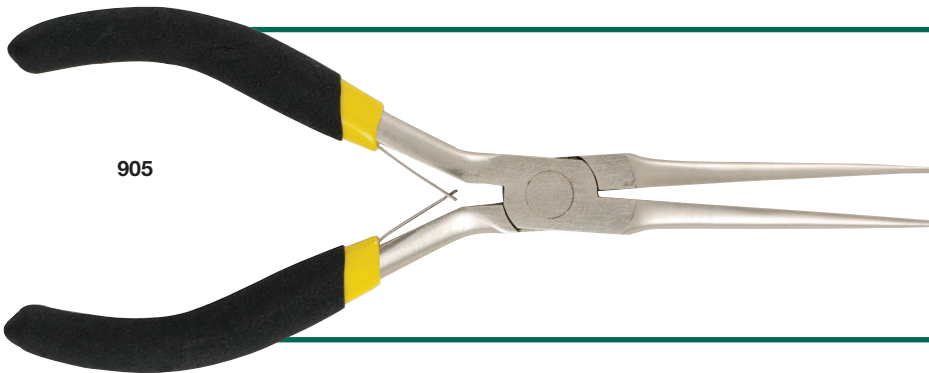

905

LONG NEEDLE NOSE PLIERS

- Used for extreme far reaching access, positioning and retrieving
- OAL jaw length - 2-1/8" (54mm)
- OAL length - 6" (152mm)

OVAL HEAD DIAGONAL CUTTER

- For cutting soft wire and other light materials. For an accurate cut in tight areas
- OAL jaw length - 1/2" (13mm)
- OAL length - 4-1/4" (108mm)

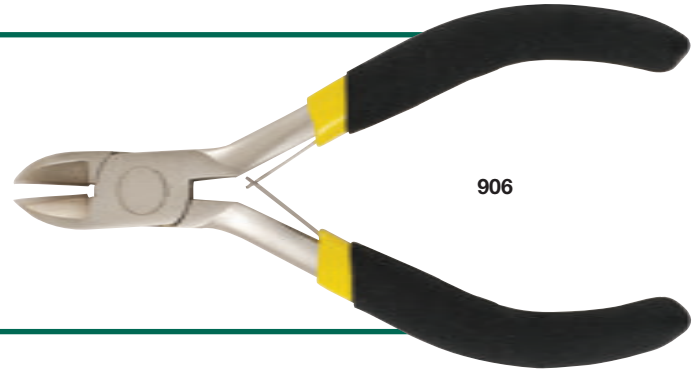

906

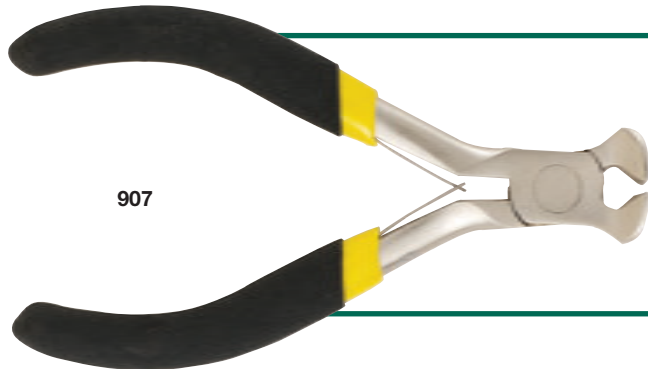

907

END CUTTER

- For accurate flush surface cutting of light materials and wire
- OAL jaw length - 9/32" (7mm)
- OAL length - 4-1/8" (105mm)

"MINI" LINEMAN'S PLIERS

- For securing a positive grip on flat objects to form a bend
- Serrated jaws for better grip
- Side cutter will handle most cutting requirements
- OAL jaw length - 7/8" (22mm)
- OAL length - 4-1/2" (114mm)

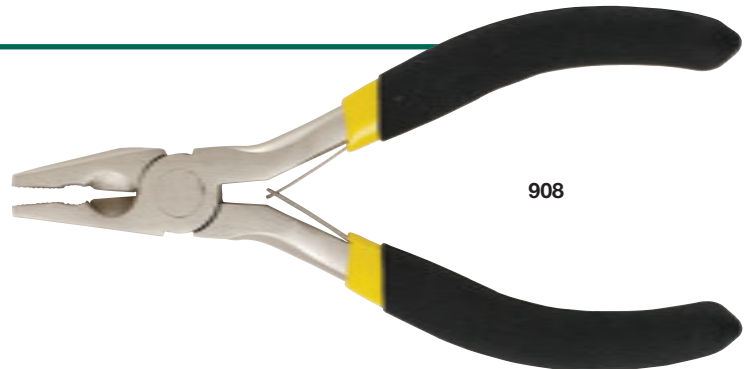

908



SPECIALTY TOOLS

Punches, Strippers & Scrapers



General's Revolving Punch Plier is a convenient spring tension, self-opening tool for punching round holes in leather, plastic, rubber, canvas cardboard and similar materials.

The Dial Wire Stripper can be set to a desired size for individual or repetitive stripping without damaging the wire.



72

REVOLVING PUNCH PLIER

- A convenient spring tension, self-opening tool for punching round holes in leather, plastic, rubber, canvas, cardboard and similar materials
- Made of plated steel with six tapered and hollow, hardened steel punches
- Punch sizes: 5/64", 3/32", 7/64", 1/8", 5/32", 3/16" (2.0, 2.5, 3.0, 3.5, 4.0, 4.5mm)

UPC	NO.	LENGTH
41039 9	72	8-1/4" (210mm)



69

DIAL WIRE STRIPPER

- Dial the wire size desired for individual or repetitive stripping without damaging wire
- Spring opening for fast and easy cutting or stripping

- Dial lock closes stripper to protect hardened cutting edges
- Vinyl cushion handles

UPC	NO.	WIRE GAGE CAPACITY
41036 8	69	12, 14, 16, 18, 20, 22, 24, 26



64

COTTER PIN PULLER

- General's compound bend design allows user to extract cotter pins with either a pull or twist motion. Ideal for use in confined work areas.
- Plated shaft and point are 4" (101mm) in length and made of long lasting heat treated high carbon steel

- A safe and easy way to remove cotter pins
- Heavy-duty plastic handle with a comfortable grip

UPC	NO.	SPECIFICATIONS
41030 6	64	Length: 7-1/2" (190mm)

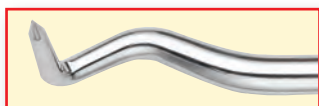

The compound bend design allows extraction with either a pull or twist motion.



478

TRIANGULAR SCRAPER

- Useful tool for scraping, trimming, and deburring metals, tubing and other materials
- Hardened and tempered triple edge blade is secured in wood handle with steel ferrule

- Hollow ground cutting edges stay sharp longer and resharpen easily

UPC	NO.
42321 4	478



890

ADJUSTABLE FILE/TOOL HANDLE

- For holding files, reamers, hacksaw blades and other tang handled tools
- Exclusive steel parallel clamping jaws grip the entire length of the inserted tang to prevent slipping
- Large, quick adjusting knurled knob ensures positive locking
- Rustproof handle with steel parts

- Conforms to government specifications NN-H-0085

UPC	NO.
43666 5	890

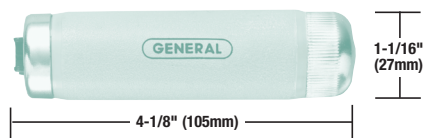



General Tool's Swiss Pattern Needle File Sets are designed to meet the exacting requirements of tool and die makers, instrument makers, jewelers, watchmakers, hobbyists and other craftspeople.

Precision made of the finest quality tool steel. The handle provides maximum filing control and comfort and precision. Will fit all styles of General's Swiss Pattern Files.

6-PIECE SWISS PATTERN NEEDLE FILE SET

- A basic set of General all purpose files to meet the needs of craftspeople, tool and die makers, hobbyists and jewelers
- Set includes six different files. All measure 5-1/2" (138mm) long with 1/8" (3mm) diameter shanks
- Files are constructed of high quality Chromium Alloy Steel
- All files are 2-1/2" (63mm) long, #2 Single Cut Swiss Pattern
- Knurled handle file can be used without handle assembly
- Precision locking screw chuck holds files securely in place
- Precision engineered 700 Series Versa-Grip™ handle for maximum performance

UPC	NO.	PKG.
70746 8	707476	Holster/Carded



FILE END VIEWS



707476

4-PIECE SWISS PATTERN NEEDLE FILE SET WITH HANDLE

- Set includes three of the most commonly used file shapes: flat, round and triangular. All are high-quality tool steel and measure 5-1/2" (138mm) long
- A 5-1/2" (138mm) long knurled aluminum handle provides maximum filing control and comfort
- 8-1/2" (213mm) overall size
- #2 single style cut
- General Purpose file set for hobbyists and craftsmen

UPC	NO.
42315 1	S477 3 files and handle



FILE END VIEWS

S477

12-PIECE SWISS PATTERN NEEDLE FILE SET

- A complete set of General Purpose files to meet the needs of craftsman, hobbyists and jewelers
- Files are made of high quality tool steel
- Set includes 12 different files including the three most commonly used file shapes: flat, round and triangular. All measure 5-1/2" (138mm) long
- Packed in snap button plastic case
- #2 single style cut

UPC	NO.	LENGTH	FILES IN SET
42315 3	S475	5-1/2"	12

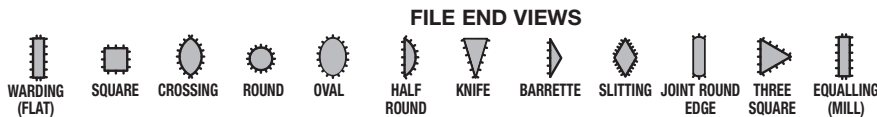

FILE END VIEWS

S475

6-PIECE SWISS PATTERN NEEDLE FILE SET

- Designed to meet the exacting requirements of tool and die makers, instrument makers, jewelers, watchmakers and other craftspeople
- Precision made of finest quality tool steel
- Packed in snap button plastic case
- #2 single style cut

UPC	NO.	LENGTH	FILES IN SET
42318 4	S476	5-1/2"	6

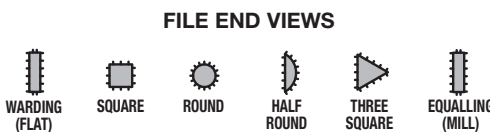

FILE END VIEWS

S476

SPECIALTY

SPECIALTY TOOLS

File & Probe Sets



General Tool's Swiss Pattern Needle File Sets are designed to meet the exacting requirements of tool and die makers, instrument makers, jewelers, watchmakers, hobbyists and other craftspeople. Precision made of the finest quality tool steel. Can be used without handle

assembly. Precision locking screw chuck holds files securely in place. General's Probe, Positioning and Spring Hooks are useful in a wide variety of mechanical and electrical functions. Ideal for probing, cleaning, picking or marking small work surfaces.



707475

12-PIECE SWISS PATTERN NEEDLE FILE SET

- A complete set of General Purpose Files to meet the needs of craftspeople, tool and die makers, hobbyists and jewelers
- Set includes 12 different files. All measure 5-1/2" (138mm) long with 1/8" (3mm) diameter shanks
- Files are constructed of high quality Chromium Alloy Steel
- All files are 2-1/2" (63mm) long, #2 Single Cut Swiss Pattern
- Knurled handle file can be used without handle assembly
- Precision locking screw chuck holds files securely in place
- Precision engineered 700 Series Versa-Grip™ handle for maximum performance
- Packaged in a fitted zippered case for convenient and safe storage

UPC	NO.	PKG.
70745 1	707475	Zippered Case/ Carded



FILE END VIEWS



707862



4-PIECE INTERCHANGEABLE STAINLESS STEEL PROBE SET

- For probing, cleaning, picking, or marking small work surfaces
- Set Includes: • Four heat treated stainless steel point configurations: • Straight • 180° Hook • 35° Bend • 90° Bend
- Precision locking screw chuck holds blades securely in place
- Each blade is 5" long (127mm); OAL 8-1/2" (216mm) with handle
- Packaged in a fitted case for convenient and safe storage
- Precision engineered 700 Series Versa-Grip™ handle for maximum performance

UPC	NO.	PKG.
70786 4	707862	Holster/Carded



60004

4-PIECE PRECISION BLADE PROBE SET - FIXED BLADE

- For probing, cleaning, picking or marking small work surfaces
- Set includes the most popular mini-tool configurations: • Straight • 180° Hook • 35° Bend • 90° Bend
- Each blade is 2-5/8" (67mm) with an overall length of 6" (152mm)
- Blades constructed of heat treated 8650 Alloy steel (nickel-chromium-molybdenum)
- Precision engineered 600 Series Versa-Grip™ handle for maximum performance

UPC	NO.	PKG.
60004 2	60004	Carded

Set contains:

NO.	TYPE	SIZE	BLADE LENGTH
610001B	Probe	Straight Probe	2-5/8" (67mm)
610002B	Probe	35° Bent Probe	2-5/8" (67mm)
610003B	Probe	90° Bent Probe	2-5/8" (67mm)
610004B	Probe	180° Hook Probe	2-5/8" (67mm)



3-PIECE PROBE AND HOOK SET

General's Probe, Positioning and Spring Hooks are useful for a wide variety of mechanical and electrical work

- Removing old gaskets and o-rings during a mechanical repair, or positioning wires during an electrical installation

- Set includes three heat treated, high carbon steel probes: 45 degree, double bend and hook bend
- Extra long aluminum bodies and knurled grips
- Hex head prevents tool from rolling

UPC	NO.	OVERALL LENGTH
24500 7	862	6-1/2" (165mm)



862

12-PIECE STAINLESS STEEL PROBE, POSITIONING & SPRING HOOK SET

- Useful in a wide variety of mechanical and electrical functions
- For separating and positioning wires, inserting and adjusting wires and springs in hard-to-reach areas
- For probing, cleaning, picking or marking small work surfaces
- Heavy-duty locking screw chuck holds blades securely in place
- Each blade is 5" long (127mm); OAL 7-1/2" - 8-1/2" (184mm - 216mm) with handle

- Set Contains: • Twist Chuck Multi-Purpose Handle • 5" Extension blade • Straight • 35° Bend • 90° Bend • 180° Loop, Double Bend • 180° Hook Probes • Offset Pull Hook • 135° Pull Hook • Pull/Push Hook • Adjusting Pull/Push Hook • Placement Guide/Lifter
- Packaged in a fitted zippered case for convenient and safe storage
- Precision engineered 700 Series Versa-Grip™ handle for maximum performance

UPC	NO.	PKG.
70962 2	707865	Zippered Case/Carded



707865

5-PIECE STAINLESS STEEL POSITIONING AND SPRING HOOK SET

- Useful in a wide variety of mechanical and electrical functions
- For separating and positioning wires, inserting and adjusting wires and springs in hard-to-reach areas
- Heavy-duty locking screw chuck holds blades securely in place
- Each blade is approximately 5" long (127mm); OAL 7-1/2" - 8-1/2" (184mm - 216mm) with handle

- Set Contains: • Twist Chuck Multi-Purpose Handle • Offset Pull Hook • 135° Pull Hook • Pull/Push Hook • Adjusting Pull/Push Hook • Placement Guide/Lifter
- Holster included for convenient storage
- Precision engineered 700 Series Versa-Grip™ handle for maximum performance

UPC	NO.	PKG.
75970 2	707863	Holster/Boxed



707863

PRECISION OILER

- For the exact placement of oil or any other lubricant
- For technicians, contractors, hobbyists and DIY'ers
- Smooth actuator allows for greater control and placement of lubricant
- Generous reservoir

- Protective screw-on cover prevents leakage
- All aluminum construction
- Convenient pocket clip
- For use with lubricants only

UPC	NO.	OVERALL LENGTH
58900 2	589	5-5/8" (143mm)

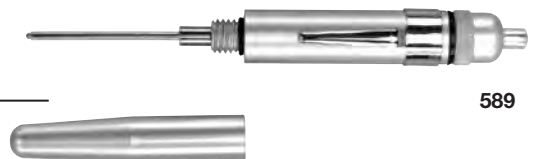

589

MAGNETIC TORPEDO LEVEL

- Quality crafted torpedo level with large reversible reading vials meets the accuracy requirements of professionals
- Heat resistant, unbreakable endplates and internal aluminum frame
- Readings possible from top, bottom or side positions

- Magnetic working edge for use with metal surfaces
- V-grooved working edge for use on pipes

UPC	NO.	LENGTH
42698 7	839	9"



839



General's 3-IN-1 LED and LCD Stud, Voltage and Metal Detectors are ideal for locating studs, pipes, wire carrying voltage and hidden metal. Micro-processor control circuits make it easy to distinguish

between battens/studs, metal pipes/tube or objects carrying voltage. An ideal for the DIY home owner, handyman, hobbyist as well a the professional.

81001



ZIP-TOP TOOL AND METER BAG, 16" WIDE

- Moisture-resistant reinforced bottom
- Steel frame mouth and rivet reinforced for rugged use and durability
- Adjustable padded non-slip shoulder strap
- Dimensions: 12"H x 16"W x 8"D (305 x 406 x 203mm)

UPC	NO.
01319 9	81001

ULTRATUFF™
TOOL BAGS



MSV250



3-IN-1 LED STUD / VOLTAGE / METAL DETECTOR

Ideal for locating studs, objects/wires carrying voltage, hidden metal.

FEATURES

- Uses four low-power LEDs and beeper to indicate direction and position of stud, batten, metal object or wiring
- Detects/distinguishes between metal pipes/tubes and wires
- Also distinguishes between battens and studs
- Simultaneously detects studs, metal and wiring
- Needs no probe

SPECIFICATIONS

- ♦ Dimensions: 6.1 x 2.6 x 1.3 in. (155 x 65 x 32mm)
- ♦ Weight: 6.3 oz. (178g)
- ♦ Power Source: 1 "9V" battery (not included)

Includes:

- User's manual

UPC	NO.
01276 5	MSV250



MSV350D



DIGITAL 3-IN-1 LCD STUD / VOLTAGE / METAL DETECTOR

Ideal for locating studs, pipes, wires carrying voltage and hidden metal

FEATURES

- Uses LCD scanning indicators and buzzer to indicate direction and position of stud, batten, metal object or wiring
- Detects/distinguishes between metal pipes/tubes and hot wires with variable sensitivity
- Also distinguishes between battens and studs
- Simultaneously detects studs and metal/wiring
- Needs no probe
- Battery charge indicator
- Auto power off

SPECIFICATIONS

- ♦ Dimensions: 6.1 x 2.6 x 1.3 in. (155 x 65 x 32mm)
- ♦ Weight: 6.5 oz. (185g)
- ♦ Power Source: 1 "9V" battery (not included)

Includes:

- User's manual

UPC	NO.
01275 8	MSV350D



SPECIALTY

RESCUE+ONE[™]

Auto Emergency Tool

+FLASHLIGHT

- Shatters automotive side windows for emergency escapes
- High-visibility red flashing emergency light
- Magnets hold the tool to the vehicle
- Bright white LED flashlight helps you see at night
- Safety blade cuts seat belts
- Includes 3 "AAA" batteries in a convenient battery compartment



UPC	NO.	PKG.
79020 0	7902	Carded



LED Flashlight

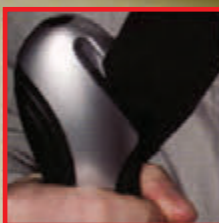

Seat Belt Cutter



Glass Breaker



Flashing Hazard Light



CE
RoHS

Easy Battery Access

"Precision, Specialty and Innovation . . . Since 1922"

T-121

GENERAL[®]

THE QUADTM

SAW/DRIVER

A 4-IN-1 CUTTING & DRIVING SYSTEM



No.
86014



The Keyless Quick Change Locking Chuck accepts both Quick Change Power Bits and Standard Reciprocating Saw Blades.

The "QUAD" Saw/Driver



"THE QUAD"[™] Saw/Driver set offers a 4-IN-1 Cutting and Driving System; a jab saw, key hole saw, power driver, and speed driver.

The two position quick change locking handle offers both power and speed. A convenient holster holds all 14-pieces.

THE QUAD[™] SAW/DRIVER

THE QUAD[™] 14-PIECE SAW/DRIVER SET

THE QUAD[™] Saw/Driver set offers a 4-IN-1 Cutting and Driving System; a jab saw, key hole saw, power driver, and speed driver. The 2 position quick change locking handle offers both power and speed. A convenient holster holds all 14 pieces.

- A 4-IN-1 cutting and driving system
- (1) Jab Saw with straight handle and special Sheetrock reciprocal blade
- (2) Keyhole Saw in the pistol grip handle position
- (3) Power Driver in the pistol grip position
- (4) Speed Driver, screw or nut driver with straight handle
- The keyless Quick-Change locking chuck accepts both Quick-Change bits and industry standard reciprocating saw blades

14-PIECE SET INCLUDES:

- 3 saw blades; drywall, Metal/PVC, wood,
- 7 insert bits
- 1 hex to square adaptor
- 1 quick change handle
- 1 holster with belt-clip
- 1 bit extender
- Swivel locking chuck holds all reciprocating blades and speed shank power bits
- Comfortable handle easily locks in the straight or pistol grip position

UPC	NO.
86014 9	86014

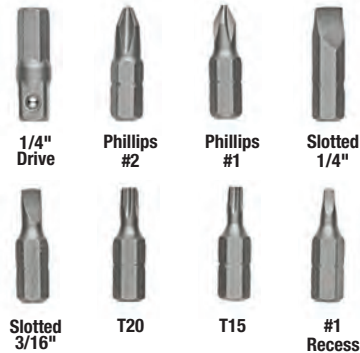

86014 Patented

THE KEYLESS QUICK CHANGE LOCKING CHUCK ACCEPTS BOTH QUICK CHANGE POWER BITS AND STANDARD RECIPROCATING SAW BLADES.

SPECIALTY



T6 Cell Phone Screwdriver

Display Item No.	Qty Per Display	Individual Item No.
No. 666CD	18	No. 666

- Use on cellular phones: For repairs, battery changes or phone cover (faceplate) changes
- Rotating cap; recess fits fingertip
- Removable cap to store small screws

UltraTech Clip-On LED Light

Display Item No.	Qty Per Display	Individual Item No.
No. 580CD	18	No. 580

- Great for lighting obstructed work areas
- Clips onto almost anything
- Alligator clip with non-slip grip; rubber padding inside teeth

4-IN-1 Pocket Mini Screwdriver

Display Item No.	Qty Per Display	Individual Item No.
No. 744CD	20	No. 744

- For Mechanics, Technicians, Hobbyists, and Do-It-Yourselfers
- Great for tight, close up work
- Removable, individual blades
- Includes: Phillips #1, #00 and Slotted tip 1/16" and 1/8"

Maximize Impulse Sales & Profits

- Displays are eye-catching & compact
- Impulse items are great for high-traffic areas like checkout counters and end-cap shelving
- Order products **Individually** or in the **Display Box**
- When you order the display box, it comes:
 - **FREE!**
 - Pre-filled with product at regular price
 - Ready to assemble . . . A few simple folds and it is ready to go!

Precision Knife Set

Display Item No.	Qty Per Display	Individual Item No.
No. 1914CD	24	No. 1914

- For precision cutting, carving & trimming
- Rust-proof, aluminum handle is compatible with standard No.11 blades
- Carrying case with six standard blade sizes



No. 602CD



No. 609CD



No. 601CD

Precision Micro Screwdriver Set – 2pc

Display Item No.	Qt. Per Display	Individual Item No.
No. 602CD	18	No. 602

- Ideal for close, delicate work
- Durable and rust-resistant
- Includes: Phillips #0 and Slotted tip 3/32"

Precision Screwdriver Set - 6pc

Display Item No.	Qty Per Display	Individual Item No.
No. 609CD	9	No. 609

- For repairing jewelry, cameras, eyeglasses and instruments
- Fingertip swivel head for greater control
- Convenient stand-up case
- Includes: Phillips #1, #0 and Slotted tip 1/8", 3/32", 6/64", 1/16"

Eyeglass Repair Kit

Display Item No.	Qty Per Display	Individual Item No.
No. 601CD	50	No. 601

- Travel-size with plastic carry case
- Great for emergencies
- Includes: screwdriver, tweezers, screws, nose pads and rubber rings for tightening side arm/frame



No. 1914CD

MEASURE'N MARK Pen/Tape

Display Item No.	Qty Per Display	Individual Item No.
No. 309CD	15	No. 309

- 3' (914mm) removable tape measure
- Pen with comfort grip
- Convenient pocket clip
- Available only as a 15-piece counter display



No. 309CD



No. 744DB



No. 735DB
Patented



No. 741DB
Patented

4-IN-1 Pocket Mini Screwdriver

Display Item No.	Qt. Per Display	Individual Item No.
No. 744DB	24	No. 744

- For mechanics, technicians, hobbyists, and do-it-yourselfers
- Great for tight, close up work
- Removable, individual blades
- Includes: Phillips #1, #00 and Slotted tip 1/16" and 1/8"

Multi-Blade Precision Screwdriver

Display Item No.	Qty Per Display	Individual Item No.
No. 735DB	12	No. 735

- Five blade storage in handle
- Cushion grip
- Set includes: Five interchangeable blades; Phillips - #00; Torx - T6
Slotted - 1/16", 5/64", 3/32;

Precision 4-IN-1 Screwdriver

Display Item No.	Qty Per Display	Individual Item No.
No. 741DB	12	No. 741

- High-quality precision screwdriver for mechanics, technicians, hobbyists and do-it-yourselfers
- Change blade sizes instantly
- Includes: Two double-ended blades: Phillips - #0, #000; Slotted - 5/64", 1/8"



No. 745DB

4-IN-1 Pocket Screwdriver

Display Item No.	Qty Per Display	Individual Item No.
No. 745DB	24	No. 745

- This screwdriver is ideal for technicians, hobbyists and do-it-yourselfers
- Two double-ended chrome vanadium blades
- Blades are held in carrier handle
- Change blade sizes instantly
- Convenient pocket clip and capped ends
- Length is 5-1/4" (133mm)
- Includes: Phillips - #0, #1; Slotted - 1/8", 5/32"



Countertop & Stand Alone Displays



No. 86014

THE QUAD™

The Quad Saw/Driver

Display Item No.	Qt. Per Display
No. 86014	6

- 4-IN-1 cutting system
- Keyhole saw, jab saw, power driver and speed driver
- Set includes:
3 - reciprocating saw blades; drywall, metal/pvc and wood
7 - insert bits: Slotted - 3/16", 1/4"
Phillips - #1, #2 Torx - T15, T20
Recess Bit - #1



No. D397

Magnetic Pick-Up Stick™

Display Item No.	Qt. Per Display
No. 397	9

- Powerful magnet for a no-stoop pick-up
- Vinyl covered magnet for long life and durability
- Retrieves iron, steel and all ferrous materials
- 37 inch steel shaft for greater strength and durability

Pocket Screwdriver Fishbowls

Display Item No.	Qt. Per Display	Individual Item No.
No. 744FB	72	No. 744
No. 745FB	72	No. 745

- Maximize impulse sales and profits
- The displays are eye-catching and compact
- Impulse items are great for for high-traffic areas like check out counters and end-cap shelving



No. 744FB



No. 745FB



RESCUE+ONE™

Auto Emergency Escape Tool/Flashlight

Display Item No.	Qt. Per Display
No. 7902	6

- Essential safety tool for the car
- Features flashing hazard light, glass breaker, seat belt cutter and LED flashlight.
- Includes: 3 "AAA" batteries



No. 7902

Shop Notes

A large rectangular area with a grey border, containing 20 horizontal lines for writing notes.

Tools Reference



**Reference
Tables**

**Alphabetical
Index**

**Numerical
Index**



INCH/METRIC DRILL-TAP-WIRE EQUIVALENTS TABLE

Inches	Metric (mm)	Twist Drill	B&S Wire	U.S. Plate	Tap Drill	Clearance Hole	Inches	Metric (mm)	Twist Drill	B&S Wire	U.S. Plate	Tap Drill	Clearance Hole	Inches	Metric (mm)	Twist Drill	B&S Wire	U.S. Plate	Tap Drill	Clearance Hole	Inches	Metric (mm)	Twist Drill	B&S Wire	U.S. Plate	Tap Drill	Clearance Hole
.0003936	.0100						.03196	.8118			20			.0995	2.5273	#39					.209	5.3086	#4				
.001	.0254						.032	.8128	#67					.1	2.5400						.2125984	5.4000	5.40mm				
.002	.0508						.033	.8382	#66					.1003937	2.5500	2.55mm					.213	5.4102	#3				
.003	.0762						.0334646	.8500	.85mm			1.0mm		.1015	2.5781	#38			5-40		.2165354	5.5000	5.50mm				
.003145	.0799		40				.034	.8636						.1019	2.5883		10				.21875	5.5562	7/32		5		
.003531	.0897		39				.034375	.8731			21			.1023622	2.6000	2.60mm					.2204724	5.6000	5.60mm				
.003965	.1007		38				.035	.8890	#65			00-90		.104	2.6416	#37					.221	5.6134	#2				
.004	.1016						.0035433	.9000	.90mm					.1043397	2.6500	2.65mm					.2244095	5.7000	5.70mm				
.004453	.1131		37				.03589	.9116			19			.1062992	2.7000	2.70mm					.228	5.7912	#1				
.005	.1270		36				.036	.9144	#64					.1065	2.7051	#36					.2283465	5.8000	5.80mm				
.005614	.1426		35				.037	.9398	#63					.1082677	2.7500	2.75mm					.2294	5.8268		3			
.0059	.1499	#97					.0374016	.9500	.95mm					.109375	2.7781	1/64			12		.2322834	5.9000	5.90mm				
.006	.1524						.0375	.9525	.0		20			.11	2.7940	#35			6-32		.234	5.9436	A				
.00625	.1587			38			.038	.9625	#62					.1102362	2.8000	2.80mm					.234375	5.9531	11/64		4		
.0063	.1600	#96					.039	.9906	#61					.111	2.8194	#34					.2362204	6.0000	6.00mm				
.006304	.1601		34				.0393701	1.0000	1.00mm			1.2mm		.112	2.8448						.238	6.0452	B				
.0066406	.1687			37			.04	1.0160	#60					.1122047	2.8500	2.85mm					.2401574	6.1000	6.10mm				6.0mm
.0067	.1702	#95					.0403	1.0236			18			.113	2.8702	#33					.242	6.1468	C				
.007	.1720						.041	1.0414	#59					.1141732	2.9000	2.90mm					.246	6.2484	D				
.0070312	.1786			36			.0413386	1.0500	1.05mm					.1144	2.9058		9				.25	6.3500	1/4-E	3			1/4-20
.00708	.1798		33				.042	1.0668	#58					.116	2.9464	#32					.2559055	6.5000	6.50mm				
.0071	.1803	#94					.043	1.0922	#57					.1161417	2.9500	2.95mm					.257	6.5278	F			5/16-18	1/4-20
.0075	.1905	#93					.0433971	1.1000	1.10mm				1.0mm	.1181102	3.0000	3.00mm					.2756	6.5430		2			
.0078125	.1948	1/128		35			.04375	1.1112			19			.12	3.0480	#31					.261	6.6294	G				
.0078740	.2000	20mm					.044	1.1176						.1279528	3.2500	3.25mm					.265625	6.7462	17/64		2		
.0079	.2007	#92					.0444444	1.1289						.1285	3.2639	#30	8				.266	6.7564	H				
.00795	.2019		32				.04526	1.1496			17		1.4mm	.1299213	3.3000	3.30mm			4.0mm		.272	6.9088	I				
.008	.2032						.0452756	1.1500	1.15mm					.13	3.3020						.2755906	7.0000	7.00mm				
.0083	.2108	#91					.0465	1.1811	#56					.1318898	3.3500	3.35mm					.277	7.0358	J				
.0085937	.2183			34			.046875	1.1906	3/64			0-80		.1338583	3.4000	3.40mm					.281	7.1374	K				
.0097	.2210	#90					.0472441	12.000	1.20mm					.1358268	3.4500	3.45mm					.28125	7.1437	9/32		1		
.008928	.2261		31				.0492126	1.2500	1.25mm			1.6mm		.136	3.4544	#29			8-32		.2893	7.3482		1			
.009	.2286						.049261	1.2512						.1377726	3.4994						.29	7.3660	L				
.0091	.2231	#89					.05	1.2700			18			.1377953	3.5000	3.50mm					.295	7.4930	M				
.009375	.2381		33				.05082	1.2908			16			.138	3.5052						.2952756	7.5000	7.50mm				
.0095	.2413	#88					.0511811	1.3000	1.30mm			1.7mm	1.2mm	.14	3.5560						.296875	7.5387	19/64				
.0098425	.2500	25mm					.052	1.3208	#55			00-90		.1405	3.5687	#28				6-32	.302	7.6708	N				
.01	.2540	#87					.0531469	1.3500	1.35mm					.140625	5.719	9/64			10		.3125	7.9375	5/16		0		3/8-16
.01003	.2548		30				.055	1.3970	#54					.1417323	3.6000	3.60mm					.3149606	8.0000	8.00mm				
.0101562	.2580			32			.0551181	1.4000	1.4mm					.144	3.6576	#27					.316	8.0264	O				5/16-18
.0105	.2667	#86					.05625	1.4287			17			.1443	3.6652		7				.323	8.2042	P				
.0109375	.2778		31				.05707	1.4496			15			.1456693	3.7000	3.70mm					.3249	8.2525		0			
.0111	.2819	#85					.0570866	1.4500	1.45mm			1.8mm		.147	3.7338	#26					.328125	8.3347	21/64				
.01126	.2860		29				.0590551	1.5000	1.50mm				1.4mm	.1495	3.7973	#25					.332	8.4328	Q				
.011481	.2916						.0595	1.5113	#53			1-72		.1496063	3.8000	3.80mm					.339	8.6106	R				
.0115	.2921	#84					.06	1.5240						.15	3.8100						.34375	8.7132	11/32		2/0		
.011811	.3000	.30mm					.0610236	1.5500	1.55mm					.152	3.8608	#24					.348	8.8392	S				
.012	.3048	#83					.0625	1.5875	1/16		16			.1535433	3.9000	3.90mm					.3543307	9.0000	9.00mm				
.0125	.3175	#82		30			.0629921	1.6000	1.60mm			2.00		.154	3.9116	#23					.358	9.0932	T				
.01264	.3210		28				.063	1.6002						.15625	3.9687	5/32			9		.359375	9.1281	23/64				
.013	.3302	#81					.0635	1.6129	#52					.157	3.9878	#22					.3648	9.2659		2/0			
.0135	.0000	#80					.06408	1.6276			14			.1574803	4.0000	4.00mm					.368	9.3472	U				
.0137795	.3500	.35mm					.0649606	1.6500	1.65mm					.159	4.0386	#21					.375	9.5250	3/8		3/0		
.0140625	.3572			29			.0669291	1.7000	1.70mm				1.6mm	.16	4.0640						.377	9.5758	V				
.01419	.3604		27				.067	1.7018	#51					.161	4.0894	#20			10-32		.386	9.8044	W				3/8-16
.0145	.3683	#79					.068976	1.7000	1.75mm			2.2mm		.1614173	4.1000	4.10mm				4.0mm	.390625	9.9219	25/64				
.015	.3810						.07	1.7780	#50			2-56		.162	4.1148		6				.393701	10.0000	10.00mm				
.015625	.3969	1/64		28	0000-160		.0703125	1.7859			15			.164	4.1656						.407	10.0838	X				
.0157480	.4000	.40mm					.0708661	1.8000	1.80mm					.1653543	4.2000	4.20mm			5.0mm		.404	10.2616	Y				
.01594	.4049		26				.07196	1.8278			13			.166	4.2164	#19					.40625	10.3187	13/32		4/0		
.016	.4064	#78					.072	1.8288						.1692913	4.3000	4.30mm					.4096	10.4038		3/0			
.0171875	.4366		27				.0728346	1.8500	1.85mm				1.8mm	.1695	4.3053	#18				8-32	.413	10.4902	Z				
.0177165	.4500	.45mm					.073	1.8542	#49					.17	4.3280						.4218745	10.7156	27/64				1/2-13
.0179	.4547		25				.0748031	1.9000	1.90mm					.171875	4.3656	11/64			8		.433071	11.0000	11.00mm				
.018	.4572	#77					.075	1.9050						.173	4.3942	#17					.4375	11.1125	7/16		5/0		
.01875	.4762		26																								

CONVERSION FACTORS

Multiply	By	To Obtain	Multiply	By	To Obtain
Centimeters	.03281	Feet	Liters	1.000	Kilograms of water
Centimeters	.3937	Inches	Liters	2.113	Pints (liquid)
Centimeters	.01	Meters	Liters	1.057	Quarts (liquid)
Centimeters	393.7	Mils	Meters	100	Centimeters
Cubic Inches	16.39	Cubic centimeters	Meters	3.281	Feet
Cubic Inches	5.787x10 ⁻⁴	Cubic feet	Meters	39.37	Inches
Cubic Inches	1.639x10 ⁻⁵	Cubic meters	Meters	.001	Kilometers
Cubic Inches	2.143x10 ⁻⁵	Cubic yards	Meters	6.214x10 ⁻⁴	Miles
Cubic Inches	.004329	Gallons	Meters	5.396x10 ⁻⁴	Miles (nautical)
Cubic Inches	.01639	Liters	Meters	1000	Millimeters
Degrees (Celsius)	(°Cx9/5)+32	Degrees (Fahrenheit)	Meters	1.094	Yards
Degrees (Celsius)	°C+273.15	Degrees (Kelvin)	Milliliters	.001	Liters
Degrees (Fahrenheit)	(°F-32)x5/9	Degrees (Celsius)	Millimeters	.1	Centimeters
Degrees (Fahrenheit)	°F+459.67	Degrees (Rankine)	Millimeters	.03937	Inches
Degrees (Kelvin)	°K-273.15	Degrees (Celsius)	Millimeters	.003281	Feet
Feet	30.48	Centimeters	Millimeters	39.37	Mils
Feet	12	Inches	Ounces	16	Drams
Feet	3.048x10 ⁻⁴	Kilometers	Ounces	437.5	Grains
Feet	.3048	Meters	Ounces	28.349527	Grams
Feet	1.894x10 ⁻⁴	Miles	Ounces	.9115	Ounces (troy)
Feet	1.645x10 ⁻⁴	Miles (nautical)	Ounces	.0625	Pounds
Feet	304.8	Millimeters	Ounces	2.790x10 ⁻⁵	Tons (long)
Feet	.3333	Yards	Ounces	2.835x10 ⁻⁵	Tons (metric)
Gallons	3785	Cubic centimeters	Ounces (fluid)	1.805	Cubic inches
Gallons	.1337	Cubic feet	Ounces (fluid)	.02957	Liters
Gallons	231.0	Cubic inches	Pints (dry)	33.60	Cu. Inches
Gallons	.003785	Cubic meters	Pints (liquid)	473.2	Cu. centimeters
Gallons	.004951	Cubic yards	Pints (liquid)	.01671	Cu. feet
Gallons	.83267	Gallons (Imperial)	Pints (liquid)	28.87	Cu. inches
Gallons	3.785	Liters	Pints (liquid)	6.189x10 ⁻⁴	Cu. yards
Gallons	8	Pints (liquid)	Pints (liquid)	.125	Gallons
Gallons	8.3453	Pounds of water	Pints (liquid)	.4732	Liters
Gallons	4	Quarts (liquid)	Pints (liquid)	.5	Quarts (liquid)
Grams	.001	Kilograms	Pounds	453.59237	Grams
Grams	1000	Milligrams	Pounds	.45359237	Kilograms
Grams	.03527	Ounces	Pounds	16	Ounces
Grams	.03215	Ounces (troy)	Pounds	32.17	Poundals
Grams	.002205	Pounds	Pounds	.0005	Tons
Inches	2.54	Centimeters	Pounds/cubic foot	.01602	Grams/cu. centimeter
Inches	.0254	Meters	Pounds/cubic foot	16.02	Kilograms/cu. meter
Inches	25.4	Millimeters	Pounds/cubic foot	5.787x10 ⁻⁴	Pounds/cu. inch
Inches	1,000	Mils	Pounds/cubic inch	27.68	Grams/cu. centimeter
Inches	.02778	Yards	Pounds/cubic inch	27,680	Kilograms/cu. meter
Kilograms	1000	Grams	Pounds/cubic inch	1728	Pounds/cu. foot
Kilograms	70.93	Poundals	Pounds/foot	1.488	Kilograms/meter
Kilograms	2.205	Pounds	Pounds/inch	178.6	Grams/centimeter
Kilograms	.001102	Tons	Quarts (dry)	67.20	Cubic inches
Kilometers	100,000	Centimeters	Quarts (dry)	1.164	Quarts (liquid)
Kilometers	3281	Feet	Quarts (liquid)	946.4	Cubic centimeters
Kilometers	1000	Meters	Quarts (liquid)	.03342	Cubic feet
Kilometers	.6214	Miles	Quarts (liquid)	57.75	Cubic inches
Kilometers	1094	Yards	Quarts (liquid)	9.464x10 ⁻⁴	Cubic meters
Liters	1000	Cubic centimeters	Quarts (liquid)	.25	Gallons
Liters	.03531	Cubic feet	Quarts (liquid)	.9463	Liters
Liters	61.02	Cubic inches	Quarts (liquid)	.8594	Quarts (dry)
Liters	.001	Cubic meters	Square inches	6.452	Square centimeters
Liters	.001308	Cubic yards	Square inches	.006944	Square feet
Liters	.2642	Gallons	Square inches	645.2	Square millimeters

AISI/SAE NUMBERING SYSTEM FOR CARBON AND ALLOY STEEL

10 18
12L14
 Type └┘ Carbon content └┘ L denotes leaded steels
 (Hundredths of a %) B denotes boron steels

Carbon Steels	10XX	Plain Carbon, Mn 1.00% max
	11XX	Resulfurized Free Machining
	12XX	Resulfurized/Rephosphorized Free Machining
Manganese Steels	15XX	Plain Carbon, Mn 1.00-1.65%
	13XX	Mn 1.75%
Nickel Steels	23XX	Ni 3.50%
	25XX	Ni 5.00%
Nickel-Chromium Steels	31XX	Ni 1.25%, Cr .65-.80%
	32XX	Ni 1.75%, Cr 1.07%
	33XX	Ni 3.50%, Cr 1.50-1.57%
	34XX	Ni 3.00%, Cr .77%
Molybdenum Steels	40XX	Mo .20-.25%
	44XX	Mo .40-.52%
Chromium-Molybdenum Steels	41XX	Cr .50-.95%, Mo .12-.30%
Nickel-Chromium-Molybdenum Steels	43XX	Ni 1.82%, Cr .50-.80%, Mo .25%
	47XX	Ni 1.05%, Cr .45%, Mo .20-.35%
Nickel-Molybdenum Steels	46XX	Ni .85-1.82%, Mo .20-.25%
	48XX	Ni 3.50%, Mo .25%
Chromium Steels	50XX	Cr .27-.65%
	51XX	Cr .80-1.05%
	50XXX	Cr .50%, C 1.00% min
	51XXX	Cr 1.02%, C 1.00% min
	52XXX	Cr 1.45%, C 1.00% min
Chromium-Vanadium Steels	61XX	Cr .60-.95%, V .10-.15%
Tungsten-Chromium Steels	72XX	W 1.75%, Cr .75%
Nickel-Chromium-Molybdenum Steels	81XX	Ni .30%, Cr .40%, Mo .12%
	86XX	Ni .55%, Cr .50%, Mo .20%
	87XX	Ni .55%, Cr .50%, Mo .25%
	88XX	Ni .55%, Cr .50%, Mo .35%
Silicon-Manganese Steels	92XX	Si 1.40-2.00%, Mn .65-.85%, Cr 0-.65%
Nickel-Chromium-Molybdenum Steels	93XX	Ni 3.25%, Cr 1.20%, Mo .12%
	94XX	Ni .45%, Cr .40%, Mo .12%
	97XX	Ni .55%, Cr .20%, Mo .20%
	98XX	Ni 1.00%, Cr .80%, Mo .25%

FOR STAINLESS STEELS

AISI	SAE	Stainless Steels	
2XX	302XX	Chromium-Manganese-Nickel Steels	Austenitic 1
3XX	303XX	Chromium-Nickel Steels	Austenitic 1
4XX	514XX	Chromium Steels	See Note 2
5XX	515XX	Chromium Steels	Heat Resisting

NOTE 1: Austenitic Steels are not capable of heat treatment but are available in varied harnesses.

NOTE 2: ANSI 4XX (SAE 514XX) Chromium Steels are either ferritic (not heat treatable) or martensitic (heat treatable) both have magnetic properties.

Tools

- Adjustable Welding Magnet T-109
 Alnico Magnets T-109
 Auto Emergency Tool T-121
 Crown Molding Jig T-8
 Plumb Bobs T-88
 Tool Bag & Stud/Voltage/Metal Detectors T-120
- Builder's Tools/Woodworking T-5 – T-30**
- Calipers/Squares T-26
 Circle Cutters T-25
 Layout Tools T-21 – T-23
 Precision Drill Guide T-24
 Pin & Pinless Moisture Meters T-30
 Scratch Awl & Blade Shapener T-29
 Trammels T-27
 Wood Jigs & Accessories T-6 – T-20
 Wood Joinery & Drill Accessories T-6 – T-20
- Calipers/Micrometers T-68 – T-69, T-96 – T-97
 Calipers/Squares T-26
 Carded/Boxed Sets, Screwdrivers T-77 – T-80
 Carded/Bulk, Screwdrivers T-80
 Carving Sets T-110, T-111
 Center Punches T-48 – T-49
 Circle Cutters T-25
 Cleaning Brushes T-39
 Combination Squares T-26, T-70
 Cordless Precision Engraver T-86, T-88
 Countersinks, Drill Bits & Gages T-28
 Cutting & Carving Tools T-110 – T-111
 Cutting/Bending T-36
 Deburring Tools T-39
 Dial Caliper T-69, T-96
 Dial Indicator & Square Sets T-70
 Digital Calipers T-68, T-94, T-95
 Digital Layout Tools T-21, T-67
 Digital Sliding T-Bevel T-21
 Dividers T-51
 Drive Pin Punches T-49
 Economy Steel Rules T-54, T-61 – T-62
 Faucet Wrenches T-43 – T-45
 Feeler Gages T-63
 Fiber Glass Folding Rule T-29
 File & Probe Sets T-117 – T-119
 Fraction+ Calipers T-68, T-94 – T-95
 Gages T-63 – T-66
- Grommets, Snaps & Screw Fasteners T-112
 Holding Tools T-93
 Industrial Steel Rules T-54, T-58 – T-60
 Inspection Mirrors T-102 – T-105
 Inspection Sets T-105
 Layout Tools T-21 – T-23
 Lighted Tweezers Sets/Tweezers T-92 – T-93
- Machinists Tools T-47 – T-70**
- Center Punches T-48 – T-49
 Dividers T-51
 Drive Pin Punches T-49
 Measuring & Repair Tools T-53
 Scribers T-50 – T-51
 Tap Wrenches T-52
- Magnetic Retrieving Tools T-106 – T-108
 Magnetic Sweeper T-108
 Magnets T-109
 Magnifiers/Lighted Magnifiers T-99 – T-101
 Measuring & Repair Tools T-53
 Measuring/Marking Kits T-98
 Mechanical Pick-Ups/Retrieving Tools T-90 – T-91
 Micrometers T-69
 Mirrors/Mini-Lights T-102 – T-105
 Multi-File & Needle File Sets T-117
 Phillips-Open Stock Boxed T-80
 Phillips-Open Stock Carded T-80
 Pin Vises T-83, T-89
 Pipe, Specialty Wrenches T-40 – T-46
 Pliers/Plier Sets T-42, T-114 – T-115
- Plumbing Tools T-31 – T-46**
- Flaring T-37
 Cleaning Brushes T-39
 Cutting/Bending T-36
 Deburring Tools T-39
 Faucet Wrenches T-43
 Pipe, Specialty Wrenches T-40 – T-46
 Reamers T-38
 Swaging Tools T-38
 Tubing Cutters T-32 – T-35
- Pot Alnico Magnets T-109
 Power Alnico Magnets T-109
 Power Precision Screwdriver T-72
 Precision Engraver/Plumb Bobs T-86, T-88
 Precision Screwdriver Sets T-77 – T-82

Precision Squares T-64
 Probe Sets T-118 – T-119
 Professional Moisture Meters T-30
 Protractors T-66 – T-67
 Punches & Punch Sets T-113
 Punches, Strippers & Scrapers T-116
 Ratchet Offset Screwdriver Sets T-84 – T-85
 Reamers T-38
 Scratch Awl & Blade Shapener T-29

Screwdrivers T-71 – T-85

 Carded/Boxed Sets T-77 – T-80
 Carded/Bulk T-80
 Lighted Screwdrivers T-73 – T-75
 Phillips-Open Stock Boxed T-80
 Phillips-Open Stock Carded T-80
 Power Precision Screwdriver T-72
 Precision Screwdriver Sets T-77 – T-82
 Ratchet Offset Screwdriver Sets T-84 – T-85
 Slotted-Open Stock Boxed T-80
 Slotted-Open Stock Carded T-79
 Torx-Open Stock Boxed T-80
 Torx-Open Stock Carded T-79

Scribers T-50 – T-51
 Shallow Pot Magnets T-108
 Slotted-Open Stock Boxed T-80
 Slotted-Open Stock Carded T-79

Specialty Tools T-87 – T-123

 Adjustable Welding Magnet T-109
 Alnico Magnets T-109
 Auto Emergency Tool T-121
 Tool Bag & Stud/Voltage/Metal Detectors ... T-120
 Calipers/Micrometers T-68 – T-69, T-97
 Carving Sets T-110, T-111
 Cutting & Carving Tools T-110 – T-111
 Dial Calipers T-69, T-96
 File & Probe Sets T-118 – T-119
 Fraction Calipers T-68, T-94 – T-95
 Grommets, Snaps & Screw Fasteners T-112
 Holding Tools T-93
 Inspection Mirrors T-102 – T-105
 Inspection Sets T-105
 Lighted Tweezers Sets/Tweezers T-92 – T-93
 Magnetic Retrieving Tools T-106 – T-108
 Magnetic Sweeper T-108

Magnets T-109
 Magnifiers/Lighted Magnifiers T-99 – T-101
 Measuring/Marking Kits T-98
 Mechanical Pick-Ups/Retrieving Tools .. T-90 – T-91
 Mirrors/Mini-Lights T-102 – T-105
 Multi-File & Needle File Sets T-117, T-118
 Pin Vises T-83, T-89
 Pliers/Plier Sets T-42, T-114 – T-115
 Pot Alnico Magnets T-109
 Power Alnico Magnets T-109
 Precision Engraver/Plumb Bobs T-86, T-88
 Probe Sets T-118 – T-119
 Punches & Punch Sets T-113
 Punches, Strippers & Scrapers T-116
 Quad Saw Driver T-122 – T-123
 Tweezers T-92 – T-93
 Welding Magnet T-109

Steel Rules T-54 – T-62

 Economy Steel Rules T-54, T-61 – T-62
 Industrial Steel Rules T-54, T-58 – T-60
 Protractors T-66 – T-67
 Ultra Rule Marking Rules T-62
 Ultratest Steel Rules T-54 – T-57

Swaging Tools T-38
 Tap Wrenches T-52
 Torx-Open Stock Boxed T-80
 Torx-Open Stock Carded T-79
 Trammels T-27
 Tubing Cutters T-32 – T-35
 Tweezers T-92 – T-93

Ultra Rule™ Marking Rules T-62

Ultratest™ Steel Rules T-54 – T-57

Welding Magnet T-109
 Wood Jigs & Accessories T-6 – T-20
 Wood Joinery & Drill Accessories T-6 – T-20

Merchandising T-124 – T-127

 Countertop Displays T-124 – T-127

Woodworking Jigs

 Crown King Jig T-6, T-8
 Dovetail Jig T-7, T-10
 Doweling Jig T-7, T-16
 Mortise & Tennon Jig T-7, T-11
 Pocket Hole Jig T-7, T-12 – T-13
 Pro Dowling Jig T-17

NUMERIC INDEX

Tools

NCL = Not In Catalog
 General Mfg UPC #038728
 * General Mfg UPC #681035
 † General Mfg UPC #708200

Due to continuous improvements,
 actual product may differ slightly
 from photograph.



MODEL NO.	UPC CODE	KEY	CATALOG PAGE #	MODEL NO.	UPC CODE	KEY	CATALOG PAGE #	MODEL NO.	UPC CODE	KEY	CATALOG PAGE #	MODEL NO.	UPC CODE	KEY	CATALOG PAGE #
4/5 BLADE	27003 0		T-25	83	31098 9	+	T-50	140XL	01401 6		T-40	270-2	31340 9		T-64
5B	21009 8		T-25	83P	31100 9		T-50	141ME	44139 3		T-97	270-3	31343 0		T-64
5/6/55 DRILL	21014 2		T-25	84	31102 3		T-50	142	44145 4		T-96	270-4	31346 1		T-64
06	21010 4		T-25	84P	31104 7		T-27,50	144MM	44148 5		T-96	270-6	31349 2		T-64
6 BLADE	21013 5		T-25	85	31106 1		T-51	145	44150 8		T-96	291	22154 4		T-28
11	21024 1		T-25	87	31108 5		T-48	146	01460 3		T-26,68,95	292	22149 0		T-28
11B	27024 5		T-25	88	31112 2		T-50	147	01470 2		T-26,68,95	293	22150 6		T-28
13	22006 6		T-65	88CM	31116 0		T-50	151	14008 1		T-37	300/1*	32036 0	•	T-60
14	22009 7	+	T-65	88P	31114 6		T-50	152	14022 7		T-37	300ME*	32042 1	•	T-61
15	22012 7		T-65	89	02131 1	*	T-48	153	14019 7		T-36	300MM*	32041 4	•	T-60
16ME	22015 8		T-66	90	41058 0		T-89	154ST	14018 0		T-38	301/1*	32046 9	•	T-61
17	22018 9		T-66	92	41062 7		T-89	155	14009 8		T-37	301ME	32049 0		T-61
18	22024 0		T-66	93	41065 8		T-89	157	14015 9		T-37	305ME	32060 5		T-61
19	22027 1		T-67	94A	41074 0		T-89	159	01590 7		T-42	307	32063 6		T-61
20	22036 3		T-65	94B	41077 1		T-89	160R	31200 6		T-52	308	30266 3		T-62
21	22041 7		T-65	94C	41080 1		T-89	161R	31203 7	+	T-52	309CD	02126 8	*	T-98,125
24	22011 0		T-65	94D	41083 2		T-89	162R	31209 9		T-52	310	32072 8		T-62
29	22148 3		T-23	102	44103 4		T-69	163	31212 9		T-52	311ME	32075 9		T-62
30	22165 0		T-67	107	10700 8		T-69,96	164	31215 0		T-52	354	22189 6		T-108
31A	23024 9		T-15	109	10900 2		T-70,98	165	01650 8		T-52	360	42021 3		T-107
31B	23030 0		T-15	110	22075 2		T-39	166	31218 1		T-52	366	42027 5		T-108
31C	23033 1		T-15	111	22076 9		T-39	167	01670 6		T-52	368	42033 6		T-108
32	†00052 2		T-13-14	114	01140 4		T-39	175	31325 6		T-53	369	42036 7		T-108
34ST	23041 6		T-15	115	01150 3		T-34	177-1	31236 5		T-53	369-100	42038 1		T-108
36/37	23059 1		T-24	115B	11500 3		T-34	177-2	31240 2		T-53	370-1	42041 1		T-109
55	21012 8		T-25	117	01170 1	*	T-35	177-8	31242 6		T-53	370-2	42044 2		T-109
55 BLADE	27015 3		T-25	117BG	01171 8	*	T-35	180	22158 2		T-45	370-4	42050 3		T-109
64	41030 6		T-116	118	01181 7		T-35	182	22159 9		T-45	370-6	42053 4		T-109
69	41036 8		T-116	118BG	01180 0		T-35	183	01830 4		T-44	370-8	42056 5		T-109
72	41039 9		T-116	119	31173 3		T-35	185	01850 2		T-44	370-12	42061 9		T-109
75A	31034 7		T-49	119BG	01194 7		T-35	186	01860 1		T-43	370-16	42064 0		T-109
75B	31036 1		T-49	120	12003 8		T-32	188	22161 2		T-44	370-24	42067 1		T-109
75C	31038 5		T-49	123R	12009 0		T-33	189	18900 4		T-42	372A	42073 2		T-109
75D	31040 8		T-49	124	01240 1		T-33	190	22155 1		T-43	372B	42076 3		T-109
75E	31042 2		T-49	125	12015 1		T-32	191	22156 8		T-43	372C	42079 4		T-109
75F	31044 6		T-49	126	12017 5		T-32	192	01920 2		T-45	372D	42082 4		T-109
75G	31046 0		T-49	129X	12032 8		T-33	193	22157 5		T-43	372E	42085 5		T-109
75H	31048 4		T-49	130	13003 7		T-38	195-1/2	23047 8		T-28	374A	42093 0		T-109
76A	31052 1	+	T-49	131	13006 8		T-38	195-3/4	23050 8		T-28	374B	42096 1		T-109
76B	31054 5	+	T-49	132ME	44136 2		T-97	195-5/8	23053 9		T-28	374C	42102 9		T-109
76C	31056 9	+	T-49	133	13300 7		T-34	196	23054 6		T-38	374D	42105 0		T-109
76D	31058 3	+	T-49	134	22077 6		T-38	201	00201 3		T-46	375	42108 1		T-109
76E	31060 6	+	T-49	135	01350 7		T-34	226	31306 5	+	T-63	376A	42111 1		T-108
77	31062 0		T-48	138S	13020 4	XX	T-40	226T	31309 6	+	T-63	376B	42114 2		T-108
78	31066 8		T-48	138T	13016 7		T-40	230	31311 9		T-63	376C	42117 3		T-108
78P	31068 2		T-48	139/4	13026 6		T-41	231	31313 3		T-63	376D	42120 3		T-108
79	31072 9		T-48	139A	13013 6		T-41	232	31316 4		T-63	377	42122 7		T-109
79P	31078 1		T-48	139B	13014 3		T-41	251	31321 8		T-64	380A	31400 0		T-51
79P/2	31079 8		T-48	139C	13015 0		T-41	255MM	31326 3		T-64	380B	31403 1		T-51
80	31090 3		T-51	139D	13023 5		T-41	260	31329 4		T-53	383NX	42208 8		T-107
80C	31091 0		T-51	139ST	13017 4		T-41	262	31331 7		T-53	384N	42210 1		T-106
81	31092 7		T-50	140	13019 8		T-40	263	31334 8		T-53	386	42219 4		T-106
81P	31094 1		T-50	140X	13033 4		T-40	264	31337 9		T-53	388	42214 9		T-90

KEY: * = New Item, XX = Discontinued after supply is depleted, *** = Certified, NCL = Not In Catalog,
 Z = Not standard discount, SO = Special Order, PC = Price Change,



INDEX



NCL = Not In Catalog
 General Mfg UPC #038728
 * General Mfg UPC #681035
 † General Mfg UPC #708200

Due to continuous improvements,
 actual product may differ slightly
 from photograph.

NUMERIC INDEX

Tools

MODEL NO.	UPC CODE	KEY	CATALOG PAGE #	MODEL NO.	UPC CODE	KEY	CATALOG PAGE #	MODEL NO.	UPC CODE	KEY	CATALOG PAGE #	MODEL NO.	UPC CODE	KEY	CATALOG PAGE #
392	42224	8	T-106	555	42465	5	T-103	790-12	42618	5	T-88	1251	32180	0	T-59
394	42228	6	T-106	557	42468	6	T-103	800-8	42624	6	T-88	1261-0	41103	7	T-112
395	42229	3	T-107	557RMF	42481	5	T-103	800-12	42630	7	T-88	1261-2	41104	4	T-112
396	22145	2	T-90	558	42471	6	T-103	800-16	42633	8	T-88	1261-4	41105	1	T-112
397	31434	5	T-108	559	05590	3	PC T-103	800-32	42639	0	T-88	1265	41106	8	T-112
400	42217	0	T-90	560	42473	0	T-103	800NP	42641	3	T-88	1266	41107	5	T-112
401AA	42240	8	T-92	560RMF	42484	6	T-103	803	24009	5	T-28	1267	41108	2	T-112
401XX	42263	7	T-92	565	42509	6	T-100	806	24018	7	T-28	1268	41109	9	T-112
403	42266	8	T-92	570	42477	8	T-103	807	42664	2	T-84	1271A	43793	8	T-113
408	42271	2	T-92	577	42480	8	T-103	807SX	42667	3	T-84	1271C	43799	0	T-113
410	42280	4	T-92	580	58001	6	T-102	807X	42670	3	T-84	1271E	43804	1	T-113
414	42291	0	T-92	580CD	00580	0	T-124	809	24024	8	T-29	1271G	43810	2	T-113
415	42294	1	T-92	582	05820	1	T-102,107	811	24030	9	T-26	1271H	43813	3	T-113
416	42297	2	T-92	589	58900	2	T-119	812	24036	1	T-26	1271I	43816	4	T-113
423-3	42249	1	T-92	600-0	42515	7	T-80	812-CA	22193	3	T-26	1271J	43819	5	T-113
423-3C	42251	4	T-92	600-1	42518	8	T-80	818	24047	7	T-29	1271K	43821	8	T-113
425	42258	3	T-92	600-2	42521	8	T-80	820	24050	7	T-26	1271L	43822	5	T-113
444	31586	1	T-69	600-3	42524	9	T-80	822	80822	0	T-21	1271M	43825	6	T-113
450-4	31598	4	T-51	600-4	42527	0	T-80	823	00823	7	T-21	1271N	43827	0	T-113
450-6	31601	1	T-51	600-5	42530	0	T-80	825	24070	5	T-29	1271O	43829	4	T-113
450-8	31604	2	T-51	601	00601	1	T-81	828	08280	0	T-21	1271P	43831	7	T-113
450-10	31592	2	T-51	601CD	00601	2	* T-81,125	829	24100	9	T-23	1271Q	43833	1	T-113
450-12	31595	3	T-51	602	06020	4	T-81	833	08330	2	T-22	1271ST	43849	2	T-113
452-4	31615	8	T-51	602CD	06020	5	* T-81,125	836	08360	9	T-22	1276	31286	0	T-59
452-6	31618	9	T-51	609	06090	7	T-81	837	24116	0	T-22	1280A	43856	0	T-113
452-8	31621	9	T-51	609CD	06090	8	* T-81,125	839	42698	7	T-119	1280B	43859	1	T-113
452-10	31607	3	T-51	616	32096	4	T-58	840	24120	7	T-17	1280C	43862	1	T-113
452-12	31610	3	T-51	634	32108	4	T-58	841	†00031	7	T-16	1280D	43865	2	T-113
454-4	31636	3	T-51	641	32112	1	T-62	842	24126	9	T-23	1280E	43868	3	T-113
454-6	31639	4	T-51	666	22415	6	T-83	843/1	24132	0	T-23	1280F	43870	6	T-113
454-8	31641	7	T-51	666CD	22415	7	T-124	846	†00001	0	T-20	1280G	43872	0	T-113
454-10	31624	0	T-51	676	32111	4	T-58	849	†00051	5	T-12,13	1280H	43874	4	T-113
454-12	31627	1	T-51	678MED	32114	5	T-58	850	00850	3	* T-12,13	1280I	43876	8	T-113
478	42321	4	T-116	690	22200	8	T-81	851	08510	8	* T-16	1280J	43878	2	T-113
481	00481	9	T-39	700	22066	0	T-79	852-100	43030	4	T-111	1280K	43880	5	T-113
482	42324	5	T-39	711	22121	6	T-79	855	43046	5	T-111	1280L	43882	9	T-113
482A	42327	6	T-39	714	35018	3	T-66	858	08580	1	T-36	1280M	43884	3	T-113
482B	42330	6	T-39	715	35015	2	T-64	861	00861	9	* T-10	1280N	43886	7	T-113
500	02133	8	* T-72	722	72200	3	T-97	862	24500	7	T-119	1280-O	43888	1	T-113
500B	05001	4	* T-72	729	42581	2	T-97	864	43067	0	T-36,144	1280P	43890	4	T-113
502	05020	5	* T-73,75	729ME	42594	2	T-97	870	00870	1	* T-11	1280ST	43896	6	T-113
505	02139	4	T-86,88	735	22412	5	T-77	880	00880	0	* T-8	1293	43900	0	T-111
520	23090	4	T-27	735DB	22412	6	T-126	888	25099	5	T-20	1390	01390	3	T-41
523	23093	5	T-27	741	22394	4	T-78	890	43666	5	+ T-89,116	1392	01392	7	XX T-41
524	23095	9	T-27	741DB	22394	5	T-126	934	00934	0	T-114	1393	01393	4	XX T-41
527	42339	9	T-101	744	74401	2	T-80	938	00938	8	T-114	1395	01395	8	T-41
532	42400	6	T-101	744CD	00744	6	T-80,1214	950-5	43734	1	T-101	1399	01399	6	T-44
533	42403	7	T-101	744DB	74400	6	T-80,126	1102	01102	2	T-39	1433	01433	7	T-26,68,95
536	42409	9	T-101	744FB	74400	7	T-127	1191	01191	6	T-35	1478	01478	3	T-26,68,95
537	42412	9	T-101	745DB	02147	3	* T-80,126	1201ME	32162	6	T-58	1491	01491	7	T-42
538	42414	3	T-100	745FB	02147	2	T-127	1210	32171	8	T-58	1492	01492	4	T-42
553	42456	3	T-99	790-5	42612	3	T-88	1216	32174	9	T-59	1493	01493	1	T-42
554	42462	4	T-99	790-8	42615	4	T-88	1241	32181	7	T-62	1545	01545	7	T-38

KEY: * = New Item, XX = Discontinued after supply is depleted, *** = Certified, NCL = Not In Catalog,
 Z = Not standard discount, SO = Special Order, PC = Price Change,

NUMERIC INDEX

Tools

NCL = Not In Catalog
 General Mfg UPC #038728
 * General Mfg UPC #681035
 † General Mfg UPC #708200

Due to continuous improvements,
 actual product may differ slightly
 from photograph.



MODEL NO.	UPC CODE	KEY	CATALOG PAGE #	MODEL NO.	UPC CODE	KEY	CATALOG PAGE #	MODEL NO.	UPC CODE	KEY	CATALOG PAGE #	MODEL NO.	UPC CODE	KEY	CATALOG PAGE #	
1566	01566	2	T-46	70557	22347	0	T-104	713008	71380	3	T-82	MG-S278-4R	33800	6	T-70	
1702	26008	6	T-21,67	70801	70965	3	T-83	713015	71306	3	T-82	MG-S281-4R	33840	2	T-70	
1809	01809	0	T-45	71260	22341	8	T-112	750541	50541	5	T-100	MM1E	*10188	9	T-30	
1850	43960	4	T-89	71262	22342	5	T-112	750542	50542	2	T-100	MM70	*07020	8	NCL	
1881	01881	6	T-44	71264	22343	2	T-112	750543	50543	9	T-100	MM70D	*07010	9	NCL	
1882	01882	3	T-44	75108	26002	4	T-74,75	750544	50544	6	T-100	MMD4E	*41447	7	T-30	
1883	01883	0	T-44	75801	75973	3	T-83	750545	50545	3	T-100	MMD5NP	*40142	2	T-30	
1901	43974	1	T-110	75806	75974	0	T-83	751016	75106	5	T-78	MMD7003	*07003	1	NCL	
1902	43976	5	T-110	80075	80075	6	T-85	751028	75102	7	T-78	MP7003	*01255	0	Z	NCL
1903	43978	9	T-110	80078	80078	7	T-85	759383	75933	7	T-106	MP7021	*70604	6	Z	NCL
1914CD	01914	2	T-124	80557	80557	7	T-102	759398	75939	9	T-106	MP7022	*07070	3	Z	NCL
1915	43984	0	T-110	80560	02146	5	T-102	759563	75959	7	T-104	MSV250	*01276	5	T-120	
1920	43988	8	T-110	81001	01319	9	T-120	759570	75950	4	T-104	MSV350D	*01275	8	T-120	
1922	43992	5	T-110	86014	86014	9	T-122,123	759581	75966	5	XXT-102,107	RW121/2	12023	6	T-32	
1923	43994	9	T-110	86014	86014	9	T-127	759582	75967	2	T-102,107	RW122	12027	4	T-32	
1924	43996	3	T-110	90601	90601	4	T-110	759905	75961	0	T-105	RW135/2	01351	4	T-34	
3601	36010	6	T-107	95602	95602	6	T-110	759909	75962	7	T-105	S004	34106	8	T-98	
5561	05531	3	PC	95622	75623	7	T-110	800543	26001	7	T-99	S008	34112	9	T-98	
5562	05562	0	PC	311012	02106	9	T-18	840012	02104	5	T-18	S106	11009	1	T-36	
5563	05563	7	PC	311038	02105	2	T-18	840014	02101	4	T-18	S1270	43759	4	T-113	
7200	25300	2	T-29	312012	02108	3	T-18	840038	02103	8	T-18	S1274	43751	8	T-113	
7902	79020	0	T-121,127	312038	02107	6	T-18	840516	02102	1	T-18	S270	02701	6	T-64	
8071	42673	4	T-84	313012	02110	6	T-18	841014	02119	9	T-16	S31	23036	2	T-15	
8075	80750	2	T-84	313038	02109	0	T-18	841038	02121	2	T-16	S389-4	31418	5	T-64	
8078	80780	9	T-84	314038	02112	0	T-19	841516	02120	5	T-16	S475	42315	3	T-117	
8081	42682	6	T-93	315012	02115	1	T-18	C421	42309	2	T-92	S476	42318	4	T-117	
8082	42684	0	T-93	315038	02114	4	T-18	CF17	22021	9	T-66	S477	42319	1	T-117	
8083	42686	4	T-93	315516	02113	7	T-18	CF616	32123	7	T-59	S605	42565	2	T-80	
8401	08401	9	T-16	316012	02117	5	T-19	CF640MM	39021	9	T-55	S607	42566	9	T-80	
8492	02122	9	T-13-14	316038	02116	8	T-19	CF645	33020	8	T-55	S838	23096	6	T-20	
8495	02123	6	T-13-14	317000	02118	2	T-19	CF649MD	33035	2	T-55	S94	41068	9	T-89	
8497	08497	2	T-13-14	318000	02134	2	T-19	CF661	33040	6	T-56	S98-6	31130	6	T-53	
8498	08498	9	T-13-14	318010	02135	9	T-19	CF664	33050	5	T-56	SPC600	42568	3	T-80	
8501	43061	8	T-111	318020	02136	6	T-19	CF667ME	33065	9	T-56	SPC606	42571	3	T-80	
14712	14712	7	T-26,68,95	318050	02133	5	T-19	CF676	32141	1	T-59	SPC74	31018	7	T-49	
60004	60004	2	T-118	611078	61108	6	T-82	CF678MED	32147	3	T-60	SPC75	31032	3	T-49	
63518	63518	1	T-77	611094	61100	0	T-82	CF778	35010	7	T-6	SPC76	31050	7	T-49	
63528	63528	0	T-77	612020	61203	8	T-82	CF1216	32150	3	T-60					
67123	67123	3	T-79	613005	61350	9	T-82	CF1227ME	32153	4	T-60					
70079	22339	5	T-49	613006	61360	8	T-82	CF1245	33085	7	T-56					
70088	22340	1	T-50	613007	61370	7	T-82	CF1246	33090	1	T-56					
70390	70390	3	T-91	700540	00540	3	T-100	CF1247ME	33095	6	T-57					
70391	70391	0	T-91	707475	70745	1	T-118	CF1249MD	33100	7	T-57					
70393	70399	6	T-90,91	707476	70746	8	T-117	CF1264	33110	6	T-57					
70396	26003	1	T-90,91	707862	70786	4	T-118	CF1276	32159	6	T-60					
70399	70393	4	T-90,91	707863	75970	2	T-119	CF1845	33140	3	T-57					
70400	70400	9	T-93	707865	70962	2	T-119	CF2445	33190	8	T-57					
70401	26004	8	T-93	709392	70972	1	T-105	D397	31434	2	T-127					
70402	70402	3	T-93	711125	71110	6	T-82	MB560	42475	4	T-104					
70403	26005	5	T-93	711140	71140	3	T-82	MG1758	33587	6	T-70					
70408	26006	2	T-93	712010	71202	8	T-82	MG1780	33605	7	T-70					
70555	22344	9	T-104	712101	71211	0	T-82	MG6001DC	33450	3	T-69					

KEY: * = New Item, XX = Discontinued after supply is depleted, *** = Certified, NCL = Not In Catalog, Z = Not standard discount, SO = Special Order, PC = Price Change,



INDEX

INVENTORS AND INNOVATORS TAKE NOTE!

**Do You Have a Problem Solving Tool,
Instrument or Time Saving Idea?
Then General Tools & Instruments
Wants to Work With YOU!**

General had been in the tool manufacturing and distribution business for over 90 years and has forged numerous relationships with international and domestic manufacturers and has built an extensive product distribution network.

If you are interested in getting your product into our global channel we invite you to submit your original idea for evaluation.

Here's how to get started. Simply scan the QR Code to get to our Instruction Page or visit our web site directly at www.generaltools.com/inventionswanted



Specialty Tools & Instruments

GENERAL TOOLS & INSTRUMENTS
80 White Street, New York, NY 10013-3567
PHONE (212) 431-6100 • FAX (212) 431-6499 • TOLL FREE (800) 697-8665
e-mail: gentools@generaltools.com
www.generaltools.com

“Man is a tool using animal. Weak in himself and of small stature, he stands on a basis of some half-square-foot, and has to straddle out his legs lest the very winds supplant him. Nevertheless, he can use tools, can devise tools; with these the granite mountains melt into light dust before him; seas are his smooth highways, winds and fire his unwearied steeds, Nowhere do you find him without tools. Without tools he is nothing, but with tools he is all.”

Thomas Carlyle (1795–1881)

“It’s Your Job . . . General Tools Make It Easier”



Specialty Tools & Instruments

GENERAL TOOLS & INSTRUMENTS
80 White Street, New York, NY 10013-3567
PHONE (212) 431-6100 • FAX (212) 431-6499 • TOLL FREE (800) 697-8665
e-mail: gentools@generaltools.com
www.generaltools.com

Catalog No. TCAT14 Printed in USA Effective January 2014

©2014 GENERAL TOOLS & INSTRUMENTS 1/14 20M

Not responsible for typographical errors.

