

PULSAFEEDER®

Metering Pumps and Control Systems



Product

Effective 01/01/16

TABLE OF CONTENTS

Important Information When Placing An Order	3
Feature Selection Guide	4
Model Selection Guide	5-9
PULSAtron - Electronic Metering Pumps	
Series MP	10-11
Series E Plus	12-13
Series HV	14-15
Series E	16-17
Series A Plus	20-21
Series T7	22-23
Series C Plus	24-25
Series C	26-27
Electronic Metering Pump Accessories	
KOPkits	28-29
Suction/Discharge Valves	30
Parts	31-33
BLACKLINE - Mechanical Diaphragm Pumps	
Model Selection	34-35
Accessories and KOPkits	36
Chem-Tech Pumps – Peristaltic Metering Pumps	
Series XP	37
Series XPV	38
Series XP and XPV Parts	39
Chem-Tech Pumps – Mechanical Diaphragm Pumps	
Prime Performance	40
Series 100, 150, 200 and Parts	41-43
Series 250 and Parts	44
Mec-O-Matic Pumps – Peristaltic Metering Pumps	
Dolphin Series and Related Parts	45
VSP Series and Parts	46
2400T, 2400T Plus, 2400T-DC and Parts	47
Policies and Procedures	48-49
Terms and Conditions	50-51

IMPORTANT INFORMATION

WHEN PLACING AN ORDER

1. Fax, mail or telephone orders directly to the Customer Service Department:

Pulsafeeder Incorporated—A Unit of IDEX Corporation
 Standard Product Operations Main Office & Manufacturing Facility
 27101 Airport Road, Punta Gorda, Florida, USA 33982-2462 E-Mail: pulsaspo.cs@idexcorp.com
 Telephone: 800-333-6677 or 941-575-3800 Fax: 800-456-4085 or 941-575-4085
 www.pulsatron.com

2. Please have the following information available when placing an order:

Account Name	Special Tags or Marks (if needed)
Billing Zip Code	Item(s) Being Ordered
Purchase Order Number	Quantity of Each Item
Ship To Address	Pricing
Payment Terms	Shipping Information

3. Orders are entered upon receipt. Our ability to change in house orders is limited. Please be certain your orders are complete when placed. Any order cancellation or change request is subject to a cancelation fee.

4. Orders are assigned standard lead times based on the size of the order and product mix.

Orders requiring expedited shipping (sooner than the standard lead times) are subject to a expedite charge.

Unless the order clearly requests expedited shipping, the order will be treated as a routine order. When expedited shipping is requested a designated carrier must be selected. Orders that need to ship the same day must be received by 2:00 PM EST.

Same day and next working day shipping is generally available for larger orders but not guaranteed, please verify with customer service. Pulsafeeder shall have no liability if it is unable to provide expedited shipping of an order.

5. Repairs and returns are coordinated through our Customer Service Department. All orders returned must have factory authorization and are subject to a 25% restocking charge for standard product

6. Other Locations:

PULSAFEEDER-Europe
 Via Kennedy, 12-20090
 Segrate—Milano— Italy
 Tel: +0039 377 706 6300

Far East (Office Only)

Room 3502-3504, Zhao Feng Plaza
 No. 1027 Changning Rd
 Shanghai 200050, China
 Tel: 86-2163906367
 Fax: 86-2163863338

Latin America (Office Only)

Mario Pani 400, Piso 1, Oficina 111
 Col. Lomas de Santa Fe, Cuajimalpa de Morelos
 C.P 05300, México, D.F.
 Tel: 52-55-4738-4124

IDEX India Private Ltd.

S14, First Floor
 Solitaire Corporate Park,
 167, Guru Hargovindji Marg, Chakala
 Andheri (East)
 Mumbai 400 093, India
 Tel: 91-22-66435500
 Fax: 91-22-66780055

- Prices are subject to change without notice and are effective when order is accepted and acknowledged at point of shipment.
- When ordering, specify your P.O. number, model number, quantity, price, shipping and/or billing address and order date.
- Standard terms are NET 30 days from date of invoice for approved domestic accounts on open account and NET 60 days from date of invoice for approved international accounts.
- WE ACCEPT VISA AND MASTERCARD.
- PAYMENT BY CREDIT CARD WILL NOT RECEIVE AN ADDITIONAL DISCOUNT.
- All prices are FCA, Shippers Dock, Punta Gorda, FL.
- Custom product sales are final.
- Charges for export documentation may apply an very by requirements.
- Expedite fees may apply. Orders requiring expedited shipping (sooner than the standard lead times) are subject to an expedite charge
- Fees for changes to or cancellation of orders may apply.
- Minimum factory order of \$30.
- Possession of price schedule does not guarantee right to purchase direct from factory.

PULSAtron®

Feature Selection Guide

Pulsafeeder offers one of the most flexible electronic metering pumps in the world. The product can be configured to meet a large variety of applications and needs. The next few pages will guide you in structuring a complete and correct model number.

The first step in selecting the right model for your application is to select the correct Series. Each Series offers a variety of features that distinguish it from other Series. Within each Series are selections of models that offer different flow/pressure envelopes to choose from.

The following descriptions will help you understand the different features and then the chart at the bottom of the page will let you select the appropriate models that have the features you need.

4-20mA	Control the pump stroke frequency based on a current input signal from an external device. At 4mA input, the pump will not stroke. At 20mA input, the pump will stroke 100%
20-4mA	Same as 4-20 except that at 20mA input, the pump will not stroke and at 4mA input, the pump strokes at 100%.
External Pace / Water Meter	Allows the pump stroke to be controlled by an external dry contact closure, such as is provided by a Water Meter. For each closure, the pump will stroke one time. Some models provide the ability to multiply or divide the pulses.
Stop Function	A dry contact input that will stop the pump on closure and allow the pump to operate when open.
Touch Pad	Electronic 'touch pad' control with internationally recognized symbols.
Digital Display	Pump parameters are displayed on an LCD or LED type display.
Signal Relay	Provides a 24V DC signal output from the pump based on user specified conditions.
Power Relay	Provides AC power output from the pump based on user specified conditions.
Alarm Display	Flashing display or LED indicator that will display an alarm condition on the front panel of the pump.
Timed Sequences	Ability to pre-program operation for repetitive metering.
Programmable Timer	Timer that can be programmed with up to 8 on/off cycles per day during a 7-day week.
Hall Effect	Hall Effect Water Meter input.
Bleed Relay	Separate relay used to control a solenoid that will "Bleed" a cooling tower as part of a control system.
Timer Control	User defined timer functions that control when the pump will operate. Used in Cooling Tower control systems.
Flow Control	Optional Flow Switch turns pump on when flow is active.

Series	Flow Capacity		Pressure		Turn Down Ratio	4-20 mA	20-4 mA	External Pace And Stop Function	External Pace Or Stop Function	Touch Pad	Digital Display	Signal/Power Relay	Alarm Signals	Timed Sequences	Programmable Timer
	GPH	LPH	PSIG	BAR											
MP	0.13 to 21	0.50 to 79.5	20 to 300	1.3 to 21	1000:1	S	S	S		S	S	S	S	S	
E Plus	0.13 to 25	0.50 to 94.6	30 to 300	2.0 to 21	100:1	O		O							
HV	0.50 to 10	1.9 to 37.9	80 to 100	5.6 to 17	100:1	O									
E	0.21 to 1.85	0.80 to 7.0	100 to 250	7 to 17	100:1										
E-DC	0.25 to 1.85	0.90 to 7.0	100 to 150	7 to 10	100:1										
A Plus	0.25 to 2	0.90 to 7.6	50 to 250	3.3 to 17	100:1			O	O						
T7	0.50 to 2	1.9 to 7.6	100	7	10:1										S
C Plus	0.25 to 1.25	0.90 to 4.7	80	5.6	100:1				O						
C	0.25 to 1.25	0.90 to 4.7	80	5.6	10:1				O						

PULSAtron® *Model Selection Guide*

Once you have selected the appropriate Series, you must configure the model so that it is built with the features you desire. The Configuration Guide associated with each Series will present the most popular selections. Select one code from each category to build up a complete model string.

To help you better understand the model string, in the following pages, we will explain what each of the digits represent and provide you some additional charts to help you select options not found in the Configuration Guides.

Model Selection:

The first four digits represent the Series and Flow/Pressure Selection.

LB02



The first digit will always start with the letter 'L'.

All PULSAtron models begin with this letter. The second letter designates the Series (e.g. Series MP, Series E+, Series A+, etc.). Each series has a different set of features that are available in terms of control and flow/pressure capacity. The next two digits represent the flow/pressure capacity of the pump.

Series Code Designator	
Series MP	M
Series E Plus	P
Series HV	V
Series E	E
Series E-DC	S
Series A Plus	B
Series C Plus	D
Series C & T7	C

LB02



Digits 3 & 4 represent the Flow/Pressure Code.

This code represents the specific flow/pressure rating for the model and can be found in the specification for each Series.

LB02SA



Digits 5 & 6 represent the Controls and Electrical selections.

These selections are explained for each model in the Configuration Guide.

Selecting the Wet-End Code & Connection Type:

Digits 7-10 in the string represent the wet-end code. It is the group of four digits set apart by the dash lines.

LB02SA-PTC1



These four digits represent your wet-end code and connection type.

The four digits in the wet-end code represent the Head Material, Seats & O-Rings, Ball Material and Connection type. Using the above example, the code breaks down as follows:

- P** - Head Material, including fittings. In this example, the P represents GFPPPL.
- T** - Seat & O-Ring Material. In this example, the T represents TFE.
- C** - Types of Balls used in the valves. In this example, the C represents Ceramic.
- 1** - Connection type. In this example, the 1 represents tubing connections for 3/8" OD tubing.

In the configuration Guide, we have listed the most popular Wet-End codes. If you don't find the materials or connection selection to meet your needs, refer to the following selection guides to configure the proper Wet-End Code.

Selecting the Wet-End Code:

The wet-end code represents the materials of construction that will be in contact with the chemical you are pumping. It is critical that the materials selected are compatible. If you do not find the wet-end code to meet your application in the configuration guides, you can use the Wet-End Code Selection Guide to determine the correct Head Material, Seats & O-Rings and Balls. If you do not know what materials are compatible with the chemicals you are pumping, refer to the chemical compatibility chart below. We have identified the proper wet-end code for the chemicals in the list. If your chemical is not found in the list, please contact your chemical supplier or visit www.pulsatron.com for a complete listing.

PULSAtron Wet-End Code Selection Guide	
Head & Fittings	
A	= 316 Stainless Steel (All models except H8)
K	= PVDF (Kynar) (Consult factory for J7, H8 models)
P	= GFPPPL (Polypropylene)
V	= PVC (Poly Vinyl Chloride) (for models rated < 150 psi excluding J7, K7, H7, H8)
W	= PVC (for models > 150 psi and J7, K7, H7, H8)
Seats	
H	= CSPE
T	= TFE (not available with TFE ball over 150 psi)
V	= Viton (150 psi max.)
Balls	
C	= Ceramic
H	= Alloy C (Hastelloy)
S	= 316 Stainless Steel
T	= TFE (not available with TFE seat over 150 psi)

CSPE is generic formulation of Hypalon, a registered trademark of E.I. DuPont Co.

Viton is a registered trademark of E.I. DuPont Company.

Chemical Compatibility Chart

Chemical	Liquid End Code
ACETIC ACID, 5 - 10%	PHC
ALUMINUM SULFATE	VHC
AMMONIA, 10%	PHC
BROMINE	KTC
CALCIUM HYPOCHLORITE	VVC
CITRIC ACID, 10 - 20%	PHC
DEAE - Steamline Treatment	ATS
ETHYLENE GLYCOL	PTC
FERRIC CHLORIDE	VTC
FERRIC SULFATE	PTC
FLUOSILICIC ACID	PTT
HYDROCHLORIC ACID, 0 - 37%	PTC
HYDROCHLORIC ACID, 37 - 100%	KTT
HYDROFLUOSILICIC ACID, 20%	PTT
HYDROGEN PEROXIDE, 0 - 30%	VVC
LACTIC ACID	PTC
NITRIC ACID, 0 - 20%	PVC
PHOSPHORIC ACID, 0 - 100%	KTC
POTASSIUM CHLORIDE	PTC
POTASSIUM PERMANGANATE	PTC
SODIUM BI-CARBONATE	PTC
SODIUM BI-SULFATE	PTC
SODIUM BI-SULFITE	PTC
SODIUM CARBONATE	PTC
SODIUM HYDROXIDE, 0 - 50%	PHC
SODIUM HYPOCHLORITE	VVC
SODIUM NITRATE	PTC
SODIUM SILICATE	PHC
SODIUM SULFATE	PHC
SODIUM SULFIDE	PHC
SULFURIC ACID, 0 - 10%	PTC
SULFURIC ACID, 10 - 75%	PTC
SULFURIC ACID, 95 - 100%	KTC

This is an abbreviated version using most common chemicals. Refer to the Chemical Resistance Guide (EMP-030) for a more detailed listing.

Selecting the Connection Code:

Selecting the proper connection code is probably the most difficult part of choosing a PULSAtron pump. Because of the flexibility built into this product line to meet a large variety of applications, the connection codes are determined by a lot more factors than just the size of the tubing. Connection code is probably the wrong name for this selection because you are selecting more than just the tubing size. This code also determines the type of valves used in the pump. The valve type is determined by factors such as flow rate of the pump, ball type selected and viscosity of the fluid you will be pumping.

Flow Rate:

The pump you select is rated to pump a certain number of gallons per hour (GPH). When selecting the connection code, please note the GPH limitations and select a connection that fits within the parameters of the pump model that you selected.

Ball Type:

If the material selected for the balls used in the check valves is TFE, you will probably need to use a spring-loaded connection. This is due to the fact that the weight of the balls will not allow them to seat properly without the spring. See the connection chart for a list of spring loaded connection types.

Viscosity:

Viscosity of the fluid you are pumping impacts the connection. The higher viscosity fluids (>3000 cps) require larger connection types and spring-loaded valves. Medium viscosity fluids (1000 to 3000 cps) can be pumped without the spring-loaded valves but you must use SS balls with these connections in order for the balls to seat properly in the valve.

Degassing Head:

The degassing head assembly is the solution to pumping gas producing chemicals such as hydrogen peroxide or high strength sodium hypochlorite. The unique de-gas valve system is designed to allow air to be vented from the pump head while minimizing the return fluid volume. It also prevents the pump from losing its prime due to gas build up. The degassing head will be available on all PULSAtron pumps with volumes <44GPD & pressures <150PSI. This feature is only available with the wet-end codes VVC9, VHC9, and VTC9.

Connection Codes

Code	Connect Type	Suction	Discharge	Spring	GPH Flow Limitations-125 SPM	GPH Flow Limitations-250 SPM	Viscosity	Other Factors
2	Piping	.25" FNPT	.25" FNPT		0 - 1.88	0-3.76	1000 up to 3000 cps w/ SS balls	No Bleed Valve
4	Piping	.25" FNPT	.25" FNPT		1.63 - 10	3.26-20	1000 up to 3000 cps w/ SS balls	No Bleed Valve
6	Piping	.25" FNPT	.25" FNPT	Yes	Up to 10	NA	less than 10,000 cps	No Bleed Valve
8	Piping	.50" FNPT	.50" FNPT	Yes	Up to 25	NA	less than 10,000 cps	No Bleed Valve
C	Piping	.50" FNPT	.50" FNPT		25	50	1000 up to 3000 cps w/ SS balls	No Bleed Valve
G	Piping	.25" FNPT	.25" FNPT	Yes	0 - 1.88	0-3.76	1000 up to 3000 cps w/ SS balls	No Bleed Valve
I	Piping	.50" MNPT	.50" MNPT	Yes	Up to 10	NA	less than 10,000 cps	No Bleed Valve
L	Piping	.50" MNPT	.50" MNPT		0 - 1.88	0-3.76	1000 up to 3000 cps w/ SS balls	No Bleed Valve
X	Piping	.50" MNPT	.50" MNPT		1.63 - 10	3.26-20	1000 up to 3000 cps w/ SS balls	No Bleed Valve
1	Tubing	.25" x .38"	.25" x .38"		0 - 1.88	0-3.76	1000 up to 3000 cps w/ SS balls	
3	Tubing	.38" x .50"	.38" x .50"		1.63 - 10	3.26-20	1000 up to 3000 cps w/ SS balls	
5	Tubing	.50" x .75"	.38" x .50"	Yes	Up to 10	NA	less than 10,000 cps	
7	Tubing	.50" x .75"	.50" FNPT	Yes	Up to 25	NA	less than 10,000 cps	No Bleed Valve
9	Tubing	.25" x .38"	.25" x .38"	Yes	0 - 1.88	0-3.76	1000 up to 3000 cps w/ SS balls	Degas Head/No Bleed Valve
A	Tubing	.38" x .50"	.38" x .50"		0 - 1.88	0-3.76	1000 up to 3000 cps w/ SS balls	
B	Tubing	.50" x .75"	.50" x .75"		25	50	1000 up to 3000 cps w/ SS balls	No Bleed Valve
D	Tubing	.25" x .38"	.25" x .38"	Yes	0 - 1.88	0-3.76	1000 up to 3000 cps w/ SS balls	
E	Tubing	.38" x .50"	.38" x .50"	Yes	0 - 1.88	0-3.76	1000 up to 3000 cps w/ SS balls	
F	Tubing	.38" x .50"	.38" x .50"	Yes	1.63 - 10	3.26-20	1000 up to 3000 cps w/ SS balls	Not Available In PVDF
H	Tubing	.25" x .38"	.25" x .38"		1.63 - 10	3.26-20	1000 up to 3000 cps w/ SS balls	
J	Tubing	.25" x .38"	.25" x .38"		0 - 1.04	0-2.08	1000 up to 3000 cps w/ SS balls	
K	Tubing	.50" x .75"	.50" x .75"	Yes	1.88 - 25 (<50 psi)	NA	less than 10,000 cps	No Bleed Valve
Metric Connections					LPH Flow Limitations	LPH Flow Limitations		
M	Piping	G 1/2 A	G 1/2 A		6.15 - 37.85	12.3-75.7	1000 up to 3000 cps w/ SS balls	
R	Piping	G 1/2 A	G 1/2 A		0 - 7.10	0-14.2	1000 up to 3000 cps w/ SS balls	
P	Tubing	4 x 6 mm	4 x 6 mm		0 - 3.94	0-7.88	1000 up to 3000 cps w/ SS balls	
S	Tubing	6 x 8 mm	6 x 8 mm		> 18.93	> 37.86	1000 up to 3000 cps w/ SS balls	
T	Tubing	6 x 8 mm	6 x 8 mm		0 - 7.10	0-14.2	1000 up to 3000 cps w/ SS balls	Degas Head/No Bleed Valve
U	Tubing	6 x 8 mm	6 x 8 mm		0 - 7.10	0-14.2	1000 up to 3000 cps w/ SS balls	
V	Tubing	12 x 19 mm	12 x 19 mm		> 29.96	>59.92	1000 up to 3000 cps w/ SS balls	No Bleed Valve
W	Tubing	8 x 12 mm	8 x 12 mm		3.94 - 37.85	7.88-75.7	1000 up to 3000 cps w/ SS balls	
Y	Tubing	9 x 12 mm	9 x 12 mm		0 - 7.10	0-14.2	1000 up to 3000 cps w/ SS balls	

Pumps ranging from 0.25 gph (0.9 lph) to 0.90 gph (3.4 lph) with the stainless steel ball option ("S" in the 9th digit of the model number) must select a connection code with a spring.

- Pumps less than or equal to .25 gph (0.9 lph) require a connection code with a spring and must use a ceramic ball in place of stainless steel.
- Stainless steel head assemblies are only available in piping connections.

Suffix Code:

LB02SA-PTC1-XXX ← Suffix Code

The last three digits of the model string are referred to as the Suffix Code. It is through the suffix code that the pump can be customized with optional features or customer specific features, e.g. private labeling. If your company has specific features that will be ordered on every pump, contact customer service with a description of what you want customized. We will then assign a unique suffix code that can be used as the last three digits in the model string when you place an order.

Standard Suffix Code Descriptions:

On the following pages are additional features that can be added to your PULSAtron pump through the use of the Suffix Code. Anytime you order a pump with one of these codes, it will be configured with that option.

CZ XXX = CE Approval

This suffix code tells us that you require CE Approval on the pump you are ordering. This suffix code is seven to nine digits and can be used in conjunction with other suffix codes by replacing the XXX after the CZ ___ with another suffix code. For instance, if you require CE Approval and a Five Function Valve, the suffix code would be CZEURO500.

130 = PVDF Tubing

This suffix code will replace the standard pump tubing with PVDF Tubing.

500 = Five Function Valve

The five function valve is easily installed, no tools required. The valve operates with all PULSAtron models up to 240 GPD. The five function valve is packed with features that increase safety, enhance performance and generally improves the convenience of operation.

FEATURES

- Pressure Relief – Allows for relief of excessive pressure in discharge line to protect connections and tubing.
- Back Pressure – Maintains output reproducibility and allows metering into atmospheric discharge.
- Anti-Siphon – Prevents siphoning through the pump when point of injection is lower than the pump or into the suction line of another pump. Rated at total vacuum.
- Air Bleed – Used during priming to manually remove air from the pump head.
- Discharge Drain – Depressurize pump discharge line without loosening tubing or fittings. Protects the operator from chemical exposure.

SPECIFICATIONS

Material Of Construction:

Valve Body	Polyvinylidene Flouride (PVDF)
Diaphragm	TFE faced CSPE
O-Rings	TFE
Hardware	18-8 Stainless Steel (Recessed)

Maximum Operating

Pressure:	250 PSI/17 BAR
Maximum Flow:	10 GPH (37.85 LPH)
Maximum Viscosity:	1000 CPS

Pressure Relief

Settings:	275 PSI (17 BAR) - red
(nominal cracking	175 PSI (12 BAR) - green
pressure)	125 PSI (8.6 BAR) - blue
	50 PSI (2.8 BAR) - black (PVC only)

Note: Pressure relief will occur at no more than 50% above maximum rating of pump.

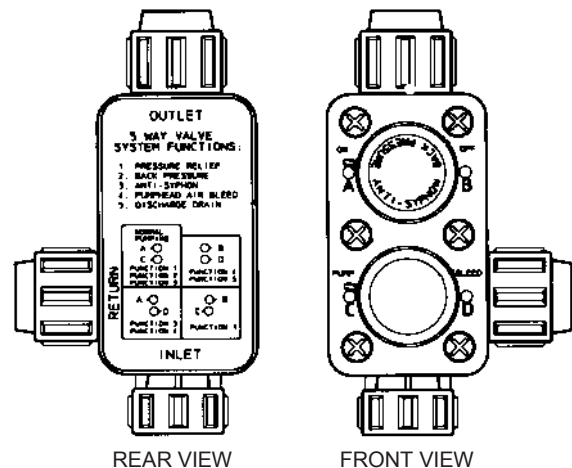

OPERATION

The functions are selected by setting two dual position selector knobs. The label on the back panel of the valve identifies each function with selector knob positions.

The five function valve is compatible with most PULSAtron pumps. Connected to the existing discharge valve the five function valve is capable of handling a large output flow as well as viscous liquids. A return port located on the side body provides flow of chemical back to the solution tank when in the air bleed or drain discharge mode.

520 = DG/5FV Five Function Valve with De-Gas

With the DG/5FV you don't have to give up the accuracy and control of a solenoid metering pump in order to pump gaseous solutions. Available in a variety of materials and popular sizes, the DG/5FV is ready to tackle most applications. Not only does the DG/5FV provide degassing, it is packed with features that increase safety, enhance performance and generally improves the convenience of operation.

FEATURES

- De-Gas – Bypass gasses and fluid during normal pump operation. Allows for the constant removal of gases that would otherwise “air bind” the pump.
- Back Pressure – Maintains output reproducibility and allows metering into atmospheric discharge.
- Anti-Siphon – Prevents siphoning through the pump when point of injection is lower than the pump or into the suction line of another pump. Rated at total vacuum.
- Air Bleed – Used during priming to manually remove air from the pump head.
- Discharge Drain – Depressurize pump discharge line without loosening tubing or fittings. Protects the operator from chemical exposure.

SPECIFICATIONS

Material Of Construction:

Valve Body	Polyvinylidene Fluoride (PVDF)
Diaphragm	TFE faced CSPE
O-Rings	Viton or CSPE
Hardware	18-8 Stainless Steel (Recessed)
Maximum Flow:	10 GPH (37.85 LPH)
Minimum Flow:	3 GPD (.47LPH)
Maximum Viscosity:	1000 CPS
MAX Pressure Ratings:	Up to 250 psi (17 BAR)
Note:	Degas/bypass volume is adjustable, typically 1-10% of pump output.
Connections:	1/4" (0.635 cm) Male NPT 1/2" (1.27 cm) OD tubing 3/8" (0.95 cm) OD tubing

All ports (input, output & bypass) on the selected valve will be the same.

ITS = Integrated Tank System

The ITS System is a completely integrated tank system constructed of high density UV resistant polyethylene (PE) with a 15 gallon capacity. This tank system is translucent with 5 gallon increments and the tank's low level indicator allows visual monitoring of chemicals without opening the tank. The tight fitting child-proof lid keeps the chemical free of contaminants and protects the surrounding area from chemical fumes.

The ITS System also allows for easy access to the liquid end and control panel of the mounted pump.

A system consists of a chemical tank with lid and bulkhead fittings; a liquid level indicator float assembly; and feeder mounting hardware.

ITS Tank not available on LM, LP, If you require a different type or size tank, please refer to our accessory price book.

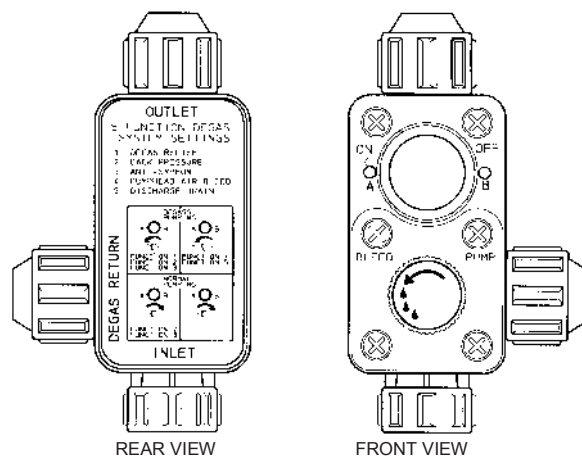

OPERATION

The functions are selected by setting two dual position selector knobs. The label on the back panel of the DG/5FV identifies each function with selector knob positions.

The DG/5FV is compatible with most PULSAtron pumps. Connected to the existing discharge valve the GG/5FV is capable of handling a large output flow as well as viscous liquids. A return port located on the side body provides flow of chemical back to the solution tank when in the degas, air bleed or drain discharge mode.



PULSAtron® Electronic Metering Pumps

Series MP

Key Features

- Automatic Control, Fully scalable 4-20mA current signal that can also be calibrated to precisely match the current signal reading of the sending device.
- Manual Control allows for a combined 1000:1 turndown resulting in accurate metering for critical applications.
- Flow Verification option is available on select sizes.
- Relay Output for computer interface or AC power allows for external control.
- Six-button Touch Pad Control with internationally recognized symbols for simplified programming.
- Simple Prompts in plain language allow for easy-to-understand instructions for programming. Available in three languages.
- Alarm Signals for signal loss, full count, circuit failure, pulse overflow and pulse rate high. Liquid low level indicator capability is standard.
- Timed Sequences can be set for selected intervals and rate for repetitive metering.
- Pulse Signals can be multiplied or divided by 1 to 999 allowing for pumps to handle peak requirements.
- LCD, 3 line backlit multi-lingual display allows for easy reading and user-friendly programming.
- Calibrated Flow Rate display with total volume pumped last day, month and since last reset.



Pressure and Flow Rate Capacity

MODEL	LMK2	LMB2	LMA2	LMD3	LMB3	LMA3	LMK3	LMF4	LMD4	LMB4	LMH4	LMG4	LME4	LMK5	LMH5	LMH6	LMK7	LMH7	LMH8	
Capacity nominal	GPH	0.13	0.21	0.25	0.50	0.50	0.50	0.60	0.85	0.90	1.00	1.70	1.75	1.85	2.50	3.15	5.00	8.00	10.00	21.00
	GPD	3	5	6	12	12	12	14	20	22	24	41	42	44	60	76	120	192	240	504
Pressure (max.)	LPH	0.5	0.8	0.9	1.9	1.9	1.9	2.3	3.2	3.4	3.8	6.4	6.6	7.0	9.5	11.9	18.9	30.3	37.9	79.5
	PSIG	300	250	150	250	150	100	100	250	150	100	250	150	100	150	150	100	50	35	20
Connections	Tubing	1/4" ID X 3/8" OD											3/8" ID X 1/2" OD							
		3/8" ID X 1/2" OD											1/2" ID X 3/4" OD (LPH8 ONLY) FLOW VERIFICATION (See Note)							
Piping	1/4" FNPT											1/4" FNPT								
												1/2" FNPT								

Note: Flow Verification: Available on K3, B4 and E4 with connection code 1; H6, K7 and H7 with connection code H; 1/4" ID x 3/8" OD only.

Engineering Data

Reproducibility:	+/- 2% at maximum capacity
Viscosity Max CPS:	
For viscosity up to 3000 CPS, select connection size 3, 4, B or C with 316SS ball material. Flow rate will determine connection/ball size. Greater than 3000 CPS require spring loaded ball checks. See Selection Guide for proper connection.	
Controls:	6-Station Membrane Switch
Status Display:	16-Position LCD Dot Matrix Backlight
LED Indicator Lights, Panel Mount:	Power On - Green Pulsing - Green Flashing Stop - Red
Stroke Frequency Max SPM:	125
External Stroke Frequency Control (Automatic):	4-20 mADC, 20-4 mADC External Pacing
Output Relay (Signal Level Option):	24 VDC, 10 mA
Output Relay (Power Option):	250 VAC, 50/60 HZ, 0.5A
Stroke Frequency Turn-Down Ratio:	100:1
Stroke Length Turn-Down Ratio:	10:1

Engineering Data

Power Input:	115 VAC/50-60 HZ/1 ph 230 VAC/50-60 HZ/1 ph
Average Current Draw:	
@ 115 VAC; Amps:	1.0 Amps
@ 230 VAC; Amps:	0.5 Amps
Peak Input Power:	300 Watts
Average Input Power @ Max SPM:	130 Watts

PULSAtron Series MP Selection Guide

MODELS:		
K2	=	0.13 gph / 3 gpd (0.5 lph) max pres.: 300 PSI (21 BAR)
B2	=	0.21 gph / 5 gpd (0.8 lph) max pres.: 250 PSI (17 BAR)
D3	=	0.50 gph / 12 gpd (1.9 lph) max pres.: 250 PSI (17 BAR)
F4	=	0.85 gph / 20 gpd (3.2 lph) max pres.: 250 PSI (17 BAR)
H4	=	1.70 gph / 41 gpd (6.4 lph) max pres.: 250 PSI (17 BAR)
A2	=	0.25 gph / 6 gpd (0.9 lph) max pres.: 150 PSI (10 BAR)
B3	=	0.50 gph / 12 gpd (1.9 lph) max pres.: 150 PSI (10 BAR)
D4	=	0.90 gph / 22 gpd (3.4 lph) max pres.: 150 PSI (10 BAR)
G4	=	1.75 gph / 42 gpd (6.6 lph) max pres.: 150 PSI (10 BAR)
K5	=	2.50 gph / 60 gpd (9.5 lph) max pres.: 150 PSI (10 BAR)
H5	=	3.15 gph / 76 gpd (11.9 lph) max pres.: 150 PSI (10 BAR)
A3	=	0.50 gph / 12 gpd (1.9 lph) max pres.: 100 PSI (7 BAR)
K3	=	0.60 gph / 14 gpd (2.3 lph) max pres.: 100 PSI (7 BAR)
B4	=	1.00 gph / 24 gpd (3.8 lph) max pres.: 100 PSI (7 BAR)
E4	=	1.85 gph / 44 gpd (7.0 lph) max pres.: 100 PSI (7 BAR)
G5	=	4.00 gph / 96 gpd (15.1 lph) max pres.: 100 PSI (7 BAR)
H6	=	5.00 gph / 120 gpd (18.9 lph) max pres.: 100 PSI (7 BAR)
K7	=	8.00 gph / 192 gpd (30.3 lph) max pres.: 50 PSI (3.3 BAR)
H7	=	10.0 gph / 240 gpd (37.9 lph) max pres.: 35 PSI (2.4 BAR)
H8	=	21.0 gph / 504 gpd (79.5 lph) max pres.: 20 PSI (1.3 BAR)

CONTROLS:		
T	=	Signal Level Output Relay
K	=	Power Level Output Relay

ELECTRICAL:		
A	=	115 Volt / 50-60Hz
1	=	115 Volt / 50-60Hz (without agency approvals)
B	=	230 Volt / 50-60Hz / 1ph with 6' (1.8m) 3-wire US Plug
2	=	230 Volt / 50-60Hz (without agency approvals)

LIQUID END MATERIALS:		
PTC	=	GFPPL / TFE / Ceramic
KTC	=	PVDF / TFE / Ceramic (not available on H8)
VHC	=	PVC / CSPE / Ceramic (not available on H7, H8, K7)
VTC	=	PVC / TFE / Ceramic (models <= 150 psi excluding H7, H8, K7)
WTC	=	PVC / TFE / Ceramic (models > 150 psi and H7, H8, K7)
VVC	=	PVC / Viton / Ceramic (not available on H8)
ATS	=	316 S.S. / TFE / 316 S.S. (must use FNPT piping connection) (not available on H8)

See page 6 for additional liquid end materials.

CONNECTION SIZES:		
1	=	Tubing .25" I.D. x .38" O.D. / .25" Ball, 0 - 1.88 GPH
3	=	Tubing .38" I.D. x .50" O.D. / .38" Ball, 1.63 - 10 GPH
9	=	Degas Head: .25" I.D. x .38" O.D. / 0-1.83 GPH
J	=	Tubing, .25" I.D. x .38" O.D. / .19 Ball; 0 - 1.04 GPH
METRIC:		
M	=	G 1/2 A Threads, .38" Ball, 6.15 - 37.85 LPH
R	=	G 1/2 A Threads, .25" Ball, 0 - 7.10 LPH
Y	=	9 x 12mm, .25" Ball, 0 - 7.10 LPH

Please Refer to page 7 for additional connection sizes. All pumps with tubing connections come with the following items (except for LMH8, LPH8, HV Series pumps): 4' Suction, 4' Return, 8' discharge tubing, footvalve/strainer assy., injection valve and bleed valve.

SUFFIX CODES:		
XXX	=	No Additional Options
130	=	PVDF Tubing
500	=	Five Function Valve
520	=	Five Function Degas Valve
FVE	=	Flow Verification / EPDM (not available on pumps greater than 100 psi or H8 pump)
FVV	=	Flow Verification / Viton (not available on pumps greater than 100 psi or H8 pump)
ITS	=	15 gal. ITS Tank System (ITS Tank not available on LM, LP, LT, and LE: H4, H5, H6, H7, H8, J7, K7 models)
CZ_XXX	=	CE Approval (CZXXX=Europe; CZUKXXX=UK; CZSUIXXX=Switzerland/Liechtenstein)

See pages 8 & 9 for additional information and specs.

A completed model number should look like 'LMB3TA-PTC1-XXX'

Dimensions

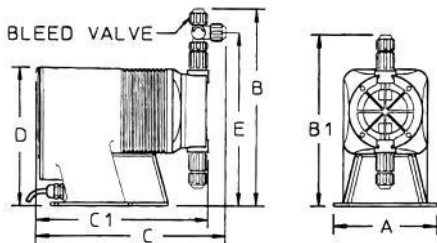

Series MP Dimensions (inches)

Model No.	A	B	B1	C	C1	D	E	Shpg Wt	Model No.	A	B	B1	C	C1	D	E	Shpg Wt
LMA2	5.4	10.3	-	10.8	-	7.5	8.9	13	LMH4	6.2	10.9	-	11.2	-	8.2	9.5	21
LMA3	5.4	10.6	-	10.7	-	7.5	9.2	13	LMH5	6.2	11.3	-	11.2	-	8.2	9.9	21
LMB2	5.4	10.3	-	10.8	-	7.5	8.9	13	LMH6	6.2	11.3	-	11.2	-	8.2	9.9	21
LMB3	5.4	10.6	-	10.7	-	7.5	9.2	13	LMH7	6.1	11.7	-	11.2	-	8.2	10.3	21
LMB4	5.4	10.6	-	10.7	-	7.5	9.2	13	LMH8*	6.1	-	10.9	-	10.6	8.2	-	25
LMD3	5.4	10.6	-	11.2	-	7.5	9.2	15	LMK2	5.4	10.3	-	10.8	-	7.5	8.9	13
LMD4	5.4	10.6	-	11.2	-	7.5	9.2	15	LMK3	5.4	10.6	-	10.7	-	7.5	9.2	13
LME4	5.4	10.6	-	11.2	-	7.5	9.2	15	LMK5	5.4	10.9	-	11.7	-	7.5	9.5	18
LMF4	5.4	10.6	-	11.7	-	7.5	9.2	18	LMK7	6.1	11.7	-	11.2	-	8.2	10.3	21
LMG4	5.4	10.6	-	11.7	-	7.5	9.2	18									

NOTE: Inches X 2.54 = cm / * the LMH8 is designed without a bleed valve available

PULSAtron® *Electronic Metering Pumps*

Series E PLUS

Key Features

- **Automatic Control**, available with 4-20 mA DC direct or external pacing, with stop function.
- **Manual Control** by on-line adjustable stroke rate and stroke length.
- **Auto-Off-Manual** switch.
- **Highly Reliable** timing circuit.
- **Circuit Protection** against voltage and current upsets.
- **Panel Mounted Fuse**.
- **Solenoid Protection** by thermal overload with auto reset.
- **Water Resistant**, for outdoor and indoor applications.
- **Indicator Lights**, panel mounted.
- **Guided Ball Check Valve Systems**, to reduce back flow and enhance outstanding priming characteristics.
- **Safe & Easy Priming** with durable leak-free bleed valve assembly (standard).



Pressure and Flow Rate Capacity

MODEL	LPK2	LPB2	LPA2	LPD3	LPB3	LPA3	LPK3	LPF4	LPD4	LPB4	LPH4	LPG4	LPE4	LPK5	LPH5	LPG5	LPH6	LPK7	LPH7	LPJ7	LPH8	
Capacity nominal (max.)	GPH	0.13	0.21	0.25	0.5	0.50	0.50	0.60	0.85	0.90	1.00	1.70	1.75	1.85	2.50	3.15	4	5.00	8.00	10.00	10.00	25.00
	GPD	3	5	6	12	12	12	14	20	22	24	41	42	44	60	76	96	120	192	240	240	600
Pressure (max.)	LPH	0.5	0.8	0.9	1.9	1.9	1.9	2.3	3.2	3.4	3.8	6.4	6.6	7	9.5	11.9	15.1	18.9	30.3	37.9	37.9	94.6
	PSIG	300	250	150	250	150	100	100	250	150	100	250	150	100	150	150	100	100	50	35	80	30
Connections	BAR	21	17	10	17	10	7	7	17	10	7	17	10	7	10	10	7	7	3.3	2.4	5.5	2
	Tubing	1/4" ID X 3/8" OD 3/8" ID X 1/2" OD										3/8" ID X 1/2" OD 1/2" ID X 3/4" OD (LPH8 ONLY)										
Piping	1/4" FNPT										1/4" FNPT 1/2" FNPT											

Engineering Data

Reproducibility: +/- 2% at maximum capacity

Viscosity Max CPS :

For viscosity up to 3000 CPS, select connection size 3, 4, B or C with 316SS ball material. Flow rate will determine connection/ball size. Greater than 3000 CPS require spring loaded ball checks. See Selection Guide for proper connection.

Stroke Frequency Max SPM: 125

Stroke Frequency Turn-Down Ratio: 10:1

Stroke Length Turn-Down Ratio: 10:1

Power Input: 115 VAC/50-60 HZ/1 ph

230 VAC/50-60 HZ/1 ph

Average Current Draw:

@ 115 VAC; Amps: 1.0 Amps

@ 230 VAC; Amps: 0.5 Amps

Peak Input Power: 300 Watts

Average Input Power @ Max SPM: 130 Watts

PULSAtron Series E Plus Selection Guide

MODELS:	K2	= 0.13 gph / 3 gpd (0.5 lph) max pres.: 300 PSI (21 BAR)
	B2	= 0.21 gph / 5 gpd (0.8 lph) max pres.: 250 PSI (17 BAR)
	D3	= 0.50 gph / 12 gpd (1.9 lph) max pres.: 250 PSI (17 BAR)
	F4	= 0.85 gph / 20 gpd (3.2 lph) max pres.: 250 PSI (17 BAR)
	H4	= 1.70 gph / 41 gpd (6.4 lph) max pres.: 250 PSI (17 BAR)
	A2	= 0.25 gph / 6 gpd (0.9 lph) max pres.: 150 PSI (10 BAR)
	B3	= 0.50 gph / 12 gpd (1.9 lph) max pres.: 150 PSI (10 BAR)
	D4	= 0.90 gph / 22 gpd (3.4 lph) max pres.: 150 PSI (10 BAR)
	G4	= 1.75 gph / 42 gpd (6.6 lph) max pres.: 150 PSI (10 BAR)
	K5	= 2.50 gph / 60 gpd (9.5 lph) max pres.: 150 PSI (10 BAR)
	H5	= 3.15 gph / 76 gpd (11.9 lph) max pres.: 150 PSI (10 BAR)
	A3	= 0.50 gph / 12 gpd (1.9 lph) max pres.: 100 PSI (7 BAR)
	K3	= 0.60 gph / 14 gpd (2.3 lph) max pres.: 100 PSI (7 BAR)
	B4	= 1.00 gph / 24 gpd (3.8 lph) max pres.: 100 PSI (7 BAR)
	E4	= 1.85 gph / 44 gpd (7.0 lph) max pres.: 100 PSI (7 BAR)
	G5	= 4.00 gph / 96 gpd (15.1 lph) max pres.: 100 PSI (7 BAR)
	H6	= 5.00 gph / 120 gpd (18.9 lph) max pres.: 100 PSI (7 BAR)
	K7	= 8.00 gph / 192 gpd (30.3 lph) max pres.: 50 PSI (3.3 BAR)
	H7	= 10.0 gph / 240 gpd (37.9 lph) max pres.: 35 PSI (2.4 BAR)
	J7	= 10.0 gph / 240 gpd (37.9 lph) max pres.: 80 PSI (5.5 BAR)
	H8	= 25.0 gph / 600 gpd (94.6 lph) max pres.: 30 PSI (2 BAR)

CONTROLS:	S	= Manual On/Off
	M	= 4-20mADC Direct, w/ Stop
	E	= External/Remote Pacing, w/ Stop

ELECTRICAL:	A	= 115 Volt / 50-60Hz
	1	= 115 Volt / 50-60Hz (without agency approvals)
	B	= 230 Volt / 50-60Hz / 1ph with 6' (1.8m) 3-wire US Plug
	2	= 230 Volt / 50-60Hz (without agency approvals)

LIQUID END MATERIALS:	PTC	= GFPP / TFE / Ceramic
	PTT	= GFPP / TFE / TFE
Pump Head & Fittings/Seats & O-rings/Balls	KTC	= PVDF / TFE / Ceramic (not available on H8)
	VHC	= PVC / CSPE / Ceramic (not available on H7, H8, J7, K7)
	VTC	= PVC / TFE / Ceramic (models <= 150 psi excluding H7, H8, J7, K7)
	WTC	= PVC / TFE / Ceramic (models > 150 psi and H7, H8, J7, K7)
	ATS	= 316 S.S. / TFE / 316 S.S. (must use FNPT piping connection) (not available on H8)

See page 6 for additional liquid end materials.

CONNECTION SIZES:	1	= Tubing .25" I.D. x .38" O.D. / .25" Ball, 0 - 1.88 GPH
	3	= Tubing .38" I.D. x .50" O.D. / .38" Ball, 1.63 - 10 GPH
	4	= Piping .25" FNPT / .38" Ball, 1.63 - 10 GPH
	B	= Tubing .50" I.D. x .75" O.D. / .50" Ball, 25 GPH only
	METRIC:	
	M	= G 1/2 A Threads, .38" Ball, 6.15 - 37.85 LPH
	R	= G 1/2 A Threads, .25" Ball, 0 - 7.10 LPH
	Y	= 9 x 12mm, .25" Ball, 0 - 7.10 LPH

Please Refer to page 7 for additional connection sizes. All pumps with tubing connections come with the following items (except for LMH8, LPH8, HV Series pumps): 4' Suction, 4' Return, 8' discharge tubing, footvalve/strainer assy., injection valve and bleed valve.

SUFFIX CODES:	XXX	= No Additional Options
	130	= PVDF Tubing
	500	= Five Function Valve
	520	= Five Function Degas Valve
	ITS	= 15 gal. ITS Tank System (ITS Tank not available on LM, LP, LT, and LE: H4, H5, H6, H7, H8, J7, K7 models)
	CZ XXX	= CE Approval (CZXXX=Europe; CZUKXXX=UK; CZSUIXXX=Switzerland/Liechtenstein)

See pages 8 & 9 for additional information and specs.

A completed model number should look like 'LPB3SA-PTC1-XXX'

Dimensions

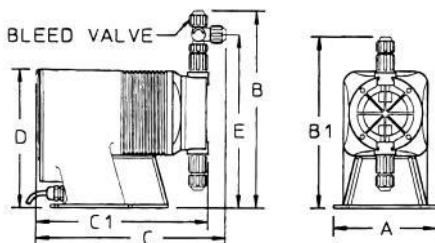

Series E Plus Dimensions (inches)

Model No.	A	B	B1	C	C1	D	E	Shpg Wt	Model No.	A	B	B1	C	C1	D	E	Shpg Wt
LPA2	5.4	10.3	-	10.8	-	7.5	8.9	13	LPH4	6.2	10.9	-	11.2	-	8.2	9.5	21
LPA3	5.4	10.6	-	10.7	-	7.5	9.2	13	LPH5	6.2	11.3	-	11.2	-	8.2	9.9	21
LPB2	5.4	10.3	-	10.8	-	7.5	8.9	13	LPG5	6.2	11.3	-	11.2	-	8.2	9.9	21
LPB3	5.4	10.6	-	10.7	-	7.5	9.2	13	LPH6	6.2	11.3	-	11.9	-	8.2	9.9	21
LPB4	5.4	10.6	-	10.7	-	7.5	9.2	13	LPH7	6.1	11.7	-	11.9	-	8.2	10.3	21
LPD3	5.4	10.6	-	11.2	-	7.5	9.2	15	LPH8*	6.1	-	10.9	-	11.3	8.2	-	26
LPD4	5.4	10.6	-	11.2	-	7.5	9.2	15	LPK2	5.4	10.3	-	10.8	-	7.5	8.9	13
LPE4	5.4	10.6	-	11.2	-	7.5	9.2	15	LPK3	5.4	10.6	-	10.7	-	7.5	9.2	13
LPF4	5.4	10.6	-	11.7	-	7.5	9.2	18	LPK5	5.4	10.9	-	11.7	-	7.5	9.5	18
LPG4	5.4	10.6	-	11.7	-	7.5	9.2	18	LPK7	6.1	11.7	-	11.2	-	8.2	10.3	21
									LPJ7	6.1	10.0	-	10.7	-	-	-	21

NOTE: Inches X 2.54 = cm /* the LPH8 is designed without a bleed valve available

PULSAtron® *Electronic Metering Pumps*

Series HV

Key Features

- **Automatic Control**, available with 4-20 mADC direct or external pacing, with stop function.
- **Manual Control** by on-line adjustable stroke rate and stroke length.
- **Agency approved** for demanding **OUTDOOR** and indoor applications.
- **Auto-Off-Manual** switch.
- **Highly Reliable** timing circuit.
- **Circuit Protection** against voltage and current upsets.
- **Panel Mounted Fuse.**
- **Solenoid Protection** by thermal overload with auto reset.
- **Water Resistant**, for outdoor and indoor applications.
- **Indicator Lights**, panel mounted.
- **Guided Ball Check Valve Systems**, to reduce back flow and enhance outstanding priming characteristics.
- **Viscosities to 20,000 CPS.**



Pressure and Flow Rate Capacity

MODEL		LVB3	LVF4	LVG4	LVG5	LVH7
Capacity nominal (max.)	GPH	0.50	1.00	2.00	4.00	10.00
	GPD	12	24	48	96	240
	LPH	1.9	3.8	7.6	15.1	37.9
Pressure (max.)	PSIG	150	150	110	110	80
	BAR	10	10	7	7	5.6
Connections	Tubing	(S) .50" I.D. X .75" O.D. .38" I.D. X .50" OD (LVB3 & F4 only) (S & D) .50" I.D. X .75" O.D. (LVG4,G5 & H7 only)				

Engineering Data

Reproducibility:	+/- 2% at maximum capacity
Viscosity Max CPS:	20,000 CPS
Stroke Frequency Max SPM:	125
Stroke Frequency Turn-Down Ratio:	10:1
Stroke Length Turn-Down Ratio:	10:1
Power Input:	115 VAC/50-60 HZ/1 ph 230 VAC/50-60 HZ/1 ph
Average Current Draw:	
@ 115 VAC; Amps:	1.0 Amps
@ 230 VAC; Amps:	0.5 Amps @ 230 VAC
Peak Input Power:	300 Watts
Average Input Power @ Max SPM:	130 Watts

PULSAtron Series HV Selection Guide		LV	---	---	---	---	---
MODELS:	B3	= 0.50 gph / 12 gpd (1.9 lph) max pres.: 150 PSI (10 BAR)					
	F4	= 1.00 gph / 24 gpd (3.8 lph) max pres.: 150 PSI (10 BAR)					
	G4	= 2.00 gph / 48 gpd (7.6 lph) max pres.: 110 PSI (7 BAR)					
	G5	= 4.00 gph / 96 gpd (15.1 lph) max pres.: 110 PSI (7 BAR)					
	H7	= 10.0 gph / 240 gpd (37.9 lph) max pres.: 80 PSI (5.6 BAR)					
CONTROLS:	S	= Manual On/Off					
	M	= 4-20mADC Direct, w/ Stop					
	E	= External/Remote Pacing, w/ Stop					
ELECTRICAL:	A	= 115 Volt / 50-60Hz					
	1	= 115 Volt / 50-60Hz (without agency approvals)					
	B	= 230 Volt / 50-60Hz / 1ph with 6' (1.8m) 3-wire US Plug					
	2	= 230 Volt / 50-60Hz (without agency approvals)					
LIQUID END MATERIALS:	PTT	= GFPL / TFE / TFE - LVB3 & F4 only					
Pump Head & Fittings/Seats & O-rings/Balls	PTS	= GFPL / TFE / 316 SS - LVG4, G5 & H7 only					
	WTS	= PVC / TFE / 316 SS - LVH7 only					
	VTT	= PVC / TFE / TFE - LVB3 & F4 only					
	VTS	= PVC / TFE / 316 SS - LVG5 & G4					
No other liquid end materials available.							
CONNECTION SIZES:	5	= Tubing (S) .50" I.D. x .75" O.D. / .38" I.D. x .50" O.D. - LVB3 & F4 only					
	K	= Tubing .50" I.D. x .75" O.D. - LVG4, G5 & H7 only					
No other connection sizes available. Pumps come with 4' suction tubing and 8' discharge tubing. No bleed valve available.							
SUFFIX CODES	XXX	= No Additional Options					
See pages 8 & 9 for additional information and specs.							
A completed model number should look like 'LVB3SA-VTT5-XXX'							

Dimensions

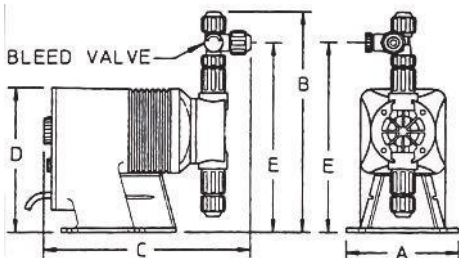

Series HV Dimensions (inches)					
Model No.	A	B	C	D	Shipping Weight
LVB3	5.4	9.3	9.5	7.5	13
LVF4	5.4	10.8	10.8	7.5	18
LVG4	5.4	9.5	10.6	7.5	18
LVG5	5.4	10.8	10.8	7.5	18
LVH7	6.1	11.5	11	8.2	25

NOTE: Inches X 2.54 = cm

PULSAtron® *Electronic Metering Pumps*

Series E

Key Features

- **Manual Control** by on-line adjustable stroke rate and stroke length.
- **Agency approved** for demanding **OUTDOOR** and indoor applications.
- **Highly Reliable** timing circuit.
- **Water Resistant** excellent for **OUTDOOR** and indoor applications.
- **Internally Dampened To Reduce Noise**, very acceptable for household installations.
- **Guided Ball Check Valve Systems**, to reduce back flow and enhance outstanding priming characteristics.
- **Premium Standard Wetted Component Materials**.
- **Few Moving Parts** and **Wall Mountable**.
- **Safe & Easy Priming** with durable leak-free **bleed valve assembly** (standard).



Pressure and Flow Rate Capacity

MODEL	LE12	LE02	LE33	LE13	LE03	LE34	LE14	LE44	
Capacity nominal (max.)	GPH	0.21	0.25	0.50	0.50	0.50	0.90	1.00	1.85
	GPD	5	6	12	12	12	22	24	44
	LPH	0.8	0.9	1.9	1.9	1.9	3.4	3.8	7
Pressure (max.)	PSIG	250	150	250	150	100	150	100	100
	BAR	17	10	17	10	7	10	7	7
Connections	Tubing	1/4" ID X 3/8" OD							
		3/8" ID X 1/2" OD							
	Piping	1/4" FNPT							

Engineering Data

Reproducibility:	+/- 3% at maximum capacity
Viscosity Max CPS:	For viscosity up to 3000 CPS, select connection size 3, 4, B or C with 316SS ball material. Flow rate will determine connection/ball size. Greater than 3000 CPS require spring loaded ball checks. See Selection Guide for proper connection.
Stroke Frequency Max SPM:	125
Stroke Frequency Turn-Down Ratio:	10:1
Stroke Length Turn-Down Ratio:	10:1
Power Input:	115 VAC/50-60 HZ/1 ph 230 VAC/50-60 HZ/1 ph
Average Current Draw:	
@ 115VAC; Amps:	1.0 Amps
@ 230 VAC; Amps:	0.5 Amps
Peak Input Power:	300 Watts
Average Input Power @ Max SPM:	130 Watts

PULSAtron Series E Selection Guide		LE	S				
MODELS:	12 = 0.21 gph / 5 gpd (0.8 lph) max pres.: 250 PSI (17 BAR) 33 = 0.50 gph / 12 gpd (1.9 lph) max pres.: 250 PSI (17 BAR) 02 = 0.25 gph / 6 gpd (0.9 lph) max pres.: 150 PSI (10 BAR) 13 = 0.50 gph / 12 gpd (1.9 lph) max pres.: 150 PSI (10 BAR) 34 = 0.90 gph / 22 gpd (3.4 lph) max pres.: 150 PSI (10 BAR) 03 = 0.50 gph / 12 gpd (1.9 lph) max pres.: 100 PSI (7 BAR) 14 = 1.00 gph / 24 gpd (3.8 lph) max pres.: 100 PSI (7 BAR) 44 = 1.85 gph / 44 gpd (7.0 lph) max pres.: 100 PSI (7 BAR)						
CONTROLS:	S = No Options Available						
ELECTRICAL:	A = 115 Volt / 50-60Hz 1 = 115 Volt / 50-60Hz (without agency approvals) B = 230 Volt / 50-60Hz / 1ph with 6' (1.8m) 3-wire US Plug 2 = 230 Volt / 50-60Hz (without agency approvals)						
LIQUID END MATERIALS: Pump Head & Fittings/Seats & O-rings/Balls	PHC = GFPP / CSPE / Ceramic PTC = GFPP / TFE / Ceramic KTC = PVDF / TFE / Ceramic (not available on J7 or H8) VHC = PVC / CSPE / Ceramic (not available on H7, H8, J7, K7) VTC = PVC / TFE / Ceramic (models <= 150 psi excluding H7, H8, J7, K7) WTC = PVC / TFE / Ceramic (models > 150 psi and H7, H8, J7, K7) ATS = 316 S.S. / TFE / 316 S.S. (must use FNPT piping connection) (not available on J7 or H8)						
See page 6 for additional liquid end materials.							
CONNECTION SIZES:	1 = Tubing .25" I.D. x .38" O.D. / .25" Ball, 0 - 1.88 GPH 3 = Tubing .38" I.D. x .50" O.D. / .38" Ball, 1.63 - 10 GPH METRIC: M = G 1/2 A Threads, .38" Ball, 6.15 - 37.85 LPH P = 4 x 6mm, .25" Ball, 0 - 3.94 LPH						
Please Refer to page 7 for additional connection sizes. All pumps with tubing connections come with the following items (except for LMH8, LPH8, HV SAeries pumps): 4' Suction, 4' Return, 8' discharge tubing, footvalve/strainer assy., injection valve and bleed valve.							
SUFFIX CODES:	XXX = No Additional Options 130 = PVDF Tubing 500 = Five Function Valve 520 = Five Function Degas Valve ITS = 15 gal. ITS Tank System (ITS Tank not available on LM, LP, LT, and LE: H4, H5, H6, H7, H8, J7, K7 models) CZ_XXX = CE Approval (CZXXX=Europe; CZUKXXX=UK; CZSUIXXX=Switzerland/Liechtenstein)						
See pages 8 & 9 for additional information and specs.							
A completed model number should look like 'LE33SA-PTC1-XXX'							

Dimensions

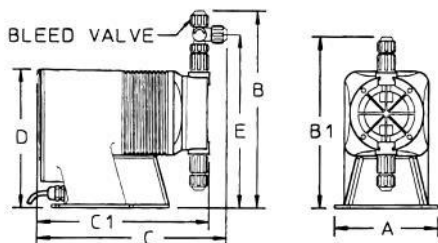

Model No.	A	B	B1	C	C1	D	E	Shpg Wt
LE02	5	9.6	-	9.5	-	6.4	8.2	7
LE03	5	9.8	-	9.5	-	6.4	8.4	7
LE12	5	9.6	-	9.5	-	6.4	8.2	7
LE13	5	9.8	-	9.5	-	6.4	8.4	7
LE14	5	9.8	-	9.5	-	6.4	8.4	7
LE33	5.4	10.6	-	11.2	-	7.5	9.2	12
LE34	5.4	10.6	-	11.2	-	7.5	9.2	12
LE44	5.4	10.6	-	11.2	-	7.5	9.2	12

NOTE: Inches X 2.54 = cm

PULSAtron® *Electronic Metering Pumps*

Series E-DC

Key Features

- **Powered by 12 Volt DC.**
- **Manual Control** by on-line adjustable stroke rate and stroke length.
- **Agency approved** for demanding **OUTDOOR** and indoor applications.
- **Highly Reliable** timing circuit.
- **Water Resistant** excellent for **OUTDOOR** and indoor applications.
- **Internally Dampened To Reduce Noise**, very acceptable for household installations.
- **Guided Ball Check Valve Systems**, to reduce back flow and enhance outstanding priming characteristics.
- **Premium Standard Wetted Component Materials.**
- **Few Moving Parts** and **Wall Mountable.**
- **Safe & Easy Priming** with durable leak-free bleed valve assembly (standard).



Pressure and Flow Rate Capacity

MODEL		LS02	LS13	LS14	LS44
Capacity nominal (max.)	GPH	0.25	0.50	1.00	1.85
	GPD	6	12	24	44
	LPH	0.9	1.9	3.8	7.0
Pressure (max.)	PSIG	150	150	100	100
	BAR	10	10	7	7
Connections	Tubing	1/4" ID X 3/8" OD			
		3/8" ID X 1/2" OD			
	Piping	1/4" FNPT			

Engineering Data

Reproducibility:	+/- 3% at maximum capacity
Viscosity Max CPS:	
LS02, 13:	300 CPS
LS14, 44:	1000 CPS
Stroke Frequency Max SPM:	125
Stroke Frequency Turn-Down Ratio:	10:1
Stroke Length Turn-Down Ratio:	10:1
Power Input:	12.6 VDC Nominal Range 11.8-14.0 VDC
Average Current Draw:	
LS02, 13, 14 Amps:	4.0 Amps
LS44 Amps:	8.0 Amps
Peak Input Power:	
LS02, 13, 14 Power:	138.6 Watts
LS44 Power:	189 Watts
Average Input Power @ Max SPM:	
LS02, 13, 14 Power:	50.4 Watts
LS44 Power:	100.8 Watts

PULSAtron Series E-DC Selection Guide

MODELS:	02	= 0.25 gph / 6 gpd (0.9 lph) max pres.: 150 PSI (10 BAR)	LS	S	4	-	-	-
	13	= 0.50 gph / 12 gpd (1.9 lph) max pres.: 150 PSI (10 BAR)						
	14	= 1.00 gph / 24 gpd (3.8 lph) max pres.: 100 PSI (7 BAR)						
	44	= 1.85 gph / 44 gpd (7.0 lph) max pres.: 100 PSI (7 BAR)						
CONTROLS:	S	= No Options Available						
ELECTRICAL:	4	= 12V DC						
LIQUID END MATERIALS:	PHC	= GFPPL / CSPE / Ceramic						
Pump Head & Fittings/Seats & O-rings/Balls	PTC	= GFPPL / TFE / Ceramic						
	PVC	= GFPPL / Viton / Ceramic						
	VTC	= PVC / TFE / Ceramic						
See page 6 for additional liquid end materials.								
CONNECTION SIZES:	1	= Tubing .25" I.D. x .38" O.D. / .25" Ball, 0 - 1.88 GPH						
	J	= Tubing .25" I.D. x .38" O.D./ 19" Ball, 0 - 1.04 GPH						
	METRIC:							
	M	= G 1/2 A Threads, .38" Ball, 6.15 - 37.85 LPH						
	R	= G 1/2 A Threads, .25" Ball, 0 - 7.10 LPH						
Please Refer to page 7 for additional connection sizes. All pumps with tubing connections come with the following items (except for LMH8, LPH8, HV Series pumps): 4' Suction, 4' Return, 8' discharge tubing, footvalve/strainer assy., injection valve and bleed valve.								
SUFFIX CODES:	XXX	= No Additional Options						
	130	= PVDF Tubing						
	500	= Five Function Valve						
	520	= Five Function Degas Valve						
	ITS	= 15 gal. ITS Tank System						
	CZ_XXX	= CE Approval (CZXXX=Europe; CZUKXXX=UK; CZSUIXXX=Switzerland/Liechtenstein)						
See pages 8 & 9 for additional information and specs.								

A completed model number should look like 'LS02S4-PTC1-XXX'

Dimensions

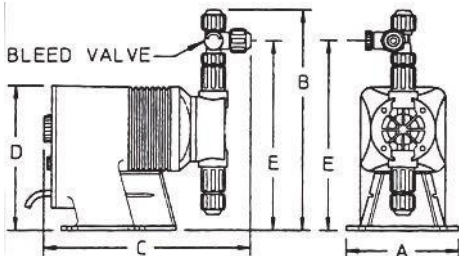

Series E-DC Dimensions (inches)						
Model No.	A	B	C	D	E	Shipping Weight
LS02	5.0	9.6	9.6	6.5	8.2	10
LS13	5.0	9.9	9.5	6.5	8.5	10
LS14	5.0	9.9	9.5	6.5	8.5	10
LS44	5.0	10.6	11.4	7.5	9.2	15

NOTE: Inches X 2.54 = cm

PULSAtron® *Electronic Metering Pumps*

Series A PLUS

Key Features

- **Manual Control** by on-line adjustable stroke rate and stroke length.
- **Agency approved** for demanding **OUTDOOR** and indoor applications.
- **Highly Reliable** timing circuit.
- **Water Resistant** excellent for **OUTDOOR** and indoor applications.
- **Internally Dampened To Reduce Noise**, very acceptable for household installations.
- **Guided Ball Check Valve Systems**, to reduce back flow and enhance outstanding priming characteristics.
- **Premium Standard Wetted Component Materials.**
- **Few Moving Parts** and **Wall Mountable.**
- **Safe & Easy Priming** with durable leak-free **bleed valve assembly** (standard).
- **Optional Control:**
 - External pace with auto/manual selection.
 - External stop function
 - 1000:1 turndown control (S2, S3 & S4 sizes only)



Pressure and Flow Rate Capacity

MODEL		LBC2	LB02	LBC3	LB03	LB04	LB64	LBC4	LBS2	LBS3	LBS4	
Capacity nominal (max.)	GPH	0.25	0.25	0.42	0.50	1.00	1.25	2.00	0.50	1.38	2.42	
	GPD	6	6	10	12	24	30	48	12	33	58	
	LPH	0.9	0.9	1.6	1.9	3.8	4.7	7.6	1.9	5.2	9.14	
Pressure ¹ (max.)	GFPP, PVDF, 316SS or PVC (W code) w/TFE Seats	PSIG (Bar)	250 (17)	150 (10)	250 (17)	150 (10)	100 (7)	100 (7)	50 (3.3)	250 (17)	150 (10)	100 (7)
	PVC (V code) Viton or CSPE Seats / Degas Liquid End		150 (10)							150 (10)		
Connections	Tubing	1/4" ID X 3/8" OD						3/8" ID X 1/2" OD		1/4" ID X 3/8" OD		
	Piping	1/4" FNPT										
Strokes/Minute	SPM	125								250		

Note 1: Pumps with rated pressure above 150 PSI will be de-rated to 150 PSI Max. when selecting certain valve options, see Price Book for details.

Engineering Data

Reproducibility: +/- 3% at maximum capacity
Viscosity Max CPS: 1000 CPS
Stroke Frequency Max SPM: 125 / 250 by Model
Stroke Frequency Turn-Down Ratio: 10:1 / 100:1 by Model
Stroke Length Turn-Down Ratio: 10:1
Power Input: 115 VAC/50-60 HZ/1 ph
 230 VAC/50-60 HZ/1 ph

Average Current Draw:
@ 115 VAC; Amps: 0.6 Amps
@ 230 VAC; Amps: 0.3 Amps
Peak Input Power: 130 Watts
Average Input Power @ Max SPM: 50 Watts

Pulsatron Series A Plus Selection Guide

Models

Product Code	Flow Rate			Pressure Rating ¹		Stroke Rate (SPM)	Standard Valve Size	Max. Viscosity (cps)
	GPD	GPH	LPH	PSI	BAR			
S2	12	0.50	1.9	250	17	250	J (TFE Only)	1,000
S3	33	1.38	5.2	150	10			
S4	58	2.42	9.1	100	7			
C2	6	0.25	0.9	250	17	125	J (TFE only)	
C3	10	0.42	1.6					
O2	6	0.25	0.9	150	10			
O3	12	0.50	1.9	100	7	1	3	
O4	24	1.00	3.8					
64	30	1.25	4.7	50	3.3			
C4	48	2.00	7.6					

Controls

S	Manual Control	100:1 Turndown	10:1 Stroke Length 10:1 Frequency
E	External Pace w/ Auto/Manual Switch		
P	Stop Function Option		
Q	External Pace w/ Stop (125 SPM only)		
X	Manual Control (S2, S3 & S4 sizes only)	1000:1 Turndown	10:1 Stroke Length 100:1 Frequency

Electrical

A	115 VAC, 60Hz
B	230 VAC, 50-60Hz, 1 Ph, 6' (2m) cord with 3 prong US plug
1	115 VAC, 60Hz less Agency Approvals
2	230 VAC, 50-60Hz, 1 Ph, 6' (2m) cord, no plug, less Agency

Liquid End Configuration - Head & Valves / Seats & O-Rings / Check Balls

PHC	GFPP / CSPE / Ceramic (150 PSI Max) ¹
PTC	GFPP / TFE / Ceramic
VTC	PVC / TFE / Ceramic (150 PSI Max) ¹
WTC	PVC / TFE / Ceramic (models > 150 PSI Max); For use on S2, C2, C3
KTC	PVDF / TFE / Ceramic
VVC	PVC / Viton / Ceramic (Not available with J Valve) (150 PSI Max) ¹
VHC	PVC / CSPE / Ceramic (Not available with J Valve) (150 PSI Max) ¹
Other	See Page 6 for additional materials of construction

Connection Sizes

J	Tubing .25" I.D. x .38" O.D. Standard for pumps from 0 - 33 GPD
1	Tubing .25" I.D. x .38" O.D. Standard for pumps from 20 - 45 GPD
3	Tubing .38" I.D. x .50" O.D. Standard for pumps from 45 - 240 GPD
9	Degas Head: Vent Tubing .25" I.D. x .38" O.D. (0-150 PSI pumps only)
Metric	
R	G 1/2 A Threads, .25" Ball, 0-7.1 LPH
Y	Tubing 9 x 12mm, .25" Ball, 0-7.1 LPH
Other	See Page 7 for additional connection options

Options

XXX	Standard Pump - No Options
130	PVDF Tubing
500	Five Function Valve
520	Five Function Degassing Valve
ITS	15 gal. ITS Tank System
CZ_XXX	CE Approval (CZXXX=Europe; CZUKXXX=UK; CZSUIXXX=Switzerland/Liechtenstein)

A completed model number should look like 'LB03SA-PTCJ-XXX'

Note 1: Pumps with rated pressure above 150 PSI will be de-rated to 150 PSI Max. when selecting these valve options.

Dimensions

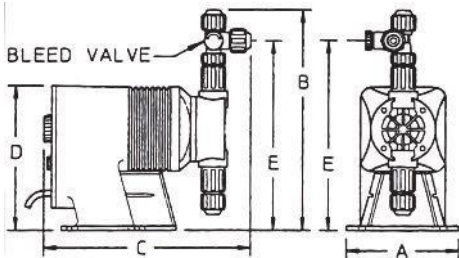

Series A PLUS Dimensions (inches)

Model No.	A	B	C	D	E	Shipping Weight
LB02 / S2	5.0	9.6	9.5	6.5	8.2	10
LBC2	5.0	9.9	9.5	6.5	8.5	10
LBC3	5.0	9.9	9.5	6.5	8.5	10
LB03 / S3	5.0	9.9	9.5	6.5	8.5	10
LB04 / S4	5.0	9.9	9.5	6.5	8.5	10
LB64	5.0	9.9	9.5	6.5	8.5	10
LBC4	5.0	9.9	9.5	6.5	8.5	10

NOTE: Inches X 2.54 = cm

PULSAtron® Electronic Metering Pumps with Integrated Controller

Series T7

Feed Control with 7 Day Timer

The Series T7 was designed to feed chemical products on a timed schedule. Typical applications include the feed of biocides in open-air cooling towers. The feed cycle is initiated and controlled by the programmable timer. The Series T7 provides everything you need in one unique, compact package to create a simple and cost effective metering system for timed applications.

Principal of Operation

The Series T7 is controlled by a 7-day programmable timer. The timer is programmable in 1-minute increments with up to 8 on/off cycles per day. Each timed event can be set to run any day of the week on a 7-day cycle.

Other control features include a standby mode, continuous 'ON' mode and the ability to adjust the stroke length from 0 – 100%.

Features

- Isolated from Earth Ground
- Mode Select Knob, Stroke Length
- 12, 22, 30 & 44 GPD @ 100 psi – 7 bar
- Stroke length adjust 0-100%. Turn down ratio 10:1



Pressure and Flow Rate Capacity

MODEL		LC13BA	LC14BA	LC64BA	LC44BA
Capacity nominal (max.)	GPH	0.50	1.00	1.25	2.00
	GPD	12	24	30	48
	LPH	1.9	3.8	4.7	7.6
Pressure (max.)	PSIG	100	100	100	50
	BAR	7	7	7	3.3

Engineering Data

Reproducibility:	+/- 3% at maximum capacity
Stroke Length Turn-Down Ratio:	10:1
Power Input:	115 VAC/50-60 HZ/1 ph 230 VAC/50-60 HZ/1 ph
Average Current Draw:	
@ 115 VAC; Amps:	0.6 Amps
@ 230 VAC; Amps:	0.3 Amps @ 230 VAC



7-Day Timer

Solid-state 7-day electronic timer for easy adjustment of metering schedules and feed rates. Manual control allows for easy priming and start-up. The timer is programmable in 1 minute increments, with up to 8 events per day.

PULSAtron Series T7 Selection Guide		LC	B				
MODELS:	13 = 0.50 gph / 12 gpd (1.9 lph) max pres.: 100 PSI (7 BAR) 14 = 1.00 gph / 24 gpd (3.8 lph) max pres.: 100 PSI (7 BAR) 64 = 1.25 gph / 30 gpd (4.7 lph) max pres.: 100 PSI (7 BAR) 44 = 2.00 gph / 48 gpd (7.6 lph) max pres.: 50 PSI (3.3 BAR)						
CONTROLS:	B = No Options Available						
ELECTRICAL:	A = 115 Volt / 50-60Hz 1 = 115 Volt / 50-60Hz (without agency approvals) B = 230 Volt / 50-60Hz / 1ph with 6' (1.8m) 3-wire US Plug 2 = 230 Volt / 50-60Hz (without agency approvals)						
LIQUID END MATERIALS:	PHC = GFPPL / CSPE / Ceramic PTC = GFPPL / TFE / Ceramic KTC = PVDF / TFE / Ceramic VHC = PVC / CSPE / Ceramic VTC = PVC / TFE / Ceramic						
See page 6 for additional liquid end materials.							
CONNECTION SIZES:	1 = Tubing .25" I.D. x .38" O.D. / .25" Ball, 0 - 1.88 GPH 9 = Degas Head: .25" I.D. x .38" O.D. / 0-1.83 GPH J = Tubing, .25" I.D. x .38" O.D. / .19 Ball; 0 - 1.04 GPH METRIC: Y = 9 x 12mm, .25" Ball, 0 - 7.10 LPH T = 6 x 8mm, Degassing (Note: has 8 mm suction), 0 - 7.10 LPH						
Please Refer to page 7 for additional connection sizes. All pumps with tubing connections come with the following items (except for LMH8, LPH8, HV Series pumps): 4' Suction, 4' Return, 8' discharge tubing, footvalve/strainer assy., injection valve and bleed valve.							
SUFFIX CODES:	XXX = No Additional Options 130 = PVDF Tubing 500 = Five Function Valve 520 = Five Function Degas Valve ITS = 15 gal. ITS Tank System						
See pages 8 & 9 for additional information and specs.							
A completed model number should look like 'LC13BA-PTC1-XXX'							

Dimensions

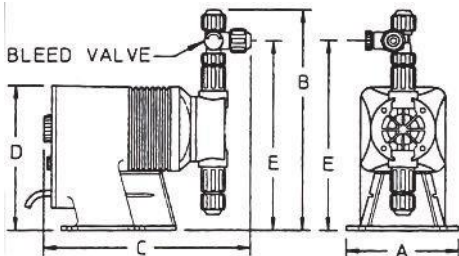

Series T7 Dimensions (inches)						
Model No.	A	B	C	D	E	Shipping Weight
LC13BA	5.0	9.6	9.5	6.5	8.2	10
LC14BA	5.0	9.9	9.5	6.5	8.5	10
LC64BA	5.0	9.9	9.5	6.5	8.5	10
LC44BA	5.4	10.6	11.3	7.4	9.2	11.8

NOTE: Inches X 2.54 = cm

PULSAtron® *Electronic Metering Pumps*

Series C PLUS

Key Features

- **Manual Control** by on-line adjustable stroke rate and stroke length.
- **Agency approved** for demanding **OUTDOOR** and indoor applications.
- **Highly Reliable** timing circuit.
- **Water Resistant** excellent for **OUTDOOR** and indoor applications.
- **Internally Dampened To Reduce Noise**, very acceptable for household installations.
- **Guided Ball Check Valve Systems**, to reduce back flow and enhance outstanding priming characteristics.
- **Premium Standard Wetted Component Materials.**
- **Few Moving Parts** and **Wall Mountable.**
- **Safe & Easy Priming** with durable leak-free **bleed valve assembly** (standard).
- **Optional Control:** External pace with auto/manual selection.



Pressure and Flow Rate Capacity

MODEL		LD02	LD03	LD04	LD54
Capacity	GPH	0.25	0.50	1.00	1.25
	GPD	6	12	24	30
	(max.) LPH	0.9	1.9	3.8	4.7
Pressure	PSIG	80	80	80	80
	(max.) BAR	5.6	5.6	5.6	5.6
Connections	Tubing	1/4" ID X 3/8" OD 3/8" ID X 1/2" OD			
	Piping	1/4" FNPT			

Engineering Data

Reproducibility:	+/- 3% at maximum capacity
Viscosity Max CPS:	1000 CPS
Stroke Frequency Max SPM:	125
Stroke Frequency Turn-Down Ratio:	10:1
Stroke Length Turn-Down Ratio:	10:1
Power Input:	115 VAC/50-60 HZ/1 ph 230 VAC/50-60 HZ/1 ph
Average Current Draw:	
@ 115 VAC; Amps:	0.6 Amps
@ 230 VAC; Amps:	0.3 Amps @ 230 VAC
Peak Input Power:	130 Watts
Average Input Power @ Max SPM:1	50 Watts

PULSAtron Series C Plus Selection Guide		LD					
MODELS:	02	= 0.25 gph / 6 gpd (0.9 lph) max pres.: 80 PSI (5.6 BAR)					
	03	= 0.50 gph / 12 gpd (1.9 lph) max pres.: 80 PSI (5.6 BAR)					
	04	= 1.00 gph / 24 gpd (3.8 lph) max pres.: 80 PSI (5.6 BAR)					
	54	= 1.25 gph / 30 gpd (4.7 lph) max pres.: 80 PSI (5.6 BAR)					
CONTROLS:	S	= Manual					
	E	= External Pacing w/ Auto/Manual Switch					
	G	= External Pacing w/ Prime Button					
	P	= Stop Function Option					
ELECTRICAL:	A	= 115 Volt / 50-60Hz					
	1	= 115 Volt / 50-60Hz (without agency approvals)					
	B	= 230 Volt / 50-60Hz / 1ph with 6' (1.8m) 3-wire US Plug					
	2	= 230 Volt / 50-60Hz (without agency approvals)					
LIQUID END MATERIALS:	PHC	= GFPP / CSPE / Ceramic					
Pump Head & Fittings/Seats & O-rings/Balls	PTC	= GFPP / TFE / Ceramic					
	KTC	= PVDF / TFE / Ceramic					
	VHC	= PVC / CSPE / Ceramic					
	VTC	= PVC / TFE / Ceramic					
See page 6 for additional liquid end materials.							
CONNECTION SIZES:	1	= Tubing .25" I.D. x .38" O.D. / .25" Ball, 0 - 1.88 GPH					
	A	= Tubing .38" I.D. x .50" O.D. / .25" Ball, 0 - 1.88 GPH					
	J	= Tubing .25" I.D. x .38" O.D. / .19" Ball; 0 - 1.04 GPH					
	METRIC:						
	R	= G 1/2 A Threads, .25" Ball, 0 - 7.10 LPH					
	Y	= 9 x 12mm, .25" Ball, 0 - 7.10 LPH					
Please Refer to page 7 for additional connection sizes. All pumps with tubing connections come with the following items (except for LMH8, LPH8, HV Series pumps): 4' Suction, 4' Return, 8' discharge tubing, footvalve/strainer assy., injection valve and bleed valve.							
SUFFIX CODES:	XXX	= No Additional Options					
	130	= PVDF Tubing					
	500	= Five Function Valve					
	520	= Five Function Degas Valve					
	ITS	= 15 gal. ITS Tank System					
	CZ_XXX	= CE Approval (CZXXX=Europe; CZUKXXX=UK; CZSUIXXX=Switzerland/Liechtenstein)					
See pages 8 & 9 for additional information and specs.							
A completed model number should look like 'LD03SA-PTC1-XXX'							

Dimensions

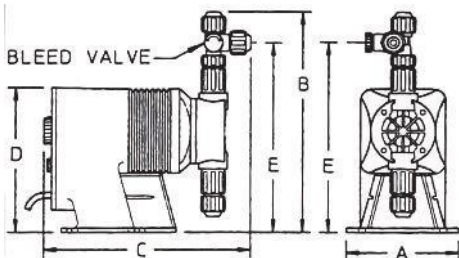

Series C PLUS Dimensions (inches)						
Model No.	A	B	C	D	E	Shipping Weight
LD02	5.0	9.6	9.5	6.5	8.2	10
LD03	5.0	9.9	9.5	6.5	8.5	10
LD04	5.0	9.9	9.5	6.5	8.5	10
LD54	5.0	9.9	9.5	6.5	8.5	10

NOTE: Inches X 2.54 = cm

PULSAtron® Electronic Metering Pumps

Series C

Key Features

- **Automatic Control** by external pacing with prime switch (optional).
- **Manual Control** by on-line adjustable stroke length (fixed stroke rate).
- **Liquid Low Level Option** available to prevent loss of prime.
- **Agency approved** for demanding **OUTDOOR** and indoor applications.
- **Highly Reliable** timing circuit.
- **Water Resistant** excellent for **OUTDOOR** and indoor applications.
- **Internally Dampened To Reduce Noise**, very acceptable for household installations.
- **Guided Ball Check Valve Systems**, to reduce back flow and enhance outstanding priming characteristics.
- **Premium Standard Wetted Component Materials**.
- **Few Moving Parts** and **Wall Mountable**.
- **Safe & Easy Priming** with durable leak-free bleed valve assembly (standard).



Degas Head Option



Pressure and Flow Rate Capacity

MODEL		LC02	LC03	LC04	LC54
Capacity	GPH	0.25	0.50	1.00	1.25
	GPD	6	12	24	30
	(max.) LPH	0.9	1.9	3.8	4.7
Pressure	PSIG	80	80	80	80
	(max.) BAR	5.6	5.6	5.6	5.6
Connections	Tubing	1/4" ID X 3/8" OD 3/8" ID X 1/2" OD			
	Piping	1/4" FNPT			

Engineering Data

Reproducibility:	+/- 3% at maximum capacity
Viscosity Max CPS:	1000 CPS
Stroke Frequency Max SPM:	125
Stroke Length Turn-Down Ratio:	10:1
Power Input:	115 VAC/50-60 HZ/1 ph 230 VAC/50-60 HZ/1 ph
Average Current Draw:	
@ 115 VAC; Amps:	0.6 Amps
@ 230 VAC; Amps:	0.3 Amps @ 230 VAC
Peak Input Power:	130 Watts
Average Input Power @ Max SPM:	50 Watts

PULSAtron Series C Selection Guide		LC					
MODELS:	02 = 0.25 gph / 6 gpd (0.9 lph) max pres.: 80 PSI (5.6 BAR) 03 = 0.50 gph / 12 gpd (1.9 lph) max pres.: 80 PSI (5.6 BAR) 04 = 1.00 gph / 24 gpd (3.8 lph) max pres.: 80 PSI (5.6 BAR) 54 = 1.25 gph / 30 gpd (4.7 lph) max pres.: 80 PSI (5.6 BAR)						
CONTROLS:	S = Manual E = External Pacing w/ Auto/Manual Switch G = External Pacing w/ Prime Button P = Stop Function Option						
ELECTRICAL:	A = 115 Volt / 50-60Hz 1 = 115 Volt / 50-60Hz (without agency approvals) B = 230 Volt / 50-60Hz / 1ph with 6' (1.8m) 3-wire US Plug 2 = 230 Volt / 50-60Hz (without agency approvals)						
LIQUID END MATERIALS:	PHC = GFPP / CSPE / Ceramic PTC = GFPP / TFE / Ceramic VHC = PVC / CSPE / Ceramic VTC = PVC / TFE / Ceramic VVC = PVC / Viton / Ceramic						
See page 6 for additional liquid end materials.							
CONNECTION SIZES:	1 = Tubing .25" I.D. x .38" O.D. / .25" Ball, 0 - 1.88 GPH A = Tubing .38" I.D. x .50" O.D. / .25" Ball, 0 - 1.88 GPH J = Tubing, .25" I.D. x .38" O.D. / .19 Ball; 0 - 1.04 GPH METRIC: P = 4 x 6mm, .25" Ball, 0 - 3.94 LPH U = 6 x 8mm, .25" Ball, 0 - 7.10 LPH						
Please Refer to page 7 for additional connection sizes. All pumps with tubing connections come with the following items (except for LMH8, LPH8, HV series pumps): 4' Suction, 4' Return, 8' discharge tubing, footvalve/strainer assy., injection valve and bleed valve.							
SUFFIX CODES:	XXX = No Additional Options 130 = PVDF Tubing 500 = Five Function Valve 520 = Five Function Degas Valve ITS = 15 gal. ITS Tank System CZ XXX = CE Approval (CZXXX=Europe; CZUKXXX=UK; CZSUIXXX=Switzerland/Liechtenstein)						
See pages 8 & 9 for additional information and specs.							
A completed model number should look like 'LC03SA-PTC1-XXX'							

Dimensions

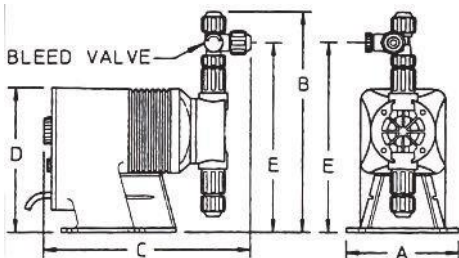

Series C Dimensions (inches)						
Model No.	A	B	C	D	E	Shipping Weight
LC02	5.0	9.6	9.5	6.5	8.2	10
LC03	5.0	9.9	9.5	6.5	8.5	10
LC04	5.0	9.9	9.5	6.5	8.5	10
LC54	5.0	9.9	9.5	6.5	8.5	10

NOTE: Inches X 2.54 = cm

PULSAtron® KOPkits

Selecting a KOPkit:

All KOPkit model strings begin with the letter K. The remainder of the string can be determined by knowing your pump model.

When you select your KOPkit, you will need to build the model number based on the pump model string that you purchased. The two pieces of information you need are the head size and the wet-end code, which is part of the model string of the pump.

The pump head size is the fourth digit in the pump model number.

LB02SA-PTC1-XXX

|

The 2 represents your pump head size.

Digits 7-20 in the pump model string represent the wet-end code. It is the group of four digits set apart by the dash lines.

LB02SA-PTC1-XXX

|

These four digits represent your wet-end code.

In the following selection guide, you will break down your wet-end code into the four parts to get your total price for the KOPkit. The four digits in the wet-end code represent the Head Material, Seats & O-Rings, Ball Material and Connection Type. Using the above example, the code breaks down as follows:

- P** - Head Material, including fittings. In this example, the P represents GFPPL.
- T** - Seat & O-Ring Material. In this example, the T represents Teflon.
- C** - Types of Balls used in the valves. In this example, the C represents Ceramic.
- 1** - Connection type. In this example, the 1 represents tubing connections for 3/8" OD tubing.

The completed KOPkit number for the above example is:

K2PTC1

Note: If you do not find your connection size in the following selection guide, please consult the factory for accurate pricing. Our philosophy with the PULSAtron product line is to make it as flexible as our customers need it to be.

PULSAtron KOPkit Selection Guide				
HEAD SIZE		2 =		
		3 =		
		4 =		
		5 =		
		6 =		
		7 =		
		8 =	(Applies to WTCB only-for other options Consult factory)	
The digits 2-8 following the K represents the pump head size. This is represented by the fourth digit in the pump model string.				
HEAD MATERIALS		A = 316 Stainless Steel		
		K = PVDF (Kynar)		
		P = GPPPL (Polypropylene)		
		V = PVC (Poly Vinyl Chloride) (models <= 150 psi excluding H7, H8, K7)		
		W = PVC (models > 150 psi and H7, H8, K7)		
SEATS/O-RINGS		H = CSPE		
		V = Viton		
		T = TFE		
BALLS		T = TFE		
		C = Ceramic		
		S = 316 Stainless Steel		
		H = Alloy C (Hastelloy)		
CONNECTION TYPE	Type	Suction	Discharge	Spring
	1 = Tubing	.25" x .38"	.25" x .38"	
	2 = Piping	.25" FNPT	.25" FNPT	
	3 = Tubing	.38" x .50"	.38" x .50"	
	4 = Piping	.25" FNPT	.25" FNPT	
	5 = Tubing	.50" x .75"	.38" x .50"	Yes
	6 = Piping	.25" FNPT	.25" FNPT	Yes
	7 = Tubing	.50" x .75"	.50" FNPT	Yes
	8 = Piping	.50" FNPT	.50" FNPT	Yes
	9 = Tubing	25" x .38"	.25" x .38"	Yes Degas
	A = Tubing	.38" x .50"	.38" x .50"	
	B = Tubing	.50" x .75"	.50" x .75"	
	C = Piping	.50" FNPT	.50" FNPT	
	D = Tubing	.25" x .38"	.25" x .38"	Yes
	E = Tubing	.38" x .50"	.38" x .50"	Yes
	F = Tubing	.38" x .50"	.38" x .50"	Yes
	G = Piping	.25" FNPT	.25" FNPT	Yes
	I = Piping	.50" MNPT	.50" MNPT	Yes
	J = Tubing	25" x .38"	.25" x .38"	
	K = Tubing	.50" x .75"	.50" x .75"	Yes
	L = Piping	.50" MNPT	.50" MNPT	
	M = Piping	G 1/2 A	G 1/2 A	
	P = Tubing	4 x 6 mm	4 x 6 mm	
	R = Piping	G 1/2 A	G 1/2 A	
	S = Tubing	6 x 8 mm	6 x 8 mm	
	T = Tubing	6 x 8 mm	6 x 8 mm	Degas
	U = Tubing	6 x 8 mm	6 x 8 mm	
	V = Tubing	12 x 19 mm	12 x 19 mm	
	W = Tubing	8 x 12 mm	8 x 12 mm	
	Y = Tubing	9 x 12 mm	9 x 12 mm	
	X = Piping	.50" MNPT	.50" MNPT	



PULSAtron® Suction/Discharge Valves

Suction/Discharge Valve Selection Guide		L3	-	-	-	-
VALVE TYPE:	101 = Suction Valve 201 = Discharge Valve					
SEATS:	H = CSPE V = Viton T = TFE					
BALLS:	T = TFE C = Ceramic S = 316 Stainless Steel H = Alloy C (Hastelloy)					
CONNECTION TYPE:	1 = Double Balls when TFE seats selected 2 = Double Balls when TFE seats selected 3 = Double Balls when TFE seats selected 4 = Double Balls when TFE seats selected 5* = Available for Discharge Only (L3201) 6 = 7* = Available for Suction Only (L3101) 8 = A = B* = C = D = Spring Loaded with SS Balls E = Spring Loaded with SS Balls F = Spring Loaded with SS Balls G = Spring Loaded with SS Balls I = J = K* = L = M = P = R = S = U = V* = W = Y = X =					
MATERIALS OF CONSTRUCTION:	FPP = Glass Filled Polypropylene PVC = Poly Vinyl Chloride PVD = Kynar(not available w/ "B" connection type) 316 = 316 Stainless Steel					

* Available with Ceramic Balls and PVC Body Only - Consult factory for pricing on other options

LIQUID END COMPONENTS

Item No.	Part Number	Description	
1	L0200200-316	HEAD, PUMP	.750
1	L0200900-FPP	HEAD, PUMP HSA #2 HEAD J	.750
1	L0200900-PVC	HEAD, PUMP HSA #2 HEAD J	.750
1	L0200300-FPP	HEAD, PUMP	1.000
1	L0202500-HPV	HEAD, PUMP	1.000
1	L0200300-PVD	HEAD, PUMP	1.000
1	L0200300-PVC	HEAD, PUMP	1.000
1	L0201000-FPP	HEAD, PUMP HSA #3 HEAD J	1.000
1	L0201000-PVC	HEAD, PUMP HSA #3 HEAD J	1.000
1	L0200400-FPP	HEAD, PUMP	1.250
1	L0200400-PVC	HEAD, PUMP	1.250
1	L0200400-PVD	HEAD, PUMP	1.250
1	L0200500-SST	HEAD, PUMP	1.625
1	L0200500-FPP	HEAD, PUMP	1.625
1	L0200500-PVC	HEAD, PUMP	1.625
1	L0200500-PVD	HEAD, PUMP	1.625
1	L0200600-SST	HEAD, PUMP	2.000
1	L0200600-FPP	HEAD, PUMP	2.000
1	L0200600-PVC	HEAD, PUMP	2.000
1	L0200600-PVD	HEAD, PUMP	2.000
1	L0200700-316	HEAD, PUMP	2.500
1	L0200700-FPP	HEAD, PUMP	2.500
1	L0200700-HPV	HEAD, PUMP	2.500
1	L0200700-PVD	HEAD, PUMP	2.500
1	L0200800-PPL	HEAD, PUMP	3.625
1	L0200800-HPV	HEAD, PUMP	3.625
2	L0300900-THY	DIAPHRAGM	.750
2	L0301000-THY	DIAPHRAGM	1.000
2	L0301100-THY	DIAPHRAGM	1.250
2	L0301200-THY	DIAPHRAGM	1.625
2	L0301300-THY	DIAPHRAGM	2.000
2	L0301400-THY	DIAPHRAGM	2.500
2	L0301600-THY	DIAPHRAGM	3.625
18	L1501300-HYP	SUC/DIS VLV O-RING, CSPE	
18	L1501300-TFE	SUC/DIS VLV O-RING, TFE	
18	L1501300-VTN	SUC/DIS VLV O-RING, VTN	
24	L1103400-PVC	COUPLING NUT 5/16" OD	
24	L1100300-FPP	COUPLING NUT 3/8" OD	
24	L1100300-PVC	COUPLING NUT 3/8" OD	
24	L1100300-PVD	COUPLING NUT 3/8" OD	
24	L1100400-FPP	COUPLING NUT 1/2" OD	
24	L1100400-PVC	COUPLING NUT 1/2" OD	
24	L1100400-PVD	COUPLING NUT 1/2" OD	
25	L9906700-000	WEIGHT, CERAMIC TUBE	
36	L1501200-TFE	BLEED VLV O-RING, TFE	
60	L1500700-NTR	SECONDARY SEAL, O-RING 2-109	

DRIVE END COMPONENTS

Item No.	Part Number	Description	
3	L2100200-FPP	DEFLECTION PLATE	.750
3	L2100300-FPP	DEFLECTION PLATE	1.000
3	L2100400-FPP	DEFLECTION PLATE	1.250
3	L2100500-FPP	DEFLECTION PLATE	1.625
3	L2100600-FPP	DEFLECTION PLATE	2.000
3	L2100700-FPP	DEFLECTION PLATE	2.500
4	L0400200-FPP	ADAPTER, .750	HSG #2
4	L0400300-FPP	ADAPTER, 1.000	HSG #2
4	L0400400-FPP	ADAPTER, 1.250	HSG #2
4	L0400500-FPP	ADAPTER, 1.625	HSG #2
4	L0400600-FPP	ADAPTER, 1.250	HSG #3
4	L0400700-FPP	ADAPTER, 1.625	HSG #3
4	L0400800-FPP	ADAPTER, 2.000	HSG #3
4	L0400900-FPP	ADAPTER, 2.500	HSG #3
4	L0401100-FPP	ADAPTER, .750	HSG #1
4	L0401200-FPP	ADAPTER, 1.000	HSG #1
4	L0401300-FPP	ADAPTER, 1.250	HSG #1
4	L0401400-PPL	ADAPTER, 3.625	HSG #3
5	L9901200-BRS	SHIM, DIAPHRAGM	
6	L1500400-NTR	EPM/ADAPTER O-RING	
6	L1500600-NTR	EPM/ADAPTER O-RING (ALL H PUMPS)	
7	L9801700-188	#10-32 X 2.62 PAN HEAD, PHILLIPS	LP_2-4
7	L9801800-188	.25-20 X 2.62 PAN HEAD, PHILLIPS	LP_5-7
7	L9803400-188	.25-20 X 2.00 PAN HEAD	LP_8
7	L9803300-188	#10-32 X 2.00 PAN HEAD	316SS
8	L9801300-188	#10 REG FLAT WASHER	LP_2-4
8	L9801400-188	.25 REG FLAT WASHER	LP_5-8

DRIVE END COMPONENTS

Item No.	Part Number	Description	
50	L0100100-115	EPM A, B, K2, 3	115V
50	L0100300-115	EPM F, G, K5	115V
51	L0500100-080	HOUSING #3	.080 STRK
51	L0501100-040	HOUSING #2	.040 STRK
51	L0501100-080	HOUSING #2	.080 STRK
51	L0500300-040	HOUSING #1	.040 STRK
51	L0500300-080	HOUSING #1	.080 STRK
52	L0700101-125	CNTRL BD, A-B-D-E SIZE SLD	115V
52	L0700102-125	CNTRL BD, A-B-D-E SIZE SLD	230V
52	L0700201-125	CNTRL BD, EXT/STOP; A, B, D, E	115V
52	L0700202-125	CNTRL BD, EXT/STOP; A, B, D, E	230V
52	L0700401-125	CNTRL BD, 4-20MA/STOP; A, B, D, E	115V
52	L0700402-125	CNTRL BD, 4-20MA/STOP; A, B, D, E	230V
52	L0700501-150	CNTRL BD, F-G SIZE SLD	115V
52	L0700502-150	CNTRL BD, F-G SIZE SLD	230V
52	L0700501-200	CNTRL BD, H-K SIZE SLD	115V
52	L0700502-200	CNTRL BD, H-K SIZE SLD	230V
52	L0709401-220	CNTRL BD, LEH8	115V
52	L0709402-220	CNTRL BD, LEH8	230V
52	L0709101-220	CNTRL BD, LVH7, LP/LVH8	115V
52	L0709102-220	CNTRL BD, LVH7, LP/LVH8	230V
52	L0700801-150	CNTRL BD, EXT/STOP; F, G	115V
52	L0700802-150	CNTRL BD, EXT/STOP; F, G	230V
52	L0700801-200	CNTRL BD EXT/STOP H SIZE SLD	115V
52	L0700802-200	CNTRL BD EXT/STOP H SIZE SLD	230V
52	L0709301-220	CNTRL BD EXT/STOP LVH7, LP/LVH8	115V
52	L0709302-220	CNTRL BD EXT/STOP LVH7, LP/LVH8	230V
52	L0700901-150	CNTRL BD, 4-20 MA/STOP; F, G	115V
52	L0700902-150	CNTRL BD, 4-20 MA/STOP; F, G	230V
52	L0700901-200	CNTRL BD, 4-20 MA/STOP; H	115V
52	L0700902-200	CNTRL BD, 4-20MA/STOP; H	230V
52	L0709201-220	CNTRL BD, 4-20MA/STP, LVH7, LP/LVH8	
52	L0709202-220	CNTRL BD, 4-20MA/STP, LVH7, LP/LVH8	
52	L0701900-150	CNTRL BD, E - DC	
52	L9906500-000	CNTRL BD, 0, 5 SIZE SING FUNC	115V
52	L9906600-000	CNTRL BD, 0, 5 SIZE SING FUNC	230V
52	L9906201-000	CNTRL BD, C+, A+	115V
52	L9906202-000	CNTRL BD, C+, A+	230V
52	L0702801-190	CNTRL BD, LM H, K7 Signal Relay	115V
52	L0705006-120	CNTRL BD, EXT, C+, A+	230V
52	L0705110-120	CNTRL BD, EXT, C (LC54)	230V
53	L0601600-000	CNTRL PNL (ALL H & K7 PUMPS)	
54	L1600400-000	DUST COVER, CONT PNL	HSG #3
54	L1600500-000	DUST COVER, CONT PNL	HSG #2
55	L2000100-040	SHAFT, ADJ FEMALE .040	HSG #2,3
55	L2000100-080	SHAFT, ADJ FEMALE .080	HSG #2,3
55	L2000200-040	SHAFT, ADJ FEMALE .040	HSG #1
55	L2000200-080	SHAFT, ADJ FEMALE .080	HSG #1
56	L2000300-PBT	SHAFT, ADJ MALE	HSG #2,3
56	L2000400-PBT	SHAFT, ADJ MALE	HSG #1
59	L1500100-EPB	O-RING, HSG #1/CONT PNL	
59	L1500300-NTR	O-RING, HSG #2/CONT PNL	
59	L1500500-NTR	O-RING, HSG #3/CONT PNL	
61	L9900600-000	CONNECTOR, LIQUID TIGHT	
61	L9900700-000	CONNECTOR, STRAIN RELIEF	
62	L9700300-000	CORD, POWER, SERIES C, E	125V
62	L9700400-000	CORD, POWER, SERIES C, E	230V
62	L9701200-000	CORD, POWER, SERIES E PLUS	125V
62	L9701300-000	CORD, POWER, SERIES E PLUS	230V
63	L9700700-250	CIRCUIT BREAKER, SERIES MP	
63	L9707300-000	FUSE 2 AMP, SERIES E, E PLUS	
63	L9706900-000	BOARD MNTD FUSE, SERIES A+, C+, C, E	
64	L9800200-188	CNTRL PNL SCREW	
65	L1500800-NTR	GROMMET, STROKE LENGTH	
66	L1900800-000	KNOB, STROKE RATE/SWITCH	
71	L1900100-FPP	KNOB, STROKE LENGTH	
71	L1900300-FPP	KNOB, STROKE LENGTH	
72	L9800200-188	KNOB MOUNTING SCREW	
76	L1500900-NTR	GROMMET STROKE LENGTH	
81	L5000801-115	CNTRL PANEL ASSY; A-B-D-E SIZE SLDs,	115V
81	L5000901-115	CNTRL PANEL ASSY, EXT/STOP; A-B-D-E	115V
81	L5000901-230	CNTRL PANEL ASSY, EXT/STOP; A-B-D-E	230V
81	L5001001-115	CNTRL PANEL ASSY, 4-20MA/STOP; A-B-D-	115V
81	L5001001-230	CNTRL PANEL ASSY, 4-20MA/STOP; A-B-D-	230V
81	L5001301-115	CNTRL PANEL ASSY, H SIZE SLD	115V
81	L5028500-115	CNTRL PANEL ASSY, LEH8	115V

DRIVE END COMPONENTS

Item No.	Part Number	Description
81	L5028201-115	CNTRL PANEL ASSY, LVH7, LP/LVH8 115V
81	L5001401-115	CNTRL PANEL ASSY, EXT/STOP; H SIZE 115V
81	L5001401-230	CNTRL PANEL ASSY, EXT/STOP; H SIZE 230V
81	L5028301-115	CNTRL PANEL ASSY, EXT/STOP; LVH7, 115V
81	L5028300-230	CNTRL PANEL ASSY, EXT/STOP; LVH7, 230V
81	L5001501-115	CNTRL PANEL ASSY, 4-20MA/STOP; H 115V
81	L5001501-230	CNTRL PANEL ASSY, 4-20MA/STOP; H 230V
81	L5028401-115	CNTRL PANEL ASSY, 4-20MA/STOP; 115V
81	L5028401-230	CNTRL PANEL ASSY, 4-20MA/STOP; 230V
81	L5000100-115	CNTRL PANEL ASSY, SERIES E; 0- 115V
81	L5000100-230	CNTRL PANEL ASSY, SERIES E; 0- 230V
81	L5000200-115	CNTRL PANEL ASSY, 3-4 SIZE SLDS 115V
81	L5000200-230	CNTRL PANEL ASSY, 3-4 ZISE SLDS 230V
81	L5002900-115	CNTRL PANEL ASSY SIN-FUNC; 0-SIZE 115V
81	L5003000-115	CNTRL PANEL ASSY SIN-FUNC; 5-SIZE
81	L5011000-115	CNTRL PANEL ASSY EXT PACE; SIZE
81	L5013000-115	CNTRL PANEL ASSY EXT PACE; SIZE
81	L5003016-115	CNTRL PANEL ASSY, 4-20MA/STOP; 115V
81	L5003701-115	CNTRL PANEL ASSY, STD; K SIZE SLD 115V
81	L5003801-115	CNTRL PANEL ASSY, EXT/STOP; K SIZE 115V
81	L5003801-230	CNTRL PANEL ASSY, EXT/STOP; K SIZE 230V
81	L5003903-115	CNTRL PANEL ASSY, 4-20MA/STOP; K7 115V
81	L5003903-230	CNTRL PANEL ASSY, 4-20MA/STOP; K7 230V
81	L5004100-115	CNTRL PANEL ASSY, SIN-FUNC; SIZE 115V
81	L5010800-230	CNTRL PANEL ASSY EXT PACE; SIZE 230V
81	L5010900-230	CNTRL PANEL ASSY EXT PACE; SIZE 230V
81	L5005200-115	CNTRL PANEL ASSY; SIZE 02, 03, 04, 115V
81	L5005300-230	CNTRL PANEL ASSY; SIZE 02, 03, 04, 230V
81	L5004800-115	CNTRL PANEL ASSY; SIZE 54, 64 115V
81	L5007501-115	CNTRL PNL ASSY LMK2; SIGNAL RELAY 115V
81	L5007301-115	CNTRL PNL ASSY LM A,B,C,D,E,K3; 115V
81	L5007301-230	CNTRL PNL ASSY LM A,B,C,D,E,K3; 230V
81	L5007401-115	CNTRL PNL ASSY LM A,B,C,D,E,K3; 115V
81	L5007401-230	CNTRL PNL ASSY LM A,B,C,D,E,K3; 230V
81	L5007701-115	CNTRL PNL ASSY LMK5; SIGNAL RELAY 115V
81	L5007101-115	CNTRL PNL ASSY LM F, G; SIGNAL 115V
81	L5007701-230	CNTRL PNL ASSY LMK5; SIGNAL RELAY 230V
81	L5007101-230	CNTRL PNL ASSY LM F, G; SIGNAL 230V
81	L5007801-115	CNTRL PNL ASSY LMK5; POWER RELAY 115V
81	L5007201-115	CNTRL PNL ASSY LM F, G; POWER 115V
81	L5007901-115	CNTRL PNL ASSY LMK7; SIGNAL RELAY 115V
81	L5006901-115	CNTRL PNL ASSY LM H; SIGNAL RELAY 115V
81	L5007901-230	CNTRL PNL ASSY LMK7; SIGNAL RELAY 230V
81	L5006901-230	CNTRL PNL ASSY LM H; SIGNAL RELAY 230V
81	L5007001-115	CNTRL PNL ASSY H; POWER RELAY 115V
88	L9804000-000	GROUND LUG NUT
89	L9800500-STL	GROUND LUG BOLT
92	L9700800-000	BREAKER COVER
	L9700200-000	CORD, SIGNAL, 10 FT
	L9700201-000	CORD, SIGNAL, 20 FT
	L9700800-000	PROTECTIVE BOOT, CKT BRKER

BLEED VALVE ASSEMBLIES

Item No.	Part Number	Description	
11	L3300H01-FPP	FPP/CSPE	3/8"
11	L3300H01-PVC	PVC/CSPE	3/8"
11	L3300H03-FPP	FPP/CSPE	1/2"
11	L3300H03-PVC	PVC/CSPE	1/2"
11	L3300T01-FPP	FPP/TFE	3/8"
11	L3300T01-PVC	PVC/TFE	3/8"
11	L3300T01-PVD	PVD/TFE	3/8"
11	L3300T03-FPP	FPP/TFE	1/2"
11	L3300T03-PVC	PVC/TFE	1/2"
11	L3300T03-PVD	PVD/TFE	1/2"
11	L3300V01-FPP	FPP/VTN	3/8"
11	L3300V01-PVC	PVC/VTN	3/8"
11	L3300V01-PVD	PVD/VTN	3/8"
11	L3300V03-FPP	FPP/VTN	1/2"
11	L3300V03-PVC	PVC/VTN	1/2"
11	L3300V03-PVD	PVD/VTN	1/2"

FOOT VALVE / STRAINER ASSEMBLIES

Item No.	Part Number	Description	
12	J40117	FPP/CSPE/C	3/8" X 1/2"
12	J40123	FPP/CSPE/TFE	3/8" X 1/2"
12	J60509	FPP/VTN/C	3/8" X 1/2"
12	J40141	FPP/VTN/3/16	3/8" X 1/2"
12	J40125	FPP/VTN/TFE	3/8" X 1/2"
12	J40212	FPP/FTF/C	3/8" X 1/2"
12	J40175	FPP/FTF/3/16	3/8" X 1/2"
12	J40171	FPP/FTF/TFE	3/8" X 1/2"
12	J60728	PVD/FTF/C	3/8" X 1/2"
12	J60729	PVD/CSPE/C	3/8" X 1/2"
12	J60730	PVD/VTN/C	3/8" X 1/2"
12	J40116	FPP/CSPE/C	1/4" X 3/8"
12	J40156	FPP/CSPE/3/16	1/4" X 3/8"
12	J40122	FPP/CSPE/TFE	1/4" X 3/8"
12	J60524	FPP/VTN/C	1/4" X 3/8"
12	J40158	FPP/VTN/3/16	1/4" X 3/8"
12	J40124	FPP/VTN/TFE	1/4" X 3/8"
12	J40211	FPP/FTF/C	1/4" X 3/8"
12	J40170	FPP/FTF/3/16	1/4" X 3/8"
12	J40169	FPP/FTF/TFE	1/4" X 3/8"
12	J60716	PVD/FTF/C	1/4" X 3/8"
12	J60717	PVD/CSPE/C	1/4" X 3/8"
12	J60718	PVD/VTN/C	1/4" X 3/8"
12	J40095	3/16	.25 NPT
12	J40195	FPP/CSPE/C	.25 NPT
12	J40187	FPP/VTN/C	.25 NPT
12	J40179	FPP/FTF/C	.25 NPT
12	J60503	FPP	.50 NPT
12	J60561	FPP	1/2 X 3/4"
12	J60564	FPP/FTF/C	3/16 X 5/16"
12	J60712	PVD/FTF/C	3/16 X 5/16"
12	J60564	FPP/TFE/C	
12	J60712	PVD/TFE/C	

STAINLESS STEEL VALVE REPAIR KITS

Part Number	Description
L9904200-316	VALVE REPAIR KIT - ATS2
L9904600-316	VALVE REPAIR KIT - ATS4
L9904900-316	VALVE REPAIR KIT - ATSG

TUBING

Part Number	Description	Per Foot
00007	SUCT, 3/8 OD, CLEAR PVC	FT
00008	DISCH, 1/2 OD, WHITE PE	FT
00009	DISCH, 1/2 OD, BLACK PE	FT
00010	DISCH, 3/8 OD, WHITE PE	FT
00011	DISCH, 3/8 OD, BLACK PE	FT
J00012	DISCH, 1/2 OD, HIPRES, WHITE	FT
00013	DISCH, 1/2 OD, HIPRES, BLACK	FT
J00022	DISCH, 3/8 OD, HIPRES, WHITE	FT
J00023	SUCT, 1/2 OD, CLEAR PVC	FT
J00024	DISCH, 3/8 OD, HIPRES, BLACK	FT
J00032	SUCT/DISCH, 3/4 OD, CLEAR PVC	FT
L9902900-000	PVDF TUBING, 3/8 OD	FT
L9903000-000	PVDF TUBING, 1/2 OD	FT
L9904300-PEB	SUCT, 5/16 OD, PE BLACK	FT
L9904300-PEW	SUCT, 5/16 OD, PE WHITE	FT
L9904300-PVC	SUCT, 5/16 OD, CLEAR PVC	FT
L9904300-PVD	SUCT, 5/16 OD, PVDF WHITE	FT
L9904500-PEW	DISCH, 1/2 X 5/8, PE WHITE	FT
L9913200-BRD	PVC CLEAR BRAIDED, 3/4 OD	FT

INJECTION BACK PRESS VALVE ASSEMBLIES

Item No.	Part Number	Description
13	J41767	FPP/CSPE/C 3/8" X 1/2"
13	J41863	FPP/CSPE/316 3/8" X 1/2"
13	J41773	FPP/CSPE/TFE 3/8" X 1/2"
13	41716	FPP/VTN/C 3/8" X 1/2"
13	J41882	FPP/VTN/316 3/8" X 1/2"
13	J41775	FPP/VTN/TFE 3/8" X 1/2"
13	J41872	FPP/FTF/C 3/8" X 1/2"
13	J41879	FPP/FTF/316 3/8" X 1/2"
13	J41875	FPP/FTF/TFE 3/8" X 1/2"
13	J41694	PVC/CSPE/C 3/8" X 1/2"
13	41698	PVC/CSPE/C 6" 3/8" X 1/2"
13	41702	PP/VTN/C 6" 3/8" X 1/2"
13	J41865	PVC/CSPE/316 3/8" X 1/2"
13	J41759	PVC/CSPE/TFE 3/8" X 1/2"
13	J41714	PVC/VTN/C 3/8" X 1/2"
13	J41761	PVC/VTN/TFE 3/8" X 1/2"
13	J41873	PVC/FTF/C 3/8" X 1/2"
13	J41881	PVC/FTF/316 3/8" X 1/2"
13	J41877	PVC/FTF/TFE 3/8" X 1/2"
13	J61073	PVD/FTF/TFE 3/8" X 1/2"
13	J61021	PVD/FTF/C 3/8" X 1/2"
13	J41766	FPP/CSPE/C 1/4" X 3/8"
13	J41862	FPP/CSPE/316 1/4" X 3/8"
13	J41772	FPP/CSPE/TFE 1/4" X 3/8"
13	41715	FPP/VTN/C 1/4" X 3/8"
13	41701	FPP/VTN/C 6" 1/4" X 3/8"
13	J41866	FPP/VTN/316 1/4" X 3/8"
13	J41774	FPP/VTN/TFE 1/4" X 3/8"
13	J61098	FPP/FTF/C 1/4" X 3/8"
13	J41878	FPP/FTF/316 1/4" X 3/8"
13	J41874	FPP/FTF/TFE 1/4" X 3/8"
13	41693	PVC/CSPE/C 1/4" X 3/8"
13	41705	PVC/CSPE/C 6" 1/4" X 3/8"
13	J41758	PVC/CSPE/TFE 1/4" X 3/8"
13	J61237	PVC/VTN/C 1/4" X 3/8"
13	J41867	PVC/VTN/316 1/4" X 3/8"
13	41760	PVC/VTN/TFE 1/4" X 3/8"
13	J41996	PVC/FTF/C 1/4" X 3/8"
13	J41880	PVC/FTF/316 1/4" X 3/8"
13	J41876	PVC/FTF/TFE 1/4" X 3/8"
13	J61020	PVD/FTF/C 1/4" X 3/8"
13	J61026	PVD/FTF/TFE 1/4" X 3/8"
13	J41911	FPP/CSPE/C .25 NPT
13	J41901	FPP/VTN/C .25 NPT
13	J41944	FPP/FTF/C .25 NPT
13	J41904	PVC/CSPE/C .25 NPT
13	J41858	PVC/VTN/C .25 NPT
13	J41908	PVC/FTF/C .25 NPT
13	J61015	PVD/FTF/C .25 NPT
13	J61025	316/FTF/316 .25 NPT
13	J41969	PVC/CSPE/C 1/2 X 3/4"
13	J61149-10P	FPP/FTF/C 1/2 X 3/4"
13	J61157-10P	PVC/FTF/C .50 NPT
13	J61156-10P	PVC/TFE/S .50 NPT

OTHER

Part Number	Description
26858	BULKHEAD FITTING - PP 1/2"
26859	BULKHEAD FITTING - PVC 1/2"
26860	BULKHEAD FITTING - PVC 3/8"
26867	BULKHEAD FITTING - PP 3/8"
L9905000- PVC	J CONVERSION KIT (PVC/TFE/C)
L9905100- PVC	J CONVERSION KIT (PVC/TFE/C)
L9906901-000	CONV. KIT (.75" VVC9) DEGAS HEA
L9907001-000	CONV. KIT (1.00" VVC9) DEGAS HE
L9907101-000	CONV. KIT (1.25" VVC9) DEGAS HE

BLACK LINE *Mechanical Diaphragm Pumps*

Series MD

Key Features

- Liquid End Materials – GFPPPL, 316SS & PVDF.
- Rugged double-sided PTFE faced, long life diaphragm.
- Oil Lubricated Ball Bearings in die-cast aluminum housing.
- Manual micrometer style stroke adjustment; 10:1 turndown, up to 100:1 with VFD Vector drive.
- Standard NEMA 56C or IEC71 motor frames available.

Optional Features

- Variable Frequency Drive for Automatic Control.
 - ◆ Fully Scalable 4-20mA, 0-10VDC signals.
 - ◆ NEMA 4X Enclosure.
- ATEX Group II, Category 3 – Zone 2/22 for non-flammable liquids with proper motor selection.



CE

Pressure and Flow Rate Capacity

MODEL		MD1A	MD1B	MD1C	MD1D	MD1E	MD2F	MD2G	MD2H	MD3G
Capacity nominal (max.)	GPH	7	14	22	29	35	59	79	98	132
	LPH	26	53	82	111	133	225	298	371	501
Pressure (max.)	PSIG	150	150	150	150	150	90	90	75	75
	BAR	10	10	10	10	10	6	6	5	5
Connections:	FNPT	1/2"					3/4"	1"		
	BSPT-F	1/2"					3/4"	1"		
Strokes/Minute	SPM	84	60	84	116	138	84	118	138	118

Engineering Data

Reproducibility:	+/- 2% at maximum capacity
Viscosity Max CPS:	up to 1000 CPS
Stroke Frequency Max SPM:	60 to 138 Strokes Per Minute max. (Depending on model selection)
Stroke Length Turn-Down Ratio:	10:1
Power Input:	115 VAC/60 Hz/1 ph 230 VAC/50-60 Hz/1 ph or 3 ph
Max Ambient Temperature:	104 ^o F (40 ^o C)
Max Fluid Temperature:	104 ^o F (40 ^o C)
Oil Capacity:	15.2 oz (0.4 L)

Blackline Series MD Selection Guide		MD	---	---	---	---	---	---	XXX
MODELS:	1A = 7 gph (26 lph) max pres.: 150 PSI (10 BAR) 1B = 14 gph (53 lph) max pres.: 150 PSI (10 BAR) 1C = 22 gph (82 lph) max pres.: 150 PSI (10 BAR) 1D = 29 gph / (111 lph) max pres.: 150 PSI (10 BAR) 1E = 35 gph / (133 lph) max pres.: 150 PSI (10 BAR) 2F = 59 gph / (225 lph) max pres.: 90 PSI (6 BAR) 2G = 79 gph / (298 lph) max pres.: 90 PSI (6 BAR) 2H = 98 gph / (371lph) max pres.: 75 PSI (5 BAR) 3G = 132 gph / (501 lph) max pres.: 75 PSI (5 BAR)								
LIQUID END	KTP = PVDF Head / PTFE Valve Seat / Pyrex Valve Check Ball PPP = Glass Filled Polypropylene Head / PVC Valve Seat / Pyrex Valve Check Ball AAS = 316SS Head / 316SS Valve Seat / 316SS Valve Check Ball KMM** = PVDF Head / Incoloy 825 Valve Seat/ Hastelloy C-276 Valve Check Ball								
Size 1A-E									
Size 2F-H	KTP = PVDF Head / PTFE Valve Seat / Pyrex Valve Check Ball PPP = Glass Filled Polypropylene Head / PVC Valve Seat / Pyrex Valve Check Ball AAS = 316SS Head / 316SS Valve Seat / 316SS Valve Check Ball KMM** = PVDF Head / Incoloy 825 Valve Seat/ Hastelloy C-276 Valve Check Ball								
Size 3G	KTP = PVDF Head / PTFE Valve Seat / Pyrex Valve Check Ball PPP = Glass Filled Polypropylene Head / PVC Valve Seat / Pyrex Valve Check Ball AAS = 316SS Head / 316SS Valve Seat / 316SS Valve Check Ball KMM** = PVDF Head / Incoloy 825 Valve Seat/ Hastelloy C-276 Valve Check Ball								
VALVE CONNECTION:	N = NPT Connection B = BSPT Connection								
MOTOR SELECTION:	1 = TEFC - NEMA 56C, 1P, 115/230V, 60Hz, 1/2 Hp 2 = TEFC - NEMA 56C, 3P, 230/460V, 50/60Hz, 1/2 Hp (VFD 10:1) 3 = Ex.Proof - NEMA 56C, 1P, 115/230V, 60Hz, 1/2 Hp 4 = Ex. Proof - NEMA 56C, 3P, 230/460V, 60Hz, 1/2 Hp 6 = TEFC - IEC 71, 3P, 220/380/460V, 50/60Hz, .37kW (VFD 10:1, Required for CE Approved VFD) 8 = Ex. Proof - IEC 71, 3P, 220/380/460V, 50/60Hz, .37kW X = No Motor - NEMA 56C Frame Ready Y = No Motor - IEC 71 Frame Ready								
VFD OPTIONS	A = No VFD C = VFD, 115/230V, NEMA 4X, IP65 Enclosure, 1 Phase, Motor 2 & 6 Only								
OPTIONS	XXX = No Options								

A completed model number should look like 'MD1BKTPN1A-XXX'

** For use with high concentration of Sulfuric acid and poly-alum-chloride.

Dimensions

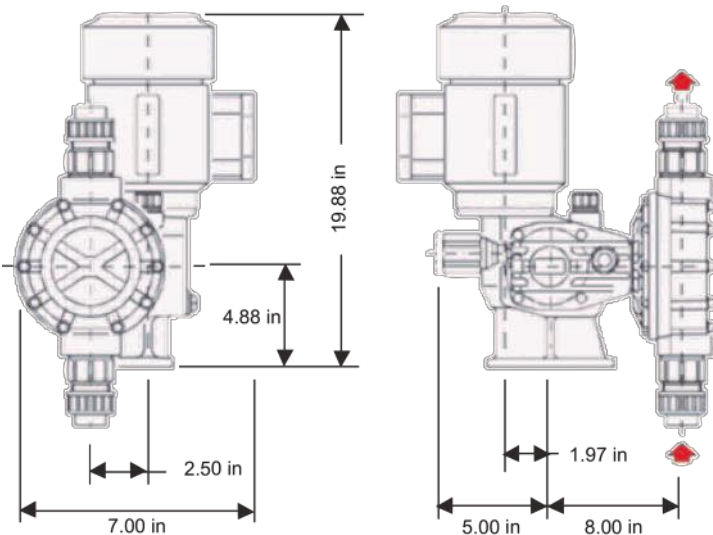

Series MD Dimensions (inches)			
Model	Box Dimensions	Weight Plastic (lbs)	Weight Stainless Steel (lbs)
MD1A (NO MOTOR)	19 x 19 x 10	21.5	26.0
MD1B (NO MOTOR)	20 x 19 x 10	21.5	26.0
MD1C (NO MOTOR)	21 x 19 x 10	21.5	26.0
MD1D (NO MOTOR)	22 x 19 x 10	21.5	26.0
MD1E (NO MOTOR)	23 x 19 x 10	21.5	26.0
MD2F (NO MOTOR)	24 x 19 x 10	26.0	37.0
MD2G (NO MOTOR)	25 x 19 x 10	26.0	37.0
MD2H (NO MOTOR)	26 x 19 x 10	26.0	37.0
MD3G (NO MOTOR)	27 x 19 x 10	29.0	46.0
MD1A W/VFD & MOTOR	27 x 17.4 x 18.75	67.0	71.5
MD1B W/VFD & MOTOR	28 x 17.4 x 18.75	67.0	71.5
MD1C W/VFD & MOTOR	29 x 17.4 x 18.75	67.0	71.5
MD1D W/VFD & MOTOR	30 x 17.4 x 18.75	67.0	71.5
MD1E W/VFD & MOTOR	31 x 17.4 x 18.75	67.0	71.5
MD2F W/VFD & MOTOR	32 x 17.4 x 18.75	71.5	82.5
MD2G W/VFD & MOTOR	33 x 17.4 x 18.75	72.5	83.5
MD2H W/VFD & MOTOR	34 x 17.4 x 18.75	73.5	84.5
MD3G W/VFD & MOTOR	35 x 17.4 x 18.75	74.5	91.5

BLACKLINE Mechanical Diaphragm Pumps

Common Pump Accessories			
Component	Size	Material	Part No.
Drip Cover, Motor	56C	Steel, Baldor	NP999119
Pressure Relief Valves	1/2"	PVC/TFE	NA100001-PVC
	1/2"	PVDF/TFE	NA100001-PVD
	1/2"	SS/TFE	NA100001-316
	1"	PVC/TFE	NA100002-PVC
	1"	PVDF/TFE	NA100002-PVD
	1"	SS/TFE	NA100002-316
	1.5"	PVC/TFE	NA100003-PVC
	1.5"	PVDF/TFE	NA100003-PVD
Back Pressure Valves	1/2"	PVC/TFE	NA200001-PVC
	1/2"	PVDF/TFE	NA200001-PVD
	1/2"	SS/TFE	NA200001-316
	1"	PVC/TFE	NA200002-PVC
	1"	PVDF/TFE	NA200002-PVD
	1"	SS/TFE	NA200002-316
	1.5"	PVC/TFE	NA200003-PVC
	1.5"	PVDF/TFE	NA200003-PVD
Gauge Isolator w/ 200PSI Gauge	1/4"	PVC/TFE	NA500001-PVC
	1/4"	PVDF/TFE	NA500001-PVD
	1/4"	316SS/TFE	NA500001-316
Calibration Column	1/2"	PVC 100mL	NA300001-PVC
	1/2"	PVC 200mL	NA300002-PVC
	3/4"	PVC 500mL	NA300003-PVC
	3/4"	PVC 1000mL	NA300004-PVC
	1"	PVC 2000mL	NA300005-PVC
	1"	PVC 4000mL	NA300006-PVC
	2"	PVC 10,000mL	NA300007-PVC
	2"	PVC 20,000mL	NA300008-PVC
	1/2"	Glass/PVD 100mL	NA300009-PVD
	1/2"	Glass/PVD 200mL	NA300010-PVD
	3/4"	Glass/PVD 500mL	NA300011-PVD
	3/4"	Glass/PVD 1000mL	NA300012-PVD
	1"	Glass/PVD 2000mL	NA300013-PVD
	1"	Glass/PVD 4000mL	NA300014-PVD
	1/2"	Glass/SS 100mL	NA300015-316
	1/2"	Glass/SS 200mL	NA300016-316
	3/4"	Glass/SS 500mL	NA300017-316
	3/4"	Glass/SS 1000mL	NA300018-316
	1"	Glass/SS 2000mL	NA300019-316
	1"	Glass/SS 4000mL	NA300020-316
Y Strainer	1/2"	PVC	40085
	1/2"	CPVC	NA400001-CPVC
	1/2"	PVD	NA400001-PVD
	1"	PVC	NA400002-PVC
	1"	CPVC	NA400002-CPVC
1"	PVD	NA400002-PVD	

150 PSI Pulsation Dampeners - Chargeable					
Volume	Body	Bladder	Connection	Part Number	
10 cubic inches	POLY	EPDM	3/8" FNPT	NA601038-FPPE	
		CSPE	3/8" FNPT	NA601038-FPPC	
		TFE	3/8" FNPT	NA601038-FPPT	
		Viton	3/8" FNPT	NA601038-FPPV	
		CSPE	1/2" FNPT	NA601050-FPPC	
		TFE	1/2" FNPT	NA601050-FPPT	
		Viton	1/2" FNPT	NA601050-FPPV	
	PVC	CSPE	1/2" FNPT	NA601050-PVCC	
		TFE	1/2" FNPT	NA601050-PVCT	
		Viton	1/2" FNPT	NA601050-PVCV	
	PVDF	EPDM	3/8" FNPT	NA601038-PVDE	
		CSPE	3/8" FNPT	NA601038-PVDC	
		TFE	3/8" FNPT	NA601038-PVDT	
		Viton	3/8" FNPT	NA601038-PVDV	
316 SS	EPDM	3/8" FNPT	NA601038-316E		
	CSPE	3/8" FNPT	NA601038-316C		
	TFE	3/8" FNPT	NA601038-316T		
	Viton	3/8" FNPT	NA601038-316V		
85 cubic inches	POLY	EPDM	3/4" FNPT	NA608575-FPPE	
		CSPE	3/4" FNPT	NA608575-FPPC	
		TFE	3/4" FNPT	NA608575-FPPT	
		Viton	3/4" FNPT	NA608575-FPPV	
	PVDF	EPDM	3/4" FNPT	NA608575-PVDE	
		CSPE	3/4" FNPT	NA608575-PVDC	
		TFE	3/4" FNPT	NA608575-PVDT	
		Viton	3/4" FNPT	NA608575-PVDV	
	316 SS	EPDM	3/4" FNPT	NA608575-316E	
		CSPE	3/4" FNPT	NA608575-316C	
		TFE	3/4" FNPT	NA608575-316T	
		Viton	3/4" FNPT	NA608575-316V	
	370 cubic inches	POLY	EPDM	2" FNPT	NA637020-FPPE
			CSPE	2" FNPT	NA637020-FPPC
TFE			2" FNPT	NA637020-FPPT	
Viton			2" FNPT	NA637020-FPPV	
PVDF		EPDM	2" FNPT	NA637020-PVDE	
		CSPE	2" FNPT	NA637020-PVDC	
		TFE	2" FNPT	NA637020-PVDT	
		Viton	2" FNPT	NA637020-PVDV	
316 SS		EPDM	2" FNPT	NA637020-316E	
		CSPE	2" FNPT	NA637020-316C	
		TFE	2" FNPT	NA637020-316T	
		Viton	2" FNPT	NA637020-316V	
36 cubic inches		POLY	EPDM	3/4" FNPT	NA603675-FPPE
			CSPE	3/4" FNPT	NA603675-FPPC
	TFE		3/4" FNPT	NA603675-FPPT	
	Viton		3/4" FNPT	NA603675-FPPV	
	PVDF	EPDM	3/4" FNPT	NA603675-PVDE	
		CSPE	3/4" FNPT	NA603675-PVDC	
		TFE	3/4" FNPT	NA603675-PVDT	
		Viton	3/4" FNPT	NA603675-PVDV	
	316 SS	EPDM	3/4" FNPT	NA603675-316E	
		CSPE	3/4" FNPT	NA603675-316C	
		TFE	3/4" FNPT	NA603675-316T	
		Viton	3/4" FNPT	NA603675-316V	
	175 cubic inches	POLY	EPDM	2" FNPT	NA617520-FPPE
			CSPE	2" FNPT	NA617520-FPPC
TFE			2" FNPT	NA617520-FPPT	
Viton			2" FNPT	NA617520-FPPV	
PVDF		EPDM	2" FNPT	NA617520-PVDE	
		CSPE	2" FNPT	NA617520-PVDC	
		TFE	2" FNPT	NA617520-PVDT	
		Viton	2" FNPT	NA617520-PVDV	
316 SS		EPDM	2" FNPT	NA617520-316E	
		CSPE	2" FNPT	NA617520-316C	
		TFE	2" FNPT	NA617520-316T	
		Viton	2" FNPT	NA617520-316V	

BLACKLINE KOPkit		
Pump Size	Wetted Material	KOPkit Number
Size 1A - 1E	PVDF	K1AE-KTP
	PP	K1AE-PPP
	Stainless	K1AE-AAS
	PVDF/Alloy C	K1AE-KMM
Size 2F	PVDF	K2F-KTP
	PP	K2F-PPP
	Stainless	K2F-AAS
	PVDF/Alloy C	K2F-KMM
Size 2H	PVDF	K2GH-KTP
	PP	K2GH-PPP
	Stainless	K2GH-AAS
	PVDF/Alloy C	K2GH-KMM
Size 3G	PVDF	K3G-KTP
	PP	K3G-PPP
	Stainless	K3G-AAS
	PVDF/Alloy C	K3G-KMM

Specification 150 PSI Maximum Pressure

CHEM-TECH Peristaltic Pumps

Series XP

The Chem-Tech XP Series with peristaltic technology delivers worry-free dosing in a modern design. Each and every component of the XP Series is designed and manufactured for optimum reliability and durability for **REAL** Performance.

The electronic timing circuit in the adjustable 'A' Models provides **reliable** pump control, without relying on mechanical adjustment components that wear out over time.

The intuitive interface and controls provide **easy** operation and the peristaltic design is virtually maintenance-free.

Tailor-made for the water conditioning market, the XP Series offer **affordable** solutions in both initial cost and operation. A rugged gear train and computer-aided peristaltic design ensure **long-lasting** performance.



Tested and Certified by WQA
against NSF/ANSI 61-Section 8,
and CSA B483.1



Intertek
9700150

Intertek
9700150

Chem-Tech XP Series Selection Guide

MODELS:	Pump Size	Flow	Pressure Rating - PSI (Bar)				Tube Size	Speed (RPM)	XP ___	-	-	-	-
			Single Head Options			Duplex							
			'H' Tube	'L' Tube	'F' Tube	'L' Tube							
XP004	4 GPD (0.6 LPH)					2	30						
XP007	7 GPD (1.1 LPH)		125 (8.6)	80 (5.5)	60 (4.1)		50						
XP009	9 GPD (1.4 LPH)					3	30						
XP015	15 GPD (2.4 LPH)		110 (7.6)	70 (4.8)	50 (3.4)		50						
XP014	14 GPD (2.3 LPH)					4	30						
XP023	23 GPD (3.6 LPH)		100 (5.9)	50 (3.4)	40 (2.8)		50						
XP030	30 GPD (4.7 LPH)		80 (5.5)			6	30						
XP050	50 GPD (7.9 LPH)			40 (2.8)			50						
XP048	48 GPD (7.5 LPH)					8	30						
XP080	80 GPD (12.6 LPH)			25 (1.7)			50						

ELECTRICAL:	L	115V, 60Hz
	H	230V, 50/60Hz
	R	230V, 50Hz with Grounded Right Angle European Plug
Note: 50Hz pumps will produce 5/6 of the rated flow		

DRIVE:	F	Fixed Rate, On / Off Only
	A	Adjustable 20:1 Turndown, On / Off with Current Interrupter Timer
	G	Duplex Head - Fixed Rate, On / Off Only, 'L' Tube
	B	Duplex Head - Adjustable, On / Off with Current Interrupter Timer, 'L' Tube
	1	Pulse Input, .1 to 1 Second Timer
	2	Pulse Input, .2 to 10 Second Timer
	3	Pulse Input, 1 to 60 Second Timer
	4	Dry Contact Input - Fixed Rate Pump
	5	Dry Contact Input - Adjustable Pump
	6	Flow Switch Activated with 3/4" NPT Flow Switch - Fixed Rate Pump
	7	Flow Switch Activated with 3/4" NPT Flow Switch - Adjustable Rate Pump
	8	7 Day - 8 Event Electronic Timer - Fixed Rate Pump

TUBING:	L	Low Pressure Norprene with 1/4" Tube Fittings
	H	High Pressure Norprene with 1/4" Tube Fittings
	3	Low Pressure Norprene with 3/8" Tube Fittings
	4	High Pressure Norprene with 3/8" Tube Fittings
	F	Fluran, Acid resistant tubing with 1/4" Tube Fittings (Doesnot include strainer & injector accessories)
	G	Fluran, Acid resistant tubing with 3/8" Tube Fittings (Doesnot include strainer & injector accessories)

SYSTEM:	X	Pump Only
	1	15 Gallon Tank System
	3	35 Gallon Tank System
	T	15 Gallon ITS System

A completed model should look like "XP030LFLX"

CHEM-TECH Peristaltic Pumps

Series XPV

The Chem-Tech XPV Series pump combines the best in variable speed peristaltic pump technology with state of the art control electronics, providing you with unparalleled performance, control and value. The XPV represents the leading edge of microprocessor performance management, giving you many choices of input signal types, and onboard timer programs to customize this pump to any application. Of course, this pump is as rugged and reliable as it's fixed speed siblings, the XPF and the XPA.



Key Features

- Variable Speed
- Fully Scalable 4-20mA Input
- Hall Effect Input
- Contacting Head Water Meter
- Flow Totalization
- Cycle Timer
- Daily Timer
- LCD Display

Tested and Certified by WQA
against NSF/ANSI 61-Section 8.
and CSA B483.1



Intertek
9700150

Intertek
9700150

Chem-Tech Series XPV uses Chem-Tech Large Pump Discount Structure

Chem-Tech XPV Series Selection Guide							XP_---	-	-	-	-	
MODELS:	Pump Size	Flow	Pressure Rating - PSI (Bar)				Tube Size	Speed (RPM)				
			Single Head Options		Duplex							
			'H' Tube	'L' Tube	'F' Tube	'L' Tube						
XP008	8 GPD (1.3 LPH)	125 (8.6)	80 (5.5)	60 (4.1)	80 (5.5)	2	65 Max.					
XP017	17 GPD (2.7 LPH)	110 (7.6)	70 (4.8)	50 (3.4) ¹	70 (4.8)	3						
XP033	33 GPD (5.2 LPH)	100 (5.9)	50 (3.4)	40 (2.8) ²	50 (3.4)	4						
XP055	55 GPD (8.7 LPH)	80 (5.5)	40 (2.8)		40 (2.8)	6	60 Max.					
XP100	100 GPD (15.8 LPH)		25 (1.7)		25 (1.7)	8						
ELECTRICAL:	L	115V, 60Hz										
	H	230V, 60/50Hz										
	R	230V, 60/50Hz with Grounded Right Angle European Plug										
DRIVE:	V	Variable Input Control with I/O Cable										
	G	Duplex Head - Low Pressure Norprene with 1/4" Tube Fitting										
TUBING:	L	Low Pressure Norprene with 1/4" Tube Fittings										
	H	High Pressure Norprene with 1/4" Tube Fittings										
	3	Low Pressure Norprene with 3/8" Tube Fittings										
	4	High Pressure Norprene with 3/8" Tube Fittings										
	F	Fluran, Acid resistant tubing with 1/4" Tube Fittings (Doesnot include strainer & injector accessories)										
	G	Fluran, Acid resistant tubing with 3/8" Tube Fittings (Doesnot include strainer & injector accessories)										
SYSTEM:	X	Pump Only										
	1	15 Gallon Tank System										
	3	35 Gallon Tank System										
	T	15 Gallon ITS System										

A completed model should look like "XP033LVLX"

¹Max flow rate is 15 GPD (2.4 LPH) with Fluran tube.

²Max flow rate is 28 GPD (4.4 LPH) with Fluran tube.

XP & XPV Series Parts Schedule

Part Number	Description	Part Number	Description
KOPkits - Low Pressure			
NCKA2LPAP1	KOPkit XP - 004 / 007 / 008	J63051	Access. Kit, PVC/VTN, .25N
NCKA3LPAP1	KOPkit XP - 009 / 015 / 017	J30257	Grease Kit
NCKA4LPAP1	KOPkit XP - 023 / 033 / 014	J60609	Strainer Assembly w/o Valve
NCKA6LPAP1	KOPkit XP - 030 / 050 / 055	J63002	Control Panel Cover (Clear)
NCKA8LPAP1	KOPkit XP - 048 / 080 / 100	J63004	Rain Hood
KOPkits - High Pressure			
NCKA2HPAP1	KOPkit XP - 004 / 007 / 008	J63007	Switch, On-Off
NCKA3HPAP1	KOPkit XP - 009 / 015 / 017	J63013	Timer Assy
NCKA4HPAP1	KOPkit XP - 023 / 033 / 014	J63016	Gear Motor, 30RPM / 120V / 50-60Hz
NCKA6HPAP1	KOPkit XP - 030 / 055	J63017	Gear Motor, 30RPM / 240V / 50-60Hz
NCKA24PAP1	KOPkit XP - 004 / 008 - 3/8"	J63018	Gear Motor, 50RPM / 120V / 50-60Hz
NCKA34PAP1	KOPkit XP - 009 / 015 / 017- 3/8"	J63019	Gear Motor, 50RPM / 240V / 50-60Hz
NCKA44PAP1	KOPkit XP - 033 / 014 - 3/8"	J63023	Housing Assy, 100% Fixed Rate
KOPkits - Duplex Low Pressure			
NCKD2LPAP1	KOPkit XP - 004 / 008	L1900500-000	Thumb Screw #6 (Control Pnl Cover)
NCKD3LPAP1	KOPkit XP - 009 / 017	NC110002-PVC	Coupling Nut, .25 NPT
NCKD4LPAP1	KOPkit XP - 033 / 014	NC110016-000	Sleeve, .25 OD Tube
NCKD6LPAP1	KOPkit XP - 030 / 055	NC170004-000	Label, Earth Ground
NCKD8LPAP1	KOPkit XP - 048 / 100	NC190000-000	Knob, #10 Thumb Screw (Head Mtg)
TUBE KITS			
Low Pressure 1/4" Tube Fittings			
NC90XX2LPA-XXXXX	Kit, Tube Assy - 004 / 007 / 008	U8800712	Injection Valve Assembly
NC90XX3LPA-XXXXX	Kit, Tube Assy - 009 / 015 / 017	NC82XX3LP1-XXXXX	Roller Assembly For Size 2-6 Tubes
NC90XX4LPA-XXXXX	Kit, Tube Assy - 023 / 033 / 014	NC82XX8LP1-XXXXX	Roller Assembly For Size 8 Tube
NC90XX6LPA-XXXXX	Kit, Tube Assy - 030 / 050 / 055		
NC90XX8LPA-XXXXX	Kit, Tube Assy - 048 / 080 / 100		
High Pressure 1/4" Tube Fittings			
NC90XX2HPA-XXXXX	Kit, Tube Assy - 004 / 007 / 008		
NC90XX3HPA-XXXXX	Kit, Tube Assy - 009 / 015 / 017		
NC90XX4HPA-XXXXX	Kit, Tube Assy - 023 / 033 / 014		
NC90XX6HPA-XXXXX	Kit, Tube Assy - 030 / 055		
Low Pressure 3/8" Tube Fittings			
NC90XX23PA-XXXXX	Kit, Tube Assy - 004 / 007 / 008		
NC90XX33PA-XXXXX	Kit, Tube Assy - 009 / 015 / 017		
NC90XX43PA-XXXXX	Kit, Tube Assy - 023 / 033 / 014		
NC90XX63PA-XXXXX	Kit, Tube Assy - 030 / 050 / 055		
NC90XX83PA-XXXXX	Kit, Tube Assy - 048 / 080 / 100		
High Pressure 3/8" Tube Fittings			
NC90XX24PA-XXXXX	Kit, Tube Assy - 004 / 007 / 008		
NC90XX34PA-XXXXX	Kit, Tube Assy - 009 / 015 / 017		
NC90XX44PA-XXXXX	Kit, Tube Assy - 023 / 033 / 014		
NC90XX64PA-XXXXX	Kit, Tube Assy - 030 / 055		
Fluran 1/4" Tubing Fittings			
NC90XX2FPA-XXXXX	Kit, Tube Assy - 004 / 007 / 008		
NC90XX3FPA-XXXXX	Kit, Tube Assy - 009 / 015 / 017		
NC90XX4FPA-XXXXX	Kit, Tube Assy - 023 / 033 / 014		
Fluran 3/8" Tubing Fittings			
NC90XX2GPA-XXXXX	Kit, Tube Assy - 004 / 007 / 008		
NC90XX3GPA-XXXXX	Kit, Tube Assy - 009 / 015 / 017		
NC90XX4GPA-XXXXX	Kit, Tube Assy - 023 / 033 / 014		

TANK / WALL MOUNT KITS

J63047	15 Gal Tank Bracket
J63048	ITS Tank Adaptor Plate

XPV Series Parts

J63006	Drive Motor, Variable Speed
J63115	Fuse Kit, Variable Speed

CHEM-TECH Mechanical Diaphragm Pumps

Prime Performance

The Chem-Tech Prime Performance Series pumps have a specially designed degassing valve system for applications using off-gassing chemicals like sodium hypochlorite. Built upon motorized-diaphragm technology, the Prime Performance Series delivers dependable performance, extended longevity and consistent metering over long periods of time in a compact form.

A top-mounted, one-way vent valve assembly evacuates gas bubbles from the pump head, providing for reliable operation.

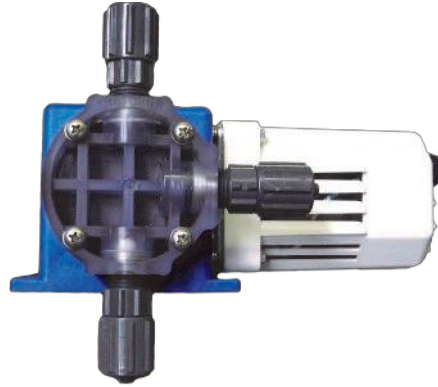

Standard Agency Listings		
Model	ETL	ETLsan
All 60Hz	X	X
All 50Hz		
Contact factory for alternate listings		



Contact factory for applicable agency approvals.

PRIME PERFORMANCE Selection Guide		X	---	---	---	A	---	---
MODELS:	015 = 15 gpd (2.34 lph) max pres.: 100 PSI (7 BAR) 024 = 24 gpd (3.78 lph) max pres.: 100 PSI (7 BAR) 030 = 30 gpd (4.72 lph) max pres.: 100 PSI (7 BAR) 068 = 68 gpd (10.72 lph) max pres.: 60 PSI (4 BAR) 100 = 100 gpd (15.76 lph) max pres.: 60 PSI (4 BAR)							
ELECTRICAL:	XA = 115V, 60 Hz XB = 230V, 50 Hz XC = 230V, 60 Hz							
LIQUID END MATERIALS: Head, Fittings/ Diaph., Seats/ Balls	BAA = PVC / CSPE / Ceramic BBA = PVC / Viton / Ceramic							
CONNECTION SIZES:	6 = Tubing .38" PE BLK Suction / .38" PE BLK Discharge / .38" PE BLK Return 8 = Tubing .38" PVC Suction / .38" PE Discharge / .38" PVC Return 7 = Tubing .50" PE BLK Suction / .50" PE BLK Discharge / .50" PE BLK Return 9 = Tubing .44" PVC Suction / .50" PE Discharge / .44" PVC Return							
SUFFIX CODES:	XXX = Standard 001 = Current Interrupter 15T = 15 gal tank w/ bulkhead for vent,level wand,safety cap & fasteners 35T = 35 gal tank w/ bulkhead for vent and fasteners							
A complete model should look like "X024-XA-BBA9XXX"								

Pumps come with foot valve/strainer/weight, 4' of suction tubing, 4' of return tubing, 8' of discharge tubing, and injection/back pressure valve assembly.

CHEM-TECH KOPkits

PRIME PERFORMANCE KOPkit Selection Guide		KX100	---	A	---
PRODUCT DESIGNATOR:	KX100 = Chem-Tech Kopkit				
LIQUID END MATERIALS: Head, Diaph., Seats & Balls	BAA = PVC / CSPE / Ceramic BBA = PVC / Viton / Ceramic				
CONNECTION :	6 = Tubing .38" Suction / Discharge / Return 8 = Tubing .38" Suction / Discharge / Return 7 = Tubing .50" Suction / Discharge / Return 9 = Tubing .44" Suction & Return / .50" Discharge				

CHEM-TECH Mechanical Diaphragm Pumps

Series 100, 150, 200



Series 100 Models - The preferred metering pump for water conditioning professionals around the world. Perfect for applications where economical, consistent performance is required. Capable of a wide range of flows, from less than 3 USgpd up to 30 USgpd and pressures up to 100 psig.

Series 150 Models - Built upon the same solid platform as the 100 Models, these units are capable of higher flowrates. With a range offering up to 100 USgpd, the Series 150 can meet the demands of larger applications. Maximum pressure is 60 psig.

Series 200 Models - The pump popular for their rugged design for continuous duty operation offers feed rates from 10 to 120 gpd and pressures up to 150 psi.

Standard Agency Listings		
Model	ETL	ETLsan
All 60Hz	X	X
100-150 50Hz		
200 50Hz		
Contact factory for alternate listings		



Contact factory for applicable agency approvals.

Note: Standard Features do not add to the pump price.

Chem-Tech Series 100, 150, 200 Selection Guide

MODELS:	Series 100	Series 150	Series 200
	X003 = 3 gpd (0.47 lph) max pres.: 100 PSI (7 BAR)		
	X007 = 7 gpd (1.00 lph) max pres.: 100 PSI (7 BAR)		
	X015 = 15 gpd (2.34 lph) max pres.: 100 PSI (7 BAR)		
	X024 = 24 gpd (3.78 lph) max pres.: 100 PSI (7 BAR)		
	X030 = 30 gpd (4.72 lph) max pres.: 100 PSI (7 BAR)		
		X068 = 68 gpd (10.72 lph) max pres.: 60 PSI (4 BAR)	
		X100 = 100 gpd (15.76 lph) max pres.: 60 PSI (4 BAR)	
			X210 = 10 gpd (1.5 lph) max pres.: 150 PSI (10 BAR)
			X215 = 15 gpd (2.34 lph) max pres.: 150 PSI (10 BAR)
			X220 = 20 gpd (3.15 lph) max pres.: 150 PSI (10 BAR)
			X230 = 30 gpd (4.72 lph) max pres.: 125 PSI (9 BAR)
			X240 = 40 gpd (6.31 lph) max pres.: 125 PSI (9 BAR)
			X260 = 60 gpd (9.46 lph) max pres.: 125 PSI (9 BAR)
			X280 = 80 gpd (12.6 lph) max pres.: 100 PSI (7 BAR)
			2100 = 100 gpd (15.76 lph) max pres.: 100 PSI (7 BAR)
			2120 = 120 gpd (18.91 lph) max pres.: 80 PSI (6 BAR)

ELECTRICAL:	XA	XB	XC	XD	XL
	= 115V, 60 Hz	= 230V, 50 Hz (not available in 2120)	= 230V, 60 Hz	= 115V, 50/60 Hz, T.E.F.C. (X200's only)	= 230V, 50/60 Hz, T.E.F.C. (X200's only)

LIQUID END MATERIALS:	AAA	AAB	ABA	ABB	ACA	AHA	BAA	BAB	BBA	BBB	BHA	DAA	DAB	DBA	DBB	GFA	GFB	EFC
Pump Head & Fittings/Seats & O-rings/Balls	= Clear PVC / CSPE / Ceramic	= Clear PVC / CSPE / TFE	= Clear PVC / Viton / Ceramic	= Clear PVC / Viton / TFE	= Clear PVC / TFE/Viton / Ceramic	= Clear PVC / TFE/CSPE / Ceramic	= PVC / CSPE / Ceramic	= PVC / CSPE / TFE	= PVC / Viton / Ceramic	= PVC / Viton / TFE	= PVC / TFE/CSPE / Ceramic	= PP / CSPE / Ceramic	= PP / CSPE / TFE	= PP / Viton / Ceramic	= PP / Viton / TFE	= Clear PVC / TFE / Ceramic (dbl)	= Clear PVC / TFE / TFE (dbl)	= 316SS / TFE / 316SS (dbl)

CONNECTION SIZES:	A	C	F	S	X w/ 316
	= Tubing .44" PVC Suction / .50" PE Discharge	= Tubing .38" PVC Suction / .38" PE Discharge	= Tubing .44" PVC Suction / .50" PE BLK Discharge	= Tubing .38" PVC Suction / .38" PE BLK Discharge	= .25" FNPT Suction / .25" FNPT Discharge

SUFFIX CODES:	XXX	001	500*	520*	ITS
	= Standard	= Current Interrupter	= Five Function Valve	= Five Function Degas Valve	= 15 gal ITS Tank System

* Not available in SS. Adder price is per head.

A completed model number should look like "X015-XA-BAAAXX"



Chem-Tech KOPkit Selection Guide

KX100 -

PRODUCT DESIGNATOR: KX100 = Chem-Tech Kopkit

LIQUID END MATERIALS: Head, Diaph., Seats & Balls	Material Code	Description
	AAA	= Clear PVC / CSPE / Ceramic
	AAB	= Clear PVC / CSPE / TFE
	ABA	= Clear PVC / Viton / Ceramic
	ABB	= Clear PVC / Viton / TFE
	ACA	= Clear PVC / TFE/Viton / Ceramic
	AHA	= Clear PVC / TFE/CSPE / Ceramic
	BAA	= PVC / CSPE / Ceramic
	BAB	= PVC / CSPE / TFE
	BBA	= PVC / Viton / Ceramic
	BBB	= PVC / Viton / TFE
	BHA	= PVC / TFE/CSPE / Ceramic
	DAA	= PP / CSPE / Ceramic
	DAB	= PP / CSPE / TFE
	DBA	= PP / Viton / Ceramic
	DBB	= PP / Viton / TFE
	GFA	= Clear PVC / TFE / Ceramic (dbl)
	GFB	= Clear PVC / TFE / TFE (dbl)
	EFC	= 316SS / TFE / 316SS (dbl)

CONNECTION :	Code	Description
	A	= Tubing .44" PVC Suction / .50" PE Discharge
	C	= Tubing .38" PVC Suction / .38" PE Discharge
	F	= Tubing .44" PVC Suction / .50" PE BLK Discharge
	S	= Tubing .38" PVC Suction / .38" PE BLK Discharge
	X w/ 316	= .25" FNPT Suction / .25" FNPT Discharge

Series 100, 150, 100D, 150D And 200 Parts Schedule

Part Number	Description	Part Number	Description
00006	Suction Tubing - per foot 7/16" OD	J27903	Gasket, TFE
00007	Suction Tubing - per foot 3/8"	27911	Gasket
00008	Discharge Tubing - per foot 1/2" OD	28215	Gear Housing Assembly #260
00009	Discharge Tubing - per foot 1/2" Black	28217	Gear Housing Assembly #2-100
00010	Discharge Tubing - per foot 3/8"	28218	Gear Housing Assembly #2-120
00011	Discharge Tubing - per foot 3/8" Black	28521	Grommet
20038	1/2" NPT Connection - PVC - fits Suction side of Pump Head and Back Ck. Vlv. Assy. (per connection)	28800	Head, Clear PVC
20039	1/2" NPT Connection - PVC - fits Discharge side of Pump Head and Strainer Assy. (per connection)	28803	Head, Polypropylene
J20560	Ball Check (ceramic)	28899	Head Assy, (PP-VT-C-1/2" S/D)
21829	Drive Bracket Assy. S100	28902	Head Assy, (PVC-VT-C-3/8" S/D)
21971	Diaphragm Shaft Bushing	29230	Motor Housing
22255	Cam Bearing Assy. S100 - 3, 7, 15, 30 GPD	29313	Main Housing 10, 15, 20, 30, 40, 60, 100 GPD
22256	Cam Bearing Assy. S100 - 24 GPD	29314	Main Housing 120 GPD only
22257	Cam Bearing Assy. S150 - 68, 100 GPD	30460	Output Adjustment Knob
J24269	Oil (quart)	30467	Output Adj Knob Asm S150
24450	Current Interrupter - S100 - 115V	J30496	Housing - S100 - 3, 7, 15, 30 GPD
24453	Current Interrupter/Plug Receptacle S200 - 115V	J30498	Housing - S150, 68, 100 GPD
24454	Current Interrupter/Plug Receptacle/Bottom Plate (Std) 115V	J30503	Motor - 115V, 60 Hz, S200
24820	Cord Assy. - 115V, 60 Hz	J30504	Motor - 230V, 50 Hz, S200
24821	Cord - 230V, 50 or 60 Hz	J30505	Motor - 230V, 60 Hz, S200
J24960	Coupling Nut, PVC 1/2" (Standard)	J30507	Kit, Bleed, Valve, PVC/HPY/ 3/8
24961	Coupling Nut, PP 1/2"	J30509	Kit, Bleed, Valve, PVC/VTN/ 3/8
24963	Coupling Nut, PVC 3/8"	J30510	Kit, Bleed, Valve, PVC/TFE/ 3/8
25180	Motor Cover	J30511	Kit, Bleed, Valve, FPP/CSPE/ 3/8
25704	Diaphragm, CSPE	J30513	Kit, Bleed, Valve, FPP/VTN/ 3/8
25706	Diaphragm, Viton		
25707	Diaphragm, PTFE Coated		
J26780	Injection Fitting, PVC 3/8"		
26781	Injection Fitting, PVC 1/2"		
26858	Bulkhead Fitting (PP-1/2")		
26867	Bulkhead Fitting (PP-3/8")		
J26907	Bulkhead Fitting (PVC-1/2")		
J26910	Bulkhead Fitting without strainer (PVC-3/8")		
J26905	Bulkhead Fitting for ITS (PVC-1/4")		

Series 100, 150, 100D, 150D And 200 Parts Schedule

Part No.	Description	Part No.	Description
J30514	Kit, Bleed, Valve, FPP/TFE/ 3/8	28218	Gear Housing Assembly #2-120
J30515	Kit, Bleed, Valve, PVC/HPY/ 1/2	28521	Grommet
J30517	Kit, Bleed, Valve, PVC/VTN/ 1/2	28800	Head, Clear PVC
J30518	Kit, Bleed, Valve, PVC/TFE/ 1/2	28803	Head, Polypropylene
J30519	Kit, Bleed, Valve, FPP/CSPE/ 1/2	28899	Head Assy, (PP-VT-C-1/2" S/D)
L3300V03-FPP	Kit, Bleed, Valve, FPP/VTN/ 1/2	28902	Head Assy, (PVC-VT-C-3/8" S/D)
J30522	Kit, Bleed, Valve, FPP/TFE/ 1/2	29230	Motor Housing
31081	Locking Lever - S100, 215, 230, 260	29313	Main Housing 10, 15, 20, 30, 40, 60, 100 GPD
31082	Locking Lever 20, 40, GPD S200	29314	Main Housing 120 GPD only
31083	Locking Lever - S150, 280, 2-100, 2-120	30460	Output Adjustment Knob
32520	Motor - 7 SPM, 115V, 60 Hz, 003	30467	Output Adj Knob Asm S150
32521	Motor - 13 SPM, 115V, 60 Hz, 007	J30496	Housing - S100 - 3, 7, 15, 30 GPD
32522	Motor - 25 SPM, 115V, 60 Hz, 015	J30498	Housing - S150, 68, 100 GPD
32523	Motor - 51 SPM, 115V, 60 Hz, 024/030/068	J30503	Motor - 115V, 60 Hz, S200
32524	Motor - 7 SPM, 230V, 60 Hz, 003	J30504	Motor - 230V, 50 Hz, S200
32527	Motor - 51 SPM, 230V, 60 Hz, 024/030/068	J30505	Motor - 230V, 60 Hz, S200
32528	Motor - 7 SPM, 230V, 50 Hz, 003	J30507	Kit, Bleed, Valve, PVC/HPY/ 3/8
32530	Motor - 25 SPM, 230V, 50 Hz, 015	J30509	Kit, Bleed, Valve, PVC/VTN/ 3/8
32531	Motor - 51 SPM, 230V, 50 Hz, 024/030/068	J30510	Kit, Bleed, Valve, PVC/TFE/ 3/8
32532	Motor - 70 SPM, 115V, 60 Hz, 100	J30511	Kit, Bleed, Valve, FPP/CSPE/ 3/8
32533	Motor - 70 SPM, 230V, 50 Hz, 100	J30513	Kit, Bleed, Valve, FPP/VTN/ 3/8
32535	Motor - 70 SPM, 230V, 60 Hz, 100	41588	Anti-Siphon Valve (PVC-VT-1/2")
J34379	Backing Plate	41624	Anti-Siphon Valve (PVC-CSPE-1/2") (Standard)
34405	Plate, Motor Cover	41657	Back Check Valve Assy (PVC-CSPE-C-3/8")
34423	Back Plate	J41658	Back Check Valve Assy (PVC-CSPE-C-1/2")
34532	Oil Filler Plug w/Cap	41659	Back Check Valve Assy (PP-VT-C-1/2")
37080	Output Adjust Screw 10, 20, 40 GPD	41661	Back Check Valve Assy (PVC-VT-C-1/2")
37081	Output Adjust Screw 15, 30, 60 GPD	J41667	Double Ball Ck Vlv Cart Assy (PVC-1/2") Suct
37083	Output Adjust Screw 80, 100, 120 GPD	41668	Double Ball Ck Vlv Cart Assy (PVC-3/8") Disch
37300	Oil Seal	J41669	Double Ball Ck Vlv Cart Assy (PVC-1/2") Disch
J37440	Valve Seat, CSPE	J41694	Back Check Valve Assy (PVC-CSPE-C-1/2")
J37442	Valve Seat, Viton	41695	Back Check Valve Assy (PVC-VT-C-3/8")
37886	Diaphragm Shaft	41696	Back Check Valve Assy (PP-VT-C-3/8")
38080	Locking Sleeve	41705	6" Ck Vlv Inj Assy (PVC-CSPE-C-3/8")
38980	Diaphragm Return Spring	41707	6" Ck Vlv Inj Assy (PVC-VT-C-3/8")
38981	Coupling Spring	41708	6" Ck Vlv Inj Assy (PVC-VT-C-1/2")
38984	Valve Spring - top - light	41710	6" Ck Vlv Inj Assy (PP-VT-C-1/2")
J38985	Valve Spring	41720	Anti-Siphon Valve (PVC-CSPE-1/2" NPT)
J60717	Foot Valve & Strainer Assy (PVD-CSPE-C-3/8")	41795	Back Check Valve Assy (PVC-CSPE-C-1/2" x 1/2" NPT)
J60729	Foot Valve & Strainer Assy (PVD-CSPE-C-1/2")	J42020	Head Bolt Washer SS .20 x .38
J60718	Foot Valve & Strainer Assy (PVD-VT-C-3/8")	J42030	Fiber Washer
J60730	Foot Valve & Strainer Assy (PVD-VT-C-1/2")	42031	Washer, Fiber
J41540	Valve Housing Discharge, PVC 1/2"	J60030	Head Assy (SAN-CSPE-C-3/8" D)
41543	Valve Housing Discharge, PVC 3/8"	J61222	Kit, 5 Function Valve incl L380DT03-PVC for Series 100/200
41544	Valve Housing Discharge, PP 3/8"	J61539	Kit, 5 Function Valve incl L380DT02-PVC for Series 100/200
J41548	Valve Housing Suction, PVC 1/2"	J61503	Kit, S200 Back Plate Screws (5 - J37017, 5 - J42030)
J41834	Valve Housing Suction, PP 1/2"	J61504	Kit, S200 Motor Cover Hdwe (2 - J37002, 2 - J42030)
41551	Valve Housing Suction, PVC 3/8"	J61508	Kit, S200 Main Housing Screw (2 - 37021, 2 - J42083, 2 - 42031)
J41835	Valve Housing Suction, PP 3/8"	J61509	Kit, S200 Shaft Coupling Motor (1 - 24966, 1 - 37060)
		J61510	Kit, S200 Shaft Coupling Gear (1 - 24967, 1 - 37061)
		J61511	Kit, Screw Motor Cover (2 - J37073)

CHEM-TECH Mechanical Diaphragm Pumps

Series 250

The Series 250 is a mechanically activated, heavy duty diaphragm feed pump that provide excellent efficiency under strenuous conditions. The Series 250 combines the power and repeatability of piston pumps with the chemical resistance of diaphragm pumps for high pressure applications.

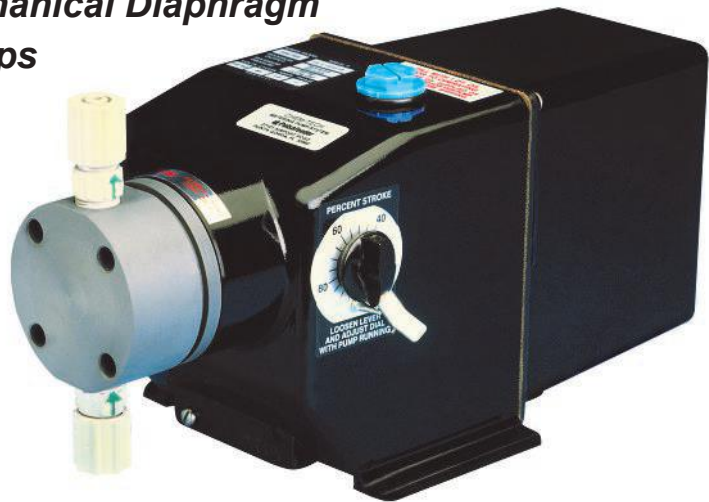

Chem-Tech Series 250 Selection Guide

MODELS:	3 = 76.8 gpd (12.11 lph) max pres.: 225 PSI (15.52 BAR)	X25	-	---	-	---	Q	XXX
	4 = 108 gpd (17.03 lph) max pres.: 160 PSI (11.03 BAR)							
ELECTRICAL:	XD = 115V, 50/60 Hz, T.E.F.C.							
	XL = 230V, 50/60 Hz, T.E.F.C.							
LIQUID END MATERIALS:	GFA = PVC / TFE (dbl) / Ceramic							
CONNECTION SIZES:	Q = 44" PVC Suction / .50" PP Discharge							
SUFFIX CODES:	XXX = Standard							

A complete model should look like "X253-XD-GFAQXXX"

IMPORTANT NOTES:

1. KOPkits are not available for this model.
2. Shipping weight is 21 lbs.

STANDARD ACCESSORIES:

Models with tubing connections come with a footvalve/strainer/weight, 4' of suction tubing, 8' of discharge tubing, and an injection valve.

Series 250 Parts Schedule

Part No.	Description	Part No.	Description
00006	Suction Tubing (per foot) 7/16" OD	29230	Motor Cover / 253 - 254
J00012	Polypropylene Tubing, 1/2" OD - Discharge (per ft)	29313	Pump Housing
00013	Polypropylene Tubing, 1/2" OD-Discharge (per ft) - Black	30460	Output Adjustment Knob
J20560	Ball Check, Ceramic	32545	Motor, 115/230V, 50/60 Hz, TEFC
23705	Collar - Model 253	34532	Oil Filler Plug with Cap
23706	Collar - Model 254	37084	Adjustment Screw
J24269	Oil (quart)	37886	Diaphragm Shaft
24820	Cord Assembly, 115V, 60Hz	J41658	Back Check Valve Assy (PVC-CSPE-C-1/2")
24821	Cord, 230V, 50-60 Hz	J41667	Double Ball Check Valve Cart Assy (PVC 1/2") Suc.
J24960	Coupling Nut - PVC 1/2"	41668	Double Ball Check Valve Cart Assy (PVC 3/8") Disch
25681	Diaphragm Assembly - Model 253	J41669	Double Ball Check Valve Cart Assy (PVC 1/2") Disch
25682	Diaphragm Assembly - Model 254	J42020	Bolt Washer (4 required) SS
J27903	Gasket, TFE	J60729	Foot Valve & Strainer Assy (PVC-CSPE-C-1/2")
J28815	Pump Head, PVC - Model 253	J61516	Kit, Head Mounting Bolts (4 - J37005, 4 - J42020)
28816	Pump Head, PVC - Model 254	J61518	Kit, Gasket TFE (4 - J27930)
J28919	Head Assembly, PVC - Model 253 - 1/2"		
28920	Head Assembly, PVC - Model 254 - 1/2"		

MEC-O-MATIC *Peristaltic Pumps*

Dolphin Series

- Exclusive quick-release, twist-off, clear polycarbonate, acid-resistant head to withstand the harshest environment.
- Self-lubricating chemical resistant roller assembly.
- Durable, long lasting tubing with no tube adjustment.
- Rugged and dependable – Heavy-duty shaded pole gearmotor with lifetime lubrication.
- Flexibility in feed rates - from .13 gallons to 97 gallons per day ... to meet the demands of the pool and spa Industry, and elsewhere.
- Agency approvals.



Tested and Certified by WQA
against NSF/ANSI 61-Section 8.
and CSA B483.1



Contact
factory for
applicable
agency
approvals.

Mec-O-Matic DOLPHIN Series Selection Guide		UD	---	---	U	XXX
MODELS:	10 = 13.0 gpd (2.05 lph) max pres.: 25 PSI (1.72 BAR) 50 = 60.0 gpd (9.46 lph) max pres.: 25 PSI (1.72 BAR) 75 = 97.0 gpd (15.30lph) max pres.: 25 PSI (1.72 BAR)					
ELECTRICAL:	XA = 115V, 60 Hz XL = Standard 230V, 50/60 Hz, used w/ Model 10 only XB = Standard 230V, 50 Hz, used w/ Models 50 & 75 only XC = Standard 230V, 60 Hz, used w/ Models 50 & 75 only					
LIQUID END MATERIALS:	LSA = Norprene Tubing LBA = Viton Tubing					
CONNECTION SIZES:	U = Tubing .25" I.D. X .44" O.D.					
SUFFIX CODES:	XXX = Standard					

A completed model should look like "UD75-XA-LBAUXXX"

Junction Box option is available on 230V models at no additional charge. Contact the factory for model numbers.

Shipping weight for Dolphin Pumps is 7 lbs.

MEC-O-MATIC *KOPkits*

Mec-O-Matic DOLPHIN KOPkit Selection Guide		KUDXX	---
PRODUCT DESIGNATOR:	KUDXX = Dolphin Kopkit		
LIQUID END MATERIALS:	LSAU = Norprene Tubing CRM LLAU = Norprene Tubing BLK LBAU = Viton Tubing		

DOLPHIN Series Parts Schedule

Part No.	Description	Part No.	Description
J60552	Strainer Assembly w/o valve	U0818616	Gearmotor Assembly, 120V, 10 RPM - D10
24820	Power Cord 120V	U0818617	Gearmotor Assembly, 240V, 10 RPM - D10
24821	Power Cord 240V	U0818618	Gearmotor Assembly, 120V, 50 RPM - D50
U0817635	Knob	U0818619	Gearmotor Assembly, 240V, 50 RPM - D50
U0817923	Switch, Rocker	U0818620	Gearmotor Assembly, 120V, 75 RPM - D75
U0817942	Screw 10 - 32 X .688", Motor Mount	U0818621	Gearmotor Assembly, 240V, 75 RPM - D75
U0819142	Box, Front	U8800431	Tubing cut 1/4" X 15 ft. PE
U0819143	Box, Back	U8800637	Tubing Replacement Kit (7/16"Norprene Crm)
U0818180	Potentiometer Assembly	U8800651	Pump Head Assembly
U0818564	Fan D10 (CW)	U8800712	Injection Fitting
U0818565	Fan D50, D75 (CCW)	U8800740	Kit, Timer 120V (1 - U0818183, 1 - U0020522)
U0812955	Screw 8 - 32 X 1/4", Fan	U8800741	Kit, Timer 240V (1 - U0818182, 1 - U0020522)
L9900700-000	Strain Relief	U8800742	Kit, Pump Head Bearings (2 - U0817121)
		U8800743	Kit, Collars (2 - U0817123)
		U8800758	Kit, Pump Head Tubing (Viton)

MEC-O-MATIC *Peristaltic Pumps*

VSP Series

- Versatile - The VSP is engineered to dispense low volumes of chemicals at exacting amounts.
- Reliable – Heavy-duty gearmotor... fieldtested, proven peristaltic head... durable chemical-resistant housing.
- Low Maintenance – Self-lubricating roller assembly... NO tube adjustment required... exclusive quick-release, twist-off head.
- Guaranteed – Full one year warranty on dispenser.



Mec-O-Matic VSP Series Selection Guide

		UVSP__	__	---	U	XXX
MODELS:	12	= 12.0 gpd (1.89 lph) max pres.: 25 PSI (1.72 BAR)				
	20	= 20.0 gpd (3.15 lph) max pres.: 25 PSI (1.72 BAR)				
ELECTRICAL:	XP	= 24VAC				
	XR	= 120V 50/60 Hz				
LIQUID END MATERIALS:	LLA	= Norprene Tubing				
	LBA	= Viton Tubing				
CONNECTION SIZES:	U	= Tubing .19" I.D. X .38" O.D. used w/ UVSP12 only				
	U	= Tubing .25" I.D. X .44" O.D. used w/ UVSP20 only				
SUFFIX CODES:	XXX	= Standard				

A completed model should look like "UVSP12XRLLAUXXX"

Shipping weight for all VSP pumps is 6 lbs.

VSP Series Parts Schedule

Part Number	Description
J60552	Strainer w/o Valve
U0817122	Collar VSP - 12
U0817123	Collar VSP - 20
U0817742	Hose Clamps
U0817923	Switch
24820	Power Cord 120 V
U0819142	Front Housing
U0819143	Rear Assembly
L9710200-000	Lead Assembly
U0818083	Hole Plug
U0818305	Printed Circuit Board 24V
U0818306	Printed Circuit Board 120V
U0818320	Power Cord 24V
U0818463	Fuse 24V, 1/2 Amp
U0818464	Fuse 120V, 1/8 Amp
U0818667	Gearmotor Kit
U7013397	Tube Kit VSP - 20
U8800431	15" X 1/4" Poly Tubing
U8800651	Pump Head Kit
U8800700	Tube Kit VSP - 12
U8800712	IPF Auto Clean Injection Fitting
U8800739	Kit, Motor Mount (2 - U0818666, 2 - 32946, 2 - U0811297)
U8800742	Kit, Pump Head Bearings (2 - U0817121)
L9900700-000	Strain Relief

MEC-O-MATIC *Peristaltic Pumps*

Series 2400T Grease Trap Dispenser

- Capable of Dispensing Low Volumes
- Programmable
- Simple Installation
- Prime Push Button for Quick Start-Up
- Quick Release Twist Off Head
- Built-In Timer
- No Tube Adjustment Needed
- Self Lubricating Roller Assembly



Contact
factory for
applicable
agency
approvals.

Mec-O-Matic 2400T Series Selection Guide		UT24	---	---	---	---
MODELS:	UT24 = 2.5 gpd (0.39 lph) max pres.: 25 PSI (1.72 BAR) used w/ 2400T & 2400T PLUS					
	UT24 = 3.0 Oz / 1 Min max pres.: 25 PSI (1.72 BAR) used w/ 2400T-DC only					
ELECTRICAL:	-XA = 115V, 60 Hz used w/ 2400T only					
	PXA = 115V, 60 Hz used w/ 2400T PLUS only					
	-AD = 12V DC used w/ 2400T-DC only					
LIQUID END MATERIALS:	LT = Silicone Tubing					
	LB = Viton Tubing					
	LL = Norprene Tubing used w/ 2400T-DC only					
CONNECTION SIZES:	AU = Tubing .125" I.D. X .31" O.D.					
	XU = Tubing .25" I.D. X .44" O.D. used w/ 2400T-DC only					
SUFFIX CODES:	XXX = Standard					
A completed model should look like "UT24-XA-LBAUXXX"						

1. 2400T comes standard with 24 hour mechanical timer. 2400T plus and DC utilizes a 7 day, 8 event programmable timer
2. 2400T DC Pump requires 8 "D" cell batteries (not included).
3. Shipping weight is 7.5 lbs.

2400T & T PLUS Series Parts Schedule

Part No.	Description	Part No.	Description
J60552	Strainer Assembly w/o Valve	U0819143	Pump Housing (rear)
U0817131	Tubing Assy 5/16" X 9" Silicone	U0818564	Fan
U0817742	Hose Clamp	U0818602	Gearmotor Assembly
U0817888	Pump Head Screw	U0818740	Timer (2400T Plus)
U0817942	Screw 10 - 30 X .688", Motor Mount	U8800431	15' X 1/4" PE Tubing
U0817952	Timer (2400T)	U8800712	Injection Fitting
U0818018	Indicator Light	U8800753	Pump Head Assembly Kit (No Tubing)
U0819145	Pump Housing (front-2400T Plus)	U0812955	Hex Screw 8 - 32 X 1/4"
U0819144	Pump Housing (front-2400T)	L9900700-000	Strain Relief

2400T DC Series Parts Schedule

Part No.	Description	Part No.	Description
U0812955	Screw 6 - 32 X .25" PHP	U0818902	Battery Holder Assembly
U0817888	Shoulder Screw	U0819037	12V DC Timer LO AMP
U0818026	Spacer SST (Motor)	U8800490	Injection Fitting
U0818666	Screw 8 - 32 X 1.25 PHP	U8800637	7/16" Tubing Kit (Peristaltic)
U0818881	12V DC Motor	U8800651	Pump Head Assembly Kit (No Tubing)
U0818895	1/4" X 20' Tubing PE	U8800700	3/8" Tubing Kit
		U8800742	Kit, Pump Head Bearings (2 - U0817121)

Policies and Procedures

1. **Manufacturer's Equipment Warranty**
 - a. Pulsafeeder warrants all pumps and controllers of its manufacture to be free of defects in material or workmanship. Liability under this policy extends for 24 months from the date of shipment. The manufacturer's liability is limited to repair or replacement of any failed equipment or part which is proven defective in material or workmanship upon manufacturer's examination. This warranty does not include removal or installation costs and in no event shall the manufacturer's liability exceed the selling price of such equipment or part.
 - b. The manufacturer disclaims all liability for damage to its products through improper installation, maintenance, use or attempts to operate such products beyond their functional capacity, intentionally or otherwise, or any other unauthorized repair. The manufacturer is not responsible for consequential or other damages, injuries or expense incurred through the use of its products.
 - c. The above warranty is in lieu of any other warranty, whether expressed or implied. The manufacturer makes no warranty of fitness or merchantability. No agent of ours is authorized to provide any warranty other than the above.
2. **Pulsafeeder's Parts and Accessory Warranty**
 - a. Pulsafeeder, Inc. warrants parts and accessories provided to be free of defects in material or workmanship. Unless otherwise noted below, liability under this policy extends for 90 days from date of shipment from the factory when sold as service parts. (Replaceable elastomeric parts (PTFE) are expendable and are not covered by any warranty either expressed or implied.)
 - b. This policy is extended to a full 12 months from the date of installation or 18 months from shipment from the factory whichever comes first on the following accessories:

Digital Glycol Feeders	Pre-Engineered Systems	Corrosion Coupon Racks
Analog Timers	Water Meters	Flow Controllers
 - c. MicroTrac and MicroVision toroidal probes are warranted for 24 months from date of shipment from the factory when purchased in conjunction with the controller.
All other electrodes/probes and sensors are considered maintenance items and such are warranted for six (6) months from the date of shipment when purchased in conjunction with the controller.
Any electrodes/probes other than toroidal and sensors purchased as spare parts are warranted for 90 days from date of shipment.
 - d. The manufacturer's liability is limited to repair or replacement of any failed equipment or part which is proven defective in material or workmanship upon manufacturer's examination. This warranty does not include removal or installation costs and in no event shall the manufacturer's liability exceed the selling price of such equipment or part.
 - e. The manufacturer disclaims all liability for damages to its products through improper installation, maintenance, use or attempts to operate such products beyond their functional capacity, intentionally or otherwise, or any unauthorized repair. The manufacturer is not responsible for consequential or other damages, injuries or expense incurred through the use of its products.
 - f. The above warranty is in lieu of any other warranty, whether expressed or implied. The manufacturer makes no warranty of fitness or merchantability. No agent of ours is authorized to provide any warranty other than the above.
3. **Process for All Returned Goods (Warranty Items)**
 - a. Please contact our Technical Service Department to request a RMA (Return Material Authorization) number prior to returning any goods. The following information will be required:
Billing and ship-to address
Model number and serial number
Contact name and phone number
Reason for return
Purchase order (where applicable)
A packing slip will be provided to the shipper and MUST accompany the product being returned. Packages received without our proper packing list will be refused by the receiver.
 - b. All material must be returned freight prepaid.
 - c. All material must be properly packaged to prevent damage in shipment.
 - d. All products used in a chemical application MUST accompany an MSDS
 - e. All products MUST be wiped and flushed clean of any and all chemicals, solvents or buffers and be warranted to be safe for handling. You will be requested to acknowledge the condition of the product being returned on our packing list. Any product received that is deemed to be unsafe for handling or without this acknowledgement will be refused by our receiver.
 - f. All warranty repairs will follow the 2 year warranty policy and will refer to the original purchase date.
4. **Non-Warranty Return Procedure (Charge Repair)**
 - a. If you are experiencing a concern with your Pulsafeeder product, first consult the distributor, dealer or Regional Sales Manager or the operation and maintenance manual for assistance. If service of your non-warranty unit is necessary, you must request a return material authorization. A RMA form will be issued and must be used as the packing list attached to the outside of the box. Please send the unit freight prepaid with the RMA number visibly displayed on the outside of the carton. All products MUST be wiped and flushed clean of any and all chemicals, solvents or buffers and be warranted to be safe for handling. You will be requested to acknowledge the condition of the product being returned on our packing list. Any product received that is deemed to be unsafe for handling or without this acknowledgement will be refused by our receiver.
 - b. All products used in a chemical application MUST accompany an MSDS
 - c. The charges listed in the following table will apply.

Product	Repair Cost
Pumps and Pump Accessories – within 5 years of sale date	Current List Price x .50 x Part Discount Multiplier
Controllers and Controller Accessories within 5 years of sale date	Current List Price x .50 x Part Discount Multiplier
Any item older than 5 years from date of sale	With purchase order, \$50 bench fee to evaluate. The \$50 bench fee may be applied towards repair cost of unit or towards a new controller

All Charge Repairs have a 90 day warranty from date of repair.

Policies and Procedures continued

- 5. Credit for Return of New, Unused Equipment**
- a. No equipment will be accepted beyond six months after date of shipment from factory for credit.
 - b. Only new, unused and undamaged standard equipment will be accepted for return to stock.
 - c. All credits are based on evaluation and acceptance of material as new and unused by Pulsafeeder. You will be requested to acknowledge the condition of the product being returned on our packing list. Any product received that is deemed to be unsafe for handling or without this acknowledgement will be refused by our receiver.
 - d. A restocking fee of 25% will apply to returned goods. When a PO is provided for a replacement item at the time of the return request the restocking fee will be 15%. Note: any product mounted on a panel or skid will be charged a 50% re-stocking fee.
 - e. A request for a Returned Material Authorization (RMA) number must be made prior to returning product to Pulsafeeder.
 - f. All equipment shall be returned with the RMA Packing List form attached to the outside of the box.
 - g. If any chemical, solvent or buffer has been introduced into the product it must be wiped and flushed clean of any and all substances prior to returning to Pulsafeeder.
 - h. All material shall be returned freight prepaid.
 - i. Private label products or Engineered Panel Mount Systems are not returnable.
- 6. Pricing Errors**
- a. Pulsafeeder does their very best to avoid errors in billing. You will receive a confirmation of your order within 24 hours of order entry. If upon review the customer feels there is a discrepancy, they should contact Pulsafeeder Customer Service as soon as possible to resolve.
 - b. Should an invoice be received that the customer believes to have incorrect pricing, they should notify Pulsafeeder Customer Service to investigate.
- 7. Missing Items**
- a. If a product is received by the customer with an item missing the customer must notify Pulsafeeder Customer Service within 7 days of receipt of the product by the end user. A replacement item will be sent at no charge as quickly as possible.
 - b. If a shipment is received by the customer with a line item missing they must notify Pulsafeeder Customer Service within 7 days of receipt of the product by the end user. If the customer had been billed for that item, a credit will be issued against the original Sales Order and a new Sales Order will be created for the replacement product.
- 8. Damaged Items**
- a. Should the customer receive an order that was damaged in transit, the customer must notify the carrier directly to initiate a claim on the day of delivery.
 - b. Should the customer receive a product with damaged components due to improper packaging they should notify Pulsafeeder Customer Service within 7 days of receipt of product by end user. A replacement item will be sent at no charge as quickly as possible.
- 9. Technical Support Services Available**
- a. Pulsafeeder's Sales Support team available all your and support. *The principle mission of this group is to sell and support our customer base in a timely and effective manner. This includes the ability to provide in-field service training, assistance in start-up of our products and perform field repair of goods when required.*
 - b. Scope
Pulsafeeder, Inc. factory Field Service Technicians are available throughout the World for field services on all Pulsafeeder products. Services include:
 - i. Maintenance Training Seminars, including Classroom slide presentations and or Hands-on Training. The seminar will take approximately four to five hours, and if time permits minor repair and or adjustments may be made to the customer's pumps, controllers or accessories.
 - ii. Pre-start up inspections and start up testing/calibration of pumps, controllers and accessories.
 - iii. Field repairs of pumps controllers and accessories
 - iv. Diagnosing and recommending solutions to systems problems.

Fee Schedule	Service Rate (1)
Normal 8 hour day	\$125.00 / hour
Overtime (in excess of 8 hrs each day)	\$175.00 / hour
Sundays, National Holiday	\$225.00 / hour
Travel time to job site and return	\$115.00 / hour
Travel expenses (air fare, hotel, car and meals)	Chargeable to customer at cost.
Minimum charge	4 hour labor, plus travel time and expenses
End User Training Seminars	
Normal work day	\$1000.00 / day plus expenses (air fare, car rental, hotel and meals at cost)
Sundays, National Holiday	\$1800.00 / day plus expenses (air fare, car rental, hotel and meals at cost)

⁽¹⁾ All rates listed in this section are actual hourly and daily rates, not reference rates

TERMS & CONDITIONS

1 . AGREEMENT. The contract of sale resulting from Seller's documentation together with these terms and conditions ("Contract") constitutes the entire agreement between the parties hereto, except as modified in writing signed by both the Seller and Purchaser. The Seller is Pulsafeeder, Inc. and the Purchaser is identified in the Contract. Any terms in a purchase order, irrespective of their materiality, which are either different from or additional to Seller's conditions of sale, are objected to and are excluded unless the Seller expressly agrees in writing to such terms. Execution of such forms by Seller to accommodate Purchaser's procurement or accounting procedures or to evidence agreed up on change orders shall not be construed as assent to Purchaser's terms. Acceptance of the goods shipped shall constitute assent to Seller's conditions of sale. This Contract shall be binding up on Purchaser and Seller, and on their successors and assigns.

2 . PROPOSAL OR QUOTATION. A proposal shall not become binding up on Seller until it has been executed and returned by Purchaser. An oral quotation shall not be considered an offer: only a written confirmation thereof incorporating Seller's terms and conditions shall constitute an offer. All quotations are valid for 30 days unless stated different on the written quotation.

3 . ORDER PLACEMENT. All orders shall be subject to acknowledgement by Pulsafeeders and shall be subject to Pulsafeeder's terms and conditions in effect on the date the order is accepted. No modifications to the terms and conditions referred to or contained in any request for proposal, order, or other document from a customer shall apply unless negotiated and approved via written documentation with Pulsafeeder SPO. Any order cancellation or change request is subject to a cancelation / change fee.

The minimum order amount is US\$30.00 based on Pulsafeeders list prices in effect at the time the order is received.

All orders must be submitted with correct pricing and shipping information. Orders submitted without correct pricing and shipping information may be rejected or delayed.

4 . CREDIT. Credit terms of payment must have the approval of Seller's Credit Department and must be specified in writing on Seller's invoice or in the Contract. If Purchaser's credit is found by Seller to be unsatisfactory . Seller may rescind or terminate this contract. If at any time during the term of this contract purchaser's financial responsibility becomes impaired or unsatisfactory to Seller, Seller reserves the right to stop shipment on notification to Purchaser, project owner and surety with a demand for payment in advance or at time of delivery for future deliveries or to require other security satisfactory to Seller and in the absence thereof, to cancel the unfilled portion of the Contract. Seller will notify Purchaser promptly of its decision to stop shipments and give an advance notice to the extent this is possible. In the absence of credit terms, sales are for cash.

5 . PAYMENT. Specific terms of payment for this order shall be set forth on the reverse side of this Contract or identified and appended hereto. Purchaser agrees to make payment at Seller's location specified in this Contract in lawful money of the United States. Purchaser further agrees to make all payments when due to Seller in accordance with the agreed terms of payment in this Contract without reference to Purchaser's agreement with or payments by the owner and with no right of retention.

6 . INTEREST AND COSTS. Purchaser agrees to pay interest at 1.5% per month (to the extent permitted by law) on all delinquent balances if and when assessed by Seller, and any attorney's fees or court costs arising out of and made necessary in collection of its obligation to Seller created by this Contract.

7 . TAXES. Any federal, state or local tax assessment, fee, duty or charge hereafter imposed on or measured by the products purchased hereunder shall be for Purchaser's account unless Purchaser furnishes Seller an acceptable exemption certificate from such tax, fee, duty or charge prior to shipment.

8 . FORCE MAJEURE. Seller shall make delivery in accordance with the terms of this Contract or within a reasonable time in the absence of any commitment, but Seller shall not be liable for delays or defaults in delivery caused by floods, fires, storms, or other acts of God, by war or act of public enemy (or civil disturbance), strikes, lock outs, shortages of labor or raw materials and supplies (including fuel) or production facilities, transportation service or equipment shortages or failures, action of any governmental authority or other conditions beyond Seller's reasonable control.

9 . CANCELLATION. If Purchaser desires to cancel or change any portion of this Contract, the purchaser must make such request in writing to Seller. Seller may, in its sole discretion, accept or reject any such request. If accepted, the Purchaser nonetheless must take delivery and make payment to Seller for all material manufactured and in process of manufacture at time of notice, and all special materials ordered at time of notice and for which Seller must take delivery , unless otherwise agreed by Seller in writing. All such materials must be removed from Seller's premises within 30 days after payment and payment will due at time of notice. Seller also reserves the right to make a cancellation charge in the event of cancellation by the Purchaser of an order placed in Seller's shipping schedule and acknowledged by Seller. **Any order cancellation is subject to a cancellation fee.**

10 . INSPECTION AND TESTING . Seller's standard specifications and tests apply to all orders. All charges for inspections or tests not regularly furnished are for Purchaser's account and subject to prior negotiation. All inspections shall be conducted at Seller's plant, and failure of Purchaser to avail himself of inspection privileges shall be deemed a waiver of such privileges.

11 . PRICES. Prices are subject to change without notice. Orders based on published prices and accepted for scheduled shipment will be invoiced at Seller's applicable price in effect on the scheduled date of shipment, unless otherwise specifically noted on the order acknowledgment. All prices will be in accordance with applicable government regulations. Orders specifying palletizing or special packaging will involve special charges.

12 . DELAYS. All orders are accepted subject to Seller's ability to make delivery at the time and in the quantities specified, and Seller shall not be liable for damages for failure to make partial or complete shipment or for any delay in making shipments. Purchaser shall be liable for any added expenses incurred by Seller because of Purchaser's delay in furnishing requested information to Seller, delay resulting from order changes by Purchaser, or delay in unloading shipments at delivery point.

13 . SHIPMENT. Seller will select method of shipment and routing when transportation charges are for account of Seller. When shipping instructions are specified by the Purchaser, all costs will be for the account of the Purchaser. The foregoing includes, but is not limited to, carriers charges for notification prior to delivery, demurrage, delay in unloading, diversion, or reconsignment. All shipments are Free Carrier (FCA) or EX Works(EXW) (Incoterms 2010) shippers dock Punta Gorda FL.

On all customer arranged freight (will advise) the customer has 48 hours after Pulsafeeder has advised them that the shipment is complete and ready for shipment to arrange pickup. If the shipment has not left Pulsafeeder within the 48 hour period the customer will be charged 1% of the shipment invoice value for each 24 hour period that the shipment remains at the Pulsafeeder facility. Pulsafeeder may also place the shipment in a public storage at the customer's expense and without liability to Pulsafeeder.

Any expedited order will be subject to a expedite fee.

Unless the order clearly requests expedited shipping, the order will be treated as a routine order. When expedited shipping is requested a designated carrier must be selected. Orders that need to ship the same day must be received by 2:00 PM EST. Same day and next working day shipping is generally available for larger orders but not guaranteed, please verify with customer service. Pulsafeeder shall have no liability if it is unable to provide expedited shipping of an order.

14 . TITLE. Title to products transfers up on shipment from the Pulsafeeder facility according to FCA Shippers Dock or EXW Punta Gorda FL (Incoterms 2010). Purchaser is then responsible for proper protection of product, placement, compliance with all regulations and ordinances, and will indemnify Seller against all claims for personal injuries or property damage arising from the storage, use or handling of such products.

15 . IN TRANSIT CLAIMS. Claims for damage or shortage in transit must be made against the carrier by the owner of the shipment according to the FCA or EXW terms of the Contract. Purchaser has the responsibility to inspect shipments before or during unloading to identify any such damage or shortage and see that appropriate notation is made on the delivery tickets or an inspection report furnished by the local agent of the carrier in order to support a claim.

16 . CLAIMS. Notice of Claims against Seller hereunder for any reason, must be made to Seller in writing promptly after discovery and within any applicable warranty period. Failure to give such notice to Seller shall constitute a waiver by Purchaser of any right later to assert such a claim.

17 . RETURNS. Returned goods shall be accepted for credit only if in salable condition and only with evidence of Seller's prior written consent. Seller will assess charges for freight both ways and any costs necessary to restore such goods to the regular plant inventory . The amount of credit given will depend further up on the degree of salability of products accepted in opinion of Seller.

18 . PATENTS. Seller agrees to defend, and to protect Purchaser against loss or damage arising out of any legal action for patent infringement in connection with the manufacture of its products sold to Purchaser, provided Seller is notified promptly of any such action with complete information and is given an opportunity to defend.

19 . WARRANTY : LIMITATION OF LIABILITY. Seller warrants title to each individual product sold under this Contract and further warrants for a period of twenty four (24) months from ship date, but only to the extent and limit of the purchase price paid for such individual product, that such product conforms to the specifications set forth in the Contract and is free from defects in material and workmanship under normal service and use for which it was designed. Seller's sole obligation and Purchaser's exclusive remedy under this warranty shall be limited to one of the following, as selected by Seller: delivering to Purchaser a replacement for any product or part thereof determined by Seller to be defective, repairing such product or part, or refunding the purchase price (or an equitable portion thereof) paid for such product or part by Purchaser. SELLER MAKES NO WARRANTY OF FITNESS OR MERCHANTABILITY, AND NO OTHER WARRANTY, WHETHER EXPRESS OR ARISING BY OPERATION OF LAW, COURSE OF DEALING, USAGE OF TRADE OR OTHERWISE IMPLIED SHALL EXIST IN CONNECTION WITH SELLER'S PRODUCTS OR ANY SALE OR USE THERE OF. Purchaser must notify Seller promptly and within the warranty period of any claim under this warranty. Seller's warranty extends only to the first purchaser of a product from Seller or Seller's authorized distributor. All goods not manufactured by Seller are warranted only to the extent of the warranties of the original manufacturer. Seller disclaims any liability arising from tort, including strict liability , and Seller further disclaims any liability (whether arising under this or any other provision of this Contract or otherwise) for any costs (including costs of removal or replacement), liabilities, lost profits, loss of good will or any other general, special, incidental or consequential damages incurred by Purchaser in connection with this Contract or any product purchased there under.

20 . LAW . This order shall be governed by and shall be construed by the law of the State of New York .

21 . GOVERNMENTAL REGULATIONS. Seller warrants that no code, law, regulation or ordinance of the United States, a state or any other governmental authority or agency or any applicable Executive Order has been violated in the manufacture or sale of the items covered by this Agreement and warrants that the equipment, supplies, and/or articles covered thereby conform with all such requirements.

22 . NUCLEAR FINANCIAL PROTECTION. Purchaser agrees to procure and maintain, as available to it, nuclear energy liability insurance, in a form of policy approved by the Nuclear Regulatory Commission, and protection, as available, against liability for nuclear incidents not covered by such insurance through an indemnity agreement, as provided in Section 170 of the Atomic Energy Act of 1954, as amended, or any succeeding comparable statutory provision, and the regulations there under. Such financial protection shall be effective prior to the time any equipment purchased from us is used or installed at or in connection with any nuclear facility and shall cover us an insured party . To the extent that such financial protection is not suitable to Purchaser. Purchaser agrees to use its best efforts to cause such financial protection to be obtained by eligible parties. We will cooperate with Purchaser and representatives of the nuclear energy insurance syndicates in complying with all underwriting requirements and with those insurance recommendations which may be mutually agreed up on. Notwithstanding any representations or warranties made by us elsewhere in these conditions of sale, we shall not be responsible for any bodily injury or property damage liability or any other public liability for any nuclear incidents, whether or not in respect of or arising in connection with use or installation of our equipment at any nuclear facility or in connection with any such facility . Purchaser hereby assumes any liability which might otherwise be imposed up on us and agrees to indemnify us and hold harmless from any such liability and costs or expenses in connection therewith.

 **PULSAFEEDER**

27101 Airport Road
Punta Gorda, FL 33982
Phone: +1(941) 575-3800
Fax: +1(941) 575-4085

www.pulsatron.com



An ISO 9001 Certified Company

PLM001 L15

FLUID & METERING