

Lenovo™ **Think**Products

PSREF



Product Specifications Reference

Version 545, July 2019

Visit <http://psref.lenovo.com> for the latest version

Lenovo ThinkPad Laptops

PSREF



Product Specifications Reference

Version 545, July 2019

Visit <http://psref.lenovo.com> for the latest version

Contents

Cover		33
Contents		
Summary Of Change		
11e Series		
ThinkPad 11e (5th Gen)		
ThinkPad 11e (5th Gen) Platform Specifications		
A Series		
ThinkPad A275		
ThinkPad A275 Platform Specifications		
ThinkPad A285		
ThinkPad A285 Platform Specifications		
ThinkPad A475		
ThinkPad A475 Platform Specifications		
ThinkPad A485		
ThinkPad A485 Platform Specifications		
E Series		
ThinkPad E480		
ThinkPad E480 Platform Specifications		
ThinkPad E485		
ThinkPad E485 Platform Specifications		
ThinkPad E490		
ThinkPad E490 Platform Specifications		
ThinkPad E490s		
ThinkPad E490s Platform Specifications		
ThinkPad E495		
ThinkPad E495 Platform Specifications		
ThinkPad E580		
ThinkPad E580 Platform Specifications		
ThinkPad E585		
ThinkPad E585 Platform Specifications		
ThinkPad E590		
ThinkPad E590 Platform Specifications		
ThinkPad E595		
ThinkPad E595 Platform Specifications		
L Series		
	1 ThinkPad L380	33
	2 ThinkPad L380 Platform Specifications	34
	4 ThinkPad L390	35
	5 ThinkPad L390 Platform Specifications	36
	5 ThinkPad L470	37
	6 ThinkPad L470 Platform Specifications	38
	7 ThinkPad L480	39
	7 ThinkPad L480 Platform Specifications	40
	8 ThinkPad L490	41
	9 ThinkPad L490 Platform Specifications	42
	10 ThinkPad L570	43
	11 ThinkPad L570 Platform Specifications	44
	12 ThinkPad L580	45
	13 ThinkPad L580 Platform Specifications	46
	14 ThinkPad L590	47
	15 ThinkPad L590 Platform Specifications	48
	15 P Series	49
	16 ThinkPad P1	49
	17 ThinkPad P1 Platform Specifications	50
	18 ThinkPad P1 (2nd Gen)	51
	19 ThinkPad P1 (2nd Gen) Platform Specifications	52
	20 ThinkPad P51	53
	21 ThinkPad P51 Platform Specifications	54
	22 ThinkPad P52	55
	23 ThinkPad P52 Platform Specifications	56
	24 ThinkPad P52s	57
	25 ThinkPad P52s Platform Specifications	58
	26 ThinkPad P53s	59
	27 ThinkPad P53s Platform Specifications	60
	28 ThinkPad P72	61
	29 ThinkPad P72 Platform Specifications	62
	30 T Series	63
	31 ThinkPad T470	63
	32 ThinkPad T470 Platform Specifications	64
	33 ThinkPad T470s	65

Contents

ThinkPad T470s Platform Specifications	66
ThinkPad T480	67
ThinkPad T480 Platform Specifications	68
ThinkPad T480s	69
ThinkPad T480s Platform Specifications	70
ThinkPad T490	71
ThinkPad T490 Platform Specifications	72
ThinkPad T490s	73
ThinkPad T490s Platform Specifications	74
ThinkPad T495	75
ThinkPad T495 Platform Specifications	76
ThinkPad T495s	77
ThinkPad T495s Platform Specifications	78
ThinkPad T580	79
ThinkPad T580 Platform Specifications	80
ThinkPad T590	81
ThinkPad T590 Platform Specifications	82
X Series	83
ThinkPad X1 Carbon (5th Gen)	83
ThinkPad X1 Carbon (5th Gen) Platform Specifications	84
ThinkPad X1 Carbon (6th Gen)	85
ThinkPad X1 Carbon (6th Gen) Platform Specifications	86
ThinkPad X1 Carbon (7th Gen)	87
ThinkPad X1 Carbon (7th Gen) Platform Specifications	88
ThinkPad X1 Extreme	89
ThinkPad X1 Extreme Platform Specifications	90
ThinkPad X270	91
ThinkPad X270 Platform Specifications	92
ThinkPad X280	93
ThinkPad X280 Platform Specifications	94
ThinkPad X390	95
ThinkPad X390 Platform Specifications	96
ThinkPad X395	97
ThinkPad X395 Platform Specifications	98
Legal Information	99

Summary of Changes

This section describes the technical changes made in this edition.

This edition might also include minor corrections and editorial changes which are not identified.

July 17, 2019 - Version 545

Additions in this update

▶ **New product(s)**

ThinkPad P1 (2nd Gen) announced July 2019

ThinkPad X1 Extreme (2nd Gen) announced July 2019

▶ **Others**

ThinkPad X395 - Ethernet corrected to Realtek RTL8153

Withdrawals in this update

▶ **Withdrawn product(s)**

None



ThinkPad 11e (5th Gen) Platform Specifications

Product Specifications Reference (PSREF)

Processor	7th Generation Intel® Core™ m / i5 Processor, Intel Celeron® processor, or Intel Pentium® Silver processor							Dimensions	<i>WxDxH:</i> 11.81" x 8.27" x 0.86"; 300mm x 210mm x 21.9mm
								Weight	Starting at 2.99 lb (1.36 kg)
								Case color	Black
								Case material	<i>Display cover:</i> PC/ABS+GF; <i>Bottom:</i> PC/ABS plastic
								Media reader	MicroSD card reader
							Ports	Two USB 3.1 Gen 1, one USB 3.1 Type-C Gen 1 (with the function of Power Delivery and DisplayPort), HDMI 1.4b, Ethernet (RJ-45), headphone / microphone combo jack, microSD card reader, security keyhole <i>* Depending on many factors, actual data transfer speed may be lower than theoretical speed</i>	
							Camera	HD720p camera, fixed focus	
							Audio support	HD Audio, Realtek® ALC3287 codec, stereo speakers, 2W x 2, Dolby® Audio™, monaural digital microphone, combo audio/microphone jack	
Graphics	Intel HD Graphics 615, Intel UHD Graphics 600 or 605 in processor, supports external digital monitor via HDMI or USB Type-C; supports dual independent display; Max resolution: 3840x2160@60Hz (USB Type-C); 4096x2160@30Hz (HDMI)							Keyboard	6-row, spill-resistant, multimedia Fn keys
Chipset	Intel SoC (System on Chip) platform							Touchpad	Buttonless Mylar surface touchpad below keyboard, multi-touch
Memory	4GB or 8GB / 1866MHz LPDDR3 or 2400MHz DDR4 / soldered to systemboard, no sockets							Security	Power-on password, supervisor password, security keyhole
Display	<i>Some:</i> 11.6" (295mm) HD (1366x768), anti-glare, LED backlight, 250 nits, 16:9 aspect ratio, 400:1 or 500:1 contrast ratio <i>Some:</i> 11.6" (295mm) HD (1366x768), anti-glare, LED backlight, IPS, multi-touch, 250 nits, 16:9 aspect ratio, 800:1 contrast ratio, 170° viewing angle							Security chip	Discrete TPM 2.0, TCG Certified
Multi-touch	Capacitive-type multi-touch, supports 10-finger gesture (HD IPS only)							vPro	None
Storage	eMMC flash memory on board or M.2 SSD / PCIe NVMe, PCIe 3.0 x 2, 16Gb/s							Fingerprint reader	None
Optane™ memory	None							NFC	None
Optical	None							Battery	Integrated Li-ion 42Wh battery
Ethernet	Realtek RTL8111GUS Gigabit Network Connection							Max battery life	<i>MobileMark® 2014:</i> 13.9 hr <i>* Battery life varies significantly with settings, usage, & other factors</i>
WLAN + Bluetooth™	<i>One of the following, configurable by model:</i> • Intel Wireless-AC 9260, Wi-Fi 2x2 802.11ac + Bluetooth 5.0, M.2 card • Intel Wireless-AC 9560, Wi-Fi 2x2 802.11ac + Bluetooth 5.0, M.2 card (US only)							AC adapter	45W or 65W slim tip AC adapter, 45W or 65W USB Type-C AC adapter
WWAN	None							Preload	Windows® 10 Home 64 or Windows 10 Pro 64
							Limited warranty	<i>One of the following, configurable by model:</i> • 1-year depot repair service • 3-year/1-yr battery depot repair service	
							Mil-Spec test	MIL-STD-810G military testing	
							Environment	EPEAT™ Silver; ENERGY STAR® 6.1; RoHS-compliant	

Lenovo
June 2019



ThinkPad A275 Platform Specifications

Product Specifications Reference (PSREF)

Processor	AMD PRO A-Series APUs								Smart card reader Media reader Ports	<i>Optional:</i> Smart card reader 4-in-1 reader (MMC, SD, SDHC, SDXC) Two USB 3.1 Gen 1 (USB 3.0, one Always On), USB 3.1 Type-C Gen 1 (with the function of Power Delivery and DisplayPort), HDMI 1.4b, Ethernet (RJ-45) <i>* Depending on many factors, actual data transfer speed may be lower than theoretical speed</i>								
	Processor Number	# of Cores	# of Threads	Base Frequency	Max Turbo Frequency	Cache	Memory Types	Processor Graphics										
	PRO A10-8730B	4	4	2.4 GHz	3.3 GHz	2MB	DDR4-1866	AMD Radeon™ R5 Graphics										
	PRO A12-8830B			2.5 GHz	3.4 GHz			AMD Radeon R7 Graphics										
	PRO A10-9700B			2.5 GHz	3.4 GHz													
PRO A12-9800B	2.7 GHz			3.6 GHz														
<i>* Windows 7 is only supported by PRO A10-8730B and PRO A12-8830B</i>								Monitor cable (optional)	<i>HDMI to VGA:</i> Lenovo HDMI to VGA Monitor Adapter <i>USB-C to VGA:</i> Lenovo USB-C to VGA Adapter <i>USB-C to DP:</i> Lenovo USB-C to DisplayPort Adapter									
Graphics	AMD Radeon R5 or R7 Graphics in processor only; supports external digital monitor via HDMI or USB Type-C; supports three independent displays; Max resolution: 4096x2160@60Hz (USB Type-C); 4096x2160@30Hz (HDMI)								Camera (optional)	HD720p resolution, fixed focus								
	Chipset	AMD SoC (System on Chip) platform								Audio support	HD Audio, Realtek ALC3268 codec / stereo speakers, 1.5W x 2 / dual array microphone, combo audio/microphone jack							
Memory	16Gb max / 1866MHz DDR4, one DDR4 SO-DIMM socket								Keyboard	6-row, spill-resistant, multimedia Fn keys, optional LED backlight								
Display	<i>Some:</i> 12.5" (317.5mm) HD (1366x768), anti-glare, LED backlight, 220 nits, 16:9 aspect ratio, 500:1 contrast ratio <i>Some:</i> 12.5" (317.5mm) FHD (1920x1080), anti-glare, LED backlight, IPS, 300 nits, 16:9 aspect ratio, 700:1 contrast ratio, 170° viewing angle								UltraNav™	TrackPoint® pointing device and buttonless Mylar surface multi-touch touchpad								
Multi-touch (opt)	On-cell touch, supports 10-finger gesture (FHD only, US only)								Security	Power-on password, hard disk password, supervisor password, security keyhole								
Storage	<i>System has one HDD slot or one M.2 slot exclusively for storage</i> <i>Some:</i> HDD / SATA 6.0Gb/s, 2.5" wide, 7mm high, Active Protection System™ <i>Some:</i> SSD / SATA 6.0Gb/s, 2.5" wide, 7mm high (e.g. xxxGB SSD) <i>Some:</i> M.2 SSD / PCIe NVMe, PCIe 3.0 x 2, 16Gb/s								Security chip	<i>dTPM 1.2:</i> discrete TPM 1.2, TCG Certified <i>dTPM 2.0:</i> discrete TPM 2.0, TCG Certified								
Optical	None								Fingerprint reader	<i>Optional:</i> Touch style match on chip fingerprint reader on the palm rest								
Ethernet	Realtek® RTL8111EPV Gigabit Ethernet connection								NFC	None								
WLAN	Realtek RTL8822BE, Wi-Fi 2x2 802.11ac + BT4.1, M.2 card								Internal battery	<i>Optional:</i> Integrated Li-ion or Li-Polymer 3-cell (23Wh)								
Bluetooth™	Bluetooth 4.1 wireless, integrated in Wi-Fi + Bluetooth combo adapter								External battery	Li-ion 3-cell (23Wh) or 6-cell (48Wh)								
WWAN (optional)	<i>One of the following, configurable by model:</i> <ul style="list-style-type: none"> Wireless WAN upgradable Integrated Mobile Broadband 4G LTE-A, Qualcomm® Snapdragon™ X7 LTE-A (Sierra Wireless EM7455) <i>* For non-WWAN model, it means the model is NOT WWAN upgradable</i>								Max battery life (MobileMark® 2014)	<table border="1"> <thead> <tr> <th>Models</th> <th>No + 3-cell</th> <th>3-cell + 3-cell</th> <th>3-cell + 6-cell 48Wh</th> </tr> </thead> <tbody> <tr> <td>Max battery life</td> <td>5.05 hr</td> <td>10.1 hr</td> <td>15.6 hr</td> </tr> </tbody> </table>	Models	No + 3-cell	3-cell + 3-cell	3-cell + 6-cell 48Wh	Max battery life	5.05 hr	10.1 hr	15.6 hr
Models	No + 3-cell	3-cell + 3-cell	3-cell + 6-cell 48Wh															
Max battery life	5.05 hr	10.1 hr	15.6 hr															
SIM card (opt)	Micro-SIM card slot, opt Verizon LTE (US) SIM card								<i>* Battery life varies significantly with settings, usage, & other factors</i>									
Dimensions	<i>WxDxH:</i> 12.03" x 8.21" x 0.80"; 305.5mm x 208.5mm x 20.3mm								AC adapter	45W slim tip AC adapter or 45W USB Type-C AC adapter								
Weight	<table border="1"> <thead> <tr> <th>Models</th> <th>No + 3-cell</th> <th>3-cell + 3-cell</th> <th>3 + 6-cell</th> </tr> </thead> <tbody> <tr> <td>Weight</td> <td>2.79 lb / 1.27 kg</td> <td>2.98 lb / 1.36 kg</td> <td>3.33 lb / 1.52 kg</td> </tr> </tbody> </table>								Models	No + 3-cell	3-cell + 3-cell	3 + 6-cell	Weight	2.79 lb / 1.27 kg	2.98 lb / 1.36 kg	3.33 lb / 1.52 kg	Preload	Windows® 7 Professional 64 preinstalled through downgrade rights in Windows 10 Pro 64 <ul style="list-style-type: none"> Lenovo Solution Center Lenovo PowerEngage ThinkVantage Product Recovery ThinkVantage System Update Adobe® Reader® Microsoft® Office preloaded; purchase a product key to activate McAfee® LiveSafe™ (30-day trial)
Models	No + 3-cell	3-cell + 3-cell	3 + 6-cell															
Weight	2.79 lb / 1.27 kg	2.98 lb / 1.36 kg	3.33 lb / 1.52 kg															
Case color	Black								Limited warranty	<i>One of the following, configurable by model:</i> <ul style="list-style-type: none"> 1-year depot repair service 3-year/1-yr battery depot repair service 3-year/1-yr battery limited onsite service 								
Case material	Glass-Fiber Reinforced Plastic								Mil-Spec test	MIL-STD-810G military testing								
Environment									EPEAT™ Gold (US only); ENERGY STAR® 6.1; RoHS-compliant									

Note: The specifications above may not be available in all regions.

Lenovo
April 2019



ThinkPad A285 Platform Specifications

Product Specifications Reference (PSREF)

Processor	AMD Ryzen™ PRO Mobile Processors with Radeon™ Vega Graphics	Smart card reader Media reader Ports	Optional: Smart card reader MicroSD card reader, in the combo slot with nano-SIM card One USB 3.1 Gen 1 (Always On), one USB 3.1 Gen 2, two USB 3.1 Type-C Gen 2 (with the function of Power Delivery and DisplayPort), HDMI 2.0, Ethernet extension connector, combo slot of nano-SIM card (WWAN models) and microSD card reader, headphone / microphone combo jack, optional smart card reader, side docking connector, security keyhole <i>* Depending on many factors, actual data transfer speed may be lower than theoretical speed</i>																										
	<table border="1"> <thead> <tr> <th>Processor Number</th> <th># of Cores</th> <th># of Threads</th> <th>Base Frequency</th> <th>Max Turbo Frequency</th> <th>Cache</th> <th>Memory Types</th> <th>Processor Graphics</th> </tr> </thead> <tbody> <tr> <td>Ryzen 3 PRO 2300U</td> <td rowspan="3">4</td> <td>4</td> <td>2.0 GHz</td> <td>3.4 GHz</td> <td rowspan="3">2MB L2 / 4MB L3</td> <td rowspan="3">DDR4-2400</td> <td>Radeon Vega 6 Graphics</td> </tr> <tr> <td>Ryzen 5 PRO 2500U</td> <td>8</td> <td>2.0 GHz</td> <td>3.6 GHz</td> <td>Radeon Vega 8 Graphics</td> </tr> <tr> <td>Ryzen 7 PRO 2700U</td> <td>8</td> <td>2.2 GHz</td> <td>3.8 GHz</td> <td>Radeon Vega 10 Graphics</td> </tr> </tbody> </table>	Processor Number	# of Cores	# of Threads	Base Frequency	Max Turbo Frequency	Cache	Memory Types	Processor Graphics	Ryzen 3 PRO 2300U	4	4	2.0 GHz	3.4 GHz	2MB L2 / 4MB L3	DDR4-2400	Radeon Vega 6 Graphics	Ryzen 5 PRO 2500U	8	2.0 GHz	3.6 GHz	Radeon Vega 8 Graphics	Ryzen 7 PRO 2700U	8	2.2 GHz	3.8 GHz	Radeon Vega 10 Graphics	Monitor cable (optional) Bundled Accy	HDMI to VGA: Lenovo HDMI to VGA Monitor Adapter USB-C to VGA: Lenovo USB-C to VGA Adapter USB-C to DP: Lenovo USB-C to DisplayPort Adapter Optional: ThinkPad Ethernet Extension Adapter Gen 2
Processor Number	# of Cores	# of Threads	Base Frequency	Max Turbo Frequency	Cache	Memory Types	Processor Graphics																						
Ryzen 3 PRO 2300U	4	4	2.0 GHz	3.4 GHz	2MB L2 / 4MB L3	DDR4-2400	Radeon Vega 6 Graphics																						
Ryzen 5 PRO 2500U		8	2.0 GHz	3.6 GHz			Radeon Vega 8 Graphics																						
Ryzen 7 PRO 2700U		8	2.2 GHz	3.8 GHz			Radeon Vega 10 Graphics																						
Graphics	AMD Radeon Vega 6, Vega 8, or Vega 10 Graphics in processor only; supports external digital monitor via HDMI or USB Type-C; supports four independent displays; Max resolution: 5120x2880@60Hz (USB Type-C); 4096x2160@60Hz (HDMI)	Camera (optional)	One of the following, configurable by model: • HD720p camera with ThinkShutter camera privacy, fixed focus • IR camera and HD720p camera, fixed focus																										
Chipset	AMD SoC (System on Chip) platform	Audio support	HD Audio, Realtek ALC3287 codec / stereo speakers, 2W x 2, Dolby® Audio™ Premium / dual array microphone, headphone / microphone combo jack																										
Memory	8GB or 16GB / 2400MHz DDR4, soldered to systemboard, no sockets	Keyboard	6-row, spill-resistant, multimedia Fn keys, optional LED backlight																										
Display	Some: 12.5" (317.5mm) HD (1366x768), anti-glare, LED backlight, 220 nits, 16:9 aspect ratio, 400:1 contrast ratio Some: 12.5" (317.5mm) FHD (1920x1080), anti-glare, LED backlight, IPS, 300 nits, 16:9 aspect ratio, 800:1 contrast ratio, 170° viewing angle	UltraNav™	TrackPoint® pointing device and buttonless Mylar surface multi-touch touchpad																										
Multi-touch (opt)	On-cell touch, supports 10-finger gesture (FHD only)	Security	Power-on password, hard disk password, supervisor password, security keyhole																										
Storage	One of the following, configurable by model: • M.2 SSD / SATA 6.0Gb/s • M.2 SSD / PCIe NVMe, PCIe 3.0 x 4, 32Gb/s	Security chip	Discrete TPM 2.0, TCG Certified																										
Optical	None	System Mgt	DASH Management																										
Ethernet	Gigabit Ethernet connection via bundled or optional ThinkPad Ethernet Extension Adapter Gen 2	Fingerprint reader	Optional: Touch style match on chip fingerprint reader on the palm rest																										
WLAN	Realtek® RTL8822BE, Wi-Fi 2x2 802.11ac + Bluetooth 4.2, M.2 card	NFC	None																										
Bluetooth™	Bluetooth 4.2 wireless, integrated in Wi-Fi + Bluetooth combo adapter	Battery	Integrated Li-ion 48Wh battery, supports Rapid Charge (charge up to 80% in 1hr) with 65W USB Type-C AC adapter																										
WWAN (optional)	Integrated Mobile Broadband 4G LTE-A, Intel XMM™ 7360 (Fibocom L850-GL), M.2 card <i>* For non-WWAN model, it means the model is NOT WWAN upgradable</i>	Max battery life	MobileMark® 2014: 10.55 hr <i>* Battery life varies significantly with settings, usage, & other factors</i>																										
SIM card (opt)	Nano-SIM card slot, in the combo slot with microSD card reader, optional Verizon LTE (US) SIM card	AC adapter	45W or 65W USB Type-C AC adapter																										
Dimensions	WxDxH (HD & FHD multi-touch): 12.11" x 8.26" x 0.69"; 307.7mm x 209.8mm x 17.4mm WxDxH (FHD non-touch): 12.11" x 8.26" x 0.70"; 307.7mm x 209.8mm x 17.8mm	Preload	Windows® 10 Home 64 or Windows 10 Pro 64																										
Weight	FHD non-touch model: 2.49 lb / 1.13 kg; HD non-touch model: 2.78 lb / 1.26 kg; FHD multi-touch model: 2.79 lb / 1.27 kg	Limited warranty	One of the following, configurable by model: • 1-year depot repair service • 3-year/1-yr battery depot repair service • 3-year/1-yr battery limited onsite service																										
Case color	Black	Mil-Spec test	MIL-STD-810G military testing																										
Case material	Display cover: Carbon Fiber (FHD non-touch model) or PPS (HD & FHD multi-touch model); Bottom: Magnesium/Aluminum	Environment	EPEAT™ Gold (US only); ENERGY STAR® 6.1; RoHS-compliant																										

Note: The specifications above may not be available in all regions.

Lenovo
April 2019



ThinkPad A475 Platform Specifications

Product Specifications Reference (PSREF)

Processor	AMD PRO A-Series APUs								Smart card reader Media reader Ports Monitor cable Camera (optional) Audio support	Optional: Smart card reader 4-in-1 reader (MMC, SD, SDHC, SDXC), supports SD 3.0, UHS-I Three USB 3.1 Gen 1 (USB 3.0, one Always On), USB 3.1 Type-C Gen 2 (with the function of Power Delivery and DisplayPort), HDMI 1.4b, Ethernet (RJ-45), Dock connector * Depending on many factors, actual data transfer speed may be lower than theoretical speed Optional: Lenovo USB-C to VGA Adapter HD720p resolution, fixed focus HD Audio, Realtek ALC3268 codec / stereo speakers, 2W x 2 / dual array microphone, combo audio/microphone jack										
	Processor Number	# of Cores	# of Threads	Base Frequency	Max Turbo Frequency	Cache	Memory Types	Processor Graphics												
	PRO A10-8730B	4	4	2.4 GHz	3.3 GHz	2MB	DDR4-1866	AMD Radeon™ R5 Graphics												
	PRO A12-8830B			2.5 GHz	3.4 GHz			AMD Radeon R7 Graphics												
	PRO A10-9700B			2.5 GHz	3.4 GHz															
PRO A12-9800B	2.7 GHz			3.6 GHz																
* Windows 7 is only supported by PRO A10-8730B and PRO A12-8830B																				
Graphics	AMD Radeon R5 or R7 Graphics in processor only; supports external digital monitor via HDMI or USB Type-C; supports three independent displays; Max resolution: 4096x2160@60Hz (USB Type-C); 4096x2160@30Hz (HDMI)								Keyboard UltraNav™	6-row, spill-resistant, multimedia Fn keys, optional LED backlight TrackPoint® pointing device and buttonless Mylar surface multi-touch touchpad										
Chipset Memory	AMD SoC (System on Chip) platform 32GB max / 1866MHz DDR4, dual-channel capable, two DDR4 SO-DIMM sockets								Security Security chip	Power-on password, hard disk password, supervisor password, security keyhole dTPM 1.2: discrete TPM 1.2, TCG Certified dTPM 2.0: discrete TPM 2.0, TCG Certified										
Display	Some: 14.0" (355mm) HD (1366x768), anti-glare, LED backlight, 220 nits, 16:9 aspect ratio, 350:1 contrast ratio Some: 14.0" (355mm) FHD (1920x1080), anti-glare, LED backlight, IPS, 250 nits, 16:9 aspect ratio, 700:1 contrast ratio, 170° viewing angle								Fingerprint reader NFC	Optional: Touch style match on chip fingerprint reader on the keyboard bezel None										
Multi-touch (opt)	On-cell touch, supports 10-finger gesture (FHD only, US only)								Internal battery External battery Max battery life (MobileMark® 2014)	Optional: Integrated Li-Polymer 3-cell (24Wh) Li-Polymer 3-cell (24Wh) or Li-ion 6-cell (48Wh) <table border="1"> <thead> <tr> <th>Models</th> <th>3-cell</th> <th>3 + 3-cell</th> <th>6-cell 48Wh</th> <th>3 + 6-cell 48Wh</th> </tr> </thead> <tbody> <tr> <td>Max battery life</td> <td>5.13 hr</td> <td>10.26 hr</td> <td>10.26 hr</td> <td>15.4 hr</td> </tr> </tbody> </table> * Battery life varies significantly with settings, usage, & other factors	Models	3-cell	3 + 3-cell	6-cell 48Wh	3 + 6-cell 48Wh	Max battery life	5.13 hr	10.26 hr	10.26 hr	15.4 hr
Models	3-cell	3 + 3-cell	6-cell 48Wh	3 + 6-cell 48Wh																
Max battery life	5.13 hr	10.26 hr	10.26 hr	15.4 hr																
Storage	System has one HDD slot or one M.2 2280 slot exclusively for storage Some: HDD / SATA 6.0Gb/s, 2.5" wide, 7mm high, Active Protection System™ Some: SSD / SATA 6.0Gb/s, 2.5" wide, 7mm high (e.g. xxxGB SSD) Some: M.2 SSD / PCIe NVMe, PCIe 3.0 x 2, 16Gb/s								AC adapter	45W or 65W slim tip AC adapter, 45W or 65W USB Type-C AC adapter										
Optical	None								Preload	Windows® 7 Professional 64 preinstalled through downgrade rights in Windows 10 Pro 64 • Lenovo Solution Center • Lenovo PowerEngage • ThinkVantage Product Recovery • ThinkVantage System Update • Adobe® Reader® • Microsoft® Office preloaded; purchase a product key to activate • McAfee® LiveSafe™ (30-day trial) Some: Windows 10 Home 64 Some: Windows 10 Pro 64 • Lenovo Companion • Lenovo Setting • Microsoft Office preloaded; purchase a product key to activate										
Ethernet	Realtek® RTL8111EPV Gigabit Ethernet connection																			
WLAN Bluetooth™	Realtek RTL8822BE, Wi-Fi 2x2 802.11ac + BT4.1, M.2 card Bluetooth 4.1 wireless, integrated in Wi-Fi + Bluetooth combo adapter																			
WWAN (optional)	One of the following, configurable by model: • Wireless WAN upgradable • Integrated Mobile Broadband 4G LTE-A, Qualcomm® Snapdragon™ X7 LTE-A (Sierra Wireless EM7455) * For non-WWAN model, it means the model is NOT WWAN upgradable																			
SIM card (opt)	Micro-SIM card slot, opt Verizon LTE (US) SIM card																			
Dimensions Weight	WxDxH: 13.25" x 9.15" x 0.79"; 336.6mm x 232.5mm x 19.95mm <table border="1"> <thead> <tr> <th>Models</th> <th>3-cell or 3 + 3-cell</th> <th>6-cell or 3 + 6-cell</th> </tr> </thead> <tbody> <tr> <td>Magnesium</td> <td>3.49 lb / 1.58 kg</td> <td>3.92 lb / 1.78 kg</td> </tr> <tr> <td>PPS</td> <td>3.63 lb / 1.65 kg</td> <td>4.35 lb / 1.85 kg</td> </tr> </tbody> </table>								Models	3-cell or 3 + 3-cell	6-cell or 3 + 6-cell	Magnesium	3.49 lb / 1.58 kg	3.92 lb / 1.78 kg	PPS	3.63 lb / 1.65 kg	4.35 lb / 1.85 kg	Limited warranty	One of the following, configurable by model: • 1-year depot repair service • 3-year/1-yr battery depot repair service • 3-year/1-yr battery limited onsite service	
Models	3-cell or 3 + 3-cell	6-cell or 3 + 6-cell																		
Magnesium	3.49 lb / 1.58 kg	3.92 lb / 1.78 kg																		
PPS	3.63 lb / 1.65 kg	4.35 lb / 1.85 kg																		
Case color Case material	Black Display cover: Magnesium Hybrid or PPS (Magnesium Hybrid for US only); Bottom: Glass-Fiber Reinforced Plastic								Mil-Spec test	MIL-STD-810G military testing										
									Environment	EPEAT™ Gold (US only); ENERGY STAR® 6.1; RoHS-compliant										

Note: The specifications above may not be available in all regions.

Lenovo
April 2019



ThinkPad A485 Platform Specifications

Product Specifications Reference (PSREF)

Processor	AMD Ryzen™ PRO Mobile Processors with Radeon™ Vega Graphics	Smart card reader Media reader Ports	<i>Optional:</i> Smart card reader 4-in-1 reader (MMC, SD, SDHC, SDXC), supports SD 3.0, UHS-I One USB 3.1 Gen 1 (Always On), one USB 3.1 Gen 2, two USB 3.1 Type-C Gen 2 (with the function of Power Delivery and DisplayPort), HDMI 2.0, Ethernet (RJ-45), nano-SIM card slot (WWAN models), headphone / microphone combo jack, optional smart card reader, 4-in-1 media reader (MMC, SD, SDHC, SDXC), side docking connector, security keyhole <i>* Depending on many factors, actual data transfer speed may be lower than theoretical speed</i>																															
	<table border="1"> <thead> <tr> <th>Processor Number</th> <th># of Cores</th> <th># of Threads</th> <th>Base Frequency</th> <th>Max Turbo Frequency</th> <th>Cache</th> <th>Memory Types</th> <th>Processor Graphics</th> </tr> </thead> <tbody> <tr> <td>Ryzen 3 PRO 2300U</td> <td rowspan="3">4</td> <td>4</td> <td>2.0 GHz</td> <td>3.4 GHz</td> <td rowspan="3">2MB L2 / 4MB L3</td> <td rowspan="3">DDR4-2400</td> <td>Radeon Vega 6 Graphics</td> </tr> <tr> <td>Ryzen 5 PRO 2500U</td> <td>8</td> <td>2.0 GHz</td> <td>3.6 GHz</td> <td>Radeon Vega 8 Graphics</td> </tr> <tr> <td>Ryzen 7 PRO 2700U</td> <td>8</td> <td>2.2 GHz</td> <td>3.8 GHz</td> <td>Radeon Vega 10 Graphics</td> </tr> </tbody> </table>	Processor Number	# of Cores	# of Threads	Base Frequency	Max Turbo Frequency	Cache	Memory Types	Processor Graphics	Ryzen 3 PRO 2300U	4	4	2.0 GHz	3.4 GHz	2MB L2 / 4MB L3	DDR4-2400	Radeon Vega 6 Graphics	Ryzen 5 PRO 2500U	8	2.0 GHz	3.6 GHz	Radeon Vega 8 Graphics	Ryzen 7 PRO 2700U	8	2.2 GHz	3.8 GHz	Radeon Vega 10 Graphics	Monitor cable(<i>opt</i>) Bundled Accy Camera (<i>optional</i>) Audio support	HDMI to VGA: Lenovo HDMI to VGA Monitor Adapter USB-C to DP: Lenovo USB-C to DisplayPort Adapter None <i>One of the following, configurable by model:</i> <ul style="list-style-type: none"> HD720p camera with ThinkShutter camera privacy, fixed focus IR camera and HD720p camera, fixed focus HD Audio, Realtek® ALC3287 codec / stereo speakers, 2W x 2, Dolby® Audio™ Premium / dual array microphone, headphone / microphone combo jack					
Processor Number	# of Cores	# of Threads	Base Frequency	Max Turbo Frequency	Cache	Memory Types	Processor Graphics																											
Ryzen 3 PRO 2300U	4	4	2.0 GHz	3.4 GHz	2MB L2 / 4MB L3	DDR4-2400	Radeon Vega 6 Graphics																											
Ryzen 5 PRO 2500U		8	2.0 GHz	3.6 GHz			Radeon Vega 8 Graphics																											
Ryzen 7 PRO 2700U		8	2.2 GHz	3.8 GHz			Radeon Vega 10 Graphics																											
Graphics	AMD Radeon Vega 6, Vega 8, or Vega 10 Graphics in processor only; supports external digital monitor via HDMI or USB Type-C; supports four independent displays; Max resolution: 5120x2880@60Hz (USB Type-C); 4096x2160@60Hz (HDMI)	Keyboard UltraNav™	6-row, spill-resistant, multimedia Fn keys, optional LED backlight TrackPoint® pointing device and buttonless Mylar surface multi-touch touchpad																															
Chipset Memory	AMD SoC (System on Chip) platform 32GB max / 2400MHz DDR4, dual-channel capable, two DDR4 SO-DIMM sockets <i>* Installed DIMMs are actually 2666MHz but run at 2400MHz due to AMD limitation</i>	Security Security chip System Mgt Fingerprint reader NFC	Power-on password, hard disk password, supervisor password, security keyhole Discrete TPM 2.0, TCG Certified DASH Management <i>Optional:</i> Touch style match on chip fingerprint reader on the keyboard bezel None																															
Display	<i>Some:</i> 14.0" (355mm) HD (1366x768), anti-glare, LED backlight, 220 nits, 16:9 aspect ratio, 400:1 contrast ratio <i>Some:</i> 14.0" (355mm) FHD (1920x1080), anti-glare, LED backlight, IPS, 250 nits, 16:9 aspect ratio, 700:1 contrast ratio, 170° viewing angle	Battery	Integrated Li-ion 24Wh battery and external Li-ion 24Wh, 48Wh, or 72Wh battery Max battery life (MobileMark® 2014)																															
Multi-touch (<i>opt</i>)	On-cell touch, supports 10-finger gesture (FHD only)		<table border="1"> <thead> <tr> <th>Models</th> <th>24Wh</th> <th>48Wh</th> <th>72Wh</th> <th>24Wh + 24Wh</th> <th>24Wh + 48Wh</th> <th>24Wh + 72Wh</th> </tr> </thead> <tbody> <tr> <td>Max battery life</td> <td>5.37 hr</td> <td>10.76 hr</td> <td>16.4 hr</td> <td>10.76 hr</td> <td>16.4 hr</td> <td>22.15 hr</td> </tr> </tbody> </table> <i>* Battery life varies significantly with settings, usage, & other factors</i>						Models	24Wh	48Wh	72Wh	24Wh + 24Wh	24Wh + 48Wh	24Wh + 72Wh	Max battery life	5.37 hr	10.76 hr	16.4 hr	10.76 hr	16.4 hr	22.15 hr												
Models	24Wh	48Wh	72Wh	24Wh + 24Wh	24Wh + 48Wh	24Wh + 72Wh																												
Max battery life	5.37 hr	10.76 hr	16.4 hr	10.76 hr	16.4 hr	22.15 hr																												
Storage	System has one HDD slot or one M.2 2280 slot exclusively for storage <i>Some:</i> HDD / SATA 6.0Gb/s, 2.5" wide, 7mm high, Active Protection System™ <i>Some:</i> SSD / SATA 6.0Gb/s, 2.5" wide, 7mm high <i>Some:</i> M.2 SSD / PCIe NVMe, PCIe 3.0 x 4 <i>Some:</i> 128GB M.2 SSD / PCIe NVMe, PCIe 3.0 x 2, in WWAN slot as 2nd Storage, mutually exclusive with WWAN <i>* Installed M.2 SSD is PCIe 3.0 x 4 but run at PCIe 3.0 x 2 due to M.2 SSD adapter limitation</i>	AC adapter	45W or 65W USB Type-C AC adapter																															
Optical	None	Preload	Windows® 10 Home 64 or Windows 10 Pro 64																															
Ethernet	Realtek® RTL8111GUL Gigabit Ethernet connection	Limited warranty	<i>One of the following, configurable by model:</i> <ul style="list-style-type: none"> 1-year depot repair service 3-year/1-yr battery depot repair service 3-year/1-yr battery limited onsite service 																															
WLAN Bluetooth™	Realtek RTL8822BE, Wi-Fi 2x2 802.11ac + Bluetooth 4.1, M.2 card Bluetooth 4.1 wireless, integrated in Wi-Fi + Bluetooth combo adapter	Mil-Spec test	MIL-STD-810G military testing																															
WWAN (<i>optional</i>)	Integrated Mobile Broadband 4G LTE-A, Intel XMM™ 7360 (Fibocom L850-GL), M.2 card <i>* For non-WWAN model, it means the model is NOT WWAN upgradable</i>	Environment	EPEAT™ Gold (US only); ENERGY STAR® 6.1; RoHS-compliant																															
SIM card (<i>opt</i>)	Nano-SIM card slot, optional Verizon LTE (US) SIM card																																	
Dimensions Weight	WxDxH: 13.25" x 9.15" x 0.79"; 336.6mm x 232.5mm x 19.95mm <table border="1"> <thead> <tr> <th>Models</th> <th>24Wh or 24Wh + 24Wh</th> <th>48Wh, 72Wh, or 24Wh + 48Wh / 72Wh</th> </tr> </thead> <tbody> <tr> <td>Magnesium</td> <td>3.49 lb / 1.58 kg</td> <td>3.92 lb / 1.78 kg</td> </tr> <tr> <td>PPS</td> <td>3.63 lb / 1.65 kg</td> <td>4.08 lb / 1.85 kg</td> </tr> </tbody> </table>	Models	24Wh or 24Wh + 24Wh	48Wh, 72Wh, or 24Wh + 48Wh / 72Wh	Magnesium	3.49 lb / 1.58 kg	3.92 lb / 1.78 kg	PPS	3.63 lb / 1.65 kg	4.08 lb / 1.85 kg																								
Models	24Wh or 24Wh + 24Wh	48Wh, 72Wh, or 24Wh + 48Wh / 72Wh																																
Magnesium	3.49 lb / 1.58 kg	3.92 lb / 1.78 kg																																
PPS	3.63 lb / 1.65 kg	4.08 lb / 1.85 kg																																
Case color Case material	Black Display cover: Magnesium Hybrid or PPS; Bottom: Glass-Fiber Reinforced Plastic																																	

Note: The specifications above may not be available in all regions.

Lenovo
May 2019



ThinkPad E480 Platform Specifications

Product Specifications Reference (PSREF)

Processor	7th Generation Intel® Core™ i3 / i5 Processor (i3-7130U is NOT available in US and EMEA) or	Dimensions	Aluminum (WxDxH): 12.96" x 9.53" x 0.78"; 329mm x 242mm x 19.9mm PC/ABS (WxDxH): 12.96" x 9.53" x 0.83"; 329mm x 242mm x 21.9mm																										
	<table border="1"> <thead> <tr> <th>Processor Number</th> <th># of Cores</th> <th># of Threads</th> <th>Base Frequency</th> <th>Max Turbo Frequency</th> <th>Cache</th> <th>Memory Types</th> <th>Processor Graphics</th> </tr> </thead> <tbody> <tr> <td>i3-7020U</td> <td rowspan="3">2</td> <td rowspan="3">4</td> <td>2.3 GHz</td> <td>-</td> <td>3MB</td> <td rowspan="3">DDR4-2133</td> <td rowspan="3">Intel HD Graphics 620</td> </tr> <tr> <td>i3-7130U</td> <td>2.7 GHz</td> <td>-</td> <td>3MB</td> </tr> <tr> <td>i5-7200U</td> <td>2.5 GHz</td> <td>3.1 GHz</td> <td>3MB</td> </tr> </tbody> </table>	Processor Number	# of Cores	# of Threads	Base Frequency	Max Turbo Frequency	Cache	Memory Types	Processor Graphics	i3-7020U	2	4	2.3 GHz	-	3MB	DDR4-2133	Intel HD Graphics 620	i3-7130U	2.7 GHz	-	3MB	i5-7200U	2.5 GHz	3.1 GHz	3MB	Weight	Starting at 3.87 lb / 1.75kg		
Processor Number	# of Cores	# of Threads	Base Frequency	Max Turbo Frequency	Cache	Memory Types	Processor Graphics																						
i3-7020U	2	4	2.3 GHz	-	3MB	DDR4-2133	Intel HD Graphics 620																						
i3-7130U			2.7 GHz	-	3MB																								
i5-7200U			2.5 GHz	3.1 GHz	3MB																								
	8th Generation Intel Core i3 / i5 / i7 Processor	Case color	Black or silver																										
	<table border="1"> <thead> <tr> <th>Processor Number</th> <th># of Cores</th> <th># of Threads</th> <th>Base Frequency</th> <th>Max Turbo Frequency</th> <th>Cache</th> <th>Memory Types</th> <th>Processor Graphics</th> </tr> </thead> <tbody> <tr> <td>i3-8130U</td> <td rowspan="2">2</td> <td rowspan="2">4</td> <td>2.2 GHz</td> <td>3.4 GHz</td> <td>4MB</td> <td rowspan="3">DDR4-2400</td> <td rowspan="3">Intel UHD Graphics 620</td> </tr> <tr> <td>i5-8250U</td> <td>1.6 GHz</td> <td>3.4 GHz</td> <td>6MB</td> </tr> <tr> <td>i7-8550U</td> <td>4</td> <td>8</td> <td>1.8 GHz</td> <td>4.0 GHz</td> <td>8MB</td> </tr> </tbody> </table>	Processor Number	# of Cores	# of Threads	Base Frequency	Max Turbo Frequency	Cache	Memory Types	Processor Graphics	i3-8130U	2	4	2.2 GHz	3.4 GHz	4MB	DDR4-2400	Intel UHD Graphics 620	i5-8250U	1.6 GHz	3.4 GHz	6MB	i7-8550U	4	8	1.8 GHz	4.0 GHz	8MB	Case material	Display cover: Aluminum or PC/ABS plastic; Bottom: PC/ABS plastic
Processor Number	# of Cores	# of Threads	Base Frequency	Max Turbo Frequency	Cache	Memory Types	Processor Graphics																						
i3-8130U	2	4	2.2 GHz	3.4 GHz	4MB	DDR4-2400	Intel UHD Graphics 620																						
i5-8250U			1.6 GHz	3.4 GHz	6MB																								
i7-8550U	4	8	1.8 GHz	4.0 GHz	8MB																								
		Smart card reader	None																										
		Media reader	MicroSD card reader																										
		Ports	One USB 2.0, two USB 3.1 Gen 1 (one Always On), one USB 3.1 Type-C Gen 2 (with the function of Power Delivery and DisplayPort), HDMI 1.4b, Ethernet (RJ-45), headphone / microphone combo jack, microSD card reader, security keyhole * Depending on many factors, actual data transfer speed may be lower than theoretical speed																										
Graphics	Intel HD Graphics 620 or Intel UHD Graphics 620 in processor only or Intel HD Graphics 620 or Intel UHD Graphics 620 in processor and AMD Radeon RX 550 Graphics, 2GB DDR5 memory; supports external digital monitor via HDMI or USB Type-C; supports dual independent display; Max resolution: 1920x1080 (HDMI) @60Hz	Camera	HD720p camera, fixed focus																										
		Audio support	HD Audio, Synaptic® CX11852 codec / stereo speakers, 1.5W x 2, Dolby® Advanced Audio / dual array microphone, headphone / microphone combo jack																										
Chipset	Intel SoC (System on Chip) platform	Keyboard	6-row, spill-resistant, multimedia Fn keys, optional LED backlight																										
Memory	32GB max / 2400MHz DDR4, dual-channel capable, two DDR4 SO-DIMM sockets * System clocks down for processors with lower memory controller	UltraNav™	TrackPoint® pointing device and buttonless Mylar surface multi-touch touchpad																										
Display	Some: 14.0" (355mm) HD (1366x768), anti-glare, LED backlight, 220 nits, 16:9 aspect ratio, 400:1 contrast ratio Some: 14.0" (355mm) FHD (1920x1080), anti-glare, LED backlight, IPS, 250 nits, 16:9 aspect ratio, 400:1 contrast ratio	Security	Power-on password, hard disk password, supervisor password, security keyhole																										
Multi-touch	None	Security chip (opt)	Firmware TPM 2.0 integrated in chipset or discrete TPM 2.0 TCG Certified																										
Storage	Up to 2 drives (one M.2 SSD and one HDD) Some: HDD / SATA 6.0Gb/s, 2.5" wide, removable, upgradable, Active Protection System™ Some: M.2 SSD / PCIe NVMe	vPro	None																										
Optane™ memory	Optional: Intel Optane memory, PCIe NVMe, PCIe 3.0 x 2	Fingerprint reader	Optional: Touch style fingerprint reader on the palm rest																										
Optical	None	NFC	None																										
Ethernet	Gigabit Ethernet Connection, Realtek R8111GUS	Battery	Integrated Li-ion 45Wh battery, supports Rapid Charge (charge up to 80% in 1hr) with 65W USB Type-C AC adapter																										
WLAN + Bluetooth™	One of the following, configurable by model: • Realtek® RTL8821CE, Wi-Fi 1x1 802.11ac + Bluetooth 4.1, M.2 card • Realtek RTL8822BE, Wi-Fi 2x2 802.11ac + Bluetooth 4.1, M.2 card • Intel Dual Band Wireless-AC 3165, 1x1, Wi-Fi + Bluetooth 4.1, M.2 Card * Intel 3165ac card supports BT4.2 but is limited to BT4.1 by Windows OS	Max battery life	MobileMark® 2014: 13.51 hr * Battery life varies significantly with settings, usage, & other factors																										
WWAN	None	AC adapter	45W or 65W USB Type-C AC adapter																										
SIM card	None	Preload (optional)	Windows® 10 Home 64 or Windows 10 Pro 64																										
		Limited warranty	1-year depot repair service																										
		Mil-Spec test	MIL-STD-810G military testing																										
		Environment	EPEAT™ Gold (US only); ENERGY STAR® 6.1; RoHS-compliant																										

Note: The specifications above may not be available in all regions.

Lenovo
June 2019



ThinkPad E485 Platform Specifications

Product Specifications Reference (PSREF)

Processor	AMD Ryzen™ Mobile Processors with Radeon™ Vega Graphics							Dimensions <i>Aluminum (WxDxH):</i> 12.96" x 9.53" x 0.78"; 329mm x 242mm x 19.9mm <i>PC/ABS (WxDxH):</i> 12.96" x 9.53" x 0.86"; 329mm x 242mm x 21.9mm	
	Processor Number	# of Cores	# of Threads	Base Frequency	Max Turbo Frequency	Cache	Memory Controller		Processor Graphics
	Ryzen 3 2200U	2	4	2.5 GHz	3.4 GHz	1MB L2 / 4MB L3	DDR4-2400		Radeon Vega 3 Graphics
	Ryzen 5 2500U	4	8	2.0 GHz	3.6 GHz	2MB L2 / 4MB L3			Radeon Vega 8 Graphics
Ryzen 7 2700U	2.2 GHz			3.8 GHz	2MB L2 / 4MB L3	Radeon RX Vega 10 Graphics			
Graphics	AMD Radeon Vega 3, Vega 8, or RX Vega 10 Graphics in processor; supports external digital monitor via HDMI or USB Type-C; supports dual independent display; Max resolution: 1920x1080 (HDMI) @60Hz							Weight Case color Case material	
Chipset	AMD SoC (System on Chip) platform							Smart card reader Media reader Ports	
Memory	32GB max / 2400MHz DDR4, dual-channel capable, two DDR4 SO-DIMM sockets							None MicroSD card reader One USB 2.0, two USB 3.1 Gen 1 (one Always On), one USB 3.1 Type-C Gen 2 (with the function of Power Delivery and DisplayPort), HDMI 1.4b, Ethernet (RJ-45), headphone / microphone combo jack, microSD card reader, security keyhole <i>* Depending on many factors, actual data transfer speed may be lower than theoretical speed</i>	
Display	<i>Some:</i> 14.0" (355mm) HD (1366x768), anti-glare, LED backlight, 220 nits, 16:9 aspect ratio, 400:1 contrast ratio <i>Some:</i> 14.0" (355mm) FHD (1920x1080), anti-glare, LED backlight, IPS, 250 nits, 16:9 aspect ratio, 400:1 contrast ratio							Camera Audio support	
Multi-touch	None							HD720p camera, fixed focus HD Audio, Synaptic® CX11852 codec / stereo speakers, 1.5W x 2, Dolby® Advanced Audio / dual array microphone, headphone / microphone combo jack	
Storage	<i>Up to 2 drives (one M.2 SSD and one HDD)</i> <i>Some:</i> HDD / SATA 6.0Gb/s, 2.5" wide, removable, upgradable, Active Protection System™ <i>Some:</i> M.2 SSD / PCIe NVMe							Keyboard UltraNav™	
Optical	None							6-row, spill-resistant, multimedia Fn keys TrackPoint® pointing device and buttonless Mylar surface multi-touch touchpad	
Ethernet	Gigabit Ethernet Connection, Realtek RTL8111GUS							Security Security chip Fingerprint reader NFC	
WLAN + Bluetooth™	<i>One of the following, configurable by model:</i> • Qualcomm QCNFA435, Wi-Fi 1x1 802.11ac + Bluetooth 4.1, M.2 card • Realtek® RTL8821CE, Wi-Fi 1x1 802.11ac + Bluetooth 4.1, M.2 card • Realtek RTL8822BE, Wi-Fi 2x2 802.11ac + Bluetooth 4.1, M.2 card							Power-on password, hard disk password, supervisor password, security keyhole Discrete TPM 2.0, TCG Certified None None	
WWAN SIM card	None None							Battery Max battery life AC adapter	
None								Integrated Li-ion 45Wh battery, supports Rapid Charge (charge up to 80% in 1hr) with 65W USB Type-C AC adapter <i>MobileMark® 2014:</i> 9.37 hr <i>* Battery life varies significantly with settings, usage, & other factors</i> 45W or 65W USB Type-C AC adapter	
None								Preload (<i>optional</i>) Windows® 10 Home 64 or Windows 10 Pro 64	
None								Limited warranty 1-year depot repair service	
None								Mil-Spec test None	
None								Environment EPEAT™ Gold (US only); ENERGY STAR® 6.1; RoHS-compliant	

Note: The specifications above may not be available in all regions.

Lenovo
June 2019



ThinkPad E490 Platform Specifications

Product Specifications Reference (PSREF)

Processor	8th Generation Intel® Core™ i3 / i5 / i7 Processor								Dimensions <i>Aluminum (WxDxH):</i> 12.96" x 9.53" x 0.78"; 329mm x 242mm x 19.9mm <i>PC/ABS (WxDxH):</i> 12.96" x 9.53" x 0.83"; 329mm x 242mm x 21.9mm
	Processor Number	# of Cores	# of Threads	Base Frequency	Max Turbo Frequency	Cache	Memory Types	Processor Graphics	
	i3-8145U	2	4	2.1 GHz	3.9 GHz	4MB	DDR4-2400	Intel UHD Graphics 620	
	i5-8265U	4	8	1.6 GHz	3.9 GHz	6MB			
i7-8565U	1.8 GHz			4.6 GHz	8MB				
Graphics	Intel UHD Graphics 620 in processor only or Intel UHD Graphics 620 in processor and AMD Radeon RX 550X Graphics, 2GB DDR5 memory; supports external digital monitor via HDMI or USB Type-C; supports dual independent display; Max resolution: 4096x2304@60Hz (USB Type-C); 4096x2160@24Hz (HDMI)								Weight Case color Case material
Chipset	Intel SoC (System on Chip) platform								Smart card reader
Memory	32GB max / 2400MHz DDR4, dual-channel capable, two DDR4 SO-DIMM sockets <i>* Installed memory is actually 2666MHz but run at 2400MHz due to Intel limitation</i>								Media reader
Display	Size / Resolution	Surface	Type	Brightness	Aspect Ratio	Contrast Ratio	Viewing Angle	Multi-touch	Ports
	14.0" HD (1366x768)	Anti-glare	TN	220 nits	16:9	400:1	90°	Non-touch	One USB 2.0, two USB 3.1 Gen 1 (one Always On), one USB 3.1 Type-C Gen 2 (with the function of Power Delivery and DisplayPort), HDMI 1.4b, Ethernet (RJ-45), headphone / microphone combo jack, microSD card reader, security keyhole <i>* Depending on many factors, actual data transfer speed may be lower than theoretical speed</i>
	14.0" FHD (1920x1080)	Anti-glare	IPS	250 nits	16:9	600:1	170°	Non-touch	
Multi-touch	None								Monitor cable
Storage	Up to two drives (one M.2 SSD and one HDD)								Bundled Accy
	<ul style="list-style-type: none"> HDD / SATA 6.0Gb/s, 2.5" wide, 7mm high, Active Protection System™ M.2 2280 SSD / SATA 6.0Gb/s M.2 2280 SSD / PCIe NVMe, PCIe 3.0 x 2 M.2 2242 SSD / PCIe NVMe, PCIe 3.0 x 2 								Camera
Optane™ memory	Optional: Intel Optane memory, PCIe NVMe, PCIe 3.0 x 2								Audio support
Optical	None								Keyboard
Ethernet	Gigabit Ethernet Connection, Realtek R8111GUS								UltraNav™
WLAN + Bluetooth™	One of the following, configurable by model: <ul style="list-style-type: none"> Realtek® RTL8822BE, Wi-Fi 2x2 802.11ac + Bluetooth 4.2, M.2 card Intel Wireless-AC 9260, Wi-Fi 2x2 802.11ac + Bluetooth 5.0, M.2 card 								Security
WWAN	None								Security chip
SIM card	None								System Mgt
									Fingerprint reader
									NFC
									Battery
									Max battery life
									AC adapter
									Preload (optional)
									Limited warranty
									Mil-Spec test
									Environment

Note: The specifications above may not be available in all regions.

Lenovo
July 2019



ThinkPad E490s Platform Specifications

Product Specifications Reference (PSREF)

Processor	8th Generation Intel® Core™ i5 / i7 Processor								Dimensions	WxDxH: 12.96" x 9.13" x 0.70"; 329mm x 232mm x 17.9mm		
	Processor Number	# of Cores	# of Threads	Base Frequency	Max Turbo Frequency	Cache	Memory Types	Processor Graphics	Weight	Starting at 3.68 lb / 1.67 kg		
	i5-8265U i7-8565U	4	8	1.6 GHz 1.8 GHz	3.9 GHz 4.5 GHz	6MB 8MB	DDR4-2400	Intel UHD Graphics 620	Case color	Black or silver		
								Case material	Aluminum			
Graphics	Intel UHD Graphics 620 in processor only or Intel UHD Graphics 620 in processor and AMD Radeon RX 540X Graphics, 2GB DDR5 memory; supports external digital monitor via HDMI or USB Type-C; supports three independent display; Max resolution: 4096x2304@60Hz (USB Type-C); 4096x2160@24Hz (HDMI)								Smart card reader	None		
									Media reader	MicroSD card reader		
Chipset	Intel SoC (System on Chip) platform 32GB max / 2400MHz DDR4, dual-channel capable, two DDR4 SO-DIMM sockets <i>* Installed memory is actually 2666MHz but run at 2400MHz due to Intel limitation</i>								Ports	One USB 2.0, two USB 3.1 Gen 1 (one Always On), one USB 3.1 Type-C Gen 2 (with the function of Power Delivery and DisplayPort), HDMI 1.4b, Ethernet (RJ-45), headphone / microphone combo jack, microSD card reader, security keyhole <i>* Depending on many factors, actual data transfer speed may be lower than theoretical speed</i>		
									Camera	HD720p camera, fixed focus		
Memory									Audio support	HD Audio, Synaptic® CX11880 codec / stereo speakers, 2W x 2, Dolby® Audio™ Premium / dual array microphone, headphone / microphone combo jack		
Display	Size / Resolution		Surface	Type	Brightness	Aspect Ratio	Contrast Ratio	Viewing Angle	Multi-touch	Keyboard	6-row, spill-resistant, multimedia Fn keys, optional LED backlight	
	14.0" FHD (1920x1080)		Anti-glare	TN	220 nits	16:9	400:1	90°	Non-touch	UltraNav™	TrackPoint® pointing device and buttonless Mylar surface multi-touch touchpad	
	14.0" FHD (1920x1080)		Anti-glare	IPS	250 nits	16:9	600:1	170°	Non-touch	Security	Power-on password, hard disk password, supervisor password, security keyhole	
Multi-touch	None								Security chip	<i>Integrated model:</i> discrete TPM 2.0, TCG Certified <i>Discrete model:</i> firmware TPM 2.0 integrated in chipset		
Storage	One of the following, configurable by model: • M.2 2280 SSD / SATA 6.0Gb/s • M.2 2242 SSD / PCIe NVMe, PCIe 3.0 x 2								System Mgt	None		
Optane™ memory	None								Fingerprint reader	Touch style fingerprint reader on the palm rest		
Optical	None								NFC	None		
Ethernet	Gigabit Ethernet Connection, Realtek R8111GUS								Battery	Integrated Li-ion 42Wh battery, supports Rapid Charge (charge up to 80% in 1hr) with 65W USB Type-C AC adapter		
WLAN + Bluetooth™	One of the following, configurable by model: • Realtek® RTL8822BE, Wi-Fi 2x2 802.11ac + Bluetooth 4.2, M.2 card • Intel Wireless-AC 9260, Wi-Fi 2x2 802.11ac + Bluetooth 5.0, M.2 card								Max battery life	<i>MobileMark® 2014:</i> 11.5 hr <i>* Battery life varies significantly with settings, usage, & other factors</i>		
WWAN	None								AC adapter	45W or 65W USB Type-C AC adapter		
SIM card	None								Preload (optional)	Windows® 10 Home 64 or Windows 10 Pro 64		
									Limited warranty	1-year depot repair service		
									Mil-Spec test	MIL-STD-810G military testing		
									Environment	EPEAT™ Silver; ENERGY STAR® 7.1; RoHS-compliant		

Note: The specifications above may not be available in all regions.

Lenovo
July 2019



ThinkPad E495 Platform Specifications

Product Specifications Reference (PSREF)

Processor	AMD Ryzen™ Mobile Processors with Radeon™ Vega Graphics								Dimensions <i>Aluminum (WxDxH):</i> 12.96" x 9.53" x 0.78"; 329mm x 242mm x 19.9mm <i>PC/ABS (WxDxH):</i> 12.96" x 9.53" x 0.83"; 329mm x 242mm x 21.9mm																							
	Processor Number	# of Cores	# of Threads	Base Frequency	Max Turbo Frequency	Cache	Memory Controller	Processor Graphics		Weight Starting at 3.87 lb / 1.75 kg Case color Black Case material <i>Display cover:</i> Aluminum or PC/ABS plastic; <i>Bottom:</i> PC/ABS plastic																						
	Ryzen 3 3200U	2	4	2.6 GHz	3.5 GHz	1MB L2 / 4MB L3	DDR4-2400	Radeon Vega 3 Graphics																								
	Ryzen 5 3500U	4	8	2.1 GHz	3.7 GHz	2MB L2 / 4MB L3		Radeon Vega 8 Graphics																								
Ryzen 7 3700U	2.3 GHz			4.0 GHz	2MB L2 / 4MB L3	Radeon RX Vega 10 Graphics																										
Graphics	AMD Radeon Vega 3, Vega 8, or RX Vega 10 Graphics in processor; supports external digital monitor via HDMI or USB Type-C; supports dual independent display; Max resolution: 3840x2160@60Hz (USB Type-C); 3840x2160@30Hz (HDMI)								Smart card reader None Media reader MicroSD card reader Ports One USB 2.0, two USB 3.1 Gen 1 (one Always On), one USB 3.1 Type-C Gen 1 (with the function of Power Delivery and DisplayPort), HDMI 1.4b, Ethernet (RJ-45), headphone / microphone combo jack, microSD card reader, security keyhole <i>* Depending on many factors, actual data transfer speed may be lower than theoretical speed</i> Monitor cable None Bundled Accy None Camera HD720p camera, fixed focus Audio support HD Audio, Synaptic® CX11880 codec / stereo speakers, 1.5W x 2, Dolby® Advanced Audio / dual array microphone, headphone / microphone combo jack																							
Chipset	AMD SoC (System on Chip) platform																															
Memory	32GB max / 2400MHz DDR4, dual-channel capable, two DDR4 SO-DIMM sockets <i>* Installed memory is actually 2666MHz but run at 2400MHz due to AMD limitation</i>																															
Display	<table border="1"> <thead> <tr> <th>Size / Resolution</th> <th>Surface</th> <th>Type</th> <th>Brightness</th> <th>Aspect Ratio</th> <th>Contrast Ratio</th> <th>Viewing Angle</th> <th>Multi-touch</th> </tr> </thead> <tbody> <tr> <td>14.0" HD (1366x768)</td> <td>Anti-glare</td> <td>TN</td> <td>220 nits</td> <td>16:9</td> <td>400:1</td> <td>90°</td> <td>Non-touch</td> </tr> <tr> <td>14.0" FHD (1920x1080)</td> <td>Anti-glare</td> <td>IPS</td> <td>250 nits</td> <td>16:9</td> <td>600:1</td> <td>170°</td> <td>Non-touch</td> </tr> </tbody> </table>									Size / Resolution	Surface	Type	Brightness	Aspect Ratio	Contrast Ratio	Viewing Angle	Multi-touch	14.0" HD (1366x768)	Anti-glare	TN	220 nits	16:9	400:1	90°	Non-touch	14.0" FHD (1920x1080)	Anti-glare	IPS	250 nits	16:9	600:1	170°
Size / Resolution	Surface	Type	Brightness	Aspect Ratio	Contrast Ratio	Viewing Angle	Multi-touch																									
14.0" HD (1366x768)	Anti-glare	TN	220 nits	16:9	400:1	90°	Non-touch																									
14.0" FHD (1920x1080)	Anti-glare	IPS	250 nits	16:9	600:1	170°	Non-touch																									
Multi-touch	None								Keyboard 6-row, spill-resistant, multimedia Fn keys UltraNav™ TrackPoint® pointing device and buttonless Mylar surface multi-touch touchpad Security Power-on password, hard disk password, supervisor password, security keyhole Security chip Discrete TPM 2.0, TCG Certified Fingerprint reader None NFC None Battery Integrated Li-ion 45Wh battery, supports Rapid Charge (charge up to 80% in 1hr) with 65W USB Type-C AC adapter Max battery life <i>MobileMark® 2014:</i> 11 hr <i>* Battery life varies significantly with settings, usage, & other factors</i> AC adapter 45W or 65W USB Type-C AC adapter Preload (optional) Windows® 10 Home 64 or Windows 10 Pro 64 Limited warranty 1-year depot repair service Mil-Spec test None Environment EPEAT™ Silver; ENERGY STAR® 7.1; RoHS-compliant																							
Storage	Up to two drives (one M.2 SSD and one HDD) • HDD / SATA 6.0Gb/s, 2.5" wide, 7mm high, Active Protection System™ • M.2 2242 SSD / PCIe NVMe, PCIe 3.0 x 2 or PCIe 3.0 x 4																															
Optical	None																															
Ethernet	Gigabit Ethernet Connection, Realtek R8111GUS																															
WLAN + Bluetooth™	One of the following, configurable by model: • Realtek® RTL8822BE, Wi-Fi 2x2 802.11ac + Bluetooth 4.2, M.2 card • Intel Wireless-AC 9260, Wi-Fi 2x2 802.11ac + Bluetooth 5.0, M.2 card																															
WWAN	None																															
SIM card	None																															

Note: The specifications above may not be available in all regions.

Lenovo
July 2019





ThinkPad E585 Platform Specifications

Product Specifications Reference (PSREF)

Processor	AMD Ryzen™ Mobile Processors with Radeon™ Vega Graphics							Dimensions	<i>WxDxH:</i> 14.53" x 9.92" x 0.79"; 369mm x 252mm x 19.95mm	
	Processor Number	# of Cores	# of Threads	Base Frequency	Max Turbo Frequency	Cache	Memory Controller	Processor Graphics	Weight	Starting at 4.7 lb / 2.1kg
	Ryzen 3 2200U	2	4	2.5 GHz	3.4 GHz	1MB L2 / 4MB L3	DDR4-2400	Radeon Vega 3 Graphics	Case color	Black
	Ryzen 5 2500U	4	8	2.0 GHz	3.6 GHz	2MB L2 / 4MB L3		Radeon Vega 8 Graphics	Case material	<i>Display cover:</i> Aluminum; <i>Bottom:</i> PC/ABS plastic
Ryzen 7 2700U	2.2 GHz			3.8 GHz	2MB L2 / 4MB L3	Radeon RX Vega 10 Graphics		Smart card reader	None	
Graphics	AMD Radeon Vega 3, Vega 8, or RX Vega 10 Graphics in processor only; supports external digital monitor via HDMI or USB Type-C; supports dual independent display; Max resolution: 1920x1080 (HDMI) @60Hz							Media reader	MicroSD card reader	
Chipset	AMD SoC (System on Chip) platform							Ports	One USB 2.0, two USB 3.1 Gen 1 (one Always On), one USB 3.1 Type-C Gen 2 (with the function of Power Delivery and DisplayPort), HDMI 1.4b, Ethernet (RJ-45), headphone / microphone combo jack, microSD card reader, security keyhole <i>* Depending on many factors, actual data transfer speed may be lower than theoretical speed</i>	
Memory	32GB max / 2400MHz DDR4, dual-channel capable, two DDR4 SO-DIMM sockets							Camera	HD720p camera, fixed focus	
Display	<i>Some:</i> 15.6" (396mm) HD (1366x768), anti-glare, LED backlight, 220 nits, 16:9 aspect ratio, 400:1 contrast ratio (NOT available in EMEA) <i>Some:</i> 15.6" (396mm) FHD (1920x1080), anti-glare, LED backlight, IPS, 250 nits, 16:9 aspect ratio, 600:1 contrast ratio							Audio support	HD Audio, Synaptic® CX11852 codec / stereo speakers, 1.5W x 2, Dolby® Advanced Audio / dual array microphone, headphone / microphone combo jack	
Multi-touch	None							Keyboard	6-row, spill-resistant, multimedia Fn keys	
Storage	<i>Up to 2 drives (one M.2 SSD and one HDD)</i> <i>Some:</i> HDD / SATA 6.0Gb/s, 2.5" wide, removable, upgradable, Active Protection System™ <i>Some:</i> M.2 SSD / PCIe NVMe							UltraNav™	TrackPoint® pointing device and buttonless Mylar surface multi-touch touchpad	
Optical	None							Security	Power-on password, hard disk password, supervisor password, security keyhole	
Ethernet	Gigabit Ethernet Connection, Realtek RTL8111GUS							Security chip	Discrete TPM 2.0, TCG Certified	
WLAN + Bluetooth™	<i>One of the following, configurable by model:</i> • Qualcomm QCNFA435, Wi-Fi 1x1 802.11ac + Bluetooth 4.1, M.2 card • Realtek® RTL8821CE, Wi-Fi 1x1 802.11ac + Bluetooth 4.1, M.2 card • Realtek RTL8822BE, Wi-Fi 2x2 802.11ac + Bluetooth 4.1, M.2 card							Fingerprint reader	None	
WWAN	None							NFC	None	
SIM card	None							Battery	Integrated Li-ion 45Wh battery, supports Rapid Charge (charge up to 80% in 1hr) with 65W USB Type-C AC adapter	
								Max battery life	<i>MobileMark® 2014:</i> 8.63 hr <i>* Battery life varies significantly with settings, usage, & other factors</i>	
								AC adapter	45W or 65W USB Type-C AC adapter	
								Preload (optional)	Windows® 10 Home 64 or Windows 10 Pro 64	
								Limited warranty	1-year depot repair service	
								Mil-Spec test	None	
								Environment	EPEAT™ Gold (US only); ENERGY STAR® 6.1; RoHS-compliant	

Note: The specifications above may not be available in all regions.

Lenovo
June 2019



ThinkPad E590 Platform Specifications

Product Specifications Reference (PSREF)

Processor	8th Generation Intel® Core™ i3 / i5 / i7 Processor								Dimensions	<i>WxDxH:</i> 14.53" x 9.94" x 0.78"; 369mm x 252.5mm x 19.9mm
	Processor Number	# of Cores	# of Threads	Base Frequency	Max Turbo Frequency	Cache	Memory Types	Processor Graphics	Weight	Starting at 4.68 lb / 2.12 kg
	i3-8145U	2	4	2.1 GHz	3.9 GHz	4MB	DDR4-2400	Intel UHD Graphics 620	Case color	Black or silver
	i5-8265U	4	8	1.6 GHz	3.9 GHz	6MB			Case material	<i>Display cover:</i> Aluminum; <i>Bottom:</i> PC/ABS plastic
i7-8565U	1.8 GHz			4.6 GHz	8MB	Smart card reader			None	
Graphics	Intel UHD Graphics 620 in processor only or Intel UHD Graphics 620 in processor and AMD Radeon RX 550X Graphics, 2GB DDR5 memory; supports external digital monitor via HDMI or USB Type-C; supports dual independent display; Max resolution: 4096x2304@60Hz (USB Type-C); 4096x2160@24Hz (HDMI)								Media reader	MicroSD card reader
Chipset	Intel SoC (System on Chip) platform								Ports	One USB 2.0, two USB 3.1 Gen 1 (one Always On), one USB 3.1 Type-C Gen 2 (with the function of Power Delivery and DisplayPort), HDMI 1.4b, Ethernet (RJ-45), headphone / microphone combo jack, microSD card reader, security keyhole <i>* Depending on many factors, actual data transfer speed may be lower than theoretical speed</i>
Memory	32GB max / 2400MHz DDR4, dual-channel capable, two DDR4 SO-DIMM sockets <i>* Installed memory is actually 2666MHz but run at 2400MHz due to Intel limitation</i>								Monitor cable	None
Display	Size / Resolution	Surface	Type	Brightness	Aspect Ratio	Contrast Ratio	Viewing Angle	Multi-touch	Bundled Accy	None
	15.6" HD (1366x768)	Anti-glare	TN	220 nits	16:9	400:1	90°	Non-touch	Camera	HD720p camera, fixed focus
	15.6" FHD (1920x1080)	Anti-glare	IPS	250 nits	16:9	600:1	170°	Non-touch	Audio support	HD Audio, Synaptic® CX11880 codec / stereo speakers, 2W x 2, Dolby® Advanced Audio / dual array microphone, headphone / microphone combo jack
Multi-touch	None								Keyboard	6-row, spill-resistant, multimedia Fn keys, numeric keypad, optional LED backlight
Storage	Up to two drives (one M.2 SSD and one HDD) • HDD / SATA 6.0Gb/s, 2.5" wide, 7mm high, Active Protection System™ • M.2 2280 SSD / SATA 6.0Gb/s • M.2 2280 SSD / PCIe NVMe, PCIe 3.0 x 2 • M.2 2242 SSD / PCIe NVMe, PCIe 3.0 x 2								UltraNav™	TrackPoint® pointing device and buttonless Mylar surface multi-touch touchpad
Optane™ memory	Optional: Intel Optane memory, PCIe NVMe, PCIe 3.0 x 2								Security	Power-on password, hard disk password, supervisor password, security keyhole
Optical	None								Security chip	<i>Integrated model:</i> discrete TPM 2.0, TCG Certified <i>Discrete model:</i> firmware TPM 2.0 integrated in chipset
Ethernet	Gigabit Ethernet Connection, Realtek R8111GUS								System Mgt	None
WLAN + Bluetooth™	One of the following, configurable by model: • Realtek® RTL8822BE, Wi-Fi 2x2 802.11ac + Bluetooth 4.2, M.2 card • Intel Wireless-AC 9260, Wi-Fi 2x2 802.11ac + Bluetooth 5.0, M.2 card								Fingerprint reader	<i>Optional:</i> Touch style fingerprint reader on the palm rest
WWAN	None								NFC	None
SIM card	None								Battery	Integrated Li-ion 45Wh battery, supports Rapid Charge (charge up to 80% in 1hr) with 65W USB Type-C AC adapter
									Max battery life	<i>MobileMark® 2014:</i> 11 hr <i>* Battery life varies significantly with settings, usage, & other factors</i>
									AC adapter	45W or 65W USB Type-C AC adapter
									Preload (optional)	Windows® 10 Home 64 or Windows 10 Pro 64
									Limited warranty	1-year depot repair service
									Mil-Spec test	MIL-STD-810G military testing
									Environment	EPEAT™ Silver; ENERGY STAR® 7.1; RoHS-compliant

Note: The specifications above may not be available in all regions.

Lenovo
July 2019



ThinkPad E595 Platform Specifications

Product Specifications Reference (PSREF)

Processor	AMD Ryzen™ Mobile Processors with Radeon™ Vega Graphics								Dimensions	<i>WxDxH:</i> 14.53" x 9.92" x 0.78"; 369mm x 252mm x 19.9mm
	Processor Number	# of Cores	# of Threads	Base Frequency	Max Turbo Frequency	Cache	Memory Controller	Processor Graphics	Weight	Starting at 4.7 lb / 2.1kg
	Ryzen 3 3200U	2	4	2.6 GHz	3.5 GHz	1MB L2 / 4MB L3	DDR4-2400	Radeon Vega 3 Graphics	Case color	Black
	Ryzen 5 3500U	4	8	2.1 GHz	3.7 GHz	2MB L2 / 4MB L3		Radeon Vega 8 Graphics	Case material	<i>Display cover:</i> Aluminum; <i>Bottom:</i> PC/ABS plastic
Ryzen 7 3700U	2.3 GHz			4.0 GHz	2MB L2 / 4MB L3	Radeon RX Vega 10 Graphics		Smart card reader	None	
Graphics	AMD Radeon Vega 3, Vega 8, or RX Vega 10 Graphics in processor; supports external digital monitor via HDMI or USB Type-C; supports dual independent display; Max resolution: 3840x2160@60Hz (USB Type-C); 3840x2160@30Hz (HDMI)								Media reader	MicroSD card reader
Chipset	AMD SoC (System on Chip) platform								Ports	One USB 2.0, two USB 3.1 Gen 1 (one Always On), one USB 3.1 Type-C Gen 1 (with the function of Power Delivery and DisplayPort), HDMI 1.4b, Ethernet (RJ-45), headphone / microphone combo jack, microSD card reader, security keyhole <i>* Depending on many factors, actual data transfer speed may be lower than theoretical speed</i>
Memory	32GB max / 2400MHz DDR4, dual-channel capable, two DDR4 SO-DIMM sockets <i>* Installed memory is actually 2666MHz but run at 2400MHz due to AMD limitation</i>								Monitor cable	None
Display	Size / Resolution	Surface	Type	Brightness	Aspect Ratio	Contrast Ratio	Viewing Angle	Multi-touch	Bundled Accy	None
	15.6" HD (1366x768)	Anti-glare	TN	220 nits	16:9	400:1	90°	Non-touch	Camera	HD720p camera, fixed focus
	15.6" FHD (1920x1080)	Anti-glare	IPS	250 nits	16:9	600:1	170°	Non-touch	Audio support	HD Audio, Synaptic® CX11880 codec / stereo speakers, 2W x 2, Dolby® Advanced Audio / dual array microphone, headphone / microphone combo jack
Multi-touch	None								Keyboard	6-row, spill-resistant, multimedia Fn keys
Storage	Up to two drives (one M.2 SSD and one HDD) • HDD / SATA 6.0Gb/s, 2.5" wide, 7mm high, Active Protection System™ • M.2 2242 SSD / PCIe NVMe, PCIe 3.0 x 2 or PCIe 3.0 x 4								UltraNav™	TrackPoint® pointing device and buttonless Mylar surface multi-touch touchpad
Optical	None								Security	Power-on password, hard disk password, supervisor password, security keyhole
Ethernet	Gigabit Ethernet Connection, Realtek R8111GUS								Security chip	Discrete TPM 2.0, TCG Certified
WLAN + Bluetooth™	One of the following, configurable by model: • Realtek® RTL8822BE, Wi-Fi 2x2 802.11ac + Bluetooth 4.2, M.2 card • Intel Wireless-AC 9260, Wi-Fi 2x2 802.11ac + Bluetooth 5.0, M.2 card								Fingerprint reader	None
WWAN	None								NFC	None
SIM card	None								Battery	Integrated Li-ion 45Wh battery, supports Rapid Charge (charge up to 80% in 1hr) with 65W USB Type-C AC adapter
									Max battery life	<i>MobileMark® 2014:</i> 10.3 hr <i>* Battery life varies significantly with settings, usage, & other factors</i>
									AC adapter	45W or 65W USB Type-C AC adapter
									Preload (optional)	Windows® 10 Home 64 or Windows 10 Pro 64
									Limited warranty	1-year depot repair service
									Mil-Spec test	None
									Environment	EPEAT™ Silver; ENERGY STAR® 7.1; RoHS-compliant

Note: The specifications above may not be available in all regions.

Lenovo
July 2019



ThinkPad L380 Platform Specifications

Product Specifications Reference (PSREF)

Processor	Intel® Celeron® Processor, 7th Generation Intel Core™ i3 / i5 Processor or							Dimensions	<i>WxDxH:</i> 12.67" x 8.83" x 0.74"; 321.8mm x 224.2mm x 18.8mm	
	Processor Number	# of Cores	# of Threads	Base Frequency	Max Turbo Frequency	Cache	Memory Types	Processor Graphics	Weight	Starting at 3.22 lb / 1.46 kg
	Cel 3965U	2	2	2.2 GHz	-	2MB	DDR4-2133	Intel HD Graphics 610	Case color	Black or Silver
	i3-7130U		4	2.7 GHz	-	3MB		Intel HD Graphics 620	Case material	<i>Display cover:</i> Aluminum
i5-7200U			2.5 GHz	3.1 GHz	3MB			<i>Bottom:</i> GFRP		
8th Generation Intel Core i5 / i7 Processor										
Processor Number	# of Cores	# of Threads	Base Frequency	Max Turbo Frequency	Cache	Memory Types	Processor Graphics	Smart card reader	None	
i3-8130U	2	4	2.2 GHz	3.4 GHz	4MB	DDR4-2400	Intel UHD Graphics 620	Media reader	MicroSD card reader	
i5-8250U	4	8	1.6 GHz	3.4 GHz	6MB			Ports	Two USB 3.1 Gen 1 (one Always On), two USB 3.1 Type-C Gen 1 (with the function of Power Delivery and DisplayPort), HDMI 1.4b, Ethernet extension connector, headphone / microphone combo jack, microSD card reader, security keyhole	
i5-8350U			1.7 GHz	3.6 GHz	6MB			Monitor cable (optional)	<i>* Depending on many factors, actual data transfer speed may be lower than theoretical speed</i> <i>HDMI to VGA:</i> Lenovo HDMI to VGA Monitor Adapter <i>USB-C to VGA:</i> Lenovo USB-C to VGA Adapter <i>USB-C to DP:</i> Lenovo USB-C to DisplayPort Adapter	
i7-8550U			1.8 GHz	4.0 GHz	8MB			Bundled Accy	<i>Optional:</i> ThinkPad Ethernet Extension Cable	
Graphics										
Intel HD Graphics 610, 620 or Intel UHD Graphics 620 in processor; supports external digital monitor via HDMI or USB Type-C; supports three independent displays; Max resolution: 4096x2304@60Hz (USB Type-C); 4096x2160@30Hz (HDMI)								Camera	HD720p camera, fixed focus	
Chipset								Audio support	HD Audio, Realtek ALC3287 codec / stereo speakers, 2W x 2, Dolby® Audio™ / dual array microphone, headphone / microphone combo jack	
Memory								Keyboard	6-row, spill-resistant, multimedia Fn keys, optional LED backlight	
32GB max / 2400MHz DDR4, dual-channel capable, two DDR4 SO-DIMM sockets								UltraNav™	TrackPoint® pointing device and buttonless Mylar surface touchpad, multi-touch	
* System clocks down for processors with lower memory controller								Security	Power-on password, hard disk password, supervisor password, security keyhole	
Display								Security chip	Discrete TPM 2.0, TCG Certified	
Some: 13.3" (338mm) HD (1366x768), anti-glare, LED backlight, 250 nits, 16:9 aspect ratio, 500:1 contrast ratio								vPro (optional)	Intel vPro Technology	
Some: 13.3" (338mm) FHD (1920x1080), anti-glare, LED backlight, IPS, 250 nits, 16:9 aspect ratio, 700:1 contrast ratio, 170° viewing angle								Fingerprint reader	<i>Optional:</i> Touch style fingerprint reader on the keyboard bezel, anti-spoofing technology	
Multi-touch (opt) on-cell touch, supports 10-finger gesture								NFC (optional)	Near Field Communication	
Storage								Battery	Integrated Li-ion 45Wh battery, supports Rapid Charge (charge up to 80% in 1hr) with 65W USB Type-C AC adapter	
One of the following, configurable by model:								Max battery life	<i>MobileMark® 2014:</i> 16.1 hr	
• M.2 SSD / SATA 6.0Gb/s (e.g. xxxGB SSD M.2)								AC adapter	45W or 65W USB Type-C AC adapter	
• M.2 SSD / PCIe NVMe, PCIe 3.0 x 4, 32Gb/s (e.g. xxxGB SSD M.2 PCIe NVMe)								Preload	Windows® 10 Home 64 or Windows 10 Pro 64	
Optane™ memory								Limited warranty	<i>One of the following, configurable by model:</i>	
Optical									• 1-year depot repair service	
Ethernet									• 3-year/1-yr battery depot repair service	
Native Intel Ethernet Connection I219-V (Non-vPro) or I219-LM (vPro) via optional ThinkPad Ethernet Extension Cable									• 3-year/1-yr battery limited onsite service	
WLAN + Bluetooth™								Mil-Spec test	MIL-STD-810G military testing	
Intel Dual Band Wireless-AC 8265, Wi-Fi 2x2 802.11ac + Bluetooth 4.1, M.2 card								Environment	EPEAT™ Gold (US only); ENERGY STAR® 6.1; RoHS-compliant	
* Intel 8265ac card supports BT4.2 but is limited to BT4.1 by Windows OS										
WWAN										
SIM card										
None										
None										

Note: The specifications above may not be available in all regions.

Lenovo
April 2019



ThinkPad L390 Platform Specifications

Product Specifications Reference (PSREF)

Processor	8th Generation Intel® Core™ i3 / i5 / i7 Processor								Smart card reader	None
	Processor Number	# of Cores	# of Threads	Base Frequency	Max Turbo Frequency	Cache	Memory Types	Processor Graphics	Media reader	MicroSD card reader
	i3-8145U	2	4	2.1 GHz	3.9 GHz	4MB	DDR4-2400	Intel UHD Graphics 620	Ports	Two USB 3.1 Gen 1 (one Always On), two USB 3.1 Type-C Gen 1 (with the function of Power Delivery and DisplayPort), HDMI 1.4b, Ethernet extension connector, headphone / microphone combo jack, microSD card reader, security keyhole
	i5-8265U	4	8	1.6 GHz	3.9 GHz	6MB				
	i5-8365U			1.6 GHz	4.1 GHz	6MB				
i7-8565U	1.8 GHz			4.6 GHz	8MB					
Graphics	Intel UHD Graphics 620 in processor; supports external digital monitor via HDMI or USB Type-C; supports three independent displays; Max resolution: 4096x2304@60Hz (USB Type-C); 4096x2160@30Hz (HDMI)								Monitor cable (optional)	<ul style="list-style-type: none"> USB-C to VGA: Lenovo USB-C to VGA Adapter USB-C to VGA + Power Adapter: Lenovo USB-C to VGA plus Power Adapter USB-C to HDMI: Lenovo USB-C to HDMI Adapter USB-C to HDMI + Power Adapter: Lenovo USB-C to HDMI plus Power Adapter USB-C to DP: Lenovo USB-C to DisplayPort Adapter USB-C to RJ45: Lenovo USB-C to Ethernet Adapter USB-C to USB-A: Lenovo USB-C to USB-A Adapter USB-C to USB-C: Lenovo USB-C to USB-C Cable 2M
Chipset Memory	Intel SoC (System on Chip) platform 32GB max / 2400MHz DDR4, dual-channel capable, two DDR4 SO-DIMM sockets * Installed memory is actually 2666MHz but run at 2400MHz due to Intel limitation								Bundled Accessories (optional)	
Display	Size	Resolution	Surface	Type	Brightness	Aspect Ratio	Contrast Ratio	Viewing Angle	Camera	HD720p camera, fixed focus
	13.3"	HD (1366x768)	Anti-glare	TN	250 nits	16:9	500:1	90°	Audio support	HD Audio, Realtek ALC3287 codec / stereo speakers, 2W x 2, Dolby® Audio™ Premium / dual array microphone, headphone / microphone combo jack
	13.3"	FHD (1920x1080)	Anti-glare	IPS	250 nits	16:9	700:1 (non-touch) 800:1 (multi-touch)	170°	Keyboard	6-row, spill-resistant, multimedia Fn keys, optional LED backlight
Multi-touch (opt)	On-cell touch, supports 10-finger gesture (FHD only)								UltraNav™	TrackPoint® pointing device and buttonless Mylar surface touchpad, multi-touch
Storage	<i>One of the following, configurable by model:</i> <ul style="list-style-type: none"> M.2 2280 SSD / SATA 6.0Gb/s M.2 2242 SSD / PCIe NVMe, PCIe 3.0 x 2 M.2 2280 SSD / PCIe NVMe, PCIe 3.0 x 4 Intel Optane™ Memory H10 with Solid State Storage, M.2 2280, PCIe NVMe 3.0 x 4 								Security	Power-on password, hard disk password, supervisor password, security keyhole
Optical	None								Security chip	Discrete TPM 2.0, TCG Certified
Ethernet	Native Intel Ethernet Connection I219-V (Non-vPro) or I219-LM (vPro) via optional ThinkPad Ethernet Extension Cable or Lenovo USB-C to Ethernet Adapter								System Mgt (opt)	Intel vPro Technology
WLAN	Intel Wireless-AC 9560, Wi-Fi 2x2 802.11ac + Bluetooth 5.0, M.2 card								Fingerprint reader	Optional: Touch style fingerprint reader on the palm rest
Bluetooth™	Bluetooth 5.0 wireless, integrated in Wi-Fi + Bluetooth combo adapter								NFC (optional)	Near Field Communication
WWAN	None								Battery	Integrated Li-ion 45Wh battery, supports Rapid Charge (charge up to 80% in 1hr) with 65W USB Type-C AC adapter
SIM card	None								Max battery life	MobileMark® 2014: 14.61 hr * Battery life varies significantly with settings, usage, & other factors
Dimensions	WxDxH: 12.67" x 8.83" x 0.74"; 321.8mm x 224.2mm x 18.8mm								AC adapter	45W or 65W USB Type-C AC adapter
Weight	Starting at 3.22 lb / 1.46 kg								Preload	Windows® 10 Home 64 or Windows 10 Pro 64
Case color	Black or Silver								Limited warranty	<i>One of the following, configurable by model:</i> <ul style="list-style-type: none"> 1-year depot repair service 3-year/1-yr battery depot repair service 3-year/1-yr battery limited onsite service
Case material	Display cover: Aluminum Bottom: GFRP								Mil-Spec test	MIL-STD-810G military testing
									Environment	EPEAT™ Silver; ENERGY STAR® 7.1; RoHS-compliant

Note: The specifications above may not be available in all regions.

Lenovo
July 2019



ThinkPad L470 Platform Specifications

Product Specifications Reference (PSREF)

Processor	6th Generation Intel® Core™ i3 / i5 / i7 Processor or								WWAN (optional) <i>One of the following, configurable by model:</i> <ul style="list-style-type: none"> Wireless WAN upgradable Integrated Mobile Broadband 4G LTE-A, Qualcomm® Snapdragon™ X7 LTE-A (Sierra Wireless EM7455), M.2 card Integrated Mobile Broadband 4G LTE, Intel XMM™ 7160 (Fibocom L831-EAU), M.2 card (EMEA only) SIM card (opt) Micro-SIM card slot, opt Verizon LTE (US) or Lenovo® Connect (EMEA) SIM card
	Processor Number	# of Cores	# of Threads	Base Frequency	Max Turbo Frequency	Cache	Memory Types	Processor Graphics	
	i3-6006U	2	4	2.0 GHz	-	3MB	DDR4-2133	Intel HD Graphics 520	
	i3-6100U			2.3 GHz	-	3MB			
	i5-6200U			2.3 GHz	2.8 GHz	3MB			
	i5-6300U			2.4 GHz	3.0 GHz	3MB			
	Intel Celeron® Processor or 7th Generation Intel Core i3 / i5 / i7 Processor								
	Processor Number	# of Cores	# of Threads	Base Frequency	Max Turbo Frequency	Cache	Memory Types	Processor Graphics	
	Cel 3965U	2	4	2.2 GHz	-	2MB	DDR4-2133	Intel HD Graphics 610	
	i3-7100U			2.4 GHz	-	3MB		Intel HD Graphics 620	
	i5-7200U			2.5 GHz	3.1 GHz	3MB			
	i5-7300U			2.6 GHz	3.5 GHz	3MB			
	i7-7500U			2.7 GHz	3.5 GHz	4MB			
	i7-7600U			2.8 GHz	3.9 GHz	4MB			
	* i7 processor is NOT available in EMEA								
Graphics	Intel HD Graphics 610 or 620 in processor only, or Intel HD Graphics 620 in processor and AMD Radeon™ R5 M430, 2GB memory; supports external analog monitor via VGA and digital monitor via Mini DisplayPort; supports three independent displays; Max resolution: 3840x2160@60Hz (DP via mDP cable); 1920x1200@60Hz (VGA)								
Chipset	Intel SoC (System on Chip) platform								
Memory	32GB max / 2400MHz DDR4, dual-channel capable, two DDR4 SO-DIMM sockets * System clocks down for processors with lower memory controller								
Display	Some: 14.0" (355mm) HD (1366x768), anti-glare, LED backlight, 220 nits, 16:9 aspect ratio, 500:1 contrast ratio Some: 14.0" (355mm) FHD (1920x1080), anti-glare, LED backlight, IPS, 250 nits, 16:9 aspect ratio, 700:1 contrast ratio, 170° viewing angle								
Multi-touch	None								
Storage	System has one HDD slot or one M.2 2280 slot exclusively for storage Some: HDD / SATA 6.0Gb/s, 2.5" wide, 7mm or 9.5mm high, Active Protection System™ Some: SSD / SATA 6.0Gb/s, 2.5" wide, 7mm high (e.g. xxxGB SSD) Some: M.2 SSD / PCIe NVMe, PCIe 3.0 x 2, 16Gb/s Some: 128GB M.2 SSD / SATA 6.0Gb/s, in WWAN slot as 2nd Storage, mutually exclusive with WWAN								
Optical	None								
Ethernet	Non-vPro model: Intel Ethernet Connection I219-V (Jacksonville) vPro model: Intel Ethernet Connection I219-LM (Jacksonville)								
WLAN	One of the following, configurable by model: <ul style="list-style-type: none"> Realtek® RTL8822BE, Wi-Fi 2x2 802.11ac + BT4.1, M.2 card Intel Dual Band Wireless-AC 8260, Wi-Fi 2x2 802.11ac + BT4.1, M.2 card Intel Dual Band Wireless-AC 8265, Wi-Fi 2x2 802.11ac + BT4.1, M.2 card Bluetooth 4.1 wireless, integrated in Wi-Fi + Bluetooth combo adapter * Intel 8260ac / 8265ac card support BT4.2 but is limited to BT4.1 by Windows OS								
Bluetooth™									
Camera (optional)	HD720p resolution, fixed focus								
Audio support	HD Audio, Realtek ALC3268 codec / stereo speakers, 1W x 2 / dual array microphone, combo audio/microphone jack								
Keyboard	6-row, spill-resistant, multimedia Fn keys								
UltraNav™	TrackPoint® pointing device and buttonless Mylar surface multi-touch touchpad								
Security	Power-on password, hard disk password, supervisor password, security keyhole								
Security chip	Discrete TPM 2.0, TCG Certified								
vPro (optional)	Intel vPro Technology								
Fingerprint reader	Optional: Swipe style fingerprint reader on the keyboard bezel								
NFC	None								
Battery	Li-ion 3-cell (24Wh) or 6-cell (48Wh or 72Wh)								
Max battery life ¹⁰ (MobileMark® 2014)	Models	3-cell	6-cell 48Wh	6-cell 72Wh					
	Integrated model	7.24 hr	14.48 hr	21.72 hr					
	Discrete model	4.34 hr	8.68 hr	13.02 hr					
	* Battery life varies significantly with settings, usage, & other factors								
AC adapter	45W or 65W slim tip AC adapter								
Preload	Windows® 7 Professional 64 preinstalled through downgrade rights in Windows 10 Pro 64				Some: Windows 10 Home 64 Some: Windows 10 Pro 64				
	<ul style="list-style-type: none"> Lenovo Solution Center Lenovo PowerEngage ThinkVantage Product Recovery ThinkVantage System Update Adobe® Reader® Microsoft® Office preloaded; purchase a product key to activate McAfee® LiveSafe™ (30-day trial) 				<ul style="list-style-type: none"> Lenovo Companion Lenovo Setting Microsoft Office preloaded; purchase a product key to activate 				
Limited warranty	One of the following, configurable by model: <ul style="list-style-type: none"> 1-year depot repair service 3-year/1-yr battery depot repair service 3-year/1-yr battery limited onsite service 								
Mil-Spec test	MIL-STD-810G military testing								
Environment	EPEAT™ Gold (US only); ENERGY STAR® 6.1; RoHS-compliant								

Note: The specifications above may not be available in all regions.

Lenovo
September 2018



ThinkPad L480 Platform Specifications

Product Specifications Reference (PSREF)

Processor	7th Generation Intel® Core™ i3 / i5 Processor or							Processor Graphics	Intel HD Graphics 620	WWAN (optional) <i>One of the following, configurable by model:</i> <ul style="list-style-type: none"> Integrated Mobile Broadband 4G LTE, Intel XMM™ 7262 (Fibocom L830-EB), M.2 card (EMEA only) Integrated Mobile Broadband 4G LTE-A, Intel XMM™ 7360 (Fibocom L850-GL), M.2 card <i>* For non-WWAN model, it means the model is NOT WWAN upgradable</i> Nano-SIM card slot, optional Verizon LTE (US) SIM card
	Processor Number	# of Cores	# of Threads	Base Frequency	Max Turbo Frequency	Cache	Memory Types			
	i3-7130U	2	4	2.7 GHz	-	3MB	DDR4-2133		SIM card (opt)	
	i5-7200U			2.5 GHz	3.1 GHz	3MB				
	i5-7300U			2.6 GHz	3.5 GHz	3MB				
	8th Generation Intel Core i3 / i5 / i7 Processor									Dimensions WxDxH: 13.19" x 9.25" x 0.89"; 335mm x 235mm x 22.5mm
	Processor Number	# of Cores	# of Threads	Base Frequency	Max Turbo Frequency	Cache	Memory Types	Processor Graphics	Weight Starting at 3.71 lb / 1.68 kg	
	i3-8130U	4	8	2.2 GHz	3.4 GHz	4MB	DDR4-2400	Intel UHD Graphics 620	Case color Black	
	i5-8250U			1.6 GHz	3.4 GHz	6MB			Case material PC/ABS plastic	
	i5-8350U			1.7 GHz	3.6 GHz	6MB			Smart card reader <i>Optional:</i> Smart card reader	
	i7-8550U			1.8 GHz	4.0 GHz	8MB			Media reader MicroSD card reader	
	<i>* i3-7130U is NOT available in US and EMEA</i>									Ports Two USB 3.1 Gen 1 (one Always On), two USB 3.1 Type-C Gen 1 (with the function of Power Delivery and DisplayPort), HDMI 1.4b, Ethernet (RJ-45), nano-SIM card slot (WWAN models), headphone / microphone combo jack, optional smart card reader, microSD card reader, side docking connector, security keyhole <i>* Depending on many factors, actual data transfer speed may be lower than theoretical speed</i>
Graphics	Intel HD Graphics 620 or Intel UHD Graphics 620 in processor only or Intel HD Graphics 620 or Intel UHD Graphics 620 in processor and AMD Radeon 530, 2GB GDDR5 memory (discrete models are NOT available in EMEA); supports external digital monitor via HDMI or USB Type-C; supports three independent displays; Max resolution: 4096x2304@60Hz (USB Type-C); 4096x2160@30Hz (HDMI)									
Chipset	Intel SoC (System on Chip) platform									
Memory	32GB max / 2400MHz DDR4, dual-channel capable, two DDR4 SO-DIMM sockets <i>* System clocks down for processors with lower memory controller</i>									
Display	<i>Some:</i> 14.0" (355mm) HD (1366x768), anti-glare, LED backlight, 220 nits, 16:9 aspect ratio, 500:1 contrast ratio <i>Some:</i> 14.0" (355mm) FHD (1920x1080), anti-glare, LED backlight, IPS, 250 nits, 16:9 aspect ratio, 800:1 contrast ratio, 170° viewing angle									
Multi-touch (opt)	On-cell touch, supports 10-finger gesture (FHD only)									
Storage	<i>System has one HDD slot or one M.2 2280 slot exclusively for storage</i> <i>Some:</i> HDD / SATA 6.0Gb/s, 2.5" wide, 7mm high, Active Protection System™ <i>Some:</i> SSD / SATA 6.0Gb/s, 2.5" wide, 7mm high (e.g. xxxGB SSD) <i>Some:</i> M.2 SSD / PCIe NVMe, PCIe 3.0 x 2, 16Gb/s <i>Some:</i> 128GB M.2 SSD / PCIe NVMe, PCIe 3.0 x 2, 16Gb/s, in WWAN slot as 2nd Storage, mutually exclusive with WWAN									
Optane™ memory	None									
Optical	None									
Ethernet	<i>Non-vPro model:</i> Intel Ethernet Connection I219-V (Jacksonville) <i>vPro model:</i> Intel Ethernet Connection I219-LM (Jacksonville)									
WLAN + Bluetooth™ (optional)	<i>One of the following, configurable by model:</i> <ul style="list-style-type: none"> Realtek® RTL8822BE, Wi-Fi 2x2 802.11ac + Bluetooth 4.1, M.2 card (US only) Intel Dual Band Wireless-AC 8265, Wi-Fi 2x2 802.11ac + Bluetooth 4.1, M.2 card <i>* Intel 8265ac card supports BT4.2 but is limited to BT4.1 by Windows OS</i>									
									Camera (optional) <i>One of the following, configurable by model:</i> <ul style="list-style-type: none"> HD720p camera, fixed focus IR camera and HD720p camera, fixed focus Audio support HD Audio, Realtek ALC3287 codec / stereo speakers, 2W x 2, Dolby® Audio™ / dual array microphone, headphone / microphone combo jack	
									Keyboard 6-row, spill-resistant, multimedia Fn keys, optional LED backlight UltraNav™ TrackPoint® pointing device and buttonless Mylar surface multi-touch touchpad	
									Security Power-on password, hard disk password, supervisor password, security keyhole Security chip Discrete TPM 2.0, TCG Certified vPro (optional) Intel vPro Technology Fingerprint reader <i>Optional:</i> Touch style match on chip fingerprint reader on the keyboard bezel, anti-spoofing technology	
									NFC (optional) Near Field Communication	
									Battery Integrated Li-ion 45Wh battery, supports Rapid Charge (charge up to 80% in 1hr) with 65W USB Type-C AC adapter Max battery life <i>MobileMark® 2014:</i> 12.2 hr <i>* Battery life varies significantly with settings, usage, & other factors</i>	
									AC adapter 45W or 65W USB Type-C AC adapter	
									Preload Windows® 10 Home 64 or Windows 10 Pro 64	
									Limited warranty <i>One of the following, configurable by model:</i> <ul style="list-style-type: none"> 1-year depot repair service 3-year/1-yr battery depot repair service 3-year/1-yr battery limited onsite service 	
									Mil-Spec test MIL-STD-810G military testing	
									Environment EPEAT™ Gold (US only); ENERGY STAR® 6.1; RoHS-compliant	

Note: The specifications above may not be available in all regions.

Lenovo
April 2019



ThinkPad L490 Platform Specifications

Product Specifications Reference (PSREF)

Processor	Intel® Celeron® Processor or 8th Generation Intel Core™ i3 / i5 / i7 Processor									Dimensions	<i>WxDxH:</i> 13.19" x 9.25" x 0.89"; 335mm x 235mm x 22.5mm
	Processor Number	# of Cores	# of Threads	Base Frequency	Max Turbo Frequency	Cache	Memory Types	Processor Graphics		Weight	Starting at 3.72 lb / 1.69 kg
	Cel 4305U	2	2	2.2 GHz	-	2MB	DDR4-2133	Intel UHD Graphics 610		Case color	Black
	i3-8145U	2	4	2.1 GHz	3.9 GHz	4MB	DDR4-2400	Intel UHD Graphics 620		Case material	PC/ABS plastic
	i5-8265U	4	8	1.6 GHz	3.9 GHz	6MB				Smart card reader	<i>Optional:</i> Smart card reader
	i5-8365U	4	8	1.6 GHz	4.1 GHz	6MB				Media reader	MicroSD card reader
i7-8565U	4	8	1.8 GHz	4.6 GHz	8MB	Ports				Two USB 3.1 Gen 1 (one Always On), one USB 3.1 Type-C Gen 1 (with the function of Power Delivery and DisplayPort), one USB 3.1 Type-C Gen 2 (with the function of Power Delivery and DisplayPort), HDMI 1.4b, Ethernet (RJ-45), nano-SIM card slot (WWAN models), headphone / microphone combo jack, optional smart card reader, microSD card reader, side docking connector, security keyhole	
i7-8665U	4	8	1.9 GHz	4.8 GHz	8MB			* Depending on many factors, actual data transfer speed may be lower than theoretical speed			
Graphics	Intel UHD Graphics 610 or 620 in processor only or Intel UHD Graphics 620 in processor and AMD Radeon 535, 2GB GDDR5 memory (discrete models are NOT available in EMEA); supports external digital monitor via HDMI or USB Type-C; supports three independent displays; Max resolution: 4096x2304@60Hz (USB Type-C); 4096x2160@24Hz (HDMI)									Monitor cable (<i>optional</i>)	HDMI to VGA: Lenovo HDMI to VGA Monitor Adapter USB-C to VGA: Lenovo USB-C to VGA Adapter USB-C to DP: Lenovo USB-C to DisplayPort Adapter
Chipset	Intel SoC (System on Chip) platform									Camera (<i>optional</i>)	One of the following, configurable by model:
Memory	64GB max / 2400MHz DDR4, dual-channel capable, two DDR4 SO-DIMM sockets * Installed memory is actually 2666MHz but run at 2133MHz or 2400MHz due to Intel limitation									Audio support	• HD720p camera with ThinkShutter camera privacy, fixed focus • IR camera and HD720p camera with ThinkShutter camera privacy, fixed focus HD Audio, Realtek ALC3287 codec / stereo speakers, 2W x 2, Dolby® Advanced Audio / dual array microphone, headphone / microphone combo jack
Display	Size	Resolution	Type	Surface	Brightness	Aspect Ratio	Contrast Ratio	Color Gamut	Viewing Angle	Keyboard	6-row, spill-resistant, multimedia Fn keys, optional LED backlight UltraNav™ TrackPoint® pointing device and buttonless Mylar surface multi-touch touchpad
	14.0"	HD (1366x768)	TN	Anti-glare	220 nits	16:9	400:1	45%	90°		
	14.0"	FHD (1920x1080)	IPS	Anti-glare	250 nits	16:9	700:1	45%	170°	Security	Power-on password, hard disk password, supervisor password, security keyhole
Multi-touch (<i>opt</i>)	On-cell touch, supports 10-finger gesture (FHD only)									Security chip	Discrete TPM 2.0, TCG Certified
Storage	<ul style="list-style-type: none"> HDD / SATA 6.0Gb/s, 2.5" wide, 7mm high, Active Protection System™ SSD / SATA 6.0Gb/s, 2.5" wide, 7mm high M.2 2280 SSD / PCIe NVMe, PCIe 3.0 x 4 M.2 2242 SSD / PCIe NVMe, PCIe 3.0 x 2 * Installed M.2 2280 SSD is PCIe 3x4 but run at PCIe 3x2 due to M.2 SSD adapter limitation									System Mgt (<i>opt</i>)	Intel vPro Technology
Optane™ memory	Optional: Intel Optane memory, PCIe NVMe, PCIe 3.0 x 2									Fingerprint reader	Optional: Touch style match on chip fingerprint reader on the palm rest
Optical	None									NFC (<i>optional</i>)	Near Field Communication
Ethernet	<i>Non-vPro model:</i> Intel Ethernet Connection I219-V (Jacksonville) <i>vPro model:</i> Intel Ethernet Connection I219-LM (Jacksonville)									Battery	Integrated Li-ion 45Wh battery, supports Rapid Charge (charge up to 80% in 1hr) with 65W USB Type-C AC adapter
WLAN + Bluetooth™ (<i>optional</i>)	<i>One of the following, configurable by model:</i> <ul style="list-style-type: none"> Realtek® RTL8822BE, Wi-Fi 2x2 802.11ac + Bluetooth 4.2, M.2 card (NOT available in EMEA) Intel Wireless-AC 9260, Wi-Fi 2x2 802.11ac + Bluetooth 5.0 Intel Wi-Fi 6 AX200, Wi-Fi 2x2 802.11ax + Bluetooth 5.0 									Max battery life	MobileMark® 2014: 12 hr * Battery life varies significantly with settings, usage, & other factors
WWAN (<i>optional</i>)	<i>One of the following, configurable by model:</i> <ul style="list-style-type: none"> Wireless WAN upgradable Integrated Mobile Broadband 4G LTE, Fibocom L830-EB, M.2 card (EMEA only) Integrated Mobile Broadband 4G LTE-A, Fibocom L850-GL, M.2 card * For non-WWAN model, it means the model is NOT WWAN upgradable									AC adapter	45W or 65W USB Type-C AC adapter
SIM card	None									Preload	Windows® 10 Home 64 or Windows 10 Pro 64
										Limited warranty	<i>One of the following, configurable by model:</i> <ul style="list-style-type: none"> 1-year depot repair service 3-year/1-yr battery depot repair service
										Mil-Spec test	MIL-STD-810G military testing
										Environment	EPEAT™ Silver; ENERGY STAR® 7.1; RoHS-compliant

Note: The specifications above may not be available in all regions.

Lenovo
July 2019

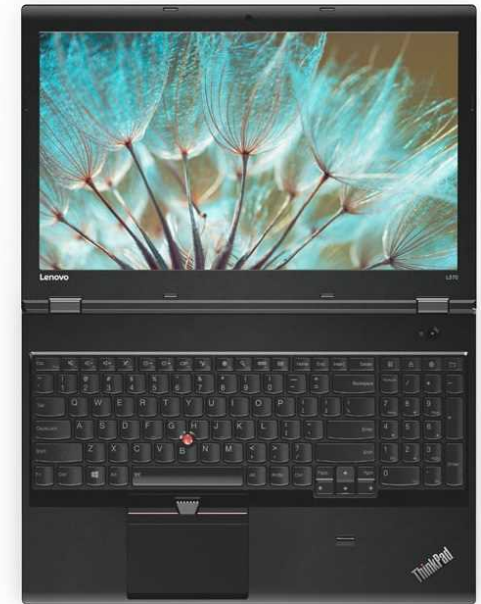

ThinkPad L570 Platform Specifications

Product Specifications Reference (PSREF)

Processor	6th Generation Intel® Core™ i3 / i5 / i7 Processor or							WWAN (optional) <i>One of the following, configurable by model:</i> <ul style="list-style-type: none"> Wireless WAN upgradable Integrated Mobile Broadband 4G LTE-A, Qualcomm® Snapdragon™ X7 LTE-A (Sierra Wireless EM7455), M.2 card Integrated Mobile Broadband 4G LTE, Intel XMM™ 7160 (Fibocom L831-EAU), M.2 card (EMEA only) SIM card (opt) Micro-SIM card slot, opt Verizon LTE (US) or Lenovo® Connect (EMEA) SIM card
	Processor Number	# of Cores	# of Threads	Base Frequency	Max Turbo Frequency	Cache	Memory Types	
	i3-6006U	2	4	2.0 GHz	-	3MB	DDR4-2133	Intel HD Graphics 520
	i3-6100U			2.3 GHz	-	3MB		
	i5-6200U			2.3 GHz	2.8 GHz	3MB		
	i5-6300U			2.4 GHz	3.0 GHz	3MB		
	i7-6500U			2.5 GHz	3.1 GHz	4MB		
	i7-6600U			2.6 GHz	3.4 GHz	4MB		
	Intel Celeron® Processor or 7th Generation Intel Core i3 / i5 / i7 Processor							
	Processor Number	# of Cores	# of Threads	Base Frequency	Max Turbo Frequency	Cache	Memory Types	Processor Graphics
	Cel 3965U	2	4	2.2 GHz	-	2MB	DDR4-2133	Intel HD Graphics 610
	i3-7100U			2.4 GHz	-	3MB		Intel HD Graphics 620
	i5-7200U			2.5 GHz	3.1 GHz	3MB		
	i5-7300U			2.6 GHz	3.5 GHz	3MB		
	i7-7500U			2.7 GHz	3.5 GHz	4MB		
	i7-7600U			2.8 GHz	3.9 GHz	4MB		
	* i7 processor is NOT available in EMEA							
Graphics	Intel HD Graphics 520, 610, or 620 in processor only; supports external analog monitor via VGA and digital monitor via Mini DisplayPort; supports three independent displays; Max resolution: 3840x2160@60Hz (DP via mDP cable); 1920x1200@60Hz (VGA)							
Chipset Memory	Intel SoC (System on Chip) platform 32GB max / 2400MHz DDR4, dual-channel capable, two DDR4 SO-DIMM sockets * System clocks down for processors with lower memory controller							
Display	Some: 15.6" (396mm) HD (1366x768), anti-glare, LED backlight, 220 nits, 16:9 aspect ratio, 350:1 contrast ratio Some: 15.6" (396mm) FHD (1920x1080), anti-glare, LED backlight, 220 nits, 16:9 aspect ratio, 400:1 or 500:1 contrast ratio Some: 15.6" (396mm) FHD (1920x1080), anti-glare, LED backlight, IPS, 250 nits, 16:9 aspect ratio, 600:1 contrast ratio, 160° viewing angle							
Multi-touch	None							
Storage	Some: HDD / SATA 6.0Gb/s, 2.5" wide, 7mm high, Active Protection System™ Some: SSD / SATA 6.0Gb/s, 2.5" wide, 7mm high (e.g. xxxGB SSD) Some: M.2 SSD / PCIe NVMe, PCIe 3.0 x 2, 16Gb/s Some: 128GB M.2 SSD / SATA 6.0Gb/s, in WWAN slot as 2nd Storage, mutually exclusive with WWAN							
Optical (optional)	DVD-ROM or DVD burner, 9mm high, fixed, not removable, tray-in							
Ethernet	Non-vPro model: Intel Ethernet Connection I219-V (Jacksonville) vPro model: Intel Ethernet Connection I219-LM (Jacksonville)							
WLAN	One of the following, configurable by model: <ul style="list-style-type: none"> Realtek® RTL8822BE, Wi-Fi 2x2 802.11ac + BT4.1, M.2 card (US only) Intel Dual Band Wireless-AC 8260, Wi-Fi 2x2 802.11ac + BT4.1, M.2 card Intel Dual Band Wireless-AC 8265, Wi-Fi 2x2 802.11ac + BT4.1, M.2 card Bluetooth 4.1 wireless, integrated in Wi-Fi + Bluetooth combo adapter * Intel 8260ac / 8265ac card support BT4.2 but is limited to BT4.1 by Windows OS							
Bluetooth™								
Keyboard	6-row, spill-resistant, multimedia Fn keys, numeric keypad							
UltraNav™	TrackPoint® pointing device and buttonless Mylar surface multi-touch touchpad							
Security chip	Power-on password, hard disk password, supervisor password, security keyhole							
vPro (optional)	Discrete TPM 2.0, TCG Certified							
Fingerprint reader	Intel vPro Technology							
NFC	Optional: Swipe style fingerprint reader on the palm rest							
Battery	Li-ion 6-cell (48Wh)							
Max battery life	MobileMark® 2014: 14.8 hr * Battery life varies significantly with settings, usage, & other factors							
AC adapter	45W slim tip AC adapter							
Preload	Windows® 7 Professional 64 preinstalled through downgrade rights in Windows 10 Pro 64 Some: Windows 10 Home 64 Some: Windows 10 Pro 64 <ul style="list-style-type: none"> Lenovo Solution Center Lenovo PowerEngage ThinkVantage Product Recovery ThinkVantage System Update Adobe® Reader® Microsoft® Office preloaded; purchase a product key to activate McAfee® LiveSafe™ (30-day trial) 							
Limited warranty	One of the following, configurable by model: <ul style="list-style-type: none"> 1-year depot repair service 3-year/1-yr battery depot repair service 3-year/1-yr battery limited onsite service 							
Mil-Spec test	MIL-STD-810G military testing							
Environment	EPEAT™ Gold (US only); ENERGY STAR® 6.1; RoHS-compliant							

Note: The specifications above may not be available in all regions.

Lenovo
September 2018



ThinkPad L580 Platform Specifications

Product Specifications Reference (PSREF)

Processor	Intel® Celeron® Processor, 7th Generation Intel Core™ i3 / i5 Processor or							WWAN (optional) <i>One of the following, configurable by model:</i> <ul style="list-style-type: none"> Integrated Mobile Broadband 4G LTE, Intel XMM™ 7262 (Fibocom L830-EB), M.2 card (EMEA only) Integrated Mobile Broadband 4G LTE-A, Intel XMM™ 7360 (Fibocom L850-GL), M.2 card <i>* For non-WWAN model, it means the model is NOT WWAN upgradable</i> SIM card (opt) Nano-SIM card slot, optional Verizon LTE (US) SIM card
	Processor Number	# of Cores	# of Threads	Base Frequency	Max Turbo Frequency	Cache	Memory Types	
	Cel 3965U	2	2	2.2 GHz	-	2MB	DDR4-2133	Intel HD Graphics 610
	i3-7130U		2.7 GHz	-	3MB	Intel HD Graphics 620		
	i5-7200U	4	4	2.5 GHz	3.1 GHz	3MB		
	i5-7300U		2.6 GHz	3.5 GHz	3MB			
	8th Generation Intel Core i3 / i5 / i7 Processor							
	Processor Number	# of Cores	# of Threads	Base Frequency	Max Turbo Frequency	Cache	Memory Types	Processor Graphics
	i3-8130U	2	4	2.2 GHz	3.4 GHz	4MB	DDR4-2400	Intel UHD Graphics 620
	i5-8250U	4	8	1.6 GHz	3.4 GHz	6MB		
	i5-8350U			1.7 GHz	3.6 GHz	6MB		
	i7-8550U			1.8 GHz	4.0 GHz	8MB		
	<i>* i3-7130U is NOT available in US and EMEA</i>							
Graphics	Intel HD Graphics 610, 620 or Intel UHD Graphics 620 in processor only or Intel HD Graphics 620 or Intel UHD Graphics 620 in processor and AMD Radeon 530, 2GB GDDR5 memory (discrete models are NOT available in EMEA); supports external digital monitor via HDMI or USB Type-C; supports three independent displays; Max resolution: 4096x2304@60Hz (USB Type-C); 4096x2160@30Hz (HDMI)							Monitor cable (optional) HDMI to VGA: Lenovo HDMI to VGA Monitor Adapter USB-C to VGA: Lenovo USB-C to VGA Adapter
Chipset	Intel SoC (System on Chip) platform							Camera (optional) HD720p camera, fixed focus
Memory	32GB max / 2400MHz DDR4, dual-channel capable, two DDR4 SO-DIMM sockets <i>* System clocks down for processors with lower memory controller</i>							Audio support HD Audio, Realtek ALC3287 codec / stereo speakers, 2W x 2, Dolby® Audio™ / dual array microphone, headphone / microphone combo jack
Display	<i>Some:</i> 15.6" (396mm) HD (1366x768), anti-glare, LED backlight, 220 nits, 16:9 aspect ratio, 500:1 contrast ratio <i>Some:</i> 15.6" (396mm) FHD (1920x1080), anti-glare, LED backlight, IPS, 250 nits, 16:9 aspect ratio, 800:1 contrast ratio, 170° viewing angle							Keyboard 6-row, spill-resistant, multimedia Fn keys, numeric keypad, optional LED backlight UltraNav™ TrackPoint® pointing device and buttonless Mylar surface multi-touch touchpad
Multi-touch	None							Security Power-on password, hard disk password, supervisor password, security keyhole Security chip Discrete TPM 2.0, TCG Certified vPro (optional) Intel vPro Technology Fingerprint reader (optional) Touch style match on chip fingerprint reader on the palm rest, anti-spoofing technology
Storage	<i>System has one HDD slot or one M.2 2280 slot exclusively for storage</i> <i>Some:</i> HDD / SATA 6.0Gb/s, 2.5" wide, 7mm high, Active Protection System™ <i>Some:</i> SSD / SATA 6.0Gb/s, 2.5" wide, 7mm high (e.g. xxxGB SSD) <i>Some:</i> M.2 SSD / PCIe NVMe, PCIe 3.0 x 2, 16Gb/s <i>Some:</i> 128GB M.2 SSD / PCIe NVMe, PCIe 3.0 x 2, 16Gb/s, in WWAN slot as 2nd Storage, mutually exclusive with WWAN							NFC (optional) Near Field Communication
Optane™ memory	None							Battery Integrated Li-ion 45Wh battery, supports Rapid Charge (charge up to 80% in 1hr) with 65W USB Type-C AC adapter
Optical	None							Max battery life <i>MobileMark® 2014: 12 hr</i> <i>* Battery life varies significantly with settings, usage, & other factors</i>
Ethernet	<i>Non-vPro model:</i> Intel Ethernet Connection I219-V (Jacksonville) <i>vPro model:</i> Intel Ethernet Connection I219-LM (Jacksonville)							AC adapter 45W or 65W USB Type-C AC adapter
WLAN + Bluetooth™ (optional)	<i>One of the following, configurable by model:</i> <ul style="list-style-type: none"> Realtek® RTL8822BE, Wi-Fi 2x2 802.11ac + Bluetooth 4.1, M.2 card (US only) Intel Dual Band Wireless-AC 8265, Wi-Fi 2x2 802.11ac + Bluetooth 4.1, M.2 card <i>* Intel 8265ac card supports BT4.2 but is limited to BT4.1 by Windows OS</i>							Preload Windows® 10 Home 64 or Windows 10 Pro 64
								Limited warranty <i>One of the following, configurable by model:</i> <ul style="list-style-type: none"> 1-year depot repair service 3-year/1-yr battery depot repair service 3-year/1-yr battery limited onsite service
								Mil-Spec test MIL-STD-810G military testing
								Environment EPEAT™ Gold (US only); ENERGY STAR® 6.1; RoHS-compliant

Note: The specifications above may not be available in all regions.

Lenovo
April 2019



ThinkPad L590 Platform Specifications

Product Specifications Reference (PSREF)

Processor	Intel® Celeron® Processor or 8th Generation Intel Core™ i3 / i5 / i7 Processor									Dimensions	<i>WxDxH:</i> 14.82" x 10.02" x 0.90"; 376.5mm x 254.5mm x 22.95mm
	Processor Number	# of Cores	# of Threads	Base Frequency	Max Turbo Frequency	Cache	Memory Types	Processor Graphics	Weight	Starting at 4.48 lb / 2.0 kg	
	Cel 4305U	2	2	2.2 GHz	-	2MB	DDR4-2133	Intel UHD Graphics 610	Case color	Black	
	i3-8145U	2	4	2.1 GHz	3.9 GHz	4MB	DDR4-2400	Intel UHD Graphics 620	Case material	PC/ABS plastic	
	i5-8265U	4	8	1.6 GHz	3.9 GHz	6MB			Smart card reader	<i>Optional:</i> Smart card reader	
	i5-8365U	4	8	1.6 GHz	4.1 GHz	6MB			Media reader	MicroSD card reader	
i7-8565U	4	8	1.8 GHz	4.6 GHz	8MB	Ports			Two USB 3.1 Gen 1 (one Always On), one USB 3.1 Type-C Gen 1 (with the function of Power Delivery and DisplayPort), one USB 3.1 Type-C Gen 2 (with the function of Power Delivery and DisplayPort), HDMI 1.4b, Ethernet (RJ-45), nano-SIM card slot (WWAN models), headphone / microphone combo jack, optional smart card reader, microSD card reader, side docking connector, security keyhole		
i7-8665U	4	8	1.9 GHz	4.8 GHz	8MB			* Depending on many factors, actual data transfer speed may be lower than theoretical speed			
Graphics	Intel UHD Graphics 610 or 620 in processor only or Intel UHD Graphics 620 in processor and AMD Radeon 535, 2GB GDDR5 memory (discrete models are NOT available in EMEA); supports external digital monitor via HDMI or USB Type-C; supports three independent displays; Max resolution: 4096x2304@60Hz (USB Type-C); 4096x2160@24Hz (HDMI)									Monitor cable (optional)	HDMI to VGA: Lenovo HDMI to VGA Monitor Adapter USB-C to VGA: Lenovo USB-C to VGA Adapter USB-C to DP: Lenovo USB-C to DisplayPort Adapter
Chipset	Intel SoC (System on Chip) platform									Camera (optional)	<i>One of the following, configurable by model:</i>
Memory	64GB max / 2400MHz DDR4, dual-channel capable, two DDR4 SO-DIMM sockets * Installed memory is actually 2666MHz but run at 2133MHz or 2400MHz due to Intel limitation									Audio support	• HD720p camera with ThinkShutter camera privacy, fixed focus • IR camera and HD720p camera with ThinkShutter camera privacy, fixed focus HD Audio, Realtek ALC3287 codec / stereo speakers, 2W x 2, Dolby® Advanced Audio / dual array microphone, headphone / microphone combo jack
Display	Size	Resolution	Type	Surface	Brightness	Aspect Ratio	Contrast Ratio	Color Gamut	Viewing Angle	Keyboard UltraNav™	6-row, spill-resistant, multimedia Fn keys, numeric keypad, optional LED backlight TrackPoint® pointing device and buttonless Mylar surface multi-touch touchpad
	15.6"	HD (1366x768)	TN	Anti-glare	220 nits	16:9	400:1	45%	90°		
	15.6"	FHD (1920x1080)	IPS	Anti-glare	250 nits	16:9	700:1	45%	170°	Security	Power-on password, hard disk password, supervisor password, security keyhole
Multi-touch	None									Security chip	Discrete TPM 2.0, TCG Certified
Storage	<ul style="list-style-type: none"> HDD / SATA 6.0Gb/s, 2.5" wide, 7mm high, Active Protection System™ SSD / SATA 6.0Gb/s, 2.5" wide, 7mm high M.2 2280 SSD / PCIe NVMe, PCIe 3.0 x 4 M.2 2242 SSD / PCIe NVMe, PCIe 3.0 x 2 * Installed M.2 2280 SSD is PCIe 3x4 but run at PCIe 3x2 due to M.2 SSD adapter limitation									System Mgt (opt)	Intel vPro Technology
Optane™ memory	<i>Optional:</i> Intel Optane memory, PCIe NVMe, PCIe 3.0 x 2									Fingerprint reader	<i>Optional:</i> Touch style fingerprint reader on the palm rest
Optical	None									NFC (optional)	Near Field Communication
Ethernet	<i>Non-vPro model:</i> Intel Ethernet Connection I219-V (Jacksonville) <i>vPro model:</i> Intel Ethernet Connection I219-LM (Jacksonville)									Battery	Integrated Li-ion 45Wh battery, supports Rapid Charge (charge up to 80% in 1hr) with 65W USB Type-C AC adapter
WLAN + Bluetooth™ (optional)	<i>One of the following, configurable by model:</i> <ul style="list-style-type: none"> Realtek® RTL8822BE, Wi-Fi 2x2 802.11ac + Bluetooth 4.2, M.2 card (NOT available in EMEA) Intel Wireless-AC 9260, Wi-Fi 2x2 802.11ac + Bluetooth 5.0 Intel Wi-Fi 6 AX200, Wi-Fi 2x2 802.11ax + Bluetooth 5.0 									Max battery life	MobileMark® 2014: 12 hr * Battery life varies significantly with settings, usage, & other factors
WWAN (optional)	<i>One of the following, configurable by model:</i> <ul style="list-style-type: none"> Wireless WAN upgradable Integrated Mobile Broadband 4G LTE, Fibocom L830-EB, M.2 card (EMEA only) Integrated Mobile Broadband 4G LTE-A, Fibocom L850-GL, M.2 card * For non-WWAN model, it means the model is NOT WWAN upgradable									AC adapter	45W or 65W USB Type-C AC adapter
SIM card	None									Preload	Windows® 10 Home 64 or Windows 10 Pro 64
										Limited warranty	<i>One of the following, configurable by model:</i> <ul style="list-style-type: none"> 1-year depot repair service 3-year/1-yr battery depot repair service
										Mil-Spec test	MIL-STD-810G military testing
										Environment	EPEAT™ Silver; ENERGY STAR® 7.1; RoHS-compliant

Note: The specifications above may not be available in all regions.

Lenovo
July 2019



ThinkPad P1 Platform Specifications

Product Specifications Reference (PSREF)

Processor	8th Generation Intel® Core™ i5 / i7 Processor or Intel Xeon® E Processor								Smart card reader	<i>Optional</i> : Smart card reader
	Processor Number	# of Cores	# of Threads	Base Frequency	Max Turbo Frequency	Cache	Memory Types	Processor Graphics	ExpressCard	None
	i5-8400H	4	8	2.5 GHz	4.2 GHz	8MB	DDR4-2666	Intel UHD Graphics 630	Media reader	SD Card reader (SD, SDHC, SDXC), supports UHS-II SD card
	i7-8750H	6	12	2.2 GHz	4.1 GHz	9MB			Ports	Two USB 3.1 Gen 1 (one Always On), two USB Type-C / Thunderbolt 3 (with the function of Power Delivery and DP), HDMI 2.0, Ethernet extension connector, headphone / microphone combo jack, optional smart card reader, SD card reader, security keyhole
	i7-8850H			2.6 GHz	4.3 GHz	9MB		Intel UHD Graphics P630		
	E-2176M			2.7 GHz	4.4 GHz	12MB				* Power Delivery only supports power-out for charging peripherals * Depending on many factors, actual data transfer speed may be lower than theoretical speed
Graphics	Intel UHD Graphics 630 or P630 in processor and NVIDIA® Quadro® P1000 or P2000 Max-Q, 4GB GDDR5 memory; supports external digital monitor via HDMI or Thunderbolt™; supports four independent displays; Max resolution: 5120x2880@30Hz (Thunderbolt); 4096x2160@60Hz (HDMI)								Monitor cable (optional)	HDMI to VGA: Lenovo HDMI to VGA Monitor Adapter
Chipset	Mobile Intel CM246 Chipset								Bundled Accy	<i>Optional</i> : ThinkPad Ethernet Extension Cable
Memory	64GB max / 2666MHz DDR4, ECC or non-ECC (ECC function supported only on Xeon processor), dual-channel capable, two DDR4 SO-DIMM sockets								Camera (optional)	<i>One of the following, configurable by model:</i> • HD720p camera with ThinkShutter camera privacy, fixed focus • IR camera and HD720p camera, fixed focus
Display	<i>Some</i> : 15.6" (396mm) FHD (1920x1080), anti-glare, LED backlight, IPS, 300 nits, 16:9 aspect ratio, 700:1 contrast ratio, 72% gamut, 170° viewing angle <i>Some</i> : 15.6" (396mm) UHD (3840x2160), anti-glare, LED backlight, IPS, 400 nits, 16:9 aspect ratio, 1200:1 contrast ratio, 100% gamut, 170° viewing angle, multi-touch, anti-reflection (AR)								Audio support	HD Audio, Realtek® ALC3286 codec / stereo speakers, 2W x 2, Dolby® Audio™ Premium / dual array microphone, headphone / microphone combo jack, Dolby Atmos® headphone
Multi-touch (opt)	Capacitive-type multi-touch, supports 10-finger gesture (4K only)								Keyboard	6-row, spill-resistant, multimedia Fn keys, LED backlight
Pen	Supports pen accessory, please see the accessory compatibility for details								UltraNav™	TrackPoint® pointing device and buttonless glass surface multi-touch touchpad
Storage	<i>Up to 2 drives (two M.2 SSD)</i> M.2 SSD / PCIe NVMe, PCIe 3.0 x 4, 32Gb/s								Security	Power-on password, hard disk password, supervisor password, security keyhole
Optane™ memory	None								Security chip	Discrete TPM 2.0, TCG Certified
RAID (optional)	RAID 0/1 support								vPro (optional)	Intel vPro Technology
Optical	None								Fingerprint reader	Touch style match on chip fingerprint reader on the keyboard bezel
Ethernet	Native Intel Ethernet Connection I219-V (Non-vPro) or I219-LM (vPro) via bundled or optional ThinkPad Ethernet Extension Cable								Color calibration	None
WLAN	Intel Wireless-AC 9560, Wi-Fi 2x2 802.11ac + Bluetooth 5.0, M.2 card								NFC	None
Bluetooth™	Bluetooth 5.0 wireless, integrated in Wi-Fi + Bluetooth combo adapter								Battery	Integrated Li-ion 80Wh battery, supports Rapid Charge (charge up to 80% in 1hr)
WWAN	None								Max battery life (MobileMark 2014)	<i>Discrete mode</i> : 7.36 hr; <i>Hybrid mode</i> : 13.87 hr <i>* Battery life varies significantly with settings, usage, & other factors</i>
SIM card	None								AC adapter	135W slim tip AC adapter
Dimensions	<i>WxDxH (non-touch)</i> : 14.24" x 9.67" x 0.72"; 361.8mm x 245.7mm x 18.4mm <i>WxDxH (multi-touch)</i> : 14.24" x 9.67" x 0.74"; 361.8mm x 245.7mm x 18.7mm <i>Non-touch model</i> : starting at 3.76 lb (1.7 kg); <i>Multi-touch model</i> : starting at 4.06 lb (1.8 kg)								Preload	<i>One of the following, configurable by model:</i> • Windows® 10 Home 64 • Windows 10 Pro 64 • Windows 10 Pro 64 for Workstations
Weight									Limited warranty	<i>One of the following, configurable by model:</i> • 1-year depot repair service • 3-year/1-yr battery depot repair service • 3-year/1-yr battery limited onsite service
Case color	Black								Mil-Spec test	MIL-STD-810G military testing
Case material	<i>Display cover</i> : CFRP/GFRP hybrid; <i>Bottom</i> : Aluminum alloy								Environment	EPEAT™ Gold (US only); ENERGY STAR® 6.1; RoHS-compliant

Note: The specifications above may not be available in all regions.

Lenovo
July 2019



ThinkPad P1 (2nd Gen) Platform Specifications

Product Specifications Reference (PSREF)

Processor	9th Generation Intel® Core™ i5 / i7 / i9 Processor or Intel Xeon® E Processor									Dimensions	<i>WxDxH (non-touch):</i> 14.24" x 9.67" x 0.72"; 361.8mm x 245.7mm x 18.4mm <i>WxDxH (multi-touch):</i> 14.24" x 9.67" x 0.74"; 361.8mm x 245.7mm x 18.7mm								
	Processor Number	# of Cores	# of Threads	Base Frequency	Max Turbo Frequency	Cache	Memory Types	Processor Graphics		Weight	<i>Non-touch model:</i> starting at 3.75 lb (1.7 kg); <i>Multi-touch model:</i> starting at 4.0 lb (1.81 kg)								
	i5-9400H	4	8	2.5 GHz	4.3 GHz	8MB	DDR4-2666	Intel UHD Graphics 630		Case color	Black paint (FHD model) or black weave (UHD model)								
	i7-9750H	6	12	2.6 GHz	4.5 GHz	12MB		Intel UHD Graphics 630		Case material	<i>Display cover:</i> CFRP/GFRP hybrid; <i>Bottom:</i> Aluminum alloy								
	i7-9850H	6	12	2.6 GHz	4.6 GHz	12MB		Intel UHD Graphics 630		Smart card reader	<i>Optional:</i> Smart card reader								
	i9-9880H	8	16	2.3 GHz	4.8 GHz	16MB		Intel UHD Graphics P630		Media reader	SD Card reader (SD, SDHC, SDXC), supports UHS-II SD card								
Graphics	Intel UHD Graphics 630 in processor only or Intel UHD Graphics 630 or P630 in processor and NVIDIA® Quadro® T1000 or T2000 Max-Q, 4GB GDDR5 memory; supports external digital monitor via HDMI or Thunderbolt™; supports four independent displays; Max resolution: 4096x2160@60Hz (Thunderbolt); 4096x2160@60Hz (HDMI)									Ports	Two USB 3.1 Gen 1 (one Always On), two USB 3.1 Type-C Gen 2 / Thunderbolt 3 (with the function of Power Delivery and DisplayPort), HDMI 2.0, Ethernet extension connector, headphone / microphone combo jack, optional smart card reader, SD card reader, security keyhole, slim tip AC adapter <i>* Power Delivery only supports power-out for charging peripherals</i> <i>* Depending on many factors, actual data transfer speed may be lower than theoretical speed</i>								
Chipset	Mobile Intel CM246 Chipset									Monitor cable (optional)	<i>HDMI to VGA:</i> Lenovo HDMI to VGA Monitor Adapter <i>USB-C to VGA:</i> Lenovo USB-C to VGA Adapter <i>USB-C to DP:</i> Lenovo USB-C to DisplayPort Adapter								
Memory	64GB max / 2666MHz DDR4, ECC or non-ECC (ECC function supported only on Xeon processor), dual-channel capable, two DDR4 SO-DIMM sockets									Bundled Accy	<i>Optional:</i> ThinkPad Ethernet Extension Cable								
Display	Size	Resolution	Type	Surface	Brightness	Aspect Ratio	Contrast Ratio	Color Gamut	Viewing Angle	Camera (optional)	<i>One of the following, configurable by model:</i> • HD720p camera with ThinkShutter camera privacy, fixed focus • IR camera and HD720p camera with ThinkShutter camera privacy, fixed focus								
	15.6"	FHD (1920x1080)	IPS	Anti-glare	300 nits	16:9	700:1	72% NTSC	170°	Audio support	HD Audio, Synaptic® CX11880 codec / stereo speakers, 2W x 2, Dolby® Audio™ Premium / dual array far-field microphone, headphone / microphone combo jack, Dolby Atmos® sound system								
	15.6"	FHD (1920x1080) HDR 400, Dolby Vision™	IPS	Anti-glare	500 nits	16:9	1200:1	72% NTSC	170°	Keyboard	6-row, spill-resistant, multimedia Fn keys, LED backlight UltraNav™ TrackPoint® pointing device and buttonless glass surface multi-touch touchpad								
	15.6"	UHD (3840x2160) HDR 400, Dolby Vision	IPS	Anti-glare	500 nits	16:9	1200:1	100% Adobe	170°	Security	Power-on password, hard disk password, supervisor password, security keyhole Security chip Discrete TPM 2.0, TCG Certified								
	15.6"	UHD (3840x2160) HDR 500 True Black, Dolby Vision, Multi-touch	OLED	AR, AS	SDR 400nit HDR 500nit (Peak)	16:9	100000:1	100% DCI-P3	170°	System Mgt (opt)	Intel vPro Technology								
Multi-touch (opt)	Capacitive-type multi-touch, supports 10-finger gesture (UHD OLED only), anti-reflection (AR), anti-smudge (AS) coating Supports pen accessory, please see the accessory compatibility for details									Fingerprint reader	Touch style match on chip fingerprint reader on the keyboard bezel								
Pen	Supports pen accessory, please see the accessory compatibility for details									Color calibration	<i>Optional:</i> X-Rite Pantone factory color calibration (UHD model only)								
Storage	Up to two M.2 SSD M.2 2280 SSD / PCIe NVMe 3.0 x 4									NFC	None								
RAID (optional)	RAID 0/1 support									Battery	Integrated Li-ion 80Wh battery, supports Rapid Charge (charge up to 80% in 1hr)								
Optical	None									Max battery life	<i>MobileMark® 2014:</i> 13.8 hr <i>* Battery life varies significantly with settings, usage, & other factors</i>								
Ethernet	Native Intel Ethernet Connection I219-V (<i>Non-vPro</i>) or I219-LM (<i>vPro</i>) via bundled or optional ThinkPad Ethernet Extension Cable									AC adapter	135W slim tip AC adapter								
WLAN	Intel Wireless-AX 22260, Wi-Fi 2x2 802.11ax + Bluetooth 5.1									Preload	<i>One of the following, configurable by model:</i> • Windows® 10 Home 64 • Windows 10 Pro 64 • Windows 10 Pro 64 for Workstations								
Bluetooth™	Bluetooth 5.1 wireless, integrated in Wi-Fi + Bluetooth combo adapter									Limited warranty	<i>One of the following, configurable by model:</i> • 1-year depot repair service • 3-year/1-yr battery depot repair service • 3-year/1-yr battery limited onsite service								
WWAN	None									Mil-Spec test	MIL-STD-810G military testing								
SIM card	None									Environment	EPEAT™ Silver; ENERGY STAR® 7.1; RoHS-compliant								

Note: The specifications above may not be available in all regions.

Lenovo
July 2019



ThinkPad P51 Platform Specifications

Product Specifications Reference (PSREF)

Processor	6th or 7th Generation Intel® Core™ i7 Processor or Intel Xeon® Processor E3 v5 or v6 Family							Dimensions	<i>WxDxH:</i> 14.86" x 9.93" x 0.96-1.16"; 377.4mm x 252.3mm x 24.5-29.4mm <i>WxDxH(Touch):</i> 14.86" x 9.93" x 1.02-1.21"; 377.4mm x 252.3mm x 25.8-30.7mm											
	Processor Number	# of Cores	# of Threads	Base Frequency	Max Turbo Frequency	Cache	Memory Types	Processor Graphics	Weight	<i>Models</i>	<i>4-cell</i>	<i>6-cell</i>								
	i7-6820HQ	4	8	2.7 GHz	3.6 GHz	8MB	DDR4-2133	Intel HD Graphics 530		<i>Non-touch</i>	5.6 lb / 2.55kg	5.9 lb / 2.67kg								
	E3-1505M v5			2.8 GHz	3.7 GHz			Intel HD Graphics P530	<i>Multi-touch</i>	6.2 lb / 2.82kg	6.4 lb / 2.90kg									
	i7-7700HQ			2.8 GHz	3.8 GHz	6MB	DDR4-2400	Intel HD Graphics 630	Case color	Black										
	i7-7820HQ			2.9 GHz	3.9 GHz			Intel HD Graphics P630	Case material	<i>Display cover:</i> Glass-Fiber Reinforced Plastic; <i>Bottom:</i> Magnesium/Aluminum										
	E3-1505M v6			3.0 GHz	4.0 GHz	8MB	DDR4-2400	Intel HD Graphics P630	Smart card reader	Optional: Smart card reader										
	E3-1535M v6			3.1 GHz	4.2 GHz			Intel HD Graphics P630	ExpressCard	One slot (ExpressCard/34)										
Graphics	Intel HD Graphics 530, 630, P530, or P630 in processor and NVIDIA Quadro® M1200 or M2200, 4GB memory; supports external digital monitor via HDMI, Mini DisplayPort, or Thunderbolt™; supports four independent displays; Max resolution: 3840x2160@60Hz (DisplayPort via Mini DisplayPort cable); 3840x2160@60Hz (Thunderbolt); 4096x2160@24Hz (HDMI)							Media reader	4-in-1 reader (MMC, SD, SDHC, SDXC), supports UHS-II SD card											
Chipset	Mobile Intel CM238 Chipset							Ports	Four USB 3.1 Gen 1 (USB 3.0, one Always On), USB Type-C / Thunderbolt 3, Mini DisplayPort 1.2a, HDMI 1.4b, Ethernet (RJ-45), Dock connector <i>* Depending on many factors, actual data transfer speed may be lower than theoretical speed</i>											
Memory	64GB max / 2400MHz DDR4, ECC or non-ECC (ECC function supported only on Xeon processor), dual-channel capable, four DDR4 SO-DIMM sockets <i>* System clocks down for processors with lower memory controller</i>							Camera (optional)	HD720p resolution, fixed focus											
Display	<i>Some:</i> 15.6" (396mm) FHD (1920x1080), anti-glare, LED backlight, IPS, 250 nits, 16:9 aspect ratio, 700:1 contrast ratio, 160° viewing angle <i>Some:</i> 15.6" (396mm) 4K (3840x2160), anti-glare, LED backlight, IPS, 300 nits, 16:9 aspect ratio, 1000:1 contrast ratio, 100% gamut, 170° viewing angle							Audio support	HD Audio, Realtek® ALC3268 codec / stereo speakers, 2W x 2 / dual array microphone, combo audio/microphone jack											
Multi-touch (opt)	Capacitive-type multi-touch, supports 10-finger gesture, 220 nits (FHD only)							Keyboard	6-row, spill-resistant, multimedia Fn keys, numeric keypad, optional LED backlight											
Pen (optional)	ThinkPad Pen Pro, active pen for multi-touch display							UltraNav™	3-button TrackPoint® pointing device and 3-button Mylar surface multi-touch touchpad											
Storage	<i>Up to 3 drives (two M.2 SSD and one HDD)</i> <i>Some:</i> HDD / SATA 6.0Gb/s, 2.5" wide, 7mm high, Active Protection System™ <i>Some:</i> M.2 SSD / PCIe NVMe, PCIe 3.0 x 4, 32Gb/s							Security	Power-on password, hard disk password, supervisor password, security keyhole											
RAID (optional)	RAID 0/1 support							Security chip	Discrete TPM 2.0, TCG Certified											
Optical	None							vPro (optional)	Intel vPro Technology											
Ethernet	<i>Non-vPro model:</i> Intel Ethernet Connection I219-V (Jacksonville) <i>vPro model:</i> Intel Ethernet Connection I219-LM (Jacksonville)							Fingerprint reader	Touch style match on chip fingerprint reader on the palm rest											
WLAN	<i>One of the following, configurable by model:</i> • Intel Dual Band Wireless-AC 8260, Wi-Fi 2x2 802.11ac + BT4.1, M.2 card • Intel Dual Band Wireless-AC 8265, Wi-Fi 2x2 802.11ac + BT4.1, M.2 card							Color calibration	Optional: Pantone® color calibrator by X-Rite® color calibration sensor in palm rest											
Bluetooth™	Bluetooth 4.1 wireless, integrated in Wi-Fi + Bluetooth combo adapter <i>* Intel 8260ac / 8265ac card support BT4.2 but is limited to BT4.1 by Windows OS</i>							NFC	None											
WWAN (optional)	<i>One of the following, configurable by model:</i> • Wireless WAN upgradable • Integrated Mobile Broadband 4G LTE-A, Qualcomm® Snapdragon™ X7 LTE-A (Sierra Wireless EM7455), M.2 card							Battery	Lithium Polymer 4-cell (66Wh) or 6-cell (90Wh)											
SIM card (opt)	Micro-SIM card slot, opt Verizon LTE (US) or Lenovo® Connect (EMEA) SIM card							Max battery life ¹⁰	<table border="1"><thead><tr><th>Model</th><th>4-cell</th><th>6-cell</th></tr></thead><tbody><tr><td><i>Discrete Graphics</i></td><td>4.5 hr</td><td>6.1 hr</td></tr><tr><td><i>Hybrid Graphics</i></td><td>6.5 hr</td><td>8.9 hr</td></tr></tbody></table> <i>* Battery life varies significantly with settings, usage, & other factors</i>			Model	4-cell	6-cell	<i>Discrete Graphics</i>	4.5 hr	6.1 hr	<i>Hybrid Graphics</i>	6.5 hr	8.9 hr
Model	4-cell	6-cell																		
<i>Discrete Graphics</i>	4.5 hr	6.1 hr																		
<i>Hybrid Graphics</i>	6.5 hr	8.9 hr																		

Note: The specifications above may not be available in all regions.

Lenovo
September 2018



ThinkPad P52 Platform Specifications

Product Specifications Reference (PSREF)

Processor	8th Generation Intel® Core™ i7 / i9 Processor or Intel Xeon® E Processor								Dimensions	<i>WxDxH:</i> 14.86" x 9.93" x 0.96-1.16"; 377.4mm x 252.3mm x 24.5-29.4mm <i>WxDxH(Touch):</i> 14.86" x 9.93" x 1.02-1.21"; 377.4mm x 252.3mm x 25.8-30.7mm
	Processor Number	# of Cores	# of Threads	Base Frequency	Max Turbo Frequency	Cache	Memory Types	Processor Graphics	Weight	<i>Non-touch model:</i> starting at 5.4 lb (2.45kg); <i>Multi-touch model:</i> starting at 6.4 lb (2.9kg)
	i7-8750H	6	12	2.2 GHz	4.1 GHz	9MB	DDR4-2400	Intel UHD Graphics 630	Case color	Black
	i7-8850H			2.6 GHz	4.3 GHz	9MB			Case material	<i>Display cover:</i> Glass-Fiber Reinforced Plastic; <i>Bottom:</i> Magnesium/Aluminum
	i9-8950HK			2.9 GHz	4.8 GHz	12MB		Smart card reader	<i>Optional:</i> Smart card reader	
E-2176M	2.7 GHz			4.4 GHz	12MB	ExpressCard		None		
Graphics	Intel UHD Graphics 630 or P630 in processor and NVIDIA Quadro® P1000 (4GB memory), P2000 (4GB memory), or P3200 (6GB memory, VR ready); supports external digital monitor via HDMI, Mini DisplayPort, or Thunderbolt™; supports four independent displays; Max resolution: 3840X2160@60Hz (DisplayPort via Mini DisplayPort cable); 5120X2880@30Hz (Thunderbolt); 4096x2160@60Hz (HDMI)								Media reader	4-in-1 reader (MMC, SD, SDHC, SDXC), supports UHS-II SD card
Chipset	Mobile Intel CM246 Chipset								Ports	Three USB 3.1 Gen 1 (one Always On), two USB Type-C / Thunderbolt 3 (with the function of Power Delivery and DP), Mini DisplayPort 1.4, HDMI 2.0, Ethernet (RJ-45), nano-SIM card slot (WWAN models), headphone / microphone combo jack, optional smart card reader, 4-in-1 reader (MMC, SD, SDHC, SDXC), security keyhole <i>* Power Delivery only supports power-out for charging peripherals</i> <i>* Depending on many factors, actual data transfer speed may be lower than theoretical speed</i>
Memory	128GB non-ECC or 64GB ECC max / 2400MHz DDR4 (ECC function supported only on Xeon processor), dual-channel capable, four DDR4 SO-DIMM sockets <i>* Installed DIMMs are actually 2666MHz but run at 2400MHz due to Intel limitation</i> <i>* 128GB non-ECC memory for special bid only</i>								Camera (optional)	<i>One of the following, configurable by model:</i> • HD720p camera with ThinkShutter camera privacy, fixed focus • IR camera and HD720p camera, fixed focus
Display	<i>Some:</i> 15.6" (396mm) FHD (1920x1080), anti-glare, LED backlight, IPS, 300 nits, 16:9 aspect ratio, 700:1 contrast ratio, 72% gamut, 160° viewing angle <i>Some:</i> 15.6" (396mm) 4K (3840x2160), anti-glare, LED backlight, IPS, 400 nits, 16:9 aspect ratio, 1000:1 contrast ratio, 100% gamut, 170° viewing angle, multi-touch								Audio support	HD Audio, Realtek® ALC3286 codec / stereo speakers, 2W x 2, Dolby® Audio™ Premium / dual array microphone, headphone / microphone combo jack, Dolby Atmos® headphone
Multi-touch (opt)	Capacitive-type multi-touch, supports 10-finger gesture (4K only)								Keyboard	6-row, spill-resistant, multimedia Fn keys, numeric keypad, LED backlight
Pen	Supports pen accessory, please see the accessory compatibility for details								UltraNav™	3-button TrackPoint® pointing device and 3-button Mylar surface multi-touch touchpad
Storage	<i>Up to 3 drives (two M.2 SSD and one HDD)</i> <i>Some:</i> HDD / SATA 6.0Gb/s, 2.5" wide, 7mm high, Active Protection System™ <i>Some:</i> M.2 SSD / PCIe NVMe, PCIe 3.0 x 4, 32Gb/s								Security	Power-on password, hard disk password, supervisor password, security keyhole
Optane™ memory	<i>Optional:</i> Intel Optane memory, PCIe NVMe, PCIe 3.0 x 2								Security chip	Discrete TPM 2.0, TCG Certified
RAID (optional)	RAID 0/1 support								vPro (optional)	Intel vPro Technology
Optical	None								Fingerprint reader	Touch style match on chip fingerprint reader on the palm rest
Ethernet	<i>Non-vPro model:</i> Intel Ethernet Connection I219-V (Jacksonville) <i>vPro model:</i> Intel Ethernet Connection I219-LM (Jacksonville)								Color calibration	None
WLAN	Intel Wireless-AC 9560, Wi-Fi 2x2 802.11ac + Bluetooth 5.0, M.2 card								NFC (optional)	Near Field Communication
Bluetooth™	Bluetooth 5.0 wireless, integrated in Wi-Fi + Bluetooth combo adapter								Battery	Li-ion 90Wh battery
WWAN (optional)	Integrated Mobile Broadband 4G LTE-A, Intel XMM™ 7360 (Fibocom L850-GL), M.2 card								Max battery life	<i>Discrete mode:</i> 6.1 hr; <i>Hybrid mode:</i> 8.9 hr <i>(MobileMark® 2014) * Battery life varies significantly with settings, usage, & other factors</i>
SIM card (opt)	Nano-SIM card slot, optional Verizon LTE (US) SIM card								AC adapter	170W slim tip AC adapter
									Preload	<i>One of the following, configurable by model:</i> • Windows® 10 Home 64 • Windows 10 Pro 64 • Windows 10 Pro 64 for Workstations
									Limited warranty	<i>One of the following, configurable by model:</i> • 1-year depot repair service • 3-year/1-yr battery depot repair service • 3-year/1-yr battery limited onsite service
									Mil-Spec test	MIL-STD-810G military testing
									Environment	EPEAT™ Silver; ENERGY STAR® 6.1; RoHS-compliant

Note: The specifications above may not be available in all regions.

Lenovo
July 2019



ThinkPad P52s Platform Specifications

Product Specifications Reference (PSREF)

Processor	8th Generation Intel® Core™ i5 / i7 Processor								Dimensions	<i>WxDxH:</i> 14.40" x 9.95" x 0.79-0.80"; 365.8mm x 252.8mm x 19.95-20.2mm																	
	Processor Number	# of Cores	# of Threads	Base Frequency	Max Turbo Frequency	Cache	Memory Types	Processor Graphics	Weight	starting at 4.39 lb / 1.99 kg																	
	i5-8350U	4	8	1.7 GHz	3.6 GHz	6MB	DDR4-2400	Intel UHD Graphics 620	Case color	Black																	
	i7-8550U			1.8 GHz	4.0 GHz	8MB			Case material	<i>Display cover:</i> Glass-Fiber Reinforced Plastic (PPS); <i>Bottom:</i> Glass-Fiber Reinforced Plastic																	
i7-8650U	1.9 GHz			4.2 GHz	8MB																						
Graphics	Intel UHD Graphics 620 in processor and NVIDIA Quadro® P500, 2GB GDDR5 memory; supports external digital monitor via HDMI or USB Type-C; supports three independent displays; Max resolution: 4096x2304@60Hz (USB Type-C); 4096x2160@30Hz (HDMI)								Smart card reader	<i>Optional:</i> Smart card reader																	
Chipset	Intel SoC (System on Chip) platform								Media reader	4-in-1 reader (MMC, SD, SDHC, SDXC)																	
Memory	32GB max / 2400MHz DDR4, dual-channel capable, two DDR4 SO-DIMM sockets <i>* System clocks down for processors with lower memory controller</i>								Ports	Two USB 3.1 Gen 1 (one Always On), one USB 3.1 Type-C Gen 1 (with the function of Power Delivery and DisplayPort), one USB 3.1 Type-C Gen 2 / Thunderbolt 3 (with the function of PD and DP), HDMI 1.4b, Ethernet (RJ-45), nano-SIM card slot (WWAN models), headphone / microphone combo jack, optional smart card reader, 4-in-1 reader (MMC, SD, SDHC, SDXC), side docking connector, security keyhole <i>* Depending on many factors, actual data transfer speed may be lower than theoretical speed</i>																	
Display	<i>Some:</i> 15.6" (396mm) FHD (1920x1080), anti-glare, LED backlight, IPS, 250 nits, 16:9 aspect ratio, 700:1 contrast ratio, 170° viewing angle <i>Some:</i> 15.6" (396mm) UHD (3840x2160), anti-glare, LED backlight, IPS, 300 nits, 16:9 aspect ratio, 1000:1 contrast ratio, 72% gamut, 170° viewing angle								Monitor cable (optional)	<i>HDMI to VGA:</i> Lenovo HDMI to VGA Monitor Adapter <i>USB-C to DP:</i> Lenovo USB-C to DisplayPort Adapter																	
Multi-touch (opt)	On-cell touch, supports 10-finger gesture (FHD only)								Camera (optional)	<i>One of the following, configurable by model:</i> • HD720p camera with ThinkShutter camera privacy, fixed focus • IR camera and HD720p camera, fixed focus																	
Storage	<i>System has one HDD slot or one M.2 2280 slot exclusively for storage</i> <i>Some:</i> HDD / SATA 6.0Gb/s, 2.5" wide, 7mm high, Active Protection System™ <i>Some:</i> SSD / SATA 6.0Gb/s, 2.5" wide, 7mm high (e.g. xxxGB SSD) <i>Some:</i> M.2 SSD / PCIe NVMe, PCIe 3.0 x 2, 16Gb/s <i>Some:</i> 128GB M.2 SSD / PCIe NVMe, PCIe 3.0 x 2, 16Gb/s, in WWAN slot as 2nd Storage, mutually exclusive with WWAN								Audio support	HD Audio, Realtek® ALC3287 codec / stereo speakers, 2W x 2, Dolby® Audio™ Premium / dual array microphone, headphone / microphone combo jack																	
Optane™ memory	<i>Optional:</i> Intel Optane memory, PCIe NVMe, PCIe 3.0 x 2								Keyboard	6-row, spill-resistant, multimedia Fn keys, numeric keypad, optional LED backlight																	
Optical	None								UltraNav™	TrackPoint® pointing device and buttonless Mylar surface multi-touch touchpad																	
Ethernet	<i>Non-vPro model:</i> Intel Ethernet Connection I219-V (Jacksonville) <i>vPro model:</i> Intel Ethernet Connection I219-LM (Jacksonville)								Security	Power-on password, hard disk password, supervisor password, security keyhole																	
WLAN + Bluetooth™	Intel Dual Band Wireless-AC 8265, Wi-Fi 2x2 802.11ac + Bluetooth 4.1, M.2 card <i>* Intel 8265ac card supports BT4.2 but is limited to BT4.1 by Windows OS</i>								Security chip	Discrete TPM 2.0, TCG Certified																	
WWAN (optional)	<i>One of the following, configurable by model:</i> • Wireless WAN upgradable • Integrated Mobile Broadband 4G LTE, Intel XMM™ 7262 (Fibocom L830-EB), M.2 card (EMEA only) • Integrated Mobile Broadband 4G LTE-A, Intel XMM™ 7360 (Fibocom L850-GL), M.2 card <i>* For non-WWAN model, it means the model is NOT WWAN upgradable</i>								vPro (optional)	Intel vPro Technology																	
									Fingerprint reader	<i>Optional:</i> Touch style match on chip fingerprint reader on the palm rest anti-spoofing technology																	
									NFC (optional)	Near Field Communication																	
									Battery	Optional integrated Li-ion 32Wh battery and external Li-ion 24Wh, 48Wh, or 72Wh battery																	
									Max battery life (MobileMark® 2014)	<table border="1"> <thead> <tr> <th>Models</th> <th>48Wh</th> <th>72Wh</th> <th>32Wh + 24Wh</th> <th>32Wh + 48Wh</th> <th>32Wh + 72Wh</th> </tr> </thead> <tbody> <tr> <td><i>Max battery life</i></td> <td>12.2 hr</td> <td>18.5 hr</td> <td>13.5 hr</td> <td>20.1 hr</td> <td>26.3 hr</td> </tr> </tbody> </table>						Models	48Wh	72Wh	32Wh + 24Wh	32Wh + 48Wh	32Wh + 72Wh	<i>Max battery life</i>	12.2 hr	18.5 hr	13.5 hr	20.1 hr	26.3 hr
Models	48Wh	72Wh	32Wh + 24Wh	32Wh + 48Wh	32Wh + 72Wh																						
<i>Max battery life</i>	12.2 hr	18.5 hr	13.5 hr	20.1 hr	26.3 hr																						
									AC adapter	65W USB Type-C AC adapter																	
									Preload	Windows® 10 Home 64 or Windows 10 Pro 64																	
									Limited warranty	<i>One of the following, configurable by model:</i> • 1-year depot repair service • 3-year/1-yr battery depot repair service • 3-year/1-yr battery limited onsite service																	
									Mil-Spec test	MIL-STD-810G military testing																	
									Environment	EPEAT™ Silver; ENERGY STAR® 6.1; RoHS-compliant																	



ThinkPad P53s Platform Specifications

Product Specifications Reference (PSREF)

Processor	8th Generation Intel® Core™ i7 Processor									Dimensions Weight Case color Case material	<i>WxDxH:</i> 14.40" x 9.76" x 0.75"; 365.8mm x 248mm x 19.1mm starting at 3.87 lb / 1.75 kg Black <i>Display cover:</i> PPS / 50% GF; <i>Bottom:</i> PA / 50% GF
	Processor Number	# of Cores	# of Threads	Base Frequency	Max Turbo Frequency	Cache	Memory Types	Processor Graphics			
	i7-8565U	4	8	1.8 GHz	4.6 GHz	8MB	DDR4-2400	Intel UHD Graphics 620			
	i7-8665U			1.9 GHz	4.8 GHz	8MB					
Graphics	Intel UHD Graphics 620 in processor and NVIDIA Quadro® P520, 2GB GDDR5 memory; supports external digital monitor via HDMI or USB Type-C; supports three independent displays; Max resolution: 3840x2160@60Hz (USB-C); 3840x2160@30Hz (HDMI)									Smart card reader Media reader Ports	<i>Optional:</i> Smart card reader MicroSD card reader Two USB 3.1 Gen 1 (one Always On), one USB 3.1 Type-C Gen 1 (with the function of Power Delivery and DisplayPort), one USB 3.1 Type-C Gen 2 / Thunderbolt 3 (with the function of PD and DP), HDMI 1.4b, Ethernet (RJ-45), nano-SIM card slot (WWAN models), headphone / microphone combo jack, optional smart card reader, microSD card reader, side docking connector, security keyhole <i>* Depending on many factors, actual data transfer speed may be lower than theoretical speed</i> <i>HDMI to VGA:</i> Lenovo HDMI to VGA Monitor Adapter <i>USB-C to VGA:</i> Lenovo USB-C to VGA Adapter <i>USB-C to DP:</i> Lenovo USB-C to DisplayPort Adapter
Chipset	Intel SoC (System on Chip) platform 48GB max / 2400MHz DDR4, dual-channel capable, 8GB or 16GB memory soldered to systemboard, one DDR4 SO-DIMM socket * Installed memory is actually 2666MHz but run at 2400MHz due to Intel limitation										
Memory										Monitor cable (optional)	
Display	Size	Resolution	Type	Surface	Brightness	Aspect Ratio	Contrast Ratio	Color Gamut	Viewing Angle	Bundled Accy	None
	15.6"	FHD (1920x1080)	IPS	Anti-glare	250 nits	16:9	700:1	45%	170°		
	15.6"	UHD (3840x2160) Dolby Vision™ HDR	IPS	Anti-glare	500 nits	16:9	1200:1	100% Adobe	170°		
Multi-touch (opt)	On-cell touch, supports 10-finger gesture (FHD only)										
Storage	<ul style="list-style-type: none"> M.2 2280 SSD / SATA 6.0Gb/s M.2 2280 SSD / PCIe NVMe, PCIe 3.0 x 4 M.2 2242 SSD / PCIe NVMe, PCIe 3.0 x 2 Intel Optane™ Memory H10 with Solid State Storage, M.2 2280, PCIe NVMe 3.0 x 4 										
Optical	None										
Ethernet	<i>Non-vPro model:</i> Intel Ethernet Connection I219-V (Jacksonville) <i>vPro model:</i> Intel Ethernet Connection I219-LM (Jacksonville)										
WLAN	Intel Wireless-AC 9560, Wi-Fi 2x2 802.11ac + Bluetooth 5.0										
Bluetooth™	Bluetooth 5.0 wireless, integrated in Wi-Fi + Bluetooth combo adapter										
WWAN (optional)	<i>One of the following, configurable by model:</i> <ul style="list-style-type: none"> Wireless WAN upgradable Integrated Mobile Broadband 4G LTE, Fibocom L830-EB, M.2 card (EMEA only) Integrated Mobile Broadband 4G LTE-A, Fibocom L850-GL, M.2 card <i>* For non-WWAN model, it means the model is NOT WWAN upgradable</i>										
SIM card (opt)	Nano-SIM card slot, optional Verizon LTE (US) SIM card										
Keyboard	6-row, spill-resistant, multimedia Fn keys, numeric keypad, optional LED backlight										
UltraNav™	TrackPoint® pointing device and buttonless Mylar surface multi-touch touchpad										
Security	Power-on password, hard disk password, supervisor password, security keyhole										
Security chip	Discrete TPM 2.0, TCG Certified										
System Mgt (opt)	Intel vPro Technology										
Fingerprint reader	<i>Optional:</i> Touch style match on chip fingerprint reader on the palm rest										
NFC (optional)	Near Field Communication										
Battery	Integrated Li-ion 57Wh battery, supports Rapid Charge (charge up to 80% in 1hr)										
Max battery life	<i>MobileMark® 2014:</i> 15 hr (FHD model) / 10 hr (UHD model) <i>* Battery life varies significantly with settings, usage, & other factors</i>										
AC adapter	65W USB Type-C AC adapter										
Preload	Windows® 10 Home 64 or Windows 10 Pro 64										
Limited warranty	<i>One of the following, configurable by model:</i> <ul style="list-style-type: none"> 1-year depot repair service 3-year/1-yr battery depot repair service 3-year/1-yr battery limited onsite service 										
Mil-Spec test	MIL-STD-810G military testing										
Environment	EPEAT™ Silver; ENERGY STAR® 7.1; RoHS-compliant										

Note: The specifications above may not be available in all regions.

Lenovo
July 2019

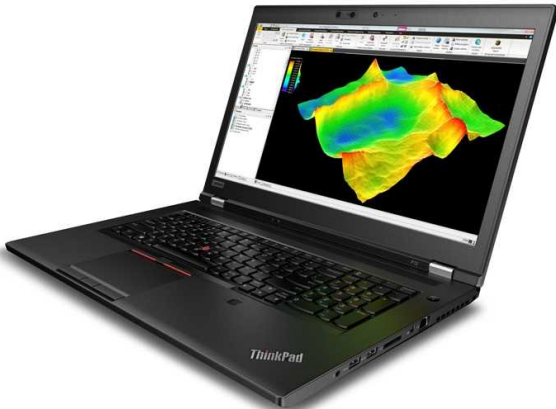

ThinkPad P72 Platform Specifications

Product Specifications Reference (PSREF)

Processor	8th Generation Intel® Core™ i7 Processor or Intel Xeon® E Processor							Dimensions	<i>WxDxH:</i> 16.38" x 11.06" x 0.96-1.16"; 416mm x 281mm x 24.5-29.4mm	
	Processor Number	# of Cores	# of Threads	Base Frequency	Max Turbo Frequency	Cache	Memory Types	Processor Graphics	Weight	Starting at 7.5 lb (3.4kg)
	i7-8750H	6	12	2.2 GHz	4.1 GHz	9MB	DDR4-2400	Intel UHD Graphics 630	Case color	Black
	i7-8850H			2.6 GHz	4.3 GHz	9MB		Intel UHD Graphics P630	Case material	<i>Display cover:</i> GFRP + PPS; <i>Bottom:</i> Magnesium/Aluminum
	E-2176M			2.7 GHz	4.4 GHz	12MB		Intel UHD Graphics P630	Smart card reader	<i>Optional:</i> Smart card reader
E-2186M	2.9 GHz			4.8 GHz	12MB	ExpressCard		None		
Graphics	Intel UHD Graphics 630 or P630 in processor and NVIDIA Quadro® P600 (4GB memory), P2000 (4GB memory), P3200 (6GB memory), P4200 (8GB memory), or P5200 (16GB memory); supports external digital monitor via HDMI, Mini DisplayPort, or Thunderbolt™; supports four independent displays; Max resolution: 3840x2160@60Hz (DisplayPort via Mini DisplayPort cable); 5120x2880@30Hz (Thunderbolt); 4096x2160@60Hz (HDMI)							Media reader	4-in-1 reader (MMC, SD, SDHC, SDXC), supports UHS-II SD card	
Chipset	Mobile Intel CM246 Chipset							Ports	Four USB 3.1 Gen 1 (one Always On), two USB Type-C / Thunderbolt 3 (with the function of Power Delivery and DP), Mini DisplayPort 1.4, HDMI 2.0, Ethernet (RJ-45), headphone / microphone combo jack, optional smart card reader, 4-in-1 reader (MMC, SD, SDHC, SDXC), security keyhole <i>* Power Delivery only supports power-out for charging peripherals</i> <i>* Depending on many factors, actual data transfer speed may be lower than theoretical speed</i>	
Memory	128GB non-ECC or 64GB ECC max / 2400MHz DDR4 (ECC function supported only on Xeon processor), dual-channel capable, four DDR4 SO-DIMM sockets <i>* Installed DIMMs are actually 2666MHz but run at 2400MHz due to Intel limitation</i>							Monitor cable	<i>Optional:</i> Lenovo Mini-DisplayPort to DisplayPort Monitor Cable	
Display	<i>Some:</i> 17.3" (439mm) FHD (1920x1080), anti-glare, LED backlight, IPS, 300 nits, 16:9 aspect ratio, 800:1 contrast ratio, 72% gamut, 170° viewing angle <i>Some:</i> 17.3" (439mm) 4K (3840x2160), anti-glare, LED backlight, IPS, 400 nits, 16:9 aspect ratio, 1000:1 contrast ratio, 100% Adobe CG, 170° viewing angle							Camera (<i>optional</i>)	IR camera and HD720p camera, fixed focus	
Multi-touch Pen	None Supports pen accessory, please see the accessory compatibility for details							Audio support	HD Audio, Realtek® ALC3286 codec / stereo speakers, 2W x 2, Dolby® Audio™ Premium / dual array microphone, headphone / microphone combo jack, Dolby Atmos® headphone	
Storage	<i>Up to 3 drives (two M.2 SSD and one HDD)</i> <i>Some:</i> HDD / SATA 6.0Gb/s, 2.5" wide, 7mm high, Active Protection System™ <i>Some:</i> M.2 SSD / PCIe NVMe, PCIe 3.0 x 4, 32Gb/s							Keyboard	6-row, spill-resistant, multimedia Fn keys, numeric keypad, LED backlight	
Optane™ memory	<i>Optional:</i> Intel Optane memory, PCIe NVMe, PCIe 3.0 x 2							UltraNav™	3-button TrackPoint® pointing device and 3-button Mylar surface multi-touch touchpad	
RAID (<i>optional</i>)	RAID 0/1 support							Security	Power-on password, hard disk password, supervisor password, security keyhole	
Optical	None							Security chip	Discrete TPM 2.0, TCG Certified	
Ethernet	<i>Non-vPro model:</i> Intel Ethernet Connection I219-V (Jacksonville) <i>vPro model:</i> Intel Ethernet Connection I219-LM (Jacksonville)							vPro (<i>optional</i>)	Intel vPro Technology	
WLAN	Intel Wireless-AC 9560, Wi-Fi 2x2 802.11ac + Bluetooth 5.0, M.2 card							Fingerprint reader	Touch style match on chip fingerprint reader on the palm rest	
Bluetooth™	Bluetooth 5.0 wireless, integrated in Wi-Fi + Bluetooth combo adapter							Color calibration	None	
WWAN	None							NFC (<i>optional</i>)	Near Field Communication	
SIM card	None							Battery	Li-ion 99Wh battery, supports Rapid Charge (charge up to 80% in 1hr)	
								Max battery life	<i>MobileMark® 2014:</i> 18 hr <i>* Battery life varies significantly with settings, usage, & other factors</i>	
								AC adapter	230W slim tip AC adapter	
								Preload	<i>One of the following, configurable by model:</i> • Windows® 10 Home 64 • Windows 10 Pro 64 • Windows 10 Pro 64 for Workstations	
								Limited warranty	<i>One of the following, configurable by model:</i> • 1-year depot repair service • 3-year/1-yr battery depot repair service • 3-year/1-yr battery limited onsite service	
								Mil-Spec test	MIL-STD-810G military testing	
								Environment	EPEAT™ Gold (US only); ENERGY STAR® 7.0; RoHS-compliant	

Note: The specifications above may not be available in all regions.

Lenovo
May 2019



ThinkPad T470 Platform Specifications

Product Specifications Reference (PSREF)

<p>Processor</p> <p>6th Generation Intel® Core™ i5 / i7 Processor or</p> <table border="1"> <thead> <tr> <th>Processor Number</th> <th># of Cores</th> <th># of Threads</th> <th>Base Frequency</th> <th>Max Turbo Frequency</th> <th>Cache</th> <th>Memory Types</th> <th>Processor Graphics</th> </tr> </thead> <tbody> <tr> <td>i5-6200U</td> <td rowspan="4">2</td> <td rowspan="4">4</td> <td>2.3 GHz</td> <td>2.8 GHz</td> <td>3MB</td> <td rowspan="4">DDR4-2133</td> <td rowspan="4">Intel HD Graphics 520</td> </tr> <tr> <td>i5-6300U</td> <td>2.4 GHz</td> <td>3.0 GHz</td> <td>3MB</td> </tr> <tr> <td>i7-6500U</td> <td>2.5 GHz</td> <td>3.1 GHz</td> <td>4MB</td> </tr> <tr> <td>i7-6600U</td> <td>2.6 GHz</td> <td>3.4 GHz</td> <td>4MB</td> </tr> </tbody> </table> <p>7th Generation Intel Core i3 / i5 / i7 Processor</p> <table border="1"> <thead> <tr> <th>Processor Number</th> <th># of Cores</th> <th># of Threads</th> <th>Base Frequency</th> <th>Max Turbo Frequency</th> <th>Cache</th> <th>Memory Types</th> <th>Processor Graphics</th> </tr> </thead> <tbody> <tr> <td>i3-7100U</td> <td rowspan="5">2</td> <td rowspan="5">4</td> <td>2.4 GHz</td> <td>-</td> <td>3MB</td> <td rowspan="5">DDR4-2133</td> <td rowspan="5">Intel HD Graphics 620</td> </tr> <tr> <td>i5-7200U</td> <td>2.5 GHz</td> <td>3.1 GHz</td> <td>3MB</td> </tr> <tr> <td>i5-7300U</td> <td>2.6 GHz</td> <td>3.5 GHz</td> <td>3MB</td> </tr> <tr> <td>i7-7500U</td> <td>2.7 GHz</td> <td>3.5 GHz</td> <td>4MB</td> </tr> <tr> <td>i7-7600U</td> <td>2.8 GHz</td> <td>3.9 GHz</td> <td>4MB</td> </tr> </tbody> </table> <p><i>* i7-6500U is NOT available in EMEA</i></p>	Processor Number	# of Cores	# of Threads	Base Frequency	Max Turbo Frequency	Cache	Memory Types	Processor Graphics	i5-6200U	2	4	2.3 GHz	2.8 GHz	3MB	DDR4-2133	Intel HD Graphics 520	i5-6300U	2.4 GHz	3.0 GHz	3MB	i7-6500U	2.5 GHz	3.1 GHz	4MB	i7-6600U	2.6 GHz	3.4 GHz	4MB	Processor Number	# of Cores	# of Threads	Base Frequency	Max Turbo Frequency	Cache	Memory Types	Processor Graphics	i3-7100U	2	4	2.4 GHz	-	3MB	DDR4-2133	Intel HD Graphics 620	i5-7200U	2.5 GHz	3.1 GHz	3MB	i5-7300U	2.6 GHz	3.5 GHz	3MB	i7-7500U	2.7 GHz	3.5 GHz	4MB	i7-7600U	2.8 GHz	3.9 GHz	4MB	<p>Dimensions <i>WxDxH:</i> 13.25" x 9.15" x 0.79"; 336.6mm x 232.5mm x 19.95mm</p> <p>Weight</p> <table border="1"> <thead> <tr> <th>Models</th> <th>3-cell or 3 + 3-cell</th> <th>6-cell or 3 + 6-cell</th> </tr> </thead> <tbody> <tr> <td>Magnesium</td> <td>3.49 lb / 1.58 kg</td> <td>3.92 lb / 1.78 kg</td> </tr> <tr> <td>PPS</td> <td>3.63 lb / 1.65 kg</td> <td>4.35 lb / 1.85 kg</td> </tr> </tbody> </table> <p>Case color Case material <i>Display cover:</i> Magnesium Hybrid or PPS; <i>Bottom:</i> Glass-Fiber Reinforced Plastic</p>	Models	3-cell or 3 + 3-cell	6-cell or 3 + 6-cell	Magnesium	3.49 lb / 1.58 kg	3.92 lb / 1.78 kg	PPS	3.63 lb / 1.65 kg	4.35 lb / 1.85 kg
Processor Number	# of Cores	# of Threads	Base Frequency	Max Turbo Frequency	Cache	Memory Types	Processor Graphics																																																															
i5-6200U	2	4	2.3 GHz	2.8 GHz	3MB	DDR4-2133	Intel HD Graphics 520																																																															
i5-6300U			2.4 GHz	3.0 GHz	3MB																																																																	
i7-6500U			2.5 GHz	3.1 GHz	4MB																																																																	
i7-6600U			2.6 GHz	3.4 GHz	4MB																																																																	
Processor Number	# of Cores	# of Threads	Base Frequency	Max Turbo Frequency	Cache	Memory Types	Processor Graphics																																																															
i3-7100U	2	4	2.4 GHz	-	3MB	DDR4-2133	Intel HD Graphics 620																																																															
i5-7200U			2.5 GHz	3.1 GHz	3MB																																																																	
i5-7300U			2.6 GHz	3.5 GHz	3MB																																																																	
i7-7500U			2.7 GHz	3.5 GHz	4MB																																																																	
i7-7600U			2.8 GHz	3.9 GHz	4MB																																																																	
Models	3-cell or 3 + 3-cell	6-cell or 3 + 6-cell																																																																				
Magnesium	3.49 lb / 1.58 kg	3.92 lb / 1.78 kg																																																																				
PPS	3.63 lb / 1.65 kg	4.35 lb / 1.85 kg																																																																				
<p>Graphics</p> <p>Intel HD Graphics 520 or 620 in processor only, or Intel HD Graphics 620 in processor and NVIDIA GeForce® 940MX, 2GB 2.5GHz GDDR5 memory (discrete models are NOT available in EMEA); supports external digital monitor via HDMI or USB Type-C; supports three independent displays; Max resolution: 4096x2304@60Hz (USB Type-C); 4096x2160@24Hz (HDMI)</p>	<p>Smart card reader <i>Optional:</i> Smart card reader</p> <p>Media reader 4-in-1 reader (MMC, SD, SDHC, SDXC), supports SD 3.0, UHS-I</p> <p>Ports Three USB 3.1 Gen 1 (USB 3.0, one Always On), USB 3.1 Type-C Gen 2 / Thunderbolt 3 (w/ the function of Power Delivery and DP), HDMI 1.4b, Ethernet (RJ-45), Dock connector <i>* Depending on many factors, actual data transfer speed may be lower than theoretical speed</i></p> <p>WiGig dock (opt) ThinkPad WiGig dock</p> <p>Monitor cable <i>Optional:</i> Lenovo USB-C to VGA Adapter</p>																																																																					
<p>Chipset Intel SoC (System on Chip) platform</p> <p>Memory 32GB max / 2400MHz DDR4, dual-channel capable, two DDR4 SO-DIMM sockets <i>* System clocks down for processors with lower memory controller</i></p>	<p>Camera (optional) <i>720p:</i> HD720p resolution, fixed focus <i>IR & 720p:</i> IR camera and HD720p camera (mutually exclusive with WiGig)</p> <p>Audio support HD Audio, Realtek ALC3268 codec / stereo speakers, 2W x 2 / dual array microphone, combo audio/microphone jack</p>																																																																					
<p>Display</p> <p><i>Some:</i> 14.0" (355mm) HD (1366x768), anti-glare, LED backlight, 220 nits, 16:9 aspect ratio, 400:1 contrast ratio</p> <p><i>Some:</i> 14.0" (355mm) FHD (1920x1080), anti-glare, LED backlight, 220 nits, 16:9 aspect ratio, 400:1 or 500:1 contrast ratio</p> <p><i>Some:</i> 14.0" (355mm) FHD (1920x1080), anti-glare, LED backlight, IPS, 250 nits, 16:9 aspect ratio, 700:1 contrast ratio, 170° viewing angle</p> <p>Multi-touch (opt) On-cell touch, supports 10-finger gesture (FHD IPS panel with PPS cover only)</p>	<p>Keyboard 6-row, spill-resistant, multimedia Fn keys, optional LED backlight UltraNav™ TrackPoint® pointing device and buttonless Mylar surface multi-touch touchpad</p> <p>Security Power-on password, hard disk password, supervisor password, security keyhole</p> <p>Security chip Discrete TPM 2.0, TCG Certified</p> <p>vPro (optional) Intel vPro Technology</p> <p>Fingerprint reader <i>Optional:</i> Touch style match on chip fingerprint reader on the keyboard bezel</p> <p>NFC (optional) Near Field Communication</p>																																																																					
<p>Storage</p> <p><i>System has one HDD slot or one M.2 2280 slot exclusively for storage</i></p> <p><i>Some:</i> HDD / SATA 6.0Gb/s, 2.5" wide, 7mm high, Active Protection System™</p> <p><i>Some:</i> SSD / SATA 6.0Gb/s, 2.5" wide, 7mm high (e.g. xxxGB SSD)</p> <p><i>Some:</i> M.2 SSD / PCIe NVMe, PCIe 3.0 x 2, 16Gb/s</p> <p><i>Some:</i> 128GB M.2 SSD / SATA 6.0Gb/s, in WWAN slot as 2nd Storage, mutually exclusive with WWAN and WiGig</p>	<p>Internal battery <i>Optional:</i> Integrated Li-Polymer 3-cell (24Wh)</p> <p>External battery Li-Polymer 3-cell (24Wh) or Li-ion 6-cell (48Wh or 72Wh)</p> <p>Max battery life (MobileMark® 2014)</p> <table border="1"> <thead> <tr> <th>Models</th> <th>3-cell</th> <th>3 + 3-cell</th> <th>6-cell 48Wh</th> <th>6-cell 72Wh</th> <th>3 + 6-cell 48Wh</th> <th>3 + 6-cell 72Wh</th> </tr> </thead> <tbody> <tr> <td><i>Integrated</i></td> <td>6.9 hr</td> <td>13.9 hr</td> <td>13.9 hr</td> <td>20.9 hr</td> <td>20.9 hr</td> <td>27.1 hr</td> </tr> <tr> <td><i>Discrete</i></td> <td>6.9 hr</td> <td>13.9 hr</td> <td>14.3 hr</td> <td>21.6 hr</td> <td>21.2 hr</td> <td>28.6 hr</td> </tr> </tbody> </table> <p><i>* Battery life varies significantly with settings, usage, & other factors</i></p> <p>AC adapter 45W or 65W slim tip AC adapter, 45W or 65W USB Type-C AC adapter</p>	Models	3-cell	3 + 3-cell	6-cell 48Wh	6-cell 72Wh	3 + 6-cell 48Wh	3 + 6-cell 72Wh	<i>Integrated</i>	6.9 hr	13.9 hr	13.9 hr	20.9 hr	20.9 hr	27.1 hr	<i>Discrete</i>	6.9 hr	13.9 hr	14.3 hr	21.6 hr	21.2 hr	28.6 hr																																																
Models	3-cell	3 + 3-cell	6-cell 48Wh	6-cell 72Wh	3 + 6-cell 48Wh	3 + 6-cell 72Wh																																																																
<i>Integrated</i>	6.9 hr	13.9 hr	13.9 hr	20.9 hr	20.9 hr	27.1 hr																																																																
<i>Discrete</i>	6.9 hr	13.9 hr	14.3 hr	21.6 hr	21.2 hr	28.6 hr																																																																
<p>Optical None</p>	<p>Preload</p> <p>Windows® 7 Professional 64 preinstalled through downgrade rights in Windows 10 Pro 64</p> <p><i>Some:</i> Windows 10 Home 64 <i>Some:</i> Windows 10 Pro 64</p> <ul style="list-style-type: none"> • Lenovo Solution Center • Lenovo PowerEngage • ThinkVantage Product Recovery • ThinkVantage System Update • Adobe® Reader® • Microsoft® Office preloaded; purchase a product key to activate • McAfee® LiveSafe™ (30-day trial) 																																																																					
<p>WLAN</p> <p><i>One of the following, configurable by model (WiGig can coexist with WWAN):</i></p> <ul style="list-style-type: none"> • Realtek® RTL8822BE, Wi-Fi 2x2 802.11ac + BT4.1, M.2 card • Intel Dual Band Wireless-AC 8260, Wi-Fi 2x2 802.11ac + BT4.1, M.2 card • Intel Dual Band Wireless-AC 8265, Wi-Fi 2x2 802.11ac + BT4.1, M.2 card • Intel Tri-Band Wireless-AC 18265, WiGig 802.11ad + Wi-Fi 2x2 802.11ac + BT4.1, M.2 card <p>Bluetooth™ Bluetooth 4.1 wireless, integrated in Wi-Fi + Bluetooth combo adapter <i>* Intel 8265ac / 18265ac card support BT4.2 but is limited to BT4.1 by Windows OS</i></p>	<p>Limited warranty</p> <p><i>One of the following, configurable by model:</i></p> <ul style="list-style-type: none"> • 1-year depot repair service • 3-year/1-yr battery depot repair service • 3-year/1-yr battery limited onsite service 																																																																					
<p>WWAN (optional)</p> <p><i>One of the following, configurable by model (WWAN can coexist with WiGig):</i></p> <ul style="list-style-type: none"> • Wireless WAN upgradable • Integrated Mobile Broadband 4G LTE-A, Qualcomm® Snapdragon™ X7 LTE-A (Sierra Wireless EM7455), M.2 card • Integrated Mobile Broadband 4G LTE, Intel XMM™ 7160 (Fibocom L831-EAU), M.2 card (EMEA only) 	<p>Mil-Spec test MIL-STD-810G military testing</p>																																																																					
<p>SIM card (opt) Micro-SIM card slot, opt Verizon LTE (US) or Lenovo® Connect (EMEA) SIM card</p>	<p>Environment EPEAT™ Gold (US only); ENERGY STAR® 6.1; RoHS-compliant</p>																																																																					



ThinkPad T470s Platform Specifications

Product Specifications Reference (PSREF)

Processor	6th Generation Intel® Core™ i5 / i7 Processor								Dimensions Weight Case color Case material	<i>WxDxH:</i> 13.03" x 8.93" x 0.67-0.74"; 331mm x 226.8mm x 16.9-18.8mm Starting at 2.9 lb (1.32kg) Black or Silver <i>Display cover:</i> CFRP Hybrid; <i>Bottom:</i> Magnesium
	Processor Number	# of Cores	# of Threads	Base Frequency	Max Turbo Frequency	Cache	Memory Types	Processor Graphics		
	i5-6200U	2	4	2.3 GHz	2.8 GHz	3MB	DDR4-2133	Intel HD Graphics 520		
	i5-6300U			2.4 GHz	3.0 GHz	3MB				
i7-6600U	2.6 GHz			3.4 GHz	4MB					
Processor	or 7th Generation Intel Core i5 / i7 Processor								Smart card reader Media reader Ports	<i>Optional:</i> Smart card reader 4-in-1 reader (MMC, SD, SDHC, SDXC) Three USB 3.1 Gen 1 (USB 3.0, one Always On), USB 3.1 Type-C Gen 2 / Thunderbolt 3 (w/ the function of Power Delivery and DP), HDMI 1.4b, Ethernet (RJ-45), Dock connector <i>* Depending on many factors, actual data transfer speed may be lower than theoretical speed</i>
	Processor Number	# of Cores	# of Threads	Base Frequency	Max Turbo Frequency	Cache	Memory Types	Processor Graphics		
	i5-7200U	2	4	2.5 GHz	3.1 GHz	3MB	DDR4-2133	Intel HD Graphics 620		
	i5-7300U			2.6 GHz	3.5 GHz	3MB				
i7-7500U	2.7 GHz			3.5 GHz	4MB					
i7-7600U	2.8 GHz			3.9 GHz	4MB					
Graphics	Intel HD Graphics 520 or 620 in processor; supports external digital monitor via HDMI or USB Type-C; supports three independent displays; Max resolution: 4096x2304@60Hz (USB Type-C); 4096x2160@24Hz (HDMI)								WiGig dock (opt) Monitor cable (optional)	ThinkPad WiGig dock, mutually exclusive with WWAN HDMI to VGA: Lenovo HDMI to VGA Monitor Adapter USB-C to VGA: Lenovo USB-C to VGA Adapter
Chipset	Intel SoC (System on Chip) platform								Camera (optional)	HD720p resolution, fixed focus (models without camera are NOT available in EMEA)
Memory	20GB or 24GB max ⁷ / 2400MHz DDR4, dual-channel capable, 4GB or 8GB memory soldered to systemboard, one DDR4 SO-DIMM socket <i>* System clocks down for processors with lower memory controller</i>								Audio support	HD Audio, Realtek® ALC3268 codec / stereo speakers, 1W x 2 / dual array microphone, combo audio/microphone jack
Display	Some: 14.0" (355mm) FHD (1920x1080), anti-glare, LED backlight, IPS, 250 nits, 16:9 aspect ratio, 700:1 contrast ratio, 160° viewing angle Some: 14.0" (355mm) WQHD (2560x1440), anti-glare, LED backlight, IPS, 300 nits, 16:9 aspect ratio, 700:1 contrast ratio, 160° viewing angle								Keyboard UltraNav™	6-row, spill-resistant, multimedia Fn keys, optional LED backlight TrackPoint® pointing device and buttonless Mylar surface multi-touch touchpad
Multi-touch (opt)	On-cell touch, supports 10-finger gesture, 250 nits (FHD only)								Security Security chip vPro (optional) Fingerprint reader NFC (optional)	Power-on password, hard disk password, supervisor password, security keyhole Discrete TPM 2.0, TCG Certified Intel vPro Technology <i>Optional:</i> Touch style match on chip fingerprint reader on the palm rest Near Field Communication
Storage	One of the following, configurable by model: • M.2 SSD / SATA 6.0Gb/s (e.g. xxxGB SSD M.2) • M.2 SSD / PCIe NVMe, PCIe 3.0 x 4, 32Gb/s (e.g. xxxGB SSD M.2 PCIe NVMe)								Internal battery Max battery life	Front Li-Polymer 3-cell (23Wh) and rear Li-ion 3-cell (26Wh), both Integrated <i>MobileMark® 2014:</i> up to 10.5 hr <i>* Battery life varies significantly with settings, usage, & other factors</i>
Optical	None								AC adapter	45W slim tip AC adapter, 45W or 65W USB Type-C AC adapter
Ethernet	Non-vPro model: Intel Ethernet Connection I219-V (Jacksonville) vPro model: Intel Ethernet Connection I219-LM (Jacksonville)								Preload	Windows® 7 Professional 64 preinstalled through downgrade rights in Windows 10 Pro 64 • Lenovo Solution Center • Lenovo PowerEngage • ThinkVantage Product Recovery • ThinkVantage System Update • Adobe® Reader® • Microsoft® Office preloaded; purchase a product key to activate • McAfee® LiveSafe™ (30-day trial)
WLAN	One of the following, configurable by model (WiGig is mutually exclusive with WWAN): • Intel Dual Band Wireless-AC 8260, Wi-Fi 2x2 802.11ac + BT4.1, M.2 card • Intel Dual Band Wireless-AC 8265, Wi-Fi 2x2 802.11ac + BT4.1, M.2 card • Intel Tri-Band Wireless-AC 18265, WiGig 802.11ad + Wi-Fi 2x2 802.11ac + BT4.1, M.2 card								Limited warranty	One of the following, configurable by model: • 1-year depot repair service • 3-year/1-yr battery depot repair service • 3-year/1-yr battery limited onsite service
Bluetooth™	Bluetooth 4.1 wireless, integrated in Wi-Fi + Bluetooth combo adapter <i>* Intel 8265ac / 18265ac card support BT4.2 but is limited to BT4.1 by Windows OS</i>								Mil-Spec test	MIL-STD-810G military testing
WWAN (optional)	One of the following, configurable by model (mutually exclusive with WiGig): • Wireless WAN upgradable • Integrated Mobile Broadband 4G LTE-A, Qualcomm® Snapdragon™ X7 LTE-A (Sierra Wireless EM7455), M.2 card • Micro-SIM card slot, opt Verizon LTE (US) or Lenovo® Connect (EMEA) SIM card								Environment	EPEAT™ Gold (US only); ENERGY STAR® 6.1; RoHS-compliant
SIM card (opt)										



ThinkPad T480 Platform Specifications

Product Specifications Reference (PSREF)

Processor	7th Generation Intel® Core™ i5 Processor							Dimensions Weight	WxDxH: 13.25" x 9.15" x 0.79"; 336.6mm x 232.5mm x 19.95mm						
	Processor Number	# of Cores	# of Threads	Base Frequency	Max Turbo Frequency	Cache	Memory Types		Processor Graphics	Models	24Wh or 24Wh + 24Wh	48Wh, 72Wh, or 24Wh + 48Wh / 72Wh			
	i5-7200U	2	4	2.5 GHz	3.1 GHz	3MB	DDR4-2133	Intel HD Graphics 620	Integrated Magnesium	3.49 lb / 1.58 kg	3.92 lb / 1.78 kg				
	i5-7300U			2.6 GHz	3.5 GHz	3MB			Integrated PPS	3.63 lb / 1.65 kg	4.08 lb / 1.85 kg				
	or 8th Generation Intel Core i3 / i5 / i7 Processor							Case color Case material	Black Display cover: Magnesium Hybrid or PPS; Bottom: Glass-Fiber Reinforced Plastic						
	Processor Number	# of Cores	# of Threads	Base Frequency	Max Turbo Frequency	Cache	Memory Types		Processor Graphics	Smart card reader	Optional: Smart card reader				
	i3-8130U	4	8	2.2 GHz	3.4 GHz	4MB	DDR4-2400	Intel UHD Graphics 620	Media reader	4-in-1 reader (MMC, SD, SDHC, SDXC)					
	i5-8250U			1.6 GHz	3.4 GHz	6MB			Ports	Two USB 3.1 Gen 1 (one Always On), one USB 3.1 Type-C Gen 1 (with the function of Power Delivery and DisplayPort), one USB 3.1 Type-C Gen 2 / Thunderbolt 3 (with the function of PD and DP), HDMI 1.4b, Ethernet (RJ-45), nano-SIM card slot (WWAN models), headphone / microphone combo jack, optional smart card reader, 4-in-1 media reader (MMC, SD, SDHC, SDXC), side docking connector, security keyhole					
	i5-8350U			1.7 GHz	3.6 GHz	6MB			Monitor cable (optional)	* Depending on many factors, actual data transfer speed may be lower than theoretical speed HDMI to VGA: Lenovo HDMI to VGA Monitor Adapter USB-C to DP: Lenovo USB-C to DisplayPort Adapter					
	i7-8550U			1.8 GHz	4.0 GHz	8MB			Camera (optional)	One of the following, configurable by model: • HD720p camera with ThinkShutter camera privacy, fixed focus • IR camera and HD720p camera, fixed focus					
	i7-8650U			1.9 GHz	4.2 GHz	8MB			Audio support	HD Audio, Realtek® ALC3287 codec / stereo speakers, 2W x 2, Dolby® Audio™ Premium / dual array microphone, headphone / microphone combo jack					
Graphics	Intel HD Graphics 620 or Intel UHD Graphics 620 in processor only or Intel HD Graphics 620 or Intel UHD Graphics 620 in processor and NVIDIA® GeForce® MX150, 2GB GDDR5 memory (discrete graphics is available only on i7 models in EMEA); supports external digital monitor via HDMI or USB Type-C; supports three independent displays; Max resolution: 4096x2304@60Hz (USB Type-C); 4096x2160@30Hz (HDMI)							Keyboard	6-row, spill-resistant, multimedia Fn keys, optional LED backlight UltraNav™ TrackPoint® pointing device and buttonless Mylar surface multi-touch touchpad						
Chipset	Intel SoC (System on Chip) platform							Security	Power-on password, hard disk password, supervisor password, security keyhole						
Memory	32GB max / 2400MHz DDR4, dual-channel capable, two DDR4 SO-DIMM sockets * System clocks down for processors with lower memory controller							Security chip	Discrete TPM 2.0, TCG Certified						
Display	Some: 14.0" (355mm) HD (1366x768), anti-glare, LED backlight, 220 nits, 16:9 aspect ratio, 400:1 contrast ratio Some: 14.0" (355mm) FHD (1920x1080), anti-glare, LED backlight, IPS, 250 nits, 16:9 aspect ratio, 700:1 contrast ratio, 170° viewing angle Some: 14.0" (355mm) WQHD (2560x1440), anti-glare, LED backlight, IPS, 300 nits, 16:9 aspect ratio, 700:1 contrast ratio, 72% gamut, 170° viewing angle							vPro (optional)	Intel vPro Technology						
Multi-touch (opt)	On-cell touch, supports 10-finger gesture (FHD only)							Fingerprint reader	Optional: Touch style match on chip fingerprint reader on the keyboard bezel, anti-spoofing technology						
Storage	System has one HDD slot or one M.2 2280 slot exclusively for storage Some: HDD / SATA 6.0Gb/s, 2.5" wide, 7mm high, Active Protection System™ Some: SSD / SATA 6.0Gb/s, 2.5" wide, 7mm high (e.g. xxxGB SSD) Some: M.2 SSD / PCIe NVMe, PCIe 3.0 x 4 Some: 128GB M.2 SSD / PCIe NVMe, PCIe 3.0 x 2, in WWAN slot as 2nd Storage, mutually exclusive with WWAN * Installed M.2 SSD is PCIe 3.0 x 4 but run at PCIe 3.0 x 2 due to M.2 SSD adapter limitation							NFC (optional)	Near Field Communication						
Optane™ memory	Intel Optane memory, PCIe NVMe, PCIe 3.0 x 2							Battery	Optional integrated Li-ion 24Wh battery and external Li-ion 24Wh, 48Wh, or 72Wh battery						
Optical	None							Max battery life (MobileMark® 2014)	Models	24Wh	48Wh	72Wh	24Wh + 24Wh	24Wh + 48Wh	24Wh + 72Wh
Ethernet	Non-vPro model: Intel Ethernet Connection I219-V (Jacksonville) vPro model: Intel Ethernet Connection I219-LM (Jacksonville)							AC adapter	45W or 65W USB Type-C AC adapter						
WLAN + Bluetooth™	Intel Dual Band Wireless-AC 8265, Wi-Fi 2x2 802.11ac + Bluetooth 4.1, M.2 card * Intel 8265ac card supports BT4.2 but is limited to BT4.1 by Windows OS							Preload	Windows® 10 Home 64 or Windows 10 Pro 64						
WWAN (optional)	One of the following, configurable by model (mutually exclusive with Intel Optane memory): • Integrated Mobile Broadband 4G LTE, Intel XMM™ 7262 (Fibocom L830-EB), M.2 card (EMEA only) • Integrated Mobile Broadband 4G LTE-A, Intel XMM™ 7360 (Fibocom L850-GL), M.2 card * For non-WWAN model, it means the model is NOT WWAN upgradable							Limited warranty	One of the following, configurable by model: • 1-year depot repair service • 3-year/1-yr battery depot repair service • 3-year/1-yr battery limited onsite service						
SIM card (opt)	Nano-SIM card slot, optional Verizon LTE (US) SIM card							Mil-Spec test	MIL-STD-810G military testing						
								Environment	EPEAT™ Gold (US only); ENERGY STAR® 6.1; RoHS-compliant						

Note: The specifications above may not be available in all regions.

Lenovo
May 2019



ThinkPad T480s Platform Specifications

Product Specifications Reference (PSREF)

Processor	7th Generation Intel® Core™ i5 Processor							Dimensions Weight Case color Case material	<i>WxDxH:</i> 13.03" x 8.93" x 0.73"; 331mm x 226.8mm x 18.45mm Starting at 2.9 lb (1.32kg) Black or Silver <i>Display cover:</i> CFRP Hybrid; <i>Bottom:</i> Magnesium
	Processor Number	# of Cores	# of Threads	Base Frequency	Max Turbo Frequency	Cache	Memory Types		
	i5-7200U	2	4	2.5 GHz	3.1 GHz	3MB	DDR4-2133	Intel HD Graphics 620	
	i5-7300U			2.6 GHz	3.5 GHz	3MB			
	or 8th Generation Intel Core i5 / i7 Processor							Smart card reader Media reader Ports	<i>Optional:</i> Smart card reader 4-in-1 reader (MMC, SD, SDHC, SDXC) Two USB 3.1 Gen 1 (one Always On), one USB 3.1 Type-C Gen 1 (with the function of Power Delivery and DisplayPort), one USB 3.1 Type-C Gen 2 / Thunderbolt 3 (with the function of PD and DP), HDMI 1.4b, Ethernet (RJ-45), nano-SIM card slot (WWAN models), headphone / microphone combo jack, optional smart card reader, 4-in-1 reader (MMC, SD, SDHC, SDXC), side docking connector, security keyhole <i>* Depending on many factors, actual data transfer speed may be lower than theoretical speed</i>
	Processor Number	# of Cores	# of Threads	Base Frequency	Max Turbo Frequency	Cache	Memory Types		
	i5-8250U	4	8	1.6 GHz	3.4 GHz	6MB	DDR4-2400	Intel UHD Graphics 620	
	i5-8350U			1.7 GHz	3.6 GHz	6MB			
	i7-8550U			1.8 GHz	4.0 GHz	8MB			
	i7-8650U			1.9 GHz	4.2 GHz	8MB			
Graphics	Intel HD Graphics 620 or Intel UHD Graphics 620 in processor only or Intel UHD Graphics 620 in processor and NVIDIA® GeForce® MX150, 2GB GDDR5 memory (discrete models are NOT available in EMEA); supports external digital monitor via HDMI or USB Type-C; supports three independent displays; Max resolution: 4096x2304@60Hz (USB Type-C); 4096x2160@30Hz (HDMI)							Monitor cable <i>(optional)</i>	USB-C to VGA: Lenovo USB-C to VGA Adapter USB-C to DP: Lenovo USB-C to DisplayPort Adapter
Chipset Memory	Intel SoC (System on Chip) platform 20GB or 24GB max / 2400MHz DDR4, dual-channel capable, 4GB or 8GB memory soldered to systemboard, one DDR4 SO-DIMM socket <i>* System clocks down for processors with lower memory controller</i>							Camera	One of the following, configurable by model: • HD720p camera with ThinkShutter camera privacy, fixed focus • IR camera and HD720p camera, fixed focus
Display	Some: 14.0" (355mm) FHD (1920x1080), anti-glare, LED backlight, IPS, 250 nits, 16:9 aspect ratio, 700:1 contrast ratio, 170° viewing angle, supports ThinkPad Privacy Guard on some models Some: 14.0" (355mm) WQHD (2560x1440), anti-glare, LED backlight, IPS, 300 nits, 16:9 aspect ratio, 700:1 contrast ratio, 72% gamut, 170° viewing angle							Audio support	HD Audio, Realtek® ALC3287 codec / stereo speakers, 1W x 2, Dolby® Audio™ Premium / dual array microphone, headphone / microphone combo jack
Multi-touch <i>(opt)</i>	On-cell touch, supports 10-finger gesture, 250 nits (FHD only)							Keyboard UltraNav™	6-row, spill-resistant, multimedia Fn keys, optional LED backlight TrackPoint® pointing device and buttonless Mylar surface multi-touch touchpad
Storage	One of the following, configurable by model: • M.2 SSD / SATA 6.0Gb/s • M.2 SSD / PCIe NVMe, PCIe 3.0 x 4, 32Gb/s							Security Security chip vPro <i>(optional)</i> Fingerprint reader	Power-on password, hard disk password, supervisor password, security keyhole Discrete TPM 2.0, TCG Certified Intel vPro Technology <i>Optional:</i> Touch style match on chip fingerprint reader on the palm rest, anti-spoofing technology
Optane™ memory Optical	None None							NFC <i>(optional)</i>	Near Field Communication
Ethernet	Non-vPro model: Intel Ethernet Connection I219-V (Jacksonville) vPro model: Intel Ethernet Connection I219-LM (Jacksonville)							Battery	Integrated Li-ion 57Wh battery, supports Rapid Charge (0-80% in 60 mins) with 65W USB Type-C AC adapter
WLAN + Bluetooth™	Intel Dual Band Wireless-AC 8265, Wi-Fi 2x2 802.11ac + Bluetooth 4.1, M.2 card <i>* Intel 8265ac card supports BT4.2 but is limited to BT4.1 by Windows OS</i>							Max battery life	MobileMark® 2014: 15.6 hr <i>* Battery life varies significantly with settings, usage, & other factors</i>
WWAN <i>(optional)</i>	One of the following, configurable by model: • Wireless WAN upgradable • Integrated Mobile Broadband 4G LTE, Intel XMM™ 7262 (Fibocom L830-EB), M.2 card (EMEA only) • Integrated Mobile Broadband 4G LTE-A, Intel XMM™ 7360 (Fibocom L850-GL), M.2 card							AC adapter	45W or 65W USB Type-C AC adapter
SIM card <i>(opt)</i>	Nano-SIM card slot, optional Verizon LTE (US) SIM card							Operating system	Windows® 10 Home 64 or Windows 10 Pro 64
Note: The specifications above may not be available in all regions.								Limited warranty	One of the following, configurable by model: • 1-year depot repair service • 3-year/1-yr battery depot repair service • 3-year/1-yr battery limited onsite service
								Mil-Spec test	MIL-STD-810G military testing
								Environment	EPEAT™ Silver; ENERGY STAR® 6.1; RoHS-compliant

Lenovo
July 2019



ThinkPad T490 Platform Specifications

Product Specifications Reference (PSREF)

Processor	8th Generation Intel® Core™ i5 / i7 Processor								Dimensions Weight	WxDxH: 12.95" x 8.94" x 0.70"; 329mm x 227mm x 17.9mm		
	Processor Number	# of Cores	# of Threads	Base Frequency	Max Turbo Frequency	Cache	Memory Types	Processor Graphics		Models	FHD	FHD Low Power / WQHD
Graphics	i5-8265U	4	8	1.6 GHz	3.9 GHz	6MB	DDR4-2400	Intel UHD Graphics 620	Weight	3.41 lb / 1.55 kg	3.23 lb / 1.46 kg	
	i5-8365U			1.6 GHz	4.1 GHz	6MB			Case color	Black		
	i7-8565U			1.8 GHz	4.6 GHz	8MB			Case material	Display cover: PPS / 50% GF; Bottom: PA / 50% GF		
	i7-8665U			1.9 GHz	4.8 GHz	8MB			Smart card reader	Optional: Smart card reader		
Media reader	MicroSD card reader											
Ports	Two USB 3.1 Gen 1 (one Always On), one USB 3.1 Type-C Gen 1 (with the function of Power Delivery and DisplayPort), one USB 3.1 Type-C Gen 2 / Thunderbolt 3 (with the function of PD and DP), HDMI 1.4b, Ethernet (RJ-45), nano-SIM card slot (WWAN models), headphone / microphone combo jack, optional smart card reader, microSD card reader, side docking connector, security keyhole * Depending on many factors, actual data transfer speed may be lower than theoretical speed											
Chipset	Intel SoC (System on Chip) platform											
Memory	48GB max / 2400MHz DDR4, dual-channel capable, 8GB or 16GB memory soldered to systemboard, one DDR4 SO-DIMM socket * Installed memory is actually 2666MHz but run at 2400MHz due to Intel limitation											
Display	Size	Resolution	Type	Surface	Brightness	Aspect Ratio	Contrast Ratio	Color Gamut	Viewing Angle	Monitor cable (optional)		
	14.0"	HD (1366x768)	TN	Anti-glare	220 nits	16:9	400:1	45%	90°	Bundled Accy		
	14.0"	FHD (1920x1080)	IPS	Anti-glare	250 nits (non-touch) 300 nits (multi-touch)	16:9	700:1	45%	170°	Camera (optional) One of the following, configurable by model: • HD720p camera with ThinkShutter camera privacy, fixed focus • IR camera and HD720p camera with ThinkShutter camera privacy, fixed focus		
	14.0"	FHD (1920x1080) Low Power	IPS	Anti-glare	400 nits	16:9	800:1	72%	170°	Audio support		
	14.0"	FHD (1920x1080) ThinkPad Privacy Guard	IPS	Anti-glare	400 nits	16:9	1000:1	72%	170°	Keyboard		
	14.0"	WQHD (2560x1440) HDR, Dolby Vision™	IPS	Glossy	500 nits	16:9	1500:1	100% Adobe	170°	UltraNav™		
Multi-touch (opt)	On-cell touch, supports 10-finger gesture (FHD only)											
Storage	<ul style="list-style-type: none"> M.2 2280 SSD / SATA 6.0Gb/s M.2 2280 SSD / PCIe NVMe, PCIe 3.0 x 4 M.2 2242 SSD / PCIe NVMe, PCIe 3.0 x 2 Intel Optane™ Memory H10 with Solid State Storage, M.2 2280, PCIe NVMe 3.0 x 4 											
Optical	None											
Ethernet	<i>Non-vPro model:</i> Intel Ethernet Connection I219-V (Jacksonville) <i>vPro model:</i> Intel Ethernet Connection I219-LM (Jacksonville)											
WLAN (optional)	Intel Wireless-AC 9560, Wi-Fi 2x2 802.11ac + Bluetooth 5.0											
Bluetooth™ (opt)	Bluetooth 5.0 wireless, integrated in Wi-Fi + Bluetooth combo adapter											
WWAN (optional)	<i>One of the following, configurable by model:</i> <ul style="list-style-type: none"> Wireless WAN upgradable Integrated Mobile Broadband 4G LTE, Fibocom L830-EB, M.2 card (EMEA only) Integrated Mobile Broadband 4G LTE-A, Fibocom L850-GL, M.2 card Integrated Mobile Broadband 4G LTE-A, Fibocom L860-GL, MIMO 4x4, M.2 card * For non-WWAN model, it means the model is NOT WWAN upgradable											
SIM card (opt)	Nano-SIM card slot, optional Verizon LTE (US) SIM card											
Battery	Integrated Li-ion 50Wh battery, supports Rapid Charge (charge up to 80% in 1hr)											
Max battery life	<i>MobileMark® 2014:</i> 16.11 hr * Battery life varies significantly with settings, usage, & other factors											
AC adapter	45W or 65W USB Type-C AC adapter											
Preload	Windows® 10 Home 64 or Windows 10 Pro 64											
Limited warranty	<i>One of the following, configurable by model:</i> <ul style="list-style-type: none"> 1-year depot repair service 3-year/1-yr battery depot repair service 3-year/1-yr battery limited onsite service 											
Mil-Spec test	MIL-STD-810G military testing											
Environment	EPEAT™ Silver; ENERGY STAR® 7.1; RoHS-compliant											

Note: The specifications above may not be available in all regions.

Lenovo
July 2019



ThinkPad T490s Platform Specifications

Product Specifications Reference (PSREF)

<p>Processor 8th Generation Intel® Core™ i5 / i7 Processor</p> <table border="1"> <thead> <tr> <th>Processor Number</th> <th># of Cores</th> <th># of Threads</th> <th>Base Frequency</th> <th>Max Turbo Frequency</th> <th>Cache</th> <th>Memory Types</th> <th>Processor Graphics</th> </tr> </thead> <tbody> <tr> <td>i5-8265U</td> <td rowspan="4">4</td> <td rowspan="4">8</td> <td>1.6 GHz</td> <td>3.9 GHz</td> <td>6MB</td> <td rowspan="4">DDR4-2400</td> <td rowspan="4">Intel UHD Graphics 620</td> </tr> <tr> <td>i5-8365U</td> <td>1.6 GHz</td> <td>4.1 GHz</td> <td>6MB</td> </tr> <tr> <td>i7-8565U</td> <td>1.8 GHz</td> <td>4.6 GHz</td> <td>8MB</td> </tr> <tr> <td>i7-8665U</td> <td>1.9 GHz</td> <td>4.8 GHz</td> <td>8MB</td> </tr> </tbody> </table>	Processor Number	# of Cores	# of Threads	Base Frequency	Max Turbo Frequency	Cache	Memory Types	Processor Graphics	i5-8265U	4	8	1.6 GHz	3.9 GHz	6MB	DDR4-2400	Intel UHD Graphics 620	i5-8365U	1.6 GHz	4.1 GHz	6MB	i7-8565U	1.8 GHz	4.6 GHz	8MB	i7-8665U	1.9 GHz	4.8 GHz	8MB	<p>Dimensions <i>WxDxH (black with FHD / Privacy Guard):</i> 12.95" x 8.90" x 0.66"; 329.0mm x 226.15mm x 16.7mm <i>WxDxH (black with FHD Low Power / WQHD):</i> 12.94" x 8.89" x 0.63"; 328.8mm x 225.8mm x 16.1mm <i>WxDxH (silver):</i> 12.96" x 8.92" x 0.68"; 329.15mm x 226.45mm x 17.2mm</p> <p>Weight</p> <table border="1"> <thead> <tr> <th>Models</th> <th>Black with FHD</th> <th>Black with FHD Low Power / WQHD / Privacy Guard</th> <th>Silver</th> </tr> </thead> <tbody> <tr> <td>Weight</td> <td>2.98 lb / 1.35 kg</td> <td>2.81 lb / 1.27 kg</td> <td>3.29 lb / 1.49 kg</td> </tr> </tbody> </table>	Models	Black with FHD	Black with FHD Low Power / WQHD / Privacy Guard	Silver	Weight	2.98 lb / 1.35 kg	2.81 lb / 1.27 kg	3.29 lb / 1.49 kg									
Processor Number	# of Cores	# of Threads	Base Frequency	Max Turbo Frequency	Cache	Memory Types	Processor Graphics																																							
i5-8265U	4	8	1.6 GHz	3.9 GHz	6MB	DDR4-2400	Intel UHD Graphics 620																																							
i5-8365U			1.6 GHz	4.1 GHz	6MB																																									
i7-8565U			1.8 GHz	4.6 GHz	8MB																																									
i7-8665U			1.9 GHz	4.8 GHz	8MB																																									
Models	Black with FHD	Black with FHD Low Power / WQHD / Privacy Guard	Silver																																											
Weight	2.98 lb / 1.35 kg	2.81 lb / 1.27 kg	3.29 lb / 1.49 kg																																											
<p>Graphics Intel UHD Graphics 620 in processor; supports external digital monitor via HDMI or Thunderbolt; supports three independent displays; Max resolution: 4096x2304@60Hz (Thunderbolt); 4096x2160@24Hz (HDMI)</p>	<p>Case color Black or Silver Case material <i>Display cover:</i> CFRP Hybrid (black) or Aluminum (silver); <i>Bottom:</i> Magnesium</p>																																													
<p>Chipset Intel SoC (System on Chip) platform Memory 8GB, 16GB or 32GB / 2400MHz DDR4 / soldered to systemboard, no sockets <i>* Installed memory is actually 2666MHz but run at 2400MHz due to Intel limitation</i></p>	<p>Smart card reader <i>Optional:</i> Smart card reader Media reader MicroSD card reader Ports Two USB 3.1 Gen 1 (one Always On), one USB 3.1 Type-C Gen 1 (with the function of Power Delivery and DisplayPort), one USB 3.1 Type-C Gen 2 / Thunderbolt 3 (with the function of PD and DP), HDMI 1.4b, Ethernet extension connector, nano-SIM card slot (WWAN models), headphone / microphone combo jack, optional smart card reader, microSD card reader, side docking connector, security keyhole <i>* Depending on many factors, actual data transfer speed may be lower than theoretical speed</i></p>																																													
<p>Display</p> <table border="1"> <thead> <tr> <th>Size</th> <th>Resolution</th> <th>Type</th> <th>Surface</th> <th>Brightness</th> <th>Aspect Ratio</th> <th>Contrast Ratio</th> <th>Color Gamut</th> <th>Viewing Angle</th> </tr> </thead> <tbody> <tr> <td>14.0"</td> <td>FHD (1920x1080)</td> <td>IPS</td> <td>Anti-glare</td> <td>250 nits (non-touch) 300 nits (multi-touch)</td> <td>16:9</td> <td>700:1</td> <td>45%</td> <td>170°</td> </tr> <tr> <td>14.0"</td> <td>FHD (1920x1080) Low Power</td> <td>IPS</td> <td>Anti-glare</td> <td>400 nits</td> <td>16:9</td> <td>800:1</td> <td>72%</td> <td>170°</td> </tr> <tr> <td>14.0"</td> <td>FHD (1920x1080) ThinkPad Privacy Guard</td> <td>IPS</td> <td>Anti-glare</td> <td>400 nits</td> <td>16:9</td> <td>1000:1</td> <td>72%</td> <td>170°</td> </tr> <tr> <td>14.0"</td> <td>WQHD (2560x1440) HDR, Dolby Vision™</td> <td>IPS</td> <td>Glossy</td> <td>500 nits</td> <td>16:9</td> <td>1500:1</td> <td>100% Adobe</td> <td>170°</td> </tr> </tbody> </table>	Size	Resolution	Type	Surface	Brightness	Aspect Ratio	Contrast Ratio	Color Gamut	Viewing Angle	14.0"	FHD (1920x1080)	IPS	Anti-glare	250 nits (non-touch) 300 nits (multi-touch)	16:9	700:1	45%	170°	14.0"	FHD (1920x1080) Low Power	IPS	Anti-glare	400 nits	16:9	800:1	72%	170°	14.0"	FHD (1920x1080) ThinkPad Privacy Guard	IPS	Anti-glare	400 nits	16:9	1000:1	72%	170°	14.0"	WQHD (2560x1440) HDR, Dolby Vision™	IPS	Glossy	500 nits	16:9	1500:1	100% Adobe	170°	<p>Monitor cable (optional) <i>HDMI to VGA:</i> Lenovo HDMI to VGA Monitor Adapter <i>USB-C to VGA:</i> Lenovo USB-C to VGA Adapter <i>USB-C to DP:</i> Lenovo USB-C to DisplayPort Adapter <i>Optional:</i> ThinkPad Ethernet Extension Adapter Gen 2</p> <p>Bundled Accy <i>Optional:</i> ThinkPad Ethernet Extension Adapter Gen 2</p> <p>Camera <i>One of the following, configurable by model:</i> • HD720p camera with ThinkShutter camera privacy, fixed focus • IR camera and HD720p camera with ThinkShutter camera privacy, fixed focus</p> <p>Audio support HD Audio, Realtek® ALC3287 codec / stereo speakers, 1W x 2, Dolby® Audio™ Premium / dual array far-field microphone, headphone / microphone combo jack</p>
Size	Resolution	Type	Surface	Brightness	Aspect Ratio	Contrast Ratio	Color Gamut	Viewing Angle																																						
14.0"	FHD (1920x1080)	IPS	Anti-glare	250 nits (non-touch) 300 nits (multi-touch)	16:9	700:1	45%	170°																																						
14.0"	FHD (1920x1080) Low Power	IPS	Anti-glare	400 nits	16:9	800:1	72%	170°																																						
14.0"	FHD (1920x1080) ThinkPad Privacy Guard	IPS	Anti-glare	400 nits	16:9	1000:1	72%	170°																																						
14.0"	WQHD (2560x1440) HDR, Dolby Vision™	IPS	Glossy	500 nits	16:9	1500:1	100% Adobe	170°																																						
<p>Multi-touch (opt) On-cell touch, supports 10-finger gesture (FHD only)</p>																																														
<p>Storage</p> <ul style="list-style-type: none"> • M.2 2280 SSD / SATA 6.0Gb/s • M.2 2280 SSD / PCIe NVMe, PCIe 3.0 x 4 • M.2 2242 SSD / PCIe NVMe, PCIe 3.0 x 2 • Intel Optane™ Memory H10 with Solid State Storage, M.2 2280, PCIe NVMe 3.0 x 4 <p>Optical None</p>	<p>Keyboard 6-row, spill-resistant, multimedia Fn keys, optional LED backlight UltraNav™ TrackPoint® pointing device and buttonless Mylar surface multi-touch touchpad</p> <p>Security Power-on password, hard disk password, supervisor password, security keyhole Security chip Discrete TPM 2.0, TCG Certified System Mgt (opt) Intel vPro Technology Fingerprint reader <i>Optional:</i> Touch style match on chip fingerprint reader on the palm rest NFC (optional) Near Field Communication</p>																																													
<p>Ethernet Native Intel Ethernet Connection I219-V (<i>Non-vPro</i>) or I219-LM (<i>vPro</i>) via bundled or optional ThinkPad Ethernet Extension Adapter Gen 2</p>																																														
<p>WLAN + Bluetooth™ (optional) <i>One of the following, configurable by model:</i></p> <ul style="list-style-type: none"> • Intel Wireless-AC 9560, Wi-Fi 2x2 802.11ac + Bluetooth 5.0 • Intel Wi-Fi 6 AX200, Wi-Fi 2x2 802.11ax + Bluetooth 5.0 	<p>Battery Integrated Li-ion 57Wh battery, supports Rapid Charge (charge up to 80% in 1hr) Max battery life <i>MobileMark® 2014:</i> 20 hr <i>* Battery life varies significantly with settings, usage, & other factors</i> AC adapter 45W or 65W USB Type-C AC adapter</p>																																													
<p>WWAN (optional) <i>One of the following, configurable by model:</i></p> <ul style="list-style-type: none"> • Wireless WAN upgradable • Integrated Mobile Broadband 4G LTE, Fibocom L830-EB, M.2 card (EMEA only) • Integrated Mobile Broadband 4G LTE-A, Fibocom L850-GL, M.2 card <p><i>* For non-WWAN model, it means the model is NOT WWAN upgradable</i></p>	<p>Preload Windows® 10 Home 64 or Windows 10 Pro 64</p> <p>Limited warranty <i>One of the following, configurable by model:</i></p> <ul style="list-style-type: none"> • 1-year depot repair service • 3-year/1-yr battery depot repair service • 3-year/1-yr battery limited onsite service 																																													
<p>SIM card (opt) Nano-SIM card slot, optional Verizon LTE (US) SIM card</p>	<p>Mil-Spec test MIL-STD-810G military testing</p> <p>Environment EPEAT™ Silver; ENERGY STAR® 7.1; RoHS-compliant</p>																																													

Note: The specifications above may not be available in all regions.

Lenovo
July 2019



AMD



AMD



AMD



AMD



AMD



AMD

ThinkPad T495 Platform Specifications

Product Specifications Reference (PSREF)

Processor	AMD Ryzen™ PRO Mobile Processors with Radeon™ Vega Graphics									Dimensions WxDxH: 12.95" x 8.94" x 0.70"; 329mm x 227mm x 17.9mm
	Processor Number	# of Cores	# of Threads	Base Frequency	Max Turbo Frequency	Cache	Memory Controller	Processor Graphics		
	Ryzen 3 Pro 3300U	4	4	2.1 GHz	3.5 GHz	2MB L2 / 4MB L3	DDR4-2400	Radeon Vega 6 Graphics		
	Ryzen 5 Pro 3500U	4	8	2.1 GHz	3.7 GHz	2MB L2 / 4MB L3		Radeon Vega 8 Graphics		
Ryzen 7 Pro 3700U	4	8	2.3 GHz	4.0 GHz	2MB L2 / 4MB L3	Radeon Vega 10 Graphics				
Graphics	AMD Radeon Vega 6, Vega 8, or Vega 10 Graphics in processor; supports external digital monitor via USB-C or HDMI; supports four independent displays; Max resolution: 5120x2880@60Hz (USB-C); 4096x2160@60Hz (HDMI)									Case color Black Case material Display cover: PPS / 50% GF; Bottom: PA / 50% GF
Chipset	AMD SoC (System on Chip) platform									
Memory	32GB max / 2400MHz DDR4, dual-channel capable, 8GB or 16GB memory soldered to systemboard, one DDR4 SO-DIMM socket * Installed memory is actually 2666MHz but run at 2400MHz due to AMD limitation									
Display	Size	Resolution	Type	Surface	Brightness	Aspect Ratio	Contrast Ratio	Color Gamut	Viewing Angle	
	14.0"	HD (1366x768)	TN	Anti-glare	220 nits	16:9	400:1	45%	90°	
	14.0"	FHD (1920x1080)	IPS	Anti-glare	250 nits (non-touch) 300 nits (multi-touch)	16:9	700:1	45%	170°	
	14.0"	FHD (1920x1080) Low Power	IPS	Anti-glare	400 nits	16:9	800:1	72%	170°	
Multi-touch (opt)	On-cell touch, supports 10-finger gesture (FHD only)									Smart card reader Optional: Smart card reader Media reader MicroSD card reader Ports One USB 3.1 Gen 1 (Always On), one USB 3.1 Gen 2, two USB 3.1 Type-C Gen 2 (with the function of Power Delivery and DisplayPort), HDMI 2.0, Ethernet (RJ-45), nano-SIM card slot (WWAN models), headphone / microphone combo jack, optional smart card reader, microSD card reader, side docking connector, security keyhole * Depending on many factors, actual data transfer speed may be lower than theoretical speed Monitor cable (optional) HDMI to VGA: Lenovo HDMI to VGA Monitor Adapter USB-C to VGA: Lenovo USB-C to VGA Adapter USB-C to DP: Lenovo USB-C to DisplayPort Adapter Bundled Accy None
Storage	<ul style="list-style-type: none"> M.2 2280 SSD / SATA 6.0Gb/s M.2 2280 SSD / PCIe NVMe, PCIe 3.0 x 4 M.2 2242 SSD / PCIe NVMe, PCIe 3.0 x 2 									
Optical	None									
Ethernet	Realtek® RTL8111 Gigabit Ethernet connection									
WLAN	Intel Wireless-AC 9260, Wi-Fi 2x2 802.11ac + Bluetooth 5.0									Camera (optional) One of the following, configurable by model: • HD720p camera with ThinkShutter camera privacy, fixed focus • IR camera and HD720p camera with ThinkShutter camera privacy, fixed focus Audio support HD Audio, Realtek® ALC3287 codec / stereo speakers, 2W x 2, Dolby® Audio™ Premium / dual array far-field microphone, headphone / microphone combo jack Keyboard 6-row, spill-resistant, multimedia Fn keys, optional LED backlight UltraNav™ TrackPoint® pointing device and buttonless Mylar surface multi-touch touchpad Security Power-on password, hard disk password, supervisor password, security keyhole Security chip Discrete TPM 2.0, TCG Certified System Mgt DASH Management Fingerprint reader Optional: Touch style match on chip fingerprint reader on the palm rest NFC None Battery Integrated Li-ion 50Wh battery, supports Rapid Charge (charge up to 80% in 1hr) Max battery life MobileMark® 2014: 13.4 hr * Battery life varies significantly with settings, usage, & other factors AC adapter 45W or 65W USB Type-C AC adapter Preload Windows® 10 Home 64 or Windows 10 Pro 64 Limited warranty One of the following, configurable by model: • 1-year depot repair service • 3-year/1-yr battery depot repair service Mil-Spec test MIL-STD-810G military testing Environment EPEAT™ Silver; ENERGY STAR® 7.1; RoHS-compliant
Bluetooth™	Bluetooth 5.0 wireless, integrated in Wi-Fi + Bluetooth combo adapter									
WWAN (optional)	One of the following, configurable by model: <ul style="list-style-type: none"> Wireless WAN upgradable Integrated Mobile Broadband 4G LTE-A, Fibocom L850-GL, M.2 card * For non-WWAN model, it means the model is NOT WWAN upgradable									
SIM card (opt)	Nano-SIM card slot, optional Verizon LTE (US) SIM card									

Note: The specifications above may not be available in all regions.

Lenovo
July 2019



AMD



AMD



AMD



AMD



AMD



AMD

ThinkPad T495s Platform Specifications

Product Specifications Reference (PSREF)

Processor	AMD Ryzen™ PRO Mobile Processors with Radeon™ Vega Graphics									Dimensions	<i>WxDxH (FHD / Privacy Guard):</i> 12.95" x 8.90" x 0.66"; 329.0mm x 226.15mm x 16.7mm			
	Processor Number	# of Cores	# of Threads	Base Frequency	Max Turbo Frequency	Cache	Memory Controller	Processor Graphics			<i>WxDxH (Low Power):</i> 12.94" x 8.89" x 0.63"; 328.8mm x 225.8mm x 16.1mm			
Graphics	Ryzen 5 Pro 3500U	4	8	2.1 GHz	3.7 GHz	2MB L2 / 4MB L3	DDR4-2400	Radeon Vega 8 Graphics		Weight	Models	FHD	FHD Low Power	FHD Privacy Guard
	Ryzen 7 Pro 3700U	4	8	2.3 GHz	4.0 GHz	2MB L2 / 4MB L3		Radeon Vega 10 Graphics			Weight	2.92 lb / 1.33 kg	2.76 lb / 1.25 kg	2.89 lb / 1.31 kg
Chipset	AMD SoC (System on Chip) platform									Case color	Black			
Memory	8GB or 16GB / 2400MHz DDR4 / soldered to systemboard, no sockets <i>* Installed memory is actually 2666MHz but run at 2400MHz due to AMD limitation</i>									Case material	<i>Display cover:</i> CFRP Hybrid; <i>Bottom:</i> Magnesium/Aluminum			
Display	Size	Resolution	Type	Surface	Brightness	Aspect Ratio	Contrast Ratio	Color Gamut	Viewing Angle	Smart card reader	Optional: Smart card reader			
	14.0"	FHD (1920x1080)	IPS	Anti-glare	250 nits (non-touch) 300 nits (multi-touch)	16:9	700:1	45%	170°	Media reader	MicroSD card reader			
	14.0"	FHD (1920x1080) Low Power	IPS	Anti-glare	400 nits	16:9	800:1	72%	170°	Ports	One USB 3.1 Gen 1 (Always On), one USB 3.1 Gen 2, two USB 3.1 Type-C Gen 2 (with the function of Power Delivery and DisplayPort), HDMI 2.0, Ethernet extension connector, nano-SIM card slot (WWAN models), headphone / microphone combo jack, optional smart card reader, microSD card reader, side docking connector, security keyhole <i>* Depending on many factors, actual data transfer speed may be lower than theoretical speed</i>			
	14.0"	FHD (1920x1080) ThinkPad Privacy Guard	IPS	Anti-glare	400 nits	16:9	1000:1	72%	170°	Monitor cable (optional)	HDMI to VGA: Lenovo HDMI to VGA Monitor Adapter USB-C to VGA: Lenovo USB-C to VGA Adapter Optional: ThinkPad Ethernet Extension Adapter Gen 2			
Multi-touch (opt)	On-cell touch, supports 10-finger gesture (FHD only)									Camera	<i>One of the following, configurable by model:</i> • HD720p camera with ThinkShutter camera privacy, fixed focus • IR camera and HD720p camera with ThinkShutter camera privacy, fixed focus			
Storage	M.2 2280 SSD / PCIe NVMe, PCIe 3.0 x 4									Audio support	HD Audio, Realtek® ALC3287 codec / stereo speakers, 1W x 2, Dolby® Audio™ Premium / dual array far-field microphone, headphone / microphone combo jack			
Optical	None									Keyboard	6-row, spill-resistant, multimedia Fn keys, optional LED backlight			
Ethernet	Native Intel Ethernet Connection I219-V (<i>Non-vPro</i>) or I219-LM (<i>vPro</i>) via bundled or optional ThinkPad Ethernet Extension Adapter Gen 2									UltraNav™	TrackPoint® pointing device and buttonless Mylar surface multi-touch touchpad			
WLAN (optional)	Intel Wireless-AC 9260, Wi-Fi 2x2 802.11ac + Bluetooth 5.0									Security	Power-on password, hard disk password, supervisor password, security keyhole			
Bluetooth™	Bluetooth 5.0 wireless, integrated in Wi-Fi + Bluetooth combo adapter									Security chip	Discrete TPM 2.0, TCG Certified			
WWAN (optional)	<i>One of the following, configurable by model:</i> • Wireless WAN upgradable • Integrated Mobile Broadband 4G LTE-A, Fibocom L850-GL, M.2 card <i>* For non-WWAN model, it means the model is NOT WWAN upgradable</i>									System Mgt	DASH Management			
SIM card (opt)	Nano-SIM card slot, optional Verizon LTE (US) SIM card									Fingerprint reader	Optional: Touch style match on chip fingerprint reader on the palm rest			
										NFC	None			
										Battery	Integrated Li-ion 57Wh battery, supports Rapid Charge (charge up to 80% in 1hr)			
										Max battery life	<i>MobileMark® 2014:</i> 16.4 hr <i>* Battery life varies significantly with settings, usage, & other factors</i>			
										AC adapter	45W or 65W USB Type-C AC adapter			
										Preload	Windows® 10 Home 64 or Windows 10 Pro 64			
										Limited warranty	<i>One of the following, configurable by model:</i> • 1-year depot repair service • 3-year/1-yr battery depot repair service			
										Mil-Spec test	MIL-STD-810G military testing			
										Environment	EPEAT™ Silver; ENERGY STAR® 7.1; RoHS-compliant			

Note: The specifications above may not be available in all regions.

Lenovo
July 2019



ThinkPad T580 Platform Specifications

Product Specifications Reference (PSREF)

Processor	7th Generation Intel® Core™ i5 Processor							Dimensions Weight	<i>WxDxH:</i> 14.40" x 9.95" x 0.79-0.80"; 365.8mm x 252.8mm x 19.95-20.2mm <i>Integrated model:</i> starting at 4.29 lb / 1.95 kg; <i>Discrete model:</i> starting at 4.39 lb / 1.99 kg														
	Processor Number	# of Cores	# of Threads	Base Frequency	Max Turbo Frequency	Cache	Memory Types			Processor Graphics													
	i5-7200U	2	4	2.5 GHz	3.1 GHz	3MB	DDR4-2133	Intel HD Graphics 620															
	i5-7300U			2.6 GHz	3.5 GHz	3MB																	
	or 8th Generation Intel Core i5 / i7 Processor							Smart card reader Media reader Ports	<i>Optional:</i> Smart card reader 4-in-1 reader (MMC, SD, SDHC, SDXC) Two USB 3.1 Gen 1 (one Always On), one USB 3.1 Type-C Gen 1 (with the function of Power Delivery and DisplayPort), one USB 3.1 Type-C Gen 2 / Thunderbolt 3 (with the function of PD and DP), HDMI 1.4b, Ethernet (RJ-45), nano-SIM card slot (WWAN models), headphone / microphone combo jack, optional smart card reader, 4-in-1 reader (MMC, SD, SDHC, SDXC), side docking connector, security keyhole <i>* Depending on many factors, actual data transfer speed may be lower than theoretical speed</i>														
	Processor Number	# of Cores	# of Threads	Base Frequency	Max Turbo Frequency	Cache	Memory Types			Processor Graphics													
	i5-8250U	4	8	1.6 GHz	3.4 GHz	6MB	DDR4-2400	Intel UHD Graphics 620															
	i5-8350U			1.7 GHz	3.6 GHz	6MB																	
	i7-8550U			1.8 GHz	4.0 GHz	8MB																	
	i7-8650U			1.9 GHz	4.2 GHz	8MB																	
Graphics	Intel HD Graphics 620 or Intel UHD Graphics 620 in processor only or Intel HD Graphics 620 or Intel UHD Graphics 620 in processor and NVIDIA® GeForce® MX150, 2GB GDDR5 memory; supports external digital monitor via HDMI or USB Type-C; supports three independent displays; Max resolution: 4096x2304@60Hz (USB Type-C); 4096x2160@30Hz (HDMI)							Monitor cable (optional)	HDMI to VGA: Lenovo HDMI to VGA Monitor Adapter USB-C to DP: Lenovo USB-C to DisplayPort Adapter														
Chipset Memory	Intel SoC (System on Chip) platform 32Gb max / 2400MHz DDR4, dual-channel capable, two DDR4 SO-DIMM sockets <i>* System clocks down for processors with lower memory controller</i>							Camera (optional)	<i>One of the following, configurable by model:</i> • HD720p camera with ThinkShutter camera privacy, fixed focus • IR camera and HD720p camera, fixed focus														
Display	<i>Some:</i> 15.6" (396mm) FHD (1920x1080), anti-glare, LED backlight, IPS, 250 nits, 16:9 aspect ratio, 700:1 contrast ratio, 170° viewing angle <i>Some:</i> 15.6" (396mm) UHD (3840x2160), anti-glare, LED backlight, IPS, 300 nits, 16:9 aspect ratio, 1000:1 contrast ratio, 72% gamut, 170° viewing angle							Audio support	HD Audio, Realtek® ALC3287 codec / stereo speakers, 2W x 2, Dolby® Audio™ Premium / dual array microphone, headphone / microphone combo jack														
Multi-touch (opt)	On-cell touch, supports 10-finger gesture (FHD only)							Keyboard UltraNav™	6-row, spill-resistant, multimedia Fn keys, numeric keypad, optional LED backlight TrackPoint® pointing device and buttonless Mylar surface multi-touch touchpad														
Storage	<i>System has one HDD slot or one M.2 2280 slot exclusively for storage</i> <i>Some:</i> HDD / SATA 6.0Gb/s, 2.5" wide, 7mm high, Active Protection System™ <i>Some:</i> SSD / SATA 6.0Gb/s, 2.5" wide, 7mm high (e.g. xxxGB SSD) <i>Some:</i> M.2 SSD / PCIe NVMe, PCIe 3.0 x 2, 16Gb/s <i>Some:</i> 128GB M.2 SSD / PCIe NVMe, PCIe 3.0 x 2, 16Gb/s, in WWAN slot as 2nd Storage, mutually exclusive with WWAN							Security Security chip vPro (optional)	Power-on password, hard disk password, supervisor password, security keyhole Discrete TPM 2.0, TCG Certified Intel vPro Technology														
Optane™ memory Optical	<i>Optional:</i> Intel Optane memory, PCIe NVMe, PCIe 3.0 x 2 None							Fingerprint reader	<i>Optional:</i> Touch style match on chip fingerprint reader on the palm rest, anti-spoofing technology														
Ethernet	<i>Non-vPro model:</i> Intel Ethernet Connection I219-V (Jacksonville) <i>vPro model:</i> Intel Ethernet Connection I219-LM (Jacksonville)							NFC (optional)	Near Field Communication														
WLAN + Bluetooth™	Intel Dual Band Wireless-AC 8265, Wi-Fi 2x2 802.11ac + Bluetooth 4.1, M.2 card <i>* Intel 8265ac card supports BT4.2 but is limited to BT4.1 by Windows OS</i>							Battery	Optional integrated Li-ion 32Wh battery and external Li-ion 24Wh, 48Wh, or 72Wh battery														
WWAN (optional)	<i>One of the following, configurable by model:</i> • Integrated Mobile Broadband 4G LTE, Intel XMM™ 7262 (Fibocom L830-EB), M.2 card (EMEA only) • Integrated Mobile Broadband 4G LTE-A, Intel XMM™ 7360 (Fibocom L850-GL), M.2 card <i>* For non-WWAN model, it means the model is NOT WWAN upgradable</i>							Max battery life (MobileMark® 2014)	<table border="1"> <thead> <tr> <th>Models</th> <th>24Wh</th> <th>48Wh</th> <th>72Wh</th> <th>32Wh + 24Wh</th> <th>32Wh + 48Wh</th> <th>32Wh + 72Wh</th> </tr> </thead> <tbody> <tr> <td><i>Max battery life</i></td> <td>5.8 hr</td> <td>12.5 hr</td> <td>18.1 hr</td> <td>13.8 hr</td> <td>20.3 hr</td> <td>26.1 hr</td> </tr> </tbody> </table> <i>* Battery life varies significantly with settings, usage, & other factors</i>	Models	24Wh	48Wh	72Wh	32Wh + 24Wh	32Wh + 48Wh	32Wh + 72Wh	<i>Max battery life</i>	5.8 hr	12.5 hr	18.1 hr	13.8 hr	20.3 hr	26.1 hr
Models	24Wh	48Wh	72Wh	32Wh + 24Wh	32Wh + 48Wh	32Wh + 72Wh																	
<i>Max battery life</i>	5.8 hr	12.5 hr	18.1 hr	13.8 hr	20.3 hr	26.1 hr																	
SIM card (opt)	Nano-SIM card slot, optional Verizon LTE (US) SIM card							AC adapter	45W or 65W USB Type-C AC adapter														
								Preload	Windows® 10 Home 64 or Windows 10 Pro 64														
								Limited warranty	<i>One of the following, configurable by model:</i> • 1-year depot repair service • 3-year/1-yr battery depot repair service • 3-year/1-yr battery limited onsite service														
								Mil-Spec test	MIL-STD-810G military testing														
								Environment	EPEAT™ Silver; ENERGY STAR® 6.1; RoHS-compliant														

Note: The specifications above may not be available in all regions.

Lenovo
July 2019



ThinkPad T590 Platform Specifications

Product Specifications Reference (PSREF)

Processor	8th Generation Intel® Core™ i5 / i7 Processor									Dimensions Weight Case color Case material	<i>WxDxH:</i> 14.40" x 9.76" x 0.75"; 365.8mm x 248mm x 19.1mm <i>FHD model:</i> 3.87 lb / 1.75 kg; <i>UHD model:</i> 3.86 lb / 1.75 kg Black <i>Display cover:</i> PPS / 50% GF; <i>Bottom:</i> PA / 50% GF
	Processor Number	# of Cores	# of Threads	Base Frequency	Max Turbo Frequency	Cache	Memory Types	Processor Graphics			
	i5-8265U	4	8	1.6 GHz	3.9 GHz	6MB	DDR4-2400	Intel UHD Graphics 620			
	i5-8365U			1.6 GHz	4.1 GHz	6MB					
	i7-8565U			1.8 GHz	4.6 GHz	8MB					
i7-8665U	1.9 GHz			4.8 GHz	8MB						
Graphics	Intel UHD Graphics 620 in processor only or Intel UHD Graphics 620 in processor and NVIDIA® GeForce® MX250, 2GB GDDR5 memory; supports external digital monitor via HDMI or Thunderbolt; supports three independent displays; Max resolution: 4096x2304@60Hz (Thunderbolt); 4096x2160@24Hz (HDMI)									Smart card reader Media reader Ports	<i>Optional:</i> Smart card reader MicroSD card reader Two USB 3.1 Gen 1 (one Always On), one USB 3.1 Type-C Gen 1 (with the function of Power Delivery and DisplayPort), one USB 3.1 Type-C Gen 2 / Thunderbolt 3 (with the function of PD and DP), HDMI 1.4b, Ethernet (RJ-45), nano-SIM card slot (WWAN models), headphone / microphone combo jack, optional smart card reader, microSD card reader, side docking connector, security keyhole <i>* Depending on many factors, actual data transfer speed may be lower than theoretical speed</i>
Chipset Memory	Intel SoC (System on Chip) platform 48GB max / 2400MHz DDR4, dual-channel capable, 8GB or 16GB memory soldered to systemboard, one DDR4 SO-DIMM socket * Installed memory is actually 2666MHz but run at 2400MHz due to Intel limitation									Monitor cable (optional) Bundled Accy	<i>HDMI to VGA:</i> Lenovo HDMI to VGA Monitor Adapter <i>USB-C to VGA:</i> Lenovo USB-C to VGA Adapter (NOT available in EMEA) <i>USB-C to DP:</i> Lenovo USB-C to DisplayPort Adapter (NOT available in EMEA) None
Display	Size	Resolution	Type	Surface	Brightness	Aspect Ratio	Contrast Ratio	Color Gamut	Viewing Angle	Camera (optional) Audio support	<i>One of the following, configurable by model:</i> <ul style="list-style-type: none"> • HD720p camera with ThinkShutter camera privacy, fixed focus • IR camera and HD720p camera with ThinkShutter camera privacy, fixed focus HD Audio, Realtek® ALC3287 codec / stereo speakers, 2W x 2, Dolby® Audio™ Premium / dual array far-field microphone, headphone / microphone combo jack
	15.6"	FHD (1920x1080)	IPS	Anti-glare	250 nits	16:9	700:1	45%	170°		
	15.6"	UHD (3840x2160) HDR, Dolby Vision™	IPS	Anti-glare	500 nits	16:9	1200:1	100% Adobe	170°		
Multi-touch (opt)	On-cell touch, supports 10-finger gesture (FHD only)									Keyboard UltraNav™	6-row, spill-resistant, multimedia Fn keys, numeric keypad, optional LED backlight TrackPoint® pointing device and buttonless Mylar surface multi-touch touchpad
Storage	<ul style="list-style-type: none"> • M.2 2280 SSD / SATA 6.0Gb/s • M.2 2280 SSD / PCIe NVMe, PCIe 3.0 x 4 • M.2 2242 SSD / PCIe NVMe, PCIe 3.0 x 2 • Intel Optane™ Memory H10 with Solid State Storage, M.2 2280, PCIe NVMe 3.0 x 4 									Security Security chip System Mgt (opt) Fingerprint reader NFC (optional)	Power-on password, hard disk password, supervisor password, security keyhole Discrete TPM 2.0, TCG Certified Intel vPro Technology <i>Optional:</i> Touch style match on chip fingerprint reader on the palm rest Near Field Communication
Optical	None									Battery	Integrated Li-ion 57Wh battery, supports Rapid Charge (charge up to 80% in 1hr) with 65W USB Type-C AC adapter
Ethernet	<i>Non-vPro model:</i> Intel Ethernet Connection I219-V (Jacksonville) <i>vPro model:</i> Intel Ethernet Connection I219-LM (Jacksonville)									Max battery life	<i>MobileMark® 2014:</i> 14.98 hr (9.5 hr for UHD model with discrete graphics) <i>* Battery life varies significantly with settings, usage, & other factors</i>
WLAN (optional) Bluetooth™	Intel Wireless-AC 9560, Wi-Fi 2x2 802.11ac + Bluetooth 5.0 Bluetooth 5.0 wireless, integrated in Wi-Fi + Bluetooth combo adapter									AC adapter	45W or 65W USB Type-C AC adapter
WWAN (optional)	<i>One of the following, configurable by model:</i> <ul style="list-style-type: none"> • Wireless WAN upgradable • Integrated Mobile Broadband 4G LTE, Fibocom L830-EB, M.2 card (EMEA only) • Integrated Mobile Broadband 4G LTE-A, Fibocom L850-GL, M.2 card <i>* For non-WWAN model, it means the model is NOT WWAN upgradable</i>									Preload	Windows® 10 Home 64 or Windows 10 Pro 64
SIM card	Nano-SIM card slot, optional Verizon LTE (US) SIM card									Limited warranty	<i>One of the following, configurable by model:</i> <ul style="list-style-type: none"> • 1-year depot repair service • 3-year/1-yr battery depot repair service • 3-year/1-yr battery limited onsite service
										Mil-Spec test	MIL-STD-810G military testing
										Environment	EPEAT™ Silver; ENERGY STAR® 7.1; RoHS-compliant

Note: The specifications above may not be available in all regions.

Lenovo
July 2019



ThinkPad X1 Carbon (5th Gen) Platform Specifications

Product Specifications Reference (PSREF)

Processor	6th Generation Intel® Core™ i5 / i7 Processor (EMEA has only i5-6300U and i7-6600U)								Smart card reader	None									
	Processor Number	# of Cores	# of Threads	Base Frequency	Max Turbo Frequency	Cache	Memory Types	Processor Graphics	Media reader	MicroSD card reader, supports UHS-II microSD card									
	i5-6200U	2	4	2.3 GHz	2.8 GHz	3MB	LPDDR3-1866	Intel HD Graphics 520	Ports	Two USB 3.1 Gen 1 (USB 3.0, one Always On), two USB 3.1 Type-C Gen 2 / Thunderbolt 3 (with the function of Power Delivery and DisplayPort), HDMI 1.4b, Ethernet extension connector									
	i5-6300U			2.4 GHz	3.0 GHz	3MB			* Depending on many factors, actual data transfer speed may be lower than theoretical speed										
	i7-6500U			2.5 GHz	3.1 GHz	4MB													
	i7-6600U			2.6 GHz	3.4 GHz	4MB													
	or 7th Generation Intel Core i5 / i7 Processor								WiGig dock (opt)	ThinkPad WiGig dock									
	Processor Number	# of Cores	# of Threads	Base Frequency	Max Turbo Frequency	Cache	Memory Types	Processor Graphics	Monitor cable (optional)	HDMI to VGA: Lenovo HDMI to VGA Monitor Adapter USB-C to VGA: Lenovo USB-C to VGA Adapter USB-C to DP: Lenovo USB-C to DisplayPort Adapter									
	i5-7200U	2	4	2.5 GHz	3.1 GHz	3MB	LPDDR3-1866	Intel HD Graphics 620	Bundled Accy	Optional: ThinkPad Ethernet Extension Cable									
	i5-7300U			2.6 GHz	3.5 GHz	3MB													
	i7-7500U			2.7 GHz	3.5 GHz	4MB													
	i7-7600U			2.8 GHz	3.9 GHz	4MB													
Graphics	Intel HD Graphics 520 or 620 in processor; supports external digital monitor via HDMI or USB Type-C; supports three independent displays; Max resolution: 4096x2304@60Hz (USB Type-C); 4096x2160@24Hz (HDMI)								Camera (optional)	720p: HD720p resolution, fixed focus IR & 720p: IR camera and HD720p camera									
Chipset	Intel SoC (System on Chip) platform								Audio support	HD Audio, Conexant® CX11871 codec / stereo speakers, 2W x 2 / dual array microphone, combo audio/microphone jack									
Memory	8GB or 16GB / 1866MHz LPDDR3 / soldered to systemboard, no sockets								Keyboard	6-row, spill-resistant, multimedia Fn keys, LED backlight									
Display	Some: 14.0" (355mm) FHD (1920x1080), anti-glare, LED backlight, IPS, 300 nits, 16:9 aspect ratio, 700:1 contrast ratio, 170° viewing angle Some: 14.0" (355mm) WQHD (2560x1440), anti-glare, LED backlight, IPS, 300 nits, 16:9 aspect ratio, 700:1 contrast ratio, 170° viewing angle								UltraNav™	TrackPoint® pointing device and buttonless Glass surface multi-touch touchpad									
Multi-touch	None								Security	Power-on password, hard disk password, supervisor password, security keyhole									
Storage	One of the following, configurable by model: • M.2 SSD / SATA 6.0Gb/s (e.g. xxxGB SSD M.2) • M.2 SSD / PCIe NVMe, PCIe 3.0 x 4, 32Gb/s (e.g. xxxGB SSD M.2 PCIe NVMe)								Security chip vPro (optional)	Discrete TPM 2.0, TCG Certified									
Optical	None								Fingerprint reader	Intel vPro Technology Touch style match on chip fingerprint reader on the palm rest									
Ethernet	Native Intel Ethernet Connection I219-V (Non-vPro) or I219-LM (vPro) via bundled or optional ThinkPad Ethernet Extension Cable								NFC (optional)	Near Field Communication									
WLAN	One of the following, configurable by model (WiGig can coexist with WWAN): • Intel Dual Band Wireless-AC 8260, Wi-Fi 2x2 802.11ac + BT4.1, M.2 card • Intel Dual Band Wireless-AC 8265, Wi-Fi 2x2 802.11ac + BT4.1, M.2 card • Intel Tri-Band Wireless-AC 18265, WiGig 802.11ad + Wi-Fi 2x2 802.11ac + BT4.1, M.2 card								Battery	Integrated Li-Polymer 3-cell (57Wh) RapidCharge battery									
Bluetooth™	Bluetooth 4.1 wireless, integrated in Wi-Fi + Bluetooth combo adapter * Intel 8265ac / 18265ac card support BT4.2 but is limited to BT4.1 by Windows OS								Max battery life	MobileMark® 2014: 15.5 hr * Battery life varies significantly with settings, usage, & other factors									
WWAN (optional)	Integrated Mobile Broadband 4G LTE-A, Qualcomm® Snapdragon™ X7 LTE-A (Sierra Wireless EM7455)								AC adapter	45W or 65W USB Type-C AC adapter									
SIM card (opt)	Micro-SIM card slot, opt Verizon LTE (US) or Lenovo® Connect (EMEA) SIM card								RapidCharge	<table border="1"> <tr> <td>AC adapter</td> <td>45W USB-C</td> <td>65W USB-C</td> </tr> <tr> <td>Charge to 80%</td> <td>Not support</td> <td>1.0 hr</td> </tr> <tr> <td>Charge to 100%</td> <td>Not support</td> <td>2.5 hr</td> </tr> </table>	AC adapter	45W USB-C	65W USB-C	Charge to 80%	Not support	1.0 hr	Charge to 100%	Not support	2.5 hr
AC adapter	45W USB-C	65W USB-C																	
Charge to 80%	Not support	1.0 hr																	
Charge to 100%	Not support	2.5 hr																	
Dimensions	WxDxH: 12.74" x 8.55" x 0.63"; 323.5mm x 217.1mm x 15.95mm								Preload	Windows® 7 Professional 64 preinstalled through downgrade rights in Windows 10 Pro 64 Some: Windows 10 Home 64 Some: Windows 10 Pro 64 • Lenovo Companion • Lenovo Setting • Microsoft Office preloaded; purchase a product key to activate									
Weight	Starting at 2.49 lb / 1.13 kg								Limited warranty	One of the following, configurable by model: • 1-year depot repair service • 3-year/1-yr battery depot repair service • 3-year/1-yr battery limited onsite service									
Case color	Black or Silver (silver is NOT available in EMEA)								Mil-Spec test	MIL-STD-810G military testing									
Case material	Display cover: CFRP/GFRP hybrid; Bottom: magnesium alloy hybrid								Environment	EPEAT™ Gold (US only); ENERGY STAR® 6.1; RoHS-compliant									



ThinkPad X1 Carbon (6th Gen) Platform Specifications

Product Specifications Reference (PSREF)

Processor	7th Generation Intel® Core™ i5 Processor								Dimensions Weight Case color Case material	<i>WxDxH:</i> 12.74" x 8.55" x 0.63"; 323.5mm x 217.1mm x 15.95mm Starting at 2.49 lb / 1.13 kg Black or Silver (silver case is NOT available in EMEA) <i>Display cover:</i> CFRP/GFRP hybrid; <i>Bottom:</i> magnesium alloy / PPS hybrid
	Processor Number	# of Cores	# of Threads	Base Frequency	Max Turbo Frequency	Cache	Memory Types	Processor Graphics		
	i5-7300U	2	4	2.6 GHz	3.5 GHz	3MB	LPDDR3-1866	Intel HD Graphics 620		
	or 8th Generation Intel Core i5 / i7 Processor									
	Processor Number	# of Cores	# of Threads	Base Frequency	Max Turbo Frequency	Cache	Memory Types	Processor Graphics		
	i5-8250U	4	8	1.6 GHz	3.4 GHz	6MB	LPDDR3-2133	Intel UHD Graphics 620		
	i5-8350U			1.7 GHz	3.6 GHz	6MB				
	i7-8550U			1.8 GHz	4.0 GHz	8MB				
	i7-8650U			1.9 GHz	4.2 GHz	8MB				
Graphics	Intel HD Graphics 620 or Intel UHD Graphics 620 in processor; supports external digital monitor via HDMI or USB Type-C; supports three independent displays; Max resolution: 5120x2880@60Hz (USB Type-C); 4096x2160@30Hz (HDMI)								Smart card reader Media reader Ports Monitor cable (optional) Bundled Accy	None MicroSD card reader, supports UHS-II Two USB 3.1 Gen 1 (one Always On), two USB 3.1 Type-C Gen 2 / Thunderbolt 3 (with the function of Power Delivery and DisplayPort), HDMI 1.4b, Ethernet extension connector, nano-SIM card slot (WWAN models), headphone / microphone combo jack, microSD card reader, side docking connector, security keyhole <i>* Depending on many factors, actual data transfer speed may be lower than theoretical speed</i> HDMI to VGA: Lenovo HDMI to VGA Monitor Adapter USB-C to DP: Lenovo USB-C to DisplayPort Adapter Optional: ThinkPad Ethernet Extension Adapter Gen 2
Chipset Memory	Intel SoC (System on Chip) platform 8GB or 16GB / 2133MHz LPDDR3 / soldered to systemboard, no sockets <i>* System clocks down for processors with lower memory controller</i>								Camera (optional) Audio support	One of the following, configurable by model: • HD720p camera with ThinkShutter camera privacy, fixed focus • IR camera and HD720p camera, fixed focus HD Audio, Realtek® ALC3286 codec / stereo speakers, 1W x 2, Dolby® Audio™ Premium / dual array microphone, headphone / microphone combo jack, Dolby® Atmos™ via headphones
Display	One of the following, configurable by model: • 14.0" (355mm) FHD (1920x1080), anti-glare, LED backlight, IPS, 300 nits, 16:9 aspect ratio, 700:1 contrast ratio, 72% gamut, 170° viewing angle • 14.0" (355mm) WQHD (2560x1440), anti-glare, LED backlight, IPS, 300 nits, 16:9 aspect ratio, 700:1 contrast ratio, 72% gamut, 170° viewing angle • 14.0" (355mm) HDR WQHD (2560x1440) with Dolby Vision™, glossy, LED backlight, IPS, 500 nits, 16:9 aspect ratio, 1500:1 contrast ratio, 100% gamut, 170° viewing angle								Keyboard UltraNav™	6-row, spill-resistant, multimedia Fn keys, LED backlight TrackPoint® pointing device and buttonless Glass surface multi-touch touchpad
Multi-touch (opt)	On-cell touch, supports 10-finger gesture (FHD only)								Security Security chip vPro (optional) Fingerprint reader	Power-on password, hard disk password, supervisor password, security keyhole Discrete TPM 2.0, TCG Certified Intel vPro Technology Touch style match on chip fingerprint reader on the palm rest, anti-spoofing technology
Storage	One of the following, configurable by model: • M.2 SSD / SATA 6.0Gb/s (e.g. xxxGB SSD M.2) • M.2 SSD / PCIe NVMe, PCIe 3.0 x 4, 32Gb/s (e.g. xxxGB SSD M.2 PCIe NVMe)								NFC (optional)	Near Field Communication
Optane™ memory Optical	None None								Battery Max battery life AC adapter	Integrated Li-ion 57Wh battery, supports Rapid Charge (charge up to 80% in 1hr) with 65W USB Type-C AC adapter MobileMark® 2014: 19.3 hr <i>* Battery life varies significantly with settings, usage, & other factors</i> 45W or 65W USB Type-C AC adapter
Ethernet	Native Intel Ethernet Connection I219-V (Non-vPro) or I219-LM (vPro) via bundled or optional ThinkPad Ethernet Extension Adapter Gen 2								Preload	Windows® 10 Home 64 or Windows 10 Pro 64
WLAN + Bluetooth™	Intel Dual Band Wireless-AC 8265, Wi-Fi 2x2 802.11ac + Bluetooth 4.1, M.2 card <i>* Intel 8265ac card supports BT4.2 but is limited to BT4.1 by Windows OS</i>								Limited warranty	One of the following, configurable by model: • 1-year depot repair service • 3-year/1-yr battery depot repair service • 3-year/1-yr battery limited onsite service
WWAN (optional)	Integrated Mobile Broadband 4G LTE-A, Intel XMM™ 7360 (Fibocom L850-GL), M.2 card <i>* For non-WWAN model, it means the model is NOT WWAN upgradable</i>								Mil-Spec test	MIL-STD-810G military testing
SIM card (opt)	Nano-SIM card slot, optional Verizon LTE (US) SIM card								Environment	EPEAT™ Gold (US only); ENERGY STAR® 6.1; RoHS-compliant



ThinkPad X1 Carbon (7th Gen) Platform Specifications

Product Specifications Reference (PSREF)

Processor	8th Generation Intel® Core™ i5 / i7 Processor									Dimensions <i>WxDxH:</i> 12.74" x 8.55" x 0.59"; 323.5mm x 217.1mm x 14.9mm Weight Starting at 2.4 lb / 1.09 kg Case color Black paint or black weave Case material <i>Display cover:</i> Carbon Fiber; <i>Bottom:</i> magnesium alloy
	Processor Number	# of Cores	# of Threads	Base Frequency	Max Turbo Frequency	Cache	Memory Types	Processor Graphics		
	i5-8265U	4	8	1.6 GHz	3.9 GHz	6MB	LPDDR3-2133	Intel UHD Graphics 620		
	i5-8365U			1.6 GHz	4.1 GHz	6MB				
	i7-8565U			1.8 GHz	4.6 GHz	8MB				
i7-8665U	1.9 GHz			4.8 GHz	8MB					
Graphics	Intel UHD Graphics 620 in processor; supports external digital monitor via HDMI or USB Type-C / Thunderbolt; supports three independent displays; Max resolution: 4096x2304@60Hz (Thunderbolt); 4096x2160@24Hz (HDMI)									Smart card reader None Media reader None Ports Two USB 3.1 Gen 1 (one Always On), two USB 3.1 Type-C Gen 2 / Thunderbolt 3 (with the function of Power Delivery and DisplayPort), HDMI 1.4b, Ethernet extension connector, nano-SIM card slot (WWAN models), headphone / microphone combo jack, side docking connector, security keyhole <i>* Depending on many factors, actual data transfer speed may be lower than theoretical speed</i> Monitor cable <i>Optional:</i> Lenovo HDMI to VGA Monitor Adapter Bundled Accy <i>Optional:</i> ThinkPad Ethernet Extension Adapter Gen 2 Camera <i>(optional)</i> <i>One of the following, configurable by model:</i> • HD720p camera with ThinkShutter camera privacy, fixed focus • IR camera and HD720p camera with ThinkShutter camera privacy, fixed focus Audio support HD Audio, Realtek® ALC3286 codec / Dolby® Atmos™ speaker system, 2W x 2, 0.8 x 2 / 4 array far-field microphones, headphone / microphone combo jack Keyboard 6-row, spill-resistant, multimedia Fn keys, LED backlight UltraNav™ TrackPoint® pointing device and buttonless Mylar surface multi-touch touchpad Security Power-on password, hard disk password, supervisor password, security keyhole Security chip Discrete TPM 2.0, TCG Certified System Mgt <i>(opt)</i> Intel vPro Technology Fingerprint reader Touch style match on chip fingerprint reader on the palm rest NFC <i>(optional)</i> Near Field Communication Battery Integrated Li-ion 51Wh battery, supports Rapid Charge (charge up to 80% in 1hr) with 65W USB Type-C AC adapter Max battery life <i>MobileMark® 2014:</i> 18.3 hr <i>* Battery life varies significantly with settings, usage, & other factors</i> AC adapter 45W or 65W USB Type-C AC adapter Preload Windows® 10 Home 64 or Windows 10 Pro 64 Limited warranty <i>One of the following, configurable by model:</i> • 1-year depot repair service • 3-year/1-yr battery depot repair service Mil-Spec test MIL-STD-810G military testing Environment EPEAT™ Silver; ENERGY STAR® 7.1; RoHS-compliant
Chipset Memory	Intel SoC (System on Chip) platform 8GB or 16GB / 2133MHz LPDDR3 / soldered to systemboard, no sockets									
Display	Size	Resolution	Type	Surface	Brightness	Aspect Ratio	Contrast Ratio	Color Gamut	Viewing Angle	
	14.0"	FHD (1920x1080) Multi-touch	IPS	Anti-glare	300 nits	16:9	700:1	72%	170°	
	14.0"	FHD (1920x1080) Low Power	IPS	Anti-glare	400 nits	16:9	800:1	72%	170°	
	14.0"	FHD (1920x1080) ThinkPad Privacy Guard	IPS	Anti-glare	400 nits	16:9	1000:1	72%	170°	
	14.0"	WQHD (2560x1440)	IPS	Anti-glare	300 nits	16:9	700:1	72%	170°	
	14.0"	UHD (3840x2160) HDR 400, Dolby Vision™	IPS	Glossy	500 nits	16:9	1400:1	90%	170°	
Multi-touch <i>(opt)</i>	Capacitive-type multi-touch, supports 10-finger gesture (FHD only), anti-reflection (AR), anti-smudge coating									
Storage	<i>One of the following, configurable by model:</i> • M.2 2280 SSD / SATA 6.0Gb/s • M.2 2280 SSD / PCIe NVMe 3.0 x 4 • Intel Optane™ Memory H10 with Solid State Storage, M.2 2280, PCIe NVMe 3.0 x 4 • Intel Optane SSD, M.2 2280, PCIe NVMe 3.0 x 2									
Optical	None									
Ethernet	Native Intel Ethernet Connection I219-V (<i>Non-vPro</i>) or I219-LM (<i>vPro</i>) via bundled or optional ThinkPad Ethernet Extension Adapter Gen 2									
WLAN Bluetooth™	Intel Wireless-AC 9560, Wi-Fi 2x2 802.11ac + Bluetooth 5.0 Bluetooth 5.0 wireless, integrated in Wi-Fi + Bluetooth combo adapter									
WWAN <i>(optional)</i>	<i>One of the following, configurable by model:</i> • Integrated Mobile Broadband 4G LTE-A, Fibocom L850-GL, M.2 card • Integrated Mobile Broadband 4G LTE-A, Fibocom L860-GL, MIMO 2x2, M.2 card <i>* For non-WWAN model, it means the model is NOT WWAN upgradable</i>									
SIM card <i>(opt)</i>	Nano-SIM card slot, optional Verizon LTE (US) SIM card									

Note: The specifications above may not be available in all regions.

Lenovo
July 2019

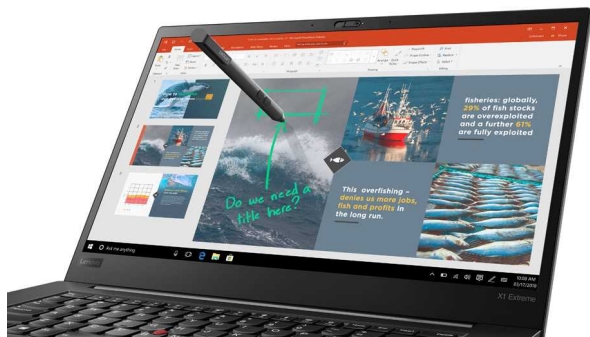

ThinkPad X1 Extreme Platform Specifications

Product Specifications Reference (PSREF)

Processor	8th Generation Intel® Core™ i5 / i7 Processor								Smart card reader	Optional: Smart card reader
	Processor Number	# of Cores	# of Threads	Base Frequency	Max Turbo Frequency	Cache	Memory Types	Processor Graphics	Media reader	SD Card reader (SD, SDHC, SDXC), supports UHS-II SD card
	i5-8300H	4	8	2.3 GHz	4.0 GHz	8MB	DDR4-2666	Intel UHD Graphics 630	Ports	Two USB 3.1 Gen 1 (one Always On), two USB 3.1 Type-C Gen 2 / Thunderbolt 3 (with the function of Power Delivery and DisplayPort), HDMI 2.0, Ethernet extension connector, headphone / microphone combo jack, optional smart card reader, SD card reader, security keyhole
	i5-8400H			2.5 GHz	4.2 GHz					
	i7-8750H	6	12	2.2 GHz	4.1 GHz	9MB				SD card reader, security keyhole
	i7-8850H			2.6 GHz	4.3 GHz					
Graphics	Intel UHD Graphics 630 in processor and NVIDIA® GeForce® GTX 1050 Ti Max-Q, 4GB GDDR5 memory; supports external digital monitor via HDMI or Thunderbolt™; supports four independent displays; Max resolution: 5120x2880@30Hz (Thunderbolt); 4096x2160@60Hz (HDMI)								Monitor cable (optional)	HDMI to VGA: Lenovo HDMI to VGA Monitor Adapter
Chipset	Mobile Intel CM246 Chipset								Bundled Accy	Optional: ThinkPad Ethernet Extension Cable
Memory	64GB max / 2666MHz DDR4, dual-channel capable, two DDR4 SO-DIMM sockets								Camera (optional)	One of the following, configurable by model:
Display	<i>Some:</i> 15.6" (396mm) FHD (1920x1080), anti-glare, LED backlight, IPS, 300 nits, 16:9 aspect ratio, 700:1 contrast ratio, 72% gamut, 170° viewing angle <i>Some:</i> 15.6" (396mm) HDR 4K (3840x2160) with Dolby Vision™, anti-glare, LED backlight, IPS, 400 nits, 16:9 aspect ratio, 1200:1 contrast ratio, 100% gamut, 170° viewing angle, multi-touch, anti-reflection (AR)								Audio support	HD Audio, Realtek® ALC3286 codec / stereo speakers, 2W x 2, Dolby® Audio™ Premium / dual array microphone, headphone / microphone combo jack, Dolby Atmos® headphone
Multi-touch (opt)	Capacitive-type multi-touch, supports 10-finger gesture (4K only)								Keyboard	6-row, spill-resistant, multimedia Fn keys, LED backlight
Pen	Supports pen accessory, please see the accessory compatibility for details								UltraNav™	TrackPoint® pointing device and buttonless glass surface multi-touch touchpad
Storage	<i>Up to 2 drives (two M.2 SSD)</i> • M.2 SSD / SATA 6.0Gb/s (e.g. xxxGB SSD M.2) • M.2 SSD / PCIe NVMe, PCIe 3.0 x 4, 32Gb/s (e.g. xxxGB SSD M.2 PCIe NVMe)								Security	Power-on password, hard disk password, supervisor password, security keyhole
Optane™ memory	None								Security chip	Discrete TPM 2.0, TCG Certified
RAID (optional)	RAID 0/1 support								vPro (optional)	Intel vPro Technology
Optical	None								Fingerprint reader	Touch style match on chip fingerprint reader on the keyboard bezel
Ethernet	Native Intel Ethernet Connection I219-V (Non-vPro) or I219-LM (vPro) via bundled or optional ThinkPad Ethernet Extension Cable								Color calibration	None
WLAN	Intel Wireless-AC 9560, Wi-Fi 2x2 802.11ac + Bluetooth 5.0, M.2 card								NFC	None
Bluetooth™	Bluetooth 5.0 wireless, integrated in Wi-Fi + Bluetooth combo adapter								Battery	Integrated Li-ion 80Wh battery, supports Rapid Charge (charge up to 80% in 1hr)
WWAN	None								Max battery life	<i>Discrete mode:</i> 9.5 hr; <i>Hybrid mode:</i> 14.9 hr
SIM card	None								(MobileMark 2014)	* Battery life varies significantly with settings, usage, & other factors
Dimensions	<i>WxDxH (non-touch):</i> 14.24" x 9.67" x 0.72"; 361.8mm x 245.7mm x 18.4mm <i>WxDxH (multi-ouch):</i> 14.24" x 9.67" x 0.74"; 361.8mm x 245.7mm x 18.7mm								AC adapter	135W slim tip AC adapter
Weight	<i>Non-touch model:</i> starting at 3.76 lb (1.7 kg); <i>Multi-touch model:</i> starting at 4.06 lb (1.8 kg)								Preload	Windows® 10 Home 64 or Windows 10 Pro 64
Case color	Black								Limited warranty	One of the following, configurable by model:
Case material	<i>Display cover:</i> CFRP/GFRP hybrid; <i>Bottom:</i> Aluminum alloy									<ul style="list-style-type: none"> 1-year depot repair service 3-year/1-yr battery depot repair service 3-year/1-yr battery limited onsite service
									Mil-Spec test	MIL-STD-810G military testing
									Environment	EPPEAT™ Gold (US only); ENERGY STAR® 7.0; RoHS-compliant

Note: The specifications above may not be available in all regions.

Lenovo
July 2019



ThinkPad X270 Platform Specifications

Product Specifications Reference (PSREF)

<p>Processor</p> <p>6th Generation Intel® Core™ i3 / i5 / i7 Processor</p> <table border="1"> <thead> <tr> <th>Processor Number</th> <th># of Cores</th> <th># of Threads</th> <th>Base Frequency</th> <th>Max Turbo Frequency</th> <th>Cache</th> <th>Memory Types</th> <th>Processor Graphics</th> </tr> </thead> <tbody> <tr> <td>i3-6006U</td> <td rowspan="6">2</td> <td rowspan="6">4</td> <td>2.0 GHz</td> <td>-</td> <td>3MB</td> <td rowspan="6">DDR4-2133</td> <td rowspan="6">Intel HD Graphics 520</td> </tr> <tr> <td>i3-6100U</td> <td>2.3 GHz</td> <td>-</td> <td>3MB</td> </tr> <tr> <td>i5-6200U</td> <td>2.3 GHz</td> <td>2.8 GHz</td> <td>3MB</td> </tr> <tr> <td>i5-6300U</td> <td>2.4 GHz</td> <td>3.0 GHz</td> <td>3MB</td> </tr> <tr> <td>i7-6500U</td> <td>2.5 GHz</td> <td>3.1 GHz</td> <td>4MB</td> </tr> <tr> <td>i7-6600U</td> <td>2.6 GHz</td> <td>3.4 GHz</td> <td>4MB</td> </tr> </tbody> </table> <p>or 7th Generation Intel Core i3 / i5 / i7 Processor</p> <table border="1"> <thead> <tr> <th>Processor Number</th> <th># of Cores</th> <th># of Threads</th> <th>Base Frequency</th> <th>Max Turbo Frequency</th> <th>Cache</th> <th>Memory Types</th> <th>Processor Graphics</th> </tr> </thead> <tbody> <tr> <td>i3-7100U</td> <td rowspan="6">2</td> <td rowspan="6">4</td> <td>2.4 GHz</td> <td>-</td> <td>3MB</td> <td rowspan="6">DDR4-2133</td> <td rowspan="6">Intel HD Graphics 620</td> </tr> <tr> <td>i5-7200U</td> <td>2.5 GHz</td> <td>3.1 GHz</td> <td>3MB</td> </tr> <tr> <td>i5-7300U</td> <td>2.6 GHz</td> <td>3.5 GHz</td> <td>3MB</td> </tr> <tr> <td>i7-7500U</td> <td>2.7 GHz</td> <td>3.5 GHz</td> <td>4MB</td> </tr> <tr> <td>i7-7600U</td> <td>2.8 GHz</td> <td>3.9 GHz</td> <td>4MB</td> </tr> </tbody> </table>	Processor Number	# of Cores	# of Threads	Base Frequency	Max Turbo Frequency	Cache	Memory Types	Processor Graphics	i3-6006U	2	4	2.0 GHz	-	3MB	DDR4-2133	Intel HD Graphics 520	i3-6100U	2.3 GHz	-	3MB	i5-6200U	2.3 GHz	2.8 GHz	3MB	i5-6300U	2.4 GHz	3.0 GHz	3MB	i7-6500U	2.5 GHz	3.1 GHz	4MB	i7-6600U	2.6 GHz	3.4 GHz	4MB	Processor Number	# of Cores	# of Threads	Base Frequency	Max Turbo Frequency	Cache	Memory Types	Processor Graphics	i3-7100U	2	4	2.4 GHz	-	3MB	DDR4-2133	Intel HD Graphics 620	i5-7200U	2.5 GHz	3.1 GHz	3MB	i5-7300U	2.6 GHz	3.5 GHz	3MB	i7-7500U	2.7 GHz	3.5 GHz	4MB	i7-7600U	2.8 GHz	3.9 GHz	4MB	<p>Dimensions WxDxH: 12.03" x 8.21" x 0.80"; 305.5mm x 208.5mm x 20.3mm</p> <p>Weight</p> <table border="1"> <thead> <tr> <th>Models</th> <th>No + 3-cell</th> <th>3-cell + 3-cell</th> <th>3 + 6-cell</th> </tr> </thead> <tbody> <tr> <td>Weight</td> <td>2.79 lb / 1.27 kg</td> <td>2.98 lb / 1.36 kg</td> <td>3.33 lb / 1.52 kg</td> </tr> </tbody> </table> <p>Case color Black</p> <p>Case material Display cover: Glass-Fiber Reinforced Plastic; Bottom: Glass-Fiber Reinforced Plastic</p> <p>Smart card reader Optional: Smart card reader</p> <p>Media reader 4-in-1 reader (MMC, SD, SDHC, SDXC)</p> <p>Ports Two USB 3.1 Gen 1 (USB 3.0, one Always On), USB 3.1 Type-C Gen 1 (with the function of Power Delivery and DisplayPort), HDMI 1.4b, Ethernet (RJ-45), Dock connector <i>* Depending on many factors, actual data transfer speed may be lower than theoretical speed</i></p> <p>WiGig dock (opt) ThinkPad WiGig dock, mutually exclusive with WWAN (US only)</p> <p>Monitor cable (optional) HDMI to VGA: Lenovo HDMI to VGA Monitor Adapter USB-C to VGA: Lenovo USB-C to VGA Adapter USB-C to DP: Lenovo USB-C to DisplayPort Adapter</p> <p>Camera (optional) HD720p resolution, fixed focus</p> <p>Audio support HD Audio, Realtek ALC3268 codec / stereo speakers, 1.5W x 2 / dual array microphone, combo audio/microphone jack</p>	Models	No + 3-cell	3-cell + 3-cell	3 + 6-cell	Weight	2.79 lb / 1.27 kg	2.98 lb / 1.36 kg	3.33 lb / 1.52 kg
Processor Number	# of Cores	# of Threads	Base Frequency	Max Turbo Frequency	Cache	Memory Types	Processor Graphics																																																																						
i3-6006U	2	4	2.0 GHz	-	3MB	DDR4-2133	Intel HD Graphics 520																																																																						
i3-6100U			2.3 GHz	-	3MB																																																																								
i5-6200U			2.3 GHz	2.8 GHz	3MB																																																																								
i5-6300U			2.4 GHz	3.0 GHz	3MB																																																																								
i7-6500U			2.5 GHz	3.1 GHz	4MB																																																																								
i7-6600U			2.6 GHz	3.4 GHz	4MB																																																																								
Processor Number	# of Cores	# of Threads	Base Frequency	Max Turbo Frequency	Cache	Memory Types	Processor Graphics																																																																						
i3-7100U	2	4	2.4 GHz	-	3MB	DDR4-2133	Intel HD Graphics 620																																																																						
i5-7200U			2.5 GHz	3.1 GHz	3MB																																																																								
i5-7300U			2.6 GHz	3.5 GHz	3MB																																																																								
i7-7500U			2.7 GHz	3.5 GHz	4MB																																																																								
i7-7600U			2.8 GHz	3.9 GHz	4MB																																																																								
Models			No + 3-cell	3-cell + 3-cell	3 + 6-cell																																																																								
Weight	2.79 lb / 1.27 kg	2.98 lb / 1.36 kg	3.33 lb / 1.52 kg																																																																										
<p>Graphics</p> <p>Intel HD Graphics 520 or 620 in processor; supports external digital monitor via HDMI or USB Type-C; supports three independent displays; Max resolution: 4096x2160@60Hz (USB Type-C); 4096x2160@24Hz (HDMI)</p>	<p>Keyboard UltraNav™</p> <p>6-row, spill-resistant, multimedia Fn keys, optional LED backlight TrackPoint® pointing device and buttonless Mylar surface multi-touch touchpad</p>																																																																												
<p>Chipset Intel SoC (System on Chip) platform</p> <p>Memory 16GB max / 2400MHz DDR4, one DDR4 SO-DIMM socket <i>* System clocks down for processors with lower memory controller</i></p>	<p>Security Security chip Discrete TPM 2.0, TCG Certified</p> <p>vPro (optional) Intel vPro Technology</p> <p>Fingerprint reader Optional: Touch style match on chip fingerprint reader on the palm rest</p> <p>NFC (optional) Near Field Communication</p>																																																																												
<p>Display</p> <p><i>Some:</i> 12.5" (317.5mm) HD (1366x768), anti-glare, LED backlight, 220 nits, 16:9 aspect ratio, 500:1 contrast ratio</p> <p><i>Some:</i> 12.5" (317.5mm) HD (1366x768), anti-glare, LED backlight, IPS, 300 nits, 16:9 aspect ratio, 800:1 contrast ratio, 170° viewing angle</p> <p><i>Some:</i> 12.5" (317.5mm) FHD (1920x1080), anti-glare, LED backlight, IPS, 300 nits, 16:9 aspect ratio, 700:1 contrast ratio, 170° viewing angle</p> <p>Multi-touch (opt) On-cell touch, supports 10-finger gesture (FHD only)</p>	<p>Internal battery Optional: Integrated Li-ion or Li-Polymer 3-cell (23Wh)</p> <p>External battery Li-ion 3-cell (23Wh) or 6-cell (48Wh or 72Wh)</p> <p>Max battery life (MobileMark® 2014)</p> <table border="1"> <thead> <tr> <th>Models</th> <th>No + 3-cell</th> <th>3-cell + 3-cell</th> <th>3-cell + 6-cell 48Wh</th> <th>3-cell + 6-cell 72Wh</th> </tr> </thead> <tbody> <tr> <td>Max battery life</td> <td>6.52 hr</td> <td>13.04 hr</td> <td>20.1 hr</td> <td>26.9 hr</td> </tr> </tbody> </table> <p><i>* Battery life varies significantly with settings, usage, & other factors</i></p> <p>AC adapter 45W slim tip AC adapter or 45W USB Type-C AC adapter</p>	Models	No + 3-cell	3-cell + 3-cell	3-cell + 6-cell 48Wh	3-cell + 6-cell 72Wh	Max battery life	6.52 hr	13.04 hr	20.1 hr	26.9 hr																																																																		
Models	No + 3-cell	3-cell + 3-cell	3-cell + 6-cell 48Wh	3-cell + 6-cell 72Wh																																																																									
Max battery life	6.52 hr	13.04 hr	20.1 hr	26.9 hr																																																																									
<p>Storage</p> <p><i>System has one HDD slot or one M.2 2280 slot exclusively for storage</i></p> <p><i>Some:</i> HDD / SATA 6.0Gb/s, 2.5" wide, 7mm high, Active Protection System™</p> <p><i>Some:</i> SSD / SATA 6.0Gb/s, 2.5" wide, 7mm high (e.g. xxxGB SSD)</p> <p><i>Some:</i> M.2 SSD / PCIe NVMe, PCIe 3.0 x 2, 16Gb/s</p> <p><i>Some:</i> 128GB M.2 SSD / SATA 6.0Gb/s, in WWAN slot as 2nd Storage, mutually exclusive with WWAN and WiGig</p>	<p>Preload</p> <p>Windows® 7 Professional 64 preinstalled through downgrade rights in Windows 10 Pro 64</p> <p><i>Some:</i> Windows 10 Pro 64</p> <ul style="list-style-type: none"> • Lenovo Companion • Lenovo Setting • Microsoft Office preloaded; purchase a product key to activate 																																																																												
<p>Optical None</p>	<p>AC adapter 45W slim tip AC adapter or 45W USB Type-C AC adapter</p>																																																																												
<p>Ethernet</p> <p><i>Non-vPro model:</i> Intel Ethernet Connection I219-V (Jacksonville)</p> <p><i>vPro model:</i> Intel Ethernet Connection I219-LM (Jacksonville)</p>	<p>Preload</p> <p>Windows® 7 Professional 64 preinstalled through downgrade rights in Windows 10 Pro 64</p> <p><i>Some:</i> Windows 10 Pro 64</p> <ul style="list-style-type: none"> • Lenovo Companion • Lenovo Setting • Microsoft Office preloaded; purchase a product key to activate 																																																																												
<p>WLAN</p> <p><i>One of the following, configurable by model (WiGig is mutually exclusive with WWAN):</i></p> <ul style="list-style-type: none"> • Realtek® RTL8822BE, Wi-Fi 2x2 802.11ac + BT4.1 • Intel Dual Band Wireless-AC 8260, Wi-Fi 2x2 802.11ac + BT4.1 • Intel Dual Band Wireless-AC 8265, Wi-Fi 2x2 802.11ac + BT4.1 • Intel Tri-Band Wireless-AC 18265, WiGig 802.11ad + Wi-Fi 2x2 802.11ac + BT4.1 (US only) 	<p>Preload</p> <p>Windows® 7 Professional 64 preinstalled through downgrade rights in Windows 10 Pro 64</p> <p><i>Some:</i> Windows 10 Pro 64</p> <ul style="list-style-type: none"> • Lenovo Companion • Lenovo Setting • Microsoft Office preloaded; purchase a product key to activate 																																																																												
<p>Bluetooth™</p> <p>Bluetooth 4.1 wireless, integrated in Wi-Fi + Bluetooth combo adapter <i>* Intel 8265ac / 18265ac card support BT4.2 but is limited to BT4.1 by Windows OS</i></p>	<p>Limited warranty</p> <p><i>One of the following, configurable by model:</i></p> <ul style="list-style-type: none"> • 1-year depot repair service • 3-year/1-yr battery depot repair service • 3-year/1-yr battery limited onsite service 																																																																												
<p>WWAN (optional)</p> <p><i>One of the following, configurable by model (mutually exclusive with WiGig):</i></p> <ul style="list-style-type: none"> • Wireless WAN upgradable • Integrated Mobile Broadband 4G LTE-A, Qualcomm® Snapdragon™ X7 LTE-A (Sierra Wireless EM7455) • Integrated Mobile Broadband 4G LTE, Intel XMM™ 7160 (Fibocom L831-EAU) (EMEA only) 	<p>Mil-Spec test MIL-STD-810G military testing</p> <p>Environment EPEAT™ Gold (US only); ENERGY STAR® 6.1; RoHS-compliant</p>																																																																												
<p>SIM card (opt) Micro-SIM card slot, opt Verizon LTE (US) or Lenovo® Connect (EMEA) SIM card</p>	<p>Mil-Spec test MIL-STD-810G military testing</p> <p>Environment EPEAT™ Gold (US only); ENERGY STAR® 6.1; RoHS-compliant</p>																																																																												



ThinkPad X280 Platform Specifications

Product Specifications Reference (PSREF)

Processor	7th Generation Intel® Core™ i3 / i5 Processor * i3-7130U is NOT available in US and EMEA; i5-7200U is NOT available in US							Dimensions	WxDxH: 12.11" x 8.26" x 0.69-0.70"; 307.7mm x 209.8mm x 17.4-17.8mm		
	Processor Number	# of Cores	# of Threads	Base Frequency	Max Turbo Frequency	Cache	Memory Types	Processor Graphics	Weight	FHD non-touch model: 2.49 lb / 1.13 kg; HD non-touch model: 2.78 lb / 1.26 kg; FHD multi-touch model: 2.79 lb / 1.27 kg	
	i3-7130U	2	4	2.7 GHz	-	3MB	DDR4-2133	Intel HD Graphics 620	Case color	Black	
	i5-7200U			2.5 GHz	3.1 GHz	3MB			Case material	Display cover: Carbon Fiber (FHD non-touch model) or Glass Fiber (HD & FHD multi-touch model);	
	i5-7300U			2.6 GHz	3.5 GHz	3MB			Bottom: Magnesium/Aluminum		
	or 8th Generation Intel Core i3 / i5 / i7 Processor							Smart card reader	Optional: Smart card reader		
	Processor Number	# of Cores	# of Threads	Base Frequency	Max Turbo Frequency	Cache	Memory Types	Processor Graphics	Media reader	MicroSD card reader, in the combo slot with nano-SIM card	
	i3-8130U	4	8	2.2 GHz	3.4 GHz	4MB	DDR4-2400	Intel UHD Graphics 620	Ports	Two USB 3.1 Gen 1 (one Always On), one USB 3.1 Type-C Gen 1 (with the function of Power Delivery and DisplayPort), one USB 3.1 Type-C Gen 2 / Thunderbolt 3 (with the function of PD and DP), HDMI 1.4b, Ethernet extension connector, combo slot of nano-SIM card (WWAN models) and microSD card reader, headphone / microphone combo jack, optional smart card reader, side docking connector, security keyhole	
	i5-8250U			1.6 GHz	3.4 GHz	6MB			* Depending on many factors, actual data transfer speed may be lower than theoretical speed		
	i5-8350U			1.7 GHz	3.6 GHz	6MB			Monitor cable (optional)	HDMI to VGA: Lenovo HDMI to VGA Monitor Adapter	
	i7-8550U			1.8 GHz	4.0 GHz	8MB			Bundled Accy	USB-C to VGA: Lenovo USB-C to VGA Adapter	
	i7-8650U	1.9 GHz	4.2 GHz	8MB		USB-C to DP: Lenovo USB-C to DisplayPort Adapter					
Graphics	Intel HD Graphics 620 or Intel UHD Graphics 620 in processor; supports external digital monitor via HDMI or USB Type-C; supports three independent displays; Max resolution: 4096x2304@60Hz (USB Type-C); 4096x2160@30Hz (HDMI)							Camera (optional)	One of the following, configurable by model: • HD720p camera with ThinkShutter camera privacy, fixed focus • IR camera and HD720p camera, fixed focus		
Chipset	Intel SoC (System on Chip) platform							Audio support	HD Audio, Realtek® ALC3287 codec / stereo speakers, 2W x 2, Dolby® Audio™ Premium / dual array microphone, headphone / microphone combo jack		
Memory	4GB, 8GB, or 16GB / 2400MHz DDR4 / soldered to systemboard, no sockets * 4GB memory is NOT available in US and EMEA * System clocks down for processors with lower memory controller							Keyboard	6-row, spill-resistant, multimedia Fn keys, optional LED backlight		
Display	Some: 12.5" (317.5mm) HD (1366x768), anti-glare, LED backlight, 220 nits, 16:9 aspect ratio, 400:1 contrast ratio Some: 12.5" (317.5mm) FHD (1920x1080), anti-glare, LED backlight, IPS, 300 nits, 16:9 aspect ratio, 700:1 contrast ratio, 170° viewing angle							UltraNav™	TrackPoint® pointing device and buttonless Mylar surface multi-touch touchpad		
Multi-touch (opt)	On-cell touch, supports 10-finger gesture (FHD only) * FHD non-touch model is NOT available in US							Security	Power-on password, hard disk password, supervisor password, security keyhole		
Storage	One of the following, configurable by model: • M.2 SSD / SATA 6.0Gb/s (e.g. xxxGB SSD M.2) • M.2 SSD / PCIe NVMe, PCIe 3.0 x 4, 32Gb/s (e.g. xxxGB SSD M.2 PCIe NVMe)							Security chip	Discrete TPM 2.0, TCG Certified		
Optane™ memory	None							vPro (optional)	Intel vPro Technology		
Optical	None							Fingerprint reader	Optional: Touch style match on chip fingerprint reader on the palm rest, anti-spoofing technology		
Ethernet	Native Intel Ethernet Connection I219-V (Non-vPro) or I219-LM (vPro) via bundled or optional ThinkPad Ethernet Extension Adapter Gen 2							NFC (optional)	Near Field Communication		
WLAN + Bluetooth™	Intel Dual Band Wireless-AC 8265, Wi-Fi 2x2 802.11ac + Bluetooth 4.1, M.2 card * Intel 8265ac card supports BT4.2 but is limited to BT4.1 by Windows OS							Battery	Integrated Li-ion 48Wh battery, supports Rapid Charge (charge up to 80% in 1hr) with 65W USB Type-C AC adapter		
WWAN (optional)	One of the following, configurable by model: • Integrated Mobile Broadband 4G LTE, Intel XMM™ 7262 (Fibocom L830-EB), M.2 card (EMEA only) • Integrated Mobile Broadband 4G LTE-A, Intel XMM™ 7360 (Fibocom L850-GL), M.2 card * For non-WWAN model, it means the model is NOT WWAN upgradable							Max battery life	MobileMark® 2014: 16.6 hr * Battery life varies significantly with settings, usage, & other factors		
SIM card (opt)	Nano-SIM card slot, in the combo slot with microSD card reader, optional Verizon LTE (US) SIM card							AC adapter	45W or 65W USB Type-C AC adapter		
								Preload	Windows® 10 Home 64 or Windows 10 Pro 64		
								Limited warranty	One of the following, configurable by model: • 1-year depot repair service • 3-year/1-yr battery depot repair service • 3-year/1-yr battery limited onsite service		
								Mil-Spec test	MIL-STD-810G military testing		
								Environment	EPEAT™ Gold (US only); ENERGY STAR® 6.1; RoHS-compliant		

Note: The specifications above may not be available in all regions.

Lenovo
April 2019

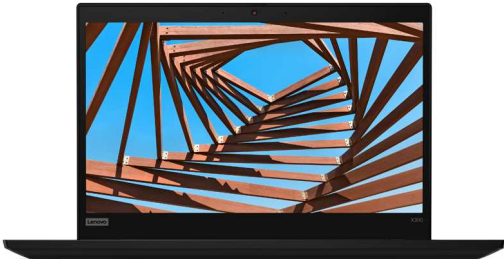

ThinkPad X390 Platform Specifications

Product Specifications Reference (PSREF)

Processor	8th Generation Intel® Core™ i3 / i5 / i7 Processor									Dimensions	Models	FHD Non-touch	HD / FHD Multi-touch	
	Processor Number	# of Cores	# of Threads	Base Frequency	Max Turbo Frequency	Cache	Memory Types	Processor Graphics	Carbon Fiber		311.9mm x 217.0mm x 16.5mm 12.28" x 8.54" x 0.65"	-		
Graphics	i3-8145U	4	8	2.1 GHz	3.9 GHz	4MB	DDR4-2400	Intel UHD Graphics 620	PPS	312.0mm x 217.2mm x 16.9mm 12.28" x 8.55" x 0.67"	312mm x 217.2mm x 16.9mm 12.28" x 8.55" x 0.67"			
	i5-8265U			1.6 GHz	3.9 GHz	6MB			Models	FHD Non-touch	HD	FHD Multi-touch		
	i5-8365U			1.6 GHz	4.1 GHz	6MB			Carbon Fiber	2.70 lb / 1.22 kg	-	-		
	i7-8565U			1.8 GHz	4.6 GHz	8MB			PPS	2.85 lb / 1.29 kg	2.93 lb / 1.33 kg	2.84 lb / 1.28 kg		
	i7-8665U			1.9 GHz	4.8 GHz	8MB								
Chipset	Intel SoC (System on Chip) platform									Case color	Black			
Memory	8GB, 16GB or 32GB / 2400MHz DDR4 / soldered to systemboard, no sockets <i>* Installed memory is actually 2666MHz but run at 2400MHz due to Intel limitation</i>									Case material	<i>Display cover:</i> Carbon Fiber (FHD non-touch only) or PPS; <i>Bottom:</i> Magnesium/Aluminum			
Display	Size	Resolution	Type	Surface	Brightness	Aspect Ratio	Contrast Ratio	Color Gamut	Viewing Angle	Smart card reader	Optional: Smart card reader			
	13.3"	HD (1366x768)	TN	Anti-glare	250 nits	16:9	500:1	45%	90°	Media reader	MicroSD card reader, in the combo slot with nano-SIM card			
	13.3"	FHD (1920x1080)	IPS	Anti-glare	300 nits	16:9	800:1 (non-touch) 700:1 (multi-touch)	72%	170°	Ports	Two USB 3.1 Gen 1 (one Always On), one USB 3.1 Type-C Gen 1 (with the function of Power Delivery and DisplayPort), one USB 3.1 Type-C Gen 2 / Thunderbolt 3 (with the function of PD and DP), HDMI 1.4b, Ethernet extension connector, combo slot of nano-SIM card (WWAN models) and microSD card reader, headphone / microphone combo jack, optional smart card reader, side docking connector, security keyhole <i>* Depending on many factors, actual data transfer speed may be lower than theoretical speed</i>			
	13.3"	FHD (1920x1080) ThinkPad Privacy Guard	IPS	Anti-glare	400 nits	16:9	1000:1	72%	178°	Monitor cable (optional)	<i>HDMI to VGA:</i> Lenovo HDMI to VGA Monitor Adapter <i>USB-C to VGA:</i> Lenovo USB-C to VGA Adapter <i>USB-C to DP:</i> Lenovo USB-C to DisplayPort Adapter <i>Optional:</i> ThinkPad Ethernet Extension Adapter Gen 2			
Multi-touch (opt)	On-cell touch, supports 10-finger gesture (FHD only)									Bundled Accy	Optional: ThinkPad Ethernet Extension Adapter Gen 2			
Storage	<ul style="list-style-type: none"> M.2 2280 SSD / SATA 6.0Gb/s M.2 2280 SSD / PCIe NVMe, PCIe 3.0 x 4 M.2 2242 SSD / PCIe NVMe, PCIe 3.0 x 2 Intel Optane™ Memory H10 with Solid State Storage, M.2 2280, PCIe NVMe 3.0 x 4 									Camera (optional)	One of the following, configurable by model: <ul style="list-style-type: none"> HD720p camera with ThinkShutter camera privacy, fixed focus IR camera and HD720p camera with ThinkShutter camera privacy, fixed focus 			
Optical	None									Audio support	HD Audio, Realtek® ALC3287 codec / stereo speakers, 1W x 2, Dolby® Audio™ Premium / dual array far-field microphone, headphone / microphone combo jack			
Ethernet	Native Intel Ethernet Connection I219-V (Non-vPro) or I219-LM (vPro) via bundled or optional ThinkPad Ethernet Extension Adapter Gen 2									Keyboard	6-row, spill-resistant, multimedia Fn keys, optional LED backlight			
WLAN (optional)	One of the following, configurable by model: <ul style="list-style-type: none"> Intel Wireless-AC 9560, Wi-Fi 2x2 802.11ac + Bluetooth 5.0 Intel Wi-Fi 6 AX200, Wi-Fi 2x2 802.11ax + Bluetooth 5.0 									UltraNav™	TrackPoint® pointing device and buttonless Mylar surface multi-touch touchpad			
Bluetooth™	Bluetooth 5.0 wireless, integrated in Wi-Fi + Bluetooth combo adapter									Security	Power-on password, hard disk password, supervisor password, security keyhole			
WWAN (optional)	One of the following, configurable by model: <ul style="list-style-type: none"> Integrated Mobile Broadband 4G LTE, Fibocom L830-EB, M.2 card (EMEA only) Integrated Mobile Broadband 4G LTE-A, Fibocom L850-GL, M.2 card <i>* For non-WWAN model, it means the model is NOT WWAN upgradable</i>									Security chip	Discrete TPM 2.0, TCG Certified			
										System Mgt (opt)	Intel vPro Technology			
										Fingerprint reader	Optional: Touch style match on chip fingerprint reader on the palm rest			
										NFC (optional)	Near Field Communication			
										Battery	Integrated Li-ion 48Wh battery, supports Rapid Charge (charge up to 80% in 1hr) with 65W USB Type-C AC adapter			
										Max battery life	MobileMark® 2014: 17.6 hr <i>* Battery life varies significantly with settings, usage, & other factors</i>			
										AC adapter	45W or 65W USB Type-C AC adapter			
										Preload	Windows® 10 Home 64 or Windows 10 Pro 64			
										Limited warranty	One of the following, configurable by model: <ul style="list-style-type: none"> 1-year depot repair service 3-year/1-yr battery depot repair service 3-year/1-yr battery limited onsite service 			
										Mil-Spec test	MIL-STD-810G military testing			
										Environment	EPEAT™ Silver; ENERGY STAR® 7.1; RoHS-compliant			

Note: The specifications above may not be available in all regions.

Lenovo
July 2019

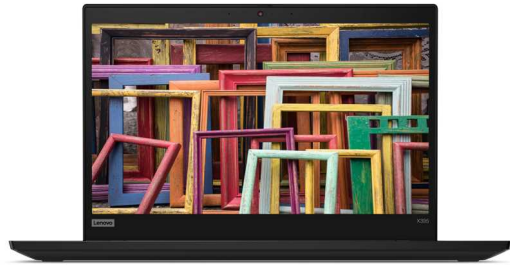

AMD



AMD



AMD



AMD



AMD



AMD

ThinkPad X395 Platform Specifications

Product Specifications Reference (PSREF)

Processor	AMD Ryzen™ PRO Mobile Processors with Radeon™ Vega Graphics								Dimensions WxDxH: 12.28" x 8.55" x 0.67"; 311.9mm x 217.2mm x 16.9mm	Weight	<table border="1"> <tr> <th>Models</th> <th>HD / FHD multi-touch</th> <th>FHD non-touch</th> <th>FHD Privacy Guard</th> </tr> <tr> <td></td> <td>2.91 lb / 1.32 kg</td> <td>2.82 lb / 1.28 kg</td> <td>3.01 lb / 1.37 kg</td> </tr> </table>				Models	HD / FHD multi-touch	FHD non-touch	FHD Privacy Guard		2.91 lb / 1.32 kg	2.82 lb / 1.28 kg	3.01 lb / 1.37 kg
	Models	HD / FHD multi-touch	FHD non-touch	FHD Privacy Guard																		
		2.91 lb / 1.32 kg	2.82 lb / 1.28 kg	3.01 lb / 1.37 kg																		
	Processor Number	# of Cores	# of Threads	Base Frequency	Max Turbo Frequency	Cache	Memory Controller	Processor Graphics			Case color Black Case material Display cover: PPS/GF; Bottom: Magnesium/Aluminum											
Ryzen 3 Pro 3300U	4	4	2.1 GHz	3.5 GHz	2MB L2 / 4MB L3	DDR4-2400	Radeon Vega 6 Graphics															
Ryzen 5 Pro 3500U	4	8	2.1 GHz	3.7 GHz	2MB L2 / 4MB L3		Radeon Vega 8 Graphics															
Ryzen 7 Pro 3700U	4	8	2.3 GHz	4.0 GHz	2MB L2 / 4MB L3		Radeon Vega 10 Graphics															
Graphics	AMD Radeon Vega 6, Vega 8, or Vega 10 Graphics in processor; supports external digital monitor via USB-C or HDMI; supports three independent displays; Max resolution: 4096x2304@60Hz (USB-C); 4096x2160@24Hz (HDMI)								Smart card reader Optional: Smart card reader	Media reader MicroSD card reader, in the combo slot with nano-SIM card	Ports One USB 3.1 Gen 1 (Always On), one USB 3.1 Gen 2, two USB 3.1 Type-C Gen 2 (with the function of Power Delivery and DisplayPort), HDMI 2.0, Ethernet extension connector, combo slot of nano-SIM card (WWAN models) and microSD card reader, headphone / microphone combo jack, optional smart card reader, side docking connector, security keyhole <i>* Depending on many factors, actual data transfer speed may be lower than theoretical speed</i>											
Chipset	AMD SoC (System on Chip) platform								Monitor cable (optional) HDMI to VGA: Lenovo HDMI to VGA Monitor Adapter	Bundled Accy Optional: ThinkPad Ethernet Extension Adapter Gen 2												
Memory	8GB or 16GB / 2400MHz DDR4 / soldered to systemboard, no sockets <i>* Installed memory is actually 2666MHz but run at 2400MHz due to AMD limitation</i>								Camera (optional) <i>One of the following, configurable by model:</i>	Audio support • HD720p camera with ThinkShutter camera privacy, fixed focus • IR camera and HD720p camera with ThinkShutter camera privacy, fixed focus HD Audio, Realtek ALC3287 codec / stereo speakers, 1W x 2, Dolby® Audio™ Premium / dual array far-field microphone, headphone / microphone combo jack												
Display	Size	Resolution	Type	Surface	Brightness	Aspect Ratio	Contrast Ratio	Color Gamut	Viewing Angle													
	13.3"	HD (1366x768)	TN	Anti-glare	250 nits	16:9	300:1	45%	90°													
	13.3"	FHD (1920x1080)	IPS	Anti-glare	300 nits	16:9	800:1 (non-touch) 700:1 (multi-touch)	72%	170°													
13.3"	FHD (1920x1080) ThinkPad Privacy Guard	IPS	Anti-glare	400 nits	16:9	1000:1	72%	178°														
Multi-touch (opt)	On-cell touch, supports 10-finger gesture (FHD only)								Keyboard 6-row, spill-resistant, multimedia Fn keys, optional LED backlight	UltraNav™ TrackPoint® pointing device and buttonless Mylar surface multi-touch touchpad												
Storage	<ul style="list-style-type: none"> M.2 2280 SSD / SATA 6.0Gb/s M.2 2280 SSD / PCIe NVMe, PCIe 3.0 x 4 								Security Power-on password, hard disk password, supervisor password, security keyhole	Security chip Discrete TPM 2.0, TCG Certified												
Optical	None								System Mgt DASH Management	Fingerprint reader <i>Optional: Touch style match on chip fingerprint reader on the palm rest</i>	NFC None											
Ethernet	Native Realtek® RTL8153 Gigabit Ethernet connection via bundled or optional ThinkPad Ethernet Extension Adapter Gen 2								Battery Integrated Li-ion 48Wh battery, supports Rapid Charge (charge up to 80% in 1hr) with 65W USB Type-C AC adapter	Max battery life <i>MobileMark® 2014: 14.5 hr</i> <i>* Battery life varies significantly with settings, usage, & other factors</i>												
WLAN (optional)	Intel Wireless-AC 9260, Wi-Fi 2x2 802.11ac + Bluetooth 5.0								AC adapter 45W or 65W USB Type-C AC adapter	Preload Windows® 10 Home 64 or Windows 10 Pro 64												
Bluetooth™	Bluetooth 5.0 wireless, integrated in Wi-Fi + Bluetooth combo adapter								Limited warranty <i>One of the following, configurable by model:</i>	• 1-year depot repair service	• 3-year/1-yr battery depot repair service											
WWAN (optional)	<i>One of the following, configurable by model:</i> <ul style="list-style-type: none"> Wireless WAN upgradable Integrated Mobile Broadband 4G LTE-A, Fibocom L850-GL, M.2 card <i>* For non-WWAN model, it means the model is NOT WWAN upgradable</i>								Mil-Spec test MIL-STD-810G military testing	Environment EPEAT™ Silver; ENERGY STAR® 7.1; RoHS-compliant												
SIM card (opt)	Nano-SIM card slot, optional Verizon LTE (US) SIM card																					

Note: The specifications above may not be available in all regions.

Lenovo
July 2019

This publication was developed for products and services offered in the North America, E.M.E.A and Asia & Pacific countries. Lenovo may not offer the products, services or features discussed in this document in other countries. Lenovo may withdraw an offering at any time. Information is subject to change without notice. Consult your local representative for information on offerings available in your area.

Lenovo reserves the right to change specifications or other product information without notice. Lenovo is not responsible for photographic or typographical errors.

LENOVO PROVIDES THIS PUBLICATION "AS IS," WITHOUT WARRANTY OF ANY KIND, EITHER EXPRESS OR IMPLIED, INCLUDING THE IMPLIED WARRANTIES OF MERCHANTABILITY OR FITNESS FOR A PARTICULAR PURPOSE.

Some jurisdictions do not allow disclaimer of express or implied warranties in certain transactions, therefore this disclaimer may not apply to you.

Availability: All offers subject to availability. Lenovo reserves the right to alter product offerings and specifications at any time, without notice. Lenovo is not responsible for photographic or typographic errors.

General: Review key information provided by Microsoft that may apply to your system purchase, including details on Windows 10, Windows 8, Windows 7, and potential upgrades/downgrades. Lenovo makes no representation or warranty regarding third-party products or services.

Trademarks: Lenovo, ThinkPad, ThinkBook, ThinkCentre, ThinkStation, ThinkVision and the Lenovo logo are trademarks of Lenovo. Microsoft, Windows, Windows NT, and the Windows logo are trademarks of Microsoft Corporation. Ultrabook, Celeron, Celeron Inside, Core Inside, Intel, Intel Logo, Intel Atom, Intel Atom Inside, Intel Core, Intel Inside, Intel Inside Logo, Intel vPro, Itanium, Itanium Inside, Pentium, Pentium Inside, vPro Inside, Xeon, Xeon Phi, and Xeon Inside are trademarks of Intel Corporation in the U.S. and/or other countries. Other company, product or service names may be trademarks or service marks of others.

Warranty: For a copy of applicable warranties, write to: Lenovo Warranty Information, 1009 Think Place, Morrisville, NC, 27560. Lenovo makes no representation or warranty regarding third party products or services. The Lenovo Limited Warranty applies only to Lenovo hardware products purchased for your own use, and does not transfer upon resale.

Limited warranty: Support unrelated to a warranty issue may be subject to additional charges.

Lenovo Services:

Carry-in or Mail-in Service: Parts and labor repair coverage where the customer is responsible for shipping (including packaging) or delivery to authorized warranty provider or repair center.

Depot or Courier Service: Parts and labor repair coverage where shipping (including packaging) or delivery to the repair center is paid for by Lenovo.

Expedited Depot: Parts and labor coverage with expedited turnaround. Shipping (including packaging) or delivery to the repair center is paid for by Lenovo.

Onsite / In-home Service: Parts and labor repair coverage where labor is provided onsite at your place of business.

If Lenovo determines your product problem is covered by the product warranty and cannot be resolved over the telephone, a technician will be dispatched to arrive onsite, typically the next day.

International Warranty Service (IWS): PC repair coverage for customers who require a critical warranty repair while travelling internationally. Visit www.lenovo.com/internationalwarranty for details. Visit www.lenovo.com/warranty for Lenovo Warranty Services terms and conditions for complete details and restrictions.

Included software: may differ from its retail version (if available), and may not include user manuals or all program functionality. Software license agreements may apply.

Battery life: Battery life (and recharge times) will vary based on many factors including screen brightness, applications, features, power management, battery conditioning, and other customer preferences.

Visit <http://psref.lenovo.com/> for the latest version of Product Specifications Reference.

© Lenovo, 2019. All rights reserved.
Lenovo 1009 Think Place Morrisville, NC 27560 U.S.A.

Lenovo **ThinkPad** Tablets
Convertibles

PSREF



Product Specifications Reference

Version 545, July 2019

Visit <http://psref.lenovo.com> for the latest version

Contents

Cover	1
Contents	2
Summary Of Change	3
ThinkPad Tablets	4
ThinkPad X1 Tablet (3rd Gen)	4
ThinkPad X1 Tablet (3rd Gen) Platform Specifications	5
ThinkPad Yoga	6
ThinkPad L380 Yoga	6
ThinkPad L380 Yoga Platform Specifications	7
ThinkPad L390 Yoga	8
ThinkPad L390 Yoga Platform Specifications	9
ThinkPad X1 Yoga (3rd Gen)	10
ThinkPad X1 Yoga (3rd Gen) Platform Specifications	11
ThinkPad X1 Yoga (4th Gen)	12
ThinkPad X1 Yoga (4th Gen) Platform Specifications	13
ThinkPad X380 Yoga	14
ThinkPad X380 Yoga Platform Specifications	15
ThinkPad X390 Yoga	16
ThinkPad X390 Yoga Platform Specifications	17
ThinkPad Yoga 11e (5th Gen)	18
ThinkPad Yoga 11e (5th Gen) Platform Specifications	19
Legal Information	20

Summary of Changes

This section describes the technical changes made in this edition.

This edition might also include minor corrections and editorial changes which are not identified.

July 7, 2019 - Version 545

Additions in this update

▶ **New product(s)**

None

▶ **New model(s)**

None

▶ **Others**

None

Changes in this update

▶ None

Withdrawals in this update

▶ **Withdrawn product(s)**

None



ThinkPad X1 Tablet (3rd Gen) Platform Specifications

Product Specifications Reference (PSREF)

Processor	8th Generation Intel® Core™ i5 / i7 Processor								Control buttons Power button, volume control button, reset switch Dock <i>Optional:</i> Hybrid dock Monitor cable (<i>opt</i>) None Adapter (<i>optional</i>) <i>USB-C to RJ45:</i> Lenovo USB-C to Ethernet Adapter <i>USB-C to VGA:</i> Lenovo USB C to VGA Plus Power Adapter <i>USB-C to HDMI:</i> Lenovo USB-C to HDMI Plus Power Adapter
	Processor Number	# of Cores	# of Threads	Base Frequency	Max Turbo Frequency	Cache	Memory Types	Processor Graphics	
	i5-8250U	4	8	1.6 GHz	3.4 GHz	6MB	LPDDR3-2133	Intel UHD Graphics 620	
	i5-8350U			1.7 GHz	3.6 GHz	6MB			
	i7-8550U			1.8 GHz	4.0 GHz	8MB			
i7-8650U	1.9 GHz			4.2 GHz	8MB				
Graphics	Intel UHD Graphics 620 in processor, supports external digital monitor via USB Type-C								
Chipset	Intel SoC (System on Chip) platform								
Memory	8GB, or 16GB / 2133MHz LPDDR3 / soldered to systemboard, no sockets								
Display	13.0" (330mm) QHD+ (3000x2000), glossy, LED backlight, IPS, anti-fingerprint display with Corning® Gorilla® Glass, WideView (160° viewing), 400 nits, 3:2 aspect ratio, 1200:1 contrast ratio								
Multi-touch Pen	Capacitive touch panel, supports ten-finger gesture <i>Optional:</i> Lenovo Pen Pro or Lenovo Active Pen (ThinkPad Pen Pro) for multi-touch display								
Kick stand	Opening angle up to 170 degrees								
Storage	<i>Some:</i> M.2 SSD / SATA 6.0Gb/s (e.g. xxxG SSD) <i>Some:</i> M.2 SSD / PCIe NVMe, PCIe 3.0 x 4, 32Gb/s (e.g. xxxG SSD PCIe NVMe)								
Optical	None								
Storage extension	One microSD card reader, in the combo slot with nano-SIM card, support USH-I, microSDHC, microSDXC								
Ethernet	None								
WLAN	Intel Dual Band Wireless-AC 8265, Wi-Fi 2x2 802.11ac + Bluetooth 4.1, M.2 card <i>* Intel 8265ac card supports BT4.2 but is limited to BT4.1 by Windows OS</i>								
Bluetooth™	Bluetooth 4.1 wireless, integrated in Wi-Fi + Bluetooth combo adapter								
WWAN (<i>optional</i>)	Integrated Mobile Broadband 4G LTE-A, Qualcomm® Snapdragon™ X7 LTE-A (Sierra Wireless EM7455)								
SIM card (<i>opt</i>)	Nano-SIM card slot, in the combo slot with microSD card reader								
Dimensions	<i>Tablet only:</i> 11.97" x 8.9" x 0.35"; 304.1mm x 226mm x 8.9mm <i>Tablet + keyboard:</i> 11.97" x 8.9" x 0.57"; 304.1mm x 226mm x 14.4mm								
Weight	<i>Tablet only:</i> starting at 1.96 lb (0.89kg) <i>Tablet+keyboard:</i> starting at 2.8 lb (1.27kg)								
Case color	Black								
Case material	Magnesium/Aluminum								
Smart card reader	None								
Ports	Two USB 3.1 Type-C Gen 1 / Thunderbolt 3 / Power Delivery 3.0, one Pogo keyboard connector, one Pen holder slot, headphone / microphone combo jack, combo slot of nano-SIM card (WWAN models) and microSD card reader <i>* Depending on many factors, actual data transfer speed may be lower than theoretical speed</i>								
Pogo keyboard	Magnetic attached thin keyboard, with TrackPoint® pointing device and buttonless Mylar surface touchpad, multi-touch, backlit								
Keyboard color	Black								
Security	Kensington lock slot								
Security chip	Discrete TPM 2.0 TCG Certified								
System Mgt (<i>opt</i>)	Intel vPro Technology								
Fingerprint reader	<i>Optional:</i> Touch style Fingerprint reader								
NFC (<i>optional</i>)	Near Field Communication (Not available with the IR camera)								
Battery	Integrated Li-Ion 42Wh battery								
Max battery life	<i>MobileMark® 2014:</i> 9.5 hrs <i>* Battery life varies significantly with settings, usage, & other factors</i>								
AC adapter	45W or 65W USB Type-C AC adapter								
Light sensor	Ambient Light Sensor								
G-sensor	3D accelerometer								
Gyroscope	3D gyrometer								
GPS	GPS function is integrated into WWAN module								
Preload	<i>Some:</i> Windows 10 Pro 64 <i>Some:</i> Windows 10 Home 64								
Limited warranty	<i>One of the following, configurable by model:</i> • 1-year depot repair service • 3-year/1-yr battery depot repair service • 3-year/1-yr battery limited onsite service								
Mil-Spec test	MIL-STD-810G military testing								
Environment	EPEAT™ Silver, GREENGUARD, Low Halogen, RoHS								



ThinkPad L380 Yoga Platform Specifications

Product Specifications Reference (PSREF)

Processor	7th Generation Intel® Core™ i3 / i5 Processor								Dimensions Weight Case color Case material	<i>WxDxH:</i> 12.67" x 8.82" x 0.74"; 322mm x 224.2mm x 18.8mm Starting at 3.44 lb / 1.56 kg Black or Silver <i>Display cover:</i> Aluminum <i>Bottom:</i> GFRP
	Processor Number	# of Cores	# of Threads	Base Frequency	Max Turbo Frequency	Cache	Memory Types	Processor Graphics		
	i3-7020U	2	4	2.3 GHz	//	3MB	DDR4-2133	Intel HD Graphics 620		
	i5-7200U	2	4	2.5 GHz	3.1 GHz	3MB				
Processor	8th Generation Intel Core i3 / i5 / i7 Processor								Smart card reader Media reader Ports Monitor cable (optional)	None MicroSD card reader Two USB 3.1 Gen 1 (one Always On), two USB 3.1 Type-C Gen 1 (with the function of Power Delivery and DisplayPort), HDMI 1.4b, Ethernet extension connector, headphone / microphone combo jack, microSD card reader, security keyhole <i>* Depending on many factors, actual data transfer speed may be lower than theoretical speed</i> <i>HDMI to VGA:</i> Lenovo HDMI to VGA Monitor Adapter <i>USB-C to VGA:</i> Lenovo USB-C to VGA Adapter <i>USB-C to DP:</i> Lenovo USB-C to DisplayPort Adapter
	Processor Number	# of Cores	# of Threads	Base Frequency	Max Turbo Frequency	Cache	Memory Types	Processor Graphics		
	i3-8130U	2	4	2.2 GHz	3.4 GHz	4MB	DDR4-2400	Intel UHD Graphics 620		
	i5-8250U	4	8	1.6 GHz	3.4 GHz	6MB				
	i5-8350U			1.7 GHz	3.6 GHz	6MB				
i7-8550U	1.8 GHz			4.0 GHz	8MB					
Graphics	Intel HD Graphics 620 or Intel UHD Graphics 620 in processor; supports external digital monitor via HDMI or USB Type-C; supports three independent displays; Max resolution: 4096x2304@60Hz (USB Type-C); 4096x2160@30Hz (HDMI)								Camera	720p: HD720p resolution, low light sensitive, fixed focus IR & 720p: IR camera and HD720p camera, fixed focus World facing: Rear camera, 5MP resolution, auto focus HD Audio, Realtek ALC3287 codec, Dolby® Advance / stereo speakers, 2W x 2 / dual array microphone, headphone / microphone combo jack
Chipset	Intel SoC (System on Chip) platform								Audio support	6-row, multimedia Fn keys, optional LED backlight TrackPoint® pointing device and buttonless Mylar surface touchpad, multi-touch
Memory	Up to 32GB max / 2400MHz DDR4, dual-channel capable, two DDR4 SO-DIMM sockets * System clocks down for processors with lower memory controller								Keyboard	
Display	13.3" (338mm) FHD (1920x1080), glossy, LED backlight, IPS, 300 nits, 16:9 aspect ratio, 800:1 contrast ratio, 170° viewing angle								Security	Power-on password, hard disk password, supervisor password, security keyhole Discrete TPM 2.0, TCG Certified Intel vPro Technology Fingerprint reader <i>Optional:</i> Touch style fingerprint reader on the keyboard bezel, anti-spoofing technology NFC (optional) Near Field Communication (mutually exclusive with smart card reader)
Multi-touch (opt)	Capacitive-type multi-touch, AR (anti-reflection), supports 10-finger gesture								Security chip	
Hinge	Yoga hinge, 360 degree								System Mgt (opt)	
Convert-mode	Laptop, tent, stand, yoga and tablet								Fingerprint reader	
Pen	ThinkPad Pen Pro, active pen for multi-touch display, on-board garage								Battery	Integrated Li-Ion 45Wh battery, supports Rapid Charge (charge up to 80% in 1hr) with 65W USB Type-C AC adapter Max battery life <i>MobileMark® 2014:</i> 12.85 hrs * Battery life varies significantly with settings, usage, & other factors
Storage	One of the following, configurable by model: • M.2 SSD / SATA 6.0Gb/s (e.g. xxxGB SSD M.2) • M.2 SSD / PCIe NVMe, PCIe 3.0 x 4, 32Gb/s (e.g. xxxGB SSD M.2 PCIe NVMe)								AC adapter	45W or 65W USB Type-C AC adapter
Optane Memory	None								Preload	Windows® 10 Home 64 or Windows 10 Pro 64
Optical	None								Limited warranty	One of the following, configurable by model: • 1-year depot repair service • 3-year/1-yr battery depot repair service • 3-year/1-yr battery limited onsite service
Ethernet	Native Intel Ethernet Connection I219-V (Non-vPro) or I219-LM (vPro) via optional ThinkPad Ethernet Extension Cable Gen 2								Mil-Spec test	MIL-STD-810G military testing
WLAN + Bluetooth™	Intel Dual Band Wireless-AC 8265, Wi-Fi 2x2 802.11ac + Bluetooth 4.1, M.2 card * Wireless card supports BT4.2 but is limited to BT4.1 by Windows OS								Environment	EPEAT™ Gold; ENERGY STAR® 6.1; RoHS-compliant
WWAN	None									
SIM card	None									



ThinkPad L390 Yoga Platform Specifications

Product Specifications Reference (PSREF)

Processor	8th Generation Intel® Core™ i3 / i5 / i7 Processor								Smart card reader	None
	Processor Number	# of Cores	# of Threads	Base Frequency	Max Turbo Frequency	Cache	Memory Types	Processor Graphics	Media reader	MicroSD card reader
	i3-8145U	2	4	2.1 GHz	3.9 GHz	4MB	DDR4-2400	Intel UHD Graphics 620	Ports	Two USB 3.1 Gen 1 (one Always On), two USB 3.1 Type-C Gen 1 (with the function of Power Delivery and DisplayPort), HDMI 1.4b, Ethernet extension connector, headphone / microphone combo jack, microSD card reader, security keyhole
	i5-8265U	4	8	1.6 GHz	3.9 GHz	6MB			Monitor cable (optional)	<ul style="list-style-type: none"> USB-C to VGA: Lenovo USB-C to VGA Adapter USB-C to VGA + Power Adapter: Lenovo USB-C to VGA plus Power Adapter USB-C to HDMI: Lenovo USB-C to HDMI Adapter USB-C to HDMI + Power Adapter: Lenovo USB-C to HDMI plus Power Adapter USB-C to DP: Lenovo USB-C to DisplayPort Adapter USB-C to RJ45: Lenovo USB-C to Ethernet Adapter
	i5-8365U	4	8	1.6 GHz	4.1 GHz	6MB			Bundled	<ul style="list-style-type: none"> USB-C to USB-A: Lenovo USB-C to USB-A Adapter USB-C to USB-C: Lenovo USB-C to USB-C Cable 2M
	i7-8565U	4	8	1.8 GHz	4.6 GHz	8MB			Accessories (optional)	
Graphics	Intel UHD Graphics 620 in processor; supports external digital monitor via HDMI or USB Type-C; supports three independent displays; Max resolution: 4096x2304@60Hz (USB Type-C); 4096x2160@30Hz (HDMI)								Camera	<ul style="list-style-type: none"> 720p: HD720p resolution, low light sensitive, fixed focus IR & 720p: IR camera and HD720p camera, fixed focus (black model only) World facing: 5MP resolution, auto focus (mutually exclusive with fingerprint reader)
Chipset	Intel SoC (System on Chip) platform								Audio support	HD Audio, Realtek ALC3287 codec, Dolby® Audio™ Premium / stereo speakers, 2W x 2 / dual array microphone, headphone / microphone combo jack
Memory	32GB max / 2400MHz DDR4, dual-channel capable, two DDR4 SO-DIMM sockets								Keyboard	6-row, spill-resistant, multimedia Fn keys, optional LED backlight
Display	13.3" (338mm) FHD (1920x1080), glossy, LED backlight, IPS, 300 nits, 16:9 aspect ratio, 800:1 contrast ratio, 72% gamut, 170° viewing angle								UltraNav™	TrackPoint® pointing device and buttonless Mylar surface touchpad, multi-touch
Multi-touch	Capacitive-type multi-touch, AR (anti-reflection), supports 10-finger gesture								Security	Power-on password, hard disk password, supervisor password, security keyhole
Hinge	Yoga hinge, 360 degree								Security chip	Discrete TPM 2.0, TCG Certified
Multi-mode	Notebook, stand, tent, tablet								System Mgt (opt)	Intel vPro Technology
Pen (optional)	ThinkPad Pen Pro, active pen for multi-touch display, on-board garage								Fingerprint reader	Optional: Touch style fingerprint reader on the palm rest (mutually exclusive with World facing camera)
Storage	<i>One of the following, configurable by model:</i> <ul style="list-style-type: none"> M.2 SSD / SATA 6.0Gb/s M.2 (2242) SSD / PCIe NVMe, PCIe 3.0 x 2 M.2 (2280) SSD / PCIe NVMe, PCIe 3.0 x 4 Intel Optane Memory H10 with Solid State Storage, M.2 2280, PCIe NVMe 3.0 x 4 								NFC (optional)	Near Field Communication
Optane™ Memory	Optional: Intel Optane Memory H10								Battery	Integrated Li-Ion 45Wh battery, supports Rapid Charge (charge up to 80% in 1hr) with 65W USB Type-C AC adapter
Optical	None								Max battery life	<i>MobileMark® 2014: 12.17 hrs</i> <i>* Battery life varies significantly with settings, usage, & other factors</i>
Storage	<i>One of the following, configurable by model:</i> <ul style="list-style-type: none"> M.2 SSD / SATA 6.0Gb/s (e.g. xxxGB SSD M.2) M.2 SSD / PCIe NVMe, PCIe 3.0 x 4, 32Gb/s (e.g. xxxGB SSD M.2 PCIe NVMe) 								AC adapter	45W or 65W USB Type-C AC adapter
Optical	None								Preload	Windows® 10 Home 64 or Windows 10 Pro 64
Ethernet	Native Intel Ethernet Connection I219-V (Non-vPro) or I219-LM (vPro) via optional ThinkPad Ethernet Extension Cable or Lenovo USB-C to Ethernet Adapter								Limited warranty	<i>One of the following, configurable by model:</i> <ul style="list-style-type: none"> 1-year depot repair service 3-year/1-yr battery depot repair service 3-year/1-yr battery limited onsite service
WLAN	Intel Wireless-AC 9560, Wi-Fi 2x2 802.11ac + Bluetooth 5.0, M.2 card								Mil-Spec test	MIL-STD-810G military testing
Bluetooth™	Bluetooth 5.0 wireless, integrated in Wi-Fi + Bluetooth combo adapter								Environment	EPEAT™ Silver; ENERGY STAR® 7.1; RoHS-compliant
WWAN	None									
Dimensions	WxDxH: 12.67" x 8.82" x 0.74"; 321.8mm x 224.2mm x 18.8mm									
Weight	Starting at 3.44 lbs / 1.56 kg									
Case color	Black or Silver									
Case material	Display cover: Magnesium / Aluminum Bottom: GFRP									

Lenovo
July 2019



ThinkPad X1 Yoga (3rd Gen) Platform Specifications

Product Specifications Reference (PSREF)

Processor	7th Generation Intel® Core™ i5 Processor								Smart card reader None
	Processor Number	# of Cores	# of Threads	Base Frequency	Max Turbo Frequency	Cache	Memory Types	Processor Graphics	
	i5-7300U	2	4	2.6 GHz	3.5 GHz	3MB	LPDDR3-1866	Intel HD Graphics 620	
	8th Generation Intel Core i5 / i7 Processor								Media reader Ports Two USB 3.1 Gen 1 (one Always On), two USB 3.1 Type-C Gen 2 / Thunderbolt 3, HDMI 1.4, Ethernet extension connector, nano-SIM card slot (WWAN models), headphone / microphone combo jack, microSD card reader <i>* Depending on many factors, actual data transfer speed may be lower than theoretical speed</i>
	Processor Number	# of Cores	# of Threads	Base Frequency	Max Turbo Frequency	Cache	Memory Types	Processor Graphics	
	i5-8250U	4	8	1.6 GHz	3.4 GHz	6MB	LPDDR3-2133	Intel UHD Graphics 620	
	i5-8350U			1.7 GHz	3.6 GHz	6MB			
	i7-8550U			1.8 GHz	4.0 GHz	8MB			
	i7-8650U			1.9 GHz	4.2 GHz	8MB			
Graphics	Intel HD Graphics 620 or Intel UHD Graphics 620 in processor; supports external digital monitor via HDMI or USB Type-C; supports three independent displays; Max resolution: 5120x2880@60Hz (USB Type-C); 4096x2160@30Hz (HDMI)								WiGig dock None
Chipset	Intel SoC (System on Chip) platform								Monitor cable (optional) HDMI to VGA: Lenovo HDMI to VGA Monitor Adapter USB-C to VGA: Lenovo USB-C to VGA Adapter USB-C to DP: Lenovo USB-C to DisplayPort Adapter
Memory	8GB or 16GB / 2133MHz LPDDR3 / soldered to systemboard, no sockets								Camera (optional) <i>One of the following, configurable by model:</i> 720p: HD720p camera with ThinkShutter camera privacy, fixed focus IR & 720p: IR camera and HD720p camera, fixed focus <i>* WWAN models and HDR panel models can not support IR camera</i>
Display	<i>Some:</i> 14.0" (355mm) FHD (1920x1080), LED backlight, 300 nits, 16:9 aspect ratio, 700:1 contrast ratio, 72% gamut, 170° viewing angle, IPS <i>Some:</i> 14.0" (355mm) WQHD (2560x1440), LED backlight, 300 nits, 16:9 aspect ratio, 700:1 contrast ratio, 72% gamut, 170° viewing angle, IPS <i>Some:</i> 14.0" (355mm) HDR WQHD (2560x1440) with Dolby Vision™, LED backlight, 500 nits, 16:9 aspect ratio, 1500:1 contrast ratio, 100% gamut, 170° viewing angle, IPS								Audio support HD Audio, Realtek® ALC3286 codec, Dolby® Audio™ Premium / stereo speakers, 1W x 2 / dual array microphone, headphone / microphone combo jack
Multi-touch	Capacitive-type multi-touch, AR (anti-reflection), AS (anti-smudge), supports 10-finger gesture, reduces overall display brightness by 10%								Keyboard 6-row wave keyboard (rise & fall), spill-resistant, multimedia Fn keys, LED backlit
Hinge	Yoga hinge, 360 degree								UltraNav™ TrackPoint® pointing device and 3+2 buttons multi-touch clickpad
Convert-mode	Laptop, tent, stand, and tablet								Security Power-on password, hard disk password, supervisor password, security keyhole
Pen (optional)	ThinkPad Pen Pro, active pen for multi-touch display, on-board rechargeable								Security chip Discrete TPM 2.0 TCG Certified
Storage	<i>Some:</i> M.2 SSD / SATA 6.0Gb/s (e.g. xxxG SSD) <i>Some:</i> M.2 SSD / PCIe NVMe, PCIe 3.0 x 4, 32Gb/s (e.g. xxxG SSD PCIe NVMe)								System Mgt (opt) Intel vPro Technology
Optical	None								Fingerprint reader Touch style match on chip fingerprint reader on the palm rest
Ethernet	Native Intel Ethernet Connection WGI219-LM (vPro) via optional ThinkPad Ethernet Extension Cable								NFC (optional) Near Field Communication
WLAN	Intel Dual Band Wireless-AC 8265, Wi-Fi 2x2 802.11ac + Bluetooth 4.1, M.2 card <i>* Intel 8265ac card supports BT4.2 but is limited to BT4.1 by Windows OS</i>								Battery Integrated Li-Ion 54Wh battery, supports Rapid Charge (charge up to 80% in 1hr) with 65W USB Type-C AC adapter
Bluetooth™	Bluetooth 4.1 wireless, integrated in Wi-Fi + Bluetooth combo adapter								Max battery life <i>MobileMark® 2014: 15.4 hrs</i> <i>* Battery life varies significantly with settings, usage, & other factors</i>
WWAN (optional)	Integrated Mobile Broadband 4G LTE-A, Intel XMM™ 7360 (Fibocom L850-GL), M.2 card								AC adapter 45W or 65W USB Type-C AC adapter
SIM card (opt)	Nano-SIM card slot, optional Verizon LTE (US) SIM card								Light sensor Ambient Light Sensor
Dimensions	<i>WxDxH:</i> 13.11" x 9.02" x 0.67"; 333mm x 229mm x 17.05mm								G-sensor 3D accelerometer
Weight	Starting at 3.08 lb (1.4kg)								Gyroscope 3D gyrometer
Case color	Black or silver								GPS GPS function is integrated into WWAN module
Case material	<i>Display cover:</i> Carbon-Fiber and Glass-Fiber hybrid; <i>Bottom:</i> magnesium-PPS hybrid								Preload Windows® 10 Pro 64
									Limited warranty <i>One of the following, configurable by model:</i> • 1-year depot repair service • 3-year/1-yr battery depot repair service
									Mil-Spec test MIL-STD-810G military testing
									Environment EPEAT™ Silver; ENERGY STAR®; RoHS-compliant



ThinkPad X1 Yoga (4th Gen) Platform Specifications

Product Specifications Reference (PSREF)

Processor	8th Generation Intel® Core™ i5 / i7 Processor									Smart card reader	None
	Processor Number	# of Cores	# of Threads	Base Frequency	Max Turbo Frequency	Cache	Memory Types	Processor Graphics		Media reader	None
	i5-8265U	4	8	1.6 GHz	3.9 GHz	6MB	LPDDR3-2133	Intel UHD Graphics 620		Ports	Two USB 3.1 Gen 1 (one Always On), two USB 3.1 Type-C Gen 2 / Thunderbolt 3 (with the function of Power Delivery and DisplayPort), HDMI 1.4b, Ethernet extension connector, nano-SIM card slot (WWAN models), headphone / microphone combo jack, side docking connector, security keyhole
	i5-8365U			1.6 GHz	4.1 GHz	6MB					
	i7-8565U			1.8 GHz	4.6 GHz	8MB					
	i7-8665U			1.9 GHz	4.8 GHz	8MB					
Graphics	Intel UHD Graphics 620 in processor; supports external digital monitor via HDMI or USB Type-C / Thunderbolt; supports three independent displays; Max resolution: 5120x2880@60Hz (USB Type-C); 4096x2160@24Hz (HDMI)									Monitor cabl	Optional: Lenovo HDMI to VGA Monitor Adapter
Chipset	Intel SoC (System on Chip) platform									Bundled Accy	Optional: ThinkPad Ethernet Extension Adapter Gen 2
Memory	8GB or 16GB / 2133MHz LPDDR3 / soldered to systemboard, no sockets									Camera (optional)	One of the following, configurable by model: <ul style="list-style-type: none"> HD720p camera with ThinkShutter camera privacy, fixed focus IR camera and HD720p camera with ThinkShutter camera privacy, fixed focus
Display	Size	Resolution	Type	Surface	Brightness	Aspect Ratio	Contrast Ratio	Color Gamut	Viewing Angle	Audio support	HD Audio, Realtek® ALC1012L codec, Stereo speakers, 2W x 2, 0.8W x 2, Dolby® Audio™ Atmos / Quad array far-field microphones, headphone / microphone combo jack
	14.0"	FHD (1920x1080) Low Power	IPS	Glossy	380 nits	16:9	800:1	72%	170°	Keyboard	6-row, spill-resistant, multimedia Fn keys, LED backlight
	14.0"	FHD (1920x1080) ThinkPad Privacy Guard	IPS	Glossy	380 nits	16:9	1000:1	72%	170°	UltraNav™	TrackPoint® pointing device and buttonless Glass surface multi-touch touchpad
	14.0"	WQHD (2560x1440)	IPS	Glossy	280 nits	16:9	800:1	72%	170°	Security	Power-on password, hard disk password, supervisor password, security keyhole
	14.0"	UHD (3840x2160) Dolby Vision™ HDR400	IPS	Glossy	470 nits	16:9	1400:1	90%	170°	Security chip	Discrete TPM 2.0 TCG Certified
Multi-touch	Capacitive-type multi-touch, AR (anti-reflection), AS (anti-smudge), supports 10-finger gesture									System Mgt	Optional: Intel vPro Technology
Hinge	Yoga hinge, 360 degree									Fingerprint reader	Touch style match on chip fingerprint reader on the palm rest
Convert-mode	Laptop, tent, stand, and tablet									NFC	Optional: Near Field Communication
Pen	ThinkPad Pen Pro, active pen for multi-touch display, on-board rechargeable									Battery	Integrated Li-Ion 51Wh battery, supports Rapid Charge (charge up to 80% in 1hr) with 65W USB Type-C AC adapter
Storage	<i>One of the following, configurable by model:</i> <ul style="list-style-type: none"> M.2 2280 SSD / SATA 6.0Gb/s M.2 2280 SSD / PCIe NVMe, PCIe 3.0 x 4 Intel Optane Memory H10 with Solid State Storage, M.2 2280, PCIe NVMe 3.0 x 4 									Max battery life	MobileMark® 2014: 18.1 hrs * Battery life varies significantly with settings, usage, & other factors
Optane™ Memory	Intel Optane Memory H10									AC adapter	45W or 65W USB Type-C AC adapter
Optical	None									G-sensor	3D accelerometer
Ethernet	Native Intel Ethernet Connection I1219-LM (vPro) or I1219-V (Non-vPro) via bundled or optional ThinkPad Ethernet Extension Adapter Gen 2									Gyroscope	3D gyrometer
WLAN	Intel Wireless-AC 9560, Wi-Fi 2x2 802.11ac + Bluetooth 5.0, M.2 card									GPS	GPS function is integrated into WWAN module
Bluetooth™	Bluetooth 5.0 wireless, integrated in Wi-Fi + Bluetooth combo adapter									Preload	One of the following, configurable by model: <ul style="list-style-type: none"> Windows® 10 Pro 64 Windows 10 Home 64
WWAN (optional)	<i>One of the following, configurable by model:</i> <ul style="list-style-type: none"> Integrated Mobile Broadband 4G LTE-A, Fibocom L850-GL, M.2 card Integrated Mobile Broadband 4G LTE-A, Fibocom L860-GL, MIMO 2x2, M.2 card 									Limited warranty	One of the following, configurable by model: <ul style="list-style-type: none"> 1-year depot repair service 3-year/1-yr battery depot repair service
SIM card (opt)	Nano-SIM card slot, optional Verizon LTE (US) SIM card									Mil-Spec test	MIL-STD-810G military testing
Dimensions	WxDxH: 12.71" x 8.58" x 0.61"; 323mm x 218mm x 15.5mm									Environment	EPEAT™ Silver; ENERGY STAR® 7.1; RoHS-compliant
Weight	Starting at 2.99 lb (1.36kg)										
Case color	Iron Gray										
Case material	Display cover: Aluminium; Bottom: Magnesium										



ThinkPad X380 Yoga Platform Specifications

Product Specifications Reference (PSREF)

Processor	8th Generation Intel® Core™ i3 / i5 / i7 Processor								Dimensions Weight Case color Case Material	<i>WxDxH:</i> 12.34" x 8.75" x 0.72"; 313.5mm x 222.2mm x 18.2mm Starting at 3.17 lb (1.43kg) Black or silver Carbon-Fiber Hybrid
	Processor Number	# of Cores	# of Threads	Base Frequency	Max Turbo Frequency	Cache	Memory Types	Processor Graphics		
	i3-8130U	2	4	2.2 GHz	3.4 GHz	4MB	DDR4-2400	Intel UHD Graphics 620		
	i5-8250U	4	8	1.6 GHz	3.4 GHz	6MB				
	i5-8350U			1.7 GHz	3.6 GHz	6MB				
i7-8550U	1.8 GHz			4.0 GHz	8MB					
i7-8650U	1.9 GHz			4.2 GHz	8MB					
Graphics	Intel UHD Graphics 620 in processor only; supports external digital monitor via HDMI or USB Type-C; supports three independent displays; Max resolution: 4096x2304@60Hz (USB Type-C); 4096x2160@30Hz (HDMI)								Smart card reader Media reader Ports	<i>Optional:</i> Smart card reader (mutually exclusive with NFC) One microSD card slot (microSD, microSDHC, microSDXC), UHS-I Two USB 3.1 Gen 1 (one Always On), Ethernet extension connector, one USB 3.1 Type-C Gen 2 / Thunderbolt 3, HDMI 1.4b, microSD card reader, nano-SIM card slot (WWAN models), headphone / microphone combo jack <i>* Depending on many factors, actual data transfer speed may be lower than theoretical speed</i>
Chipset	Intel SoC (System on Chip) platform								WiGig dock Monitor cable (optional)	None <i>USB-C to VGA:</i> Lenovo USB-C to VGA Plus Power Adapter <i>USB-C to DP:</i> Lenovo USB-C to DisplayPort Adapter <i>HDMI to VGA:</i> Lenovo HDMI to VGA Monitor Adapter
Memory	8GB or 16GB / 2400MHz DDR4 / soldered to systemboard, no sockets * System clocks down for processors with lower memory controller								Camera	<i>One of the following, configurable by model:</i> <i>720p:</i> HD720p camera, fixed focus <i>IR & 720p:</i> IR camera and HD720p camera, fixed focus
Display	13.3" (337.8mm) FHD (1920x1080), LED backlight, IPS 300 nits, 16:9 aspect ratio, 800:1 contrast ratio, 170° viewing angle								Audio support	HD Audio, Conexant® CX11771 codec / stereo speakers, 2W x 2 / dual array microphone, headphone / microphone combo jack
Multi-touch	Capacitive-type multi-touch, AR (anti-reflection), AS (anti-smudge), supports 10-finger gesture								Keyboard	6-row, spill-resistant, multimedia Fn keys, LED backlight
Hinge	Yoga hinge, 360 degree								UltraNav™	TrackPoint® pointing device and 3+2 buttons Mylar surface multi-touch click pad
Convert-mode	Laptop, tent, stand, yoga and tablet								Security	Power-on password, hard disk password, supervisor password, security keyhole
Pen	ThinkPad Pen Pro, active pen for multi-touch display, on-board rechargeable								Security chip	Discrete TPM 2.0 TCG Certified
Storage	<i>Some:</i> M.2 SSD / SATA 6.0Gb/s (e.g. xxxG SSD) <i>Some:</i> M.2 SSD / PCIe NVMe, PCIe 3.0 x 4, 32Gb/s (e.g. xxxG SSD PCIe NVMe)								System Mgt (opt)	Intel vPro Technology
Optical	None								Fingerprint reader	<i>Optional:</i> Touch style match on chip fingerprint reader on the palm rest
Optane Memory	None								NFC (optional)	Near Field Communication (mutually exclusive with smart card reader)
Ethernet	Native Intel Ethernet Connection I219-V (<i>Non-vPro</i>) or I219-LM (<i>vPro</i>) via optional ThinkPad Ethernet Extension Cable								Battery	Li-Ion 51Wh battery
WLAN	Intel Dual Band Wireless-AC 8265, Wi-Fi 2x2 802.11ac + Bluetooth 4.1, M.2 card <i>* Intel 8265ac card supports BT4.2 but is limited to BT4.1 by Windows OS</i>								Max battery life	<i>MobileMark® 2014:</i> 13.6 hrs <i>* Battery life varies significantly with settings, usage, & other factors</i>
Bluetooth™	Bluetooth 4.1 wireless, integrated in Wi-Fi + Bluetooth combo adapter								AC adapter	45W or 65W AC adapter (slim tip), 45W or 65W USB Type-C AC adapter
WWAN (optional)	Integrated Mobile Broadband 4G LTE, Intel XMM™ 7262 (Fibocom L830-EB), M.2 card (EMEA only)								Light sensor	Ambient Light Sensor
SIM card (opt)	Nano-SIM card slot								G-sensor/ eCompass	3D accelerometer and 3D magnetometer
									Gyroscope	3D compass 3D gyrometer
									Preload	<i>Some:</i> Windows® 10 Home 64 <i>Some:</i> Windows 10 Pro 64
									Limited warranty	<i>One of the following, configurable by model:</i> <ul style="list-style-type: none"> • 1-year depot repair service • 3-year/1-yr battery depot repair service
									Mil-Spec test	MIL-STD-810G military testing
									Environment	EPEAT™ Gold; ENERGY STAR®; RoHS-compliant



ThinkPad X390 Yoga Platform Specifications

Product Specifications Reference (PSREF)

Processor	8th Generation Intel® Core™ i5 / i7 Processor								Smart card reader Media reader Ports	Optional: Smart card reader MicroSD card reader, in the combo slot with nano-SIM card Two USB 3.1 Gen 1 (one Always On), one USB 3.1 Type-C Gen 1 (with the function of Power Delivery and Display Port), one USB 3.1 Type-C Gen 2 / Thunderbolt 3 (with the function of PD and DP), HDMI 1.4b, Ethernet extension connector, combo slot of nano-SIM card (WWAN models) and microSD card reader, headphone / microphone combo jack, optional smart card reader, side docking connector, security keyhole * Depending on many factors, actual data transfer speed may be lower than theoretical speed USB-C to HDMI: Lenovo USB-C to HDMI Adapter USB-C to VGA: Lenovo USB-C to VGA Adapter USB-C to DP: Lenovo USB-C to DisplayPort Adapter Optional: ThinkPad Ethernet Extension Adapter Gen 2
	Processor Number	# of Cores	# of Threads	Base Frequency	Max Turbo Frequency	Cache	Memory Types	Processor Graphics		
	i5-8265U	4	8	1.6 GHz	3.9 GHz	6MB	DDR4-2400	Intel UHD Graphics 620		
	i5-8365U	4	8	1.6 GHz	4.1 GHz	6MB				
	i7-8565U	4	8	1.8 GHz	4.6 GHz	8MB				
i7-8665U	4	8	1.9 GHz	4.8 GHz	8MB					
Graphics	Intel UHD Graphics 620 in processor only; supports external digital monitor via HDMI or USB Type-C; supports three independent displays; Max resolution: 4096x2304 @60Hz (USB Type-C); 4096x2160 @24Hz (HDMI)									
Chipset	Intel SoC (System on Chip) platform									
Memory	8GB or 16GB / 2400MHz DDR4 / soldered to systemboard, no sockets * Installed memory is actually 2666MHz but run at 2400MHz due to Intel limitation									
Display	13.3" (337.8mm) FHD (1920x1080), LED backlight, IPS, Glossy, 300 nits, 16:9 aspect ratio, 800:1 contrast ratio, Color Gamut 72%, 170° viewing angle, capacitive-type multi-touch, AR (anti-reflection), AS (anti-smudge)									
Multi-touch	supports 10-finger gesture									
Hinge	Yoga hinge, 360 degree									
Convert-mode	Laptop, tent, stand and tablet									
Pen	ThinkPad Pen Pro, active pen for multi-touch display, on-board rechargeable									
Storage	<ul style="list-style-type: none"> M.2 2280 SSD / SATA 6.0Gb/s M.2 2280 SSD / PCIe NVMe, PCIe 3.0 x 4 M.2 2242 SSD / PCIe NVMe, PCIe 3.0 x 2 Intel Optane Memory H10 with Solid State Storage, M.2 2280, PCIe NVMe 3.0 x 4 									
Optane™ memory	Optional: Intel Optane Memory H10									
Optical	None									
Ethernet	Native Intel Ethernet Connection I219-V (Non-vPro) or I219-LM (vPro) via bundled or optional ThinkPad Ethernet Extension Adapter Gen 2									
WLAN	<i>One of the following, configurable by model:</i> <ul style="list-style-type: none"> Intel Wireless-AC 9560, Wi-Fi 2x2 802.11ac + Bluetooth 5.0 Intel Wi-Fi 6 AX200, Wi-Fi 2x2 802.11ax + Bluetooth 5.0 									
Bluetooth™	Bluetooth 5.0 wireless, integrated in Wi-Fi + Bluetooth combo adapter									
WWAN (optional)	<i>One of the following, configurable by model:</i> <ul style="list-style-type: none"> Integrated Mobile Broadband 4G LTE, Fibocom L830-EB, M.2 card (EMEA only) Integrated Mobile Broadband 4G LTE-A, Fibocom L850-GL, M.2 card * For non-WWAN model, it means the model is NOT WWAN upgradable									
Dimensions	WxDxH: 12.22" x 8.62" x 0.63"; 310.4mm x 219mm x 15.95mm									
Weight	Starting at 2.85 lb (1.29kg)									
Case color	Black or silver									
Case Material	Display cover: Carbon-Fiber Hybrid Bottom: Carbon-Fiber Hybrid									
Camera	<i>One of the following, configurable by model:</i> <ul style="list-style-type: none"> HD720p camera, with ThinkShutter camera privacy, fixed focus IR camera and HD720p camera, with ThinkShutter camera privacy, fixed focus 									
Audio support	HD Audio, Realtek® ALC3287 codec / stereo speakers, 2W x 2, Dolby® Audio™ Premium / dual array microphone, headphone / microphone combo jack									
Keyboard	6-row, spill-resistant, multimedia Fn keys, LED backlight									
UltraNav™	TrackPoint® pointing device and buttonless Mylar surface multi-touch touchpad									
Security	Power-on password, hard disk password, supervisor password, security keyhole									
Security chip	Discrete TPM 2.0 TCG Certified									
System Mgt (opt)	Intel vPro Technology									
Fingerprint reader	Touch style match on chip fingerprint reader on the palm rest									
NFC (optional)	Near Field Communication									
Battery	Integrated Li-ion 50Wh battery, supports Rapid Charge (charge up to 80% in 1hr) with 65W USB Type-C AC adapter									
Max battery life	MobileMark® 2014: 14.5 hrs * Battery life varies significantly with settings, usage, & other factors									
AC adapter	45W or 65W USB Type-C AC adapter									
Light sensor	None									
G-sensor	3D accelerometer									
Gyroscope	3D gyrometer									
Preload	Windows® 10 Home 64 or Windows 10 Pro 64									
Limited warranty	<i>One of the following, configurable by model:</i> <ul style="list-style-type: none"> 1-year depot repair service 3-year/1-yr battery depot repair service 3-year/1-yr battery limited onsite service 									
Mil-Spec test	MIL-STD-810G military testing									
Environment	EPEAT™ Silver; ENERGY STAR® 7.1; RoHS-compliant									



ThinkPad Yoga 11e (5th Gen) Platform Specifications

Product Specifications Reference (PSREF)

Processor	7th Generation Intel® Core™ m / i5 Processor, Intel Celeron® processor, or Intel Pentium® Silver processor							Dimensions	<i>WxDxH:</i> 11.81" x 8.27" x 0.89"; 300mm x 210mm x 22.5mm
								Weight	From 3.4 lb (1.54kg)
								Case color	Black
								Case material	<i>Display cover:</i> PC/ABS+GF; <i>Bottom:</i> PC/ABS plastic
								Media reader	MicroSD card reader
							Ports	Two USB 3.1 Gen 1, one USB 3.1 Type-C Gen 1, HDMI 1.4, Ethernet (RJ-45), headphone / microphone combo jack, microSD card reader, security keyhole <i>* Depending on many factors, actual data transfer speed may be lower than theoretical speed</i>	
							Control buttons	Power button, volume control button	
							Camera	<i>One of the following, configurable by model:</i> <i>720p:</i> HD720p resolution, low light sensitive, fixed focus <i>World facing:</i> Rear camera, 5MP resolution, auto focuss	
Graphics	Intel HD Graphics 615, Intel UHD Graphics 600 or 605 in processor, supports external digital monitor via HDMI or USB Type-C; supports dual independent display; Max resolution: 3840x2160@60Hz (USB Type-C); 4096x2160@30Hz (HDMI)							Audio support	HD Audio, Realtek® ALC3287 codec Dolby Audio / stereo speakers, 2W x 2 / monaural microphone, headphone / microphone combo jack
Chipset	Intel SoC (System on Chip) platform							Keyboard	6-row, multimedia Fn keys
Memory	4GB or 8GB / 1866MHz LPDDR3 or 2400MHz DDR4 / soldered to systemboard, no sockets							UltraNav™	Two buttons click pad below keyboard, multi-touch
Display	11.6" (295mm) HD (1366x768), anti-glare, LED backlight, IPS 250 nits, 16:9 aspect ratio, 800:1 contrast ratio, 170° viewing angle							Security	Power-on password, hard disk password, supervisor password, security keyhole
MultiTouch	Capacitive-type multi-touch, support 10 fingers							Security chip	Discrete TPM 2.0, TCG Certified
Hinge	Yoga hinge, 360 degree							System Mgt (opt)	None
Convertible mode	Laptop, tent, stand and tablet							Fingerprint reader	None
Pen	<i>Optional:</i> ThinkPad Pen Pro, batteries required, on-board garage							Battery	Integrated Li-Ion 42Wh battery
Storage	eMMC flash memory on board or M.2 SSD / PCIe NVMe, PCIe 3.0 x 2, 16Gb/s							Max battery life	<i>MobileMark® 2014:</i> 12 hrs <i>* Battery life varies significantly with settings, usage, & other factors</i>
Optical	None							AC adapter	45W or 65W slim tip AC adapter or USB Type-C AC adapter
Ethernet	Realtek RTL8111GUS-CG Gigabit Network Connection							Preload	<i>Some:</i> Windows® 10 Home 64 <i>Some:</i> Windows 10 Pro 64
WLAN	<i>One of the following, configurable by model:</i> • Intel Wireless-AC 9260, Wi-Fi 2x2 802.11ac + Bluetooth 5.0, M.2 card • Intel Wireless-AC 9560, Wi-Fi 2x2 802.11ac + Bluetooth 5.0, M.2 card							Limited warranty	<i>One of the following, configurable by model:</i> • 1-year depot repair service • 3-year depot repair service
Bluetooth™	Bluetooth wireless, integrated in Wi-Fi + Bluetooth combo adapter							Mil-Spec test	MIL-STD-810G military testing
WWAN	None							Environment	EPEAT™ Gold; ENERGY STAR® 6.1; RoHS-compliant

Lenovo
March 2019

This publication was developed for products and services offered in the North America, E.M.E.A and Asia & Pacific countries. Lenovo may not offer the products, services or features discussed in this document in other countries. Lenovo may withdraw an offering at any time. Information is subject to change without notice. Consult your local representative for information on offerings available in your area.

Lenovo reserves the right to change specifications or other product information without notice. Lenovo is not responsible for photographic or typographical errors.

LENOVO PROVIDES THIS PUBLICATION "AS IS," WITHOUT WARRANTY OF ANY KIND, EITHER EXPRESS OR IMPLIED, INCLUDING THE IMPLIED WARRANTIES OF MERCHANTABILITY OR FITNESS FOR A PARTICULAR PURPOSE.

Some jurisdictions do not allow disclaimer of express or implied warranties in certain transactions, therefore this disclaimer may not apply to you.

Availability: All offers subject to availability. Lenovo reserves the right to alter product offerings and specifications at any time, without notice. Lenovo is not responsible for photographic or typographic errors.

General: Review key information provided by Microsoft that may apply to your system purchase, including details on Windows 10, Windows 8, Windows 7, and potential upgrades/downgrades. Lenovo makes no representation or warranty regarding third-party products or services.

Trademarks: Lenovo, ThinkPad, ThinkBook, ThinkCentre, ThinkStation, ThinkVision and the Lenovo logo are trademarks of Lenovo. Microsoft, Windows, Windows NT, and the Windows logo are trademarks of Microsoft Corporation. Ultrabook, Celeron, Celeron Inside, Core Inside, Intel, Intel Logo, Intel Atom, Intel Atom Inside, Intel Core, Intel Inside, Intel Inside Logo, Intel vPro, Itanium, Itanium Inside, Pentium, Pentium Inside, vPro Inside, Xeon, Xeon Phi, and Xeon Inside are trademarks of Intel Corporation in the U.S. and/or other countries. Other company, product or service names may be trademarks or service marks of others.

Warranty: For a copy of applicable warranties, write to: Lenovo Warranty Information, 1009 Think Place, Morrisville, NC, 27560. Lenovo makes no representation or warranty regarding third party products or services. The Lenovo Limited Warranty applies only to Lenovo hardware products purchased for your own use, and does not transfer upon resale.

Limited warranty: Support unrelated to a warranty issue may be subject to additional charges.

Lenovo Services:

Carry-in or Mail-in Service: Parts and labor repair coverage where the customer is responsible for shipping (including packaging) or delivery to authorized warranty provider or repair center.

Depot or Courier Service: Parts and labor repair coverage where shipping (including packaging) or delivery to the repair center is paid for by Lenovo.

Expedited Depot: Parts and labor coverage with expedited turnaround. Shipping (including packaging) or delivery to the repair center is paid for by Lenovo.

Onsite / In-home Service: Parts and labor repair coverage where labor is provided onsite at your place of business.

If Lenovo determines your product problem is covered by the product warranty and cannot be resolved over the telephone, a technician will be dispatched to arrive onsite, typically the next day.

International Warranty Service (IWS): PC repair coverage for customers who require a critical warranty repair while travelling internationally. Visit www.lenovo.com/internationalwarranty for details. Visit www.lenovo.com/warranty for Lenovo Warranty Services terms and conditions for complete details and restrictions.

Included software: may differ from its retail version (if available), and may not include user manuals or all program functionality. Software license agreements may apply.

Battery life: Battery life (and recharge times) will vary based on many factors including screen brightness, applications, features, power management, battery conditioning, and other customer preferences.

Visit <http://psref.lenovo.com/> for the latest version of Product Specifications Reference.

© Lenovo, 2019. All rights reserved.
Lenovo 1009 Think Place Morrisville, NC 27560 U.S.A.

Lenovo™ **ThinkCentre**®

PSREF



Product Specifications Reference

Version 545, July 2019

Visit <http://psref.lenovo.com> for the latest version

Contents

Cover		
Contents		
Summary Of Change		
M Series AIO		
ThinkCentre M810z AIO		
ThinkCentre M810z AIO Platform Specifications		
ThinkCentre M820z AIO		
ThinkCentre M820z AIO Platform Specifications		
ThinkCentre M910z AIO		
ThinkCentre M910z AIO Platform Specifications		
ThinkCentre M920z AIO		
ThinkCentre M920z AIO Platform Specifications		
M Series Desktop		
ThinkCentre M600 Tiny		
ThinkCentre M600 Tiny Platform Specifications		
ThinkCentre M600 Tiny Thin Client		
ThinkCentre M600 Tiny Thin Client Platform Specifications		
ThinkCentre M625 Tiny		
ThinkCentre M625 Tiny Platform Specifications		
ThinkCentre M625 Tiny Thin Client		
ThinkCentre M625 Tiny Thin Client Platform Specifications		
ThinkCentre M630e Tiny		
ThinkCentre M630e Tiny Platform Specifications		
ThinkCentre M710 SFF		
ThinkCentre M710 SFF Platform Specifications		
ThinkCentre M710 Tiny		
ThinkCentre M710 Tiny Platform Specifications		
ThinkCentre M710 Tower		
ThinkCentre M710 Tower Platform Specifications		
ThinkCentre M710e SFF		
ThinkCentre M710e SFF Platform Specifications		
ThinkCentre M715 SFF		
ThinkCentre M715 SFF Platform Specifications		
ThinkCentre M715 Tiny		
ThinkCentre M715 Tiny Platform Specifications		
ThinkCentre M715 Tiny (2nd Gen)	35	
ThinkCentre M715 Tiny (2nd Gen) Platform Specifications		36
ThinkCentre M715 Tiny Thin Client	37	
ThinkCentre M715 Tiny Thin Client Platform Specifications		38
ThinkCentre M715 Tiny Thin Client (2nd Gen)	39	
ThinkCentre M715 Tiny Thin Client (2nd Gen) Platform Specifications		40
ThinkCentre M715 Tower	41	
ThinkCentre M715 Tower Platform Specifications		42
ThinkCentre M720 SFF	43	
ThinkCentre M720 SFF Platform Specifications		44
ThinkCentre M720 Tiny	45	
ThinkCentre M720 Tiny Platform Specifications		46
ThinkCentre M720 Tower	47	
ThinkCentre M720 Tower Platform Specifications		48
ThinkCentre M725 SFF	49	
ThinkCentre M725 SFF Platform Specifications		50
ThinkCentre M90n-1 Nano	51	
ThinkCentre M90n-1 Nano Platform Specifications		52
ThinkCentre M90n-1 Nano IoT	53	
ThinkCentre M90n-1 Nano IoT Platform Specifications		54
ThinkCentre M910 SFF	55	
ThinkCentre M910 SFF Platform Specifications		56
ThinkCentre M910 Tiny	57	
ThinkCentre M910 Tiny Platform Specifications		58
ThinkCentre M910 Tower	59	
ThinkCentre M910 Tower Platform Specifications		60
ThinkCentre M910x Tiny	61	
ThinkCentre M910x Tiny Platform Specifications		62
ThinkCentre M920 SFF	63	
ThinkCentre M920 SFF Platform Specifications		64
ThinkCentre M920 Tiny	65	
ThinkCentre M920 Tiny Platform Specifications		66
ThinkCentre M920 Tower	67	
ThinkCentre M920 Tower Platform Specifications		68
ThinkCentre M920x Tiny	69	

Contents

ThinkCentre M920x Tiny Platform Specifications	70
Smart Office	71
ThinkSmart Hub 500	71
ThinkSmart Hub 500 Platform Specifications	72
Tiny-In-One	73
ThinkCentre Tiny-In-One 22	73
ThinkCentre Tiny-In-One 22 Platform Specifications	74
ThinkCentre Tiny-In-One 22 Gen3	75
ThinkCentre Tiny-In-One 22 Gen3 Platform Specifications	76
ThinkCentre Tiny-In-One 24	77
ThinkCentre Tiny-In-One 24 Platform Specifications	78
ThinkCentre Tiny-In-One 24 Gen3	79
ThinkCentre Tiny-In-One 24 Gen3 Platform Specifications	80
ThinkCentre Tiny-In-One 27	81
ThinkCentre Tiny-In-One 27 Platform Specifications	82
Legal Information	83

Summary of Changes

This section describes the technical changes made in this edition.

This edition might also include minor corrections and editorial changes which are not identified.

July 2019 - Version 545

Additions in this update

▶ **New product(s)**

ThinkCentre M90n-1 Nano

ThinkCentre M90n-1 Nano IOT

▶ **New model(s)**

None

▶ **Others**

Update EPEAT rating for all ThinkCentre products

Withdrawals in this update

▶ **Withdrawn product(s)**

None

▶ **Withdrawn model(s)**

None



ThinkCentre M810z Platform Specifications

Product Specifications Reference (PSREF)

Processor	Intel® Celeron®, Intel Pentium®, or 6th / 7th Gen Intel Core™ i3 / i5 / i7 Processor						Security features	<ul style="list-style-type: none"> Security slot (in rear for attachment of optional Kensington® MicroSaver® cable; Kensington lock also locks chassis) Smart USB protection, allows keyboard/mouse only, blocks all storage devices Optional cable lock to physically lock keyboard and mouse 	<ul style="list-style-type: none"> Power-on, admin, hard disk password Boot sequence control Boot without keyboard and mouse Individual USB port disablement Optional Chassis intrusion switch
	Processor	Cores / Threads	Frequency Base/Max(GHz)	Cache	Memory Support (Up to)	Integrated Graphics			
	Pentium G4400	2 / 2	3.3G	3 MB	DDR4-2133	HD 510			
	Pentium G4560	2 / 4	3.5G	3 MB	DDR4-2400	HD 610			
	Pentium G4600	2 / 4	3.6G	3 MB	DDR4-2400	HD 630			
	Core i3-6100	2 / 4	3.7G	3 MB	DDR4-2133	HD 530			
	Core i5-6500	4 / 4	3.2G / 3.6G	6 MB	DDR4-2133	HD 530			
	Core i7-6700	4 / 8	3.4G / 4.0G	8 MB	DDR4-2133	HD 530			
	Core i3-7100	2 / 4	3.9G	3 MB	DDR4-2400	HD 630			
	Core i5-7400	4 / 4	3.0G / 3.5G	6 MB	DDR4-2400	HD 630			
Core i5-7500	4 / 4	3.4G / 3.8G	6 MB	DDR4-2400	HD 630				
Core i5-7600	4 / 4	3.5G / 4.1G	6 MB	DDR4-2400	HD 630				
Core i7-7700	4 / 8	3.6G / 4.2G	8 MB	DDR4-2400	HD 630				
Memory	32GB max, DDR4-2400*, two 260-pin SO-DIMM sockets, dual-channel capable * System clocks down for the processors with lower memory controller						Keyboard	<i>Some:</i> Lenovo Calliope Keyboard (USB connector), black <i>Some:</i> Lenovo Traditional Keyboard (USB connector), black <i>Some:</i> Lenovo Calliope Wireless Keyboard (2.4GHz via USB receiver), black <i>Some:</i> Lenovo Calliope Mouse (USB connector), black <i>Some:</i> Lenovo Calliope Wireless Mouse (2.4GHz via USB receiver), black	Mouse
Storage	<i>Some:</i> Hard Drive / SATA 6.0Gb/s, 2.5", 5400 rpm or 7200 rpm <i>Some:</i> Solid State Drive (SSD) / SATA 6.0Gb/s, 2.5" <i>Some:</i> M.2 Solid State Drive (SSD) / PCIe NVMe, PCIe 3.0 x 4, 32Gb/s <i>Some:</i> Intel Optane™ Memory (models with 7th gen Core processor), M.2 <i>Some:</i> DVD-ROM SATA 1.5Gb/s Drive, slim (9.5mm) <i>Some:</i> DVD Burner (DVD±RW), SATA 1.5Gb/s Drive, slim (9.5mm)								
Optical	Optional 9-in-1 media card reader								
Media reader	Optional 9-in-1 media card reader								
Graphics	Intel HD Graphics 510/530/610/630 in processor, uses main memory, DirectX® 12, external monitor support via DisplayPort™; <i>Max resolution:</i> 4096x2304 (DP)@60Hz, 1920x1080 (Panel)@60Hz								
Display	21.5" (546.1mm) Full HD 1080p (1920x1080) TFT color , MVA panel, wide viewing angle (+/- 89°), LED backlight, 250 nits, 16:9 aspect ratio, 1000:1 contrast ratio, anti-glare, support Low Blue Light Mode								
Multi-touch	Optional Projected Capacitive Touch (PCT) technology, supports 10-point touch								
Camera	Optional 1080p camera, fixed focus, with dual microphone, LED indicator, physical switch on/off								
Controls	Physical buttons for Microphone mute, brightness up/down, and power on/off								
Chipset	Intel B250 Chipset								
Rear ports*	Four USB 3.1 Gen1, ethernet (RJ-45), DisplayPort, optional serial (9-pin), Two USB 3.1 Gen1 (one is Always On and fast charge), optional card reader, one headphone / microphone combo jack (3.5mm)								
Side ports*	* Depending on many factors, actual data transfer speed may be lower than theoretical speed								
M.2 card slot	Two M.2 Card slots (one for WLAN, one for SSD/Optane)								
Audio support	High Definition (HD) Audio, Realtek ALC233 / two internal speakers (2W x 2), Dolby® Audio™ certified								
WLAN ¹³	<i>Some:</i> 11ac wireless, M.2 Card, Qualcomm Atheros QCA9377A (dual band), Wi-Fi + Bluetooth 4.1 combo adapter, 1x1 <i>Some:</i> 11ac wireless, M.2 Card, Qualcomm Atheros QCA6174A (dual band), Wi-Fi + Bluetooth 4.1 combo adapter, 2x2 <i>Some:</i> 11ac wireless, M.2 Card, Intel Dual Band Wireless-AC 3165, Wi-Fi + Bluetooth 4.1 combo adapter, 1x1 <i>Some:</i> 11ac wireless, M.2 Card, Intel Dual Band Wireless-AC 8265, Wi-Fi + Bluetooth 4.1 combo adapter, 2x2								
Bluetooth™	<i>Some:</i> Bluetooth 4.1 wireless, integrated in Wi-Fi + Bluetooth combo adapter								
Ethernet	Gigabit ethernet, Realtek RTL8111G, Wake on LAN®								
Manageability	None								
Security chip	TPM (Trusted Platform Module) 2.0, TCG Certified * Downgrade to TPM1.2 for the models with Win10 DG Win7 32 OS								
Power supply	150 watts, autosensing, 85% PSU								
Limited warranty ³	<i>Some:</i> 1-year or 3-year, depot repair service / service upgrades available <i>Some:</i> 1-year or 3-year, limited onsite service / service upgrades available								
Preload	Preloaded operating system <i>Some:</i> Windows® 7 Professional 32/64 preinstalled through downgrade rights in Windows 10 Pro 64-bit <i>Some:</i> Windows 10 Pro 64-bit <i>Some:</i> Windows 10 Home 64-bit								
Environment	Preloaded applications (only some listed) <ul style="list-style-type: none"> Microsoft Office preloaded; purchase a product key to activate - Only for Window 10 Lenovo Companion - Only for Window 7 Lenovo Solution Center Lenovo ThinkVantage Tools ThinkVantage System Update Create Recovery Media Adobe® Reader® Cyberlink PowerDVD Create (DVD±RW) 								
Environment	EPEAT™ Gold rating (North America); ENERGY STAR® 6.1; TCO AIO Computer Certified; ErP Lot 3; GREENGUARD® certified; RoHS-compliant								
MIL-SPEC test	MIL-STD-810G military certification (Low Pressure [Altitude], High Temperature, Low Temperature, Temperature Shock, Humidity, Sand and Dust, Vibration, Shock)								
Accessories	For compatible accessories, please go to http://www.lenovoquickpick.com								

See footnotes for more detailed information



ThinkCentre M820z Platform Specifications

Product Specifications Reference (PSREF)

Processor	Intel® Celeron®, Intel Pentium®, or 8th / 9th Gen Intel Core™ i3 / i5 / i7 / i9 series						WLAN <i>Some:</i> 11ac wireless, M.2 Card, Realtek RTL8821CE (dual band), Wi-Fi + Bluetooth 4.2 combo adapter, 1x1 <i>Some:</i> 11ac wireless, M.2 Card, Realtek RTL8822BE (dual band), Wi-Fi + Bluetooth 4.2 combo adapter, 2x2 <i>Some:</i> 11ac wireless, M.2 Card, Intel Dual Band Wireless-AC 3165, Wi-Fi + Bluetooth 4.2 combo adapter, 1x1 <i>Some:</i> 11ac wireless, M.2 Card, Intel Dual Band Wireless-AC 8265, Wi-Fi + Bluetooth 4.2 combo adapter, 2x2 Bluetooth™ Ethernet <i>Some:</i> Bluetooth 4.2 wireless, integrated in Wi-Fi + BT combo adapter Gigabit ethernet, Realtek RTL8111G, Wake on LAN®																				
	Processor	Cores / Threads	Frequency Base/Max(GHz)	Cache	Memory Support (Up to)	Integrated Graphics																					
	Celeron G4900	2 / 2	3.1G	2 MB	DDR4-2400	UHD 610																					
	Celeron G4920	2 / 2	3.2G	2 MB	DDR4-2400	UHD 610																					
	Celeron G4930	2 / 2	3.2G	2 MB	DDR4-2400	UHD 610																					
	Celeron G4950	2 / 2	3.3G	2 MB	DDR4-2400	UHD 610																					
	Pentium Gold G5400	2 / 4	3.7G	4 MB	DDR4-2400	UHD 610																					
	Pentium Gold G5420	2 / 4	3.8G	4 MB	DDR4-2400	UHD 610																					
	Pentium Gold G5500	2 / 4	3.8G	4 MB	DDR4-2400	UHD 630																					
	Pentium Gold G5600	2 / 4	3.9G	4 MB	DDR4-2400	UHD 630																					
	Pentium Gold G5620	2 / 4	4.0G	4 MB	DDR4-2400	UHD 630																					
	Core i3-8100	4 / 4	3.6G	6 MB	DDR4-2400	UHD 630																					
	Core i3-8300	4 / 4	3.7G	8 MB	DDR4-2400	UHD 630																					
	Core i5-8400	6 / 6	2.8G / 4.0G	9 MB	DDR4-2666	UHD 630																					
	Core i5-8500	6 / 6	3.0G / 4.1G	9 MB	DDR4-2666	UHD 630																					
	Core i5-8600	6 / 6	3.1G / 4.3G	9 MB	DDR4-2666	UHD 630																					
	Core i7-8700	6 / 12	3.2G / 4.6G	12 MB	DDR4-2666	UHD 630																					
	Core i3-9100	4 / 4	3.6G / 4.2G	6 MB	DDR4-2400	UHD 630																					
	Core i3-9300	4 / 4	3.7G / 4.3G	8 MB	DDR4-2400	UHD 630																					
	Core i5-9400	6 / 6	2.9G / 4.1G	9 MB	DDR4-2666	UHD 630																					
Core i5-9500	6 / 6	3.0G / 4.4G	9 MB	DDR4-2666	UHD 630																						
Core i5-9600	6 / 6	3.1G / 4.6G	9 MB	DDR4-2666	UHD 630																						
Core i7-9700	8 / 8	3.0G / 4.7G	12 MB	DDR4-2666	UHD 630																						
Core i9-9900	8 / 16	3.1G / 5.0G	16 MB	DDR4-2666	UHD 630																						
Memory	32GB max (16GB SO-DIMM only available via special bid models), DDR4-2666*, two 260-pin SO-DIMM sockets, dual-channel capable * System clocks down for the processors with lower memory controller																										
Storage	<i>Some:</i> Hard Drive / SATA 6.0Gb/s, 2.5", 5400 rpm or 7200 rpm <i>Some:</i> Solid State Drive (SSD) / SATA 6.0Gb/s, 2.5" <i>Some:</i> M.2 SSD / PCIe NVMe, PCIe 3.0 x 4*, 32Gb/s * 128GB SSD M.2 (2242) PCIe NVMe only supports PCIe 3.0 x 2, 16Gb/s <i>Some:</i> Intel Optane™ Memory (not support Celeron / Pentium Processor), M.2 <i>Some:</i> DVD-ROM SATA 1.5Gb/s Drive, slim (9.0mm) <i>Some:</i> DVD Burner (DVD±RW), SATA 1.5Gb/s Drive, slim (9.0mm) Optional 3-in-1 media card reader																										
Optical																											
Media reader																											
Graphics	Intel HD Graphics 610/630 in processor, uses main memory, DirectX® 12, external monitor support via DisplayPort™; <i>Max resolution:</i> 4096x2304 (DP)@60Hz, 1920x1080 (Panel)@60Hz 21.5" (546.1mm) Full HD 1080p (1920x1080) TFT color , Borderless design, MVA panel, wide viewing angle (+/- 89°), LED backlight, 250 nits, 16:9 aspect ratio, 1000:1 contrast ratio, anti-glare, support Low Blue Light Mode Optional multi-touch, supports 10-point, AIT (Advanced In-cell Touch) technology Optional 1080p camera, with dual microphone, LED indicator, physical switch on/off, supports multi-degree rotation (horizontal 0° to 180°, vertical -25° to 25°) Physical buttons on side for microphone mute and power on/off																										
Display																											
Multi-touch																											
Camera																											
Controls																											
Chipset	Intel B360 Chipset																										
Rear ports*	Four USB 3.1 Gen1 (one supports Smart Power On), one ethernet (RJ-45), one DisplayPort, one optional serial (9-pin),																										
Side ports*	one USB 3.1 Gen2 (one is Always On and fast charge), one USB 3.1 Type-C Gen 1, one optional card reader, one headphone / microphone combo jack (3.5mm) * Depending on many factors, actual data transfer speed may be lower than theoretical speed																										
M.2 card slot	Two M.2 Card slots (one for WLAN, one for SSD/Optane)																										
Audio support	High Definition (HD) Audio, Realtek ALC233 / two internal speakers (2W x 2), Dolby® Audio™ Premium																										
Manageability	None																										
Security chip	Discrete TPM 2.0, TCG Certified																										
Security features	<ul style="list-style-type: none"> Security slot (in rear for attachment of optional Kensington® MicroSaver® cable; Kensington lock also locks chassis) Smart USB protection, allows keyboard/mouse only, blocks all storage devices Power-on, admin, hard disk password Boot sequence control Boot without keyboard and mouse Individual USB port disablement Optional Chassis intrusion switch 																										
Keyboard	<i>Some:</i> Lenovo Calliope Keyboard (USB connector), black <i>Some:</i> Lenovo Traditional Keyboard (USB connector), black <i>Some:</i> Lenovo Calliope Wireless Keyboard (2.4GHz via USB receiver), black																										
Mouse	<i>Some:</i> Lenovo Calliope Mouse (USB connector), black <i>Some:</i> Lenovo Fingerprint Mouse (USB connector), Windows Hello support, black <i>Some:</i> Lenovo Calliope Wireless Mouse (2.4GHz via USB receiver), black																										
Mechanical	<ul style="list-style-type: none"> Business black color Toolless back cover, stand, memory removal Support VESA mount (100mm) <table border="1"> <thead> <tr> <th>Dimensions (WxDxH)</th> <th>Max weight (lb / kg)</th> <th>Adjustments</th> </tr> </thead> <tbody> <tr> <td colspan="3">Without stand (No camera):</td> </tr> <tr> <td>19.3 X 1.9 X 13.5 (inch) 491 X 49 X 342 (mm)</td> <td>(Touch) 11.6 / 5.25 (Non-touch) 11.1 / 5.05</td> <td>N/A</td> </tr> <tr> <td colspan="3">With Full Function Monitor stand (No camera):</td> </tr> <tr> <td>19.3 X 9.9 X 14.8 to 19.1 (inch) 491 X 252 X 377 to 486 (mm)</td> <td>(Non-touch) 15.8 / 7.18</td> <td>Tilt: 45° back, -5° forward; Lift: 110mm; Swivel: +/-45°</td> </tr> <tr> <td colspan="3">With UltraFlex III stand (No camera):</td> </tr> <tr> <td>19.3 X 9.9 X 16.4 (highest) (inch) 491 X 252 X 416 (highest) (mm)</td> <td>(Touch) 17.3 / 7.85 (Non-touch) 16.9 / 7.65</td> <td>Tilt: 70° back, -5° forward; Lift: 136mm; Swivel: +/-45°</td> </tr> </tbody> </table>						Dimensions (WxDxH)	Max weight (lb / kg)	Adjustments	Without stand (No camera):			19.3 X 1.9 X 13.5 (inch) 491 X 49 X 342 (mm)	(Touch) 11.6 / 5.25 (Non-touch) 11.1 / 5.05	N/A	With Full Function Monitor stand (No camera):			19.3 X 9.9 X 14.8 to 19.1 (inch) 491 X 252 X 377 to 486 (mm)	(Non-touch) 15.8 / 7.18	Tilt: 45° back, -5° forward; Lift: 110mm; Swivel: +/-45°	With UltraFlex III stand (No camera):			19.3 X 9.9 X 16.4 (highest) (inch) 491 X 252 X 416 (highest) (mm)	(Touch) 17.3 / 7.85 (Non-touch) 16.9 / 7.65	Tilt: 70° back, -5° forward; Lift: 136mm; Swivel: +/-45°
Dimensions (WxDxH)	Max weight (lb / kg)	Adjustments																									
Without stand (No camera):																											
19.3 X 1.9 X 13.5 (inch) 491 X 49 X 342 (mm)	(Touch) 11.6 / 5.25 (Non-touch) 11.1 / 5.05	N/A																									
With Full Function Monitor stand (No camera):																											
19.3 X 9.9 X 14.8 to 19.1 (inch) 491 X 252 X 377 to 486 (mm)	(Non-touch) 15.8 / 7.18	Tilt: 45° back, -5° forward; Lift: 110mm; Swivel: +/-45°																									
With UltraFlex III stand (No camera):																											
19.3 X 9.9 X 16.4 (highest) (inch) 491 X 252 X 416 (highest) (mm)	(Touch) 17.3 / 7.85 (Non-touch) 16.9 / 7.65	Tilt: 70° back, -5° forward; Lift: 136mm; Swivel: +/-45°																									
Power supply	150 watts, autosensing, 90% PSU																										
Limited warranty ³	<i>Some:</i> 1-year or 3-year, depot repair service / service upgrades available <i>Some:</i> 1-year or 3-year, limited onsite service / service upgrades available																										
Preload	Preloaded operating system <i>Some:</i> Windows 10 Pro 64-bit <i>Some:</i> Windows 10 Home 64-bit Preloaded applications (only some listed) <ul style="list-style-type: none"> Lenovo Vantage Microsoft Office preloaded; purchase a product key to activate Cyberlink PowerDVD (only for models with DVD / DVD±RW) Cyberlink Power2GO (only for models with DVD±RW) LinkedIn 																										
Environment	ENERGY STAR® 7.0*, EPEAT™ Silver rating* (*not for non-OS models), ErP Lot 3, TCO AIO Computer certified, GREENGUARD® certified, TUV Eye comfort certified (for Full Function Monitor Stand only), TUV Low Blue Light certified, TUV Ultra Low Noise certified (on some models), RoHS-compliant																										
MIL-SPEC test	MIL-STD-810G military certification (Low Pressure [Altitude], High Temperature, Low Temperature, Temperature Shock, Humidity, Sand and Dust, Vibration, Shock, Fungus)																										
Accessories	For compatible accessories, please go to http://smartfind.lenovo.com																										

Note: The specifications above may not be available in all regions.

Lenovo, June 2019

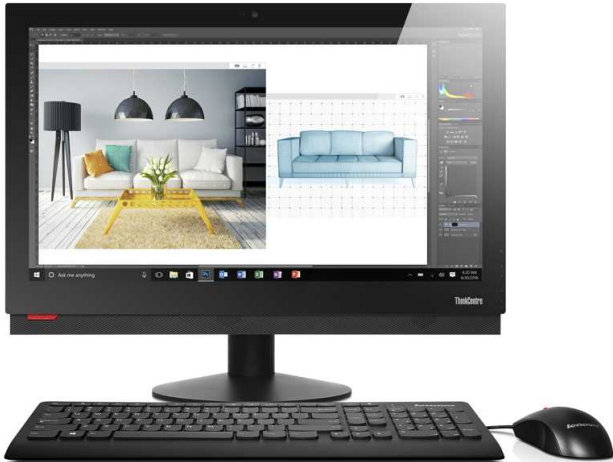

ThinkCentre M910z Platform Specifications

Product Specifications Reference (PSREF)

Processor	Intel® Celeron®, Intel Pentium®, or 6th / 7th Gen Intel Core™ i3 / i5 / i7 Processor	Security chip	TPM (Trusted Platform Module) 2.0, TCG Certified * Downgrade to TPM1.2 for the models with Win10 DG Win7 32 OS																																																						
	<table border="1"> <thead> <tr> <th>Processor</th> <th>Cores / Threads</th> <th>Frequency Base/Max(GHz)</th> <th>Cache</th> <th>Memory Support (Up to)</th> <th>Integrated Graphics</th> </tr> </thead> <tbody> <tr> <td>Core i3-6100</td> <td>2 / 4</td> <td>3.7G</td> <td>3 MB</td> <td>DDR4-2133</td> <td>HD 530</td> </tr> <tr> <td>Core i5-6500</td> <td>4 / 4</td> <td>3.2G / 3.6G</td> <td>6 MB</td> <td>DDR4-2133</td> <td>HD 530</td> </tr> <tr> <td>Core i7-6700</td> <td>4 / 8</td> <td>3.4G / 4.0G</td> <td>8 MB</td> <td>DDR4-2133</td> <td>HD 530</td> </tr> <tr> <td>Core i3-7100</td> <td>2 / 4</td> <td>3.9G</td> <td>3 MB</td> <td>DDR4-2400</td> <td>HD 630</td> </tr> <tr> <td>Core i5-7400</td> <td>4 / 4</td> <td>3.0G / 3.5G</td> <td>6 MB</td> <td>DDR4-2400</td> <td>HD 630</td> </tr> <tr> <td>Core i5-7500</td> <td>4 / 4</td> <td>3.4G / 3.8G</td> <td>6 MB</td> <td>DDR4-2400</td> <td>HD 630</td> </tr> <tr> <td>Core i5-7600</td> <td>4 / 4</td> <td>3.5G / 4.1G</td> <td>6 MB</td> <td>DDR4-2400</td> <td>HD 630</td> </tr> <tr> <td>Core i7-7700</td> <td>4 / 8</td> <td>3.6G / 4.2G</td> <td>8 MB</td> <td>DDR4-2400</td> <td>HD 630</td> </tr> </tbody> </table>	Processor	Cores / Threads	Frequency Base/Max(GHz)	Cache	Memory Support (Up to)	Integrated Graphics	Core i3-6100	2 / 4	3.7G	3 MB	DDR4-2133	HD 530	Core i5-6500	4 / 4	3.2G / 3.6G	6 MB	DDR4-2133	HD 530	Core i7-6700	4 / 8	3.4G / 4.0G	8 MB	DDR4-2133	HD 530	Core i3-7100	2 / 4	3.9G	3 MB	DDR4-2400	HD 630	Core i5-7400	4 / 4	3.0G / 3.5G	6 MB	DDR4-2400	HD 630	Core i5-7500	4 / 4	3.4G / 3.8G	6 MB	DDR4-2400	HD 630	Core i5-7600	4 / 4	3.5G / 4.1G	6 MB	DDR4-2400	HD 630	Core i7-7700	4 / 8	3.6G / 4.2G	8 MB	DDR4-2400	HD 630	Security features	<ul style="list-style-type: none"> Security slot (in rear for attachment of optional Kensington® MicroSaver® cable; Kensington lock also locks chassis) Smart USB protection, allows keyboard/mouse only, blocks all storage devices Optional cable lock to physically lock keyboard and mouse Power-on, admin, hard disk password Boot sequence control Boot without keyboard and mouse Individual USB port disablement Optional Chassis intrusion switch
Processor	Cores / Threads	Frequency Base/Max(GHz)	Cache	Memory Support (Up to)	Integrated Graphics																																																				
Core i3-6100	2 / 4	3.7G	3 MB	DDR4-2133	HD 530																																																				
Core i5-6500	4 / 4	3.2G / 3.6G	6 MB	DDR4-2133	HD 530																																																				
Core i7-6700	4 / 8	3.4G / 4.0G	8 MB	DDR4-2133	HD 530																																																				
Core i3-7100	2 / 4	3.9G	3 MB	DDR4-2400	HD 630																																																				
Core i5-7400	4 / 4	3.0G / 3.5G	6 MB	DDR4-2400	HD 630																																																				
Core i5-7500	4 / 4	3.4G / 3.8G	6 MB	DDR4-2400	HD 630																																																				
Core i5-7600	4 / 4	3.5G / 4.1G	6 MB	DDR4-2400	HD 630																																																				
Core i7-7700	4 / 8	3.6G / 4.2G	8 MB	DDR4-2400	HD 630																																																				
Memory	32GB max, DDR4-2400*, two 260-pin SO-DIMM sockets, dual-channel capable * System clocks down for the processors with lower memory controller	Keyboard	<i>Some:</i> Lenovo Calliope Keyboard (USB connector), black <i>Some:</i> Lenovo Traditional Keyboard (USB connector), black <i>Some:</i> Lenovo Calliope Wireless Keyboard (2.4GHz via USB receiver), black <i>Some:</i> Lenovo Calliope Mouse (USB connector), black <i>Some:</i> Lenovo Calliope Wireless Mouse (2.4GHz via USB receiver), black																																																						
Storage	<i>Some:</i> Hard Drive / SATA 6.0Gb/s, 2.5", 5400 rpm or 7200 rpm <i>Some:</i> Solid State Drive (SSD) / SATA 6.0Gb/s, 2.5" <i>Some:</i> M.2 Solid State Drive (SSD) / PCIe NVMe, PCIe 3.0 x 4, 32Gb/s <i>Some:</i> Intel Optane™ Memory (models with 7th gen Core processor), M.2 <i>Some:</i> DVD-ROM SATA 1.5Gb/s Drive, slim (9.5mm) <i>Some:</i> DVD Burner (DVD±RW), SATA 1.5Gb/s Drive, slim (9.5mm)	Mouse																																																							
Optical	Optional 9-in-1 media card reader	Mechanical	<ul style="list-style-type: none"> Business black color Toolless back cover, stand, disk, memory removal Support VESA mount (100mm) <table border="1"> <thead> <tr> <th></th> <th>Dimensions (WxDxH)</th> <th>Max weight (lb / kg)</th> <th>Adjustments</th> </tr> </thead> <tbody> <tr> <td>Without stand:</td> <td>23.0 X 1.8 X 15.4 (inch); 584 X 45 X 390 (mm)</td> <td>(Touch) 17.2 / 7.8 (Non-touch) 15.0 / 6.8</td> <td>N/A</td> </tr> <tr> <td>With Basic Monitor stand:</td> <td>23.0 X 9.6 X 18.0 (inch); 584 X 245 X 458 (mm)</td> <td>(Non-touch) 19.4 / 8.8</td> <td>Tilt: 45° back, -5° forward</td> </tr> <tr> <td>With UltraFlex II stand:</td> <td>23.0X 10.0 X 19.9 (inch); 584 X 253 X 505 (mm)</td> <td>(Touch) 22.7 / 10.3 (Non-touch) 20.7 / 9.4</td> <td>Tilt: 61° back, -5° forward; Lift: 110mm; Swivel: +/-45°</td> </tr> </tbody> </table>		Dimensions (WxDxH)	Max weight (lb / kg)	Adjustments	Without stand:	23.0 X 1.8 X 15.4 (inch); 584 X 45 X 390 (mm)	(Touch) 17.2 / 7.8 (Non-touch) 15.0 / 6.8	N/A	With Basic Monitor stand:	23.0 X 9.6 X 18.0 (inch); 584 X 245 X 458 (mm)	(Non-touch) 19.4 / 8.8	Tilt: 45° back, -5° forward	With UltraFlex II stand:	23.0X 10.0 X 19.9 (inch); 584 X 253 X 505 (mm)	(Touch) 22.7 / 10.3 (Non-touch) 20.7 / 9.4	Tilt: 61° back, -5° forward; Lift: 110mm; Swivel: +/-45°																																						
	Dimensions (WxDxH)	Max weight (lb / kg)	Adjustments																																																						
Without stand:	23.0 X 1.8 X 15.4 (inch); 584 X 45 X 390 (mm)	(Touch) 17.2 / 7.8 (Non-touch) 15.0 / 6.8	N/A																																																						
With Basic Monitor stand:	23.0 X 9.6 X 18.0 (inch); 584 X 245 X 458 (mm)	(Non-touch) 19.4 / 8.8	Tilt: 45° back, -5° forward																																																						
With UltraFlex II stand:	23.0X 10.0 X 19.9 (inch); 584 X 253 X 505 (mm)	(Touch) 22.7 / 10.3 (Non-touch) 20.7 / 9.4	Tilt: 61° back, -5° forward; Lift: 110mm; Swivel: +/-45°																																																						
Media reader	Optional 9-in-1 media card reader	Power supply	150 watts, autosensing, 85% PSU																																																						
Graphics	Intel HD Graphics 530/630 in processor, uses main memory, DirectX® 12, external monitor support via DisplayPort™; <i>Max resolution:</i> 4096x2304 (DP)@60Hz, 1920x1080 (Panel)@60Hz	Limited warranty ³	<i>Some:</i> 1-year or 3-year, depot repair service / service upgrades available <i>Some:</i> 1-year or 3-year, limited onsite service / service upgrades available																																																						
Display	23.8" (604.5mm) Full HD 1080p (1920x1080) TFT color , WVA panel, wide viewing angle (+/- 89°), LED backlight, 250 nits, 16:9 aspect ratio, 1000:1 contrast ratio, anti-glare, support Low Blue Light Mode, work as standalone monitor via DisplayPort (DP in / out combo)	Preload	Preloaded operating system <i>Some:</i> Windows® 7 Professional 32/64 preinstalled through downgrade rights in Windows 10 Pro 64-bit <i>Some:</i> Windows 10 Pro 64-bit <i>Some:</i> Windows 10 Home 64-bit Preloaded applications (only some listed) <ul style="list-style-type: none"> Microsoft Office preloaded; purchase a product key to activate Only for Window 10 Lenovo Companion Only for Window 7 Lenovo Solution Center Lenovo ThinkVantage Tools ThinkVantage System Update Create Recovery Media Adobe® Reader® Cyberlink PowerDVD Create (DVD±RW) 																																																						
Multi-touch	Optional Projected Capacitive Touch (PCT) technology, supports 10-point touch	Environment	EPEAT™ Gold rating (North America); ENERGY STAR® 6.1; TCO AIO Computer Certified; ULE Gold; ErP Lot 3; GREENGUARD® certified; RoHS-compliant																																																						
Camera	Optional 1080p camera, fixed focus, with dual microphone, LED indicator, physical switch on/off	MIL-SPEC test	MIL-STD-810G military certification (Low Pressure [Altitude], High Temperature, Low Temperature, Temperature Shock, Humidity, Sand and Dust, Vibration, Shock)																																																						
Controls	Physical buttons for Microphone mute, monitor mode switch, brightness up/down, and power on/off	Accessories	For compatible accessories, please go to http://www.lenovoquickpick.com																																																						
Chipset	Intel Q270 Chipset																																																								
Rear ports*	Four USB 3.1 Gen1, ethernet (RJ-45), DisplayPort in/out combo port, optional serial (9-pin)																																																								
Side ports*	Two USB 3.1 Gen1 (one is Always On and fast charge), optional card reader, one headphone / microphone combo jack (3.5mm), optional USB 3.1 Type-C Gen1																																																								
M.2 card slot	* Depending on many factors, actual data transfer speed may be lower than theoretical speed Two M.2 Card slots (one for WLAN, one for SSD/Optane)																																																								
Audio support	High Definition (HD) Audio, Realtek ALC233 / two internal speakers (3W x 2), Dolby® Audio™ certified																																																								
WLAN ¹³	<i>Some:</i> 11ac wireless, M.2 Card, Qualcomm Atheros QCA9377A (dual band), Wi-Fi + Bluetooth 4.1 combo adapter, 1x1 <i>Some:</i> 11ac wireless, M.2 Card, Qualcomm Atheros QCA6174A (dual band), Wi-Fi + Bluetooth 4.1 combo adapter, 2x2 <i>Some:</i> 11ac wireless, M.2 Card, Intel Dual Band Wireless-AC 3165, Wi-Fi + Bluetooth 4.1 combo adapter, 1x1 <i>Some:</i> 11ac wireless, M.2 Card, Intel Dual Band Wireless-AC 8265, Wi-Fi + Bluetooth 4.1 combo adapter, 2x2 <i>Some:</i> 11ac wireless, M.2 Card, Intel Dual Band Wireless-AC 8265, Wi-Fi + Bluetooth 4.1 combo adapter, Intel vPro technology support, 2x2																																																								
Bluetooth™	<i>Some:</i> Bluetooth 4.1 wireless, integrated in Wi-Fi + Bluetooth combo adapter																																																								
Ethernet	Gigabit ethernet, Intel Ethernet Connection I219-LM (Jacksonville), Wake on LAN®																																																								
Manageability	Intel Active Management Technology 11.0 (Intel AMT 11.0); Intel vPro technology on some models (require choosing a vPro-support Wi-Fi adapter to enable vPro function through wireless connection)																																																								

See footnotes for more detailed information



ThinkCentre M920z Platform Specifications

Product Specifications Reference (PSREF)

Processor	Intel® Celeron®, Intel Pentium®, or 8th / 9th Gen Intel Core™ i3 / i5 / i7 / i9 series						Audio support	High Definition (HD) Audio, Realtek ALC233 / two internal speakers (3W x 2), Dolby® Audio™ Premium
	Processor	Cores / Threads	Frequency Base/Max(GHz)	Cache	Memory Support (Up to)	Integrated Graphics	WLAN	<i>Some:</i> 11ac wireless, M.2 Card, Realtek RTL8821CE (dual band), Wi-Fi + Bluetooth 4.2 combo adapter, 1x1 <i>Some:</i> 11ac wireless, M.2 Card, Realtek RTL8822BE (dual band), Wi-Fi + Bluetooth 4.2 combo adapter, 2x2 <i>Some:</i> 11ac wireless, M.2 Card, Intel Dual Band Wireless-AC 3165, Wi-Fi + Bluetooth 4.2 combo adapter, 1x1 <i>Some:</i> 11ac wireless, M.2 Card, Intel Dual Band Wireless-AC 8265, Wi-Fi + Bluetooth 4.2 combo adapter, 2x2 <i>Some:</i> 11ac wireless, M.2 Card, Intel Wireless-AC 9560 (dual band), Wi-Fi + Bluetooth 5.0 combo adapter, Intel vPro technology support, 2x2 <i>Some:</i> Bluetooth 4.2/5.0 wireless, integrated in Wi-Fi + BT combo adapter Gigabit ethernet, Intel Ethernet Connection I219-LM (Jacksonville), Wake on LAN®
	Celeron G4900	2 / 2	3.1G	2 MB	DDR4-2400	UHD 610	Bluetooth™ Ethernet	Manageability
	Celeron G4920	2 / 2	3.2G	2 MB	DDR4-2400	UHD 610		
	Celeron G4930	2 / 2	3.2G	2 MB	DDR4-2400	UHD 610		
	Celeron G4950	2 / 2	3.3G	2 MB	DDR4-2400	UHD 610		
	Pentium Gold G5400	2 / 4	3.7G	4 MB	DDR4-2400	UHD 610		
	Pentium Gold G5420	2 / 4	3.8G	4 MB	DDR4-2400	UHD 610		
	Pentium Gold G5500	2 / 4	3.8G	4 MB	DDR4-2400	UHD 630		
	Pentium Gold G5600	2 / 4	3.9G	4 MB	DDR4-2400	UHD 630		
	Pentium Gold G5620	2 / 4	4.0G	4 MB	DDR4-2400	UHD 630		
	Core i3-8100	4 / 4	3.6G	6 MB	DDR4-2400	UHD 630		
	Core i3-8300	4 / 4	3.7G	8 MB	DDR4-2400	UHD 630		
	Core i5-8400	6 / 6	2.8G / 4.0G	9 MB	DDR4-2666	UHD 630		
	Core i5-8500	6 / 6	3.0G / 4.1G	9 MB	DDR4-2666	UHD 630		
	Core i5-8600	6 / 6	3.1G / 4.3G	9 MB	DDR4-2666	UHD 630		
	Core i7-8700	6 / 12	3.2G / 4.6G	12 MB	DDR4-2666	UHD 630		
	Core i3-9100	4 / 4	3.6G / 4.2G	6 MB	DDR4-2400	UHD 630		
	Core i3-9300	4 / 4	3.7G / 4.3G	8 MB	DDR4-2400	UHD 630		
	Core i5-9400	6 / 6	2.9G / 4.1G	9 MB	DDR4-2666	UHD 630		
Core i5-9500	6 / 6	3.0G / 4.4G	9 MB	DDR4-2666	UHD 630			
Core i5-9600	6 / 6	3.1G / 4.6G	9 MB	DDR4-2666	UHD 630			
Core i7-9700	8 / 8	3.0G / 4.7G	12 MB	DDR4-2666	UHD 630			
Core i9-9900	8 / 16	3.1G / 5.0G	16 MB	DDR4-2666	UHD 630			
Memory	32GB max (16GB SO-DIMM only available via special bid models), DDR4-2666*, two 260-pin SO-DIMM sockets, dual-channel capable * System clocks down for the processors with lower memory controller						Mechanical	<ul style="list-style-type: none"> Business black color Toolless back cover, stand, disk, memory removal Support VESA mount (100mm)
Storage	<i>Some:</i> Hard Drive / SATA 6.0Gb/s, 2.5", 5400 rpm or 7200 rpm, supports up to two HDDs (2nd HDD occupies ODD bay), RAID0/1 support (RAID preset only available via special bid model) <i>Some:</i> Solid State Drive (SSD) / SATA 6.0Gb/s, 2.5" <i>Some:</i> M.2 SSD / PCIe NVMe, PCIe 3.0 x 4*, 32Gb/s * 128GB SSD M.2 (2242) PCIe NVMe only supports PCIe 3.0 x 2, 16Gb/s <i>Some:</i> Intel Optane™ Memory (not support Celeron / Pentium Processor), M.2 <i>Some:</i> DVD-ROM SATA 1.5Gb/s Drive, slim (9.0mm) <i>Some:</i> DVD Burner (DVD±RW), SATA 1.5Gb/s Drive, slim (9.0mm)							
Optical	Optional 3-in-1 media card reader							
Media reader	Optional 3-in-1 media card reader							
Graphics	Intel HD Graphics 610/630 in processor, uses main memory, DirectX® 12, external monitor support via DisplayPort™; Max resolution: 4096x2304 (DP) @60Hz, 1920x1080 (Panel)@60Hz							
Display	23.8" (604.5mm) Full HD 1080p (1920x1080) TFT color, Borderless design, WVA panel, wide viewing angle (+/- 89°), LED backlight, 250 nits, 16:9 aspect ratio, 1000:1 contrast ratio, anti-glare, support Low Blue Light Mode, work as standalone monitor via DisplayPort (DP in / out combo)							
Multi-touch	Optional multi-touch, supports 10-point, AIT (Advanced In-cell Touch) technology							
Camera	<i>Some:</i> 1080p camera, with dual microphone, LED indicator, physical switch on/off, supports multi-degree rotation (horizontal 0° to 180°, vertical -25° to 25°) <i>Some:</i> RGBIR camera, 1080p, with dual microphone, physical switch on/off, supports multi-degree rotation (horizontal 0° to 180°, vertical -25° to 25°) Windows Hello support, only available via special bid models							
Controls	Physical buttons on side for microphone mute and power on/off							
Chipset	Intel Q370 Chipset							
Rear ports*	Four USB 3.1 Gen1 (one supports Smart Power On), one ethernet (RJ-45), one DisplayPort in/out combo port, one optional serial (9-pin)							
Side ports*	one USB 3.1 Gen2 (one is Always On and fast charge), one USB 3.1 Gen1, one USB 3.1 Type-C Gen 1, one optional card reader, one headphone / microphone combo jack (3.5mm)							
M.2 card slot	Two M.2 Card slots (one for WLAN, one for SSD/Optane) * Depending on many factors, actual data transfer speed may be lower than theoretical speed							
Power supply	150 watts, autosensing, 90% PSU							
Limited warranty ³	<i>Some:</i> 1-year or 3-year, depot repair service / service upgrades available <i>Some:</i> 1-year or 3-year, limited onsite service / service upgrades available							
Preload	Preloaded operating system <i>Some:</i> Windows 10 Pro 64-bit <i>Some:</i> Windows 10 Home 64-bit Preloaded applications (only some listed) <ul style="list-style-type: none"> Lenovo Vantage Microsoft Office preloaded; purchase a product key to activate Cyberlink PowerDVD (only for models with DVD / DVD±RW) Cyberlink Power2GO (only for models with DVD±RW) LinkedIn 							
Environment	ENERGY STAR® 7.0*, EPEAT™ Silver rating* (*not for non-OS models), ErP Lot 3, TCO AIO Computer certified, GREENGUARD® certified, TUV Eye comfort certified, TUV Low Blue Light certified, TUV Ultra Low Noise certified (on some models), RoHS-compliant							
MIL-SPEC test	MIL-STD-810G military certification (Low Pressure [Altitude], High Temperature, Low Temperature, Temperature Shock, Humidity, Sand and Dust, Vibration, Shock, Fungus)							
Accessories	For compatible accessories, please go to http://smartfind.lenovo.com							

Note: The specifications above may not be available in all regions.

Lenovo, June 2019



ThinkCentre M600 Tiny Platform Specifications

Product Specifications Reference (PSREF)

Processor	Intel® Celeron® Processor N3000 Series or Intel Pentium® Processor N3000 Series						Keyboard <i>Some:</i> Preferred Pro USB Keyboard (USB connector), Lenovo logo <i>Some:</i> Lenovo USB Fingerprint Keyboard (USB connector) <i>Some:</i> Ultralim Plus Wireless Keyboard (2.4GHz via USB receiver), black <i>Some:</i> Enhanced Optical USB Mouse, black, Lenovo logo <i>Some:</i> Ultralim Plus Wireless Mouse (2.4GHz via USB receiver), black												
	Processor	Cores / Threads	Frequency (Base/Max)	Cache	Memory Types	Integrated Graphics													
	Celeron N3050	2 / 2	1.6 / 2.16 GHz	2MB	DDR3L-1600	Intel HD													
	Celeron J3060	2 / 2	1.6 / 2.48 GHz	2MB	DDR3L-1600	Intel HD 400													
	Pentium N3700	4 / 4	1.6 / 2.4 GHz	2MB	DDR3L-1600	Intel HD													
	Pentium J3710	4 / 4	1.6 / 2.64 GHz	2MB	DDR3L-1600	Intel HD 405													
Chipset	Intel Architecture (IA) SoC that integrates Intel processor core, graphics, memory controller, and I/O interfaces into a single system-on-chip solution						Mechanical • Tiny (1L), black color, metal case <table border="1"> <thead> <tr> <th></th> <th>Dimensions (WxDxH)</th> <th>Max weight (lb / kg)</th> </tr> </thead> <tbody> <tr> <td>M600 Tiny only (1L)</td> <td>7.05" X 7.20" X 1.36" 179mm X 182.9mm X 34.5mm</td> <td>2.9 lb (1.3 kg)</td> </tr> <tr> <td>M600 Tiny (1L) with VESA mount & ODD box</td> <td>7.42" X 7.30" X 2.48" 188.4mm X 185.38mm X 63mm</td> <td>4.12 lb (1.87 kg)</td> </tr> <tr> <td>M600 Tiny (1L) with VESA mount & I/O box</td> <td>7.42" X 7.30" X 2.62" 188.4mm X 185.38mm X 66.6mm</td> <td>3.53 lb (1.6 kg)</td> </tr> </tbody> </table>		Dimensions (WxDxH)	Max weight (lb / kg)	M600 Tiny only (1L)	7.05" X 7.20" X 1.36" 179mm X 182.9mm X 34.5mm	2.9 lb (1.3 kg)	M600 Tiny (1L) with VESA mount & ODD box	7.42" X 7.30" X 2.48" 188.4mm X 185.38mm X 63mm	4.12 lb (1.87 kg)	M600 Tiny (1L) with VESA mount & I/O box	7.42" X 7.30" X 2.62" 188.4mm X 185.38mm X 66.6mm	3.53 lb (1.6 kg)
	Dimensions (WxDxH)	Max weight (lb / kg)																	
M600 Tiny only (1L)	7.05" X 7.20" X 1.36" 179mm X 182.9mm X 34.5mm	2.9 lb (1.3 kg)																	
M600 Tiny (1L) with VESA mount & ODD box	7.42" X 7.30" X 2.48" 188.4mm X 185.38mm X 63mm	4.12 lb (1.87 kg)																	
M600 Tiny (1L) with VESA mount & I/O box	7.42" X 7.30" X 2.62" 188.4mm X 185.38mm X 66.6mm	3.53 lb (1.6 kg)																	
Graphics	Intel HD Graphics in processor, uses main memory, DirectX® 11.1, twoDisplayPort™, one optional 3rd DP (not support DP to HDMI dongle) or VGA, supports triple independent display; Maximum resolution: 3840x2160(DP)@30Hz; 1920x1200(optional VGA)@60Hz; 1920x1080(DP to VGA dongle)@60Hz; 1920x1080(DP to DVI dongle)@60Hz; 3840x2160(DP to HDMI dongle)@30Hz																		
Monitor cable	Optional DP to VGA, DP to DVI-D (single link), or DP to HDMI 1.4 dongle																		
Memory	8GB max / DDR3 Low Voltage, DDR3L-1600, non-parity, one 204-pin SO-DIMM socket																		
Storage	<i>Some:</i> hard disk, 5400 or 7200 rpm, SATA 6.0Gb/s, 2.5" Wide <i>Some:</i> 500GB (5400 rpm) Solid State Hybrid Drive (SSHD) / with 8GB MLC NAND flash memory, SATA 6.0Gb/s, 2.5" wide																		
Optical	<i>Some:</i> Solid State Drive (SSD) / SATA 6.0Gb/s, 2.5" Wide <i>Some:</i> external ODD box with DVD-ROM, 9.5mm high, via USB <i>Some:</i> external ODD box with DVD±RW, 9.5mm high, via USB <i>Some:</i> external ODD box (for TIO) with DVD-ROM, 9.5mm high, via USB <i>Some:</i> external ODD box (for TIO) with DVD±RW, 9.5mm high, via USB																		
Onboard SATA Media reader	SATA 6.0Gb/s controller, one connectors on planar None																		
Front ports*	Two USB 3.0 (one is Always On and fast charge), one microphone (stereo, 3.5mm), one headphone / microphone combo jack (stereo, 3.5mm)																		
Rear ports*	Two USB 2.0, two USB 3.0 (optional external optical box or I/O box occupies one or two specific USB on some models), ethernet (RJ-45), two DisplayPort, one optional port (VGA, 3rd DP, or serial on some models), one headphone																		
I/O box*	Optional external I/O box, extends two USB 2.0, two USB 3.0, and one serial on rear, two USB 2.0 on front, via USB (occupy two specific USB 3.0 of M600 Tiny) * Depending on many factors, actual data transfer speed may be lower than theoretical speed																		
Audio support	High Definition (HD) Audio, Realtek ALC223 / optional internal speaker (1 watt)																		
WLAN ¹³	<i>Some:</i> 11ac wireless, M.2 Card, Realtek RTL8821AE (dual band), Wi-Fi + Bluetooth 4.0 combo adapter, 1x1 <i>Some:</i> 11ac wireless, M.2 Card, Qualcomm Atheros QCA9377 (dual band), Wi-Fi + Bluetooth 4.1 combo adapter, 1x1 <i>Some:</i> 11ac wireless, M.2 Card, Qualcomm Atheros QCA6174 (dual band), Wi-Fi + Bluetooth 4.1 combo adapter, 2x2 <i>Some:</i> 11ac wireless, M.2 Card, Intel Dual Band Wireless-AC 3165, Wi-Fi + Bluetooth 4.0 combo adapter, 1x1 <i>Some:</i> 11ac wireless, M.2 Card, Intel Dual Band Wireless-AC 8260, Wi-Fi + Bluetooth 4.1 combo adapter, 2x2																		
Bluetooth™	<i>Some:</i> Bluetooth 4.0 or 4.1 wireless, integrated in Wi-Fi + BT combo adapter																		
Ethernet	One gigabit ethernet port, Realtek RTL8111GN, Wake on LAN®																		
Modem	None																		
Manageability	None																		
Security chip	Trusted Platform Module, TCG 1.2-compliant																		
Security features	<ul style="list-style-type: none"> • Security slot (in rear for optional Kensington® MicroSaver® cable) • Padlock loop • Smart USB protection, allows keyboard/mouse only, blocks all storage devices • Power-on password • Administrator password • Hard disk password • Boot sequence control • Boot without keyboard and mouse • Individual USB port disablement • Chassis intrusion switch 																		
Environment	ENERGY STAR® 6.0*, EPEAT™ Gold rating* (*not for non-OS models); GREENGUARD®; RoHS-compliant; Cisco EnergyWise compatible; ErP Lot 3																		
Accessories	For compatible accessories, please go to TC-AQP sheet																		

See footnotes for more detailed information

Lenovo, November 2017



ThinkCentre M600 Tiny Thin Client Platform Specifications

Product Specifications Reference (PSREF)

Processor	Intel® Celeron® Processor N3000 Series or Intel Pentium® Processor N3000 Series						Keyboard <i>Some:</i> PS/2 Keyboard (PS/2 connector), Lenovo logo (for 2L models) <i>Some:</i> Preferred Pro USB Keyboard (USB connector), Lenovo logo <i>Some:</i> Ultralim Plus Wireless Keyboard (2.4GHz via USB receiver), black <i>Some:</i> PS/2 Optical Wheel Mouse, black, Lenovo logo (for 2L models) <i>Some:</i> Enhanced Optical USB Mouse, black, Lenovo logo <i>Some:</i> Ultralim Plus Wireless Mouse (2.4GHz via USB receiver), black									
	Processor	Cores / Threads	Frequency (Base/Max)	Cache	Memory Types	Integrated Graphics										
	Celeron N3000	2 / 2	1.04 / 2.08 GHz	2MB	DDR3L-1600	Intel HD										
	Celeron N3010	2 / 2	1.04 / 2.24 GHz	2MB	DDR3L-1600	Intel HD 400										
Chipset	Intel Architecture (IA) SoC that integrates Intel processor core, graphics, memory controller, and I/O interfaces into a single system-on-chip solution						Mechanical • Tiny (1L or 2L), black color, metal case <table border="1"> <thead> <tr> <th></th> <th>Dimensions (WxDxH)</th> <th>Max weight (lb / kg)</th> </tr> </thead> <tbody> <tr> <td>M600 Tiny only (1L)</td> <td>7.05" X 7.20" X 1.36" 179mm X 182.9mm X 34.5mm</td> <td>2.9 lb (1.3 kg)</td> </tr> <tr> <td>M600 Tiny only (2L)</td> <td>7.05" X 7.20" X 3.15" 179mm X 182.9mm X 80mm</td> <td>4.2 lb (1.9 kg)</td> </tr> </tbody> </table>		Dimensions (WxDxH)	Max weight (lb / kg)	M600 Tiny only (1L)	7.05" X 7.20" X 1.36" 179mm X 182.9mm X 34.5mm	2.9 lb (1.3 kg)	M600 Tiny only (2L)	7.05" X 7.20" X 3.15" 179mm X 182.9mm X 80mm	4.2 lb (1.9 kg)
	Dimensions (WxDxH)	Max weight (lb / kg)														
M600 Tiny only (1L)	7.05" X 7.20" X 1.36" 179mm X 182.9mm X 34.5mm	2.9 lb (1.3 kg)														
M600 Tiny only (2L)	7.05" X 7.20" X 3.15" 179mm X 182.9mm X 80mm	4.2 lb (1.9 kg)														
Graphics	Intel HD Graphics in processor, uses main memory, DirectX® 11.1, twoDisplayPort™, one optional 3rd DP (not support DP to HDMI dongle) or VGA, supports triple independent display; Maximum resolution: 3840x2160(DP)@30Hz; 1920x1200(optional VGA)@60Hz; 1920x1080(DP to VGA dongle)@60Hz; 1920x1080(DP to DVI dongle)@60Hz; 3840x2160(DP to HDMI dongle)@30Hz Optional DP to VGA, DP to DVI-D (single link), or DP to HDMI 1.4 dongle															
Monitor cable	Optional DP to VGA, DP to DVI-D (single link), or DP to HDMI 1.4 dongle															
Memory	8GB max / DDR3 Low Voltage, DDR3L-1600, non-parity, one 204-pin SO-DIMM socket						VESA mount Optional VESA mount bracket kit, supports VESA 75mm and 100mm Floor Stand Optional system floor stand for vertical orientation									
Storage	16GB, 32GB, or 128GB M.2 Solid State Drive (SSD), SATA interface						Power supply 65 watts AC/DC adapter, autosensing, 88% PSU (not included for TIO models)									
Optical	None						Limited warranty ³ <i>Some:</i> 1-year or 3-year, depot service / service upgrades available <i>Some:</i> 1-year or 3-year, limited onsite service / service upgrades available <i>Some:</i> 3-year, limited onsite service, OID (Onsite International Delivery) / service upgrades available <i>For Lenovo service upgrade options, please go to S-TC sheet</i>									
Onboard SATA	SATA 6.0Gb/s controller, one connectors on planar															
Media reader	None															
Front ports*	Two USB 3.0 (one is Always On and fast charge), one microphone (stereo, 3.5mm), one headphone / microphone combo jack (stereo, 3.5mm)						Preload <i>Some:</i> Windows Embedded Standard 7 (WES 7) <i>Some:</i> Windows Embedded Standard 7 V2 (WES 7 V2) <i>Some:</i> Windows 10 IoT Enterprise <i>Some:</i> LeTOS (Lenovo Terminal Operating System, Linux-based) <i>Some:</i> LeTOS V2 (Lenovo Terminal Operating System, Linux-based)									
Rear ports*	Two USB 2.0, two USB 3.0, ethernet (RJ-45), two DisplayPort, one optional port (VGA, 3rd DP, or serial on some models), one headphone; additional four serial (9-pin), one parallel (25-pin), and two PS/2 ports on 2L models * Depending on many factors, actual data transfer speed may be lower than theoretical speed															
I/O box	None															
Audio support	High Definition (HD) Audio, Realtek ALC223 / optional internal speaker (1 watt)						Environment ENERGY STAR® 6.0*, EPEAT™ Gold rating* (*not for non-OS models); GREENGUARD®; RoHS-compliant; Cisco EnergyWise compatible; ErP Lot 3									
WLAN ¹³	<i>Some:</i> 11ac wireless, M.2 Card, Realtek RTL8821AE (dual band), Wi-Fi + Bluetooth 4.0 combo adapter, 1x1 <i>Some:</i> 11ac wireless, M.2 Card, Qualcomm Atheros QCA9377 (dual band), Wi-Fi + Bluetooth 4.1 combo adapter, 1x1 <i>Some:</i> 11ac wireless, M.2 Card, Qualcomm Atheros QCA6174 (dual band), Wi-Fi + Bluetooth 4.1 combo adapter, 2x2 <i>Some:</i> 11ac wireless, M.2 Card, Intel Dual Band Wireless-AC 3165, Wi-Fi + Bluetooth 4.0 combo adapter, 1x1 (only for 1L models)						Accessories For compatible accessories, please go to TC-AQP sheet									
Bluetooth™	<i>Some:</i> Bluetooth 4.0 or 4.1 wireless, integrated in Wi-Fi + BT combo adapter															
Ethernet	One gigabit ethernet port, Realtek RTL8111GN, Wake on LAN®															
Modem	None															
Manageability	None															
Security chip	Trusted Platform Module, TCG 1.2-compliant															
Security features	<ul style="list-style-type: none"> • Security slot (in rear for optional Kensington® MicroSaver® cable) • Padlock loop • Smart USB protection, allows keyboard/mouse only, blocks all storage devices • Power-on password • Administrator password • Hard disk password • Boot sequence control • Boot without keyboard and mouse • Individual USB port disablement • Chassis intrusion switch 															

Note: The specifications above may not be available in all regions.

Lenovo, November 2017



ThinkCentre M625 Tiny Platform Specifications

Product Specifications Reference (PSREF)

Processor	AMD A9 series APU						Keyboard Mouse	<i>Some:</i> Fullsize USB Keyboard (USB connector), black, Lenovo logo <i>Some:</i> USB Optical Wheel Mouse, black, Lenovo logo	
	APU	Cores	Frequency Base/Max	L2 Cache	Memory Support (Up to)	Integrated Graphics		Mechanical	Tiny (1L), black color; metal case • Toolless chassis open (for models with optional toolless chassis screw) • Toolless HDD, SSD, memory, Wi-Fi removal • Optional dust filter M625 Tiny only: 7.05" W X 7.20" D X 1.36" H 179mm W X 182.9mm D X 34.5mm H 2.9 lb (1.3 kg), weight may vary by configuration Optional VESA mount bracket kit, supports VESA 75mm and 100mm Optional system floor stand for vertical orientation
Memory	8GB max, DDR4-2666, one 260-pin SO-DIMM socket * System frequency automatically clocks down for the lower capability of memory controller in processor						VESA mount Floor Stand		Optional system floor stand for vertical orientation
Disk	<i>Some:</i> SATA 6.0Gb/s, 2.5" Wide, 5400 rpm or 7200 rpm <i>Some:</i> 128GB M.2 Solid State Drive (SSD) / PCIe NVMe interface <i>Some:</i> 256GB M.2 Solid State Drive (SSD) / PCIe NVMe interface							Power supply	65 watts AC/DC adapter, autosensing, 88% PSU (not included for TIO models)
Optical Onboard SATA Media reader	None						Limited warranty ³		<i>Some:</i> 1-year, depot service / service upgrades available <i>Some:</i> 1-year, limited onsite service / service upgrades available
Graphics	AMD Radeon™ Graphics in processor, uses main memory, DirectX® 12, two DisplayPort™, one optional port (VGA or USB 2.0 Type-C with DisplayPort Alternate Mode), supports up to 2 independent displays; <i>Max resolution:</i> 3840x2160 (DP)@60Hz; 2048x1280 (VGA)@60Hz; 3840x2160 (USB 2.0 Type-C)@60Hz							Preload	Preloaded operating system <i>Some:</i> Windows® 10 Pro 64-bit <i>Some:</i> Windows 7 Professional 64 preinstalled through downgrade rights in Windows 10 Pro 64-bit
Monitor cable	Optional DP to VGA, DP to DVI-D (single link), or DP to HDMI 1.4 dongle						Preloaded applications (only some listed) - <i>Windows 10 only</i> • Lenovo Vantage • LinkedIn • Microsoft Office preloaded; purchase a product key to activate - <i>Windows 7 only</i> • Lenovo Solution Center • Lenovo System Update • Factory Recovery • User Guide Viewer • Microsoft Office preloaded; purchase a product key to activate • Adobe® Reader®		
Chipset	AMD SoC platform						Front ports*	Two USB 3.1 Gen1 (one is Always On and fast charge), one microphone (3.5mm), one headphone / microphone combo jack (3.5mm)	
Front ports*	Two USB 3.1 Gen1 (one is Always On and fast charge), one microphone (3.5mm), one headphone / microphone combo jack (3.5mm)							Rear ports*	One USB 3.1 Gen1, three USB 2.0, ethernet (RJ-45), two DisplayPort, two optional ports (Port 1 for VGA / serial / USB 2.0 Type-C (with DisplayPort Alternate Mode), Port 2 for serial)
I/O box	None						Audio support		High Definition (HD) Audio, Realtek ALC233-VB2-CG/ internal speaker (1.5 watt)
WLAN ¹³	<i>Some:</i> 11ac wireless, M.2 Card, Realtek RTL8822BE (dual band), Wi-Fi + Bluetooth 4.2* combo adapter, 2x2 <i>Some:</i> 11ac wireless, M.2 Card, Qualcomm Atheros QCA6174A (dual band), Wi-Fi + Bluetooth 4.2* combo adapter, 2x2							Environment	ENERGY STAR® 6.1*, EPEAT™ Silver rating* (*Not for non-OS models), ErP Lot 3, RoHS-compliant, WEEE, TCO
Bluetooth™	<i>Some:</i> Bluetooth 4.2* wireless, integrated in Wi-Fi + BT combo adapter * Win 10 RS3 and Win10 earlier version only support Bluetooth 4.1						MIL-SPEC test		MIL-STD-810G military certification (Low Pressure [Altitude], High Temperature, Low Temperature, Temperature Shock, Humidity, Sand and Dust, Vibration, Shock, Fungus, Solar Radiation)
Ethernet Modem	Gigabit ethernet, Realtek RTL8111HN, Wake on LAN®							Accessories	For compatible accessories, please go to http://smartfind.lenovo.com
Manageability Security chip Security features	None Discrete TPM 2.0, TCG Certified • Security slot (in rear for optional Kensington® MicroSaver® cable) • Smart USB protection, allows keyboard/mouse only, blocks all storage devices • Power-on password • Administrator password • Hard disk password • Boot sequence control • Boot without keyboard and mouse • Individual USB port disablement • Chassis intrusion switch								

Lenovo, May 2018



ThinkCentre M625 Tiny Thin Client Platform Specifications

Product Specifications Reference (PSREF)

Processor	AMD E2 series APU						Keyboard Mouse	<i>Some:</i> Fullsize USB Keyboard (USB connector), black, Lenovo logo <i>Some:</i> USB Optical Wheel Mouse, black, Lenovo logo
	APU	Cores	Frequency Base/Max	L2 Cache	Memory Support (Up to)	Integrated Graphics	Mechanical	Tiny (1L), fan-less design, black color, metal case <ul style="list-style-type: none"> • Toolless chassis open (for models with optional toolless chassis screw) • Toolless SSD, memory, Wi-Fi removal M625 Tiny Thin Client only: 7.05" W X 7.20" D X 1.36" H 179mm W X 182.9mm D X 34.5mm H 2.9 lb (1.3 kg), weight may vary by configuration Optional VESA mount bracket kit, supports VESA 75mm and 100mm Optional system floor stand for vertical orientation
Memory	8GB max, DDR4-2666, one 260-pin SO-DIMM socket * System frequency automatically clocks down for the lower capability of memory controller in processor						VESA mount Floor Stand	65 watts AC/DC adapter, autosensing, 88% PSU (not included for TIO models)
Disk	<i>Some:</i> 32GB M.2 Solid State Drive (SSD) / SATA interface <i>Some:</i> 128GB M.2 Solid State Drive (SSD) / PCIe NVMe interface						Power supply	Limited warranty ³ <i>Some:</i> 1-year, depot service / service upgrades available <i>Some:</i> 1-year, limited onsite service / service upgrades available
Optical Onboard SATA Media reader	None one SATA 6.0Gb/s connector on planar None						Preload	Preloaded operating system <i>Some:</i> Windows Embedded Standard 7 V2 (WES 7 V2) <i>Some:</i> Windows 10 IoT Enterprise <i>Some:</i> LeTOS V2 (Lenovo Terminal Operating System, Linux-based)
Graphics	AMD Radeon™ Graphics in processor, uses main memory, DirectX® 12, two DisplayPort™, one optional port (VGA or USB 2.0 Type-C with DisplayPort Alternate Mode), supports up to 2 independent displays; <i>Max resolution:</i> 3840x2160 (DP) @60Hz; 2048x1280 (VGA) @60Hz; 3840x2160 (USB 2.0 Type-C) @60Hz						Environment	ENERGY STAR® 6.1*, EPEAT™ Silver rating* (*Not for non-OS models), ErP Lot 3, RoHS-compliant, WEEE, TCO
Monitor cable	Optional DP to VGA, DP to DVI-D (single link), or DP to HDMI 1.4 dongle						MIL-SPEC test	MIL-STD-810G military certification (Low Pressure [Altitude], High Temperature, Low Temperature, Temperature Shock, Humidity, Sand and Dust, Vibration, Shock, Fungus, Solar Radiation)
Chipset	AMD SoC platform						Accessories	For compatible accessories, please go to http://smartfind.lenovo.com
Front ports*	Two USB 3.1 Gen1 (one is Always On and fast charge), one microphone (3.5mm), one headphone / microphone combo jack (3.5mm)							
Rear ports*	One USB 3.1 Gen1, three USB 2.0, ethernet (RJ-45), two DisplayPort, two optional ports (Port 1 for VGA / serial / USB 2.0 Type-C (with DisplayPort Alternate Mode), Port 2 for serial) * Depending on many factors, actual data transfer speed may be lower than theoretical speed							
I/O box	None							
Audio support	High Definition (HD) Audio, Realtek ALC233-VB2-CG / internal speaker (1.5 watt)							
WLAN ¹³	<i>Some:</i> 11ac wireless, M.2 Card, Realtek RTL8821CE (dual band), Wi-Fi + Bluetooth 4.2* combo adapter, 1x1 <i>Some:</i> 11ac wireless, M.2 Card, Qualcomm Atheros QCA9377 (dual band), Wi-Fi + Bluetooth 4.2* combo adapter, 1x1 <i>Some:</i> 11ac wireless, M.2 Card, Realtek RTL8822BE (dual band), Wi-Fi + Bluetooth 4.2* combo adapter, 2x2 <i>Some:</i> 11ac wireless, M.2 Card, Qualcomm Atheros QCA6174A (dual band), Wi-Fi + Bluetooth 4.2* combo adapter, 2x2							
Bluetooth™	<i>Some:</i> Bluetooth 4.2* wireless, integrated in Wi-Fi + BT combo adapter * Win 10 RS3 and Win10 earlier version only support Bluetooth 4.1							
Ethernet Modem	Gigabit ethernet, Realtek RTL8111HN, Wake on LAN®							
Manageability Security chip Security features	None Discrete TPM 2.0, TCG Certified <ul style="list-style-type: none"> • Security slot (in rear for optional Kensington® MicroSaver® cable) • Smart USB protection, allows keyboard/mouse only, blocks all storage devices • Power-on password • Administrator password • Hard disk password • Boot sequence control • Boot without keyboard and mouse • Individual USB port disablement • Chassis intrusion switch 							



ThinkCentre M630e Tiny Platform Specifications

Product Specifications Reference (PSREF)

Processor	Intel® Pentium®, or 8th Generation Intel Core™ i3 / i5 Processor						Manageability Security chip Security features	None							
	Processor	Cores / Threads	Frequency Base/Max(GHz)	Cache	Memory Support (Up to)	Integrated Graphics		Firmware TPM 2.0, integrated in chipset							
	Pentium Gold 5405U	2 / 4	2.3G	2 MB	DDR4-2133	UHD 610		<ul style="list-style-type: none"> Security slot (in rear for optional Kensington® MicroSaver® cable) Chassis intrusion switch Power-on password Administrator password Hard disk password 							
	Core i3-8145U	2 / 4	2.1G / 3.9G	4 MB	DDR4-2400	UHD 620		<ul style="list-style-type: none"> Boot sequence control Boot without keyboard and mouse Individual USB port disablement Smart USB protection, allows keyboard/mouse only, blocks all storage devices 							
	Core i5-8265U	4 / 8	1.6G / 3.9G	6 MB	DDR4-2400	UHD 620									
Memory	16GB max, DDR4-2666*, one 260-pin SO-DIMM sockets, non-ECC * System automatically clocks down for the processors with lower memory controller						Keyboard	Some: Lenovo Calliope Keyboard (USB connector), black							
Storage	Some: Hard Drive / SATA 6.0Gb/s, 2.5", 5400 rpm or 7200 rpm Some: Solid State Drive (SSD) / SATA 6.0Gb/s, 2.5" Some: M.2 SSD (2280) / PCIe NVMe, PCIe 3.0 x 4, 32Gb/s Some: M.2 SSD (2242) / PCIe NVMe, PCIe 3.0 x 2, 16Gb/s						Mouse	Some: Lenovo Calliope Mouse (USB connector), black							
Onboard SATA	One onboard SATA 6.0Gb/s connector						Mechanical	Tiny (1L), black color; metal case							
Graphics	Intel HD Graphics 610/620 in processor, uses main memory, DirectX® 12, one DisplayPort™, one HDMI, up to 2 independent displays; Max resolution: 4096x2304 (DP) @60Hz; 4096x2304 (HDMI) @24Hz							<ul style="list-style-type: none"> Optional dust filter One 2.5" bay for HDD/SSD, two M.2 slots (one for WLAN, one for M.2 SSD) 							
Monitor cable	Optional DP to VGA dongle or DP to HDMI 1.4 dongle						<table border="1"> <thead> <tr> <th></th> <th>Dimensions (WxDxH)</th> <th>Weight (Approx.)</th> </tr> </thead> <tbody> <tr> <td>Tiny only</td> <td>7.05" X 7.20" X 1.36" 179mm X 182.9mm X 34.5mm</td> <td>2.91 lb (1.32 kg), vary by config</td> </tr> </tbody> </table>				Dimensions (WxDxH)	Weight (Approx.)	Tiny only	7.05" X 7.20" X 1.36" 179mm X 182.9mm X 34.5mm	2.91 lb (1.32 kg), vary by config
	Dimensions (WxDxH)	Weight (Approx.)													
Tiny only	7.05" X 7.20" X 1.36" 179mm X 182.9mm X 34.5mm	2.91 lb (1.32 kg), vary by config													
Chipset	Intel SoC (System on Chip) platform						VESA mount	None							
Front ports* (Std.)	One USB 3.1 Gen1, one USB 3.1 Type-C Gen 1, one microphone (3.5mm), one headphone / microphone combo jack (3.5mm)						Floor Stand	Optional system floor stand for vertical orientation							
Rear ports* (Std.)	Two USB 3.1 Gen1, two USB 2.0, one ethernet (RJ-45), one DisplayPort, one HDMI						Power supply	Some: 65 watts adapter, autosensing, 88% PSU							
Rear ports* (Opt.)	None * Depending on many factors, actual data transfer speed may be lower than theoretical speed						Limited warranty	Some: 1-year, depot service / service upgrades available Some: 1-year, limited onsite service / service upgrades available							
Audio support	Realtek ALC233VB / internal speaker (1.5 watt)						Preload	Preloaded operating system							
WLAN	Some: 11ac wireless, M.2 Card, Realtek RTL8821CE (dual band), Wi-Fi + Bluetooth 4.2 combo adapter, 1x1 Some: 11ac wireless, M.2 Card, Realtek RTL8822BE (dual band), Wi-Fi + Bluetooth 4.2 combo adapter, 2x2 Some: 11ac wireless, M.2 Card, Intel Dual Band Wireless-AC 3165, Wi-Fi + Bluetooth 4.2 combo adapter, 1x1 Some: 11ac wireless, M.2 Card, Intel Dual Band Wireless-AC 8265, Wi-Fi + Bluetooth 4.2 combo adapter, 2x2							Some: Windows® 10 Pro 64-bit Some: Windows 10 Home 64-bit							
Bluetooth	Some: Bluetooth 4.2 wireless, integrated in Wi-Fi + BT combo adapter						Environment	Preloaded applications (only some listed)							
Ethernet	Gigabit ethernet, Realtek RTL8111HN-CG							<ul style="list-style-type: none"> Lenovo Vantage Microsoft Office preloaded; purchase a product key to activate LinkedIn 							
Ethernet (Opt.)	None						MIL-SPEC test	Coming soon							
							Accessories	For compatible accessories, please go to http://smartfind.lenovo.com							

Note: The specifications above may not be available in all regions.

Lenovo, Mar 2019



ThinkCentre M710 SFF Platform Specifications

Product Specifications Reference (PSREF)

Processor	Intel® Celeron®, Intel Pentium®, or 6/7th Generation Intel Core™ i3 / i5 / i7 Processor	Security features	<ul style="list-style-type: none"> Security slot (in rear for optional Kensington® MicroSaver® cable) Padlock loop Smart USB protection, allows keyboard/mouse only, blocks all storage devices Optional cable lock to physically lock both keyboard and mouse Power-on password Administrator password Hard disk password Boot sequence control Boot without keyboard and mouse Individual USB port disablement Optional chassis intrusion switch 																																																																								
	<table border="1"> <thead> <tr> <th>Processor</th> <th>Cores / Threads</th> <th>Frequency Base/Max(GHz)</th> <th>Cache</th> <th>Memory Support (Up to)</th> <th>Integrated Graphics</th> </tr> </thead> <tbody> <tr> <td>Pentium G4400</td> <td>2 / 2</td> <td>3.3G</td> <td>3 MB</td> <td>DDR4-2133</td> <td>HD 510</td> </tr> <tr> <td>Pentium G4560</td> <td>2 / 4</td> <td>3.5G</td> <td>3 MB</td> <td>DDR4-2400</td> <td>HD 610</td> </tr> <tr> <td>Pentium G4600</td> <td>2 / 4</td> <td>3.6G</td> <td>3 MB</td> <td>DDR4-2400</td> <td>HD 630</td> </tr> <tr> <td>Core i3-6100</td> <td>2 / 4</td> <td>3.7G</td> <td>3 MB</td> <td>DDR4-2133</td> <td>HD 530</td> </tr> <tr> <td>Core i5-6500</td> <td>4 / 4</td> <td>3.2G / 3.6G</td> <td>6 MB</td> <td>DDR4-2133</td> <td>HD 530</td> </tr> <tr> <td>Core i7-6700</td> <td>4 / 8</td> <td>3.4G / 4.0G</td> <td>8 MB</td> <td>DDR4-2133</td> <td>HD 530</td> </tr> <tr> <td>Core i3-7100</td> <td>2 / 4</td> <td>3.9G</td> <td>3 MB</td> <td>DDR4-2400</td> <td>HD 630</td> </tr> <tr> <td>Core i5-7400</td> <td>4 / 4</td> <td>3.0G / 3.5G</td> <td>6 MB</td> <td>DDR4-2400</td> <td>HD 630</td> </tr> <tr> <td>Core i5-7500</td> <td>4 / 4</td> <td>3.4G / 3.8G</td> <td>6 MB</td> <td>DDR4-2400</td> <td>HD 630</td> </tr> <tr> <td>Core i5-7600</td> <td>4 / 4</td> <td>3.5G / 4.1G</td> <td>6 MB</td> <td>DDR4-2400</td> <td>HD 630</td> </tr> <tr> <td>Core i7-7700</td> <td>4 / 8</td> <td>3.6G / 4.2G</td> <td>8 MB</td> <td>DDR4-2400</td> <td>HD 630</td> </tr> </tbody> </table>	Processor	Cores / Threads	Frequency Base/Max(GHz)	Cache	Memory Support (Up to)	Integrated Graphics	Pentium G4400	2 / 2	3.3G	3 MB	DDR4-2133	HD 510	Pentium G4560	2 / 4	3.5G	3 MB	DDR4-2400	HD 610	Pentium G4600	2 / 4	3.6G	3 MB	DDR4-2400	HD 630	Core i3-6100	2 / 4	3.7G	3 MB	DDR4-2133	HD 530	Core i5-6500	4 / 4	3.2G / 3.6G	6 MB	DDR4-2133	HD 530	Core i7-6700	4 / 8	3.4G / 4.0G	8 MB	DDR4-2133	HD 530	Core i3-7100	2 / 4	3.9G	3 MB	DDR4-2400	HD 630	Core i5-7400	4 / 4	3.0G / 3.5G	6 MB	DDR4-2400	HD 630	Core i5-7500	4 / 4	3.4G / 3.8G	6 MB	DDR4-2400	HD 630	Core i5-7600	4 / 4	3.5G / 4.1G	6 MB	DDR4-2400	HD 630	Core i7-7700	4 / 8	3.6G / 4.2G	8 MB	DDR4-2400	HD 630	Keyboard	<i>Some:</i> Lenovo Calliope Keyboard (USB connector), black <i>Some:</i> Lenovo Traditional Keyboard (USB connector), black <i>Some:</i> Lenovo Calliope Wireless Keyboard (2.4GHz via USB receiver), black <i>Some:</i> Lenovo Calliope Mouse (USB connector), black <i>Some:</i> Lenovo Calliope Wireless Mouse (2.4GHz via USB receiver), black
Processor	Cores / Threads	Frequency Base/Max(GHz)	Cache	Memory Support (Up to)	Integrated Graphics																																																																						
Pentium G4400	2 / 2	3.3G	3 MB	DDR4-2133	HD 510																																																																						
Pentium G4560	2 / 4	3.5G	3 MB	DDR4-2400	HD 610																																																																						
Pentium G4600	2 / 4	3.6G	3 MB	DDR4-2400	HD 630																																																																						
Core i3-6100	2 / 4	3.7G	3 MB	DDR4-2133	HD 530																																																																						
Core i5-6500	4 / 4	3.2G / 3.6G	6 MB	DDR4-2133	HD 530																																																																						
Core i7-6700	4 / 8	3.4G / 4.0G	8 MB	DDR4-2133	HD 530																																																																						
Core i3-7100	2 / 4	3.9G	3 MB	DDR4-2400	HD 630																																																																						
Core i5-7400	4 / 4	3.0G / 3.5G	6 MB	DDR4-2400	HD 630																																																																						
Core i5-7500	4 / 4	3.4G / 3.8G	6 MB	DDR4-2400	HD 630																																																																						
Core i5-7600	4 / 4	3.5G / 4.1G	6 MB	DDR4-2400	HD 630																																																																						
Core i7-7700	4 / 8	3.6G / 4.2G	8 MB	DDR4-2400	HD 630																																																																						
Memory	64GB max, UDIMM, DDR4-2400, four 288-pin DIMM sockets, non-ECC, dual-channel capable* * System automatically clocks down for the processors with lower memory controller	Mouse																																																																									
Storage	<i>Some:</i> Hard Drive / SATA 6.0Gb/s, 2.5" or 3.5", 5400 rpm or 7200 rpm <i>Some:</i> Solid State Drive (SSD) / SATA 6.0Gb/s, 2.5" <i>Some:</i> M.2 Solid State Drive (SSD) / PCIe NVMe, PCIe 3.0 x 4, 32Gb/s <i>Some:</i> Intel Optane™ Memory (models with 7th gen Core processor), M.2 <i>Some:</i> DVD-ROM SATA 1.5Gb/s Drive, slim (9.0mm) <i>Some:</i> DVD Burner (DVD±RW), SATA 1.5Gb/s Drive, slim (9.0mm)	Mechanical	<ul style="list-style-type: none"> SFF (8.4L), black color; metal case (WxDxH) 3.6" X 11.4" X 13.5"; 92.5mm X 290.5mm X 343.5mm Approx. 13.2 lb (6.0 kg), weight may vary by configuration Toolless cover, disk, optical removal Optional dust filter Bay 1: Slim external ODD bay Bay 2: 3.5", 1" high, internal, HDD/SSD Bay 3: 2.5", internal, HDD/SSD (optional bay) Slot 1: low-profile (length < 150mm, height < 68mm), PCIe 3.0 x16* Slot 2: low-profile (length < 150mm, height < 68mm), PCIe 3.0 x1* Slot 3: low-profile (length < 150mm, height < 68mm), PCIe 3.0 x1* Slot 4: no slot, only bracket for optional port extension* M.2 card slots: Two (one for WLAN, one for SSD/Optane) * Optional 2 front USB3.1 Type-C ports module occupies PCIe x16 slot (x4 card), optional rear 2x USB2.0 / parallel / 2nd serial occupies one expansion slot 																																																																								
Optical	Three onboard SATA 6.0Gb/s connectors Optional 7-in-1 media reader	Floor Stand	Optional system floor stand for vertical orientation																																																																								
Onboard SATA Media reader		Power supply	<i>Some:</i> 180 watts, autosensing, 85% PSU <i>Some:</i> 210 watts, autosensing, 85% PSU <i>Some:</i> 210 watts, autosensing, 92% PSU (only available via special bid)																																																																								
Graphics	Intel HD Graphics 510/530/610/630 in processor, uses main memory, DirectX® 12, one VGA, two DisplayPort™, supports 3 independent displays, works along with discrete graphics to support more displays; Max resolution: 4096x2304 (DP) @60Hz; 2048x1536 (VGA) @50Hz <i>Some:</i> NVIDIA GeForce® GT 730, DirectX 12, 2GB, PCIe 2.0 x8 adapter, two DisplayPort, 35 watts; Max resolution: 3840x2160 (DisplayPort) @60Hz;	Limited warranty ³	<i>Some:</i> 1-year or 3-year, depot service / service upgrades available <i>Some:</i> 1-year or 3-year, limited onsite service / service upgrades available																																																																								
Monitor cable	Optional DP to VGA, DP to DVI-D (single link), DP to dual DP, or DP to HDMI 1.4	Preload	Preloaded operating system <i>Some:</i> Windows® 7 Professional 32/64 preinstalled through downgrade rights in Windows 10 Pro 64-bit (not available with 7th Gen Intel processor) <i>Some:</i> Windows 10 Pro 64-bit <i>Some:</i> Windows 10 Home 64-bit Preloaded applications (only some listed) <ul style="list-style-type: none"> Microsoft Office preloaded; purchase a product key to activate - Only for Window 10 Lenovo Companion - Only for Window 7 Lenovo Solution Center Lenovo ThinkVantage Tools Create Recovery Media Adobe® Reader® Cyberlink Power2Go Create (DVD±RW) 																																																																								
Chipset	Intel B250 Chipset	Environment	ENERGY STAR® 6.1, EPEAT™ Gold rating (North America), ErP Lot 3, GREENGUARD®, RoHS-compliant, TUV low noise verified (on some models)																																																																								
Front ports*	Four USB 3.1 Gen1, optional two USB 3.1 Type-C Gen 2 (only available via special bid), microphone (3.5mm), headphone (3.5mm)	Accessories	For compatible accessories, please go to http://www.lenovoquickpick.com																																																																								
Rear ports*	Two USB 3.1 Gen1, two USB 2.0, optional two USB 2.0, serial (9-pin), optional 2nd serial (9-pin), optional parallel (25-pin), ethernet (RJ-45), one VGA, two DisplayPort, two PS/2 ports (keyboard/mouse); additional DisplayPort on optional graphics on some models																																																																										
Rear audio ports* IEEE 1394*	Line-in (3.5mm), line-out (3.5mm), microphone-in (3.5mm) None * Depending on many factors, actual data transfer speed may be lower than theoretical speed																																																																										
Audio support	High Definition (HD) Audio, Realtek ALC662 / optional internal speaker (1.5 watt)																																																																										
WLAN ¹³	<i>Some:</i> 11ac wireless, M.2 Card, Qualcomm Atheros QCA9377A (dual band), Wi-Fi + Bluetooth 4.1 combo adapter, 1x1 <i>Some:</i> 11ac wireless, M.2 Card, Qualcomm Atheros QCA6174A (dual band), Wi-Fi + Bluetooth 4.1 combo adapter, 2x2 <i>Some:</i> 11ac wireless, M.2 Card, Intel Dual Band Wireless-AC 3165, Wi-Fi + Bluetooth 4.1 combo adapter, 1x1 <i>Some:</i> 11ac wireless, M.2 Card, Intel Dual Band Wireless-AC 8265, Wi-Fi + Bluetooth 4.1 combo adapter, 2x2																																																																										
Bluetooth™	<i>Some:</i> Bluetooth 4.1 wireless, integrated in Wi-Fi + BT combo adapter																																																																										
Ethernet	Gigabit ethernet, Realtek RTL8111GN, Wake on LAN®																																																																										
Modem	None																																																																										
Manageability	None																																																																										
Security chip	TPM (Trusted Platform Module) 2.0, TCG Certified * Downgrade to TPM1.2 for the models with Win10 DG Win7 32 OS																																																																										

Note: The specifications above may not be available in all regions.

Lenovo, June 2017



ThinkCentre M710 Tiny Platform Specifications

Product Specifications Reference (PSREF)

Processor	Intel® Celeron®, Intel Pentium®, or 6/7th Generation Intel Core™ i3 / i5 / i7 Processor						Security features <ul style="list-style-type: none"> Security slot (in rear for optional Kensington® MicroSaver® cable) Smart USB protection, allows keyboard/mouse only, blocks all storage devices Power-on password Administrator password Hard disk password Boot sequence control Boot without keyboard and mouse Individual USB port disablement Chassis intrusion switch
	Processor	Cores / Threads	Frequency Base/Max(GHz)	Cache	Memory Support (Up to)	Integrated Graphics	
	Pentium G4400T	2 / 2	2.9G	3 MB	DDR4-2133	HD 510	
	Pentium G4560T	2 / 4	2.9G	3 MB	DDR4-2400	HD 610	
	Pentium G4600T	2 / 4	3.0G	3 MB	DDR4-2400	HD 630	
	Core i3-6100T	2 / 4	3.2G	3 MB	DDR4-2133	HD 530	
	Core i5-6500T	4 / 4	2.5G / 3.1G	6 MB	DDR4-2133	HD 530	
	Core i7-6700T	4 / 8	2.8G / 3.6G	8 MB	DDR4-2133	HD 530	
	Core i3-7100T	2 / 4	3.4G	3 MB	DDR4-2400	HD 630	
	Core i5-7400T	4 / 4	2.4G / 3.0G	6 MB	DDR4-2400	HD 630	
	Core i5-7500T	4 / 4	2.7G / 3.3G	6 MB	DDR4-2400	HD 630	
	Core i5-7600T	4 / 4	2.8G / 3.7G	6 MB	DDR4-2400	HD 630	
Core i7-7700T	4 / 8	2.9G / 3.8G	8 MB	DDR4-2400	HD 630		
Memory	32GB max, DDR4-2400*, two 260-pin SO-DIMM sockets, non-ECC, dual-channel capable * System automatically clocks down for the processors with lower memory controller						
Storage	<i>Some:</i> Hard Drive / SATA 6.0Gb/s, 2.5", 5400 rpm or 7200 rpm <i>Some:</i> Solid State Drive (SSD) / SATA 6.0Gb/s, 2.5" <i>Some:</i> M.2 Solid State Drive (SSD) / PCIe NVMe, PCIe 3.0 x 4, 32Gb/s <i>Some:</i> Intel Optane™ Memory (models with 7th gen Core processor), M.2 <i>Some:</i> DVD-ROM, slim (9.0mm), via USB external ODD box <i>Some:</i> DVD Burner (DVD±RW), slim (9.0mm), via USB external ODD box						
Optical	None						
Onboard SATA Media reader	One onboard SATA 6.0Gb/s connector						
Graphics	Intel HD Graphics 510/530/610/630 in processor, uses main memory, DirectX® 12, two DisplayPort™, one optional video port (HDMI, VGA, 3rd DP, or USB 3.1 Type-C with DisplayPort Alternate Mode), up to 3 independent displays; <i>Max resolution:</i> 4096x2304 (DP) @60Hz; 4096x2304 (Type-C) @60Hz; 4096x2160 (HDMI) @24Hz; 1920x1200 (VGA) @60Hz						
Monitor cable	Optional DP to VGA, DP to DVI-D (single link), DP to dual DP, or DP to HDMI 1.4						
Chipset	Intel B250 Chipset						
Front ports*	Two USB 3.1 Gen1 (one is Always On and fast charge), one microphone (3.5mm), one headphone / microphone combo jack (3.5mm)						
Rear ports*	Four USB 3.1 Gen1 (optional external optical box or external I/O box occupies one or two specific USB 3.1 Gen1 on some models), ethernet (RJ-45), two DisplayPort, two optional ports (Port 1 for VGA / 3rd DP / HDMI / serial / USB 3.1 Type-C Gen 1 (with DisplayPort Alternate Mode), Port 2 for serial)						
I/O box*	Optional external I/O box, extends two USB 2.0, two USB 3.1 Gen1, and one serial on rear, two USB 2.0 on front, via USB cable (occupy two specific USB 3.1 Gen1 of Tiny) * Depending on many factors, actual data transfer speed may be lower than theoretical speed						
Audio support	High Definition (HD) Audio, Realtek ALC294 / optional internal speaker (1w or 2w)						
WLAN ¹³	<i>Some:</i> 11ac wireless, M.2 Card, Qualcomm Atheros QCA9377A (dual band), Wi-Fi + Bluetooth 4.1 combo adapter, 1x1 <i>Some:</i> 11ac wireless, M.2 Card, Qualcomm Atheros QCA6174A (dual band), Wi-Fi + Bluetooth 4.1 combo adapter, 2x2 <i>Some:</i> 11ac wireless, M.2 Card, Intel Dual Band Wireless-AC 3165, Wi-Fi + Bluetooth 4.1 combo adapter, 1x1 <i>Some:</i> 11ac wireless, M.2 Card, Intel Dual Band Wireless-AC 8265, Wi-Fi + Bluetooth 4.1 combo adapter, 2x2						
Bluetooth™ Ethernet Modem	<i>Some:</i> Bluetooth 4.1 wireless, integrated in Wi-Fi + BT combo adapter Gigabit ethernet, Intel Ethernet Connection I219-V (Jacksonville), Wake on LAN® None						
Manageability Security chip	None TPM (Trusted Platform Module) 2.0*, TCG Certified * Downgrade to TPM1.2 for the models with Win10 DG Win7 32 OS						
VESA mount Floor Stand	Optional VESA mount bracket kit, supports VESA 75mm and 100mm Optional system floor stand for vertical orientation						
Power supply	65 watts AC/DC adapter, autosensing, 88% PSU (not included for TIO models) 90 watts AC/DC adapter, autosensing, 88% PSU (only for models with I/O box)						
Limited warranty ³	<i>Some:</i> 1-year or 3-year, depot service / service upgrades available <i>Some:</i> 1-year or 3-year, limited onsite service / service upgrades available						
Preload	<i>Some:</i> Windows® 7 Professional 32/64 preinstalled through downgrade rights in Windows 10 Pro 64-bit (not available with 7th Gen Intel processor) <i>Some:</i> Windows 10 Pro 64-bit <i>Some:</i> Windows 10 Home 64-bit Preloaded applications (only some listed) <ul style="list-style-type: none"> Microsoft Office preloaded; purchase a product key to activate - Only for Window 10 Lenovo Companion - Only for Window 7 Lenovo Solution Center Lenovo ThinkVantage Tools Create Recovery Media Adobe® Reader® Cyberlink PowerDVD Create (DVD±RW) 						
Environment	ENERGY STAR® 6.1, EPEAT™ Gold rating (North America), ErP Lot 3, GREENGUARD®, RoHS-compliant, TUV low noise verified (on some models)						
MIL-SPEC test	MIL-STD-810G military certification (Low Pressure [Altitude], High Temperature, Low Temperature, Temperature Shock, Humidity, Sand and Dust, Vibration, Shock, Fungus, Solar Radiation)						
Accessories	For compatible accessories, please go to http://www.lenovoquickpick.com						

See footnotes for more detailed information

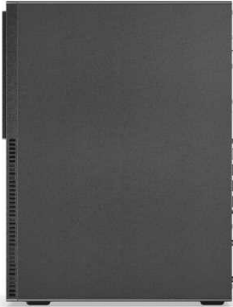

ThinkCentre M710 Tower Platform Specifications

Product Specifications Reference (PSREF)

Processor	Intel® Celeron®, Intel Pentium®, or 6/7th Generation Intel Core™ i3 / i5 / i7 Processor						Manageability None Security chip TPM (Trusted Platform Module) 2.0, TCG Certified * Downgrade to TPM1.2 for the models with Win10 DG Win7 32 OS Security features <ul style="list-style-type: none"> Security slot (in rear for optional Kensington® MicroSaver® cable) Padlock loop Smart USB protection, allows keyboard/mouse only, blocks all storage devices Optional cable lock to physically lock both keyboard and mouse Power-on password Administrator password Hard disk password Boot sequence control Boot without keyboard and mouse Individual USB port disablement Optional chassis intrusion switch
	Processor	Cores / Threads	Frequency Base/Max(GHz)	Cache	Memory Support (Up to)	Integrated Graphics	
	Pentium G4400	2 / 2	3.3G	3 MB	DDR4-2133	HD 510	
	Pentium G4560	2 / 4	3.5G	3 MB	DDR4-2400	HD 610	
	Pentium G4600	2 / 4	3.6G	3 MB	DDR4-2400	HD 630	
	Core i3-6100	2 / 4	3.7G	3 MB	DDR4-2133	HD 530	
	Core i5-6500	4 / 4	3.2G / 3.6G	6 MB	DDR4-2133	HD 530	
	Core i7-6700	4 / 8	3.4G / 4.0G	8 MB	DDR4-2133	HD 530	
	Core i3-7100	2 / 4	3.9G	3 MB	DDR4-2400	HD 630	
	Core i5-7400	4 / 4	3.0G / 3.5G	6 MB	DDR4-2400	HD 630	
	Core i5-7500	4 / 4	3.4G / 3.8G	6 MB	DDR4-2400	HD 630	
Core i5-7600	4 / 4	3.5G / 4.1G	6 MB	DDR4-2400	HD 630		
Core i7-7700	4 / 8	3.6G / 4.2G	8 MB	DDR4-2400	HD 630		
Memory	64GB max, UDIMM, DDR4-2400*, four 288-pin DIMM sockets, non-ECC, dual-channel capable * System automatically clocks down for the processors with lower memory controller						
Storage	<i>Some:</i> Hard Drive / SATA 6.0Gb/s, 2.5" or 3.5", 5400 rpm or 7200 rpm <i>Some:</i> Solid State Drive (SSD) / SATA 6.0Gb/s, 2.5" <i>Some:</i> M.2 Solid State Drive (SSD) / PCIe NVMe, PCIe 3.0 x 4, 32Gb/s <i>Some:</i> Intel Optane™ Memory (models with 7th gen Core processor), M.2 <i>Some:</i> DVD-ROM SATA 1.5Gb/s Drive, slim (9.0mm) <i>Some:</i> DVD Burner (DVD±RW), SATA 1.5Gb/s Drive, slim (9.0mm)						
Optical	Three onboard SATA 6.0Gb/s connectors Optional 7-in-1 media reader						
Onboard SATA Media reader	Optional 7-in-1 media reader						
Graphics	Intel HD Graphics 510/530/610/630 in processor, uses main memory, DirectX® 12, one VGA, two DisplayPort™, supports 3 independent displays, works along with discrete graphics to support more displays; <i>Max resolution:</i> 4096x2304 (DP) @60Hz; 2048x1536 (VGA) @50Hz <i>Some:</i> NVIDIA GeForce® GT 730 , DirectX 12, 2GB, PCIe 2.0 x8 adapter, two DisplayPort, 35 watts; <i>Max resolution:</i> 3840x2160 (DisplayPort) @60Hz; <i>Some:</i> AMD Radeon™ R7 350 , DirectX 11, 2GB, PCIe 3.0 x8 adapter, one VGA, one HDMI, 75 watts, occupies two slots; <i>Max resolution:</i> 4096x2160 (HDMI) @24Hz; 2048x1536 (VGA) @85Hz						
Power supply	<i>Some:</i> 180 watts, autosensing, 85% PSU <i>Some:</i> 210 watts, autosensing, 85% PSU <i>Some:</i> 210 watts, autosensing, 92% PSU (only available via special bid)						
Limited warranty ³	<i>Some:</i> 1-year or 3-year, depot service / service upgrades available <i>Some:</i> 1-year or 3-year, limited onsite service / service upgrades available						
Preload	Preloaded operating system <i>Some:</i> Windows® 7 Professional 32/64 preinstalled through downgrade rights in Windows 10 Pro 64-bit (not available with 7th Gen Intel processor) <i>Some:</i> Windows 10 Pro 64-bit <i>Some:</i> Windows 10 Home 64-bit Preloaded applications (only some listed) <ul style="list-style-type: none"> Microsoft Office preloaded; purchase a product key to activate Only for Window 10 Lenovo Companion Only for Window 7 Lenovo Solution Center Lenovo ThinkVantage Tools Create Recovery Media Adobe® Reader® Cyberlink PowerDVD Create (DVD±RW) 						
Monitor Cable	Optional DP to VGA, DP to DVI-D (single link), DP to dual DP, or DP to HDMI 1.4						
Chipset	Intel B250 Chipset						
Front ports*	Four USB 3.1 Gen1, optional two USB 3.1 Type-C Gen 2 (only available via special bid), microphone (3.5mm), headphone (3.5mm)						
Rear ports*	Two USB 3.1 Gen1, two USB 2.0, optional two USB 2.0, serial (9-pin), optional 2nd serial (9-pin), optional parallel (25-pin), ethernet (RJ-45), one VGA, two DisplayPort, two PS/2 ports (keyboard/mouse); additional VGA, DisplayPort, or HDMI on optional graphics on some models						
Rear audio ports* IEEE 1394*	Line-in (3.5mm), line-out (3.5mm), microphone-in (3.5mm) None * Depending on many factors, actual data transfer speed may be lower than theoretical speed						
Audio support	High Definition (HD) Audio, Realtek ALC662 / optional internal speaker (1.5 watt)						
WLAN ¹³	<i>Some:</i> 11ac wireless, M.2 Card, Qualcomm Atheros QCA9377A (dual band), Wi-Fi + Bluetooth 4.1 combo adapter, 1x1 <i>Some:</i> 11ac wireless, M.2 Card, Qualcomm Atheros QCA6174A (dual band), Wi-Fi + Bluetooth 4.1 combo adapter, 2x2 <i>Some:</i> 11ac wireless, M.2 Card, Intel Dual Band Wireless-AC 3165, Wi-Fi + Bluetooth 4.1 combo adapter, 1x1 <i>Some:</i> 11ac wireless, M.2 Card, Intel Dual Band Wireless-AC 8265, Wi-Fi + Bluetooth 4.1 combo adapter, 2x2						
Bluetooth™ Ethernet Modem	<i>Some:</i> Bluetooth 4.1 wireless, integrated in Wi-Fi + BT combo adapter Gigabit ethernet, Realtek RTL8111GN, Wake on LAN® None						
Environment	ENERGY STAR® 6.1, EPEAT™ Gold rating (North America), ErP Lot 3, GREENGUARD®, RoHS-compliant, TUV low noise verified (on some models)						
Accessories	For compatible accessories, please go to http://www.lenovoquickpick.com						

Note: The specifications above may not be available in all regions.

Lenovo, June 2017



ThinkCentre M710e SFF Platform Specifications

Product Specifications Reference (PSREF)

Processor	Intel® Celeron®, Intel Pentium®, or 6/7th Generation Intel Core™ i3 / i5 / i7 Processor						<p>Security features</p> <ul style="list-style-type: none"> Security slot (in rear for optional Kensington® MicroSaver® cable) Padlock loop Smart USB protection, allows keyboard/mouse only, blocks all storage devices Optional smart cable clip to physically lock both keyboard and mouse Power-on password Administrator password Hard disk password Boot sequence control Boot without keyboard and mouse Individual USB port disablement Optional chassis intrusion switch <p>Keyboard Some: Lenovo Calliope Keyboard (USB connector), black Some: Lenovo Traditional Keyboard (USB connector), black</p> <p>Mouse Some: Lenovo Calliope Mouse (USB connector), black Some: Lenovo Fingerprint Mouse (USB connector), Windows Hello support, black</p> <p>Mechanical</p> <ul style="list-style-type: none"> SFF (7.4L), black color, metal case (WxDxH) 3.9" X 11.9" X 10.8"; 100mm X 303.5mm X 273.5mm Approx. 9.37 lb (4.25 kg), weight may vary by configuration Bay 1: Slim external ODD bay Bay 2: 3.5", 1" high, internal, supports 2.5" or 3.5" HDD/SSD (2.5 to 3.5 bracket comes with disk) Slot 1: low-profile (length < 152mm, height < 64mm), PCIe 3.0 x16* Slot 2: low-profile (length < 152mm, height < 64mm), PCIe 3.0 x1* M.2 card slots: one for SSD *Optional rear 2x USB2.0 / parallel occupies one expansion slot <p>Floor Stand Optional system floor stand for vertical orientation</p>
	Processor	Cores / Threads	Frequency Base/Max(GHz)	Cache	Memory Support (Up to)	Integrated Graphics	
	Celeron G3900	2 / 2	2.8G	2 MB	DDR4-2133	HD 510	
	Celeron G3930	2 / 2	2.9G	3 MB	DDR4-2133	HD 610	
	Pentium G4400	2 / 2	3.3G	3 MB	DDR4-2133	HD 510	
	Pentium G4500	2 / 2	3.5G	3 MB	DDR4-2133	HD 530	
	Pentium G4560	2 / 4	3.5G	3 MB	DDR4-2400	HD 610	
	Pentium G4600	2 / 4	3.6G	3 MB	DDR4-2400	HD 630	
	Core i3-6100	2 / 4	3.7G	3 MB	DDR4-2133	HD 530	
	Core i5-6400	4 / 4	2.7G / 3.3G	6 MB	DDR4-2133	HD 530	
	Core i5-6500	4 / 4	3.2G / 3.6G	6 MB	DDR4-2133	HD 530	
	Core i7-6700	4 / 8	3.4G / 4.0G	8 MB	DDR4-2133	HD 530	
	Core i3-7100	2 / 4	3.9G	3 MB	DDR4-2400	HD 630	
	Core i3-7300	2 / 4	4.0G	4 MB	DDR4-2400	HD 630	
	Core i5-7400	4 / 4	3.0G / 3.5G	6 MB	DDR4-2400	HD 630	
	Core i5-7500	4 / 4	3.4G / 3.8G	6 MB	DDR4-2400	HD 630	
	Core i5-7600	4 / 4	3.5G / 4.1G	6 MB	DDR4-2400	HD 630	
Core i7-7700	4 / 8	3.6G / 4.2G	8 MB	DDR4-2400	HD 630		
Memory	32GB max, UDIMM, DDR4-2400*, two 288-pin DIMM sockets, non-ECC, dual-channel capable *System automatically clocks down for the processors with lower memory controller						
Storage	Some: Hard Drive / SATA 6.0Gb/s, 2.5" or 3.5", 5400 rpm or 7200 rpm Some: Solid State Drive (SSD) / SATA 6.0Gb/s, 2.5" Some: M.2 Solid State Drive (SSD) / PCIe NVMe, PCIe 3.0 x 4, 32Gb/s						
Optical	Some: DVD-ROM SATA 1.5Gb/s Drive, slim (9.0mm) Some: DVD Burner (DVD±RW), SATA 1.5Gb/s Drive, slim (9.0mm)						
Onboard SATA	Two onboard SATA 6.0Gb/s connectors						
Media reader	Optional 7-in-1 media reader						
Graphics	Intel HD Graphics 510/530/610/630 in processor, uses main memory, DirectX® 12, one VGA, one DisplayPort™, supports 2 independent displays, works along with discrete graphics to support more displays; Max resolution: 4096x2160 (DP)@60Hz; 1920x1200 (VGA)@60Hz Some: NVIDIA GeForce® GT 730, DirectX 12, 2GB, PCIe 2.0 x8 adapter, two DisplayPort, 35 watts; Max resolution: 3840x2160 (DisplayPort)@60Hz;						
Monitor cable	Optional DP to VGA, DP to DVI-D (single link), DP to dual DP, or DP to HDMI 1.4						
Chipset	Intel B250 Chipset						
Front ports*	Two USB 3.1 Gen1, microphone (3.5mm), one headphone / microphone combo jack (3.5mm)						
Rear ports*	Two USB 3.1 Gen1, two USB 2.0, optional two USB 2.0, serial (9-pin), optional 2nd serial (9-pin), optional parallel (25-pin), ethernet (RJ-45), one VGA, one DisplayPort, optional external USB to PS/2 ports cable (for PS/2 keyboard / mouse); additional DisplayPort on optional graphics on some models						
Rear audio ports*	Line-out jack (3.5mm)						
IEEE 1394*	None * Depending on many factors, actual data transfer speed may be lower than theoretical speed						
Audio support	High Definition (HD) Audio, Realtek ALC233 / internal speaker (1.5 watt)						
WLAN ¹³	None						
Bluetooth™	None						
Ethernet	Gigabit ethernet, Realtek RTL8111HN, Wake on LAN®						
Modem	None						
Manageability	None						
Security chip	TPM (Trusted Platform Module) 2.0, TCG Certified * Downgrade to TPM1.2 for the models with Win10 DG Win7 32 OS						
Packaging	• (WxDxH) 7.7" X 15.4" X 19.7"; 195mm X 390mm X 500mm • Cross weight (approx.) 14.22 lb (6.45 kg)						
Power supply	Some: 180 watts, autosensing, 85% PSU						
Limited warranty ³	Some: 1-year or 3-year, depot service / service upgrades available Some: 1-year or 3-year, limited onsite service / service upgrades available						
Preload	<p>Preloaded operating system</p> <p>Some: Windows® 10 Pro 64-bit Some: Windows 10 Home 64-bit Some: Windows 7 Professional 32/64 preinstalled through downgrade rights in Windows 10 Pro 64-bit(not available with 7th Gen Intel processor)</p> <p>Preloaded applications (only some listed)</p> <ul style="list-style-type: none"> Microsoft Office preloaded; purchase a product key to activate Cyberlink PowerDVD (DVD, DVD±RW) Cyberlink PowerDVD Create (DVD±RW) - Only for Window 10 Lenovo Companion - Only for Window 7 Lenovo Solution Center Lenovo System Update Create Recovery Media Adobe® Reader® 						
Environment	ENERGY STAR® 6.1, EPEAT™ Silver rating (North America), ErP Lot 3, RoHS-compliant, WEEE						
Accessories	For compatible accessories, please go to http://www.lenovoquickpick.com						

Note: The specifications above may not be available in all regions.

Lenovo, January 2018

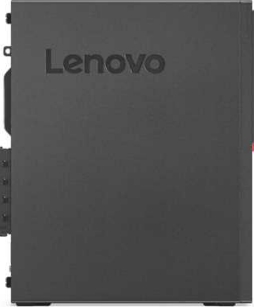

ThinkCentre M715 SFF Platform Specifications

Product Specifications Reference (PSREF)

Processor	AMD A6 / A8 / A10 / A12 series APU and Ryzen 3 / 5 / 7 series processor	Security features	<ul style="list-style-type: none"> Security slot (in rear for optional Kensington® MicroSaver® cable) Padlock loop Smart USB protection, allows keyboard/ mouse only, blocks all storage devices Optional cable lock to physically lock both keyboard and mouse Power-on password Administrator password Hard disk password Boot sequence control Boot without keyboard and mouse Individual USB port disablement Optional chassis intrusion switch 																																																												
	<table border="1"> <thead> <tr> <th>APU / processor</th> <th>Cores / Threads</th> <th>Frequency (Base/Max)</th> <th>L2 Cache</th> <th>Integrated Graphics</th> </tr> </thead> <tbody> <tr> <td>Ryzen 3 PRO 1200</td> <td>4 / 4</td> <td>3.1 / 3.4</td> <td>2MB</td> <td>None</td> </tr> <tr> <td>Ryzen 3 PRO 1300</td> <td>4 / 4</td> <td>3.5 / 3.7</td> <td>2MB</td> <td>None</td> </tr> <tr> <td>Ryzen 5 PRO 1500</td> <td>4 / 8</td> <td>3.5 / 3.7</td> <td>2MB</td> <td>None</td> </tr> <tr> <td>Ryzen 7 PRO 1700</td> <td>8 / 16</td> <td>3.0 / 3.7</td> <td>4MB</td> <td>None</td> </tr> <tr> <td>PRO A6-8570</td> <td>2 / 2</td> <td>3.5 / 3.8</td> <td>1MB</td> <td>Radeon R5 Series</td> </tr> <tr> <td>PRO A10-8770</td> <td>4 / 4</td> <td>3.5 / 3.8</td> <td>2MB</td> <td>Radeon R7 Series</td> </tr> <tr> <td>PRO A12-8870</td> <td>4 / 4</td> <td>3.7 / 4.2</td> <td>2MB</td> <td>Radeon R7 Series</td> </tr> <tr> <td>PRO A6-9500</td> <td>2 / 2</td> <td>3.5 / 3.8</td> <td>1MB</td> <td>Radeon R5 Series</td> </tr> <tr> <td>PRO A8-9600</td> <td>4 / 4</td> <td>3.1 / 3.4</td> <td>2MB</td> <td>Radeon R7 Series</td> </tr> <tr> <td>PRO A10-9700</td> <td>4 / 4</td> <td>3.5 / 3.8</td> <td>2MB</td> <td>Radeon R7 Series</td> </tr> <tr> <td>PRO A12-9800</td> <td>4 / 4</td> <td>3.8 / 4.2</td> <td>2MB</td> <td>Radeon R7 Series</td> </tr> </tbody> </table>	APU / processor	Cores / Threads	Frequency (Base/Max)	L2 Cache	Integrated Graphics	Ryzen 3 PRO 1200	4 / 4	3.1 / 3.4	2MB	None	Ryzen 3 PRO 1300	4 / 4	3.5 / 3.7	2MB	None	Ryzen 5 PRO 1500	4 / 8	3.5 / 3.7	2MB	None	Ryzen 7 PRO 1700	8 / 16	3.0 / 3.7	4MB	None	PRO A6-8570	2 / 2	3.5 / 3.8	1MB	Radeon R5 Series	PRO A10-8770	4 / 4	3.5 / 3.8	2MB	Radeon R7 Series	PRO A12-8870	4 / 4	3.7 / 4.2	2MB	Radeon R7 Series	PRO A6-9500	2 / 2	3.5 / 3.8	1MB	Radeon R5 Series	PRO A8-9600	4 / 4	3.1 / 3.4	2MB	Radeon R7 Series	PRO A10-9700	4 / 4	3.5 / 3.8	2MB	Radeon R7 Series	PRO A12-9800	4 / 4	3.8 / 4.2	2MB	Radeon R7 Series	Keyboard	<i>Some:</i> Lenovo Calliope Keyboard (USB connector), black <i>Some:</i> Lenovo Traditional Keyboard (USB connector), black <i>Some:</i> Lenovo Calliope Wireless Keyboard (2.4GHz via USB receiver), black
APU / processor	Cores / Threads	Frequency (Base/Max)	L2 Cache	Integrated Graphics																																																											
Ryzen 3 PRO 1200	4 / 4	3.1 / 3.4	2MB	None																																																											
Ryzen 3 PRO 1300	4 / 4	3.5 / 3.7	2MB	None																																																											
Ryzen 5 PRO 1500	4 / 8	3.5 / 3.7	2MB	None																																																											
Ryzen 7 PRO 1700	8 / 16	3.0 / 3.7	4MB	None																																																											
PRO A6-8570	2 / 2	3.5 / 3.8	1MB	Radeon R5 Series																																																											
PRO A10-8770	4 / 4	3.5 / 3.8	2MB	Radeon R7 Series																																																											
PRO A12-8870	4 / 4	3.7 / 4.2	2MB	Radeon R7 Series																																																											
PRO A6-9500	2 / 2	3.5 / 3.8	1MB	Radeon R5 Series																																																											
PRO A8-9600	4 / 4	3.1 / 3.4	2MB	Radeon R7 Series																																																											
PRO A10-9700	4 / 4	3.5 / 3.8	2MB	Radeon R7 Series																																																											
PRO A12-9800	4 / 4	3.8 / 4.2	2MB	Radeon R7 Series																																																											
		Mouse	<i>Some:</i> Lenovo Calliope Mouse (USB connector), black <i>Some:</i> Lenovo Calliope Wireless Mouse (2.4GHz via USB receiver), black <i>Some:</i> Lenovo Fingerprint Mouse (USB connector), Windows Hello support, black																																																												
Memory	64GB max, UDIMM, DDR4-2400, four 288-pin DIMM sockets, non-ECC, dual-channel capable* * System automatically clocks down for the processors with lower memory controller	Mechanical	<ul style="list-style-type: none"> SFF (8.4L), black color; metal case (WxDxH) 3.6" X 11.4" X 13.5"; 92.5mm X 290.5mm X 343.5mm Approx. 13.2 lb (6.0 kg), weight may vary by configuration Toolless cover, disk, optical removal Optional dust filter Bay 1: Slim external ODD bay Bay 2: 3.5", internal, HDD/SSD Bay 3: 2.5", internal, HDD/SSD (bay only comes with 2.5" 2nd disk) Slot 1: low-profile (length < 150mm, height < 68mm), PCIe 3.0 x16* Slot 2: low-profile (length < 150mm, height < 68mm), PCIe 2.0 x1* Slot 3: low-profile (length < 150mm, height < 68mm), PCIe 2.0 x1* Slot 4: no slot, only bracket for optional port extension* M.2 card slots: two (one for WLAN, one for SSD) * Optional front USB3.1 Type-C x2 module occupies PCIe x16 slot (x4 card), optional rear 2x USB2.0 / parallel / 2nd serial occupies one expansion slot 																																																												
Storage	<i>Some:</i> Hard Drive / SATA 6.0Gb/s, 2.5" or 3.5", 5400 rpm or 7200 rpm <i>Some:</i> Solid State Drive (SSD) / SATA 6.0Gb/s, 2.5" <i>Some:</i> M.2 Solid State Drive (SSD) / PCIe NVMe, PCIe 3.0 x 4, 32Gb/s	Floor Stand	Optional system floor stand for vertical orientation																																																												
Optical	<i>Some:</i> DVD-ROM SATA 1.5Gb/s Drive, slim (9.0mm) <i>Some:</i> DVD Burner (DVD±RW), SATA 1.5Gb/s Drive, slim (9.0mm)	Power supply	<i>Some:</i> 180 watts, autosensing, 85% PSU <i>Some:</i> 210 watts, autosensing, 85% PSU <i>Some:</i> 210 watts, autosensing, 92% PSU (only available via special bid)																																																												
Onboard SATA Media reader	Three onboard SATA 6.0Gb/s connectors Optional 7-in-1 media reader	Limited warranty	<i>Some:</i> 1-year or 3-year, depot service / service upgrades available <i>Some:</i> 1-year or 3-year, limited onsite service / service upgrades available																																																												
Graphics	AMD Radeon™ Graphics in processor (not for AMD Ryzen processor), uses main memory, DirectX® 12, one VGA, two DisplayPort™ (Onboard VGA and DP ports are invalid on the models with AMD Ryzen processor), supports 3 independent displays, works along with AMD discrete graphics to support more displays; <i>Max resolution:</i> 4096x2160 (DP) @60Hz; 1920x1200 (VGA) @60Hz <i>Some:</i> NVIDIA GeForce® GT 730 , DirectX 12, 2GB, PCIe 2.0 x8 adapter, two DisplayPort, 35 watts; <i>Max resolution:</i> 3840x2160 (DisplayPort) @60Hz;	Preload	Preloaded operating system <i>Some:</i> Windows® 7 Professional 32/64 preinstalled through downgrade rights in Windows 10 Pro 64-bit (Only available with Pro A6/A10/A12-8xxx APUs) <i>Some:</i> Windows 10 Pro 64-bit <i>Some:</i> Windows 10 Home 64-bit Preloaded applications (only some listed) <ul style="list-style-type: none"> Microsoft Office preloaded; purchase a product key to activate Only for Window 10 Lenovo Companion Only for Window 7 Lenovo Solution Center Lenovo ThinkVantage Tools Create Recovery Media Adobe® Reader® Cyberlink Power2Go Create (DVD±RW) 																																																												
Monitor cable	Optional DP to VGA, DP to DVI-D (single link), DP to dual DP, or DP to HDMI 1.4	Environment	ENERGY STAR® 6.1, EPEAT™ Gold rating (North America), ErP Lot 3, GREENGUARD®, RoHS-compliant																																																												
Chipset	AMD B350 Chipset	Accessories	For compatible accessories, please go to http://www.lenovoquickpick.com																																																												
Front ports*	Two USB 3.1 Gen2, two USB 3.1 Gen1, optional two USB 3.1 Type-C Gen 2 (only available via special bid), microphone (3.5mm), headphone (3.5mm)																																																														
Rear ports*	Two USB 3.1 Gen1, two USB 2.0, optional two USB 2.0, serial (9-pin), optional 2nd serial (9-pin), optional parallel (25-pin), ethernet (RJ-45), one VGA and two DisplayPort (not available on models with AMD Ryzen processor), two PS/2 ports (keyboard / mouse); additional DisplayPort on optional graphics on some models																																																														
Rear audio ports* IEEE 1394*	Line-in (3.5mm), line-out (3.5mm), microphone-in (3.5mm) None * Depending on many factors, actual data transfer speed may be lower than theoretical speed																																																														
Audio support	High Definition (HD) Audio, Realtek ALC662 / optional internal speaker (1.5 watt)																																																														
WLAN	<i>Some:</i> 11ac wireless, M.2 Card, Realtek RTL8821AE (dual band), Wi-Fi + Bluetooth 4.0 combo adapter, 1x1 <i>Some:</i> 11ac wireless, M.2 Card, Qualcomm Atheros QCA6174A (dual band), Wi-Fi + Bluetooth 4.1 combo adapter, 2x2 <i>Some:</i> 11ac wireless, M.2 Card, Qualcomm Atheros QCA9377 (dual band), Wi-Fi + Bluetooth 4.1 combo adapter, 1x1																																																														
Bluetooth™ Ethernet Modem	<i>Some:</i> Bluetooth 4.0 or 4.1 wireless, integrated in Wi-Fi + BT combo adapter Gigabit ethernet, Realtek RTL8111EPV, Wake on LAN® None																																																														
Manageability Security chip	DASH TPM (Trusted Platform Module) 2.0, TCG Certified * Downgrade to TPM1.2 for the models with Win10 DG Win7 32 OS																																																														

Note: The specifications above may not be available in all regions.

Lenovo, July 2017



ThinkCentre M715 Tiny Platform Specifications

Product Specifications Reference (PSREF)

Processor	AMD A6, A10, or A12 series APUs						Keyboard	<i>Some:</i> Fullsize USB Keyboard (USB connector), Lenovo logo <i>Some:</i> Lenovo New Slim USB Keyboard (USB connector), black, Lenovo logo
	APU	Cores	Frequency Base/Max	L2 Cache	Memory Types	Integrated Graphics	Mouse	<i>Some:</i> USB Optical Wheel Mouse, black, Lenovo logo
	PRO A6-9500E	2	3.0 / 3.4 GHz	1 MB	DDR4-2400	Radeon R5 Series	Mechanical	Tiny (1L), black color; metal case
	PRO A10-9700E	4	3.0 / 3.5 GHz	2 MB	DDR4-2400	Radeon R7 Series		M715 Tiny only: 7.05" W X 7.20" D X 1.36" H 179mm W X 182.9mm D X 34.5mm H 2.9 lb (1.3 kg), weight may vary by configuration
	PRO A12-9800E	4	3.1 / 3.8 GHz	2 MB	DDR4-2400	Radeon R7 Series		With VESA mount & ODD box: 7.42" W X 7.30" D X 2.48" H 188.4mm W X 185.38mm D X 63mm H 4.12 lb (1.87 kg), weight may vary by configuration
	PRO A6-8570E	2	3.0 / 3.4 GHz	1 MB	DDR4-2400	Radeon R5 Series		With VESA mount & I/O box: 7.42" W X 7.30" D X 2.62" H 188.4mm W X 185.38mm D X 66.6mm H 3.53 lb (1.6 kg), weight may vary by configuration
	PRO A10-8770E	4	2.8 / 3.5 GHz	2 MB	DDR4-2400	Radeon R7 Series		Optional VESA mount bracket kit, supports VESA 75mm and 100mm
PRO A12-8870E	4	2.9 / 3.8 GHz	2 MB	DDR4-2400	Radeon R7 Series	Optional system floor stand for vertical orientation		
PRO A12-8870E	4	2.9 / 3.8 GHz	2 MB	DDR4-2400	Radeon R7 Series			
Memory	32GB max, DDR4 2400, two 260-pin SO-DIMM sockets, dual-channel capable *16GB single SO-DIMM memory is only available via special bid models						VESA mount	
Disk	<i>Some:</i> SATA 6.0Gb/s, 2.5" Wide, 5400 rpm or 7200 rpm <i>Some:</i> Solid State Drive (SSD) / SATA 6.0Gb/s, 2.5" <i>Some:</i> M.2 Solid State Drive (SSD) / SATA interface or PCIe NVMe interface						Floor Stand	
Optical	<i>Some:</i> DVD-ROM, 9.0mm high, via USB external ODD box <i>Some:</i> DVD±RW, 9.0mm high, via USB external ODD box						Power supply	65 watts AC/DC adapter, autosensing, 88% PSU (not included for TIO models) 90 watts AC/DC adapter, autosensing, 88% PSU (only for models with I/O box)
Onboard SATA	One SATA cable (1-drop to device), one SATA 6.0Gb/s connector on planar						Limited warranty ³	<i>Some:</i> 1-year or 3-year, depot service / service upgrades available <i>Some:</i> 1-year or 3-year, limited onsite service / service upgrades available
Media reader	None						Preload	Preloaded operating system <i>Some:</i> Windows 10 Pro 64-bit <i>Some:</i> Windows 10 Home 64-bit <i>Some:</i> Windows® 7 Professional 64 preinstalled through downgrade rights in Windows 10 Pro 64-bit
Graphics	AMD Radeon™ Graphics in processor, uses main memory, DirectX® 12, two DisplayPort™, one optional port (HDMI, VGA, or 3rd DP), supports 3 independent displays (supports maximum of 2 concurrent HDMI/DVI displays when using HDMI port or DP to DVI/HDMI dongles); <i>Max resolution:</i> 4096x2160 (DP) @60Hz; 4096x2160 (HDMI) @30Hz; 1920x1200 (VGA) @60Hz						Preloaded applications (only some listed) - <i>Windows 10 only</i> ● Lenovo Companion ● Microsoft Office preloaded; purchase a product key to activate - <i>Windows 7 only</i> ● Lenovo Solution Center ● ThinkVantage System Update ● Create Recovery Media ● Lenovo ThinkVantage Tools ● CyberlinkPowerDVD Create(DVD±RW) ● Microsoft Office preloaded; purchase a product key to activate ● Adobe® Reader®	
DP cable	Optional DP to VGA, DP to DVI-D (single link), or DP to HDMI 1.4 dongle						Environment	ENERGY STAR® 6.1*, EPEAT™ Gold rating* (*Not for non-OS models); ErP Lot 3; GREENGUARD®; RoHS-compliant
Chipset	AMD B300 Chipset						Accessories	For compatible accessories, please go to http://www.lenovoquickpick.com
Front ports*	Two USB 3.0 (one is Always On and fast charge), one microphone (stereo, 3.5mm), one headphone / microphone combo jack (stereo, 3.5mm)							
Rear ports*	One USB 3.0 and three USB 2.0 (optional external optical box or I/O box occupies one specific USB 2.0 on some models), ethernet (RJ-45), two DisplayPort, one optional port (VGA, 3rd DP, HDMI, or serial on some models), one headphone							
I/O box*	Optional external I/O box, extends four USB 2.0 (two on front and two on rear), one serial, and two PS/2, via USB port (occupy one specific USB 2.0 of M715q Tiny) * Depending on many factors, actual data transfer speed may be lower than theoretical speed							
Audio support	High Definition (HD) Audio, Realtek ALC233-CG / internal speaker (1.5 watt)							
WLAN ¹³	<i>Some:</i> 11ac wireless, M.2 Card, Realtek RTL8821AE (dual band), Wi-Fi + Bluetooth 4.0 combo adapter, 1x1 <i>Some:</i> 11ac wireless, M.2 Card, Realtek RTL8822BE (dual band), Wi-Fi + Bluetooth 4.1 combo adapter, 2x2 <i>Some:</i> 11ac wireless, M.2 Card, Qualcomm Atheros QCA9377 (dual band), Wi-Fi + Bluetooth 4.1 combo adapter, 1x1							
Bluetooth™	<i>Some:</i> Bluetooth 4.0 or 4.1 wireless, integrated in Wi-Fi + BT combo adapter							
Ethernet	Gigabit ethernet, Realtek RTL8111EPV, Wake on LAN®							
Modem	None							
Manageability	DASH 1.0/1.1							
Security chip	Discrete TPM 2.0, TCG Certified							
Security features	<ul style="list-style-type: none"> ● Security slot (in rear for optional Kensington® MicroSaver® cable) ● Padlock loop ● Smart USB protection, allows keyboard/mouse only, blocks all storage devices ● Power-on password ● Administrator password ● Hard disk password ● Boot sequence control ● Boot without keyboard and mouse ● Individual USB port disablement ● Chassis intrusion switch 							

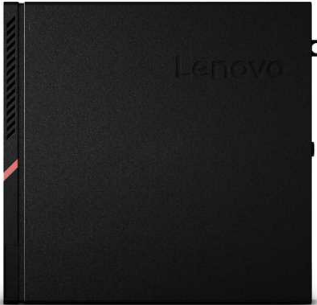

ThinkCentre M715 Tiny (2nd Gen) Platform Specifications

Product Specifications Reference (PSREF)

Processor	AMD Athlon, A6, A10, A12, or Ryzen processor	Security features	<ul style="list-style-type: none"> Security slot (in rear for optional Kensington® MicroSaver® cable) Administrator password Padlock loop Hard disk password Smart USB protection, allows keyboard/ mouse only, blocks all storage devices Boot sequence control Power-on password Boot without keyboard and mouse Individual USB port disablement Chassis intrusion switch 																																																																								
	<table border="1"> <thead> <tr> <th>Processor</th> <th>Cores / Threads</th> <th>Frequency Base/Max</th> <th>L2 Cache</th> <th>Memory Support (Up to)</th> <th>Integrated Graphics</th> </tr> </thead> <tbody> <tr> <td>Athlon 200GE</td> <td>2 / 4</td> <td>3.2 GHz</td> <td>1 MB</td> <td>DDR4-2933</td> <td>Radeon Vega 3</td> </tr> <tr> <td>Athlon PRO 200GE</td> <td>2 / 4</td> <td>3.2 GHz</td> <td>1 MB</td> <td>DDR4-2933</td> <td>Radeon Vega 3</td> </tr> <tr> <td>PRO A6-8570E</td> <td>2 / 2</td> <td>3.0 / 3.4 GHz</td> <td>1 MB</td> <td>DDR4-2400</td> <td>Radeon R5</td> </tr> <tr> <td>PRO A10-8770E</td> <td>4 / 4</td> <td>2.8 / 3.5 GHz</td> <td>2 MB</td> <td>DDR4-2400</td> <td>Radeon R7</td> </tr> <tr> <td>PRO A6-9500E</td> <td>2 / 2</td> <td>3.0 / 3.4 GHz</td> <td>1 MB</td> <td>DDR4-2400</td> <td>Radeon R5</td> </tr> <tr> <td>PRO A10-9700E</td> <td>4 / 4</td> <td>3.0 / 3.5 GHz</td> <td>2 MB</td> <td>DDR4-2400</td> <td>Radeon R7</td> </tr> <tr> <td>PRO A12-9800E</td> <td>4 / 4</td> <td>3.1 / 3.8 GHz</td> <td>2 MB</td> <td>DDR4-2400</td> <td>Radeon R7</td> </tr> <tr> <td>Ryzen 3 2200GE</td> <td>4 / 4</td> <td>3.2 / 3.6 GHz</td> <td>2 MB</td> <td>DDR4-2933</td> <td>Radeon Vega 8</td> </tr> <tr> <td>Ryzen 3 PRO 2200GE</td> <td>4 / 4</td> <td>3.2 / 3.6 GHz</td> <td>2 MB</td> <td>DDR4-2933</td> <td>Radeon Vega 8</td> </tr> <tr> <td>Ryzen 5 2400GE</td> <td>4 / 8</td> <td>3.2 / 3.8 GHz</td> <td>2 MB</td> <td>DDR4-2933</td> <td>Radeon RX Vega 11</td> </tr> <tr> <td>Ryzen 5 PRO 2400GE</td> <td>4 / 8</td> <td>3.2 / 3.8 GHz</td> <td>2 MB</td> <td>DDR4-2933</td> <td>Radeon RX Vega 11</td> </tr> </tbody> </table>	Processor	Cores / Threads	Frequency Base/Max	L2 Cache	Memory Support (Up to)	Integrated Graphics	Athlon 200GE	2 / 4	3.2 GHz	1 MB	DDR4-2933	Radeon Vega 3	Athlon PRO 200GE	2 / 4	3.2 GHz	1 MB	DDR4-2933	Radeon Vega 3	PRO A6-8570E	2 / 2	3.0 / 3.4 GHz	1 MB	DDR4-2400	Radeon R5	PRO A10-8770E	4 / 4	2.8 / 3.5 GHz	2 MB	DDR4-2400	Radeon R7	PRO A6-9500E	2 / 2	3.0 / 3.4 GHz	1 MB	DDR4-2400	Radeon R5	PRO A10-9700E	4 / 4	3.0 / 3.5 GHz	2 MB	DDR4-2400	Radeon R7	PRO A12-9800E	4 / 4	3.1 / 3.8 GHz	2 MB	DDR4-2400	Radeon R7	Ryzen 3 2200GE	4 / 4	3.2 / 3.6 GHz	2 MB	DDR4-2933	Radeon Vega 8	Ryzen 3 PRO 2200GE	4 / 4	3.2 / 3.6 GHz	2 MB	DDR4-2933	Radeon Vega 8	Ryzen 5 2400GE	4 / 8	3.2 / 3.8 GHz	2 MB	DDR4-2933	Radeon RX Vega 11	Ryzen 5 PRO 2400GE	4 / 8	3.2 / 3.8 GHz	2 MB	DDR4-2933	Radeon RX Vega 11	Keyboard	<i>Some:</i> Lenovo Calliope Keyboard (USB connector), black <i>Some:</i> Lenovo Traditional Keyboard (USB connector), black <i>Some:</i> Lenovo Calliope Wireless Keyboard (2.4GHz via USB receiver), black
Processor	Cores / Threads	Frequency Base/Max	L2 Cache	Memory Support (Up to)	Integrated Graphics																																																																						
Athlon 200GE	2 / 4	3.2 GHz	1 MB	DDR4-2933	Radeon Vega 3																																																																						
Athlon PRO 200GE	2 / 4	3.2 GHz	1 MB	DDR4-2933	Radeon Vega 3																																																																						
PRO A6-8570E	2 / 2	3.0 / 3.4 GHz	1 MB	DDR4-2400	Radeon R5																																																																						
PRO A10-8770E	4 / 4	2.8 / 3.5 GHz	2 MB	DDR4-2400	Radeon R7																																																																						
PRO A6-9500E	2 / 2	3.0 / 3.4 GHz	1 MB	DDR4-2400	Radeon R5																																																																						
PRO A10-9700E	4 / 4	3.0 / 3.5 GHz	2 MB	DDR4-2400	Radeon R7																																																																						
PRO A12-9800E	4 / 4	3.1 / 3.8 GHz	2 MB	DDR4-2400	Radeon R7																																																																						
Ryzen 3 2200GE	4 / 4	3.2 / 3.6 GHz	2 MB	DDR4-2933	Radeon Vega 8																																																																						
Ryzen 3 PRO 2200GE	4 / 4	3.2 / 3.6 GHz	2 MB	DDR4-2933	Radeon Vega 8																																																																						
Ryzen 5 2400GE	4 / 8	3.2 / 3.8 GHz	2 MB	DDR4-2933	Radeon RX Vega 11																																																																						
Ryzen 5 PRO 2400GE	4 / 8	3.2 / 3.8 GHz	2 MB	DDR4-2933	Radeon RX Vega 11																																																																						
		Mouse	<i>Some:</i> Lenovo Calliope Mouse (USB connector), black <i>Some:</i> Lenovo Fingerprint Mouse (USB connector), Windows Hello support, black <i>Some:</i> Lenovo Calliope Wireless Mouse (2.4GHz via USB receiver), black																																																																								
		Mechanical	Tiny (1L), black color; metal case <ul style="list-style-type: none"> Toolless chassis open (need optional toolless chassis screw) Optional dust filter M715 Gen2 Tiny only: 7.05" W X 7.20" D X 1.36" H 179mm W X 182.9mm D X 34.5mm H 2.91 lb (1.32 kg), weight may vary by configuration With VESA mount & ODD box: 7.42" W X 7.30" D X 2.48" H 188.4mm W X 185.38mm D X 63mm H 3.66 lb (1.66 kg), weight may vary by configuration Optional VESA mount bracket kit, supports VESA 75mm and 100mm Optional system floor stand for vertical orientation																																																																								
Memory	32GB max, DDR4 2666*, two 260-pin SO-DIMM sockets, dual-channel capable * System automatically clocks down for the lower memory controller	VESA mount Floor Stand	Optional VESA mount bracket kit, supports VESA 75mm and 100mm Optional system floor stand for vertical orientation																																																																								
Disk	<i>Some:</i> Hard Drive / SATA 6.0Gb/s, 2.5", 5400 rpm or 7200 rpm <i>Some:</i> Solid State Drive (SSD) / SATA 6.0Gb/s, 2.5" <i>Some:</i> M.2 SSD / PCIe NVMe, PCIe 3.0 x 4*, 32Gb/s * 128GB SSD M.2 (2242) PCIe NVMe only supports PCIe 3.0 x 2, 16Gb/s	Power supply	65 watts AC/DC adapter, autosensing, 88% PSU (not included for TIO models)																																																																								
Optical	<i>Some:</i> DVD-ROM, 9.0mm high, via USB external ODD box <i>Some:</i> DVD±RW, 9.0mm high, via USB external ODD box	Limited warranty	1-year or 3-year, limited onsite service / service upgrades available																																																																								
Onboard SATA	One SATA cable (1-drop to device), one SATA 6.0Gb/s connector on planar	Preload	Preloaded operating system <i>Some:</i> Windows® 10 Pro 64-bit <i>Some:</i> Windows 10 Home 64-bit <i>Some:</i> Windows 7 Professional 64 preinstalled through downgrade rights in Windows 10 Pro 64-bit																																																																								
Graphics	AMD Radeon™ Graphics in processor, uses main memory, DirectX® 12, two DisplayPort™, one optional port (HDMI, VGA, or 3rd DP), supports 3 independent displays (supports maximum of 2 concurrent HDMI/DVI displays when using HDMI port or DP to DVI/HDMI dongles, and Athlon / Athlon PRO only support 2 displays); <i>Max resolution:</i> 4096x2160 (DP) @60Hz; 4096x2160 (HDMI) @30Hz; 1920x1200 (VGA) @60Hz	Preloaded applications (only some listed)	- Windows 10 only <ul style="list-style-type: none"> Lenovo Vantage Microsoft Office preloaded; purchase a product key to activate Cyberlink PowerDVD (only for models with DVD / DVD±RW) Cyberlink Power2GO (only for models with DVD±RW) LinkedIn Windows 7 only Lenovo Solution Center ThinkVantage System Update Create Recovery Media Microsoft Office preloaded; purchase a product key to activate Adobe® Reader® 																																																																								
Monitor cable	Optional DP to VGA dongle, DP to DVI-D dongle, or DP to HDMI 1.4 dongle	Environment	ENERGY STAR® 7.0*, EPEAT™ Silver rating* (*Not for non-OS models); ErP Lot 3; ; RoHS-compliant																																																																								
Chipset	AMD B300 Chipset	MIL-SPEC test	MIL-STD-810G military certification (Low Pressure [Altitude], High Temperature, Low Temperature, Temperature Shock, Humidity, Sand and Dust, Vibration, Shock)																																																																								
Front ports* (Std.)	Two USB 3.1 Gen1 (one is Always On and fast charge), one microphone (stereo, 3.5mm), one headphone / microphone combo jack (stereo, 3.5mm)	Accessories	For compatible accessories, please go to http://smartfind.lenovo.com																																																																								
Rear ports* (Std.)	One USB 3.1 Gen1 and three USB 2.0, ethernet (RJ-45), two DisplayPort, one headphone																																																																										
Rear ports* (Opt.)	One optional port (VGA**, 3rd DP**, HDMI**, or serial on some models) * Depending on many factors, actual data transfer speed may be lower than theoretical speed ** Not support VGA, 3rd DP, HDMI for the models with Athlon / Athlon PRO																																																																										
Audio support	High Definition (HD) Audio, Realtek ALC233-VB2 / internal speaker (1.5 watt)																																																																										
WLAN	<i>Some:</i> 11ac wireless, M.2 Card, Realtek RTL8821CE (dual band), Wi-Fi + Bluetooth 4.2* combo adapter, 1x1 <i>Some:</i> 11ac wireless, M.2 Card, Qualcomm Atheros QCA9377 (dual band), Wi-Fi + Bluetooth 4.2* combo adapter, 1x1 <i>Some:</i> 11ac wireless, M.2 Card, Realtek RTL8822BE (dual band), Wi-Fi + Bluetooth 4.2* combo adapter, 2x2 <i>Some:</i> 11ac wireless, M.2 Card, Qualcomm Atheros QCA6174A (dual band), Wi-Fi + Bluetooth 4.2* combo adapter, 2x2 <i>Some:</i> Bluetooth 4.2* wireless, integrated in Wi-Fi + BT combo adapter * Hardware supports BT 4.2, but Win10 RS3 and earlier only supports BT 4.1 Gigabit ethernet, Realtek RTL8111EPV, Wake on LAN®																																																																										
Bluetooth																																																																											
Ethernet																																																																											
Manageability	DASH 1.0/1.1																																																																										
Security chip	Discrete TPM 2.0, TCG Certified																																																																										

Note: The specifications above may not be available in all regions.

Lenovo, July 2018



ThinkCentre M715 Tiny Thin Client Platform Specifications

Product Specifications Reference (PSREF)

Processor	AMD A6, A10, or A12 series APUs						Keyboard	<i>Some:</i> Fullsize USB Keyboard (USB connector), Lenovo logo
	APU	Cores	Frequency Base/Max	L2 Cache	Memory Types	Integrated Graphics	Mouse	<i>Some:</i> USB Optical Wheel Mouse, black, Lenovo logo
	PRO A6-8570E	2	3.0 / 3.4 GHz	1 MB	DDR4-2400	Radeon R5 Series	Mechanical	Tiny (1L), black color; metal case M715 Tiny only: 7.05" W X 7.20" D X 1.36" H 179mm W X 182.9mm D X 34.5mm H 2.9 lb (1.3 kg), weight may vary by configuration Optional VESA mount bracket kit, supports VESA 75mm and 100mm Optional system floor stand for vertical orientation
	PRO A10-8770E	4	2.8 / 3.5 GHz	2 MB	DDR4-2400	Radeon R7 Series		
PRO A12-8870E*	4	2.9 / 3.8 GHz	2 MB	DDR4-2400	Radeon R7 Series			
*PRO A12-8870E (support Windows 10 IOT only) is only available via special bid models								
Memory	4GB max, DDR4 2400, two 260-pin SO-DIMM sockets						VESA mount	Optional VESA mount bracket kit, supports VESA 75mm and 100mm Optional system floor stand for vertical orientation
Disk	<i>Some:</i> 256GB Solid State Drive (SSD) / SATA 6.0Gb/s, 2.5"* *256GB SATA (support Windows 10 IOT only) is only available via special bid models <i>Some:</i> 32GB M.2 Solid State Drive (SSD) / SATA interface <i>Some:</i> 128GB M.2 Solid State Drive (SSD) / PCIe NVMe interface						Floor Stand	
Optical	None						Power supply	65 watts AC/DC adapter, autosensing, 88% PSU (not included for TIO models)
Onboard SATA	One SATA cable (1-drop to device), one SATA 6.0Gb/s connector on planar						Limited warranty ³	<i>Some:</i> 1-year or 3-year, depot service / service upgrades available <i>Some:</i> 1-year or 3-year, limited onsite service / service upgrades available
Media reader	None						Preload	Preloaded operating system <i>Some:</i> Windows Embedded Standard 7 V2 (WES 7 V2) <i>Some:</i> Windows 10 IoT Enterprise <i>Some:</i> LeTOS V2 (Lenovo Terminal Operating System, Linux-based)
Graphics	AMD Radeon™ Graphics in processor, uses main memory, DirectX® 12, two DisplayPort™, one optional port (HDMI, VGA, or 3rd DP), supports 3 independent displays (supports maximum of 2 concurrent HDMI/DVI displays when using HDMI port or DP to DVI/HDMI dongles); <i>Max resolution:</i> 4096x2160 (DP) @60Hz; 4096x2160 (HDMI) @30Hz; 1920x1200 (VGA) @60Hz						Environment	ENERGY STAR® 6.1*, EPEAT™ Gold rating* (*not for non-OS models); ErP Lot 3; GREENGUARD®; RoHS-compliant
DP cable	Optional DP to VGA, DP to DVI-D (single link), or DP to HDMI 1.4 dongle						Accessories	For compatible accessories, please go to http://www.lenovoquickpick.com
Chipset	AMD B300 Chipset							
Front ports*	Two USB 3.0 (one is Always On and fast charge), one microphone (stereo, 3.5mm), one headphone / microphone combo jack (stereo, 3.5mm)							
Rear ports*	One USB 3.0 and three USB 2.0 (optional external optical box or I/O box occupies one specific USB 2.0 on some models), ethernet (RJ-45), two DisplayPort, one optional port (VGA, 3rd DP, HDMI, or serial on some models), one headphone * Depending on many factors, actual data transfer speed may be lower than theoretical speed							
I/O box	None							
Audio support	High Definition (HD) Audio, Realtek ALC233-CG / internal speaker (1.5 watt)							
WLAN ¹³	<i>Some:</i> 11ac wireless, M.2 Card, Realtek RTL8821AE (dual band), Wi-Fi + Bluetooth 4.0 combo adapter, 1x1							
Bluetooth™	<i>Some:</i> Bluetooth 4.0 or 4.1 wireless, integrated in Wi-Fi + BT combo adapter							
Ethernet	Gigabit ethernet, Realtek RTL8111EPV, Wake on LAN®							
Modem	None							
Manageability	DASH 1.0/1.1							
Security chip	Discrete TPM 2.0, TCG Certified							
Security features	<ul style="list-style-type: none"> ● Security slot (in rear for optional Kensington® MicroSaver® cable) ● Padlock loop ● Smart USB protection, allows keyboard/mouse only, blocks all storage devices ● Power-on password ● Administrator password ● Hard disk password ● Boot sequence control ● Boot without keyboard and mouse ● Individual USB port disablement ● Chassis intrusion switch 							

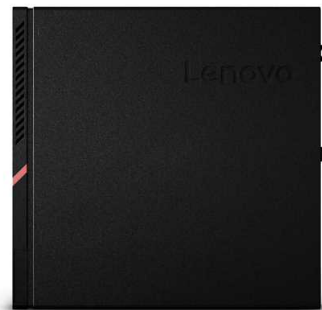

ThinkCentre M715 Tiny Thin Client (2nd Gen) Platform Specifications

Product Specifications Reference (PSREF)

Processor	AMD Athlon, A6, A10, or Ryzen processor						Keyboard	Some: Lenovo Calliope Keyboard (USB connector), black Some: Lenovo Traditional Keyboard (USB connector), black
	APU	Cores / Threads	Frequency Base/Max	L2 Cache	Memory Support (Up to)	Integrated Graphics	Mouse	Some: Lenovo Calliope Wireless Keyboard (2.4GHz via USB receiver), black Some: Lenovo Calliope Mouse (USB connector), black Some: Lenovo Fingerprint Mouse (USB connector), Windows Hello support, black Some: Lenovo Calliope Wireless Mouse (2.4GHz via USB receiver), black
	Athlon PRO 200GE	2 / 4	3.2 GHz	1 MB	DDR4-2933	Radeon Vega 3		
	PRO A6-8570E	2 / 2	3.0 / 3.4 GHz	1 MB	DDR4-2400	Radeon R5		
	PRO A10-8770E	4 / 4	2.8 / 3.5 GHz	2 MB	DDR4-2400	Radeon R7		
	Ryzen 3 PRO 2200GE	4 / 4	3.2 / 3.6 GHz	2 MB	DDR4-2933	Radeon Vega 8		
Memory	8GB max, DDR4 2666*, two 260-pin SO-DIMM sockets, dual-channel capable * System automatically clocks down for the lower memory controller						Mechanical	Tiny (1L), black color; metal case • Toolless chassis open (need optional toolless chassis screw) • Optional dust filter M715 Gen2 Tiny only: 7.05" W X 7.20" D X 1.36" H 179mm W X 182.9mm D X 34.5mm H 2.91 lb (1.32 kg), weight may vary by configuration
Disk	Some: 32GB M.2 Solid State Drive (SSD) / SATA interface Some: 128GB M.2 Solid State Drive (SSD) / PCIe NVMe, PCIe 3.0 x 2						VESA mount	Optional VESA mount bracket kit, supports VESA 75mm and 100mm
Optical	None						Floor Stand	Optional system floor stand for vertical orientation
Onboard SATA	One SATA cable (1-drop to device), one SATA 6.0Gb/s connector on planar						Power supply	65 watts AC/DC adapter, autosensing, 88% PSU (not included for TIO models)
Graphics	AMD Radeon™ Graphics in processor, uses main memory, DirectX® 12, two DisplayPort™, one optional port (HDMI, VGA, or 3rd DP), supports 3 independent displays (supports maximum of 2 concurrent HDMI/DVI displays when using HDMI port or DP to DVI/HDMI dongles, and Athlon / Athlon PRO only support 2 displays); Max resolution: 4096x2160 (DP) @60Hz; 4096x2160 (HDMI) @30Hz; 1920x1200 (VGA) @60Hz						Limited warranty	1-year or 3-year, limited onsite service / service upgrades available
Monitor cable	Optional DP to VGA dongle, DP to DVI-D dongle, or DP to HDMI 1.4 dongle						Preload	Preloaded operating system Some: Windows Embedded Standard 7 V2 (WES 7 V2) Some: Windows 10 IoT Enterprise Some: LeTOS V2 (Lenovo Terminal Operating System, Linux-based)
Chipset	AMD B300 Chipset						Environment	ENERGY STAR® 6.1*, EPEAT™ Silver rating* (*not for non-OS models); ErP Lot 3; RoHS-compliant
Front ports* (Std.)	Two USB 3.1 Gen1 (one is Always On and fast charge), one microphone (stereo, 3.5mm), one headphone / microphone combo jack (stereo, 3.5mm)						MIL-SPEC test	MIL-STD-810G military certification (Low Pressure [Altitude], High Temperature, Low Temperature, Temperature Shock, Humidity, Sand and Dust, Vibration, Shock)
Rear ports* (Std.)	One USB 3.1 Gen1 and three USB 2.0, ethernet (RJ-45), two DisplayPort, one headphone						Accessories	For compatible accessories, please go to http://smartfind.lenovo.com
Rear ports* (Opt.)	One optional port (VGA**, 3rd DP**, HDMI**, or serial on some models) * Depending on many factors, actual data transfer speed may be lower than theoretical speed ** Not support VGA, 3rd DP, HDMI for the models with Athlon / Athlon PRO							
Audio support	High Definition (HD) Audio, Realtek ALC233-VB2 / internal speaker (1.5 watt)							
WLAN	Some: 11ac wireless, M.2 Card, Realtek RTL8821CE (dual band), Wi-Fi + Bluetooth 4.2* combo adapter, 1x1 Some: 11ac wireless, M.2 Card, Qualcomm Atheros QCA9377 (dual band), Wi-Fi + Bluetooth 4.2* combo adapter, 1x1 Some: 11ac wireless, M.2 Card, Realtek RTL8822BE (dual band), Wi-Fi + Bluetooth 4.2* combo adapter, 2x2 Some: 11ac wireless, M.2 Card, Qualcomm Atheros QCA6174A (dual band), Wi-Fi + Bluetooth 4.2* combo adapter, 2x2 Some: Bluetooth 4.2* wireless, integrated in Wi-Fi + BT combo adapter							
Bluetooth	* Hardware supports BT 4.2, but Win10 RS3 and earlier only supports BT 4.1							
Ethernet	Gigabit ethernet, Realtek RTL8111EPV, Wake on LAN®							
Manageability	DASH 1.0/1.1							
Security chip	Discrete TPM 2.0, TCG Certified							
Security features	<ul style="list-style-type: none"> • Security slot (in rear for optional Kensington® MicroSaver® cable) • Padlock loop • Smart USB protection, allows keyboard/mouse only, blocks all storage devices • Power-on password • Administrator password • Hard disk password • Boot sequence control • Boot without keyboard and mouse • Individual USB port disablement • Chassis intrusion switch 							

Note: The specifications above may not be available in all regions.

Lenovo, July 2018

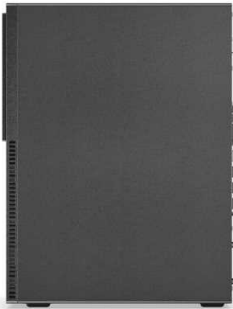

ThinkCentre M715 Tower Platform Specifications

Product Specifications Reference (PSREF)

Processor	AMD A6 / A8 / A10 / A12 series APU and Ryzen 3 / 5 / 7 series processor	Manageability	DASH																																																												
	<table border="1"> <thead> <tr> <th>APU / processor</th> <th>Cores / Threads</th> <th>Frequency (Base/Max)</th> <th>L2 Cache</th> <th>Integrated Graphics</th> </tr> </thead> <tbody> <tr> <td>Ryzen 3 PRO 1200</td> <td>4 / 4</td> <td>3.1 / 3.4</td> <td>2MB</td> <td>None</td> </tr> <tr> <td>Ryzen 3 PRO 1300</td> <td>4 / 4</td> <td>3.5 / 3.7</td> <td>2MB</td> <td>None</td> </tr> <tr> <td>Ryzen 5 PRO 1500</td> <td>4 / 8</td> <td>3.5 / 3.7</td> <td>2MB</td> <td>None</td> </tr> <tr> <td>Ryzen 7 PRO 1700</td> <td>8 / 16</td> <td>3.0 / 3.7</td> <td>4MB</td> <td>None</td> </tr> <tr> <td>PRO A6-8570</td> <td>2 / 2</td> <td>3.5 / 3.8</td> <td>1MB</td> <td>Radeon R5 Series</td> </tr> <tr> <td>PRO A10-8770</td> <td>4 / 4</td> <td>3.5 / 3.8</td> <td>2MB</td> <td>Radeon R7 Series</td> </tr> <tr> <td>PRO A12-8870</td> <td>4 / 4</td> <td>3.7 / 4.2</td> <td>2MB</td> <td>Radeon R7 Series</td> </tr> <tr> <td>PRO A6-9500</td> <td>2 / 2</td> <td>3.5 / 3.8</td> <td>1MB</td> <td>Radeon R5 Series</td> </tr> <tr> <td>PRO A8-9600</td> <td>4 / 4</td> <td>3.1 / 3.4</td> <td>2MB</td> <td>Radeon R7 Series</td> </tr> <tr> <td>PRO A10-9700</td> <td>4 / 4</td> <td>3.5 / 3.8</td> <td>2MB</td> <td>Radeon R7 Series</td> </tr> <tr> <td>PRO A12-9800</td> <td>4 / 4</td> <td>3.8 / 4.2</td> <td>2MB</td> <td>Radeon R7 Series</td> </tr> </tbody> </table>	APU / processor	Cores / Threads	Frequency (Base/Max)	L2 Cache	Integrated Graphics	Ryzen 3 PRO 1200	4 / 4	3.1 / 3.4	2MB	None	Ryzen 3 PRO 1300	4 / 4	3.5 / 3.7	2MB	None	Ryzen 5 PRO 1500	4 / 8	3.5 / 3.7	2MB	None	Ryzen 7 PRO 1700	8 / 16	3.0 / 3.7	4MB	None	PRO A6-8570	2 / 2	3.5 / 3.8	1MB	Radeon R5 Series	PRO A10-8770	4 / 4	3.5 / 3.8	2MB	Radeon R7 Series	PRO A12-8870	4 / 4	3.7 / 4.2	2MB	Radeon R7 Series	PRO A6-9500	2 / 2	3.5 / 3.8	1MB	Radeon R5 Series	PRO A8-9600	4 / 4	3.1 / 3.4	2MB	Radeon R7 Series	PRO A10-9700	4 / 4	3.5 / 3.8	2MB	Radeon R7 Series	PRO A12-9800	4 / 4	3.8 / 4.2	2MB	Radeon R7 Series	Security chip	TPM (Trusted Platform Module) 2.0, TCG Certified * Downgrade to TPM1.2 for the models with Win10 DG Win7 32 OS
APU / processor	Cores / Threads	Frequency (Base/Max)	L2 Cache	Integrated Graphics																																																											
Ryzen 3 PRO 1200	4 / 4	3.1 / 3.4	2MB	None																																																											
Ryzen 3 PRO 1300	4 / 4	3.5 / 3.7	2MB	None																																																											
Ryzen 5 PRO 1500	4 / 8	3.5 / 3.7	2MB	None																																																											
Ryzen 7 PRO 1700	8 / 16	3.0 / 3.7	4MB	None																																																											
PRO A6-8570	2 / 2	3.5 / 3.8	1MB	Radeon R5 Series																																																											
PRO A10-8770	4 / 4	3.5 / 3.8	2MB	Radeon R7 Series																																																											
PRO A12-8870	4 / 4	3.7 / 4.2	2MB	Radeon R7 Series																																																											
PRO A6-9500	2 / 2	3.5 / 3.8	1MB	Radeon R5 Series																																																											
PRO A8-9600	4 / 4	3.1 / 3.4	2MB	Radeon R7 Series																																																											
PRO A10-9700	4 / 4	3.5 / 3.8	2MB	Radeon R7 Series																																																											
PRO A12-9800	4 / 4	3.8 / 4.2	2MB	Radeon R7 Series																																																											
		Security features	<ul style="list-style-type: none"> Security slot (in rear for optional Kensington® MicroSaver® cable) Padlock loop Smart USB protection, allows keyboard/mouse only, blocks all storage devices Optional cable lock to physically lock both keyboard and mouse Power-on password Administrator password Hard disk password Boot sequence control Boot without keyboard and mouse Individual USB port disablement Optional chassis intrusion switch 																																																												
		Keyboard	<i>Some:</i> Lenovo Calliope Keyboard (USB connector), black <i>Some:</i> Lenovo Traditional Keyboard (USB connector), black <i>Some:</i> Lenovo Calliope Wireless Keyboard (2.4GHz via USB receiver), black <i>Some:</i> Lenovo Calliope Mouse (USB connector), black <i>Some:</i> Lenovo Calliope Wireless Mouse (2.4GHz via USB receiver), black <i>Some:</i> Lenovo Fingerprint Mouse (USB connector), Windows Hello support, black																																																												
		Mouse	<i>Some:</i> Lenovo Calliope Mouse (USB connector), black <i>Some:</i> Lenovo Calliope Wireless Mouse (2.4GHz via USB receiver), black <i>Some:</i> Lenovo Fingerprint Mouse (USB connector), Windows Hello support, black																																																												
Memory	64GB max, UDIMM, DDR4-2400*, four 288-pin DIMM sockets, non-ECC, dual-channel capable * System automatically clocks down for the processors with lower memory controller	Mechanical	<ul style="list-style-type: none"> Tower (15L), black color, metal case (WxDxH) 5.7" X 11.5" X 14.4"; 145mm X 292.7mm X 366mm Approx. 14.3 lb (6.5 kg), weight may vary by configuration Optional dust filter Bay 1: Slim external ODD bay Bay 2: 3.5", internal, HDD/SSD Bay 3: 2.5", internal, HDD/SSD Slot 1: half-length full-height (length < 189mm, height < 104mm), PCIe 3.0 x16* Slot 2: half-length full-height (length < 189mm, height < 104mm), PCIe 2.0 x1* Slot 3: half-length full-height (length < 189mm, height < 104mm), PCIe 2.0 x1* Slot 4: no slot, only bracket for optional port extension* M.2 card slots: two (one for WLAN, one for SSD) * Optional front USB3.1 Type-C x2 module occupies PCIe x16 slot (x4 card), optional rear 2x USB2.0 / parallel / 2nd serial occupies one expansion slot 																																																												
Storage	<i>Some:</i> Hard Drive / SATA 6.0Gb/s, 2.5" or 3.5", 5400 rpm or 7200 rpm <i>Some:</i> Solid State Drive (SSD) / SATA 6.0Gb/s, 2.5" <i>Some:</i> M.2 Solid State Drive (SSD) / PCIe NVMe, PCIe 3.0 x 4, 32Gb/s	Power supply	<i>Some:</i> 180 watts, autosensing, 85% PSU <i>Some:</i> 210 watts, autosensing, 85% PSU <i>Some:</i> 210 watts, autosensing, 92% PSU (only available via special bid)																																																												
Optical	<i>Some:</i> DVD-ROM SATA 1.5Gb/s Drive, slim (9.0mm) <i>Some:</i> DVD Burner (DVD±RW), SATA 1.5Gb/s Drive, slim (9.0mm)	Limited warranty	<i>Some:</i> 1-year or 3-year, depot service / service upgrades available <i>Some:</i> 1-year or 3-year, limited onsite service / service upgrades available																																																												
Onboard SATA Media reader	Three onboard SATA 6.0Gb/s connectors Optional 7-in-1 media reader	Preload	Preloaded operating system <i>Some:</i> Windows® 7 Professional (32/64 preinstalled through downgrade rights in Windows 10 Pro 64-bit (Only available with Pro A6/A10/A12-8xxx APUs) <i>Some:</i> Windows 10 Pro 64-bit <i>Some:</i> Windows 10 Home 64-bit Preloaded applications (only some listed) <ul style="list-style-type: none"> Microsoft Office preloaded; purchase a product key to activate Only for Window 10 Lenovo Companion Only for Window 7 Lenovo Solution Center Lenovo ThinkVantage Tools Create Recovery Media Adobe® Reader® Cyberlink PowerDVD Create (DVD±RW) 																																																												
Graphics	AMD Radeon™ Graphics in processor (not for AMD Ryzen processor), uses main memory, DirectX® 12, one VGA, two DisplayPort™ (Onboard VGA and DP ports are invalid on the models with AMD Ryzen processor), supports 3 independent displays, works along with AMD discrete graphics to support more displays; <i>Max resolution:</i> 4096x2160 (DP)@60Hz; 1920x1200 (VGA)@60Hz <i>Some:</i> NVIDIA GeForce® GT 730 , DirectX 12, 2GB, PCIe 2.0 x8 adapter, two DisplayPort, 35 watts; <i>Max resolution:</i> 3840x2160 (DisplayPort)@60Hz; <i>Some:</i> AMD Radeon™ RX 550 , DirectX 12, 2GB, PCIe 3.0 x8 adapter, one VGA, one HDMI, one DisplayPort, 50 watts, occupies two slots; <i>Max resolution:</i> 4096x2160 (HDMI)@60Hz; 2048x1536 (VGA)@60Hz; 5120x2880 (DP)@60Hz	Monitor Cable	Optional DP to VGA, DP to DVI-D (single link), DP to dual DP, or DP to HDMI 1.4																																																												
Chipset	AMD B350 Chipset	Front ports*	Two USB 3.1 Gen2, two USB 3.1 Gen1, optional two USB 3.1 Type-C Gen 2 (only available via special bid), microphone (3.5mm), headphone (3.5mm)																																																												
Monitor Cable	Optional DP to VGA, DP to DVI-D (single link), DP to dual DP, or DP to HDMI 1.4	Rear ports*	Two USB 3.1 Gen1, two USB 2.0, optional two USB 2.0, serial (9-pin), optional 2nd serial (9-pin), optional parallel (25-pin), ethernet (RJ-45), one VGA and two DisplayPort (not available on models with AMD Ryzen processor), two PS/2 ports (keyboard / mouse); additional VGA, DisplayPort, or HDMI on optional graphics on some models																																																												
Chipset	AMD B350 Chipset	Rear audio ports* IEEE 1394*	Line-in (3.5mm), line-out (3.5mm), microphone-in (3.5mm) None * Depending on many factors, actual data transfer speed may be lower than theoretical speed																																																												
Front ports*	Two USB 3.1 Gen2, two USB 3.1 Gen1, optional two USB 3.1 Type-C Gen 2 (only available via special bid), microphone (3.5mm), headphone (3.5mm)	Audio support	High Definition (HD) Audio, Realtek ALC662 / optional internal speaker (1.5 watt)																																																												
Rear ports*	Two USB 3.1 Gen1, two USB 2.0, optional two USB 2.0, serial (9-pin), optional 2nd serial (9-pin), optional parallel (25-pin), ethernet (RJ-45), one VGA and two DisplayPort (not available on models with AMD Ryzen processor), two PS/2 ports (keyboard / mouse); additional VGA, DisplayPort, or HDMI on optional graphics on some models	WLAN	<i>Some:</i> 11ac wireless, M.2 Card, Realtek RTL8821AE (dual band), Wi-Fi + Bluetooth 4.0 combo adapter, 1x1 <i>Some:</i> 11ac wireless, M.2 Card, Qualcomm Atheros QCA6174A (dual band), Wi-Fi + Bluetooth 4.1 combo adapter, 2x2 <i>Some:</i> 11ac wireless, M.2 Card, Qualcomm Atheros QCA9377 (dual band), Wi-Fi + Bluetooth 4.1 combo adapter, 1x1																																																												
Rear audio ports* IEEE 1394*	Line-in (3.5mm), line-out (3.5mm), microphone-in (3.5mm) None * Depending on many factors, actual data transfer speed may be lower than theoretical speed	Bluetooth™	<i>Some:</i> Bluetooth 4.0 or 4.1 wireless, integrated in Wi-Fi + BT combo adapter																																																												
Audio support	High Definition (HD) Audio, Realtek ALC662 / optional internal speaker (1.5 watt)	Ethernet	Gigabit ethernet, Realtek RTL8111EPV, Wake on LAN®																																																												
WLAN	<i>Some:</i> 11ac wireless, M.2 Card, Realtek RTL8821AE (dual band), Wi-Fi + Bluetooth 4.0 combo adapter, 1x1 <i>Some:</i> 11ac wireless, M.2 Card, Qualcomm Atheros QCA6174A (dual band), Wi-Fi + Bluetooth 4.1 combo adapter, 2x2 <i>Some:</i> 11ac wireless, M.2 Card, Qualcomm Atheros QCA9377 (dual band), Wi-Fi + Bluetooth 4.1 combo adapter, 1x1	Modem	None																																																												
Bluetooth™	<i>Some:</i> Bluetooth 4.0 or 4.1 wireless, integrated in Wi-Fi + BT combo adapter	Environment	ENERGY STAR® 6.1, EPEAT™ Gold rating (North America), ErP Lot 3, GREENGUARD®, RoHS-compliant																																																												
Ethernet	Gigabit ethernet, Realtek RTL8111EPV, Wake on LAN®	Accessories	For compatible accessories, please go to http://www.lenovoquickpick.com																																																												
Modem	None																																																														

Note: The specifications above may not be available in all regions.

Lenovo, July 2017



ThinkCentre M720 SFF Platform Specifications

Product Specifications Reference (PSREF)

Processor	Intel® Celeron®, Intel Pentium®, or 8th Generation Intel Core™ i3 / i5 / i7 Processor	<p><i>Some:</i> 11ac wireless, M.2 Card, Realtek RTL8822BE (dual band), Wi-Fi + Bluetooth 4.2 combo adapter, 2x2</p> <p><i>Some:</i> 11ac wireless, M.2 Card, Intel Dual Band Wireless-AC 3165, Wi-Fi + Bluetooth 4.2 combo adapter, 1x1</p> <p><i>Some:</i> 11ac wireless, M.2 Card, Intel Dual Band Wireless-AC 8265, Wi-Fi + Bluetooth 4.2 combo adapter, 2x2</p> <p><i>Some:</i> Bluetooth 4.2 wireless, integrated in Wi-Fi + BT combo adapter</p>																																																																																																																								
	<table border="1"> <thead> <tr> <th>Processor</th> <th>Cores / Threads</th> <th>Frequency Base/Max(GHz)</th> <th>Cache</th> <th>Memory Support (Up to)</th> <th>Integrated Graphics</th> </tr> </thead> <tbody> <tr><td>Celeron G4900</td><td>2 / 2</td><td>3.1G</td><td>2 MB</td><td>DDR4-2400</td><td>UHD 610</td></tr> <tr><td>Celeron G4920</td><td>2 / 2</td><td>3.2G</td><td>2 MB</td><td>DDR4-2400</td><td>UHD 610</td></tr> <tr><td>Pentium Gold G5400</td><td>2 / 4</td><td>3.7G</td><td>4 MB</td><td>DDR4-2400</td><td>UHD 610</td></tr> <tr><td>Pentium Gold G5500</td><td>2 / 4</td><td>3.8G</td><td>4 MB</td><td>DDR4-2400</td><td>UHD 630</td></tr> <tr><td>Pentium Gold G5600</td><td>2 / 4</td><td>3.9G</td><td>4 MB</td><td>DDR4-2400</td><td>UHD 630</td></tr> <tr><td>Core i3-8100</td><td>4 / 4</td><td>3.6G</td><td>6 MB</td><td>DDR4-2400</td><td>UHD 630</td></tr> <tr><td>Core i3-8300</td><td>4 / 4</td><td>3.7G</td><td>8 MB</td><td>DDR4-2400</td><td>UHD 630</td></tr> <tr><td>Core i5-8400</td><td>6 / 6</td><td>2.8G / 4.0G</td><td>9 MB</td><td>DDR4-2666</td><td>UHD 630</td></tr> <tr><td>Core i5-8500</td><td>6 / 6</td><td>3.0G / 4.1G</td><td>9 MB</td><td>DDR4-2666</td><td>UHD 630</td></tr> <tr><td>Core i5-8600</td><td>6 / 6</td><td>3.1G / 4.3G</td><td>9 MB</td><td>DDR4-2666</td><td>UHD 630</td></tr> <tr><td>Core i7-8700</td><td>6 / 12</td><td>3.2G / 4.6G</td><td>12 MB</td><td>DDR4-2666</td><td>UHD 630</td></tr> <tr><td>Core i3-9100</td><td>4 / 4</td><td>3.6G / 4.2G</td><td>6 MB</td><td>DDR4-2400</td><td>UHD 630</td></tr> <tr><td>Core i3-9300</td><td>4 / 4</td><td>3.7G / 4.3G</td><td>8 MB</td><td>DDR4-2400</td><td>UHD 630</td></tr> <tr><td>Core i3-9320</td><td>4 / 4</td><td>3.7G / 4.4G</td><td>8 MB</td><td>DDR4-2400</td><td>UHD 630</td></tr> <tr><td>Core i5-9400</td><td>6 / 6</td><td>2.9G / 4.1G</td><td>9 MB</td><td>DDR4-2666</td><td>UHD 630</td></tr> <tr><td>Core i5-9500</td><td>6 / 6</td><td>3.0G / 4.4G</td><td>9 MB</td><td>DDR4-2666</td><td>UHD 630</td></tr> <tr><td>Core i5-9600</td><td>6 / 6</td><td>3.1G / 4.6G</td><td>9 MB</td><td>DDR4-2666</td><td>UHD 630</td></tr> <tr><td>Core i7-9700</td><td>8 / 8</td><td>3.0G / 4.7G</td><td>12 MB</td><td>DDR4-2666</td><td>UHD 630</td></tr> <tr><td>Core i9-9900</td><td>8 / 16</td><td>3.1G / 5.0G</td><td>16 MB</td><td>DDR4-2666</td><td>UHD 630</td></tr> </tbody> </table>	Processor	Cores / Threads	Frequency Base/Max(GHz)	Cache	Memory Support (Up to)	Integrated Graphics	Celeron G4900	2 / 2	3.1G	2 MB	DDR4-2400	UHD 610	Celeron G4920	2 / 2	3.2G	2 MB	DDR4-2400	UHD 610	Pentium Gold G5400	2 / 4	3.7G	4 MB	DDR4-2400	UHD 610	Pentium Gold G5500	2 / 4	3.8G	4 MB	DDR4-2400	UHD 630	Pentium Gold G5600	2 / 4	3.9G	4 MB	DDR4-2400	UHD 630	Core i3-8100	4 / 4	3.6G	6 MB	DDR4-2400	UHD 630	Core i3-8300	4 / 4	3.7G	8 MB	DDR4-2400	UHD 630	Core i5-8400	6 / 6	2.8G / 4.0G	9 MB	DDR4-2666	UHD 630	Core i5-8500	6 / 6	3.0G / 4.1G	9 MB	DDR4-2666	UHD 630	Core i5-8600	6 / 6	3.1G / 4.3G	9 MB	DDR4-2666	UHD 630	Core i7-8700	6 / 12	3.2G / 4.6G	12 MB	DDR4-2666	UHD 630	Core i3-9100	4 / 4	3.6G / 4.2G	6 MB	DDR4-2400	UHD 630	Core i3-9300	4 / 4	3.7G / 4.3G	8 MB	DDR4-2400	UHD 630	Core i3-9320	4 / 4	3.7G / 4.4G	8 MB	DDR4-2400	UHD 630	Core i5-9400	6 / 6	2.9G / 4.1G	9 MB	DDR4-2666	UHD 630	Core i5-9500	6 / 6	3.0G / 4.4G	9 MB	DDR4-2666	UHD 630	Core i5-9600	6 / 6	3.1G / 4.6G	9 MB	DDR4-2666	UHD 630	Core i7-9700	8 / 8	3.0G / 4.7G	12 MB	DDR4-2666	UHD 630	Core i9-9900	8 / 16	3.1G / 5.0G	16 MB	DDR4-2666	UHD 630	<p><i>Some:</i> Intel Ethernet Server Adapter I350-T4*, gigabit ethernet, 4x RJ-45, PCIe x4</p> <p><i>Some:</i> Bitland BN8E88*, gigabit ethernet, PCIe x1 (only available via special bid)</p> <p>* Choose either I350-T4 or BN8E88</p>
Processor	Cores / Threads	Frequency Base/Max(GHz)	Cache	Memory Support (Up to)	Integrated Graphics																																																																																																																					
Celeron G4900	2 / 2	3.1G	2 MB	DDR4-2400	UHD 610																																																																																																																					
Celeron G4920	2 / 2	3.2G	2 MB	DDR4-2400	UHD 610																																																																																																																					
Pentium Gold G5400	2 / 4	3.7G	4 MB	DDR4-2400	UHD 610																																																																																																																					
Pentium Gold G5500	2 / 4	3.8G	4 MB	DDR4-2400	UHD 630																																																																																																																					
Pentium Gold G5600	2 / 4	3.9G	4 MB	DDR4-2400	UHD 630																																																																																																																					
Core i3-8100	4 / 4	3.6G	6 MB	DDR4-2400	UHD 630																																																																																																																					
Core i3-8300	4 / 4	3.7G	8 MB	DDR4-2400	UHD 630																																																																																																																					
Core i5-8400	6 / 6	2.8G / 4.0G	9 MB	DDR4-2666	UHD 630																																																																																																																					
Core i5-8500	6 / 6	3.0G / 4.1G	9 MB	DDR4-2666	UHD 630																																																																																																																					
Core i5-8600	6 / 6	3.1G / 4.3G	9 MB	DDR4-2666	UHD 630																																																																																																																					
Core i7-8700	6 / 12	3.2G / 4.6G	12 MB	DDR4-2666	UHD 630																																																																																																																					
Core i3-9100	4 / 4	3.6G / 4.2G	6 MB	DDR4-2400	UHD 630																																																																																																																					
Core i3-9300	4 / 4	3.7G / 4.3G	8 MB	DDR4-2400	UHD 630																																																																																																																					
Core i3-9320	4 / 4	3.7G / 4.4G	8 MB	DDR4-2400	UHD 630																																																																																																																					
Core i5-9400	6 / 6	2.9G / 4.1G	9 MB	DDR4-2666	UHD 630																																																																																																																					
Core i5-9500	6 / 6	3.0G / 4.4G	9 MB	DDR4-2666	UHD 630																																																																																																																					
Core i5-9600	6 / 6	3.1G / 4.6G	9 MB	DDR4-2666	UHD 630																																																																																																																					
Core i7-9700	8 / 8	3.0G / 4.7G	12 MB	DDR4-2666	UHD 630																																																																																																																					
Core i9-9900	8 / 16	3.1G / 5.0G	16 MB	DDR4-2666	UHD 630																																																																																																																					
		<p>None</p> <p>Discrete TPM 2.0, TCG Certified</p> <p>Security features</p> <ul style="list-style-type: none"> Security slot (in rear for optional Kensington® MicroSaver® cable) Padlock loop Optional cable lock to physically lock both keyboard and mouse Optional chassis intrusion switch Optional chassis E-Lock (special bid) Power-on password Administrator password Hard disk password Boot sequence control Boot without keyboard and mouse Individual USB port disablement Smart USB protection, allows keyboard/mouse only, blocks all storage devices 																																																																																																																								
		<p>Keyboard</p> <p><i>Some:</i> Lenovo Calliope Keyboard (USB connector), black</p> <p><i>Some:</i> Lenovo Traditional Keyboard (USB connector), black</p> <p><i>Some:</i> Lenovo Calliope Wireless Keyboard (2.4GHz via USB receiver), black</p> <p><i>Some:</i> Lenovo Keyboard (PS/2 connector), black (only available via special bid)</p> <p><i>Some:</i> Lenovo Calliope Mouse (USB connector), black</p> <p><i>Some:</i> Lenovo Fingerprint Mouse (USB connector), Windows Hello support, black</p> <p><i>Some:</i> Lenovo Calliope Wireless Mouse (2.4GHz via USB receiver), black</p> <p><i>Some:</i> Lenovo Mouse (PS/2 connector), black (only available via special bid)</p>																																																																																																																								
Memory	64GB max, UDIMM, DDR4-2666, four 288-pin DIMM sockets, non-ECC, dual-channel capable* * System automatically clocks down for the processors with lower memory controller																																																																																																																									
Storage	<p><i>Some:</i> Hard Drive / SATA 6.0Gb/s, 2.5" or 3.5", 5400 rpm or 7200 rpm</p> <p><i>Some:</i> Solid State Drive (SSD) / SATA 6.0Gb/s, 2.5"</p> <p><i>Some:</i> M.2 Solid State Drive (SSD) / PCIe NVMe, PCIe 3.0 x 4*, 32Gb/s</p> <p>* M.2 SSD (2242) PCIe NVMe only supports PCIe 3.0 x 2, 16Gb/s</p> <p><i>Some:</i> Intel Optane™ Memory (not support Celeron / Pentium Processor), M.2</p>																																																																																																																									
Optical	<p><i>Some:</i> DVD-ROM SATA 1.5Gb/s Drive, slim (9.0mm)</p> <p><i>Some:</i> DVD Burner (DVD±RW), SATA 1.5Gb/s Drive, slim (9.0mm)</p>																																																																																																																									
Onboard SATA Media reader	<p>Three onboard SATA 6.0Gb/s connectors</p> <p>Optional 7-in-1 media reader</p>																																																																																																																									
Graphics	<p>Intel UHD Graphics 610/630 in processor, uses main memory, DirectX® 12, one VGA, two DisplayPort™, supports 3 independent displays, works along with discrete graphics to support more displays;</p> <p><i>Max resolution:</i> 4096x2304 (DP)@60Hz; 2048x1536 (VGA)@50Hz</p> <p><i>Some:</i> NVIDIA GeForce® GT 730, DirectX 12, 2GB, PCIe 2.0 x16 adapter, two DisplayPort, 35 watts;</p> <p><i>Max resolution:</i> 3840x2160 (DisplayPort)@60Hz;</p>																																																																																																																									
Monitor cable	Optional DP to VGA dongle, DP to DVI-D dongle, DP to dual DP dongle (for Collage Display with intel integrated graphics), or DP to HDMI 1.4 dongle																																																																																																																									
Chipset	Intel B360 Chipset																																																																																																																									
Front ports* (Std.)	2x USB 3.1 Gen2, 2x USB 3.1 Gen1, 1x USB 3.1 Type-C Gen1 (15W charging), 1x microphone (3.5mm), 1x headphone / microphone combo jack (3.5mm)																																																																																																																									
Front ports* (Opt.)	Optional: 1x media reader																																																																																																																									
Rear ports* (Std.)	4x USB 2.0, 1x serial (9-pin), 1x ethernet (RJ-45), 1x VGA, 2x DisplayPort, 1x line-out (3.5mm)																																																																																																																									
Rear ports* (Opt.)	Optional: 2x USB 3.1 Gen1 via PCI2 x1**, 2x USB 3.1 Type-C Gen2 via PCIe x4** (special bid only), 1x 2nd serial (9-pin), 4x serial (9-pin) via PCIe x1, 1x parallel (25-pin), 2x PS/2 ports (keyboard/mouse), additional RJ-45 and video ports available on optional graphics or ethernet card																																																																																																																									
	* Depending on many factors, actual data transfer speed may be lower than theoretical speed																																																																																																																									
	** Choose either 2x USB 3.1 Gen1 or 2x USB 3.1 Type-C Gen2																																																																																																																									
Audio support	High Definition (HD) Audio, Realtek ALC233VB2 / internal speaker (2 watt)																																																																																																																									
WLAN	<i>Some:</i> 11ac wireless, M.2 Card, Realtek RTL8821CE (dual band), Wi-Fi + Bluetooth 4.2 combo adapter, 1x1																																																																																																																									
Mechanical	<ul style="list-style-type: none"> SFF (8.4L), black color; metal case (WxDxH) 3.64" X 11.44" X 13.52"; 92.5mm X 290.5mm X 343.5mm Approx. 13.24 lb (6.0 kg), weight may vary by configuration Toolless cover, disk, optical, and extension card removal Optional dust filter <p>Bay 1: Slim external ODD bay</p> <p>Bay 2: 3.5", 1" high, internal, HDD/SSD</p> <p>Bay 3: 2.5", internal, HDD/SSD (optional bay)</p> <p>Slot 1: low-profile (length < 147mm, height < 68.9mm), PCIe 3.0 x16</p> <p>Slot 2: low-profile (length < 147mm, height < 68.9mm), PCIe 3.0 x1</p> <p>Slot 3: low-profile (length < 147mm, height < 68.9mm), PCIe 3.0 x1</p> <p>Slot 4: no slot, only bracket for optional port extension</p> <p>M.2 card slots: Two (one for WLAN, one for SSD/Optane)</p> <p>Optional system floor stand for vertical orientation</p>																																																																																																																									
Floor Stand																																																																																																																										
Power supply	<p><i>Some:</i> 180 watts, autosensing, 85% PSU</p> <p><i>Some:</i> 210 watts, autosensing, 85% PSU</p> <p><i>Some:</i> 260 watts, autosensing, 92% PSU (only available via special bid)</p>																																																																																																																									
Limited warranty ³	<p><i>Some:</i> 1-year or 3-year, depot service / service upgrades available</p> <p><i>Some:</i> 1-year or 3-year, limited onsite service / service upgrades available</p>																																																																																																																									
Preload	<p>Preloaded operating system</p> <p><i>Some:</i> Windows® 10 Pro 64-bit</p> <p><i>Some:</i> Windows 10 Home 64-bit</p> <p>Preloaded applications (only some listed)</p> <ul style="list-style-type: none"> Lenovo Vantage Microsoft Office preloaded; purchase a product key to activate Cyberlink PowerDVD (only for models with DVD / DVD±RW) Cyberlink Power2GO (only for models with DVD±RW) LinkedIn 																																																																																																																									
Environment	ENERGY STAR® 6.1, EPEAT™ Silver rating (North America), ErP Lot 3, TCO, TUV low noise verified (coming soon, on some models), RoHS-compliant																																																																																																																									
Accessories	For compatible accessories, please go to http://smartfind.lenovo.com																																																																																																																									

Note: The specifications above may not be available in all regions.

Lenovo, June 2019



ThinkCentre M720 Tiny Platform Specifications

Product Specifications Reference (PSREF)

Processor	Intel® Celeron®, Intel Pentium®, or 8th Generation Intel Core™ i3 / i5 / i7 Processor						Manageability None Security chip Discrete TPM 2.0, TCG Certified Security features <ul style="list-style-type: none"> Security slot (in rear for optional Kensington® MicroSaver® cable) Chassis intrusion switch Power-on password Administrator password Hard disk password <ul style="list-style-type: none"> Boot sequence control Boot without keyboard and mouse Individual USB port disablement Smart USB protection, allows keyboard/mouse only, blocks all storage devices 						
	Processor	Cores / Threads	Frequency Base/Max(GHz)	Cache	Memory Support (Up to)	Integrated Graphics							
	Celeron G4900T	2 / 2	2.9G	2 MB	DDR4-2400	UHD 610							
	Pentium Gold G5400T	2 / 4	3.1G	4 MB	DDR4-2400	UHD 610							
	Pentium Gold G5500T	2 / 4	3.2G	4 MB	DDR4-2400	UHD 630							
	Core i3-8100T	4 / 4	3.1G	6 MB	DDR4-2400	UHD 630							
	Core i3-8300T	4 / 4	3.2G	8 MB	DDR4-2400	UHD 630							
	Core i5-8400T	6 / 6	1.7G / 3.3G	9 MB	DDR4-2666	UHD 630							
	Core i5-8500T	6 / 6	2.1G / 3.5G	9 MB	DDR4-2666	UHD 630							
	Core i5-8600T	6 / 6	2.3G / 3.7G	9 MB	DDR4-2666	UHD 630							
	Core i7-8700T	6 / 12	2.4G / 4.0G	12 MB	DDR4-2666	UHD 630							
	Core i3-9100T	4 / 4	3.1G / 3.7G	6 MB	DDR4-2400	UHD 630							
	Core i3-9300T	4 / 4	3.2G / 3.8G	8 MB	DDR4-2400	UHD 630							
	Core i5-9400T	6 / 6	1.8G / 3.4G	9 MB	DDR4-2666	UHD 630							
	Core i5-9500T	6 / 6	2.2G / 3.7G	9 MB	DDR4-2666	UHD 630							
	Core i5-9600T	6 / 6	2.3G / 3.9G	9 MB	DDR4-2666	UHD 630							
	Core i7-9700T	8 / 8	2.0G / 4.3G	12 MB	DDR4-2666	UHD 630							
Core i9-9900T	8 / 16	2.1G / 4.4G	16 MB	DDR4-2666	UHD 630								
Memory	32GB max, DDR4-2666*, two 260-pin SO-DIMM sockets, non-ECC, dual-channel capable * System automatically clocks down for the processors with lower memory controller												
	Storage	<i>Some:</i> Hard Drive / SATA 6.0Gb/s, 2.5", 5400 rpm or 7200 rpm <i>Some:</i> Solid State Drive (SSD) / SATA 6.0Gb/s, 2.5" <i>Some:</i> M.2 SSD / PCIe NVMe, PCIe 3.0 x 4*, 32Gb/s * 128GB SSD M.2 (2242) PCIe NVMe only supports PCIe 3.0 x 2, 16Gb/s <i>Some:</i> Intel Optane™ Memory (not support Celeron / Pentium Processor), M.2 <i>Some:</i> DVD-ROM, slim (9.0mm), via USB external ODD box <i>Some:</i> DVD Burner (DVD±RW), slim (9.0mm), via USB external ODD box One onboard SATA 6.0Gb/s connector											
		<table border="1"> <thead> <tr> <th></th> <th>Dimensions (WxDxH)</th> <th>Weight (Approx.)</th> </tr> </thead> <tbody> <tr> <td>Tiny only</td> <td>7.05" X 7.20" X 1.36" 179mm X 182.9mm X 34.5mm</td> <td>2.91 lb (1.32 kg), vary by config</td> </tr> <tr> <td>With VESA mount & ODD box</td> <td>7.42" X 7.30" X 2.48" 188.4mm X 185.38mm X 63mm</td> <td>3.66 lb (1.66 kg), vary by config</td> </tr> </tbody> </table>						Dimensions (WxDxH)	Weight (Approx.)	Tiny only	7.05" X 7.20" X 1.36" 179mm X 182.9mm X 34.5mm	2.91 lb (1.32 kg), vary by config	With VESA mount & ODD box
	Dimensions (WxDxH)	Weight (Approx.)											
Tiny only	7.05" X 7.20" X 1.36" 179mm X 182.9mm X 34.5mm	2.91 lb (1.32 kg), vary by config											
With VESA mount & ODD box	7.42" X 7.30" X 2.48" 188.4mm X 185.38mm X 63mm	3.66 lb (1.66 kg), vary by config											
VESA mount Floor Stand	Optional VESA mount bracket kit, supports VESA 75mm and 100mm Optional system floor stand for vertical orientation												
Power supply	<i>Some:</i> 65 watts AC/DC adapter, autosensing, 88% PSU <i>Some:</i> 90 watts AC/DC adapter, autosensing, 88% PSU <i>Some:</i> 135 watts AC/DC adapter, autosensing, 88% PSU												
Limited warranty	<i>Some:</i> 1-year or 3-year, depot service / service upgrades available <i>Some:</i> 1-year or 3-year, limited onsite service / service upgrades available												
Preload	Preloaded operating system <i>Some:</i> Windows® 10 Pro 64-bit <i>Some:</i> Windows 10 Home 64-bit Preloaded applications (only some listed) <ul style="list-style-type: none"> Lenovo Vantage Microsoft Office preloaded; purchase a product key to activate Cyberlink Power2GO (only for models with DVD / DVD±RW) Cyberlink Power2GO (only for models with DVD±RW) LinkedIn 												
Environment	ENERGY STAR® 7.0, EPEAT™ Gold rating (North America), ErP Lot 3, TCO, TUV ultra low noise verified (coming soon, on some models), RoHS-compliant												
MIL-SPEC test	MIL-STD-810G military certification (Low Pressure [Altitude], High Temperature, Low Temperature, Temperature Shock, Humidity, Sand and Dust, Vibration, Shock, Fungus, Solar Radiation)												
Accessories	For compatible accessories, please go to http://smartfind.lenovo.com												
Optical	<i>Some:</i> DVD-ROM, slim (9.0mm), via USB external ODD box <i>Some:</i> DVD Burner (DVD±RW), slim (9.0mm), via USB external ODD box												
Onboard SATA	One onboard SATA 6.0Gb/s connector												
Graphics	Intel HD Graphics 610/630 in processor, uses main memory, DirectX® 12, one DisplayPort™, one HDMI, one optional video port (2nd HDMI, VGA, 2nd DP, or USB 3.1 Type-C Gen1 with DisplayPort function), up to 3 independent displays; <i>Max resolution:</i> 4096x2304 (DP)@60Hz; 4096x2304 (Type-C)@60Hz; 4096x2160 (onboard HDMI)@24Hz; 2048x1536 (VGA)@50Hz												
Monitor cable	Optional DP to VGA dongle, DP to DVI-D dongle, DP to dual DP dongle (for Collage Display with intel integrated graphics), or DP to HDMI 1.4 dongle												
Chipset	Intel B360 Chipset												
Front ports* (Std.)	one USB 3.1 Gen1 (Always On and fast charge), one USB 3.1 Type-C Gen 1, one microphone (3.5mm), one headphone / microphone combo jack (3.5mm)												
Rear ports* (Std.)	2x USB 3.1 Gen2, 2x USB 3.1 Gen1, 1x ethernet (RJ-45), 1x DisplayPort, 1x HDMI												
Rear ports* (Opt.)	Two optional ports (mutually exclusive with PCIe card): Port 1 for VGA / 2nd DP / 2nd HDMI / serial / USB 3.1 Type-C Gen 1 with DP function); Port 2 for serial; Optional ports via PCIe card: 2x USB 3.1 Gen1 via PCIe x1, 4x serial (9-pin) via PCIe x1 * Depending on many factors, actual data transfer speed may be lower than theoretical speed												
Audio support	Realtek ALC233VB2 / optional internal speaker (1.5 watt or 2 watt)												
WLAN	<i>Some:</i> 11ac wireless, M.2 Card, Realtek RTL8821CE (dual band), Wi-Fi + Bluetooth 4.2 combo adapter, 1x1 <i>Some:</i> 11ac wireless, M.2 Card, Realtek RTL8822BE (dual band), Wi-Fi + Bluetooth 4.2 combo adapter, 2x2 <i>Some:</i> 11ac wireless, M.2 Card, Intel Dual Band Wireless-AC 3165, Wi-Fi + Bluetooth 4.2 combo adapter, 1x1 <i>Some:</i> 11ac wireless, M.2 Card, Intel Dual Band Wireless-AC 8265, Wi-Fi + Bluetooth 4.2 combo adapter, 2x2												
Bluetooth	<i>Some:</i> Bluetooth 4.2 wireless, integrated in Wi-Fi + BT combo adapter												
Ethernet	Gigabit ethernet, Intel Ethernet Connection I219-V (Jacksonville), Wake on LAN®												
Ethernet (Opt.)	<i>Some:</i> Intel Ethernet Server Adapter I350-T4, gigabit ethernet, 4x RJ-45, PCIe x4												

Note: The specifications above may not be available in all regions.

Lenovo, June 2019



ThinkCentre M720 Tower Platform Specifications

Product Specifications Reference (PSREF)

<p>Processor</p>	<p>Intel® Celeron®, Intel Pentium®, or 8th Generation Intel Core™ i3 / i5 / i7 Processor</p> <table border="1"> <thead> <tr> <th>Processor</th> <th>Cores / Threads</th> <th>Frequency Base/Max(GHz)</th> <th>Cache</th> <th>Memory Support (Up to)</th> <th>Integrated Graphics</th> </tr> </thead> <tbody> <tr><td>Celeron G4900</td><td>2 / 2</td><td>3.1G</td><td>2 MB</td><td>DDR4-2400</td><td>UHD 610</td></tr> <tr><td>Celeron G4920</td><td>2 / 2</td><td>3.2G</td><td>2 MB</td><td>DDR4-2400</td><td>UHD 610</td></tr> <tr><td>Pentium Gold G5400</td><td>2 / 4</td><td>3.7G</td><td>4 MB</td><td>DDR4-2400</td><td>UHD 610</td></tr> <tr><td>Pentium Gold G5500</td><td>2 / 4</td><td>3.8G</td><td>4 MB</td><td>DDR4-2400</td><td>UHD 630</td></tr> <tr><td>Pentium Gold G5600</td><td>2 / 4</td><td>3.9G</td><td>4 MB</td><td>DDR4-2400</td><td>UHD 630</td></tr> <tr><td>Core i3-8100</td><td>4 / 4</td><td>3.6G</td><td>6 MB</td><td>DDR4-2400</td><td>UHD 630</td></tr> <tr><td>Core i3-8300</td><td>4 / 4</td><td>3.7G</td><td>8 MB</td><td>DDR4-2400</td><td>UHD 630</td></tr> <tr><td>Core i5-8400</td><td>6 / 6</td><td>2.8G / 4.0G</td><td>9 MB</td><td>DDR4-2666</td><td>UHD 630</td></tr> <tr><td>Core i5-8500</td><td>6 / 6</td><td>3.0G / 4.1G</td><td>9 MB</td><td>DDR4-2666</td><td>UHD 630</td></tr> <tr><td>Core i5-8600</td><td>6 / 6</td><td>3.1G / 4.3G</td><td>9 MB</td><td>DDR4-2666</td><td>UHD 630</td></tr> <tr><td>Core i7-8700</td><td>6 / 12</td><td>3.2G / 4.6G</td><td>12 MB</td><td>DDR4-2666</td><td>UHD 630</td></tr> <tr><td>Core i3-9100</td><td>4 / 4</td><td>3.6G / 4.2G</td><td>6 MB</td><td>DDR4-2400</td><td>UHD 630</td></tr> <tr><td>Core i3-9300</td><td>4 / 4</td><td>3.7G / 4.3G</td><td>8 MB</td><td>DDR4-2400</td><td>UHD 630</td></tr> <tr><td>Core i3-9320</td><td>4 / 4</td><td>3.7G / 4.4G</td><td>8 MB</td><td>DDR4-2400</td><td>UHD 630</td></tr> <tr><td>Core i5-9400</td><td>6 / 6</td><td>2.9G / 4.1G</td><td>9 MB</td><td>DDR4-2666</td><td>UHD 630</td></tr> <tr><td>Core i5-9500</td><td>6 / 6</td><td>3.0G / 4.4G</td><td>9 MB</td><td>DDR4-2666</td><td>UHD 630</td></tr> <tr><td>Core i5-9600</td><td>6 / 6</td><td>3.1G / 4.6G</td><td>9 MB</td><td>DDR4-2666</td><td>UHD 630</td></tr> <tr><td>Core i7-9700</td><td>8 / 8</td><td>3.0G / 4.7G</td><td>12 MB</td><td>DDR4-2666</td><td>UHD 630</td></tr> <tr><td>Core i9-9900</td><td>8 / 16</td><td>3.1G / 5.0G</td><td>16 MB</td><td>DDR4-2666</td><td>UHD 630</td></tr> </tbody> </table>	Processor	Cores / Threads	Frequency Base/Max(GHz)	Cache	Memory Support (Up to)	Integrated Graphics	Celeron G4900	2 / 2	3.1G	2 MB	DDR4-2400	UHD 610	Celeron G4920	2 / 2	3.2G	2 MB	DDR4-2400	UHD 610	Pentium Gold G5400	2 / 4	3.7G	4 MB	DDR4-2400	UHD 610	Pentium Gold G5500	2 / 4	3.8G	4 MB	DDR4-2400	UHD 630	Pentium Gold G5600	2 / 4	3.9G	4 MB	DDR4-2400	UHD 630	Core i3-8100	4 / 4	3.6G	6 MB	DDR4-2400	UHD 630	Core i3-8300	4 / 4	3.7G	8 MB	DDR4-2400	UHD 630	Core i5-8400	6 / 6	2.8G / 4.0G	9 MB	DDR4-2666	UHD 630	Core i5-8500	6 / 6	3.0G / 4.1G	9 MB	DDR4-2666	UHD 630	Core i5-8600	6 / 6	3.1G / 4.3G	9 MB	DDR4-2666	UHD 630	Core i7-8700	6 / 12	3.2G / 4.6G	12 MB	DDR4-2666	UHD 630	Core i3-9100	4 / 4	3.6G / 4.2G	6 MB	DDR4-2400	UHD 630	Core i3-9300	4 / 4	3.7G / 4.3G	8 MB	DDR4-2400	UHD 630	Core i3-9320	4 / 4	3.7G / 4.4G	8 MB	DDR4-2400	UHD 630	Core i5-9400	6 / 6	2.9G / 4.1G	9 MB	DDR4-2666	UHD 630	Core i5-9500	6 / 6	3.0G / 4.4G	9 MB	DDR4-2666	UHD 630	Core i5-9600	6 / 6	3.1G / 4.6G	9 MB	DDR4-2666	UHD 630	Core i7-9700	8 / 8	3.0G / 4.7G	12 MB	DDR4-2666	UHD 630	Core i9-9900	8 / 16	3.1G / 5.0G	16 MB	DDR4-2666	UHD 630	<p>WLAN¹³ <i>Some:</i> 11ac wireless, M.2 Card, Realtek RTL8821CE (dual band), Wi-Fi + Bluetooth 4.2 combo adapter, 1x1 <i>Some:</i> 11ac wireless, M.2 Card, Realtek RTL8822BE (dual band), Wi-Fi + Bluetooth 4.2 combo adapter, 2x2 <i>Some:</i> 11ac wireless, M.2 Card, Intel Dual Band Wireless-AC 3165, Wi-Fi + Bluetooth 4.2 combo adapter, 1x1 <i>Some:</i> 11ac wireless, M.2 Card, Intel Dual Band Wireless-AC 8265, Wi-Fi + Bluetooth 4.2 combo adapter, 2x2 <i>Some:</i> Bluetooth 4.2 wireless, integrated in Wi-Fi + BT combo adapter</p> <p>Bluetooth™ <i>Some:</i> Bluetooth 4.2 wireless, integrated in Wi-Fi + BT combo adapter</p> <p>Ethernet Ethernet (Opt.) Gigabit ethernet, Intel Ethernet Connection I219-V (Jacksonville), Wake on LAN® <i>Some:</i> Intel Ethernet Server Adapter I350-T4*, gigabit ethernet, 4x RJ-45, PCIe x4 <i>Some:</i> Bitland BN8E88*, gigabit ethernet, 1x RJ-45, PCIe x1 (special bid only) * Choose either I350-T4 or BN8E88</p> <p>Manageability Security chip None Discrete TPM 2.0, TCG Certified</p> <p>Security features <ul style="list-style-type: none"> • Security slot (in rear for optional Kensington® MicroSaver® cable) • Padlock loop • Optional cable lock to physically lock both keyboard and mouse • Optional chassis intrusion switch • Optional chassis E-Lock (special bid) • Power-on password • Administrator password • Hard disk password • Boot sequence control • Boot without keyboard and mouse • Individual USB port disablement • Smart USB protection, allows keyboard/mouse only, blocks all storage devices </p> <p>Keyboard <i>Some:</i> Lenovo Calliope Keyboard (USB connector), black <i>Some:</i> Lenovo Traditional Keyboard (USB connector), black <i>Some:</i> Lenovo Calliope Wireless Keyboard (2.4GHz via USB receiver), black <i>Some:</i> Lenovo Keyboard (PS/2 connector), black (only available via special bid) <i>Some:</i> Lenovo Calliope Mouse (USB connector), black <i>Some:</i> Lenovo Fingerprint Mouse (USB connector), Windows Hello support, black <i>Some:</i> Lenovo Calliope Wireless Mouse (2.4GHz via USB receiver), black <i>Some:</i> Lenovo Mouse (PS/2 connector), black (only available via special bid)</p> <p>Mouse <i>Some:</i> Lenovo Calliope Mouse (USB connector), black <i>Some:</i> Lenovo Fingerprint Mouse (USB connector), Windows Hello support, black <i>Some:</i> Lenovo Calliope Wireless Mouse (2.4GHz via USB receiver), black <i>Some:</i> Lenovo Mouse (PS/2 connector), black (only available via special bid)</p> <p>Mechanical <ul style="list-style-type: none"> • Tower (15L), black color, metal case • (WxDxH) 5.91" X 10.65" X 14.17"; 150mm X 270.5mm X 360mm • Approx. 15.21 lb (6.9 kg), weight may vary by configuration • Optional dust filter • Bay 1: Slim external ODD bay • Bay 2: 3.5", 1" high, internal, HDD/SSD • Bay 3: 3.5", 1" high, internal, HDD/SSD (optional bay) • Slot 1: half-length full-height (length < 189mm, height < 104mm), PCIe 3.0 x16 • Slot 2: half-length full-height (length < 189mm, height < 104mm), PCIe 3.0 x1 • Slot 3: half-length full-height (length < 189mm, height < 104mm), PCIe 3.0 x1 • Slot 4: no slot, only bracket for optional port extension • M.2 card slots: Two (one for WLAN, one for SSD/Optane) </p> <p>Power supply <i>Some:</i> 180 watts, autosensing, 85% PSU <i>Some:</i> 210 watts, autosensing, 85% PSU <i>Some:</i> 260 watts, autosensing, 92% PSU (only available via special bid)</p> <p>Limited warranty³ <i>Some:</i> 1-year or 3-year, depot service / service upgrades available <i>Some:</i> 1-year or 3-year, limited onsite service / service upgrades available</p> <p>Preload Preloaded operating system <i>Some:</i> Windows® 10 Pro 64-bit <i>Some:</i> Windows 10 Home 64-bit Preloaded applications (only some listed) <ul style="list-style-type: none"> • Lenovo Vantage • Microsoft Office preloaded; purchase a product key to activate • Cyberlink PowerDVD (only for models with DVD / DVD±RW) • Cyberlink Power2GO (only for models with DVD±RW) • LinkedIn </p> <p>Environment ENERGY STAR® 6.1, EPEAT™ Silver rating (North America), ErP Lot 3, TCO, TUV low noise verified (coming soon, on some models), RoHS-compliant</p> <p>Accessories For compatible accessories, please go to http://smartfind.lenovo.com</p>
Processor	Cores / Threads	Frequency Base/Max(GHz)	Cache	Memory Support (Up to)	Integrated Graphics																																																																																																																					
Celeron G4900	2 / 2	3.1G	2 MB	DDR4-2400	UHD 610																																																																																																																					
Celeron G4920	2 / 2	3.2G	2 MB	DDR4-2400	UHD 610																																																																																																																					
Pentium Gold G5400	2 / 4	3.7G	4 MB	DDR4-2400	UHD 610																																																																																																																					
Pentium Gold G5500	2 / 4	3.8G	4 MB	DDR4-2400	UHD 630																																																																																																																					
Pentium Gold G5600	2 / 4	3.9G	4 MB	DDR4-2400	UHD 630																																																																																																																					
Core i3-8100	4 / 4	3.6G	6 MB	DDR4-2400	UHD 630																																																																																																																					
Core i3-8300	4 / 4	3.7G	8 MB	DDR4-2400	UHD 630																																																																																																																					
Core i5-8400	6 / 6	2.8G / 4.0G	9 MB	DDR4-2666	UHD 630																																																																																																																					
Core i5-8500	6 / 6	3.0G / 4.1G	9 MB	DDR4-2666	UHD 630																																																																																																																					
Core i5-8600	6 / 6	3.1G / 4.3G	9 MB	DDR4-2666	UHD 630																																																																																																																					
Core i7-8700	6 / 12	3.2G / 4.6G	12 MB	DDR4-2666	UHD 630																																																																																																																					
Core i3-9100	4 / 4	3.6G / 4.2G	6 MB	DDR4-2400	UHD 630																																																																																																																					
Core i3-9300	4 / 4	3.7G / 4.3G	8 MB	DDR4-2400	UHD 630																																																																																																																					
Core i3-9320	4 / 4	3.7G / 4.4G	8 MB	DDR4-2400	UHD 630																																																																																																																					
Core i5-9400	6 / 6	2.9G / 4.1G	9 MB	DDR4-2666	UHD 630																																																																																																																					
Core i5-9500	6 / 6	3.0G / 4.4G	9 MB	DDR4-2666	UHD 630																																																																																																																					
Core i5-9600	6 / 6	3.1G / 4.6G	9 MB	DDR4-2666	UHD 630																																																																																																																					
Core i7-9700	8 / 8	3.0G / 4.7G	12 MB	DDR4-2666	UHD 630																																																																																																																					
Core i9-9900	8 / 16	3.1G / 5.0G	16 MB	DDR4-2666	UHD 630																																																																																																																					
<p>Memory</p>	<p>64GB max, UDIMM, DDR4-2666*, four 288-pin DIMM sockets, non-ECC, dual-channel capable * System automatically clocks down for the processors with lower memory controller</p>																																																																																																																									
<p>Storage</p>	<p><i>Some:</i> Hard Drive / SATA 6.0Gb/s, 2.5" or 3.5", 5400 rpm or 7200 rpm <i>Some:</i> Solid State Drive (SSD) / SATA 6.0Gb/s, 2.5" <i>Some:</i> M.2 Solid State Drive (SSD) / PCIe NVMe, PCIe 3.0 x 4*, 32Gb/s * 128GB SSD M.2 (2242) PCIe NVMe only supports PCIe 3.0 x 2, 16Gb/s <i>Some:</i> Intel Optane™ Memory (not support Celeron / Pentium Processor), M.2</p>																																																																																																																									
<p>Optical</p>	<p><i>Some:</i> DVD-ROM SATA 1.5Gb/s Drive, slim (9.0mm) <i>Some:</i> DVD Burner (DVD±RW), SATA 1.5Gb/s Drive, slim (9.0mm)</p>																																																																																																																									
<p>Onboard SATA Media reader</p>	<p>Three onboard SATA 6.0Gb/s connectors Optional 7-in-1 media reader</p>																																																																																																																									
<p>Graphics</p>	<p>Intel UHD Graphics 610/630 in processor, uses main memory, DirectX® 12, one VGA, two DisplayPort™, supports 3 independent displays, works along with discrete graphics to support more displays; <i>Max resolution:</i> 4096x2304 (DP)@60Hz; 2048x1536 (VGA)@50Hz <i>Some:</i> NVIDIA GeForce® GT 730, DirectX 12, 2GB, PCIe 2.0 x16 adapter, two DisplayPort, 35 watts; <i>Max resolution:</i> 3840x2160 (DisplayPort)@60Hz;</p>																																																																																																																									
<p>Monitor Cable</p>	<p>Optional DP to VGA dongle, DP to DVI-D dongle, DP to dual DP dongle (for Collage Display with intel integrated graphics), or DP to HDMI 1.4 dongle</p>																																																																																																																									
<p>Chipset</p> <p>Front ports* (Std.)</p> <p>Front ports* (Opt.)</p> <p>Rear ports* (Std.)</p> <p>Rear ports* (Opt.)</p>	<p>Intel B360 Chipset</p> <p>2x USB 3.1 Gen2, 2x USB 3.1 Gen1, 1x USB 3.1 Type-C Gen1 (15W charging), 1x microphone (3.5mm), 1x headphone / microphone combo jack (3.5mm) <i>Optional:</i> 1x media reader</p> <p>4x USB 2.0, 1x serial (9-pin), 1x ethernet (RJ-45), 1x VGA, 2x DisplayPort, 1x line-out (3.5mm)</p> <p><i>Optional:</i> 2x USB 3.1 Gen1 via PCIe x1**, 2x USB 3.1 Type-C Gen2 via PCIe x4** (special bid only), 1x 2nd serial (9-pin), 4x serial (9-pin) via PCIe x1, 1x parallel (25-pin), 2x PS/2 ports (keyboard/mouse), additional RJ-45 and video ports available on optional graphics or ethernet card * Depending on many factors, actual data transfer speed may be lower than theoretical speed ** Choose either 2x USB 3.1 Gen1 or 2x USB 3.1 Type-C Gen2</p>																																																																																																																									
<p>Audio support</p>	<p>High Definition (HD) Audio, Realtek ALC233VB2 / internal speaker (2 watt)</p>																																																																																																																									

Note: The specifications above may not be available in all regions.



ThinkCentre M725 SFF Platform Specifications

Product Specifications Reference (PSREF)

Processor	AMD A6 / A8 / A10 / A12 and Ryzen 3 / 5 / 7 series processor						Ethernet	Gigabit ethernet, Realtek RTL8111EPV, Wake on LAN®																																																																		
	<table border="1"> <thead> <tr> <th>Processor</th> <th>Cores / Threads</th> <th>Frequency (Base/Max)</th> <th>L2 Cache</th> <th>Memory Support (Up to)</th> <th>Integrated Graphics</th> </tr> </thead> <tbody> <tr> <td>PRO A6-9500</td> <td>2 / 2</td> <td>3.5 / 3.8</td> <td>1MB</td> <td>DDR4-2400</td> <td>Radeon R5</td> </tr> <tr> <td>PRO A8-9600</td> <td>4 / 4</td> <td>3.1 / 3.4</td> <td>2MB</td> <td>DDR4-2400</td> <td>Radeon R7</td> </tr> <tr> <td>PRO A10-9700</td> <td>4 / 4</td> <td>3.5 / 3.8</td> <td>2MB</td> <td>DDR4-2400</td> <td>Radeon R7</td> </tr> <tr> <td>PRO A12-9800</td> <td>4 / 4</td> <td>3.8 / 4.2</td> <td>2MB</td> <td>DDR4-2400</td> <td>Radeon R7</td> </tr> <tr> <td>Ryzen 3 2300X</td> <td>4 / 4</td> <td>3.5 / 4.0</td> <td>2MB</td> <td>DDR4-2933</td> <td>None</td> </tr> <tr> <td>Ryzen 5 2500X</td> <td>4 / 8</td> <td>3.6 / 4.0</td> <td>2MB</td> <td>DDR4-2933</td> <td>None</td> </tr> <tr> <td>Ryzen 3 PRO 2200G</td> <td>4 / 4</td> <td>3.5 / 3.6</td> <td>2MB</td> <td>DDR4-2933</td> <td>Radeon Vega 8</td> </tr> <tr> <td>Ryzen 5 PRO 2400G</td> <td>4 / 8</td> <td>3.6 / 3.8</td> <td>2MB</td> <td>DDR4-2933</td> <td>Radeon RX Vega 11</td> </tr> <tr> <td>Ryzen 5 PRO 2600</td> <td>6 / 12</td> <td>3.4 / 3.9</td> <td>3MB</td> <td>DDR4-2933</td> <td>None</td> </tr> <tr> <td>Ryzen 7 PRO 2700</td> <td>8 / 16</td> <td>3.2 / 4.1</td> <td>4MB</td> <td>DDR4-2933</td> <td>None</td> </tr> </tbody> </table>						Processor	Cores / Threads	Frequency (Base/Max)	L2 Cache	Memory Support (Up to)	Integrated Graphics	PRO A6-9500	2 / 2	3.5 / 3.8	1MB	DDR4-2400	Radeon R5	PRO A8-9600	4 / 4	3.1 / 3.4	2MB	DDR4-2400	Radeon R7	PRO A10-9700	4 / 4	3.5 / 3.8	2MB	DDR4-2400	Radeon R7	PRO A12-9800	4 / 4	3.8 / 4.2	2MB	DDR4-2400	Radeon R7	Ryzen 3 2300X	4 / 4	3.5 / 4.0	2MB	DDR4-2933	None	Ryzen 5 2500X	4 / 8	3.6 / 4.0	2MB	DDR4-2933	None	Ryzen 3 PRO 2200G	4 / 4	3.5 / 3.6	2MB	DDR4-2933	Radeon Vega 8	Ryzen 5 PRO 2400G	4 / 8	3.6 / 3.8	2MB	DDR4-2933	Radeon RX Vega 11	Ryzen 5 PRO 2600	6 / 12	3.4 / 3.9	3MB	DDR4-2933	None	Ryzen 7 PRO 2700	8 / 16	3.2 / 4.1	4MB	DDR4-2933	None	Ethernet (Opt.)	<i>Some:</i> Bitland BN8E88, gigabit ethernet, 1x RJ-45, PCIe x1 (special bid only)
	Processor	Cores / Threads	Frequency (Base/Max)	L2 Cache	Memory Support (Up to)	Integrated Graphics																																																																				
	PRO A6-9500	2 / 2	3.5 / 3.8	1MB	DDR4-2400	Radeon R5																																																																				
	PRO A8-9600	4 / 4	3.1 / 3.4	2MB	DDR4-2400	Radeon R7																																																																				
	PRO A10-9700	4 / 4	3.5 / 3.8	2MB	DDR4-2400	Radeon R7																																																																				
	PRO A12-9800	4 / 4	3.8 / 4.2	2MB	DDR4-2400	Radeon R7																																																																				
	Ryzen 3 2300X	4 / 4	3.5 / 4.0	2MB	DDR4-2933	None																																																																				
	Ryzen 5 2500X	4 / 8	3.6 / 4.0	2MB	DDR4-2933	None																																																																				
	Ryzen 3 PRO 2200G	4 / 4	3.5 / 3.6	2MB	DDR4-2933	Radeon Vega 8																																																																				
Ryzen 5 PRO 2400G	4 / 8	3.6 / 3.8	2MB	DDR4-2933	Radeon RX Vega 11																																																																					
Ryzen 5 PRO 2600	6 / 12	3.4 / 3.9	3MB	DDR4-2933	None																																																																					
Ryzen 7 PRO 2700	8 / 16	3.2 / 4.1	4MB	DDR4-2933	None																																																																					
Memory	64GB max, UDIMM, DDR4-2666*, four 288-pin DIMM sockets, non-ECC, dual-channel capable * Systemboard supports up to DDR4-2666, memory frequency may automatically clocks down for the lower capability of memory controller in processor						Manageability	DASH 10/1.1																																																																		
Storage	<i>Some:</i> Hard Drive / SATA 6.0Gb/s, 2.5" or 3.5", 5400 rpm or 7200 rpm <i>Some:</i> Solid State Drive (SSD) / SATA 6.0Gb/s, 2.5" <i>Some:</i> M.2 SSD / PCIe NVMe, PCIe 3.0 x 4*, 32Gb/s * 128GB SSD M.2 (2242) PCIe NVMe and AMD A6 / A8 / A10 / A12 processor only supports PCIe 3.0 x 2, 16Gb/s						Security chip	Discrete TPM 2.0, TCG Certified																																																																		
Optical	<i>Some:</i> DVD-ROM SATA 1.5Gb/s Drive, slim (9.0mm) <i>Some:</i> DVD Burner (DVD±RW), SATA 1.5Gb/s Drive, slim (9.0mm)						Security features	<ul style="list-style-type: none"> Security slot (in rear for optional Kensington® MicroSaver® cable) Padlock loop Smart USB protection, allows keyboard/ mouse only, blocks all storage devices Optional cable lock to physically lock both keyboard and mouse <ul style="list-style-type: none"> Power-on password Administrator password Hard disk password Boot sequence control Boot without keyboard and mouse Individual USB port disablement Optional chassis intrusion switch 																																																																		
Onboard SATA	Three onboard SATA 6.0Gb/s connectors, RAID 0/1 support (RAID preset only available via special bid model)						Keyboard	<i>Some:</i> Lenovo Calliope Keyboard (USB connector), black <i>Some:</i> Lenovo Traditional Keyboard (USB connector), black <i>Some:</i> Lenovo Calliope Wireless Keyboard (2.4GHz via USB receiver), black <i>Some:</i> Lenovo Keyboard (PS/2 connector), black (only available via special bid)																																																																		
Media reader	Optional 7-in-1 media reader						Mouse	<i>Some:</i> Lenovo Calliope Mouse (USB connector), black <i>Some:</i> Lenovo Fingerprint Mouse (USB connector), Windows Hello support, black <i>Some:</i> Lenovo Calliope Wireless Mouse (2.4GHz via USB receiver), black <i>Some:</i> Lenovo Mouse (PS/2 connector), black (only available via special bid)																																																																		
Graphics	AMD Radeon™ Graphics in processor (only for some processors), uses main memory, DirectX® 12, one VGA, two DisplayPort™ (Onboard VGA and DP ports are only available on the models with integrated graphics), supports 3 independent displays, works along with AMD discrete graphics to support more displays; <i>Max resolution:</i> 4096x2160 (DP)@60Hz; 1920x1200 (VGA)@60Hz <i>Some:</i> NVIDIA GeForce® GT 730 , DirectX 12, 2GB GDDR5, PCIe 2.0 x16 (x8 elec.) adapter, two DisplayPort, 35 watts; <i>Max resolution:</i> 3840x2160 (DisplayPort)@60Hz						Mechanical	<ul style="list-style-type: none"> SFF (8.4L), black color; metal case (WxDxH) 3.6" X 11.4" X 13.5"; 92.5mm X 290.5mm X 343.5mm Approx. 13.2 lb (6.0 kg), weight may vary by configuration Toolless cover, disk, optical removal Optional dust filter Bay 1: Slim external ODD bay Bay 2: 3.5", internal, HDD/SSD Bay 3: 2.5", internal, HDD/SSD (bay only comes with 2.5" 2nd disk) Slot 1: low-profile (length < 150mm, height < 68mm), PCIe 3.0 x16 Slot 2: low-profile (length < 150mm, height < 68mm), PCIe 2.0 x1 Slot 3: low-profile (length < 150mm, height < 68mm), PCIe 2.0 x1 Slot 4: low-profile (length < 150mm, height < 68mm), PCI 3.0 M.2 card slots: two (one for WLAN, one for SSD) Optional system floor stand for vertical orientation																																																																		
Monitor cable	Optional DP to VGA dongle, DP to DVI-D dongle, DP to dual DP dongle, or DP to HDMI 1.4 dongle						Floor Stand	Optional system floor stand for vertical orientation																																																																		
Chipset	AMD B450 Chipset						Power supply	<i>Some:</i> 180 watts, autosensing, 85% PSU <i>Some:</i> 210 watts, autosensing, 85% PSU <i>Some:</i> 260 watts, autosensing, 92% PSU (only available via special bid)																																																																		
Front ports* (Std.)	2x USB 3.1 Gen2, 2x USB 3.1 Gen1, 1x microphone (3.5mm), 1x headphone (3.5mm)						Limited warranty	1-year or 3-year, limited onsite service / service upgrades available																																																																		
Front ports* (Opt.)	Optional: 1x media reader, 2x USB 3.1 Type-C Gen2 via PCIe card (special bid only)						Preload	Preloaded operating system <i>Some:</i> Windows 10 Pro 64-bit <i>Some:</i> Windows 10 Home 64-bit Preloaded applications (only some listed) <ul style="list-style-type: none"> Lenovo Vantage Microsoft Office preloaded; purchase a product key to activate Cyberlink Power2GO (only for models with DVD / DVD±RW) Cyberlink Power2GO (only for models with DVD±RW) LinkedIn 																																																																		
Rear ports* (Std.)	2x USB 3.1 Gen1, 2x USB 2.0, 1x serial (9-pin), 1x ethernet (RJ-45), 1x VGA**, 2x DisplayPort**, 2x PS/2 ports (keyboard / mouse); 1x line-in (3.5mm), 1x line-out (3.5mm), 1x microphone (3.5mm)						Environment	ENERGY STAR® 7.0*, EPEAT™ Silver rating* (*not for non-OS models); ErP Lot 3; RoHS-compliant																																																																		
Rear ports* (Opt.)	Optional: 2x USB 2.0, 1x 2nd serial (9-pin), 1x parallel (25-pin), additional RJ-45 and video ports available on optional graphics or ethernet card * Depending on many factors, actual data transfer speed may be lower than theoretical speed ** only available on the models with integrated graphics						Accessories	For compatible accessories, please go to http://smartfind.lenovo.com																																																																		
Audio support	High Definition (HD) Audio, Realtek ALC662 / optional internal speaker (1 watt)																																																																									
WLAN	<i>Some:</i> 11ac wireless, M.2 Card, Realtek RTL8821CE (dual band), Wi-Fi + Bluetooth 4.2 combo adapter, 1x1 <i>Some:</i> 11ac wireless, M.2 Card, Qualcomm Atheros QCA9377A (dual band), Wi-Fi + Bluetooth 4.2* combo adapter, 1x1 <i>Some:</i> 11ac wireless, M.2 Card, Realtek RTL8822BE (dual band), Wi-Fi + Bluetooth 4.2* combo adapter, 2x2 <i>Some:</i> 11ac wireless, M.2 Card, Qualcomm Atheros QCA6174A (dual band), Wi-Fi + Bluetooth 4.2* combo adapter, 2x2																																																																									
Bluetooth™	<i>Some:</i> Bluetooth 4.2* wireless, integrated in Wi-Fi + BT combo adapter * Hardware supports BT 4.2, but Win10 RS3 and earlier only supports BT 4.1																																																																									

Note: The specifications above may not be available in all regions.

Lenovo, July 2018

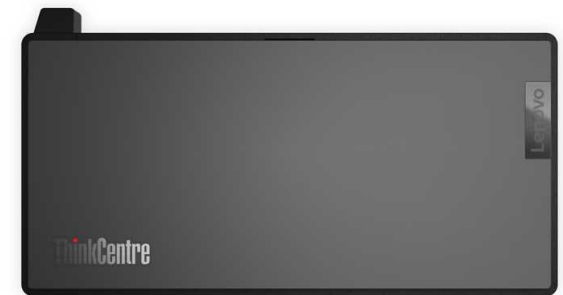

ThinkCentre M90n-1 Nano Platform Specifications

Product Specifications Reference (PSREF)

Processor	Intel® 8th Generation Intel Core™ i3 / i5 / i7 Processor						Manageability Intel vPro technology on some models (require choosing a vPro-support Wi-Fi adapter to enable vPro function through wireless connection) Discrete TPM 2.0, TCG Certified						
	Processor	Cores / Threads	Frequency Base/Max(GHz)	Cache	Memory Support (Up to)	Integrated Graphics							
	Core i3-8145U	2 / 4	2.1G / 3.9G	4 MB	DDR4-2400	UHD 620							
	Core i5-8265U	4 / 8	1.6G / 3.9G	6 MB	DDR4-2400	UHD 620							
	Core i5-8365U	4 / 8	1.6G / 4.1G	6 MB	DDR4-2400	UHD 620							
Core i7-8665U	4 / 8	1.9G / 4.8G	8 MB	DDR4-2400	UHD 620								
Memory	8GB or 16GB / DDR4-2666* / soldered to systemboard, no sockets, non-ECC * System automatically clocks down for the processors with lower memory controller						Security chip Security features						
Storage	Support up to two M.2 SSD <i>Some:</i> M.2 2280 SSD / PCIe NVMe, PCIe 3.0 x 4* <i>Some:</i> M.2 2242 SSD / PCIe NVMe, PCIe 3.0 x 2 <i>Some:</i> Intel Optane™ Memory H10 with Solid State Storage, M.2 2280, PCIe NVMe 3.0 x 4 (not support Celeron) * M.2 SSD / Optane with SSD in PCIe 3.0 x 2 M.2 slot can only run at PCIe 3.0 x2												
RAID	RAID 0/1 support (RAID preset only available via special bid model)						Keyboard <i>Some:</i> Lenovo Calliope Keyboard (USB connector), black <i>Some:</i> Lenovo Traditional Keyboard (USB connector), black <i>Some:</i> Lenovo Calliope Wireless Keyboard (2.4GHz via USB receiver), black Mouse <i>Some:</i> Lenovo Calliope Mouse (USB connector), black <i>Some:</i> Lenovo Fingerprint Mouse (USB connector), Windows Hello support, black <i>Some:</i> Lenovo Calliope Wireless Mouse (2.4GHz via USB receiver), black						
Optical	None												
Graphics	Intel HD Graphics 610/620 in processor, uses main memory, DirectX® 12, one DisplayPort™, one USB 3.1 Type-C Gen2 with display function, up to 2 independent displays; <i>Max resolution:</i> 4096x2304 (DP) @60Hz; 4096x2304 (Type-C)@60Hz;						Mechanical Nano (0.35L), black color; metal case Three M.2 slots: two for M.2 SSD (one PCIe 3.0 x4 and one PCIe 3.0 x2) and one for WLAN						
Monitor cable	Optional DP to VGA dongle, DP to HDMI dongle, Type-C to VGA dongle, Type-C to HDMI dongle, Type-C to DP dongle												
Chipset	Intel SoC (System on Chip) platform						<table border="1"> <thead> <tr> <th></th> <th>Dimensions (WxDxH)</th> <th>Weight (Approx.)</th> </tr> </thead> <tbody> <tr> <td>M90n-1 Nano (with fan, 0.35L)</td> <td>7.05" X 3.46" X 0.87" 179mm X 88mm X 22mm</td> <td>1.11 lb (0.505 kg), vary by config</td> </tr> </tbody> </table>		Dimensions (WxDxH)	Weight (Approx.)	M90n-1 Nano (with fan, 0.35L)	7.05" X 3.46" X 0.87" 179mm X 88mm X 22mm	1.11 lb (0.505 kg), vary by config
	Dimensions (WxDxH)	Weight (Approx.)											
M90n-1 Nano (with fan, 0.35L)	7.05" X 3.46" X 0.87" 179mm X 88mm X 22mm	1.11 lb (0.505 kg), vary by config											
Front ports (Std.)*	2x USB 3.1 Gen2, 1x USB 3.1 Type-C Gen 2, one headphone / microphone combo jack (3.5mm)						Mounting <i>Some:</i> VESA mount bracket kit, supports VESA 75mm <i>Some:</i> VESA mount bracket kit with adapter holder, supports VESA 75mm <i>Some:</i> DIN rail mount bracket kit						
Rear ports (Std.)*	2x USB 3.1 Gen2, 1x USB 3.1 Type-C Gen 2 (with display function, support power-in [20V and >45W]), 1x ethernet (RJ-45), 1x DisplayPort * Depending on many factors, actual data transfer speed may be lower than theoretical speed												
Audio support	Realtek ALC233VB / internal speaker (1 watt)						Floor Stand None						
WLAN	<i>Some:</i> 11ac wireless, M.2 Card, Realtek RTL8822CE (dual band), Wi-Fi + Bluetooth 5.0 combo adapter, 1x1 <i>Some:</i> 11ac wireless, M.2 Card, Realtek RTL8822CE (dual band), Wi-Fi + Bluetooth 5.0 combo adapter, 2x2 <i>Some:</i> 11ac wireless, M.2 Card, Intel Wireless-AC 9462 (dual band), Wi-Fi + Bluetooth 5.0 combo adapter, 1x1 <i>Some:</i> 11ac wireless, M.2 Card, Intel Wireless-AC 9560 (dual band), Wi-Fi + Bluetooth 5.0 combo adapter, 2x2 <i>Some:</i> 11ac wireless, M.2 Card, Intel Wireless-AC 9560 (dual band), Wi-Fi + Bluetooth 5.0 combo adapter, Intel vPro technology support, 2x2						Power supply 65 watts AC/DC adapter, autosensing, 88% PSU (Not for TIO models)						
Bluetooth	<i>Some:</i> Bluetooth 5.0 wireless, integrated in Wi-Fi + BT combo adapter						Limited warranty <i>Some:</i> 1-year, limited onsite service / service upgrades available <i>Some:</i> 3-year, limited onsite service / service upgrades available						
Ethernet	Gigabit ethernet, Intel Ethernet Connection I219-LM(Jacksonville), Wake on LAN®						Preload Preloaded operating system <i>Some:</i> Windows® 10 Pro 64-bit <i>Some:</i> Windows 10 Home 64-bit						
							Environment ENERGY STAR® 7.1, EPEAT™ Silver rating (North America), ErP Lot 3, TCO 8.0, TUV ultra low noise verified (on some models), RoHS, WEEE, REACH						
							MIL-SPEC test MIL-STD-810H (Low Pressure [Altitude], High Temperature, Low Temperature, Temperature Shock, Humidity, Sand and Dust, Vibration, Shock, Solar Radiation)						
							Accessories For compatible accessories, please go to http://smartfind.lenovo.com						

Note: The specifications above may not be available in all regions.

Lenovo, July 2019



ThinkCentre M90n-1 Nano IoT Platform Specifications

Product Specifications Reference (PSREF)

Processor	Intel® Celeron® or 8th Generation Intel Core™ i3 Processor						Manageability Security chip Security features	None Discrete TPM 2.0, TCG Certified ● Security slot (in rear for optional Kensington® MicroSaver® cable) ● Chassis intrusion switch ● Power-on password ● Administrator password ● Hard disk password	● Boot sequence control ● Boot without keyboard and mouse ● Individual USB port disablement
	Processor	Cores / Threads	Frequency Base/Max(GHz)	Cache	Memory Support (Up to)	Integrated Graphics			
	Celeron 4205U	2 / 2	1.8G	2 MB	DDR4-2133	UHD 610			
	Core i3-8145U	2 / 4	2.1G / 3.9G	4 MB	DDR4-2400	UHD 620			
Memory	4GB / DDR4-2666* / soldered to systemboard, no sockets, non-ECC * System automatically clocks down for the processors with lower memory controller								
Storage	Support up to two M.2 SSD <i>Some:</i> M.2 2280 SSD / PCIe NVMe, PCIe 3.0 x 4* <i>Some:</i> M.2 2242 SSD / PCIe NVMe, PCIe 3.0 x 2 <i>Some:</i> Intel Optane™ Memory H10 with Solid State Storage, M.2 2280, PCIe NVMe 3.0 x 4 (not support Celeron) * M.2 SSD / Optane with SSD in PCIe 3.0 x 2 M.2 slot can only run at PCIe 3.0 x2						Keyboard	<i>Some:</i> Lenovo Calliope Keyboard (USB connector), black <i>Some:</i> Lenovo Traditional Keyboard (USB connector), black <i>Some:</i> Lenovo Calliope Wireless Keyboard (2.4GHz via USB receiver), black	
RAID Optical	RAID 0/1 support (RAID preset only available via special bid model) None						Mouse	<i>Some:</i> Lenovo Calliope Mouse (USB connector), black <i>Some:</i> Lenovo Fingerprint Mouse (USB connector), Windows Hello support, black <i>Some:</i> Lenovo Calliope Wireless Mouse (2.4GHz via USB receiver), black	
Graphics	Intel HD Graphics 610/620 in processor, uses main memory, DirectX® 12, one DisplayPort™, one USB 3.1 Type-C Gen2 with display function, up to 2 independent displays; <i>Max resolution:</i> 4096x2304 (DP)@60Hz; 4096x2304 (Type-C)@60Hz;						Mechanical	Nano (fanless 0.55L), black color; metal case Four M.2 slots: two for M.2 SSD (one PCIe 3.0 x4 and one PCIe 3.0 x2), one for WLAN, and one for WWAN	
Monitor cable	Optional DP to VGA dongle, DP to HDMI dongle, Type-C to VGA dongle, Type-C to HDMI dongle, Type-C to DP dongle								
Chipset	Intel SoC (System on Chip) platform								
Front ports (Std.)	* 2x USB 3.1 Gen2, 1x USB 3.1 Type-C Gen 2, one headphone / microphone combo jack (3.5mm), 2x serial								
Rear ports (Std.)	* <i>With Celeron:</i> 1x USB 2.0, 1x USB 3.1 Type-C Gen 2 (with display function, support power-in [20V, > 45W]), 1x ethernet (RJ-45), 1x DisplayPort <i>With Core i3:</i> 1x USB 3.1 Gen2, 1x USB 3.1 Type-C Gen 2 (with display function, support power-in [20V, > 45W]), 2x ethernet (RJ-45), 1x DisplayPort * Depending on many factors, actual data transfer speed may be lower than theoretical speed						Mounting	<i>Some:</i> VESA mount bracket kit, supports VESA 75mm <i>Some:</i> VESA mount bracket kit with adapter holder, supports VESA 75mm <i>Some:</i> DIN rail mount bracket kit	
Audio support	Realtek ALC233VB / internal speaker (1watt)						Floor Stand	None	
WLAN	<i>Some:</i> 11ac wireless, M.2 Card, Realtek RTL8822CE (dual band), Wi-Fi + Bluetooth 5.0 combo adapter, 1x1 <i>Some:</i> 11ac wireless, M.2 Card, Realtek RTL8822CE (dual band), Wi-Fi + Bluetooth 5.0 combo adapter, 2x2 <i>Some:</i> 11ac wireless, M.2 Card, Intel Wireless-AC 9462 (dual band), Wi-Fi + Bluetooth 5.0 combo adapter, 1x1 <i>Some:</i> 11ac wireless, M.2 Card, Intel Wireless-AC 9560 (dual band), Wi-Fi + Bluetooth 5.0 combo adapter, 2x2 <i>Some:</i> 11ac wireless, M.2 Card, Intel Wireless-AC 9560 (dual band), Wi-Fi + Bluetooth 5.0 combo adapter, Intel vPro technology support, 2x2						Power supply	<i>Some:</i> 65 watts AC/DC adapter, autosensing, 88% PSU <i>Some:</i> 65 watts AC/DC adapter (wide temperature), autosensing, 88% PSU (only for Machine Type 11AS)	
Bluetooth Ethernet	<i>Some:</i> Bluetooth 5.0 wireless, integrated in Wi-Fi + BT combo adapter <i>With Celeron:</i> Gigabit ethernet, Realtek RTL8111K, 1x RJ-45, Wake on LAN® <i>With Core i3:</i> Two gigabit ethernet, Realtek RTL8111K and RTL8111HN, 2x RJ-45 Wake on LAN®						Limited warranty	<i>Some:</i> 1-year, limited onsite service / service upgrades available <i>Some:</i> 3-year, limited onsite service / service upgrades available	
							Preload	Preloaded operating system <i>Some:</i> Windows® 10 Pro 64-bit <i>Some:</i> Windows 10 Home 64-bit <i>Some:</i> Windows 10 IoT Enterprise (only available via special bid model)	
							Environment	ENERGY STAR® 7.1, EPEAT™ Silver rating (North America), ErP Lot 3, TCO 8.0, TUV ultra low noise verified (on some models), RoHS, WEEE, REACH	
							MIL-SPEC test	MIL-STD-810H (Low Pressure [Altitude], High Temperature, Low Temperature, Temperature Shock, Humidity, Sand and Dust, Vibration, Shock, Solar Radiation)	
							Accessories	For compatible accessories, please go to http://smartfind.lenovo.com	

Note: The specifications above may not be available in all regions.

Lenovo, July 2019



ThinkCentre M910 SFF Platform Specifications

Product Specifications Reference (PSREF)

Processor	Intel® Celeron®, Intel Pentium®, or 6/7th Generation Intel Core™ i3 / i5 / i7 Processor	Security features	<ul style="list-style-type: none"> Security slot (in rear for optional Kensington® MicroSaver® cable) Padlock loop Smart USB protection, allows keyboard/mouse only, blocks all storage devices Optional cable lock to physically lock both keyboard and mouse Power-on password Administrator password Hard disk password Boot sequence control Boot without keyboard and mouse Individual USB port disablement Optional chassis intrusion switch 																																																
	<table border="1"> <thead> <tr> <th>Processor</th> <th>Cores / Threads</th> <th>Frequency Base/Max(GHz)</th> <th>Cache</th> <th>Memory Support (Up to)</th> <th>Integrated Graphics</th> </tr> </thead> <tbody> <tr> <td>Core i5-6500</td> <td>4 / 4</td> <td>3.2G / 3.6G</td> <td>6 MB</td> <td>DDR4-2133</td> <td>HD 530</td> </tr> <tr> <td>Core i7-6700</td> <td>4 / 8</td> <td>3.4G / 4.0G</td> <td>8 MB</td> <td>DDR4-2133</td> <td>HD 530</td> </tr> <tr> <td>Core i3-7300</td> <td>2 / 4</td> <td>4.0G / --</td> <td>4 MB</td> <td>DDR4-2400</td> <td>HD 630</td> </tr> <tr> <td>Core i5-7400</td> <td>4 / 4</td> <td>3.0G / 3.5G</td> <td>6 MB</td> <td>DDR4-2400</td> <td>HD 630</td> </tr> <tr> <td>Core i5-7500</td> <td>4 / 4</td> <td>3.4G / 3.8G</td> <td>6 MB</td> <td>DDR4-2400</td> <td>HD 630</td> </tr> <tr> <td>Core i5-7600</td> <td>4 / 4</td> <td>3.5G / 4.1G</td> <td>6 MB</td> <td>DDR4-2400</td> <td>HD 630</td> </tr> <tr> <td>Core i7-7700</td> <td>4 / 8</td> <td>3.6G / 4.2G</td> <td>8 MB</td> <td>DDR4-2400</td> <td>HD 630</td> </tr> </tbody> </table>	Processor	Cores / Threads	Frequency Base/Max(GHz)	Cache	Memory Support (Up to)	Integrated Graphics	Core i5-6500	4 / 4	3.2G / 3.6G	6 MB	DDR4-2133	HD 530	Core i7-6700	4 / 8	3.4G / 4.0G	8 MB	DDR4-2133	HD 530	Core i3-7300	2 / 4	4.0G / --	4 MB	DDR4-2400	HD 630	Core i5-7400	4 / 4	3.0G / 3.5G	6 MB	DDR4-2400	HD 630	Core i5-7500	4 / 4	3.4G / 3.8G	6 MB	DDR4-2400	HD 630	Core i5-7600	4 / 4	3.5G / 4.1G	6 MB	DDR4-2400	HD 630	Core i7-7700	4 / 8	3.6G / 4.2G	8 MB	DDR4-2400	HD 630	Keyboard	<i>Some:</i> Lenovo Calliope Keyboard (USB connector), black <i>Some:</i> Lenovo Traditional Keyboard (USB connector), black <i>Some:</i> Lenovo Calliope Wireless Keyboard (2.4GHz via USB receiver), black
Processor	Cores / Threads	Frequency Base/Max(GHz)	Cache	Memory Support (Up to)	Integrated Graphics																																														
Core i5-6500	4 / 4	3.2G / 3.6G	6 MB	DDR4-2133	HD 530																																														
Core i7-6700	4 / 8	3.4G / 4.0G	8 MB	DDR4-2133	HD 530																																														
Core i3-7300	2 / 4	4.0G / --	4 MB	DDR4-2400	HD 630																																														
Core i5-7400	4 / 4	3.0G / 3.5G	6 MB	DDR4-2400	HD 630																																														
Core i5-7500	4 / 4	3.4G / 3.8G	6 MB	DDR4-2400	HD 630																																														
Core i5-7600	4 / 4	3.5G / 4.1G	6 MB	DDR4-2400	HD 630																																														
Core i7-7700	4 / 8	3.6G / 4.2G	8 MB	DDR4-2400	HD 630																																														
		Mouse	<i>Some:</i> Lenovo Calliope Mouse (USB connector), black <i>Some:</i> Lenovo Calliope Wireless Mouse (2.4GHz via USB receiver), black																																																
Memory	64GB max, UDIMM, DDR4-2400*, four 288-pin DIMM sockets, non-ECC, dual-channel capable * System automatically clocks down for the processors with lower memory controller	Mechanical	<ul style="list-style-type: none"> SFF (8.4L), black color, metal case (WxDxH) 3.6" X 11.4" X 13.5"; 92.5mm X 290.5mm X 343.5mm Approx. 11.92 lb (5.4 kg), weight may vary by configuration Toolless cover, disk, optical, graphic card removal Optional dust filter Bay 1: Slim external ODD bay Bay 2: 3.5", 1" high, internal, HDD/SSD Bay 3: 2.5", internal, HDD/SSD (optional bay) Slot 1: low-profile (length < 150mm, height < 68mm), PCIe 3.0 x16* Slot 2: low-profile (length < 150mm, height < 68mm), PCIe 3.0 x1* Slot 3: low-profile (length < 150mm, height < 68mm), PCIe 3.0 x16 (x4 signal)* Slot 4: no slot, only bracket for optional port extension* M.2 card slots: Two (one for WLAN, one for SSD/Optane) * Optional 2 front USB3.1 Type-C ports module occupies PCIe x16 (x4 signal) slot, optional rear 2x USB2.0 / parallel / 2nd serial / cable lock / Wi-Fi antenna occupies one expansion slot 																																																
Storage	<i>Some:</i> Hard Drive / SATA 6.0Gb/s, 2.5" or 3.5", 5400 rpm or 7200 rpm <i>Some:</i> Solid State Drive (SSD) / SATA 6.0Gb/s, 2.5" <i>Some:</i> M.2 Solid State Drive (SSD) / PCIe NVMe, PCIe 3.0 x 4, 32Gb/s <i>Some:</i> Intel Optane™ Memory (models with 7th gen Core processor), M.2 <i>Some:</i> DVD-ROM SATA 1.5Gb/s Drive, slim (9.0mm) <i>Some:</i> DVD Burner (DVD±RW), SATA 1.5Gb/s Drive, slim (9.0mm)	Floor Stand	Optional system floor stand for vertical orientation																																																
Optical	Four onboard SATA 6.0Gb/s connectors, RAID 0/1 support (RAID preset only available via special bid model)	Power supply	<i>Some:</i> 180 watts, autosensing, 85% PSU <i>Some:</i> 210 watts, autosensing, 85% PSU <i>Some:</i> 210 watts, autosensing, 92% PSU (only available via special bid)																																																
Onboard SATA	Optional 7-in-1 media reader	Limited warranty ³	<i>Some:</i> 1-year or 3-year, depot service / service upgrades available <i>Some:</i> 1-year or 3-year, limited onsite service / service upgrades available																																																
Media reader	Intel HD Graphics 510/530/610/630 in processor, uses main memory, DirectX® 12, one VGA, two DisplayPort™, supports 3 independent displays, works along with discrete graphics to support more displays; Max resolution: 4096x2304 (DP)@60Hz; 2048x1536 (VGA)@50Hz <i>Some:</i> NVIDIA GeForce® GT 730, DirectX 12, 2GB, PCIe 2.0 x8 adapter, two DisplayPort, 35 watts; Max resolution: 3840x2160 (DisplayPort)@60Hz;	Preload	Preloaded operating system <i>Some:</i> Windows® 7 Professional 32/64 preinstalled through downgrade rights in Windows 10 Pro 64-bit (not available with 7th Gen Intel processor) <i>Some:</i> Windows 10 Pro 64-bit <i>Some:</i> Windows 10 Home 64-bit																																																
Graphics	Intel HD Graphics 510/530/610/630 in processor, uses main memory, DirectX® 12, one VGA, two DisplayPort™, supports 3 independent displays, works along with discrete graphics to support more displays; Max resolution: 4096x2304 (DP)@60Hz; 2048x1536 (VGA)@50Hz <i>Some:</i> NVIDIA GeForce® GT 730, DirectX 12, 2GB, PCIe 2.0 x8 adapter, two DisplayPort, 35 watts; Max resolution: 3840x2160 (DisplayPort)@60Hz;	Preloaded applications (only some listed)	<ul style="list-style-type: none"> Microsoft Office preloaded; purchase a product key to activate Only for Window 10 Lenovo Companion Only for Window 7 Lenovo Solution Center Lenovo ThinkVantage Tools Create Recovery Media Adobe® Reader® Cyberlink PowerDVD Create (DVD±RW) 																																																
Monitor cable	Optional DP to VGA, DP to DVI-D (single link), DP to dual DP, or DP to HDMI 1.4	Environment	ENERGY STAR® 6.1, EPEAT™ Gold rating (North America), ErP Lot 3, GREENGUARD®, RoHS-compliant, TUV low noise verified (on some models)																																																
Chipset	Intel Q270 Chipset	Accessories	For compatible accessories, please go to http://www.lenovoquickpick.com																																																
Front ports*	Four USB 3.1 Gen1, optional two USB 3.1 Type-C Gen 2 (only available via special bid), microphone (3.5mm), headphone (3.5mm)	Manageability	Intel Active Management Technology 11.0 (Intel AMT 11.0); Intel vPro technology on some models (require choosing a vPro-support Wi-Fi adapter to enable vPro function through wireless connection)																																																
Rear ports*	Four USB 3.1 Gen1, optional two USB 2.0, serial (9-pin), optional 2nd serial (9-pin), optional parallel (25-pin), ethernet (RJ-45), one VGA, two DisplayPort, optional two PS/2 ports (keyboard/mouse); additional DisplayPort on optional graphics on some models	Security chip	TPM (Trusted Platform Module) 2.0, TCG Certified * Downgrade to TPM1.2 for the models with Win10 DG Win7 32 OS																																																
Rear audio ports* IEEE 1394*	Line-in (3.5mm), line-out (3.5mm), microphone-in (3.5mm) None * Depending on many factors, actual data transfer speed may be lower than theoretical speed																																																		
Audio support	High Definition (HD) Audio, Realtek ALC662 / optional internal speaker (1.5 watt)																																																		
WLAN ¹³	<i>Some:</i> 11ac wireless, M.2 Card, Qualcomm Atheros QCA9377A (dual band), Wi-Fi + Bluetooth 4.1 combo adapter, 1x1 <i>Some:</i> 11ac wireless, M.2 Card, Qualcomm Atheros QCA6174A (dual band), Wi-Fi + Bluetooth 4.1 combo adapter, 2x2 <i>Some:</i> 11ac wireless, M.2 Card, Intel Dual Band Wireless-AC 3165, Wi-Fi + Bluetooth 4.1 combo adapter, 1x1 <i>Some:</i> 11ac wireless, M.2 Card, Intel Dual Band Wireless-AC 8265, Wi-Fi + Bluetooth 4.1 combo adapter, 2x2 <i>Some:</i> 11ac wireless, M.2 Card, Intel Dual Band Wireless-AC 8265, Wi-Fi + Bluetooth 4.1 combo adapter, Intel vPro technology support, 2x2																																																		
Bluetooth™ Ethernet Modem	<i>Some:</i> Bluetooth 4.1 wireless, integrated in Wi-Fi + BT combo adapter Gigabit ethernet, Intel Ethernet Connection I219-LM(Jacksonville), Wake on LAN® None																																																		

Note: The specifications above may not be available in all regions.

Lenovo, August 2017



ThinkCentre M910 Tiny Platform Specifications

Product Specifications Reference (PSREF)

Processor	Intel® Celeron®, Intel Pentium®, or 6/7th Generation Intel Core™ i3 / i5 / i7 Processor						Security features <ul style="list-style-type: none"> Security slot (in rear for optional Kensington® MicroSaver® cable) Smart USB protection, allows keyboard/mouse only, blocks all storage devices Power-on password Administrator password Hard disk password Boot sequence control Boot without keyboard and mouse Individual USB port disablement Chassis intrusion switch
	Processor	Cores / Threads	Frequency Base/Max(GHz)	Cache	Memory Support (Up to)	Integrated Graphics	
	Core i5-6500T	4 / 4	2.5G / 3.1G	6 MB	DDR4-2133	HD 530	
	Core i7-6700T	4 / 8	2.8G / 3.6G	8 MB	DDR4-2133	HD 530	
	Core i5-7500T	4 / 4	2.7G / 3.3G	6 MB	DDR4-2400	HD 630	
	Core i5-7600T	4 / 4	2.8G / 3.7G	6 MB	DDR4-2400	HD 630	
Core i7-7700T	4 / 8	2.9G / 3.8G	8 MB	DDR4-2400	HD 630		
Memory	32GB max, DDR4-2400*, two 260-pin SO-DIMM sockets, non-ECC, dual-channel capable * System automatically clocks down for the processors with lower memory controller						
Storage	<i>Some:</i> Hard Drive / SATA 6.0Gb/s, 2.5", 5400 rpm or 7200 rpm, APS <i>Some:</i> Solid State Drive (SSD) / SATA 6.0Gb/s, 2.5" <i>Some:</i> M.2 Solid State Drive (SSD) / PCIe NVMe, PCIe 3.0 x 4, 32Gb/s <i>Some:</i> Intel Optane™ Memory (models with 7th gen Core processor), M.2 <i>Some:</i> DVD-ROM, slim (9.0mm), via USB external ODD box <i>Some:</i> DVD Burner (DVD±RW), slim (9.0mm), via USB external ODD box						
Optical	One onboard SATA 6.0Gb/s connector						
Onboard SATA Media reader	None						
Graphics	Intel HD Graphics 510/530/610/630 in processor, uses main memory, DirectX® 12, two DisplayPort™, one optional video port (HDMI, VGA, 3rd DP, or USB 3.1 Type-C with DisplayPort Alternate Mode), up to 3 independent displays; <i>Max resolution:</i> 4096x2304 (DP)@60Hz; 4096x2304 (Type-C)@60Hz; 4096x2160 (HDMI)@24Hz; 1920x1200 (VGA)@60Hz						
Monitor cable	Optional DP to VGA, DP to DVI-D (single link), DP to dual DP, or DP to HDMI 1.4						
Chipset	Intel Q270 Chipset						
Front ports*	Two USB 3.1 Gen1 (one is Always On and fast charge), one microphone (3.5mm), one headphone / microphone combo jack (3.5mm)						
Rear ports*	Four USB 3.1 Gen1 (optional external optical box or external I/O box occupies one or two specific USB 3.1 Gen1 on some models), ethernet (RJ-45), two DisplayPort, two optional ports (Port 1 for VGA / 3rd DP / HDMI / serial / USB 3.1 Type-C Gen 1 (with DisplayPort Alternate Mode), Port 2 for serial)						
I/O box*	Optional external I/O box, extends two USB 2.0, two USB 3.1 Gen1, and one serial on rear, two USB 2.0 on front, via USB cable (occupy two specific USB 3.1 Gen1 of Tiny) * Depending on many factors, actual data transfer speed may be lower than theoretical speed						
Audio support	High Definition (HD) Audio, Realtek ALC294 / optional internal speaker (1w or 2w)						
WLAN ¹³	<i>Some:</i> 11ac wireless, M.2 Card, Qualcomm Atheros QCA9377A (dual band), Wi-Fi + Bluetooth 4.2 combo adapter, 1x1 <i>Some:</i> 11ac wireless, M.2 Card, Qualcomm Atheros QCA6174A (dual band), Wi-Fi + Bluetooth 4.2 combo adapter, 2x2 <i>Some:</i> 11ac wireless, M.2 Card, Intel Dual Band Wireless-AC 3165, Wi-Fi + Bluetooth 4.2 combo adapter, 1x1 <i>Some:</i> 11ac wireless, M.2 Card, Intel Dual Band Wireless-AC 8265, Wi-Fi + Bluetooth 4.2 combo adapter, 2x2 <i>Some:</i> 11ac wireless, M.2 Card, Intel Dual Band Wireless-AC 8265, Wi-Fi + Bluetooth 4.2 combo adapter, Intel vPro technology support, 2x2						
Bluetooth™	<i>Some:</i> Bluetooth 4.2 wireless, integrated in Wi-Fi + BT combo adapter * Hardware supports BT 4.2, but Win10 RS3 and earlier only supports BT 4.1						
Ethernet	Gigabit ethernet, Intel Ethernet Connection I219-LM(Jacksonville), Wake on LAN®						
Manageability	Intel Active Management Technology 11.0 (Intel AMT 11.0); Intel vPro technology on some models (require choosing a vPro-support Wi-Fi adapter to enable vPro function through wireless connection)						
Security chip	TPM (Trusted Platform Module) 2.0*, TCG Certified * Downgrade to TPM1.2 for the models with Win10 DG Win7 32 OS						
VESA mount Floor Stand	Optional VESA mount bracket kit, supports VESA 75mm and 100mm Optional system floor stand for vertical orientation						
Power supply	65 watts AC/DC adapter, autosensing, 88% PSU (not included for TIO models) 90 watts AC/DC adapter, autosensing, 88% PSU (only for models with I/O box)						
Limited warranty ³	<i>Some:</i> 1-year or 3-year, depot service / service upgrades available <i>Some:</i> 1-year or 3-year, limited onsite service / service upgrades available						
Preload	<i>Some:</i> Windows® 7 Professional 32/64 preinstalled through downgrade rights in Windows 10 Pro 64-bit (not available with 7th Gen Intel processor) <i>Some:</i> Windows 10 Pro 64-bit <i>Some:</i> Windows 10 Home 64-bit						
Environment	ENERGY STAR® 6.1, EPEAT™ Gold rating (North America), ErP Lot 3, GREENGUARD®, RoHS-compliant, TUV low noise verified (on some models)						
MIL-SPEC test	MIL-STD-810G military certification (Low Pressure [Altitude], High Temperature, Low Temperature, Temperature Shock, Humidity, Sand and Dust, Vibration, Shock, Fungus, Solar Radiation)						
Accessories	For compatible accessories, please go to http://www.lenovoquickpick.com						

See footnotes for more detailed information



ThinkCentre M910 Tower Platform Specifications

Product Specifications Reference (PSREF)

Processor	Intel® Celeron®, Intel Pentium®, or 6/7th Generation Intel Core™ i3 / i5 / i7 Processor						Ethernet Modem	Gigabit ethernet, Intel Ethernet Connection I219-LM(Jacksonville), Wake on LAN® None
	Processor	Cores / Threads	Frequency Base/Max(GHz)	Cache	Memory Support (Up to)	Integrated Graphics	Manageability	Intel Active Management Technology 11.0 (Intel AMT 11.0); Intel vPro technology on some models (require choosing a vPro-support Wi-Fi adapter to enable vPro function through wireless connection)
	Core i5-6500	4 / 4	3.2G / 3.6G	6 MB	DDR4-2133	HD 530	Security chip	TPM (Trusted Platform Module) 2.0, TCG Certified * Downgrade to TPM1.2 for the models with Win10 DG Win7 32 OS
	Core i7-6700	4 / 8	3.4G / 4.0G	8 MB	DDR4-2133	HD 530	Security features	<ul style="list-style-type: none"> Security slot (in rear for optional Kensington® MicroSaver® cable) Power-on password Administrator password Padlock loop Hard disk password Smart USB protection, allows keyboard/ mouse only, blocks all storage devices Boot sequence control Boot without keyboard and mouse Optional cable lock to physically lock both keyboard and mouse Individual USB port disablement Optional chassis intrusion switch
	Core i3-7300	2 / 4	4.0G / --	4 MB	DDR4-2400	HD 630		
	Core i5-7400	4 / 4	3.0G / 3.5G	6 MB	DDR4-2400	HD 630		
	Core i5-7500	4 / 4	3.4G / 3.8G	6 MB	DDR4-2400	HD 630		
	Core i5-7600	4 / 4	3.5G / 4.1G	6 MB	DDR4-2400	HD 630		
Core i7-7700	4 / 8	3.6G / 4.2G	8 MB	DDR4-2400	HD 630			
Memory	64GB max, UDIMM, DDR4-2400*, four 288-pin DIMM sockets, non-ECC, dual-channel capable * System automatically clocks down for the processors with lower memory controller						Keyboard	Some: Lenovo Calliope Keyboard (USB connector), black Some: Lenovo Traditional Keyboard (USB connector), black Some: Lenovo Calliope Wireless Keyboard (2.4GHz via USB receiver), black
Storage	Some: Hard Drive / SATA 6.0Gb/s, 2.5" or 3.5", 5400 rpm or 7200 rpm Some: Solid State Drive (SSD) / SATA 6.0Gb/s, 2.5" Some: M.2 Solid State Drive (SSD) / PCIe NVMe, PCIe 3.0 x 4, 32Gb/s Some: Intel Optane™ Memory (models with 7th gen Core processor), M.2 Some: Front accessible and removable HDD, 3.5", lockable via physical key						Mouse	Some: Lenovo Calliope Mouse (USB connector), black Some: Lenovo Calliope Wireless Mouse (2.4GHz via USB receiver), black
Optical	Some: DVD-ROM, SATA 1.5Gb/s, 5.25" or slim (9.0mm) Some: DVD Burner (DVD±RW), SATA 1.5Gb/s, 5.25" or slim (9.0mm)						Mechanical	<ul style="list-style-type: none"> Tower (18L), black color, metal case (WxDxH) 6.5" X 12.65" X 16.15"; 165mm X 321.35mm X 410.25mm Approx. 15.45 lb (7 kg), weight may vary by configuration Toolless cover, disk, optical, graphic card removal Optional carry handle, dust filter Bay 1: Slim external ODD bay Bay 2: 5.25", 1.6" high, external, ODD / optional front access HDD Bay 3: 3.5", 1" high, internal, HDD/SSD Bay 4: 3.5", 1" high, internal, HDD/SSD (optional bay, bay comes with disk) Bay 5: 2.5", internal, HDD/SSD (optional bay) Notes: M910 Tower supports up to 3 SATA devices (ODD/HDD/SSD) and 1 eSATA device (front access HDD) Slot 1: full-length full-height (length < 268mm, height < 112mm), PCIe 3.0 x16* Slot 2: full-length full-height (length < 268mm, height < 112mm), PCIe 3.0 x1* Slot 3: full-length full-height (length < 268mm, height < 112mm), PCIe 3.0 x16 (x4 signal)* Slot 4: no slot, only bracket for optional port extension* M.2 card slots: Two (one for WLAN, one for SSD/Optane) * Optional 2 front USB3.1 Type-C ports module occupies PCIe x16 (x4 signal) slot, optional rear 2x USB2.0 / parallel / 2nd serial occupies one expansion slot
Onboard SATA	Four onboard SATA 6.0Gb/s connectors (1x eSATA and 3x SATA), RAID 0/1 support (RAID preset only available via special bid model)						Power supply	Some: 180 watts, autosensing, 85% PSU Some: 250 watts, autosensing, 85% PSU Some: 400 watts, autosensing, 92% PSU (only available via special bid)
Media reader	Optional 7-in-1 media reader						Limited warranty	Some: 1-year or 3-year, depot service / service upgrades available Some: 1-year or 3-year, limited onsite service / service upgrades available
Graphics	Intel HD Graphics 510/530/610/630 in processor, uses main memory, DirectX® 12, one VGA, two DisplayPort™, supports 3 independent displays, works along with discrete graphics to support more displays; Max resolution: 4096x2304 (DP) @60Hz; 2048x1536 (VGA) @50Hz Some: NVIDIA GeForce® GT 730, DirectX 12, 2GB, PCIe 2.0 x8 adapter, two DisplayPort, 35 watts; Max resolution: 3840x2160 (DisplayPort) @60Hz; Some: AMD Radeon™ R7 350, DirectX 11, 2GB, PCIe 3.0 x8 adapter, one VGA, one HDMI, 75 watts, occupies two slots; Max resolution: 4096x2160 (HDMI) @24Hz; 2048x1536 (VGA) @85Hz Some: NVIDIA GeForce GTX™ 1080 (only available via special bid model), DirectX 12, 8GB, PCIe 3.0 x16 adapter, one DVI-D, one HDMI, three DisplayPort, 180 watts, occupies two slots; Max resolution: 2560x1600 (DVI-D) @60Hz; 4096x2160 (HDMI) @60Hz 7680x4320 (with Single DP) @60Hz						Preload	Preloaded operating system Some: Windows® 7 Professional 32/64 preinstalled through downgrade rights in Windows 10 Pro 64-bit (not available with 7th Gen Intel processor) Some: Windows 10 Pro 64-bit Some: Windows 10 Home 64-bit Preloaded applications (only some listed) <ul style="list-style-type: none"> Microsoft Office preloaded; purchase a product key to activate Only for Window 10 Lenovo Companion Only for Window 7 Lenovo Solution Center Lenovo ThinkVantage Tools Create Recovery Media Adobe® Reader® Cyberlink PowerDVD Create (DVD±RW)
Monitor Cable	Optional DP to VGA, DP to DVI-D (single link), DP to dual DP, or DP to HDMI 1.4						Environment	ENERGY STAR® 6.1, EPEAT™ Gold rating (North America), ErP Lot 3, GREENGUARD®, RoHS-compliant, TUV low noise verified (on some models)
Chipset	Intel Q270 Chipset						Accessories	For compatible accessories, please go to http://www.lenovoquickpick.com
Front ports*	Four USB 3.1 Gen1, optional two USB 3.1 Type-C Gen 2 (only available via special bid), microphone (3.5mm), headphone (3.5mm)							
Rear ports*	Four USB 3.1 Gen1, optional two USB 2.0, serial (9-pin), optional 2nd serial (9-pin), optional parallel (25-pin), ethernet (RJ-45), one VGA, two DisplayPort, optional two PS/2 ports (keyboard/mouse); additional VGA, DisplayPort, DVI-D, or HDMI on optional graphics on some models							
Rear audio ports* IEEE 1394*	Line-in (3.5mm), line-out (3.5mm), microphone-in (3.5mm) None * Depending on many factors, actual data transfer speed may be lower than theoretical speed							
Audio support	High Definition (HD) Audio, Realtek ALC662 / optional internal speaker (1.5 watt)							
WLAN	Some: 11ac wireless, M.2 Card, Qualcomm Atheros QCA9377A (dual band), Wi-Fi + Bluetooth 4.1 combo adapter, 1x1 Some: 11ac wireless, M.2 Card, Qualcomm Atheros QCA6174A (dual band), Wi-Fi + Bluetooth 4.1 combo adapter, 2x2 Some: 11ac wireless, M.2 Card, Intel Dual Band Wireless-AC 3165, Wi-Fi + Bluetooth 4.1 combo adapter, 1x1 Some: 11ac wireless, M.2 Card, Intel Dual Band Wireless-AC 8265, Wi-Fi + Bluetooth 4.1 combo adapter, 2x2 Some: 11ac wireless, M.2 Card, Intel Dual Band Wireless-AC 8265, Wi-Fi + Bluetooth 4.1 combo adapter, Intel vPro technology support, 2x2							
Bluetooth™	Some: Bluetooth 4.1 wireless, integrated in Wi-Fi + BT combo adapter							

Note: The specifications above may not be available in all regions.

Lenovo, August 2017



ThinkCentre M910x Tiny Platform Specifications

Product Specifications Reference (PSREF)

Processor	Intel® Celeron®, Intel Pentium®, or 6/7th Generation Intel Core™ i3 / i5 / i7 Processor						Ethernet	Gigabit ethernet, Intel Ethernet Connection I219-LM(Jacksonville), Wake on LAN®														
	Processor	Cores / Threads	Frequency Base/Max(GHz)	Cache	Memory Support (Up to)	Integrated Graphics	Manageability	Intel Active Management Technology 11.0 (Intel AMT 11.0); Intel vPro technology on some models (require choosing a vPro-support Wi-Fi adapter to enable vPro function through wireless connection)														
	Core i5-6500T	4 / 4	2.5G / 3.1G	6 MB	DDR4-2133	HD 530	Security chip	TPM (Trusted Platform Module) 2.0*, TCG Certified * Downgrade to TPM1.2 for the models with Win10 DG Win7 32 OS														
	Core i7-6700T	4 / 8	2.8G / 3.6G	8 MB	DDR4-2133	HD 530	Security features	<ul style="list-style-type: none"> Security slot (in rear for optional Kensington® MicroSaver® cable) Smart USB protection, allows keyboard/ mouse only, blocks all storage devices Power-on password Administrator password Hard disk password Boot sequence control Boot without keyboard and mouse Individual USB port disablement Chassis intrusion switch 														
	Core i5-7500T	4 / 4	2.7G / 3.3G	6 MB	DDR4-2400	HD 630	Keyboard	<i>Some:</i> Lenovo Calliope Keyboard (USB connector), black <i>Some:</i> Lenovo Traditional Keyboard (USB connector), black <i>Some:</i> Lenovo Calliope Wireless Keyboard (2.4GHz via USB receiver), black <i>Some:</i> Lenovo Calliope Mouse (USB connector), black <i>Some:</i> Lenovo Calliope Wireless Mouse (2.4GHz via USB receiver), black														
	Core i5-7600T	4 / 4	2.8G / 3.7G	6 MB	DDR4-2400	HD 630	Mouse															
	Core i7-7700T	4 / 8	2.9G / 3.8G	8 MB	DDR4-2400	HD 630	Mechanical	Tiny (1L), black color; metal case <ul style="list-style-type: none"> Toolless chassis open Toolless HDD, SSD, memory removal Optional toolless chassis screw Optional dust filter 														
	Core i5-6500	4 / 4	3.2G / 3.6G	6 MB	DDR4-2133	HD 530		<table border="1"> <thead> <tr> <th></th> <th>Dimensions (WxDxH)</th> <th>Weight (Approx.)</th> </tr> </thead> <tbody> <tr> <td>M910 Tiny only</td> <td>7.05" X 7.20" X 1.36" 179mm X 182.9mm X 34.5mm</td> <td>2.91 lb (1.32 kg), vary by config</td> </tr> <tr> <td>With VESA mount & ODD box</td> <td>7.42" X 7.30" X 2.48" 188.4mm X 185.38mm X 63mm</td> <td>3.66 lb (1.66 kg), vary by config</td> </tr> <tr> <td>With VESA mount & I/O box</td> <td>7.42" X 7.30" X 2.62" 188.4mm X 185.38mm X 66.6mm</td> <td>3.66 lb (1.66 kg), vary by config</td> </tr> </tbody> </table>				Dimensions (WxDxH)	Weight (Approx.)	M910 Tiny only	7.05" X 7.20" X 1.36" 179mm X 182.9mm X 34.5mm	2.91 lb (1.32 kg), vary by config	With VESA mount & ODD box	7.42" X 7.30" X 2.48" 188.4mm X 185.38mm X 63mm	3.66 lb (1.66 kg), vary by config	With VESA mount & I/O box	7.42" X 7.30" X 2.62" 188.4mm X 185.38mm X 66.6mm	3.66 lb (1.66 kg), vary by config
	Dimensions (WxDxH)	Weight (Approx.)																				
M910 Tiny only	7.05" X 7.20" X 1.36" 179mm X 182.9mm X 34.5mm	2.91 lb (1.32 kg), vary by config																				
With VESA mount & ODD box	7.42" X 7.30" X 2.48" 188.4mm X 185.38mm X 63mm	3.66 lb (1.66 kg), vary by config																				
With VESA mount & I/O box	7.42" X 7.30" X 2.62" 188.4mm X 185.38mm X 66.6mm	3.66 lb (1.66 kg), vary by config																				
	Core i7-6700	4 / 8	3.4G / 4.0G	8 MB	DDR4-2133	HD 530	VESA mount Floor Stand	Optional VESA mount bracket kit, supports VESA 75mm and 100mm Optional system floor stand for vertical orientation														
	Core i5-7500	4 / 4	3.4G / 3.8G	6 MB	DDR4-2400	HD 630	Power supply	135 watts AC/DC adapter, autosensing, 88% PSU														
	Core i5-7600	4 / 4	3.5G / 4.1G	6 MB	DDR4-2400	HD 630	Limited warranty ³	<i>Some:</i> 1-year or 3-year, depot service / service upgrades available <i>Some:</i> 1-year or 3-year, limited onsite service / service upgrades available														
	Core i7-7700	4 / 8	3.6G / 4.2G	8 MB	DDR4-2400	HD 630	Preload	<i>Some:</i> Windows® 7 Professional 32/64 preinstalled through downgrade rights in Windows 10 Pro 64-bit (not available with 7th Gen Intel processor) <i>Some:</i> Windows 10 Pro 64-bit <i>Some:</i> Windows 10 Home 64-bit Preloaded applications (only some listed) <ul style="list-style-type: none"> Microsoft Office preloaded; purchase a product key to activate Only for Window 10 Lenovo Companion Intel Unite download link (vPro models only) Only for Window 7 Lenovo Solution Center Lenovo ThinkVantage Tools Create Recovery Media Adobe® Reader® Cyberlink PowerDVD Create (DVD±RW) Intel Unite (vPro models only) 														
Memory	32GB max, DDR4-2400*, two 260-pin SO-DIMM sockets, non-ECC, dual-channel capable * System automatically clocks down for the processors with lower memory controller																					
Storage	<i>Some:</i> Hard Drive* / SATA 6.0Gb/s, 2.5", 5400 rpm or 7200 rpm, APS <i>Some:</i> Solid State Drive (SSD)* / SATA 6.0Gb/s, 2.5" (* 2.5" HDD/SSD and RX 460 graphics are mutually exclusive) <i>Some:</i> M.2 SSD (support up to two M.2 SSD) / PCIe NVMe, PCIe 3.0 x 4, 32Gb/s, RAID 0/1 support (RAID preset only available via special bid model)																					
Optical	<i>Some:</i> Intel Optane™ Memory (models with 7th gen Core processor), M.2 <i>Some:</i> DVD-ROM, slim (9.0mm), via USB external ODD box <i>Some:</i> DVD Burner (DVD±RW), slim (9.0mm), via USB external ODD box																					
Onboard SATA Media reader	One onboard SATA 6.0Gb/s connector None																					
Graphics	Intel HD Graphics 510/530/610/630 in processor, uses main memory, DirectX® 12, two DisplayPort™, one optional video port (HDMI, VGA, 3rd DP, or USB 3.1 Type-C with DisplayPort Alternate Mode), up to 3 independent displays; <i>Max resolution:</i> 4096x2304 (DP) @60Hz; 4096x2304 (Type-C) @60Hz; 4096x2160 (HDMI) @24Hz; 1920x1200 (VGA) @60Hz <i>Some:</i> AMD Radeon™ RX 460 , DirectX 12, 4GB, PCIe 3.0 x8 adapter (low profile), four mini DisplayPort, 35 watts (TDP), up to 4 independent displays, works along with 2 onboard DisplayPort to support up to 6 independent displays; <i>Max resolution:</i> 5120x2880 @60Hz (up to 2 mini DisplayPort); 4096x2160 @60Hz (up to 4 mini DisplayPort)																					
Monitor cable	Optional DP to VGA, DP to DVI-D, DP to dual DP, mini DP to DP, or DP to HDMI 1.4																					
Chipset	Intel Q270 Chipset																					
Front ports*	Two USB 3.1 Gen1 (one is Always On and fast charge), one microphone (3.5mm), one headphone / microphone combo jack (3.5mm)																					
Rear ports*	Four USB 3.1 Gen1 (optional optical box or I/O box occupies one or two specific USB 3.1 Gen1), ethernet (RJ-45), two DisplayPort, two optional ports (not available for the models with RX 460 graphics): Port 1 for [VGA / 3rd DP / HDMI / serial / USB 3.1 Type-C Gen 1 (with DisplayPort Alternate Mode)]; Port 2 for [serial]																					
I/O box*	Optional external I/O box, extends two USB 2.0, two USB 3.1 Gen1, and one serial on rear, two USB 2.0 on front, via USB cable (occupy 2 specific USB 3.1 G1 of Tiny) * Depending on many factors, actual data transfer speed may be lower than theoretical speed																					
Audio support	High Definition (HD) Audio, Realtek ALC294 / optional internal speaker (1w or 2w)																					
WLAN ¹³	<i>Some:</i> 11ac wireless, M.2 Card, Qualcomm Atheros QCA9377A (dual band), Wi-Fi + Bluetooth 4.2 combo adapter, 1x1 <i>Some:</i> 11ac wireless, M.2 Card, Qualcomm Atheros QCA6174A (dual band), Wi-Fi + Bluetooth 4.2 combo adapter, 2x2 <i>Some:</i> 11ac wireless, M.2 Card, Intel Dual Band Wireless-AC 3165, Wi-Fi + Bluetooth 4.2 combo adapter, 1x1 <i>Some:</i> 11ac wireless, M.2 Card, Intel Dual Band Wireless-AC 8265, Wi-Fi + Bluetooth 4.2 combo adapter, 2x2 <i>Some:</i> 11ac wireless, M.2 Card, Intel Dual Band Wireless-AC 8265, Wi-Fi + Bluetooth 4.2 combo adapter, Intel vPro technology support, 2x2																					
Bluetooth™	<i>Some:</i> Bluetooth 4.2 wireless, integrated in Wi-Fi + BT combo adapter * Hardware supports BT 4.2, but Win10 RS3 and earlier only supports BT 4.1																					
Environment	ENERGY STAR® 6.1, EPEAT™ Gold rating (North America), ErP Lot 3, GREENGUARD®, RoHS-compliant, TUV low noise verified (on some models)																					
MIL-SPEC test	MIL-STD-810G military certification (Low Pressure [Altitude], High Temperature, Low Temperature, Temperature Shock, Humidity, Sand and Dust, Vibration, Shock, Fungus, Solar Radiation)																					
Accessories	For compatible accessories, please go to http://www.lenovoquickpick.com																					

See footnotes for more detailed information

© Lenovo (M910x Tiny-Spec) May 2017



ThinkCentre M920 SFF Platform Specifications

Product Specifications Reference (PSREF)

Processor	Intel® Celeron®, Intel Pentium®, or 8th / 9th Gen Intel Core™ i3 / i5 / i7 / i9 Processor	Audio support	High Definition (HD) Audio, Realtek ALC233VB2 / internal speaker (2 watt)																																																																																																																																															
	<table border="1"> <thead> <tr> <th>Processor</th> <th>Cores / Threads</th> <th>Frequency Base/Max(GHz)</th> <th>Cache</th> <th>Memory Support (Up to)</th> <th>Integrated Graphics</th> </tr> </thead> <tbody> <tr><td>Celeron G4900</td><td>2 / 2</td><td>3.1G</td><td>2 MB</td><td>DDR4-2400</td><td>UHD 610</td></tr> <tr><td>Celeron G4920</td><td>2 / 2</td><td>3.2G</td><td>2 MB</td><td>DDR4-2400</td><td>UHD 610</td></tr> <tr><td>Celeron G4930</td><td>2 / 2</td><td>3.2G</td><td>2 MB</td><td>DDR4-2400</td><td>UHD 610</td></tr> <tr><td>Celeron G4950</td><td>2 / 2</td><td>3.3G</td><td>2 MB</td><td>DDR4-2400</td><td>UHD 610</td></tr> <tr><td>Pentium Gold G5400</td><td>2 / 4</td><td>3.7G</td><td>4 MB</td><td>DDR4-2400</td><td>UHD 610</td></tr> <tr><td>Pentium Gold G5500</td><td>2 / 4</td><td>3.8G</td><td>4 MB</td><td>DDR4-2400</td><td>UHD 630</td></tr> <tr><td>Pentium Gold G5600</td><td>2 / 4</td><td>3.9G</td><td>4 MB</td><td>DDR4-2400</td><td>UHD 630</td></tr> <tr><td>Pentium Gold G5420</td><td>2 / 4</td><td>3.8G</td><td>4 MB</td><td>DDR4-2400</td><td>UHD 610</td></tr> <tr><td>Pentium Gold G5620</td><td>2 / 4</td><td>4.0G</td><td>4 MB</td><td>DDR4-2400</td><td>UHD 630</td></tr> <tr><td>Core i3-8100</td><td>4 / 4</td><td>3.6G</td><td>6 MB</td><td>DDR4-2400</td><td>UHD 630</td></tr> <tr><td>Core i3-8300</td><td>4 / 4</td><td>3.7G</td><td>8 MB</td><td>DDR4-2400</td><td>UHD 630</td></tr> <tr><td>Core i5-8400</td><td>6 / 6</td><td>2.8G / 4.0G</td><td>9 MB</td><td>DDR4-2666</td><td>UHD 630</td></tr> <tr><td>Core i5-8500</td><td>6 / 6</td><td>3.0G / 4.1G</td><td>9 MB</td><td>DDR4-2666</td><td>UHD 630</td></tr> <tr><td>Core i5-8600</td><td>6 / 6</td><td>3.1G / 4.3G</td><td>9 MB</td><td>DDR4-2666</td><td>UHD 630</td></tr> <tr><td>Core i7-8700</td><td>6 / 12</td><td>3.2G / 4.6G</td><td>12 MB</td><td>DDR4-2666</td><td>UHD 630</td></tr> <tr><td>Core i3-9100</td><td>4 / 4</td><td>3.6G / 4.2G</td><td>6 MB</td><td>DDR4-2400</td><td>UHD 630</td></tr> <tr><td>Core i3-9300</td><td>4 / 4</td><td>3.7G / 4.3G</td><td>8 MB</td><td>DDR4-2400</td><td>UHD 630</td></tr> <tr><td>Core i3-9320</td><td>4 / 4</td><td>3.7G / 4.4G</td><td>8 MB</td><td>DDR4-2400</td><td>UHD 630</td></tr> <tr><td>Core i5-9400</td><td>6 / 6</td><td>2.9G / 4.1G</td><td>9 MB</td><td>DDR4-2666</td><td>UHD 630</td></tr> <tr><td>Core i5-9500</td><td>6 / 6</td><td>3.0G / 4.4G</td><td>9 MB</td><td>DDR4-2666</td><td>UHD 630</td></tr> <tr><td>Core i5-9600</td><td>6 / 6</td><td>3.1G / 4.6G</td><td>9 MB</td><td>DDR4-2666</td><td>UHD 630</td></tr> <tr><td>Core i7-9700</td><td>8 / 8</td><td>3.0G / 4.7G</td><td>12 MB</td><td>DDR4-2666</td><td>UHD 630</td></tr> <tr><td>Core i9-9900</td><td>8 / 16</td><td>3.1G / 5.0G</td><td>16 MB</td><td>DDR4-2666</td><td>UHD 630</td></tr> </tbody> </table>	Processor	Cores / Threads	Frequency Base/Max(GHz)	Cache	Memory Support (Up to)	Integrated Graphics	Celeron G4900	2 / 2	3.1G	2 MB	DDR4-2400	UHD 610	Celeron G4920	2 / 2	3.2G	2 MB	DDR4-2400	UHD 610	Celeron G4930	2 / 2	3.2G	2 MB	DDR4-2400	UHD 610	Celeron G4950	2 / 2	3.3G	2 MB	DDR4-2400	UHD 610	Pentium Gold G5400	2 / 4	3.7G	4 MB	DDR4-2400	UHD 610	Pentium Gold G5500	2 / 4	3.8G	4 MB	DDR4-2400	UHD 630	Pentium Gold G5600	2 / 4	3.9G	4 MB	DDR4-2400	UHD 630	Pentium Gold G5420	2 / 4	3.8G	4 MB	DDR4-2400	UHD 610	Pentium Gold G5620	2 / 4	4.0G	4 MB	DDR4-2400	UHD 630	Core i3-8100	4 / 4	3.6G	6 MB	DDR4-2400	UHD 630	Core i3-8300	4 / 4	3.7G	8 MB	DDR4-2400	UHD 630	Core i5-8400	6 / 6	2.8G / 4.0G	9 MB	DDR4-2666	UHD 630	Core i5-8500	6 / 6	3.0G / 4.1G	9 MB	DDR4-2666	UHD 630	Core i5-8600	6 / 6	3.1G / 4.3G	9 MB	DDR4-2666	UHD 630	Core i7-8700	6 / 12	3.2G / 4.6G	12 MB	DDR4-2666	UHD 630	Core i3-9100	4 / 4	3.6G / 4.2G	6 MB	DDR4-2400	UHD 630	Core i3-9300	4 / 4	3.7G / 4.3G	8 MB	DDR4-2400	UHD 630	Core i3-9320	4 / 4	3.7G / 4.4G	8 MB	DDR4-2400	UHD 630	Core i5-9400	6 / 6	2.9G / 4.1G	9 MB	DDR4-2666	UHD 630	Core i5-9500	6 / 6	3.0G / 4.4G	9 MB	DDR4-2666	UHD 630	Core i5-9600	6 / 6	3.1G / 4.6G	9 MB	DDR4-2666	UHD 630	Core i7-9700	8 / 8	3.0G / 4.7G	12 MB	DDR4-2666	UHD 630	Core i9-9900	8 / 16	3.1G / 5.0G	16 MB	DDR4-2666	UHD 630	<p>WLAN</p> <p><i>Some:</i> 11ac wireless, M.2 Card, Realtek RTL8821CE (dual band), Wi-Fi + Bluetooth 4.2 combo adapter, 1x1</p> <p><i>Some:</i> 11ac wireless, M.2 Card, Realtek RTL8822BE (dual band), Wi-Fi + Bluetooth 4.2 combo adapter, 2x2</p> <p><i>Some:</i> 11ac wireless, M.2 Card, Intel Dual Band Wireless-AC 3165, Wi-Fi + Bluetooth 4.2 combo adapter, 1x1</p> <p><i>Some:</i> 11ac wireless, M.2 Card, Intel Dual Band Wireless-AC 8265, Wi-Fi + Bluetooth 4.2 combo adapter, 2x2</p> <p><i>Some:</i> 11ac wireless, M.2 Card, Intel Wireless-AC 9560 (dual band), Wi-Fi + Bluetooth 5.0 combo adapter, Intel vPro technology support, 2x2</p> <p>Bluetooth</p> <p>Ethernet</p> <p>Ethernet (Opt.)</p> <p><i>Some:</i> Bluetooth 4.2/5.0 wireless, integrated in Wi-Fi + BT combo adapter</p> <p><i>Some:</i> Gigabit ethernet, Intel Ethernet Connection I219-LM(Jacksonville), Wake on LAN®</p> <p><i>Some:</i> Intel Ethernet Server Adapter I350-T4, gigabit ethernet, 4x RJ-45, PCIe x4</p> <p><i>Some:</i> Bitland BN8E88, gigabit ethernet, 1x RJ-45, PCIe x1 (special bid only)</p> <p>Manageability</p> <p>Intel Active Management Technology 12 (Intel AMT 12); Intel vPro technology on some models (require choosing a vPro-support Wi-Fi adapter to enable vPro function through wireless connection)</p> <p>Security chip</p> <p>Discrete TPM 2.0, TCG Certified</p> <p>Security features</p> <ul style="list-style-type: none"> • Security slot (in rear for optional Kensington® MicroSaver® cable) • Padlock loop • Optional cable lock to physically lock both keyboard and mouse • Optional chassis intrusion switch • Optional chassis E-Lock (special bid) • Power-on password • Administrator password • Hard disk password • Boot sequence control • Boot without keyboard and mouse • Individual USB port disablement • Smart USB protection, allows keyboard/mouse only, blocks all storage devices <p>Keyboard</p> <p><i>Some:</i> Lenovo Calliope Keyboard (USB connector), black</p> <p><i>Some:</i> Lenovo Traditional Keyboard (USB connector), black</p> <p><i>Some:</i> Lenovo Calliope Wireless Keyboard (2.4GHz via USB receiver), black</p> <p><i>Some:</i> Lenovo Keyboard (PS/2 connector), black (only available via special bid)</p> <p><i>Some:</i> Lenovo Calliope Mouse (USB connector), black</p> <p><i>Some:</i> Lenovo Fingerprint Mouse (USB connector), Windows Hello support, black</p> <p><i>Some:</i> Lenovo Calliope Wireless Mouse (2.4GHz via USB receiver), black</p> <p><i>Some:</i> Lenovo Mouse (PS/2 connector), black (only available via special bid)</p> <p>Mouse</p> <p>Mechanical</p> <ul style="list-style-type: none"> • SFF (8.4L), black color, metal case • (WxDxH) 3.6" X 11.4" X 13.5"; 92.5mm X 290.5mm X 343.5mm • Approx. 13.23 lb (6 kg), weight may vary by configuration • Toolless cover, disk, optical, extension card removal • Optional dust filter Bay 1: Slim external ODD bay Bay 2: 3.5", 1" high, internal, HDD/SSD Bay 3: 2.5", internal, HDD/SSD (optional bay) Slot 1: low-profile (length < 150mm, height < 68mm), PCIe 3.0 x16 Slot 2: low-profile (length < 150mm, height < 68mm), PCIe 3.0 x1 Slot 3: low-profile (length < 150mm, height < 68mm), PCIe 3.0 x16 (x4 signal) Slot 4: no slot, only bracket for optional port extension M.2 card slots: Two (one for WLAN, one for SSD/Optane) <p>Floor Stand</p> <p>Optional system floor stand for vertical orientation</p> <p>Power supply</p> <p><i>Some:</i> 180 watts, autosensing, 85% PSU</p> <p><i>Some:</i> 210 watts, autosensing, 85% PSU</p> <p><i>Some:</i> 260 watts, autosensing, 92% PSU (only available via special bid)</p> <p>Limited warranty</p> <p><i>Some:</i> 1-year or 3-year, depot service / service upgrades available</p> <p><i>Some:</i> 1-year or 3-year, limited onsite service / service upgrades available</p> <p>Preload</p> <p><i>Some:</i> Windows® 10 Pro 64-bit</p> <p><i>Some:</i> Windows 10 Home 64-bit</p> <p>Environment</p> <p>ENERGY STAR® 6.1, EPEAT™ Silver rating (North America), ErP Lot 3, TCO, TUV low noise verified (coming soon, on some models), RoHS-compliant</p> <p>Accessories</p> <p>For compatible accessories, please go to http://smartfind.lenovo.com</p>
Processor	Cores / Threads	Frequency Base/Max(GHz)	Cache	Memory Support (Up to)	Integrated Graphics																																																																																																																																													
Celeron G4900	2 / 2	3.1G	2 MB	DDR4-2400	UHD 610																																																																																																																																													
Celeron G4920	2 / 2	3.2G	2 MB	DDR4-2400	UHD 610																																																																																																																																													
Celeron G4930	2 / 2	3.2G	2 MB	DDR4-2400	UHD 610																																																																																																																																													
Celeron G4950	2 / 2	3.3G	2 MB	DDR4-2400	UHD 610																																																																																																																																													
Pentium Gold G5400	2 / 4	3.7G	4 MB	DDR4-2400	UHD 610																																																																																																																																													
Pentium Gold G5500	2 / 4	3.8G	4 MB	DDR4-2400	UHD 630																																																																																																																																													
Pentium Gold G5600	2 / 4	3.9G	4 MB	DDR4-2400	UHD 630																																																																																																																																													
Pentium Gold G5420	2 / 4	3.8G	4 MB	DDR4-2400	UHD 610																																																																																																																																													
Pentium Gold G5620	2 / 4	4.0G	4 MB	DDR4-2400	UHD 630																																																																																																																																													
Core i3-8100	4 / 4	3.6G	6 MB	DDR4-2400	UHD 630																																																																																																																																													
Core i3-8300	4 / 4	3.7G	8 MB	DDR4-2400	UHD 630																																																																																																																																													
Core i5-8400	6 / 6	2.8G / 4.0G	9 MB	DDR4-2666	UHD 630																																																																																																																																													
Core i5-8500	6 / 6	3.0G / 4.1G	9 MB	DDR4-2666	UHD 630																																																																																																																																													
Core i5-8600	6 / 6	3.1G / 4.3G	9 MB	DDR4-2666	UHD 630																																																																																																																																													
Core i7-8700	6 / 12	3.2G / 4.6G	12 MB	DDR4-2666	UHD 630																																																																																																																																													
Core i3-9100	4 / 4	3.6G / 4.2G	6 MB	DDR4-2400	UHD 630																																																																																																																																													
Core i3-9300	4 / 4	3.7G / 4.3G	8 MB	DDR4-2400	UHD 630																																																																																																																																													
Core i3-9320	4 / 4	3.7G / 4.4G	8 MB	DDR4-2400	UHD 630																																																																																																																																													
Core i5-9400	6 / 6	2.9G / 4.1G	9 MB	DDR4-2666	UHD 630																																																																																																																																													
Core i5-9500	6 / 6	3.0G / 4.4G	9 MB	DDR4-2666	UHD 630																																																																																																																																													
Core i5-9600	6 / 6	3.1G / 4.6G	9 MB	DDR4-2666	UHD 630																																																																																																																																													
Core i7-9700	8 / 8	3.0G / 4.7G	12 MB	DDR4-2666	UHD 630																																																																																																																																													
Core i9-9900	8 / 16	3.1G / 5.0G	16 MB	DDR4-2666	UHD 630																																																																																																																																													
Memory	64GB max, DDR4-2666*, four 288-pin DIMM sockets, dual-channel capable * System automatically clocks down for the processors with lower memory controller																																																																																																																																																	
Storage	<i>Some:</i> Hard Drive / SATA 6.0Gb/s, 2.5" or 3.5", 5400 rpm or 7200 rpm <i>Some:</i> Solid State Drive (SSD) / SATA 6.0Gb/s, 2.5" <i>Some:</i> M.2 Solid State Drive (SSD) / PCIe NVMe, PCIe 3.0 x 4*, 32Gb/s * 128GB SSD M.2 (2242) PCIe NVMe only supports PCIe 3.0 x 2, 16Gb/s <i>Some:</i> Intel Optane™ Memory (not support Celeron / Pentium Processor), M.2 <i>Some:</i> DVD-ROM, SATA 1.5Gb/s Drive, slim (9.0mm) <i>Some:</i> DVD Burner (DVD±RW), SATA 1.5Gb/s Drive, slim (9.0mm)																																																																																																																																																	
Optical	Four onboard SATA 6.0Gb/s connectors, RAID 0/1 support (RAID preset only available via special bid model)																																																																																																																																																	
Onboard SATA	Optional 7-in-1 media reader																																																																																																																																																	
Media reader																																																																																																																																																		
Graphics	Intel UHD Graphics 610/630 in processor, uses main memory, DirectX® 12, one VGA, two DisplayPort™, supports 3 independent displays, works along with discrete graphics to support more displays: <i>Max resolution:</i> 4096x2304 (DP)@60Hz; 2048x1536 (VGA)@50Hz <i>Some:</i> NVIDIA GeForce® GT 730 , DirectX 12, 2GB, PCIe 2.0 x16 adapter, two DisplayPort, 35 watts; <i>Max resolution:</i> 3840x2160 (DisplayPort)@60Hz;																																																																																																																																																	
Monitor cable	Optional DP to VGA dongle, DP to DVI-D dongle, DP to dual DP dongle (for Collage Display with intel integrated graphics), or DP to HDMI 1.4 dongle																																																																																																																																																	
Chipset	Intel Q370 Chipset																																																																																																																																																	
Front ports* (Std.)	2x USB 3.1 Gen2, 2x USB 3.1 Gen1, 1x USB 3.1 Type-C Gen1 (15W charging), 1x microphone (3.5mm), 1x headphone / microphone combo jack (3.5mm)																																																																																																																																																	
Front ports* (Opt.)	<i>Optional:</i> 1x media reader																																																																																																																																																	
Rear ports* (Std.)	4x USB 3.1 Gen1, 1x serial (9-pin), 1x ethernet (RJ-45), 1x VGA, 2x DisplayPort, 1x line-out (3.5mm)																																																																																																																																																	
Rear ports* (Opt.)	<i>Optional:</i> 2x USB 2.0, 2x USB 3.1 Gen1 via PCIe x1, 2x USB 3.1 Type-C Gen2 via PCIe x4 (special bid only), 1x 2nd serial (9-pin), 4x serial (9-pin) via PCIe x1, 1x parallel (25-pin), 2x PS/2 ports (keyboard/mouse), 1x Thunderbolt 3 (combo USB3.1 Type-C Gen 2 / DisplayPort) via PCIe x4 (available on 09/30/2018), additional RJ-45 and video ports available on optional graphics or ethernet card * Depending on many factors, actual data transfer speed may be lower than theoretical speed																																																																																																																																																	

Note: The specifications above may not be available in all regions.

Lenovo, June 2019



ThinkCentre M920 Tiny Platform Specifications

Product Specifications Reference (PSREF)

Processor	Intel® Celeron®, Intel Pentium®, or 8th / 9th Gen Intel Core™ i3 / i5 / i7 / i9 Processor						Bluetooth Ethernet (Opt.) Some: Bluetooth 4.2/5.0 wireless, integrated in Wi-Fi + BT combo adapter Gigabit ethernet, Intel Ethernet Connection I219-LM(Jacksonville), Wake on LAN® Some: Intel Ethernet Server Adapter I350-T4, gigabit ethernet, 4x RJ-45, PCIe x4									
	Processor	Cores / Threads	Frequency Base/Max(GHz)	Cache	Memory Support (Up to)	Integrated Graphics										
	Celeron G4900T	2 / 2	2.9G	2 MB	DDR4-2400	UHD 610										
	Celeron G4930T	2 / 2	3.0G	2 MB	DDR4-2400	UHD 610										
	Pentium Gold G5400T	2 / 4	3.1G	4 MB	DDR4-2400	UHD 610										
	Pentium Gold G5500T	2 / 4	3.2G	4 MB	DDR4-2400	UHD 630										
	Pentium Gold G5600T	2 / 4	3.3G	4 MB	DDR4-2400	UHD 630										
	Pentium Gold G5420T	2 / 4	3.2G	4 MB	DDR4-2400	UHD 610										
	Core i3-8100T	4 / 4	3.1G	6 MB	DDR4-2400	UHD 630										
	Core i3-8300T	4 / 4	3.2G	8 MB	DDR4-2400	UHD 630										
	Core i5-8400T	6 / 6	1.7G / 3.3G	9 MB	DDR4-2666	UHD 630										
	Core i5-8500T	6 / 6	2.1G / 3.5G	9 MB	DDR4-2666	UHD 630										
	Core i5-8600T	6 / 6	2.3G / 3.7G	9 MB	DDR4-2666	UHD 630										
	Core i7-8700T	6 / 12	2.4G / 4.0G	12 MB	DDR4-2666	UHD 630										
	Core i3-9100T	4 / 4	3.1G / 3.7G	6 MB	DDR4-2400	UHD 630										
	Core i3-9300T	4 / 4	3.2G / 3.8G	8 MB	DDR4-2400	UHD 630										
	Core i5-9400T	6 / 6	1.8G / 3.4G	9 MB	DDR4-2666	UHD 630										
	Core i5-9500T	6 / 6	2.2G / 3.7G	9 MB	DDR4-2666	UHD 630										
	Core i5-9600T	6 / 6	2.3G / 3.9G	9 MB	DDR4-2666	UHD 630										
	Core i7-9700T	8 / 8	2.0G / 4.3G	12 MB	DDR4-2666	UHD 630										
Core i9-9900T	8 / 16	2.1G / 4.4G	16 MB	DDR4-2666	UHD 630											
Memory	32GB max, DDR4-2666*, two 260-pin SO-DIMM sockets, dual-channel capable * System automatically clocks down for the processors with lower memory controller						<table border="1"> <thead> <tr> <th></th> <th>Dimensions (WxDxH)</th> <th>Weight (Approx.)</th> </tr> </thead> <tbody> <tr> <td>Tiny only</td> <td>7.05" X 7.20" X 1.36" 179mm X 182.9mm X 34.5mm</td> <td>2.91 lb (1.32 kg), vary by config</td> </tr> <tr> <td>With VESA mount & ODD box</td> <td>7.42" X 7.30" X 2.48" 188.4mm X 185.38mm X 63mm</td> <td>3.66 lb (1.66 kg), vary by config</td> </tr> </tbody> </table>		Dimensions (WxDxH)	Weight (Approx.)	Tiny only	7.05" X 7.20" X 1.36" 179mm X 182.9mm X 34.5mm	2.91 lb (1.32 kg), vary by config	With VESA mount & ODD box	7.42" X 7.30" X 2.48" 188.4mm X 185.38mm X 63mm	3.66 lb (1.66 kg), vary by config
	Dimensions (WxDxH)	Weight (Approx.)														
Tiny only	7.05" X 7.20" X 1.36" 179mm X 182.9mm X 34.5mm	2.91 lb (1.32 kg), vary by config														
With VESA mount & ODD box	7.42" X 7.30" X 2.48" 188.4mm X 185.38mm X 63mm	3.66 lb (1.66 kg), vary by config														
Storage	Some: Hard Drive / SATA 6.0Gb/s, 2.5", 5400 rpm or 7200 rpm Some: Solid State Drive (SSD) / SATA 6.0Gb/s, 2.5" Some: M.2 SSD / PCIe NVMe, PCIe 3.0 x 4*, 32Gb/s * 128GB SSD M.2 (2242) PCIe NVMe only supports PCIe 3.0 x 2, 16Gb/s Some: Intel Optane™ Memory (not support Celeron / Pentium Processor), M.2 Some: DVD-ROM, slim (9.0mm), via USB external ODD box Some: DVD Burner (DVD±RW), slim (9.0mm), via USB external ODD box															
Optical	Some: DVD Burner (DVD±RW), slim (9.0mm), via USB external ODD box															
Onboard SATA	One onboard SATA 6.0Gb/s connector															
Graphics	Intel HD Graphics 610/630 in processor, uses main memory, DirectX® 12, one DisplayPort™, one HDMI, one optional video port (2nd HDMI, VGA, 2nd DP, or USB 3.1 Type-C Gen1 with DisplayPort function), up to 3 independent displays; Max resolution: 4096x2304 (DP)@60Hz; 4096x2304 (Type-C)@60Hz; 4096x2160 (onboard HDMI)@24Hz; 2048x1536 (VGA)@50Hz															
Monitor cable	Optional DP to VGA dongle, DP to DVI-D dongle, DP to dual DP dongle (for Collage Display with intel integrated graphics), or DP to HDMI 1.4 dongle															
Chipset	Intel Q370 Chipset															
Front ports (Std.)*	one USB 3.1 Gen1 (Always On and fast charge), one USB 3.1 Type-C Gen 1, one microphone (3.5mm), one headphone / microphone combo jack (3.5mm)															
Rear ports (Std.)*	2x USB 3.1 Gen2, 2x USB 3.1 Gen1, 1x ethernet (RJ-45), 1x DisplayPort, 1x HDMI															
Rear ports (Opt.)*	Two optional ports (mutually exclusive with PCIe card): Port 1 for VGA / 2nd DP / 2nd HDMI / serial / USB 3.1 Type-C Gen 1 with DP function); Port 2 for serial; Optional ports via PCIe card: 2x USB 3.1 Gen1 via PCIe x1, 4x serial (9-pin) via PCIe x1, 1x Thunderbolt 3 (combo USB3.1 Type-C Gen 2 / DisplayPort) via PCIe x4 * Depending on many factors, actual data transfer speed may be lower than theoretical speed															
Audio support	Realtek ALC233VB2 / optional internal speaker (1.5 watt or 2 watt)															
WLAN	Some: 11ac wireless, M.2 Card, Realtek RTL8821CE (dual band), Wi-Fi + Bluetooth 4.2 combo adapter, 1x1 Some: 11ac wireless, M.2 Card, Realtek RTL8822BE (dual band), Wi-Fi + Bluetooth 4.2 combo adapter, 2x2 Some: 11ac wireless, M.2 Card, Intel Dual Band Wireless-AC 3165, Wi-Fi + Bluetooth 4.2 combo adapter, 1x1 Some: 11ac wireless, M.2 Card, Intel Dual Band Wireless-AC 8265, Wi-Fi + Bluetooth 4.2 combo adapter, 2x2 Some: 11ac wireless, M.2 Card, Intel Wireless-AC 9560 (dual band), Wi-Fi + Bluetooth 5.0 combo adapter, Intel vPro technology support, 2x2															
Manageability	Intel Active Management Technology 12 (Intel AMT 12); Intel vPro technology on some models (require choosing a vPro-support Wi-Fi adapter to enable vPro function through wireless connection)															
Security chip	Discrete TPM 2.0, TCG Certified															
Security features	<ul style="list-style-type: none"> Security slot (in rear for optional Kensington® MicroSaver® cable) Chassis intrusion switch Power-on password Administrator password Hard disk password Boot sequence control Boot without keyboard and mouse Individual USB port disablement Smart USB protection, allows keyboard/mouse only, blocks all storage devices 															
Keyboard	Some: Lenovo Calliope Keyboard (USB connector), black Some: Lenovo Traditional Keyboard (USB connector), black Some: Lenovo Calliope Wireless Keyboard (2.4GHz via USB receiver), black															
Mouse	Some: Lenovo Calliope Mouse (USB connector), black Some: Lenovo Fingerprint Mouse (USB connector), Windows Hello support, black Some: Lenovo Calliope Wireless Mouse (2.4GHz via USB receiver), black															
Mechanical	Tiny (1L), black color; metal case <ul style="list-style-type: none"> Toolless chassis open (need optional toolless chassis screw) Toolless HDD, SSD, memory removal Optional dust filter one 2.5" bay for HDD/SSD, one PCIe 3.0 x8 slot (low-profile), two M.2 slots (one for WLAN, one for M.2 SSD), 2.5" HDD/SSD and PCIe card are mutually exclusive															
VESA mount	Optional VESA mount bracket kit, supports VESA 75mm and 100mm															
Floor Stand	Optional system floor stand for vertical orientation															
Power supply	Some: 65 watts AC/DC adapter, autosensing, 88% PSU Some: 90 watts AC/DC adapter, autosensing, 88% PSU Some: 135 watts AC/DC adapter, autosensing, 88% PSU															
Limited warranty	Some: 1-year or 3-year, depot service / service upgrades available Some: 1-year or 3-year, limited onsite service / service upgrades available															
Preload	Preloaded operating system Some: Windows® 10 Pro 64-bit Some: Windows 10 Home 64-bit Preloaded applications (only some listed) <ul style="list-style-type: none"> Lenovo Vantage Microsoft Office preloaded; purchase a product key to activate Cyberlink PowerDVD (only for models with DVD / DVD±RW) Cyberlink Power2GO (only for models with DVD±RW) LinkedIn Intel Unite (Machine Type 10V8 models only) 															
Environment	ENERGY STAR® 7.0, EPEAT™ Silver rating (North America), ErP Lot 3, TCO, TUV ultra low noise verified (coming soon, on some models), RoHS-compliant															
MIL-SPEC test	MIL-STD-810G military certification (Low Pressure [Altitude], High Temperature, Low Temperature, Temperature Shock, Humidity, Sand and Dust, Vibration, Shock, Fungus, Solar Radiation)															
Accessories	For compatible accessories, please go to http://smartfind.lenovo.com															

Note: The specifications above may not be available in all regions.

Lenovo, June 2019



ThinkCentre M920 Tower Platform Specifications

Product Specifications Reference (PSREF)

Processor	Intel® Celeron®, Intel Pentium®, or 8th /9th Gen Intel Core™ i3 / i5 / i7 / i9 Processor						USB3.1 Type-C Gen 2 / DisplayPort) via PCIe x4 (available on 09/30/2018), additional RJ-45 and video ports available on optional graphics or ethernet card * Depending on many factors, actual data transfer speed may be lower than theoretical speed
	Processor	Cores / Threads	Frequency Base/Max(GHz)	Cache	Memory Support (Up to)	Integrated Graphics	
	Celeron G4900	2 / 2	3.1G	2 MB	DDR4-2400	UHD 610	Audio support
	Celeron G4920	2 / 2	3.2G	2 MB	DDR4-2400	UHD 610	High Definition (HD) Audio, Realtek ALC233VB2 / internal speaker (2 watt)
	Celeron G4930	2 / 2	3.2G	2 MB	DDR4-2400	UHD 610	WLAN
	Celeron G4950	2 / 2	3.3G	2 MB	DDR4-2400	UHD 610	<i>Some:</i> 11ac Wi-Fi + BT 4.2, M.2 Card, Realtek RTL8821CE (dual band), 1x1 <i>Some:</i> 11ac Wi-Fi + BT 4.2, M.2 Card, Realtek RTL8822BE (dual band), 2x2 <i>Some:</i> 11ac Wi-Fi + BT 4.2, M.2 Card, Intel Dual Band Wireless-AC 3165, 1x1 <i>Some:</i> 11ac wireless, M.2 Card, Intel Dual Band Wireless-AC 8265, 2x2 <i>Some:</i> 11ac Wi-Fi + BT 5.0, M.2 Card, Intel Wireless-AC 9560 (dual band), Intel vPro technology support, 2x2
	Pentium Gold G5400	2 / 4	3.7G	4 MB	DDR4-2400	UHD 610	Bluetooth™
	Pentium Gold G5500	2 / 4	3.8G	4 MB	DDR4-2400	UHD 630	Gigabit ethernet, Intel Ethernet Connection I219-LM(Jacksonville), Wake on LAN®
	Pentium Gold G5600	2 / 4	3.9G	4 MB	DDR4-2400	UHD 630	<i>Some:</i> Intel Ethernet Server Adapter I350-T4, gigabit ethernet, 4x RJ-45, PCIe x4
	Pentium Gold G5420	2 / 4	3.8G	4 MB	DDR4-2400	UHD 610	Ethernet (Opt.)
	Pentium Gold G5620	2 / 4	4.0G	4 MB	DDR4-2400	UHD 630	<i>Some:</i> Bitland BN8E88, gigabit ethernet, 1x RJ-45, PCIe x1 (special bid only)
	Core i3-8100	4 / 4	3.6G	6 MB	DDR4-2400	UHD 630	Manageability
	Core i3-8300	4 / 4	3.7G	8 MB	DDR4-2400	UHD 630	Intel Active Management Technology 12 (Intel AMT 12); Intel vPro technology on some models (require choosing a vPro-support Wi-Fi adapter to enable vPro function through wireless connection)
	Core i5-8400	6 / 6	2.8G / 4.0G	9 MB	DDR4-2666	UHD 630	Security chip
	Core i5-8500	6 / 6	3.0G / 4.1G	9 MB	DDR4-2666	UHD 630	Discrete TPM 2.0, TCG Certified
	Core i5-8600	6 / 6	3.1G / 4.3G	9 MB	DDR4-2666	UHD 630	Security features
	Core i7-8700	6 / 12	3.2G / 4.6G	12 MB	DDR4-2666	UHD 630	<ul style="list-style-type: none"> Security slot (in rear for optional Kensington® MicroSaver® cable) Padlock loop Optional cable lock to physically lock both keyboard and mouse Optional chassis intrusion switch Optional chassis E-Lock (special bid) Power-on password Administrator password Hard disk password Boot sequence control Boot without keyboard and mouse Individual USB port disablement Smart USB protection, allows keyboard/mouse only, blocks all storage devices
	Core i3-9100	4 / 4	3.6G / 4.2G	6 MB	DDR4-2400	UHD 630	Keyboard
	Core i3-9300	4 / 4	3.7G / 4.3G	8 MB	DDR4-2400	UHD 630	<i>Some:</i> Lenovo Calliope Keyboard (USB connector), black <i>Some:</i> Lenovo Traditional Keyboard (USB connector), black <i>Some:</i> Lenovo Calliope Wireless Keyboard (2.4GHz via USB receiver), black <i>Some:</i> Lenovo Keyboard (PS/2 connector), black (only available via special bid)
	Core i3-9320	4 / 4	3.7G / 4.4G	8 MB	DDR4-2400	UHD 630	Mouse
	Core i5-9400	6 / 6	2.9G / 4.1G	9 MB	DDR4-2666	UHD 630	<i>Some:</i> Lenovo Calliope Mouse (USB connector), black <i>Some:</i> Lenovo Fingerprint Mouse (USB connector), Windows Hello support, black <i>Some:</i> Lenovo Calliope Wireless Mouse (2.4GHz via USB receiver), black <i>Some:</i> Lenovo Mouse (PS/2 connector), black (only available via special bid)
	Core i5-9500	6 / 6	3.0G / 4.4G	9 MB	DDR4-2666	UHD 630	Mechanical
	Core i5-9600	6 / 6	3.1G / 4.6G	9 MB	DDR4-2666	UHD 630	<ul style="list-style-type: none"> Tower (18L), black color, metal case (WxDxH) 6.5" X 12.65" X 16.15"; 165mm X 321.35mm X 410.25mm Approx. 15.45 lb (7 kg), weight may vary by configuration Toolless cover, disk, optical, extension card removal Optional carry handle, dust filter Bay 1: Slim external ODD bay Bay 2: 5.25", 1.6" high, external, ODD / optional front access HDD Bay 3: 3.5", 1" high, internal, HDD/SSD Bay 4: 3.5", 1" high, internal, HDD/SSD (optional bay, bay comes with disk) Bay 5: 2.5", internal, HDD/SSD (optional bay) Notes: M920 Tower supports up to 3 SATA devices (ODD/HDD/SSD) and 1 eSATA device (front access HDD) Slot 1: full-length (< 268mm) full-height (< 112mm), PCIe 3.0 x16 Slot 2: full-length (< 268mm) full-height (< 112mm), PCIe 3.0 x1 Slot 3: full-length (< 268mm) full-height (< 112mm), PCIe 3.0 x16 (x4 signal) Slot 4: no slot, only bracket for optional port extension M.2 card slots: Two (one for WLAN, one for SSD/Optane)
	Core i7-9700	8 / 8	3.0G / 4.7G	12 MB	DDR4-2666	UHD 630	Power supply
	Core i9-9900	8 / 16	3.1G / 5.0G	16 MB	DDR4-2666	UHD 630	<i>Some:</i> 180 watts, autosensing, 85% PSU <i>Some:</i> 250 watts, autosensing, 85% PSU <i>Some:</i> 400 watts, autosensing, 92% PSU (only available via special bid)
Memory	64GB max, DDR4-2666*, four 288-pin DIMM sockets, dual-channel capable * System automatically clocks down for the processors with lower memory controller						Limited warranty
Storage	<i>Some:</i> Hard Drive / SATA 6.0Gb/s, 2.5" or 3.5", 5400 rpm or 7200 rpm <i>Some:</i> Solid State Drive (SSD) / SATA 6.0Gb/s, 2.5" <i>Some:</i> M.2 Solid State Drive (SSD) / PCIe NVMe, PCIe 3.0 x 4*, 32Gb/s * SSD M.2 (2242) PCIe NVMe only supports PCIe 3.0 x 2, 16Gb/s <i>Some:</i> Intel Optane™ Memory (not support Celeron / Pentium Processor), M.2 Optional DVD-ROM or DVD Burner (DVD±RW), SATA 1.5Gb/s Drive, slim (9.0mm)						Preload
Optical	Four onboard SATA 6.0Gb/s connectors, RAID 0/1 support (RAID preset only available via special bid model)						Environment
Onboard SATA	Optional 7-in-1 media reader						Accessories
Media reader	Optional 7-in-1 media reader						For compatible accessories, please go to http://smartfind.lenovo.com
Graphics	Intel UHD Graphics 610/630 in processor, uses main memory, DirectX® 12, one VGA, two DisplayPort™, supports 3 independent displays, works along with discrete graphics to support more displays; <i>Max resolution:</i> 4096x2304 (DP)@60Hz; 2048x1536 (VGA)@50Hz <i>Some:</i> NVIDIA GeForce® GT 730 , DirectX 12, 2GB, PCIe 2.0 x16 adapter, two DisplayPort, 35 watts; <i>Max resolution:</i> 3840x2160 (DisplayPort)@60Hz; <i>Some:</i> NVIDIA GeForce GTX 1060 (special bid only), DirectX 12, 6GB, PCIe 3.0 x16 adapter, 1x DVI-D, 1x HDMI, 3x DP, 120 watts, occupies two slots; <i>Max resolution:</i> 2560x1600 (DVI-D)@60Hz; 4096x2160 (HDMI)@60Hz 5120x3200 (DP)@60Hz						
Monitor Cable	Optional DP to VGA dongle, DP to DVI-D dongle, DP to dual DP dongle (for Collage Display with intel integrated graphics), or DP to HDMI 1.4 dongle						
Chipset	Intel Q370 Chipset						
Front ports* (Std.)	2x USB 3.1 Gen2, 2x USB 3.1 Gen1, 1x USB 3.1 Type-C Gen1 (15W charging), 1x microphone (3.5mm), 1x headphone / microphone combo jack (3.5mm)						
Front ports* (Opt.)	Optional: 1x media reader						
Rear ports* (Std.)	4x USB 3.1 Gen1, 1x serial (9-pin), 1x ethernet (RJ-45), 1x VGA, 2x DisplayPort, 1x line-out (3.5mm)						
Rear ports* (Opt.)	Optional: 2x USB 2.0, 2x USB 3.1 Gen1 via PCIe x1, 2x USB 3.1 Type-C Gen2 via PCIe x4 (special bid only), 1x 2nd serial (9-pin), 4x serial (9-pin) via PCIe x1, 1x parallel (25-pin), 2x PS/2 ports (keyboard/mouse), 1x Thunderbolt 3 (combo)						

Note: The specifications above may not be available in all regions.

Lenovo, June 2019



ThinkCentre M920x Tiny Platform Specifications

Product Specifications Reference (PSREF)

Processor		Intel® Celeron®, Intel Pentium®, or 8th / 9th Gen Intel Core™ i3 / i5 / i7 / i9 Processor													
Processor	Cores / Threads	Frequency Base/Max(GHz)	Cache	Memory Support (Up to)	Integrated Graphics										
Celeron G4900	2 / 2	3.1G	2 MB	DDR4-2400	UHD 610	4x Mini DisplayPort, up to 4 independent displays, works along with onboard DP and HDMI to support up to 6 independent displays; <i>Max resolution:</i> 5120x2880@60Hz ((up to 2 Mini DisplayPort); 4096x2160@60Hz ((up to 4 Mini DisplayPort)									
Celeron G4920	2 / 2	3.2G	2 MB	DDR4-2400	UHD 610										
Celeron G4930	2 / 2	3.2G	2 MB	DDR4-2400	UHD 610	Optional DP to VGA dongle, DP to DVI-D dongle, DP to dual DP dongle (for Collage Display with Intel integrated graphics), or DP to HDMI 1.4 dongle, Mini DP to DP									
Celeron G4950	2 / 2	3.3G	2 MB	DDR4-2400	UHD 610										
Pentium Gold G5400	2 / 4	3.7G	4 MB	DDR4-2400	UHD 610	Intel Q370 Chipset									
Pentium Gold G5500	2 / 4	3.8G	4 MB	DDR4-2400	UHD 630										
Pentium Gold G5600	2 / 4	3.9G	4 MB	DDR4-2400	UHD 630	Front ports (Std.)* one USB 3.1 Gen1 (Always On and fast charge), one USB 3.1 Type-C Gen 1, one microphone (3.5mm), one headphone / microphone combo jack (3.5mm) Rear ports (Std.)* 2x USB 3.1 Gen2, 2x USB 3.1 Gen1, 1x ethernet (RJ-45), 1x DP, 1x HDMI Rear ports (Opt.)* Two optional ports (mutually exclusive with PCIe card): Port 1 for VGA / 2nd DP / 2nd HDMI / serial / USB 3.1 Type-C Gen 1 with DP function); Port 2 for serial; Optional ports via PCIe card: 2x USB 3.1 Gen1 via PCIe x1, 4x serial (9-pin) via PCIe x1, 1x Thunderbolt 3 (combo USB3.1 Type-C Gen 2 / DP) via PCIe x4 * Depending on many factors, actual data transfer speed may be lower than theoretical speed									
Pentium Gold G5420	2 / 4	3.8G	4 MB	DDR4-2400	UHD 610										
Pentium Gold G5620	2 / 4	4.0G	4 MB	DDR4-2400	UHD 630	Audio support Realtek ALC233VB2 / optional internal speaker (1.5 watt or 2 watt)									
Core i3-8100	4 / 4	3.6G	6 MB	DDR4-2400	UHD 630										
Core i3-8300	4 / 4	3.7G	8 MB	DDR4-2400	UHD 630	WLAN <i>Some:</i> 11ac Wi-Fi + BT 4.2, M.2 Card, Realtek RTL8821CE (dual band), 1x1 <i>Some:</i> 11ac Wi-Fi + BT 4.2, M.2 Card, Realtek RTL8822BE (dual band), 2x2 <i>Some:</i> 11ac Wi-Fi + BT 4.2, M.2 Card, Intel Dual Band Wireless-AC 3165, 1x1 <i>Some:</i> 11ac Wi-Fi + BT 4.2, M.2 Card, Intel Dual Band Wireless-AC 8265, 2x2 <i>Some:</i> 11ac Wi-Fi + BT 5.0, M.2 Card, Intel Wireless-AC 9560 (dual band), Intel vPro technology support, 2x2									
Core i5-8400	6 / 6	2.8G / 4.0G	9 MB	DDR4-2666	UHD 630										
Core i5-8500	6 / 6	3.0G / 4.1G	9 MB	DDR4-2666	UHD 630	Bluetooth <i>Some:</i> Bluetooth 4.2/5.0 wireless, integrated in Wi-Fi + BT combo adapter Ethernet Gigabit ethernet, Intel Ethernet Connection I219-LM(Jacksonville), Wake on LAN® Ethernet (Opt.) <i>Some:</i> Intel Ethernet Server Adapter I350-T4, gigabit ethernet, 4x RJ-45, PCIe x4									
Core i5-8600	6 / 6	3.1G / 4.3G	9 MB	DDR4-2666	UHD 630										
Core i7-8700	6 / 12	3.2G / 4.6G	12 MB	DDR4-2666	UHD 630	Manageability Intel Active Management Technology 12 (Intel AMT 12); Intel vPro technology on some models (require choosing a vPro-support Wi-Fi adapter to enable vPro function through wireless connection)									
Core i3-9100	4 / 4	3.6G / 4.2G	6 MB	DDR4-2400	UHD 630										
Core i3-9300	4 / 4	3.7G / 4.3G	8 MB	DDR4-2400	UHD 630	Security chip Discrete TPM 2.0, TCG Certified Security features <ul style="list-style-type: none">• Security slot (in rear for optional Kensington® MicroSaver® cable)• Chassis intrusion switch• Power-on password• Administrator password• Hard disk password <ul style="list-style-type: none">• Boot sequence control• Boot without keyboard and mouse• Individual USB port disablement• Smart USB protection, allows keyboard/mouse only, blocks all storage devices									
Core i3-9320	4 / 4	3.7G / 4.4G	8 MB	DDR4-2400	UHD 630										
Core i5-9400	6 / 6	2.9G / 4.1G	9 MB	DDR4-2666	UHD 630	Keyboard <i>Some:</i> Lenovo Calliope Keyboard (USB connector), black <i>Some:</i> Lenovo Traditional Keyboard (USB connector), black <i>Some:</i> Lenovo Calliope Wireless Keyboard (2.4GHz via USB receiver), black Mouse <i>Some:</i> Lenovo Calliope Mouse (USB connector), black <i>Some:</i> Lenovo Fingerprint Mouse (USB connector), Windows Hello support, black <i>Some:</i> Lenovo Calliope Wireless Mouse (2.4GHz via USB receiver), black									
Core i5-9500	6 / 6	3.0G / 4.4G	9 MB	DDR4-2666	UHD 630										
Core i5-9600	6 / 6	3.1G / 4.6G	9 MB	DDR4-2666	UHD 630	Mechanical Tiny (1L), black color; metal case <ul style="list-style-type: none">• Toolless chassis open (need optional toolless chassis screw)• Toolless HDD, SSD, memory removal• Optional dust filter one 2.5" bay for HDD/SSD, one PCIe 3.0 x8 slot (low-profile), three M.2 slots (one for WLAN, two for M.2 SSD), 2.5" HDD/SSD and PCIe card are mutually exclusive									
Celeron G4900T	2 / 2	2.9G	2 MB	DDR4-2400	UHD 610										
Celeron G4930T	2 / 2	3.0G	2 MB	DDR4-2400	UHD 610	<table border="1"> <thead> <tr> <th></th> <th>Dimensions (WxDxH)</th> <th>Weight (Approx.)</th> </tr> </thead> <tbody> <tr> <td>Tiny only</td> <td>7.05" X 7.20" X 1.36" 179mm X 182.9mm X 34.5mm</td> <td>2.91 lb (1.32 kg), vary by config</td> </tr> <tr> <td>With VESA mount & ODD box</td> <td>7.42" X 7.30" X 2.48" 188.4mm X 185.38mm X 63mm</td> <td>3.66 lb (1.66 kg), vary by config</td> </tr> </tbody> </table>		Dimensions (WxDxH)	Weight (Approx.)	Tiny only	7.05" X 7.20" X 1.36" 179mm X 182.9mm X 34.5mm	2.91 lb (1.32 kg), vary by config	With VESA mount & ODD box	7.42" X 7.30" X 2.48" 188.4mm X 185.38mm X 63mm	3.66 lb (1.66 kg), vary by config
	Dimensions (WxDxH)	Weight (Approx.)													
Tiny only	7.05" X 7.20" X 1.36" 179mm X 182.9mm X 34.5mm	2.91 lb (1.32 kg), vary by config													
With VESA mount & ODD box	7.42" X 7.30" X 2.48" 188.4mm X 185.38mm X 63mm	3.66 lb (1.66 kg), vary by config													
Pentium Gold G5400T	2 / 4	3.1G	4 MB	DDR4-2400	UHD 610	VESA mount Optional VESA mount bracket kit, supports VESA 75mm and 100mm Floor Stand Optional system floor stand for vertical orientation									
Pentium Gold G5500T	2 / 4	3.2G	4 MB	DDR4-2400	UHD 630										
Pentium Gold G5600T	2 / 4	3.3G	4 MB	DDR4-2400	UHD 630	Power supply 135 watts AC/DC adapter, autosensing, 88% PSU									
Pentium Gold G5420T	2 / 4	3.2G	4 MB	DDR4-2400	UHD 610										
Core i3-8100T	4 / 4	3.1G	6 MB	DDR4-2400	UHD 630	Limited warranty <i>Some:</i> 1-year or 3-year, depot service / service upgrades available <i>Some:</i> 1-year or 3-year, limited onsite service / service upgrades available									
Core i3-8300T	4 / 4	3.2G	8 MB	DDR4-2400	UHD 630										
Core i5-8400T	6 / 6	1.7G / 3.3G	9 MB	DDR4-2666	UHD 630	Preload <i>Some:</i> Windows® 10 Pro 64-bit <i>Some:</i> Windows 10 Home 64-bit									
Core i5-8500T	6 / 6	2.1G / 3.5G	9 MB	DDR4-2666	UHD 630										
Core i5-8600T	6 / 6	2.3G / 3.7G	9 MB	DDR4-2666	UHD 630	Environment ENERGY STAR® 7.0, EPEAT™ Silver rating (North America), ErP Lot 3, TCO, TUV ultra low noise verified (coming soon, on some models), RoHS-compliant									
Core i7-8700T	6 / 12	2.4G / 4.0G	12 MB	DDR4-2666	UHD 630										
Core i3-9100T	4 / 4	3.1G / 3.7G	6 MB	DDR4-2400	UHD 630	MIL-SPEC test MIL-STD-810G military certification (Low Pressure [Altitude], High Temperature, Low Temperature, Temperature Shock, Humidity, Sand and Dust, Vibration, Shock, Fungus, Solar Radiation)									
Core i3-9300T	4 / 4	3.2G / 3.8G	8 MB	DDR4-2400	UHD 630										
Core i5-9400T	6 / 6	1.8G / 3.4G	9 MB	DDR4-2666	UHD 630	Accessories For compatible accessories, please go to http://smartfind.lenovo.com									
Core i5-9500T	6 / 6	2.2G / 3.7G	9 MB	DDR4-2666	UHD 630										
Core i5-9600T	6 / 6	2.3G / 3.9G	9 MB	DDR4-2666	UHD 630	Memory 32GB max, DDR4-2666*, two 260-pin SO-DIMM sockets, dual-channel capable * System automatically clocks down for the processors with lower memory controller									
Core i7-9700T	8 / 8	2.0G / 4.3G	12 MB	DDR4-2666	UHD 630										
Core i9-9900T	8 / 16	2.1G / 4.4G	16 MB	DDR4-2666	UHD 630	Storage <i>Some:</i> Hard Drive / SATA 6.0Gb/s, 2.5", 5400 rpm or 7200 rpm <i>Some:</i> Solid State Drive (SSD) / SATA 6.0Gb/s, 2.5" <i>Some:</i> M.2 SSD (support up to two M.2 SSD) / PCIe NVMe, PCIe 3.0 x 4", 32Gb/s, RAID 0/1 support (RAID preset only available via special bid model) * 128GB SSD M.2 (2242) PCIe NVMe only supports PCIe 3.0 x 2, 16Gb/s <i>Some:</i> Intel Optane™ Memory (not support Celeron / Pentium Processor), M.2 <i>Some:</i> DVD-ROM, slim (9.0mm), via USB external ODD box <i>Some:</i> DVD Burner (DVD±RW), slim (9.0mm), via USB external ODD box									
Core i9-9900T	8 / 16	2.1G / 4.4G	16 MB	DDR4-2666	UHD 630										
Optical						Onboard SATA One onboard SATA 6.0Gb/s connector									
Graphics							Intel HD Graphics 610/630 in processor, uses main memory, DirectX® 12, one DisplayPort™, one HDMI, one optional video port (2nd HDMI, VGA, 2nd DP, or USB 3.1 Type-C Gen1 with DisplayPort function), up to 3 independent displays; <i>Max resolution:</i> c4096x2304 (DP) @60Hz; 4096x2304 (Type-C) @60Hz; 4096x2160 (onboard HDMI) @24Hz; 2048x1536 (VGA) @50Hz <i>Some:</i> AMD Radeon™ RX 560, DirectX 12, 4GB GDDR5, PCIe 3.0 x8 adapter,								

Note: The specifications above may not be available in all regions.

Lenovo, June 2019



ThinkSmart Hub 500 Platform Specifications

Product Specifications Reference (PSREF)

Positioning	Purpose-built Skype Room Systems device						Security chip	TPM (Trusted Platform Module) 2.0, TCG Certified
Processor	7th Gen Intel Core™ i5 Processor with vPro						Security features	<ul style="list-style-type: none"> • Security slot (in rear for attachment of optional Kensington® MicroSaver® cable; Kensington lock also locks chassis) • Secure cable management door • Power-on, admin, hard disk password • Boot sequence control • Boot without keyboard and mouse • USB port disablement
	Processor	Cores / Threads	Frequency Base/Max(GHz)	Cache	Memory Support (Up to)	Integrated Graphics		
	Core i5-7500T	4 / 4	2.7G / 3.3G	6 MB	DDR4-2400	HD 630		
Memory	4GBx2, DDR4-2400, two 260-pin SO-DIMM sockets, dual-channel capable						Keyboard	None
Storage	128GB M.2 Solid State Drive (SSD) / PCIe NVMe, PCIe 3.0 x 4, 32Gb/s						Mouse	None
Graphics Display	Intel HD Graphics 630 in processor, uses main memory, DirectX® 12 11.6" (294.64mm) Full HD 1080p (1920x1080) TFT color , wide viewing angle (+/- 85°), LED backlight, 300 nits, 16:9 aspect ratio, 800:1 contrast ratio, anti-glare, smudge resistant						Mechanical	<ul style="list-style-type: none"> • Business black color • (WxDxH) 7.60" X 10.98" X 7.02"; 193.25mm X 278.9mm X 178.45mm • Approx. 5.51 lb (2.5 kg) • Secure Cable Management Door, secures physical ports and prevents cables being accidentally disconnected • 360 degree rotatable Display
Multi-touch Sensor	Supports 10-point touch, OGS IR Presence/Motion sensor, automatically dim / brighten display (Detection angle: +/- 45% (from display); detection distance: 3 meters at minimum)						Power supply	90 watts adapter, autosensing, 88% efficiency
LED indicators	360 degree LED ring on hinge neck, indicates Skype status for all users in the room; power LED on power button						Limited warranty ³	3-year, limited onsite service / service upgrades available
Chipset	Intel Q270 Chipset						Preload	Preloaded operating system Windows® 10 IoT Enterprise CBB X64 (RS3) Preloaded applications Microsoft Skype Room Systems App
Ports*	Four USB 3.1 Gen1(Type A), two HDMI-out, one HDMI-in (1920x1080@60Hz at maximum), one ethernet (RJ-45), one headphone / microphone combo jack (3.5mm), one power connector <small>* Depending on many factors, actual data transfer speed may be lower than theoretical speed</small>						Certification	Skype for Business Group Certified
M.2 card slot	Two M.2 Card slots (one for WLAN, one for SSD)						Environment	ErP Lot 26, GREENGUARD® certified, RoHS, WEEE
Audio support	Dual 4W speakers, 2 omnidirectional microphones for 360 degree audio capture						Accessories	For compatible accessories, please go to http://www.lenovoquickpick.com
WLAN ¹³	11ac wireless, M.2 Card, Intel Dual Band Wireless-AC 8265,Wi-Fi + Bluetooth 4.1* combo adapter, Intel vPro technology support, 2x2							
Bluetooth™	Bluetooth 4.1* wireless, integrated in Wi-Fi + Bluetooth combo adapter * Hardware supports Bluetooth 4.2, but Win10 RS3 only supports Bluetooth 4.1							
Ethernet	Gigabit ethernet, Intel Ethernet Connection I219-LM (Jacksonville), Wake on LAN®							
Manageability	Intel Active Management Technology 11.0 (Intel AMT 11.0), Intel vPro technology							

See footnotes for more detailed information

© Lenovo
(Hub500-Spec) March 2018



ThinkCentre Tiny-in-One (TIO) 22

Product Specifications Reference (PSREF)

Model	10LKPAR6++ / 10LKPAT6++		
Form factor	Tiny-in-One, offers a full All-In-One experience when optional Tiny slots into the back of TIO 22, clean cabling and effortless setup		
Compatible Tiny:	M900 Tiny, M700 Tiny, M600 Tiny, M93/p Tiny*, M83 Tiny, M73 Tiny*, or M53 Tiny, Chromebox * Non-TIO models can't be turned on by pressing power button of TIO 22		
Panel	TFT-LCD, In-Plane Switching (IPS), White LED backlight		
Viewable image size	21.5" (546.1mm) diagonal		
Max view area (W x H)	18.74" x 10.54" / 476.06mm x 267.79mm		
Bezel Width	Top / Side: 2mm, Bottom: 16.3mm		
Optimum resolution	1920x1080		
Aspect ratio	16:9		
Pixel pitch (mm)	0.24795mm		
Dot/Pixel per Inch	102.4 dpi		
Brightness	250 nits or cd/m ² (typical)		
Contrast ratio	1000:1 (typical)		
Pixel response time	7ms		
Color gamut	72%		
Anti-reflective	Anti-glare		
Viewing angle at 10:1 CR	178° (+/- 89°) horizontal, 178° (+/- 89°) vertical		
Preset resolutions	640x350 @ 70Hz 640x480 @ 60Hz, 66Hz, 72Hz, 75Hz 720x400 @ 70Hz 800x600 @ 60Hz, 72Hz, 75Hz 1024x768 @ 60Hz, 70Hz, 75Hz 1152x864 @ 75Hz 1280x800 @ 60Hz 1280x1024 @ 60Hz, 72Hz, 75Hz 1366x768 @ 60Hz 1440x900 @ 60Hz, 75Hz 1600x1200 @ 60Hz, 70Hz, 75Hz 1680x1050 @ 60Hz 1920x1080 @ 60Hz		
Presets / user settings	Presets: 25; user settings: 25		
On screen display	On screen display with digital user controls (8 languages)		
Control features	Mode-switching (TIO mode / standalone monitor mode, switches video / audio / USB input sources) / Back button, Left shift button, Right shift / Brightness button, Selection button / Menu button, Power button		
Tiny-in-One Power On	Pressing Alt + P on keyboard or pressing Power button positioned on TIO can turn on both TIO and Tiny (only some Tiny support, see compatible list)		
Front ports	Two USB 3.0 or two USB 2.0 (when M73 or M53 installed or USB 2.0 connected via USB upstream port), one headphone / microphone combo jack (3.5mm) * The USB ports are only available when a Tiny is installed or a PC is connected via USB upstream port		
Side ports	Side ports offered by installed Tiny (optional)		
Rear ports	One DisplayPort 1.2 port, one USB upstream port, one power connector		
3-in-1 Cable	Undetachable 3-in-1 cable (Power connector, USB 3.0 [supports USB 3.0/USB 2.0], DisplayPort 1.2), only for connecting to Tiny installed (optional)		
Internal Speaker	1.5 watt x1		
Security	Security keyhole for attachment of optional cable lock (Kensington® lock compatible), locks optional Tiny with TIO 22 together, more security features offered by Tiny installed (optional)		
Mechanical	Dimensions	TIO 22 without stand	TIO 22 with stand
	W x D x H (inch)	19.25 x 2.65 x 12.47	19.25 x 9.90 x 14.02 - 18.35
	W x D x H (mm)	489.06 x 67.2 x 316.78	489.06 x 251.4 x 356.07 - 466.07
	Weight (approximately)	11.27 lb /5.11 kg (with stand)	
Mounting features	Wall or desk mounting using the extend arm or third-party accessories meeting the VESA FPMPMI® (100mm mount) <i>Tilt: 35° back, -5° forward; lift: 4.3" (110mm); swivel: +/-45°</i>		
Adjustable stand			
Power supply	90 watts AC/DC adapter, 88% PSU, universal		
Power consumption	15.57 watts typical, 35 watts maximum, <0.5 watts standby / suspend		
Limited warranty ³	3-years , Customer Carry-In or Mail-In via Rapid Replacement Service		
VESA-compliant ²	VESA DDC2B/CI, VESA DPMS-compliant		
Ergonomics	ISO 9241-307		
Emission standards	FCC Class B		
Environmental	TCO 7.0, TCO Edge 2.0, WEEE, RoHS, ENERGY STAR® 7.0 EPEAT™ Gold rating, ULE Gold, TUV, VOC		
Windows certifications	Windows 7, Windows 8/8.1, and Windows 10 certified		
Ship group	TIO 22 (Monitor), detachable stand, AC/DC power adapter, power cord, user's guide and driver CD, quick start and safety poster		
Accessories	For compatible accessories, please go to http://www.lenovoquickpick.com		
ThinkCentre Tiny-in-One 22 Compatible list			
Model	M900 Tiny, M700 Tiny, M600 Tiny, M83 Tiny, M53 Tiny	M93/p Tiny, M73 Tiny	Chromebox
Turn on TIO and Tiny together via Alt + P on USB KB	All models	All models	Not support
Turn on TIO and Tiny together via TIO Power Button	All models	TIO models	All models

See footnotes for more detailed information



ThinkCentre Tiny-in-One (TIO) 22 Gen3

Product Specifications Reference (PSREF)

Model	<i>Non-touch model:</i> 10R1PAR1++/10R1PAT1++; <i>Touch model:</i> 10R0PAR1++/10R0PAT1++			Mounting features	Wall or desk mounting using the extend arm or third-party accessories meeting the VESA FPMPI® (100mm mount)																
Form factor	Tiny-in-One, offers a full All-In-One experience when optional Tiny slots into the back of TIO, clean cabling and effortless setup			Adjustable stand	<i>Tilt:</i> 30° back, -5° forward; <i>lift:</i> 4.3" (110mm); <i>swivel:</i> +/-45°; <i>Pivot:</i> clockwise 0° to 90°																
Compatible Tiny:	M910 / M710 / M900 / M700 / M600 / M715 / M93/p* / M83 / M73* / M53 / Chromebox Tiny * Non-TIO models can't be turned on by pressing power button of TIO			Power supply	90 watts AC/DC adapter, 88% PSU, universal																
Panel	TFT-LCD, In-Plane Switching technology**, White LED backlight <i>Notes:</i> In-Plane Switching may refer to VA, PLS, and IPS panels			Power consumption	19 watts typical, 32 watts maximum, <0.5 watts standby / suspend																
Viewable image size	21.5" (546.1mm) diagonal			Limited warranty	3-years , Customer Carry-In or Mail-In via Rapid Replacement Service																
Max view area (W x H)	18.74" x 10.54" / 476.1mm x 267.8mm			VESA-compliant	VESA DDC2B/CI, VESA DPMS-compliant																
Bezel Width	Top / Side: 2mm, Bottom: 22.1mm			Ergonomics	ISO 9241-307, TUV Eye Comfort certified																
Native resolution	1920x1080			Emission standards	FCC Class B																
Multi-touch	Optional 10-point multi-touch, supports Wake on Touch			Environmental	TCO 7.0, TCO Edge 2.0, WEEE, RoHS, ENERGY STAR® 7.0, EPEAT™ Silver rating, ULE Gold, TUV, VOC																
Aspect ratio	16:9			Windows certifications	Windows 7 and Windows 10 certified																
Pixel pitch (mm)	0.24795mm			Ship group	TIO (Monitor), detachable stand, AC/DC power adapter, power cord, user's guide and driver CD, quick start and safety poster																
Dot/Pixel per Inch	102.4 dpi			Accessories	For compatible accessories, please go to http://www.lenovoquickpick.com																
Brightness	250 nits or cd/m ² (typical)			<table border="1"> <thead> <tr> <th colspan="4">ThinkCentre Tiny-in-One 22 Gen3 Compatible list</th> </tr> </thead> <tbody> <tr> <td>Model</td> <td>M910 / M710 / M900 / M700 / M600 / M715 / M83 / M53 Tiny</td> <td>M93/p Tiny, M73 Tiny</td> <td>Chromebox</td> </tr> <tr> <td>Turn on TIO and Tiny together via Alt + P on USB KB</td> <td>All models</td> <td>All models</td> <td>Not support</td> </tr> <tr> <td>Turn on TIO and Tiny together via TIO Power Button</td> <td>All models</td> <td>TIO models</td> <td>All models</td> </tr> </tbody> </table>		ThinkCentre Tiny-in-One 22 Gen3 Compatible list				Model	M910 / M710 / M900 / M700 / M600 / M715 / M83 / M53 Tiny	M93/p Tiny, M73 Tiny	Chromebox	Turn on TIO and Tiny together via Alt + P on USB KB	All models	All models	Not support	Turn on TIO and Tiny together via TIO Power Button	All models	TIO models	All models
ThinkCentre Tiny-in-One 22 Gen3 Compatible list																					
Model	M910 / M710 / M900 / M700 / M600 / M715 / M83 / M53 Tiny	M93/p Tiny, M73 Tiny	Chromebox																		
Turn on TIO and Tiny together via Alt + P on USB KB	All models	All models	Not support																		
Turn on TIO and Tiny together via TIO Power Button	All models	TIO models	All models																		
Contrast ratio	1000:1 (typical)																				
Pixel response time	14ms (default), over drive to 4ms, 6ms																				
Color gamut	72%																				
Anti-reflective	Anti-glare																				
Viewing angle at 10:1 CR	178° (+/- 89°) horizontal, 178° (+/- 89°) vertical																				
Preset resolutions	640x350 @ 70Hz 640x480 @ 60Hz, 66Hz, 72Hz, 75Hz 720x400 @ 70Hz 800x600 @ 60Hz, 72Hz, 75Hz 1024x768 @ 60Hz, 70Hz, 75Hz 1152x864 @ 75Hz 1280x800 @ 60Hz 1280x1024 @ 60Hz, 72Hz, 75Hz 1366x768 @ 60Hz 1440x900 @ 60Hz, 75Hz 1600x1200 @ 60Hz, 70Hz, 75Hz 1680x1050 @ 60Hz 1920x1080 @ 60Hz																				
Presets / user settings	Presets: 25; user settings: 25																				
On screen display	On screen display with digital user controls (8 languages)																				
Control features	<i>Font:</i> Exit button, Left / Mode-switching button (TIO / monitor mode), Right / Brightness button, Enter / Menu button, Power button <i>Bottom:</i> Volume up button, Volume down button																				
Tiny-in-One Power On	Pressing Alt + P on keyboard or pressing Power button positioned on TIO can turn on both TIO and Tiny (only some Tiny support, see compatible list)																				
Side ports (TIO)	One USB 3.1 Gen1 / USB 2.0 (when M73 or M53 installed or USB 2.0 connected via USB upstream port) <i>Notes:</i> The USB port is only available when a Tiny is installed or a PC is connected via USB upstream port																				
Side ports (Tiny)	Side ports offered by installed Tiny (optional)																				
Rear ports	One DisplayPort in port, one USB upstream port, one power connector																				
3-in-1 Cable	Undetachable 3-in-1 cable (Power connector, USB [supports USB 3.1 Gen1 / USB 2.0], DisplayPort), only for connecting to Tiny installed (optional)																				
Camera	720p camera with dual microphone for VOIP, LED indicator																				
Internal Speaker	2 watt x2																				
Security	Security keyhole for attachment of optional cable lock (Kensington® lock compatible), locks optional Tiny with TIO together, more security features offered by Tiny installed (optional)																				
Mechanical	<table border="1"> <thead> <tr> <th>Dimensions</th> <th>TIO without stand</th> <th>TIO with stand</th> </tr> </thead> <tbody> <tr> <td>W x D x H (inch)</td> <td>19.26 x 2.85 x 13.35</td> <td>19.26 x 10.76 x 14.59 - 18.93</td> </tr> <tr> <td>W x D x H (mm)</td> <td>489.3 x 72.5 x 339</td> <td>489.3 x 273.3 x 370.7 - 480.7</td> </tr> <tr> <td>Weight (Approx.)</td> <td>7.01 lb / 3.19 kg</td> <td>11.77 lb / 5.34 kg</td> </tr> </tbody> </table>			Dimensions	TIO without stand	TIO with stand	W x D x H (inch)	19.26 x 2.85 x 13.35	19.26 x 10.76 x 14.59 - 18.93	W x D x H (mm)	489.3 x 72.5 x 339	489.3 x 273.3 x 370.7 - 480.7	Weight (Approx.)	7.01 lb / 3.19 kg	11.77 lb / 5.34 kg						
Dimensions	TIO without stand	TIO with stand																			
W x D x H (inch)	19.26 x 2.85 x 13.35	19.26 x 10.76 x 14.59 - 18.93																			
W x D x H (mm)	489.3 x 72.5 x 339	489.3 x 273.3 x 370.7 - 480.7																			
Weight (Approx.)	7.01 lb / 3.19 kg	11.77 lb / 5.34 kg																			



ThinkCentre Tiny-in-One (TIO) 24

Product Specifications Reference (PSREF)

Model	10LLPAR6++ / 10LLPAT6++		
Form factor	Tiny-in-One, offers a full All-In-One experience when optional Tiny slots into the back of TIO 24, clean cabling and effortless setup		
Compatible Tiny:	M900 Tiny, M700 Tiny, M600 Tiny, M93/p Tiny*, M83 Tiny, M73 Tiny*, or M53 Tiny, Chromebox * Non-TIO models can't be turned on by pressing power button of TIO 24		
Panel	TFT-LCD, In-Plane Switching (IPS), White LED backlight		
Viewable image size	23.8" (604.7mm) diagonal		
Max view area (W x H)	21.06" x 12.32" / 535.0mm x 313.0mm		
Bezel Width	Top / Side: 2mm, Bottom: 16.3mm		
Optimum resolution	1920x1080		
Aspect ratio	16:9		
Pixel pitch (mm)	0.2745mm		
Dot/Pixel per Inch	92.6 dpi		
Brightness	250 nits or cd/m ² (typical)		
Contrast ratio	1000:1 (typical)		
Pixel response time	7ms		
Color gamut	72%		
Anti-reflective	Anti-glare		
Viewing angle at 10:1 CR	178° (+/- 89°) horizontal, 178° (+/- 89°) vertical		
Preset resolutions	640x350 @ 70Hz 640x480 @ 60Hz, 66Hz, 72Hz, 75Hz 720x400 @ 70Hz 800x600 @ 60Hz, 72Hz, 75Hz 1024x768 @ 60Hz, 70Hz, 75Hz 1152x864 @ 75Hz 1280x800 @ 60Hz 1280x1024 @ 60Hz, 72Hz, 75Hz 1366x768 @ 60Hz 1440x900 @ 60Hz, 75Hz 1600x1200 @ 60Hz, 70Hz, 75Hz 1680x1050 @ 60Hz 1920x1080 @ 60Hz		
Presets / user settings	Presets: 25; user settings: 25		
On screen display	On screen display with digital user controls (8 languages)		
Control features	Mode-switching (TIO mode / standalone monitor mode, switches video / audio / USB input sources) / Back button, Left shift button, Right shift / Brightness button, Selection button / Menu button, Power button		
Tiny-in-One Power On	Pressing Alt + P on keyboard or pressing Power button positioned on TIO can turn on both TIO and Tiny (only some Tiny support, see compatible list)		
Front ports	Two USB 3.0 or two USB 2.0 (when M73 or M53 installed or USB 2.0 connected via USB upstream port), one headphone / microphone combo jack (3.5mm) * The USB ports are only available when a Tiny is installed or a PC is connected via USB upstream port		
Side ports	Side ports offered by installed Tiny (optional)		
Rear ports	One DisplayPort 1.2 port, one USB upstream port, one power connector		
3-in-1 Cable	Undetachable 3-in-1 cable (Power connector, USB 3.0 [supports USB 3.0/USB 2.0], DisplayPort 1.2), only for connecting to Tiny installed (optional)		
Internal Speaker	1.5 watt x1		
Security	Security keyhole for attachment of optional cable lock (Kensington® lock compatible), locks optional Tiny with TIO 24 together, more security features offered by Tiny installed (optional)		
Mechanical	Dimensions	TIO 24 without stand	TIO 24 with stand
	W x D x H (inch)	21.24 x 2.7 x 13.64	21.24 x 9.90 x 15.16 - 19.46
	W x D x H (mm)	539.6 x 68.2 x 346.45	539.6 x 251.4 x 385.08 - 495.08
	Weight (approximately)	12.25 lb /5.57 kg (with stand)	
Mounting features	Wall or desk mounting using the extend arm or third-party accessories meeting the VESA FPMPMI® (100mm mount)		
Adjustable stand	Tilt: 35° back, -5° forward; lift: 4.3" (110mm); swivel: +/-45°		
Power supply	90 watts AC/DC adapter, 88% PSU, universal		
Power consumption	16.7 watts typical, 35 watts maximum, <0.5 watts standby / suspend		
Limited warranty ³	3-years , Customer Carry-In or Mail-In via Rapid Replacement Service		
VESA-compliant ²	VESA DDC2B/CI, VESA DPMS-compliant		
Ergonomics	ISO 9241-307		
Emission standards	FCC Class B		
Environmental	TCO 7.0, TCO Edge 2.0, WEEE, RoHS, ENERGY STAR® 7.0		
Windows certifications	EPEAT™ Gold rating, ULE Gold, TUV, VOC Windows 7, Windows 8/8.1, and Windows 10 certified		
Ship group	TIO 24 (Monitor), detachable stand, AC/DC power adapter, power cord, user's guide and driver CD, quick start and safety poster		
Accessories	For compatible accessories, please go to http://www.lenovoquickpick.com		

ThinkCentre Tiny-in-One 24 Compatible list			
Model	M900 Tiny, M700 Tiny, M600 Tiny, M83 Tiny, M53 Tiny	M93/p Tiny, M73 Tiny	Chromebox
Turn on TIO and Tiny together via Alt + P on USB KB	All models	All models	Not support
Turn on TIO and Tiny together via TIO Power Button	All models	TIO models	All models

See footnotes for more detailed information



ThinkCentre Tiny-in-One (TIO) 24 Gen3

Product Specifications Reference (PSREF)

Model	<i>Non-touch model:</i> 10QYPAR1++/10QYPAT1++; <i>Touch model:</i> 10QXPAR1++/10QXPAT1++			Mounting features	Wall or desk mounting using the extend arm or third-party accessories meeting the VESA FPMPI® (100mm mount)												
Form factor	Tiny-in-One, offers a full All-In-One experience when optional Tiny slots into the back of TIO, clean cabling and effortless setup			Adjustable stand	<i>Tilt:</i> 30° back, -5° forward; <i>lift:</i> 4.3" (110mm); <i>swivel:</i> +/-45°; <i>Pivot:</i> clockwise 0° to 90°												
Compatible Tiny:	M910 / M710 / M900 / M700 / M600 / M715 / M93/p* / M83 / M73* / M53 / Chromebox Tiny * Non-TIO models can't be turned on by pressing power button of TIO			Power supply	90 watts AC/DC adapter, 88% PSU, universal												
Panel	TFT-LCD, In-Plane Switching technology**, White LED backlight <i>Notes:</i> In-Plane Switching may refer to VA, PLS, and IPS panels			Power consumption	19 watts typical, 32 watts maximum, <0.5 watts standby / suspend												
Viewable image size	23.8" (604.7mm) diagonal			Limited warranty	3-years , Customer Carry-In or Mail-In via Rapid Replacement Service												
Max view area (W x H)	21.06" x 12.32" / 535.0mm x 313.0mm			VESA-compliant	VESA DDC2B/CI, VESA DPMS-compliant												
Bezel Width	Top / Side: 2mm, Bottom: 22.1mm			Ergonomics	ISO 9241-307, TUV Eye Comfort certified												
Native resolution	1920x1080			Emission standards	FCC Class B												
Multi-touch	Optional 10-point multi-touch, supports Wake on Touch			Environmental	TCO 7.0, TCO Edge 2.0, WEEE, RoHS, ENERGY STAR® 7.0, EPEAT™ Silver rating, ULE Gold, TUV, VOC												
Aspect ratio	16:9			Windows certifications	Windows 7 and Windows 10 certified												
Pixel pitch (mm)	0.2745mm			Ship group	TIO 24 (Monitor), detachable stand, AC/DC power adapter, power cord, user's guide and driver CD, quick start and safety poster												
Dot/Pixel per Inch	92.6 dpi			Accessories	For compatible accessories, please go to http://www.lenovoquickpick.com												
Brightness	250 nits or cd/m² (typical)																
Contrast ratio	1000:1 (typical)																
Pixel response time	14ms (default), over drive to 4ms, 6ms																
Color gamut	72%																
Anti-reflective	Anti-glare																
Viewing angle at 10:1 CR	178° (+/- 89°) horizontal, 178° (+/- 89°) vertical																
Preset resolutions	640x350 @ 70Hz 640x480 @ 60Hz, 67Hz, 72Hz, 75Hz 720x400 @ 70Hz 800x600 @ 60Hz, 72Hz, 75Hz 1024x768 @ 60Hz, 70Hz, 75Hz 1152x864 @ 75Hz 1280x800 @ 60Hz 1280x1024 @ 60Hz, 72Hz, 75Hz 1366x768 @ 60Hz 1440x900 @ 60Hz, 75Hz 1600x1200 @ 60Hz, 70Hz, 75Hz 1680x1050 @ 60Hz 1920x1080 @ 60Hz																
Presets / user settings	Presets: 25; user settings: 25																
On screen display	On screen display with digital user controls (8 languages)																
Control features	Font: Exit button, Left / Mode-switching button (TIO / monitor mode), Right / Brightness button, Enter / Menu button, Power button Bottom: Volume up button, Volume down button																
Tiny-in-One Power On	Pressing Alt + P on keyboard or pressing Power button positioned on TIO can turn on both TIO and Tiny (only some Tiny support, see compatible list)																
Side ports (TIO)	One USB 3.1 Gen1 / USB 2.0 (when M73 or M53 installed or USB 2.0 connected via USB upstream port) <i>Notes:</i> The USB port is only available when a Tiny is installed or a PC is connected via USB upstream port																
Side ports (Tiny)	Side ports offered by installed Tiny (optional)																
Rear ports	One DisplayPort in port, one USB upstream port, one power connector																
3-in-1 Cable	Undetachable 3-in-1 cable (Power connector, USB [supports USB 3.1 Gen1 / USB 2.0], DisplayPort), only for connecting to Tiny installed (optional)																
Camera	1080p camera with dual microphone for VOIP, LED indicator																
Internal Speaker	2 watt x2																
Security	Security keyhole for attachment of optional cable lock (Kensington® lock compatible), locks optional Tiny with TIO together, more security features offered by Tiny installed (optional)																
Mechanical	<table border="1"> <thead> <tr> <th>Dimensions</th> <th>TIO without stand</th> <th>TIO with stand</th> </tr> </thead> <tbody> <tr> <td>W x D x H (inch)</td> <td>21.25 x 2.85 x 14.47</td> <td>21.25 x 11.11 x 15.72 - 20.06</td> </tr> <tr> <td>W x D x H (mm)</td> <td>539.8 x 72.5 x 367.6</td> <td>539.8 x 282.3 x 399.4 - 509.4</td> </tr> <tr> <td>Weight (Approx.)</td> <td>7.96 lb /3.61 kg</td> <td>12.92 lb /5.86 kg</td> </tr> </tbody> </table>					Dimensions	TIO without stand	TIO with stand	W x D x H (inch)	21.25 x 2.85 x 14.47	21.25 x 11.11 x 15.72 - 20.06	W x D x H (mm)	539.8 x 72.5 x 367.6	539.8 x 282.3 x 399.4 - 509.4	Weight (Approx.)	7.96 lb /3.61 kg	12.92 lb /5.86 kg
Dimensions	TIO without stand	TIO with stand															
W x D x H (inch)	21.25 x 2.85 x 14.47	21.25 x 11.11 x 15.72 - 20.06															
W x D x H (mm)	539.8 x 72.5 x 367.6	539.8 x 282.3 x 399.4 - 509.4															
Weight (Approx.)	7.96 lb /3.61 kg	12.92 lb /5.86 kg															

ThinkCentre Tiny-in-One 24 Gen3 Compatible list			
Model	M910 / M710 / M900 / M700 / M600 / M715 / M83 / M53 Tiny	M93/p Tiny, M73 Tiny	Chromebox
Turn on TIO and Tiny together via Alt + P on USB KB	All models	All models	Not support
Turn on TIO and Tiny together via TIO Power Button	All models	TIO models	All models



ThinkCentre Tiny-in-One (TIO) 27

Product Specifications Reference (PSREF)

Form factor	Tiny-in-One, offers a full All-In-One experience when optional Tiny slots into the back of TIO, clean cabling and effortless setup	Mechanical	<table border="1"> <tr> <td></td> <td>TIO without stand</td> <td>TIO with stand</td> </tr> <tr> <td>Dimensions (W x D x H mm / inch)</td> <td>614.0 x 73.89 x 413.1 / 24.17 x 2.91 x 16.26</td> <td>614.0 x 329.0 x 444.25 - 554.25 / 24.17 x 12.95 x 17.49 - 21.82</td> </tr> <tr> <td>Weight (Approx.)</td> <td>4.91 kg / 10.82 lb</td> <td>7.95 kg / 17.53 lb</td> </tr> </table>			TIO without stand	TIO with stand	Dimensions (W x D x H mm / inch)	614.0 x 73.89 x 413.1 / 24.17 x 2.91 x 16.26	614.0 x 329.0 x 444.25 - 554.25 / 24.17 x 12.95 x 17.49 - 21.82	Weight (Approx.)	4.91 kg / 10.82 lb	7.95 kg / 17.53 lb
	TIO without stand	TIO with stand											
Dimensions (W x D x H mm / inch)	614.0 x 73.89 x 413.1 / 24.17 x 2.91 x 16.26	614.0 x 329.0 x 444.25 - 554.25 / 24.17 x 12.95 x 17.49 - 21.82											
Weight (Approx.)	4.91 kg / 10.82 lb	7.95 kg / 17.53 lb											
Compatible Tiny:	ThinkCentre Tiny, ThinkCentre Nano, and ThinkStation Tiny	Mounting features	Wall or desk mounting using the extend arm or third-party accessories meeting the VESA FPMPI® (100mm mount)										
Panel	TFT-LCD, In-Plane Switching technology**, White LED backlight **Notes: In-Plane Switching may refer to IPS, PLS, ADS, AHVA, and AA	Adjustable stand	<i>Tilt:</i> 35° back, -5° forward; <i>lift:</i> 4.3" (110mm); <i>swivel:</i> +/-45°; <i>Pivot:</i> clockwise -5° to 90°										
Viewable image size	27" (685.8mm) diagonal	Power supply	170 watts adapter, 88% PSU, universal										
Max view area (W x H)	23.49" x 13.22" / 596.7mm x 335.7mm	Power consumption	37 watts typical, 57 watts maximum, <0.5 watts standby / suspend										
Bezel Width	Top / Side: 2mm, Bottom: 23.3mm	Limited warranty	3-years , Product Exchange Service (US and EMEA) or Customer Carry-In Service (EMEA)										
Native resolution	2560x1440	VESA-compliant	VESA DDC/CI, VESA DPMS-compliant										
Multi-touch	None	Ergonomics	ISO 9241-307, TUV Eye Comfort certified										
Aspect ratio	16:9	Emission standards	FCC Class B										
Pixel pitch (mm)	0.2331mm	Environmental	TCO 8.0, TCO Edge 2.0, WEEE, RoHS, ENERGY STAR® 7.0, EPEAT™ Silver rating, ULE Gold, TUV, VOC										
Dot/Pixel per Inch	109 dpi	Windows certifications	Windows 7 and Windows 10 certified										
Brightness	350 nits or cd/m² (typical)	Ship group	TIO 27 (Monitor), detachable stand, power adapter, power cord, reference and driver CD										
Contrast ratio	1000:1 (typical)	Accessories	For compatible accessories, please go to http://smartfind.lenovo.com										
Pixel response time	14ms (default), over drive to 4ms, 6ms												
Color gamut	99% sRGB												
Anti-glare	Yes (25%)												
Viewing angle at 10:1 CR	178° (+/- 89°) horizontal, 178° (+/- 89°) vertical												
Preset resolutions	640x350 @ 70Hz 640x480 @ 60Hz, 66Hz, 72Hz, 75Hz 720x400 @ 70Hz 800x600 @ 60Hz, 72Hz, 75Hz 1024x768 @ 60Hz, 70Hz, 75Hz 1152x864 @ 75Hz 1280x768 @ 60Hz 1280x800 @ 60Hz 1280x1024 @ 60Hz, 72Hz, 75Hz 1366x768 @ 60Hz 1440x900 @ 60Hz, 75Hz 1600x1200 @ 60Hz, 70Hz, 75Hz 1680x1050 @ 60Hz 1920x1080 @ 60Hz 2560x1440 @ 60Hz												
Presets / user settings	Presets: 27; user settings: 25												
On screen display	On screen display with digital user controls (8 languages)												
Control features	Font: Exit button, Left / Mode-switching button (TIO / monitor mode), Right / Brightness button, Enter / Menu button, Power button Bottom: Volume up button, Volume down button												
Tiny-in-One Power On	Pressing Alt + P on keyboard or pressing Power button positioned on TIO can turn on both TIO and Tiny (only some support, see Compatible Matrix)												
Side ports (TIO)	Two USB 3.1 Gen1 (downgrade to USB 2.0 when installing M73 or M53 or connecting USB 2.0 via USB upstream port), one headphone / microphone combo jack <i>Notes:</i> The USB ports are enabled by installing a Tiny or connecting USB upstream port; the audio port is enabled by installing a Tiny or connecting USB upstream, DisplayPort(in), or HDMI(in) port												
Side ports (Tiny)	Side ports offered by the installed Tiny (optional)												
Rear ports	One DisplayPort(in) port, one HDMI(in) port, one USB (Type-B) upstream port, one power connector												
3-in-1 Cable	Undetachable 3-in-1 cable, connecting to the power connector, one USB, and one DisplayPort of the installed Tiny (optional)												
Camera	RGBIR camera with dual microphone, supports Window Hello and Facial Recognition, Think Shutter for Privacy Security, LED indicator												
Internal Speaker	2 watt x2												
Security	Security keyhole for attachment of optional cable lock (Kensington® lock compatible), locks optional Tiny with TIO together, more security features offered by Tiny installed (optional)												

ThinkCentre Tiny-in-One 27 Compatible Matrix			
Model	P320 / P330 / M920(x) / M720 / M910(x) / M710 / M900(x) / M700 / M600 / M715 / M83 / M53 Tiny	M93/p Tiny, M73 Tiny	Chromebox
Turn on TIO and Tiny together via Alt + P on USB KB	All models	All models	Not support
Turn on TIO and Tiny together via TIO Power Button	All models	TIO models	All models

This publication was developed for products and services offered in the United States and E.M.E.A countries. Lenovo may not offer the products, services or features discussed in this document in other countries. Lenovo may withdraw an offering at any time. Information is subject to change without notice. Consult your local representative for information on offerings available in your area.

Lenovo reserves the right to change specifications or other product information without notice. Lenovo is not responsible for photographic or typographical errors.

LENOVO PROVIDES THIS PUBLICATION "AS IS," WITHOUT WARRANTY OF ANY KIND, EITHER EXPRESS OR IMPLIED, INCLUDING THE IMPLIED WARRANTIES OF MERCHANTABILITY OR FITNESS FOR A PARTICULAR PURPOSE.

Some jurisdictions do not allow disclaimer of express or implied warranties in certain transactions, therefore this disclaimer may not apply to you.

Availability: All offers subject to availability. Lenovo reserves the right to alter product offerings and specifications at any time, without notice. Lenovo is not responsible for photographic or typographic errors.

General: Review key information provided by Microsoft that may apply to your system purchase, including details on Windows 10, Windows 8, Windows 7, and potential upgrades/downgrades. Lenovo makes no representation or warranty regarding third-party products or services.

Trademarks: Lenovo, ThinkPad, ThinkCentre, ThinkStation and the Lenovo logo are trademarks of Lenovo. Microsoft, Windows, Windows NT, and the Windows logo are trademarks of Microsoft Corporation. Ultrabook, Celeron, Celeron Inside, Core Inside, Intel, Intel Logo, Intel Atom, Intel Atom Inside, Intel Core, Intel Inside, Intel Inside Logo, Intel vPro, Itanium, Itanium Inside, Pentium, Pentium Inside, vPro Inside, Xeon, Xeon Phi, and Xeon Inside are trademarks of Intel Corporation in the U.S. and/or other countries. Other company, product or service names may be trademarks or service marks of others.

Warranty: For a copy of applicable warranties, write to: Lenovo Warranty Information, 1009 Think Place, Morrisville, NC, 27560. Lenovo makes no representation or warranty regarding third party products or services. The Lenovo Limited Warranty applies only to Lenovo hardware products purchased for your own use, and does not transfer upon resale.

Limited warranty: Support unrelated to a warranty issue may be subject to additional charges.

Lenovo Services:

Carry-in or Mail-in Service: Parts and labor repair coverage where the customer is responsible for shipping (including packaging) or delivery to authorized warranty provider or repair center.

Depot or Courier Service: Parts and labor repair coverage where shipping (including packaging) or delivery to the repair center is paid for by Lenovo.

Expedited Depot: Parts and labor coverage with expedited turnaround. Shipping (including packaging) or delivery to the repair center is paid for by Lenovo.

Onsite / In-home Service: Parts and labor repair coverage where labor is provided onsite at your place of business.

If Lenovo determines your product problem is covered by the product warranty and cannot be resolved over the telephone, a technician will be dispatched to arrive onsite, typically the next day.

International Warranty Service (IWS): PC repair coverage for customers who require a critical warranty repair while travelling internationally. Visit www.lenovo.com/internationalwarranty for details. Visit www.lenovo.com/warranty for Lenovo Warranty Services terms and conditions for complete details and restrictions.

Included software: may differ from its retail version (if available), and may not include user manuals or all program functionality. Software license agreements may apply.

Battery life: Battery life (and recharge times) will vary based on many factors including screen brightness, applications, features, power management, battery conditioning, and other customer preferences.

Visit <http://psref.lenovo.com/> for the latest version of Product Specifications Reference.

© Lenovo, 2019. All rights reserved.
Lenovo 1009 Think Place Morrisville, NC 27560 U.S.A.

Lenovo ThinkStation.

PSREF

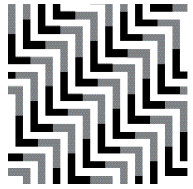

Product Specifications Reference

Version 545, July 2019

U.S. **EMEA**

Visit <http://psref.lenovo.com> for the latest version

Summary of Changes

This section describes the changes made in this version of ThinkStation PSREF and in previous version. This edition might also include minor corrections and editorial changes which are not identified.

July 17, 2019 - Version 545

- ▶ Update EPEAT rating to Silver on most ThinkStation

June 26, 2019 - Version 544

- ▶ Add ThinkStation P330 Tower Gen 2/P330 SFF Gen 2 CPU Async update

May 15, 2019 - Version 542

- ▶ New ThinkStation P330 Tower Gen 2/P330 SFF Gen 2 announced on April 2019
- ▶ Update ThinkStation P920/P720/P520 specifications, add Quadro RTX 8000, DDR4-2933, Xeon Scalable Gen 2

March 13, 2019 - Version 539

- ▶ Add Intel vPro information on ThinkStation P330 Tower/P330 SFF/P520c/P520/P720/P920

February 20, 2019 - Version 538

- ▶ New ThinkStation P330 Tower models announced on February 2019
- ▶ Update ThinkStation P920/P720/P520/P520c specifications, add Quadro RTX4000/5000/6000

August 22, 2018 - Version 529

- ▶ New ThinkStation P330 Tower/SFF/Tiny models announced on August 2018
- ▶ Update ThinkStation P920/P720 specifications, update flex bay and graphics adapter section

August 1, 2018 - Version 528

- ▶ New product ThinkStation P330 Tower/SFF/Tiny announced on July 2018
- ▶ Update ThinkStation P920/P720/P520/P520c, add Refresh 2.0 information
- ▶ Remove all MTM PNs from PDF version

June 20, 2018 - Version 526

- ▶ New ThinkStation P320 Tower models announced on June 2018
- ▶ Update ThinkStation P720 and P920 models, remove EOL models for US
- ▶ Update Windows 10 Pro 64 for Workstations for some ThinkStation P720/P920 models

May 30, 2018 - Version 525

- ▶ Added ThinkStation P720/P920 EMEA May 2018 models

April 18, 2018 - Version 523

- ▶ New ThinkStation P320 Tower/ P320 SFF/P520c/P520/P720/P920 models announced on April 2018

March 28, 2018 - Version 522

- ▶ New ThinkStation P320 Tower/ P320 SFF/P520c/P520/P920 announced on March 2018

March 7, 2018 - Version 521

- ▶ New ThinkStation P320 Tower/ P320 SFF/P720/P920 announced on February 2018

January 30, 2018 - Version 519

- ▶ New ThinkStation P520c and P520 announced on January 2018
- ▶ New ThinkStation P320 Tower/P320 SFF announced on January 2018

December 20, 2017 - Version 517

- ▶ New ThinkStation P920 models announced on December 2017
- ▶ Add Optional Ports on ThinkStation P320 Tiny

September 29, 2017 - Version 513

- ▶ New ThinkStation P920 and P720 announced on September 2017
- ▶ New ThinkStation P320 Tower/P320 SFF/P410/P510/P710/P910 announced on September 2017

September 12, 2017 - Version 512

- ▶ New ThinkStation P320 Tower and P320 SFF models announced on August 2017

August 23, 2017 - Version 511

- ▶ New ThinkStation P320 Tiny models announced on August 2017

August 2, 2017 - Version 510

- ▶ New ThinkStation P320 Tiny/P320 Tower/ P320 SFF/P410/P510 models announced on July 2017

June 21, 2017 - Version 508

- ▶ New ThinkStation P320 Tiny announced on June 2017

May 26, 2017 - Version 507

- ▶ Add ThinkStation P410/P510/P710/P910 Refresh 3.0 Wave 1 models and update platform specifications

April 19, 2017 - Version 505

- ▶ New ThinkStation P320 Tower announced on April 2017
- ▶ New ThinkStation P320 SFF announced on April 2017

March 29, 2017 - Version 504

- ▶ Added ThinkStation P310 Tower and SFF models announced on March 2017
- ▶ Added ThinkStation P410 models announced on March 2017

January 25, 2017 - Version 501

- ▶ Update quantity of PCIe SSD adapter in ThinkStation P510/P910

January 4, 2017 - Version 500

- ▶ Added ThinkStation P310 models announced on December 2016

December 14, 2016 - Version 499

- ▶ Added ThinkStation P410/P510/P710/P910 EMEA models
- ▶ Added 1TB M.2 PCIe SSD, Quadro P5000, Quadro P6000 support on ThinkStation P510/P710/P910
- ▶ Added Quadro P5000 support on ThinkStation P410
- ▶ Added 6TB 7.2K SATA6Gbs HDD support on ThinkStation P410/P510/P710/P910
- ▶ Added ThinkStation P410/P510/P710/P910 models announced on December 2016

November 23, 2016 - Version 498

- ▶ Removed ThinkStation P500/P900 due to EOL
- ▶ Added ThinkStation P310 Tower and SFF models announced on November 2016

October 12, 2016 - Version 496

- ▶ Removed flash option on ThinkStation P510/P710/P910
- ▶ Added ThinkStation P310/P410/P510/P710/P910 models announced on September 2016

August 3, 2016 - Version 493

- ▶ Removed ThinkStation P500/P700/P900 Windows 7 DG from Win8.1 U.S. models
- ▶ Added keyboard and mouse features on all ThinkStation

July 13, 2016 - Version 492

- ▶ Added ThinkStation P500, P700, and P900 Windows 10 downgrade to Windows 7 models
- ▶ Updated Maximum configuration weight of ThinkStation P410
- ▶ Added ThinkStation P710 and P910 models announced on on July 2016
- ▶ Added "Maximum drives in 3.5" bay" feature on ThinkStation P500/P510/P700/P710/P900/P910

June 22, 2016 - Version 491

- ▶ Added new product ThinkStation P410/P510
- ▶ Added NVIDIA Quadro M2000 on ThinkStation P310 Tower
- ▶ Added keyboard and mouse information on ThinkStation P710/P910
- ▶ Added internal USB information on ThinkStation P710/P910

June 2, 2016 - Version 490

- ▶ Added ThinkStation P710/P910 US models
- ▶ Updated ThinkStation P710/P910 processor information

May 19, 2016 - Version 489

- ▶ Added NVIDIA Quadro M2000 on compatible product
- ▶ Updated maximum weight on ThinkStation P710
- ▶ Removed 30AT000BUS

April 27, 2016 - Version 488

- ▶ Added ThinkStation P710 and P910 models for EMEA, announced on April 2016
- ▶ Updated Energy star information on ThinkStation P500/P700/P710/P900/P910

April 6, 2016 - Version 487

- ▶ New ThinkStation P710 and P910, announced April 5, 2016 (specification only)

March 23, 2016 - Version 486

- ▶ Added processors specifications for P310/P500/P700/P900

February 24, 2016 - Version 485

- ▶ Added ThinkStation P310 and P700 models for US, announced on February 2016
- ▶ Added ThinkStation P700 and P900 models for EMEA, announced on February 2016

December 9, 2015 - Version 482

- ▶ New ThinkStation P310 Tower and SFF, announced November 24, 2015

November 18, 2015 - Version 481

- ▶ Combines ThinkStation PSREF United States version and Western Europe version.
- ▶ Extends the supported GEO into Europe, Middle East and Africa.
- ▶ Covers all TopSeller and Relationship models for US and all focus models for EMEA



ThinkStation P320 SFF Platform Specifications

Product Specifications Reference (PSREF)

Components	Specification																																			
Chipset	Intel C236 Chipset																																			
Intel AMT	Intel Active Management Technology 11 on Xeon models, Intel Standard Manageability on other models																																			
Processor	One Intel "Kabylake" or "Skylake" processor as listed: "Kaby Lake"																																			
	<table border="1"> <tr><td>Xeon E3-1280 v6</td><td>4C/3.9GHz/8MB/72W/DDR4-2400</td></tr> <tr><td>Xeon E3-1275 v6</td><td>4C/3.8GHz/8MB/73W/DDR4-2400</td></tr> <tr><td>Xeon E3-1270 v6</td><td>4C/3.8GHz/8MB/72W/DDR4-2400</td></tr> <tr><td>Xeon E3-1245 v6</td><td>4C/3.7GHz/8MB/73W/DDR4-2400</td></tr> <tr><td>Xeon E3-1240 v6</td><td>4C/3.7GHz/8MB/72W/DDR4-2400</td></tr> <tr><td>Xeon E3-1230 v6</td><td>4C/3.5GHz/8MB/72W/DDR4-2400</td></tr> <tr><td>Xeon E3-1225 v6</td><td>4C/3.3GHz/8MB/73W/DDR4-2400</td></tr> <tr><td>Xeon E3-1220 v6</td><td>4C/3GHz/8MB/72W/DDR4-2400</td></tr> <tr><td>Core i7-7700</td><td>4C/3.6GHz/8MB/65W/DDR4-2400</td></tr> <tr><td>Core i5-7600</td><td>4C/3.5GHz/6MB/65W/DDR4-2400</td></tr> <tr><td>Core i5-7500</td><td>4C/3.4GHz/6MB/65W/DDR4-2400</td></tr> <tr><td>Core i5-7400</td><td>4C/3GHz/6MB/65W/DDR4-2400</td></tr> <tr><td>Core i3-7300</td><td>2C/4GHz/4MB/51W/DDR4-2400</td></tr> <tr><td>Core i3-7100</td><td>2C/3.9GHz/3MB/51W/DDR4-2400</td></tr> </table>	Xeon E3-1280 v6	4C/3.9GHz/8MB/72W/DDR4-2400	Xeon E3-1275 v6	4C/3.8GHz/8MB/73W/DDR4-2400	Xeon E3-1270 v6	4C/3.8GHz/8MB/72W/DDR4-2400	Xeon E3-1245 v6	4C/3.7GHz/8MB/73W/DDR4-2400	Xeon E3-1240 v6	4C/3.7GHz/8MB/72W/DDR4-2400	Xeon E3-1230 v6	4C/3.5GHz/8MB/72W/DDR4-2400	Xeon E3-1225 v6	4C/3.3GHz/8MB/73W/DDR4-2400	Xeon E3-1220 v6	4C/3GHz/8MB/72W/DDR4-2400	Core i7-7700	4C/3.6GHz/8MB/65W/DDR4-2400	Core i5-7600	4C/3.5GHz/6MB/65W/DDR4-2400	Core i5-7500	4C/3.4GHz/6MB/65W/DDR4-2400	Core i5-7400	4C/3GHz/6MB/65W/DDR4-2400	Core i3-7300	2C/4GHz/4MB/51W/DDR4-2400	Core i3-7100	2C/3.9GHz/3MB/51W/DDR4-2400							
	Xeon E3-1280 v6	4C/3.9GHz/8MB/72W/DDR4-2400																																		
	Xeon E3-1275 v6	4C/3.8GHz/8MB/73W/DDR4-2400																																		
	Xeon E3-1270 v6	4C/3.8GHz/8MB/72W/DDR4-2400																																		
	Xeon E3-1245 v6	4C/3.7GHz/8MB/73W/DDR4-2400																																		
	Xeon E3-1240 v6	4C/3.7GHz/8MB/72W/DDR4-2400																																		
	Xeon E3-1230 v6	4C/3.5GHz/8MB/72W/DDR4-2400																																		
	Xeon E3-1225 v6	4C/3.3GHz/8MB/73W/DDR4-2400																																		
	Xeon E3-1220 v6	4C/3GHz/8MB/72W/DDR4-2400																																		
	Core i7-7700	4C/3.6GHz/8MB/65W/DDR4-2400																																		
	Core i5-7600	4C/3.5GHz/6MB/65W/DDR4-2400																																		
	Core i5-7500	4C/3.4GHz/6MB/65W/DDR4-2400																																		
	Core i5-7400	4C/3GHz/6MB/65W/DDR4-2400																																		
	Core i3-7300	2C/4GHz/4MB/51W/DDR4-2400																																		
	Core i3-7100	2C/3.9GHz/3MB/51W/DDR4-2400																																		
	"Skylake"	<table border="1"> <tr><td>Xeon E3-1245 v5</td><td>4C/3.5GHz/8MB/80W/DDR4-2133</td></tr> <tr><td>Xeon E3-1240 v5</td><td>4C/3.5GHz/8MB/80W/DDR4-2133</td></tr> <tr><td>Xeon E3-1230 v5</td><td>4C/3.4GHz/8MB/80W/DDR4-2133</td></tr> <tr><td>Xeon E3-1225 v5</td><td>4C/3.3GHz/8MB/80W/DDR4-2133</td></tr> <tr><td>Xeon E3-1220 v5</td><td>4C/3GHz/8MB/80W/DDR4-2133</td></tr> <tr><td>Core i7-6700</td><td>4C/3.4GHz/8MB/65W/DDR4-2133</td></tr> <tr><td>Core i5-6500</td><td>4C/3.2GHz/6MB/65W/DDR4-2133</td></tr> <tr><td>Core i5-6400</td><td>4C/2.7GHz/6MB/65W/DDR4-2133</td></tr> <tr><td>Core i3-6100</td><td>2C/3.7GHz/3MB/51W/DDR4-2133</td></tr> </table>	Xeon E3-1245 v5	4C/3.5GHz/8MB/80W/DDR4-2133	Xeon E3-1240 v5	4C/3.5GHz/8MB/80W/DDR4-2133	Xeon E3-1230 v5	4C/3.4GHz/8MB/80W/DDR4-2133	Xeon E3-1225 v5	4C/3.3GHz/8MB/80W/DDR4-2133	Xeon E3-1220 v5	4C/3GHz/8MB/80W/DDR4-2133	Core i7-6700	4C/3.4GHz/8MB/65W/DDR4-2133	Core i5-6500	4C/3.2GHz/6MB/65W/DDR4-2133	Core i5-6400	4C/2.7GHz/6MB/65W/DDR4-2133	Core i3-6100	2C/3.7GHz/3MB/51W/DDR4-2133																
		Xeon E3-1245 v5	4C/3.5GHz/8MB/80W/DDR4-2133																																	
		Xeon E3-1240 v5	4C/3.5GHz/8MB/80W/DDR4-2133																																	
		Xeon E3-1230 v5	4C/3.4GHz/8MB/80W/DDR4-2133																																	
Xeon E3-1225 v5		4C/3.3GHz/8MB/80W/DDR4-2133																																		
Xeon E3-1220 v5		4C/3GHz/8MB/80W/DDR4-2133																																		
Core i7-6700		4C/3.4GHz/8MB/65W/DDR4-2133																																		
Core i5-6500		4C/3.2GHz/6MB/65W/DDR4-2133																																		
Core i5-6400		4C/2.7GHz/6MB/65W/DDR4-2133																																		
Core i3-6100		2C/3.7GHz/3MB/51W/DDR4-2133																																		
Memory DIMM slots	4 DIMM slots, 2-channel (integrated memory controller in processor)																																			
Memory type/capacity	Up to 64GB ECC/non-ECC (4 x 16GB), DDR4-2400. UDIMM. "Skylake" processor supports up to DDR4-2133. Core i7 and i5 processors cannot support ECC.																																			
Intel HD Graphics in processor	Integrated Intel HD P530 in Xeon E3-12x5 v5 processors, or Intel HD P630 in Xeon E3-12x5 v6 processors, or Intel HD 530 in Core i7, i5, or i3 6000 processors. or Intel HD 630 in Core i7, i5, or i3 7000 processors. Works along with discrete graphics to support multi-display, enables three display connectors (2 DP, 1 VGA) on rear.																																			
Discrete graphics	Two PCI Express 3.0 x16 slots for graphics adapters. Up to two NVIDIA Quadro P1000. Supports the following NVIDIA graphic adapters:																																			
	<table border="1"> <thead> <tr> <th>Adapter</th> <th>Cores</th> <th>Memory</th> <th>Power</th> <th>Connector</th> </tr> </thead> <tbody> <tr> <td>NVS 310</td> <td>48</td> <td>1GB</td> <td>19.5W</td> <td>2xDP</td> </tr> <tr> <td>NVS 315</td> <td>48</td> <td>1GB</td> <td>19.5W</td> <td>2xDVI-I SL/2xDP</td> </tr> <tr> <td>NVS 510</td> <td>192</td> <td>2GB</td> <td>33.4W</td> <td>4xmini DP</td> </tr> <tr> <td>Quadro P400</td> <td>256</td> <td>2GB</td> <td>30W</td> <td>3xminiDP</td> </tr> <tr> <td>Quadro P600</td> <td>384</td> <td>2GB</td> <td>40W</td> <td>4xminiDP</td> </tr> <tr> <td>Quadro P1000</td> <td>640</td> <td>4GB</td> <td>47W</td> <td>4xminiDP</td> </tr> </tbody> </table>	Adapter	Cores	Memory	Power	Connector	NVS 310	48	1GB	19.5W	2xDP	NVS 315	48	1GB	19.5W	2xDVI-I SL/2xDP	NVS 510	192	2GB	33.4W	4xmini DP	Quadro P400	256	2GB	30W	3xminiDP	Quadro P600	384	2GB	40W	4xminiDP	Quadro P1000	640	4GB	47W	4xminiDP
	Adapter	Cores	Memory	Power	Connector																															
	NVS 310	48	1GB	19.5W	2xDP																															
	NVS 315	48	1GB	19.5W	2xDVI-I SL/2xDP																															
	NVS 510	192	2GB	33.4W	4xmini DP																															
	Quadro P400	256	2GB	30W	3xminiDP																															
	Quadro P600	384	2GB	40W	4xminiDP																															
Quadro P1000	640	4GB	47W	4xminiDP																																
Onboard drive controller	Five onboard SATA 6.0Gb/s connectors for optical and disk drives plus one SATA connector for optional eSATA. RAID 0, 1, 5* support * RAID 5 needs three 2.5" SSD drives.																																			
Drive Bays	One external 5.25" bay, one internal 3.5" bay (see right). Up to one 9mm optical + 2 x 3.5" disk drive bays + 1 x 2.5" disk drive bay + two M.2 NVMe SSD																																			
Supporting disk drives	3.5" SATA HDD (7.2K 6Gbs)																																			
	2.5" SATA SSD (6Gbs)																																			
	M.2 NVMe SSD, via PCIe adapter																																			
Max internal storage	10TB (2 x 4TB 3.5" HDDs + 1 x 2TB 2.5" SSD) plus two 1TB M.2 NVMe SSD																																			
Media reader	9-in-1 card reader. Optional 29-in-1 card reader on selected models																																			
Power supply	210 watts with variable speed fan, autosensing, Climate Savers Computing Bronze, 80 PLUS Bronze qualified																																			
Onboard Ethernet	One onboard gigabit ethernet, Intel I219LM, supports Wake-on-LAN																																			
HD Audio	Realtek ALC662 codec																																			
TPM	Standard, TCG 2.0-compliant																																			

Components	Specification
Front ports	Two USB 3.0, microphone (3.5mm), headphone (3.5mm)
Rear ports	1 VGA and 2 DisplayPort (for Intel HD Graphics models only), two USB 2.0, four USB 3.0, one serial (9-pin), one ethernet (RJ-45), three analog audio ports (line-in, line-out, mic-in)
Mechanical	<ul style="list-style-type: none"> Raven black color; metal case 4.02"W x 15.53"D x 13.31"H 102mm W x 394.5mm D x 338mm H 17.2 lb (7.9kg) max configuration 12.9-liter
Environmental certifications	GREENGUARD certified/RoHS-compliant/EPEAT Gold rating/ENERGY STAR 6.1 qualified
Limited warranty	1 or 3-year limited onsite service with 9x5/NBD. Some parts are Customer Replaceable Units.
ISV certifications	Please visit www.thinkworkstations.com/isv-certifications/

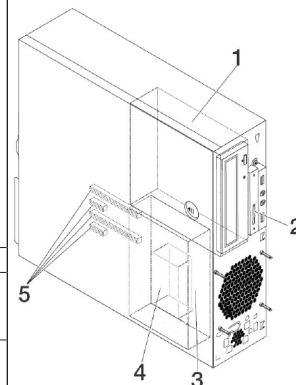

Drive Bays and PCIe Slots

Bay 1	5.25", supports one of the following: HH optical/flex module***/9mm optical+3.5" HDD bay/ 3.5" HDD bay/Front Access Storage Enclosure *** Flex module supports one or more of the following: 9mm optical/ 29-in-1 reader/front IEEE 1394/front eSATA. Up to one flex module is supported per system.
Bay 2	Optional 9-in-1 single slot reader
Bay 3	Standard 3.5" HDD bay
Bay 4	Optional 2.5" HDD bay (under Bay 3)
5 -Slots	Four PCIe slots (top-down): Slot 1: Low Profile, PCIe 3.0 x16 (near CPU) Slot 2: Low Profile, PCIe 3.0 x1 Slot 3: Low Profile, PCIe 3.0 x16 (x4 elec) Slot 4: Low Profile, PCIe 3.0 x1



ThinkStation P320 Tower Platform Specifications

Product Specifications Reference (PSREF)

Components	Specification																																																		
Chipset	Intel C236 Chipset																																																		
Intel AMT	Intel Active Management Technology 11 on Xeon models, Intel Standard Manageability on other models																																																		
Processor	One Intel "Kaby Lake" or "Skylake" processor as listed: "Kaby Lake"																																																		
	<table border="1"> <tbody> <tr><td>Xeon E3-1280 v6</td><td>4C/3.9GHz/8MB/72W/DDR4-2400</td></tr> <tr><td>Xeon E3-1275 v6</td><td>4C/3.8GHz/8MB/73W/DDR4-2400</td></tr> <tr><td>Xeon E3-1270 v6</td><td>4C/3.8GHz/8MB/72W/DDR4-2400</td></tr> <tr><td>Xeon E3-1245 v6</td><td>4C/3.7GHz/8MB/73W/DDR4-2400</td></tr> <tr><td>Xeon E3-1240 v6</td><td>4C/3.7GHz/8MB/72W/DDR4-2400</td></tr> <tr><td>Xeon E3-1230 v6</td><td>4C/3.5GHz/8MB/72W/DDR4-2400</td></tr> <tr><td>Xeon E3-1225 v6</td><td>4C/3.3GHz/8MB/73W/DDR4-2400</td></tr> <tr><td>Xeon E3-1220 v6</td><td>4C/3GHz/8MB/72W/DDR4-2400</td></tr> <tr><td>Core i7-7700K</td><td>4C/4.2GHz/8MB/91W/DDR4-2400</td></tr> <tr><td>Core i7-7700</td><td>4C/3.6GHz/8MB/65W/DDR4-2400</td></tr> <tr><td>Core i5-7600</td><td>4C/3.5GHz/6MB/65W/DDR4-2400</td></tr> <tr><td>Core i5-7500</td><td>4C/3.4GHz/6MB/65W/DDR4-2400</td></tr> <tr><td>Core i5-7400</td><td>4C/3GHz/6MB/65W/DDR4-2400</td></tr> <tr><td>Core i3-7300</td><td>2C/4GHz/4MB/51W/DDR4-2400</td></tr> <tr><td>Core i3-7100</td><td>2C/3.9GHz/3MB/51W/DDR4-2400</td></tr> </tbody> </table>	Xeon E3-1280 v6	4C/3.9GHz/8MB/72W/DDR4-2400	Xeon E3-1275 v6	4C/3.8GHz/8MB/73W/DDR4-2400	Xeon E3-1270 v6	4C/3.8GHz/8MB/72W/DDR4-2400	Xeon E3-1245 v6	4C/3.7GHz/8MB/73W/DDR4-2400	Xeon E3-1240 v6	4C/3.7GHz/8MB/72W/DDR4-2400	Xeon E3-1230 v6	4C/3.5GHz/8MB/72W/DDR4-2400	Xeon E3-1225 v6	4C/3.3GHz/8MB/73W/DDR4-2400	Xeon E3-1220 v6	4C/3GHz/8MB/72W/DDR4-2400	Core i7-7700K	4C/4.2GHz/8MB/91W/DDR4-2400	Core i7-7700	4C/3.6GHz/8MB/65W/DDR4-2400	Core i5-7600	4C/3.5GHz/6MB/65W/DDR4-2400	Core i5-7500	4C/3.4GHz/6MB/65W/DDR4-2400	Core i5-7400	4C/3GHz/6MB/65W/DDR4-2400	Core i3-7300	2C/4GHz/4MB/51W/DDR4-2400	Core i3-7100	2C/3.9GHz/3MB/51W/DDR4-2400																				
	Xeon E3-1280 v6	4C/3.9GHz/8MB/72W/DDR4-2400																																																	
	Xeon E3-1275 v6	4C/3.8GHz/8MB/73W/DDR4-2400																																																	
	Xeon E3-1270 v6	4C/3.8GHz/8MB/72W/DDR4-2400																																																	
	Xeon E3-1245 v6	4C/3.7GHz/8MB/73W/DDR4-2400																																																	
	Xeon E3-1240 v6	4C/3.7GHz/8MB/72W/DDR4-2400																																																	
	Xeon E3-1230 v6	4C/3.5GHz/8MB/72W/DDR4-2400																																																	
	Xeon E3-1225 v6	4C/3.3GHz/8MB/73W/DDR4-2400																																																	
	Xeon E3-1220 v6	4C/3GHz/8MB/72W/DDR4-2400																																																	
	Core i7-7700K	4C/4.2GHz/8MB/91W/DDR4-2400																																																	
	Core i7-7700	4C/3.6GHz/8MB/65W/DDR4-2400																																																	
	Core i5-7600	4C/3.5GHz/6MB/65W/DDR4-2400																																																	
	Core i5-7500	4C/3.4GHz/6MB/65W/DDR4-2400																																																	
	Core i5-7400	4C/3GHz/6MB/65W/DDR4-2400																																																	
	Core i3-7300	2C/4GHz/4MB/51W/DDR4-2400																																																	
	Core i3-7100	2C/3.9GHz/3MB/51W/DDR4-2400																																																	
		"Skylake"																																																	
		<table border="1"> <tbody> <tr><td>Xeon E3-1245 v5</td><td>4C/3.5GHz/8MB/80W/DDR4-2133</td></tr> <tr><td>Xeon E3-1240 v5</td><td>4C/3.5GHz/8MB/80W/DDR4-2133</td></tr> <tr><td>Xeon E3-1230 v5</td><td>4C/3.4GHz/8MB/80W/DDR4-2133</td></tr> <tr><td>Xeon E3-1225 v5</td><td>4C/3.3GHz/8MB/80W/DDR4-2133</td></tr> <tr><td>Xeon E3-1220 v5</td><td>4C/3GHz/8MB/80W/DDR4-2133</td></tr> <tr><td>Core i7-6700</td><td>4C/3.4GHz/8MB/65W/DDR4-2133</td></tr> <tr><td>Core i5-6500</td><td>4C/3.2GHz/6MB/65W/DDR4-2133</td></tr> <tr><td>Core i5-6400</td><td>4C/2.7GHz/6MB/65W/DDR4-2133</td></tr> <tr><td>Core i3-6100</td><td>2C/3.9GHz/3MB/51W/DDR4-2133</td></tr> </tbody> </table>	Xeon E3-1245 v5	4C/3.5GHz/8MB/80W/DDR4-2133	Xeon E3-1240 v5	4C/3.5GHz/8MB/80W/DDR4-2133	Xeon E3-1230 v5	4C/3.4GHz/8MB/80W/DDR4-2133	Xeon E3-1225 v5	4C/3.3GHz/8MB/80W/DDR4-2133	Xeon E3-1220 v5	4C/3GHz/8MB/80W/DDR4-2133	Core i7-6700	4C/3.4GHz/8MB/65W/DDR4-2133	Core i5-6500	4C/3.2GHz/6MB/65W/DDR4-2133	Core i5-6400	4C/2.7GHz/6MB/65W/DDR4-2133	Core i3-6100	2C/3.9GHz/3MB/51W/DDR4-2133																															
	Xeon E3-1245 v5	4C/3.5GHz/8MB/80W/DDR4-2133																																																	
Xeon E3-1240 v5	4C/3.5GHz/8MB/80W/DDR4-2133																																																		
Xeon E3-1230 v5	4C/3.4GHz/8MB/80W/DDR4-2133																																																		
Xeon E3-1225 v5	4C/3.3GHz/8MB/80W/DDR4-2133																																																		
Xeon E3-1220 v5	4C/3GHz/8MB/80W/DDR4-2133																																																		
Core i7-6700	4C/3.4GHz/8MB/65W/DDR4-2133																																																		
Core i5-6500	4C/3.2GHz/6MB/65W/DDR4-2133																																																		
Core i5-6400	4C/2.7GHz/6MB/65W/DDR4-2133																																																		
Core i3-6100	2C/3.9GHz/3MB/51W/DDR4-2133																																																		
Memory DIMM slots	4 DIMM slots, 2-channel (integrated memory controller in processor)																																																		
Memory type/capacity	Up to 64GB ECC/non-ECC (4 x 16GB), DDR4-2400. UDIMM. "Skylake" processor supports up to DDR4-2133. Core i7 and i5 processors cannot support ECC.																																																		
Intel HD Graphics in processor	Integrated Intel HD P530 in Xeon E3-12x5 v5 processors, or Intel HD P630 in Xeon E3-12x5 v6 processors, or Intel HD 530 in Core i7, i5, or i3 6000 processors, or Intel HD 630 in Core i7, i5, or i3 7000 processors. Works along with discrete graphics to support multi-display, enables three display connectors (2 DP, 1 VGA) on rear.																																																		
Discrete graphics	Two PCI Express 3.0 x16 slots for graphics adapters. Up to two Quadro P1000 on 250 watts models. Or up to two Quadro P2000, or up to one Quadro P4000 on 400 watts models. Supports the following NVIDIA graphics adapters:																																																		
	<table border="1"> <thead> <tr> <th>Adapter</th> <th>Cores</th> <th>Memory</th> <th>Power</th> <th>Connector</th> </tr> </thead> <tbody> <tr><td>NVS 310</td><td>48</td><td>1GB</td><td>19.5W</td><td>2xDP</td></tr> <tr><td>NVS 315</td><td>48</td><td>1GB</td><td>19.5W</td><td>2xDVI-I SL/2xDP</td></tr> <tr><td>NVS 510</td><td>192</td><td>2GB</td><td>33.4W</td><td>4xmini DP</td></tr> <tr><td>NVS 810</td><td>1024</td><td>4GB</td><td>68W</td><td>8xmini DP</td></tr> <tr><td>Quadro P400</td><td>256</td><td>2GB</td><td>30W</td><td>3xminiDP</td></tr> <tr><td>Quadro P600</td><td>384</td><td>2GB</td><td>40W</td><td>4xminiDP</td></tr> <tr><td>Quadro P1000</td><td>640</td><td>4GB</td><td>47W</td><td>4xminiDP</td></tr> <tr><td>Quadro P2000</td><td>1024</td><td>5GB</td><td>75W</td><td>4xDP</td></tr> <tr><td>Quadro P4000</td><td>1792</td><td>8GB</td><td>105W</td><td>4xDP</td></tr> </tbody> </table>	Adapter	Cores	Memory	Power	Connector	NVS 310	48	1GB	19.5W	2xDP	NVS 315	48	1GB	19.5W	2xDVI-I SL/2xDP	NVS 510	192	2GB	33.4W	4xmini DP	NVS 810	1024	4GB	68W	8xmini DP	Quadro P400	256	2GB	30W	3xminiDP	Quadro P600	384	2GB	40W	4xminiDP	Quadro P1000	640	4GB	47W	4xminiDP	Quadro P2000	1024	5GB	75W	4xDP	Quadro P4000	1792	8GB	105W	4xDP
	Adapter	Cores	Memory	Power	Connector																																														
	NVS 310	48	1GB	19.5W	2xDP																																														
	NVS 315	48	1GB	19.5W	2xDVI-I SL/2xDP																																														
	NVS 510	192	2GB	33.4W	4xmini DP																																														
	NVS 810	1024	4GB	68W	8xmini DP																																														
	Quadro P400	256	2GB	30W	3xminiDP																																														
	Quadro P600	384	2GB	40W	4xminiDP																																														
	Quadro P1000	640	4GB	47W	4xminiDP																																														
Quadro P2000	1024	5GB	75W	4xDP																																															
Quadro P4000	1792	8GB	105W	4xDP																																															
Onboard drive controller	Five onboard SATA 6.0Gb/s connectors for optical and disk drives plus one SATA connector for optional eSATA. RAID 0, 1, 5, 10 support																																																		
Drive Bays	Two external 5.25" bays, two internal 3.5" bays (see right). Up to one 9mm optical plus 4 x 3.5" disk drive bays plus two M.2 NVMe SSD																																																		
Supporting disk drives	3.5" SATA HDD (7.2K 6Gbs)																																																		
	2.5" SATA SSD (6Gbs)																																																		
	M.2 NVMe SSD, via PCIe adapter																																																		
Max internal storage	16TB (4 x 4TB 3.5" HDDs) plus 2TB (2 x 1TB) M.2 NVMe SSD																																																		
Media reader	9-in-1 card reader. Optional 29-in-1 card reader on selected models																																																		

Components	Specification
Power supply	One 250 watts with variable speed fan, autosensing, Climate Savers Computing Bronze, 80 PLUS Bronze qualified. Or one 400 watts with variable speed fan, autosensing, Climate Savers Computing Platinum, 80 PLUS Platinum qualified.
Onboard Ethernet	One onboard gigabit ethernet, Intel I219LM, supports Wake-on-LAN
HD Audio	Realtek ALC662 codec
TPM	Standard, TCG 2.0-compliant
Front ports	Two USB 3.0, microphone (3.5mm), headphone (3.5mm)
Rear ports	1 VGA and 2 DisplayPort (for Intel HD Graphics models only), two USB 2.0, four USB 3.0, one serial (9-pin), one ethernet (RJ-45), three analog audio ports (line-in, line-out, mic-in)
Mechanical	<ul style="list-style-type: none"> Raven black color; metal case 6.89"W x 16.77"D x 14.8"H 175mm W x 426mm D x 376mm H 28.66 lb (13kg) max configuration 25-liter
Environmental certifications	GREENGUARD certified/RoHS-compliant/EPEAT Gold rating/ENERGY STAR 6.1 qualified
Limited warranty	1 or 3-year limited onsite service with 9x5/NBD. Some parts are Customer Replaceable Units.
ISV certifications	Please visit www.thinkworkstations.com/isv-certifications/

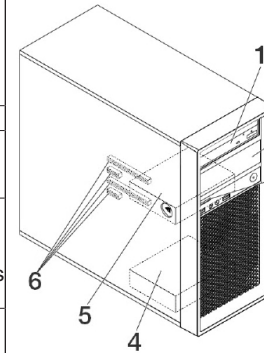

Drive Bays and PCIe Slots

Bay 1 and Bay 2	5.25", support one of the following: HH optical/flex module/9mm optical+3.5" HDD bay/ 3.5" HDD bay/Front Access Storage Enclosure (FASE) <i>Note:</i> 1. Flex module supports one or more of the following: 9mm optical/ 29-in-1 reader/front IEEE 1394/front eSATA. 2. Up to one flex module/FASE per system.
Bay 3	Optional 9-in-1 single slot reader
Bay 4	Standard 3.5" HDD bay
Bay 5	Standard 3.5" HDD bay
6 -Slots	Four PCIe slots (top-down): Slot 1: Half length, full height, PCIe 3.0 x16 (near CPU) Slot 2: Half length, full height, PCIe 3.0 x16 Slot 3: Half length, full height, PCIe 3.0 x16 (x4 elec) Slot 4: Half length, full height, PCIe 3.0 x1 <i>Note:</i> 1. Both discrete graphics adapter and M.2 NVMe SSD should be installed on slot 1 or slot 3, the maximum quantity of discrete graphics adapter and M.2 NVMe SSD is 2. 2. When two discrete graphics adapters are used, no other PCIe card can be used.



ThinkStation P330 SFF Platform Specifications

Product Specifications Reference (PSREF)

Components	Specification																							
Machine Type	MT 30C7 for Transactional model and MT 30C8 for Relationship model. For configuration of all 30C7 EMEA and US models, please visit: http://psref.lenovo.com/Product/ThinkStation/ThinkStation_P330_SFF																							
Form factor	8.4L mini-tower																							
Dimensions	Height: 343.5 mm (13.5 in). Width: 92.5 mm (3.6 in). Depth: 305.6 mm (12 in)																							
Weight	Maximum configuration: 13.23 lb (6.0kg)																							
Processor	Up to one Intel Xeon E-2100 family processor, up to 80W, up to 6 cores at 3.7GHz, up to 3.8GHz with 4 cores, up to 12MB cache, DDR4-2666 memory speed. Or up to one 8th Intel Core family processor, i7, i5, or i3, up to 65W, up to 6 cores at 3.2GHz, up to 3.7GHz with 4 cores, up to 12MB cache, up to DDR4-2666 memory speed. Or up to one Intel Pentium G5400 via Special Bids, 58W, 2 cores at 3.7GHz, 4MB cache, DDR4-2400 memory speed																							
Chipset	Intel C246 Chipset																							
Memory	4 DIMM sockets. DDR4-2666. UDIMM. ECC and non-ECC are supported, but memory types cannot be intermixed																							
Memory capacity	Up to 64GB with 4x 16GB, both ECC and non-ECC																							
Memory protection	ECC with ECC UDIMM. Core i7 and i5 processors cannot support ECC UDIMM																							
Expansion slots	Three PCIe 3.0 slots as following:																							
	Slot 1 PCIe 3.0 x16, full height, half length, links to CPU																							
	Slot 2 PCIe 3.0 x1, full height, full length, links to PCH																							
Graphics - Processor graphics	Slot 3 PCIe 3.0 x16 (negotiable link width x4), full height, half length, links to PCH																							
	Integrated Intel UHD Graphics P630 in -G suffix Xeon processors, or Intel UHD Graphics 630 in Core i7, i5, or i3 processors, or Intel UHD Graphics 610 in Pentium Gold G5400. Works along with discrete graphics to support multi-display, enables three display connectors (2x DP, 1x HDMI. HDMI is optional) on rear																							
Graphics - Discrete graphics card	Up to two PCIe 3.0 x16 slots for discrete graphics adapter (Slot 1 and 3). Supports the following graphics adapters:																							
	<table border="1"> <thead> <tr> <th>Adapter</th> <th>Cores</th> <th>Memory</th> <th>Power</th> <th>Connectors</th> <th>Max qty</th> </tr> </thead> <tbody> <tr> <td>Quadro P400</td> <td>256</td> <td>2GB GDDR5</td> <td>30W</td> <td>3x miniDP</td> <td>2</td> </tr> <tr> <td>Quadro P620</td> <td>512</td> <td>2GB GDDR5</td> <td>40W</td> <td>4x miniDP</td> <td>2</td> </tr> <tr> <td>Quadro P1000</td> <td>640</td> <td>4GB GDDR5</td> <td>47W</td> <td>4x miniDP</td> <td>2</td> </tr> </tbody> </table>	Adapter	Cores	Memory	Power	Connectors	Max qty	Quadro P400	256	2GB GDDR5	30W	3x miniDP	2	Quadro P620	512	2GB GDDR5	40W	4x miniDP	2	Quadro P1000	640	4GB GDDR5	47W	4x miniDP
Adapter	Cores	Memory	Power	Connectors	Max qty																			
Quadro P400	256	2GB GDDR5	30W	3x miniDP	2																			
Quadro P620	512	2GB GDDR5	40W	4x miniDP	2																			
Quadro P1000	640	4GB GDDR5	47W	4x miniDP	2																			
Storage controllers	Integrated Intel SATA AHCI/RAID controller in chipset, 6Gbps SATA, RAID 0/1. Four onboard SATA ports for max 4 SATA HDD/SSD/ODD																							
Internal storage bay	Up to 3 bays with two disk bays and one slim optical bay:																							
	Bay 1 Primary 3.5" SATA bay																							
	Bay 2 2.5" SATA bay (Optional)																							
Disks	Bay 3 9mm Slim ODD bay																							
	3.5" HDD supports up to 4TB each, 6Gbps SATA, 7.2K. 2.5" SSD supports up to 1TB each, 6Gbps SATA																							
M.2 slot for SSD	Up to 3x M.2 SSD with one dedicated onboard M.2 slot plus two PCIe to M.2 adapters. PCIe to M.2 adapter uses slot 1 or 3. Supports RAID 0/1 with PCH, When used as RAID, M.2 SSD should be installed in onboard M.2 slot and slot 3. Up to one Optane memory per system; Optane memory must work with a HDD or SSD; Optane memory cannot supported on Pentium G5400 models																							
M.2 SSD	M.2 SSD supports up to 1TB each, PCIe 3.0 x4, NVMe, Opal. Optane memory supports 32GB, PCIe 3.0 x2, NVMe, 3D Xpoint																							
M.2 slot for Wi-Fi and Bluetooth	One dedicated onboard M.2 slot for optional Intel Wireless-AC 9560, 2x2, 2.4GHz/5GHz (160MHz channels), 802.11ac, Bluetooth 5, up to 1.73Gbps																							

Components	Specification
Media reader	Optional SD card reader on most models
Network interfaces	One onboard GbE port via integrated gigabit ethernet Intel i219LM, supports Wake-on-LAN. Optional PCIe ethernet adapters are available
Security features	Power-on and admin password. Trusted Platform Module, TCG 2.0 compliant. Optional chassis intrusion switch, cable lock, Kensington lock, and pad lock
Intel vPro	Supports Intel vPro on Xeon models. vPro also requires Wireless-AC 9560 if Wi-Fi is needed
Intel AMT	Intel Active Management Technology 12 on Xeon models, Intel Standard Manageability on other models
Base warranty	US models comes with 3-year limited onsite service with 9x5/NBD. 1 or 3-year limited onsite service with 9x5/NBD in EMEA or other GEOs
HD Audio	Intel HD Audio interface with Realtek ALC233 Codec
Front ports	2x USB 3.1 Gen 1 Type A. 2x USB 3.1 Gen 2 Type A. 1x USB 3.1 Gen 1 Type-C. 1x Mic-in. 1x Combo jack
Rear ports	2x USB 3.1 Gen 1 Type A. 2x USB 2.0 Type-A. 1x RJ-45. 1x COM. 2x DP. 1x Audio line-out <i>Notes: DP needs Core, Pentium, or -G suffix Xeon processor</i>
Optional rear ports	2x USB 3.1 Type-C. 1x COM. PS/2. 1x Parallel. 1x Thunderbolt. 1x IEEE1394. 1x HDMI. 1x Audio line-out <i>Notes: HDMI needs Core, Pentium, or -G suffix Xeon processor</i>
Temperature	Operating: 41 °F to 104 °F (10 °C to 35 °C) Non operating (no package): 14 °F to 140 °F (-10 °C to 60 °C) Non operating (with package): -40 °F to 140 °F (-40 °C to 60 °C)
Altitude	Operating: -15.2 m (-50 ft) to 3048 m (10 000 ft). Storage: -15.2 m (-50 ft) to 10, 668 m (35 000 ft)
Humidity	Operating: 30%-90%, non-condensing Storage (with package): 20%-90%, non-condensing
Environmental certification	RoHS-compliant. GREENGUARD. EPEAT Silver rating and ENERGY STAR 7 qualified
Power supply	Supports one 210W or 260W power supply. 210W is 100V - 240V, 85% PSU, Climate Savers Computing Bronze and 80 PLUS Bronze qualified. 260W is 100V - 240V, 92% PSU, Climate Savers Computing Platinum and 80 PLUS Platinum qualified
ISV certifications	Please visit www.thinkworkstations.com/isv-certifications/

Note:
1. Depending on many factors, actual data transfer speed mentioned on this page may be lower than theoretical speed.
2. Any questions or advice on ThinkStation PSREF, please contact [ThinkStation PSREF developer](#)

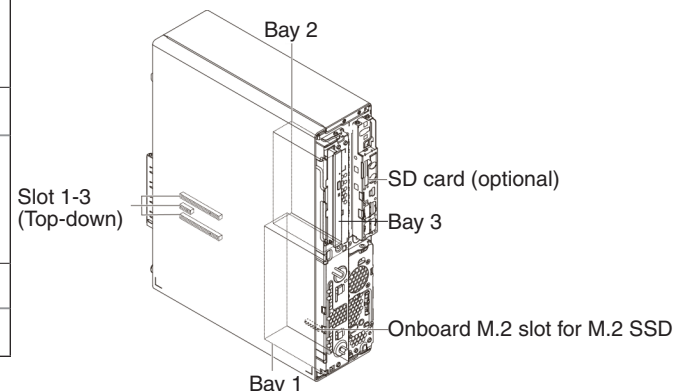



ThinkStation P330 SFF Gen 2 (30D1 and 30D2) Platform Specifications

Product Specifications Reference (PSREF)

Components	Specification																														
Form factor	8.4L mini-tower																														
Dimensions	Height: 343.5 mm (13.5 in). Width: 92.5 mm (3.6 in). Depth: 305.6 mm (12 in)																														
Weight	Maximum configuration: 13.23 lb (6.0kg)																														
Processor	<p>Supports one of the following processor:</p> <ul style="list-style-type: none"> Xeon E-2278G 8C/16T/3.4GHz/16MB/80W/DDR4-2666 (260W PSU needed) Xeon E-2276G 6C/12T/3.8GHz/12MB/80W/DDR4-2666 Xeon E-2274G 4C/8T/4.0GHz/8MB/83W/DDR4-2666 Xeon E-2246G 6C/12T/3.6GHz/12MB/80W/DDR4-2666 Xeon E-2244G 4C/8T/3.8GHz/8MB/71W/DDR4-2666 Xeon E-2236 6C/12T/3.4GHz/12MB/80W/DDR4-2666 Xeon E-2234 4C/8T/3.6GHz/8MB/71W/DDR4-2666 Xeon E-2226G 6C/6T/3.4GHz/12MB/80W/DDR4-2666 Xeon E-2224G 4C/4T/3.5GHz/8MB/71W/DDR4-2666 Xeon E-2224 4C/4T/3.4GHz/8MB/71W/DDR4-2666 Xeon E-2174G 4C/8T/3.8GHz/8MB/71W/DDR4-2666 Core i9-9900 8C/16T/3.1GHz/16MB/65W/DDR4-2666 Core i7-9700 8C/8T/3.0GHz/12MB/65W/DDR4-2666 Core i7-8700 6C/12T/3.2GHz/12MB/65W/DDR4-2666 Core i5-9600 6C/6T/3.1GHz/9MB/65W/DDR4-2666 Core i5-9500 6C/6T/3.0GHz/9MB/65W/DDR4-2666 Core i5-9400 6C/6T/2.9GHz/9MB/65W/DDR4-2666 Core i5-8500 6C/6T/3.0GHz/9MB/65W/DDR4-2666 Core i3-9300 4C/4T/3.7GHz/8MB/62W/DDR4-2400 Core i3-9100 4C/4T/3.6GHz/6MB/65W/DDR4-2400 Core i3-8300 4C/4T/3.7GHz/8MB/62W/DDR4-2400 Core i3-8100 4C/4T/3.6GHz/6MB/65W/DDR4-2400 Pentium Gold G5620 2C/4T/4.0GHz/4MB/54W/DDR4-2400 																														
Chipset	Intel C246 Chipset																														
Memory Sockets	4 DIMM sockets with 2 channels																														
Memory Types	8GB/16GB DDR4-2666 UDIMM ECC or 4GB/8GB/16GB DDR4-2666 UDIMM non-ECC																														
Memory Capacity	64B with 4 x 16GB, both UDIMM ECC or UDIMM non-ECC																														
Memory Protection	ECC on models with UDIMM ECC memory																														
Expansion slots	<p>Three PCIe 3.0 slots as following:</p> <table border="1"> <tr> <td>Slot 1</td> <td>PCIe 3.0 x16, low profile, links to CPU</td> </tr> <tr> <td>Slot 2</td> <td>PCIe 3.0 x1, low profile, links to PCH</td> </tr> <tr> <td>Slot 3</td> <td>PCIe 3.0 x16 (negotiable link width x4), low profile, links to PCH</td> </tr> </table>	Slot 1	PCIe 3.0 x16, low profile, links to CPU	Slot 2	PCIe 3.0 x1, low profile, links to PCH	Slot 3	PCIe 3.0 x16 (negotiable link width x4), low profile, links to PCH																								
Slot 1	PCIe 3.0 x16, low profile, links to CPU																														
Slot 2	PCIe 3.0 x1, low profile, links to PCH																														
Slot 3	PCIe 3.0 x16 (negotiable link width x4), low profile, links to PCH																														
Processor graphics	<p>Integrated Intel UHD Graphics P630 in -G suffix Xeon processors, or Intel UHD Graphics 630 in Core i5 or i3 processors.</p> <p>Works along with discrete graphics to support multi-display, enables three rear display connectors (2 DP standard, 1 DP or HDMI optional)</p>																														
Discrete graphics card	<p>Up to two PCIe 3.0 x16 slots for discrete graphics adapter (Slot 1 and 3). Supports the following graphics adapters:</p> <table border="1"> <thead> <tr> <th>Adapter</th> <th>Cores</th> <th>Memory</th> <th>Power</th> <th>Connectors</th> <th>Max qty</th> </tr> </thead> <tbody> <tr> <td>Quadro P400</td> <td>256</td> <td>2GB GDDR5</td> <td>30W</td> <td>3x miniDP</td> <td>2</td> </tr> <tr> <td>Quadro P620</td> <td>512</td> <td>2GB GDDR5</td> <td>40W</td> <td>4x miniDP</td> <td>2</td> </tr> <tr> <td>Quadro P1000</td> <td>640</td> <td>4GB GDDR5</td> <td>47W</td> <td>4x miniDP</td> <td>2</td> </tr> </tbody> </table>	Adapter	Cores	Memory	Power	Connectors	Max qty	Quadro P400	256	2GB GDDR5	30W	3x miniDP	2	Quadro P620	512	2GB GDDR5	40W	4x miniDP	2	Quadro P1000	640	4GB GDDR5	47W	4x miniDP	2						
Adapter	Cores	Memory	Power	Connectors	Max qty																										
Quadro P400	256	2GB GDDR5	30W	3x miniDP	2																										
Quadro P620	512	2GB GDDR5	40W	4x miniDP	2																										
Quadro P1000	640	4GB GDDR5	47W	4x miniDP	2																										
Storage Controller	<table border="1"> <thead> <tr> <th>Storage Controller</th> <th>Type</th> <th>Interface</th> <th>Disk Type</th> <th>RAID</th> </tr> </thead> <tbody> <tr> <td>Onboard Intel RST SATA RAID</td> <td>Std</td> <td>SATA 6Gb/s</td> <td>HDD or SSD</td> <td>0/1</td> </tr> <tr> <td>Onboard Intel RST PCIe RAID</td> <td>Std</td> <td>PCIe NVMe</td> <td>M.2 PCIe SSD</td> <td>0/1</td> </tr> </tbody> </table>	Storage Controller	Type	Interface	Disk Type	RAID	Onboard Intel RST SATA RAID	Std	SATA 6Gb/s	HDD or SSD	0/1	Onboard Intel RST PCIe RAID	Std	PCIe NVMe	M.2 PCIe SSD	0/1															
Storage Controller	Type	Interface	Disk Type	RAID																											
Onboard Intel RST SATA RAID	Std	SATA 6Gb/s	HDD or SSD	0/1																											
Onboard Intel RST PCIe RAID	Std	PCIe NVMe	M.2 PCIe SSD	0/1																											
Storage Support	<table border="1"> <thead> <tr> <th>Disk Type</th> <th>Interface</th> <th>RPM</th> <th>Offering</th> <th>Max Qty</th> </tr> </thead> <tbody> <tr> <td>3.5" SATA HDD</td> <td>SATA 6Gb/s</td> <td>7.2K</td> <td>1TB/2TB/4TB</td> <td>1</td> </tr> <tr> <td>2.5" SATA HDD</td> <td>SATA 6Gb/s</td> <td>7.2K</td> <td>500GB FIPS</td> <td>2</td> </tr> <tr> <td>2.5" SATA SSD</td> <td>SATA 6Gb/s</td> <td></td> <td>256GB/512GB/1TB</td> <td>2</td> </tr> <tr> <td>Optane Memory</td> <td>PCIe NVMe</td> <td></td> <td>32GB</td> <td>1, used with HDD/SSD</td> </tr> <tr> <td>M.2 PCIe SSD</td> <td>PCIe NVMe</td> <td></td> <td>256GB/512GB/1TB</td> <td>3</td> </tr> </tbody> </table>	Disk Type	Interface	RPM	Offering	Max Qty	3.5" SATA HDD	SATA 6Gb/s	7.2K	1TB/2TB/4TB	1	2.5" SATA HDD	SATA 6Gb/s	7.2K	500GB FIPS	2	2.5" SATA SSD	SATA 6Gb/s		256GB/512GB/1TB	2	Optane Memory	PCIe NVMe		32GB	1, used with HDD/SSD	M.2 PCIe SSD	PCIe NVMe		256GB/512GB/1TB	3
Disk Type	Interface	RPM	Offering	Max Qty																											
3.5" SATA HDD	SATA 6Gb/s	7.2K	1TB/2TB/4TB	1																											
2.5" SATA HDD	SATA 6Gb/s	7.2K	500GB FIPS	2																											
2.5" SATA SSD	SATA 6Gb/s		256GB/512GB/1TB	2																											
Optane Memory	PCIe NVMe		32GB	1, used with HDD/SSD																											
M.2 PCIe SSD	PCIe NVMe		256GB/512GB/1TB	3																											
Storage bay	<p>Up to 3 bays with two disk bays and one slim optical bay:</p> <table border="1"> <tr> <td>Bay 1</td> <td>Primary 3.5" SATA bay</td> </tr> <tr> <td>Bay 2</td> <td>2.5" SATA bay (Optional)</td> </tr> <tr> <td>Bay 3</td> <td>9mm Slim ODD bay</td> </tr> <tr> <td>M.2</td> <td>3x M.2 SSD (1 onboard, 2 via PCIe to M.2 adapter)</td> </tr> </table>	Bay 1	Primary 3.5" SATA bay	Bay 2	2.5" SATA bay (Optional)	Bay 3	9mm Slim ODD bay	M.2	3x M.2 SSD (1 onboard, 2 via PCIe to M.2 adapter)																						
Bay 1	Primary 3.5" SATA bay																														
Bay 2	2.5" SATA bay (Optional)																														
Bay 3	9mm Slim ODD bay																														
M.2	3x M.2 SSD (1 onboard, 2 via PCIe to M.2 adapter)																														

Components	Specification
M.2 slot for Wi-Fi and Bluetooth	One dedicated onboard M.2 slot for optional Intel Wireless-AC 9560, 2x2, 2.4GHz/5GHz (160MHz channels), 802.11ac, Bluetooth 5, up to 1.73Gbps
Media reader	Optional SD card reader on most models
Network interfaces	One onboard GbE port via integrated gigabit ethernet Intel i219LM, supports Wake-on-LAN. Optional PCIe ethernet adapters are available
Security features	Power-on and admin password. Trusted Platform Module, TCG 2.0 compliant. Optional chassis intrusion switch, cable lock, Kensington lock, and pad lock
Intel vPro	Supports Intel vPro on Xeon models. vPro also requires Wireless-AC 9560 if Wi-Fi is needed
Intel AMT	Intel Active Management Technology 12 on Xeon models, Intel Standard Manageability on other models
Base warranty	US models comes with 3-year limited onsite service with 9x5/NBD. 1 or 3-year limited onsite service with 9x5/NBD in EMEA or other GEOs
HD Audio	Intel HD Audio interface with Realtek ALC233 Codec
Front ports	2x USB 3.1 Gen 1 Type A. 2x USB 3.1 Gen 2 Type A. 1x USB 3.1 Gen 1 Type-C. 1x Mic-in. 1x Combo jack
Rear ports	2x USB 3.1 Gen 1 Type A. 2x USB 2.0 Type-A. 1x RJ-45. 1x COM. 2x DP. 1x Audio line-out <i>Notes: DP needs Core, Pentium, or -G suffix Xeon processor</i>
Optional rear ports	<p>Supports the following via cable:</p> <p>1x COM. 1x Parallel. 2x PS/2. 1x DP or 1x HDMI. 2x USB 2.0</p> <p>Supports the following via PCIe adapter:</p> <p>4x COM. 2x USB 3.1 Type-C. 2x USB 3.0. 1x Thunderbolt. <i>Notes: DP or HDMI needs Core, Pentium, or -G suffix Xeon processor</i></p>
Temperature	<p>Operating: 41 °F to 104 °F (10 °C to 35 °C)</p> <p>Non operating (no package): 14 °F to 140 °F (-10 °C to 60 °C)</p> <p>Non operating (with package): -40 °F to 140 °F (-40 °C to 60 °C)</p>
Altitude	<p>Operating: -15.2 m (-50 ft) to 3048 m (10 000 ft).</p> <p>Storage: -15.2 m (-50 ft) to 10, 668 m (35 000 ft)</p>
Humidity	<p>Operating: 30%-90%, non-condensing</p> <p>Storage (with package): 20%-90%, non-condensing</p>
Environmental certification	RoHS-compliant. GREENGUARD. EPEAT Silver rating and ENERGY STAR 7 qualified
Power supply	<p>Supports one 210W or 260W power supply.</p> <p>210W is 100V - 240V, 85% PSU, Climate Savers Computing Bronze and 80 PLUS Bronze qualified.</p> <p>260W is 100V - 240V, 92% PSU, Climate Savers Computing Platinum and 80 PLUS Platinum qualified</p>
ISV certifications	Please visit www.thinkworkstations.com/isv-certifications/

Note:
 1. Depending on many factors, actual data transfer speed mentioned on this page may be lower than theoretical speed.
 2. Any questions or advice on ThinkStation PSREF, please contact [ThinkStation PSREF developer](mailto:ThinkStation_PSREF_developer)

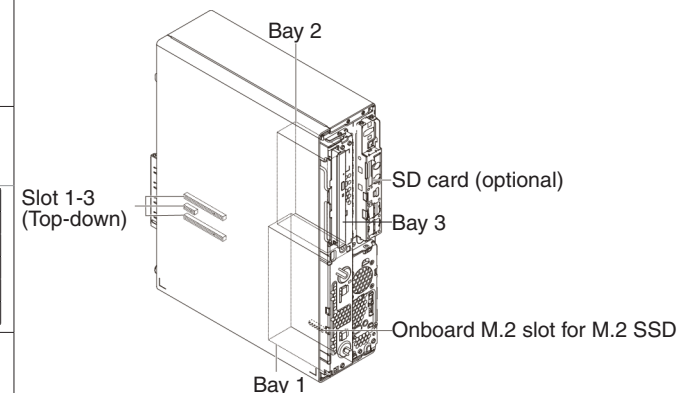



ThinkStation P330 Tiny Platform Specifications

Product Specifications Reference (PSREF)

Components	Specification	Components	Specification															
Machine Type	MT 30CF for Transactional model and MT 30CE for Relationship model. For configuration of all 30CF EMEA and US models, please visit: http://psref.lenovo.com/Product/ThinkStation/ThinkStation_P330_Tiny	Media reader	None. Using USB adapter															
Form factor	1L. Optional VESA mount bracket kit, supports VESA 75mm and 100mm. Optional floor stand for vertical orientation. Optional tool-less chassis open. Optional dust filter	Network interfaces	One onboard GbE port via integrated gigabit ethernet Intel i219LM, supports Wake-on-LAN. Optional Intel i350-T4 for 4x GbE ports, using PCIe slot															
Dimensions	Height: 179 mm (7.0 in). Width: 36.5 mm (1.437 in). Depth: 182.9 mm (7.2 in)	Security features	Power-on and admin password. Trusted Platform Module, TCG 2.0 compliant. Chassis intrusion switch. Optional Kensington lock															
Weight	Maximum configuration: 3.08 lb (1.4kg)	Intel vPro Technology	Supports vPro on models with the following processors: Core i7-8700T, Core i7-8700, Core i5-8600T, Core i5-8600, Core i5-8500T, Core i5-8500. vPro also requires Wireless-AC 9560 if Wi-Fi is needed															
Supported TIO monitors	Tiny-in-One 23 (MT: 10DQ). Tiny-in-One 22 (MT: 10LK). Tiny-in-One 24 (MT: 10LL). Tiny-in-One22 Gen3 (MT: 10R1). Tiny-in-One22 Gen3 Touch (MT: 10R0). Tiny-in-One24 Gen3 (MT: 10QY). Tiny-in-One24 Gen3 Touch (MT: 10QX).	Systems management	Intel Active Management Technology 12 on vPro models, Intel Standard Manageability on other models															
Recommended monitors	Lenovo recommends ThinkVision P series monitors for best display performance and productivity	Base warranty	US models comes with 3-year limited onsite service with 9x5/NBD. 1 or 3-year limited onsite service with 9x5/NBD in EMEA or other GEOs															
Processor	Up to one Intel Core family processor, i7, i5, or i3. Core i7 supports 65W or 35W, 6 cores, up to 3.2GHz, 12MB cache, DDR4-2666 memory speed. Core i5 supports 65W or 35W, 6 cores, up to 3.1GHz, 9MB cache, DDR4-2666 memory speed. Core i3 supports 65W, 62W, or 35W, 4 cores, up to 3.7GHz, 6MB or 8MB cache, DDR4-2400 memory speed.	HD Audio	Intel HD Audio interface with Realtek ALC233 Codec															
Chipset	Intel Q370 Chipset	Front standard ports	1x USB 3.1 Gen 1 Type A (charging). 1x USB 3.1 Gen 1 Type-C. 1x Mic-in. 1x Combo jack															
Memory	2 DIMM sockets. DDR4-2666. SoDIMM. Non-ECC	Rear standard ports	2x USB 3.1 Gen 2 Type A. 2x USB 3.1 Gen 1 Type-A. 1x RJ-45. 1x DP. 1x HDMI															
Expansion slots	One PCIe slot via specific riser card: PCIe 3.0 x16 (negotiable link width x8) and low profile for discrete graphics card; PCIe 3.0 x4 and low profile for i350-T4 adapter and quad COM ports adapter	Optional rear ports - via punch out cable	Up to two optional rear ports via punch out cable. Port 1 supports one of the following: 1x USB 3.1 Gen 1 Type-C, also supports DP function. 1x COM. 1x VGA. 1x DP. 1x HDMI. Port 2 supports one COM															
Graphics	65W or 62W processor models supports processor graphics only. 35W processor models come with processor graphics plus a discrete graphics adapter	Optional rear ports - via PCIe adapter	Supports one of the following: 4x miniDP with Quadro P620 or P1000, 35W processor models only 2x USB 3.1 Gen 1. 4x RJ-45 GbE with Intel I350-T4. 4x COM <i>Note: Punch out cable and PCIe adapter are mutually exclusive</i>															
Graphics - Processor graphics	Integrated Intel UHD Graphics 630. Works along with discrete graphics to support multi-display	Temperature	Operating: 50 °F to 95 °F (10 °C to 35 °C) Non operating (with package): -40 °F to 140 °F (-40 °C to 60 °C)															
Graphics - Discrete graphics card	One of the following discrete graphics cards on 35W processor models: <table border="1"> <thead> <tr> <th>Adapter</th> <th>Cores</th> <th>Memory</th> <th>Power</th> <th>Connectors</th> </tr> </thead> <tbody> <tr> <td>Quadro P620</td> <td>512</td> <td>2GB GDDR5</td> <td>40W</td> <td>4x miniDP</td> </tr> <tr> <td>Quadro P1000</td> <td>640</td> <td>4GB GDDR5</td> <td>47W</td> <td>4x miniDP</td> </tr> </tbody> </table>	Adapter	Cores	Memory	Power	Connectors	Quadro P620	512	2GB GDDR5	40W	4x miniDP	Quadro P1000	640	4GB GDDR5	47W	4x miniDP	Altitude	Operating: -15.2 m (-50 ft) to 3048 m (10 000 ft). Storage: -15.2 m (-50 ft) to 10, 668 m (35 000 ft)
Adapter	Cores	Memory	Power	Connectors														
Quadro P620	512	2GB GDDR5	40W	4x miniDP														
Quadro P1000	640	4GB GDDR5	47W	4x miniDP														
Storage controllers	Integrated Intel SATA AHCI controller in chipset, 6Gbps SATA, one onboard SATA port for 2.5" HDD	Humidity	Operating: 20%~80%, non-condensing Storage (with package): 20%~90%, non-condensing															
Internal storage bay	Up to one 2.5" HDD	MIL-SPEC	Certified															
Disks	2.5" HDD supports up to 1TB, 6Gbps SATA, 7.2K or 5.4K	Environmental certification	RoHS-compliant. GREENGUARD. EPEAT Silver rating and ENERGY STAR 7 qualified															
M.2 slot for SSD	Two onboard M.2 slots for M.2 SSD, one for M.2 2280 SSD, one for M.2 2280 or 2242 SSD	Power supply	Supports one 135W power adapter, 100V - 240V, 88% PSU															
M.2 SSD	M.2 2280 SSD supports up to 1TB each, PCIe 3.0 x4, NVMe, optional Opal. M.2 2242 SSD supports up to 128GB, PCIe 3.0 x2, NVMe	ISV certifications	Please visit www.thinkworkstations.com/isv-certifications/															
Optane memory	Up to one 16GB Optane memory per system. Optane memory must work with a 2.5" HDD																	
M.2 slot for Wi-Fi and Bluetooth	One dedicated M.2 2230 slot for optional Wi-Fi card, supports one of the following: Intel Wireless-AC 9560, 2x2, 2.4GHz/5GHz (160MHz channels), 802.11ac, Bluetooth 5, up to 1.73Gbps. Intel Wireless-AC 8265, 2x2, 2.4GHz/5GHz, 802.11ac, Bluetooth 4.2, up to 867Mbps. <i>Note: Wi-Fi card, or specific functions of Wi-Fi- card may not be supported in some countries</i>																	
Wi-Fi antenna	Optional Tiny 2.4GHz/5GHz SMA antenna kit																	
Optical	Optional one 9.0mm optical drive via optical drive kit, DVD-ROM or DVD±RW. VESA mount is required																	



ThinkStation P330 Tower Platform Specifications

Components	Specification																																																																								
Machine Type	MT 30C5 for Transactional model and MT 30C6 for Relationship model. For configuration of all 30C5 EMEA and US models, please visit: http://psref.lenovo.com/Product/ThinkStation/ThinkStation_P330_Tower																																																																								
Form factor	18L Tower																																																																								
Dimensions	Height: 376 mm (14.8 in). Width: 165 mm (6.5 in). Depth: 328 mm (12.9 in)																																																																								
Weight	Maximum configuration: 23.4 lb (10.6kg)																																																																								
Processor	Up to one Intel Xeon E family processor, up to 95W, up to 6 cores at 3.8GHz, up to 12MB cache, up to DDR4-2666 memory speed. Or up to one 8th Intel Core family processor, i7, i5, or i3, up to 95W, up to 6 cores at 3.7GHz, up to 12MB cache, up to DDR4-2666 memory speed. Or up to one Intel Pentium Gold G5400 via Special Bids, 54W, 2 cores at 3.7GHz, 4MB cache, DDR4-2400 memory speed																																																																								
Chipset	Intel C246 Chipset																																																																								
Memory	4 DIMM sockets. DDR4-2666. UDIMM. ECC and non-ECC are supported, but memory types cannot be intermixed																																																																								
Memory capacity	Up to 64GB with 4x 16GB, both ECC and non-ECC																																																																								
Memory protection	ECC with ECC UDIMM. Core i7 and i5 processors cannot support ECC UDIMM																																																																								
Expansion slots	Three PCIe 3.0 slots as following:																																																																								
	Slot 1 PCIe 3.0 x16, full height, half length, links to CPU																																																																								
	Slot 2 PCIe 3.0 x1, full height, full length, links to PCH																																																																								
	Slot 3 PCIe 3.0 x16 (negotiable link width x4), full height, half length, links to PCH																																																																								
Graphics - Processor graphics	Integrated Intel UHD Graphics P630 in -G suffix Xeon processors, or Intel UHD Graphics 630 in Core i7, i5, or i3 processors, or Intel UHD Graphics 610 in Pentium Gold G5400. Works along with discrete graphics to support multi-display, enables three display connectors (2x DP, 1x HDMI. HDMI is optional) on rear																																																																								
Graphics - Discrete graphics card	Up to two PCIe 3.0 x16 slots for discrete graphics card (Slot 1 and 3). Supports the following graphics adapters:																																																																								
	<table border="1"> <thead> <tr> <th>Adapter</th> <th>Cores</th> <th>Memory</th> <th>Power</th> <th>Connectors</th> <th>Max qty</th> </tr> </thead> <tbody> <tr> <td>NVS 810</td> <td>1024</td> <td>4GB DDR3</td> <td>68W</td> <td>8x miniDP</td> <td>1</td> </tr> <tr> <td>Quadro P400</td> <td>256</td> <td>2GB GDDR5</td> <td>30W</td> <td>3x miniDP</td> <td>2</td> </tr> <tr> <td>Quadro P620</td> <td>512</td> <td>2GB GDDR5</td> <td>40W</td> <td>4x miniDP</td> <td>2</td> </tr> <tr> <td>Quadro P1000</td> <td>640</td> <td>4GB GDDR5</td> <td>47W</td> <td>4x miniDP</td> <td>2</td> </tr> <tr> <td>Quadro P2000</td> <td>1024</td> <td>5GB GDDR5</td> <td>75W</td> <td>4x DP</td> <td>2</td> </tr> <tr> <td>Quadro P4000</td> <td>1792</td> <td>8GB GDDR5</td> <td>105W</td> <td>4x DP</td> <td>1</td> </tr> <tr> <td>Geforce GTX 1060</td> <td>1280</td> <td>6GB GDDR5</td> <td>120W</td> <td>DVI-D DL, HDMI, 3x DP</td> <td>1</td> </tr> <tr> <td>Geforce GTX 1070</td> <td>1920</td> <td>8GB GDDR5</td> <td>150W</td> <td>DVI-D DL, HDMI, 3x DP</td> <td>1</td> </tr> <tr> <td>Geforce GTX 1080</td> <td>2560</td> <td>8GB GDDR5X</td> <td>180W</td> <td>DVI-D DL, HDMI, 3x DP</td> <td>1</td> </tr> <tr> <td>Radeon Pro WX 3100</td> <td>512</td> <td>4GB GDDR5</td> <td>50W</td> <td>DP, 2x miniDP</td> <td>2</td> </tr> <tr> <td>Radeon Pro WX 4100</td> <td>1024</td> <td>4GB GDDR5</td> <td>50W</td> <td>4x miniDP</td> <td>2</td> </tr> </tbody> </table>	Adapter	Cores	Memory	Power	Connectors	Max qty	NVS 810	1024	4GB DDR3	68W	8x miniDP	1	Quadro P400	256	2GB GDDR5	30W	3x miniDP	2	Quadro P620	512	2GB GDDR5	40W	4x miniDP	2	Quadro P1000	640	4GB GDDR5	47W	4x miniDP	2	Quadro P2000	1024	5GB GDDR5	75W	4x DP	2	Quadro P4000	1792	8GB GDDR5	105W	4x DP	1	Geforce GTX 1060	1280	6GB GDDR5	120W	DVI-D DL, HDMI, 3x DP	1	Geforce GTX 1070	1920	8GB GDDR5	150W	DVI-D DL, HDMI, 3x DP	1	Geforce GTX 1080	2560	8GB GDDR5X	180W	DVI-D DL, HDMI, 3x DP	1	Radeon Pro WX 3100	512	4GB GDDR5	50W	DP, 2x miniDP	2	Radeon Pro WX 4100	1024	4GB GDDR5	50W	4x miniDP	2
	Adapter	Cores	Memory	Power	Connectors	Max qty																																																																			
	NVS 810	1024	4GB DDR3	68W	8x miniDP	1																																																																			
	Quadro P400	256	2GB GDDR5	30W	3x miniDP	2																																																																			
	Quadro P620	512	2GB GDDR5	40W	4x miniDP	2																																																																			
	Quadro P1000	640	4GB GDDR5	47W	4x miniDP	2																																																																			
	Quadro P2000	1024	5GB GDDR5	75W	4x DP	2																																																																			
	Quadro P4000	1792	8GB GDDR5	105W	4x DP	1																																																																			
	Geforce GTX 1060	1280	6GB GDDR5	120W	DVI-D DL, HDMI, 3x DP	1																																																																			
	Geforce GTX 1070	1920	8GB GDDR5	150W	DVI-D DL, HDMI, 3x DP	1																																																																			
	Geforce GTX 1080	2560	8GB GDDR5X	180W	DVI-D DL, HDMI, 3x DP	1																																																																			
	Radeon Pro WX 3100	512	4GB GDDR5	50W	DP, 2x miniDP	2																																																																			
Radeon Pro WX 4100	1024	4GB GDDR5	50W	4x miniDP	2																																																																				
<i>Notes:</i>																																																																									
1. Quadro P4000, 2x Quadro P2000, Geforce GTX1060/1070/1080 needs 400W PSU.																																																																									
2. Geforce GTX 1060/1070/1080 are dual-slot width.																																																																									
3. Geforce GTX 1060/1070/1080 and Radeon Pro WX 3100/4100 are SBO.																																																																									
Storage controllers	Integrated Intel SATA AHCI/RAID controller in chipset, 6Gbps SATA, RAID 0/1/10/5. Four onboard SATA ports for max 4 SATA HDD/SSD/ODD																																																																								
Internal storage bay	Up to five bays with four disk bays plus one slim optical bay, supports up to 3x 3.5" HDD plus 1x 2.5" SSD, or 4x 2.5" SSD																																																																								
	Bay 1 Primary disk bay, 3.5" or 2.5"																																																																								
	Bay 2 2.5" SATA bay, cannot be available when 2nd Quadro P2000 is used																																																																								
	Bay 3 Secondary disk bay, 3.5" or 2.5"																																																																								
	Bay 4 5.25" Flex bay, supports one of the following: <ul style="list-style-type: none"> Flex module for optional front eSATA/Thunderbolt/IEEE1394 3rd disk bay, 3.5" or 2.5", removable, via Front Access Storage Enclosure, using SATA 4 connector as eSATA mode 3rd disk bay, 3.5" or 2.5", via 5.25" to 3.5" HDD Kit M.2 drive, via Front removable M.2 enclosure, also occupies slot 1 or 3 																																																																								
	Bay 5 9mm Slim ODD bay																																																																								
Disks	3.5" HDD supports up to 4TB each, 6Gbps SATA, 7.2K 2.5" SSD supports up to 1TB each, 6Gbps SATA																																																																								

Components	Specification
M.2 slot for SSD	Up to 3x M.2 SSD with one dedicated onboard M.2 slot plus two PCIe to M.2 adapters. PCIe to M.2 adapter uses slot 1 or 3. Supports RAID 0/1 with PCH, When used as RAID, M.2 SSD should be installed in onboard M.2 slot and slot 3. Up to one Optane memory per system; Optane memory must work with a HDD or SSD; Optane memory cannot supported on Pentium G5400 models
M.2 SSD	M.2 SSD supports up to 1TB each, PCIe 3.0 x4, NVMe, Opal. Optane memory supports 32GB, PCIe 3.0 x2, NVMe, 3D Xpoint
M.2 slot for Wi-Fi and Bluetooth	One dedicated onboard M.2 slot for optional Intel Wireless-AC 9560, 2x2, 2.4GHz/5GHz (160MHz channels), 802.11ac, Bluetooth 5, up to 1.73Gbps
Media reader	Optional SD card reader on most models
Network interfaces	One onboard GbE port via integrated gigabit ethernet Intel i219LM, supports Wake-on-LAN. Optional PCIe ethernet adapters are available
Security features	Power-on and admin password. Trusted Platform Module, TCG 2.0 compliant. Optional chassis intrusion switch, cable lock, Kensington lock, and pad lock
Intel vPro	Supports Intel vPro on Xeon models. vPro also requires Wireless-AC 9560 if Wi-Fi is needed
Intel AMT	Intel Active Management Technology 12 on Xeon models, Intel Standard Manageability on other models
Base warranty	US models comes with 3-year limited onsite service with 9x5/NBD. 1 or 3-year limited onsite service with 9x5/NBD in EMEA or other GEOs
HD Audio	Intel HD Audio interface with Realtek ALC233 Codec
Front ports	2x USB 3.1 Gen 1 Type A. 2x USB 3.1 Gen 2 Type A. 1x USB 3.1 Gen 1 Type-C. 1x Mic-in. 1x Combo jack
Rear ports	2x USB 3.1 Gen 1 Type A. 2x USB 2.0 Type-A. 1x RJ-45. 1x COM. 2x DP. 1x Audio line-out <i>Notes: DP needs Core, Pentium, or -G suffix Xeon processor</i>
Optional front ports (on flex module)	2x Thunderbolt (USB Type-C), one of two ports supports video-out. 1x eSATA. 1x IEEE1394
Optional rear ports	2x USB 3.1 Type-C. 1x COM. PS/2. 1x Parallel. 1x Thunderbolt. 1x IEEE1394. 1x HDMI. <i>Notes: HDMI needs Core, Pentium, or -G suffix Xeon processor</i>
Temperature	Operating: 41 °F to 104 °F (10 °C to 35 °C) Non operating (no package): 14 °F to 140 °F (-10 °C to 60 °C) Non operating (with package): -40 °F to 140 °F (-40 °C to 60 °C)
Altitude	Operating: -15.2 m (-50 ft) to 3048 m (10 000 ft). Storage: -15.2 m (-50 ft) to 10, 668 m (35 000 ft)
Humidity	Operating: 30%-90%, non-condensing Storage (with package): 20%-90%, non-condensing
Environmental certification	RoHS-compliant. GREENGUARD. EPEAT Silver rating and ENERGY STAR 7 qualified
Power supply	Supports one 250W or 400W power supply, 100V - 240V, 92% PSU. Climate Savers Computing Platinum and 80 PLUS Platinum qualified. 400W PSU supports one 6+2-pin aux power connector.
ISV certifications	Please visit www.thinkworkstations.com/isv-certifications/

Note:
1. Depending on many factors, actual data transfer speed mentioned on this page may be lower than theoretical speed.
2. Any questions or advice on ThinkStation PSREF, please contact [ThinkStation PSREF developer](mailto:ThinkStation_PSREF_developer)

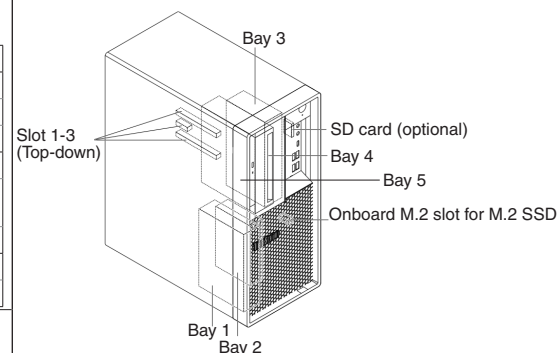



ThinkStation P330 Tower Gen 2 (30CY and 30D0) Platform Specifications - I of II

Product Specifications Reference (PSREF)

Components	Specification																																																																																																																																																		
Form factor	18L Tower																																																																																																																																																		
Dimensions	Height: 376 mm (14.8 in). Width: 165 mm (6.5 in). Depth: 328 mm (12.9 in)																																																																																																																																																		
Weight	Maximum configuration: 28.22 lb (12.8kg)																																																																																																																																																		
Processor	Supports one of the following processors:																																																																																																																																																		
	<table border="1"> <thead> <tr> <th>Processor</th> <th>CPU</th> <th>Cache</th> <th>Memory</th> <th>Power</th> <th>PSU</th> </tr> </thead> <tbody> <tr> <td>Xeon E-2288G</td> <td>8C/16T/3.7GHz/16MB/95W/DDR4-2666</td> <td>16MB</td> <td>95W</td> <td>400W PSU needed</td> </tr> <tr> <td>Xeon E-2286G</td> <td>6C/12T/4.0GHz/12MB/95W/DDR4-2666</td> <td>12MB</td> <td>95W</td> <td>400W PSU needed</td> </tr> <tr> <td>Xeon E-2278G</td> <td>8C/16T/3.4GHz/16MB/80W/DDR4-2666</td> <td>16MB</td> <td>80W</td> <td>400W PSU needed</td> </tr> <tr> <td>Xeon E-2276G</td> <td>6C/12T/3.8GHz/12MB/80W/DDR4-2666</td> <td>12MB</td> <td>80W</td> <td></td> </tr> <tr> <td>Xeon E-2274G</td> <td>4C/8T/4.0GHz/8MB/83W/DDR4-2666</td> <td>8MB</td> <td>83W</td> <td></td> </tr> <tr> <td>Xeon E-2246G</td> <td>6C/12T/3.6GHz/12MB/80W/DDR4-2666</td> <td>12MB</td> <td>80W</td> <td></td> </tr> <tr> <td>Xeon E-2244G</td> <td>4C/8T/3.8GHz/8MB/71W/DDR4-2666</td> <td>8MB</td> <td>71W</td> <td></td> </tr> <tr> <td>Xeon E-2236</td> <td>6C/12T/3.4GHz/12MB/80W/DDR4-2666</td> <td>12MB</td> <td>80W</td> <td></td> </tr> <tr> <td>Xeon E-2234</td> <td>4C/8T/3.6GHz/8MB/71W/DDR4-2666</td> <td>8MB</td> <td>71W</td> <td></td> </tr> <tr> <td>Xeon E-2226G</td> <td>6C/6T/3.4GHz/12MB/80W/DDR4-2666</td> <td>12MB</td> <td>80W</td> <td></td> </tr> <tr> <td>Xeon E-2224G</td> <td>4C/4T/3.5GHz/8MB/71W/DDR4-2666</td> <td>8MB</td> <td>71W</td> <td></td> </tr> <tr> <td>Xeon E-2224</td> <td>4C/4T/3.4GHz/8MB/71W/DDR4-2666</td> <td>8MB</td> <td>71W</td> <td></td> </tr> <tr> <td>Xeon E-2186G</td> <td>6C/12T/3.8GHz/12MB/95W/DDR4-2666</td> <td>12MB</td> <td>95W</td> <td>400W PSU needed</td> </tr> <tr> <td>Xeon E-2174G</td> <td>4C/8T/3.8GHz/8MB/71W/DDR4-2666</td> <td>8MB</td> <td>71W</td> <td></td> </tr> <tr> <td>Pentium Gold G5620</td> <td>2C/4T/4.0GHz/4MB/54W/DDR4-2400</td> <td>4MB</td> <td>54W</td> <td></td> </tr> <tr> <td>Core i9-9900</td> <td>8C/16T/3.1GHz/16MB/65W/DDR4-2666</td> <td>16MB</td> <td>65W</td> <td></td> </tr> <tr> <td>Core i7-9700K</td> <td>8C/8T/3.6GHz/12MB/95W/DDR4-2666</td> <td>12MB</td> <td>95W</td> <td>400W PSU needed</td> </tr> <tr> <td>Core i7-9700</td> <td>8C/8T/3.0GHz/12MB/65W/DDR4-2666</td> <td>12MB</td> <td>65W</td> <td></td> </tr> <tr> <td>Core i7-8700</td> <td>6C/12T/3.2GHz/12MB/65W/DDR4-2666</td> <td>12MB</td> <td>65W</td> <td></td> </tr> <tr> <td>Core i5-9600K</td> <td>6C/6T/3.7GHz/9MB/95W/DDR4-2666</td> <td>9MB</td> <td>95W</td> <td>400W PSU needed</td> </tr> <tr> <td>Core i5-9600</td> <td>6C/6T/3.1GHz/9MB/65W/DDR4-2666</td> <td>9MB</td> <td>65W</td> <td></td> </tr> <tr> <td>Core i5-9500</td> <td>6C/6T/3.0GHz/9MB/65W/DDR4-2666</td> <td>9MB</td> <td>65W</td> <td></td> </tr> <tr> <td>Core i5-9400</td> <td>6C/6T/2.9GHz/9MB/65W/DDR4-2666</td> <td>9MB</td> <td>65W</td> <td></td> </tr> <tr> <td>Core i5-8500</td> <td>6C/6T/3.0GHz/9MB/65W/DDR4-2666</td> <td>9MB</td> <td>65W</td> <td></td> </tr> <tr> <td>Core i3-9300</td> <td>4C/4T/3.7GHz/8MB/62W/DDR4-2400</td> <td>8MB</td> <td>62W</td> <td></td> </tr> <tr> <td>Core i3-9100</td> <td>4C/4T/3.6GHz/6MB/65W/DDR4-2400</td> <td>6MB</td> <td>65W</td> <td></td> </tr> <tr> <td>Core i3-8300</td> <td>4C/4T/3.7GHz/8MB/62W/DDR4-2400</td> <td>8MB</td> <td>62W</td> <td></td> </tr> <tr> <td>Core i3-8100</td> <td>4C/4T/3.6GHz/6MB/65W/DDR4-2400</td> <td>6MB</td> <td>65W</td> <td></td> </tr> </tbody> </table>	Processor	CPU	Cache	Memory	Power	PSU	Xeon E-2288G	8C/16T/3.7GHz/16MB/95W/DDR4-2666	16MB	95W	400W PSU needed	Xeon E-2286G	6C/12T/4.0GHz/12MB/95W/DDR4-2666	12MB	95W	400W PSU needed	Xeon E-2278G	8C/16T/3.4GHz/16MB/80W/DDR4-2666	16MB	80W	400W PSU needed	Xeon E-2276G	6C/12T/3.8GHz/12MB/80W/DDR4-2666	12MB	80W		Xeon E-2274G	4C/8T/4.0GHz/8MB/83W/DDR4-2666	8MB	83W		Xeon E-2246G	6C/12T/3.6GHz/12MB/80W/DDR4-2666	12MB	80W		Xeon E-2244G	4C/8T/3.8GHz/8MB/71W/DDR4-2666	8MB	71W		Xeon E-2236	6C/12T/3.4GHz/12MB/80W/DDR4-2666	12MB	80W		Xeon E-2234	4C/8T/3.6GHz/8MB/71W/DDR4-2666	8MB	71W		Xeon E-2226G	6C/6T/3.4GHz/12MB/80W/DDR4-2666	12MB	80W		Xeon E-2224G	4C/4T/3.5GHz/8MB/71W/DDR4-2666	8MB	71W		Xeon E-2224	4C/4T/3.4GHz/8MB/71W/DDR4-2666	8MB	71W		Xeon E-2186G	6C/12T/3.8GHz/12MB/95W/DDR4-2666	12MB	95W	400W PSU needed	Xeon E-2174G	4C/8T/3.8GHz/8MB/71W/DDR4-2666	8MB	71W		Pentium Gold G5620	2C/4T/4.0GHz/4MB/54W/DDR4-2400	4MB	54W		Core i9-9900	8C/16T/3.1GHz/16MB/65W/DDR4-2666	16MB	65W		Core i7-9700K	8C/8T/3.6GHz/12MB/95W/DDR4-2666	12MB	95W	400W PSU needed	Core i7-9700	8C/8T/3.0GHz/12MB/65W/DDR4-2666	12MB	65W		Core i7-8700	6C/12T/3.2GHz/12MB/65W/DDR4-2666	12MB	65W		Core i5-9600K	6C/6T/3.7GHz/9MB/95W/DDR4-2666	9MB	95W	400W PSU needed	Core i5-9600	6C/6T/3.1GHz/9MB/65W/DDR4-2666	9MB	65W		Core i5-9500	6C/6T/3.0GHz/9MB/65W/DDR4-2666	9MB	65W		Core i5-9400	6C/6T/2.9GHz/9MB/65W/DDR4-2666	9MB	65W		Core i5-8500	6C/6T/3.0GHz/9MB/65W/DDR4-2666	9MB	65W		Core i3-9300	4C/4T/3.7GHz/8MB/62W/DDR4-2400	8MB	62W		Core i3-9100	4C/4T/3.6GHz/6MB/65W/DDR4-2400	6MB	65W		Core i3-8300	4C/4T/3.7GHz/8MB/62W/DDR4-2400	8MB	62W		Core i3-8100	4C/4T/3.6GHz/6MB/65W/DDR4-2400	6MB	65W	
	Processor	CPU	Cache	Memory	Power	PSU																																																																																																																																													
	Xeon E-2288G	8C/16T/3.7GHz/16MB/95W/DDR4-2666	16MB	95W	400W PSU needed																																																																																																																																														
	Xeon E-2286G	6C/12T/4.0GHz/12MB/95W/DDR4-2666	12MB	95W	400W PSU needed																																																																																																																																														
	Xeon E-2278G	8C/16T/3.4GHz/16MB/80W/DDR4-2666	16MB	80W	400W PSU needed																																																																																																																																														
	Xeon E-2276G	6C/12T/3.8GHz/12MB/80W/DDR4-2666	12MB	80W																																																																																																																																															
	Xeon E-2274G	4C/8T/4.0GHz/8MB/83W/DDR4-2666	8MB	83W																																																																																																																																															
	Xeon E-2246G	6C/12T/3.6GHz/12MB/80W/DDR4-2666	12MB	80W																																																																																																																																															
	Xeon E-2244G	4C/8T/3.8GHz/8MB/71W/DDR4-2666	8MB	71W																																																																																																																																															
	Xeon E-2236	6C/12T/3.4GHz/12MB/80W/DDR4-2666	12MB	80W																																																																																																																																															
	Xeon E-2234	4C/8T/3.6GHz/8MB/71W/DDR4-2666	8MB	71W																																																																																																																																															
	Xeon E-2226G	6C/6T/3.4GHz/12MB/80W/DDR4-2666	12MB	80W																																																																																																																																															
	Xeon E-2224G	4C/4T/3.5GHz/8MB/71W/DDR4-2666	8MB	71W																																																																																																																																															
	Xeon E-2224	4C/4T/3.4GHz/8MB/71W/DDR4-2666	8MB	71W																																																																																																																																															
	Xeon E-2186G	6C/12T/3.8GHz/12MB/95W/DDR4-2666	12MB	95W	400W PSU needed																																																																																																																																														
	Xeon E-2174G	4C/8T/3.8GHz/8MB/71W/DDR4-2666	8MB	71W																																																																																																																																															
	Pentium Gold G5620	2C/4T/4.0GHz/4MB/54W/DDR4-2400	4MB	54W																																																																																																																																															
	Core i9-9900	8C/16T/3.1GHz/16MB/65W/DDR4-2666	16MB	65W																																																																																																																																															
	Core i7-9700K	8C/8T/3.6GHz/12MB/95W/DDR4-2666	12MB	95W	400W PSU needed																																																																																																																																														
	Core i7-9700	8C/8T/3.0GHz/12MB/65W/DDR4-2666	12MB	65W																																																																																																																																															
	Core i7-8700	6C/12T/3.2GHz/12MB/65W/DDR4-2666	12MB	65W																																																																																																																																															
Core i5-9600K	6C/6T/3.7GHz/9MB/95W/DDR4-2666	9MB	95W	400W PSU needed																																																																																																																																															
Core i5-9600	6C/6T/3.1GHz/9MB/65W/DDR4-2666	9MB	65W																																																																																																																																																
Core i5-9500	6C/6T/3.0GHz/9MB/65W/DDR4-2666	9MB	65W																																																																																																																																																
Core i5-9400	6C/6T/2.9GHz/9MB/65W/DDR4-2666	9MB	65W																																																																																																																																																
Core i5-8500	6C/6T/3.0GHz/9MB/65W/DDR4-2666	9MB	65W																																																																																																																																																
Core i3-9300	4C/4T/3.7GHz/8MB/62W/DDR4-2400	8MB	62W																																																																																																																																																
Core i3-9100	4C/4T/3.6GHz/6MB/65W/DDR4-2400	6MB	65W																																																																																																																																																
Core i3-8300	4C/4T/3.7GHz/8MB/62W/DDR4-2400	8MB	62W																																																																																																																																																
Core i3-8100	4C/4T/3.6GHz/6MB/65W/DDR4-2400	6MB	65W																																																																																																																																																
Chipset	Intel C246 Chipset																																																																																																																																																		
Memory Sockets	4 DIMM sockets with 2 channels																																																																																																																																																		
Memory Types	8GB/16GB DDR4-2666 UDIMM ECC or 4GB/8GB/16GB DDR4-2666 UDIMM non-ECC																																																																																																																																																		
Memory Capacity	64B with 4 x 16GB, both UDIMM ECC or UDIMM non-ECC																																																																																																																																																		
Memory Protection	ECC on models with UDIMM ECC memory																																																																																																																																																		
Expansion slots	Three PCIe 3.0 slots as following:																																																																																																																																																		
	Slot 1 PCIe 3.0 x16, full height, half length, links to CPU																																																																																																																																																		
	Slot 2 PCIe 3.0 x1, full height, full length, links to PCH																																																																																																																																																		
	Slot 3 PCIe 3.0 x16 (negotiable link width x4), full height, half length, links to PCH																																																																																																																																																		
Processor graphics	Integrated Intel UHD Graphics P630 in -G suffix Xeon processors, or Intel UHD Graphics 630 in Core i7, i5, i3, or Pentium processors. Works along with discrete graphics to support multi-display, enables three rear display connectors (2 DP standard, 1 DP or HDMI optional)																																																																																																																																																		
Discrete Graphics Offering	Up to two PCIe 3.0 x16 slots for discrete graphics card (Slot 1 and 3). Supports the following graphics adapters:																																																																																																																																																		
	<table border="1"> <thead> <tr> <th>Graphics</th> <th>Memory</th> <th>Power</th> <th>Connector</th> <th>Max Qty</th> </tr> </thead> <tbody> <tr> <td>Quadro P400</td> <td>2GB GDDR5</td> <td>30W</td> <td>3x miniDP</td> <td>2</td> </tr> <tr> <td>Quadro P620</td> <td>2GB GDDR5</td> <td>40W</td> <td>4x miniDP</td> <td>2</td> </tr> <tr> <td>Quadro P1000</td> <td>4GB GDDR5</td> <td>50W</td> <td>4x miniDP</td> <td>2</td> </tr> <tr> <td>Quadro P2000</td> <td>5GB GDDR5</td> <td>75W</td> <td>4x DP</td> <td>2</td> </tr> <tr> <td>Quadro P2200</td> <td>5GB GDDR5X</td> <td>75W</td> <td>4x DP</td> <td>2</td> </tr> <tr> <td>Quadro P5000</td> <td>16GB GDDR5X</td> <td>180W</td> <td>DVI-D DL + 4x DP</td> <td>1</td> </tr> <tr> <td>Quadro RTX 4000</td> <td>8GB GDDR6</td> <td>160W</td> <td>3x DP, 1x VirtualLink</td> <td>1</td> </tr> </tbody> </table>	Graphics	Memory	Power	Connector	Max Qty	Quadro P400	2GB GDDR5	30W	3x miniDP	2	Quadro P620	2GB GDDR5	40W	4x miniDP	2	Quadro P1000	4GB GDDR5	50W	4x miniDP	2	Quadro P2000	5GB GDDR5	75W	4x DP	2	Quadro P2200	5GB GDDR5X	75W	4x DP	2	Quadro P5000	16GB GDDR5X	180W	DVI-D DL + 4x DP	1	Quadro RTX 4000	8GB GDDR6	160W	3x DP, 1x VirtualLink	1																																																																																																										
	Graphics	Memory	Power	Connector	Max Qty																																																																																																																																														
	Quadro P400	2GB GDDR5	30W	3x miniDP	2																																																																																																																																														
	Quadro P620	2GB GDDR5	40W	4x miniDP	2																																																																																																																																														
	Quadro P1000	4GB GDDR5	50W	4x miniDP	2																																																																																																																																														
	Quadro P2000	5GB GDDR5	75W	4x DP	2																																																																																																																																														
Quadro P2200	5GB GDDR5X	75W	4x DP	2																																																																																																																																															
Quadro P5000	16GB GDDR5X	180W	DVI-D DL + 4x DP	1																																																																																																																																															
Quadro RTX 4000	8GB GDDR6	160W	3x DP, 1x VirtualLink	1																																																																																																																																															
<i>Note: 2x Quadro P2000, Quadro P5000, or Quadro RTX 4000 needs 400W PSU</i>																																																																																																																																																			

Components	Specification				
Storage Controller	Storage Controller	Type	Interface	Disk Type	RAID
	Onboard Intel RST SATA RAID	Std	SATA 6Gb/s	HDD or SSD	0/1/10/5
	Onboard Intel RST PCIe RAID	Std	PCIe NVMe	M.2 PCIe SSD	0/1
Storage Support	Disk Type	Interface	RPM	Offering	Max Qty
	3.5" SATA HDD	SATA 6Gb/s	7.2K	1TB/2TB/4TB	3
	2.5" SATA HDD	SATA 6Gb/s	7.2K	500GB FIPS	4
	2.5" SATA SSD	SATA 6Gb/s		256GB/512GB/1TB	4
	Optane Memory	PCIe NVMe		32GB	1, used with HDD/SSD
M.2 PCIe SSD	PCIe NVMe		256GB/512GB/1TB	3	
Storage Bays	Up to five bays with four disk bays plus one slim optical bay, supports up to 3x 3.5" HDD plus 1x 2.5" SSD, or 4x 2.5" HDD/SSD				
	Bay 1	Primary disk bay, 3.5" or 2.5"			
	Bay 2	2.5" SATA bay, cannot be available when 2nd Quadro P2000 is used			
	Bay 3	Secondary disk bay, 3.5" or 2.5"			
	Bay 4	5.25" Flex bay, supports one of the following: <ul style="list-style-type: none"> Flex module for optional front eSATA/Thunderbolt/IEEE1394 3rd disk bay, 3.5" or 2.5", removable, via Front Access Storage Enclosure, using SATA 4 connector as eSATA mode 3rd disk bay, 3.5" or 2.5", via 5.25" to 3.5" HDD Kit 			
	Bay 5	9mm Slim ODD bay			
M.2	3x M.2 SSD (1 onboard, 2 via PCIe to M.2 adapter)				
Media reader	Optional SD card reader on most models				
Network interfaces	One onboard GbE port via integrated gigabit ethernet Intel i219LM, supports Wake-on-LAN. Optional PCIe ethernet adapters are available				
WLAN + Bluetooth	One dedicated onboard M.2 slot for optional Intel Wireless-AC 9560, 2x2, 2.4GHz/5GHz (160MHz channels), 802.11ac, Bluetooth 5, up to 1.73Gbps				
Security features	Power-on and admin password. Trusted Platform Module, TCG 2.0 compliant. Optional chassis intrusion switch, e-lock, cable lock, Kensington lock, and pad lock				
Intel vPro	Supports Intel vPro on Xeon models. vPro also requires Wireless-AC 9560 if Wi-Fi is needed				
Intel AMT	Intel Active Management Technology 12 on Xeon models, Intel Standard Manageability on other models				
Base warranty	US models comes with 3-year limited onsite service with 9x5/NBD. 1 or 3-year limited onsite service with 9x5/NBD in EMEA or other GEOs				
HD Audio	Intel HD Audio interface with Realtek ALC233 Codec				
Front ports	2x USB 3.1 Gen 1 Type A. 2x USB 3.1 Gen 2 Type A. 1x USB 3.1 Gen 1 Type-C. 1x Mic-in. 1x Combo jack				
Rear ports	2x USB 3.1 Gen 1 Type A. 2x USB 2.0 Type-A. 1x RJ-45. 1x COM. 2x DP. 1x Audio line-out <i>Notes: DP needs Core, Pentium, or -G suffix Xeon processor</i>				
Optional front ports (on flex module)	2x Thunderbolt (USB Type-C), one of two ports supports video-out. 1x eSATA. 1x IEEE1394				
Optional rear ports	Supports the following via cable: 1x COM. 1x Parallel. 2x PS/2. 1x DP or 1x HDMI. 2x USB 2.0 Supports the following via PCIe adapter: 4x COM. 2x USB 3.1 Type-C. 2x USB 3.0. 1x Thunderbolt. <i>Notes: DP or HDMI needs Core, Pentium, or -G suffix Xeon processor</i>				
Temperature	Operating: 41 °F to 104 °F (10 °C to 35 °C) Non operating (no package): 14 °F to 140 °F (-10 °C to 60 °C) Non operating (with package): -40 °F to 140 °F (-40 °C to 60 °C)				

Components	Specification
Altitude	Operating: -15.2 m (-50 ft) to 3048 m (10 000 ft). Storage: -15.2 m (-50 ft) to 10, 668 m (35 000 ft)
Humidity	Operating: 30%~90%, non-condensing Storage (with package): 20%~90%, non-condensing
Environmental certification	RoHS-compliant. GREENGUARD. EPEAT Silver rating and ENERGY STAR 7 qualified
Power supply	Supports one 250W or 400W power supply, 100V - 240V, 92% PSU. Climate Savers Computing Platinum and 80 PLUS Platinum qualified. 400W PSU supports one 6+2-pin aux power connector.
ISV certifications	Please visit www.thinkworkstations.com/isv-certifications/

Note:

1. Depending on many factors, actual data transfer speed mentioned on this page may be lower than theoretical speed.
2. Any questions or advice on ThinkStation PSREF, please contact [ThinkStation PSREF developer](#)

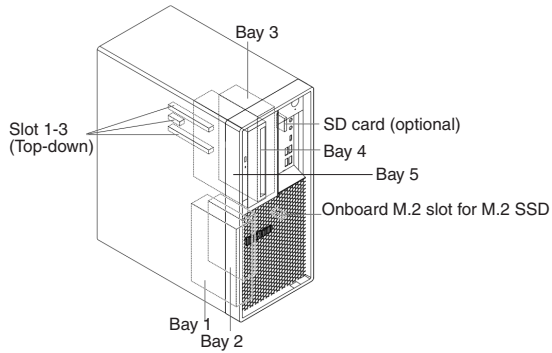



ThinkStation P520 Platform Specifications

Product Specifications Reference (PSREF)

Form factor	33L Tower					
Dimensions	165mm/6.5" W x 460mm/18.1" D x 440mm/17.3" H (with feet)					
Weight	Maximum configuration: 52.91 lb (24kg)					
Processor Family	Up to one 140W Intel Xeon W family processor: <ul style="list-style-type: none"> Up to 18 cores at 2.3 GHz Up to 4.0 GHz with 4 cores Up to 24.75 MB cache Up to DDR4-2666 memory speed 					
Processor Sockets	1x FCLGA2066					
Chipset	Intel C422 Chipset					
Memory Sockets	8 DIMM sockets with 4 channels					
Memory Types	DDR4-2666 RDIMM					
Memory Capacity	256GB with 8 x 32GB RDIMMs					
Memory Protection	ECC					
Expansion slots	Slot 1 (CPU)	PCIe 3.0 x8, full height, full length, 25W, open ended				
	Slot 2 (CPU)	PCIe 3.0 x16, full height, full length, 75W, double-width				
	Slot 3 (PCH)	PCIe 3.0 x4, full height, half length, 25W, open ended				
	Slot 4 (CPU)	PCIe 3.0 x16, full height, full length, 75W, double-width				
	Slot 5	PCI, full height, full length, 25W				
	Slot 6 (PCH)	PCIe 3.0 x4, full height, half length, 25W, open ended				
Discrete Graphics Offering	Graphics	Memory	Power	Connector	SLI / NVlink	Max Qty
	NVS 810	4GB DDR3	68W	8xmini DP		2
	Quadro P400	2GB GDDR5	30W	3xminiDP		2
	Quadro P600	2GB GDDR5	45W	4xminiDP		2
	Quadro P620	2GB GDDR5	40W	4xminiDP		2
	Quadro P1000	4GB GDDR5	50W	4xminiDP		2
	Quadro P2000	5GB GDDR5	75W	4xDP		2
	Quadro P4000	8GB GDDR5	120W	4xDP		2
	Quadro P5000	16GB GDDR5X	180W	DVI-D DL+4xDP	SLI	2
	Quadro P6000	24GB GDDR5X	250W	DVI-D DL+4xDP		1
	Quadro RTX 4000	8GB GDDR6	160W	3xDP, 1xVirtualLink		2
	Quadro RTX 5000	16GB GDDR6	265W	4xDP, 1xVirtualLink		1
	Quadro RTX 6000	24GB GDDR6	295W	4xDP, 1xVirtualLink		1
	Quadro RTX 8000	48GB GDDR6	295W	4xDP, 1xVirtualLink		1
Quadro GP100	16GB HBM2	235W	1xDVI-D DL, 4xDP	NVLink	2	
Quadro GV100	32GB HBM2	250W	4xDP		1	
Storage Controller	Storage Controller	Type	Interface	RAID	Cache	
	Onboard Intel RSTe	Std	SATA 6Gb/s	0/1/10/5		
	9440-8i PCIe	Opt	SAS 12Gb/s, SATA 6Gb/s	0/1/10/5		
	9460-16i PCIe	Opt	SAS 12Gb/s, SATA 6Gb/s	0/1/10/5/6	4GB DDR4, SuperCap	
	NVMe Basic	Opt	PCIe NVMe	0/1/10		
	NVMe Premium	Opt	PCIe NVMe	0/1/10/5		
NVMe for Intel SSD	Opt	PCIe NVMe	0/1/10/5			
Storage Support	Disk Type	Interface	RPM	Offering	Max Qty	
	3.5" SATA HDD	SATA 6Gb/s	7.2K	1TB/2TB/4TB/6TB	6	
	2.5" SATA HDD	SATA 6Gb/s	7.2K	500GB/500GB FIPS	6	
	2.5" SATA SSD	SATA 6Gb/s		256GB/512GB/1TB/2TB	6	
	M.2 PCIe SSD	PCIe NVMe		256GB/512GB/1TB/2TB	9	
	PCIe AIC SSD	PCIe NVMe		480GB	2 (1 when quad M.2 adapter used)	
Storage Bays	Bay Type	Maximum Drives Qty				
	M.2 slot	9x M.2 SSD (2 onboard, 7 via PCIe to M.2 adapter)				
	Flex Bay	2 flex bays. Supports the following: <ul style="list-style-type: none"> 2x half-height optical drives 2x 5.25" 9.0mm optical drives 1x 5.25" 9.0mm optical drive + 2x 3.5"/2.5" SATA SSD/HDD 1x 3.5"/2.5" SATA SSD/HDD with Front Access Storage Enclosure 1x flex module for the following options: Tray 1: 9.0mm optical Tray 2: 15-in-1 USB 3.0 reader, 2x Thunderbolt, or 4-digit diagnostic display Port 1 and 2: Front USB 3.0 Type-C or eSATA 2x M.2 SSD with 2x Front Removable Drive Enclosures				
Disk bay	Up to 4x 3.5" or 2.5" disks with 4 disk bays (2 bays standard, 2 bays optional)					

Max Storage	Supports up to 9x M.2 SSD + 6x 3.5" HDD/6x 2.5" SATA disks/4x 2.5" SAS HDD + 1x PCIe AIC SSD. All HDD: 36TB using 6x 3.5" HDD All SSD: 30.48TB using 6x 2.5" SATA SSD, 9x M.2 SSD, and 1x PCIe AIC SSD	
Power supply	Supports one of the following: <ul style="list-style-type: none"> One fixed 690W, autosensing, 92%, 80 PLUS Platinum qualified One fixed 900W, autosensing, 92%, 80 PLUS Platinum qualified 	
Media reader	SD USB 2.0 card reader on most models. Optional UHS-II 15-in-1 USB 3.0 reader on flex module	
Network interfaces	Integrated one gigabit ethernet (Intel i219LM), supports Wake-on-LAN. Optional PCIe ethernet or wireless adapters are available	
WLAN + Bluetooth	Optional Intel Wireless-AC 8265, 2x2, 2.4GHz/5GHz, 802.11ac, Bluetooth 4.2, up to 867Mbps	
Security features	Power-on and admin password. Trusted Platform Module, TCG 2.0 compliant, switch to 1.2 via UEFI setting. Optional access panel lock, Kensington lock, and pad lock	
Intel vPro	Intel vPro technology supported. vPro requires Wireless-AC 8265 if Wi-Fi is needed	
Intel AMT	Intel Active Management Technology 11	
Diagnostic	Front panel warning LED. ThinkStation Diagnostics for Windows. Photo-audio transfer with Lenovo PC Diag-nostics for Android and iOS. Optional front 4-digit diagnostic display on flex module	
Base warranty	1 or 3-year limited onsite service with 9x5/NBD	
HD Audio	Realtek ALC662 codec	
Front ports	4x USB 3.0 (includes one 11W charging), 1x combo audio/microphone jack (3.5mm)	
Rear ports	2x USB 2.0, 4x USB 3.0, 1x RJ-45, 3x analog audio ports (line-in, line-out, mic-in), 2x PS/2	
Optional ports	Supports the following optional ports: Front: <ul style="list-style-type: none"> 2x Thunderbolt ports (USB Type-C) on flex module, one of two ports supports video-out 1x eSATA on flex module 1x USB Type-C on flex module, USB 3.1 gen 1 Rear: <ul style="list-style-type: none"> 1x COM port 2x USB Type-C ports via PCIe adapter, USB 3.1 gen 2. One 15W, one 5W Internal: <ul style="list-style-type: none"> 1x internal USB 3.0 port 	
	Temperature - operating	50 °F to 95 °F (10 °C to 35 °C)
	Temperature - storage (no package)	14 °F to 140 °F (-10 °C to 60 °C)
Environmental specification	Temperature - storage (with package)	-40 °F to 140 °F (-40 °C to 60 °C)
	Altitude - operating	(Unpressurized): -50ft-10000ft (-15.2m-3048m)
	Humidity - operating	10%~80%, non-condensing
	Humidity - storage (with package)	10%~90%, non-condensing
Environmental Certifications	RoHS-compliant. GREENGUARD. EPEAT Silver rating. ENERGY STAR 6.1 qualified on model 30BE0008US and 30BE0009US	
ISV certifications	Please visit www.thinkworkstations.com/isv-certifications/	

Note:
 1. Depending on many factors, actual data transfer speed mentioned on this page may be lower than theoretical speed.
 2. To support the maximum expandability, 900W power supply may be needed.
 3. Any questions or advice on ThinkStation PSREF, please contact [ThinkStation PSREF developer](mailto:ThinkStation_PSREF_developer)



ThinkStation P520c Platform Specifications

Product Specifications Reference (PSREF)

Form factor	25L Tower					
Dimensions	175mm/6.89" W x 426mm/16.77" D x 376mm/14.8" H (with feet)					
Weight	Maximum configuration: 31.97 lb (14.5kg)					
Processor Family	Up to one 140W Intel Xeon W family processor: <ul style="list-style-type: none"> Up to 18 cores at 2.3 GHz Up to 4.0 GHz with 4 cores Up to 24.75 MB cache Up to DDR4-2666 memory speed 					
Processor Sockets	1x FCLGA2066					
Chipset	Intel C422 Chipset					
Memory Sockets	4 DIMM sockets with 4 channels					
Memory Types	DDR4-2666 RDIMM					
Memory Capacity	128GB with 4 x 32GB RDIMMs					
Memory Protection	ECC					
Expansion slots	Slot 1 (CPU)	PCIe 3.0 x16, full height, full length, 75W,				
	Slot 2 (CPU)	PCIe 3.0 x8, full height, full length, 25W, open ended				
	Slot 3 (CPU)	PCIe 3.0 x16, full height, full length, 75W				
	Slot 4 (PCH)	PCIe 3.0 x4, full height, half length, 25W, open ended				
Discrete Graphics Offering	Graphics	Memory	Power	Connector	SLI / NVlink	Max Qty
	NVS 810	4GB DDR3	68W	8xmini DP		1
	Quadro P400	2GB GDDR5	30W	3xminiDP		2
	Quadro P600	2GB GDDR5	45W	4xminiDP		2
	Quadro P620	2GB GDDR5	40W	4x miniDP		2
	Quadro P1000	4GB GDDR5	50W	4xminiDP		2
	Quadro P2000	5GB GDDR5	75W	4xDP		2
	Quadro P4000	8GB GDDR5	120W	4xDP		2
	Quadro P5000	16GB GDDR5X	180W	DVI-D DL+4xDP		1
Quadro RTX 4000	8GB GDDR6	160W	3xDP, 1xVirtualLink		1	
Storage Controller	Storage Controller	Type	Interface	RAID	Cache	
	Onboard Intel RSTe	Std	SATA 6Gb/s	0/1/10/5		
	9440-8i PCIe	Opt	SAS 12Gb/s, SATA 6Gb/s	0/1/10/5		
	NVMe Basic	Opt	PCIe NVMe	0/1/10		
	NVMe for Intel SSD	Opt	PCIe NVMe	0/1/10/5		
Storage Support	Disk Type	Interface	RPM	Offering	Max Qty	
	3.5" SATA HDD	SATA 6Gb/s	7.2K	1TB/2TB/4TB/6TB	4	
	2.5" SATA HDD	SATA 6Gb/s	7.2K	500GB/500GB FIPS	4	
	2.5" SATA SSD	SATA 6Gb/s		256GB/512GB/1TB/2TB	4	
	M.2 PCIe SSD	PCIe NVMe		256GB/512GB/1TB/2TB	5	
Storage Bays	Bay Type	Maximum Drives Qty				
	M.2 slot	5x M.2 SSD (2 onboard, 3 via PCIe to M.2 adapter)				
	Flex Bay	2 flex bays. Supports the following: <ul style="list-style-type: none"> 2x half-height optical drives 2x 5.25" 9.0mm optical drives 1x 5.25" 9.0mm optical drive + 2x 3.5"/2.5" SATA SSD/HDD 1x 3.5"/2.5" SATA SSD/HDD with Front Access Storage Enclosure 1x flex module for the following options: Tray 1: 9.0mm optical Tray 2: 15-in-1 USB 3.0 reader, 2x Thunderbolt, or 4-digit diagnostic display Port 1 and 2: Front USB 3.0 Type-C or eSATA 2x M.2 SSD with 2x Front Removable Drive Enclosures 				
Disk bay	Up to 2x 3.5"/2.5" disks with 2 disk bays					

Max Storage	Supports up to 5x M.2 SSD + 4x 3.5" HDD/4x 2.5" SSD/4x 2.5" HDD All HDD: 24TB using 4x 3.5" HDD All SSD: 18TB using 4x 2.5" SATA SSD and 5x M.2 SSD													
Power supply	One fixed 500W, autosensing, 92%, 80 PLUS Platinum qualified													
Media reader	SD USB 2.0 card reader on most models. Optional UHS-II 15-in-1 USB 3.0 reader on flex module													
Network interfaces	Integrated one gigabit ethernet (Intel i219LM), supports Wake-on-LAN. Optional PCIe ethernet or wireless adapters are available													
WLAN + Bluetooth	Optional Intel Wireless-AC 8265, 2x2, 2.4GHz/5GHz, 802.11ac, Bluetooth 4.2, up to 867Mbps													
Security features	Power-on and admin password. Trusted Platform Module, TCG 2.0 compliant, switch to 1.2 via UEFI setting. Optional access panel lock, Kensington lock, and pad lock													
Intel vPro	Intel vPro technology supported. vPro requires Wireless-AC 8265 if Wi-Fi is needed													
Intel AMT	Intel Active Management Technology 11													
Diagnostic	ThinkStation Diagnostics for Windows. Optional front 4-digit diagnostic display on flex module													
Base warranty	1 or 3-year limited onsite service with 9x5/NBD													
HD Audio	Realtek ALC662 codec													
Front ports	2x USB 3.0, microphone (3.5mm), headphone (3.5mm)													
Rear ports	2x USB 2.0, 4x USB 3.0, 1x RJ-45, 3x analog audio ports (line-in, line-out, mic-in), 2x PS/2													
Optional ports	Supports the following optional ports: Front: <ul style="list-style-type: none"> 2x Thunderbolt ports (USB Type-C) on flex module, one of two ports supports video-out 1x eSATA on flex module 1x USB Type-C on flex module, USB 3.1 gen 1 Rear: <ul style="list-style-type: none"> 1x COM port 2x USB Type-C ports via PCIe adapter, USB 3.1 gen 2. One 15W, one 5W Internal: <ul style="list-style-type: none"> 1x internal USB 3.0 port 													
	Environmental specification	<table border="1"> <tr> <td>Temperature - operating</td> <td>50 °F to 95 °F (10 °C to 35 °C)</td> </tr> <tr> <td>Temperature - storage (no package)</td> <td>14 °F to 140 °F (-10 °C to 60 °C)</td> </tr> <tr> <td>Temperature - storage (with package)</td> <td>-40 °F to 140 °F (-40 °C to 60 °C)</td> </tr> <tr> <td>Altitude - operating</td> <td>(Unpressurized): -50ft-10000ft (-15.2m-3048m)</td> </tr> <tr> <td>Humidity - operating</td> <td>10%~80%, non-condensing</td> </tr> <tr> <td>Humidity - storage (with package)</td> <td>10%~90%, non-condensing</td> </tr> </table>		Temperature - operating	50 °F to 95 °F (10 °C to 35 °C)	Temperature - storage (no package)	14 °F to 140 °F (-10 °C to 60 °C)	Temperature - storage (with package)	-40 °F to 140 °F (-40 °C to 60 °C)	Altitude - operating	(Unpressurized): -50ft-10000ft (-15.2m-3048m)	Humidity - operating	10%~80%, non-condensing	Humidity - storage (with package)
Temperature - operating	50 °F to 95 °F (10 °C to 35 °C)													
Temperature - storage (no package)	14 °F to 140 °F (-10 °C to 60 °C)													
Temperature - storage (with package)	-40 °F to 140 °F (-40 °C to 60 °C)													
Altitude - operating	(Unpressurized): -50ft-10000ft (-15.2m-3048m)													
Humidity - operating	10%~80%, non-condensing													
Humidity - storage (with package)	10%~90%, non-condensing													
Environmental Certifications	RoHS-compliant. GREENGUARD. EPEAT Silver rating. ENERGY STAR 6.1 qualified on model 30BX0008US and 30BX0009US													
ISV certifications	Please visit www.thinkworkstations.com/isv-certifications/													

Note:
 1. Depending on many factors, actual data transfer speed mentioned on this page may be lower than theoretical speed.
 2. Any questions or advice on ThinkStation PSREF, please contact [ThinkStation PSREF developer](#)



Expansion slots

Slot 1 (CPU2)	PCIe 3.0 x16, full height, full length, 75W
Slot 2 (CPU1)	PCIe 3.0 x16, full height, full length, 75W, double-width
Slot 3 (CPU1)	PCIe 3.0 x8, full height, full length, 25W, open ended
Slot 4 (CPU1)	PCIe 3.0 x16, full height, full length, 75W, double-width
Slot 5	PCI, full height, full length, 25W
Slot 6 (PCH)	PCIe 3.0 x4, full height, half length, 25W, open ended

900W PSU supports two 6+2-pin aux power connectors.
690W PSU supports one 6+2-pin aux power connector.

Note: All expansion cards are optional

ThinkStation P720 Platform Specifications

Product Specifications Reference (PSREF)

Form factor	36L Tower					
Dimensions	175mm/6.89" W x 485mm/19.1" D x 446mm/17.6" H (with feet)					
Weight	Maximum configuration: 52.25 lb (23.7kg)					
Processor Family	Up to two 150 W Gen 1 or Gen 2 Intel Xeon Scalable family processors, Bronze, Silver, Gold, or Platinum: <ul style="list-style-type: none"> Up to 24 cores at 2.1 GHz Up to 3.6 GHz with 4 cores Up to 33 MB cache Up to DDR4-2933 memory speed 					
Processor Sockets	2x FCLGA3647					
Chipset	Intel C621 Chipset					
Memory Sockets	12 DIMM sockets with 12 channels. 6 DIMM sockets with 6 channels per processor					
Memory Types	DDR4-2666 RDIMM					
Memory Capacity	768GB (DDR4-2933 RDIMM) or 384GB (DDR4-2666 RDIMM)					
Memory Protection	ECC					
Expansion slots	Slot 1 (CPU2)	PCIe 3.0 x16, full height, full length, 75W				
	Slot 2 (CPU1)	PCIe 3.0 x16, full height, full length, 75W, double-width				
	Slot 3 (CPU1)	PCIe 3.0 x8, full height, full length, 25W, open ended				
	Slot 4 (CPU1)	PCIe 3.0 x16, full height, full length, 75W, double-width				
	Slot 5	PCI, full height, full length, 25W				
Slot 6 (PCH)	PCIe 3.0 x4, full height, half length, 25W, open ended					
Discrete Graphics Offering	Graphics	Memory	Power	Connector	SLI / NVlink	Max Qty
	NVS 810	4GB DDR3	68W	8xmini DP		2
	Quadro P400	2GB GDDR5	30W	3xminiDP		3
	Quadro P600	2GB GDDR5	45W	4xminiDP		3
	Quadro P620	2GB GDDR5	40W	4xminiDP		3
	Quadro P1000	4GB GDDR5	50W	4xminiDP		3
	Quadro P2000	5GB GDDR5	75W	4xDP		3
	Quadro P4000	8GB GDDR5	120W	4xDP		2
	Quadro P5000	16GB GDDR5X	180W	DVI-D DL+4xDP	SLI	2
	Quadro P6000	24GB GDDR5X	250W	DVI-D DL+4xDP		1
	Quadro RTX 4000	8GB GDDR6	160W	3xDP, 1xVirtualLink		2
	Quadro RTX 5000	16GB GDDR6	265W	4xDP, 1xVirtualLink		1
	Quadro RTX 6000	24GB GDDR6	295W	4xDP, 1xVirtualLink		1
	Quadro RTX 8000	48GB GDDR6	295W	4xDP, 1xVirtualLink		1
	Quadro GP100	16GB HBM2	235W	1xDVI-D DL, 4xDP		1
Quadro GV100	32GB HBM2	250W	4xDP		1	
Storage Controller	Storage Controller	Type	Interface	RAID	Cache	
	Onboard Intel RSTe	Std	SATA 6Gb/s	0/1/10/5		
	9440-8i PCIe	Opt	SAS 12Gb/s, SATA 6Gb/s	0/1/10/5		
	9460-16i PCIe	Opt	SAS 12Gb/s, SATA 6Gb/s	0/1/10/5/6	4GB DDR4, SuperCap	
	NVMe Basic	Opt	PCIe NVMe	0/1/10		
	NVMe Premium	Opt	PCIe NVMe	0/1/10/5		
NVMe for Intel SSD	Opt	PCIe NVMe	0/1/10/5			
Storage Support	Disk Type	Interface	RPM	Offering	Max Qty (Blind connection + 9460 used)	
	3.5" SATA HDD	SATA 6Gb/s	7.2K	1TB/2TB/4TB/6TB	6 (Also supports additional 4x 2.5" SATA SSD/HDD)	
	2.5" SATA HDD	SATA 6Gb/s	7.2K	500GB/500GB FIPS	10	
	2.5" SAS HDD	SAS 12Gb/s	10K	300GB/600GB	8	
	2.5" SATA SSD	SATA 6Gb/s		256GB/512GB/1TB/2TB	10	
	2.5" PCIe SSD	PCIe NVMe		1.5TB	2	
	M.2 PCIe SSD	PCIe NVMe		256GB/512GB/1TB/2TB	9	
	PCIe AIC SSD	PCIe NVMe		480GB	2	

Storage Bays	Bay Type	Maximum Drives Qty												
	M.2 slot	9x M.2 SSD (2 onboard, 7 via PCIe to M.2 adapter)												
	Flex Bay	2 flex bays. Supports the following: <ul style="list-style-type: none"> 2x half-height optical drives 2x 5.25" 9.0mm optical drives 1x 5.25" 9.0mm optical drive + 1x 3.5"/2.5" SATA SSD/HDD 1x 3.5"/2.5" SATA SSD/HDD with Front Access Storage Enclosure 1x flex module for the following options: <ul style="list-style-type: none"> Tray 1: 9.0mm optical Tray 2: 15-in-1 USB 3.0 reader or 2x Thunderbolt Port 1 and 2: Front USB 3.0 Type-C or eSATA 2x M.2 SSD with 2x Front Removable Drive Enclosures 												
Disk bay	4 disk bays (2 bays standard, 2 bays optional). Supports one of the following configurations: <ul style="list-style-type: none"> 4x 3.5" SATA HDD 4x 3.5" SATA HDD + 4x 2.5" SATA SSD/HDD (Blind connection needed) 8x 2.5" SATA SSD/HDD or 8x 2.5" SAS HDD (Blind connection needed) 2x 2.5" PCIe SSD + 2x 3.5"/2.5" disks (Blind connection needed) 													
Max Storage	Supports up to 9x M.2 SSD + 6x 3.5" HDD/10x 2.5" SSD/10x 2.5" HDD + 2x PCIe AIC SSD. All HDD: 36TB using 6x 3.5" HDD All SSD: 38.96TB using 10x 2.5" SATA SSD, 9x M.2 SSD, and 2x PCIe AIC SSD													
Power supply	Supports one of the following: <ul style="list-style-type: none"> One fixed 690W, autosensing, 92%, 80 PLUS Platinum qualified One fixed 900W, autosensing, 92%, 80 PLUS Platinum qualified 													
Media reader	SD USB 2.0 card reader on most models. Optional UHS-II 15-in-1 USB 3.0 reader on flex module													
Network interfaces	Integrated two-port gigabit ethernet (Intel i219LM and i210AT), supports Wake-on-LAN on both two ports. Optional PCIe ethernet are available													
WLAN + Bluetooth	Optional Intel Wireless-AC 8265, 2x2, 2.4GHz/5GHz, 802.11ac, Bluetooth 4.2, up to 867Mbps													
Security features	Power-on and admin password. Trusted Platform Module, TCG 2.0 compliant, switch to 1.2 via UEFI setting. Chassis intrusion switch. Optional access panel lock, Kensington lock, and pad lock													
Intel vPro	Intel vPro technology supported. vPro requires Wireless-AC 8265 if Wi-Fi is needed													
Intel AMT	Intel Active Management Technology 11													
Diagnostic	Front panel warning LED. ThinkStation Diagnostics for Windows. Photo-audio transfer with Lenovo PC Diag-nostics for Android and iOS. Optional front 4-digit diagnostic display on flex module													
Base warranty	1 or 3-year limited onsite service with 9x5/NBD													
HD Audio	Realtek ALC662 codec													
Front ports	4x USB 3.0 (includes one 11W charging), 1x combo audio/microphone jack (3.5mm)													
Rear ports	2x USB 2.0, 4x USB 3.0, 2x RJ-45, 3x analog audio ports (line-in, line-out, mic-in), 2x PS/2													
Optional ports	Supports the following optional ports: Front: <ul style="list-style-type: none"> 2x Thunderbolt ports (USB Type-C) on flex module, one of two ports supports video-out 1x eSATA on flex module 1x USB Type-C on flex module, USB 3.1 gen 1 Rear: <ul style="list-style-type: none"> 1x COM port 2x USB Type-C ports via PCIe adapter, USB 3.1 gen 2. One 15W, one 5W Internal: <ul style="list-style-type: none"> 1x internal USB 3.0 port 													
	Environmental specification	<table border="1"> <tr> <td>Temperature - operating</td> <td>50 °F to 95 °F (10 °C to 35 °C)</td> </tr> <tr> <td>Temperature - storage (no package)</td> <td>14 °F to 140 °F (-10 °C to 60 °C)</td> </tr> <tr> <td>Temperature - storage (with package)</td> <td>-40 °F to 140 °F (-40 °C to 60 °C)</td> </tr> <tr> <td>Altitude - operating</td> <td>(Unpressurized): 0-10000ft (0-3048m)</td> </tr> <tr> <td>Humidity - operating</td> <td>10%-80%, non-condensing</td> </tr> <tr> <td>Humidity - storage (with package)</td> <td>10%-90%, non-condensing</td> </tr> </table>		Temperature - operating	50 °F to 95 °F (10 °C to 35 °C)	Temperature - storage (no package)	14 °F to 140 °F (-10 °C to 60 °C)	Temperature - storage (with package)	-40 °F to 140 °F (-40 °C to 60 °C)	Altitude - operating	(Unpressurized): 0-10000ft (0-3048m)	Humidity - operating	10%-80%, non-condensing	Humidity - storage (with package)
Temperature - operating	50 °F to 95 °F (10 °C to 35 °C)													
Temperature - storage (no package)	14 °F to 140 °F (-10 °C to 60 °C)													
Temperature - storage (with package)	-40 °F to 140 °F (-40 °C to 60 °C)													
Altitude - operating	(Unpressurized): 0-10000ft (0-3048m)													
Humidity - operating	10%-80%, non-condensing													
Humidity - storage (with package)	10%-90%, non-condensing													
Environmental Certifications	RoHS-compliant. GREENGUARD. EPEAT Silver rating. ENERGY STAR 6.1 qualified on model 30BA0007US and 30BA0008US													
ISV certifications	Please visit www.thinkworkstations.com/isv-certifications/													

Note:
1. Depending on many factors, actual data transfer speed mentioned on this page may be lower than theoretical speed.
2. To support the maximum expandability, 900W power supply may be needed.
3. Any questions or advice on ThinkStation PSREF, please contact [ThinkStation PSREF developer](mailto:ThinkStation_PSREF_developer)



ThinkStation P920 Platform Specifications

Product Specifications Reference (PSREF)

Form factor	55L Tower					
Dimensions	200mm/7.87" W x 620mm/24.4" D x 446mm/17.56" H (with feet)					
Weight	Maximum configuration: 71.3 lb (32.3kg)					
Processor Family	Up to two 205 W Gen 1 or Gen 2 Intel Xeon Scalable family processors, Bronze, Silver, Gold, or Platinum: <ul style="list-style-type: none"> Up to 28 cores at 2.5 GHz Up to 3.6 GHz with 4 cores Up to 38.5 MB cache Up to DDR4-2933 memory speed 					
Processor Sockets	2x FCLGA3647					
Chipset	Intel C621 Chipset					
Memory Sockets	16 DIMM sockets with 12 channels. 8 DIMM sockets with 6 channels per processor					
Memory Types	DDR4-2666 RDIMM, DDR4-2666 LRDIMM, or DDR4-2933 RDIMM					
Memory Capacity	1TB (DDR4-2666 LRDIMM or DDR4-2933 RDIMM) or 512GB (DDR4-2666 RDIMM)					
Memory Protection	ECC					
Expansion slots	Slot 1 (CPU1)	PCIe 3.0 x16, full height, full length, 75W, double-width				
	Slot 2 (CPU1)	PCIe 3.0 x4, full height, full length, 25W, open ended				
	Slot 3 (CPU1)	PCIe 3.0 x16, full height, full length, 75W, double-width				
	Slot 4 (CPU1)	PCIe 3.0 x4, full height, full length, 25W, open ended				
	Slot 5 (PCH)	PCIe 3.0 x4, full height, half length, 25W, open ended				
	Slot 6 (CPU2)	PCIe 3.0 x16, full height, half length, 75W				
	Slot 7 (CPU2)	PCIe 3.0 x16, full height, full length, 75W, double-width				
	Slot 8 (CPU2)	PCIe 3.0 x16, full height, full length, 75W				
	Discrete Graphics Offering	Graphics	Memory	Power	Connector	SLI / NVLink
NVS 810		4GB DDR3	68W	8xmini DP		2
Quadro P400		2GB GDDR5	30W	3xminiDP		5
Quadro P600		2GB GDDR5	45W	4xminiDP		4
Quadro P620		2GB GDDR5	40W	4xminiDP		4
Quadro P1000		4GB GDDR5	50W	4xminiDP		4
Quadro P2000		5GB GDDR5	75W	4xDP		4
Quadro P4000		8GB GDDR5	120W	4xDP		4
Quadro P5000		16GB GDDR5X	180W	DVI-D DL+4xDP	SLI	3
Quadro P6000		24GB GDDR5X	250W	DVI-D DL+4xDP	SLI	3
Quadro RTX 4000		8GB GDDR6	160W	3xDP, 1xVirtualLink		3
Quadro RTX 5000		16GB GDDR6	265W	4xDP, 1xVirtualLink	NVLink	3
Quadro RTX 6000		24GB GDDR6	295W	4xDP, 1xVirtualLink	NVLink	2
Quadro RTX 8000		48GB GDDR6	295W	4xDP, 1xVirtualLink	NVLink	2
Quadro GP100	16GB HBM2	235W	1xDVI-D DL, 4xDP	NVLink	3	
Quadro GV100	32GB HBM2	250W	4xDP	NVLink	3	
Storage Controller	Storage Controller	Type	Interface	RAID	Cache	
	Onboard Intel RSTe	Std	SATA 6Gb/s	0/1/10/5		
	9440-8i PCIe	Opt	SAS 12Gb/s, SATA 6Gb/s	0/1/10/5		
	9460-16i PCIe	Opt	SAS 12Gb/s, SATA 6Gb/s	0/1/10/5/6	4GB DDR4, SuperCap	
	NVMe Basic	Opt	PCIe NVMe	0/1/10		
	NVMe Premium	Opt	PCIe NVMe	0/1/10/5		
Storage Support	Disk Type	Interface	RPM	Offering	Max Qty (9460 used)	
	3.5" SATA HDD	SATA 6Gb/s	7.2K	1TB/2TB/4TB/6TB	6 (Also supports additional 4x 2.5" SATA SSD/HDD)	
	2.5" SATA HDD	SATA 6Gb/s	7.2K	500GB/500GB FIPS	10	
	2.5" SAS HDD	SAS 12Gb/s	10K	300GB/600GB	8	
	2.5" SATA SSD	SATA 6Gb/s		256GB/512GB/1TB/2TB	10	
	2.5" PCIe SSD	PCIe NVMe		1.5TB	4	
	M.2 PCIe SSD	PCIe NVMe		256GB/512GB/1TB/2TB	9	
	PCIe AIC SSD	PCIe NVMe		480GB	2	

Storage Bays	Bay Type	Maximum Drives Qty	
	M.2 slot	9x M.2 SSD (2 onboard, 7 via PCIe to M.2 adapter)	
	Flex Bay	<ul style="list-style-type: none"> 2x 3.5" or 2.5" disks. Supports the following: <ul style="list-style-type: none"> 3x half-height optical drives 2x 5.25" 9.0mm optical drives 1x 5.25" 9.0mm optical drive + 1x 3.5"/2.5" SATA SSD/HDD 1x 3.5"/2.5" SATA SSD/HDD with Front Access Storage Enclosure 1x flex module for the following options: <ul style="list-style-type: none"> Tray 1: 9.0mm optical Tray 2: 15-in-1 USB 3.0 reader or 2x Thunderbolt Port 1 and 2: Front USB 3.0 Type-C or eSATA 3x M.2 SSD with 3x Front Removable Drive Enclosures 	
Disk bay	<ul style="list-style-type: none"> 8 disk drives with 4 bays (2 bays standard, 2 bays optional). Supports one of the following configurations: <ul style="list-style-type: none"> 4x 3.5" SATA HDD 4x 3.5" SATA HDD + 4x 2.5" SATA SSD/HDD 8x 2.5" SATA SSD/HDD or 8x 2.5" SAS HDD 		
Max Storage	Supports up to 9x M.2 SSD + 6x 3.5" HDD/10x 2.5" SSD/10x 2.5" HDD + 2x PCIe AIC SSD. All HDD: 36TB using 6x 3.5" HDD. All SSD: 38.96TB using 10x 2.5" SATA SSD, 9x M.2 SSD, and 2x PCIe AIC SSD		
Power supply	One fixed 1400 watts, autosensing, 92% PSU, 80 PLUS Platinum qualified. Countries with input voltage under 115V, output power limited to 1125 watts		
Media reader	SD USB 2.0 card reader on most models. Optional UHS-II 15-in-1 USB 3.0 reader on flex module		
Network interfaces	Integrated two-port gigabit ethernet (Intel i219LM and i210AT), supports Wake-on-LAN on both two ports. Optional PCIe ethernet are available		
WLAN + Bluetooth	Optional Intel Wireless-AC 8265, 2x2, 2.4GHz/5GHz, 802.11ac, Bluetooth 4.2, up to 867Mbps		
Security features	Power-on and admin password. Trusted Platform Module, TCG 2.0 compliant, switch to 1.2 via UEFI setting. Chassis intrusion switch. Optional access panel lock, Kensington lock, and pad lock		
Intel vPro	Intel vPro technology supported. vPro requires Wireless-AC 8265 if Wi-Fi is needed		
Intel AMT	Intel Active Management Technology 11		
Diagnostic	Front 4-digit diagnostic display. ThinkStation Diagnostics for Windows. Photo-audio transfer with Lenovo PC Diagnostics for Android and iOS		
Base warranty	1 or 3-year limited onsite service with 9x5/NBD		
HD Audio	Realtek ALC662 codec		
Front ports	4x USB 3.0 (includes one 11W charging), 1x combo audio/microphone jack (3.5mm)		
Rear ports	2x USB 2.0, 4x USB 3.0, 2x RJ-45, 3x analog audio ports (line-in, line-out, mic-in), 2x PS/2		
Optional ports	Supports the following optional ports:		
	<p>Front:</p> <ul style="list-style-type: none"> 2x Thunderbolt ports (USB Type-C) on flex module, one of two ports supports video-out 1x eSATA on flex module 1x USB Type-C on flex module, USB 3.1 gen 1 <p>Rear:</p> <ul style="list-style-type: none"> 1x COM port 2x USB Type-C ports via PCIe adapter, USB 3.1 gen 2. One 15W, one 5W <p>Internal:</p> <ul style="list-style-type: none"> 1x internal USB 3.0 port 		
Environmental specification	Temperature - operating	50 °F to 95 °F (10 °C to 35 °C)	
	Temperature - storage (no package)	14 °F to 140 °F (-10 °C to 60 °C)	
	Temperature - storage (with package)	-40 °F to 140 °F (-40 °C to 60 °C)	
	Altitude - operating	(Unpressurized): 0-10000ft (0-3048m)	
	Humidity - operating	10%~80%, non-condensing	
	Humidity - storage (with package)	10%~90%, non-condensing	
Environmental Certifications	RoHS-compliant. GREENGUARD. EPEAT Silver rating. ENERGY STAR 6.1 qualified on model 30BC0008US and 30BC0009US		
ISV certifications	Please visit www.thinkworkstations.com/isv-certifications/		

Note:
1. Depending on many factors, actual data transfer speed mentioned on this page may be lower than theoretical speed.
2. Any questions or advice on ThinkStation PSREF, please contact [ThinkStation PSREF developer](mailto:ThinkStation_PSREF_developer)

This publication was developed for products and services offered in the United States and E.M.E.A countries. Lenovo may not offer the products, services or features discussed in this document in other countries. Lenovo may withdraw an offering at any time. Information is subject to change without notice. Consult your local representative for information on offerings available in your area.

Lenovo reserves the right to change specifications or other product information without notice. Lenovo is not responsible for photographic or typographical errors.

LENOVO PROVIDES THIS PUBLICATION "AS IS," WITHOUT WARRANTY OF ANY KIND, EITHER EXPRESS OR IMPLIED, INCLUDING THE IMPLIED WARRANTIES OF MERCHANTABILITY OR FITNESS FOR A PARTICULAR PURPOSE.

Some jurisdictions do not allow disclaimer of express or implied warranties in certain transactions, therefore this disclaimer may not apply to you.

Availability: All offers subject to availability. Lenovo reserves the right to alter product offerings and specifications at any time, without notice. Lenovo is not responsible for photographic or typographic errors.

General: Review key information provided by Microsoft that may apply to your system purchase, including details on Windows 10, Windows 8, Windows 7, and potential upgrades/downgrades. Lenovo makes no representation or warranty regarding third-party products or services.

Trademarks: Lenovo, ThinkPad, ThinkCentre, ThinkStation and the Lenovo logo are trademarks of Lenovo. Microsoft, Windows, Windows NT, and the Windows logo are trademarks of Microsoft Corporation. Ultrabook, Celeron, Celeron Inside, Core Inside, Intel, Intel Logo, Intel Atom, Intel Atom Inside, Intel Core, Intel Inside, Intel Inside Logo, Intel vPro, Itanium, Itanium Inside, Pentium, Pentium Inside, vPro Inside, Xeon, Xeon Phi, and Xeon Inside are trademarks of Intel Corporation in the U.S. and/or other countries. Other company, product or service names may be trademarks or service marks of others.

Warranty: For a copy of applicable warranties, write to: Lenovo Warranty Information, 1009 Think Place, Morrisville, NC, 27560. Lenovo makes no representation or warranty regarding third party products or services. The Lenovo Limited Warranty applies only to Lenovo hardware products purchased for your own use, and does not transfer upon resale.

Limited warranty: Support unrelated to a warranty issue may be subject to additional charges.

Lenovo Services:

Carry-in or Mail-in Service: Parts and labor repair coverage where the customer is responsible for shipping (including packaging) or delivery to authorized warranty provider or repair center.

Depot or Courier Service: Parts and labor repair coverage where shipping (including packaging) or delivery to the repair center is paid for by Lenovo.

Expedited Depot: Parts and labor coverage with expedited turnaround. Shipping (including packaging) or delivery to the repair center is paid for by Lenovo.

Onsite / In-home Service: Parts and labor repair coverage where labor is provided onsite at your place of business.

If Lenovo determines your product problem is covered by the product warranty and cannot be resolved over the telephone, a technician will be dispatched to arrive onsite, typically the next day.

International Warranty Service (IWS): PC repair coverage for customers who require a critical warranty repair while travelling internationally. Visit www.lenovo.com/internationalwarranty for details. Visit www.lenovo.com/warranty for Lenovo Warranty Services terms and conditions for complete details and restrictions.

Included software: may differ from its retail version (if available), and may not include user manuals or all program functionality. Software license agreements may apply.

Battery life: Battery life (and recharge times) will vary based on many factors including screen brightness, applications, features, power management, battery conditioning, and other customer preferences.

Visit <http://psref.lenovo.com/> for the latest version of Product Specifications Reference.

© Lenovo, 2018. All rights reserved.
Lenovo 1009 Think Place Morrisville, NC 27560 U.S.A.

Lenovo™ **ThinkVision**

PSREF



Product Specifications Reference

Version 545, July 2019

Visit <http://psref.lenovo.com> for the latest version

Contents

Cover		
Contents		
Summary Of Change		
13 Inch - 16 Inch		
ThinkVision M14		
ThinkVision M14 Platform Specifications		
17 Inch - 20 Inch		
ThinkVision E1922s		
ThinkVision E1922s Platform Specifications		
ThinkVision E2054		
ThinkVision E2054 Platform Specifications		
ThinkVision LT1913p Square		
ThinkVision LT1913p Square Platform Specifications		
ThinkVision T1714		
ThinkVision T1714 Platform Specifications		
ThinkVision T1714p		
ThinkVision T1714p Platform Specifications		
ThinkVision T2054p		
ThinkVision T2054p Platform Specifications		
21 Inch - 24 Inch		
ThinkVision E21		
ThinkVision E21 Platform Specifications		
ThinkVision E24		
ThinkVision E24 Platform Specifications		
ThinkVision P24h		
ThinkVision P24h Platform Specifications		
ThinkVision P24q		
ThinkVision P24q Platform Specifications		
ThinkVision S22e		
ThinkVision S22e Platform Specifications		
ThinkVision S24e		
ThinkVision S24e Platform Specifications		
ThinkVision T2224d		
ThinkVision T2224d Platform Specifications		
ThinkVision T2254		
1 ThinkVision T2254 Platform Specifications	34	
2 ThinkVision T2254p	35	
4 ThinkVision T2254p Platform Specifications	36	
5 ThinkVision T22i	37	
5 ThinkVision T22i Platform Specifications	38	
6 ThinkVision T22v	39	
7 ThinkVision T22v Platform Specifications	40	
7 ThinkVision T2324d	41	
8 ThinkVision T2324d Platform Specifications	42	
9 ThinkVision T23d	43	
10 ThinkVision T23d Platform Specifications	44	
11 ThinkVision T23i	45	
12 ThinkVision T23i Platform Specifications	46	
13 ThinkVision T2454p	47	
14 ThinkVision T2454p Platform Specifications	48	
15 ThinkVision T24d	49	
16 ThinkVision T24d Platform Specifications	50	
17 ThinkVision T24i-10	51	
18 ThinkVision T24i-10 Platform Specifications	52	
19 ThinkVision T24i-19	53	
19 ThinkVision T24i-19 Platform Specifications	54	
20 ThinkVision T24m	55	
21 ThinkVision T24m Platform Specifications	56	
22 ThinkVision T24v	57	
23 ThinkVision T24v Platform Specifications	58	
24 ThinkVision X24 Pro	59	
25 ThinkVision X24 Pro Platform Specifications	60	
26 ThinkVision X24-20	61	
27 ThinkVision X24-20 Platform Specifications	62	
28 Above 25 Inch	63	
29 ThinkVision P27h	63	
30 ThinkVision P27h Platform Specifications	64	
31 ThinkVision P27q	65	
32 ThinkVision P27q Platform Specifications	66	
33 ThinkVision P27u	67	

Contents

ThinkVision P27u Platform Specifications	68
ThinkVision P32u	69
ThinkVision P32u Platform Specifications	70
ThinkVision P44w-10	71
ThinkVision P44w-10 Platform Specifications	72
ThinkVision S27i	73
ThinkVision S27i Platform Specifications	74
ThinkVision T25d-10	75
ThinkVision T25d-10 Platform Specifications	76
ThinkVision T25m-10	77
ThinkVision T25m-10 Platform Specifications	78
ThinkVision T27i	79
ThinkVision T27i Platform Specifications	80
ThinkVision T27p-10	81
ThinkVision T27p-10 Platform Specifications	82
ThinkVision X1	83
ThinkVision X1 Platform Specifications	84
ThinkVision X1 (2nd Gen)	85
ThinkVision X1 (2nd Gen) Platform Specifications	86
Legal Information	88

Summary of Changes

This section describes the technical changes made in this edition.

This edition might also include minor corrections and editorial changes which are not identified.

JuJj , 2019 - Version 5%&

Additions in this update

▶ **New product(s)**

ThinkVision M14 announced June 2019

▶ **New model(s)**

None

▶ **Others**

None

Withdrawals in this update

▶ **Withdrawn product(s)**

None

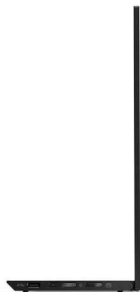



PORTABLE USB-C MONITOR CRAFTED FOR IMPROVED PRODUCTIVITY

The ThinkVision M14 is an ultraslim and ultralight mobile monitor. Its 14-inch screen helps you extend your workspace comfortably no matter where work takes you. Compatible with notebooks of any screen size that come with an advanced USB Type-C port*, the ThinkVision M14 can either extend or duplicate your notebook display with one plug. The USB Type-C ports on either side allow both left- and right-handed users to work efficiently, and the ergonomic design enhances user experience. Packed with impressive portability, connectivity, and flexibility features, the ThinkVision M14 is ideal for mobile productivity.



Extreme Portability



Superior Connectivity



Remarkable Flexibility

ACHIEVE TARGETS ON THE GO

The ThinkVision M14 boosts productivity with its thin and light form factor. Weighing 570g, this 4.4mm sleek mobile monitor enables easy portability. The stylish design with a Full HD, IPS display provides vivid lifelike visuals, ensuring you never miss out on any detail. With a brightness of 300 nits, the ThinkVision M14 offers a stunning visual experience while consuming content online.



4.4mm sleek: approximately as thin as two USD \$1 coins

- Weight**
570g
- Screen Size**
14 inches
- Brightness**
300 nits (Typical)



EXPERIENCE ADVANCED CONNECTIVITY

Two innovative USB Type-C ports on either side of the monitor make connectivity effortless. These ports support both power and video delivery simultaneously from a single port. The ThinkVision M14 also offers a 'power pass through' design that powers the mobile monitor by an adapter and charges the notebook at the same time. This feature is suitable for smartphones or notebooks with one USB Type-C port*. The ambidextrous design of this monitor enhances user comfort.



Ambidextrous design: built to enable both left- and right-handed users to work with ease

- USB Ports**
2 x USB Type-C
- Cable**
USB Type-C to C

WORK THE WAY YOU LIKE

The ThinkVision M14 with its admirable flexibility is built for varied job roles. With a tilt angle of -5°-90°, you can position your monitor in a way that suits your style. Compare content with ease even as you use laptops of different screen sizes with the ergonomic height adjustable foot. Also, you can wall mount your monitor effortlessly with mounting support for a hands-free viewing experience. The advanced low blue light technology minimizes eye strain, making extended working hours easy.

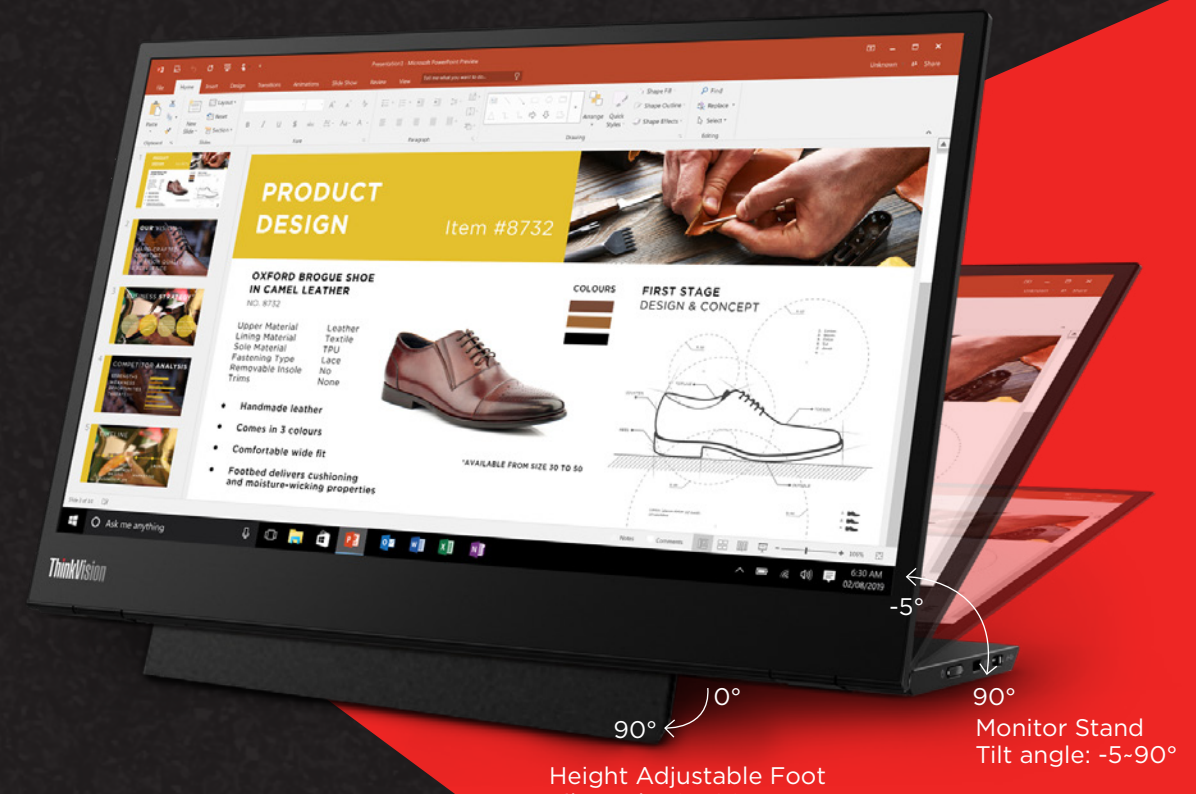

- Height Adjustable Foot**
Tilt 0°-90°
- Monitor Stand**
Tilt -5°-90°
- Eye-care Technology**
Low blue light

Remarkable flexibility: position the monitor in the way that suits your style

*For charging usage, a Lenovo branded 65W adapter (Part No.: SA10E75874) is recommended

TECH SPECS

<p>LCD PANEL</p> <p>Panel Size 14-inch</p> <p>Screen Dimensions (W x H, mm) 309.31 x 173.99 mm</p> <p>Panel Type In-Plane Switching</p> <p>Backlight WLED</p> <p>Aspect Ratio 16:9</p> <p>Resolution 1920 x 1080</p> <p>Pixel Pitch (H x V, mm) 0.1611 x 0.1611 mm</p> <p>Dot/Pixel Per Inch (DPI/PPI) 157</p> <p>Viewing angle (H x V @ CR 10:1) 178° / 178°</p> <p>Response Time (typical) 6ms with OD</p> <p>Refresh Rate 60 Hz</p> <p>Brightness (typical) 300 cd/m²</p> <p>Contrast Ratio (typical) 700:1</p> <p>Dynamic Contrast Ratio (typical) 3M:1</p> <p>Colour Gamut NTSC (CIE 1931) 72%</p> <p>Color Support (typical) 16.7 Million</p> <p>Color Depth 8bit (6bit + FRC)</p> <p>Anti-Glare Yes</p>	<p>Power Consumption Switch-Off Mode < 0.3 W</p> <p>USB Type-C/Power Delivery Up to 65 W</p> <p>Power Supply External (no adapter bundle)</p> <p>Voltage Required DC 5 V to 20 V</p> <p>MECHANICAL</p> <p>Tilt Angle (front/back) -5° / 90°</p> <p>Mounting Support Yes (100 mm)</p> <p>Kensington™ Lock Slot Yes</p> <p>Cable Management Yes</p> <p>Bezel Color Raven Black</p> <p>Bezel Width (Side) 5.48mm</p> <p>Bezel Width (top / bottom) 5.47 mm / 23.87 mm</p> <p>DIMENSIONS</p> <p>Size Packed (D x H x W) (mm / inch) 276 x 61 x 402 mm / 10.87 x 2.40 x 15.83 inches</p> <p>Size Unpacked w/stand (D x H x W) (mm / inch) (Lowest position) 96.54 x 209.03 x 323.37 mm / 3.8 x 8.23 x 12.73 inches</p> <p>Size Unpacked w/stand (D x H x W) (mm / inch) (Highest position) 96.54 x 220.03 x 323.37 mm / 3.8 x 8.66 x 12.73 inches</p> <p>Stand base footprint area (mm²) 260.87 x 69.55 mm / 10.27 x 2.74 inches</p> <p>Weight Packed (kg / lbs.) 1.67 kg / 3.67 lbs.</p> <p>Weight Unpacked (kg / lbs.) 0.57 kg / 1.26 lbs.</p>	<p>ENVIRONMENTAL</p> <p>Temperature - Operating 0° to 40°C</p> <p>Temperature - Non-operating -20° to 60°C</p> <p>Humidity - Operating 30 to 80%</p> <p>Humidity - Non-operating 30 to 90%</p> <p>Altitude - Operating 0 to 5000 m</p> <p>Altitude - Non-operating 0 to 40,000 ft</p> <p>Arsenic-free Glass Yes</p> <p>PVC free Yes</p> <p>Mercury free Yes</p> <p>PCC % of plastic resins 85%</p> <p>WARRANTY</p> <p>Geography Availability WW</p> <p>Warranty 3 Years</p> <p>CERTIFICATIONS</p> <p>ENERGY STAR® Rating 7,1</p> <p>EPEAT Bronze</p> <p>RoHS (EU 2002/95/EC) Yes (Arsenic free / Pb free / Mercury free)</p> <p>Windows Certification Windows 7 / 10</p> <p>Image Quality Capability ISO 9241-307</p> <p>China Energy Efficiency Standard Tier 2</p> <p>Low Blue Light / Eye Comfort Yes (Low BlueLight)</p>
--	--	--



<p>Name E1922s Wide Flat Panel Monitor Case color Black Type-model 60G2AAR6US / 60G2AAT6EU Panel TFT-LCD, twisted nematic (TN), White LED backlight Viewable image size 18.5" (470mm) diagonal Max view area (W x H) 16.1" x 9.1" / 409.8mm x 230.4mm Native resolution 1366x768 Aspect ratio 16:9 Pixel pitch (mm) 0.3mm Dot/Pixel per Inch 85 dpi Brightness 200 nits or cd/m² (typical) Contrast ratio 600:1 (typical) Pixel response time 5ms (typical) Color gamut 72% Viewing angle at 10:1 CR 180° (+/- 90°) horizontal, 100° (+/- 50°) vertical Stand Tilt adjustable stand Bezel width Sides: 0.73" (18.5mm) Dimensions (HxWxD) 13.44" H x 17.65" W x 6.58" D; 341.5mm H x 448.4mm W x 167.2mm D Power supply 13.7 watts typical, 17 watts maximum, <0.5 watts standby/suspend, universal, integrated (no external brick-like power supply) Weight 6.03 lb; 2.74 kg Limited warranty⁴ 3 year (includes backlight) Available date March 2014</p>	<p style="text-align: center;">Features</p> <ul style="list-style-type: none"> • Widescreen 18.5-inch monitor • Supports HD 1366x768 resolution • Supports VESA mount (100mm) • Mercury free panel and arsenic free glass • Kensington lock slot ready for enhanced security • Support Lenovo Tiny PC via VESA mount • Supports optional soundbar • Microsoft® Windows® 7 certified • Microsoft Windows 8 / Windows 8.1 certified 				
<p>VESA-compliant² VESA DPMS-compliant Power management ENERGY STAR® 7.0 Ergonomics ISO 9241-307 Emission standards FCC Class B Environmental TCO (TCO Displays 7.0), WEEE, RoHS, EPEAT™ Silver rating</p>	<div style="text-align: center;">  <p>ThinkVision E1922s Wide Monitor</p> </div>				
<p>Preset resolutions VGA: 640x350, 640x480, 720x400 SVGA: 800x600, 832x624 XGA: 1024x768, 1152x864 SXGA: 1280x1024 WXGA: 1366x768</p> <p>Presets / user settings Standard presets: 15 user settings: 16</p>					
<p>Viewing adjustments Tilt: 20° backward, -5° forward Rotating screen None On screen display On screen display with digital user controls (8 languages) Control features Direct access (control buttons on front) for automatic image setup and adjustment for brightness Multiple input None Monitor connectors VGA 15-pin D-shell, analog, blue Signal cables detachable, VGA 15-pin D-shell at each end, analog, 1.8 meter Mounting features Wall or desk mounting using the Extend Arm or third-party accessories meeting the VESA FPMPI® (100mm mount) Security Security keyhole for attachment of optional cable lock (Kensington® lock-compatible)</p>					
<p>Ship group Monitor with stand, 1.8 meter analog signal cable, 1.8 meter black power cord</p>					
<p style="text-align: center;">Limited Warranty</p> <p>See details at http://support.lenovo.com/en_US/guides-and-manuals/detail.page?DocID=UM008281</p>	<p style="text-align: center;">Accessories</p> <table border="0"> <tr> <td>Kensington MicroSaver Cable Lock</td> <td style="text-align: right;">73P2582</td> </tr> <tr> <td>Kensington Twin Head Cable Lock</td> <td style="text-align: right;">45K1620</td> </tr> </table> <p>See details at www.lenovo.com/support/monitoraccessories</p> <p>See all monitors at www.lenovo.com/thinkvision</p>	Kensington MicroSaver Cable Lock	73P2582	Kensington Twin Head Cable Lock	45K1620
Kensington MicroSaver Cable Lock	73P2582				
Kensington Twin Head Cable Lock	45K1620				



<p>Name E2054 Wide Flat Panel Monitor Case color Raven black Type-model 60DFAAR1US / 60DFAAT1EU Panel TFT-LCD, In-Plane Switching (IPS), LED backlight Viewable image size 19.5" (494mm) diagonal Max view area (W x H) 16.48" x 10.33" / 418.6mm x 262.4mm Native resolution 1440x900 Aspect ratio 16:10 Pixel pitch (mm) 0.097mm x 0.292mm Dot/Pixel per Inch 87 dpi Brightness 250 nits or cd/m² (typical) Contrast ratio 1000:1 (typical) Pixel response time 7ms (typical) Color gamut 72% Viewing angle at 10:1 CR 178° (+/- 89°) horizontal, 178° (+/- 89°) vertical Stand Tilt adjustable stand Bezel width Top: 0.71" (18.0mm) Bottom: 0.70" (17.9mm) Sides: 1.02" (26.0mm) Dimensions (HxWxD) 14.65" H x 17.95" W x 7.41" D; 372.0mm H x 456.0mm W x 188.3mm D Power supply 16 watts typical, 20 watts maximum, <0.5 watts standby/suspend, universal, integrated (no external brick-like power supply) Weight 6.17 lb; 2.8 kg Limited warranty 3 year (includes backlight) Available date November 2015</p>	<p style="text-align: center;">Features</p> <ul style="list-style-type: none"> • Widescreen 19.5-inch monitor • Supports HD 1440x900 resolution • Supports VESA mount (100mm) • Mercury free panel and arsenic free glass • Kensington lock slot ready for enhanced security • Support Lenovo Tiny PC via VESA mount • Microsoft® Windows® 7 certified • Microsoft Windows 8 / Windows 8.1 certified • Microsoft Windows 10 certified 				
<p>VESA-compliant VESA DPMS-compliant Power management ENERGY STAR® 6.0 Ergonomics ISO 9241-307 Emission standards FCC Class B Environmental TCO (TCO Displays 6.0), WEEE, RoHS, EPEAT™ Silver rating</p>	<div style="text-align: center;">  <p>ThinkVision E2054 Wide Monitor</p> </div>				
<p>Preset resolutions VGA: 640x480, 720x400 SVGA: 800x600 XGA: 1024x768 SXGA: 1280x768, 1280x1024 WXGA: 1366x768 WXGA+: 1440x900</p> <p>Presets / user settings Standard presets: 18 user settings: 10</p>					
<p>Viewing adjustments Tilt: 22° backward, -5° forward Rotating screen None On screen display On screen display with digital user controls (8 languages) Control features Direct access (control buttons on front) for automatic image setup and adjustment for brightness Multiple input None Monitor connectors VGA 15-pin D-shell, analog, blue Signal cables detachable, VGA 15-pin D-shell at each end, analog, 1.8 meter Mounting features Wall or desk mounting using the Extend Arm or third-party accessories meeting the VESA FPMPI® (100mm mount) Security Security keyhole for attachment of optional cable lock (Kensington® lock-compatible)</p>					
<p>Ship group Monitor with stand, 1.8 meter analog signal cable, 1.8 meter black power cord</p>					
<p style="text-align: center;">Limited Warranty</p> <p>See details at http://support.lenovo.com/en_US/guides-and-manuals/detail.page?DocID=UM008281</p>	<p style="text-align: center;">Accessories</p> <table border="0" style="width: 100%;"> <tr> <td>Kensington MicroSaver Cable Lock</td> <td style="text-align: right;">73P2582</td> </tr> <tr> <td>Kensington Twin Head Cable Lock</td> <td style="text-align: right;">45K1620</td> </tr> </table> <p>See details at www.lenovo.com/support/monitoraccessories</p> <p>See all monitors at www.lenovo.com/thinkvision</p>	Kensington MicroSaver Cable Lock	73P2582	Kensington Twin Head Cable Lock	45K1620
Kensington MicroSaver Cable Lock	73P2582				
Kensington Twin Head Cable Lock	45K1620				



<p>Name LT1913p Square Flat Panel Monitor Case color Black Type-model 60FBHAR1US / 60FBHAT1EU Panel TFT-LCD, In-Plane Switching (IPS), White LED backlight</p> <p>Viewable image size 19.0" (480.0mm) diagonal Max view area (W x H) 14.76" x 11.80" (374.7mm x 299.8mm) Optimum resolution 1280x1024 Max pixel rate 205MHz (VGA), 165MHz (DVI) Aspect ratio 5:4 Pixel pitch (mm) 0.0976 (H) x 0.2928 (V) mm Dot/Pixel per Inch 86.8 dpi Brightness 250 nits or cd/m² (typical) Contrast ratio 1000:1 (typical) Pixel response time 7ms (typical) Color gamut 72% Viewing angle at 10:1 CR 178° horizontal, 178° vertical</p> <p>Stand Tilt, swivel, pivot, and height adjustable stand Bezel width Sides: 0.68" (17.4mm); top: 0.68" (17.4mm); bottom: 0.68" (17.4mm)</p> <p>Dimensions (HxWxD) 14.63" H x 16.18" W x 10.40" D; 371.5mm H x 411.0mm W x 264.2mm D</p> <p>Power supply 24 watts typical, 27 watts maximum, <0.5 watts standby/suspend, universal, integrated (no external brick-like power supply) 10.69 lb; 4.85kg</p> <p>Weight 10.69 lb; 4.85kg Limited warranty⁴ 3 year (includes backlight) Available date April 2015</p>	<p>Features</p> <ul style="list-style-type: none"> • 19-inch Square IPS LED backlight panel • Supports 1280x1024 resolution • Supports ThinkCentre Tiny Clamp Bracket • Mercury and arsenic free glass • Low Halogen • Recycled content in plastic material • Supports optional soundbar • Microsoft® Windows® 7 certified • Microsoft Windows 8 / Windows 8.1 certified • Microsoft Windows 10 certified 								
<p>VESA-compliant² VESA DDC2B/C1, EDID 1.3 Power management ENERGY STAR® 7.0 Ergonomics ISO 9241-307 Emission standards FCC Class B Environmental TCO Displays 7.0, TCO Certified Edge 1.1, WEEE, RoHS, EPEAT™ Silver rating, ULE Gold</p> <p>Preset resolutions VGA: 640x350, 640x480, 720x400 SVGA: 800x600, 823x624 XGA: 1024x768, 1152x864, 1152x900 SXGA: 1280x1024</p> <p>Presets / user settings Standard presets: 20; user settings: 20</p>	 <p>ThinkVision LT1913p Square Monitor</p>								
<p>Viewing adjustments Tilt: 30° back, -5° forward; lift: 4.3" (110mm); swivel: +/- 45° Rotating screen Screen pivots 90 degrees from landscape to portrait On screen display On screen display with digital user controls (8 languages) Control features Direct access (buttons on front) for automatic image setup, input switch, and brightness Multiple input Dual input (two different PCs attach to two different connectors; one PC shows image; select via button) Monitor connectors (1) VGA 15-pin D-shell, analog, blue (2) Digital Visual Interface (DVI-D), digital, white, HDCP-compliant Signal cables (1) detachable, VGA 15-pin D-shell at each end, analog, 1.8 meter (2) detachable, DVI-D at each end, digital, 1.8 meter Mounting features Wall or desk mounting using the Extend Arm or third-party accessories meeting the VESA FPMPI® (100mm mount) Security Security keyhole for attachment of optional cable lock (Kensington® lock-compatible)</p> <p>Ship group Monitor, attached stand, Setup poster, Safety and Warranty Information, 1.8 meter analog signal cable, 1.8 meter DVI-D cable, 1.8 meter black power cord</p>									
<p>Limited Warranty</p> <p>See details at http://support.lenovo.com/en_US/guides-and-manuals/detail.page?DocID=UM008281</p>	<p>Accessories</p> <table border="0"> <tr> <td>Kensington MicroSaver Cable Lock</td> <td>73P2582</td> </tr> <tr> <td>Kensington Twin Head Cable Lock</td> <td>45K1620</td> </tr> <tr> <td>Lenovo Security Cable Lock</td> <td>57Y4303</td> </tr> <tr> <td>Lenovo Easy Reach Monitor Stand</td> <td>55Y9258</td> </tr> </table> <p>See details at www.lenovo.com/support/monitoraccessories</p> <p>See all monitors at www.lenovo.com/thinkvision</p>	Kensington MicroSaver Cable Lock	73P2582	Kensington Twin Head Cable Lock	45K1620	Lenovo Security Cable Lock	57Y4303	Lenovo Easy Reach Monitor Stand	55Y9258
Kensington MicroSaver Cable Lock	73P2582								
Kensington Twin Head Cable Lock	45K1620								
Lenovo Security Cable Lock	57Y4303								
Lenovo Easy Reach Monitor Stand	55Y9258								



<p>Name T1714 Square Flat Panel Monitor Case color Black Type-model 60FDHAR1US / 60FDHAT1EU Panel TFT-LCD, twisted nematic (TN), White LED backlight Viewable image size 17.0" (432mm) diagonal Max view area (W x H) 13.3" x 10.6" (337.9mm x 270.3mm) Optimum resolution 1280x1024 Aspect ratio 5:4 Pixel pitch (mm) 0.264mm Dot/Pixel per Inch 96 dpi Brightness 250 nits or cd/m² (typical) Contrast ratio 1000:1 (typical) Pixel response time 5ms (typical) Color gamut 72% Viewing angle at 10:1 CR 170° (+/- 85°) horizontal, 160° (+/- 80°) vertical Stand Tilt stand Bezel width Sides: 0.69" (17.5mm) Dimensions (HxWxD, including stand) 14.72" H x 14.74" W x 7.87" D; 373.9mm H x 374.5mm W x 200mm D Power supply 14.0 watts typical, 18.0 watts maximum, <0.5 watts standby/suspend, universal, integrated (no external brick-like power supply) Weight 5.75 lb; 2.61kg Limited warranty 3 year (includes backlight) Available date September 2015</p>	<p>Features</p> <ul style="list-style-type: none"> • 17-inch Square LCD monitor • Supports SXGA 1280x1024 resolution • Includes dual input connection for attachment to two systems concurrently (analog and digital) • Mercury Arsenic free glass • Supports optional soundbar • Microsoft® Windows® 7 certified • Microsoft Windows 8 certified • Microsoft Windows 8.1 certified • Microsoft Windows 10 certified 						
<p>VESA-compliant VESA DDC2B/CI Power management ENERGY STAR® 7.0 Ergonomics ISO 9241-307 Emission standards FCC Class B Environmental TCO Displays 7.0, TCO Certified Edge 2.0, WEEE, RoHS, EPEAT™ Silver rating</p>	<div style="text-align: center;">  <p>ThinkVision T1714 Monitor</p> </div>						
<p>Preset resolutions VGA: 640x350, 640x480, 720x400 SVGA: 800x600 XGA: 1024x768, 1152x864, SXGA: 1280x800, 1280x1024</p> <p>Presets / user settings Standard presets: 17; user settings: 17</p>							
<p>Viewing adjustments Tilt: 22° back, -5° forward Rotating screen None On screen display On screen display with digital user controls (8 languages) Control features Direct access (buttons on front) for automatic image setup and brightness Multiple input Dual input (two different PCs attach to two different connectors; one PC shows image; select via button) Monitor connectors (1) VGA 15-pin D-shell, analog, blue (2) Digital Visual Interface (DVI-D), digital, white, HDCP-compliant Signal cables (1) detachable, VGA 15-pin D-shell at each end, analog, 1.8 meter (2) detachable, DVI-D at each end, digital, 1.8 meter Mounting features Wall or desk mounting using the Extend Arm or third-party accessories meeting the VESA FPMPI® (100mm mount) Security Security keyhole for attachment of optional cable lock (Kensington® lock-compatible)</p>							
<p>Ship group Monitor and stand, Setup poster, Safety and Warranty Information, 1.8 meter analog signal cable, 1.8 meter DVI-D cable, 1.8 meter black power cord</p>	<p>Limited Warranty</p> <p>See details at http://support.lenovo.com/en_US/guides-and-manuals/detail.page?DocID=UM008281</p> <p>Accessories</p> <table border="0"> <tr> <td>Kensington MicroSaver Cable Lock</td> <td>73P2582</td> </tr> <tr> <td>Kensington Twin Head Cable Lock</td> <td>45K1620</td> </tr> <tr> <td>Lenovo Easy Reach Monitor Stand</td> <td>55Y9258</td> </tr> </table> <p>See details at www.lenovo.com/support/monitoraccessories</p> <p>See all monitors at www.lenovo.com/thinkvision</p>	Kensington MicroSaver Cable Lock	73P2582	Kensington Twin Head Cable Lock	45K1620	Lenovo Easy Reach Monitor Stand	55Y9258
Kensington MicroSaver Cable Lock	73P2582						
Kensington Twin Head Cable Lock	45K1620						
Lenovo Easy Reach Monitor Stand	55Y9258						



<p>Name T1714p Square Flat Panel Monitor Case color Black Type-model 60FELAR1US / 60FELAT1EU Panel TFT-LCD, twisted nematic (TN), White LED backlight Viewable image size 17.0" (432mm) diagonal Max view area (W x H) 13.3" x 10.6" (337.9mm x 270.3mm) Optimum resolution 1280x1024 Aspect ratio 5:4 Pixel pitch (mm) 0.264mm Dot/Pixel per Inch 96 dpi Brightness 250 nits or cd/m² (typical) Contrast ratio 1000:1 (typical) Pixel response time 5ms (typical) Color gamut 72% Viewing angle at 10:1 CR 170° (+/- 85°) horizontal, 160° (+/- 80°) vertical Stand Tilt height adjustable stand Bezel width Sides: 0.69" (17.5mm) Dimensions (HxWxD, including stand) 17.63" H x 14.74" W x 9.61" D; 447.9mm H x 374.5mm W x 244.2mm D Power supply 14.0 watts typical, 18.0 watts maximum, <0.5 watts standby/suspend, universal, integrated (no external brick-like power supply) Weight 8.71 lb; 3.95kg Limited warranty 3 year (includes backlight) Available date September 2015</p>	<p>Features</p> <ul style="list-style-type: none"> • 17-inch Square LCD monitor • Supports SXGA 1280x1024 resolution • Includes dual input connection for attachment to two systems concurrently (analog and digital) • Mercury Arsenic free glass • Supports Lenovo Tiny PC and 3rd party thin client via optional Lenovo bracket • Supports optional soundbar • Microsoft® Windows® 7 certified • Microsoft Windows 8 certified • Microsoft Windows 8.1 certified • Microsoft Windows 10 certified 						
<p>VESA-compliant VESA DDC2B/CI Power management ENERGY STAR® 7.0 Ergonomics ISO 9241-307 Emission standards FCC Class B Environmental TCO Displays 7.0, TCO Certified Edge 2.0, WEEE, RoHS, EPEAT™ Silver rating</p>	<div style="text-align: center;">  <p>ThinkVision T1714p Monitor</p> </div>						
<p>Preset resolutions VGA: 640x350, 640x480, 720x400 SVGA: 800x600 XGA: 1024x768, 1152x864, SXGA: 1280x800, 1280x1024 Presets / user settings Standard presets: 22; user settings: 22</p>							
<p>Viewing adjustments Tilt: 22° back, -5° forward; lift: 4.3" (110mm) Rotating screen None On screen display On screen display with digital user controls (8 languages) Control features Direct access (buttons on front) for automatic image setup and brightness Multiple input Dual input (two different PCs attach to two different connectors; one PC shows image; select via button) Monitor connectors (1) VGA 15-pin D-shell, analog, blue (2) Digital Visual Interface (DVI-D), digital, white, HDCP-compliant (3) DisplayPort, digital, black, HDCP-compliant Signal cables (1) detachable, VGA 15-pin D-shell at each end, analog, 1.8 meter (2) detachable, DVI-D at each end, digital, 1.8 meter Mounting features Wall or desk mounting using the Extend Arm or third-party accessories meeting the VESA FPMPI® (100mm mount) Security Security keyhole for attachment of optional cable lock (Kensington® lock-compatible)</p>	<p>Ship group Monitor and stand, Setup poster, Safety and Warranty Information, 1.8 meter analog signal cable, 1.8 meter DVI-D cable, 1.8 meter black power cord</p>						
<p style="text-align: center;">Limited Warranty</p> <p>See details at http://support.lenovo.com/en_US/guides-and-manuals/detail.page?DocID=UM008281</p>	<p style="text-align: center;">Accessories</p> <table border="0"> <tr> <td>Kensington MicroSaver Cable Lock</td> <td style="text-align: right;">73P2582</td> </tr> <tr> <td>Kensington Twin Head Cable Lock</td> <td style="text-align: right;">45K1620</td> </tr> <tr> <td>Lenovo Easy Reach Monitor Stand</td> <td style="text-align: right;">55Y9258</td> </tr> </table> <p>See details at www.lenovo.com/support/monitoraccessories</p> <p>See all monitors at www.lenovo.com/thinkvision</p>	Kensington MicroSaver Cable Lock	73P2582	Kensington Twin Head Cable Lock	45K1620	Lenovo Easy Reach Monitor Stand	55Y9258
Kensington MicroSaver Cable Lock	73P2582						
Kensington Twin Head Cable Lock	45K1620						
Lenovo Easy Reach Monitor Stand	55Y9258						



<p>Name T2054p Wide Flat Panel Monitor Bezel color Raven black Type-model 60G1MAR2US / 60G1MAT2EU Panel TFT-LCD, In-Plane Switching (IPS), White LED backlight</p> <p>Viewable image size 19.5" (495mm) diagonal Max view area (W x H) 16.48" x 10.33" (418.6mm x 262.4mm) Native resolution 1440x900 Aspect ratio 16:10 Pixel pitch (mm) 0.2915 x 0.2915 mm Dot/Pixel per Inch 87 dpi Brightness 250 nits or cd/m² (typical) Contrast ratio 1000:1 (typical) Pixel response time 7ms (typical) Color gamut 72% Viewing angle at 10:1 CR 178° (+/- 89°) horizontal, 178° (+/- 89°) vertical Stand Tilt, swivel, and height adjustable Bezel width Sides: 0.67" (17.0mm) Dimensions (HxWxD) 13.62" H x 17.88" W x 9.55" D; 345.9mm H x 454.2mm W x 242.6mm D</p> <p>Power supply 14.5 watts typical, 21 watts maximum, <0.3 watts standby/suspend, universal, integrated (no external brick-like power supply)</p> <p>Weight 8.16 lb; 3.70 kg Limited warranty⁴ 3 year (includes backlight) Available date September 2015</p>	<p style="text-align: center;">Features</p> <ul style="list-style-type: none"> • Widescreen 19.5-inch monitor • Supports 1440x900 resolution • Supports ThinkCentre Tiny Clamp Bracket • Includes dual input connection for attachment to two systems concurrently (analog and digital) • EPEAT Gold certified • Supports optional soundbar • Microsoft® Windows® 7 certified • Microsoft Windows 8 / Windows 8.1 certified • Microsoft Windows 10 certified 				
<p>VESA-compliant² VESA DDC2B/CI Power management ENERGY STAR® qualified Ergonomics ISO 9241-307 Emission standards FCC Class B Environmental TCO Displays 7.0, TCO Certified Edge 2.0, WEEE, RoHS, EPEAT™ Silver rating</p>	<div style="text-align: center;">  <p>ThinkVision T2054p Wide Monitor</p> </div>				
<p>Preset resolutions VGA: 640x480, 720x400, 720x576 SVGA: 800x600 XGA: 1024x768, 1152x864 SXGA: 1280x800, 1280x1024 WXGA: 1366x768 WXGA+: 1440x900</p> <p>Presets / user settings Standard presets: 22 user settings: 16</p>					
<p>Viewing adjustments Tilt: 22° backward, -5° forward; lift: 4.3" (110mm); swivel: +/-45°; detachable stand Rotating screen None On screen display On screen display with digital user controls (8 languages) Control features Direct access (buttons on front) for automatic image setup, dual input and brightness Multiple input Dual input (two different PCs attach to two different connectors; one PC shows image; select via button) Monitor connectors (1) VGA 15-pin D-shell, analog, blue (2) HDMI (1.4), digital, HDCP-compliant (3) DisplayPort, digital, black, HDCP-compliant</p> <p>Signal cables (1) detachable, VGA 15-pin D-shell at each end, analog, 1.8 meter (2) detachable, DisplayPort at each end, digital, 1.8 meter</p> <p>Mounting features Wall or desk mounting using the Extend Arm or third-party accessories, 100mm x 100mm mount Security Security keyhole for attachment of optional cable lock (Kensington® lock-compatible)</p> <p>Ship group Monitor with stand, Safety and Warranty Information, 1.8 meter analog signal cable, 1.8 meter DP signal cable, 1.8 meter black power cord</p>					
<p style="text-align: center;">Limited Warranty</p> <p>See details at http://support.lenovo.com/en_US/guides-and-manuals/detail.page?DocID=UM008281</p>	<p style="text-align: center;">Accessories</p> <table border="0"> <tr> <td>Kensington MicroSaver Cable Lock</td> <td style="text-align: right;">73P2582</td> </tr> <tr> <td>Kensington Twin Head Cable Lock</td> <td style="text-align: right;">45K1620</td> </tr> </table> <p>See details at www.lenovo.com/support/monitoraccessories</p> <p>See all monitors at www.lenovo.com/thinkvision</p>	Kensington MicroSaver Cable Lock	73P2582	Kensington Twin Head Cable Lock	45K1620
Kensington MicroSaver Cable Lock	73P2582				
Kensington Twin Head Cable Lock	45K1620				



<p>Name E21 Wide Flat Panel Monitor Bezel color Black Type-model 61B9JAR1US / 61B9JAT1EU Panel TFT-LCD, twisted nematic (TN), White LED backlight Viewable image size 20.7" (525.78mm) diagonal Max view area (W x H) 18.03" x 10.14" (457.92mm x 257.58mm) Native resolution 1920x1080 Aspect ratio 16:9 Pixel pitch (mm) 0.2385 x 0.2385 mm Dot/Pixel per Inch 106 dpi Brightness 250 nits or cd/m² (typical) Contrast ratio 1000:1 (typical) Pixel response time 5ms (typical) Color gamut 72% Viewing angle at 10:1 CR 170° (+/- 85°) horizontal, 160° (+/- 80°) vertical Stand Tilt adjustable stand Bezel width Sides: 0.6" (15.3mm) Dimensions (HxWxD) 14.6" H x 19.31" W x 8.07" D; 370.9mm H x 490.5mm W x 204.9mm D Power supply 18 watts typical, 23 watts maximum, <0.3 watts standby/suspend, universal, integrated (no external brick-like power supply) Weight 5.82 lb; 2.64 kg Limited warranty 3 year (includes backlight) Available date August 2017</p>	<p style="text-align: center;">Features</p> <ul style="list-style-type: none"> • Widescreen 20.7-inch monitor • Supports 1920x1080 resolution • Supports ThinkCentre Tiny Clamp Bracket • Supports optional soundbar • EPEAT Gold certified • Low Blue Light certification • Microsoft® Windows® 7 certified • Microsoft Windows 10 certified 				
<p>VESA-compliant VESA DDC2B/CI Power management ENERGY STAR® qualified Ergonomics ISO 9241-307 Emission standards FCC Class B Environmental TCO Displays 7.0, TCO Certified Edge 2.0, WEEE, RoHS, EPEAT™ Silver rating</p>	<div style="text-align: center;">  <p>ThinkVision E21 Wide Monitor</p> </div>				
<p>Preset resolutions VGA: 640x350, 640x480, 720x400 SVGA: 800x600, 832x624 XGA: 1024x768, 1152x864 SXGA: 1280x1024 WXGA+: 1440x900 WSXGA+: 1680x1050 Full HD: 1920x1080</p> <p>Presets display modes Standard presets: 22</p>					
<p>Viewing adjustments Tilt: 22° back, -5° forward Rotating screen None On screen display On screen display with digital user controls (8 languages) Control features Direct access (buttons on front) for power, menu, input source select and brightness USB hub None Multiple input Dual input (two different PCs attach to two different connectors; one PC shows image; select via button) Monitor connectors (1) VGA 15-pin D-shell, analog, blue (2) DisplayPort (1.2), digital, black, HDCP-compliant Signal cables (1) detachable, VGA 15-pin D-shell at each end, analog, 1.8 meter Mounting features Wall or desk mounting using the Extend Arm or third-party accessories, 100mm x 100mm mount Security Security keyhole for attachment of optional cable lock (Kensington® lock-compatible)</p>					
<p>Ship group Monitor with stand, Safety and Warranty Information, 1.8 meter analog signal cable, 1.8 meter black power cord</p>	<p style="text-align: center;">Accessories</p> <table border="0" style="width: 100%;"> <tr> <td>Kensington MicroSaver Cable Lock</td> <td style="text-align: right;">73P2582</td> </tr> <tr> <td>Kensington Twin Head Cable Lock</td> <td style="text-align: right;">45K1620</td> </tr> </table> <p>See details at www.lenovo.com/support/monitoraccessories</p> <p>See all monitors at www.lenovo.com/thinkvision</p>	Kensington MicroSaver Cable Lock	73P2582	Kensington Twin Head Cable Lock	45K1620
Kensington MicroSaver Cable Lock	73P2582				
Kensington Twin Head Cable Lock	45K1620				



<p>Name E24 Wide Flat Panel Monitor Bezel color Black Type-model 61B7JAR6US / 61B7JAT6EU Panel TFT-LCD, In-Plane Switching (IPS), White LED backlight Viewable image size 23.8" (604.7mm) diagonal Max view area (W x H) 20.75" x 11.67" (527.04mm x 296.46mm) Native resolution 1920x1080 Aspect ratio 16:9 Pixel pitch (mm) 0.2745 x 0.2745 mm Dot/Pixel per Inch 92.5 dpi Brightness 250 nits or cd/m² (typical) Contrast ratio 1000:1 (typical) Pixel response time 6ms (typical) Color gamut 72% Viewing angle at 10:1 CR 178° (+/- 89°) horizontal, 178° (+/- 89°) vertical Stand Tilt adjustable stand Bezel width <i>Sides:</i> 0.51" (13mm) Dimensions (HxWxD) 15.9" H x 21.81" W x 8.07" D; 403.8mm H x 554mm W x 204.9mm D Power supply 18 watts typical, 23 watts maximum, <0.3 watts standby/suspend, universal, integrated (no external brick-like power supply) Weight 8.2 lb; 3.7 kg Limited warranty 3 year (includes backlight) Available date August 2017</p>	<p style="text-align: center;">Features</p> <ul style="list-style-type: none"> • Widescreen 23.8-inch monitor • Supports 1920x1080 resolution • Supports ThinkCentre Tiny VESA mount • Supports optional soundbar • Includes dual input connection for attachment to two systems concurrently • EPEAT Gold certified • Microsoft® Windows® 7 certified • Microsoft Windows 10 certified 				
<p>VESA-compliant VESA DDC2B/CI Power management ENERGY STAR® qualified Ergonomics ISO 9241-307 Emission standards FCC Class B Environmental TCO Displays 7.0, TCO Certified Edge 2.0, WEEE, RoHS, EPEAT™ Gold rating</p>	<div style="text-align: center;">  <p>ThinkVision E24 Wide Monitor</p> </div>				
<p>Preset resolutions VGA: 640x350, 640x480, 720x400 SVGA: 800x600, 832x624 XGA: 1024x768, 1152x864 SXGA: 1280x1024 WXGA: 1366x768 WXGA+: 1440x900, 1600x900 WSXGA+: 1680x1050 Full HD: 1920x1080</p> <p>Presets display modes Standard presets: 24; user settings: 20</p>					
<p>Viewing adjustments <i>Tilt:</i> 22° back, -5° forward Rotating screen None On screen display On screen display with digital user controls (8 languages) Control features Direct access (buttons on front) for power, menu, input source select and brightness USB hub None Multiple input Dual input (two different PCs attach to two different connectors; one PC shows image; select via button) Monitor connectors (1) VGA 15-pin D-shell, analog, blue (2) DisplayPort, digital, black, HDCP-compliant Signal cables (1) detachable, VGA 15-pin D-shell at each end, analog, 1.8 meter (2) detachable, DisplayPort at each end, digital, 1.8 meter Mounting features Wall or desk mounting using the Extend Arm or third-party accessories, 100mm x 100mm mount Security Security keyhole for attachment of optional cable lock (Kensington® lock-compatible)</p>					
<p>Ship group Monitor with stand, Safety and Warranty Information, 1.8 meter analog signal cable, 1.8 meter DP signal cable, 1.8 meter black power cord</p>	<p style="text-align: center;">Accessories</p> <table border="0"> <tr> <td>Kensington MicroSaver Cable Lock</td> <td style="text-align: right;">73P2582</td> </tr> <tr> <td>Kensington Twin Head Cable Lock</td> <td style="text-align: right;">45K1620</td> </tr> </table> <p>See details at www.lenovo.com/support/monitoraccessories</p> <p>See all monitors at www.lenovo.com/thinkvision</p>	Kensington MicroSaver Cable Lock	73P2582	Kensington Twin Head Cable Lock	45K1620
Kensington MicroSaver Cable Lock	73P2582				
Kensington Twin Head Cable Lock	45K1620				
<p style="text-align: center;">Limited Warranty</p> <p>See details at http://support.lenovo.com/en_US/guides-and-manuals/detail.page?DocID=UM008281</p>					



<p>Name P24h Wide Flat Panel Monitor Bezel color Black Type-model 61AEGAR3US / 61AEGAT3EU Panel TFT-LCD, In-Plane Switching (IPS), White LED backlight Viewable image size 23.8" (604.7mm) diagonal Max view area (W x H) 20.74" x 11.67" (526.9mm x 296.4mm) Native resolution 2560x1440 Aspect ratio 16:9 Pixel pitch (mm) 0.2058x 0.2058 mm Dot/Pixel per Inch 124 dpi Brightness 300 nits or cd/m² (typical) Contrast ratio 1000:1 (typical) Pixel response time 4ms (extreme) / 6ms (typical) Color gamut 99% sRGB Viewing angle at 10:1 CR 178° (+/- 89°) horizontal, 178° (+/- 89°) vertical Stand Tilt, swivel, pivot, and height adjustable stand Bezel width <i>Sides:</i> 0.08" (2.0mm) Dimensions (HxWxD) 14.7" H x 21.26" W x 10.3" D; 373.4mm H x 540.2mm W x 261.75mm D Power supply 24 watts typical, 120 watts maximum (with USB 3.0 hub), <0.5 watts standby/suspend, universal, integrated (no external brick-like power supply) Weight 12.54 lb; 5.69 kg Limited warranty 3 year (includes backlight) Available date April 2017</p>	<p style="text-align: center;">Features</p> <ul style="list-style-type: none"> • Widescreen 23.8-inch monitor • Supports 2560x1440 resolution • Supports optional soundbar • Supports ThinkCentre Tiny Clamp Bracket • Includes dual input connection for attachment to two systems concurrently • EPEAT Gold certified • Microsoft® Windows® 7 certified • Microsoft Windows 10 certified 				
<p>VESA-compliant VESA DDC2B/CI Power management ENERGY STAR® qualified Ergonomics ISO 9241-307 Emission standards FCC Class B Environmental TCO Displays 7.0, TCO Certified Edge 2.0, WEEE, RoHS, EPEAT™ Silver rating</p>	<div style="text-align: center;">  <p>ThinkVision P24h Wide Monitor</p> </div>				
<p>Preset resolutions VGA: 640x480, 720x400 SVGA: 800x600 XGA: 1024x768 SXGA: 1280x1024 WXGA: 1366x768 WXGA+: 1440x900, 1680x900 WSXGA+: 1680x1050 Full HD: 1920x1080, 1920x1200 QHD: 2560x1440 Presets display modes HDMI: 22; DP: 14</p>					
<p>Viewing adjustments <i>Tilt:</i> 30° back, -5° forward; <i>lift:</i> 4.3" (110mm); <i>swivel:</i> +/-45°; detachable stand Rotating screen Screen pivots 90 degrees from landscape to portrait On screen display On screen display with digital user controls (8 languages) Control features Direct access (buttons on front) for power, menu, input source select and brightness USB hub USB Hub: one USB 3.1 Type-C upstream port, four USB 3.0 Type-A downstream ports Multimedia Audio-out, optional sound bar supported Camera None Multiple input Support HDMI, DisplayPort, USB 3.1 Type-C, DisplayPort-out Monitor connectors (1) 2*HDMI (1.4), digital, HDCP-compliant (2) DisplayPort (1.2), digital, HDCP-compliant (3) DisplayPort-out, digital (4) USB 3.1 Type-C Signal cables (1) USB 3.1 Type-C cable, 1.8 meter Mounting features Wall or desk mounting using the Extend Arm or third-party accessories, 100mm x 100mm mount Security Security keyhole for attachment of optional cable lock (Kensington® lock-compatible)</p>					
<p>Ship group Monitor with stand, Safety and Warranty Information, 1.8 meter USB 3.1 Type-C cable, 1.8 meter black power cord</p>	<p style="text-align: center;">Accessories</p> <table border="0" style="width: 100%;"> <tr> <td>Kensington MicroSaver Cable Lock</td> <td style="text-align: right;">73P2582</td> </tr> <tr> <td>Kensington Twin Head Cable Lock</td> <td style="text-align: right;">45K1620</td> </tr> </table> <p>See details at www.lenovo.com/support/monitoraccessories</p> <p>See all monitors at www.lenovo.com/thinkvision</p>	Kensington MicroSaver Cable Lock	73P2582	Kensington Twin Head Cable Lock	45K1620
Kensington MicroSaver Cable Lock	73P2582				
Kensington Twin Head Cable Lock	45K1620				
<p style="text-align: center;">Limited Warranty</p> <p>See details at http://support.lenovo.com/en_US/guides-and-manuals/detail.page?DocID=UM008281</p>					



<p>Name P24q Wide Flat Panel Monitor Case color Black Type-model 61A5GAR3US / 61A5GAT3EU Panel TFT-LCD, IPS (In-Plane Switching), White LED backlight Viewable image size 23.8" (604.5mm) diagonal Max view area (W x H) 20.74" x 11.67" (526.85mm x 296.35mm) Optimum resolution 2560x1440 Max pixel rate 300MHz Aspect ratio 16:9 Pixel pitch (mm) 0.2058 x 0.2058mm Dot/Pixel per Inch 123 dpi Brightness 300 nits or cd/m² (typical) Contrast ratio 1000:1 (typical) Pixel response time 4ms Color gamut 99% sRGB Viewing angle at 10:1 CR 178° horizontal, 178° vertical Stand Tilt, swivel, pivot, and height adjustable stand Bezel width <i>Sides:</i> 0.08" (2mm) Dimensions 14.7" H x 21.26" W x 10.3" D; (HxWxD, including stand) 373.4mm H x 540.2mm W x 261.75mm D Power supply 24 watts typical, 67 watts maximum (with USB), <0.5 watts sleep/off; <0.5 watts switch off integrated (no external brick-like power supply) Weight 12.35 lb; 5.6kg (including stand) Limited warranty 3 year Available date January 2017</p>	<p>Features</p> <ul style="list-style-type: none"> • 23.8-inch IPS LED backlight monitor • Supports 2560x1440 resolution • 5-Ports USB hub, support USB 3.0 • Support ThinkCentre Tiny • Supports optional soundbar • Microsoft® Windows® 7 certified • Microsoft Windows 10 certified 						
<p>VESA-compliant VESA DDC2B/CI Power management ENERGY STAR® 7.0 Ergonomics ISO 9241-307 Emission standards FCC Class B Environmental TCO Displays 7.0, RoHS, EPEAT™ Silver rating, ULE Gold</p>	 <p>ThinkVision P24q Monitor</p>						
<p>Preset resolutions VGA: 640x480, 720x400 SVGA: 800x600 XGA: 1024x768 SXGA: 1280x1024 WXGA: 1366x768 WXGA+: 1440x900, 1600x900 WSXGA+: 1680x1050 Full HD: 1920x1080, 1920x1200 QHD: 2560x1440</p> <p>Presets / user settings Standard presets: 20; user settings: 24</p>							
<p>Viewing adjustments <i>Tilt:</i> 30° back, -5° forward; <i>lift:</i> 4.33" (110mm); <i>swivel:</i> +/-45° Rotating screen Screen pivots 90 degrees from landscape to portrait On screen display On screen display with digital user controls (8 languages) Control features Direct access for menu, source switch, and brightness USB hub USB Hub: one USB 3.0 upstream port, four USB 3.0 downstream ports Multimedia Audio-out, optional sound bar supported Camera None Multiple input Support HDMI, DisplayPort, mini DisplayPort, DisplayPort-out Monitor connectors (1) 2*HDMI (1.4), digital, HDCP-compliant (2) DisplayPort (1.2), digital, HDCP-compliant (3) Mini DisplayPort, digital, HDCP-compliant Signal cables (1) detachable, mini DisplayPort to DisplayPort, digital, 1.8 meter Mounting features Wall or desk mounting using the Extend Arm or third-party accessories meeting the VESA FPMPI® (100mm mount) Security Security keyhole for attachment of optional cable lock (Kensington® lock-compatible)</p>							
<p>Ship group Monitor, detachable stand, Quick start and safety poster, 1.8 meter USB 3.0 cable, 1.8 meter mini DP to DP cable, 1.8 meter black power cord</p>	<p>Limited Warranty</p> <p>See details at http://support.lenovo.com/en_US/guides-and-manuals/detail.page?DocID=UM008281</p> <p>Accessories</p> <table border="0"> <tr> <td>Kensington MicroSaver Cable Lock</td> <td>73P2582</td> </tr> <tr> <td>Kensington Twin Head Cable Lock</td> <td>45K1620</td> </tr> <tr> <td>Lenovo Security Cable Lock</td> <td>57Y4303</td> </tr> </table> <p>See details at www.lenovo.com/support/monitoraccessories</p> <p>See all monitors at www.lenovo.com/thinkvision</p>	Kensington MicroSaver Cable Lock	73P2582	Kensington Twin Head Cable Lock	45K1620	Lenovo Security Cable Lock	57Y4303
Kensington MicroSaver Cable Lock	73P2582						
Kensington Twin Head Cable Lock	45K1620						
Lenovo Security Cable Lock	57Y4303						



ThinkVision® S22e-19

DISPLAY

Panel Size

21.5 inch

Screen Dimensions (H x V) (mm)

476.06 (H) × 267.79 (V)

Panel Type

VA

Backlight

WLED

Aspect Ratio

16:9

Resolution

1920 x 1080

Pixel Pitch (H x V) (mm)

0.2480 × 0.2480

Viewing Angle (H x V)

178°/178°

Response Time (gray to gray)

4 ms (extreme mode)
6 ms (normal mode)

Contrast Ratio (typical)

3000:1

Dynamic Contrast Ratio (typical)

3M:1

Color Gamut NTSC (CIE 1931)

72%

Color Support (typical)

16.7M

CONNECTIVITY

Video Input Signals

VGA + HDMI1.4

Video Cable Length

1.8 m

Audio Out

Yes (3.5 mm)

MULTI-MEDIA

Optional Soundbar Support

Yes

DIMENSIONS

Size Packed (D x H x W) (mm/inch)

120 x 350 x 582 mm / 4.7 x 13.7 x 22.9 inch

Size Unpacked w/stand (D x H x W) (mm/inch) (Lowest Position)

200.0 x 373.8 x 489.3 mm / 7.87 x 14.71 x 19.26 inch

Size Unpacked w/stand (D x H x W) (mm/inch) (Highest Position)

200.0 x 373.8 x 489.3 mm / 7.87 x 14.71 x 19.26 inch

Size Unpacked w/o stand (D x H x W) (mm/inch) (Head Only)

41.5 x 296.8 x 489.3 mm / 1.63 x 11.68 x 19.26 inch

Weight Packed (kg/lbs.)

4.07kg / 8.97 lbs.

Weight Unpacked (kg/lbs.)

2.75kg / 6.06 lbs.

Weight (Monitor Head Only) (kg/lbs.)

2.46kg / 5.42 lbs.

SPECIAL FEATURES

Anti-Glare

Yes

Thin Client Support (Tiny)

Yes (by VESA mount PN:4XF0N03161)

MECHANICAL

Tilt Angle (front / back)

-5°/22°

VESA Mount

Yes (100 mm)

Kensington™ Lock Slot

Yes

Cable Management

Yes

Bezel Color

Raven Black

Bezel Width (side)

2.0 mm

Bezel Width (top / bottom)

2.0 mm / 21.2 mm

WHAT'S IN THE BOX

Monitor with stand

1 x HDMI Cable

1 x Power Cable

Quick setup guide

CERTIFICATIONS

ENERGY STAR Rating

7.0

CCC

Yes

TCO

TCO 7.0/TCO Edge 2.0

EPEAT™

Gold

RoHS

Yes

Windows Certification

Windows 7, Windows 10

China Energy Efficiency Standard

Tier 2

Ambient Operating Temperature

0°C to 40°C

Low Blue Light

Yes



© 2018 Lenovo. All rights reserved. These products are available while supplies last. Prices shown are subject to change without notice. For any questions concerning price, please contact your Lenovo Account Executive. Lenovo is not responsible for photographic or typographic errors. Warranty: For a copy of applicable warranties, write to: Warranty Information, 500 Park Offices Drive, RTP, NC 27709, Attn: Dept. ZPYA/B600. Lenovo makes no representation or warranty regarding third-party products or services. Trademarks: Lenovo, the Lenovo logo, Rescue and Recovery, ThinkPad, ThinkCentre, ThinkStation, ThinkVantage, and ThinkVision are trademarks or registered trademarks of Lenovo. Microsoft, Windows, and Vista are registered trademarks of Microsoft Corporation. Intel, the Intel logo, Intel Inside, Intel Core, and Core Inside are trademarks of Intel Corporation in the U.S. and/or other countries. Other company, product, and service names may be trademarks or service marks of others.

Specifications may vary depending upon region.

Lenovo™



ThinkVision® S24e-10

DISPLAY

Panel Size

23.8"

Screen Dimensions (H x V) (mm)

527.04 (H) × 296.46 (V)

Panel Type

VA

Backlight

WLED

Aspect Ratio

16:9

Resolution

1920 × 1080

Pixel Pitch (H x V) (mm)

0.2745 × 0.2745

Viewing Angle (H x V)

178°/178°

Response Time (gray to gray)

4 ms (extreme mode)
6 ms (normal mode)

Contrast Ratio (typical)

3000:1

Dynamic Contrast Ratio (typical)

3M:1

Color Gamut NTSC (CIE 1931)

72%

Color Support

16.7M

CONNECTIVITY

Video Input Signals

VGA + HDMI 1.4

Video Cable Length

1.8 m

Audio Out

Yes (3.5 mm)

MULTI-MEDIA

Optional Soundbar Support

Yes

DIMENSIONS

Size Packed (D x H x W) (mm/inch)

122 × 405 × 639 mm / 4.80 × 15.94 × 25.16 inch

Size Unpacked w/stand (D x H x W) (mm/inch) (Lowest Position)

200.0 × 402.7 × 539.5 mm / 7.87 × 15.85 × 21.24 inch

Size Unpacked w/stand (D x H x W) (mm/inch) (Highest Position)

200.0 × 402.7 × 539.5 mm / 7.87 × 15.85 × 21.24 inch

Size Unpacked w/o stand (D x H x W) (mm/inch) (Head Only)

41.5 × 325.7 × 539.5 mm / 1.63 × 12.82 × 21.24 inch

Weight Packed (kg/lbs.)

4.84kg / 10.67 lbs.

Weight Unpacked (kg/lbs.)

3.36kg / 7.41 lbs.

Weight (Monitor Head Only) (kg/lbs.)

3.07kg / 6.77 lbs.

SPECIAL FEATURES

Anti-Glare

Yes

Thin Client Support (Tiny)

Yes (by VESA mount PN:4XFON03161)

MECHANICAL

Tilt Angle (front/back)

-5° / 22°

VESA Mount

Yes (100 mm)

Kensington™ Lock Slot

Yes

Cable Management

Yes

Bezel Color

Raven Black

Bezel Width (Side)

2.0 mm

Bezel Width (top / bottom)

2.0 mm / 22 mm

WHAT'S IN THE BOX

Monitor with stand
1 x HDMI Cable
1 x Power Cable
Quick setup guide

CERTIFICATIONS

ENERGY STAR Rating

7.0

CCC

Yes

EPEAT™

Gold

ULE

Gold

RoHS

Yes

Windows Certification

Windows 7, Windows 10

China Energy Efficiency Standard

Tier 2

Ambient Operating Temperature

0 to 40°C

Low Blue Light

Yes



© 2018 Lenovo. All rights reserved. These products are available while supplies last. Prices shown are subject to change without notice. For any questions concerning price, please contact your Lenovo Account Executive. Lenovo is not responsible for photographic or typographic errors. Warranty: For a copy of applicable warranties, write to: Warranty Information, 500 Park Offices Drive, RTP, NC 27709, Attn: Dept. ZPYA/B600. Lenovo makes no representation or warranty regarding third-party products or services. Trademarks: Lenovo, the Lenovo logo, Rescue and Recovery, ThinkPad, ThinkCentre, ThinkStation, ThinkVantage, and ThinkVision are trademarks or registered trademarks of Lenovo. Microsoft, Windows, and Vista are registered trademarks of Microsoft Corporation. Intel, the Intel logo, Intel Inside, Intel Core, and Core Inside are trademarks of Intel Corporation in the U.S. and/or other countries. Other company, product, and service names may be trademarks or service marks of others.

Specifications may vary depending upon region.

Lenovo™



<p>Name T2224d Wide Flat Panel Monitor Bezel color Black Type-model 61B1JAR1US / 61B1JAT1EU Panel TFT-LCD, In-Plane Switching (IPS), White LED backlight Viewable image size 21.5" (546mm) diagonal Max view area (W x H) 18.74" x 10.54" (476.1mm x 267.8mm) Native resolution 1920x1080 Aspect ratio 16:9 Pixel pitch (mm) 0.248 x 0.248 mm Dot/Pixel per Inch 102 dpi Brightness 250 nits or cd/m² (typical) Contrast ratio 1000:1 (typical) Pixel response time 7ms (typical); 4ms (extreme mode) Color gamut 72% Viewing angle at 10:1 CR 178° (+/- 89°) horizontal, 178° (+/- 89°) vertical Stand Tilt stand Bezel width <i>Sides:</i> 0.69" (17.6mm) Dimensions (HxWxD) 15.02" H x 20.19" W x 8.06" D; 381.4mm H x 512.9mm W x 204.9mm D Power supply 20 watts typical, 25 watts maximum <0.5 watts standby/suspend, universal, integrated (no external brick-like power supply) Weight 6.48 lb; 2.94 kg Limited warranty 3 year (includes backlight) Available date March 2017</p>	<p style="text-align: center;">Features</p> <ul style="list-style-type: none"> • Widescreen 21.5-inch monitor • Supports 1920x1080 resolution • Supports optional soundbar • Supports ThinkCentre Tiny via VESA back mount • Includes dual input connection for attachment to two systems concurrently (analog and digital) • EPEAT Gold certified • Microsoft® Windows® 7 certified • Microsoft Windows 10 certified 				
<p>VESA-compliant VESA DDC2B/CI Power management ENERGY STAR® qualified Ergonomics ISO 9241-307 Emission standards FCC Class B Environmental TCO Displays 7.0, TCO Certified Edge 2.0, WEEE, RoHS, EPEAT™ Silver rating</p>	<div style="text-align: center;">  <p>ThinkVision T2224d Wide Monitor</p> </div>				
<p>Preset resolutions VGA: 640x350, 640x480, 720x400 SVGA: 800x600 XGA: 1024x768, 1152x864 SXGA: 1280x1024 WXGA: 1280x768, 1280x800, 1366x768 WXGA+: 1440x900 WSXGA+: 1680x1050 Full HD: 1920x1080 Presets / user settings Standard presets: 22; user settings: 22</p>					
<p>Viewing adjustments <i>Tilt:</i> 22° back, -5° forward Rotating screen None On screen display On screen display with digital user controls (8 languages) Control features Direct access (buttons on front) for automatic image setup, dual input and brightness USB hub None Multiple input Dual input (two different PCs attach to two different connectors; one PC shows image; select via button) Monitor connectors (1) VGA 15-pin D-shell, analog, blue (2) DisplayPort, digital, black, HDCP-compliant Signal cables (1) detachable, VGA 15-pin D-shell at each end, analog, 1.8 meter (2) detachable, DisplayPort at each end, digital, 1.8 meter Mounting features Wall or desk mounting using the Extend Arm or third-party accessories, 100mm x 100mm mount Security Security keyhole for attachment of optional cable lock (Kensington® lock-compatible)</p>					
<p>Ship group Monitor with stand, Safety and Warranty Information, 1.8 meter analog signal cable, 1.8 meter DP signal cable, 1.8 meter black power cord</p>					
<p style="text-align: center;">Limited Warranty</p> <p>See details at http://support.lenovo.com/en_US/guides-and-manuals/detail.page?DocID=UM008281</p>	<p style="text-align: center;">Accessories</p> <table border="0"> <tr> <td>Kensington MicroSaver Cable Lock</td> <td style="text-align: right;">73P2582</td> </tr> <tr> <td>Kensington Twin Head Cable Lock</td> <td style="text-align: right;">45K1620</td> </tr> </table> <p>See details at www.lenovo.com/support/monitoraccessories</p> <p>See all monitors at www.lenovo.com/thinkvision</p>	Kensington MicroSaver Cable Lock	73P2582	Kensington Twin Head Cable Lock	45K1620
Kensington MicroSaver Cable Lock	73P2582				
Kensington Twin Head Cable Lock	45K1620				



<p>Name T2254 Wide Flat Panel Monitor Bezel color Raven black Type-model 60F6HAR1EU Panel TFT-LCD, twisted nematic (TN), White LED backlight Viewable image size 22.0" (559mm) diagonal Max view area (W x H) 18.70" x 11.70" (473.8mm x 296.1mm) Native resolution 1680x1050 Aspect ratio 16:10 Pixel pitch (mm) 0.282 x 0.282 mm Dot/Pixel per Inch 90 dpi Brightness 250 nits or cd/m² (typical) Contrast ratio 1000:1 (typical) Pixel response time 5ms (typical) Color gamut 72% Viewing angle at 10:1 CR 170° (+/- 85°) horizontal, 160° (+/- 80°) vertical Stand Tilt and height adjustable stand Bezel width Sides: 0.67" (17mm) Dimensions (HxWxD) 14.97" H x 20.05" W x 9.61" D; 380.2mm H x 509.3mm W x 244.2mm D Power supply 16 watts typical, 22 watts maximum, <0.5 watts standby/suspend, universal, integrated (no external brick-like power supply) Weight 10.38 lb; 4.71 kg Limited warranty 3 year (includes backlight) Available date March 2015</p>	<p style="text-align: center;">Features</p> <ul style="list-style-type: none"> • Widescreen 22.0-inch monitor • Supports 1680x1050 resolution • Supports ThinkCentre Tiny Clamp Bracket • Includes dual input connection for attachment to two systems concurrently (analog and digital) • EPEAT Gold certified • Supports optional soundbar • Microsoft® Windows® 7 certified • Microsoft Windows 8 / Windows 8.1 certified • Microsoft Windows 10 certified 				
<p>VESA-compliant VESA DDC2B/CI Power management ENERGY STAR® qualified Ergonomics ISO 9241-307 Emission standards None Environmental TCO Displays 7.0, TCO Certified Edge 2.0, WEEE, RoHS, EPEAT™ Gold rating</p>	<div style="text-align: center;">  <p>ThinkVision T2254 Wide Monitor</p> </div>				
<p>Preset resolutions VGA: 640x350, 640x480, 720x400 SVGA: 800x600 XGA: 1024x768, 1152x864 SXGA: 1280x1024 WXGA: 1280x768, 1280x800, 1366x768 WXGA+: 1440x900 WSXGA+: 1600x900, 1680x1050</p> <p>Presets / user settings Standard presets: 26; user settings: 20</p>					
<p>Viewing adjustments Tilt: 30° back, -5° forward; lift: 4.3" (110mm) Rotating screen None On screen display On screen display with digital user controls (8 languages) Control features Direct access (buttons on front) for automatic image setup, dual input and brightness USB hub None Multiple input Dual input (two different PCs attach to two different connectors; one PC shows image; select via button) Monitor connectors (1) VGA 15-pin D-shell, analog, blue (2) Digital Visual Interface (DVI-D), digital, white, HDCP-compliant Signal cables (1) detachable, VGA 15-pin D-shell at each end, analog, 1.8 meter (2) detachable, DVI-D at each end, digital, 1.8 meter Mounting features Wall or desk mounting using the Extend Arm or third-party accessories, 100mm x 100mm mount Security Security keyhole for attachment of optional cable lock (Kensington® lock-compatible)</p>					
<p>Ship group Monitor with stand, Safety and Warranty Information, 1.8 meter analog signal cable, 1.8 meter DVI-D cable, 1.8 meter black power cord</p>	<p style="text-align: center;">Limited Warranty</p> <p>See details at http://support.lenovo.com/en_US/guides-and-manuals/detail.page?DocID=UM008281</p> <p style="text-align: center;">Accessories</p> <table border="0" style="width: 100%;"> <tr> <td>Kensington MicroSaver Cable Lock</td> <td style="text-align: right;">73P2582</td> </tr> <tr> <td>Kensington Twin Head Cable Lock</td> <td style="text-align: right;">45K1620</td> </tr> </table> <p>See details at www.lenovo.com/support/monitoraccessories</p> <p>See all monitors at www.lenovo.com/thinkvision</p>	Kensington MicroSaver Cable Lock	73P2582	Kensington Twin Head Cable Lock	45K1620
Kensington MicroSaver Cable Lock	73P2582				
Kensington Twin Head Cable Lock	45K1620				



<p>Name T2254p Wide Flat Panel Monitor Bezel color Raven black Type-model 61BAMAR2US / 60E1MAR2US / 60CCMAR2US / 60CCMAT2EU / 61BAMAT2EU Panel TFT-LCD, twisted nematic (TN), White LED backlight Viewable image size 22.0" (559mm) diagonal Max view area (W x H) 18.70" x 11.70" (473.8mm x 296.1mm) Native resolution 1680x1050 Aspect ratio 16:10 Pixel pitch (mm) 0.282 x 0.282 mm Dot/Pixel per Inch 90 dpi Brightness 250 nits or cd/m² (typical) Contrast ratio 1000:1 (typical) Pixel response time 5ms (typical) Color gamut 72% Viewing angle at 10:1 CR 170° (+/- 85°) horizontal, 160° (+/- 80°) vertical Stand Tilt, swivel, pivot, and height adjustable Bezel width Sides: 0.67" (17.1mm) Dimensions (HxWxD) 14.63" H x 20.01" W x 9.55" D; 371.7mm H x 509.3mm W x 242.7mm D Power supply 20 watts typical, 25 watts maximum, <0.5 watts standby/suspend, universal, integrated (no external brick-like power supply) Weight 10.14 lb; 4.60 kg Limited warranty 3 year (includes backlight) Available date March 2015</p>	<p style="text-align: center;">Features</p> <ul style="list-style-type: none"> • Widescreen 22.0-inch monitor • Supports 1680x1050 resolution • Supports ThinkCentre Tiny Clamp Bracket • Supports optional soundbar • Includes dual input connection for attachment to two systems concurrently (analog and digital) • EPEAT Gold certified • Microsoft® Windows® 7 certified • Microsoft Windows 8 / Windows 8.1 certified • Microsoft Windows 10 certified 				
<p>VESA-compliant VESA DDC2B/CI Power management ENERGY STAR® qualified Ergonomics ISO 9241-307 Emission standards FCC Class B Environmental TCO Displays 7.0, TCO Certified Edge 2.0, WEEE, RoHS, EPEAT™ Gold rating</p>	<div style="text-align: center;">  <p>ThinkVision T2254p Wide Monitor</p> </div>				
<p>Preset resolutions VGA: 640x350, 640x480, 720x400 SVGA: 800x600 XGA: 1024x768, 1152x864 SXGA: 1280x1024 WXGA: 1280x768, 1280x800, 1366x768 WXGA+: 1440x900 WSXGA+: 1600x900, 1680x1050 Presets / user settings Standard presets: 28; user settings: 20</p>					
<p>Viewing adjustments <i>Tilt:</i> 30° back, -5° forward; <i>lift:</i> 4.3" (110mm); <i>swivel:</i> +/-45°; detachable stand Rotating screen Screen pivots 90 degrees from landscape to portrait On screen display On screen display with digital user controls (8 languages) Control features Direct access (buttons on front) for automatic image setup, dual input and brightness USB hub None Multiple input Dual input (two different PCs attach to two different connectors; one PC shows image; select via button) Monitor connectors (1) VGA 15-pin D-shell, analog, blue (2) HDMI (1.4), digital, HDCP-compliant (3) DisplayPort, digital, black, HDCP-compliant Signal cables (1) detachable, VGA 15-pin D-shell at each end, analog, 1.8 meter (2) detachable, DisplayPort at each end, digital, 1.8 meter Mounting features Wall or desk mounting using the Extend Arm or third-party accessories, 100mm x 100mm mount Security Security keyhole for attachment of optional cable lock (Kensington® lock-compatible)</p>					
<p>Ship group Monitor with stand, Safety and Warranty Information, 1.8 meter analog signal cable, 1.8 meter DP signal cable, 1.8 meter black power cord</p>					
<p style="text-align: center;">Limited Warranty</p> <p>See details at http://support.lenovo.com/en_US/guides-and-manuals/detail.page?DocID=UM008281</p>	<p style="text-align: center;">Accessories</p> <table border="0"> <tr> <td>Kensington MicroSaver Cable Lock</td> <td style="text-align: right;">73P2582</td> </tr> <tr> <td>Kensington Twin Head Cable Lock</td> <td style="text-align: right;">45K1620</td> </tr> </table> <p>See details at www.lenovo.com/support/monitoraccessories</p> <p>See all monitors at www.lenovo.com/thinkvision</p>	Kensington MicroSaver Cable Lock	73P2582	Kensington Twin Head Cable Lock	45K1620
Kensington MicroSaver Cable Lock	73P2582				
Kensington Twin Head Cable Lock	45K1620				





<p>Name T22i Wide Flat Panel Monitor Bezel color Black Type-model 61A9MAR1US / 61A9MAT1EU Panel TFT-LCD, In-Plane Switching (IPS), White LED backlight Viewable image size 21.5" (546mm) diagonal Max view area (W x H) 18.74" x 10.54" (476.1mm x 267.8mm) Native resolution 1920x1080 Aspect ratio 16:9 Pixel pitch (mm) 0.248 x 0.248 mm Dot/Pixel per Inch 102 dpi Brightness 250 nits or cd/m² (typical) Contrast ratio 1000:1 (typical) Pixel response time 6ms (typical); 4ms (extreme mode) Color gamut 72% Viewing angle at 10:1 CR 178° (+/- 89°) horizontal, 178° (+/- 89°) vertical Stand Tilt, swivel, pivot, and height adjustable stand Bezel width <i>Sides:</i> 0.08" (2.0mm) Dimensions (HxWxD) 14.08" H x 19.28" W x 9.92" D; 357.6mm H x 489.7mm W x 251.9mm D Power supply 16.5 watts typical, 55 watts maximum (with USB 3.0 hub), <0.5 watts standby/suspend, universal, integrated (no external brick-like power supply) Weight 10.85 lb; 4.92 kg Limited warranty 3 year (includes backlight) Available date April 2017</p>	<p style="text-align: center;">Features</p> <ul style="list-style-type: none"> • Widescreen 21.5-inch monitor • Supports 1920x1080 resolution • Supports optional soundbar • Supports ThinkCentre Tiny via VESA back mount • Includes dual input connection for attachment to two systems concurrently • EPEAT Gold certified • Microsoft® Windows® 7 certified • Microsoft Windows 10 certified 				
<p>VESA-compliant VESA DDC2B/CI Power management ENERGY STAR® qualified Ergonomics ISO 9241-307 Emission standards FCC Class B Environmental TCO Displays 7.0, TCO Certified Edge 2.0, WEEE, RoHS, EPEAT™ Silver rating</p>	<div style="text-align: center;">  <p>ThinkVision T22i Wide Monitor</p> </div>				
<p>Preset resolutions VGA: 640x350, 640x480, 720x400 SVGA: 800x600 XGA: 1024x768, 1152x864 SXGA: 1280x1024 WXGA: 1280x768, 1366x768 WXGA+: 1440x900, 1680x900 WSXGA+: 1680x1050 Full HD: 1920x1080 Presets display modes HDMI: 17; DP: 17</p>					
<p>Viewing adjustments <i>Tilt:</i> 30° back, -5° forward; <i>lift:</i> 4.3" (110mm); <i>swivel:</i> +/-45°; detachable stand Rotating screen Screen pivots 90 degrees from landscape to portrait On screen display On screen display with digital user controls (8 languages) Control features Direct access (buttons on front) for power, menu, input source select and brightness USB hub USB 3.0 Hub: 1 port into PC (USB 3.0); 4 ports for accessories (4 USB 3.0) Multiple input Dual input (two different PCs attach to two different connectors; one PC shows image; select via button) Monitor connectors (1) VGA 15-pin D-shell, analog, blue (2) HDMI (1.4), digital, HDCP-compliant (3) DisplayPort, digital, black, HDCP-compliant Signal cables (1) detachable, VGA 15-pin D-shell at each end, analog, 1.8 meter (2) detachable, DisplayPort at each end, digital, 1.8 meter Mounting features Wall or desk mounting using the Extend Arm or third-party accessories, 100mm x 100mm mount Security Security keyhole for attachment of optional cable lock (Kensington® lock-compatible)</p>					
<p>Ship group Monitor with stand, Safety and Warranty Information, 1.8 meter analog signal cable, 1.8 meter DP signal cable, 1.8 meter USB signal cable, 1.8 meter black power cord</p>					
<p style="text-align: center;">Limited Warranty</p> <p>See details at http://support.lenovo.com/en_US/guides-and-manuals/detail.page?DocID=UM008281</p>	<p style="text-align: center;">Accessories</p> <table border="0"> <tr> <td>Kensington MicroSaver Cable Lock</td> <td style="text-align: right;">73P2582</td> </tr> <tr> <td>Kensington Twin Head Cable Lock</td> <td style="text-align: right;">45K1620</td> </tr> </table> <p>See details at www.lenovo.com/support/monitoraccessories</p> <p>See all monitors at www.lenovo.com/thinkvision</p>	Kensington MicroSaver Cable Lock	73P2582	Kensington Twin Head Cable Lock	45K1620
Kensington MicroSaver Cable Lock	73P2582				
Kensington Twin Head Cable Lock	45K1620				

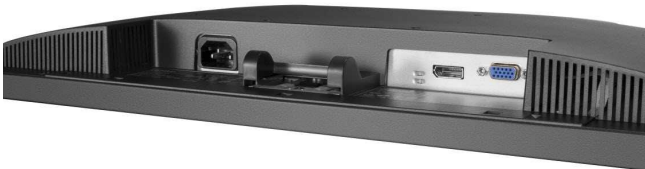

<p>Name T22v Wide Flat Panel Monitor Bezel color Black Type-model 61BBMAR6US / 61BBMAT6EU Panel TFT-LCD, In-Plane Switching (IPS), White LED backlight Viewable image size 21.5" (546mm) diagonal Max view area (W x H) 18.74" x 10.54" (476.1mm x 267.8mm) Native resolution 1920x1080 Aspect ratio 16:9 Pixel pitch (mm) 0.248 x 0.248 mm Dot/Pixel per Inch 102 dpi Brightness 250 nits or cd/m² (typical) Contrast ratio 1000:1 (typical) Pixel response time 6ms (typical); 4ms (extreme mode) Color gamut 72% Viewing angle at 10:1 CR 178° (+/- 89°) horizontal, 178° (+/- 89°) vertical Stand Tilt, swivel, pivot, and height adjustable stand Bezel width <i>Sides:</i> 0.08" (2.0mm) Dimensions (HxWxD) 19.14" H x 19.28" W x 9.92" D; 485.8mm H x 489.7mm W x 251.9mm D Power supply 18 watts typical, 43 watts maximum (with USB 3.0 hub), <0.5 watts standby/suspend, universal, integrated (no external brick-like power supply) Weight 10.16 lb; 4.61 kg Limited warranty 3 year (includes backlight) Available date October 2017</p>	<p style="text-align: center;">Features</p> <ul style="list-style-type: none"> • Widescreen 21.5-inch monitor • Supports 1920x1080 resolution • Supports optional soundbar • Supports ThinkCentre Tiny via VESA back mount • EPEAT Gold certified • Microsoft® Windows® 7 certified • Microsoft Windows 10 certified
<p>VESA-compliant VESA DDC2B/CI Power management ENERGY STAR® qualified Ergonomics ISO 9241-307 Emission standards FCC Class B Environmental TCO Displays 7.0, TCO Certified Edge 2.0, WEEE, RoHS, EPEAT™ Silver rating</p>	<div style="text-align: center;">  <p>ThinkVision T22v Wide Monitor</p> </div>
<p>Preset resolutions VGA: 640x480, 720x400 SVGA: 800x600, 832x624 XGA: 1024x768, 1152x864 SXGA: 1280x1024 WXGA+: 1440x900, 1600x900 WSXGA+: 1680x1050 Full HD: 1920x1080 Presets display modes Presets: 24; user modes: 20</p>	
<p>Viewing adjustments <i>Tilt:</i> 30° back, -5° forward; <i>lift:</i> 4.3" (110mm); <i>swivel:</i> +/-45°; detachable stand Rotating screen Screen pivots 90 degrees from landscape to portrait On screen display On screen display with digital user controls (8 languages) Control features Direct access for power, menu, input source select, volume up / down, speaker mute and microphone mute USB hub USB 3.0 Hub: 1 port into PC (USB 3.0); 2 ports for accessories (2 USB 3.0) Multimedia Integrated speakers, dual-array microphone, audio-in and Audio-out, optional sound bar supported Camera Integrated FHD camera with IR Multiple input Support HDMI, DisplayPort, VGA Monitor connectors (1) VGA 15-pin D-shell, analog, blue (2) HDMI (1.4), digital, HDCP-compliant (3) DisplayPort, digital, black, HDCP-compliant Signal cables (1) detachable, VGA 15-pin D-shell at each end, analog, 1.8 meter (2) detachable, DisplayPort at each end, digital, 1.8 meter Mounting features Wall or desk mounting using the Extend Arm or third-party accessories, 100mm x 100mm mount Security Security keyhole for attachment of optional cable lock (Kensington® lock-compatible)</p>	
<p>Ship group Monitor with stand, Safety and Warranty Information, 1.8 meter analog signal cable, 1.8 meter DP signal cable, 1.8 meter USB signal cable, 1.8 meter black power cord, 1.8 meter HDMI signal cable (Row)</p>	

<p style="text-align: center;">Limited Warranty</p> <p>See details at http://support.lenovo.com/en_US/guides-and-manuals/detail.page?DocID=UM008281</p>	<p style="text-align: center;">Accessories</p> <table border="0"> <tr> <td>Kensington MicroSaver Cable Lock</td> <td style="text-align: right;">73P2582</td> </tr> <tr> <td>Kensington Twin Head Cable Lock</td> <td style="text-align: right;">45K1620</td> </tr> </table> <p>See details at www.lenovo.com/support/monitoraccessories</p> <p>See all monitors at www.lenovo.com/thinkvision</p>	Kensington MicroSaver Cable Lock	73P2582	Kensington Twin Head Cable Lock	45K1620
Kensington MicroSaver Cable Lock	73P2582				
Kensington Twin Head Cable Lock	45K1620				



<p>Name T2324d Wide Flat Panel Monitor Bezel color Black Type-model 60F3JAR2US / 60F3JAT2EU Panel TFT-LCD, twisted nematic (TN), White LED backlight Viewable image size 23.0" (584mm) diagonal Max view area (W x H) 20.07" x 11.29" (509.8mm x 286.7mm) Native resolution 1920x1080 Aspect ratio 16:9 Pixel pitch (mm) 0.2655 x 0.2655 mm Dot/Pixel per Inch 96 dpi Brightness 250 nits or cd/m² (typical) Contrast ratio 1000:1 (typical) Pixel response time 5ms (typical) Color gamut 72% Viewing angle at 10:1 CR 170° (+/- 85°) horizontal, 160° (+/- 80°) vertical Stand Tilt stand Bezel width Sides: 0.68" (17.3mm) Dimensions (HxWxD) 15.75" H x 21.48" W x 8.06" D; 400.3mm H x 545.8mm W x 204.9mm D Power supply 20 watts typical, 27 watts maximum <0.3 watts standby/suspend, universal, integrated (no external brick-like power supply) Weight 7.06 lb; 3.20 kg Limited warranty 3 year (includes backlight) Available date June 2016</p>	<p style="text-align: center;">Features</p> <ul style="list-style-type: none"> • Widescreen 23.0-inch monitor • Supports 1920x1080 resolution • Supports optional soundbar • Supports ThinkCentre Tiny via VESA back mount • Includes dual input connection for attachment to two systems concurrently (analog and digital) • EPEAT Gold certified • Microsoft® Windows® 7 certified • Microsoft Windows 10 certified 				
<p>VESA-compliant VESA DDC2B/CI Power management ENERGY STAR® qualified Ergonomics ISO 9241-307 Emission standards FCC Class B Environmental TCO Displays 7.0, TCO Certified Edge 2.0, WEEE, RoHS, EPEAT™ Gold rating</p>	<div style="text-align: center;">  <p>ThinkVision T2324d Wide Monitor</p> </div>				
<p>Preset resolutions VGA: 640x350, 640x480, 720x400 SVGA: 800x600 XGA: 1024x768, 1152x864 SXGA: 1280x1024 WXGA: 1280x768, 1280x800, 1366x768 WXGA+: 1440x900 WSXGA+: 1680x1050 Full HD: 1920x1080</p> <p>Presets / user settings Standard presets: 26; user settings: 16</p>					
<p>Viewing adjustments Tilt: 22° back, -5° Rotating screen None On screen display On screen display with digital user controls (8 languages) Control features Direct access (buttons on front) for automatic image setup, dual input and brightness USB hub None Multiple input Dual input (two different PCs attach to two different connectors; one PC shows image; select via button) Monitor connectors (1) VGA 15-pin D-shell, analog, blue (2) DisplayPort, digital, black, HDCP-compliant Signal cables (1) detachable, VGA 15-pin D-shell at each end, analog, 1.8 meter (2) detachable, DisplayPort at each end, digital, 1.8 meter Mounting features Wall or desk mounting using the Extend Arm or third-party accessories, 100mm x 100mm mount Security Security keyhole for attachment of optional cable lock (Kensington® lock-compatible)</p>					
<p>Ship group Monitor with stand, Safety and Warranty Information, 1.8 meter analog signal cable, 1.8 meter DP signal cable, 1.8 meter black power cord</p>	<p style="text-align: center;">Limited Warranty</p> <p>See details at http://support.lenovo.com/en_US/guides-and-manuals/detail.page?DocID=UM008281</p> <p style="text-align: center;">Accessories</p> <table border="0" style="width: 100%;"> <tr> <td>Kensington MicroSaver Cable Lock</td> <td style="text-align: right;">73P2582</td> </tr> <tr> <td>Kensington Twin Head Cable Lock</td> <td style="text-align: right;">45K1620</td> </tr> </table> <p>See details at www.lenovo.com/support/monitoraccessories</p> <p>See all monitors at www.lenovo.com/thinkvision</p>	Kensington MicroSaver Cable Lock	73P2582	Kensington Twin Head Cable Lock	45K1620
Kensington MicroSaver Cable Lock	73P2582				
Kensington Twin Head Cable Lock	45K1620				

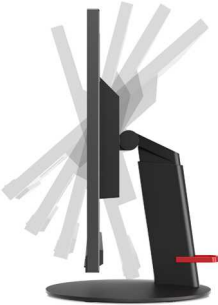

<p>Name T23d-10 Wide Flat Panel Monitor Bezel color Black Type-model 61C3MAR6US / 61C3MAT6EU Panel TFT-LCD, In-Plane Switching (IPS), White LED backlight</p> <p>Viewable image size 22.5" (571.5mm) diagonal Max view area (W x H) 19.5" x 12.4" (496.2mm x 313.9mm) Native resolution 1920x1200 Aspect ratio 16:10 Pixel pitch (mm) 0.25 x 0.25 mm Dot/Pixel per Inch 100.6 dpi Brightness 250 nits or cd/m² (typical) Contrast ratio 1000:1 (typical) Pixel response time 6ms (typical) Color gamut 72% Viewing angle at 10:1 CR 178° (+/- 89°) horizontal, 178° (+/- 89°) vertical Stand Tilt, swivel, pivot, and height adjustable stand Bezel width Sides: 0.09" (2.3mm) Dimensions (HxWxD) 19.37" H x 19.73" W x 9.9" D; 491.9mm H x 501.2mm W x 251.9mm D</p> <p>Power supply 15 watts typical, 18 watts maximum, <0.3 watts standby/suspend, universal, integrated (no external brick-like power supply)</p> <p>Weight 10.67 lb; 4.85 kg Limited warranty 3 year (includes backlight) Available date June 2018</p>	<p style="text-align: center;">Features</p> <ul style="list-style-type: none"> • Widescreen 22.5-inch monitor • Supports 1920x1200 resolution • Supports ThinkCentre Tiny Clamp Bracket • Supports optional soundbar • Includes dual input connection for attachment to two systems concurrently • EPEAT Gold certified • Microsoft® Windows® 7 certified • Microsoft Windows 10 certified 																	
<p>VESA-compliant VESA DDC2B/CI Power management ENERGY STAR® qualified Ergonomics ISO 9241-307 Emission standards FCC Class B Environmental TCO Displays 7.0, TCO Certified Edge 2.0, WEEE, RoHS, EPEAT™ Silver rating</p>	<div style="text-align: center;">  <p>ThinkVision T23d-10 Wide Monitor</p> </div>																	
<p>Preset resolutions</p> <table border="0"> <tr><td>VGA:</td><td>640x480, 720x400</td></tr> <tr><td>SVGA:</td><td>800x600</td></tr> <tr><td>XGA:</td><td>1024x768</td></tr> <tr><td>SXGA:</td><td>1280x1024</td></tr> <tr><td>WXGA:</td><td>1366x768</td></tr> <tr><td>WXGA+:</td><td>1440x900</td></tr> <tr><td>WSXGA+:</td><td>1680x1050</td></tr> <tr><td>Full HD:</td><td>1920x1080</td></tr> <tr><td>WUXGA:</td><td>1920x1200</td></tr> </table> <p>Presets display modes Standard presets: 27; user settings: 20</p>		VGA:	640x480, 720x400	SVGA:	800x600	XGA:	1024x768	SXGA:	1280x1024	WXGA:	1366x768	WXGA+:	1440x900	WSXGA+:	1680x1050	Full HD:	1920x1080	WUXGA:
VGA:	640x480, 720x400																	
SVGA:	800x600																	
XGA:	1024x768																	
SXGA:	1280x1024																	
WXGA:	1366x768																	
WXGA+:	1440x900																	
WSXGA+:	1680x1050																	
Full HD:	1920x1080																	
WUXGA:	1920x1200																	
<p>Viewing adjustments Tilt: 30° back, -5° forward; lift: 4.3" (110mm); swivel: +/-45°; detachable stand Rotating screen Screen pivots 90 degrees from landscape to portrait On screen display On screen display with digital user controls (8 languages) Control features Direct access (buttons on front) for power, menu, input source select and brightness USB hub None Multiple input Dual input (two different PCs attach to two different connectors; one PC shows image; select via button) Monitor connectors (1) VGA 15-pin D-shell, analog, blue (2) HDMI (1.4), digital, HDCP-compliant (3) DisplayPort, digital, black, HDCP-compliant Signal cables (1) detachable, VGA 15-pin D-shell at each end, analog, 1.8 meter (2) detachable, DisplayPort at each end, digital, 1.8 meter Mounting features Wall or desk mounting using the Extend Arm or third-party accessories, 100mm x 100mm mount Security Security keyhole for attachment of optional cable lock (Kensington® lock-compatible)</p>																		
<p>Ship group Monitor with stand, Safety and Warranty Information, 1.8 meter analog signal cable, 1.8 meter DP signal cable, 1.8 meter black power cord, 1.8 meter HDMI signal cable (NA only)</p>																		
<p style="text-align: center;">Limited Warranty</p> <p>See details at http://support.lenovo.com/en_US/guides-and-manuals/detail.page?DocID=UM008281</p>	<p style="text-align: center;">Accessories</p> <table border="0"> <tr> <td>Kensington MicroSaver Cable Lock</td> <td style="text-align: right;">73P2582</td> </tr> <tr> <td>Kensington Twin Head Cable Lock</td> <td style="text-align: right;">45K1620</td> </tr> </table> <p>See details at www.lenovo.com/support/monitoraccessories</p> <p>See all monitors at www.lenovo.com/thinkvision</p>	Kensington MicroSaver Cable Lock	73P2582	Kensington Twin Head Cable Lock	45K1620													
Kensington MicroSaver Cable Lock	73P2582																	
Kensington Twin Head Cable Lock	45K1620																	

Note: The specifications above may not be available in all regions.



<p>Name T23i Wide Flat Panel Monitor Bezel color Black Type-model 61ABMAR1US / 61ABMAT1EU Panel TFT-LCD, In-Plane Switching (IPS), White LED backlight Viewable image size 23" (584.2mm) diagonal Max view area (W x H) 20.36" x 11.92" (517.2mm x 302.8mm) Native resolution 1920x1080 Aspect ratio 16:9 Pixel pitch (mm) 0.2652 x 0.2652 mm Dot/Pixel per Inch 95.8 dpi Brightness 250 nits or cd/m² (typical) Contrast ratio 1000:1 (typical) Pixel response time 6ms (typical) Color gamut 72% Viewing angle at 10:1 CR 178° (+/- 89°) horizontal, 178° (+/- 89°) vertical Stand Tilt, swivel, pivot, and height adjustable stand Bezel width Sides: 0.08" (2.0mm) Dimensions (HxWxD) 13.3" H x 20.56" W x 10.4" D; 337.7mm H x 522.2mm W x 264.2mm D Power supply 16 watts typical, 45 watts maximum (with USB 3.0 hub), <0.5 watts standby/suspend, universal, integrated (no external brick-like power supply) Weight 10.85 lb; 4.92 kg Limited warranty 3 year (includes backlight) Available date April 2017</p>	<p style="text-align: center;">Features</p> <ul style="list-style-type: none"> • Widescreen 23-inch monitor • Supports 1920x1080 resolution • Supports ThinkCentre Tiny Clamp Bracket • Includes dual input connection for attachment to two systems concurrently • EPEAT Gold certified • Microsoft® Windows® 7 certified • Microsoft Windows 10 certified 				
<p>VESA-compliant VESA DDC2B/CI Power management ENERGY STAR® qualified Ergonomics ISO 9241-307 Emission standards FCC Class B Environmental TCO Displays 7.0, TCO Certified Edge 2.0, WEEE, RoHS, EPEAT™ Silver rating</p>	<div style="text-align: center;">  <p>ThinkVision T23i Wide Monitor</p> </div>				
<p>Preset resolutions VGA: 640x480, 720x400 SVGA: 800x600 XGA: 1024x768, 1152x864 SXGA: 1280x1024 WXGA+: 1440x900 WSXGA+: 1680x1050 Full HD: 1920x1080</p> <p>Presets display modes HDMI: 18; DP: 18</p>					
<p>Viewing adjustments Tilt: 30° back, -5° forward; lift: 4.3" (110mm); swivel: +/-45°; detachable stand Rotating screen Screen pivots 90 degrees from landscape to portrait On screen display On screen display with digital user controls (8 languages) Control features Direct access (buttons on front) for power, menu, input source select and brightness and automatic image setup USB hub USB 3.0 Hub: 1 port into PC (USB 3.0); 4 ports for accessories (4 USB 3.0) Multiple input Dual input (two different PCs attach to two different connectors; one PC shows image; select via button) Monitor connectors (1) VGA 15-pin D-shell, analog, blue (2) HDMI (1.4), digital, HDCP-compliant (3) DisplayPort, digital, black, HDCP-compliant Signal cables (1) detachable, VGA 15-pin D-shell at each end, analog, 1.8 meter (2) detachable, DisplayPort at each end, digital, 1.8 meter Mounting features Wall or desk mounting using the Extend Arm or third-party accessories, 100mm x 100mm mount Security Security keyhole for attachment of optional cable lock (Kensington® lock-compatible)</p>					
<p>Ship group Monitor with stand, Safety and Warranty Information, 1.8 meter analog signal cable, 1.8 meter DP signal cable, 1.8 meter USB signal cable, 1.8 meter black power cord</p>					
<p style="text-align: center;">Limited Warranty</p> <p>See details at http://support.lenovo.com/en_US/guides-and-manuals/detail.page?DocID=UM008281</p>	<p style="text-align: center;">Accessories</p> <table border="0"> <tr> <td>Kensington MicroSaver Cable Lock</td> <td style="text-align: right;">73P2582</td> </tr> <tr> <td>Kensington Twin Head Cable Lock</td> <td style="text-align: right;">45K1620</td> </tr> </table> <p>See details at www.lenovo.com/support/monitoraccessories</p> <p>See all monitors at www.lenovo.com/thinkvision</p>	Kensington MicroSaver Cable Lock	73P2582	Kensington Twin Head Cable Lock	45K1620
Kensington MicroSaver Cable Lock	73P2582				
Kensington Twin Head Cable Lock	45K1620				



<p>Name T2454p Wide Flat Panel Monitor Bezel color Raven black Type-model 60F9MAR1US / 60F9MAT1EU Panel TFT-LCD, In-Plane Switching (IPS), White LED backlight</p> <p>Viewable image size 24.0" (609.6mm) diagonal Max view area (W x H) 20.41" x 12.76" (518.4mm x 324.0mm) Native resolution 1920x1200 Aspect ratio 16:10 Pixel pitch (mm) 0.270 x 0.270 mm Dot/Pixel per Inch 94 dpi Brightness 300 nits or cd/m² (typical) Contrast ratio 1000:1 (typical) Pixel response time 7ms (typical) Color gamut 77.4% Viewing angle at 10:1 CR 178° (+/- 89°) horizontal, 178° (+/- 89°) vertical Stand Tilt, swivel, pivot, and height adjustable stand Bezel width Sides: 0.74" (18.8mm) Dimensions (HxWxD) 15.85" H x 21.94" W x 10.39" D; 402.5mm H x 557.4mm W x 264.2mm D</p> <p>Power supply 24 watts typical, 27 watts maximum (without USB 3.0 hub), 54 watts maximum (with USB 3.0 hub), <0.5 watts standby/suspend, universal, integrated (no external brick-like power supply)</p> <p>Weight 13.60 lb; 6.15 kg Limited warranty 3 year (includes backlight) Available date March 2015</p>	<p style="text-align: center;">Features</p> <ul style="list-style-type: none"> • Widescreen 24.0-inch monitor • Supports 1920x1200 resolution • Supports ThinkCentre Tiny Clamp Bracket • Supports optional soundbar • Includes dual input connection for attachment to two systems concurrently (analog and digital) • EPEAT Gold certified • Microsoft® Windows® 7 certified • Microsoft Windows 8 / Windows 8.1 certified • Microsoft Windows 10 certified 				
<p>VESA-compliant VESA DDC2B/CI Power management ENERGY STAR® qualified Ergonomics ISO 9241-307 Emission standards FCC Class B Environmental TCO Displays 7.0, TCO Certified Edge 2.0, WEEE, RoHS, EPEAT™ Gold rating</p> <p>Preset resolutions VGA: 640x350, 640x480, 720x400 SVGA: 800x600 XGA: 1024x768 SXGA: 1280x1024 WXGA: 1280x720, 1280x768, 1280x800 WXGA+: 1440x900 WSXGA+: 1680x1050, 1600x1200 Full HD: 1920x1080, 1920x1200</p> <p>Presets / user settings Standard presets: 21; user settings: 20</p>	<div style="text-align: center;">  <p>ThinkVision T2454p Wide Monitor</p> </div>				
<p>Viewing adjustments Tilt: 30° back, -5° forward; lift: 4.3" (110mm); swivel: +/-45°; detachable stand Rotating screen Screen pivots 90 degrees from landscape to portrait On screen display On screen display with digital user controls (8 languages) Control features Direct access (buttons on front) for automatic image setup, dual input and brightness USB hub USB 3.0 Hub: 1 port into PC (USB 3.0); 4 ports for accessories (4 USB 3.0) Multiple input Dual input (two different PCs attach to two different connectors; one PC shows image; select via button) Monitor connectors (1) VGA 15-pin D-shell, analog, blue (2) HDMI (1.4), digital, HDCP-compliant (3) DisplayPort, digital, black, HDCP-compliant</p> <p>Signal cables (1) detachable, VGA 15-pin D-shell at each end, analog, 1.8 meter (2) detachable, DisplayPort at each end, digital, 1.8 meter</p> <p>Mounting features Wall or desk mounting using the Extend Arm or third-party accessories, 100mm x 100mm mount Security Security keyhole for attachment of optional cable lock (Kensington® lock-compatible)</p>					
<p>Ship group Monitor with stand, Safety and Warranty Information, 1.8 meter analog signal cable, 1.8 meter DisplayPort cable, 1.8 meter USB signal cable, 1.8 meter black power cord</p>					
<p style="text-align: center;">Limited Warranty</p> <p>See details at http://support.lenovo.com/en_US/guides-and-manuals/detail.page?DocID=UM008281</p>	<p style="text-align: center;">Accessories</p> <table border="0" style="width: 100%;"> <tr> <td>Kensington MicroSaver Cable Lock</td> <td style="text-align: right;">73P2582</td> </tr> <tr> <td>Kensington Twin Head Cable Lock</td> <td style="text-align: right;">45K1620</td> </tr> </table> <p>See details at www.lenovo.com/support/monitoraccessories</p> <p>See all monitors at www.lenovo.com/thinkvision</p>	Kensington MicroSaver Cable Lock	73P2582	Kensington Twin Head Cable Lock	45K1620
Kensington MicroSaver Cable Lock	73P2582				
Kensington Twin Head Cable Lock	45K1620				



<p>Name T24d Wide Flat Panel Monitor Bezel color Black Type-model 61B4MAR1US / 61B4MAT1EU Panel TFT-LCD, In-Plane Switching (IPS), White LED backlight Viewable image size 24" (609.6mm) diagonal Max view area (W x H) 20.41" x 12.75" (518.4mm x 324mm) Native resolution 1920x1200 Aspect ratio 16:10 Pixel pitch (mm) 0.27 x 0.27 mm Dot/Pixel per Inch 94 dpi Brightness 300 nits or cd/m² (typical) Contrast ratio 1000:1 (typical) Pixel response time 7ms (typical) Color gamut 99% Viewing angle at 10:1 CR 178° (+/- 89°) horizontal, 178° (+/- 89°) vertical Stand Tilt, swivel, pivot, and height adjustable stand Bezel width Sides: 0.08" (2.0mm) Dimensions (HxWxD) 19.58" H x 20.99" W x 10.25" D; 497.4mm H x 533.2mm W x 260.4mm D Power supply 22 watts typical, 64 watts maximum (with USB 3.0 hub), <0.3 watts standby/suspend, universal, integrated (no external brick-like power supply) Weight 12.41 lb; 5.63 kg Limited warranty 3 year (includes backlight) Available date June 2017</p>	<p style="text-align: center;">Features</p> <ul style="list-style-type: none"> • Widescreen 24-inch monitor • Supports 1920x1200 resolution • Supports ThinkCentre Tiny Clamp Bracket • Supports optional soundbar • Includes dual input connection for attachment to two systems concurrently • EPEAT Gold certified • Microsoft® Windows® 7 certified • Microsoft Windows 10 certified 																		
<p>VESA-compliant VESA DDC2B/CI Power management ENERGY STAR® qualified Ergonomics ISO 9241-307 Emission standards FCC Class B Environmental TCO Displays 7.0, TCO Certified Edge 2.0, WEEE, RoHS, EPEAT™ Silver rating</p> <p>Preset resolutions</p> <table border="0"> <tr><td>VGA:</td><td>640x480, 720x400</td></tr> <tr><td>SVGA:</td><td>800x600</td></tr> <tr><td>XGA:</td><td>1024x768</td></tr> <tr><td>SXGA:</td><td>1280x1024</td></tr> <tr><td>WXGA:</td><td>1366x768</td></tr> <tr><td>WXGA+:</td><td>1440x900</td></tr> <tr><td>WSXGA+:</td><td>1680x1050</td></tr> <tr><td>Full HD:</td><td>1920x1080</td></tr> <tr><td>WUXGA:</td><td>1920x1200</td></tr> </table> <p>Presets display modes Standard presets: 22; user settings: 20</p>	VGA:	640x480, 720x400	SVGA:	800x600	XGA:	1024x768	SXGA:	1280x1024	WXGA:	1366x768	WXGA+:	1440x900	WSXGA+:	1680x1050	Full HD:	1920x1080	WUXGA:	1920x1200	<div style="text-align: center;">  <p>ThinkVision T24d Wide Monitor</p> </div>
VGA:	640x480, 720x400																		
SVGA:	800x600																		
XGA:	1024x768																		
SXGA:	1280x1024																		
WXGA:	1366x768																		
WXGA+:	1440x900																		
WSXGA+:	1680x1050																		
Full HD:	1920x1080																		
WUXGA:	1920x1200																		
<p>Viewing adjustments <i>Tilt: 30° back, -5° forward; lift: 4.3" (110mm); swivel: +/-45°; detachable stand</i> Rotating screen <i>Screen pivots 90 degrees from landscape to portrait</i> On screen display <i>On screen display with digital user controls (8 languages)</i> Control features <i>Direct access (buttons on front) for power, menu, input source select and brightness</i> USB hub <i>USB 3.0 Hub: 1 port into PC (USB 3.0); 4 ports for accessories (4 USB 3.0)</i> Multiple input <i>Dual input (two different PCs attach to two different connectors; one PC shows image; select via button)</i> Monitor connectors <i>(1) VGA 15-pin D-shell, analog, blue (2) HDMI (1.4), digital, HDCP-compliant (3) DisplayPort, digital, black, HDCP-compliant</i> Signal cables <i>(1) detachable, VGA 15-pin D-shell at each end, analog, 1.8 meter (2) detachable, DisplayPort at each end, digital, 1.8 meter</i> Mounting features <i>Wall or desk mounting using the Extend Arm or third-party accessories, 100mm x 100mm mount</i> Security <i>Security keyhole for attachment of optional cable lock (Kensington® lock-compatible)</i></p>	<p>Ship group <i>Monitor with stand, Safety and Warranty Information, 1.8 meter analog signal cable, 1.8 meter DP signal cable, 1.8 meter USB signal cable, 1.8 meter black power cord, 1.8 meter HDMI signal cable (NA only)</i></p>																		
<p style="text-align: center;">Limited Warranty</p> <p>See details at http://support.lenovo.com/en_US/guides-and-manuals/detail.page?DocID=UM008281</p>	<p style="text-align: center;">Accessories</p> <table border="0"> <tr> <td>Kensington MicroSaver Cable Lock</td> <td style="text-align: right;">73P2582</td> </tr> <tr> <td>Kensington Twin Head Cable Lock</td> <td style="text-align: right;">45K1620</td> </tr> </table> <p>See details at www.lenovo.com/support/monitoraccessories</p> <p>See all monitors at www.lenovo.com/thinkvision</p>	Kensington MicroSaver Cable Lock	73P2582	Kensington Twin Head Cable Lock	45K1620														
Kensington MicroSaver Cable Lock	73P2582																		
Kensington Twin Head Cable Lock	45K1620																		



ThinkVision T24i-10 MONITOR



SPECIFICATIONS

DISPLAY		DIMENSIONS (W x D x H)	
Panel Size	23.8" Wide	Size Packed	422 x 622 x 190
Panel Type	In-Plane Switchng	(mm)	16.61" x 24.48" x 7.48"
Backlight	WLED	(inches)	
Resolution (H x V)	1920 x 1080	Size Unpacked with Stand	
Aspect Ratio	16:9	Lowest Position	
Anti-Glare	Yes	(mm)	540.2 x 261.75 x 373.4
Near Edgeless Screen	Yes	(inches)	21.26" x 10.3" x 14.7"
Screen Dimensions (W x H)		Highest Position	
(mm)	527.04 x 296.46	(mm)	540.2 x 261.75 x 483.4
(inches)	20.75" x 11.67"	(inches)	21.26" x 10.3" x 19"
Maximum Brightness (Typical)	250 cd/m ²	Size Unpacked without Stand	
Viewing Angle (H/V at CR 10:1)	178°/178°	(Monitor Head Only)	
Contrast Ratio (Typical)	1000:1	(mm)	540.2 x 46.45 x 325.98
Dynamic Contrast Ratio	3M:1	(inches)	21.26" x 1.82" x 12.83"
Pixel Pitch (mm)	0.2745 x 0.2745	Stand Base Footprint Area	
Color Gamut (CIE 1931)	72% NTSC	(mm)	250 x 250
Color Support (Typical)	16.7 Million	(inches)	9.84" x 9.84"
Response Time (gray to gray)	4 ms (Extreme mode)	Weight	
OSD Controls	6 ms (Normal mode)	Packed	Starting at 16.39 lbs (7.45 kg)
Buttons	5	Unpacked	Starting at 11.33 lbs (5.15 kg)
Languages	English, French, German, Spanish, Italian, Japanese, Simplified Chinese, Russian	Monitor Head Only	Starting at 7.26 lbs (3.3 kg)
		Full Container Load	1140 / 540 Units
		(40' STD / 20' STD)	
CONNECTIVITY		POWER CONSUMPTION	
Video Input Signals	VGA + HDMI™ 1.4 + DisplayPort™ 1.2	Typical	16.5 W
Video Cables Supplied (Length)	1.8 m	Maximum	55 W
USB Hub	1 x USB 3.0 ¹ (Upstream) 4 x USB 3.0 ¹ (Downstream, Incl. 1 BC)	Sleep-Mode	<0.5 W
Audio Out	Yes (3.5 mm)	Switch Off-Mode	<0.3 W
		Power Supply	Internal
		Power Voltage	90 VAC – 264 VAC
MECHANICAL		WHAT'S IN THE BOX	
Tilt Angle (Front / Back)	-5° / 30°	Monitor with Stand	
Swivel Angle (Left / Right)	+/-45°	1 x Power Cable	
Lift Range (mm)	110	1 x VGA Cable	
Pivot	+/-90°	1 x DisplayPort™ - DisplayPort™ Cable	
Cable Management	Yes	1 x HDMI™ Cable (NA Only)	
Kensington® Lock	Yes	Quick Setup Guide	
VESA® Mount (mm x mm)	Yes (100 X 100)		
Bezel Color	Raven Black	CERTIFICATIONS	
Bezel Width		EPEAT™	Gold
Top (mm / inches)	2 / 0.08"	ENERGY STAR® Rating	7.1
Sides (mm / inches)	2 / 0.08"	TCO®	7.0
		TCO Edge	2.0
		RoHS (EU 2002/95/EC)	Yes
		China Energy Efficiency Standard	Tier 2
		Windows Certification	Windows 7 / Windows 10
		TÜV Eye Comfort Certification	Yes

¹ Depending on many factors such as the processing capability of peripheral devices, file attributes, and other factors related to system configuration and operating environments, the actual transfer rate using the various USB connectors on this device will vary and is typically slower than the data rates as defined by the respective USB specifications: - 5 Gbit/s for USB 3.1 Gen 1; 10 Gbit/s for USB 3.1 Gen 2 & 20 Gbit/s for USB 3.2.



WWW.LENOVO.COM



ThinkVision T24i-19 MONITOR



SPECIFICATIONS

DISPLAY		DIMENSIONS (W x D)	
Panel Size	23.8" Wide	Size Packed (mm)	422 x 622 x 190
Panel Type	In-Plane-Switching	Size Packed (inches)	16.61" x 24.48" x 7.48"
Backlight	WLED	Size Unpacked with Stand Lowest Position (mm)	540.2 x 261.75 x 373.4
Resolution	FHD (1920 x 1080)	Size Unpacked with Stand Highest Position (mm)	540.2 x 261.75 x 483.4
Aspect Ratio	16:9	Size Unpacked without Stand (Monitor Head Only) (mm)	540.2 x 46.45 x 325.98
Anti-Glare	Yes	Size Unpacked without Stand (inches)	21.26" x 1.82" x 12.83"
Near Edgeless Screen	Yes	Stand Base Footprint Area (mm)	250 x 250
Screen Dimensions (W x H) (mm)	527.04 x 296.46	Stand Base Footprint Area (inches)	9.84" x 9.84"
Screen Dimensions (W x H) (inches)	20.75" x 11.67"	Weight Packed	Starting at 16.39 lbs (7.45 kg)
Brightness	250 nits	Weight Unpacked	Starting at 11.33 lbs (5.15 kg)
Viewing Angle (H/V at CR 10:1)	178°/178°	Weight Monitor Head Only	Starting at 7.26 lbs (3.3 kg)
Contrast Ratio (Typical)	1000:1	Full Container Load (40' STD / 20' STD)	1140 / 540 Units
Dynamic Contrast Ratio	3M:1		
Speakers	2 x 2W		
Pixel Pitch (mm)	0.2745 x 0.2745		
Color Gamut (CIE 1931)	72% NTSC		
Color Depth	8 bit		
Color Support (Typical)	16.7 Million		
Response Time (GtG) Extreme / Normal	4 ms / 6 ms		
OSD Controls Buttons	5		
OSD Controls Languages	English, French, German, Spanish, Italian, Japanese, Simplified Chinese, Russian		
CONNECTIVITY		POWER CONSUMPTION	
Video Input Signals	VGA + HDMI™ + DisplayPort™	Typical	16.5 W
Video Cables Supplied	VGA, DisplayPort™, USB, Power, HDMI™ (for NA only)	Maximum	59 W
USB Hub	USB 3.0 (4 x down, 1 x BC)	Sleep-Mode	<0.5 W
Audio Out	Yes (3.5 mm)	Switch Off-Mode	<0.3 W
Power	Internal	Power Supply	Internal
		Power Voltage	90 VAC - 264 VAC
		ENERGY STAR® (P _{on})	13.67 W
		ENERGY STAR® (E _{TEC})	43.51 kWh
MECHANICAL		WHAT'S IN THE BOX	
Tilt Angle (Front / Back)	-5° / 30°	Monitor with Stand	
Swivel Angle (Left / Right)	+/-45°	1 x Power Cable	
Lift Range (mm)	110	1 x VGA Cable	
Pivot	+/-90°	1 x DisplayPort™ - DisplayPort™ Cable	
Stand	LTPS	1 x HDMI Cable (NA Only)	
Cable Management	Yes	Quick Setup Guide	
Kensington® Lock	Yes	CERTIFICATIONS	
VESA® Mount (mm x mm)	Yes (100 X 100)	EPEAT™	Gold
Bezel Color	Raven Black	ENERGY STAR® Rating	7.1
Bezel Width		TCO	7.0
Top (mm / inches)	2 / 0.08"	TCO Edge	2.0
Sides (mm / inches)	2 / 0.08"	ULE	Yes
		RoHS (EU 2002/95/EC)	Yes
		China Energy Efficiency Standard	Tier 2
		Windows Certification	Windows 7 / Windows 10
		TüV Eye Comfort Certification	Yes
		TINY Support	Yes
		Soundbar Support*	Yes
		Package	EPS Cushion

* Optional.



WWW.LENOVO.COM

Lenovo reserves the right to alter product offerings and specifications at any time, without notice. Lenovo makes every effort to ensure accuracy of all information but is not liable or responsible for any editorial, photographic or typographic errors. All images are for illustration purposes only. For full Lenovo product, service and warranty specifications visit www.lenovo.com. Lenovo makes no representations or warranties regarding third party products or services. **Trademarks:** The following are trademarks or registered trademarks of Lenovo: Lenovo, the Lenovo logo, Rescue and Recovery, ThinkPad, ThinkCentre, ThinkStation, ThinkServer, ThinkVantage and ThinkVision. Microsoft, Windows and Vista are registered trademarks of Microsoft Corporation. Ultrabook, Celeron, Celeron Inside, Core Inside, Intel, Intel Logo, Intel Atom, Intel Atom Inside, Intel Core, Intel Inside, Intel Inside Logo, Intel vPro, Itanium, Itanium Inside, Pentium, Pentium Inside, vPro Inside, Xeon, Xeon Phi, and Xeon Inside are trademarks of Intel Corporation in the U.S. and/or other countries. Other company, product and service names may be trademarks or service marks of others. Battery life (and recharge times) will vary based on many factors including system settings and usage. Visit www.lenovo.com/lenovo/us/en/safecom/ periodically for the latest information on safe and effective computing. ©2019 Lenovo. All rights reserved.

Lenovo™

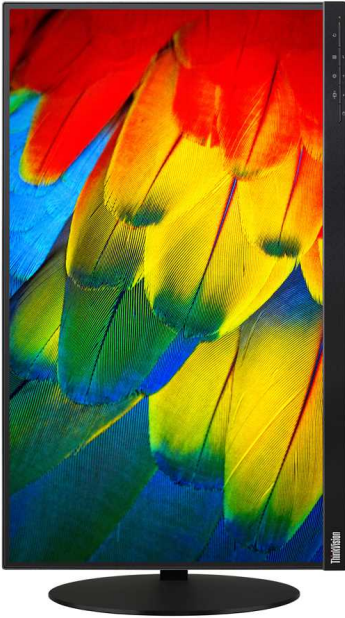

<p>Name T24m Wide Flat Panel Monitor Bezel color Black Type-model 61B8RAR3US / 61B8RAT3EU Panel TFT-LCD, In-Plane Switching (IPS), White LED backlight Viewable image size 23.8" (604.7mm) diagonal Max view area (W x H) 20.75" x 11.67" (527.04mm x 296.46mm) Native resolution 1920x1080 Aspect ratio 16:9 Pixel pitch (mm) 0.2745 x 0.2745 mm Dot/Pixel per Inch 92 dpi Brightness 250 nits or cd/m² (typical) Contrast ratio 1000:1 (typical) Pixel response time 6ms (typical) Color gamut 99% sRGB Viewing angle at 10:1 CR 178° (+/- 89°) horizontal, 178° (+/- 89°) vertical Stand Tilt, swivel, pivot, and height adjustable Bezel width <i>Sides:</i> 0.08" (2.0mm) Dimensions (HxWxD) 19.03" H x 21.26" W x 10.3" D; 483.4mm H x 540.2mm W x 261.75mm D Power supply 17 watts typical, 110 watts maximum (with USB 3.0 hub), <0.5 watts standby/suspend, universal, integrated (no external brick-like power supply) Weight 12.34 lb; 5.6 kg Limited warranty 3 year (includes backlight) Available date August 2017</p>	<p style="text-align: center;">Features</p> <ul style="list-style-type: none"> • Widescreen 23.8-inch monitor • Supports 1920x1080 resolution • Supports ThinkCentre Tiny Clamp Bracket • Supports optional soundbar • EPEAT Gold certified • Microsoft® Windows® 7 certified • Microsoft Windows 10 certified 				
<p>VESA-compliant VESA DDC2B/CI Power management ENERGY STAR® qualified Ergonomics ISO 9241-307 Emission standards FCC Class B Environmental TCO Displays 7.0, TCO Certified Edge 2.0, WEEE, RoHS, EPEAT™ Silver rating</p>	<div style="text-align: center;">  <p>ThinkVision T24m Wide Monitor</p> </div>				
<p>Preset resolutions VGA: 640x480 SVGA: 800x600 XGA: 1024x768 SXGA: 1280x1024 WXGA: 1366x768 WXGA+: 1440x900, 1600x900 WSXGA+: 1680x1050 Full HD: 1920x1080, 1920x1200 HDMI: 19; DP: 11</p>					
<p>Viewing adjustments <i>Tilt:</i> 30° back, -5° forward; <i>lift:</i> 4.3" (110mm); <i>swivel:</i> +/-45°; detachable stand Rotating screen Screen pivots 90 degrees from landscape to portrait On screen display On screen display with digital user controls (8 languages) Control features Direct access (buttons on front) for power, menu, input source select and brightness USB hub USB 3.0 Hub: 1 port into PC (USB 3.0); 4 ports for accessories (4 USB 3.0) Multimedia Audio-out, optional sound bar supported Multiple input Support HDMI, DisplayPort, USB 3.1 Type-C Monitor connectors (1) HDMI (1.4), digital, HDCP-compliant (2) DisplayPort (1.2), digital, HDCP-compliant (3) USB 3.1 Type-C Signal cables (1) 1.8 meter USB Type-C to USB Type-C cable Mounting features Wall or desk mounting using the Extend Arm or third-party accessories, 100mm x 100mm mount Security Security keyhole for attachment of optional cable lock (Kensington® lock-compatible)</p>					
<p>Ship group Monitor with stand, Safety and Warranty Information, 1.8 meter USB Type-C to USB Type-C cable, 1.8 meter black power cord</p>					
<p style="text-align: center;">Limited Warranty</p> <p>See details at http://support.lenovo.com/en_US/guides-and-manuals/detail.page?DocID=UM008281</p>	<p style="text-align: center;">Accessories</p> <table border="0"> <tr> <td>Kensington MicroSaver Cable Lock</td> <td style="text-align: right;">73P2582</td> </tr> <tr> <td>Kensington Twin Head Cable Lock</td> <td style="text-align: right;">45K1620</td> </tr> </table> <p>See details at www.lenovo.com/support/monitoraccessories</p> <p>See all monitors at www.lenovo.com/thinkvision</p>	Kensington MicroSaver Cable Lock	73P2582	Kensington Twin Head Cable Lock	45K1620
Kensington MicroSaver Cable Lock	73P2582				
Kensington Twin Head Cable Lock	45K1620				



<p>Name T24v Wide Flat Panel Monitor Bezel color Black Type-model 61BCMAR6US / 61BCMAT6EU Panel TFT-LCD, In-Plane Switching (IPS), White LED backlight Viewable image size 23.8" (604.5mm) diagonal Max view area (W x H) 20.75" x 11.67" (527.04mm x 296.46mm) Native resolution 1920x1080 Aspect ratio 16:9 Pixel pitch (mm) 0.2745 x 0.2745 mm Dot/Pixel per Inch 92 dpi Brightness 250 nits or cd/m² (typical) Contrast ratio 1000:1 (typical) Pixel response time 6ms (typical); 4ms (extreme mode) Color gamut 72% Viewing angle at 10:1 CR 178° (+/- 89°) horizontal, 178° (+/- 89°) vertical Stand Tilt, swivel, pivot, and height adjustable stand Bezel width <i>Sides:</i> 0.08" (2.0mm) Dimensions (HxWxD) 19.72" H x 21.28" W x 10.32" D; 500.5mm H x 540.2mm W x 261.9mm D Power supply 20 watts typical, 45 watts maximum (with USB 3.0 hub), <0.5 watts standby/suspend, universal, integrated (no external brick-like power supply) Weight 11.18 lb; 5.07 kg Limited warranty 3 year (includes backlight) Available date October 2017</p>	<p style="text-align: center;">Features</p> <ul style="list-style-type: none"> • Widescreen 23.8-inch monitor • Supports 1920x1080 resolution • Supports ThinkCentre Tiny Clamp Bracket • Supports optional soundbar • EPEAT Gold certified • Microsoft® Windows® 7 certified • Microsoft Windows 10 certified 				
<p>VESA-compliant VESA DDC2B/C1 Power management ENERGY STAR® qualified Ergonomics ISO 9241-307 Emission standards FCC Class B Environmental TCO Displays 7.0, TCO Certified Edge 2.0, WEEE, RoHS, EPEAT™ Silver rating</p> <p>Preset resolutions VGA: 640x480, 720x400 SVGA: 800x600, 832x624 XGA: 1024x768, 1152x864 SXGA: 1280x1024 WXGA+: 1440x900, 1600x900 WSXGA+: 1680x1050 Full HD: 1920x1080</p> <p>Presets display modes Presets: 24; user modes: 20</p>	 <p style="text-align: center;">ThinkVision T24v Wide Monitor</p>				
<p>Viewing adjustments <i>Tilt:</i> 30° back, -5° forward; <i>lift:</i> 4.3" (110mm); <i>swivel:</i> +/-45°; detachable stand Rotating screen Screen pivots 90 degrees from landscape to portrait On screen display On screen display with digital user controls (8 languages) Control features Direct access for power, menu, input source select, volume up / down, speaker mute and microphone mute USB hub USB 3.0 Hub: 1 port into PC (USB 3.0); 2 ports for accessories (2 USB 3.0) Multimedia Integrated speakers, dual-array microphone, audio-in and Audio-out, optional sound bar supported Camera Integrated FHD camera with IR Multiple input Support HDMI, DisplayPort, VGA Monitor connectors (1) VGA 15-pin D-shell, analog, blue (2) HDMI (1.4), digital, HDCP-compliant (3) DisplayPort, digital, black, HDCP-compliant Signal cables (1) detachable, VGA 15-pin D-shell at each end, analog, 1.8 meter (2) detachable, HDMI at each end, digital, 1.8 meter Mounting features Wall or desk mounting using the Extend Arm or third-party accessories, 100mm x 100mm mount Security Security keyhole for attachment of optional cable lock (Kensington® lock-compatible)</p>	<p>Viewing adjustments <i>Tilt:</i> 30° back, -5° forward; <i>lift:</i> 4.3" (110mm); <i>swivel:</i> +/-45°; detachable stand Rotating screen Screen pivots 90 degrees from landscape to portrait On screen display On screen display with digital user controls (8 languages) Control features Direct access for power, menu, input source select, volume up / down, speaker mute and microphone mute USB hub USB 3.0 Hub: 1 port into PC (USB 3.0); 2 ports for accessories (2 USB 3.0) Multimedia Integrated speakers, dual-array microphone, audio-in and Audio-out, optional sound bar supported Camera Integrated FHD camera with IR Multiple input Support HDMI, DisplayPort, VGA Monitor connectors (1) VGA 15-pin D-shell, analog, blue (2) HDMI (1.4), digital, HDCP-compliant (3) DisplayPort, digital, black, HDCP-compliant Signal cables (1) detachable, VGA 15-pin D-shell at each end, analog, 1.8 meter (2) detachable, HDMI at each end, digital, 1.8 meter Mounting features Wall or desk mounting using the Extend Arm or third-party accessories, 100mm x 100mm mount Security Security keyhole for attachment of optional cable lock (Kensington® lock-compatible)</p>				
<p>Ship group Monitor with stand, Safety and Warranty Information, 1.8 meter analog signal cable, 1.8 meter DP signal cable, 1.8 meter USB signal cable, 1.8 meter black power cord, 1.8 meter HDMI signal cable (Row)</p>					
<p style="text-align: center;">Limited Warranty</p> <p>See details at http://support.lenovo.com/en_US/guides-and-manuals/detail.page?DocID=UM008281</p>	<p style="text-align: center;">Accessories</p> <table border="0"> <tr> <td>Kensington MicroSaver Cable Lock</td> <td style="text-align: right;">73P2582</td> </tr> <tr> <td>Kensington Twin Head Cable Lock</td> <td style="text-align: right;">45K1620</td> </tr> </table> <p>See details at www.lenovo.com/support/monitoraccessories</p> <p>See all monitors at www.lenovo.com/thinkvision</p>	Kensington MicroSaver Cable Lock	73P2582	Kensington Twin Head Cable Lock	45K1620
Kensington MicroSaver Cable Lock	73P2582				
Kensington Twin Head Cable Lock	45K1620				



<p>Name X24 Pro Wide Flat Panel Monitor Bezel color Black Type-model 60E4ECR1US / 60E4ECT1US / 60E4ECT1EU Panel TFT-LCD, AH-IPS (In-Plane Switching), White LED backlight Viewable image size 23.8" (604.5mm) diagonal Max view area (W x H) 20.75" x 11.67" (527.0mm x 296.5mm) Native resolution 1920x1080 Aspect ratio 16:9 Pixel pitch (mm) 0.2745 x 0.2745 mm Dot/Pixel per Inch 92 dpi Brightness 250 nits or cd/m² (typical) Contrast ratio 1000:1 (typical) Pixel response time 7ms (typical) Color gamut 72% Viewing angle at 10:1 CR 178° (+/- 89°) horizontal, 178° (+/- 89°) vertical Stand Tilt stand Bezel width <i>Sides:</i> 0.09" (2.3mm) Dimensions (HxWxD) 17.61" H x 21.30" W x 9.39" D; 447.4mm H x 540.9mm W x 238.4mm D Power supply 20 watts typical, 90 watts maximum, <0.5 watts standby/suspend, universal, external power supply Weight 9.26 lb; 4.20 kg Limited warranty 1 year (includes backlight) Available date July 2016</p>	<p style="text-align: center;">Features</p> <ul style="list-style-type: none"> • Widescreen 23.8-inch monitor • Supports 1920x1080 resolution • Includes dual input connection for attachment to two systems concurrently • EPEAT Silver certified • Intel RealSense 3D camera • Stereo speakers 3 watts x 2 • One cable docking through USB 3.1 Type C with power delivery • Windows Hello certified • Microsoft® Windows® 10 certified 				
<p>Power management ENERGY STAR® qualified Ergonomics ISO 9241-307 Emission standards FCC Class B Environmental TCO Displays 6.0, WEEE, RoHS, EPEAT™ Silver rating</p> <p>Preset resolutions VGA: 640x350, 640x480, 720x400 SVGA: 800x600 XGA: 1024x768 SXGA: 1280x1024 WXGA: 1366x768 WXGA+: 1440x900, 1600x900 WSXGA+: 1680x1050 Full HD: 1920x1080</p> <p>Presets / user settings Standard presets: 16; user settings: 20</p>	<div style="text-align: center;">  <p>ThinkVision X24 Pro Wide Monitor</p> </div>				
<p>Viewing adjustments <i>Tilt:</i> 22° back, -5° forward Rotating screen None On screen display On screen display with digital user controls Control features Direct access (buttons on side bezel) for dual input and brightness USB hub USB Hub: two USB 3.1 Type-C and one micro USB 3.0 ports Multimedia Integrated stereo speakers (3 watts x 2), built-in microphone Camera RealSense 3D camera SR300 Multiple input Dual input (two different PCs attach to two different connectors; one PC shows image; select via button) Monitor connectors (1) mDP, Mini DisplayPort, digital, HDCP-compliant (2) USB Type-C, digital Signal cables (1) detachable, mDP to DP, digital, 2.0 meter (2) DP to mDP adapter (3) Micro USB 3.0 cable Mounting features None Security Security keyhole for attachment of optional cable lock (Kensington® lock-compatible)</p>	<p>Ship group Monitor with stand, Safety and Warranty Information, ThinkPad 90W Square tip power adaptor, 2.0 meter Mini DisplayPort to DisplayPort signal cable (with DP to mDP adapter), Micro USB 3.0 cable (for using camera)</p>				
<p style="text-align: center;">Limited Warranty</p> <p>See details at http://support.lenovo.com/en_US/guides-and-manuals/detail.page?DocID=UM008281</p>	<p style="text-align: center;">Accessories</p> <table border="0"> <tr> <td>Kensington MicroSaver Cable Lock</td> <td style="text-align: right;">73P2582</td> </tr> <tr> <td>Kensington Twin Head Cable Lock</td> <td style="text-align: right;">45K1620</td> </tr> </table> <p>See details at www.lenovo.com/support/monitoraccessories</p> <p>See all monitors at www.lenovo.com/thinkvision</p>	Kensington MicroSaver Cable Lock	73P2582	Kensington Twin Head Cable Lock	45K1620
Kensington MicroSaver Cable Lock	73P2582				
Kensington Twin Head Cable Lock	45K1620				

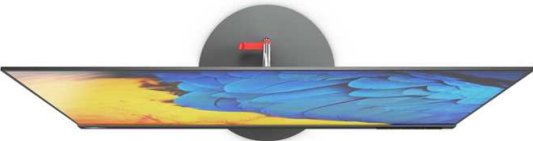

<p>Name X24-20 Flat Panel Monitor Bezel color Raven black Type-model 61BDGAR3US / 61BDGAT3EU Panel TFT-LCD, IPS (In-Plane Switching), White LED backlight Viewable image size 23.8" (604.5mm) diagonal Max view area (W x H) 20.75" x 11.67" (527.0mm x 296.5mm) Native resolution 1920x1080 Aspect ratio 16:9 Pixel pitch (mm) 0.2745 x 0.2745 mm Dot/Pixel per Inch 92 dpi Brightness 250 nits or cd/m² (typical) Contrast ratio 1000:1 (typical) Pixel response time 6ms (typical) Color gamut 72% (NTSC) Viewing angle at 10:1 CR 178° (+/- 89°) horizontal, 178° (+/- 89°) vertical Stand Tilt stand Bezel width <i>Sides:</i> 0.04" (1.1mm) Dimensions (HxWxD) 12.85" H x 21.16" W x 8.66" D; 326.4mm H x 537.4mm W x 220mm D Power supply 20 watts typical, 25 watts maximum, <0.5 watts standby/suspend, universal, external power supply Weight 7.3 lb; 3.3 kg Limited warranty 3 year (includes backlight) Available date December 2017</p>	<p style="text-align: center;">Features</p> <ul style="list-style-type: none"> • Widescreen 23.8-inch monitor • Supports 1920x1080 resolution • Includes dual input connection for attachment to two systems concurrently • EPEAT Silver certified • Microsoft® Windows® 7 certified • Microsoft Windows 10 certified 				
<p>Power management ENERGY STAR® qualified Ergonomics ISO 9241-307 Emission standards FCC Class B Environmental TCO Displays 7.0, TCO Certified Edge 2.0, WEEE, RoHS, EPEAT™ Silver rating</p>	<div style="text-align: center;">  <p>ThinkVision X24-20 Monitor</p> </div>				
<p>Preset resolutions VGA: 640x350, 640x480, 720x400 SVGA: 800x600 XGA: 1024x768 SXGA: 1280x1024 WXGA: 1366x768 WXGA+: 1440x900, 1600x900 WSXGA+: 1680x1050 Full HD: 1920x1080 Presets / user settings Standard presets: 18; user settings: 0</p>					
<p>Viewing adjustments <i>Tilt:</i> 30° back, -5° forward Rotating screen None On screen display On screen display with digital user controls (8 languages) Control features Direct access (buttons on side bezel) for power, dual input and brightness USB hub None Multiple input Dual input (two different PCs attach to two different connectors; one PC shows image; select via button) Monitor connectors (1) HDMI (1.4a), digital, HDCP-compliant (2) DisplayPort, digital, black, HDCP-compliant Signal cables (1) detachable, HDMI at each end, digital, 1.8 meter Mounting features None Security Security keyhole for attachment of optional cable lock (Kensington® lock-compatible)</p>					
<p>Ship group Monitor with stand, Safety and Warranty Information, 1.8 meter HDMI signal cable, 1.8 meter black power cord</p>	<div style="text-align: center;"> <p>Limited Warranty</p> <p>See details at http://support.lenovo.com/en_US/guides-and-manuals/detail.page?DocID=UM008281</p> </div> <div style="text-align: center;"> <p>Accessories</p> <table border="0"> <tr> <td>Kensington MicroSaver Cable Lock</td> <td style="text-align: right;">73P2582</td> </tr> <tr> <td>Kensington Twin Head Cable Lock</td> <td style="text-align: right;">45K1620</td> </tr> </table> <p>See details at www.lenovo.com/support/monitoraccessories</p> <p>See all monitors at www.lenovo.com/thinkvision</p> </div>	Kensington MicroSaver Cable Lock	73P2582	Kensington Twin Head Cable Lock	45K1620
Kensington MicroSaver Cable Lock	73P2582				
Kensington Twin Head Cable Lock	45K1620				



<p>Name P27h Wide Flat Panel Monitor Case color Black Type-model 61AFGAR1US / 61AFGAT1EU Panel TFT-LCD, IPS (In-Plane Switching), White LED backlight Viewable image size 27" (685.8mm) diagonal Max view area (W x H) 23.49" x 13.21" (596.7mm x 335.7mm) Optimum resolution 2560x1440 Max pixel rate 300MHz Aspect ratio 16:9 Pixel pitch (mm) 0.2331 x 0.2331mm Dot/Pixel per Inch 109 dpi Brightness 350 nits or cd/m² (typical) Contrast ratio 1000:1 (typical) Pixel response time 4ms (extreme) / 6ms (typical) Color gamut 99% sRGB Viewing angle at 10:1 CR 178° horizontal, 178° vertical Stand Tilt, swivel, pivot, and height adjustable stand Bezel width <i>Sides:</i> 0.08" (2mm) Dimensions 20.21" H x 24.08" W x 10.62" D; (HxWxD, including stand) 513mm H x 611.6mm W x 269.8mm D Power supply 38 watts typical, 140 watts maximum (with USB), <0.5 watts sleep/off; <0.5 watts switch off integrated (no external brick-like power supply) Weight 15.43 lb; 7.0kg (including stand) Limited warranty 3 year Available date April 2017</p>	<p style="text-align: center;">Features</p> <ul style="list-style-type: none"> • 27-inch IPS LED backlight monitor • Supports 2560x1440 resolution • 5-Ports USB hub, support USB 3.0 • Supports optional soundbar • Support ThinkCentre Tiny • Microsoft® Windows® 7 certified • Microsoft Windows 10 certified 						
<p>VESA-compliant VESA DDC2B/CI Power management ENERGY STAR® 7.0 Ergonomics ISO 9241-307 Emission standards FCC Class B Environmental TCO Displays 7.0, RoHS, EPEAT™ Silver rating, ULE Gold</p>	<div style="text-align: center;">  <p>ThinkVision P27h Monitor</p> </div>						
<p>Preset resolutions VGA: 640x480, 720x400 SVGA: 800x600 XGA: 1024x768 SXGA: 1280x1024 WXGA: 1366x768 WXGA+: 1440x900, 1680x900 WSXGA+: 1680x1050 Full HD: 1920x1080, 1920x1200 QHD: 2560x1440</p>							
<p>Presets display modes HDMI: 22; DP: 14</p>							
<p>Viewing adjustments <i>Tilt:</i> 30° back, -5° forward; <i>lift:</i> 4.33" (110mm); <i>swivel:</i> +/-45° Rotating screen Screen pivots 90 degrees from landscape to portrait On screen display On screen display with digital user controls (8 languages) Control features Direct access (buttons on front) for power, menu, input source select and brightness USB hub USB Hub: one USB 3.1 Type-C upstream port, four USB 3.0 Type-A downstream ports Multimedia Audio-out, optional sound bar supported Camera None Multiple input Support HDMI, DisplayPort, USB 3.1 Type-C, DisplayPort-out Monitor connectors (1) 2*HDMI (1.4), digital, HDCP-compliant (2) DisplayPort (1.2), digital, HDCP-compliant (3) DisplayPort-out, digital (4) USB 3.1 Type-C Signal cables (1) USB 3.1 Type-C cable, 1.8 meter Mounting features Wall or desk mounting using the Extend Arm or third-party accessories meeting the VESA FPMPI® (100mm mount) Security Security keyhole for attachment of optional cable lock (Kensington® lock-compatible)</p>							
<p>Ship group Monitor, detachable stand, Quick start and safety poster, 1.8 meter USB 3.1 Type-C cable, 1.8 meter black power cord</p>							
<p style="text-align: center;">Limited Warranty</p> <p>See details at http://support.lenovo.com/en_US/guides-and-manuals/detail.page?DocID=UM008281</p>	<p style="text-align: center;">Accessories</p> <table border="0"> <tr> <td>Kensington MicroSaver Cable Lock</td> <td style="text-align: right;">73P2582</td> </tr> <tr> <td>Kensington Twin Head Cable Lock</td> <td style="text-align: right;">45K1620</td> </tr> <tr> <td>Lenovo Security Cable Lock</td> <td style="text-align: right;">57Y4303</td> </tr> </table> <p>See details at www.lenovo.com/support/monitoraccessories See all monitors at www.lenovo.com/thinkvision</p>	Kensington MicroSaver Cable Lock	73P2582	Kensington Twin Head Cable Lock	45K1620	Lenovo Security Cable Lock	57Y4303
Kensington MicroSaver Cable Lock	73P2582						
Kensington Twin Head Cable Lock	45K1620						
Lenovo Security Cable Lock	57Y4303						



<p>Name P27q Wide Flat Panel Monitor Case color Black Type-model 61A8GAT1EU Panel TFT-LCD, IPS (In-Plane Switching), White LED backlight Viewable image size 27" (685.8mm) diagonal Max view area (W x H) 23.49" x 13.21" (596.7mm x 335.7mm) Optimum resolution 2560x1440 Max pixel rate 300MHz Aspect ratio 16:9 Pixel pitch (mm) 0.2331 x 0.2331mm Dot/Pixel per Inch 109 dpi Brightness 350 nits or cd/m² (typical) Contrast ratio 1000:1 (typical) Pixel response time 4ms Color gamut 99% sRGB Viewing angle at 10:1 CR 178° horizontal, 178° vertical Stand Tilt, swivel, pivot, and height adjustable stand Bezel width <i>Sides:</i> 0.08" (2mm) Dimensions 20.21" H x 24.17" W x 10.62" D; (HxWxD, including stand) 513mm H x 614mm W x 269.8mm D Power supply 38 watts typical, 75 watts maximum (with USB), <0.5 watts sleep/off; <0.3 watts switch off integrated (no external brick-like power supply) Weight 15.43 lb; 7.0kg (including stand) Limited warranty 3 year Available date January 2017</p>	<p>Features</p> <ul style="list-style-type: none"> • 27-inch IPS LED backlight monitor • Supports 2560x1440 resolution • 5-Ports USB hub, support USB 3.0 • Support ThinkCentre Tiny • Supports optional soundbar • Microsoft® Windows® 7 certified • Microsoft Windows 10 certified 						
<p>VESA-compliant VESA DDC2B/CI Power management ENERGY STAR® 7.0 Ergonomics ISO 9241-307 Emission standards FCC Class B Environmental TCO Displays 7.0, RoHS, EPEAT™ Silver rating, ULE Gold</p>	 <p>ThinkVision P27q Monitor</p>						
<p>Preset resolutions VGA: 640x480, 720x400 SVGA: 800x600 XGA: 1024x768 SXGA: 1280x1024 WXGA: 1366x768 WXGA+: 1440x900, 1600x900 WSXGA+: 1680x1050 Full HD: 1920x1080, 1920x1200 QHD: 2560x1440</p> <p>Presets / user settings Standard presets: 20; user settings: 24</p>							
<p>Viewing adjustments <i>Tilt:</i> 30° back, -5° forward; <i>lift:</i> 4.33" (110mm); <i>swivel:</i> +/-45° Rotating screen Screen pivots 90 degrees from landscape to portrait On screen display On screen display with digital user controls (8 languages) Control features Direct access for menu, source switch, and brightness USB hub USB Hub: one USB 3.0 upstream port, four USB 3.0 downstream ports Multimedia Audio-out, optional sound bar supported Camera None Multiple input Support HDMI, DisplayPort, mini DisplayPort, DisplayPort-out Monitor connectors (1) 2*HDMI (1.4), digital, HDCP-compliant (2) DisplayPort (1.2), digital, HDCP-compliant (3) Mini DisplayPort, digital, HDCP-compliant Signal cables (1) detachable, mini DisplayPort to DisplayPort, digital, 1.8 meter Mounting features Wall or desk mounting using the Extend Arm or third-party accessories meeting the VESA FPMPI® (100mm mount) Security Security keyhole for attachment of optional cable lock (Kensington® lock-compatible)</p>							
<p>Ship group Monitor, detachable stand, Quick start and safety poster, 1.8 meter USB 3.0 cable, 1.8 meter mini DP to DP cable, 1.8 meter black power cord</p>	<p>Limited Warranty</p> <p>See details at http://support.lenovo.com/en_US/guides-and-manuals/detail.page?DocID=UM008281</p> <p>Accessories</p> <table border="0"> <tr> <td>Kensington MicroSaver Cable Lock</td> <td>73P2582</td> </tr> <tr> <td>Kensington Twin Head Cable Lock</td> <td>45K1620</td> </tr> <tr> <td>Lenovo Security Cable Lock</td> <td>57Y4303</td> </tr> </table> <p>See details at www.lenovo.com/support/monitoraccessories</p> <p>See all monitors at www.lenovo.com/thinkvision</p>	Kensington MicroSaver Cable Lock	73P2582	Kensington Twin Head Cable Lock	45K1620	Lenovo Security Cable Lock	57Y4303
Kensington MicroSaver Cable Lock	73P2582						
Kensington Twin Head Cable Lock	45K1620						
Lenovo Security Cable Lock	57Y4303						



<p>Name P27u Wide Flat Panel Monitor Case color Black Type-model 61CBGAR1US / 61CBGAT1EU / 61CBGAR1EU / 61B0GAR1US / 61B0GAT1EU Panel TFT-LCD, IPS (In-Plane Switching), White LED backlight Viewable image size 27" (684.7mm) diagonal Max view area (W x H) 23.49" x 13.21" (596.74mm x 335.66mm) Optimum resolution 3840x2160 Max pixel rate 600MHz Aspect ratio 16:9 Pixel pitch (mm) 0.1554 x 0.1554mm Dot/Pixel per Inch 163 dpi Brightness 350 nits or cd/m² (typical) Contrast ratio 1000:1 (typical) Pixel response time 6ms (typical) Color gamut 1.457 sRGB Viewing angle at 10:1 CR 178° horizontal, 178° vertical Stand Tilt, swivel, pivot, and height adjustable stand Bezel width Sides: 0.08" (2mm) Dimensions (HxWxD, including stand) 20.21" H x 24.08" W x 10.62" D; 513.3mm H x 611.6mm W x 269.8mm D Power supply 50 watts typical, 160 watts maximum (with USB), <0.5 watts sleep/off; <0.3 watts switch off integrated (no external brick-like power supply) Weight 15.32 lb; 6.95kg (including stand) Limited warranty 3 year Available date August 2017</p>	<p>Features</p> <ul style="list-style-type: none"> • 27-inch IPS LED backlight monitor • Supports 3840x2160 resolution • 5-Ports USB hub, support USB 3.0 • Support ThinkCentre Tiny • Supports optional soundbar • Microsoft® Windows® 7 certified • Microsoft Windows 10 certified 						
<p>VESA-compliant VESA DDC2B/CI Power management ENERGY STAR® 7.0 Ergonomics ISO 9241-307 Emission standards FCC Class B Environmental TCO Displays 7.0, TCO Certified Edge 2.0, WEEE, RoHS, EPEAT™ Silver rating, ULE Gold</p>	 <p>ThinkVision P27u Monitor</p>						
<p>Preset resolutions VGA: 640x480, 720x400, 720x480, 720x576 SVGA: 800x600 XGA: 1024x768 SXGA: 1280x720, 1280x800, 1280x1024 WXGA+: 1440x900, 1600x900 WSXGA+: 1680x1050 Full HD: 1920x1080, 1920x1200 QHD: 2560x1440 UHD: 3840x2160</p> <p>Presets / user settings Standard presets: 27; user settings: 20</p>							
<p>Viewing adjustments Tilt: 30° back, -5° forward; lift: 4.33" (110mm); swivel: +/-45° Rotating screen Screen pivots 90 degrees from landscape to portrait On screen display On screen display with digital user controls (8 languages) Control features Direct access (buttons on front) for power, menu, input source select and brightness USB hub USB Hub: one USB 3.1 Type-C port, four USB 3.0 Type-A downstream ports Multimedia Audio-out, optional sound bar supported Camera None Multiple input Support HDMI, DisplayPort, USB 3.1 Type-C Monitor connectors (1) 2*HDMI (2.0), digital, HDCP-compliant (2) DisplayPort (1.2), digital, HDCP-compliant (3) USB 3.1 Type-C Signal cables (1) detachable, DisplayPort to DisplayPort, digital, 1.8 meter Mounting features Wall or desk mounting using the Extend Arm or third-party accessories meeting the VESA FPMPI® (100mm mount) Security Security keyhole for attachment of optional cable lock (Kensington® lock-compatible)</p>							
<p>Ship group Monitor, detachable stand, Quick start and safety poster, 1.8 meter USB Type-C to USB Type-C cable, 1.8 meter DP to DP cable, 1.8 meter HDMI to HDMI cable (NA only), 1.8 meter black power cord, 1.8 meter USB Type-C to USB Type-A cable</p>							
<p>Limited Warranty</p> <p>See details at http://support.lenovo.com/en_US/guides-and-manuals/detail.page?DocID=UM008281</p>	<p>Accessories</p> <table border="0"> <tr> <td>Kensington MicroSaver Cable Lock</td> <td>73P2582</td> </tr> <tr> <td>Kensington Twin Head Cable Lock</td> <td>45K1620</td> </tr> <tr> <td>Lenovo Security Cable Lock</td> <td>57Y4303</td> </tr> </table> <p>See details at www.lenovo.com/support/monitoraccessories</p> <p>See all monitors at www.lenovo.com/thinkvision</p>	Kensington MicroSaver Cable Lock	73P2582	Kensington Twin Head Cable Lock	45K1620	Lenovo Security Cable Lock	57Y4303
Kensington MicroSaver Cable Lock	73P2582						
Kensington Twin Head Cable Lock	45K1620						
Lenovo Security Cable Lock	57Y4303						



ThinkVision P32u-10 MONITOR



SPECIFICATIONS

DISPLAY		ENVIRONMENTAL	
Panel Size	32"	Temperature	
Panel Type	In-Plane Switching	Operating	0°C – 40°C
Backlight	WLED	Non-Operating	-20°C – 60°C
Resolution	3840 x 2160	Humidity	
Aspect Ratio	16:9	Operating	8% – 80%
Anti-Glare	Yes	Non-Operating	5% – 95%
Screen Dimensions (W x H) (mm)	708.48 (H) x 398.52 (V)	Altitude	
Maximum Brightness (Typical)	300 cd/m ²	Operating	0 ft – 5000 ft
Viewing Angle (H/V at CR 10:1)	178°/178°	Non-Operating	0 ft – 40,000 ft
Contrast Ratio (Typical)	1000:1	Arsenic-Free Glass	Yes
Dynamic Contrast Ratio	3M:1	PVC-Free	Yes
Pixel Pitch (W x H) (mm)	0.1845 (H) x 0.1845 (V)	Mercury-Free	Yes
Dot/Pixel Per Inch (DP/PPI)	137	PCC % of Plastic Resins	85% with >25 g Plastic Parts
Color Gamut (1931)	99.5% AdobeRGB		
Response Time (Typical)	6 ms		
POWER CONSUMPTION		DIMENSIONS (W x D x H)	
Typical	70 W	Size Packed	
Maximum	200 W	(mm)	844 x 228 x 528
Sleep-Mode	≤0.5 W	(inches)	33.23" x 8.98" x 20.79"
Switch Off-Mode	≤0.5 W	Size Unpacked with Stand	
Power Supply	External	Lowest Position	
Power Voltage	90 VAC – 264 VAC	(mm)	726.7 x 350 x 497.8
Voltage Dynamic Frequency	47 Hz – 63 Hz	(inches)	28.61" x 13.78" x 19.6"
		Highest Position	
		(mm)	726.7 x 350 x 606.8
		(inches)	28.61" x 13.78" x 23.89"
		Size Unpacked without Stand	
		(Monitor Head Only)	
		(mm)	726.7 x 63.3 x 431.5
		(inches)	28.61" x 2.49" x 16.99"
		Distance from Table to Panel	
		Lowest Pixel at Bottom of Screen	
		(mm / inches)	90.9 / 3.58"
		Highest Pixel at Top of Screen	
		(mm / inches)	489.4 / 19.27"
		Stand Base Footprint Area	
		(mm / inches)	350 x 350 / 13.78" x 13.78"
		Weight	
		Packed	Starting at 29.32 lbs (13.3 kg)
		Unpacked	Starting at 22.05 lbs (10 kg)
		Monitor Head Only	Starting at 15.21 lbs (6.9 kg)
SIGNAL INPUT		COMPLIANCE	
Video Input Signals	2 x HDMI™ 2.0 + DisplayPort™ 1.2 + Thunderbolt™ 3.0-In + Thunderbolt™ 3.0-Out	EPEAT™	Gold
Video Cables Supplied	HDMI™, DisplayPort™, Thunderbolt™ 3.0	ENERGY STAR® Rating	7.0
Video Cable Length	2 m for Thunderbolt™, 1.8 m for HDMI™ and DisplayPort™	TCO	TCO 7.0 / TCO Edge 2.0
USB Hub	Yes (4 x Downstream, 1 x BC)	Windows Certification	Windows 7 / Windows 10
USB Cable Supplied	Yes (USB Type-A to Type-B)	China Energy Efficiency Standard	Tier 2
Audio-Out	Yes (3.5 mm)		
SIGNAL INTERFACE / PERFORMANCE		WARRANTY AND AVAILABILITY	
Horizontal Frequency	30 kHz – 160 kHz	Warranty	3 Years
Vertical Frequency	23 Hz – 80 Hz	Geography Availability	WW
Native Resolution	3840 x 2160		
Maximum Pixel Clock Speed / Bandwidth	HDMI™ : 600 MHz Display Port™: 5.4 Gbps Thunderbolt™: 10 Gbps		
Preset / User	28 / 20		
OSD Buttons	5 Buttons		
OSD Languages	English, French, German, Spanish, Italian, Japanese, Simplified Chinese, Russian		
MECHANICAL			
Tilt Angle (Front / Back)	-5° / 22°		
Swivel Angle (Left / Right)	45° / 45°		
Lift (mm)	110		
(CW / CCW)	90° / 90°		
VESA® Mount (mm)	100 x 100		
Kensington® Lock Slot	Yes		
Cable Management	Yes		
Bezel Color	Raven Black		
Bezel Width			
Top (mm / inches)	2 / 0.08"		
Bottom (mm / inches)	23.8 / 0.94"		
Sides (mm / inches)	2 / 0.08"		



WWW.LENOVO.COM

Lenovo reserves the right to alter product offerings and specifications at any time, without notice. Lenovo makes every effort to ensure accuracy of all information but is not liable or responsible for any editorial, photographic or typographic errors. All images are for illustration purposes only. For full Lenovo product, service and warranty specifications visit www.lenovo.com. Lenovo makes no representations or warranties regarding third party products or services. **Trademarks:** The following are trademarks or registered trademarks of Lenovo: Lenovo, the Lenovo logo, Rescue and Recovery, ThinkPad, ThinkCentre, ThinkStation, ThinkServer, ThinkVantage and ThinkVision. Microsoft, Windows and Vista are registered trademarks of Microsoft Corporation. Ultrabook, Celeron, Celeron Inside, Core Inside, Intel, Intel Logo, Intel Atom, Intel Atom Inside, Intel Core, Intel Inside, Intel Inside Logo, Intel vPro, Itanium, Itanium Inside, Pentium, Pentium Inside, vPro Inside, Xeon, Xeon Phi, and Xeon Inside are trademarks of Intel Corporation in the U.S. and/or other countries. Other company, product and service names may be trademarks or service marks of others. Battery life (and recharge times) will vary based on many factors including system settings and usage. Visit www.lenovo.com/lenovo/us/en/safecomp/ periodically for the latest information on safe and effective computing. ©2017 Lenovo. All rights reserved.



ThinkVision P44w-10

Specifications

DISPLAY

Panel Size
43.4 inches

Screen Dimensions (H x V)
1052.3 x 328.8mm
41.4 x 12.9 inches

Panel Type
VA NearEdgeless,
anti-glare

Curvature
1800R

Backlight
WLED

Aspect Ratio
32:10

Resolution
3840 x 1200

HDR
VESA Certified DisplayHDR™ 400

Pixel Pitch (H x V)
0.2740 x 0.2740mm

Viewing Angle (H x V)
178°/178°

Response Time (gray to gray)
4/6ms (extreme/typical)

Refresh Rate
Max. 144Hz

Contrast Ratio (typical)
3000:1

Dynamic Contrast Ratio (typical)
3M:1

Color Support (typical)
1.07B

Color Gamut
sRGB: 99.5%
BT.709: 99.5%
DCI-P3: 90%

Brightness
380 nits (typical)
450 nits (peak)

CONNECTIVITY

Video Input Signals
2 x HDMI 2.0
1 x DP1.4

1 x USB Type-C Gen1 (DP1.2 Alt Mode)
1 x USB Type-C Gen2 (DP1.4 Alt Mode)

Video Cable Length
1.5m for USB Type-C Gen2
1.8m for others

Audio Out
Yes (3.5mm)

USB Hub
Yes

USB Upstream
2 x USB 3.1 (1 x USB Type-C Gen1,

1 x USB Type-C Gen2)
USB Downstream
4 x USB 3.1 Gen1 (1 BC)

Power
Internal

Power Consumption
Typical/Max: 70W/250W
Switch-off Mode: <0.5W
Sleep/Off Mode: <0.5W

DIMENSIONS

Size Packed (D x H x W)
1219 x 500 x 376mm
47.99 x 19.68 x 14.80 inches

Size Unpacked w/stand (D x H x W) (Lowest Position)
269.8 x 461.1 x 1058.3mm
10.62 x 18.15 x 41.67 inches

Size Unpacked w/stand (D x H x W) (Highest Position)
269.8 x 591.1 x 1058.3mm
10.62 x 23.27 x 41.67 inches

Size Unpacked w/o stand (D x H x W) (Head Only)
137.2 x 366.1 x 1058.3mm
5.40 x 14.21 x 41.67 inches

Weight Packed
18.59kg/40.98lbs.

Weight Unpacked
13.45kg/29.65lbs.

Weight (Monitor Head Only)
9.35kg/20.61lbs.

SPECIAL FEATURES

Anti-Glare
Yes

PIP/PBP
Yes

Software
Yes (ThinkColor)

Speaker
Supports optional Harman
Kardon certified speaker

MECHANICAL

Tilt Angle (front/back)
-5°/22°

Swivel Angle (left/right)
±30°

Lift (Max. range)
Yes (130mm)

VESA Mount Capability
Yes (100 x 100mm)

Kensington™ Lock Slot
Yes

Cable Management
Yes

Bezel Color
Raven Black

Bezel Width (side)
2.4mm

Bezel Width (top/bottom)
2.4/25.6mm

WHAT'S IN THE BOX

Monitor with stand
1 x Power cable
1 x HDMI cable
1 x DP cable
1 x USB Type-C Gen2 cable
1 x USB Type-C to Type-A cable
Quick setup guide

CERTIFICATIONS

ENERGY STAR® Rating
71

CCC
Yes

RoHS
Yes

ULE
Gold

TCO
8.0

Windows Certification
Windows 7, Windows 10

China Energy Efficiency Standard
Tier 2

Ambient Operating Temperature
0°C to 45°C

TÜV Eye Comfort
Yes



*with FreeSync support graphic cards

© 2019 Lenovo. All rights reserved. Depending on many factors such as the processing capability of peripheral devices, file attributes, and other factors related to system configuration and operating environments, the actual transfer rate using the various USB connectors on this device will vary and is typically slower than the data rates as defined by the respective USB specifications: 5 Gbit/s for USB 3.1 Gen1, 10 Gbit/s for USB 3.1 Gen2 & 20 Gbit/s for USB 3.2. These products are available while supplies last. Prices shown are subject to change without notice. For any questions concerning price, please contact your Lenovo Account Executive. Lenovo is not responsible for photographic or typographic errors. Warranty: For a copy of applicable warranties, write to: Warranty Information, 500 Park Offices Drive, RTP, NC 27709, Attn: Dept. ZPYA/B600. Lenovo makes no representation or warranty regarding third-party products or services. Trademarks: Lenovo, the Lenovo logo, Rescue and Recovery, ThinkPad, ThinkCentre, ThinkStation, ThinkVantage, and ThinkVision are trademarks or registered trademarks of Lenovo. Microsoft, Windows, and Vista are registered trademarks of Microsoft Corporation. Intel, the Intel logo, Intel Inside, Intel Core, and Core Inside are trademarks of Intel Corporation in the U.S. and/or other countries. Other company, product, and service names may be trademarks or service marks of others.



ThinkVision® S27i-10

DISPLAY

Panel Size

27 inch

Screen Dimensions (H x V) (mm)

597.89 (H) × 336.31 (V)

Panel Type

In-Plane Switching

Backlight

WLED

Aspect Ratio

16:9

Resolution

1920 x 1080

Pixel Pitch (H x V) (mm)

0.3110 × 0.3110

Viewing angle (H x V)

178° / 178°

Response Time (gray to gray)

4 ms (extreme mode)

6 ms (normal mode)

Contrast Ratio (typical)

1000:1

Dynamic Contrast Ratio (typical)

3M:1

Color Gamut NTSC (CIE 1931)

72%

Color Support

16.7M

CONNECTIVITY

Video Input Signals

VGA + HDMI 1.4

Video Cable Length

1.8 m

Audio Out

Yes (3.5 mm)

MULTI-MEDIA

Optional Soundbar Support

Yes

DIMENSIONS

Size Packed (D x H x W) (mm/inch)

132 x 455 x 715 mm / 5.20 x 17.91 x 28.15 inch

Size Unpacked w/stand (D x H x W) (mm/inch) (Lowest Position)

220.0 x 443.5 x 611.9 mm / 8.66 x 17.46 x 24.10 inch

Size Unpacked w/stand (D x H x W) (mm/inch) (Highest Position)

220.0 x 443.5 x 611.9 mm / 8.66 x 17.46 x 24.10 inch

Size Unpacked w/o stand (D x H x W) (mm/inch) (Head Only)

46.2 x 366.5 x 611.9 mm / 1.82 x 14.43 x 24.10 inch

Weight Packed (kg/lbs.)

6.80kg / 14.99 lbs.

Weight Unpacked (kg/lbs.)

4.76kg / 10.49 lbs.

Weight (Monitor Head Only) (kg/lbs.)

4.22kg / 9.30 lbs.

SPECIAL FEATURES

Anti-Glare

Yes

Thin Client Support (Tiny)

Yes

(by VESA mount PN:4XFON03161)

MECHANICAL

Tilt Angle (front/back)

-5° / 22°

VESA Mount

Yes (100 mm)

Kensington™ Lock Slot

Yes

Cable Management

Yes

Bezel Color

Raven Black

Bezel Width (Side)

2.0 mm

Bezel Width (top / bottom)

2.0 mm / 21.68 mm

WHAT'S IN THE BOX

Monitor with stand

1 x HDMI Cable

1 x VGA Cable (AP, EMEA only)

1 x Power Cable

Quick setup guide

CERTIFICATIONS

ENERGY STAR Rating

7.0

TCO

7.0

EPEAT™

Gold

ULE

Gold

RoHS

Yes

Windows Certification

Windows 7, Windows 10

China Energy Efficiency Standard

Tier 2

Ambient Operating Temperature

0°C to 40°C

TÜV Eye Confort Certification

Yes



© 2018 Lenovo. All rights reserved. These products are available while supplies last. Prices shown are subject to change without notice. For any questions concerning price, please contact your Lenovo Account Executive. Lenovo is not responsible for photographic or typographic errors. Warranty: For a copy of applicable warranties, write to: Warranty Information, 500 Park Offices Drive, RTP, NC 27709, Attn: Dept. ZPYA/B600. Lenovo makes no representation or warranty regarding third-party products or services. Trademarks: Lenovo, the Lenovo logo, Rescue and Recovery, ThinkPad, ThinkCentre, ThinkStation, ThinkVantage, and ThinkVision are trademarks or registered trademarks of Lenovo. Microsoft, Windows, and Vista are registered trademarks of Microsoft Corporation. Intel, the Intel logo, Intel Inside, Intel Core, and Core Inside are trademarks of Intel Corporation in the U.S. and/or other countries. Other company, product, and service names may be trademarks or service marks of others.

Specifications may vary depending upon region.

Lenovo™



ThinkVision T25d-10

DISPLAY

Panel Size
25.0 inches

Screen Dimensions (H x V)
533.45 x 338.76mm

Panel Type
In-Plane Switching

Backlight
WLED

Aspect Ratio
16:10

Resolution
1920 x 1200 pixels

Refresh Rate
60Hz

Pixel Pitch (H x V)
0.2789 x 0.2823mm

Viewing Angle (H x V)
178°/178°

Response Time (gray to gray)
4ms (extreme mode)
6ms (normal mode)

Contrast Ratio (typical)
1000:1

Dynamic Contrast Ratio (typical)
3M:1

Brightness (typical)
300 cd/m²

Color Gamut sRGB (CIE 1931)
99%

Color Support
16.7M

CONNECTIVITY

Video Input Signals
HDMI 1.4 + DP 1.2 + VGA

Video Cables Supplied
DP + HDMI*

Video Cable Length
1.8m

USB Hub
Yes

USB Upstream
1 x USB 3.1 Gen1

USB Downstream
4 x USB 3.1 Gen1 (with 1 BC)

Audio Out
Yes (3.5mm)

POWER

Power Consumption (Typical/Max)
25W/66W

Power Consumption Sleep/Off Mode
<0.5W

Power Consumption Switch Off-Mode
<0.3W

Power Supply
Internal

ENERGY STAR® (P_{on})
16.54W

ENERGY STAR® (E_{rec})
52.06kWh

Voltage Required
100-240VAC (50/60Hz)

DIMENSIONS

Size Packed (D x H x W)
706 x 450 x 160mm/
27.79 x 17.72 x 6.30 inches

Size Unpacked w/stand (D x H x W)(mm/inch) (Lowest position)
260.4 x 399.5 x 548.7mm/
10.25 x 15.73 x 21.60 inches

Size Unpacked w/stand (D x H x W)(mm/inch) (Highest position)
260.4 x 509.5 x 548.7mm/
10.25 x 20.06 x 21.60 inches

Size Unpacked w/o stand (D x H x W)(mm/inch) (Head Only)
43.0 x 369.1 x 548.7mm/
1.69 x 14.53 x 21.60 inches

Weight Packed
7.8kg/17.20lbs.

Weight Unpacked
5.5kg/12.13lbs.

Weight (Monitor Head Only)
3.58kg/7.89lbs.

SPECIAL FEATURES

Anti-glare
Yes

Optional Soundbar Support
Yes

ThinkCentre Tiny Support
Yes

MECHANICAL

Tilt Angle (front/back)
-5°/30°

Swivel Angle (left/right)
+/-45°

Lift
Yes (110mm)

Pivot
+/-90°

VESA Mount Capability
Yes (100 x 100mm)

Kensington™ Lock Slot
Yes

Bezel Width (Side)
2.0mm

Bezel Width (top/bottom)
2.0/22.2mm

WHAT'S IN THE BOX

Monitor with stand
1 x Power Cable
1 x USB 3.1 Gen1 Cable
1 x HDMI™ Cable*
1 x DP Cable
Quick Setup Guide

CERTIFICATIONS

ENERGY STAR® Rating
7.1

EU RoHS
Yes

CCC
Yes

TCO
TCO 8.0/TCO Edge 2.0

Windows Certification
Windows 7, Windows 10

China Energy Efficiency Standard
Tier 2

TÜV Eye Comfort
Yes

ULE
Gold



*For NA and LA only

Depending on many factors such as the processing capability of peripheral devices, file attributes, and other factors related to system configuration and operating environments, the actual transfer rate using the various USB connectors on this device will vary and is typically slower than the data rates as defined by the respective USB specifications: - 5 Gbit/s for USB 3.1 Gen1; 10 Gbit/s for USB 3.1 Gen2 & 20 Gbit/s for USB 3.2.

© 2019 Lenovo. All rights reserved. These products are available while supplies last. Prices shown are subject to change without notice. For any questions concerning price, please contact your Lenovo Account Executive. Lenovo is not responsible for photographic or typographic errors. Warranty: For a copy of applicable warranties, write to: Warranty Information, 500 Park Offices Drive, RTP, NC 27709, Attn: Dept. ZPYA/B600. Lenovo makes no representation or warranty regarding third-party products or services. Trademarks: Lenovo, the Lenovo logo, Rescue and Recovery, ThinkPad, ThinkCentre, ThinkStation, ThinkVantage, and ThinkVision are trademarks or registered trademarks of Lenovo. Microsoft, Windows, and Vista are registered trademarks of Microsoft Corporation. Intel, the Intel logo, Intel Inside, Intel Core, and Core Inside are trademarks of Intel Corporation in the U.S. and/or other countries. Other company, product, and service names may be trademarks or service marks of others.

Specifications may vary depending upon region.

Lenovo



ThinkVision T25m-10

DISPLAY

Panel Size
25.0 inches

Screen Dimensions (H x V)
535.45 x 338.76mm

Panel Type
In-Plane Switching

Backlight
WLED

Aspect Ratio
16:10

Resolution
1920 x 1200 pixels

Pixel Pitch (H x V)
0.2789 x 0.2823mm

Viewing Angle (H x V)
178°/178°

Response Time (gray to gray)
4ms (extreme mode)
6ms (normal mode)

Contrast Ratio (typical)
1000:1

Dynamic Contrast Ratio (typical)
3M:1

Brightness (typical)
300 cd/m²

Color Gamut sRGB (CIE 1931)
99%

Color Support
16.7M

CONNECTIVITY

Video Input Signals
HDMI 1.4 + DP 1.2 + USB 3.1 Type-C™
(DP 1.2 Alt Mode)

Video Cables Supplied
USB 3.1 Type-C™

Video Cable Length
1.8m

USB Hub
Yes

USB Upstream
1 x USB 3.1 Gen1 (by USB Type-C™)

USB Downstream
4 x USB 3.1 Gen1 (with 1 BC)

Audio Out
Yes (3.5mm)

POWER

Power Consumption (Typical/Max)
30W/150W

Power Consumption Sleep/Off Mode
<0.5W

Power Consumption Switch Off-Mode
<0.3W

Power Supply
Internal

ENERGY STAR® (P_{on})
17.05W

ENERGY STAR® (E_{TEC})
63.12kWh

Power Voltage
100-240VAC (50/60Hz)

DIMENSIONS

Size Packed (D x H x W)
706 x 450 x 160mm/
27.79 x 17.72 x 6.30 inches

Size Unpacked w/stand (D x H x W) (mm/inch) (Lowest position)
260.4 x 399.5 x 548.7mm/
10.25 x 15.73 x 21.60 inches

Size Unpacked w/stand (D x H x W) (mm/inch) (Highest position)
260.4 x 509.5 x 548.7mm/
10.25 x 20.06 x 21.60 inches

Size Unpacked w/o stand (D x H x W) (mm/inch) (Head Only)
43.0 x 369.1 x 548.7mm/
1.69 x 14.53 x 21.60 inches

Weight Packed
7.8kg/17.20lbs.

Weight Unpacked
5.5kg/12.13lbs.

Weight (Monitor Head Only)
3.58kg/7.89lbs.

SPECIAL FEATURES

Anti-glare
Yes

Smart Power*
Yes

ThinkCentre Tiny Support
Yes

Optional Soundbar Support
Yes

Internal Speakers
Yes (3W x 2)

MECHANICAL

Tilt Angle (front/back)
-5°/30°

Swivel Angle (left/right)
+/-45°

Lift
Yes (110mm)

Pivot
+/-90°

VESA Mount Capability
Yes (100 x 100mm)

Kensington™ Lock Slot
Yes

Bezel Width (Side)
2.0mm

Bezel Width (top/bottom)
2.0/22.2mm

WHAT'S IN THE BOX

Monitor with stand
1 x Power Cable
1 x USB Type-C™ to Type-C™ cable
Quick Setup Guide

CERTIFICATIONS

ENERGY STAR® Rating
7.1

EU RoHS
Yes

CCC
Yes

TCO
TCO 8.0/TCO Edge 2.0

Windows Certification
Windows 7, Windows 10

China Energy Efficiency Standard
Tier 2

TÜV Eye Comfort
Yes

ULE
Gold



*The Smart Power function intelligently detects overall power consumption and dynamically manages the power delivery to other devices. 75W power delivery by USB Type-C can be achieved when downstream USB ports are not connected and OSD brightness setting is <31.

Depending on many factors such as the processing capability of peripheral devices, file attributes, and other factors related to system configuration and operating environments, the actual transfer rate using the various USB connectors on this device will vary and is typically slower than the data rates as defined by the respective USB specifications: - 5 Gbit/s for USB 3.1 Gen1; 10 Gbit/s for USB 3.1 Gen2 & 20 Gbit/s for USB 3.2.

© 2019 Lenovo. All rights reserved. These products are available while supplies last. Prices shown are subject to change without notice. For any questions concerning price, please contact your Lenovo Account Executive. Lenovo is not responsible for photographic or typographic errors. Warranty: For a copy of applicable warranties, write to: Warranty Information, 500 Park Offices Drive, RTP, NC 27709, Attn: Dept. ZPYA/B600. Lenovo makes no representation or warranty regarding third-party products or services. Trademarks: Lenovo, the Lenovo logo, Rescue and Recovery, ThinkPad, ThinkCentre, ThinkStation, ThinkVantage, and ThinkVision are trademarks or registered trademarks of Lenovo. Microsoft, Windows, and Vista are registered trademarks of Microsoft Corporation. Intel, the Intel logo, Intel Inside, Intel Core, and Core Inside are trademarks of Intel Corporation in the U.S. and/or other countries. Other company, product, and service names may be trademarks or service marks of others.

Specifications may vary depending upon region.

Lenovo



ThinkVision® T27i-10

DISPLAY

Panel Size

27 inch

Screen Dimensions (H x V) (mm)

597.89 (H) × 336.31 (V)

Panel Type

In-Plane Switching

Backlight

WLED

Aspect Ratio

16:9

Resolution

1920 x 1080

Pixel Pitch (H x V) (mm)

0.3110 × 0.3110

Viewing angle (H x V)

178° / 178°

Response Time (gray to gray)

4 ms (extreme mode)

6 ms (normal mode)

Contrast Ratio (typical)

1000:1

Dynamic Contrast Ratio (typical)

3M:1

Color Gamut NTSC (CIE 1931)

72%

Color Support

16.7M

CONNECTIVITY

Video Input Signals

VGA + HDMI 1.4 + DP 1.2

USB Hub

Yes

1 x USB 3.0 (Upstream)

4 x USB 3.0 (Downstream, incl. 1BC)

Cable Length

1.8 m

Audio Out

Yes (3.5 mm)

Power Consumption

22W (Typical) / 58W (max) at On mode;

<0.5W at Sleep mode; <0.3W at Switch off mode

MULTI-MEDIA

Optional Soundbar Support

Yes

DIMENSIONS

Size Packed (D x H x W) (mm/inch)

187 x 455 x 715 mm / 7.362 x 17.913 x 28.15 inch

Size Unpacked w/stand (D x H x W) (mm/inch) (Lowest Position)

269.8 x 403.3 x 611.9 mm / 10.62 x 15.88 x 24.09 inch

Size Unpacked w/stand (D x H x W) (mm/inch) (Highest Position)

269.8 x 513.3 x 611.9 mm / 10.62 x 20.21 x 24.09 inch

Size Unpacked w/o stand (D x H x W) (mm/inch) (Head Only)

49.9 x 366.5 x 611.9 mm / 1.96 x 14.43 x 24.09 inch

Weight Packed (kg/lbs.)

9.32kg / 20.55 lbs.

Weight Unpacked (kg/lbs.)

6.55kg / 14.44 lbs.

Weight (Monitor Head Only) (kg/lbs.)

4.60kg / 10.14 lbs.

SPECIAL FEATURES

Anti-Glare

Yes

Thin Client Support (Tiny)

Yes

(by Tiny Clamp Bracket Kit+VESA

mount PN:4XFON82412+

PN:4XFON03161)

MECHANICAL

Tilt Angle (front/back)

-5°/30°

Swivel Angle (left/right)

-45°/+45°

Lift (Max range)

110 mm

Pivot

-90°/90°

VESA Mount

Yes (100 mm)

Kensington™ Lock Slot

Yes

Cable Management

Yes

Bezel Color

Raven Black

Bezel Width (Side)

2.0 mm

WHAT'S IN THE BOX

Monitor with stand

1 x Power cable

1 x DP-DP cable

1 x HDMI cable (NA only)

1 x USB 3.0 cable

Quick setup guide

CERTIFICATIONS

ENERGY STAR Rating

7.0

CCC

Yes

TCO

7.0

EPEAT™

Gold

ULE

Gold

Windows Certification

Windows 7, Windows 10

China Energy Efficiency Standard

Tier 2

Ambient Operating Temperature

0°C to 40°C

Eye Comfort Certification

Yes



Lenovo™

© 2018 Lenovo. All rights reserved. These products are available while supplies last. Prices shown are subject to change without notice. For any questions concerning price, please contact your Lenovo Account Executive. Lenovo is not responsible for photographic or typographic errors. Warranty: For a copy of applicable warranties, write to: Warranty Information, 500 Park Offices Drive, RTP, NC 27709, Attn: Dept. ZPYA/B600. Lenovo makes no representation or warranty regarding third-party products or services. Trademarks: Lenovo, the Lenovo logo, Rescue and Recovery, ThinkPad, ThinkCentre, ThinkStation, ThinkVantage, and ThinkVision are trademarks or registered trademarks of Lenovo. Microsoft, Windows, and Vista are registered trademarks of Microsoft Corporation. Intel, the Intel logo, Intel Inside, Intel Core, and Core Inside are trademarks of Intel Corporation in the U.S. and/or other countries. Other company, product, and service names may be trademarks or service marks of others.

Specifications may vary depending upon region.



ThinkVision T27p-10

DISPLAY

Panel Size
27.0 inches

Screen Dimensions (H x V)
596.74 x 335.66mm

Panel Type
In-Plane Switching

Backlight
WLED

Aspect Ratio
16:9

Resolution
3840 x 2160 pixels

Pixel Pitch (H x V)
0.1554 x 0.1554mm

Viewing Angle (H x V)
178°/178°

Response Time (gray to gray)
4ms (extreme mode)
6ms (normal mode)

Refresh Rate
60Hz

Contrast Ratio (typical)
1000:1

Dynamic Contrast Ratio (typical)
3M:1

Brightness (typical)
350 cd/m²

Color Gamut sRGB (CIE 1931)
99%

Color Support
1.07 Billion

POWER

Power Consumption (Typical/Max)
50W/140W

Power Consumption Sleep/Off Mode
<0.5W

Power Consumption Switch Off-Mode
<0.3W

Power Supply
Internal

ENERGY STAR® (P_{on})
23.40W

ENERGY STAR® (E_{TEC})
101.94kWh

Voltage Required
100-240VAC (50/60Hz)

CONNECTIVITY

Video Input Signals
HDMI 2.0 + DP 1.2 + USB 3.1 Type-C™
(DP 1.2 Alt Mode)

Video Cables Supplied
USB 3.1 Type-C™ + HDMI

Video Cable Length
1.8m

USB Hub
Yes

USB Upstream
1 x USB 3.1 Gen1 (by USB Type-C™)

USB Downstream
4 x USB 3.1 Gen1 (with 1 BC)

Audio Out

Yes (3.5mm)

DIMENSIONS

Size Packed (D x H x W)
732 x 210 x 453mm/
28.82 x 8.27 x 17.83 inches

Size Unpacked w/stand (D x H x W) (mm/inch)
269.8 x 403.3 x 611.6mm/
10.62 x 15.88 x 24.08 inches

Size Unpacked w/o stand (D x H x W) (mm/inch) (Head Only)
45.5 x 368.4 x 611.6mm/
1.79 x 14.5 x 24.08 inches

Weight Packed
11.00kg/24.25lbs.

Weight Unpacked
6.95kg/15.32lbs.

Weight (Monitor Head Only)
5.0kg/11.02lbs.

SPECIAL FEATURES

Smart Power*
Yes

Anti-glare
Yes

ThinkCentre Tiny Support
Yes

Optional Soundbar Support
Yes

MECHANICAL

Tilt Angle (front/back)
-5°/30°

Swivel Angle (left/right)
+/-45°

Lift
Yes (110mm)

Pivot
+/-90°

VESA Mount Capability
Yes (100 x 100mm)

Kensington™ Lock Slot
Yes

Bezel Width (Side)
2.0mm

Bezel Width (top/bottom)
2.0/24.5mm

WHAT'S IN THE BOX

Monitor with stand
1 x Power Cable
1 x HDMI Cable
1 x USB Type-C™ to Type-C™ cable
Quick Setup Guide

CERTIFICATIONS

ENERGY STAR® Rating
7.1

EU RoHS
Yes

CCC
Yes

Windows Certification
Windows 7, Windows 10

China Energy Efficiency Standard
Tier 2

TÜV Eye Comfort
Yes

TCO
TCO 8.0/TCO Edge 2.0

ULE
Gold



*The Smart Power function intelligently detects overall power consumption and dynamically manages the power delivery to each device. 75W power delivery can be achieved when downstream USB ports are not connected and OSD brightness setting is <61.

Depending on many factors such as the processing capability of peripheral devices, file attributes, and other factors related to system configuration and operating environments, the actual transfer rate using the various USB connectors on this device will vary and is typically slower than the data rates as defined by the respective USB specifications: - 5 Gbit/s for USB 3.1 Gen1; 10 Gbit/s for USB 3.1 Gen2 & 20 Gbit/s for USB 3.2.

© 2019 Lenovo. All rights reserved. These products are available while supplies last. Prices shown are subject to change without notice. For any questions concerning price, please contact your Lenovo Account Executive. Lenovo is not responsible for photographic or typographic errors. Warranty: For a copy of applicable warranties, write to: Warranty Information, 500 Park Offices Drive, RTP, NC 27709, Attn: Dept. ZPYA/B600. Lenovo makes no representation or warranty regarding third-party products or services. Trademarks: Lenovo, the Lenovo logo, Rescue and Recovery, ThinkPad, ThinkCentre, ThinkStation, ThinkVantage, and ThinkVision are trademarks or registered trademarks of Lenovo. Microsoft, Windows, and Vista are registered trademarks of Microsoft Corporation. Intel, the Intel logo, Intel Inside, Intel Core, and Core Inside are trademarks of Intel Corporation in the U.S. and/or other countries. Other company, product, and service names may be trademarks or service marks of others.

Specifications may vary depending upon region.



<p>Name X1 Wide Flat Panel Monitor Case color Black Type-model 60E2GAR1US / 60E2GAT1US / 60E2GAT1EU Panel TFT-LCD, IPS (In-Plane Switching), White LED backlight Viewable image size 27" (684.7mm) diagonal Max view area (W x H) 23.49" x 13.21" (596.7mm x 335.7mm) Optimum resolution 3840x2160 Max pixel rate 600MHz Aspect ratio 16:9 Pixel pitch (mm) 0.16 x 0.16mm Dot/Pixel per Inch 163 dpi Brightness 300 nits or cd/m² (typical) Contrast ratio 1300:1 (typical) Pixel response time 6ms Color gamut 99% Viewing angle at 10:1 CR 178° horizontal, 178° vertical Stand Tilt stand Bezel width Sides: 0.088" (2.23mm) Dimensions (HxWxD, including stand) 19.35" H x 24.19" W x 10.63" D; 491.4mm H x 614.5mm W x 270.0mm D Power supply 40 watts typical, 130 watts maximum (with USB), <0.5 watts sleep/off; <0.5 watts switch off Weight 14.11 lb; 6.40kg (including stand) Limited warranty⁴ 3 year Available date March 2016</p>	<p>Features</p> <ul style="list-style-type: none"> • 27-inch IPS LED backlight monitor with speaker • Supports 3840x2160 resolution • 5-Ports USB hub, support USB Type-C • 3watts x 2 stereo speakers • Microsoft® Windows® 7 certified • Microsoft Windows 10 certified 						
<p>VESA-compliant² VESA DDC2B/CI Power management ENERGY STAR® 7.0 Ergonomics ISO 9241-307 Emission standards FCC Class B Environmental TCO Displays 7.0, RoHS, EPEAT™ Silver rating, ULE Gold</p>	 <p style="text-align: center;">ThinkVision X1 Monitor</p>						
<p>Preset resolutions VGA: 640x350, 640x480, 720x400 SVGA: 800x600 XGA: 1024x768, 1152x864 SXGA: 1280x1024 WXGA: 1280x720, 1280x768, 1280x800, 1360x768 WXGA+: 1440x900, 1600x900 WSXGA+: 1680x1050 Full HD: 1920x1080, 1920x1200 UHD: 3840x2160</p> <p>Presets / user settings Standard presets: 20; user settings: 20</p>							
<p>Viewing adjustments <i>Tilt: 22° back, -5° forward;</i> Rotating screen None On screen display On screen display with digital user controls (8 languages) Control features Direct access (touch buttons on front) for menu, mute, volume up/down, and brightness USB hub USB Hub: one USB 3.1 Type-C upstream port, four USB 3.0 Type-A downstream ports Multimedia Integrated stereo speakers (3 watts x 2), built-in microphone Camera Full HD camera with LED light Multiple input Support HDMI, DisplayPort Monitor connectors (1) HDMI (1.4), digital, HDCP-compliant (2) DisplayPort (1.2), digital, HDCP-compliant Signal cables (1) detachable, HDMI at each end, digital, 1.8 meter (2) detachable, DisplayPort at each end, digital, 1.8 meter Mounting features Wall or desk mounting using the Extend Arm or third-party accessories meeting the VESA FPMPI® (100mm mount) Security Security keyhole for attachment of optional cable lock (Kensington® lock-compatible)</p>							
<p>Ship group Monitor, detachable stand, Quick start and safety poster, 1.8 meter DisplayPort cable, 1.8 meter HDMI cable, 1.8 meter USB Type-C cable, 1.8 meter USB Type-C to Type-A cable, 1.8 meter black power cord, mini DP to DP adapter, power adapter (135W)</p>	<p style="text-align: center;">Limited Warranty</p> <p>See details at http://support.lenovo.com/en_US/guides-and-manuals/detail.page?DocID=UM008281</p> <p style="text-align: center;">Accessories</p> <table border="0"> <tr> <td>Kensington MicroSaver Cable Lock</td> <td style="text-align: right;">73P2582</td> </tr> <tr> <td>Kensington Twin Head Cable Lock</td> <td style="text-align: right;">45K1620</td> </tr> <tr> <td>Lenovo Security Cable Lock</td> <td style="text-align: right;">57Y4303</td> </tr> </table> <p>See details at www.lenovo.com/support/monitoraccessories</p> <p>See all monitors at www.lenovo.com/thinkvision</p>	Kensington MicroSaver Cable Lock	73P2582	Kensington Twin Head Cable Lock	45K1620	Lenovo Security Cable Lock	57Y4303
Kensington MicroSaver Cable Lock	73P2582						
Kensington Twin Head Cable Lock	45K1620						
Lenovo Security Cable Lock	57Y4303						

See footnotes for important warranty information



ThinkVision X1 (2nd GEN) MONITOR

EXTREME STYLISH, EXTREME FOREFRONT.



THE MILESTONE OF X-SERIES, 27" FULL-SCREEN, 4K, THUNDERBOLT™ 3 MONITOR.

Pushing the limit of screen share ratio with innovative technology, the 27" Lenovo™ ThinkVision® X1 (2nd GEN) display brings full-screen and ultra-slim appearance in elegant design. With 4K resolution and >99% sRGB color gamut, you will be assured of excellent watching experience and Thunderbolt™ 3 interface will bring the best user experience. "Motor" camera is first used on monitor, which will move up and down automatically and with it you will own standard VoIP system.

WHY YOU SHOULD BUY THE LENOVO THINKVISION X1 (2nd GEN) MONITOR



Full-screen appearance

With world's slimmest (4.7 mm) 27" 4K TBT monitor you will experience full-screen 4-side Near-Edgeless display with the screen ratio of approximately 93%. The monitor also comes with a metal stand and a base.



Brilliant performance

The 4K UHD IPS screen displays 3840 x 2160 resolution at 60 Hz, 99% sRGB color gamut, 10-bit depth, with 1.07 billion color support assures you stunning visuals and superb color experience.



Convenient user experience

Total versatility with Thunderbolt™ 3 interface supporting 4K + USB 3.0 & 45W PD + motor-camera with dual-array microphone. A Think RedDot tracking button is integrated in the back cover.

THE LENOVO THINKVISION X1 (2nd GEN) MONITOR IS BEST SUITED FOR

1

The Executives and CXO of company.

2

SOHO and Gold Collars with high income.

3

Trendsetters who pursue an extreme and forefront monitor.



ThinkVision X1 (2nd GEN) MONITOR



SPECIFICATIONS

DISPLAY		ENVIRONMENTAL	
Panel Size	27"	Temperature	
Panel Type	IPS	Operating	0°C - 45°C
Backlight	WLED	Non-Operating	-20°C - 60°C
Resolution	3840 (H) x 2160 (V)	Humidity	
Aspect Ratio	16:9	Operating	8% - 80%
Anti-Glare	Yes	Non-Operating	5% - 95%
Screen Dimensions (W x H) (mm)	596.7 (H) x 335.7 (V)	Altitude	
Maximum Brightness (Typical)	350 cd/m ²	Operating	16,000 ft
Viewing Angle (H/V at CR 10:1)	178°/178°	Non-Operating	40,000 ft
Contrast Ratio (Typical)	1000:1	Arsenic-Free Glass	Yes
Dynamic Contrast Ratio	3M:1	PVC-Free	Yes (W/O cable)
Pixel Pitch (W x H) (mm)	0.1554 x 0.1554	Mercury-Free	Yes
Dot/Pixel Per Inch (DP/PPI)	163	PCC % of Plastic Resins	25%
Color Gamut (CIE 1931)	99% sRGB		
Response Time (Extreme/Typical/Off)	4/6/14 ms (G-to-G)		
POWER CONSUMPTION		DIMENSIONS (W x D x H)	
Typical	65 W	Size Packed	
Maximum	135 W	(mm)	718 x 140 x 470
Sleep-Mode	0.5 W	(inches)	28.27" x 5.51" x 18.5"
Switch Off-Mode	0.5 W	Size Unpacked with Stand	
Power Supply	External	(mm)	609.74 x 234.81 x 474.76
Power Voltage	100 VAC - 240 VAC	(inches)	24" x 9.24" x 18.69"
Voltage Dynamic Frequency	50 Hz - 60 Hz	Size Unpacked without Stand	
		(Monitor Head Only)	
		(mm)	609.74 x 32.7 x 351.71
		(inches)	24" x 1.29" x 13.85"
		Distance from Table to Panel	
		Lowest Pixel at Bottom of Screen	
		(mm / inches)	134 / 5.276"
		Highest Pixel at Top of Screen	
		(mm / inches)	450 / 17.717"
		Stand Base Footprint Area	
		(mm)	234.81 x 234.81
		(inches)	9.24" x 9.24"
		Weight	
		Packed	Starting at 18.45 lbs (8.37 kg)
		Unpacked	Starting at 12.21 lbs (5.54 kg)
		Monitor Head Only	Starting at 9.46 lbs (4.29 kg)
SIGNAL INPUT		COMPLIANCE	
Video Input Signals	DisplayPort™ 1.2 + HDMI™ 2.0 + Thunderbolt™ 3	EPEAT™	Silver
Video Cables Supplied	HDMI™ + Thunderbolt™ 3	ENERGY STAR® Rating	7.0
Video Cable Length	1.8 m	ULE	Silver
USB Hub	Yes (4 x USB 3.0)	TCO®	7.0
USB Cable Supplied	N/A	RoHS	Yes
Audio-Jack	Yes	Windows Certification	Windows 10
		China Energy Label	Grade 2
SIGNAL INTERFACE / PERFORMANCE		WARRANTY AND AVAILABILITY	
Horizontal Frequency	30 kHz - 136 kHz	Warranty	3 Years
Vertical Frequency	30 Hz - 60 Hz	Geography Availability	WW
Native Resolution	3840 x 2160		
Maximum Pixel Clock Speed/ Bandwidth	20 Gbps		
Default Color Temperature	6500K		
Preset Modes	24		
OSD Buttons	2 Buttons + Tracking Point		
OSD Languages	English, French, Italian, German, Spanish, Japanese, Chinese, Russian		
MECHANICAL			
Tilt Angle (Front / Back)	-5° / 30°		
Swivel Angle (Left / Right)	N/A		
Lift (mm)	N/A		
Pivot	N/A		
VESA® Mount (mm)	N/A		
Kensington® Lock Slot	Yes		
Cable Management	Yes		
Bezel Color	N/A		
Bezel Width			
Top (mm / inches)	1.2 / 0.05"		
Bottom (mm / inches)	1.2 / 0.05"		
Sides (mm / inches)	1.2 / 0.05"		



WWW.LENOVO.COM

Lenovo reserves the right to alter product offerings and specifications at any time, without notice. Lenovo makes every effort to ensure accuracy of all information but is not liable or responsible for any editorial, photographic or typographic errors. All images are for illustration purposes only. For full Lenovo product, service and warranty specifications visit www.lenovo.com. Lenovo makes no representations or warranties regarding third party products or services. **Trademarks:** The following are trademarks or registered trademarks of Lenovo: Lenovo, the Lenovo logo, Rescue and Recovery, ThinkPad, ThinkCentre, ThinkStation, ThinkServer, ThinkVantage and ThinkVision. Microsoft, Windows and Vista are registered trademarks of Microsoft Corporation. Ultrabook, Celeron, Celeron Inside, Core Inside, Intel, Intel Logo, Intel Atom, Intel Atom Inside, Intel Core, Intel Inside, Intel Inside Logo, Intel vPro, Itanium, Itanium Inside, Pentium, Pentium Inside, vPro Inside, Xeon, Xeon Phi, and Xeon Inside are trademarks of Intel Corporation in the U.S. and/or other countries. Other company, product and service names may be trademarks or service marks of others. Battery life (and recharge times) will vary based on many factors including system settings and usage. Visit www.lenovo.com/lenovo/us/en/safecom/ periodically for the latest information on safe and effective computing. ©2018 Lenovo. All rights reserved.

This publication was developed for products and services offered in the United States and E.M.E.A countries. Lenovo may not offer the products, services or features discussed in this document in other countries. Lenovo may withdraw an offering at any time. Information is subject to change without notice. Consult your local representative for information on offerings available in your area.

Lenovo reserves the right to change specifications or other product information without notice. Lenovo is not responsible for photographic or typographical errors.

LENOVO PROVIDES THIS PUBLICATION "AS IS," WITHOUT WARRANTY OF ANY KIND, EITHER EXPRESS OR IMPLIED, INCLUDING THE IMPLIED WARRANTIES OF MERCHANTABILITY OR FITNESS FOR A PARTICULAR PURPOSE.

Some jurisdictions do not allow disclaimer of express or implied warranties in certain transactions, therefore this disclaimer may not apply to you.

Availability: All offers subject to availability. Lenovo reserves the right to alter product offerings and specifications at any time, without notice. Lenovo is not responsible for photographic or typographic errors.

General: Review key information provided by Microsoft that may apply to your system purchase, including details on Windows 10, Windows 8, Windows 7, and potential upgrades/downgrades. Lenovo makes no representation or warranty regarding third-party products or services.

Trademarks: Lenovo, ThinkPad, ThinkCentre, ThinkStation and the Lenovo logo are trademarks of Lenovo. Microsoft, Windows, Windows NT, and the Windows logo are trademarks of Microsoft Corporation. Ultrabook, Celeron, Celeron Inside, Core Inside, Intel, Intel Logo, Intel Atom, Intel Atom Inside, Intel Core, Intel Inside, Intel Inside Logo, Intel vPro, Itanium, Itanium Inside, Pentium, Pentium Inside, vPro Inside, Xeon, Xeon Phi, and Xeon Inside are trademarks of Intel Corporation in the U.S. and/or other countries. Other company, product or service names may be trademarks or service marks of others.

Warranty: For a copy of applicable warranties, write to: Lenovo Warranty Information, 1009 Think Place, Morrisville, NC, 27560. Lenovo makes no representation or warranty regarding third party products or services. The Lenovo Limited Warranty applies only to Lenovo hardware products purchased for your own use, and does not transfer upon resale.

Limited warranty: Support unrelated to a warranty issue may be subject to additional charges.

Lenovo Services:

Carry-in or Mail-in Service: Parts and labor repair coverage where the customer is responsible for shipping (including packaging) or delivery to authorized warranty provider or repair center.

Depot or Courier Service: Parts and labor repair coverage where shipping (including packaging) or delivery to the repair center is paid for by Lenovo.

Expedited Depot: Parts and labor coverage with expedited turnaround. Shipping (including packaging) or delivery to the repair center is paid for by Lenovo.

Onsite / In-home Service: Parts and labor repair coverage where labor is provided onsite at your place of business.

If Lenovo determines your product problem is covered by the product warranty and cannot be resolved over the telephone, a technician will be dispatched to arrive onsite, typically the next day.

International Warranty Service (IWS): PC repair coverage for customers who require a critical warranty repair while travelling internationally. Visit www.lenovo.com/internationalwarranty for details. Visit www.lenovo.com/warranty for Lenovo Warranty Services terms and conditions for complete details and restrictions.

Included software: may differ from its retail version (if available), and may not include user manuals or all program functionality. Software license agreements may apply.

Battery life: Battery life (and recharge times) will vary based on many factors including screen brightness, applications, features, power management, battery conditioning, and other customer preferences.

Visit <http://psref.lenovo.com/> for the latest version of Product Specifications Reference.

© Lenovo, 2018. All rights reserved.
Lenovo 1009 Think Place Morrisville, NC 27560 U.S.A.